



RADIO'S LIVEST MAGAZINE

Special
**SHORT
WAVE**
Number

Radio-Craft

January
25 Cents
Canada 30c

HUGO GERNSBACK Editor

HE BUILT THIS
"4-IN-2" SHORT-WAVE
ALL-ELECTRIC SET
See page 398



NRA
CODE

Hi-Fidelity on Short-Waves—Novel 1 Tube All-Wave All-Electric Set
5 Meter Transceiver—All-Wave Oscillator—6 Tube All-Wave Receiver

SERVICE MEN'S ESSENTIALS FOR ALL MEMBERS OF THE

ORSMA

WHAT ARE THE SERVICE MEN'S ESSENTIALS?

THE OFFICIAL RADIO SERVICE MEN'S ASSOCIATION has arranged to supply a number of "Service Men's essentials" for its members and associate members only.

These essentials are priced at cost, plus a small additional fee which is the only source of income that the Association has. No one obtains any profit or benefit, except the Association itself. Whatever profit accrues, is reinvested for the furtherance and enlargement of the Association.

By using the letterheads, billheads, etc., you present the business-like appearance to your customers. In addition, the Association has made arrangements with most of the prominent manufacturers to allow special discounts to members, providing ORSMA letterheads are used when ordering.



No. 11—50c each
(Plus 10c for Postage)



No. 5—50c each

No. 1 ORSMA LETTERHEADS

These letterheads, shown on the right, are furnished with your name, address and telephone number. Printed on excellent paper. They are sold in lots of 100 or multiples thereof, with a distinct saving for single orders of 1,000 or more. Per 100, 60c; per 1000, \$3.00.

No. 2 ORSMA ENVELOPES

These are furnished to match the letterheads, printed with your name and address and seal of the Association. They go hand in hand with the letterheads and are usually ordered in the same quantity. Per 100, 60c; per 1000, \$3.00.

No. 3 ORSMA SERVICE RECORD CARDS

These serve a double purpose; whenever you complete a job you fill out the report-bill and hand it to the customer; this is the "psychological moment" to collect. By the use of carbon paper a permanent record is kept. Furnished with name, address and telephone number. Per pad of 50, 60c; per 10 pads, each of 50, \$3.00.

No. 4 ORSMA INSPECTION LABELS

The label is to be filled in with the proper dates, and pasted inside the set or cabinet where the customer will see it. It is a continuous reminder to him that when service is needed, he can call you again. The advantage is apparent. Per 100, 60c; per 1000, \$3.00.

No. 5 ORSMA LAPEL BUTTON

At the suggestion of many members a handsome lapel button bearing the name and emblem of the Association has been designed. It signifies that you belong to the ORSMA; and in addition it gives your customers a better appreciation of the professional nature of your work. 50c each.

No. 6 ORSMA BUSINESS CARDS

These are furnished on a fine grade of paper in two colors with a blotter back. Thus they present an incentive to customers to keep them in a prominent place. They are printed with your name, address and telephone and bear the official seal of the Association. Per 100, 75c; per 1000, \$4.00.

Nos. 9 & 10 ORSMA EMBLEM CUTS

These cuts for printing, advertising, etc., are furnished in two styles and sizes. They may be used for newspaper or telephone-book advertisements or for printing of any kind. Large size, 1 1/4 x 1 1/4 in., \$1.35 each; small size, 3/4 x 3/4 in., \$1.20 each.

No. 11 ORSMA MEMBERSHIP SIGN

A set of three signs, printed on heavy cards, and having holes punched in order to hang in office or store. These are sold to members and associate members. Large enough to be quite prominent and the two tone effect makes them attractive. Set of three, 50c.

No. 12 ORSMA ADVERTISING DISPLAY SIGN

A two color sign printed in large letters with your name, address and telephone, with the seal of the Association. This sign is sold in quantities of 25 or more and is ideal for hanging in stores, offices, etc., for advertising purposes. Set of 25 cards, \$3.00.

No. 13 RADIO SERVICE MEN'S ASSORTMENT PACKAGE

This includes one gold filled lapel button, 100 letterheads, 100 envelopes, 50 service record cards, and 100 labels printed with your name and address as described above. The whole assortment costs only—\$3.00—a worth-while saving. Complete, \$3.00.

No. 14 ORSMA MEMBER CERTIFICATE

A handsome diploma-like certificate engraved on stiff vellum-bond. The certificate is personally signed by the President and Executive Secretary and the corporation stamp of the Association is impressed on a red seal attached to it. Your name, certificate number and date of registration are lettered by hand and the certificate is mailed in a cardboard tube to insure safe delivery. Each 50c, plus 10c for postage.



No. 1—60c per 100
\$3.00 per 1000

No. 3—60c per pad of 50
\$3.00 per ten pads, each of 50



No. 6—75c per 100
\$4.00 per 1000



No. 4—60c per 100
\$3.00 per 1000

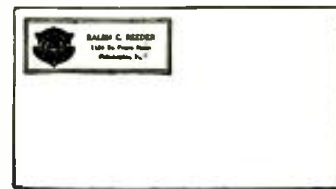

No. 2—60c per 100
\$3.00 per 1000

Application for Membership in ORSMA

Executive Secretary, ORSMA
99 Hudson Street, New York, N. Y.

Kindly send an application blank for

- Full Membership
 Associate Membership

Name

Street or Box

City..... State.....

RC-1-35

OFFICIAL RADIO SERVICE MEN'S ASSOCIATION

RC-1-35

99 Hudson Street, New York, N. Y.

Please send me the following RADIO SERVICE MEN'S ESSENTIALS which I have selected from this advertisement. My remittance for \$..... is enclosed. Send remittance in form of check or money order. Register letter if it contains cash, currency or unused U. S. Postage Stamps.

Name ORSMA No.
Address City and State

OPPORTUNITIES *are many* for the Radio Trained Man



Don't spend your life slaving away in some dull, hopeless job! Don't be satisfied to work for a mere \$20 or \$30 a week. Let me show you how to get your start in Radio — the fastest-growing, biggest money-making game on earth.

Jobs Leading to Salaries of \$50 a Week and Up
Prepare for jobs as Designer, Inspector and Tester—as Radio Salesman and in Service and Installation Work—as Operator or Manager of a Broadcasting Station—as Wireless Operator on a Ship or Airplane, or in Talking Picture or Sound Work—HUNDREDS OF OPPORTUNITIES for a real future in Radio!

Ten Weeks of Shop Training Pay Your Tuition After Graduation

We don't teach by book study. We train you on a great outlay of Radio, Television and Sound equipment—on scores of modern Radio Receivers, huge Broadcasting equipment, the very latest and newest Television apparatus, Talking Picture and Sound Reproduction equipment, Code Practice equipment, etc. You don't need advanced education or previous experience. We give you—RIGHT HERE IN THE COYNE SHOPS—the actual practice and experience you'll need for your start in this great field. And because we cut out all useless theory and only give that which is necessary you get a practical training in 10 weeks.

TELEVISION *and* TALKING PICTURES

And Television is already here! Soon there'll be a demand for THOUSANDS of TELEVISION EXPERTS! The man who learns Television now can have a great future in this great new field. Get in on the ground-floor of this amazing new Radio development! Come to COYNE and learn Television on the very latest, newest Television equipment. Talking Picture and Public Address Systems offer opportunities to the Trained Radio Man. Here is a great new Radio field just beginning to grow! Prepare NOW for these wonderful opportunities! Learn Radio Sound Work at COYNE on actual Talking Picture and Sound Reproduction equipment.

PAY FOR YOUR TRAINING *After You Graduate*

I am making an offer that no other school has dared to do. I'll take you here in my shops and give you this training and you pay your tuition after you have graduated. Two months after you complete my course you make your first payment, and then you have ten months to complete your payments. There are no strings to this offer. I know a lot of honest fellows haven't got a lot of money these days, but still want to prepare themselves for a real job so they won't have to worry about hard times or lay offs.

I've got enough confidence in these fellows and in my training to give them the training they need and pay me back after they have their training.

If you who read this advertisement are really interested in your future here is the chance of a life time. Mail the coupon today and I'll give you all the facts.

ALL PRACTICAL WORK *At COYNE in Chicago*

ALL ACTUAL, PRACTICAL WORK. You build radio sets, install and service them. You actually operate great Broadcasting equipment. You construct Television Receiving Sets and actually transmit your own Television programs over our mod-

ern Television equipment. You work on real Talking Picture machines and Sound equipment. You learn Wireless Operating on actual Code Practice apparatus. We don't waste time on useless theory. We give you the practical training you'll need—in 10 short, pleasant weeks.

MANY EARN WHILE LEARNING

You get Free Employment Service for Life. And don't let lack of money stop you. Many of our students make all or a good part of their living expenses while going to school and if you should need this help just write to me. Coyne is 33 years old. Coyne Training is tested—proven beyond all doubt. You can find out everything absolutely free. Just mail coupon for my big free book!

**H. C. Lewis, Pres. RADIO DIVISION Founded 1899
COYNE ELECTRICAL SCHOOL**

500 S. Paulina St., Dept. 15-8H, Chicago, Ill.

Mail Coupon Today for All the Facts

H. C. LEWIS, President
Radio Division, Coyne Electrical School
500 S. Paulina St., Dept. 15-8H, Chicago, Ill.
Dear Mr. Lewis:—Send me your Big Free Radio Book, and all details of your Special Offer, including your "Pay After Graduate" offer.

Name
Address
City State



HUGO GERNSBACK, Editor-in-Chief
 J. T. BERNSELY, Managing Editor
 C. W. PALMER Associate Editor
 R. D. WASHBURNE Technical Editor



CONTENTS OF THE JANUARY, 1935, ISSUE

VOLUME VI

Number 7

Editorial: Short-Wave Applications. Hugo Gernsback	391
The Radio Month in Review	392
Short-Wave Radio Pictorial	394
Hi-Fidelity on Short Waves	396
How to Build the "Four-in-Two" Short-Wave Electric Set	J. T. Bernsley 398
The Latest in Police Radio Receivers	399
New Short-Wave Link to Byrd	399
Short-Wave Stations of the World	400
The Latest Radio Equipment	402
An Improved 6-Tube All-Wave Set	M. K. Baker 404
Build This Novel 1-Tube All-Electric, All-Wave Set	H. G. Cisin 40
How to Build a New 5-Meter Transceiver	A. G. Heller 406
Elements of 4th Dimension P.A. or Sound Systems (Part I)	H. S. Manney and C. R. Shaw 407
International Radio Review	408
A Short-Wave Band-Spread 2-Tube Portable Set	Frank J. Lester 410
An Improved 2-Tube Short-Wave Booster	S. Miller 410
The Listening Post for All-Wave DX-ers	C. A. Morrison 411
An Economical P.A. Amplifier	A. J. Koenig 412
An Impressive 7-Tube Dual-Range Superhet	412
New Design in All-Wave Antennas	A. H. Lynch 413
Short-Cuts in Radio	414
Readers' Department	415
A Real "How to Build" Service Man's All-Wave Oscillator	Howard J. Benner 416
ORSMA Members' Forum	417
Operating Notes	418
RADIO SERVICE DATA SHEETS:	
No. 129—RCA Victor Model 102 4-Tube A.C.-D.C. T.R.F. Receiver; General Electric Table Model M-49 4-Tube Radio-Phonograph Dual-Wave Super	419
No. 130—Stromberg-Carlson No. 69 4-Tube All-Wave Superhet. Selector (Converter); Pilot Model 63 All-Wave 6-Tube Superheterodyne	422
RADIO-CRAFT'S Information Bureau	420

FEATURING BROADCASTING IN OUR NEXT ISSUE:

WATCH for the next issue of RADIO-CRAFT in which you will find descriptions of all the new developments in radio operation, from studio to home.

ALL ABOUT BROADCASTING. If you want to know just how far the American broadcast system has progressed to date, and just what are its trends, read the article on this subject which has been prepared by one of its active participants.

HOW TO CHOOSE YOUR RADIO SET. With a veritable galaxy of radio sets staring him in the face as he enters the store door of the average radio dealer, it is no wonder most persons buy by "luck" (or lack of it!), rather than good judgment. All the sets seem to "listen" alike, and so our hero takes a second squint at an attractive cabinet, checks with the bank roll, and says, "gi-'me." But the CHASSIS harbors the real value. How does one chassis differ from another; how can you tell a "good" chassis from a "poor" one? Well, the answers constitute our author's story.

RADIO-CRAFT is published monthly, on the fifth of the month preceding that of date; its subscription price is \$2.50 per year. (In Canada and foreign countries, \$3.00 a year to cover additional postage.) Entered at the post office at Mt. Morris, Ill., as second-class matter under the act of March 3, 1879.

Text and illustrations of this magazine are copyright and must not be reproduced without permission of the copyright owners. We are also agents for WONDER STORIES and EVERYDAY SCIENCE AND MECHANICS. Subscription to these magazines may be taken in combination with RADIO-CRAFT at reduced Club rates. Write for information.

Copyright 1934. Continental Publications, Inc.

HUGO GERNSBACK, President I. S. MANHEIMER, Secretary
 Published by Continental Publications, Inc. Publication office: 404 N. Wesley Ave., Mount Morris, Illinois. Editorial and Advertising Office: 99 Hudson Street, New York City. Chicago Advertising Office: L. F. McClure, 919 North Michigan Avenue, Chicago, Ill. Western Advertising Office: Loyd B. Chappell, 511 So. Alexandria St., Los Angeles, Calif.

London Agent:

Hachette & Cie., 3 La Belle Sauvage, Ludgate Hill, E.C. 4
 Paris Agent: Hachette & Cie., Australian Agent: McGills Agency,
 111 Rue Reamur 179 Elizabeth St., Melbourne

How a "Tip" got Tom a Good Job

Panel 1: GEE, THERE'S DJC IN BERLIN. THAT'S THE TENTH FOREIGN STATION TONIGHT. RADIO IS SURELY FUN.

Panel 2: HELLO, TOM, HOW'S EVERYTHING? OH, NOT SO GOOD BILL, BUT I'M STILL HAVING FUN PLAYING WITH RADIO. HADD JCLAST NIGHT ON A LITTLE SET I BUILT. IS RADIO STILL YOUR HOBBY TOO?

Panel 3: NO, TOM. I'VE BEEN TOO BUSY MAKING GOOD MONEY OUT OF RADIO TO SPEND TIME "PLAYING" WITH IT. GOSH, BILL, YOU'RE SURE LUCKY. I NOTICED YOUR SWELL CLOTHES AND SNAPPY CAR. I THOUGHT YOU HAD INHERITED A MILLION. TELL ME ABOUT IT.

Panel 4: I AM LUCKY, TOM, BUT YOU HAD THE SAME CHANCE. REMEMBER ABOUT A YEAR AGO I SHOWED YOU A BOOK FROM NATIONAL RADIO INSTITUTE THAT TOLD ABOUT THE OPPORTUNITIES AND BIG FUTURE IN RADIO, AND HOW OTHERS HAD SUCCEEDED THROUGH THEIR HOME TRAINING? REMEMBER, I TRIED TO GET YOU TO ENROLL FOR THEIR COURSE WHEN I DID.

Panel 5: WELL, IT WAS THE SMARTEST MOVE I EVER MADE. I'M DOING SWELL. MARY AND I ARE TO BE MARRIED NEXT MONTH. TOM, WHY DON'T YOU SNAP OUT OF IT? DON'T STAY IN THAT DREARY LOW PAY JOB ALL YOUR LIFE. RADIO IS MORE THAN A PLAYTHING. IT'S A BIG BUSINESS. IT'S YOUR OPPORTUNITY. TAKE MY TIP. IT ISN'T TOO LATE. RADIO IS STILL YOUNG AND GROWING.

Panel 6: IF BILL SUCCEEDED, I CAN TOO! THEN I CAN MAKE REAL MONEY SERVICING RADIO SETS OR GET A JOB IN A BROADCASTING STATION OR INSTALL AND SERVICE LOUD SPEAKER SYSTEMS OR MAKE GOOD MONEY IN ANY ONE OF THE MANY OTHER NEW AND GROWING BRANCHES OF RADIO. THERE'S NO END OF GOOD JOBS FOR A TRAINED RADIO MAN! YES, SIR, I'M GOING TO SEND FOR THAT FREE BOOK AND GET THE DOPE RIGHT NOW!

Panel 7: YOU CERTAINLY KNOW RADIO. MINE NEVER SOUNDED BETTER. N.R.I. TRAINING CERTAINLY PAYS. I JUST STARTED A FEW MONTHS AGO AND I'M MAKING GOOD MONEY ALREADY. THIS SPARE TIME WORK IS SWELL FUN, AND SOON I'LL BE ALL SET FOR A GOOD FULL TIME JOB. THANKS!

OH, TOM IT'S WONDERFUL— TO THINK HOW FAST YOU'VE GONE AHEAD SINCE YOU WENT INTO RADIO. WE NEVER COULD HAVE GOTTEN MARRIED ON WHAT YOU WERE GETTING BEFORE.

OUR WORRIES ARE OVER. I'M MAKING GOOD MONEY NOW, AND THERE'S A BIG FUTURE AHEAD FOR US IN THIS LIVE WIRE RADIO FIELD.

HERE'S PROOF THAT N.R.I. MEN MAKE GOOD MONEY

"Made \$6,000 in 2 Years"

"Soon after the depression started, I found myself without a job, but I was well protected with N. R. I. training. I swung right to full time Radio servicing and I have made over \$6,000 in a little over two years."—Wm. Spurrin, Sparty Radio Service, 93 Broadway, Newark, N. J.



"\$500 a Year in Spare Time"

"Although doing spare time Radio work only, I have averaged about \$500 a year extra in addition to my regular income. Full time Radio work would net me many times that amount."—Edw. H. Fawcett, Slough Rd., Ladner, B. C., Canada.



FREE: Radio Servicing Tips

Let me PROVE that my Course is clear, easy to understand, and fascinating to study. Send the coupon for a free lesson, "Trouble Shooting in D.C., A.C. and Battery Sets." This interesting lesson gives 132 ways to correct common Radio troubles. I am willing to send this book to prove that you, too, can master Radio—just as thousands of other fellows have done. Many of them, without even a grammar school education, and no Radio or technical experience, have become Radio experts and now earn two or three times their former pay. Mail the coupon now.



I will help you start a spare time or full time Radio service business Without Capital

Many Radio Experts Make \$40, \$60, \$75 a Week

The world-wide use of Radio sets has made hundreds of opportunities for good spare time or full time Radio businesses. Many of the seventeen million Radio sets are only 25% to 40% efficient. I will show you how to cash in on this condition. I will show you how to install and service all types of receiving sets in spare time. I'll show you how to make enough money while learning Radio to start your own service business. Clip the coupon. Get my free book, "Rich Rewards in Radio." Read how hundreds of N. R. I. men have made good money in spare time or full time businesses.

Many Make \$5, \$10, \$15 a Week Extra in Spare Time While Learning

The day you enroll I send you direction for doing 28 Radio Jobs common in almost every neighborhood for spare time money. I give you plans and ideas that have made \$200 to \$1,000 a year for many N. R. I. men in spare time. My Course is famous as "The Training that pays for itself."

Get Ready Now for a Business of Your Own and for Jobs Like These

In just about 15 years Radio's growth has created over 300,000 jobs. Thousands more jobs will be opened by new Radio developments. Broadcasting stations use engineers, operators, station managers and pay up to \$5,000 a year. Manufacturers employ testers, inspectors, foremen, engineers, servicemen, buyers, managers, and pay up to \$100 a week. My Free Book tells about these and other opportunities.

Television, Short Wave, Loud Speaker Systems Included

There is opportunity for you in Radio. Its future is certain. Television, short wave, loud speaker systems, ship Radio, police Radio, automobile Radio, aviation Radio—in every branch, developments and improvements are taking place. Here is a real future for thousands of men who really know Radio—men with N. R. I. training. Get the training that opens the door to good pay and success in this growing industry.

Find Out What Radio Offers You

I am so sure N. R. I. can train you satisfactorily that I agree in writing to refund every penny of your tuition if you are not satisfied with my Lesson and Instruction Service upon completion. Get my 64-page book of facts. It's free to any ambitious fellow over 15 years of age. It tells you about Radio's opportunities; about my Course; what others are doing and making. Find out what Radio offers you. No obligation. ACT NOW! Mail coupon in an envelope, or paste it on a 10-cent postcard.

J. E. SMITH, President
Nat'l Radio Institute, Dept., SAX
Washington, D. C.



Dear Mr. Smith: Without obligation, send me the Servicing Manual and your free book about spare time and full time Radio opportunities and how I can train for them at home in spare time. (Please print plainly.)

NAME _____ ADDRESS _____ CITY _____ STATE _____

J. E. SMITH, President
National Radio Institute, Department SAX
Washington, D. C.

MAIL THIS for FREE 64 page book

Please Say That You Saw It in RADIO-CRAFT

Radio Men!

**GOOD BOOKS WHICH HELP
MAKE RADIO WORK MORE PROFITABLE**

Presented on this page are books of the RADIO-CRAFT LIBRARY SERIES—a most complete and authentic set of volumes treating individually, important divisions of radio. Each book has been designed to give radio men the opportunity to specialize in one or more of the popular branches of the industry. You will find them a real help in your work and they will contribute to your money earning capacity. Read these books during your spare time at home.

The authors of these books are well-known to everyone. Each is an expert radio man; an authority on the subject—each is thoroughly familiar with the field which he represents.

This is the first real opportunity that you have ever had to build a library of radio books that are authentic. **MOST OF THE BOOKS HAVE BEEN RECENTLY REVISED AND REWRITTEN TO KEEP THEM UP TO THE MINUTE.** Mail coupon below for your books.

Book No. 1
Radio Set Analyzers
And How To Use Them
By L. VAN DER MEL

With Full Instructions and Descriptions of Set Analyzers, Tube Checkers, Oscillators, etc. (Just revised.)

Book No. 2
Modern Vacuum Tubes
And How They Work
By ROBERT HERTZBERG

With complete Technical Data on All Standard and Many Special Tubes. (Just revised.)

Book No. 3
The Superheterodyne Book

All About Superheterodynes
By CLYDE FITCH
How They Work, How to Build and How to Service Them.

Book No. 4
Modern Radio Hook-Ups
The Best Radio Circuits
By R. D. WASHBURNE

A Complete Compendium of the Most Important Experimental and Custom-built Receivers.

Book No. 5
How to Become a Radio Service Man
By LOUIS MARTIN

How to get started in the business of servicing radios and how to make money in this field.

Book No. 6
Bringing Electric Sets Up to Date
By CLIFFORD E. DENTON

With Pentodes, Multi-Mus, Dynamic Speakers—Complete Information How to Modernize A. C., D. C. and Battery Operated Receivers.

Book No. 7
Radio Kinks and Wrinkles
By C. W. PALMER

For Service Men and Experimenters
A Complete Compendium on the Latest Radio Short-Cuts and Money Savers—These Kinks Are Great Time-Savers.

Book No. 8
Radio Questions and Answers
By R. D. WASHBURNE

A Selection of the Most Important of 5,000 Questions Submitted by Radio Men During the Course of One Year—They Are All Answered by a Technical Expert.

Book No. 9
Automobile Radio and Servicing
By LOUIS MARTIN

A Complete Treatise on the Subject Covering All Phases from Installing to Servicing and Maintenance. A Book That is Greatly Needed Today. (Just Revised.)

Book No. 10
Home Recording and All About It
By GEORGE J. SALIBA

A Complete Treatise on Instantaneous Recordings, Microphones, Recorders, Amplifiers, Commercial Machines, Servicing, etc.

Book No. 11
Point-to-Point Resistance Measurements

By CLIFFORD E. DENTON
The Modern Method of Servicing Radio Receivers—a Book Which Radio Service Men Have Referred to More Than Any Other.

Book No. 12
Public Address Installation and Service
By J. T. BERNSELY

Modern Methods of Servicing and Installing Public Address Equipment.

Big Discount To You

In order to make it possible for everyone to buy these books, the fifty (50) cent price has been made uniform for all volumes. You can buy these books separately, but you should take advantage of our special offer:

When Five (5) Books Or More Are Ordered Deduct 20% From Your Remittance

Simply fill in the coupon at left, and mail it to us together with our remittance. Checks, stamps or money orders accepted.

Here are the subjects covered--

- Set Analyzers
- Tubes
- Superheterodyne Circuits
- Radio Hook-ups
- Servicing Business
- Modernizing Electric Sets
- Kinks and Wrinkles
- Questions and Answers
- Auto-Radio Servicing
- Home Recording
- Resistance Measurements
- Public Address

All Books Uniform Volumes are all uniform size, 6 x 9 inches, and contain on an average of 50 to 120 illustrations. Each book is printed on fine paper and no expense has been spared to make it an outstanding value.



CLIP-MAIL THIS COUPON TODAY!

GERNSBACK PUBLICATIONS, INC., 99 Hudson Street, New York, N. Y.

I have circled below the numbers of books in the RADIO-CRAFT LIBRARY SERIES which you are to send me, and have deducted 20% for ordering five (5) books or more. I have included my remittance in full, at the price of 50c each, when less than five books are ordered.

The amount of my remittance is..... (Stamps, checks or money orders accepted.)

Circle numbers wanted: 1 2 3 4 5 6 7 8 9 10 11 12

Name Address

City State RC-135

Please Say That You Saw It in RADIO-CRAFT

Be a RADIO EXPERT

THE ONE MAN IN 1000 WHO CAN SERVICE MODERN RADIO RECEIVERS

RADIO SERVICE WORK NOW OFFERS GREATEST OPPORTUNITIES SINCE RADIO BEGAN.....

Radical changes have taken place in radio receiver design during the past year. Circuits and construction are very different from the receivers with which the radio service industry has had its greatest experience. Even more sensational developments with further complications are coming next season. Who will service these receivers? Certainly not the "old timer" who knows nothing about modern receivers! He can't do it. That is why, right now, there is an urgent demand for reliable service men with up-to-the-minute knowledge of modern radio receivers. Such men can step right out and earn up to \$3 an hour doing nothing but pleasant service work in the better homes around town.



THIS CIRCUIT ANALYZER AND POINT-TO-POINT RESISTANCE TESTER INCLUDED FREE OF EXTRA CHARGE. Also FOUR LARGE KITS OF HOME PRACTICE EQUIPMENT.....

No Past Experience Needed

Past experience actually counts for little at this time, because the swift changes in receiver construction have made knowledge of old equipment practically useless. Even though you may not know one tube from another today . . . still, you can take R.T.A. training and make more money servicing modern radios than most of the "old timers" are making. R.T.A. graduates are doing it every day. Many of them are making more money as R.T.A. Certified Radio Technicians than they ever made in their lives before!

Be An R. T. A. Man and You'll Be the One Man in 1000

R.T.A. training will equip you to give fast, complete service to any radio receiver built. The jobs that puzzle and sometimes battle the usual service man will be simple as "A.B.C." to you . . . when you become an R.T.A. Certified Radio Technician. It is very possible that you will be the only service man in your locality able to quickly diagnose and quickly repair the new types of radio receivers. Be the one man in 1000! You can.

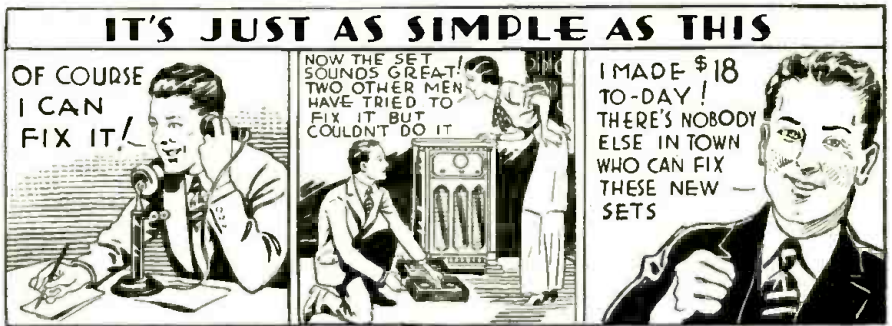

R.T.A. Membership Keeps You Ahead of Competition

With your course of training, and without extra cost, you get a valuable lifetime membership in R.T.A. This gives you a big advantage over ordinary service men . . . because we constantly furnish *advanced* information to our members . . . information that puts money in your pocket while the other fellow is stumbling around in the dark.

To Start You Making Money Right Away

Quickly following your enrollment for training with R.T.A. you get, *without extra cost*, the R.T.A. Set Analyzer and Resistance Tester . . . the handiest piece of portable service equipment ever devised. Instantly helps you locate the trouble in any type of receiver, old or new, and shows you precisely what to do about it.

RADIO TRAINING ASSOCIATION of AMERICA
4513 Ravenswood Avenue CHICAGO, ILLINOIS

SEND COUPON

A. G. Mohaupt, Engineer
Radio Training Ass'n. of America
Dept. RC-51, 4513 Ravenswood Ave., Chicago, Ill.

Dear Mr. Mohaupt: Please send me your free book of facts about radio opportunities and how I can make big money quickly. Also tell me how I can obtain your Set Analyzer and four big experimental outfits—FREE OF EXTRA CHARGE.

Name.....
Address.....
City..... State.....

Please Say That You Saw It in RADIO-CRAFT



The Last Opportunity

You Will Have to Order

The 1935 Manual

AT THE SPECIAL

Pre-Publication Price

NO other radio book in history is comparable to the 1935 OFFICIAL RADIO SERVICE MANUAL. In contents, in style of printing, in grade of paper, in illustrations, there has never been published such a comprehensive volume.

★ The 1935 Manual contains over a thousand pages—yet it will be only 1 1/4 inches thick because it will be printed on a special Bible stock which is an exceptionally good stock, yet one of the thinnest and most durable papers. This new Manual will be voted as the most authentic and elaborate service guide ever used in the radio industry. Service Men and dealers who use this 1935 Manual will be astonished by finding in it such a wealth of profitable service information which has never been previously made available.

Contents Reveal Important Chapters in the Contents of the 1935 Manual

- Over 1,000 pages full of diagrams and essential information of manufactured receivers—only data of real use in servicing is included. This new Manual is really portable since it will be extremely thin and light as well.
- Volume V continues where the preceding manual left off—none of the circuits published have ever appeared in any previous volumes of the OFFICIAL RADIO SERVICE MANUALS.
- Many circuits of extremely old sets not previously available are included.
- Service Men know every radio set has certain weak points which are really the cause of trouble. Wherever the information could be obtained, these weaknesses with their cures are printed right with the circuits. This is an entirely new and valuable addition to the Manual.
- All the latest receivers are included—

all-wave sets, short-wave sets, auto-radio sets, midset and clear-box sets, etc.; as well as P. A. amplifiers and equipment, and commercial testing and servicing instruments.

- The cumulative index is even more complete than before; including cross-reference to sets sold under different names and type numbers identical with circuits printed in this or previous volumes.
- Volume V includes resistance data; socket layouts; I. F. data; voltage data; color codes of wiring, cables, etc.; and the purpose of each tube in the set is clearly indicated on the diagram.
- Tube data on latest tubes and all previous types will be included to facilitate servicing.
- Free question and answer service—as included in our last three manuals.

Three Big, Special Offers—See Coupon

In the coupon below will be found the same three special offers as they appeared in our recent circular. Here is the last opportunity for you to save a few dollars by taking advantage of our PRE-PUBLICATION OFFER—BUT YOU MUST ORDER NOW before the book is published—about December 20. Check the offer in the coupon most convenient to you and mail it to the publishers today. DON'T DELAY!

OVER 1,000 PAGES

Over 3,000 Illustrations. Flexible, loose-leaf covers
Size 9 x 12 inches - yet only 1 1/4 inches thick

GERNSBACK PUBLICATIONS, Inc.
99 Hudson Street New York, N. Y.

GERNSBACK PUBLICATIONS, INC. RC-195
99 HUDSON ST., NEW YORK, N. Y.

Gentlemen:—Herewith is my remittance for \$..... to cover the pre-publication price for one copy of the 1935 OFFICIAL RADIO SERVICE MANUAL, the regular price of which Manual is \$7.00. I have marked in the square below the offer chosen. It is distinctly understood by me that, should this Manual be offered for sale within a year by a reputable mail-order house or dealer for less than this amount, you will return the difference to me.

I understand that the new Manual is to be published about October 15th. On all three offers the postage is prepaid the publishers. This is an additional saving for you.

- OFFER NO. 1
 I enclose \$5.00 in full (during the month of September, 1934), for the total price of the 1935 Manual. This saves me \$2.00.
- OFFER NO. 2
 I enclose \$3.00 now (during the month of September, 1934). I will pay the postman \$3.00 when the 1935 Manual is delivered. This saves me \$1.00.
- OFFER NO. 3
 I enclose \$6.50 now (during the month of September, 1934), and I am to get FREE, a one-year subscription to RADIO-CRAFT Magazine. This saves me \$3.00.

CLIP THIS COUPON AND MAIL TODAY!

NAME

ADDRESS

CITY

STATE

(Remittance should be made in U. S. or International Money Order; we also accept personal checks. If you remit in cash, or should you send new and unused U. S. Postage stamps, which we also accept, be sure to register your letter.)

SET SERVICING



Authentic service information found in the 1935 Manual of a thousand pages covers all types of radio receivers in use today. The material will be extremely valuable to every Dealer and Service Man. On the diagrams of the receivers, wherever possible, appear voltage readings of tubes, socket connections, intermediate frequencies, transformer data, alignment details, common causes of trouble and other valuable service notes.

PUBLIC ADDRESS

The many pages on new, outstanding developments in Public Address Installation and Service will be found helpful to Service Men and P. A. specialists. Such prominent features as class A and B amplifiers—single and dual channel systems—attenuators, and mixers—super-power stages—pre-amplifiers and other commercial devices available for public address and call work, will be found in this complete reference volume.

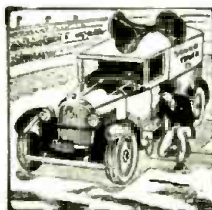

ALL-WAVE RECEIVERS

Information relative to short waves have found their way into the 1935 by popular demand. The numerous all-wave receivers now being sold by practically all the large radio set manufacturers are included. For these sets, wherever possible, complete aligning details for all wave bands are included in addition to the service material listed for other sets.

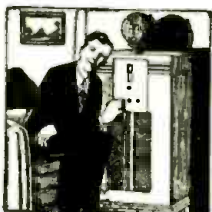

AUTO-RADIO RECEIVERS

No service manual could be complete without a section devoted to auto-radio. All available service information on new auto-radio sets has been included. From this section alone Service Men could derive sufficient knowledge to venture in a specialty field—that of servicing only auto-radios. It is one of the biggest opportunities in radio today.



Please Say That You Saw It in RADIO-CRAFT

SHORT-WAVE APPLICATIONS

An Editorial by HUGO GERNSBACK

THE short-wave art today has assumed such vast proportions that it is difficult even for the man well versed in radio to keep track of all its ramifications. Each month there are new developments and applications in this fastest growing branch of radio.

In short-wave reception we have, today, close to 10,000 short-wave stations which transmit 'phone or code. The largest and most powerful transmitters are those that send international programs of the entertainment type which can be heard all over the world. Incidentally, it is a peculiarity of short waves that the effectiveness of the transmitter is not realized within about 500 miles of the transmitting station, but becomes apparent as the distance increases (up to a certain point).

However, while the average man associates "short waves" only with the reception of foreign programs, and while no doubt this is their foremost application, newer applications are cropping up every day.

Short-wave transmitters are used, for instance, for commercial purposes such as transatlantic and overseas short-wave telephony. Other radio transmitters are required in the ship-to-shore telephone service. In fact, there are today, 21 passenger liners equipped with short-wave telephone whereby, for a reasonable sum, the passenger at sea may telephone from his own ship to almost any part of the world, via short waves. Then, of course, there are the many thousands of stations operating daily in airplane work, for communication purposes between ground and 'plane, and vice versa. There are also over 50,000 short-wave amateur transmitters scattered all over the world. Most of these use code, but 'phone is on the increase.

An entirely different field of short-wave radio operation is that of "facsimile" transmission, or the sending of photographs and the like. The facilities of such transmitters are being utilized more and more by most of the larger companies. This branch of short-wave radio has been greatly developed in the past few years. Since it is now possible to transmit a photograph from London to New York in the short time of 15 minutes, important press photographs are now flashed across oceans at lightning speed and record reproduction. Witness the recent photo-radio service of the assassination of King Alexander where the actual views of the assassination were published in the morning newspapers in New York within 10 hours after the assassination took place in Marseilles, France.

Television, of course, is accomplished by means of short waves, and while the final word has not yet been spoken, one thing is certain: when we finally have regular television service, it must be via short waves and most probably ultra short waves, or the wavelengths below 6 meters. And here it might be well to state that the further down in the short-wave spectrum we go (the higher the frequency) the less strong becomes static interference until, finally, there is reached a point in the "micro short-wave" band where static is entirely absent. This highly important advantage will be a boon to television because the use of such micro waves will enable us to have images unmarred by static.

Still another application of high-frequency radiations is

found in "radio therapeutics." Less than 10 years ago it was discovered by physicists that short waves could be used to produce artificial fever in patients simply by placing them directly in the field set up between two plates energized by a short-wave transmitter. The artificial fever, which can be controlled accurately, thus is induced in the patient and many diseases are today treated by such short-wave therapy. This particular branch of short-wave radio is still in its infancy, and much work remains to be done.

Many surprising things will come about in this field. One of them, for instance, has to do with the extermination of insect pests whereby the larvae are killed by the direct application of short waves. This can be accomplished right in fields where crops are grown and no doubt this branch of short-wave radio will, in due time, reach vast proportions.

Geo-radio is still another branch of short-wave radio by which geologists and others make use of the versatile short waves to explore the ground for its mineral contents. Nowadays, new mines are no longer discovered by the hit-or-miss procedure, but the prospecting miner uses short-wave radio equipment and systematically explores his terrain by noting the reflection, refraction and absorption of short waves sent out by a miniature, portable transmitter. Excellent results are had by this method, which is always certain, and cheaper in the long run. In this country alone, the Federal Communications Commission set aside wavelengths just for the purpose of radio exploration of this type. Much is to be expected from this branch of radio in the near future.

These items do not by any means exhaust the list because there still are numerous other applications of short waves, many of which have, as yet, no practical value. For instance, down in the micro short wave region, that is, in the spectrum where the wavelengths are only 4 inches (about 10 centimeters) in length, the action of the radiations becomes entirely different. As we all know, the usual short and ultra short waves penetrate brick and wooden buildings just as if they did not exist, but down in the *micro* short waves, conditions suddenly change, when it is no longer possible to send the waves through solid buildings; nor do these waves follow the curvature of the earth as do their sister waves. Indeed, micro waves behave much like light waves, and transmitter and receiver must be in sight of each other—the signals will not ordinarily carry below the horizon.

Senatore Marconi is reported as pursuing experiments toward utilizing these micro waves in "radiodynamics," or the control of mechanical devices at a remote point by means of radio waves. Reports so far received seem to indicate that results as reliable as those obtainable over a regular copper-wire line may be secured by using these "beam" waves, which may be directed like a beam of light.

Still further down, in the micro-wave band we come to a point where the so-called "radio" short waves are no longer really radio at all. Here the frequencies merge into those of heat waves, and behave exactly as such. Very little is known about these borderline waves, and there is no gainsaying that some of our greatest surprises in radio will come in the application of these *microscopic* waves!

THE RADIO MONTH



The latest move in Germany is the establishment of a huge network of television transmitters for disbursing propaganda.

HITLER TAKES UP TELEVISION

WITHIN the past month, RADIO-CRAFT has received a report that Chancellor Hitler is preparing a huge network of television stations in Germany which will probably be used as an aid to broadcasting as a medium for disbursing Nazi propaganda.

As mentioned in the report, Hitler's plan includes the making of cheap television sets available throughout the country. This will make Germany the first nation to establish extensive television programs on a large scale.

Short waves will be employed for these transmissions, so that the required number of channels can be obtained. In this way, with numerous stations properly spaced, it is expected that even the outlying districts will be adequately covered.

Television transmitters manufactured by the Baird Television Co. of England are said to have been ordered by the German officials. These transmitters are of special design to cover the conditions required for each individual installation. They include sound facilities as well as the vision units, so that the voices of Hitler and his Nazi orators will be heard, in addition to visualizing the speakers, themselves.

While no actual data is available regarding the type of receivers which

will be merchandised, it is expected that only a single design, approved by the government, will be manufactured by all the manufacturers. This is in line with the present plan in Germany to make "Hitler's own" receiver (a set of small size, and relatively insensitive so that only local programs can be picked up) the distinctive set. Thus, the citizens of Germany will be prevented from hearing the powerful transmitters of Russia and other foreign countries from which undesirable programs might be heard.

"FINAL" ACTION IN RADIO FEED-BACK CASE

THERE have been so many "final" decisions in the long-drawn-out case between the de Forest and the Armstrong interests regarding who actually invented regeneration that there is no wonder that cries of "wolf, wolf" have been heard from all sides in the radio industry.

It will be remembered (RADIO-CRAFT, August 1934, page 70) that the United States Supreme Court, presided over by Judge Cardozo decided that Lee de Forest was the inventor, and held that de Forest had heard a "clear heterodyne" before Edwin H. Armstrong, then a student at Columbia University, had struck upon the same phenomenon.

Major Armstrong recently petitioned for a rehearing of the case with the object of reversing the Supreme Court ruling, and the latest decision of the court is a denial of that application.

In addition to the legal actions which have taken place, a heated argument has been progressing in the *New York Times*, between Professor Pupin and Dr. de Forest concerning the opinions of the former who has rallied to the support of his colleague, Armstrong. This argument has become heated to the point where many bitter words are being said by both parties involved.

In the latest epistle by Prof. Pupin, over half a column in the *Times*, is devoted to a "tabulation" of the names of famous scientists and radio engineers who take sides with Armstrong. So famous an authority as Dr. Irving Langmuir is quoted as having made the following statement:

"Ever since 1913 when I first learned of your (Armstrong's) pioneering work in this field, I have known the great value of your contributions. On several occasions after that I have had

conversations with de Forest which convinced me that he did not know of or understand the production of radio frequencies by vacuum tubes. I have therefore been amazed at the fact that the highest court has previously upheld the de Forest patent."

Professor Pupin sums up his letter with the following remarks: "The court holds Dr. de Forest to be the inventor; the scientific world is a unit holding Armstrong to be the inventor."—and—"... I have never heard of any scientific opinion of recognized weight supporting the de Forest claims."

"Dr. Langmuir, a recent Nobel Prize man, was one of the claimants of the same invention which was under litigation between Armstrong and de Forest for eighteen years.

"Third, the famous radio engineer, Mr. Round of England, one of Marconi's right-hand men, also sent hearty approval of the decision of the Court of Appeals of the Second Circuit. (Which gave the decision to Armstrong—Ed.) Both these letters appeared in full in the *Columbia Alumni News* of Sept. 29, 1933.

"Fourth, the very significant fact that Cyril Elwell, who was the chief engineer of the Federal Telegraph Company, the company employing de Forest at the time he claims to have made the invention, supported Armstrong, as did Professor Leonard Fuller, now head of the Electrical Engineering Department at the University of California."

It seems that while Dr. de Forest has the upper hand as far as legal proceedings are concerned, he must now vindicate himself in the eyes of Professor Pupin and his supporters. And so the Feed-back case seems no nearer to an end, in one sense, than it has been for the past ten or twelve years.

This is how one of our staff artists visualizes the arguments in and out of court concerning the "regeneration patents."



IN REVIEW

Radio is now such a vast and diversified art it becomes necessary to make a general survey of important monthly developments. RADIO-CRAFT analyzes these developments and presents a review of those items which interest all.

RCA MAKES A BUSINESS STATEMENT

IF the financial position of the largest radio corporation in the world has any bearing on the condition of the radio business, then their latest financial statement, issued last month, covering the first three quarters of 1934 must give other manufacturers an optimistic outlook for the future.

A glance at the chart shown here, which is reproduced directly from their printed statement, shows that the total gross income for 1934 is well above the same figure for the equivalent period of time in 1933.

Also, the part of this income which is applied to surplus (the amount left when all deductions have been made—Ed.) has been substantially increased as indicated by the chart.

While these figures do not have a direct bearing on the radio business as a whole, it is safe to assume that it is indicative of a gradual rise out of the depression slump for the majority of radio organizations.

In connection with the Radio Corporation of America, or rather its subsidiary, the RCA Victor Company, which has been extensively advertised as the largest radio manufacturer in the world, we note with interest an advertisement which recently appeared in the *London Times*, in which Phillips Lamps Ltd., a European concern, claims in bold-face letters to be the "world's largest radio manufacturers."

We wonder who is correct? Is RCA Victor or Phillips the world's "largest"?

The Radio Corporation of America is evidently climbing well out of the mire of depression according to these figures.

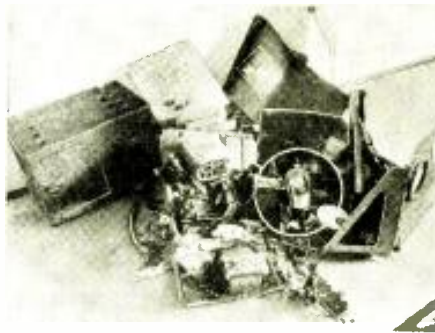
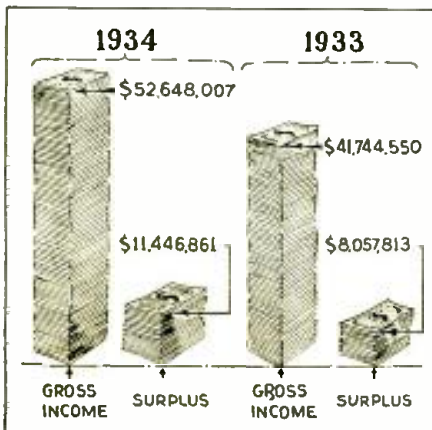

This is what happens when you drop a radio transmitter from a height of 1 mile.

STRATOSPHERE RADIO EQUIPMENT

RADIO has played an important part in the numerous flights made recently by scientists in their efforts to learn more about the mysterious cosmic rays. It was more than an ordinary aid to Professor Picard in his flights, and has enabled him to communicate constantly with the ground—thus facilitating the flight and subsequent landing, as well as keeping the ground informed of progress of the scientific investigations.

An interesting result of the recent flight conducted by the National Geographic Society and the Army Air Corps, is found in the photo of the radio equipment shown below. This tiny 8-watt transmitter which was used during the flight was dropped through space a mile or more and was recovered last month by the NBC, which cooperated with the National Geographic Society in broadcasting the signals from the gondola of the balloon.

The battered transmitter which is now on display in the studios at Radio City, illustrates a phenomenal incident. Panels, transformers, resistors, meters, sockets, condensers, and virtually every part with one exception, was completely wrecked by the drop through space. Oddly enough, the one part which remained intact is a vacuum tube. Even the socket in which the tube was mounted was cracked, but the tube, with its fragile glass envelope withstood the shock.

While there is no practical significance to this freak incident one cannot help but wonder whether the fact that present day tubes are made more ruggedly is illustrated by this lone survivor.

POLICE CAR TALKS TO AUSTRALIA

IN A spectacular demonstration, one day last month, engineers in Schenectady, New York, working on a new type of police "prowl" car accomplished two-way telephone conversation with Sydney, Australia, with the cooperation of station W2XAF.

The conversations were carried by ultra-short waves from the car to the control board of WGY and W2XAF, where incoming signals from Australia were also being relayed. By carefully regulating the incoming and outgoing signals the two-way conversations were made possible.

The police car was one of many new developments in police radio which will be first used in Boston, Mass.

A few words about the car and its equipment might be of interest. The car is a light sedan, bearing no evidence of an antenna or other special features. A French-type phone is installed in a convenient position on the instrument panel, while the 8-meter transmitter is located in the rear trunk. The rear bumper is mounted on insulated brackets, and acts as the transmitting aerial.

The receiver is kept in operation at all times, according to regular "police practice." When the car is called by headquarters and the phone is lifted from its hook, the mobile transmitter, on a different wavelength from the one at headquarters begins to function immediately. This method permits "duplex" conversations between the

(Continued on page 423)

An engineer at Schenectady, N.Y., talking to Australia from a new type of police car.



SHORT-WAVE RADIO PICTORIAL

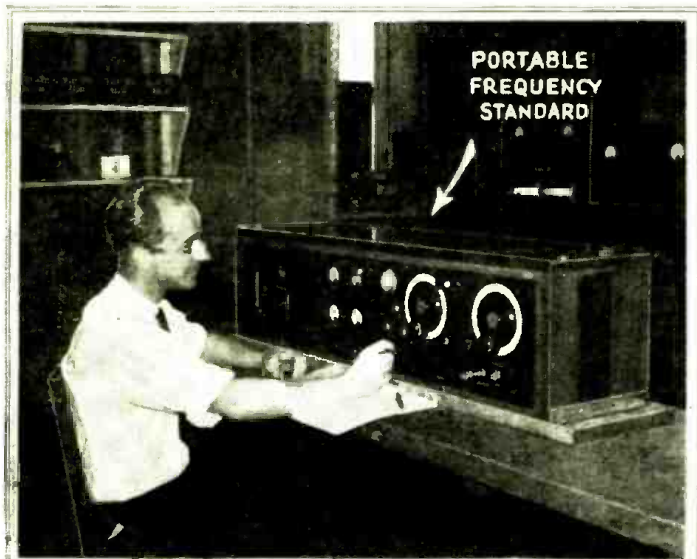

To facilitate the work of policing the numerous channels throughout the broadcast and short-wave bands, the Federal Communications Commission has just purchased six of the devices shown above. These portable frequency monitors are designed for use in special trucks which travel around the country checking the accuracy of tuning of the various broadcasting stations. Each of these consists of a highly stabilized quartz crystal oscillator, a harmonic generator and a radio receiver. They are accurate to three parts in a million.

CONTRARY to popular understanding in the U.S., radio amateurs across the "big pond" are showing much interest in ultra-short waves. The interesting photo on the right depicts an elaborate mobile installation of an English amateur (G5BY). The "rig" consists of a 5 meter transmitter and receiver, each with a separate aerial for duplex transmission. The transmitter is mounted at one end of the box, while the receiver occupies the other end. The antenna poles can be removed while the car is in motion.

THERE seems to be no limit to the height of frequency which can be utilized for radio communication. Several years ago, transmission on 5 meters was a most unusual and mystifying study, and was utilized mostly for spectacular demonstrations and laboratory experiments—today it is used for commercial communication. The photo below shows an apparatus set up in the Bell Telephone Laboratories for transmitting and receiving waves of 60 centimeters which is equivalent to about 24 inches. The specially designed receiver has 4 tuned circuits for detector tuning.

Photos: Westinghouse; Wireless World; Bell Tel. Labs.



To the "round the world" flier, whether he contemplates a speed record or simply a leisurely flown tour, radio communication is perhaps the most essential and most used instrument on the plane. This was realized by Dr. R. U. Light, who recently started on a flight in a Bellanca monoplane equipped with two-way radio equipment.

The transmitter is rated at 75 watts and covers the complete range of frequencies of 330 to 14,000 kc. The receiver is also of the wide range variety by the use of a special coil changing mechanism. All of the equipment, including the transmitter operated from the plane's 12 volt storage battery.

Photo: Westinghouse.

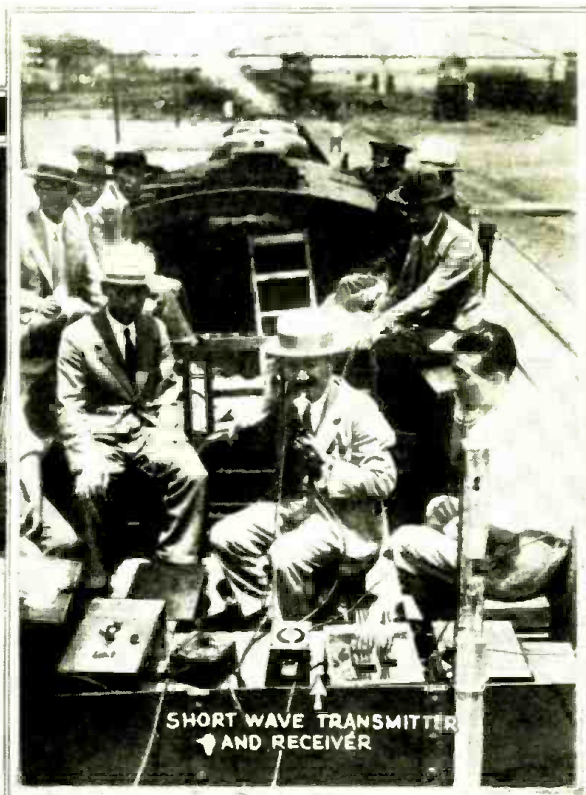

HERE is another use for ultra-short waves. The Japanese government is at present trying to introduce radio telephony on the important railways, for signaling and communication to nearby towns and cities for the convenience of passengers. The photo above illustrates some of the experiments which were conducted recently in duplex transmission and reception. Note the apparatus.

Photo: A. N. Mirzoeff.

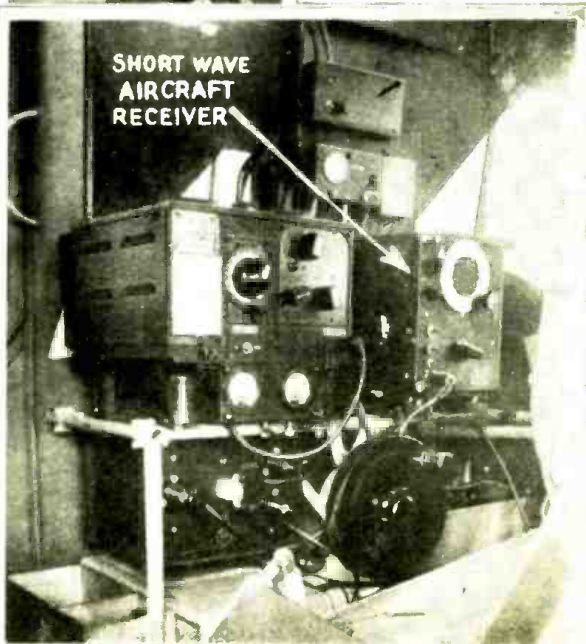

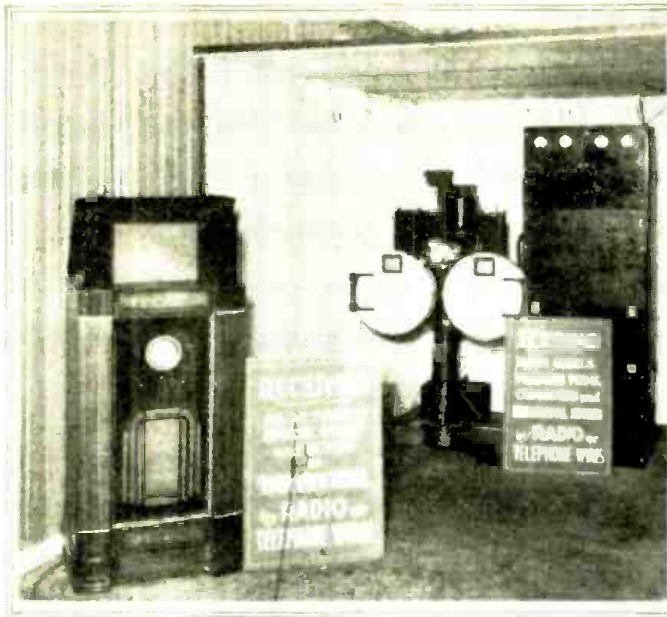

TELEVISION, as a commercial product—to be used and enjoyed as a source of entertainment by the general public—is fast approaching that stage of development where actual instruments will be sold in stores. This fact was brought out recently, at the New York Radio and Electric Show—where the instruments shown above were demonstrated. A more complete description of the technicalities attached to this system for sending and receiving pictures appeared in the December, 1934, issue of RADIO-CRAFT, page 330. The receiving set appears at the left in the above photo, while the transmitting devices are at the right.



THE two photos, above and to the left, show a new installation just completed in Paris, for providing radio aid to the Prefecture of Police. The transmitting car, with its large aerial structure is shown above, while one of the patrol cars equipped with receiving apparatus appears at the left.

While this installation is, no doubt, a distinct departure from previous practices of the police department of that metropolis, we cannot help but remark at the antique appearance of the auto receiver, with its large cabinets for speaker and set, and the pretentious appearance of the aerial of the transmitter equipped truck. A comparison of recent photos of American police radio installations, which have appeared in RADIO-CRAFT, and these pictures, indicate how far advanced is American equipment.

The incident shown in these photos is the inauguration of the new cars, in the courtyard of the Prefecture of Police.



THE Radio Doctor has made his appearance in far off Australia. In the isolated mission stations and settlements "out" from Cloncurry, it often took weeks to get a message through, by water or land. Now, when medical aid is needed, the radio equipped planes of the Aerial Medical Service can reach a patient in a matter of hours. The photo below shows the flying doctor attending a patient, while in the picture at the right is one of the short-wave transmitters in actual use.

Photos Wireless Weekly.



DR. CARL SPITZ, inventor of the device appearing at the right, is shown explaining its operation. It is a recorder designed to indicate constantly the exact location of an airplane in flight. A small light, actuated by short-wave radio signals, moves across a strip map of the plane's route, thus keeping track of its movements. The device is intended to eliminate some of the hazards of blind flying for mail and transport lines. Some of the equipment is seen behind the inventor.

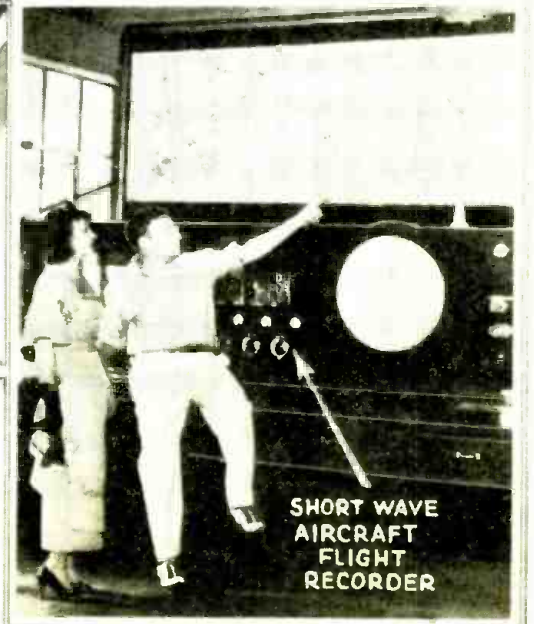



Fig. A
High-fidelity piano music broadcasts aided by a crystal mike.

HI-FIDELITY ON

There is a high-fidelity broadcasting station, operating on 1550 kc.—just below the broadcast band, which is aiding listeners in obtaining lifelike reproduction. This station, W2XR, is blazing new trails with daily broadcasts that cover the entire audio frequency range. Its marvelous quality is causing nation-wide comment, and this may be attributed to the unusually high standard of equipment employed, besides the unusual precautions to ensure high quality.

IN THIS present era of high-fidelity one hears much about new receiver design which will permit the attainment of the ultimate in radio reproduction, but little regarding the broadcaster's efforts to aid in this respect. While a 14-year period of radio broadcasting development has given the average listener-in much to be grateful for, there has always been that feeling (when listening to the majority of stations) that there is something lacking to lend realism to the quality of the broadcasts. This may be attributed to: the tonal (audio frequency) range of the transmitting equipment; the government's regulations in regard to adherence, within 10 kc, of the frequency assigned to the broadcast station (see "Problems in High-Fidelity Design," December 1934. RADIO-CRAFT); and, by no means least of all, the receiving set which, with the exception of the new high-fidelity receivers, restricts the reproduction to below high-fidelity level.

These limitations permit only a frequency range of from 20 to 5,000 cycles (maximum) to be broadcast and received. Since it has been definitely

ascertained that realism in reproduction can only be attained when high-fidelity is attained, and, also, inasmuch as high-fidelity reproduction can be obtained when frequencies upwards of 10,000 cycles (at least up to 7,500 cycles) are broadcast, received, and reproduced.—realism or natural reproduction becomes contingent upon whether these conditions are satisfied. With manufacturers now producing high-fidelity receivers, the listener may wonder where the required "wide-range" broadcasts may be obtained.

Such a station is in existence in New York City; its call letters are W2XR, and its daily high-fidelity broadcasts have been amazing to all who have listened to this station. (The station is really a vast research laboratory where Mr. Hogan and a large staff of engineers are putting the finishing touches on their facsimile and television devices, as well as the high-fidelity broadcasting.)

Broadcasting on 1,550 kc. (193.5 meters, just below the broadcast band), and authorized by the Federal Communications Commission to use a chan-

nel 20 kc. wide, this station has a flat frequency characteristic from 20 to over 15,000 cycles, handling at least 9½ octaves of the musical scale! The quality of the broadcasts from this station is so uncanny that it completely upsets preconceived ideas of high-fidelity and, because of the favorable comment, three other stations with similar equipment are now under construction (one each) in California, Missouri, and Connecticut. John V. L. Hogan, noted engineer and past-president of the Institute of Radio Engineers, developed W2XR which is destined to make history as *the first real, licensed high-fidelity broadcast station in the world!*

So complete is the equipment, and of such fine engineering design, that amongst the radio engineering fraternity this station is considered as being a model installation. No ordinary type of microphone or auxiliary pick-up device is employed. Crystal microphones are employed exclusively, and the "wide-range" response of this type of unit is an established fact. In Fig. A the studio can be seen and the crystal microphone on a stand, at the extreme

Fig. B
The bank of transmitters at W2XR for all types of broadcasts.

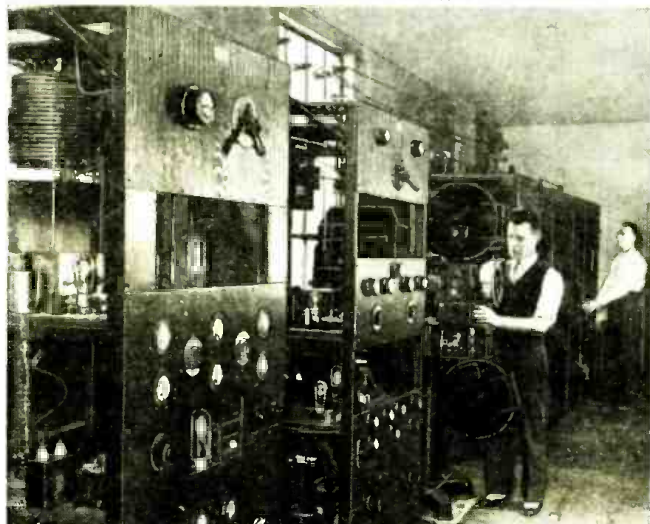
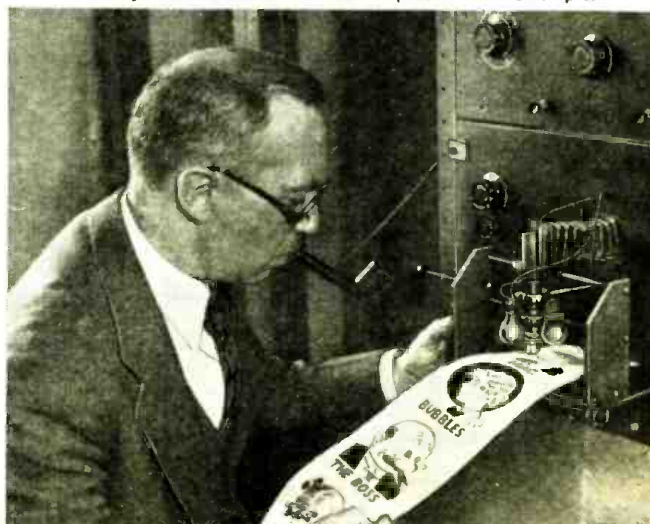

Fig. C
Mr. Hogan at the facsimile transmitter, and facsimile sample.



SHORT WAVES

No hit-or-miss methods, or conventional design will be found in this station. Results are obtained only through sound engineering, good design, and continuous research towards improving the quality of transmission. The station is equipped, in addition to the regular quality broadcasting paraphernalia, for facsimile and television transmission. Only crystal microphones and pickups, resistance-coupled amplifiers, and cathode ray tubes for monitoring, are employed.



Fig. D
Visual and audible monitoring, with Mr. A. A. Barber, sound engineer.

right, picking-up piano notes for broadcasting. So lifelike is the transmission that even on an ordinary receiver the quality of reproduction is superior to that of ordinary broadcasts. With a high-fidelity set the reproduction becomes so realistic that the listener actually feels that he is present in the studio.

While the station is licensed to use 1,000 W. it only broadcasts 350 W. of power. Nevertheless, it is heard at very great distances, Seattle, Washington, as well as all through the middle west, reporting excellent quality and reception. The bank of transmitters in this station (W2XR) is shown in Fig. B. (Note the motion picture projector in the foreground, used for television broadcasts of motion picture film. The equipment necessary for transmitting television impulses must be of an exceedingly "wide-range" nature, generally from 15 to over 50,000 cycles.) The equipment, as seen in this photo, from left to right, are: high-fidelity transmitter (1,550 kc.), television transmitter (2,050 kc., designed for modulation of 50 kc. each side), sound-

movie projector, ultra-short wave transmitter (46 megacycles or approximately 6.3 meters), and a facsimile and television transmitter (2,500 kc.).

From the description given thus far, it can readily be seen that W2XR differs greatly from most radio broadcast stations. Few, if any, have so versatile an array of equipment. Some few months ago Mr. Hogan demonstrated to an amazed engineering group an exceedingly simple facsimile receiving and transmitting system (described in July 1934 RADIO-CRAFT, "The Radio Pen," page 13). Its applications are multitudinous and can be employed, if desired, along with broadcast talks to illustrate certain essential points. However, at the present time the equipment is applied only to commercial use. An idea as to the simplicity of the transmitter, apparatus, and a sample of the pictures it can send out into the ether, may be gained by reference to Fig. C. Mr. Hogan is shown operating the machine, a duplicate of which is being installed at Station WTMJ in Milwaukee.

The high-fidelity broadcasting from

this station is not the result of hit-or-miss methods, but rather due to sound engineering, good design, and long research. The combination of crystal microphones, phonograph, pickups, resist-

(Continued on page 426)

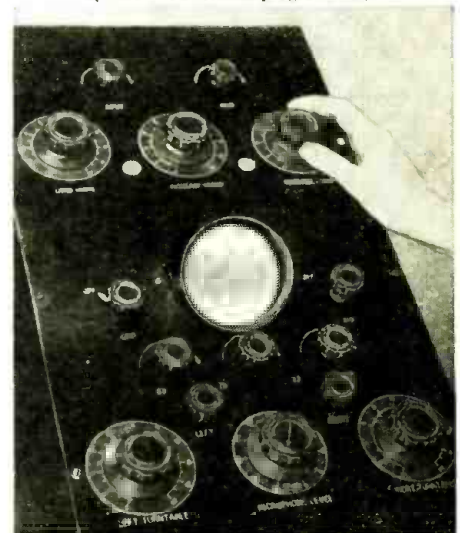

Fig. F
A control panel for correcting the deficiencies in recordings.

Photos: Halbran

Fig. E
The equipment for phonograph renditions using crystal pickups.

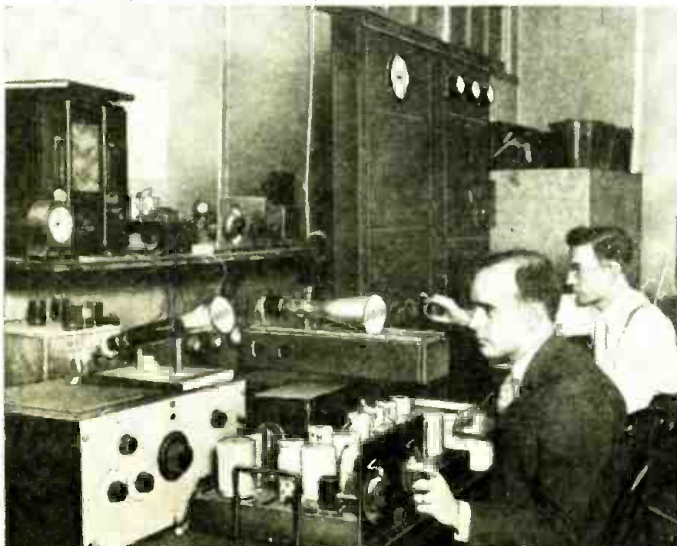

Fig. G
Daily quality tests are made on the equipment by means of tuning forks.



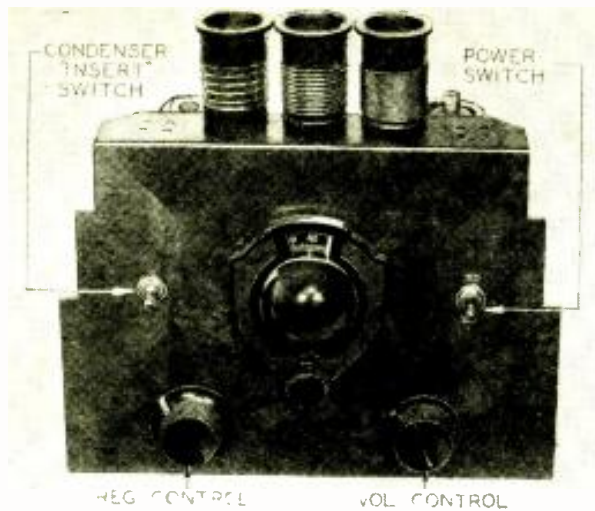

Fig. A. The chassis includes a spare coil rack.

HOW TO BUILD THE "FOUR-IN-TWO" SHORT-WAVE ELECTRIC SET

This amazing little short-wave and broadcast set incorporates the functions and possesses the efficiency of four tubes, yet uses only two. It is remarkably simple and economical to construct.

J. T. BERNSELY

IT WAS with the realization that short-wave set constructors preferred a set that is economical to build and operate, and employs a minimum of tubes with a maximum of efficiency, that this receiver was designed. Before discussing the relative merits of the circuit, and the theory involved, it would undoubtedly be of greater interest to the constructor to learn, first, just what this set can do. Well, in the first place, it will operate a loud-speaker (magnetic, or permanent magnet dynamic types) on most signals transmitted within a radius of 750 miles.

On broadcast tests, conducted in a steel office building in New York City, stations 1,500 miles away were brought in with fair loudspeaker volume.

On short waves police calls all over the country were more than comfortably heard on the loudspeaker. At the time the receiver was completed and first tested some police stations in the middle west were tuned in. On that particular night they were extremely active and engaged in pursuing the late Dillinger. It was a distinct thrill to listen-in on the various stations in numerous cities who were cooperating in this almost nation-wide man hunt.

Foreign broadcasts, on short waves, were received from numerous countries. At the time of these tests LSY in Argentina, South America, was heard with good loudspeaker volume. Also YV3RC, in Venezuela, with exceptionally good volume. DJC, in Berlin, Germany, was tuned in (on loudspeaker) consistently for several weeks. Amateur radiophone stations in abundance, to delight any ham or other interested listener, were received in the various bands assigned to amateur phone communication.

Using only two tubes, and of the most unique types that have ever been produced, it is possible to obtain full four-tube results. The set is distinctly designed for electric operation, either 110 V. D.C., or A.C. (of any frequency), but only this combination of tubes, as will be explained later, will permit such operation—and the equivalent performance of four tubes. By using conventional plug-in coils the complete short-wave range of from 15 to 200 meters is covered.

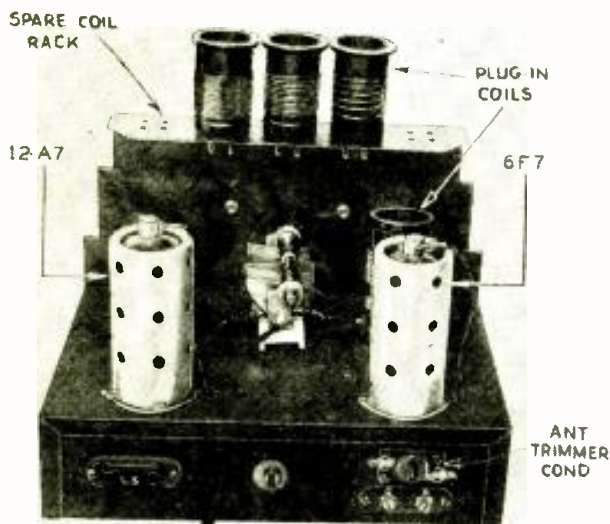

Fig. B, above. Rear view showing parts layout and workmanlike appearance.

Broadcast Reception, Too!

However, the necessity for ever-changing coils to cover various wave-bands is reduced considerably by a special feature included within the tuning circuit. This consists

(Continued on page 424)

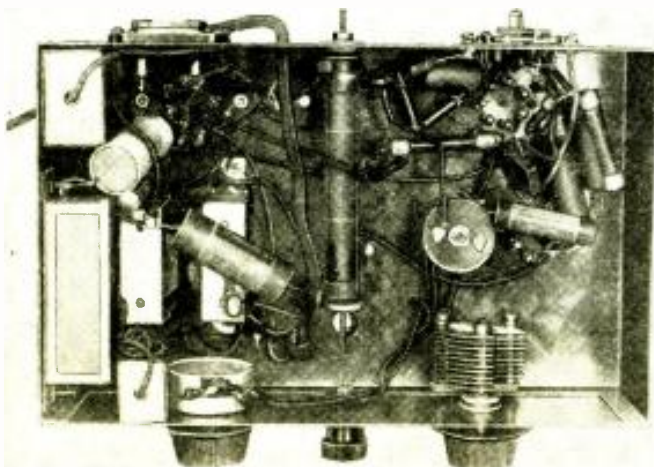
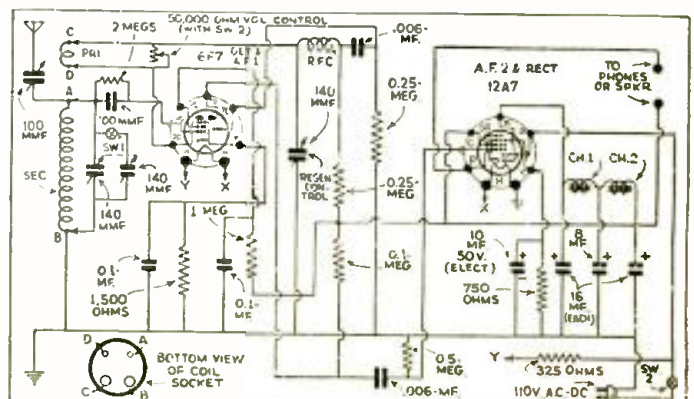

Fig. C, left. Bottom view. Note regeneration and vol. control. Fig. 1, below. Wiring diagram. Operates from 110 volts A.C. or D.C.



THE LATEST IN POLICE RADIO RECEIVERS

New miniature police receivers may ante-date present cumbersome models. The new sets are extremely small, light, and efficient.



The complete equipment of the personal set.



A PORTABLE radio receiver designed for use by patrolmen and mounted police has been perfected by Sol J. Levy, of New York City.

Weighing only 3½ pounds, the five tube super receiver delivers loudspeaker volume on police broadcasts.

The receiver is made in three styles for patrolmen, for motorcycle men, and for mounted police.

The motorcycle model operates from the 6 volt storage battery supply of the motorcycle, the plate voltage being supplied by a small motor-generator mounted on the motorcycle supplying 225 volts.

The receiver proper weights only 1½ pounds and is mounted on the driver's belt. It is easily removable

without taking the belt off and can instantly be mounted on a bracket provided for it on the handle-bars of the motorcycle.

The loudspeaker for the motorcycle model is also mounted on the handle-bars. A female plug in front of the rider on the machine connects the set speaker and batteries; plugging in the cord instantly puts the set and speaker into operation.

The receiver has excellent sensitivity, being tuned to a fixed wave to include only the police calls desired. It has an output of 3 watts and can be clearly heard above traffic noises.

The antenna for the motorcycle model is comprised of metal tubing mounted on the handle-bars, and to the

(Continued on page 423)

NEW SHORT-WAVE LINK TO BYRD

How the air-waves were made to travel when Byrd talked.

SHORT waves carried a two-way conversation between Rear-Admiral Richard E. Byrd and his mother, Mrs. Eleanor Bolling Byrd, over the ten thousand miles of space separating Winchester, Virginia, and Little America. This interesting exchange of greetings between Mrs. Byrd and her illustrious son took place on October 17, during the weekly broadcasts with Little America conducted by the WABC-Columbia broadcasting network.

The voice of the Admiral's mother was plainly heard by millions of listeners when she said: "I am thrilled to hear that you are back in Little America again safe and sound." This sentence and a number of others were carried to the Admiral via the powerful 20 kilowatt short-wave transmitting station of the RCA system located at Rocky Point, Long Island. The wavelength used to transmit the voice to and from Little America was 25.6 meters or a frequency of 11,830 kc.

One of the most interesting and little known facts concerning these broadcast programs carried over the CBS network from Little America is the fact that there are three short-wave "stand-by" circuits always ready to pick up the voice from Little America and bring it to New York. Ordinarily the short-wave signals from Little America, via Buenos Aires, South America, are amplified, the short waves being picked up on a receiver and immediately passed through a powerful S-W. transmitter at Buenos Aires, whence they are again flung northward with the speed of light, and intercepted at the RCA receiving station at Riverhead, Long Island. Here the signals are picked up on a special receiver and suitably amplified through sev-

(Continued on page 426)

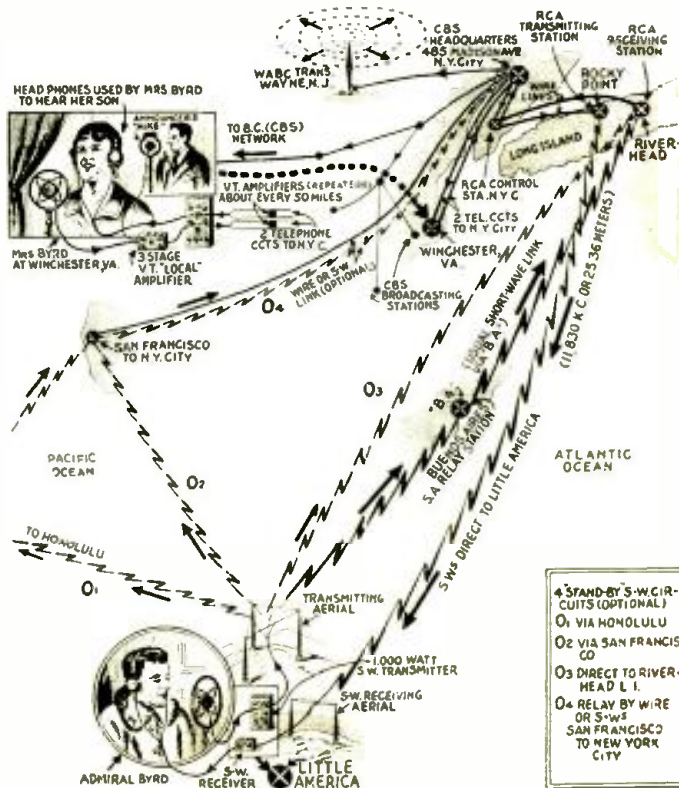

SHORT-WAVE STATIONS OF THE WORLD

A list of the important short-wave phone stations throughout the world listed according to frequency. Stations are classified as follows:
 B—Broadcast Service. C—Commercial Phone. X—Experimental Transmissions.

Call Letters	Location	Freq. (kc.)	Wave-length (meters)	Service	Call Letters	Location	Freq. (kc.)	Wave-length (meters)	Service	Call Letters	Location	Freq. (kc.)	Wave-length (meters)	Service
XGBA	Shanghai, China	21550	13.92	B	I2RO	Rome, Italy	11810	25.40	B	HKE	Bogota, Colombia	7220	41.55	B
VK3LR	Lynnhurst, Australia	21540	13.93	B	OER3	Vienna, Austria	11801	25.42	B	HJ4ABB	Manizales, Colombia	7210	41.60	B
WBXX	Pittsburgh, Pa.	21540	13.93	B	W1XAL	Boston, Mass.	11790	25.45	B	YV2AM	Maracaibo, Venezuela	7200	41.60	B
NAA	Washington, D. C.	21500	13.95	B	T1TR	San Jose, Costa Rica	11790	25.45	B	OA4B	Lima, Peru	7160	42.00	B
FYA	Paris, France	21490	13.96	B	F3ICD	Saigon, Indo-China	11780	25.46	B	HJ4ABB	Manizales, Colombia	7140	42.02	B
GSH	Daventry, England	21470	13.97	B	DJD	Berlin, Germany	11760	25.51	B	LUSCZ	Buenos Aires, Argentine	7080	42.37	B
W1XAL	Boston, Mass.	21460	13.98	B	GSD	Daventry, England	11750	25.53	B	HJ1ABE	Cartagena, Colombia	7000	42.86	B
WKK	Lawrenceville, N. J.	21420	14.01	C	HRB	Teguigalpa, Honduras	11740	25.55	B	LCL	Jeloy, Norway	6990	42.92	B
LSN6	Hurlingham, Argentine	21020	14.20	C	RRRR	Tachkent, U. S. S. R.	11740	25.55	B	EAR110	Madrid, Spain	6977	43.00	B
LSY	Monte Grande, Argentine	20700	14.49	C	NAA	Washington, D. C.	11730	25.58	B	GDS	Rugby, England	6905	43.45	C
GAA	Rugby, England	20380	11.72	C	PHI	Huizen, Holland	11730	25.58	B	KEL	Bolinas, Calif.	6860	43.70	X
LSG	Monte Grande, Argentine	19990	15.08	C	CJRX	Winnipeg, Canada	11720	25.60	B	WOA	Lawrenceville, N. J.	6755	44.41	C
WKN	Lawrenceville, N. J.	19820	15.14	C	FYA	Paris, France	11720	25.60	B	BC2RL	Guayaquil, Ecuador	6676	44.93	B
EAQ	Aranjuez, Spain	19720	15.21	B	VE9DR	Winnipeg, Canada	11720	25.60	B	FBKR	Constantine, Algeria	6667	45.00	B
LSN5	Hurlingham, Argentine	19650	15.27	C	VE9JR	Winnipeg, Canada	11715	25.60	B	HC2RL	Guayaquil, Ecuador	6666	45.00	B
LSF	Monte Grande, Argentine	19600	15.31	C	FYA	Paris, France	11710	25.63	B	YNCRG	Granada, Nicaragua	6664	45.00	B
WOP	Ocean Gate, N. J.	19380	15.48	C	KIO	Kaluku, Hawaii	11680	25.68	X	IAC	Piza, Italy	6650	45.10	C
WKF	St. Assise, France	19355	15.50	C	CT3AQ	Funchal, Madeira	11180	26.83	B	PRADO	Riobamba, Ecuador	6620	45.30	B
GAP	Lawrenceville, N. J.	19220	15.60	C	GBP	Rugby, England	10770	27.85	C	RW72	Moscow, U. S. S. R.	6611	45.38	B
GAQ	Rugby, England	19160	15.66	C	JVM	Nazaki, Japan	10740	27.93	C	REN	Moscow, U. S. S. R.	6610	45.38	B
PLE	Rugby, England	18970	15.81	C	WNB	Lawrenceville, N. J.	10675	28.10	C	HJ5ABD	Manizales, Colombia	6500	46.14	B
GAX	Bandoeng, Java	18830	15.93	C	JVN	Naasaki, Japan	10660	28.14	C	HJ1ABB	Barranquilla, Colombia	6447	46.83	B
GAU	Rugby, England	18680	16.06	X	WNB	Naasaki, Japan	10660	28.14	C	HJ3A	Barranquilla, Colombia	6425	46.70	B
FZS	Rugby, England	18620	16.11	C	WOK	Lawrenceville, N. J.	10550	28.44	C	W3XL	Bound Brook, N. J.	6425	46.70	X
WLA	Saigon, Indo-China	18345	16.35	C	GBK	Rugby, England	10530	28.49	X	HIZ	Santo Domingo, Dom. Rep.	6320	47.50	B
GAS	Lawrenceville, N. J.	18340	16.36	C	VLK	Sydney, Australia	10525	28.50	B	HJ3ABF	Bogota, Colombia	6275	47.81	B
FTO	Rugby, England	18310	16.38	C	YBG	Medan, Sumatra	10430	28.76	C	H11A	Santiago, Dom. Rep.	6272	47.84	B
GAW	St. Assise, France	18250	16.43	C	XGW	Shanghai, China	10420	28.79	C	HJ3ABF	Bogota, Colombia	6250	48.00	B
PMC	Rugby, England	18200	16.48	C	KES	Bolinas, Calif.	10410	28.80	X	OCN	Lima, Peru	6235	48.10	B
LSY3	Bandoeng, Java	18135	16.54	C	PKD	Kootwijk, Holland	10410	28.80	C	CJRO	Winnipeg, Canada	6150	48.78	B
GAB	Monte Grande, Argentine	18115	16.56	C	LSX	Monte Grande, Argentine	10350	28.99	C	YV3BC	Caracas, Venezuela	6150	47.87	B
PCV	Rugby, England	18040	16.63	C	ORK	Ruyselede, Belgium	10330	29.04	C	KZRM	Manila, P. I.	6140	48.86	B
GSX	Kootwijk, Holland	17810	16.84	C	LSL2	Hurlingham, Argentine	10300	29.13	C	W3XK	Pittsburgh, Pa.	6140	48.86	B
W3XAL	Daventry, England	17790	16.86	B	PMN	Bandoeng, Java	10260	29.24	C	ZGE	Kula Lumpur, Fed. Malay States	6135	48.90	B
W3XK	Bound Brook, N. J.	17780	16.87	B	LSK3	Hurlingham, Argentine	10250	29.27	C	JB	Johannesburg, U. of South Africa	6122	49.00	B
W3XF	Saxonburg, Pa.	17780	16.87	B	PSH	Rio de Janeiro, Brazil	10220	29.35	C	ITJ	Johannesburg, U. of South Africa	6122	49.00	B
W3XAA	Downer's Grove, Ill.	17780	16.87	B	ZFB	Hamilton, Bermuda	10055	25.57	C	NAA	Washington, D. C.	6120	49.02	B
FYA	Chicago, Ill.	17780	16.87	B	LSN	Buenos Aires, Argentine	9990	30.03	C	OOU	Basankusu, Bel. Congo	6120	49.02	B
PHI	Paris, France	17775	16.88	B	GCU	Rugby, England	9950	30.15	C	PK1WK	Bandoeng, Java	6120	49.02	B
DJE	Huizen, Holland	17775	16.88	B	LSN	Hurlingham, Argentine	9890	30.33	C	RKOM	Dnepropetrovsk, U.S.S.R.	6120	49.02	B
W3XAL	Berlin, Germany	17760	16.89	B	LSN	Hurlingham, Argentine	9890	30.33	C	W2XE	Wayne, N. J.	6120	49.02	B
HSP	Piza, Italy	17760	16.89	B	WON	Lawrenceville, N. J.	9870	30.40	C	F3LCD	Saigon, Fr. Indo-China	6116	49.02	B
W3XL	Bangkok, Siam	17740	16.91	X	EAQ	Aranjuez, Spain	9860	30.43	B	HJ1ABD	Cartagena, Colombia	6116	49.02	B
HAS5	Bound Brook, N. J.	17740	16.91	X	JYS	Tokio, Japan	9840	30.49	X	YV2RC	Caracua, Venezuela	6112	49.08	B
WOO	Szekesfehervar, Hungary	17310	17.33	B	LSE	Monte Grande, Argentine	9800	30.61	C	EAQ	Aranjuez, Spain	6110	49.10	B
GBC	Ocean Gate, N. J.	17130	17.51	B	GCW	Rugby, England	9790	30.64	C	VESHX	Hullfuta, N. S. Canada	6110	49.10	B
WOC	Ocean Gate, N. J.	17120	17.52	C	WOF	Lawrenceville, N. J.	9750	30.77	C	VUC	Caleutta, India	6110	49.10	B
WBY	Lawrenceville, N. J.	17120	17.52	C	GCA	Rugby, England	9710	30.89	C	YV1BC	Caracas, Venezuela	6110	49.10	B
GBC	Rugby, England	17086	17.56	C	CT1AA	Lisbon, Portugal	9600	31.25	B	HJ1ABD	Cartagena, Colombia	6109	49.18	B
WLK	Lawrenceville, N. J.	16270	18.44	C	XETE	Mexico City, Mex	9600	31.25	B	W3XAL	Bound Brook, N. J.	6100	49.18	B
WOG	Ocean Gate, N. J.	16270	18.44	C	HBL	Geneva, Switzerland	9595	31.27	B	W3XF	Downers Grove, Ill.	6100	49.18	B
FZRS	Saigon, Indo-China	16233	18.48	C	KZME	Sydney, Australia	9590	31.28	B	VE9GW	Bowmanville, Canada	6095	49.22	B
FTK	St. Assise, France	15880	18.90	C	PCJ	Hilversum, Holland	9590	31.28	B	OXV	Skamlebak, Denmark	6090	49.26	B
LSL	Hurlingham, Argentine	15810	18.98	C	TIRA	Cartago, Costa Rica	9590	31.28	B	VE9JW	Saint Johns, N. B.	6090	49.26	B
JYT	Kemikawa-Cho, Chikiken, Japan	15760	19.04	X	W3XAU	Newtown Square, Pa.	9590	31.28	B	VE9W	Bowmanville, Canada	6090	49.26	B
HC1FG	Riobamba, Ecuador	15410	19.47	B	GSC	Daventry, England	9585	31.30	B	VE9W	Bowmanville, Canada	6090	49.26	B
HAS3	Szekesfehervar, Hungary	15370	19.52	B	VK3LR	Melbourne, Australia	9580	31.32	B	OXV	Skamlebak, Denmark	6090	49.26	B
CT1AA	Lisbon, Portugal	15350	19.55	B	XGBD	Shanghai, China	9579	31.32	B	VE9JW	Saint Johns, N. B.	6090	49.26	B
W2XAD	Schenectady, N. Y.	15330	19.56	B	VUC	Caleutta, India	9575	31.33	B	VE9W	Bowmanville, Canada	6090	49.26	B
CP7	La Paz, Bolivia	15300	19.60	B	KZRM	Manila, P. I.	9570	31.35	B	CP5	La Paz, Bolivia	6080	49.34	B
FYA	Paris, France	15295	19.61	B	SRI	Posen, Poland	9570	31.36	B	TIRA	Cartago, Costa Rica	6080	49.34	B
W2XE	Wayne, N. J.	15270	19.65	B	W1XAZ	Millis, Mass.	9570	31.35	B	W3XAA	Chicago, Ill.	6080	49.34	B
EAQ	Aranjuez, Spain	15265	19.65	B	W3XK	Saxonburg, Pa.	9570	31.35	B	OER2	Vienna, Austria	6072	49.41	B
W1XAL	Boston, Mass.	15250	19.67	B	VUB	Bombay, India	9565	31.36	B	EAQ	Madrid, Spain	6070	49.42	B
VK3LR	Paris, France	15243	19.68	B	DJA	Berlin, Germany	9560	31.38	B	OXV	Skamlebak, Denmark	6070	49.42	B
WBXX	Lynnhurst, Australia	15230	19.70	B	NAA	Washington, D. C.	9550	31.41	B	VE9CS	Vancouver, Canada	6070	49.42	B
GSH	Pittsburgh, Pa.	15210	19.72	B	LKJ1	Jeloy, Norway	9550	31.41	B	YV5RMO	Maracaibo, Venezuela	6070	49.42	B
DJB	Konigswusterhausen, Ger.	15200	19.74	B	EAQ	Aranjuez, Spain	9545	31.43	B	H1X	Santo Domingo, Dom. Rep.	6065	49.46	B
GSF	Daventry, England	15140	19.82	B	LCL	Jeloy, Norway	9540	31.45	B	SASH	Motala, Sweden	6065	49.46	B
NAA	Washington, D. C.	15130	19.83	B	YNA	Managua, Nicaragua	9530	31.48	C	OSC	Boende, Belgium Congo	6060	49.50	B
HVJ	Vatican City, Italy	15120	19.84	B	W2XAF	Schenectady, N. Y.	9530	31.48	C	OXV	Skamlebak, Denmark	6060	49.50	B
DJL	Konigswusterhausen, Ger.	15110	19.85	B	OXV	Skamlebak, Denmark	9520	31.51	B	VQ7LO	Nairobi, Kenya, Africa	6060	49.50	B
WNC	Hialeah, Florida	15065	19.92	C	GSB	Daventry, England	9510	31.55	B	W3XAU	Newtown Square, Pa.	6060	49.50	B
KAY	Manila, P. I.	14980	20.03	C	VK3ME	Melbourne, Australia	9510	31.55	B	W3XAL	Cincinnati, Ohio	6060	49.50	B
HJB	Bogota, Colombia	14960	20.07	C	PRF5	Rio de Janeiro, Brazil	9500	31.58	B	ZL2ZX	Wellington, New Zealand	6060	49.50	B
WMN	Lawrenceville, N. J.	14590	20.56	C	YV3BC	Caracas, Venezuela	9500	31.58	B	GSA	Daventry, England	6050	49.59	B
LSM2	Hurlingham, Argentine	14560	20.69	C	SRI1	Posen, Poland	9493	31.60	B	EAQ	Aranjuez, Spain	6045	49.63	B
WFM	Lawrenceville, N. J.	14470	20.73	C	PLV	Bandoeng, Java	9415	31.87	C	HJ5ABI	Bogota, Colombia	6045	49.63	B
GBW	Rugby, England	14440	20.78	C	CJA2	Drummondville, Canada	9330	32.15	C	CMCI	Havana, Cuba	6040	49.67	B
GBA	Rugby, England	13990	21.44	C	GCB	Rugby, England	9280	32.33	C	RILD	Omsk, U. S. S. R.	6040	49.67	C
LCO	Jeloy, Norway	13980	21.46	B	YUR	Maracay, Venezuela	9175	32.70	B	RLEC	Tehta, U. S. S. R.	6040	49.67	C
GBB	Rugby, England	13585	22.08	C	WNA	Lawrenceville, N. J.	9170	32.72	C	W1XAL	Boston, Mass.	6040	49.67	B
GCJ	Rugby, England	13415	22.36	C										

Call Letters	Location	Freq. (kc.)	Wave-length (meters)	Service	Call Letters	Location	Freq. (kc.)	Wave-length (meters)	Service	Call Letters	Location	Freq. (kc.)	Wave-length (meters)	Service
HVJ	Vatican City, Italy	5968	50.27	B	WCN	Lawrenceville, N. J.	5077	59.08	C	HCJB	Quito, Ecuador	4110	73.00	B
HIX	Santo Domingo, Dom. Rep.	5953	50.40	B	ZFA	Hamilton, Bermuda	5025	59.70	C	WND	Hialeah, Florida	4098	73.21	B
HJ4ABE	Medellin, Colombia	5952	50.40	B	GBC	Rugby, England	4975	60.30	C	12RO	Rome Prato Smeraldo, Italy	3750	80.00	B
HJ4ABE	Medellin, Colombia	5930	50.60	B	GDW	Rugby, England	4820	62.24	C	CT2AJ	Ponta Delgada, Azores	3600	83.50	B
HJ2ABA	Tunja, Colombia	5880	51.02	B	WOO	Ocean Gate, N. J.	4752	63.10	C	CR7AA	Mosambique, E. Africa	3543	84.70	B
WOB	Lawrenceville, N. J.	5853	51.25	C	WOY	Lawrenceville, N. J.	4752	63.10	C	PK1WK	Bandoeng, Java	3490	85.96	B
VK3LR	Lynchhurst, Australia	5800	51.70	B	YID	Baghdad, Iraq	4470	67.10	B	PLV	Bandoeng, Java	3199	94.00	C
HCK	Quito, Ecuador	5714	52.50	B	GDB	Rugby, England	4320	69.44	C	PMY	Bandoeng, Java	3183	94.30	C
FIQA	Tananarive, Madagascar	5690	52.70	B	RW15	Khabarovsk, U. S. S. R.	4273	70.22	B	OXB	Blaavand, Denmark	1622	185.00	B
HJ5ABC	Cali, Colombia	5660	53.00	B	WOO	Ocean Gate, N. J.	4272	70.22	C	OZP	Lynghy, Denmark	1595	188.00	B
PMY	Bandoeng, Java	5170	58.00	B	WOY	Lawrenceville, N. J.	4272	70.22	C	SCJ	Karlskron, Sweden	1530	196.00	B
OKIMPT	Prague, Czechoslovakia	5145	58.30	B	RW15	Khabarovsk, U. S. S. R.	4270	70.40	B					

POLICE ALARM STATIONS BY CALL LETTERS

Call Letters	Location	Freq. (kc.)	Call Letters	Location	Freq. (kc.)	Call Letters	Location	Freq. (kc.)
CGZ	Vancouver, B. C.	2452	KGZR	Salem, Ore.	2442	WPEI	E. Providence, R. I.	1712
CJW	St. Johns, N. B.	2416	KGZS	McAlester, Okla.	2458	WPEK	New Orleans, La.	2430
CJZ	Verdean, Que.	2452	KGZT	Santa Cruz, Calif.	1674	WPEL	W. Bridgewater, Mass.	1666
KGHG	Las Vegas, Nev.	2474	KGZU	Lincoln, Neb.	2490	WPEM	Woonsocket, R. I.	2466
KGHK	Palo Alto, Calif.	1674	KGZW	Lubbock, Tex.	2458	WPEP	Arlington, Mass.	1712
KGHM	Reno, Nev.	2474	KGZX	Albuquerque, N. Mex.	2414	WPES	Saginaw, Mich.	2442
KGHO	Des Moines, Iowa	1682	KSW	Berkeley, Calif.	1658	WPET	Lexington, Ky.	1706
KGHX	Santa Ana, Calif.	2430	KVP	Dallas, Tex.	1712	WPEW	Northampton, Mass.	1666
KGHY	Whittier, Calif.	1712	VYR	Montreal, Can.	1712	WPFA	Newton, Mass.	1712
KGHZ	Little Rock, Ark.	2406	VYW	Winnipeg, Man.	2416	WPFK	Muskegon, Mich.	2442
KGJX	Pasadena, Calif.	1712	WCK	Belle Island, Mich.	2114	WPFH	Reading, Pa.	2442
KGLX	Albuquerque, N. Mex.	2414	WEY	Boston, Mass.	1558	WPFJ	Jacksonville, Fla.	2442
KGOZ	Cedar Rapids, Iowa	2466	WKDT	Detroit, Mich.	1558	WPFH	Baltimore, Md.	2414
KGPA	Seattle, Wash.	2414	WKDU	Cincinnati, Ohio	1706	WPFJ	Columbus, Ga.	2414
KGPB	Minneapolis, Minn.	2430	WMDZ	Indianapolis, Ind.	2442	WPFJ	Hammond, Ind.	1712
KGPC	St. Louis, Mo.	1706	WMJ	Buffalo, N. Y.	2422	WPFK	Hackensack, N. J.	2430
KGPD	San Francisco, Calif.	1674	WMO	Highland Park, Mich.	2414	WPFM	Gary, Ind.	2470
KGPE	Kansas City, Mo.	2422	WMP	Framingham, Mass.	1666	WPFM	Birmingham, Ala.	2382
KGPG	Vallejo, Calif.	2422	WPDA	Tulare, Calif.	2414	WPFN	Fairhaven, Mass.	1712
KGPH	Oklahoma City, Okla.	2450	WPDB	Chicago, Ill.	1712	WPFQ	Knoxville, Tenn.	2474
KGPI	Omaha, Neb.	2466	WPDC	Chicago, Ill.	1712	WPFQ	Clarksburg, W. Va.	2490
KGPI	Beaumont, Tex.	1712	WPDD	Chicago, Ill.	1712	WPFQ	Swatmore, Pa.	2474
KGPK	Sioux City, Iowa	2466	WPDE	Louisville, Ky.	2442	WPFQ	Johnson City, Tenn.	2470
KGPL	Los Angeles, Calif.	1712	WPDF	Flint, Mich.	2466	WPFQ	Asheville, Md.	2458
KGPM	San Jose, Calif.	1674	WPDG	Youngstown, Ohio	2458	WPFU	Portland, Me.	2422
KGPN	Davenport, Iowa	2466	WPDH	Richmond, Ind.	2442	WPFV	Pawtucket, R. I.	2466
KGPO	Tulsa, Okla.	2450	WPGI	Columbus, Ohio	2430	WPFV	Palm Beach, Fla.	2442
KGPP	Portland, Ore.	2442	WPKD	Milwaukee, Wis.	2450	WPFZ	Miami, Fla.	2442
KGQX	Honolulu, T. H.	2450	WPLD	Lansing, Mich.	2442	WPGA	Bay City, Mich.	2466
KGPS	Bakersfield, Calif.	2414	WPLM	Dayton, Ohio	2430	WPGB	Port Huron, Mich.	2466
KGPW	Salt Lake City, Utah	2406	WPDN	Auburn, N. Y.	2382	WPGC	S. Schenectady, N. Y.	1658
KGPX	Denver, Colo.	2442	WPDO	Akron, Ohio	2458	WPGD	Rockford, Ill.	2458
KGQY	Baton Rouge, La.	1574	WPDQ	Philadelphia, Pa.	2474	WPGF	Providence, R. I.	1712
KGZJ	Wichita, Kans.	2450	WPDR	Rochester, N. Y.	2382	WPGG	Findlay, Ohio	1682
KGZA	Fresno, Calif.	2414	WPDS	St. Paul, Minn.	2430	WPGH	Albany, N. Y.	2414
KGZB	Houston, Tex.	1712	WPDY	Kokomo, Ind.	2490	WPGI	Portsmouth, Ohio	2430
KGZC	Topeka, Kans.	2422	WPDZ	Pittsburgh, Pa.	1712	WPGJ	Utica, N. Y.	2414
KGZD	San Diego, Calif.	2490	WPDV	Charlotte, N. C.	2458	WPGK	Cranston, R. I.	2466
KGZE	San Antonio, Tex.	2482	WPDW	Washington, D. C.	2422	WPLG	Binghamton, N. Y.	2442
KGZF	Chanute, Kans.	2450	WPDY	Detroit, Mich.	2414	WPLG	South Bend, Ind.	2490
KGZG	Des Moines, Iowa	2466	WPEA	Atlanta, Ga.	2414	WPGO	Huntington, N. Y.	2490
KGZH	Klamath Falls, Ore.	2382	WPEB	Fort Wayne, Ind.	2490	WPGS	Mineola, N. Y.	2490
KGZI	Wichita Falls, Tex.	2458	WPEC	Syracuse, N. Y.	2382	WPGU	Boston, Mass.	1712
KGZJ	Phoenix, Ariz.	2430	WPED	Grand Rapids, Mich.	2442	WPGW	Mobile, Ala.	2382
KGZL	Shreveport, La.	1712	WPEE	Memphis, Tenn.	2466	WRBH	Cleveland, Ohio	2458
KGZM	El Paso, Tex.	2414	WPEF	Arlington, Mass.	1712	WRDQ	Toledo, Ohio	2474
KGZN	Tacoma, Wash.	2414	WPEG	New York, N. Y.	2450	WRDR	Gross Pt. Village, Mich.	2414
KGZO	Santa Barbara, Calif.	2414	WPEH	New York, N. Y.	2450	WRDS	E. Lansing, Mich.	1666
KGZP	Coffeyville, Kans.	2450		New York, N. Y.	2450			
KGZQ	Waco, Tex.	1712		Somerville, Mass.	1712			

TELEVISION STATIONS BY FREQUENCIES AND CALL LETTERS

Call Letters	Location	Call Letters	Location	Call Letters	Location
W2XDR	2000-2100 kc. Long Island City, N. Y.	W6XS	Los Angeles, Calif.	W3XE	Philadelphia, Pa.
W8XAN	Jackson, Mich.	W9XAL	Kansas City, Mo.	W3XAD	Camden, N. J.
W9XK	Iowa City, Iowa	W9XG	W. Lafayette, Ind.	W10XX	Portable & Mobile (Vicinity of Camden)
W9XAK	Manhattan, Kansas	W2XAB	New York, N. Y.	W2XDR	Long Island City, N. Y.
W9XAO	Chicago, Ill.			W8XAN	Jackson, Mich.
W6XAH	Bakersfield, Calif.			W9XE	Chicago, Ill.
				W9XAT	Portable
	2750-2850 kc.	W2XAX	New York, N. Y.	W2XD	New York, N. Y.
W3XAK	Portable	W6XAO	Los Angeles, Calif.	W2XAG	Portable
W9XAP	Chicago, Ill.	W9XD	Milwaukee, Wis.	W1XG	Boston, Mass.
W2XBS	Bellmore, N. Y.	W2XBT	Portable		
		W2XF	New York, N. Y.		

THE LATEST RADIO EQUIPMENT



Pee-wee variable condenser. This condenser will fit inside a tube base. (604)



High-grade service oscillator. Use this unit in field or lab. work. (605)



Above, an improved 2B6 tube. Two triodes in one envelope. (606)

Below, a low-cost all-wave set. The manufacturers have 11 more new models. (607)



MIDGET VARIABLE CONDENSER (604)

(The Hammarlund Mfg. Co.)

IN THIS day of extremes, the tendency is to build equipment to bigger and bigger, or smaller and smaller proportions; the latter trend is exemplified in the newest design of variable condenser, which measures only $1\frac{7}{32} \times 1\frac{1}{2}$ ins. deep. This condenser is particularly well adapted for use in short-wave and ultra short-wave fields; also, as a tuning condenser for I.F. transformers, trimming R.F. coils, trimming gang condensers, antenna tuning, for fixed tuning of R.F. circuits or plug-in coils, and for padding purposes in general. The capacity per air gap is about 4 mmf.; commercial maximum values, 25, 50, 75 and (illustrated) 100 mmf. Terminals are extensible from either end; the shaft may be extended. These tiny condensers are "swell" for fitting inside a coil form of tube-base size.

NEWEST IN SERVICE OSCILLATORS (605)

(Earl Webber Co.)

HOW good is it? Let the following facts speak for themselves. Frequency calibration: checked at 6 points on each band against crystal-controlled frequency standards; modulation: 35% at 400 cycles, supplied by separate tube and switch controlled, and available at A.F. tip-jacks; range: 90 kc. to 25 megacycles at fundamental frequencies in 8 bands; attenuation: complete control over entire frequency range. Equipment: two type 30 tubes, dummy antenna, demodulation jumper; uses one $4\frac{1}{2}$ V. and one 22½ V. battery. The dial of this portable service oscillator is of direct-reading, full-vision type.

IMPROVED 2B6 TUBE (606)

IMPROVED-life characteristics and a fast-heater cathode are features recently announced for the latest version of the 2B6 "direct-coupled"

Full-vision, recording-type dial. (608)



tube, which incorporates two triodes in one envelope. This type of tube (first described at length in the article, "The 2B6—A Duplex Triode," in the September, 1933 issue of RADIO-CRAFT merits the special consideration of foresighted engineers.

TABLE-TYPE ALL-WAVE SUPERHET (607)

THE least expensive 110 V. A.C. model of a series of 12 receivers recently introduced by one manufacturer utilizes 5 tubes in a dual-wave chassis that covers the range of 540 to 1,800, and 5,600 to 18,000 kc. Incorporated are a two-position tone control, limited A.V.C., and dual-ratio tuning.

A MASTODON IN SET DIALS (608)

(Crowe Name Plate & Mfg. Co.)

SHOWN at the recent Radio Show, and one of a large number of recent models brought out by a manufacturer that specializes in the production of stock and custom models, the latest in full-vision dials is nothing if not arresting in appearance; its overall diameter is 7 ins.! The center portion of the dial is covered with a glass 4 ins. in diameter that can be graduated to suit; the station names are printed on a removable ring. Standard tuning ratio, 5½ to 1.

HARMONIC-TYPE OSCILLATOR (609)

(Try-Mo Radio Co., Inc.)

WHERE cost is an important factor it is usual to select the "harmonic" type of service oscillator. One of four recent models, in this design, brought out by this manufacturer utilizes, in the portable (illustrated) and cabinet types, A.C. with a single type 56 tube. The two companion types are battery models using a type 30 tube.

The fundamental frequency range is 50 to 150 kc.; common I.F. settings within this range, and at 260,

Harmonic-type service oscillator. (609)



400 and 450 kc., are indicated on an upper section of the main scale. Harmonics of the Hartley circuit are available to the 50th, and often the 150th harmonic.

ELECTRIC PHONOGRAPHS (610)

IF YOU want to "play" the best in phonograph records, i.e.—"electric" recordings, it will be necessary to use an "electric" phonograph, which incorporates a "phonograph pickup" rather than a "tone arm." A recent design in portable type is available in either single-play or automatic type, and optional 33½ or 78 r.p.m. operation; a piezo-electric pickup is used. Connected to the usual A.F. amplifier of high-quality type the instrument affords the finest available musical and other programs at an instant's notice.

"SHORT-WAVE" FIXED CONDENSERS (611)

SHORT-WAVE receivers and transmitters of high-quality design necessarily are large and expensive, due mainly to the need for components that will meet the "specs." Now, "oil-impregnated" fixed condensers are available at lower cost and less bulk than the mica condensers formerly required for such services in short-wave equipment as bypass, antenna coupling, blocking, filter, rotor-grounding, and buffer units, at capacity values from .002 to 0.1 mf., at potentials of 1,500 to 1000 V., and to pass up to 50 A. per mf. at 28 megacycles. The power factor is extremely low. An 0.1-mf. unit measures only 2½ x 7¼-in. dia. (Retain mica units only for padding or trimming resonant circuits.)

MULTIPLE OUTLETS FOR ALL-WAVE SETS (612)

YOU have read about all-wave antennas of increasingly improved types, but did you know that the all-wave idea has been applied to the "multiple radio outlet antenna system" described in past issues of RADIO-CRAFT? After "stringing" the all-wave antenna, the downlead cable is bared at each floor, and a lead tapped off to an "all-wave outlet," to which the antenna post of the radio set connects. The downlead cable ends at a "terminal outlet" which is grounded.

A "POKER GAME" RECEIVER (613)

FIRST, as boon companion, we had recommended to us the "cocktail" set, described in the preceding October issue, which included with the receiver chassis a full 6-person complement of drinking glasses and assorted liquors. (The "beer bottle" set described in the following December issue was more decorative than practical—unfortunately!) Now we are urged to purchase the very

Name of manufacturer of any device will be sent on receipt of a self-addressed, stamped envelope. Kindly give (number) in description under picture.



High-quality electric phonograph. (610)

companionable receiver, illustrated, that includes not only the drinking paraphernalia, but also (under the lid) chips and cards for "a quiet little game."

DUAL RANGE A.C.-D.C. OSCILLATOR (614)

(Delta Radio Co.)

THE dial of a service oscillator recently developed for the low-priced trade is accurately calibrated for two ranges; one covers fundamental frequencies from 132 to 380 kc., and the other, the fourth-harmonic range (broadcast band) of 540 to 1,500 kc. On A.C., A.F. modulation is obtained from the line ripple; on D.C., at 1,000 cycles from a neon tube. The oscillator is a type 37 tube.

WALL-TYPE "ORDER" MICROPHONE (615)

SERVICE Men who have been making "side" money selling and installing P.A. systems in restaurants, lunch counters, etc., will be glad to know of a new "wall"-type microphone. A pilot lamp lights directly over the press-to-talk button, when the button is operated; the lamp also may be wired to a button at the opposite end, for "O.K." signals.

TUBE-TYPE CODE PRACTICE SET (616)

IT IS an amazing fact that a large number of people of prominence (in radio) point with pride to an apprenticeship served in "pounding brass." For those who aspire to learn the radio code there is no better practice transmitter than the unit just put on the market which utilizes a type 30, 2 V. vacuum tube (in an oscillatory circuit comprising an A.F. transformer) to produce a whistling note exactly like the C.W. (continuous wave) signal of a regular transmitting station. (The "A" and "B" supply fit into the case of the instrument.)

OIL-FILLED HIGH-VOLTAGE CONDENSERS (617)

(Aerovox Corp.)

BUILDING a high-power amplifier or transmitter? Well, we can tell you where you can get fixed condensers that can "stand the cat" without the need for a half-

Oil-filled S.-W. condensers. (617)

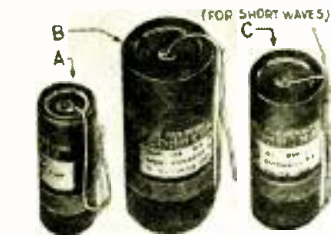
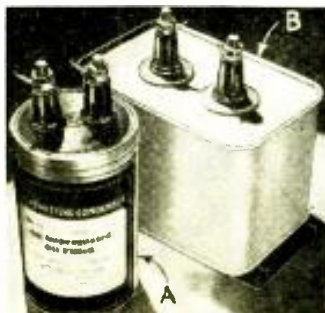

Oil-impregnated 5.-W. condensers. (611)

acre of parking space, in capacities from 1 to 4 mf. at 1,000 V., and 1 or 2 mf. at 2,000 V., in round cans (A, in the figure); and 1 to 4 mf. in 1,000, 1,500, 2,000, 2,500 and 3,000 V. rating, and 0.5 to 2 mf. at 4,000 V., and 0.5 or 1. mf. at 5,000 V. rating, in rectangular cans (B, in the illustration). Pure linen insulating paper, impregnated with oil, is used; the assembly is immersed in an oil bath. As the section becomes heated in operation it expands and the oil flows into the section, thereby maintaining a perfect oil film throughout the condenser section. As the section cools and contracts the oil is forced out of the section back into the can.

MULTI-POLE WAVE-BAND SWITCH (618)

ARTICLE after article has appeared in the technical "mags.," pointing out the need for good contact in wave-band switches. A switch designed to meet this major demand uses silver-plated contacts, and self-cleaning rotors. The stator contacts are laced, and then staked in place. Available in 6 pole, 18 point, (95 wiring combinations) and 8 pole, 24 point (500 wiring combinations) models, in double-throw types, diameters, 2, and 2½ ins., respectively.

A "SHORT-WAVE" LOUD-SPEAKER (619)

(Wright-DeCoster, Inc.)

WHAT is the difference between a 'short-wave' speaker, and any other kind? is the first question the radio man will ask. The major portion of the answer is as follows: In the new "short-wave" reproducer particular emphasis is placed on reproduction of the voice frequencies from 200 to 3,000 cycles. Frequencies above 3,000 cycles are attenuated so that noises generated either by the radio set itself, or picked up from the air are reduced. Care has been taken to prevent resonance effects at frequencies below 500 cycles, in order to retain the intelligibility of low-pitched voices. Field excitation is obtained from 110 V. A.C. by means of a 25Z5 rectifier tube; voice coil impedance is 10 ohms at 400 cycles; the standard output transformer primary impedance

Improved wave-changing switch. (618)

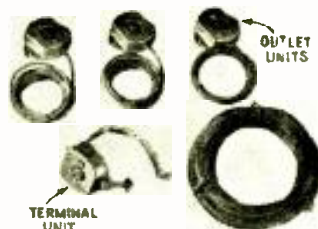
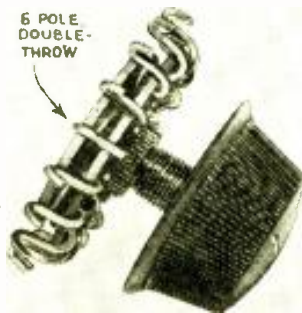

All-wave type multiple outlets. (612)

value is 4,000 ohms, but "specials" are available. Cone diameter is 10 ins.; the over-all width, across the baffle, is 14 ins.; a solid spider acts as a dust cap.

DUAL-WAVE MIRROR SET (620)

JUST when it appeared that radio set makers had about "reached the end of their ropes in designing new cabinets, out comes an instrument that takes first prize for originality in a regular commercial production job. The set in question utilizes a simple and effective 4-tube R.F. chassis, with a wave-length range of 75 to 550 meters, encased in a cabinet composed entirely of mirrors! A modernistic design is sand-blasted on the portion of the glass that comprises the speaker grille; the colored grille cloth is interchangeable with cloth of other colors.

A 3-TUBE SHORT-WAVE KIT SET (621)

(Harrison Radio Co.)

SHORT-WAVE reception over the range of 15 to 200 meters may be obtained, by means of plug-in coils, in a new short-wave set that embodies 5-tube performance with only 3 tubes; an additional set of coils is available which increases the tuning range to 625 meters (Reception of regular broadcast stations and long-wave ship and press transmissions is possible.). Operates on 110 V., A.C., a 220 V. adapter is available. This receiver has the volume, selectivity and sensitivity of a 5-tube set, although only 3, "multi-purpose" tubes are used. These tubes are: (a) the new 6F7, used as a combined variable-mu R.F. pentode, and regenerative detector; (b) a 76 high-gain triode first-stage A.F. amplifier, and (c) a 12A7 combined pentode second-stage A.F. (power) amplifier, and half-wave rectifier.

Provision has been made for optional operation with the built-in speaker, an external reproducer, or headphones. Hum level is very low, even when sensitive headphones are used. Available complete or in kit form. Cabinet is 7x5½x9 ins. long.

(Continued on page 421)

A "short-wave" loudspeaker. (619)



Dealing cards, music and a sip! (613)



A dual-range service oscillator. (614)



Wall-type "order" microphone. (615)



Above, tube code-practice set. (616)

Below, a fine set for the boudoir. (620)



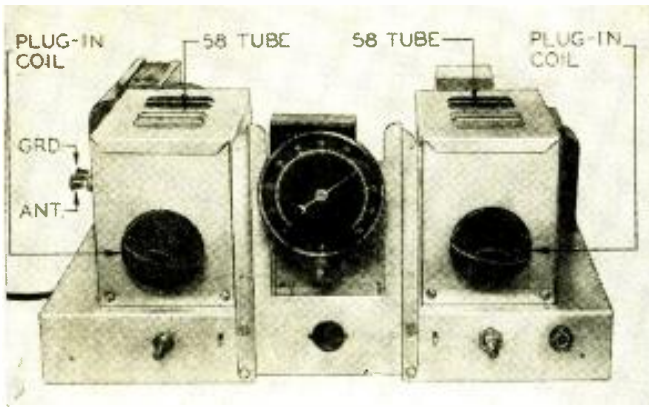

Fig. A
Airplane dial and special shielding gives commercial appearance.

M. K. BAKER*

AN IMPROVED 6-TUBE ALL-WAVE SET

This receiver will come as a welcome surprise to constructors who thought that a "super" was necessary to get good results. It employs a T.R.F. circuit with plug-in coils to cover the complete short-wave and broadcast ranges. It is designed for 110 volt A.C. operation, and includes many design innovations.

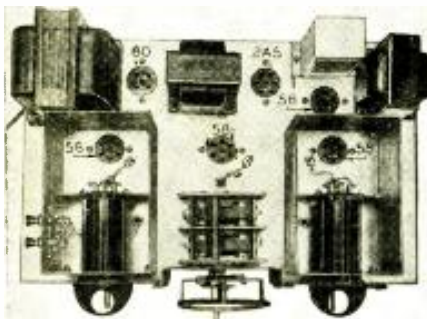

Fig. B
Top view illustrating coil compartments.

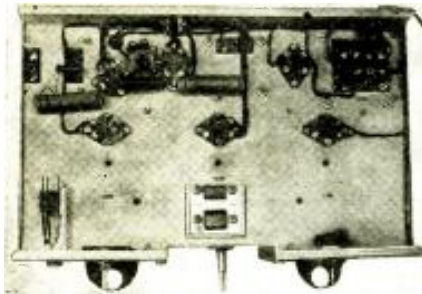

Fig. C
Sub-base view showing layout of parts.

THE construction of an all-wave receiver, when it involves more than 5 tubes, should (the writer feels) be made as simple as possible for other constructors. The use of a superheterodyne circuit with its consequent elaborate padding and trimming condensers, and elaborate aligning procedure (which, it should be mentioned, if not performed carefully and precisely will impair the efficiency of the set) frightens most set constructors. Not only that, but it is an established fact that few of the average constructors are even partially equipped with the necessary all-wave oscillator and output meter to correctly align such a set.

For these reasons a tuned R.F. circuit was selected as the basis for this receiver. However, the usual shortcomings of such design were given more than careful attention, with the net result that this set, if built carefully and as per instructions, will be found equivalent in efficiency and selectivity to most "supers" of complicated design. All of the usual ills associated with T.R.F. receivers have been completely removed, and what is more, instead of sacrificing any of the desirable qualities in such a receiver an actual and appreciable improvement was effected.

Good Distance Getter!

When discussing the relative merits of a receiver, theoretical design and potential possibilities are never as convincing as actual practical results that are obtained when a receiver is put on an "air-test." Nor is it possible to make any comparison with receivers of other design, unless the conditions (which affect reception) are exactly similar for each. Consequently, when this set was ultimately completed, it was placed on test alongside of a prominent 6-tube "super" which also employs plug-in coils for band changing. The same special antenna (all-wave type, with transposed lead-in) was used for both, a single-pole, double-throw switch serving to connect the antenna to the set which was to be tested. Antenna, weather conditions, location, and even the operator were therefore the same for each receiver.

On practically every wave-band this receiver out-performed the "super." On foreign broadcasts the actual volume of reception was greater on this set, and numerous stations were received which were impossible to get on the "super." The selectivity on the ham 'phone band (80 meters) was as good in each case. Amateur code on this set was so far

(Continued on page 427)

*Chief Eng. Alan Radio Corp.

Fig. 1. Wiring diagram. Regeneration is employed in first R.F. and detector stages. Second R.F. stage is untuned.

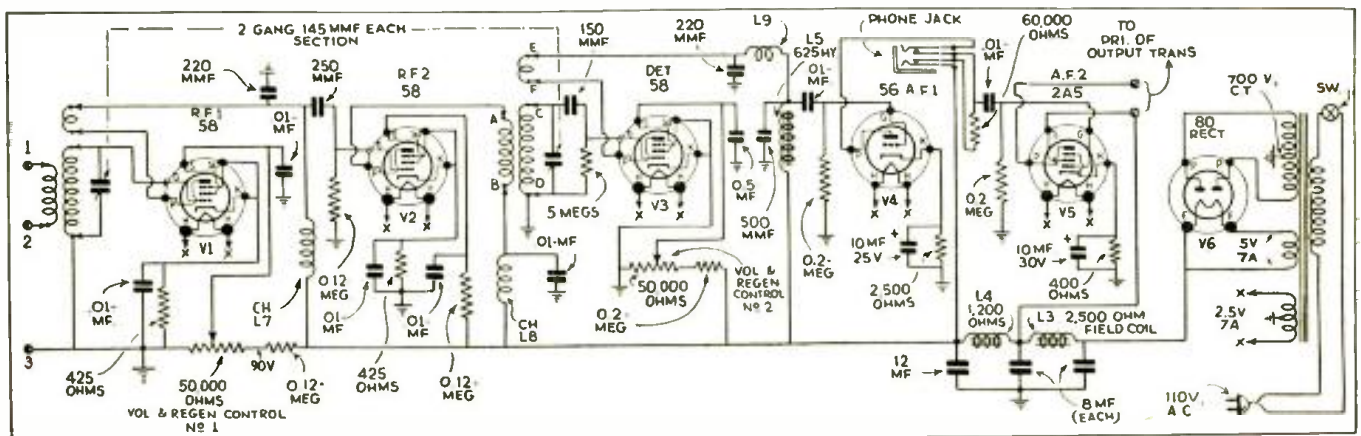

BUILD THIS NOVEL 1-TUBE ALL-ELECTRIC ALL-WAVE SET

The receiver, using only a 12A7, is built within a "cash box." This automatically serves to completely shield the set. The circuit is a standard regenerative detector, using the pentode portion of the tube. It will operate from 110 V., A.C. or D.C.

H. G. CISIN

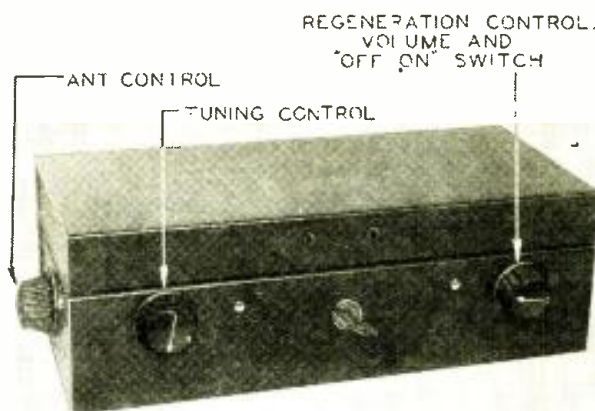

THIS receiver is so small and light that it can be carried around like a camera. Nevertheless, it will work from any 110 V. house lighting circuit, either A.C. or D.C., and will bring in short-wave stations from 10 to 200 meters and also the regular broadcast station from 200 to 550 meters.

The circuit is built into a compact metal carrying case ("cash box") and the entire outfit including the five plug-in coils and the earphone, weighs less than three pounds. Only one tube is used, this being the remarkable dual purpose 12A7 tube. The wide tuning range from 10 to 550 meters is attained through the use of five special plug-in coils, wound on compact composition forms. A single variable tuning condenser (3), shunted across the longer winding of the plug-in coil, takes care of the broadcast as well as the short-wave tuning. As a matter of fact, it is possible to cover a much higher range with this same tuning condenser, through the use of specially wound long-wave coils.

Circuit Operation and Adjustments

Regeneration is controlled by means of the potentiometer (6), shunted across the ticker winding C, D, of coil (2). For broadcast reception, a short indoor aerial or a wire thrown on the floor will suffice. Naturally, a well-constructed outdoor antenna will produce best results in bringing in the distant short-wave stations. The antenna trimmer (1), provides a convenient means of adjusting the set for varying lengths of aerials and this component also furnishes an additional tuning control for short-wave reception.

The second radio circuit utilized in this set, is a unique A.C.-D.C. circuit, whereby chokes are eliminated and resistors substituted. The receiver can then be operated equally well from alternating or direct current sources. No power-supply transformer is necessary in this circuit, which results in a cheaper, lighter, and simpler receiver. Since the 12A7 is a cathode heater tube, it is possible to heat the filament with raw A.C., without introducing noticeable hum. The filament voltage is reduced to the correct value by means of a 350 ohm resistor, contained within the line

cord (15). This resistor is connected in series with the filament terminals A and B of the tube. Adequate filtering is accomplished by means of a dual electrolytic condenser having 8 mf. sections, one being connected at each end of the 10,000 ohm filter resistor (11) in the plate supply circuit. To save space, the "on-off" switch (16) is combined with the potentiometer (6).

cord (15). This resistor is connected in series with the filament terminals A and B of the tube.

Adequate filtering is accomplished by means of a dual electrolytic condenser having 8 mf. sections, one being connected at each end of the 10,000 ohm filter resistor (11) in the plate supply circuit. To save space, the "on-off" switch (16) is combined with the potentiometer (6).

Construction

The construction is very simple due to the fact that the parts are few in number. The antenna trimmer is mounted on the left side wall of the carrying case (see Fig. B). It has a short shaft soldered to the adjusting screw and a knob fastened to the shaft. The tuning condenser and the potentiometer switch are mounted on the front wall. The twin phone jack is mounted on the rear wall. The tube socket is mounted in a horizontal position on the inside wall, by means of two 5/8-in brass bushings. The other parts are mounted on the bottom of the case. The antenna trimmer and the jacks must be well insulated from the metal case. The potentiometer must be of the type which will not short circuit against the case. The coil socket may also be mounted on short brass bushings.

The wiring can be completed in a very short time. The socket connections are shown in the schematic diagram (Fig. 1). In socket (8), A and B (Continued on page 433)

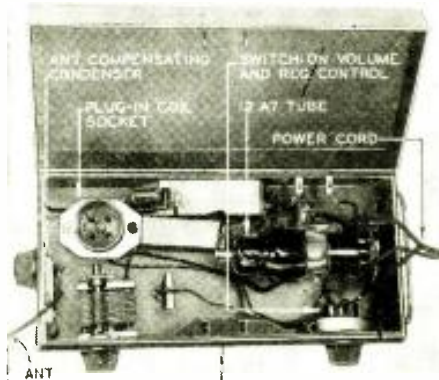

Fig. B. How the set looks when opened.

Fig. 1. The diagram. Resistor filter employed instead of chokes.

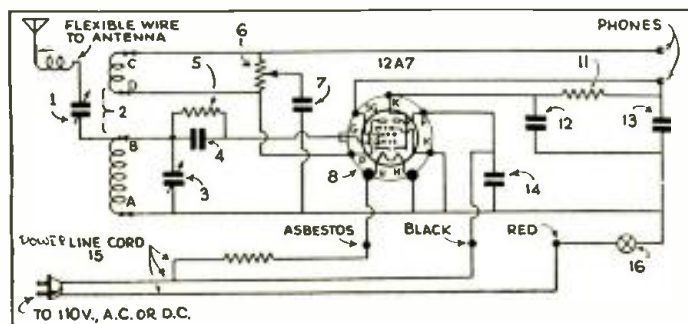
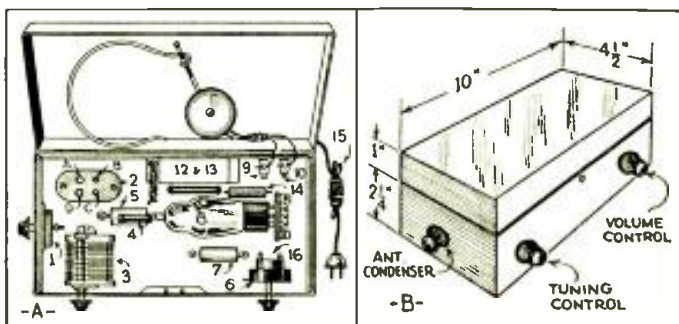
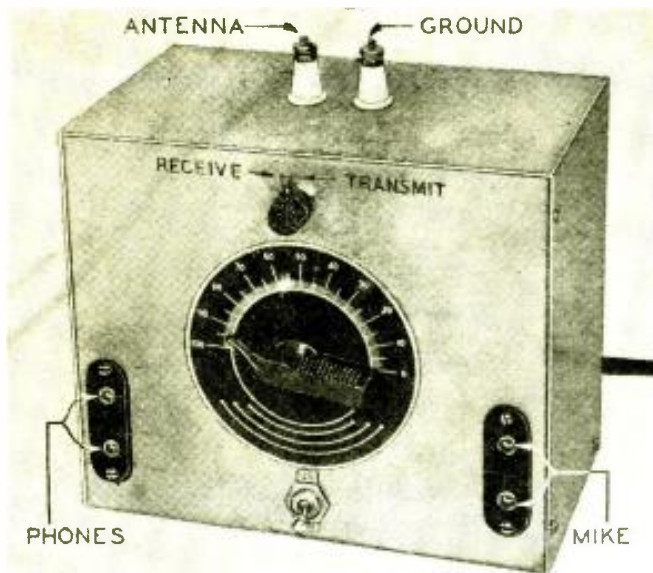

Fig. 2. A—layout; parts list identifies numbers. B—dimensions.





HOW TO BUILD A NEW 5-METER TRANSCEIVER

Complete construction details are given here for an improved and highly efficient transmitting and receiving unit. Its features are: 6 volt battery operation, radiophone transmission, small dimensions, ultra-portability, and employs only 2 tubes.

A. G. HELLER*

THE popularity of transceivers is increasing steadily with short-wave "hams." The reason for this becomes obvious when one considers the numerous features of a unit that can be readily used for transmission as well as for reception purposes. Ignoring the novelty of such a device, we find that a transceiver has individual features and characteris-

*Chief Engineer, Insuline Corp. of America

tics which make it admirably suited for specialized work. The tremendous saving in parts and auxiliary equipment that an instrument of this type requires, as compared to that needed by two separate instruments for transmitting and receiving, is in itself a paramount feature. By the elimination of this added equipment the saving in weight is, of course, a consequence which follows and which adds to the unit's virtues. In addition, the construction of the entire unit is possible in a casing of comparatively small dimensions, thus enhancing its value for portable operation. The 5 meter transceiver pictured at the top was carefully designed after considerable experience in constructing numerous similar units. Needless to say that all of its predecessors have been finally overcome in the construction of this, the final transceiver.

The Circuit

Analysis of the circuit shown in Fig. 1 will indicate that only 2 tubes are employed; namely a 37 and a 41. With the switch in the "Receive" position, the 37 functions as a super-regenerative detector and the 41 becomes an A.F. amplifier stage. With the switch in the "Transmit" position, the 37

functions as an oscillator and the 41 as a modulator tube coupling back to the plate of the oscillator tube (plate modulation).

The microphone transformer has, in addition to the single-button microphone winding, another primary for audio coupling to the 41 which is introduced into the circuit when the switch is in "Receive" position.

The selection of a super-regenerative detector circuit is practically a necessity on 5 meters. The tuning characteristics of such a circuit are essentially "broad," and since the frequency "drift" or "shifting" of an oscillator on 5 meters is considerable, it becomes readily apparent that such a broad tuning circuit will aid materially in keeping the signal "tuned-in."

Assembly

The chassis and cover may be obtained drilled. Assembly will then consist of merely attaching the component parts, and fastening them to the chassis with nuts and bolts. The picture diagram (Fig. 2) is a rear view of the transceiver chassis. It clearly illustrates the positions of the various parts and the manner of mounting them. A close study of the picture diagram should be more than sufficient

(Continued on page 435)



Fig. A, above. Interior view illustrating compactness.

Fig. 1. Schematic wiring diagram of 5 meter transceiver.

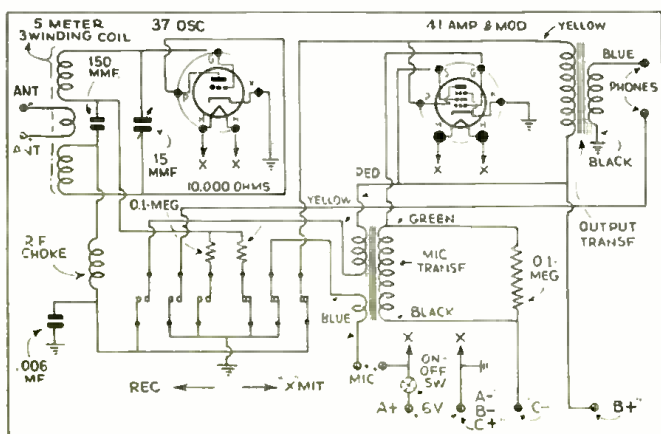
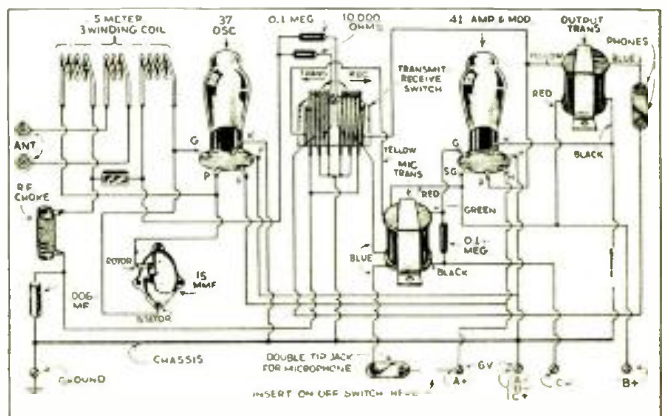

Fig. 2. Pictorial diagram. The layout of parts is not critical.



ELEMENTS OF 4TH DIMENSION P.A. OR SOUND SYSTEMS

This is the first of two articles which discloses, in a non-technical manner, all of the principles involved for attaining absolute realism in sound reproduction. Part 2 will cover practical construction and installation.

H. S. MANNEY* AND C. R. SHAW†

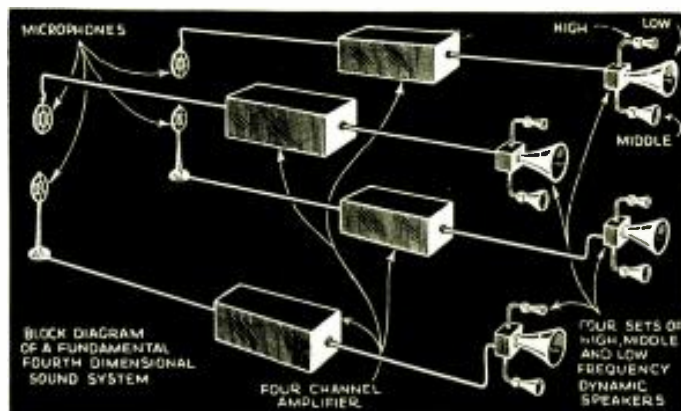

Fig. A
Block diagram of a fundamental 4th dimensional sound system.

PART I

IF ARTIFICIALLY recreated sound is not "perfect" in all respects to natural creation, it cannot produce an illusion of true reality.

Inasmuch as the purpose of all entertainment is to help the auditor to forget himself, the more perfectly we create the feeling that he is listening to real people, the more will he "lose" himself and the greater will be his feeling of real enjoyment.

Very many people regard mechanical sound reproducing equipment frankly as a mechanical device and therefore do not expect it to simulate reality. The consequence of such a point of view is that they accept this unnatural sound on the basis that it represents perfection for modern artificial creative means and methods.

Musically trained and artistically tempered people, on the other hand, have oftentimes complained that reproduced sounds (as furnished by "talkies", radio broadcasts, P.A. Systems, electric recordings, etc.) are too flat

and centralized. In fact, a critic is quoted as saying, "To listen to a symphonic orchestra reproduced by electro-mechanical systems, is like listening to the performance through a knothole in a fence."

Although innumerable attempts have previously been made to attain a true and natural state of sound recreation, few have approached the goal as closely as did the Bell Telephone Laboratories during the early part of last year. This organization demonstrated to the Institute of Radio Engineers a three dimensional sound system, which was subsequently described by R. D. Washburne in RADIO CRAFT for May 1934 (Page 654).

To understand why this apparently "perfect" system does not attain a full 100% naturalness, we must first define "perfect artificially recreated sound". For our purposes of discussion we will simply consider it as a *true reproduction of the original sources of sound in a spatial relationship corresponding exactly to the placement of the original sound sources*. If upon closing your

eyes you cannot tell whether you are listening to an electro-mechanical device or to the original rendition—if you can mentally locate the true position of each sound source, then, and only then, are you hearing perfect artificially recreated sound!

Why then, has this perfect illusion not been achieved before, and what elementary principles are involved in presenting such an ultimate in electro-mechanical sound recreation?

Before we answer these questions, let us consider two points of the definition for "perfect artificially recreated sound" as given above.

First, we have "true reproduction" which involves the use of a sound collective, amplifying, and distributive system which will not modify or alter in any manner whatsoever the frequency, phase relationships, or proportional intensity of the sound or sounds undergoing recreation. Such a system will of necessity employ microphones with a series of performance characteristics equivalent to the human

(Continued on page 430)

Fig. 1. When we hear a natural sound, we subconsciously make three measurements.

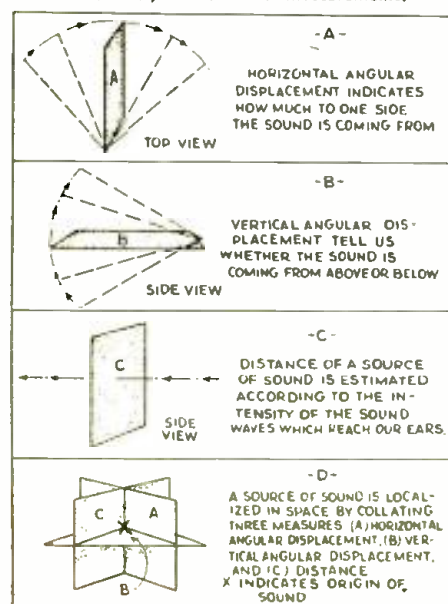

Fig. 2. Block diagram of sound localizing mechanism. X indicates source of sound.

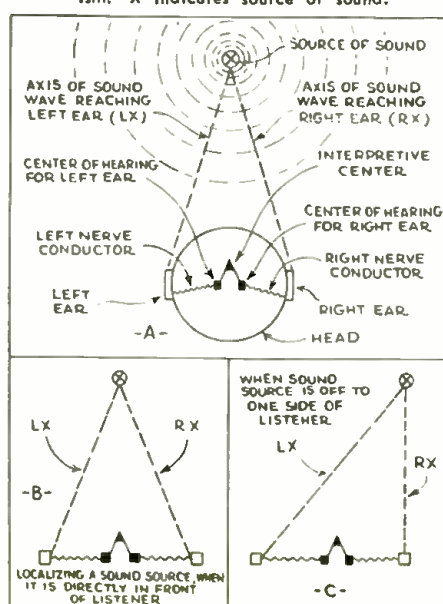
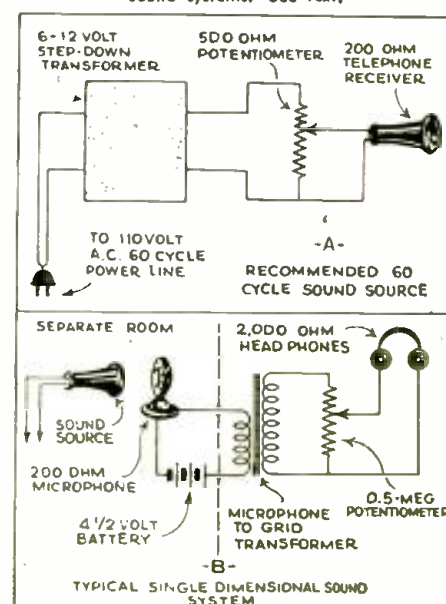

Fig. 3. Practical experiments in single dimensional sound systems. See text.



INTERNATIONAL RADIO REVIEW

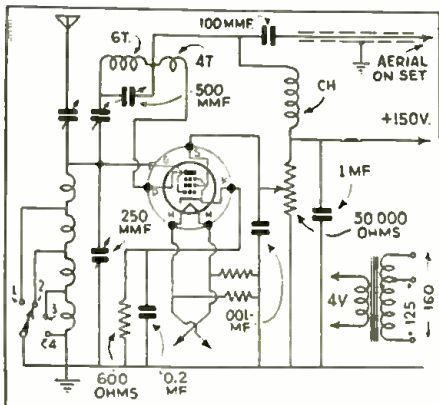

Fig. 1

A short-wave converter covering the wavelengths from 12 to 70 meters.



Fig. A

The appearance of the new television set which supplies black and white pictures.

Fig. B

The triode-hexode frequency converter. Triode-hexode coupling at short wavelengths is nil.



HERE is what the radio experimenter has been wanting for a long time—a semi-technical review of the thousands of new ideas which are continually appearing in overseas publications. Each month there are received at the offices of RADIO-CRAFT hundreds of daily, weekly and monthly magazines originating from all over the world.

SINCE the cost of subscribing to each of these would be prohibitive for most radio men, we have arranged with technical translators to prepare for our readers reviews of all the really important, new developments illustrated and described each month in these publications.

NOTE that the only available information is that which is published; the experimenter must adapt the ideas to whatever equipment he has on hand.

AN ITALIAN SHORT-WAVE CONVERTER

IN reviewing the foreign magazines received this month, an endeavor has been made to cover some of the outstanding items on short-wave subjects—inasmuch as we are featuring short-waves in this number.

The Italian magazine, Radio Lux, contains a description of an interesting short-wave converter to be attached to the broadcast set. It comprises a pentode of the R.F. variety. The particular tube advocated is one of European manufacture, though American tubes are extensively used in Italy, as we have mentioned before.

A grid coil, tapped in three places (see Fig. 1) tunes the grid circuit, while two coils wound on the same tube act as the oscillator grid and plate coils. The wavelengths between 12 and 70 meters are covered by the coil combination, and with this coverage, no taps are required on the oscillator coils. The coils are wound on tubes, 1½ ins. in diameter, with No. 24 enameled wire. The grid coil contains 4 turns on the first section, 4 on the second, 5 on the third, and 6 on the fourth. The oscillator contains 6 turns on the tuned section and 4 on the plate side. The grid coil sections are separated by about ¼-in. while the two coils of the oscillator are wound as one continuous coil, with a tap at the sixth turn.

The remaining values for this converter are indicated on the diagram.

TELEVISION IN EUROPE

WHILE television is gradually nearing the point of commercial production in the U.S.A., depending on public interest to awaken suddenly; the condition in Europe is somewhat more advanced.

Experimental transmitters are in constant use in England, Germany, and several other countries, with varying degrees of success. Commercial receivers are available for picking up these transmissions and there is considerable interest shown in the radio magazines of these countries on the subject.

The photo at Fig. A, shows a commercial instrument being sold in England. It contains a four tube receiver having an audio frequency characteristic of 20 to 9,000 cycles according to claims of the manufacturer. A glow discharge lamp of special design permits black and white images.

It is reported that the B.B.C. is contemplating a change to 30 lines which will increase the picture definition, though it will necessitate changes in existing receivers.

A NEW FREQUENCY-CHANGER

PENTAGRID converter tubes have made a very definite step forward in the design of superheterodyne receivers, since the electron-coupling overcomes certain defects which were present in all other types of frequency changers. However, it appears that the pentagrid converter is also imperfect in certain other respects, especially on short waves. An interaction between the oscillator plate and the control-grid causes degenerative effects which become particularly noticeable when high frequency signals are being received. The effect is so marked in some cases, that the oscillator section of the tube refuses to operate above a certain critical frequency.

To overcome this disadvantage, a new tube has been introduced on the European market, according to a recent issue of WIRELESS WORLD. (Fig. B). It consists of two separate tubes, a triode and a hexode, built in a single envelope. The hexode has six electrodes, a cathode, control-grid, two screen-grids, a coupling-grid, and a plate. The control-grid immediately surrounds the cathode and is surrounded by the screen-grid. The coupling-grid comes next and is separated from the plate by the second screen-grid. The coupling-grid is connected internally to the triode (oscillator) grid which supplies the desired electron coupling.

Variations in the oscillator plate potential have no effect upon the screen and plate currents of the hexode, and changes in the hexode screen, plate or

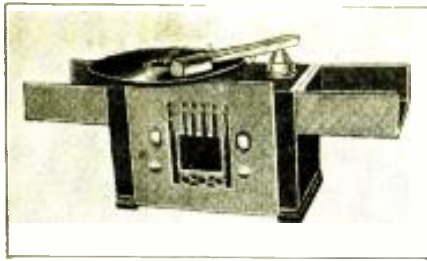

Fig. C

A novel combination radio-phonograph.

control-grid voltages do not alter the oscillator plate current. Thus the two tubes are independent, except for the electron coupling which takes place. This tube shows markedly improved characteristics for high frequency work.

AN INTERESTING DESIGN

IN the Italian radio magazine, LA RADIO PER TUTTI, was included an interesting design for a combined radio and phonograph, in one of its recent issues. The cabinet, when closed, appeared as an ordinary radio of the table type, having two wave ranges, with separate dials for each band. The cabinet, however, was split across the top in such a way that the two halves opened out, as shown in Fig. C. When opened, a complete phonograph of the electric type was revealed. The amplifier of the radio receiver provided the necessary increase in volume for ordinary room enjoyment.

SOME WORTH-WHILE EXPERIMENTS

WHILE ultra-short-wave experiments are exceedingly interesting to the lively radio experimenter, even this field becomes prosaic if definite direction is not given to the experimenter which will make his work of value to others.

The latest issue of WIRELESS WORLD takes this point in hand and points out some very interesting ways in which experiments in the ultra-short-wave field can be made useful. One of these is in the field of aerials for ultra-short-wave transmission and reception. It is known that the sky waves from such transmitters are not reflected back to

the earth and this definitely limits the distance which can be covered by such units. But on the other hand, the aerials used for these transmitters and receivers determine to a large extent their effectiveness. Aerials, on these very high frequencies, do not exhibit the same characteristics as similar designs do on longer waves. Marked directional effects are encountered with horizontal and vertical dipoles, half-wave and other types which should not show these effects. Loops on the other hand, are found to be markedly effective for reception purposes—and the directional “selectivity” depends to a great extent on the dimensions of the loop, its shape and height above ground.

Thus, the ambitious ultra-short-wave fan has a fine chance to experiment with different types of aerials, and thus achieve real results which can be of use to the entire “ultra-short-wave world.”

In giving some facts regarding the above subject, a circuit for a 5 meter super-regenerative receiver was given. (See Fig. 2.) The values of parts used in this set were not given, but the interested fan will find the method of connecting the loop to the set advantageous. Suitable sizes for the various condensers and resistors can be found by a little experimental work.

A REAL PORTABLE

TO digress for a time from short-waves; the tiny portable receiver shown at Fig. D, using the newly developed small tubes which we mentioned several months ago, has just appeared on the English market. The entire receiver box measures $4\frac{3}{8} \times 6\frac{1}{4} \times 4\frac{1}{2}$ ins. high and it weighs only 3 lbs., complete with batteries. The set tunes over the broadcast band, and with only a temporary aerial will pick up broadcasts over a distance of 75 to 100 miles. This “really” portable set was announced in WIRELESS WORLD magazine.

PERMEABILITY TUNER

IN A number of past issues, we have mentioned the popularity of metal core coils for R.F. tuning.

The idea has been developed a step
(Continued on page 426)

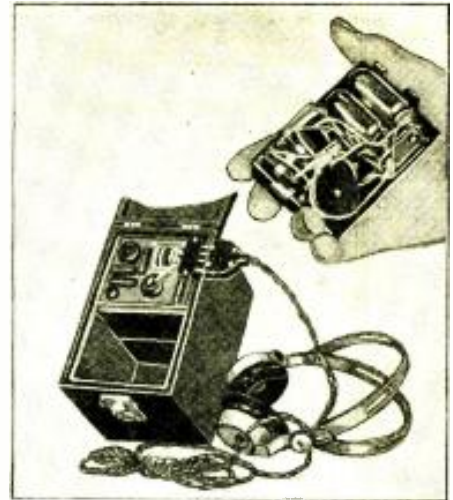

Fig. D. A really portable receiver.

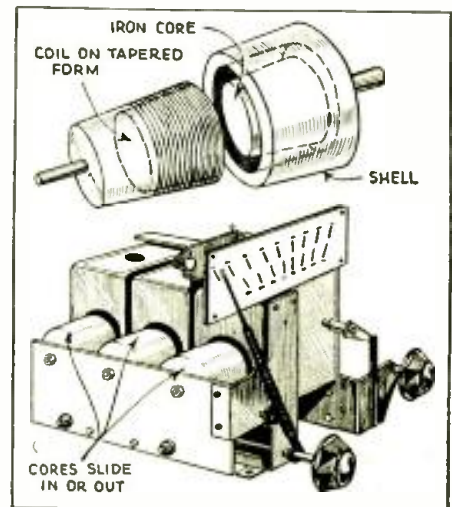

Fig. E. A complete permeability tuner.

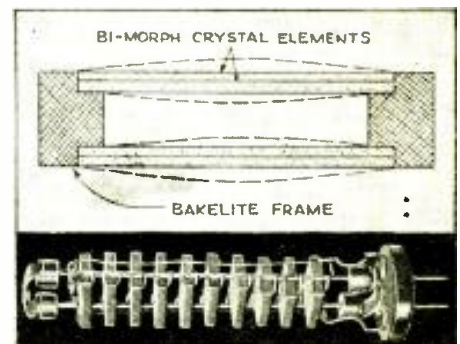

Fig. F
A high-quality piezo-electric mike.

Fig. G
This rectifier covers the broadcast band.

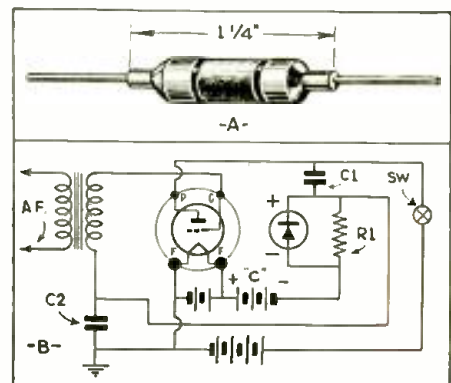
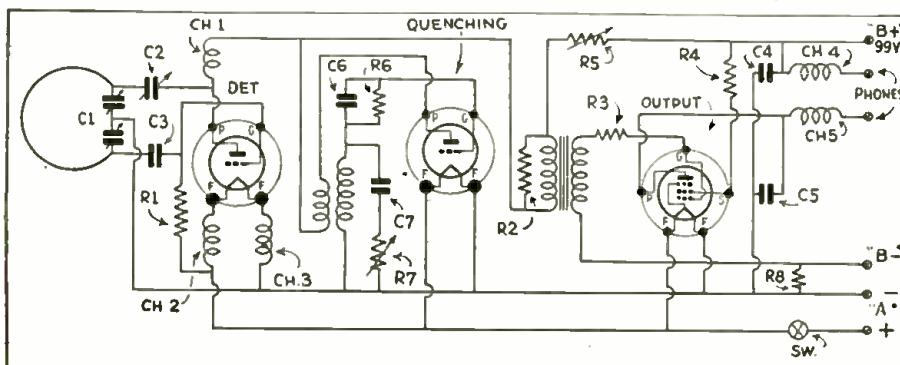

Fig. 2
A loop-operated 5 meter super-regenerative receiver for direction finding.



THE LISTENING POST FOR ALL-WAVE DX-ERS

The author imparts some very valuable information on how to best obtain proof, or verification, of foreign station reception. Also, schedules and hints on DX on all waves.

C. A. MORRISON



Zeesen's (Germany) directional antennas.

WITH that feeling of pride that comes to every Dx'er upon hearing his first foreign station, whether it be on the broadcast band, or short waves, there arises a natural desire to have some way of proving to other people that he actually received this station. It is through this desire to show proof of foreign reception that the hobby of acquiring verifications or confirmations has arisen. A verification of reception is nothing more than a written statement by letter or postal card from a station that, upon a certain day and at a certain hour, you actually received their station. It stands to reason that for a station to issue such a positive statement they must be reasonably sure that you actually heard them. The more accurate and concise information you can furnish to the station the better are your chances for securing a verification. A report of value to the station is never turned down. The approved method for the securing of verifications is as follows:

When listening to a foreign station, and if you wish to verify, have a reliable clock and your log book handy. Carefully note down *what* is heard and the *time* in your log book. When noting musical selections, *titles* should be given if possible, *type of musical instruments*, *type of music* (whether march, jazz, classic, etc.) When noting songs include *titles* if possible and always specify whether male or female voices, *number of voices*, *type of music* (jazz, blues, operatic, etc.), *type of voice* (bass, tenor, soprano, etc.). When noting a speaking voice include actual words spoken when possible and type of voice (high pitched, or low pitched, etc.). If in a foreign tongue state kind of language if possible. *Call letters* should be noted, along with location, and musical signal if any. If station is signing off be sure and note the exact time.

In writing to the station be sure you have the correct address by referring to some good station log. The letter should consist of a resumé of what you heard as given above, and the time each item was recorded. *Return postage* should always be enclosed. When writing to a

foreign country return postage should be enclosed in the form of an *International Reply Coupon* which you can purchase at your local post office for a few cents.

For your report to be of value to the station these general items should be included in your letters; (1) State weather conditions, (2) temperature, (3) direction of wind, (4) volume of station's signal, (5) whether fading—and how bad, (6) whether natural static was present, (7) was station interference experienced, (8) type of receiver in use—and number of tubes. These facts, in addition to your report, will certainly insure you an interesting and attractive confirmation of reception. In the case of foreign stations it should be kept in mind that several weeks, or even months, may be necessary before you receive your reply. Many DX'ers have accumulated, over a period of years, collections of hundreds of verifications which are greatly prized by them.

Next month we shall delve deeper into this fascinating subject of securing foreign verifications, describing how you may obtain a verification of a program, even though both music and voice are of a foreign nature, and describing for you some of the logs of the greatest DX'ers of all times, and to what they attribute their success.

What to Listen For During December-January

—Broadcast Band—

With the exception of Australian-New Zealand stations, December and January are usually the peak months for foreign reception in North America

on the broadcast band. At this time signals from Japan, China, Hawaii, Alaska, Central America, South America, Europe, Australia, and New Zealand are heard under good weather conditions.

Foreign countries which will be received best during this period on the eastern coast of the United States will be about as follows in order of consistency: (1) Europe and South America. (2) Australia, New Zealand, and Hawaii. (3) Japan and Central America. (4) Alaska and China—very rarely.

Foreign countries which will be received best in the central area (From the Appalachian to the Rocky Mountains) will be about as follows in consistency: (1) Australia, New Zealand, and Hawaii. (2) South and Central America. (3) Japan and Europe. (4) China and Alaska rare.

Foreign countries in order of best reception for the Pacific coast area will generally be (1) Japan, China, and Hawaii. (2) Australia, New Zealand, and Alaska. (3) South America rare. (4) Europe very rare.

Foreign stations from the east are best received for a period of one or two hours after the U.S. stations have signed off for the night. Foreign stations from the west are best received one or two hours before dawn. Stations to the south are received good to fair almost daily with average weather conditions. Their reception being limited principally by their power, or to the times when they are on the air unusually late on a clear channel. Once in a while, they will break through the U.S. stations in the early evening.

DX'ing reports for the early part of the season indicate foreign stations being received with unusual excellence. Europeans coming in very good on the eastern coast. Japanese and Chinese stations good on the Pacific coast, and Australia and New Zealand stations fair to good over the whole area. South Americans are breaking through in the early evenings.

Short-Wave Band

As fall changes slowly into winter the seasonal high-
(Continued on page 428)

A view of the transmitting equipment at Reykjavik, Iceland.

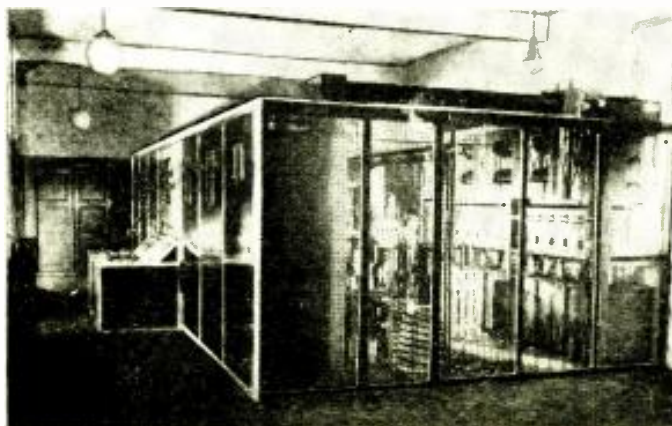

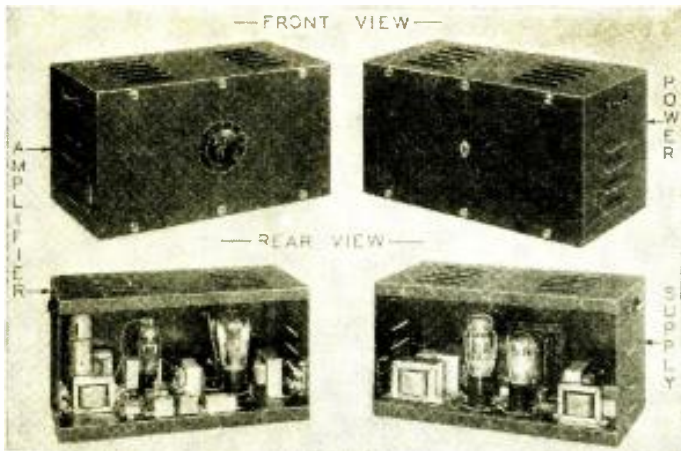

AN ECONOMICAL P.A. AMPLIFIER

This amplifier is suitable for the majority of P.A. installations. It has a power output of 18 watts, total distortion less than 5 per cent, and uses type 45 tubes in the power stage. Power supply is built separately, facilitating rack and panel installations.

A. J. KOENIG*

SERVICE Men and other technicians who are bemoaning the shrinkage of their income on radio receivers, would do well to devote some serious thought to the lucrative opportunities offered in public address applications. Many have been quick to realize the wisdom of an investment in a sound system but have been deterred largely because of limited funds. It is the purpose of this paper to describe an amplifier which shall meet all the necessary requirements and at the same time be well within the price range of those who have procrastinated on account of financial considerations.

*Engineer, Kenyon Transformer Co., Inc.

Many amplifiers on the market at present are tainted with the stigma of fallacious power output ratings. It is significant that no mention is made of the total per cent distortion at full power output. The amplifier described herein possesses a gain of 75 db. and is capable of delivering 18 watts with a total distortion of only 5%, which is almost negligible.

Power Output: While several factors are taken into consideration in the choice of an amplifier, power output is perhaps first in importance. The coverage value of a sys-
(Continued on page 440)

Fig. 1. Wiring diagram of amplifier; employs only 4 tubes.

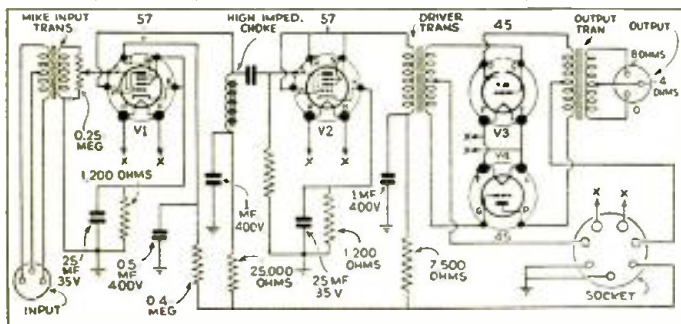
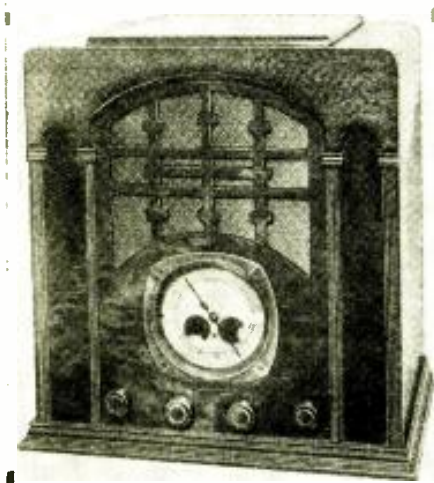
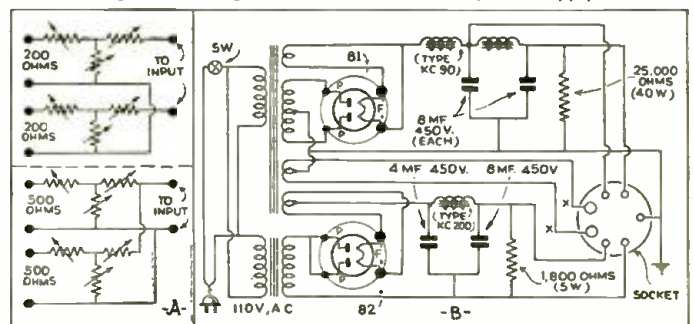

Fig. 2. A—diagram of mixer circuit; B—power supply.



AN IMPRESSIVE 7-TUBE DUAL-RANGE SUPERHET

This receiver has distinctive design features which make it an outstanding performer on broadcast and short-waves.

THE RECEIVER illustrated in the adjacent photograph is of unusual design, both in regard to appearance and engineering. One is im-

mediately impressed by these facts, which are later proved when a closer scrutiny is made of the set's construction. The 5-inch tuning dial is of such intriguing design that it lends distinction to the physical appearance! It incorporates, in addition to the dual-wave range scale, two novel indicators which are directly and respectively controlled by the volume and tone controls.

Diagram. Receiver employs 6 volt tubes.

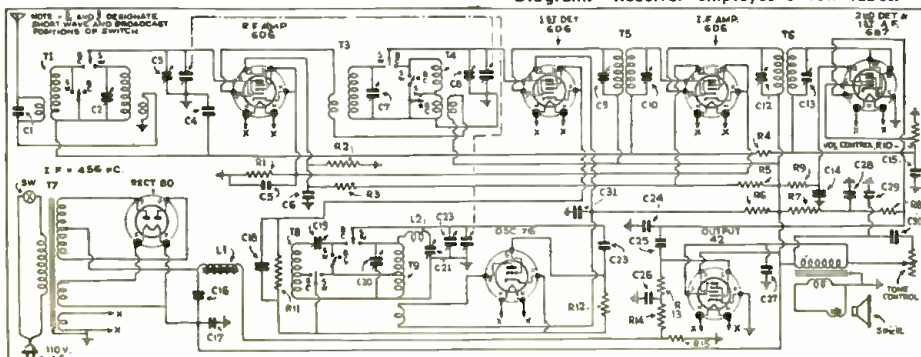

mediately impressed by these facts, which are later proved when a closer scrutiny is made of the set's construction. The 5-inch tuning dial is of such intriguing design that it lends distinction to the physical appearance! It incorporates, in addition to the dual-wave range scale, two novel indicators which are directly and respectively controlled by the volume and tone controls.

Circuit

This receiver is a broadcast and short-wave set with a frequency coverage of 530 to 1,740 kc. on the broadcast band, and 5.8 to 18.3 mc. on the short-wave band. Dual-band coverage is accomplished by means of dual sets of

(Continued on page 439)

NEW DESIGN IN ALL-WAVE ANTENNAS

The improvements described result in greater volume on the broadcast as well as short-wave bands. Also, they assure reduction of local interference, which permits full efficiency from high-fidelity receivers. Since most listeners make use of the tone control to minimize the strength of noise, the advantage of an efficient noise-reducing antenna, as an aid to fidelity, becomes obvious.

A. H. LYNCH*

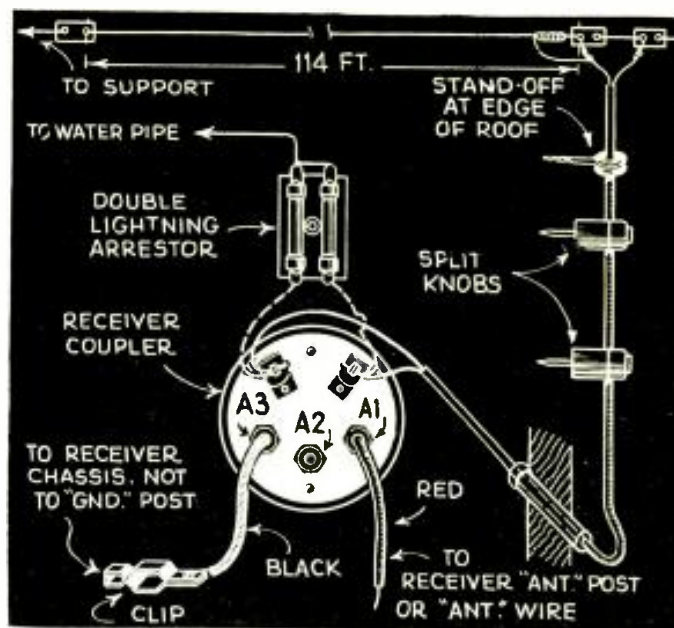

Fig. 2. A simple, complete noise-reducing, all-wave antenna system.

UP TO the present time every all-wave noise-reducing antenna system has been deficient in signal strength on the broadcast band. In some systems a compromise has been made with noise by including a switching arrangement which converted the antenna from a doublet with noise-reducing properties to an ordinary "T" antenna with no noise-reducing properties. It had been thought impossible to provide an antenna system which would be efficient over the very broad band of frequencies which lie between 5 meters and 600 meters, which is equivalent to 55,000 to 550 kilocycles.

The ordinary broadcast receiver has a frequency ratio of approximately 3 to 1. New and improved antenna systems, now available, have a frequency ratio of more than 40 to 1.

Location Determines Better Type

For the person who is located in the city or who lives on a modest-sized plot in the suburbs, the new doublet antenna system shown in Fig. 1D is recommended because the total length of the horizontal portion of the antenna need not be more than 41 feet. Naturally an antenna of such small dimensions will not have the pick-up of one made with a very much longer flat-top. But this deficiency is overcome in a most practical manner in the afore-

mentioned system by the use of an impedance-matching device at the antenna which eliminates the losses usually sustained in the ordinary type of noise-reducing lead-in.

Where suitable space is available an entirely different type of antenna is suggested having a total over-all length of 114 feet which is approximately half a wave-length at 70 meters or 4.3 kilocycles. With this type of horizontal antenna the lead-in is taken from the end rather than in the center. This has been done as a matter of mechanical

convenience rather than electrical efficiency. This system is shown in Fig. 2. Its commercial prototypes were known as inverted L-type antenna systems.

The latter system does not require the elaborate and rather expensive antenna transformer and where space is available it is recommended as being superior to the doublet type. As is true with the duplex system, the flat top need not be in a straight line. It may zig-zag, but it should not double back on itself.

How the Systems Work

Most of the important short-wave broadcast stations operate on approximately 13, 16, 19, 24, 31, 49, and 70 meters. A long horizontal antenna cut to receive on 70 meters is fairly efficient on all of the other wavelengths and it is extremely good in the broadcast band. Such an antenna should be at least 30 feet above the ground. By reason of the size of the collector (antenna) the signal strength it picks up is rather large and compensates for small deficiencies between the antenna and the receiver which could not be tolerated with a collector of the smaller size. Therefore, the impedance-matching transformer at the antenna is eliminated for both mechanical and financial reasons. A low-impedance transmission line is used on both sys-

(Continued on page 438)

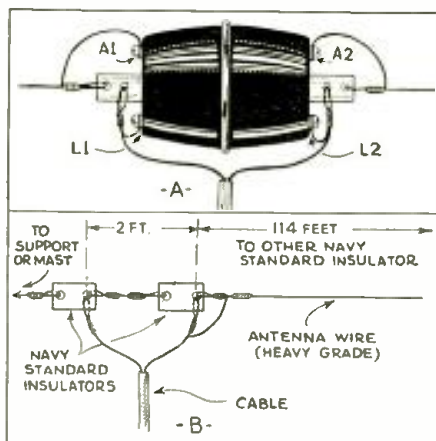
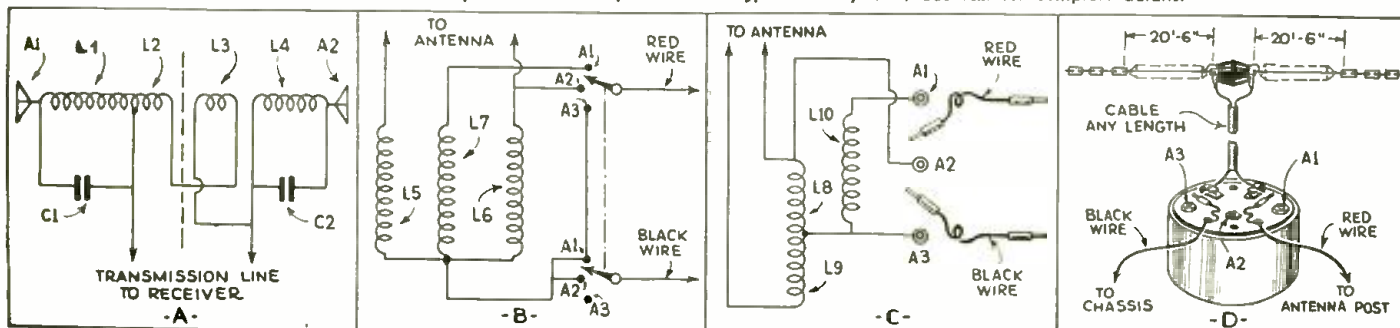

Fig. 3, above.
A—new antenna coupler; B—end-fed antenna.

Fig. 1. Fundamental and practical all-wave, noise-reducing, antenna systems. See text for complete details.



SHORT-CUTS IN RADIO

FIRST PRIZE \$10.00
 SECOND PRIZE 5.00
 THIRD PRIZE 2.50
 Honorable Mention
 EXPERIMENTERS: Three cash prizes will be awarded for the best "short-cuts" — time- and money-saving ideas—submitted by readers of RADIO-CRAFT; Honorable mention will be given for all other published items concerning radio and its allied fields.
 Send us your "kinks" right away.

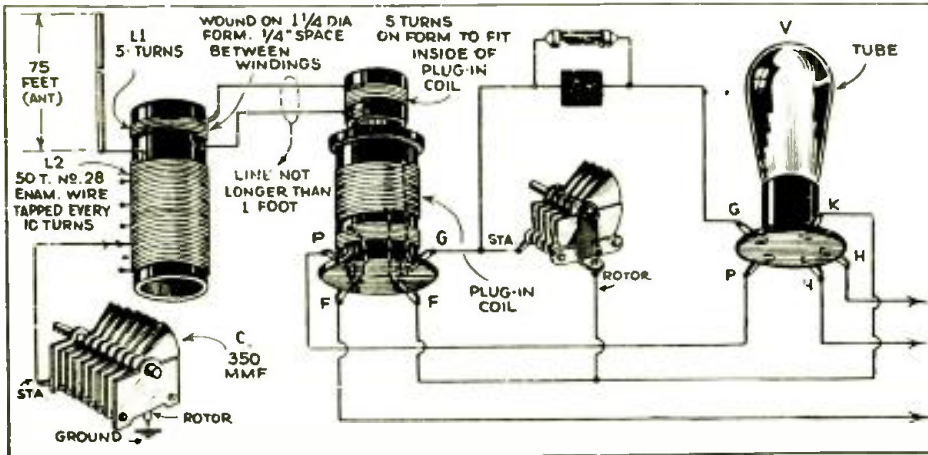

Device to increase short-wave sensitivity, and signal-to-noise ratio.

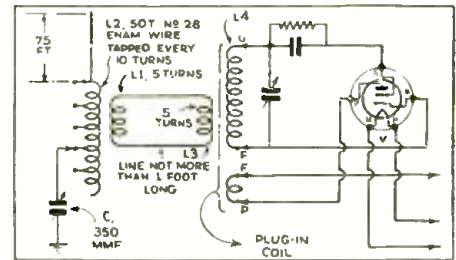

Circuit of unit pictured at left.

FIRST PRIZE

IF AN antenna is resonated at the frequency to which the receiver is tuned a considerable increase in signal strength can be obtained; also, the signal-to-noise ratio will be improved. The illustrations above show a simple device that can be constructed for tuning the antenna of a short-wave set from approximately 15 to 75 meters. The antenna proper is roughly tuned by L2, which is tapped at every

10 turns; fine tuning is accomplished by means of condenser C. Coupling between antenna and receiver (represented by tube V) is accomplished by a "link" circuit, one coil of which is inductively coupled to the antenna loading coil, and the other to the receiver. The little 5-turn coil, L3, at the receiver end of the link may be slipped inside the grid end of coil L4. We strongly recommend that short-wave fans give this gadget a try.
 GEORGE N. SHORTT

SECOND PRIZE

SOLVED!—the problem of how to successfully groove short-wave coil forms at home. The idea is to cut in the tube base, by means of a coping saw, as many closed-circle grooves as may be required for the desired number of turns of wire; the form is conveniently rotated for the purpose by utilizing a hand-saw. Just drill a hole in the center of the base of the coil form, run a bolt through the hole and tighten in place by using a lock-washer, nut, and lock-nut, and grip the bolt in the chuck of a hand-drill. Hold the saw-blade against the coil form and rotate the form until a groove of suitable depth has been cut. The final step is to mount the coil in a vise and a series of diagonal grooves along the top of the form, at an angle of 45 degrees. These straight, diagonal incisions join each successive ring, as shown in the illustration at the right. S. S. MARGLON

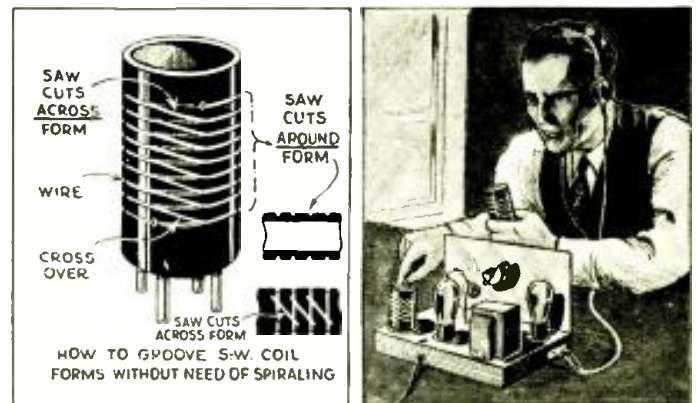

At last! short-wave coil forms may be easily grooved

This kink saves set builders a dollar or two.

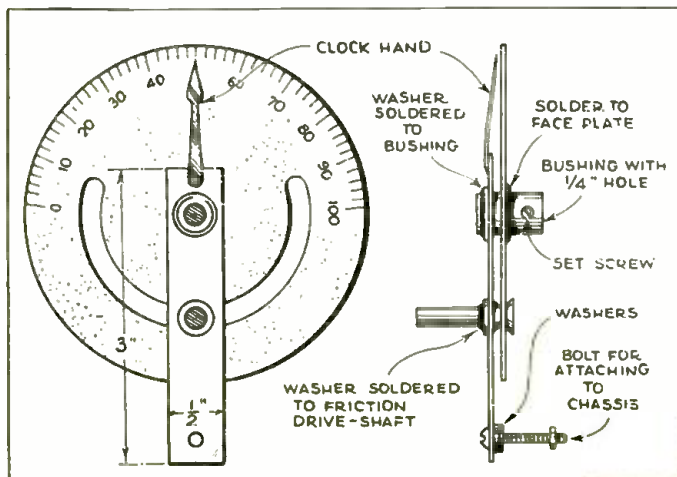

THIRD PRIZE

HERE is the way you can make a back-of-panel control from an old front-of-panel dial—such as Marco, etc. Just discard the bakelite cover and retain only the dial and friction drive-shaft. (The particular dial illustrated at the left is a rebuilt Pilot.) An escutcheon on the panel will complete the commercial appearance of the job; most mail-order houses carry an assortment of designs and sizes. Many of the front-of-panel dials were equipped with translucent discs on which the graduations were marked, consequently, these lend themselves very nicely to illumination by means of a pilot light mounted in back.

Little mechanical ideas such as this one may be applied by the radio man who wishes to save a dollar here and there, in conjunction with the valuable information contained in RADIO-CRAFT LIBRARY BOOK NO. 6, "Bringing Electric Sets Up to Date," to "cash in" on the intrinsic value of a great number of older set models that are now available for a song.
 GEORGE H. MORSE

READERS' DEPARTMENT

A department in which the reader may exchange thoughts and ideas with other readers.

S.-W. SERVICING IN HAITI

Editor, RADIO-CRAFT:

A Lincoln SW33 battery-operated set, after 1 month of service cut off suddenly. When called to service this set I thought first it was the primary of the first A.F. transformer which had burned out, but this transformer proved good after test. The defect was in the tuning meter. "It's a long way to New York," from Port-de-Paix, to get a replacement meter, so I connected a wire across the terminal leads in the meter and the set worked as perfectly as before.

GEO. A. CELESTIN,
Port-de-Paix,
Haiti,
British West Indies.

THE WHOLE STAFF THANKS YOU!

Editor, RADIO-CRAFT:

Have been buying Gernsback publications since they first came out years ago and I think they are "all to the berries" (if you'll pardon my French).

To date I have built and used nearly all test equipment and literally hundreds of various hookups, and while some of them had an error or two in the diagram, I have never been stumped, and have not had a failure yet. I have no kicks to make.

I take this opportunity of thanking the whole staff, for their fine dope and wish them many years of continued success.

JACK GEIER,
% Valley Radio Shop,
San Fernando, Calif.

PSK-PRF-5 RIO DE JANEIRO

Editor, RADIO-CRAFT:

For your information and in case it is of any use to you for publication, I tender a few details of PSK-PRF-5, the "I.T. & T." short-wave transmitter of Rio de Janeiro which I have seen mentioned repeatedly in your columns (sometimes erroneously by our old call sign PRBA, or by PRA-3, the call sign of a medium-wave station we frequently relay).

Operating Company: The transmitter belongs and is operated by the Companhia Radio Internacional do Brasil (a member of the International Telephone & Telegraph Corp.) and is employed regularly for the international telephone service to New York, Buenos Aires and Madrid, and from these points to the rest of the world, and also for special short-wave broadcast programs.

Operating Schedules: International telephone daily channels and special programs through the following stations:

FREQ. IN KC.	W. L. IN METERS	CALL LETTERS	MISC. REMARKS
21,080	14.23	PSA	Tele. to New York
14,690	20.4	PSF	Tele. to Buenos Aires and Madrid
14,935	20.7	PSE	Ditto
10,220	29.35	PSH	Tele. to Madrid
9,505	31.5	PRF-5	Special Broadcast Programs
8,185	36.65	PSK	Tele. and Special Night Programs to Buenos Aires

For the telephone channels "inverters" or "speech scramblers" are employed to assure secrecy of communication.

Broadcast Programs: The Brazilian government transmits daily, with the exception of Sundays, their news bulletin of the "Programs Nacional" through PRF-5 (31.5 M.). From 22:30 G.M.T. news in Portuguese; and from 23:00 until 23:15 G.M.T., news in English, French, Spanish and German.

Special musical broadcast programs are frequently relayed in combination with some of the local medium-wave stations. Station PSK with directive antennas to Buenos Aires is frequently used to relay Rio programs to the Argentine stations, and PRF-5 is employed when the program is meant for the rest of the world.

Transmitter: The equipment employed is a "Standard" 60 kw. short-wave radio-phone transmitter (similar to the B.B.C. Empire transmitter), and is located in Marapicú in the middle of the Brazilian jungle, at a distance of 80 kilometers from the beautiful city of Rio de Janeiro.

Reception and Exchange of International Programs: With great success we have very frequently received and relayed programs from other countries. Among these we may mention England, France, Italy, U.S.A., Germany, Argentine, Uruguay, Spain, Portugal, etc. For these relays special high-gain superheterodyne receivers together with "double-vee" directive antennas are employed.

Listeners' Reports: Listeners' reports will be greatly appreciated. Correspondence should be addressed to:

Short-Wave Station,
Caixa Postal 709,
Rio de Janeiro, Brazil.

We hope that this information will be of use to the readers of RADIO-CRAFT.

J. C. BRAGGIO, *Comm'l. Mgr.*,
Companhia Radio Internacional do Brasil,
Caixa Postal 709,
Rue Visc. Inhaúma, 64-40,
Rio de Janeiro, Brazil.

We are sure that owners of short-wave and all-wave receivers will be interested in the above information concerning this transmitter in the jungles of Brazil. Undoubtedly, the operators of this installation will be "tickled pink" to receive reports from listeners, and we urge our readers to give these boys some consolation in their isolation.

(Continued on page 437)

View of transmitting station located at Marapicú near Rio de Janeiro, S.A. Directive antenna arrays to Madrid in background. Thick jungle had to be cleared to build this station.



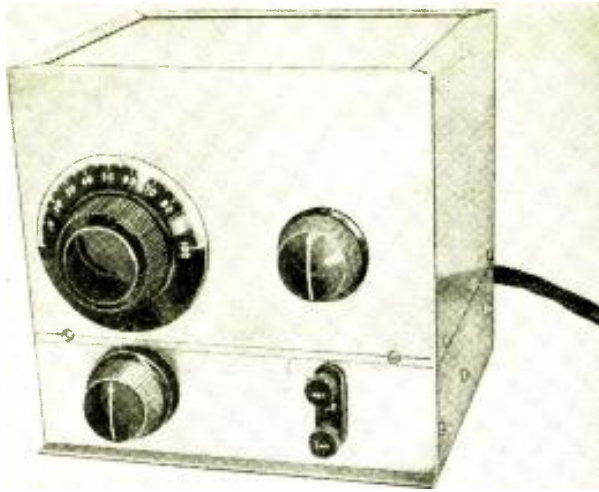

A REAL "HOW-TO-BUILD" SERVICE MAN'S ALL-WAVE OSCILLATOR

Here is what all Service Men have been looking for! A really complete article on building your own 110 V. A.C.-D.C. all-wave oscillator; all fundamental frequencies from 7 mc. to 110 kc.

HOWARD J. BENNER

THE TREND of the radio market toward receivers having more than one band has created a serious problem for the Service Man. He is confronted with the problem of servicing all-wave receivers with equipment that was designed only for the broadcast band. The use of harmonics has been one way out of this problem, but at higher frequencies the harmonics are so close together that a calibration is

next to impossible and proper tracking becomes difficult.

This article presents a simple and inexpensive A.C.-D.C. all-wave service oscillator or "signal generator" which the Service Man or amateur can easily construct. This instrument is not of the usual type that works on harmonics, but instead supplies fundamental frequencies, and is in every sense a laboratory instrument.

The output control completely attenuates the signals, and no signal is evident even on the ultra-sensitive receivers of today. This has been accomplished by effectively filtering the line and completely shielding the generator. A shielded lead from the signal generator to the receiver must be used to reduce stray field. For use on the higher frequencies a 400-ohm resistor is placed in series with the "hot" lead from the generator. This is necessary because the average antenna does not have the characteristics of our usual

dummy antenna but has effectively a higher impedance, and 400 ohms is considered the proper match.

Figure 1 shows the circuit diagram. As can be seen, the instrument consists of four units. These are: (1) the oscillator; (2) modulator; (3) attenuator, and (4) power supply.

The oscillator circuit uses a type 77 tube operated as an electron-coupled oscillator. The control-grid, screen-grid, and cathode are used as the oscillator elements. The plate is used only to couple the generated signal to the output posts. The oscillator is of the familiar Hartley type with the tuned grid coil tapped to provide feed-back. This type oscillator with the advantage of electronic coupling has proved very satisfactory, since a variation of output load, even at the highest frequencies, has little reaction on the oscillator. This is accomplished as a result of the suppressor-grid being tied to the screen-

(Continued on page 434)

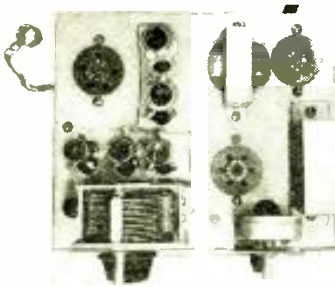

Here is how the parts should be placed

Fig. 1. Wiring diagram of oscillator.

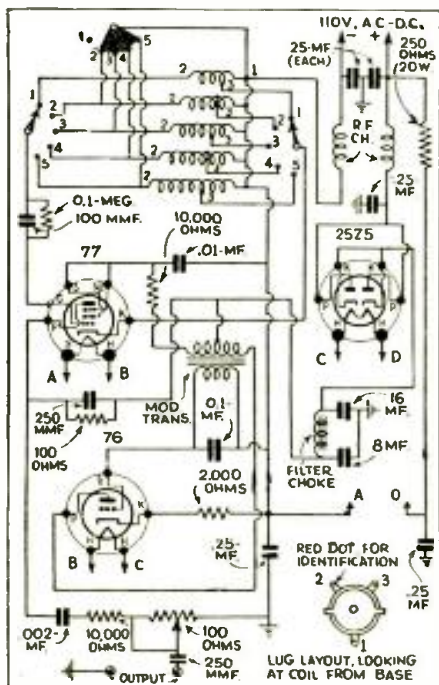

Fig. 2. Building and drilling the chassis.

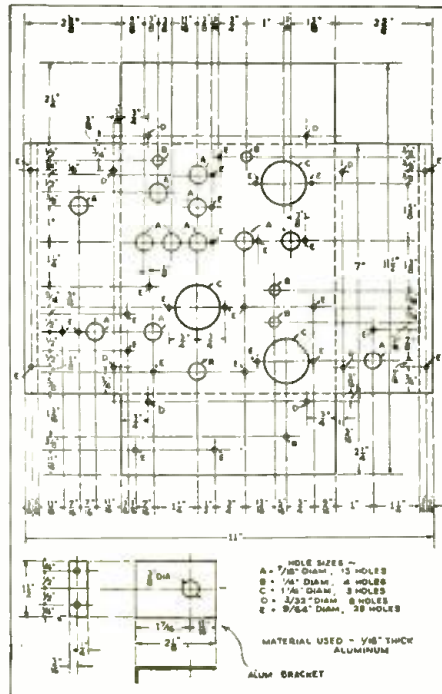
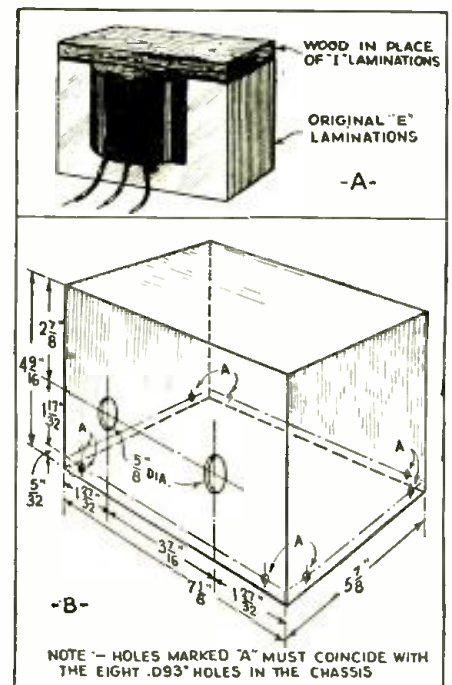

Fig. 3. A—modulation transf.; B—cover.



OFFICIAL RADIO SERVICE MEN'S ASSOCIATION, INC.

MEMBERS' FORUM

This department is devoted to members and those interested in the Official Radio Service Men's Association. It is the medium for exchanging ideas, kinks, gossip and notes of interest to those who comprise the membership.

SOMETHING WRONG?

RADIO-CRAFT, ORSMA Dept.:

In the course of the last year or so I have had a good many car radio sets come into my service shop with stuck vibrators. Apparently the sets have been O. K. otherwise. At the present time I have a Philco N, an Atwater Kent 424, a Ford Majestic and a small G. E., all with the familiar trouble of a sticking vibrator.

Surely there must be something wrong that I am missing as it wouldn't be likely that all these power units are defective, and as many are only a few weeks old it can't be because they are worn out.

I would like to know if it is advisable to clean the contact points, readjust the contact gaps, etc., as a remedy or if it is best to replace the entire assembly. It has been my experience that replacing the entire unit is the only remedy after the points have become pitted.

JESSE SMITH, JR.

Here is a question which has stumped many a Service Man. What do other members of the ORSMA think about this letter. Are the sets at fault? Is it best to replace the entire vibrator assembly or can the units be repaired to the advantage of both the Service Man and the customer? These are questions which can be settled best by the opinions of other members who have experienced the same or similar troubles.

The opinion of one auto-radio expert is that wherever the aforementioned trouble occurs the best remedy would be to replace the entire vibrator assembly. His experience has been that the early models which incorporated such devices have always given trouble due to design kinks which did not develop until the sets were placed in the field. Since then, improved vibrators have been developed, which, when installed, will eliminate almost completely this type of trouble.

A VERSATILE TEST PANEL

RADIO-CRAFT, ORSMA Dept.:

Knowing your interest in the Service Men and their problems, I feel that you will be interested in an up-to-date test panel which I use in my service shop and which has been just completed after several weeks of drafting and study.



A complete test panel for the shop, built by one member.

I enclose a picture (shown below) which shows the panel (center) with the dynamic and magnetic speakers on the panel above. These speakers can be arranged for use on any radio set I might receive for servicing, by means of various field coils brought out and connected in series (with proper cores) by means of phone-tip jack connections between each coil. This permits any resistance unit to be "thrown" into a set circuit where necessary. Also, tips are provided for connecting the voice coil to the output of the set with clip connections. Where the set carries no output transformer, arrangements are made by a switch and jacks to connect a transformer behind the speaker panel to the set and speaker, thus providing coupling.

All parts used in building this board are parts of old test units or parts thrown around the junk box. The only part bought was a new multitester unit. This can be connected to the board by "loop wires" with phone tips. A ten wire cable connects from plug (6-prong with phone-tip center jack) to panel sockets,—one each of the 4, 5, 6 and composite 6-7 sockets, each socket lug hooking into phone-tip jacks shown in line at the bottom of the panel. The cathode, plate, screen-grid and suppressor-grid lines can be opened by toggle switches. I have the filament lines going to a 0-15 volt A.C. meter, the screen-grid and plate lines looping through a special 3-way switch (from the junk box) one for each circuit—to the milliammeter. This arrangement is necessary because of using one meter for both screen-grid and plate—to keep them separate. The meter is 0-20-100. I use two large and two small push-buttons, shown under the meter (center top) one large and one small for each circuit, the large one reading the higher scale, and the smaller the lower scale. A push-button under the filament A.C. meter cuts in this meter across the filament circuit.

On this board is provided an output meter with two ranges, which is more easily accessible than changing the multitester, as well as a separate 0-200 D.C. voltmeter (upper left) and a 0-10,000 ohmmeter. These are brought out to phone jacks in line with the other tip jacks.

The large Weston meter is a heavy duty type, used
(Continued on page 425)

THE ANALYSIS OF RADIO RECEIVER SYMPTOMS

OPERATING NOTES

WHAT THIS DEPARTMENT IS FOR

It is conducted especially for the professional Service Man. In it will be found the most unusual troubles encountered in radio service work, written in a practical manner, by Service Men for you.

Have you, as a professional man, encountered any unusual or interesting Service Kinks that may help your fellow workers? If so, let us have them. They will be paid for, upon publication, at regular space rates.

STEWART-WARNER MODEL 116A

THIS is a broadcast receiver incorporating a police band, and using a 6A7 first-detector and oscillator. The complaint was, "no reception on the broadcast band, accompanied by noise at several positions of the station selector." See Fig. 1.

After testing all tubes and checking socket voltages a continuity test was made on the coils in the radio-frequency section which revealed an open section of the antenna coil. This coil is wound with large enough wire to be easily rewound.

CHESTER MCCLINTLOCK

BEST 4 TUBE MIDGET

THIS receiver uses 6C6, 6D6, 43 and 25Z5 tubes. Receiver was dead as far as signal was concerned. Speaker had an alive sound. Refer to Fig. 2.

No voltage anywhere except at speaker field. Trouble was found to be due to defective 25Z5 tube. One of

the cathode leads had opened inside the tube. This receiver uses the 25Z5 as two half-wave rectifiers, one-half supplying current to the speaker field and the other half to the tubes.

An emergency repair due to lack of a 25Z5 tube was made by connecting the 2 cathodes together. This put the tube load in parallel with the speaker field portion of the rectifier. No harm resulted by connecting in this way and the receiver worked fine until a new tube was procured.

Difficulty in tuning to and holding a station was traced to insufficient tension of the springs on the tuning condenser rotors.

Soldering pigtails eliminated this trouble.

MARIO BORNUCA

DEFECTIVE TUBES—

Are not to be considered as the subject for an Operating Note. It is assumed that all Service Men test tubes when making a service call. Their experiences on the subject of testing tubes, unless most unusual, are not of sufficient interest to other Service Men. Operating Notes should be confined to those faults which are characteristic of, and repeatedly occur in connection with a particular model of radio receiver.

"NEW YORKER" (U.S. RADIO & TELEVISION CORP.)

RARELY has a set come in with so much wrong with it. Receiver received dead. Due to an open 5,000 ohm section of the voltage dividing system, i. e., the 5,000 ohm section of the two fields. Symptoms, no screen-grid voltage on either 24A and no control-grid bias, and hence high plate current in the 71A—nearly 40 ma. By careful inspection of the removed field coil the break was located approximately 2,400 ohms in from the outer end of the coil, and at this point, only a few turns were lost until the continuity was again picked up from the inner end of the coil, and the two sections soldered together. Corrosion probably caused the trouble. For schematic see Fig. 3.

Each electrolytic condenser was drawing far too much current and the two were replaced to avoid trouble here. Originals were each 8 mf.,

275 V., but 400 V. jobs were used for replacement. Placed in operation, after the field repair and condenser renewal, the set was practically dead! Cause: a shorted 0.01-mf. R.F. cathode resistor bypass condenser. Theoretically, this should give maximum volume as it gives no bias and hence high plate current in the R.F. 24A, but such was actually not the case, perhaps due to overloading. Be this as it may, replacement of this condenser was in order. On the usual routine test of all condensers it was found that replacement of the following condensers was necessary:

(1) the above-mentioned R.F. cathode bypass, 0.01-mf.; the 0.05-mf. detector control-grid to cathode isolating condenser; the 0.1-mf. detector screen-grid bypass; the 0.01-mf. detector plate to 71A control-grid coupling condenser (a 600 V. job here); and the 0.1-mf. 71A control-grid resistor bypass. All were leaky, and except

(Continued on page 443)

Fig. 1
Stewart-Warner 116A; noisy, no reception.

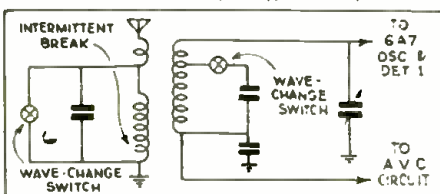

Fig. 2, below. Best 4 tube; fading.

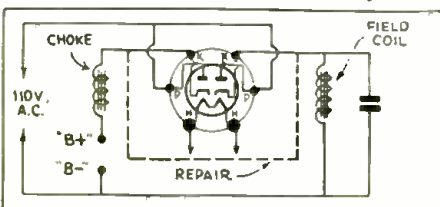
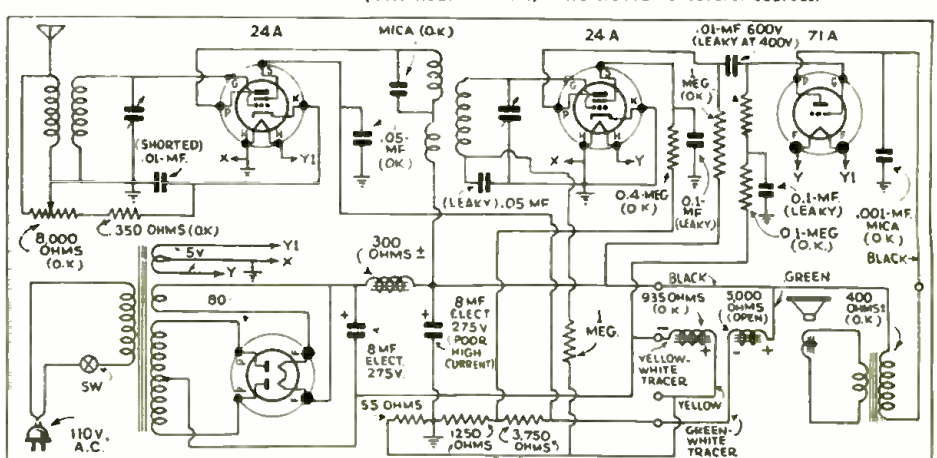

Fig. 3
Troubles in a "New Yorker" (U.S. Rad. & Telev.) were traced to several sources.



RCA VICTOR MODEL 102 4-TUBE A.C.-D.C. T.R.F. RECEIVER

(Incorporates wide tuning range: 540 to 1,712 kc.; A.F. power output, 0.18-W.; circuit permits compact chassis design.)

Following are operating voltage and current figures for this set, measured to K, or fil.

Tube Type	C.-G. Volts	S.-G. Volts	Plate Volts	Plate Ma.
V1	2.5	105	105	7.0
V2	2.0*	17.5*	40*	0.1
V3	10.0	100	95	5.5
V4			115**	16.0

(* Impossible to measure on ordinary voltmeter; (**) r.m.s. Above voltages for A.C. will be approximately 5% lower on 115 V. D.C. Measure at maximum volume.

The receiver is aligned at 1,400 kc. for maximum output. Align the tuned circuits with the trimmers in position of minimum capacity. After alignment, check to make sure that a 1,712 kc. signal can be heard when the main tuning condenser is near its extreme minimum position. Power consumption, 40 W.

Care should be taken to avoid restriction of natural ventilation as would occur with the set resting upon or placed close to a radiator or other heating device.

In most localities the 20 ft. antenna lead of the set will provide sufficient pick-up.

This set is observed as being one of the most simple and effective designs that can be produced. A single, type 78, variable-mu pentode, V1, is coupled to a type 77, non-variable-mu pentode, V2; the A.F. output of V2 is amplified by the type 38 tube, also a pentode. The 37 rectifier furnishes adequate current for this combination. Inasmuch as a tuned radio frequency circuit is utilized there can be no whistles of any sort when tuning across the scale as often occurs in sets of the superheterodyne type which incorporate only a limited number of tubes.

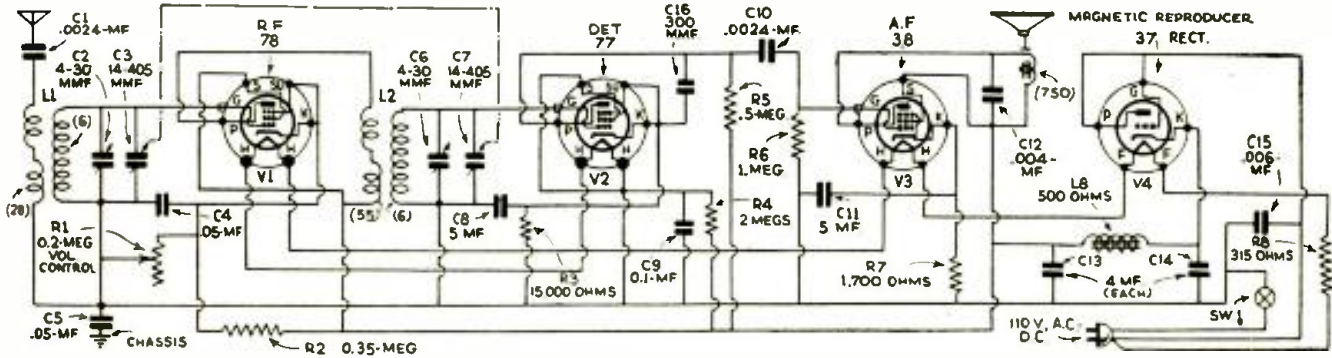

GENERAL ELECTRIC TABLE MODEL M-49 4 TUBE RADIO-PHONOGRAPH DUAL-WAVE SUPER.

(Features: frequency range, 540 to 1,500 and 1,600 to 3,500 k.c.; A.F. power output, 1.9 W.; tone control; phono. is 78 r.p.m.)

Following are the operating voltage and current figures for this receiver, at 120 V. line potential; maximum volume setting of R6, and no signal. Measure to cathode.

Tube Type	C.-G. Volts	S.-G. Volts	Plate Volts	Plate Ma.
V1	1.25	70	235	2.5
V1*			180	3.5
V2	1.25	70	235	5.5
V2**	19		145'	0.4
V3	17	240	230	26.5
V4			335"	50.0

A feature of the power supply circuit—only one secondary is used in power auto-transformer P.T. This is accomplished by having a cathode-type rectifier, series filaments, and taps on the secondary of P.T.

(* Oscillator section; (**) second-detector section; (') actual voltage cannot be measured; (") r.m.s.

Second-detector coil L1 is tapped so that the tuning range may be extended merely by shorting out a portion of the coil. The oscillator circuit is not tapped, the high-frequency range being obtained by use of its second harmonic instead of the fundamental for obtaining the I.F.

Align at 1,400 and 600 kc. The magnetic pickup and tone-arm assembly are of new design and unique construction. Service work will consist mainly of centering the armature, replacing the rubber pivots, and replacing the magnet coil.

Care should be taken to avoid restriction of natural ventilation through the cabinet as would occur with the set situated so that its back is flush with a wall of the room or with the instrument resting upon or close to a radiator or other heating device. Black wire connects to antenna, and yellow, to ground.

The Synchronous motor used in this instrument is of simple design; the two stator coils are connected in series and the motor is started by giving it a clockwise spin by hand. If it is found difficult to start, or if it runs at a sub-synchronous speed such as at 70 r.p.m., such action may result from one of the following causes:

Difficult to Start: May be due to stator failing to rotate on outer bearing (due to spaghetti sleeve being jammed in the slot, or sticking to the resilient bumper). Outer bearing may not be properly lubricated. See that the ball bearings are at the bottom of the main assembly.

Slow Speed: Lift tone-arm from turntable until motor reaches normal speed.

At 125 V. the motor consumption is 4 W. Do not turn on motor with rotor removed as the heat rise will be excessive.

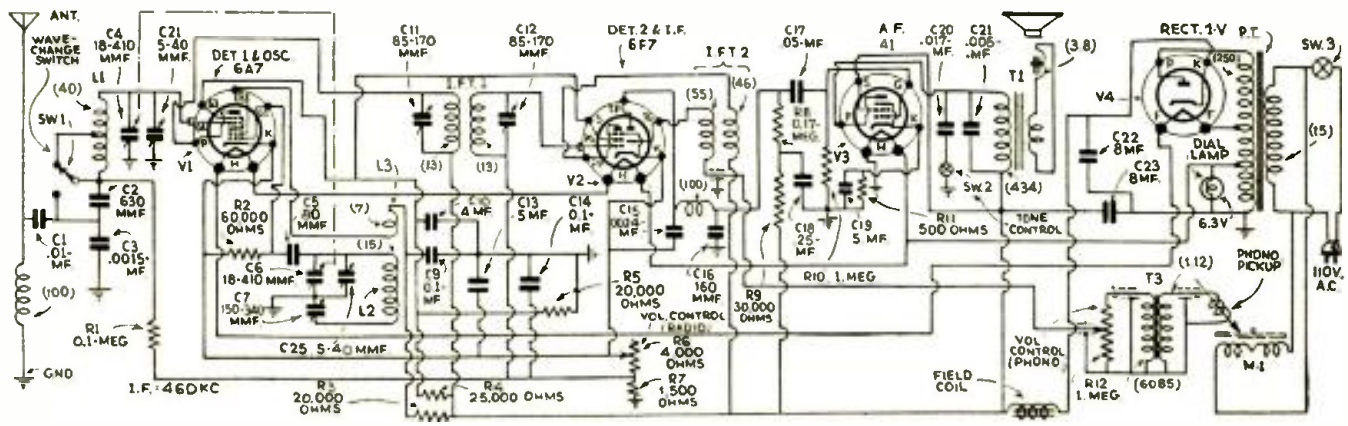

RADIO-CRAFT'S INFORMATION BUREAU

THAT REMOTE SPEAKER

(300) Mr. Lee C. Davies, Imperial, Pa.
(Q.) In the department, Short-Cuts in Radio, in the October 1934 issue of RADIO-CRAFT, page 225, is shown a circuit to permit a remote speaker to be controlled either at the radio set or at the speaker. However, I fail to see how, if the extra speaker is wired in such a manner, it would work. Is the circuit correct as shown?
(A.) We thank you for calling to our attention the diagram in question which, unfortunately, is in error; a correct version is shown in Fig. Q.300.

"BUILD THIS ALL-WAVE SET" (Re. "B" Unit)

(300) Mr. E. E. Randall, Mattoon, Ill.
(Q.) In the November 1934 issue of RADIO-CRAFT, in the article, "Build This All-Wave Set," is the wiring of the power supply shown correctly? Are the plates of the type 84 rectifier in the tube-type "B" supply unit, that operates from the 6 V. "A" supply, shown correctly wired? I am building this set and want to be sure that it is wired right, inasmuch as the set itself is just what I have been looking for.
(A.) Although the diagram of the "B" section of the unit is correct according to the original copy, we find upon further checking that this portion of the circuit is incorrect. A revision is shown as Fig. Q.301. Note that, now, the plates of the rectifier connect to either end of the high-voltage winding of T1, and that "B—" now connects only to the centertap on this winding, the two buffer condensers, one side of the filament of the 84, and the low-potential leads of the two 25 mf., 25 V. electrolytic condensers. A point of interest in connection with this circuit is that, at first glance, an R.F. choke (connected to the cathode of the 84) appears to be the only A.F. filter unit in the "B" circuit; however, the fact is that the 1,800 ohm field coil, which is bypassed by two 8 mf. condensers, in the receiver circuit supplies the requisite filtering.

1 TUBE LOUDSPEAKER ALL-WAVE SET (The "Twinplex")

(302) Mr. Marion Stine, Somerville, N.J.
(Q.) Is it possible to make a "loudspeaker" set using only drycell tubes of the 2 V. type? I would like to be able to make such a set if it is not too complicated. Most of the circuits I have seen, and which are capable of giving "decent" volume on the loudspeaker from local stations, have required at least 2 and usually 3 tubes, but it seems to me that the old Armstrong or "Ambassador" regenerative circuit could be used to advantage in some *really modern* circuit utilizing one of the new multi-purpose tubes, such as the 1A6.

(A.) We do not know of any really effective "loudspeaker" circuit utilizing the 1A6 pentagrid converter tube. You see, this tube does not have satisfactory output characteristics for matching into a loudspeaker as the output "load." Instead, we recommend the circuit shown in Fig. Q.302, which utilizes a type 19 tube.

This tube, too, is in the 2 V. class, but is well-designed for operation as an output device. In addition, having two triodes in one envelope, this tube is well adapted to the special circuit shown, in which one section of this tube is used as a triode regenerative detector, and the other section is used as a triode A.F. amplifier. The use of plug-in coils permits all-wave operation from 15 meters to 550 meters—and higher, if suitable coils are used.

(Note that this is *not* a "reflex" connection, inasmuch as each set of triode elements performs only a single function in the circuit—the diagram is reproduced by courtesy of SHORT WAVE CRAFT magazine. The cost of building this set is next to nothing.)

It would be a "wise stunt" to mount the antenna trimmer right on the front panel where it would be easily accessible. The value of the grid leak shown as 3 megs. should be varied to meet individual requirements; once set, it should not again require adjustment.

"WIRED RADIO" LAWS

(303) Mr. John Butterworth, Pasadena, Calif.
(Q.) In the November 1933 and several subsequent issues of RADIO-CRAFT, have been described radiophone equipment designed for operation over the electric light lines, on the principle of "wired radio." Does operation of this equipment come under the jurisdiction of the Federal Radio Commission?
(A.) In this connection we are advised by the Federal Radio Commission, as follows:

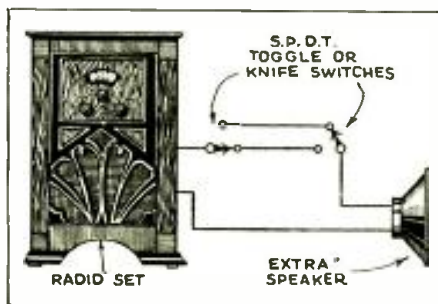

Fig. Q.300, above
Off-on operation of remote speakers.
Fig. Q.301, right
Correction of vibrator-type "B" unit.
Fig. Q.302, below
A REAL 1 tube "loudspeaker" set.

SPECIAL NOTICE

Those questions which are found to represent the greatest general interest will be published here, to the extent that space permits. (At least 5 weeks must elapse between the receipt of a question and the appearance of its answer here.) Mark such inquiries, "For Publication."

Replicas, magazines, etc., cannot be sent C.O.D. Back issues of RADIO-CRAFT prior to December, 1932, are available at 50c per copy; except the following issues: 7/29, 2, 3, 4, 6, 7, 9 and 11/30; 5, 8 and 9/31; and 10/32, which are out of print. Succeeding issues are still available at the regular price of 25c per copy.

Inquiries to be answered by mail MUST be accompanied by 25c (stamps) for each separate question; answers are subject to subsequent publication if considered of exceptional interest.

Furnish sufficient information (in reference to magazine articles, be sure to mention issue, page, title, author and figure numbers), and draw a careful diagram (on separate paper) when needed to explain your meaning; use only one side of the paper. List each question. Be SURE to sign your name AND address.

Enclose only a STAMPED and self-addressed envelope for names and addresses of manufacturers; or, in connection with correspondence concerning corrections to articles, as this information is gratis.

Individual designs can be furnished at an additional service charge. The fee may be secured by addressing the inquiry to the SPECIAL SERVICE department, and furnishing COMPLETE specifications of desired information and available data.

"The Commission has no special regulations with reference to wired radio, but investigation has shown that in all cases where wired radio operations were being claimed they were merely radio stations emitting signals into the air as any other radio stations. Under these circumstances they were all subject to regulation by this Commission.

"The mere fact that these stations may operate outside the broadcast band would not exempt them from Commission regulation. The

(Continued on page 425)

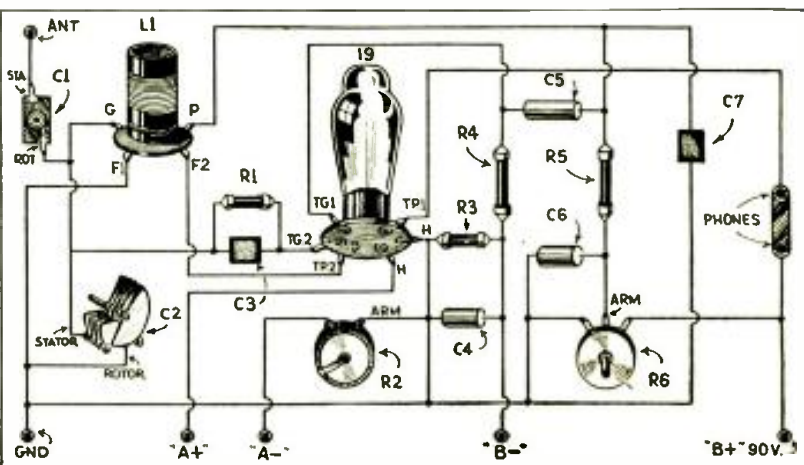
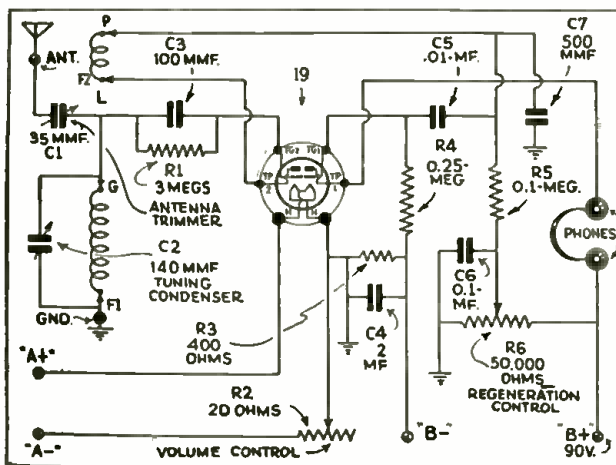
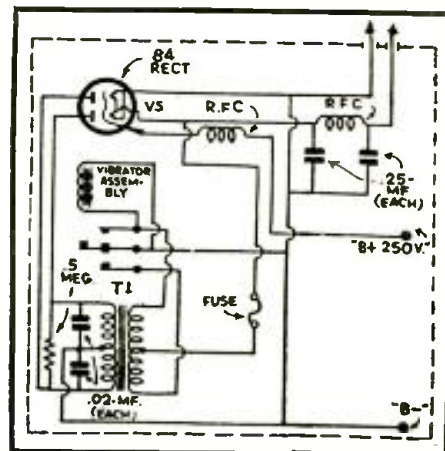



A 3-tube short-wave set. (621)



Hi-fidelity, 15 W. P.A. unit. (622)



"Free reference" analyzer. (623)



Aircraft-broadcast set. (624)



Above, modernized checker. (625)

Below, 5-tube all-wave set. (626)



LATEST IN RADIO

(Continued from page 403)
HIGH-FIDELITY 15 W. AMPLIFIER (622)
 (Marlo Products Co.)

A FREQUENCY range of 60 to 12,000 cycles, at high fidelity, is claimed for this 4-stage amplifier; the figures are given on the basis of a 2%+ power variation, at 5% maximum harmonic content. The tubes are arranged as follows: type 57 first voltage amplifier; 56, second voltage amplifier; 2A5, driver; two 2A3s, class A prime power output. Chassis incorporates tone and volume controls.

"FREE REFERENCE" ANALYZER (623)

(Radio City Products Co.)

AN EXTERNAL, multi-range meter, and this new analyzer unit, and you are all equipped for making practically any circuit analysis. Connect set and analyzer via the 10-wire, 6-ft. cable, then rotate the two switches for voltage, current, or resistance measurements between any two circuits, or any circuit and ground ("free reference"). Available in kit form, or completely assembled, wired and tested.

AIRCRAFT-BROADCAST A.C.-D.C. PORTABLE (624)

AIRPLANE travel has shown the need for accurate knowledge of weather conditions at air-ports ahead. To meet this need a portable, 6-tube, 110 V. A.C.-D.C. superheterodyne has been developed which enables the owner, ensconced in his hotel room, to tune in the Department of Commerce weather and other aircraft data on the 140 to 375 kc. (2,142 to 620 meters) band. A switch provides programs on 500 to 1,500 kc. (600 to 200 meters) band. Set incorporates a tone control, A.V.C., built-in aerial, and dynamic speaker.

MODERNIZING SERVICE INSTRUMENTS (625)

(Precision Apparatus Corp.)

SERVICE Men will be pleasantly surprised to learn that their old test apparatus, now beginning to exhibit increasing inadequacy, may be modernized. A Jewell type 538 tube checker, modernized by a company that specializes in doing this sort of work, is illustrated. Job includes complete new wiring, and provision for double test on all dual-purpose tubes and full-wave rectifiers. New molded sockets, a new filament transformer, and new engraved metal panel were installed. Other makes and models are similarly improved.

5-TUBE ALL-WAVE SUPERHET. (626)

(Pilot Radio Corp.)

ALL-WAVE reception over the range of 16 to 550 meters is not the only feature of the newest in 5-tube, 110 V. (also, 125 to 240 V.) 60 cycle supers. (Export model: 16-55, 168-550, and 835-2,000 meters.) The cabinet, for instance, is acoustically designed; vernier-dial action permits either 10-to-1 or 80-to-1 tuning ratio. A phono. pickup is provided; also, A.V.C., and a tone control. Tubes (one each): types 6A7, 6D6, 75, 80, and 42.

SERVICE MEN VOTE FOR THE BURGESS 8 HOUR DAY

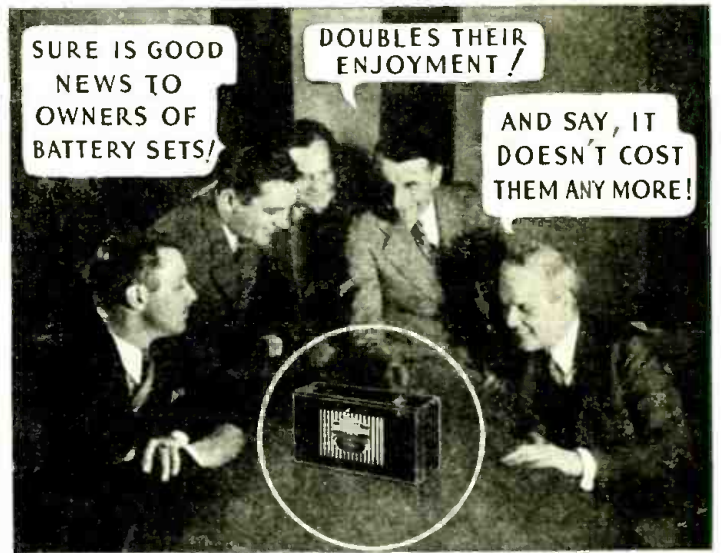

SURE IS GOOD NEWS TO OWNERS OF BATTERY SETS!

DOUBLES THEIR ENJOYMENT!

AND SAY, IT DOESN'T COST THEM ANY MORE!

SERVICE MEN KNOW

that many owners of battery-operated sets still have the old-fashioned belief that batteries give fewer hours of service when used more than 3 or 4 hours a day. That belief has been exploded by BURGESS engineers. Repeated tests in our laboratories and in actual use have proved that you can use BURGESS Batteries 7 or 8 hours a day—and get maximum service!*

When battery-operated sets need new batteries, tell your customers about the BURGESS "8 hour day". They will be glad to know they can double their enjoyment at no increase in their battery cost per hour!

Owners of 2-volt sets can buy 400 hours of dependable "A" power in the BURGESS Power House for only \$3.20. The Power House is 100% DRY, requires no attention and is not affected by weather. Like the world-famous BURGESS "B" and "C" Batteries, it costs no more per hour when operated 7 or 8 hours a day. BURGESS BATTERY COMPANY, Freeport, Illinois.

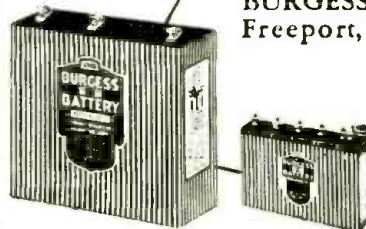
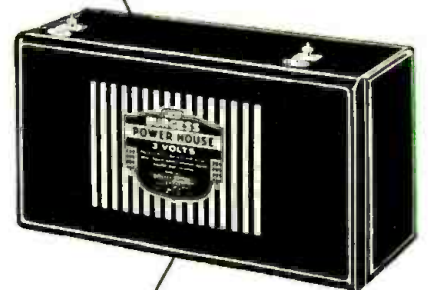

*For economical operation of 7 to 8 hours a day, sets should be powered by batteries of proper capacity. Set owners should ask their Service Men to recommend type and size of batteries best suited for their use.

BURGESS

BATTERIES AND FLASHLIGHTS

Please Say That You Saw It in RADIO-CRAFT

STROMBERG-CARLSON NO. 69 4-TUBE ALL-WAVE SUPERHET. SELECTOR (CONVERTER)

[Frequency range: 1,500 kc. to 25 megacycles; makes any broadcast set an "all-wave" receiver; power consumption, 28 W.]

Voltage readings are obtained by measuring between the various tube socket contacts and the bases with the tubes in place. Figures are given for a line voltage of 120 V., using a high-resistance meter. Measure on Range B, at 2,400 kc.

Tube Type	C.-G. Volts	S.-G. Volts	Sup.-G. Volts	Cath. Volts	Plate Volts
V1	0	103	2.9	2.9	191
V2	0*	103	103**	3.1	191
V3	14	—	—	0	160
V4	—	—	—	207	173

(*) Modulator grid; (**) G2 (G1, -1 V., approx.); (*) modulator plate; (") A.C., per plate.

A bank of individual coils is used to obtain complete coverage at maximum efficiency, over the wavelength range of 12 to 200 meters.

The manner of connecting the combination inverted-L and doublet antenna system recommended for use with this type of short-wave converter is described in Part II of the article, "Important Facts About the New All-Wave Antenna Systems," (RADIO-CRAFT, August 1934, p. 84); note Fig. 7 in the article.

Position A of the range switch establishes a straight-through connection from the antenna to the standard broadcast, 200 to 550 meter receiver with which the selector or converter is being operated. The output of the selector, at 545 kc., is fed through a grounded shield; one output lead connects to the antenna post of the set, and the other connects to the ground post.

Condensers C31 and C32 bypass line interference due to refrigerators, lights, etc.

Sections T of the 7-section range switch connect to the primary windings of the R.F. inductances in the converter. Sections B connect to the secondaries of these coils. In the operating position for a given range, the range switch shorts and grounds the adjacent unused grid inductances. This prevents "dead spots" and erratic operation.

The use of the stage of tuned radio frequency amplification ahead of the first-detector or modulator tube is an extremely important factor in preventing cross-talk and image-frequency reception.

A double superheterodyne receiver results when this selector is connected to a superhet. receiver. The first superhet. action is in the selector, and the second in the receiver. Consequently, both units must be tuned exactly to resonance to prevent cutting sidebands.

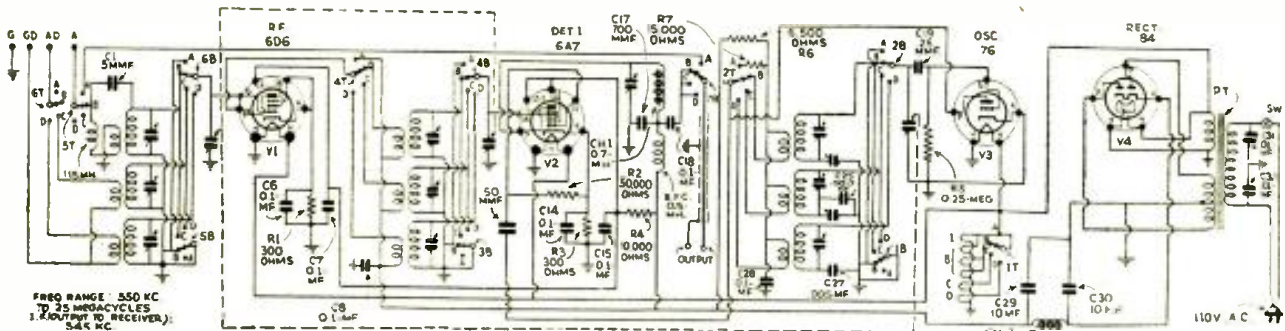

PILOT MODEL 63 ALL-WAVE 6-TUBE SUPERHETERODYNE

[A.V.C.; tone control; phono. pick-up jacks; frequency range, 16 to 550 meters; A.F. output, 3 W.]

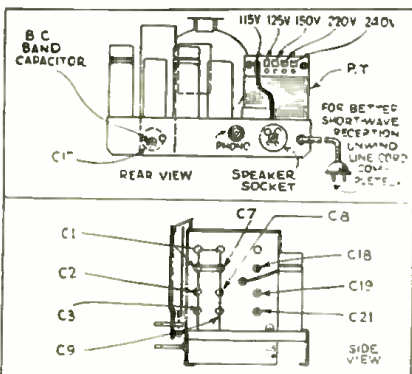

Operating voltages for this receiver are given below. Use a high-resistance meter.

Tube Type	S.-G. Volts	Cath. Volts	Plate Volts
V1	90	4.0	235
V2	90	4.5	235
V3	90	4.0	235
V4	—	1.5	120*
V5	230	14.0	210

(*) Voltage measured through a plate resistor of 0.25-meg. Speaker field, 110 V. All plate and screen-grid voltages are measured to cathode; cathode voltages are measured to the chassis.

The power consumption of this set is 70 W.; the undistorted power output is 3 W. If it becomes necessary to realign the set, be sure to reconnect the speaker cable to the receiver after having removed the chassis from its cabinet, before connecting to power line.

To align the I.F. circuits turn the band-selector switch to "Broadcast," and connect the service oscillator to the control-grid of V3, through a fixed condenser of .002-mf. The return of the service oscillator connects to the receiver ground. After alignment of I.F.T.2 feed the oscillator output to the control-grid of V2, and align I.F.T.1 for maximum output. Repeat procedure.

To align broadcast band, connect service oscillator to antenna and ground posts, turn range switch to "Broadcast," and align oscillator, interstage and antenna trimmers at 1,400 kc.; and oscillator padder at 600 kc. Repeat procedure. Rock tuning control while aligning padder.

Align bands 1 and 2 at service oscillator frequencies of 17,800 kc. and 6,100 kc., respectively, setting the receiver dial at 16.8 and 49 meters, respectively.

There are no padding condenser adjustments on short-wave bands 1 and 2.

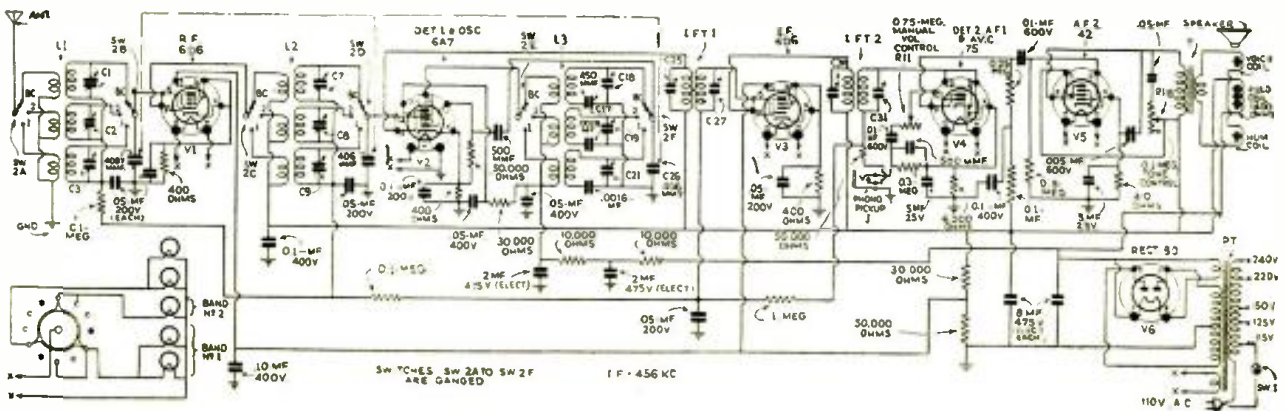

RADIO MONTH IN REVIEW

(Continued from page 393)

crusing car and headquarters, just like ordinary telephone communication.

The transmitter used in the car has a power of 15 watts.

G. F. McCLELLAND BROADCAST EXECUTIVE DEAD

Within the past month, one of the outstanding hopes for a third broadcast chain to rival the NBC and CBS faded, with the untimely death of George F. McClelland.

Mr. McClelland, formerly a vice president of the NBC and a pioneer in broadcasting had been working for almost a year on his new chain, which was expected by those in the "know" to be the most promising of the many attempts made to formulate a new national network.

As stated in our February 1934 issue, Mr. McClelland expected to tackle the problem from a logical and sound business standpoint—to avoid the pitfalls encountered by Ed Wynn and others who have tried to rival the "big two."

It is with regret that we print this notice of his death, by his own hand, when the future looked so bright for his "Broadcasting Stations Corporation."

THE LATEST IN POLICE RADIO RECEIVERS

(Continued from page 399)

front fender of the motorcycle.

The same model receiver is also supplied for use on automobiles, a special bracket permitting the clamping of the receiver onto the steering column post, making an exceedingly compact and unobtrusive installation.

Advantages claimed by the inventor include the fact that in the motorcycle model the receiver is worn on the body of the policeman, vibration being largely eliminated by the dampening effect of the body. Damage to tubes, condensers and coils often occurs in a few days on the average receiver mounted on motorcycles due to the excessive vibration. Attached to the belt with all heavy parts built onto the motorcycle, it is claimed this model eliminates most trouble of this character.

Because the receiver is self-contained and not permanently affixed to the vehicle, it is easily accessible for repairs. Naturally various receivers of the same model are interchangeable and can be used on different motorcycles at different times. This makes it possible for the motorcycle to be constantly ready for use, and avoids tying up a complete motorcycle while minor repairs are being made in a radio receiver.

The portable receiver for mounted police is similar to the other receiver model, except that it operates from a filament supply of 2 volts with a plate supply of 90 volts. The batteries for this receiver are enclosed in leather saddle bags, strapped to the saddle of the policeman.

A female plug in the front of the saddle horn permits instant connection of the receiver worn on the belt with the loudspeaker and the battery supply.

In this receiver the horse is used as antenna, a special connection to his bridle giving sure contact at all times.

The pedestrian police model uses the body of the patrolman as the aerial and requires no ground. The small loudspeaker is worn either under the lapel or under the coat of the policeman. The power supply consists of especially constructed small, light weight batteries, worn in a special belt.

The receiver weighs only 1 pound and like the other models is worn on the policeman's belt.

The five tube super-heterodyne receiver, batteries and loudspeaker together weigh less than the average police revolver worn by patrolmen, totaling an ounce or two under 3½ pounds. Only 67½ volts of plate battery are used on this model.

Master INTERCHANGEABILITY

By **TRIPLETT**

TRIPLETT interchangeable Master Units make possible different combinations of test equipment... a complete tester for every purpose. Units may be used as furnished, or placed in convenient portable cases holding one, two, three or four units. A counter case is furnished for the tube tester unit.

Triplett instruments are recognized standards. They are reliably accurate and dependable in performance. These new Master Units typify Triplett adaptability to meet every servicing requirement.

Triplett Master Test Set No. 1205

includes

VOLT-OHM-MILLIAMMETER

No. 1200

FREE-POINT TESTER No. 1220

ALL-WAVE SIGNAL GENERATOR

No. 1230

TUBE TESTER No. 1210

Complete in Portable Case No. 1204

Dealer's net price

\$71.33

One Unit Portable Case No. 1201
Takes Any Master Line Unit. Case only—Dealer's net price \$1.00

Two Unit Portable Case No. 1202
Takes Any Two Master Line Units. Case only—Dealer's net price \$1.67

Four Unit Portable Case No. 1204
Case only—Dealer's net price \$6.00

Slant Top Oak Counter Case No. 1211

for TUBE TESTER No. 1210. Case only—Dealer's net price \$4.00

Three Unit Portable Case No. 1203
Takes Any Three Master Line Units. Case only, Dealer's net price \$5.33

No. 1200 VOLT-OHM-MILLIAMMETER. Exclusive Triplett double AC and DC filling instrument, readable from any angle. NO TESTER IS MODERN WITHOUT THIS FEATURE. Reads AC and DC up to 1000 volts, 250 DC milliamperes, 3 megohms. Gives output measurement. DC millimeter has 2000 ohms per volt resistance. Dealer's net price **\$21.67**

No. 1210 TUBE TESTER. GOOD and BAD Scale. Life voltage control. Tests all inter-element shorts. Tests degree of leakages. Provides separate tests for diodes. Easily operated. Dealer's net price **\$20.00**

No. 1220 FREE-POINT TESTER, used with No. 1200 to analyze radio sets. Tests voltages, currents, resistances, continuity, capacity from point-to-point. Complete with plug socket connections and lead wires. Dealer's net price **\$8.33**

No. 1230 ALL-WAVE SIGNAL GENERATOR. Supplies continuously variable signal, frequencies from 100 Kc to 18 Megacycles, either modulated or unmodulated. Furnished with batteries and two Type 30 tubes, connecting wires and six graphs on large size charts. Dealer's net price **\$15.33**

The Triplett Electrical Instrument Co. 
103 Main St. Bluffton, Ohio, U. S. A.

Write for FREE Literature

The Triplett Electrical Instrument Co.
103 Main St., Bluffton, Ohio

Please send me details on the new Triplett Master Line Radio Testing Instruments.

Address

Name

City..... State.....

Please Say That You Saw It in RADIO-CRAFT

KENYON

PRODUCTS

Power and Economy—

A Public Address System capable of delivering 18 watts of undistorted output power.

Primary Features Are:

- * Amplifier system possesses a gain of 80 db.
- * Delivers 18 watts with only 5% total harmonic distortion
- * Input from 200 ohms, 500 ohms or a double-button carbon microphone
- * Output impedance of 4 or 8 ohms
- * Total power consumption is less than 100 watts



AUDIO AMPLIFIER Illustrations to and left show the Audio Amplifier with the chassis exposed and completely enclosed in its crackled case. The tubes employed in this amplifier are: 2-77; 2-45.

Extremely Versatile For All Sound Installations

Can be used for permanent installation or for mobile sound truck. It can be equipped with straps to make it adaptable for portable public address work when necessary. Total weight is approximately 20 pounds.

Complete in Kit Form

- No. 11 Transformer Kit..... **\$23.50** List
- No. 11 Accessory Kit..... **33.00** List

Write today, addressing Dept. RC, for complete literature on KENYON Transformers and other essential radio accessories. Mention your dealer's name.

KENYON TRANSFORMER CO., Inc.
840 Barry St. New York, N. Y.



POWER AMPLIFIER

The illustration just above and at the right shows the Power Amplifier with chassis exposed and also enclosed in its crackled case. Tubes used in the Power Amplifier are: 1-3; 1-82.



HOW TO BUILD THE "4-IN-2" SHORT-WAVE ELECTRIC SET

(Continued from page 398)

of a tandem 140 mmf. condenser gang, one section of which is constantly in the tuning circuit—the other section inserted at will (in parallel, to increase the total effective tuning capacity) from the front panel by means of a toggle switch mounted as shown in Fig. A. Thus, not only does this feature facilitate a wider tuning frequency range, but should the constructor desire to use this set for regular broadcast reception (using a broadcast plug-in coil from which a few secondary turns are removed) he will find that the operation is much more highly efficient and satisfactory. This may be attributed, in engineering parlance, to an "improved" L/C ratio.

The unusual sensitivity and volume obtained from this set can be attributed to circuit design, and the successful manipulation of the regeneration control which will permit obtaining the maximum possible sensitivity.

Circuit Design

Referring to Fig. 1 it will be noted that the two tubes employed are the new "multi-purpose" types 6F7 and 12A7. The 6F7 tube really comprises two tubes in one glass envelope, a pentode and a triode. In this receiver the pentode section is employed as the detector, with regeneration, and the triode section as the first audio stage. Thus, two-tube efficiency is obtained from this single tube. The 12A7 also comprises two tubes in one glass envelope, but the type of operation and arrangement of the elements within the tube are entirely different. Here we find a power pentode (whose characteristics are identical with the 38 power tube) and a half-wave rectifier all in one unit. By utilizing the power pentode section of this tube as the final power audio stage, and the half-wave rectifier for rectifying the alternating current, when it is operated from A.C. (on D.C. the direct current continuously passes through the tube) we obtain two-tube efficiency from this single tube. The net total, as a result of this arrangement, is a full four-tube efficiency from two tubes. No reflexing or other tricks, just a straightforward regenerative detector followed by two stages of resistance-coupled audio amplification, the final stage being a power audio, and a rectifier for "B" supply—all from two tubes.

The heaters of these two tubes are wired in series, thus requiring a filament voltage of 18 V. and a current of 0.6 of an ampere (or 600 ma.). This is obtained from the power line by means of a series resistor (325 ohms), or a power cord in which this value of resistance is included. No power transformer, or any other transformer whatsoever, is employed. The 110 V. supply—A.C. or D.C.—is fed directly to the half-wave rectifier section of the 12A7 tube. The efficiency of this rectifier is such that the voltage drop through it may be considered as being almost negligible. Since resistance coupling is used in the audio stages, no audio transformers are necessary.

Two low-resistance power chokes (only 100 ohms resistance, approx., each) are employed in the filter section. This design, coupled to the use of three electrolytic condensers, completes the filtering arrangement, as shown in Fig. 1, and has been found more than sufficient to remove any trace of ripple or hum.

Regeneration is obtained by inductive coupling of the "plate" winding to the secondary or "grid" winding. It is controlled, however, by a midget 140 mmf. variable condenser (mounted under the sub-base, as shown in Fig. C) which regulates the amount of R.F. energy existing in the plate circuit. Regeneration may also be controlled by the volume control, which is shunted across the plate coil and thus serves as a controlled short-circuiting device to regulate volume or regeneration. For broadcast reception this control will be found considerably more effective for regeneration regulation. It is recommended that the single variable condenser be used on short-waves for this purpose, and left at maximum capacity for the broadcast band in which case the volume control is used in its stead.

It is felt that it is more or less superfluous to give specific dimensions and layout drawings, since the impression left with the constructors

**THE WORLD'S
MOST COMPLETE
CONDENSER LINE**

FOR

SERVICEMEN AMATEURS and EXPERIMENTERS

PAPER • MICA • OIL • ELECTROLYTIC

Backed by *twenty-five* years of scientific research and quality production. One billion since 1910. Available at all leading suppliers. Use a C-D the next time.

WRITE
FOR OUR
CATALOG
TODAY

CORNELL-DUBILIER

CORPORATION
4347 BRONX BOULEVARD
NEW YORK

Bargain Bulletin
RADIO CIRCULAR

BIG
NEW ISSUE
JUST OUT

SEND FOR THIS

FREE

CATALOG

Check full of BARGAINS in RADIO SETS, Loud and Short Wave Apparatus, Servicemen's Repair and Replacement Parts, Electrical Appliances and hundreds of miscellaneous specialties at TREMENDOUS SAVINGS. Get this big new Bargain Book. It's absolutely FREE without obligation—just send us your Name and Address on a post card.

WRITE FOR YOUR COPY NOW.

25c

Postage Stamps for your copy of the SHORT WAVE COIL BOOK. Sent to you prepaid.

JUST OFF THE PRESS

RADIO CIRCULAR CO., INC.
225 RC VARICK ST., NEW YORK

SHORT-WAVE SET BUILDERS NEED THIS BOOK

Every experimenter who has ever tried to build a short wave set knows by experience, the difference between a good and a poor receiver is usually found in the short wave coils. Often you have to hunt through magazines, books, etc., to find the information you require. The present book has been gotten up to obviate these difficulties.

In this book you find every possible bit of information on coil winding. Only the most modern "dope" has been published.

Illustrations show, giving not only full instructions on how to wind coils, but dimensions, size of wire, curves, how to plot them, by means of which any coil for any particular short wave set can be figured in advance, as to number of turns, size of wire, spacing, etc. There has never been such data published in such easy accessible form as this.

RADIO PUBLICATIONS, 101C Hudson St., New York, N. Y.

Please Say That You Saw It in RADIO-CRAFT

is then that this phase of building a receiver is rather critical and therefore must be followed precisely. This idea, in this case, is farthest from the truth, inasmuch as only two tubes are employed in a space that is ample for constructors to arrange the necessary parts as they see fit. For convenience sake, those who desire to imitate the original as closely as possible may consult the photographs showing different views of the receiver in Fig. A, B and C. As mentioned previously, neither circuit nor layout is at all critical, and any moderate deviation is entirely permissible.

List of Parts

Due to the simplicity and excellent choice of tubes in a carefully arranged circuit, the parts necessary are surprisingly few and low in cost. They are as follows:

- One Hammarlund tandem, dual-section, 140 mmf. (each) variable condenser gang;
- One complete set of plug-in coils (5. with broadcast coil, 4 only for complete short-wave coverage);
- One single Hammarlund midget variable condenser, 140 mmf.;
- Two General Transformer chokes, 30 hy., 100 ohms each;
- One Hammarlund R.F. choke, 85 mhy.;
- Two Cornell-Dubilier electrolytic condensers, 16 mf., 200 V.;
- One Cornell-Dubilier electrolytic condenser, 8 mf., 220 V.;
- Two 7 prong wafer sockets (small) for 12A7 and 6F7 tubes;
- One 4 prong wafer socket for plug-in coils;
- One I.R.C. resistor, 1,500 ohms, 1 W.;
- One I.R.C. resistor, .1-meg., 1 W.;
- Two I.R.C. resistors, .25-meg., 1 W.;
- One I.R.C. resistor, .5-meg., 1 W.;
- One I.R.C. resistor, 750 ohms, 1 W.;
- One I.R.C. resistor, 2 meg., 1 W.;
- One special (wire-wound) resistor, 325 ohms, 40 W. size, or power cord with equivalent;
- Two S.P.S.T. toggle switches;
- One Electrad volume control, 75,000 ohms;
- Two Cornell-Dubilier tubular condensers, .1-mf., 400 V.;
- Two Cornell-Dubilier tubular condensers, .006 mf., 400 V.;
- One Cornell-Dubilier mica condenser, .001-mf.;
- One Cornell-Dubilier electrolytic condenser, 10 mf., 25 V.;
- One Insuline antenna trimmer condenser;
- One drilled sub-base and panel unit (as shown in illustrations);
- One Sylvania type 12A7 tube;
- One Sylvania type 6F7 tube;
- Miscellaneous supplies, such as wire, hardware, vernier dial, etc.

Conclusion

This receiver, if wired carefully and as per Fig. 1, should operate to the complete satisfaction of any constructor. The adjustment of the antenna trimmer condenser may be rather critical if an antenna system of relatively long dimensions is employed. For best results use a short overhead wire (about 35 ft.) placed as high as possible.

To those who encounter any difficulties in the construction of this set, or who find the results not up to par, or desire any further particulars relative to this set, the writer will be glad to give any desired information, and will welcome queries.

ORSMA—MEMBERS' FORUM

(Continued from page 417)

by means of the double-pole double-throw switch shown, to measure voltage from an exterior source, or by throwing over the switch, secure power through the meter for testing condensers' continuity, etc. The same power unit furnishing voltage for this use supplies voltage for battery sets, and "pre-heater" voltage, sockets for which are also provided. Two oscillators are used with the work. Note also, a graduated resistor (lower right) for trial use where resistance is unknown.

J. B. MCGIRT.

This is a very interesting installation, Mr. McGirt, and we feel sure that some of the members will profit by your design.

INFORMATION BUREAU

(Continued from page 420)

principal question is whether their signals may be construed to be in interstate commerce, and if so they come under the Radio Act of 1927.

"The Radio Act itself does not include the reception of signals and, therefore, the commission has made no regulations with reference to receiving sets. It is understood that some states have passed laws pertaining to this matter but the Commission has no record of these."

The above clearly outlines the question of the legal status of wired radio operation, as first raised in a letter received from another department of the Federal Radio Commission—Division of Field Operations, Dallas, Texas—from which we quote, as follows:

"Your attention is called to the fact that the proposed apparatus" ("A Wired-Radio Public Address System," RADIO-CRAFT, November 1933, page 272) consists of a simple radio transmitter coupled to the unshielded general lighting system of the city, in which the shielded wires within the building act only as a transmission system to the open wire leading away, from which radiation will occur.

"Several of these 'wired wireless systems' have been constructed, and put into use in this district, and a number of people have gotten into trouble as a result of the inspiration furnished by this article in your magazine.

"It is suggested that you advise Mr. Freeling" (the author of the article) "to investigate the radiating ability of his system when connected to a house wiring system having unshielded wires leading away from it, and to warn your readers of the danger connected with the use of this system."

Unfortunately, it was not clearly brought out, in the article, that interference radiation is prevented by the correct use of R.F. chokes placed in the power line. If the building is entirely of metal construction, it ordinarily is sufficient to place these R.F. chokes at the main power switch, where the power lines enter the building. If the building is of frame construction, it may be necessary to place the chokes on the individual floor level on which the equipment is to be used, and to limit the radiation by controlling the amount of R.F. energy delivered by the transmitter.

The extreme importance that attaches to this procedure is evident by reference to the case of Norman Cohen of Bridgeport, Conn., who, in operating a "wired radio station," was convicted of operation of a broadcasting station without a license from the Federal Commission. Defendant Cohen claimed his broadcasts were carried only on the wires of a Bridgeport power company, but Government witnesses said they were able to hear his programs without any hook-up with the lighting company's lines.

Actually, the facts of the case were approximately as follows, according to the recollections of Assistant U.S. Attorney George H. Cohen:

"Cohen was charged in an indictment containing two counts, the first charging him with operating a radio station without obtaining a radio station license, and second—with operating a radio station without having a radio operator's license. He was found 'guilty' on both counts after a trial by Jury.

"The testimony showed that in spite of the fact that Cohen was attempting to send his programs through the wires of the United Illuminating Company, radio signals were picked up on radio receivers which were not connected with the electric wires, and furthermore such signals were picked up by similar sets in Long Island, across State lines.

"Cohen's experts attempted to prove that it is possible to send radio signals through wires and confine these signals to the wires, but this was disproved by Government experts, particularly when the signals are of the strength of a very large number of kilocycles" (apparently, the wording should have been, "when the signals are of the frequency of a very large number of kilocycles"). "In this case, as I recall it, the signals were in the 1,300 kc. band.

"The Jury, in other words, found that Cohen was in effect running a radio station as the radio waves were passing through the air outside the wires and were crossing State lines."

It is possible that the new Federal Communications Commission will be a little more lenient than the past Commission, in permitting experimental transmissions.

Shhh! Shhh!

QUIET

Please!



Individually TESTED for NOISE

ELECTRAD
Quiet
VOLUME CONTROL



Standard Replacement Unit with Power-switch attached

REVOLUTIONARY in its operating mechanism, Electrad's new *Guaranteed Quiet* Volume Control fills a long-felt want. Absolute quiet, smooth, positive control of volume is accomplished for the first time in radio history.

Built on a Radically New Engineering Principle



Resistance element baked on flat outer rim of Bakelite ring



Floating contact shoe slides over resistance element in straight path

More even distribution of current, smoother control and longer life are attained with this construction. Molded Bakelite case, when mounted, projects only one-half inch behind panel. New Type power-switch (*approved by underwriters*) instantly attachable. Long aluminum shaft—easily cut. All standard replacement values. Mail coupon for descriptive folder.

from
RESISTOR
Headquarters



ELECTRAD

1935 CATALOG

Electrad, Inc.
175 Varick St.,
New York, N. Y.

Please send new 1935 Resistor Catalog. Check here for folder on new QUIET Volume Control.

Name.....
Address.....

RC--1

Please Say That You Saw It in RADIO-CRAFT



**Announcing
a 50 WATT
P.A. AMPLIFIER**

BIG NEWS FROM COLUMBIA

Something New and Exciting in P. A. Amplifiers
 Equipped with a broadcast type Four Position Mixer, High-Gain Pre-Amplifier, High-Fidelity Voltage Amplifier and Phase Inverter, as well as a High-Powered Broad-Band Power Amplifier—five stages—all contained within one compact chassis! Operates from 110 or 220 volts AC or from a 6 volt storage battery. Write for low net prices and free pamphlet "What's New in Public Address Amplifiers."

Ideal For All Sound Truck Installations!
 Can be used directly with all microphones—carbon, crystal, condenser, dynamic and ribbon (velocity) types!
 Write stating your prospects problem. Give full particulars. Our design engineer, Mr. Charles R. Shaw, will personally recommend the best type of sound system to employ and supply free diagrams, cost estimates, etc. Get our estimate before you buy.



free →

COLUMBIA SOUND SYSTEM CO.

135 A LIBERTY ST. NEW YORK CITY

INTERNATIONAL RADIO REVIEW

(Continued from page 409)

further in the device shown at Fig. E, which is a complete tuner. This method of tuning eliminates the usual gang condenser as tuning is accomplished by moving the high permeability core with respect to the inductances, thus increasing or decreasing the effective inductance. It is claimed that this tuner has constant selectivity over the entire wave band covered. Different types are available for T.R.F. sets and superhets. In the latter type, a slightly differently shaped section of the gang control provides the necessary difference in oscillator tuning.

A PIEZO-ELECTRIC MIKE

ROCHELLE salt crystals have found many applications in radio and associated fields. One of the numerous fields of applications, which promises to become quite fertile, is that of microphones.

Several types have been developed in recent months, but one of the most intriguing, in design, that we have ever seen was described in an English magazine—WIRELESS WORLD.

As shown in Fig. F, it consists of a large number of individual crystals of special design, which produces not only a large output but also prevents resonance effects over the audible spectrum. It is claimed that a variation of less than 1 db. is experienced between the lower limit of audibility and 10,000 cycles. The individual crystals are made in a unique manner as shown in the sketch Fig. F. A bakelite frame supports two very thin cut crystals which are varnished in the usual manner to prevent absorption of water. The sound is impinged on the edge of the crystal units to reduce resonance effects to a minimum.

A HIGH-FREQUENCY CUPROUS OXIDE RECTIFIER

A NEW cuprous oxide crystal which has a sufficiently low internal capacity to permit it to rectify efficiently on frequencies as high as 1500 kc. (or over the entire broadcast band) has just been introduced under the trade name of Sirutor. This new device was described in a late issue of RAFA, a German publication. The device is about 1 1/4 ins. long by 5/16-in. in diameter and will carry a current of .25 ma. continuously, without any ill effects. These metal rectifiers are finding much favor in European sets, where they are used for replacing diode tubes. A.V.C. controls, and plate current economizers where the action is similar to class B amplification.

NEW SHORT-WAVE LINK TO BYRD

(Continued from page 399)

eral stages of vacuum tube amplification. Then they go over a telephone circuit approximately seventy miles long to New York. The voice currents are passed through the RCA control center at 24 Broad Street, New York, and then routed through the distribution switchboard to the CBS headquarters and network control switchboard at 485 Madison Avenue, New York City. Here the engineers re-route the voice from Little America over the telephone circuits reaching out like fingers across the country, as they carry the voice currents to the various broadcasting stations of the Columbia Network. One outgoing wire circuit from 485 Madison Avenue carries the Little America program twenty-five miles from New York to the powerful WABC transmitter located at Wayne, New Jersey. In the event that the programs are to be broadcast to foreign countries, via short waves, then the wire circuit to Wayne is also connected to the Columbia short-wave transmitter (located at Wayne also).

The second short-wave circuit is the direct one from Little America, and with good radio weather conditions the Riverhead station has picked up the Little America programs over 10,000 miles of space, a severe test for the

HI-FIDELITY ON SHORT WAVES

(Continued from page 397)

ance-coupled amplifiers, etc., are all employed to attain the ultimate in high-fidelity.

As a means of assuring this high standard of transmission cathode ray tube monitoring is employed exclusively. Not only that but engineers are constantly on watch checking the quality of transmission by actual reception methods. In Fig. D we see this process actually being performed. The cathode-ray tubes can be plainly seen before Mr. Alfred A. Barber, sound engineer, who is on the alert for any visible indication of distortion, in addition to checking the audible quality with a special receiver amplifier.

A special monitor board, being operated by Edward Rhoad, staff engineer, is employed for holding the volume from the studio at a constant level.

Another control panel, in which the cathode-ray tube is mounted (projecting horizontally), is employed separately for phonograph rendition as shown in Fig. E. There are 4 phonograph turntables—2 on either side of the control panel. All employ crystal-type pickups only. It is from this point that the beautiful broadcasts heard daily originate. (Note also the crystal microphone over the panel.)

Phonograph records, it should be understood, suffer from various deficiencies, and to broadcast these record programs with high quality an instrument was devised as a means of overcoming their inherent defects. A sample of the visible indication of the quality of the voice amplifier voice impulses can be seen from the screen of the cathode ray tube mounted in this panel.

The unit which performs this is shown in a close-up view in Fig. F. This particular panel controls the recording, and is so designed that provision is made for compensating any deficiencies in phonograph records only.

However, it is interesting to note that original broadcasts from the studio require no loading or tone controls (frequency compensation) of any kind. The whole system, from microphones to antenna, is so well designed in the frequency range, so wide and flat, that no compensation is necessary. Thus the listener hears a true rendition of the original program.

As a matter of fact nothing was overlooked in the design of this station. Many of the testing devices are unique, such as the tuning fork mounted on a sound chamber shown in Fig. G. This particular tuning fork has a frequency period of 250 cycles, and when tapped with a hammer a pure tone is heard through one open end of the sound box. The crystal microphone on the left of this phonograph picks up this tone and passes it on to the various amplifiers, where it is conducted through one of the laboratories making some tests. This general procedure, over the entire audio spectrum, is performed daily; this "check-up" on the equipment is made so as to insure absolute maximum efficiency.

SHORT PRODUCTS OF



WAVE RELIABILITY

Service men, Amateurs and Experimenters know that ICA stands for QUALITY. In fact upon ICA products for reliability and dependability. The list prices shown are subject to a discount of 40% when purchased thru your Jobber or favorite Mail Order House. Or send your order direct naming Jobber and we will see that you are promptly supplied.

Build Your Own Short Wave Receiver

ICA Short Wave kits are the World's easiest to build! Each comes complete with point-to-point diagrams. Like consists of 1 and 2 tube battery sets and 3, 4, and 5 tube All-Electric models. List prices \$9.95 and up. Licensed under RCA and Hazlett patents. Don't build until you see full details!

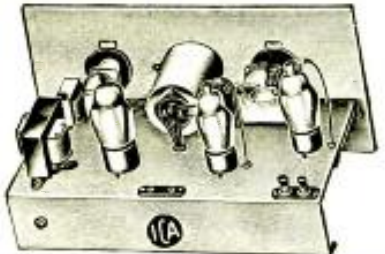

5 METER TRANSCEIVER KITS

Choice of 7 models; 2 volt, 6 volt or A.C. model. Easy to build. Made completely of RCA parts. Complete instructions, diagrams, list prices respectively:

\$19.50. \$19.25. \$19.75



BIG NEW 1935 CATALOG

Send 10c stamps or coin to cover the cost of handling and mailing Big New 1935 catalog listing hundreds of parts and accessories, as well as our complete line of receiver kits. Supply limited. Send now to avoid disappointment!

INSULINE CORP. of AMERICA
23-25 Park Place, Dept. C-15, New York, N. Y.

MEN WANTED—SELL RADIOS SPARE TIME—BIG PROFITS

Since 1921 I have sold radios through trained radio men. Not the type of "price cutting" radios generally sold in stores but radios of a quality which only radio men can appreciate.

I need more men in my organization, men who actually know radio values, because no other could ever sell my quality of radio. Give me your spare time . . . evenings, and I'll show you radios which will sell . . . with a simple demonstration.

I'll guarantee that any eight year old child can actually tune in the European stations on my \$25.50 six tube. It's one thing to tune in London but . . . quite another to tune them in as . . . easy as any local and . . . with real volume.

I make all sizes, a . . . 5 tube super at \$16.95 with 10 KC sensitivity to 12 tube radios in cabinets of 1 1/2 inch solid walnut. My line is complete, 2 volt air cell operated, 6 volt no "B" batteries, 32 volt, and in "A.C." from five to twelve tubes and all of a quality you can sell and . . . make friends.

I know the radio service man's problem. There is real money to be made if . . . you get lined up right, but it never will be with the regular lines on which prices are slashed . . . Just where you least expect. My prices are never cut.

Send for the illustrated literature and price list. You'll find both very interesting . . . write today.

J. MATHEW BELL
308-710 W. Randolph St., Chicago

Please Say That You Saw It in RADIO-CRAFT

1,000 watt phone-transmitter at Little America, the third short-wave "stand-by" link from Little America is that running northward to San Francisco, from which point the program can be transmitted to New York over a leased telephone wire circuit, or else by short waves. The fourth short-wave emergency circuit extends northward from Little America to Honolulu; the program when picked up at Honolulu is re-transmitted on short waves to San Francisco, whence the voice can travel by wire or short-wave circuit to New York.

One of the most interesting angles of the short-wave conversation carried on between Admiral Byrd and his mother a few weeks ago was the telephone circuit set-up arranged between Winchester, Virginia, and New York City, a distance of about 275 miles. Two leased telephone circuits were kept open for several weeks before conditions were considered suitable to permit this special program to be carried out, and a pretty penny it cost the sponsor for the leasing of these two complete telephone circuits to Winchester, which were kept open for test by the CBS engineers at all times.

Headphones were worn by Mrs. Byrd in her Winchester home and she had a special microphone of her own, while the second microphone served the purposes of the announcer. As the diagram shows, a local three-stage amplifier was located at Mrs. Byrd's home, and the out-going voices bound for Little America passed over one of the telephone circuits to New York. Amplifiers spaced at a distance of about every fifty miles helped to boost the voice currents as they sped on their way. The voice of Mrs. Byrd passed through the control switchboard at CBS headquarters at 485 Madison Avenue, thence down-town to the RCA control center at 21 Broad Street, out over a telephone wire circuit to the RCA 20-kilowatt short-wave transmitter located at Rocky Point. Thus, with the speed of over 186,000 miles per second, the voice of Mrs. Byrd was hurled from the little town of Winchester, Virginia, to her waiting son at Little America 10,000 miles away, thanks to the magic of short waves.

The Return Circuit

The return short-wave circuit from Little America which carried the voice of Admiral Byrd as he answered his mother's questions, is also very interesting. When the 25 meter waves carried the Admiral's voice to Buenos Aires, they passed through the transmitter and were relayed northward to Riverhead. Here the voice passed over a telephone circuit to the RCA control center in down-town New York, to 485 Madison Avenue (CBS Control Center), thence out over one of the telephone circuits going southward to Winchester, Virginia.

Mrs. Byrd could have listened to her son's voice on a regular broadcast receiver and loud-speaker, picking the voice up on a broadcast wave from either the New York WABC station or from a Washington station; but the headphones and private receiving circuits from New York to Winchester were considered a more reliable and positive way of solving the problem. As with the transmitter telephone circuit, the receiving circuit also passed through the V. T. amplifiers in the exchanges at New York, located approximately fifty miles apart on the way from New York to Virginia, which served to boost the voice at regular intervals as it raced over the 275 mile circuit.

It is interesting to note that the facilities of the RCA receiving and transmitting stations at Riverhead and Rocky Point, Long Island, which distributed these programs through the RCA Control Center at Broad Street, comprise a service available to anyone who wishes to use it on a regular fee basis. Admiral Byrd at Little America has several code or C.W. transmitters at his command but the most powerful phone transmitter is a 1 kilowatt unit used for this and another weekly broadcast.

Radio code messages are exchanged daily between Little America and New York and other points, two-way code communications being carried on regularly and practically all the time. During the special Wednesday evening Little America broadcast programs conducted over the CBS network, the "cuing" circuit used by the engineers and announcers is that taking place via the RCA 20 kw. short-wave transmitter at Rocky Point, and this transmitting link with Little America has permitted some extremely interesting two-way "interviews" to be carried on during the program, much to the delight of the radio audience.

AN IMPROVED 6-TUBE ALL-WAVE SET

(Continued from page 401)

superior that no question as to the superiority of this set remained. The controlled regeneration action, which enables the listener to bring a receiver up to its maximum point of efficiency, was the attributable factor for such remarkable performance.

Let us examine the circuit. One 58 tube as regenerative T.R.F., one 58 tube as buffer, one 58 tube as regenerative detector, one 56 tube as first A.F., one 2A5 tube as output A.F., and one 80 tube as rectifier. Each tube performs a single purpose and therefore does it most efficiently.

Mechanical Features

Aside from its improved circuit characteristics this receiver incorporates other notable features. Of primary importance is that of front panel plug-in coils. A glance at Figs. A and B will indicate the convenient method of changing the coils so that the wave-band desired may be covered. This type of construction not only features complete accessibility to the coils, but also keeps the coils effectively shielded, which adds considerably in obtaining stability and selectivity. The coils employed are of the 6-prong type and consist of 3 windings on each. These are mainly the primary (enameled winding), feed-back or tickler coil (enameled wound), and a silver plated, space-wound secondary winding. These coils contribute in no small way to the selectivity characteristic of the receiver; also to the sensitivity on short-waves because of extremely good high-frequency characteristics.

A special dual ratio (60-1 and 8-1) airplane dial permits careful tuning, which is extremely essential for good short-wave reception.

The power supply is so designed that practically zero hum level is encountered. A built-in tunable hum filter, see Fig. 1, is directly responsible for this.

List of Parts

- One Alan set of 6-prong special front plug-in coils;
- Three H.F. chokes, grid-leak style;
- One audio impedance, 625 hy.;
- One Alan filter choke, 30 hy., 1,200 ohms, CH39;
- One power transformer, 2.5 V. 7 amp., 5 V. 2 amp., 700 V. center-tap;
- Two Electrad 50,000 ohm potentiometers (one with switch);
- Two I.R.C. carbon pigtail resistors, 425 ohms, 1 W.;
- Three I.R.C. carbon pigtail resistors, 120,000 ohms, 1 W.;
- One I.R.C. carbon pigtail resistor, 5 meg., 1 W.;
- Three I.R.C. carbon pigtail resistor, 0.2-meg., 1 W.;
- One I.R.C. carbon pigtail resistor, 2,500 ohms, 1 W.;
- One I.R.C. carbon pigtail resistor, 60,000 ohms, 1 W.;
- Eight Cornell-Dubilier or Aerovox tubular condensers, .01-mf.;
- Two Cornell-Dubilier or Aerovox mica pigtail condensers, 220 mmf.;
- One Cornell-Dubilier or Aerovox condenser, 350 mmf.;
- One Cornell-Dubilier or Aerovox condenser, 150 mmf.;
- One 2-rang variable condenser with planetary drive, 115 mmf. (each section);
- Two Cornell-Dubilier or Aerovox electrolytic tubular condensers, 10 mf., 35 V.;
- One Cornell-Dubilier or Aerovox tubular condenser, .5-mf.;
- One Cornell-Dubilier or Aerovox electrolytic condenser, block, 8 mf., 8 mf., 12 mf., 500 V.;
- One antenna trimmer condenser, 45 mmf. maximum capacity;
- Three 58 wafer sockets;
- One 56 wafer socket;
- One 2A5 wafer socket;
- One 80 wafer socket;
- One dynamic speaker (2,500 ohm field);
- One "Ant." and "Grid" terminal strip;
- Three wiring terminal strips;
- One phone jack, double-circuit;
- One Alan drilled and formed chassis;
- Two Alan special coil and tube compartments;
- One Alan special dial mechanism;
- One Alan metal cabinet with hinged cover.

Please Say That You Saw It in RADIO-CRAFT

LATEST TECHNICAL INFORMATION....

YOURS FOR 10c



Now available. A convenient 104-page Manual containing essential information users must have to get optimum performances from any device using vacuum tubes.

Complete data on over 90 receiving tubes. Base Symbols. Recommended Operating conditions, circuit applications, amplifier classifications. Over 150 cuts and diagrams. Represents months of painstaking research by Sylvania's famous technical staff.

This Manual is as necessary as your voltmeter. Just fill in the coupon, attach 10c in stamps and mail.

YOURS! for 10c in STAMPS

HYGRADE SYLVANIA CORPORATION

Makers of SYLVANIA TUBES, HYGRADE LAMPS, ELECTRONIC PRODUCTS
 Factories ST. MARY'S, PA., EMPORIUM, PA., SALEM, MASS., CLIFTON, N. J.



10c- TECHNICAL MANUAL -10c

Hygrade Sylvania Corporation, Emporium, Pennsylvania. (B-18)
 Please send me the new Sylvania Technical Manual. I enclose 10 cents in stamps.

Name

Address

City State

The **TOBE** CONDENSER ANALYZER
Greatly simplifies
Radio Service!



The TOBE CONDENSER ANALYZER instantly indicates if condensers of any type—paper, mica, oil, electrolytic—of any capacity from .00005 to 100 mfd—have low dielectric resistance and high current leakage and will soon break down or become "open"; are operating intermittently (loose internal connections) or if they are "open" or "shorted."

Thousands of servicemen are now using this new instrument.

110 volt, 60 cycle Model
Only \$11.40 Net

Stocked by leading parts jobbers everywhere. Available in 25 cycle, and 220 volt Models. Send for complete description

Tobe Deutschmann Corporation
CANTON, MASSACHUSETTS

Truly a Pioneer!

This modern all-wave receiver features every conceivable improvement known in radio today—it is a receiver that you will be proud to own.

The "MJ" receiver for the truly critical listener!



There is no finer all-wave receiver built today!

Write for Complete Details on this Modern All-Wave Receiver

Pioneer Sound Laboratory
135 Liberty St., New York, N.Y.

Stop Guessing!

Radio service is easy when you know just where to look for the troubles. And, the securing of profitable fees for the repairs makes the work still more attractive. A CHUCKKER eliminates guess-work in "What is Wrong and What to Charge." This trouble-localizer, with a really profitable repair-order schedule included, enables radio men to localize any trouble in any radio, quickly, right in the field, without dismantling the radio. It looks official, and permits you easily to convince set-owners that you are not guessing at either the trouble or the price of the repair job. Your competitor makes good money by using a CHUCKKER! Send \$1.00 NOW for yours, postpaid. Also, ask how you might secure Weston testing equipment FREE for answering one simple question.

FREED'S RADIO CO.
Publishing Division R
5053 Baltimore Ave. Philadelphia, Pa.

LEARN RADIO

200 Graduates Placed in the Last Three years
At the oldest, largest and best equipped privately owned radio operating school in the East. Western Electric and RCA tube transmitters; 200 licensed graduates placed in past three years in broadcasting, shipping, police radio, aviation, service work, etc. Course prepares for all U.S. Government Telegraph and Telephone licenses. Send for 40-page catalog. Investigate. New classes every six weeks from Sept. 10th. Open all year around.
MASS. RADIO SCHOOL 18 Boylston St., BOSTON
R. F. Trop, Treas.—EST. 1899—G. R. Entwistle, Pres.
One of America's leading Radio Schools

Spain, 795 kc.; London-Regional on 877 kc.; West Regional 977 kc.; Bordeaux-Lafayette, France on 1077 kc. All of these are being heard from 5:30-7 P.M. E.S.T. Toulouse, France, was so loud I could hear it on a three-foot piece of wire for an antenna, from 6 to 6:30 P.M. The TP's (Trans-Pacifics) are astonishing, as every morning from 4:45-5:30 P.M. I am able to tune in 15 or more. JOIK, Tokyo on 830 kc. is the only Japanese station I have heard so far."

—Short Waves—

Don H. Townsend, Fallon, Nev., sends us the following valuable data on the Japanese short-wave transmitters. "The S.W. stations of Japan who are relaying the Japanese Broadcasting System's programs are JVM, Nagasaki, 10740 kc.; JVR Nagasaki, 7390 kc.; JVT 6750 kc.; and JYT 15760 kc. in Kemikawa. The schedule observed in E.S.T. is—4:00 A.M. Children's Hour, 4:25 A.M. talks in Japanese, 4:55 A.M. news in English, 5:00 A.M. news in Japanese, 5:30 A.M. variety program (talks and music), 7:30 A.M. time signals and news, 7:45 A.M. sign off." (At the time of compiling this article JVT could be heard each morning with good signal strength—Ed.) "TIEP, La Voz del Tropic, San Jose, Costa Rica operates on 6710 kc., and 850 kc. The owner Eduardo Pinto Hernandez also operates amateur station T12EP on 7238 kc. These stations are both members of the newly-formed "Latin American Chain of Radiobroadcasting Stations."

The Gist of the News
Broadcast Band

The following Japanese broadcast stations will increase power during 1935-1936. JOAK-1, Tokyo, 870 kc., from 10 to 150 kw. JOGK, Kumamoto, Japan, 790 kc., from 10 kw. to 100 kw. JOBK-1, of Osaka, Japan, on 750 kc. will increase from 10 to 100 kw. JOSK, Kokura, Japan, on 835 kc., from 1 to 10 kw. These fine super-power transmitters will definitely place Japan in the vanguard of the international race for super power. Beromunster, Switzerland, on 556 kc., has increased power from 60 to 100 kw. East coast DX'ers should be able to get this station nicely. New Newfoundland frequencies are as follows: VOWR at St. Johns, 681 kc., 500w. VOGY, at St. Johns, 845 kc., 400w. VOAS, St. Johns, 945 kc., 100w. VONF, St. Johns, 960 kc., with 5000 watts.

Short Waves

That popular radio station PHI, at Huizen, Holland, is now back on their winter wavelength of 25.57m.-11730 kc. Radio ROMA 12RO on 25.40m.-11810 kc., which has been making extensive repairs and improvements in their transmitter will be back on the air with greatly increased power and a full Empire service using directional antenna array about the first of the new year. They will transmit different programs daily to the various continents. RNE, Moscow, U.S.S.R., on 25m.-12000 kc., and RKI on 39.87m.-7520 kc., are being well heard again with their transmissions for NBC rebroadcast in this country. At the present writing the NBC rebroadcasts RNE-RKI on Saturdays at 11:30 to 12 noon E.S.T. and Sundays from 9:30-10 A.M. E.S.T. PRADO of Rio Bamba, Ecuador, have abandoned their popular Sunday afternoon concerts on 19 meters until next spring when the band begins to show a little life again at this time of day. XEBT, Mexico City, have a habit of camping almost right on top of DJC, Zeesen, Germany, on 49.80 meters, although XEBT is supposed to be on 49.92 meters. A new station being heard early each morning on about 6100 kc., with only Dutch being spoken and typical Asiatic music, is believed to be the new short-wave station YDA, at Bandoeng, Java. They seem to sign off at about 8 A.M. E.S.T. Senor Pompilio Sanchez states that the schedule of HJ2ABA at Tunja, Colombia, on 6150 kc.-48.78 meters, is Tuesdays, Thursdays, and Saturdays from 6 to 9 P.M. E.S.T.

Radio-Craft Awards

Each month a prize of a year subscription to RADIO-CRAFT will be awarded to the DX'er who sends in the best ten foreign verifications. (Verifications for stations on same continent as DX'er will not be considered.) Award will be announced in the successive issue of this publication. All verifications should include self-addressed envelope and return postage, to insure their return. Address DX Editor, RADIO-CRAFT, 99 Hudson St., New York City.

Ideal for Original
or Replacement
Construction

HAMMARLUND
Air-Tuned
INTERMEDIATE
TRANSFORMERS

MAXIMUM efficiency of superheterodyne circuits depends more on the I.F. Transformers than any other factors.

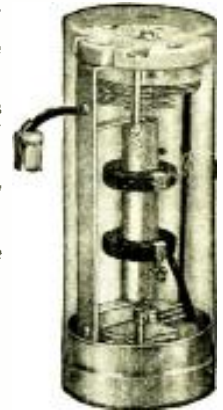

The HAMMARLUND Air-Tuned TRANSFORMERS have proved their mettle in the famous COMET "PRO" Receiver. They are equally well adapted to other high-grade circuits, or for replacement purposes.

The coils are Litz-wound and are tuned by AIR-DIELECTRIC, Isolantite-insulated condensers. This feature assures peak I.F. selectivity and a gain of 200 per stage. They are unaffected by temperature vibration, or humidity.

Midget R.F. CHOKES



The HAMMARLUND Midget R.F. CHOKES are the smallest and lightest ever devised. Inexpensive, they may be used wherever R.F. filtering is desirable. Inductance, 2.1 mh. Five impregnated pies on Isolantite core. Tinned copper leads ample for support. Choke size: 1/2 in. x 1 1/2 in.

HAMMARLUND MANUFACTURING CO.,
424-438 W. 33rd St., New York.



— Check here and attach 10c for 16-page Hammarlund 1935 Short-Wave Manual, illustrating and describing most popular S-W circuits of past year, with schematic and picture diagrams and parts lists.

— Check here for FREE information on Chokes and Transformers.

— Check here for FREE General Catalog.

Name

Address

RC-1



Please Say That You Saw It in RADIO-CRAFT

"Here's more fan mail Mr. C!"

"Since using your control I feel like a new radio. . . . 'never performed better in my life,' writes another. . . . thousands of old, worn out, tired radios are being rejuvenated by alert servicemen with a small stock of CENTRALAB replacement units.

The new patented RADIOHM

The Sturdy Fixed RESISTOR

Every Radio Service Man should be a member of the Institute of Radio Service Men

Centralab

RADIOHMS—RESISTORS
(Division of)
GLOBE UNION MFG. CO.
MILWAUKEE

ELEMENTS OF 4TH DIMENSION SOUND SYSTEMS

(Continued from page 407)

ears. The amplifiers will of course, be of the high-fidelity type while the speakers will operate with performance characteristics identical to those of the original sound producing devices.

Second, we have "spatial relationship"—which appears to be the stumbling block for perfect artificial sound. Although Dr. Harvey Fletcher (of the Bell Telephone Laboratories) succeeded in closely approaching exact spatial relationships of the original and reproduced sounds with a tri-dimensional system, the "last word" will not have occurred in the recreation of sound, which completely fulfills the requirements for perfect illusion, until a fourth dimension is taken into consideration.

Before we delve into the elements of artificially recreated fourth dimensional sounds, let us briefly analyze our own hearing sense so that we can use it as a standard of comparison. For, without such a "yardstick" it would be difficult for us to realize how far we actually are from the goal of perfection. Then again, if we understand how people normally react to natural sounds, (which, strange as it may seem, continuously occur in a fourth dimensional world) we can easily grasp the elementary spatial principles and conditions involved in our everyday hearing, and possibly find it a relatively simple matter to duplicate in an artificial system.

Our Directional Hearing Sense

Our first bit of investigation, therefore, involves itself with the mechanism of hearing—particularly the spatial localization of stationary and moving sound sources.

When we normally localize a natural source of sound in space we subconsciously make three measurements; first, we estimate its horizontal angular displacement (Fig. 1A) which indicates how much to one side the sound is coming from; then we estimate its vertical angular displacement (Fig. 1B) which tells us whether the sound is coming from above or below; and finally we judge its distance (Fig. 1C). When the sound source is moving, we make an additional fourth measurement in order to approximate its direction and speed of motion. The accuracy with which we localize a sound depends upon a number of factors, among which are; familiarity with the sound, tilt of the head, and ability to see the source of sound. The important part played by these secondary hearing-aids account in a large measure for the manner in which the brain deceives the interpretive hearing centers by supplying the missing directive properties of sound. Because we become accustomed to this deception, we frequently remain unaware of the handicaps characteristic of single dimensional sound reproducing systems. The directive "hearing" aid offered by the eyes can easily be checked the next time you view a "talkie." Note how easily you recognize unusual sounds—and locate them, because you see the apparent source of sound. Now close your eyes and you will be surprised to find how difficult it becomes to localize the shot of pistol, the clicking of a typewriter, the approach of an automobile or the movement of an actor from one side of the screen to the other. In fact, unless the theatre is equipped with a fourth dimensional sound system, it will be impossible to localize any sound whatsoever that would correspond to natural localization as would occur if you were at the actual scene while the picture was taken.

How We Judge Direction

A casual study of Fig. 2 shows the elements involved in normal binaural hearing of a single stationary sound source in free space. (For simplicity sake, we will limit our discussion to direct sound waves and not the reflected or reverberant waves because the former are far more important in the localization of sound sources than the latter. Any system which can recreate direct sound waves in their natural spatial relations will automatically reproduce reflected and reverberant sound waves identical with those of the original rendition if the acoustics of both the localities involved are identical.)

If the source of sound is directly in front of the listener, the axis of the sound waves (RX and LX Fig. 2) are of equal length. Sound will therefore reach both ears at the same time

(in phase) and with equal intensity. These waves are converted into nerve impulses, by the inner ear, and sent along their respective nerve fibers to their individual centers of hearing located within the brain. The interpretive center then compares the pattern in each hearing center (with respect to phase and intensity) and gauges the *direction* and *distance* of the sound, basing its judgment solely upon previous hearing experiences with that sound. In this particular instance, as there is no difference in phase or intensity, the source of sound is localized in the median plane that is directly in front or behind the listener (Fig. 1A). It should be borne in mind from the foregoing illustration, that in order to naturally localize a sound, a complete circuit (acousto-physiological) must be completed between the source of sound and the interpretive center through both ears and their respective hearing centers (Fig. 2A).

The First Dimension: Distance

If a source of sound (Fig. 3A) is kept in a horizontal plane level with the ears, but moved in the median plane to and from the listener, a sensation of distance will be noted as only the intensity of the sound wave, but not the phase changes. As the intensity is decreased the source of sound is localized at a greater distance, while with a gradual increase of intensity the source of sound appears to be coming closer to the listener. This same effect can be created artificially with the use of a simple electrical circuit (Fig. 3B) which is analogous to present sound systems. By keeping the sound source at a fixed distance from the microphone, and regulating the attenuator, a listener located in another room will be unable to tell whether the source of sound is moved or the attenuator setting changed.

With this arrangement it will be noted that if the sound source is moved in any direction, up or down, from side to side, or to and from the microphone, the listener in another room will interpret all directional movements as either directly approaching or receding from him. No sensation of horizontal angular displacement or vertical angular displacement of the sound source will be experienced. This single dimension illusion is representative of the working limitations of our present radio broadcasting, sound picture, telephone and public address systems.

The Second Dimension: Angular Displacement in Horizontal Plane

If the sound source used in Fig. 2 is displaced 30 degrees to the right (Fig. 2B), but kept in a horizontal plane level with both ears, two different acousto-physiological circuits are set up from the sound source to the interpretive hearing center. In this instance, the axis (RX) of the sound wave reaching the right ear is much shorter than (LX) the axis of sound reaching the left ear. The result is that the

Fig. 4
Detail illustrations of 4th dimension sound.

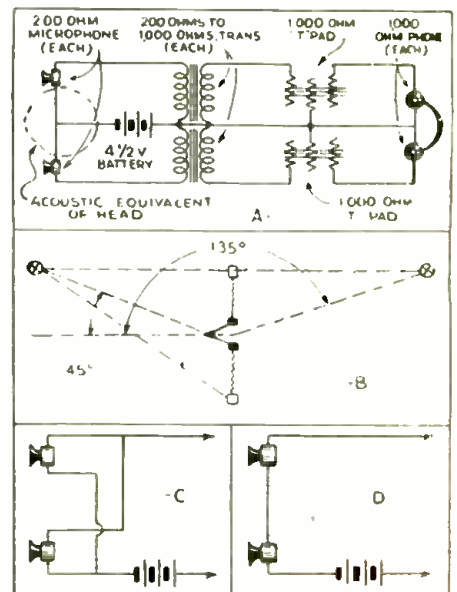

TOBE UNIVERSAL ALL-WAVE ANTENNA SYSTEMS

Model 34
List Price **\$6.95**

Thousands of TOBE antenna kits are now in use. Here's why!

- ✓ Can be used with ordinary flat tops or doublet antennas.
- ✓ Receiver coupling transformer has two wave band toggle switches.
- ✓ Tremendous noise reduction.
- ✓ Contains everything required for a complete antenna system.

Model 35, a basic kit of 2 couplers and 50 ft. of twisted pair lead-in, at only \$4.95 list. Sold by leading parts jobbers everywhere at regular trade discounts.

Tobe Deutschmann Corporation
Canton, Massachusetts

Please Say That You Saw It in RADIO-CRAFT

WATCH THE "LEADERS" FOLLOW LYNCH

For more than two years Arthur H. Lynch has been emphasizing the fact that

"No Radio Can Be Better Than Its Aerial"

LYNCH
HI-FI
TRADE MARK REGISTERED
(High-Fidelity)

ANTENNA SYSTEMS

are as superior to all other antenna systems as the present high-fidelity radio receivers are superior to the noisy, squealing sets of years ago. The "leaders" are just beginning to realize they have been playing a game of Rip Van Winkle.

ASK YOUR DEALER
to demonstrate a LYNCH Antenna—or write us for free literature.

Then COMPARE!

ARTHUR H. LYNCH, INC.
227 Fulton St., New York, N. Y.
PIONEER OF NOISE-REDUCING AERIALS

Presenting the
new improved JIFFY 3 SHORT WAVE SET

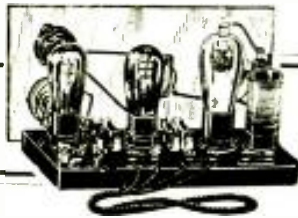

World-Wide Earphone Reception!

Here is a three-tube set that can be assembled in a jiffy! Has very little wiring—the wonder set for amateurs and beginners. The set employs 2-30's and a 32—and has bakelite base. The 32 tube controls both regeneration and detection. Complete band-spread tuning and low current drain is assured. Smooth, clear and quiet operation at all times.

KIT, including 4 short wave \$6.25
coils.

Wired, \$7.75; tubes extra \$1.50

We welcome inquiries and comparison.

LEOTONE RADIO COMPANY
63 Dey St. New York, N.Y.

WHEN CHOOSING A RADIO SCHOOL

RCA Institutes, with its reputation established by 25 year-service, is an institution recognized as an important factor in the radio industry.

Whether elementary radio principles or advanced subjects—sound applications or practical radio engineering, RCA Institutes is prepared to give you the instruction you need.

RESIDENT SCHOOLS NEW YORK AND CHICAGO
with modern standard equipment

EXTENSION COURSES FOR HOME STUDY
under convenient "no obligation" plan

Illustrated Catalog on Request.

R. C. A. INSTITUTES, Inc. Dept. RT-35
75 Varick St., New York—1154 Merchandise Mart, Chicago

Socket Operated SOUND SYSTEM

MILES SOCKET MIKE (Pat. Pend.) designed to operate in conjunction with your mike and phone throughout a building without interconnecting wires. Sold in kit form complete with diagram, double instructions \$16.75 not including wire and total \$21.75

MILES REPRODUCER CO., INC.
112-14 West 14th St., Dept. RC1, New York, N. Y.

NOW READY
The 1935 Profit Guide

104 Pages—Full of marvelous buys. A complete line of public address amplifiers and equipment—short wave accessories—speaker—replacement parts—service men's supplies, etc.

Send for Your Free Copy Today

BALTIMORE RADIO CORPORATION
721C Broadway New York, N.Y.

right and left center of hearing present entirely different patterns to the interpretive center, which therefrom approximates the horizontal angular displacement. The listener usually turns his head in the estimated direction until the differences of phase and intensity are equalized in both ears and thereby assumes that the sound source is directly in line with his nose. If the source of sound is sighted, definite localization takes place, if not seen the direction of the sound source is imagined.

As two separate patterns must be formed by both hearing centers, it becomes evident that a special pickup and reproducing system must be employed (Fig. 4A) so that the phase and intensity differences, as would normally be picked up by both ears, be preserved. The best procedure is to separate both microphones with some object acoustically equivalent to the head. By adjusting both attenuators to match the sensitivity of the ears true stereophonic reproduction will result. A listener sitting in another room will be able to follow a sound source moved from side to side. Some ambiguity will result because of the listener's inability to move his head towards the sound image for purposes of confirmation. Thus, when the sound source is at a 45° angle to the right it might appear to be at a 135° angle. (Fig. 4B). By moving either attenuator and keeping the sound source stationary, the apparent location of the sound image can be changed. A perfect illusion, however, will not be created unless an appropriate phase lag is introduced into the circuit having the greatest attenuation. Experiments conducted have shown that considerable deviation may be made from ideal phase and intensity patterns, without seriously affecting the accuracy of the sound image localization.

When two different sound sources are used (bell and telephone receiver), the listener will be amazed at the ease with which he can follow both sources even though they be moved from side to side or to and from the microphones. Not until one experiences stereophonic reproduction can he begin to realize how limited and unnatural are our ordinary systems of artificial sound reproduction.

If the microphones are connected either in series or parallel (Figs. 4C and 4D) the stereophonic properties of the circuit will be lost as both ears receive identical sound patterns, and thereby shunt the interpretive center out of the acousto-physiologic circuit.

**The Third Dimension:
Angular Displacement in a Vertical Plane**

Strange as it may seem, a listener with his eyes closed, and without tilting his head will be unable to localize a source of sound coming from above or below the level of his ears. This physiologic handicap plays an important part in the design of a fourth dimensional sound system, and is caused by the location of both our ears in a horizontal plane. If we had two additional ears in a vertical plane, we could accurately gauge the vertical angular displacement of a sound image by using the same process as used in judging horizontal angular displacements.

We can however localize a sound coming from above or below us by simply tilting our head until the sound attains maximum intensity. Here again localization is hastened by sighting the source of sound. Inasmuch as the eyes play a secondary part in sound localization, it would appear that sightless people, as well as the audience of our fourth dimensional sound system, would be seriously handicapped. Such is not the case however, for our inner ear contains an organ of balance (semi-circular canals) which play no direct part in hearing, but afford an accurate measurement of the tilt of the head. It therefore becomes evident, that in order to achieve perfect illusion in a fourth dimensional sound system we must project sound from above and below the level of our ears by using a set of overhead and sub-level speakers.

The demonstration staged by the Bell Telephone Laboratories was lacking in this respect because all sound was picked up from one horizontal plane and projected in a series of planes most suitable for adequate sound distribution, but without regard to the vertical angular displacement of the original sound sources. While it is true that the reproduced version of the airplane roar seemed to come from overhead, this false localization was sensed only by individuals whose past experiences associated airplane roars with elevated positions.

Please Say That You Saw It in RADIO-CRAFT

MAKE MORE CALLS and BIGGER PROFITS

with New
READRITE
Point to Point
TESTER
• No. 720 •



HERE is the tester that every serviceman needs for properly servicing radio receivers. The new Readrite No. 720 Tester enables you to make more calls per day at less cost per call—and make bigger profits because of its speed, its accuracy and its dependability.

The new No. 720 unit operates *faster . . . more efficiently* and with *less manipulation*. It tests all resistances, continuities, voltages, current and capacities from the set socket by the reliable point-to-point method. And it is built to withstand severe field service.

Two highly developed Vane-type AC and DC meters are incorporated into this new tester. They are simple in design and dependably accurate. The DC scales are 15, 150, 300 and 600 volts, 15-150 milliamperes. AC scales 10, 25, 150 and 750 volts.

Your Jobber Can Supply You . . .

With the Readrite No. 720 Tester at Dealer's net price of only \$15.00. Write direct for literature to

READRITE METER WORKS
136 College Ave. Bluffton, Ohio



MAIL COUPON FOR CATALOG

Readrite Meter Works
136 College Avenue. Bluffton, Ohio.

Send me catalog on Readrite No. 720 Tester and folder showing Readrite leader-hip.

Name.....

Address.....

City..... State.....

SPRAGUE Short Wave

HIGH FREQUENCY By-Pass Condensers

ANOTHER Sprague development of utmost importance to every amateur and short wave enthusiast is the development of a new type of Short Wave Condensers guaranteed an excellent substitute for tuba condensers in any of the circuits illustrated. And look at the prices—from 50¢ to 75¢ less than you have been paying for mica units.

Just the thing for by-pass purposes in Short Wave receivers, although they are not recommended as series padding condensers or as mica substitutes in tuned circuits. Thus, while not a universal substitute for mica, Sprague Short Wave Condensers CAN be used with entire safety and effectiveness in the circuits mentioned.

YOU JUST CAN'T BREAK THEM DOWN, TESTS AT HEAVY CURRENT AND TREMENDOUS HEAT HAVE SHOWN NO FAILURES. QUALITY AT A PRICE BECAUSE OF NEW, IMPROVED CONSTRUCTION. OIL CONDENSERS ARE ALWAYS BEST.

Sturdy—self-supporting. Unusually small—from one-half to one-half as large as mica condensers of the same ratings. Metal encasing—non-inductive—extremely low power factor—impregnated with a specially developed oil—1500 V. and 1000 V. continuous D.C. rating. Guaranteed unconditionally, when used as specified. Sold by leading jobbers. **TRY THEM TODAY!**

Cat. No.	D. C. Working Cap.	Di. Volt.	Length	List	Net
SW-22	.002	1500	9/16"	by 1	9/16" \$4.45 \$2.27
SW-25	.005	1500	5/8"	by 1	13/16" .45 .27
SW-11	.01	1500	11/16"	by 1	13/16" .70 .42
SW-15	.05	1000	7/8"	by 2	1/4" .80 .48
SW-1	0.1	1000	7/8"	by 2	1/4" .90 .54

Write for our complete Condenser Catalog including famous Sprague Transmitting Condensers

SPRAGUE PRODUCTS CO.
North Adams, Mass.

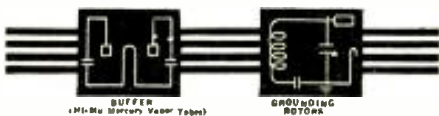

for Short Wave

Model S. W. 429 Reproducer

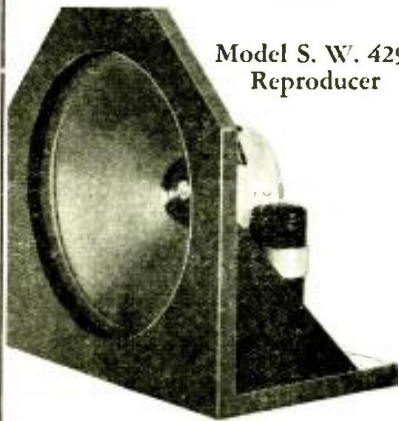

DR. G. W. TWOMEY, U. S. Veteran's Hospital, Minneapolis, Minn., operating a most complete short wave receiving station, gives his report on the S. W. 429 after a most thorough and exhaustive test.

A copy of this complete report will be sent to you upon request and you will find it not only interesting but instructive—write for a copy today.

The Model S. W. 429 is designed and manufactured especially for use in short wave reception and is extremely efficient. The sensitivity in the voice frequencies makes it capable of bringing in weak signals which would be practically lost when using any ordinary speaker.

Also write for our catalog—a speaker for every purpose.

WRIGHT-DECOSTER, Inc.
2251 University Ave., St. Paul, Minn.
Export Dept. M. Simons & Son Company
25 Warren Street, New York
Cable Address: Simontrice, New York.

One cannot doubt the fact that illusion of some other sound like the overhead sawing of wood or singing while swinking could not have been produced by this system.

A block diagram for a system used to directively project a sound depending upon the position of the original sound source, is shown in Fig. A. The four microphones pick up the original sound with a proportionate intensity depending upon its nearness to anyone or all units. By using four separate channels, the pick-up pattern is maintained clear through the amplification to the recreation and projection.

The Fourth Dimension: Time and Its Measurement of the Rate of Change of a Moving Sound Source

The factors which determine the localization of a moving sound source involve all of the perceptive and interpretive facilities used for the location of sound in any one of the three planes of space; as well as the coordination of the rate of change with which the various patterns of the right and left hearing centers are presented to the interpretive center.

It thus becomes evident, that in order for us to recreate the illusion of fourth dimensional sound we must use a system which will present to both ears a series of changing patterns identical in every respect to the sound patterns we would hear if we were listening to the moving sound source directly. In other words, the system should be capable of picking up amplifying and projecting all sources of moving sound in exact accordance with their original speed, motion and direction.

Past experiences have shown that the complete recreation of moving and multi-sound sources, in their exact spatial relationship and aesthetic aspects, is possible only by employing a special sound system and using a new technique in its installation and operation. Such a system will be presented in next month's issue of RADIO-CRAFT together with detailed information for the construction, installation and operation of this system.

In the meantime, the authors will be pleased to receive comments and answer questions relative to the fundamentals of fourth dimensional sound.

IMPROVED 2-TUBE S.-W. BOOSTER

(Continued from page 410)

Receiver selectivity is obviously of paramount importance in successful short-wave reception. R.F. boosters not only provide for attainment of an ultimate degree of selectivity but also furnish a successful method for signal and noise rejection. Both of these functions are essential for dependable transoceanic reception and both of these conditions are best accomplished by increasing the selectivity of your present receiver, for the reasons outlined below:

1. Increased Selectivity Minimizes Static.
2. Increased Selectivity Avoids Interference.

With the constantly increasing number of foreign short-wave stations, owners of both elaborate and simple receivers are becoming aware of the inferior selectivity of their sets. The active 19, 25, 30, and 49 meter bands are particularly notorious for their interference. The only effective remedy for this form of interference is increased selectivity and is best accomplished by adding at least one (or more) tuned R.F. stages to your present receiver.

The duplex drawer coil unit employed in the booster, diagram of which is shown in Fig. 1, is essentially composed of two precision space-wound coils fully shielded from each other, but contained within one catacomb drawer and so arranged that the entire unit slides into its receptacle through the front panel, in a manner similar to changing drawers of a miniature desk.

The cadmium-plated steel receptacle, into which the drawer coil slides, is equipped with three specially designed double-spring, butt-wiping and self-cleaning contacts which are in no small measure responsible for the unusual performance and permanent operation of this band-changing system. Each contact is composed of two springs; one made of phosphor bronze, for connection and the other made of tempered high carbon steel (similar to clock springs), for tension. The tension spring absorbs all bending stress.

There's plenty of

Servicing Material

in the 1934 Manual

Radio Service Men and others engaged in various branches of radio know the importance of the GERNSBACK Manuals, and how much they depend on them for reliable information. Whether for public address work, receiver diagrams or tube information, the material needed is certain to be found in one of the volumes of the OFFICIAL RADIO SERVICE MANUAL.

Contents of the 1934 Manual in Brief

Diagrams and service notes, more complete than ever before in any manual. Voltage readings for practically all sets, as an aid in checking tubes and wiring. All values of I.F. transformers used in superheterodynes, with the manufacturers' own suggestions as to correct balancing. A complete compilation of radio tube data, covering both old and new types. A complete list of American broadcast stations with their frequencies in kilocycles; extremely useful in calibrating test oscillators and receivers. Free question and answer service. No theory; only service information in quickly accessible form. A handy, easily-consulted master index making it easy to find almost anything pertaining to service problems, instantly. This index includes all the diagrams published in all the previous GERNSBACK manuals, as well as the 1934 diagrams. A big convenience and time saver.

400 PAGES

Over 2,000 Illustrations

9 x 12 Inches

Flexible Looseleaf Leatherette Cover

ORDER TODAY! No need to delay sending us your order—the 1934 MANUAL, like its predecessors, is a necessity in your business. We strongly advise you to order your copy today.

\$3.50 LIST



GERNSBACK PUBLICATIONS, INC.
99 Hudson St. New York, N. Y.

GERNSBACK PUBLICATIONS, Inc.
99 Hudson Street, New York, N. Y.

Enclosed find my remittance of \$3.50 for which send me **Postage Prepaid, One Copy of the 1934 OFFICIAL RADIO SERVICE MANUAL.** [Send remittance by check or money order; or register letter if it contains cash, currency or unused U. S. Postage stamps.]

Name

Address

City State.....

100-135

Please Say That You Saw It in RADIO-CRAFT

BUILD THIS NOVEL I-TUBE ALL-WAVE SET

(Continued from page 405)

B are the filament terminals, G is the cathode of the detector portion. This has a suppressor-grid connected to it within the tube. C is the plate of the detector, while D is the screen-grid of the detector. E is the cathode of the rectifier portion and F is the plate of the rectifier. The cap of the tube (H) is connected to the control-grid of the detector. It is suggested that the grid circuits be wired in first, then plates, cathodes, bypass condensers, and filter condensers, and finally the filament circuit. A flexible wire is soldered to the antenna trimmer for the aerial connection. This set does not require a ground connection and in fact, none should be used. If A.C. hum is noticeable, use an additional dual 8 electrolytic condenser, connecting both sections in parallel so as to obtain 16 more microfarads at point (10).

List of Parts

- One Hammarlund variable condenser, .00014 mf., type MC-110-M, (3);
 - One Hammarlund antenna trimmer condenser, 3 to 35 mmf., (1);
 - One Aerovox mica condenser, .0001 mf., type 1460, (5);
 - One Aerovox mica condenser, .0005 mf., type 1460, (7);
 - One Aerovox cartridge condenser, .01 mf., type 484-N, (14);
 - One Aerovox double section cardboard container electrolytic condenser, 8 mf. per section, type PB-2, (12, 13);
 - One Electrad potentiometer, 75,000 ohms, type RI-202-P, (6) with Sw., (16);
 - One power line cord, 350 ohms, (15);
 - One set of five 4-prong plug-in coils, covering 10 to 550 meters, (2);
 - One I.R.C. metallized resistor, 1 meg., 1/2-W., (4);
 - One I.R.C. metallized resistor, 10,000 ohms, 1 W., (11);
 - One twin jack, (9, 10);
 - One seven-prong (large) wafer-type socket (8);
 - One Hammarlund Isolantite socket, 4 prongs, (2);
 - One 12A7 tube, (8);
 - One roll of Corwico braidite solid core hook-up wire;
 - One metal box, 1 1/4 x 5 1/2 x 3 1/4 ins. high;
 - One screen-grid clip; three knobs;
 - One headphone.
- Note: Numbers in parentheses refer to corresponding numbers indicated on the diagram and layout view (Figs. 1 and 2).

A SHORT-WAVE 2-TUBE PORTABLE

(Continued from page 410)

a comfortable carrying handle. Its feature is the use of special band-spread coils, which make station finding a comparatively simple matter, and also permit the use of the receiver as a complete amateur station monitor.

Exactly half of the space inside the cabinet is occupied by the receiver components proper and the other half by the batteries.

The main tuning condenser C1, of 140 mmf. capacity, is controlled by a small vernier dial. In the lower left-hand corner of the end of the cabinet is the antenna trimmer condenser, C6; in the lower right-hand corner the combined regeneration control and filament switch, R1-SW. Between the two lower knobs is a short single-circuit earphone jack, J. This is carefully insulated from the cabinet, as the latter forms the grounded "A+" side of the circuit.

The band-spread coils, which are described in an accompanying illustration, are of the double winding type. The small winding at the bottom of the form serves as the tickler, and is connected in series with the plate circuit of the detector tube, V1. The R.F. choke coil, L2, of 2.2 mh. inductance, keeps the R.F. energy out of the primary of the audio transformer.

It will be observed that the main tuning condenser C1 is connected across only a portion of the entire grid or secondary winding. The tap is about a quarter of the way up from the grounded end. The variable condenser represent-

ed in the diagram as C5 is a tiny trimmer type condenser mounted directly in the end of the coil form and connected across the entire grid winding. This condenser is adjusted by means of a screw sticking out of the end of the coil. It acts as a fixed loading condenser, while condenser C1, which is connected across only a portion of the entire secondary inductance, has a relatively slight tuning effect, and therefore the entire dial movement represents only a limited frequency range; hence the "band-spread" action. Of course, the particular section of any band to be covered depends on the coil used and the settings of the individual C5 condensers.

Regeneration Control

Regeneration is controlled by the 1 megohm variable resistor, R1, which is connected directly in series with the "B+" 22 1/2 volt lead to the audio transformer primary. This is bypassed by a .5-mf. condenser which effectively eliminates any tendency of the control to be noisy. The regenerative action is smooth and quiet, and phone stations can be brought in just at the critical point of oscillation.

The secondary of the transformer is shunted by a 1 megohm resistor, R4, merely for the purpose of eliminating fringe howl.

On the left side of the cabinet is a double binding-post strip for aerial and ground connections. It has been found in actual practice that most any sort of an antenna will bring in signals. Fifteen feet of insulated flexible wire draped over the roof of a car worked very well in some road tests and brought in programs from numerous foreign short-wave stations. A fire hydrant and an iron railing have all been used successfully as "ground" connections.

List of Parts

- One Two-winding 5-prong band-spread coils as described below, L1;
- One 2.2 mh. R.F. choke coil, L2;
- One 140 mmf. midget variable, C1;
- One .00025 mf. mica grid condenser, C2;
- One .0005 mf. mica bypass condenser, C3;
- One .5-mf. paper bypass condenser, C4;
- One trimmer condenser built into coils, C5;
- One Two-plate 5 mmf. antenna trimmer, C6;
- One 1,000,000 ohm potentiometer, R1;
- One 8 ohm wire-wound resistor, R2;
- One 10 megohm grid leak, R3;
- One 1 megohm grid leak, R4;
- One single open circuit phone jack with insulating washers, J;
- Two Type 30 tubes, V1, V2;
- One 3 1/2-to-1 ratio uncased audio transformer, T;
- One Steel cabinet as specified;
- One 4 1/2 volt "C" battery, Burgess No. 2370;
- One 45 volt "B" battery, Burgess No. 5308;
- Three-inch vernier dial for condensers C1, knobs for R1 and C6, double binding-post strip, 5-prong socket for plug-in coil L1, and incidental hardware and mounting screws.

Coil Data Table

Wave Band (meters)	Secondary No. of turns	Primary bottom Turns	Trimmer No. of Turns	Capacity* (mmf.)
19	4 1/2	1 1/4	4 3/4	80
25	4 1/2	1 1/4	4 3/4	180
31	11 1/2	4 3/4	6	180
49	11 1/2	4 3/4	6	180

*Fixed variable condenser. Values shown are maximum. All secondary coils are wound with No. 24 bare wire spaced to a winding length of 1 1/4 ins. Ticklers are close wound with No. 28 or 30 S.C.C. wire.

The 2-tube portable in use.



Please Say That You Saw It in RADIO-CRAFT

The New NATIONAL
1935 CATALOGUE
Lists a Variety of
New Parts and Receivers
for SHORT-WAVE Set
Construction—



Send for YOUR COPY Today!

The new NATIONAL Company Catalogue No. 240 is ready. Many new items are illustrated and described, including the new HRO Amateur Receiver, new TR 5-Meter Transceiver, new Cathode Ray Oscilloscope, new Transmitting Condensers, new PW Precision Condenser and Micrometer Dial Unit, many other new components for Short Wave Receiver construction; and the latest catalogue information on the well known NATIONAL SW-3, FB-7A, FB-XA, PSK Preselector, and other SW Receivers and Converters; and Power Units, Dials, Condensers, Transformers, Chokes, etc., for high frequency work.

USE COUPON BELOW

NATIONAL CO., Inc.,
61 Sherman Street, Malden, Mass.



Gentlemen: Please send me your new catalogue No. 240. I enclose 6c to cover postage and mailing.

Name

Address

City

State



Announcing A NEW DEAL in getting acquainted with **SPEED** RADIO TUBES

Pioneers in tube development since 1921.

We make this get-acquainted, money-saving offer to servicemen, dealers and technicians for a period of 60 days only, with the idea of giving old customers and new the same opportunity to save money. We believe this announcement to be of outstanding importance . . . and worthy of immediate action.

SPEED RADIO CORPORATION is up-to-the-minute in latest tube achievements. Listed below are included many popular types of tubes for short-wave use. **ALL TUBES ARE GUARANTEED FOR A PERIOD OF SIX MONTHS.**

Here is the Tube List:

Type	Net Price	Type	Net Price	Type	Net Price
01A	\$.27	45	\$.33	145	\$.65
210	1.13	47	.59	182	.74
12A	.41	48	1.35	182B	.74
22	.68	250	1.13	183	.74
24	.50	53	.50	2A3	.80
26	.29	56	.33	2A5	.50
27	.32	57	.50	2A6	.50
30	.36	58	.50	2A7	.60
31	.36	11A	.32	2A7	.68
32	.63	75	.50	6A7	.60
33	.63	77	.54	6B7	.63
31	.68	78	.54	6C6	.50
35	.50	80	.32	6D6	.50
36	.50	281	1.13	6E7	.72
37	.39	82	.41	6Z6	.34
38	.50	83	.50	12Z6	.50
39-11	.54	84	.59	2Z6	.72
11	.50	X99	.45	Type 1-V	.50
12	.54	V99	.56	Type 1-V	1.13
13	.57	866	3.26		

If your jobber cannot fill your order promptly, send it direct to us for immediate shipment.

No order for less than \$3.00 can be accepted. Send 25% deposit, balance C.O.D. All tube prices shown are net—and orders are F.O.B. factory. IF FIFTY TUBES OR MORE ARE ORDERED, ORDERS ARE SHIPPED PREPAID.

SPEED RADIO CORP.
22-14 40th Avenue Long Island City, New York
Jobbers and Large Users—write for our special offer!



new! Moving Coil Microphones

● An improved type of moving coil microphone is now available, at low cost, to the general Public Address, Broadcast and Talkies-Recording trade. This instrument retains all the desirable characteristics of moving coil microphones—low impedance, permitting long transmission lines without noise pick-up; freedom from hiss, etc.; performance unaffected by atmospheric conditions, and operation while being moved around. The new standard and deluxe models, Moving Coil MI microphone offers the following features: wide-angle pick-up, which eliminates grouping; rugged construction; small dimensions, making concealment convenient, and high-quality pick-up, with response flat to 3,000 cycles, and showing 3 db. at 5,000 cycles, without resonance peaks. Specifications: field coil, 2 to 6 volts; voice coil, 20 ohms. (The Deluxe model is equipped with suspension yoke.)

Standard Model Moving Coil Microphone (without matching auto-transformer). Net price **\$14.95**
Matching Auto-Transformer for use with above microphone. Net price \$3.95 additional.

RADIO EQUIPMENT CORP.
155 East Genesee St., Buffalo, N. Y.
Los Angeles Office: Ben S. Rothstein Company, 1028 S. Olive Street, Los Angeles, Calif.
New York Office: Albee Radio Corp., 16 Hudson Street, New York, N. Y.

When It's Needed in a Hurry!
Servicemen—Amateurs—Experimenters
Depend on
BURSTEIN-APPLEBEE CO.
America's Largest Radio House
in America's Handiest Shipping Point.
101-2-A McGee St.
Dept. 14
Kansas City, Mo.

1935 Catalog
148 Pages
Write us if you have a "want"

A "HOW TO BUILD" SERVICE MAN'S ALL-WAVE OSCILLATOR

(Continued from page 416)

grid and, as far as R.F. is concerned, these elements are at ground potential. This shields the plate from the frequency-controlling elements of the tube and effectively isolates the output. Therefore, a variation of output load has very little effect on the oscillator.

The tuning condenser used has a capacity of 365 mmf. Any condenser such as is used in the average receiver can be used. This condenser must be insulated from the chassis, as is shown in the print. Nothing is returned to the chassis except bypass condensers. This has been done to prevent short-circuits on the power line when an A.C.-D.C. receiver is being tested.

The switch used is a 3-pole, 5-position assembly. One pole is used as a shorting switch to short the preceding coils, that is, the lower-frequency coils. This is done to prevent the natural period resonances of the unused coils from falling in the other bands where they would affect the oscillator in use. The other two poles switch both the control-grid and cathode of the oscillator circuit.

The coils are the hardest thing to build and it is recommended that a set be purchased that corresponds with the calibration shown in Fig. 4. However, below is listed the data for winding the coils.

COIL No.	FREQ. RANGE	TYPE OF WINDING	SIZE WIRE
1—OSC.	26.7 mc.	Solenoid	26
2—OSC.	8.3-2.5mc.	Solenoid	26
3—OSC.	2700-800kc.	Solenoid	32
4—OSC.	900-300kc.	Universal	36S.S.E.
5—OSC.	360-110kc.	Universal	36S.S.E.
6—CHOKE		Universal	32D.S.

COIL No.	TURNS TO TAP	INS.	NO. OF TURNS
1	3 1/2	9 1/16	8 1/2
2	8	9 1/16	32
3	30	9 1/16	100
4	50	9 1/16	150
5	75	9 1/16	300
6		3 8	300

Coil No. 1 is space-wound. (This spacing is done by winding two wires at the same time, and when the one to be used is properly secured the remaining wire is removed, leaving an accurately-spaced coil.) The remaining coils are tight-wound.

The R.F. oscillator section of the type 77 tube is modulated at A.P. in a novel way—that is, via the screen-grid circuit, which is the anode of the oscillatory circuit. The audio frequency oscillator uses a type 76 tube and a push-pull audio transformer for the modulation transformer. Figure 3 shows the way the transformer is assembled before it is ready for use. All the "I" laminations are removed leaving only the "E's", and a block of wood is used to replace the "I" laminations that were removed so that the old mounting bracket can be used.

The untapped side of the transformer is the grid coil and one half of the tapped side is used in the plate circuit of the audio oscillator. The unused half is used as a pick-up coil to introduce the audio signal into the R.F. oscillator circuit. If when the generator is assembled the audio oscillator does not function, reverse the connections of the grid coil to make the phase relationship correct.

The attenuator consists of a 100-ohm potentiometer. This should preferably be tapered to 25 ohms at 50% of the rotation so that the scale will not be too crowded at the low-signal end, although a standard potentiometer may be used.

The chokes and condensers used in the line prevent R.F. from feeding back into the line and thus into the receiver on test. These are very essential and the success of the instrument depends on this filter system.

Figure 2 shows the chassis, shield, and the other metal parts that must be drilled, with dimensional data. These parts may be made of steel, aluminum, or any other available metal.

After the signal generator is completed and shields in place, reverse the grid coil of the modulation transformer, if necessary. If the signal generator works satisfactorily the problem of calibration is next. The simplest way, of course, is to calibrate with a calibrated all-wave receiver, but if higher accuracy is desired, the best way would be to compare directly with crystal-controlled stations whose frequencies are known.

As is shown in Fig. 4, ranges 3 and 4 cover the broadcast band. These bands can be calibrated by comparison with stations in these

A MAGAZINE WHICH NEEDS NO INTRODUCTION TO SHORT-WAVE FANS—

SHORT WAVE CRAFT

This popular magazine interests the great army of short-wave enthusiasts who have recently acquired a third for more knowledge about short waves. **SHORT WAVE CRAFT**, a monthly magazine, contains everything you want to know about the art of Short Waves.

The wonders of world-wide short-wave reception are clearly described and illustrated in each issue. Latest practical information for radio fans, experimenters, and "hams" will be found of tremendous interest. Tells you how to build short-wave receivers and transmitter; constructed sets of one and two tubes or as many as seven, eight or more. Tells best foreign stations to log and when to tune them. Every month will be found newest and best circuits of the time. **SHORT WAVE CRAFT** is a fascinating, instructive magazine, edited by Hugo Gernsback.

NEW FEATURE RECENTLY ADDED: To the short wave fan who has looked and obtained verification of the largest number of short-wave stations from all over the world during one month, will be awarded a magnificent 24" silver trophy.

Special Offer This Month Only

For the month of December only, we offer readers of this magazine the opportunity to read radio's greatest short-wave magazine at a special saving. The regular subscription price is \$2.50 per year. You can now get **SHORT WAVE CRAFT** for the next Eight Months for one Dollar. The coupon below makes it convenient for you to send us your subscription. **SEND IT TODAY.**

25c The Copy

4-Color Cover 9" x 12"
Over 200 Illustrations



On All Newsstands

SHORT WAVE CRAFT, Dept. RC-135
99 Hudson Street, New York, N. Y.

Gentlemen: Enclosed you will find my remittance of \$ for which please send me a subscription to **SHORT WAVE CRAFT** for

() Eight Months @ \$1.00 (Canada and foreign, \$1.50)
() Sixteen Months @ \$2.00 (Canada and foreign, \$3.00)

Name _____
Address _____
City _____ State _____

Please Say That You Saw It in **RADIO-CRAFT**

bands. The receiver that is used to calibrate the generator is set at some known frequency and the generator is tuned until a beat is found, this beat being carried to zero, and the point indicated on graph paper. If this procedure is followed at several points on the band, a curve can be drawn.

Range 5 may be calibrated by the harmonic method. For instance, the receiver used may be set at some known frequency, say 600 kc. When the generator dial is moved it will be noticed that beats will be heard. Analyzing these beats (being careful to avoid taking cognizance of beats resulting through reaction with the local oscillator in superheterodyne sets) it will be found that the following occur:

- 100 kc. its 6th Harmonic being 600 kc.
- 120 kc. its 5th Harmonic being 600 kc.
- 150 kc. its 4th Harmonic being 600 kc.
- 200 kc. its 3rd Harmonic being 600 kc.
- 300 kc. its 2nd Harmonic being 600 kc.

By repeating the above procedure and plotting these points, a curve may be drawn. If a superheterodyne receiver is used to calibrate the generator, care must be taken that the signals do not beat with the intermediate frequency. This will be easily determined by turning the dial of the receiver every time a beat is found. If the modulated signal still remains, although the beat vanishes, it will be known that the signal is at the frequency of the intermediate frequency of the receiver. Therefore, these points will not be used in the calibration.

Calibration of bands 1 and 2 will be rather hard unless both care and time are taken. There are numerous sources from which reliable signals can be heard. Station WWV at 5,000 kc. is the outstanding frequency standard for this country. The amateurs have several in their own bands. The various commercial short-wave services are largely crystal-controlled and sufficiently accurate for calibration. Even at the highest frequencies, fixed frequency band services are now in use, mostly on phone. Hence, with a reasonably good all-wave receiver, and care to have the right beat from the signal generator, it is fairly easy to provide a sufficient number of points in each band so that reasonably accurate curves can be drawn.

If the constructor of this signal generator follows the data given, especially that of the coils and the tuning condenser, it will be possible to match the calibration given in Fig. 4 as this calibration was made with parts of the same specifications.

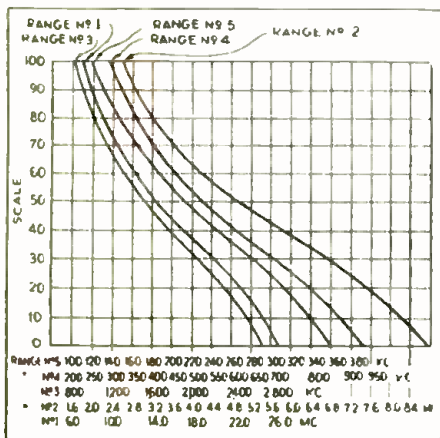

Fig. 4, above
Representative output-frequency graph.

Fig. 5, below
Underside view of 3-tube oscillator.



HOW TO BUILD A NEW 5-METER TRANSCEIVER

(Continued from page 406)

to guide the assembly, but, in order to facilitate the work, it is best that the following supplementary explanations be observed.

The .006 mf. condenser is connected between the R.F. choke and the ground lug. The 250,000 and 10,000 ohm resistors connecting to the "Transmit-Receive" switch are supported away from the switch by their pig-tails and must not touch it. The other pig-tails are twisted together and soldered, forming a connection to which a wire is soldered. The .00015 mf. mica condenser is connected between the 2 inner lugs of the 5 meter coil. The remaining 250,000 ohm resistor is connected between the terminal strip and the 6 prong socket. It must be supported by its pig-tails so that it does not touch the 4 lead transformer over which it straddles.

The inner winding of the 5 meter coil, shown connected to the stand-off insulators, is not to be connected until after the transceiver has been tested.

Testing

Place the 11 and 37 tubes in their proper sockets. Connect the positive post of the 6 V. storage battery to terminal 1 and the minus post to terminal 2 of the terminal strip. Snap on the "on-off" switch. The heaters of the tubes should glow. Connect two 7½ V. "C" batteries in series. Connect the plus post of one to terminal 3, and the -3 V. post of the other (giving -10½ V.) to terminal 6 of the terminal strip. Connect three 45 V. "B" batteries in series.

Connect the minus clip to terminal 4 and the plus 135 V. clip to terminal 5 of the terminal strip. The battery wires may be of any convenient length or a battery cable may be used. If greater power is desired, use four 45 V. "B" batteries in series to give +180 V., and connect the two 7½ V. "C" batteries to give -13½ V. Plug a pair of headphones into the double tip jack for phones and turn the "Transmit-Receive" switch to the right (Receive position). If everything is in order the characteristic hissing sound of super-regeneration will be heard in the phones. If the transceiver does not super-regenerate, disconnect all the batteries and recheck the wiring completely. Plug a sensitive single-button microphone into the double tip jack for microphone. (The microphone current is supplied by the "A" battery.) Turn the "Transmit-Receive" switch to the "Transmit" position. With a short piece of wire momentarily ground the upper pin of the double tip jack for phones to the chassis. Speech should now be heard clearly in the headphones. (Ordinarily, in transmitting, the phones are disconnected by the "Transmit-Receive" switch to avoid microphonic feedback.)

If the transceiver has been found to test properly, connect the inner winding of the 5 meter coil to the 2 stand-off insulators on the top of the cover with 6 in. lengths of wire. Then clip the cover over the chassis, fastening the two together with 3 self-tapping screws on each side.

Antenna

Because of the harmonic effect, an ordinary broadcast or short-wave antenna may be used for 5 meter work with fair results. In this case, the antenna is connected to either stand-off insulator, while a ground is connected to the other. If a doublet antenna is used the lead-in is connected to both stand-off insulators and no ground is used.

However, for the most efficient operation any one of the various types of 5 meter antennas should be used. An efficient antenna is obtained by suspending an 8, 16, 32, 64 or 128 ft. length of wire horizontally or vertically and as high as possible (the higher—the better the results) and connect a lead-in to it at a point 1/7 of its length away from the center. The lead-in must extend at right angles to the antenna for a distance equal to at least ¼ of the antenna's length. The rest of the lead-in may then be of any length and is connected to one of the stand-off insulators. The other stand-off insulator may be connected to ground or left unconnected entirely.

For portable operation, the simplest antenna is a 4 ft. length of copper or aluminum wire.

Working With One Hand Tied Behind?

How often have you spent hours, perhaps days, trying to locate the cause of oscillation in a radio receiver? You checked the screen bypass capacitor—tried to lower the screen potential—removed the tuning capacitor and cleaned the wiping contacts, installed pig tails, bonded the shielding, and tried to re-align the tuning stages, but still the radio oscillated and refused to operate satisfactorily.

Then, you probably packed up the receiver and carried it to a jobber whose service department may have repeated your "cut and try" methods in an effort to locate the trouble. Finally, a procedure of substitution of parts was tried as a last resort, and it was found that the trouble cleared up when one of the electrolytic filter capacitors was replaced.

What was wrong with the original electrolytic capacitor? You probably assumed that it had "opened up" or lost some of its capacity, and you reasoned that you could have saved yourself a lot of lost time and trouble if you had been able to check the electrolytic capacitor, but you did not have facilities for measuring the capacity of electrolytic capacitors.

In other words, you did not have a Supreme Model 333 DeLuxe Analyzer which is the first and only analyzer to offer facilities to measure electrolytic, as well as paper capacitors, in six ranges from 0.001 to 125 mids.



SUPREME 333 DELUXE RADIO ANALYZER

Dealers Net Cash **\$39.95**
Wholesale Price

Supreme 333 Standard **\$29.95**
Radio Analyzer.....

Under today's service conditions, if you are working with an analyzer that does not give you this facility, you are slowing up your own skill, shrinking your own income—it's like working with one hand tied behind you. And when you pay as much as \$40.00 for an analyzer, you are entitled to a complete electrolytic capacitor tester, as well as a complete analyzer. The Model 333 DeLuxe Analyzer is the only way to get it.

Ask your jobber to show you this supremely fine and complete, compact radio laboratory. Includes such additional exclusive features as circuit for compensating effects of temperature and other variations of the full wave rectifier unit, free reference point system of analysis, Supreme's 5" fan-shape, full-vision meter. Meanwhile, write for detailed technical data and complete catalog on Supreme instruments.

SUPREME NEON-IZED TUBE TESTER
Portable Model (85-P) **\$39.95**

Upright Counter Model (85-C) ...

TUBE TESTER MODEL 35 **\$29.95**

SUPREME INSTRUMENTS CORPORATION,
512 Supreme Bldg., Greenwood, Miss.

Please Say That You Saw It in RADIO-CRAFT

HOW TO BUILD, TEST AND REPAIR RADIO SETS



Radio Construction Library

Including Television, Short-Wave Receivers and Auto Radios. 3 Volumes. 5 1/2x8—1177 pages, 561 illustrations

This practical Library includes: PRACTICAL RADIO—The fundamental principles of radio, presented in an understandable manner. Illustrated with working diagrams. PRACTICAL RADIO CONSTRUCTION AND REPAIR—Methods of locating trouble and reception faults and making workmanlike repairs. Discusses modern Short-Wave Receivers and installation of automobile radio—fully. RADIO RECEIVING TUBES—Principles underlying the operation of all vacuum tubes and their use in reception, remote control and precision measurements.

Helps you to understand modern type receiving sets—full of construction data and practical kinks for the experimenter.

10 Days' Free Examination Easy Terms

McGraw-Hill FREE EXAMINATION COUPON

McGraw-Hill Book Company, Inc. 330 W. 42nd St., New York. Gentlemen:—Send me the RADIO CONSTRUCTION LIBRARY, all charges prepaid, for 10 days' Free Examination. If satisfactory I will send \$1.50 in 10 days, and \$2.00 a month until \$7.50 has been paid. If not wanted I will return the books postpaid.

Name.....
 Home Address.....
 City and State.....
 Position.....
 Name of Company..... RC-1-35

TOBE EXACT DUPLICATE CONDENSERS

Take the mystery out of electrolytic blocks! The TOBE label tells you all! Make of radio, model, factory part number, capacity and voltage of each section, and color code.

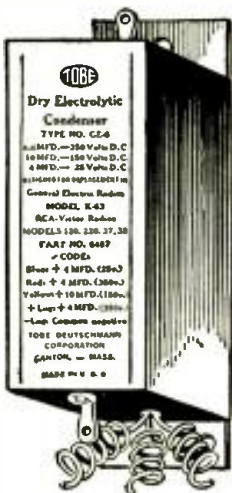

Electrolytic condenser blocks like the one illustrated are available at parts jobbers everywhere for all popular receivers.

Tobe Deutschmann Corporation
 CANTON MASSACHUSETTS

ALUMINUM PANELS
 16 Gauge..... 7x12, 28c; 7x14, 32c
 5/64 Inch or 13 Gauge..... 7x10, 29c
 7x12, 34c; 7x14, 41c; 7x18, 49c; 7x24, 58c.....
 These panels are a special lot at the above prices. Longer and wider at correspondingly low prices. Add postage on 2 lbs. for each. We do not publish a catalogue. Estimates gladly furnished on request.

Radio parts for over 10 Years.
BLAN THE RADIO MAN, Inc.
 177 Greenwich St. Dept. RC New York, N. Y.

rod or tubing, attached directly to one of the stand-off insulators and extending vertically above it. The other stand-off insulator may be left unconnected, or may be connected to the transceiver case or nearby metallic body (as a counterpoise); or it may be connected to ground. Experimentation alone will reveal which method is the best.

Operation

With the batteries and antenna connected and the "Transmit-Receive" switch turned to the "Receive" position, the hissing sound of super-regeneration will be heard as the tuning knob is turned. However this hiss will be moderated or will entirely disappear whenever a signal is tuned in.

The frequency for both transmitting and receiving is set by the tuning knob and dial scale on the front of the transceiver. To minimize hand capacity effects in tuning grasp the knob at the extreme end. The frequency range is approximately 50-63 megacycles, permitting the reception of special experimental stations, which may be located outside of the amateur 5 meter band.

Identification of the 5 meter band can be obtained in localities where there is some 5 meter activity by contact with other amateurs who have calibrated frequency meters, or receivers. Otherwise a calibrated frequency meter, or wavemeter, or lecher wire system must be used to check the frequency of transmission, in order to be certain of legal operation.

The battery current drain is greater when transmitting than when receiving. For reasons of economy, then, turn the "Transmit-Receive" switch to the "Transmit" position only when you are ready to talk, turning it to the neutral or to the "Receive" position, immediately afterward. In the neutral position the battery drain is reduced, but the transceiver is completely turned off only when the on-off switch is snapped off.

The transmitting range, as with every sort of 5 meter equipment, is greatly dependent upon its location. Over flat country or from elevations overlooking the surroundings, distances of from 10 to 20 miles may be worked. From higher elevations even greater distances are possible. Because of the quasi-optical nature of 5 meter waves, the limiting range upon transmission and reception appears to be the line-of-sight distance as determined by the curvature of the earth and intervening topographical obstacles.

List of Parts

The kit contains the following parts for building a 5 meter 6 V. battery operated radiophone transmitter-receiver.

- One I.C.A. 5 plate midget condenser, 15 mmf.;
 - One I.C.A. 5 meter 3 winding coil;
 - One I.C.A. transmit-recvie switch;
 - One I.C.A. R.F. choke;
 - Two I.C.A. double tip jacks;
 - One I.C.A. 5 prong socket;
 - One I.C.A. 6 prong socket;
 - Two resistors, 250,000 ohms, (red body-green end-yellow dot);
 - One resistor, 10,000 ohms, (brown body-black end-orange dot);
 - One cartridge condenser, .006-mf.;
 - One mica condenser, .00015-mf., (orange-brown-green dots);
 - One I.C.A. output transformer, with 4 leads);
 - One I.C.A. microphone-audio transformer, (with 6 leads);
 - One I.C.A. on-off switch;
 - One I.C.A. 100-0 dial scale;
 - One I.C.A. pointer knob;
 - Two I.C.A. stand-off insulators;
 - One I.C.A. 6 terminal strip;
 - One I.C.A. drilled chassis and cover;
 - Two insulating bushings;
 - Six brass bushings;
 - Hook-up wire, hardware.
- The following accessories will be required:
- One Sylvania type 37 (or 76) tube;
 - One Sylvania type 41 tube;
 - One pair headphones;
 - One Shure microphone, single button, 200 ohms, high gain;
 - One storage battery, 6 V.;
 - Three "B" batteries (or "B" eliminator), 45 V.;
 - Two "C" batteries, 7 1/2 V.;
 - Material for antenna (see paragraph "Antenna");
 - Stranded insulated wire (or 4 or 6 wire battery cable) for connecting batteries.

It's NOW

EVERYDAY SCIENCE AND MECHANICS is the finest scientific — technical — mechanical — constructional magazine in the field. Up-to-the-minute with news flashes of scientific events. Dozens of constructional articles and many popular experiments. Ideas from which you can make things to sell.

10¢



A HOST OF INTERESTING SUBJECTS COVERED:—Woodworking—Photography—Magic—Patents and Invention—Book Reviews—Metalworking—Chemistry—Engineering—Microscopy—Electrical Experiments—Household Hints—Shop Hints and other subjects.

Get your copy today! On all newsstands 10c the copy

Over 150 Illustrations

Most Amazing TYPEWRITER BARGAIN

10 DAY FREE TRIAL OFFER EVER OFFERED



NEW REMINGTON PORTABLE only **10¢ A DAY**

FIRST TIME! Remington's new purchase plan now lets you buy a genuine latest model Remington Portable No. 5 direct from the factory for only 10¢ a day. Not used or rebuilt. Not incomplete. A beautiful brand new Regulation Remington Portable. Standard 4-row keyboard, standard width carriage, margin release on keyboard, back spacer, automatic ribbon reverse; every essential feature found in standard typewriters. With your machine we send you free a 18-page course in typewriting. Teaches touch system quickly, easily. Soon you dash off letters quicker than with pen and ink. You also get a handsome, sturdy carrying case free.

FREE Typewriting Course **BIG PRICE REDUCTION**

The amazing low price and easy terms now make it possible for you to buy this genuine complete Remington Portable for only 10¢ a day. But we cannot guarantee present prices long. Higher wage scales, rising cost of materials, everything, points to higher prices. So we say, "Act now... while our liberal offer still holds good!"

FREE Carrying Case **You Don't Risk One Cent**
 Try this typewriter in your home or office on our 10-day FREE TRIAL OFFER. Then, if you do not agree that it is the finest portable at any price, return it at our expense. You don't even risk shipping charges. Don't wait. Mail coupon now. It's the best chance you've ever had to own so complete a machine for so little money. So act NOW!

CLIP COUPON NOW

Remington Rand Inc., Dept. 189-1 Buffalo, N. Y.

Please tell me how I can buy a new Remington Portable typewriter for only 10¢ a day. Also enclose your new catalog.

Name.....
 Address.....
 City..... State.....

Please Say That You Saw It in RADIO-CRAFT



Mr. E. H. Rietzke, President of CREI and originator of the first thorough course in Practical Radio Engineering.

Are You Doing the Work That ANY Service Man Can Do?

Every year *thousands* of men join the crowded service field . . . yet, every year only *a few* of those equip themselves to handle bigger, better and more service work. Radio is setting a fast pace, new developments call for increased knowledge, and more Service "Engineers" rather than Mechanics.

CREI Training Is Available To Every Service Man . . .

We actually know that there are many ambitious Service Men who would welcome any opportunity to improve themselves by studying to meet the ever-increasing needs of the present-day Radio man. The complete training that our courses offer is available to everyone at specially arranged terms. Write today for complete details.

New 44-Page Catalog Mailed on Request



CAPITOL RADIO ENGINEERING INSTITUTE
14th and Park Road, Washington, D. C.
Dept. RC-1

POWERTONE

Portable Oscillator
Guaranteed 2% Accuracy

The primary scale is calibrated from 50 to 150 K.C. The lines are 1 K.C. apart from 50 to 80 K.C., and 2 K.C. apart from 80 to 150 K.C. Therefore when used with TRF receivers (using the 101k harmonic) the separation as registered by the calibration points is 10 K.C. from 500 to 800 K.C. to 1500 K.C.

On the upper or secondary scale the popular intermediate frequencies are clearly marked: 157, 200, 300 and 450 K.C. with 17.5-17.7-17.25 spotted. It is mounted in a neat leatherette case, with genuine leather handle and removable cover.

A.C. MODEL
Model 66 uses one 56 tube

BATTERY MODEL
Model 66-B uses 1 230 type tube.

SEND for FREE Catalog

TRY-MO RADIO CO., INC.
85-C Cortlandt St., New York City



\$6.75
Complete with Tube

1935 POSTAL SW BOOSTER



The only two-size custom-built short-wave PRE-SELECTOR and BOOSTER that is completely self-powered. It can be easily connected to any short- or all-wave receiver. Guaranteed to suppress images and to increase the sensitivity and selectivity of any receiver over 100% of your money refunded. Tune in those weak foreign stations with a Postal BOOSTER. Write immediately for 16-page descriptive booklet and special price offer.

POSTAL RADIO
135-K LIBERTY ST. NEW YORK, N.Y.

NEW DESIGN IN ALL-WAVE ANTENNAS

(Continued from page 413)

tens between the antenna and the newly developed receiver impedance-matching transformer which is connected directly between the lower end of the transmission line and the antenna and ground posts of the receiver itself.

The impedance of the transmission line is approximately 70 ohms and the input impedance of the receiver transformer employed as shown in Fig. 1D, is also approximately 70 ohms. The output impedance of this transformer may be selected by means of simple telephone tap-jacks to match receivers with either high or low input impedance. A third connection is provided on this transformer which enables the entire antenna plus the lead-in, to be utilized as a regular T-type antenna, in areas where noise occurs on one band and not on the others. This new transformer which is very simple to use incorporates some of the most advanced radio engineering and provides, for the first time, a means of coupling a transmission line to the ordinary type of receiver without requiring any changes in the receiver itself and without noticeable loss in either the broadcast or the short-wave bands. In fact there is an actual gain in the broadcast band.

Improving All Doublets

The new type of all-wave antenna system employing a doublet for the horizontal portion of the antenna may be made to operate satisfactorily over all the existing wave-bands as a result of some important developments in impedance-matching transformers combined with accurate fixed condensers. The fundamental system employed in this intricate network is shown in Fig. 1 and the theory of the operation of this complicated looking system is not very difficult to understand. It is common radio engineering knowledge that fixed condensers have a lower impedance at high frequencies than they do at low frequencies. Therefore, when the receiver is tuned to the high frequencies, that is, any of the short-wave bands, the impedance of condensers C1 and C2 shown in Fig. 1A offers the path of least resistance to the incoming radio waves which pass directly through the condensers to the low-impedance transmission-line. From this line it goes into the receiver impedance-matching transformer and then, by one of three distinct methods, directly to the receiver.

It is also well understood in radio engineering circles that a doublet antenna cut to a size which is most efficient on the short-wave band will not function satisfactorily when used in the broadcast band. For this reason the transformers shown at either side of the dotted line (in Fig. 1A) are utilized to carry the broadcast signal into the transmission line at a considerable gain over the signal which would be possible without these transformers. In this case the impedance of the transformer is very much lower than the impedance of the fixed condenser and the incoming broadcast signal passes through the transformer in preference to the condenser.

NOTE:—It should be borne in mind that in each half of this antenna impedance-matching device we have a tuned circuit comprising the inductance L1 and condenser C1 in one case, and L1 and C2 in the other case. Both these circuits have infinite impedance at the frequency to which they are tuned and therefore this point of resonant frequency must be located in some portion of the frequency spectrum which is not used for either the short-wave or the regular broadcast bands.

Special Adaptations

Where any type of doublet is used, including double-doublet arrangements, the system shown in Fig. 1D improves performance. The fundamental circuit is shown in Figs. 1A and 1B. Both the units shown are coupled together by means of the necessary length of special cable, in the manner shown in Fig. 1D. One distinctive feature of this arrangement is that the length of this cable is not important. It can be any length from a few feet to several hundred feet.



10 HOURS
of Reading Pleasure

Many Stirring Stories of Future Science in Current Issue

WONDER STORIES brings to its readers vivid, thrilling, and absorbing tales of adventure on alien planets—stories of biological monstrosities, time-travel, the future civilizations of man, and other educational science-fiction themes.

Contents for January: THE HIDDEN COLONY by Otrif and Hanstein, THE PRENATAL PLAGIARISM by Morris West-fuser, ONE-WAY TUNNEL by David H. Keller, M.D., THE EMOTION METER by W. Varko Nordin III, MASTER OF THE GENES by Edmund Hamilton, COSMIC JOKE by Leslie F. Stone, and DAWN TO DARK by Eando Binder plus several interesting departments and short items. The voice of the INTERNATIONAL SCIENCE FICTION LEAGUE.

SPECIAL OFFER (in U.S.A. only)—One year for \$2.00. Send check or money order.
WONDER STORIES, 99-R Hudson St., New York, N. Y.

THERE'S GOOD READING IN HIGH-SEAS

ADVENTURES Magazine

Don't miss the COMPLETE NOVEL in the FEBRUARY ISSUE

LEONARD H. NASON'S "THE WAR GANG"

A story by an author known all over the world for his exciting and authentic stories of the War

ALSO SHORT STORIES BY CAPTAIN DINGLE, FRANCIS ROTCH AND PETER HUNTLEY MacARTHUR

Look for HIGH-SEAS ADVENTURES now on all newsstands

15c a Copy



Please Say That You Saw It in RADIO-CRAFT

The manner in which the duplex coupling device, shown in Fig. 1A, operates has been described. Fig. 1B, represents one of the receiver impedance-matching devices of an early type in which a multi-point rotary switch was employed. This has been replaced by the improved type of unit shown in Fig. 1C. The use of pins and pin jacks assures perfect contact and prevents moisture getting inside the unit, through the switch opening.

It is important to keep the leads from the receiver transformer as short as possible. The red and black wire, supplied with the transformer are of the correct length and they should not be lengthened. This is particularly true of the black wire. Increasing the length of the black wire will tend to throw the entire system out of balance, resulting in a reduction in its noise-reducing properties.

On receivers equipped with wires in place of binding posts, connect to those wires; the antenna wire, coming from the receiver should be cut very short.

For the best results, on all bands, it is suggested that the user try the various connections and keep a record of those which prove most suitable. In the vast majority of instances the best results will be had from inserting the tip of the black wire in A3 and the tip of the red wire in either A1 or A2 and leaving them there.

The difference between the doublet system (Fig. 1D), and that shown in Fig. 2 (commonly referred to as a "zep" or zeppelin-type antenna, in radio parlance) is that the lead-in wire is taken from one end instead of from the center, as in the case of the doublet or doublet-doublet.

This type of system may be made to have the same noise-reducing properties as the regular doublet system by the proper application of the transmission line and receiver impedance-matching transformer.

The details for connecting the transmission line to the antenna are shown in Fig. 3B. The connections at the lower end of the transmission line are identical to those shown in the lower-half of Fig. 1D.

Best results are secured when the horizontal portion of the aerial is in a straight line. However, where space is limited, this portion may be zig-zagged without serious loss. In making such an installation, no section of the horizontal portion should be nearer than 90 percent to any other section, as shown in Fig. 2. The length of any individual leg is unimportant and may be any dimension which convenience permits.

DUAL-RANGE SUPERHET

(Continued from page 412)

R.F. and oscillator coils, and a three-section, double-throw switch. The various circuits, made and broken as this switch is thrown, are indicated in the schematic circuit diagram.

Referring to the antenna transformer in this diagram, T1 is the broadcast transformer and T2 the short-wave transformer. The two primaries are connected in series. With the switch in the short-wave position, the short-wave secondary is connected to the grid circuit of the 6D6 R.F. amplifier tube and the broadcast secondary is short-circuited. When the switch is in the broadcast position, the short-wave secondary circuit is opened up and the broadcast secondary is connected to the grid circuit of this tube. The secondary being used, is tuned by the R.F. section of the 3 gang condenser. A separate variable trimmer condenser C2 is used for the short-wave secondary.

The output of the 6D6 R.F. amplifier is fed into a second 6D6 which functions as the first-detector. A type 76 tube is employed in a separate oscillator circuit. A third 6D6 tube is used as an I.F. amplifier. This stage feeds into a 6B7 combined second-detector and first A.F. stage. The second A.F. (power) stage uses a type 42 tube.

The A.V.C. voltage is applied through isolating resistors to the control-grid circuits of the R.F. and I.F. tubes. The audio voltage developed across volume control resistor R10 is applied through the movable arm to the control-grid of the 6B7 tube.



National Union plays Santa Claus to Service experts all year round!

NATIONAL UNION gives tube testers, set analyzers, oscillators and service manuals with tube purchases. National Union gives these valuable instruments and servicing books so that service dealers can build a larger better more efficient business for themselves. The instruments are all brand new models made by such famous makers as Supreme, Hickok, Triplett and Egert. The manuals are compiled by John F. Rider.

The alert Service-Dealer who equips himself the easy National Union way knows his equipment is backed both by the maker and National Union.

National Union gives service charts and data not available from any other single source.

National Union gives sales promotion aids and business forms.

National Union supplies radio tubes which are acclaimed by experimenters, amateurs and service experts for their accuracy and superiority. National Union tubes never fail to build customer good will. You can quickly prove this fact to yourself as thousands have already done.

Let National Union play Santa Claus to you Mr. Service-Dealer by giving you the instruments you need and giving your customers the fine radio performance they should demand!

National Union Radio Corp. of N. Y.
400 Madison Ave., New York City

RC-135



Tell me about.....
Name.....
Address.....
City.....State.....

SEND
COUPON
NOW



ALAN

D. R. 6

DUAL

REACTION

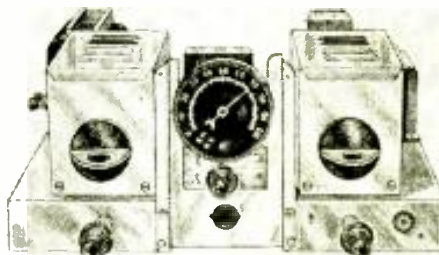

Employs six tubes. Dual Reaction circuit using 3-58's; 1-56; 1-2A5; 1-80. Built in power supply—utilize Alan silver wound, 3-circuit front plug-in coils, phone jack, dual ratio dial, field supply. Completely enclosed in beautiful crackled metal cabinet.

Complete kit of parts, including 4 sets of coils, cabinet and complete constructional data, list, less tubes and speaker \$11.60. Net to amateurs..... **\$24.95**

Wired and laboratory tested additional..... \$4.50 Net Kit of Sylvania tubes for same..... \$3.75 Net
8 in. Dynamic speaker to match (Utah, Rola, Magnavox)..... \$3.50 Net

Order from your nearest source of supply.

ALAN RADIO CORP.

172 Washington Street New York, N.Y.
Dept. R. 1
1028 South Olive Street Los Angeles, Calif.

AGENTS WANTED! MOTION PICTURE SOUND

Most fascinating field awaits live Radio Service Men—quick, sure profits
ASK FOR FREE CATALOGS
S.O.S. CORPORATION
1600 Broadway New York, N. Y.
Cable Address: "Sosound" New York



RUN YOUR A. C. RADIO BY DIRECT CURRENT

Kato Converters operate AC Radio, amplifiers, transmitters, etc. from 6-12 32 or 110 volt DC. Sent on trial.
KATO ENGINEERING CO.
Mankato, Minn. U. S. A.

Manufacturers of Kato AC light plants. Ask for literature.

VAN Shunts and Dials

Come with schematic diagrams and hook-ups. For meter models 301, 88, 321,—324, 50 millivolt; 30 millivolt, and 27 millivolt.

Distributed and sold by reliable jobbers and dealers everywhere.

Folders and list prices on request
Write for New Catalog No. 7.

D. L. VAN LEUVEN
410 East 15th St. New York, N.Y.

FREE LEADING CATALOG For 1935!

Send for the most complete and truly timely book in Radio. Over 100 amazing pages—a great Radio Profit Guide—packed with real Radio “Receipts.”

- NEW. Dual Wave, All-Wave, Short Wave and Broadband receivers—all with new Airplane Dials and Dual Purpose tubes, etc.—Electric, Battery, and 32 Volt models—at new low prices.
- NEW. An entirely new line of Build-Your-Own Kits. Band-spread types, Short Wave, All-Wave, Superhets and T. R. F.'s. Also the famous All-Star and the New National Experimenters' 2 tube S.W. sets. More than 20 great Kits to choose from.
- NEW. An amazing selection of Test Equipments: New Supreme 57" Full Vision Meters; Tri-Ohm, a magnificent Master Line, etc. A complete set of wiring for the Radio Service—an unusually low price.



SEND FOR THIS GREAT NEW BOOK!

- NEW. A great section devoted to Amateur Radio. New professional type receivers, the complete National line, new antenna kits, new tubes, including everything for S. W. Transmitting and Receiving.
- NEW. The greatest P. A. array in Radio, a 50 watt—portable, mobile, and permanent systems. New steel cabinet design. Latest phono and mike equipment. A wonderful offering doubling your profit opportunities.

SEND FOR YOUR COPY TODAY

Allied Radio

833 W. Jackson Blvd., Chicago, Dept. D.

Please send me your FREE 1935 Catalog.

Please quote for Kit described in _____

Name _____

Address _____

City _____ State _____

RCA makes aerial history!



“Provides a new source of profit for the wide-awake service man”—says A. H. Prow, Pres. Phila. Radio Service Men's Association.

EVERY home with an all wave set is an immediate prospect... so get busy! Tell your customers how this remarkable new antenna brings up weak signals, cuts down man-made interference, gives more uniform response because of special “double doublet” feature. Kit of essential parts retails for \$6.00. Your installation charge extra.

Special “Dealer Demonstration” Antenna Kit, Net Price \$9.85, makes possible convincing demonstrations in your store. Connects to four receivers.

Have you seen the remarkable new RCA Full Range Test Oscillator? 90 to 25,000 K. C. Direct Reading Dial, weighs 5 pounds with batteries. Only \$29.50



AN ECONOMICAL P.A. AMPLIFIER

(Continued from page 412)

tem is a function of its power. Experience has shown that about 20 watts of audio power delivered to a reasonably efficient speaker system is usually adequate to meet most outdoor and indoor applications.

Frequency Response: Inasmuch as the equipment associated with the amplifier is the limiting factor in frequency response, little need be said of the amplifier in this regard.

Versatility: The amplifier design should be such that it is suitable for permanent installation, sound truck requirements and temporary set-ups.

Efficiency: This is important for two reasons. First, in sound truck installation where A.C. power supply is derived from an auxiliary such as a small gasoline engine or a fan belt driven generator. Second, to keep down operating costs in permanent installations.

Reliability: This can hardly be over-emphasized as anyone familiar with the operation of a P.A. system which is to show a profit well knows. Breakdowns are costly incidents, when considered in the light of rental loss and servicing.

The Amplifier and Power Supply: Electrical

Referring to Fig. 1, the input is designed to accommodate a 200-ohm line, a 500-ohm line or a double-button carbon microphone. The input transformer feeds from either of these into the grid of a type 57 tube. The output of this tube which is operated as a pentode, its impedance coupled into the succeeding tube, also a type 57. The coupling choke has been designed to possess a very high inductance with relatively low distributed capacity. This is necessary to extend the frequency response at both the low and high frequency ends of the spectrum. The second tube is a type 57 which has its screen and suppressor grids connected to the plate and thus operates as a triode. Under these conditions the tube has an amplification factor of 21, plate impedance of 10,500 ohms, a mutual conductance of 2,000 microhms, a power output sufficient to drive the power stage. The output of this tube is coupled to the power stage input through the medium of a push-pull input transformer. A push-pull plate to voice coil output transformer transfers the energy from the power stage to speakers.

Both these transformers have been designed for class AB operation. The impedances available from the secondary of the output transformer are 8 and 4 ohms. This permits of several speaker combinations. Bias for the first and second stages is obtained by means of bias resistors from cathode to “B” minus. Ample bypassing is provided to minimize degeneration and extend the low-frequency range of which the transformers are capable. The screen-grid and plate supplies of the second stage are each passed through its individual resistance-capacity filter to provide stability and eliminate common-source coupling. Inasmuch as class AB operation is a comparatively recent development, a word as to its mode of operation is in order.

The tubes are slightly overbiased so that with low signal levels they operate as class A. At high signal levels grid current flows alternately in each tube on the positive half of the cycle when the grid signal voltage exceeds the negative bias voltage. The magnitude of the grid current is considerably less than if the tubes were operated class B. Hence the intermediate condition—“class AB.” The flow of grid cur-

Underside view of power supply.

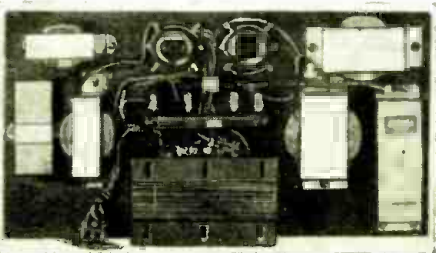

Please Say That You Saw It in RADIO-CRAFT

FREE

48-Page Supplement to the Auto-Radio Service Manual!

To everyone who now purchases the OFFICIAL AUTO-RADIO SERVICE MANUAL this big 48-page Supplement is issued FREE. Practically all of the latest sets, together with servicing information will be found in these new pages. The new Supplement does not increase the cost of the book to you, but gives you an Auto-Radio Service Manual that is right up-to-the-minute with servicing notes.

Good Money in Servicing Auto-Radios

If you are overlooking servicing auto radios, you're missing a great deal of business. The auto-radio business had its greatest boom last summer when thousands of sets were sold. By now many of these same sets require servicing and with hundreds of them right in your own community, you can build up a good auto-radio servicing business. In a short time you can easily add 25% profit or more to your regular servicing business.

List of sets covered in the Manual

- | | |
|-------------------------------|---------------------------------|
| Acme Radio Mfg. Co. | P. R. Mallory & Co. |
| Allied Radio Corp. | Melborn Radio Mfg. Co. |
| Atwater Kent Mfg. Co. | Montgomery Ward & Co. |
| Audiotone Radio Co. | National Co., Inc. |
| Auto-Radio Company | Nobiliti-Sparks Inc., Inc. |
| Automatic Radio Mfg. Co. | Philco Radio & Tel. Corp. |
| Carter General Corp. | Pierce-Air, Inc. |
| Century Radio Prods. Co. | Premier Electric Co. |
| Chevrolet Motor Company | Radio Chassis, Inc. |
| Consolidated Industries, Ltd. | RCA-Victor Co., Inc. |
| Crosley Radio Corp. | Sentinel Radio Corp. |
| Decca Appliance Corp. | Sparks-Withington Corp. |
| Detroit Radio Corp. | Stewart Radio & Tel. Corp. |
| Emerson Electric Mfg. Co. | Stewart-Warner Corp. |
| Fada Radio & Elec. Corp. | Stronberg-Carlson Tel. Mfg. Co. |
| Federated Purchaser, Inc. | Transformer Corp. of Am. |
| Ford-Majestic | United Amer. Bosch Corp. |
| Franklin Radio Corp. | United Motors Service |
| Galvin Mfg. Corp. | U. S. Radio & Tel. Corp. |
| General Electric Co. | Utah Radio Prods. Co. |
| General Motors Corp. | Well-Gardner Company |
| A. H. Grebe & Co. | Wholesale Radio Serv. Co. |
| Gristley-Grunow Co. | Rudolph Wurflitzer Mfg. Co. |
| Clas. Hoodwin Company | Zenith Radio Corp. |
| International Radio Corp. | |

\$2.50

Over 200 Pages
Over 500 Illustrations
9 x 12 Inches
Flexible, Loose-Leaf Cover

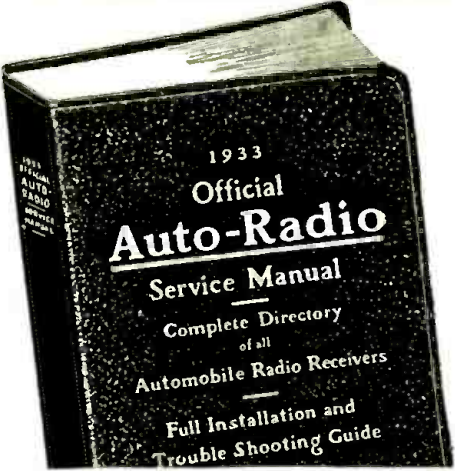

MAIL THIS COUPON TODAY!

GERNSBACK PUBLICATIONS, INC. RC-135
99 Hudson Street, New York, N. Y.

Enclosed you will find my remittance of \$2.50 for which please send me One Copy of the OFFICIAL AUTO-RADIO SERVICE MANUAL with FREE 48-page Supplement. Send remittance in check or money order. Register letter if it contains cash or currency. WE PAY POSTAGE.

Name _____

Address _____

City _____ State _____

rent increases the useful linear portion of the tube characteristic and greatly increases the power output. Naturally the transformers associated with such an arrangement must be correctly designed for the purpose.

It is well to point out here two things of importance. First: the tubes utilized in the power stage are the 45 type which are inexpensive and economical in a class AB system. Second: Successful operation of a class AB amplifier requires a low-voltage regulation in both the plate and grid bias supplies. Regulation in the plate supply has been brought to a negligible minimum by correct design and great care in manufacture of the transformers and chokes. Use of the mercury vapor rectifier tube minimizes regulation from this source. There remains only the one offender—the bias resistor from filament center-tap to "B" minus. This has been eliminated and a bias power supply substituted in its place. It is important that the bias voltage on the power stage grids remain constant. The bias supply accomplishes this.

Inasmuch as the transformers and chokes in both the amplifier and power supply are the very heart of an amplifying system, not enough emphasis can be placed upon the importance of correct design and care exercised in manufacture. The units utilized in this amplifier and power supply possess both of these necessary qualifications. Conservative ratings, high-grade materials, liberal use of insulating material, high safety factor and great care in assembly make for a uniform, dependable, efficient, quality product of long life. All coils in these units are impregnated and baked under a vacuum; a special process which makes them impervious to moisture and greatly minimizes the possibility of breakdown.

As shown in Fig. 2, the high-voltage power supply is comprised of a power transformer, a type 83 mercury vapor rectifier tube and a double-section filter. Choke input is utilized for the excellent voltage regulation it provides. A bleeder resistor is shunted across the filter output to maintain the proper voltage, whether the amplifier is turned "on" or not. This is a measure of precaution to protect the electrolytic filter condensers which might be subjected to the peak voltage if no load were present.

The bias voltage power supply consists of a transformer designed for this purpose, a type 82 tube as a half-wave rectifier and a single choke with two filter condensers (condenser input) as filter. A suitable bleeder resistor is connected across the output of the filter. The rectified grid currents of the power stage are a very small percentage of the bleeder current so that there is practically no change in bias voltage with full power output. The result is a "fixed bias" which is so essential. The filament of the rectifier tube is excited by a winding on the "B" power transformer.

An idea of the efficiency can readily be gained when it is realized that the total power consumed is less than 100 watts, at full power output.

In cases where it is desirable to mix more than one channel into the amplifier a mixer arrangement can be used. Reference to the wiring diagram, Fig. 2A, will show how this can be accomplished.

Mechanical

While economy has been a guiding factor in the electrical design it is evident that this has not been neglected in the mechanical design.

The amplifier and power supply are each contained in their own sheet steel boxes. Thickness of the box material was determined with regard to strength and weight. Louvers on three sides provide adequate ventilation. The control equipment such as volume control for the amplifier

Underside view of amplifier

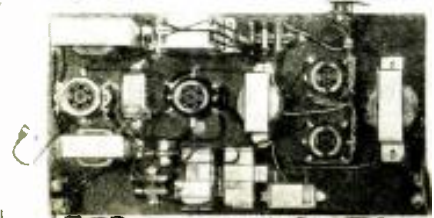

YOU C'N HAVE THE FILTHY LUCRE, BILL. HERE'S SOMETHING FAR MORE INTERESTING TO ME!!!

NEW IRC POWER WIRE WOUND RESISTORS

NEW—LOW PRICES. 10 Watt Unit now only 21c net (*)

- NEW—higher wattage ratings smaller sizes.
- NEW—Cement coating. Durable—dissipates heat quickly.
- NEW—A COMPLETE line—Low Wattage, High Wattage. Fixed and Adjustables, Higher resistance limits.
- NEW—IRC Power Wire Wound Resistor Catalog containing helpful resistance data and computation charts. Write for a copy today—Ask for RC-100.

(*) Prices slightly higher in Canada.
INTERNATIONAL RESISTANCE CO.
2100 Arch St., Philadelphia, Pa.
(In Canada, 187 Duquesne St., Toronto, Ont.)

IRC RESISTORS

and "on-off" power switch for the power supply is mounted on the front panels of the respective units. These panels are fastened to the boxes by means of tapped flanges which are an integral part of the box. Two miniature handles known as "Footman's Loops" are fastened one to each end of each box. By the simple expedient of fastening either a leather or woven-cloth belt to these loops the units can be easily moved about by merely slinging over the shoulder in portable work. The component parts of both units are mounted on their respective wood baseboards. This involves a minimum of assembly labor and facilitates removal of either unit from the box as a complete assembly whenever occasion might arise.

Mounting of the bleeder resistors in the power supply is simple but very effective. The mounting screws pass through holes in the resistor lugs and down through pillars to the wood base board. Thus the resistor is free from contact with the board and mounted quite rigidly.

The photographs of the two units show the plan layout of the amplifier and location of the component parts. It is recommended that this arrangement be followed closely as possible.

Attention is called to the manner in which the input, output, and power transfer are provided for. This is accomplished by means of a plug receptacle arrangement which has proved itself most satisfactory. The plugs have rubber caps which extend along the cable and relieve stress from the connection when the cables are moved about.

The thought given to safety is readily apparent in the method used for bringing the power line to the power supply unit. A recessed flush motor plug receptacle is located on the box. The power cord is connected to a body connector which fits into the recessed receptacle. In the event that the power cord should be alive when the body connector is removed from the receptacle, there are no exposed blades, thus eliminating the possibility of a short-circuit or shock.

Conclusion

It is believed the system described will fulfill a long-felt need in the public address field and its existence is more than justified by the demand for an economical, efficient, reliable amplifier, with relatively high power output.

Operating Data

TYPE	PLATE VOLTS	PLATE MA.	S.-G. VOLTS	C. G. VOLTS
V1 (57)	250 V.	2 ma.	100 V.	-3 V.
V2 (57)	250 V.	7 ma.	250 V.	-8 V.
V3 (45)	300 V.	36 ma.	-60 V.
V4 (45)	300 V.	36 ma.	-60 V.

Please Say That You Saw It in RADIO-CRAFT

There's pep behind this
HIGH FIDELITY
Class "A" Prime Amplifier

**4 STAGES
15 WATTS**

This remarkable high fidelity Class "A" Prime P.A. Amplifier employs tubes exceptionally low in cost, and yet it delivers an output of 15 watts. The Marlo Amplifier contains as many of the finer characteristics usually found only in most expensive equipment. It features stepless tone control, over-size hum-free filters, high safety factor, full-range volume control and separate speaker outlet. The frequency range at the rated maximum power output, with a harmonic content not exceeding 5%, and a power variation not exceeding 2 db. ±, is about 60 to 12,000 cycles. The circuit of this highly efficient Marlo Amplifier has been developed by proficient sound engineers—it is designed to operate on 105-120 volts A.C., giving perfect performance under all conditions. Its chassis is of rugged auto-body steel—finished in a beautiful black crackle crystal-like effect. **4 Tubes used in the circuit are: 1-57; 1-56; 1-6AG5; 6-45s and 1-6Z5 AMPLIFIER—completely assembled, wired and tested, less tubes.**

\$14.75 NET

Speaker equipment available at lowest possible prices. Complete details sent immediately on request.

MARLO PRODUCTS CO. 16 Hudson St. New York, N. Y.

FULTONE V

NEW FIVE-IN-THREE SET

6F7

76

12A7

AC-DC

A remarkable receiver— at a remarkable price!

Sensitive—powerful—world-wide reception—all electric—full five tube performance—compact—speaker or headphones operation—easy to operate—easy to build! A receiver you will be proud of!!

Complete kit, including all necessary parts, crystal finished metal chassis with all holes, and complete, easily followed instructions—**\$7.45**

Set of Sylvania Tubes \$2.20. Metal cabinet \$1.25. Special loud speaker \$1.15. 200-625 meter coils \$1.25

SPECIAL COMBINATION OFFER

Complete kit, speaker, cabinet, tubes, and broadcast band coils—only **\$12.75**

Kits wired and tested—\$1.00
At your dealer or order direct. Deposit required.

HARRISON RADIO CO., Dept. R-1. 142 Liberty St. New York City

Your OBSOLETE Tube Checker CAN BE Modernized By "Precision"



Your JEWELL No. 214 transformed from its small case into a new modern black crystalline cabinet 15x25. Gives the complete instrument a larger and more impressive tube-checker appearance.

As the leaders in the field of modernizing obsolete receiving equipment, Precision offers its extensive resources of rebuilding instruments to radio men. Our engineers have developed plans for rebuilding thirteen obsolete tube tester models.

NOW AVAILABLE MODERNIZATIONS FOR

JEWELL No. 214	WESTON No. 676
JEWELL No. 333	WESTON No. 677
JEWELL No. 334	WESTON No. 678
JEWELL No. 335	SYLVANIA No. 678
JEWELL No. 338	ARCTURUS No. 27
SYLVANIA No. 538	CECO No. 535
DAYRAD No. 381	

WRITE FOR OUR PLAN "48" HOUR SERVICE

PRECISION APPARATUS CORPORATION
Dept. RA. 821 E. N. Y. Ave. Brooklyn, N. Y.

SERVICEMEN!

Step Ahead of the rank and file—



with "CASE RECORDS of BROADCAST RECEIVER REPAIRS"

- ADD 10,000 Hours to your experience!
- ELIMINATE GUESS-WORK IN YOUR SERVICING!
- DON'T PUZZLE YOUR PROFITS AWAY!

Your work is already done and recorded for you in "CASE RECORDS." This 9x12" loose-leaf binder contains 1,500 alphabetically and numerically arranged "CASE RECORDS" of SUCCESSFULLY COMPLETED SERVICE JOBS!

\$4.75

Each CASE RECORD tells all details for satisfactory repair. SUPPLEMENTED QUARTERLY FREE for 1 year. 108 receiver makes . . . 3,000 models.

. . . the FASTEST Technique known to the Professional!

CAPITOL RADIO RESEARCH LABORATORIES, INC.
1503 21st Street, N.W., Washington, D.C.

gentlemen: Kindly forward full details on "CASE RECORDS."

NAME _____

ADDRESS _____

BIG RADIO VALUES

1935 MODELS! Amazing bargains in the newest and finest of 1935 models! BUY DIRECT from us and SAVE UP TO 50%. Factory prices on the complete line, every set guaranteed: AC-DC midsets; world-wide all-wave; dual wave; consoles; car, farm and battery models. Also 2, 6 and 32 volt. Beautiful modern cabinets; illuminated airplane type dials; separate short wave switch control; foreign reception bands marked; greater **\$9.95** power and selectivity. From.....

30-DAY HOME TRIAL you risk nothing! Satisfaction guaranteed. Try your Fordson 30 days before deciding. Send TODAY for complete FREE information!

FORDSON RADIO INC.

Dept. 39-12, Oakman Bldg., Detroit, Mich.

OUR AGENTS MAKE MONEY!
Openings for several active representatives. Write now!

The above values are based upon no signal through the amplifier.

Notes on Construction and Wiring

- (1) Keep all grid and plate leads separated as much as possible.
- (2) Keep grid and plate leads from close proximity to wires carrying alternating current (in this case, filament wires).
- (3) Filament wires should be twisted up to the socket terminals to keep radiated fields to a minimum.
- (4) To eliminate possibility of undesired, spurious coupling bring all wires which return to ground, to a SINGLE COMMON GROUND POINT.
- (5) Wire the power supply and input-output receptacles to their proper places before placing the units in their respective boxes. This will provide for a finished job and eliminate unnecessary lengths of wire when the units are placed in the boxes and the receptacles screwed into place.
- (6) Under certain conditions depending upon the degree of coupling outside the amplifier box between input and output, it may be found advisable to ground one side of the low impedance output and the primary center-tap of the input transformer.
- (7) Connect all transformer cores to ground.

List of Parts

TRANSFORMERS AND CHOKES

- One Kenyon type KMG input transformer;
- One Kenyon type KAC high-impedance plate choke;
- One Kenyon type KR-45 driver transformer;
- One Kenyon type KR-462 output transformer;
- One Kenyon type KR-1 power transformer;
- One Kenyon type K-15C bias transformer;
- One Kenyon type KC-90 filter choke;
- One Kenyon type KC-350 filter choke;
- One Kenyon type KC-200 filter choke.

ACCESSORIES

- One Kenyon amplifier baseboard;
- One Kenyon power supply baseboard;
- One Kenyon amplifier panel;
- One Kenyon amplifier container;
- One Kenyon power supply panel;
- One Kenyon power supply container;
- Two 6-prong bakelite tube sockets;
- Four 4-prong bakelite tube sockets;
- One Cornell-Dubilier or Aerovox dual condenser, 8-8 mf., 450 V.;
- One Cornell-Dubilier or Aerovox dual filter condenser, 8-8 mf.;
- Two Cornell-Dubilier or Aerovox filter condensers, 25 mf., 35 V.;
- Two Cornell-Dubilier or Aerovox filter condensers, 1 mf., 400 V.;
- One Cornell-Dubilier or Aerovox condenser, .5-mf., 400 V.;
- One Cornell-Dubilier or Aerovox condenser, .1-mf., 400 V.;
- Two metal clamps for 25 mf. condensers;
- One metal clamp for dual 4-8 mf. condenser;
- Five plate filter and "C" bias resistors;
- One Electrad bleeder resistor, 40 W.;
- One Electrad bleeder resistor, 5 W.;
- One tube shield, base and cap;
- One Electrad volume control;
- Two screen-grid caps;
- One knob for volume control;
- One face-plate for volume control;
- Two 7-contact power transfer plugs with rubber caps;
- Two 3-contact power transfer plugs with rubber caps;
- Two 7-contact power transfer receptacles;
- Two 7-contact power transfer receptacles;
- Two 3-contact power transfer receptacles;
- One recessed flush motor plug receptacle;
- One body connector with armored cord grip;
- One toggle switch with "on-off" plate;
- One coil wire for wiring;
- One coil power transfer cable;
- One roll solder;
- Four handles;
- One package of miscellaneous hardware.

RADIO-CRAFT INDEX

By Subjects, Issues and Authors, the July 1929 to June 1932 issues of RADIO-CRAFT are indexed and cross-indexed, in a publication you may obtain for only 25c (stamps or cash). Write to us for this valuable 24 page reference; its use will save you time and money!

Read the next issue of

PIRATE STORIES

A Complete Book - Length Novel
SKULL ISLAND

By C. M. BENNETT
A Story of Blood and Thunder on the Main
Also

TREACHERY OF MOW GHEE
Thrilling Story of Chinese Sea-Bandits
By ELTON STERRETT

And
SUBMARINE HOLD-UP
By LEROY LAKE

A Story of Sea-Gangsters Who Threaten a Transatlantic Liner

A specially drawn series of Exploits of Modern Pirates

A regular reader's department, "Jolly Roger's Log," in which your questions are answered.

Buy your copy of January Pirate Stories now from any newsstand

15c The Copy



The 'Little Red'

In this one-room cottage at Saranac Lake, N. Y., called "Little Red," the modern treatment of tuberculosis began in 1885 because Dr. E. L. Trudeau discovered the value of rest in curing tuberculosis. Progress has been made in the fight against tuberculosis, but it still kills more persons between 15 and 45 than any other disease. Help conquer it by using Christmas Seals on your holiday letters and packages.



The National, State and Local Tuberculosis Associations of the United States

BUY CHRISTMAS SEALS

SEXOLOGY

THE MAGAZINE OF SEX SCIENCE
SEXOLOGY, foremost educational sex magazine, is written in simple language and can be read by every member of the family. It is instructive, enlightening—not a risqué book—contains no offensive matter.
Contains 25 important articles on Sex Science, 68 pages, with attractive two-color cover. Here are a few of the more important articles:
Sex Incompatibility—Is Pregnancy Dangerous in Women over 30?—Neuralgia of the Sex Organs—Vaginismus and Married Life—Circumcision among the Jews—Aged Men as Fathers—Should I Be Cystoscoped?—Sexual Life of Athletes—Spurious Pregnancy—The "Juvenator"
Fraud—Malformations of the Male Organ—Man Carries Twin in Tumor—Female Breast Development—Protection against Ignorance—Mother at 11—Is Frigidity Inherited?—Gestation in Man and Animals—Extraordinary Sex Habits—Questions and Answers.
*Article illustrated.

Get a copy of SEXOLOGY on any newsstand, or if your dealer cannot supply you, send 25c cash or stamps for current issue.

SEXOLOGY, 95R Hudson St., NEW YORK, N. Y.

CLASSIFIED ADVERTISEMENTS

Advertisements in this section are inserted at the cost of twelve cents per word for each insertion—name, initials and address each count as one word. Cash should accompany all classified advertisements unless placed by a recognized advertising agency. No less than ten words are accepted. Advertising for the February 1935 issue should be received not later than Dec. 5.

A. C. GENERATOR

10 PRACTICAL AND LOW-COST CHANGES converting Dodge 12-V., Ford T. A., Chevrolet Deleo 6-V. generators into 100-500 watt capacity A.C. generators, or into 32-110 V., D.C. motor or generator. Dodge is 500-W. self-exciter. All in one book illustrated with complete simplified instructions and drawings for only \$1. Autopower, 410 S. Hoyne Ave., Chicago.

ELECTRICAL SUPPLIES

INSULATION, WIRE, VARNISHES, SUPPLIES, etc. Send 3c stamp for bulletin. Autopower, 410 Hoyne Ave., Chicago.

PATENT ATTORNEYS

PATENTS—REASONABLE TERMS. BOOK and advice free. I. F. Randolph, Dept. 562, Washington, D.C.

PATENT INVENTIONS IS MY SPECIALTY through 28 years.; Sterling Buck, Registered Patent Attorney 7780, 629 F. Washington, D. C. (Free Booklet-R).

RADIO

NEW TUBELESS 1850 MILE RADIO. Operates Speaker, Blueprint 17 Others, 25c Coin. Setbuilders List Free. Modern Radiolabs, 151-15 Liberty, San Francisco.

RADIO INSTRUCTION

RADIO ENGINEERING, BROADCASTING, aviation and police radio, Servicing, Marine and Morse Telegraphy taught thoroughly. All expenses low. Catalog free. Dodge's Institute, Pine St., Valparaiso, Indiana.

UNDERGROUND TREASURES

TREASURE SEEKERS—MAKE YOUR OWN gold finders. Learn facts about mineral machines, free outfits, etc. E. Dodenhoff, 114 E. 28th St., New York City.

BACK ISSUES of RADIO-CRAFT

which you might need to complete your files, can still be had at the price of 25c per copy. Send us your requirements, together with your remittance in check or money order.

RADIO-CRAFT

99 Hudson Street, New York, N.Y.

Know Thyself!

Well Illustrated

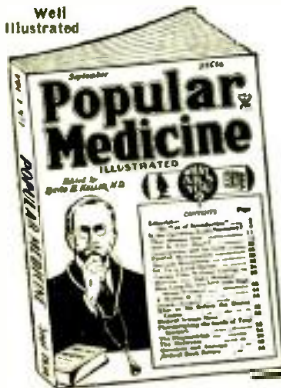

This new monthly magazine is also your own doctor. WHAT ALES YOU? POPULAR MEDICINE tells and advises you thoroughly. Written for you by doctors. Non-technical yet authoritative for all laymen. Many anatomical illustrations.

Special Offer!

8 Months \$1 for

Send 25c for sample copy POPULAR MEDICINE 979 Hudson St., New York, N. Y.

On All Newsstands

OPERATING NOTES

(Continued from page 418)

as noted all were 400 V. cartridge type. All contacts were put in order and rotor wipers cleaned, as per usual, and the set played fairly well, but seemed to be lacking in "pep" in the audio output. This was due to the fact that the two fields had been so connected that they were bucking instead of aiding mutually. Reversal of the 935 ohm section cured this trouble and the set worked fine, and has ever since.

JOHN MUEHLKE

ATWATER KENT 188

I HAD an unusual case of an Atwater Kent 188 which had all the symptoms of a loose connection, that is, it would rattle when shaken, or when the floor was jarred. Usual diagnosis failed to reveal noisy tubes or loose connections. Finally, on looking further, I found that moving the control-grid lead to one of the screen-grids would produce the noise. Sweating all connections on the R.F. coil and lead failed to remedy the trouble. At last, as an experiment, I substituted a new wire which cleared up the trouble. Careful examination of the old wire failed to show any defects, so I put it back in place. The noise reappeared. Apparently the rubber insulation of this wire must have had a high content of some mineral which made it conductive, as there were no broken strands in the wire or breaks whatever. A new wire made a permanent repair in this case!

ATWATER KENT 260

A SHORT time ago there appeared in your columns an article regarding a set from which they had to take the transformer and bake it in an oven to show up the trouble. I am going to "go them one better." I had a late model Atwater Kent 260, which is the short-wave combination, which we had to put in a refrigerator to make the trouble appear!

This machine performed normally in the store before it was sold, but upon being placed in the customer's home, it would sometimes take from 2 to 3 hours before the set would start to operate after being turned on, although every time I made a service call, the machine would perform normally. We brought it into the shop and over a period of 2 or 3 days the machine failed to play sick. After questioning the owner closely, we found that the only times the machine failed to work was when they had been away from home and the house had been cold during the day. Finding this out, I put the chassis into a large Frigidaire and chilled it thoroughly, and it worked; that is, the set did not work, which was what we were looking for!

On checking through, I found a short in the first input A. F. Transformer. Upon removing this I discovered that the case was very full of tar, so much so, that the tar was pushing against the chassis. When pressure was released, in other words, when the tar was cold, it contracted and the short would appear. However, when pressure was applied to the tar, the same as when the machine warmed up the tar expanded, and the short would clear. I might mention that in this model there is a plate resistor mounted on the inside of the transformer case instead as had been former practice in the Atwater Kent. This was a little confusing at first since a test did not indicate a complete short.

CROSLEY 30-S, 31-S, AND 34-S

THE trouble in these models seems to be centered in the electrolytic condenser—variable condenser assembly, and in the resistors. I find in case of hum the quickest method to locate the source of trouble is to put an 0 to 100 ma. milliammeter in series with each lead to the electrolytic condenser. If the drain in any section is over 5 ma., the section or sections should be replaced. I invariably find on these machines which have not been serviced for some time that the condenser bearings have worn to such an extent that the plates are too close on one side, and find it a very good policy in many cases to put a pigtail on these models, as the friction bearing is very hard to keep clean. A little care in centering the condenser plates will make a

(Continued on page 415)

Here's the Amazing!
BANDSPREAD
Short Wave Portable

Compact as a CAMERA and as Easy to Use.

You'll be amazed that such a trim small set can give such performance! This two-tube Band Spread Portable Short Wave Receiver brings in London, Berlin, Madrid and other foreign stations with an ordinary 15 ft. insulated wire for an antenna!

You can take it any place for it weighs but 9 lbs. complete with self-contained batteries. If you want short wave reception when the rest of the family wants U.S. stations—just take it upstairs and tune in without bothering the others. Or put it in your car and get short wave reception on your week-end trip.



Complete kit of parts \$7.95, kit of 2 tubes, add \$1.44; kit of 6 batteries, add \$1.18; if wanted wired ready to use add \$1.35. Coils covering 19, 25, 31, 40, 49, 80 and 160 meter bands are available at 55c each!

BIG FREE CATALOG

192 pages of amazing bargains. Over 50,000 items. Contains Great Specialized Section on Short Wave, including sets and kits from 2 to 10 tubes, Transceivers, Preselectors, Converters, 5 M. Equipment, etc. Also sections on Public Address, Replacement Parts, Tubes, Refrigerator Parts. Get your FREE copy of this amazing Bargain Book where everything is listed at LOWEST WHOLESALE PRICES!

WHOLESALE RADIO SERVICE CO.
NEW YORK ATLANTA
100 Sixth Avenue 430 W. Peachtree St. N.W.
Local Branch 219 Central Ave., Newark, New Jersey.

DEPARTMENT C-15

() Send me the order for Band Spread Portable I have described in attached letter.
() Send me your FREE 192 Pg. Catalog with Big Short Wave Section.

NAME

ADDRESS

CITY

STATE

AND NOW WEBSTER CHICAGO
Hard of Hearing Systems

FROM "mike" to amplifier... to one, two or forty head-sets so that those in the audience who are "hard of hearing" may hear without strain—that is the new WEBSTER-CHICAGO unit.

It is called the Hard of Hearing system and is the newest WEBSTER-CHICAGO PA system to be designed to help you get all the PA business in your community.

NEW BULLETINS

Ask for special bulletins and be sure your name is on the list to receive the new Bulletins on co-ordinated systems that are now being prepared.

THE WEBSTER COMPANY
3930 West Lake Street, Chicago, Ill.

Please Say That You Saw It in RADIO-CRAFT

- - ahead of others in **TUBE TESTER** Value

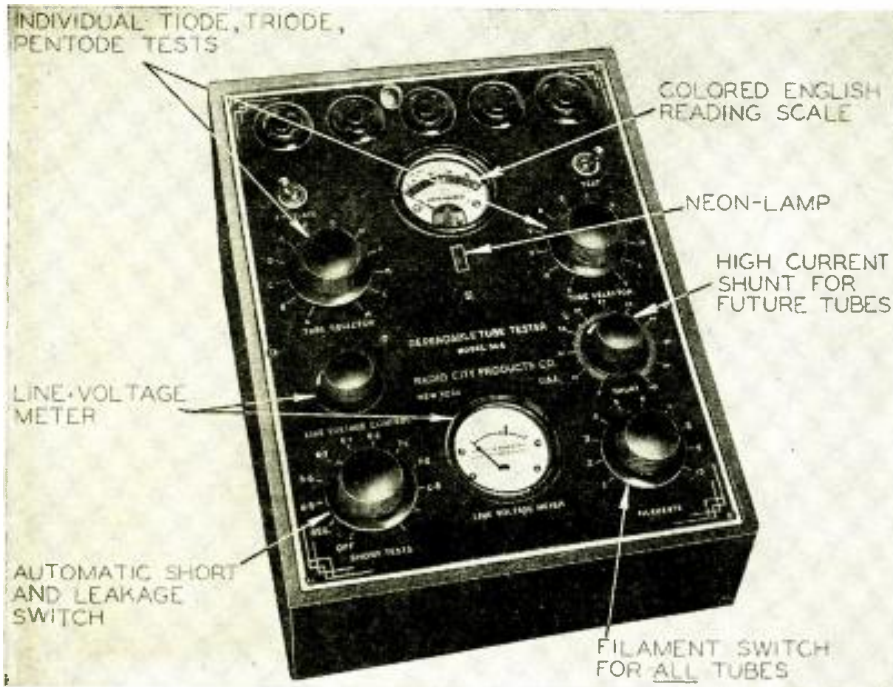

12 Outstanding Features!

- 1-ENGLISH READING Scale — COLORED DIAL indicates "GOOD-POOR-?"
- 2-TESTS EVERY TYPE of tube made to-day and many new ones which shall arrive in the future.
- 3-TESTS SHORTS and LEAKAGES between ANY TWO elements.
- 4-NEON LIGHT indicates leakages above 1,000,000 ohms.
- 5-SEPARATE LINE VOLTAGE meter with line voltage control.
- 6-INDIVIDUAL TESTS OF DIODE, triode, pentode, etc., sections of all combination-type tubes—both plates of all full-wave rectifiers.
- 7-PROVIDES AGAINST OBSOLESCENCE—Spare switching capacity for three times the present number of tubes.
- 8-SIMPLE TO OPERATE; convenient to use.
- 9-PROFESSIONAL APPEARANCE—etched panel; leatherette case.
- 10-ACCURATE D'Arsonval moving-coil meter, guaranteed 2% accuracy.
- 11-NO ADAPTERS of any kind necessary.
- 12-ECONOMY—Costs less than other testers that do not have all these features.

The new, Model 304, Dependable Tube Tester establishes a new "high" in test equipment to meet all modern requirements in testing. Simplicity in design and operation permit even the average consumer, who knows very little about radio technicalities, to follow the testing procedure, and to accept without further question the "good" or "bad" evaluation of every tube in the set.

Dependable Model 304—100-135 volts; 50-60 cycles
NET TO DEALERS **\$19.95**
(25 cycle—\$2.25 extra)

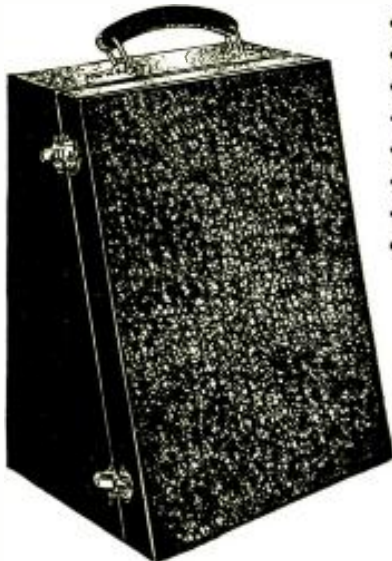

Combination Portable Carrying Case for Model 304
— illustrated — \$2.25 additional.

KIT FORM

In kit form — "to build your own" Model 304 Dependable Tube Tester — with all instructions. NET TO DEALERS... **\$15.65**

MODEL 304

Dependable Tube Tester also in Portable Model

There is an important economy factor in purchasing a Model 304 Dependable Tube Tester. The instrument is capable of making all essential tests, and, because it is portable, may be taken from store or laboratory and used on outside service calls. In addition it has a handy compartment for small tools.

2,000 OHMS PER VOLT MULTITESTER

A high-quality test instrument. The moving-coil instrument sensitivity is 2,000 ohms per volt. This instrument meets 4 major specifications. Ohm-meter range: ¼-ohm to 2 megohms; individual range: 0-2,000 (ohms)—0.2 (-meg.) -2 (megs.), (batteries, self-contained). Voltmeter range: 0-5-50-250-750 V. Milliammeter ranges: 0-50 ma. Microampere range: 0-500. The automatic selector switch connects the meter only to the desired circuit and range.



KNOCK-DOWN KIT—Model 403K
Complete with instructions (less batteries and case). NET TO DEALERS **\$10.95**

Net to Dealers .. **\$14.95**

WE ISSUE NO CATALOG

All orders are F. O. B. New York. Terms: A deposit of 20% is required with every order. Balance may be paid on delivery. Deduct 2% if full amount is sent.

GREN PARK COMPANY

101 Hudson St.

Dept. RC

New York, N. Y.

Please Say That You Saw It in RADIO-CRAFT

WELLWORTH TRADING CO., CHICAGO

560 W. Washington Blvd.

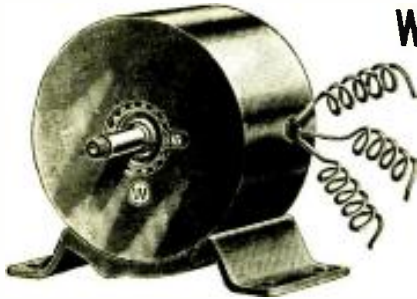

WESTINGHOUSE POWER GENERATOR

MANUFACTURED FOR U. S. SIGNAL CORPS

SPECIFICATIONS:

WEIGHT—14½ lbs.
HOUSING—Aluminum (Diameter—6¼ in. Length—5¼ in.)
SHAFT—2 3/16 in. (driving end) Diameter 9/16 in. the end is threaded for a distance of ¼ in.)
BASE—Cast Iron (Length—7¾ in. Height 1¾ in. Width 4 in.)
OUTPUT—200 Watt 110 volts AC speed 4500 R.P.M.)
STATORS—Two pairs (two North and two South)
ROTOR—12 tooth inductor. Build in commutator Rotor turns in ballbearings.
(GENERATORS HAVE NEVER BEEN USED)

SHORT WAVE TRANSMITTER supplying 110 Volts AC for operating "Ham" transmitter.
 OPERATING 110 V. AC 60 CYCLE RADIO RECEIVER in DC districts.
 MOTOR GENERATOR.
 PUBLIC ADDRESS SYSTEMS.
 ELECTRIC SIRENS on Motor boats, yachts, etc.
 CAMP LIGHTING.
 SHORT WAVE artificial "fever" apparatus.
 TELEVISION.
 PELTON WATERWHEEL for lighting or other purposes.
 AIRPLANE: for lighting strong search lights or electric signs.
 LABORATORY WORK.
 Furthermore the following uses are explained:

FREE

With each Westinghouse Generator we supply free of charge a set of diagram-blue prints and instructions showing twenty-five different uses, giving technical information, electrical Hookups and installing explanations. We also include free of charge a set of four replacement carbon brushes.

How to obtain electrical power: from a Windmill, from available Waterpower, from your Automobile, from your Motorcycle, from your Bicycle, Footpedals or Handcrank (for transportable Radio Transmitters, Strong Floodlights, Advertising Signs); how to operate AC Radio sets from 32 V. DC farm light systems; how to operate two generators in series to get 200 V. AC; how to obtain two phase and three phase AC, etc., etc.

Generator as described above including four replacement carbon brushes and folder containing instructions and uses..... **\$7.90**
 Shipping weight 18 lbs
 (Replacement carbon brushes bought separately \$1.50 per set of four. Set of instructions bought separately \$1.00)

THERE ARE OVER 25 APPLICATIONS SOME OF WHICH ARE:

A.C. DYNAMO lighting from eight to ten 20 Watt 110 Volts lamps.

G. E. Phonograph Motor

Variable speed induction type self-starting. 110 volt. 60 cycle, AC, with lever control. Speed range from 5 to 200 R.P.M. Can be installed in place of old-fashioned, hand-winding speed motor. Also ideal for display turn table, and a hundred other uses. These G.E. Electric Motors are brand new, in original factory cartons. Same motor that formerly sold for \$15.00. **\$3.95** only

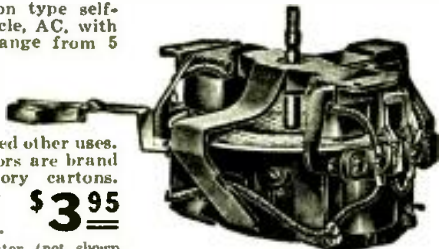

Complete with speed regulator (not shown in above picture).
 Shipping weight, 11 lbs.

Formerly Sold for \$15.00

ORDER FROM THIS PAGE Since We Do Not Publish Any Catalog

Remit by check or money order for full amount of each item—shipped by express collect, if no money for P.P. enclosed. No. C.O.D. order accepted. Money refunded if not satisfied. Be sure to state shipping point if express or freight office is not in your town.

WELLWORTH TRADING CO. RC-135
 560 West Washington Blvd., Chicago, Ill.

I enclose \$..... for which please send me the following:

.....
 Name
 Address..... City..... State.....

Electrical Portable Sprayer Outfit

\$27.50 COMPLETE
 Formerly sold for \$68.50

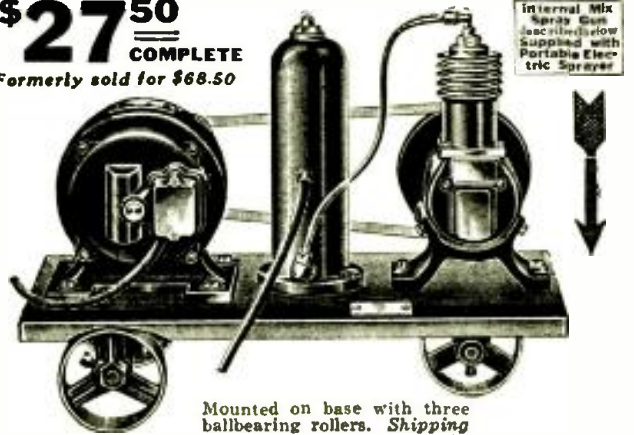

Mounted on base with three ballbearing rollers. Shipping weight of complete outfit, 55 lbs.

This is the ideal outfit for all-around spraying work wherever current is available. With this electric sprayer you can spray paint, varnish, duco, enamel, lacquer, insecticides, etc., with speed. You can move it from one room to another with ease. Simply insert plug into electric socket and this marvelous machine is ready to do a man-size job—and do it efficiently.
 This electric portable sprayer saves its cost over and over again on your own work. It will make money for you doing jobs for others.
 Outfit equipped complete with Internal Mix Spray Gun, with quart aluminum cup, which enables you to obtain round or fan spray, ¼ H.P. heavy duty motor, 110-volt, 60-cycle AC, air filter, Kellogg Air-Cooled Compressor, 1½x1½, 15 feet of hose, cord and plug.

Price of complete outfit with gun, \$27.50
 Price of outfit without motor, \$20.00

Internal Mix Spray Gun

This Pressure Type Internal Mix Spray Gun is the Finest Value on the Market. It Embodies the Seven Following Outstanding Features

1. Hardened steel paint valve needle and nozzles, to resist the cutting action of abrasives in paint.
2. Quart capacity aluminum cup with concave bottom to resist high pressures—very light and durable.
3. Air control (shown on top of gun, just back of the nozzle) gives instantaneous control over the "wetness" of spray.
4. Positive material control (shown at back of gun, above handle).
5. New type construction of cup cover allows instant removal for cleaning or for attaching a paint hose to the gun.
6. Latest type handle—"fits the hand."
7. Two-finger trigger.

In this gun the material is forced up to the nozzle under pressure, properly mixed within the nozzle and discharged, perfectly atomized, in a fan-shaped spray 6 to 12 inches wide. One hardened steel nozzle for round spray also furnished with gun.



Shipping **\$7.50**
 Wt. 3 lbs.

Filter Tank \$4.25

Complete with tank, gauge and 60 lb. safety valve

Compressed air filter and expansion tank, equipped with gauge and safety valve. Has standard taps in tank and base ready to install. Eliminates oil and moisture. Same as illustrated in Electric Portable Sprayer Outfit shown above.
 Shipping weight 8 lbs.

Kellogg Air-Cooled Compressors at less than half price!

Same as illustrated in Electric Portable Sprayer Outfit shown above.

Size	Maximum Pressure	Speed	Motor Required	Price
1½ x 1½	75 lbs.	600	¼ H.P.	\$7.50
1½ x 2	100 lbs.	600	¼ H.P.	9.00
2 x 2	125 lbs.	600	1/3 H.P.	10.50
2½ x 2	175 lbs.	500	1/3 H.P.	12.50

Shipping weight, 12, 15, 14, and 18 lbs.

G. E. MOTORS

These Motors were manufactured by the General Electric Company and originally intended for use by a large manufacturing company. Here are the specifications: 1/30 h.p.—4800 R.P.M., Universal A.C. and D.C. 110 volts instant reverse. Size: Diameter 3 inch, length 5 inch. Shipping weight, 3 lbs. Add 25c for special packing and mailing anywhere in U.S.A. **\$2.45 EACH**



WHILE THEY LAST.

Original Price \$12.00

All Merchandise Offered On This Page Is Absolutely New and Unused

● Index to Advertisers ●

A	
Alan Radio Corp.	439, 445
Allied Engineering Institute	445
Allied Radio Corp.	440
American Red Cross	438
B	
Baltimore Radio Corp.	431
J. Matheson Bell	426
Blun the Radio Man, Inc.	436
Bud Speaker Company	445
Burzess Battery Company	421
Burstein-Apple-lee Company	434
C	
Capitol Radio Engineering Institute	433
Capitol Radio Research Labs.	442
Central Radio Laboratories	430
Classified Section	413
Coast-to-Coast Radio Corp.	445
Columbia Sound System, Inc.	426
Cornell-Dubilier Corp.	424
Cornish Wire Company	447
Coyne Electrical School	385
D	
Tobe Deuschmann Corp.	429, 430, 436
E	
Eilen Radio Laboratories	445
Electrad, Inc.	425
Electrical Laboratories Co., Inc.	447
F	
Fordson Radio Mfg. Co.	442
Freed Radio Company	429
G	
General Transformer Corp.	437
Grenpark Company	444
H	
Hammarlund Mfg. Company	429
Harrison Radio Company	441
Hygrade-Sylvania Corp.	427
I	
Insuline Corp. of America	426
International Resistance Co.	441
K	
Kato Engineering Company	439
Kenyon Transformer Co., Inc.	424
L	
Leotone Radio Company	431
Arthur H. Lynch, Inc.	431
M	
McGraw-Hill Book Company	436
Marlo Products Company	441
Massachusetts Radio School	429
Matthews Radio Company	428
Midwest Radio Corp.	Back Cover
Miles Reproducer Company	431
N	
National Company	433
National Radio Institute	387
National Tuberculosis Association	442
National Union Radio Corp.	439
P	
Pioneer Sound Laboratories	429
Popular Book Corp.	434
Popular Medicine	443
Postal Radio Corp.	438
Precision Instrument Corp.	442
R	
Radio Circular Company	424
Radio City Products Company	437
Radio Equipment Corp.	434
Radio Publications	424
Radio Trading Company	448
Radio Training Association	389
Radolek Company	447
RCA Institutes, Inc.	431
RCA-Victor Co., Inc.	440
Readrite Meter Works	431
Remington Rand, Inc.	436
Roth Press	445
S	
S. O. S. Corporation	439
Sexology Magazine	442
Shure Brothers Company	445
Simplex Electric Company	455
Solar Mfg. Corporation	445
Speed Radio Tube Corp.	434
Sprague Products Company	432
F. L. Sprayberry	428
Supreme Instruments Corp.	435
T	
Triplett Elec. Instrument Co.	423
Try-Mo Radio Co., Inc.	438
V	
D. L. VanLeuven Laboratories	440
W	
The Webster Company	443
Wellworth Trading Company	446
Wholesale Radio Service Company	443
Wright-DeCoster, Inc.	432

(While every precaution is taken to insure accuracy, we cannot guarantee against the possibility of an occasional change or omission in the preparation of this index.)

OPERATING NOTES

(Continued from page 145)

the power converter is connected directly from the hot heater prong of the first R.F. type 78 tube.

(1) Replace the 89 output pentode with a 41 tube, and replace R11 (a 1000-ohm cathode resistor) with a 500-ohm, 2-watt unit.

(5) Replace T2, the input transformer, (part No. 6488) with a higher-ratio unit (such as part No. 6732).

(6) Replace R10 (a 60,000-ohm resistor shunting the audio frequency transformer) with an 0.25-meg. unit.

(7) Remove the trimmer adjustment plate on the bottom of case to relieve back pressure, or drill 8 half-inch holes in the center of the top of the case.

(8) Replace R6 (a 500,000-ohm in the 6B7 control-grid circuit return lead) with an 0.3-meg., 1/2-watt unit.

Worthwhile results will be obtained only when all these changes are carried as specified, due to the fact that partial changes will not show the improvement that is possible when all the specified changes are made.

LEO J. DRAUS.

VICTOR R-32

AN UNUSUAL trouble was experienced with a set of this model, and one which gave the writer and his partner quite a bit of trouble in finding the cure. Upon looking over the set, the 80 socket was seen to be burned to charcoal from no apparent cause. Upon replacing it with a standard wafer socket, the 80 was found to be passing a "terribly" high current and the rest of the tubes getting almost no voltage at all. The condensers, resistors, tubes, and in fact everything else checked O.K. Finally in order to localize the trouble, various feeder lines to the different circuits were disconnected, one at a time, until it was found that if the lead from one of the 45 socket's plate terminal to the output transformer was disconnected, the voltages jumped to normal and the current of the 80 dropped to a little less than normal. It was found that this 45 socket was leaking badly to the chassis so it was replaced and the set returned O.K.

In about two months another call came in on this same set and the 80 socket was found to be in the same condition as before, although the other sockets were O.K.! The 80 socket was replaced this time with an old type having over 3/4-in. between the plate terminals, and a heavy bakelite base. As there is a potential between 600 and 800 V. across the plates of this tube and there is only about 1/8-in. between the terminals on some wafer sockets, the writer came to the conclusion that a film of dust and dampness possibly started the trouble, in the narrow gap. This conclusion was strengthened by the fact that the set has been operating satisfactorily ever since.

GENERAL MOTORS 258

CONSIDERABLE trouble was experienced with this set in finding a bad hum which was finally traced to the power transformer input bypass condensers of which there are two with the center-tap grounded. We used a pair of .003-mf. units which worked nicely although the size is not critical.

PHILCO 19 AND 89

IF YOU can't get a signal through this set try changing oscillator-detector cathode resistor from 15,000 to 8,000 ohms. This change has been recommended by the factory. Removing the 5,000-ohm resistor in the R.F. plate lead improves the volume of this set.

C. BRITTON.

CROSLEY DYNA-COIL SPEAKERS

AVERY puzzling rattle and blasting in sets using these speakers is often due to loose voice coil windings. If the entire voice coil, cone base, etc., are given a coat of cement this peculiar rattle, which appears to come from nowhere, will be silenced.

ROBERT COE HANNUM

Please Say That You Saw It in RADIO-CRAFT

New RADOLEK 1935
148 PAGE CATALOG
Is Now Ready

Know What You Are Buying

- Radolek's 1935 Radio Profit Guide accurately describes every piece of merchandise required in Radio Service.
- Radolek's Engineering Staff examines every new item! These technicians write the descriptions published in the Radolek Profit Guide. When you choose merchandise from this big catalog, you are assured of reading an accurate description of what the item consists and what purpose it serves!
- Lowest Prices! Our Engineers compare Radolek's merchandise with competition. Our prices are determined by comparative quality and are equal to or lower than prices on any similar quality items offered by other distributors of fresh, new merchandise. Whenever market prices are reduced, you will always receive the benefit of these new lower prices.
- Radolek protects your interests by restricting distribution of the Radolek Profit Guide to active and legitimate Radio accounts. Full co-operation is extended to Radio Dealers and Service Associations to restrict wholesale prices to the Trade only.
- Secure Greater Radio Profits! Send for your copy of the 1935 Radio Profit Guide! Use your letterhead or card. Just out—the Radolek Broadcaster. A 16 page bulletin of ideas, new merchandise, and valuable information. Ask for it.

The Radolek Co.
 579 West Randolph Street
 Chicago, Illinois

CORWICO

Get this map
FREE

- Famous for high grade antenna and radio wire products. This company now offers to service men a chart showing all short-wave foreign and American stations on a world map, with call letters and kilocycles.
- Also catalogs latest CORWICO Antenna Kits and parts, tells why the aerial is more important than ever before, sends the consumer direct to the service man for his installation! A real help toward increasing your business. Send for this valuable data at once. How many copies could you distribute free to your customers?

CORNISH WIRE CO.
 30 Church Street
 New York City

WALCO'S SOUND
RECORDING INSTRUMENTS
 Servicemen—Dealers—Technicians

Write for our latest catalog covering the Home Recording Field and its opportunities.

FREE No obligations. Consult us about P. A. and Home Recording Installations.

ELECTRICAL LABORATORIES CO., Inc.
 141 East 25th St. New York, N. Y.

★ ★ ★ ★ ★ RTC-BARGAINS!



BIG 8-TUBE CONSOLE CHASSIS

Complete With 11-inch Dynamic Speaker
AIRPLANE DIAL :: TONE CONTROL

"THE GREATEST SET BUY IN AMERICA" is by all means a mild description of the value which we are offering here. This very same 8-tube receiver as recent as eight months ago, sold for more than \$95.00. Yet now, because of the advent of even later type tubes, you can purchase this receiver for only a small fraction of that price. The tubes employed in this set are still comparatively new; and not only that, but all modern features such as 2A5 parallel output, tone control, phonograph attachment provisions, full dynamic speaker, airplane dial, etc., are incorporated.

ONLY \$15.95
WHILE THEY LAST

Not a Midget!
but a full-sized CONSOLE CHASSIS

The selectivity and sensitivity of this 8-tube receiver, due to its 4 tuned stages, are just as sharp as those of an 11-tube superheterodyne. The construction of the set is best described as "standard" for its circuit is none other than the "good old stand-by" T.R.F. type modified and improved to use these later type tubes.

The supply of these large console chassis is limited. The moral is, "Don't delay, order today." Overall size of chassis, 15 1/2" x 11" x 8 1/2". Shipping weight, 40 lbs.

List Price \$95.00
No. 2000N—8-Tube T.R.F. Receiver, Including Dynamic Speaker But Less Tubes
TUBES: 3 5B's, 2 56's, 2 2A5's, 1 80.....\$6.30

LIMITED QUANTITIES

REMOTE CONTROL Attachment

Complete Nothing Else to Buy

This remote control unit was made by the Utah Company for more than \$200.00. Yet, you or anyone else, without the use of tools can attach it to your own radio in less than a half-hour's time. In a closet, basement, or some other out-of-the-way place, any extend in various parts of your guests' strategic surprise of your friends on a beautiful evening by merely turning a knob on a beautiful etched metal plaque. The room is gradually flooded with beautiful music or other entertaining programs.

EXTREMELY SIMPLE TO OPERATE

This instrument has no rewiring motor gears or other elaborate machinery to get out of order. In order to connect it to your radio you need to connect the shaft of the motor you use to the shaft of your tuning condenser. That's all the mechanical work required! Then you merely attach the volume control wires.

No. 338 Utah Remote Attachment
YOUR PRICE, ONLY **\$4.95**

STRETCH YOUR DOLLAR

By **BUYING FROM US**

FLASH

ACT FAST ORDER TO-DAY

READRITE TUBE CHECKER

Designed to test quickly and accurately all tubes, these new Readrite tube testers have incorporated two instruments in one large 3 1/2" x 3 1/2" instrument housing. It reads directly with coil—(FOOT) the worth of a tube. The other is a Readrite A.C. meter adjusting the filament are tested with the selector switch at the required filament voltage. Chart furnished in the case shows or leakage. Two models shipping in 12 pounds. No. 421 Counter Type. List Price \$40.00. **YOUR PRICE, ONLY \$23.52**

Portable Model

Includes Oak Cover, with substantial leather handle, with sub-case, rateners hand, 11 x 9 1/2" x 2 1/2" sides of tube. No. 422 (as shown) Portable. List Price \$24.99. **YOUR PRICE, ONLY \$20.00**

TERMS

Send money order, certified check or new U. S. stamps. C. O. D. shipments only if 20% remittance accompanies order. If sent via parcel post include charges; excess refunded.

NEW!

Readrite Model 720 Analyzer

Flexible Point-to-Point Tester

Tests ALL Latest Type Tube Circuits

Requires minimum manipulation. Is extremely flexible and so arranged that voltage and current can be measured in any tube circuit. Hesitancy, capacitance and capacities are also quickly measured.

Point-to-point tests are made through an 9 conductor cable and plug connected to the set.

Has one AC and one DC meter. Rugged, simple, speedy and accurate in use. The DC scales are 15, 150, 300 and 600 volts, 15 and 150 milliamperes. The AC scales are 10, 25, 150 and 750 volts. Shlp. wt. 11 lbs.

No. 720 Readrite Point-to-Point Set Analyzer.
YOUR PRICE \$14.70

THINK OF IT!

★ **Sound movies - - - Electric recordings**

More than \$350 worth of entertainment for only \$82.95. That's value without precedent. Synchronized talking movies—Modern electric phonograph—Large 8-tube console radio and dynamic speaker—all this we offer you in a single full-sized genuine walnut cabinet for only \$82.95.

WORTH \$350.00

20 WATTS

NOW ONLY \$82.95

\$20

Write for Details

Class "B" Amplifier Kit

Here is a splendid opportunity to buy a real, professional amplifier at a substantial saving! There are only 20 of these kits available at this price. First come, first served! No. 46K 20-Watt Amplifier Kit.

FREE!

Radio and Short Wave Treatise

108 Pages
1500 Illustrations

Enclose five cents (coin) for postage. Treatise sent by return mail. Print name and address clearly on request.

Completely revised and enlarged, this new 1935 edition contains 108 solid pages of useful radio information, diagrams, illustrations, radio links and real live radio merchandise.

PARTIAL LIST OF CONTENTS: Fundamental Principles of Radio for the Beginner, Chapter 2—Fundamental Circuits and Uses of New Tubes—Revolving Six-Volt Battery Sets for Two-Volt Tubes—Public Address Systems—How to Build Short-Wave Transmitters and Receivers—Up-to-Date Tube Chart and Socket Connections, etc., etc.

WRITE TO-DAY

Radio Trading Co., 97 Hudson St., New York City

Please Say That You Saw It in RADIO-CRAFT

NOW READY

Official Air Conditioning Service Manual

A GOLDEN OPPORTUNITY FOR ALERT MEN IN THE NEXT GREAT INDUSTRY

THE idea of electricians, radio service men and other mechanically inclined men servicing Air Conditioning and Refrigeration Units is self-evident and the thought has occurred to some untold thousands ever since air conditioning equipment has been installed in public auditoriums, theatres, studios, department stores, office buildings and manufacturing plants. The tremendously broad possibilities in this new industry are bound to give employment and success to men far-sighted enough to see its advancement and development. We quote an excerpt from Mr. Hugo Gernsback's editorial which appeared in a recent issue of *Everyday Science and Mechanics*:

"I advise young and progressive men to go into the air-conditioning business during the next few years; because this, without a doubt, is the coming industry in this country. Thousands of small firms will spring up, undertaking to air-condition private houses, small business offices, factories, etc. We are not going to tear down every building in the United States immediately. It will be a gradual growth; yet small installation firms will air-condition small houses, and even single offices in small buildings."

This is only partial proof of the certain success of this new field. Further assurance is that engineering schools have already added many important courses on air conditioning to their regular curriculum. Architects and building contractors are giving considerable thought to installation of this equipment in structures which are now being planned and built. The beginning of this business will probably be similar to the auto and radio industry, but in a few short years it will surpass these two great fields.

The OFFICIAL AIR CONDITIONING SERVICE MANUAL is edited by L. K. Wright, an expert and a leading authority on air conditioning and refrigeration. He is a member of the American Society of Refrigerating Engineers, American Society of Mechanical Engineers, National Association of Practical Refrigerating Engineers; also author of the OFFICIAL REFRIGERATION SERVICE MANUAL and other volumes.

In this Air Conditioning Service Manual nearly every page is illustrated; every modern installation and individual part carefully explained; diagrams furnished of all known equipment; special care given to the servicing and installation end. The tools needed are illustrated and explained; there are plenty of charts and page after page of service data.

Remember there is a big opportunity in this new field and plenty of money to be made in the servicing end. There are thousands of firms selling installations and parts every day and this equipment must be cared for frequently. Eventually air conditioning systems will be as common as radios and refrigerators in homes, offices and industrial plants. Why not start now—increase your earnings with a full- or spare-time service business.

Here are some of the chapter heads of the AIR CONDITIONING SERVICE MANUAL:

CONTENTS IN BRIEF

History of Air Conditioning; Fundamental Laws; Methods of Refrigeration; Ejector System of Refrigeration; Compression System of Refrigeration; Refrigerants; Lubricating Oils; Liquid Throttle Devices; Servicing Expansion and Float Valves; Servicing Refrigerating Systems; Control Devices; Thermodynamics of Air Conditioning; Weather in the United States; The Field of Air Conditioning; Insulating Materials; Heat Transmission Through Walls; Complete Air Conditioning Systems; Estimating Requirements for the Home, Small Store, Restaurant; Layout of Duct Systems; Starting Up a System; Operating and Servicing Air Conditioning Systems; Air Filtration, Ventilating and Noise Eliminating Devices; Portable Electric Humidifiers and Room Coolers; Automatic Humidifiers; Air Conditioning Units for Radiator Systems and Warm Air Systems; Central Conditioning Units, etc.

GERNSBACK PUBLICATIONS, INC.

99 Hudson Street

New York, N. Y.



NOW
\$5.00
A COPY

352 Pages

Over 600 Illustrations

9" x 12" in Size

Flexible, Loose Leaf
Leatherette Cover



MAIL COUPON TODAY!

GERNSBACK PUBLICATIONS Dept. RC-135
99 Hudson Street, New York, N. Y.

Gentlemen: Enclosed you will find my remittance of Five Dollars for which you are to send me One Copy of the OFFICIAL AIR CONDITIONING SERVICE MANUAL, POSTAGE PREPAID.

Name

Address

City State

(Send remittance in form of check, money order or unused U. S. Postage Stamps. Register letter if it contains stamps or currency.)

SAVE UP TO 50% BY BUYING YOUR RADIO *Direct from* MIDWEST LABORATORIES

Thrill to *Guaranteed World-Wide* **HIGH FIDELITY** Performance with This
 Amazing New 1935 **MIDWEST** *SUPER Deluxe* **16-TUBE ALL-WAVE** Radio!
 (ALL FIVE WAVE BANDS)

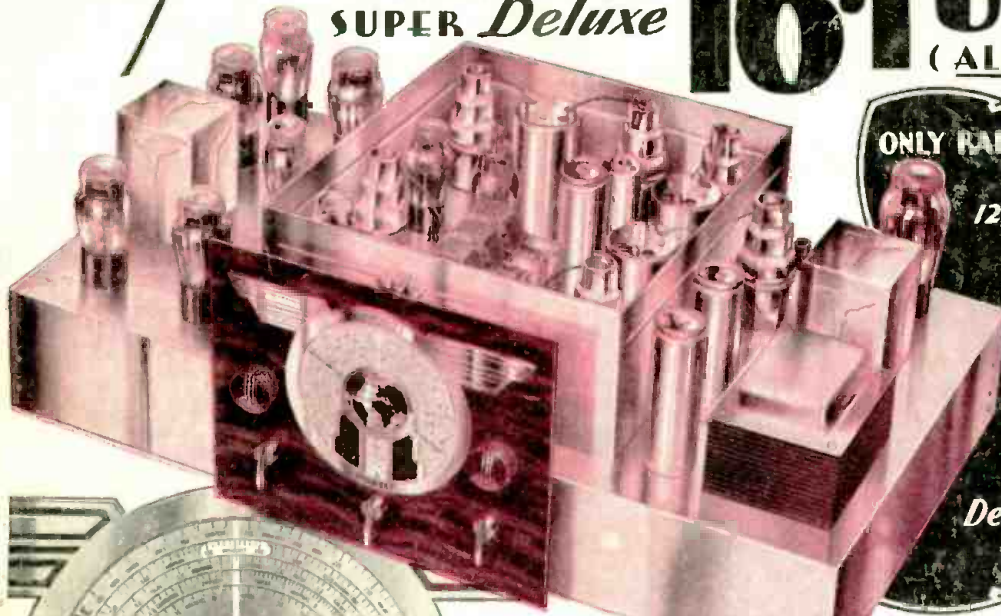

ONLY RADIO COVERING
 9 TO 2,400 METERS.
 12,000 MILE TUNING RANGE

WORLD'S GREATEST
 RADIO VALUE

\$57⁵⁰
 with
 New
 Deluxe Auditorium-Type
 SPEAKER

30 Days FREE Trial!

TERMS
 as low as
\$5⁰⁰
 DOWN

BEFORE you buy any radio write for the new FREE 1935 Midwest "Fifteenth Anniversary" catalog and see for yourself the many reasons why 110,000 satisfied customers bought their radios direct from the Midwest Laboratories and saved from 1/3 to 1/2. Why pay more than the direct-to-you laboratory price? You, too, can make a positive saving of from 30% to 50% by buying this more economical way. Learn why Midwest outperforms sets costing up to \$200.00 and more. Never before so much radio for so little money! Midwest gives you triple protection with: **One-Year Guarantee, Foreign Reception Guarantee, Money-Back Guarantee.**

World - Wide Reception
 Middle-town, O.—Here are some of the stations I have heard: EAQ, Madrid. Spain—DJB, Zeelen, Germany—GSB, GSF, Daventry, England—VK3ME, Melbourne, Australia—VK2ME, Sydney, Australia—HJ2ABA, HJ3ABE, HJ3ABF, Colombia, S. A., and many more. Golden Hatfield, 2202 Grand Avenue.

Peruvian Praises Foreign Reception
 Lima, Peru.—We have heard the five continents with your Midwest. Have received Madrugada, Sydney, London, Paris, Vienna, Moscow, Madrid, New York, Shanghai, Tokio and also South American transmitters. Marquis H. Buchanan, Apartado 96, Plaza San Martin, 171.

Only Midwest Gives You Multi-Function Dial
 This dial was designed in keeping with the trend of the times, yet is not an airplane dial! It is a many-purpose dial that performs many functions. Now, Midwest guarantees that inexperienced persons can secure good foreign reception. Send for FREE miniature of actual rotating dial which clearly shows these outstanding advantages:

1. Dial calibrated in Kilocycles, Megacycles and Meters;
2. Call letters of American Broadcast Stations printed on dial and illuminated;
3. Slow-Fast, Smooth-Acting Tuning;
4. Station Group Locator;
5. Simplified Tuning Guide Lights;
6. Automatic Select-O-Band Indicator;
7. Illuminated Pointer Indicator;
8. Silent Shadow Tuning—Improvement on Meter Tuning;
9. Centralized Tuning.

50 ADVANCED 1935 FEATURES
 Many exclusive features include: Micro-Tenuator... Fidel-A-Stat... Separate Audio Generator... Ceramic Coil Forms, etc. Only Midwest covers a tuning range of 9 to 2400 meters (33 Megacycles to 125 KC)—enabling you to easily and successfully tune in even low-powered foreign stations up to 12,000 miles away with crystal-clear, loud-speaker reception. All 5 Wave Bands enable you to enjoy today's finest High Fidelity American programs. In addition, you get Canadian, police, amateur, commercial, airplane and ship broadcasts and derive new delight and new excitement from un-

equalled world-wide broadcasts... England, France, Germany, Spain, Italy, Russia, Australia, etc. Send today for money-saving facts!

SENSATIONAL HIGH FIDELITY RECEPTION
 This bigger, better, more powerful, clearer-toned, super selective, 16-tube radio gives you absolute realism—assures you of life-like, crystal-clear tone—unlike anything you have ever experienced before. You will hear one more octave—overtone—that cannot be brought in with ordinary radios. Now, hear every instrument, every voice, every shade and inflection of speech.



Take advantage of the amazing 30-day FREE trial offer. Send for FREE catalog.



New Style Consoles
 The Midwest 36-page catalog pictures a complete line of beautiful, artistic de luxe console and chassis in four colors. Write for new FREE catalog today!
 Midwest long-range radios are priced as **\$27⁵⁰** low as...

DEAL DIRECT WITH LABORATORIES
 Increasing costs are sure to result in higher radio prices soon. Buy before the big advance... NOW... while you can take advantage of Midwest's sensational values... no middlemen's profits to pay. You can order your 1935 High Fidelity radio from the new Midwest catalog with as much certainty of satisfaction as if you were to select it in our great radio laboratories. You save 30% to 50% when you buy this popular way... you get 30 days FREE trial... as little as \$5.00 down puts a Midwest radio in your home. Satisfaction guaranteed or money back. Write for new FREE catalog today.

MAIL COUPON TODAY! FOR AMAZING 30-DAY FREE TRIAL OFFER AND NEW 1935 CATALOG

MIDWEST RADIO CORP., Dept. 849 Cincinnati, Ohio.

Without obligation on my part send me your new FREE 1935 catalog, FREE Miniature Dial, and complete details of your liberal 30-day FREE trial offer. This is NOT an order.

Name.....
 Address.....
 Town..... State.....

User-Agents Make Easy Extra Money
 Check Here for Details

MIDWEST RADIO CORP.
 DEPT. 849 - CINCINNATI, OHIO, U. S. A.
 Established 1920 Cable Address Miraco, All Codes