

RADIO'S LIVEST MAGAZINE



October
25 Cents

Radio-Craft

HUGO GERNSBACK Editor

18-Mile
Loud Speaker

See Page 202

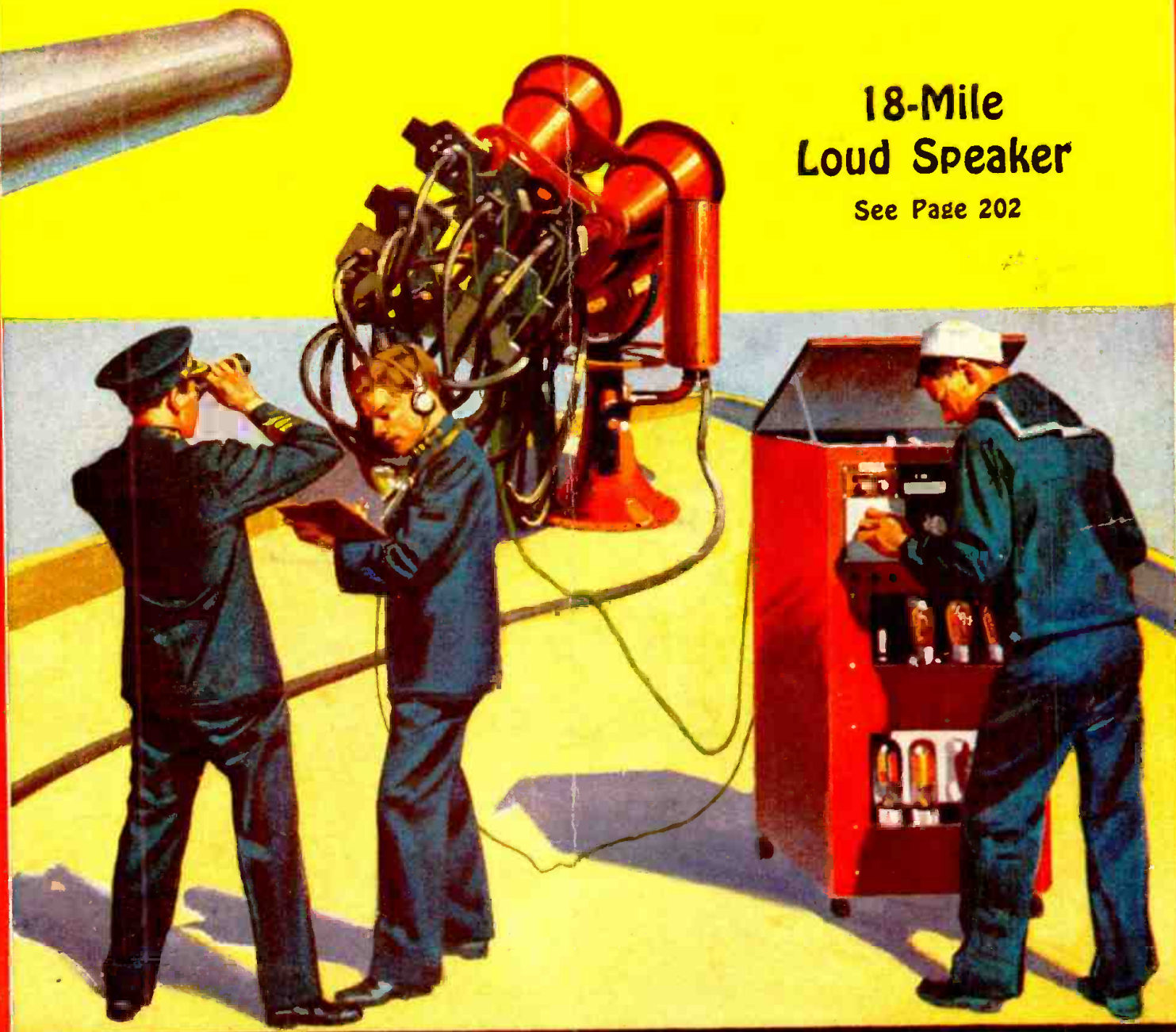

The A. C. Superregenerative — Home Movies and the Radio — Set Testing and Servicing
The "Antenaplex" System — The "Simplified Super" — How to "Scramble" Speech

NEW **SPEED** TUBES

FOR ALL NEW RECEIVERS

EVER ABREAST OF THE RADIO TIMES

SPEED adds new important types to an already complete line of receiving tubes.



235

New screen grid tube—designed to reduce cross modulation and similar distortion.

551

New screen grid tube—designed for same purpose as type 235, although having slightly different characteristics.

230

New general purpose tube, operating economically at 2 volts, giving unusual service though using very little power.

231

New amplifier using 2 volts and extremely low current consumption, in same group as types 230 and 232.

232

New screen grid tube—for use as radio frequency amplifier, operating at 2 volts.

233

New power amplifier in the Pentode group, operating on 2 volts with low current consumption.

236

New screen grid tube used mainly as R.F. amplifier or detector in automobile sets. In same group as type 237 and 238. Also for use in D.C. sets.

237

New general purpose tube—especially adapted to automobile use. Can be used either as a detector or amplifier. Also for use in D.C. sets.

238

New power amplifier Pentode for use in automobile receivers designed for it. Gives unusual volume for small input signal strength.

S 84

Developed expressly for replacement of type C 484 in Sparton sets. Somewhat similar in characteristics to the type 227.

S 82 B

Developed expressly for replacement of the C 182 B in Sparton sets, possessing all the peculiar characteristics necessary for this purpose.

247

New power amplifier Pentode, for use in the output stage of AC receivers.

S 83

Developed expressly for replacement of the C 183 in Sparton sets, possessing all the peculiar characteristics necessary for this purpose.

SPEED Quality is Making History Today. Write for Complete Details.

Still another addition to a big family. **SPEED** FOTO-LECTRIC TUBES. Standard gas-filled type, red sensitive, caesium on caesium-oxide silver-oxide. Six months guarantee against defects. Write for FOTO-LECTRIC booklet.



CABLE RADIO TUBE CORPORATION

230-240 NORTH 9th STREET, BROOKLYN, NEW YORK

RCA
LICENSED

Train *with* R.T.A. *for* Radio Service Work

Important and far-reaching developments in Radio create sudden demand for specially equipped and specially trained Radio Service Men.



*This excellent
set analyzer
and trouble
shooter included
with our course
of training*

MANY skilled Radio Service Men are needed now to service all-electric sets. By becoming a certified R. T. A. Service Man, you can make big money, full time or spare time, and fit yourself for the big-pay opportunities that Radio offers.

We will quickly give you the training you need to qualify as a Radio Service Man . . . certify you . . . furnish you with a marvelous Radio Set Analyzer. This wonder instrument, together with our training, will enable you to compete successfully with experts who have been in the radio business for years. With its help you can quickly diagnose any ailing Radio set. The training we give you will enable you to make necessary analysis and repairs.

Serving as a "radio doctor" with this Radio Set Analyzer is but one of the many easy ways by which we help you make money out of Radio. Wiring rooms for Radio, installing and servicing sets for dealers, building and installing automobile Radio sets, constructing and installing short wave receivers . . . those are a few of the other ways in which our members are cashing in on Radio.

As a member of the Radio Training Association, you receive personal instruction from skilled Radio Engineers. Upon completion of the training, they will advise you personally on any problems which arise in your work. The Association will help you make money in your spare time, increase your pay, or start you in business. The easiest, quickest, best-paying way for you to get into Radio is by joining the Radio Training Association.

This amazing Radio Set Analyzer plus the instructions given you by the Association will transform you into an expert quickly. With it, you can locate troubles in all types of sets, test circuits, measure resistance and condenser capacities, detect defective tubes. Knowing how to make repairs is easy; knowing what the trouble is requires expert knowledge and a Radio Set Analyzer. With this Radio Set Analyzer, you will be able to give expert service and make big money. Possessing this set analyzer and knowing how to use it will be but one of the benefits that will be yours as a member of the R. T. A.

Write for No-Cost Membership Plan

We have worked out a plan whereby a membership enrollment need not cost you a cent. Our thorough training and the valuable Radio set analyzer can be yours. Write at once and find out how easily both of these can be earned.

Now is the time to prepare to be a Radio Service Man. Greater opportunities are opening up right along. For the sake of extra money in your spare time, bigger pay, a business of your own, a position with a future, get in touch with the Radio Training Association of America now.

Send for this No-Cost Membership plan and Free Radio Handbook that will open your eyes as to what Radio has in store for the ambitious man. Don't wait. Do it now.

RADIO TRAINING ASSOCIATION OF AMERICA
Dept. RCA-10 4513 Ravenswood Ave. Chicago, Ill.

Fill Out and Mail Today!

RADIO TRAINING ASSOCIATION OF AMERICA
Dept. RCA-10 4513 Ravenswood Ave., Chicago, Ill.

Gentlemen: Send me details of your No-Cost Membership Enrollment Plan and information on how to learn to make real money in radio quick.

Name

Address

City..... State.....

H. GERNSBACK, President
 S. GERNSBACK, Treasurer
 J. M. HERZBERG, Vice-President
 I. S. MANHEIMER, Secretary



R. D. WASHBURNE
 Technical Editor

C. P. MASON,
 Associate Editor

VOLUME III
 NUMBER 4

Contents of This Issue

OCTOBER
 1931

	PAGE		PAGE
EDITORIAL:			
The Radio Experimenter.....By Hugo Gernsback	201	Leaves from Service Men's Note Books	
		By RADIO-CRAFT Readers	219
NEW DEVELOPMENTS IN RADIO:			
An Eighteen-Mile Loud Speaker.....By H. G. Cisin	202	Servicing Stromberg-Carlson Receivers..By C. F. Rexer	221
The Antenaplex System.....By E. Jay Quinby	203	Repairing the "Music Box" Amplifier	
Latest Radio Devices.....	205	By Russell L. Woolley	221
The Audio Amplifier in "Talkie" Roles		RADIO THEORY AND CONSTRUCTION:	
By R. D. Washburne	206	The New A. C. Superregeneode.....By Clifford E. Denton	222
SERVICE MEN'S DEPARTMENT:			
Favorite Testing Equipment of Service Men.....	210	The "Antipodes" Short-Wave Super Converter	
Modernizing the "133A" Set Analyzer		By C. F. Brooks	224
By Edward M. Heiser	211	The Speech Inverter.....By C. H. W. Nason	226
The R. T. A. Set Analyzer.....By Arthur G. Mohaupt	212	How to Use Pentodes (Part III).....By C. E. Denton	227
Operating Notes for Service Men..By Bertram M. Freed	214	The Stenode System (A Discussion)	
Sales Dollars from Your Telephone..By Fred E. Kunkel	215	By Verne V. Gunsolley and Percy W. Harris	227
RADIO SERVICE DATA SHEETS:			
No. 51—RCA Victor "Radiolette" and Allied Models	216	The Radio Craftsman's Page.....By Himself	228
No. 52—Apex "Series 10".....	217	Elimination of Inductive Interference	
The Service Man's Open Forum.....	218	By Louis van der Mel	229
		RADIO-CRAFT's Information Bureau.....	230
		Sound Recording Questions and Answers	
		By George J. Saliba	231

In Forthcoming Issues

LISTENING IN ON EVERY BROADCAST STATION. Uncle Sam is a DX fan who keeps a log on every station. How it is done from the big monitoring station will be explained for the edification of other DX fans.

SERVICING THE MIDGET RECEIVERS. Making it quick and snappy is a necessity with these popular nites; they do not warrant the Service Man in spending too much of his time on a call. Helpful hints will appear in the near future in the Service Men's Department.

RADIO GIVES SIGHT TO THE BLIND. Application of the principles of radio and television has enabled an inventor

to devise a machine which will make a copy—enlarged and in embossed type which can be read with the fingers—of any piece of printing in any language, while the "reader" goes over it.

SHORT-WAVE CONVERTERS. A review of the apparatus now commercially available, in this important supplemental field of the radio trade.

A DIRECT-READING CONDUCTANCE METER. This, and many other handy devices for the Service Man, will be described.

RADIO-CRAFT is published monthly, on the fifth of the month preceding that of date; its subscription price is \$2.50 per year. (In Canada and foreign countries, \$3.00 a year to cover additional postage.) Entered at the postoffice at Mt. Morris, Ill., as second-class matter under the act of March 3, 1879. Trademarks and copyrights by permission of Gernsback Publications, Inc., 98 Park Place, New York City.

Text and illustrations of this magazine are copyright and must not be reproduced without permission of the copyright owners. We are also agents for WONDER STORIES and WONDER STORIES QUARTERLY. Subscriptions in these magazines may be taken in combination with RADIO-CRAFT at reduced Club rates. Write for information.

Copyright 1931, GERNSBACK PUBLICATIONS, INC.

Published by
TECHNI-CRAFT PUBLISHING CORPORATION

Publication Office: 404 No. Wesley Ave., Mount Morris, Illinois

Editorial and Advertising Offices 96-98 Park Place, New York City	Chicago Advertising Office 737 North Michigan Avenue, Chicago, Ill.	Western Advertising Office 220 No. Catalina St., Los Angeles, Calif.
L. F. McCLURE, Chicago Advertising Representative London Agent: Hachette & Co., 3 La Belle Sauvage, Ludgate Hill, E.C. 4	LOYD B. CHAPPELL, Western Advertising Representative Paris Agent: Hachette & Co., 111 Rue Reaumur	Australian Agent: McGill's Agency, 179 Elizabeth St., Melbourne

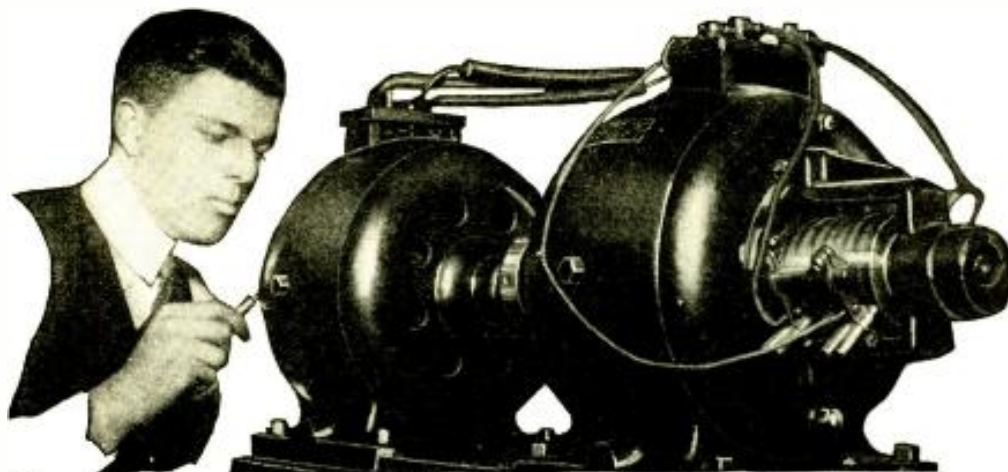

Amazingly Easy Way to get into ELECTRICITY

Don't spend your life waiting for \$5 raises in a dull, hopeless job. Let me show you how to prepare for a real job and how to make real money—in ELECTRICITY, the money-making field. Getting into Electricity is far easier than you imagine!

12 Weeks of Practical Shop Training

Come to Coyne in Chicago and learn Electricity the quick and practical way—by actual shop work on actual machinery and equipment. No useless theory! The average time to complete the course in only 12 Weeks. You work on real dynamos, switchboards, armatures, auto and airplane engines, transmitting stations, etc.—everything from door bells to power plants—in full operation every day! No previous experience necessary.



Prepare for Jobs Like These

Here are a few of the splendid positions open to Trained Electrical Men!

Power Plant Operator	\$40 to \$60 a week
Maintenance Engineer	\$250 to \$600 a month
Armature Winding	\$45 to \$75 a week
Auto Ignition	\$45 to \$65 a week
Contractor-Dealer	\$3,000 to \$10,000 a year
Motor Inspector	\$200 to \$300 a month
Electric Lighting	\$40 to \$70 a week
Signal Engineering	\$50 to \$75 a week

Coyne is 32 Years Old

Thirty-two years is a long time. No school or business could continue that long unless it were rendering real service and getting real results. Yet Coyne has been located right in Chicago since 1899. Coyne Training is tested—proven by hundreds of successful graduates.

What Graduates Say About Coyne

"One week after graduating, I started my electrical job," writes Leland Hinds of Indiana. "After graduating I was home only two days when appointed Engi-

neer in a light plant in South Dakota," writes George Bagley, of Canada. Two weeks after graduating I received a splendid job. The main consideration given my application was that I was a Coyne Trained man," reports Harold Soucy of Illinois. "I wish to thank your Employment Manager for securing this position for me," writes Albert Yagon, "he sent me out to this Company the first day and I was employed there immediately." And I could go on quoting from hundreds of letters of successful Coyne Trained Men. What they have done, you should be able to do!

Get the Facts

Get all the facts! You can find out everything absolutely free. JUST MAIL THE COUPON BELOW FOR A FREE COPY OF OUR BIG ELECTRICAL BOOK, telling all about jobs . . . salaries . . . opportunities. This does not obligate you. Just Mail the Coupon!



FREE Employment Help

When you graduate, we'll do all we can to help you get the job you want. We employ three men on a full time basis whose sole job is to help secure positions for our students. Also we'll help you to earn while learning. Some of our students pay a large part of their living expenses through part-time work we get them.

Now in Our New Home

This is our new fire-proof, modern home wherein is installed thousands of dollars' worth of Electrical Equipment of all kinds. Every comfort and convenience has been arranged to make you happy and contented during your training.



H. C. LEWIS, President
Coyne Electrical School
 500 S. Paulina St., Dept. 71-76, Chicago, Ill.

Dear Mr. Lewis:
 Without obligation send me your big free catalog and all details of your Free Employment Service, and how I can "earn while learning."

Name.....
 Address.....
 City.....State.....

COYNE ELECTRICAL SCHOOL
 H. C. LEWIS, Pres. Founded 1899
 500 S. Paulina St., Dept. 71-76, Chicago, Ill.

**A Better TUBE*
KEEPS
A Customer
LONGER
Satisfied**



WHEN you speak about the replacement —you should talk PERRYMAN.* You as counsel to your customers must be backed by a tube of outstanding quality. PERRYMAN tubes meet the most exacting requirements and will build permanent good will and an ever increasing volume of sales for you.



Your stock should include a varied supply of PERRYMAN Tubes. Write Dept. RC for the name of nearest wholesale distributor; also our special proposition for service men.

PERRYMAN Tube production has increased steadily during the past few months to keep pace with the demand for new tubes. The new low list prices have been carefully adjusted to enable dealers and servicemen to make a fair profit—PERRYMAN Replacement Policy assures recommendation by others for new tubes.

PERRYMAN ELECTRIC CO.
INCORPORATED

NORTH BERGEN :: :: NEW JERSEY

PERRYMAN



RADIO TUBES



WIN FAME and FORTUNE in RADIO!

Scores of jobs are open to the Trained Man—jobs as Designer, Inspector and Tester—as Radio Salesman and in Service and Installation work—as Operator, Mechanic or Manager of a Broadcasting station—as Wireless Operator on a Ship or Airplane—jobs with Talking Picture Theatres and Manufacturers of Sound Equipment—with Television Laboratories and Studios—fascinating jobs, offering unlimited opportunities to the Trained Man.

Ten Weeks of Shop Training

Come to Coyne in Chicago and prepare for these jobs the QUICK and PRACTICAL way—BY ACTUAL SHOP WORK ON ACTUAL RADIO EQUIPMENT. Some students finish the entire course in 8 weeks. The average time is only 10 weeks. But you can stay as long as you please, at no extra cost to you. No previous experience necessary.

TELEVISION and Talking Pictures

In addition to the most modern Radio equipment, we have installed in our shops a complete model Broadcasting Station, with sound-proof

Studio and modern Transmitter with 1,000 watt tubes—the Jenkins Television Transmitter with dozens of home-type Television receiving sets—and a complete Talking Picture installation for both "sound on film" and "sound on disk." We have spared no expense in our effort to make your training as COMPLETE and PRACTICAL as possible.

Free Employment Service to Students

After you have finished the course, we will do all we can to help you find the job you want. We employ three men on a full time basis whose sole job is to help our students in finding positions. And should you be a little short of funds, we'll gladly help you in finding part-time work

while at school. Some of our students pay a large part of their living expenses in this way.

Coyne Is 32 Years Old

Coyne has been located right here in Chicago since 1899. Coyne Training is tested—proven by hundreds of successful graduates. You can get all the facts—FREE. JUST MAIL THE COUPON FOR A FREE COPY OF OUR BIG RADIO AND TELEVISION BOOK, telling all about jobs . . . salaries . . . opportunities. This does not obligate you. Just mail the coupon.

H. C. Lewis, Pres. **Radio Division** Founded 1899
Coyne Electrical School
 500 S. Paulina Street Dept. 71-4K Chicago, Illinois

H. C. LEWIS, President
 Radio Division, Coyne Electrical School
 500 S. Paulina St., Dept. 71-4K, Chicago, Ill.
 Send me your Big Free Radio, Television and Talking Picture Book. This does not obligate me in any way.

Name.....
 Address.....
 City..... State.....

You're Wanted

Take your pick of these fine Big Pay Radio Jobs



Broadcasting Stations offer fascinating jobs paying from \$1,200 to \$5,000 a year.



Police Departments are finding Radio a great aid in their work. Many good jobs have been made in this new field.

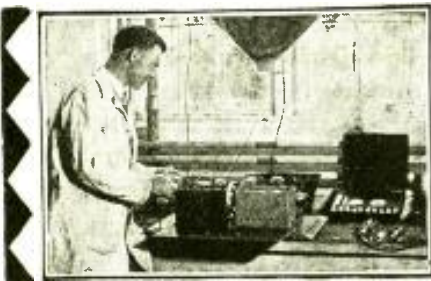

Spare time set servicing is paying N.R.I. men \$200 to a \$1,000 a year. Full time men are making as much as \$65, \$75, \$100 a week.



Talking Movies—an invention made possible only by radio—offers many fine jobs to trained radio men paying \$75 to \$200 a week.

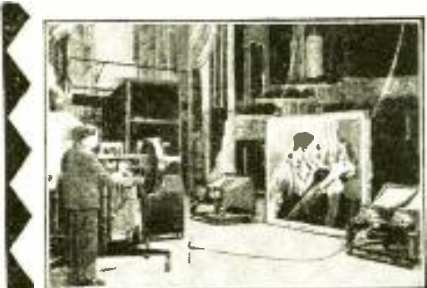

Television—the coming field of many great opportunities—is covered by my course.

YOU have seen how the men and young men who got into the automobile, motion picture and other industries when they were started had the first chance at the key jobs—are now the \$5,000, \$10,000 and \$15,000 a year men. Radio offers you the same chance that made men rich in those businesses. Its growth has already made men independent and will make many more wealthy in the future. Its amazing growth can put you ahead, too. Don't pass up this opportunity for a good job and future financial independence.

Many Fine \$50 to \$100 a Week Jobs Opening Every Year

Radio needs more trained men badly. Why slave your life away for \$25 to \$40 a week in a no-future job when you can get ready in a short time for Radio where the good jobs pay \$50, \$60, \$75 and \$100 a week? And many of these jobs can quickly lead to \$150 to \$200 a week. Many fine jobs are opening every year for men with the right training—the kind of training I'll give you.

I Am Doubling and Tripling Salaries

Where you find big growth you always find many big opportunities. I am doubling and tripling the salaries of many men every year. After training with me only a short time they are able to make \$1,000 to \$3,000 a year more than they were getting before. Figure out for yourself what an increase like this would mean to you—the many things that mean so much in happiness and comfort that you could buy with an additional \$1,000 to \$3,000 a year.

Many Make \$10 to \$25 a Week Extra Almost at Once

The day you start I'll show you how to do 28 jobs common in most every neighborhood that you can do in your spare time. I'll show you how to repair and service all makes of sets and do many other jobs all through my course. I'll give you the plans and ideas that are making \$200 to \$1,000 for my students while they are taking my course. G. W. Page, 133 Pine Street, McKenzie, Tenn., writes: "I made \$935 in my spare time while taking your course."

You Have Many Jobs to Choose From

Broadcasting stations use engineers, operators, station managers. Radio manufacturers continually need testers, inspectors, foremen, engineers, service men, buyers and managers. Shipping companies, Police departments, commercial land stations, aircraft companies, offer good operators jobs from time to time. There's hundreds of opportunities for you to have a spare time or full time Radio business of your own. I'll show you how to start one with practically no capital. My book tells you of other opportunities. Be sure to get it at once.



\$400 a Month

"I spent fifteen years as traveling salesman and was making good money but could see the opportunities in Radio. Believe me I am not sorry, for I have made more money than ever before. I have made more than \$400 each month and it really was your course that brought me to this. I can't say too much for your school." J. G. DAHLSTED, Radio Station KYA, San Francisco, Cal.



\$800 in Spare Time

"Money could not pay for what I got out of your course. I did not know a single thing about Radio before I enrolled but I have made \$800 in my spare time although my work keeps me away from home from 6:00 A. M. to 7:00 P. M. Every word I ever read about your course I have found true." MILTON I. LEIBY, JR., Topton, Pennsylvania.



Seldom Under \$100 a Week

"My earnings in Radio are many times greater than I ever expected them to be. In November I made \$577, December \$645, January \$465. My earnings seldom fell under \$100 a week. I'll say the N. R. I. course is thorough and complete. You give a man more for his money than anybody else. E. E. WINBORS, 1267 W. 48th St., Norfolk, Va.

for a **Big Pay** Radio Job



I will train you AT HOME free book gives facts and proof

I Will Train You at Home In Your Spare Time

Hold your job. There is no need for you to leave home. I will train you quickly and inexpensively during your spare time. You don't have to be a high school graduate. My course is written in a clear, interesting style that most anyone can grasp. I'll give you practical experience under my 50-50 method of training—one half from lesson books and one-half from practical experiments. When you graduate you won't have to take any kind of a job to get experience—you will be trained and experienced ready to take a responsible job in the radio field of your choice.

Television and Talking Pictures Included

My course not only gives you a thorough training in Radio—all you need to know to get and hold a good job—but also your choice, without extra charge, of any one of my special advanced courses: 1. Television; 2. Aircraft Radio; 3. Broadcasting, Commercial and Ship Radio Stations; 4. Sound Pictures and Public Address Systems; 5. Advanced Radio Servicing and Merchandising. You won't be a "one job" man when you finish my course. You'll know how to handle a job in any one of Radio's 20 different branches of opportunity.

J. E. SMITH, President

NATIONAL RADIO INSTITUTE

Dept. 1-KX

WASHINGTON, D. C.

Lifetime Employment Service to All Graduates

When you finish my course you won't be turned loose to shift for yourself. Then is when I will step in to help you find a job through my Employment Department. This Employment Service is free of extra charge both to you and the employer.

Your Money Back If Not Satisfied

You do not risk a penny when you enroll with me. I will give you an agreement in writing, legal and binding upon the Institute, to refund every penny of your money if upon completing my course you are not satisfied with my Lessons and Instruction Service. The resources of the N. R. I., Pioneer and Largest Home Study Radio training organization stands back of this agreement.

Find Out What Radio Offers You—Get My Book at Once

One copy of my valuable book, "Rich Rewards in Radio," is free to anyone interested in making more money. It tells you where the good jobs are, what they pay, how you can quickly and easily fit yourself to get one. The coupon below will bring you a copy. Send it at once. Your request does not obligate you in any way. Act NOW.

I give You 8 Big Outfits of Radio parts for Extensive Practical Experiments

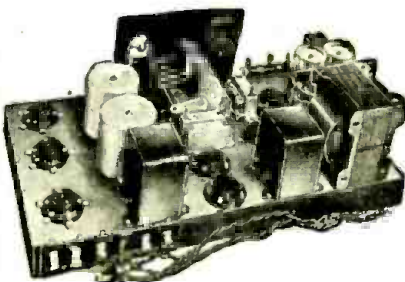

Seven tube screen grid tuned radio frequency receiver.

You can build over 100 circuits with the

outfits I give you. You learn from actual experience about A.C., Screen Grid circuits, push-pull amplification and the other features in modern sets. Shown here are two of the outfits you build. You work out with your hands the principles, diagrams, and circuits you learn from my lesson books. You get as much practical experience under this unequalled method of home training, in a few months, as the average fellow gets in two to four years in the field.

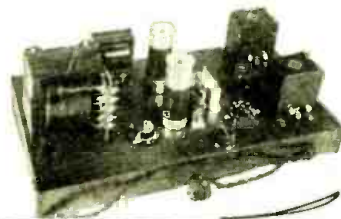

Public Address Audio System.



Salary Three Times Larger

"Before I completed your course I went to work for a Radio dealer. Now I am Assistant Service Manager of the Sparks-Withington Company. My salary is three times what it was before taking your course. I could not have obtained this position without it. I owe my success to N. R. I. training." H. A. WILMOTH, Sparks-Withington Co., Jackson, Mich.



Clip and mail NOW for FREE INFORMATION

J. E. Smith, President,
National Radio Institute, Dept. 1-KX,
16th and U Sts., N. W., Washington, D. C.

Dear Mr. Smith: Send me "Rich Rewards in Radio." Tell me more about Radio's opportunities for good jobs and quick promotion; also about your practical method of Home training. I understand this request does not obligate me and that no agent will call on me.

Name

Address Age.....

City..... State.....

Pilot Achieves Radio's Greatest Sensation!

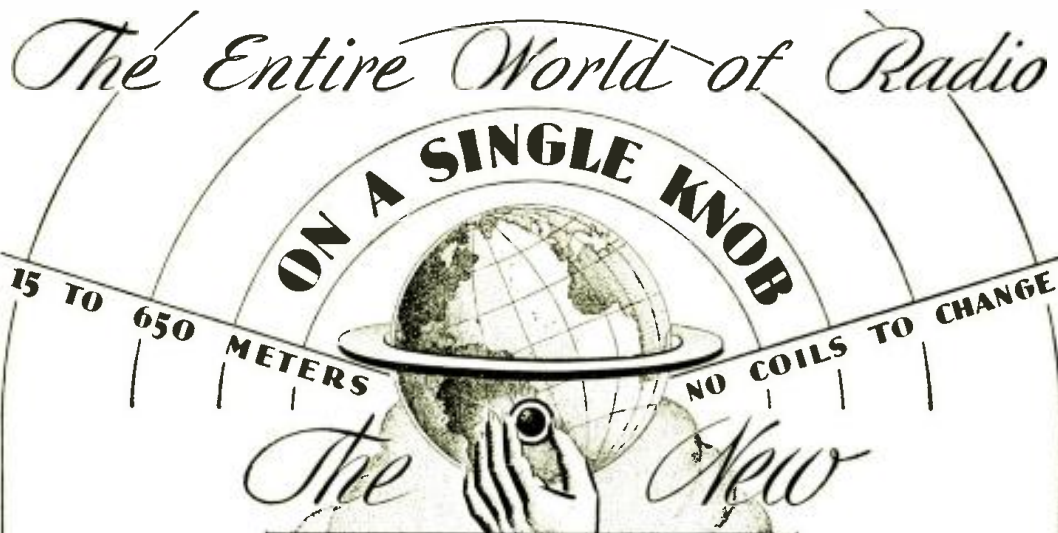

PILOT UNIVERSAL SUPER WASP RECEIVER

Partly assembled "Universal" for the man who likes to "roll his own". With walnut cabinet, less tubes and speaker.

85⁰⁰

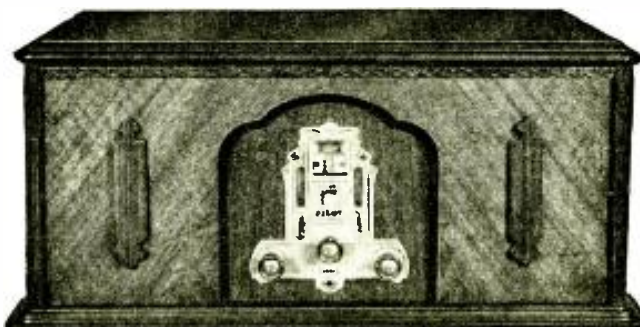

Pilot's wonderful wave band changing switch, incorporated in the new Universal Super-Wasp, revolutionizes the short wave art. No longer need numerous coils be changed to cover the various wave bands. No longer need dial settings change each time the same distant stations are tuned in. You can log permanently all the stations you can get throughout the world, you can tune from the short waves to the high ship waves without removing your hand from the single control knob.

Universal Features Revolutionizing the Short Wave Art

Complete coverage all wave bands from 15 to 650 meters *without coil changing*. Complete A.C. operated *chassis in cabinet*. (Also available in battery model) . . . All Metal Chassis

. . . Highly sensitive and selective circuit . . . Screen Grid TRF amplifier *plus* Screen Grid *Detector* . . . 227 First Audio Stage . . . Two 245's in push-pull output stage . . . Stations can be logged *permanently on dial* . . . Regeneration control does not alter tuning . . . Provision for *Phonograph Pick-up* . . . Earphone Jack on *Front Panel* . . . Illuminated Dials . . . Handsome Walnut Cabinet . . . Most advanced construction yet used for short wave work . . . In kit form for easy home assembly; no drilling or cutting, all parts fully prepared.

NOTICE TO "HAMS": Pilot will continue building the original Super-Wasp in kit form for licensed amateurs and others who want to spread the tuning on their pet wave bands and add their own audio features. A.C. and battery models.

PILOT RADIO & TUBE CORP., Lawrence, Mass.



Chicago: 234 S. Wells St.

New York: 525 Broadway

San Francisco: 1278 Mission Street

OFFICES IN PRINCIPAL COUNTRIES OF THE WORLD

RADIO

Manufacturers, Distributors, Jobbers *and* Dealers

If in need of Service Men wire or write us and we will send you the name and address of Service Men in your city or vicinity.

THIS SERVICE IS FREE TO THE RADIO TRADE.

OFFICIAL RADIO SERVICE MEN'S ASSOCIATION, Inc.

98 Park Place, New York, N. Y.

Radio Service Men—Join the ORSMA

EVER since the appearance of the commercial radio broadcast receiver as a household necessity, the Radio Service Man has been an essential factor in the radio trade; and, as the complexity of electrical and mechanical design in receivers increases, an ever-higher standard of qualifications in the Service Man becomes necessary.

The necessity, also, of a strong association of the technically-qualified radio Service Men of the country is forcing itself upon all who are familiar with radio trade problems; and their repeated urging that such an association must be formed has led us to undertake the work of its organization.

This is the fundamental purpose of the OFFICIAL RADIO SERVICE MEN'S ASSOCIATION, which is not a money-making institution, or organized for private profit; to unite, as a group with strong common interests, all well qualified Radio Service Men; to make it readily possible for them in keeping up with the demands of their profession; and, above all, to give them a recognized standing in that profession, and acknowledged as such by radio manufacturers, distributors and dealers.

To give Service Men such a standing, it is obviously necessary that they must prove themselves entitled to it; any Service

Man who can pass the examination necessary to demonstrate his qualifications will be elected as a member and a card will be issued to him under the seal of this Association, which will attest his ability and prove his identity.

The terms of the examination have been drawn up in co-operation with a group of the best-known radio manufacturers, as well as the foremost radio educational institutions.

We shall not attempt to grade the members into different classes. A candidate will be adjudged as either passing or not passing. If the school examining the papers passes the prospective member as satisfactory, we shall issue to him an identification card with his photograph.

If the candidate does not pass this examination the first time, he may apply for another examination three or six months later.

There is absolutely no cost attached to any service rendered by the Association to its members, no dues, no contributions.

If you wish to become a member, just fill out the coupon below and mail it to us. We will send you all the papers necessary to become a member.

The following firms are cooperating with us in formulating the examination papers.

- The Crosby Radio Corporation, Cincinnati, O. Mr. D. J. Butler, Service Mgr.
- Grigsby-Grunow Company (Majestic), Chicago, Ill. Mr. L. G. Wilkinson, Service Mgr.
- Stromberg-Carlson Telephone Mfg. Co., Rochester, N. Y. Mr. E. S. Browning, Service Mgr.
- Collin B. Kennedy, Corp., South Bend, Ind. Mr. B. F. McNamee, Prod. Mgr.
- RCA-Victor Company, Inc., Camden, N. J. Mr. H. C. Grubb, Vice-President.
- Stewart-Warner Corporation, Chicago, Ill. Mr. T. N. Golden, Service, Mgr.

The schools who have consented to act as an examination board are:

- International Correspondence Schools, Scranton, Penna. Mr. D. E. Carpenter, Dean.
- RCA Institutes, Inc., New York, N. Y.
- East Bay Radio Institute, Oakland, Calif. Mr. T. T. Tommehlt, Director.
- Radio Training Association of America, Chicago, Ill. Mr. A. G. Mohaupt, President.
- School of Engineering of Milwaukee, Milwaukee, Wis. Mr. W. Wersath, President.
- Radio College of Canada, Toronto, Canada. Mr. J. C. Wilson, President.
- Radio Division, Coyne Electrical School, Chicago, Ill. Mr. H. C. Lewis, President.



MAIL COUPON TODAY!

OFFICIAL RADIO SERVICE MEN'S ASSOCIATION, Inc. RC-10
 98 Park Place, New York, N. Y.

I wish to become a member of your Association. Please mail me the examination papers and application blanks.

Name

Address

Town..... State.....

Build Your CUSTOMERS

THE Revolutionary STENODE



STENODE selectivity curve makes 10KC selectivity, so-called, look like broad tuning.

STENODE selectivity is compared, at left, to that of ordinary receivers. All background noise is contained in outer curve. Stenode's curve, shaded, contains but 1-10 the total noise.



STENOTUBE. Only one required in each Stenode. This heart of the Stenode circuit consists of a quartz crystal ground to 175KC frequency and mounted in tube form for easy handling. Standard UX socket base. Price \$15.

Made in England

None genuine without the inventor's signature.

James Robinson



The Receiver That Is NOISE FREE

on SHORT WAVES or BROADCAST

A STENODE demonstration will create more new custom set prospects than any radio receiver ever did before. People listen in amazement when they hear stations free of background noises and absolute silence between stations. When you tune out heterodynes and whistles and stations STAY IN STRANG and crystal clear, owners of all other sets gasp in astonishment. The former chief of wireless research of the British Royal Air Force, Dr. James Robinson has given an entirely new principal to radio in STENODE.

By the STENODE principal the highest selectivity ever attained as well as unprecedented tonal range is now made possible. All engineers agree that it is impossible with ordinary super-heterodynes.

STENODE amplifies signals most and static least. That's why YOU want to build an 11 tube STENODE to work with a SHORT WAVE adapter when it is not used to log and listen with enjoyment to more broadcasters than can be heard on any other type of radio. STENODE selectivity is 5 to 1 greater than that of so called 10KC Supers. The noise does not get in along with the high audio frequencies, and the STENODE reproduces perfectly higher frequencies than ever heard on any other receiver giving

500% BETTER SELECTIVITY
1000% MORE FREEDOM FROM NOISE
INFINITELY BETTER QUALITY

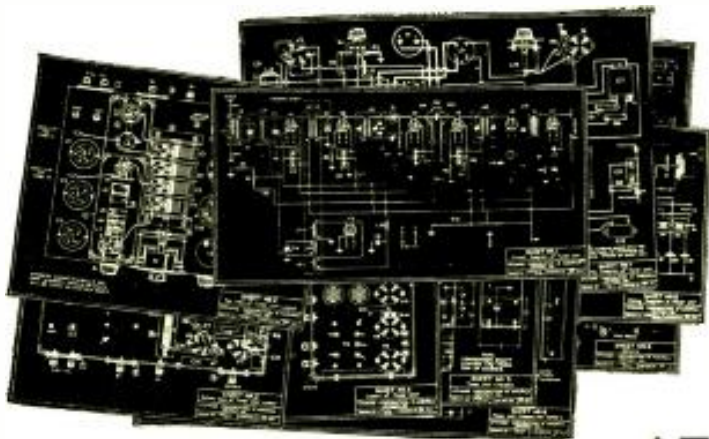

9 Blue Prints - Data Book - Direction Book Now \$5

Increased demand for Stenode Data Book, Instruction Book and Blue Prints permits our cutting former price in half. Those who have already sent in full price will receive our check for \$5. We are not interested in making profit from our engineering service. Our profits come solely from Royalties paid us by our licensees.

STENODE CORP. OF AMERICA
 Hempstead Gardens, L. I., N. Y.

Enclosed find Money Order, Check, for \$..... Please forward me STENOTUBE, BLUE PRINTS, DATA BOOK and DIRECTION BOOK for building STENODE.

Name

Street

City State

The STENODE opens up new fields for short-wave and television work, as well as broadcasting. Full details of all sorts of applications are given in the STENODE Data Book. Nine full-sized diagrams show where to place every part. How to make every connection is clearly told in STENODE Book of Directions. Your finished STENODE will put you into a new field of radio. Fill in and mail the coupon with your money order for the biggest value ever offered custom set builders.

STENODE CORP. OF AMERICA
 HEMPSTEAD GARDENS, L. I., N. Y.
 (FORMERLY AMERICAN RADIOSTAT CORP.)

IF IT ISN'T A STENODE IT ISN'T A MODERN RECEIVER



“Takes the Resistance Out of Radio”

Editorial Offices, 96-98 Park Place, New York, N. Y.

The Radio Experimenter

By HUGO GERNSBACK

IF one were to take a poll among radio Service Men and other radio enthusiasts, it would be found that a great number—perhaps a majority—have a hobby to do radio experimenting of one sort or another.

This may sound like a surprising statement in these latter days of radio; but the daily mail which comes across my desk, as well as the desk of every other radio editor, proves that radio experimenting is still a very important activity in the life of radio people.

Of course, there are nowadays different sorts of radio experimenting because, as the art advances, the type of radio experimenting that was going on ten years ago, when the radio boom had just started, is, of course, passed for good. At that time, the experimenting was chiefly with crystal sets, and there was not a great deal of variety in apparatus in those days. A little later on, when vacuum tubes were introduced, the crystal was promptly forgotten, and the one-tube experimental set became the order of the day.

Later, all sorts of hook-ups were tried out on the breadboard; and still later, complete sets, of anywhere from three up to a dozen tubes or more, were experimented with. In those days, as soon as one set was constructed by the experimenter, it was pulled apart in short order—and a new and later Cosmodyne was constructed. Still, radio experimenting goes on with undiminished enthusiasm.

I have often made the statement in the past, that there will always be, in this country alone, some 200,000 radio experimenters. Authorities may take issue with me over this large number; yet I steadfastly believe that the figure of 200,000 radio experimenters is not at all exaggerated. When one radio mail order house sends out as many as one million catalogs a year, and several others as many as half a million a year, this surely must prove that the experimenters still exist.

Surely, there cannot be 200,000 Service Men. There are probably not more than 100,000 of all classes combined. That leaves another 100,000 made up of radio engineers and other radio *interstants* and pure radio experimenters. As a matter of fact, the class of pure radio experimenters who experiment just as a hobby, or for the sport of it, seems to be on the increase at the present time.

What does the 1931 experimenter experiment with? There are quite a number who tinker around with new circuits, but it might be said that the broadcast experimenter today is not in the majority. At least, a recent survey would bear this out. At the present time, the radio short-wave experimenter is probably in the lead. There is a tremendous amount of short-wave experi-

menting going on, in both the receiving and transmitting classes. Naturally the receiving experimenters numerically outclass the transmitting amateurs; because you do not require a radio license to receive the short waves but, if you wish to build a radio transmitter for either 'phone or code, a station as well as an operator's license must be taken out.

Again, the short-wave experimenters fall naturally into different classes. There are quite a good many who are experimenting with various adapters and converters, whereby short waves can be received on a broadcast receiver. Then, there is also a good-sized class who experiment with ultra-short waves in the lower wavebands, where a good deal of activity is going on at the present time. Quite a good deal of this work takes on the nature of serious research, and the experimentations along this line are of a more serious and scientific nature.

Then, of course, we have a large class of radio experimenters who are interested only in sound recording; and this group too, judging by the editor's daily mail, seems to be a vast one and increasing at a very rapid rate.

Following this, we have still another class which is also growing by leaps and bounds. I refer to the audio-amplifier experimenters. There is really a large amount of work going on in this line, because experimenters no doubt realize that a lot is to be learned about amplifiers that, sooner or later, will make a handsome living for the experimenter.

No experimenter seems to be content in these days unless he has developed his own pet amplifier, which he utilizes for the most-unheard of purposes. Naturally, every purpose requires a special amplifier; and these are usually built and constructed by the experimenter himself.

Then, of course, there still is a fairly large class of those experimenters who are interested only in sets, and who will build anything from a two-tube portable to a ten-tube superheterodyne, if a new circuit happens to appeal to them. These workers, for instance, like to take battery sets and revamp them for A.C. 110-volt operation. It is surprising how many experimenters do this sort of thing, just for the pleasure of it, and how much enjoyment they derive therefrom.

There seems to be a feeling in the radio trade that the radio experimenter has passed away and is non-existent.

Nothing could be more erroneous. The experimenter, today, is fully alive, and is just as up-to-date as the latest radio wrinkle; and, in many instances, he is a step or two ahead of many a radio manufacturer.

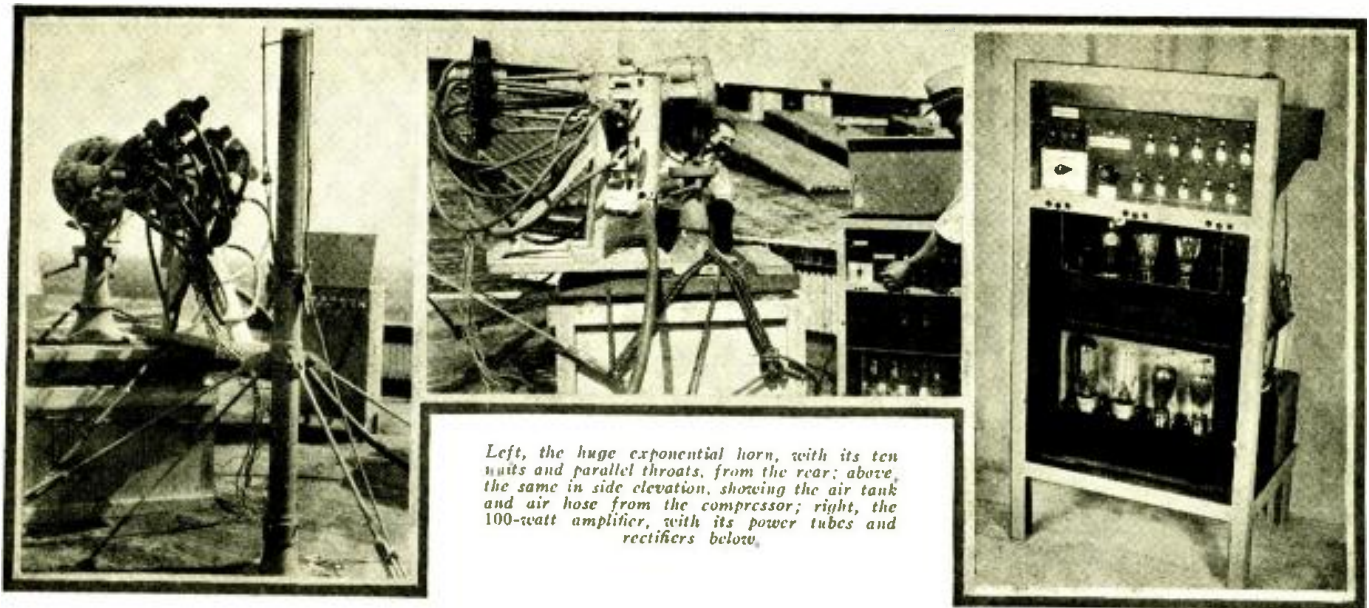

Left, the huge exponential horn, with its ten units and parallel throats, from the rear; above, the same in side elevation, showing the air tank and air hose from the compressor; right, the 100-watt amplifier, with its power tubes and rectifiers below.

An Eighteen-Mile Loud Speaker

Electro-Mechanical Control of Compressed Air Blast Gives Stupendous Range to New Device Designed for Long-Distance Speech Communication

By H. G. CISIN, M.E.

THE recent announcement of the purchase of two of a new type "Radio-Compressed Air" sound system by the Navy Department, undoubtedly signals the advent of a new era in aviation communication. The official approval of the purchase of this new equipment followed tests which have been carried on, over a period of six months, at the naval air station at Lakehurst, N. J.

The result of these tests is to demonstrate, beyond all question, the enormous value of these new sound systems for audio communication from a ship to airplanes or dirigibles, from ship to ship, and between ship and shore. During their course, it was found possible to communicate from the ground to the dirigible *Los Angeles* while she was flying at an altitude of about 3,000 feet, at fifty miles per hour, with all engines running.

With the same apparatus, voice was projected perfectly for *eighteen miles*, with a wind of 23 miles an hour in the direction

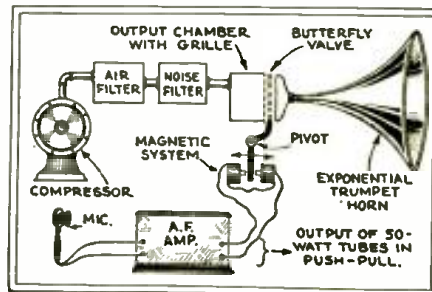

Fig. 1

General arrangement of the apparatus, showing only one unit, however

of transmission; and for eight miles in the teeth of a 23-mile wind, blowing against the transmitter. This is unquestionably the loudest reproduction of the human voice ever attained.

The development involved in this sound system has followed a novel trend—different from other methods of audio amplification, and for the purposes which have been described, better.

A Mechanical Voice-Box

The essential feature is a mechanical larynx, patterned after the human larynx or voice-box (*the well-publicized "Adam's apple"*), which is the natural and original audio modulation apparatus. The principle of its operation has been adapted to modern high-amplification requirements, as a result of the research work performed by C. F. Dilks, chief engineer of the Hoovenaire Corporation.

The construction of the mechanical larynx is extremely simple; in effect, it is simply a "butterfly" valve, which permits or checks the passage of air, from a compressor to an exponential horn, in accordance with

the audio impulses received from a microphone through an amplifier.

The enormous volume is obtained by the use of a blast of compressed air to actuate the horn; the pressure being from 20 to 22 pounds per square inch above normal atmospheric.

The butterfly valve is a thin metal plate about an inch square, containing very fine parallel apertures for the passage of the compressed air. Before the latter reaches the valve, it is forced to pass through an output chamber, which is provided with openings corresponding to those of the valve. These openings, however, are not normally opposite the slots of the valve, but alternate with them; so that the escape of the air is prevented. It is necessary that this valve be constructed with the most extreme precision; it is made of a special alloy, and will last indefinitely.

As regards the frequency-characteristic of the valve, it has a range up to 14,000 cycles; the only limitation being, apparently, in the response of the magnetic unit by which it is controlled. The standard unit employed has an input impedance of 2,000 ohms, and a favorable response-curve from 81 to 5000 cycles.

The valve is pivoted, and flutters back and forth, in accordance with the movements of the armature, which is balanced in a magnetic field, like that of the ordinary magnetic-speaker unit. In other words, the system is a large conventional permanent magnet, with small electromagnets connected in series, one on each pole piece, and the armature balanced in the center. These small magnets are in the output circuit of the audio amplifier, which may be connected to either a microphone, a radio tuner, or a phonograph pickup.

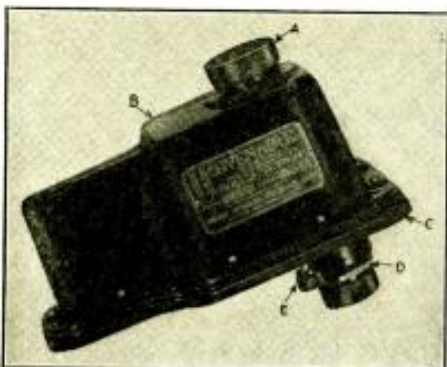

One of these units is on each throat of the horn: A, output blast; B, casing; C, base; D, filter lock nut; E, binding post

Power Supply System

The air compressor is of the rotary type, and specially designed for work of this nature; it delivers 11 cubic feet of air a minute, at 30 pounds pressure, which gives a reserve of 25% over maximum needs. The compressor is operated by a 1½-hp. motor, either A.C. or D.C., revolving at 1,750 R.P.M.

Fig. 1, showing the general arrangement of the apparatus, illustrates two filters immediately after the compressor. The first, or air filter, is packed with waste, to keep impurities and foreign substances out of the delicate valve. The second, or noise filter, is packed with copper shavings and felt washers, and contains baffles which give a muffler effect. From the noise filter, the air passes into the output chamber mentioned before; and through its output grille and the butterfly valve into the exponential horn, at a velocity of about a thousand feet per second, or in the order of the speed of sound.

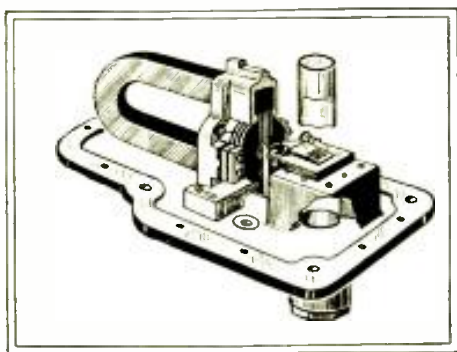

Fig. 2

A sketch of the inside of the Hooveraire unit, showing the position of the butterfly valve

The horn is of the trumpet type, made of pure aluminum, and designed especially for use with this system; since fiber horns are not heavy enough for this duty. The larger sizes are constructed in telescoping sections.

The system provides an output energy of 100 dynes per square centimeter (.00145-pound per sq. in.) at 1,000 cycles; requiring a voice energy of 1.5 watts. This is the equivalent of ten large dynamic speakers, which require approximately 125 watts of voice energy.

The amplifier which was used during the tests at Lakehurst was designed by Mr. Cornwell, the chief engineer of the Amplion Products Corporation. Under ordinary circumstances, with only a single compressed-

(Continued on page 239)

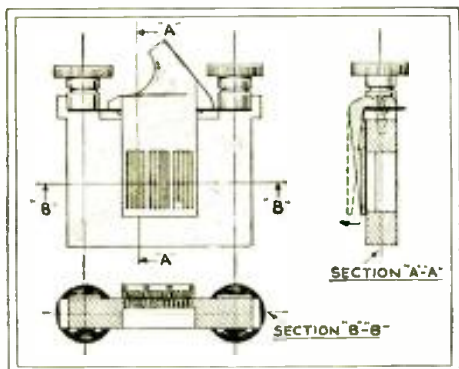

Fig. 3

The butterfly valve in detail; its motion on the pivot gives the air blast "articulation"

The "Antenaplex" System

The Final Knockout for the Haywire Antenna From Which Radio Has So Long Suffered

By E. JAY QUINBY*

NOT all radio troubles are in the sets, any more than all car troubles are the fault of the engine. The best Rolls-Royce will sputter and falter on poor, dirty gasoline—and the healthiest physical specimen of mankind will develop sickness on a diet of polluted water and contaminated food.

Consider your Adam's antenna! That's where receiving troubles start. Ahead of that point, the troubles are in the transmission category; but that tangled mess on the roof of your own apartment house—that's where many radio receiving ailments are bred. Today the average apartment house roof-top looks like the underbrush of a Borneo jungle; although, later, somebody discovered that the steam radiator made a better antenna than the one on the roof. (It would, under such conditions; 'most anything would be a relief and improvement.)

In the meantime, we take high-priced radio sets all apart to find out what makes them spit and cough, and render intermittent music. Maybe we find a sub-normal tube, or a superheated condenser which we replace at a modest sum. But, where the conditions warrant it, why not go after bigger business and clean up the whole job at once? Let's get organized on this antenna problem. Let's plan an orderly system into these new buildings, and let's modernize the old ones to the satisfaction and gain of all concerned.

A strong and clean radio signal input, minus the usual background of local interference from surrounding electrical devices and circuits, is more economical and satisfactory than two or three additional stages of R.F. amplification employed to build up correspondingly weaker signals, which are usually burdened with a high ratio of local "mush". Bearing this in mind, some of the best radio engineers in the country have collaborated to produce a centralized antenna system for the modern multi-family dwelling; and, after intensive research work covering a period of more than a year, the "Antenaplex" System emerged from the laboratory to take its place beside running water, electric lights, telephones, and electric refrigerators in the up-to-date building.

Aperiodic Master Amplifier

The Antenaplex system employs one central antenna, approximately 100 feet long, located in the most advantageous position atop the structure; where it will be clear of surrounding objects—and as far away as possible from the source of undesirable local interference—and where it will collect

a maximum of the desirable radio signal energy. This radio energy is fed into a device known as the "Antensifier" (1, Fig. A), usually located in a penthouse as near as possible to the antenna. It employs four Radiotrons—one UX-280 rectifier, and three UX-245 amplifiers; which make it possible to transmit and distribute 100% of the antenna signal energy to each and every radio outlet throughout the building. This device draws approximately 100 watts under normal operating conditions.

The Antensifier is coupled into the "Cabloy" line, which is a lead-covered conductor, new to the radio art. The "Cabloy" is only 5/16-inch in diameter, and may be run in concealed metal conduit, or in surface wire-mold. Cabloy may be fished through hollow partitions, or it may be run on the surface, secured by little clips designed for the purpose. Thus it is suitable, practical, and economical for installation in new construction work, as well as for existing structures.

Where power-line noises are troublesome, a specially designed filter (2) is employed between this device and the 110-volt, 60-cycle power line, to keep these disturbances from being passed through the Antensifier into the Cabloy lines. A suitable fused switch (3) for the power line, and the usual approved antenna lightning arrestor (4) and grounding devices are also employed at this point on the system.

Connections to Receivers

Wherever a "radio outlet" is to be located, a small metal box is mounted, flush

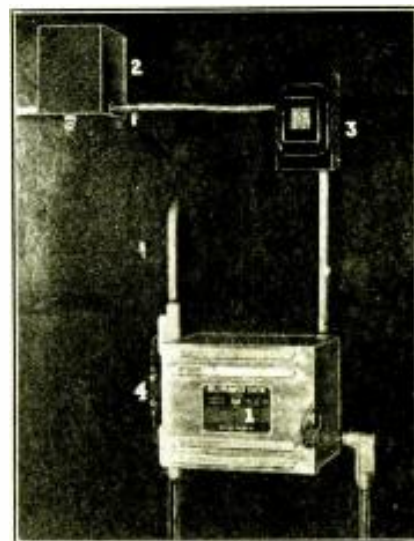

Fig. A

The "Antensifier" (1) is a master amplifier for all broadcast frequencies; its output through the Cabloy at the lower right feeds all the receivers in the system, which tune independently.

*National Sales Engineer, Centralized Radio, RCA Victor Co., Inc.

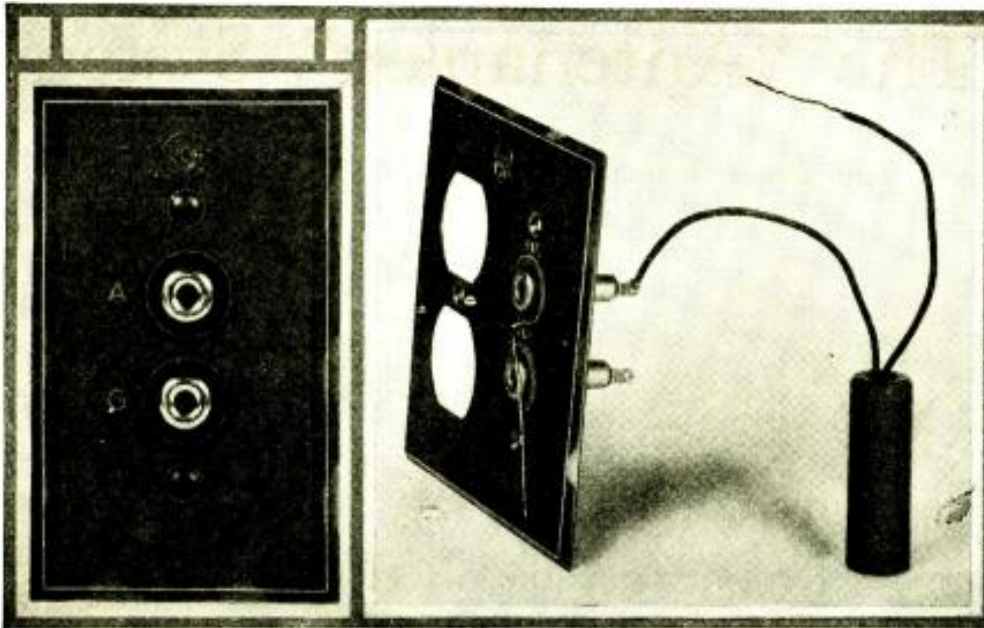

Fig. B
Flush plate, serving one set

Fig. C
The "Taplet" or "Terminet" connection fits behind the plate

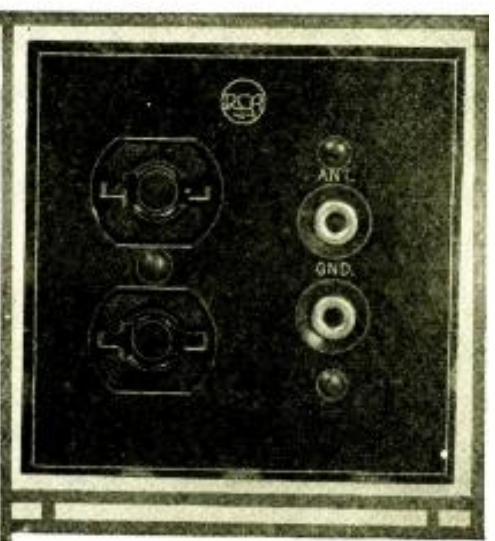

Fig. D
A combination outlet for light and radio plugs; an internal metal partition separates the circuits. As many as fifty outlets are served by one "Cabloy."

in the wall in the case of new construction; while for existing structures, the box may be mounted on the surface, if desired. On a suitable plate (Fig. B) attached to this box, is mounted a pair of pin jacks, for convenient antenna and ground connections to the radio set.

Concealed within this box is a little cartridge-like device known as a "Taplet" (Fig. C), which performs the happy function of passing the R.F. energy from the antenna on to the radio set, without accepting any

kind of interference back into the transmission line; thus preventing any interaction between the various radio sets which may be operating simultaneously on the same system.

In the last outlet box on such a transmission line, there is located also another little cartridge-like device, known as a "Terminet." It looks just like the Taplet but, instead of being finished in black, it is finished in red, for identification. It serves as a line-terminating device and, of course, is

connected across the line between the central conductor and the sheath. The sheath of such a line is efficiently grounded to the nearest cold-water supply pipe: (a) at the Antensifier end of the line; (b) at the other extreme end of the line; and (c), at the lowest point on any lines which, for convenience, may be run downwards, and looped upwards again to some higher level in the building.

Characteristics of the System

The Antenaplex system is designed for a 500-foot maximum line with a limit of fifty radio outlets, but longer lines with correspondingly fewer outlets may be employed, as shown by the curve (Fig. 1). The design of this system permits as many as five Antensifier units to be connected to one antenna, and, since as many as fifty outlets can be fed by one Antensifier on a 500-foot line, this means that a maximum of two hundred and fifty outlets may be energized by a single antenna.

It is of special significance that, even at this maximum loading, all outlets on the system deliver 100% of the antenna signal energy to the radio set, without the local interference which would otherwise be picked up by the usual long lead-in wires. The Cabloy, being metal sheathed, effectively shuts out everything except that which is picked up at the antenna, and, having located the antenna where it will pick up good, clean signals, these signals can be kept clean and transmitted all over the distribution system to all points where it is desired to deliver them to the radio sets.

A curve (Fig. 2) is reproduced herewith, showing how successfully the engineers of the RCA Victor Company, Inc., have produced a "flat" response, on this system, over the entire broadcast band, from 500 to 1500 kc. (It is interesting to note that a difference of 5 D.B., while readily measured by instruments, is only slightly noticeable by the human ear, because of the logarithmic response of the latter. It corresponds to a voltage increase of 80%, or drop of 44%.)

A forthcoming issue of RADIO-CRAFT will illustrate and describe methods of installing the Antenaplex system.

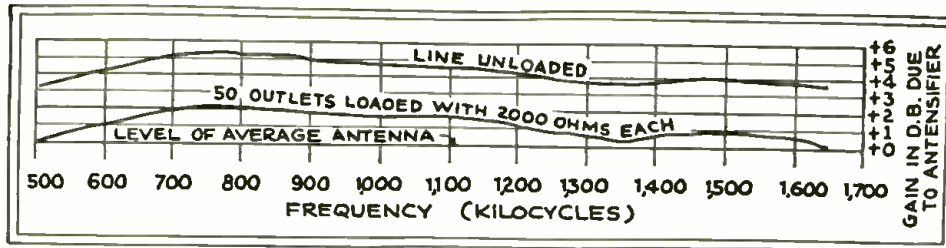

Fig. 1

The effect of loading the line, with reference to its signal level at various broadcast frequencies, is shown here by a measured curve.

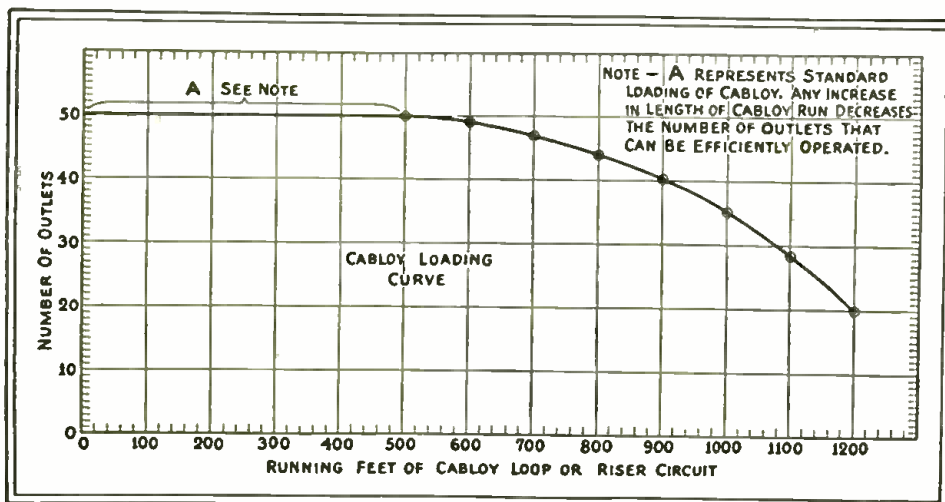

Fig. 2

The "Cabloy" or output line from the "Antensifier," or aperiodic master amplifier, is designed to supply signals for fifty receivers, and will do so if not over 500 feet of line is used. Above this the number falls off as shown. The "Cabloy" is a complete shield against the pickup of local interference; while the "Taplet" connection prevents feed-back into the line from a receiver

The Latest Radio Appliances

New Commercial Products of interest to the radio trade, Service Men, and radio constructors.

RADIO-ROOM CLOCK

A TIME-KEEPER, distinctly for the radio room, is illustrated in Fig. A; it is a product of the combined efforts of the Radiomarine Corp. of America and the Chelsea Clock Co., and was designed with particular regard to international radio regulations, and laws and regulations of this country, in connection with watch-keeping in the shipboard radio stations.

It has been especially designed also to facilitate transmission of the alarm signal

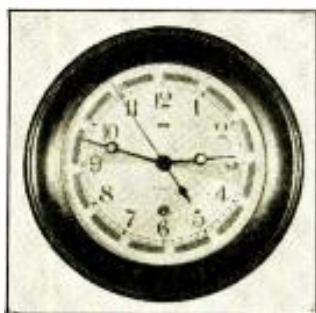

Fig. A
Here is "Sparks" official clock

authorized by the International Radiotelegraph Convention and the International Radiotelegraph Convention and the International Conference on Safety of Life at Sea; which consists of 12 dashes (each 4 seconds long, with intervals of 1 second) to be transmitted during a period of 1 minute.

The clock is provided with a sweep second hand and special red markings on the dial, making it easy for the operator to accurately time the 4-second dashes and 1-second spacing. Still other markings are provided to call the operator's attention to the 3¹/₂ minute silent periods; which must be observed by commercial radio stations at 15 and 45 minutes past each hour.

The movements are of 7-jewel lever-escapement type; having compensation balance, Bréguet hairspring, cut wheels, cut steel pinions, hardened, ground and polished.

Altogether, this is a fine bit of precision clockwork, and what the well-dressed radio room should sport.

DOUBLE-PUSH-PULL POWER AMPLIFIER

FOR the extremely great volume required for operation of an address system over large outdoor areas (as at parks, airports, conventions, and other large gatherings) an unusual degree of power is required. This condition is met in the new "Type E-250" power amplifier shown in Fig. B. This design by the engineers of Electrad, Inc., has the following features:

The circuit, which includes one '24, one '45, four '50's in double-push-pull, and four '81 rectifiers, is of the Loftin-White direct-coupled type. The undistorted power output, 21.9 watts, is sufficient to drive twenty 1-watt reproducers. The input may be ob-

tained from a high-impedance phonograph pickup, a microphone, or a radio tuner chassis; input terminals are grid and cathode connections—output, to specifications. Weight, 115 lbs.; dimensions, 23 x 15 x 10¹/₂ inches high; current consumption, 315 watts.

A VACUUM-SWITCH

NEWEST among developments of the Burgess Battery Co. is a device, illustrated in Fig. C, called the "vacuum contact"; actually, it is a simple contact device which, operating in a vacuum, opens (or closes) circuits of relatively high power without the usual degree of arcing. An exterior mechanism is required to control its operation.

The standard type shown in Fig. C is rated at 6 amps., 220 volts, without arcing.

The principle of the device is clearly shown in Fig. 1; within the specially-annealed glass bellows A and cylinder B are sealed the contact block C, contact D, and the leads. The rod E protrudes, and may be moved up or down .02-in. (pressure, 10 oz.)

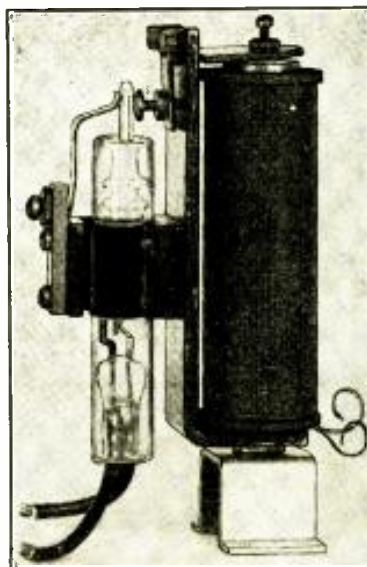

Fig. C
The glass tube contains a switch, working in a vacuum, relay-operated

by external pressure, to close or open the contacts. Fig. C shows an electromagnetic system (using an ordinary telephone-type magnet) designed for the purpose. Because of the internal vacuum there is between the electrodes no arcing, with a spacing of over .001-in. Life tests equivalent to 250 million makes and breaks have been satisfactorily completed.

This is an entirely new device and all its adaptations have not as yet been determined. Specific mention is made, however,

This high-power amplifier meets the demand for outdoor volume, using the economical '50-type amplifiers—four of them

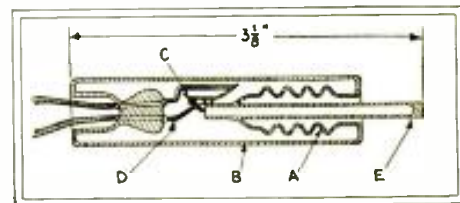

Fig. 1
The flexibility of glass allows the switch of Fig. C to function

of its use in the following services: alarm circuits, oil burners, motor control, remote-switching circuits, thermostat-switch operation, telephone, telegraph and radio circuits.

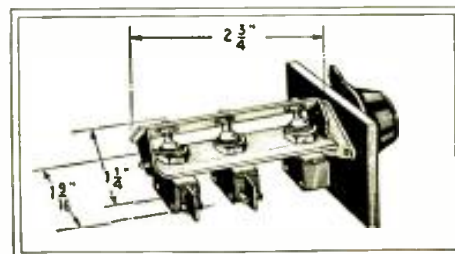

Fig. D
A new multi-power triple switch

NEW SNAP SWITCHES

ONE of the pioneer organizations in the field of power switches has now completed an extensive line of components of interest to private and commercial technicians. One novel arrangement of these new switches, under the well-known "H & H" brand, of Hart & Hegeman (a division of The Arrow-Hart & Hegeman Electric Co.), is illustrated in Fig. D. This is a multi-purpose unit composed of three different models, the "rotorpower," "multipower," and "push-pull" units; all ganged together, as shown.

The new units catalog as follows: "No. 1561," single-pole rotorpower switch, with soldering lugs, "No. 20510," S. P. tumbler switch, with 6 in. wire leads; "No. 21349," three-way, or two-circuit, tumbler switch; "No. 1561-AW," S.P. rotorpower lock switch; "No. 80175" two-speed switch, with an "off" position (available at either end); "No. 1572," D.P. rotorpower switch. These switches are particularly adaptable to use in radio, and radio-phono. chassis.

(Continued on page 238)

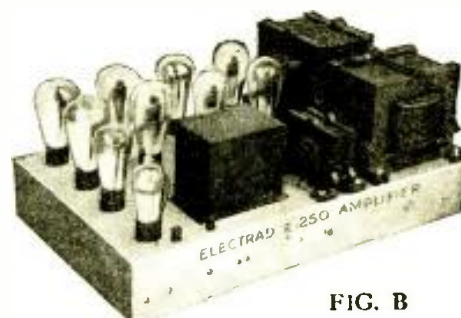

FIG. B

Audio Amplifiers in Talkie Roles

A review of the recent ingenious developments in the linking up of sight and sound reproduction.

By R. D. WASHBURNE

NUMEROUS past issues of *RADIO-CRAFT* have contained articles discussing the design, construction and use of power amplifiers and associated equipment, from the standpoint of the radio Service Man, the design engineer, and the experimental constructor. It is now time to illustrate, by practical examples, the manner in which these numerous phases of developments in the electronic field are being commercialized, both by manufacturers and by the wideawake radio man who keeps in contact with the consumer.

As far back as July, 1929, the second (August) issue of *RADIO-CRAFT* first described a successful, commercial design of home talking-picture machine (the "Home Talkie"). This magazine has constantly taken an active interest in the progress of equipment design tending toward the perfection of a union between high-grade audio amplifiers and the associated sound equipment (photograph pickups, recording heads, turntables, microphones, radio chassis, sound-film apparatus).

In Fig. A is illustrated a late instrument design, which attracted considerable attention at the radio Trade Show in Chicago this summer, (and which should arouse equal or greater interest at the Trade Show in

Fig. A
The projector lens of this RCA Victor combination appears at the right of the horizontal tuning scale.

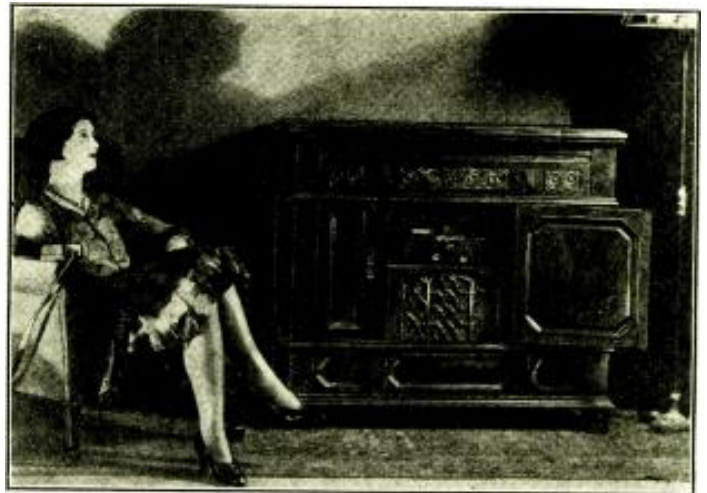

New York City, scheduled for the early part of September).

In the final analysis, we find that, although it lists for close to a thousand dollars, its complexity lies more in the imagination of the observer than in the machine. It incorporates talkies, an automatic record changer, a recorder, a microphone, and a radio receiver (with tone control, remote tuning control, late-model superheterodyne chassis, and twin-reproducers).

The writer feels that there lies, almost totally dormant at the present moment, a tremendous market for an instrument combining these features in manners particularly suited to individual localities.

"Sound" in Schools

The following enlightening statements of Mr. William S. Paley, President of the Columbia Broadcasting System, is quoted from Martin Codel's book, *Radio and Its Future*:

"During the summer of 1929, the Secretary of the Interior, at the request of the department of Superintendence, appointed a commission to study the educational pos-

sibilities of the radio. The stage was thus set for a new era of progress."

And again:

"Educational radio will do much for one-room rural schools. There are now in the United States 160,000 one-teacher schools which give instruction to more than six million young people. Several million more are in small rural or town schools. As an experiment and research reveal the most effective educational uses of radio, there will grow up a system of broadcasts to serve the schools throughout the nation.

"No one need think that it will be easy to harness radio for the schools. It is a hard and difficult problem. But, inescapably, this new tool of learning will find its place in the schoolroom and in the home."

(A more intimate light on the possibilities of school radio is found in *Radio in Education*, by Armstrong Perry. See also, *This Thing Called Broadcasting*, by Goldsmith and Lescarbours.)

A concrete aspect of this virgin field is found in the figures which indicate that there are more than 250,000 school buildings in this country of ours, having a daily attendance of over 20,000,000 students. Couple this with the fact that the average county school being put up today costs about \$250,000, to properly take care of a thousand or more pupils; and it is seen that a few hundred dollars more or less, the cost of some form of sound equipment, can make little difference in the financial budget.

It now remains to prove that sound equipment will make a *great* difference in raising educational standards. This the writer will attempt by clearly showing the merits and adaptations of various types of newly developed sound devices; while at the same time pointing out additional (and perhaps primary) uses.

Classifications

Preparatory to listing the classes, into which fall the various circuit and instrument designs, there may be in order an explanation of the nomenclature.

"Talkies" are talking motion pictures; whether the synchronized sound is on disc or film. "Automatic" phonographs are equipped with mechanisms which cause the disc records to be exchanged automatically. "Pre-pay" instruments include a coin device which controls the operation. "Portable" units are designed with particular regard to

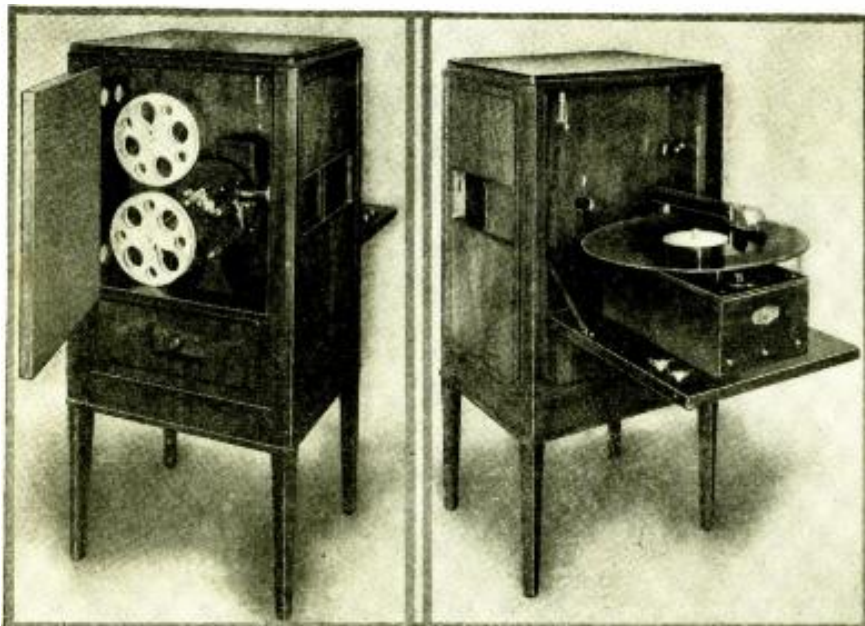

Fig. B

The "Consolette," the projector, on the left, with the control panel inset beneath it. In the view of the right side, the synchronous turntable in position; observe its large size.

Fig. C

compactness, lightness, and portability. "Combinations" incorporate two or more distinct functions. "Non-sync." devices provide for sound (such as incidental music or microphone announcements) which is not synchronized with the picture.

Following is a list of nearly all the combinations at present available as commercial devices; of course, it is possible to combine these units, within certain limits, to obtain a particular effect:

- Home Talkies;
- Industrial Talkies;
- Advertising Talkies;
- Non-Sync. Talkies;
- Talkies and Radio;
- Radio-Phono. Combinations;
- Automatic Phonographs;
- Pre-Pay Automatic Phonographs;



Fig. D

The lecturer is using a microphone with the portable "Filmophone" to explain the film.

- Pre-Pay Automatic Recorders;
- Midget Radio-Phono. Comb.;
- Special Combination: Talkies, Automatic Phono., Recorder, Radio (with remote-control), tone-control, and twin reproducers).

"Home" talkies is a misnomer; for there is nothing to prevent a "home" talkie being used in a school, or in any other public or private institution. The only limit is the size of its audience; which is, mostly, a matter of the camera-to-screen distance and the projector-lamp's power. In general, though, exceptional care is taken in the cabinetry of talking motion-picture machines designed for milady's home.

A particularly fine example of sound engineering and woodcraft is the "Consolette" Home Talkie, "No. 750 C," illustrated in Figs. B and C. It is a product of the Patent Electric Company, and one of the most refined instruments of this type developed to date.

As the cabinet top is immovable, it may be permanently trimmed. The front left panel slides (in steel springs and felt, to prevent vibration) to the right, exposing the projector. A door on the left side of the cabinet, Fig. B, presents the projector for adjustment; but is closed during projection. The door on the right side, Fig. C, during the "show" is in the convenient position shown, for exchange of records, etc.

The projector is equipped with a motor-driven rewind; silent claw intermittent; silent, high-torque induction motor (common to projector and turntable); special gear box to insure absolute synchronism; helical micarta gears; automatic framing device; automatic light trap, to prevent injury to

film. The projection speed of the 16-mm. film may be switched from 16 frames per second to 24; smooth projector motion has been adopted to eliminate film flicker; a 165-watt lamp makes available a picture measuring 6 x 8 feet, although a collapsible screen measuring 3 x 4 feet, or a special one, 26 x 34 inches, is available.

The turntable rotates at 33 1/3 r.p.m., regardless of projector speed; a 16-in. tone-arm pickup is used; equipped for silent or sound picture projection, and non-sync. (incidental) or synchronous sound. The midget reproducer is removable, for placement near the screen during large image projection. This amplifier uses one each of types '24, '45, and '80 tubes (volume controls appear in Fig. B, underneath the projector).

Films Available

About eight concerns are producing film reels in the 16-mm. or "home-movie" class. These films, of which there are available more than 2,000 subjects (comedy, educational, feature, sporting, travel and special), are rapidly becoming available to the home projectionist through the process of "rotation."

Circulating book libraries (usually in stationery stores) are familiar to everyone, and the few cents they cost us, per week, is a small charge for the benefits we derive. Circulating film libraries, at our favorite radio supply house, will afford even greater



Fig. E

The Filmophone is shown in a console, with radio combination, for home or auditorium

pleasure and education; and, films thus being available at low cost, should be profitable to the dealer for the same reason. Film libraries already are established in many cities.

Industry Speaks

The U. S. Navy, Army, and Bureau of Mines, and many manufacturers, have available 16-mm. films, illustrating various activities and processes, which are lent gratis. "Miniature Movies," official organ of the 16-mm Motion Picture Board of Trade, is dedicated to the promotion of this type of film in all its uses.

Mr. Allen Mogensen, assistant editor of *Factory and Industrial Management*, is

quoted as follows: "Movies offer one of the most effective methods yet discovered of eliminating waste motion in factory production."

As a matter of interest it may be remarked that, where impromptu or incidental sound is to be employed (non-sync. operation), an ordinary hand movie camera may be used with perfect satisfaction for the taking of industrial pictures. One method used by Bell & Howell experts for obtaining a time-check of mechanical operations is to arrange a standard stop-watch on the front of the camera, so that its time indication appears in one corner of the finished picture.

Clearly, movies can be used to cut down manufacturing costs by affording a means of detecting waste motion in factory operations; this is done most successfully by means of a camera which functions at the rate of 1,000 to 4,000 frames per minute. The completed film is studied by industrial engineers, who detect and correct procedure which is seen to be faulty. Factory workers may gather from this that they may be compelled to work harder. This is erroneous. In fact, it has been proven, (and recently demonstrated to The Society of Industrial Engineers), that, after cutting down waste motion portrayed on the "miniature movie" screen, the production of a worker can be increased *and, at the same time*, unnecessary fatigue reduced—*more work is done more easily*, than a lesser amount previously.

Synchronized records may be prepared at the same time, or the sound may be "dubbed" in at leisure. (Details of recording procedure have appeared in the "Home Recording" department of *RADIO-CRAFT*).

Still another way of handling such educational films is to run the picture "silent," except for pertinent, impromptu remarks, or synchronized sound interspersed with running comments; both of which effects are accomplished by means of a hand microphone and a cut-in switch or "fader." In Fig. D the factory representative is shown breaking into a talkie to give to a group of district sales managers an oral explanation of an illustration. These managers, in turn, may use the same procedure later in addressing a "pep" meeting of salesmen.

In Fig. E is shown a close-up of the Bell & Howell "Filmophone-Radio"; which in part, as the "Filmophone" portable, appears also in Fig. D and, when equipped with the new 375-watt Filmo lamp is said to fill a

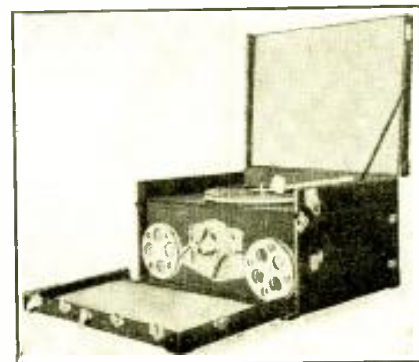

Fig. F

The "Talkiola" portable in its carrying case; it also handles large (16-in.) records.

16-foot screen (90-ft. projection), and may be heard throughout a filled theater of over 2,000-seat capacity. This is something "to write home about."

A separate microphone connection permits the operator to make extemporaneous remarks. A single motor turns projector and turntable in synchronism. The portable instrument is of the two-unit type, the total weight being 88 lbs. One unit case measures 25 x 17 x 8 in. (approx.); the other, 25 x 19 x 7 in. (approx.). The audio amplifier is of a high-gain type, and includes two '27s, two '45s in push-pull, and an '80 rectifier.

One case contains a Filmio 16-mm. projector, three extra reels of film, empty reel, connecting cords, cables and accessories, and the reproducers; the second, the turntable and coupling shaft, magnetic pickup, power amplifier, tubes, needles, and has provision for 16-inch records.

The Filmophone-Radio, Fig. E, incorporates radio, talkies, and electric phonograph.

The turntable is rotatable either at ordinary phonograph speed, at 33 1/3 r.p.m. for talkies. The films may be run silent, synchronized, or non-sync. A Howard radio chassis is used.

The "Talkiola"

In Fig. F is illustrated the "Talkiola Portable," manufactured by the Talkiola Corporation; and most of the technical data concerning it are applicable also to the "Talkiola."

The projector handles 16-mm. film, a "noisless" mechanism being used. Projection is upon a transparent screen; which may be as large as 7 x 9 feet, for a focal length of 25 feet, with the standard 250-watt lamp. A 1/20-h.p. A.C. motor drives both the projector and turntable; which start immediately in synchronism.



Fig. G

The "Visionola" contains its own screen, utilized in the manner shown for compactness.

A turntable speed of 33 1/3 r.p.m. is available for standard picture records, and, for domestic records, 78 r.p.m. (lever shift).

The power amplifier employs a type '24 tube and push-pull '45's, with an '80 rectifier. The dynamic reproducer is portable within the limits of a 25-foot cable. A microphone may be plugged into the circuit for announcements.

The "Talkiola Portable" weighs 80 lbs., complete with screen, and measures 23 x 18 x 14 in. in height.

The home model, the "Talkiola" secretary, incorporates also a radio set and is characterized "the miniature theatre in your home."

The "Visionola" and "Visivox"

Another instrument designed particularly to enhance and entertain in the home is the "Visionola," ("—that brings to your

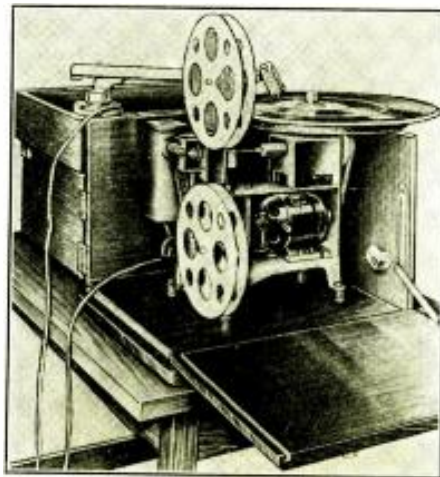

Fig. H

The portable "Visivox" may be plugged into any radio receiver to use its audio end.

living-room the whole wide world of entertainment.") which is illustrated in Fig. G. (It is manufactured by Visionola Mfg. Corp.), and a good idea of the appearance of the "Model C660" instrument, open for adjustment, threading of film, etc., and closed, is obtained.

The phonograph mechanism is in the top of the cabinet; the radio chassis is beneath the projector. A standard Columbia "Screen-Grid 8" chassis is used. The audio channel of this receiver, which is of particular interest, is schematized in Fig. I; this shows the manner in which most radio-talkies combinations are wired. Microphones may be wired in, in a number of different ways, depending upon the individual audio circuit, and the characteristics of the microphone.

Equipment classed as accessories, and required for operation of the Visionola, are as follows: one G.E. "Type T10 Prefocus," 200-watt projection lamp; one G. E. "Type T8," 15-watt intermediate screw-base pilot lamp; three type '21, two type '27, two type '45, and one type '80 tubes; antenna and ground installation materials.

One lever controls the projector for sync, non-sync, or rewind; another adjusts the framing. Four more, on the receiver panel, control radio tuning, off-on, tone, and volume, and talkies and plain phonograph volume.

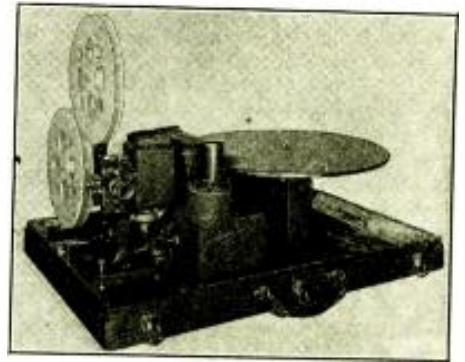

Fig. I

The "Cinetone," especially intended for industrial and scientific use, is assembled on its carrying case as shown.

Projection is obtained by reflection upon a screen; this makes for compactness.

In Fig. II is shown the "Visivox" in the open position of the "Model A" portable 16-mm. talkie; it is manufactured by Sprague Specialties Company. (A pretentious console Model C is not illustrated.)

A feature of the "Model A Visivox" is the manner in which it derives its audio amplification. One plug connects to the light-line, for motor power; and a second plugs into an existing radio set, thus connecting the pickup of the Visivox to the amplifier and reproducer system of the radio set. Where no radio set is available, the "Model B" unit, incorporating the required amplifier and reproducer, is used.

The "Model C" unit also projects upon a screen, and comprises the projector, phonograph mechanism for 16-in. records (for sync. or non-sync. operation with or without the projector), amplifier, and reproducer.

Industrial-Type Talkies

The "Industrial Cinetone" manufactured by Q.R.S.-DeVry Corporation, and illustrated in Fig. I, is another portable talkie; the sale of which, however, at the present time is mainly in the industrial and scientific fields.

A large reel permits running a 28-minute show (800-ft. reel); with sync. sound on 33 1/3 r.p.m., 16-in. records. A 250-watt lamp results in clear pictures up to 60-foot projection. Amplifier and reproducer are mounted with the projector on the base of the carrying case.

The scientific aspect is gleaned from the following words of Mr. T. M. Pletcher, president of the company. "The inestimable good of having talking motion-picture equipment, with which to portray surgical operations for students of medicine and surgery,

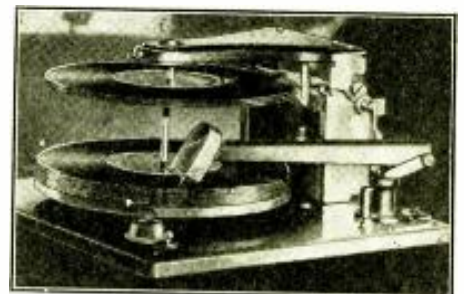

Fig. J

The Capchart "10-12-C" automatically changes ten records to playing position; the last repeats until it receives the operator's attention.

can be readily recognized. On the other hand, actual talking motion pictures, taken in the field of industry and accurately presented to laymen as well as to engineering groups, have a value that cannot be measured in dollars and cents. . . . It (the "Cin-tone") is something that will revolutionize the method of showing the world how science and industry perform—and actually tell about it at the same time."

Midget Combination

"Lady, play your — radio-phonograph" may become a rather common request, if manufacturers follow the lead of the Cardinal Radio Manufacturing Company, which originated the particularly neat and compact midget radio-phonograph illustrated and described on page 238.

The adaptation of this small-space combination instrument to use in conjunction with an ordinary 16-mm. movie projector should be obvious (for instance, as an aid in the study of languages, where the filmed motions of the mouth in pronunciation are accompanied by verbal explanations via the electric phonograph).

There are now available several models of "pre-pay" instruments. Most of them are of the electric-phonograph type, and operate when a coin is put into the machine. In general, they incorporate a standard power amplifier, phonograph pickup, turntable and motor, and the reproducer; the only distinction being in the cabinet design, the inclusion of a simple coin-operated switch which closes the power circuit during the playing of a record, and a mechanism for exchanging the records.

For dance halls, restaurants, and other places where continuous sound programs are desired, substantially the same equipment, minus the coin-control, is used. In these installations the record-changer ordinarily operates automatically to play either or both sides of a large number of records (perhaps 15) consecutively; and then, either reset automatically or to require manual resetting.

Home Record-Changers

In most instances, the record-changer in these big commercial jobs is an integral part of the construction and therefore not available to the technician who would incorporate automatic change of records in a sound installation of his own. Under these conditions a separate record-changer, distinct from every other part of the equipment, becomes desirable; and now is available in several makes. A particularly compact record-changer, designed by a firm which has specialized for a number of years

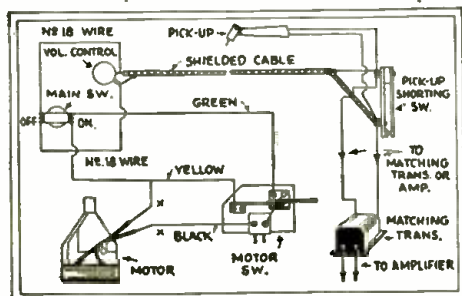

Fig. 2

The system of the record-changer shown in Fig. J; any record may be selected for playing at any time.

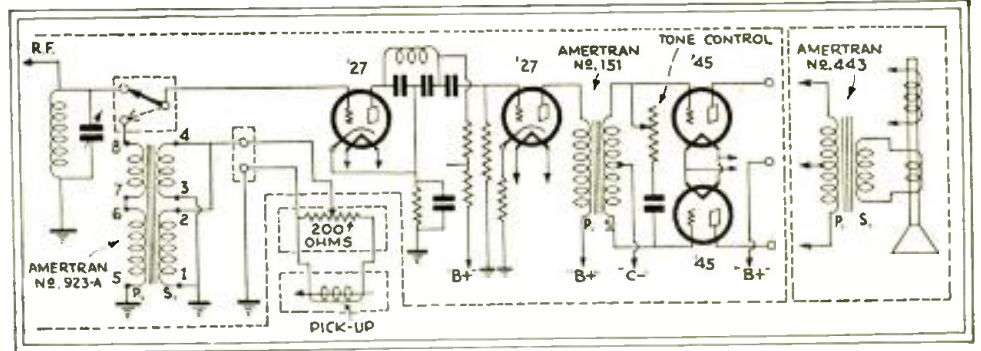

Fig. 1

The audio channel of the Columbia receiver, used as the amplifier of the "Visionola"; the connections are typical of radio-talkie practice.

in the perfecting of these devices, is the new "Capchart" record-changer, "Model 10-12-C," shown in Fig. J. It is manufactured by The Capchart Corporation, long makers of domestic and commercial electric phonograph and radio-phonograph combinations.

Both 10- and 12-in. records can be played,



Fig. L

The "Auto-Cinema" adds speech to the familiar advertising movies; the sound is on the endless film.

changed, and turned over. With a special switch one record can be placed on the turntable, the adjustment set according to the size of the record and the magazine loaded while the pickup automatically comes into position and the first record is being

played. The magazine of this model holds 9 records; the playing time, therefore, may be up to 45 minutes. Control connections are as shown in Fig. 2.

The Capchart record-changer may be used in conjunction with a radio set or a motion-picture projector. The latter arrangement calls for non-sync. operation (incidental music, or home-recorded commentaries); since the rotational speed is 78 r.p.m., the standard for domestic records, and there is no provision for coupling the turntable to the projector. The record-changer is provided with a reject device, record unloading lever, volume control, and master switch.

Consider the application of these units; they now are installed, to name a few instances, in the following places: In automobiles, as part of "sound trucks" for advertising purposes; on merry-go-rounds; in yachts; on warships; at bathing beaches; in tourist camps; in hotels, inns, etc.

Portable Amplifiers

In addition to the 46 uses of audio systems listed on page 122 of the August, 1930, issue of RADIO-CRAFT, we may add the following: armories, auctions, banks, colleges, gymnasiums, lecture rooms, lodges, prisons, steamships, steamship terminals, yachts, stock and trade exchanges, theatres and civic centers.

Demonstrations to prospects of a sound installation, or the use of a sound system under the conditions of temporary operation, are conveniently met by means of the twin-unit public address system shown in Fig. K. This illustrates the "Model 101-A" portable public address system, manufactured also by Electrad, Inc. (Several other models are available.)

Features of the "Model 101-A" portable
(Continued on page 249)

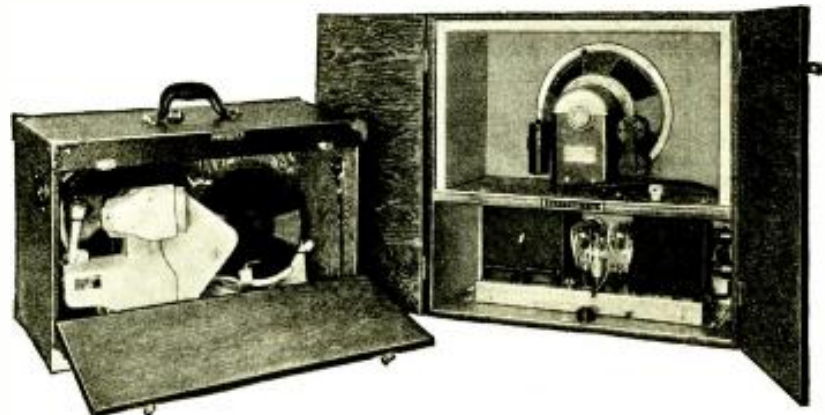

Fig. K

The two units shown compose the Electrad "Model 101-A" portable public-address amplifier, arranged for convenient transportation. A record-changer for phonograph programs, and a dynamic reproducer are parts of the equipment.

Favorite Testing Equipment of Service Men

Our Readers Describe Their Handy Kinks

MODERNIZING OLD TESTERS

By L. W. Herman

COUNTLESS tube testers are in use which can easily be modernized to handle the latest tubes. Although the improvements herein noted were made on a Weston "Model 533," they may be applied to practically any tester. By the use of three Yaxley No. 2003 S.P.D.T. push-button switches and one 50,000-ohm resistor, all of the latest tubes including the pentode may be tested.

Fig. 1 shows the original circuit as found in most testers, while Fig. 2 indicates the changes made. When "X" is pressed, 115 volts is impressed upon the screen of the new pentode power tube; the grid test may then be made as usual. Switch "Y" is pressed to obtain the reading of the second plate of the '80 rectifier tube. By pressing "Z", approximately 75 volts is thrown on the screen of any four- or five-prong screen-grid or R.F. pentode tube; the grid test is made as usual. All switches are shown in position as used with ordinary tubes.

In order to eliminate a loose plug-in wire for the cap of the screen grid, I used the method shown in Fig. 3, which illustrates the underside of the tester panel. When a screen-grid tube is to be tested, the clip is lifted from its position between the sockets and placed on the cap of the tube; after the test, the clip wire when released will snap back into the case. The half-hour spent in constructing the disappearing grid wire will pay for itself many times, as a convenience and time saver. Knurled nuts from dry cells make excellent pulleys, when reamed free of their threads. Silk-covered loop wire is very good for the grid wire; wax this for long life.

It is a simple trick to unwind the sec-

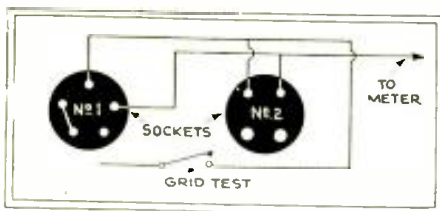

Fig. 1

Ordinary connection of VY and VZ sockets in tube tester.

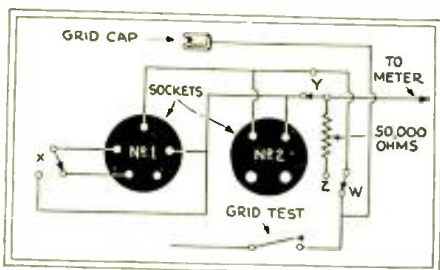

Fig. 2

Three push-button switches—X, Y and Z—and a resistor fit a tester to take pentodes

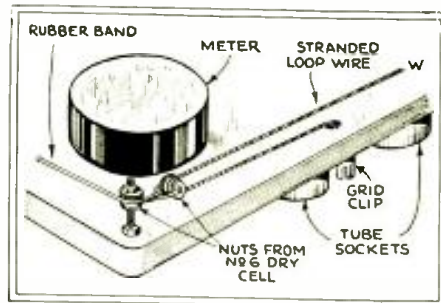

Fig. 3

Borrowing a trick from the parlor magician's bag of tricks. The cap is out of the way except when wanted

ondary from the filament transformer, noting the number of turns per volt. Half way between the 1.5- and 2.5-volt taps, bring out a tap for the 2-volt tubes. Half-way between the 5- and 7.5-volt leads, bring out a tap for the new 6.3-volt auto tubes. Install a Yaxley 8-point complete-break switch in place of the old selector; and your tester will be up-to-date—that is, until a new batch of tubes are thrown on the market.

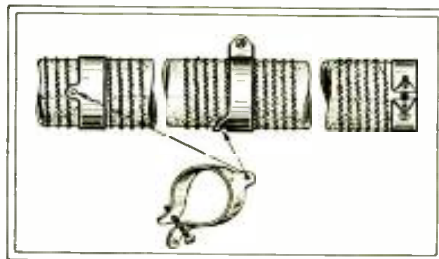

Fig. 4

Mr. Noble uses this slider to obtain very fine adjustments on a standard wire-wound resistor for calibration purposes

FINE RESISTOR ADJUSTMENTS

By J. E. Noble

WHEN a fine adjustment of resistor values was required for some experimental work, I made up the vernier slider, for a "Truvolt" wire-wound resistor, which is illustrated herewith. As may be seen, it consists of a slider made slightly wider at its midpoint, with a distinct semi-globular indentation impressed or stamped therein; this indentation is made to ride the threaded channels of the resistors, allowing almost a micrometric adjustment to be made. Rough adjustments are first made in the regular up-and-down manner; then a turn to the right or left does the trick.

Those who desire an easier method of constructing the slider can simply cut two small slots in a standard slider; filing away the part which is not required, and giving the remaining small portion a slight inward bend with a pair of pliers. Be sure to file off any sharp corners which remain, to prevent cutting the resistance wire when making the adjustment.

I used this method to calibrate an 0-1 milliammeter for use as an ohmmeter; establishing a starting point and a halfway point by fastening two threads, top and bottom, running lengthwise on a 15,000-ohm resistor. Every time the slider rode over the thread, the contact was broken, and a deflection of the needle occurred. This made it possible to keep tab on the number of turns, which on a 6-inch, 15,000-ohm Electrad resistor was found to be a hundred; indicating 150 ohms per turn, or 75 per half-turn. In this manner, a fairly good job was made of the calibration

SIMPLE OUTPUT METER

By Andrew Frevert

A SMALL output meter, that is made up to use in conjunction with a service oscillator, is shown in the sketch.

The combination (of jacks A, B, C, D; switches S1, S2; and transformer T) makes a variable input to meter M and detector CD which forms the output indicator; depending on types of sets.

With connections to set on jacks A and

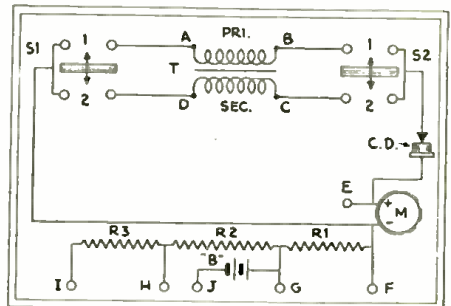

Fig. 5

This set-up is flexible for measurements on various sets; and also for continuity tests.

B and switches in No. 2 position, primary of transformer is in series with speaker; secondary in series with meter and detector. With switches in No. 1 position, input with primary in parallel is fed direct to meter and crystal.

With input leads in jacks C and D and switches in No. 1 position, secondary is in series with input, primary feeding to meter. With switches in No. 2 position, input is series with input, primary feeding to meter, in parallel with secondary and feeding to meter.

With input leads in A and C jacks, S1 on No. 1 position and S2 on No. 2 position, meter is connected direct to input signal.

For use as voltmeter: Jack E plus, G minus 5 volts; Jack E plus, H minus 25 volts; Jack E plus, I minus 100 volts.

Jacks E and J are for continuity testing or, if scale is calibrated, for use as ohmmeter.

A HOME-MADE TUBE TESTER

By Gerald G. Wells

OTHER Service Men may be interested in the tube tester which I have built and had in use for some time; it may be used for all types, including the new two-volt tubes. The cost will be low, especially as most of the parts may (as a rule) be found around the shop.

It will be necessary to wind the transformer, because of the various voltages

Modernizing the "133A" Set Analyzer

An Ingenious Enlargement of a Standard Instrument, for Modern Requirements.

By EDWARD M. HEISER

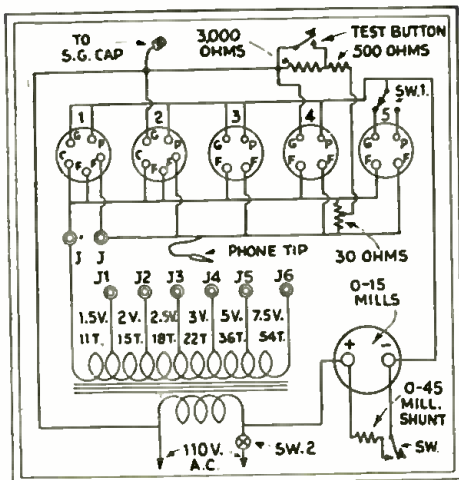

Fig. 6

Mr. Wells built his tester, transformer and all. It is calibrated to the meter used.

which it must furnish; mine was made from a burnt-out choke coil, taken from a power pack. The core has a cross-section 3/4-inch through the winding spool, which was 1 1/4 inches long and 2 inches square; the required turns just fill this. The primary consists of 600 turns of No. 30 enamelled wire, each layer insulated with waxed paper (such as bread is wrapped in). The secondary comprises 54 turns of No. 18 double-cotton-covered wire, tapped at the 11th, 15th, 22nd and 36th turns. While assembling, paint the whole transformer generously with thin shellac, before tightening the screws.

The shunt also must be made to fit the milliammeter used; a resistance strip from an old rheostat may be cut down, in this manner. Put a variable high resistance in series with the meter and a 22 1/2-volt "B" battery; adjust it until a full-scale reading is obtained, and then shunt the resistance strip across the meter and remove resistance wire until a 5-mil. reading is obtained.

IMPROVING THE OHMMETER

By J. E. Kitchin

THE ordinary method of measuring resistances with a 4,500-ohm resistor and 0-1-scale milliammeter will not go below 50 ohms with a shunt; and the slide-wire bridge is not suitable for carrying around. The answer to Mr. Prince, on page 611 of *RADIO-CRAFT* for April, 1931, gave the right idea, but used too much gear. It formed, however, the basis of my experiments, which

(Continued on page 240)

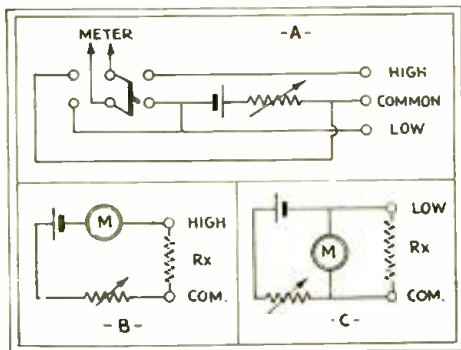

Fig. 7

Mr. Kitchin designed his ohmmeter thus; the P.F.D.T. switch may be part of a larger unit.

NO doubt there are many Service Men who have a Jewell "Model 133A" set analyzer, and would like to modernize it with a minimum of expense. I believe they will be interested in the arrangement which I made of mine, and with which it is possible to make practically all tests that are necessary in the field.

The original analyzer (shown within the dot-and-dash lines) had a UX socket and a four-wire cable. It was necessary to add a UY socket; a five-wire cable and a five-prong plug, made from an old tube base, were needed also. The new apparatus was mounted to the former apparatus with two angle brackets, one on each side, which are

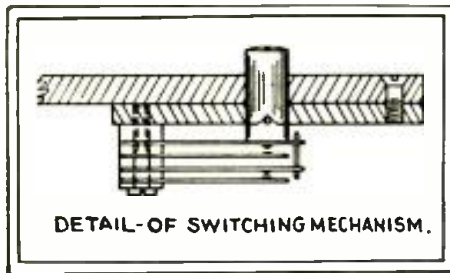

Fig. 1

The push-button switch locks when twisted

also fastened to the carrying case and help to support the panels. The arrangement was dictated, of course, by the parts on hand. With that shown, the enlarged analyzer is kept symmetrical.

The detail of the switching mechanism shows the method of mounting used; Yaxley jack switches were removed from their frames and mounted on a piece of bakelite, which is fastened to the main panel by four screws. The holes for the push buttons were then drilled and reamed. The buttons were made of 3/8-inch bakelite rod, matching those on the original analyzer; on each button there is engraved a line, which is filled with white. The position of the line is kept vertical by a pin through the button, which plays in a groove in the bakelite strip mounting the switches. By pressing the button down, and giving it a slight twist, the switch is locked in the closed position. In the circuit diagram, the brackets indicate which contacts each button controls.

The phone-tip jack and the screen-grid push-button switch are used in conjunction with the adapters to test screen-grid tubes. The adapters are made from old tube bases, and sockets, wired as shown.

To test screen-grid tubes, one adapter plug is placed in the socket of the set, and the analyzer plug is inserted into the adapter socket. The control-grid lead is then snapped on the lead from the adapter, the other plug of which is inserted into the socket in the analyzer; and the tube is placed in the adapter. The phone tip is plugged into the tester panel, and the

lead from the adapter is snapped over the control grid cap of the tube.

To take the readings, the screen-grid push button and 100-volt push buttons are pressed simultaneously. The other readings are taken in the same manner as with three-element tubes. To change over to the next socket, it is necessary only to remove the control-grid lead and move the adapter and plug as one unit to the next socket.

For use in conjunction with the cathode-voltage switch, a reversing switch has been incorporated; with this in normal position, the cathode voltage will be negative. When it is reversed, a positive reading is obtained. A 50,000-ohm resistor is used for cathode voltage readings on the 50-volt scale.

The following parts were used:

- One black bakelite panel, 8 x 7 9/16 x 1/4-inch;
- One piece black bakelite, grooved as shown, 4 1/2 x 4 1/2 x 1/4-inch;
- Seven pieces 3/8-inch bakelite rod, cut and drilled for buttons;
- One Jewell "Pattern 71" A.C. meter; 0-3-15-150 volts;
- One Weston "Model 506" 0-5 scale ammeter;
- One Frost "No. AC 609" snap switch;
- One Na-Ald "No. 423" CY socket;
- One Yaxley "No. 416" pup jack;
- Five Eby binding posts;

(Continued on page 237)

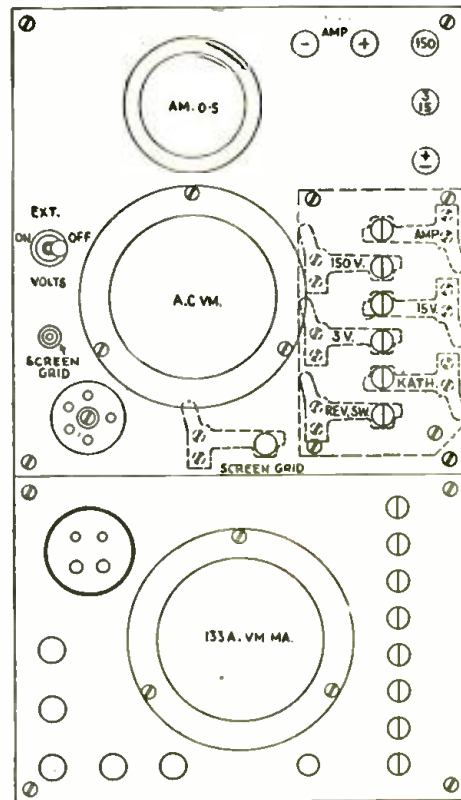

Fig. 2

Panel arrangement of the enlarged analyzer, the circuit of which is shown on page 237.

The R. T. A. Set Analyzer

The Design of a Simple, Effective Testing Instrument for Assembly by the Service Man Who Is to Use It

By ARTHUR G. MOHAUPT*

IN connection with the work of servicing radio receivers, the importance of accurate, labor-saving test equipment needs no discussion. The increasing complexity of modern radio equipment makes greater demands upon the Service Man, which can be met only with suitable professional equipment.

For this reason, it was found that a necessary adjunct to the course of the Radio Training Association was the design of a suitable set analyzer, meeting all the demands of modern servicing; with the construction, as well as the operation of which every student should be familiar.

After much consideration of the problems of efficiency in operation, the R. T. A. Set Analyzer illustrated here was designed for the purpose; and, at the request of Radio-Craft, the details of its layout and construction are here explained for the general benefit of the servicing profession.

The instrument is to be assembled, wired, and tested by its future operator, giving him therefore valuable practical experience and insight into the principles by which each measurement is obtained.

Construction of the Instrument

The completed analyzer is housed in a neat black carrying case of professional appearance, the cover of which is held down by a pair of spring clips, and having a comfortable leather handle. The apparatus is mounted upon an engraved black panel, the front and rear of which are shown in

*President, Radio Training Association of America.

Figs. A and B; this carries the three meters, selector switch, and necessary buttons, etc. In Fig. 1 the connections are shown; and the method of construction to be followed by the student is explained in logical order.

First, mount the 5-prong socket in the upper left corner and the 4-prong socket in the upper right corner. Now fasten the three toggle switches. Next, place the two push buttons in their places below the D.C. voltmeter. The metal tip jacks are now mounted in their places, and then the red and black-topped tip jacks. The selector switch is mounted in the lower center hole. It must be secured very rigidly and placed so that, when the knob is turned clockwise as far as possible, the white arrow will point to the first marking, which is "Plate Volts." Lastly, the three meters are mounted in their proper places. Each unit must be placed exactly as shown in the diagram, Fig. 1.

It is extremely important that all connections in the Analyzer be well soldered.



A. G. MOHAUPT

An interesting step-wiring plan has been worked out for the guidance of R. T. A. students, and is retained in this article for the guidance of RADIO-CRAFT readers to whom the simple schematic circuit may seem a bit hazy. Make each connection in sequence, as follows: Connect point 5 to 9; 9-21; 5-39; 39-44; 6-17; 17-24; 6-37; 37-45; 1-3; 3-8; 8-10; 10-12; 1-42; 42-31; 31-33; 4-7; 7-41; 41-34; 34-40; 11-32; 32-36; 43-38; 38-48; 53-48; 47-19; 46-18; 50-52; 52-14; 29-27; 27-51; 51-13.

Now connect into circuit the two resistors

Fig. B (right)
Rear view of the analyzer's panel (reversed from Fig. A). The coil between the two meters and the 'X' socket, at the upper left here, is the scale multiplier for the D.C. voltmeter ("large resistor"); that at the lower right is the multiplier for the A.C. voltmeter ("small resistor").

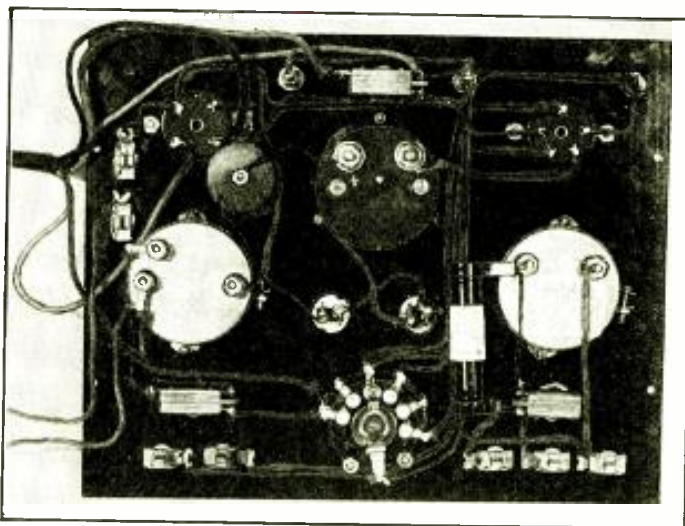

Fig. A (left)
Appearance of the R. T. A. set analyzer's panel, seated in the carrying case, with the accessories—plug, adapter, and screen-grid clip (carried with the 3½-volt battery in the compartment at the right). The meters are: upper, Hoyt No. 563 D. C. voltmeter; left, Readrite 0-10-140 A.C. voltmeter; right, Readrite 0-15-150 milli-ammeter.



and the cable. The red wire on the large resistor connects to 49 on the D.C. voltmeter; and the black lead, to 28. Connect 49-26.

Next, connect the small resistor into circuit; one end to 25 and the other, point 23, to 15. Connect 25 also to 22, and 22 to 16.

The five-wire cable is passed through the hole in the partition of the case and its separate wires are connected as follows: green wire to point 35; black to 37; yellow to 39; red to 2; blue to 1; and point 2 to point 20.

Two six-inch lengths of wire are each connected to points 54 and 47, the wires passing through the hole in the partition of the case. (The 4½ volt battery shown is not supplied with the analyzer.) Lead 54 is attached to its negative post, and 47 to the positive.

Pre-Service Testing

If a receiving set is not handy to test the completed analyzer, this may be done very easily through the use of a 22½-volt "B" battery. It must be remembered that the "30V" button of the D. C. voltmeter should be pressed to obtain a reading.

Connect the negative terminal of the battery to the grid prong of the plug; and the positive to the cathode prong. The D. C. voltmeter should indicate 22½ volts, with the rotor switch in the "Grid," "Screen-Grid," or "S.G.C. V." positions.

Next, connect the positive lead to the plate, and the negative to the cathode. The same reading should be obtained with the rotor switch in position "Plate Volts."

Across the filament prongs, the meter switch set at "Fil. V." should indicate the same potential; also, when the positive terminal is connected to the positive filament prong, the negative to the cathode, and the switch set at "cathode."

The final pre-service test is made by connecting the negative lead to the plate connection of either socket, and the positive to the

cathode. With the switch in the "Plate Volts" position the D. C. meter should read backwards; and the milliammeter should show a slight reading at the "15" position of its toggle switch.

Using the Analyzer

The primary function of a set analyzer is to enable the Service Man to check the electrical conditions, which exist at the successive sockets of a receiver, against the normal operating data, furnished by the manufacturer. It is advisable to check the tubes in their order, following the signal through the receiver; that is, begin with first R. F., second, etc.; detector, and then the audio stages in their order. Instructions will be given here, as to a student, for the benefit of younger radio workers.

To start the analysis, the first R. F. tube is removed and inserted into the socket in the tester, and the plug at the end of the cable is inserted in its place. A 5-prong plug is attached but, if the socket is of the 4-prong type, then an adapter with a 5-prong socket and 4-prong base is put to use. The set is turned on and the volume control adjusted for maximum.

First, the applied filament voltage is measured by turning the selector switch to the position marked filament volts ("Fil. V."). If the set is a D. C. battery-operated type, the push-button labeled "30" is pressed and the reading taken on the lower or 0-30 scale;

but, if it is an A. C. set, then the A. C. voltmeter is cut in by throwing the switch to the side marked "in" and the reading taken on the lower or 0-10 scale. If no filament voltage is present, it is evident that the filament circuit feeding the first R. F. tube is open or shorted at some point.

Next, the plate circuit is checked up by turning the selector switch to the position marked "Plate Volts." The voltmeter button marked "300" is pressed, and the reading taken on the upper or 0-300 scale. If no plate voltage exists (as shown by a zero indication) the trouble may be a defective rectifier tube, or a break or short somewhere in the "B" supply circuit. If the plate voltage is low or high the line-voltage should be checked; the rectifier also may be weak.

The plate current also can be checked at the same time by reading the milliammeter. The switch is always left in the "150" position; but, if the reading is below 15, it is thrown to the "15" position, so that a more accurate reading can be obtained. (Important: As soon as the reading has been taken, the switch must again be returned to the "150" position.) If the plate current is low, it may be due to a weak or defective tube; the line-voltage may be low or the grid bias too high. Too much plate current may be due to excessive "B" voltage, to insufficient grid bias, to a defective tube, or to a high line-voltage.

(Continued on page 235)

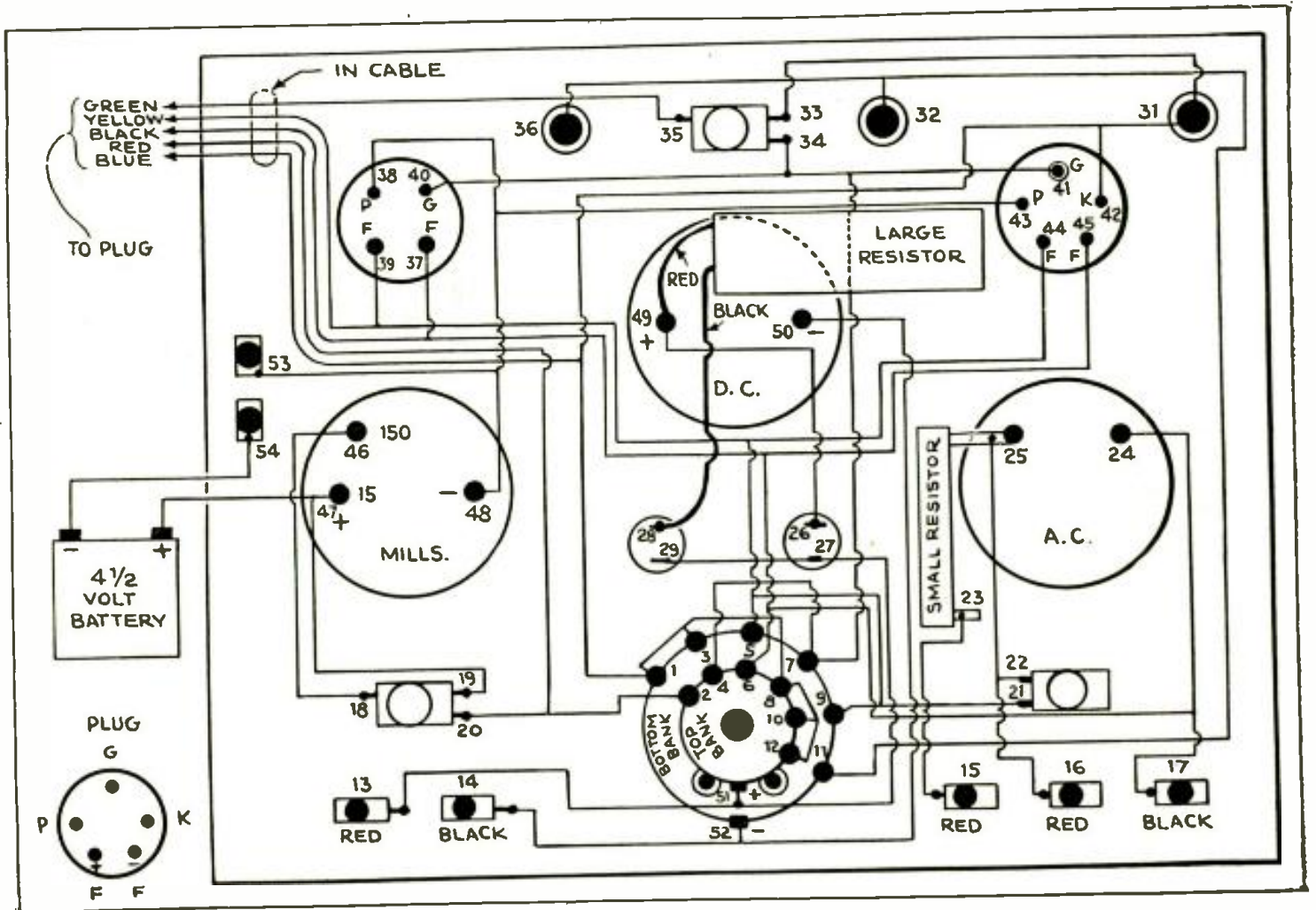

Fig. 1

The schematic circuit and wiring connections (explained in the text) of the R. T. A. Set Analyzer; the arrangement of parts corresponds to that of Fig. B, while the buttons, jacks and switches are shown from the upper side of the panel (in reverse order) in Fig. A. The connections of the selector switch are indicated at the lower center. The end view of the plug (lower left) corresponds to the bottom view of the UY socket.

Operating Notes for Service Men

Some of the Points to be First Examined When Servicing Well-Known Models

By BERTRAM M. FREED

AN old adage, "History repeats itself," is suggested continually in the repair and servicing of radio receivers. Certain makes and models have definite points where the first weakness is most liable to appear; and the Service Man who knows these tendencies can do the quickest and best job. Some of the key positions of a number of well-known receivers have been found, in the writer's experience, as follows:

Bosch

In the Bosch "60 A. C.," a most remarkable condition may be found; on tuning for a given station, it may be found in two places, each ten kilocycles on the dial from its normal position. This condition will be accompanied by lack of volume, insensitivity, choking, and improper operation of the silent tuning meter. The trouble lies in a small (one-inch) black and white resistor, which is located directly under the second '24 socket from the left (looking from the rear of the chassis) and is connected in the detector's screen circuit. If this resistor is defective, it must be replaced with a one- or two-megohm leak.

In this model, as well as in the "58," when the local-distance switch is in "local" position, the aerial is disconnected, and a 500-ohm yellow carbon resistor is placed in series between the antenna tuning condenser and ground. If vibration causes the ends of this resistor to loosen and cause an "open," signal pickup in local position will be greatly decreased or lost entirely.

In both these models, hum or resonance will be caused by open circuits in the 1-mf. condensers connected between one side of the l.c. and the chassis.

Brunswick

In the Brunswick "31 A C" filter-condenser block, the components seldom break down or short; but their opening results in abnormal hum; bridging the filter condensers successively with a unit of one or two microfarads will soon determine the section at fault. Erratic reception (that is, sudden loud bursts) can usually be traced to the contacts of the local-distance switch; the switch screws should be tightened and the blades bent until contact can be made only upon closing the switch.

In the "15" and "22" Brunswick models, resonance hum may be eliminated by removing the small (.00025-mf.) condenser which is soldered to the local-distance switch; it will be found also that the performance of the receiver has been much improved by this change. Cases of fading have been caused by short-circuiting of the small black, oblong bypass condensers located next to each UY socket. The symptoms are rapid changes in volume under vibration; and the condensers are easily checked by bridging them with 1/4-mf. capacities. Inoperation, with lowered plate voltages, as often said before, may be caused by a short in the 1-mf. condenser across the filter output; this is identified by two green wires, emerging from the filter block assembly, and connected to the last two lugs of the terminal block.

Colonial

In the Colonial "33" and "34," the most common defect is found in the 121,000-ohm voltage divider; the carbon-strip wound resistor often will not carry the current. Failure of the 11,000-ohm section will result in lack of voltage on the R. F. plates, while if the 60,000-ohm section opens, there is no voltage on the screens. The 50,000-ohm center section usually gives little trouble; but the indication when it is open is oscillation, and R. F. screen and plate voltages higher than 90 and 200, respectively. (See page 82, August, 1931, issue.)

The 420-ohm center tapped resistor located between the two '45 sockets, and in the negative leg of the power supply, may be the cause of an inoperative receiver; the negative side of this resistor opens more frequently. To short this will give reception; but this expedient should be only temporary.

Occasionally, one of these models will be found to oscillate very weakly; aligning the set on the higher frequencies will give poor reception on the lower frequencies, and vice versa. This condition may be due to one or more open 0.2-mf. condensers, located beneath the condenser-gang shield; these are by-passes in the secondary returns of the first, second and detector stages. One terminal is soldered directly to each coil.

Distortion and lack of grid bias on the

'45 amplifiers is seldom due to an open biasing resistor, in these models; it is much more likely to be found due to an open 100,000-ohm (green) carbon resistor, which connects from the center tap of the input push-pull transformer secondary to the chassis, and is mounted directly on the transformer (Fig. 1A).

It may, infrequently, be found that volume is good on all stations except those at the higher frequencies, although resistors and condensers test perfect; tube voltages are O.K., etc. The cause of this condition will probably be found in two small bobbin coils, which are mounted in the antenna and first R. F. units of the band-pass filter; but these are electrically unconnected to the circuit. The bottom shield must be removed, and a continuity test made of each coil (A and B, Fig. 1B). Since these are used to couple the tuning unit more effectively, an open in either coil will cause reduced volume; it will probably occur at the lug from which the lead breaks away.

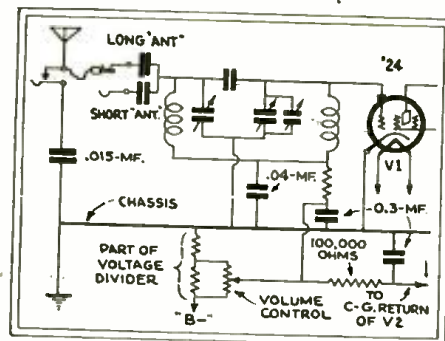

Fig. 2
Input of the Stromberg-Carlson "10" and "11," showing the "range" condenser and the connection of the volume control

Stromberg-Carlson

Little trouble is experienced with the Stromberg-Carlson "10" and "11," except in certain instances; the most common troubles lie in an ineffective range control or volume control. Since some Service Men make a practice of using a ground as an aerial, the small (.015-mf.) range condenser is subjected to a stress for which it was not designed; it sometimes opens, and sometimes breaks down. In the first case, pulling the switch out has no result, and reception will be unchanged; in the second, the aerial is shorted directly to ground when the switch is in local position. (Fig. 2.)

Ineffectiveness of the volume control, when the set will operate at full volume without regard to the setting, may be caused by one of several defects; most frequently, by the 100,000-ohm (black) carbon resistor connected from the control-grid return of the first and third R. F. tubes and the arm of the potentiometer. Sometimes a shorted 0.3-mf. condenser will cause the same effect; these condensers are in the same unit, between chassis and the secondary return of the first and third tubes.

This condenser unit will be seen, on the under side of the chassis, between the first and second R. F. sockets; only two lugs are visible, each connecting to a condenser, while the can is common, being mounted on the chassis. The 100,000-ohm resistor is contained, with another resistor, in a bakelite mounting, located next to the condenser unit.

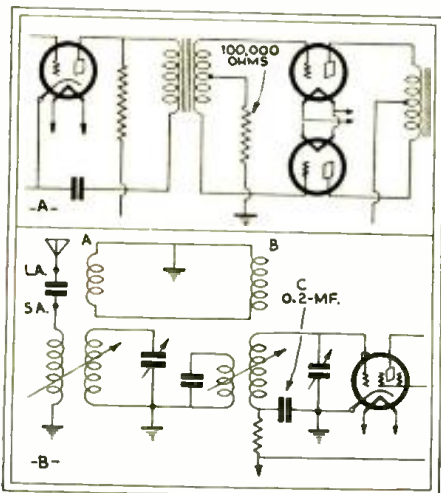

Fig. 1

Portions of the Colonial "33" and "34" circuit; above, grid resistor in the push-pull input; below, a coupling unit in the band-pass filter, outside the electrical system of the receiver.

Annoying fading, found lately in the Stromberg-Carlson "642" and "654," was due to the unit containing the detector's plate choke; the included condensers short intermittently to the metal can.

Sparton

On Sparton "737" and "740" models, the type-485 tubes may be the cause of hum and lack of control over volume; seven of these are used in the set. The number of shorted, loose-element and microphonic tubes of this type found upon installation is probably increased by the method of shipping them along with the set.

With the great number of sets of this make in use, service calls due to fading are increasing; the complaint is usually of "a continuous cutting in and out of volume."

So far, three types of causes have been found. The first is in a poor contact between the band-pass pre-selector unit and the R.F. amplifier proper, which I have described in a previous article in RADIO-CRAFT. The connection is made by a bayonet pin sliding into a special spring socket or clip; the spring must be tight, and the pin guided correctly into its receptacle.

The R.F. unit, with five stages of amplification and a detector, is untuned. The coils are wound on small wooden bobbins which are fastened both above and below the subpanel carrying the tube sockets; the wire is very fine and may readily snap at the soldering lug, or where it emerges from the hole. While a make-and-break connection may not interrupt reception altogether (since the primary and secondary are wound together, giving very close coupling), the intermittent increase and decrease of the signal transfer is very marked. Sometimes intermittent shorts of a coil cause similar complaints. The usual remedy is replacement; though sometimes the loose end can be fished out and resoldered into place.

A third trouble is less frequently experienced: if the nuts work loose from the bolts which ground together the units of these sets (by metal strips passing under them), intermittent connection is produced.

Victor

In the Victor five-circuit "Micro-Synchronous" chassis, used in the "57" and other models, failure or burnout of one of the many R.F. chokes may occur; these are used in the plate and screen-grid leads of the R.F. tubes. The temptation of the Service Man to restore operation by shorting the defective part should be resisted; for the removal of the choke makes possible circuit oscillation, which will ruin tone quality and make tuning difficult.

Before servicing Victor "RE-35," "RE-39" and "RE-57" receivers, it is good policy for the Service Man to equip himself with several carbon resistors and several R. F. chokes; seldom is any other part of these receivers the cause of complaint. The most common reason for lack of operation is an open detector plate resistor; this 500,000-ohm carbon resistor is located beneath the bakelite resistor bracket. Although the current flowing through it is never more than 0.4 milliamperes the original resistor may be unable to carry the current; replacement with a 2-watt component is advisable. (See

(Continued on page 243)

Sales Dollars from Your Telephone

A Discussion of the Methods of Inducing the Customer to "Give Us a Ring" At the Right Time

By FRED E. KUNKEL

WHEN a customer wants radio service, he wants it in a hurry. Is your telephone number well known? Is it easily remembered? How many people know your telephone number offhand? How many people have your telephone number at their finger tips and associate it with your business in their minds? Do you make it easy for customers to call up your office, or do they have to fumble through a big fat telephone book for your number?

One cannot overestimate the value of one's telephone number. It should occupy a prominent place in every piece of advertising, on letterheads and billheads, circulars, blotters or what not, statements of account, receipts, wrappings and containers. Displaying your telephone number prominently adds thirty per cent. to the value of your advertising.

Newspaper advertising, when used, should always feature the telephone, which is just

as important as the firm name and address; and a reproduction of a telephone or of a person talking into a telephone is always an insured eye catcher.

"The telephone, if rightly advertised, is your greatest silent salesman," says one radio Service Man interviewed: "It pays to emphasize your telephone number in all of your advertising, and particularly in the classified telephone directory, which is frequently a great first-aid to sales building.

"Advertising your phone number prominently in the telephone directory with ample display space is not only profitable advertising, but it also brings in business; because the classified section of the telephone directory is fast becoming a dictionary of where to go, what to buy, etc.—thus making a mere listing unprofitable and a prominent display advertisement a sure business getter.

"When a person is unfamiliar with your (Continued on page 242)

The collage features several overlapping advertisements:

- Columbia Music Shop:** "FOR QUICK RADIO SERVICE DAY OR NIGHT COLUMBIA 1640-41 MT. PLEASANT MUSIC SHOP INC. IMMEDIATE DELIVERY ON R.C.A. RADIOLA, ATWATER-KENT MAJESTIC & ZENITH RADIOS VICTROLA-RADIOLA-COMMODORE EXPERT REPAIR 3317"
- Monarch Radio Shop:** "Monarch Radio Shop ATWATER-KENT Free Home Demonstration of Any Model Liberal Terms NO rth 0790 N. W."
- ROYAL:** "ROYAL RADIO And Specialty Company Call PO Tomac 3040" and "ROYAL RADIO NATIONAL BRANDS---KNIGHT ACCESSORIES 4188"
- Radio Service:** "RADIO SERVICE AUTHORIZED DEALERS RADIO CORPORATION OF AMERICA ATWATER-KENT--MAJESTIC R.H. SMITH COLORADO RADIO SERVICE 5514 COLORADO AVE. N.W. MAJESTIC R.C.A. Sales and Service We Do Anything Electrical OPEN EVENINGS 1825 Conn. av. ... CL. evland-251"
- Radio Service Laboratories:** "RADIO SERVICE LABORATORIES 5405 GALAVE—ALWAYS OPEN INSTANT SERVICE GEORGIA 4019"
- FOR ANY RADIO TROUBLE:** "FOR ANY RADIO TROUBLE Equipped To Locate Trouble On Any Set Courteous Experienced Radioticians Await Your Call ACCESSORIES DELIVERED BATTERIES RECHARGED"
- 3 BIG STORES:** "3 BIG STORES 1350 F Street N.W.—FR anklin 0852 485-11th St. N.W.—FR anklin 0060 3218-14th St. N.W.—FR anklin 0051 Radio Repairs ALL STANDARD SETS ON TERMS"

Mr. Kunkel sent with his article a bunch of ads. of which these are samples. Cut out one, and lay it on a page of the telephone book. It will be seen how much more attractive an advertisement becomes, with good, hand-lettered display; and in a city of many service organizations, it is necessary to have your advertising stand out of the crowd

RCA VICTOR "MODEL R-5" RADIOLETTE

Also Graybar "Model 4 Graybarette;" Westinghouse "Model WR-14;" General Electric Model "G. E. T-12"

In this smallest RCA-Victor receiver, the following are the condenser and resistor values. Condensers C1, C2, 14- to 320-nmf. tuning condensers, shunted by 4- to 26-nmf. trimmers; C3, .00013-mf.; C4, C5, C6, 0.1-mf.; C7, .001-mf.; C8, C12, 0.25-mf.; C9, .02-mf.; C10, 320 nmf.; C11, .005-mf.; C13, 10. mf., (electrolytic); C14, C16, 0.5-mf.; C15, .05-mf.; C17, 2 mf.

Resistor R1, 20,000 ohms (volume control); R2, 600 ohms; R3, 28,000 ohms; R4, 8,000 ohms; R5, 1/4-meg.; R6, 45,000 ohms; R7, 1/2-meg.; R8, 20,000 ohms; R9, 13,000 ohms; R10, 280,000 ohms; R11, 50,000 ohms.

Operating values are as follows. Filament potentials: V1, V2, V3, 2.2 volts. Plate currents: V1, 4 ma.; V2, 0.25-ma.; V3, 30 ma. Control-grid potentials: V1, 3 volts; V2, 7 volts; V3, 2 volts. Screen-grid potentials: V1, 85 volts; V2, 65 volts; V3, 225 volts. Plate potentials: V1, 225 volts; V2, 100 volts; V3, 215 volts. Heater-to-cathode potentials: V1, 3 volts; V2, 7 volts.

The only volume control in this receiver is by variation of potentiometer R1; the regeneration which exists in the circuit of detector V2, through feedback between the secondary and tickler coils of L2, being non-adjustable. The tickler coil is wound in two sections (high- and low-wave) to obtain even regeneration over the broadcast band. The output of the detector is resistance-capacity coupled to the single stage of A.F. amplification—pentode V3.

Grid bias for the pentode is obtained from a portion of the voltage drop across the field coil; due mostly to the plate current of V3, which is a considerable portion of the total drain. Consequently, increased current through this choke coil, due to a strong incoming signal, causes an increase in the grid bias; thus obtaining automatically a certain degree of compensation which prevents overload.

One filter condenser is of the electrolytic type, and the other is of standard paper type. Align the R.F. circuits at 1400 kc. It is advisable to use an audio-modulated service oscillator, connected to the input of the receiver, and a thermo-galvanometer connected to the secondary of the output transformer (in place of the voice coil of the dynamic reproducer), to obtain accurate alignment of the tuned circuits.

The first step, in resonating the tuner of the "Model R-5," is to turn the station selector's knob until the reading is exactly 0, and then

remove the chassis from the cabinet; being careful not to disturb the setting of the dial. The gage condenser plates should be fully meshed with the stators; otherwise, the dial drum must be adjusted until they are. Having made certain of the positions of the condenser plates, replace the chassis in the cabinet.

With the oscillator working at 1400 kc., and coupled to the input of the radio set, set the dial scale at 85 and put the receiver in operation. Place a soft pad on the service bench and turn the receiver on its side. It is now convenient to adjust the trimmers; a special wrench is required. A second alignment compensates for any interlocking of adjustments.

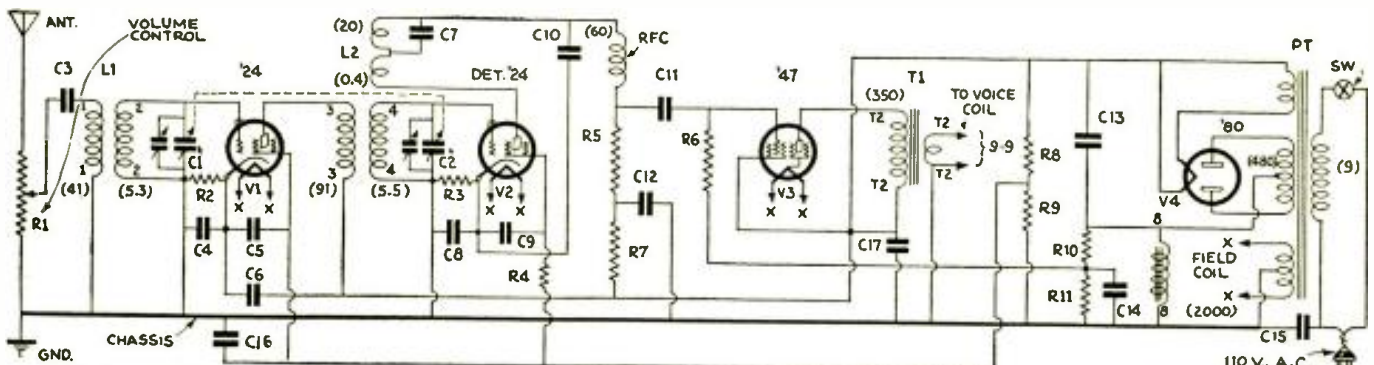
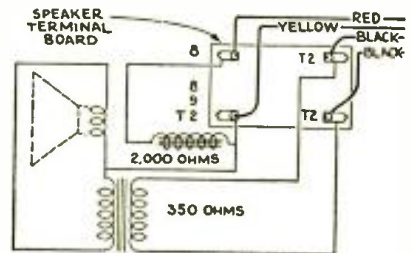
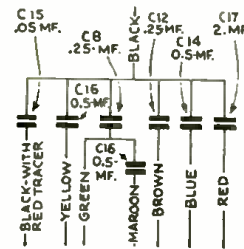
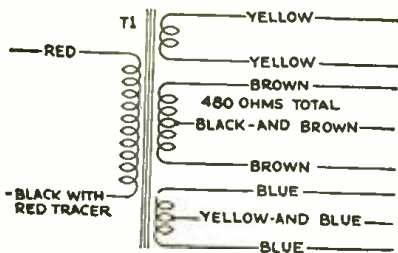
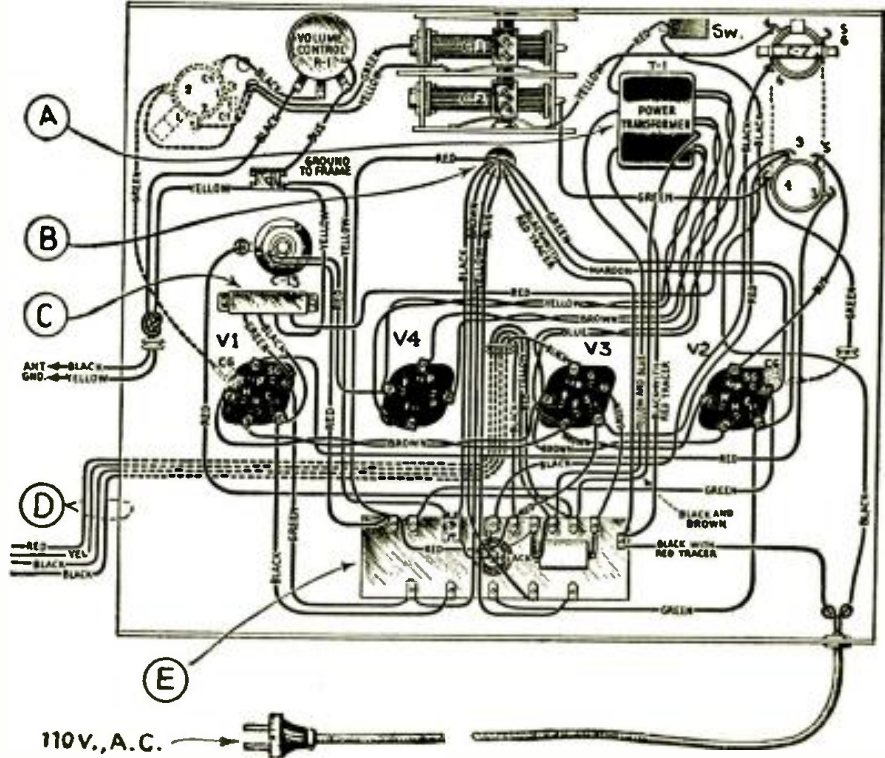
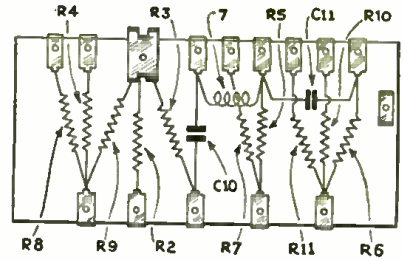

Figures in parentheses are resistances (in ohms); coil terminals correspond to the layout. Other details are shown in sketches above.

Superregenode

Sensitivity on the Highest Frequencies, Simple in the high power Obtained with A.C. Operation

E. DENTON

the eliminator's high-voltage tap and the "B + 300" connection to the receiver chassis.

This method may place two voltage dividers in shunt—one in the receiver chassis and, perhaps, one in the "B" eliminator; differ-

to one megohm to reduce the voltage to the correct value to match the characteristics of the voltage divider in the receiver chassis.

The type '47 pentode operates best at a plate potential of 250 volts and a control-

A may be needed to obtain maximum A. F. amplification; this is the most critical operating value in the receiver.

The use of a separate filament winding for the pentode, as specified, is not absolutely essential; it is possible to operate all the tubes from a single 2½-volt winding, to which the two sets of filament leads shown are connected.

The power supply should be kept away from the set; so that the magnetic fields between iron-core units in the receiver do not couple with the filter chokes and the power transformer.

Assembly of the Receiver

For details of the aluminum case employed, the reader is referred to the August issue of RADIO-CRAFT. No mechanical detail drawings are included in this article; since experimenters will use the parts that are available; and it is impossible to specify drilling holes for all the existing types of suitable equipment on the market.

If the constructor follows the mechanical design of the author (see Figs. A and B), the following method of assembly works out well:

On the top cover, mount the antenna coil and secondary plug-in base I.1, and the plate coil base I.2; spotting them so that they are mounted in line with their tuning condensers. The effect of placing the coils on top helps the type '24 tube to oscillate more readily; since magnetic coupling between the plate and grid coils is added to the inter-element capacitive coupling of the tube V1.

On the rear panel, or back, mount the antenna and ground posts 1 and 2, the output tip-jack terminals 9 and 10, and the receptacle for connection to external power supply leads Nos. 3, 4, 5, 6, 7 and 8.

The front panel carries the grid and plate tuning condensers, C1 and C2 respectively, which are mounted beneath their respective coils. The upper right-hand knob controls R2, which is insulated from the panel and varies the voltage on the oscillator's plate; the lower knob, governing R1, which is also insulated from the panel, controls the screen-grid voltage of V1.

Varying the Suppressor-Frequency

The switch Sw, which cuts in or out the condenser C3 shunting L3, changes the frequency of the local oscillation. With the

(Continued on page 234)

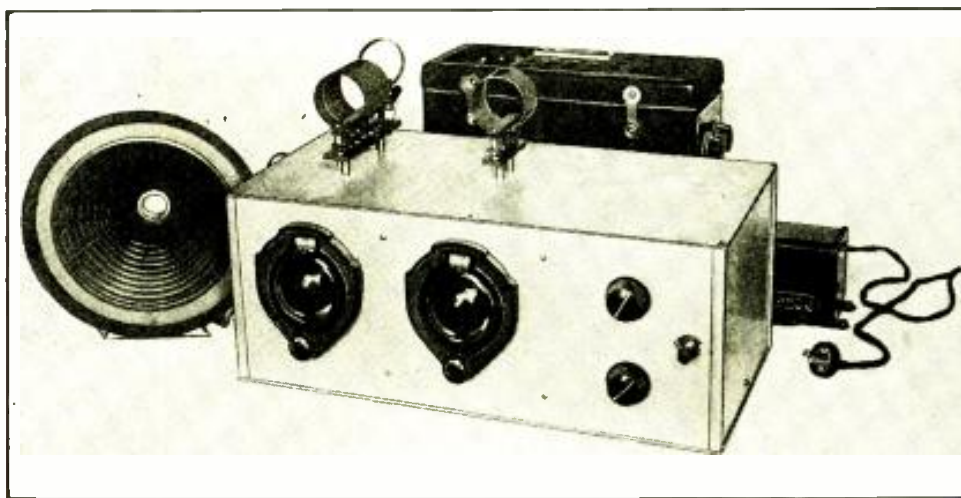

Fig. A

The A. C. receiver, showing the exterior coil mountings. The external "B" power unit, filament transformer, and dynamic speaker appear behind it. The controls are easy to operate.

ences in eliminator design determine whether it is desirable to connect in the "B" supply circuit to the receiver chassis a circuit-opening switch, to prevent drain of the "B" blocks when the set is not in use. Where the "B" eliminator circuit from "B + Max." to "B—" tests "open," when disconnected from the light-line, there is no need to use such a circuit-opening switch.

Any standard '45-type power pack may be used, as long as it delivers about 65 ma. at 300 volts or more; in the latter instance, it may be necessary to connect in series with the "B +" lead of the eliminator a heavy-duty variable resistor, such as the compression-type Charostat, with a range of zero

grid bias of 16.5 volts. In the A. C. Superregenode, this plate or "B" potential is obtained directly from the current-supply system; while from the total output of this system must be subtracted the required "C" bias (obtained by means of bias resistor R7 and, for V3, R3).

The voltage divider in the receiver proper must be adjusted carefully to obtain maximum efficiency; the setting of its taps will vary with the output obtainable from the power pack, as well as with the demands of the individual pentode tube selected. The voltage readings at the taps should be about as follows: A, 18; B, 90; C, 180; D, 250; and E, 350 volts. A slight readjustment of

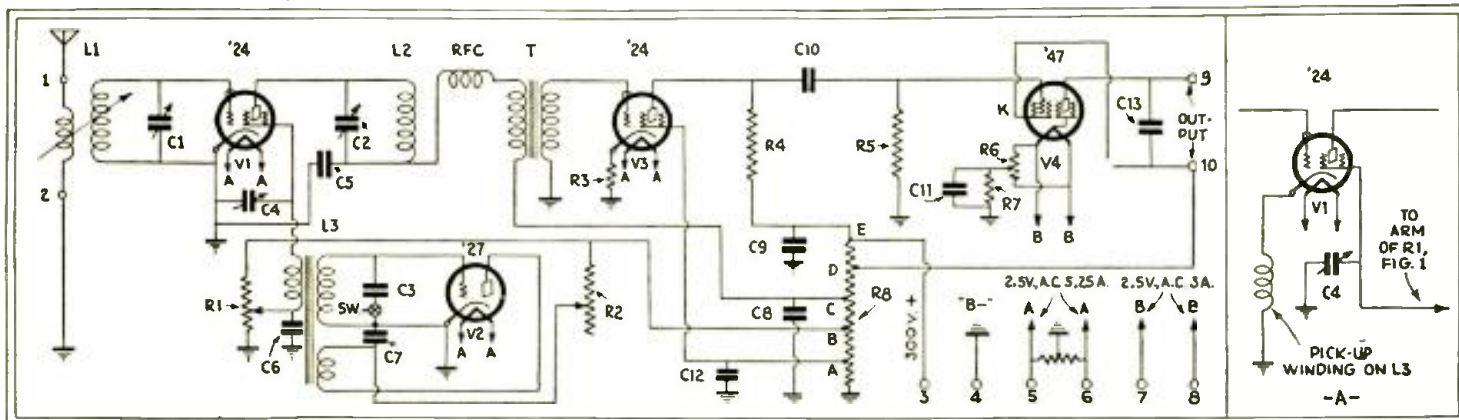

Fig. 1

The circuit of the A.C. Superregenode follows the principle of the receiver using 2-volt battery tubes, which was illustrated in the August issue of RADIO-CRAFT; but incorporated a screen-grid first audio stage, as well as the necessary changes for current supply. At the right, an alternative method of coupling the suppressor-frequency into the detector tube is shown.

The "Antipodes" Short-Wave Super Converter

A Self-Powered, Sensitive Frequency-Changer Adapted for Distance Work With Any Electric Set

By GEORGE F. BROOKS

ONE of the greatest difficulties encountered, when using a Superhet converter, is to couple it in the most efficient manner to the B.C. (broadcast) receiver, to approach as near as possible a maximum transfer of signal energy. It is rarely convenient to alter the antenna input of the B.C. set; so this must be provided for in the output of the converter.

For the past year and a half nearly every converter described has used a type '24 tube detector; though, since practically all B.C. sets have a comparatively low impedance in the antenna input circuit, it is ridiculous to attempt to transfer energy from a circuit having an impedance of at least 500,000 ohms (when using the '24 as a detector) to one of about 8,000, which is about the maximum of any receiver's antenna input circuit.)

Of course, it is possible to lead a wire from the output of a converter to the grid of the first R.F. stage; but this would detune it to some extent, so that any theoretical gain obtained would be minimized in effect.

Then again, tuning the output of the converter to resonance with that of the chosen wavelength of the B.C. set would give the desired matching; but this means an extra control with its attendant complications (particularly the probability of R.F. oscillation in the B.C. set at the higher frequencies). This method may, however, be used safely and to some advantage on sets such as the Radiola "33" and others with untuned first R.F. stages (Fig. 2A.)

Effective Coupling

Without entering into further technicalities it is obvious that the '27, with its comparatively low plate resistance, offers the solution. True, it is less efficient than a '24,

which makes a very sensitive detector; but it is more adaptable for our purpose and, when used as a heterodyned detector feeding into the antenna of a standard B.C. set, the better match results in a much louder signal.

Having decided upon that, we now encounter another difficulty; that of obtaining the necessary voltages, both filament and plate, for the converter.

It has been the practice in the past to tap off these voltages from the B.C. set; either from the power pack, when this is a separate unit, or by means of adapters placed under a socket, usually the last R.F. stage.

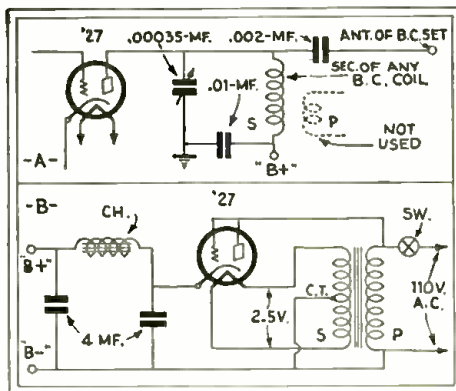

Fig. 2

Above, a method of coupling to a broadcast receiver which is suitable with certain models. Below, a satisfactory power circuit for the purpose

This is a bad method; for, in addition to the increased load on the power supply of the B.C. set, the drain of seven or eight mills, required by the oscillator and detector, and the extra 3.5 amperes drawn by the filaments, has the effect of reducing the voltages supplied to the tubes in the B.C. set. Consequently the amplification is lowered; not to mention the probability of damage to the power transformer.

A very simple power supply, which can be built into the converter, as shown in Fig. 2B, consists of a '27 tube used as a half-wave rectifier, delivering about 12 mills. at a voltage of 98 to 196 (depending to a great extent upon the voltage of the A.C. line and the D.C. resistance of choke Ch.)

Numerous experimenters claim the origination of this circuit; but this writer is of the opinion that the credit should go to F. A. Stapler (late of the Victor Co. and now European representative for Fox Movietone Co.) who used this arrangement in 1927, to supply the necessary voltages to a portable oscillator for service work.

The Frequency Changer

Perhaps the most interesting feature about this converter is the method of coupling between detector and oscillator. On

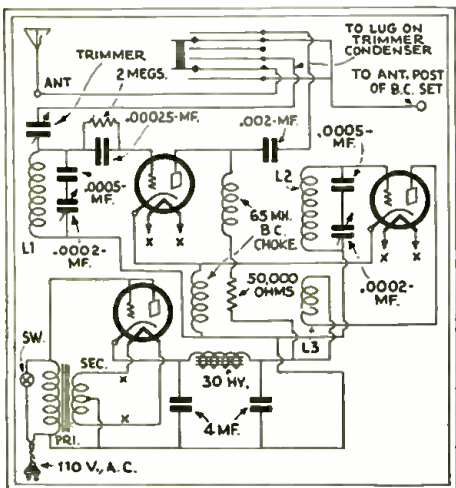

Fig. 1

The complete circuit of the converter, using three '27 tubes, one as rectifier. A jack switch gives choice of long- or short-wave reception on the B. C. set

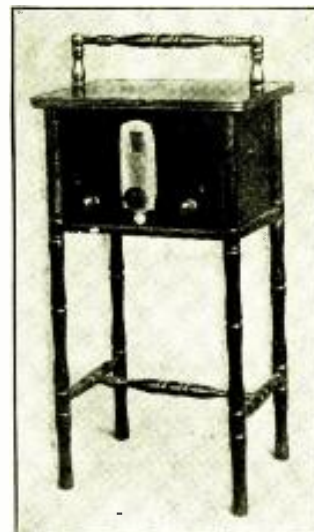

Fig. A

One way of solving the furniture problem; the converter thus housed is attractive and handy to move.

B.C. supers it is the custom to couple the grid circuits, inductively or capacitatively. On the B.C. band this is quite suitable but, on wavelengths below 50 meters, it is out of the question. Sufficient to say here that coupling between the grid circuit of the oscillator and that of the detector must be reduced to a minimum; and coupling must take place between the untuned circuits.

Thus it would appear that the most logical point would be between the plate circuits, but here again trouble arose. For some reason, not clear to the writer, plate coupling caused severe hand capacity, which could not be overcome, even when the converter was housed in a copper can.

A number of other systems were tried out, but the choice was finally narrowed down to the two methods shown in Fig. 3. Inductive cathode coupling was first used and, while efficient otherwise, had the effect of reducing the intensity of oscillation on the higher frequencies; necessitating the use of a '24 oscillator with variable voltage on the screen-grid (as shown in Fig. 3 at "A") or some other means of varying oscillation intensity. This means another knob to twist, and is objectionable in that respect; so the final choice is that shown in Fig. 3 at B. The choke R.F.C. is a regular B.C. unit and must not be bypassed. The writer advises that it be mounted directly on the oscillator tube socket without recourse to a mounting screw through its center; as a

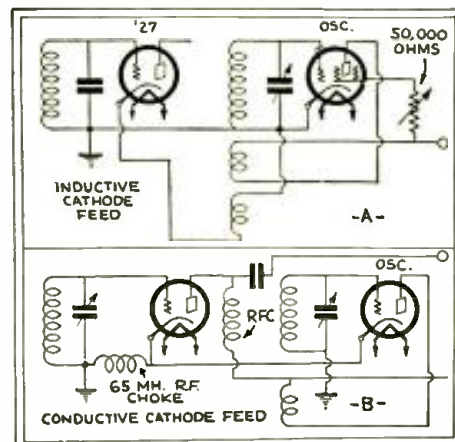

Fig. 3

The method of coupling oscillator and modulator, shown above takes an added control; so that below was used for simplicity.

matter of fact it is a bad policy to mount any R.F. choke by a center screw, and this should be avoided whenever possible.

Design and Assembly

From the complete layout (Fig. 4) it will be seen that a 4-mf. electrolytic condenser (8 mf. is advisable on 25-cycle lines) is located at each corner of the sub-panel. The plug-in coils should be placed as far apart as the panel will permit.

Below the sub-panel, as shown by the dotted line in Fig. 4, are located the transformer choke, the detector tuning condenser, and the grid-leak-and-condenser. Immediately in front of the detector coil and below the sub-panel, is the trimming condenser, which is adjusted through a 3/4-inch hole in the sub-panel; this should be set for the antenna with which the converter is to be used and then need not be changed. The best way to do this is to tune the oscillator dial to some point around 50, and then set the trimmer in or out until the arrow on the detector knob is about vertical.

Space was at a premium in this case, so midget condensers were used; unfortunately, the only value obtainable at the time was 200-nmf., making tuning rather critical on the higher frequencies. Therefore, a midget fixed condenser of .0005-mf. was connected in series with each tuning condenser, giving

band is active. It was felt, therefore, that if the 25-52-meter band could be covered with one pair of coils, less changing would be necessary.

Operation and Results

With the coils wound as specified and using an wavelength of 480 meters (this happens to be a cleared channel so far as the New York area is concerned and also a fairly sensitive point on the writer's set) the upper setting of W8XK on 25.25 meters is at 9 on the "Osc." dial; 12RO at 13; G5SW at 14 1/2; FYA at 16; VK2ME at 27 and 48, (31.28 meters); VK3ME at 31 and 52 (31.55 meters). W2XE, W8XA1, W9XF, and other American stations in the 49-meter band come in between 80 and 86 (lower setting); the Newark airport on 52 meters is logged at 94.

This is on the 25-52 meter coils. On the lower wavelengths, there is little life other than scrambled speech and code; occasionally W2XAD is heard on 19.68 meters. Above 52 meters there is a host of "Hams" on phone, and other signals too numerous to detail.

The knob on the right controls the "SW-BC" switch; this is a Yaxley "Pup" arranged as shown in Fig. 1. With this wired as shown, the converter may be left permanently connected.

Simply change over the lead-in from the antenna post of the B.C. set to the "Ant" post on the converter; run a lead (as short as possible) from the output post on the converter to the "Ant" post of the B.C. set (no ground is necessary on the converter); make the necessary connection to the A.C. supply and you are all set to go.

While the best results will be obtained with any modern B.C. receiver using screen-grid tubes in the R.F. amplifier, this converter has been tried out with great success on several sets of the 1927 vintage using '26 tubes. As a matter of fact, the B.C. set

**AMALGAMATED WIRELESS
(AUSTRALASIA) LIMITED**
Wireless House
167-9 Queen Street, Melbourne,
2nd July, 1931

Mr. G. F. Brooks,
9408 78th St.,
Ozone Park, N. Y.

Dear Mr. Brooks:
Very many thanks for the interest you are taking in our experimental transmitter, VK3ME. We have received your reports for 15th April, 23rd April, 29th April and the 2nd May.
Your report of the 15th April, supported by the gramophone record, is the most interesting one we have yet received. We have tried the record and, considering the number of stages through which the transmitter has passed from the microphone to the output of your gramophone record, the quality is very good. In such circumstances, it would be rather ambitious to think that final reproduction from your gramophone record would closely approximate the transmission as it left the aerial; but it was extremely interesting to hear VK3ME on your record. We thank you particularly for sending us this record and we hope to hear from you again.

Yours faithfully,
**AMALGAMATED WIRELESS
(A/ASIA) LTD.**
H. JOHNSTON, *Engineer.*

Copy of a verification of his recording, received from Melbourne, Australia, by Mr. Brooks.

used by the writer is a Sonora (1928) "Model 40": using the equivalent of three '27 tubes in a Loftin-White R.F. amplifier; the usual detector; and a '27 stage of A.F., with push-pull 245 output.

With this combination, some excellent home recordings have been made of the chimes of "Big Ben" in London, England, as relayed by G5SW; also selections of operas from 12RO, Rome, Italy; and announcements from VK2ME and VK3ME, Sydney and Melbourne, Australia.

In conclusion the writer would like to mention that he will faithfully reply to all inquiries on this converter, and will assist as far as possible those who are sufficiently interested to attempt its construction.

List of Parts

Two Hammarlund 200-nmf. midget condensers (140 nmf. preferable, as explained);
One National "Type G" dial, clockwise movement;
(Continued on page 249)

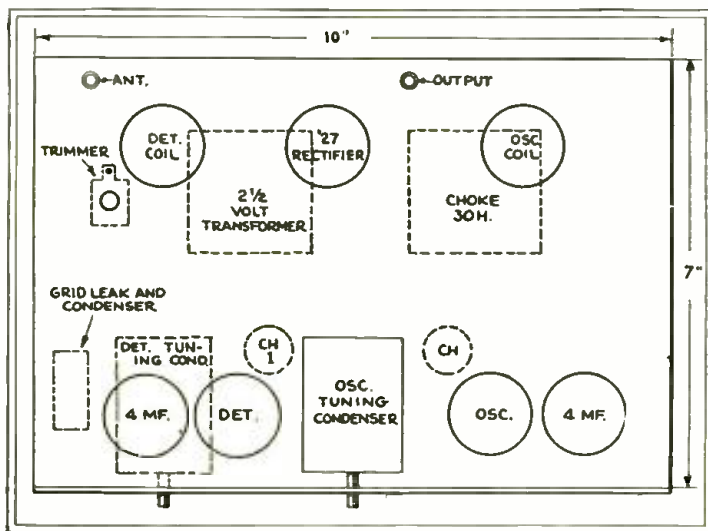
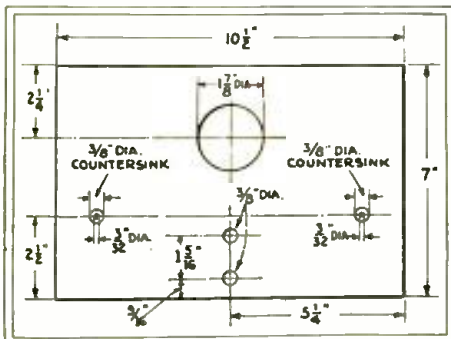

Fig. 4
The panel is shown in the small sketch above with its dimensions; it is wooden. The general layout appears below and may be compared with the photograph

an effective value of 143 nmf. which is suitable.

The coil winding data are given with Fig. 5; the reason for the unusual steps is that most of the interesting reception is between 25 and 52 meters, and few of us are able to devote much time to listening during the early morning hours when the 14-24 meter

Fig. B

The chassis of the "Antipodes" converter (the reason for the name may be seen above.) It will be seen that parts are few, and shielding is not required. Operation is simple; there are only two controls

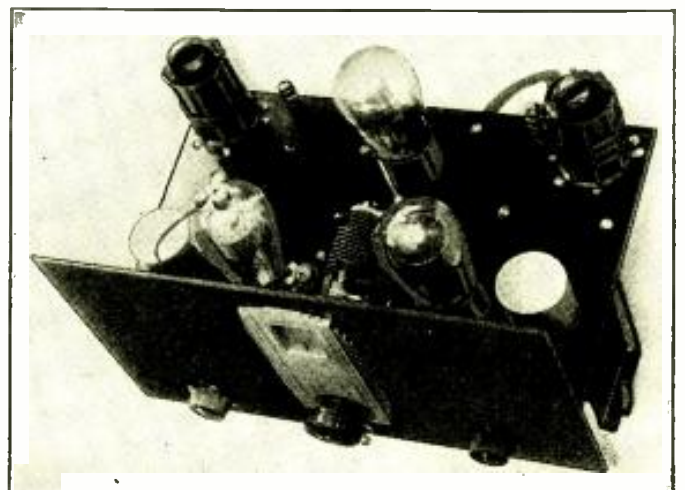

The Speech Inverter

"Scrambled Speech," That Peculiar International Language, is Familiar to Many Short-Wave Fans. Here is How it is Created.

By C. H. W. NASON

YOU may have guessed, in view of the distortion found in radio receivers, that many startling effects could be produced were it not for the uselessness of such "stunts" at speech frequencies. The push-pull amplifier, for example though renowned for the fact that it automatically cancels out distortion, will produce nothing but second harmonics of the input if one of the windings is reversed as shown in Fig. 1.

Now, although harmonics are easy to produce electrically, we have not as yet discovered any suitable method for producing the sub-harmonic or "fractional" frequencies. Thus, if we were to "mess up" a signal by producing and transmitting a harmonic thereof, there would be no way in which we could rescue the signal and bring it back to its original form.

Demonstrators have recently shown, under the auspices of one of the large electrical manufacturers, a device for speech "inversion" in which the words spoken into the microphone come out distorted utterly beyond recognition by the ear—but still in such a state that they may be rescued for translation.

Use of such a system in transoceanic telephony results in privacy of messages without resort to special systems of transmission. Outside of this (and the possibility of broadcast programs being "sewed up solid," so that the listener would have to pay for his entertainment) there seems to be little use for such a device. It does, however, make an interesting toy for scientific demonstrations. The operator says

something in plain English into the "mike"—such as "telephone company"—only to have a bit of gibberish such as "play-o-fine, crink-o-nope," come out of the speaker. Then, by studying the effects, he may reverse the procedure; he speaks some unintelligible phrase into the microphone, so that the voice from the loud speaker will be fraught with meaning.

Method of "Scrambling"

This is done by a complete inversion of the frequencies of speech; that is to say, the "lows" become "highs," and vice versa

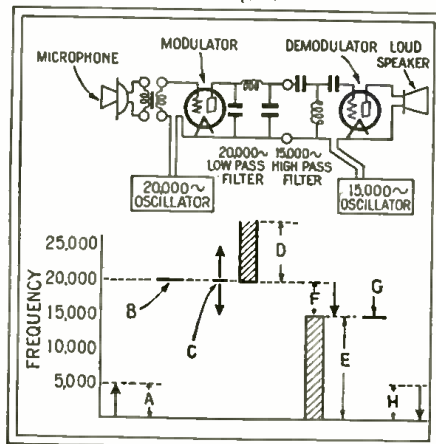

Fig. 3
Above, general arrangement of the speech scrambler; below, the corresponding stages of the signal. A, natural speech-band; B, simple inverter-carrier; C, inverter-carrier, modulated; D, low-pass suppression; E, high-pass suppression; F, inverted sideband; G, demodulating carrier; H, inverted- or scrambled-speech-band, as transmitted

(Fig. 2). The resultant sound-wave impulses can be sent out over a telephone line or a radio transmitter-receiver system; at the far end of which the procedure is reversed so that the speech becomes normal again.

Let us suppose that an incoming signal, such as the output of a microphone, will contain frequencies ranging from sixty to five thousand cycles. If this incoming signal is combined with a steady oscillation of about five thousand cycles, resulting frequencies can be as follows, in cycles:

Input	Carrier	Sum	Difference
100	5000	5100	4900
500	5000	5500	4500
2000	5000	7000	3000
3000	5000	8000	2000
4500	5000	9500	500
4900	5000	9900	100

A glance at the first and last columns will show that they are exact transpositions of each other. We must then achieve our required frequency inversion by transmitting to the loud speaker only the "difference" terms of the resultant beats.

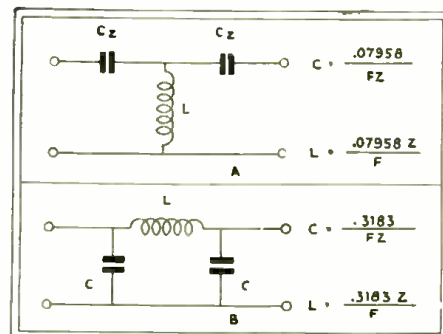

Fig. 4
The fundamental formulas (L and C in henries and farads) for the design of (A) high-pass and (B) low-pass band filters

This is readily understandable; as it is the same procedure carried out in the design of superheterodyne receivers; except that here the local oscillation is fixed and the intermediate frequency variable. The incoming signal, which is mixed with the 5000-cycle oscillation, is variable between 60 cycles and 5000.

We must devise a method for mixing the incoming signal with the local oscillation and a method for removing from the signal fed into the loud speaker, the sum-frequencies, the carrier and the original incoming frequency. The sum-frequencies and the carrier proper can readily be removed by the use of a "low-pass" filter cutting off at 5000 cycles. For example, such filters as those shown in Fig. 4 would serve this purpose. (The design of such filters has been covered completely by G. W. Pierce in his monumental work, "Electric Oscillations and Waves," but may well be repeated.)

All we require is a knowledge of the impedances between which the filter is to work, and the cut-off frequency desired. In the equations shown in Fig. 4, Z is the impedance of the structure in which the filter is to be inserted, and L and C are the inductance and capacity expressed in henries and farads. Fig. 4A is for a "high-pass" filter, and Fig. 4B is for the "low-pass" filter.

Such an arrangement would not, however, give satisfactory speech inversion; because the direct speech would come through the filter much stronger than the inverted speech, and the effect would be spoiled.

To avoid this difficulty, it is necessary to separate the direct and inverted speech sufficiently, in frequency, so that they can be filtered apart. A simplified sketch of the arrangement for doing this is shown in Fig. 3. The speech A (in the frequency graph below) modulates a 20,000-cycle carrier B, producing upper and lower sidebands C. After passing through the low-pass (D) and high-pass (E) filters, only the lower sideband G, which is inverted, remains. Demodulating this with a 15,000-cycle carrier G brings the inverted sideband down to natural speech frequency H, but quite free of any content of the original uninverted speech.

The commercial apparatus used for inverting speech is, of course, more elaborate and refined; involving balanced modulators and demodulators, band-filters and testing apparatus.

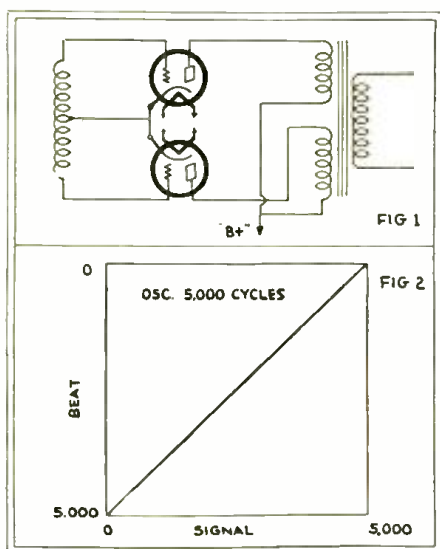

Above, a circuit producing a second-harmonic output. Below the straight-line graph (diagonal) of the difference-frequency created by a varying audio tone modulating a constant 5,000-cycle oscillation.

How to Use Pentodes

PART III

By C. E. DENTON

IN the preceding issue of RADIO-CRAFT, the writer discussed the electrical characteristics and presented graphs showing the effects of various plate and screen-grid voltages, on the performance of the pentode tubes; carefully ignoring the selection or specific mention of devices to be used as efficient coupling units in the output circuits. It would be well, at this point, to discuss various ways of coupling the output of a pentode to the standard types of reproducers.

The calculation of the required load in the plate circuit of a pentode, for maximum undistorted output, is governed by the degree of second-harmonic distortion permissible.

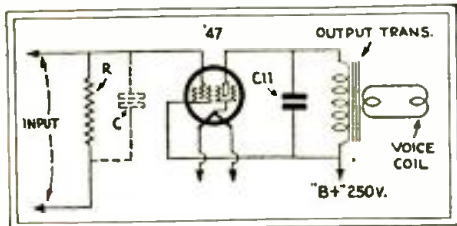

Fig. 1

The added grid-filament capacity C is created, in tube operation, by the "reflection" of the plate load back into the input

Push-pull connections, because of their effect of even-harmonic cancellation, do not offer the same problem; but it is still advisable to have a condition for minimum second-harmonic distortion, since this offers a reasonable value of plate load for a practical third-harmonic minimum.

The third harmonic, in either push-pull or straight circuits having a load in the plate circuit designed for minimum second-harmonic distortion, will equal about 0.15-watt, with a fundamental output of 2.6 watts, or 6% (third-harmonic output in per cent. of fundamental. See RADIO-CRAFT September issue, Page 162, Fig. 9.)

This exceeds the permissible RMA rating but, strangely enough, has the advantage of giving more power to musical overtones, which occur at the higher audio frequencies; and it is beneficial in so-called "sideband-cutting" R.F. amplifiers.

Reference has been made to the fact that the load in the plate circuit of a pentode should be about one-fourth of the plate resistance, for minimum harmonic distortion; and that, because of the high plate impedance, the maximum voltage gain, indicated by the amplification factor, cannot be attained.

If the conventional load in the plate circuit (twice the plate resistance) could be used in the case of the pentode, the voltage gain would be approximately 63; but, under the limitations imposed by the inductive load, we find that our voltage gain is less than 15!

How these tubes with screens build up our hopes, and then break them down again!

Bass Reproduction

Many experimenters hearing pentode-equipped sets for the first time are surprised that the tubes are capable of bass-note reproduction. Perhaps we should say that the higher audio frequencies are not accentuated as much as would be expected at first thought.

As the increase of frequency causes the effective load in the plate circuit to increase, so are the capacities of the load and tube reflected back to the input circuit; and this, in turn, tends to limit the amplitude of the higher audio frequencies (See Fig. 1). This input capacity C may vary from about 4 to as much as 60 mmf.; depending upon the tube and plate-load factors, and the effect of the change in frequency of the signal on the grid.

Output transformers for coupling pentodes to dynamic reproducers are available and work quite well when their primaries are slanted with suitable capacities to limit their impedance at the higher audio frequencies.

The best results will be obtained from pentodes when they are made to work into dynamic reproducers. This is due to the small variation of the voice-coil's impedance over the audio-frequency band. This condition of constant secondary impedance is reflected in the primary, and appears as a primary load which tends to make the primary impedance more constant.

The inductive value of the load should be 7,500 ohms (for the types '33 and '47 tubes), at some low audio frequency, depending upon the design of the reproducer. An average value of 100 cycles should be quite satisfactory; and is approximately equivalent to the figure for an ohmic resistance load as given in tube tables.

Output Transformer Values

For these conditions the primary of the output transformer should have an inductance of about 12½ henries, with a direct current of 32.5 ma. flowing through its windings.

The value of the shunt condenser should be such as to bring the effective load impedance, at 5,000 cycles, down to a value of approximately 7,500 ohms. This condenser (C11) will have a capacity of .002-mf. The inductive reactance at 5,000 cycles would be 375,000 ohms, if it were not slanted by the capacity C11 the connections of which are shown in Fig. 1.

The turns ratio of the transformer which
(Continued on page 245)

The Stenode System

A Technical Debate, Pro and Con, on the Actions in the New Circuit

A COMMENT

Editor, RADIO-CRAFT:

Your article on the Stenode in the August issue was brought to my attention by one of the members of our organization, with the request that I clear up some misconceptions that might arise from a reading of the same.

You are quite right that it matters not on what basis the mathematical analysis is carried out, "all will finally bring us to the same point." The reason for this is very simple: It is simply because the ability of a circuit to pass modulation without suppression of the higher frequencies depends solely upon its *time constant*.

Now there is absolutely nothing mysterious about this term, which seems to be avoided with horror in most practical magazines. The time constant of any circuit is merely the time in seconds required for the current to come to 63% of its final value, after any change in the impressed voltage. For a common D.C. circuit it is given simply by L/R ; and for the common tuned circuit by $2L/R$ where L is the inductance in henries and R is the radio-frequency resistance in ohms.

The interesting fact is that the capacity of the circuit has nothing to do with the time constant, but merely determines at what frequency the tuned circuit is resonant. Therefore the fidelity of any receiver is determined at once, as soon as the L and R of the coil to be used are known. Since R varies over the band of frequencies; that is, is variable instead of a constant at radio frequencies, the fidelity correspondingly varies with the frequency to which the coil is tuned.

In the case of a frequency-modulated circuit (as in the Stenode), the fidelity is limited by the ability of the circuit to change from one frequency to another in a given time. The faster it can do it, the faster the modulation it will stand. Suppose therefore that we have the circuit working on 1000 kc. and suddenly cut it off; and at the same instant impress on it a frequency
(Continued on page 240)

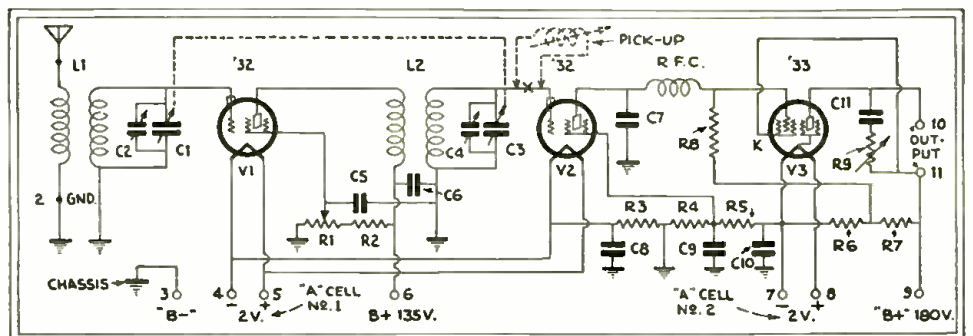

Fig. 2

This circuit, which the author chooses to call the "Odds and Ends," is intended for construction out of the experimenter's junk box; it is designed for battery operation, but obtains biasing voltages from resistors instead of taps. It may be used also for phonograph amplification.

The Radio Craftsman's Page

You like to hear what the other fellow has been doing, and he to hear what you learn. C'mon in, Craftsmen!

(Letters asking further particulars should be addressed to the writers directly, to save delay)

A HAM'S DX RECEIVER

Editor, RADIO-CRAFT:

I like your magazine, and I especially like to read "The Craftsman's Own Page." After experimenting with many circuits, in both receivers and transmitters, I now have a receiver of which I am very proud. It consists of a screen-grid detector, followed by two '27s in the audio stages, and is capable of giving loud-speaker volume.

As an amateur station operator, I find this a great help for DX work. I have heard England, France, Germany, Italy, Spain, Norway, Argentina, Chile, Surinam, Egypt, Africa, China, New Zealand, and a flock of others; some being very loud.

The diagram shows the details. The values are: C1, 9-plate midjet; C2, .0001-mf.; C3, .00014-mf.; C4, C6, 0.5-mf.; C5, .002-mf.; C7, 1 mf.; C8, .01-mf.; R1, variable grid leak; R2, 0-500,000 ohms; R3, 100,000 ohms fixed; R4, 1 megohm. L4 is an 85-millihenry choke, and T1 is a 5:1 audio transformer. I use also a good, well-filtered home-made "B" eliminator.

The aerial switch permits me to use a primary coil, which gives more volume, or the variable antenna condenser, which gives more selectivity, but with less volume.

The coils, L1-L2-L3 may be of either tube-base construction or the larger (3-inch) plug-in type.

An impedance unit may be used instead of the resistance coupling; though I did not find any increase in volume therefrom, and I prefer the resistance coupling, which is cheaper. I experimented also with an audio transformer in its place; but, though it gave a great deal more volume, the tone was very bad and could not be remedied, even by using more "C" bias. The resistance coupling gives both tone and volume. I mention this so that others may profit at my cost; but if some have better results, I would certainly like to hear from them.

The resistor R2 gives very smooth control of regeneration; the screen-grid tube

may give better results with a variable resistor in the screen lead. The latter makes the tube oscillate more smoothly, and sometimes gives more volume. However, I do not show it; since I obtain variation of voltage from the tap on my eliminator.

I will gladly answer all who wish to write me concerning this circuit, or otherwise correspond with me.

ED. PALGUTA, W8BJR,
328 No. Watt Street, Youngstown, Ohio.

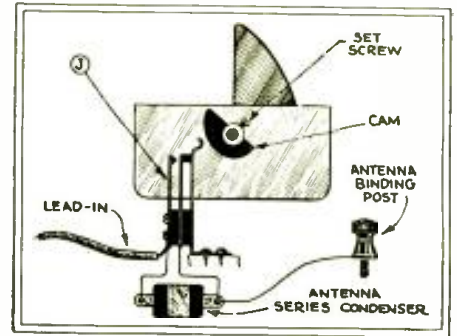

Mr. Seaton switches his aerial shortening condenser in or out, automatically, in this manner

(Other readers may, perhaps, experiment with a variable instead of a fixed condenser in the aerial lead, to bring the antenna tuning to an even finer degree over the whole scale.—Editor.)

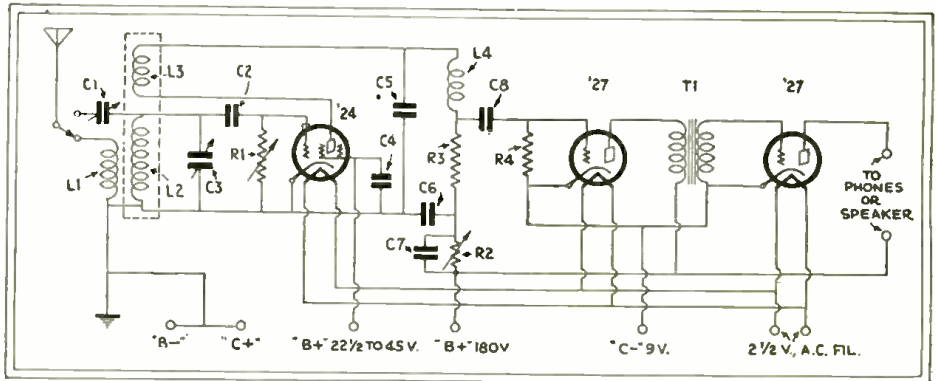

Mr. Palguta uses this three-stage short-wave receiver at his amateur station, and obtains excellent DX with all-electric operation.

AERIAL CONDENSER SWITCH

Editor, RADIO-CRAFT:

It is often desirable to insert a small fixed condenser in series with the antenna. This will usually remedy interference on the lower wavelengths, but will affect the upper wavelengths. By using the stunt shown in the accompanying diagram, the cam may be adjusted to cut this condenser into and out of the circuit at the point desired.

The cam, as will be seen, is mounted on the end of the tuning condenser's shaft, to which it is fixed by a set screw; an old jack: J is revamped and so mounted that the cam will open and close the circuit at the predetermined point on the tuning dial, thus shorting out the condenser.

A SHORT-WAVE ADAPTER

Editor, RADIO-CRAFT:

After trying many short-wave converters, adapters, etc., I have found the method sketched the only one which is foolproof and works in any location. As I am located in the heart of this city, have two 25-kw. transformers fifteen feet away and a creamery with seven motors next door, and there is an all-metal roof on the building where my shop is, you can see I have some interference problems of my own.

I do not recommend this to anyone who is not able to chase out the "bugs" himself; but I will endeavor to answer all letters (some job!) The schematic is self-explanatory; but keep all grid and plate leads short

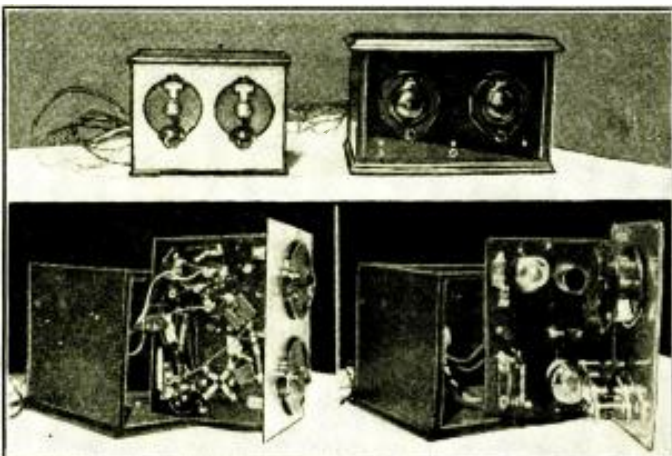

F. W. SEATON,
1357 F Street, N. E.,
Washington, D. C.

At the right, the circuit of Mr. McNece's short-wave adapter which, it will be observed, is NOT of the super type. At the left, two of the adapters which he has built for sale; and below, above- and below-panel views of the chassis.

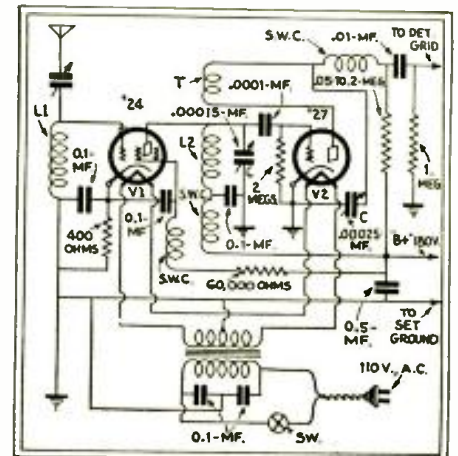

and do not use other capacity values. The A.C. transformer must be enclosed completely in 1/16-in. charcoal iron; that is, totally shielded. (*Why not in copper or aluminum?*) All parts must be clear of the metal by at least half an inch; and ground the cabinet.

The filaments are in series, taking 1 1/4 amp. at 5 volts; insert a heavy-duty 1-ohm rheostat and set it to give five volts. (For 110-volt D.C. supply, the same filament wiring is used, with a suitable ballast resistor on each side of the line, and by-passed to ground by a 2-mf. condenser. We have no D.C. here, but this instruction was given me by a ship's engineer.) On storage batteries, the adapter works fine in the shop; and it is very quiet with "B" batteries.

(*On direct current, it would be preferable to use the 6.3-volt '36 and '37 tubes, which have become available, since Mr. McNeese wrote.—Editor.*)

The parts I used are those which were available: the aerial condenser is a Hammarlund midget; the antenna coupler I.1 a National impedance, No. 10; the chokes SWC were Twin-Coupler; the plug-in coils I.2 wound on tube bases, according to the data below; the tuning condensers C and C, Pilot 8- and 13-plate variables; the fixed bypass condensers are 300-volt D.C. rating, and must be good.

A hard rubber sub-panel was used, with a piece of metal the size of the bottom of the cabinet for an inductive shield; for an all-metal cabinet, this is not needed. The regeneration as well as the tuning condenser is equipped with a vernier dial.

The tube base coils cover the range approximately from 17 to 110 meters. The first has 7 turns for the secondary, of No. 22 D.C.C., and 4 for the tickler of No. 30 D.C.C. The second has 14 turns for the secondary, and 7 for the tickler; of the same respective sizes of wire. In these, the wire is spaced by its own width.

The third coil has 26 turns of No. 26 D.C.C. for the secondary, and 13 of No. 30 D.C.C. for the tickler; both close-wound.

The output goes to the detector grid of the broadcast receiver; to the "G" prong on a grid-leak detector; to the cap on a '24 detector; and with a power detector, to the phonograph pickup. With high amplification in the A.F. amplifier, it may go to the first audio or pentode grid. The 1-megohm leak may be omitted entirely.

Elimination of Inductive Interference

A Discussion of the Correction of "Noisy Reception" Troubles

By LOUIS VAN DER MEL

THE problem of eliminating inductive interference is one that the Service Man is continually being called upon to solve. Inductive interference may arise from various causes, the remedies for which are not always practical; but, even if they are, the cost of such elimination may be prohibitive. In discussing this problem, let

the brushes; and the line feeding the motor

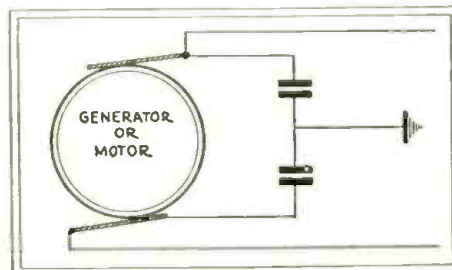

Fig. 1

The added capacity, shunting the inductance of the motor windings, raises the wave-length of the spark circuit out of the broadcast range.

us first begin by defining "inductive interference" and then proceed to analyze its causes and, what is far more important, its elimination.

Inductive interference may be defined as the extraneous "signal" which is induced

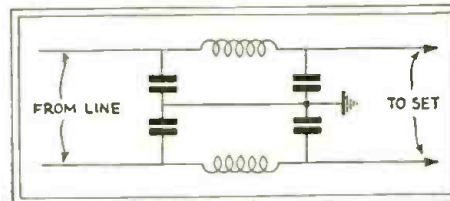

Fig. 2

The filter system shown by-passes R.F. currents picked up by the light-line, and prevents them from entering the set at the back door—the power unit.

into a radio receiver via the power supply, the antenna, or the set itself. Since the

Radio-Craft's Information Bureau

SPECIAL NOTICE TO CORRESPONDENTS: Ask as many questions as you like, but please observe these rules:

Furnish sufficient information, and draw a careful diagram when needed, to explain your meaning; use only one side of the paper. List each question.

Those questions which are found to represent the greatest general interest will be published here, to the extent that space permits. At least five weeks must elapse between the receipt of a question and the appearance of its answer here.

Replies, magazines, etc., cannot be sent C. O. D.

Inquiries can be answered by mail only when accompanied by 25 cents (stamps) for each separate question. Other inquiries should be marked "For Publication," to avoid misunderstanding.

Instruments are of differing construction, please state which one the pattern illustrated is intended to fit; and the change required for the one remaining.

(A.2) A scale for the Jewell "Pattern 88," or equivalent, instrument is shown, the holes measuring $1 \frac{7}{16}$ in. between centers, and $1 \frac{5}{16}$ in. from centers to top edge of scale; for the Weston "Model 301," or equivalent instrument, these dimensions are, respectively, $1 \frac{13}{16}$ in. and $1 \frac{3}{8}$ in. The scales otherwise are identical.

I. F. TRANSFORMERS—R. F. TRANSFORMERS

(135) Mr. Charles T. Knowlton, Baton Rouge, La. (S.1) Numerous issues of RADIO-CRAFT have contained descriptions of service oscillators, designed for use in aligning superheterodynes in which the

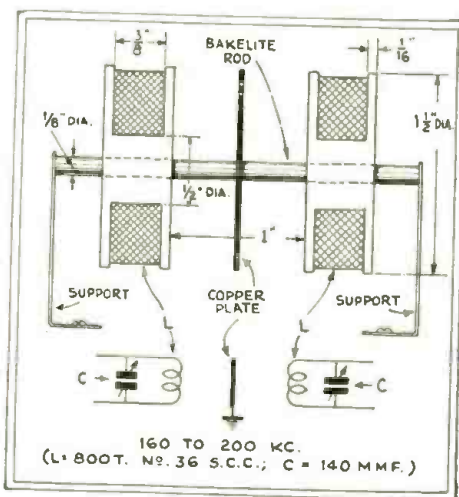

Fig. Q. 135

Values of an intermediate-frequency transformer for the popular 180-kc. range. The electrostatic shield may not be required.

intermediate frequency is in the neighborhood of 175 or 190 kc. However, I never have seen a description of an I.F. transformer operating in this

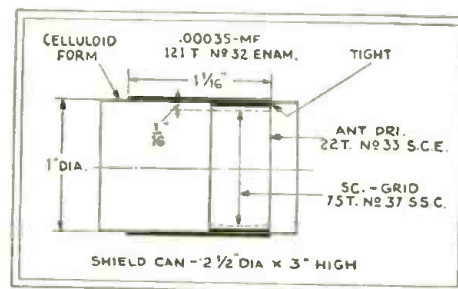

Fig. Q. 135 A

Design of an R. F. transformer for use with screen-grid tubes; the windings are small.

range. While this may not be a service request, at least it should be of interest to a large number of set builders; and even, perhaps, to a few Service Men who sometime might be stuck with a badly burned I.F. transformer and have no immediate repair unit on hand for replacement. Please publish construction details for an I.F. transformer of the shielded type, similar to average I.F. transformers. This should be a good item for use in modernizing old superhets.

(A.1) In Fig. Q.135 is illustrated a suitable design for an I.F. transformer which by adjustment of variable condensers C will operate over the frequency band of 160 to 200 kc. (one type of small-space unit is shown on page 22, of the July issue). The copper plate is required only when exceptional selectivity is required—as when a limited number of stages are to be used. Selectivity and volume are controlled also by the spacing of coils L. Brass supports may be used, bent as shown. The formers, or spools, may be lathe-turned bakelite or wood, or a job built up of insulating washers and rods. Scramble-wind the coils.

(Q.2) Please print details for the construction of R.F. transformers of a design suitable for use as antenna and interstage units in modernizing old '01A- and '27-(tube) type receivers to the use of screen-grids or variable-mus. The coils should be as small as possible.

(A.2) This is rather a large order. In the first place, the proximity of the shield to the R.F. coil will greatly affect the tuning range of the receiver; as will the characteristics of the particular tubes used. Perhaps the greatest factor with

which to contend is the minimum capacity and the capacity range of the tuning condenser, as pointed out in past issues of this magazine. Furthermore, reference should be made to recent articles on coil design of the latest type; in which reception at both low- and high-frequency ends of the tuning spectrum are compensated in the design of the primary winding.

However, still another, and more common design, as illustrated in Fig. Q135A. The object

here has been to obtain good operation, though using coil forms and shield cans of very small dimensions. The values are those of a commercial product.

The primary of the antenna coil fits tightly inside of the form, on the outside of which is wound the secondary. The primary of the screen-grid coils is to be spaced 1/16-in. from the inside of the celluloid winding form. All secondaries have the same number of turns, and are tuned by a variable condenser rated at ".00035-mf."

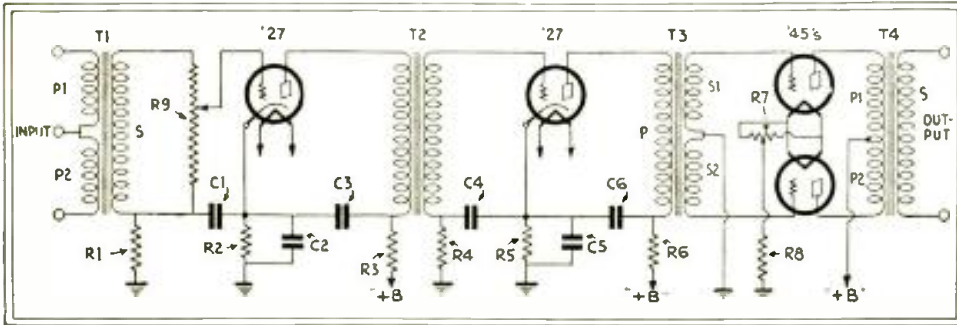

Fig. 1

A suitable transformer-coupled amplifier for instantaneous recording; high-quality parts should be used to obtain good results, and the input and output impedances must be of proper values.

Sound Recording Questions and Answers

By GEORGE J. SALIBA, B.S.

Mr. Jack Rich, Chicago, Ill.

(Q.) Can you give me any information as to what type of amplifier to use, and how to connect a microphone to an amplifier?

(A.) Any good three-stage transformer-coupled amplifier will be satisfactory for recording; the diagram of such an amplifier is shown in Fig. 1.

The parts illustrated have the following characteristics; potentiometer R9, 1/4-meg.; R1, R4, 50,000 ohms; R2, R5, 1,000 ohms; R3, 30,000 ohms; R6, 20,000 ohms; R7, 20 ohms, center-tapped; R8, 1,000 ohms. Condensers C1, C3, C4, C6, 1.0 mf.; C2, C5, 0.5-mf. Transformer T1 is a microphone transformer; and is indicated with a two-winding primary, for matching a double-button microphone into a type '27 tube. T2 is a standard '27 to '27 transformer. T3 and T4 are the usual input and output transformers, respectively; the latter being provided with a secondary S which exactly matches the impedance of the particular recording head which is being used.

Care must be taken to isolate this amplifier unit from the power unit, to prevent induction hum. The use of high-grade transformers will be repaid in recordings of high quality. Remember that the use of any unit of inferior quality is reflected immediately in the quality of the recordings; ordinarily by lack of extreme bass or treble notes. Test all resistors and condensers for rated values; making certain also that the units will operate under the rated loads. Use only tested tubes.

The method of connecting a microphone to an amplifier is clearly shown in the January, 1931, issue of RADIO-CRAFT, page 440; the succeeding July issue, page 28; and the September number.

Mr. A. P. Redmon, San Benito, Texas

(Q.) I am using my radio receiver for recording, and the results are poor. When I reproduce commercial records, the volume is good; but with home-made records the volume is very low. My pickup (when recording) is connected to the plates of the output tubes. Can you tell where my trouble may be?

(A.) Evidently your trouble lies in an improper impedance match between the cutter and the amplifier output. Check your pick-up to see if it is of high-impedance; the value should be around 4000 ohms.

Mr. Molina Font, New York City.

(Q.) Does the re-recording of an aluminum record change its tone or volume? How can it be reproduced to make several copies?

(A.) Re-recording an aluminum record results in an efficiency loss of about 10%. In order to make several inexpensive copies of the original, the latter is placed on a turntable provided with an electric pickup, the output of which is connect-

ed to the input of the usual audio amplifier; the procedure from then on is the same as in making the original.

Mr. Charles Rowe, St. Louis, Mo.

(Q.) I own a condenser microphone and would appreciate it very much if you will send me a diagram of how to hook it up to an amplifier for recording purposes.

(A.) The diagram requested is shown in Fig. 2. The voice leads are either 50 ohms or 200 ohms. In the amplifier case the output transformer secondary has two windings and these may be connected together in two ways; either for 200 ohms or 50 ohms, depending upon the input impedance of the microphone transformer.

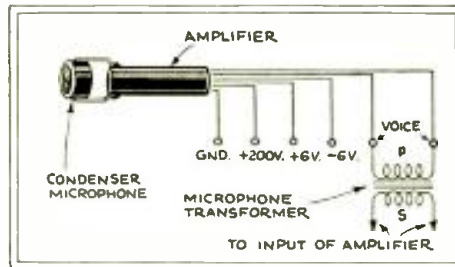

Fig. 2

Connections of a condenser microphone, which has its own pretransformation amplifier.

RADIO BOOK REVIEW

TALKING PICTURES AND ACOUSTICS, by Charles M. R. Balbi. Foreword by Sir Oliver Lodge. Published by The Electrical Review, London. 5 x 7 1/4 inches, 126 pages, cloth; 70 illustrations, and two folding charts.

The first portion of this book is devoted to the history of sound-moving pictures; the first practical development of which is attributed to Eugene Lauste, whose principal patent (British 18,057 of 1906) "has long been the 'best seller' of the English patent office, having already gone through seven editions, with an eighth in prospect because of the unprecedented demand for it." The American and British systems of recording and reproducing are interestingly, and not too technically, described.

The second half of the work is devoted to the problems of the acoustic; of an auditorium, and the methods of design and construction which must be followed to obtain the best results; as well as some discussion of the characteristics of reproducers and of the human ear. A final short chapter deals with power supply for a theatre. The illustrations are valuable and informative.

Take the ??? out of repair work
Know at once the Resistors you need



This valuable book tells you the type, range, and power rating of the units required by any make of radio receiver

The I. R. C. Resistor Replacement Guide has simplified the work of thousands of Servicemen. We are now offering it in a new pocket size as shown above—handier to carry and use. It has more pages than before, more complete data, and is bound in a durable leatherette cover, to stand rough wear.

FREE With Metallized Resistors

Purchase any 10 I. R. C. Metallized Resistors of any recognized jobber and you will get this authoritative Replacement Guide free—or it may be bought for \$1.

Loose-leaf sheets, made up by our engineers, are mailed periodically without charge to every holder of the Guide—and keep it constantly up to date. Mail the coupon—get this new and improved book at once.

Published by INTERNATIONAL RESISTANCE CO. Philadelphia and Toronto

Makers of



Metallized RESISTORS

All orders for Resistors referred to Jobbers

INTERNATIONAL RESISTANCE CO., 2006 Chestnut St., Philadelphia C-10

Gentlemen: (Check offer you are interested in)

I enclose \$1.00 for Replacement Guide.
 Please send price list of Metallized Resistors. I wish to purchase assortment of ten, which will entitle me to Resistor Guide Free.

NAME
ADDRESS
CITY STATE

Announcing the *NEW* 1932

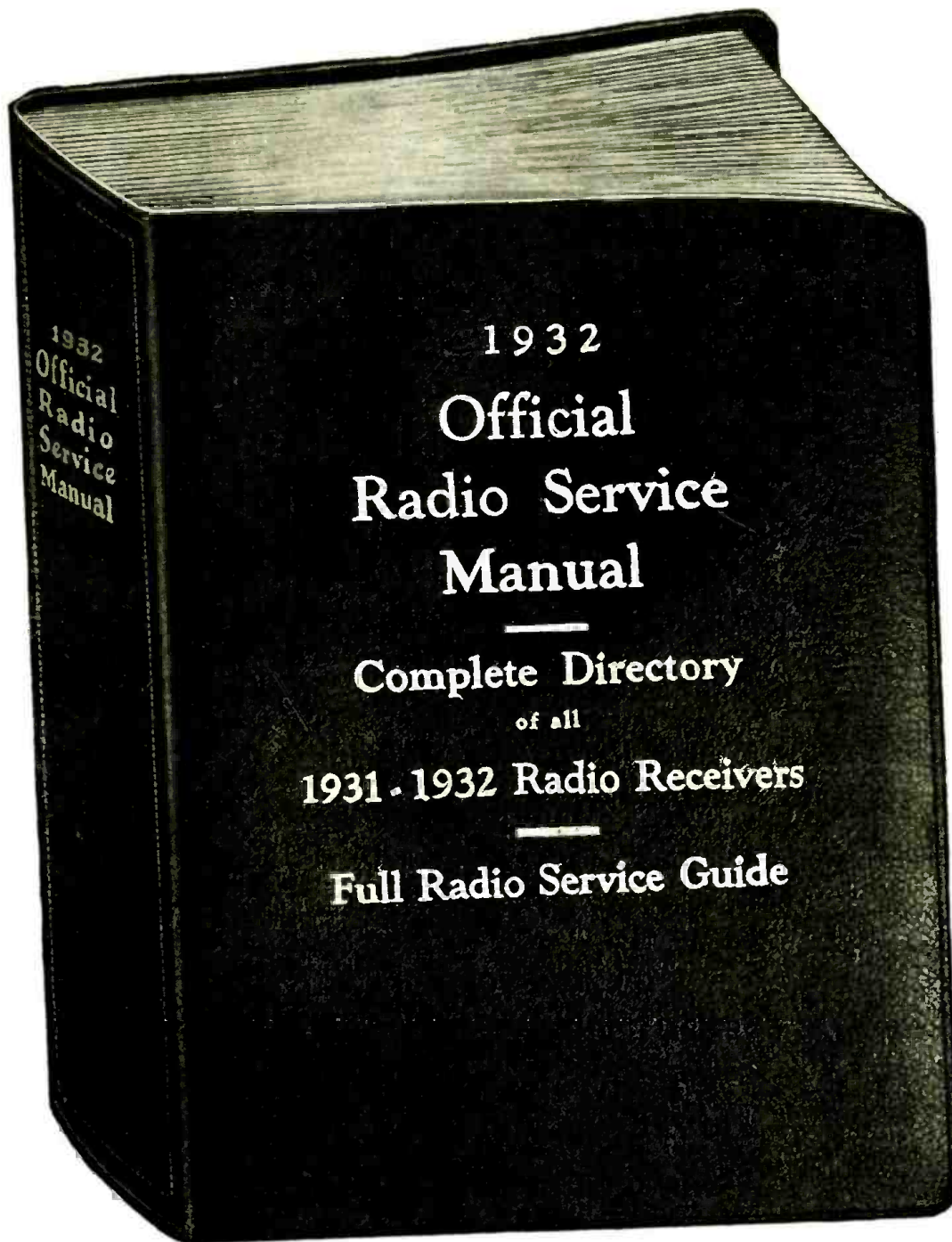

Over 1000 Pages.

Over 2,000 Diagrams,
Hook-ups, Charts and
Illustrations.

Flexible Looseleaf
Binder.

Size 9" x 12".

Complete Directory of
all 1931-1932 Radio
Receivers.

Full Radio Service
Guide.

For Radio Service Men,
Manufacturers, Jobbers,
Dealers and Amateurs.

HUGO GERNSBACK,
Editor

C. H. W. Nason,
Managing Editor

Clyde Fitch,
Managing Editor

NEW MATERIAL
THROUGHOUT

NO REPRINTS

ALL ORIGINAL
MATERIAL

ONE MONTH

ONLY

AT THIS PRICE

\$4.00
A COPY

After September 30th the
Manual will sell for
\$5.00 a copy.

Official RADIO Service Manual

WITH FREE Supplements

mailed to Manual Owners every 60 days —

THE progressive Service Man finds it essential to keep right up-to-the minute with new sets as they are placed on the market, particularly from the servicing viewpoint. It is required of him to repair accurately any receiver, regardless of model or manufacture. To facilitate the work of the Service Man, the NEW 1932 OFFICIAL RADIO SERVICE MANUAL will give every diagram or circuit that

will ever be needed; and in addition, it will show him how to service properly and in a much shorter time, a receiver of any make and construction.

Over 30,000 copies of the first Manual were bought by men in every branch of the radio industry. THE NEW 1932 MANUAL WILL BE BOUGHT BY EVERYONE IN THE RADIO FIELD.

The Contents of the 1932 Official Radio Service Manual

N
E
W
!

A step-by-step analysis of a typical radio receiver, which has all the features and all possible combinations of modern radio practice; all this has been included in a single design for the instruction of the service technician. This chapter contains a great many pages, fully illustrated by many diagrams to make every point plain. It is the most valuable contribution to the radio service field that has been made, and nothing like it has ever appeared in print.

A complete Manual on the operation of all types of vacuum tubes, whether new, standard or obsolete. No question that you could possibly ask in connection with the operation or usage of vacuum tubes has been omitted. A discussion of the operating voltages for various types of tubes, and what occurs when they are under- or over-loaded, is given. Completely illustrated with charts and diagrams.

Complete service data covering all modern radio receivers which the technician is likely to encounter in his work, together with specialized service notes covering the peculiarities of the individual receivers. A special chapter is devoted to some of the newer receivers which were not included in the first Manual.

Practically all data of an exclusive resume on the operation of the new Pentode and Variable Mu tubes, as used in the latest receivers, with complete information and their characteristics.

A complete discussion of the superheterodyne and its inherent peculiarities with detailed instruction on the alignment of the oscillator and intermediate frequency circuits. Complete trouble-hunting information on the superhetero-

odynes, leaving no important detail untouched. Also a special chapter on tools used on superheterodyne circuits.

A Manual on the full operation of the various set testers, and analyzes how on the market. Data on the construction of serviceable testing equipment; tube voltmeters, output meters, oscillators, aligning tools, etc.

A special large section is devoted to Midget receivers. This chapter contains the difficult problems that are met with in these type receivers—how to service them most economically—time-saving short-cuts—where to look first for trouble; and, of course, a sub-section devoted to the circuit diagrams of the most important midget sets on the market.

Practically all of the schematic diagrams and hook-ups are now augmented by full color codings, and by the inclusion of the complete circuit and coding arrangements of the individual parts, according to IRMA specifications. This innovation alone is of tremendous importance to the Service Man, and will save the cost of the book many times over.

Complete Service Manual on the commercial aircraft equipment now being supplied for use on commercial airways; in order that the technician may be put in a position of increasing his income by the servicing of receivers on planes passing through the local airport.

All available new data on the commercial short-wave receivers and converters, including hook-ups, diagrams, and servicing data on such receivers and converters. Many 1932 receivers are now equipped with shortwave tuners, or converters, and it is important to the Service

Man and technician to know this phase of the art, as it is increasing year by year. The problems of connecting exterior converters, and a description of them, including hook-ups of such converters, is included in this chapter.

A complete and exhaustive chapter featuring circuits and service data on the more important public-address systems, and on talking motion-picture equipment. This is a phase of radio which the Service Man often overlooks; and yet it is an important source of his income. A large amount of material shown here is entirely new.

A complete section giving dozens of tables of data on various phases of radio servicing. The material shown in this chapter is all "meat," and is of a practical nature; this information, alone, is worth the entire price of the book.

Complete tables of standardized color codings for resistors. These tables are most important, and will be referred to daily by thousands and thousands of radio Service Men all over the country.

IN ADDITION—

there are over 2,000 complete diagrams, hook-ups, and special reference data on commercial receivers. In many cases, the book contains special information on the servicing of such receivers as recommended by the manufacturer. In our last year's Manual we showed mainly the receiver diagrams themselves, and we included little servicing data. In the 1932 Manual, we are giving a tremendous amount of servicing data for many of the important receivers, which is also a distinct and important departure.

Additional Features—

Supplement to the New Manual will be issued every 60 days FREE OF CHARGE.

FREE Question and Answer Service to every owner of the Manual.

Blank pages for recording notes, diagrams or sketches are included, and are transferable to any part of the book.

The New Manual will contain three times as many pages and twice as many diagrams and circuits as the first Manual.

THERE WILL BE NO CUT PRICE ON THE 1932 MANUAL ANYWHERE. After it is published, the price becomes \$5.00.

NOTE!

Last year the Supplements were mailed to subscribers on a regular subscription basis at the rate of \$3.50. This cost was in addition to the price of \$3.50 for the Manual. WITH THE 1932 OFFICIAL RADIO SERVICE MANUAL YOU WILL RECEIVE THE SUPPLEMENTS EVERY 60 DAYS WITHOUT ANY ADDITIONAL CHARGE. This is the most sensational offer given by any publisher at any time.

Mail Coupon TODAY!

GERNSBACK PUBLICATIONS, Inc. RC-10
96-98 Park Place, New York, N. Y.

I enclose herewith remittance of \$4.00, check or money order preferred, for which you are to send me the NEW 1932 OFFICIAL RADIO SERVICE MANUAL at the pre-publication price. I understand that all the Additional Features and the New material will be included in the Manual and Supplements.

Name

Address

City State

SKINDERVIKEN



The Most Sensitive Microphone Button
(ACTUAL SIZE NOT BIGGER THAN A QUARTER)

You can easily make a highly sensitive detectophone by using a Skinderviken Transmitter Button to collect the sound waves. You can build your own outfit without buying expensive equipment. Think of the fun you can have with such an instrument.

You can install an outfit in your home and hear the conversation being held all over the house.

Full directions for connecting up the button for use as a detectophone are given in our 12-page booklet.

These wonderful little SKINDERVIKEN microphone buttons may be used for hundreds of uses, such as:

- | | |
|-----------------------------|------------------------|
| RADIO AMPLIFIER | PHONOGRAPH AMPLIFIER |
| DETECTOPHONE | TELEPHONE AMPLIFIER |
| STETHOSCOPE | LOUD SPEAKER AMPLIFIER |
| MICROPHONE | CRYSTAL SET AMPLIFIER |
| HOME RECORDING OUTFIT, ETC. | |

95c EACH Two for **\$1.75**
12-PAGE INSTRUCTION BOOKLET
 containing suggestions and diagrams for innumerable uses, furnished with each unit.

EVERY AMATEUR SHOULD HAVE TWO OR THREE OF THESE AMPLIFIERS IN HIS LABORATORY

WE PAY \$5.00 IN CASH for every new use developed for this unit and accepted and published by us.

SEND NO MONEY

When the postman delivers your order you pay him for whatever you have ordered, plus a few cents postage.

(Canada and Foreign: cash with orders)

PRESS GUILD, Inc., RC-1031

16 Murray St., New York, N. Y.

Please mail me at once as many of the following items as I have indicated.

....Skinderviken Transmitter Units at 95c. for 1; \$1.75 for 2; \$2.50 for 3; \$3.20 for 4.

When delivered I will pay the postman the cost of the items specified plus postage.

Name

Address

City..... State.....

The ROOSEVELT



SUPER-HETERODYNE
 Uses new Pentode power tubes, also new type variable-mu screen grid. 7 tubes in all. 10 KC. separation, wonderful tone and great distance. "Litz" Bank - Wound Coils. The most perfect radio ever built.

Price, complete with tubes **\$64.50**

NEW CUB MIDGET
 T.R.F. Circuit, Pentode, Variable - Mu, Fine Tone. Price complete, \$49.75.

Dealers and Agents: Write for Discounts!
COMMONWEALTH RADIO MFG. CO.
 843-C W. Harrison St., Cable RADCOM, CHICAGO

The New A. C. Superregenode

(Continued from page 223)

parts utilized, the oscillating circuit works at the natural frequency of the transformer (30 kilocycles) when C3 is out of circuit; when it is cut in, its capacity of .001-mf. tunes the oscillations to 21 kilocycles. In Table 1, the values of C3 corresponding to various suppressor frequencies, and the signal frequencies to which they are best adapted, are shown as computed on this basis. With other specifications of L3, of course, capacity values will change in inverse proportion to the inductance comprised. (See "How to Figure the R. F. Coil Secondary," by the author, beginning on page 37 of the July, 1931, issue of RADIO-CRAFT.)

It is even possible for the ingenious constructor to use a fan switch, or condensers fitted with plug-in terminals, to approximate most closely the optimum suppressor-frequency over the whole range of the receiver's tuning.

The base is drilled for the 5-prong detector socket V1; the 250-millihenry R.F. choke RFC; the equalizing condenser C4; the bypass condenser C5; the A. F. transformer T; the oscillator socket, V2; the A. F. socket, V3; the pentode socket, V4.

The A. F. coupling condenser C10 is bolted to the base. The condenser bank with five 1-mf. units, C6, C7, C8, C9, C12, is placed in the center; with the voltage divider resistor R8 held in place, by busbar connections to the condenser bank. Mounting C11 near socket V4, and the oscillator coil L3 near V2, completes the layout.

More letters covering experiences with the super-regenerative circuit are invited; and, if questions do not come too fast, and are accompanied by stamped and self-addressed envelopes, the author will endeavor to answer them all promptly.

List of Parts Used

- Two Hammarlund "MLW-125" 125-mmf. short-wave condensers, C1-C2, and two Kurz-Kasch vernier dials;
- One Hammarlund 14-to-110 meter "Model LWT-4" short-wave kit, L1;
- One Hammarlund 14-to-110 meter "Model LWI-4" short-wave kit, L2;
- One Hammarlund "Type RFC 250" 250-mh. R.F. Choke, RFC1;
- One Hammarlund "Type EC 80" 80 mmf. equalizing condenser, C4;
- One Flechtbeim filter block (five 1-mf. units), C6-C7-C8-C9-C12;
- One Ferranti "Type AF-5," 3.75-to-1 ratio audio transformer, T;
- One Sangamo .002-mf. double fixed condenser unit, C5-C13;
- One Aerovox .001-mf. fixed condenser, C3;
- One Sangamo .006-mf. fixed condenser, C10;
- One Aerovox 25-mf., 25-volt dry electrolytic condenser, C11;
- Two Electrad 50,000-ohm "Super-Tonatrols, R1-R2;
- Two Electrad 20-ohm V-type resistors, R6-R9;
- One Electrad 500-ohm wire-wound grid resistor, R3;
- Two Durham 1/2-meg. 1-watt resistors, R4-R5;

Fig. 2
 This diagram, showing the effective amplification of the Superregenode's audio circuit, which gives a margin of power for automatic control to overcome fading.

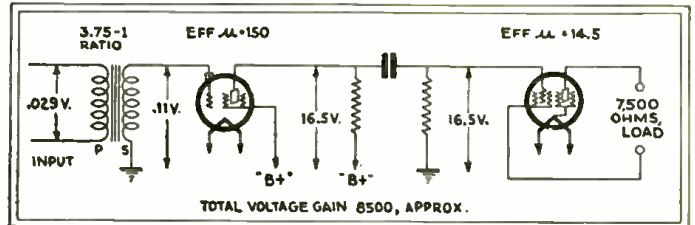

Wiring and Operation

The filaments are wired in first, running the twisted leads under the chassis. All other leads are run in the most direct manner, depending upon the design of the parts used, and their placement. The center-tapped resistor R6 is soldered to socket V4, and the resistors R3, R4, R5, R7 are soldered to their respective terminals, becoming self-supporting.

Little more need be said; as the illustrations show the simplicity of the whole design and wiring.

The leads to the plug-in R. F. coils should be left just long enough so that the metal cover can be removed to replace tubes, when required. Do not depend upon the metallic connection between shields at this point for grounding. Run wires to all grounded parts, especially between tuning coils and condensers.

Hum and other local disturbances seem low in comparison with the signal level, and the high signal-noise ratio is an excellent condition in a short-wave receiver.

- One Electrad 400-ohm wire-wound grid resistor, R7;
- One Electrad "R 71" 13,000-ohm voltage divider, R8;
- One Carter battery switch;
- One Acme 30-lc. I. F. transformer or equivalent (see preceding article for other options), L3;
- Four Pilot UY (5-prong) sockets, V1-V2-V3-V4;
- One Yaxley 7-wire cable, 3-4-5-6-7-8;
- Two Eby lettered binding posts, 1 and 2;
- One output connection block, 9-10;
- One aluminum cabinet 7 x 9 x 18 x 3/32-in. thick;

Miscellaneous hardware (two National screen-grid clips; screws, nuts, lock-washers, wire, etc.).

Data for the coils L1 and L2 were also given in the August issue of RADIO-CRAFT; this and the articles on short-wave coils which have appeared in recent issues may be consulted by the constructor. The widest option, of course, is open to him. The coil design may be modified (with tuning con-

densers of very small capacity and larger inductances) to spread the tuning over the bands below 40 meters; and, with proper regulation of the suppressor-frequency, extraordinary results may be obtained—as other experimenters with this circuit have reported to the author.

Optional Oscillator Design

While three methods of constructing the oscillator circuit, used to generate the suppressor-frequency, were given in the original article, a large proportion of the letters received by the author are complaints from constructors that they could not purchase the 30-ke. Acme transformer specified, and are unwilling to accept the other suggestions.

Another alternative is therefore given here. Take a Silver-Marshall "130 T" coil form (1 inch in diameter, 2½ inches long, with 98 threads in the winding space) and wind on it 630 turns, in seven layers, of

No. 32 D. C. C. wire, for the secondary or grid coil. Over this, at the lower end, the pickup coil L3 is wound—100 turns of No. 38 enamelled wire. Do not bank-wind.

The tickler or plate coil is 300 turns of No. 38 enamelled, wound into the small slot which is cut into the base of the coil form for the purpose. The form is made to plug into a regular UY socket, for ease in connection.

With a shunt capacity of .001-mf., the secondary will then tune to about 45 kilocycles, suitable to an ultra-short wavelength; and higher capacities will lower the frequency in proportion to the square roots of their value—as indicated in the table, which was made for a transformer of much higher inductance. For the coil just described, the capacities needed will be in the order of .01-mf. at 20 meters; .05 at 40, and 0.2 at 80 meters.

The R. T. A. Set Analyzer

(Continued from page 213)

Control-grid bias or "C" voltage is determined by moving the selector switch to the position marked "Grid," and pressing the voltmeter push-button labeled "300." If the reading is less than 30, the button marked "30" is pressed so that a more accurate reading may be obtained. If the "C" bias is too high, it may be due, in general, to a grounded grid connection, an open grid circuit, or shorted bypass condenser. If the "C" bias is too low, this may be due to an exhausted "C" battery, a defective grid-bias resistor, wrong line-voltage, or a defective tube, in most cases.

If the tube under test is of the 5-prong type, then the cathode is the next circuit to be checked, by turning the selector switch to the position marked "cathode." The voltmeter button marked "30" is pressed, and the reading taken on the lower scale. If the reading is materially different from the specified value, it is evident that the biasing resistor is shorted, either partially or completely. A break may also be somewhere in the circuit.

Screen-Grid Tube Tests

In the case of screen-grid tubes, two other tests must be made; while a few changes are necessary. The tube is inserted into the 5-prong socket, and the control-grid at the top of the tube is connected (by means of the special cord that is provided) to the metal tip jack marked "Grid." The tip jack marked "Grid Lead" is connected by means of a wire to the connection in the set which

was formerly made to the control-grid on the tube.

The first of two tests is the bias on the control-grid, which is obtained by turning the selector switch to the position marked "S.G.C.V.," and pressing the voltmeter button. (Always press the button labeled "300" first, to make sure that the reading does not exceed 30.) When this has been done, the other button can be used and the bias read on the lower scale. If the value indicated is not correct, the trouble will be due, ordinarily, to a defective grid-bias resistor, a defective tube, a grounded connection, or a shorted condenser.

Second, the voltage applied to the screen-grid is checked by turning the selector switch to the position marked "Screen-Grid" and pressing voltmeter button "300." If the indicated value is not correct, a thorough check-up should be made.

This completes the analysis of the first R. F. tube socket; if everything is found as it should be, the tube is returned to the socket and the same tests repeated with the succeeding tubes.

Of course, there are a number of faults which cannot be uncovered in the above analysis, such as an open center-tapped resistor, defective detector tube, wrong speaker connections, defective output transformer, poor speaker, shorted variable condenser, poor grid leak, open by-pass condenser, microphonic tubes, defective grid resistors, or a poor ground connection. These, however, can generally be located by the use of the continuity tester which will be described later.

DO NOT under any circumstances make the mistake of inserting the analyzer plug into a rectifier tube socket, or the D. C. voltmeter will be damaged. To determine whether the rectifier tube is in good condition, the plate voltage on the last audio tube should be measured. If the plate voltage is normal, the rectifier is evidently in good condition. However, if the plate voltage is low, the rectifier in use should be replaced with a new tube known to be good. If, upon placing a new tube in the rectifier socket, the voltages rise to their normal value, it is an indication that the first rectifier was

CROSLEY NEW

8 Tube Push-Pull Pentode Output SUPERHETERODYNE



\$49⁷⁵
Complete With Tubes

The Crosley PLAYBOY

An exquisitely designed all wood table or mantle model, 17 inches high, housing the new Crosley 8-tube push-pull Pentode output, Variable Mu, Superheterodyne chassis with latest type Crosley full floating moving coil dynamic speaker. Incorporates all the new Crosley features. Never before so much superlative radio performance at so low a price.

All of the beautiful new Crosley cabinets shown here incorporate the entirely new Crosley Superheterodyne radio receiver which embodies sensational new features, many of them exclusively Crosley. Two five-element Pentode output tubes connected in push-pull; two Variable Mu tubes; continuous (stepless) variable static and tone control; illuminated hairline shadow dial with vernier drive; combined volume control and on-off switch; full floating moving coil dynamic speaker. Features such as these have never before been offered in radio receivers at anything like the low prices shown here. See your Crosley dealer today—hear the wonderful performance of these outstanding sets—know the rare values they represent.



The Crosley CHEERIO

A forty-inch console of unusually attractive design housing the new Crosley 8-tube push-pull Pentode, Variable Mu, Superheterodyne chassis and newest Crosley full floating moving coil dynamic speaker. Every new Crosley feature is incorporated.
\$65.00
Complete With Tubes

The Crosley MERRYMAKER

A truly magnificent cabinet of rare beauty, forty inches high, housing the new Crosley 8-tube push-pull Pentode, Variable Mu, Superheterodyne chassis plus the new Crosley Auditorium size full floating moving coil dynamic speaker.
\$75.00
Complete With Tubes



The Crosley ANNOUNCER

One of the most beautiful of all door console models. Stands forty-two inches high. Incorporates the new Crosley 8-tube push-pull Pentode, Variable Mu, Superheterodyne chassis plus the new type Crosley Auditorium size full floating moving coil dynamic speaker.
\$85.00
Complete With Tubes

The Crosley PLAYTIME

Here it is! A dream come true! A grandfather type A. C. electric hall clock incorporating the new Crosley 8-tube push-pull Pentode, Variable Mu, Superheterodyne radio receiver and Crosley Auditorium size full floating moving coil dynamic speaker. One connection to the house current operates both clock and radio. Western prices slightly higher.
\$95.00
Complete With Tubes



The Crosley Radio Corporation
POWEL CROSLEY, Jr., President
Home of "the Nation's Station"—WLW
CINCINNATI

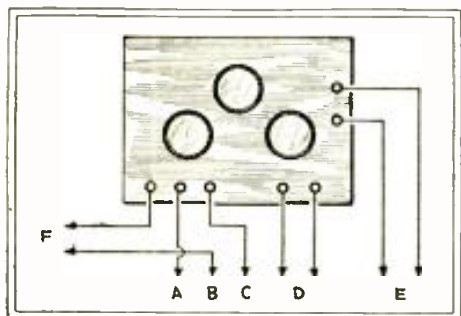

Fig. 2

The external connections of the set analyzer, through the jacks, permit continuity, resistance and capacity tests.

"CHI-RAD"

Full Information and Best Prices
on the
NEW S-M 726 SW
Short and Long Wave Receiver
NEW NATIONAL AC 5 SW
Using 235 and 245 Tubes
Can Be Had By Writing to Us

National Distributors
MERSON CONDENSERS
Full Line in Stock
Supplies of All Kinds for
Short Wave Experimenters

CHICAGO RADIO APPARATUS CO.
415 So. Dearborn St., Chicago, Ill.
Est. 1921 Dept. CF-10

AUTO RADIO

Long Distance Receiver

Amazing Low Price!
Quality Performance



Six tube triple screen-grid using 3-224, 2-227, and 1-245 power tube. Easy to install. Will fit any car. Single dial control. We guarantee that this set will pull in stations within a radius of 1,000 miles and that it will deliver the volume and tone qualities of an electric set, or your money refunded.

PRICE OF SET ONLY \$20.00
Price Complete, including tubes, batteries, dynamic speaker and suppressors, all ready to install and use, \$39.50. Send \$5.00 deposit with order, balance C.O.D. On foreign orders remittance in full required. ORDER TODAY.

CHAS. HOODWIN CO.
4240 Lincoln Avenue, Dept. K-150 Chicago, Illinois

Radio's Greatest Service Manual
is now in the process of preparation. Be sure to read the announcement on pages 232 and 233 and learn about the many new things that are to be incorporated in the 1932 OFFICIAL RADIO SERVICE MANUAL.

defective and should be replaced. If the voltages do not rise, the trouble is undoubtedly due to some cause other than the rectifying tube.

The "Grid Test"

The real value of a tube as an amplifier is not given by the amount of plate current flowing, but by the amount of change in plate current caused by a given change in grid voltage. For this purpose, it is common practice to observe the plate current under operating conditions, and then make the grid more positive by reducing the negative "C" bias. This is known as the "grid test." The plate current will increase, and the amount of increase determines the quality of the tube.

The "Grid Test" is applied by throwing the upper switch, first to "Normal" and then to "Grid Test"; and taking the difference of the readings. Screen-grid tubes are tested with the control-grid cord in the "Grid" and "Grid Test" jacks, respectively.

The above discussion explains the use of the analyzer when the chassis of the radio is in the cabinet. By the use of the red and black jacks on the lower edge of the analyzer panel, the D. C. meter and the A. C. meter may be used externally. To test batteries, a wire from the negative of the battery is placed into the black jack marked "-." A wire from the positive side of the battery is placed into the red jack marked "300." First press the "300" voltmeter button and, if the voltage of the battery is less than 30, the "30" push-button. To measure line-voltage, wires from the A. C. power line are connected into the "-" black jack and the red jack "140." The voltage is read on the 140-volt scale of the A. C. meter. To use the 0-10-volt scale on the A. C. meter, wires are placed into the black "+" and the red "10."

External Measurements

A continuity tester for the location of open resistors, shorted condensers, poorly soldered connections, etc., is available simply

TABLE I

Reading Mills.	Ohms Res.	Reading Mills.	Ohms Res.
14.0	25	5.3	600
13.8	30	4.8	700
13.5	35	4.3	800
13.3	40	4.0	900
13.0	45	3.6	1000
12.9	50	2.6	1500
12.0	75	2.2	2000
11.5	100	1.6	2500
9.4	200	1.5	3000
7.8	300	1.0	4000
6.8	400	.9	5000
6.0	500	.5	100000

15 Mills. indicates no resistance in circuit.
0 Mills. indicates very high resistance or open circuit.

by plugging two wires into the two black jacks on the right side of the analyzer (as indicated in outline in Fig. 2).

By referring to Table I, the resistance of the circuit in ohms can quickly be found. For example, if the meter pointer indicates 2.6-milliamps, the circuit under test has a resistance of 1500 ohms. Any resistor between the value of 25 ohms and 5000 ohms can quickly be tested in this manner.

When it is desired to test batteries or power supplies, the separate connections to the D. C. voltmeter are made across terminals D.

In testing condenser capacities, B and C are connected to the unit under test, and 110 volts A. C. is impressed on F; the capacity is then found from Table II. If the condenser is found to have more than four microfarads capacity, terminals F are then put under 5 volts A. C., and the values are found from Table III. The necessary voltage can usually be obtained from a receiver.

If the condenser gives a full voltage reading, it is evidently shorted, and should be replaced. However, electrolytic condensers cannot be tested with alternating current; because they are designed for a D. C. voltage of constant polarity.

The components of the analyzer, in addition to its carrying case and engraved panel with the three meters and their resistors, are: a 5-wire cable, with plug; adapter plug; UX and UY tube sockets; the bi-polar 6-point selector switch, with knob; one 2-terminal and two 3-terminal toggle switches; two push buttons; three metal, three red-top and four black-top tip jacks; an 8-inch screen-grid test cord, seven soldering lugs and the other small hardware—wire, screws, nuts and bolts.

TABLE II

Meter	110-volt A. C. Test Reading Capacity Volts	5-volt A. C. Test Volts	
	Mf.	Mf.	
1.9	.5	1.3	8
3.0	1.0	1.6	10
4.5	1.5	2.0	12
5.4	2.0	2.3	14
6.0	2.5	2.5	16
6.5	3.0	2.6	18
7.0	3.5	2.9	20
7.1	4.0	3.0	22
		3.1	24

TABLE III

Meter	110-volt A. C. Test Reading Capacity Volts	5-volt A. C. Test Volts	
	Mf.	Mf.	
1.9	.5	1.3	8
3.0	1.0	1.6	10
4.5	1.5	2.0	12
5.4	2.0	2.3	14
6.0	2.5	2.5	16
6.5	3.0	2.6	18
7.0	3.5	2.9	20
7.1	4.0	3.0	22
		3.1	24



LESS STOCK TO CARRY - SAVES TIME

cause they save time, expense, labor and they cost less.

The exclusive Truvolt Sliding Adjustable Clips enable you quickly to obtain the exact voltages required and the unique open-air winding insures superior cooling and more stable performance.

Use TRUVOLT Adjustables and you need fewer resistor sizes, less investment in stock on the shelves—fewer parts in the service kit and you give prompter service to your customers.

Mail Coupon for Truvolt Catalog

ELECTRAD, INC.
175 Varick St., New York, N.Y.

Please send me complete 36-page catalog and special replacement volume control guide.

Name _____
Address _____
Dept. RC-10

have shown that this value is quite adequate to damp out the frequencies of radio wavelength which cause all the rumpus; while higher values cause erratic operation of the motor. The spark-gap spacing, with recommended figures given above, is then about .020- to .025-in.

NEW BINDING POSTS

IT HAS been some time since manufacturers ventured to suggest that the binding post might be more effective in some more modern form. Now, all at once, two manufacturers announce improvements in this important device.

In Fig. 3 at A is illustrated the com-

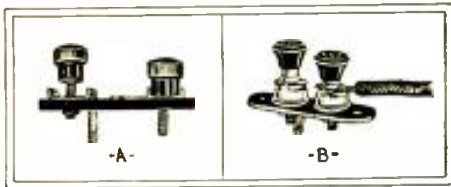

Fig. 3

Two types of improved binding posts for antenna and ground connections

bination binding post manufactured by the Alden Products Co.; its features are given below.

Wire of small "magnet" size to large "antenna" diameter will fit the post, which fastens to the chassis or panel by means of an eyelet or screw. The wire retaining clip is extended to provide room for soldered connections, and the knurled bakelite tops are non-removable. The unit shown is particularly designed so that the antenna post, when mounted on the same strip with the ground post, will not short to the chassis, on which the ground post automatically will ground.

The "Cinch" push-button binding post "No. 70," illustrated at B is a product of the Cinch Mfg. Co. You push the button, insert the wire, and release the button—the wire is connected. These posts are provided with soldering lugs and have engraved bakelite tops. The model illustrated is designed for antenna and ground connection; and therefore is arranged to connect the ground lead automatically to the chassis when the post is mounted.

The Eighteen-Mile Horn

(Continued from page 203)

air unit to be controlled, a two-stage amplifier with '50-type tubes, in push-pull, furnishes ample power. For the heavy-duty tests, however, eight reproducers were used at once. For this purpose, a special amplifier was constructed, using a '24, a '45 and two 545s (50-watt type), fed from two mercury rectifiers of the 566 type. The amplifier operated from a standard 110-volt 60-cycle power supply; its output circuit was designed to operate as many as ten compressed-air units; each adding a thousand times the volume originally delivered from the output of the amplifier.

Control of the Horn

A control panel also was provided, for switching from microphone to electric phonograph; and also permitting any or all of the compressed-air units to be thrown on or off, as desired.

The amplifier, to withstand transportation from one ship to another, had to be designed with a view to portability; as well as to withstand the terrific shocks caused

by gunfire on board the ship during practice.

A special Amplion "transverse-current" microphone was used during the many tests; this type is extremely efficient, and characterized by an entire absence of background noise; though it is very sensitive, and the speaker need not talk directly into it. (For the Lakehurst experiments, the microphone was mounted on the speaker's chest, below his chin, and held in place by straps around the shoulders; the speaker's hands were thus left free, and his vision and breath unobstructed. This assembly was also worked out by Mr. Cromwell.) The microphone is specially designed for heavy duty and rough handling; it is built into a water- and moisture-proof housing of cast bakelite and aluminum.

At Lakehurst, the apparatus was installed on top of the great dirigible hangar; by the use of long flexible cable, the officer using the microphone was able to move about, and give directions to the *Los Angeles*. The great aircraft followed his directions with uncanny obedience, moving to the right, left, or turning, in accordance with the giant voice from below. Communication from the dirigible back to the hangar was kept up by radio.

STORING UP A CHARGE

THE latest development in German electrostatic speakers, says *Amateur Wireless*, is to make the diaphragm carry a permanent charge of electricity, so that the use of any outside biasing voltage becomes unnecessary. It has been found that if a strong electric field is applied to certain kinds of wax when melted, the wax will retain the charge as it solidifies. The result is called an "electret," and may be considered as the electrical counterpart of a permanent magnet.

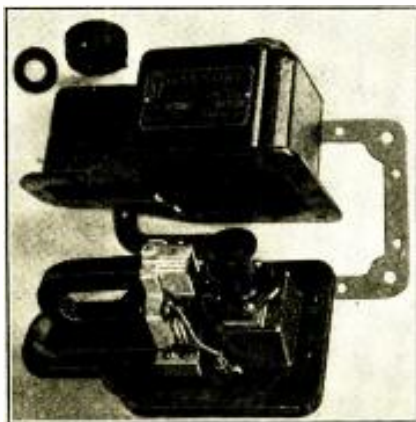

Interior view of the unit; the outlet tube covers the butterfly valve. At its left is the motor of the speaker which moves the valve.

Announcing!

A complete line of instruction in Practical Radio Engineering and Practical Television Engineering.

Due to the demand from the less experienced radiomen who felt unable to handle our advanced course in Practical Radio Engineering we have added complete preparatory work. This, combined with our advanced course, forms our complete course which can be handled by even the less experienced radiomen.

Practical Television Engineering is handled in the same manner with both complete and advanced courses.

We are the oldest home study school in America offering advanced training in Practical Radio Engineering. Write for full details of this Practical Engineering Training.

CAPITOL RADIO ENGINEERING INSTITUTE, Riggs Bank Bldg., 14th and Park Road, N.W., Washington, D. C.

Please send me without obligation complete details of the following course: (Check course).

- Advanced course in Practical Radio Engineering.
- Complete course in Practical Radio Engineering.
- Advanced course in Practical Television Engineering.
- Complete course in Practical Television Engineering.

Name

Address

Oct. RO

SERVICE MEN Send for this Book FREE!



YOU NEED IT!
Everything for your business from the finest mike to the smallest screw is in this book.

GUARANTEED QUALITY GOODS
PRICES LOWEST EVER QUOTED
Fresh new dependable Merchandise at Bargain Prices!
Leading Manufacturers Lines Complete
Send For Your Copy Now!
HEADQUARTERS
for **SERVICE MEN'S SUPPLIES**

RADOLEK CO.

601 W. Randolph St.
CHICAGO
Illinois

USE THIS CONVENIENT COUPON
Radolek Co.,
601 West
Randolph St.,
Chicago, Ill.

Please send me without obligation your Service Man's Supply Book.

Name

Address

City State



Pentode Radio
 5-Tube Midset at
 Amazing Low Price!
 The best toned small
 receiver on the market.
 Uses 2-235s, 1-224,
 1-247, and 1-280.
 Full range dynamic
 speaker. A radio with
 a real wallop. The
 latest product of our
 laboratory. Fully
 guaranteed.
 Special
 Dealers Price **\$24.75**
 Made to sell for
 \$49.50 complete
 Dealers net price
 only \$21.75 com-
 plete with quality tubes. Send \$5.00 with order, balance
 C.O.D. A great value—ORDER TODAY!
PIONEER RADIO LABORATORIES
 857 W. HARRISON ST. CHICAGO, ILL.

The SUPERLATIVE
BROADCAST
MICROPHONE
Extra Heavy Type—Two Button
 Outstanding beauty of work-
 manship and finish. True,
 Natural Tone. Tremendous Vol-
 ume. Scientifically Damped.
 Extra Heavy 24-Karat Pure
 Gold Centers. Duralumin dia-
 phragms. Accurately Machined.
 Three degrees of Sensitivity.
 Other Models from \$5.00 up.
UNIVERSAL MICROPHONE CO., Ltd.,
 1163 Hyde Park Blvd.
 Inglewood Calif., U.S.A.

The
OFFICIAL REFRIGERATION
SERVICE MANUAL
 is
NOW
READY
BE SURE TO GET YOUR COPY

Study RADIO in
CANADA
 CANADA'S PIONEER COLLEGE, endorsed
 by leading radio manufacturers, offers DAY,
 EVENING, HOME STUDY and SPECIAL
 TRADE COURSES with free scholarships
 and trip to Toronto (all expenses paid).
 Write for booklet to Principal.
RADIO COLLEGE OF CANADA
 Limited
 310 Yonge Street . . . Toronto

TUBE CHECKER
 Transformers: 1, 1½, 2, 2½, 3, 5, 6.3, 7½
 volts, 30 watts. Full instructions included for
 building new type tube tester. Will test pen-
 todes, 6.3 auto all screen grid and new 2 volt
 type. Shipping wt. 5 lbs. Add P. P. \$2.25 net.
L & L ELECTRIC CO.
 336 Madison Ave. Memphis, Tenn.

CAN YOU SOLVE THIS PROBLEM
 There is a tremendous market for a home recording
 machine that will give **FIRST CLASS** results. We
 can put you in touch with interested manufacturers
 if you can solve this problem and produce a real
 working model.
 Write for **FREE** details of what has been done so
 far in this field to Dept. J.
MILES REPRODUCER COMPANY
 26 East 22nd Street New York

Leaves From Service Men's Note Books

(Continued from page 220)

honest with you, I believe that after all my work it was worse than ever.

At last I conceived the bright idea of moving the regenerative coil (in the detector circuit) a short distance from its mounting by the use of several cardboard washers and, at last, I ascertained the happy medium between oscillation and loss of sensitivity.

The variable condensers on the "R21" and other R. C. A. sets are very fine for obtaining maximum sensitivity and real aligning; inasmuch as they have on the rotor split outside plates which can be bent just as you want. You can have your condensers match at every degree of the dial.

Again, I was called on a service job by a customer who had just purchased a new Radiola "46," which would not produce any signals whatsoever. In my hurry I forgot that I was out of '24s; and I arrived at the customer's home to find a '24 tube with a short from screen-grid to filament. An odd short, isn't it? To give him operation for the evening, I replaced the tubes in their respective sockets, except that for the first stage which I left vacant. I connected the aerial to the control-grid cap of the second R. F. tube. This is not a good idea for operation, for any length of time; the voltage runs a little higher when one tube is removed, no matter how well the filament transformer is designed. Resistances in the circuit play funny pranks.

On a call to check interference in an "R80," I found a '24 tube with elements

that shorted at times. Walking across the floor would start it, and it seemed to keep up the noise for a considerable period of time. The cause of this noise was not as easy to discern as it sounds; and I believe that a Service Man should tap the tubes as a first test for interference in this type of set.

Testing Equipment

(Continued from page 211)

resulted in the method shown; it can be incorporated in many set testers by adding one binding post to the existing circuit. The writer used two positions on his Weston bi-polar switch, instead of adding a D.P.-D.T. switch.

To operate it, close the meter switch on the low side, and adjust the current to one milliamperes. Then, if the unknown resistor Rx is of high value, switch the meter to the high side, and connect Rx across II and C (as at B). The higher the resistance, the less will be the current indicated by the meter, as is well known.

If Rx has a low value, leave the meter on low, and connect Rx across terminals L and C (as at C). The meter reading will be low in proportion as the value of Rx is low; for Rx is a shunt around the meter.

Calibration, by means of Ohm's Law, is performed in the usual way; the low scale should be calibrated with known resistance values, since the internal resistance of the meter must be taken into consideration.

(This is the same as the circuit illustrated on page 564 of RADIO-CRAFT for May, 1930, with a table of readings for an 0-5 milliammeter. Mr. Kitchen's suggestion for the use of a switch, however, may be appreciated by other Service Men.—Editor.)

The Stenode Circuit—A Discussion

(Continued from page 227)

of 1001 kc. In 2/10ths of a second the 1000-ke. frequency will have 63% faded out, while the 1001 kc. frequency will have risen to 63% of its final value—which is assumed to be the same as before for the 1000 kc. This means that it takes the same time to change frequency in the circuit as it does to change amplitude. The frequency-modulated circuit is therefore no exception to the rule that, no matter what the form of analysis, "all will finally bring us to the same point."

Because the frequency-modulated circuit cannot be resolved into sidebands, any more than the D.C. circuit can, we do not therefore make the error of assuming that the frequency-modulated circuit can pass an unlimited frequency of modulation on a narrow band; for the resistance necessary, to reduce the time constant to any given value, also decreases the selectivity to a point where, if there were frequencies outside the frequency-modulated band, they would be admitted. A given fidelity requires the same selectivity, therefore; whether on the frequency-modulated Stenode or the amplitude-modulated neutrodyne. The time constant

not only determines the fidelity of all circuits, but particularly determines the selectivity also of the special tuned A.C. circuit.

Now comes the joker in the deck—the compensated audio amplifier; this is compensated only in part. When compensated to where it will give the same fidelity over all to the receiver, it will compensate the interference, if any, along with the higher audio frequencies; because they all lie in the same region and therefore are suppressed equally and naturally have to be compensated equally.

Since most of the energy of speech and music lies in the region below 500 cycles, while the intelligibility lies mostly above this value, if the Stenode is selective to 2000 cycles it may pass a fairly respectable audio output; and 2000 cycles of selectivity is an enormous improvement over the usual 10,000 or more that is encountered. However, if the Stenode is compensated to a point where it will give a flat response from 60 to 5000 cycles, then tests with interference less than 5000 cycles away from the carrier must fail; just as they would with a neutrodyne of equal fidelity.

The only advantage of the Stenode, therefore, lies in those fields where modulation rates of 1000 cycles or less are all that it is required to pass. It may be made so much more selective than the ordinary receiver that it may be used on these narrow bands; but it is of no advantage on the broadcast band except for those who do not mind trading the higher frequencies for freedom from interference. If such "tubby" reception is not objectionable, the Stenode will find a commercial development.

Thus, while it is not denied that the selectivity of the Stenode is revolutionary, it is proven that for equal fidelity it is no better than any other receiver.

VERNE V. GUNSOLEY, Consultant,
116 South Fourth St., Minneapolis, Minn.

A REPLY

Editor, RADIO-CRAFT:

I have read Mr. Gunsolley's letter with great interest. Summarized, it may be said to consist of the following statements:

(1) That the theory of what happens in a feebly-damped circuit is clearly understood.

(2) That fidelity and selectivity are so interrelated that one cannot have both.

(3) That the Stenode is a frequency-modulated circuit.

(4) That a given fidelity requires the same selectivity in the Stenode as in any other circuit.

(5) That compensated audio amplification is compensated only in part.

(6) That "if the Stenode is compensated to a point where it will give a flat response from 60 to 5,000 cycles, then tests with interference less than 5,000 cycles away from the carrier must fail; just as they would with a neutrodyne of equal fidelity."

Finally, Mr. Gunsolley states that "it is proven that for equal fidelity the Stenode is no better than any other receiver."

These arguments are, of course, precisely those put forward by all scientists and radio engineers prior to the advent of the Stenode.

day for your correspondent to make statements of this kind; and we are quite willing to demonstrate to him in our Laboratory several Stenode receivers having a faithful reproduction of all tones up to 5,000 cycles and more, with a selectivity many times greater than the most selective receiver on the American market, regardless of the tone of that receiver. I am afraid this is one more case where, since the facts do not fit the theory, the theory must be altered. Such fidelity and selectivity have, of course, already been demonstrated to the technical staff of Radio-Craft.

Statement No. 3, that the Stenode is a frequency-modulated circuit, is erroneous. No statement to this effect has ever been made by Dr. Robinson or his associates, nor has any proof been brought forward by any other organization that this is the case.

Statement No. 4 is an assertion, the falsity of which is demonstrated and has been demonstrated, many times, with the Stenode. Statement No. 5 is also quite erroneous, and I fail to understand why your correspondent should state that the compensation is only in part. The actual curve of the audio amplifier, taken by independent laboratories, has been shown by experts on many occasions.

In statement No. 6, Mr. Gunsolley is once more quite wrong. A demonstration of the Stenode, which has been given on numerous occasions, is as follows:

The Stenode is tuned to a broadcast station of high quality. Two local transmitters designed to be free from frequency modulation, with means for modulating up to 5,000 cycles, are next set up; the two transmitters being adjusted to 5,000 cycles on either side of the broadcast transmitter. The percentage modulation of the two transmitters and the field strength at the Stenode are adjusted; so that all three stations are of equal strength and the same order of modulation. The two local transmitters are then modulated with speech and music up to 5,000. The Stenode is then tuned to each of these stations in turn.

We will call the center station B, and the two side stations A and C, respectively. When the Stenode is tuned to Station B there is no interference from Stations A and C, although the full quality of reproduction is given over the whole scale. The Stenode is then tuned between A and B, at a point of silence. Next, Station B is tuned in with perfect quality, with no interference from Stations A and C. Next, the Stenode is tuned between Stations B and C at silence and, finally, it is tuned to Station C, without any interference from A and B.

We are fully aware that this demonstration is entirely contrary to the older theory, according to which the two sets of sidebands completely overlap, and it should be quite impossible to receive the modulations of Station B with fidelity without at the same time getting the modulations from Stations A and C.

We should like to have Mr. Gunsolley realize that the Stenode has long since passed out of the realm of theory; it is no longer a question of theoretical discussion, but of practical fact. Numerous curves showing the selectivity and fidelity



EVERY RADIO SERVICE MAN should read this book which tells you how to make more money out of radio service. There are secrets which "old timers" have learned through years of experience. You can now have the benefits of these. You don't pay a penny—you don't promise to pay any—for this book will be sent to you without any obligation of any kind with our compliments if you will sign and send in the coupon. It is part of our plan to help independent radio men profit by the experience of others in the industry and make a bigger income.

Brim Full of Facts

This book was written by a man who has probably had more experience than any one else in the industry. It tells you in simple language the principles and practices which made him the outstanding figure in the radio world that he is today. These are a few of the subjects fully covered: Selling the public on radio service—Value of Personality Newspaper advertising—Business literature—Types of service letters—Electric signs—Making tubes business builders.

This book is for service men only and will be sent FREE and fully post paid upon receipt of the coupon completely filled in.

RADIO SERVICE MEN'S GUILD
1253 Fullerton Avenue
Chicago, Illinois.

You may send me your book "Making Money Out of Radio Service" absolutely FREE and fully post paid. (Please answer these simple questions):

What radio training have you had?.....
No. of years in radio?.....
Do you give radio all your time?.....
Have you a store?.....
Do you work for some one else, if so who?.....
Name

Read the Important Announcement About the Two New Books on Page 251

HEADQUARTERS

for all

RADIO SERVICEMEN'S SUPPLIES

We carry the largest supply of replacement parts and general radio parts in the mid-west. Our store is the rendezvous for radio servicemen who will always find the latest and the best in radio merchandise in stock. We specialize in replacement transformers, condensers, resistors and volume controls for all makes of radio sets.

Be sure to drop in and see us when you are in Chicago.

NEWARK ELECTRIC CO.

A Radio Service Institution

229 West Madison St. Chicago, Ill.

PATENTS Write for Free Guide Book, "HOW TO OBTAIN A PATENT" and Record of Invention Blank. Send model or sketch and description of your invention for our Free Opinion whether it comes within Patent Office Rules. RADIO and ELECTRICAL Cases a Specialty. Prompt, Efficient Service. PAYMENT OF FEES IN INSTALLMENTS. VICTOR J. EVANS & CO., 923 - 9th, Washington, D. C.

The
FOURTH
Supplement
 to the
Official Radio Service
MANUAL
 is *NOW* Ready

TO BRING the First Manual right up - to - the - minute, you should NOW have the four Supplements now ready—included in their proper places available for immediate use.

Many important new developments which have made their appearance in radio only a short time ago are published in the fourth Supplement. Dozens of Diagrams of new receivers, both midget and standard, are also included in the pages. You will find the latest data on new tubes, their characteristics and uses.

The index pages, newly arranged, include a long list of set manufacturers and the trade names of the sets they produce. This simplifies greatly the method of determining the manufacturer when only the name of the set is known.

The supply of Supplements is limited, and if you do not want to be without yours, send your remittance today. You will be entitled to all the Supplements issued so far—four in all. The other two supplements, to finish the year's subscription will be mailed on the regular publication dates. Supplements are not sold individually.

MAIL COUPON TODAY!

GERNSBACK PUBLICATIONS, Inc., RC-10
 96-98 Park Place, New York, N. Y.

I enclose \$2.50 for which you are to enter my subscription for the Supplements of the OFFICIAL RADIO SERVICE MANUAL. It is understood that I will receive in all six supplements, the four already issued and the two to be published.

Name
 Address
 City..... State.....

of the Stenode have been made, not only by ourselves, but also by independent laboratories; while the actual performance of the Stenode can be appreciated in five minutes by anyone trying it.

A further demonstration of great importance is that of *eliminating very powerful heterodyne interference, without in any way altering the tone quality of reception.* No other receiver can do this, even to a small degree; and indeed, it was thought to be, theoretically, impossible until the Stenode was demonstrated.

In view of the facts I have stated, and which have already been demonstrated to RADIO-CRAFT, your correspondent's final statement that it is proven that for equal fidelity the Stenode is no better than any other receiver," is entirely erroneous. In fact, we are reminded by this letter of the old story of the farmer who, on first seeing a giraffe at the zoo, stated that "there ain't no such animal!"

Pracy W. Harris, President,
 The Stenode Corporation of America,
 Hempstead Gardens, L. I., New York.

Dollars from Your Telephone

(Continued from page 215)

other advertising or forgets your trade name, the chances are they will immediately look in the classified section; which emphasizes the importance of having an attractive set up, one that will quickly catch the eye. A person consulting a telephone directory is generally motivated by the type of ad which he sees there. The eye is naturally attracted to the best and most prominent display, and a new-comer will invariably say to himself: "There, that looks like a good reliable radio man—I'll just give him a ring."

Of course, every telephone ad should be dignified, contain an attractive illustration, and the phone number should be prominently featured in large display type, with a reproduction of a telephone or of a man or a woman talking into a telephone. Every telephone directory ad needs certain "action" elements in its layout; because there must be stored within the ad's limited space enough latent energy to cause the message to spring out at the prospective customer when he opens the page. This can be best accomplished by:

Using, for prominent portions of the message, distinctive type which conveys the impression of action, and designs containing "action" elements; curved and slanting lines usually convey more action than straight horizontal lines;

Illustrate the telephone number by pictures of a telephone, or animate objects in action; preferably something associated with your business, which is being advertised.

In all cases, be sure that the telephone number is displayed with outstanding prominence.

Several radio dealers of Washington, D. C., have taken different means of emphasizing their telephone numbers; some of the best of the displays are reproduced in this article.

As the prospective customer turns to the classified telephone directory section of radio dealers, he immediately finds the most

attractive ads and those which naturally catch his eye; and he invariably picks those phone numbers which are in largest letters, while others, less imposing, are ignored.

When the radio dealer circularizes his mailing list, it is also a good plan to make a special feature of his telephone number. A telephone slogan may also be used to drive home the advantages of using the telephone; such as "As Near As Your Telephone"; "Prompt and Efficient Service Over the Phone"; "Save Worry—Just Ring Main 100," etc.

Some radio dealers prefer to select and use a trade name which will get them at the top of the telephone directory list, such as: "Acme," "Ambassador," etc. A lot of people, especially newcomers, are looking in the telephone book for the name of a radio man; and it helps to get more business when he heads the list.

The radio man who seeks to enlarge the scope of his business contacts cannot help but see the value of the telephone, not only as a customer convenience, but as a valuable first-aid to business building.

THE INAUDIBLE JINGLING

MOVING-PICTURE engineers, says the *Broadcaster and Wireless Retailer*, of London, "are experimenting with speakers that will reproduce frequencies as high as 12,000 cycles. The highest notes given by the new speaker are inaudible. It is said, however, that they give realism of the reproduction of sounds, such as the clink of glass and the jingling of coins. The speaker, which employs a very small and thin diaphragm, cannot handle low notes; so it is used in conjunction with a speaker of the usual type." The opinion is then editorially expressed, that unwanted noise would become much more troublesome.

There is great difference of opinion as to what sounds are superaudible; for that is a personal question. However, this item is interesting especially as regards the present low audibility of money.

"Antipodes" Super Converter

(Continued from page 225)

- One 2½-volt filament transformer, and one 30-henry filter choke, not over 27½ inches high;
 - Two R.F. chokes, 65-millihenry;
 - One Lynch 50-000-ohm, 2-watt resistor, and one Lynch 2-meg. grid leak;
 - Two Aerovox 4-mf. electrolytic condensers, with mounting rings;
 - Five Aerovox fixed condensers: two .0002-mf. nidgets; two .0005; one .002;
 - One Vazley 6-point change-over switch, and one on-off switch; two Eby binding posts; two knobs; six wafer-type sockets;
 - One panel of 3/16-inch mahogany; one sub-panel of 1/8-inch bakelite, and a cabinet, without humidor.
- Hardware, screws, nuts, etc.

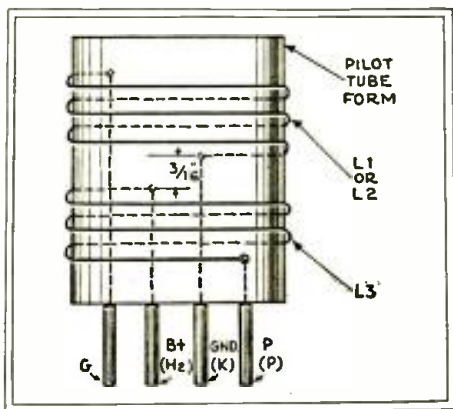

Fig. 5

Connections of the coils (four sets of two)

The coils are wound on Pilot plug-in forms, as shown in Fig. 5; L1 on one set, L2-L3 on another, all with No. 24 D. S. C. wire. L2 is spaced 3/16-inch away from L3 on the form. The number of turns is as follows:

Meters	L1	L2	L3
14-26	3	3	3
25-52	7	6¾	6
50-106	18	16	9
100-197	46	40	18

With the "40" Sonora (a diagram of which was given in the September issue of RADIO-CRAFT, page 172), a Presto pickup with a 4½-oz. weight was used; and, since the motor of this receiver combination creates noise which the converter would pick up, a turntable operated by a powerful spring was used to make the records spoken of above. The recording needle, as a test of position, should swing over and center exactly on the spindle.

This receiver has been rewired to use standard instead of special tubes; it now has two '45s in the output stage, while two 30-henry filter chokes (resistance 150 ohms each) replace the primary of the original output transformer. The output was coupled, through two 2-mf. condensers, into a 4,000-ohm magnetic pickup. Pregrooved records were used.

For playback, the same pickup was used, connected into the cathode return of the set's detector, in place of the biasing resistor.

The Amplifier and the Talkies

(Continued from page 209)

public-address system are as follows: automatic record changer, playing 20 records, with automatic repeat; auditorium-type dynamic reproducer. The type C-250 power amplifier uses one '21, one '50, and one '81 tube (undistorted power output, 4.9 watts; current consumption, 85 watts); carrying cases, plywood, leatherette-covered.

Advertising Talkies

The police of many cities have been bothered with the traffic problem that arises when good fellows get together—to gaze with rapt attention at an advertising motion picture; this problem should become worthy of special consideration when the new *advertising talkie*, of which the "Auto-Cinema" illustrated in Fig. 1 is an example, makes its appearance on Main Street. The Auto-Cinema is a product of the combined efforts of the Auto-Cinema Corporation and RCA Photophone, Inc.

A feature of this innovation in the advertising world is the device for obtaining continuous rewind of the endless film, which contains both picture and sound. A standard photoelectric cell is used for the sound pickup.

A floor space two feet square is sufficient for this advertising talkie. The pictures appear on a transparent screen measuring 18 x 22 in. The complete cabinet, which

weighs less than 100 lbs., is 5½ ft. high; within it are included the projector, amplifier, motor, and 6-in. reproducer. Money-making uses for the instrument were clearly stated by Mr. Sydney E. Abel, general sales manager of RCA Photophone, Inc., as follows: "For the motion-picture theatre it (the Auto-Cinema) should be particularly essential. Placed in the lobby of the theatre, the new projector would maintain a continuous performance in the sound reproduction of advance trailers, or selected sequences from current attractions. It is our opinion, however, that advertisers of standard products of every description will find the projector a great medium. Conveniently placed in hotel lobbies, railroad stations, auditoriums, department stores for style exhibitions or, in fact, in any place where crowds congregate, it would be bound to attract interest and attention."

Once again we pay our respects to Dr. DeForest, originator of the vacuum-tube audio amplifier (recollection of the thrill that was felt when the technical journals announced his success in obtaining "cascade amplification" still is vivid); even though, in 1922 he remarked, concerning his "Phono-film," or sound-on-film, "—it probably never would come out of the luxury class, since the special machine required will cost at least \$1,500 and film records from \$20

Learn Chemistry

Dr. Sloane Will Teach You in Your Own Home



Chemistry offers those who are ambitious and willing to apply themselves conscientiously, the greatest opportunities of any vocation today. Industrial firms of all kinds pay tempting salaries to get the right men. Opportunities abound on every hand.

Now Is the Time to Study Chemistry

Never before has the world seen such splendid opportunities for chemists as exist today. In factories, mills, laboratories, radio and electrical shops, industrial plants of all kinds, chemistry plays a vital part in the continuation and expansion of the business. No profession offers such opportunities and the next ten years are going to show the greatest development in this science that this country has even seen.

You Can Learn at Home

Our home study course, written by Dr. Sloane himself, is practical, logical and remarkably simple. It is illustrated by so many experiments that are performed right from the start that anyone, no matter how little education he may have, can thoroughly understand every lesson. Dr. Sloane will, in addition, give you any individual help you may need in your studies.

Easy Monthly Payments

You do not have to have even the whole price of the course to start. You can pay in small monthly amounts, earning the cost as you go along. The tuition is very low, and includes your laboratory outfit—there are no extras to buy with our course.

Experimental Equipment Given to Every Student

We give to every student without additional charge his chemical equipment, including fifty pieces of laboratory apparatus and supplies and forty-two different chemicals and re-agents.

Tuition Price Reduced

Besides furnishing the student with his Experimental Equipment, we have been able, through the big increase in our student body, to reduce the cost of the course. Write today for full information and free book, "Opportunities for Chemists."

Mail the Coupon NOW!

CHEMICAL INSTITUTE OF NEW YORK, Inc.

HOME EXTENSION DIVISION
19 Park Place New York, N. Y.

CHEMICAL INSTITUTE OF NEW YORK.
Home Extension Division
19 Park Place, New York, N. Y.

Please send me at once, without any obligation on my part, your free book "Opportunities for Chemists," and full particulars about the Experimental Equipment given to every student. Also please tell me about your plan of payment.

NAME

ADDRESS

CITYSTATE.....

HC-1031



THE NEW HOTEL LINCOLN
 EIGHTH AV.-44th 45th STS.
 Just a Step from B'way
 NEW YORK CITY

The New and Beautiful
HOTEL LINCOLN
 You are assured of MAXIMUM COMFORT and MAXIMUM SERVICE

1400 Rooms, each with tub and shower-Servidor

SINGLE:
 \$3.00, \$3.50, \$4.00, \$5.00

DOUBLE:
 \$4.00, \$5.00, \$6.00, \$7.00

RADIO—DeForest Direct—now being installed in every guest room

ROY MOULTON
 MANAGER

"AN ADDRESS OF DISTINCTION"



Special Advantages for "Big Game" Visitors

Fans visiting Chicago for the big football games will find THE DRAKE location unusually convenient. All playing fields are easily reached. After the game... there's gaiety... or quiet... as you prefer. A smart Supper Dance... the rhythmic tunes of a famed Orchestra. No rate advance. Write for Football schedule.

THE DRAKE HOTEL, CHICAGO
 Under Blackstone Management

to \$25 each." (Georgette Carneal, in *Conqueror of Space*.) While these figures still are effective for 32-mm. or standard theatre-film projection, they do not hold true for 16-mm. machinery. The entire advertising talkie mentioned above costs less than \$1,500; and sound-on-film home-talkies costing considerably less, are raising their heads on the horizon.

With these words the writer closes his discussion of the new roles for the once conventional power audio amplifier; hoping to have interested some of the readers of *RADIO-CRAFT* (including, perhaps, a few educators) in these practical applications of the principles of radio, insofar as they involve audio circuits; and trusting that the imagination and foresight of radio technicians who are in position to take advantage of the opportunities afforded will find these data profitable.

(Letters addressed to concerns mentioned in this article will be forwarded, if contained in a separate, stamped envelope.)

The Radio Craftsman

(Continued from page 229)

amply achieved, so far as I am concerned, in that you have considered the Service Man as the vital factor of radio today.

There are now many manufacturers who, through various means, have become wealthy, and fail to consider that it has been only through our body of Service Men that they have been able to achieve anything. With their present riches, they fail to consider the Service Man enough.

I've only a small offering this time, though I promise you a greater crop of service dope in the near future. I find Mr. Hubert's article on modernizing old battery sets (in the October 1930 issue of *RADIO-CRAFT*) is quite all right, except that he does not stress the problem of ridding the finished sets of hum. Of some twenty sets I converted in this manner, all had a considerable amount of hum which was impossible to get rid of until the cathode of the detector was disconnected from the ground and given a grid bias through a 2,000-ohm resistor with a 1-mf. bypass. This may help some of our great body of readers who have tried this conversion business and failed.

J. J. LA PLER,

357 New Street, Newark, N. J.

(This will be of interest to many constructors who are making over old battery sets for A.C. operation. They may also consult with profit "Location and Reduction of Hum" on page 528, March 1931 *RADIO-CRAFT*.—Editor.)



\$5,000 WILL BE PAID TO ANYONE WHO PROVES THAT THIS IS NOT THE ACTUAL PHOTO OF MYSELF showing my superb physique and how the Ross System has increased my own height to 6 ft. 3 3/4 inches. Hundreds of Testimonials. Clients up to 45 years old gain from 1 to 6 inches in a few weeks!!



First in 1907 First To-day

No Appliances—No Drugs—No Dieting. ROSS SYSTEM NEVER FAILS. Fee Ten Dollars Complete. Counseling Testimony and Particulars 5 cents stamps. "Allow time for return mails across the Atlantic." G. MALCOLM ROSS, Height Specialist, Scarborough, England. (P. O. Box 15).

Classified Advertisements

Advertisements in this section are inserted at the cost of ten cents per word for each insertion—name, initial and address each count as one word. Cash should accompany all classified advertisements unless placed by a recognized advertising agency. No less than ten words are accepted. Advertising for the November issue should be received not later than September 7th.

DETECTIVES

DETECTIVES Earn Big Money. Excellent opportunity. Experience unnecessary. Particulars Free. Write, George Wagner, 2190B Broadway, New York.

FORMULAS

MAKE AND SELL your own products. We will furnish you any formulas. Write for our literature. Chemical Institute, 19R Park Place, New York, N. Y.

MISCELLANEOUS

BENCH Legs—Angle Iron—shipped knockeddown and display—\$3.00 up. Kirk Hardware, Dept. 308, 128 East 23rd Street, New York City.

PERSONAL

IF You want to get acquainted quickly? Send for my big (free) list of introductions. Box 100-HA. Detroit, Michigan.

RADIO

SERVICE MEN, ATTENTION—Speakers re-wound, magnetized, repaired, \$2.00 to \$2.75. Complete Power Pack Service—Transformers re-wound, condenser blocks repaired, resistors duplicated. Guaranteed. Clark Brothers Radio Co., Albia, Iowa.

SERVICE MEN double your business and pile up the profits with our new plan for procuring business. For free particulars write, R. Roose, Louisville, Kentucky.



For Convenience and Comfort

come to the Bismarck . . . right in the heart of the Loop . . . next to the wholesale, financial and theatre district. Large, light, outside rooms with super-comfort beds . . . soft water for your bath . . . room signals indicating the arrival of your mail . . . national reputation for Good Food . . . four distinctive dining rooms . . . courteous hospitality urging you to "come again."

Rooms, \$2.50 up—With Bath, \$3.50 up

NEW BISMARCK HOTEL CHICAGO

RANDOLPH AT LASALLE

RADIO EXPERIMENTERS!

EVERYDAY SCIENCE AND MECHANICS magazine should be of especial interest to every radio man because in this magazine will be found a very fine department on radio construction radio kinks, radio experimenting, television experimenting, etc. This department is especially important to all radio service men.

Then too, this magazine contains a tremendous amount of other worthwhile experiments and money-making kinks, which, while not radio, are still of great importance to every radio man to keep abreast of the times. No radio man should be one-sided and know only radio. It is just as important to know mechanics and science from the everyday viewpoint because sooner or later you will find this knowledge important in your daily work.

A single copy of the magazine will convince you that it is the one general science and mechanics magazine you MUST have.

8 MONTHS \$1.00

For a brief period only this new magazine will be given to charter subscribers at a specially reduced subscription rate. The regular rate for One Year is \$2.50 (Newsstand \$3.00). **OUR SPECIAL PRICE TO YOU IS EIGHT MONTHS FOR ONE DOLLAR.** Clip coupon at left and mail today.

Special Offer Coupon!

EVERYDAY SCIENCE AND MECHANICS
98 Park Place, New York, N. Y. RC-10
I enclose herewith my remittance of \$_____ for which you are to enter my subscription for
() 8 months _____ \$1.00
() 1 year _____ \$1.50
Name _____
Address _____
City _____ State _____

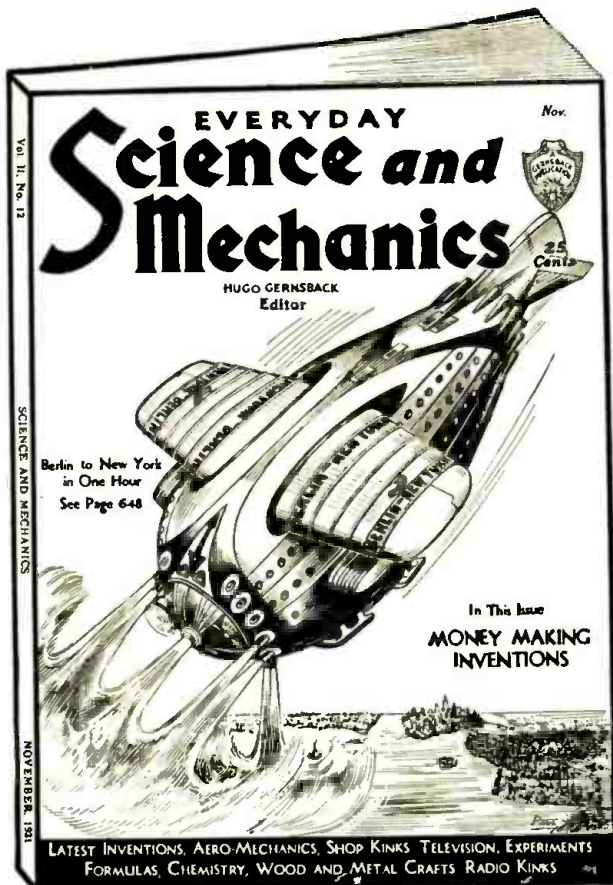

Vol. 11, No. 12

SCIENCE AND MECHANICS

NOVEMBER, 1931

EVERYDAY Science and Mechanics

HUGO GERNSBACK
Editor

Nov.



25
Cents

Berlin to New York
in One Hour
See Page 648

In This Issue
**MONEY MAKING
INVENTIONS**

LATEST INVENTIONS, AERO-MECHANICS, SHOP KINKS, TELEVISION, EXPERIMENTS
FORMULAS, CHEMISTRY, WOOD AND METAL CRAFTS, RADIO KINKS

A Most Important and Timely NEW Radio Publication Radio Set Analyzers and How to Use Them

with full instructions and descriptions of modern
set analyzers, tube checkers, oscillators, etc.

by L. VAN DER MEL
Famous Radio Instructor

HERE is the latest book, and one of the most important which we have ever issued. It fills a long-recognized need; for there is not a Service Man or a radiotrician who has not an immediate use for this welcome book.

It is the first book that explains COMPLETELY the operation of analyzers, tube checkers, oscillators, etc., from a thoroughly practical standpoint. The book is intended for Service Men of all classes, whether junior grade or expert. Everyone will find a tremendous amount of live "meat" in its pages. Nothing has been left to your own ingenuity; everything is complete.

The contents:

CHAPTER 1, Introduction—The Problems of the Service Man; General Methods of Analyzing Trouble; General Description of Modern Receivers; The Need for a Radio Set Analyzer; What to Expect from an Analyzer.
CHAPTER 2, The Analyzer—The Fundamental Requirements of an Analyzer; The Switches or Push Buttons; The Ammeter; Multiscale Ammeters; The Shunt and Its Calibration; The D.C. Voltmeter; The Multiscale D.C. Voltmeter; The Multiplier and Its Calibration; The O.C. Voltmeter; The Design of a Simple Analyzer.
CHAPTER 3, Trouble Shooting with the Analyzer—Classification of Trouble—(1) External to the receiver; (2) In the receiver proper: (a) Mechanical troubles; (b) Electrical troubles. Detailed Analysis of Electrical Troubles—(1) Tube testing; (2) Localizing trouble: (a) By past experience; (b) By actual test of circuit. (3) Interpretation of analyzer readings; (4) Tube charts (use of); (5) Circuit diagrams (use of); (6) Testing the power unit; (7) The use of the analyzer in testing individual units. Additional Features and Uses of the Analyzer—(1) As a modulated R.F. oscillator; (2) As a means of tuning up R.F. and I.F. amplifiers; (3) As an output meter. Care and Maintenance of Analyzers. Conclusion and Brief Summary.
Chapter 4—Detailed descriptions, photographs, and circuit diagrams of commercial set analyzers.

We have purposely published this book at a ridiculously low price, because it is our aim to put this valuable work in the hands of 100,000 Service Men before the end of this year.

50c The Copy
Postage Prepaid

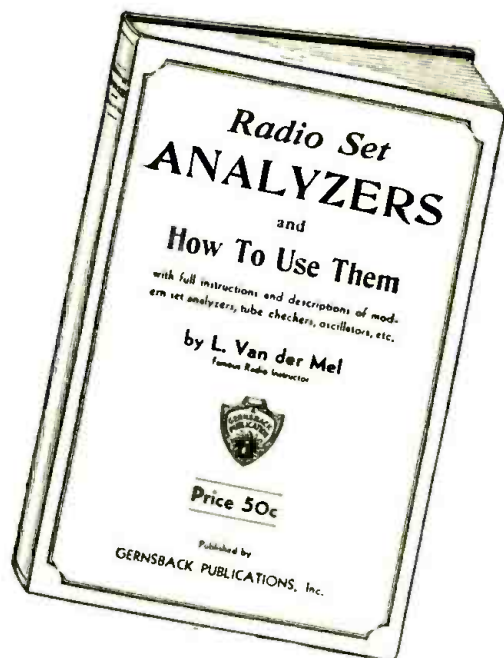

GERNSBACK PUBLICATIONS, Inc., RC-10
96-98 Park Place, New York, N. Y.

Gentlemen:—

I enclose herewith fifty (50c) cents, for which send me when issued a copy of your book "Radio Set Analyzers and How to Use Them."

Name _____

Address _____

City and State _____

Sonora

CLEAR AS A BELL

PEERLESS 12" AUDITORIUM DYNAMIC SPEAKER

The Peerless Dynamic Speaker is positively the last word in efficiency and powerful reproduction. As a suitable companion it is housed in a beautiful two-toned Sonora walnut cabinet of excellent workmanship. This speaker is properly fitted in a chamber 15" deep, 17 1/2" wide and 18" high. The front is baffled with 3/4" thick baffle board cut out to fit the cone of the speaker. No rattling, no distortion but just a perfect reproduction of sound. Built with double heavy duty A.C. rectifiers and the famous Elkon hum condenser added makes reception perfect. For that matter it is equally suited with ordinary sets, employing the average type of audio amplification systems, using as low as 90 volts "B" current!



Will work with any set, regardless of output characteristics. Overall dimensions: 40" high, 24" wide, 12" deep. For 110 volt, 50-60 cycle A.C. Shipping weight, 60 lbs.

List, \$155.00
OUR PRICE **\$19.50**

MERESHON FILTER CONDENSERS

Their small size makes them especially desirable for use in midget receivers where a minimum of space is available. Their self-

healing and surge-proof characteristics prevent damage to the condenser and other apparatus and increase the life of the condenser indefinitely.



	Volts	Anode	Price
S- 8	430	1	.75
S-18	430	1	1.15
S-20	35 (for A Elim.)	1	1.15
S-25	200	1	1.15
D- 8	430	2 (8-8)	1.50
T- 5	430	3 (5-5-5)	1.90
T- 8	430	3 (8-8-8)	2.25
T-36	430	3 (1-18, 2-9)	3.25

PENTODE ADAPTER

This Pentode Adapter permits the insertion of a type 247 Pentode Power Tube in place of the type 245 tube. Simply remove 245 tube, and insert the Adapter, and plug in the 247.

OUR NET PRICE

\$1.20



There are now available to the Service Man, experimenter, and custom set builder three models of power packs designed to supply "A," "B," and "C" potentials to radio receiver chassis of almost any type. Each pack is complete with voltage divider, filter condensers, filter choke, by-pass condensers, and taps for intermediate voltages (R.F., Detector, A.F., etc.). Two leads are provided for connection to a dynamic reproducer field; or the circuit may be completed through a filter choke supplied with each instrument, where the reproducer is a magnetic, or self-powered dynamic unit.

Pentode, screen-grid, variable-mu, and all the other tubes may be powered from one of these packs. The characteristics of each are as follows:

Type A. Filament supply for four type '26 tubes, one '27, two 71A's, and an '80. Plate Potential, 180 volts; and the "C" voltage requisite for type '71A tubes.

Type B. Filament supply for four type '24 or '27 tubes, two '45's and an '80. Plate potential, 180; and "C" for the '45's.

Type C. Filament supply for four type '24 or '27 tubes, two '47 pentodes, and an '80 rectifier. Plate potential, 250 volts; and "C" for the '47's.

Each of these units is provided with taps supplying the usual R.F., detector, and A.P. voltages. These A.B.C. Power Units are going like hot-cakes!

OUR PRICE FOR ANY TYPE

\$6.75

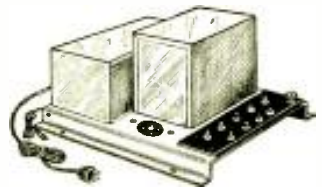

A-B-C POWER PACK

HARMONIC TELEVISION TUBES



These Television Tubes have been especially designed and manufactured to encourage television experiments among amateurs in this new field. HARMONIC Television Tubes are guaranteed to be perfect and they are priced extremely low.

1 1/2" Cathode Plate
1" Cathode Plate

OUR NET PRICE

\$3.90

MAGNAVOX DYNAMIC SPEAKER MODEL 130

130 Push Pull (2500 ohms).
130 Push Pull (5000 ohms).
130 Single 245 (2500 ohms).
130 Single 245 (5000 ohms).

Cone and required Baffle Hole Diameter 7 3/4 inches; Height - Base to Center of Cone 4 1/2 inches; Overall Height 9-1/32 inches; Overall Depth 4-1/16 inches; Overall Width 8-13/16 inches; Front to Center Line of Front Holes in Three Sided Upright Base 1 inch; Front to Center Line to Rear Holes in three Sided Upright Base 3 inches; Spacing of Holes Upright Base Side to Side 4-13/16 inches.

OUR NET PRICE

\$3.45



MAGNAVOX DYNAMIC SPEAKER MODEL 110

110 - Single Pentode (2500 ohms)
110 - Push Pull 245 (2500 ohms)
Cone and Required Baffle Hole Diameter 7 3/4"; Height, Base to Center of Cone, 4 1/2"; Height, Overall, 9 1/4"; Depth, Overall, 6 5/32"; Width, Overall, 8 3/4".

Our Net Price

\$3.45



PHOTOELECTRIC CELLS

These Photoelectric Cells are manufactured by one of the largest Eastern tube manufacturers. A large supply was purchased from them at a very low price and they are offered to you almost at cost. The tubes are perfect and guaranteed to give complete satisfaction in operating.



OUR

NET PRICE **\$3.90**

HARMONIC TUBES—Guaranteed 6 Months

Every tube is carefully meter-tested before being shipped. Free replacement on any tube within 6 months provided they still light.

222	1.58	171	.79
210	1.58	112A	.69
250	1.58	200A	.69
281	1.58	199UV	.69
235	1.50	199UX	.69
247	1.50	120	.69
230	1.08	224	.69
231	1.08	226	.63
232	1.08	227	.63
245	.79	171A	.63
280	.79	201A	.63

All offers are F.O.B. New York, and subject to prior sale. Terms: A deposit of 20% is required with every order. Balance may be paid on delivery. Or, deduct 2% if full amount is sent with order.

DO NOT WRITE FOR CATALOG!

GRENPARK CO., Dept. RC, 245 Greenwich Street, New York, N.Y.



Prices YOU can make a REAL profit on!



Famous Model "G" Gordon Phono-Motor and Turntable

First time at this price. Ruggedly constructed throughout. Spanish felt gears assure silence. Equipped with automatic stop control. Induction type, no brushes. Easy to install—exceptionally quick starting torque. For 110 volt 60 cycle alternating current. Proven dependability has made this New Gordon Electric Phonograph Motor and Turntable the accepted standard of excellence for the industry.

First time at this price. Make a nice profit and build good will with everyone.

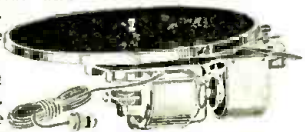

List \$30.00
OUR PRICE \$8.95

Farrand Dynamic Chassis

Famed for its simplicity and reliability. Easily installed in all types of radio or phonograph consoles. Tonal range and fidelity superior to any other reproducing unit in general use. Dimension: Height 9 inches, width 8 3/4 inches, depth 7 inches. For A.C. current.



OUR PRICE \$5.95

Condenser Block for Majestic "B" Eliminator



OUR PRICE \$2.75

Replacement for defective blocks in "B" Eliminators—identical in electrical characteristics and outside dimensions. Can also be used in any make "B" Eliminator as well as most power packs.

Gordon Acme 4 Pick-Up with Volume Control

Genuine Bakelite arm with beautiful natural wood finish will not show wear as will plated metal. Faithfully reproduces the entire musical range.



OUR PRICE \$4.50

I.C.A. Test Leads—a necessity to the dealer or serviceman. Unsurpassed for testing sets and tracing shorts, opens and other common defects. Easily attached to testing meter or electrical apparatus. **40c**

R. C. A. Radiola Magnetic Chassis



Will stand up to 600 volts without distortion. Contains output transformer. Used in 100B and 103 speakers. Outside diameter 9 in.; depth over all 4 1/2 in. Ideal for any radio installation. Complete with 5 ft. radio cord.

OUR PRICE \$2.95

R. C. A. Loudspeaker 103

A beautiful speaker, superb in its faithful reproduction. Molded frame and pedestal resemble hand carved oak. Mechanism concealed by attractive tapestry.



(Genuine R.C.A.)
List \$18.00
OUR PRICE \$3.95

Atwater-Kent Condenser & Filter Block

For Model 37 and 38 Sets

Ideal filtering system for ANY make A. C. set using 171-A tube. Contains proper chokes and high voltage condensers. Flexible wire colored leads same as original.



HOOK-UP
Green wire to 280, black to R.F. plate, yellow to Power Tube plate, white to first audio by-pass, white to C.T. of 226 resistance, red to detector plate. Wire from **OUR PRICE** can to ground. **\$2.95**

Kolster K-6 Speaker

Magnetic type cone speaker. Remarkable tone quality; volume to spare. Beautifully carved. Fine Walnut cabinet. Equipped with highly sensitive oversize magnet and driving unit. Faithful reproduction from the faintest whisper to fullest volume of a brass band.



List \$20.00
OUR PRICE \$3.95

AIR-KING

Superheterodyne S.W. Converter

The greatest converter ever built.

Brings in European stations clear as a bell. Converts any set into a short wave receiver. Employs 3-227 tubes; covers from 20 to 115 meters. Coil switch covers all wave lengths. Single dial control, no body capacity, no squeals. Has built-in filament transformer to heat the 3-227's. All you need from your receiver is a positive B. voltage from 45 to 180 volts. Voltage is not critical; no modulation of the receiver. Size 7x10x5 in. Weight 8 lbs.

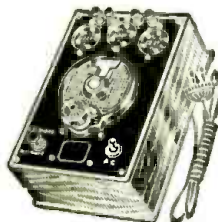

OUR PRICE \$14.70

New Type Elkon Dry Disc Rectifier

Standard on "A" Eliminators for Majestic, Mayolian, Webster, Elkon, Bernard, Fada, Knapp, Sentinel, Metro, General Instrument, Philco (Elkon equipped) and also on Elkon 3 amp., and Briggs & Stratton chargers.

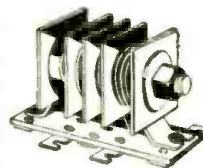

OUR PRICE \$3.45
List \$7.00

Baldwin Rival Unit



This Nathaniel Baldwin unit is one of the finest. For phonograph, automobile and portable radio outfits. We offer this famous unit now at a sensationally reduced price.

OUR PRICE 50c

VICTOR ABC Power Transformer

For use with 6-226, 2-245, 1-227 and 1-280 tubes. Magnetically shielded preventing hum. Can safely be overloaded 30%. High voltages, 400 volts at 150 mils on either side of center tap. Extra large case especially designed to prevent overheating.

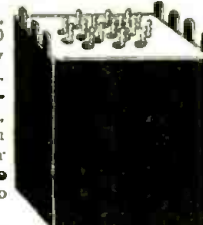

Can Be Used For Any Power Amplifier Using 245 Tubes

Size: 4 1/2 x 5 x 5 1/2 inches.
No. 1—Center tap of 9 and 14 (6 volts).
No. 2 and 4—2 1/2 Volts.
No. 5 and 7—1 in. V. High amp. (226).
No. 3 and 6—Primary (110V. input).
No. 8—Center tap of 12 and 17 (2 1/2 V.)
No. 9 and 14—5 Volts (280).
No. 16 and 15—High voltage for B supply.
No. 16—Center tap of above.
No. 12 and 17—2 1/2 in. volts high amp. (224).

OUR PRICE \$2.75

FREE Catalog—means money to you

These are only a few samples of the values to be found in our catalog. It is full of items on which you can make from 50% to 300% profit. And the best of them is, they are sound, well known, trademarked articles you can depend upon.

Send 20¢ with the order and articles will be shipped C.O.D. Order any of the above articles direct from this page. And be sure to ask for the catalog. It means money to you!

RADIO CIRCULAR CO.

225 Varick St. New York City

ORDER DIRECT...from this page!

TEAR IT OUT NOW!

RADIO CIRCULAR CO., 225 Varick Street, New York City

Enclosed find \$..... This is 20% of items listed below. I will pay balance upon receipt of merchandise.

Name.....

Address.....

Also please send catalog.

Send for FREE catalog!

RADIO CIRCULAR CO.
225 Varick Street, New York City

Please send me your catalog of radio bargains I can make a profit on.
I understand this obligates me in no way.

Name.....

Address.....

City.....

State.....

STOP SHOPPING!!

HERE'S A NEW plan, which saves you money. Stop shopping—the lowest prices are right on this page. Yes, lower than in our own catalog. Why? Because no house can get out a new catalog every month, but by advertising in this magazine we can bring

you the latest and lowest prices up to the time this ad is printed. We watch our competitors and do not allow anyone to undersell us. We meet ANY price on NEW merchandise. Order direct from this page and save money. 100% satisfaction on every transaction.

Patent "250" Power Auditorium Amplifier



One of the Most Powerful Super Power Amplifiers ever made.

Now \$8.75

CONTAINS 2 STAGES SUPER POWER A.F. AMPLIFICATION

This famous amplifier is provided with input and output transformers for working from a phonograph pick-up into a 2000 ohm transmission line or into the coupling transformer furnished with most dynamic reproducers. The tubes required are one '26, one '50 and one '81 rectifier. Where maximum output is not required a '10 may be substituted for the '50 in the output. Automatic adjustment takes care of the discrepancy in voltages. The undistorted power output is 2.5 watts—enough for four small dynamic reproducers. This degree of power output provides satisfactory average for auditoriums having a volume of 25,000 cubic feet. The input voltage necessary to provide maximum output is but .025 volts.

Ideal for theatres seating approximately 3,000 people, dance halls, schools, lectures, hospitals, auditoriums, outdoor gatherings, etc., etc. The gigantic power is at all times within control—for that matter, it can be used in any home, as the volume can be regulated down to a whisper. A PHONOGRAPH AMPLIFIER—PUBLIC ADDRESS AMPLIFIER SYSTEM, ETC. Use of the '26 tube in the input stage makes the long "warming up" period unnecessary. Shipping weight, 30 lbs. Overall size, 16 x 9 1/2 x 6 3/4" high. List Price, \$90.00.

No. 1925—Patent Model 250 Power Amplifier (less tubes). YOUR PRICE \$8.75

BRAND NEW! RADIO MIRROR PENLITE



The Latest and Cleverest Tool for Radio Servicemen. The only device that enables you to LOOK AROUND THE CORNERS or UNDERNEATH the most inaccessible spots. Your vision is ONLY in a straight line, but with the Mirror-Penlite you can look around a 45 degree angle. You can now look under the whole chassis and see every nut, every wire, every socket, behind condensers, transformers, etc. This is made possible by the powerful pocket flashlight to which is attached a GENUINE DENTAL MAGNIFYING MIRROR. Mirror clips on or off so flashlight can be used alone if desired. The cleverest device yet. Complete with battery and bulb. Shipping weight 6 ozs.

No. 1695—Mirror-Penlite. List Price \$2.50. YOUR PRICE 85c

Earl Power Transformers

Make easy rewinding of the old battery set. This power transformer used in Earl Model 22 receiver supplies "A," "B," and "C" potentials for two '27's or screen-grid '21's, three '26's, two '71A's and one '80 rectifier; total current output of high-voltage winding at maximum output (about 200 volts) is 80 ma. High-voltage secondary. Filament winding for '27's and for '71A's are center-tapped. Size, 3 3/4 x 3 x 2 3/4 inches. 16 long leads and full wiring directions. Shipping weight 5 lbs. List Price, \$7.50.

No. 1410—Earl Transformer (with-out brackets). YOUR PRICE \$1.73

No. 1411—Earl Transformer, the same but with mounting brackets. \$1.98

SPECIAL!

Baldwin RIVAL Speaker Unit
A loud speaker unit bearing the world famous Baldwin mark. Designed for use with horn type speakers or with old style phonographs. Complete with cord. Shipping weight 1 lb. POSITIVELY LOWEST PRICE THIS UNIT HAS EVER BEEN SOLD.
No. 1520—Baldwin "Rival" Unit. YOUR PRICE 45c



NEW READRITE Analyzer

This three-meter analyzer has selector switch for checking all parts of tube circuits by connecting to the set sockets. Selection for testing voltages of plate, grid, cathode and screen-grid done quickly and accurately. Plate current, filament volts, line and power supply volts are measured. Grid swing test for tubes used. Just push one button for screen-grid and other button for other tubes. Makes testing of all type tubes simple and thorough. 4 1/2-volt grid battery is furnished. Battery is used for grid test and continuity testing of transformers, chokes, etc. Capacity and resistance charts furnished showing use of instruments for testing condensers, also measuring resistances up to 100,000 ohms. Eight scale readings of meters may be used separately with the jack terminals provided. Scale readings are 0-60-300-600 D.C. volts, 0-10-140 measured on the one meter. Strong raso with leatherette covering. Attractive. Compact. Size 10 1/2 x 3 1/2 x 8 inches. Shipping weight 15 lbs. List Price \$25.00.

700 A.C. volts and 0-20-120 milliamperes. A.C. and D.C. filament voltages are accurately measured on the one meter. Shipping weight 15 lbs. List Price \$25.00. No. 700—READRITE ANALYZER. YOUR PRICE \$14.70

New 36 page Summer Edition No. 23



The new Summer Edition of our greatly enlarged RADIO SERVICE TREATISE has just come off the press. If you liked the Winter Issue, you will like this one a hundred-fold. It contains some 75 new hook-ups, circuit diagrams; and some 350 illustrations. POSITIVELY THE GREATEST BOOK EVER PUT OUT BY ANYONE. Among the new matters listed are:

VACUUM TUBE TREATISE, with many illustrations; full page Vacuum Tube Average Characteristics Chart; How to Take Care of Your Tubes; How to Connect Phonograph Pick-ups; Improving the Tone Quality of Old Sets; Connecting Additional Loud Speakers; all fully illustrated with diagrams.

Other articles: Modernizing Old Radio Sets; How to Convert Battery to Power Sets; Selection of Tubes; Push-Pull Amplifiers; Replacing Audio Transformers; Photo Attachments; How to Choose Power Transformers; Voltage Dividers; Wattage of Power Transformers; Selecting and Installing Replacement Parts in Radio Sets; Filter Condensers; Re-wiring Eliminator.

WRITE TODAY. Enclose 2 cents for postage. Treatise sent by return mail.

75 New Hook-Ups, etc. 350 Illustrations.

NEW! NEW!!

Superheterodyne S-W Converter



At last a short-wave converter that converts any broadcast set into a superheterodyne short-wave receiver. Employs three 227 tubes and covers from 20 to 115 meters. No plug-in coils! Coil switch is used to cover all wavelengths. Single dial control, no body capacity, no squeals. This converter has built-in filament transformer to heat the three 227's.

All you need to obtain from your receiver is a positive B voltage anywhere from 45 to 130 volts. Voltage is not critical; no modulation of the receiver. So simple a child can operate it. Size 7 x 10 x 5 inches. Shipping weight, 8 lbs. List Price \$25.00.

No. 1614—Super Converter (less tubes). YOUR PRICE \$14.69

World-Wide Short-Wave Set NOT A CONVERTER

A perfect radio short-wave receiver for use between 17 and 84 meters. To put in operation, connect antenna, ground, 45-volt "B," and 6-volt "A" batteries, and headphones to the posts provided, plug in a type '01A tube, and tune in! An ingenious circuit makes possible a 4-coil single-winding plug-in design. This little instrument has the same sensitivity as many big, shielded short-wave receivers costing ten times as much. A power amplifier may be added for any degree of volume. Complete with 4 plug-in coils. Has fine vernier dial for precision tuning. Never has a first class short-wave set sold for so little money. This short-wave set measures 5 1/2 x 7 1/2 in. high, over all. Ship. weight, 3 lbs. List price, \$12.50.

No. 1686—World-Wide S.W. Set. \$6.25 Your price.....

6 MONTHS GUARANTEED NEONTRON TUBES

Sold on a 6 MONTHS FREE REPLACEMENT GUARANTEE BASIS, PROVIDING TUBE LIGHTS! All tubes are carefully meter-tested before shipment, and carefully packed. Do not confuse these HIGH QUALITY tubes with any other "low priced" tubes—our low prices are possible because we do a VOLUME business!

NEW					
Choice	Choice	Choice	Choice	Choice	Choice
226	112A	215	222	230	235
227	200A-199X	280	210	231	247
171A	199V-120	171	250	221	
201A	221		281	222	
63c ea.	69c ea.	79c ea.	1.58 ea.	1.08 ea.	1.50 ea.

R.C.A. LICENSED TRIAD AND PERRYMAN TUBES

These nationally advertised tubes are guaranteed UNCONDITIONALLY for six months. The prices are slightly higher than our NEONTRONS because these tubes are of much better quality. See listing above for tube numbers.

Choice	Choice	Choice	Choice	Choice	Choice
Price	Price	Price	Price	Price	Price
76c	96c	86c	\$1.76	\$1.46	\$2.09

THORDARSON

"245" Power Transformer

A Miniature Power Plant — Supplies All ABC Voltages — 80 Watts



In addition to supplying a full 250 volts to the plates and 50 volts to the grids of two type '45 tubes in push-pull, this transformer may be used to light the filaments of seven or eight 2.5-volt filament tubes; and by connecting in series two of the three 2.5-volt filament secondaries it is possible to light 5-volt filaments too. Five secondaries: S1—5 V., 2 Amp.; S2—340 V., Cent. T.; S3—2 1/2 V., 3 Amp., Cent. T.; S4—2 1/2 V., 10 1/2 Amp.; S5—2 1/2 V., 3 Amp., Cent. T. Just the power transformer for building up a high-grade public address amplifier to use a screen-grid A.F. amplifier to boost the output of a microphone or phonograph pick-up; follow this with two stages of push-pull amplification consisting of two '27's in the first stage and two '45's in the second. Bottom of transformer has bakelite panel on which are mounted all taps. It outperforms ANY similar transformer. Many Service Men keep this model transformer on hand for emergency replacements in hundreds of makes of radio sets. For 110-120 volts, 50-60 cycles. Size: 5 in. high x 4 x 3 1/2 in. Shipping weight, 8 lbs. List Price, \$15.00.

No. 1450—Thordarson Power Transformer. YOUR PRICE \$3.84

Flewelling-Dayton SW Adapter

This wonderful instrument connects to any A.C. radio set by putting into tube socket in place of the tube (which must be a type '27, or "heater" tube) the plug which is on the end of its 2-ft. cable; then put tube into tube-socket of adapter. Its wave aerial from broadcast set connect to antenna post on adapter. Special plug-in coil No. 1 covers a wavelength band of 17 to 29 meters; coil No. 2, 27-28 meters; coil No. 3, 17-84 meters. Plug-in coil induces comes with the adapter. 5 1/2 x 7 1/2 x 4 1/2" high, overall. Ship. weight 4 lbs.

No. 1613—Dayton Flewelling Short-Wave Adapter. List Price, \$15.00. YOUR PRICE (without tube).... \$4.93

Short-Wave Converter

Build a short wave converter at lowest price on record, but with which excellent results are obtainable nevertheless. The voltage for the three 227 tubes used may be obtained from an external filament transformer or from a secondary winding of 2 1/2 volts in a power pack. Wavelength from 30 to 110 meters. No plug-in coils; coil switching is used to cover wave-band. Single dial tuning is no grunting, no body capacity, no squeals. Leak-condenser modulation. Converter consisting of all parts (less filament transformer) including cabinet, panel, diagram and 4-base instruction sheet (less tubes). No. 1619—YOUR PRICE \$4.85 No. 1615—6-Volt Battery Model, same price.

High-Voltage Condenser Units

We guarantee these condensers unconditionally. They are ideal for general replacement purposes and can be installed in any new power-pack. All condensers are furnished with 8-inch lengths of tinned "push-back" wire.

600 VOLTS			800 VOLTS		
Cat. No.	Mid. Capac.	Your Price	Cat. No.	Mid. Capac.	Your Price
1702	1/2	\$0.25	1706	1	\$0.40
1703	1	.30	1707	2	.70
1704	2	.49	1708	4	1.05
1705	4	.60			

WE ARE A WHOLESALE HOUSE AND CANNOT ACCEPT ORDERS FOR LESS THAN \$3.00.

If C. O. D. shipment is desired, please remit 20% remittance, which must accompany all orders.

If full cash accompanies order, deduct 2% discount. Send money order—certified check—U. S. stamps.

Radio Trading Co.
23 West Broadway
New York, N. Y.

ORDER FROM THIS PAGE. You will find special prices from time to time in this magazine. Get our big FREE catalog for the greatest Radio Bargains.

Should you wish goods shipped by parcel post, be sure to include sufficient extra remittance for same. Any excess will be refunded.

Servicing Stromberg-Carlson Receivers

By C. F. REXER

IN the older Stromberg-Carlson battery receivers (which include Models "501," "502," "601" and "602") very little trouble has been experienced with the chassis itself; although some trouble has been found in

should be removed. (Incidentally, remove your wrist watch when making these adjustments, as the strong magnetic field around the choke will magnetize it.) There is no danger of being shocked while making these adjustments to the copper band.

Dropping of the voltmeter hand in these models to zero, or one or two volts is an indication of one or both Tungar bulbs being burnt out or bad.

In the "635-636-638" Stromberg-Carlson A.C. models, the '27 tubes should be carefully matched; *i.e.*, for hum, particularly in the detector and first audio stages. Noisy tubes have been found to show up very plainly in these models, as do those which are microphonic. Socket springs should be kept clean by sliding the tube up and down in its socket.

These receivers employ a dual volume control; the first unit being a 10,000-ohm potentiometer controlling the amount of signal admitted to the radio-frequency amplifiers; and the second also a 10,000-ohm potentiometer, which regulates the amount of signal passed to the detector system. These two operate from the same control knob and when noisy may be cleaned by disassembling, and cleaning the contacts, roller, and resistance strip. Extreme care should

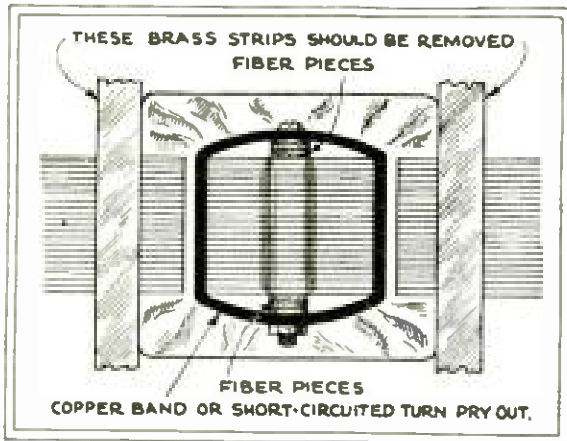

Fig. 1

In models lighting '01.1 tubes from an eliminator, it may be necessary to operate on the "Siamese" filter choke.

the various makes of equipment used, such as "A" and "B" eliminators. Very little trouble should be found with tubes in these models, since they are equipped with filament voltmeters which enables the customer to keep the tubes at the correct rating of 5 volts. Dirt on the volume and filament rheostats may cause a scratching sound when they are moved, and also may be a cause of voltage fluctuation in the filament circuit. This can be quickly repaired by cleaning with a piece of sandpaper, and wiping the wire clean. Microphonic tubes may be encountered; moving these about in different sockets will clear this trouble.

In the later Models "633" and "634," which are equipped with A.C. power units to furnish direct current to the 201-A tubes, some trouble may be experienced with A.C. "hum" or ripple. These models use a Stromberg-Carlson cone speaker, and have a very low hum level when correctly adjusted. The power unit known as the "103-A" has a rheostat for hum control, located just above the loud-speaker jack in the front of the unit. All hum adjustments should be made with the power unit in its normal position with respect to the receiver. The antenna should be disconnected, or detuned, and the speaker brought close to the operator. The rheostat is then very carefully adjusted.

If adjusting the rheostat fails to lower the hum to a satisfactory degree, turn the receiver off, and with a 5/16 in. end wrench loosen the copper band's

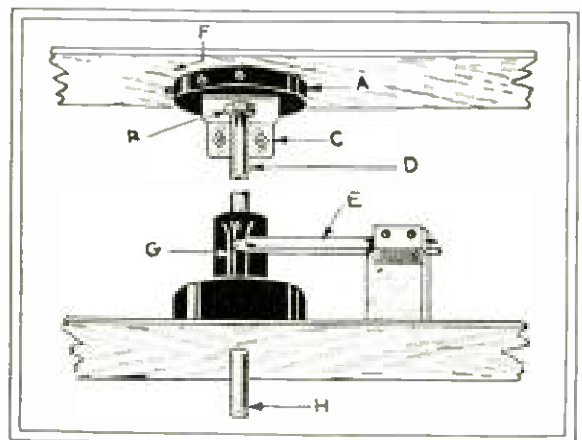

Fig. 2

A, rear volume control; B, hex. nut; C, mounting bracket; D, shaft; E, cam switch; G, cam. Turn casing F counter-clockwise, and control knob H clockwise.

be used in replacing them; in order that the two controls shall operate at the same time. This is done by loosening the nut holding the casing to its mounting bracket, and turning the volume control knob to its full

(Continued on page 246)

The New A. C.

A Superregenerative Receiver of Extraordinary Construction and Certain in its Operation With

By CLIFFORD

The previous method of tuning has been retained; but, for convenience in exchanging them, the plug-in coils are mounted externally. Once the plate voltages have been correctly regulated, and the screen-grid voltage control adjusted, tuning can be accomplished with the receiver in stable operation from

sult this or, if he prefers, use his own pet oscillator design. The Superregenerative is sure to work if the fundamental principle is followed and the oscillator V2 feeds enough energy to V1; at 90 volts on the plate, the '27 type oscillator will deliver ample power.

TABLE I

R. F. Input Signal		Suppressor Frequency	C3	
Meters	Kc.	Cycles (Meters)	Cap. Mf.*	
10	30,000	30,000	10,000	None
15	20,000	20,000	15,000	.001
20	15,000	15,000	20,000	.0025
24	12,500	12,500	24,000	.004
30	10,000	10,000	30,000	.006
37½	8,000	8,000	37,500	.01
50	6,000	6,000	50,000	.02
60	5,000	5,000	60,000	.03
75	4,000	4,000	75,000	.05
100	3,000	3,000	100,000	.08
120	2,500	2,500	120,000	.10
150	2,000	2,000	150,000	.2
200	1,500	1,500	200,000	.3

High Audio Output

The audio end has been redesigned, to give larger output on weak signals. An output pentode was retained for the final stage, but with the added power of a '47; while a first A. F. stage tube V3 was added. The latter is of the '24 screen-grid type, with resistance-capacity coupling into the power stage. A consideration of the effective circuit (Fig. 2) will show that an A. F. signal of only .029-volt will develop the full 2.5-watt output of the pentode; that is, the total effective voltage gain of the audio amplifier is approximately 8,500.

Another reason, however, for such high audio amplification was the desire to have available ample energy to permit experimenting with automatic volume control in the audio end of the receiver. This phase of the work was suggested by the numerous letters on automatic volume control which the author has received. More work will be necessary on this interesting refinement but, as soon as the data are compiled and experiments tried, the results will be published in RADIO-CRAFT. Several ingenious and novel methods have presented themselves; but no suggestions will be passed out until they have been tested.

Although such a first A. F. stage may be included in the battery model, the type '32 tube has been found to have microphonic tendencies when so used.

The increased output brought the speaker volume to such a point that it was uncomfortable to listen to American stations, especially, even in a large room. On extremely weak signals, however, the receiver was tremendously pepped up; while the reproduction obtained with the transformer-coupled input and interstage resistance coupling is of very high quality.

* Approximating computed value.

one end of the band to the other. This cannot be said of the ordinary short-wave receiver.

Modifications of the circuit may be employed; such as placing the oscillator's pick-up coil in the cathode lead, instead of the screen-grid lead, of V1; still controlling the oscillation by varying R1 (see Fig. 1A).

Various methods for the construction of the local-oscillator circuit were shown in the preceding article. The constructor may con-

Supplying Operating Voltages

is shown in Fig. 1 without

(external); con-

Stromberg-Carlson

(Continued from page 221)

clockwise position. Hold the knob in this position, and rotate the rear resistor casing to its *counter-clockwise* position. Without allowing the volume-control knob to turn, tighten the nut holding the rear casing to its bracket. (Fig. 2).

This model is provided with an extra binding post marked "X" on the rear of the chassis for connection to the ground in cases of line noise. Controls for hum reduction are located on the rear of the chassis and should be very carefully balanced.

In the newer models, "642," "652," and "654," the chassis is the same, using three '24 tubes, one '27, one '45 amplifier, and one '80 rectifier. The "Model 641" is somewhat different in the audio system, being wired for use with a magnetic speaker only. Care should be used in matching the '24 tubes, both for hum, and tone quality; the second stage of radio frequency being that in which a tube of normal characteristics should be used.

Noisy volume controls may be experienced which should be cleaned or, if badly worn, replaced.

If the dial seems to tighten after some months of use, so that it is very hard to turn, it should be taken apart. The chassis is removed from the cabinet, and the spring clip, and collar which clamps the dial, removed. The dial is then taken off by removing the three screws which hold it; this will give access to the shaft and mounting. Three screws are removed which hold the

has been used to eliminate inductive interference of this type. The entire lead-in was enclosed by a tightly-drawn copper braid, which was in turn covered with an insulating and weatherproof material, such as rubber, tar, or wax. *This braid is not grounded*, and is run directly from the horizontal portion of the antenna to the antenna binding post of the receiver proper. The installation of this braid has in three cases of very serious interference produced a very marked reduction in the amount of noise received. If the braid were grounded, the high capacity existing between the lead-in wire and the ground would be sufficient to by-pass the desired signals. For this reason, the braid should be covered with an insulating material and, in order to prevent grounding during wet weather, the insulating material should also be weatherproof.

From a theoretical standpoint the operation of this lead-in is similar to that of a simple vertical, single-wire antenna. The waves, both noise and from the desired station, induce a voltage in this low-resistance braid. This voltage causes in the braid a flow of current which is 90 degrees out of phase with the induced voltage, and generates a magnetic field which opposes the fields due to the station and noise; with a consequent reduction of the strength of the fields in the vicinity of the lead-in. The lead-in wire, being inside the braid, has no voltage induced in it. The entire signal is then picked up by the horizontal portion of the antenna, which has a very directional characteristic which can be used to advantage.

shaft and mounting to the chassis. This assembly is carefully taken apart, wiping out the mounting and shaft; after which a little vaseline is put on the shaft, allowing it to turn freely in the mounting. It is then carefully assembled, being careful not to scratch the dial when replacing the spring. (See Fig. 3). This same trouble may also appear in the "Model 846" receiver, but not in the later Stromberg-Carlson receivers.

The "846" receiver is very sensitive; and great care should be used in balancing the tubes in these sets, in order to obtain the proper tone and sensitivity. The second stage of radio frequency and the automatic-volume control tubes are very important. These sets use a "tuning meter," which is a milliammeter connected from the cathode biasing resistor for the second R.F. amplifier tube, and which reads the plate current for that tube. This same plate current is controlled by the control-grid bias; which is supplied by the automatic volume control, a '27 tube, which controls the bias of the control grids of the first and second R.F. tubes in accordance with the strength of the signal being received. It serves thus as an indicator to show exact tuning to the carrier wave, and enable one to use a "silent key" for tuning from one station to another. Care should be used in selecting the automatic-volume-control tube; as a tube with little or no emission will show little change in the needle pointer when tuning in a strong signal. Also, a tube with

GREATEST TUBE SALE OF 1931

The Largest Variety of Tubes in the World

All tubes are guaranteed to be first-grade quality—comparable to the best obtainable on the market today. We will replace within 30 days any tube that has not given complete satisfaction. Such an amazing tube sale has never been conducted.

COMPLETE STOCK ALWAYS READY FOR IMMEDIATE SHIPMENTS

Order from this page and note the following terms:
No order accepted for less than \$5.00.
It is not necessary to send the full amount of cash with the order as long as your order is accompanied by 20% of the value.
Shipment will go forward to you by express or parcel post C. O. D.
All prices are F. O. B. Factory, Newark.

UX-201A.....	.30	Special 171A-C 1-2 amp. extra control filament.....	.60
UX-226.....	.30	T-11 (201A High Mu) high emission.....	.60
UY-227.....	.30	Switch tube, 201A or 112 or 171 double life all in one.....	.60
UX-171A.....	.30	Adapter tube 226, 227, 171A, to convert bak. sets to AC, each.....	.60
UX-171.....	.30	UX-210—For power amplifier, high voltage.....	1.10
UX-210.....	.40	UX-250—Power amp. used in last stage of audio freq.....	1.10
UX-129.....	.40	Ballast tube.....	1.00
UX-159.....	.40	UX-222—Screen grid radio frequency amp.....	1.10
UX-199.....	.40	Tellon Television Tube 1" Cathode Square.....	3.85
UX-112 Standard base.....	.40	Tellon Television Tube, 1 1/2" Cathode Square.....	3.85
UX-112.....	.40	Photoelectric cell, "Caesium", 2-inch.....	4.95
UX-112A.....	.40	Photoelectric cell, "Potassium", 2-inch.....	3.85
UX-200A.....	.40		
UY-221.....	.40		
UX-215.....	.40		

RECTIFIER AND CHARGER BULBS

125 MH. rectifying tube (B. H. type).....	\$1.40
6/10 amp. trickle charger bulb.....	2.00
2 amp. old and new type charger bulbs (list \$4.00), our price (Tungar Type).....	2.00
5 and 6 amp. old type charger bulbs (list \$4.00), our price (Tungar Type).....	3.75
UX-281—Used as a full-wave rectifier for high emission.....	.40
UX-281—Half wave rectifier.....	1.10
Rectifying Tube especially designed for use with Freshman Master "B" Eliminator.....	.30
UX-866—Half-wave rectifier mercury vapor.....	5.00

Discounts: 100 tubes and over 10%
500 tubes and over 10% and 10%

ARCO TUBE COMPANY, 38-40 Park Place, Newark, N. J.



NEW TYPE TUBES

UY-236—Screen Grid Radio Frequency Amp. (D. C. Heater).....	.85
UY-237—Detector Amplifier (D. C. Heater).....	.85
UY-238—Power Amplifier Pentode (D. C. Heater).....	.85
UX-230—Dry cell amp. and detector.....	.60
UX-231—Dry cell amp.....	.60
UX-232—Dry cell screen grid amp.....	.60
UY-217—Power pentode.....	.85
UY-235—Super control screen grid amp.....	.85
UY-551—Variable Mu.....	.85
WD-11—Detector Amp.....	.60
WD-12—Detector Amp.....	.60

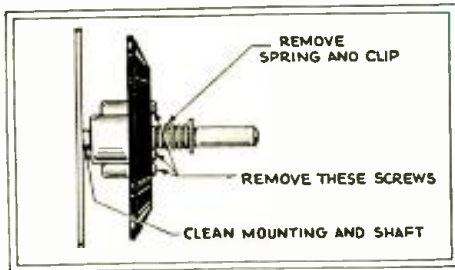

Fig. 3

Method of correcting undue tightness in the dial, in certain models where this may appear.

a very high emission will effect the sensitivity of the receiver. Care should also be shown in selecting the second stage '24 tube, in order to get the correct "swing" of the needle, and the best tone from these receivers. A.C. hum can be caused by a '45 tube weak or out, or by one side of the pilot light socket grounding to the frame, or chassis (Fig. 4).

The "Model 10" and "11" receivers are somewhat different from the other models; in that they employ a broad-band transformer, which couples the first and second R.F. circuits. A second "bi-resonator" cir-

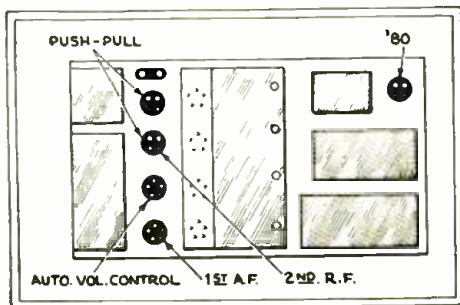

Fig. 4

Chassis layout of the "Model 846"

cuit couples the second and third stages, and a single-band transformer couples the third R.F. stage to the detector. This makes for sharper tuning, another feature being uniform quality and sharpness throughout the tuning range. This model uses a "range control" for local and distance reception. Provision is made in connection with this for long and short antennas, by a pin-and-jack arrangement on the rear of the chassis. Care should be used to get the correct setting for the antenna used. Tune in a weak signal on the high-frequency end of the dial; the position of the pin giving the loudest signal is correct, indicating resonance in the first tuned circuit. Provision for hum balance is provided on the rear of the chassis; the correct position is midway, but a milliammeter may be used in the '45 sockets to balance them together. The "Model 11" has a convertible cabinet in which a turntable and motor, together with a pickup, may be installed. Little trouble has been encountered here.

The "Model 12" and "1F" receivers are alike, except that the latter contains the automatic phonograph. These sets employ the same radio-frequency system as the "10"; except for the addition of a '27 tube in the automatic-volume-control circuit and the "tuning meter" before mentioned, as well as an additional '80 tube to supply the speaker's field winding. The automatic-volume-control tube and the second-stage '24 should be carefully selected for proper tone and sensitivity.

Now a word about antennas for these sets; the writer has found that the proper selection of the aerial and ground systems to use with these receivers, in the locality in which they are to be installed, means a lot. Take everything into consideration, and then build the antenna system. It may mean a little extra work, and thought but it will be worth it.

Radio Dealers! Radio Service Men!

NEW LOW PRICES
Guaranteed Replacement Condenser Blocks and Transformers

Atwater-Kent 37 Cond. Block with chokes.....	\$2.75
Atwater-Kent 37 Power Transformer.....	2.10
Atwater-Kent 40 Pack Complete.....	5.50
Zenith ZES, Stewart-Warner, Mohawk Blocks.....	3.15
Majestic "B" Eliminator Cond. Block.....	2.10
Crosley Electrolytic Condenser, 2 Anode.....	2.10
Crosley Electrolytic Condenser, 3 Anode.....	2.75

Hard-to-get parts—We have them
Send us your repair work for estimate
Write for our FREE CATALOGUE

Grant Radio Laboratories
6521 1/2 South Halsted St., Chicago, Ill.

ALUMINUM BOX SHIELDS

Genuine "ALCOA" stock, silverplated finish,
5 x 9 x 6, \$1.89—14 x 6 x 6, \$3.85, 10 x
6 x 7 Monitor size \$3.25, 5 x 5 x 5 Cell
Shield (like picture on right) \$1.00.



Any Size to Order.
Pentode adapters, \$1.25. Patent Pick-up leads, only \$2.25. Flexible shafts for Auto Sets.



"BUDDY" TEST PROD
Always sharp pointed, using phonograph needles, 3-ft. wires, shade or phone tips. Colored nipples identify each lead. \$1.50 pair.

We specialize in radio parts exclusively—parts furnished for any kit in any magazine. Please include Postage.

BLAN, THE RADIO MAN, Inc.
89 Cortlandt St. Dept. RC-1031 New York, N. Y.

PATENTS — TRADE MARKS

All cases submitted given personal attention by members of the firm. Information and booklet free.
Patent Office and Federal Court Practice
Lancaster, Allwine & Rommel
Patent Law Offices
475 OURAY BLDG., WASHINGTON, D. C.

LYNCH Resistors

Precision Wire Wound
1% Tolerance
Write for NEW illustrated catalog
LYNCH MFG. CO., Inc. Dept. RC, 1775 B'way, N. Y.

Using New "K" Filament
1/2, 1, 1 1/2, 2, and 3 Watts

BIG News for you

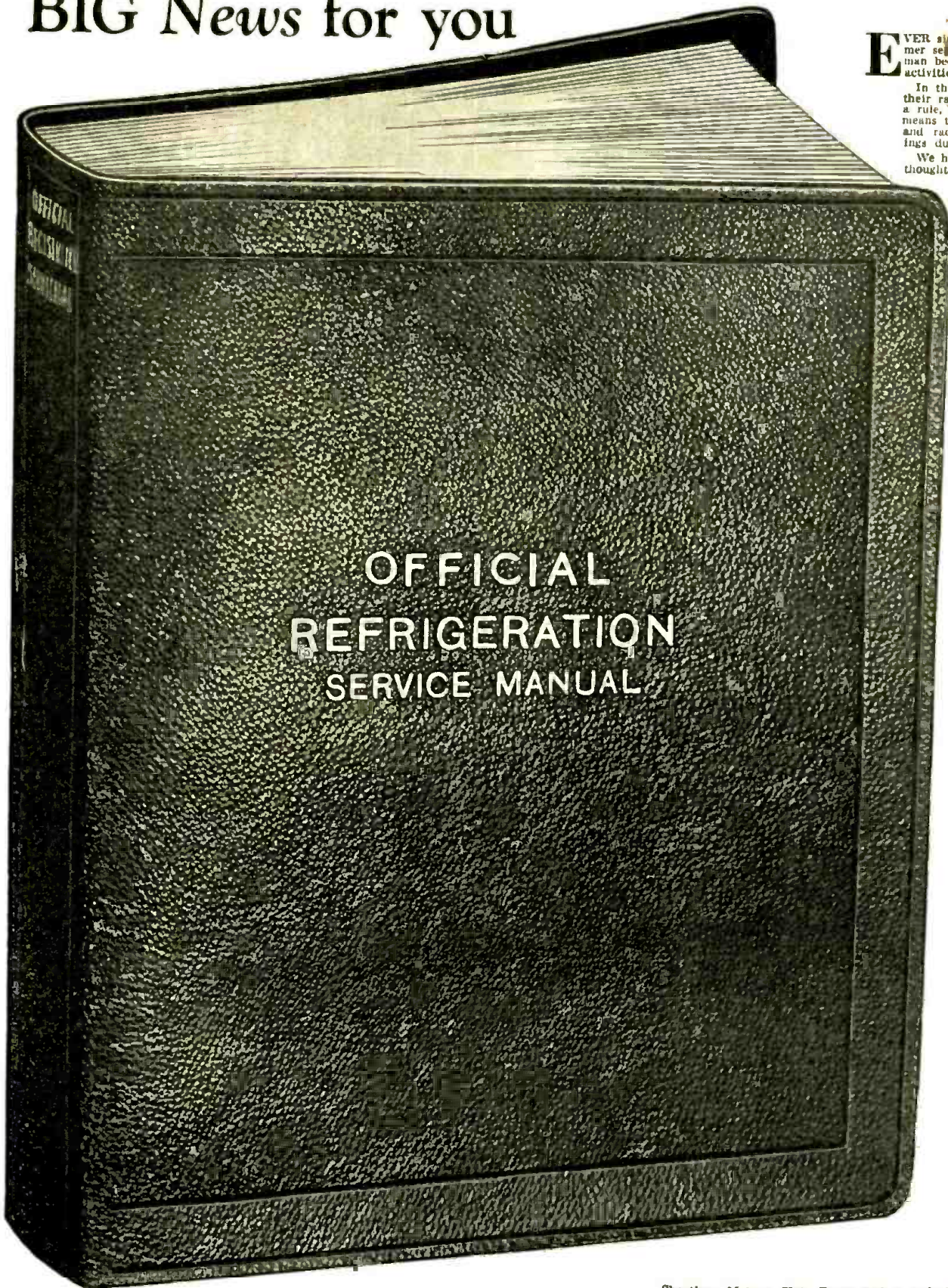

OFFICIAL REFRIGERATION SERVICE MANUAL

EVER since the advent of radio, the summer season has been a curse to the radio man because that is the time when radio activities are at their lowest.

In the summer time, people do not use their radio sets so much and there is, as a rule, little servicing to be done. This means that the average radio service man and radiotrician finds pretty slim pickings during the summer months.

We have given this problem considerable thought and for over a year worked quietly on the problem; and from now on every radio man, service man and radiotrician will have a steady income all the year around, incredible as this may seem.

The idea of radio people servicing refrigeration units is self-evident and the thought has occurred to perhaps untold thousands of radio men ever since electric refrigeration started. Yet nothing was done, because the average radio man knows little or nothing about refrigeration. Our survey of the field convinces us that, compared with servicing a radio set, the servicing of a refrigerator is absurdly simple, once you get the hang of it; and that is exactly why the OFFICIAL REFRIGERATION SERVICE MANUAL is going to be a side-partner to the OFFICIAL RADIO SERVICE MANUAL, with which you are well acquainted.

When you are called in to service a radio set, it is easy to find out if your customers own a refrigerator. If they do, you can now tell them that you can service the refrigerator as well. Place your card somewhere near the refrigerator so that, if trouble comes, you will be called in to fix it.

From whatever point you look at it, you will make money. And don't ever lose sight of the fact that refrigerators usually need servicing in the summer time and that it is here that you will get a new and extra income.

But don't take our word for all this. Study the situation yourself and see if we are not right. Look around in your locality and find out how many refrigerators there are. At the present time the servicing of these refrigerators goes to other trades when this business might just as well belong to you.

So we say to you, why not go into the refrigeration servicing business at once? Remember, there is big money in it and the refrigeration business is growing enormously every year; and it won't be very long before there will be more refrigerators than radios.

The OFFICIAL REFRIGERATION SERVICE MANUAL has been edited by L. K. Wright, who is an expert and a leading refrigeration authority. He is a member of the American Society of Mechanical Engineers, American Society of Refrigeration Engineers, The National Association of Practical Refrigeration Engineers, etc.

The new Manual, as you will see from the photographic reproduction, is the same size as our OFFICIAL RADIO SERVICE MANUAL. It will be 9 x 12 inches, and will contain 352 pages—loose-leaf, bound in leatherette, gold-stamped cover; in fact, it is a gold mine of information on the entire art of refrigeration.

Here are the chapter contents: Preface; Introduction; History of Refrigeration; Fundamentals of Refrigeration; Description of All Known Types of Refrigeration; Service Tools and Shop Equipment; Troubleshooting; Motors; Unit Parts, Valves and Automatic Equipment; Manufacturers, Makes and Specifications of Units; Manufacturers of Cabinets.

Every page is profusely illustrated; every refrigerator part is explained; diagrams are furnished of every known machine; special care is given to the servicing end, of course; all the tools needed are illustrated and their use explained; there are trouble shooting charts, and other service data.

This by no means exhausts the contents of the book, and it would take much more space to give you all of the details. Last year, when we brought out the OFFICIAL RADIO SERVICE MANUAL, we made a special pre-publication offer to our friends, which actually saved them thousands of dollars. We are now giving you the same chance again for a very short time.

GERNSBACK PUBLICATIONS, Inc. RC-10
96-98 Park Place, New York, N. Y.

I enclose herewith my remittance for \$5.00 (check or money order preferred) for which you are to send to me, postage prepaid, one copy of the OFFICIAL REFRIGERATION SERVICE MANUAL.

Name
Address
City
State

MAIL COUPON TODAY FOR YOUR COPY!

GERNSBACK PUBLICATIONS, Inc.

96-98 Park Place

New York, N. Y.



Will YOU Be One of the First to PROFIT From TELEVISION?

Television Will Give Employment to Thousands Who KNOW the Business!
This Complete Instruction Book on Television Tells You What You Should Know.

*Prepare For Your Future—
Learn About Television NOW!*

SEVERAL hundred thousand men were given employment in the many branches of the radio art. Those who were first to profit from radio were those who had the foresight to prepare for its coming. They were the men who, ten years ago, were given the same opportunity as is now offered you to get in on the ground floor of TELEVISION. You have heard much about television but not until a few weeks ago was it possible to bring talking motion pictures into the home by means of a vacuum tube. With this sensational discovery by Philo T. Farnsworth and with the acceptance of this system by PHILCO, one of the world's greatest radio manufacturers, it is evident that astounding progress in television will be made during the next few months. Farnsworth has perfected the needed device by means of which a 400 line picture, twelve by fourteen inches in size, will be brought directly into the home by radio. You will see and hear talking-motion-pictures by radio SOON. And when this equipment is ready for the market it is evident that there will be an over-night demand for thousands of trained television men who know how to sell, service, install, repair and design television equipment. The radio boom was of great and timely need, ten years ago, to give employment to men who had the vision to know that radio would be the principal means of modern entertainment for the home. But Television offers far wider possibilities than radio. Seeing the artists while they perform—looking at motion picture films brought into the home by radio—is of greater significance than mere radio speech and music. Pictures “talk a universal language.” Everybody knows what talking pictures did for the theatre. Now . . . these pictures, with synchronized voice, will be brought into the home by radio.

HISTORY WILL REPEAT ITSELF

Ten years ago those who had an early start in radio training were FIRST to find profitable employment. Today . . . 10 years later . . . those who STUDY television will be FIRST to share in its rewards. Television for the home will be ready for the market sooner than anybody has predicted.

Industrial leaders say it will lead the nation out of the business depression . . . just as radio did ten years ago when this country experienced a depression almost as marked as the depression of today. Television opens new fields of instruction. Entirely new fields of entertainment. Trained men will be needed everywhere. But only those who know the art of television will find employment. Wise is the man who heeds our advice . . . “STUDY TELEVISION.” We gave this same advice ten years ago. So we repeat . . . STUDY TELEVISION NOW . . . today . . . learn all there is to know about this revolutionary new art which will bring new opportunities to the man with vision. We have for sale a 340-page text-book, “PRINCIPLES OF TELEVISION”—written, in part by the inventor FARNSWORTH . . . chapters from his own pen . . . complete instructive information telling how his and all other systems of television operate. How to

master the art and how to prepare yourself for the greater opportunity which is coming SOON.

*Get This Complete
Text-Book!*

“PRINCIPLES OF TELEVISION”—our complete book of instruction, has more than 100 pictures and illustrations, showing how television works. It is a book worth its weight in gold. Tells you all you should know about scanning, optics, electrons, light waves, sound, projection, conversion of image into light and how it is done.

In short, this book is a course of instruction in Television. No other book in the world tells you how the Farnsworth system works. No other book tells you of the *accepted* type of equipment which will be used in the home. It has taken almost one full year to prepare this book. It will be ready for delivery within sixty days. In order to insure yourself against delay in getting one of the first copies when they come off the press, we urge you to send us your pre-publication order today.

\$3.75 If You Order NOW.

\$5.00 If You Wait. SAVE \$1.25.

Mail Coupon Before You Turn This Page.

GERNSBACK PUBLICATIONS, Inc.
96-98 Park Place, New York, N. Y.

Here is \$1.75 the pre-publication price for a copy of “PRINCIPLES OF TELEVISION,” which you are to send me immediately after it is off the press. This coupon saves me \$1.25. (Price on publication will be \$5.00.)

Name

Street and No.

City

State



*“and these Apartments are all wired for Radio — you’re sure of ideal radio reception through the **RCA Antenaplex System**”*

One perfect antenna on the roof, and radio outlets all through the building for the convenience of the tenants. Just plug in your set, and it’s ready to work. You get better reception this way than with separate antenna wires,—clean signals, minus the usual local interference from electrical devices throughout the house.

**Attention !
RADIO
SERVICE
MEN**

The RCA Antenaplex System solves the apartment house radio problem, delivering 100% of antenna signal energy to every outlet. The lead covered cabling may be run exposed, concealed, or in metal conduit.

An attractive proposition awaits Radio Service men and electrical contractors who want to promote sales and install this equipment in new or existing structures.

Write for information and illustrated instructions.

ENGINEERING PRODUCTS DIVISION

RCA Victor Company, Inc.

Camden, New Jersey

A Radio Corporation of America Subsidiary



Centralized Radio Systems

