



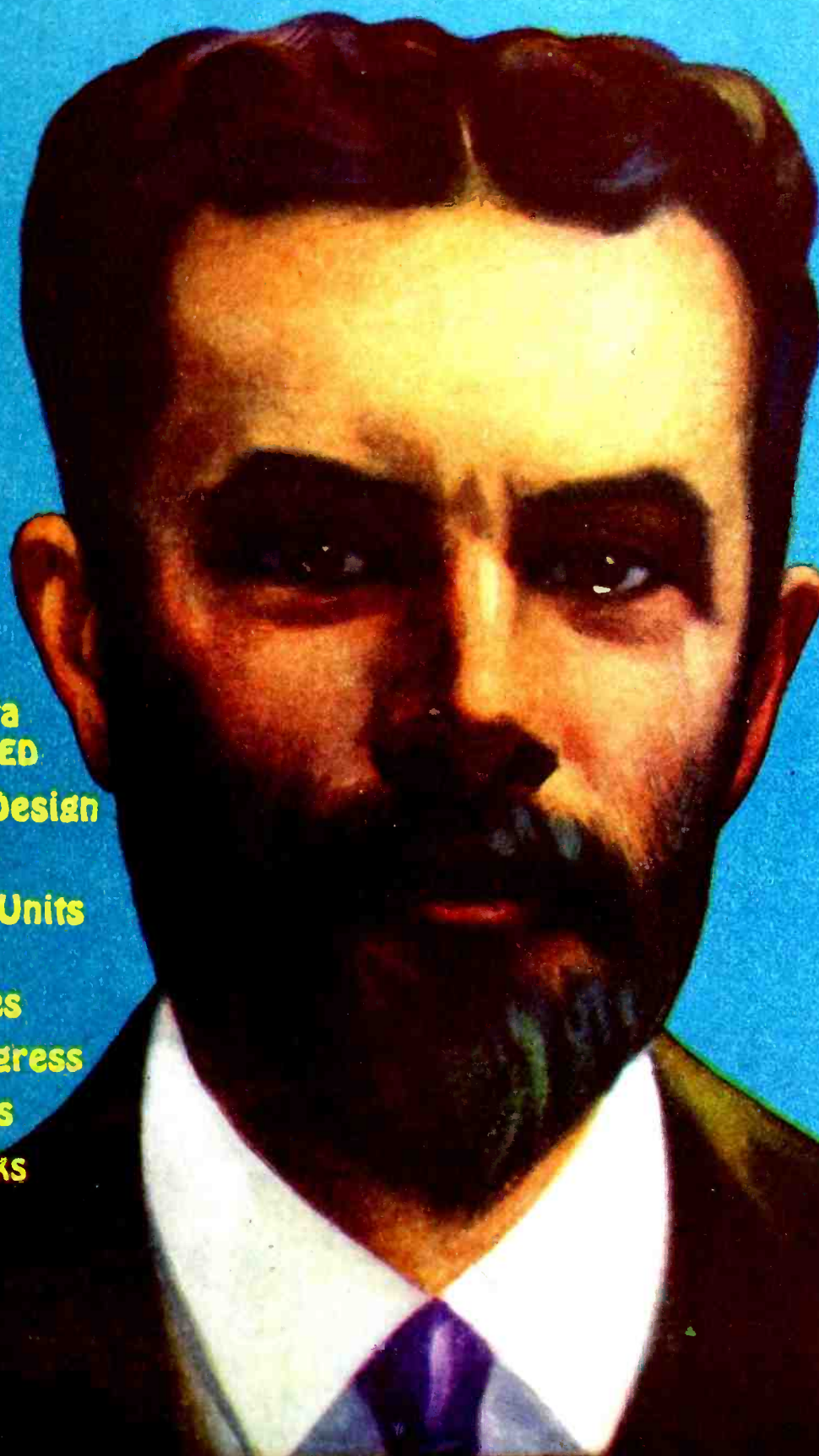
August

25 Cents

# Radio-Craft

for the  
Professional-Serviceman-Radiotrician

HUGO GERNSBACK Editor



Service Men's Data

By BERTRAM M. FREED

Short-Wave Receiver Design

By L. W. HATRY

Repairing "B" Power Units

By C. W. PALMER

New Radio Devices

Latest Television Progress

Radio Data Sheets

RADIO-CRAFT Kinks

Men who have made Radio: Oliver Heaviside

**R. T. I.** QUALIFIES YOU TO MAKE MONEY AND ITS SERVICE KEEPS YOU UP-TO-THE-MINUTE ON THE NEWEST DEVELOPMENTS IN RADIO, TELEVISION, AND TALKING PICTURES

**R. T. I.**

Easy to Get into  
this **BIG**  
Money Making  
Work

\$60 to \$125<sup>00</sup>  
A WEEK  
Radio  
Operator

\$8 to \$15<sup>00</sup>  
A DAY  
Servicing and  
Repairing Radio Sets

\$5000<sup>00</sup> A YEAR  
AND UP  
Radio Engineer  
for Broadcasting Station

\$85<sup>00</sup> A WEEK  
Installing and  
Repairing Talking  
Picture Equipment

**GOOD JOBS** Right at Your Finger Tips  
WHEN YOU ARE R.T.I. TRAINED IN  
**RADIO-TELEVISION - Talking Pictures**

BIG PAY JOBS! SPARE TIME PROFITS! A FINE BUSINESS OF YOUR OWN! They're all open to you and other live wire men who answer the call of RADIO. The fastest growing industry in the world needs more trained men. And now come Television and Talking Movies—the magic sisters of Radio. Will you answer this call? Will you get ready for you answer this call? Will you get ready for a big pay job Now and step into a BIGGER ONE later on? You can do it EASILY now.

**R. T. I. Home Training Puts You In This Big Money Field**

Radio alone, pays over 200 MILLION DOLLARS a year in wages in Broadcasting, Manufacturing, Sales, Service, Commercial Stations and on board the big sea going ships, and many more men are needed. Television and Talking Movies open up other vast fields of money-making opportunities for ambitious men. Get into this great business that is live, new and up-to-date, where thousands of trained men easily earn \$60 to \$100 a week—where \$10,000 a year jobs are plentiful for men with training plus experience.

**Easy To Learn At Home—In Spare Time**

Learning Radio the R. T. I. way with F. H. Schnell, the "Ace of Radio" behind you is EASY, INTERESTING, really FUN. Only a few spare hours are needed and lack of education or experience won't bother you a bit. We furnish all necessary testing and working apparatus and start you off on practical work you'll enjoy—you learn to do the jobs that pay real money and which are going begging now for want of competent men to fill them.

**Amazingly Quick Results**

You want to earn BIG MONEY, and you want some of it QUICK. R. T. I. "Three in One" Home Training—Radio-Television-Talking Movies—will give it to you, because it's easy, practical, and



**FRED H. SCHNELL**  
Chief of R. T. I. Staff  
Twenty years of Radio Experience. First to establish two-way amateur communication with Europe. Former Traffic Manager of American Radio Relay League. Lieut. Commander U.S.N.R. Inventor and Designer Radio Apparatus. Consultant Radio Engineer. Now in charge of R. T. I. Radio Training—and you will like his friendly manner of helping you realize your ambition.

is kept right up-to-date with last minute information. In a few weeks you can be doing actual Radio work, making enough EXTRA MONEY to more than pay for your training. In a few short months you can be all through—ready to step into a good paying job or start a business of your own. A BIG JOB—BIG MONEY—A BIG FUTURE. There is no other business in the world like it.

**Investigate—Send For R. T. I. Book Now**

Don't waste a minute. Find out what the great Radio Industry, which has grown faster than the Automobile and Motion Picture business, has to offer you. Find out what other men are earning. SEE HOW EASILY YOU CAN GET STARTED. Get the facts about Radio, Television and the Talking Pictures, first hand, in the big R. T. I. FREE BOOK. Learn what this R. T. I. "Three in One" Home Training can do for you. Mail the Coupon for FREE BOOK NOW.

**Radio & Television Institute**  
Dept. 76-C  
4806 St. Anthony Court, Chicago



**R.T.I. Training Brings Big Jobs Like These!**



**Earned \$600 Extra Money in Two Months**

Your radio course has enabled me to earn over \$600 in two months' spare time work. Understand that this is all spare time work, as I have a permanent position with my father in our store. I give you all the credit for the above and as I said before, I wish to finish the entire course as soon as I can.—Your student, J. NORRIS, Greenville, Ky. R. I. Box 37.



**Salary Raised 331-3% Since Enrolling**

You may be interested to know that I am now Radio Service Manager for the H. N. Knight Supply Co. who are distributors for Eveready Radio Receivers in the State of Oklahoma, and Texas Panhandle, with an increase in salary of about 331-3% since I enrolled with your school. Thanking you for your interest you have shown in me, and your wonderful course, I am, EARL P. GORDON, 618 East 6th St., Oklahoma City, Okla.



**Makes \$25 a Day**

Haven't forgotten you. How could I when I make as high as \$25.00 per day and have made \$600.00 in two months from Radio work. That's not so bad when I'm only 19 and in a small town. I just looked over the catalog you sent me before I enrolled, and you did about all you said you would and about as much more.—FLOYD KNISELY, R. F. D. 2, Box 91, St. Joe, Ind.

**RADIO & TELEVISION INSTITUTE**  
Dept. 76-C 4806 St. Anthony Court, Chicago

Send me Free and prepaid your BIG BOOK "Tune In On Big Pay" and full details of your three-in-one Home Training (without obligating me in any way).

Name.....  
Address.....  
City..... State.....

**R. T. I.** TRAINS YOU AT HOME FOR A GOOD JOB OR A PROFITABLE PART TIME OR FULL TIME BUSINESS OF YOUR OWN

# 5,000



## Radio Service Men Needed Now!

The replacing of the old battery operated receivers with all-electric Radios has created a tremendous country-wide demand for expert Radio Service Men. Thousands of trained men are needed quick!

### 30 Days of R.T.A. Home Training

*... enables you to cash in on this latest opportunity in Radio*

**\$40 to \$100**  
*a week*  
**Full Time**  
**\$3.00** *an hour*  
**Spare Time**

Ever on the alert for new ways of helping our members make more money out of Radio, the Radio Training Association of America now offers ambitious men an intensified training course in Radio Service Work. By taking this training you can qualify for Radio Service Work in 30 days, earn \$3.00 an hour and up, spare time; prepare yourself for full-time work paying \$40 to \$100 a week.

#### More Positions Open Than There Are Trained Men to Fill Them

If you were qualified for Radio Service Work today, we could place you. We can't begin to fill the requests that pour in from great Radio organizations and dealers. Members wanting full-time positions are being placed as soon as they qualify. 5,000 more men are needed *quick!* If you want to get into Radio, earn \$3.00 an

**We furnish you with all the equipment you need to become a Radio Service Man!**

hour spare time or \$40 to \$100 a week full time, this R. T. A. training offers you the opportunity of a lifetime.

#### Radio Service Work a Quick Route to the Big-Pay Radio Positions

Radio Service Work gives you the basic experience you need to qualify for the big \$8,000, \$10,000 to \$25,000 a year Radio positions. Once you get this experience, the whole range of rich opportunities in Radio lies open before you. Training in the Association, starting as a Radio Service Man, is one of the quickest, most profitable ways of qualifying for rapid advancement.

If you want to get out of small-pay, monotonous work and cash in on Radio quick, investigate this R. T. A. training and the rich money-making opportunities it opens up. No special education or electrical experience necessary. The will to succeed is all you need.

## Mail Coupon for No-Cost Training Offer

Cash in on Radio's latest opportunity! Enroll in the Association. For a limited time we will give to the ambitious man a No-Cost Membership which need not . . . should not. . . cost you a cent. But you must act quickly. Filling out coupon can enable you to cash in on Radio within 30 days, lift you out of the small-pay, no-opportunity rut, into a field where phenomenal earnings await the ambitious. You owe it to yourself to investigate. Fill out coupon NOW for details of No-Cost Membership.

**The Radio Training Association of America**  
4513 Ravenswood Ave. Dept. RCA-8, Chicago, Ill.

THE RADIO TRAINING ASSOCIATION OF AMERICA  
4513 Ravenswood Ave., Dept. RCA-8, Chicago, Ill.  
Gentlemen: Please send me details of your No-Cost training offer by which I can qualify for Radio Service Work within 30 days. This does not obligate me in any way.

Name.....  
Address.....  
City..... State.....

H. GERNSBACK, President  
 S. GERNSBACK, Treasurer  
 J. M. HERZBERG, Vice-President  
 I. S. MANHEIMER, Secretary

R. D. WASHBURNE,  
 Technical Editor



HUGO GERNSBACK, Editor-in-Chief

JOHN F. RIDER,  
 Editor Service Dept.

C. P. MASON,  
 Associate Editor

VOLUME II  
 NUMBER 2

## Contents of This Issue

AUGUST  
 1930

	PAGE		PAGE
<b>EDITORIAL:</b>			
Money from Radio in the Country....By Hugo Gernsback	71	New Models in Automotive Radio Receivers.....	90
<b>SERVICE MEN'S DEPARTMENT:</b>			
Leaves from Service Men's Notebooks		New Radio Devices for Shop and Home.....	92
By RADIO-CRAFT Readers	72	<b>SHORT-WAVE CRAFT</b>	
Some Notes on Repairing "B" Power Units		Design Your Own Short-Wave Receiver	
By C. Walter Palmer	75	By L. W. Hatry	94
An Easily-Made Tube Holder.....By H. Berman	77	Short-Wave Reflection from the Sky.....	95
<b>RADIO SERVICE DATA SHEETS:</b>			
Bosch "Model 35" Cruisers.....	78	<b>EXPERIMENTAL AND CONSTRUCTIONAL:</b>	
All-American "Mohawk" One Dial, Battery and A.C.	79	Practical Applications of Photoelectric Cells	
The Service Man's Open Forum.....	80	By C. H. W. Nason	96
Operating Notes for Service Men..By Bertram M. Freed	81	Higher Voltage from the "B" Eliminator	
Internal Troubles of Late Tube Models		By James P. Darden	97
By Sylvan Harris	82	The Effective Use of By-Pass Condensers and Resistors	
<b>NEW DEVELOPMENTS IN RADIO:</b>			
Television in the Theatre Takes Its Bow.....	84	By P. H. Greeley	98
Latest Developments of German Television Methods		A Direct-Coupled, Push-Pull, Pentode Amplifier.....	100
By Dr. Fr. Noack	86	RADIO-CRAFT Kinks.....	101
Men Who Have Made Radio—(XI) Oliver Heaviside	87	Eliminating the Unused "Super" Beat..By S. R. Winters	102
Announcement of RADIO-CRAFT's \$100 Prize Slogan Award	87	A Heavy-Duty High-Voltage D.C. Supply	
The Rotor-Grid Vacuum Tube.....By Joseph Riley	88	By Ralph Stair	103
		RADIO-CRAFT's Information Bureau.....	104
		The Progress of Radio and Television Abroad.....	113
		Correspondents Wanted.....	124

## In Forthcoming Issues

**THE CONSTRUCTION OF AN ALL-WAVE SUPER-HETERODYNE**, by R. William Tanner. The vogue of the superheterodyne among constructors is increasing; because the frequency-changing principle adapts itself to covering the broadcast band which now runs from 550 meters down to 17 meters instead of 200. Full constructional details are given.

**OSCILLATORS FOR SERVICING**, by A. Binneweg, Jr. No topic seems to arouse more interest than this among Service Men, judging from the amount of material we receive. This

article is by a well-known radio authority and will be accompanied by others on favorite testing equipment worked out in practice by our readers.

**RUNNING YOUR RADIO FOR NOTHING**, by Arthur T. Brown. All set builders are not supplied with alternating current, and do not care for the alternative of batteries. The methods described are for those who have D.C. house lighting.

And numerous other articles on practical subjects for Service Men and experimenters, of all degrees of proficiency.

RADIO-CRAFT is published monthly, on the fifth of the month preceding that of date; its subscription price is \$2.50 per year. (In Canada and foreign countries, \$3.00 a year to cover additional postage.) Entered at the postoffice at Mt. Morris, Ill., as second-class matter under the act of March 3, 1879. Trademarks and copyrights by permission of Gernsback Publications, Inc., 98 Park Place, New York City.

Text and illustrations of this magazine are copyright and must not be reproduced without permission of the copyright owners. We are also agents for WONDER STORIES, AMAZING DETECTIVE TALES and WONDER STORIES QUARTERLY. Subscriptions to these magazines may be taken in combination with RADIO-CRAFT at reduced Club rates. Write for information.

Copyright 1930, GERNSBACK PUBLICATIONS, INC.

Published by  
**TECHNI-CRAFT PUBLISHING CORPORATION**

Publication Office: 404 No. Wesley Ave., Mount Morris, Illinois

Editorial and Advertising Offices  
 96-98 Park Place, New York City

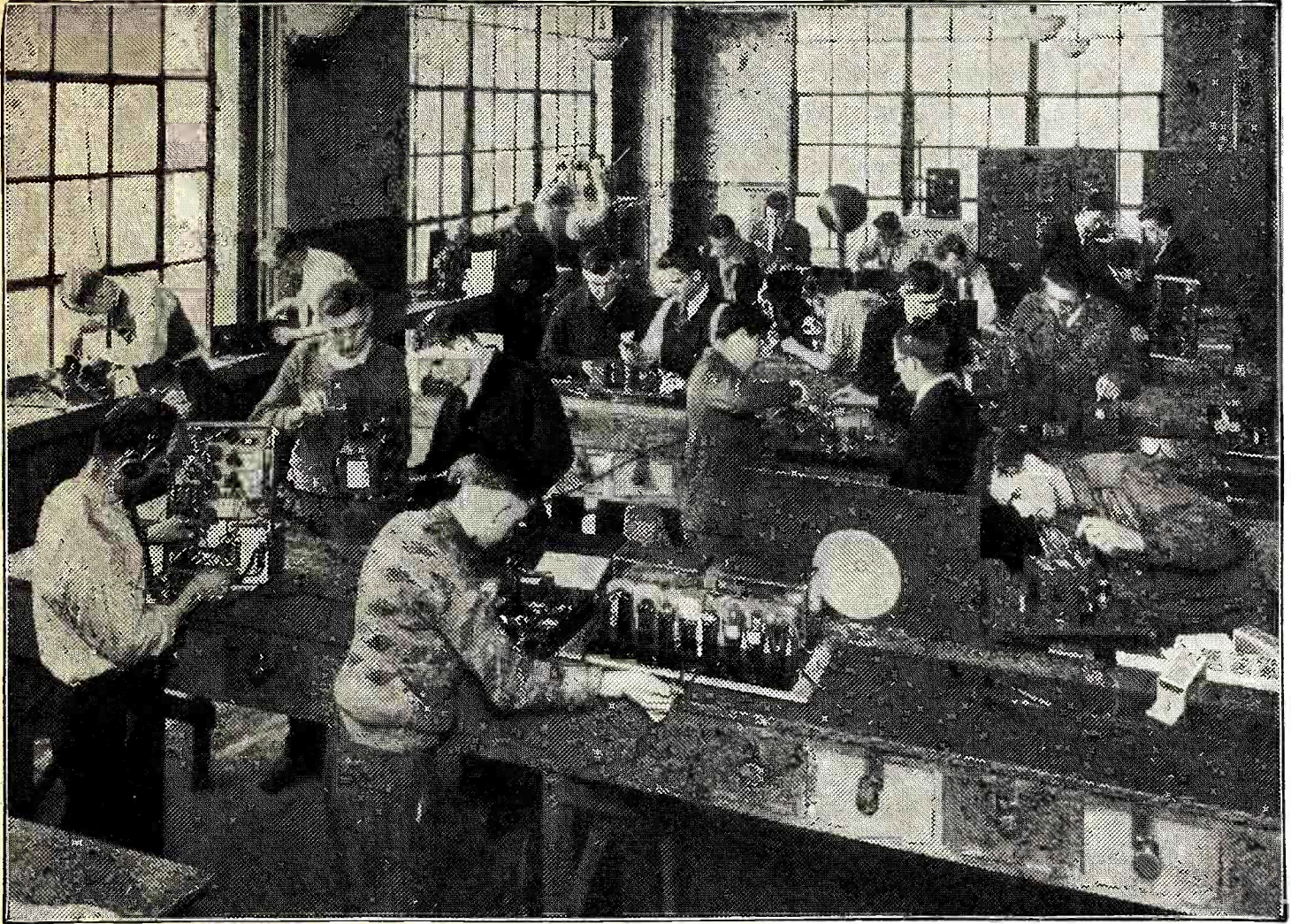
Western Advertising Office  
 737 North Michigan Avenue, Chicago, Ill.

L. F. McCLURE, Western Advertising Representative

London Agent: Hachette & Cie.,  
 16-17 King William St., Charing Cross, W.C. 2

Paris Agent: Hachette & Cie.,  
 111 Rue Reaumur

Australian Agent: McGill's Agency,  
 179 Elizabeth St., Melbourne



# YOU Radio Men!

**S**TATISTICS in the radio industry show that at the present time the ordinary radio man, either as a repair man or Service Man, makes an average of \$35.00 a week. Let us show you how you can quickly qualify for jobs leading to salaries of \$60.00, \$70.00, or \$100.00 a week and up—NOT by books or correspondence, but by an entirely new way.

**We Teach You How—No Books—No Lessons—No Classes!**

Coyne is not a correspondence school. We actually show you, by expert instructors, every phase of radio; which it is impossible to learn from books or from correspondence courses.

The majority of Radio Service Men and Radio Experts today do not earn what they should, because they have never been properly grounded in the fundamentals of radio—that is to say, in electricity.

Remember, you will never qualify as an expert radio man unless you know the fundamentals of electricity. All of this is taught by ACTUAL WORK on real equipment in our school.

**From \$20.00 a Week to \$100.00 a Week**

"Before going to Coyne, I had worked in a garage for five years at \$20.00 a week. I had no advanced education and didn't know a volt from an ampere. Yet I graduated in three months with a grade of 98%. Since I left Coyne, I have jumped from \$20.00 to \$100.00 a week, and am still going strong. I owe all my success to the practical training I got in the Coyne Shops."—Harry A. Ward, Iowa.

**COYNE ELECTRICAL SCHOOL, H. C. Lewis, Pres. 500 S. Paulina St. Founded 1899 Dept. CO-85, Chicago, Ill.**

Most self-taught radio Service Men fail utterly because their electrical education has been neglected; and, incidentally, they lose a good income because statistics show that radio alone cannot support the independent radio man all year around.

In the Spring and Summer time, particularly, radio is notoriously dull; and the radio man who is an electrical expert will make more money in the end.

## Radio Training

The photograph above shows how men are actually trained in our big radio shop, where students are shown by experts how to take apart and put together the various modern radio sets. We will show you how to get at the root of servicing troubles; and within 90 days you can be a radio expert.

Most radio men today founder around because they do not know the peculiarities of many sets, and have to puzzle these out, tediously, for themselves; whereas our instructors, with years of experience behind them, can show you how to locate any set troubles.

**No Previous Training Necessary!**

Remember, I do not teach you out of books. You are actually doing the work yourself, and get all the experience you need right here at Coyne.

I do not care whether you cannot tell a vacuum tube from a C-battery; whether you are sixteen years old or forty-five. It is my job to prepare YOU for a big-pay radio and electrical job in 90 days' time.

## The Future of Radio

At the present time, there is a dire need for REAL and experienced Service Men, who

also know the ins-and-outs of electricity. Even though you may work on a good salary job for an employer at first, sooner or later you will wish to establish yourself in your community and start in business for yourself. The combination of radio and electricity cannot be beat; it is an all-year-round business.

Even if you do not want to go in business, there are more jobs today than good men to fill them. Coyne training settles the job question for life. Only recently one concern called on me for 150 graduates, and calls for more men are coming in daily. Coyne maintains an expert Employment Department, which will help you and back you as long as you live, WITHOUT ONE CENT OF COST TO YOU.

## Special Offer!

In connection with the radio training, you are also given electrical training in all its branches—auto ignition and aviation electricity—WITHOUT ONE CENT EXTRA COST!

## Get My Free Book

Mail the coupon today, and let me send you the big Coyne book of 150 photographs—facts—jobs—salaries. It costs nothing, and does not obligate you in any way. Just mail the coupon.

## MAIL THIS COUPON—NOW!

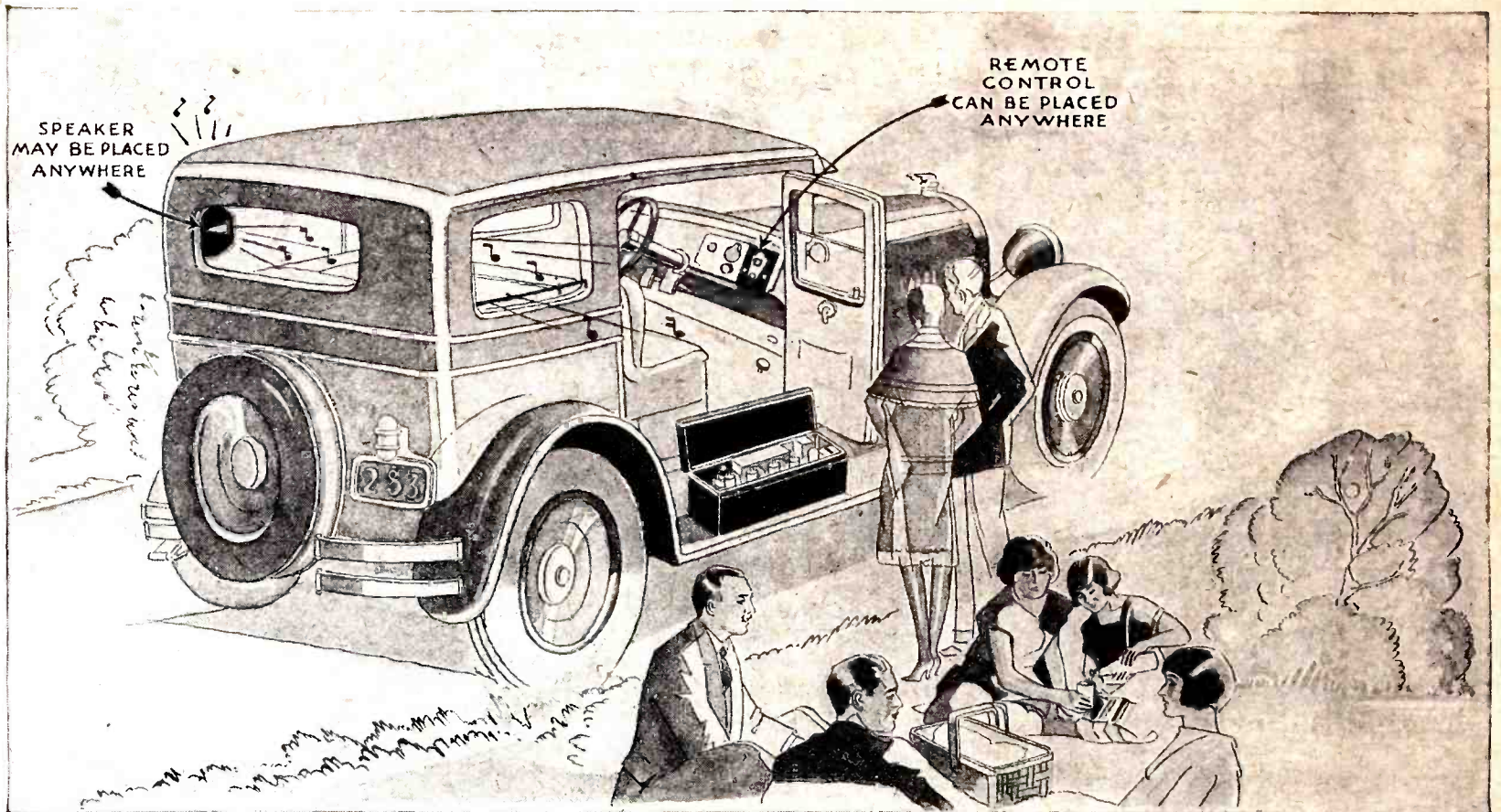
Mr. H. C. LEWIS, President  
COYNE ELECTRICAL SCHOOL, Dept. CO-85  
500 S. Paulina St., Chicago, Ill.

Dear Mr. Lewis:  
Without obligation send me your big free catalog and all details of Railroad Fare to Chicago, Free Employment Service, Radio, Aviation Electricity, and Automotive Courses, and how I can "earn while learning."

Name .....

Address .....

City..... State.....



*The "AUTO PILOT" goes on your running board and does not lessen the car's trade-in value when taken off to go on your next car*

## "Auto Pilot" Full Screen Grid Radio

LICENSED UNDER R.C.A. PATENTS

## Increases Your Automobile Pleasure

Nobody will have a more up-to-date automobile than yours when you have assembled this powerful "AUTO PILOT" Screen Grid broadcast receiver kit, placed it on your running board in its attractive black japanned case and connected its remote control dial and speaker. Even the specially designed PILOT "undercar" aerial attaches between the axles without necessity for harming your car's exterior or interior.

This new and advanced "AUTO PILOT" not only has every up-to-date feature of radio to assure you distance, selectivity, tone quality and volume—but the welfare and future trade-in value of your car has also been a chief consideration of design. The New "AUTO PILOT" requires no mutilation of floor, instrument board or upholstery to make a solid installation—convenient to operate, taking up no foot or seat room.

*You Can Install the "Auto Pilot" in Your Car in An Evening.*

Four-224 A.C. Screen Grid Pilotrons comprising three stages of radio frequency and detector give the "Auto Pilot" tremendous pick-up and distance range. A. C. Pilotrons are operated from the car's battery instead of battery type tubes because they are rugged and non-microphonic.



**Auto Pilot Kit 4750**  
Complete with aerial less  
Pilotrons and Speaker

Thick sponge rubber mountings take up road shocks. The audio amplifier system gives enough volume for outdoor dancing, with tone quality of the highest order. Filament current drain from car's storage battery is only 4 amperes. Plate current is 20 milliamperes from three 45-volt "B" batteries.

*Inquire of your local Pilot Radio Dealer or write direct to*

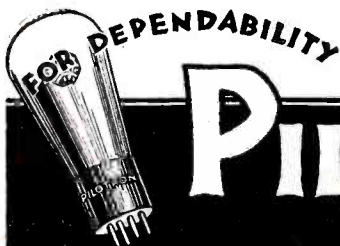
**PILOT RADIO & TUBE CORP.**

323 BERRY ST., BROOKLYN, NEW YORK

Chicago Office: 234 South Wells St.

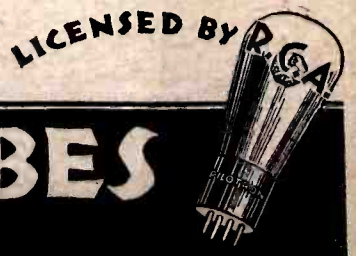
San Francisco Office: 1278 Mission St.

FACTORIES AT LAWRENCE, MASS.



# PILOTRON RADIO TUBES

*Endorsed by Professionals*



# I will train you at home



## to fill a **BIG PAY** Radio Job!

**Here's Proof**

If you are earning a penny less than \$50 a week, send for my book of information on the opportunities in Radio. It is free. Clip the coupon NOW. Why be satisfied with \$25, \$30 or \$40 a week for longer than the short time it takes to get ready for Radio.

### Radio's growth opening hundreds of \$50, \$75, \$100 a week jobs every year

In about ten years Radio has grown from a \$2,000,000 to a \$1,000,000,000 industry. Over 300,000 jobs have been created. Hundreds more are being opened every year by its continued growth. Men and young men with the right training—the kind of training I give you—are needed continually.

### You have many jobs to choose from

Broadcasting stations use engineers, operators, station managers and pay \$1,800 to \$5,000 a year. Manufacturers continually need testers, inspectors, foremen, engineers, service men, buyers, for jobs paying up to \$15,000 a year. Shipping companies use hundreds of Radio operators, give them world wide travel at practically no expense and a salary of \$85 to \$200 a month. Dealers and jobbers employ service men, salesmen, buyers, managers, and pay \$30 to \$100 a week. There are many other opportunities too. My book tells you about them.

### So many opportunities many N. R. I. men make \$5 to \$25 a week while learning

The day you enroll with me I'll show you how to do 10 jobs, common in most every neighborhood, for spare time money. Throughout your course I send you information on servicing popular makes of sets; I give you the plans and ideas that are making \$200 to \$1,000 for hundreds of N. R. I. students in their spare time while studying.

### Talking Movies, Television, Wired Radio included

Radio principles as used in Talking Movies, Television and home Television experiments, Wired Radio, Radio's use in Aviation, are all given. I am so sure that I can train you satisfactorily that I will agree in writing to refund every penny of your tuition if you are not satisfied with my Lessons and Instruction Service upon completing.

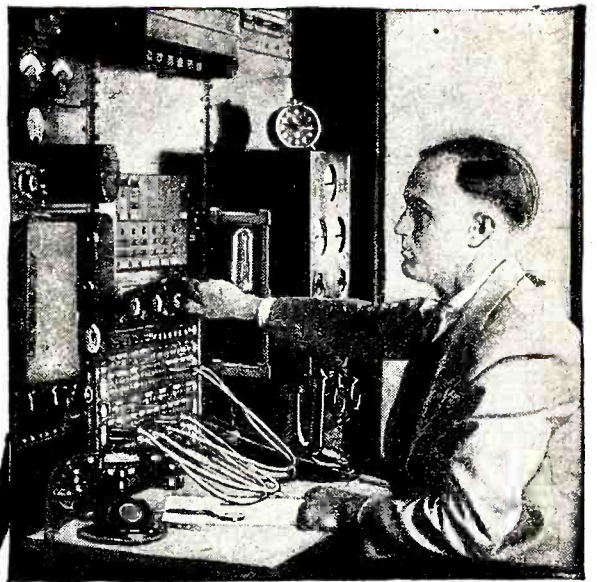
### 64-page book of information FREE

Get your copy today. It tells you where Radio's good jobs are, what they pay, tells you about my course, what others who have taken it are doing and making. Find out what Radio offers you, without the slightest obligation. ACT NOW.

**J. E. SMITH, President**  
National Radio Institute Dept., OHY  
Washington, D. C.

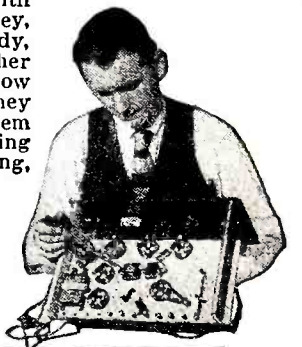
### Our Own Home

Pioneer and World's Largest Home-Study Radio training organization devoted entirely to training men and young men for good jobs in the Radio industry. Our growth has paralleled Radio's growth. We occupy three hundred times as much floor space now as we did when organized in 1914.

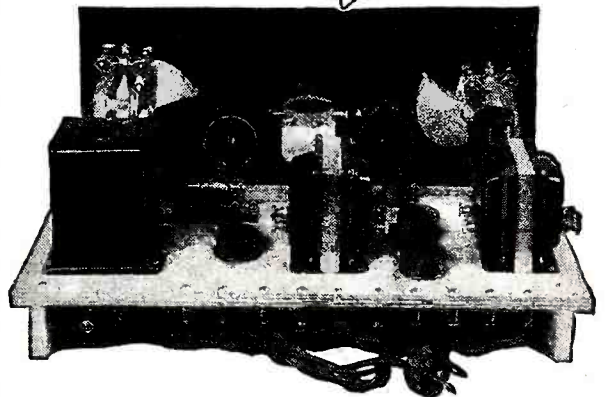


I will give you my new 8 OUTFITS of RADIO PARTS for a home Experimental Laboratory

You can build over 100 circuits with these outfits. You build and experiment with the circuits used in Crosley, Atwater - Kent, Eveready, Majestic, Zenith, and other popular sets. You learn how these sets work, why they work, how to make them work. This makes learning at home easy, fascinating, practical.



Back view of 5 tube Screen Grid A. C. tuned Radio frequency set—only one of many circuits you can build with my outfits.



I am doubling and tripling the salaries of many in one year and less Find out about this quick way to **BIGGER PAY**



**FILL OUT AND MAIL THIS COUPON TODAY**

J. E. SMITH, President,  
National Radio Institute, Dept. OHY  
Washington, D. C.

Dear Mr. Smith: Send me your book. This request does not obligate me.

Name .....  
Address .....  
City ..... State .....



\$100 a week

"My earnings in Radio are many times greater than I ever expected they would be when I enrolled. They seldom fall under \$100 a week. If your course cost four or five times more I would still consider it a good investment."

E. E. WINBORNE  
1414 W. 48th St.,  
Norfolk, Va.



Jumped from \$35 to \$100 a week

"Before I entered Radio I was making \$35 a week. Last week I earned \$110 servicing and selling Radios. I owe my success to N. R. I. You started me off on the right foot."

J. A. VAUGHN  
3715 S. Kingshighway,  
St. Louis, Mo.



\$500 extra in 6 months

"In looking over my records I find I made \$500 from January to May in my spare time. My best week brought me \$107. I have only one regret regarding your course—I should have taken it long ago."

HOYT MOORE  
R. R. 3, Box 919,  
Indianapolis, Ind.,

**Lifetime Employment Service to all Graduates**

# Announcement!



## NATIONAL RADIO SERVICE MEN'S ASSOCIATION

### BOARD OF DIRECTORS

*L. M. Cockaday*

*David Grimes*

*John F. Rider*

*Hugo Gernsback*

*Sidney Gernsback*

*I. S. Manheimer*

**E**VER since the appearance of the commercial radio broadcast receiver as a household necessity, the Radio Service Man has been an essential factor in the radio trade; and, as the complexity of electrical and mechanical design in receivers increases, an ever-higher standard of qualifications in the Service Man becomes necessary.

The necessity, also, of a strong association of the technically-qualified radio Service Men of the country is forcing itself upon all who are familiar with radio trade problems; and their repeated urgings that such an association must be formed has led us to undertake the work of its organization.

This is the fundamental purpose of the NATIONAL RADIO SERVICE MEN'S ASSOCIATION, which is not a money-making institution, or organized for private profit; to unite, as a group with strong common interests, all well-qualified Radio Service Men; to make it readily possible for them to obtain the technical information required by them in keeping up with the demands of their profession; and, above all, to give them a recognized standing in that profession, and acknowledged as such by radio manufacturers, distributors and dealers.

To give Service Men such a standing, it is obviously necessary that they must prove themselves entitled to it; any Service Man who can pass the examination necessary to demonstrate his qualifications will be elected as a member and a card will be issued to him under the seal of this Association, which will attest his ability and prove his identity.

The terms of the examination are being drawn up in co-operation with a group of the best-known

radio manufacturers, as well as the foremost radio educational institutions.

The following firms are co-operating with us:

- GRIGSBY-GRUNOW CO (Majestic), CHICAGO
- STROMBERG-CARLSON TELEPHONE MFG. CO., ROCHESTER, N. Y.
- CROSLY RADIO CORP., CINCINNATI, OHIO
- COLIN B. KENNEDY CORP., SOUTH BEND, IND.

The schools who have consented to act as an examination board are:

- International Correspondence Schools, Scranton, Penna.; Mr. D. E. Carpenter, Dean.
- RCA Institutes, Inc., New York, N. Y.; Mr. R. L. Duncan, President.
- Radio & Television Institute, Inc., Chicago, Ill.; Mr. F. G. Wellman, Managing Director.
- Radio Training Association of America, Chicago, Ill.; Mr. A. G. Mohaupt, President.
- School of Engineering of Milwaukee, Milwaukee, Wisc.; Mr. W. Werwath, President.
- Rider-Goll Radio School, New York, N. Y.; Mr. John F. Rider, Director.
- Radio College of Canada, Toronto, Canada; Mr. J. C. Wilson, President.

We shall not attempt to grade the members into different classes. A candidate will be adjudged as either passing or not passing. If the school examining the papers passes the prospective member as satisfactory, we shall issue to him an identification card with his photograph.

If the candidate does not pass this examination the first time, he may apply for another examination three or six months later.

There is absolutely no cost attached to any service rendered by the Association to its members, no dues, no contributions.

If you wish to become a member, just fill out the coupon below and mail it to us. We will send you all the papers necessary to become a member.

N. R. S. M. A.,  
c/o RADIO CRAFT,  
98 Park Place,  
New York, N. Y.

I wish to become a member of your Association. Please mail me the examination papers and application blanks.

Name .....

Address .....

Town..... State.....





**"Takes the Resistance Out of Radio"**

Editorial Offices, 96-98 Park Place, New York, N. Y.

# Money From Radio in the Country

By Hugo Gernsback

**T**HE situation that presents itself, as far as radio is concerned, in the country—that is to say in small towns and hamlets and on the farms—is not new; and the observations which I make here are only to emphasize the crying need in these small communities for radio sets adapted to their needs.

While radio was young, and even until nearly three years ago, there was no such thing as an A.C. receiver. Set builders, as well as set manufacturers, competed with each other in turning out increasingly efficient battery-operated receivers; since there were no others to be had. These sets at that time were, of course, suitable for the country; and the type still is an ideal, for the simple reason that in the more isolated homes of the country there is usually no electric light and whatever radio sets there are must, of necessity, be operated by battery power.

During the last few years, this market, which is a tremendous one, has been almost entirely overlooked by most radio set manufacturers; only very recently have some of the larger concerns come to their senses and realized the big opportunity they have missed in the past two years. They are now trying to make up for lost time.

As far as the Service Man and radiotrician, as well as the set builder, are concerned, there is still a good deal of money to be made by installing either factory-made sets or sets built to order. In many communities, for instance, there are numerous 32-volt lighting systems; yet there are practically no manufactured sets in the market that can be hooked up to such a lighting circuit. The wide-awake Service Man and radiotrician will take advantage of this fact, find out where such lighting plants are located and then try selling special sets to this trade. Since sets to operate on 32 volts are rare, they naturally will bring a pretty good price; which should make it worthwhile for the industrious constructor who wishes to earn a few dollars. We know of one man who, in a single season, has sold not less than sixty such sets at a price that would usually be thought of as being exorbitant; but this custom builder cashed in on a real demand by making up a set, and taking it around to farms, hooking it up and demonstrating it, and he found little trouble in getting an order each time. This usually brought new business in the neighborhood, from other isolated farm groups which had similar lighting equipment; and the builder in question was kept busy installing such sets.

Of course, it is not absolutely necessary to have the farm radio set work on 32 volts; because an ordinary battery set can be operated from a storage battery which can be "floated on the line." This presents no difficulty to the radio man and does away with the special set.

There are two avenues open to installing sets of this kind. One, and of course the better way, is to sell an up-to-date set to the farmer or small-town man; there are some excellent receivers of this type on the market today. Or, if the radio man is a builder himself, he can make up a screen-grid set with three or four tubes which, with their tremendous amplification, will perform surprisingly well in practically any locality. Incidentally, there is always the additional sale of the antenna equipment, loud speaker, tubes, batteries, etc. And,

once you have the confidence of your customer, he will stick by you and you will be engaged to service the set for a long time to come. Then, later on, when a better set comes along, you will be able to sell it to the same customer. The business, therefore, is cumulative as time goes on.

The Service Man or custom builder who owns his car, and can get around easily, will have little trouble in drumming up a good deal of trade in this manner.

Of course, it is important that one or more demonstration sets be carried along; because to the small-town man or farmer a demonstration is everything. Selling from a catalogue or description means nothing because, incredible as this may sound, thousands of individuals in this country have as yet never listened to a radio set. Such individuals are always hard to convince, if only a description of a set with its picture can be shown. An actual demonstration is a different story, and usually a sale can be made on the spot.

I have mentioned before, and I wish to repeat it, that there is a particularly lucrative market for such sets in summer communities; and, once you get to such a summer community, it will be found that there are, not far away, many isolated dwellings which can be canvassed. Nine times out of ten, a dwelling or farmhouse that has no visible aerial should prove an excellent prospect. While, of course, not everyone will be sold, still it will be found that the percentage of sales runs high.

A thing to remember—and many of our correspondents who have had such experiences point this out—is that eight out of ten of such sets sold must be reasonably-priced. The small-town man, as well as the average farmer, is not blessed with too much money, and in many cases \$50.00 is the limit that can be gotten for an installation. Of course, for such an amount it is impossible to furnish a really first-class set. In such a case, a second-hand battery set which has been overhauled and repaired will have to be sold to the customer; but even here a very good profit can be made if the radio man knows his business.

Another thing the radio man will come up against, is that many individuals wish to buy a set on the installment plan; in this case, it is usually best to sell a reconstructed set. Such receivers can be bought quite reasonably and, in nine cases out of ten, the first down-payment will practically repay the investment, while the installments will be so much profit. A little money invested here will show good returns and, if a few dozen installments are made, the industrious Service Man will have quite a little money coming to him when he will need it most. Incidentally, it might be said that few of these sales ever go bad; for the average small-town man and farmer is honest and pays his just debts on the dot. If the radio man has a banking connection, and if he can obtain written orders for the installations, it should not be impossible to obtain from the bank a sufficient amount to keep on going until all the installments are paid. Most any small-town bank, if it knows with whom it is dealing, is in a position to finance small loans of this kind; and, if the radio man has a good reputation and is known to the bank, he should be able to obtain accommodation.

There is still a good deal of money to be made along these lines, and it behooves every wide-awake radio man to take advantage of them during the summer time.

# Leaves from Service Men's Note Books

The "Meat" of what our professionals have learned by their own practical experiences of many years

By RADIO-CRAFT READERS

## A HANDY TESTER

By Arthur J. Lamm

IN radio servicing over a period of ten years I have used all the usual devices in continuity testing—phone and battery, flashlight bulb and battery, and small neon bulb with 110 volts D.C., and so on—but the one which tells the story in no uncertain terms is a 0-1 millimeter calibrated as an ohmmeter and used in series with a 1½- or 3-volt "C" battery and two probes. This I use in the manner Mr. Geo. C. Miller explains in the February 1930, issue of RADIO-CRAFT, and as described in greater detail by Mr. J. M. Conesa in December 1929, RADIO-CRAFT. Of course a suitable variable resistor is part of the tester.

I made up a neat little outfit which is easily carried in one's pocket. My battery is made up of fountain-pen type flashlight cells which, placed end to end, slip in the coat or vest pocket out of the way when testing. The probes are made from two ten-cent propel-style lead pencils with composition barrels and brass tips through which the steel plunger protrudes. I ground

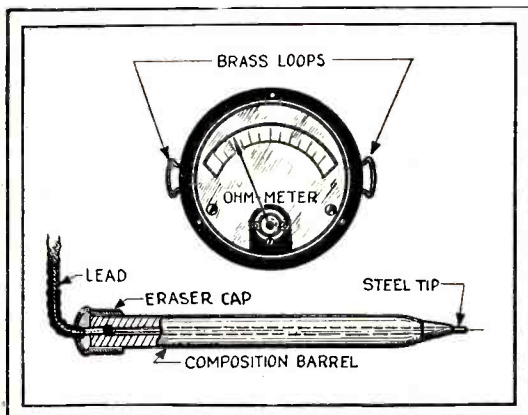


Fig. 1

Mr. Lamm's two vest-pocket test prods are used with batteries in his pocket and a meter strapped by its loops to the back of his hand.

the ends of the plungers to a chisel edge, better to cut through any deposit on the conductor being probed and give a maximum of contact surface. I soldered the bared end of a length of fixture cord in the eraser end of the pencil and slipped a cap-type rubber eraser over the wire and the end of the probe; thus insulating all but the tip.

The meter is provided with two flat loops of brass wire, one soldered on each side so that a strap or piece of elastic may be sewed to them, like straps on a wrist watch. The meter is handily slipped over the fingers and held in place on the back of the hand by the strap across the palm.

With a probe in each hand the readings are easily taken without turning away and gazing at a meter in some unhandy place and, often, allowing the probe to slip from a difficult position. The speed gained by using this arrangement more than pays for the trouble of making it.

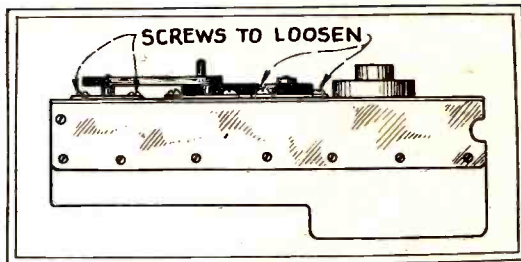


Fig. 2

Condensers, being the principal mechanical parts of a set, are liable to the greatest share of their mechanical difficulties. Here is a tip.

## MAKING CONDENSER ADJUSTMENTS

By J. U. Roane

IN Atwater Kent, "Model 35" battery sets, which had lost their pep, I have found about eighty per cent. of the trouble in the tuning condenser's being off center. This is caused by too much tension on the belts of the first tuning condenser and the third; the middle condenser is almost always satisfactory. To remedy this trouble, remove the chassis from its metal case and loosen the three screws on the front of the condenser which is out of alignment; move the entire condenser a fraction towards the center condenser, until the rotor plates are centered. The little flat springs in the front and rear of condensers will throw them back to center, making the set perform as it should.

## TESTING THROUGH INSULATION

By Arthur Bernd

ON close wiring jobs, and where it is not desirable to scrape insulation from wires, the following kink is useful to check continuity, shorts, etc.:

Take ordinary steel sewing needles; stick them in through the insulation until they make contact with the wires; and apply the test prods to the needles. This is a time-saver and often saves messing up a set.

## TESTING DRY-DISC RECTIFIERS

By A. H. Matthews, E.E.

FLUCTUATION of the tube filament will usually indicate a poor "A" rectifier of the dry type; when the voltage is normal

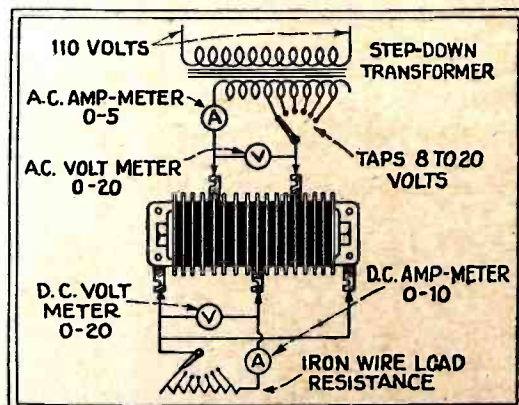


Fig. 3

Mr. Matthews' method of testing a dry-disc rectifier is systematic. When he gets through, he knows exactly where the trouble lies.

and the light steady, the unit is O. K. However, in order to be sure that a unit is good, I use the method shown in the sketch, with a load test and a standard unit for comparison. Rectifiers of other types are tested in a similar manner.

## TONING RECEIVER OUTPUT

By H. Fred Pitzer

MANY customers, of the better sort, desire the tone of their radio receivers to be very low—the lower, the better. There are many methods of increasing the low-frequency response, or cutting down the intensity of the upper register; and the most favored seems to be the insertion of a fixed condenser across the audio transformer.

This can be improved greatly, and variable tone obtained, in a push-pull output stage, by soldering a wire to the grid terminal of each push-pull tube socket. Bring one wire to a 500,000-ohm variable resistor, which may be mounted on the panel for ease of access. In series with the other grid wire, and the resistor, insert a fixed condenser with capacity sufficient to give the greatest desired depth of tone when the tone

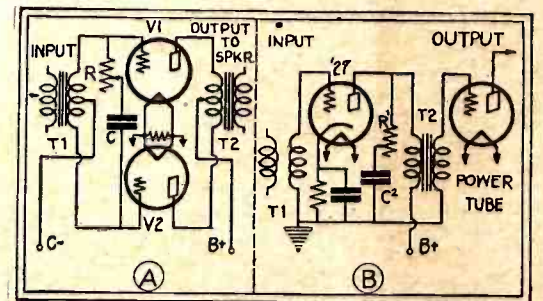


Fig. 4

One of the outstanding features of late receiver development is the introduction of tone control for particular customers. The same idea may profitably be applied by the Service Man to older models.

control is turned on "Full." Turning the tone control will then give any tone from normal to any depth required. One advantage of this method is that, regardless of the tone depth produced, the hum is seldom increased to an objectionable degree.

In many receivers using only one audio stage, the tone may be deepened by using the same combination connected from the plate of the detector tube to the ground. However, if a '45 or larger tube is used as the output stage, better results will be obtained by running from the plate of this tube to ground. (The condenser must be of suitable voltage rating, then; and of considerably larger capacity.—Editor.)

To give a set whatever tone the customer desires (within reasonable limits, of course), use a .006-mf. fixed condenser in series with a 500,000-ohm resistor. Connect one end of the resistor to the plate of the first audio transformer, and one end of the condenser to the "B+" of the primary winding. If the tone thus produced is not deep enough, increase the capacity.

**A NEW SOURCE OF STATIC**

By John Nisslein

**W**ITHIN two days after we had installed a standard set, which tested perfect, the customer complained of noise,

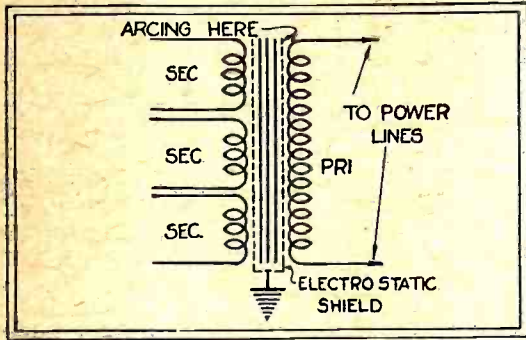


Fig. 5

An electric set may originate disturbance in a 110-volt A.C. line, like any other appliance. One service organization had hard work before they tumbled to this fact.

especially on low wavelengths. Our Service Man could not find it, on two visits; he tried removing the aerial, a line-filter, etc. On taking up the matter with the power company, we were asked to try out another set before they sent a man.

We sent over another set: the two were connected to the A.C. outlet and allowed to warm up. Switching the aerial from one to the other brought in noise with equal loudness on both. So we called in the company's interference man. He could find no noise until, towards afternoon, he located it in the same house where the set was. He tested every fixture, cut-out, etc. in the house; and finally noted that the noise was present in his portable only when our set was turned on. So he cursed us all out, and went back to the office; and we gave the customer a new set and went back to the shop to locate the trouble.

The set played perfectly for some hours, without noise; and then noise gradually developed in it and every other set in the store when it was turned on. To make a long story short, after long search, it was located in the power transformer. The primary winding had been arcing over to the electrostatic shield.

This did not occur until the transformer was thoroughly heated and, presumably, the position of the windings slightly changed.

**SOME SHOP HINTS**

By M. W. Sterns

**M**ANY Majestic packs submitted for repairs have nothing wrong with them. When testing such a pack, it is always necessary to substitute an iron-core choke (such as an AmerChoke, or "B" filter choke) for the field of the dynamic speaker. If this is not done, there will be no "B" voltage from the pack.

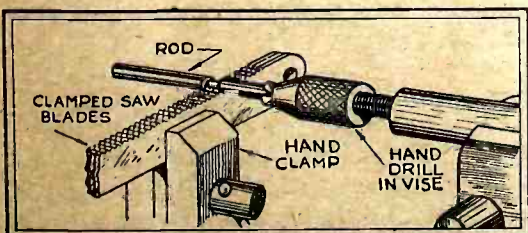


Fig. 6

Very few shops have a lathe; but the same result, for a light piece of soft metal, may be attained as shown.

Connect the choke between the second contacts from the left (when the connecting cable is on the right) on the top and the bottom rows. If there is then no "B" voltage at the proper terminals, trouble is in the condenser block of the pack, or one of the by-pass condensers in the set chassis.

For that reason it is always best to bring in the chassis and the speaker for test, as well as the power pack; then it will be unnecessary to make a second trip, if the pack is O.K. and the trouble is to be looked for in the other units.

When testing an '80 rectifier, always apply 3 volts across the filament. This will give you a truer indication of the emission of the tube. Many a tube which tests within the proper limits on 5 volts will show up woefully weak when the lower voltage is applied. A good '80 should give 60 milliamperes or more current with 3 volts across the filament and 90 on the plates.

If it is necessary to cut a groove in a rod, at right angles to its length, and a lathe is not handy, place the rod in a hand (or electric) drill and rotate it while holding a hacksaw against it in the proper place. If a single sawblade cuts too narrow a groove, use two or three blades in the holder, and you will be surprised to see what a rapid, accurate job can be accomplished.

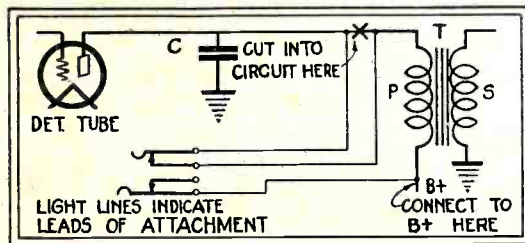


Fig. 7

There is still a lure in distance, and there are yet many night-hawks. Mr. Cherry finds profit in selling them an old idea they may have forgotten.

**FOR THE LATE LISTENER**

By Elden L. Cherry

**Q**UITE often, some member of a family may wish to listen in after the others have retired. Since turning down the volume on most sets will usually reduce the sensitivity of the set, and perhaps make it impossible to hear some of the weaker stations, it is not always satisfactory to listen in with the set turned low enough to avoid disturbing others. Old-model battery sets had a jack in the detector stage, for the use of headphones; but this was eliminated on later models. While the use of headphones is almost forgotten they are extremely useful on a modern set equipped to use them; as the listener can then use the full power of the set with the loud speaker silent, and listen as late as he cares to without interfering with the sleep of others.

Headphones cannot be used across the output of an electric set, or even on the first audio stage; as a loud hum will usually result. The detector output of a good all-electric set, however, should be quite free from hum; and the volume obtained at this point is ample for the use of headphones.

Incidentally, a great deal of the extraneous noise, that comes up so strongly in a loud speaker, is avoided when the audio amplification is eliminated. The reduction of static and interference noises will often

permit listening to a program that would be nearly ruined if heard from the speaker.

The diagram shows how a four-prong, double-circuit jack can be used for the purpose, with only three of the prongs connected. It is a comparatively short job to install such an attachment on almost any factory-built set having a console cabinet; as the jack may be mounted directly on the wood panel. However, the arrangement will not work with a metal cabinet unless the jack is insulated from the case. The jack will not interfere with removing the chassis from the cabinet; since the jack may be removed readily by unscrewing the one nut which holds it to the panel.

Flexible wire should be used for the connections, and the three leads twisted together. If this is done there will be no interference in any way with the normal operation of the set.

The Service Man may have some trouble selling the headphone idea to the first customer; but he will probably find that one installation will result in a number of demonstrations by the customer to friends who, perhaps, never before listened with headphones, and some of these will want the same attachment applied to their sets. It is not necessarily limited to one listener; since, if the user desires, he can obtain a multiple plug which will permit the use of a number of headphones at once.

**DIAL-DRIVE PROBLEMS**

By Henry Burwen

**P**UTTING a new drive cable in a Steinite screen-grid set is a mean job until you get the hang of it, and then it becomes very simple.

First, thread the cable around the drum. Starting with the end nearest the front, attach cable eyelet to screw on front collar. Attach other end to set-screw on collar at rear of shaft, then loosen the small set screw A which holds rear collar to shaft. This allows you to wind up the cable on one side; then, to wind up the other, start to turn by hand the collar which you have loosened and to which one end of the cable is fastened. (The windings must of course be in opposite directions at each end.)

Now, to take up the slack and make a tight job, turn the small set-screw in far enough to make a friction hold; then hold the collar in one hand and turn hard on the main tuning dial with the other. Then tighten down the set-screw fastening collar to shaft.

There must be at least one extra turn of

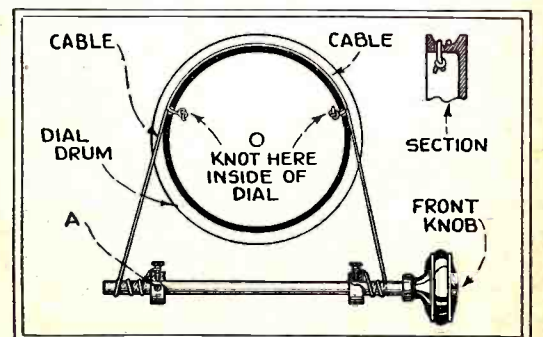


Fig. 8

The method shown above will remove many troubles which may be encountered with slipping drive-belts.

cable around the shaft at either end when the dial is at 0 and 100.

Another thing: the cable as installed at the factory gives trouble, due to its slipping around the drum, if operator keeps on turning at end of dial movement. This causes the cable to completely unwind on one end; at which point it slacks off more on that end than is taken up on the other, the cable becomes completely loose, and the system is out of kilter. To prevent this, cut the cable in two after threading through the drum, tie a knot at each end so it won't pull through the hole, and proceed as before. You have then two separate cables instead of one, without possibility of slippage; and a little stretch in the cable will not affect the operation. With this arrangement the tension spring can be discarded. I have installed a number of them this way, and no further trouble has developed. This method also permits the use of short or broken pieces of cable.

### BURNT-OUT VOLUME CONTROLS

By Sydney Fletcher

ON numerous occasions, I have been called upon to replace volume controls in D.C. sets which have had no more than a month's use in the customer's home. In every instance but one, I have found that the man who installed the set had placed the ground wire on the aerial post—because he obtained more volume in this way, no doubt.

The majority of D.C. sets are so wired that the aerial is led to the positive side of the line; which, in turn, is wired, directly or indirectly, to the volume control. Service Men should know that the volume control is going to act as a fuse in the set and burn up. As recently as last Christmas Eve I encountered such an instance. It is bad enough to try to think without knowing better; but to know better and not stop to think is unpardonable. I believe that this mistake is due to one or the other of these two reasons: don't you?

### MISCELLANEOUS NOTES

By Joseph Schiller

WHEN balancing the Majestic "Model 90," be sure that the tube shields are in place, or your work will mean nothing; for this set is very critical and care must be taken not to introduce any body capacity.

A loud hum sometimes develops, in the Temple "Model 8-60" and "8-61," that none of the ordinary prescriptions seem to help. It may be due to high line-voltage, which may be corrected by setting the fuse in the power pack to the "125-volt" position; or it may be due to the breakdown of a filter condenser (1.5-mf.) shunted across the

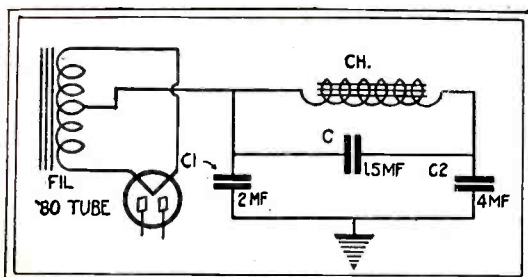


Fig. 9

In certain Temple models the condenser C is across a filter choke; if it shorts, hum starts at once.

choke in the pack (Fig. 9). The hum caused by shorting the choke can be remedied only by replacing the defective condenser or shorting it out of the circuit. The former remedy is to be advised, especially as the whole filter block is in one piece.

Receivers of this make were first produced with cadmium plating on the tuning condensers; and many of them are still in use. This plating, after some use, develops a very fine fuzz which can be seen with difficulty, but causes lack of selectivity and weak signals. It is best to replace the condenser assembly but, if this is not practicable, the fuzz may be burned off by applying a high voltage across the condenser. Use a transformer with one side of the secondary connected to the frame and the other to the stator plates. Turn the condenser

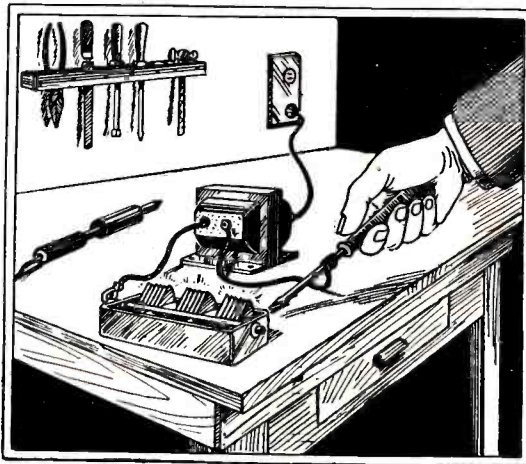


Fig. 10

In certain condensers, a slight slivering of the metal takes place. It may be removed, cautiously, as shown.

plates out, and switch the current into the transformer (Fig. 10). Be careful that the knob is a good insulator, and mesh the plates, a bit at a time. Sparking results, burning off the fuzz. Do not apply the current too long at a time; so that the transformer will not burn up. After each section has been burned off, and there is no more sparking, put back the condenser gang and resolder it.

In the Eveready "Model 52" and "54," a small "phono-radio" switch is fitted to the frame of the tuning condenser, near the dial, and operated by a lever, attached to the dial. As no stop is included, this switch is opened and closed every time the dial is turned to the end of the scale. This causes after a while a bad contact and opens the detector plate lead. When the set is dead, look to this point before removing the chassis from the cabinet; it may save you some time. The switch is easily reached from the back of the cabinet.

### SALVAGING A "RADIOLA 25"

By E. T. Johnson

IN dealing with the "Radiola 25" whose circuit was shown in RADIO-CRAFT Data Sheet No. 16 (April, 1930, issue), I had no desire to buy a new catacomb merely because a grid condenser inside had gone bad. Here is what I did:

After marking the leads from the terminal strip with a little red paint and unsoldering them, I took out the bolts holding the "cat" and lifted it out of the chassis. Then I put it on an electric "hot plate"

with the heat turned low. The special insulating compound around the parts gradually became fluid, and could be drained out. After a second heating, to get it all free from the coils, it could be tested and repaired. The beeswax-paraffin sealing compound may be used for various purposes; I believe it was originally used for coating coils.

Care must be taken to melt out all the compound; as the leads are of very fine wire, and not too strong. (The A.F. transformers are connected directly to sockets and associated apparatus, and no strain can be put on the wires.)

### BROIL TO A TURN AND SERVE

By R. Fels

HAVING a set of UV-99s from a Radiola 26 that would not play at all, I decided to try the reactivation method described by Mr. Stoneham in the April issue of RADIO-CRAFT. However, I had no electric heater, so I held the tubes over a gas flame for a few minutes. I found that they now play as well as new.

### GAS IN REACTIVATED TUBES

By John W. Busacker

ON page 490 of the April issue of RADIO-CRAFT, under the heading "Leaves from the Service Man's Notebook," there is an article written by George Stoneham, regarding the reactivation of tubes.

We have used this form of reactivator in our wholesale service department here, and find that, though the emission of the tube is restored, a sufficient quantity of gas is introduced into the tube to make it useless in a radio receiver. The test of a tube after having been treated in this manner will show far more than a permissible amount of gas. The application of heat to the tube explodes the coating of getter on the inside of the glass, and deposits it on the elements. This is no actual disadvantage, except where it accumulates between the leads going to the elements where they enter the stem of the tube. As this getter is an electrical conductor, its presence in this position will create small arcs between the internal leads when the tube gets in operation. This will cause a rasping noise in the speaker any time the tube is jarred.

The presence of gas in the tube will create a hissing noise when the tube is in operation, that will sound like the station carrier wave. This noise is evident only when a station is tuned in and, for that reason, makes it appear that the broadcast station has a very pronounced carrier wave; even though this is not the case. We do not feel that this is a successful means of reactivating tubes.

The writer is quite pleased to note the amount of space you are devoting to the excellent service articles that are published in RADIO-CRAFT.

### USE OF A.C. ADAPTERS

By Russell L. Woolley

"FADING" on local stations is frequently caused by the adapter used to convert a battery set into an electrified set. The reason is that the ends of the resistance wire (inserted into slots in the adapter sockets to serve as grid suppressors) are wound

(Continued on page 109)

# Some Notes on Repairing "B" Power Units

*A testing routine intended to get most quickly at the defective point of the apparatus, with suggestions for correction of troubles commonly experienced*

By C. WALTER PALMER, Assoc. I. R. E.

**M**OST Service Men learn to adopt a certain individual procedure when testing a certain piece of apparatus or a certain type of unit. However, there is naturally a "shortest way"—one more convenient than others—which will save both the patience and the time of the professional man.

Repairing manufactured power units is not difficult if the parts are accessible. In most cases, even though the unit is enclosed in a metal case, the parts are mounted on a chassis; so that, when the case has been removed, the parts are easily reached and tested. In some few cases, of course, units are sealed in wax or pitch and it is advisable to return such a unit to the manufacturer for repairs.

### Difficulties Encountered

The defects encountered in "B" power units may be classified into several groups; each group in turn being sub-divided according to the element causing the trouble.

The first defect is a low output voltage from the unit. This may be caused by the line-voltage being below normal; by a defective rectifier tube; a defect in the receiver, causing too much drain on the unit; a defect in the voltage divider; or a defective filter condenser.

The second principal defect is a loud hum in the set. This may be due also to a defective rectifier tube; or to an insufficient number of filter condensers, or a defect in one or more of them; a defect in one of the filter choke coils; a defective transformer; or, in some few cases, reduced line-voltage.

The third characteristic defect is total failure of the unit. This may be caused by poor design or by defective apparatus. Under poor design may be listed the use of incorrect parts as, for example, where the wrong type of rectifier tube is placed in the socket or even used for a time. The use of a condenser with a working voltage too low, for the surges encountered when turning the power off, is also a common cause of trouble. Under defective apparatus, may be listed any of the parts used to make up the complete unit; since a breakdown in any of the parts in the unit may cause complete failure. The connections must also be accounted for and, finally, the line-voltage must not be neglected.

This last point brings to mind a case encountered by the writer some time ago, in which a blown fuse necessitated a train ride of over an hour, in order to make a set operate again! Naturally, if the owner had used a little care, or if the circumstances had permitted the writer to question him by telephone, the trip would have been saved.

The outline of troubles given above is not complete, since each group includes a number of minor causes. It does, however, in-

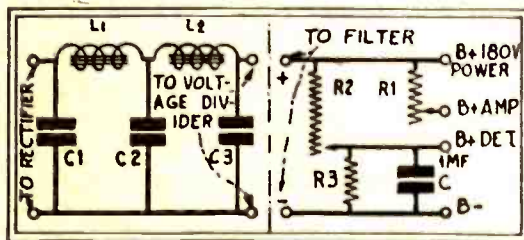


Fig. 2 At the left, the fundamental filter circuit of most power units. At the right, a type of voltage-divider sometimes found.

clude the main points and those most likely to give trouble. For instance, suppose the trouble is insufficient output potential. (See Fig. 1.) This may be due to either low line-voltage; a defective rectifier tube; excessive current drain in the receiver, a defective transformer, choke or condenser; or an incorrect voltage divider. All of these causes of trouble are mentioned above.

Other sources of trouble may also be included in the outline above, as sub-entries. For example, if part of the secondary winding of the power transformer is short-circuited the output voltage is reduced; and the winding will therefore probably burn out, because of the excessive current flowing in the closed part of the winding.

If the rectifier tube is defective, the output will naturally be reduced or entirely lacking. In the filament type rectifier (such as the '80 tube shown) the rectifying action depends on the electron flow from the filament. If the filament is operated at an excessive voltage for a period of time, the electronic emission is rapidly reduced; and this causes a reduction in the output current and voltage.

### Lack of Voltage or Hum

The design of the voltage divider is another important point with regards to the output voltage. If its resistance is too low, a great deal of the available current is lost as the "bleeder" current flow through this resistor; and the result might be insufficient current output for the set. If

one of the filter condensers between the taps and the negative terminal ruptures, the resistance of the divider will be reduced; but, in this case, the trouble will be easily located by lack of voltage on the taps between the condenser and the negative end of the voltage divider.

With respect to the second group of troubles, excessive hum may be caused by low line-voltage; because the rectifier can not operate correctly with the reduced input voltage. The hum may also be caused by a defective or short-circuited choke; for this piece of apparatus is the mainstay of the filter circuit. Lack of filter condensers will also cause a loud hum.

It is not necessary to go into further details about these troubles and how they are allied. We are all familiar with the faults; it is the remedy which is most needed. In order to illustrate the method used in locating a defect, we will consider another example.

### Continuity Tests

Suppose we have a dead power unit to repair. There are a group of tests which may be used to locate the source of the trouble in a very short time. First, measure the line-voltage with a suitable A.C. voltmeter. If this is correct, or nearly so, test the continuity of the primary circuit of the power transformer. A battery and a voltmeter connected in series across the two prongs of the plug will show this very well and, in addition, indicate any defect in the power switch or wiring which completes the primary circuit. The power switch must be in the "On" position, of course. If, when we first examined the unit, the rectifier tube was warm or the filament lighted, this first test is unnecessary. In the filament type of rectifier, it is possible for the high-voltage winding, or one side of it, to burn out and the filament of the rectifier tube still to light. In this case, the continuity of the high-voltage winding must be checked.

This may be accomplished without removing any of the wires, by placing a plug

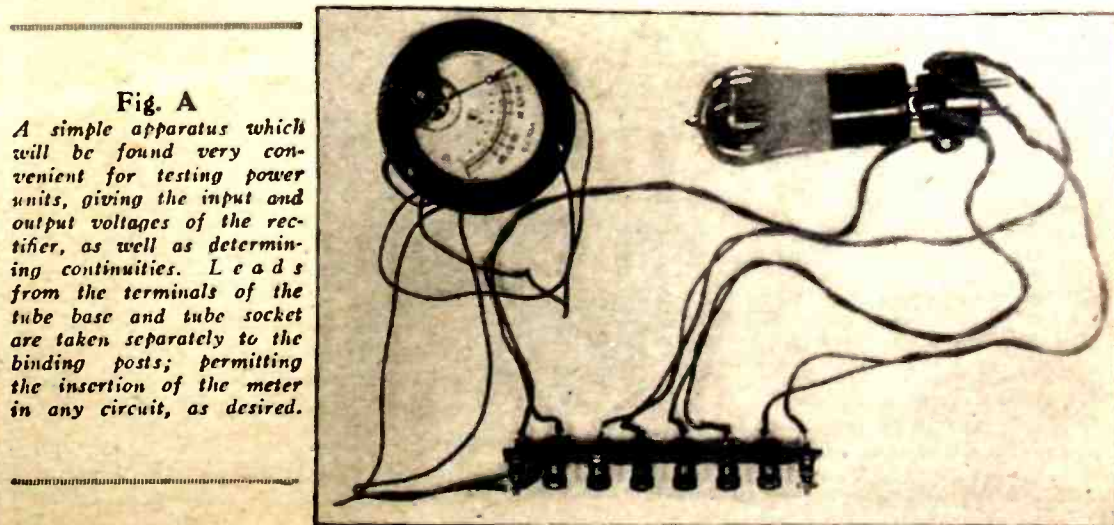


Fig. A A simple apparatus which will be found very convenient for testing power units, giving the input and output voltages of the rectifier, as well as determining continuities. Leads from the terminals of the tube base and tube socket are taken separately to the binding posts; permitting the insertion of the meter in any circuit, as desired.

similar to the base of an old tube in the socket of the power unit, and connecting wires to the grid and plate prongs. We will find further use for this plug, later. The conductivity between the two ends of the winding, and also between each end and the negative terminal of the power unit, in the case of the full-wave system, should be determined. It is possible for the negative lead to be open, while the continuity of the complete winding may not be affected.

There is one other test which must be made at the transformer. In the power units designed for the "BH" or cold-cathode type of rectifier tube, two condensers (known as buffer condensers) are connected across the sections of the secondary winding. In case one of these condensers breaks down, a continuity test will not indicate the trouble unless the condensers are disconnected from the circuit; since they are shunted by the secondary winding.

Fortunately, these condensers are usually quite accessible, being located close to the transformer; and the wires are connected directly to the terminals of the winding. After they have been disconnected, they may be tested in the usual manner with a "B" battery or other source of direct voltage. The battery is connected across the condenser for a moment, and then the condenser is short-circuited with a piece of wire. If a spark is evident when the condenser is shorted, it is in good condition. If a spark is observed when the battery is connected, the condenser is undoubtedly short-circuited. It is advisable to short-circuit the condenser in a rather dark place, so that the spark can be readily seen. This is more important with small condensers, of about 0.1-mf. or so; since their spark is not very large. Smaller condensers than this cannot be tested in this manner.

### Testing the Filter System

We have now tested the unit (except for the rectifier tube) up to the filter section. If any defect is found, it is necessary to localize it by making tests of the particular part suspected. In other words, if one side of the power transformer's secondary winding appears to be open, tests should be made at the terminals or the wires coming directly from the transformer, in order to be certain that the trouble is not due to a defective connection.

The next section of the power unit is the filter. We are all familiar with the appa-

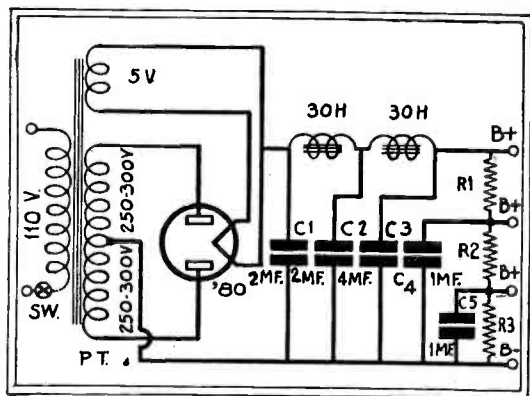


Fig. 1

The general layout of a power unit; values vary, but are generally in the order of those shown. Connections must be broken, to test the continuity of shunted condensers.

ratus used in the conventional type of filter; hence a description is not required. Two tests are necessary for this part of the unit; tests for the continuity of the choke coils and tests for the condition of the filter condensers.

The choke coils may be tested by connecting the continuity tester that we used before (the "B" battery and voltmeter) between the cathode of the rectifier and the maximum output terminal of the unit. The correct terminals are the filament of the '80 type tube and the "plate" terminal on the tube socket for the "B—" rectifier. It will be noted that the reading on the meter is lower than when the two wires of the tester are connected directly together; this is due to the resistance of the chokes.

The filter condensers cannot be tested while connected to the power unit; because they are joined together. Also, they should be disconnected while testing the chokes, as a precaution in the event that one of them is defective. When testing the chokes the voltmeter and battery is connected across the terminals of each of the chokes individually.

In case they are enclosed in a single container, the center terminal is one end of each of the coils, and the other two terminals are the extreme ends. While making this test, it is well to make sure that one of the windings is not short-circuited to the core or the container. This test can be made with the continuity tester, by connecting one terminal to any bright metal part of the case and each end terminal, in turn. In case of defect, the complete unit must be discarded and replaced, unless the chokes are enclosed in separate containers.

### Convenient Condenser Tests

Next, we test the filter condensers. We have already disconnected them from the unit, on the choke side. The easiest and most satisfactory way to test them is to connect a "B" battery, or other source of fairly high voltage, across the condenser for a moment; and then short-circuit the terminals of the condenser with a piece of wire as explained before. In case of doubt, it is advisable to try the test several times. (The battery should be connected for only a moment.) In most cases, all the filter condensers are enclosed in a single container. A common terminal is brought out, and connected to the center or end of the power-transformer winding, and also to the end of the voltage divider. This common terminal is used for testing each of the condensers.

If one of the condensers is short-circuited or ruptured, it may be possible to place another condenser in the power unit without removing the complete block. The capacity of the defective condenser may be approximated by noticing its position in the unit. (See Fig. 2.) The first condenser C1 usually has a capacity of 2 mf. The next, C2, is usually 2 mf.; and the third is seldom more than 4 mf. In many units condensers of about 1 mf. are connected between the negative terminal and the taps on the voltage divider. These condensers can be tested in the same manner.

The final section of the unit is the voltage divider. Dividers may be of different types. The first is a number of resistors

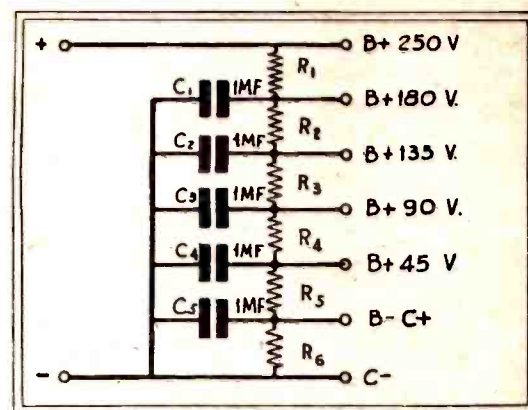


Fig. 3

The standard arrangement of a "B" voltage divider, whether the resistors are separate components, or represent only taps on one or two resistors. Values vary with the voltages desired and current drawn.

connected in series, with taps at the connecting links; this is shown in Fig. 3. In this type of resistor unit, if one of the resistors near the negative end breaks down, the voltages at the higher (or rather more positive) taps will be excessive, and the taps on the negative side will not give any voltage reading. The defective resistor or connection can be located in this way, and may be either repaired or replaced.

### Voltage Divider Arrangements

The next type of divider is electrically similar to the first; but a single resistor is used, with taps at the required points. The method of finding the defect is the same as in the first case.

The third and last method is different in design; it uses several resistors of the variable type and a fixed resistor, connected as shown in Fig. 4. If the fixed resistor R3 breaks down, the voltage on the detector tap will be high. If either of the variable resistors breaks down, no voltage reading will be obtained. In testing any of the voltages of the power unit, a high-resistance voltmeter must be used. By "high resistance" we do not mean necessarily as high as 1000 ohms per volt, but at least 250 ohms for each volt on the scale.

If the trouble in the unit is excessive hum, a difficult set of tests must be made. In this case, the voltage is of little value; as the voltages may be correct, and the hum still be too prominent. If one of the filter chokes is short-circuited, the hum will be excessive. At this time, it might be well to point out that many power units do not contain two chokes. Some units use the field coil of a dynamic speaker as one of the chokes. If the wires to this coil become twisted, shorting the winding, the hum will be excessive and the volume of the set will be greatly reduced.

### Rapid Testing Methods

In some cases, a reversed plug in the line will cause hum. Lack of correct grounds at the proper points will cause loud hum. The effect of the chokes on the set can be checked, by deliberately short-circuiting each of the filter chokes in turn. If the hum increases when they are short-circuited, they are in good condition and operating.

The condensers can be checked by disconnecting them from the set. If the hum increases they are working properly while, if no difference is noted, either the condenser is defective or it is not needed there

and can be used to better advantage at some other point in the unit.

If the design of the power unit does not permit changes, external chokes and condensers may be added. In many cases, the operation of a power unit is improved very much by inserting an audio-frequency choke in series with the detector plate lead, with a by-pass condenser connected from the choke to the negative lead of the power unit. The condenser is connected on the side of the choke which leads to the set, as shown in Fig. 5.

### Testing the Tubes

We have now accounted for all the apparatus used in the ordinary types of power unit. We have not yet considered the testing of tubes; but, since they are one of the most important parts of the unit, and one of the most frequent sources of trouble, we will consider them separately.

We mentioned the need of a test unit while checking the continuity of the windings of the power transformer, and suggested using a unit with the base of an old tube, so that we could reach the connections at the rectifier socket, without any difficulty. We will now elaborate on this simple unit, so that we can also use it for testing tubes. A socket of the ordinary UX type, made for sub-panel assembly, is mounted to the top of the tube base, after connecting short leads to each of the prongs of the base and the terminals of the socket.

Next, a terminal strip, with eight binding posts, is prepared; and the wires from the socket and base are connected to these terminals. The plate prong and terminal wires are connected to the first two posts, which are adjacent. Then the grid and the two filament circuits are treated in the same manner. Finally jumpers are connected across the corresponding posts.

In using the unit to test the continuity of transformer windings, it is merely placed

in the socket of the rectifier tube; and the two ends of the winding are then available at the terminals of the unit, which correspond to the grid and plate for the units using the '80 type tube, and to the two filament terminals for the "BH" type.

When testing the rectifier tube, after the rest of the power unit has been found in good condition (either by making the necessary tests on the various parts or by replacing the rectifier to be sure that this is not the cause of failure) the A.C. input voltages to the tube are first measured with a suitable A.C. voltmeter; and then the D.C. output of the rectifier is checked with a suitable D.C. voltmeter.

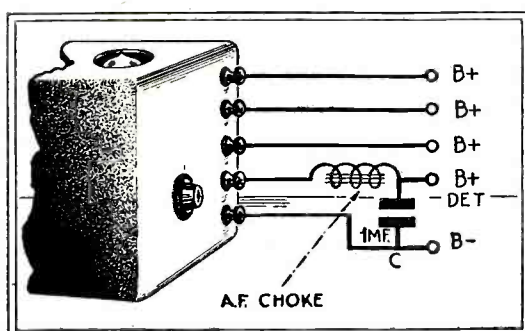


Fig. 5

Since this is the critical stage of a receiver it may be desirable to add additional filtration to a detector's power supply by connecting an external choke and condenser in series with the tap on the power unit.

### The "BH"-type Rectifier

Suppose, for example, we consider a unit using a "BH"-type rectifier tube. The A.C. voltages of the power transformer's secondary winding are checked by placing the test unit in the rectifier socket and connecting the A.C. meter between each of the filament terminals on the binding-post

strip and the negative output terminal of the power unit. When these voltages have been determined, the rectifier tube should be placed in the socket at the top of the test unit plug; and the D.C. output voltage measured with the D.C. meter. The jumper between the two terminals of the plate prong should first be removed, so that the rectifier is not connected to the filter and voltage divider. This is done to protect the tube being tested.

The D. C. output of the rectifier will be somewhat lower than the A.C. voltage; because of the voltage drop in this tube. The difference in the voltages, however, is not very great for good tubes. After the tube has been checked in this manner, it should be checked under load, by replacing the jumper on the "plate" binding posts of the test plug. The operation of the filter and voltage divider must be known before this is done. When making changes in the connections of the jumper or other wiring to the power unit, the power switch should be turned "off."

When testing the '80 type tube, the connection between the rectifier filament winding and the first filter choke must be removed; so that the rectifier is not connected to the filter when making the first voltage test. By removing the jumpers on each of the two anodes (plates) in turn, the operation of each side of the full-wave rectifier can be checked. This is done by removing the "F" jumpers for the "BH" type tube and the "G" and "P" jumpers for the '80 type tube. The output is reduced, of course, when only one side of the rectifier is used.

The test plug can be made as a complete unit by obtaining a combination A.C. and D.C. voltmeter with a suitable scale reading. This meter can then be mounted in a small box, with the eight binding posts, and fastened permanently to the test plug. See Fig. A.

## An Easily Made Tube Holder

By H. BERMAN

HERE is a way of saving tubes, keeping them handy for testing purposes, and carrying them from place to place when desired, without much labor. The author has used this method, and applied the idea for dozens of his friends, for a long time.

In a word, it consists of using a corrugated paper box instead of the usual board for holding tubes. Its construction is clear from Fig. 1 but additional details are given below.

Many set builders, Service Men, experimenters and laboratory workers resort to the use of a common large box to hold the many tubes used in testing work; because it is not always convenient to construct the wooden rack with holes generally used.

A corrugated paper box, however, may be worked with a penknife; it may be carried from place with ease, and without danger to the tubes. These tubes should all be carefully tested and the characteristics of each clearly indicated on a paster which is to be stuck on the glass. Some technicians will have more of these tubes than

others and it is both inexpensive and convenient to make up several of these boxes; putting tubes of a particular class in each box. The cartons in which batteries are packed are the ideal type for this purpose.

The type of box selected, whatever its other dimensions, must be from three to three and one-half inches in depth. This is required to take care of the smaller tubes; as the glass portion of the tube must be kept from touching the bottom, while it is held suspended by its inverted base.

The diameters of the holes in the cardboard top for the different types of tubes are as follows: '01A, '40, '00A, '26, '27, '12A, '71A, '22 and '24, 1 5/8-in.; '99, '20, 'D11 and 'D12, 1 in. (these are to be inserted with their bases up.); '80, '81, '10, '45, '50, '74, 1 3/4-in.

Although the author has not yet tried it, the suggestion is made that boxes only wide enough for a single tube, but sufficient in number, placed end-to-end, to accommodate all the necessary tubes, may be used. This will make it convenient to put pasters

all along the front, indicating the type of the tubes immediately behind each. The experienced shop Service Man will recognize this as a big time saver.

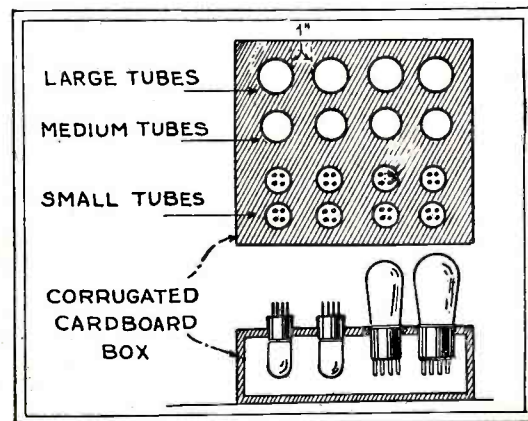


Fig. 1

The necessity of a suitable rack for tubes in service is met most easily by the construction of a holder of corrugated board, in the manner shown. This will afford excellent protection for the bulbs.

## BOSCH "CRUISER," "ROYAL CRUISER," AND "IMPERIAL CRUISER" MODEL 35 BATTERY SETS

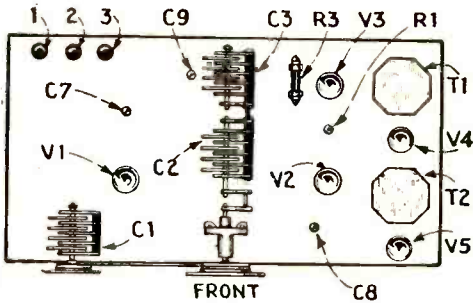
An unusual method of obtaining neutralization is observed in these popular "Cruisers." Windings (A) in coils L2 and L3 are in the negative filament leads of V1 and V2, for this purpose, and function in conjunction with condensers C7 and C8.

Resistor R1 is a master control to maintain the filament potential at five volts. Volume is further controlled through R2 (marked "Amplifier") which, at its position of highest resistance, operates switch SW1. Selectivity is governed by SW2 (marked "Clarifier") and C10. A nine-wire cable connects the current supply to the set.

As this model of the Bosch receiver is not provided with an output transformer, or choke coil and condenser, trouble may be experienced from de-polarized magnets in magnetic-type reproducers, if the leads of the reproducer have been accidentally reversed.

The location of the main rheostat, R1, is indicated in the top and bottom views of this receiver. The slot in the top of the control will be parallel with the front of the set for the five-volt setting.

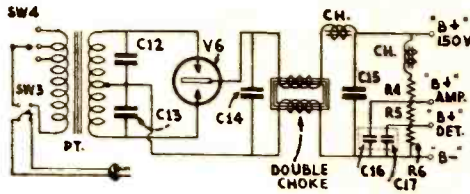
Four '01A tubes and a '12A or '71A tube are recommended for this set.



Top view of parts layout of Bosch "Cruisers." The coupling devices for C2, C3 are clearly shown.

Nearest to the panel is the knob that controls C2 and C3, the settings of which are indicated on the upper or "Main Tuning Scale." The other knob controls the antenna for tuning condenser C1, with its position indicated on the lower or "Antenna Tuning Scale." The reading on the lower scale depends, in part, on the length of the antenna.

This receiver is balanced like a regular neodyne receiver, a "dummy" or open-filament tube (or similar expedient) being used in place of the regular tube; first, in place of V2, and then as a substitute for V1. Adjustments of C7 and C8 are made for minimum signal. Condenser C9 resonates the detector circuit for maximum signal.



Schematic circuit of "Type BAN (Edition 3) Nobattery" eliminator.

If either of the above adjustments cannot be made, check the R.F. circuit for faults. Remove the shields from C1, C2 and C3, and note whether, at the zero setting of the dial, all the condenser rotors align perfectly straight at the tapered ends of the stators. Adjustment of the stators is accomplished through the bolts which join two end plates (if it is desired to change the spacing between interleaved rotor and stator plates); and the proper spacing here, for minimum setting, is easily obtained by adjustment of the screws on the condenser-shaft couplings.

If the condenser shafts lose their alignment, the condensers may be loosened and reset to the correct positions. Condenser C2 may be shifted for proper alignment after removing the coil assemblies.

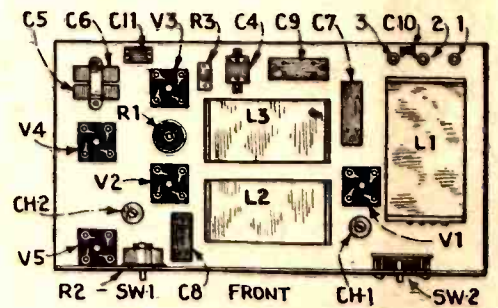
With all condensers set at maximum capacity, the dial should indicate 100. If this reading is not obtained, compensation may be secured by adjustment of two stop screws provided for this purpose.

A six-ohm rheostat may be used as replacement for R1; R2 has a resistance of about 30 ohms; R3 is the usual 2-meg. leak; C1, C2, C3 are the tuning condensers; C4 is .00025 mf.; C5, C6, 1.0 mf. each; C7, C8, C9, 100 mmf., maximum (approx.); C10 125 mmf. (approx.); C11 .006 mf.

The "Type BAN" (Edition 3) "Nobattery" eliminator is usually used with this model of the "Cruiser" line. (Other models of the "Cruiser" embodying somewhat the same general features but varying in details are the "Model 96DC, 110 volts"; "Model 156," (for direct current); "Models 66, 76, 76L" (battery-operated); "Models 66AC, 96, 116, 136" (for A.C. operation).

Constants for the above "Nobattery" unit are as follows: C12, C13 0.1-mf.; C14, 3 mf.; C15, 2 mf.; C16, C17, 2 mf.; R4, 4,000 ohms (or a variable 5,000-ohm unit); R5, 15,000 ohms; R6, 25,000 ohms. V6 is a gaseous rectifier; SW3 the power switch. The principal choke unit in the filter system is a "double" choke.

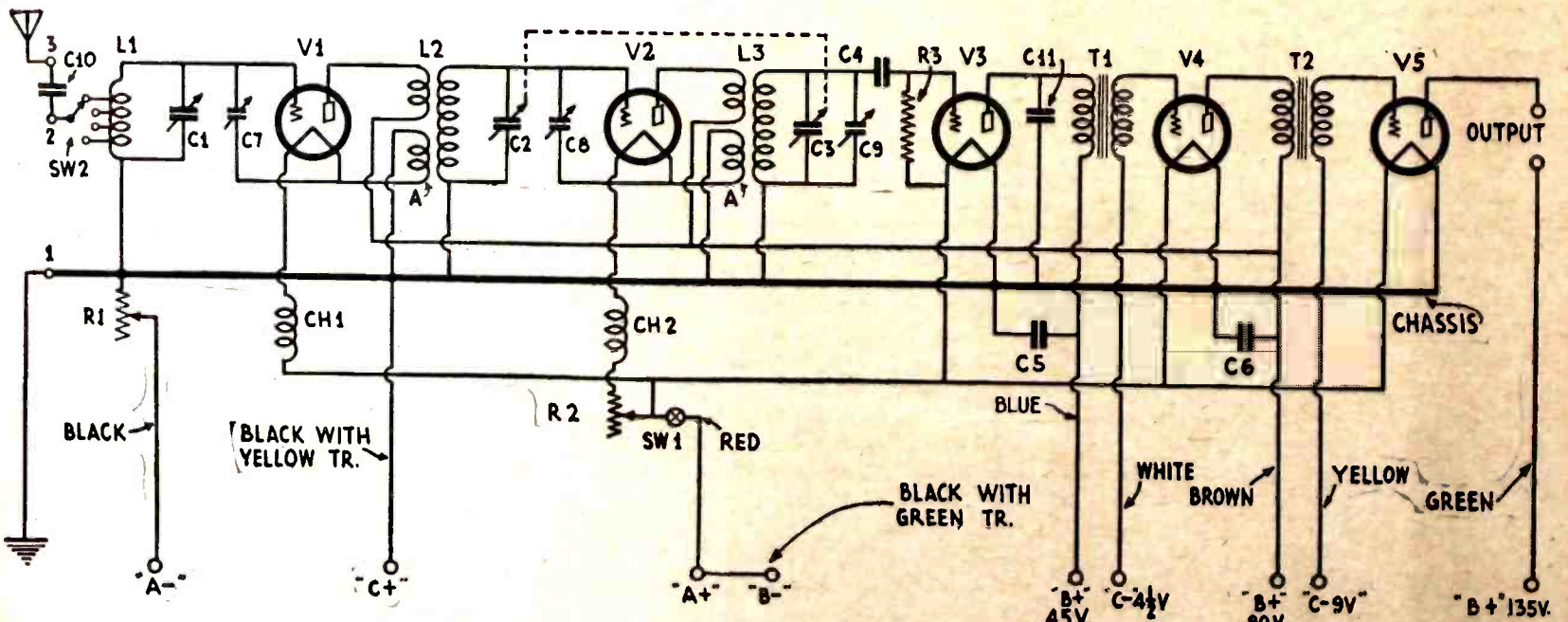
Although the circuit diagram does not indicate that there is a mechanical connection between C2, C3, and antenna condenser C1, there is a slip coupling which permits C1 to turn readily when the other two tuning condensers



Underside appearance of "Model 35" receivers. Units R1, C7, C8, C9, shown here, adjust from above.

are adjusted or to be operated independently of these two. More complete control of the dial reading designated "Antenna Tuning Scale" will be secured by making C10 one of the compact adjustable units now available. Then, by varying C10 and SW2, it will be possible to obtain nearly identical readings on both scales for any average antenna conditions.

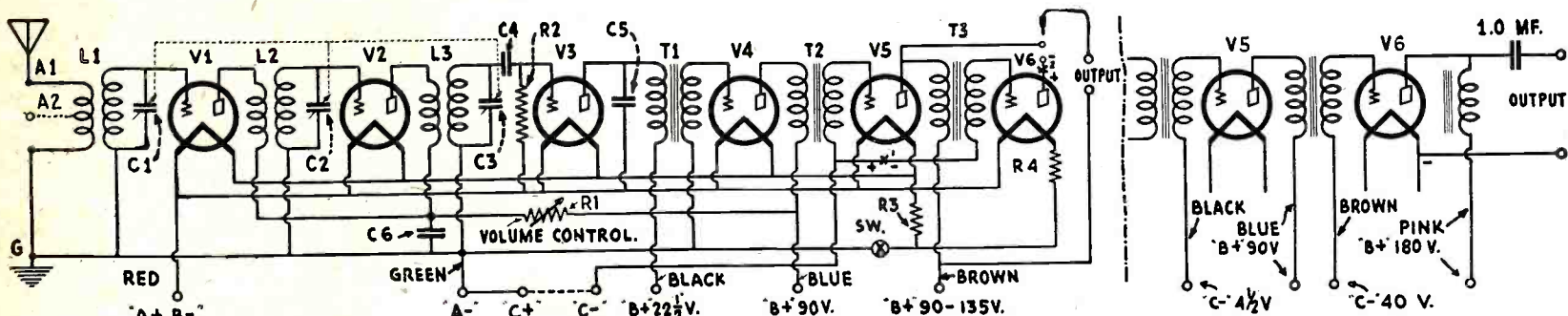
If it is found that circuit oscillation cannot be stopped, test windings A for reversed connections; checking L3 first and L2 last.



Schematic circuit of the "Cruiser," "Royal Cruiser," and "Imperial Cruiser," designs of the Bosch "Model 35" battery sets. The arrangement of the neutralizing circuit is such that the respective grids are connected to the grounded "A—" lead if the neutralizing condensers short, without affecting any of the batteries in the set.



ALL-AMERICAN "MOHAWK" ONE-DIAL RECEIVERS  
BATTERY AND A.C. 226-227



Above. Battery model of the "Mohawk" One-Dial receiver. If the original switching system for cutting V6 into the circuit is to be retained, special connections must be employed, as described in the text. At right: Modifications in later models; this standard arrangement of the output stage provides for the use of a power tube at V6.

There are two principal variations in the battery-model Mohawk receiver. The first circuit, shown above does not make provisions for a power tube at V6; six type '01A tubes are required. A 5-wire cable is used. An odd arrangement of the A.F. output circuit, to select two or three stages of A.F., by means of tip-jacks and a plug, necessitates placing the additional battery required for power-tube operation on the plate side of the A.F. output, at the point marked X2 (otherwise, this supplementary potential would be added to the plate supply of V5). The corresponding "C" potential is added at X1.

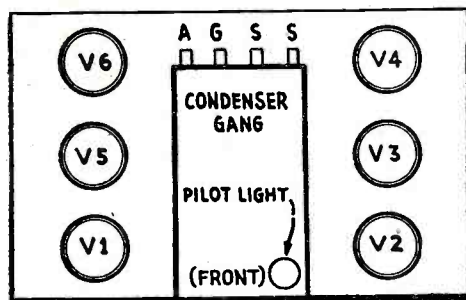
In later models, provisions were made for a power tube; and the usual connections are shown at the right of the main diagram. The color code of the (7-wire) cable is then as follows: Green, "A-"; red, "A+"; white (connected to red), "B-"; slate, "B+" 22½ or 45 volts; blue, "B+" 67½ or 90 volts; pink, "B+" 90, 135 or 180 volts; black, "C-" 4½ volts; brown, "C-" 4½, 9, 22½ or 45 volts; yellow (connected to green), "C+".

The available constants for this receiver are as follows: L1, L2, L3, shielded R.F. transformers; volume control R1 is a 500,000-ohm variable resistor which turns off the set by operating switch SW when R1 is turned to extreme left; R2, 2 megs.; R3, 1¼-amp. filament ballast; R4, 1-ohm resistor; C4, .00025-mf.; C5, .002-mf.; C6, 0.5-mf. In some sets, R3 is a 10-ohm rheostat.

In later production a selectivity control was incorporated. This was in effect a single-pole, single-throw switch arranged to select either all, or half, the primary of L1.

The circuit of this receiver will oscillate; but is controlled by R1. Trimming plates are provided on the condenser gang.

The tube layout shown is the same for A.C. and battery models.



Layout of parts in receivers of the All-American "Mohawk" line.

The A.C. model requires four '26s for V1, V2, V4, V5; a '27 for V3; and a '71A for V6.

The constants of the A.C. model are as follows: C4, .00025-mf.; C5, .002-mf.; C6, C7, C8, C15, 0.5-mf.; C9, .003-mf.; C10, C11, 1.0-mf.; C12, 6-mf.; C13, 3-mf.; C14, 2-mf.; R1, 650 ohms; R2, 850 ohms; R3, 2 to 3 megs.; R4, R7, R8, 20 ohms; R5, R9, 1,000 to 1,200 ohms; R6, 0.5-ohm; R10, 2,000 ohms.

The heater of V3 is held at 45 volts positive. If this positive tap open-circuits, there will be a noticeable increase in hum.

Resistor R6 varies the heater current to V1 and V2. It has a value from 0.5- to 0.75-ohm. Lack of volume control may be due to a short in this unit; while a ground will result in hum. Transformers T1, T2, T3 have a ratio of 3¼ to 1; T4, 1 to 1.

Uncontrollable circuit oscillation will result if R1 or R2 becomes shorted, and may be the result if R1 and R2 are interchanged. If the

set cannot be made to oscillate on medium to high wavelengths, try changing the R.F. tubes; though this may be due to C15 being open. A particularly high noise level may be an indication of C9 being open.

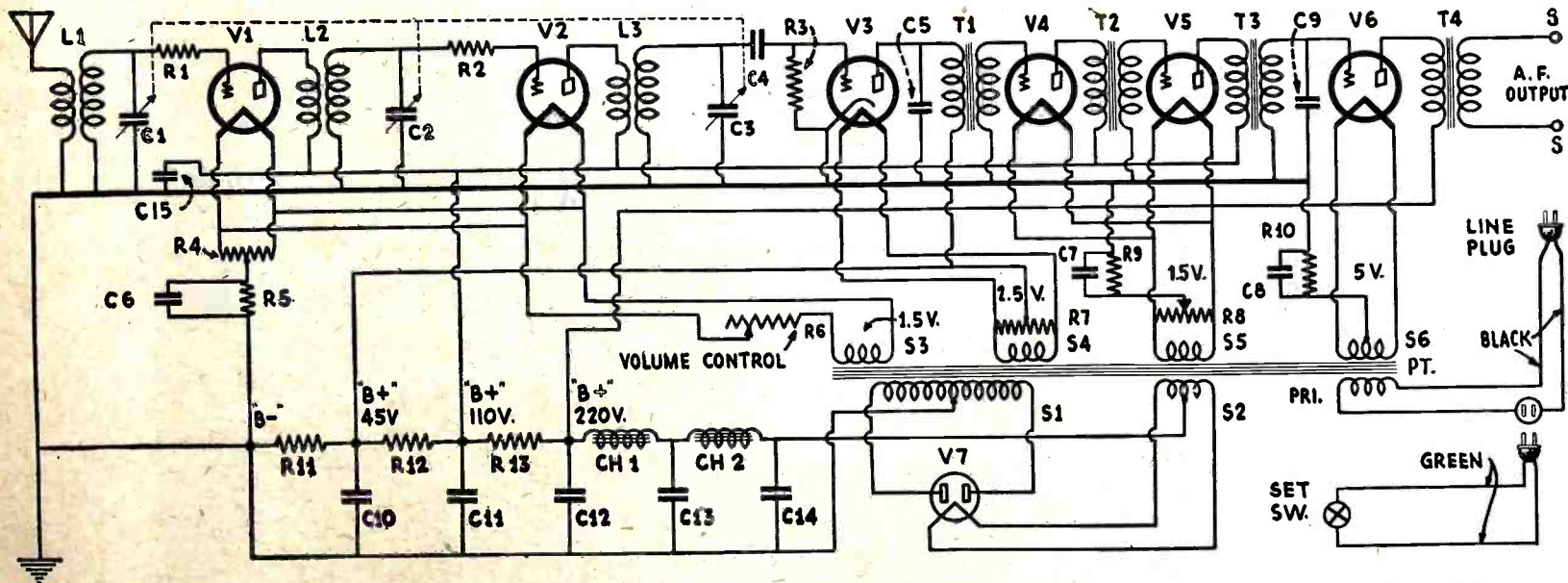
The "Mohawk" receivers carry further designating names, such as "Navajo," "Iroquois," "Cortes," "Hiawatha," "Seminole." Some of these are table models, others consoles with or without speakers. One of the early models was designed to use Kellogg tubes, with their side connections for the heater leads.

The voltage divider of the current-supply unit used in the electric model calls for these resistor values: R11 ("B-" to "B+" 45) 6,500 ohms; R12 ("B+" 45 to "B+" 110) 6,000 ohms; R13 ("B+" 110 to "B+" 220) 1,600 ohms.

Attention is called to the fact that, although some of the circuit sheets which have been issued do not show a ground, there is a return circuit to ground for the power unit, as shown in the diagram at the bottom of this page.

The color-code of the Jones cable used in this receiver to couple the receiver to the power pack is as follows: Pink (2), 1½-volt filament supply for R.F. tubes V1 and V2 (the output of secondary S3); yellow (2), 1½-volt filament supply for A.F. tubes V4 and V5 (the output of secondary S5); black (2), 5-volt filament winding for power tube V6 (the output of secondary S6); purple and gray leads, the 2½-volt supply leads (from secondary S4) for the filament of detector tube V3; green, "B+" 45 volts; white, "B+" 110 to 150 volts; red, "B+" 220 to 250 volts; brown, the "B-" lead, is to be grounded.

Most receivers require a good ground connection; but this is particularly true of the "Mohawks," if hum is to be held at a minimum level.



Schematic circuit of the A.C. design of the All-American "Mohawk" radio set. The color codes of its Jones cable and the voltage divider do not appear in the regular manual, but are given in the text of this sheet.

# The Service Man's Open Forum

## A SIMPLE SOLUTION

Editor, RADIO-CRAFT:

Why should a radio manufacturer be bothered by every Tom, Dick and Harry asking for service? I think it is the duty of RADIO-CRAFT to get this information and publish it, so that your readers will not have to trouble the manufacturers. If RADIO-CRAFT cannot get the information from the factory, then get it from the dealers or distributors who have received it from the factory.

I have not seen an article in any radio paper with a description of how to make a simple R.F. oscillator of the type used by a radio manufacturer to line up condensers and for neutralizing purposes; it has always been some ham's idea. A service and repair shop must have the factory idea, for quick service and a good job.

J. BARTLETT,

261 Whitman St., New Bedford, Mass.

(The method of obtaining data suggested by Mr. Bartlett is good, but only to the extent to which it obtains cooperation. Some manufacturers and their distributors are, however, averse to having this information in the hands of Service Men outside their own organization, for the reasons assigned by them in the May issue of RADIO-CRAFT; and other information, often wanted, concerns the product of extinct organizations.

Mr. Harris' article on testing apparatus, in the June RADIO-CRAFT, is based on a knowledge of factory methods. The small repair shop, however, cannot undertake to duplicate the equipment of a large factory, for obvious reasons.—Editor.)

## THE PART-TIMER REPLIES

Editor, RADIO-CRAFT:

I wish to take issue with Mr. Edward H. Olson, who in the May issue of RADIO-CRAFT condemned the part-time Service Man—because *I am one of those animals*. Mr. Olson's theory seems to be "that to know the mechanics of one or two receivers is better than knowing the principles underlying radio communication." I am not defending the crowd, however; as all professions have quacks.

My regular occupation is secretary-stenographer but, a little over two years ago, I became interested in radio as a hobby at first, later as a prospective occupation. My location is in the mountains of Kentucky, far from authorized service stations. My office hours are from 7:30 a. m. to 4:30 p. m., which gives me plenty of time for study and spare-time work. Am now a student of RCA Institutes, Inc., and own a Jewell "408" analyzer. The company for which I work sells Majestic and Atwater-Kent receivers, and I do its installing and servicing as well as any other work that is given me by individuals, including one other dealer in this territory. My work has been very satisfactory as no sets have to be returned to the distributors. The distributors for above-mentioned receivers approve of my work, and I am on the regular mailing list for service information from their factories.

The following is an illustration of repairs made to another receiver about which I do

not possess service information. A doctor called me on Saturday night and informed me that his Graybar "330-S" would not work. I went to his home on Sunday, as he lived six miles away. A check with the analyzer showed no plate potential on any of the R.F. tubes, but normal potential on the balance. A continuity test showed the receiver circuit all right. The trouble was quickly analyzed as being in the voltage divider and a test showed an open circuit in the 2250-ohm resistor of the divider. The owner insisted that temporary repairs be made, if possible, in order that he might not be deprived of the use of his receiver. The open ends of the resistance wire were

This page is for the expression of opinions on the customs and conditions of the radio trade as they affect the Service Man and representative letters with the writers' signatures are published without reference to the editorial viewpoint. For their benefit, and the profession's, Service Men who have not already done so are invited to enroll in the National Radio Service Men's Association by filling out and sending in the blank on page 70.

cleaned of the enamel and twisted together, and a new resistor ordered. The charge of service was \$3.00. Will Mr. Olson go the same distance and do the same work for less? The express on this set to a service station would have been approximately that amount one way. The customer was highly pleased and I will receive his future business.

I am a part-time Service Man; don't have any title; am a free lance, the customer is my boss; I never install inferior or improper material. I have never damaged a receiver and have only burnt out one tube in my experience. I'll be glad to consider any better proposition, either to my customers or myself, that Mr. Olson cares to suggest.

A. F. BREEZE,  
Jenkins, Kentucky.

## THIS IS A SYSTEM

Editor, RADIO-CRAFT:

I would like to pass on to other Service Men two thoughts which may save some time and trouble. Test dry batteries with a low-resistance voltmeter, and test them when the set is on. The more expensive instrument is an awful liar in many cases. In many articles the high-resistance device is recommended unreservedly, and many Service Men, like myself, think that the low-resistance meter is unnecessary. Yet it will save a lot of trouble in the case of bad dry cells.

I have noticed also, in a recent issue of RADIO-CRAFT, a filing system used by one Service Man. It is O. K. if you want to cut up the magazine; but I find that too often what is cut out ruins something else I want,

on the other side of the sheet. In fact, in the case of RADIO-CRAFT, it would sometimes mean getting half a dozen copies or so in order to file everything I want.

As each magazine comes in (I take several) I index everything alphabetically in a loose-leaf notebook, cross-indexing wherever possible. I might say that RADIO-CRAFT is the worst to index, as it is so full of meat that one column, in some departments, may mean as many as forty entries. I have separate pages for the various letters and, in addition, a section, "Service Notes," under which I index all the little notes on servicing which are at all likely to come up in the future. Another addition is a "Miscellaneous" section in which I also put any notes that may come up in connection with my work so often that I do not want to have to go to the magazine to look it up.

I find it best to index everything fully; as the points which seem, on reading, least likely to come up are those I usually want later.

R. B. OXRIEDER,  
Juneau, Alaska.

## WHY SERVICE MANUALS?

Editor, RADIO-CRAFT:

After studying the replies of the various manufacturers, which appeared in the May issue of RADIO-CRAFT, I think that one side of the story has been neglected. Just what do the service manuals do for the Service Man? My personal opinion is that they have done more harm than good to the real Service Man, and also to the set owner.

Time was when a Service Man had at least to know the fundamental circuits of the various sets, and therefore commanded some respect from his employer, but times have changed; for now the employer tucks a bunch of service manuals and a Jewell 199 under the arm of the office boy, truck driver, "or what have you"—and another Service Man is made.

And still some of our foremost manufacturers maintain that these are the only places capable of servicing their sets!

If you drove your car into a garage for repairs, and the mechanic came forth with an instruction book in one hand and a wrench in the other, would he command your respect, and would you let him work on your car? You certainly would not; then why expect the buyer of a radio to be satisfied with service of this kind?

It seems to me it is up to the manufacturers to demand that their dealers maintain service departments, not wrecking crews. It would pay the manufacturer to send around an inspector to his dealers; and, if they have least doubt as to the ability of some of the drug clerks, suit salesmen, etc., who don at a moment's notice the title of "Service Man," why not appoint various known service companies to service their sets?

The sooner the dealer recognizes that it takes more than a bunch of service manuals and a test set to make a Service Man, the better for all concerned.

H. S. PEARSON,  
104 Bridge St., Etna, Penna.

# Operating Notes for Service Men

*Mr. Freed follows the excellent idea of keeping a notebook and jotting down his experiences with sets of this and that model. Consequently, he has a "line" on many of them which saves time and worries.*

By BERTRAM M. FREED

**T**HE lead-in window strip, used in the majority of radio installations, makes a neat and simple job of bringing the aerial into a house; unfortunately, after the strip has been in use for a short time, troubles arise. Most of these devices have Fahnestock clips, which are fastened by means of rivets to the insulated copper strip. The parts of the strip which are exposed to the elements, quickly corrode; and this produces high resistance in the electrical contact between the strip and the clip. The clip loses its tension, and the wire comes loose; thus causing "static." (See Fig. 1A.)

The best method to follow, when bringing the lead-in into the house, is to cut away a

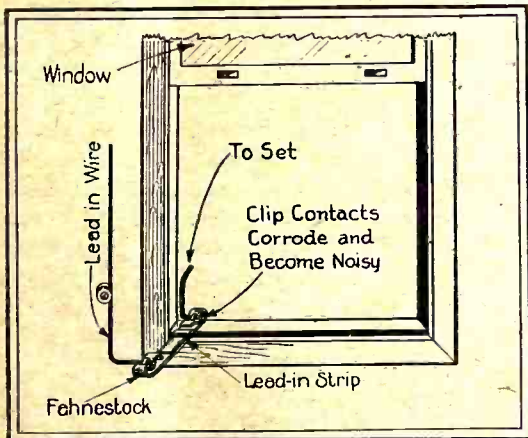


Fig. 1A

A common form of lead-in installation, which is very good until the exposed connections corrode.

small portion of the wooden (or metal) sill, and tack the wire down, out of the way of the window. (Fig. 1B). The writer knows many Service Men who use this method to obviate future calls.

Ignition-noise pickup, in automotive radio, is reduced to a minimum by the insertion of resistors in all spark-plug leads, as well as in the main distributor lead. However, to shield the entire distributor head will be of value. The metal shield should be carefully insulated from the distributor itself, and a good ground made to the chassis. Care should be taken with the lamp sockets; all contacts, including those of the bulb, should

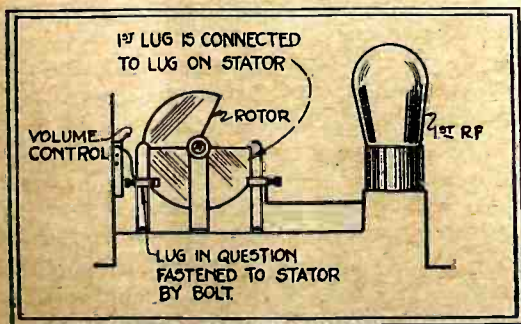


Fig. 3

The volume-control resistor in a Bosch "28" or "29" may work loose at the point shown.

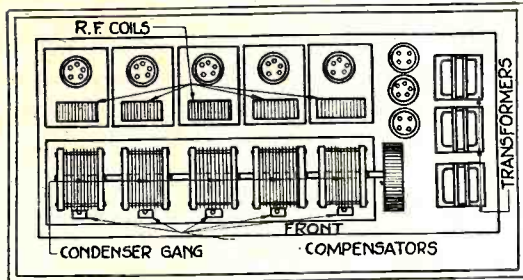


Fig. 2

The layout of the Zenith "39A" chassis; the positions of the compensating condensers are shown.

be cleaned. The connection of the car's battery to "ground," or chassis, should be one of minimum resistance, and exceptionally sure mechanically.

### Zenith Sets

"Fading" in models of the Zenith "50" series has been found, in many cases, due to the carbon-resistance volume control which, in these sets, is part of the switch unit. To remedy the trouble, the easiest way is replacement. However, if the unit is removed, all metal parts polished bright, and the resistor element carefully wiped with alcohol, the component may be found as good as new.

The Zenith "39A," after operation for some time, may lose its original "kick." This is often due to the condenser tuning gang getting out of alignment. If the cover of its shield can be removed, the compensating condensers will be seen, each in front of its gang. Adjustment for maximum response

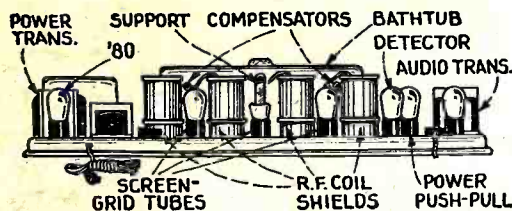


Fig. 5

In early "Philco" models with two screen-grid tubes the compensators are behind the gang.

is quickly made by turning the screws, one way or the other. See Fig. 2 for the layout of this chassis.

The cause of lowered volume in Zenith "15E," "16E" and "16EP" is frequently an open detector-plate resistor, which is indicated by absence of voltage at the detector socket "P." The 100,000-ohm resistor is located, not in the "B" pack (this receiver has two packs), but in the set chassis, at the audio end, and in a regular leak mounting.

### Bosch Models

When replacing condenser drive cords on the Bosch "18," "48," "49," etc., it is wise to remove the condenser-gang shield and to

loosen the dial from the gang shaft; also remove the dial-lamp bracket. At the same time, the low-value carbon grid resistors within the shield can should be tested; these sometimes open.

Intermittent reception or low volume, in the Bosch "28" or "29," may be caused by loosening of the screw which holds the connecting lug to the first tuning condenser; one terminal of the volume control is connected to this lug, the position of which is shown in Fig. 3. Constant jarring of the gang may cause this effect.

When neutralizing these models, it is of course necessary to remove the shield; its replacement affects all the adjustments

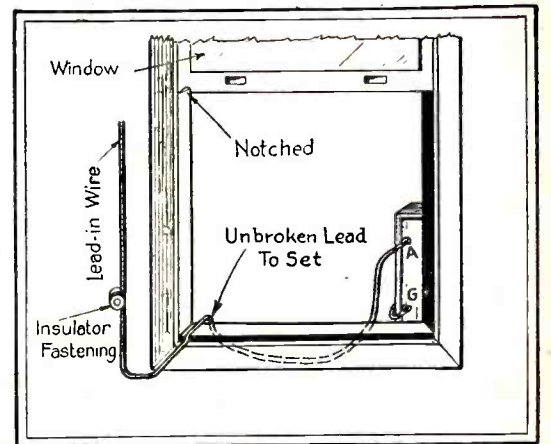


Fig. 1B

If the insulated lead-in wire is brought inside and a good connection made, it will last.

which have been made and, sometimes, sets the receiver back into a state of oscillation. The writer employs shield cans, similar to those used with screen-grid tubes, to cover the R.F. tubes while neutralizing, and removes them before replacing the shield. Care must be taken to ground these tube shields to the chassis, and to see that they do not short to the socket terminals.

### Miscellaneous Hints

"Fading" in Colonial "32" models was touched upon in a previous article (page 653 of the May issue) as due sometimes to an open circuit in the 0.1-mf. blocking condenser of a resistance-coupled stage, which cuts off the signal without effecting any

(Continued on page 109)

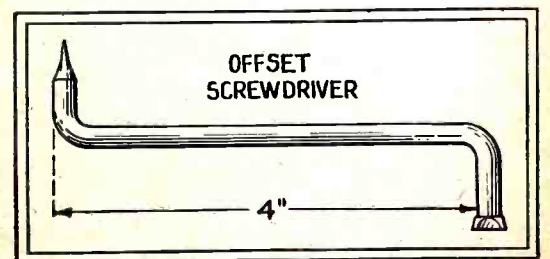


Fig. 4

The simple tool shown here will prove very convenient to tighten voice-coil screws.

# Internal Troubles of Late Tube Models

*A study of the problem of gas content introduced by the additional elements*

By SYLVAN HARRIS

**E**VERY one knows that gas is undesirable in vacuum tubes; but it was unnecessary to worry about it while we were using the improved three-element tubes, such as the '01A type, operated by batteries. Tubes of this type were in use long enough for the manufacturers to find a method of expelling gas from them; and the operation, moreover, was fairly simple.

In the development of the heater-type tube for A.C. operation, the gas problem was again encountered in a perceptible degree, because of the insertion into the tube's glass envelope of a new element, the cathode. Every element or electrode added to the tube affords another avenue by which gas may enter; since the gas is "occluded" or imprisoned in ultra-microscopic pores in the surface of the metal, from which it escapes under the influence of heat and electrical action.

The more complicated the tube's construction, the more difficult it is for the chemical "getter" used for that purpose to penetrate every portion of the space within the tube, and so take up the gas. Pockets are formed, wherein a small quantity of gas may lurk for the time being; only to manifest its unwanted presence later on, after it has been liberated by continual heating and operation of the tube.

We have now the heated-cathode screen-grid tube and are coming to the pentode; and we may some day add even more electrodes to the tube. This increasingly complicated structure adds to the danger of introducing more gas into the tube during manufacture.

## Ionization of Gas

The most injurious effect of gas in a tube, probably, is that of shortening the tube's life. When plate voltage is applied to a gassy tube, the electrons emitted by the cathode are attracted toward the plate at very high velocities and collide with atoms of any gas which they encounter (Fig. 1A). This produces ionization; that is, when an electron is traveling with sufficient speed, it may knock one or more electrons out of an atom, which it thus splits into two oppositely-electrified parts (Fig. 1B). One of these is the negatively-charged free electron, or electrons; and the other the positively-charged nucleus, which then becomes an "ion." The latter is much more massive—relatively speaking—than the electron. The hydrogen ion weighs 1,845 times as much as its electron, and the ions of other gases are heavier in proportion to their atomic weights. (The atomic weight of hydrogen is 1, of helium 4, of nitrogen 14, of oxygen 16, and of neon 20.)

The addition to the plate current of the liberated electrons is not detrimental, except as it makes the operation of the tube somewhat erratic; but the bombardment of the cathode or filament, by the heavy, positively-charged ions, wears away that element and



**M**R. HARRIS, in his sixth article on the problems of modern radio design, deals with gassy tubes, and their internal action; and describes suitable testing methods.

thus shortens the life of the tube. For, since the cathode is negatively charged, the ions are strongly attracted to it.

It is therefore desirable to provide means for detecting gas in a tube, and determining its comparative amount. There are several ways to do this but, since other effects may mask the one for which we are looking, it is necessary to understand all of them and analyze the combination correctly.

## Direction of Current

Before considering the reverse-grid-current method of detecting gas, it is well to consider these practical rules:

- (1) The direction of electrical current flow is always indicated in the direction opposite to the actual flow of the electron stream which constitutes the current; and
- (2) Direct-current meters, therefore, are always marked in such a manner that the flow of current through the meter is indicated from the "+" terminal to the "-" terminal.

Manufacturers have always marked meters in this manner for uniformity; the "+" terminal of the meter is always connected to the positive terminal of the battery or other source of current, and the "-" terminal of the meter to the negative battery terminal.

The reason is that when, in the early days of electricity, two polarities were distinguished, it was arbitrarily assumed that electric current flows in the direction from positive to negative in a circuit. Later, when it was discovered that an electric current is only a stream of electrons in motion, and that they flow toward a more positive

potential, it was seen that a mistake had been made more than a century before; but it was impracticable to remedy the error by altering all the books on electricity and all the polarized electrical apparatus in existence. We, therefore, continue to say that a current flows in the opposite direction from that which we now know that the electrons actually take.

## The Grid Circuit

A simple tube circuit, in which a "C" battery makes the grid negative with respect to the cathode, is indicated in Fig. 2A. If there were absolutely no gas in the tube and if there were no "secondary emission" (which we shall explain later), there could be no current flowing through the microammeter MA which is connected in series with the grid.

If we reverse the "C" battery to impress a positive voltage on the grid (as shown in Fig. 2B) the grid will then act as a second plate within the tube; because it can attract and collect the negative electrons emitted from the cathode. Hence there will be a stream of electrons flowing from the cathode to the grid; which is equivalent to saying that there is an electrical current flowing from the grid to the cathode, as indicated by the arrows. With our microammeter in series with the grid, we will be able to measure this current; which we will call a current *to the grid*—because it flows into the grid from the outside—and will also designate, for convenience, as a *positive* grid current.

As the positive charge on the grid is increased, the current to the grid will increase; and vice versa. But this current is not always zero when the grid voltage is zero; for if the cathode, as in some tubes, is not exactly "equipotential" (of the same potential throughout) enough bias can be obtained from its negative side to permit a small current to flow, even when the grid voltage is nominally zero. (This effect may result also from high contact potentials within the tube; but we are not concerned here with this condition.)

It will therefore be found necessary sometimes to place a small negative bias on the grid to prevent any flow of grid current. This condition is indicated in Fig. 3A, where the curve indicates the relation between the grid current (plotted on the vertical line) and the grid voltage (plotted on the horizontal).

This is the first type of grid current with which we have to deal: it is called the *grid electron-convection current*.

## Effect of Gas

We shall next consider the grid current which flows when there is gas in the tube; this is called the *grid ionization current*, because it is caused by the ionization of gas. (Refer to Fig. 3B.) Electrons shooting off the cathode on their way to the plate collide with gas molecules and split them, as

previously explained, into negative electrons, which travel toward the plate, and positive ions which travel toward the cathode. Many of the ions are collected also by the grid, since the latter is negatively charged by the "C" battery; this is the same thing as saying that within the tube there is an electric current flowing to the grid. (Another way of looking at it is to regard the acquiring

The story is simply this: the screen-grid, placed in these tubes to increase the amplification, accomplishes this by increasing the speed of the electrons as they travel from the cathode to the plate. On account of their high velocity, those electrons that strike the grid do so with such force that they knock out of the grid electrons which were in it. It actually happens that more electrons are knocked out of the grid than strike it. The effect can very well be illustrated by directing a stiff stream of water from a hose into a bucket which is only partly filled with water; the stream enters the bucket with such force as to push out of it the water already there.

components are:

- (a) Grid electron-convection current (positive)
- (b) Ionization (or gas) current (negative)
- (c) Secondary-emission current (negative)

If the three components are added together, we may get a curve such as that shown in Fig. 3D; which is an experimental curve, taken by the writer, of the total grid current, of a "power" pentode tube. The shape of the curve may vary considerably, depending upon the relative magnitudes of the several components.

The final problem is to separate the three components; so that we may know how much importance to attach to each. If most of the grid current is due to secondary emission or to electron convection, there may be ways of operating the tube to avoid these difficulties. If, however, the grid current is due mainly to gas, we cannot expect the tube to live a "normal" life. This depends on the amount of gas present.

The gas current is perhaps the easiest to measure. If the plate and screen-grid, or other elements, are held at their normal rated voltages, and the control grid is made so negative that plate and screen currents are both reduced to zero, it is clear that no electrons can reach the grid, since it is so highly negative. Since no electrons can reach the grid, it can neither gather in electrons, nor have any knocked out of it. Hence there can be no convection current nor secondary-emission current; the only effect that remains is ionization or gas current.

At grid voltages not close enough to zero to permit an appreciable convection current to flow, the total grid current measured is the sum of the secondary emission and the ionization current. The current due to secondary emission is the total current minus the ionization current, measured as described in the preceding paragraph.

We do not know of any way to separate the secondary emission and convection currents which occur at low grid biases; since both these effects require a stream of electrons from the cathode. But, since tubes are rarely, if ever, operated with "C" bias voltages low enough to permit a convection current to flow, this need not worry us very much in a practical way. At all operating voltages, therefore, the total grid current is the algebraic sum of the ionization or gas current and the current due to secondary emission.

The gas current can also be measured by connecting together the grid, plate and screen, and placing on them a negative bias, as shown in Fig. 2D. With the negative charge on the grid, there can be no electron

(Continued on page 113)

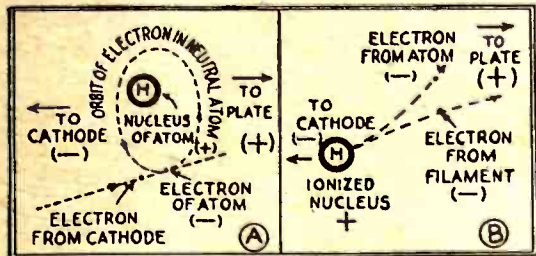


Fig. 1

The ionization of gas in a tube is caused by the collision of a fast-moving electron with a gas molecule; which is thus broken into two parts, one positively, and one negatively, charged.

of positive charges by the grid as equivalent to its losing negative charges or electrons.) Therefore, we have the equivalent of a stream of electrons away from the grid; which is the same thing as saying that there is a current to the grid. So, if we connect our microammeter with its positive terminal to the grid (as in Fig. 2C), we will be able to measure this ionization or gas current. The arrows indicate the direction of the current, which is opposite to that shown in Fig. 2B; hence, it is popularly known as a "reverse" grid current. We shall call it a "negative" grid current, in order to distinguish it from the other.

Fig. 3B shows how this ionization current varies with the grid voltage. When the grid is sufficiently negative, it collects all of the ions; so that, as we decrease the negative grid voltage, the ionization current hardly changes. This is the portion *ab* of the curve; note that it is plotted below the horizontal axis, indicating that it is negative or "reverse" current.

As the bias on the grid is decreased further, that element becomes unable to collect so many of the ions, and the ionization current decreases; this is indicated by the portion *bc* of the curve. But, as we approach zero grid voltage, the grid not only refuses to collect the positive ions, but begins to collect a few electrons coming from the cathode; since the grid is placed in the path of these electrons as they travel to the plate. Hence, when the grid bias is very near zero, the ionization current ceases and the positive "convection current," which we discussed before, begins. This is shown in the portion of the curve marked *cd*.

**Secondary Emission**

There is still another type of grid current, caused by what is called secondary emission. This effect did not trouble us, with the older types of tubes; but it has become serious since we began to use screen-grid tubes with their high amplification. The effect is also quite serious in the new pentodes.

\* An algebraic sum is obtained by deducting the sum of all the negative quantities from the sum of all the positive quantities, or vice versa; depending on which is larger. If the negative total was larger, the resulting remainder is a negative quantity, and the "sum."

There is caused, therefore, a stream of electrons flowing away from the grid. This is the same thing as saying that there is a current flowing to the grid; so the conditions are similar to those shown in Fig. 2C for the ionization current. We have another reverse grid current. It is obvious that, the greater the plate current of the tube, the greater will be the secondary emission; for more electrons will be caused to

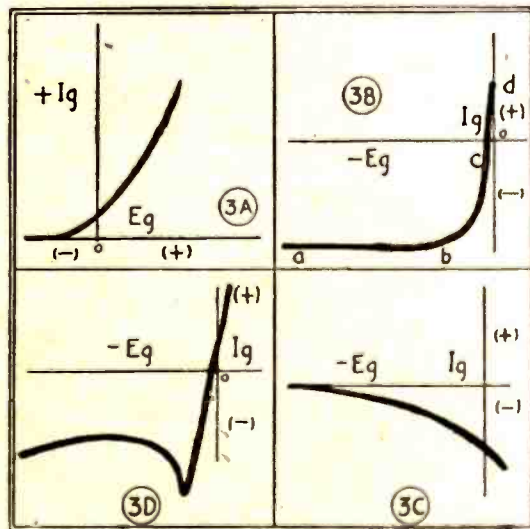


Fig. 3

The upper left curve is that existing between grid voltage (horizontal) and grid current (vertical) in a normal tube; the upper right, that caused by ionization of gas. At the lower right, we have the effect of "secondary emission;" and the composite results at the lower left.

strike the grid. So, as the plate current is increased, or as the grid bias is decreased, the secondary emission will increase. The relation between the grid bias and the negative grid current, due to secondary emission, is indicated in Fig. 3C. When the plate current is zero, the secondary-emission grid current is zero.

**Analyzing Grid-Current Readings**

We now have considered three kinds of grid current. When we make a measurement of grid current in a tube, we measure the algebraic sum of all three. These three

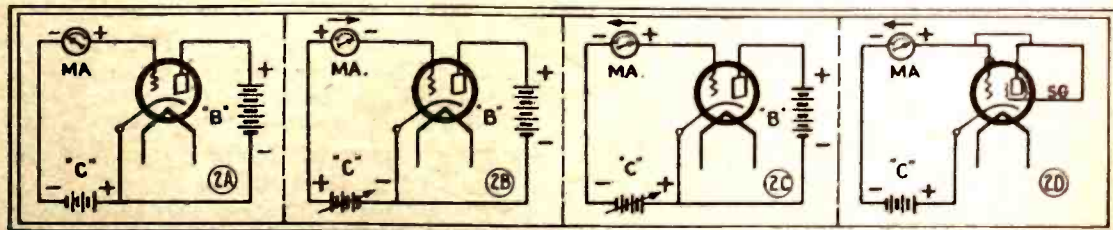


Fig. 2

Extreme left, negative bias, zero current flow; next, positive bias, current flow, in a normal tube. Thirdly, reverse grid current caused by gas; extreme right, method of measuring gas contents.

# Television in the Theatre Takes Its Bow

*A few days ago, a Schenectady "movie audience" was entertained by television on the screen. The new era, thus opened in the amusement world, is one of opportunity for television experts.*

THE commercial possibilities of television as an adjunct to theatrical entertainment—surpassing the newsreels by increased timeliness, making it possible to see and hear distant events while they are actually occurring—have been agitating the amusement world for the past two years. That television in the theatre may precede its general acceptance in the home—just as happened in the motion-picture line—presents itself as probable; especially when the fact is considered that it may be possible to transmit by wire visual programs for which there is no room in the ether just at present.

It has been known for some time that experiments toward full-sized television have been made by the General Electric Co., under the direction of Dr. E. F. W. Alexanderson, one of the world's leading television authorities. On May 22 the curtain rose, and first representatives of the press and of technical organizations, and then an audience of the general public, saw television images projected on a large screen, on the stage of the RKO-Proctor Theatre at Schenectady. The images, furthermore, as well as the accompanying sounds, were carried by radio.

While, even today, image projection is far from perfected (Dr. Alexanderson has compared it to radiophone reproduction in 1915), this demonstration marks a considerable increase in technique over previous work, aside from its size. In 1927, a three-inch television image could be produced, but the reproduction on a 3-foot grille of neon tubes was more ingenious than practical. In 1928, Dr. Alexanderson obtained, by the use of the Moore "crater lamp," a fourteen-inch image, which could be seen by a group of spectators in a small room.

The images exhibited now at Schenectady, though of only standard 48-line detail, are projected upon a screen six feet square, clearly visible from all parts of a good-sized theatre. In distinction to previous work, employing neon tubes, the Karolus

system (illustrated also in the following article, on German television) is employed. This permits the use of a more powerful light-source, an arc lamp, to create the image; while the tones are in green instead of pink, and show varying depths of shading.

The moving images (busts only) are comparable in quality to newspaper illustrations, according to the general consensus of the observers. The features, their movement, and even small details, are apparent. The superior speed of the scanning disc (1200 revolutions a minute, giving twenty complete images a second instead of the standard 15) helps to obtain this better definition and smoother movement.

## The System Employed

The arrangement employed is shown in diagram form, which may better explain the accompanying photographs. At the studio, as indicated by Fig. 1, the person to be televised stands before the bank of photoelectric cells (Fig. A); while a large lamp (Fig. B) casts a ray of light, which is directed by the scanning disc, over the features of the subject. The reflectivity of the

chestra took his stand before the televisior, and conducted his musicians from a distance of several miles.

After the first technical demonstration,

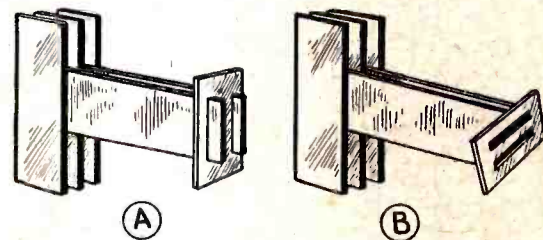


Fig. 4

*A mechanical illustration of the principle of the plane-polarization of light. The beams pass, at A; but are stopped when the slots are not parallel, as at B.*

the demonstration was presented as a vaudeville feature to a regular, paying audience of movie fans; who will, undoubtedly, be able to describe their experience at the first television show to a later generation for whom it has lost all novelty, notwithstanding its improved technique.

How long it will take to perfect television to the point, at which the reproduced

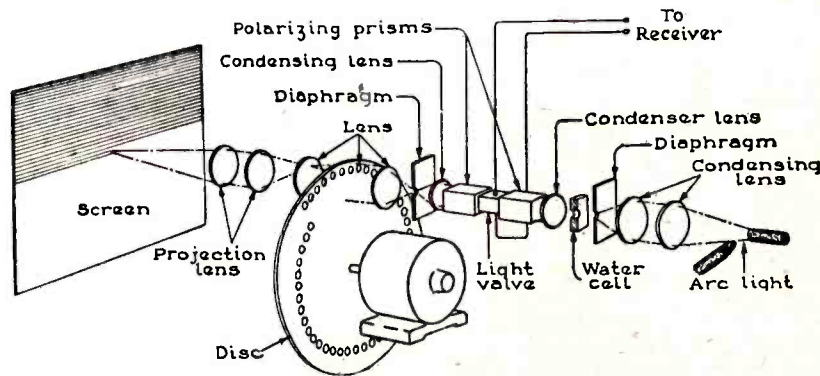


Fig. 3

*The details of the Karolus system: the water cell removes heat rays; the Nicoll polarizing prism at the right polarizes the light; the "light valve" (Kerr cell) then rotates the ray, to a degree which determines the amount to be cut off by the polarizing prism at the left; and the light-spot is then caused to move over the screen, reproducing the image.*

area covered by this spot—about half an inch in diameter—at any time governs the strength of the impulse being instantaneously sent out from the transmitter (Fig. C).

The reception arrangement, which requires two distinct channels, is indicated in Fig. 2. The television signal on 140 meters is picked up, amplified, and conducted to the projector (at the left of Figs. 2 and D, and shown in greater detail in Fig. E). Here a steady ray of light, projected from an arc lamp, passes through the Karolus cell, or "light valve"; this, so to speak, acts as a shutter, opposing the passage of the light when the signal is weak, and permitting passage when it is strong. The light, so modulated, is built up to a reproduced image, thrown upon the back of a transparent screen, seventeen feet away, where it becomes visible to the audience. Dynamic speakers beside the screen make the image "talk" or "sing" in the manner already familiar to movie fans.

In the demonstration at Schenectady, the link of theatre and studio by a telephone connection permitted of odd effects. Those present in the theatre were able to converse with others in the studio, and receive a reply apparently from the image, larger than life. The director of the theatre or-

image will seem perfect to the eyes of the audience, is another question, to which those concerned with its development are cautious in replying. The present degree of television makes it possible to transmit little more than a single face; but as yet the technique of picking up moving subjects outdoors has not been very successfully de-

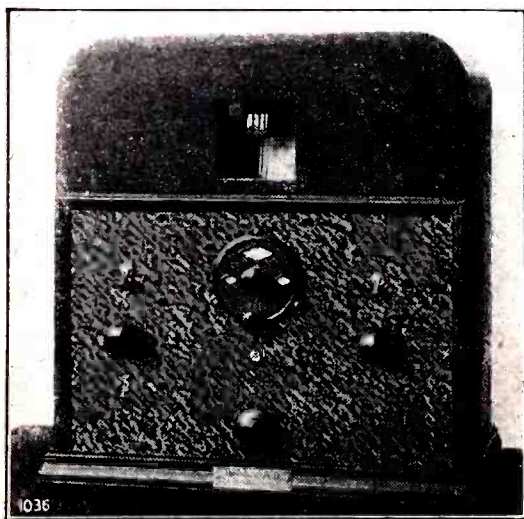


Fig. J

*The larger model of the Mihaly "Telehor," a German televisior, now being marketed for reception of European television on broadcast wavelengths.*

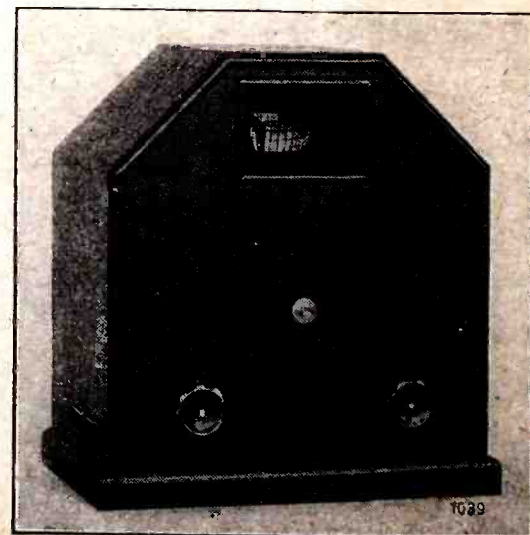
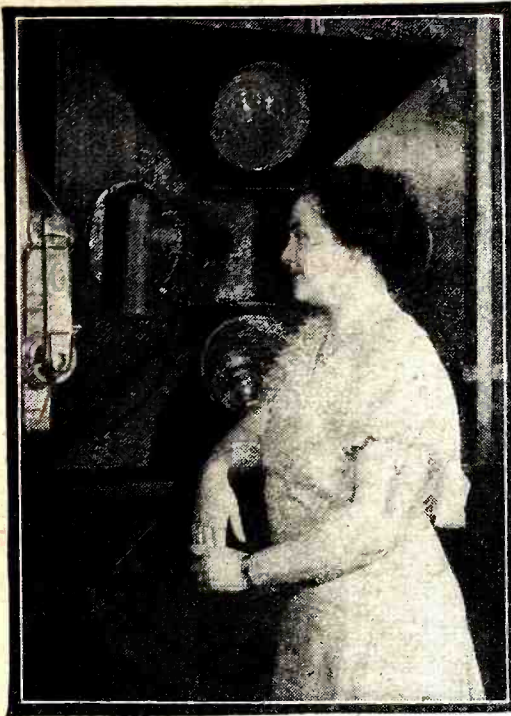


Fig. K

*A receiver model of the Deutsche Fernseh-A.G., described by Dr. Noack in his article on German television methods, on pages 86 and 112.*

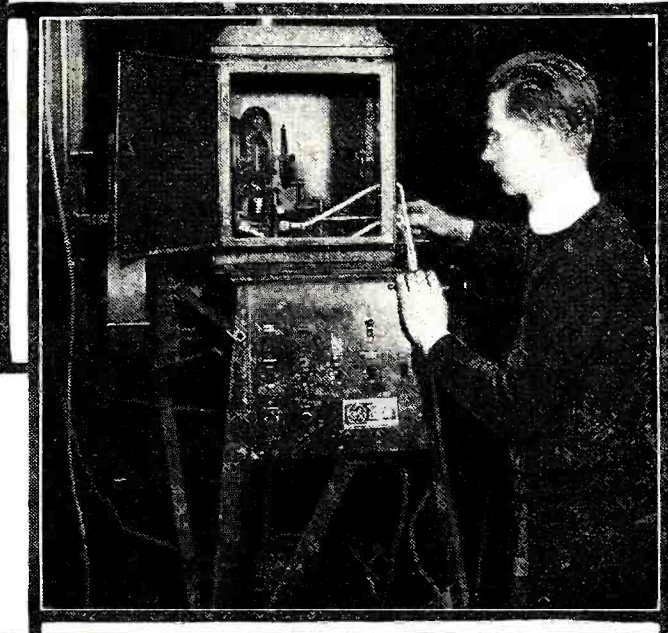


veloped, notwithstanding some very interesting experiments of the Bell Laboratories two years ago, and others by Baird in London.

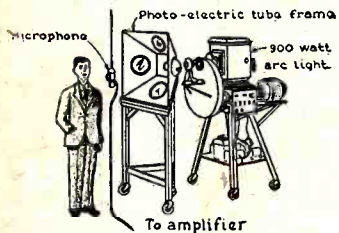
It is believed that apparatus will be installed in some large theatres in the greater cities before long, and though the cost of the necessary apparatus is high, some metropolitan audiences will have the opportunity of seeing our next presidential inauguration

in 1933. Before that time, studio acts will undoubtedly have become familiar on the television screen.

The progress of television abroad is steady; and reception from England in Germany, and from Germany in England, has been reported. In the article following an account of the newest German television receivers is given by one of that country's chief television authorities.

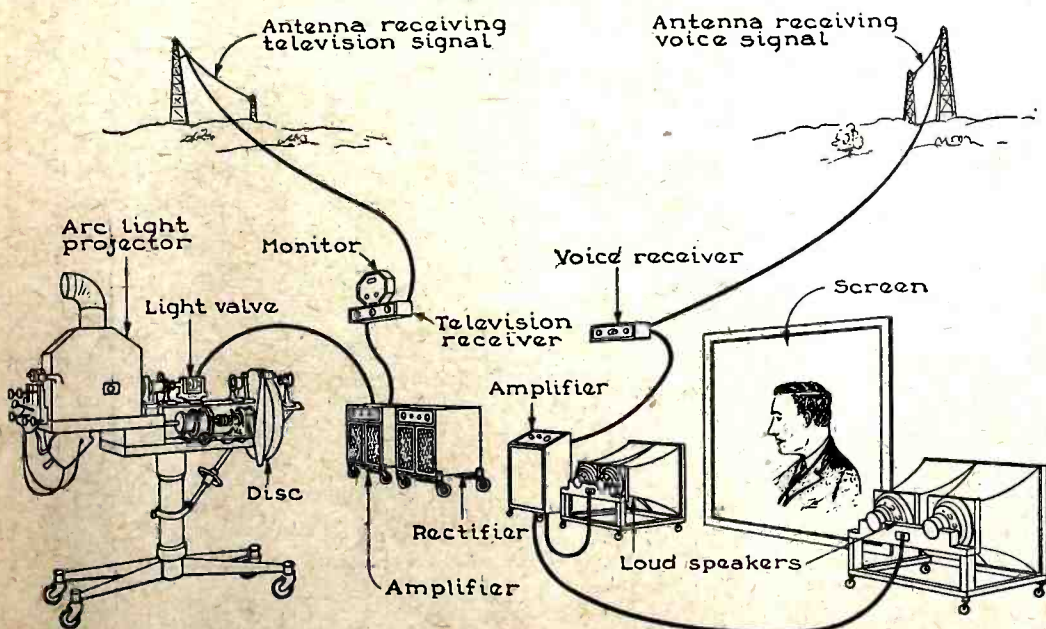
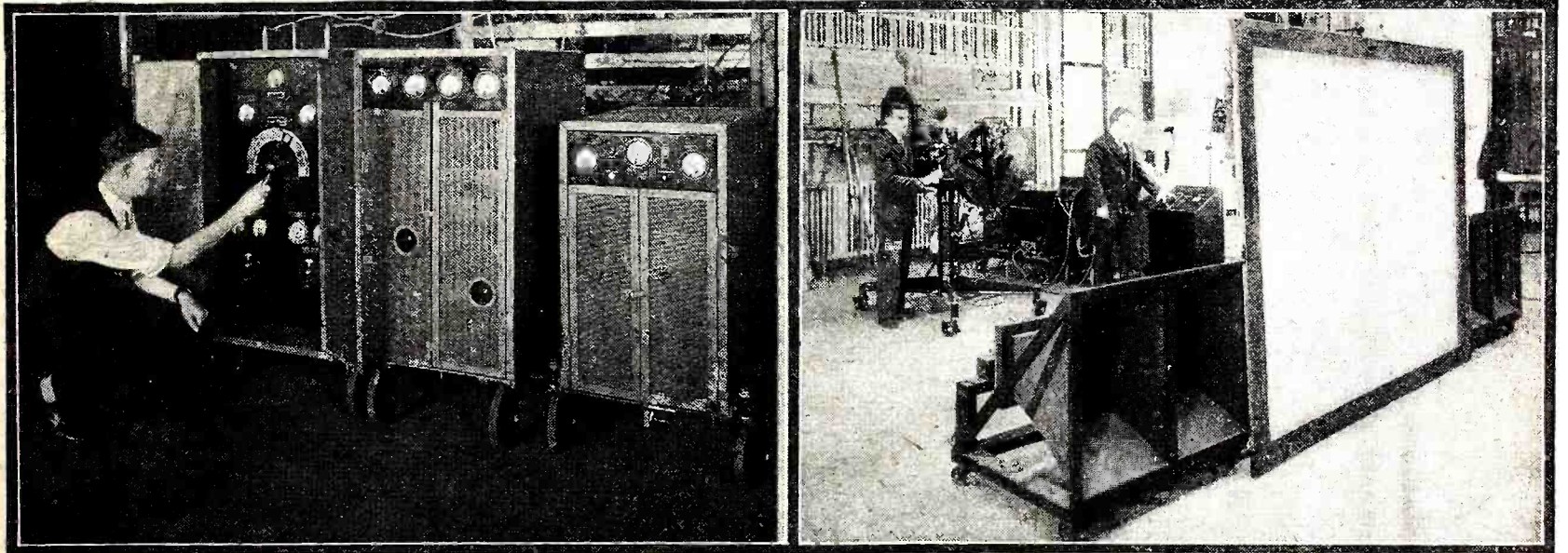


In FIG. A (left) photo-cell pickup and microphone; FIG. B (center) lamp house with incandescent lamp and scanning disc. The signals are passed on to the transmitter shown in FIG. C (left center); the images were transmitted by W2XCII on 139.5 meters, voice on 92 meters.

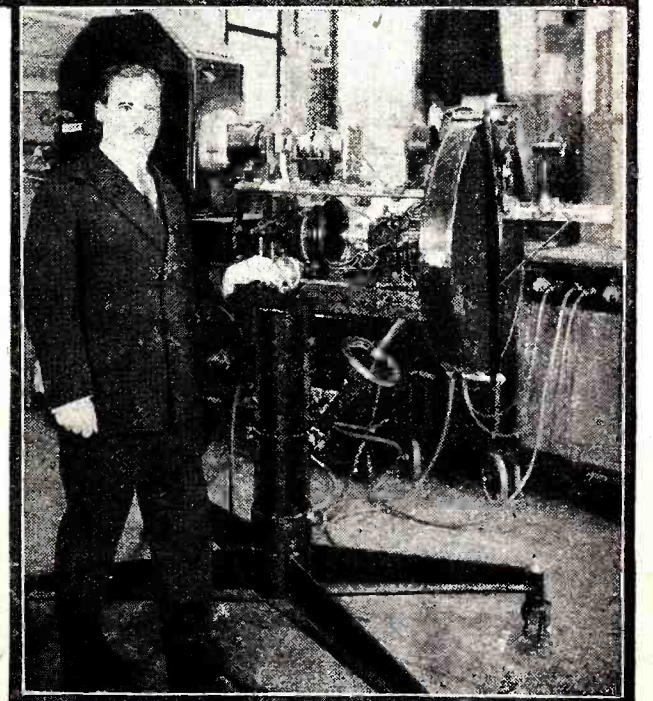


**Fig. 1**  
Arrangement of pickup apparatus at the studio, feeding into transmitter shown below.

In FIG. D (center right) the stage of the television theatre; the transparent projection screen in front is draped, over top and sides, during operation. The amplifier shown in the center puts its 1-milliamp. output, at 2600 volts, across the plates of the Kerr cell in the projector. The illuminating ray, passing through a suitable fluid (nitrobenzol) is thus modulated, and then caused to scan the screen. The system is shown in Fig. 2.



**Fig. 2** Arrangement of image and voice-reception systems. (Illustrations courtesy General Electric Co.)



**Fig. E** Dr. Alexanderson beside his projector.

# Latest Developments of German Television Methods

*Some interesting details of the principles incorporated in new commercial apparatus*

By DR. FR. NOACK  
(Berlin, Germany)

**T**O obtain standard television apparatus, the following specifications have been adopted by the three German companies which are working in its development: clockwise scanning, as seen by the observer, from top to bottom; a ratio of 4 units of breadth to 3 in height for the image; a 30-line image reproduced at the rate of  $12\frac{1}{2}$  "frames" a second, or 750 a minute. In addition, each line of the image is to be scanned in the same time; that is, the holes in the disc are to be spaced at equal angles, between the radii.

It is noteworthy that this does not correspond to the system of scanning used in the English transmission (or the American). Its selection is dictated by the fact that broadcast waves must be used for television, under the present European allotment of 9-kilocycle channels, which cannot be changed for two years; and the modulating frequency is thereby automatically limited, which restricts the detail of the image.

The progress of television demands, primarily, low prices and easy operation of receivers; which we cannot have with the short waves, which would permit the use of higher frequencies, giving more detailed pictures. In addition to this, short-wave reception in the near neighborhood of the transmitter is subject to great fluctuations due to fading, echoing, etc. The ultra-short waves, according to Prof. Esau, the great authority on that subject, are not yet sufficiently understood for practical use.

While the technicians express the opinion that the pictorial quality of ordinary television, under these conditions, is too poor to satisfy the general public, we must make a start with what we have now. After all, the question is, what does the public want?

For these technical reasons, however, the Telefunken Co. is not at present undertaking to make televisors for general use; and the Deutsche Fernsehgesellschaft ("German Television Company") hesitates to do so. The Telehor Company is the only one undertaking this on a production basis. The systems developed by these three are:

The Telefunken Co. will retain the mirror-wheel system, which offers great possibilities of development, and almost unlimited illumination. Yet its price cannot be lowered, below a certain figure.

The Deutsche Fernsehgesellschaft system includes the scanning disc, which is most familiar in England and America. An image-frequency (normally 375 cycles) is used to obtain synchronization.

### The Mihaly Methods

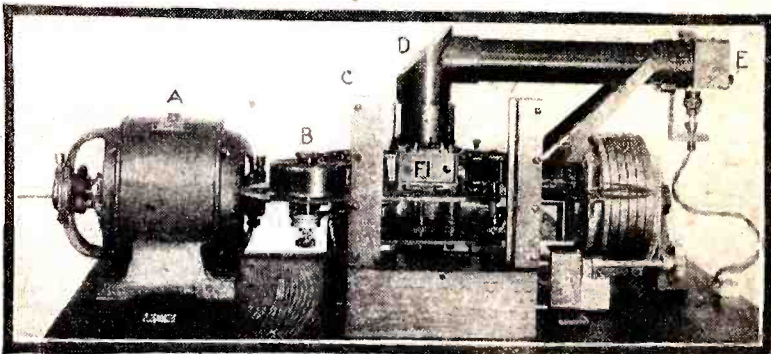
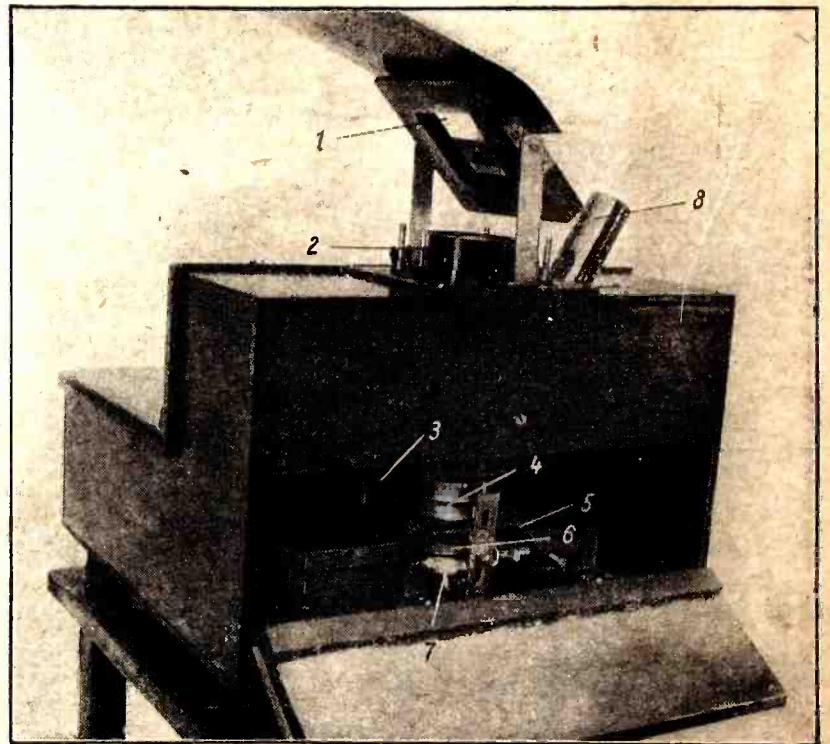
The Telehor Company also uses a scan-

ning disc with a glow-lamp, a driving motor and synchronizing wheel; the motor is connected by a belt to the axle of the synchronizing motor and, consequently, to that of the scanning disc also. Phasing is effected by turning the frame of the synchronizing motor around its axis while it is in operation. To produce the necessary voltage for the glow lamp, a special battery or power unit will be required.

In a larger type, to be used as a universal television receiver, there is also a small vacuum tube oscillator generating a local synchronizing frequency of 375 cycles to which it is tuned by a small rotary condenser; an ordinary receiving tube will serve. This current is amplified and conducted to the synchronizing motor, which operates on 375 cycles; unlike that in the  
(Continued on page 112)

**Fig. I (right)**

The equipment shown here is a design of the Telehor Company, for the purpose of scanning images illuminated by daylight, to be broadcast through a portable transmitter. The mirror 1 reflects the rays, from the object to be televised, through the lens 2 which concentrates them on the scanning disc 3. The lens 4, screen 5 and lens 6 pass on the ray to the photo-cell 7, which is connected to an amplifier. The tube 8 contains a magnifying glass through which the scanned image may be observed.

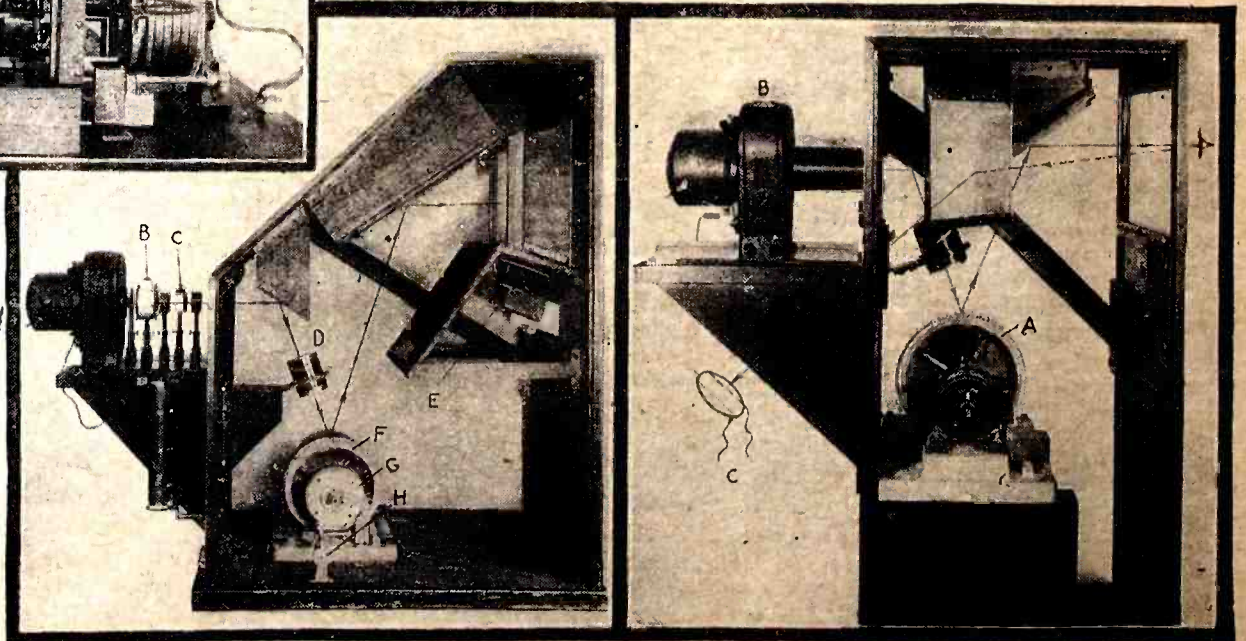


**Fig. F (above)**

A moving-picture television transmitter: A, motor; B, film reel; C, frame; D, mirror; E, exciter lamp; F1, photo-cell housing.

**Fig. G (center)**

Telefunken-Karolus television receiver: A, arc lamp; B, cooling cell; C, Kerr cell; D, lens; F, mirror scanning wheel; G, synchronizing motor; H, phase control; E, dynamic speaker.



**Fig. H (right)**

The corresponding transmitter: B, arc lamp to illuminate subject; A, mirror-wheel, scanning subject with light spot. The illumination is reflected, as indicated by the dotted lines, to the photo-cell C, which is really in the triangular box.



# Men Who Made Radio—Oliver Heaviside

THE ELEVENTH OF A SERIES

**T**HE tombs of the prophets, we are told, are decorated by the children of their persecutors; but it must be remembered that a prophet is too often an uncongenial acquaintance, and his merits are most easily appreciated by those who have never come into personal contact with him. The scientific prophet is no exception to the rule; he comes in conflict with those conservative scientists who speak with authority; and, if his nature is sensitive, he may give way.

Oliver Heaviside lived to see a second and a third generation concede that he had been right and the great majority wrong, and to impress his name imperishably upon the language, in a unique manner. He was a man of the nature we call "impractical;" yet his writings have had results of incalculable value in the field of practical electricity. With a scientific mind of the first

order, he was not of the mental type necessary for a successful promoter of inventions, a distinguished professor, or a chief



engineer. His career in the field of technical activity was brief; but during half a century of retirement from the world, he sent out from his hermitage writings which were to compel ultimate acceptance.

Born at London, May 13, 1850, Oliver Heaviside was the nephew of Sir Charles Wheatstone, inventor of the famous "bridge" and one of the leaders in the development of telegraphy. The nephew, without the advantages or disadvantages of a formal collegiate education, entered the service of a large telegraph company. The position, which his associates were inclined to attribute to favoritism, was soon irksome; the eccentric genius resigned it after a short career, and at the age of twenty-four withdrew to Torquay (in Devonshire, southwestern England) to spend the remainder of his long life almost as a solitary recluse. He

(Continued on page 113)

## Radio-Craft—"Takes the Resistance Out of Radio"

**R**ADIO-CRAFT comes in as a regenerative power and *Takes the Resistance Out of Radio* by supplying fresh, new ideas from Radio Craftsmen, Experimenters, Writer-Experts and humble beginners; and these same ideas, in turn, daily enable thousands to take the resistance out of their work, to take it out, roots and all.

How many of us have run into a flint-like wall of resistance and turned to RADIO-CRAFT for help, to find just the information needed to overcome the resistance and complete the "impossible" task?

In its dual capacity of instructor and mouthpiece of radio workers, RADIO-CRAFT *Takes the Resistance Out of Radio* by co-operating with the Professional, the Service Man, and the Radiotrician; as well as with the Set Owner and the Enthusiast who prefers to roll his own.

The slogan is unusual, catchy, euphonious, convincing, of convenient length, and appropriate for the magazine that *Takes the Resistance Out of Radio*.

HARRY F. WILSON, Glendale, California:

## Award of the \$100 Slogan Prize

**E**ARLIER in the year RADIO-CRAFT offered a prize of \$100 for the best and most appropriate slogan for this magazine to adopt. The offer was repeated in several months' issues, and attracted much interest among our numerous readers. Entries, each accompanied by a letter, flooded in. To encourage readers to concentrate on the best suggestion each could offer, entries were restricted to one from each individual. Of course, family co-operation was apparent in the returns; and a few "ghost writers" had evidently entered under their pen names as well. Each of the large pile of entries received careful examination and, as announced in the July issue of this magazine, it proved impossible to complete the task properly in the few days between the ending of the contest and the closing of the July forms of the magazine.

In every contest of this nature, experience has shown, a large proportion of the contestants (although far from a majority) independently hit upon a single idea, and express it in the same or similar words. The largest plurality in this contest was obtained by "Service for the Service Man," "The Service Man's Side Kick" and "The Radio Man's Encyclopedia," or similar ex-

pressions of esteem, were very numerous. This magazine was even described as a "Treasure Chest," and a "Treasure Island," for the radio man.

As usual, many contestants exercised their sense of humor, and many witty slogans were submitted; but the principal fault with a slogan of this kind is that it would have to be changed monthly, or the joke would become a trifle wearisome. Nevertheless, the editors chuckled with the readers who suggested, more or less poetically: "The Open Door to Radio Lore;" "The Latest Kinks for Radio Ginks;" "A Soldering Lug for the Radio Bug;" "The Latest Dope in Radio's Scope;" "RADIO-CRAFT Cures Radio Graft"—this idea appealed to several of the entrants; "The Rejuvenator for the Paralyzed Radiotrician;" "Pills for the Radio Doctor;" "Its Feed-Back is Gold;" "We Take the L from Play to Make Radio Pay;" "Not a Dead Spot in It;" "The Detector and Amplifier of Radio Knowledge;" "The Organ the Listeners Grind;" "Needs No Volume Control—Always Full;" "The High-Frequency Magazine;" "A Pre-Selector of Straight-Line Information;" "The Audio Stage to Radio;" "Our Instruction, Your Gumption, Radio Functions;" and, finally,

we must record the best DX of the contest. A reader in India suggested, with the best of intentions: "It Keeps a Radio Man Ever Green."

Other slogans which were considered in the last analysis included: "Tuned to Success;" "Clear as a Crystal;" "Where Troubles and Solutions Meet;" "Covers the Band;" "RADIO-CRAFT Means Radio Knowledge;" "Supplies the Missing Kinks;" "Radio Facts for Radio Folks;" "The Most Essential Part of the Kit;" "Hook-Ups of Today, Yesterday and Tomorrow;" and "The Transmitter of Practical Waves."

In the final selection, the winning slogan which appears in the "box" above on this page was considered from all standpoints, and awarded the prize. The hundred dollars goes to Harry F. Wilson, of 213 South Orange Street, Glendale, California, whose occupation is given by him as student, and age as 43. Mr. Wilson is evidently an experienced student and a reflective one; and his slogan is that which RADIO-CRAFT will henceforth adopt. It is, as you have seen:

**Radio-Craft—"Takes the Resistance Out of Radio."**

# The Rotor-Grid Vacuum Tube

*This article introduces a new electron-operated apparatus, which has revolutionary possibilities, by reason of its affording synchronized control of mechanism operating in a vacuum.*

By JOSEPH RILEY

**T**HE full possibilities of the novel electronic device described here—the first fundamental innovation since the three-element tube was created by de Forest—are not yet appreciable. It took several years to discover the simpler applications of the audion and the photoelectric cell, and their fields of usefulness are still extending. The rotor-grid principle obviously lends itself to countless uses beyond the few suggested here. It now remains for the technician and the experimenter to avail themselves of the remarkable new instrumentality which is to be placed at their disposal, for industrial and domestic applications, when the problems of production are worked out satisfactorily.—*Editor.*

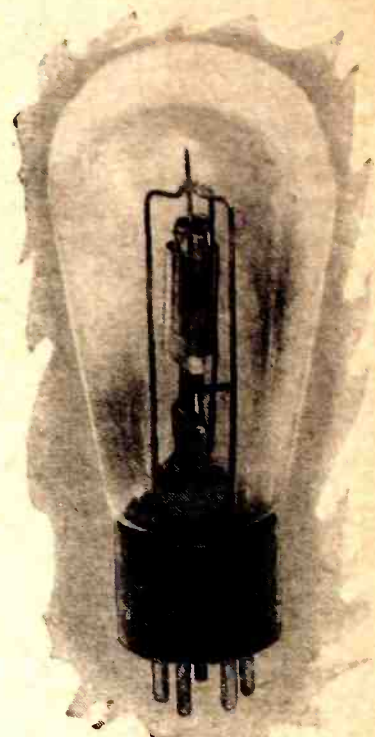


Fig. A  
The "27-type" simple rotor-grid tube described below.

**A** NEW type of vacuum tube, radically different from the many variations of the DeForest audion tube of 1906, has been developed by A. B. Du Mont, chief engineer of the De Forest Radio Co. Before drawing any conclusions, the reader is requested to note that no attempt is made here to claim impossible things for this new device, since it is very much in the experimental stage; the data given are solely for the information of the technician who may find immediate application in his sphere for a device incorporating the principles outlined.

It is so entirely different in construction, from all previous conceptions of the vacuum tube, as to require well over one hundred patent claims to cover adequately its construction. Among its properties is the ability to function as a switch, a commutator, an interrupter, converter (with control of the form of the A.C. wave), an electron motor in an electric clock, or as a television device. The fundamental design is shown in Fig. 1 and pictured in Fig. A.

The tube shown in this photograph looks like a '27 and works like one. It may be



Mr. DuMont holding an experimental model of the new tube which he has recently invented.

plugged into a regular radio set and its performance will then be the same as that of a regular '27—except that the grid may be seen to be whirling (at about 500 to 1,000 r.p.m.). There is no audio-frequency indication of this motion within a vacuum; the reproduction continues uninterrupted.

What is the difference in construction, between this "rotor '27" and the regular '27, that makes its grid turn without a visible driving force?

Referring now to Fig. 1, it will be noted that the tube contains the fundamental elements; a heater or filament, the usual electron-emitting cathode, a grid of unusual design, and the customary plate that surrounds the entire assembly. Vertical slots in the grid, with deflecting vanes attached to one side of each slot, and a pivot mounting (clearly shown in Fig. 2), allow this electrode to work as a "rotor-grid." The wires that support the various elements of the tube are indicated at W. The rotor-grid RG is welded to a cross-arm which, in turn, is welded to a spindle. One end of the spindle is pointed and rests in a cup; the other end runs through a bearing which

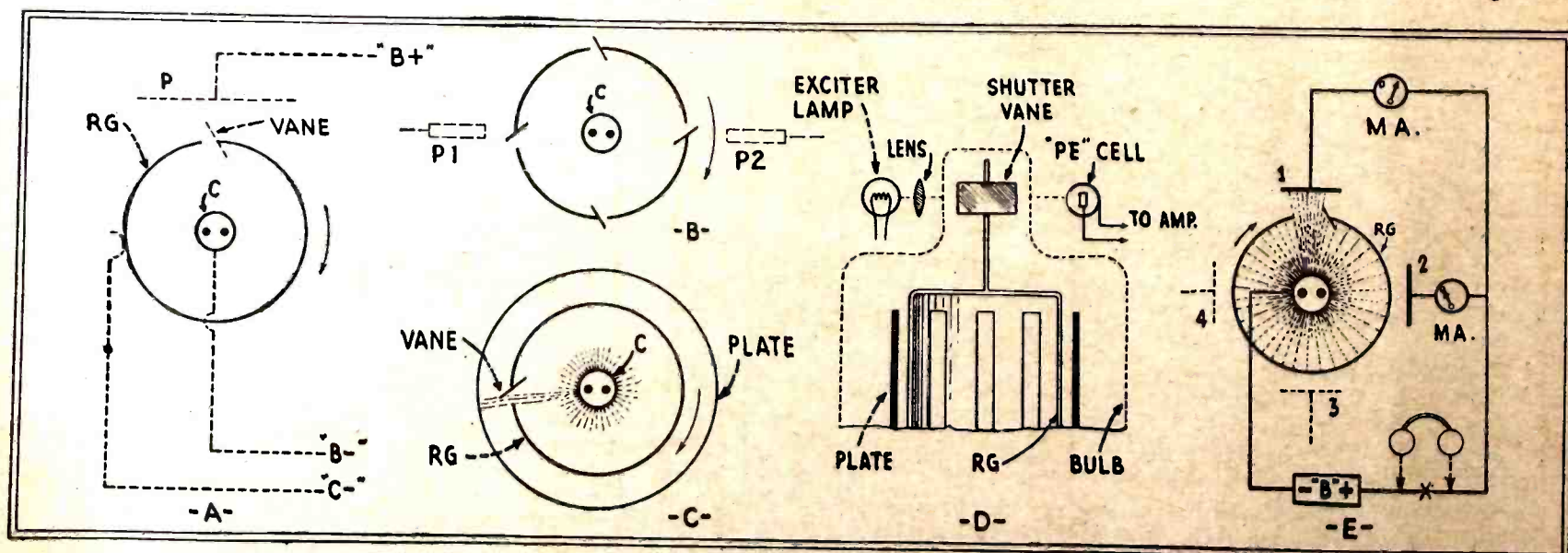


Fig. 3

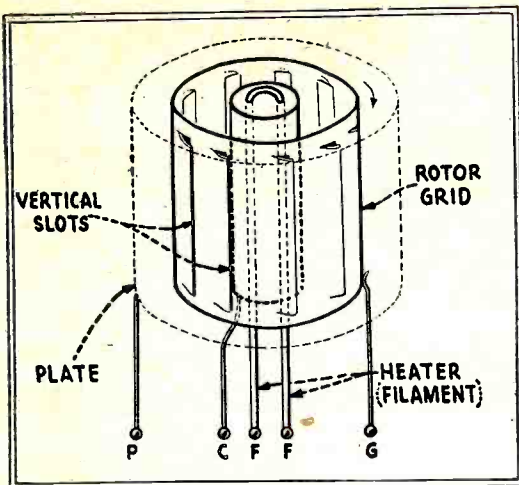
This illustration, which is continued on the opposite page, shows the elements of the rotor-grid tube and indicates the fundamental method of its operation.

prevents the slotted grid from swinging from side-to-side. (This is one convenient form of mounting used in experimental tubes.)

**The Electronic Turbine**

Now that a means of mounting the grid rotably has been shown, the action by which it turns will be explained.

That this cannot be caused by some form of "rotating field" is proved by the lack of rotation when the grid is merely slotted. However, as soon as the vane (shown as a dotted line in Fig. 3A) is added to one side of the slot, rotation is obtained. (The electron-emitting cathode is indicated as C; it



**Fig. 1**

A schematic view of the elements of the simple rotor-grid tube; slots are essential to current flow, and vanes to rotation.

ture of the heater. (A plate was not required or used in the above experiments; and the only outside voltage used was the A.C. for the filament.)

That the rotation is caused by the impetus of the electron stream from the cathode was further indicated by incorporating a standard grid-encircling plate, with an accompanying "B" potential, and applying to the rotor-grid a biasing connection, as shown dotted; varying the "B" and "C" values to increase the electron flow increased the speed of rotation.

In the early part of this discussion the writer mentioned the action of the rotor-grid in a simple type-'27 tube construction. Reference to C (Fig. 3) will show why there is no noise in the reproducer (no change in plate current) with this design. The electron stream from the cathode strikes the plate continuously, regardless of the position of the rotor-grid.

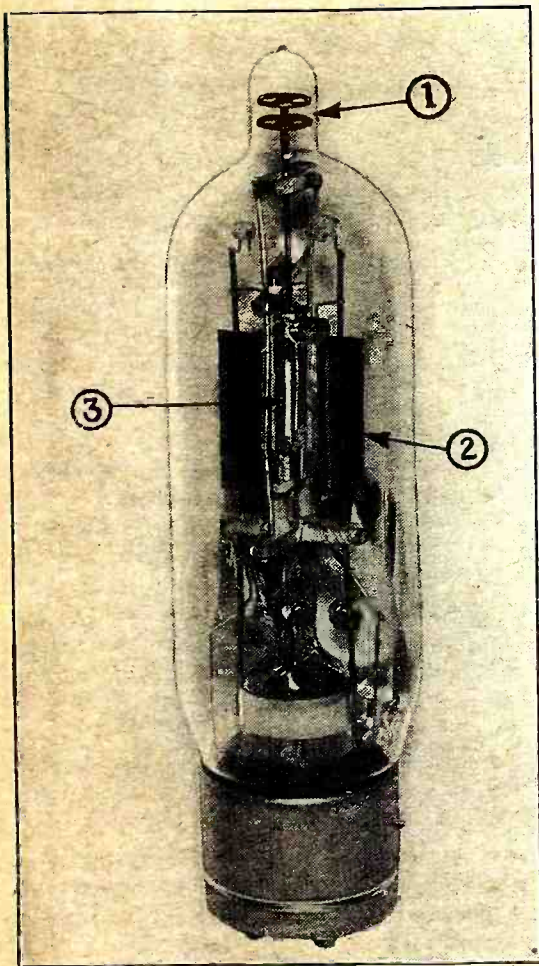
However, while the grid is quietly rotating, a vane may be arranged to rotate with it, by mounting the vane on the end of the spindle of the rotor-grid. This construction is shown in D in Fig. 3. Just as a matter of experiment, let us consider that the rays of an exciter lamp are focused on a photoelectric cell. Now, by interposing the vane extension in the line of this beam, the vane is caused to act as a shutter, and thus produce an audible sound from the amplifier connected to the photo cell. The ramifications of this single design are numerous

and intriguing. For instance, the audio variation may be superimposed on the carrier of a small transmitter and, so long as the receiver is in operation, this will be made known at remote points by the reception of the tone which is generated by the use of the vane on the spindle of the rotor-grid.

That the idea of attaching control elements to the spindle is not purely theoretical is made evident by reference to Fig. B; which is the picture of a larger experimental tube of this design. It will be described a little further on.

**Regulating the Time Period**

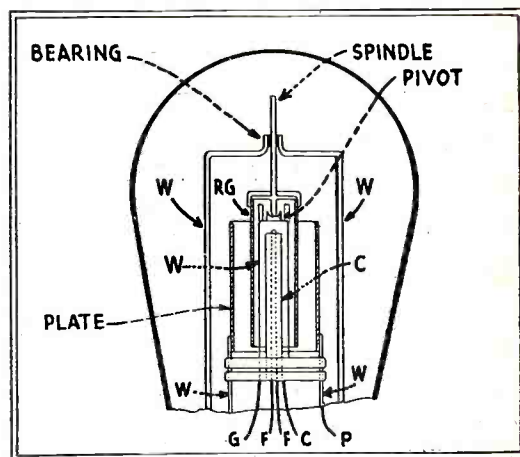
By shaping the grid opening it is, of course, possible to vary the value of the electron stream from a small amount to a large one, and then to cut it off; or to vary it from minimum, to maximum, and back again to minimum; and to produce numerous other variations, all of which are reproducible as variations of plate current. These mechanical effects may be still further augmented by modulations due to changes



**Fig. B**

The larger rotor-grid tube described here: 1, motor rings; 2, plate (see Fig. 3B and H); 3, rotor-grid.

has the usual hairpin filament through its center.) That the rotation is not a function of the heat of the cathode, was proved by the use of a tube containing a heater without an electron-emitting coating; when no rotation could be obtained at any tempera-

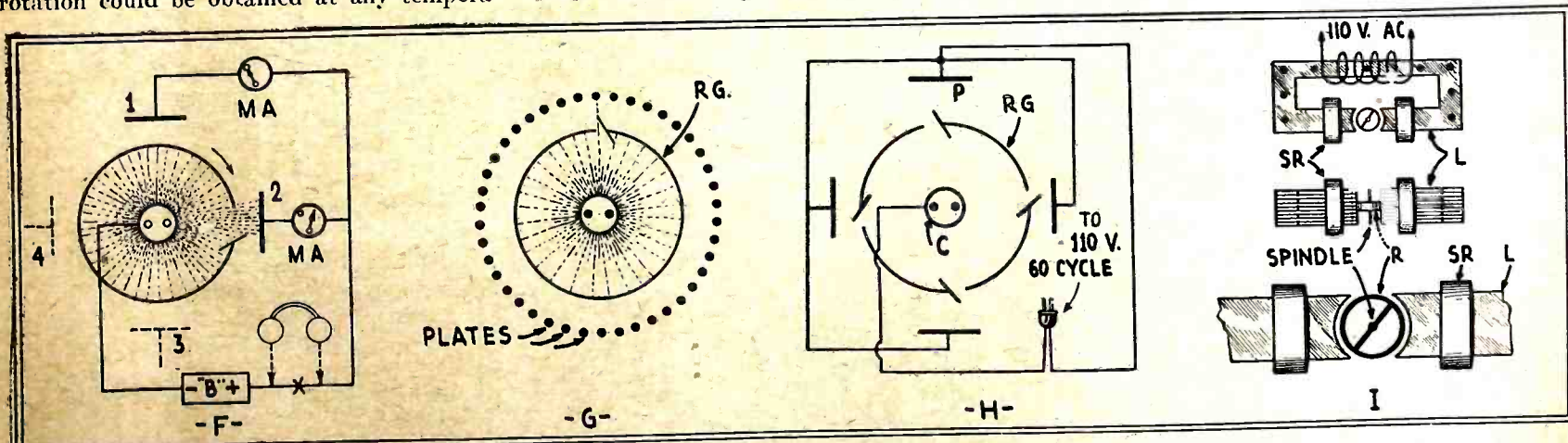


**Fig. 2**

A section through the elements of the tube, showing the method of mounting. The lettering is explained on page 88.

caused by variations of the grid bias, when a "C" potential is used. These effects may be produced in the ordinary "type-'27" rotor-grid tube, as shown at E, Fig. 3.

This figure also shows the first step in the production of an audio note, which may be detected by a pair of headphones at "X". The electron stream striking the plate (which for this experiment has been divided into (Continued on page 111)



**Fig. 3 (continued)**

The electrons emitted from the cathode will turn the rotor-grid, like a windmill, as at A, without applying plate voltage; but the latter increases their speed. If the plate is in sections, as at B, the current it receives will be interrupted; but if it is continuous, as at C, there is no modulation. We may turn a light-vane, as at D, to give a signal; or modulate the plate current by intercepting it with the grid segments, as at E and F, and increase the frequency by multiplying the plate segments as at G. H shows a synchronous, non-inductive motor action; and I shows how the rings (1 in Fig. B) of a rotor-grid element may be used to send or receive inductive impulses through the tube walls.

# New Models in Automotive Radio Receivers

Two of the latest motor-car installations are described here, with circuit details

## THE PILOT AUTOMOBILE RECEIVER AFFORDS GREATER CONVENIENCE

By Robert Hertzberg

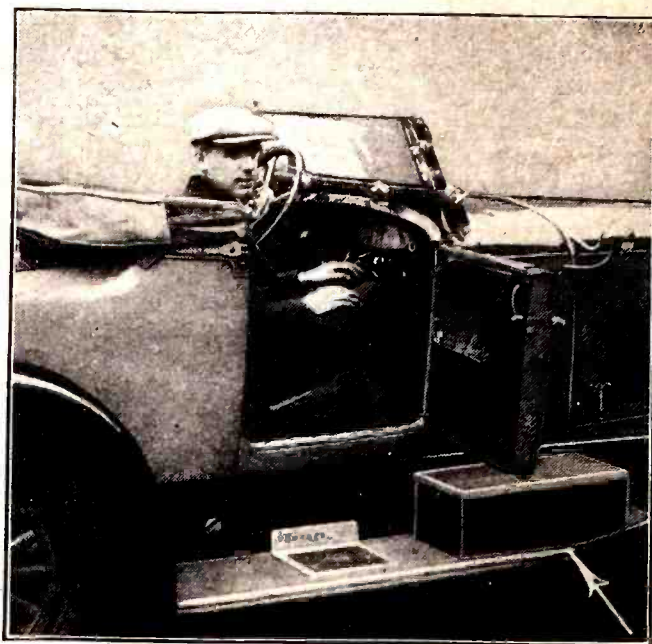
**P**RACTICALLY all of the automobile radio receivers which have appeared in such numbers during the last several months, have been for mounting somewhere inside the car, usually behind the instrument board. However, a new outfit just placed on the market by the Pilot Radio & Tube Corporation, of Lawrence, Mass., is designed for placement on the running board; while by means of its six-foot flexible cable, the attached control box may be placed anywhere inside the machine. One great advantage of this arrangement is that the receiver is instantly accessible for inspection and repair, as may be seen in Fig. A.

The Pilot auto set differs from other receivers of this class also in the absence of provisions for the elimination of ignition interference. It is the manufacturer's belief that automobile radio receivers should be used only when the car is stationary, and that they should not be turned on to distract the driver's attention while the car is in motion.

The new receiver is supplied in kit form, and may be assembled, wired and installed in a short time. The Service Man and custom set builder who can sell automotive radio sets to their customers will do well to consider this outfit, as its price is low.

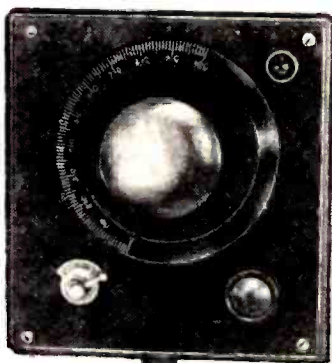
The receiver proper, which is built on a formed and drilled aluminum chassis, comprises three screen-grid ('24 type) stages of T.R.F., a screen-grid detector, and two A.F. stages. Tubes of the A.C. type are used throughout, with their filaments wired in series-parallel to work from the regular six-volt storage battery in the car. The

**Fig. A**  
The Pilot automotive receiver installed unobtrusively (in the box in the lower right-hand corner) on the right running board of a Hudson roadster.

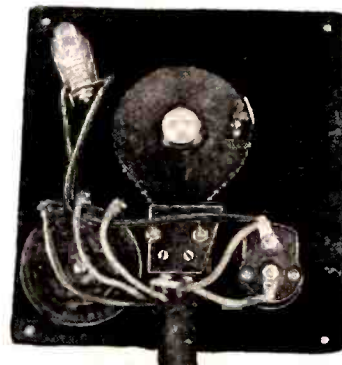


The receiver, located as shown (above arrow), does not interfere with the opening of the door of the car. It is no trouble to get at it when desired. In this installation, the control box is fastened to the right-hand side of the car, above the seat; and the speaker is underneath the dashboard.

'45 output tube, commonly used with 250 volts for the plate and 50 for the grid, is operated in this set with 135 and 22½ volts, respectively, and produces highly satisfactory results; it is much more convenient than a '71A in this particular circuit, because of its 2½-volt filament, working in series with the '27. The total filament drain is four amperes;

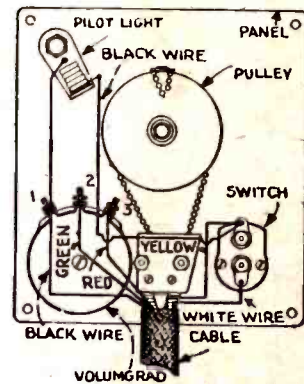


**Fig. C**



**Fig. D**

The control box of the Pilot automotive receiver may be mounted anywhere in the car, where the driving cable can be run. Its front and rear are illustrated here; the connections and colors at the right.



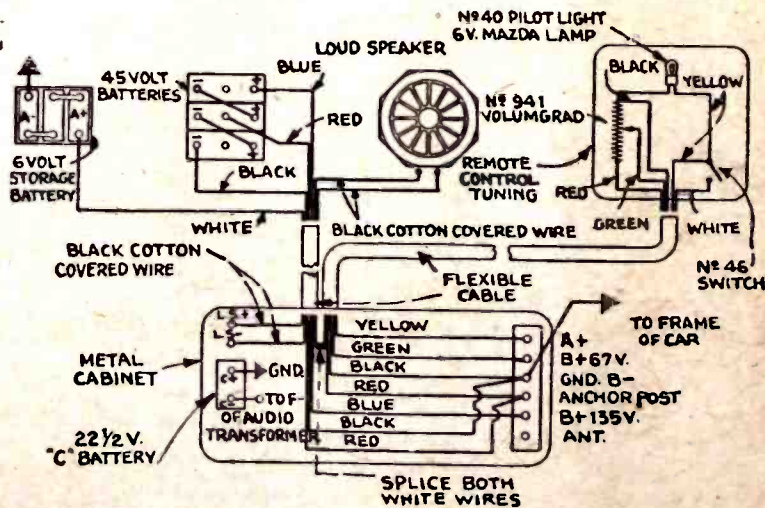
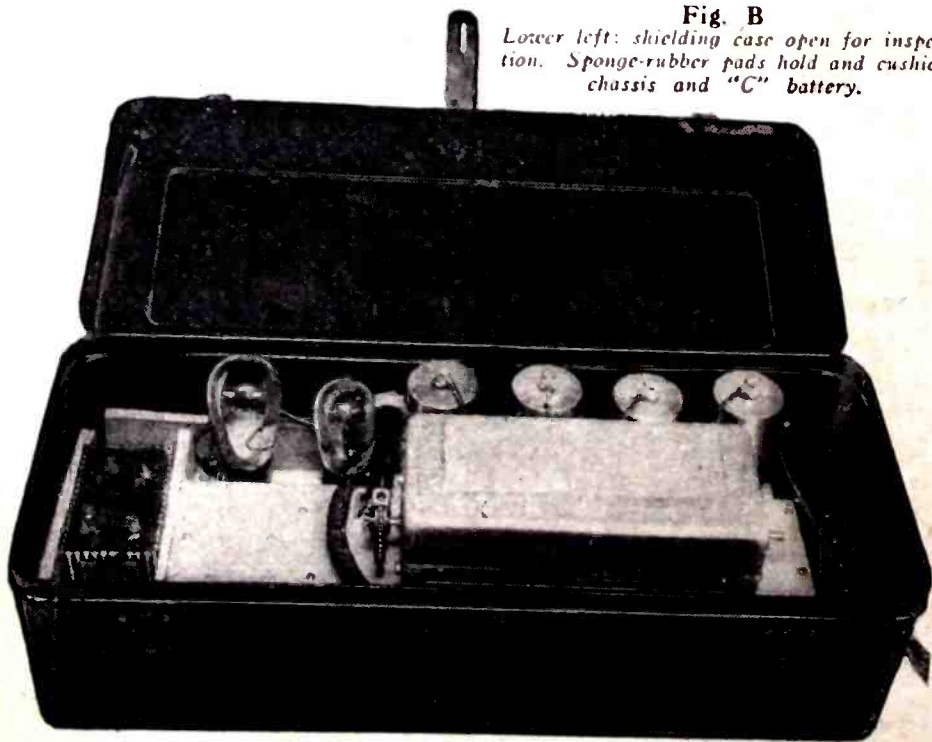
**Fig. 2**

the plate current drain 20 milliamperes. The circuit is shown in Fig. 1.

The sensitivity, selectivity and tone quality of the outfit leave little to be desired. Mechanically, both chassis and control ap-

paratus are very sturdy and will last indefinitely. The set has been tested very thoroughly in a number of different cars, representing different price classes and body types, and all the weak points which

**Fig. B**  
Lower left: shielding case open for inspection. Sponge-rubber pads hold and cushion chassis and "C" battery.



**Fig. 3**  
(Above)

Wiring arrangement and code of Pilot set illustrated at left.

showed up during thousands of miles' driving have been eliminated.

### Control Connections

The receiver unit is contained in a black japanned steel case (Fig. B) which goes on the running board, and is controlled from

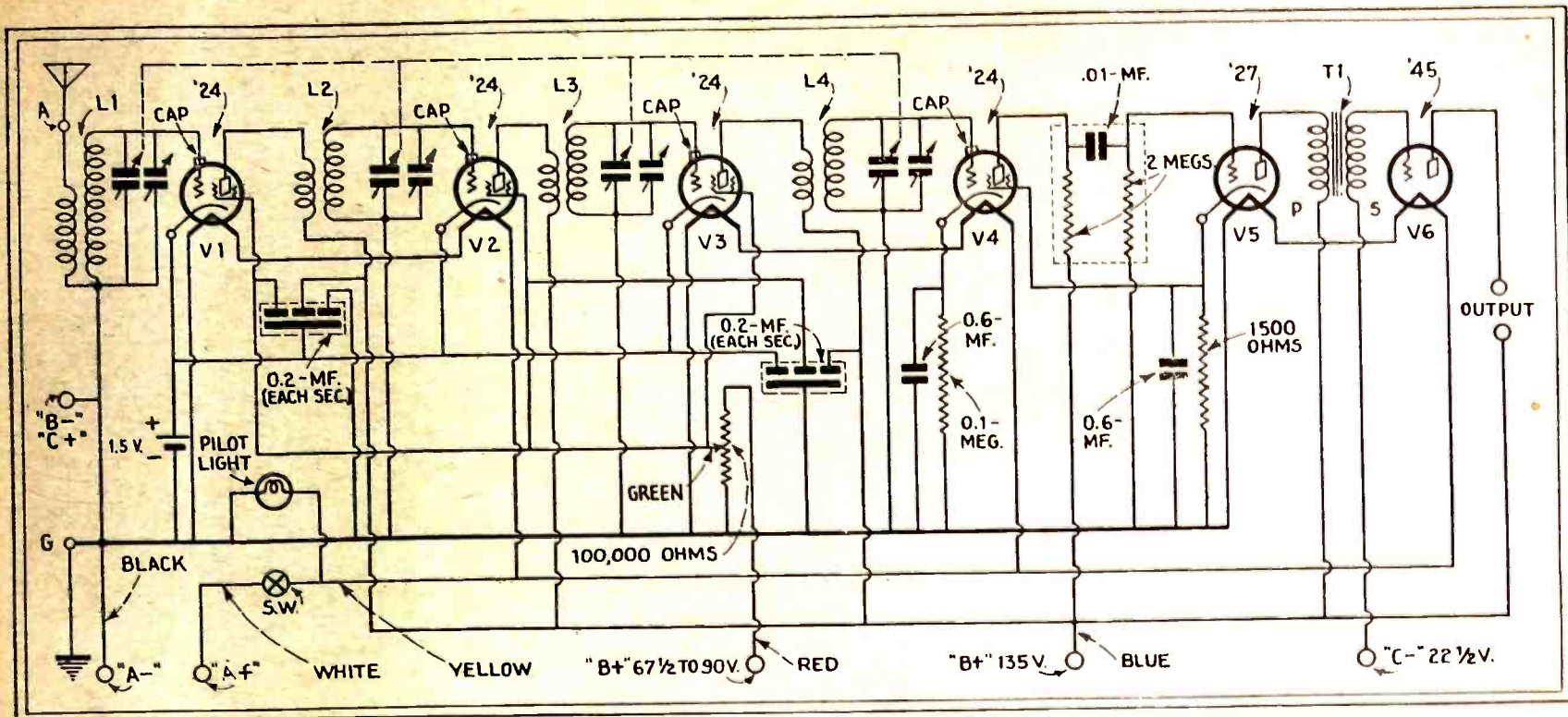


Fig. 1

Circuit of the Pilot automotive radio receiver, with three stages of screen-grid R.F. amplification, screen-grid detector, resistance-coupled '27 first audio, and a '45 power tube, in place of the '12 commonly used; its use improves output and simplifies the circuit.

the inside of the car by means of a thick flexible cable which terminates at a small panel (Fig. C) on which are mounted the tuning dial, a filament switch, a volume control and a pilot light. In the cable are five wires for the connections of the electrical devices, and a pair of flexible metal tubes; these last carry lengths of brass chain which transmit the motion of the control dial to the shaft of the variable condenser gang on the chassis. Special fixtures to guide the chain and make it run smoothly are provided. Its ends are secured to molded bakelite pulleys, one on the dial and the other on the condenser. The wires and tubes are enclosed in a strong waterproof fabric sheath. (See Fig. D and Fig. 2 for details of the control box.)

The steel case is 22 inches long, 8 inches wide and 6 7/8 inches high and, when placed on the running board, will not interfere with opening the door of a car of, practically, any make. It may also be mounted in the rumble seat of a roadster or coupé.

The control box, molded in one piece of natural-color bakelite, is 6 1/2 inches long, 5 7/8 inches wide and 1 1/4 inches high; the front panel, on which the controls are placed, is also of bakelite. The box is fitted with a removable aluminum back-plate, by means of which the whole unit may readily be screwed down.

The cable leaves the receiver case through a hole in the back, passes through a hole cut in the step-plate, and reappears inside the car through another hole made in the floorboard. (In some cars it is not necessary to drill the floorboard; as there are already openings in it through which the cable may be "snaked"). Additional wires, passing through the same hole in the side of the car, lead to the storage battery, the "B" batteries and the loud speaker. The cable and the extra wires are sleeved by a short length of flexible metal hose, clamped to the back of the case; to prevent them from chafing against the edges of the hole in the step-plate, and possibly causing a short-circuit to ground.

The Pilot auto kit includes all the parts for the receiver itself, the steel case, the

control cable and control panel, and wire and insulators for an under-car aerial. A special cone speaker, only 8 7/8 inches in diameter and 3 3/4 inches thick, is supplied as a separate accessory.

No "B" battery container is furnished; since each car is an individual problem in this regard. The three 45-volt blocks required for the set may be slung under the rear floorboard of a closed car in a wood-and-metal container which the constructor can make himself; or they may be put under the rear seat or in the luggage carrier. In roadsters and coupés, the rumble seat is convenient for the purpose. The wiring circuit is Fig. 3.

For an aerial, a length of wire is merely strung from insulators between the front and rear axles, under the car. This is easily and quickly installed, and works perfectly. It is unnecessary to tack unsightly copper screens to the inside of the car, or to disfigure the upholstery in any way.

The control panel may be mounted in any convenient place inside the car; the instrument board is the favorite spot, although

in some cars it is just as handy to have it somewhere in the rear. In any event, the connecting control-cable should be kept as free of kinks as possible.

### DELCO AUTOMOTIVE SET EMPLOYS GANGED VARIOMETERS

IN the Delco automotive radio receiver, in contrast to the accepted practice of recent years, tuning is accomplished by a gang of three variometers under single control, instead of three condensers; each is housed in a separate compartment, through which the tuning drive shaft passes. The latter, as usual, is connected to a tuning dial on the dash of the car, at the right of the instrument panel; there are also placed a key switch and volume control. The receiver chassis, with its separate controls and flexible cable, is illustrated externally in Fig. F, and the internal appearance in Fig. E; while the schematic circuit is Fig. 4.

The receiver, it will be noted, uses '24 type tubes in two R.F. stages and as a  
(Continued on page 106)

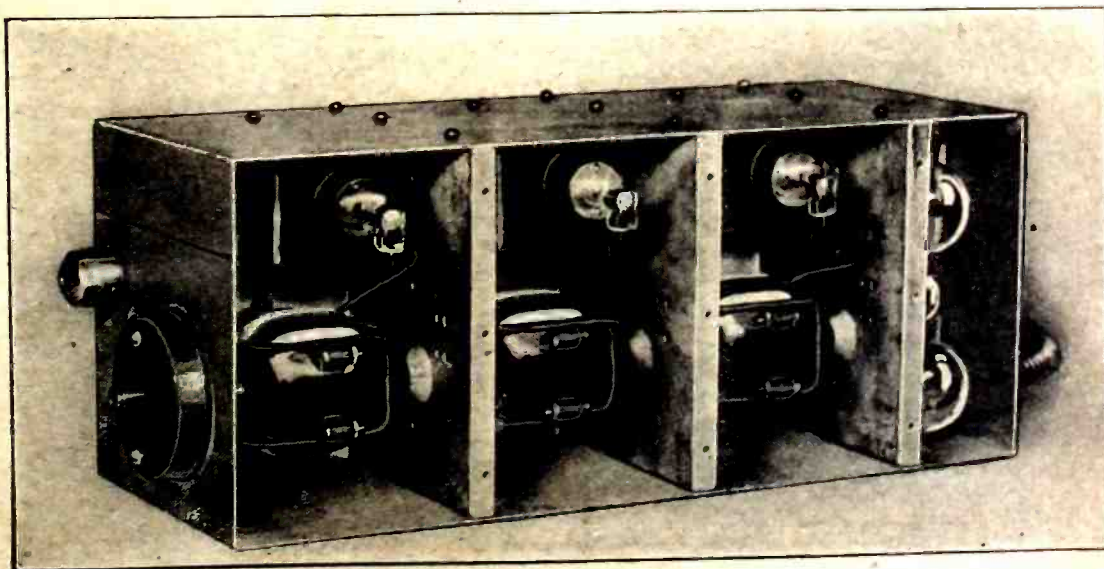


Fig. E

Internal appearance of the new Delco automotive receiver, the circuit of which appears on page 106. The three variometers, ganged together, control the tuned circuits, being trimmed by adjustable condensers. The shaft visible at the left is connected by cable with the tuning dial on the instrument board.

# New Radio Devices for Shop and Home

In this department are reviewed commercial products of most recent interest. Manufacturers are requested to submit descriptions of forthcoming developments.

## A TWO-TAPER-PLATE VARIABLE CONDENSER

NEW design marks a product of The Allen D. Cardwell Mfg. Corp., Brooklyn, N. Y., known as the "Model 201E Taper-plate Variable Condenser," in which only two plates are used, with adjustable spacing.

This unusual construction permits various tuning characteristics, as the accompanying graph (Fig. 1) indicates. Minimum capacity

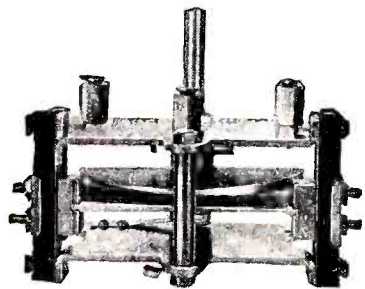


Fig. A

A new special short-wave tuning condenser.

is about 6 to 7 mmf.; and adjustment is possible for any desired maximum between 10 and 50 mmf. This is accomplished by loosening the nuts holding the stator plate assembly to the insulator strips and moving the stator plate away the required distance, after which the nuts are again locked.

The tuning graph was obtained with a 40-meter coil (8 turns of standard 3-in. space-wound inductance) connected in the grid circuit of a typical short-wave throttle-control autodyne; the coil being within a shield can, and a fixed shunt capacity of 25 mmf. placed across the tuned circuit.

As a laboratory and experimental instrument, this condenser should find considerable application; particularly in short-wave work.

## THE SERVICE MAN'S KIT BAG

A CASE especially designed for the innumerable and necessary items that constitute the radio Service Man's equipment is at last available for his convenience; its attractiveness, as well as utility, may be seen from Figs. B and C. This accessory is offered by the Grenpark Tool Company of New York City.

Though the bag is constructed of stout leather and provided with a sturdy three-position snap-and-key lock, it weighs but six pounds; the substantial construction insures years of service. It is 12 x 16½ inches, 6 inches from side to side, and finished in black. The two strong leather drop-handles, which encircle the case and adjust automatically to varying contents, are equipped with a comfortable little leather pad, the convenience of which the carrier will quickly appreciate. Two big snap-fasteners adjust it to the handles.

A pocket behind the lock carries cards, literature, ready references—such as street directories—and other matter which the Service Man requires in addition to his instruments; it is 5 x 8 inches, 1½ inches deep.

Two long leather flaps snap into position over the five interior compartments, the

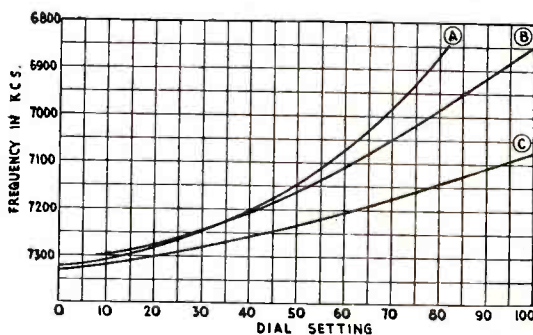


Fig. 1

The tuning curves of the instrument in Fig. A, at three different spacings of the stator plate.

cover, entirely separate, clips over all into the lock. The design is especially convenient for the Service Man who must "go places and do things" in a hurry.

The inner compartments, of varying depth, are especially suitable for servicing equipment and material; a stiff leather insert, 7½ x 17½ inches, is fitted with adjustable loops for securing the principal tools. When the case is closed, its contents are secure.

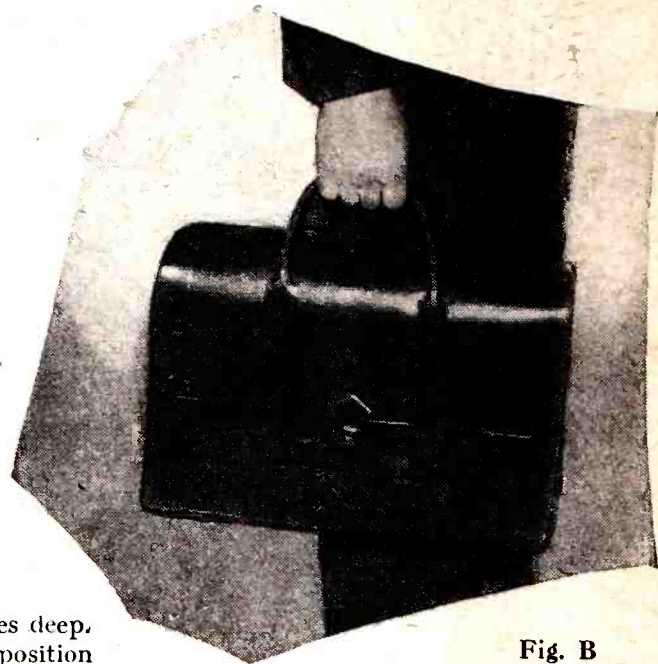


Fig. B

The Service Man has a profession; he is better able to live up to it when he presents a thoroughly professional appearance, with an instrument bag like this.

## STIKTAPE AERIAL

"YOU stick it where you want it." That is all there is to the installation of "Stiktape Aerial," a product of Sampson Industries, Inc., St. Louis, Mo. Speed and convenience of installation are its foremost virtues.

It consists of a roll of ¼-inch black tape (about as adhesive as ordinary surgical tape) on one side of which is a continuous

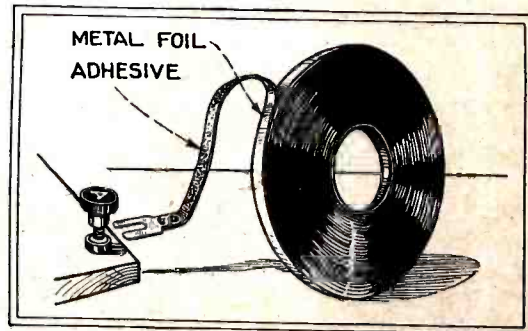


Fig. C

An indoor aerial which can be run anywhere in a minute.

strip of metal foil of the same width. A lug is provided at one end for connection to the aerial post of the set, as indicated in the accompanying illustration.

## SIMPLIFIED TUBE CHECKER

A VERY accurate and effective tube checker, to sell at a popular price, is announced by the Jewell Electrical Instrument Company, Chicago, Ill. This instrument operates on 50-60-cycle, 110-120-volt alternating current and uses no batteries.

The Jewell "Pattern 209" tube checker comprises a D.C. milliammeter and six tube sockets, in a case of molded bakelite. A filament transformer provides A.C. filament voltages of 1.5, 2.5, 3.3, 5, and 7.5 at four-

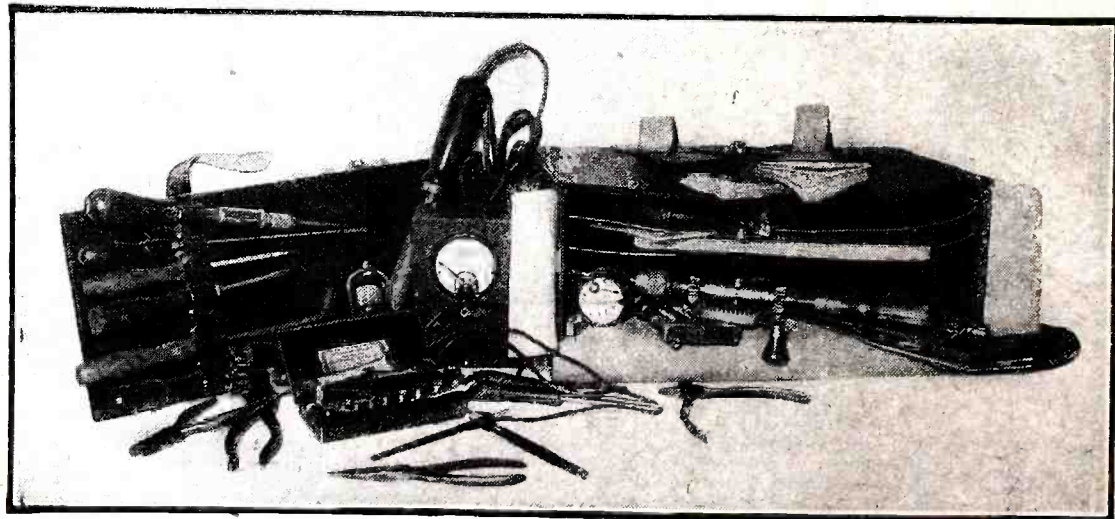


Fig. C

The Service Man's kit bag opened to show its carrying capacity. As a matter of fact, the Service Man will be a little more orderly; since this bag provides a place for everything. It is very strongly, as well as attractively, built.



Fig. D

A very complete tester for quick and thorough checking of tube efficiency, which will be a decided asset on any counter or work-bench.

prong sockets, and 2.5 at a five-prong socket (from a line voltage of 115).

Two terminals, giving 3 volts, are provided for tubes such as the older Kellogg which have heater terminals on top. A jack and suitable lead are provided for a grid-control connection.

The actual grid test is accomplished by shifting the grid from one position in the network to another, thereby giving a definite change in plate current corresponding to the difference between the two grid polarities. Expected values of the first plate current reading are given in an engraved chart on the face of the tube checker, together with the expected increase in plate current when the button is pressed. The base plate carries detailed instructions.

The meter used is a Jewell "Pattern 88," with a 50-division scale, 2-5/16 inches long. The instrument is accurately calibrated to two ranges, of 10 and 50 milliamperes, full scale. The lower range is read by pressing a button-switch which does not add series resistance, but accurately calibrates the instrument to the 10-milliamperere scale.

A vitrified-porcelain resistor in the circuit prevents damage in most cases of short-circuited tubes, but is of value too low to affect the readings.

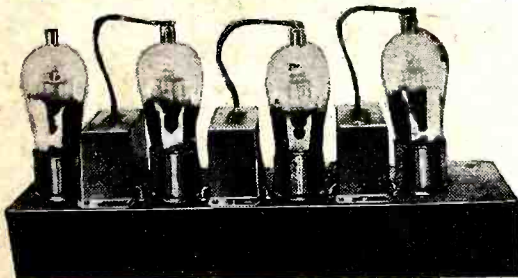


Fig. E

Three stages of untuned screen-grid R.F. amplification and a power screen-grid detector in this compact unit.

THE SCREEN-GRID APERIODIC AMPLIFIER

WITH the announcement by Dubilier Condenser Corporation, New York, of the "Model PL 1985 S-G Duratran" untuned R.F. assembly, pictured in these columns, there becomes available to the set designer a compact, wired unit incorporating the "Screen-grid Duratran" R.F. transformer described in the May, 1930 issue of RADIO-CRAFT (to which reference should be made). The grounded metal case measures approximately 2 x 3 x 12 in.

The schematic circuit adopted by the manufacturers is shown in these columns. Resistors R1 have a value of 750 ohms; R2, 25,000 ohms; C1 ("No. PL-1686"), 0.25-mf. (each condenser); C2 ("No. PL-1687"), 1.0-mf. V1 (1st R.F.), V2 (2nd R.F.), V3 (3rd R.F.), and V4 (power detector), are type '24 tubes (Fig. 2).

A standard band-selector arrangement should precede this unit, and may be followed by any desired A.F. arrangement.

IMPROVED SERVICE PLIERS

BY converting the ends of the handles or bows of a pair of forged pliers into a device for stripping insulation from wire, and by the addition of two cutting jaws, that handy tool becomes three in one.

This improvement, for which patent application has been made, has been incorporated in a product of the American Swiss

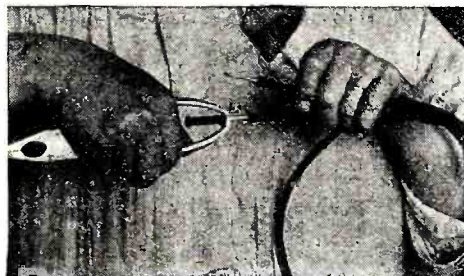


Fig. F

An ingenious addition to the use of pliers.

File and Tool Company, of Elizabeth, N. J.

The plier ends are so arranged that while the jaws bite into the insulation, they cannot cut into the wire. While the tool is designed for average conditions, the resiliency of the handles makes it possible to strip wire of different gauges without danger of biting the wire. Beveled cutting jaws at the side of the stripping jaws provide for wire cutting as well.

The compactness and serviceability afforded by this construction should appeal to everyone who works with wire.

ELLIS "MODEL 20" MICROPHONE

TO meet the demand for a medium-priced microphone, the Ellis Electrical Laboratory, Chicago, Ill., has developed the "Models 20N" (nickel finish) and "20G" (gold finish) microphones illustrated in Fig. H.

The "20" series is of the two-button, stretched-diaphragm, carbon-granule, type. The construction is rigid and the "carbon hiss" is exceptionally low. Maximum current, 10 ma. per button; excellent response is obtained at 5 ma., 3 volts per button; recommended current, 6 to 8 ma. per button. Diameter, 27/8 x 15/8 in. thick. Mounts in

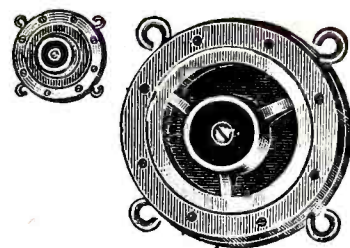


Fig. H

A new microphone for public-address and other voice-amplification purposes.

regular stands.

Harmonic distortion is eliminated by tuning the diaphragm above the audio range.

SHIELDED WIRE

SEVEN strands of No. 22 tinned soft copper wire, rubber insulation, and an over-all sheath of finely-woven tinned copper compose the new, flexible so-called "Shielded Lead-in Wire" developed by the Belden Mfg. Co., Chicago, Ill., and illustrated in these columns (Fig. G).

A grounding lead may be attached to the outer shield; thus affording a measure of protection from stray electrical disturbances.

To offset the by-pass effect by capacity coupling to ground, the antenna should be lengthened until satisfactory pick-up and input to the set are obtained.

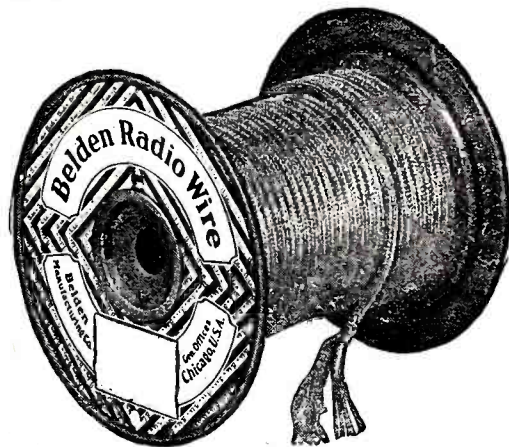


Fig. G

The increasing necessity of limiting pick-up and feed-back in modern sets makes shielded leads a necessity. They are provided easily with this wire.

Service Men should familiarize themselves with this convenient wire, and learn how and when to use it to overcome installation difficulties. Set constructors will find it very useful in certain types of circuit design.

KIEL "GOLDEN VOICED TABLE"

DEPARTING from conventional design in cabinet construction, the Kiel Furniture Co., Milwaukee, Wis., has conceived a (Continued on page 108)

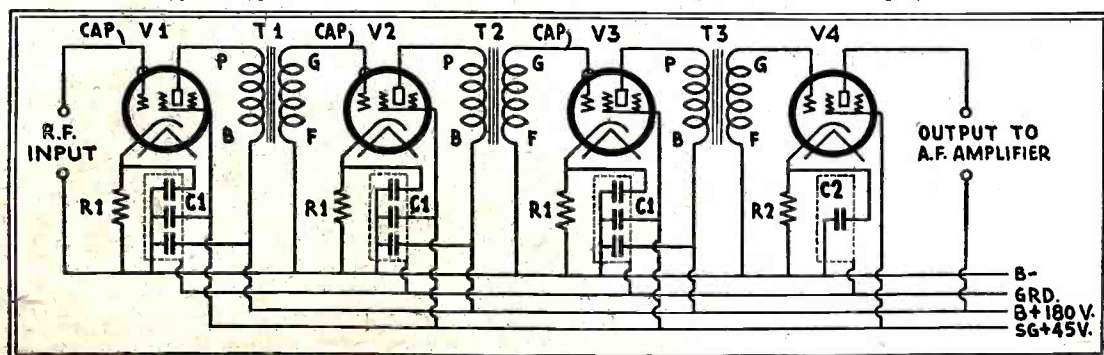


Fig. 2

Circuit of the R.F. amplification unit shown in Fig. E; the transformers T1, T2 and T3 give a very flat characteristic with '24-type tubes. A suitable band-pass tuning unit must precede this and the desired A.F. channel follow.

# SHORT WAVE CRAFT

## Design Your Own Short-Wave Receiver

By L. W. HATRY

**S**HORT-WAVE receiver design is not difficult; but, because of the importance of small variations, to obtain over-all uniform result, smoothly or finely controllable, is half the task. Consequently, the final touches to a receiver are just as important as its general construction. These small variations are what make set-builders boost one plan over another, although both may use the same circuit. Even though the builder may substitute parts of the same electrical values as those recommended, he frequently ignores small physical differences which introduce wide electrical variations.

Most short-wave receivers, even though elaborate, are based on the fundamental regenerative-detector circuit. If no R.F. tube (as in Fig. 1) or an untuned stage, precedes the detector, results are governed by the efficiency of the detector circuit. This requires for L fair-sized wire (No. 18 to 24), good insulation in the coil-form, and fair spacing between copper turns, accomplished by using D.C.C. or D.S.C. wire, or separation. T is not so important; the wire can be very small, but must have generous insulation.

The turn ratios of L/T should be about in this order:

Waveband	Ratio L/T
1,500 kc.—200 meters.....	3:1
3,000 kc.—100 meters.....	2.5:1
6,000 kc.— 50 meters.....	2:1
12,000 kc.— 25 meters.....	1.5:1
20,000 kc.— 15 meters.....	1:1.2

But these ratios will differ with the method of regeneration control, the range of this control, the tube type, and the capacity range of C. However, the tickler can easily be reduced or increased.

Consider the waves listed as being near the first third of the tuning range of a coil wound to the ratio. If three coils are to cover the general range of 25-50 meters,

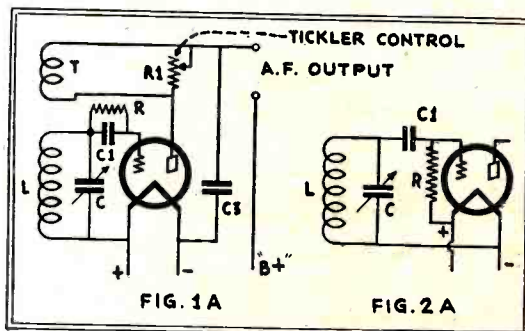
wind the middle coil to the lower wave ratio. Given any size of L, then T can be determined by use of the above ratio table. T is to be wound close to, or just within, the filament or ground end, of L.

### Design of Coils

Decide on the lowest wave you want and, in choosing your coil-form, be limited by this wave, thus:

- Above 50 meters.....3-inch diameter
- Above 20 meters.....2-inch diameter
- Above 8 meters.....1-inch diameter

This second table is intended as a guide to certainty of oscillation. Large coils will work; but smaller diameters and more turns are nearly certain to give the desired action. This guide is primarily for the constructor who makes his forms. Manufactured ones are available in satisfactory dimensions. The users of tube-bases for coil-forms should be



The resistance method of controlling regeneration (left) requires fewer tickler turns. At the right, the preferred grid-leak connection used in Fig. 3.

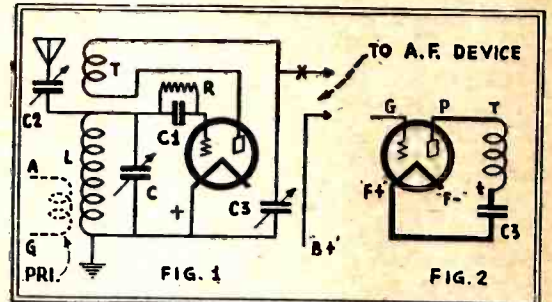
sure to get bakelite bases, for many bases are made of material worthless for coil use. This should be easy; since high-grade new bakelite bases are sold, as low as 6 cents each, to experimenters. Isolantite or Crolite bases are excellent.

### Grid Condenser and Leak

Because the grid leak R is nearly always from 5 to 10 megohms, the grid condenser C1 should be as small as allowable. This recommended value is merely to preserve the tone; it works out about as follows, for best results:

- Above 50 meters.....0001-mf.
- Above 25 meters.....00005-mf.
- Above 12 meters.....000025-mf.

Actually, C1 may be between the rated value and .0005-mf.; but good tone demands about 2.5 megohms with .00025-mf.; while .0001-mf. with 6 megohms, or .00007-mf. with 10 megohms. are better because larger capacities reduce the treble tones. Determine the value



The well-known regenerative circuit (left) is most popular for short waves. The heavy leads shown at the right should introduce minimum R.F. resistance.

of C1 by the maximum wavelength you want; although .0001-mf. is a good all-round size.

The regeneration control most in use is a variable condenser at C3. But the method of control has nothing to do with ultimate results, if adjustments have made the control smoothly effective. When C3 is large, T tends to be smaller than the L/T table suggests. The trend of best value for C3 is like this:

- Above 100 meters.....00025-mf.
- Above 20 meters.....0001-mf.
- Above 8 meters.....00005-mf.

Use your highest wave as gauge; for the electrical value is not very critical. The smaller physical dimensions are best. The larger capacity at C3 is more desirable than the smaller; larger tubes, having a large plate-to-filament capacity, generally need a higher capacity at C3.

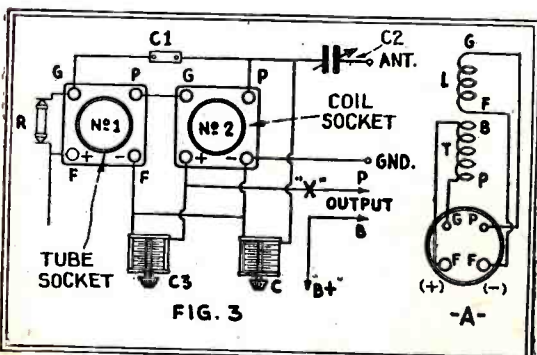
An R.F. choke is not likely to be needed except below 20 meters. It is connected at X in Fig. 1.

Resistance control by shorting out the tickler, as in Fig. 1A, calls for slightly smaller ticklers. C3 may be .001-mf.

The method of coupling to the antenna need not be that shown in Fig. 1. (On the longer wavelengths a primary is often used, as indicated by dotted lines.) But the use of C2 is a good and satisfactory method for one- to three-tube receivers; do not attempt to get above 150 meters unless both C and C2 are changed. C2 should be from 25-mmf. down, or the usual 5- to 7-plate "midget." Above 150 meters it should be 50 to 100-mmf.

### Short Plate Leads

Not only the physical dimensions of LT, but the actual physical assembly of the set, should be determined by wavelength. Notice that the heavy lines in Fig. 2, indicating the complete R.F. wiring of the plate circuit, are extremely important, in determining the possibility, as well as the amount and smoothness of oscillation, at 20 meters and



The layout at the left is very well adapted to short-wave work; the connections of the coil in Socket No. 2 are made as at the right.



below. That is why I insist that, from a practical standpoint, the lengths of the leads P-T, T-C3, and C3-"F—" are more important than those of the grid lead, or the leads to C or L. The latter affect only the general tuning range; but the former may prevent oscillation. And notice that I indicate the filament itself, from plus to minus, as part of this circuit: on the shorter waves this effect is very noticeable, in the larger tubes. "F—" is the zero point—the R.F. return—and therefore it is wise to connect the leak directly from grid to "F+" (see Fig. 2A), in order that the L-C and plate circuits may go directly to "F—."

**High Audio Amplification**

In conclusion, consider the A.F. end. Few short-wave DX chasers pay attention to it, ignoring the very thing they consider most in longer-wave sets. Remember:

(a) Only high-grade transformers, a good speaker, and a power tube are going to give the good tone and volume possible from short-wave reception.

(b) More audio amplification than usual is wise.

A dynamic or high-grade magnetic speaker preceded by at least one '71A power tube, is recommended under (a); and as to (b), it will be found that *three* A.F. stages are frequently made necessary by the lower undistorted-output power of the detector run on low "B" voltages. Capable of delivering only an eighth- to a quarter-volt, undistorted, the short-wave detector cannot work a loud speaker without detector distortion unless there is a voltage gain of at least 300 following it and before the grid of the last A.F. tube. This means two A.F. transformers and a resistor-coupler, utilizing two '01A or '27 tubes, feeding a '71A run on 180 volts; or else three stages of resistance-

capacity coupling, using two '40-type, high-mu tubes.

In a battery set, three stages sometimes are stopped from howling by the use of a separate "B" supply on the detector; but half the battle is in the A.F. wiring; *i. e.*, the battery wiring.

Fig. 3 shows in layout form the arrangement employed by the writer in a set which was operated as low as 9 meters. It will be observed that the tickler leads from the coil socket (No. 2) to the tube socket (No. 1) are minimized in every way. The coils were wound on bakelite tube bases and connected as shown at (A), where the terminals of the tube bases are shown from above. Control of regeneration by a resistor in the "B" circuit would replace C3 by a fixed condenser; and this part of the R.F. plate circuit could have thus been made even smaller. The windings shown at (A) have their turns in the same direction.

With a tuning condenser maximum of from 140 to 160-mmf. (.00014- to .00016-mf.) and winding of No. 20 D S.C. wire on a 1½-inch

form, the following numbers of turns should be used on L, for the different wavebands:

Band Covered	Turns of L
16-32	4½
32-64	10
64-128	21
128-250	47

For a suitable audio amplifier, (Fig. 4), constants are: R, 100,000 ohms for 220 volts (150,000 for 300); R1, ½- to 1-meg.; R2, 50,000 ohms and C1, 2 mf. (or R2 15,000 ohms—C1, 8 mf.); R3, 100,000 ohms and C2, 1 mf. (or R3, 50,000 ohms—C2, 2 mf., etc.); R4, 2000 ohms; R5, same with '71A (1500 for '45); R6, 20,000 ohms (40,000 for '45); R7, 10,000 ohms and C3, 8 mf. (or R7, 20,000 ohms—C3 4 mf. for No. '45); R8, 10 ohms center-tapped; R9, 20 ohms, center-tapped (10 ohms for '45); C, .01-mf.; C3, 4 mf.; C4, 2 mf.; C5 (when needed) 8 mf. electrolytic (Sprague); others 300-volt working rating except C4, 1000-volt. Resistors, 2-watt (such as Durham). The value of R2 may be varied, to alter detector potential and obtain the best operating conditions.

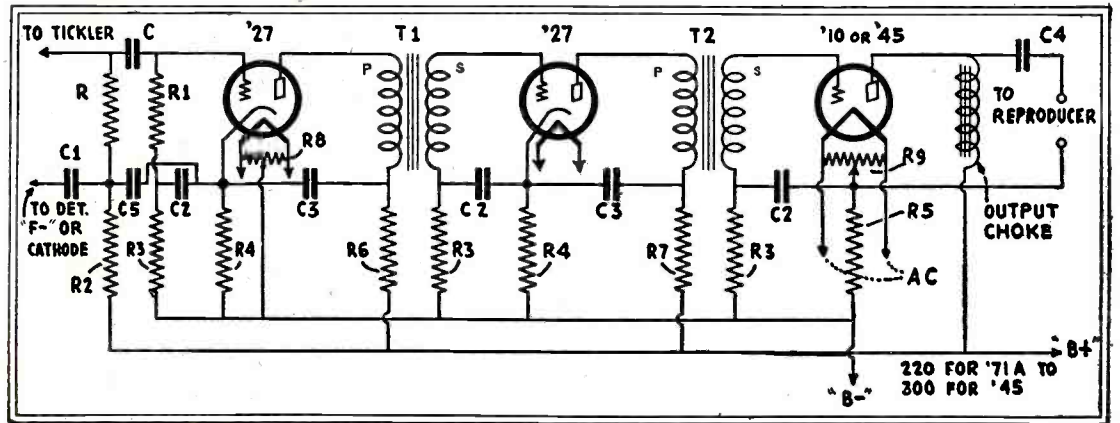


Fig. 4

Mr. Hatry has found this three-stage audio amplifier very successful after any short-wave regenerative detector. The by-passes are for A.C. operation; C5 is either essential or superfluous. For D.C. operation, only the detector output filtering—C1, C2, C5 and R1-R3—is required.

**Short-Wave Reflection from the Sky**

WHEN a short wave is received from a nearby transmitter, it produces a double signal; that is, one component travels directly through the earth, while another comes down from the upper air, by which it has been reflected. The latter phenomenon has made the "Heaviside layer" a common figure of speech; and it is one of especial importance in short-wave operation.

The Bureau of Standards, working on this problem, has been making and studying oscillograph records, taken at its field laboratory in Kensington, Maryland, of signals received from NKF, the transmitter of the naval research laboratory at Bellevue, D. C., a few miles away.

On these records signal irregularities, occurring in a space of time too short to be measured or detected by the ear, are recorded in permanent form; and the application of measuring devices determines the length of time separating the arrivals of a code impulse by "ground wave" and by "sky wave." This varies between 1/700 and 1/333 of a second; indicating that the path of the sky wave has been from 270 to 550 miles longer than that of the ground wave. The record shows two or more series of sharp peaks, each of which corresponds, hump by hump, to the others; and each of which carries the code message.

Similar methods have been previously employed to estimate the height of the Heaviside layer, by measuring the intervals separating the arrivals of an impulse, from a powerful commercial transmitter, from two directions. One would cover a path of, say 500 miles and the other, which had gone almost completely around the world, would arrive about 1/7-second later and make a faint "shadow" of the first upon the automatic recorder of high-frequency signals. The interval, however, indicated a longer path than one measured directly upon the surface of the earth, because of the numerous reflections of the wave.

With short waves (4,045 kilocycles or 74.1 meters, and 8,650 kc. or 34.7 meters) the Bureau finds the differential greater for the higher frequency. This is attributed to the fact that, the shorter the wave, the more readily it is turned aside, and the longer the path it will follow. (The same is true of light: "the index of refraction increases with the frequency.")

While the shorter waves, therefore, do not necessarily rise higher, they take a time one-fourth longer, to cover the distance by the sky route; this time is less affected comparatively by the hour of the day than that of the 74-meter waves. The delay of the latter, during the night, amounts to as much

as .003 second, or the time taken by them to travel 550 miles.

The 74-meter waves, however, were less affected by a magnetic storm (on March 13 last) than the shorter ones.

These phenomena, which have a direct bearing on the steadiness of short-wave reception over great distances, because atmospheric changes in the path of waves cause the two major evils of skip-distance and fading, are being studied systematically; and there is no doubt that much information of practical value will be obtained.

**MORE FIRE AND POLICE TRANSMITTERS**

NEW YORK'S fire department now has a telephone transmitter for the fireboat *John Purroy Mitchel*; and the other nine of the city's fleet will later be equipped. The call is WRBC and the wavelength 187.85 meters (1596 kilocycles). The increased efficiency will, it is believed, quickly repay the cost, even from the standpoint of operating expense.

The State of Michigan is providing radio equipment for its state police; a transmitter of 1000 watts night power, and 5,000 watts daytime, having been authorized to operate on 180.4 meters (1662 kilocycles).

# Practical Applications of Photoelectric Cells

*Methods and purposes of amplifying their impulses, to operate relays and set light to work, guiding electrical and mechanical devices*

By C. H. W. NASON

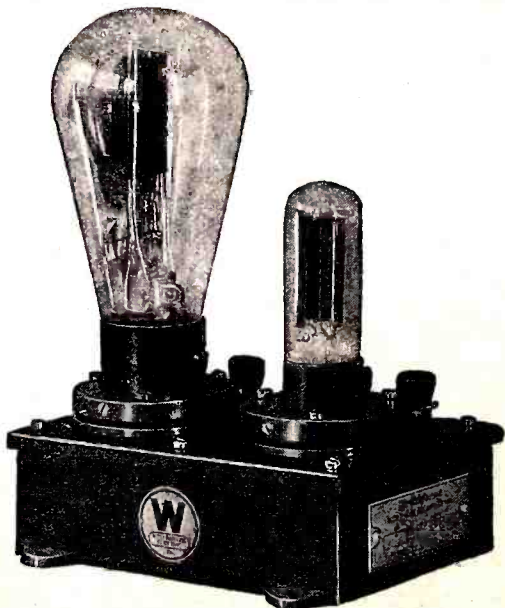
**H**ALF a century ago, the German investigator Hallwachs made the startling discovery that certain substances, when exposed to light, give off electricity. Heinrich Hertz, discoverer of radio waves, turned his attentions to this "Hallwachs effect" and made the basic discoveries which laid the foundations for the profound photoelectric science of to-day.

As early as this writer can remember, selenium cells were available to the experimenter; the wireless catalogs of fifteen to twenty years ago listed the element selenium in a suitable form. One of them, at least, gave complete directions for the preparation of such light-sensitive cells. John Hays Hammond, Jr., who developed the radio-controlled torpedo, and even crewless battleships, for our navy had an "Electric Dog" which obediently followed a flashlight about.

The modern science of photoelectrics has been advanced to its present state of development through the tireless work of de Forest, Case and Hoxie in the field of the talking motion picture, Jenkins and Ives in television, and other engineers such as Wein, working on light-control in various forms.

A brief tabulation of the inexhaustible uses for the photo-cells to today gives us the following major list:

- The talking motion picture;
  - Television;
  - Picture transmission;
  - Dynamic control of mechanisms (elevator levelling devices, for example);
  - Photometry (the qualitative or quantitative measurement of light, whether visible or invisible);
  - Counting and sorting (inspection);
  - Relay operation (Switching at dawn or dusk, or by artificial light, of signs, alarms, door openers, etc.);
- The applications are so numerous that a complete list is quite impossible. The uses



A commercial unit incorporating a photoelectric cell and amplifier, for closing a relay at a predetermined light intensity. (Photo courtesy Westinghouse El. & Mfg. Co.)

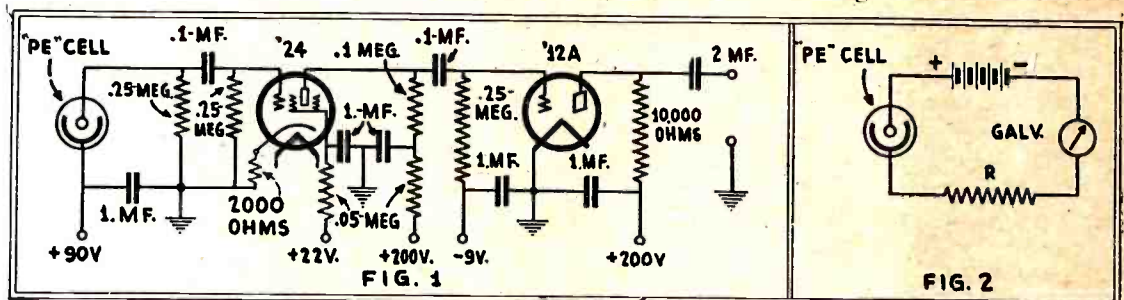
may, however, be classified under three headings, as the cell is called upon to do one of three things:

- (a) Produce an alternating current;
- (b) Produce a direct current of varying magnitude;
- (c) Produce a direct current of fixed magnitude (relay action).

This listing is, approximately, in the order of the cell sensitivity required.

## Construction of the Cell

The cell is usually in the form of a glass bulb or "envelope," on the wall of which has been deposited the light-sensitive material, or cathode. The material is usually the



The resistance-coupled amplifier at the left is of the type required where considerable amplification, with fidelity to all frequencies, is essential, as in television transmission and sound reproduction. For mere measuring work, the simple circuit at the right will do.

hydride (an "alloy" with hydrogen) of one of the alkaline metals—sodium, potassium, lithium, caesium. The choice is determined by the color range over which the cell is to be operated.

The anode is in the shape of a wire ring, placed between the active cathode material and the source of light.

The envelope may be highly evacuated, or it may contain some inert gas at a low pressure. Where rapid variation of the light source is to be encountered, the high-vacuum cell is employed, because of the time-lag exhibited by the gas-filled cells. Where sensitivity and high output are requisite, the gaseous type is used, because of the increased sensitivity attained through partial ionization of the gas.

## Design of Amplifiers

In all cases some form of amplifier is necessary. Where simple relay operation is desired, the "amplifier" is merely the relay contacts used to open or close a higher-powered circuit than that of the cell itself. In television, particularly rapid variations of light are encountered and the vacuum cell must be used. Because of the small output of the cell, high-gain amplifiers, with a frequency characteristic flat from as low as fifteen cycles up to nearly fifty thousand cycles, must be used. In talking-picture work, and in the transmission of pictures, the frequency restriction encountered in the gaseous cell does not assume so great an importance; and we may employ an amplifier having, not only a lower over-all gain, but a frequency-band decidedly narrower in

scope. The amplifier shown in Fig. 1 is suitable for television or for talking-picture work. In the latter case, the same constants should be employed; because the use of a transformer, to match the impedance of the output tube to that of the input transformer feeding the main amplifier, will result in considerable loss at both high and low frequencies.

In photometric work, such as measuring the intensity of illumination in a motion-picture studio, a different type of circuit is employed. Where the light intensity is great enough, a microammeter in the cell circuit (as shown in Fig. 2) would suffice.

But, where our range of measurement is

to include weak illumination, we must employ a D.C. amplifier—not a standard amplifier circuit, because the cell variation is not pulsating but steady. The circuit for such an amplifier is given in Fig. 3; the reader will recognize this as the familiar Loftin-White arrangement. The additional equipment in the output circuit is for the purpose of balancing out the steady current through the indicating meter.

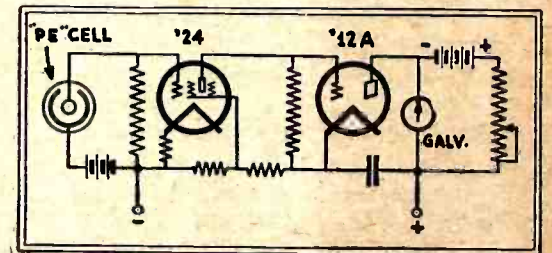


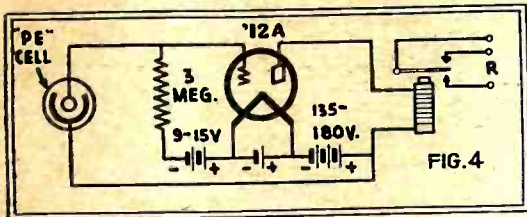
Fig. 3  
When light is extremely dull, we require an amplifier like this—which will reproduce slight D.C. variations.

We have already discussed the fact that our choice of photo-sensitive materials is governed by the color sensitivity required. In the case of photometers for use in motion-picture studios, the cells are designed to have a color sensitivity identical with the characteristics of the photographic film used. Highly-sensitive amplifiers of this type are used in astronomical investigation, to measure the light intensity of distant stars.

## Workshop Experiments

Those of you who are Owen Johnson addicts will remember Stover's brief business connection with the "Tennessee Shad," and

the corner on alarm clocks. Alarm clocks were quite the thing for closing windows, turning on radiators, and what-not, at the writer's Alma Mater as well as at Lawrenceville; but the photoelectric cell, operating at



With the simple circuit above, the response of the photoelectric cell to a change in the light falling upon it is the signal for the relay R to operate.

the first rays of dawn, is a superior piece of apparatus. The circuit of Fig. 4 is suitable for such work, as well as for the saner operations of counting traffic past a point like the entrance to the Holland tunnels in New York City, or for opening your garage door when the headlights actuate the relay.

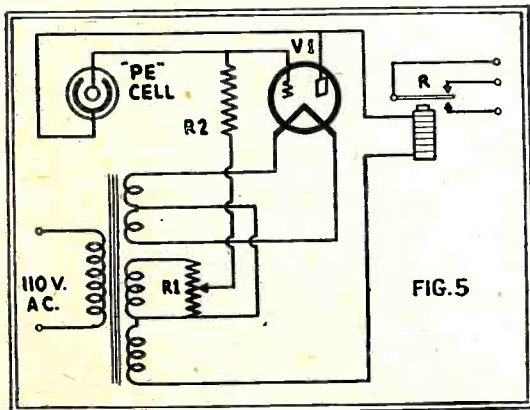
Such equipment is now used for the operation of electric-sign circuits at dawn and at dusk; this double action is obtained by using contacts at either the closed or the released positions of the relay armature. The relay indicated at R may be of the 10,000-ohm type manufactured by Yaxley, or the new General Radio non-polar relay, designed for the operation of temperature regulators in crystal-controlled radio transmitters. Fig. 5 shows a circuit similar to that of Figure 4, but for full A.C. operation.

Hundreds of uses will suggest themselves to the serious experimenter. Only a few days ago, during one of the recent prison disturbances, some little publicity was given a device by which a gun was sighted along a ray of light and automatically fired if the beam were interrupted; the apparatus was suggested as useful in preventing jail breaks.

A relay arrangement as shown would be entirely practical for the purpose.

A reference to Fig. 4 will show the mode of operation to be as follows: with the relay in the circuit, the grid bias is adjusted to a point just negative enough to reduce the plate current to such a value that the armature is released when the cell is dark. When light strikes the photo-sensitive surface, the resistance of the cell is lowered, and current is passed. Now the grid is highly positive, and the increased plate current actuates the relay. When the light source is removed, the plate current returns to normal and the relay armature is released. For a sensitive condition, where the light is not very intense, some adjustment may be necessary; since the releasing current is somewhat lower than the closing current.

For the more ambitious experimenter, a modern version of Hammond's "Dog" would be possible by



The photo-cell may be connected to an A.C.-operated amplifier, if desired. The cell passes current, like a vacuum tube, in but one direction.

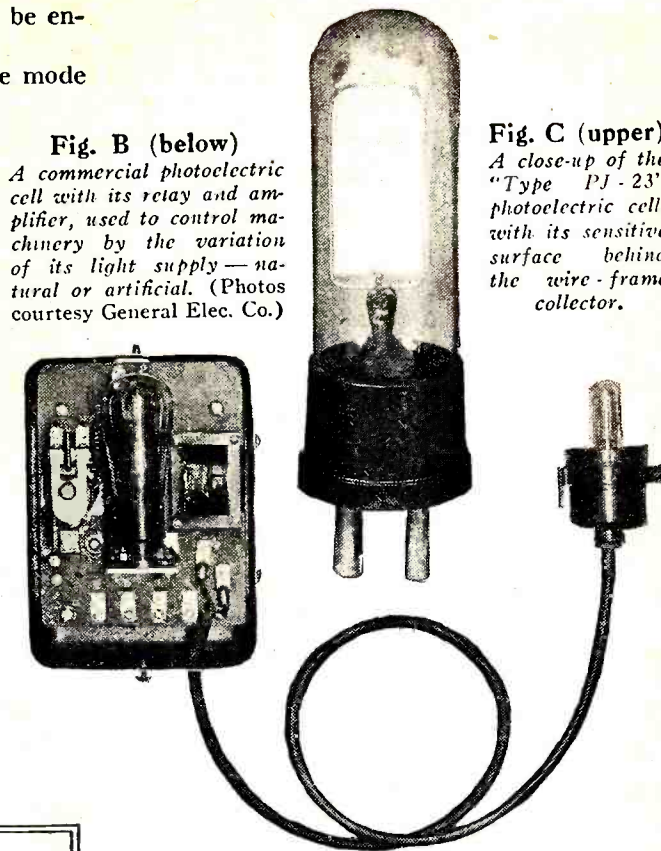


Fig. B (below)

A commercial photoelectric cell with its relay and amplifier, used to control machinery by the variation of its light supply—natural or artificial. (Photos courtesy General Elec. Co.)

Fig. C (upper)  
A close-up of the "Type PJ-23" photoelectric cell, with its sensitive surface behind the wire-frame collector.

the use of two cells and two driving motors—both cells being operative when the light source was dead ahead, and both motors running. With the guiding light displaced to one side, only one driving motor would operate and the "Dog" would turn. Another method would be that of employing a single motor and a cell-actuated steering gear. With these few suggestions you should be able to find endless entertainment with a single cell and relay and whatever junk in the way of bells and motors you happen to have around.

## Higher Voltage from the "B" Eliminator

By JAMES P. DARDEN

FOR those who wish to bring an old-model audio amplifier up to date, but do not care to go to the expense of new apparatus throughout, the methods described below provide a means whereby the old "B" unit may be used to furnish the requisite voltages for higher-powered tubes than those used before. The rectified voltage from the eliminator may be doubled,

tripled or quadrupled through the use of a circuit connecting the rectifying tubes to the transformer; which means that practically any "B" eliminator may be made to deliver sufficient voltage to operate even a '50 power tube.

To do this requires only the purchase of condensers to stand the higher voltages, two resistors, a buffer condenser, one or two

rectifying tubes and, possibly, a small filament transformer. The selection of the transformer depends upon the type of output tube used at present and the new type to be installed. Some additional apparatus, this depending also on the contemplated changes, may also be necessary in the audio system.

(Continued on page 115)

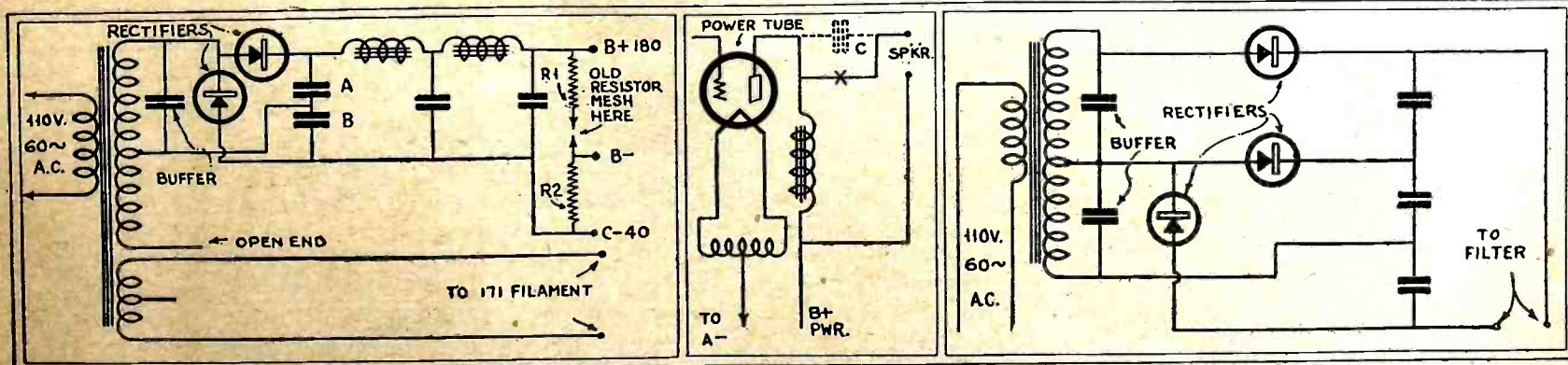


Fig. 1

Fig. 2

Fig. 3

At the left, the method of employing two cold-cathode, ionized gas rectifiers to increase the power available from an old-fashioned "B" power unit of small output. Center, the necessary change to substitute a '71A for an '01 final stage. Right, means of tripling the output voltage for a '45 or '10.

# The Effective Use of By-Pass Condensers and Resistors

The writer, a radio engineer, gives a few facts and simple figures which make it possible for anyone to figure what capacity will be required to produce desired results in a given circuit.

By P. H. GREELEY

**R**ESISTANCE units of various values and types, together with by-pass condensers of differing capacity values and voltage ratings, are essential components of electric radio sets and are required to some lesser extent in battery-operated sets.

If we have a limited amount of by-pass capacity and a number of resistance units, and want to arrange a system of voltage distribution and by-passing suitable for operating a particular radio set, we may try one arrangement and find that the radio set does not work satisfactorily; even though all tubes are supplied with suitable operating voltages. Yet, by simply re-arranging the same condensers and resistors it may be possible to get satisfactory operation.

### Reducing Undesirable Coupling

Disregarding A.C. hum (which may be reduced or eliminated by better A.C. tubes and more effective filter circuits) the main difficulty in obtaining best tone quality with A.C. operation is to limit or prevent interstage-coupling effects.

In battery-operated sets, if there is any serious interstage coupling effect, a separate "B" battery is often recommended to operate one or two of the tubes, especially the detector tube.

It is possible to design "B" eliminator devices so that they have practically the same characteristics as good "B" batteries; but relatively great amounts of condenser capacity, and perhaps some devices such as voltage-regulator tubes, may be required for satisfactory results. The idea here is to make the A.C. impedance across the "B" terminals so low that it does not seriously affect the operation of radio sets of ordinary types. Condensers of very large capacity are expensive; unless they are of the electrolytic type, which is used in some commercial sets but not so widely as paper condensers. Voltage-regulator tubes do not

seem to be popular; possibly because of their cost and the load they put on the "B" power rectifier.

The best results from any radio set, however, will be obtained when undesired or unintentional coupling effects between the

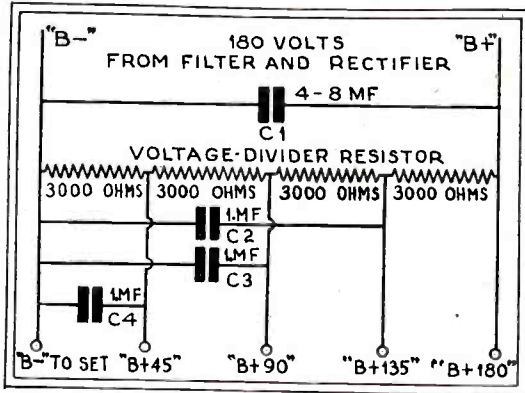


Fig. 1

Here is a voltage divider, of the typical arrangement found in a power pack. The condenser C4 is only one-third as good a by-pass as C2, of the same size.

several tubes employed are kept very small by effectively segregating the A.C. and D.C. plate and grid voltages of one tube from another.

As theoretical and mathematical consideration of circuit effects is bothersome to follow, it is important only to keep in mind the approximate coupling effect between any two circuits and the amplification between them; and to know the approximate effectiveness of such resistors, condensers and chokes as can be used to separate such circuits.

### Resistors and Condensers

Where a resistor is used to regulate the "B" or "C" voltage applied to a tube, we are generally advised to connect a by-pass condenser across this resistor. Following this advice will not hurt anything and may help; but we might just as well save its cost and the bother of connecting it unless we are sure that the condenser accomplishes its purpose.

A condenser has capacitive reactance (measured in ohms) and a resistor has resistance (measured in ohms) and the two together form an impedance (which is also measured in ohms) which is not their sum. The actual value of an impedance of this type may be found by multiplying the reactance by the square root of the sum of the squares of the reactance and the resistance.

If the resistance and the reactance have equal values, the impedance will be .707 times the value of either. This does not

represent a material reduction, which is to say, an effective use of the by-pass condenser. If the by-pass condenser is to do any appreciable good, its reactance should be materially lower than the resistance which it by-passes. No exact ratio is important; though it would appear that a by-pass condenser is hardly worth while if its reactance is more than one-fifth the resistance which it by-passes. (The reactance of a condenser may be considered to be in round numbers  $1600/fC$ ; where  $f$  is the frequency, in hundreds of cycles, and  $C$  is the capacity of the condenser in microfarads.)

### CAPACITATIVE REACTANCES (In Ohms)

Capacity Mf.	Audio Frequencies		
	25 Cycles	100 Cycles	1,000 Cycles
0.1	64,000	16,000	1,600
0.5	12,800	3,200	320
1.0	6,400	1,600	160
1.5	4,267	1,067	107
2.0	3,200	800	80
2.5	2,560	640	64
4.0	1,600	400	40
5.0	1,280	320	32
8.0	800	200	20
10.0	640	160	16
20.0	320	80	8
50.0	128	32	3

Capacity Mf.	Radio Frequencies		
	50 kc.	520 kc.	1,500 kc.
.0001	32,000	3,200	1,067
.0005	6,400	640	213
.001	3,200	320	107
.002	1,600	160	53
.006	533	53	18
.01	320	32	11
.05	64	6	2
.1	32	3	1

In an audio amplifier using good A.F. transformers, one may expect to get good amplification of frequencies near 100 cycles, but not much below that figure; and by-pass condensers to be used in such an amplifier should be considered on the basis of 100 cycles. If considered satisfactory at this frequency, the by-pass condensers will be more effective at all higher frequencies. In other words, the effectiveness of by-pass

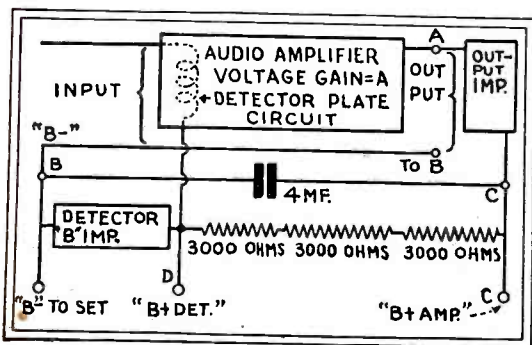


Fig. 2

When we mentally replace a section of the voltage divider by the plate impedance of the detector, we see at once that part of the variations in the audio output must be impressed on the detector's plate voltage.

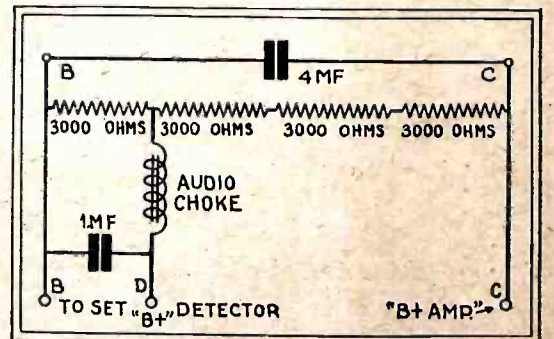


Fig. 3

Comparing this with Fig. 2, we see that the choke in the detector plate lead will keep out a great deal of the feed-back through the power unit.

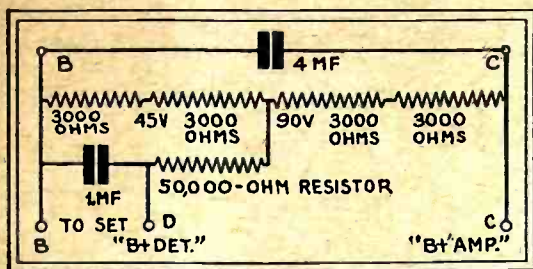


Fig. 4

The connection shown above greatly reduces feed-back from the power stage to the detector, through the "B" supply.

condensers should be considered on the basis of the lowest frequency effectively passed by the amplifier. With a high-quality audio amplifier, the basis of figuring may be 50 or even as low as 25 cycles; and condensers of two to four times the capacity satisfactory in a 100-cycle amplifier may be necessary.

Practical Applications

An output arrangement, similar to that commonly employed for "B" eliminators or power packs, is shown diagrammatically in Fig. 1. An output voltage-divider resistor, having four sections of approximately 3,000 ohms each, and a 4-mf. condenser are connected in parallel across the full-voltage output; which then may be approximately 180 volts. The voltage across any portion of this resistor "network" will be a certain fraction of the total voltage, represented by the resistance of this portion divided by the total resistance. In the instance given, this will be 45 volts for each of the four equal sections. The usual condenser block, designed for use with power packs, provides a main output condenser of from 4 to 8-mf. capacity, and additional 1-mf. condensers to be connected across the output taps from "B—" to each "B+" post.

Now the question is, how efficient is each of these by-pass condensers, in reality, and can any of them be used more effectively? At 100 cycles, the 1-mf. condensers have a reactance of 400 ohms. Condenser C1 effectively by-passes a 12,000-ohm resistance with a reactance of only 400 ohms, a ratio

of 30 to 1 (well within our suggested ratio limit), which means that the by-passing is effective and worth while. Condenser C2 by-passes a 9,000-ohm resistance with a reactance of 1,600 ohms, which is fairly effective by-passing. Condenser C3 does not so well, and condenser C4 rather poorly; because the last by-passes a resistance of 3,000 ohms by a reactance that is no lower than 1,600 ohms.

Where a condenser does not by-pass a resistor effectively, it can be omitted without serious detriment. By-passing resistors of 2,000 or 3,000 ohms or less by condensers of 1-mf. capacity, or thereabouts, although common practice, does not do much good at low audio frequencies. Such by-passing is effective at radio frequencies; since a condenser having a reactance of 1,600 ohms at 100 cycles will have a reactance of only 0.16-ohm at 1,000 kilocycles, which is about the middle of the broadcast range. Even

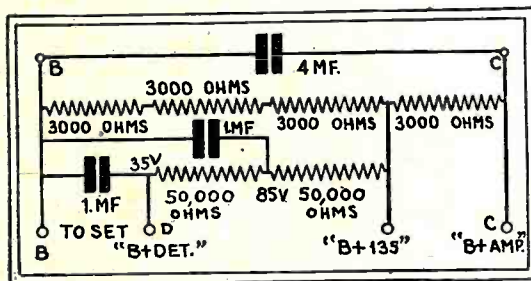


Fig. 5

The connections shown above are even more efficient than those of Fig. 4 to isolate the different amplifying circuits.

though middle- and high-range audio frequencies may be satisfactorily by-passed by such a condenser, the low frequencies cannot be neglected if good results are to be obtained. We must find a way to obtain effective by-passing at the lowest frequency at which the particular circuit is expected to work.

Separation of Circuits

The need for separating current supply circuits for tubes used in an amplifier may be shown by reference to Fig. 2. For simplicity, the possible coupling or feed-back effect between detector and output circuits only will be considered. Detector and output plate circuits are operated from a single plate-current supply device; and the audio amplifier gives a voltage-amplification of, let us say, 200 between the detector output and the final audio output. (A two-transformer audio amplifier having transformers of 3 to 1 ratio, with a '26 and a '71A tube, will give about this amplification.) With such an amplifier, if 0.1-volt is applied to the input, 20 volts will be impressed across the output, at any frequency within the range amplified. Now, if there is a feed-back from the output of the amplifier into the input, through the detector plate circuit, and this feed-back is one two-hundredth or more of the output voltage, it will be greater than the original signal input voltage. In other words, a feed-back voltage greater than the intentional input voltage will get into the amplifier and will completely upset normal performance.

How much feed-back can be tolerated with satisfactory performance of the amplifier? If the feed-back voltage is in "phase" or step with the normal input voltage, regenerative amplification will result. In most of the amplifiers commonly used,

the phase of a feed-back voltage will be different for different frequencies or between different tubes and, at some frequency or frequencies, the phase will be such as to cause regenerative amplification. Serious feed-back will usually cause some tone frequencies to be either greatly over-amplified or under-amplified, with consequent inferior and unsatisfactory tone quality. Reversing the connections of one audio transformer's winding (a trick that is often suggested to stop motorboating) may stop one strong regenerative feed-back; but another may appear. Generally speaking, good tone quality will not be obtained if feed-back effects are considerable; even though their phase can be changed to a large extent.

If regenerative feed-back exists in an amplifier giving a normal amplification of 200, and it is desired to limit the feed-back so that the amplification is not over 25 per cent. above normal it will be seen that not over one-thousandth of the output voltage should be permitted to get back into the input to the amplifier.

The reduction is a matter of degree, and the performance of many radio sets indicates that their designers or constructors have not gone far enough. Since the degree of feed-back reduction necessary depends upon amplification, greater reduction is necessary between the detector and last audio tubes than between the detector and first audio tubes in the usual type of amplifier. (See note at end of article.)

Analyzing the Power Supply

It is not always easy to determine exactly just how much of the output voltage gets back into the input; but, if we have a fair idea where to expect difficulties, and know approximately what can be done to correct them, we certainly are better off than when we work entirely without thinking.

In estimating how much feed-back exists in a circuit such as that shown in Fig. 2, it is seen that the output voltage of the

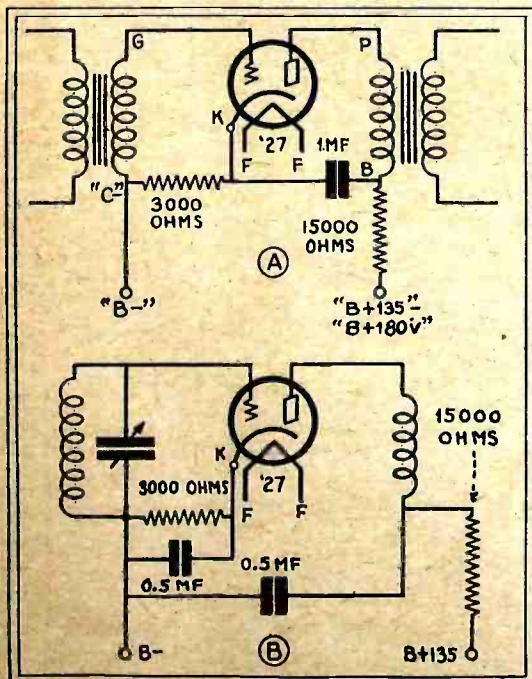


Fig. 6 (A-B)

The '27 type tube in an audio stage, as at A, frequently operates better without the by-pass around the grid-bias resistor, desirable in the R.F. stage shown at B.

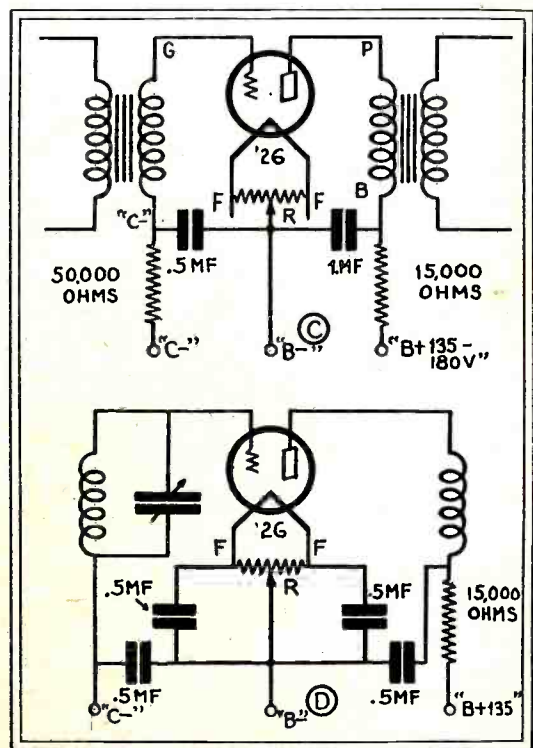


Fig. 6 (C-D)

The '26 type tube or even a '45—with suitable circuit changes—may be used in an audio stage, as at C. The by-passing and balancing needed in an R.F. stage (D) is discouraging.

amplifier is impressed across the points "A" and "B;" and a certain percentage of this output voltage will be present across points "C" and "B," where the voltage-divider resistor is used. The A.C. voltage across "B" and "C" may be figured, but we do not need to do this. We are interested only in knowing approximately what portion of the voltage "B-C" is impressed across "B" and "D," the detector supply terminals; and, if this voltage "B-D" is not sufficiently reduced (which will be shown by amplifier trouble or poor tone quality) we want to know how we can effectively reduce this voltage.

Where a voltage is impressed across a condenser and resistor in series, if the condenser's reactance is small compared to the value of the resistor, that portion of the voltage which is effective across the condenser is found, approximately, by dividing the reactance by the resistance. If the portion of the voltage-divider resistance across "B" and "D" is neglected, since the condenser C4 has a capacity of 1 mf. (with a reactance of 1,600 ohms at 100 cycles) 1600/9000 of the 100-cycle voltage impressed across "B" and "C" will be effective across "B" and "D." This is not a satisfactory reduction, in view of the need for reducing feed-back between output and input to one-thousandth. Most of this reduction would have to be accomplished elsewhere in the circuits. Changing the circuit to include a choke coil, as shown in Fig. 3, will result in a great reduction of the A.C. voltage effective across the detector supply terminals, if the choke has at that frequency a rather high inductance—30 henries or more.

**Economy in Resistors**

Since chokes of such high inductance are bulky and comparatively expensive, it is preferable to get desired effects by means of small-sized high-resistance units. Resistance units, when they must pass appre-

ciable current, cause a voltage drop, which requires that a higher direct-current voltage be applied in order to get the desired plate potential across a tube. A detector tube may be operated with a plate current of about 1 milliamperes; and a resistor in series with its plate will drop 1 volt for each 1,000 ohms of resistance. As shown in Fig. 4, a 50,000-ohm resistor will drop about 50 volts when used in series with a detector; and one such should be connected to the 90-volt tap if the applied detector voltage is to be about 40. An A.C. voltage of 100-cycle frequency, effective across "B" and "C," will be cut in half at "B-D"; and will be further reduced in a ratio of 16/500, which is that of the condenser reactance across "B" and "D" to the 50,000-ohm resistor.

A comparison of the arrangements shown in Figs. 2 and 4 will show that a 100-cycle A.C. voltage across "B" and "C" will be reduced at "B-D"; to about one-sixth, in the case of Fig. 2, and to about one-sixtieth in the case of Fig. 4. Obviously, the latter is ten times as effective in eliminating feed-back effects. In some cases, a two-section filter, as shown in Fig. 5, may be used. It is still more effective; the voltage reduction being to about one-thousandth.

Similar resistance-and-capacity filter circuits can be used to advantage in the grid and plate circuits of other tubes, as shown in Fig. 6. In the case of amplifier plate circuits, the plate current will usually be around 2 to 5 milliamperes; and resistors (which must be of "heavy-duty" type) of 25,000 to 10,000 ohms will give voltage drops of about 50. The grid circuits of amplifier tubes should not carry or "draw" an appreciable current; and resistors of about 50,000 ohms can be used without need for compensating for any voltage difference.

In Fig. 6A, which shows the use of a '27-type tube in a transformer-coupled audio amplifier, the primary of the output transformer is by-passed directly to the cathode,

shunting a 15,000-ohm resistor in series with "B+." It is not, as a rule, necessary to by-pass the 3,000-ohm grid-bias resistor, except when A.C. hum is present; then a 1-mf. condenser may aid.

In Fig 6B, however, the same tube is shown as an R.F. amplifier, in a circuit where the by-pass capacity becomes effective. A half-microfarad condenser is shown; but larger or smaller capacities make little difference.

While the '26-type tube is now but little used, it can be made to give good results in an audio circuit as shown in Fig. 6C. A similar circuit may be used for a single '45 power tube, with the understanding that because of the high plate current and consequent voltage drop, little or no resistance should be introduced into the "B+" lead.

A comparison of Fig. 6D will readily show why the '26-type has been quickly discarded as a radio-frequency amplifier, in favor of the '27 and the very popular screen-grid '24. The heater-type tubes are easily arranged in circuits which make effective use of by-pass condensers, and prevent inter-stage coupling troubles; while the attempt to obtain similar results with the '26-type is discouraging.

The use of a by-pass across the grid-bias resistor (as at B in Fig 6) may have some benefit, as stated above, in reducing hum without hurting the frequency-response appreciably. Yet the writer can show that, in a carefully designed amplifier which he possesses, the introduction of a by-pass across the resistor will actually spoil the excellence of its performance. The benefit of omitting the by-pass sometimes, is, that the resistor reduces greatly the effect of a resonance point in its circuit, without making much difference elsewhere.

Difficulties in design are increased by the fact that one trouble is frequently obscured by others; but in running down or avoiding (Continued on page 116)

# A Direct-Coupled Push-Pull Pentode Amplifier

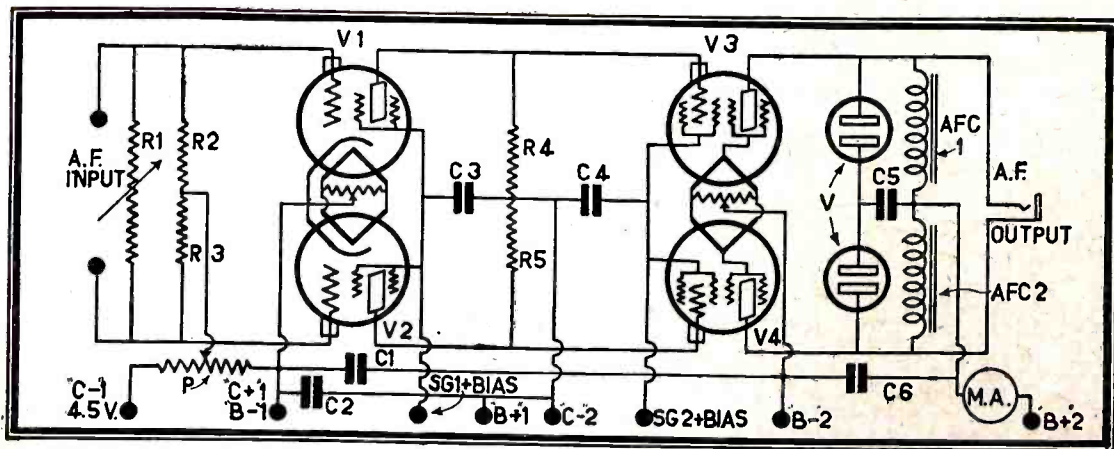
PROBLEMS of direct-coupling have been discussed in recent issues of RADIO-CRAFT, and it is probable that many of our readers will find interest in the accompanying circuit, designed by Señor J. Sar, of Buenos Aires, although the tubes utilized by him for the purpose are not available in the United States.

The first stage, into which the input is fed, utilizes two 422s (4-volt screen-grid tubes), with alternating current on the filament) and the second stage two 433s, which are 4-volt pentodes, of very high amplification. A double power pack is used with the receiver, a half-wave rectifier tube supplying 300 volts for the power tubes. The

neon tubes used as voltage ballasts across the plates of the pentodes, also, are of a European type evidently not available here.

In the diagram reproduced here, R1 is a volume control, of 500,000-ohm maximum; R2, R3, R4 and R5, 500,000-ohm carborundum grid leaks; P, a 400-ohm potentiometer shunting a 4½-volt "C" battery; the by-pass condensers are 1 or 2 microfarad; and the A.F. chokes are 30-henry, 60-ma. rating. The tubes are lit from separate 4-volt, center-tapped transformers. The apparatus, as constructed, mounted the tube sockets, resistors and volume control on a heavy grounded aluminum plate, which formed the top of a cabinet housing the transformers, chokes and condensers; while the hard-rubber panel in front carried the potentiometer and meters.

The designer points out the need of exact tube and resistor matching, in order to obtain balance of the opposed stages, and prevent distortion. The apparatus is intended for phonograph as well as radio reproduction. Whether or not it provides the "perfect quality" claimed, it presents several points of interest to the experimenter.



This ingenious circuit has enormous amplification with, presumably, little distortion; the pentodes V3-V4 being equal to a second stage of audio before ordinary power tubes. A separate "B" unit puts on their plates 300 volts, kept constant by voltage regulators V. The tubes are European.

# RADIO CRAFT KINKS

Constructors and experimenters are invited to send in all original and ingenious ideas which they have hit upon in their work; "Kinks" are paid for at regular space rates. Make your descriptions as clear as possible; preferably by sketches, to guide our staff artists.

## "CONVENIENCE MOUNTINGS" — IMPROVED NEUTRALIZING TOOL

By R. H. Siemens

FOR several years, the writer has been specializing in the construction of special receivers; usually, they consist of five stages of T.R.F., single-dial controlled. During the course of many experiments, it has been desirable to make rapid comparisons,

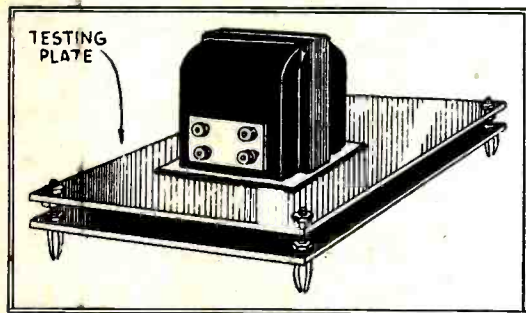


Fig. 1

The plug-in instruments thus made permit a test of any component of a circuit conveniently.

In a given set, between different makes of apparatus. Satisfactory results in this respect were obtained by arranging the different instruments on removable plates, such as are illustrated in these columns.

General Radio plugs, and receptacles, of the type used on their plug-in coils, were used as shown (Fig. 1). In the illustration, only the plugs at three of the four corners are visible.

Each instrument is mounted on its own bakelite plate; wiring is run underneath. To prevent the wiring from touching any other apparatus, the lower plate, or "cover" plate, is then made. The plugs bolt these together.

Although an A.F. transformer is shown, the idea has been applied to almost every instrument which can be used in the receiver.

Most of the experimental circuits incorporated neutralization. The usual "screw-driver," made by putting an edge on a rod of bakelite, was used to balance the stages. However, tight condensers necessitated con-

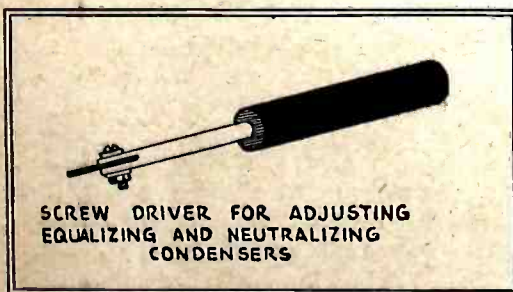


Fig. 2

A very convenient tool for circuit adjustments.

tinual filing of the bakelite, as the edge twisted off. As this became annoying, the tool shown in Fig. 2 was developed.

A small rod was inserted into a larger one, then slotted; and a small piece of hard brass was inserted into the slot, where it was held in place with a small bolt, and then edged.

The area of metal used as a blade is so small as to cause negligible disturbance of the fields.

## ROSIN STOPS SLIPPING

By J. B. McGirt

THE "fish-cord windlass" used in some types of drum-dial tuner frequently slips; the cord slipping over the windlass without turning the condenser shaft. A little crystal rosin, pulverized and sprinkled on this point where the cord slips, will usually correct the trouble and in no way harm the instrument or parts.

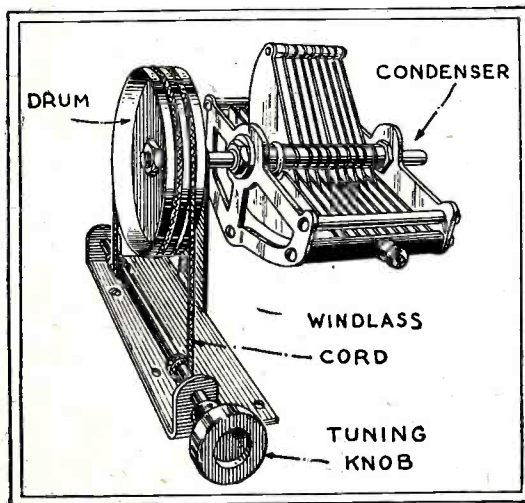


Fig. 3

A simple kink—yet one of the great inventions of history was perfected by the same principle.

## FINDING ELIMINATOR "REGULATION"

By Samuel Eidensohn

IF the experimenter knows just how the voltage delivered by his power supply varies with the load, he is in possession of some important information.

He knows, for instance, whether he can change the audio circuit to include push-pull operation without altering his "B" supply; perhaps by purchasing a new power transformer.

The simplest method of determining the "regulation" of the "B" output is to connect a 0-100 milliammeter MA, a 0-500 voltmeter VA, and a 0-25,000-ohm variable re-

sistor R (capable of carrying 100 milliamps without burning) in accordance with the diagram (Fig. 4.) R1 and R2 are portions of the voltage divider in the "B" unit.

As indicated, only one wire in the unit, the "B Max.," is broken. The lead from the rectifier and filter network is to be connected to the "+" post on the milliammeter.

The resistance of the voltmeter doesn't

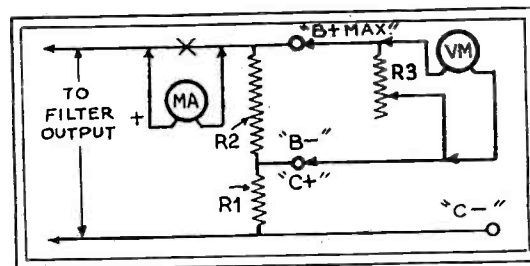


Fig. 4

It is standard practice now to test the A.C. input for fluctuations. It should be equally so, to test the D.C. input of the voltage divider.

matter; because the current it consumes is a relatively slight proportion of the total amount indicated by the milliammeter. However, if the resistance of the voltmeter VM is wanted the following procedure is followed: Read MA with VM disconnected; reading equals I<sub>0</sub>. Re-connect VM, and read both meters; current in milliamps I<sub>a</sub>, and voltage equals V. To find the resistance of the voltmeter, these values are to be interpolated in the following formula:

$$\frac{V}{I_a - I_0} = 1000$$

With the instruments connected as shown in the diagram, resistor R is varied and the readings on the meters are plotted.

This method is applicable to all power supplies. It is advisable to keep the voltage-divider unit, R1-R2, and the milliammeter permanently in circuit to avoid the strain on the filter condensers that would result if this portion of the filter circuit were open while the current is on.

(Continued on page 117)

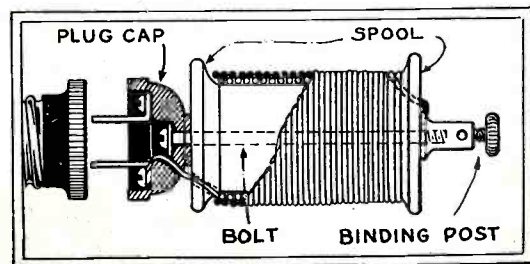


Fig. 5

A handy and inexpensive indoor aerial. A description of its construction is found on page 117.

# Eliminating the Unused "Super" Beat

*How a Tuned Circuit of Coil and Condenser in Series May be Placed Across Loop Antenna to Eliminate Station Interference to Which a Frequency-Changing Circuit is Liable*

By S. R. WINTERS\*

**A** SUPERHETERODYNE radio receiving circuit in which there is only one so-called "tuning hump," and the tuning system is responsive to only one frequency, has been designed by George L. Beers of the Westinghouse Electric and Manufacturing Company and Wendell L. Carlson, formerly in the Naval radio service, and now of the General Electric Company. A "drain coil" is the solution presented by the authors. It was described at a meeting of the Institute of Radio Engineers in New York City.

When a high-power broadcast station is functioning in close proximity to a superheterodyne receiver, it may force oscillations of low amplitude in the pick-up system, which is usually a loop antenna. If these uninvited oscillations differ from the frequency of the local oscillator to the same extent, in the opposite direction, that the desired signals vary, they will be heterodyned to the same frequency. As a result, this uninvited frequency is received.

(This inherent factor in superheterodyne operation was considered at length in the article, "Putting New Life Into Old Supers," by R. H. Siemens, which appeared in the September, 1929 issue of RADIO-CRAFT magazine.—*Editor.*)

## Eliminating a Beat Frequency

The invention of the two engineers affords an avenue of forced exit for the interfering frequency—it is "drained" or by-passed from the radio receiver before it reaches the heterodyne oscillator.

The circuit diagram of the system (Fig. 1) shows the usual pick-up, a loop aerial. This is tuned by a variable condenser and

connected to the first R.F. tube, which amplifies the signals at the received or "signal" frequency. The R.F. output feeds two R.F. coils. The local oscillation generator is placed in inductive relation to one of these coils, as usual.

## Use of the "Drain Coil"

In the new system of beat reception, however, a tuned circuit is interposed *between the loop antenna and the first vacuum-tube grid*. This individual resonant circuit consists only of an inductance coil and a variable condenser. This "series-resonant" circuit is connected across the terminals of the coil or loop pick-up system, in parallel with the first variable condenser in the main receiving system. Like any acceptor wave-trap, it offers extremely low resistance to the *undesired* frequency (the one to which it is tuned) and, at the same time, high impedance to all other frequencies.

The signals from a broadcast station are picked up in the usual way, in a receiver thus equipped, by the loop antenna, tuned by the main tuning condenser. The signals are impressed on the first tube, which amplifies them. Here is where the series-resonant circuit is placed in operation. Its inductance coil and condenser are tuned to a frequency *differing* from that admitted by the main circuit and, as a consequence, it does not by-pass from the R.F. tube grid any appreciable amount of the *desired* incoming signal-energy; but it does by-pass to ground (filament) the undesired frequency for which it is set. Then, the output from the R.F. amplifier is detected, heterodyned, etc., as usual.

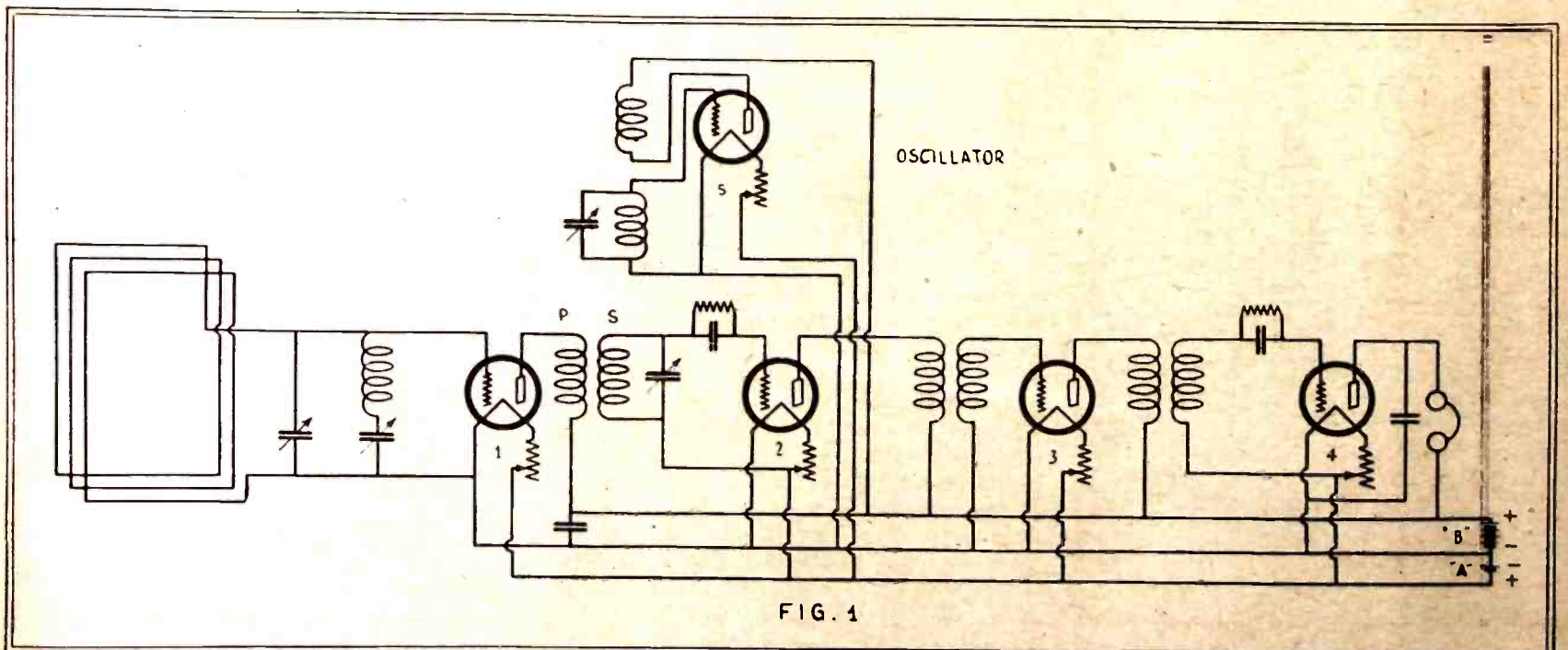
## Reducing Local Interference

If, of course, your local broadcast station is within a few blocks of the receiving set and the transmitter radiates relatively large power, a single one of these drain coils or by-pass circuits may not be adequate; two drain coils may be necessary. In addition to the one connected across the terminals of the loop antenna and the first variable condenser, a second series-resonant circuit is interposed across the terminals of the grid-coil of the beat-resolving detector tube. These two secondary circuits should serve to absorb such interfering signals. This is diagrammed in Fig. 2.

"If but a single station produces interference," states Mr. Beers, "the parallel resonant circuit may be tuned to the frequency of that station and may remain continuously adjusted to that frequency. If, however, several stations are causing interference, more condensers may be used."

Another use to which a "drain-coil" may be put is to filter out the unused beat-frequency, whether upper or lower, in a superheterodyne circuit not of the "one-spot" type.

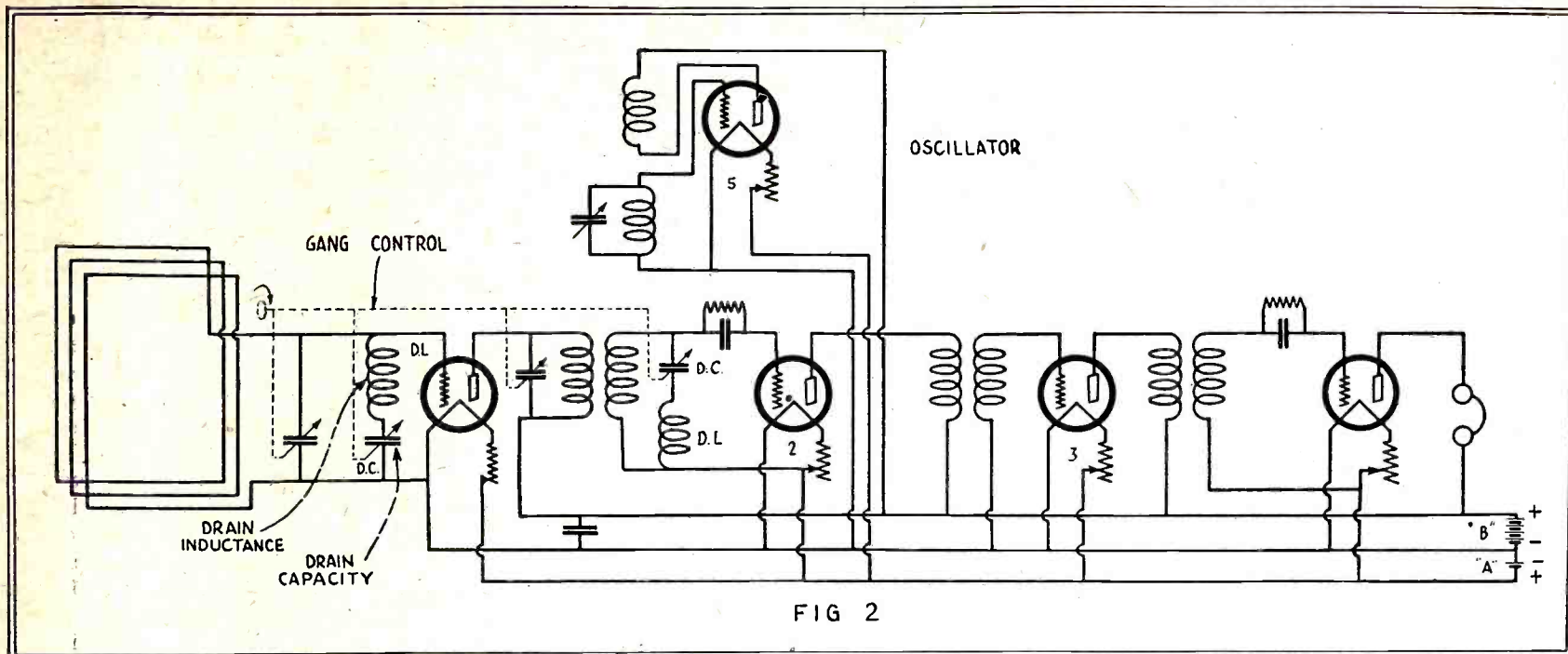
(With a receiver of loop-operation type, a coil of 50 turns of say No. 24 D.C.C. wire and a .0005-mf. condenser might be placed across the first grid circuit for manual adjustment; or any other coil-and-condenser combination which is convenient, tried experimentally. To effect satisfactory full-band gang control, however, as shown in the diagram [Fig. 2] will require careful engineering in the whole receiver's design. The patentees of the new idea have been working to reduce it to commercial practicability.—*Editor.*)



The "drain coil" tuned by its series condenser eliminates the undesired frequency (separated from the wanted signal by twice the oscillator frequency) which would otherwise cause interference in the intermediate amplifier, shown here schematically as one stage (3).

\* Washington, D. C. Correspondent of RADIO-CRAFT.





This proposed single-control system of tuning circuits and "drain coils" will require high skill to design; constants for such a receiver are not available.

# A Heavy-Duty High-Voltage D. C. Supply

*How the Experimenter May Use Low-Voltage, Inexpensive Rectifiers to Build Up A "B" Unit of Almost Unlimited Potential Rating*

By RALPH STAIR \*

SINCE the advent of the A.C. electric radio, "B" eliminators, as such, together with other battery accessories, have for the greater part become a thing of the past. They continue, however, to have a place in the work of the experimenter and radio Service Man. Not only are there still in use sets which require batteries and eliminators, but the "B" eliminator remains a hidden part in the power pack of every A. C. set.

The essential differences of the D.C. voltage-supply herein explained, from those previously described elsewhere, are its ruggedness and its flexibility, as to voltages supplied. For the radio Service Man and experimenter these are important features, and justify the publication of this article.

### Construction of Transformer

Other than the power transformer and the rectifier units, the parts used in the construction of this power supply are standard and may be purchased almost anywhere; but the former must be constructed, since they are not obtainable in the open market.

As shown in the accompanying diagram (Fig. 1), the transformer consists of one primary and six independent secondaries, each center-tapped. (Since each secondary with its rectifier cell is independent of the others, the builder may incorporate any number he wishes, in order to obtain the maximum voltage required.)

The most simple construction of the transformer is to use a rectangular core 1 1/4-inch by 1 1/4-inch in cross section, and having an inside opening, after assembly, about 2 by 4 inches (Fig. 2). The windings should be made in two equal parts; that is, one-half of the primary and one-half of each secondary are wound to slip over each of the long arms of the transformer. The secondaries should be wound over the primary, but carefully insulated from it and from each other. As a further precaution, in making connections to the secondaries, care should be taken to hook them to the rectifier cells in such manner that adjacent windings are

connected to adjacent cells; or else short-circuits may occur, due to arcing as a result of high-voltage conductors being too close together in the windings.

In the construction of the transformer for the circuit shown here, 600 turns of No. 18 D.C.C. copper wire were used for the primary, and 600 turns of No. 30 D.C.C. copper wire for each of the secondaries (No. 28 would have been better, because of its lower  
(Continued on page 118)

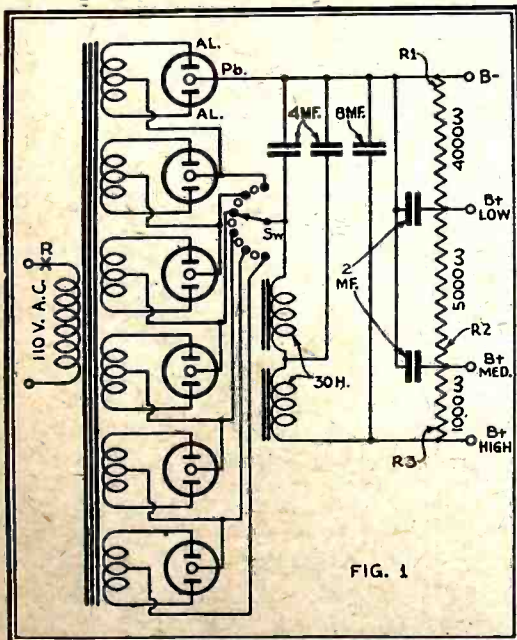


FIG. 1

Any desired number of secondary-and-rectifier circuits may be combined, in the manner shown, to produce a rugged D.C. supply.

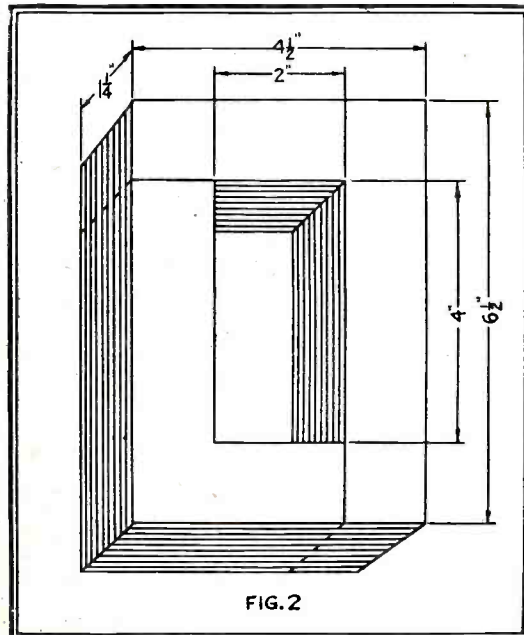


FIG. 2

Design of a suitable core, for the transformer shown at the left of Fig. 1, to be built up of staggered L-shaped laminations.

\* Junior Physicist, Bureau of Standards. Manager, Ace Radio Service, Washington, D. C.



# INFORMATION BUREAU

## SPECIAL NOTICE TO CORRESPONDENTS: Ask as many questions as you like, but please observe these rules:

Furnish sufficient information, and draw a careful diagram when needed, to explain your meaning; use only one side of the paper. List each question.

Those questions which are found to represent the greatest general interest will be published here, to the extent that space permits. At least five weeks must elapse between the receipt of a question and the appearance of its answer here.

Inquiries can be answered by mail only when accompanied by 25 cents (stamps) for each separate question. Other inquiries should be marked "For Publication," to avoid misunderstanding. Replies, magazines, etc., cannot be sent C. O. D.

### RADIOLA VII-B — OSCILLATOR COUPLER — AEO LAMP

(74) Mr. Jas. Stryker, Los Angeles, Cal.

(Q.1) Can the inductances in the tuning circuits of the Radiola VII-B receiver be altered to obtain short wavelengths? Please analyze the circuit.

(A.1) The most satisfactory method of obtaining short-wave reception is to use a receiver designed specially throughout for short waves. This admission has repeatedly appeared in these columns.

Upon consideration of the circuit connections of the VII-B receiver, shown in Fig. Q.74, it will be noted that an acceptor circuit comprises the pancake R.F. transformer primary inductance L1 and the antenna tuning condenser, which are connected in series. Secondary L2 is tuned by the secondary tuning condenser; the grid return circuit of L2 is completed through a variable resistor (stabilizer) which is in the tuned circuit and therefore increases the broadness of tuning and reduces signal volume at the same time that it prevents circuit oscillation. L1 and L2 are partly shielded by the grounded shield L3.

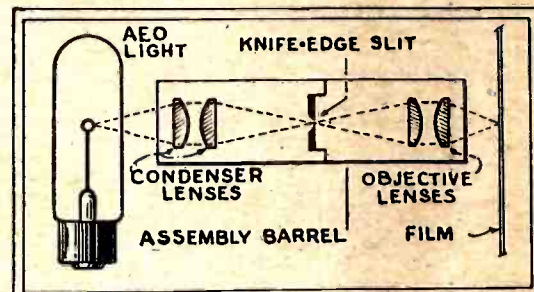
The signal, after being selected by the tuning system described above, is amplified by V1 and V2, through the aperiodic R.F. transformers RFT1 and RFT2. A grounded absorption loop controls the amplification possible through RFT1 and RFT2 through the shorting of a selected number of turns by the 5-point switch SW. Detector V3 is followed by two stages of A.F. amplification; type '99 tubes are required for each socket.

This receiver, it will be seen, is not adapted to amplify frequencies above the usual broadcast range.

(Q.2) What is an oscillator coupler?

(A.2) This term is applied to the oscillator coil of a superheterodyne receiver, which usually comprises a grid winding, a plate (feed-back or tickler) winding, and a coupling or pick-up winding of but a few turns. The grid and plate inductance are coupled to produce circuit oscillation, and the pick-up coil transfers a small portion of this high-frequency current to the frequency-changer. The rest of the action has been fully discussed in past issues of RADIO-CRAFT.

(Q.3) What is an "AEO" light?



(Fig. Q.74B) The "AEO" lamp is used to record sound changes upon talking film. Its cathode (filament) responds to current fluctuations with a varying intensity of light.

(A.3) The "AEO" ("alkaline earth oxides") light, a development of the Case Research Laboratory, was specially designed for recording sound in Fox "Movietone" productions. This tube, with a gas content mostly helium, is about 1 1/2 in. in diameter and 6 in. long. Within the tube, at one end, are mounted the sheet nickel anode, about 1/8 in. wide and 1/4 in. long, and a U-shaped cathode of platinum coated with oxides which ionize at 350 volts and 10 milliamps. The resulting intense blue glow at the cathode is capable of affecting photographic film; the anode, at this time, shows a less actinic pale pink glow. Sounds picked up by the microphones in the recording studio cause the blue light to vary in intensity, at audio frequencies. This light of varying intensity is focused on the margin of the film and photographed; producing the "sound track," illustrated in the articles on "Modern Sound Projection" in recent issues of RADIO-CRAFT.

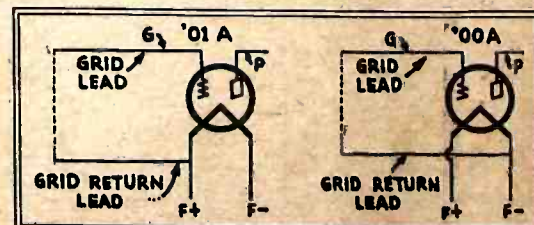
### '00A DETECTOR — SNAPPING DIAPHRAGM

(75) Mr. Von K. Thibodeau, Ellsworth, Maine.

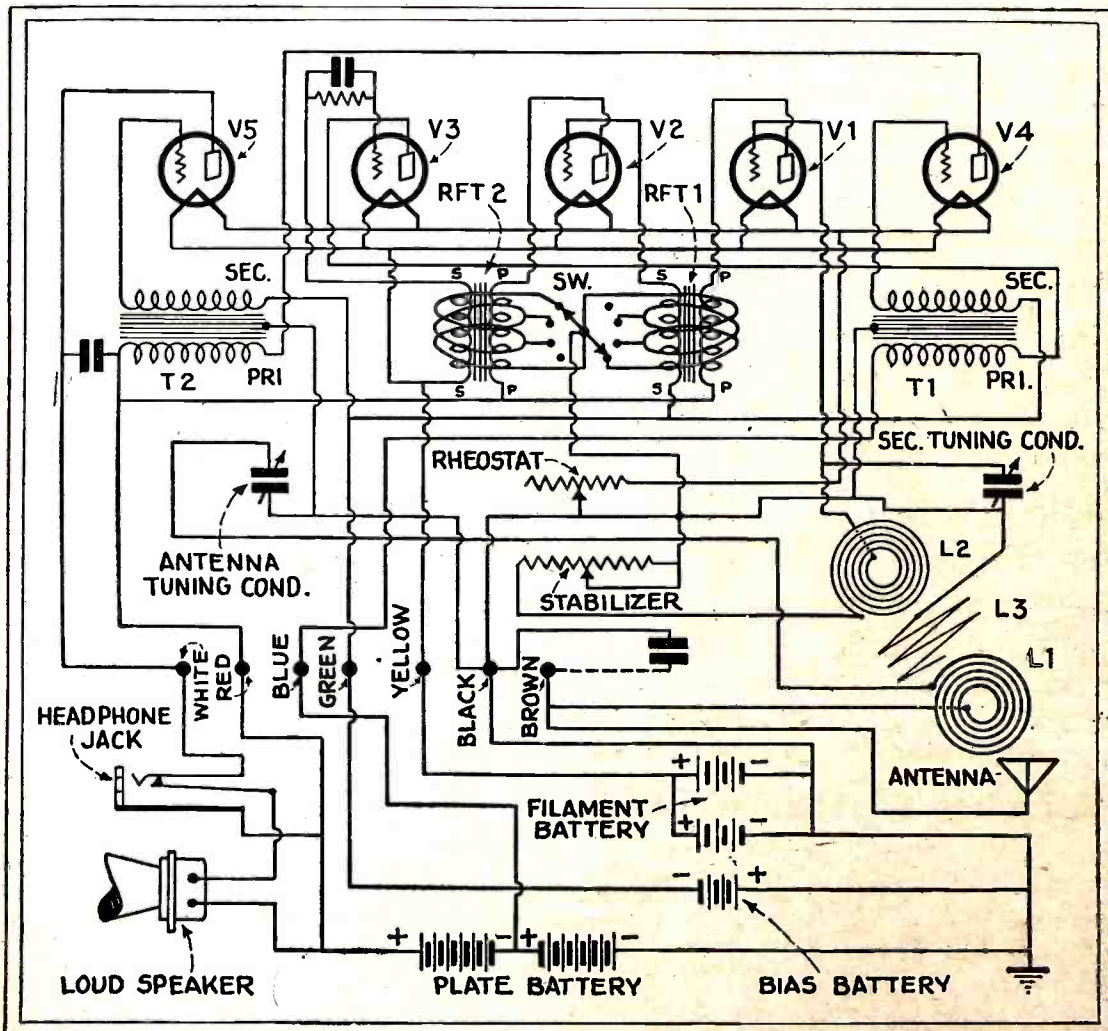
(Q.1) A type "'00" tube, when inserted in a certain radio set, lights but does not function. Please explain why this tube is "dead" in a regular radio receiver, and yet tests satisfactory on a meter.

(A.1) This type of tube is extremely critical because of its very high "gas content." It is probable that the grid-return circuit is wrong; or the voltages used are not just right for this particular tube. If the set was designed for type '01A tubes the grid return is probably to "A+"; this should be changed to "A-" for the type '00A tube, as illustrated in Fig. Q.75.

(Continued on page 119)



(Fig. Q.75) The normal connection of an '01A detector grid-lead is to the positive filament leg; but the '00A is used with a negative bias, because of its different characteristics.



(Fig. Q.74A) The "Radiola VII-B" circuit has fixed R.F. amplification designed for 200-550-meter operation, and is therefore not well suited to conversion into a short-wave receiver. It might be used complete, as an amplifier following a short-wave frequency changer.



# Open this FREE BOOK

and you open  
the door to

# SUCCESS in

# RADIO

**Y**OU, too, can be trained for a worth-while radio job... Clip this coupon now and send for this FREE BOOK... Read it page by page... see for yourself why thousands of fellows just like you are now on the road to success in Radio... why hundreds of men are now cashing in on RCA Institutes' practical training. This free book gives you 40 fascinating pages of pictures and text, all about RCA Institutes, the only school that is endorsed by the Radio Corporation of America... The school that actually is a part of the great world-wide radio industry.

### Easy to Learn Radio At Home in Your Spare Time

Let the RCA Institutes' Home Laboratory Training Course give you the real inside facts of radio... quickly and easily. Use your spare time to train for success with the remarkable outlay of screen-grid apparatus given to every

student of this course. You learn how to solve every radio problem such as installing, repairing and servicing fine sets. You also learn ship, shore and broadcast station operation. This is the training that will help *you to make money in radio!*

### RCA Graduates in Big Demand

For more than 20 years, there has been a well-paid position in Radio waiting for practically every graduate of RCA Institutes—mechanics, operators, service men, etc. Only the vast resources of RCA could give you this practical training...

### Send for this Free RCA Book "Radio... the Field of Unlimited Opportunity"

Start today on the road to Success in Radio... Send for this FREE BOOK. Every page is packed with pictures and text telling you all you want to know about RCA Institutes, the oldest and foremost Radio training organization in the world. Radio can easily be YOUR ROAD TO SUCCESS... That's why you should

**Clip this Coupon NOW!**

## RCA INSTITUTES, INC.

A Division of Radio Corporation of America

RCA Institutes, Inc.

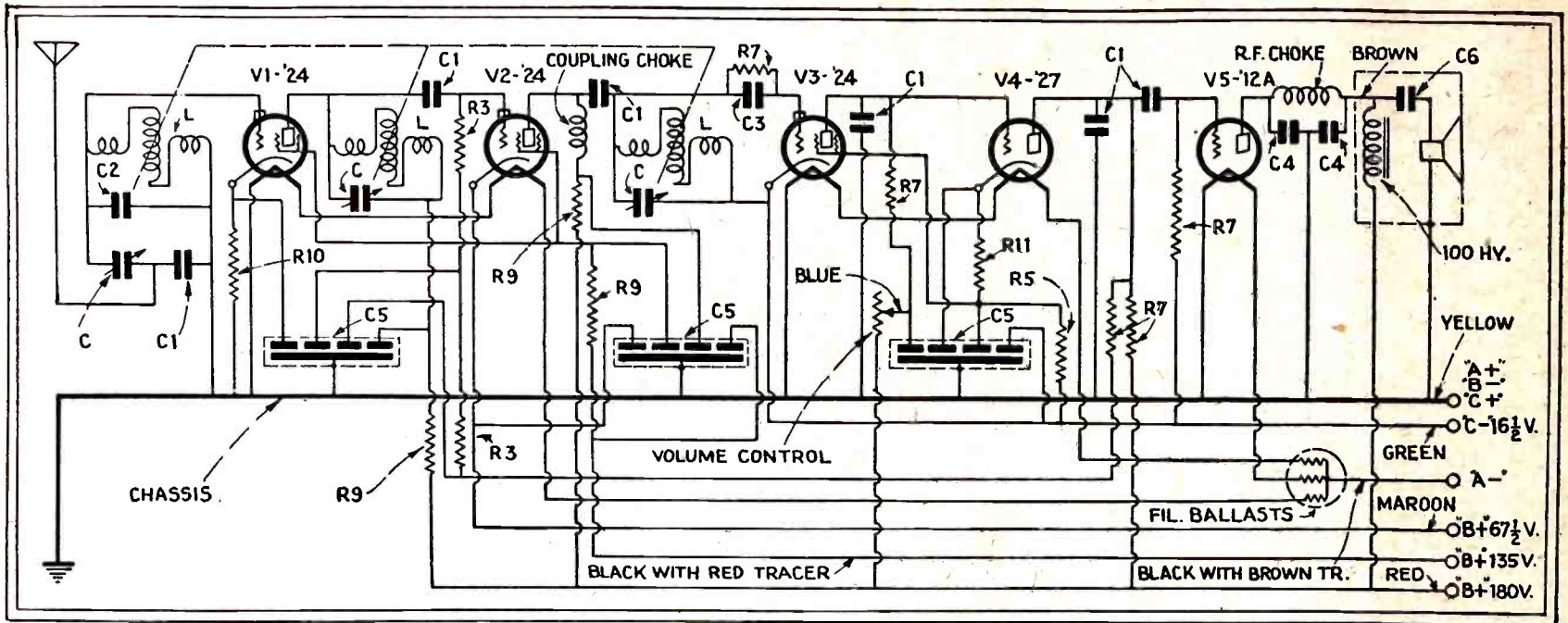
Dept. RC-8, 75 Varick St., New York.

Gentlemen: Please send me your FREE 40-page book which illustrates the opportunities in Radio and describes your home laboratory method of instruction.

Name.....

Address.....

Occupation.....

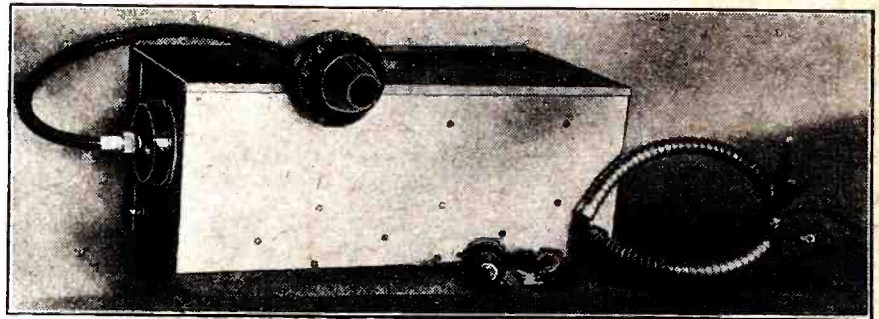


**Automotive Radio**  
(Continued from page 91)

detector; with their filaments supplied, as usual in automotive sets, from the storage battery. For this purpose, the first two heaters are in series; and the third is in series with that of the '27 first audio tube. A '12A power tube provides the input to a magnetic speaker which incorporates an output filter. The use of direct coupling from the detector into the first audio stage, and

Fig. 4 (above)  
The circuit of the Delco automotive receiver. The variometer tuning arrangement and other novelties are obvious.

Fig. F (right)  
Appearance of the Delco chassis, with cables connected. The switch and volume control are seen in the foreground, separately



EVERY  
SERVICE MAN  
SHOULD OWN  
THIS BOOK!

**S. GERNSBACK'S  
RADIO ENCYCLOPEDIA**

*The First Real Radio Encyclopedia Ever Published*

Regular Price \$2.00

Our Special Price \$1.49



(1930 Definitions)  
**FULLY ILLUSTRATED**  
Size 9 x 12 in.  
Over One Inch Thick  
168 Pages  
*Written in Plain English*

**E**DITED by SIDNEY GERNSBACK, Author of "Wireless Course in Twenty Lessons" — "One Thousand and One Formulas" — "Practical Electricity Course" — "The Radio Educator," etc.

S. GERNSBACK'S RADIO ENCYCLOPEDIA is the only standard work ever published in America attempting to classify alphabetically the countless words used in the highly specialized science of RADIO. The ENCYCLOPEDIA is written in plain English so that everybody can understand the definitions and descriptions.

No expense has been spared, covering over two years in compilation, to make it worthy a place in your library.

It is published in one volume—168 pages—size 9 x 12 inches, over an inch thick and nicely accommodates the beautiful illustrations and the large, easy-to-read type.

The work contains 549 photographs, drawings and diagrams.

**REMEMBER THIS IS A REAL ENCYCLOPEDIA — NOT A DICTIONARY** — and very few of the things described and illustrated in this volume can be found in any diction-

ary, or any other encyclopedia.

The book contains as a supplement a classified cross index designed to bring together radio references under one heading having relations in common.

All circuits new and old are described by word and picture and every part and apparatus used in Radio is explained and made understandable by means of photographs and drawings.

The volume is printed upon fine paper—bound in full black Keratol, marbled paper fly leaves and end sheets, with the title stamped in gold.

**SEND NO MONEY**  
*Just Pay Postman*  
(Canada or Foreign send Check or Money Order for \$1.75)

ISKOR PRESS, Inc., RC-8-30  
19 Park Place,  
New York, N. Y.

Send me one copy of Sidney Gernsback's First Radio Encyclopedia in one volume as advertised. I will pay postman \$1.49 plus postage on delivery.

Name .....

Address .....

Town and State.....

of a tone filter to provide timbre suitable for the enclosed interior of a car, will be observed; as well as an automatic volume control to maintain steady output against the sudden changes in signal strength caused by the movements of the car from one location to another—as into and out of the electrical “shadow” of a steel structure.

Other features are the screw-adjusted trimming condensers C for trimming the variometers (the first of these compensates variations in the antenna); the filament ballasts, which are three resistors in a single glass bulb, designed for the purpose; a special shock-cushioning device to protect the tubes; reduction gearing, to eliminate the effect of road bumps while tuning; and a spring stop for the tuning dial, at the end of the scale.

For convenience, the battery connections are made, not directly to the set chassis, but to a distribution plate on the reproducer, which is mounted at the right of the receiver, also under the cowl; from here they are carried to the chassis through a shielded cable. The “B” batteries drop into a shield can, which is recessed into the floor, and are held in place by two strips of wood. The shielded cable leading from them to the reproducer is laid in the frame channel and carried through the dash. The “C” battery is supported by a little bracket under the cowl. The case of the receiver is grounded, thus picking up one side of the filament circuit.

#### Details of Circuit

The constants of the parts shown in Fig. 4 are as follows: R3 (brown), 250,000 ohms; R5 (yellow), 100,000 ohms; R7 (gray), 500,000 ohms; R9 (black and red), 10,000 ohms; R10 (lavender), 1,250 ohms; R11 (black and brown), 75,000 ohms; grid leak (white), 2 megs.; C1, .00025-mf.; C2, .00003-mf.; C3, .0001-mf.; C4, .01-mf.; C5, four 0.25-mf. units; C6, 1.0-mf.; C7, .0005-mf.

Tests with a Jewell No. 134 analyzer should read as follows:

Tube No.	Fil.	Voltages			
		Plate	Control-grid	Screen-grid	Plate Ma.
V1	1.9	125	4.8	100	3.2
V2	1.9	72	0.0	42	2.2
V3	1.9	15	0.0	10	0.13
V4	1.9	45	1.0	....	0.19
V5	3.9	137	0.2	....	5.5

(This is a special instrument, with a 2500-ohm-per-volt meter, and the readings are therefore different from those of other testers.)

With a 0-10-ma. meter in the “B+” 67½-volt lead, the plate reading should drop from 3 or 4 ma. to zero, when the volume-control knob is turned to the left. If it does not do so try changing the type '24 tube at V3; and the '27 and remaining '24s if this result is not obtained. The 10-ma. meter should be used to check the resonant condition of the antenna circuit; maximum signal strength, with volume control full on, being indicated by minimum meter reading, when condenser C is properly adjusted.

The receiver is built by the Delco Radio Corporation, for the General Motors Corp. and distributed through United Motors Service. Factory-equipped cars are provided with built-in aeriels, which lead in beneath the cowl; others have special installations, in accordance with their construction.

# PATENTS INVENTORS



**Write for these  
FREE BOOKS!**

**MY PATENT  
LAW OFFICES  
OPPOSITE  
U.S. PATENT  
OFFICE**



At the left is a view of my drafting and specification offices where a large staff of experienced experts is in my constant employ. All drawings and specifications are prepared in my offices.

## Protect Your Ideas Take the First Step Today

If you have a useful, practical, novel idea for any new article or for an improvement on an old one, you should communicate with a competent Registered Patent Attorney AT ONCE. Every year thousands of applications for patents are filed in the U. S. Patent Office. Frequently two or more applications are made for the same or substantially the same idea (even though the inventors may live in different sections of the country and be entirely unknown to one another). In such a case, the burden of proof rests upon the last application filed. Delays of even a few days in filing the application sometimes mean the loss of a patent. So lose no time. Get in touch with me at once by mailing the coupon below.

### Prompt, Careful, Efficient Service

This large, experienced organization devotes its entire time and attention to patent and trademark cases. Our offices are directly across the street from the U. S. Patent Office. We understand the technicalities of patent law. We know the rules and requirements of the Patent Office. We can proceed in the quickest, safest and best ways in preparing an application for a patent covering your idea. Our success has been built on the strength of careful, efficient, satisfactory service to inventors and trademark owners located in every state in the Union.

### Strict Secrecy Preserved— Write Me in Confidence

All communications, sketches, drawings, etc., are held in strictest confidence in strong, steel, fire-proof files, which are accessible only to authorized members of my staff. Feel free to write me fully and frankly. It is probable that I can help you. Highest references. But FIRST—clip the coupon and get my free book. Do THAT right now.

### No Charges for Information on How to Proceed

The booklet shown here contains valuable information relating to patent procedure that every inventor should have. And with it I will also send you my “Record of Invention” form, on which you can sketch your idea and establish its date before a witness. Such evidence may later prove valuable to you. Simply mail the coupon and I will send you the booklet and the “Record of Invention” form, together with detailed information on how to proceed and the costs involved. Do this NOW. No need to lose a minute’s time. The coupon will bring you complete information entirely without charge or obligation.

#### Clarence A. O'Brien Registered Patent Attorney

Member of Bar of Supreme Court of the United States; Court of Appeals, District of Columbia; Supreme Court, District of Columbia; United States Court of Claims.  
Practice confined exclusively to Patents, Trademarks, and Copyrights



**Mail this Coupon NOW**

**CLARENCE A. O'BRIEN**  
Registered Patent Attorney

3505 Security Savings and Comm'l Bank Bldg.,  
Washington, D. C.

— or —  
Suite 1106, Dept. K-1, Woolworth Bldg., New  
York City

Please send me your free book, “How to Obtain a Patent,” and your “Record of Invention” form without any cost or obligation on my part.

Name .....

Address .....

(Important: Print or Write name clearly  
and address office nearest you)

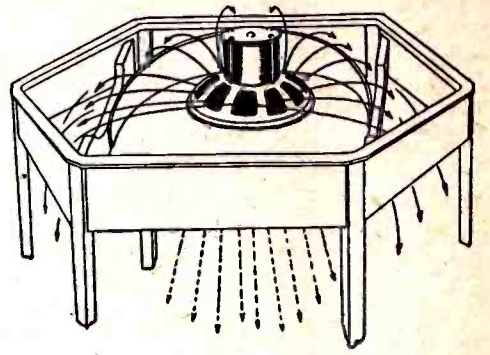


Fig. 3 The action of the table console, which serves as a baffle; sound is projected outward in all directions.

New Radio Devices (Continued from page 93)

very practical pattern for a radio housing in the "Golden Voiced Table," illustrated here. This beautifully ornamented and finished table, with a rising top, has space for any compact receiver and its reproducer. The dimensions are, 24 1/2 x 36, x 31 in. high.

The feature of this design is the placement of the reproducer; which is, preferably, a dynamic. As the accompanying diagram (Fig. 3) shows, sound is projected downward, toward the floor.

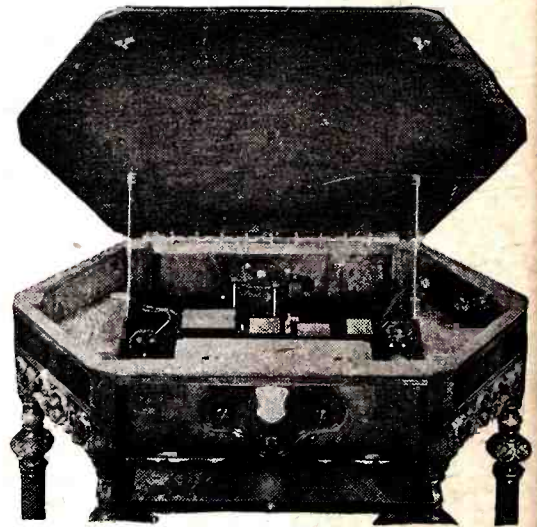


Fig. 1 This attractive piece of furniture may be used as a table without interfering with its use as a radio receiver.

DIRECT-READING RESISTANCE METER

A NEW ohmmeter, "Pattern 135," has been designed by the Jewell Electrical Instrument Co., Chicago, Ill., for those who want an accurate instrument to determine the values of resistors.

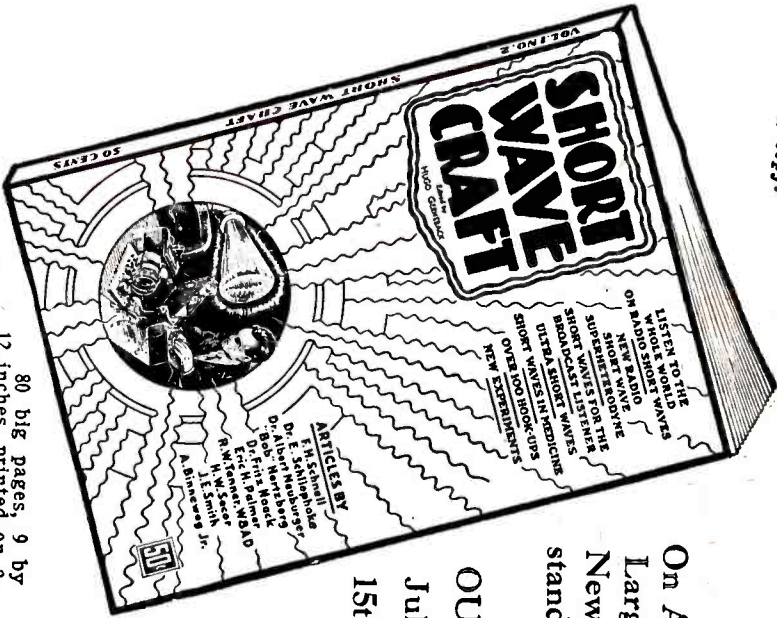


Fig. J A very useful instrument for accurate measurement of values, both of resistors and circuits.

This instrument, of special value to Service Men, is pictured in these columns. It is obtainable in three models: The 0-3-volts model is to be used with two dry cells and, at full range, resistors having a value of

you have never seen anything like it in Radio

Contains more material than a \$2.50 book, yet the price is but 50c. a copy.



80 big pages, 9 by 12 inches, printed on a heavy grade of book paper, with a beautiful cover in four colors—that's SHORT WAVE CRAFT.

On All Large News-stands

OUT July 15th.

PARTIAL CONTENTS in SHORT WAVE CRAFT No. 2 Aug.—Sept. Issue

SHORT WAVE CRAFT, Mr. Hugo Gerneck's latest radio magazine, has been called his greatest achievement in radio magazine publishing. SHORT WAVE CRAFT is the one and only real big magazine on short waves you have wished for so long. HERE IS PROOF!

New Short Wave Receiver with Push-Pull R.F. and Detector Stages, by F. H. Schnell, famous short wave expert. How to Build a Successful Short Wave Super-Heterodyne Receiver, by R. Wm. Tanner (W8AD), well known short wave amateur and author. Short Wave Operation Hints, by "Bob" Hertzberg.

Short Wave Aerials, by C. H. W. Nason. Television Reception on Short Waves, by D. E. Replogle. Radio in Carlsbad Cavern, by Eric H. Palmer Jr.

New Experiments in the Short Wave Field, by Dr. Ernst Busse (Germany). Quasi-Optical Waves, by Kappelmeier. The High Power Short Wave Station Operated by WGT, by H. Winfield Secor. Experimenting with the Short Wave Regenerative Receiving Circuits, by Clyde A. Randon.

Local Reception on the 20-meter band, by Carl Wurtz (DE939, Cologne, Germany). Western Electric Airplane Short Wave Radio Equipment, with photos and hook-ups of the apparatus. Short Wave Antennae

Transmitting Newspaper Pages by Photo-Radio on Short Waves

Besides these features, SHORT WAVE CRAFT Number 2 contains a wealth of constructional experimental matter for short wave fans, including question and answer box edited by Mr. Tanner (W8AD), together with pictures and descriptions of all the latest short wave apparatus from the manufacturers' workshops.

Unlike other magazines, it does not contain purely technical matter of interest only to the advanced amateur and ham.

Quite to the contrary, SHORT WAVE CRAFT contains a tremendous wealth of short wave material of interest to everyone who wishes to get into short wave activities.

Over 250 illustrations, maps, charts, circuit diagrams, dozens of actual photographs of receivers, transmitters, and a wealth of practical stuff.

Filled to the top with real meat—not a picture book, no mathematics, no theories that are over your head, but rather practical dope, live "meat." That's what SHORT WAVE CRAFT offers you in every issue.

Regular Departments in SHORT WAVE CRAFT

Photographic Section—pictures of latest short wave sets and stations. Transmitters for Short Waves—How to build them. Short Wave Receivers—Construction data for all types and kinds

The Short Wave Experimenter The Short Wave Beginner Television on Short Waves Short Waves for the Broadcast Listener Ultra Short Waves Aircraft Short Wave Sets How to Build Short Wave Aerials Short Wave Question Box

PUBLISHED ON THE 15th OF EVERY OTHER MONTH

Extra Special Offer Void After August 15th.

The regular subscription price to SHORT WAVE CRAFT is \$3.00 a year. But up to August 15th, we will accept \$1.80 for a full year's subscription (Canada and foreign, \$2.00) AND IN ADDITION will send you FREE the 1st number of SHORT WAVE CRAFT. This will give you in reality a subscription of one year and two months, value \$3.50, for \$1.80!

MAIL COUPON TODAY!

SHORT WAVE CRAFT RC-8 96-98 Park Place, New York, N. Y.

As per your special offer I enclose \$1.80, for which please enter my subscription for one year to SHORT WAVE CRAFT and send me also the first issue gratis.

NAME ..... ADDRESS ..... CITY ..... STATE .....

10,000 ohms are indicated; the 0-4½-volt model requires three cells (4½ volts) to read 0-15,000 ohms; while another 0-4½-volt model may be obtained to read 0-1000 ohms.

Scales for both ohms and volts are etched on the silvered dial. The case measures 2 inches in diameter, and the black metal flange is 2½-in. in diameter. This instrument, with an accuracy of 2% is an excellent continuity tester.

## Service Men's Notebooks

(Continued from page 74)

around pressed eyelets which form the terminals. The heat from the radio-frequency tubes is conducted to this suppressor through the tube pins; and this causes the wire to expand and pull away from the eyelet, thus producing the apparent fading.

I found this condition while servicing a "Radiola 17" which had been electrified in the method described. When the set analyzer was plugged into the defective socket, the set played perfectly; because the tube was then in the analyzer and could not heat and distort the suppressor.

## Operating Notes

(Continued from page 81)

change in the voltage readings of the set. Not only this, but the condenser may test O. K., yet become open during operation of the set. There are three of these Sprague by-pass condensers in this D. C. chassis; they should be replaced by the tubular condensers supplied by this company.

Incidentally, the addition of an "offset" screwdriver to the kit of the Service Man who works on Colonials will not be found amiss when a speaker's voice coil requires adjustment. (See Fig. 4.)

Noisy and unstable operation of Kolster "Model K" sets may be caused by a bad volume control; follow the same suggestion given above with regard to the Zenith "50."

The Stromberg-Carlson "Model 641" and "642" have two volume controls, which may occasion similar complaints. One of these components is wire-wound, and the other a carbon resistor: the former should be cleaned with fine sandpaper and given a fine coating of vaseline or Nujol; the other polished and cleaned with alcohol.

In the Fada "35," a loud hum will be caused by an '80 rectifier tube which is not up to par; a slight hum, when the push-pull '45s are not evenly matched.

In certain Philco models, of an early type, using two screen-grid tubes, the compensating condensers are located immediately behind the "bathtub" condenser. They have lock-nuts on the adjusting screws; loosen the nuts, and adjust the screws. When this is completed, tighten the nuts again, to prevent changes in the setting, caused by vibration in the set. (See Fig. 5.)

### COLLEGE TEACHES TELEVISION

TELEVISION is the subject of a new home study course announced by the engineering extension department of Pennsylvania State College; it is to be presented in a non-technical manner.

# Leaders in the Field . . .

because of unexcelled engineering experience

## WEBSTER Power Amplifier

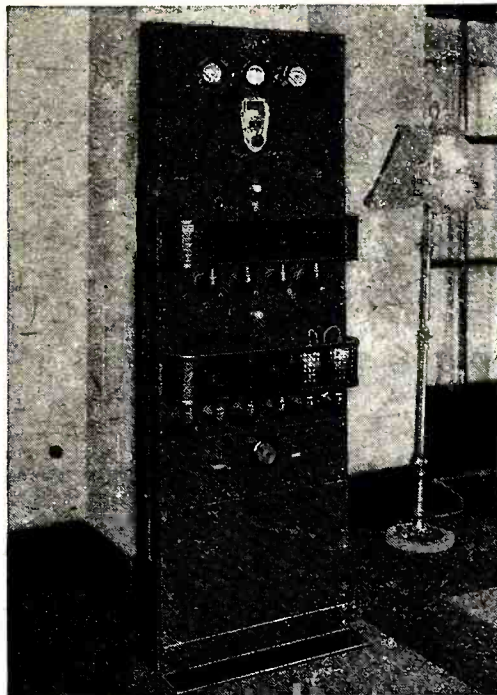
Webster amplifiers, the product of an institution specializing in the manufacture of precise electrical apparatus for nearly a quarter of a century, are compact, finely built and adapted to a variety of applications. They are the heart of highly efficient Sound Distribution Systems.

There is an ever-widening market in every community for the installation of Sound Distribution Systems in—

Apartment Buildings  
Amusement Parks  
Airports  
Baseball Parks  
Camps  
Churches  
Civic Centers  
Convention Halls  
Dance Halls  
Factories  
Gymnasiums  
Hospitals  
Hotels  
Playgrounds  
Public Parks  
Race Tracks  
Railroad Depots  
Restaurants

Riding Academies  
Sanitariums  
Skating Rinks  
Schools  
Sporting Arenas  
Stadiums  
Swimming Pools  
Yacht Clubs

Write for complete descriptive literature



## The New Webster Model "4" Electric Pick-up

The Model "4" is completely new in design; compact, neat, and finely finished in a two-tone scheme of rose-gold and mahogany brown. The matchless fidelity of its tone is remarkably balanced over the entire range of tone frequencies.

And the volume too, is unusual, offering a solution of the problem of phonograph reproduction through screen-grid receiving sets having a low gain in their audio amplifiers . . . As in the past, this new model is packed in an attractive self-selling carton and attractive selling literature is supplied.



### FEATURES

Webster knife-edge bearing without rubber  
Free, highly sensitive stylus movement  
37% Cobalt magnet  
Pole pieces of special high permeability alloy  
Counterbalancing ensures correct weight on record  
Ball-bearing base  
And many others

## WEBSTER ELECTRIC COMPANY

Est. 1909

Racine, Wisconsin

# Webster

## Electric Pick-up and Power Amplifier

## I CHALLENGE

you that I will teach you, by mail, in one lesson, the simplest, shortest method all for \$1.00. Not telepathy. You can read one's mind to a dot, by only looking in the eyes of partner, chum, sweetheart, etc. Praised by New York, Boston, Montreal Police Chiefs; colleges; Thurston, Blackstone, etc. If fake, let them arrest me.  
A. HONIGMAN, Dept. SWS-O, Sta. E., P. O. B. 85, Montreal, Canada

Write for Information about the NEW

## H-F-L MASTERTONE

LABORATORY MADE RECEIVER

The Year's Outstanding Radio Achievement

HIGH FREQUENCY LABORATORIES

3900 N. Claremont Dept. 79 Chicago, Ill.

## A LUMINUM BOX SHIELDS M

Standard sizes in stock, special sizes to order. One-day delivery. Write for prices.

BLAN THE RADIO MAN, INC.

89A CORTLANDT ST. NEW YORK

## SMOOTHES OUT RADIO VOLTAGE "BUMPS"

The new AMPERITE for electric radio automatically prevents line voltage variation which spoils reception and ruins tubes. AMPERITE improves performance. Reduces free service. It pays to buy and sell radios equipped for AMPERITE.

FREE—Useful AMPERITE Bulletin and list of AMPERITE-equipped radios. Write Dept. RC-8

AMPERITE Corporation  
561 BROADWAY, NEW YORK



# Service Men Attention!

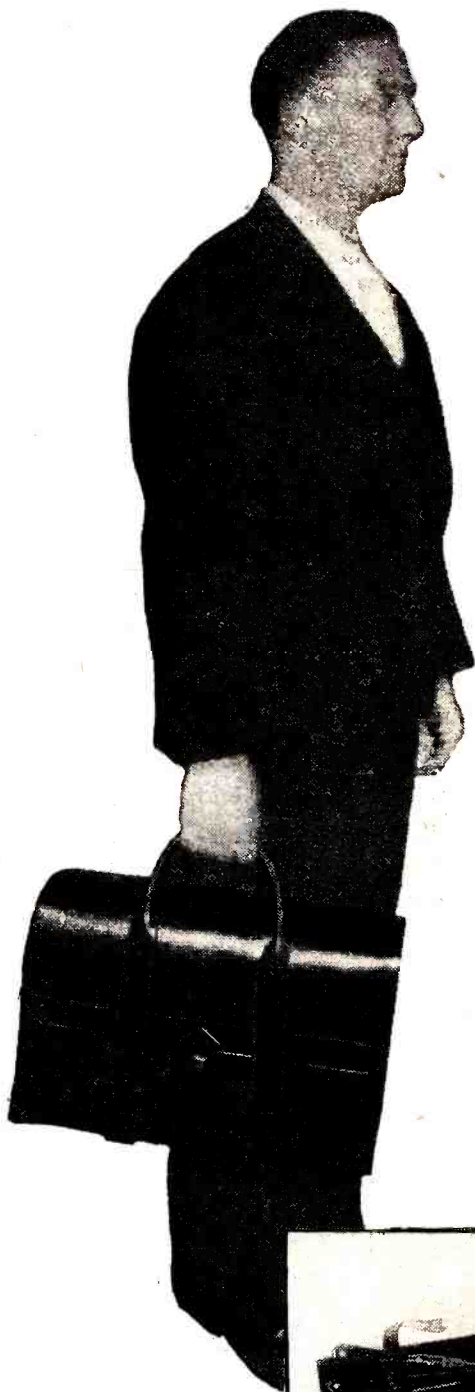
## Add snap and style to your tool kit--

### SERVICE MAN'S BAG

No more jumbled tool kits —

No more lost tools —

Everything in its place —



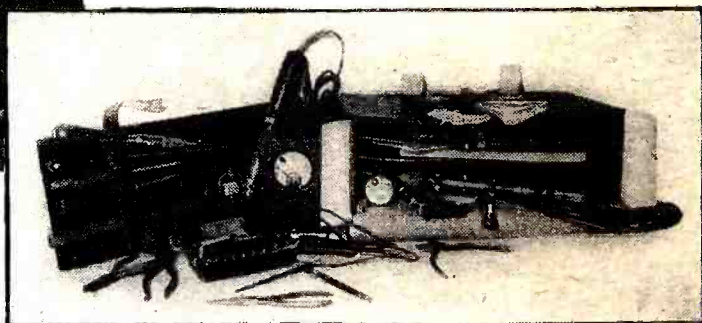
THE tools of a Service Man are his means of livelihood. They are the instruments by which he brings his knowledge into play. Without them his knowledge is of little use. As important as the tools themselves is a suitable bag in which to carry them. Not only that—but a bag that offers a systematic lay-out that saves time, avoids losses and adds to the appearance of the Service Man himself.

We offer you the SERVICE MAN'S BAG that has been especially designed for him. It is roomy, serviceable, snappy and inexpensive. It is compact in appearance, yet has sufficient room to accommodate an entire kit of tools, meters, books, service manuals, blueprints, etc., with ease.

Bag is made of a heavy grade, black cowhide leather and is 16½ inches in length, 6 inches wide and 11 inches high. Illustration shows the comparative size of bag and tools. The interior of the bag is divided into five compartments. Three of these run the entire length of the bag and the other is divided in the center making two compartments. Two of these compartments are 1 inch in width and a third is suitable for papers, diagrams and data sheets. The remaining compartment is 3½ inches in width and is fitted with a removable strip of double thick leather with adjustable strap. Strap is 7½ inches wide and 18 inches in length and can be adjusted to accommodate seven different tools. The strap makes it impossible for the tools to become lost or misplaced. The sides and bottom of the bag are reinforced with an extra thickness of leather. Leather side flaps close over the top and snap into place completely closing the interior of the bag.

On the front of the bag is a pocket 8 inches long and 5 inches high, with V-shaped sides and suitable to hold service books, blueprints, business cards, etc. When the bag is closed this pocket is completely covered. Handle is set of double straps that run completely around the bag and form two handles as on a suitcase or briefcase. It is fitted with protecting cover that snaps in place and forms a hand rest. Also holds the two handles together. Bag is fitted with lock and key, adjustable to three positions depending on the contents of the bag. Five metal sliders are on the bottom of the bag so that it will not rest on the ground or mar the furniture upon which it may be set. When bag is completely closed no tools or papers can be lost from it. You may turn it on end, upside down or whichever way you desire but nothing can fall out.

The SERVICE MAN'S BAG will make your calls more efficient—save you time and trouble and will prove its worth within a short time. Fill out and mail the coupon today—we'll do the rest.



DO NOT SEND ANY MONEY

Fill Out Coupon—Mail Today

-----

GREN PARK TOOL COMPANY, RC-8  
245 Greenwich Street,  
New York, N. Y.

Gentlemen:  
Please send me your new SERVICE MAN'S  
TOOL BAG. I will pay express company \$14.00  
plus the small amount for shipping charges after  
I have received the tool bag.

Name .....

Address .....

City..... State.....

Designed and manufactured for the Radio Service Man. Has plenty of room for an entire kit of tools. Places tools at your finger tips. Price is reasonable.

SERVICE  
MAN'S  
BAG

**\$14<sup>00</sup>**

(Tools not included)

GREN PARK TOOL COMPANY  
245 Greenwich Street . . . . . New York, N. Y.



# The Rotor-Grid Vacuum Tube

(Continued from page 89)

four segments—1, 2, 3, 4) completes the circuit from plate to cathode and causes current to pass through the headphones. This current then drops to zero as the rotor-grid directs the electrons to a point midway between plates 1 and 2. When the position

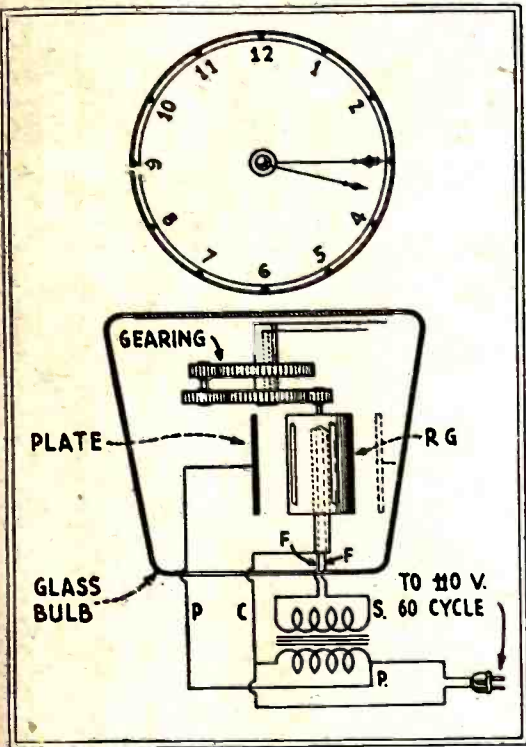


Fig. 4

The design of a vacuum-tube clock, all of whose mechanism is enclosed within a glass bulb. It is operated by the rotor-grid turning in synchronism with the A.C. supply.

shown at F is reached, there will be another current rise; and so on for plates 3 and 4. The resulting frequency may be increased by making the slot very narrow, to produce a narrow stream, and increasing the number of plate units by using very small plates (a grille of vertical wires as shown at G) bonded in parallel at the ends. Thus, the rotor-grid tube can be used as a generator of A.C. from a D.C. source. There is a possibility that some such construction would render possible the production of signals at radio frequencies. (At the moment a limiting factor, to be overcome, is bearing friction.)

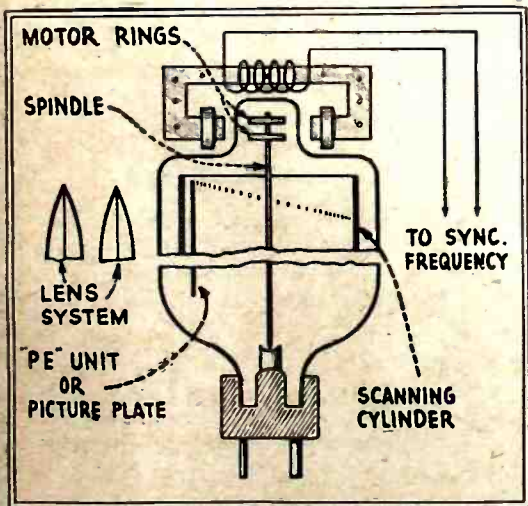


Fig. 6

A television scanning-drum device, for either transmission or reception, to be built within a glass bulb and operated by the electron stream.

## Applications of the Principle

Again referring to Fig. 3, we find a simple connection that may have wide application in the future; arrangement H is the diagram for an "electronic synchronous motor."

An interesting application proposed for the rotor-grid tube is in the construction of a clock. Granting that bearing friction is overcome by proper design, and with electron emitters having sufficient energy, there should be little difficulty in producing a synchronous electronic clock, as shown in schematic form in Fig. 4. To eliminate confusion, the details of the "clock" have been left out of the picture; but we see the hour and minute hands geared to the rotor-grid, and the control plate wired to control the rotor-grid (as illustrated in circuit H, Fig. 3), which maintains its synchronism with the A.C. supply. Thus, an inexpensive design of the utmost simplicity is afforded; to put the clock into operation, it will be necessary only to screw the lamp into the supply socket. There is, of course, the obvious difficulty (which may not be very great) presented by residual gases occluded by the numerous parts.

## D.C. Conversion and Television

Now that we know that the device will function as an interrupter, the circuit arrangement shown in Fig. 5 is proposed, for operating an A.C. set from a D.C. supply line. Until now, a motor-generator or a rotary converter of conventional design has been used.

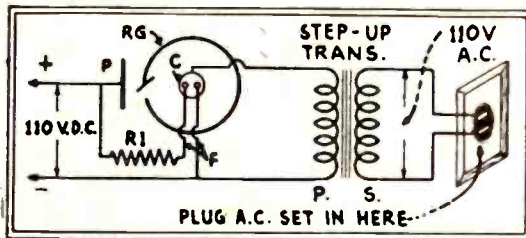


Fig. 5

A rotary converter, with action exactly the reverse of a rectifier, may be made of a tube filled with mercury vapor, and designed for proper grid-rotational speed.

The magnetic system required to rotate the iron rings (contained in the tip of the tube shown in Fig. B) is shown in greater detail at I, Fig. 3. It consists of iron laminations carrying copper "shading rings" and an A.C. winding, which are mounted outside of the glass bulb. A single iron wheel is shown within the bulb in this figure, for simplicity; but two appear in Fig. B. Alternating current applied to the winding will cause the iron wheel of the rotor-grid to rotate.

By using a similar motor construction, it is suggested, a tube may be arranged somewhat in the fashion illustrated in Fig. 6. Utilizing the principle of the synchronous motor for the external driving unit, by fastening a four-spiral scanning drum (as proposed some time ago by Mr. Jenkins) to the rotating grid, placing the necessary photoelectric or glow-lamp electrodes within the scanning drum, and using caesium or neon gas in the tube, a television unit may be built inside a single envelope.

# A Jewell Self-Contained Ohmmeter for Trouble Shooting!



THIS Jewell Pattern 89 Ohmmeter has been developed especially for making resistance and continuity tests quickly and accurately in radio service work.

The instrument consists of a Jewell Pattern 88 D. C. meter mounted in a bakelite case which also contains a 1½ volt flash light cell. The scale reads ohms direct and a convenient adjustment is provided to compensate for variation in battery voltage. The current drawn from the battery is so low that the cell will last several months. It is easily replaced.

Due to the fact that adjustment can be made for variation of battery voltage very accurate resistance measurements may be made rapidly.

The Pattern 89 Ohmmeter represents a distinct advance in design for instruments of this kind. Every radio service man should be equipped with one of these time savers.

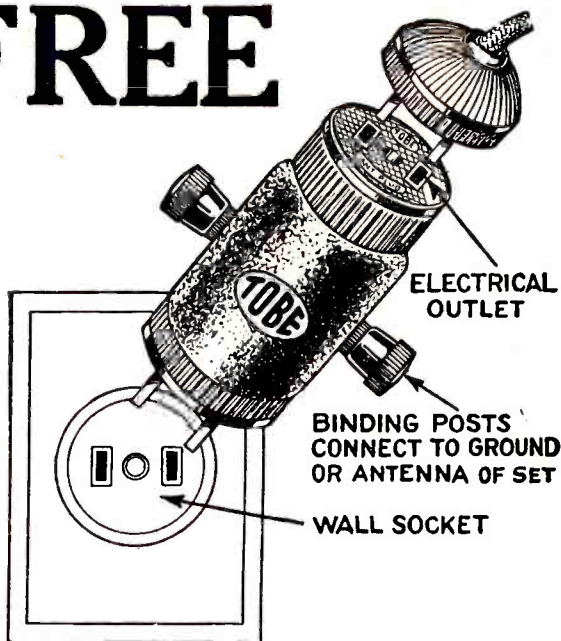
A new bulletin just off the press describes the Pattern 89 and tells how to use it. Mail the coupon for your copy.

Jewell Electrical Instrument Co.  
1642-K Walnut Street, Chicago, Ill.

Please mail at once description of the Pattern 89 Ohmmeter together with instructions on how to use it in radio testing work.

Name \_\_\_\_\_  
Address \_\_\_\_\_

# FREE



## for your promptness!

**A** TOBE 4-Way Purpose Light Socket Aerial with every radio convenience in one small unit—and given to you free with one year's subscription to RADIO-CRAFT.

This unit serves as a perfect indoor antenna, reduces static pick-up, and gives clear, pure tone reception, or—

A convenient and efficient ground without troublesome water-pipe connections or long wires, and—

A power-socket outlet which may be used for operating set, "B" eliminator, power pack, charger or any electrical apparatus, and—

A lightning arrester, protecting the set from all high-potential atmospheric discharges.

The most convenient of all radio antenna developments. TOBE SOCKET AERIAL is sold with a two-year guarantee. Complete instructions showing many combinations included with each aerial.

### Mail this Coupon TODAY!

RADIO-CRAFT, Dept. C  
98 Park Place, New York, N. Y.

I have enclosed \$2.50 for a year's subscription to RADIO-CRAFT. Please send me FREE Tobe 4-Way Light Socket Aerial.

Name .....

Address .....

City..... State.....

## Prepare for BIG PAY JOBS! Learn Radio and Television

Organized Labor—owner of Station WCFL, Chicago, the first station to broadcast television on an aural wavelength—is conducting a nation-wide good-will campaign and suggests the study of Radio and Television as a happy and profitable way of getting better acquainted, and makes this astounding offer:

- |                                      |   |
|--------------------------------------|---|
| Complete Radio and Television Course | <b>ALL FOR</b><br><b>\$2</b><br><b>ONLY</b> |
| Handy Loose-leaf Lesson Folder       |   |
| Radio and Television Dictionary      |   |
| Large Schematic of Federation Four   |   |
| WCFL Radio Magazine for One Year     |   |

The WCFL Radio and Television Course is used as standard text in 400 high schools and is being studied by nearly 60,000 adults. It has helped thousands to increase their earnings.

**OPENS THE DOOR OF GREATER OPPORTUNITY IN RADIO FIELD.**

WCFL, 623 South Wabash Ave., Chicago.

For the attached \$2 enroll me for the WCFL Radio and Television Course, also send me Loose-leaf Lesson Binder, Radio and Television Dictionary, Large Schematic of Federation Four and WCFL Radio Magazine for one year.

Name .....

Street .....

Postoffice..... State.....

### Beware of Air Monopoly

WCFL Radio Magazine is the only publication fighting for the freedom of the air—the gravest question now before the public. Whoever monopolizes broadcasting will dominate the Nation. The air MUST remain FREE.

**DO YOU WANT TO STOP TOBACCO?**

Banish the craving for tobacco as thousands have. Make yourself free and happy with Tobacco Redeemer. Not a substitute, not habit forming. Write for free booklet telling of injurious effect of tobacco and dependable, easy way to relieve the craving many men have.

**FREE BOOK**

Newell Pharmacal Co.  
Dept. 928 Clayton, Mo.

**TURN TO PAGE 123**

and read of the interesting announcement regarding technical, mechanical and home workshop magazine which is now published.

## German Television

(Continued from page 86)

simpler model, which is designed for 50 cycles. The synchronizing motor and scanning disc are so delicately balanced that the output of the oscillator and its amplifier are sufficient to keep the apparatus operating at the proper speed. To maintain perfect synchronism between the transmitted image frequency and the locally-generated 375-cycle current, the Telehor circuit conducts the A.C. plate potential of the receiver's tube to the oscillator. The oscillator-frequency is thus restored to the normal value if it should vary; a very slight amplitude of the image-frequency will suffice. Only when the received image-frequency is completely lost, through fading, can the receiver get out of synchronism; and this cannot last.

If the image is improperly framed in the "window" of the receiver—say, with the bottom half at the top—this can be corrected by turning the mounting of the synchronizing motor, as already explained.

The possibility of using a tuning-fork, instead of the tube oscillator, to obtain the local synchronizing frequency, has been considered; but the tuning fork, although it has been successfully employed in transmitting photographs by radio, must be carefully protected against changes of temperature, or its note will vary. So the use of the tube is simpler and cheaper; however, its construction entails some practical difficulties if exact frequency-regulation is to be required. As the frequency decreases, resistance will cause a lessened peak of the curve of frequency-response.

With the Telehor, the television receiver is connected to the loud-speaker terminals of the radio receiver, and the speaker across the terminals provided on the television apparatus; a switch permits immediate change over from sound to images, and vice versa. To provide the necessary voltages, a power unit will probably be built into the receivers; the televisor will then have only two cords, one to the receiver output and one to the house socket, with terminals for the speaker, as stated.

The designs so far made are only for alternating-current operation; direct-current house supply does not give a voltage sufficiently high. It is not impossible that a battery-operated model may be provided for those who have D.C. receivers.

The German Reichspost (post office department, with control of wire and radio communications) is making test broadcasts for the benefit of experimenters in Germany, from which others will also benefit. The Berlin transmitters are used, and perhaps others, such as Stuttgart, will be used later. This will permit of determining the practical value of the television apparatus, and the suitability of different radio receivers for operating them, before official programs are regularly undertaken.

In my opinion, this is a little too paternal, for these things should be left to the radio trade, which will adapt its apparatus to the conditions it meets. However, this is the way things are done in Germany.

(In a second article, Dr. Noack will describe some novel and interesting television systems now being brought out in Germany.)

# The Progress of Radio and Television Abroad

## AUTOMATIC TELEVISION RECORDER

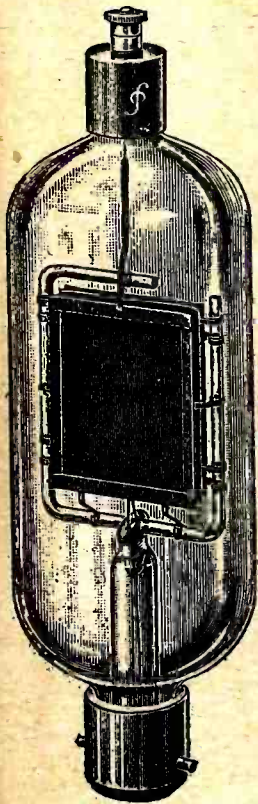
A very interesting idea is now under development by the Baird Company in England, according to *Amateur Wireless*: that of recording simultaneous transmissions of separated parts of an image, and recombining them into a whole. One of the methods suggested is akin in principle to the telegraph: a series of steel discs, equal to the number of signal groups, is rotated, and magnetising coils impress on each the record of the current variations received. The group can be "read" together by pick-ups, and the discs are then "wiped" by an A.C. coil which removes the magnetic record. The suggestion is made, by the chronicler, that the same method can lend itself to the reception of speech, "speeded up" to a very high frequency for transmission, and then stepped down again in reproduction from the record disc.

## IMPROVED NEON LAMP

**I**n a new German television lamp, invented by the well-known experimenters, Dr. Geffcken and Richter, and which is said to be produced at a lower price than former

types, a mixture of helium and neon with mercury vapor is used to give a bright red-dish light.

In structure, the anode (positive element) is frame-shaped and parallel to the



A drawing of the new German television glow-lamp, using a gaseous mixture to give greater brilliancy. Constant ionization is maintained.

cathode; thus sharply outlining the luminous area over the latter, as well as causing a more uniform glow. In addition to this, there is

an auxiliary anode behind the cathode, so close that no glow charge can be formed between the two elements; this auxiliary plate

## Tube Troubles

(Continued from page 83)

or secondary-emission currents. The ionization current thus measured is found to be independent of the grid bias. In some tubes, it can be measured even at zero bias, without encountering the masking effect of the convection current, as indicated in Fig. 3B.

(The reader who is not entirely familiar with the internal actions of vacuum tubes will do well to consult the series of articles on "Vacuum Tubes for Radio Reception" in the October, November and December, 1929, issues of *RADIO-CRAFT*.—*Editor*.)

is connected with the polarizing voltage through a 100,000-ohm resistor. The result is to concentrate the glow and make it brighter; while a small discharge between the elements, hidden entirely by the frame, keeps the gaseous contents continually ionized and eliminates time lag which would be caused by a complete cessation of ionization. The external appearance of the tube is shown in the accompanying illustration. The manufacturer is the Otto Pressler Thuringian Tube Works of Leipzig.

## NOISEMAKING COSTLY IN FRANCE

**F**RENCH law is rough on radio interference. While the French government does not, like some others, seek for sources of noise which interferes with reception, a remedy is provided for sufferers. In a recent lawsuit, a doctor whose receiver suffered interference from an electrical phonograph in a cafe next door, was awarded a verdict of 500 francs (\$20.00) damages; with an added penalty of 50 francs a day assessed against the offender until he should remove the cause of interference.

## GREECE TAKES UP RADIO

**"THE ISLES OF GREECE"** have been better known in the literary than in the radio world; for Greece is one of the few countries of Europe without a broadcast station. However, it is announced that duplex radio-telephony stations are to be erected; one at Athens, one on the island of Chios, and one on the large island of Crete, to facilitate communication.

## NO TAX ON RECEPTION

**I**n most countries of the world, the ownership of a radio receiver is taxed, for the benefit of the broadcast stations, or the government, or both. However, since Portugal has no broadcast stations, its citizens are allowed to own sets and listen to foreign countries—which are near by—and are only restricted in putting up aerials, which may not cross roads or streets.

## MAGNETIC NEWS BY RADIO

**I**n addition to "weather broadcasts," there are "magnetic broadcasts." A daily report on the prevailing magnetic conditions is broadcast from the station at Issy-le-Moulineaux, near Paris, in French and in code, at 8:10 each evening, Greenwich Mean Time, on 32.50 meters.

## Oliver Heaviside

(Continued from page 87)

lived alone, in his own fashion, shunning visitors, and composing the works which were to revolutionize the art of electrical communication.

"Perhaps no one in his time," says Sir Oliver Lodge, summing up the life work of Heaviside, "had an equal grasp of the present and future outcome of Maxwell's theory. He expressed the generation of electric waves in his own style. Everything relating to electrical induction, and the energy of electric currents, and the forces and fluxes



# How to Build, Test, Repair, Maintain - - Radio Receiving Sets

The three volumes of this Library cover the entire field of building, repairing and "trouble-shooting" on modern radio receivers. The Library is up-to-the-minute in every respect and is based on the very latest practice in the design and manufacture of radio equipment. The rapidly-growing interest in this type of apparatus. The modern types of power tubes which permit greater sound volume with less distortion—push-pull amplifiers—and dynamic speakers—every modern development is comprehensively and simply treated.

## Radio Construction Library

By JAMES A. MOYER and JOHN F. WOSTREL

Faculty, University Extension, Massachusetts Department of Education

3 volumes, 993 pages, 561 illustrations, Price \$7.50

\$1.50 in 10 days and \$2.00 a month

**VOLUME I:** presents the fundamental principles of radio so clearly and simply that anyone of average training will be able to read, understand and apply them. In one chapter alone, it gives actual working drawings and lists of materials for the construction of eight typical sets.

**VOLUME II:** fully discusses all of the elementary principles of radio construction and repair. An explanation of the necessary steps for "trouble-shooting," repairing, servicing and constructing radio sets successfully.

**VOLUME III:** covers the essential principles underlying the operation of vacuum tubes in as non-technical a manner as is consistent with accuracy. It discusses the construction, action, reactivation, testing and use of vacuum tubes; and an interesting section is devoted to remote control of industrial processes; and precision measurements.

### EXAMINE these books for 10 days FREE

This Library is not only a thorough home-study course, but a handy means of reference for the more experienced radio experimenter, repair man, and radio shop-owner. To these men, as well as to those who desire to advance in the radio profession, this offer of a 10 days' Free Examination is made.

Simply fill in, and mail this coupon NOW

**McGRAW-HILL**  
**FREE EXAMINATION COUPON**

McGRAW-HILL BOOK COMPANY, INC.,  
370 Seventh Avenue, New York.

Gentlemen:—Send me the new RADIO CONSTRUCTION LIBRARY, all charges prepaid, for 10 days' Free Examination. If satisfactory I will send \$1.50 in 10 days, and \$2.00 a month until \$7.50 has been paid. If not wanted I will return them at your expense.

Name .....

Home Address .....

City and State .....

Position .....

Name of Company.....R.C. 8-30

**SEND FOR THIS**

**Radio Bargain News**

**Dealers and Service Men**  
**\$100,000**  
**WORTH OF RADIO**  
**MERCHANDISE SUCH AS REPLACEMENT**  
**CONDENSER BLOCKS, TRANSFORMERS**  
**SETS, SPEAKERS, AND TUBES SOLD**  
**AT 75% OFF THE LIST PRICE.**  
**SEND FOR FREE COPY OF THIS**  
**BIG CATALOG JUST ISSUED**

**Federated Purchaser**  
 22-A HUDSON ST., NEW YORK CITY

*If you are not one of the 20,000 dealers on our mailing list, write in now.*

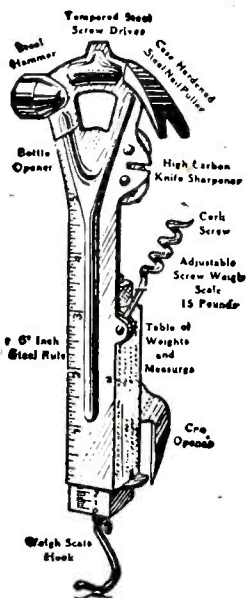
**Ten Tools In One**

**\$1.00**

A small but handy article which serves for every possible need of the all-round mechanic. Invaluable in any emergency.

An excellent combination of utilities for the household—every necessity featured: hammer, knife-sharpener, nail-puller, bottle-opener, screw-driver, can-opener, cork-screw and weigh-scale. Just glance at the illustration and you will see how really useful this article is. Only 10 in. high. Indispensable to autoists, campers, Boy Scouts, canoeists, picknickers, etc.

Price \$1.00 Postage Paid. Be the first one in your town to own the "Ten Tools in One." Send coupon with your name, address, city and state with one dollar.



**SEND FOR YOURS**

**TODAY**

**MAIL COUPON**

**NOW!**

Grenpark Company, 245 Greenwich Street, New York, N. Y. FG-8

Enclosed find \$1.00 for which please send me prepaid your "Ten Tools in One."

Name .....

Address .....

City..... State.....

**SIGNAL**  
**Wireless Keys**

High-grade transmitting keys, constructed of best materials and workmanship. Three contact sizes. If your dealer cannot supply you write direct.

R62—3/16"	\$3.50
R63—1/4"	3.70
R64—3/8"	3.90

**SIGNAL ELECTRIC MFG. CO.**  
 Menominee, Mich.

**Dealers and Servicemen**  
**Keep Posted on Prices**

**S. S. JOBBING HOUSE**  
 156 W. 26th Street  
 New York City, N. Y.

Without obligation add my name to your list so that I get your Radio and Electrical Merchandising Bargains regularly.

Name .....

Street .....

City..... State.....

**TO NEW READERS** Back issues of RADIO-CRAFT for reference needs can still be had at the regular price of twenty-five cents each. Send cash, check or money order to RADIO-CRAFT, 98 Park Place, New York, N. Y.

of energy in the electromagnetic field, was elaborately worked out in these early papers. It seems probable that workers in the science of the ether will make more use of his methods and results than they have at present done. \* \* \* Though there is much originality, there is little orthodoxy in the manner of presentation."

A scientific heretic, Heaviside certainly was—a "nihilist," as he remembered that Kelvin had humorously called him. With unbounded disrespect for the errors of those in authority, and a strong sense of humor, he advanced his proofs in a form unfamiliar to men of science and, though a mathematician of a high order, he refused to be limited by the conventional mathematical forms.

"Let not the reader imagine that thinking can be dispensed with," he wrote in one of his books. "There is no royal road to knowledge, and hard thinking and rigid fixation of ideas are required. But earnest students, if they will not or cannot learn the mathematical methods, need not therefore be discouraged: for the name of Faraday will shine forth to the end of time as a beacon of hope and encouragement to them."

The problems, with which he began, were those of the actions which take place in a telegraph wire. In 1873 he had indicated the possibilities of quadruplex telegraphy, which Edison put in practice; but, as Heaviside truly said, "Will it pay?" has never interested me."

He was first to see in the telegraph line the phenomenon which we now call "wired wireless." In 1885, two years before Hertz' detection of radio waves, Heaviside wrote: "When we have little distortion, we get into the regions of radiation. The dielectric should be the central object of attraction, the wires subsidiary, determining the rate of attenuation. The waves are waves of light in all save wavelength, which is great, and gradual attenuation as they travel, by dissipation of energy in the wires.

"It is to such long waves that I attribute the magnetic disturbances that come from the sun occasionally, and simultaneously show themselves all over the world; there are induced currents in the sea, earth's crust, telegraph lines, etc."

At that time the possibilities of "wireless telegraphy" were being more carefully considered than they had been since the days of Morse. Sir William Preece, director of the British telegraph system, who later was to give official support to the experiments of Marconi, had authorized research. A. W. Heaviside, a brother of Oliver, and one of the engineers of the system, in 1887 demonstrated cross-signals between two wire systems, one in a mine and one on the surface, 360 feet above it. But when A. W. Heaviside endeavored to present a paper on "wireless," embodying his brother's principles, to a technical society, it was rejected.

The problem of long-distance telephony, especially, was complicated by the fact that an impulse embodying varying frequencies, traveling through a lengthy electrical system, suffers from discriminatory distortion as well as attenuation. In 1893 Heaviside indicated the solution; which later was to be carried out by Pupin who, acknowledging it, testified that Heaviside had "introduced the living language of physics."

As, gradually, the science of radio and the art of telephony caught up with the theories of Heaviside, his ability was more and more recognized in scientific circles. The Faraday medal of the Institution of Electrical Engineering was first awarded to him; he was elected a Fellow of the Royal Society, and it was evident that amends were being made for former ridicule. The logic of facts was strongly in favor of Heaviside. His opinion was taken in many scientific investigations; and his writings became in more favor among scientific publications.

The fact that radio signals did not obey the inverse-square law of unconfined radiation had become apparent as soon as long-distance signaling was attempted. Heaviside saw the reason, and his explanation has associated his name with the sky, as other men have been honored by bestowing their names upon mountains and rivers:

"Sea water, though transparent to light, has quite enough conductivity to make it behave as a conductor of Hertzian waves; and the same is true of the earth. The irregularities make confusion, but the main waves are pulled around by the curvature of the earth, and do not jump off. There is another consideration: *there may be a sufficiently conducting layer in the upper air.* Then the guidance will be the sea on one side and the upper layer on the other."

Thirty years have passed; and the theory

of Heaviside has been verified and is becoming more and more important in the practical utilization of radio. Millions who are unfamiliar with the life work and the elaborate calculations of Heaviside make his name a household word.

The years went by: the aging scientist had never sought for wealth and he bore poverty philosophically. It was with reluctance that he consented to accept the modest pension which the British government is accustomed to bestow upon literary men and scientists to whom the nation feels itself indebted. He died on February 3, 1925.

It has since been suggested that his memory might well have been honored by such a rush as fell over the wires at the passing of Bell. However, when Oliver Heaviside was laid in his grave, there stood beside it, in addition to a little band of relatives, only two men; they were the representatives of the engineering profession of Great Britain and of the telephone system of America.

"He lived," said Lodge, his great contemporary, "an independent and self-contained life." His career was not one to inspire the ambitious, nor to be emulated by the prudent: but he followed the dictates of a nature which weighed nothing else against the desire to advance scientific knowledge and, in the pursuit of his great task, who shall say that he did not live a satisfying as well as a useful life?

## Higher Voltage from the "B" Eliminator

(Continued from page 97)

If doubling, tripling or quadrupling the present D.C. voltage would mean too high a potential for the new tube, the higher voltage may always be cut down by the use of resistors; but, if the new load is to be much heavier than the old one, then the rectified voltage will be somewhat less than an integral multiple of the old value. That is, the regulation of the line-voltage transformer and filter system may be such as to reduce the increased voltage by as much as 20% from that which would normally be expected.

So that if the present output is, say, 135 volts, then by doubling it and allowing for the drop due to poor regulation, the new voltage will be about right for operation of the '71 or the new '45 tubes. Quadrupling the voltage from such an eliminator would give sufficient voltage for either the '10 or '50 tube, depending on this regulation factor. As for the '50 tube, it does not have to run at its *maximum* voltages to give excellent results; in fact, considering its cost, it is really desirable to run it a little low, in order to lengthen its life.

The rectifying circuit in mind is not new, though not very generally used; it is entirely practical, however, for the writer has used it on a number of occasions and never experienced any difficulties over and above those of the standard rectifying circuit. In fact, where full-wave rectification is not used at present, the new circuit allows that method, and provides better filtering for the plate supply with the same filter apparatus.

### Replacing an '01A

There are large numbers of '01A's still in

use as output tubes, the plate supply being furnished by "B" eliminators. Therefore the change from an '01A to a '71A tube will be described in detail, to illustrate how the new circuit is put into use.

If the rectifying tube in use is the '13 or '80 type, discard it and purchase two gas-filled rectifiers, such as the Raytheon "BH" tube. Use the filament winding of the old rectifier to light the '71A filament. Then follow the schematic diagram of Fig. 1 for re-wiring the eliminator.

The buffer condenser will be found necessary to prevent radio-frequency disturbances. Two of the old condensers may be used in the positions marked A and B, provided they are of the proper capacity.

If the rectifier used at present is of the gas-filled type, then, of course, only one new tube is needed and the buffer condenser is already in use; in this case the filament of the '71A may be lighted from the "A" battery which supplies the other tubes in the set.

An output choke is necessary and may be hooked in as shown (in solid lines) in Fig. 2, *provided* its D.C. resistance is not over 800 ohms. If it has been designed for this purpose, the resistance will not be higher. If the resistance of the choke is more than 800 ohms, a 1-mf. condenser (160-volt type) will be needed where it is shown (at C) in dotted lines. A higher-resistance choke, without the use of the condenser, may burn out the speaker; while the low-resistance choke does not force the direct current through the speaker in quantities large enough to harm it.

(Continued on page 116)

# Open this FREE BOOK



## and you open the door to SUCCESS IN RADIO

YOU, too, can be trained for a worth-while radio job... Clip this coupon now and send for this FREE BOOK... Read it page by page... see for yourself why thousands of fellows just like you are now on the road to success in Radio... why hundreds of men are now cashing in on RCA Institutes' practical training. This free book gives you 40 fascinating pages of pictures and text, all about RCA Institutes, the only school that is endorsed by the Radio Corporation of America... The school that actually is a part of the great world-wide radio industry.

### Easy to Learn Radio at Home in Your Spare Time

Let the RCA Institutes' Home Laboratory Training Course give you the real inside facts of radio... quickly and easily. Use your spare time to train for success with the remarkable outlay of screen-grid apparatus given to every student of this course. You learn how to solve every radio problem such as installing, repairing and servicing fine sets. You also learn ship, shore and broadcast station operation. This is the training that will help you to make money in radio!

### RCA Graduates in Big Demand

For more than 20 years, there has been a well-paid position in Radio waiting for practically every graduate of RCA Institutes—mechanics, operators, service men, etc. Only the vast resources of RCA could give you this practical training...

### Send for this Free RCA Book

"Radio... the Field of Unlimited Opportunity"

Start today on the road to Success in Radio... Send for this FREE BOOK. Every page is packed with pictures and text telling you all you want to know about RCA Institutes, the oldest and foremost Radio training organization in the world. Radio can easily be YOUR ROAD TO SUCCESS... That's why you should CLIP THIS COUPON NOW!

## RCA INSTITUTES, INC.

A Division of Radio Corporation of America

RCA INSTITUTES, Inc.  
Dept. SRA-8, 75 Varick Street, New York.  
Gentlemen: Please send me your FREE 40-page book which illustrates the opportunities in Radio and describes your home laboratory method of instruction.

Name.....

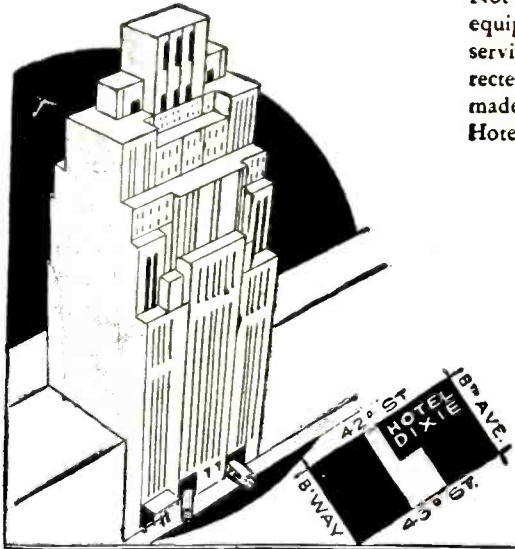
Address.....

Occupation.....

# Hotel Dixie

42<sup>d</sup>-43<sup>d</sup> Streets West of Broadway

A New and Better Hotel for Times Square



Not alone new in construction and equipment, but new in conception of service and comfort to its guests. Directed by S. Gregory Taylor, who has made such enviable successes of the Hotels Montclair and Buckingham.

#### Single Rooms

with tub and shower

\$3, \$4 and \$5

#### Double Rooms

with tub and shower

\$4, \$5 and \$6

A few terraced rooms and suites, exceptionally large closets, on an attractive monthly basis.

#### RADIO IN EVERY ROOM

Entrances on 42nd and 43rd Sts.

## CENTRAL UNION BUS TERMINAL

LOCATED IN THE DIXIE HOTEL BUS CONNECTIONS FOR ALL POINTS IN THE UNITED STATES

New Hotel

# LA SALLE

WOODWARD at ADELAIDE

750 ROOMS  
EACH WITH BATH

\$2<sup>50</sup> to \$4 a day Single  
\$4 and up Double

IN THE CENTER OF

# DETROIT

LA SALLE  
GRILL  
for  
QUALITY  
FOOD



When the '71A filament is lighted by alternating current, the center tap of the filament secondary is connected to the "A—" of the set. The resistors R1 and R2 (Fig. 1) are added; R1 is required to prevent the plate voltage to the amplifying tubes from mounting up proportionally with the increase in that applied to the power tube, while R2 is provided to eliminate the necessity of a "C" battery. Definite values of these resistors can not be given here; because the actual current load in individual cases is not known. However, the Service Man is familiar enough with the method of applying Ohm's law to determine these values.

If it is desired to quadruple the voltage, the entire secondary is used instead of just half of it, as shown. The filter condensers and resistors are selected to meet the new requirements, of course. With this arrangement, the center tap of the high-voltage secondary is left open.

#### High-Power Tubes

In some cases the change will be from the '71A tube to the '10. When this is done, since the load is practically the same with either tube, the output voltage will be just doubled. The gas-filled tubes may still be used, because the A.C. voltage applied to them has not been changed; the other changes will be practically the same as those described before. If push-pull amplification is incorporated, the D.C. voltage will drop off a little; but that means longer life for the power tubes.

Fig. 3 shows the circuit used to triple the eliminator voltage; but, because three rectifiers are needed, this idea will, probably, appeal to few. It should be remembered, however, that the current load is equally distributed among the rectifiers used; so that their individual lives are greatly increased, beyond what they would be if any one were to carry all the load.

Since specific instructions cannot be given for all cases, a little good judgment will have to be used by the Service Man, but he will be well repaid for it from a business viewpoint.

## By-Pass Condensers

(Continued from page 100)

trouble, it is well to keep in mind what is good and effective in theory. The writer finds, in amplifiers operated from the power lines, that balancing or compensating effects (as described in his patent, No. 1,735,750) are more satisfactory than dependence upon filters. High-quality, quiet, and inexpensive circuits can be designed along the lines which he has indicated.

#### General Rules

A by-pass condenser is used most effectively where its reactance is small, compared with the value of a resistor connected in series with or across it.

The effectiveness of the resistance-and-capacity filters, separating any two applied-voltage points in an amplifier, should be considered with respect to the amplification between these points.

By-pass condensers should have sufficient capacity to be effective at the *lowest frequencies* they are expected to by-pass.

For best tone quality and the elimination

**EVERY** Radio Service Man should read the interesting announcement of the OFFICIAL RADIO SERVICE MANUAL which appears on page 120 of this issue. This Manual is a complete directory of all commercial wiring diagrams of commercial receivers, and is indispensable to Service Men.

of serious regenerative effects, filtering between any two points should be about five times as effective as that necessary merely to obtain stable operation of an amplifier.

This last point is seldom observed; since amplifiers which are stable and use good parts are often supposed to be necessarily all right. But regeneration in electric sets often is the cause of rumbling and barrel-like tone quality; since the regeneration is particularly likely to cause over-amplification of bass notes. Effective elimination of regeneration in an amplifier, if good parts are used, is an essential step in getting the delicate shading and really natural tone that is most highly appreciated. If the reader has built an amplifier that is stable but not altogether satisfactory in tone, the addition of a little more filter, or some improvement in the effectiveness of filters already used, will often accomplish desired results.

Several other points are worth keeping in mind: That which the writer considers most important is that by-pass condensers should be capable of standing the highest D.C. voltages that may be applied. Remember that, in some cases, with A.C. tubes which warm up slowly, the voltage at first applied to the condensers when the tubes are cold will be considerably higher than when the tubes reach operating heat and are drawing normal plate (and perhaps screen-grid) current. A principal voltage-divider resistance, as shown in Fig. 2, may be eliminated if it is certain that all condensers (as well as other units) are safe at the high voltages that may be applied when the "B" eliminator is working without much load—as while tubes are warming up.

**Separating R.F. Stages**

It is a good plan to have very good filter separation of R.F. tube circuits from the detector and audio amplifier circuits; because radio-frequency tubes rectify (or detect) to some extent under strong signals,

and such detected currents may be coupled into the detector or audio amplifier circuits. Likewise, strong audio signals, if they get back into the R.F. tube circuits, may cause some modulation of radio-frequency signals; and will thereby affect the detector. Such conditions result in poor selectivity and performance.

The present tendency, in the design of electric radio sets, is to use less audio amplification. It has been shown that detectors can be operated to put out sufficient power to operate a power tube without any intermediate stage of audio amplification. Under such conditions, more amplification is required in the R.F. stages to make up for the lower voltage-gain in the audio amplifier.

For equal over-all amplification and performance of a receiver, we have the choice of more amplification—with increased difficulty of stopping coupling and feed-back effects—either at radio frequencies, or at audio frequencies. An audio amplifier of moderate step-up does not present great difficulties, and may be preferable to the proposition of cutting the audio amplifier to a single step, while increasing the R.F. amplification and the power-handling capacity of the detector.

In either case, it is important to make effective use of by-pass condensers and resistors, and get adequate filter separation between the circuits of the several tubes.

Note: Where amplification is regenerative, the actual amplification may be called *A*, the normal amplification *a* and the feed-back *r*. Then, for unit input:

$$A = \frac{a-r}{1-r}$$

$$125 = \frac{a-r}{1-r}$$

To limit *A* to 125% of *a*, since  $100-r$

Then,  $125-125r = 100-r$ , or  $124r=25$ , and  $r = 0.2$ . Therefore, the portion of output voltage that may be fed back is 0.2 divided by *a*.

**Radio-Craft Kinks**

(Continued from page 101)

**LIGHT-SOCKET ANTENNA**

By W. W. Heidloff

THE writer constructed a very satisfactory light-socket antenna without incorporating the usual fixed condenser, by utilizing the capacity that exists between two wires wound parallel. The finished unit is shown on page 101 (Fig. 5).

The only requirements are: one large spool; one light-socket plug; some sealing wax; and about forty feet of No. 24 D.S.C. and enamelled wire.

Cut the wire into two equal lengths. Shove two ends through a hole in one end

of the spool, and wind the twenty feet of paralleled wire on the spool; the further ends are to be pushed through a hole in the opposite end of the spool.

Now, make a continuity test of each winding; connect one end of one winding to one of the two prongs of the cap of a light-socket plug, and connect the opposite end of the other winding to a binding post, which is fastened on one head of the spool. The two remaining and unconnected ends of the wire are to be taped, carefully, and so placed as to prevent any possibility of either unconnected end coming in contact with any metal part of the unit (otherwise, the house line would be short-circuited).

The wire and leads are secured in position with the sealing wax; finished appearance may be given to the unit by lacquering it. To use the unit it is plugged into a current-outlet and a lead is taken from the binding post on spool to the "Ant." post on the set.

**A FORM FOR COILS**

By Glen C. Anderson

WITH a hack-saw, cut lengthwise through a piece of bakelite of the desired diameter, as shown in Fig. 6.

The next step is to wind a piece of stout

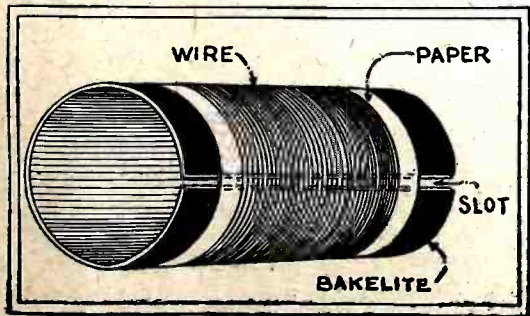


Fig. 6

The method shown makes it possible to prepare coils with lessened dielectric losses.

**When Your Tubes Have Three Lives**

Like the proverbial cat, your tubes can have several lives. It's just a question of treatment. If your A.C. tubes last less than six months, you are throwing away six to twelve months of full normal life. Charge it to EXCESSIVE line voltage.

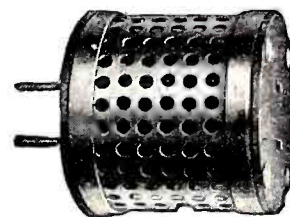
If your set sours early in the evening, when folks turn on lights and radios, blame it on LOW line voltage.

In either event, it now becomes your fault. Because, by investing the small sum of \$1.75, you can overcome the effects of high and low line voltages forever. Here's how:

**Automatic Line Voltage Regulator Clarostat**

Its name tells the story. Compensates for all line voltage fluctuations. Applied to attachment plug of usual A.C. set—no tools, fussing, experience. AUTOMATIC—provides immediate change in compensating resistance for all voltages. No taps, switches, worry. Neat. Compact. DIFFERENT.

Install it—forget it—and save the price of two or three sets of A.C. tubes per year—and perhaps a costly power pack failure.



ASK your dealer to show you the greatest investment in radio today—the AUTOMATIC Line Voltage Regulator Clarostat. But beware of substitutes!

Watch out for switching! Demand what you ask for.

CLAROSTAT MFG. CO., INC.

Specialists in Aids to Better Radio

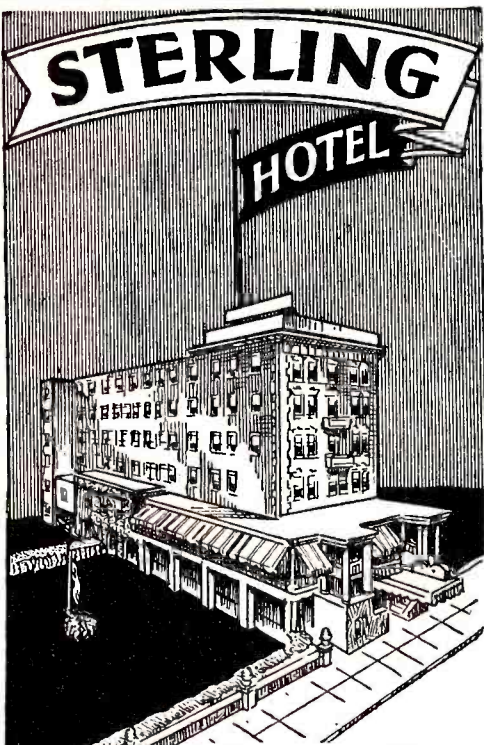
285-7 N. 6th St. :: Brooklyn, N. Y.

**DOING ONE THING WELL**

Making good resistors a life work has made ELECTRAD resistors longer-lived. They are preferred by Radio Service men for replacement purposes.

Write Dept. RC-8 for helpful data.

175 Varick St., New York, N. Y. **ELECTRAD**



**Atlantic City  
NEW JERSEY**  
COMFORT

*Without Extravagance*

Beach Front Service at Moderate Prices. Service, cuisine and appointments equal to that offered at the best beach-front hotels.

**Fireproof  
All Outside Rooms**  
With or Without Private Baths  
Phone in All Rooms — Garage  
**The Norris Co.**  
FRED M. ALLGAIER, Mgr.

**KENTUCKY AVE  
near BEACH**



*The*  
**FORT HAYES  
HOTEL**

*Around the Corner  
from Everything*

300 ROOMS EACH WITH BATH **\$250** A DAY SINGLE — \$4 DOUBLE

*Finest Hotel in*

**COLUMBUS**

*You'll enjoy the beautiful lobby with its \$150,000 worth of the late Sarah Bernhardt's Furniture*

**PLENTY OF PARKING SPACE  
GARAGE IN CONNECTION  
R. B. BUNSTINE—MANAGER**

paper around the (now slotted) tube, and paste it firmly, using care to prevent the paste from sticking the paper to the tube. (The paper should be spaced about 1½ inches from each end of the tube.)

Wind the wire on the paper, under which is the bakelite tube, being careful not to wind so tightly as to cause the slot in the tube to close completely.

Coat the finished winding with the usual mixture of acetone and celluloid.

When dry, the coil is easily removed by sliding it off the bakelite tube after pressing the tube until the slot has closed.

The finished coil may be mounted in any convenient manner; the writer usually bolts two strips together, one inside and one out, and then fastens the mounting in the position dictated by the circuit.

**AN EMERGENCY WIRE-CONNECTOR**  
By X.

**EXPERIMENTERS** will welcome the little idea, illustrated below, for quickly connecting two wires.

There are objections, at times, to twisting leads, or to soldering them. A convenient and quick way to connect wires is to use a paper clip, and weave the wires back and forth. Most temporary connec-

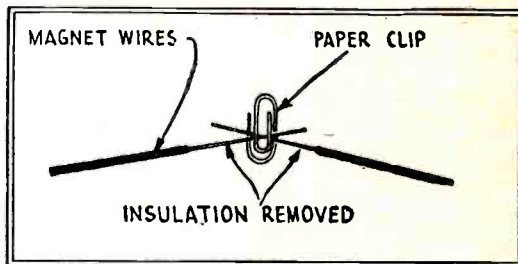


Fig. 7

*The paper clips shown effect very rigid contact with comparatively low resistance, for temporary use.*

tions are so insecure that they develop microphonic contact; but this idea seems to afford good contact.

Another type of paper clip with two parallel jaws in clamp formation may be used for holding phone-tips and wires, in a pinch (ouch!); but, though this clip is more adaptable to conductors of all sizes, it does not hold small wires as tightly as the one illustrated here.

**Heavy-Duty D. C. Supply**

*(Continued from page 103)*

resistance). The number of turns on the secondaries may be increased considerably, in view of the high break-down voltage of the rectifier cells used; but the writer has found that better results are obtained by using a lower voltage on each cell and incorporating a larger number of cells.

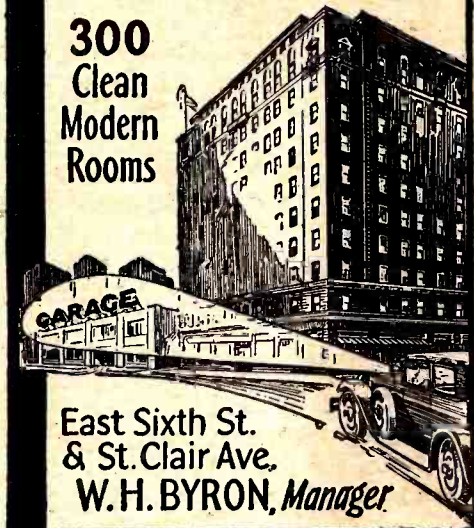
**The Rectifiers**

Each electrolytic cell is a full-wave rectifier, consisting of a central electrode of lead and two outer electrodes of aluminum, in a saturated solution of ordinary "borax." A one-quarter-inch layer of mineral oil is poured into each cell, to prevent evaporation of the electrolyte and "creeping" of the salt over the electrodes and jar. Once properly set up, the cells need no further care for months. Each cell functions independently of the others, and any number may be used

Reduced Rates at  
**CLEVELAND'S  
Newest  
HOTEL**

**AUDITORIUM**  
\$2  
EVERY ROOM WITH BATH \$2.50 \$3

**300  
Clean  
Modern  
Rooms**



East Sixth St. & St. Clair Ave.  
W. H. BYRON, Manager



**The MADISON**

**ILLINOIS AVENUE**  
Overlooking Boardwalk and Ocean

**"A Hotel Distinctively Different"**

JUST COMPLETED IN

**Atlantic City**

Unexcelled Colonial Hospitality

**Now Ready for YOU**

Fireproof — Showers and Baths Throughout

From \$4.00 daily  
European Plan

From \$7.00 daily  
American Plan

**FETTER & HOLLINGER, INC.**  
Eugene C. Fetter  
Managing Director



(with a proportionate voltage increase) by a manipulation of the switch Sw. If further flexibility is desired in the output voltage, an ordinary *rheostat* R, of suitable resistance, may be inserted in one side of the primary circuit as a vernier voltage control.

The filter system is standard, except that the units are more massive than those used in most "B" power units. As will be noted by reference to Fig. 1, the main condensers are 4, 4 and 8 mf., while the choke coils are rated at 30 henries each. Care must be taken in the selection of the filter condensers, to obtain units of sufficiently high rating to easily withstand the high working voltages impressed on them. Also, the chokes should be of a low resistance to prevent overheating and breakdown.

Vacuum tubes (type '80 or their equivalent) might be used in place of the electrolytic cells to get high voltages; but the unit thus constructed would be neither so flexible as to voltage nor so rugged. An accidental short circuit, for example, in the plate circuit (such as often occurs in experiment or radio servicing) might ruin the vacuum tubes; while the electrolytic cells will be unharmed by like treatment.

The potentiometer (voltage-divider) system (R1, R2, R3) consists of three tubular resistors mounted in series; these are interchangeable and exchangeable for others on the work bench. Fixed resistors have been found more reliable than variables, for keeping the voltage fixed after an adjustment for the problem at hand has once been made.

In practice, when using this power supply as a "B" eliminator, very little hum is ever observed, even though it may be operating

a regenerative receiver. It may thus be used as a complete substitute for "B" batteries, for many purposes.

**The Voltage Divider**

The resistors used by the writer are tubular commercial units of the metallized or carbonized kind, capable of heavy-current duty, which were found in his junk box. They were interchangeable with others of various ratings to suit the requirements which came up. For most purposes, units of 1,000, 4,000 and 5,000 ohms rating were found satisfactory. With the above values, the output voltages on open circuit were about as follows, with one rectifier jar in use:

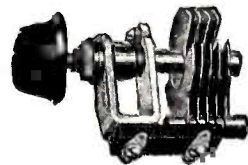
Eighty volts output, with the 1,000-ohm resistor between this and a 72-volt tap; 5,000 ohms between 72 and 32 volts; 4,000 ohms between 32 volts and the negative terminal. With two jars in the circuit, the voltages were found to be increased about 75 per cent.

With the resistors mentioned in circuit, and making use of the six jars illustrated, the "dead" current flowing through the resistors was of the order of 35 milliamperes. Hence, for certain purposes, it has been found better to substitute resistors of, say, 2,000, 10,000 and 10,000 ohms, if higher voltages are desired and smaller amperages are satisfactory. For certain types of work, the resistors are removed entirely.

As for the switch S, between each of the live contacts, connecting to the jars as shown, there is placed a dead contact, enamelled black; so that the "B" circuit is broken for an instant whenever a change of voltage is made.

**Little CONDENSERS with BIG JOBS!**

Success in radio depends on small things. The smaller the part, the better it must be built. Hammarlund precision workmanship, famous for twenty years, was never more perfectly expressed than in these two types of small balancing condensers. They have many uses in modern radio you should know about.



"Hammarlund, Jr." has all of the characteristics of the renowned larger Hammarlund models and is well-built for hard service. Knob variation. Five sizes:—\$1.50 to \$2.25.



The Hammarlund Equalizing Condenser has mica dielectric and a phosphor bronze spring plate, riveted to a Bakelite base. Cannot short. Wide adjustment range with screw. Used chiefly for balancing sections of a multiple condenser. Two capacities:—50 and 60 cents.

Write Dep't. RC-8 for "Set Builders' Guide of Outstanding Radio Circuits"

HAMMARLUND MFG. CO., 424-438 W. 33rd St., New York

For Better Radio  
**Hammarlund**  
PRECISION PRODUCTS

**Radio-Craft's Information Bureau**

(Continued from page 104)

(Q.2) A Crosley "Model 601" receiver was brought in for repair. The diaphragm of its reproducer would snap loudly, although it seemed to be fastened tightly. After making a few minor repairs, the operation was again found satisfactory. What was the reason for the snapping?

(A.2) The diaphragm of the reproducer was so adjusted at the factory that it was very close to the iron core. A slight overload caused it to buckle sufficiently to hit this pole piece. Just what caused the overload is problematical; possibly an open grid circuit, low grid bias, defective tube, or circuit oscillation.

**SCREEN-GRID COILS**

(76) Mr. L. K. Waring, Tottenville (S. I.), New York.

(Q.1) What are the general rules to be observed in making screen-grid coils?

(A.1) The number of turns on the secondary is governed mainly by the capacity of the variable tuning condenser. For good selectivity, wind the primary so that it has approximately two-thirds the inductance (about two-thirds the number of turns) of the secondary. The primary should be wound with very fine wire; No. 36 or 38 is usually used. Wind both coils in the same direction, with the primary on a paper tube that will just slip inside the secondary; space-wind the primary so that it extends the length of the secondary. The end of the primary, nearest to the grid end of the secondary, is the plate connection.

(Q.2) Can D.C. screen-grid coils be used with A.C. tubes? Can coils designed for type '26, '27 and '24 tubes be used with equivalent battery tubes?

(A.2) Coils designed for A.C. operation may be used in battery sets; but coils designed for battery operation may cause circuit oscillation when used in conjunction with A.C. tubes, because of the higher amplification and the higher inter-element capacity of the latter.

**INCREASING SENSITIVITY**

(77) Mr. Walter C. Fellows, Philadelphia, Pa.

(Q.) Please check over the diagram of my 5-tube set, which uses the dual-impedance audio system, and advise why it lacks sensitivity. Locals are heard very well and quality is excellent. The set is powered by an "A" and "B" eliminator; a Farrand power cone reproducer is used; and the pick-up is a 45-foot aerial (lead-in is 20 feet long). Local interference is negligible.

(A.) The schematic circuit referred to is reproduced in these columns (Fig. Q.77).

Although this circuit can be "modernized" to include a screen-grid tube, this operation will necessitate a complete re-design of the set to include adequate shielding; which is not recommended except to the experienced Service Man.

However, such drastic changes should not be necessary in this instance: begin by lengthening the aerial to 80 or 100 feet, being sure that there are no partial grounds, and check the ground connection to see that it is good.

Increase the R.F. plate voltage from 67½ to 90, and by-pass this tap to "F—" with the 2-mf. condenser C. shown dotted in the diagram; and connect a 4½-volt "C" battery, poled as usual, into the R.F. stage grid return circuit. To keep the leads short, it will be best to place this battery inside the receiver.

To prevent the circuit from becoming highly regenerative before V1 has been enabled to function as a signal amplifier, it is necessary that the spacing should be adequate between L1 and L2; short leads and non-inductive placement will be necessary.

Dust off the set analyzer and put it to work: try a more sensitive detector and another R.F. tube—a complete set of new tubes might help. Check the voltages at the filament terminals of the tube sockets, to make sure that the filaments are receiving their rated current; and increase the value of the grid leak.

(Continued on page 121)

**FREE! RADIO BARGAIN CATALOG**

**ALSO FREE RADIO GIFT**

Send now for this new free radio catalog which saves you many dollars on radio outfits, kits, parts, tubes and accessories! Also **TIME CONVERSION CHART FREE**. Tells you instantly what time it is in any part of the world! Given free if your request for catalog reaches us this month.

**20th CENTURY MAIL ORDER CORP.**

202 JACKSON ST., CHICAGO, ILL.

Genuine **PILOT** Products



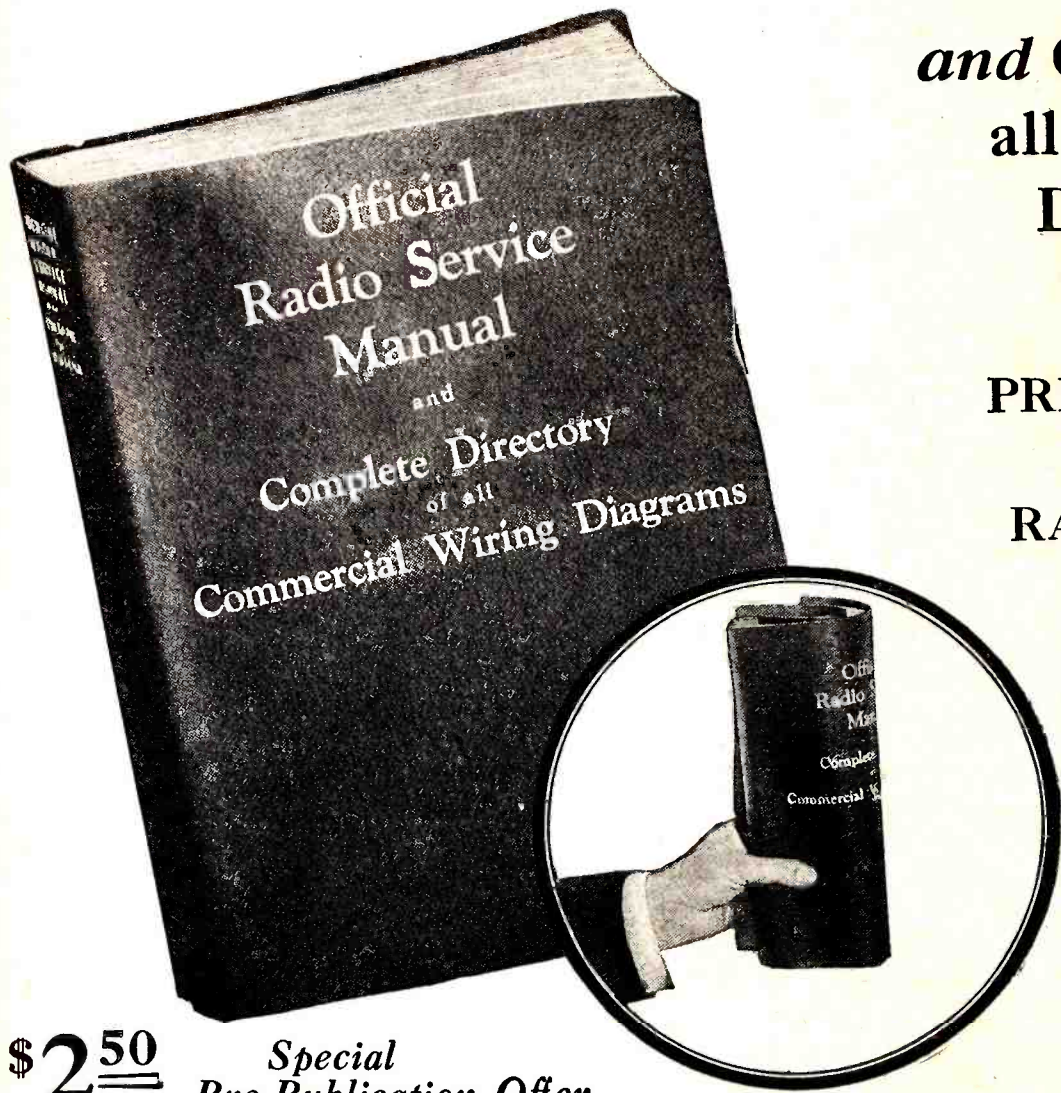
SOMETHING DIFFERENT No Flint. No Friction. MAKE UP TO

**\$40 A DAY**

Showing My Mystery Lighter to Men. What Makes It Light? All Guaranteed. No Flint or Friction. New Principle of Ignition. Sample with Sales Plan, 25c. Sample Gold or Silver Plated, \$1.00. Agents write for proposition. **NEW METHOD MFG. CO.**, Desk SF-8, New Method Bldg., Bradford, Pa.

# ◆ ◆ Official RADIO SERVICE MANUAL

and Complete Directory of  
all Commercial Wiring  
Diagrams of Receivers



PREPARED ESPECIALLY  
FOR THE  
RADIO SERVICE MAN !

HUGO GERNSBACK  
*Editor*

CLYDE FITCH  
*Managing Editor*

**\$2<sup>50</sup>** *Special  
Pre-Publication Offer*

**W**E ANNOUNCE the early publication of the long-awaited OFFICIAL RADIO SERVICE MANUAL. This manual is the first complete and most up-to-date book of this kind. Nothing else like it has ever appeared in print.

A tremendous amount of material has been collected, not only for the Service Man, but for everyone interested in radio. A complete directory of every radio circuit of commercial receivers is now possible, and not only do you get every circuit of every set manufactured, of which there is any record, but in addition, an entirely new idea makes it possible to keep the manual up-to-date.

The OFFICIAL RADIO SERVICE MANUAL is made in loose-leaf form—handsomely made of flexible leatherette—the entire book can be folded and slipped easily into your pocket or put in your bag.

Rarely do manufacturers supply information about receivers made before 1927—even 1930 service data are not always available because many manufacturers do not supply independent Service Men with such data. And, when you can get the material from some of the manufacturers, it is of little use to you because it is not uniform, and it is scattered in different places; difficult to get at.

Additional service data, for new receivers as they appear on the market will be published and supplied at trifling cost so that the MANUAL may be kept up-to-date at all times.

## SERVICE INFORMATION

But that is not all. The OFFICIAL RADIO SERVICE MANUAL contains also a most comprehensive instruction

course for radio Service Men, giving practical information from every angle on how to service sets.

In short, the OFFICIAL RADIO SERVICE MANUAL is the biggest thing of its kind that ever came along in radio. It will be hailed by every wide-awake radio man throughout the entire industry.

The size of the OFFICIAL RADIO SERVICE MANUAL is 9 in. by 12 in. There are several hundred pages, printed on good paper, and the book contains hundreds of illustrations and diagrams.

## SPECIAL OFFER

The price will be \$3.50 upon publication of the book; but to our own subscribers and readers, we have a special pre-publication price of \$2.50, prepaid. This price will be withdrawn the minute the book is published, which will be during the next six weeks or sooner.

GERNSBACK PUBLICATIONS, INC.,  
96-98 Park Place, New York, N. Y.

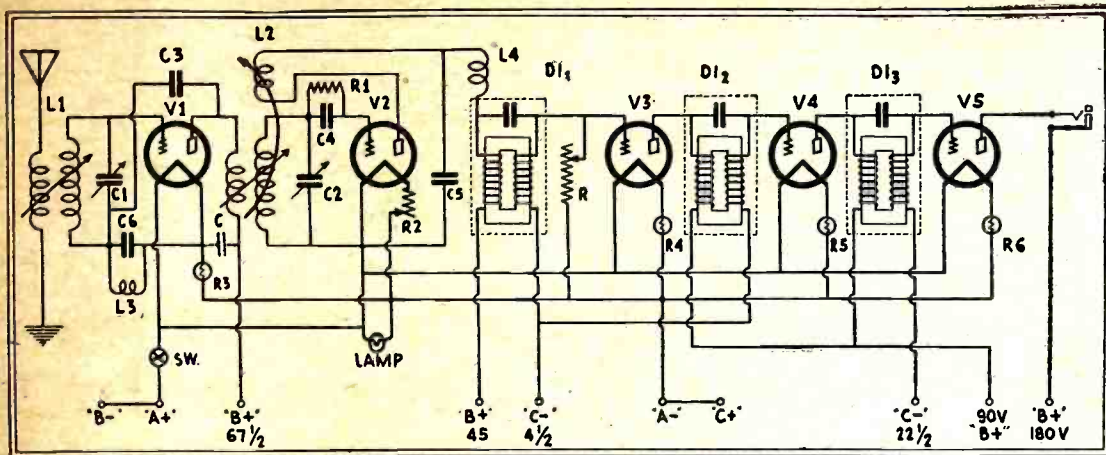
RC-8

As per your special offer, I enclose herewith \$2.50 for which you are to send me postpaid, one copy of the OFFICIAL RADIO SERVICE MANUAL as soon as it is published, at the pre-publication price of \$2.50. I understand that the price will be \$3.50 as soon as the MANUAL is published.

Name .....

Address .....

City..... State.....



(Fig. Q77.) The R.F. circuit of this receiver, once one of the best available, should be capable of good work yet, in the hands of a skillful operator. Higher voltages may be used to advantage, with good tubes.

The values of the parts employed, shown in Fig. Q.77, are:

C1, C2, .0005-mf.; C3, "midget" neutralizing condenser; C4, .00025-mf.; C5, .001-mf.; C6, .0001-mf.; L3, L4, R.F. chokes; R, 500,000-ohm volume control; R1, 2 meg.; R2, rheostat; R3, R4, R5, R6, ¼-ampere filament ballasts. V2 is a CeCo "Type H" detector; V1, V3, V4, are '01A's and V5 is a '71A tube. An output transformer and 30-henry choke used by Mr. Fellows are not shown.

The two- and three-circuit coils shown are Samson parts, the latter of the "double-rotor" type; and DI1, DI2 and DI3 are Samson "dual-impedance" coupling units.

loop tuning condenser, is lacking. However, no difficulty should be found in making an antenna coupler. There is nothing to it but a primary and secondary winding. The exact number of secondary turns are to be determined by experiment; try 110 turns of No. 28 D.C.C. wire on a tube 1½ in. in diameter. Over this coil, at the filament end, bunch 30 turns of the same (or smaller) wire; taking taps at the 10th and 20th turns. This antenna coupler should be shielded, with a minimum of 1½ inches between coil and can.

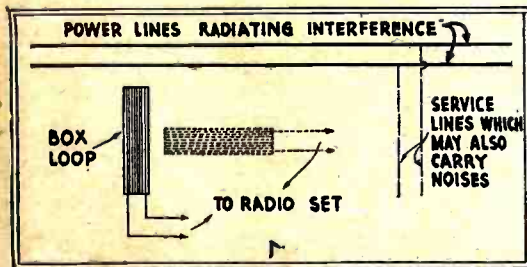
Connect the antenna coupler in an ordinary detector circuit, with antenna and ground connected to the primary, to determine whether turns should be added to, or removed from, the secondary to cover the broadcast band properly. The peak of the I.F. transformers has no bearing on the design of the antenna coupler.

(Q.2) Is it possible to build a receiver with six or seven stages of tuned R.F.?

(A.2) Receivers having this number of stages have been built. They are impractical for ordinary commercial production; because it is too difficult to maintain circuit resonance throughout the tuning band, with one-dial control, except as a laboratory job.

(Q.3) What is the recommended capacity for a variable condenser to be used as a shunt capacity to balance the secondaries of intermediate-frequency transformers?

(A.3) A small unit (100-mmf. rating) is usually suitable. However, a larger capacity may be required if the transformers were not carefully constructed to close limits. This is usually evident by lack of resonance in one I.F. stage.



(Fig. Q78A.) One of the troubles in locating interference—or getting away from it—is the fact that wires at right angles to each other carry noise.

**INTERFERENCE — SELECTIVE A.F. TUNING**

(78) Mr. Claude L. DePippo, Lawrence, Mass.

(Q.1) Will a loop antenna completely eliminate interference from power lines?

(A.1) The efficacy of a loop in this respect is dependent upon the particular conditions that exist in its locality. This is illustrated in Fig. Q.78A. The directional properties of a loop are often a successful means of balancing out interference of various kinds. In many cases, however, the effect of balancing is particularly evident in only one position; and in all others the interference again become fully evident. It may be pointed out that, in numerous instances, persistent trouble from line noise pick-up can be successfully balanced out with an outdoor aerial properly located, as explained on page 16 of the July, 1930, issue of RADIO-CRAFT.

(Q.2) Is it possible to tune the secondary of an audio transformer to receive only one audio frequency from the primary?

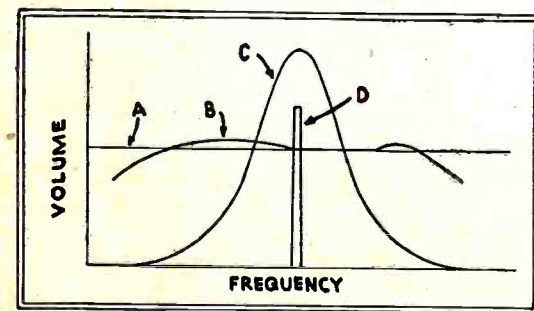
(A.2) This is common practice in selective, or multiplex, commercial code transmission; and amateurs have used "peaked" transformers, which respond to only a few frequencies, for a long time (for amateur code transmission; this renders it possible to select one station from several others on the same wavelength). It is a laboratory feat to select a particular frequency to the total exclusion of all others (thus obtaining a "flat-top" characteristic). (See Fig. Q.78B.)

**ANTENNA COUPLING — NUMBER OF R.F. STAGES — TUNING I.F. TRANSFORMERS**

(79) Mr. Milton Auerbach, Cleveland, Ohio.

(Q.1) Please furnish construction details for an antenna coupler to be used with a superheterodyne. The I.F. coils are peaked at 4,300 meters.

(A.1) An essential value, the capacity of the



(Fig. Q78B.) A good A.F. transformer has a response curve B very close to even amplification (A); while the tuned transformer has a curve C to peak at one signal tone—or even, as at D, to shut out all others.

**SCREEN-GRID SET DESIGN**

(80) Mr. Fred D. Smith, Oklahoma City, Okla.

(Q.) After trying everything I can think of to make my screen-grid receiver work, I must acknowledge I am "stumped." The coils were home-made, and all constants are given with the diagram I am furnishing as reference. Selectivity is not a paramount consideration.

The set works excellently with a type '99 tube in the R.F. stage, with the wiring changed to accommodate this tube; but, with the '22 in use, the only reception is local stations with volume no greater than with the '99. Changing screen-grid tubes does not remedy the fault.

What is the best procedure to follow without testing apparatus to balance a set?

(A.) The diagram of connections referred to by

.. leaders of radio forecast the future!

**RADIO**

AND ITS FUTURE

Edited by MARTIN CODEL



Price \$3.98

What is the present status of radio, and what will be its future place in American life?

To answer these questions, twenty-nine of the best minds affiliated with the several branches of radio have collaborated to give an authoritative and fascinating picture of the present significance and the probable development of the radio industry as a whole.

What the leaders of the industry are thinking, what they expect of the future, and how they are making plans in accordance with their own well-founded beliefs, will be of immense value to every one connected in any way with radio or who is interested in any of its many complex phases.

Each chapter in this book was prepared by the acknowledged leader in his branch of radio, and the volume thoroughly reviews the present and the future of radio broadcasting, communications, the radio industry, regulation, and the science of radio.

So inclusive is the choice of authors, so broad the field covered, that the book will have a wide general appeal to all types of readers. And its practical value is tremendously increased by the authoritative nature of each chapter, thus making the volume a practical manual for workers in the field of radio and for all who want to increase their knowledge of this fascinating subject.

**Of Special Interest to:**

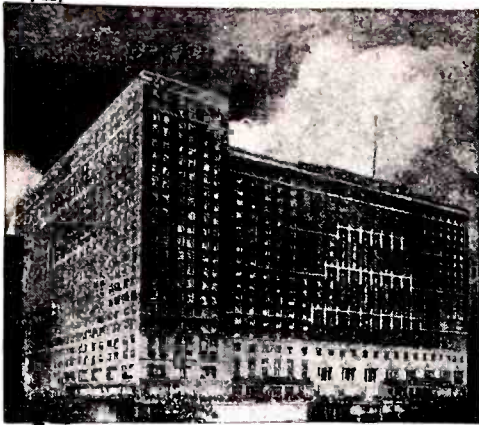
- Radio Manufacturers and Dealers
- Radio Advertisers and Prospects
- Advertising Agencies
- Broadcasting Stations
- Educators—Publicists—Radio Fans

**MAIL COUPON TODAY!**

GREN PARK COMPANY 245 Greenwich St., New York, N. Y. RC-8

Enclosed find check, money order or stamps (check which) for \$3.98 for which send me, postage prepaid, a copy of RADIO AND ITS FUTURE, edited by Martin Codel.

NAME .....  
 ADDRESS .....  
 CITY..... STATE.....



## Famous

For years as the hotel where courteous service, unexcelled food and comfortable rooms make a visit to Chicago a memorable event. The atmosphere prevailing is surprisingly homelike. Directly adjoining principal office buildings, shops and theatres.

Rooms, \$2.50 up—  
with bath \$3.50 up

# NEW BISMARCK HOTEL CHICAGO

Write for Booklet with city map

## QUIT TOBACCO

No man or woman can escape the harmful effects of tobacco. Don't try to banish unaided the hold tobacco has upon you. Join the thousands of inveterate tobacco users that have found it easy to quit with the aid of the Keeley Treatment.

## KEELEY Treatment For Tobacco Habit Successful For Over 50 Years

Quickly banishes all craving for tobacco. Write today for Free Book telling how to quickly Free yourself from the tobacco habit and our Money Back Guarantee.

THE KEELEY INSTITUTE  
Dept. L-704 Dwight, Illinois

## Become a Reporter!

Thousands of opportunities for young men to enter the Newspaper field. Fascinating work. You will meet interesting people; interview celebrities. A famous New York reporter with twenty years of practical experience has written a whole course of journalism and reporting in six easy lessons. He shows you the short-cut to success. He tells you what to do and what not to do, to become a successful reporter. Send today for the "PRACTICAL COURSE IN JOURNALISM," by Henry John Brockmeyer of *The New York Evening Post*. Just drop us a Postal Card—no need to send money. We will mail you the whole set of six books and you pay the Postman \$3.00 plus a few cents for postage. No more to pay. Money absolutely refunded if not satisfied.

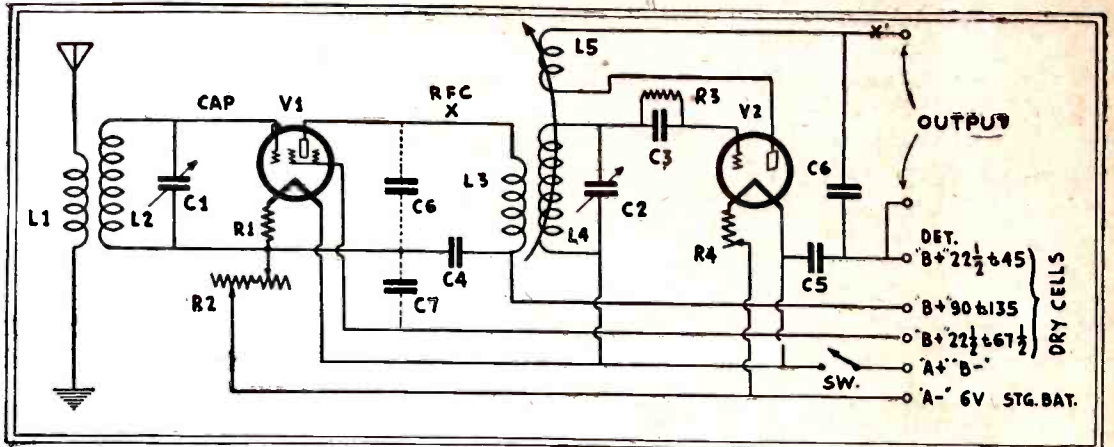
PRESS GUILD

16 W. Murray Street, New York.

## SONG WRITERS!



Substantial Advance Royalties are paid on work found acceptable for publication. Anyone wishing to write either the words or music for songs may submit work for free examination and advice. Past experience unnecessary. New demand created by "Talking Pictures" fully described in our free book. Write for it Today—Newcomer Associates  
751 Earle Building, New York, N. Y.



(Fig. Q.80) The tuning unit of a home-made screen-grid broadcast receiver, designed for use where local station interference is not a problem in the search for distant reception. Close coupling to the detector is desirable under these conditions only.

Mr. Smith is Fig. Q.80. The constants supplied by him are as follows: L1, 28 turns of No. 22 D.C.C. wire on a 1-in. spiderweb form (form removed after winding); L2, 50 turns of No. 20 D.S.C. wire on a 3-in. tube; L3, 20 turns, No. 26 D.C.C., 3-in. tube; L4, 50 turns, No. 26 D.C.C., 3-in. tube; L5, 20 turns, No. 36 D.S.C., 2 1/2-in. tube; C1, C2, .0005-mf.; C3, .00025-mf.; C4, C6, .001-mf.; C5, .002-mf.; R1, 6 ohms; R2, two 30-ohm rheostats in series; R3, 2 1/2 meg.; R4, 30 ohms; V1, type '22 tube; V2, '00A; at X an 85-mh. R.F. choke coil was tried.

Sensitivity in this circuit may be obtained by shielding the R.F. inductances; at least, shield L3, L4, L5. There is no logic in connecting an R.F. choke coil at X (as diagrammed) and by-passing the signal to ground through the .001-mf. condenser C6A (dotted lines); it should pass unimpeded through primary winding L3. An 85-mh. choke at X1, on the other hand, is to be recommended; C6 should then be reduced to .0005- or even .00025-mf. Change the value of C4 and C5 to 2-mf.; add a 0.25-mf. condenser at C7.

Rewind L3 and L4 so that there are as many turns in L3 as are in L4, and so that the wires will be side-by-side as though they were a single wire; the close coupling of these two coils will probably necessitate only about 46 or 47 turns to obtain balanced dial readings. The selectivity will not be as high as when looser coupling is employed.

Check over the ground connections; use an aerial about 80 to 100 ft. long.

The type '00A tube ordinarily works best with a negative grid return; check this point. Try a type '01A tube as V2, for the connections as now shown, and try other grid leaks. For distance reception, make all adjustments while listening to distant stations and do not change values because locals are thereby received better.

The control-grid lead (cap lead) of the '22 tube used at V1 should be kept as short as possible; be sure that there is 135 volts on the plate.

The value of the plate resistor coupling the detector into the A.F. amplifier should be determined by experiment. High plate coupling resistance can be compensated by increasing the "Det. B+" potential until good regeneration control is obtained by adjustment of L5.

The principal reasons for poor amplification through V1 are lack of plate impedance (corrected by increasing the number of turns in L3 and tightly coupling this winding to L4) and circuit feed-back between the input and output of V1.

### APPLICATIONS OF PUBLIC-ADDRESS UNITS

(81) Mr. N. A. Laney, Akron, Ohio.

(Q.) Are there very many applications of the modern "public-address" type of audio amplifier, aside from the generally known ones: (a) at parks; (b) at political gatherings; (c) in theatres; (d) in dance halls?

(A.) By checking over sales records, Samson Electric Company has been able to compile a representative list of applications of their own product, the "PAM" public-address unit, and we present additional uses taken from this list:

"Airplanes, amusement parks, apartment houses, auditoriums, athletic fields, bathing beaches, banquet halls, baseball parks, brokerage offices, cabarets, charitable institutions, churches, clubs, conventions, dancing schools, encampments, factories, fairs, filling stations, flying fields, football games, hockey matches, home entertainments, hospitals, hotels, ice skating rinks, merry-go-rounds, motor cars, open-air

assemblies, orphan asylums, paging systems, polo games, railroad depots, race tracks, regattas, receptions, restaurants, roller skating rinks, sanitariums, schools, stores, summer resorts, swimming pools, veterans' homes and carnivals."

The sound requirements of these various demands vary within wide limits, from one reproducer or pair of headphones to forty or fifty reproducers and perhaps fifteen hundred or two thousand pairs of headphones.

From a study of these figures it becomes evident that the chances for placing a public-address system are very numerous, for the technician with a little sales ability.

(Continued on page 124)

### A Reference List of the Schematic Circuits of COMMERCIAL RECEIVERS Which Have Appeared in Past Issues of RADIO-CRAFT

April, 1930

- Kellogg "523" and "526" (No. 15 Data Sheet), p. 494;
- Radiola "25" Superheterodyne (No. 16 Data Sheet), p. 495;
- Pilot "P.E.6" Broadcast Receiver, p. 511;
- Crosley "5-38" Tuned R.F. Receiver, p. 525;
- Majestic "Model 90" Receiver Chassis, p. 525;

May, 1930

- Atwater Kent Models "30," "33," "35," "48," and "49" (No. 17 Data Sheet), p. 558;
- Crosley "AC-7" and "AC-7C" (No. 18 Data Sheet), p. 559;
- Radiola "64" (without power pack), p. 562;
- Bosch Motor Car Radio Receiver, p. 571;
- Hammarlund "HiQ-30" Receiver, p. 581;
- Atwater Kent "Model 10B," p. 588;
- Crosley "Model 3B and 3C," p. 588;
- Crosley "Trirdyn" (Model "3R3"), p. 588;
- Crosley "Model XJ and XL," p. 590;
- Crosley "Type V," p. 590;
- Crosley "Model 51," p. 590;
- Crosley 2-stage A.F. Amplifier, p. 590;

June, 1930

- Amrad "Model 81" ("Bel Canto" Series) Receiver, (No. 19 Data Sheet), p. 626;
- Radiolas "Super VIII" (AR-810), "Semi-Portable" (AR-812), "24," and "26" (No. 20 Data Sheet), p. 627;
- Jewell "Model 199" Set Analyzer, p. 630;
- "The Voice of the Road" Automobile Receiver (Continental Wireless Supply Corp.), p. 639;
- "Ambassador Four" Receiver, p. 648;
- "Tom Thumb" Portable Receiver (Screen-Grid Model), p. 670;

July, 1930

- Silver Radio Models "30" (Chassis), "60 Lowboy," "95 Highboy" and "75 Concert Grand" (No. 21 Data Sheet), p. 18;
- Eveready "Series 30," "Series 30-C," and "Series 40" Receivers (No. 22 Data Sheet), p. 19;
- Amateur's Television Projector (Insuline Corp. of America), p. 26;
- "Aerodyne Six" Receiver, p. 42.

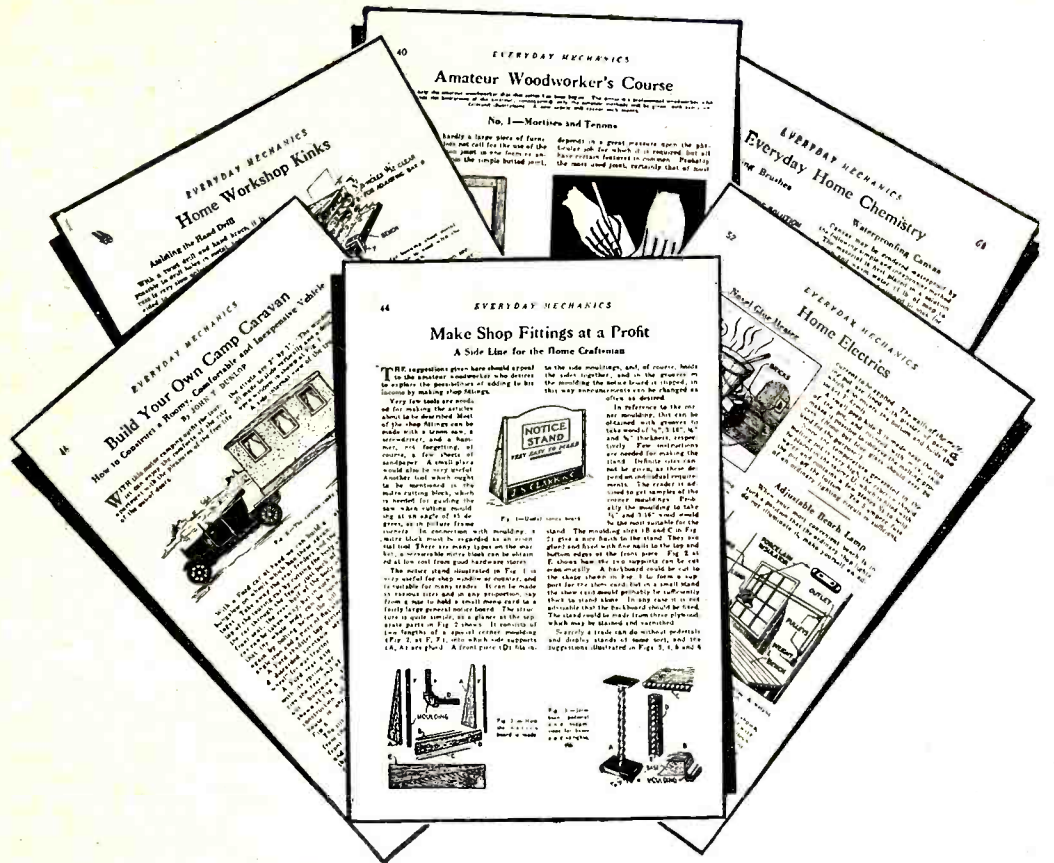
Copies of any of these back numbers are still available at 25 cents each, postpaid

# EVERYDAY MECHANICS

## Will Increase Your Earning Power

Whatever your job, you will find in **EVERYDAY MECHANICS** labor-saving kinks which will help you to get more work done in less time and will bring you recognition from your employers. If you do machine shop work of any kind, auto repairing, sheet metal work, electrical work, farming, concrete work, carpentering, tool making, poultry raising, painting, plumbing, masonry, building, glass work, welding, or general repairing, a yearly subscription to **EVERYDAY MECHANICS** will pay for itself a thousand times over.

A few of the interesting pages from **EVERYDAY MECHANICS**



## Make Money in Your Spare Time

Hundreds and thousands of amateur mechanics and spare-time workers are making \$10 to \$100 a week **EXTRA MONEY** by servicing vacuum cleaners and washing machines; repairing automobiles; manufacturing book-ends, lamp-shades, tool chests, chairs, tables, unique ornaments, concrete articles, photo frames, flower boxes, ladders, tanks, garages, gliders, and innumerable products in everyday use. **EVERYDAY MECHANICS** teaches you **HOW** to turn your spare time into **MONEY**. **EVERYDAY MECHANICS** is staffed by real engineers and practical mechanics who tell you about the latest ideas and inventions which you can **CAPITALIZE** to your **OWN PROFIT**.

## A Special Offer

In order that you may not miss any of the splendid features now appearing in **EVERYDAY MECHANICS** and opportunities for making money from the unique 'tips' that are published in every issue the publishers will send this valuable magazine **DIRECTLY TO YOUR HOME** every month at a reduction of **ONE-THIRD** off the usual subscription price. But to take advantage of this offer you must act quickly. Tear off the coupon to the right and mail it today. **YOUR FIRST COPY OF EVERYDAY MECHANICS WILL BE SENT YOU BY RETURN MAIL.**

**EVERYDAY MECHANICS PUBLICATIONS, INC.**  
96-98 Park Place . . . . . New York, N. Y.

## CONTENTS

Space does not permit us to print the 58 features in the current issue of **EVERYDAY MECHANICS**. But the following titles will give you some indication of the interesting and valuable contents:

- USEFUL FACTS FOR THE GLIDER ENTHUSIAST** (soar over your house on a primary glider)
- SIMPLE MODEL STEAM ENGINE RUNS ON GAS STOVE** (teach your child the principles of engineering)
- TRICKS THAT MADE MAGICIANS FAMOUS** (there's spare-time money for the amateur magician)
- ELECTRICAL MACHINE TRANSMITS SPEECH IN MANY LANGUAGES** (a wonderful invention of the World Power Conference)

and fifty-four other helps and fascinating features about Automobiles, Aviation, Chemistry, Construction Work, Electricity, Magic, Metal Work, Radio, Photography, Shop Work, Woodworking and new devices.

## Mail Coupon Today

**EVERYDAY MECHANICS PUBLICATIONS, Inc.**  
96-98 Park Place, New York, N. Y. RC:8

Please rush my first copy of **EVERYDAY MECHANICS**. I enclose

\$1.00 for one year's subscription  
 1.90 for two years' subscription  
 2.70 for three years' subscription

(Check one of the above)

NAME .....

ADDRESS .....

CITY..... STATE.....

NOTE: This special subscription offer may be withdrawn at any time.

**HOTEL  
EMBASSY**  
BROADWAY AT 70<sup>TH</sup> ST.  
NEW YORK

**400 LARGE LIGHT ROOMS  
ALL WITH BATH**

**\$2.50 A DAY FOR ONE PERSON  
\$3.50 A DAY AND UP FOR TWO**

*Special Rates for Permanent  
Guests*

FINE RESTAURANT  
REASONABLE PRICES  
Club Breakfast, 30¢ to 50¢  
Luncheon, 75¢  
Table d'Hote Dinner, \$1.00

**EDMUND P. MOLONY**  
*Manager*

### THE SKLAR MULTI-METER

(82) Mr. Behringer, Philadelphia, Pa.  
(Q.1) Referring to the article, "A Multi-Meter and Tester," by Louis B. Sklar, which appeared in the December, 1929, issue of RADIO-CRAFT, I find that I cannot get a reading on the meter when trying to use K2-K2, K3-K3 terminals and an 110 A.C. supply. What is the explanation for this?

(A.1) The author of this article advises as follows:

"There may be several reasons why you cannot get a reading on the meter, which are as follows: (a) defective tube; (b) keeping switch 8B closed, or 8A and 8C open, while taking the reading on meter; (c) an incorrect connection; or (d) a break in the wire-wound resistor (a not uncommon occurrence).

"Trace out your connections, make sure that your units are not defective and perform the tests described in the article; and I do not see any reason why you should not get results."

(Q.2) How does the 0-25-ma. meter connect with the 6,000-ohm resistor?

(A.2) The 6,000-ohm resistor is not supposed to connect with the milliammeter. The purpose of this resistance is to impress a voltage (A.C. or D.C.) between the grid and filament of the vacuum tube; which is the case when it is desired to measure an unknown A.C. voltage, as explained in the article.

(Q.3) Should a 200- or 300-ohm rheostat be used in the Multi-Meter at (2); both are mentioned?

(A.3) Either may be used. This rheostat, as will be observed, is a shunt across the milliammeter and, by using this unit, it becomes possible to obtain an additional range with the meter.

### PHASE SHIFTING IN AMPLIFIER

(83) Mr. H. M. Barnes, Akabo, Ainsdale, Lancs., England.

(Q.) I have read with great interest the article by C. H. W. Nason, "Amplifying the Television Signal," in the March, 1930, issue of RADIO-CRAFT. I note, however, that he says, "As the signal passes through each stage (of resistance-capacity coupled amplification) it becomes shifted in phase 90°." In respect to what? Surely what takes place is a reversal of sign and, if expressed in degrees, could only be called 180°. Perhaps Mr. Nason's 90° does not refer to the ordinary rotating vector of A.C. phasing. If so, I should be very interested to have an explanation of his method of designation.

(A.) The reference given was for a regular rotating vector and should have read, as you state, 180°.

### CORRESPONDENTS WANTED

Editor, RADIO-CRAFT:

I wish to let other boys know of the correspondence club that I and another with whom I have been corresponding have started. Our idea is to swap data, as much as can be learned this way. There are no dues; each member will be given a list of the others and their ages, and he can pick those with whom he wishes to correspond. A separate list will be made out for those who operate short-wave transmitters and receiving sets. My associate has a transmitting license, and I hope to have one shortly.

I would not part with my file, almost complete from the first, of your former magazine and RADIO-CRAFT. My broadcast receiver is the Peridyne, which I constructed myself; and I am now using the "Craft Box" for short-wave reception.

KENNETH T. ADAMSON,  
234 East 5th St.,  
Plainfield, N. J.

I would like to correspond with readers all over the world who are interested in sound projection, to know just how conditions compare with those in the United States, and will reply promptly to all letters.

DAVID BOROVIK,  
1612 Summit Lake Boulevard,  
Akron, Ohio.

I would like to hear from any reader who caught the call letters of a station at Drummondville, Canada, sending a program to the *Laurentic* and the *Duchess of Richmond*; they seemed to be in French.

W. GOSCH,  
296 Peck St., New Haven, Conn.

Other readers inviting the correspondence of short-wave fans are Richie T. Hepburn, Rogers, Ohio; Carl Skatzes, 45 Flax St., Delaware, Ohio; and Ralph Wynne, 1438 Chester St., Toledo, Ohio.

## Classified Advertisements

Advertisements in this section are inserted at the cost of ten cents per word for each insertion—name, initial and address each count as one word. Cash should accompany all classified advertisements unless placed by a recognized advertising agency. No less than ten words are accepted. Advertising for the September 1930 issue should be received not later than July 9th.

### CHEMICALS

BOOKLET OF EXPERIMENTS and chemical catalog, 15c. General Chemical Company, Box 397, Reading, Penna.

### DETECTIVES

DETECTIVES Earn Big Money. Excellent opportunity. Experience unnecessary. Particulars Free. Write, George Wagner, 2190B Broadway, N. Y.

### INSTRUCTION

LEARN TATTOOING. Instruction catalog, dime. Miller, X431 Main, Norfolk, Virginia.

### INVENTIONS

INVENTIONS COMMERCIALIZED. Patented or unpatented. Write Adam Fisher Mfg. Co., 594 Enright, St. Louis, Missouri.

### MISCELLANEOUS

TO THE MAN OR WOMAN seeking correspondence, matrimony or pen pals, we offer entirely different service. Box 1540, Sta. G, Los Angeles, Cal.

### OLD MONEY WANTED

\$5 to \$500 EACH paid for Old Coins. Keep ALL old money. Many VERY valuable. Get Posted. Send 10c. for illustrated Coin Value Book, 4x6. Guaranteed Prices. We buy and sell. COIN EXCHANGE, Room 10. Le Roy, N. Y.

### PRINTING

100 OF EACH, Business letterheads and Envelopes, printed, your copy \$1.50. CRANE, Box 7622 Kansas City, Missouri.

### RADIO

AUDIO-TRANSFORMERS repaired for \$1.00, push-pull \$1.50. All work guaranteed 90 days. ANDOVER RADIO LABORATORY, Andover, Illinois.

### STATEMENT OF THE OWNERSHIP, MANAGEMENT, CIRCULATION, ETC., REQUIRED BY THE ACT OF CONGRESS OF AUGUST 24, 1912.

Of Radio-Craft, published monthly at Mt. Morris, Ill., for April 1, 1930.  
State of New York | ss.  
County of New York

Before me, a Notary Public in and for the State and county aforesaid, personally appeared Irving S. Manheimer, who, having been duly sworn according to law, deposes and says that he is the business manager of Radio-Craft and that the following is, to the best of his knowledge and belief, a true statement of the ownership, management, etc., of the aforesaid publication for the date shown in the above caption, required by the Act of August 24, 1912, embodied in section 411, Postal Laws and Regulations, to wit:

1. That the names and addresses of the publisher, editor, managing editor, and business managers are: Publisher, Techni-Craft Publishing Corporation, 404 North Wesley Ave., Mt. Morris, Ill.  
Editor, Hugo Gernsback, 98 Park Place, New York City.  
Managing Editor, B. D. Washburne, 98 Park Place, New York City.  
Business Manager, Irving S. Manheimer, 98 Park Place, New York City.

2. That the owners are: Techni-Craft Publishing Corporation, 404 North Wesley Avenue, Mt. Morris, Ill.  
Hugo Gernsback, 98 Park Place, New York City.  
Sidney Gernsback, 98 Park Place, New York City.  
D. Manheimer, 98 Park Place, New York City.

3. That the known bondholders, mortgagees, and other security holders owning or holding 1 per cent. or more of total amount of bonds, mortgages, or other securities are: None.

4. That the two paragraphs next above, giving the names of the owners, stockholders, and security holders, if any, contain not only the list of stockholders and security holders as they appear upon the books of the company but also, in cases where the stockholder or security holder appears upon the books of the company as trustee or in any other fiduciary relation, the name of the person or corporation for whom such trustee is acting, is given; also that the said two paragraphs contain statements embracing affiant's full knowledge and belief as to the circumstances and conditions under which stockholders and security holders who do not appear upon the books of the company as trustees, hold stock and securities in a capacity other than that of a bona fide owner; and this affiant has no reason to believe that any other person, association, or corporation has any interest direct or indirect in the said stock, bonds, or other securities than as so stated by him.

Sworn to and subscribed before me this 26th day of May, 1930.

ROZELLA BENNETT, Notary Public.  
(My commission expires March 30, 1931.)

  
**PATENTS  
TRADE-MARKS**

DO NOT LOSE YOUR RIGHTS  
TO PATENT PROTECTION

Before disclosing your invention to anyone send for blank form "EVIDENCE OF CONCEPTION" to be signed and witnessed.

LANCASTER, ALLWINE & ROMMEL  
(Registered Patent Attorneys)  
475 Ouray Bldg., Washington, D. C.  
Originators of forms "Evidence of Conception"

**PATENTS** Write for Free Guide Book, "HOW TO OBTAIN A PATENT" and Record of Invention Blank. Send model or sketch and description of your invention for our Free Opinion whether it comes within Patent Office Rules. RADIO and ELECTRICAL Cases a Specialty. Prompt, Efficient Service. PAYMENT OF FEES IN INSTALLMENTS  
VICTOR J. EVANS & CO., 923 - 9th, Washington, D. C.

**Orders - Inquiries**

60 pages  
Send for  
**FREE COPY**

Can be Secured by  
**MAIL**

**POLK'S REFERENCE BOOK  
and Mailing List Catalog**

Gives counts and prices on over 8,000 different lines of business. No matter what your business, in this book you will find the number of your prospective customers listed. Valuable information showing how to use the mails to secure orders and inquiries for your products or services is given.

Write for **FREE COPY**  
**R. L. POLK & CO., Detroit, Mich.**  
Largest City Directory Publishers in the World. Branches in Principal Cities  
Mailing List Compilers—Business Statistics  
Producers of Direct Mail Advertising

FACTORY TO YOU—SAVE to 50%—COMPARE WITH COSTLIEST OUTFITS BEFORE YOU BUY

# Enjoy a powerful new Miraco 30 DAYS FREE

Latest 1931 SUPER Screen Grid Outfit (No obligation to buy)



### NEWEST IN RADIO! TOP OPERATION

in this 1931 Miraco "Easy-Chair" model with magazine racks, each end. Place it anywhere in any room. Easily moved about. Small door in top conceals dial and controls when not in use. 26 in. high, 15 in. wide — yet it contains a complete full-size radio and Super-Dynamic speaker! No outside aerial or ground required. Many other new, clever models, obtainable nowhere else, shown in free literature.

Get Our "SEND NO MONEY" 11th Anniversary Offer!

## Latest 1931 Super Screen Grid FULL YEAR'S GUAR.

lighted 1 dial steel chassis  
Vari-Tone and Automatic Sensitivity Control  
Also latest PUSH-PULL Amplification

Built like—looks like—performs like newest radios in many outfits much more costly. Latest, finest, heavy duty construction. Skillfully engineered to super-utilize a battery of "224" SCREEN GRID tubes—in addition to "245" PUSH-PULL POWER, "224" HUM-FREE long-lived POWER DETECTOR and AMPLIFIER and "280" A-C TUBES. Vari-tone feature gives any tone-pitch your ears prefer. Automatic Sensitivity Control reduces "fading," protects tubes. Phonograph pick-up connection. Built-in house wiring aerial and ground. Built-in plug for electric clock, lighter, lamp, etc. Super-sturdy power section. Razor-edge selectivity; Super-Dynamic Cathedral tone quality; marvelous distance-getter. Solid one-year guarantee if you buy! Wide choice of cabinets.

Easy Chair Model

(as illustrated less tubes)

# Only \$49<sup>88</sup>

COMPLETELY ASSEMBLED

Values possible because you deal direct with big factory

# MIRACO

TRADE MARK REGISTERED

CATHEDRAL TONED, SUPER SELECTIVE, POWERFUL DISTANCE GETTERS

You need not send us a cent! For its 11th successful year, America's big, old, reliable Radio Factory again sets the pace in high-grade, latest guaranteed radios *direct to you*. And

### Don't Confuse with Cheap Radios

With Miraco's rich, clear Cathedral Tone, quiet operation, razor-sharp separation of nearby stations, tremendous "kick" on distant stations, Vari-Tone and automatic sensitivity control, and other latest features—be the envy of many who pay 2 or 3 times as much!

## EASY TERMS

to reliable persons only

### USER-AGENTS WANTED

Exclusive Territory—Try it at Our Risk!

Spare or full time. No contract, no experience required. Big money! Send coupon now!

Send for proof that delighted thousands of Miraco users cut through locals, get coast to coast, with tone and power of costly sets.

Miraco's are built of finest parts—approved by Radio's highest authorities. Our 11th successful year!

### Deal Direct with Big Factory

Miraco outfits arrive splendidly packed, rigidly tested, to plug in like a lamp and enjoy at once. No experience needed. Entertain yourself 30 days—then decide. Liberal year's guarantee if you buy. Play safe, save lots of money, insure satisfaction—deal direct with Radio's big, reliable, pioneer builders of fine sets—successful since 1920. SEND POSTAL OR COUPON NOW for Amazing Offer!

At our risk, compare a Miraco outfit with highest priced radios 30 days and nights. Surprise, entertain your friends—get their opinions. Unless 100% delighted, don't buy! Your decision is final—no argument!

Only marvelously fine radios, of latest perfected type, at rock-bottom prices, can back up such a guarantee. Send postal or coupon for *Amazing Special Factory Offer!*

Only marvelously fine radios, of latest perfected type, at rock-bottom prices, can back up such a guarantee. Send postal or coupon for *Amazing Special Factory Offer!*

MIDWEST RADIO CORP. 895-AA Miraco Dept., Cincinnati, Ohio

BEAUTIFULLY ILLUSTRATED LITERATURE, TESTIMONY OF NEARBY USERS, PROOF OF OUR RELIABILITY—

All the proof you want—of our honesty, fairness, size, financial integrity, radio experience and the performance of our sets—including Amazing Factory Offer—sent without obligation!

# Free!

MIDWEST RADIO CORPORATION  
Pioneer Builders of Sets—11th Successful Year  
895-AA Miraco Dept., Cincinnati, Ohio

THIS COUPON IS NOT AN ORDER

WITHOUT OBLIGATION, send latest literature, Amazing Special Free Trial Send-No-Money Offer, testimony of nearby users and all Proof.  User.  Agent.  Dealer  
 Check here if interested in an EXCLUSIVE TERRITORY PROPOSITION  
NAME..... ADDRESS.....



## NEW LOW FACTORY PRICES

### SAVE to 50%

Similar Low Prices on Beautiful Variety of Latest Fine Consoles. Send Coupon!

### 30 DAYS FREE TRIAL

Electric Clock Model Medium-size "Hi-Boy." Built-in clock over dial. Latest drop-panel front. Rich design, fine woods, fine finish. Astonishingly low factory to you price.



Stylish small console with convenient magazine racks, each end. Another exclusive Miraco-Mastercrest 1931 design. Bargain factory to you price!



Full-size wall console with latest 1931 features. Beautiful design and woods. Priced very low, factory to you.

These Consoles are Equipped with **SUPER DYNAMIC CATHEDRAL TONE REPRODUCERS**

Also: built-in aerial and ground—and built-in extra light socket!

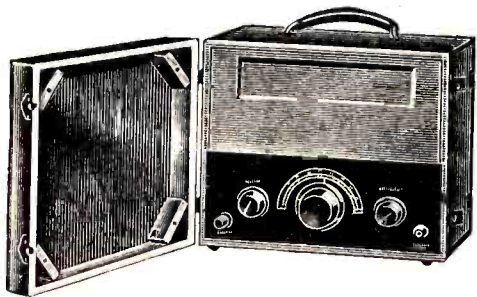
Magnificent new 1931 Miraco-Mastercrest creation. Send coupon for complete showing including Radio-Phonographs. Low factory-to-you prices.



# BARGAINS *unheard of before!*

◆ DEALERS — RADIO SERVICE MEN: Astounding prices such as presented on this page for merchandise are rarely found anywhere. Advantage of these wonderful buys should be taken NOW. Even stocking them will save you considerable money. ◆

## TOURIST PORTABLE



Size 8½ x 10 x 12½ in. Weight only 23 pounds complete.

No outside wires—everything in one small traveling case. Has provisions for Antenna and Ground which can be used efficiently and with selectivity on local broadcasting stations. Complete set can be taken indoors or outdoors—at home or on a trip—in the auto, train, boat, camp—anywhere—and good music is there.

List Price \$49.50—\$24.75 Your Price  
Without Accessories

**\$29<sup>95</sup>**

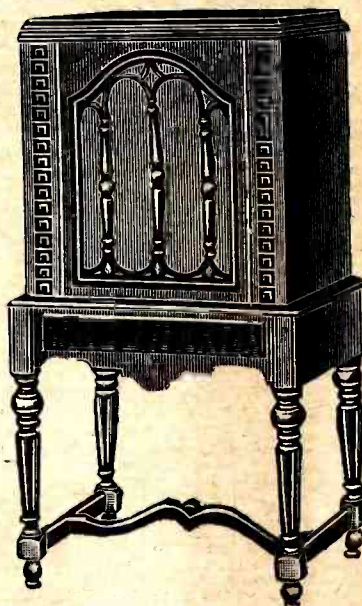
With all Accessories ready to play

Volume  
Selectivity  
Tone  
Compact  
Light  
Attractive  
Efficient  
Simple to  
Operate

## Peerless Super Speaker

and Sonora Cabinet

You cannot completely capture the musical splendor hidden in your radio set until you tune it in on programs with the new Sonora Melodonic Speaker. Of advanced dynamic design, it improves the performance of any radio set, regardless of its already seeming perfection. The MELODONIC loud speaker, with a PEERLESS SUPER DYNAMIC 10" cone, is enshrined in a beautiful cabinet designed by master craftsmen. Operates from 110 volts; 60 cycles, A.C. current. Size: 40" high; 21" wide; 18" deep—all in factory cases. List \$155.00



Price **\$24<sup>95</sup>**

CABINET ONLY \$13.50

## Powertone "B" Eliminator

Fully Guaranteed

Operates on 110 volts A.C.—"B" Eliminator with 3 taps — variable detector, 45, 90 and 200 volts — with tube — totally dry

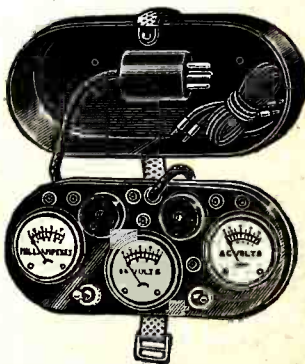


**\$9<sup>50</sup>**

## Readrite No. 245

A handy tester for all circuits and tubes — for accurate testing. Especially designed for sets using 245 power tube.

PRICE **\$9<sup>95</sup>**



## DUO-MAGNETIC SPEAKER



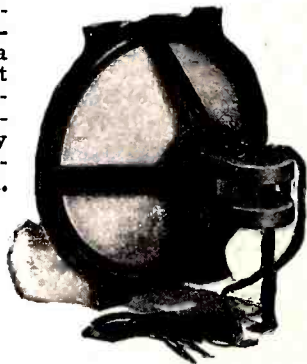
Here is a speaker you will be very proud to recommend to your trade! Low priced! Very efficient! Plenty of volume! No distortion! No blasting! Just sweet, mellow music—100% faithful reproduction. The cabinet is not only beautiful to look at, but it serves as a most efficient baffle chamber as well—acoustically correct! Note the highly decorative effects on the grille. Five-ply veneer walnut housing. Completely assembled, including a Duo-Magnetic Unit and Burtex Cloth Cone (8 in. in diameter). Dimensions: 9¼ x 9¼ x 7½ in. Shipping weight 8 pounds.

List \$30.00. Your Special Cost

**\$5<sup>95</sup>**

## FARRAND INDUCTOR DYNAMIC CHASSIS

Here is not only true Dynamic operation and performance at a popular price, but opportunity to enjoy Dynamic reception from every type of radio receiver. 9 in. Diam.



**\$7<sup>49</sup>**

## ALLEN ROTOR

Turn Table for A.C.



The ROTOR is the one silent electric phonograph motor that is favored by the majority. Motor is 1¼" thick—it is a marvel of engineering—with table.

PRICE **\$4<sup>45</sup>**

If C.O.D. shipment is desired at least 20% remittance must accompany order—balance on delivery. If cash accompanies order for full amount deduct 2% discount. Include sufficient remittance if parcel-post shipment is desired—any excess will be refunded.

# Radio Surplus Corp.

56R VESEY ST. . . NEW YORK, N. Y.

FREE  
CATALOG!

Dealers are requested to send for our latest bulletin showing real bargains in excellent radio merchandise.



# MERCHANDISE

*of Standard Manufacture*

Merchandise presented on these two pages are the products of well-known radio manufacturers. All products are guaranteed, and are offered at prices far below actual manufacturing costs. Opportunity of these bargains should be taken advantage of immediately.

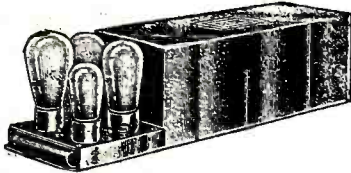


## Power Amplifiers and Power Supply Units

(In original factory cases)

### S.M. 679-250 Power Amplifier for Phonograph or Radio

The new AUDITORIUM two-stage amplifier for use where medium power amplification is desired. Operates directly from the detector output of any standard radio set, magnetic phonograph pickup, or single or double button microphone. Unusually efficient design permits an undistorted output of 7 to 8 watts. Will successfully operate from 4 to 8 dynamos or 15 to 30 magnetic types of speakers. This 250 unit offers indoor coverage up to 2000 people, or up to 5000 people outdoors. Incorporates the finest of parts, making possible high quality reproduction and years of carefree operation. Housed in a sturdy metal container of dark crackle brown finish, size 21 x 5 3/4 x 5 1/4 inches. For 105-120 volt, 50-60 cycle A.C. operation. Tubes required: 1-UX226, 1-UX250, 2-UX281. The SM 679-250 Amplifier, completely assembled and wired, priced without tubes. List, \$125.00.



**\$22 50**

YOUR NET PRICE.....

## VARION "A" "B" and "C"

### ELIMINATOR WITH 245 ADAPTER

This Bone-dry "A-B-C" Eliminator will furnish a full 250 volts of "B," sufficient "A" current for 10 tubes and a maximum of 40 volts for "C." Besides this, it is equipped with an adapter which, when inserted into the audio socket of the battery set, will convert it into an up-to-date electric set using the new 245 super power tubes. The eliminator furnishes all the "A," "B" and "C" current for the 245 tubes. Thus, this eliminator will convert any good battery set into a modern electric receiver. Uses 280 full-wave rectifier for "B" current and the Benwood Lenz Dry Disc Rectifier for "A" current. Furnishes 4 to 6 volts "A," 250 volts "B," 40 volts "C." Also filament and plate current for 245 tubes.



Our Price **\$13 95**

## Rola Dynamic

For sound recreation of brilliant quality, Rola sets a new standard that is hard to beat. Sturdy construction and the latest approved engineering designs combine to make a speaker that is rugged and dependable in operation and capable of the finest reproduction, undistorted and hum-free.

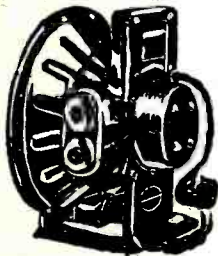
(In factory cartons)

### ROLA CHASSIS

Model J-110, for 110-volt A.C. operation, employing Rectifier.

List, \$35.00. **\$12 50**

YOUR PRICE.....



## New Balanced Shielded Dynamic Chassis

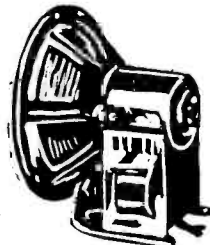
The perfection of the Utah Balanced Shielded Dynamic Chassis marks the highest development in sound reproduction. This speaker has been built to combine volume with quality of tone. An outstanding feature of the new chassis is its ability to reproduce the full range of musical instruments, catching subtle overtones and presenting them clearly and faithfully.

Utah Model 53R Dynamic Chassis for 6-volt storage battery operation.

(In factory cartons)

Retail Price, \$22.50.

YOUR PRICE .....



**\$8 95**

## NEWCOMB HAWLEY

Licensed by Magnavox

### LATEST TYPE DYNAMIC

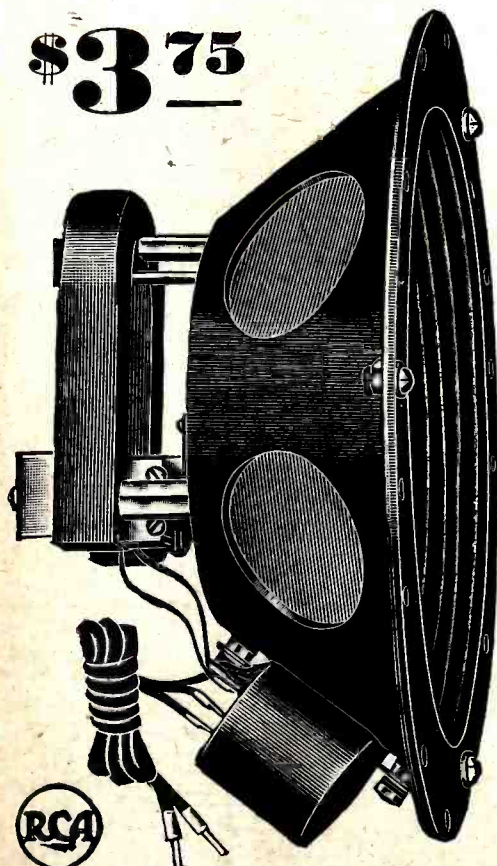
Speaker imparts new charm to radio reception. It has a marvelously truthful voice and its potencies for rich, full-bodied tone know only the limits of the broadcasting performers. It has full frequency range and has more than ample provision to absorb A.C. hum. Extra full driving power to moving coil. Battleship construction to better assure interpretation of both delicate and concert reproduction. Balanced mounting and perfect non-resonance of spider-control of moving coil. (In factory cartons.)



**\$14 75**

YOUR PRICE .....

**\$3 75**



## RCA MAGNETIC CHASSIS

What better recommendation can be made of this LATEST MODEL SPEAKER CHASSIS THAN TO MENTION THAT TWO OF THE GREATEST ORGANIZATIONS IN THE RADIO INDUSTRY, GENERAL ELECTRIC COMPANY AND RADIO CORPORATION OF AMERICA, ARE SPONSORS OF THIS PRODUCT! Before any item enters into the General Electric Co. production department, it must first pass through their WORLD RENOWNED LABORATORIES; no wonder then, that this speaker is conceded to be the WORLD'S BEST! This chassis is the identical one used in the RCA Model 100A and 100B Speakers, WHICH LIST FOR AS HIGH AS \$35.00.

Note built-in OUTPUT TRANSFORMER—this enables the speaker to be used with voltages applied to it as high as 600 volts, without any trace of distortion, rattling or blasting. Equipped with GENEROUS OVER-SIZED MAGNETS. The thick armature is ACCURATELY CENTERED. The STURDY METAL FRAME IS LINED WITH A SPECIAL FABRIC, greatly improving the acoustic properties of this sensational speaker! NOTE THE CORRUGATED SURFACE OF THE CONE, AN EXCLUSIVE FEATURE—ENHANCES PERFECT TONAL REPRODUCTION QUALITIES CONSIDERABLY. MOST COMPACTLY MADE: 9 INCHES OUTSIDE DIAMETER, 4 1/2 INCHES DEEP OVER-ALL.

IDEAL FOR AUTOMOBILE RADIO SPEAKER INSTALLATIONS—CAN BE MOUNTED IN ANY RADIO CONSOLE, or against any baffle arrangement. Complete with durable 5-foot cord.

### SPEAKER CHAMBER FOR ABOVE CHASSIS

This speaker can be installed in this special ACOUSTICALLY PERFECT BAFFLE CHAMBER in a few moments. Front baffle board included.

OUR SPECIAL PRICE .....85c

If C.O.D. shipment is desired at least 20% remittance must accompany order—balance on delivery. If cash accompanies order for full amount deduct 2% discount. Include sufficient remittance if parcel-post shipment is desired—any excess will be refunded.

## Radio Surplus Corp.

56R VESEY ST. . . NEW YORK, N. Y.

## FREE CATALOG!

Dealers are requested to send for our latest bulletin showing real bargains in excellent radio merchandise.

# TRAIN YOURSELF FOR A BETTER JOB

in

# CHEMISTRY—The Field With a Future

**W**HY should you spend your life in the hopeless rut of the untrained workman? You know that it holds no prospects for you, and some day when you realize that you have gained nothing for your years of labor, it will be too late to pull yourself out. NOW is the time to guarantee your future by getting into Chemistry—the one field that offers you boundless opportunities for a comfortable living, an enjoyable occupation, wealth and even fame.

Not an industry in the world—not a factory, mine, mill, ranch or plantation can get along without the services of chemists. Chemistry is utilized everywhere, and so many new lines of business involving Chemistry are springing up daily that there is an actual shortage of men sufficiently trained to fill the best positions.

## No Previous Experience Required

Do not think that you are barred from this attractive profession by lack of education. THE CHEMICAL INSTITUTE has taught thousands of young men, many of whom had no previous schooling of any kind. We can train you thoroughly, and may even get you your first job. The celebrated course which we give is simplified to such a point that anyone can learn who is able to read and write English. All we ask is interest in the work and willingness to devote your spare hours to it conscientiously.

The course is simple to understand and enjoyable to study, but it does not skim over the essentials. You will get just as thorough instruction as if you took the same subjects in college, but it will be easier to grasp as well as far more convenient and inexpensive. No text-book could be as explicit and readily understood as our lessons. Many professional chemists use them in their own reference libraries. And in addition to the personal services of able instructors will be yours at all times to help you, step by step, continually.

## Learn at Home in Spare Time

But a Chemistry student has to get practical training with laboratory apparatus! So he does, but we furnish you with the equipment needed to do your experimental work at home. You do not have to give up your present work while learning or leave home to attend classes. All your study and experiments can be done in your spare time. If you have very little leisure, we can accommodate you anyway, as every student is taught individually and may take as much time as he needs to complete the course. Even then he is entitled to specialized training and to the free services of our instructors as long as he wishes.

## Extra Laboratory Equipment Supplied Free

There is absolutely no extra charge for the comprehensive laboratory set which we furnish every student, containing over one hundred pieces of apparatus and chemicals. And in addition, we have just added a splendid piece of apparatus—a fine, imported microscope, which you will treasure and enjoy all your life. Every chemist would be proud to have this microscope in his laboratory. You will get yours for nothing.

With this portable laboratory and this microscope, you can duplicate famous historical experiments. Think of all the pleasure it will give you! You will really be learning while playing.

## Tuition Price Reduced

No advance in tuition price is occasioned by this newest addition to the apparatus we supply. In fact we have even reduced the fee, so that this splendid course and equipment are within the means of every individual who is interested in following Chemistry, whether as a career or merely as a hobby. Fee can be paid on EASY MONTHLY TERMS. The one price covers everything. There are no extras to buy.

## Plenty of Money in Chemistry

Why talk about hard times and lack of opportunities when Chemistry offers you a rich variety of ways to make a fortune? Every day the papers contain news of fresh discoveries in Chemistry, and for every one you read about, there are hundreds not recorded as news because their interest is purely technical. The manufacture of steel and other metals, of glass, pottery, soap, perfumes, fertilizers, dyes, drugs, celluloid and explosives—paper making, the tanning of leather, the refining of sugar—dairying, meat packing, preserving, sugar refining, and the preparation of hundreds of food products—all these and a multitude of other activities engage the skill of a chemical army. Don't you think there is room for you also?

Chemists are well-paid employees and each one has the opportunity of exposing new chemical secrets with a literal fortune as his reward. Every one of the lines of business in any way connected with Chemistry—and you can see that there are thousands of them—has brought wealth to the many chemists who were associated with its development. Are you going to throw away your chances for the same reward, when schooling in Chemistry can be so easy and delightful as it is through our course?

## No Exaggerated Claims

This Institute does not claim that every chemist makes millions; nor do we guarantee that you will immediately get a job paying \$10,000 a year. But many have done it and there is no reason why you cannot do it also.

## Get a Start Today!

If you would like to know more about Chemistry, and if you are sincere in your desire to get out of the rut and if you have ambition enough to want to become a famous chemist some day, you will not wait until tomorrow to find out.



MR. CHARLES W. SUTTLE, of Forgan, Okla. (at left on top), is deeply interested in chemical research. He performs his experimental work in his well-equipped home laboratory.

MR. O. T. D. BRANDT, of Seattle, Wash. (center photograph), is an analytical chemist of demonstrated ability. In his home he has equipped a laboratory containing several thousand dollars' worth of equipment, bought entirely with earnings from spare-time work while he was taking our course.

MR. VIRGIL REDGATE, of Hutchinson, Kans. (bottom right-hand photo), began doing professional analysis on commission, even before he completed his course. He is also the inventor of several devices and processes used in photography.

## DIPLOMA AWARDED EVERY GRADUATE

Upon graduation every student is awarded our Diploma in Chemistry, certifying that he has successfully completed his studies. Your name on this certificate will be a source of pride to you all your life, as well as an aid in obtaining a position.

**MAIL THIS COUPON**

**TODAY**

**FOR FREE BOOK!**

**CHEMICAL INSTITUTE OF NEW YORK, INC.**

**19 Park Place . . . . . New York, N. Y.**

CHEMICAL INSTITUTE OF NEW YORK, Inc.  
Home Extension Division  
19 Park Place, New York, N. Y.

Please send me at once, without any obligation on my part, your Free Book, "Opportunities for Chemists," and full particulars about the Experimental Equipment given to every student. Also please tell me about your plan of payment and the reduction in the tuition price.

NAME .....

ADDRESS .....

CITY..... STATE.....

RC-8-30

# WHAT EVERY ELECTRICIAN WANTS TO KNOW!

**JUST OUT!**—Latest Exact Information from A to Z!

We take pleasure in announcing: "AUDELS NEW ELECTRIC LIBRARY"

New and More Uses for Electricity offer great opportunities to men who can handle this power correctly. Modern electrification of industry calls for trained men who know how to handle electricity accurately.

Simple as A. B. C.—"Audels New Electric Library" gives latest, exact information from foundations of electrical practice to latest modern applications. This is a NEW practical and theoretical course in electricity for home study and ready reference.

Here are the answers to your questions, giving you the real dope that every electrician must know. They chart your knowledge, taking away the uncertainty of guess work.

**NEW!**

As Easy As ABC



Latest information, fully illustrated, covering:—

Fundamental Principles and Rules of Electricity, Magnetism, Armature Winding, Repairs, Dynamos, D-C Motors, Construction, Installation, Maintenance and Trouble Shooting, Tests and Testing Instruments, Storage Battery, Construction and Repairs, Alternating Current Principles and Diagrams, Power Factor, Alternators, Transformers, A-C Motors, Windings, Reconnecting, Converters, Switches & Fuses, Circuit Breakers, Relays, Condensers, Regulators, Rectifiers, Motors, Switchboards, Power Station Practice, House Light & Power Wiring, Circuits, High Tension, Transmission, Plans, Calculations, Code, Electric Railways, Signals, Elevators, Hoists & Cranes, Gas Engines, Auto & Aero Ignition, Starters, Radio, Telephone, Telegraph, Bells & Signals, Motion Pictures, Talkies, Lighting, Illumination, Electric Refrigeration, Heating, X-Ray, Plating, Welding, Pumps, Compressors, Domestic & Farm Appliances, An Electric Calculator for Engineers and Mechanics, Practical Mathematics for Ready Reference, A New Electric Dictionary & Encyclopedia of Words.

**7 Books Now on Sale 5 in Preparation**

The Library contains 12 books—the first 7 books containing 3600 pages with thousands of diagrams and illustrations are now ready; the remaining 5 books are in preparation. A pocket-size, flexibly bound series that is valuable wherever electricity is used.

Beautiful, timely books for service—pocket size; completely illustrated with diagrams and charts; simplified, easy to read and understand. No electrical man can afford to pass up this opportunity. Extremely low price; buy on your own terms.

QUESTIONS AND ANSWERS  
**AUDELS NEW ELECTRIC LIBRARY**  
ILLUSTRATED

**NEW!**

**SATISFACTION GUARANTEED!**  
"Audels New Electric Library" is backed by our 50-year record as helping hand publishers. Satisfaction always guaranteed.

Beautiful, Timely Books



Read for Profit

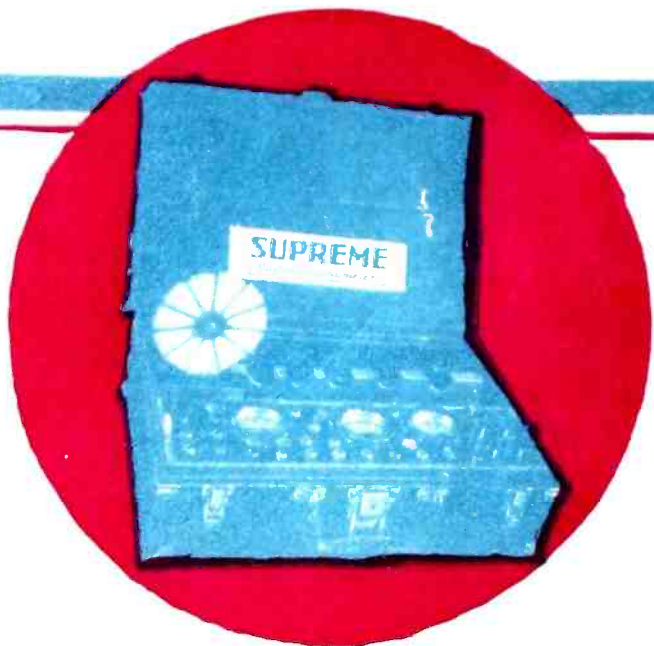
**BUY ON YOUR OWN TERMS**

- PLAN 1—ONE BOOK A MONTH**  
Please enter my subscription to "Audels New Electric Library" to consist of twelve volumes, price \$1.50 a volume (\$10.50 for the seven volumes now ready). Mail one volume each month and as they are received, I will mail you \$1.50 promptly.
- PLAN 2—PAY 50c OR MORE A WEEK**  
Please ship me for one week's free trial the first seven volumes of "Audels New Electric Library," \$1.50 each (\$10.50 for the seven volumes now ready). The remaining five volumes to be mailed as issued at \$1.50 a volume. If satisfied, I will mail you 50c or more each week as payment for the first seven books and I will pay for the last five numbers as I receive them at \$1.50 each.
- PLAN 3—CASH PRICE \$9.98**  
Please ship me postpaid "Audels New Electric Library" for which I enclose remittance \$9.98 in full payment for the seven volumes now ready. You are to ship me on one week's trial the remaining five volumes as they are issued for which I will either pay \$1.50 each as received or return to you. This price is based on 5% cash discount.

THEO. AUDEL & CO.,  
65 West 23rd St., New York, N. Y.

Please ship me the NEW "Audels Electric Library" on the plan marked (X).

NAME \_\_\_\_\_  
ADDRESS \_\_\_\_\_  
OCCUPATION \_\_\_\_\_  
EMPLOYED BY \_\_\_\_\_



Dealer's Net Price, F. O. B. Greenwood, Miss. Size 7 1/2 x 12 1/2 x 16 1/2 **\$139.50**

Also available in smaller case for the radio man who does not care to carry spare parts, tubes, etc., in same unit.

## And Now! A Revolutionary Set Analyzer

25 Testing Instruments in 1



All Readings on One Meter—Only One Meter to Read

SUPREME SET ANALYZER MODEL 90

Dealer's Net Price, F. O. B. Greenwood, Miss. Size 4 1/4 x 9 1/4 x 11 1/4. Shipping weight 6 pounds.

**\$78.50**

Responding to demand for a simple, yet more flexible and complete set analyzer, the "Supreme" Model 90 SET ANALYZER is offered to the Radio service world. Simplified to only one meter of unique design never before available in any but the most expensive laboratory equipment, it measures both A. C. and D. C. voltages up to 900 volts, and currents up to 300 milliamperes, and provides many readings and tests never before attempted with any other similar instrument. You owe it to yourself to compare "Supreme" advantages with any other set analyzer you may be considering!

Most good distributors carry the complete line of Supreme products in stock, including the Model 50 Tube Tester, Model 10 Ohmmeter, Model 17 Tube Checker, as well as the Diagonometer and Set Analyzer. If yours cannot supply you, use order coupon to the right.

# SUPREME

Testing Instruments

"SUPREME BY COMPARISON"

# Again Acclaimed "SUPREME"

Another RMA Show—Another Triumph

Standing the acid test of daily actual use in the hands of thousands of radio engineers and service men the country over, meeting every service requirement in a constantly changing field, the

## SUPREME

Radio Diagonometer

MODEL - 400 - B

remains

**UNAPPROACHED! UNCHALLENGED!**

**UNCHANGED!**

—except for the addition of Pentode Testing to its almost limitless servicing functions!



Again the SUPREME DIAGNOMETER MODEL 400-B at the RMA Show was readily conceded by engineers from all parts of the globe to be the unrivalled leader in the field of radio service instruments. Radio dealers, manufacturers, technicians and service men, in ever-increasing numbers are demanding the SUPREME DIAGNOMETER because:

1. Its unique design is outstanding—a guarantee against obsolescence.
2. Its rugged construction prevents break-down—insuring accurate operation at all times.
3. It is the one service instrument capable of making every necessary test—none other so complete.
4. It pays for itself in a few months—faster and more accurate servicing means greater profits.
5. It provides maximum efficiency with utmost simplicity—pictorial diagrams of every test supplied with each instrument.
6. It creates satisfied customers—provides a laboratory method for the solution of every service problem.
7. It provides the greatest amount of test equipment in the least possible space at the lowest cost per service unit—The service units contained in the Supreme Diagonometer, if purchased separately, would cost many times its price.

Make your Service Department outstanding—Modernize with the SUPREME DIAGNOMETER and watch your profits grow.

## SUPREME INSTRUMENTS CORPORATION

GREENWOOD, MISS.

Distributors in All Principal Cities—Service Depots in New York, Philadelphia, Pittsburgh, Chicago, Kansas City, Seattle, Toronto, San Francisco.

Supreme Instruments Corp.,  
372 Supreme Bldg.,  
Greenwood, Mississippi  
Please ship Supreme Test Instrument as checked below:

..... Model 400-B Diagonometer  
Net Cash \$139.50  
..... Time Payment Plan—\$33.50 Cash  
and 8 monthly payments of \$15.00 each

..... Model 90 Set Analyzer  
Net Cash only \$78.50

All prices are F. O. B. Greenwood, Miss. No Dealer's discount.

Date Shipment desired .....

Signed .....

Firm Name .....

Street Address .....

City .....

State .....

Please give three or more bank or trade references and names of distributors from whom most purchases are made.