

Proceedings of The Radio Club of America

Volume 38 No. 3

October, 1962



Founded 1909

SIMPLIFIED AUTOMATION

By

RALPH R. BATCHER

Prof. Engineer

THE RADIO CLUB OF AMERICA, INC.

11 West 42nd Street ★ ★ ★ New York City

FOUNDED 1909 NEW YORK, U.S.A.

The Radio Club of America

ORGANIZED FOR INTERCHANGE OF KNOWLEDGE OF THE RADIO ART, THE PROMOTION OF GOOD FELLOWSHIP AMONG THE MEMBERS THEREOF, AND THE ADVANCEMENT OF PUBLIC INTEREST IN RADIO



11 West 42nd Street, New York City

Telephone — LOnacre 5-6622

Officers for 1962

President

R. H. McMann, Jr.

Corresponding Secretary

James Morelock

Vice President

Ralph R. Batcher

Recording Secretary

Albert F. Toth

Treasurer

Joseph J. Stantley

Directors

Robert M. Akin, Jr.

Ernest V. Amy

Horace Atwood, Jr.

John H. Bose

George E. Burghard

Frank A. Gunther

Samuel N. Harmatuk

Harry W. Houck

Walter A. Knoop

Raymond E. Lafferty

Jerry B. Minter

Frank H. Shepard, Jr.

George Washington, Jr.

Committee Chairmen - 1962

Affiliations

Walter Knoop

Manuscript

George Washington, Jr.

Armstrong Memorial

George E. Burghard

Medals

Harry W. Houck

Budget

Joseph J. Stantley

Membership

Robert Finlay

Banquet & Entertainment

Albert F. Toth

Papers & Meetings

Samuel N. Harmatuk

Legal Counsellor

George E. Burghard

Publications

Ralph R. Batcher

Publicity

Lloyd Jacquet

PROCEEDINGS OF THE RADIO CLUB OF AMERICA

PUBLICATION BOARD

Editorial Director

Ralph R. Batcher

Production Manager

James Morelock

Advertising Manager

George Washington, Jr.

Papers Procurement

George Washington, Jr.

SIMPLIFIED AUTOMATION

By

RALPH R. BATCHER
Prof. Engineer

SUMMARY

Many automatic control processes have come into use using techniques and equipment items that were developed for highly sophisticated military missile programs, or for electronic computer processes. The cost of converting such items into useful industrial applications is usually prohibitive, especially when one-of-a-kind installations are considered. There are a number of simple devices that are applicable to many problems in automation which make things easier. Special types of punched tape switchers, punched card readers, special relay combinations, and heavy duty modular control units are a few of the methods and devices covered here.

A completely automatic process, one requiring no operators, exists mainly on paper. Attainment of this ultimate industry is usually unnecessary and often undesirable. However the idea is a nice one, considering the need of meeting competition with local and foreign devices. One finds that thousands of pages have been published during the last few decades about automatic control systems. Of late many of these have required the use of computers and other highly sophisticated systems, having in many cases resulted from attempts to commercialize developments first aimed at military systems. In many places the very use of a computer is a sure sign of prestige.

It has seemed to me that in many cases such methods make up the hard way of accomplishing simple operations, even considering that the use of existing devices, even if more costly, might often be cheaper in the end if no great amount of re-engineering is needed.

There are thousands of control jobs waiting to be worked out in all fields of industry that cannot afford expensive control equipments to introduce automation. Literature is sparse concerning methods and devices that can do such jobs inexpensively. More varieties of control devices seem to be in order, that would help set up these specialized projects that are found in so many places. Considering the cost of engineering these one-of-a-kind control setups, it is usually necessary for such a job to be developed by those directly concerned, as a do-it-yourself project. I have come across many exceedingly ingenious gimmicks and methods that have been developed this way, things that would have been exploited rigorously if those plants were as publicity minded as their larger competitors.

Any control system has three parts: (1) primary elements and sensing devices, manual controls, microswitches and the like that note the conditions in the process and deliver equivalent levels of a current or voltage useful in effecting control, (2) the powered devices, the motors, ovens, valves and the like that actually apply the control functioning, and (3) between these two groups of devices the part of the system that takes the signals from the primary devices (or transducers) and sorts them out to decide WHEN, HOW MUCH and WHICH of the powered items must be actuated. This central part, the brain, is that which will concern us tonight.

In setting up this control head or brain, we need a lot of special gimmicks to do all sorts of odd things. For economy these ought to be universally applicable, but actually it seems that each problem has its own requirements. If such universal items were available they would have to be easily modifiable to take care of these custom needs for the particular problem at hand.

Since we are concerned here with only electrical devices, this problem comes down to that of providing intelligent switching circuits which will reroute control paths in various ways, through timing delays and speed controls if need be, in accordance with the signals received from the primary elements.

The circuit routing, established according to conditions derived from the various signals or in accordance with pre-established programs is a matter mainly of switching processes.

Consultant, Automatic Control and Production Processes; Vice-President, Radio Club of America; Fellow, I. R. E. ; 240-02 42nd Avenue, Douglaston (63), New York.

PROGRAMMING AND SWITCHING WITH PUNCHED CARDS

This old-time device descends from one of the earliest methods of control. There are however many effects that are obtainable that are not generally well known. I will not deal at all with the usual punched card reader, found commonly as a part of a computer system, where many cards are examined in rapid succession to pick out bits of information from each. The simpler card readers where the cards are inserted one at a time, (generally manually), and left for appreciable intervals, can store information of various types and apply remedial effects whenever some specified combination of process conditions occur. This will be explained in the following.

To initiate changes in a process requires either some sort of a memory, or what is usually easier some kind of circuit maze where a definite electrical path is completed only when a predesignated combination of factors takes place. Usually many parallel operations are carried on at the same time, some independent and others related to other circuit paths. Usually these must be handled in correct sequence or in accordance with desired timing. This central "memory" is thus only a programmer. Before getting into complete system programs I will take up a few of the devices we can use.

A punched card reader may need (and have) just a few hole positions so that the card can be quite simple. A dozen or so holes will permit switching to special operating or test circuits, controlling for example current or voltage levels; delay line or filter characteristics; phase shift controls; meter shunts; audio amplifier characteristics, and others. Here is an example of one such small card device, Fig. 1. This contains a small sensitive contacting device that can be set to close (or open) a circuit at precisely 10 microamperes. In other words it is a fixed-value contact meter. To be useful however this operating point would probably have to be changed frequently and be precisely set at a selected point anywhere in a range having several decades of magnitude. The usual contact meter requires juggling of moveable contacts up and down the scale, a tedious and rather inaccurate procedure.

Figure 2a shows how a small card with only 13 holes, the arrangement used in this box, Fig. 1, can be used to give a three decade current multiplication, starting with this 10 microampere (or some higher) value. Each decade uses four holes, and since the shunts are resistances of low values, a length of suitable resistance wire can span the first contact once, the next one and the third one each twice, and the fourth one four times. Combinations of holes in the first four positions will increase the original current by 1, 2, 3 and 4 times

with combinations totalling anything from 1 to 9. The next four holes would handle from 10 to 90, etc. The thirteenth hole is used to bring the outside contact (the one in front of the holes) back to the rest of the circuit.

It generally requires five hole positions in a card per decade in the case of adjusting series resistances for a voltage multiplier, Fig. 2b. For each decade, four resistances are connected in series between these five terminals. The holes are placed in the card in accordance with the table shown with the diagram. Such a meter can be provided with a scale marked in percentage in test or inspection operations where the reading is established so that 100% reading obtains when a prescribed voltage is reached. It could be set at 63.6 volts for example or any other odd value. No fussing with moveable contacts on the contact meter itself is needed. A simple hand punch used at prescribed positions on a small card will always give the desired value. Expanding on this special purpose reader built in as a part of a definite instrument, we will look into what can be done about general purpose card readers that can be set to handle larger problems.

One excellent example is the CINCH Cardomatic, which contains a 20 by 20 hole array, using a card the size of a standard library card, 3 by 5 inches, Fig. 4. These holes are laid out on 0.2" centers horizontally, and 0.1" centers vertically, which corresponds to the standard EIA printed circuit and layout dimensions (which are based on multiples of 0.1" centers). This unit, Fig. 3, contains a precisely-molded block that carries four hundred double-ended floating contacts that bridge between two printed wiring plaques in parallel planes. These plaques carry parallel conductor strips normally touching all 20 of the floating contacts with no card in place, or as many of them as are provided for by the particular card when in place.

These readers have found application in a large variety of switching operations. In some cases, the fact that the edge connectors to the circuit plaques can be slipped off and another put on permits additional versatility, and also permits the same reader to be used temporarily at different places when only short run tests are scheduled.

For some reason I am told that there seems to be a preference among potential users for readers using "standard" cards, such as are found with IBM and Remington Rand systems, Fig. 4. When one considers that either of these cards carry far too many contacts for the ordinary control problem, and their use (especially the IBM style card) incurs very congested wiring harnesses. Except in a few cases there might never be many different cards to punch up, so that getting access to an IBM or R-R card punch by breaking into its normal routines is

not often worth the time involved, so often this preference is not valid. There are some valid reasons however why the R-R cards might serve in some of these applications, and I give this card second preference, when it is evident that a small CINCH type card is not useful.

A full R-R card (Fig. 4) carries 12 rows of 45 holes per row with holes on $5/32$ by $1/4$ th inch centers. The holes are farther apart and are round, which make them easier to punch by hand than the rectangular holes in an IBM card. Then cards can be obtained all made up with a full array of small pilot holes in place, which will accept the guiding needle of a special hand punch so that hand placed card holes are easy to handle. This permits anybody to make up a few new cards as they are needed. You realize that this use of card readers for circuit switching is an entirely different matter from that for which they generally serve.

Even with R-R cards the wires come pretty close together, as is evident from this model (Fig. 5) which have contacts that match the $5/32$ by $1/4$ th spacings. In adapting one of these cards to a control switching operation, the end four or five holes should be omitted since some space at one end of the card is needed to enable it to be pushed into or removed from a slot. This leaves say 40 useful holes in a row.

I have mentioned that the usual problem never requires large arrays of holes. It is often desirable to divide up a control problem into groups, each of which is handled by a separate card unit. A particularly useful array uses what I call a half-card reader. This uses a R-R card split down the middle, resulting in two cards each with 6 rows of 40 hole positions. A reader using these half-cards is small enough so that ten can be mounted on a standard 19 inch panel, and when provided with separate operating solenoids, it is possible to have many separate programs for any particular phase of the control situation in storage at any time, instantly available on demand by the operation of a manual toggle switch, or by a combination of different effects noted in the process.

A system having this basic plan was devised a few years ago for CBS for the control of camera wipe-out effects, where a certain few of many thousands of possibilities were always on tap during a given program. Ten units, using cards approximately the same as the half-card system mentioned, were mounted side-by-side on a panel, each operable by remotely positioned switches. Fig. 6 shows a pair of these units like those used on this ten unit panel. The contact arrangement was designed to precisely fit their circuit requirements with all other contacts (and lead congestion) eliminated.

Since then, the plan of using groups of solenoid operated units has been further developed, using the half width R-R cards. A new contact design was developed that is inexpensive but reliable and which could be assembled in various arrays during the fabrication, to handle custom requirements.

There are many unusual effects that are possible with multiple arrays of remotely controlled units. The printed circuit top plaque can be a master plate but special configurations are readily made up by using a grease pencil on the master photograph for etching. No contacts need be made to this plate with flexible wires if special contacts are made through a series of fixed holes in the card. All wiring is handled on the same terminal board. The cards can be made by slicing a standard R-R card down the middle and using a hand punch designed to enlarge the minute pilot holes available on the cards.

There is no reason why the same idea could not be used on a full card. A full sized reader could be built, except that the usual problem does not call for so many reconnections, from present experience. In fact the trend seems to be to the use of even smaller arrays. The usual problem solvable by a card reader, may have the contact arrays broken up into smaller groups, each one of which handles some part of the main problem. Typical circuit subgroups of this nature are shown in Fig. 7.

You are all aware that the usual card reader system of switching deals with circuits that are normally-open with selected closures made when the unit is operated by the solenoid, the selection of closures depending on the card hole positions. Other possibilities have proved of interest. For example in place of some of the NO contacts we may wish to have some of them normally-closed (NC) which are to be opened upon the operation of the solenoid. This can also be done. This produces what is known by relay users as a TRANSFER set of contacts. In our case the places where circuits are closed, and where others are broken are determined by positions of card holes.

Moreover a single contact can be made to connect to several others and be disconnected from still others, so that here as an almost infinitely versatile device when it comes to switching.

Since I have been told that this is impossible I had better show that NC contact types are indeed obtainable. Fig. 8 shows an enlarged view of a few contacts on one of my readers. Metal pins embedded in a block of bakelite with ends extending from both surfaces. Their centers are in accordance with the card hole centering. One end is capped with a special gold plated cup, like a small hollow eyelet, which indeed it is. This cap is held in place by an upper perforated plate which also has a full quota of

holes conforming to the card centers. A spring on each pin pushed the cap upward with adequate pressure.

At certain places on the under surface of this top perforated plate metallic conductors are placed (Printed circuit techniques) that contact the rims of the eyelets so that two or more pins are shorted. As the upper plate, with its card in place, comes down when the device is operated, the eyelets are forced down and the shorting is removed. Either of the pins is now free to be connected, through card holes, to other similar contacts so that complex redistributions of the circuits are possible. In fact if the original short must be maintained after the unit is operated, under some conditions, the card holes can be arranged so that an upper shorting conductor re-establishes the bridge between the contacts before they break away due to the movement of the eyelets. By proper shaping of the underside conductors a good reliable break can be effected. This scheme facilitates circuit connections not easily possible even with banks of relays or stepping switches, and the versatility is dependent only on the ingenuity of the circuit engineer.

I find that still other things can be accomplished if two or three different solenoids are mounted on a single half-card reader, each working on some of the parallel rows of contacts independently. Here the top printed wiring plaque is sectioned longitudinally. The separate solenoids can be operated independently or in combinations.

It is not recommended that heavy control currents be switched live by a card hole however, may be a hundred mils or less being safe. Safety switches (snap action) can be installed to insure that system power is applied only after the top plate is completely closed, and to insure that the card is not accidentally missing or inverted (which would certainly mess up things in the circuit).

This restriction of current limits is probably the greatest disadvantage of the punched card concept. We have other alternatives however that will take care of heavy loads of many amperes that I will take up later.

I believe that the greatest simplification of complicated controls is this multiple unit idea, where ten to even one hundred separate card units are arranged in arrays operated alone or in groups by other programming devices (which might also be punched card units, moving punched tapes, or stepping switches). Such systems are feasible only if the individual units are inexpensive and easy to mount and wire. The design accomplishes this to quite a degree.

Accumulated information obtained from study of proposed systems indicates that a very small unit reader would have value, so a small solenoid operated unit is now being developed controlling only six rows of seven contacts, or a 42 hole card. These would usually be used in groups of say ten or more, operated in programmed combinations. Each of these mini-card units would probably replace a group of relays each with a complicated array of contact springs. Besides handling circuit recombinations not easily accomplished by relays, those reconnections could be altered at will by just inserting cards, with other hole positions.

Let us consider a problem hypothetical in this case, of figuring out a way of controlling a large group of studio lighting spots, each one being controlled independently and having adjustable intensity with as many as 32 levels of brilliance. This may be an unrealistic problem but it is an easy one. The level of brilliance is obtained from a group of saturable reactors or magnetic amplifiers. (A modified plan would be needed to handle SCR types of control, but it could be done.) The reactors would be controlled by applying definite levels of d-c current to their control windings.

As shown in Fig. 2c, 32 levels of current can be obtained by a row of six hole positions on a card. This diagram assumes that the different levels are according to linear steps, but non-linear controls can also be handled if wanted. The six holes correspond to the cross row of holes on a half-card unit, so that forty banks of lights could be controlled at any instant with a single card.

Actually it would probably be necessary to change some of these spots at specified instants, so that a new card would have to be used, on another reader at that change instant. For rapid shifting thus many readers would be needed, bridging over the time necessary to manually replace some of the "used" cards with new ones. The succession of readers would be operated by a stepping switch, advanced by a manual key in the hands of the control operator. Even this may not be the easiest way of handling this problem either. The lamps might be connected in smaller groups with some groups remaining on for more extended periods. Here a smaller reader, such as the one with 42 holes would suffice. Depending on the time intervals between switching some of the lamps to new intensity levels, and on the total number involved, a large bank of these minicard readers would not be fantastic or overly expensive. There are other combinations of lamp banks vs reader units that could be considered, including one where a 40 point stepping switch steps from row to row along the card of a reader handling a single set of lamps, these stepping switches being advanced separately in accordance with a card-controlled program set up in advance.

Sometimes a punched tape reader will prove of interest, instead of the stepping switches. While there are many high speed tape readers on the market, very few are of the type that advance 0.1 inch at a time, when an advance key is operated. Ratchet driven tape advancers have been tried, and also a three magnet equivalent of a Geneva movement is being studied, devised in an effort to provide a cheap punched tape transport. Such devices however need some sort of delay circuits to prevent the punched card solenoids from dropping down during the advance of the tape.

RELAY CHAINS

With the availability of such gimmicks, a designer should not lose track of the many time-tested simple schemes, using maybe combinations of relays, or of manual switches, to handle parts of the system. On one extreme I might cite a small four switch unit I recently made up as a child's toy, what I call a WHOZIT (WHO IS IT?). This is a space age substitute for the old method of pulling out the short straw, or flipping coins, or the eeny-meeny game. The four rotary switches on this unit can be separately operated by contestants, and out of the many thousand possible ways that the switches may be positioned finally, each lamp has a chance of coming up exactly four times, so every one gets an equal chance. Each operator has no chance of seeing how the switches are standing when his turn comes up -- so he has no chance of developing a winner.

While this is only a toy, it does represent one of the series of logic puzzles that are commonly known. Such puzzles can be set up on a universal puzzle game with a punched card, with six rows of twenty holes per row, added each time the game is varied. Puzzles like the farmer, hen, fox and grain, and others involve logical sequenced operations and are easily handled. The discussion here last year by Dr. Langmuir relating to personality tests showed certain logic puzzles that could probably be easily handled by a punched card reader to switch to different problems. Also some of the problems mentioned in the "Operations Research" talk might likewise be handled.

Punched cards, or tapes, can handle and store information of both the digital and the binary form, even both on the same card. This helps out at times, but some sort of converter must be used to change binary signals to a digital output. One method sometimes used is the so-called relay tree. Here one relay is needed for each bit of the stored code. This tree is convenient to use up to say 4 bits, or 16 circuit leads to which a single input is connected. Usually some of the relays do have to carry quite a number of contact springs, the inter-relay harnessing is quite complicated. For

greater than four-bit codes the complexity is usually too much to consider.

Following my usual fetish of trying to eliminate assembly and wiring problems, which often gets to be quite a chore in some control systems, I made up an emblocked four-bit code converter, Fig. 9, that does away with much of the mounting difficulty and the cabling. At the same time it simplifies the relay design, since the units do not have to be dolled up for appearance. It is remarkable how much one can get away with when a simple unit is emblocked in epoxy. The pole faces of the four internal coils are flush with the top surface of the block. Four special relay armatures, all generally alike, are mounted over these pole faces. The feature is that the tail end of each relay spring forms the fixed contacts of the preceding unit so that all inter-relay wires are eliminated. These tail ends are offset a little using a simple bending jig, so that a normally-open or a normally-closed contact is produced, depending on whether these tails are bent down or up. The whole unit, shown here with a series of ten output leads is provided with a plug that fits a standard Cinch relay socket.

The fixed contact bending can be arranged to handle any binary to decade code. The arrangement can be extended to a full 16 lead output easily. For handling greater arrays several of these four coil units can be used in series-tandem. For instance, nine blocks would provide 128 outputs, one of the nine switching the operating voltage among the other eight so that only one set is operated at a time.

However for switching arrays greater than 16 (or even 32 where a simple SPDT relay switches between two of these four-bit units) it is usually well to consider alternate schemes. A modified version of one of the mentioned half-card readers is one alternate. Here the contact array is provided with the transfer contacts as mentioned and three independent solenoids, (each operated by elements of the binary code). Two of these card readers, or one of them plus a four coil relay tree can be arranged to handle a seven bit code.

It is also possible to avoid use of cards in another arrangement having the three independent top strips of the reader just tilted by the solenoid, moving from one row of contacts to an adjacent row. These no-card readers open up other control concepts useful for some problems. An eight or nine binary bit conversion is not unwieldy, but would be a fantastic array using ordinary relays. As mentioned before, however, all of these units are useful only when switching speed is nominal, as the electromagnetic methods cannot ever approach speeds possible with solid state systems.

Another useful relay bank emblocation that avoids interrelay cabling is the counting chain (or McBerty chain) array, at one time used by the millions in dial pulse counting.

Here a group of say twenty coils are emblocked in pairs, with the contact springs above the pole faces connecting to the tail ends of an adjacent pair, or to the operating coils of an adjacent unit. Such an emblocked chain, operated in sequence by timed pulses, find use in setting up precise time delays, etc. There are some other special gimmicks that might prove useful but present experience has not proved them in.

HEAVY CURRENT SWITCHING

The devices described so far relate mainly to low level control circuits, say under one-half ampere. Heavy duty relays or contactors or the like must be added that are able to switch the heavier powers usually required by process devices, up to ten amperes or more on occasion. The same thing is true of several systems of commercial control using small modular logic units assembled in various arrays that have been developed during the last decade.

A need for a modular system that would handle heavy currents was apparent, made up of similar-styled devices that would accomplish the wide variety of switching problems found in industry. You are well acquainted with many of the presently-used control systems, hardly ever two alike, and composed of large panels, usually in cabinets, filled with all sorts of relay-like devices. Photographs of some of such systems indicate what is referred to.* A typical industrial control system might be contained on a panel maybe 30 or 36 inches wide and six feet high. Sometimes several of these panels would be needed in a single system.

Even if such systems were to be used in fair quantities in some control application, it is likely that they would be made up individually. A large number of individual drawings would be needed to take care of panel layouts, assemblies, circuit diagrams and the fabrication of the wiring harnesses. Quite a number of such drawings would be needed since their size is somewhat limited by the area of a typical drawing board.* The engineering work spent in the first layout of the system and in subsequent operations is enormous. The costs usually greatly overshadow the actual cost of the parts used, unless a number of systems are to be made up.

The need for a simplified system that would simplify the development of one-of-a-kind applica-

*Examples displayed to audience.

tions was apparent. In this particular endeavor I became associated with Herbert DuVal, who was long active in the control equipment and associated fields with G. E. Co. To find out if a solution was possible, a rather ambitious search was started for a new concept that would permit the fabrication of special control systems that would handle ALL conceivable problems which combinations of relays and other control devices now serve. We hoped some sort of universal switching module could be devised that could be assembled in various arrays and interwired as necessary without specially made-up sketches.

An examination of scores of typical control installations, such as those shown in the photographs and their circuit diagrams ultimately gave us a basic theoretical concept of electrical switching in complex systems and provided a basis for a practical solution to these objectives.

Briefly it was evident that: for any control process there are say X powered items that must be individually controlled in a system; that is, they must be either turned ON, or OFF or otherwise modified in various sequences depending on process conditions reported by a variety of primary sensing devices installed at strategic parts in the system, or the machine, etc., being controlled. These modifications would take place at times or phases of operation established by combinations of signals from the primary sensing units, or from manual push-buttons of various functionings.

The difficult part of the design is the construction of a central control assembly, or brain, that would sift these incoming signals and determine which of the powered units must be actuated in the previously mentioned matters of WHEN, WHERE and HOW MUCH. It is difficult to describe just what such a brain must do, since this problem varies with each system. Usually the controlled items are relatively few in number, consisting of motors, valves, ovens, and the like.

Thus a given motor might be turned ON whenever conditions M, P and R obtain but only if conditions B and G do not. Many other variable conditions in the system, say N, Q and A would, in this example, exert no effect on that motor, at least not at that particular time. Thus if some sort of gimmick, or special device, would be assigned to handle this combination of events, each taking care of one condition M, P, R, or N, etc., at least eight modules would be needed. Probably even more would be needed when other parts of the system are examined.

In any case every module must take care of three functions: to turn one or more items ON, to turn others OFF, or thirdly avoid doing anything to still other items. In technical terms, the modules must

carry a certain number of NO contacts, some NC contacts and some "do nothing" or by-pass connections. In this case control paths to ALL of the various powered items could be lead through ALL of the modules in the system. At each of them the path would be affected in one of these three ways.

Reflection indicates that in a control system of any appreciable size the number of circuits through each module might become enormous and the plan would break down through sheer magnitude, due to the variety of possibilities that would come up. However methods were found which makes such a plan feasible, and in fact rather simple. These became the basis of patent applications covering various physical methods of handling a basic concept.

Practically, it was discovered that the great majority of industrial control systems (by examining scores of regular installations) could be handled if each module would carry maybe ten or fifteen cross circuits, certain of which would have NO contacts, others NC contacts and the rest by-pass circuits. It is then only necessary to activate the module at the correct time as determined when a particular combination of conditions obtained.

The operation is that of having a lot of watchers on hand, each assigned to keeping track of a few assigned conditions, and whenever his combination of events was noted, to do something. This something might be to turn on or off one of the power devices, but more often it would be to warn one or more of the other watchers to be on the alert so as to be able to do their jobs quickly when still other effects came up. The many signals from the system would thus be jockeyed between the watchers, only a few of which deal with the motor, the valve or whatever. Each of our proposed modules would take the place of one of these watchers.

While this dozen or more cross circuits on this proposed module might be adequate for most systems it is of course possible to install a greater number if ever needed. In case it is found that a particular module is overcrowded it is sometimes possible to add two in parallel as is done frequently in relay type control systems. It is particularly important that a single style of module be applicable to all sorts of problems, without major changes. One form of module that has proved practical, using mercury contacts, which are rated at several amperes, Fig. 10. Dry or mercury-wetted reed contacts, or regular metallic or carbon contact transfer switches could also be used.

There are many physical ways of designing a universal module, some of which are more complicated than this one, having various degrees of versatility. The patents cover mainly different ways

of interconnecting the cross-circuits without the need for wiring harnesses. In practice it is found that quite a bit of the control circuitry is set up to operate other modules in the row, and only a few of the circuits actually pass from one edge to the other.

This module, Fig. 10, has provisions for holding up to six tilt-type mercury switches carried in a single molded block or saddle. It is seen that this module is not elaborate and can be fabricated without elaborate tooling. It can be mounted on a frame work of L or T bars, their individual faces making up the so-called panel. Quite elaborate control systems can be made up with even a few of these modules in a row. If more than one row is needed, for convenience in mounting the general system can be divided up so that each row carries circuits to different powered items, so that only a few (if any) interconnections between rows is needed. If so required these inter-row leads are passed up and down at the left or right edges which terminate the separate cross circuits.

One of our objectives was to simplify the original planning of a system to reduce the engineering costs. How can this be done?

Every designer may have his own ideas, but I find that a specially ruled pad of paper, or a small slate is useful, carrying a replica of the cross circuits on a row of modules. A dozen or more of the modules would be depicted on the sketch, with the full quota of the switch elements (or preferably more) each shown as NO contacts. These can be altered by a slant bar to show a NC arrangement, or shorted if not needed at any point. Each process would be represented by a vertical tier of lines. Three such tiers are shown in Fig. 11. Each cross path would be set up by marks interconnecting one bar with a neighbor on the same module or an adjacent one, as required by reasoning.

Suppose that one powered item, a motor M, is to operate when phases A and B are activated but not when C and D, etc. are up. Phase A may be activated by a start button, activating B as soon as sensor Z shows that the process has reached a certain stage. A and B together provide parts of a path that will be completed later when other conditions occur to other powered items. Marks on the slate between the conductor segments would show these paths, with switching contacts introduced, where needed. Some of the conductors end up at the operating coil terminals of a subsequent module, such terminals for each module being available at some point in the conductor array.

The operating path for each powered device would be built up in the same way, possibly using some of the conductor segments previously used but diverging paths later on. The number of

conductor tiers on the slate should be ample to handle general problems, but not all would be used in some cases. When completed it will be found that many conductor segments on each module may be unused, as will be some of the switching elements behind the panels. It may be found that the number of cross paths used may exceed the dozen or fifteen available, but usually some of these can be interposed using some of the unused segments farther up, dodging up and down as needed.

On some problems, the designer may want to copy off a tentative solution on a pad of printed-up paper, and then some alternate solution tried for later comparisons. Several expedients are used here. A typical mercury switch can be mounted in the block to perform either as a normally open or as a normally-closed arrangement, by reversing it end for end. Some systems have been set up where each switch unit is of the transfer type with three leads. Other systems have been used where the cross conductors are mounted on several narrow, paralleled panels, each containing one or more switch elements but all switches in any one tier being actuated with a single solenoid. In some cases vertical and horizontal conductors are available in a different plane so that interconnections are made by screws or other linkage types passing from one plane to the other. It is these various physical arrangements that required different patent coverage.

When a designer thinks he has a workable solution on the slate, a group of modules can be used to try the plan out, using manual switches or other gimmicks to simulate the sensing devices, and pilot lights to indicate the operations of the motors, ovens, etc. We have found that such a test set-up, called a SIMULATOR, to be a handy design aid. Many designers may prefer to use a SIMULATOR to a slate during the planning stage.

Our first universal Simulators were quite elaborate, one containing some 64 transfer switches in eight rows of cross conductor groups. We found that some of these were seldom if ever needed. Later we set up less elaborate test Simulators. We also found that the reversible NO/NC switches which provided either function further simplified the Simulator. The use of taper-in connections, tapered lugs, wire-wraps or other removable tabs permit simple temporary connections during the study stage. Their use can be extended to the final equipment if desired, or the pins or tabs can be soldered down. All interconnections needed in the planning stage can be numbered or otherwise coded, so that the plan can be transferred to a production unit by a list of positional code numbers. No prints would be needed. End terminations at the left and right edges of the rows would be fitted with connectors

to which cables to the process elements, the control switches and sensing elements being connected in general at the left or starting edge, and the powered devices at the right end.

If a large number of these controls are to be made up for some application it is easy to make up a master printed panel for that control wherein the several solenoid-switch block units are mounted behind. This is the same as combining all the individual module panels in a single plate, with unused conductors omitted, and all temporary connections made permanent. Sometimes considerable positional changes might be attempted.

I once made up an experimental model of a typical self-service elevator car control for a seven floor system, first using the modular concept and then converting it to a permanent non-modular assembly, Fig. 12, by combining some of the individual modules and rearranging their leads. The circuit more-or-less duplicated a general circuit used by one elevator manufacturer* even as to the up-and-down stepping switch that kept track of where the car was. Fourteen modules were needed plus some heavy duty ones that reversed the leads to the lift motor and started and stopped it. The lift motor stop-start switches were not added here since it was decided that they had better be near the motor, although the reversing switches are included here. Since the latter do not handle live circuits their size is smaller than the 100 ampere mercury switches needed for handling motor currents. It has not been decided whether this non-modular conversion represented much of a gain over the modular layout. Since the modular system could be made up in advance and the terminal facilities are simple to connect up, it is not unreasonable to expect an over-night conversion from operator to automatic controls, assuming the car and its door operating and gate operating mechanisms do not have to be changed. If you have ever seen the typical installations used in self-service elevators, and know of the many weeks of time spent in conversions this small system can be appreciated. It happens that a two car system, using the modulator concept need not be more complicated than two single car installations, since inter-shaft connections are easily handled. I have not studied more elaborate systems with many cars operating in inter-related sequences, but believe that economies would always be found.

In no case studied was it found that the modular system made the installation more complicated, and usually great simplification resulted. I will note a few advantages of the modular concept:

*Original circuit shown

1. It simplifies the engineering work attached to developing a one-of-a-kind installation;
2. It is an aid to the field salesman in dealing with a prospective customer. He can take a small SIMULATOR to the plant and by using pilot lights and simulated sensors, actually set up a proposed control in conjunction with that customer's engineers, and actually show how it could run. The various functions required of the system could be roughly checked out, until all were satisfied. The connecting links, their positions, the number of modules needed, etc., would provide most of the information needed for a regular installation, and at the same time some idea would be obtained as to the size and cost of the proposed installation;
3. Any field proposed system could be further checked, using another Simulator at the factory, by control experts to see if all factors had been handled, whereupon the final equipment could be made up of stocked items, wired and shipped without delay;
4. It eliminates much of the drafting room expense and time delays, since mounting racks would be more or less standard, and inter-connection and wiring harness schematics would be eliminated;
5. It eliminates the selection and purchase of many of the special relays and contactors with special contact arrays;
6. Service manuals are easier to prepare. The front face of the modular array itself will serve to indicate wiring details and possibly maintenance points;
7. The panels, consoles or cabinets are smaller since the usual inter-relay spacings are eliminated, and space for wiring ducts is unnecessary;
8. Production time is speeded up. Modules for many different systems being more or less alike can be produced continuously and stocked;
9. In use the control operator will find it easy to trace the stages of the process, since each module has a pilot lamp that indicates its condition. In fact since many processes progress in orderly fashions, the successive operations and releasings of the modules can be paced by a master timing program, which would indicate when some delay or abnormal operation occurs at some point, operating signals or alarms;
10. It is easy to connect up many types of special gadgets to the system, such as meters, delay or timers, feed-back effects, chart indicators, and the like. It might be added that special slow-to-open or slow-to-close mercury switch units (which are commercially available having a wide variety of characteristics) onto the mounting block for switches in a given module, to provide special effects directly;
11. The time often spent by engineers in checking the effectiveness of a circuit, and to eliminate "sneak" paths which often creep in under certain combinations of conditions, is reduced, due to the simplicity of prechecking circuits on a master Simulator. Also circuit redundancy becomes quite apparent in this across-the-board form of circuit diagram, a condition not readily apparent when the drawing has random positioning of the contacts associated with various relays;
12. Obsolescence is avoided. If anticipated temporarily-unused module facilities can be added in advance, so an entire "new-deal" in the process can be started later. This is particularly useful when processes that will probably change in some respects later are being considered. It is also possible to incorporate some of the features of punched-card systems into the system, so that the process can follow one of several different programs without major changes;
13. Modules can be designed to handle any realistic level of power. The switches used in this module (Fig. 10) will handle several amperes and will last many millions of operations at the current levels actually handled. Ten ampere mercury switches could be readily handled by the same solenoid, or even larger ones. Combinations of low and heavy current switching units can be combined on same unit if wanted.

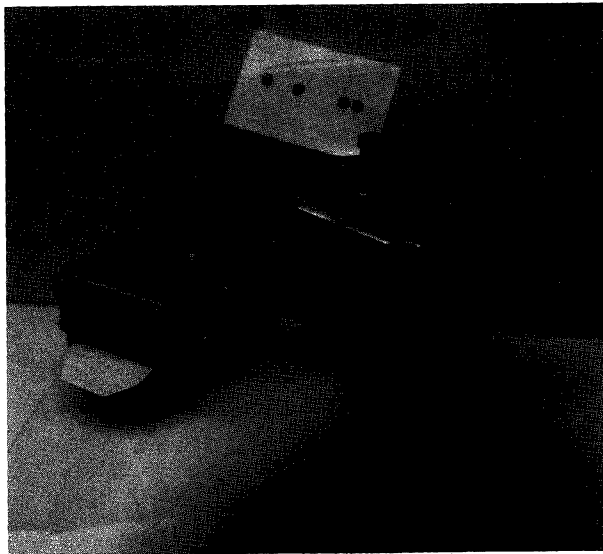

Figure 1. A fixed-value contact meter can be extremely sensitive due to the small angle swings. Larger current values are obtained by self-contained punched card control. TOP-RIGHT--Card controlled meter-relay, with typical one row, 13 hole position card above it.

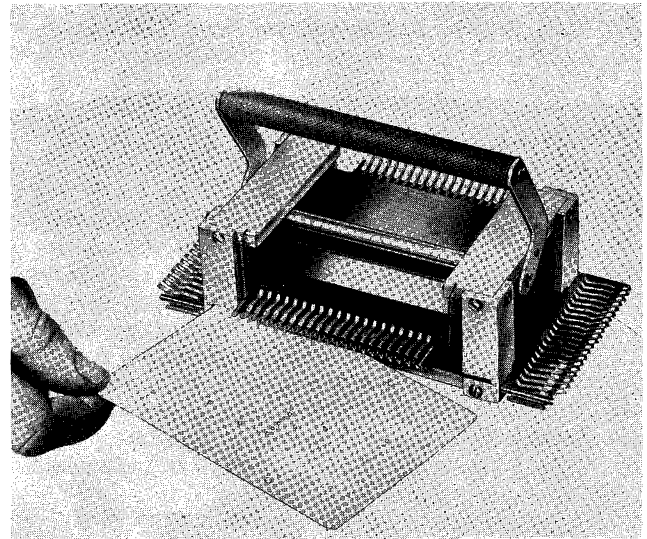

Figure 3. A CONNECT-O-MATIC punched card circuit switcher.

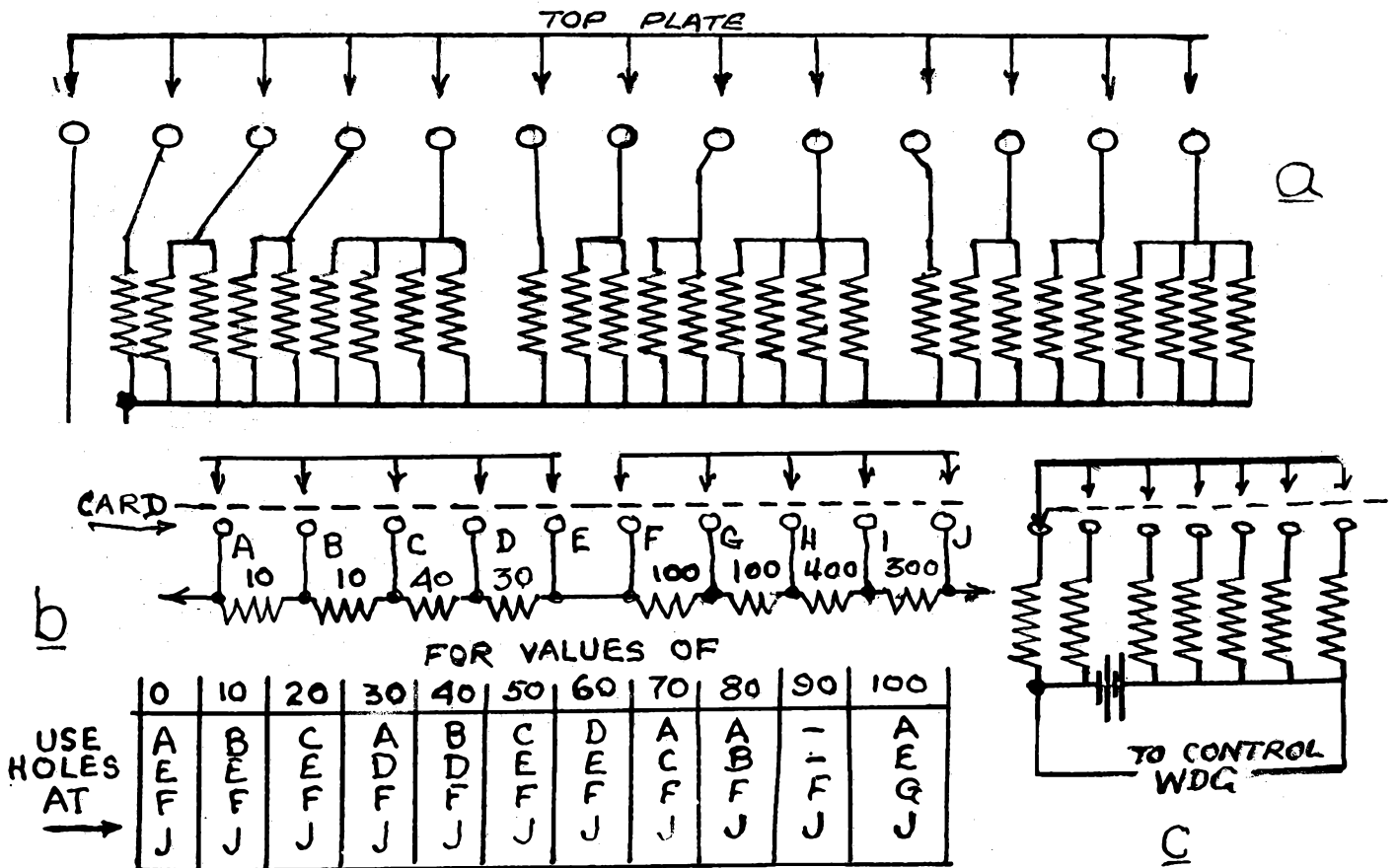

Figure 2. A three decade range of operating values for meter, Fig. 1, hole-selected combinations of shunts. Figure 2b shows a similar system for adjusting resistors in a series chain. Two decades are shown. Table shows hole positions used to obtain desired resistance in one decade. Figure 2c shows use of six card hole positions to provide a 32 value range of currents to the control winding of a mag-amp.

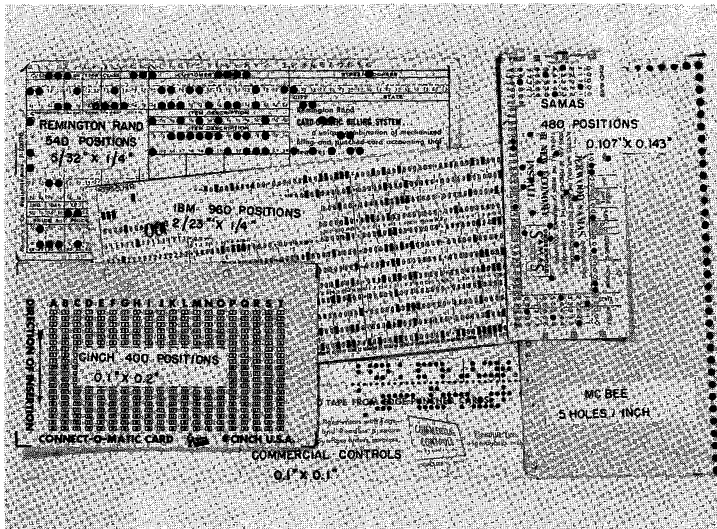

Figure 4. Many styles of cards find use in control operations.

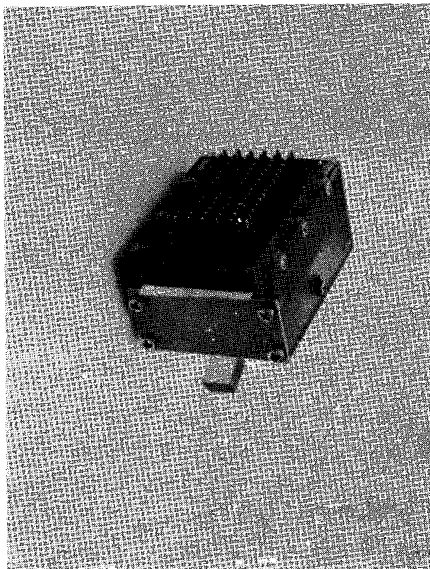

Figure 5. A small manually operated switch with an array of 6 by 16 contacts. Uses a slice of a Rem-Rand card, size of regular business card.

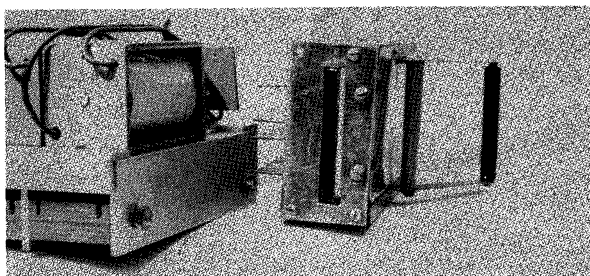

Figure 6. A pair of remotely controlled half-card switches. Ten of these units are mounted on a standard 3-1/2 by 19 inch panel, for complex programming operations. BOTTOM RIGHT--Special version of special card reader using CINCH type card.

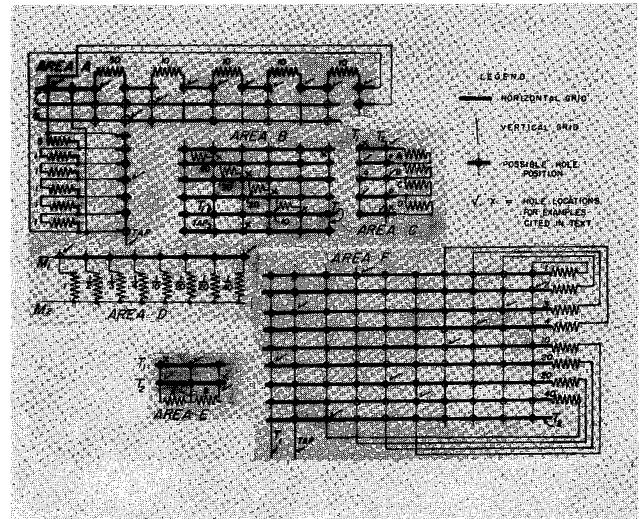

Figure 7. The parallel array of conductors comprising the top plate of a card type switcher, which is generally of the printed wiring type, can be sectioned into groups to perform several distinct wiring changes in a test or control system. Here Areas A and F create an adjustable voltage divider with 1% increments. Area B shows an alternate method handling 10% increments. Usually, however, the methods shown in Figure 2 are preferred, using fewer holes. Area E shows how two elements can be reconnected series-to-parallel and back, whereas in Area C four elements can be alternately connected in series, parallel or series parallel with different holes.

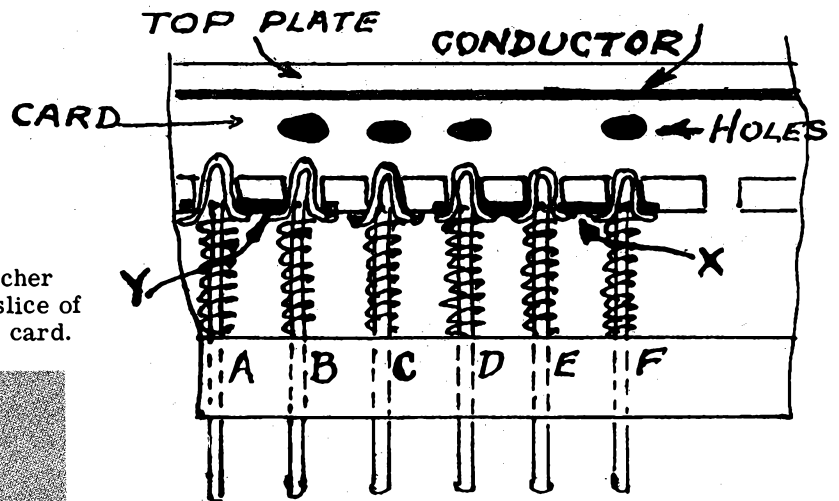

Figure 8. This figure shows several contacts arranged to open up circuits under the control of card holes. Under-surface conductors bridge contacts A and B (at Y), and another at Y bridges pin contacts D, E and F. These bridged points are opened and re-established differently when top plate is forced down against card.

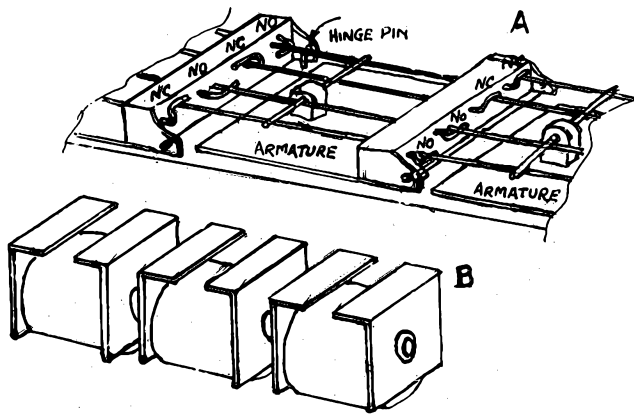

Figure 9. A four unit relay "tree" switching a circuit to any of ten different outlets.

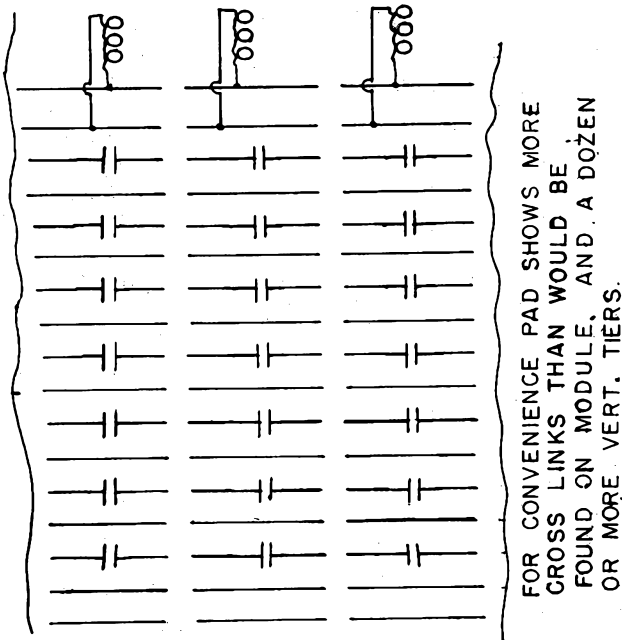

Figure 11. A grid of marks on a pad of paper or a slate can assist designer in setting up cross circuits in planning a control.

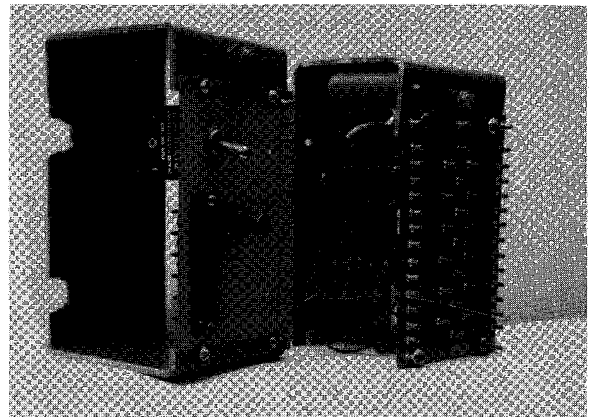

Figure 10. Typical universal control modules based on Systemation concept. Unit at right carries mercury switches and would be mounted (several to maybe a dozen or more in a row) flanked by a connection unit with cable terminals, etc., at each end, such as the unit at the left.

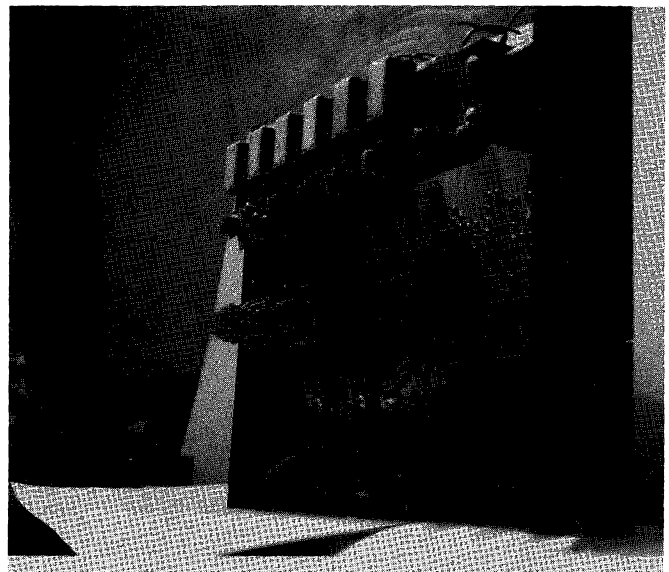

Figure 12. This figure shows a modified version of a self-service elevator control, first established using modular units, handling seven floors.

ELEMENTARY ECONOMICS OF TEST EQUIPMENT PURCHASES

by

W. A. Knoop, P. E.

The electronic industry is continuing to mature. Present and future requirements call for more elaborate testing, improved reliability, and adequate working measurement standards. A couple of work benches, soldering irons, a borrowed voltmeter and a government contract will not in themselves spell success.

While the customer has become more exacting with respect to performance, he has also exhibited an ability to buy at lower prices. The successful producer will be the one who is able to select the tools required to manufacture a quality product at minimum cost.

Many administrators and electronic engineers do not realize that minimum cost may very well require the purchase of test instruments. It has been frequently and erroneously stated that capital goods purchases are an unnecessary expenditure. The fact is that having the right equipment may well prevent costly waste. Too often, during the past eighteen months of industry shake-out, management's order to cut costs has been so literally interpreted that failure to purchase necessary test instruments has resulted in increased costs.

Test instruments are generally purchased for one of three reasons:

1. To establish a basic capability and set of tools with which to conduct a business.
2. To permit certain measurements or tests to be made, as required by the customer, or for the design and manufacture of the product, which cannot be done in any other way. In these cases, the instrument is simply a mandatory tool.
3. To improve methods and, consequently, reduce costs by providing tests and measurements at lesser labor cost, or make possible the use of lower cost material or components (tests can check significant performance parameters).

Decisions to purchase in categories 1 and 2 are usually relatively simple to make. Category 3 is more obscure. But, it need not be so, if the economic factors are understood. Most good engineers will know these factors.

For a picture of the costs involved, let us assume we are considering the purchase of equipment costing \$1,000.

1. **Capital Cost.** While a public utility may pay 4% to 6% annually for its capital money, we have observed some unseasoned electronic firms paying 20% and sometimes more. Let us assume an average of 10% per year, applied to the "book value" or depreciated value of the instrument each year.
2. **Depreciation Cost.** While some firms continue to use equipment ten or more years old, most utilize a write-off period of 5 years for electronic test equipment. There are several ways to figure depreciation. We cannot discuss all of these here, so we will choose a method which places the greatest burden on the first year of operation. This method is called the Double Declining Balance method. Here, 40% of the purchase price is depreciated in the first year, 40% of the remainder the second year, etc., and at the end of the fifth year, the residual value may be considered the instrument's salvage value.
3. **Maintenance.** There is no published guide in this area. Many well established producers have fairly well known maintenance cost data. Our own experience has been that a \$1,000 instrument requires maintenance and calibration work amounting to approximately \$100 per year, after the first year, with little or no maintenance during the first year. To be conservative, let us estimate \$50 for the first year.

With this discussion as a background, we can, then tabulate:

	1st Year	2nd Year	3rd Year	4th Year	5th Year
Capital Cost	\$ 100.	\$ 60.	\$ 36.	\$ 21.60	\$ 12.96
Depreciation	400.	240.	144.	86.40	51.84
Maintenance	50.	100.	100.	100.00	100.00
Total Cost of Owning	\$ 550.	\$ 400.	\$ 280.	\$ 208.00	\$ 164.80

Now, let's examine labor costs. Typical tester wage-rate may be considered at \$2.50/hr., and a typical overhead cost on this labor is 200%, so the total labor and overhead cost is \$7.50 per hour.

Therefore, if the test instrument will reduce labor by $\frac{\$ 550}{\$7.50} = 74$ hrs., in the first year, it is a break-even proposition. Assuming a 5 day week and 50 work weeks, this means a saving of 20 min. per day of labor at the rate stated as break-even, and any saving beyond this is "money in the bank" for your employer.

If a \$1,000 instrument reduces testing time by one hour per day and test labor is paid at \$2.50/hr. net (\$7.50/hr. gross), the cost reduction under the "most unfavorable" conditions stated above would amount to:

	1st Year	2nd Year	3rd Year	4th Year	5th Year	Total
<u>Annual Labor Savings</u> 250 hrs. @ \$7.50	\$1875.	\$1875.	\$1875.	\$1875.	\$1875.	\$9375.
<u>Annual Cost to Own</u>						
Money	\$ 100.	\$ 60.	\$ 36.	\$ 22.	\$ 13.	
Depreciation	400.	240.	144.	86.	52.	
Maintenance	50.	100.	100.	100.	100.	
Total	550.	400.	280.	208.	165.	1603.
Net Savings	\$1325.	\$1475.	\$1595.	\$1667.	\$1710.	\$7772.

or a total cost reduction over 5 years of \$7772. resulting from the purchase of the \$1000 instrument.

If you wish to use your own rates and factors, the following expression is provided:

- Let X = purchase price of instrument in \$
- Y = hours labor saved per year
- A = capital money cost in percent (expressed decimally)
- B = depreciation factor (expressed decimally)
- C = annual maintenance cost \$
- D = manufacturing overhead rate (expressed decimally)
- E = labor cost per hr.

Then $Y [E (1 + D)] - [X (A + B) + C] = \text{saving or loss} + \text{or} -$

In our example above for the first year $[250 \cdot 2.50 (1 + 2.00)] - [1000 (0.10 + 0.40) + 50] =$
 $250 (7.50) - (500 + 50) =$
 $\$1875. - \$550. = \$1325 \text{ first year saving}$

There are cases where the product will not be in production for 5 years (i. e., a single shot contract). For practical purposes then, you must calculate on the basis of time length of the contract, and assume full depreciation over that time. The instrument could still have a residual value after the contract, however, if it represents an enhancement of the company's capabilities.

The major point we wish to make is that the purchase of new test instruments does not in itself represent spending money. It can, in fact be a definite saving for you and your employer.



RESISTANCE DECADES Model DR Series

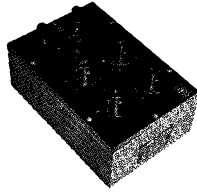

High-Precision and Stability • Low Zero-Resistance • Long-Life Switches.

DR units provide convenient selection of precise resistance values. Typical applications are found in the areas of circuit design in simulation of various factors, and as standards in bridge-type measurements.

Standard units are available with 3, 5, or 7-dials. Each decade inserts a precise ohmic resistance in series with the terminals. The basic ohmic value of any decade may be multiplied by factors of 0, 1, 2, 3, thru 10, by setting its dial at the appropriate step.

Switches are 12 position, 360-degree type. Actual resistance is the sum of zero-resistance and indicated resistance. Model DR units provide zero-resistance of less than 0.003 ohm per decade.

Model No.	Maximum Resistance	Decade Steps
DR-1D	1,110,000	10 x (1K+10K+100K)
DR-2D	111,000	10 x (100+1K+10K)
DR-3D	11,100	10 x (10+100+1K)
DR-4D	1,110	10 x (1+10+100)
DR-50D	11,111	10 x (0.1+1+10+100+1K)
DR-51D	111,110	10 x (1+10+100+1K+10K)
DR-52D	1,111,100	10 x (10+100+1K+10K+100K)
DR-70D	1,111,111	10 x (0.1+1+10+100+1K+10K+100K)
DR-71D	11,111,110	10 x (1+10+100+1K+10K+100K+1M)

CAPACITANCE DECADES Model DK Series

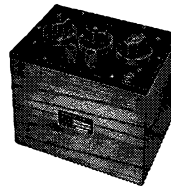

Model DK units provide convenient selection of precise capacitance values with direct reading on the dials. Typical applications are found in bridge measurements and in experimental work such as circuit design. Standard units are 3-dial types. Paralleling switches provide steps of 0 to 10 by combining four capacity values. All capacitance is connected across the terminals.

Capacitors are adjusted to the accuracies listed so that increments are correctly indicated on the dials. Zero-capacitance is less than 35 pf. Silver-mica and mylar dielectrics are used to obtain low-loss, high-stability characteristics.

Model	Maximum Capacity μ f	Decade Steps μ f	Accuracy	Power Factor	Peak Volts	Dielectric
DK-2A	1.11	0.001	All $\pm 1\%$	All 0.2%	700	All
		10x 0.01			700	Silver Mica
		0.1			500	Mica
DK-4	1.11	0.001	$\pm 1\%$	0.2%	700	Silver Mica
		10x 0.01	$\pm 1\%$	0.2%	700	Silver Mica
		0.1	$\pm 3\%$	1%	400	Mylar
DK-5A	11.1	0.01	$\pm 1\%$	0.2%	700	Silver Mica
		10x 0.1	$\pm 3\%$	1%	400	Mylar
		1.0	$\pm 3\%$	1%	400	Mylar
DK-11A	11.1	0.01	$\pm 0.5\%$	0.2%	700	Silver Mica
		10x 0.1	$\pm 0.5\%$	0.2%	500	Silver Mica
		1.0	$\pm 2\%$	1%	400	Mylar
DK-10	0.111	0.0001	$\pm 10 \mu$ f	2%	700	All
		10x 0.001	$\pm 0.5\%$	0.2%	700	Silver
		0.01	$\pm 0.5\%$	0.2%	700	Mica

DECADE ATTENUATORS Model DA Series

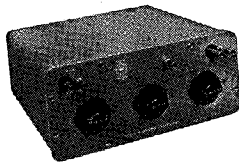

Wide attenuation ranges in small increments • All resistors wire wound and specially treated for high stability characteristics • 0.1 and 1 db decades may be continuously rotated to facilitate full-to-zero attenuation adjustments. End stop provided for 10 db decade • Mechanically ruggedized for long term heavy duty.

Model DA-1 and DA-2 Decade Attenuators can be used for gain or loss measurements on amplifiers, filters, transformers and similar equipment. Also useful for power-level measurements and may be utilized as a power-level control.

The basic decades used in the DA Decade Attenuators are adjustable 600 ohm "T" network types. The DA-1 has 3 shielded decades covering 0 to 111 decibels in steps of 0.1 decibel. The DA-2 incorporates 2 shielded decades with a range of 0 to 110 decibels in 1 db steps. Each decade consists of four shielded resistive "T" network attenuation pads having respectively 1, 2, 3, and 4 units of attenuation. Cam operated switches connect the attenuation pads in proper sequence for a total of 0, 1, 2 - 10 units of attenuation

Attenuation Range: 0 to 111 decibels in 0.1 db steps (DA-1) 0 to 110 decibels in 1 db steps (DA-2)

Attenuation Accuracy: Maximum error ± 0.1 db $\pm 1\%$ of indicated value for frequencies below 200 KC; low frequency error ± 0.2 db $\pm 25\%$, plus switch error of .005 db.

Circuit: "T" network
Impedance: 600 ohm/600 ohm
Maximum input Power: 1 watt
Resistor Accuracy: $\pm 0.25\%$

IMPEDANCE BRIDGE Model ZB Series

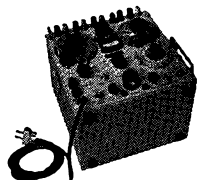

Model ZB-2 is a universal type bridge for the precise measurement of AC and DC Resistance, Inductance and Storage Factor, and Capacitance and Dissipation Factor. The instrument provides clear in-line readout, features simplified operation, and covers an exceptionally wide range for all types of measurements. In-line readings for DQ and RCL facilitate faster and more accurate reading. A new meter null detector is utilized on both AC and DC measurements to eliminate the conventional "electron-ray" or "eye" tube.

Range:	Resistance	0.0001 ohm to 11 megohms AC or DC (8 ranges)
	Capacitance	1 pf to 1100 μ f (7 ranges)
	Inductance	1 μ h to 1100 h (7 ranges)
	D	0.001 to 1.05 at 1 KC Provision for external extension
	Q	0.02 to 1000 at 1 KC external extension
Accuracy:	Resistance	$\pm (0.1\% + 1$ dial div.)
	Capacitance	$\pm (0.2\% + 1$ dial div.)
	Inductance	$\pm (0.3\% + 1$ dial div.)
	D Factor	$\pm (5\% + 0.0025)$
	Q Factor	$\pm (5\% + 0.0025)$
	to	10 HY $\pm (5\% + 0.0025)$
	at	100 HY $\pm (5\% + 0.015)$
	at	1000 HY $\pm (5\% + 0.055)$
Internal Oscillator Frequency: 1 KC $\pm 1\%$		
Internal DC Supply: 10 V at 250 ma (DC Low)		
200 V at 10 ma (DC High)		

QUIET AMPLIFIER Model 108

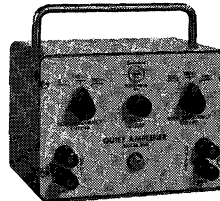

INPUT IMPEDANCE
8 megohms shunted by 30 μ f

OUTPUT IMPEDANCE
600 ohms in series with 20 μ f

POWER REQUIREMENTS
225 volts DC, @ 3.5 ma
12.6 volts DC @ 0.3 amperes

DIMENSIONS 5" x 7" x 5"

WEIGHT 3.5 pounds

VOLTAGE GAIN 100, adjustable $\pm 10\%$

FREQUENCY RESPONSE (wide band)
 ± 0.2 db, 10 cps to 200,000 cps
 ± 0.5 db, 5 cps to 500,000 cps
-3db ± 1 db at 1 cps and 1 mcs

MAXIMUM INPUT 100 millivolts AC
400 volts DC

MAXIMUM OUTPUT 10 volts RMS or 0.5 ma
5 cps to 100 kcs

EQUIVALENT INPUT NOISE 1.5 microvolts RMS maximum for 10 kc bandwidth anywhere between 10 cps and 1 mcs. 4 microvolts maximum for 100 kc bandwidth

LOWER CUTOFF FREQUENCY 1 cps, 10 cps and 100 cps selectable $\pm 20\%$

UPPER CUTOFF FREQUENCY 10 kcs, 100 kcs and 1 mcs selectable $\pm 20\%$

DISTORTION Less than 0.5% at 10 volts output, open circuit; 3 volts into 10,000 ohm load; or 1 volt into 1000 ohm load; 10 cps to 100,000 cps

The Model 108 Quiet Amplifier reduces circuit noise to a new low. Extreme care in the choice of components and circuitry has resulted in an exceptionally low noise figure throughout the entire operating spectrum. Selectable low frequency and high frequency cutoffs are provided to further reduce the noise for limited bandwidth applications. Its usefulness however, is not restricted to the microvolt region since a maximum output of 10 volts RMS makes the instrument suitable for high level measurements.

The instrument is self contained with the exception of the power supply. This has been purposely designed as a separate package (PS-108) to avoid the problem of power line fields in the vicinity of low level circuits.

See EEM Sections 1100 and 4100 for other Industrial Instruments products. For full specifications on the complete line of Electrical/Electronic Test, Measuring & Control Instruments, see your local Industrial Instruments Sales Representative or write direct. We also invite your inquiry on our line of Electrolytic Conductivity Equipment and Thermo Bridge Gas Analyzers.



Industrial Instruments Inc.

89 Commerce Road, Cedar Grove, Essex County, N. J.

Phone: CEnter 9-6200

Delivered In Quantity...

MINIATURE Narrow Band-Pass Crystal Filters

The Midland Type FB Series is a group of hermetically sealed, eight-crystal, narrow-band filters that provide bandwidths in the range of 2 KC to 30 KC @ 6 db, with a center frequency of 10.7 MC. They are designed to operate in the environmental temperature range of -55°C to $+90^{\circ}\text{C}$ with an insertion loss of 4 db max. and an inband ripple of .8 db max. The Type FB narrow-band crystal filter is ideally suited for design in two-way communication systems, telemetry systems, electronic instrumentation equipment and other 10.7 megacycle applications where small fractional bandwidth filtering plus a high degree of selectivity and temperature stability is required. It can be used to best advantage in designing single-signal RF stages to give greater adjacent channel separation and performance reliability, in addition to conserving space and reducing material and manufacturing costs. Midland invites inquiries in assisting with any engineering problem where the use of crystals and crystal filters is proposed.

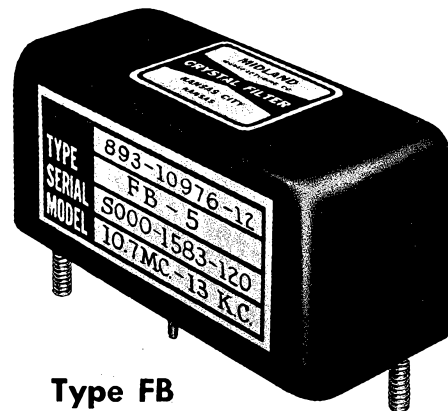

Type FB

Specifications

	FB-5
Center Freq.*	10.7 ± 375 CPS
BW @ 6 db Min.	13 KC
BW @ 60 db Max.	23 KC
60 db/6 db BWR Max.	1.8
BW @ 80 db Max.	26 KC
Ultimate Rejection Min.	105 db
Req. Source/Load Resistance (R_o)	1 K ohms
Inband Ripple Max.8 db
Insertion Loss Max.	4 db
BW @ 1 db Min.	10 KC

*Center freq is the arithmetic mean of the frequencies at 6 db.

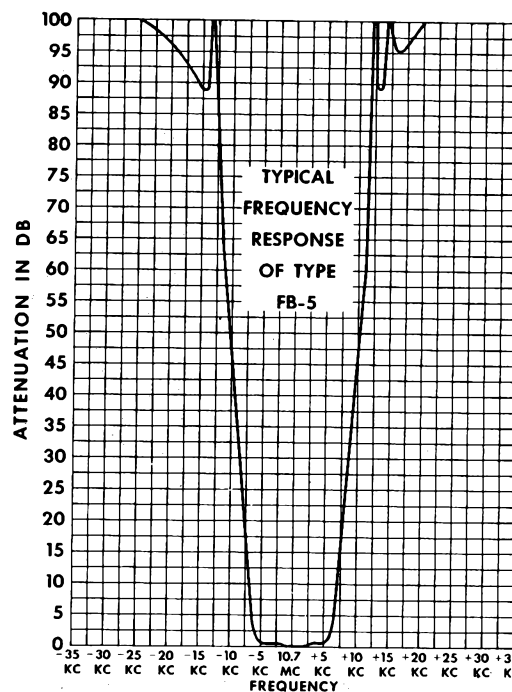

Operating Temp. Range: -55°C to $+90^{\circ}\text{C}$
 Shock: 200 g
 Vibration: 15 g to 2 KC
 Max. Input Level: +10 dbm



MANUFACTURING COMPANY, Kansas City 15, Kansas

WORLD'S LARGEST PRODUCERS OF QUARTZ CRYSTALS
 DIVISION PACIFIC INDUSTRIES INCORPORATED

Robert Finlay
 SALES COMPANY
 MANUFACTURERS REPRESENTATIVE
 RIDGEWOOD NEW JERSEY

THE ART OF AUTOMATION

AUTOMATIC TYPING

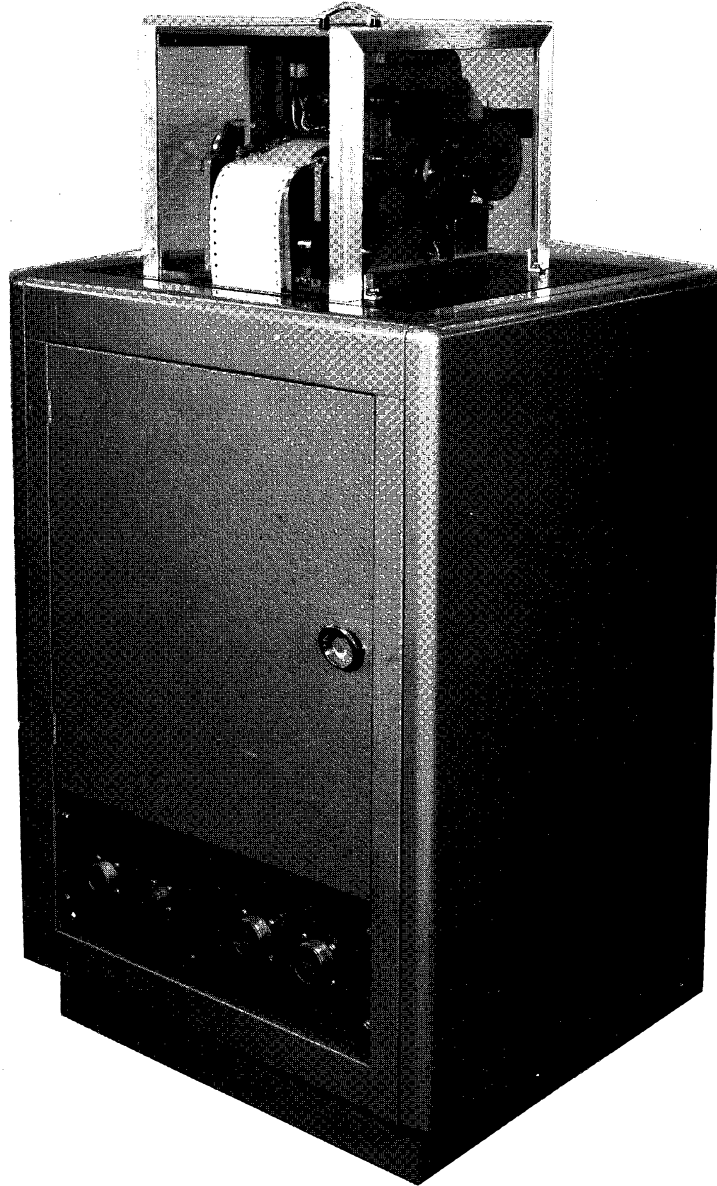

SHEPARD ELECTRONIC

HIGH SPEED TYPER MODEL 472

SHEPARD LABORATORIES, Inc. 480 MORRIS AVENUE SUMMIT, NEW JERSEY

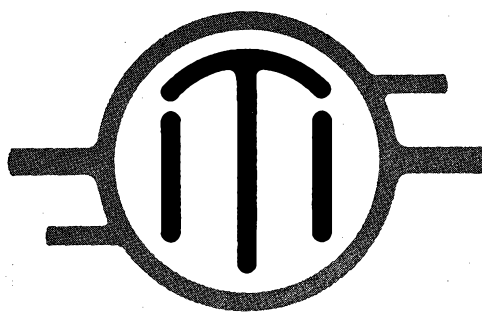

YOUR *QUALITY* SOURCE

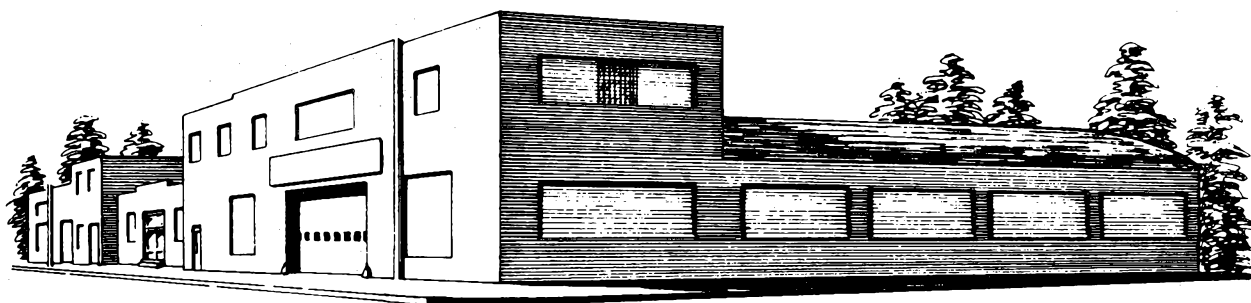

for...

PRODUCT DESIGN

PRODUCTION WITH HIGH RELIABILITY

EVALUATION STUDIES

MODELS & PROTOTYPES

CALL US — VISIT US

Inspect our facilities — Meet our people — Discuss your problems
We'll supply you with our detailed facilities data
and tell you how we can help.

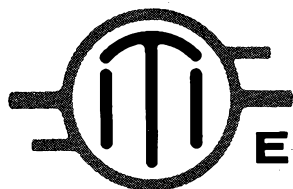

SINCE 1947

ELECTRONICS, INC.

A manufacturer's manufacturer

369 LEXINGTON AVENUE
CLIFTON, N. J.

TELEPHONE: GREGORY 3-0900
W. U. CODE: INDUSTEL, CLIFTON, N. J.

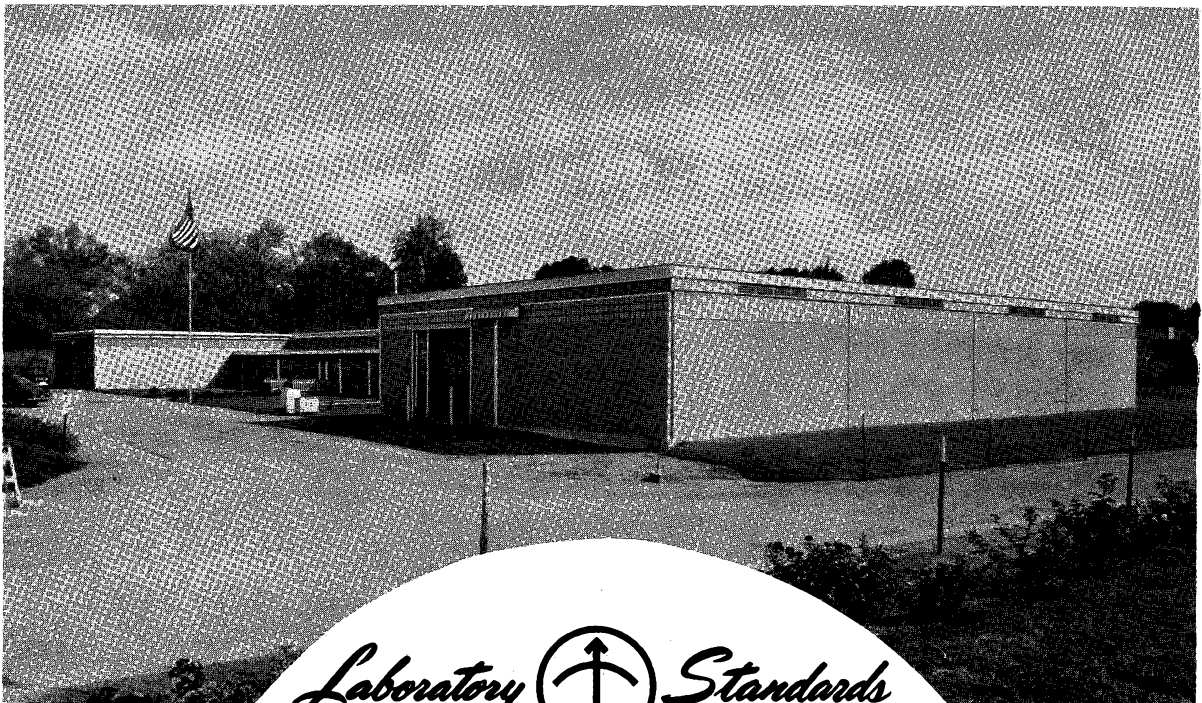

Laboratory  *Standards*

MEASUREMENTS

A McGraw-Edison Division

Boonton, New Jersey

