

N O V E M B E R 1 9 2 9

RADIO BROADCAST

PUBLISHED FOR THE RADIO INDUSTRY



SPECIAL FEATURES IN THIS ISSUE

Radio's Greatest Year

Can the Dealer Tie in With Broadcasting?

What Are the Trends in Radio Models?

Factors in Expanding a Dealer's Business · Retail Chains in Radio · Can Service Pay a Profit? · Tested Sales Ideas · Principles of Linear Detection · Power Transformer Design · Data on Band-Pass Circuits

T H I R T Y F I V E C E N T S

DUBLEDAY, DORAN & CO., INC. ♦ GARDEN CITY, NEW YORK



2-V PAM 19

New York Parks are PAM Equipped

In Central Park, New York, programmes such as Goldman's Band, speeches originating in the bandstand, etc., are picked up and amplified by a PAM amplifier similar to that illustrated above and fed over wires to twenty-five municipal parks in other sections of the city.



One of
New York's Parks

In each of these parks is installed a 2V PAM-19 shown at the left which supplies reproducers located at proper points, thus permitting simultaneous quality reproductions at widely separated points.

The parks in your city are logical prospects for a similar type of equip-

ment. Have you seen the park authorities?

A new 16-page bulletin giving mechanical and electrical characteristics, representative installations, and many new PAM amplifiers will be sent upon receipt of 10 cents in stamps to cover postage. When writing ask for bulletin No. RB12.

Main Office:
Canton, Mass.

Samson Electric Co.

MEMBER
RMA

Manufacturers Since 1882

Factories at Canton
and Watertown, Mass.

Service Plus!

It's the *plus* that counts!

Like the "it" in personality, the knockout blow in boxing, or the crashing ace in tennis, it's the punch that counts!

The SUPREME DIAGNOMETER is full of *extra punch!*

Would you patronize a plumber who couldn't stop a leak?

A doctor who couldn't cure a cold?

Then why use servicing equipment that doesn't fill your every need?

That doesn't provide for every test?

That doesn't do justice to your skill?

That doesn't enable you to give service *plus?*

Your customers expect and appreciate SUPREME LEAGUE SERVICE which is the Service *Plus* in radio. You can give SUPREME LEAGUE SERVICE with the SUPREME DIAGNOMETER.



"Set Testers" prove only 29% to 40% efficient in comparison with the SUPREME DIAGNOMETER

Thorough and complete, yet surprisingly simple. The SUPREME RADIO MANUAL gives full instruction and much valuable radio information.

The Only Complete Portable Radio Testing Laboratory

No other radio testing device can anywhere near approach the range, completeness and flexibility of the SUPREME DIAGNOMETER. Make any test you like. Send for ours, which is confidently called "A Test that Challenges Attention." Some of the outstanding features of the SUPREME are:

All tubes tested under actual operating conditions.

Screen grid socket analysis without oscillation.

750 Volt 4 scale A.C. and D.C. meters, 3 scale millimeter.

Self-contained power plant.

Modulated radiator for testing, synchronizing, neutralizing.

External connections to all apparatus.

Tests both plates '80 type rectifiers.

All continuity tests without batteries.

Universal analyzer plugs.

and a request for complete specifications will reveal numerous other superiorities.

Handy carrying case providing compartments and space for all tools and spare tubes.

750/150/16/4 A.C. Meter.

750/250/100/10 D.C. Meter.

2/12 Ampere-125-25 Millimeter.

Thermo couple meter for measuring output of a set.

Measures resistances.

Measures capacity of condenser 5 to 9 M.F.D.

Makes all analysis readings.

Supreme Service League



To Radio Owners: Look for this emblem in your radio shop, on the lapel button or card of your service man. It is your guarantee of dependable radio service. Cash in on the prestige the SUPREME SERVICE LEAGUE is building.



Order NOW

Present production permits immediate deliveries but the momentum of sales is such that buyers are cautioned to place their orders now. Reservations will be made against all orders placed for future delivery on specified dates. Make use of this plan to avoid disappointments.

Most good distributors carry the SUPREME DIAGNOMETER in stock. If yours cannot supply you, send order direct on form to right.

SUPREME

Radio Diagnometer

Makes every conceivable test on any Radio Set-

Supreme Instruments Corp.
343 Supreme Bldg.
Greenwood, Miss.

Please ship SUPREME DIAGNOMETER Model 400-B on basis checked below.

- Net cash \$139.50.
- Time payment plan—\$33.50 cash and 8 monthly payments of \$15.00 each.

All prices are F.O.B. Greenwood, Miss. No dealer's discount.

Date shipment desired

Signed

Firm Name

Street Address

City

State

Please give three or more bank or trade references and names of distributors from whom most purchases are made.

4 big features *in the* National Union Sales Policy

*Never before combined in
One Radio Tube Selling Plan*

- ① Fair Profits to All
- ② Sensible Guarantees
- ③ Quick Service
- ④ Highest Quality Tubes

The National Union Radio Corporation is a combination of the manufacturers of Sonatron, Magnatron, Marathon and Televocal tubes. It was organized on August 23rd

**NATIONAL UNION
RADIO CORPORATION**

*Executive Offices
New York*

"We'll Build Our Business On These Four Points"

Says E. A. TRACEY, *Vice-President in Charge of Sales*

TODAY these four statements are but statements. It is in our own strict adherence to them that we expect to win, in record time, the enthusiastic confidence of every jobber and retailer in America.

MOST new companies herald their formation with a blare of trumpets. Their announcements are filled with boastings and bombast. Claims of future policies and practices are quickly made, and often as quickly forgotten.

It will not be our policy to indulge in any such loose talk and idle promising. But we do feel that the radio trade will be interested at this time in a brief statement dealing with the broad general policies upon which the National Union Radio Corporation will conduct its business.

FIRST: *A fair profit to both jobbers and retailers.* Dealers and jobbers will each receive a fair profit in the sale of all National Union tubes. Our prices and discounts will take into consideration the necessity for costly, though often unwarranted, service on even tubes of the finest possible quality.

SECOND: *Sensible Guarantees.* Loose guarantees are profitable to no one. Any excess of free replacements reduces tube sales and hence tube profits.

The National Union Radio Corporation will introduce a standard form of guarantee. This guarantee will give the consumer complete protection against manufacturing or material defects.

THIRD: *Quick Service.* Quick turnover is one of the major contributing factors to long profits. Only through prompt deliveries and rapid service is quick turnover made possible. To guarantee the utmost service,



National Union will establish at strategic points throughout the United States complete stores of tubes of all types, ready for instant delivery.

FOURTH: *The Best Tubes Science Can Devise.* Mediocre tubes have been the curse of the radio industry. We are pointing our engineering facilities towards the production of only the finest tubes that can be made. Soon definite proof will be available of the high type of product manufactured by us.

National Union has adopted a unique organization set up to guarantee a consistently perfect product. The final inspection engineer, instead of answering to the production department, will answer only to the sales department, hence the sales department which serves as a contact with the trade will have final responsibility for the quality of each tube they sell.

400 Madison Avenue
New York

**NATIONAL UNION
RADIO CORPORATION**

"I've been in the Radio game fifteen years and it's by far the best book I've ever seen on Radio."

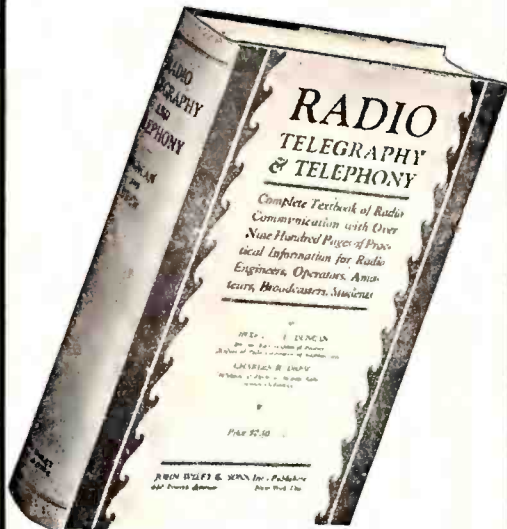

"Radio Telegraphy and Telephony"

By **RUDOLPH L. DUNCAN**
Director, Radio Institute of America
 And **CHARLES E. DREW**
Instructor in Radio, and in charge Electrical Division, Radio Institute of America

A Complete Handbook for Radio Students, Operators, Amateurs, Inspectors, and Engineers.

This new book contains most of the information that anyone seriously interested in Radio would want to know. Subjects *never before treated in a Radio book* are covered here in a thorough, simple, and lucid manner.

26 Chapters: Introduction to Radio; Magnetism—The Electron Theory; The Production of Electromotive Force; Electromagnetic Induction; Motor-Generators—Starters; Curve Diagrams; Storage Batteries and Charging Circuits; Meters; Alternating Current and Frequencies; Condensers—Electrostatic Capacity—Capacity Measurements; Vacuum Tubes; Receiving Circuits; Alternating Current Operated Receivers and A-C Tubes; Telephone Receivers—Loudspeaker Reproducing Units; Commercial Receivers; Rectifier Devices—Rectifier Circuits—Voltage Divider Resistors—Filter Circuits; High Voltage Condensers; Antennae or Aerials; Resonance; Commercial Broadcast and Telegraph Transmitters; Commercial Tube Transmitters; Short Wave Transmitters and Receivers; Spark Transmitters; The Arc Transmitter; Direction Finders—Radio Compass; Radio Telephone Broadcast Transmitter Equipment; Appendix.

"Radio Telegraphy and Telephony" was published in May. You will find in this book the most recent information on current principles, methods, and equipment. Over 900 pages for \$7.50. You may have it on approval for 10 days—but as one radio expert wrote us, "Ten minutes, not ten days, should be sufficient to convince any real radio man that he needs 'Radio Telegraphy and Telephony.'"

A Wiley Book

ON APPROVAL COUPON
 JOHN WILEY AND SONS, Inc.
 440 Fourth Ave., New York City

Gentlemen:—Please send me for examination "Radio Telegraphy and Telephony." Within ten days after its receipt I will send you \$7.50 or return the book.

Name.....
 Address.....
 Reference..... RB 11-29

Your Radio Can Be Only as Good as Its Speaker



"The Speaker of the Year"

Perfect your reception with a
WRIGHT-DeCOSTER REPRODUCER

Write Department "G" for descriptive folder of chassis and different cabinet models.

WRIGHT-DeCOSTER, Inc. St. Paul, Minnesota

HE LOST CONTROL and... FUMBLLED

A brilliant play . . . a sure touch-down . . . ruined by a FUMBLED BALL.

The follow through was bad . . .

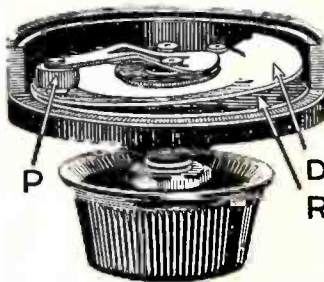

This shows the exclusive rocking disc construction of Centralab volume control. "R" is the resistance. Contact disc "D" has only a rocking action on the resistance. Pressure arm "P" together with shaft and bushing is fully insulated.

. . . a beautiful concert . . . a good radio set . . . a fine speaker . . . all ruined by a faulty volume control.

Instead of an even flow of current the listener is rewarded with an incoherent, sputtering programme.

CENTRALAB equipped receivers ALWAYS permit the reception of a rich, clear, coherent programme—smoothly and without a break.

Centralab

CENTRAL RADIO LABORATORIES
 20 Keefe Ave. Milwaukee, Wis.

PRESTIGE FOR SALES-VOLUME

The Webster Electric Pick-up is universally used in homes and theatres because of its outstanding quality and tone reproducing ability. Its satisfactory record in the past makes it the world's standard of the present. No competitive equipment offers such a group of original and distinctive features. No other pick-up is so looked to for the introduction of latest engineering developments.

The Webster record of performance and sales is of interest to every dealer. The Webster Electric Pick-up enjoys buyer-preference because its rich full-toned music is so appealingly lifelike. It reproduces all the notes of the musical scale, from the highest to the lowest frequencies, with satisfying fidelity and volume.

The new Webster Pick-up is available in two models, both for either battery-operated or A.C. sets. Both models are packed in attractive self-selling cartons. If your jobber has not stocked the Webster, order direct—now!

WEBSTER ELECTRIC COMPANY
Racine, Wisconsin

SPECIAL FEATURES

Webster low-inertia stylus bearing with all-metal pivoting action. Small, light-weight, perfectly balanced head.

Highest grade Cobalt magnet of greatest density.

Shock-absorbing arm bearing with pivot at base—exclusively Webster.

Head turnable for needle-insertion.

Volume control in base.

Weighted base.

Cord completely concealed—all bearings free from chatter.

Can be used for standard or talking picture records.

The New Webster Model 2-B includes Pick-up head, separate volume control, and necessary adapters.



The new Webster Model 2-A includes Pick-up head, supporting arm, built-in volume control, and necessary adapters.

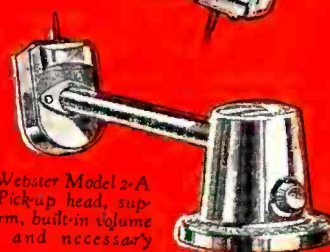

The Webster Electric Theatre Pick-up is for use with 16" records at 33 1/3 R.P.M. Adjustable counterbalance permits correct control of weight on record. Base may be mounted with rubber bands to absorb vibration. With standard or low impedance head.

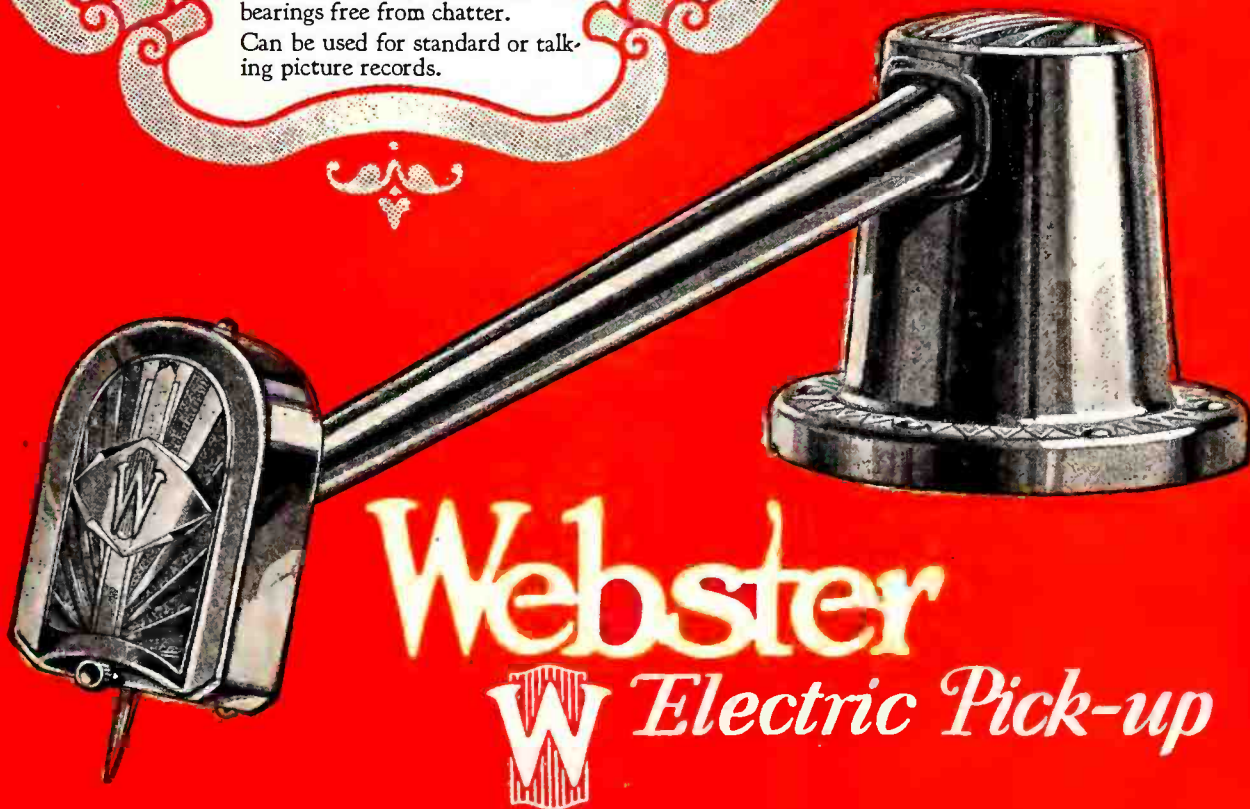

Webster
W Electric Pick-up

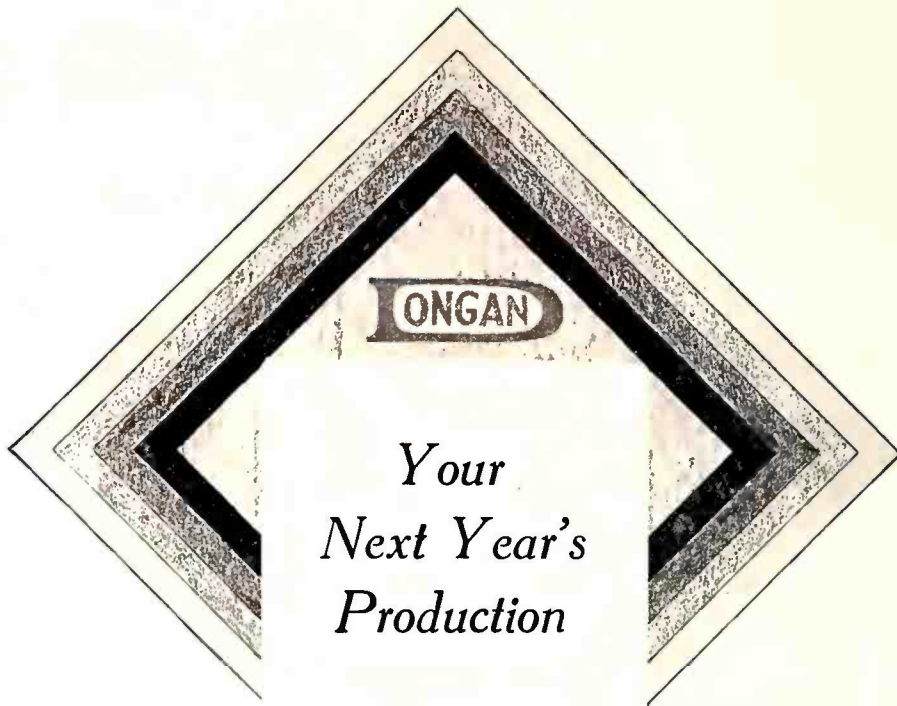

*Your
Next Year's
Production*

THIS year is scheduled by all seasoned manufacturers, both sales and manufacturing. It is on next year's production that Dongan best can serve you.

You then will require a source for the finest of transformers—a source that will always keep your production line moving.

You are assured exactly that from Dongan—designing and manufacturing the finest of approved audio and power transformers. Our sales-engineering department is ready to discuss with you next year's work in Transformers.

We are prepared to furnish complete parts for construction of amplifiers for theaters, dance halls, or public address systems.

*Exclusively M'fr's
of Parts for the
Set Manufacturer*

*Transformers
Chokes
Condenser Units*

Dongan Electric Manufacturing Co.

2991-3001
Franklin Street



Detroit
Michigan

A Radio Parts Guide

THE NEW

YAXLEY

Catalog

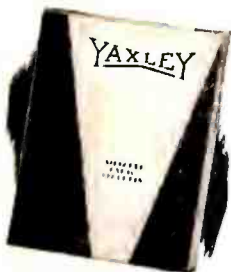

Send for it today for complete listings of Radio Convenience Outlets, Connector Plugs, Rheostats, Fixed and Grid Resistances, Jacks, Jack Switches, Phone Plugs, etc.

YAXLEY MFG. CO.

Dept. B, 1528W Adams St., Chicago, Ill.

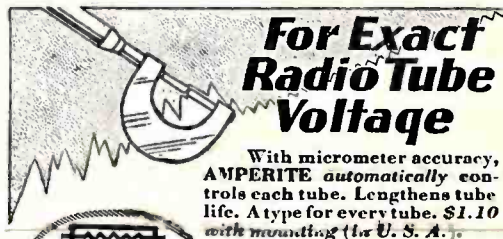

For Exact Radio Tube Voltage

With micrometer accuracy, **AMPERITE** automatically controls each tube. Lengthens tube life. A type for every tube. \$1.10 with mounting (in U. S. A.)



This symbol in a radio diagram means—

AMPERITE

REG. U. S. PAT. OFF.
The "SELF-ADJUSTING" Rheostat

AMPERITE Corporation
661 BROADWAY, NEW YORK
FREE—"Amperite Vest Pocket Tube Chart."
Write Dept. RB-11

! ATTENTION! SERVICE MEN

Quality Replacement Blocks and By-Pass Units

for
**Radio Receivers
"B" Eliminators**

Power Supply Units

Replacement Blocks

Code	Eliminator used with	Price
4341	Majestic Standard "B"	\$10.00
4343	Majestic Special Master	\$11.00
4347	Majestic Super "B"	\$12.00
4359	Majestic Master "B"	\$11.50
4360	Brown "B" Super Power (Green Brown)	\$11.00
22-54	Zenith ABC Power Supply ZE-9	\$12.00
572-S	Mohawk AC (27-28) 226 Type Power Unit	\$12.00
572-S	Stewart Warner	\$12.00

The Potter Co.

North Chicago, Illinois

A National Organization at Your Service

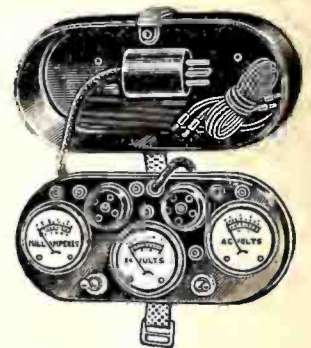

No. 245

Set and Tube Tester

Readrite

A new 3-meter model. Tests screen grid. Compact, Simple, Rugged, Accurate. At your jobbers. Dealers net price \$12.00. If ordered direct, remittance must accompany order.

READRITE METER WORKS

Established 1904

14 College Ave. Bluffton, Ohio



IT'S YOURS

All this advertising material — newspapers — magazines — trade papers — folders — brochures — broadsides — and many other novelties. (Remember the SPEED pistols at the Trade Show? Ask any man who was there!) SPEED advertising backs SPEED sales nationally and locally. Every day is "moving" day with SPEED advertising — it "moves" SPEED Tubes from your shelves to your customers' sets. A few SPEED jobber franchises are still available. SPEED quality + SPEED advertising + your sales ability = an unbeatable combination. The answer will be in \$ and ¢; mostly \$. Get 'em! Write right now!!

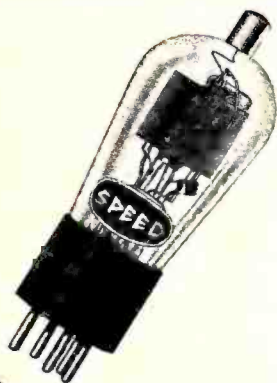

SPEED
CABLE RADIO TUBE CORPORATION
 84-90 North Ninth Street
 Brooklyn, New York



MAKERS OF RADIO TUBES SINCE 1924

RADIO BROADCAST

WILLIS KINGSLEY WING Editor
KEITH HENNEY Director of the Laboratory
HOWARD E. RHODES Technical Editor
EDGAR H. FELIX Contributing Editor



VOL. XVI. NO. 1

PUBLISHED FOR THE RADIO INDUSTRY

Contents for November, 1929

MERCHANDISING SECTION

The Radio World's Fair - - - - -	11
Views of Nine New Receiver Chassis - - - - -	13
Let's Look at Radio's Largest Year - - - - T. A. Phillips	14
What Made This Dealer Succeed - - - - Edgar H. Felix	16
Service—Do You or Your Customers Pay? John S. Dunham	18
Tested Sales Ideas - - - - Merchandising Shorts	20
Typing in with Factory Advertising - A Novel Sales Stunt	
The Gas Station Is a Prospect - An Automobile as a Sales Builder	
Selling Radio - - - - - Howard W. Dickinson	22
Professionally Speaking - - - - - Keith Henney	24
Problems for Standards Committees - Our Service Problem	
Yesterday, To-day, and To-morrow - What Dealers Suggest	25
What They Say - - - - - Interesting Letters	27
A Good Side Line for Radio Dealers - The Time Payment Problem	
How Sales by States Compare - - - - -	27
The March of Radio - - - - An Editorial Interpretation	28
If Automobile Dealers Sell Radio - The New Monitoring Station	
More Patent Difficulties on the Way - Radio's Largest Chain Store	
- Radio Commission Reorganized	
The Tube Business - - - - News of the Tube Industry	30
Views of the Hazeltine Laboratories - - - - -	31
News of the Radio Industry - - - - -	32
In the Radio Marketplace - - Offerings of Manufacturers	36
The Serviceman's Corner - - - - -	38
Strays from the Laboratory - - - - Technical Shorts	40
A.R.C. Radio Altimeter - Advice to Students	
Linear Detection - Screen-Grid Ratings	

ENGINEERING SECTION

Characteristics of A.F. Transformers - - - H. M. Turner	43
Designing the Power Supply Circuit - - - Richard F. Shea	47
Linear Power Detection - - - Frederick Emmons Terman	49
"Radio Broadcast's" Set Data Sheets - - - - -	51
The Gilfillan Model 100 - The Kennedy Model 10	
An Efficient Radio Set Diagnoser - - - Herbert M. Isaacson	52
A High-Resistance Voltmeter Substitute - Frederic B. Fuller	54
The Stewart-Warner Series 950 - - - A. C. Matheus	55
Band-Pass Filter Design - - - - E. A. Uehling	57
Radio Broadcast Laboratory Information Sheets	
Howard E. Rhodes	58
No. 304. Distributed Capacity Measurements - No. 306. Advantages of Automatic Volume Control	
No. 305. Distributed Capacity Measurements	

The contents of this magazine are indexed in *The Readers' Guide to Periodical Literature*, which is on file at all public libraries

... among other things

Now that the two largest public radio shows—those in New York and Chicago—have been held, it is worth while pointing out that the exhibitions did full justice to the merchandise offered by manufacturers this year. That was to be expected, but the more interesting point is that the public did justice to the shows, too. With an astounding number of paid admissions to the shows in both cities, we have ample evidence that radio has the strongest of holds on the public. Great attendance does not mean that every buyer of "a coveted pasteboard" for admission will immediately rush to the nearest dealer and open his heart and checkbook. But it does mean that dealers can be certain that they do not lack for prospects.

It may be observed in a still small voice that may be heard through the current verbal sales excitement about screen-grid tubes and their good works that the use of these tubes is also responsible for the greatly decreased a.c. hum which is an important but not much-stressed feature of this year's models. Screen-grid tubes properly used mean plenty of r.f. amplification, and plenty of amplification before the detector means that only one audio stage is required. And less amplification in the audio side means decreased hum. The hum is no longer a serious problem of the sales groups and the designers have been freed of these worries by this unexpected benefit of the proper use of this tube.

Those who are interested in trends—and who isn't?—will find our summary of exhibits at the New York show and its comparison with exhibits at the earlier Trade Show of interest and probably considerable use.

Coming issues will contain a variety of articles of use to those who sell radio. These will discuss such subjects as the future of the jobber, where trouble is apt to develop in house-to-house selling, how a successful merchant manages his sales staff, the present trend in time-payment selling, how color can best be used in window display, what the dealer thinks about factory newspaper tie-in advertising, and something about the wide variety of outlets now handling radio. The engineering section will present, among many others, articles on the pentode tube, economy in power supply circuit design, a discussion of the relation between cost and permissible performance tolerances, and a design description of the Philco 95 receiver.

—WILLIS KINGSLEY WING.

TERMS: \$4.00 a year; single copies 35 cents; All rights reserved. Copyright, 1929, in the United States, Newfoundland, Great Britain, Canada, and other countries by

DOUBLEDAY, DORAN & COMPANY, INC., Garden City, New York

MAGAZINES
 COUNTRY LIFE WORLD'S WORK THE AMERICAN HOME RADIO BROADCAST SHORT STORIES LE PETIT JOURNAL EL ECO WEST

BOOK SHOPS (Books of all Publishers)
 NEW YORK: <LORD & TAYLOR, JAMES MCCREERY & COMPANY, PENNSYLVANIA TERMINAL, 166 WEST 32ND ST., 848 MADISON AVE., 51 EAST 44TH STREET, 420, 526, and 819 LEXINGTON AVENUE, GRAND CENTRAL TERMINAL, 10 WALL STREET> ATLANTIC CITY: <2807 BOARDWALK> CHICAGO: <75 EAST ADAMS STREET> ST. LOUIS: <223 N. 8TH ST. and 4914 MARYLAND AVE.> CLEVELAND: <HIGBEE COMPANY> SPRINGFIELD, MASS: <MEEKINS, PACKARD & WHEAT.

OFFICES
 GARDEN CITY, N. Y. NEW YORK: 244 MADISON AVENUE. BOSTON: PARK SQUARE BUILDING. CHICAGO: PEOPLES GAS BUILDING. SANTA BARBARA, CAL. LONDON: WM. HEINEMANN, LTD. TORONTO: DOUBLEDAY, DORAN & GUNDEY, LTD.

OFFICERS
 F. N. DOUBLEDAY, Chairman of the Board; NELSON DOUBLEDAY, President; GEORGE H. DORAN, Vice-President; RUSSELL DOUBLEDAY, Secretary; JOHN J. HESSIAN, Treasurer; LILLIAN A. COMSTOCK, Asst'l Secretary; L. J. MCNAUGHTON, Asst'l Treasurer



EVEREADY RAYTHEON

4-PILLAR TUBES

BRING OUT THE BEST THAT'S
IN ANY RADIO RECEIVER



THE GREATLY superior performance of new Eveready Raytheon Tubes means the very best reception a radio receiver can give. People in all parts of the country report amazing results from their own receivers since installing these marvelous new tubes. Greater distance, more power, improved tone, quicker action!

Put a new Eveready Raytheon Tube in each socket of a receiver—and note the vast improvement. Then examine one of these tubes. Observe the solid, four-cornered glass stem at the base of the elements, supporting the four rigid pillars which hold the elements. Notice how the elements are anchored at both sides as well as at the ends. Note how this *4-Pillar construction* is braced still further by a stiff mica plate at the top.

The jolts and jars all tubes receive in shipment cannot distort the elements in an Eveready Raytheon. Handling these tubes and installing them cannot impair their performance. For the elements are permanently held in their correct and accurate positions by the patented Eveready Raytheon *4-Pillar construction*.

No other tube can give you all the advantages of this *4-Pillar construction*, for it is patented and exclusive with Eveready Raytheon. These fine tubes come to you in the same perfect condition as when they leave our laboratory test room... all their superlative performance intact.

NATIONAL CARBON CO., INC.

General Offices: New York, N. Y.

Branches: Chicago Kansas City
New York San Francisco

Unit of Union Carbide  and Carbon Corporation



Trade-marks

THESE INTERESTING TUBE TESTS ARE FEATURED
IN ARCTURUS SATURDAY EVENING POST ADVERTISING



There's no question about Arcturus' 7-second action when your customer holds the watch.



A two-minute demonstration of Arcturus' clear, humless tone is more convincing than a twenty-minute sales talk.



Arcturus Tubes hold the world's record for long life because they withstand the line surge that burns out other tubes. Show your customers that Arcturus Tubes easily withstand 75% more current than they are designed for.

A NEW IDEA IN SELLING TUBES

THAT MEANS MORE PROFITS FOR EVERY ARCTURUS DEALER

137
FACTORY
INSPECTIONS
GUARD
ARCTURUS
QUALITY

THE more Arcturus Tubes you sell, the better for your business.

And the best way to sell these superior tubes is to demonstrate their many good points.

Our National Advertising Campaign, beginning with a half page in the October 26th Saturday Evening Post, tells radio set owners to *make sure* of tube performance before they buy tubes. We tell them what points to check, and how to check them. And Arcturus Dealers will be glad to make these tests, because Arcturus performance measures up to the highest standards at every point.

These photographs, reproduced from our Saturday Evening Post advertising, illustrate three easy tube tests that clinch sales. Show your customers what Arcturus Blue Tubes can do, and watch your tube sales jump.

When your Arcturus sales go up your customers get better reception and your service overhead goes down.

Try selling Arcturus Blue A-C Tubes this way, and see what happens to your tube and set sales.

ARCTURUS RADIO TUBE COMPANY
Newark, N. J.

ARCTURUS

BLUE A-C LONG-LIFE TUBES

THE RADIO WORLD'S FAIR

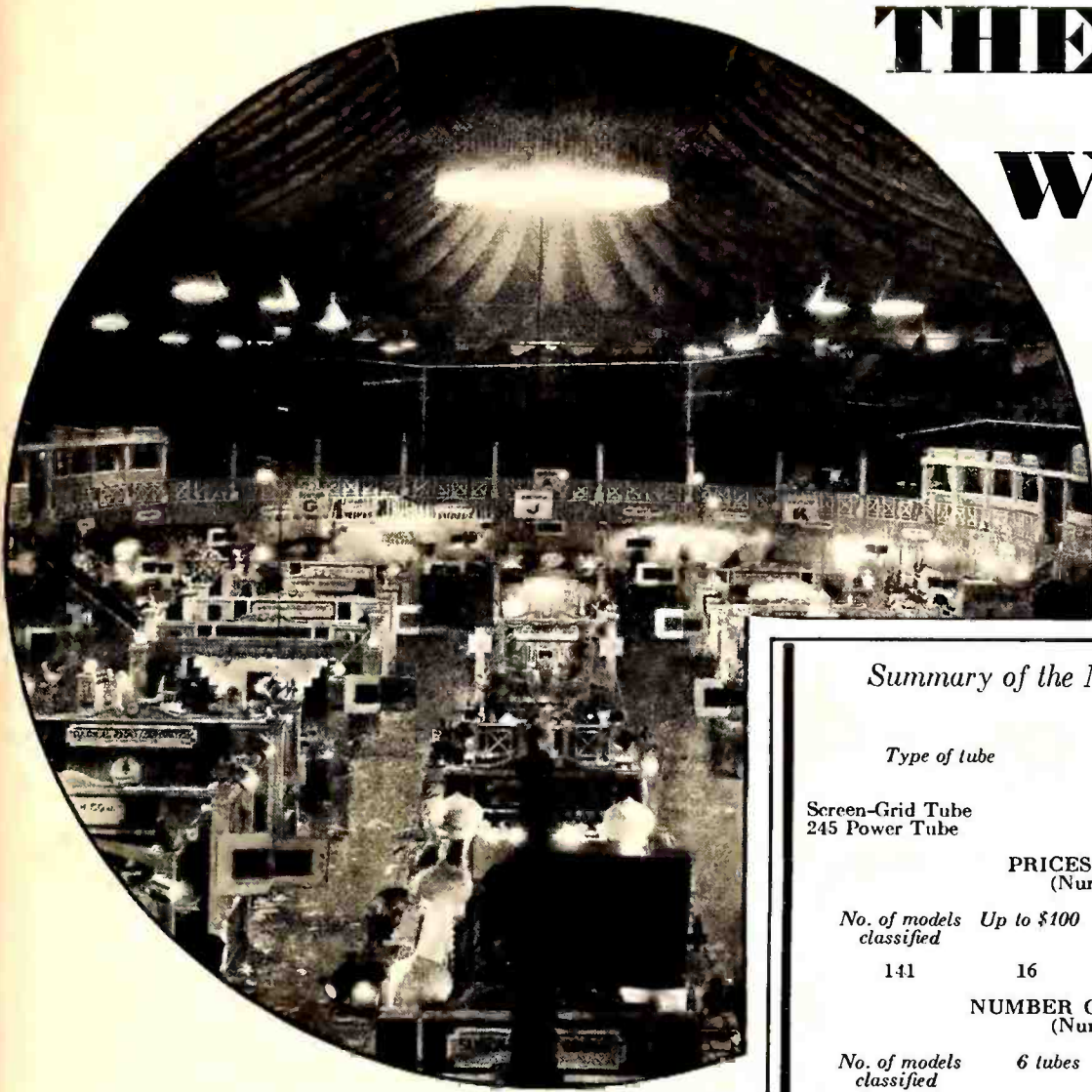

Summary of the New York Radio World's Fair

TUBES USED

Type of tube	No. of models classified	No. of models using tube	No. of models not using tube
Screen-Grid Tube	161	88	73
245 Power Tube	134	103	31

PRICES OF RECEIVING SETS (Number of models below)

No. of models classified	Up to \$100	\$100-\$150	\$150-\$200	\$200-\$300	\$300 up
141	16	27	42	34	22

NUMBER OF TUBES USED IN SETS (Number of models using)

No. of models classified	6 tubes	7 tubes	8 tubes	9 tubes or more
133	13	65	35	20

TYPES OF CABINETS

No. of models classified	No. of consoles	No. of phonograph-radios	No. of tables
139	99	20	20

LOUD SPEAKERS

No. of models classified	No. using dynamics	No. not using dynamics
122	114	8

POWER TUBES

No. of models classified	No. using 245's	No. using 210's	No. using 171's	No. using 250's	No. using 112's
134	103	2	14	12	3

PUSH PULL

No. of models classified	No. using push pull	No. not using push pull
129	114	15

AVERAGE PRICES OF VARIOUS TYPES

Type of receiver	Average price
All phonograph-radio combinations	\$395
All table models	\$107
All console models	\$232

An Analysis of the New Receivers Displayed at the Radio Show at the New Madison Square Garden, New York City.



SUMMARY of the exhibits of receiving sets at the New York Radio World's Fair has been made by RADIO BROADCAST. The results are presented here in the hope that they will be useful to the entire trade. A similar survey was made of the exhibits at the Chicago Radio Trade Show last June and was published in RADIO BROADCAST for July, 1929. Comparisons between the two exhibits are somewhat difficult, due to the fact that exhibitors at the two shows were not exactly alike either in number or in name. The purpose of this survey, however, is to summarize the salient facts and to give a general picture of the industry's present offerings of radio sets.

Our summary shows—in figures—what the trade in a general way knows: the console model still rules supreme, the dynamic loud speaker is on top of the heap, there is a wide range of offerings in the medium-price field, the phono-radio combination is returning to favor, screen-grid models predominate, and prices are, on the average, only a little higher. Two tables show in compact form what the offerings to the trade and public are and how they compare with the first-season offerings at the Radio Trade Show in June.

1. How about screen-grid models?

Somewhat more than half of the models at the show used the screen-grid tube. Of 161 models, 88 sets (55 per cent.) used the

tube and 73 models did not. The trend toward the more general use of the tube is shown by the fact that our survey at the Chicago show indicated the use of this tube in only 45 per cent. of the models.

2. How about prices?

At the show 141 models were classified. Sixteen were priced at less than \$100, 27 at from \$100 to \$150, 42 at \$150 to \$200, 34 at \$200 to \$300, and 22 at more than \$300. Sixty per cent. of all the models listed at \$200 or less. At the Chicago show 65 per cent. listed at \$200 or less so, in general, there hasn't been any definite change in price trends since June when the Chicago show was held. Table model prices do, however, average somewhat

N-1

higher, the average at the New York show being \$107 and at the Chicago show \$80.60. But, with some 60 per cent. of all models at \$200 or less, the buying public will have a wide choice of moderately priced, well-designed radio sets.

3. Tables, consoles, or combinations?

Consoles quite definitely. Of the 139 models classified, 99 receivers (71 per cent.) were consoles, 14 per cent. were tables, and 14 per cent. were combination radio phonographs. The buyer now gets a "swell" piece of furniture when he buys his radio receiver. Buying the set complete in a cabinet with a loud speaker also has the advantage that the manufacturer will always pick out a loud speaker that will give best results with his particular receiver, a good argument for the dealer when a customer wants to use an old already-owned loud speaker.

4. Dynamic loud speakers vs. non-dynamic types.

Dynamic loud speakers continue to run away with the field. The slight increase (4 per cent.) in receivers using non-dynamic loud speakers at the New York show may or may not be a trend. One fact is certain however—the dynamic is still, by far, the most popular loud speaker.

5. How much power will the September buyer get?

At the Chicago show 77 per cent. of all models analyzed used the 245-type power tube. Exactly the same percentage held for the models analyzed at New York. Since the majority of these receivers used two of the new power tubes, the average user will get at least 3.0 watts (if he wants it) from his radio, or about three times that obtainable from sets of a year ago which used a single 171 tube. No wonder New York is considering laws to regulate the amount of noise (unwanted radio music) which anyone can thrust upon the neighborhood air.

6. How do push-pull and single tubes compare?

Only 1.5 per cent. of the sets analyzed at Chicago used single tubes in the power stage. At New York there was a decrease in percentage of models using push pull (one company alone had some ten models none of which used push pull.) Does this mean that set designers are finding single audio stages are as quiet with single tubes as they are in push pull? Or that (as is true) the average person cannot tell the difference between the output of a single tube compared to that obtainable from push-pull tubes?

7. Have prices changed since June?

There has been no change in the average price of console models, which nearly everyone buys (or sclls). Table models seem to be somewhat higher, and phono-radio combinations are as expensive as ever, the average being \$395.

8. How many tubes do the sets use?

Sets are using fewer tubes. Models using 7 tubes or less made up 59 per cent. of the exhibits at the New York show and only 33 per cent. at the Chicago show. Here, apparently, is a definite

trend towards the use of fewer tubes—due possibly to the effect of the screen-grid tube which gives some three times as much amplification as from ordinary tubes. At the New York show, 133 models were classified and 13 used 6 tubes or less, 65 used 7 tubes, 35 used 8 tubes, and 20 used 9 or more tubes.

9. What about d.c. and battery-operated sets?

Out of 141 models on which data was obtained there were 13 of the d.c. and battery-operated types. The industry has put most emphasis on the a.c. set, but indications are that the d.c. set will soon get more attention—which it certainly deserves.

Some consolation may be had from the fact that only 9 such sets were exhibited at the Chicago show whereas 13 were shown at the New York Radio World's Fair.

10. What are the special features?

The use of screen-grid tubes must be classed as the major feature which radio receivers boasted at the September show. There were also other features which time will probably bring into even greater prominence. These are automatic tuning, remote control of tuning, phonograph jacks, automatic control of the voltage into the receiver (line-voltage control), tone-control knobs which enable the listener to remove high or low audio tones if desired—as when static is bad—greater use of local-distance switches, linear and power detection, single stage audio amplifiers, humless amplifiers, illuminated tuning dials, and other dials in which the entire scale is always visible.

11. What does the customer get?

If the models exhibited at the show indicate the trend in the public's buying, most of the sales will be consoles—table models are in the minority. An average console model receiver costs \$232 and includes, almost invariably, a dynamic loud speaker, push-pull 245-type power tubes or tubes of even more

power output, a sensitive and selective tuning system. The table models cost about half as much as a console, i.e., \$107, and have everything the consoles have except the special features which go with the latter type of set, such as loud speakers, etc. The table model purchaser buys, or owns, a separate loud speaker. The table set will be more selective and more sensitive than sets of a year or more ago.

If the purchaser wants the best of modern radio, he will buy a combination phonograph-radio set which will cost him, on the average, about \$400. It will include a dynamic loud speaker, the power output of push-pull 245-type tubes or more power output if desired, and space for records with which to while away the time when there is no (or no good) broadcasting.

No matter what type of receiver your customer buys, this year he receives more value for his money than he did last year. Sets are not only generally better, giving improved sensitivity, selectivity, and fidelity, but prices on the average are lower than a year ago. Prices vary from a low limit of about \$50 to an upper limit of about \$2500—there is a radio set to fit every pocketbook.

Comparison of Chicago and New York Shows											
TUBES											
Type of tube	No. of models classified		% using tube		% not using tube						
	CHICAGO	N. Y.	CHICAGO	N. Y.	CHICAGO	N. Y.					
Screen Grid	215	161	45.5	55	54.5	45					
245 Power	202	134	77	77	23	23					
PRICES OF RECEIVING SETS											
No. of models classified	Up to \$100	\$100-\$150	\$150-\$200	\$200-\$300	\$300 up						
	No.	%	No.	%	No.	%	No.	%			
Chicago	212	36	17.	36	17.	66	31.	45	21.	29	14.
New York	141	17	11.	27	19.	42	30.	34	24.	22	16.
NUMBER OF TUBES USED IN RECEIVERS											
Number of models classified	6 tubes		7 tubes		8 tubes		9 tubes or more				
	No.	%	No.	%	No.	%	No.	%			
Chicago	190	18	10.	44	23.	77	40.	51	27.		
New York	133	13	9.	65	49.	35	27.	20	15.		
CABINETS											
No. models classified	Consoles		Table		Phono-radio						
	No.	%	No.	%	No.	%					
Chicago	219	166	76.	32	15.	21	9.				
New York	139	99	72.	20	14.	20	14.				
LOUD SPEAKERS											
No. of models classified	Dynamics				Not dynamics						
	No.	%	No.	%	No.	%					
Chicago	215	209	97	6	3						
New York	122	114	93	8	7						
POWER TUBE TYPES											
No. of models classified	245's		210's		171's		250's		112's		
	No.	%	No.	%	No.	%	No.	%	No.	%	
Chicago	202	156	77	26	13	16	8	4	2.0		
New York	134	103	77	2	1.5	14	10	12	9 3 4.2		
PUSH PULL											
No. of models classified	Push pull				Not push pull						
	No.	%	No.	%	No.	%					
Chicago	202	199	98	3	2						
New York	129	114	88	15	12						
AVERAGE PRICE OF VARIOUS TYPES											
Type of receiver	Average price										
	Chicago	New York									
Table Model	\$ 80.69	\$107.00									
Console	240.00	232.00									
Phonograph-Radio		395.00									

N-2

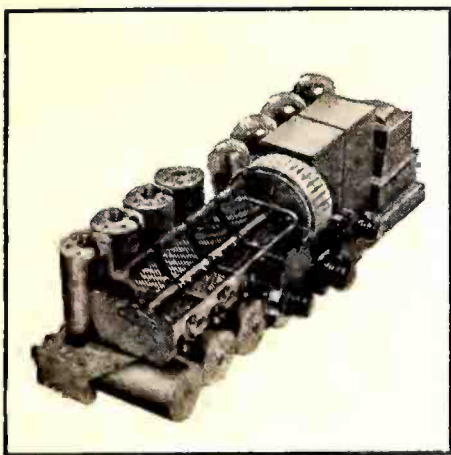

COURIER MODEL 65

This chassis is made by the United Reproducers Corporation. It uses three screen-grid tubes, power detection, and a combination of resistance- and transformer-coupled audio amplification. All the condensers rotate in ball bearings.

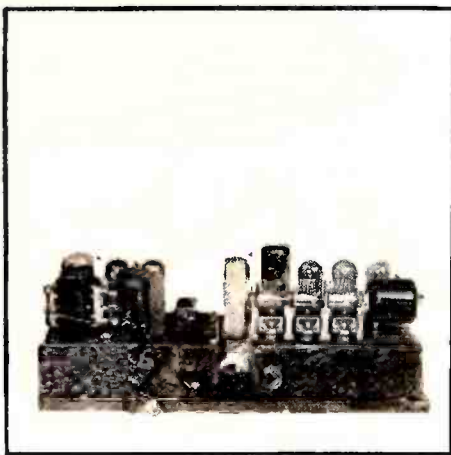

EVEREADY SERIES 30

The shields over the tuning condensers and transformers were removed when this picture was taken to show compactness and accessibility of transformers, condenser drive, and variable condenser. The antenna circuit is tuned by the variometer at the extreme right.

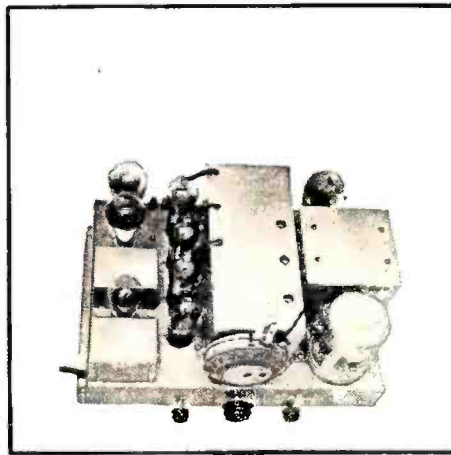

AMRAD RECEIVER

An example of a well-designed chassis assembly. Three screen-grid tubes are used in the radio-frequency stages and in the audio output are two 245-type tubes in push pull. In the filter circuit is a Mershon condenser, a "self-healing" electrolytic filter unit.

NINE NEW CHASSIS DISPLAYED

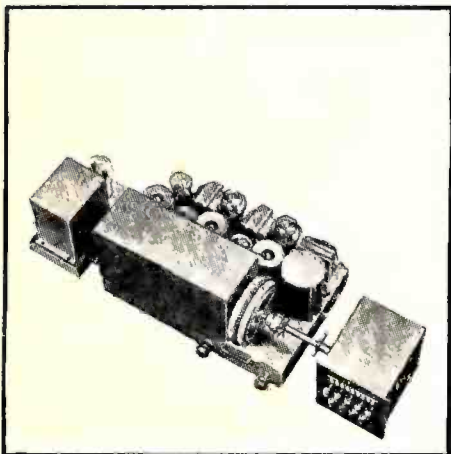

ZENITH SERIES 50

Double push-pull audio amplification is used in this receiver in combination with a new twelve-inch dynamic loud speaker. At the right is the well-known Zenith feature, the automatic tuning device. "Press the button and there's your station."

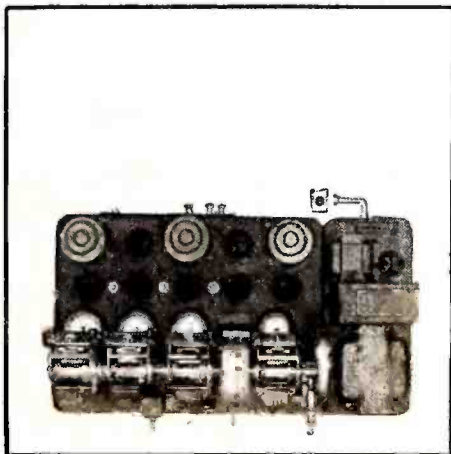

FADA MODEL 35

Features of this receiver are band-pass tuning circuits, screen-grid tubes in the r.f. amplifier, two 245-type tubes in push pull in the output. Note that the tuning dial is not only marked in degrees but also in kilocycles and wavelengths.

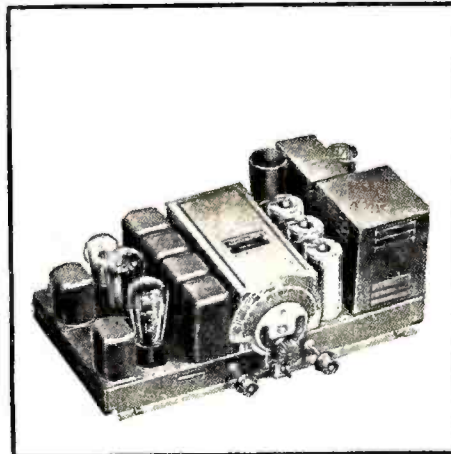

STEWART-WARNER SERIES 900

In this chassis are found the following interesting features: power detector circuit, resistance-coupled audio-frequency amplifier, three screen-grid radio-frequency stages. Varying line voltage is compensated automatically by means of a line-voltage control.

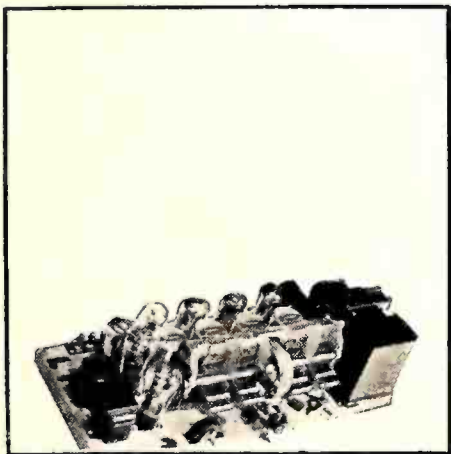

PHILCO CHASSIS

An eight-tube a.c. neotrodyne receiver with tuned antenna input followed by three stages of radio-frequency amplification using 226-type tubes. One of the line of Philco "Neotrodyne-Plus" receivers manufactured by the Philadelphia Storage Battery Co.

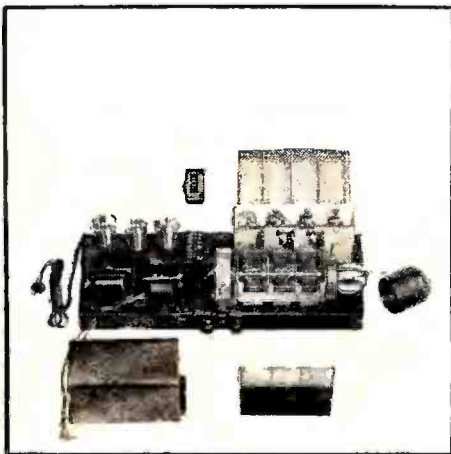

BOSCH MODEL 48

Three screen-grid radio-frequency stages, a linear high-voltage detector, and a single audio-frequency stage employing two 245-type tubes in push pull are employed in the new Bosch receiver. In the above picture all shields have been removed.

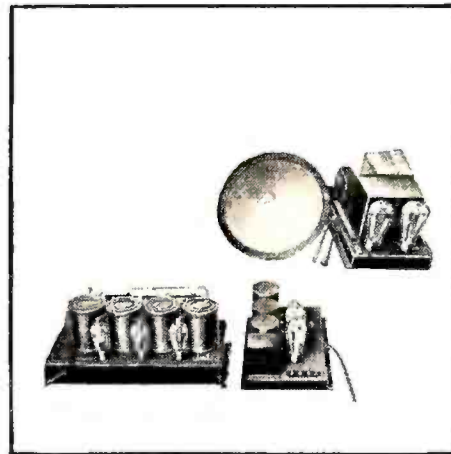

KOLSTER MODEL K-44

This picture illustrates a dismantled chassis to show the various sections. At the left is the receiver, and above is the loud speaker and the power supply. The a.f. amplifier is not shown. The set uses three screen-grid tubes in the r.f. stages and a 245 in the output.

AT THE RADIO WORLD'S FAIR



Let's Look at Radio's Largest Year

By T. A. PHILLIPS

Manager, Research Division, Doubleday, Doran & Co., Inc.

JULY							AUGUST							SEPTEMBER						
3	4	5	6	7			1	2	3	4										
10	11	12	13	14	15	16	5	6	7	8	9	10	2	3	4	5	6	7		
17	18	19	20	21	22	23	12	13	14	15	16	17	8	9	10	11	12	13		
24	25	26	27	28	29	30	18	19	20	21	22	23	14	15	16	17	18	19		
31							24	25	26	27	28	29	20	21	22	23	24	25		
							30	31					26	27	28	29				
													23	24	25	26	27	28		
													30	31						
OCTOBER							NOVEMBER							DECEMBER						
2	3	4	5	6			1	2	3											
9	10	11	12	13	14	15	4	5	6	7	8	9	2	3	4	5	6	7		
16	17	18	19	20	21	22	10	11	12	13	14	15	8	9	10	11	12	13		
23	24	25	26	27	28	29	16	17	18	19	20	21	14	15	16	17	18	19		
30	31						22	23	24	25	26	27	20	21	22	23	24	25		
							28	29	30				26	27	28	29				
													23	24	25	26	27	28		
													30	31						
JANUARY							FEBRUARY							MARCH						
1	2	3	4	5			1	2												
8	9	10	11	12	13	14	3	4	5	6	7	8	3	4	5	6	7	8		
15	16	17	18	19	20	21	10	11	12	13	14	15	10	11	12	13	14	15		
22	23	24	25	26	27	28	17	18	19	20	21	22	17	18	19	20	21	22		
29	30	31					24	25	26	27	28	24	25	26	27	28	29			
												24	25	26	27	28	29			
												31								
APRIL							MAY							JUNE						
2	3	4	5	6			1	2	3	4										
9	10	11	12	13	14	15	5	6	7	8	9	10	2	3	4	5	6	7		
16	17	18	19	20	21	22	12	13	14	15	16	17	9	10	11	12	13	14		
23	24	25	26	27	28	29	19	20	21	22	23	24	16	17	18	19	20	21		
30							26	27	28	29	30	31	23	24	25	26	27	28		
												23	24	25	26	27	28			

THREE MILLION receivers were sold in the year between July 1, 1928, and July 1, 1929, a figure never before exceeded in the history of radio. To the 38,500 dealers who participated in this extraordinary sale, the figure itself is exceeded in importance by only one fact, and that is this—these dealers who turned over three million receivers purchased only 94,000 more sets than they sold, an average individual excess of purchase over sale of less than three sets.

The high quarter in this year (1928) was, as is to be expected, October, November, and December. In this period 1,177,916 sets were sold followed by 798,813 in the next three months, i.e., January, February, and March of 1929. The low quarter was April, May, and June when a total of only 553,550 sets was disposed of, but this figure is half of the number sold in the best period, showing that the wide divergence between the good season and the bad no longer exists.

How Dealers' Stocks Changed

During 1929, stocks in dealers' hands increased over the same periods of 1928. In the period ending January 1, 1929 (including October, November, and December, 1928) the same amount of stock was in the hands of the dealers as existed at the end of the three-month period including October, November, and December, 1927 (actually it was 0.5 per cent. less, a negligible figure). In the next three-month period, however, dealers' stocks of sets were 24 per cent. greater than in the year before and at the end of the next quarter

(April, May, and June, 1929) these stocks were 31 per cent. greater than at the end of the same period the previous year.

Dealers' Purchases by Quarters

Table I gives, for the first time, figures showing the indicated purchases of sets by dealers in each of the three-month periods covered by this survey.

Table II contrasts the situation on the dealers' shelves for the years 1929 and 1928. Although inventories tended to decrease in 1928, they increased in 1929, each period showing an increase over the one previous. This may indicate that at the beginning of the three-month period, July to October, 1928, dealers were generally overstocked with receivers, a fact which is partially borne out by the excess of sales to purchases in the months of October, November, and December, 1928. Abnormal stocks naturally slowed up purchases of new stocks, but this increase in sales over purchase is also due to the fact that these three months were in the half year when set sales are at their peak.

Purchases of receiving sets by dealers in the last three months of the 1928 radio year, i.e., April, May, and June, 1929, were not much in excess of sales by dealers; the data in Table I shows that dealers had disposed of 98 per cent. of their purchases, an obviously excellent situation. During this period dealers were evidently exercising caution in their purchases; in spite of this caution, however, the entire year showed that the improvement in ratio between purchase and sales was not sufficient to reduce inventories materially. The figures for the April, May, and June, 1929, period would seem

to show that even though dealers cut their purchases tremendously, their inventories increased over the preceding three months (January, February, and March, 1929). One conclusion from this fact is that the seasonal decline in set sales for April, May, and June of 1929 was more pronounced than usual.

Sales of sets during this so-called "bad" season were almost a quarter of a million less than the previous months (January, February, and March, 1929) and about 600,000 less than the last three months of 1928. The latter period, however, accounted for a total sale of 1,177, 916 radio receivers.

Dealers showed a bearish attitude toward new purchases during the quarter ending on January 1, 1929. Evidence indicates that dealers are more closely regulating their commitments. In the months of April, May, and June, of 1929, for example, sales dropped 40 per cent. under the preceding three months, dealers purchases receded 45 per cent., and, as already pointed out, the dealers sold 98 per cent. of their purchases. This indicates, probably, that dealers in general were doing everything in their power to improve their inventory status.

The data for the entire radio year suggests some interesting conclusions. First, sales were higher than ever before. Secondly, dealers have become more cautious in their purchases of sets. Thirdly, inventories progressively increased from January, 1929, to June, 1929.

It must be pointed out, however, that while small inventories are temporarily fortunate, they do not press the dealer to get out and sweat for new sales as he would be forced to do if his inventory were larger. If the dealer is doing his level best to sell the merchandise he now has, however, it may be fair to conclude that the present condition is for the moment healthy—for the dealer.

We cannot escape the important fact that dealers must no longer be behind-the-counter experts alone and that the dealer

who waits for trade to come into his store may wait too long. The manufacturer-jobber-dealer combination must work in closer harmony than ever before if the sales record of three million receivers per year is to be equaled or excelled. Manufacturers must consider their responsibility to the dealer greater than is required to create merely public demand by national advertising. They must map out and furnish to the dealer increasingly effective merchandising assistance. The jobber must share in this new responsibility, too.

As for the dealer—he must soberly reflect upon his sales methods of the past year, and make a conscious effort to make them more effective than before if he is to better his previous record.

The data in this article were compiled from the quarterly surveys conducted by the Electrical Equipment Division, Bureau of Foreign and Domestic Commerce, in cooperation with the National Electrical Manufacturers Association. With the report for the last quarter (which ended on July 1, 1929) summaries of dealers' sales, inventories, and indicated purchases became possible for the first time in the history of radio sales.

TABLE I—RADIO RECEIVER DATA

Quarter Ending	Inventory in hands of dealers at end of Quarter	Sales for Quarter	Indicated Purchases for Quarter	Percentage of Sales to Purchases for Quarter
July 1, 1928	297,000			
Oct. 1, 1928	422,900			
Jan. 1, 1929	334,400	573,639	698,539 (a)	82.0%
Apr. 1, 1929	385,600	1,177,916	1,089,416 (b)	107.0%
July 1, 1929	392,000	798,813	850,013 (c)	92.0%
Totals, July 1, 1928 to July 1, 1929	3,103,918	3,197,918	559,950 (d)	98.0%

(a) Inventories being greater on October 1st than on July 1st, dealers must have purchased MORE sets than they sold, i.e., 422,900 minus 297,400 therefore, 573,639 plus 125,900, or 698,539 sets.
 (b) Since inventories in hand of dealers were less on January 1st, than October 1st, dealers must have purchased less sets than they sold, i.e., 422,900 minus 334,400 = 88,500 (excess of sales over purchases). Indicated purchases were, therefore, 1,177,916 minus 88,500, or 1,089,416
 (c) & (d) Same method as (a)

TABLE II—STOCK OF RECEIVERS IN HANDS OF RADIO DEALERS

Quarter Ending	1928	1929	Per cent. Increase or Decrease over same period of previous year
July	297,000	392,000	
Apr.	309,300	385,600	-31.0%
Jan.	350,600	334,400	-24.0%
Oct.	1927	1928	-0.5%
	295,200	422,900	-43.0%

*Figures estimated from quarterly survey of Electrical Equipment Division, Bureau of Foreign and Domestic Commerce with cooperation of National Electrical Manufacturers Association.

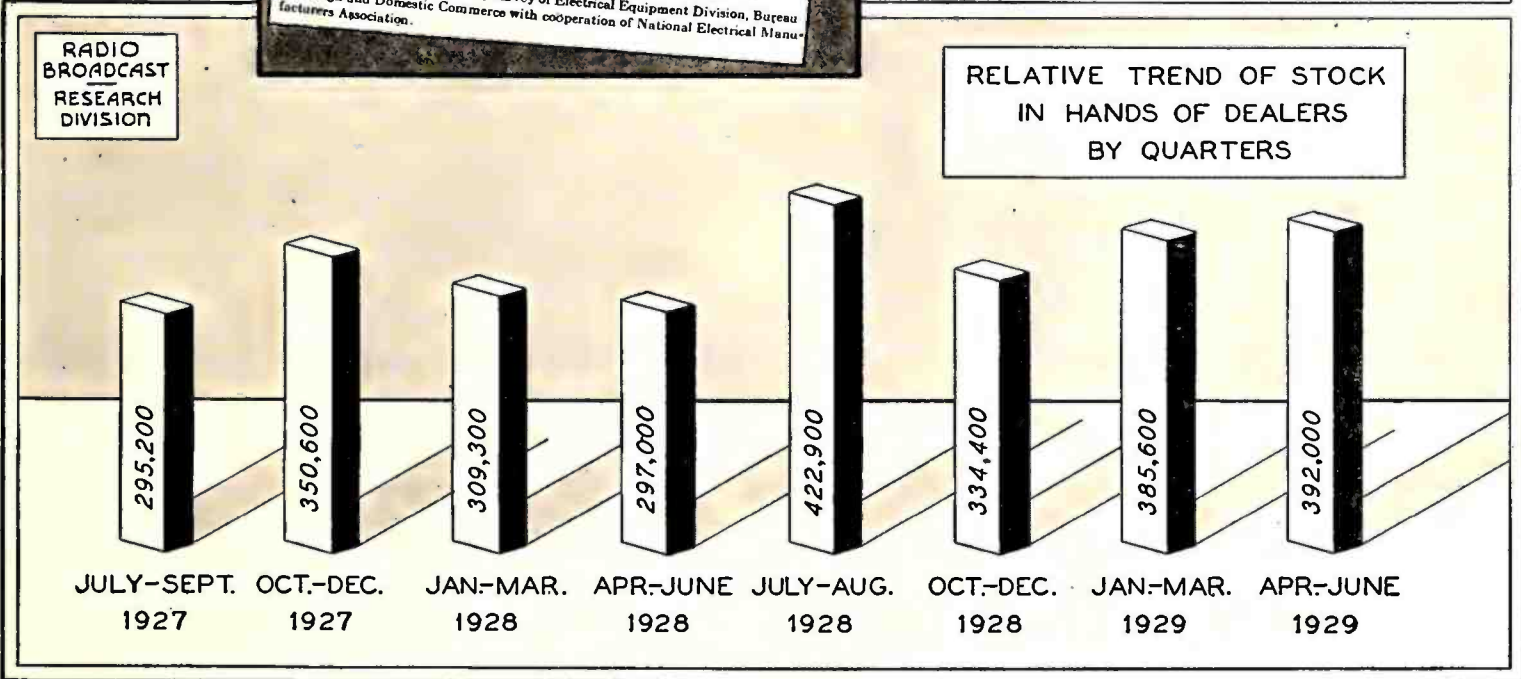
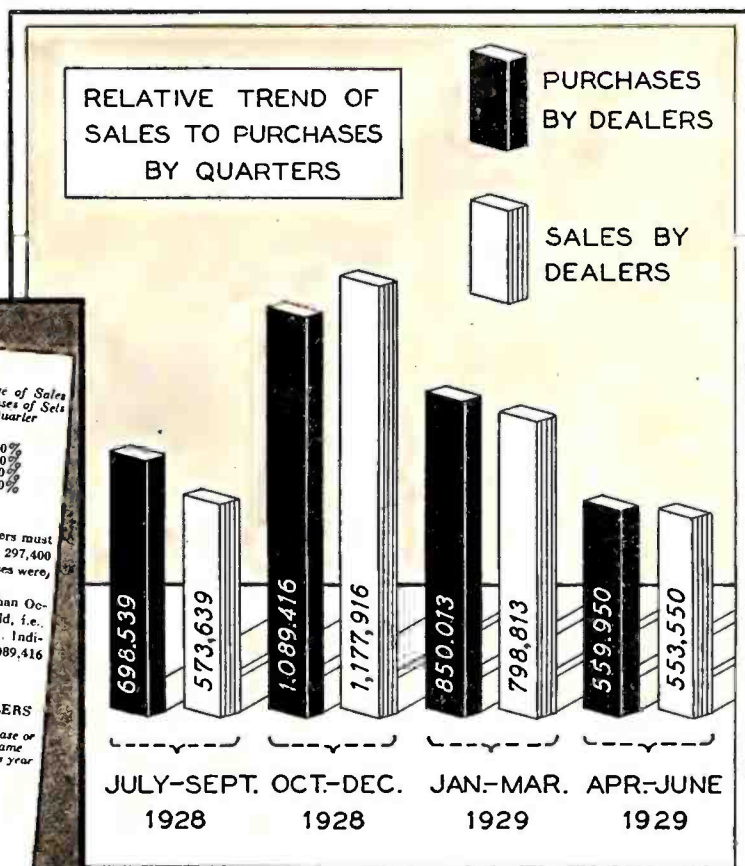

RADIO BROADCAST RESEARCH DIVISION

RELATIVE TREND OF STOCK IN HANDS OF DEALERS BY QUARTERS

WHAT MADE THIS DEALER SUCCEED?

By EDGAR H. FELIX

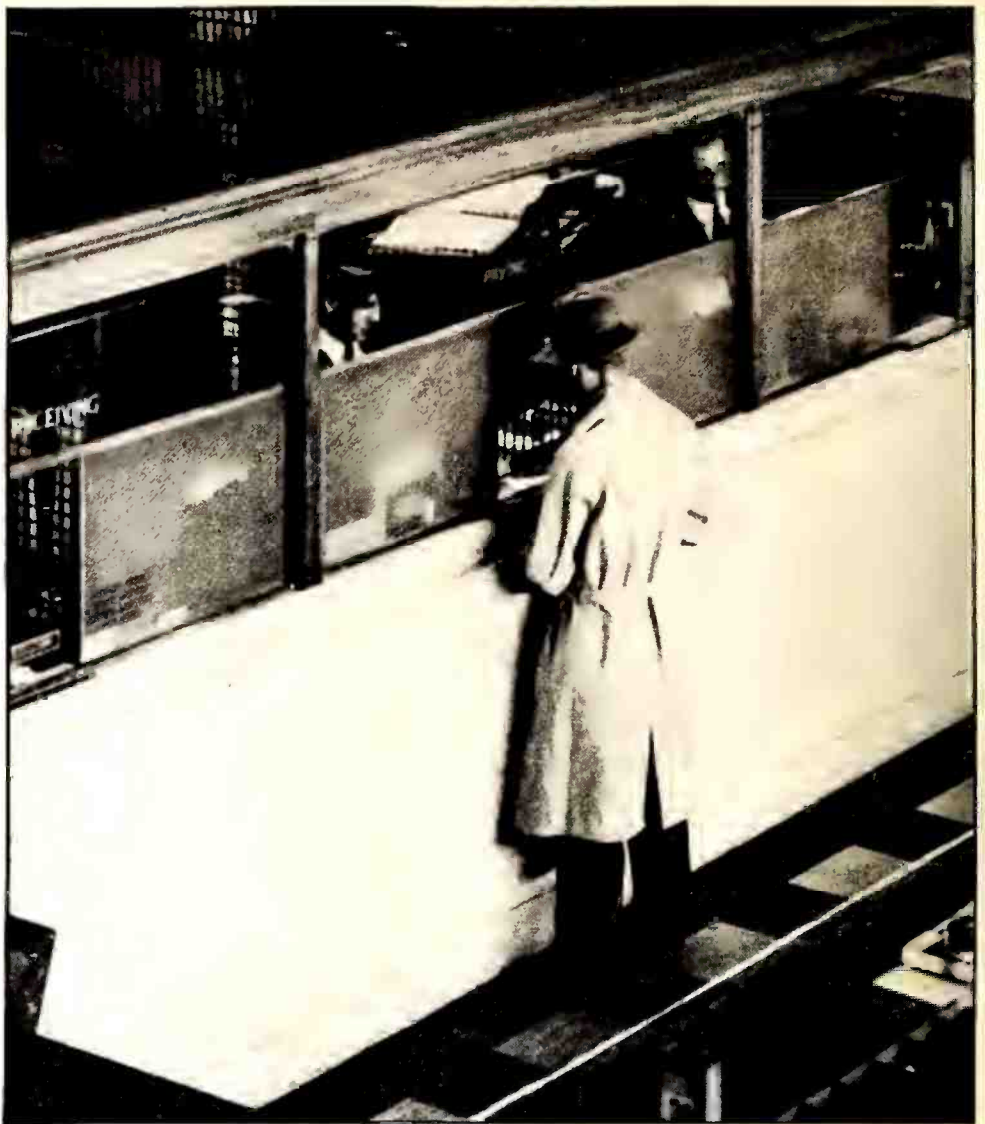

I AM CONVINCED that neither salesman nor serviceman can handle adequately more than one line of radio receivers. Since beginning business we have sold but one line of sets—a line that reaches into all price classes—and for this set we carry a very extensive line of cabinets. We understand these sets not only in general terms but technically as well. With but one line I can unhesitatingly proclaim that it is the best receiver available on the market. It is impossible to meet the demand for every set the customer is likely to ask for, and I see no objection to concentrating on a single line which will meet the needs of the customer regardless of his financial position. Also, my orders are placed through jobbers from whom I get excellent service, for they appreciate the volume of business which I give them. From a sales standpoint this policy of concentration has been entirely successful," says a radio dealer who, several years ago started in business as a custom sets builder, then to become the owner of a single radio store, and at present operating a chain of eighteen radio stores in a half dozen large cities, "The handling of but a single line of receivers is one of the cardinal principles on which the success of my business has been built."

Other Basic Principles

We might as well call the central figure of this story Smith. That is not his name. While Smith spoke freely from his experience, he was unwilling to have his name used.

The first paragraph described one of the principles on which Smith has built a successful business. But it is only one principle. Ever since his business was started Smith has kept his ear

close to the ground and displayed an ability to meet changing conditions quickly.

Smith has never used local newspaper advertising extensively. His original store was located in a small city within commuting distance of New York City and he knew it would be suicidal to try and meet the cut-price competition of the city stores. For this reason he considered it inadvisable to use the conventional advertising. To create sales he has relied mainly on two things; a careful study of store arrangement and window display and very extensive direct-mail efforts paving the way for house-to-house canvassing.

Window Displays

Utmost simplicity and dignity have always been observed in the window dressing—the windows are never crowded with innumerable items. The loud speakers over the store are the best obtainable and are always operated with the utmost attention and care to avoid blasting or any other kind of distortion.

Successful direct-mail selling is not an easy job—but Smith, after many trials, has worked it out to the point where it is responsible for a large part of his sales. In this connection it is interesting to note that for his direct-mail efforts he has generally relied on the material offered by the manufacturer of the line which he handles. His most effective direct-mail efforts have always consisted of a rapid-fire series of letters and circular matter extending over a period of about two weeks—many of the mailings being only two days apart! Timed immediately to follow the receipt of the last piece of mailing, a personal call is made by one of the Smith salesmen. This

He says—

Carry Only One Line, Use Direct Mail Advertising Followed by Salesmen, Make the Customer Come to the Store, Carry Good Side Lines, Open a Second Store When Your First Does the Maximum, Choose a Similar Location, and Experiment Unceasingly With Selling Ideas.

method of direct-mail selling has *proved* its ability to produce sales. This dealer is convinced that simple house-to-house selling is not profitable for the salesman is without introduction. However, if adequate preparation is made by a direct-mail campaign the possibility of making a sale is very much greater.

No Home Demonstrations

As part and parcel of this general scheme is Smith's policy of avoiding home demonstrations. The salesman calls on the prospect with the idea of getting them to come *to the store* for a demonstration! Two years' trial of this policy has led to a higher percentage of sales to calls made than any other method of outside selling which this dealer has tried. If after a store trial the customer insists on a home demonstration to make certain that the set will perform as well in his home as it

did in the store, the set is taken to the home, installed, and operated to the customer's satisfaction. At that time the salesman either secures an order and a deposit or the set is immediately removed.

Selling in Summer

During the slack months of the year a considerable part of Smith's revenue is obtained from side lines—well chosen items that go well in summer and which are properly advertised by their manufacturers. Smith's side lines have also been chosen with an eye for what his sales staff can sell. He carries a large line of electric clocks and home motion picture cameras and supplies. He has found that his salesmen were able to sell these products and that the shelf and display space to be had in his store was suitable for these items. He is seriously considering electrical refrigeration also, but his present delivery equipment is not suited to heavy merchandise.

While on the subject of summer sales it should be pointed out that Smith does not subscribe to the intense effort of the radio industry to increase summer sales by increasing sales pressure. That increased sales pressure, he states, involves increased cost per sale and therefore represents a profit only to the manufacturer. Smith is in the radio business to make money for himself and if, in so doing, he incidentally makes money for others, he has no objection. But he will conduct no business activity of an intensive character in a manner which does not make money for himself.

As a result of these policies, Smith's business grew rapidly. A second store was opened and the same principles which had proved so successful in the first store were carried out. To-day

Smith operates a chain of stores in half a dozen large cities—and in all cases the stores are operated on the same essential principles that had been put through the fire and proved their worth. The same policies could be used effectively in every case because Smith always made sure that the stores which he opened were located in communities similar in character and population to that surrounding his first store. Sometimes a new store was opened, sometimes a well-located existing store was bought out.

In connection with opening a new store, the location is not the only thing to be considered, Smith points out. For example, as Smith's chain grew he considered it desirable to have an outlet in a certain prosperous community. However, after an investigation of conditions he found two very competent dealers serving the territory and concluded that an additional store would simply reduce the profits of all concerned. Then, after extensive negotiations, he was unsuccessful in buying or merging with either of these stores. So, illogical as it may seem, he does not sell radio in the most prosperous community of the entire territory that his chain serves.

To the average reader the example cited above may sound like an unusual practice for a chain store, as, in other fields, such as grocery, drug, etc., chain stores frequently plunge into intense competition and, through a long period of price cutting, succeed in winning over customers of the long-established neighborhood stores. This method has also been employed in some instances by growing radio chains but, in Smith's opinion, it is financial suicide. The radio buyer's initial purchase is his most important one and, if that is not made at a profit to the dealer, there is little opportunity of making that customer profitable to him later on.

Business Management

In Smith's chain each store has its own manager. Direct-mail campaigns are conducted from offices in the parent store. New sales ideas are tried out in individual stores and are either discarded, if they don't prove in, or, if successful, are used by all the stores. Says this dealer, "Continuous experiment with selling methods is essential. I make a trial of window displays, direct-mail campaigns, side lines, and personal selling presentations at one store or another. The experiment then effects the operation of but one outlet. This method was employed for example in working out the summer side lines which have rounded out our sales curve in a very satisfactory way. My sales experiment work will never be completed. But one conclusion which I have reached, after selling millions of dollars worth of radio sets and faithfully applying scientific methods of analysis to determine the cost of sales of every class of item I carry, is that an *exclusive* radio outlet cannot succeed in the average small community. Radio must be supplemented by other speciality products."



SERVICE-

**do you or
your customers
pay?**

By **JOHN S. DUNHAM**

Q R V Radio Service, Inc.

The Service Department of a Successful New York Dealer Operates at a profit Without Any Aid from the Sales Department. A Charge Is Made for Installations, Free Service Is Limited to Ninety Days, Parts are Sold at List Prices, Service Labor Is Charged for at a rate of \$2.50 per Hour, and the Customers Are Pleased!

IN ORDER to make his service department pay a profit the radio retailer must charge for service at a rate not less than two and one-half times the net cost of the labor, free service must be limited to ninety days, and list prices must be charged for all parts and accessories sold on service calls. This basic principle has been strictly adhered to by a large and successful dealer in the New York metropolitan area and it has been largely responsible for permitting the service department of this dealer's organization to pay a profit without any aid from the sales department.

This dealer employs the highest class service personnel obtainable, pays high wages, and endeavors to give the utmost in satisfactory service to the customer. His customers understand thoroughly at the time of sale that there is a definite limit to free service, and he has found by experience that after the free period they are quite willing to pay good prices for the really excellent service he provides. He sells sets, without cutting prices on *any* items, in a city which is the largest and worst hot-bed of price cutting in the country, and is making a huge success doing so, *because he renders superlative service* and charges fair prices for that service. And there are a few others, in the New York area and scattered over the country, who are doing the same thing. When the average dealer wakes up to the fact that the individual radio user *wants* good service and is willing to pay a good price for service which is good, and that knowledge causes the dealer to give good service and charge for it, then, and then only, will he begin to make a justifiable return on his investment in the radio business.

Before radio broadcasting became prominent, this particular dealer had made a success selling other musical instruments.

Now he has built up a successful and rapidly-growing radio business which was large enough last year to keep busy an outside service force which averaged about ten men. It is worthy of note that only one make of radio is sold. Installation is charged for at a price which permits the best of antenna equipment and a *real* job of installing, with something left over to help take care of the free calls during the ninety-day period. The installation charge is added to the *list* price of set and equipment, and is credited to the service department. The cost of the free service given is *not* charged to sales, but is entirely borne by the service department. *None* of the items of service cost is charged to sales, thus relieving the sales department entirely of that usual item of selling expense. And the reason no service has to be charged to sales in that organization is simply that *the service department operates at a slight profit.*

The way in which every radio dealer's service department may be operated at a profit will be considered in greater detail in this article. However, first we will review briefly the mistakes made by the average radio retailer, who, in common with the average retailer in other lines, is without any definite knowledge of the cost of operating his various departments; that is, the accounting system employed is not sufficiently detailed to show exactly where loss is being experienced or where a profit is being made. In this connection it has been our observation that the cost of rendering satisfactory service is usually the most neglected item, and that most of those who embark in the enterprise of making their everlasting fortune by selling radio receivers actually lose money because they underestimate the cost of service. This is not only true of dealers who have just entered the radio business but also of many of those who have had years of experience.

In addition to those dealers who have not discovered the true cost of providing good service there is another class, probably the largest, who have discovered that good service costs a lot of money, but who are of the opinion that their customers will not pay for good service and that free service *must* be given in order to satisfy them. This type of dealer usually makes one of two mistakes, both of which are equally disastrous. One is giving a great deal of free service in an attempt to keep customer good will and charging this expense to sales, at the same time trying to keep the cost of the service as low as possible by hiring inexpensive servicemen. The other course which is often followed by the dealer who is afraid to charge an honest rate for good service is to perform only the very minimum of free service which is necessary during the guarantee period and attempting to reduce the cost by hiring inexperienced high school boys for the purpose.

The fact that every dealer must learn in order to be successful is that the public is willing to pay for *good* service at a rate which will permit the dealer to make a profit, but when they pay a high price for service they demand the best, i.e., the customer must be more than satisfied. However, before discussing the way in which to make a service department pay, the mistakes made by the two types of dealers described above will be considered.

In the first place it has been proved again and again that it is not possible to reduce the cost of service by hiring inexpensive, inexperienced men; more competent men earn their higher wages by doing the job well the first time and reducing repeat calls to a minimum. Secondly, the dealer who gives a great deal of free service increases his overhead to such an extent that it becomes nearly as great, and in some cases greater, than the gross profit on a sale, so that the net profit either shrinks to very small proportions or disappears entirely. On the other hand, the dealer who performs only the minimum service necessary during and after the free guarantee period experiences a large loss of customer good will with the result that the business does not grow or the cost of getting the large number of replacement customers runs the overhead up to a prohibitive degree.

Making Service an Asset

The ways in which service can be made a very real asset, from *all* standpoints, to *every* dealer, may be grouped under three general headings. First, the rendering of *good* service. Since we have been harping on this particular subject in

RADIO BROADCAST for the past eight months, this phase should be given some well-earned rest, and we shall simply review the subject by mentioning a few of the high spots. Good service requires high-class personnel, both outside and inside. That means the employing of *only* grade A servicemen, as rated by some members of the F.R.T.A. and by the Radio Service Managers Association in New York, except that lower grade men may be used successfully for installing receivers under proper supervision. It requires a contented personnel, deeply imbued with personal interest in success of the primary

objective of *satisfying* the customers of the organization. It requires promptness in rendering service, the best outside and inside equipment available, complete and carefully kept records, and intelligent experienced management.

Secondly, the cost of giving such service must be accurately and constantly known. We shall discuss that anon. Thirdly, when good service has been developed, and its cost has been definitely determined, then free service must be rigorously limited to ninety days, *or less*; customers must be made to understand the service guarantee thoroughly before they purchase the set, all service performed after the free period must be charged for at a *rate* which is a mark-up of not less than 150 per cent. of the cost, or in other words, two and one-half times the cost, and all accessories and parts sold on service calls must be sold *at list prices*. All of that sounds rather idealistic and not very practical, doesn't it? But every bit of it is practical, and can be put into practice by every single

dealer in the United States who is not yet making the most of his service possibilities. The proof of the goodness of a pudding is in the eating of it. The proof of the practical value of the three essentials of service outlined above is the *fact* that they are all a part of the policy of the most successful radio dealers in the country, and the additional fact that *no* dealers in the country who have disregarded those three fundamentals of good business—which were learned by other industries before radio broadcasting existed—have been able to make a lasting success!

Cost Accounting

There are a great many different items which enter into the cost of performing service. If all the expenses relating to service are not kept separate from sales and other expense accounts then no way exists of ascertaining accurately the cost
(Concluded on page 60)



What Does Service Labor Cost?

(Average per man of eight men over period of two years)

Pay—\$42.10 per week × 52 (weeks)	\$2189.20	per year
Insurance—Workmen's Compensation, Public Liability, Automobile Contingent Liability, and Fidelity Bond	85.48	“ “
Total Cost, per year:	2274.68	
Number of days in year	365	per year
Number of days of absence—Sundays and Holidays, vacations, sickness, Saturdays in July and August, and miscellaneous	84	“ “
Total working days:	281	“ “
Total working hours—281 (days) × 8 (hours)	2248	“ “
Labor Cost, per working hour—2274.68 (dollars) divided by 2248 (hours)	\$1.01	
Charge to customer for labor, per hour	2.50	
Inefficiency of labor—time lost out of each working hour because of wide fluctuation of service work, and other causes, 11 per cent. of \$2.50	0.275	
Maximum charge against customer for working hour	2.225	
“Free calls,” and no-charge return calls made for all reasons, 24 per cent. of \$2.225	0.535	
Actual income from labor, per working hour	1.690	
Cost of labor, per working hour	1.01	
Gross Margin on labor	0.68	
Gross Margin percentage	40.2%	



TESTED SALES IDEAS



A Method of Securing New Prospects

Operating in Minneapolis, where competition in radio is keen, we have enlisted the services of our present customers to secure new prospects. We have distributed to our entire clientele an elaborate premium book, with which goes a letter pointing out that our increased sales volume has come directly from the customers who recommend us and our product to their friends. The book shows a large variety of premiums, including electric clocks, heaters, bridge lamps, tables, and smoking stands, and explains that these articles can be obtained without charge. All our customer has to do is inform us of any of his friends who are considering the purchase of a set. If we sell the prospect within thirty days after the lead, our customer can choose any of the premiums listed as his reward. This plan is bringing in excellent results in sales and is proving a splendid good-will builder.

JOHNSON BROTHERS, Minneapolis, Minn.

The Gas Station is a Prospect

Our territory has more than the usual number of roadside gasoline filling stations and we decided to make calls on all of them to see whether or not they were equipped with radio sets. Our survey disclosed that out of 30 filling stations, only twelve had sets. Five of the stations "had been looking around" preparatory to buying a set while the other thirteen were real prospects. It did not take us quite one working day to call on all the filling stations and to talk to the owner. Repeat calls on the thirteen prospects and the five who were considering buying a set brought us a total of ten sales. We sold two of the five who had been looking around and lost three to another dealer who had shown his line. Gross sales, however, were \$1575.00 for a few days' work.

OSCAR BLONDON

A Novel Sales Stunt

C. B. Larson, a radio dealer in Virginia, Minnesota, recently inaugurated a brand new "stunt" along sales promotion lines—a slant that probably has never been touched.

Proceeding from the idea that more and more people are becoming interested in the stock market, due to its rather startling activity during the past year, Mr. Larson conceived the idea of having his bookkeeper take the stock reports over the radio at morning, noon and closing time and paste the reports in the window immediately. In addition his advertising has carried announcements of the novel service.

Mr. Larson says that it has kept his window in the public's attention and that his radio sales show very definitely its

These Pages Will Serve Each Month as a Clearing House for Merchandising Ideas of Proved Value Which Are Presented in a Concise Form. This New Department is one Which Every Dealer Will Find of Definite Value

value as an attraction and business getter.

Persuasive Display

Meier Wolf and Sons, the principal furniture store in Mason City, Ia., recently celebrated the opening of their radio department. To bring this department to the immediate attention of the entire city, they arranged a campaign which tied in with the building feature which is being conducted by many large newspapers throughout the country, the model home.

A series of displays, each representing an average dwelling was constructed along one side of the store. And in each living room, a radio was displayed prominently.

An Automobile as a Radio Sales Builder

An automobile rigged up with a battery set and loud speaker together with a double-sided sign, extending from one end of the top of the car to the other has been responsible for a large share of the A-K sales of a South Haven, Mich. dealer. He says:

"When I decided to press my car into active sales-promotion efforts, I knew that the set selected had to be a reliable performer, the arrangement had to be neat, and the sign had to



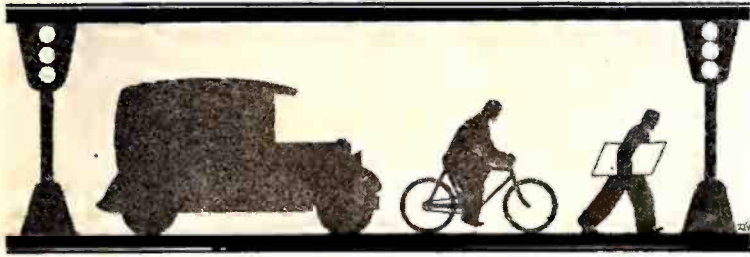

GIVE US YOUR SALES IDEAS

carry a pointed forceful message. The very fact that the car has attracted such favorable attention and has directly resulted in actual sales proves my three qualifications were actually met. I use the car for all my demonstration and service calls and so obtain, as nearly as possible, full-time coverage. Here is the 'meat' of the message on the two sides of the sign: 'Atwater Kent screen-grid radio—The purpose of a radio tube (aside from detection) is to amplify or increase—a radio tube that increases amplification tremendously and at the same time improves tone quality makes a better set: that is what screen-grid radio does.' And on the reverse side: 'Tremendous amplification at the rate of 60 times for each tube. Old style tubes at the rate of 10 times each, elimination of a.c. hum, etc.' When such a message is constantly impressed on prospect's minds, it finally sinks in and creates demand. I, at any rate, have found it to be true and the black side of my books justify my automobile promotion plan."

CHARLIE IVERSON, IVERSON Brothers,
South Haven, Mich.

Letting the Family Sell Itself

Home demonstrations have accounted for many of the sales of a dealer in a small Iowa town. Here is what Seward Heggen, of Thor, Iowa, a town of 300 people says:

"I have long since learned that store demonstrations are not always satisfactory and that sales are more apt to result from a demonstration in the home. In the store, there is often that interruption from other customers which often distracts the prospects' thought and breaks the line of selling. Frequently in the store you must tune-in an undesirable program due to the time of day and the poor location in the business section. I find it helps if the prospect comes to your store *first*. This gives an opportunity to show the complete line and to determine in your own mind the price, and style the prospect has in mind. When I have decided this, I arrange for a demonstration in the home. This is always in the evening as soon as possible after dinner. The whole family listen-in and I permit each to tune-in a few stations for himself. Out of the last twenty-five demonstrations, I have closed the sale on all but three."

Tying In With Factory Advertising

We prepared a special newspaper advertisement of our own, writing copy suitable to our own store which ties in with factory advertising in our local newspaper. The display advertisement occupied ten inches, cost \$44.10, and sold \$2200 worth of radio receivers. This represented a ratio of 4900 per

cent. between the cost of advertising and sales and showed the value of coöperation with general factory advertising.

H. SCHIRESON,
Schireson Brothers,
Los Angeles, Cal.

Making Newspaper Advertising Work

An Iowa dealer is a firm believer in regular newspaper advertising to move his radio line. A. A. Stoker, manager of the Franc Furniture Company in Davenport is speaking. He says:

"During the past year, we have developed a very satisfactory set business through no other selling medium than the newspaper. We use considerable display on our ads and our proposition is clearly stated and not misleading. Our sets are priced complete, which includes a \$5 aerial and installation charge and a \$5 carrying charge on time accounts. We feature terms because we are an installment house. We insist on a down payment of at least 13 per cent. and the balance may be paid in eight monthly installments. The down payment must be in our hands before the set is delivered, even if it is only a demonstration. If the set is not sold, we refund the customer what he has paid less \$5, the charge for erecting an aerial.

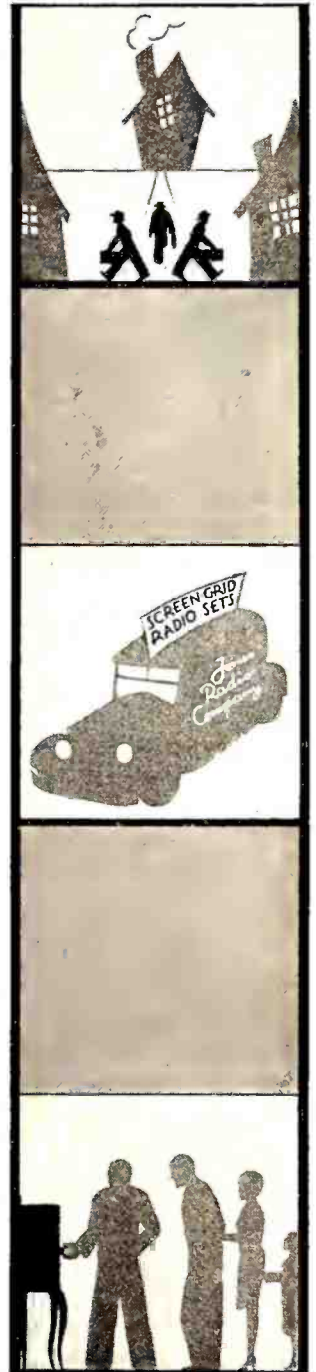



Designed and photographed by Larry June, cutouts by Walter Stiner

By **HOWARD W. DICKINSON**

Merchandising Consultant

WHY LEAVE all the wonderful power of showmanship in radio to the Graham MacNamees, the program people in the broadcasting companies, and the advertising agencies?

The business of radio, the art of radio, both are full of opportunities for showmanship. In broadcasting there is a perpetual fight between pure showmanship and advertising. So broadcasting is somewhat of a compromise, as of course it must be. We can't keep on giving a show without gate receipts. There is no fence about radio, tickets cannot be collected and it has to be endowed by advertising, sometimes well disguised, sometimes poorly disguised.

Opportunities for Showmanship

There is enormous opportunity for good showmanship in the sale of receiving sets, and in most cases it is entirely lacking.

You want a radio set. You go to a radio shop. Sets are on display. Their workings will be explained. They will be demonstrated, rather poorly in most cases. You, the customer, may be interested in only three questions, "Will it hook on to an electric light plug? How much does it cost? How will it match your furniture?" You get answers to those three questions. You buy and there you are. That has been a *demand* sale. If there are enough of them the dealer does well. If he does well another dealer settles down in the next block. If both do well, a couple more come in. Good Old Demand begins to be over-worked. A demand volume good enough for two is spread too thin over four or six. War begins, shading of prices perhaps, over-allowance on used sets, expensive service free.

Each one of the four, five, or six dealers thinks that if the rest of them would only drop dead or go broke he might have a chance. There is only so much *demand* in a community

anyway. He thinks mildly of making more demand. If he is a general handler of electrical appliances, he may find it more interesting to push vacuum cleaners or washing machines or go after wiring contracts and just take radio work and radio sales as they drop in. So, while his radio business ought to be growing fast, he is permitting it to fade.

Analyzing this situation, we find that our good dealer friend is an electrical merchant instead of a radio showman.

Analyze retail opportunity in radio and you will find that it comes particularly to the man who makes a good radio showman of himself.

The Free-Show Idea

Now as to showmanship and its value: most everybody likes a show, particularly a free show. Announce a league ball game free for one day and thousands of people will spend five or ten dollars apiece to get there. If doors open at 9 A. M.



DEMONSTRATE THE FREE SHOW

hundreds will spend most of the night waiting in line to get in. They will buy food, cigars, rent stools to sit on, and invest several times the price of admission.

Radio has that wonderful free show psychology. The dealer does not work it for one tenth of what it is worth. He makes the mistake of trying to offer things free himself. He doesn't need to if he will only stress the free things which come over the air. He is in the enviable position of providing fairly expensive transportation to a free show. His cue is to advertise the show as well as the transportation.

What is the real show in radio? Of course, it is broadcasting. Are you, Mr. Dealer, a student of broadcasting? Are you an intelligent salesman of broadcasting? Are you making full use of the fact that broadcasting is free? Are you presenting that last fact all the time, tactfully and vigorously? Or have you taken it for granted that broadcasting is a business entirely apart from your own? Do you make the mistake which the broadcasting companies themselves make of forgetting your existence, of neglecting to provide you with the wealth of fact which you could use to join with them in selling radio?

They think their own public contact is sufficient. Let us see if it is. Their daily contact is with the people who have and use receiving sets, your contact is with people who have

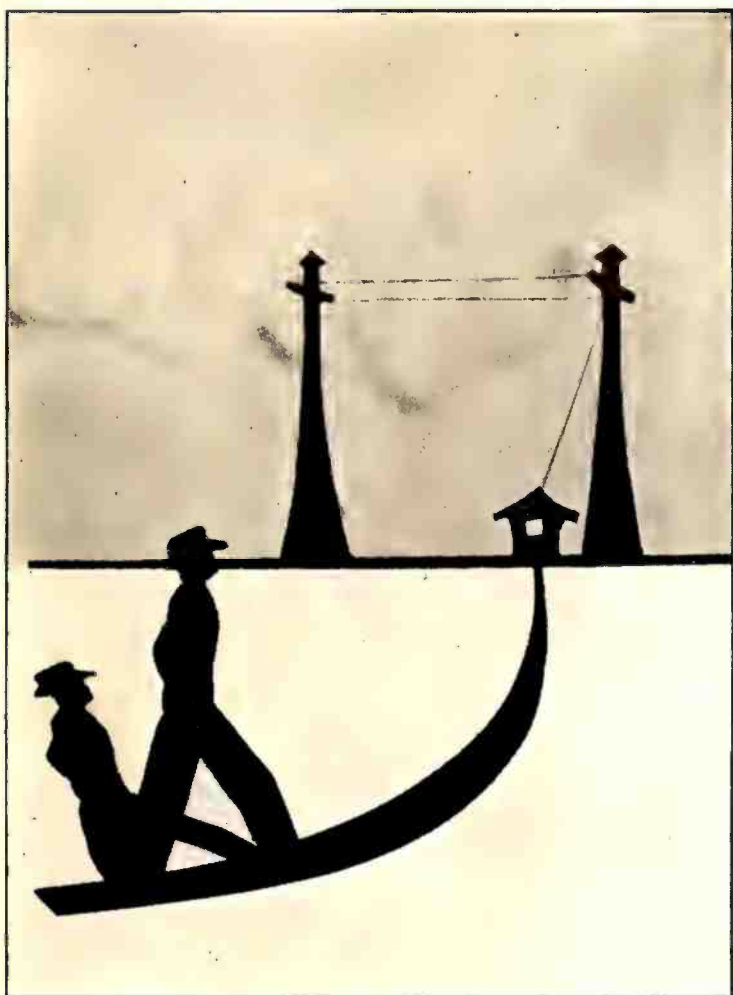

VISIT THE STUDIO

not yet bought sets, or who want better sets, or who need mechanical service. Your contact, in other words, is with those who for some reason do not see the big show or find it unsatisfactory. To see the show one must have a radio set. To enjoy the show properly one must have a good set and it must be working properly. That's simple isn't it? You stand ready to supply the good set and to service it, therefore, your contact is with the undeveloped and poorly satisfied part of the radio audience. More than that, you function regularly in adding to the audience and in giving them better seats, by which I mean the chance to hear better and enjoy more.

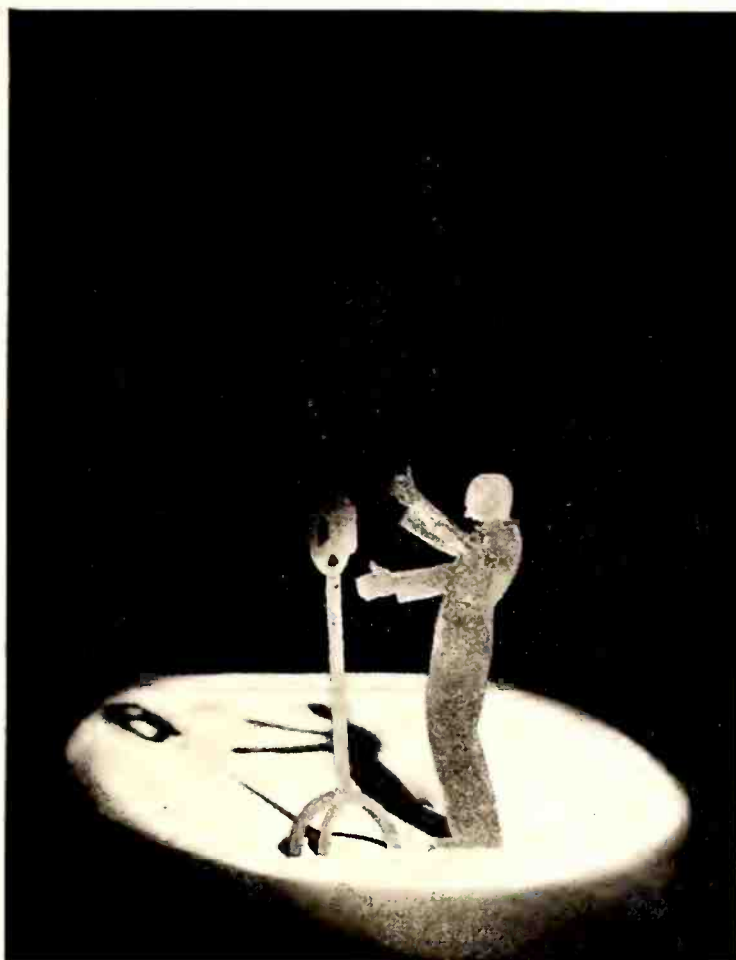

KNOW THE ANNOUNCERS

The broadcasting companies owe you more support than they give you.

Yes, the broadcasting companies give the show that makes your business possible. You need them and they need you. There's more money for them in cooperating with you, and your very existence hangs on their strength.

How can you exploit the big show profitably? Now we are getting down to cases, I'll answer this question by asking other questions.

How much time and attention do you give to broadcasting and how much do you listen-in?

Do you study the merits of the various programs which are broadcast and do you know the names of the important ones and their sponsors?

What do you know of the personalities of the various announcers? How they get their jobs and why are some of them famous?

Well, what of it? What good will it do you to do all this and learn all these things?

Right here I wish I had a magic pen that would give a vivid picture in ink of the delight and profit which lie in being a thoroughgoing expert.

Learn About Broadcasting

If your own conversational range in sales contact is purely mechanical or electrical, you will fail to use the theme which is of greatest interest to your customers, because nine out of ten of them are neither mechanically nor electrically minded. Your explanation of the construction of a set will affect them very much as a doctor's does when he says that a patient has a "sympathetic dilation of the coronal membrane." He doesn't know whether to ring up the undertaker or buy an eyewash. "Sympathetic" sounds good, he needs sympathy. But those other words have a terrible sound.

(Concluded on page 58)

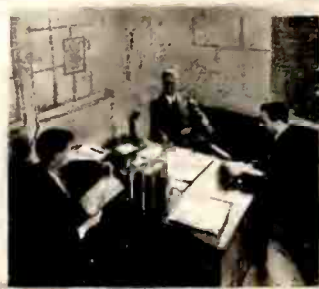

WHAT we consider to be a most dangerous practice has been recommended to servicemen recently.

Radio receivers, says a contemporary radio publication, are still so fractious and engineering is still in such an embryonic state that it is practically impossible to make significant measurements of sensitivity, selectivity, and fidelity. It is necessary—according to this editorial writer—to make hundreds of measurements on many individual units of a given model before a curve can be obtained which will be representative of that model. Even then, day to day measurements cannot check, etc., etc.

However, using home-made apparatus, this publication has made curves of several well-known receivers which are turned over to installers so that they can fix up the set on the job to best suit the customer. If the curve shows a deficiency in amplification at low frequencies, the installer can, with his handy screw driver, wiggle the condenser plates, or otherwise make up for a dip in a curve which the manufacturer of that set either could not iron out or thought was advisable.

This practice must be condemned before it even gets started. A radio receiver can be measured carefully in the set manufacturer's laboratory; apparatus for such measurements has been available for many months and it is being improved continually. The manufacturer turns out a receiver which is adjusted according to his specifications as shown by his instruments, and for the screw-driver expert to attempt to alter these adjustments is out of the question. We do not believe a single reputable manufacturer would want such local adjustments to be made.

PROBLEMS FOR STANDARDS COMMITTEES

AS WE see it, there are three problems for the Standards Committees of the various trade organizations. The question of "power detection" is one which needs attention. Power detection should be defined, just as dynamic loud speakers and electric sets were defined. At the present moment the term is used in a very loose manner, and, therefore, it has very little meaning. Some manufacturers have power detectors, some linear detectors, some linear power detectors. Definitions are needed for all these terms.

Another matter that needs attention is the business of measuring the output and frequency characteristics of loud speakers. At the present time there seems to be no accepted method by which the performance of a loud speaker may be determined, and some engineers even refuse to look at curves on other people's products because as they say, they do not mean anything.

Present practice consists in facing a loud speaker with a

calibrated microphone and amplifier, putting various electrical frequencies into the loud speaker and measuring what comes out. The differences of opinion on such measurements are regarding the distance of the microphone from the loud speaker, whether or not the loud speaker and microphone should be in a sound-proof room, or whether it should be in an infinitely absorbing space like the great out of doors. Some measurements are made in what looks like an enormous padded cell or like the refrigerating room in a steamboat. Others are made in a room in which reflection from the walls forms a considerable part of what the microphone picks up. And so on. Some standard practice should be evolved.

The present method of measuring a receiver's sensitivity in terms of the field strength required to give 50 milliwatts of power output is open to the objection that this level is too

low. The average power in a loud speaker is probably two or three times this value, and at times the peak power must run as high as 1600 milliwatts for a single 245-type tube, and twice this, at least, for a push-pull 245 power amplifier. What is the sensitivity of the receiver at these output levels?

The Standards Committees should review the method of testing sensitivity with these thoughts in mind. Detectors in 1929 differ from those of a year ago—and they may operate quite differently with a high input than they do at moderate or average output. Perhaps a more complete method would involve measuring the sensitivity at both average and peak outputs.

OUR SERVICE PROBLEM

STORIES OF how servicemen solve baffling problems are like the stories your friends tell of their killings in the stock market—they never tell of their failures. To hear a serviceman talk you would think he plays a game—and he frequently does—and that after considerable detective work, in which he is not only Sherlock Holmes but Dr. Watson too, he always wins. Probably he does, but who loses? Very frequently it is the customer.

We were called in to see a friend's radio set. It hummed something terrible. A serviceman had been called in. He said a transformer and a resistor strip had burned out. It would cost \$25 and take a couple of weeks' time to make the repair.

We took out the power tube. It still hummed. We took out the rectifier and the hum stopped. Clearly the trouble was in the rectifier or loud speaker circuit—not the radio circuit. Without throwing any bouquets at ourself, we found the trouble in a few minutes. The power tube was a 210 with 300 volts (or more) on the plate. The frame of the loud speaker was grounded, and poorly insulated binding posts brought power

(Concluded on page 60)

Please Note—

Who knows what "power" Detection is? Needed—a standard method for measuring loud speakers.

What is the measure of a receiver's sensitivity?

Who pays the high cost of poor service?

Beware of the screw-driver radio expert.

YESTERDAY, TO-DAY, and TO-MORROW

Thoughtful Opinions of Retailers on Many Topics Useful to Dealers and Manufacturers. Some Are: New Models, Distance, Selling Claims for Sets, Speedy Handling of Consumer Inquiries, Competitive Demonstrations.



THE MAN on the firing line of radio selling usually has something interesting to say about his daily problems: interesting to his fellow dealers and interesting to the manufacturer. In this article are some suggestions, selected from the report of a survey made *for*—not *by*—one of radio's leading manufacturers. These dealers who speak aim to be constructive, the emphasis is to correct radio ways of thinking and ways of action which seem to deserve it. These dealers naturally do not stop to praise what is good; they hasten to discuss conditions which seem to them less than satisfactory.

These suggestions cover a wide range of topics: competitive demonstrations, factory-dealer tie-up advertising, ill effects of selling sets on distance-getting qualities, when new models are disturbing, proper and speedy handling of consumer inquiries inspired by manufacturer-advertising, and better and more intelligent selling of present models.

These comments are worth more than merely a basis for discussion. They offer the dealer renewed opportunity to examine afresh his own house and a chance to take stock of his own selling methods. These questions concern the dealer as well as the manufacturer. Radio selling is quite as much the immediate problem of the dealer as it is the ultimate concern of the manufacturer.

MORE INFORMATION NEEDED

One dealer interviewed believes that the local store should sell sets by using compelling arguments rather than the usual generalities. He says: "Our observation is that there are too few dealers who know why the set they sell is better. It is a good one in the main and that is all they know.

"What every dealer is mightily in need of is more detailed

information so that he can explain to the average prospect *why* he has a superior product. We have had wonderful success with the Blank set, but it was no fault of the manufacturer that we did. We had a man who knew mechanical construction and when a prospect expressed interest, he showed, point by point, the superiority of that set from the mechanical viewpoint. If our salesman did not know his facts but tried to find out from what the Blank company furnished us, he would have been up against a stone wall.

"As I see it, most dealers talk in generalizations about their sets, and when they are through, they have said nothing but that it is good. To me that spells "bunk." The Blank ads rave on about beautiful cabinets, etc., and the fact of the matter seems to be that this is about all they have. We need a more sincere set of manufacturers—manufacturers who are more anxious to give the dear public a little more for their money. When they do this and when they describe their product in greater detail, then you will see a great sale of their goods right at once. Nothing succeeds, I think, like being able to talk intelligently on the item you are selling and information presented properly to the average customer sells him or her that set. Personally, I would certainly welcome more coöperation between the manufacturer and the dealer."—DEALER A.

MANUFACTURER'S ADVERTISING COPY

"You fellows in advertising have a fine lot of theoretical ideas about copy and plans—but you never make a plan for a dealer. If you did make a good one, it would be planned solely to get prospects and the way would be made easier to get them. So far, all dealer copy is built on the name of the manufacturer who fondly thinks he is the whole show—and you fellows let him do it because it is the easiest way to a big

appropriation. What is needed now is a little Harry Kirtland logic—or Ben Sweatland knowledge—and properly applied.”
—DEALER B.

A FEW NEEDED IMPROVEMENTS

“Below are listed a few things that we think the manufacturers should stop doing:

1. Advertising competitive demonstrations and urging a customer to try out all makes of sets. When he has tried out 8 or 10 of them the profit of 3 sales are eaten up.
2. Stop advertising getting distance. There are places where the best set made will not get a thing. I know a location where no set made will even get the local station one mile away.
3. Stop advertising 10 days free trial. We do not leave a set over night.
4. Stop coming out with new models in the middle of the big season. New models should come in June. They are now coming in January and February and business slackens up right after Christmas.

“We find the manufacturer loses much that should really be produced. The advertising in newspapers does bring inquiries. These, in turn, are turned over to one or two ‘distributors’ on a certain day of the week, or the ‘distributors’ receive them alternately. By the time they reach the dealer in the particular neighborhood, at least ten days to two weeks or more have passed. In the meanwhile the interested prospects have purchased something else. From sad experiences we have discovered that most radio prospects make up their minds very quickly.”
—DEALER C.

BETTER SERVICE NEEDED

“The success of a radio set depends as much on the service rendered by the distributor or jobber as by the manufacturer, if not more so. We cancelled a good franchise at one time because the jobber gave little or no service.”
—DEALER D.

ADVERTISE THE DEALER

“It is our opinion that every manufacturer’s ad in newspapers should carry a list of authorized dealers. It is educational. Customers will go to reliable dealers instead of ‘gypts.’”
—DEALER E.

ADVERTISING SHOULD CONSIDER LOCAL CONDITIONS

“Manufacturers advertise here in Great Falls where we are 500 miles from the nearest station in the same manner that they advertise in the metropolitan district where listeners are in the shadow of the towers of the transmitter. It seems to us that different conditions call for different tactics in newspaper advertising.”
—DEALER F.

And finally, here is an interesting dealer letter which points out that manufacturers should try to sell the advantages of modern radio entertainment in their ads.

“The radio situation as we see it is decidedly unhealthy. Public interest in radio entertainment is very keen, but the public is being terribly confused by the ridiculous conflict of advertising claims by manufacturers who seem to think that they are dealing with a wholly imbecile public. Years ago in the automobile trade, they had just about the same sort of orgy of extravagant advertising—everybody claiming the biggest and the best, but no one giving any facts to support his claims.

“Right now, the newspapers in this section are full of the sort of ads that might be expected from a flock of blue-sky promoters, each claiming that some particular make of radio is the only one worth considering, but none of them providing any evidence or reasons to back their claims.

“Meanwhile, no manufacturer of radio is doing anything constructive to help me send twenty-five or thirty-thousand old sets—sets that are no longer fit to be kept in service—to the scrap heap, by advertising in a way that will help sell the idea of up-to-date radio entertainment and its superiority over what could be had from the old five-tube neotrodynes and four-tube bloopers.

“No manufacturer is telling newspaper and magazine readers anything about the real delights of owning any of these modern sets. They are all good and any one of them is a mile ahead of the goods we were selling a couple of years ago, but a lot of our prospective customers think they are enjoying the best there is in radio, when as a matter of fact all they are getting is a lot of squeaks. They do not know what they are missing, but they read these ads in the papers and conclude that the radio manufacturers are a pack of liars and the result is a lot of extra resistance to overcome when we try to sell them a new radio receiver.

“If some radio outfit would come out with a line of advertising that doesn’t depend entirely on bragging about the latest model (n.p., accenting the pleasures to be had from a modern receiver and throwing in a few facts and specifications) the public could not fail to be impressed. It would be so different from the usual type of copy.

“Personally, we think we are rapidly approaching the time when it will be in order to have two or three sets in every house. We have begun to cover our field. But we should try to do a better job before the public gets altogether disgusted with us. We must sell our sets by pointing out the real advantage of listening to up-to-date radio equipment.”



LEOPOLD STOKOWSKI (Conductor, Philadelphia Orchestra): “The big thing in radio is this—that it permits us to bring our music to the people, in no matter what station in life, in every part of the world.”



D. E. REPLOGLE (Television Committee, R.M.A.): “That television will require distinct and new receivers separate from the radio broadcast receiving set is now assured from the progress being made in the laboratory.”



PAUL G. ANDRES (Temple Corporation): “The use of the earth’s magnetic field will open up communication channels that are not affected by water and land barriers which, in the case of ether waves, now are at a premium.”



J. B. KNIGHT, JR. (DeForest Radio Co.): “The South has become definitely radio-minded, in spite of its slow start.”



J. E. SMITH (National Radio Institute): “The unexpected and steadily increasing demand for radio-trained men by marine and air radio, broadcasting, production, merchandising, and service organizations has caused the demand to exceed the supply.”

WHAT

THEY

SAY . . .

“Automatic phonographs make an attractive side line.”

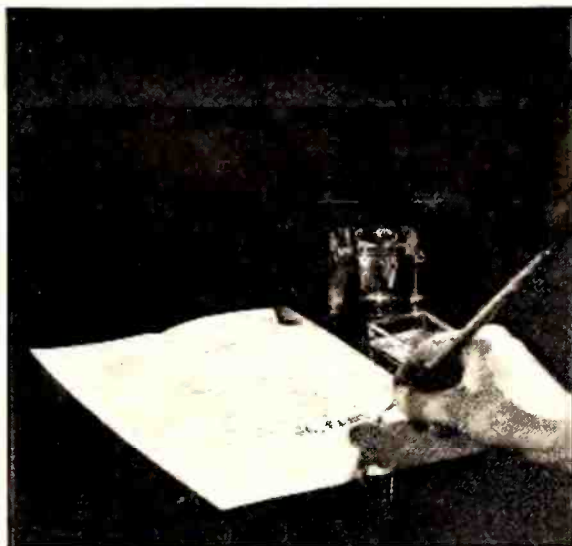

“Radio dealers, who are anxious to increase their volume and profits, will do well to investigate opportunities afforded by the introduction of new automatic musical instruments which are rapidly coming into general use by restaurants, confectioneries, clubs, auditoriums, parks, and better class homes. The unit of sale is six to eight times as great as on the average radio set, the sales expense is very little, if any, greater, and the profit margins are very attractive.

“Another attractive feature of marketing automatic phonographs is that a great majority of installations are made in the downtown business sections, convenient for sales calls.

“Among radio dealers who have made outstanding successes in the sale of automatic phonographs are the Wahn Radio Company of Boston, Mass., Alford & Fryar of Canton, Ohio, Pearson Piano Company of Indianapolis, Indiana, and Listenwalter and Gough of Los Angeles, Calif. These dealers handle the Capehart Orchestrope, manufactured by The Capehart Corporation, Fort Wayne, Indiana. This instrument plays a continuous program of fifty-six selections from twenty-eight selected phonographs records, using an electric pick-up, a three-

stage amplifier, and an electro-dynamic loud speaker. They manufacture a complete line of models, both coin and non-coin operated.”

E. D. LASHBROOK
Sales Manager, The Capehart Corporation

Time Payments

A dealer in a rural community writes on time payments as follows:

“I believe that time payments and trade-in are two things much abused and overdone. We dealers are very much in need of education on both of these matters. We have dealers in our town who are trading in old battery sets at from \$25 to \$65, and reselling them at about one fourth of this. A deplorable situation you will admit.

“To some extent we believe manufacturers are to blame for being lax in granting franchises to any Tom, Dick, or Harry. Right here in my town one of the largest of the set manufacturers has two dealers, one located in a shoe store who sells sets as a side line for most anything he can get. The other is a young fellow selling the sets from his home—he has no established place of business.

“We would appreciate any moves you might make for the betterment of the industry. Radio with us is not a side line but a business.”

HOW RADIO SALES COMPARE BY STATES

From the figures given in the article by T. A. Phillips, “An Estimate of Set Sales,” in Sept., 1929, RADIO BROADCAST, it is possible to plot a curve showing set sales by states for the radio year July, 1928, to July, 1929. This curve is given herewith and makes it possible to determine readily the percentage of the total radio business done by any given number of states. It shows quite clearly, in somewhat different form,

the fact (not new) that a very small number of the states do a major part of the radio business. For example, six states—New York, Pennsylvania, Calif., Ohio, Ill., and Mass.—do fifty per cent. of all the business; sixteen states do eighty per cent. of the business. From the curve it is, therefore, a simple matter to determine how many and what states must be covered to take care of any given percentage the total sales.

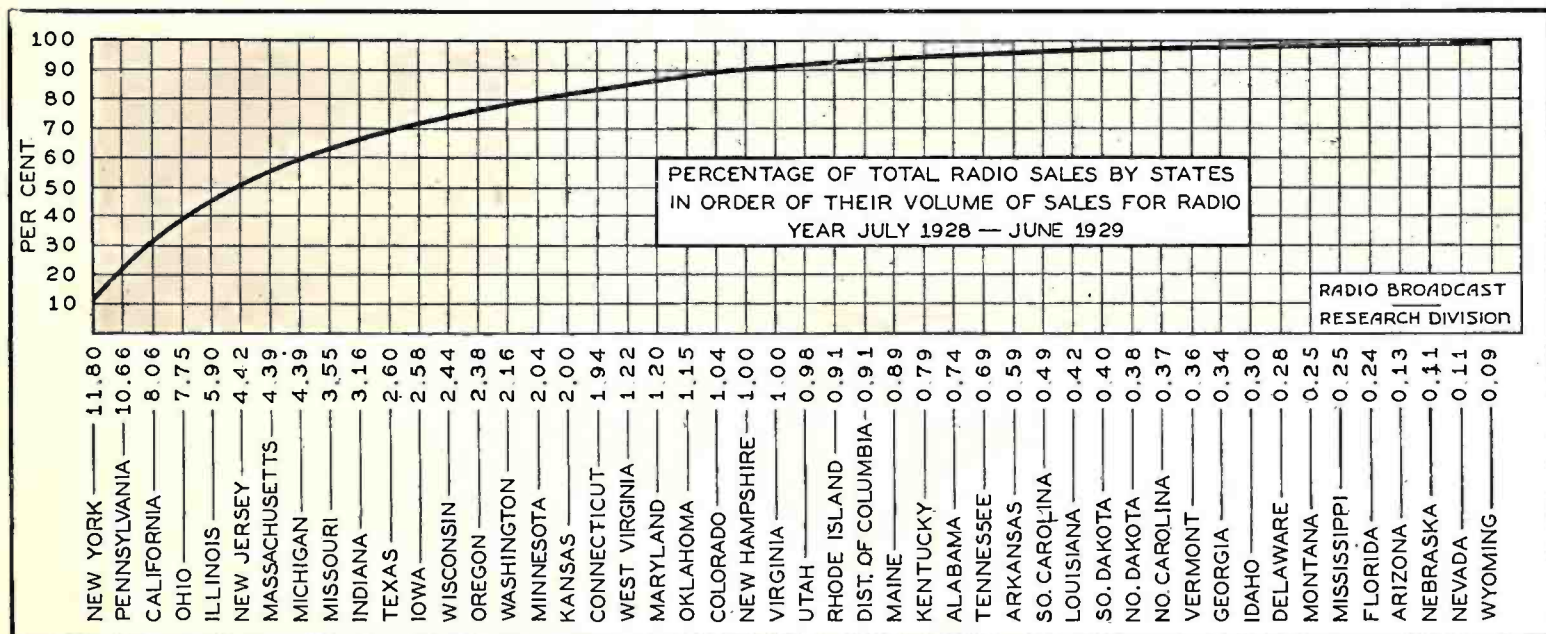

In this graph the figure accompanying each state represents the percentage of total sales by that state.

The MARCH

Keep Radio From the Side Lines
Patent Problems Are Still With Us

If Automobile Dealers Sell Radio

ISSUED APPARENTLY AS AN inspired rumor, the statement has appeared in the press that the Radio Corporation of America is negotiating with the General Motors Corporation to distribute radio receivers through the immense retail organization of the latter company. Although the correctness of this rumor has been flatly denied, radio dealers nevertheless view the threatened competition of automotive distribution channels with alarm.

From the beginning the most prejudiced observers consid-

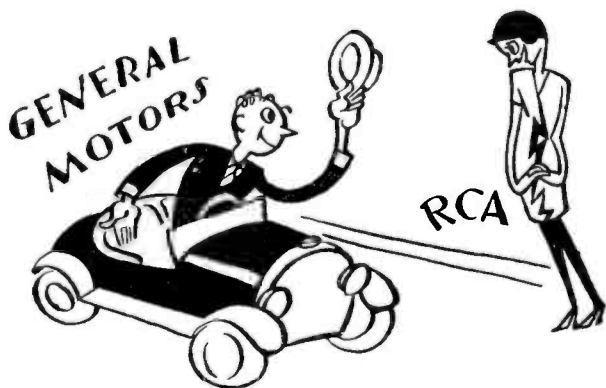

ered it highly improbable that the RCA would make such a drastic and disloyal shift in its distribution arrangements. On the other hand, if the General Motors Corporation were to decide to stabilize the business of its dealers by adding radio as a side line, it would have no difficulty in finding a radio manufacturer ready to hand over his distribution or even his entire business. That manufacturer, however, would be guilty of a serious blow to radio retailing, if he were the means of adding another major retail distribution system to the excessive number already handling radio products. His example would probably be followed by other radio manufacturers who have not been able to build up satisfactory distribution systems.

Some short-sighted radio manufacturers seem obsessed with an insatiable desire to force bona fide radio dealers out of business and to relegate the distribution of their products to the position of a mere side line of other industries. The exclusive radio store or one having a few minor side lines has always been the most satisfactory outlet for radio products, because only a specialist, an expert in the sales and service problems of radio, assures the greatest satisfaction to the buyer.

A survey, recently made by the National Electrical Manufacturers' Association in cooperation with the Department of Commerce, reveals an extraordinary diversity of outlets handling radio products, far in excess, both in number and diversity, of what is warranted by gross sales. The addition of a substantial number of outlets, such as would be affected by making every automobile dealer a radio salesman, would be a final calamity and discouragement to the dealer who concentrates on radios and phonographs. It would be necessary to add only the drug store and the grocery chain to the ranks of radio retailers to place radio distribution on a par with sales of cigarettes and safety pins.

Increasing the number of retail outlets reduces the gross sales per store. Continued progressively, the process is bound to decrease the importance of radio as a selling item and ultimately to reduce it to a minor side line. The revolting increase in distasteful advertising accompanying sponsored programs is bound to cause added sales resistance. The addition of automotive outlets may increase the number of retail distribution points from the present excessive number of nearly 40,000 to as much as 85,000. These factors combined would make concentration on radio sales and service unprofitable, a major calamity to the radio manufacturer. His merchandise would be crowded into an insignificant corner of window space, it would receive minor display in the store and negligible consideration in the management's sales plans. Radio would become, more than ever, a seasonal product, a forgotten item during all but the peak seasons.

The automobile industry, however, is not to be condemned for seeking to improve the position of its retail outlets. Radio would be highly acceptable to the automobile dealer because it would help to correct the dull fall and early winter season experienced in automobile sales. But every sale made during radio's all too short peak season would be at the expense of merchants who have for years concentrated on radio and stood by it through thick and thin. However, if a manufacturer were to distribute radio receivers through automobile agencies he would find his business highly seasonal. In the spring, when a special effort is necessary to maintain production schedules, he would find his dealers too busy selling cars to give any thought or attention to radio.

Whoever conceived this brilliant scheme of consolidating radio and automotive distribution certainly did not have the interests of radio dealers at heart. To the automotive indus-



try, radio represents merely a means to an end, and the fate of the radio dealer is none of its concern. Indeed, electric refrigerators made by subsidiaries of automobile concerns are a major source of complaint among household appliances as creators of electrical interference. Refrigerators made by manufacturers identified with the electrical and radio industries, on the other hand, are suitably shielded to prevent interference with radio reception.

So long as the radio products distributed by automobile dealers are limited to brands specially made for them, automotive outlets are not likely to cause a major disturbance to radio retailers. The public recognizes side-line selling and will prefer to patronize radio specialists handling a variety of

N-3

OF RADIO

69 Stores in Radio's Largest Chain
The New Grand Island Radio Station

standard radio receivers. But, if legitimate radio manufacturers cooperate in extending distribution through automotive outlets, they will hasten the day when there are no more radio dealers and when radio receives only the attention given to seasonal side lines.

More Patent Difficulties on the Way

THE DECISION of Judge Hugh M. Morris, holding that the Radio Corporation of America has infringed U. S. patents 1,455,141 and 1,635,117, popularly known as the Lowell and Dunmore patents, threatens to present further serious difficulties to radio manufacturers. Substantially these patents describe methods of eliminating the hum induced in radio receivers by power-supply devices. Actually, there are a considerable number of patents not covered by the Radio Corporation license to set manufacturers which are as yet unadjudicated. Many of these concern such fundamental principles as shielding, by-passing, and gang condenser construction. In absence of adjudications, such patents receive scant attention from the industry. These patents are held largely by individual inventors and, if the license scales proposed are any criterion, their values are placed sufficiently high to discourage outright purchase in advance of litigation. It will be some years before we are at the end of infringement difficulties of this kind which, if favorably adjudicated, require that the entire industry make its terms with individual inventors.

The New Monitoring Station

THE MONITORING station, to be erected by the Department of Commerce at Grand Island, Nebraska, will serve the field of radio communications throughout the world much as the British Observatory at Greenwich has influenced astronomy and navigation. We expect that the Grand Island station will become the criterion by which frequencies are judged and thereby present the solution of many of the problems of frequency stability. One of the great difficulties existing today is that we have no generally available yardstick by means of which frequency standards may be readily compared. Much heterodyning would be eliminated if stations adhered to their

reveals many more places with a heterodyne than points of good reception. Were the public not accustomed to securing its radio entertainment from two or three nearby local stations the present conditions would be intolerable. Improved con-

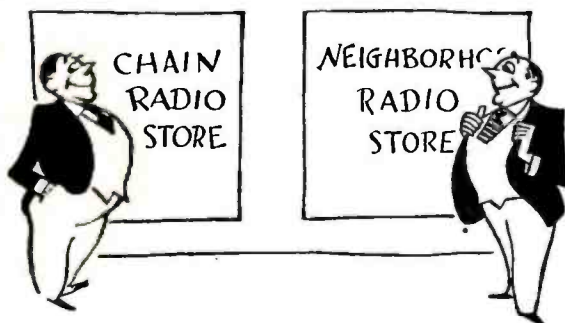

ditions, brought about by accurate frequency adherence, would make radio more acceptable to the rural listener.

Radio's Largest Chain Store

THE ATLAS STORES CORPORATION, of Philadelphia, has purchased City Radio Stores and Davega, Inc., through an exchange of stock. The consolidated earnings of the combined companies last year were \$1,400,000. The Atlas Corporation will have 69 radio stores in operation when the merger is completed and will thus be the largest radio chain in existence. Although chain store methods are making tremendous in-

roads into many forms of retail merchandising, they threaten least goods of occasional turnover and infrequent renewal. Drug and grocery products can be effectively sold through chain store merchandising methods because a wide variety of items is handled and the purchaser is protected by standardized and labelled goods. The average grocery or drug purchase involves a small amount with the result

that individual reputation and personality in selling, a factor submerged by chain distribution methods, is not of vital importance. Radio chain selling has been successful only in concentrated markets in major cities where bargain hunters and experimenters still flourish.

Radio Commission Reorganized

THE FEDERAL RADIO COMMISSION has been reorganized in accordance with recommendations of government efficiency experts. With the exception of the chairman, each member of the commission has been appointed to head a division of its activities, Commissioner Sykes being head of the legal division, Saltzman engineering, Lafount field investigation, and Starbuck liaison. Sub-committees have been established on hearings, courts and legislation, on budget and control, on planning and policies, and on procedure and publicity. Hearings will be taken by special examiners who will report the evidence to the full membership of the Commission.

This form of organization should improve greatly the consistency of the policies adopted by the Commission.

—E. H. F.



assigned frequencies. The amount of deviation tolerated is positively amazing and goes a long way toward rendering the work of the Federal Radio Commission less effective. A tour of the dials with any sensitive receiver at almost any location

N-4

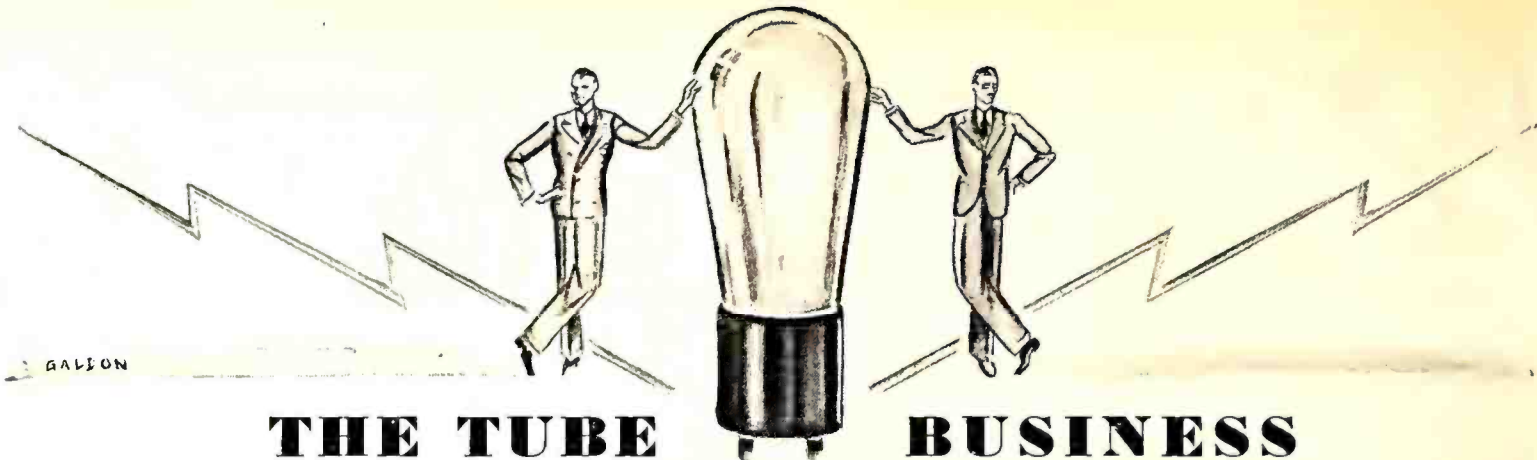

THE TUBE BUSINESS

NEW DEFOREST TUBES

A NEW D.C. screen-grid tube has been announced by De Forest. This tube uses an oxide-coated filament which is much heavier than the usual thoriated emitter. It operates at one third the temperature, has plenty of emission to last over 1000 hours, and is free from microphonic noises.

DeForest has also placed on the market a new 210-type tube with an oxide-coated filament and a very large plate with appropriate supports and insulation to guard against breakdown when used as a high-frequency oscillator. It is capable of dissipating 25 watts on the plate.

WORLD'S LARGEST TUBE LINE

SONATRON MANUFACTURES 44 distinct types of tubes, thereby backing up its well-known slogan of having the world's largest radio tube line.

MUSIC FOR EMPLOYEES

TWENTY TWO loud speakers have been installed in the assembly and manufacturing departments of CeCo's new million-dollar plant. One hour each morning and each afternoon the employees are permitted to listen to music transmitted over this network of loud speakers. It has been determined that this innovation decreases fatigue, increases production, and decreases shrinkage.

FINANCIAL NOTES

THE BALANCE SHEET of the Hy-Vac Radio Tube Corporation, as of June 30th, after giving effect to the sale of 38,000 shares of stock showed net tangible assets of \$283,640.03. Current assets amounted to \$246,910.31 including cash in the amount of \$201,309.69 as compared with current liabilities of \$12,384.02 or a current ratio of over 19 to 1.

An issue of 400,000 shares of the newly formed National Union Radio Corporation at about \$40 per share starts the company off with an initial capitalization of \$16,000,000.

In the seven months ending July 31, CeCo sales were off 3.7 per cent. from a year ago.

The Noma Electric Company with the Pilot Radio and Tube Company has purchased the plant of Everett Mills in Lawrence, Mass. The entire production will be concentrated there within a year. This plant has floor space to the extent of 1,500,000 square feet.

A MANUFACTURING FORMULA

A COMMON DENOMINATOR which any tube manufacturer can use to determine the number of tubes per day he can turn out is the amount of floor space in square feet per tube per day required. It has been determined that about two square feet is necessary and that a figure of from two to three square feet per tube per day

means a well-ventilated factory with ample space for operators so that they can work efficiently. Thus a factory with 20,000 square feet of floor space can turn out a maximum of about 10,000 tubes a day, and somewhere between this number and

c-324 tubes and they contain not only the usual material about dimensions, proper voltages, etc. but also a complete set of characteristic curves, methods of using the tubes properly, and a bibliography of articles dealing with the particular tube in question. Such material is invaluable for engineers in the tube or receiver business.

Tube Sales and the Serviceman

BY HARRY C. HOLMES

General Sales Manager, DeForest Radio Company



Harry C. Holmes

THE SERVICEMAN is one of the most valuable outlets we have in the vacuum tube industry. He is not only a serviceman, but a good-will emissary and an excellent salesman as well, since he generally speaks from experience.

The serviceman cares but little about the decorative scheme of the tube carton or the superlative claims of the maker. He is interested in just one thing: a good vacuum tube. A serviceman with faulty tubes is as badly off as a mariner without a compass, since he has nothing to go by. The serviceman is fully familiar with this point, and as a result he generally becomes "sold" on some particular line or lines of tubes. Once convinced himself, he becomes the best type of salesman.

The capable serviceman inspires confidence in the radio set owner. He is the doctor who cures the ailing set, and in nine chances out of ten the replacement tubes he prescribes are the tubes the owner will continue to buy in the future.

Serviceman salesmanship, I believe, is the greatest antidote we have to-day for "bargain" tubes and merchandising ballyhoo. You can't fool the serviceman in quality. He knows. And by his recommendations the radio public is getting to know and to appreciate quality vacuum tubes.

6000 tubes a day indicates a combination of economical use of floor space and good working conditions for the operators.

QUICK HEATING TUBES

MARVIN CLAIMS the world's record in the construction of a quick-heating tube. It is the MY-227, is guaranteed to heat in five seconds flat, and compares favorably with all other tubes of this type with respect to life, freedom from hum, etc.

GOOD TUBE BULLETINS

CHIEF ENGINEER D. F. SCHMITT, of E. T. Cunningham, Inc., and his staff engineers must be congratulated on the excellence of their engineering bulletins. We have the bulletins on the cx-345 and the

TRIAD'S TUBE BOXES

WE HAVE already commented on the triangular shaped tube boxes of Triad. Tests conducted over a period of some weeks have disclosed the fact that there was but 2 per cent. damage to boxes of this type compared to 18 per cent. with the usual four-sided carton.

OPERATING COST OF A. C. SETS

ACCORDING TO George Lewis of Arcturus all this talk that it is costing more to operate the modern a.c. sets than the old-style battery sets is unwarranted. If anyone, according to Mr. Lewis, will take the trouble to compare the number of revolutions that the wheel in his electric light meter makes when his radio is turned with the number when a 75-watt lamp is lighted, he will find out the number of watts the set takes.

It amounts to less, in dollars and cents, than is required to charge a storage battery and buy new B batteries regularly—such as we all had to do a year or so ago.

BULLETIN ON THE S. G. TUBE

THE ATWATER KENT radio dealer bulletin No. 3, July 17, 1929, has an interesting and instructive illustration of the manner in which a screen-grid tube prevents unwanted oscillation and squealing. If the receiver of a telephone is put near the mouthpiece of the transmitter, the telephone line will oscillate or howl. If the mouth piece is screened with a sheet of metal or other material the howl ceases. Thus it is with the screen-grid tube, says the Atwater Kent bulletin. The screen-grid between the grid (input or mouth-piece of tube) and the plate (the output or receiver of the tube) prevents oscillation. At the same time the amplification due to the tube can be increased some five to ten times over that obtainable with three-element tubes.

The explanation is a simple graphic picture of the screen-grid tube and might be used by tube manufacturers who want to help their dealers sell the new tubes, by informing them properly about how they work. Atwater Kent suggests that dealers put the bulletin, which is appropriately illustrated, in their show window.

NEW TUBE MANUFACTURER

THE DILCO RADIO TUBE CORPORATION, Harrison, N. J., is a new addition to the list of those in the tube business. The advertising agency is Charles Dallas Reach of Newark.



The Hazeltine Laboratories, located on the top floor of a multi-storied Manhattan building, have ample light in their well-equipped mechanical workshop.

Radio-frequency signals of amplitudes down to microvolts can be obtained from the signal generator shown above.

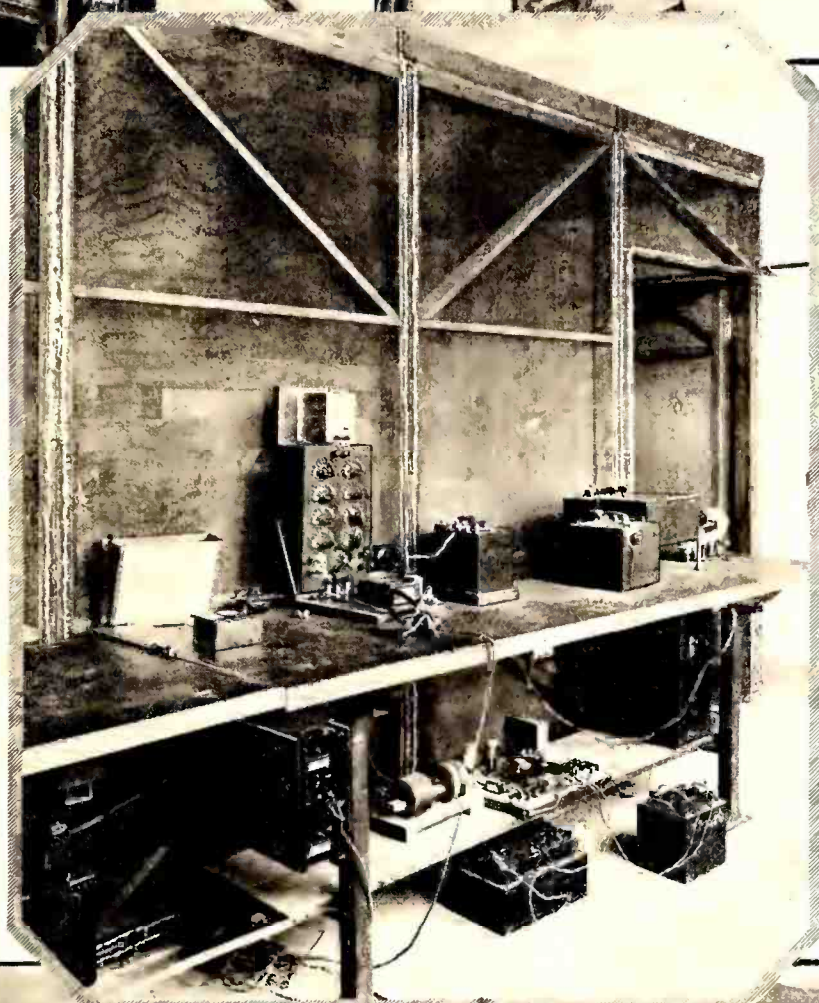

The "cage" room pictured on the left is shielded from electrical disturbances and is used for making many measurements. It is equipped with instruments (General Radio) for measuring inductance, capacity, and resistance.

Selectivity, sensitivity, and fidelity characteristics of receivers are measured with this shielded "gain set."

The drafting room is a very important part of any well-equipped laboratory.

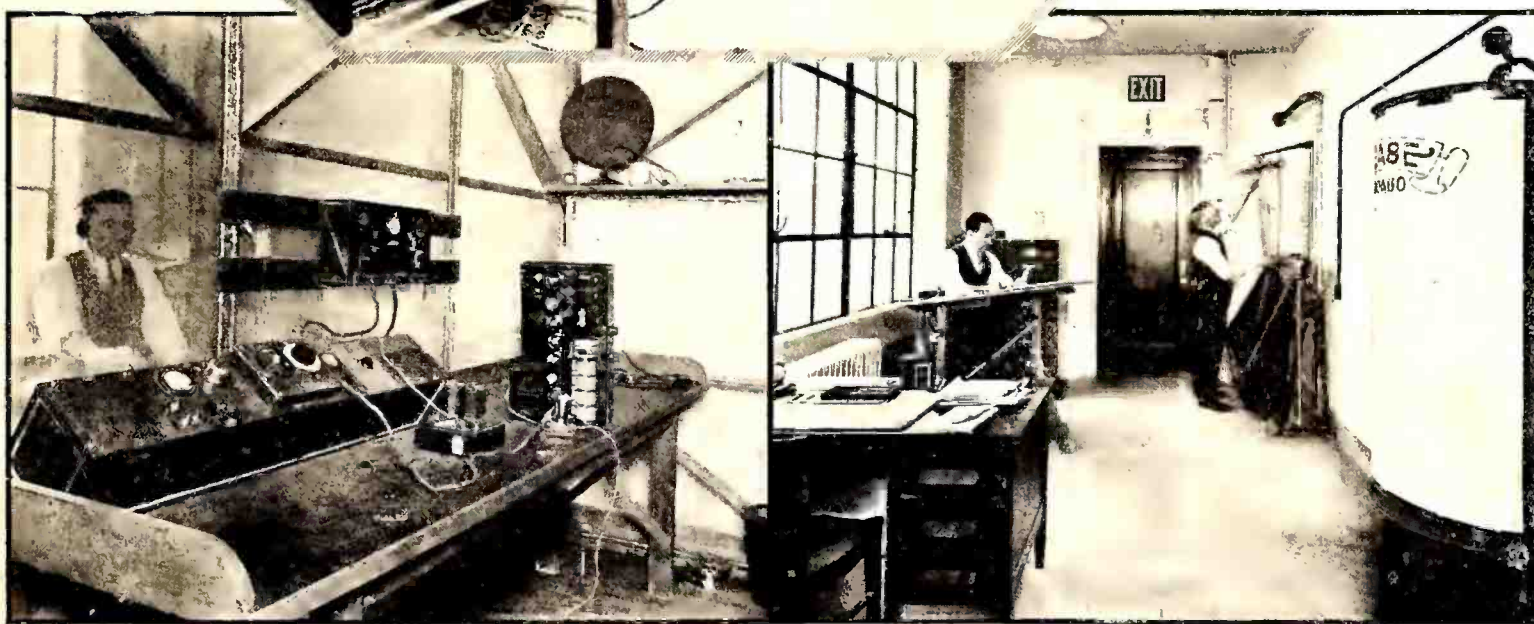

THESE UP-TO-DATE LABORATORIES SERVE HAZELTINE LICENSEES

On this page are presented various views in the new laboratories of the Hazeltine Service Corporation, maintained for the benefit of the licensees of the Hazeltine Corporation. Radio set manufacturers in the United States who are licensed under the patents of this organization are: All-American Mohawk, Amrad, Fada, Bremer-Tully, Crosley, Earl, Freed, Gilfillan, Grebe, Howard, King, Philco, Stromberg-Carlson, and U.S. Radio and Television.

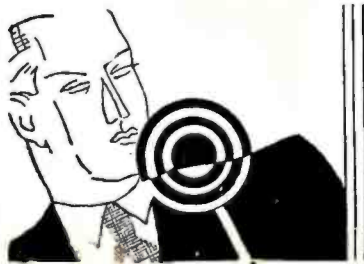

RADIO

General Motors Buys Day-Fan Electric Company

Entry of General Motors into the radio manufacturing field was announced late in September by Alfred P. Sloan, Jr., president of the corporation. General Motors has purchased the entire business of the Day-Fan Electrical Company, of Dayton, Ohio, and receivers made by this company will now be known as a product of General Motors. There will be no change in the policy of the Day-Fan Company, according to Sloan's statement.

Previous to this announcement, David Sarnoff, executive vice-president of the Radio Corporation, put to rest the rumors that General Motors would take over the distribution of Radio-Victor products by stating that negotiations had been in progress between General Motors and R. C. A. only with regard to licensing the motor organization to manufacture receivers. Purchase of Day-Fan carries with it an R. C. A. license.

R C A Institutes Formed

RCA Institutes, Inc., has been formed as a subsidiary of the Radio Corporation of America, with Rudolph L. Duncan as president. Headquarters and main school will be at 326 Broadway, New York, N. Y. The new company has acquired the Philadelphia School of Wireless, and the Eastern Radio Institute of Boston. New schools will be started in Newark and Baltimore, and others are planned for principal cities. The resident schools will provide regular classes for instruction in commercial radio operating, servicing and radio mechanics. Each school will provide correspondence courses as well.

Chas. Freshman Returns

Through acquisition of the Colonial Radio Sales Co., Inc., of New York City, Charles Freshman returns to radio. Chas. Freshman Radio Stores, Inc., has been formed with Chas. Freshman as president, B. Abrams (president, Emerson Radio & Phonograph Co.), and Sidney A. Joffe (formerly merchandise manager of Colonial Radio Sales). Eleven stores are in the chain and headquarters are at 3 East 43rd Street, New York.

More Space for Walthal

Walthal's, New York radio chain, has added 60,000 square feet of space to their warehouse at 233 Spring Street, New York. Here the main office and shipping department are located in an eleven-story building, to be renamed the Walthal Building. Walthal is a subsidiary of Wextark Radio Stores.

Addition to Crosley Plant

The new eight-story addition to the Crosley plant at Cincinnati is nearing completion and at present three floors are already finished and in operation.

Temple to Build New \$500,000 Plant in Chicago

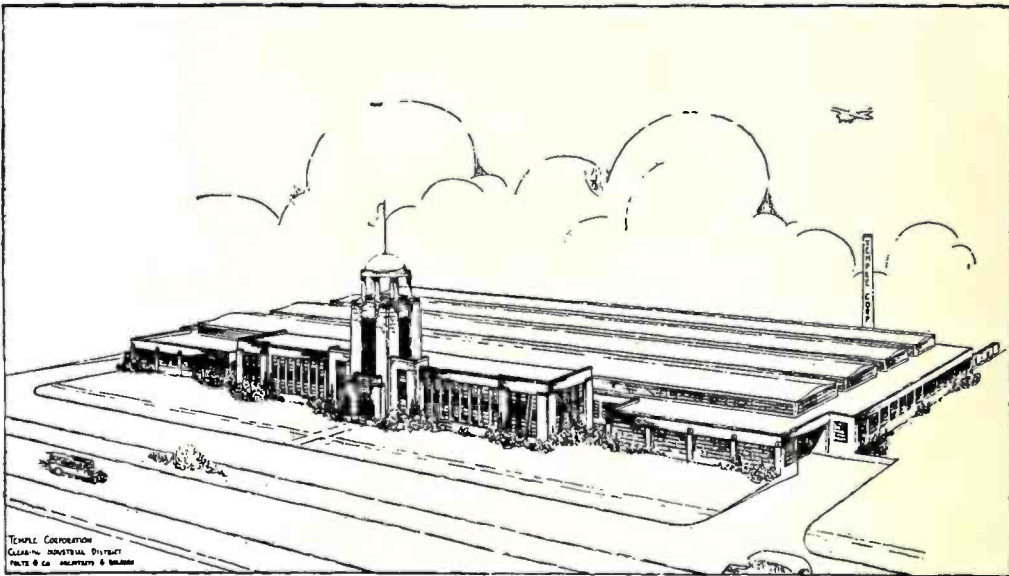

The above is an architect's drawing of the Temple Corporation's new \$500,000 manufacturing plant in the clearing industrial district of Chicago. Construction will start immediately.

Gulbransen Dealer Finance

Gulbransen of Chicago has concluded arrangements with the Commercial Investment Trust (C.I.T.) for a finance plan to be made available to their dealers. The plan in general provided a 90 per cent. advance to the dealer, low rates, and a return of the reserve on liquidation. The dealer is allowed to make his own collection, continuing his contact with the purchaser.

New Set Price Catalogue

For the first time the trade has available a complete reference handbook of all receiving sets and loud speakers. The handbook, issued by General Contract Purchasing Corp., 420 Lexington Avenue, New York, N. Y., is priced at \$2 per copy which includes a correction service. The book includes names and addresses of set and loud speaker manufacturers and their branch offices, names of company officials and their branch managers, all recent consolidations and mergers, trade association memberships, patents and patent licenses held, broadcasting of manufacturers, types of sets and loud speakers manufactured, cabinet styles, types of all tubes used in each set or loud speaker, and list prices of all the models.

Loftin Sells Patents to R. C. A.

Sale of a group of patents by the Loftin-White Laboratory to the Radio Corporation of America has been announced by E. H. Loftin. The sale includes the non-reactive plate circuit method of preventing oscillation and the constant coupling system published in technical papers some months ago. The sale does not include the direct-coupled audio amplifier which the Loftin-White organization has developed.

Gilby Wire Expands

The Gilby Wire Company, 150 Riverside Ave., Newark, N. J., is constructing additional factory space. About 30,000 square feet will be added to their present plant and a 100 per cent. increase of production potentialities will result. The engineering department has been enlarged and new products will be added to the present Gilby line. Among the new products are carbonized nickel, rolled selvaged mesh, and seamless nickel tubing.

New Radio Magazine

After two years of preparation, the Standard Publishing Company, of Cincinnati, announces the publication of *What's on the Air*, a magazine with a guaranteed circulation of 150,000 among people who listen to radio programs. The magazine is designed to enable advertisers to send their printed sales message to their listeners simultaneously with their broadcast programs.

New R. M. S. A. Headquarters

Executive offices of the Radio Service Managers Association have been established at 1400 Broadway (Room 401), New York City, under the supervision of Grover C. Kirchhoff, executive secretary. Servicemen and service managers may take examinations at this address between the hours 9 A. M. and 1 P. M. except Saturdays.

Service Problems Considered

The Radio Executive Committee, Pittsburgh Chamber of Commerce, has been discussing the question of qualified radio servicemen, and plans are being formulated to increase the supply and quality of these men. T. C. Foley is secretary of the division.

Jenkins Television Production Announced

With the recent development of a novel combination scanning drum and selector shutter disc by its engineering staff, resulting in a simpler, more economical, and far more practical scanning system, the Jenkins Television Corporation, of Jersey City, N. J., now announces the mass production of television apparatus.

"With our latest development," states James W. Garside, president, "we have evolved a remarkably simple, inexpensive, and highly practical televisor, which can be readily manufactured at a reasonable cost. The new Jenkins televisor will permit of receiving either plain black-and-pink radiomovies or full half-tone pictures, with good detail and illumination within the limitations of our 48-line system.

The R. C. A. Theremin

The forthcoming exploitation of the Theremin, a new musical device, has been announced by the Radio Corporation of America, and a new department of the Radiola Division of R. C. A. has been created under the direction of G. Dunbar Shewell, as musical devices sales manager. This device was first demonstrated publicly at the Metropolitan Opera house by its inventor, Professor Therman of Russia, and later at the Lewisohn Stadium. It consists briefly of two oscillating circuits, one of which is fixed in frequency and the other is variable and under the control of the operator both in frequency and volume. The difference between these two frequencies is an audible note which is amplified and fed into a loud speaker. It is understood that the "RCA Theremin" will be sold as a musical instrument for about \$175. It was also demonstrated during The Radio World's Fair at Madison Square Garden, September, 1929.

Personal Notes

William C. Poole has been appointed chief electrical engineer of Transcontinental Coil, Inc. He will be in complete charge of both the laboratory and inspection departments.

Rufus H. Caldwell, who previously has been associated with the American Telephone and Telegraph Company, the Sleeper Radio Corporation, and the DeForest Phonofilm Company, has been appointed chief engineer of the Colin B. Kennedy Corporation. Mr. Caldwell designed the new Kennedy screen-grid receiver.

Ralph H. Langley, director of engineering, Crosley Radio Corporation, has been elected chairman of the Cincinnati Section of the Institute of Radio Engineers for the coming year.

W. L. Marshall, formerly advertising manager of the Victor Talking Machine Corporation, has been promoted general advertising manager. Mr. Marshall will be in complete charge of all advertising, sales promotion, and publicity activities of the company.

Walter A. Coogan, has taken over the management of export sales for the Arcturus Radio Tube Company, of Newark, N. J. Mr. Coogan will specialize in foreign sales advertising.

Frank W. Dowsett is advertising and publicity representative of the Kolster Radio subsidiary, Canadian Brandes, Ltd. He has charge of the house organ, Kolster News, and prepares advertising and sales helps.

The CeCo Manufacturing Co. have announced five new appointments: Edward T. Maharin, vice president, has been appointed a director of the company; Maximilian F. Mautner has been appointed assistant treasurer; G. V. Christianson has joined the company as sales representative in northern New York; Henry C. Grout has been made sales representative in Rhode Island, and Emmett Tydings has been appointed sales representative in western Pennsylvania and West Virginia.

Frederick J. Kahn has been appointed chief field engineer of the Brandes Laboratories, Inc., a subsidiary of Kolster. Previously Mr. Kahn held the position of service manager for Kolster.

D. E. Repogle, formerly an engineering executive with Raytheon, and chairman of the R.M.A. committee on television, has joined the Jenkins

Jones Loses Suit

A decision handed down by District Judge Marcus B. Campbell in the cases of Lester W. Jones vs. Freed-Eisemann Radio Corporation and Lester L. Jones vs. Walthal Electric Corporation declares the Jones patents No. 1,658,804 and No. 1,658,805 invalid. These cases were defended by the Hazeltine Corporation due to the fact that Jones endeavored to prove that a normal neutrodyne receiver infringed the Jones patents. Judge Campbell held that even if the patents were good there was no infringement by either Freed-Eisemann or Stromberg-Carlson.

DeForest vs. R. C. A.

Claim for triple damages against the Radio Corporation of America was filed by the DeForest Radio Company on September 11 in the United States District Court at Wilmington, Delaware, as a result of the suit fought and won by the DeForest company with regard to the violation of the Clayton Act by the Radio Corporation, according to a statement issued by J. W. Garside, who claims that his company suffered serious financial losses as a result of the much-discussed Clause Nine.

Television Corporation, of Jersey City, as assistant to the president.

Leonard Welling, president of K. W. Radio, New York distributor for Sonora, has been elected a member of the Sonora board of directors.

Harry H. Steinle is still vice president and sales manager for the Triad Manufacturing Company contrary to publicity reports. Samuel S. Sanford, who was erroneously announced to be sales manager, has been appointed sales engineer.

Howard W. Angus, formerly director of public relations for the Radio Corporation of America and also in charge of the licensing activities of R.C.A., has resigned to accept an appointment with Batten, Barton, Durstine, and Osborne Advertising Agency, of New York City, as head of their radio department.

Stephen G. Pratt, of the Kolster sales department has been appointed assistant sales manager of the eastern district. Mr. Pratt was formerly affiliated with the Victor Talking Machine Co.

George Lyons has been appointed to the merchandising and market survey division of the Atwater Kent sales promotion department. Mr. Lyons has held important posts with several companies including Victor and Brunswick.

Leslie F. Muter, vice president of the Steinite Radio Company, has been elected to the board of the Radio Manufacturers' Association. He has also been appointed chairman of the Association's credit committee.

Gene M. Latham has been appointed district sales manager of the New York-New Jersey territory for the Temple Corporation.

E. F. Bergere, who for the last five seasons has been connected with F. A. D. Andrea, Inc., in the Central West, has been appointed district sales manager of the Milwaukee, Minneapolis, St. Paul, and Rockford territory.

The Friedman-Snyder Company, of 15 Park Place, New York City, are Eastern Sales Representatives for Transcontinental Coil, Inc.

Chas. Eisler, president of the Eisler Electric Corporation, Newark, sailed recently for Europe to establish permanent agencies in 15 foreign countries for the sale of tube- and lamp-making machinery.

Huge Bosch Radio Furnishes Band Music for Parade



The American Bosch Magneto Corporation mounted a huge replica of the new Bosch Radio on a decorated motor truck as a float in a recent parade in Springfield, Mass. An electric phonograph was also employed to provide band music for the marchers in the parade.

N-5

New Broadcast Programs

GULBRANSEN: Beginning Saturday Evening, October 5th, this company inaugurated a series of symphony concerts by the Manhattan Symphony Orchestra conducted by Henry Hadley. The program is broadcast over the Columbia Broadcasting system for one half hour every Saturday evening, from 9:30 to 10:00 o'clock Eastern Standard Time.

PHILCO: Three concerts by the Philadelphia Orchestra under the direction of Leopold Stokowski and sponsored by the Philadelphia Storage Battery Company will be broadcast over the air on October 6th, November 3rd, and December 8th.

CeCo: Each Monday evening the CeCo Manufacturing Company sponsors a program by the CeCo Couriers over twenty-two stations of the Columbia Broadcasting System.

Production Figures

The Arcturus Radio Tube Company broke all previous production records in August by packing a total of 776,931 tubes. This represents a considerable increase over the average monthly output of \$303,697 for the first three months of the year and is more than 1200 per cent. greater than the monthly production figure of 60,000 tubes for 1928. Production in the various Arcturus plants ran as follows: January, 326,601; February, 248,819; March, 335,672; April, 334,330; May, 431,800; June, 440,863; July, 542,781; August, 776,931. Arcturus now occupies 195,000 square feet of floor space, compared with 35,700 feet in January. More than 50 per cent. of the machinery for the new plant is in operation.

Gulbransen's production schedule was advanced to 1000 per day in October according to an announcement by John S. Gorman, vice president of the company.

The Earl Radio Corporation made and delivered 13,975 sets in June, 23,564 in July, and August production was expected to be 32,000 sets. In September production will be stepped up to 40,000 receivers.

N. Y. Association Rating Servicemen

The Radio Service Managers' Association, 1400 Broadway, New York, has begun a system of examining, rating, and placing servicemen. The first few weeks of operation have given the following results: 110 men examined, 69 passed, 41 failed, 21 placed. The men who passed the examination were rated as follows: 9 class A, 31 class B; 29 class C.

G. C. Kirchoff is executive secretary and will be interested to hear from other associations and those interested in the work the R.S.M.A. has in progress. Rating cards are issued to the successful examinees. "Of those who failed to pass our examination," says Mr. Kirchoff, "the number who claim to have been employed as servicemen is surprising."

News of the F.R.T.A.

"One of the chief purposes of the Federated Radio Trade Association" according to Michael Ert, president, "is to assist local associations to organize in their own localities. Through the medium of booklets outlining the organization of a local radio trade association and on running a local radio show, we have been successful in organizing associations in 45 communities.

NEW MEMBERS FOR F.R.T.A.

Four new local associations which have joined the Federated Radio Trade Association are: Wichita Radio Trade Ass'n., Curt Hubbell, secretary, Wichita, Kansas; Radio Dealers Ass'n. of Northern Kentucky, C. M. Johnson, secretary, Covington, Ky.; Des Moines Radio Merchants' Ass'n., J. T. Schilling, secretary, Des Moines, Ia., and the Mahoning Valley Radio Dealers' Ass'n., W. H. Conklin, secretary, Youngstown, O. With these additions, there are now 31 local trade associations with membership in the F.R.T.A. Initiation fees for local associations are \$1 and dues \$25 annually with the privileges of sending two voting delegates to annual meetings.

The Radio Wholesalers' Association announce the addition of the following new members: Charles C. Hicks and W. H. Nolan, North Central Distributors Inc., Minneapolis; J. M. Camp, Brown-Camp Hardware Co., Des Moines Ia.; Earl R. Goodin, Goodin Radio Corp., Wichita, Kans.; E. L. Kern, Kern-O'Neill Co., Minneapolis, Minn.; C. A. Winne, Stewart-Warner Sales Co., Minneapolis, Minn.; George A. Michel, The Belmont Corp, Minneapolis, Minn.; L. B. McCreary, Western Radio Co., Kansas City, Mo. The total membership of the association is now more than 200.

OBSOLETE SETS BURNED

Local trade associations in more than ten cities, in cooperation with the Federated Radio Trade Ass'n, staged radio bonfires to demonstrate the uselessness of old battery sets. Cities in which the events were held include San Francisco, St. Louis, Minneapolis, Chicago, Milwaukee, Des Moines, Kansas City, Omaha, and Covington. Dealers cooperate in collecting the sets, frequently from their own stocks, hold a parade to the spot for the fire, and the Mayor of the city is invited to touch the first match. Newspapers have been generous in their cooperation, some special radio fire sections have been published, and movie news reels have taken pictures of the event. The local associations are plugging the idea that "old sets are obsolete" and linking that thought with the slogan "The Modern Home Needs a Modern Radio."



Charles Eisler, Eister Elec. Corp.

Change of Address

Jenkins & Adair, Inc., Chicago manufacturers of special audio apparatus for broadcasting and sound pictures, have moved to 3333 Belmont Avenue where their office and factory is housed.

E. T. Cunningham has rehoused its Pacific Coast headquarters in a new building at 325 Ninth Street, San Francisco.

Recently Issued Patents

- No. 1,724,960, System of Modulation. James E. Parker, Washington, D. C. Filed March 1, 1923.
- No. 1,724,965, Amplifying Circuits. Francis X. Rettenmeyer, Montclair, N. J., assignor to Western Electric Company, Inc., New York, N. Y. Filed May 11, 1926.
- No. 1,724,987, Selective Constant Resistance Network. Otto J. Zobel, New York, N. Y., assignor to American Telephone and Telegraph Company. Filed April 13, 1928.
- No. 1,725,433, Band-Receiving Systems. Frederick K. Vreeland, Montclair, N. J., assignor to Vreeland Corporation, New York, N. Y. Filed August 1, 1927.
- No. 1,725,710, System and Method of Television. John Hays Hammond, Jr., Gloucester, Mass. Filed August 15, 1923.

Patent Suit

No. 1,418,279, Pridham & Jensen, Electrodynamic receiver, filed June 8, 1929, D. C., N. J., Doc. E 3856, The Magnavox Co. v. O'Neil Mfg. Corp.

Reproduces Current Radio Poster for Dealers' Meeting



F. M. Dinan, advertising manager (right), and R. Haynes, service manager, New Haven Electric Company, created quite a stir in Philadelphia recently by reproducing in complete detail one of the current Atwater Kent posters on the occasion of the visit of the New Haven Electric Company and 250 of their dealers to the Atwater Kent plant.

N-6

Financial Notes

Griggsby-Grunow's stockholders are smiling these days. Earnings are running in excess of \$1,000,000 a month net, or at the rate of \$30 a share, according to W. C. Grunow, vice president. Gross sales for the ensuing twelve months will reach 100 million dollars compared to 49 million last year. The capital stock has been increased from 500,000 to 2,000,000 shares; the shares have been split up four-for-one to stockholders of record on August 16.

Polymet has increased its capitalization from 60,000 to 300,000 shares of no-par value stock and the stock which is outstanding at present has been split up three-for-one. The new stock has been placed on a \$1.00 annual basis payable quarterly. Stock dividends at the annual rate of 4 per cent. have been declared. They begin on January 1, 1930 to all stockholders of record on Dec. 20, 1929. At the first annual meeting the following Board of Directors was re-elected: Carl L. Schmidt, Edmund J. Sampfer, Otto Heineman, Foster G. Smith, Judge Hadley Howd, Otto Paschkes, and Nathaniel E. Greene.

Dubilic reports a net profit for the year ending June 30 of \$169,999. This is equal to 56 cents a share on the 304,150 no-par-value shares outstanding. This is to be compared to a net loss of \$131,356 in the preceding year.



B.F. Dulweber
Supreme Inst. Corp.

Radio Products Corporation, formed by the Shultz Machine Company, Inc., will acquire the assets and business of Vacuum Tube Products. The output of this company is some 2,000,000 radio tube parts as well as tube manufacturing equipment sold to prominent tube manufacturers. To finance this purchase 50,000 shares of common stock have been offered to the public through two New York houses at \$36.50 a share. Ultimately 100,000 shares will be outstanding of a total capitalization of 200,000 shares.

Sparks-Withington's success for the past year is shown in the report of operations for the year ending June 30. A net income of \$2,510,322, which, after preferred dividends requirements have been deducted, is equal to \$14.56 a share on 168,690 shares, has been reported. This is compared to a net income of \$1,212,605 or \$8.03 a share on 149,280 shares for the previous year.

The Cardon-Phonocraft Corporation has been organized to take over the properties of Cardon Corporation and Phonocraft Corporation, manufacturer of vacuum tubes and automatic phonograph-radio combination. Sale of 100,438 shares of stock at \$24 has been consummated by W. E. Hutton & Co.

General Instrument Corporation stock has been offered through two Chicago brokers in units consisting of one share of Class A and one share of Class B. The price was \$22.50 per unit.

The Atlas Stores Corporation, of Philadelphia, have completed arrangements for the acquisition of City Radio Stores and Davega. This will bring the number of stores in the Atlas chain up to 69. An issue of 50,000 shares of stock convertible into common will probably be made, bringing the total number of shares up to 300,000.

Tube Prices Increase

New prices on several types of tubes have been announced by a number of tube manufacturers. These are increased prices and involve the following types:

200A	\$4.00
240	3.00
11	3.00
12	3.00
UV 199	2.75
UX 199	2.50
120	3.00

Last year the combined earnings were \$1,400,000.

Wextark Radio Stores, Inc., shows sales for the seven months of the present year to June 30 of \$7,049,856 and net earnings of \$730,647. This is a holding company in part and owns or controls through direct or stock ownership the following companies: Wextark Radio Stores, Inc., Columbia Radio Corp., Waltham Electric Corp., Duovac Radio Tube Corp., Chicago Salvage Stock Stores Inc., Allied Radio Corporation, as well as a loud speaker manufacturing corporation and jobbing companies.

Acoustic Products' stockholders have approved a plan of recapitalization which involves exchanging preferred stock for common on a basis of eight shares of common for one of preferred with an additional two shares of common in consideration of waiver of dividends arrearage on each share of preferred, making in effect a 10 for 1 exchange. Common stock has been increased to 1,500,000 shares. Stockholders will probably be offered the right to subscribe to 300,000 of the new shares.

The Temple Corporation, to provide additional funds for expansion, has offered holders of preference stock rights for additional stock at \$30 per share. At the present time 35,000 shares are outstanding.

The DeForest Radio Company has offered to purchase all outstanding shares of Jenkins Television through an exchange of shares on the basis of 1 for 1 1/2 of Jenkins. If the offer is accepted DeForest must issue 570,000 new shares, bringing the total to 3,570,000.

Distributors Appointed

KELLOGG: A factory branch with F. W. Lorenz in charge has been established in the Cleveland territory for direct distribution to dealers. Office and warehouse space have been leased at 1531 West 25th Street, Cleveland.

PHILCO: The May Distributing Corporation represent Philco in the New York area. D. W. May is president.

STERLING: Superior Distributors, Inc., are exclusive distributors for Sterling Concertone Receivers in the New York Metropolitan area. The Sterling line is on display at 154 West 52 Street adjacent to the company's offices at 150 West 52 Street.

SONORA: Announcement is made by this company of the appointment of the H. P. Schade Company, 1329 North 15 Street, Philadelphia, as distributors of Sonora Radios and the Sonora Radio-Melodion.

KENNEDY: This company recently announced the appointment of the following distributors: Reibold, Inc., of Bismark, N. D.; Clinton Paper Company, of Clinton, Iowa; The Northland Electric Supply Company, of Minneapolis, Minn.; Hafer Supply Company, of Joplin, Mo.; Carroll Electric Company, Inc., of Washington, D. C.

KOLSTER: The Commercial Electric Company was recently appointed distributor for Kolster and Brandes receivers. The Commercial Electric Company recently moved to its location at 14 North Erie Street, Toledo, Ohio.

TRIAD: Recent distributors appointed by the Triad Manufacturing Company include the Beaudette and Graham Company, of Boston; Stuyvesant Electric Company, of New York City, and Lehr Automotive Supply Company, of New York City.

EDISON: Roy S. Dunn, western sales manager of Thomas A. Edison, Inc., recently announced the establishment of Renier Brothers, Dubuque, Iowa, as a distributor of Edison radios, phonographs and records. The new Edison distributor will serve dealers located in northwestern Iowa, southwestern Wisconsin and northwestern Illinois.

New Equipment Ships 580 Radio Receivers per Hour

By means of a carousel conveyor, radio receiving sets can be carried to waiting freight cars at a rate of 580 per hour at the new addition to the plant of the Crosley Radio Corporation, Cincinnati, Ohio. Three floors of the eight-floor addition have been finished and are in operation.



N-7

IN THE RADIO MARKETPLACE

News, Useful Data, and Information on the Offerings of the Manufacturer

New Crosley Receiver

CROSLY RADIO CORPORATION: Two screen-grid tubes are used in this new receiver, the Monotrad, which lists at \$62.00. It is a complete a.c.-operated receiver with two 245-type tubes in the output. The feature of the set is the triple-range control switch by means of which the user has three different positions for local, nearby, and distant reception.

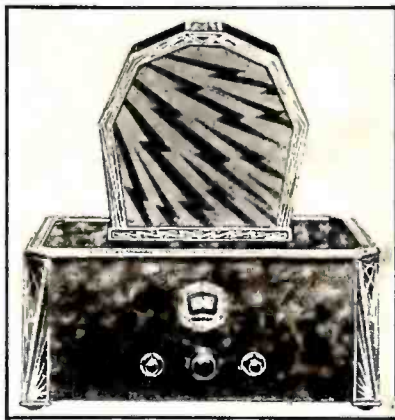

Super Akra-Ohm Resistors

SEALLCROSS MANUFACTURING COMPANY: These resistors are designed for use in radio receivers and as laboratory standards. Normally the resistors are accurate within one per cent. but greater accuracy may be had when desired. They are practically non-inductive, have a temperature co-efficient of 0.0001, and will dissipate 1 watt. They are available in values from 5000 ohms to 5 megohms.

New Kennedy Receiver

COLIN B. KENNEDY CORPORATION: The receiver employs three tuned r.f. stages with screen-grid tubes followed by a 227-type detector and two 245-type tubes in push pull. The chassis is available in two cabinets, a Lowboy and a Highboy Console. The gain of the receiver is uniformly high over the entire broadcast band.

New Columbia Receivers

COLUMBIA PHONOGRAPH COMPANY: The Selector Tuner is a feature of some of the new Columbia receivers. By means of it the dial may be adjusted for any one of eight favorite stations by pushing the proper button located on the dial. The Model c-11 is of the cabinet type which houses an eight-tube a.c.-operated radio receiver utilizing five 227-, two 245-, and one 280-type tubes. The loud speaker which uses



a Burtex diaphragm has a cone 11½ inches in diameter. Price: \$155.

The Model 940 uses the same chassis. This model is a combination phonograph and radio. The record bins contain room for sixty records. Price: \$297.50. The Model 920 is a Columbia Viva-Tonal electric phonograph, the power amplifier using one 227-, two 245-, and one 280-type tubes. An induction motor operates the turntable which is equipped with an automatic stop. Price, \$197.50. The Model 180 is a small portable electric turntable and phonograph pick-up unit designed for use in conjunction with a radio receiver for electric reproduction of phonograph records. This portable instrument can be located at any reasonable distance from the radio receiver, the two being connected by means of a flexible cord. Price: \$55.00.

Small Fixed Condensers

CORNELL ELECTRIC MANUFACTURING COMPANY, INC.: This company manufactures small fixed condensers in capacities from 0.0001 to 0.006 mfd. They are readily mounted, will stand a flash test of 1500 volts d.c., and use a dielectric consisting of three 0.0005" sheets of pure linen paper.

The Silver Model 75

Silver-Marshall, Inc.: Effective September 1, a new model of Silver Radio, known as the Model 75 Concert Grand, was added to the line which now consists of two models, the Sheraton Lowboy and Highboy cabinets. The

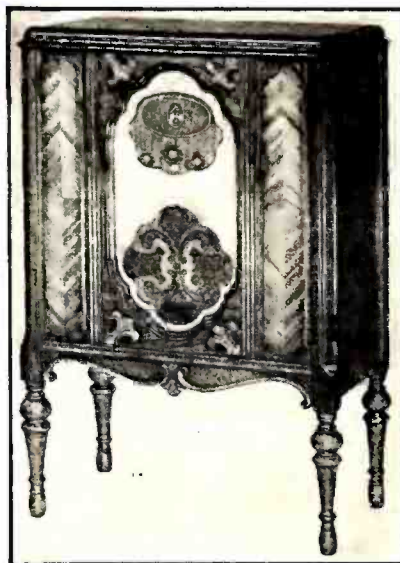

Model 75 Concert Grand houses a Model 30 Silver Radio eight-tube, screen-grid chassis exactly similar to those furnished in the Model 60 Lowboy and Model 95 Highboy. A ten-inch dynamic loud speaker is incorporated in the Model 75 cabinet.

Jenkins Television

JENKINS TELEVISION CORPORATION: This company has announced the completion of their Jersey City transmitter, w2xcr, which will be used to broadcast television signals on 140 meters. It is rated at 5 kw. The first broadcasting will transmit motion picture film.

New Phonograph Pick-Up Unit

BERG A. T. AND S. COMPANY, INC.: This company makes a small portable electric turntable and pick-up unit. List price: \$50.00.

New Thordarson Amplifiers

THORDARSON ELECTRIC MANUFACTURING COMPANY: The Type T-3715 amplifier lists at \$89.50, has a voltage amplification of 275, and a maximum output of 4.6 watts. It uses one 227- and one 250-type tube with a 281-type rectifier. The Type T-3714, listing at \$84.00, has a volt-

age amplification of 335, a maximum output of 3.5 watts, and uses one 227-, two 245- and one 280-type tubes.

The "Golden Voiced" Table

KIEL FURNITURE COMPANY: A special table has been designed by this company to house the Atwater Kent screen-grid receiver and



dynamic loud speaker. The top of the table opens and inside of it can be housed the radio receiver and loud speaker. The table acts as a baffleboard and the loud speaker plays through an opening in the bottom.

Issue New Manual

AEROVOX WIRELESS CORP.: A new condenser and resistor manual giving specifications for the various types of condensers and resistors made by this company has just been issued.

Antenna Apparatus

SWAN-HAVERSTICK, INC.: Antenna kits of various types, insulators, wall plates, light-socket antennas, lightning arrestors, etc., are illustrated in the new catalog of this company.

New Gulbransen Receivers

GULBRANSEN COMPANY: The screen-grid Model 292 is equipped with a ten-inch dynamic loud speaker and radio-frequency transformers designed to give uniform sensitivity over the entire broadcast band. Normally a light-socket antenna gives satisfactory reception. The set has a local-distance switch and a phonograph-radio switch. Price: \$149.50. The Model 291 uses a similar circuit in a different cabinet. Price: \$139.50.



N-8

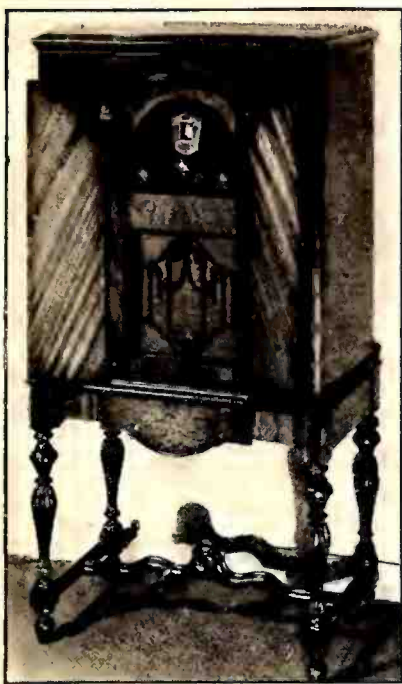

Sonora's New Line

SONORA PHONOGRAPH COMPANY, INC.: The new Sonora sets designed for screen-grid operation each have three screen-grid tubes, a power detector, and one stage of audio with two 245-type tubes in push pull. The chassis are all completely shielded. The dynamic loud speaker contains a filter to eliminate a.c. hum. The radio receivers are priced as follows: Lowboy \$149.50; Highboy \$179.50; DeLuxe \$235.00. The combination radio-phonographs range in price from \$190 to \$695. A feature of the receivers is the Synchro-tone Modulator that insures equally good reproduction at all volume levels.

New Bosch Sets

AMERICAN BOSCH MAGNETO COMPANY: The DeLuxe Highboy Model combines the new Bosch screen-grid receiver with a dynamic loud speaker. The cabinet has sliding doors. Price: \$240. The Standard Model is priced at \$168.50.

New Zenith Models

ZENITH RADIO CORPORATION: Features of the new Zenith receivers are screen-grid circuits, automatic tuning, double push-pull audio amplification, remote automatic control, etc. The Model 52 lists at \$175.00, the Model 53 at \$275.00, and the Model 54 at \$395.00.

Sparton Announces D. C. Set

SPARKS-WITHINGTON COMPANY: To meet the demand for d.c. light-socket-operated receivers two Sparton sets, the Models 931 and 301, have been designed. These models are available at the same prices as the corresponding a.c. models.

New Atwater Kent Receiver

ATWATER KENT MANUFACTURING COMPANY: The Model 66 receiver is a screen-grid set using a total of nine tubes; three 224-, two 227-, and two 250-type tubes in push pull and two 281-type rectifiers. Price: \$135.00.

Electric Phonograph Motor

PACENT ELECTRIC COMPANY: This motor, Model 140, designed for operation on a 50-60 cycle, 110-volt a.c. supply, is of the induction type and is adapted especially for use in a phonograph-radio combination.

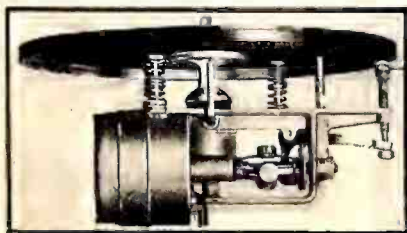

New Jewell Apparatus

JEWELL ELECTRICAL INSTRUMENT COMPANY: The latest catalog of this company illustrates a number of new miniature instruments in bakelite cases. The line includes instruments for measurement of d.c., low-frequency, and high-frequency currents.

Kellogg 25-cycle Sets

KELLOGG SWITCHBOARD AND SUPPLY COMPANY: Three new models designed especially for use in territories supplied with 25-cycle current have been added to the Kellogg line. They are known as the models 526, 527 and 528 and are similar in appearance and features to the corresponding 60-cycle models, 532, 524, and 525.

New Philco Receiver

PHILADELPHIA STORAGE BATTERY COMPANY: The new model 95 chassis employs an unusual circuit and a number of new features. Ahead of the first tube is a double-tuned circuit to eliminate cross talk. A two-element detector is used and this is followed by a 227-type audio amplifier. The two-element detector is a 227-type tube with the grid and plate socket terminals connected together. Such a tube has a linear characteristic over practically its entire operating range. The set is also arranged to equalize automatically the volume of all stations. The tubes used in the set are: three 224 screen-grid tubes, one 227 detector, one 227 as an amplifier after the detector, one 227 as an ordinary audio amplifier, two 245's in push pull, and one 280 rectifier. The set will be available as a table model and in three different console cabinets.

New Bremer-Tully Sets

BREMER-TULLY MANUFACTURING COMPANY: The new Bremer-Tully receivers utilize four tuned circuits with 227-type tubes as r.f. amplifiers. In the output are two 245 tubes in push-pull. A phonograph jack is provided for use with an electric pick-up unit. The dynamic loud speaker has a ten-inch cone and its power supply has been designed so as to eliminate any audible hum. The standard Model 81 receiver lists at \$164.00. The DeLuxe Model 82 lists at \$195.00.

New Hammarlund Units

HAMMARLUND MANUFACTURING COMPANY, INC.: Complete units for audio or radio-frequency amplifiers and several special components for use in screen-grid receivers are announced by this company. Among the new items

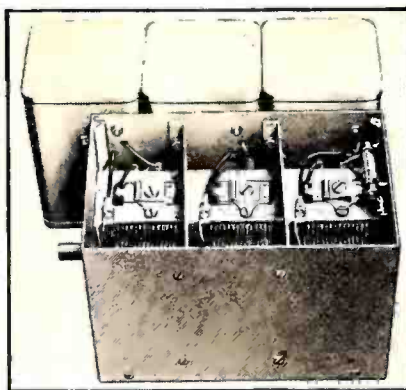

are a three-stage radio-frequency band-pass filter, a complete screen-grid r.f. amplifier, audio-frequency transformers, power-supply apparatus, etc.

Marti Receivers

Marti Radio Corporation: The Marti receivers utilize screen-grid tubes as r.f. amplifiers. The output of the r.f. amplifier feeds into a 227 type power detector and from this tube through an audio amplifier to two 245-type tubes in push-pull. A dynamic loud speaker is used and the cabinet is of such dimension that the baffle length is 47 inches in its shortest dimension. The set lists at \$295.00.

Stromberg-Carlson Model 846

STROMBERG-CARLSON TELEPHONE MANUFACTURING COMPANY: In this receiver are combined the following features: automatic volume control, linear power detection, a "silent key" to cut out noise when tuning from one station



to another, phonograph-radio switch, and a large diameter dynamic loud speaker. This company is also making an electrodynamic loud speaker which is housed in a floor type cabinet. The loud speaker is designed for use with any standard radio receiver. The loud speaker is stated to be from two to four times more efficient than previous reproducers of this type.

Grebe's Screen-Grid Radio

A. H. GREBE AND COMPANY, INC.: An equalized band-pass filter using six tuned circuits, linear power detection, single-stage audio amplifier, and a push-pull output circuit are features of the new receivers announced by this company. The set is known as the Model sk-4 and is available in four different designs. The prices range from \$219.50 for the most inexpensive model to \$450 for a combination radio-phonograph.

The Brunswick Model 14

THE BRUNSWICK-BALKE-COLLENDER COMPANY: The Model 14 Brunswick radio is a nine-tube receiver housed in a lowboy console. This set is completely a.c. operated and lists at \$148.00. The Model 21 uses the same chassis housed in a highboy console, the list price being \$174.00. The radio chassis is combined with an electric Panatropé in the Model 31 listing at \$272.00.

New Radio Accessories

INSULINE CORPORATION OF AMERICA: This company is now manufacturing a number of new items which include various types of interference eliminators, light-socket antennas, resistance type voltage regulators to control the line voltage, and a new "Screen Gridifier," a device for use in converting old type receivers to be used with screen-grid tubes. This device is made in two models, one listing at \$7.50 and the other at \$9.50.

Electrad's New Resistors

ELECTRAD, INC.: This new resistor is recommended particularly for use as a plate resistance, voltmeter multiplier, and in general laboratory work. The resistance wire is nichrome, contact bands and soldering lugs being of Monel metal. It is made in values from 10,000 to 250,000 ohms and the prices range from \$1.50 to \$5.00.

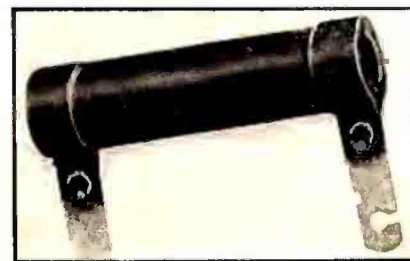

N-9

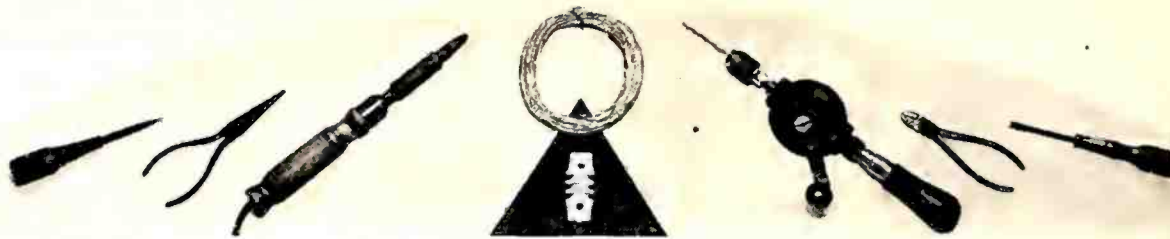

THE SERVICEMAN'S CORNER

Testing Screen-Grid Tubes

BORIS S. NAIMARK, of the Riverside Auto and Supply Company, New York City, dealer in Colonial and Steinite, sends the following interesting contribution in recognition of the test requirements of screen-grid tubes and the almost universal distribution of test sets designed before these tubes became popular.

"The advent of screen-grid tubes has rendered virtually obsolete thousands of perfectly good tube testers. Almost every radio work shop and certainly every radio store has one or more of these testers, which, while perfectly satisfactory in all other respects, are not suitable for testing screen-grid tubes. It is the purpose of this article to describe just how such tube testers may be modernized so that they may be employed to test the four-element tubes. Such a program of modernization involves only a trifling expenditure, under no circumstance exceeding fifty cents for the two units described.

"If the reader has a battery tube-tester and wishes to test the 222-type screen-tube, he can make the necessary adaptor from one UX socket, one UX tube base, two small clips, and about two feet of hook-up wire. If an a.c. tube tester is available, all one needs to do in order to test the 224-type tubes is to assemble an adaptor consisting of one UY tube socket, one UY tube base, two small clips, and hook-up wire. The circuits are shown in Figs. 1 and 2, respectively, and the construction should not present any difficulties whatever.

"All of the above mentioned materials, the reader, no doubt, will find in his 'junk-box.' The construction, of course, is very simple, all data being indicated in the self-explanatory diagrams. The operation of the adaptors is also practically obvious.

"The correct procedure is to place the tube base in the tube-tester socket, place the tube to be tested in the extra socket, connecting the clip marked 'to top of screen-grid tube' to the control grid, and the clip marked 'to B plus' to some suitable positive potential. Then the tube is tested in the usual manner. What constitutes a suitable positive potential for the screen grid? A little experimenting seems to indicate that one third of the applied plate voltage is just about right. This voltage need not be supplied by an independent source of potential and may be easily diverted or tapped off the voltage normally applied to the plate of the tubes ordinarily under test.

"The average tube-tester contains at least two meters, a voltmeter and a milli-

ammeter. The first makes it possible to secure the correct filament voltage. This, of course, should be adjusted to 3.3 volts for the d.c. screen-grid tube, and 2.5 for the a.c. screen-grid tube. The milliammeter indicates the plate current flow in the tube. It is through a comparison of

with its corresponding plate current flow as indicated on the milliammeter. When the button is depressed a different bias condition prevails and, accordingly, the value of the plate current, as indicated on the plate milliammeter, is either greater or smaller than the original reading. It is the difference between the two readings that denotes the utility of a tube in the set. It is impossible for the writer to indicate just what plate current readings will determine a good, fair, or poor screen-grid tube because it is impossible to foretell under just what conditions the test will be conducted. A slight difference in any of the potentials involved in the test affects the readings obtainable. All we can suggest, then, is that the reader test several new tubes and take the readings thus available as indicative of a good tube. Any tube giving readings that fall short of the amounts obtained from a representative group of new tubes is either poor or fair, depending upon the amount of deviation from the standard values.

"We want to enter a word of caution at this time: when a tube test is conducted it is absolutely essential that the filament potentials be adjusted accurately and exactly the same for all tubes in order that the readings obtained may be relied upon."

The serviceman is often called in to shoot trouble on a strange receiver—a set with which he is not over-familiar and one for which the owner has mislaid all operating and circuit data. On such jobs, when the trouble is not obvious, the serviceman's first task is to trace the leads—identifying the coded network of wires as those leading to definite supply voltages.

The extent to which this deciphering can be expedited often determines the efficiency with which the repairs can be effected.

We should like from our readers a description of the systems, if any, recommended for the rapid identification of unknown leads.

—THE EDITOR.

readings obtained on this meter under different control-grid conditions that the actual operating worth of a tube is determined. In the average tube-tester this change in control-grid condition is obtained by means of a specially provided button. With the button up, we have a certain definite grid voltage condition

A Portable Service Laboratory: WALDO TODD PRATT, West Hartford, Connecticut, specializing in Radiolas, is one of the service school that believes in doing the job on the spot. To work effectively on almost any job outside of his shop, he has accumulated the automobile laboratory, shown in the picture on this page and comprising the following equipment:

1. (At left) Phonograph turntable and pickup, for demonstration, and audio tests.

2. (Above) Western Electric 540w for checking loud speakers.

3. (Next to turntable) Phonograph records.

4. (Above) Oscillator. This has the necessary connectors, with suitable cords, to run as (A) a.c. with 60-cycle modulation from lighting outlet.

(B) d.c. plugged into tube testing socket of Jewell No. 117 kit, which thus provides readings of filament voltage and plate current. This provides

(1) Modulated oscillation, 550 kc. to 1500 kc.

(2) Unmodulated oscillation, 550 kc. to 1500 kc.

(C) An external socket is provided whereby tubes may be "matched" by noting the filament voltage at which they go into oscillation.

5. Radiola 26, altered to



The portable service laboratory of Waldo Todd Pratt, which makes it possible for him to carry on almost any service work under the actual conditions experienced by the set user.

detect either radio or audio signals and noises. Used for checking reception and locating noises.

6. Jewell No. 117 test kit, and tool kit. This is standard except for connection to connect grid and plate of tube together, to note total emission.

7. (Above) No. 199 Analyser. Pratt maintains (with considerable logic) that he "has always had best success in testing and adjusting sets in the location and under the conditions in which they are to be operated."

Data on Eveready sets: GEORGE W. BROWN, radioservice manager, Motor Supply Company, Boston, Massachusetts, distributors of Eveready, sends along this concentrated service data:

"I am submitting a few troubles and their solutions as I have found them in the 1929 Eveready Set. In many instances they will apply to receivers in general.

COMPLAINT SOLUTION

No C Bias—Bad 327 tube. Open volume control or resistor. Cathode lead off.

Noisy Set—Set screws on variometer loose. Shields loose.

No plate voltage—Connection broken at terminal strip in box. Plate lead off.

Oscillation—Shields on r.f. coils loose. Detector shield loose. Bad tube.

Antenna Compensator has no effect—Antenna too long. If over 20 feet should be connected to the long antenna binding post.

Volume control has no effect—Bad 327 tube.

Dynamic loud speaker does not work (Table model)—Open output transformer.

"The Eveready table model loud speaker will not work on the Console model set and visa versa. The table model set has a 1-1 ratio output transformer, and the table model loud speaker has a 25-1 ratio transformer but the console loud speaker is not equipped with a output transformer. Some dealers have returned loud speakers because they did not know this."

Testing receivers without equipment: A few pithy oscillations come from A. H. GOND, of South Portland, Maine:

"Much has been written about servicing equipment of all kinds, and every serviceman desires to acquire all the apparatus possible, to make his work easier and more accurate.

"However, emergencies do arise, and sometimes the serviceman finds himself empty handed, confronted by a balky set, with nothing but gray matter to guide him. There are quite a few tests that may be made with no equipment at all. At least, if the real trouble is not found on the spot, these preliminary tests are very helpful.

"Suppose the serviceman is asked to diagnose the trouble in an electric set. He may follow the procedure described below:

"If the set is dead: Turn on the current and wait about two minutes. Feel of the

power tube or tubes. If they are cool, there is no plate voltage on them, or a very low voltage. This would naturally suggest a blown filter condenser as the first possibility. In order to check this, place the hand on the rectifier tube. If the tube is very hot, the condenser is blown, or the wiring is shorted. Shorted elements in any of the tubes will cause trouble, and may be located readily by tapping the tubes and listening for the tell-tale crack-

priced a.c. sets and who are the owners of high-grade battery sets, such as Zenith, Stromberg, Federal, etc. These prospects are attracted to the lower-priced sets by the convenience of a.c. operation; otherwise we usually find them satisfied with their present equipment.

"To offer the owner of a \$400.00 Stromberg-Carlson set a \$40.00 allowance on, for example, a Radiola No. 44 results in his leaving your place of business in a huff; yet that is about as high as a dealer can go on a set of the type of the R. C. A. No. 44.

"We usually suggest to the owners of these sets that they let us make an a.c. set out their present job. We explain that their set can be made as convenient as the current models and they usually take us up. If their present set is equipped with a B-power supply the cost to the customer will be \$40.00 for a six-tube set, and correspondingly higher as the number of tubes increase. If a B-supply unit is not used in the present installation, the cost to the customer will be from \$60.00 up, depending on the number of tubes.

"For this work we use the equipment of the Radio Receptor Corporation and the type apparatus usually required is the Powerizer Jr. A and C or the Powerizer Jr. A, B, and C. On the first type the list and cost prices are as follows:

	LIST	COST
Powerizer A and C	\$12.00	\$ 7.20
Adapters	3.00	1.80
Tubes	12.00	7.20
Harness	5.00	3.00
Miscellaneous	2.00	1.20
Labor	6.00	2.00
Total	\$40.00	\$22.40
Profit		\$17.60

"On sets using the Powerizer A, B, and C the list and cost prices are as follows:

	LIST	COST
Powerizer A, B, and C	\$35.00	\$21.00
Adapters	3.00	1.30
Tubes	15.00	9.00
Harness	5.00	3.00
Miscellaneous	2.00	1.20
Labor	0.00	2.00
Total	\$60.00	\$37.00
Profit		\$23.00

"In many cases this price can be reduced by making our own harness and some sets require no additional volume control or reneutralization which further reduces our cost. Wherever practicable we solder the adapters to the original socket prongs. We also short the original 1 A- and C-battery leads, as the powerizer is equipped with a variable C-bias resistor and this we balance to the B-supply used.

"We limit our efforts in this field to the better grade of sets and discourage the making of this change in the lower priced units. Our record in this field to date is 96 Stromberg Carlsons, 7 Kolsters, 8 Zeniths, 4 Bosch, and 2 Atwater Kents, a total in all of 117 sets. No changes were made or found necessary in the audio channels of these sets."

B. B. ALCORN, Kew Radio Electric Inc., Kew Gardens, L. I.



George W. Brown in the service laboratory of the Motor Supply Company, Boston, Mass. The Radio Broadcast a.c. tube tester and modulated oscillator are among the prominent pieces of equipment in this laboratory.

ling noise. If the rectifier tube is cooler than usual, an open circuit in the B-supply circuit is indicated.

"If the tone quality is poor, and upon feeling of the power tubes, they are found to be very hot, there is no C-bias voltage.

"Continuing with the tests on the dead set, place the hand on the detector tube, or touch the grid leak. A hum indicates that the detector and audio system is ok. Now try tapping the antenna wire on its binding post. If the audio system is ok., and this tapping does not produce clicks in the loud speaker, the trouble is localized in the radio-frequency system. If clicks are heard, the trouble is probably due to loss of pickup caused by weak tubes, condensers out of resonance, open grid suppressor, or bad joints.

"When an analyzer is at hand, these tests are often convenient before it is used."

Number of servicemen in average shop: A recent survey made by the National Radio Institute, at Washington, D. C., showed that the average radio dealer in the United States employs four servicemen. The survey also indicates that 17 per cent. of the dealers contract for their service and repair work to be handled by outside service organizations.

New radio service school: John F. Rider, radio writer and well-known service consultant, has opened a service school at 1991 Broadway, New York City. Mr. Rider is teaching radio servicing both to attending and correspondence classes. The course is divided into two grades, an elementary course of five months and an advanced course for two months.

Electrifying Old Sets

"In reference to the modernizing of older types of battery-operated sets referred to in the August issue, we have done a large amount of this work and feel that we are qualified to give a little information on the subject, as all the sets we have powerized to date have given excellent results.

"Practically all work of this type has come to us through new set prospects who have been interested in the lower-

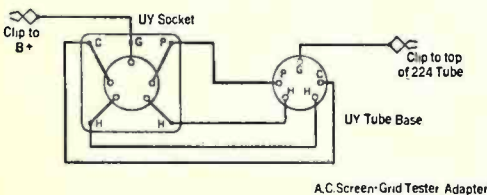

Fig. 1—The d.c. screen-grid tester adapter.

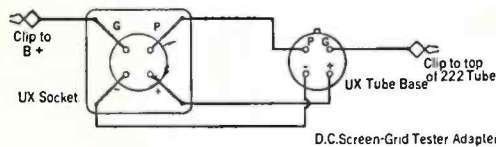
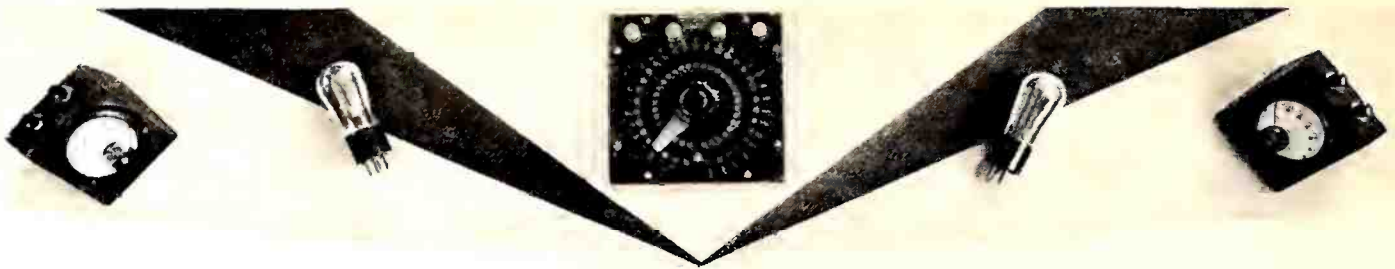

Fig. 2—The a.c. screen-grid tester adapter.



STRAYS FROM THE LABORATORY

A.R.C. Radio Altimeter

The picture herewith shows a special indicator panel installed in the pilot's compartment of a Fokker cabin monoplane, one of several planes employed in performance studies on the reflection altimeter of the Aircraft Radio Corporation, one of the Boonton (N. J.) Associates. The series of studies, continuing over many months, has included investigations of the effect of different wavelengths, antennas, airplane constructions, soils, topography, weather, and obstructions on the ground. The commercial form of the device can be made to give its indications by a needle traveling over a calibrated scale or by a sequence of lamps, each of which lights at a predetermined height above the ground or water over which the plane is traveling. In the experimental installation shown in the picture, the functions have been divided for ease of obtaining data. Two indicating instruments are provided, each of which is illuminated by a colored lamp, the two lamps lighting alternately at predetermined heights above ground. The height can be read from the instrument which is at the moment illuminated. The dial below the center of the panel enables the observer to make a balancing adjustment which is useful during tests on the effect of voltage variation, tube ageing, and the like.

Linear Detection

An interesting advantage of linear detection, as pointed out by Professor Terman in this issue of RADIO BROADCAST is its ability to discriminate automatically against unwanted signals weaker than the desired signal. Fig. 1 shows how this occurs. At (a) is the weak undesired envelope, in (b) is the desired envelope. These are envelopes of inaudible carriers and the beat note between these carriers must be inaudible; i.e., the two signals must differ by more than 10,000 cycles. The first thing that happens, then, is the production of an inaudible beat frequency. When the envelopes are in phase this beat frequency has a high amplitude; when they are out of phase, the amplitude is low. Thus the amplitude of the beat frequency varies between (c) and (d) in Fig. 1. The average value of this change in amplitude is the desired audio signal. If there is any non-linearity the increases (say) above this average will be greater than the decreases below this average and thus the undesired weak signal will affect the desired strong envelope.

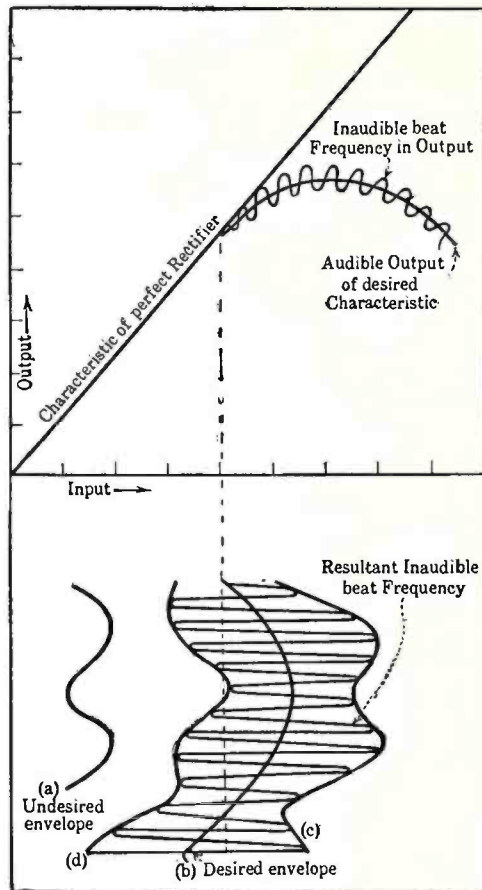
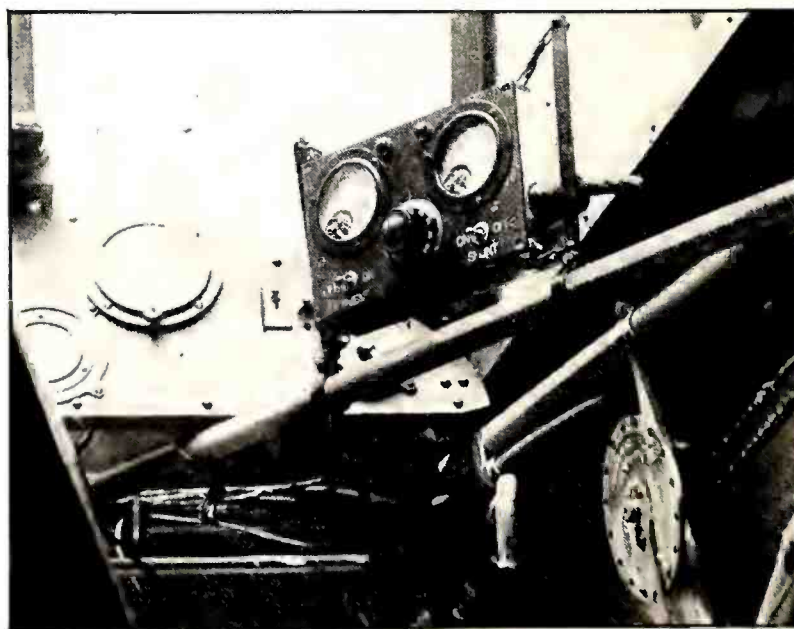

Fig. 1

Thus it appears that not only is the linear detector advantageous from the standpoint of decreased harmonics, from which the square-law detector suffers, but it is a sort of interference



View of radio equipment employed in experiments with the reflection altimeter.

eliminator too. Static may be reduced by the use of a linear detector, providing the modulation of the desired carrier signal is sufficiently great.

Advice to Students

Robert S. Kruse—who doesn't know Kruse?—has written the following letter to a reader who wants to be a radio engineer. Every word of it is true.

"No school does, or can, educate a man to be an engineer—it can only give him fundamental principles and general methods of thought and action to use as tools in attacking the special problems he meets. Problems are all special in one sense or another and no book can anticipate everything that progress brings. If such a handbook were possible we would always find the answer in a handbook, and engineering staffs could be replaced by a five-foot shelf of books.

Manifestly this is not the way things are—we do not anticipate and congeal our methods into a handbook. Instead we train men who regard the handbook as a toolrack in which concrete facts are stored but who themselves see to the use of the tools—and forge new ones as the need arises. These men are our researchers and engineers. The former deals with things exclusively—with the use by man not a controlling factor—the latter works constantly with things and men as applied to the pressing immediate needs of men.

If you wish to enter either of these two fields, learn all the mathematics you can, see all the radio equipment of any sort (it is all within 30 miles of you) and handle all you may of it, operate an experimental station of your own (but do it studiously and not as a social activity or a fad), attend I. R. E. meetings and make all possible personal contacts, and above all learn how people think, feel, and act, for the greatest danger that confronts the student engineer is that in learning how to deal with scientific things he loses contact with people—without whose aid he is useless."

Screen-Grid Ratings

Although the rating on the screen-grid tube has not been changed, we understand that the majority of set manufacturers using this tube are fixing their own control- and screen-grid voltages. With a 1.5-volt negative bias the control grid in good tubes begins to draw current at about 0.8-volt negative. This means that an incoming signal of about 0.7-volt peak would cause the grid to take current and its input resistance to

(Concluded on page 60)

Name Your Radio Ideals

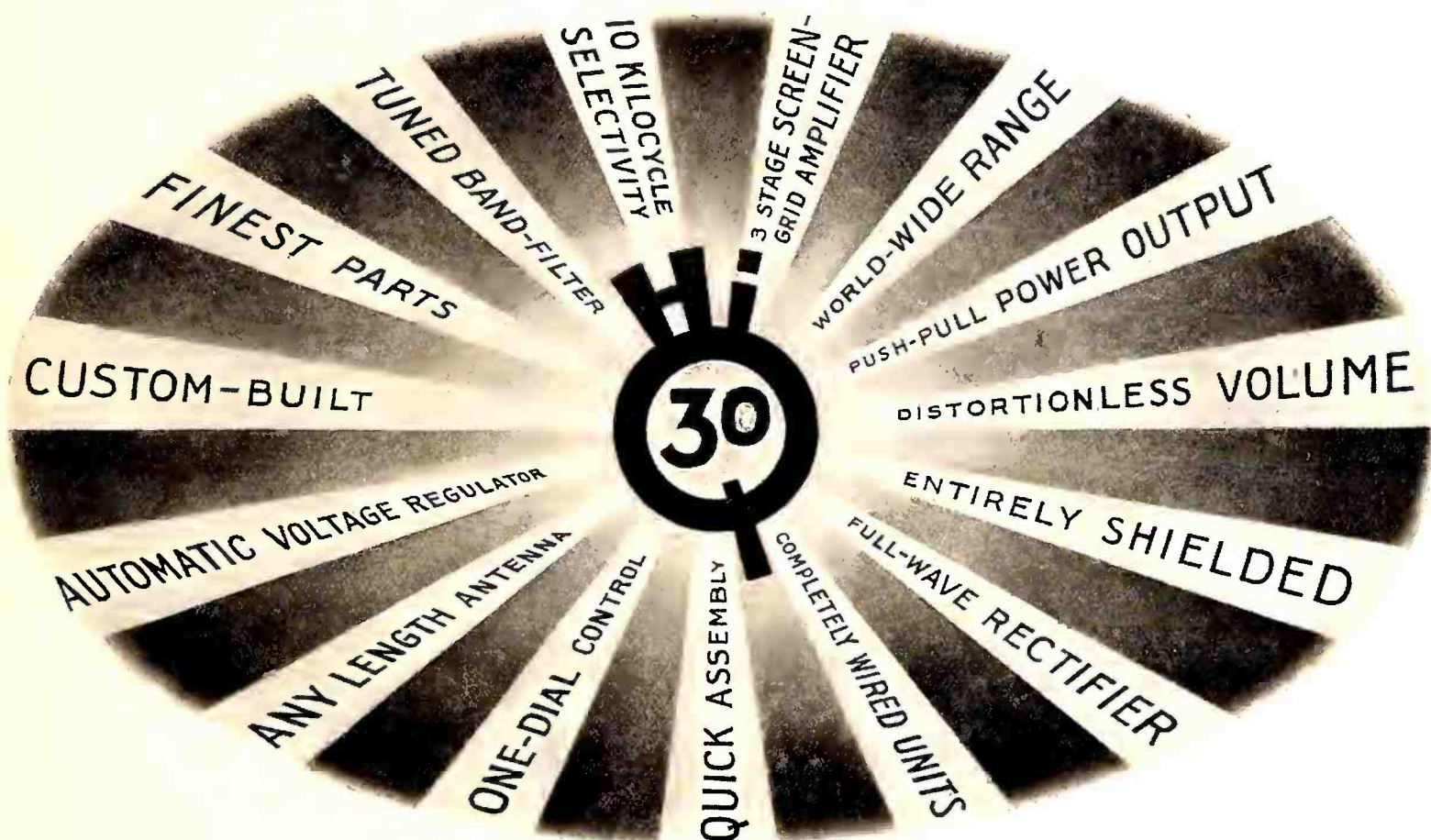

The New HAMMARLUND HAS THEM ALL!

YOU don't have to be an acoustical expert to recognize superlative tone—nor a radio engineer to know when you're listening to a program from the other side of the world—sweet, clear, free from noise or interference.

But the more you know about the fine points of radio design, the greater your appreciation of what Hammarlund engineers have accomplished in the new Custom-

built "HiQ-30" Band-Filter, Screen-Grid Radio.

For five years, Hammarlund Custom-Built Receivers have given spectacular performance—each season's model scoring greater and greater success.

And now, a glorious climax, the "HiQ-30"—premier radio of all time, with every detail a feature.

Here's amazing power, sensitivity, selectivity, tone, beauty; with unlimited choice of cabinets and speakers. For the first time a unit-built chassis with the chief units ready-wired and factory-tested, which you or your local custom-radio builder can completely assemble in two hours. A. C. and battery models, \$139.50 to \$1175, complete, less tubes.

Ask your local custom-radio builder to demonstrate the

"Hi-Q30" and to build one for you. Or assemble it yourself. It is easy and perfect results are assured.

Mail coupon for the "HiQ-30" Manual—a mint of new radio data for only 25 cents.

HAMMARLUND-ROBERTS, Inc.
424-438 West 33rd Street
New York City



The World's Premier Custom-Built Radio



MAIL THIS COUPON
and 25c
(Stamps or coin)
for 48-page "HiQ-30" Manual

Name

Address

(RB-11)



OXFORD
The "HiQ-30" chassis fits standard stock cabinets. These nine beautiful, specially-selected models are supplied by Hammarlund. Fully described in "HiQ-30" Manual.



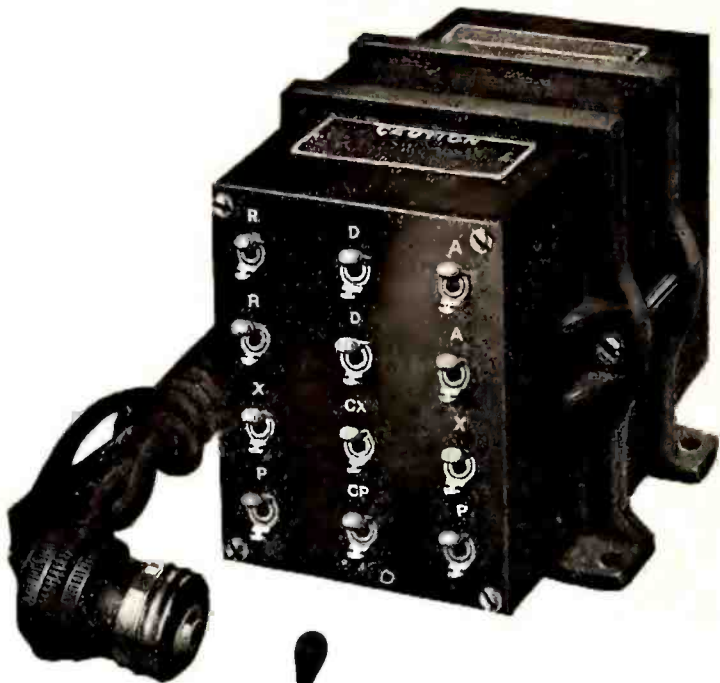

New!

the PF 245 A

AmerTran Power Transformer

Continuing its progress in the development of power transformers for all radio receiving sets the American Transformer Company announces the perfection of the new type PF 245 A. This new power transformer operates a radio receiver equipped with 2½ volt heater for heater type A. C. tubes and 2½ volt filament for a power tube (UX245 or CX345) which closely approaches the 210 in undistorted watts output.

The AmerTran Power Transformer Type PF 245 A is designed for a 60 cycle 115 volt line source, and has a continuous rating of 100 VA. with primary taps for 100—108—115—120 volts. A four point radial switch regulates the operation for different primary voltages. There are five secondary windings. Because of its lower maximum voltages, all secondary connections terminate in solder lugs attached to a bakelite terminal board.

This new, heavy duty power transformer is compact, sturdy, beautifully machined and mounted in cast iron end clamps provided with mounting feet. Like all AmerTran Transformers the PF 245 A is built to deliver sufficient excess voltage for maximum requirements.

Fill out and mail the coupon for AmerTran Bulletin No. 1088 giving complete description of the PF 245 A Power Transformer.



List Price \$22
East of the Rocky Mountains

AMERTRAN

TRADE MARK REG. U.S. PAT. OFF.

AMERICAN TRANSFORMER CO.
Builders of transformers for over 29 years
178 Emmet St., Newark, N. J.

AMERICAN TRANSFORMER CO., 178 Emmet St., Newark, N. J.

Please send me complete information on the new PF 245A Power Transformer.

Name.....

Address.....

R-B-11-9

TRIAD INSURED RADIO TUBES

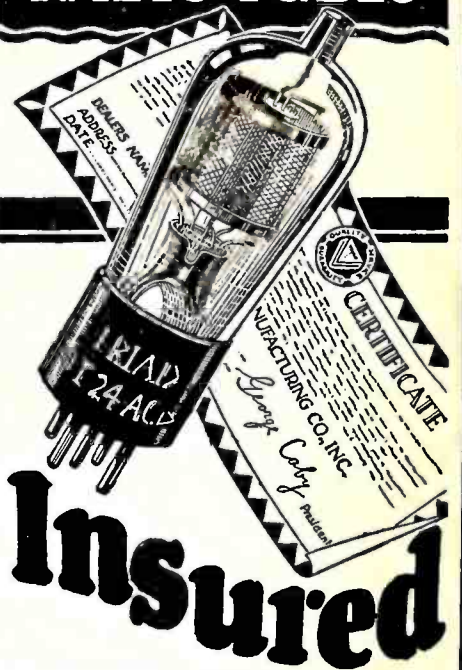

Dealers—this guarantee of performance is your guarantee of customer satisfaction and greater tube sales. TRIADS are winning a world of friends, and why wouldn't they! The TRIAD INSURANCE CERTIFICATE is the fairest replacement policy that has ever been offered in radio tube history—a minimum of six months' perfect service assured, or a satisfactory adjustment is made. There's protection for the purchaser—for the dealer—protection that is impossible to buy with any other tube.

Tune in on the TRIADORS every Friday evening, 8 to 8:30 (Eastern Standard Time) over WJZ and associated NBC Stations.

“Ask for the Tube in the Black and Yellow Triangular Box”



TRIAD MANUFACTURING CO.
INCORPORATED
PAWTUCKET, R. I.

Report on Experiments With Units of Various Designs

CHARACTERISTICS OF A.F. TRANSFORMERS

By PROF. H. M. TURNER

Sheffield Scientific School, Yale University

AS A RESULT of the keen competition among manufacturers, stimulated by the demand of the radio public for better and better quality, there has been marked improvement in the performance of audio-frequency transformers during the past few years. The subject has been extensively investigated by competent research engineers and designers but the results of their studies come to us in the form of the finished product with little information as to the exact changes that have brought about improved performance. There is in no sense a criticism of the manufacturer, for such information is his stock in trade. However, one of an inquiring mind desires to know in what way and to what extent the characteristics are modified by changes in design or operating condition.

What constitutes a good transformer? This, of course, depends upon the use that is made of it. For broadcast reception of music, the primary consideration is quality or faithful reproduction which requires, assuming an ideal loud speaker, that the amplification be essentially independent of frequency over some predetermined band, say from 30 to 8000 cycles. However, with commercial loud speakers, considerable departure from a flat characteristic is permissible, and in some cases even desirable, in order to compensate deficiencies in the reproducing unit. For telegraph purposes the primary consideration is intensity or large amplification. The band may be much narrower, say from 800 to 1200 cycles, for a peaked characteristic is quite desirable in that it may be made to give a louder response to the desired signal and at the same time greatly reduce interference from neighboring channels.

Unfortunately it is not always possible to obtain excellent quality and high amplification from the same transformer. The response characteristic of transformers, however, may be modified materially by design and operating conditions as follows: the amount of iron in the core; the ratio of turns; the actual number of turns in the windings and their position with respect to each other and to the core, that is, whether the windings are interwoven or the primary or secondary is placed next to the core; the total resistance of the plate circuit; the plate voltage and grid bias of the amplifying tube associated with the primary of the transformer; and, to some extent, the capacity in parallel with the primary and secondary.

Object of Investigation

The object of this paper is to report on some experiments on audio-frequency transformers of different design and operated under widely different conditions with the hope of at least partially answering some of the questions that occur to one but which in some cases remain un-

tory determinations. In the first place the ear, although sensitive to changes in pitch, is quite tolerant of changes in intensity; in other words, variations of 10 to 20 per cent. or more may take place without being perceived. This is fortunate for, if the response were directly proportional to the stimulus, an organ of hearing sufficiently sensitive to catch the slightest whisper would be destroyed by sound waves of great intensity, or at least they would be a source of great pain. In the second place there would be disagreement among observers. Differences that would be apparent to a trained ear would be entirely overlooked by one less discriminating. Even the results obtained by a given observer vary from day to day. Thus, for measurement purposes the ear cannot be considered an instrument of precision and for this reason an electron-tube voltmeter was used to measure the amplification as determined by the output voltage of the transformer and its associated amplifying tube.

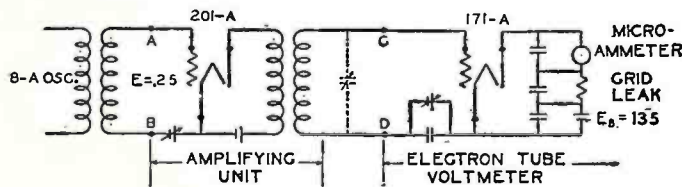

Fig. 1

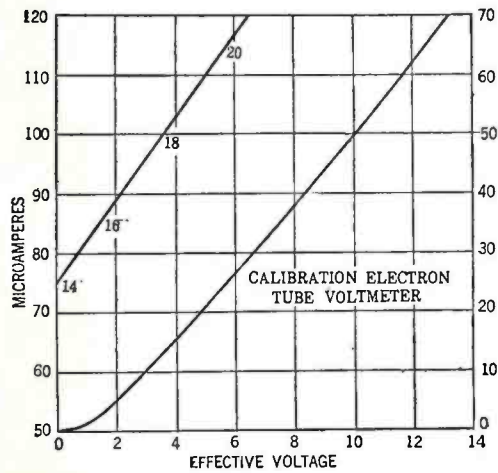
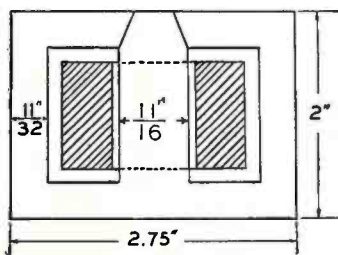

Fig. 2

answered due to lack of time or adequate facilities for conducting the necessary experiments. No attempt is made to define or to determine an ideal transformer but rather to show the effect produced upon the amplification characteristic by certain changes many of which are far removed from those encountered in practice.



CORE LAMINATION

Fig. 3

Faithful reproduction is dependent not only on the transformer but also on the associated amplifier, loud speaker, and the response characteristics of the receiving ear. But, since the imperfection of the latter are present whether one hears the original program or a loud speaker reproduction, it may be left out of consideration here. Although the ear must be the final judge of both quality and intensity it is not a satisfactory instrument for labora-

The Electric Circuit

The circuit arrangement that was used is shown in Fig. 1. A variable frequency is obtained from an 8A oscillator whose output transformer at the left supplies a voltage which is maintained at a constant value, usually 0.25 volt to the grid of a 201A amplifying tube in the plate circuit of which is connected the primary of the transformer. The secondary or output voltage being measured by an electron-tube voltmeter of the type developed by E. T. Dickey of the Radio Corporation. The condenser across the secondary of the transformer, shown dotted, was introduced in some of the experiments to be referred to later.

The Magnetic Circuit

Where the transformers were assembled in the laboratory, a core of 15 mil hipernik was used, the other dimensions being given in Fig. 3. In all cases, unless otherwise indicated, the core consisted of 50 laminations, the exception being Figs. 4 and 7 where the amount of iron was varied.

Series I: This transformer consisted of a primary of 7000 turns of No. 40 enameled wire having a resistance of the order of 2400 ohms and a secondary of

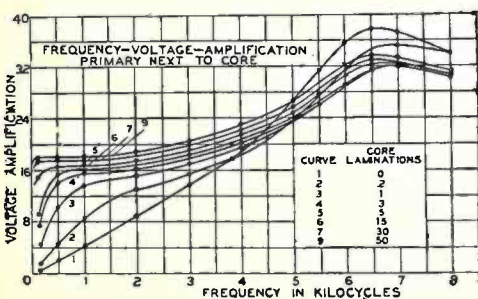

Fig. 4

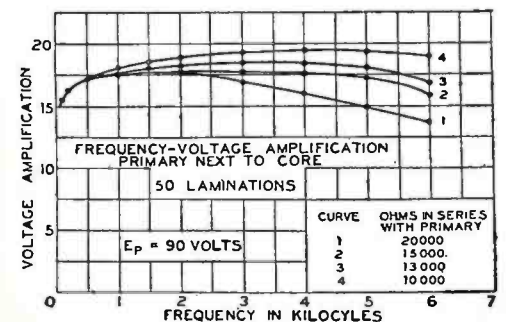

Fig. 5

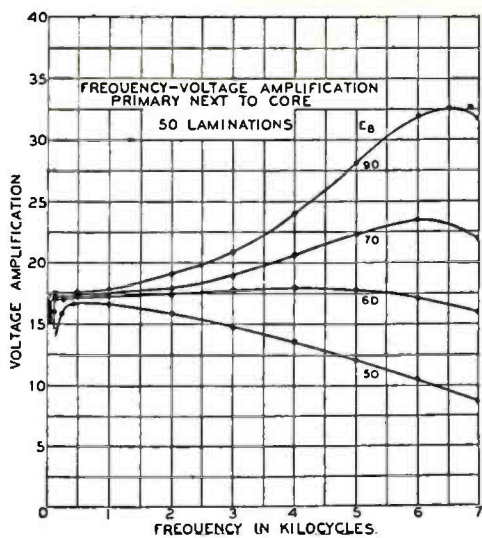

Fig. 6

15,000 turns of No. 40 of 7100-ohms resistance wound over the primary. The overall voltage amplification (Fig. 4) of the 201A tube and the transformer was measured for frequencies from 200 up to 8000 cycles, first with a core of 50 laminations and then with 30, 15, 5, 3, 1, 0.2, and 0 laminations. It will be observed that the removal of most of the iron has a relatively small effect upon the amplification over the greater portion of the frequency range, however, the effect of the core is rather pronounced at the low frequencies. Therefore, in order to retain the low notes a considerable amount of iron is required in this particular transformer. By 0.2 of a lamination is meant that portion of a single lamination which passes through the opening in the coil and which has a length equal to that of the coil or approximately one inch. The increased amplification due to this small amount of iron over that with no iron at all is pronounced below 200 cycles. Above 4500 cycles, regardless of the number of laminations, the core has practically no effect on the amplification other than to prevent an over exaggeration of the higher frequencies. Regardless of the amount of iron the maximum amplification occurs at 6500 cycles which is rather surprising and indicates that the introduction of iron does more than merely increase the induction. The maximum amplification is approximately twice that of the lower frequencies.

The form of the curve suggests a resonance effect which is due to the distributed capacity of the secondary and the grid-filament capacity of the tube to which it is connected. It is evident that the introduction of resistance in the primary circuit would tend to flatten out this curve and make the amplification much more uniform throughout the frequency range, and this is confirmed by Fig. 5.

A change of plate voltage would have something of the same effect as shown in Fig. 6 as this will change the internal resis-

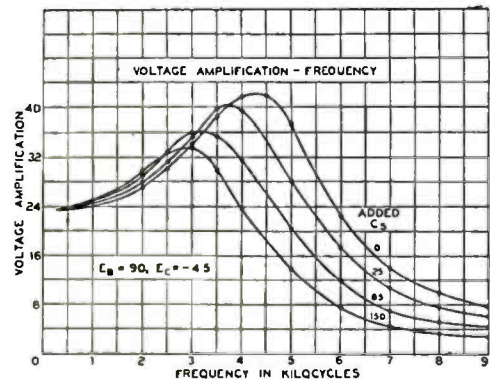

Fig. 11

tance of the tube. A decrease in plate potential from 90 to 67.5 volts for a 201A with normal grid bias causes an increase in plate resistance from approximately 10,000 to 14,000 ohms and at the same time decreases slightly the amplification factor. A decrease of plate potential from 67.5 to 45 volts would increase the resistance from 14,000 to 18,000 ohms. There are certain other factors that will have a secondary effect.

Series II: The primary of this transformer has 5000 turns of No. 40 wire with

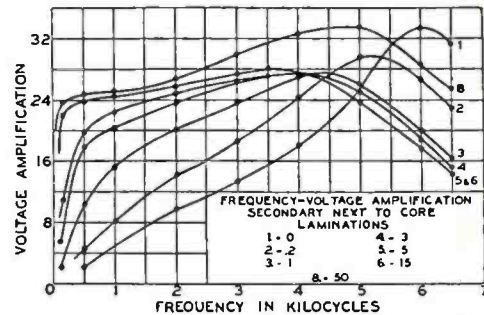

Fig. 7

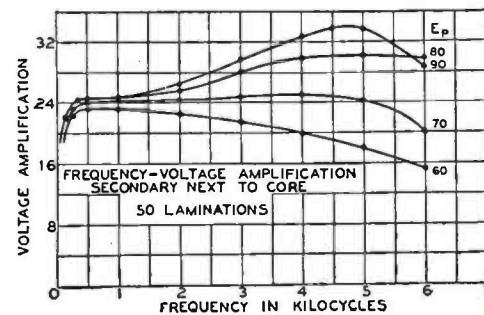

Fig. 8

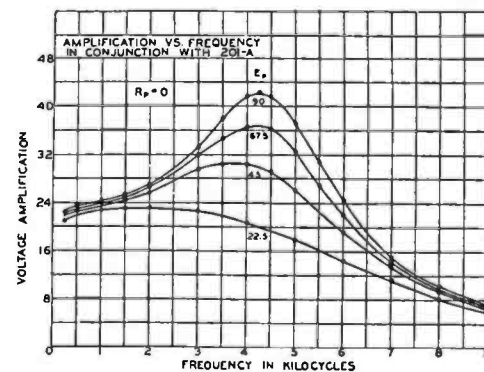

Fig. 9

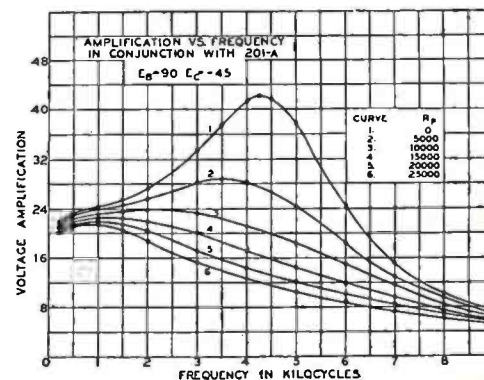

Fig. 10

a resistance of 2500 ohms. The secondary has 15,000 turns of No. 40 wire with a resistance of 6100 ohms. The amount of iron was varied as in Series I but the general appearance of the curves is quite different. There is a more pronounced spreading of the curves (see Fig. 7) and the maximum points occur at different frequencies, the maximum amplification for

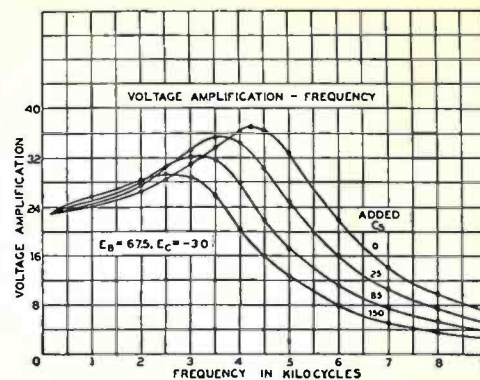

Fig. 12

the air core occurring at 6000 cycles. Introducing iron has the general effect of lowering the frequency at which the peak occurs. As the amount of iron was increased the maximum came at 5200, 4500, 4000, 3500, and then increased to 4800. The difference between this series and the last was due largely to the increased capacity of the secondary winding which was placed next to the core. Another possible difference was due to a change in leakage reactance. There is also a greater spreading of the curves for the different values of plate voltage (see Fig. 8) than for the corresponding case where the primary was wound over the secondary.

Series III: This is a commercial transformer for which there is no information regarding the number of turns or the turns ratio, but the ratio is probably between 2.5 and 3 as indicated by the amplification at the lower frequencies. The primary resistance is approximately 2000 ohms and the secondary 7500. It is considered a high-quality transformer. Figs. 9 to 13 show the effect of changing the plate voltage, adding resistance in the plate circuit, and varying the capacity across the secondary of the transformer for three different values of plate voltage with normal bias in each case. It should be noted that the effect of adding capacity is to decrease materially the amplification at the higher frequencies. The fact that the amplification varies considerably with frequency does not necessarily indicate that the quality will be poor. The maximum amplification for normal plate voltage and grid bias occurs at 4200 cycles and is approximately twice that at low frequency.

Series IV: This is a commercial transformer having a 6:1 ratio and giving an amplification of approximately twice that of the last transformer at low frequencies. The increase of amplification with frequency is less pronounced than for the last transformer, the maximum being about 30 per cent. greater in this case, although, due to the larger distributed capacity, it occurs at 3200 cycles and decreases quite rapidly for frequencies

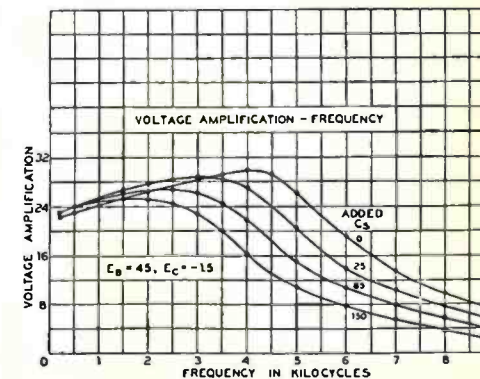

Fig. 13

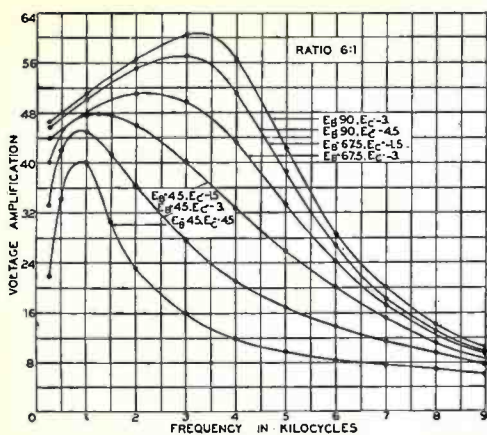

Fig. 14

above this value. The primary resistance was 1300 ohms and the secondary 12,000.

The effect of a change in either plate voltage or grid bias materially modified the shape of the characteristic, as shown by Fig. 14. The amplification increased with an increase of plate voltage and a decrease of negative grid bias. For a plate potential of 45 volts and a grid bias of 3 volts the curve rises rapidly to a maximum and then decreases rapidly to a very low value as the frequency is increased.

Series V: The five transformers here compared have the constants given in Table I on this page.

A comparison of the three transformers having 5000 turns in the primary and 15,000, 20,000, and 25,000 turns in the secondaries, respectively, is given in Fig. 15. There are two curves for each transformer but for the present consider only the higher one which is for normal conditions of operation. At low frequencies the amplification is almost exactly proportional to the number of turns in the secondaries but as the frequency is increased the amplification gradually increases to a maximum of approximately 175, 150, and 115 per cent. of the low frequency values and then decreases quite rapidly. These transformers, reach their maximum amplification at 6000, 4000, and 3000 cycles, respectively. It happens that the first and last transformers have almost exactly the same average amplification over the nine-kilocycle band while the intermediate one has a somewhat higher average and on the whole is probably the best. Although the average amplification is not necessarily the best measure of a transformer, especially if taken over a wide

band of frequencies, frequencies below five thousand may be far more important in some cases than those above. An added capacity of 50 mmfd. across the secondary has slight tendency to increase the amplification at certain frequencies. This tendency, which is greatest in the case of the low-ratio transformer, is negligible for the intermediate, and vanishes for the high ratio. Above a certain frequency, depending on the transformer, there is a marked decrease in the amplification due to the added capacity indicating the desirability of keeping the distributed capacity of the secondary and the capacity of the leads as small as possible.

Different Turns Ratios Compared

In Fig. 16 are compared transformers having a ratio of 3:1 with primaries of 5000 and 7500 turns and transformers having a ratio of 5:1 also with primaries of 5000 and 7500 turns. It will be observed that the cut-off is much more marked in the case of the high-ratio transformers. This is due largely to the increased distributed capacity of the secondaries as indicated in Fig. 15. In the case of the 5:1 transformer with the 7500-turn primary, the

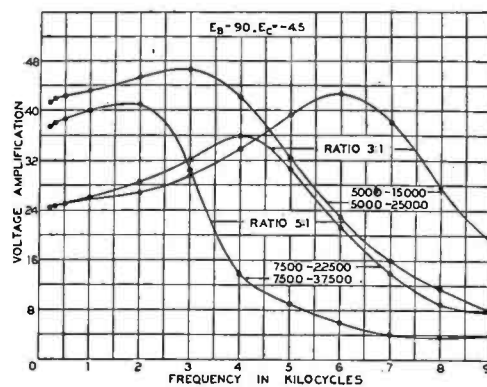

Fig. 16

and, therefore, tends to cause a larger portion of the total amplified voltage in the plate circuit to be consumed by the induced electromotive force of the primary, and, therefore, a greater induced electromotive force in the secondary. The primary current may be found from equation (3) and the secondary current is:

$$I_2 = \frac{\omega M I_1}{Z_2}$$

and what we are more concerned with is the voltage across the terminals of the secondary which is given in equation (4). For low frequencies ωL_2 is less than $1/\omega C_2$ and as the frequency is increased these two factors approach equality until a condition of resonance is reached in the secondary and the first radical in the denominator decreases to a minimum value of R_2 as a result of which a large output voltage is obtained. As the frequency is further increased ωL_2 is greater than $1/\omega C_2$ and the denominator increases, thus reducing the output voltage.

An increase of secondary capacity due to the added condenser causes the condition of resonance to be reached at a lower frequency after which the output voltage decreases rapidly as may be seen from the equation. These results will be somewhat modified by the mutual capacity

between the two windings of the transformer.

Bibliography

JOHNSON: *Transmission Circuits for Telephone Communication*. D. Van Nostrand Co.
 CASPER: "Telephone Transformers." American Institute of Electrical Engineers, March, 1924.
 MARTIN AND FLETCHER: "High-Quality Transmission and Reproduction of Speech and Music." American Institute of Electrical Engineers, March, 1924.
 KELLOGG: "Design of Non-Distorting Power Amplifiers." American Institute of Electrical Engineers, May, 1925.

—The Editor.

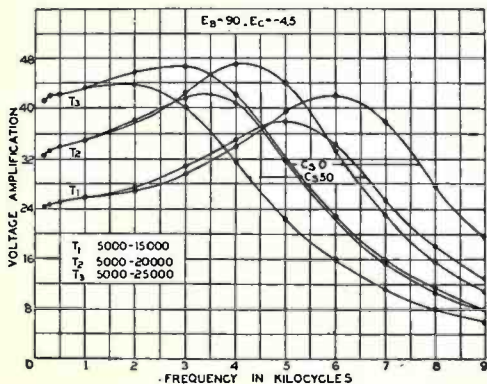

Fig. 15

cut-off is at 2000 cycles and is quite sharp. In Fig. 17, the same comparison is made but with 45 volts on the plate, and this shows that there is considerable difference between the characteristics for the two plate voltages.

In analyzing these curves in greater detail than time will permit here it will be helpful to recall the equations for the equivalent transformer constants. Where the primary of a transformer has resistance and inductance but negligible distributed capacity and the secondary has resistance, inductance, and capacity which includes the distributed capacity of the secondary and that of the leads and grid-filament of the associated tube, for the sake of simplicity, taken as a fixed value across the secondary, and further that the mutual capacity between the two windings be neglected, one may replace the transformer with an equivalent resistance and reactance in so far as the plate circuit of the amplifying tube associated with the primary is concerned. The equivalent constants then have the values indicated by equations (1) and (2).

For the low values of frequency and the capacity usually associated with the secondary, the total reactance of the secondary is capacitive and when transferred to the primary has the effect of increasing the equivalent inductive react-

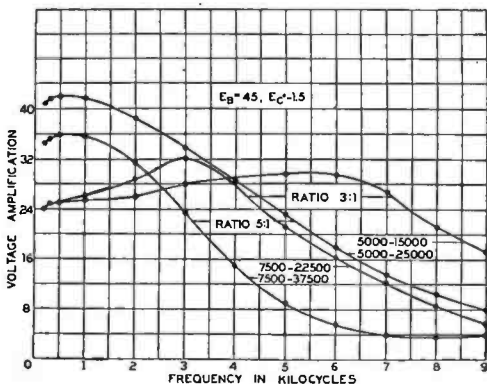

Fig. 17

A Discussion of Practical Engineering Procedure

DESIGNING THE POWER SUPPLY CIRCUIT

By RICHARD F. SHEA

Engineering Department, Atwater Kent Manufacturing Company

THE DESIGN of power-supply systems is an essential part of radio engineering. To be sure, it relies less upon the precise type of measurement which is characteristic of r.f. design, but in its place we find a great need for practical design, "cut-and-try" methods if you wish. It is the purpose of this paper to point out some of the practices and methods entering into this branch of radio engineering.

Let us then start at the beginning and follow through the procedure necessary to turn out a completed power-supply unit for a certain receiver and associated parts. Since the requirements depend upon the equipment used in conjunction with this supply unit, we must have previous knowledge of the type of set, voltages desired at the tubes, number and type of tubes, type of loud speaker, and, if a dynamic loud speaker is to be used, the voltage and current required to excite properly the field coil. Let us take a set which is fairly typical of the modern receiver. This set employs three stages of r.f. using screen-grid tubes requiring, let us say, 135 volts on the plates, 1½ volts on the control grids, and a maximum of 50 volts on the screen grids. The detector is of the C-bias or plate-rectification type requiring 120-130 volts on the plate and a grid bias of 12 volts. The first audio tube is a 227 type operating at 135 volts on the plate and a 6-volt grid bias. In the power stage 250-type tubes in push pull are used, requiring 425 to 450 volts on the plates and a bias of 70-85 volts. The speaker is a dynamic type, with a 5000-ohm 70-mA. field.

First Considerations

Let us now tentatively lay out our power pack as shown in Fig. 1. For convenience only, the 250-type tubes have been shown connected to the power supply, the other tubes going to the voltage-dividing resistor.

We can now compute the desired voltage across condenser C_2 . We want 450 volts on the plates of the 250's and 84 volts on the grids. Reference to tube tables indicates a plate current of 55 mA. for a 250-type tube under these conditions—a total drain of 110 milliamperes for the two tubes. If our output transformer's primary has a resistance of 500 ohms on each side, our drop there will be 25 volts. Our required voltage at C_2 then is $450 + 25 + 84 = 559$ volts. The bias for the 250-type tubes is obtained from the resistor R_c , between the center tap of the filament winding for the 250-type tubes and the ground. This resistor, R_c , can be calculated immediately, knowing the drop across it and current flowing through it—

$$R_c = \frac{84 \times 1000}{110} = 765 \text{ ohms.}$$

Now, since we know the desired current through the field coil and its resistance, we can compute its voltage drop as—

$$V_F = \frac{5000 \times 70}{1000} = 350 \text{ volts}$$

It must be stated here that all resistors are to be measured *hot*, after the appara-

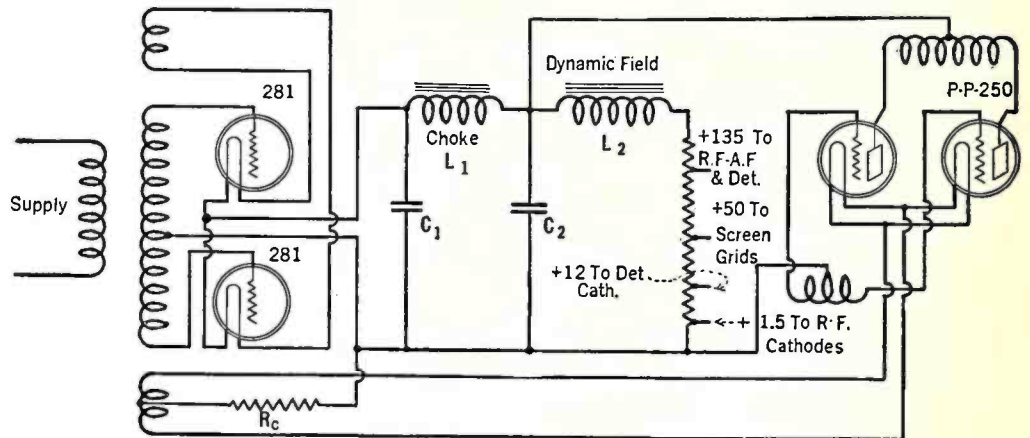

Fig. 1

tus has been in use from one half to one hour.

Knowing our voltage at C_2 and our field drop, we can compute the available voltage at the divider as $559 - 350 = 209$ volts.

Let us consult Fig. 2 which shows an enlarged diagram of the divider resistor. From this we can calculate the resistance values of the various units. We have a total of 70 mA. fed to the divider and this splits up between the tubes and the resistor according to the characteristics of the tubes. Let us refer again to our tube tables and find the plate current for the screen-grid tubes, the 227 as a detector, and the 227 as an audio amplifier. We get, respectively, 2 mA., 2 mA., and 3 mA. The three r.f. tubes then will draw a total of 6 mA. and the total of r.f., detector, and a.f. plate currents will be $6 + 2 + 3$, or 11 mA. The current at the +50-volt tap is very low as this feeds the screen-grids, at the 12-volt tap the 2 mA. returns from the detector cathode, and at the 1½-volt tap the 6 mA. returns from the r.f. tubes. The audio tube is supposed to be biased in a manner similar to that employed for the 250-type tubes, whereby the grid voltage is obtained from a resistor in series with the cathode lead. Consequently, the plate current from the audio tube returns to the ground point and does not flow through the divider.

Our resistances now have the voltages and currents shown and can be computed easily—

$$R_1 = \frac{74}{0.070} = 1059 \text{ ohms}$$

$$R_2 = \frac{85}{0.059} = 1440 \text{ ohms}$$

$$R_3 = \frac{38}{0.059} = 644 \text{ ohms}$$

$$R_4 = \frac{10.5}{0.061} = 172 \text{ ohms}$$

$$R_5 = \frac{1.5}{0.067} = 22.4 \text{ ohms}$$

Thus we find that our divider is a resistor of 3337 ohms, tapped at 22, 194, 838, and 2278 ohms.

Selecting the Choke

Having gone this far, our next step is to choose a proper size of choke coil. Most manufacturers have standard sizes of chokes and the problem becomes one of picking a choke that will not have an excessive heat rise under the current, which is $110 + 70$, or 180 mA. (a rather high current for two 281-type tubes to handle—*Editor*). Of course, the higher the inductance, the better will be our filtering, for given condenser values, and, conversely, if we use a small choke coil we must expect to use large values of filter capacity to obtain satisfactory filtering. The relationship between capacity and choke size is largely economic and each manufacturer has his own answer to the question.

Having chosen our choke coil, the biggest we can use economically, and knowing its resistance, we compute the drop in it. Let us say this resistance is 300 ohms. Then our drop is $300 \times 0.180 = 54$ volts and we now have the load our rectifiers must supply, as the voltage across condenser C is $559 + 54 = 613$ volts and the current drain will be 180 mA. It now remains for us to determine the proper secondary voltage to be applied to the rectifier tubes in order to obtain this required load. For this purpose we use characteristic rectifier tube curves, such as shown in Fig. 3. These curves show variation in output voltage, against load, for

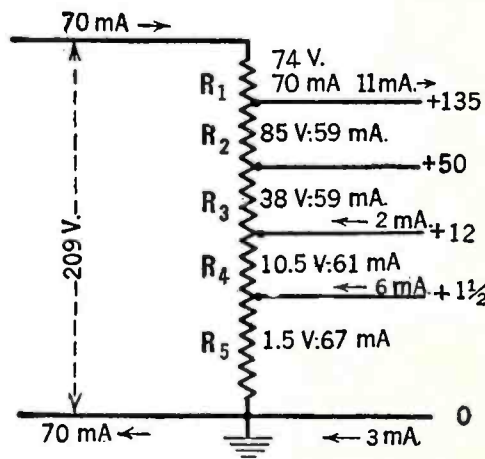

Fig. 2

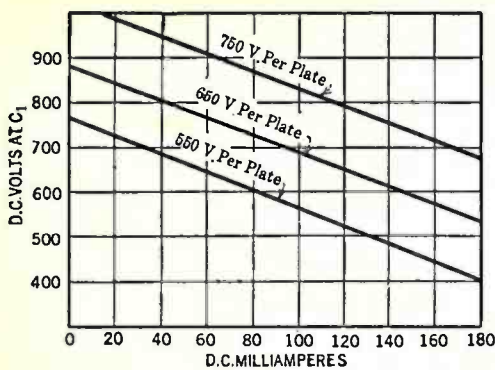

Fig. 3

a fixed value of C_1 and various secondary supply voltages. Referring to these curves, we can determine the required secondary voltage and we will then be ready to design our transformer. Here we must use some previous experience to tell us approximately how much capacity will be necessary at C_1 to secure efficient filtering. Let us try a value of 4 mfd. From the curves of Fig. 3 we find that a secondary voltage of 1400 volts is required to produce 613 volts at 180 milliamperes with 4 mfd. as the value of C_1 .

We are now ready to tackle the problem of transformer design, and it is here that practical rules and experience count very much as it is quite an art to be able to hit the nail on the head the first time. The "cut-and-try" method is used entirely in commercial practice, but a skilled designer can come within a very close margin on his first try.

Transformer Design

First we must tabulate our requirements in the way of approximate voltages and currents. Let us say our transformer is to work from a line of 115 volts at 60 cycles. We know our secondary voltage must be 1400 volts, and the load delivered by the rectifier tubes is $613 \times 0.180 = 110$ watts. Assuming an efficiency of about 75 per cent. for the rectifier tubes, we get 145 watts from the secondary winding. This tells us that our secondary current will be approximately 100 mA. We have the filaments of two 281-type tubes to light, each requiring 7.5 volts, or 15 volts at 1.25 amperes, or 18.8 watts; we have three screen-grid filaments to light at 2.5 volts, 5.2 amps, or 13.0 watts; two 250's, requiring 7.5 volts at 2.5 amps, or 18.8 watts, and two 227's, requiring 2.5 volts and 3.5 amps, or 8.8 watts. The total filament output is 58.3 watts and the total power is 203 watts. Assuming 90 per cent. efficiency, the input watts should be 225, and assuming 90 per cent. power factor, this gives a primary current of approximately 2.2 amps.

From the above we can choose our wire sizes, allowing 800-1000 circular mils per ampere for the inside windings and 600-800 circular mils per ampere for outside windings. This calls for approximately 1700 circular mils for the primary, or number 18 wire (see Fig. 4 for wire table). The secondary requires 80 circular mils or number 31 wire. The filament winding for the 281-type tubes requires 800 circular mils, or number 21 wire, all the $2\frac{1}{2}$ -volt filaments can be supplied from one winding with a consequent load of 8.75 amps, requiring 6000 circular mils, which can be obtained by using two number 15 wires in parallel. The filament winding for the 250-type tube requires 1700 circular mils, or number 18 wire. Thus we have the proper size of wire for all windings and are ready to compute the proper number of turns and the coil itself.

Most manufacturers have certain stan-

dard core sizes which are used for the various transformer jobs. Since the dies are already existent for these laminations it would be best to use the most convenient size, if it permits designing an economical and sensible transformer. In the event that a new lamination must be designed it is evident that the problem is entirely one of economics, i.e., balancing copper cost and iron cost to obtain the cheapest possible transformer. Occasionally space enters into the problem very forcibly, preventing one from realizing an ideal, and often making very weird shapes necessary.

The lamination shown in Fig. 5 illustrates a core shape that will be found quite desirable for a 60-cycle transformer of the sort needed in this specific job. If designed for 25 cycles more iron would be necessary and it would be advisable to increase all dimensions, thus allowing us to use more turns of wire and less iron than if the lamination of Fig. 5 were used.

It is obvious that if the cross section of the core were square the cost of winding the coil would be less and the space taken up would also make it more adaptable to the majority of jobs. Therefore, let us try a core $1\frac{1}{4}$ " square, an area of 3.06 square inches.

SIZE B. & S.	DIAM INCHES	AREA CIRCULAR MILS	
14	0.0661	4107	
15	0.0590	3257	
16	0.0526	2583	
17	0.0471	2048	
18	0.0419	1624	
19	0.0375	1288	
20	0.0335	1022	
21	0.0299	810.1	
22	0.0267	642.4	
23	0.0239	509.5	
24	0.0213	404.0	
25	0.0191	320.4	
26	0.0170	254.1	
27	0.0152	201.5	
28	0.0135	159.8	
29	0.0122	126.7	
30	0.0108	100.5	
31	0.0097	79.70	
32	0.0087	63.21	
33	0.0077	50.13	
34	0.0069	39.75	
35	0.0062	31.52	

FOR ENAMEL WIRE

Fig. 4

To obtain the proper number of primary turns we use the well-known formula—

$$E = 4.44 f NAB \times 10^{-9}$$

where f = Frequency in cycles per second
 A = Area in square centimeters
 N = Number of primary turns
 B = Flux density in lines per square centimeter
 E = Primary voltage

It can be shown that at 60 cycles a flux density of 10,000 to 11,000 lines per square centimeter is about correct, as more than that produces excessive core loss. Similarly, at 25 cycles we can use 12,000 or 13,000 lines per square centimeter. Substituting these values we obtain—

$$\text{At 60 cycles } \frac{NA}{E} = \frac{10^9}{4.44 \times 60 \times 10,000} = 37.5$$

$$\text{At 25 cycles } \frac{NA}{E} = \frac{10^9}{4.44 \times 25 \times 13,000} = 69.2$$

converting A to square inches this becomes—

$$\text{At 60 Cycles } \frac{NA}{E} = 5.8$$

$$\text{At 25 cycles } \frac{NA}{E} = 10.7$$

In ordinary practice we use the factors 6 and 11 to give us the proper flux densi-

ties, and this simplifies our design very considerably.

Returning to our problem at hand, we can now determine the proper number of primary turns, for 60-cycle operation, at 115 volts—

$$N_1 = \frac{6 \times 115}{3.06} = 226 \text{ turns}$$

In determining the secondary and tertiary turns we must make still greater approximation. The computation of the exact turns ratio depends upon a pre-knowledge of primary and secondary resistance and reactance, primary and secondary current, voltages, and power factors, and consequently is a very complicated process. Here it is best to use the results of experience and make a rough approximation. It will be found in the majority of cases that if the proper sizes of wire are chosen the ratio of turns will be only two or three per cent. higher than the ratio of voltages under load conditions. This, then, gives us a convenient approximation for turns ratio. We want a 1400-volt secondary with 115 volts on the primary, hence our turns

ratio will be $\frac{1400}{115}$ plus $2\frac{1}{2}$ per cent. or $\frac{1400}{115} (1.025) = 12.50$. Since our primary

has 226 turns our secondary will need 12.50×226 , or 2700 turns. Similarly, we obtain the turns on the tertiary windings—

$$281 \text{ filaments. } N_{281} = 226 \times \frac{15.00}{115} \times 1.025 = 30.2 \text{ turns}$$

$$250 \text{ filaments. } N_{250} = 226 \times \frac{7.50}{115} \times 1.025 = 15.1 \text{ turns}$$

$$224 \text{ and } 227 \text{ filaments. } N_{227} = 226 \times \frac{2.50}{115} \times 1.025 = 5.0 \text{ turns}$$

Here it must be mentioned that this transformer is being designed for zero resistance cable, which, of course, is not obtained in practice. We must know our cable drop, and add this to the desired filament voltage in order to get the required voltage at the transformer.

We now have all the windings on our transformer—

Primary	226 turns of number 18 wire
Secondary	2700 " " " " 31 "
281 fil.	30 " " " " 21 "
250 fil.	15 " " " " 18 "
224 and 227 fil.	5 " " " " 15 "

doubled

The secondary and the filament windings for the 250-type tubes must be center-tapped. Our next problem is to see whether this coil will fit inside the window in the lamination, leaving enough space for commercial variation. Here we return to our wire table (see Fig. 4) and note the

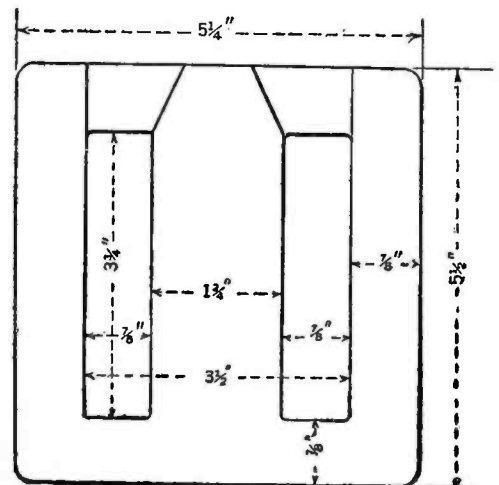

Fig. 5

diameters of the various sizes of enameled wire required. The computation of coil size follows—

core diameter	1.750"
allow 1/8" clearance	0.062"
	1.812"

We must choose the primary tubing from experience, and the choice is entirely one of rigidity, hence dependent upon the size of wire. Likewise, the choice of the paper between layers depends upon the size of wire more than upon break-down. The amount of insulation between leads and the body of the coil and between primary and secondary and the filament winding for the 281-type tubes and other windings depends largely upon break-down as well as mechanical requirements. Experience is the best guide in the choice of these values and the table in Fig. 6 give values that have been found satisfactory in transformer design. This table tells us that for our required primary of number 18 wire we will need a primary tube 0.080" thick, and an 0.007" paper between layers, preferably of gummed kraft.

The space taken by the primary winding is figured as follows—

No. 18 wire diameter (see tables)	0.0419"
Paper between layers	0.0070"
25 per cent. of paper added for varnish	0.0018"
	0.0507"
Add 10 per cent. for bow	0.0051"
	0.0558"

Then each primary layer will take up 0.0558", or will add twice this, or 0.1116", to the diameter of the coil. Inspection of Fig. 5 shows our coil can be 3 1/2" long, and this allows us a 3" winding space. We can compute the number of primary turns per layer by dividing the winding length by the wire diameter, and multiplying by the space factor, which varies from 85 per cent. for small wires to 90 per cent. for larger sizes. This gives us $\frac{3.00}{0.0419} \times 0.09 = 64$ turns per layer, or our 226-turn primary will require 4 layers, and the space taken up will be $4 \times 0.1116 = 0.4464$ ". Our coil diameter at the outside of the primary then is $1.812 + 0.446 = 2.258$ ". The usual tubing between primary and secondary is about 0.040"—0.045" thick, so our diameter at the inside of the secondary is:

tube	2.258"
1/8" for bow	0.090"
	0.031"
	2.379"

The secondary space is figured in like manner—

Wire diameter	0.0097"
Paper	0.0025"
+ 25 per cent.	0.0006"
	0.0128"
+ 10 per cent.	0.0013"
	0.0141"

Added diameter per layer = 0.0282"

Turns per layer = $\frac{3.00}{0.0097} \times 0.88 = 270$

Number layers required = $\frac{2700}{270} = 10$ layers

Secondary space = $10 \times 0.0282 = 0.282$

Our diameter at the outside of the secondary is then $2.379" + 0.282" = 2.661"$

A wrapper 0.025" thick is satisfactory between the secondary and 281 filament windings and between the various ter-

SIZE PRIMARY WIRE	PRI. TUBE THICKNESS	PAPER BETWEEN LAYERS	SIZE SECONDARY WIRE	PAPER BETWEEN LAYERS
16-18	0.080"	0.007"	28-30	0.0030
19-21	0.060"	0.005"	31-33	0.0025
22-24	0.040"	0.004"	34-37	0.0020
25-27	0.030"	0.003"		

Fig. 6

tiaries, and about 0.030" will be sufficient for an outside wrapper. We continue our computations—

Outside of secondary	2.661"
Wrapper 0.025 × 2	0.050"
	2.711"
281 fil. winding No. 21	0.030"
	2.741"
Wrapper	0.050"
	2.791"
250 fil. winding No. 18	0.042"
	2.833"
Wrapper	0.050"
227 fil. winding No. 15	0.059"
Doubled	2.942"
Outside wrapper	0.060"
	3.002"

Our coil will, therefore, be 3.002" or approximately 3" in diameter, and as we have a 3 1/2" window we can easily get the

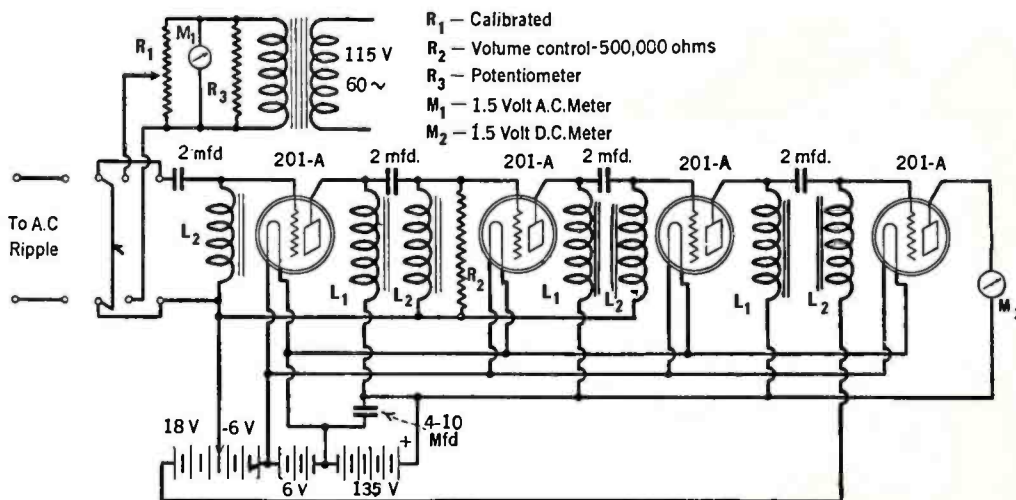

Fig. 7

coil in it, allowing for commercial variation. If the coil had turned out oversize it would have been necessary to use a larger stack of laminations, cutting down turns correspondingly.

We can tabulate our coil thus—

Core	1.750"
Outside of pri.	2.258"
Outside of sec.	2.661"
Outside of 281 fil.	2.741"
Outside of 250 fil.	2.833"
Outside of 227 fil.	2.942"
Outside diam.	3.002"

If it is necessary to design a choke coil, the same process serves to compute the space required, although the process is simplified considerably by having only one winding. Similarly it may be used in determining size of field coils, audio transformers, etc.

The Heat Run

Having designed our transformer and chosen a choke coil we must check our design by placing the apparatus on a heat run. This consists of setting the pack up under actual working conditions and let-

ting it run continuously for five or more hours, measuring the resistances of the various windings at the start and finish. The temperature rise of a winding may be computed from the following equation—

$$\Delta t = 231 \frac{(R_H - R_C)}{R_C} + \frac{T_C R_C}{R_C} - T_H$$

Where T_C is the room temperature at the start of the run, T_H the room temperature at the end, R_C the cold resistance of the winding, R_H its resistance at the end of the run, and Δt the temperature rise in degrees centigrade (all temperatures centigrade). It will be found that if the rise is not over 50 degrees centigrade the heating will not be excessive.

We are now ready to assemble our pack, properly dispose the component parts, and choose values of filter capacity. It is here, probably, that the hardest part of pack design enters, as, while it is fairly easy to evolve a good filter by brute force means, it is not as easy to get down to an economical minimum of capacity and parts and still have a satisfactory absence of hum.

In the measuring of a.c. ripple it is necessary to use a very sensitive indicating device which is capable of measuring potentials of a few millivolts and up to about a volt. This is best obtained by the use of a vacuum-tube voltmeter with an associated amplifier, such as is illustrated in Fig. 7. This employs a three-stage impedance-coupled amplifier feeding the customary vacuum-tube voltmeter. Im-

pedance coupling is advocated because resistance coupling requires more B battery potential for its operation. It would be advisable to use wet B batteries and to have as much plate by-pass condenser as possible, as is quite obvious when we consider that this amplifier must be practically flat from 25 to 120 cycles. The chokes L_1 should be as high in inductance as possible for the plate current they must carry, and chokes L_2 can be of the order of transformer secondaries.

The comparison method is used, the switch being connected so that the a.c. ripple is impressed on the amplifier, and the volume control and R_2 adjusted to give a good reading of M_2 . The switch is now thrown the other way and the attenuator adjusted to give the same reading of M_2 as before. Our a.c. ripple will then be the product of the attenuation ratio and the reading of M_1 . This gives us a convenient and sufficiently accurate means of measuring ripples from a few millivolts up to a volt.

The Hum Problem

We are now prepared to tackle our hum problem. Connect the pack to the set for which it is designed and connect the measurement set across the loud speaker. This gives us a visual indication of hum intensity and shows up small variations that the ear would not detect. Of course, experience will be necessary before the measurement of hum in millivolts can be correlated to the resulting

(Concluded on page 50)

LINEAR POWER DETECTION

By FREDERICK EMMONS TERMAN

Stanford University

TWO YEARS ago the typical radio set employed a grid-leak grid-condenser type of detector that was intended to operate with a radio-frequency input voltage of 0.1 volt or less. In contrast with this, the new receivers of the 1929-1930 season practically all use a power detector, in which the radio-frequency signal applied to the detector has a magnitude of at least several volts. In advertising the manufacturer makes this a big talking point. In some cases it is emphasized that a *linear* power detector is used. One may wonder whether this sudden change in detector practice is a real improvement, or whether it is another fad, such as the toroidal coils of several seasons ago, that is being used as a sales point, and will soon disappear.

The answer to these questions is clear and decisive. Compared with the weak-signal detector of the past, the power detector introduces less distortion, is more efficient, has a tendency to reduce static, and also increases the selectivity. Any one of these features would be very desirable, but when the change from weak-signal to power detection gives benefits in all of these ways, there is very little question as to what is the best practice.

Linear detectors and power detectors are very closely related in practice, since they usually go together. In the usual meaning of the term, "power" is used in connection with detection when the radio-frequency voltage applied to the detector is one or more volts, in contrast with a potential of 0.1 volt or less used with the weak-signal rectifier of the usual grid-leak grid-condenser type. *Linear* detection means that the detector output is proportional to the applied radio-frequency signal voltage. In the weak-signal detector the output is proportional to the *square* of the signal strength, so that the detector is proportionately more sensitive on the parts of the modulated signal when the signal voltage is at a maximum than when at a minimum. In contrast with this, the power detector as used in all of the present-day broadcast receivers has a characteristic that is approximately linear even though the manufacturers do not specifically mention this point.

The square-law characteristic of the

weak-signal detector introduces distortion frequencies which were not present in the original signal. These distortion frequencies form a larger and larger percentage of the audio-frequency output as the degree of modulation of the transmitted signal is increased. The present trend in the design of broadcasting stations is to use much higher degrees of modulation than were possible a few years ago, and all of the newer stations can modulate up to 100 per cent., in contrast with a maximum possible figure of not over 50 per cent. of a few years ago.

The distortion frequencies introduced by square-law action consist of second har-

Professor Terman brings to light an interesting and hitherto unannounced advantage of linear detection. This is its tendency to eliminate an undesired weak signal in favor of a strong desired signal; a tendency which is not shared by square-law detectors and one which increases the apparent selectivity of a receiver.

monics of the notes actually being transmitted and also all the possible sum and difference frequencies. Thus, if the sending station is simultaneously transmitting notes of 1000 and 1500 cycles, the output of the square-law detector, in addition to containing these desired frequencies, will also contain double-frequency components of 2000 and 3000 cycles and sum-and-difference frequencies of 2500 and 500 cycles. These distortion components may, under the most unfavorable conditions, be 25 per cent. as large as the desired components, making it apparent that weak-signal detection of signals that have a high degree of modulation will not give satisfactory results from the point of view of quality.

In contrast with this square-law action, a detector which has a linear characteristic introduces no frequencies in the audio-frequency output that were not present in the original signal. In order to have distortionless detection it is absolutely essential, therefore, that a linear characteristic be employed. The ordinary power detector of either the grid leak or C bias type has approximately such a characteristic and so gives substantially undistorted rectification.

Another advantage of power detection in regard to quality is that in detection of large signals the audio-frequency output is so much greater than with the weak-signal rectifier that it is possible to use one less stage of audio-frequency amplification, thus dispensing with one of the audio-frequency transformers and with the distortion which it introduces.

The efficiency with which the ordinary power detector rectifies the radio-frequency voltage is very much greater than in the case of the weak-signal rectifier. Thus, if a weak-signal detector with 0.02-volt input

is replaced by a grid-leak power detector having 0.5-volt input the audio-frequency output is increased not 25 times, but nearly 80 to 100 times. As a result of this increased efficiency with large signals, a moderate increase of radio-frequency amplification before detection is equivalent to a much larger amount of audio-frequency amplification after rectification. In the usual radio set, increasing the radio-frequency amplification about ten times, to bring the normal detector input from 0.05 volt up to 0.50 volt, will make it possible to drop out one stage of audio-frequency amplification (which amplifies about 25 times) without reducing the output of the power tube.

The performance of a typical detector for different input voltages is shown in Figs. 1 and 2. The audio-frequency output as a function of signal voltage applied to the detector is given in Fig. 1. For large signals this relation is obviously very nearly a straight line, while for small inputs the output follows a curved path. This transition from a square-law to linear characteristic as the signal is increased is typical of all detectors.

The efficiency of rectification for the case of Fig. 1 is shown in Fig. 2. This efficiency is expressed in terms of the ratio of actual audio-frequency output to the audio-frequency output that would be obtained from a perfect rectifier. The most important features to observe in Fig. 2 are the low efficiency with small signals, and the fact that the efficiency is relatively high and constant under conditions giving linear operation. It is also to be noted that grid-leak detection is much more efficient than plate detection when compared for the same signal. At the same time the C-biased power detector is always more efficient than the weak-signal grid-leak detector, and also has the very important advantage of a linear characteristic.

Detectors with a linear characteristic are much less susceptible to interference from static than are those with square-law characteristics. This can be illustrated very easily by a concrete example in which it is assumed that a static crash 10 times as strong as the signal is present. In the square-law detector this static impulse produces an output that is 100 times as strong as the signal, while with the linear

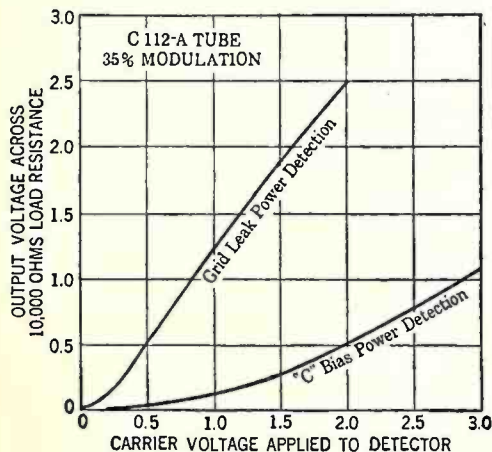

Fig. 1—Audio-frequency output of a detector as a function of the input voltage.

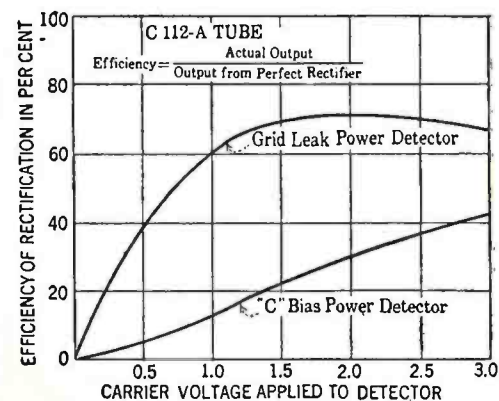

Fig. 2—Efficiency of rectification as a function of the input voltage.

detector, the straight line action operates in such a way as to make the static noise only 10 times the signal strength. It is obvious that the static will create less disturbance in the latter case.

A very important property possessed by the linear detector, and one which is not generally appreciated is that when two signals are simultaneously applied to a detector and the weaker of the two is an undesired signal, but yet is strong enough to be heard as an interfering background, the action of the linear detector is such as to suppress the weaker of the two signals, and to prevent it from being heard! This rather surprising result can be explained most readily with the aid of the diagrams in Fig. 3 in which A shows the desired signal, while B is the weaker interfering signal having a different frequency from the first, and C, which is A and B added together, represents the voltage actually applied to the detector input. With a straight-line detector the audio-frequency output is proportional to the envelope of the wave in C, resulting in the audio-frequency output shown at D. It is apparent that this output contains no contributions introduced by the weaker of the two signals other than the inaudible super-sonic beat note between the two carriers. The total result is that with a straight-line detector the strong signal prevents the weaker superimposed signal of a different frequency from being detected.

[This will not be the case if the detector characteristic is other than linear. Then the weaker signal will be rectified and the rectification products will be heard even when the strong signal is present.—*Editor.*] This is, in effect, increasing the selectivity of the receiver, but has the great advantage over selectivity gained by tuned circuits in that there is no sideband trimming involved.

The full benefit of this increased selectivity is not realizable in practical receivers for several reasons. In the first place, no detector has a perfectly straight-line characteristic, and, unless the characteristic is absolutely straight, the weaker signal is not completely suppressed. Also, in order to obtain full suppression of the weaker signal it is necessary that the strong signal always be larger than the weaker one. If the strong signal is modulated 100 per cent. there are times when its amplitude goes down to zero, and at these moments, of course, there is no suppression, or rather, what is normally the weaker signal may momentarily suppress the normally stronger one. The net

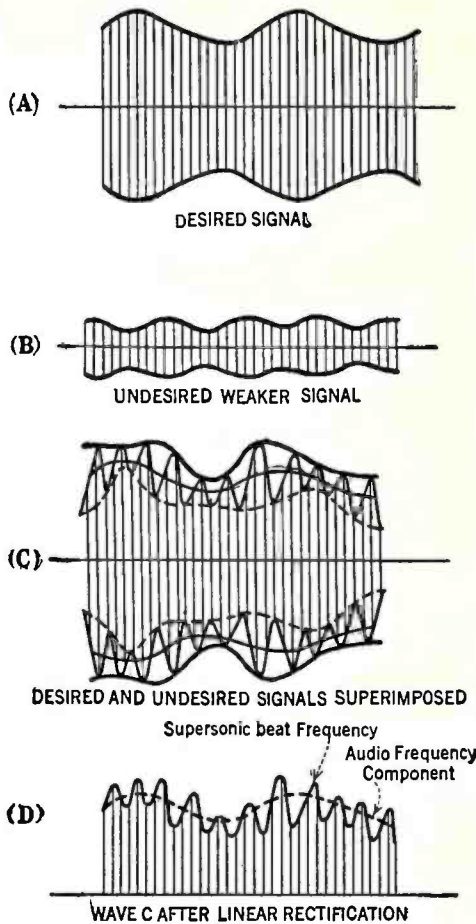

Fig. 3—Suppression of detection of weaker undesired signal by linear rectification.

result is that with the linear detector, as used in practical receivers, strong signals are able to reduce the efficiency with which weak but interfering signals are rectified

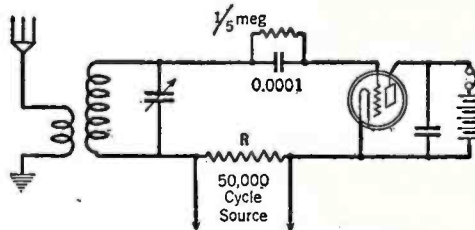

Fig. 4—Circuit for demonstrating how a strong signal can suppress detection of a weaker one when a linear detector is used.

to an extent that materially increases the apparent selectivity of the set, although complete suppression is not obtained.

The possibility of suppressing a weak signal by a strong signal of different frequency was tested with the aid of the circuit in Fig. 4, in which a grid-leak power detector was used. The test was made by tuning in a moderately weak broadcast signal when no 50,000-cycle current was flowing through the resistance R. With the music coming through satisfactorily as determined by listening in the head phones a 50,000 cycle voltage signal was superimposed upon the broadcast signal by running a current through the resistance. As soon as this was done the music practically disappeared. It was found that two or three volts across the resistance were enough to eliminate substantially all detection of the broadcast signal, although the detector was adjusted to take inputs several times this amount before overloading. It is not necessary to use 50,000 cycles for the suppressing frequency, and any frequency, other than one giving an audible beat note with the broadcast signal, would have given the same results. This little experiment shows that a strong signal is really able to suppress a weaker signal when the two are superimposed and applied to a linear detector.

This comparison of power and weak-signal detection shows that the former is superior in that it introduces less distortion, is a more efficient rectifier, gives less disturbance with strong static impulses, and results in an increase in the effective selectivity. The linear power detector is obviously here to stay, and the future will see it used more and more. It has even been suggested that some day the input to the loud speaker will be obtained by rectifying a very large radio-frequency signal of perhaps 100 volts, using a vacuum tube, or perhaps a copper-oxide element, without the use of any audio-frequency amplification.

Power detection requires more radio-frequency amplification than does the weak-signal detector, and not many years ago this was a real disadvantage. The screen-grid tube has altered the situation, however, by making it comparatively simple to obtain high amplification per stage without trouble from regeneration. Inasmuch as it is still necessary to use the same number of tuned circuits in screen-grid sets as before, in order to obtain the necessary selectivity, the additional radio-frequency is so easy to obtain as to be an advantage.

DESIGNING THE POWER-SUPPLY CIRCUIT

(Continued from page 48)

sound, and accurate limits set for acceptable hum, as this depends upon frequency, type of loud speaker, efficiency of loud speaker, and cabinet resonances. However, after a while the operator will be able to pass very accurately on the acceptability of any particular job.

To analyze the hum coming from our set and power pack we can short circuit various tubes, cutting out certain parts of the total hum. For instance, if we short circuit the primary of the last a.f. transformer all the hum we get is coming from the power tubes alone. If we put a very large by-pass condenser across the grid-bias resistor we can tell whether it is grid ripple or not, and, if it is not, then we can increase the capacity of C₂ (see Fig. 1). If this helps we know we have excessive plate ripple and either C₁ or C₂ or both must be increased to secure satisfactory filtering. However, if this does not help

then our hum is coming from the filament supply and may be due to unbalanced tubes, or unequal halves of the filament-supply winding. However, it will be found in the great majority of cases, especially when using push-pull, that the hum will be very low when the last a.f. primary is shorted.

To locate hum coming by induction from power transformers and choke coils we can remove various tubes and place resistors across the primary of the succeeding transformer. Thus, if we remove the detector tube and place 20,000 ohms across the primary of the first a.f. transformer, we can tell how much induction there is by rotating the transformer, and if it is serious we can locate the apparatus properly to minimize it. It is obvious that our first a.f. transformer will give more trouble from this source than the second due to higher succeeding amplification.

Having finally chosen our capacity

values it is only necessary to specify their working and break-down voltages. For instance, we found 613 volts necessary across C₁ at a 115-volt line. The highest line voltage we might encounter is about 130 volts, and, if no regulator were employed, this would result in an r.m.s. potential of almost 700 volts, or a peak of 980 volts. This, then, is going to be our maximum working voltage and C₁ should be specified for 1200 volts to have a sufficient margin of safety.

Of course, we must also check all our filament and plate voltages accurately to make sure our computations were correct.

We have now finished our power pack, have a job producing the required voltages, giving acceptably low hum, keeping within safe limits of heating and break-down, and costing as little as possible. Our job then, is finished, and we turn our pack over to the production department to do with as they will.

GILFILLAN MODEL 100 RADIO RECEIVER

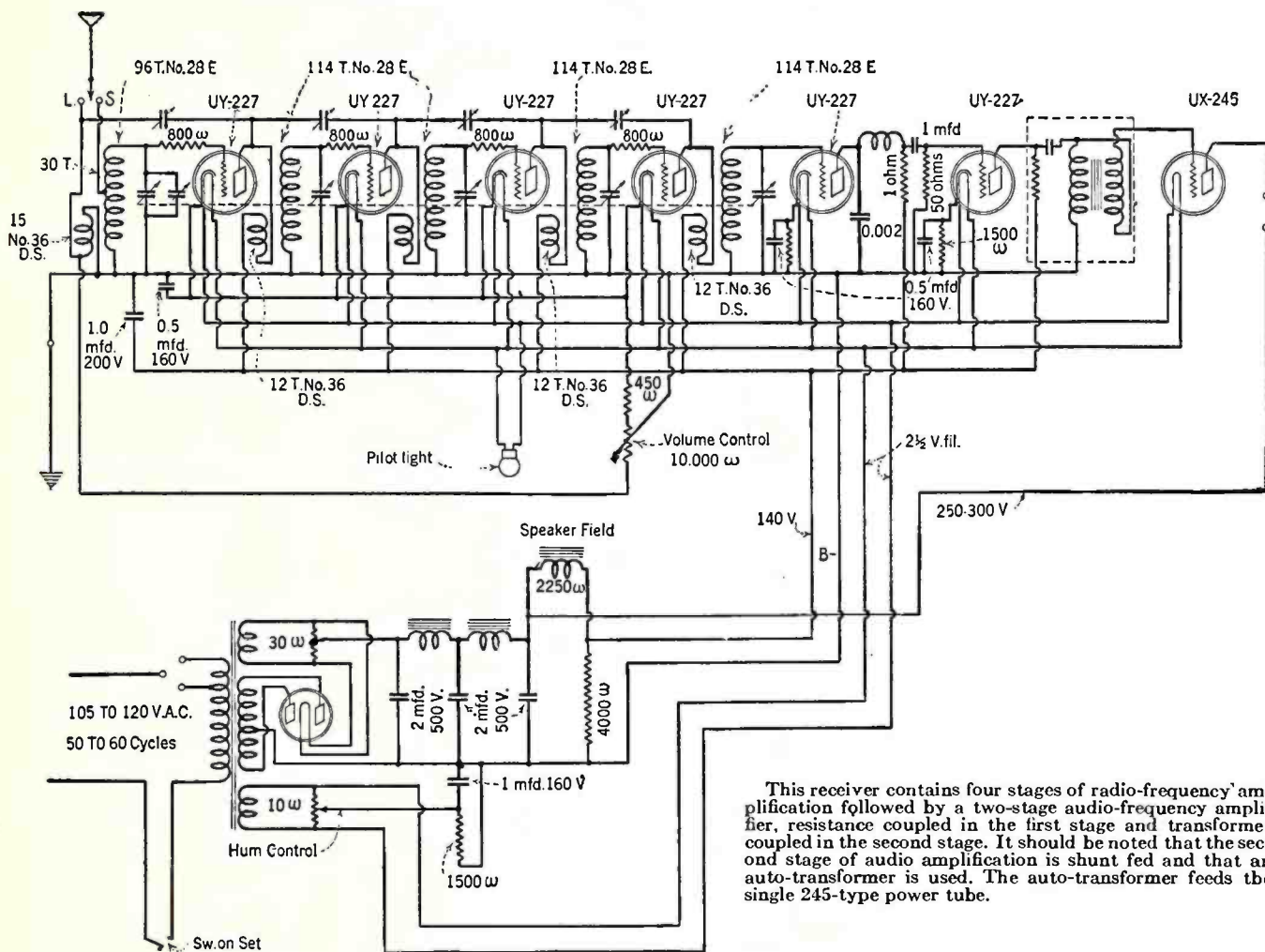

This receiver contains four stages of radio-frequency amplification followed by a two-stage audio-frequency amplifier, resistance coupled in the first stage and transformer coupled in the second stage. It should be noted that the second stage of audio amplification is shunt fed and that an auto-transformer is used. The auto-transformer feeds the single 245-type power tube.

THE KENNEDY RECEIVER CHASSIS NO. 10

This seven-tube receiver employs a three-stage radio-frequency amplifier of high sensitivity and uniform gain. All tuning condensers are ganged to a single control. The detector is followed by the conventional

two-stage transformer-coupled audio-frequency amplifier with two 245-type tubes in the output. The radio-phonograph switch connects the phonograph pick-up unit directly to the grid of the detector tube.

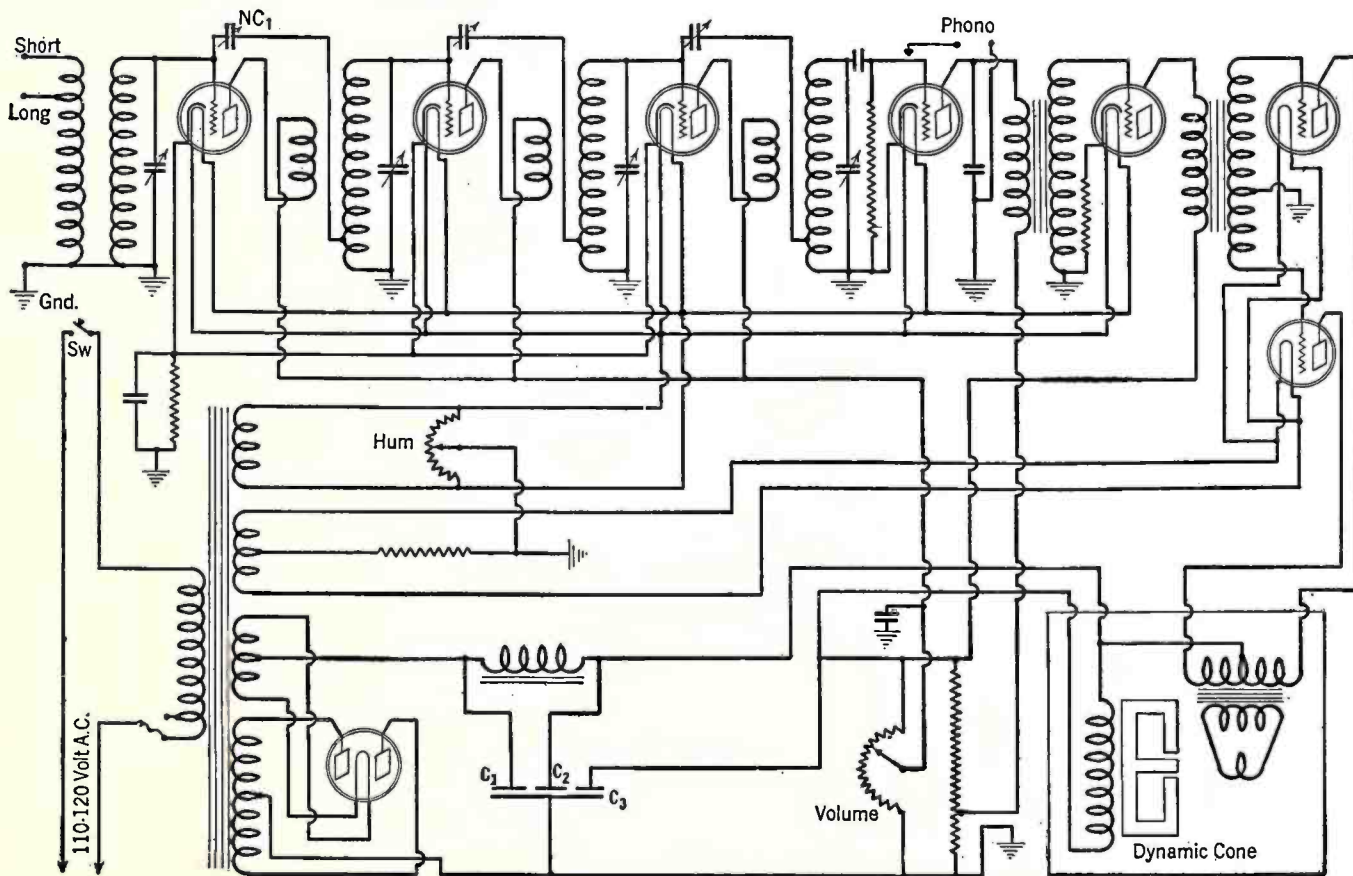

AN EFFICIENT RADIO SET DIAGNOSER

By HERBERT M. ISAACSON

Engineering Department, Colonial Radio Corporation

THE BENEFITS to be derived from the use of a set-tester or "diagnoser" have been so well rehearsed that they are familiar to every serviceman. A diagnoser facilitates rapid, systematic, and accurate testing of a receiver, since any deviation from the normal in either set or tubes gives a visual indication on the panel of the tester. Because each circuit of the receiver is checked individually, the faulty circuit is isolated quickly, and the trouble is run down to the defective piece of apparatus. To a large extent, then, it removes the guess work from servicing and enables the serviceman to make an accurate diagnosis of the fault in a minimum of time.

Important Features

The diagnoser described in this article embodies all of the features found in the best of manufactured test sets, and, in addition, it has several points of superiority which have been developed by the writer. The important features of the diagnoser are as follows:

1. **Portability:** The tester measures only 8 × 11 × 4 inches and weighs seven pounds.
2. **Ease of manipulation:** All readings are obtained by depressing push buttons. These buttons may be locked in a closed position when desired.
3. **Universality:** The tester is capable of checking any standard receiver or tube without requiring the connection of extra leads or external sources of power. (See Fig. 1.)
4. **Completeness:** The tester tells a complete story. It will measure filament, grid, plate, and screen-grid voltages and plate currents existing at the tube sockets of the set. Complete circuit continuity may be checked, with one exception—the grid circuit of a grid leak-condenser detector.

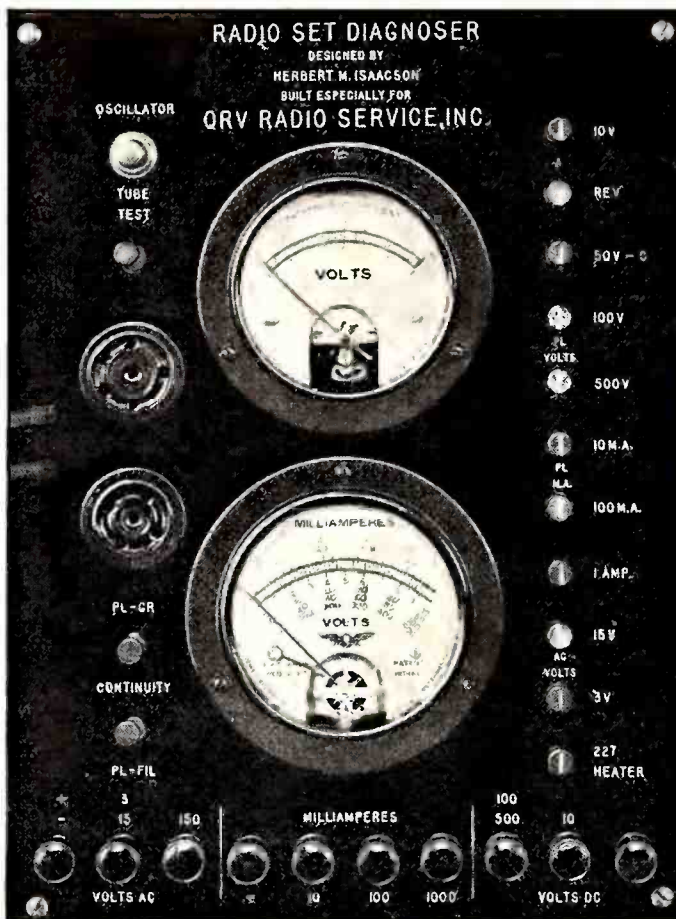

View of the diagnoser designed by the writer.

5. **Adaptability:** The various current and voltage ranges of the meters are available for external connection and the tester is designed so that special tests may be performed easily. For example, heater and line voltages may be measured and the polarity and charging rate of trickle chargers may be determined.
6. **Serviceability:** Simplicity of design in the mechanical features and the selection of quality materials in the construction insure serviceability.

7. **Foolproof:** Any or all of the buttons may be locked down simultaneously without damage to the diagnoser or the set under test.

8. **Versatility:** By use of the diagnoser, sets can be neutralized, overall sensitivity checked, effectiveness of pick-up systems tested, degree of shielding of loop-operated sets located in steel buildings investigated, position of break in concealed indoor antennas found, capacities of condensers and the value of resistors in megohms measured, and, in addition, the diagnoser incorporates a feature which has proved of great value—a modulated oscillator.

The Switching Mechanism

Since the diagnoser is built around the switching mechanism, this unit will be described first. As will be realized from a consideration of Fig. 2, the switching assembly may be made of ordinary knife switches. However, a cheaper and better method from all standpoints is to construct a push-button-operated switching mechanism. Such an assembly with all the switches necessary for the set-tester herein described can be built easily to take a space only 6 inches long, 2 inches wide, and less than 1 inch deep. A compact and symmetrical appearing piece of apparatus is the result.

The switch lever C is bent so that it exerts pressure against contact A. When the push button is pressed the contact at A is broken before contact can be made with point B. The circuit connections, of course, are made to contacts A and B and to the switch lever C. With contact A omitted we have a single-pole single-throw switch. By mounting two switches so that the one push button presses both levers at the same time a double-pole double-throw switch is obtained, with levers CC' always

Average Values of Plate Current Change for Standard Tube Types

Tube	E _g Appl'd	E _g * on Diag.	E _p	Normal I _p	Change in I _p	G _m	Limits	
							I _p	G _m
WD-11 and WD-12	0	.5	45	1.1	.17	340		
	3	3.5	67.5	1.8	1.2	360		
	4.5	5	90	2.6	2.15	430	1.8	325
UV-199 and UX-199	0	1.5	45	1.5	.5	445		
	4.5	6	67½	1.1	2.1	400		
	4.5	6	90	2.4	2.6	430	1.4	325
UX-120	16.5	18	90	3.2	7.75	430		
	22.5	24	135	7	12	500	4.5	425
UV-201A and UX-201A	1.5	4	45	.9	1.7	430		
	3	3.5	67½	1.7	3.25	570		
	4.5	7	90	2	5	725	1.3	550
UX-112A	9	11.5	135	2.5	6.85	760		
	1.5	7	90	4.8	10.5	1500		
	9	11.5	135	5.8	18.4	1600	4.5	1200
	10.5	13	157	7.9	14.2	1700		
	13.5	13.5	180	7.8	28.6	1700		

Tube	E _g Appl'd	E _g * on Diag.	E _p	Normal I _p	Change in I _p	G _m	Limits	
							I _p	G _m
UX-171A	16.5	19	90	11	22.8	1200		
	27	29.5	135	16	24.1	1360		
	33	33	157	18	46.2	1400		
	40.5	40.5	180	20	60.7	1500	11	1150
UX-226	6	6	90	3.7	5.2	870	3.5	800
	12	12	135	3	9.8	820	At 13.5v Pl	
	16.5	16.5	180	3.8	14.4	870	and 9v C	
UX-210	12	12	180	7	13.2	1100		
	18	18	250	12	23.9	1330		
	27	27	350	16	40.5	1500		
	35	35	425	18.5	54.2	1550	11	1325
UY-227	6	6	90	3	4.35	725	1.5	600
	9	9	135	5	7.38	820		
	13.5	13.5	180	6	11.75	870		

*Indicated C bias on Diagnoser is greater than applied by an amount equal to one half of filament voltage if d.c. is used on filament. Indicated and applied voltages are the same if a.c. is used.

making contact with points AA' except when the push button is depressed. By omitting contacts AA', a double-pole single-throw switch results.

It is often desirable to lock a button when making certain tests. As indicated in Fig. 2, by means of a groove cut in the panel and a pin in the button, a slight turn of the button when pressing it, keeps it down. Turning the button in the direction opposite to that used in locking it, allows the pin to sink into the groove as the spring of the switch lever brings the button up to its normal position. To indicate when the button is locked, a line is engraved on one end and parallel to the pin.

Since it is essential that the pin be in the exact center of the rod and at the proper distance from the ends, and that it must go through the rod at right angles to it, a hint on the best way to do it will not be amiss. In this connection the writer has found that best results can be obtained only by the use of a jig. Fig. 3 shows how to make one. The rod should fit snugly in the jig and it is inserted so that the engraved line is parallel to the pin hole. If care has been taken to make the distance from the pin hole to the end of the jig exactly the distance desired between the pin and the engraved end of the push button, all the buttons will come out identical and accurate.

As contact points $\frac{1}{2}$ -inch $\frac{3}{8}$ round-head brass machine screws are used. The ends of the screws should be sandpapered until they are bright. It has been found that the brass contacts give service for about a year before tarnish begins to interfere with their proper operation. The switch levers themselves can be cleaned by scratching with a needle through the contact screw holes. All the contacts of the set tester can be gone over in less than half an hour and the instrument will then be good for another year of service.

The D.C. Meter

The d.c. meter has a 1-mA. full-scale movement. This will allow the use of 1000 ohms per volt in the multiplier resistors; that is, when used as a voltmeter, the resistance for a particular scale is 1000 ohms multiplied by the highest voltage on that scale. For instance, the resistor for the 10-volt scale of the meter has a resistance of 10,000 ohms.

Meters marked with multi-range scales are obtainable from meter manufacturers or a 1-mA. scale may be used and the readings multiplied by the proper conversion factor.

Shunts are easily calibrated against another meter having the proper ranges. Be certain that the wire used for the shunt has sufficient carrying capacity for the current it is to handle. Since the shunts are in series they must each be capable of carrying the maximum current any tube might draw. There should be no trouble due to overloading the multiplier resistors, since the maximum dissipation is 1 mA. at 500 volts or 0.5 watts. Practically all wire-wound resistors will dissipate at least this much wattage. If multipliers are made for the a.c. voltmeter the matter of

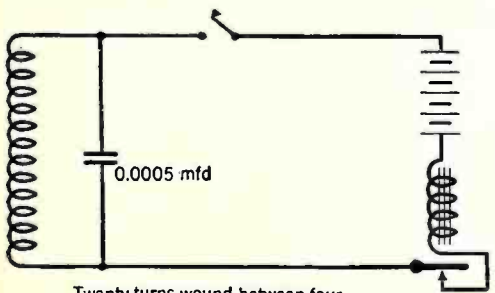

Twenty turns wound between four screws in panel to form loop 7 by 10 inches

Fig. 4

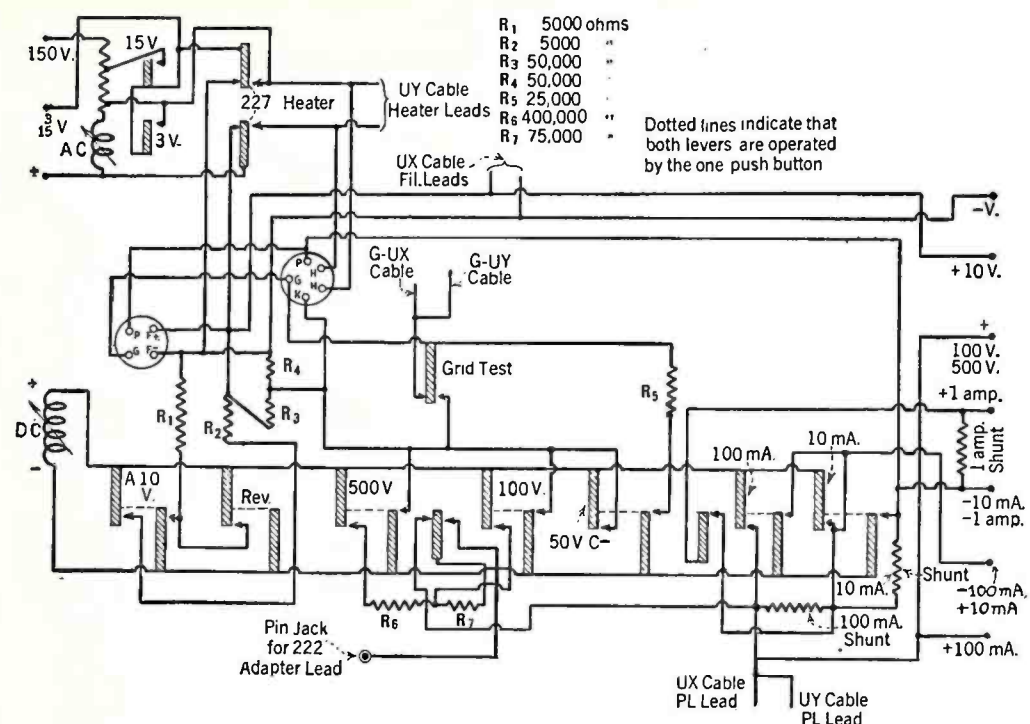

Fig. 1—Schematic of Diagnoser.

tors, since the maximum dissipation is 1 mA. at 500 volts or 0.5 watts. Practically all wire-wound resistors will dissipate at least this much wattage. If multipliers are made for the a.c. voltmeter the matter of

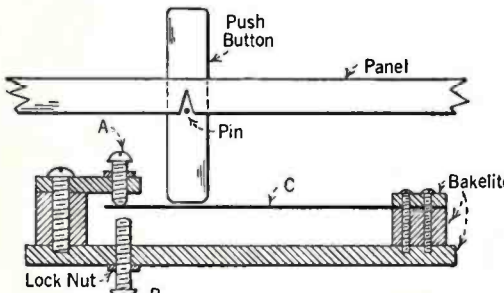

Fig. 2

Top View of Push Button showing Engraved Line

sufficient wattage capacity becomes very important since many a.c. movements draw as much as 300 mA. A 150-volt multiplier for such a movement would have a resistance slightly under 500 ohms (500 ohms minus the resistance of the movement) and would have to dissipate 45 watts at full-scale deflection.

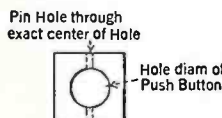

Fig. 3

A built-in oscillator is an absolutely necessary component of a set-tester. And it should be completely self contained. If it must be powered by the a.c. lines, its usefulness is largely curtailed. The oscillator used in this diagnoser consists of a tuned circuit, shock-excited by a buzzer. About 20 turns of magnet wire wound as shown in Fig. 4 and shunted by an 0.0005-mfd. condenser will give a wave of about 400 meters. The buzzer used should be of the high-resistance type. (Federal or Mesco). At 3 volts these buzzers draw less than 75 mA. and a couple of flashlight cells will, in ordinary service, last about a year. The test plugs can be made from tube bases. If you haven't access to a lathe, a wood-turner will make handles for them for twenty-five cents.

The picture shows the panel layout followed by the writer in the construction of his diagnoser.

Unless there is some manifestation of the trouble to indicate in just which circuit the fault exists, it is advisable to check through the receiver in the same order that

the signal follows— first radio-frequency stage, second radio-frequency stage . . . , detector, first and second audio stages. Insert the test plug (with an adapter if necessary) into the first socket of the set under test, and place the tube in the diagnoser socket. Pressing the button marked "A" (Fig. 1), will show the filament voltage at the socket. (Not the voltage of the A supply). Should the pointer move backwards, release this button and press the one marked "A rev." Alternating voltage is indicated when the "3V" or "15V" a.c. button is pressed. Some few sets using a.c. tubes have a resistor in series with the tube filaments. (The Garod EA and one of the Zenith models are the only ones the writer knows of.) In such a set, the voltage shown by the diagnoser's a.c. voltmeter will not be the actual voltage applied to the tube, but will be less because of the increased voltage drop across the filament series resistor occasioned by the added current of the voltmeter being passed through the resistor.

Grid circuit continuity is ascertained by pressing the "C" button. In a detector using grid-circuit rectification, the grid condenser must be shorted out to obtain a reading, since this condenser isolates the grid of the tube from the rest of the circuit, so far as direct currents are concerned.

The values of C bias have been arbitrarily taken with reference to the negative side of the filament. However, as may be seen from the circuit diagram, the grid return in the diagnoser is brought to a center-tapped resistor of 1000 ohms, across the filament. If the filament is supplied with a.c. there is no d.c. potential difference between the center tap and the filament terminals, and C bias may be read accurately with respect to it. If the filament is energized by d.c. this mid-tap, of the resistor is at a positive potential with reference to the negative end of the filament by an amount equal to one half of the filament voltage. In this way there is always a potential difference between the grid and the negative filament to indicate grid continuity, even when the set has no C battery. (There are still some antediluvian battery-operated relics, innocent of a C battery, in existence!) The actual C bias then, is the value indicated on the meter, less one half of the filament voltage, if d.c. is used on the filament. There is another effect, though, that tends

to offset this difference between the actual and the indicated C voltages, and because of it the indicated voltage may be taken as the actual voltage. It is the voltage drop in the secondary of the transformer (true only in a.f. transformers) due to the current drawn by the meter. It will depend, of course, on the resistance of the secondary, and the current drawn by the meter. As an instance, let us suppose a 112-type tube with 12 volts C bias and a transformer secondary of 10,000 ohms. Using the 50-volt C scale, at 12 volts the meter will draw about 0.25 mA. This current passing through the secondary resistance of 10,000 ohms causes a drop of 2.5 volts across it. The indicated C bias, therefore, is 2.5 volts less than the actual bias, which just offsets the 2.5 volts in excess of the actual voltage due to the mid-tapped resistor, and the indicated voltage then equals the actual voltage. Another point to watch out for when taking C readings in audio stages is the error caused by the volume control in the audio stage. The method usually employed is to connect a 200,000-ohm potentiometer across the transformer secondary and to tie the grid of the tube to the movable arm of the potentiometer. The meter current then must pass through the parallel path formed by the resistance between the center contact and one side of the potentiometer, and the resistance between the center and the other side of the potentiometer. In the case of a 200,000-ohm resistor, if the volume control happens to be half way on, the resistance in series with the meter would be 100,000 ohms, and the indicated C bias would be only one third of the actual bias. The remedy obviously is to turn the volume control all the way on.

Plate circuit continuity is indicated when either the "100V" or "500V" button is depressed. If the voltage is not known to be less than 100 volts it is best to press the "500V" button first to prevent overloading the meter. The voltage drop across transformer primaries, due both to the meter current and plate current of the tube must be taken into account to reconcile the value of indicated voltage with the voltage at the source. This difference is inconsequential except when determining the voltage of B batteries by a reading at an a.f. socket, or when the meter load assumes a considerable proportion of the total load, as in the case of a plate voltage reading on a detector tube. In this case if the plate voltage were supplied through a series resistor from a high-voltage source, the current drawn by the meter—which might be equal to half of what the tube uses—would cause a 50 per cent. increase in the drop across the series resistor.

The tube must be in the diagnoser socket when talking plate-voltage readings if the supply is from a power-supply unit.

Plate current is read by pressing the 10-mA. or the 100-mA. button. It is always best to press the 100-mA. button first, to be sure the current is not over 10 mA., and if it is not, to then press the 10-mA. button.

The heater voltage of a 227-type tube is obtained by inserting the 227 test plug in the set socket, the tube in the diagnoser socket, and pressing the "227 heater voltage" button. When taking a plate voltage reading on a 227, sufficient time must be allowed for the cathode to attain its working temperature.

From a consideration of the action of a vacuum tube as a voltage amplifier, it is

clear that the ratio of plate current change to the grid voltage change causing it is the best figure of merit of the tube. This relation is termed mutual conductance and is expressed in micromhos. Between two tubes of the same type, the one having the higher value of mutual conductance is the one better suited as a voltage amplifier. To measure the mutual conductance of a tube, with the diagnoser, divide the indicated value of grid voltage into the increase of value in plate current in milliamperes, when the "grid-test" button is pressed and multiply this figure by 1000. The result is the mutual conductance in micromhos. The table accompanying this article gives the average values of the change in plate current at the commonly used plate and grid voltages for most of the tubes encountered at present, together with their mutual conductance at these particular values of plate and grid voltage. Tubes of the same make may vary from 10 to 20 per cent. above or below the values given in this table. It should be remembered, however, that it is the change in plate current with change in grid voltage that is important. Sometimes two tubes of the same type will be encountered, one with a plate current swing from 1 mA. to 6 mA. amperes and the other with a swing from 5 mA. to 10mA. As voltage amplifiers one is as good as the other. The mutual conductance is the same for each. However, it would be preferable to use the one with the lower plate current in an audio stage since the audio transformer core would be worked at a lower flux density resulting in a higher value of permeability and hence increased primary impedance. The higher the primary impedance, the more uniform the voltage amplification.

A HIGH-RESISTANCE VOLTMETER SUBSTITUTE

By FREDERIC B. FULLER

IT IS WELL KNOWN that a low-resistance voltmeter cannot be used alone to measure the e.m.f. across a device which has considerable internal resistance. However, a milliammeter plus such a voltmeter can be used at considerable saving in cost over a high-resistance voltmeter.

The theory may seem a little complicated, but the method about to be described is simple and quick. There is a definite, though unknown, amount of resistance between the two points whose difference in potential is desired. Let this resistance be R, let the current through it be I, and the true voltage across it be E. Then by Ohm's Law $R = E/I$ expressed in ohms, volts, and amperes. Of these three unknown quantities, the current is determined most easily, by inserting a milliammeter in series with the load as shown in Fig. 1 (A) and noting its reading. Now connect the low-resistance voltmeter across both the milliammeter and the load, as shown in Fig. 1 (B). This will immediately cause a change in the reading of the milliammeter, as explained above. Let this new current reading be I' and let the reading of the voltmeter be E'. Here again, by Ohm's Law, $R = \frac{E'}{I'}$ (the resistance of the milliammeter is practically zero). Then, if we have $R = \frac{E}{I}$, we know that $\frac{E}{I} = \frac{E'}{I'}$ whence $E = E' \times \frac{I}{I'}$. In other words, the true voltage across the

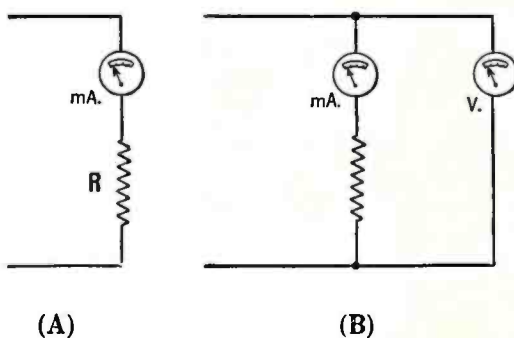

Fig. 1

load (that is, the voltage that will be there after the voltmeter has been removed) is the voltage indicated on the voltmeter multiplied by the ratio of the ammeter reading before the voltmeter was applied to the ammeter reading after the voltmeter was applied.

One simple example will be given:
I = First ammeter reading = 0.030 amperes

I' = Second ammeter reading = 0.024 amperes
E' = Voltmeter reading = 36 volts
E = True voltage = $\frac{0.030}{0.024} \times 36 = 45$ volts

This method is absolutely accurate, regardless of how low the resistance of the voltmeter, provided, of course, that both ammeter and voltmeter are themselves calibrated accurately.

Incidentally, the resistance, R, of the load is learned by this method, for $R = \frac{E'}{I'}$, which in the above example, is $\frac{36}{0.024} = 1500$ ohms.

Measuring Plate Current

In measuring the voltage across a tube it makes a difference which side of the ammeter the voltmeter is connected to. In Fig. 2 a voltage divider, "D", is shown, and two tubes, M and N. If it is desired to learn the plate-to-filament voltage of tube M, for example, the "load" is the plate-to-filament resistance of tube M. The ammeter should be connected close to tube M, not close to the voltage divider, and then the voltmeter attached across both the ammeter and the tube, as shown. There will be a slight change in the plate resistance of the tube due to the slight change in its plate potential when the voltmeter is applied. But this is so small that it may be neglected entirely in most calculations.

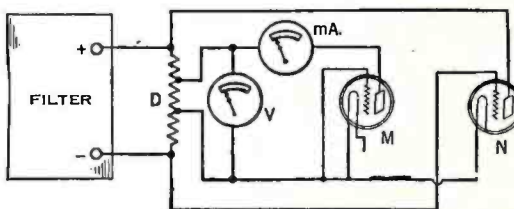

Fig. 2

Selectivity and Gain Characteristics

THE STEWART-WARNER SERIES 950

By A. C. MATTHEWS

Formerly Radio Engineer, Stewart-Warner Corporation

THE SET described in this article is known as the Stewart-Warner Series 950 Screen Grid. It utilizes eight tubes in all, including the rectifier. Three 224-type tubes are employed as radio-frequency amplifiers, two 227's, one as a plate-circuit detector and the other as an audio-frequency amplifier, and two 245's in push pull furnish approximately 3.2 watts of undistorted power output.

R. F. Circuit

From three stages of screen-grid r.f. amplification very high gain can be obtained. It was considered advisable, however, to sacrifice some of this gain by reducing the coupling in the r.f. transformers, thus gaining additional selectivity. With this thought in mind several methods of r.f. coupling were investigated, i.e., tuned plate, 1 to 1 ratio transformer, 1.25 to 1 ratio transformer, etc. Although each type gave considerable gain, they did not give uniform amplification over the entire tuning range of the set. It was not until the high-inductance primary in conjunction with a special coupling condenser was tried that it was possible to obtain uniform amplification throughout the broadcast band.

The r.f. transformer primary coil consists of 625 turns of 0.005" enameled,

cotton-covered copper wire wound on a $\frac{1}{2}$ " diameter wooden form. Its natural period, with the output capacitance of the 224-type tube shunted across it, is slightly below the lowest frequency of the broadcast band (it resonates at 490 kc.).

Theoretically, such an arrangement should give us a very stable r.f. amplifier, for, since the primaries are resonant below

tor and are adjusted before being assembled on the chassis. In general, the resonant point of the lumped primary determines the shape of the sensitivity curve at the low-frequency end, the capacity of the coupling condensers largely determines its shape at the high-frequency end, and the coupling between primary and secondary determines the height of the entire sensitivity curve. These effects as described are not strictly true, of course; for example, the setting of the coupling condensers affects slightly the sensitivity at the low-frequency end, and so on.

Considering the r.f. coil as a step-down transformer from plate to grid, it is readily seen that the impedance of the tuned circuit across the grid will be reflected back into the preceding plate circuit, thereby introducing an impedance comparable to the plate resistance of the tube. This, together with the adjusting of the capacitive coupling and the resonate point of the primaries made it possible to obtain an amplification of more than 35 per stage uniformly over the band. This was reduced slightly in order to provide a better factor of safety and to obtain a higher degree of selectivity.

Cross talk and local-station modulation of distant-station carriers is a serious matter with screen-grid circuits and neces-

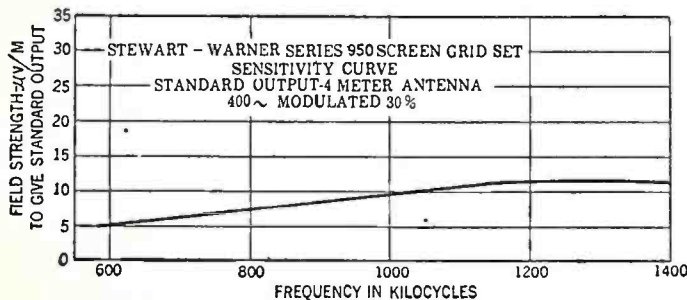

Fig. 2

the broadcast band, the plate circuits will have a capacitive load in them at any point in the band. However, the lack of perfect shielding makes it necessary to take the usual precautions in order to insure stable operation. Between the plates and control grids of succeeding 224-type tubes small capacities of about 10 mmfd. are connected. These capacitors are mounted on the side of the tuning capaci-

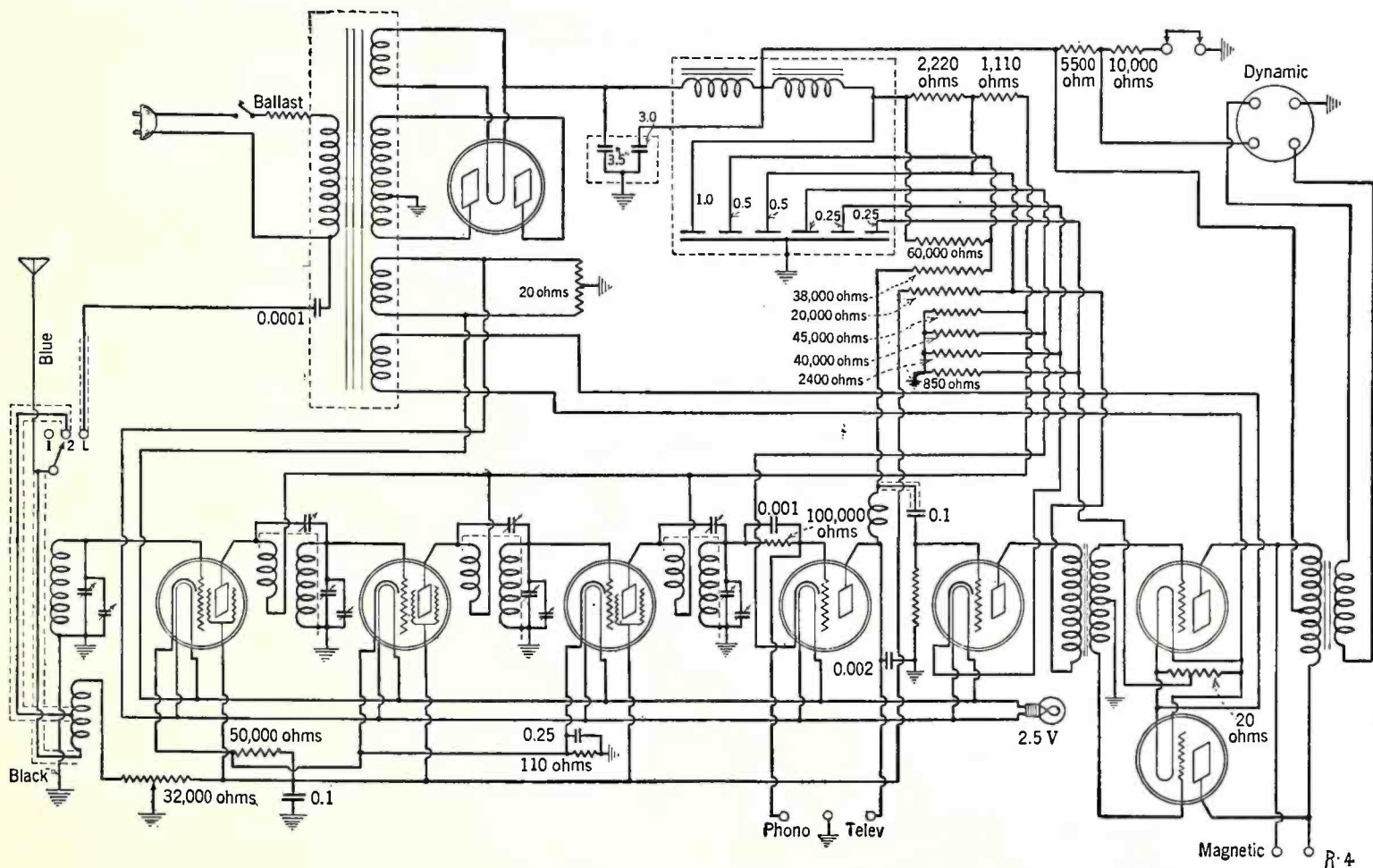

Fig. 1—Complete schematic diagram of the Stewart-Warner Series 950 Receiver.

sitates careful design of the volume-control circuit. In these receivers the volume control has a double function; first, it varies the screen-grid potential of the r.f. amplifier tubes, and second, it varies the signal input from the antenna to the set.

Detection

The large r.f. signal strength made available by the high gain in the r.f. amplifier makes possible the use of plate rectification without loss in overall sensitivity as compared with the usual grid-circuit rectifier used in conjunction with a lower gain r.f. amplifier. A 227-type tube is used as the detector. It is self biased to prevent overloading on strong signals. Such a detector will handle a very strong signal without any appreciable distortion due to overload. The resistor-capacitor combination in the detector circuit is of such a value that no grid rectification occurs and it is utilized merely to facilitate the connection of a pick-up unit to the detector grid circuit for reproducing phonograph records electrically.

Output Stage

Two 245-type power tubes connected in push pull are used in the output stage. These tubes are self biased and are operated at their maximum recommended voltages, making it possible to obtain

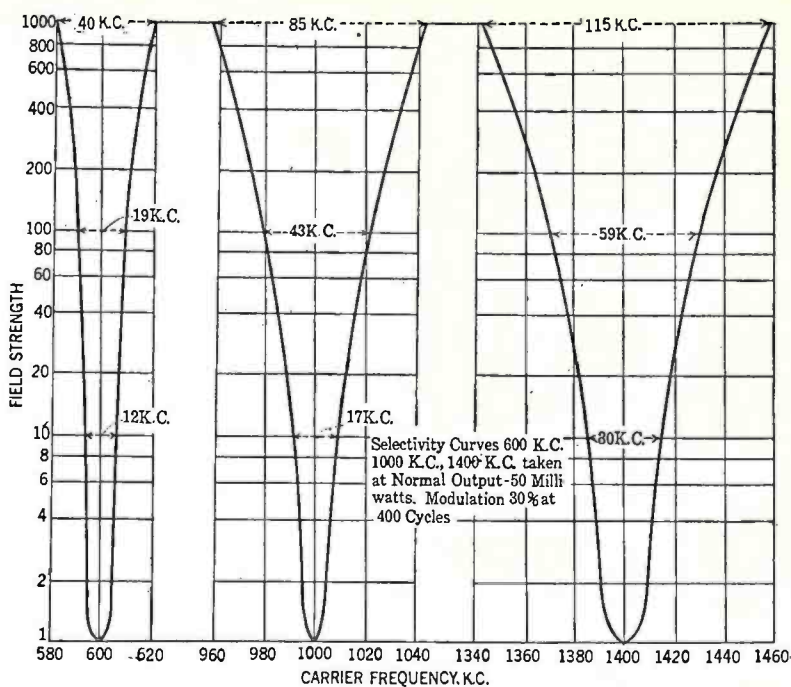

Fig. 3

approximately 3.2 watts of undistorted power output.

Either a magnetic or dynamic loud speaker may be used on this set. The magnetic loud speaker is connected by means of pup jacks in the rear of the chassis and the dynamic loud speaker is plugged in by means of a small tube base plug. This plug also connects the field coil of the dynamic to a source of rectified d.c. for magnetizing its excitation coil.

The sensitivity of this receiver shown

being received in order to have the same intensity in the loud speaker.

A circuit diagram giving the details of the circuit is shown in Fig. 1. Note the phonograph pick-up jacks, television connection, and means for connecting either a magnetic or dynamic loud speaker. Provision is also made for long, short, or light-socket antenna connections. An automatic voltage regulator is placed in series with the primary of the power transformer.



BOOK REVIEWS



ENCYCLOPEDIE DE LA RADIO, by Michel Adam. 356 pages, 1550 figures. E. Chiron, 40 Rue de Seine, Paris, 50 francs. 1928.

This illustrated dictionary of radio terms in the French should serve a useful purpose in many American radio libraries. The alphabetical arrangement is French, but in each case the German and English equivalents are given as well. The scope of the work is somewhat narrower than Sattelberg's *Dictionary of Technological Terms Used in Electrical Communication*, English-German, printed in Berlin by Julius Springer, since the Adam-Chiron effort is limited to T.S.F.—this cryptograph, it should be explained, originally stood for "télégraphie sans fils," or "telegraphy without wires," but has now been expanded to cover the whole field of radio. With a reading knowledge of French and German, the two works in combination should enable any normally trained radio engineer to steer his way through the bulk of the foreign literature of his art. The German volumes are getting a little old (1925) while the *Encyclopédie de la Radio* is up to date.

The descriptions of the various terms are succinct and in most cases exact and informing. Where a general term, such as "modulation," is involved, a more extensive discussion is presented. The size of the book, with its eight by ten inch pages, makes it possible to include a formidable amount of material.

As in every first edition of a work of this sort, there are a fair number of misprints. The number of serious errors is apparently small. Most of the blunders are amusing

but inconsequential. Edwin H. Armstrong, for instance, is consistently referred to as *Edwing* H. Armstrong. The English of *haubaner* is given as *anchor*, instead of *guy* or *stay* (in relation to masts) which is rather comical in view of the fact that *guy* comes from the Old French *gui*, a guide, whereas anchor is Anglo-Saxon. But these are trivialities and the book should interest all communication engineers whose horizon extends beyond the U. S. A.

RADIO OPERATING, QUESTIONS AND ANSWERS, by Arthur R. Nilson and J. L. Hornung. McGraw-Hill Book Co., New York. 367 pages, \$2.00. 1929.

This book by the two well-known radio educators, Messrs. Nilson and Hornung, is a second edition of their *Radio Questions and Answers*. It is intended as a companion volume to the same authors' *Practical Radio Telegraphy*, previously reviewed in these columns. *Radio Operating* is the immediate recourse of candidates about to take government license or civil service examinations, while *Practical Radio Telegraphy* is a more extended text for those who have time to study the technology of radio communication more fully.

The present volume starts with the standard request for a diagram of a complete commercial transmitting and receiving equipment, which has exhausted so many aspirants for operators' tickets in the inquisitorial chambers of the U. S. Radio Supervisors. Formerly, the transmitter shown was a spark set; now tubes are the thing. The various parts of the equipment, such as the overload circuit

breaker and the radio-frequency ammeter, are described individually.

Tube, arc, and spark transmitters are treated in turn. A typical question is, "What causes overheating of a transmitting tube?" The answer is that the plate voltage may be too high, or the circuit may not be oscillating properly, there may be a punctured plate blocking condenser, or improper bias, or the tube may be defective internally, etc. The trouble with these enumerations is that so many would-be operators memorize them as mere verbiage, with little practical idea of what the terms mean and what physical realities underlie them. That is why a theoretical text, and experience with the actual equipment, must accompany a volume like *Radio Operating* to make it really useful to the students. The authors recognize this in the bibliographies following each chapter.

Under "Receiving Apparatus" the venerable tikker is included as a means of receiving continuous waves, demonstrating that for radio equipment, at least, there is a life after the grave. The same chapter contains a brief treatment of modern radio compass technique.

Later chapters take up motor-generator sets used in radio transmission, the construction and care of storage batteries, the radio laws of the United States (brought up to date after the Washington convention of 1927), general theory, broadcasting, and amateur station operation. The appendices add useful information on examination conditions, abbreviations, wavelength allocations, etc. The book has an index.

Mathematical Discussion of the Fada Circuit

BAND-PASS FILTER DESIGN

By E. A. UEHLING

Engineering Department, F. A. D. Andrea, Inc.

SOME NOTES are given in this article on the design of the band selector used in the Fada receiver described by the writer in July, 1929, RADIO BROADCAST. In this receiver there is a signal selector of band-pass characteristics preceding the first radio-frequency amplifier tube.

In most filters already used the band of frequencies transmitted is narrow at long waves and very wide at short waves. The selectivity at the short wavelengths is usually not very good, even in the best receivers, because of the increased resistance of the radio-frequency circuits at the higher frequencies. It is obvious that if the width of the band transmitted by a band-pass filter increases as the wavelength decreases, the tendency toward broad tuning at the shorter wavelengths will be even more pronounced.

The Band-Pass Circuit

A simplified circuit of a band-pass filter having more desirable characteristics is shown in Fig. 1. It will be noted first of all that no magnetic coupling exists between the two circuits. There are two principal advantages of coupling these circuits as shown and these advantages will be described as follows: We are interested in the width of the transmission band which depends on the value of the quantity

$$\sqrt{\frac{R_2}{R_1} (M^2 - R_1 R_2)}$$

where R_1 and R_2 are the circuit resistances and M^2 is the absolute value of square of the coupling impedance. It will be seen that this coupling impedance should vary as the product $R_1 R_2$ varies with frequency, so that the quantity $(M^2 - R_1 R_2)$ is as nearly constant with frequency as it can be made. When the coupling between the circuits is magnetic the variation of the mutual reactance can be expressed as:

$$\frac{d(\omega L)}{d\omega} = L$$

If the coupling between the circuits is capacitive, the variation of the mutual reactance with frequency can be expressed as:

$$\frac{d\left(-\frac{1}{\omega C}\right)}{d\omega} = \frac{1}{\omega^2 C}$$

Suppose we decide on 4 per cent. coupling as the value which gives the desired width of band at the longest wavelengths. With 230-microhenry tuning coils the mutual inductance will then have to be 9.6 microhenries and the variation of the mutual reactance with frequency, as expressed by the first formula, will be 9.6×10^{-6} . Now, if the coupling between the circuits is capacitive and a coupling of 4 per cent. is again chosen, the coupling capacity will be about 10,000 micromicrofarads, and at 550 meters the variation of reactance with frequency, as determined by the second of the two formulas, will be 10×10^{-6} . For either type of coupling the variation of reactance with frequency at 550 meters when the coupling percentage is adjusted for the same width of band is the same.

But in the case of magnetic coupling this variation is constant regardless of frequency, and in the case of the capacity coupling the variation in reactance with change in frequency decreases as the frequency increases. Thus we find at 200 meters the variation of capacitive reactance with frequency is equal to only 1×10^{-6} as compared with 10×10^{-6} at the same frequency for magnetic coupling. So in the broadcast range capacity coupling gives a more nearly uniform width of band than magnetic coupling, provided the width of the band is made the same for both types of coupling at 550 meters. That is, the actual arithmetic variation in band width is less for capacity coupling than for inductive coupling.

The second of the two principal advantages of this type of band-pass filter is that whatever variation in band width there is, it is in the most desirable direction as already stated. As the receiver tuning dial is turned to the shorter wavelengths,

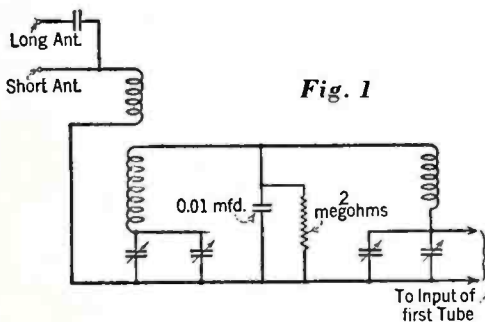

the coupling percentage is reduced constantly. This reduction in percentage of coupling is slightly more than is required to give constant width of band with the result that there is a slight decrease in band width at the lower wavelengths.

The use of a band-pass filter is not without some loss in voltage amplification as compared with other methods of signal selection. There is a voltage gain in this band-pass filter of about 2 at 550 kilocycles and about 4 or 5 at 1500 kilocycles. A comparison is given below of the voltage amplification obtained with the ordinary tuned antenna circuit and the circuit as used in this receiver will be shown.

The ratio of the voltage E_3 impressed on the grid of the first amplifier tube to the voltage E_1 impressed in the antenna is

$$\frac{E_3}{E_1} = \frac{m_1 m_2 \omega L}{Z_1'' Z_2' Z_3}$$

where (referring to Fig. 1) m_1 is the mutual impedance between the first two circuits, m_2 the mutual impedance between the last two circuits, L the inductance of the tuning coils in the band-pass filter, and Z_1'' , Z_2' , and Z_3 the impedance of the three circuits respectively as influenced by the reaction of the following circuits.

The ordinary antenna circuit differs from the circuit of Fig. 1 only in the absence of the third circuit. In this case the ratio of the voltage E_2 impressed on the grid of the first amplifier tube to the voltage E_1 impressed in the antenna is

$$\frac{E_2}{E_1} = \frac{m_1 \omega L}{Z_1' Z_2}$$

where m_1 and L are the same quantities as before, and Z_1' and Z_2 are the impedances of the two circuits which are in general of different value than Z_1'' and Z_2' given above.

But we are interested in the ratio $\frac{E_3}{E_2}$, the ratio of the voltage impressed on the grid when the band-pass filter is used to that impressed on the grid when the ordinary antenna circuit is used. We get this ratio by dividing one equation by the other.

$$\frac{E_3}{E_2} = \frac{m_1 m_2 \omega L}{Z_1'' Z_2' Z_3} \frac{Z_1' Z_2}{m_1 \omega L} = m_2 \frac{Z_1' Z_2}{Z_1'' Z_2' Z_3}$$

The resonant frequency of the antenna circuit is so far above the highest frequency of the broadcast band that its reactance to broadcast frequencies is very high, and therefore Z_1 , the impedance of the antenna circuit, is very high compared with the impedance of the other circuits. Since Z_1 is very large, its coupling to the following circuits changes its value very little. Therefore,

$$Z_1 = Z_1'' = Z_1' \text{ approximately}$$

then

$$\frac{E_3}{E_2} = m_2 \frac{Z_2}{Z_2' Z_3}$$

Now the value of Z_3 is

$$\begin{aligned} Z_3 &= \sqrt{R_3^2 + X_3^2} \\ &= \sqrt{R_3^2 + \frac{R_3}{R_2} (M^2 - R_2 R_3)} \\ &= \sqrt{R_3^2 + \frac{R_3 m_2^2}{R_2} - R_3^2} \\ &= m_2 \sqrt{\frac{R_3}{R_2}} = m_2 \end{aligned}$$

Substituting this value of Z_3 in the equation above

$$\frac{E_3}{E_2} = m_2 \frac{Z_2}{Z_2' m_2} = \frac{Z_2}{Z_2'}$$

The value of Z_2' is

$$\begin{aligned} Z_2' &= \sqrt{R_2'^2 + X_2'^2} \\ &= \sqrt{\left(R_2 + \frac{m_2^2}{Z_3^2} R_3\right)^2 + \left(X_2 - \frac{m_2^2}{Z_3^2} X_3\right)^2} \\ &= \left(R_2 + \frac{m_2^2}{Z_3^2} R_3\right) \\ &= R_2 + \frac{Z_2 Z_3}{Z_3^2} R_3 \\ &= R_2 + \frac{Z_2}{Z_3} R_3 \\ &= 2 R_2 \end{aligned}$$

then

$$\frac{E_3}{E_2} = \frac{Z_2}{2 R_2}$$

But Z_2 is the impedance of circuit II with circuit III removed, then

$$\begin{aligned} X_2 &= 0 \\ Z_2 &= R_2 \end{aligned}$$

hence

$$\frac{E_3}{E_2} = \frac{1}{2}$$

No. 304

RADIO BROADCAST Laboratory Information Sheet November, 1929

Distributed Capacity Measurements

THE method commonly used in laboratories to determine the distributed capacity of a coil is to tune it to various wavelengths by means of a condenser and then plot a curve of wavelength squared against the capacity of the tuning condenser. The curve will be a straight line but will not pass through zero because of the distributed capacity of the coil. If the curve is extended so that it intercepts the line corresponding to zero wavelength, the intercept will give the distributed capacity of the coil. The method is simple and quite accurate provided the individual measurements are carefully made. If, however, there are slight discrepancies in the various measurements it is necessary to estimate as accurately as possible the correct position for the curve.

There is another method of graphically determining the distributed capacity which is not generally used but which is sometimes more accurate than the one described. This second method is illustrated on "Laboratory Sheet," No. 305.

The general method of procedure is similar. The coil to be measured is connected across known capacities and the resonant wave-

length is determined. Some sample data is given below:

WAVELENGTH	CAPACITY TO TUNE TO RESONANCE-MMF.
300	315
247	200
134	0

The next step is to lay out a curve sheet as shown on "Laboratory Sheet" No. 305. The left-hand axis is wavelength squared and the right-hand axis is the tuning capacity in micromicrofarads. Straight lines are now drawn being the various values of tuning capacity and the corresponding values of wavelength squared.

If all the measurements were perfect, these various straight lines would all intersect at a common point but because of slight inaccuracies they do not. As a result there is formed at the center a small polygon. The center of this polygon must now be estimated and between the center and the point corresponding to zero wavelength a straight line is drawn. This line will intersect the capacity axis at the point corresponding to the distributed capacity of the coil. This latter line is shown dotted on the curve.

THE ROCHESTER I. R. E. DISTRICT CONVENTION

The following papers are scheduled to be given at the Eastern Great Lakes District Convention of the Institute of Radio Engineers to be held at Rochester on November 18 and 19: "Considerations in Screen-Grid Receiver Design" by W. A. MacDonald of the Hazeltine Corporation; "What Executives Expect of Engineers" by I. G. Maloff of the Valley Appliances Corporation; "Ultra High Frequency Transmission and Reception" by A. Hoyt Taylor of the Naval Research Laboratory; "A Broadcast Receiver for Special Purposes" by Paul O. Farnham of the Radio Frequency Laboratories; "Standardization in the Radio Vacuum Tube Field" by W. C. White of the General Electric Research Laboratory; "The Engineer in the Radio Industry" by H. B. Richmond of the General Radio Company and president of the Radio Manufacturers' Association.

Those attending the convention will be taken on inspection trips to Stromberg-Carlson plant, Kodak Park, and the Valley Appliance Corp.

The Rochester, Buffalo-Niagara, Cleveland, and Toronto Sections of the Institute are sponsoring the Convention, while the entire membership of the Institute will take part in its activities.

No. 305

RADIO BROADCAST Laboratory Information Sheet November, 1929

Distributed Capacity Measurements

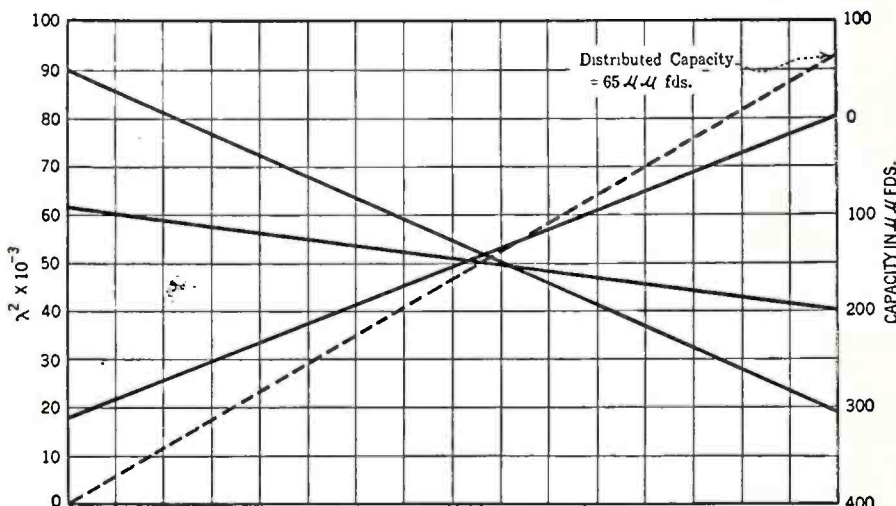

SELLING RADIO—THE BIGGEST SHOW ON EARTH

(Concluded on page 23)

But if you have made yourself an expert in your complete knowledge of broadcasting you are right on your customer's own street. You are a human being, therefore, you like to tell what you know. You know electricity and mechanics.

Make yourself a student of the drama of radio, its comedies, its utilities, its music, and its bally-hoo—all the elements which make it a big show. Get full of that kind of knowledge. Inevitably, as a human being, you will want to talk it, to tell what you know. Then conversationally you find yourself on the customer's own street and your native sales ability gets a fifty per cent. better chance to do its work.

You may even learn some things about broadcasting which the broadcasting stations themselves don't get, because your contact with the broadcasting audience becomes more intimate and more outspoken.

The radio business to-day is in the stage where both broadcasting and the receiving set trade do pretty well with the large numbers of people who really know they want to buy.

Suppose the motor car business were on that same basis. I venture to say that the total number of cars in use in the country might possibly be equal to what this year's sales will be, might be less.

Automobile makers, oil producers, retailers, highway builders, local boards of trade, state governments, all the resorts, merchants of all sorts, real estate people, all these and others are boosting the retail sale of automobiles for all they are worth, more cars, better cars, two to a family, then, three.

No, it is not quite a parallel case. I've tried to admit it before you said it. But the opportunity of profitable coöperation is in radio to similar degree, and for lack of that coöperation, radio is in some danger of slipping into a we-all-have-it and a take-it-for-granted condition long before its novelty, its romance, its daily gift of pleasure have been appreciated fully. The romance of radio and the friendly gossip of radio are still very salable.

No. 306

RADIO BROADCAST Laboratory Information Sheet November, 1929

Advantages of Automatic Volume Control

THE use of automatic volume controls in receivers has certain definite advantages. The most obvious advantage is, of course, that such a control definitely determines the output of the receiver and maintains this output constant over wide variations in field intensity. Ordinarily as we tune from one local station to another the volume varies considerably, depending upon the field strength obtained from the station, but in a set equipped with an automatic volume control, all stations will give approximately the same volume.

The second advantage of an automatic volume control is that it helps to some extent to reduce the effects of fading, since, as the signal begins to fade, the sensitivity of the set automatically begins to increase and in this way partially compensates the fading.

A third advantage of this control system, is that by its use it is possible to apply an input to the detector tube of a definite value of r.f. voltage. The set may be so designed that with this value of voltage applied to the detector, the distortion produced in the detector circuit will

be a minimum. The distortion ordinarily produced in detector circuits is a function of input voltage. It is high for small values of input voltage and also for very large values of input voltage. At some medium values determined by the operating voltages of the detector tube, the distortion will be a minimum and it is of course advisable to operate the detector tube always under the conditions for minimum distortion.

These three advantages are responsible for the greatly increased use of automatic volume control systems and it is probable that in the future their use will become quite general.

The automatic volume control tube generally works on the output of the r.f. amplifier and it automatically functions to control the output of the r.f. amplifier by varying its sensitivity. When the field strength is very high, the volume control tube causes a large reduction in the sensitivity of the amplifier and when the field strength is very low the tube functions to maintain the radio frequency amplifier at maximum sensitivity.

SM

“Can’t Beat the S-M 720?” Just Try this All-A. C. 722--And at \$74.75!

Have you heard the whisperings among the fans this fall—how Silver Marshall has brought out an all-electric custom receiver design which sells, completely wired at the factory, for only \$74.75 net—and yet which combines perfect convenience of operation with such extreme performance as has seldom been seen in the most complicated sets? Three screen-grid tubes, with band selector tuning—four tuned circuits in all—with screen-grid power detection—these, built up to the highest S-M standard of engineering, mean, of course, distance range right up among the top notchers. And if you think for one moment that selectivity has been sacrificed to full single-dial control—one test of a 722 on the most powerful local in your town will give you an entirely new conception of what S-M precision in coil manufacture can accomplish!

All-A. C. Operation

These receivers are *absolutely all electric*—even the 735 short-wave set, the first of its kind ever offered on the market. Power supplies are built into the receivers—not separate. (Power supply for the 712 is built into the 677 Amplifier.) The full advantages of the new a.c. screen-grid tubes are secured. The characteristic superior S-M tone quality, distance-range, and selectivity are in these receivers as never before, due not alone to band-selector tuning but also to still greater refinements of design and accuracy of manufacture.

Startling in perfection of tone quality, the 677 Clough-system Amplifier (right) is ideal either for powerful record amplification, or with the 712. Tubes required: 1—’27, 2—’45, 1—’80. \$58.50, less tubes. Component parts total \$43.40 net.

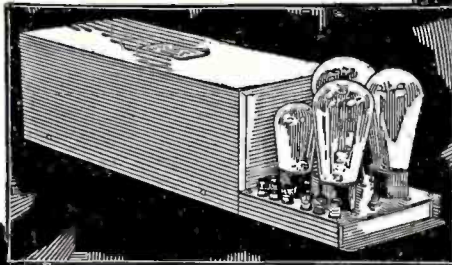

735 Short-Wave Receiver

(Left)—a screen-grid r. f. stage, new plug-in coils covering the bands from 17 to 204 meters, regenerative detector, typical S-M audio amplifier all help to make this first a. c. short-wave set first also in performance. Price, wired complete with built-in power unit, less cabinet and tubes, only \$64.90. Component parts total \$44.90. Tubes required: 1—’24, 2—’27, 2—’45, 1—’80. Two extra coils, 131P and 131Q, cover the broadcast band at an extra cost of \$1.65.

Adapted for battery use (735DC) price, \$44.80, less cabinet and tubes. Component parts total \$26.80. Tubes required: 1—’22, 4—’12A.

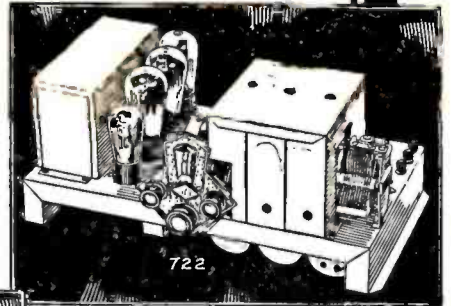

(Above)—three screen-grid tubes (including detector), band-filter, 245 push-pull stage—these help make the 722 the outstanding buy of the year at \$74.75 net, completely wired, less tubes and cabinet. Component parts total \$52.90. Tubes required: 3—’24, 1—’27, 2—’45, 1—’80.

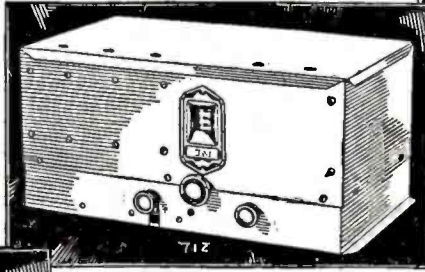

The New “Boss of the Air”--S-M 712

(Above)—A worthy successor to the famous Sargent-Rayment 710 of last season is the splendid new 712 tuner. Even if you have experienced the uncanny 10-kc. sharpness of the famous 5-vernier Sargent-Rayment—a new thrill comes with the 712. Here again are the five tuned circuits—two of them now joined in an ultra-modern band filter—and again the perfect shielding and the special shielded coils, whose tremendous accuracy makes possible the straight single dial tuning of the 712—without verniers, yet with performance far beyond competition regardless of price. Feeds perfectly into any audio amplifier; the S-M 677 is ideal, furnishing also all necessary ABC power. Tubes required: 3—’24, 1—’27. Price, only \$64.90, less tubes, in shielding cabinet. Component parts total \$40.90. *Ideally suited for rack panel installations.*

Beautiful Cabinets

The handsome new 707 table model shielding cabinet, finished in rich crystalline brown and gold, suitable for 722, 735, or 735DC, is only \$7.75. Special arrangements have been made whereby these receivers may be housed in magnificent consoles especially adapted to them. Be sure to send for the new Fall S-M General Parts Catalog, for details of these cabinets.

New!—

S-M 233U Universal Output Transformer

With a characteristic curve flat (to within 1.7 DB.) from 30 to 10000 cycles, this transformer has the further advantage of extreme flexibility. Three windings, with a total of 12 lugs, enable it to be used to match almost any impedances. As an output transformer it will work out of ’71, ’45 or ’50 tubes singly or in push-pull. It will work into 12 different impedances from 9 to 200 ohms to feed directly into the voice coils of 1, 2, 3, 4 or 8 dynamic speakers. It will also match with 1000, 2000, 4000 or 8000 ohm circuits; may be used as a line output transformer as well. Open mounted, size: 3” long, 3 3/4” high, 3 3/8” wide. Price, \$9.00.

The **RADIOBUILDER** for October contains a full description of the 712 Tuner; 677 amplifier, and the new 233 Output Transformer, as well as an interesting article on Television Amplification. If you haven’t seen it—use the coupon.

If you build professionally—write us about the authorized S-M Service Station franchise—it pays!

SILVER-MARSHALL, Inc.

6403 West 65th St., Chicago, U. S. A.

Silver-Marshall, Inc.
6403 West 65th Street, Chicago, U. S. A.

... Please send me, free, the new Fall S-M Catalog; also sample copy of The Radiobuilder.

For enclosed.....in stamps, send me the following:

.... 50c Next 12 issues of The Radiobuilder
.... \$1.00 Next 25 issues of The Radiobuilder

S-M DATA SHEETS as follows, at 2c each:

- No. 3. 730, 731, 732 Short-Wave Sets
- No. 4. 255, 256, etc., Audio Transformers
- No. 5. 720 Screen Grid Six Receiver
- No. 6. 740 "Coast-to-Coast" Screen Grid Four
- No. 7. 675ABC High-Voltage Power Supply
- No. 8. 710 Sargent-Rayment Seven
- No. 9. 678PD Phonograph-Radio Amplifier
- No. 12. 669 Power Unit (for 720AC)
- No. 14. 722 Band-Selector Seven
- No. 15. 735 Round-the-World Six
- No. 16. 712 Tuner (Development from the Sargent-Rayment)
- No. 17. 677 Power Amplifier for use with 712

Name.....

Address.....

SERVICE—DO YOU OR YOUR CUSTOMERS PAY?

(Continued from Page 19)

of service. For example, it has probably not even occurred to most dealers that the portion of the store space devoted to service—shop, service desk space, and space required for storage of parts, accessories, and antenna equipment used by the service department—is space which would be devoted to some other purpose if there were no service department, or else a smaller store would be used. Therefore, the cost of that space (rent, or taxes and upkeep) should be charged against the service department instead of against general overhead. All of the stationery used by the service department should be charged against that department, and a separate telephone, or telephones, should be installed so that, insofar as possible, all service calls can be charged to service overhead instead of the common practice of making them a general overhead expense.

In short, a complete set of books should be maintained for, and by, the service department, and the expense accounts of that department should be as carefully subdivided as those of the sales department. The dealer should know, at the end of each month, and at the end of each year, the separate cost of labor, antenna equipment, apparatus, batteries, and tubes sold by the service department; the gross income from each of those items; the gross profit on each item; the percentage of profit on each item; and the totals of all those accounts grouped together. If the service department is not large enough to keep one bookkeeper busy, or one service executive busy, then whatever portion of the time of an individual is devoted to the service department should be so charged. Otherwise, the sales department would be carrying an item of office overhead which rightfully belongs to service.

Free Service

There is just one service item which may be properly charged to sales expense if the dealer desires to do so. That is the cost of performing free service within the limited guarantee period, and the cost of free installation if the dealer believes he

cannot break away from that harmful and unnecessary practice. It is fairly common practice in the automotive industry to charge the guaranteed free service to sales, and some successful radio dealers believe it to be good practice. The author does not agree with that view, however, simply because it has been proved by several dealers that the service department itself can carry that expense and still break even or make a profit. That is to say, it can carry the expense of the free service when permitted by the sales department to make a reasonable profit on the installation. If free installations are indulged in, the sales department, and not the service department, should most certainly be the one penalized. Any free service performed after the guarantee period, as return calls resulting from improper service, should, of course, be charged to the service department. Incidentally, the cost of rendering guaranteed free service over a ninety-day period is not high if the merchandise sold is of good quality, receivers and the tubes and loud speaker to go with them are tested thoroughly in the shop before delivery, the installation is a high-quality job in every respect, and the salesman has not made exaggerated performance claims. For example, the free calls made by the dealer whose service methods we have been discussing averaged only about one and one half per sale in 1928!

Labor Costs

Before we go into the subject of how much should be charged for service, it might be well to examine the cost a little more closely, for upon the latter depends the amount of the former. The chief item of service, labor, is the one real cost which is so generally under-estimated, and the one for which dealers almost universally under-charge their customers. The chart accompanying this article gives the details of the situation, which are taken from records of the service department of a highly successful radio retailer. The figures are an average of the cost of eight men over a period of two years.

The most significant thing about the figures is the fact that the amount actually

realized by this dealer's service department—which the author considers to be in the very top rank of efficiency—is only 67.5 per cent. of the amount which is his advertised and applied rate for labor per hour. That is something which is totally neglected in the accounting of the average service department. Figured on the same basis—of efficiency as measured by percentage of the labor charge which can be considered actual gross income from labor—the average dealer would *certainly* not be rated more than 50 per cent. That would mean, with the same cost, and the same charge per hour, that his income would be \$1.25 per hour, giving him a margin of only 19 per cent. to cover all of his service overhead. It has been the experience of large dealers with good service departments that it requires the utmost care to keep the overhead down under 40 per cent. If the average dealer is able, by careful planning, to keep his service overhead down to 40 per cent., or near that figure, but he does not make more than 20 per cent. on labor, his net loss on labor is not less than 20 per cent. and often more.

Sad to relate, the actual conditions are even worse. The average dealer computes, very roughly, that his labor costs him, even with fairly good men, somewhere between 60 and 75 cents per hour. Then he calculates that if he charges \$1.50 per hour for service he will have an ample margin, in the neighborhood of 50 per cent. and everything will be lovely! In the first place, they neglect the fact that if they pay a serviceman at a weekly rate which amounts to 75 cents per hour, the cost for the hours the man actually works will be very close to \$1.00 per hour. Then they also neglect the fact that a charge of \$1.50 per hour will bring in, even with the utmost efficiency, less than \$1.00 for each hour of work. The average dealer at the present time not only shows no gain on service labor with which to take care of service overhead, but he shows a loss before his overhead is deducted. There is just one answer to the problem: If good service is to be rendered, and the dealer is to break even on the labor item of his service, then \$2.50 per hour is the lowest rate on which he can base his charges to the customer!

STRAYS FROM THE LABORATORY

(Continued on page 40)

decrease appreciably. Such a voltage is not difficult to attain from local stations and may cause appreciable cross talk. Set engineers, therefore, are increasing the control-grid bias to as high as 3.0 volts in some cases and increasing the screen-grid potential from 75 to 90 volts.

It was said in July that the screen-grid tubes were none too good, some of them drawing grid current at a negative potential as high as 1.5 volts which means either increasing the bias voltage some more, or running the risk of cross-talk trouble, or of finding some way to avoid cross talk by circuit changes, or, of course, producing better tubes.

Why does a screen-grid tube seem more prone to draw grid current than other types of tubes? The chief reason is probably because of its unpotent filament. The 227 is another offender. The high-voltage-filament tubes, such as the Arc-turus 15-volt tubes, draw but little grid current and then only under conditions at which the tube would not be operated. If the filament has a high voltage, there is

only a very small part of it that can radiate electrons to the grid. On the other hand, if the filament has a low voltage, the wd-12 type for example, a large part of the filament will be near the voltage of the grid, and consequently can contribute to the grid current. Contact potentials and the initial velocity of the electrons play an important part in this grid current business—which worries both set and tube designers.

PROFESSIONALLY SPEAKING

(Continued on page 24)

to it. One of the leads shorted to the frame through a thin mica washer. A nickle's worth of tape fixed the difficulty and left enough for the owner's bicycle.

What is the moral to this story? There are two. In the first place the serviceman was a "dumb-bell." He belonged to an authorized dealer—but not authorized to carry the receiver which hummed so badly. He did not know how to isolate trouble. He was going to charge the customer a ridiculous sum of money to fix a difficulty that the manufacturer should

have avoided by careful insulation. This is the second part of the moral. The receiver manufacturer who made that set never should have used such a flimsy device as the single mica washer to hold back some 300 volts from going straight into the ground and ruining not only reception but a rectifier too.

This fault lies primarily with the manufacturer, secondarily with the serviceman. But granted that manufacturers must save money, why could not an intelligent serviceman have found the difficulty? Is it a fact that the average serviceman is as stupid as many people think? If this is true, the manufacturer must look the situation in the face and make receivers that will not go bad in service. It can be done.

Vreeland Tuning Patents

The Vreeland Corporation, 140 Cedar Street, New York, N. Y., states that the Vreeland "band-selector" patents make possible undistorted reception of the entire modulated wave and do not require "geometric" tuning. It is claimed that the Vreeland patents make possible a non-infringing r.f. system. "The Vreeland system," says its inventor, "may eliminate completely radio-frequency tuning."

Thordarson Transformers and Chokes

For Use With

"245" Type Power Tubes and "224" Screen Grid Power Detectors

Input Couplings

Single "245" tube, from any audio amplifying tube, use any one of three transformers. (R-400 especially suited to "226" and "227" tubes)	R-260	\$5.00
	R-300	8.00
	R-400	9.00
Push-Pull "245" tube, from any audio amplifying tube. Use 1-to-1 ratio input transformer	T-2408	\$8.00
Use 2-to-1 ratio input transformer	T-2922	12.00
Screen grid power detector "224" to any single power tube, use "Autoformer" for choke-resistance type of standard circuit	R-190	\$5.00
Screen grid power detector "224" to any push-pull power tubes use R-190 Autoformer for parallel feed to detector plate and 2-to-1 coupling transformer	T-2922	\$12.00

Speaker Couplings

Single "245" tube to dynamic speaker with built-in transformer, to cone speaker, or to magnetic speaker—Use either one or two transformers	T-2876	\$6.00
	T-2901	12.00
Use choke-condenser coupling, employing one choke	R-196	5.00
Single "245" tube to moving coil of dynamic speaker—Use transformer	T-2902	\$12.00
Push-pull "245" tubes to dynamic speaker with built-in transformer, to cone speaker, or to magnetic speaker—Use coupling transformer	T-2880	\$12.00
Use choke coupling, employing double choke	T-2420	8.00
Push-pull "245" tubes to moving coil of dynamic speaker—Use either one of two transformers	T-2629	\$10.00
	T-2903	12.00

Filament Supplies

For six "224" screen grid tubes or six "227" tubes—Use filament transformer (10.5 amps at 2.5 volts)	T-3660	\$9.00
For two "224" tubes or two "227" tubes and one or two "228" tubes use double voltage transformer	T-3081	\$6.00

Power Compacts

For filament current, plate current and bias on "245" push-pull power stage, also plate current for set. Contains filter chokes. Uses one 280 rectifier tube	R-245	\$24.00
For filament current, plate current and grid bias on single "245" power tube and one "226" audio tube, also plate current for set. (Requires extra T-3081 filament transformer.) Contains filter chokes	R-480	\$17.00

THORDARSON RADIO TRANSFORMERS

Thordarson Electric Mfg. Co.
Transformer Specialists Since 1895
WORLD'S OLDEST AND LARGEST
EXCLUSIVE TRANSFORMER MAKERS
Huron and Kingsbury Streets
Chicago, Ill., U.S.A.

GOEDEN MORGEN

("Good Morning," Dutch)



Scene near Station
PCLL, Kootwijk,
Holland.



Not so easy for all of us to read. But it is much easier to hear this cheery greeting and lively music all the way from Holland when you tune in on station PCLL with the THRILL Box.

Get BOTH Short
Waves AND
Broadcasts
Write us today for
full details

Words and music from 20 different countries in a dozen different languages, may be heard with the NATIONAL Screen-Grid THRILL-BOX. This new Radio is full of new and ingenious features for your convenience and pleasure.

NATIONAL

4-Tube THRILL BOX SW-4

NATIONAL CO. INC., Malden, Mass.

Est. 1914



1906-1929

In 1906, Dr. Lee De Forest invented the first vacuum tube. Today, all radio tubes, no matter what their name, are made by license arrangement with, and under patents owned by, the De Forest Radio Co.

DE FOREST RADIO CO.
NEW JERSEY
JERSEY CITY

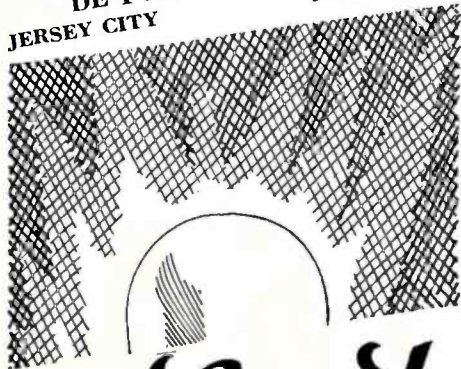

de Forest
AUDIONS



At Last!—a book containing all the rules of commercial and government radio traffic—and operating regulations.

The Only Book of Its Kind!

Radio Traffic Manual and Operating Regulations

By R. L. Duncan
and C. E. Drew
Radio Institute
of America



At last here is a book for students, amateurs, and radio operators who contemplate entering the commercial field. With the help of this little book—the only complete one of its kind—you may learn quickly and easily all the government and commercial traffic rules and operating regulations.

Duncan and Drew, the two well-known authors of "Radio Telegraphy and Telephony," have set forth clearly and accurately in 181 pages all the information on the subject that you will want. Everything from Morse Code and Conventional Signals to the Issuance of Radio Operators' Licenses is included in detail. An excellent index in the back of the book makes every topic easy to locate.

\$2.00

ON APPROVAL COUPON

John Wiley and Sons, Inc., 440 Fourth Ave., New York
Gentlemen: Kindly send me for examination Duncan and Drew's "Radio Traffic Manual." At the expiration of ten days I agree to remit \$2.00 or return the book postpaid.

Name.....
Address.....
Reference..... R. B. 11-29

Here's the Answer

to every question about the principles, methods, or apparatus of radio transmitting and receiving. A Complete Course in Radio Operation in a Single Volume.

THE RADIO MANUAL

A New Edition

Complete new chapters on aircraft radio equipment; Practical Television and Radiomovies with instructions for building a complete outfit; radio interference; 100% modulation; latest equipment of the Western Electric Co.; the Marconi Auto-Alarm System; and many other developments of the past year. All this information is added in the new edition and, besides, the entire book has been brought right up to date with much new material. *The Radio Manual* continues to be the one complete and up-to-the-minute handbook covering the entire radio field.



A Handbook for Students Amateurs Operators Inspectors

20 big chapters cover: Elementary Electricity and Magnetism; Motors and Generators; Storage Batteries and Charging Circuits; The Vacuum Tube; Circuits Employed in Vacuum Tube Transmitters; Modulating Systems and 100% Modulation; Wave-meters; Piezo-Electric Oscillators; Wave Traps; Marine Vacuum Tube Transmitters; Radio Broadcasting Equipment; Arc Transmitters; Spark Transmitters; Commercial Radio Receivers; Marconi Auto-Alarm; Radio Beacons

and Direction Finders; Aircraft Radio Equipment; Practical Television and Radiomovies; Eliminating Radio Interference; Radio Laws and Regulations; Handling and Abstracting Traffic.

An immense amount of information never before available including detailed descriptions of standard equipment is presented.

Prepared by Official Examining Officer

The author, **G. E. Sterling**, is Radio Inspector and Examining Officer, Radio Division, U. S. Dept. of Commerce. The book has been edited in detail by **Robert S. Kruse**, for five years Technical Editor of QST., the Magazine of the American Radio Relay League. Many other experts assisted them.

Free Examination

The new edition of "The Radio Manual" has just been published. Nearly 900 pages. 369 illustrations. Bound in Flexible Fabrikoid. The coupon brings the volume for free examination. If you do not agree that it is the best Radio book you have seen, return it and owe nothing. If you keep it, send the price of \$6.00 within ten days.

Order on This Coupon

D. Van Nostrand Co., Inc.,
250 Fourth Ave., New York
 Send me the Revised edition of THE RADIO MANUAL for examination. Within ten days after receipt I will either return the volume or send you \$6.00, the price in full.
 (Radio Broadcast 11-29)
 Name.....
 St. & No.
 City and State.....

The New HAMMARLUND Shielded Polarized R. F. Choke Coil



A RADIO frequency choke specially developed for modern high-gain shield-grid receivers.

Shielded in an aluminum shell and polarized.

Minimum external field. No undesired coupling to cause circuit instability or feed-back. High inductance—low distributed capacity.

Efficient. Compact. Convenient.

Write Dept. RB-11 for Details

HAMMARLUND MFG. CO.
 424-438 W. 33rd St. New York



words
 words
 words
UNTIL

someone else, who knows and uses your product, says them.

That's why Polymet is proud of this testimony:—

- "Definitely Superior Specialized Parts" —Zenith
- "Finely Built Products" —Silver
- "Quality Parts" —Stewart Warner

Condensers Resistances Coils Transformers

Polymet Manufacturing Corp.
 837 E. 134th St., New York City

POLYMET PRODUCTS

Today's Radio Demand Thoroughly Trained Service Men and Reliable Testing Equipment . . .

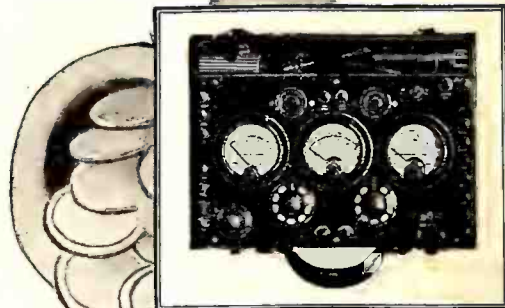

WESTON Model 547 Set Tester meets every requirement of radio's demands. Its use is proof of conscientious servicing and high professional

standing, assuring manufacturer and dealer of prime set performance wherever it is periodically employed.

With the Model 547, the operator can quickly and positively check up any receiver made—locate and correct troubles without loss of time and add materially to his profits.

It is a triumph of constructional perfection and electrical completeness—a marvel of simplicity, its operation can be quickly mastered. Enclosed in a durable, abrasion-proof case of black bakelite with all external fittings of the same material, it offers a handsome appearance which will retain its newness in spite of hard usage.

A unique instruction book including individual data for most receivers on the market accompanies each outfit. Before purchasing any testing equipment carefully investigate the unusual merits of this tester. A fair and impartial comparison will convince you of its superior qualifications for service. Write for *free copy* of "Testing Instructions for Service Men."

WESTON ELECTRICAL INSTRUMENT CORPORATION

604 Frelinghuysen Avenue Newark, N. J.



TYPE 360 TEST OSCILLATOR



One of the new test oscillators for the radio service laboratory is now ready. It will deliver a modulated radio-frequency voltage at any point in the broadcast band (500 to 1500 kilocycles) and at 175 and 180 kilocycles. The tuning control is calibrated with an accuracy of 2 per cent.

The Type 360 Test Oscillator is intended to be used for neutralizing, ganging, and tuning of the radio-frequency stages in a receiver, and it is fitted with an output voltmeter for indicating the best adjustment.

Price \$110.00

GENERAL RADIO COMPANY

30 State Street
Cambridge, Massachusetts

274 Brannan Street
San Francisco, California

Here's Radio Resistance Quality That **REPEATS!**

The buyer who wants real, bang-up QUALITY, and yet who keeps his eye out for a good "buy" finds both in ELECTRAD Resistances and Voltage Controls.

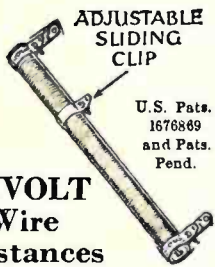

TRUVOLT
All-Wire
Resistances

The safe resistance for eliminators and power packs. Patented wire-wound construction stands up under load and keeps cool. Exclusive sliding clip for quick adjustments. All usual sizes and wattage ratings.

Also TRUVOLT Variables, with same distinctive construction plus knob control. Last longer owing to endwise travel of contact over resistance wire.
22 stock sizes—\$2.50.

Mail Coupon
for TRUVOLT Data

175 Varick St., New York, N. Y.

ELECTRAD

ELECTRAD, INC., Dept. RB11
175 Varick Street, New York
Please send Truvolt Data

Name.....
Address.....

Just Published!

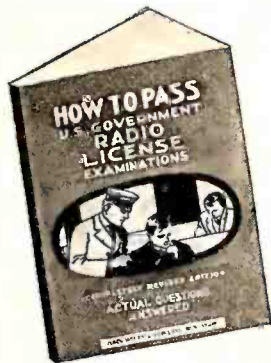

*A Sure Way of
Passing Your
Government
Examinations!*

*Here are all
the questions
—completely
answered*

IN **How to Pass U. S. Government Radio License Examinations**

By R. L. Duncan and C. E. Drew
Radio Institute of America

Don't take any chances with your examinations. Careful study of this book will insure success in obtaining your government radio license, because it contains full particulars, questions and answers, on the latest radio examinations by the government.

It will not only give you all the data, but through the question and answer method used in the text, will teach you how best to express yourself and put that knowledge into words. 259 questions with complete answers show you just what will be expected of you.

Order a copy now—and start studying!
\$2.00

ON APPROVAL COUPON

John Wiley and Sons, Inc., 440 Fourth Ave., New York
Gentlemen: Kindly send me on approval Duncan and Drew's "How to Pass." At the expiration of ten days, I agree to remit \$2.00 or return the book postpaid.

Name.....
Address.....
Reference..... R.B. 10-29

SPEAKER by OXFORD

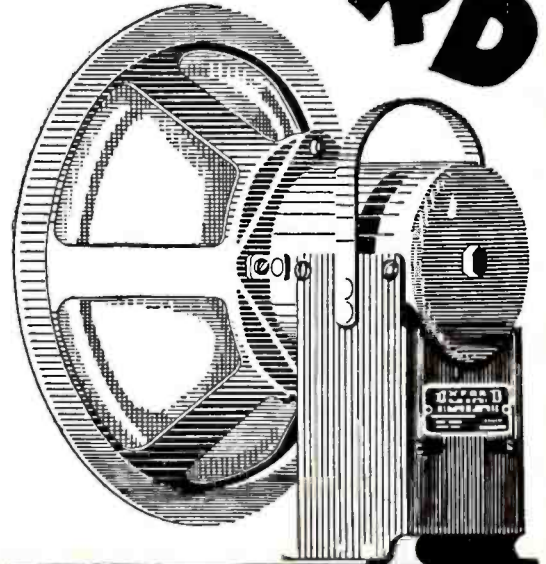

An outstanding
contribution to
the Art of Radio
Reception . . .

the higher cost
is forgotten in
the perfection
of performance

Write for prices and
further information

**OXFORD RADIO
CORPORATION**

3201 W. Carroll Ave.
CHICAGO, U. S. A.

Tune in
on
This



New
Radio Course

IT PROVIDES an easy way to prepare for a good position in radio work. It furnishes a broad knowledge of radio that applies to the job at hand, whether that job be the simple act of removing a tube or figuring on the most modern installation. It explains the technicalities of radio in clear, understandable language, first laying a fine mathematical background.

There is no better way for you to succeed in radio than to study this new course of the International Correspondence Schools. Every day new students are finding out its many advantages. The course is endorsed by leading radio experts and radio manufacturers.

Mark and mail the coupon today and let us tell you what the new Radio Course can do for you.

Mail the coupon for FREE booklet

International Correspondence Schools
Box 8299-F, Scranton, Penna.

Without cost or obligation, please tell me all about the
NEW RADIO COURSE

Name _____
Street Address _____
City _____ State _____

ROBERT S. KRUSE

Consultant and Technical Writer

103 Meadowbrook Road, West Hartford, Conn.
Telephone Hartford 45327

Helpful Technical Information

A regular feature of RADIO BROADCAST is the series of Laboratory Information Sheets, which cover a wide range of information of immediate value to every radio worker, presented in a form making it easy to preserve them. To insure your having every issue, send your check for \$4.00 for one year's subscription, to

Subscription Department, Doubleday, Doran & Co., Inc.
Garden City, N. Y.

THE RADIO PRODUCTS CO.

Leads the Field in
RADIO SERVICE INSTRUMENTS
RADIO SET ANALYZER
WITHIN THE PRICE OF EVERY SERVICE MAN



DURABLE BAKELITE BOX
Accurate as higher priced Analyzers

AC Range 4-8-16-160

DC Range 20-100-200

20 and 100 mils.

Equipped with Weston or Jewell meters, 1000 ohms per volt. Complete test on all sets including screen grid type. Compact and light weight. Selector switch enables immediate reading. No other adjustments.

Priced Net to Dealer \$58.50

Ask your jobber, he will tell you about our instruments

THE RADIO PRODUCTS CO., Dayton, Ohio



Pyrohm Resistors
Accurate — Unchanging

REDUCED sensitivity, low volume, distortion and poor tone quality are the inevitable results of using inaccurate resistors which do not maintain their proper resistance values.

To be assured of satisfactory operation in power supply units and power amplifiers, be sure to specify and use—Aerovox Pyrohm resistors of the proper resistance values and current carrying capacities.

These units are made of the best grade of resistance wire wound on a refractory tube, and protected by a porcelain enamel against moisture, oxidation and mechanical injury.

Send for Catalog

Complete specifications of all Aerovox Pyrohm resistors are contained in a complete catalog which will be sent free of charge on request.

The Research Worker

contains, each month, valuable information on radio design. It will be sent free on request.

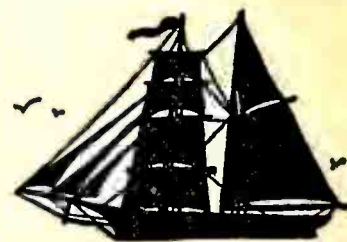

CAP'N GEORGE FRED

—George Fred Tilton

The sturdy saga of the great whaling days told by one of New England's most stalwart and venturesome sons. "I've wrung more salt-water out of my mittens than you've ever sailed over, by Godfrey!" Guess he had. He's nearly seventy now; shipped aboard a whaler at fourteen; spent a lifetime in the South Seas and the Arctic; walked alone across Alaska to summon aid for an icebound whaling fleet; quelled a mutiny with his fists in Bering Straits; and when war came it found him in the forefront of the fighting forces of the navy.

DOUBLEDAY DORAN

—\$4—

**PILOT
A. C.
SHORT
WAVE
RADIO**



UTILIZING
SPECIALLY-
DEVELOPED
**PILOTRON
227**

NEW

**RADIO ENGINEERING
ACHIEVEMENTS**

New Pilot Super-Wasp operating from A. C. light socket now brings to all the wonders of world-wide short-wave radio reception! \$34.50 is cost of complete kit for Custom Set-Builders in U.S.A. Power Pack Extra. (Pilot's K-111 ABC Power Pack is recommended. Custom Set-BUILDER'S Price \$16.50)

New specially-developed Pilotron 227—the only tube good enough to operate the A. C. Super-Wasp satisfactorily. Brilliantly illustrating that Pilotrons, endorsed by professionals, meet the exacting requirements of professional radio engineers, experimenters and custom set-builders for distinctly superior tubes! Newly developed Pilotrons are first on the market—always!

Your nearest authorized Pilot Dealer stocks the A. C. Super-Wasp, the Battery-Operated Super-Wasp and the complete Pilotron Line. Get Pilot's Catalog from your dealer or write direct.

**PILOT A. C.
SUPER-WASP**
developed by
**DAVID GRIMES
JOHN GELOSO
ROBT. S. KRUSE**

PILOT RADIO & TUBE CORP.

WORLD'S LARGEST RADIO PARTS PLANT—Established 1908

323 Berry Street, Brooklyn, New York



TRADE MARK REG.

**A Radiotron
for every purpose**

- RADIOTRON UX-201-A**
Detector Amplifier
- RADIOTRON UV-199**
Detector Amplifier
- RADIOTRON UX-199**
Detector Amplifier
- RADIOTRON WD-11**
Detector Amplifier
- RADIOTRON WX-12**
Detector Amplifier
- RADIOTRON UX-200-A**
Detector Only
- RADIOTRON UX-120**
Power Amplifier
- RADIOTRON UX-222**
*Screen Grid Radio
Frequency Amplifier*
- RADIOTRON UX-112-A**
Power Amplifier
- RADIOTRON UX-171-A**
Power Amplifier
- RADIOTRON UX-210**
Power Amplifier Oscillator
- RADIOTRON UY-224**
*Screen Grid Radio
Frequency Amplifier
(A C Heater)*
- RADIOTRON UX-240**
*Detector Amplifier for
Resistance-coupled
Amplification*
- RADIOTRON UX-245**
Power Amplifier
- RADIOTRON UX-250**
Power Amplifier
- RADIOTRON UX-226**
*Amplifier
(A C Filament)*
- RADIOTRON UY-227**
*Detector Amplifier
(A C Heater)*
- RADIOTRON UX-280**
Full-Wave Rectifier
- RADIOTRON UX-281**
Half-Wave Rectifier
- RADIOTRON UX-874**
Voltage Regulator Tube
- RADIOTRON UV-876**
Ballast Tube
- RADIOTRON UV-886**
Ballast Tube

The standard by
which other vacuum
tubes are rated



Look for this mark
on every Radiotron

C. B. SMITH
President STEWART-WARNER CORP. 5024

"Every Stewart-Warner receiving set undergoes the most exacting tests before it is approved by our laboratory engineers. For this purpose RCA Radiotrons are used. Because we have discovered that they add materially to the performance of our instruments we recommend them to all of our customers for initial equipment and replacement."

C. B. Smith

That all vacuum tubes should be replaced after a year of use is the advice of expert radio engineers. When this is done a brand new RCA Radiotron should be put in every socket. New tubes will not do their best in company with old ones.

RCA RADIOTRON
RADIOTRON DIVISION
RADIO-VICTOR CORPORATION OF AMERICA NEW YORK CHICAGO ATLANTA DALLAS SAN FRANCISCO

The national magazine advertisement reproduced at the left is one of the 1929 Radiotron series, each of which carries the signature of a leading radio manufacturer.

RCA Radiotrons are backed by continuous advertising the year around, both in newspapers and magazines. The vacuum tube replacement market, growing larger each year, is an opportunity to the dealer to make steady profits by keeping a full line of RCA Radiotrons—and maintaining a reputation in his community for always having the full line in stock. It pays to carry merchandise that gives you a quick turnover.

Superior resources of research and manufacturing guarantee to RCA Radiotrons the finest possible quality in vacuum tubes. They are the standard of the industry—and so accepted by both the trade and the public.



RADIOTRON DIVISION
RADIO VICTOR CORPORATION OF AMERICA NEW YORK CHICAGO ATLANTA DALLAS SAN FRANCISCO

RCA RADIOTRON

RADIOTRONS ARE THE HEART OF YOUR RADIO SET