

S E P T E M B E R 1 9 2 9

# RADIO BROADCAST

PUBLISHED FOR THE RADIO INDUSTRY



SPECIAL FEATURES IN THIS ISSUE

The Tube Business

House to House Selling—Does It Pay?

Radio for the Little Red Schoolhouse

Other features: News of the Industry • The Technidyne Circuit • Malevolent Trade Gossip • Features of Bosch Receiver • Maintenance Data • Data Sheets for Dealers • The Dealer and the Finance Company

T H I R T Y F I V E C E N T S

PUBLISHED BY DORAN & CO., INC. ♦ GARDEN CITY, NEW YORK

# UNIFORMITY

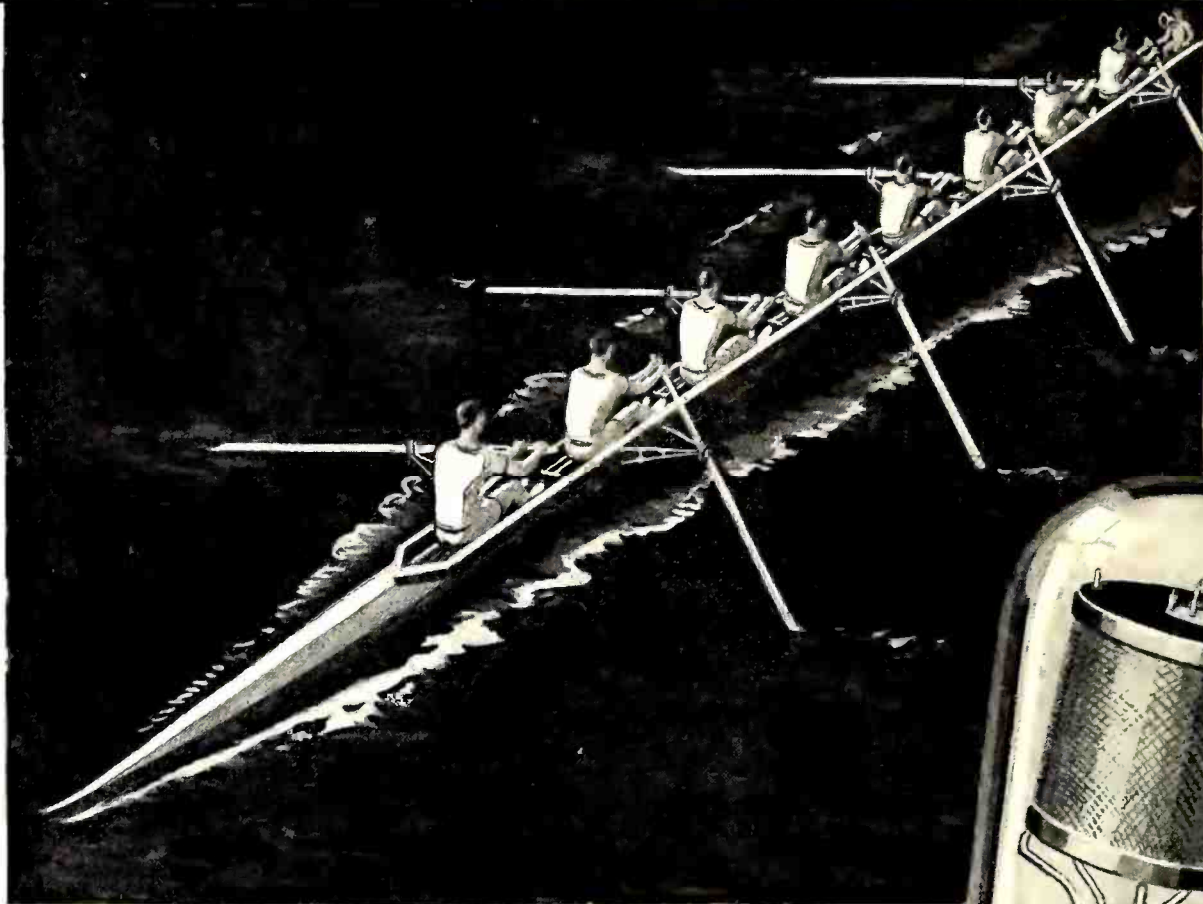

**W**HETHER in cartons or carloads, you will find TRIAD quality absolutely uniform! UNIFORM because the complete materials for TRIAD Tubes (except glass and base) are made right in the TRIAD plant; UNIFORM because the manufacturing process, from first to last, is personally supervised by world-famous radio engineers; UNIFORM because TRIAD Tubes are subjected to nine exhaustive tests for vital characteristics before ever reaching the packing department—and even there they are sorted for uniformity and *again* inspected before shipment! Even the testing machines themselves are made by the TRIAD Company, and are built to the U. S. Bureau of Standard Specifications. TRIAD Tubes are “honor-built” — throughout! That is why TRIAD *alone* can *insure* every tube for six months’ perfect service—and it is exactly the reason why *you* can win (as thousands of other dealers are now doing) far greater tube sales and profits with TRIAD than you have ever enjoyed before!

*Call your jobber or write us direct for complete TRIAD dealer information.*

**TRIAD MANUFACTURING COMPANY, INC.**  
Triad Building — Blackstone, Middle and Fountain Sts.  
PAWTUCKET, R. I.

**TRIAD**  
INSURED  
**RADIO TUBES**



Above is shown TRIAD  
T-24 — Screen Grid Tube  
for AC use.

▼  
Tune in on the “Triadors”  
— every Friday evening  
8 to 8.30 Eastern Daylight  
Time — on WJZ and as-  
sociated NBC Stations.

# The only complete portable radio testing laboratory

**T**HE SUPREME DIAGNOMETER is recognized by every radio engineer and technician as the most complete, thorough and efficient testing apparatus ever devised. Complete in every detail, yet surprisingly simple. All service can be performed so easily and quickly that the cost of servicing is negligible compared with antiquated methods, and returns to distributors or factory for repair or adjustment are completely eliminated. "Scientific Analysis" is substituted for "Guesswork" and "Experimentation," insuring the perfect results that create enthusiastic customer satisfaction and good will.

## Tube Testing Plus

The only dependable test on all tubes, including screen grid. Tests each plate separately of '80 type rectifiers. . . . An exclusive feature of prime importance. Tubes tested under actual working conditions, revealing every possible deficiency, many of which cannot be determined by any other service instrument or tube checker.

## Screen Grid Analysis, etc.

Accurate screen grid analysis without producing oscillation in the set.

Synchronizing by thermo-couple meter or A. C. meter. Easy and accurate; the same method almost universally employed in factory practice.

Neutralizing external connections to all apparatus.

All continuity tests without the use of batteries.

**THE DIAGNOMETER'S COMPLETENESS, RANGE AND FLEXIBILITY WILL PROVE ASTOUNDING.** Write for the chart, "A Test That Challenges Attention."



**"Set Testers" prove only 29% to 40% efficient in comparison with the SUPREME DIAGNOMETER**



## Order Now

Present production permits immediate deliveries but the momentum of sales is such that buyers are cautioned to place their orders now. Reservations will be made against all orders placed for future delivery on specified dates. Make use of this plan to avoid disappointments.



## Supreme Service League

TO RADIO OWNERS:

Look for this emblem in your radio shop, on the lapel button or card of your service man. It is your guarantee of dependable radio service.

Most good distributors carry the SUPREME DIAGNOMETER in stock. If yours cannot supply you, send direct on form to the right.

# SUPREME

## Radio Diagonometer

*conceivable*  
Makes every test on any Radio Set-

**SUPREME INSTRUMENTS CORP.**  
338 Supreme Bldg.  
Greenwood, Miss.

Please ship SUPREME DIAGNOMETER Model 400-B on basis checked below.

- Net cash \$139.50.
- Time payment plan—\$33.50 cash and 8 monthly payments of \$15.00 each.

All prices are F. O. B. Greenwood, Miss. No dealer's discount.

Date shipment desired .....

Signed.....

Firm Name.....

.....

Street Address .....

City ..... State .....

Please give three or more bank or trade references and names of distributors from whom most purchases are made.

## ELECTRIC TUBE BASE BRANDERS

*Impress Neat,  
Clean Letters*

*into  
your  
Bases*



*Power Driven*

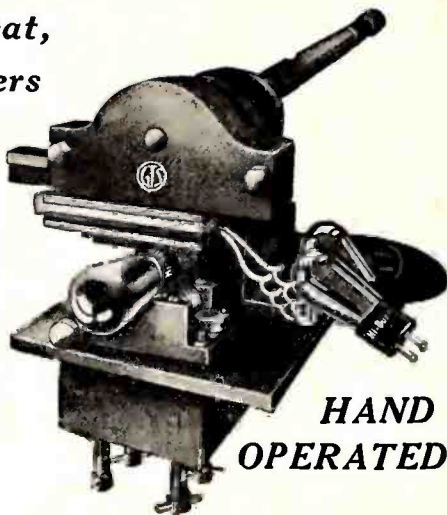

*HAND  
OPERATED*

*THE LATEST AND BEST  
Machines for Marking Bases*

*Designed and Built by*

**GEORGE T. SCHMIDT, Inc.**

**4100 Ravenswood Ave.**

**Chicago, Ill.**

## The New MODEL 547 Radio Set Tester

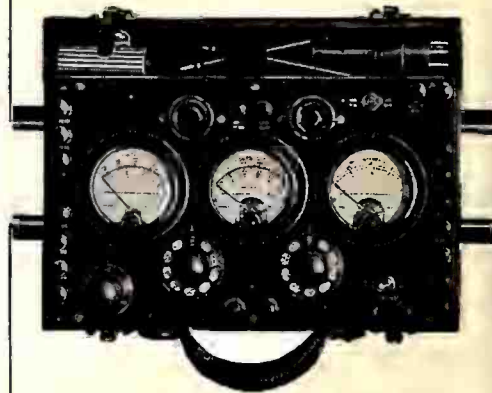

- *saves time*
- *simplifies testing*
- *increases sales*

**S**ERVICE men remember the time when radio set testing required hours of time and satchels full of equipment. The Model 537 reduced radio set testing to its utmost simplicity and made radio servicing a profitable business instead of a necessary evil.

**NOW**—Model 547—for A. C. and D. C. Receivers meets the service testing requirements of radio's latest developments, even taking into account the number of new tubes, sets, and circuits. Handsome in appearance, it is light, but rugged, convenient and complete.

Provided with three instruments, carrying case, removable cover, panels and fittings of sturdy bakelite.

A. C. Voltmeter—750/150/16/8/4 volts. Only one selector switch is necessary.

D. C. Voltmeter—high range increased to 750 volts. Other ranges—250/100/50/10/5 volts.

D. C. Milliammeter—double range 100/20 M. A. provides for lower readings with better scale characteristics.

Tests—On A. C. sets the heater voltage and plate current can be read throughout the test while the D. C. voltmeter may be indicating plate bias or cathode voltage.

Self-contained, double-sensitivity continuity test provided. This can also be used for measuring resistance as well as testing for open circuits. Grid test can be made on A. C. or D. C. screen grid tubes—also the '27 tubes when used as a detector—without the use of adapters. Two sockets on the panel—UY tube adapters eliminated.



**WESTON ELECTRICAL  
INSTRUMENT CORP.**

604 Frelinghuysen Ave.  
Newark, N. J.

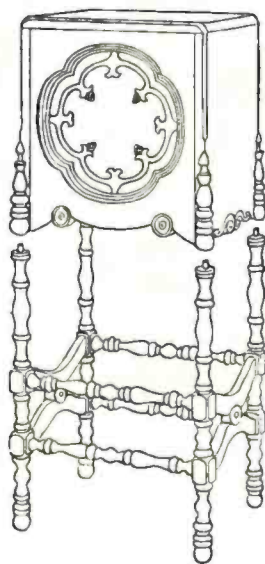

## "The Speaker OF THE YEAR"

—in these cabinets of true Early American design combine the skill of scientist and wood worker to produce an instrument that marvelously reproduces everything from the talking voice to a symphony orchestra.

Write dep't. G for descriptive folder and address of nearest sales office.

Dealers can carry a more complete, convenient and less expensive stock by purchasing separate units.

**WRIGHT DE COSTER, Inc.**

ST. PAUL, MINNESOTA

# THE BIG THREE OF RADIO



## 227

The most perfect detector made — that's why SPEED 227's cost more for us to make, but not for you to buy. Burn-out proof! Fast heating — 5 seconds flat (not by words—by test!)

## 224

New? Not to us. In production in 1928 when demand was only experimental. While others have been announcing, we have been improving. That's what foresight and tube-making experience were able to do.

## 245

Perfected and in production weeks ahead of others. Very rigidly constructed — extra bracing of the elements and special anchoring of filament in the SPEED 245 give added volume and finer tone quality.

**T**HE SPEED Tube line is, of course, complete\*. But these are the "Big Three" now—the ones you're interested in particularly, because they're the ones your customers want. Carry the quality 227's, 224's, 245's,—SPEED—and your tube business is assured.

The SPEED proposition demands the consideration of every wide-awake jobber and dealer as a matter of good business. Work fast—write at once—franchises are going fast.

\* The SPEED line also includes the 201A, 199, X140, WD11, WD12, 200AA, 112A, 171A, 171AC, 210A, 250, 226, 280, 281.



# SPEED

CABLE RADIO TUBE CORPORATION

84-90 No. Ninth St., Brook'yn, N. Y.

MAKERS OF RADIO TUBES SINCE 1924

# LIKE A CAR WITH A BALKED GAS LEVER IN HEAVY TRAFFIC

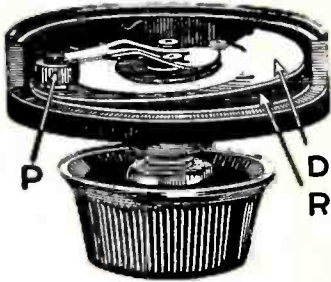

This shows the exclusive rocking disc construction of Centralab volume control. "R" is the resistance. Contact disc "D" has only a rocking action on the resistance. Pressure arm "P" together with shaft and bushing is fully insulated.



This is the action of the usual wire wound control after it has been in use for some time... like dragging a stick over a cobblestone pavement.



The tailor uses the same principle as Centralab. He does not want to ruin the garment by placing the iron on it so he places a cloth in between. Centralab controls cannot ruin the resistance because the rocking disc is in between the pressure arm and the resistance.

YOUR foot on the gas brings a jerky response . . . you're holding up traffic that's anxious to move.

Your variable resistance feeds the "gas" to your radio receiver . . . and there's all the difference in the world if it's a CENTRALAB.

Quiet, even flow of current without a crackle or a sputter . . . that's CENTRALAB performance . . . a scientifically constructed precision resistance control for the modern radio receiver.

Write us for Free Booklet  
 "Volume and Voltage Controls"  
 —Their Uses—

## Centralab

CENTRAL RADIO LABORATORIES

20 Keefe Ave.

Milwaukee, Wis.

THE TECHNICAL DEPARTMENTS OF

WIRE  
 RADIO  
 Emphasizes  
 the  
 "INSIDE"  
 as well as the  
 "OUTSIDE"

80%  
 OF THE GREAT RADIO  
 MANUFACTURERS  
 SPECIFY  
**POLYMET**  
**PRODUCTS**



This statement appeared in our Saturday Evening Post advertising. The publishers investigated its truth before we could use it. We were glad they did for now you can know that "80% equip with Polymet" is not so many words, but so much fact.

Doesn't such overwhelming endorsement of **POLYMET**

Radio Set Essentials speak for itself?

Use the Quality Parts used by the Industry.  
**POLYMET MANUFACTURING CORP.**  
 837 East 134th St. New York City

# 4 SCREEN-GRID TUBES AND POWER-DETECTION!

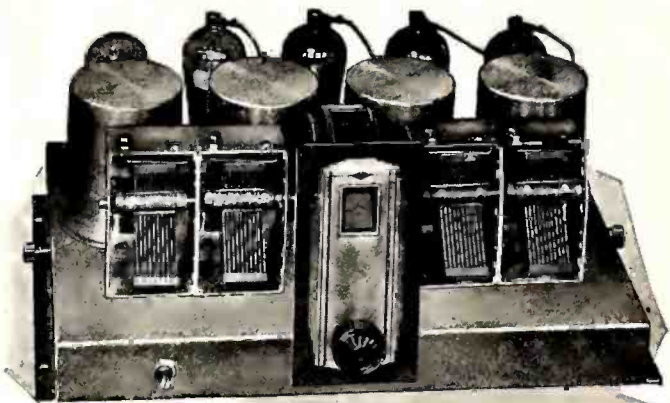

**4 SCREEN-GRID** Tubes for utmost sensitive-ness and distance,—a newly designed system of Power Detection necessary to get the most out of the modern high-percentage-modulation broadcasts;—Band-Pass Tuning for complete separation of stations without any cutting of side-bands,—these are only three of the outstanding features of the new NATIONAL MB-29 Tuner.

The shielded aluminum chassis, precision matched coils, new NATIONAL Projector Dial and Weld-Built Condensers, all make possible the construction of an A. C. Receiver which combines the clean-cut finish and appearance of the finest factory-built model with the quality and perfection of a custom-built job.

There are available a selection of beautifully finished and specially priced consoles and tables for housing the MB-29, in various popular combinations.

NATIONAL CO. INC., Malden, Mass.

Est. 1914

The NATIONAL Velv-tone Amplifier Power Supply is an R C A licensed push-pull power amplifier, sold completely wired, and designed for finest performance with the MB-29. Write today for complete information.

# NATIONAL SCREEN-GRID—MB-29

# Screen Grid Tubes and Power Detectors

Get the Thordarson August Bulletin

Input Couplings  
 Speaker Couplings  
 Filament Supply  
 Power Compacts

For the new "245" power tubes single or push-pull—and the new screen grid power detector.

## THORDARSON

Transformer Specialists Since 1895  
 THORDARSON ELECTRIC MFG. CO.  
 Huron, Kingsbury and Larrabee Streets  
 Chicago, Ill.

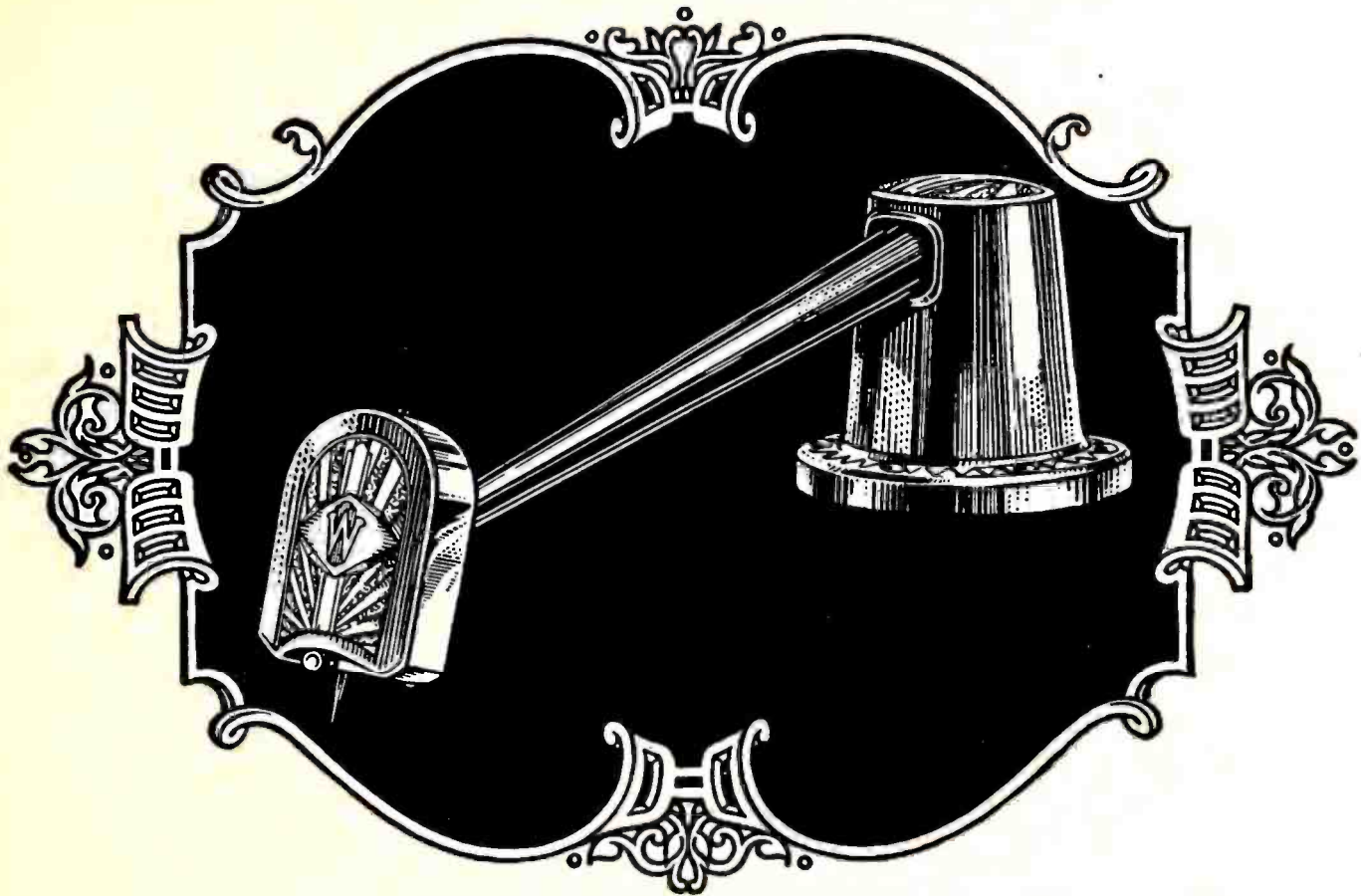

# S U P R E M E !

*in everything that counts in an Electric Pick-up*

**S**ALES-PRODUCING features — engineering leadership, correctness of design, precision manufacture, and a resulting magnificence of tone — you get them all in the newest, finest Webster Electric Pick-up!

What a profitable success it has been for dealers everywhere. The few weeks since its introduction have proved this irrefutable fact:

The public wants Webster's product! They recognize the Webster Electric Pick-up as a perfect medium for the true reproduction of music in any form.

Accurate, life-like interpretation of instrument or voice, in soft whispers or crashing crescendos, determines Webster selection in every comparison.

Webster tone is the logical result of the Webster features listed below. Collectively, they represent the highest pick-up development in the sound-reproduction field.

The new Webster Pick-up is available in two models, each for either battery-operated or A. C. sets. Both models are packed in attractive self-selling cartons—if your jobber has not stocked the Webster, order direct.

### These Features Make the Webster Supreme

- 1—The famous Webster low-inertia stylus bearing, utilizing an all-metal pivoting action, eliminates necessity for bulky construction. Positively no rubber on bearings. Perfect balance is assured.
- 2—The Webster Pick-up head is small and compact, perfectly balanced, light in weight. Weight of head on record only 4½ ozs. No counterbalancing or springs necessary.
- 3—Highest grade Cobalt magnet of greatest possible density is used.
- 4—Shock-absorbing arm bearing with pivot at base — an exclusive Webster development.
- 5—Unique method of turning head with arm to conveniently insert playing needle.
- 6—Volume control incorporated in base—compact and easiest to install — an original Webster feature.
- 7—Base is weighted. Can be screwed to motor board or merely set in place.
- 8—Card completely concealed — all bearings free from play and chatter.
- 9—Construction lends itself easily to use of varied lengths of arm for either standard or talking picture records.

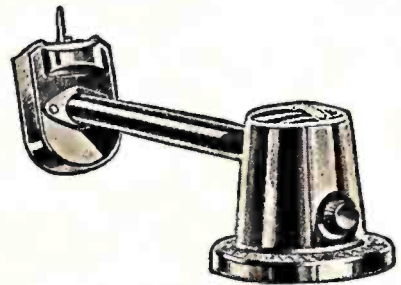

The New Webster Model 2A includes Pick-up head, supporting arm, built-in volume control and adapters.



**The Webster Electric Theater Pick-up**  
This special model is offered for use with 16" records operating at 33½ R. P. M. An adjustable counterbalance makes it possible to correctly control the weight on the record. Provisions are made for mounting of base with rubber bands to obtain vibration-free mounting. Standard length from needle point to center of base is 12", but shorter length may be specified. Finished in instrument black.

Model 2D—Standard Impedance Head .....List \$25.00  
Model 2D-1—Low Impedance Head (200 ohm).....List 30.00  
Model 2D-1 can also be furnished with an impedance matching transformer at \$7.50 extra.



Model 2B includes Pick-up head, separate volume control, and necessary adapters.



# Webster

## W Electric Pick-up

WEBSTER ELECTRIC CO.  
Racine, Wisconsin  
Export Department:  
154 Nassau Street, New York City

# Only the BEST is Good Enough for The FREED RADIO



FREED NR 95 Radio

*Metallized*



DURHAM Metallized RESISTORS and POWEROHMS are available for every practical resistance purpose in radio and television circuits, 500 to 200,000 ohms in power types; 1 to 100 Megohms in resistor types; ratings for all limited power requirements; standard, pigtail, or special tips.

There are many makes of resistance units—but only one DURHAM—the Resistors and Powerohms which are used by leading quality receivers. Freed Radio could cut the cost of their resistances by a small fraction, but their engineers, their dealers, their jobbers and their ultimate consumers get added value in finer reception because FREED RADIO RECEIVERS use Durhams. The presence of Durhams in a receiver is a guide to the quality of all other parts.

We shall be glad to send engineering data sheets and samples for testing upon request. Please state ratings in which you are interested.

THE LEADERS STANDARDIZE ON

# DURHAM

METALLIZED

# RESISTORS & POWEROHMS

INTERNATIONAL RESISTANCE CO.  
2006 Chestnut Street, Philadelphia, Pa.

Something  
NEW



## A Resistance Unit

that embodies an entirely new development in construction—the only doubly-insulated, moisture-proof, wire-wound, non-inductive accurate resistor.  $\frac{3}{32}$  screw terminals permit its instant use in any type of circuit in any convenient manner as well as in standard grid-leak mountings or fuse-clip mountings or by soldering.

## The SUPER AKRA-OHM

besides containing all these unusual features has a very low temperature coefficient, a minimum distributed capacity made to dissipate one watt but will stand an overload without injury. Type 6-M has a tolerance of accuracy of approximately 1% plus or minus. Closer tolerances made on special order.

Complete stock of all values enables us to make immediate shipments. Full information and prices will be furnished promptly on request.

Shallcross Mfg. Company  
ELECTRICAL SPECIALTIES  
700 PARKER AVENUE  
Collingdale, Pa.

## Analyze Set Troubles Accurately & Quickly



Jewell Radio Set Analyzers revolutionize radio servicing. They service screen grid sets, test tubes, and test receivers in service, stage by stage. Binding posts make all instruments available for special tests. Data and instructions simplify servicing, and make it accurate. Every serviceman should have a Jewell. For sale by jobbers everywhere.

## FREE to SERVICEMEN

Jewell Booklet containing data on sets of leading radio manufacturers furnished free to servicemen. Mail coupon today.



Jewell Electrical Instrument Company  
1650 Walnut Street, Chicago, Illinois

Send your booklet, "Instructions for Servicing Radio Receivers," also literature describing Jewell Radio Service Instruments.

Name.....  
Address.....



PLUG in a Falck Claroceptor between wall socket and radio set and eliminate "static" from motors, street cars, telephones and electrical appliances. This new improvement by a pioneer radio parts manufacturer grounds and thus blocks out line interference noise and radio frequency disturbances. Also improves selectivity and distance. Requires no changes in set. Measures just  $3\frac{1}{2}$  x  $5\frac{1}{2}$  x  $2\frac{1}{2}$  inches. Thousands now all over America use the Claroceptor for clearer A. C. reception. Get one right away—at radio parts dealers. Write for descriptive folder.

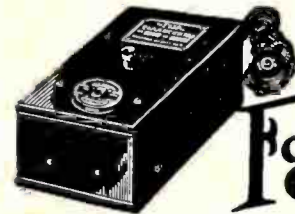

\$7.50 complete with cord and plug

# Falck

## CLAROCEPTOR

Built by ADVANCE ELECTRIC CO.  
1260 W. Second St. Los Angeles, Calif.  
JOBBERs and DEALERS, GET OUR PROPOSITION

# AEROVOX

BUILT BETTER  
CONDENSERS AND RESISTORS

## Moulded Mica Condenser Acknowledged Standard

ACCURACY, minimum dielectric losses and freedom from change under the influence of varying temperature, weather and chemical action have contributed to the acknowledged pre-eminence of the moulded mica condenser for use in radio frequency circuits.

In Aerovox Moulded Mica Condensers—made in a variety of shapes and sizes to fit every requirement—only the best grade of India Ruby mica, pure tinfoil plates and high quality bakelite are employed. High quality materials, skilled workmanship and constant research combine to produce a moulded mica condenser that is accurate, permanent and efficient.

### Send for Catalog

Complete specifications of Aerovox moulded mica condensers and other units are contained in a complete catalog that will be sent free of charge on request.

The Research Worker contains, each month, valuable information on radio design. It will be sent free on request.

AEROVOX WIRELESS CORP.  
76 1/2 Washington St., Bklyn, N. Y.  
PRODUCTS THAT ENDURE





# With EVEREADY RAYTHEON 4-PILLAR Tubes, you can get the MOST from your present radio receiver

PEOPLE in all parts of the country are telling of the greater power, increased distance, improved tone, and quick action of these remarkable new tubes. The reason is that

Eveready Raytheons are built stronger—immune to the bumps and jolts of shipment and handling. They come to you in as perfect condition as when they leave our laboratory test room.

types. At your dealer's. He also has the famous B-H tube for "B" eliminator units.

NATIONAL CARBON CO., INC.  
General Offices: New York, N. Y.

Unit of  and Carbon Corporation



Showing the exclusive, patented Eveready Raytheon 4-Pillar construction. Note the sturdy four-cornered glass stem, the four heavy wire supports, and the bracing by a stiff mica sheet at the top.

The Eveready Raytheon 4-Pillar construction is exclusive and patented. Examine the illustration at the bottom of this page. See how the elements of this tube are anchored at eight points.

This is of particular importance in tubes of the 280 rectifier and 224 screen-grid type which have heavier elements, and in tubes used for push-pull audio amplification, where uniform characteristics are most essential. Eveready Raytheon 4-Pillar Tubes come in all



Eveready Raytheon Screen-Grid Tube, ER 224. Without Eveready Raytheon's 4-Pillar construction, this type of tube is delicate, liable to severe damage in shipment.



Trade-marks

# RADIO BROADCAST

WILLIS KINGSLEY WING . . . . . Editor  
 KEITH HENNEY . . . . . Director of the Laboratory  
 HOWARD E. RHODES . . . . . Technical Editor  
 EDGAR H. FELIX . . . . . Contributing Editor



VOL. XV. NO. 5

PUBLISHED FOR THE RADIO INDUSTRY

## Contents for September, 1929

### MERCHANDISING SECTION

House to House Selling - - - - -	253
The Dealer and the Finance Company - G. S. Corpe	256
That Trade Gossip - - - - - Howard W. Dickinson	258
How Tube Sales Go - - - - - T. A. Phillips	260
"The Court Decides" - - - - - Leo T. Parker	261
The Little Red School House Comes to Market B. H. Darrow	263
Radio Vs. Auto Service - - - - - John S. Dunham	266
Clippings - - - - - What Radio Men Say	268
Professionally Speaking - - - - - Keith Henney	269
What Cost Engineering? Uniform Selectivity in 1930?	
A Word to the Wise is Sufficient	
An Estimate of Set Sales - - - - - T. A. Phillips	270
The March of Radio - - - - - An Editorial Interpretation	272
Tying In With Aviation A Fortune for a Feature	
Let Dealers Write Advertising Paramount in Broadcasting	
The WCFL Controversy Judges Become Commissioners	
In the Radio Marketplace - - - - - News of the Industry	274
New Receivers Announced News from Distributors	
Miscellaneous New Apparatus News of the Industry	
Personal Notes	
The Tube Business - - - - -	278
The Serviceman's Corner - - - - -	279
Why Servicemen Go Home Reducing Man-Made Static	
Tube Troubles Service Managers Organize	
Miscellaneous Kinks	
Strays from the Laboratory - - - - - Technical Shorts	282
Regarding Cross Talk Comparison of Noise Intensities	
The Berne Radio List Grid Leak Condenser Detection	
Municipal Radio Laws	

### ENGINEERING SECTION

Copper-Oxide Rectifier Voltmeters - - - R. J. Kryter	287
Designing R. F. Circuits for the 224 Benedict V. K. French	290
"Radio Broadcast's" Set Data Sheets - - - - -	293
Rrandes Models B-15 and B-16 The Continental Model R-30	
Quality Control of Radio Production - - - David Sonkin	294
Advantages of Pre-Selection - - - - - Jacob Yolles	295
The Light Bulb—A Handy Resistor William H. Wenstrom	297
Designing Coils for the Modern Set Hugh S. Knowles	299
Radio Broadcast Laboratory Information Sheets Howard E. Rhodes	301
No. 296. Output transformer Ratios	
No. 297. Output transformer Ratios	
No. 298. Circuits for the 245-type tube	
No. 299. Circuits for the 245-type tube	
No. 300. Center-tapped Filament Resistors	

The contents of this magazine is indexed in *The Readers' Guide to Periodical Literature*, which is on file at all public libraries

... among other things

THE many readers of this magazine who are interested in the selling of radio and all that pertains to it have welcomed the division of our articles into the two distinct sections of the magazine. The Merchandising section of RADIO BROADCAST contains interesting and useful information about selling problems as they are and as we would like them to be. It happened that in our August issue, wholesalers and retailers from many different parts of the country found a number of our articles notable enough to request reprints. These were gladly furnished and it is our hope that they were of help in the merchandising of radio—a continual problem of this industry in which RADIO BROADCAST is primarily interested.

THOSE primarily interested in radio selling will find the issue now before them of more than usual service. A successful house-to-house selling plan is described in the story beginning on page 253; comments on deferred payments selling are helpfully made by G. S. Corpe (page 256) who has been on the firing line for years; Howard Dickinson, a merchandising authority of national reputation, discusses trade gossip and its evils (page 258); the annual behavior of tube sales are detailed on page 260—and interesting information it is too; and B. H. Darrow, who has been associated with schools for many years, outlines the size of the radio school market (page 263).

THE October RADIO BROADCAST will present many short articles on the most useful sales ideas, tested in the furnace of practical experience, a discussion of the best means of advertising a local radio shop, a consideration of the merchandising plans for the current year to meet new problems, and many other articles written from a practical background.

THE technical section will contain a description, published for the first time anywhere, of the new Stromberg-Carlson automatic volume control set, an engineering discussion of the British pentode tube (about which we are going to hear much more in this country as the months roll by), and an unusual article on detection problems by a tube engineer of national repute. These articles are all in addition to the regular features which regularly appear and which have become so popular.

—WILLIS KINGSLEY WING.

TERMS: \$4.00 a year; single copies 35 cents; All rights reserved. Copyright, 1929, in the United States, Newfoundland, Great Britain, Canada, and other countries by

DOUBLEDAY, DORAN & COMPANY, INC., Garden City, New York

MAGAZINES . . . . . WORLD'S WORK . . . THE AMERICAN HOME . . . RADIO BROADCAST . . . SHORT STORIES . . . LE PETIT JOURNAL . . . EL ECO . . . WEST COUNTRY LIFE . . .

BOOK SHOPS (Books of all Publishers) . . . . .

NEW YORK: <LORD & TAYLOR, JAMES MCCREERY & COMPANY, PENNSYLVANIA TERMINAL, 166 WEST 32ND ST., 848 MADISON AVE., 51 EAST 44TH STREET, 420, 526, and 819 LEXINGTON AVENUE, GRAND CENTRAL TERMINAL, 10 WALL STREET> ATLANTIC CITY: <2807 BOARDWALK> CHICAGO: <75 EAST ADAMS STREET> ST. LOUIS: <223 N. 8TH ST. and 4914 MARYLAND AVE.> CLEVELAND: <HIGBEE COMPANY> SPRINGFIELD, MASS: <MEEKINS, PACKARD & WHEAT.

OFFICES . . . . .

GARDEN CITY, N. Y. NEW YORK: 244 MADISON AVENUE. BOSTON: PARK SQUARE BUILDING. CHICAGO: PEOPLES GAS BUILDING. SANTA BARBARA, CAL. LONDON: WM. HEINEMANN, LTD. TORONTO: DOUBLEDAY, DORAN & GUNDBY, LTD.

OFFICERS . . . . .

F. N. DOUBLEDAY, Chairman of the Board; NELSON DOUBLEDAY, President; S. A. EVERITT, Vice-President; GEORGE H. DORAN, Vice-President; RUSSELL DOUBLEDAY, Secretary; JOHN J. HESSIAN, Treasurer; LILLIAN A. COMSTOCK, Ass't Secretary; L. J. MCNAUGHTON, Ass't Treasurer

# will you trust your ears ?

By the only standard which gauges sales success—the ears of the purchaser—the T·C·A Dynamic is a better speaker.

T·C·A's claim for superiority does not hang on the slender thread of a detail here or a detail there. It does not hang on an obscure characteristic of only academic interest.

It hangs on a definite and perfectly apparent *tone value* that impresses itself not only upon the critical ear of the engineer, but upon the unpracticed ear of the ultimate layman who buys the set.

After all, the most important function of a speaker is to *faithfully* reproduce the broadcast program.

It is this characteristic that sells the set and pays the dividends.

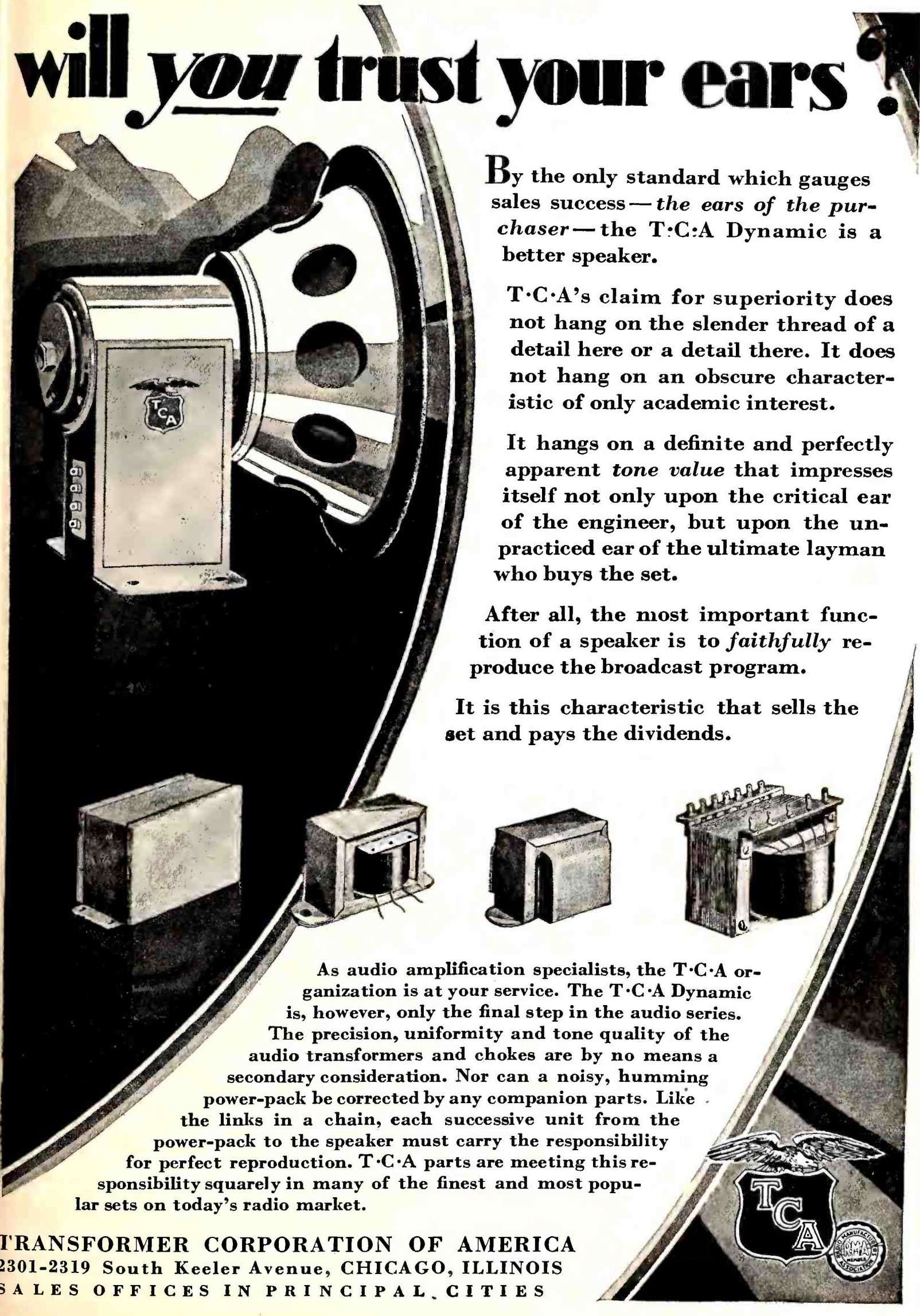

As audio amplification specialists, the T·C·A organization is at your service. The T·C·A Dynamic is, however, only the final step in the audio series. The precision, uniformity and tone quality of the audio transformers and chokes are by no means a secondary consideration. Nor can a noisy, humming power-pack be corrected by any companion parts. Like the links in a chain, each successive unit from the power-pack to the speaker must carry the responsibility for perfect reproduction. T·C·A parts are meeting this responsibility squarely in many of the finest and most popular sets on today's radio market.



**TRANSFORMER CORPORATION OF AMERICA**  
2301-2319 South Keeler Avenue, CHICAGO, ILLINOIS  
SALES OFFICES IN PRINCIPAL CITIES

SECOND CHURCH OF CHRIST, SCIENTIST, BOSTON, MASS., PAM EQUIPPED



PAM  
9

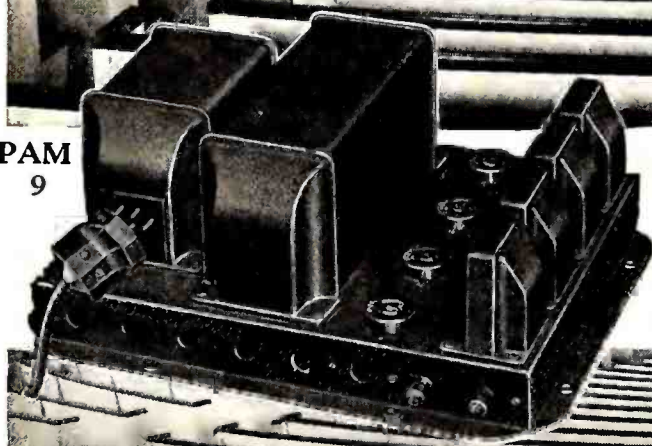

# PAM increases seating capacity



**B**ECAUSE of the PAM installation no one need stand or be turned away for lack of seats at the Second Church of Christ, Scientist, Boston, as long as there is a seat available in the Sunday School Room or other parts of the church.

Every word of the speaker is picked up by microphone and PAM amplified for the loud speakers, which deliver it crystal clear to the overflow assemblages.

Every church or parish house is a logical prospect for PAM equipment for this or entertainment purposes, and every radio dealer should see to its installation.

A new 16-page bulletin giving mechanical and electrical characteristics, representative installations and many new PAM amplifiers will be sent upon receipt of 10c in stamps to cover postage. When writing ask for bulletin No. R.B.-10.

Main Office:  
Canton, Mass.

*Samson Electric Co.*

MEMBER  
**RMA**

Manufacturers Since 1882

Factories at Canton  
and Watertown, Mass.



# House to House SELLING

**A**

AFTER EIGHTEEN months of experience, a small but active organization in New York City has proved to its own satisfaction that the principle of house-to-house canvassing, so successful in selling washing machines, vacuum cleaners, and other electrical appliances, can be applied to radio receiving sets with profit. Furthermore, the two men behind Reynolds Radio, Inc., of 130 West 42nd Street, New York City, have found that when properly modified and amplified to fit the particular needs of the trade, the house-to-house method of radio sales has produced greater profits than can be expected from the less intricate and supposedly more stable appliance lines.

The two men, K. L. Saunders and Herman Resnick, started on January 1, 1928, with what Mr. Saunders describes as "two salesmen, ourselves, and an idea." The two salesmen were good, Saunders and Resnick had worked successfully together in managing a direct-to-consumer washing-machine business, and the idea seemed to have a few more advantages than disadvantages.

## *Disadvantages of Plan*

The disadvantages which militate against a house-to-house selling business in New York City are more numerous in the radio trade than in any other, especially so since Saunders and Resnick decided to confine their efforts to Manhattan and the Bronx. There are almost as many radio stores in those boroughs as there are drug-stores. The New York newspapers carry more radio advertising of retail shops than do the papers in any other city, and a large proportion of those shops are cut-

## *How Two Young Men Built Up a Paying Business in New York City*

price stores. Furthermore, house-to-house selling is of necessity a time-payment business, and with one-third of New York's population "transient," and one-quarter of the "permanent" residents addicted to moving to new addresses on every October 1st, the possibilities for lost sets and untraceable debtors are large.

## *The Advantages*

To offset those drawbacks, Saunders and Resnick figured that the all-electric set has a greater appeal to apartment dwellers than it has to house-owners, a greater appeal to the always-busy New Yorker than to the suburbanite who has long evenings in which to tinker over his own concoction or keep his old set in good condition. They balanced the possibilities of absconding debtors against the natural honesty of human nature and the highly developed credit statistics available to all New York merchants through the credit associations. And they knew that a radio set is a luxury, and that people will buy luxuries for the home far more readily than they will buy such efficient labor-saving appliances as washing machines.

At the end of the first year, they had a force of fifteen salesmen, had done a gross business of \$157,000, and cleared a net profit of \$15,000, or 15 per cent. And they had found some very interesting facts.

"From the beginning, we handled only one line of sets. We have found that our policy has more than justified itself. Our salesman know the set thoroughly, and have confidence in it. The customer feels that if we didn't think it was the best set, we wouldn't be banking on it to the exclusion of others.

And by handling only one line, our service problem is simplified, and we are sure that our servicemen can give expert work and satisfaction. Once the set is installed and has been serviced, subsequent complaints can often be handled over the telephone. At the present time, we are giving service satisfaction by telephone in about 20 per cent. of our complaints, since we can diagnose the trouble from the customer's description."

The average contract has been for \$200, and the medium-class market has been the best. Some business has been done in the very wealthy districts, and a little in the very poor, but the people who are buying radio sets are those in the middle level of salary and social position.

The quality of service rendered has been the determining factor in clinching the house-to-house sales, and Saunders and Resnick have built up a service department which few if any retail stores have attempted to equal. The installation problems in New York apartments have made an "interference elimination" department absolutely necessary, and the work of that department has in turn brought increased business to the salesmen.

Sets are never sold at less than list prices, despite the competition of cut-price stores, and with the quality of service which accompanies that higher price, only one customer out of every three hundred has made any complaint regarding the initial cost.

The policies and practices of the successful house-to-house canvass are best illustrated by taking a theoretical case. The salesman makes his contact, interests the customer, and arranges to have a set installed for demonstration. No sales contracts are signed until after the customer has heard the set in actual operation in his or her home, and is satisfied with its performance. If the delivery-man who makes the installation finds that there is interference or noise, he will not let the customer accept the set until it has been serviced by the interference-elimination department. If the interference-elimination is successful, the customer pays for the cost of the materials (the filter condensers and so on), but pays nothing for the labor involved. If the interference cannot be eliminated, the set is not sold.

### *One Year Guarantee*

All sets are sold with a service guarantee of one year, and a six-months guarantee on tubes. A record card of each set sold, showing the date of sale, with customer's and salesman's name, details of installation work, and individual records of each service call during the year, is kept at the office.

If a set proves faulty, or otherwise in need of repair, it is removed from the customer's home and another one substituted during the time required for repairs.

"We never let a repairman work on the interior of a set in the customer's home, where the customer can see him fiddling around with a soldering iron or puzzling over a diagnosis. We pull the set right out, replacing it with a good set. In many cases, we leave the loaned set there permanently, and, after the other set has been reconditioned to our satisfaction, we treat it as a new set. Our follow-up service system assures us that there will be no dissatisfaction from the purchaser of the set, since if we can't recondition it properly we discard it,"

Mr. Saunders explained.

The operations of the interference-elimination department can be shown by one incident, where the cost to the customer ran to the unusual total of \$127.50. The usual cost varies from \$7.50 to \$20. The customer was a wealthy man, living in a large cooperative apartment. He had never been able to get a radio set that suited him, because no dealer could eliminate the house interference. The Reynolds man went to work, and before he was through he had to take care of interference from six elevators, five service pumps, and eight electric ice-boxes. The customer was more than pleased, paid the cost of materials gladly, and, as a result of that work, the salesman was able to place two other sets in the same apartment.

In several apartments, where house interference had made radio reception virtually impossible, the salesman have arranged with four, six, or eight prospective customers to share the cost of eliminating

the interference, and in every such case each prospective customer signed a sales contract gladly as soon as the interference was removed.

### *Quoting Prices*

The Reynolds salesman always quote the final price to the prospective customer. They are not permitted to use the "less tubes" or "less speaker" quotations. The price given the customer at first approach is the price he will pay for the set complete, installed, and in actual operation, unless there is an interference-elimination charge.

Frank confession of previous troubles in "bad" areas is also a first tenet of the Reynolds sales policy. No set is sold without actual trial in the location where it will be used, and in some cases sets are removed against the prospective customer's wishes.

"We've found that if the set doesn't function to suit our servicemen's standards, there is no sense in leaving it there, even though the customer says he doesn't mind the interference or the other deficiencies. Sooner or later, the customer will mind them, and then we will be in for more service trouble than the sale is worth. Sometimes, of course, if the customer insists that he wants the set and is willing to forego the guarantee which we won't give him, the set is sold. There was one



*Keith L. Saunders*

case like that, a man who lived in the same building with a beauty parlor. We couldn't eliminate the interference, we tried three different types of filters without getting results that suited us, and finally we told him we couldn't give him the kind of radio service we insist on giving, so we took the set out. A few weeks later, he came in, said he missed the radio, and bought the set because, even with the poor reception he got, he liked it," Saunders said.

Service within twenty-four hours of every complaint has been a fixed rule of the company ever since it started. That service is possible because

of the accessibility of all of the company's customers, the boroughs of Manhattan and the Bronx being easily divided into service districts.

Repossessions, or charge-backs, sets which have had to be removed because the customers failed to pay up their installments, amounted to 2 per cent. of the gross business in 1928, and will be smaller in the future because of added safeguards now taken by the company. One thing that the Reynolds company learned during its first year was never to install sets on trial just before an important prize-fight, election, or other

### COST OF OPERATION

#### Sales Expenses

Service .....	\$5,345.29
Advertising.....	220.65
Trade-in allowance.....	1,014.13
Installations .....	2,588.53
Installation supplies.....	1,580.75

#### General Expenses

Office rent.....	\$ 2,250.00
Stationery, printing.....	766.83
Telegrams.....	104.09
Telephones.....	525.54
Office salaries.....	11,382.00

#### Income

Gross sales.....	\$157,152.91
Regular sales (cash).....	31,724.50
Net profit.....	15,095.90

major broadcast attraction. The rule now is that no sets are sent out on trial on the two days preceding such events.

"Ninety-five per cent. of the repossessions were due to outside misfortunes which made it impossible for the customers to continue payments, and are the natural hazards of installment selling. Many of those repossessions, however, were transferred directly to friends of the original customer with the service guarantee still in force," said Mr. Resnick. "Less than one-half of one per cent. of our sets were stolen by customers moving away before their payments were completed."

In the accompanying table are figures of sales and general expenses for the year 1928. These will make interesting comparison with those of retail store dealers in the same area. The figures are not completely reproduced here, only the more important and unusual items having been selected. Office salaries were about \$5,000.00 larger than necessary during the first year of operation (1928), owing to what Mr. Saunders calls "our experiments and inexperience." They will be considerably lower than the 1928 figure this year, despite the expansion of the business.

## HOW RETURNS AND ALLOWANCES VARY WITH VOLUME OF BUSINESS

**T**HE PRELIMINARY report on the National Retail Credit Survey, recently released by the Domestic Commerce Division of the Department of Commerce, includes statistics on the percentage of bad debts on open and installment credit sales for department stores, automobile dealers, and independent retail grocery stores reporting by April 13, 1929.

The open credit loss, in the case of both department and grocery stores, was found to vary inversely with the size of establishments, i.e., the larger the store the smaller the proportion of open-credit loss. No such relationship was found between the size of department stores and their installment-credit losses.

The average loss for the 440 department stores reporting, representing the ratio of total bad debts to total open and installment credit sales, was 0.4 per cent. on open-credit accounts and 1.1 per cent. on installment accounts. Chain department stores had an average loss on open-credit sales of 0.8 per cent. and on installment sales of 1.3 per cent. compared with 0.4 per cent. and 1.0 per cent. for other department stores.

The 339 automobile dealers, on the other hand, lost less on their installment accounts than on open-credit sales, bad debts representing 0.4 per cent. of installment credit and 0.9 per cent. of open-credit sales.

The percentage of bad debts on open-credit accounts for

the 843 grocery stores doing cash and credit business was 0.6 per cent., the range being from 4.9 per cent. loss for stores with total sales under \$9000 to 0.4 per cent. for stores with total sales of \$250,000 and over.

### VALUE OF CREDIT INFORMATION

**T**HE data collected in the study of credit conditions among Louisville retail grocery stores showed that, as a rule, the credit stores which used a credit bureau had a lower percentage of bad debts than those which did not. The difference is brought out by the following table:

VOLUME GROUP OF STORES	NO. OF STORES	AVERAGE BAD DEBT LOSSES	
		With Credit Bureau	Without Credit Bureau
Under \$5000	10	9.4%	11.6%
\$5000 to \$9000	9	2.4	5.5
\$10,000 to \$24,000	59	2.7	3.9
\$25,000 to \$49,000	52	1.3	1.7
\$50,000 to \$99,000	25	0.5	1.1
Over \$100,000	10	0.4	0.3

Retail radio dealers who are not using credit information available to them through their local Merchant's Association credit bureau should investigate the cost and compare it with the cost of doing without it. It is especially interesting in examining these Louisville figures to note that the most severe losses were not in the largest volume stores but those doing less than \$10,000 annually.

# THE DEALER

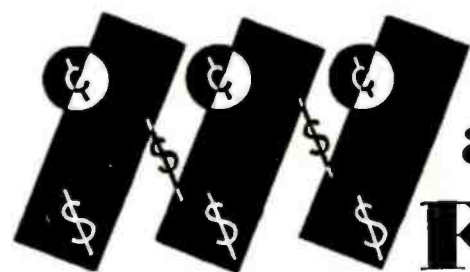

# and the FINANCE COMPANY

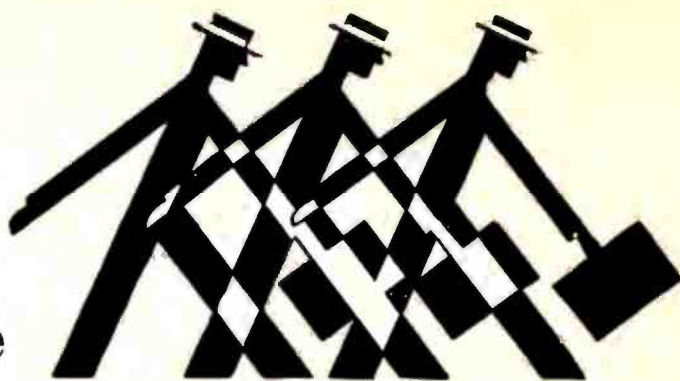

By G. S. CORPE

**Y**OU KNOW, although all of us prefer other parts of our business, the financial side of it just must have at least a small portion of our attention and effort. Whether we like it or not, we have to mix in a little collecting of slow accounts with shooting bugs out of somebody's bum radio; and we are forced to call on our banker once in a while, along with our calling on prospects for a new model radio receiver.

Regardless of how much money a radio dealer may have, it seems to be the consensus that it is best to let a finance company handle and collect time-sale paper. And now-a-days, when 85 per cent. or more of our sets are sold on the monthly payment plan, what dealer has not a connection with some

sort of a finance company? That is what we wish to talk about here—your relations, as a dealer, with a finance company.

It doesn't matter much whether the party who handles your paper is a big million-dollar corporation, or just a well-heeled friend; there are certain things in connection with your relationship that deserve the same careful attention that your advertising, servicing, selling, or any other department gets.

Speaking broadly, the good old Golden Rule covers the subject. Don't try any "fast ones" on your bank or finance company that you wouldn't want to have tried on you, were your positions reversed. Handle every transaction with your financier just exactly like you would wish him to do for you.

If he asks that you get one-third down on all sets sold on contract, get one-third down. Don't try to get by with a

Table Shows Cost of Financing Radio Installations of Various Values

(These data were prepared from the rate table of one of the largest finance companies handling radio paper, and are considered representative.)

UN-PAID** BALANCE	TOTAL COST OF FINANCING OVER A PERIOD OF*							COST OF SET (APPROXIMATE†)	DOWN PAYMENT	UN-PAID** BALANCE	TOTAL COST OF FINANCING OVER A PERIOD OF*							COST OF SET (APPROXIMATE†)	DOWN PAYMENT										
	4 Mos.	6 Mos.	8 Mos.	10 Mos.	12 Mos.	15 Mos.	18 Mos.				4 Mos.	6 Mos.	8 Mos.	10 Mos.	12 Mos.	15 Mos.	18 Mos.												
\$ 55	\$ 8	\$ 8						\$ 69	\$ 14	\$280	\$11.20	\$14.00	\$16.80	\$19.60	\$22.40	\$28.00	\$30.80	\$350	\$ 70	\$285	\$11.40	\$15.25	\$17.10	\$19.95	\$22.80	\$28.50	\$31.35	\$356	\$ 71
60	8	8						75	15	290	11.60	14.50	17.40	20.30	23.20	29.00	31.90	363	73	300	12.00	15.00	18.00	21.00	24.00	30.00	33.00	375	75
65	8	8						81	16	305	12.20	15.25	18.30	21.35	24.40	30.50	33.55	381	76	310	12.40	15.50	18.60	21.70	24.80	31.00	34.10	388	78
70	8	8						88	18	315	12.60	15.75	18.90	22.05	25.20	31.50	34.65	394	79	320	12.80	16.00	19.20	22.40	25.60	32.00	35.30	400	80
75	8	8	\$10					94	19	325	13.00	16.25	19.50	22.75	26.00	32.50	35.75	406	81	330	13.20	16.50	19.80	23.10	26.40	33.00	36.30	413	83
80	8	8	10					100	20	335	13.40	16.75	20.10	23.45	26.80	33.50	36.85	419	84	340	13.60	17.00	20.40	23.80	27.20	34.00	37.40	425	85
85	8	8	10					106	21	345	13.80	17.25	20.70	24.15	27.60	34.50	37.95	431	86	350	14.00	17.50	21.00	24.50	28.00	35.00	38.50	438	88
90	8	8	10	\$10				112	22	355	14.20	17.75	21.30	24.85	28.40	35.50	39.05	444	89	360	14.40	18.00	21.60	25.20	28.80	36.00	39.60	450	90
95	8	8	10	10				119	24	365	14.60	18.25	21.90	25.55	29.20	36.50	40.15	456	91	370	14.80	18.50	22.20	25.90	29.60	37.00	40.70	463	93
100	8	8	10	10				126	26	375	15.00	18.75	22.50	26.25	30.40	37.50	41.25	469	94	380	15.20	19.00	22.80	26.60	30.80	38.00	41.80	475	95
105	8	8	10	10				132	27	385	15.40	19.25	23.10	26.95	30.80	38.50	42.35	481	96	390	15.60	19.50	23.40	27.30	31.20	39.00	42.90	488	98
110	8	8	10	10	\$12			138	28	395	15.80	19.75	23.70	27.65	31.60	39.50	43.45	494	99	400	16.00	20.00	24.00	28.00	32.00	40.00	44.00	500	100
115	8	8	10	10	12			144	29	410	16.20	20.25	24.30	28.40	32.40	41.00	44.20	505	101	420	16.80	21.00	25.20	29.40	33.60	42.00	46.20	525	105
120	8	8	10	10	12			150	30	430	17.00	21.50	26.00	30.80	35.20	44.00	48.40	550	110	440	17.60	22.00	26.40	31.60	36.00	45.00	50.00	563	113
125	8	8	10	10	12			156	31	450	18.00	22.25	26.70	31.15	35.60	44.50	48.95	556	111	460	18.40	22.50	27.00	31.50	36.00	45.00	50.00	569	114
130	8	8	10	10	12			163	33	470	18.80	23.00	27.30	31.85	36.40	45.50	50.05	569	114	480	19.20	23.50	27.90	32.25	37.20	46.50	51.15	581	116
135	8	8	10	10	12			169	34	490	19.20	23.75	28.10	32.60	37.20	47.00	51.70	588	118	500	19.60	24.00	28.40	33.00	38.00	48.00	52.80	600	120
140	8	8	10	10	12			175	35	510	19.60	24.50	29.10	33.45	38.00	48.50	53.35	606	121	520	20.00	25.00	29.60	34.00	39.00	49.50	54.50	619	124
145	8	8	10	10	12			181	36	530	20.00	25.00	29.60	34.30	39.20	49.50	54.75	625	125	540	20.40	25.50	30.00	34.65	40.00	50.50	55.55	631	126
150	8	8	10	10	12			188	38	550	20.40	25.50	30.00	35.00	40.40	51.00	56.10	638	128	560	20.80	26.00	30.40	35.35	40.80	51.50	56.65	644	129
155	8	8	10	10	12	12.40		194	39	570	20.80	26.00	30.40	35.35	41.20	52.00	57.20	650	130	580	21.20	26.50	30.80	35.70	41.60	52.50	57.50	656	131
160	8	8	10	11	12	12.80	\$16	200	40	590	21.20	27.00	31.20	36.00	42.00	53.00	58.40	663	132	600	21.60	27.50	31.60	36.35	42.40	53.50	58.75	670	133
165	8	8.25	10	11	12	13.20	16.50	206	41	610	22.00	28.00	32.40	37.20	43.20	54.00	59.60	670	133	620	22.40	28.50	32.80	37.60	43.60	54.50	60.00	676	134
170	8	8.50	10.20	11	12	13.60	17.00	213	43	630	22.80	29.00	33.60	38.40	44.40	55.00	60.80	676	134	640	23.20	29.00	33.60	38.00	44.00	55.00	60.80	682	135
175	8	8.75	10.50	12	12	14.00	17.50	219	44	650	23.60	29.50	34.80	39.60	45.60	56.00	62.00	682	135	660	24.00	30.00	34.80	39.00	45.00	56.00	62.00	688	136
180	8	9.00	10.80	12	12	14.40	18.00	225	45	670	24.40	30.00	36.00	40.80	46.80	57.00	63.20	688	136	680	24.80	30.50	36.00	40.20	46.20	57.00	63.20	694	137
185	8	9.25	11.10	12	12	14.80	18.50	231	46	690	25.20	31.00	37.20	41.40	47.40	58.00	64.40	694	137	700	25.60	31.50	37.20	40.80	47.00	58.00	64.40	700	138
190	8	9.50	11.40	13	13	15.20	19.00	237	47	710	26.00	32.00	38.40	42.00	48.00	59.00	65.60	700	138	720	26.40	32.50	38.40	41.40	48.00	59.00	65.60	706	139
195	8	9.75	11.70	13	13	15.60	19.50	243	48	730	26.80	33.00	39.60	42.60	48.60	60.00	66.80	706	139	740	27.20	33.50	39.60	42.00	48.60	60.00	66.80	712	140
200	8	10.00	12.00	14	14	16.00	20.00	250	50	750	27.60	34.00	40.80	43.20	49.20	61.00	68.00	712	140	760	28.00	34.50	40.80	42.60	49.20	61.00	68.00	718	141
205	8.20	10.25	12.30	14	14	16.40	20.50	256	51	770	28.40	35.00	42.00	43.80	50.00	62.00	69.20	718	141	780	28.80	35.50	42.00	43.20	50.00	62.00	69.20	724	142
210	8.40	10.50	12.60	14	14	16.80	21.00	263	53	790	29.20	36.00	43.20	44.40	51.00	63.00	70.40	724	142	800	29.60	36.50	43.20	43.80	51.00	63.00	70.40	730	143
215	8.60	10.75	12.90	15	15	17.20	21.50	269	54	810	30.00	37.00	44.40	45.00	52.00	64.00	71.60	730	143	820	30.40	37.50	44.40	44.40	52.00	64.00	71.60	736	144
220	8.80	11.00	13.20	15	15	17.60	22.00	275	55	830	30.80	38.00	45.60	45.00	53.00	65.00	72.80	736	144	840	31.20	38.50	45.60	45.00	53.00	65.00	72.80	742	145
225	9.00	11.25	13.50	15	15	18.00	22.50	281	56	850	31.60	39.00	46.80	45.60	54.00	66.00	74.00	742	145	860	32.00	39.50	46.80	45.60	54.00	66.00	74.00	748	146
230	9.20	11.50	13.80	16	16	18.40	23.00	288	58	870	32.40	40.00	48.00	46.20	55.00	67.00	75.20	748	146	880	32.80	40.50	48.00	46.20	55.00	67.00	75.20	754	147
235	9.40	11.75	14.10	16	16	18.80	23.50	294	59	890	33.20	41.00	49.20	46.80	56.00	68.00	76.40	754	147	900	33.60	41.50	49.20	46.80	56.00	68.00	76.40	760	148
240	9.60	12.00	14.40	16	16	19.20	24.00	300	60	910	34.00	42.00	50.40	47.40	57.00	69.00	77.60	760	148	920	34.40	42.50	50.40	47.40	57.00	69.00	77.60	766	149
245	9.80	12.25	14.70	17	17	19.60	24.50	306	61	930	34.80	43.00	51.60	48.00	58.00	70.00	78.80	766	149	940	35.20	43.50	51.60	48.00	58.00	70.00	78.80	772	150
250	10.00	12.50	15.00	17	17	20.00	25.00	313	63	950	35.60	44.00	52.80	48.60	59.00	71.00	80.00	772	150	960	36.00	44.50	52.80	48.60	59.00	71.00	80.00	778	151
255	10.20	12.75	15.30	17	17	20.40	25.50	319	64	970	36.40	45.00	54.00	49.20	60.00	72.00	81.20	778	151	980	36.80	45.50	54.00	49.20	60.00	72.00	81.20	784	152
260	10.40	13.00	15.60	18	18	20.80	26.00	325	65	990	37.20	46.00	55.20	49.80	61.00	73.00	82.40	784	152	1000	37.60	46.50	55.20	49.80	61.00	73.00	82.40	790	153
265	10.60	13.25	15.90	18	18	2																							



contract with only one-fourth down; and let's not try the old trick of "bubbling" the contract, so that it appears that the total price and the down payment are more than they actually are; finance people make it their business to have full knowledge of prices on all sets they will handle paper on.

If your financier asks that payments do not run longer than 10 months, make all your contracts that way. Don't bother him by asking him to make a special exception and take on a 12-month contract just because you know the buyer is good pay, or because he is a close friend of yours, or for any other reason.

Probably one of the most common causes for a falling-out between a radio dealer and his finance company is the failure to cooperate in making collections. The payments on radio paper are usually of such a small amount that the finance company cannot afford to be sending out a collector, and depends upon the dealer to take care of delinquent payments. The usual procedure is to send a past-due notice when the payment becomes five days delinquent; then another stronger one ten days after the due date; and usually a final notice five days later, or 15 days after the due date. The dealer gets copies of these past-due notices. And if he wants to continue to get along with his financier, he will get busy and find out why the payment has not been made—just as soon as he gets the first notice, and without letting a second notice become necessary. Don't throw that notice in the waste-paper basket and just hope the customer will pay soon; give it honest attention, right away. You will find that prompt collecting on any slow accounts will help you in more ways than one. It increases the respect of not only the finance company for you, but actually of the customer, also. And remember that a prompt follow-up may often save you from a serious loss.

Why a customer will sign a contract, setting forth payments on certain dates and then proceed promptly to forget it, is a mystery; but it seems to be human nature, which we cannot change; and the live-wire dealer will be right on the job reminding his customer and getting the money.

Advertising your ability to sell sets on monthly payments in a judicious way will often give you a profit that otherwise might be lost. The angle of this depends upon the community where you do business; study it and work it accordingly. For example, if your business is in a rural community you would hardly advertise that "Sets can be paid for on the budget plan"—most of your customers may not even know what you mean. And likewise, if your business is in a city where industry

is the main-stay, tell your customers that payments may be arranged to be met from their salary, each month, and on the date most convenient for them to pay. Or if you are selling to farmers where their money is received only from one or two principal crops a year, go to your bank and arrange to discount that type of paper, and don't be bashful in telling your farmer customer that you can put a radio in his home upon the payment of only one-third down and that you have arranged

so that the balance may all be paid in one payment, when his crop is sold.

A successful connection that I have observed between a good dealer and a good finance company resulted in several hundred dollars additional profit each year. The dealer knew the finance company would "go the limit" with him; and in turn, the finance company knew that the dealer was absolutely dependable and that anything or everything he told them would always check up 100 per cent. With that common ground to work from, the dealer proceeded to sell successfully all kinds of radio accessories on small monthly payments; many of them on such small payments that the paper would be hopeless to sell, ordinarily. He sold complete sets of replacement tubes, instead of selling only the one which absolutely needed replacement; and he took as down-payment the price of the one necessary tube; the balance, of course, was covered by a contract and note with monthly installments. He sold dynamic loud speakers to people who had a good set but wanted a modern loud speaker; and he took their old



Now-a-days 85 per cent. or more of our sets are sold on the monthly payment plan.

Don't throw that past-due notice in the waste-paper basket and just hope that the customer will pay soon; give it honest attention, right away.

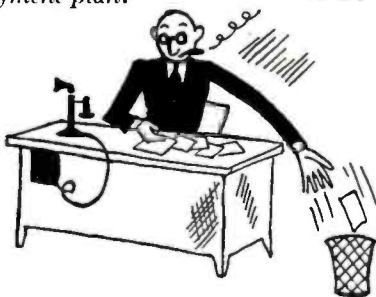

Advertising your ability to sell sets on monthly payments in a judicious way will often give you a profit that otherwise might be lost.

Nearly all finance companies have what is called a "road man" . . . Here is your chance to get some valuable information. Talk over general business conditions with him.

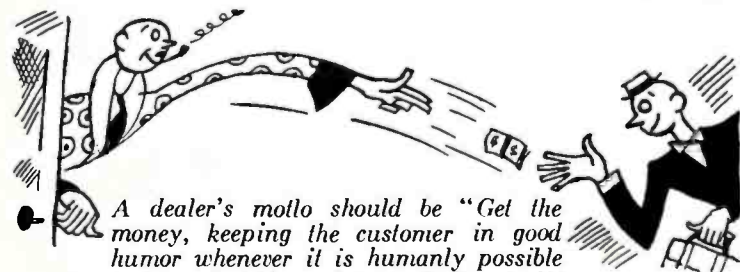

A dealer's motto should be "Get the money, keeping the customer in good humor whenever it is humanly possible to do so; but if you have to do it, get him mad enough to pay."

loud speakers at a very low figure for the down-payments and got the balances in such easy installments that the buyers were not hurt at all. One of the most important things he did along this line was getting clear of old sets; all of us know how these will accumulate. But he moved them out at from \$10 to \$25 each, on mighty easy terms and his finance company handled the paper on them, too—because they knew he would get the money on every contract, promptly. Phonograph pick-ups, short-wave receivers, power amplifiers, and even amateur transmission equipment, were sold on the monthly payment basis. And, at the risk of boring you, let me repeat: the only way he was able to swing all this extra volume of business was through the implicit confidence his finance company had in him. Every dealer should conduct his dealings with his outlet for paper in the same manner, and with the same end in view.

I stated above that it probably is best to let someone else handle time-sale paper, even if you have enough money to

(Concluded on page 289)

# THAT TRADE GOSSIP

By  
HOWARD W.  
DICKINSON

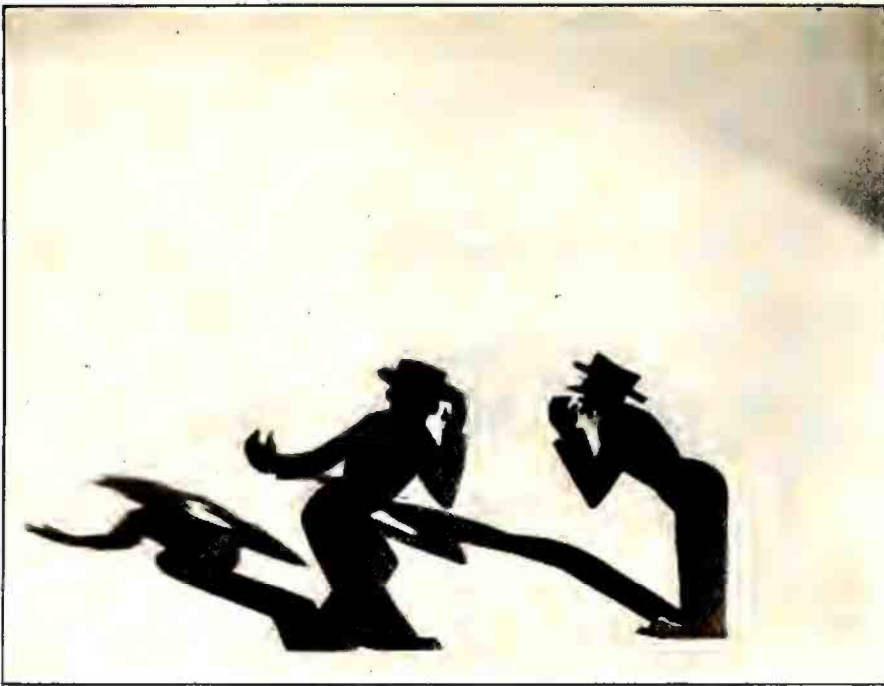

## GOSSIP

**I**T IS REALLY a wonder that any industry ever settles into its stride. The men who make their bread and butter through a particular industry seem bound to keep the industry upset and themselves in a perilous state of uncertainty by the recklessness of their gossip. This would be easy to correct if it were not based on human nature. *Gossip is a very human pastime.*

Radio dealers want their business to "stay put" long enough to sell their stocks on hand, at least. But—"I hear that Manufacturer A is coming out with a set which utilizes the wind on the roof for power." Or "They tell me that ABC is about to go broke and their sets will be in job lot sales." Or "The Gyps have all the best of this business. I can't keep prices where there's a living in it." Or "We got stung by XYZ's advertising promises and stocked up and look what happened to XYZ." Or "Wonder how PQ gets away with it, he never made a good set in his life." Or "JZ is playing up to the big dealers and doesn't give the regular radio shop a look in," or worse and worse.

### *The Dangers of Gossip*

Gossip in a new trade presents great dangers and a very difficult problem.

Actual news of the trade is very important. It is very foolish to shut your eyes to the *facts* of your industry. You should know them. And yet unrestrained gossip in an industry is a breeder of many evils. Here are some of them.

*Fear* or getting the imagination set upon the difficulties of your business. These things grow and grow in the imagination, and soon fear looms bigger than the hope of profit and growth. That is a condition which almost surely dooms a dealer to failure. It has many forms, such as fear to invest in necessary stock, lest it shall go stale; fear that a competitor will allow more on a turn-in and so you will lose the sale; fear that the industry as a whole is on the skids. Fear is not the frame of mind to carry one to success. Careless gossip is its breeder. Fear and Success do not ride in the same car.

*Price Cutting.* "Everybody's doing it." "Only way to compete with the big people." "This business just won't let you make a good living and get ahead." "So much new stuff on the market, no chance to move it all—then bang! Prices will go right under us and leave us carrying the bag."

There are insidious forms of price cutting, sometimes fostered by the very same manufacturer who should protect you. I have been offered an unbelievable "turn-in" allowance, provided I would buy a certain high-priced set. The offer was \$150 on *any* set I might turn in, even an old one-tube set. I was tempted to wrap some wire around a couple of old tin cans and see if I could get \$150 allowance for that. I believe it would have been accepted.

How can I ever figure I am getting the bottom price on that expensive set? As a believer in reasonable performance in trade, I wouldn't have that set at any price, even if it were the most perfect reproducer on the market, and no matter how much it is advertised. Until it is priced reasonably, no dealer should be asked to carry it.

Uncontrolled gossip breeds *distrust*. This is shown in an



FEAR

attitude of repulsion to ideas which may be profitable to you, but which you refuse because you think that maybe you are being played for a sucker. "Why is he so anxious to unload this thing on me? He makes it sound good, but how do I know there isn't a nigger in that woodpile?"

A dealer needs to buy well just the same as he needs to sell well. An over-suspicious attitude makes him a poor buyer both selectively and in the quantity he buys. It spoils his trade judgment and dumps him into just the hole he is trying to avoid.

Gossip in the retail trade spreads to the *distributor* and the *manufacturer*. Such gossip upsets them and injures the coöperative friendliness which should extend through all the parts of an industry. A salesman suspicious of the good intent of a dealer, working with a dealer suspicious of the manufacturer whom the salesman represents—that is an all too common picture and does not make a good background for a mutually profitable business. The only man who wins under those conditions is the Gyp, who has learned how to make a



DISTRUST

and begs you to sell to it. Imagination working upward leads to the necessary boldness, taking full profit and letting it be known that you intend to keep on doing it, insuring yourself in credits, and not falling for turn-ins on which you can't make full profit. Allowing \$50 on a set that you've got to sell for \$7, if you can sell it at all, is ridiculous, and no matter if a million dealers are doing it, it is unnecessary. Customers will admit it, too, if you tell them so frankly. If it is done it is because dealers are weak-kneed—because they follow each other in this thing like a flock of sheep. Some other industries have cleaned their houses of this pest and have standardized profits.

*Price Cutting*

Losing customers by *price cutting* of competitors is unnecessary to any great extent. Building a reputation for fine service, quality goods, and courteous treatment will absolutely cure it. Price isn't always the customer's first consideration. Competition shopping takes time and most people are busy. Be known as a fine, reliable shop and you can get along without the bargain hunters. In fact, if you have a fine reliable shop you will give many genuine bargains on which you will make your profit.

In a certain great city there are two fine stores, not radio shops, a block apart. They carry similar lines of merchandise. In one store the mark-up is 50 per cent. In the other it is 100 per cent. There is one line—a standard line which they both carry—on which they both *do just about an equal volume* at very different prices.

*Distrust* is destructive to an open mind. If a mind is not open it is not receptive to new ideas. You need new ideas. You need progressive development of your store display, ideas on demonstration, on new and better merchandise, on how you can advertise at a profit. These things are all upset by uncontrolled and foolish gossip. The wise man realizes that talk is cheap and that there are many cheap talkers. I have lost a little money in the years past by trusting friends. But by *having* friends I have made a hundred dollars for every dollar I have lost. With an attitude of distrust it is hard to have friends. The balance of profit is overwhelmingly in favor of having friends.

*Coöperate With Manufacturers*

Ever since manufacturers made goods and retailers sold them, these two partners in trade have been suspicious of each other, have made love to each other, have fought each

(Concluded on page 302)

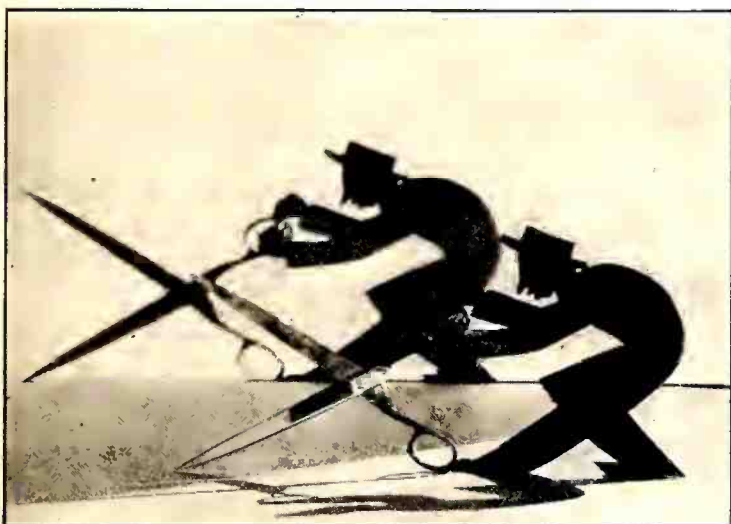

PRICE CUTTING

profit out of being suspicious of everybody, and who has no good will to protect. He doesn't care a hang who is suspicious of him. Extravagant and foolish gossip plays right into his hands. He does not appeal to the quality sense, anyway. The price nerve is all he tries to excite.

*Customer Distrust*

Worst of all, upsetting gossip works on the *customer* and makes him doubtful about what to buy, makes him wonder if this is the time to buy. If a dealer is in a gossipy condition his customers get reflection of it, shy off from their intentions to buy and wait for things to settle down or until the wild-cat predictions of impossible new inventions shall come true. Those vague predictions come to the customer through customer gossip as well. Customer gossip can be made harmless only through the dealer's calmness and his knowledge of facts.

Everybody in radio knows pretty well that the business has suffered greatly from foolish and uncontrolled gossip ever since it started. How can we keep up to the minute in the real news of the industry and also help kill destructive gossip? The answer is not to keep mum, but to be sensible in what we say.

To go back—

*Fear* is an imaginative bogie man. He can be killed by realities and by getting the imagination as well as the legs and voice at work doing business and making money. There is plenty of business to be had, even if too little of it comes in



The shadow cast by the twelve representative tube cartons in the illustration on the left indicates the way in which the sale of vacuum tubes varies throughout the calendar year. Each tube carton represents a month, starting on the left with January and ending with December on the right.

# HOW TUBE SALES GO

By T. A. PHILLIPS

Manager, Research Division, Doubleday Doran, Inc.



T. A. Phillips

SPORTING EVENTS and other broadcasts which create national interest affect the sale of radio tubes tremendously. A study of the monthly sales of tubes in the past three years demonstrates the influence of such events on tube sales. It was found, for example, that the Tunney-Dempsey fights of 1926 and 1927, and the Presidential Campaign of 1928, made decided changes in the trend of the sales curves for radio tubes for the years in which they occurred.

tubes varies throughout the average year. In June—the beginning of the radio year—the sale of radio tubes is near its lowest ebb, and from this point business begins to pick up gradually during the months of July and August. Sales take a big jump in September, and, in October, according to the average curve, reach the peak of the year. After October tube sales begin to drop, gradually at first and then more rapidly after the first of March. The lowest point in the sales curve is reached during the month of May.

It was possible also to determine how the demand for

These facts are illustrated graphically on this page. Below will be found a chart giving tube sales in percentages by (Concluded on page 301)

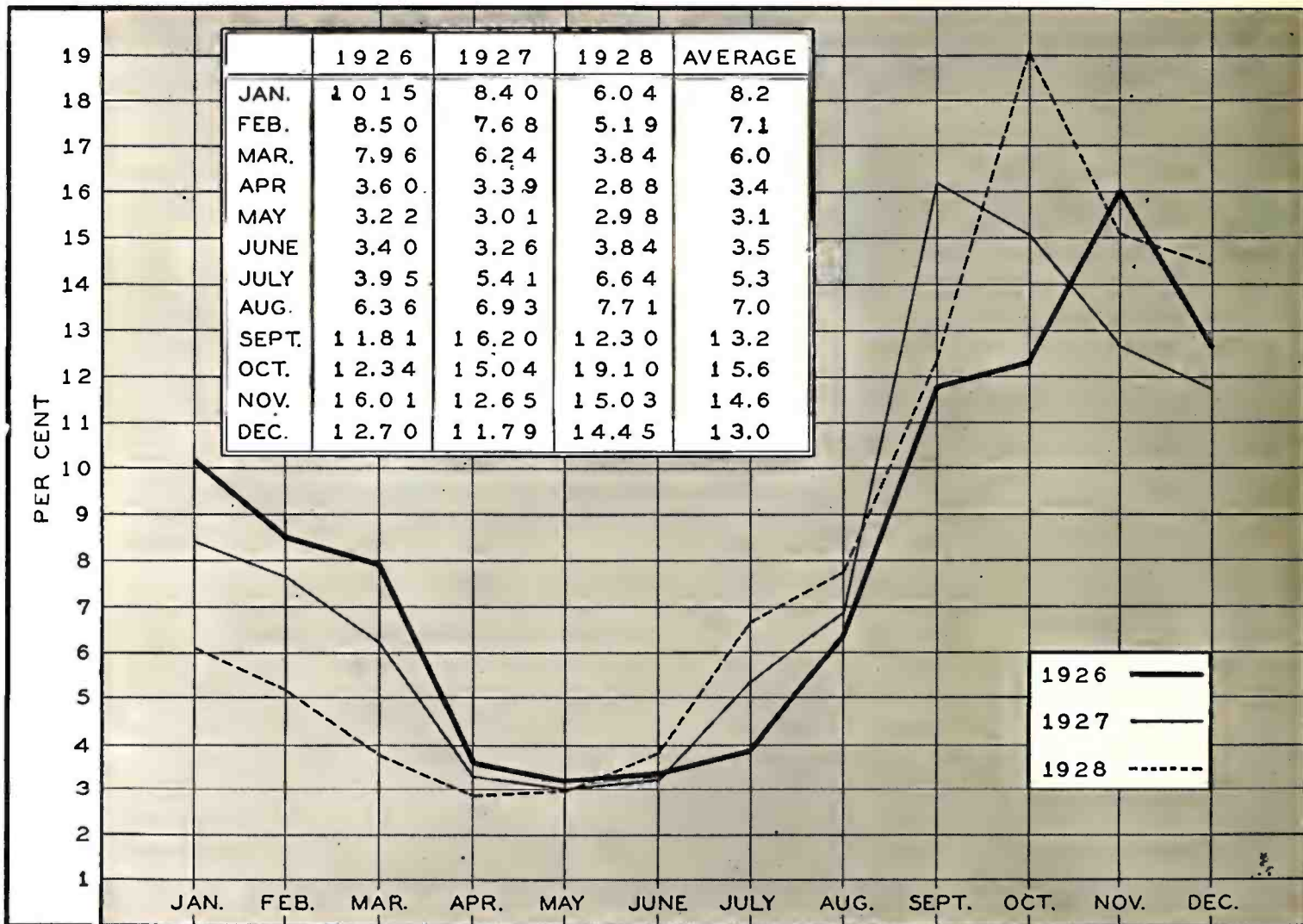

These curves show how the demand for tubes has varied during the last three years.

L-1

# “THE COURT DECIDES”

*Some Decisions of the Higher Courts of the Country Affecting the Daily Interests of Dealers*

By **LEO T. PARKER**  
*Attorney at Law*

**T**HE PRINCIPAL advantage of radio dealers obtaining legal information is the avoidance of litigations. Obviously, a person who understands his obligations is less likely to perform acts that will result in legal liability, when compared with a dealer who is unfamiliar with the law or one who relies upon “hear-say” information which, in the majority of instances, is quite undependable.

Moreover, frequently the records of fresh higher Court cases may be utilized advantageously in defending a suit. Therefore, the purpose of this article is to review several higher Court cases, decided during the past few months, involving radio dealers in which unusually important points of the law are explained.

## *Purchaser of Defective Radio Sets*

The majority of persons are familiar with the established law that the maker of a negotiable note is bound to pay the proceeds to a disinterested and innocent party, who purchased it from the original holder, although the latter defrauded the maker when receiving the note.

In other words, a retail dealer of radio receivers is bound to pay a note given in payment for defective radio equipment, providing the manufacturer of this apparatus sold the note in good faith to an innocent purchaser.



On the other hand, it is important to know that this law is not effective under circumstances where the manufacturer sells the note to a person for the purpose of avoiding the responsibilities of the law, which is a rather frequent practice.

For illustration, in *Stevens vs. Gaude*, 120 So. (Louisiana) 79, it was disclosed that a retail radio dealer purchased several radio sets from a manufacturer who guaranteed them to be satisfactory. The manufacturer accepted notes in payment for the equipment and soon thereafter sold the notes to a man named Stevens.

When the radio dealer discovered that the radio sets would not operate satisfactorily he refused to pay the notes and Stevens filed suit, contending that he was a disinterested party.

However, in view of the fact that the manufacturer had agreed to repay Stevens any expenses he incurred in collecting

the notes, the Court held the retail dealer not required to pay the same, saying:

“The testimony of the defendant, Gaude (radio dealer), corroborated by his son and two other witnesses, shows that the radio receiving sets were not satisfactory, and that for some reason they would not work in a satisfactory manner. . . . We therefore find that the notes are and were without consideration at the time they were executed. . . . It is our conclusion that these notes were never negotiated and delivered to Mr. Stevens in the execution and performance of an intent to sell them to him outright, but that the transaction between Mr. Stevens and the manufacturing



company was merely a plan whereby the notes were sued on in the name of Mr. Stevens for the purpose of cutting off the equity of the makers.”

## *Contract Held Legally Altered*

In many instances, buyers and sellers enter into contracts the terms of which are cancelled or altered by mutual consent of the parties, although no written evidence may be introduced to prove conclusively the facts.

Therefore, it is important to know that the Courts look through obscurities surrounding sale contracts and endeavor to render verdicts in accordance with the true intentions of the parties.

For example, in *F. A. D. Andrea, Inc., vs. Dodge*, 28 F. (2d) 147 (Pennsylvania), it was disclosed that a manufacturer of radio cabinets and a manufacturer of radio receivers entered into a contract by the terms of which the latter agreed to purchase approximately 900 cabinets each month.

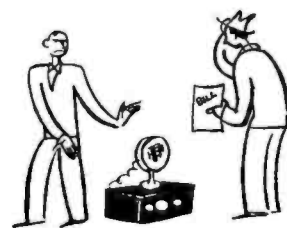

Later the buyer required a greater number of cabinets monthly and wrote the seller the following letter:

“Starting December 1, we are willing to allow you a bonus \$1.00 per cabinet for each cabinet that you deliver, provided that deliveries of 1100 cabinets per week are sustained throughout the balance of the contracts. We are willing to pay you this bonus at the end of each month if your deliveries throughout that month amount to 1100 or more cabinets each and every week.”

Some time after Christmas, the radio manufacturer wrote the seller explaining that he did not require so many cabinets

monthly, and requested the seller to reduce the shipments and revoke the bonus agreement. The seller answered that he had rearranged his production and agreed to supply fewer cabinets each month, but did not agree to reduce the \$1.00 bonus per cabinet which the purchaser had agreed to pay in the above quoted letter. However, the seller failed to bill the buyer the \$1.00 bonus for the cabinets delivered after agreeing to reduce the monthly shipments.

Later, controversy arose between the parties and the seller filed suit against the purchaser to recover \$14,571, including \$1.00 bonus for all cabinets delivered after the purchaser agreed to pay this additional amount. The seller contended that the purchaser was liable because the offer to pay \$1.00 was accepted

by both parties and became a part of the contract which neither party had altered after the monthly deliveries were reduced. However, the Court held the buyer *not* liable for payment of the bonus, thus showing that in litigations involving uncertain contracts, the Courts endeavor to interpret the intended meaning of the parties.

### Employer's Liability

Since in many instances radio dealers have been held liable for damages caused by employees who install radio sets in purchasers' homes, the recent case of *Davis vs. Harry B. Loeb Piano Co., Inc.*, 119 So. 746 (Louisiana), imparts unusually valuable information.

The facts of this case are that an employee, sent by a radio dealer to install a radio set in the purchaser's home, removed a screen and in restoring it he failed to fasten or secure it properly. Subsequently the purchaser's minor child, who was accustomed to play on the window and use the screen as a support, fell through the window by reason of the insecurity of the fastening of the screen, and sustained severe injuries.

The child's parents sued the radio dealer for heavy damages, contending that the employee's neglect to fasten securely the screen in its position was the proximate cause of the injury. However, it is interesting to observe that this Court held the radio dealer not liable and stated important law, as follows:

"In order to be a proximate cause, a cause must be, either in itself or in connection with other causes, in direct and unbroken sequence, an efficient cause of an accident; but where the supervening cause, such as in this case, the permitting of the child to use the screen as a support, was in itself an efficient cause of the accident, the other cause then becomes the remote cause. . . . To hold a person liable under the circumstances set forth in this case would be far-reaching in its effect, because any one who made an installation of any kind would, by virtue thereof, become liable to third persons injured by coming in contact with or through the use or misuse of the particular installation, notwithstanding the damage could not be foreseen, and notwithstanding it was caused by some supervening cause."

### Minor Not Required to Pay

Contrary to the opinion of the majority of persons, the law gives to a minor, for his protection against persons taking advantage of his inexperience, the privilege of avoiding contracts which are injurious to him and rescinding all others, whether fair or not, excepting contracts for necessaries, and

executed contracts, where he has enjoyed the benefit of them and cannot restore the other party to his original position.

In other words, if an "infant" makes a sale contract for a radio, and receives the radio and disposes of it before his majority, either by losing, expending, or squandering it, *this is nothing more than the law anticipates of him*, and he is not required to pay for it.

For instance, in *Shutter vs. Fudge*, 143 Atl. 896 (Connecticut), a minor seventeen years old purchased \$415 worth of radio parts and used them for the purpose of building radio sets which he sold to various purchasers. He refused to pay for the parts and the dealer filed suit. However, the Court held the boy not required to pay the bill, saying:

"It is evident that, if the infant is, in every case, bound to return the consideration which he received, or its equivalent, in order to avoid or rescind his contract, the protection accorded to him, as such infant, is seriously impaired, and may often be destroyed, for it is precisely because he is supposed to be improvident, and likely to misuse and squander what he receives, that his contracts are made voidable. . . . Where he (infant) has exercised his right to repudiate the contract, the infant may be required to return the consideration, or such part thereof received by him, as still remains in his hands and under his control. But if, during his minority, the infant has lost, wasted, or otherwise disposed of the property or other consideration received under the contract, he may, nevertheless, repudiate it without making restitution in order to give effect to his disaffirmance."

### Monopoly of Patent Contract

In *Radio Corporation of America vs. Lord*, 28 F. (2d) 257 (Delaware), it was disclosed that the Radio Corporation owned certain patents and made contracts with various firms containing clauses by which the Radio Corporation endeavored to induce the firms licensed to build radio sets under its patents to use in such sets the vacuum tubes manufactured by the former, on which its patents had expired. The Court said:

"A single old element, whose patent monopoly has expired, cannot be put into a new patented combination as a constituent element, and thus have its individual monopoly revived for seventeen years more. This would be a new method of securing a patent, or a means of evading the patent law, by doubling the length of the life of a patent. . . . A patentee may not prevent the individual manufacture, use, and sale of a single unpatented element, which the world is free to make, use, and sell, by simply including it as an element in a new patented combination. To put it differently, the inclusion in a patented combination of an unpatented element does not give the patentee of the combination a monopoly of each element, and the exclusive right to make, use, and sell that element independent of the combination. So long as the patent covering vacuum tubes was in existence, the patentee of this element of the combination was protected, and it could not be included in the combination without a license to do so; but, when the patent on this tube element expired, the rights, which were theretofore vested in the patentee, became the property of the public, and not of the patentee of the combination. . . . A patentee may sell his patented product at any price he desires, to whomsoever he will, and under whatever restrictions he conceives to be advantageous, provided he does not violate the law in doing so."

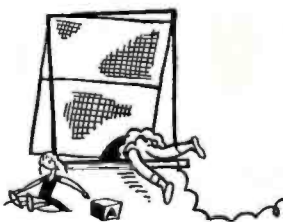
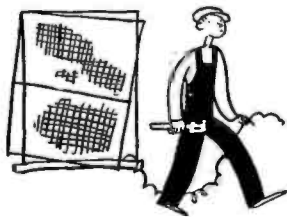

L-2

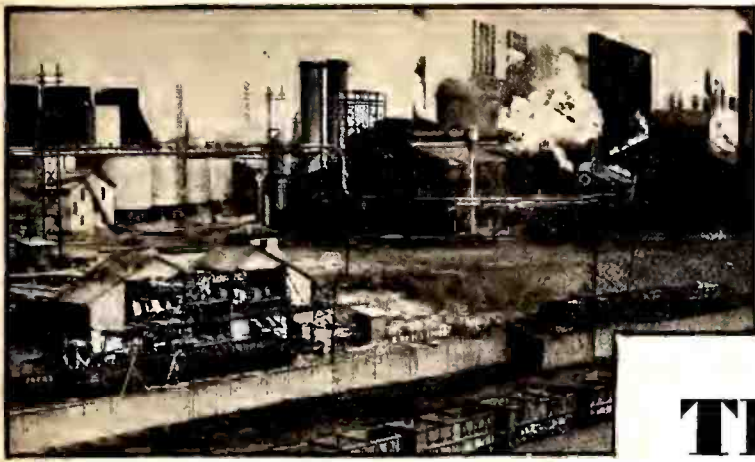

# THE LITTLE RED SCHOOL HOUSE COMES TO MARKET

By B. H. DARROW

**A**MERICA'S GREATEST INDUSTRY—*Education*—is turning to radio. Here lies a golden opportunity for the radio industry which should receive the careful consideration of every manufacturer, distributor, and dealer. Briefly, it means that the schools in the United States represent a potential market for three hundred thousand radio receivers and for nearly one million loud speakers!

The fact that radio broadcasting has been recognized generally by educators as a medium of instruction in schools is a question which no longer need be debated. Many of the schools which are radio equipped have reported enthusiastically upon the results which have been obtained, and every day word is received that new schools are planning to install radio apparatus. However, there is still much room for development in this field, for only a very small number of the schools—probably not more than one per cent.—have facilities for receiving broadcast programs.

Interest on the part of educators in broadcast programs is, of course, a direct result of the effort made by station managements during the last few months to provide educational programs. Whereas until recently practically all daytime radio programs were made up of "talks to the housewife," music, direct advertising, etc., to-day there are many features of interest to schools which are broadcast regularly. Such programs as the Damrosch lessons in music over the WEAJ chain, the "Ohio School of the Air" over WLW, the school broadcast by

WMAQ, Chicago, the standard educational program of KFI, Los Angeles, etc., provide adequate proof of this trend.

In addition to the deliberately planned educational programs which are regular features of many stations, education by radio has other values which are axiomatic, and which alone are quite sufficient to make it imperative that radio be unleashed and set to work with the childhood of America. For example, an address by the president of the United States or events of current historical interest may be brought directly to the classrooms. In this and in many other ways radio makes possible an equality of opportunity never before dreamed of, in which the smallest country school with an inexpensive radio set is on an equal footing with the million-dollar metropolitan school.

## *Size of the Market*

From the viewpoint of those in the radio industry, statistics on the size of the educational market should be of interest. In the opening paragraph of this article it was stated that education is America's greatest industry, and, after analyzing the tables accompanying this article, this fact should not be difficult to appreciate. In this connection the following figures are also rather convincing: the value of school buildings in the United States is over \$5,000,000,000; the yearly cost of operating our schools is \$2,750,000,000; there are approximately 1,000,000 classrooms in 275,000 school buildings; 978,310 persons are employed as teachers; 29,001,761 persons are enrolled as pupils; and it is forecast that \$569,172,000 will be

## *Number of Elementary, Secondary, and High Schools*

STATE	ELEMEN- TARY AND SECOND- ARY	PUBLIC HIGH SCHOOLS	PRIVATE HIGH SCHOOLS AND ACADEMIES	STATE	ELEMEN- TARY AND SECOND- ARY	PUBLIC HIGH SCHOOLS	PRIVATE HIGH SCHOOLS AND ACADEMIES	STATE	ELEMEN- TARY AND SECOND- ARY	PUBLIC HIGH SCHOOLS	PRIVATE HIGH SCHOOLS AND ACADEMIES
Alabama	6,237	220	47	Maine	2,807	212	54	Oklahoma	6,344	519	38
Arizona	525	41	5	Maryland	2,369	157	50	Oregon	2,709	249	21
Arkansas	6,611	255	26	Massachusetts	2,959	347	117	Pennsylvania	12,854	999	145
California	5,348	406	109	Michigan	9,007	567	77	Rhode Island	503	22	17
Colorado	2,888	190	14	Minnesota	9,192	529	52	South Carolina	4,306	224	22
Connecticut	1,496	92	58	Mississippi	6,347	327	33	South Dakota	5,101	287	13
Delaware	444	25	6	Missouri	10,099	725	61	Tennessee	6,488	307	42
District of Columbia	160	15	30	Montana	3,546	191	11	Texas	12,395	722	51
Florida	2,285	177	25	Nebraska	7,653	565	35	Utah	722	71	7
Georgia	6,867	313	36	Nevada	381	23	Not listed	Vermont	1,370	76	18
Idaho	1,694	131	11	New Hampshire	1,073	105	28	Virginia	6,133	353	67
Indiana	5,385	809	36	New Jersey	2,182	174	77	Washington	3,045	313	27
Iowa	11,950	917	102	New Mexico	1,479	92	17	West Virginia	7,116	240	18
Kansas	9,196	722	33	New York	12,101	766	258	Wisconsin	8,280	425	39
Kentucky	7,853	540	74	North Carolina	6,759	567	57	Wyoming	1,491	62	2
Louisiana	3,250	251	50	North Dakota	5,097	355	16	Illinois	14,028	958	113
				Ohio	7,975	1,077	105	<i>Total</i>	<u>256,104</u>	<u>17,710</u>	<u>2,350</u>

spent for new school building construction during the current year.

The table on page 263 shows the number of schools of various types in the forty-eight states. These figures include schools of all sizes from the one-room country school, of which there are approximately 150,000, to the large city school. However, it must be remembered every school regardless of its size is a sales opportunity, and some of the larger schools may find need for four or more receivers.

The illustrations and tables on pages 264 and 265 give more specific facts which are of definite aid in determining the size of the educational market in the various states. The data

below were taken from "Statistics on Public School Systems" prepared by the U. S. Department of the Interior, Bureau of Education. These figures show, for elementary schools, the number of pupils enrolled, the number of teachers, and the value of all property used for school purposes. From these figures it is also possible to estimate the approximate number of classrooms (usually there is one teacher for each classroom) which is useful as it is indicative of the number of loud speakers which would be required in order to equip fully each school.

The way in which the pupils and teachers are divided among the various kinds of schools is shown clearly on the next page. It is important to note that 79.5 per cent. of the total number

*How Educational Demands and Facilities Compare in the Forty-Eight States*

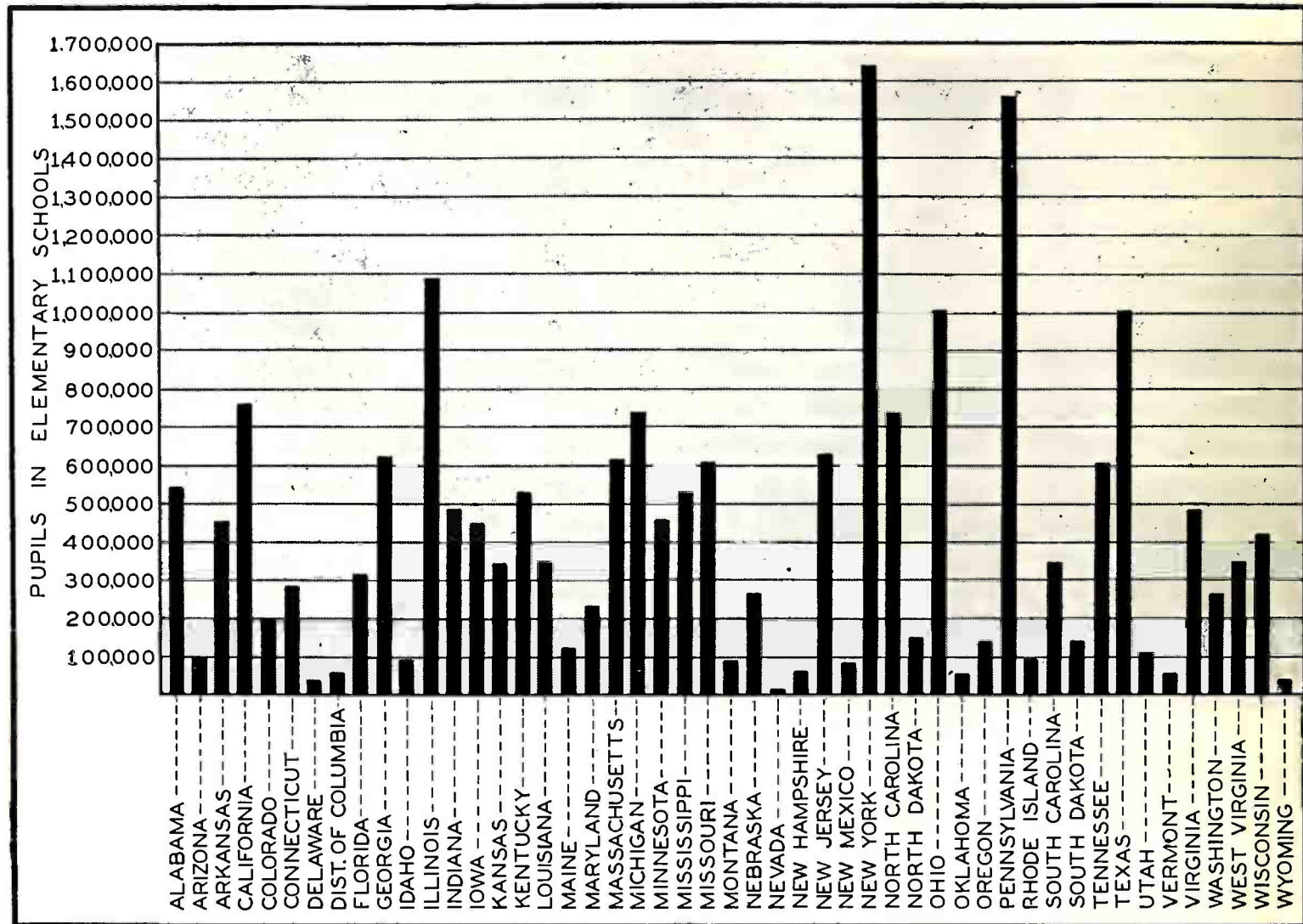

STATE	TEACHERS EMPLOYED IN ELEMENTARY SCHOOLS	PUPILS ENROLLED IN ELEMENTARY SCHOOLS	VALUE OF ALL PROPERTY USED FOR SCHOOL PURPOSES	STATE	TEACHERS EMPLOYED IN ELEMENTARY SCHOOLS	PUPILS ENROLLED IN ELEMENTARY SCHOOLS	VALUE OF ALL PROPERTY USED FOR SCHOOL PURPOSES
Alabama	13,237	538,984	\$ 43,738,697	Nebraska	11,405	266,828	66,045,345
Arizona	2,204	70,745	12,131,560	Nevada	588	12,804	4,664,986
Arkansas	11,078	462,175	28,443,757	New Hampshire	2,363	59,628	16,217,312
California	20,854	759,676	328,428,349	New Jersey	16,707	629,774	212,243,706
Colorado	7,879	195,101	54,643,686	New Mexico	2,424	79,529	9,516,286
Connecticut	7,592	279,106	83,352,004	New York	60,352	1,643,215	625,182,175
Delaware	1,114	33,590	6,912,068	North Carolina	20,691	734,170	82,764,628
District of Columbia	1,996	60,027	22,885,000	North Dakota	7,946	149,565	38,052,613
Florida	9,462	307,603	53,370,802	Ohio	30,616	1,031,644	171,083,252
Georgia	14,548	623,684	40,876,987	Oklahoma	14,453	565,884	80,857,406
Idaho	3,284	95,831	20,897,820	Oregon	5,758	142,711	39,514,790
Illinois	34,725	1,095,618	322,871,774	Pennsylvania	43,103	1,581,767	419,964,289
Indiana	14,482	488,780	155,313,649	Rhode Island	2,897	96,486	23,131,959
Iowa	18,179	121,376	129,470,931	South Carolina	11,200	435,425	33,911,840
Kansas	14,256	340,330	74,382,427	South Dakota	7,103	138,166	26,246,471
Kentucky	12,937	529,996	35,339,705	Tennessee	14,518	600,584	40,432,610
Louisiana	9,041	349,488	45,748,847	Texas	26,981	1,015,951	145,543,621
Maine	5,408	112,534	27,420,035	Utah	3,205	110,695	25,018,095
Maryland	6,913	229,971	38,678,684	Vermont	2,383	53,551	9,757,365
Massachusetts	18,333	616,869	182,799,503	Virginia	13,704	481,799	54,850,000
Michigan	27,040	744,253	240,017,020	Washington	7,526	258,814	68,403,558
Minnesota	16,668	455,853	136,075,817	West Virginia	12,331	346,716	61,733,333
Mississippi	12,772	529,881	36,737,629	Wisconsin	14,856	415,888	131,933,085
Missouri	19,911	612,414	128,090,771	Wyoming	2,436	40,474	13,717,006
Montana	5,172	96,949	27,190,286	<b>Total</b>	<b>644,631</b>	<b>20,984,902</b>	<b>\$4,676,603,539</b>



of pupils and teachers are in elementary schools which compose radio's largest educational market, not only because of the large number of pupils but also because education by radio is best suited to the requirements of this class of school.

The tremendous growth of education in America is indicated by the figures on the right. These data, which were prepared by the *Architectural Forum*, show the forecast of the money which will be spent for new building construction during the current year. It will be noted that schools hold the third place on the list.

### What Has Been Done

It has already been explained that at the present time the installation of radio apparatus in public schools is almost a virgin field, that only a few thousand of the one million classrooms have been equipped for radio reception. However, this condition is changing very rapidly and in some sections of the country as many as 20 per cent. of the schools are able to tune-in on educational broadcasts. This is true of Ohio.

In the state of Ohio there are 240 cities, towns, and villages part or all of whose schools are equipped. Some of the villages have but one school, whereas some of the cities have as many as forty. In the latter class is Dayton which has auditorium or classroom reception for every school. The city of Cincinnati now has thirty-eight schools equipped and several other schools in the city are planning to have receivers installed. Columbus will have 128 classrooms equipped for reception when the schools open next fall. In addition, Cleveland, Youngstown, Sandusky, Elyria, Kent, Barnesville, and many others from modest beginnings are starting on a program which calls for equipping every classroom.

### Forecast of New Building Construction

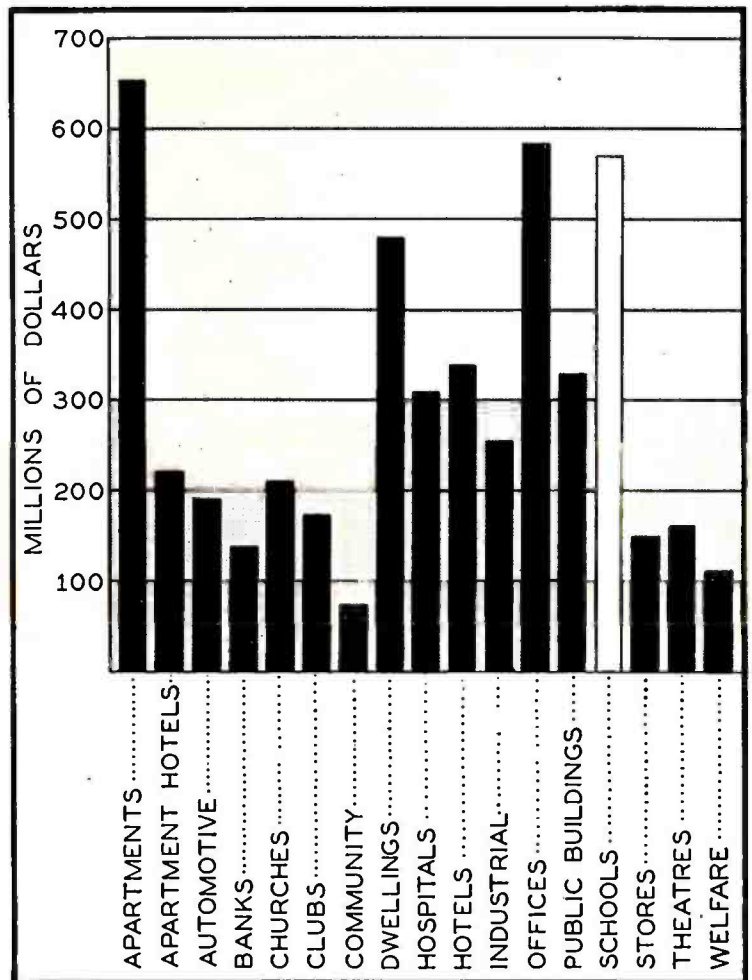

### How Pupils Are Divided

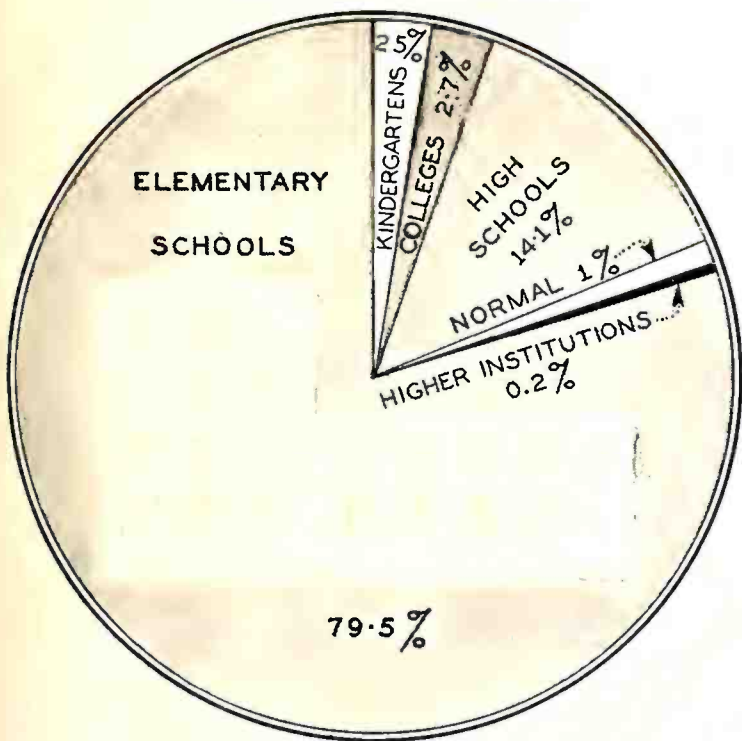

BUILDING TYPES	VALUE	PER CENT.
Apartments	\$ 652,829,000	13.2
Office Buildings	584,510,000	11.8
Schools	569,172,000	11.5
Dwellings	479,877,000	9.7
Hotels	342,001,000	6.9
Public Buildings	330,801,000	6.7
Hospitals	306,283,000	6.2
Industrial	260,816,000	5.3
Apartment Hotels	217,518,000	4.4
Churches	211,142,000	4.2
Automotive	197,431,000	4.0
Club	175,963,000	3.6
Theaters	161,938,000	3.3
Stores	146,221,000	2.9
Banks	137,394,000	2.7
Welfare	106,574,000	2.1
Community	74,796,000	1.5
Total Value	\$4,955,266,000	100%

SCHOOLS	TOTAL TEACHERS	PUPILS	PER CENT. TEACHERS & PUPILS
Kindergarten	Public 10,852	673,231	2.5
	Private 2,140	54,458	
Elementary	Public 644,631	20,984,902	79.5
	Private 56,272	2,143,100	
High Schools and Academies	Public 169,538	3,757,466	14.1
	Private 20,145	295,625	
Preparatory Departments of Higher Institutions	Public 721	10,456	0.2
	Private 3,196	45,176	
Universities, Colleges and Professional	Public 20,169	280,437	2.7
	Private 38,138	486,704	
Teachers' Colleges and Normal	Public 11,216	252,907	
	Private 1,292	17,299	1.0
Total	Public 857,127	25,959,399	
	Private 121,483	3,042,362	
Grand Total	978,310	29,001,761	100

Although the cities in the state of Ohio are probably the most progressive from the radio instruction viewpoint, there are several other areas which are rather heavily equipped. In the East there is considerable activity in the vicinity of New York City, Boston, and Hartford; in the South, radio interest is greatest near Atlanta and New Orleans, and the vicinity around Chicago and parts of California also report a considerable number of school radio installations. In each of the cases cited above it is most interesting to note that the equipping of the schools has followed the provision of suitable programs by the broadcasting stations.

The facts given above show that although the addition of radio instruction to the curriculum is not general throughout the entire country, the schools have been quick to take advantage of radio when regular programs of a suitable character have been made available by the stations. This is especially noticeable in Ohio which may be taken as an example of the results which may be accomplished by coöperation between station managements and educators.

It was believed originally that few schools boards would have both the money and the inclination to purchase radio equipment for their schools, but this proved false. In the Ohio

(Concluded on page 292)

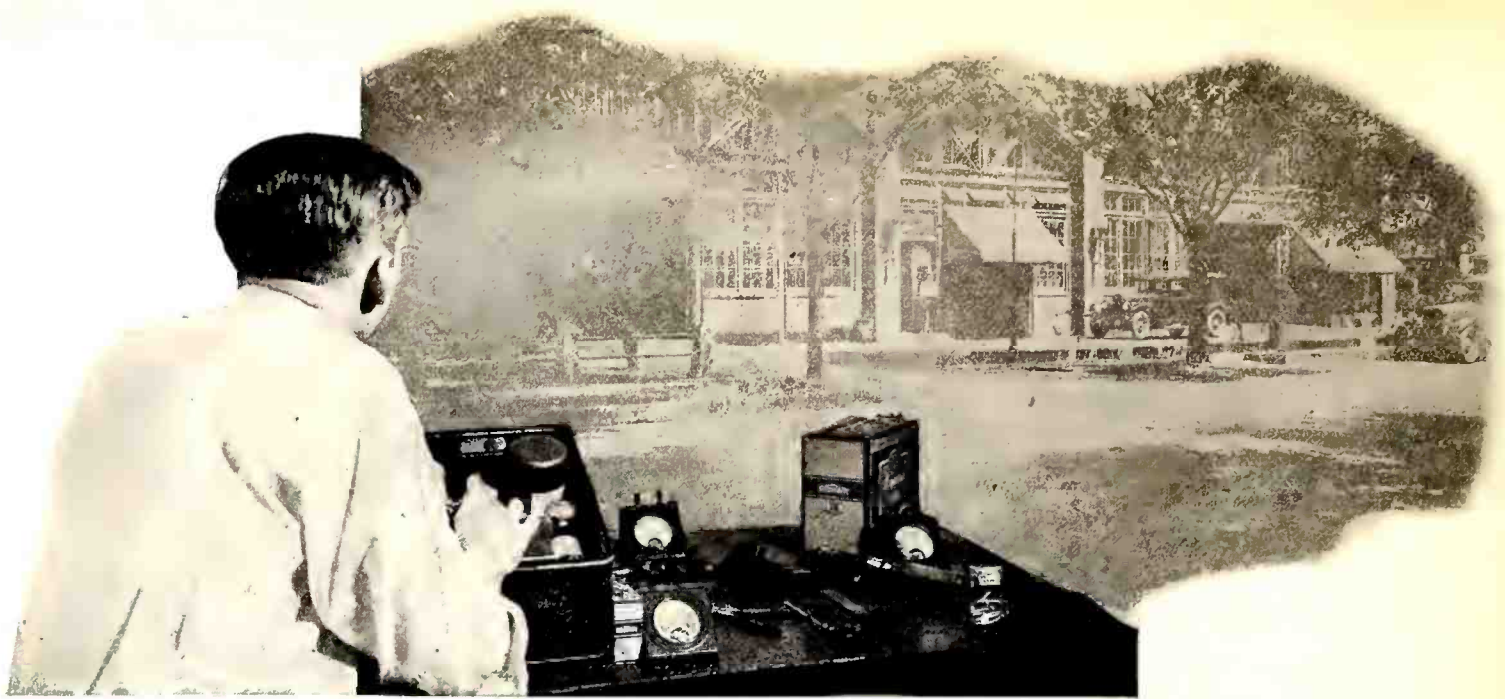

## RADIO VS. AUTO SERVICE

*Dealers Who Look into the Service Systems in the Automotive Field May Find Ideas Which Will Aid in Solving Their Problems*

By  
**JOHN S.  
DUNHAM**



*John S.  
Dunham*

THERE IS no one sure way of getting rich in any line of endeavor, and, in the radio service field, there is no single method which may be followed that will by itself spell success. That magic word "success" must be made up of a large number of well-planned systems for doing everything which needs to be done in any particular business. A group of good servicemen will not make a service business or a service department pay for itself unless the prices are correctly designed, the records are carefully kept and intelligently used, and the costs of giving good service and the overhead costs of doing business are known and closely regulated. We must also know how to secure customers without spending too much money getting them, and, once gained, how to keep them.

In the space of this article we can't discuss all the ways that experience has taught us are conducive to success in the radio service game, but we shall consider briefly a few of them. In this connection a few of the remarks made to the author by H. R. Cobleigh, secretary of the National Automobile Chamber of Commerce in New York, should be of interest, as they considered the solutions to service problems in the automotive industry which might very profitably be applied to problems in the service branch of the radio industry.

Perhaps the most striking thing Mr. Cobleigh pointed out was the difference between the words "maintenance" and "service." Some years ago there was a great deal of discussion among automobile men about the advisability of employing the word "service," he explained. There were many who thought "maintenance" would be a better term because they felt that "service" was firmly fixed in the customer's mind as meaning something that is free, whereas the use of "maintenance" would remove some of the difficulties in collecting for service performed after the end of the free-service period. The answer to the question was that maintenance means keeping a car in proper running order, but that *service means satisfying the customer*, and there is a wide difference between the two.

An actual experience with automobile service illustrates

this point very clearly. A car owner went into a repair shop, waited fifteen minutes before anyone paid attention to him, asked for an estimate of the cost of the work he desired done and how long it would take. He was told it would cost somewhere between thirty and forty dollars, and that they would try to have it ready by two o'clock the next afternoon. He returned at the time mentioned the next day, waited an hour to get his car, found that the bill was \$45., and noticed as he drove out that his steering wheel was greasy and the windshield had not been wiped off. The repair job by that concern was properly done and the fee charged was a fair one for the time spent and materials used, so that the work could be justly called proper maintenance, but the customer was very far from being satisfied.

The next time that car owner wanted service performed on his car he went to a new service station a block away from the first one. He was greeted promptly and courteously, was given an exact statement of the cost of the needed repairs, and was told definitely when his car would be ready. When he called for the car at the specified time, it was waiting for him, the windshield was cleaned off, the whole car had been dusted, the steering wheel and the seat were clean, and the bill presented to him was exactly the amount he had been told it would be. The radiator was filled with water. The service salesman asked if he might fill the gas tank and check the oil and air in order to replenish them if necessary. That work was *service*. The customer was more than satisfied—he was *pleased*—and he has consistently patronized that service station ever since.

Suppose a radio serviceman went into the home of a customer, looked at the radio without asking what the complaint was, found no trouble in the set other than a dirty volume-control rheostat which he cleaned, and then immediately packed up his kit and left without regard to the question of whether or not the work done would satisfy the customer. If the set was working normally when he left, the work done could be termed proper maintenance. However, suppose the customer's complaint was not about the slight noise experienced when adjusting volume, but that his complaint

was of variation of volume during the course of an evening and of *much* noise which he was experiencing and very naturally blaming on the set. Although such a call would result in the rendering of proper maintenance, it very decidedly would not result in the rendering of *service*. The customer would be dissatisfied, it would be difficult to collect from him, and the next time he wanted service he would go to some other service organization.

Flat rates for all kinds of service work, against the old method of rendering service on a time and material basis, was another subject which Mr. Cobleigh discussed at some length. In the automotive field their experience has been—and it applies to owners of radio receivers just as much as to owners of automobiles, because they usually are the same individuals—that people want to know before they have a job done exactly what the work is going to cost. When they know beforehand that it will cost them \$100 to have a car overhauled, or \$15 to have their radio overhauled, if they accept that figure and give the order and the work is satisfactorily done, they are invariably satisfied that the money was well spent. On the other hand, if either the automobile or radio service organization cannot give them a definite figure at all, or can give them only the cost of parts and tell them that the labor charge will depend on the time it is found necessary to spend on the job, there will be many cases of dissatisfaction with the amount actually charged, even though the work is properly done. Our own experience of nearly six years with an independent radio service organization has amply proven that the experience of the automotive industry in that respect can be very profitably used as a guide in the radio industry. Before we instituted the flat-rate system we had a great deal of dissatisfaction, not with the work done but with the cost of that work, simply because the customer thought he might have been able to have the same work done much cheaper somewhere else. If he knows just what a service call will cost he can then get estimates from other concerns, and he will be satisfied with the cost of the job because he has found, by comparing estimates and the quality of service rendered by various concerns whose work he has tried, ap-

proximately what it will cost to get the kind of work he wants. Since we instituted the flat-rate system some three years ago, we have had practically no complaints or dissatisfaction because of our charges.

The U. S. Chamber of Commerce has stated, as a result of a very comprehensive survey made in all retail fields, that only about fifteen per cent. of the business that is lost by the average individual retailer is lost because the customer considers his prices too high. When we started business in 1923 we charged for labor at the rate of \$1.50 an hour. In 1925, in fear and trembling lest we lose too many customers, we raised our rate to \$2 an hour, and we were surprised and greatly relieved to find that, so far as we were able to determine, we did not lose *any* customers. About a year ago we realized that our rates were still too low for the service we were rendering and again with a great deal of trepidation we revised our entire schedule of flat rates on the basis of \$2.50 per hour, or \$20 per man per day. The tabulation of the results of a survey made this past summer showed us that only about two per cent. of the customers we lost following our last raise in rates left us because of that raise. So long as a service department or a service organization in any industry gives the best service that is humanly possible, the customers and prospective customers of that organization will not worry about the cost of service, provided it is not appreciably higher than other service concerns charge for rendering *comparable* service. The average individual is far more concerned about the quality of the service he gets than about the cost of that service, and the dealer's service department or the service organization can safely charge fees which will permit a reasonable net profit over the cost of rendering the best of service, without any fear of losing customers thereby.

In the automotive business, a policy which has grown up out of the flat-rate practice, is the method of paying mechanics, not by the month, week, or hour, but by the job. Approximately two-thirds of the automotive service stations in the New York metropolitan area pay their men on that basis, according to Mr. Cobleigh. The mechanics make more

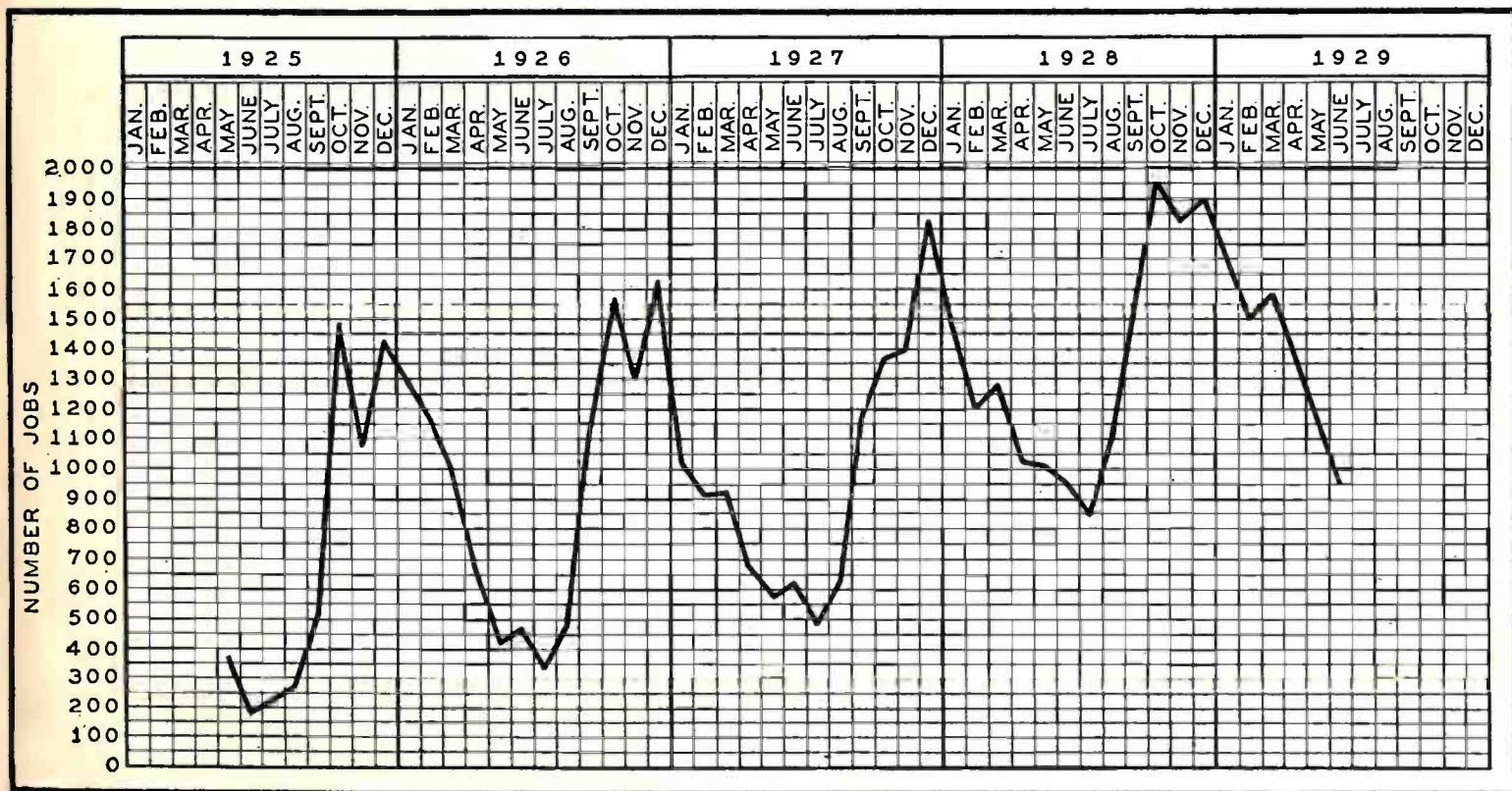

This curve showing the number of service jobs handled per month during the last four years by a well-known radio firm in New York City indicates a slight tendency to flatten out.

money on an average over the year than they made before on the hourly basis, the employer pays his labor only for work done, and he knows exactly what his labor cost for each job will be. The disadvantage of the system appears to be two-fold: one is that the men work overtime in the busy season and make abnormally high wages, while in the slack season they do not have enough work to do and consequently make less than their average weekly pay over a period of a year. The other disadvantage is that at all times, and especially whenever there is insufficient work, considerable care must be exercised by the service manager to distribute the work equally among his men.

When employed on a piece-work basis, fewer men are required in each shop than were previously needed because each mechanic does more work than he did before and the men in a shop do not want to have additional help taken on, even in the busy season, as long as it is physically possible for them to handle all the work. That has the advantage that less labor turnover is required—less hiring of men at the beginning of a busy season and less firing of men when work slackens. In a certain repair shop which was using the old hourly system of pay, twenty-two men were employed. When the piece-work system was instituted during a somewhat slack period, eleven of those men were discharged. The remaining eleven men were able to handle the work easily and made considerably more money. When the busier season arrived and the work became heavier day by day, the men in the shop went to their employer, asked him to please refrain from hiring any more men, and assured him that they could handle the additional work by staying overtime. The boss consented, as a matter of trial, and the shop went through the busy season without hiring more men. Those mechanics made a great deal more money than they would have made had more men been taken on, the cost to the employer for the work done was no greater than it would have been with twice the number of men employed, and he was relieved of the high cost of hiring and breaking in new men.

Perhaps you are thinking that when a man is paid a flat rate for a certain job his natural tendency will be to hurry that job at the expense of doing it properly, and that much customer dissatisfaction would therefore result from careless work. The way the problem has been solved in the automotive field is by requiring, whenever a job is incorrectly done in any respect, that the serviceman responsible shall do the

work over on his own time. The result is that each mechanic is very careful to do the job as it should be done the first time. Whether the piece-work system would work out satisfactorily in the service branch of the radio industry, as it has in the automotive industry, is a question well worth while considering. It seems to the author that the majority of our problems so closely parallel those of auto-

mobile service that the method of paying men a definite percentage of the flat labor charge for each job should be tried out. The only way to determine whether it would be better than the present haphazard

method of paying for labor is by trial.

We believe that a graph of the amount of radio service performed during the year has higher mountains and lower valleys than a similar graph depicting the work of the average automotive service department or organization, which, under the piece-work system of pay, has the disadvantage that either the pay of a radio serviceman would fluctuate more widely or else that more hiring and firing would be necessary than is the case at present in the older industry. However, progressive automobile shops have done a great deal to fill up the hollows in their yearly volume graph and to straighten out the whole curve by selling combination jobs and general overhaul jobs at much lower than normal rates during their slack periods and by selling an increasingly large proportion of their customers on the benefits and the economy of regular periodic service. If those remedies can be applied successfully to automobile service they certainly can be applied to radio service.

The yearly curve of radio business has straightened itself out gradually during these nine years of broadcasting by reason of better summer features, better quality of transmission and reception, and greater power used by local stations to permit a very high signal to noise ratio even under bad atmospheric conditions. Although there has been gradual improvement, the maximum amplitude of that curve is still a large multiple of its minimum and it will always be so unless the minimum portions are artificially stimulated by intensive sales effort. The fact that an older industry has been successful in artificially raising the low periods of their yearly curve is very hopeful evidence indeed that we can do exactly the same thing if we start employing both mental and physical activity to get that work which can be obtained.

## clippings

N. P. BLOOM (Adler): "The manufacturers of radio have been laying the ground for the interchange of patents within the radio industry, and I believe before the present year is over this will have been achieved."



JOHN W. VAN ALLEN (counsel, R.M.A.): "Radio program sponsors need listeners to be successful. The public has accepted sponsors of programs but has not accepted sales talks as sufficiently entertaining to sustain interest."



GORDON C. SLEEPER (Temple): "Radio dealers are increasingly prosperous and daily becoming increasing factors in their communities."



H. B. RICHMOND (General Radio): "This year we find a large number of manufacturers putting their receivers through a complete performance test. Receiver design has been reduced nearly to a mathematical formula."



SOSTHENES BEHN (president I. T. & T.): "The engineering development of communications facilities, in respect to cables, wires, and wireless, has outdistanced the adoption of more advanced commercial practices in the use of such services. . . . The new types of cables, carrier current for wire service, and short-wave wireless equipment will have so much greater traffic capacity that new commercial practices and services must be adopted to absorb these capacities."



ALFRED HAND (Edison): "The questions before most companies is not whether to advertise; it is how to advertise. Manufacturers, in general, owe a certain obligation to their distributors and should do all they can to build up good will and a buying urge in favor of their product."



Domestic Commerce (Government): "The opinion of 53.3 per cent. of manufacturers definitely answering the question (does dealer-price cutting affect my distribution?) was that when dealers cut the price of a manufacturer's product its distribution is decreased."



## WHAT COST ENGINEERING?

**A** FEW YEARS ago there was little demand for high-grade radio engineers. Pseudo-engineers did most of the engineering, chiefly because they were young enough and with so few responsibilities that they did not mind getting small pay for the work they would do at home anyhow at no income. Competition among set manufacturers has put a stop to this business of flirting with the undertaker, technically speaking. At the present time no high-grade set manufacturer can stay in business if he does not possess a laboratory and a staff to work in it.

What does it cost to engineer radio receivers?

In reply to such a question RADIO BROADCAST received some very strange answers. One chief engineer stated that "in our own case, it would be a matter of considerable difficulty and would involve a very considerable expense to give even approximate answers" to the questions we asked on the cost of engineering radio sets made by this well-known company. In other words, the chief engineer did not know how much it cost him to engineer his company's production! Fortunately this answer was not at all characteristic.

For example, the following figures are quoted from a letter from another well-known manufacturer:

1. Total amount charged to radio engineering in 1928:	
Production drafting	\$10,451.27
Engineering administration	34,797.24
Experimental	12,968.27
Research	1,401.82
<i>Total 1928</i>	<u>\$59,618.60</u>

2. The total cost of apparatus (meters, bridges, etc.) utilized by Engineering Department plus the equity in a well-known licensing organization was \$75,000. This company employed six engineers and three laboratory assistants. In 1928, the company sold 145,000 sets.

Another company which made approximately 100,000 receivers and 10,000 dynamic loud speakers had a technical staff of five engineers and two electrical mechanics. The laboratory equipment, which represented an investment of about \$18,000, was being increased all the time. The engineering costs, exclusive of inspection, ran close to 1½ per cent. of the net selling price. These are comparable figures, certainly. Such figures come from the books of successful manufacturers; they indicate that the manufacturers in question are not content to let amateurs do their engineering. The only conclusion is that such expenditures must pay.

A side light on this subject is the fact that there seems to be a dearth of really high-grade experienced engineers. A licensing organization with home office in New York had two long-distance calls from the Chicago area within an hour recently, both asking for engineers who were equipped so that they could step into positions paying up to \$7500 a year. The licensing organization receiving these urgent requests had no engineers in mind; they did know where to look. Consolidations

among set manufacturers will release some men of the proper caliber, but there will always be good positions for good men.

One of the manufacturer's best safeguards against decadence must lie in his engineering department. This department will cost about 1½ per cent. for engineering alone; and the manufacturer will have some difficulty in finding and keeping good engineers unless he is willing to pay good money for them.

## A WORD TO THE WISE IS SUFFICIENT

**T**HE FOLLOWING quotation from the *Exhibitors' Herald World*—a trade journal of the motion-picture industry—is so succinct and needs so little paraphrasing to make it a shoe for the foot of some manufacturers of radio receivers that we reprint it as it appeared in the May 4, 1929, issue of that journal.

"It would be amusing—if the matter were not one of such vital importance—to see the number of persons connected in one way or another with motion-picture affairs who have suddenly set themselves up as experts on reproducing devices. The intentions of some of these may be worthy enough but the exhibitor who depends upon their guidance is headed for a painful and expensive experience.

"It seems almost too obvious to state that when a person wants advice on a technical matter he should go to a technician—and not to a banker, baker, or candlestick maker. But this very thing is being done by exhibitors in connection with contracting for reproducing equipment. The theatre man who follows this course will have to be lucky indeed to escape seriously unpleasant results."

## UNIFORM SELECTIVITY IN 1930?

**O**NE OF THE engineering advances which the screen-grid fervor has masked rather thoroughly is that which gives radio-frequency amplifiers a flat frequency characteristic and endows a receiver with uniform r.f. gain. The tuned r.f. set of a year or so ago had a voltage amplification that varied at least three to one over the band and many varied in a much greater ratio than this. At the same time the selectivity of the set varied in at least a three to one ratio. The result was a set which seemed very selective and somewhat dead at 550 kc., and very broad and of proper gain at 1500 kc.

Now what is really desired is an amplifier that has constant gain over the band—disregarding any peculiar method of allotting station frequencies indulged in by the Radio Commission—and in which the percentage selectivity at the high frequencies is three times as great as at 550 kc. For example, at the lower end of the band we desire to pick a 10-kc. channel out of 550 kilocycles, or one in 55. This calls for a frequency separation of 1.82 per cent. Now at 1500 kc. we want the same 10-kc. channel, or one part in 150 or a frequency separation of 0.66 per cent.—three times as great as is required at the other end of the broadcast band.

(Concluded on page 298)

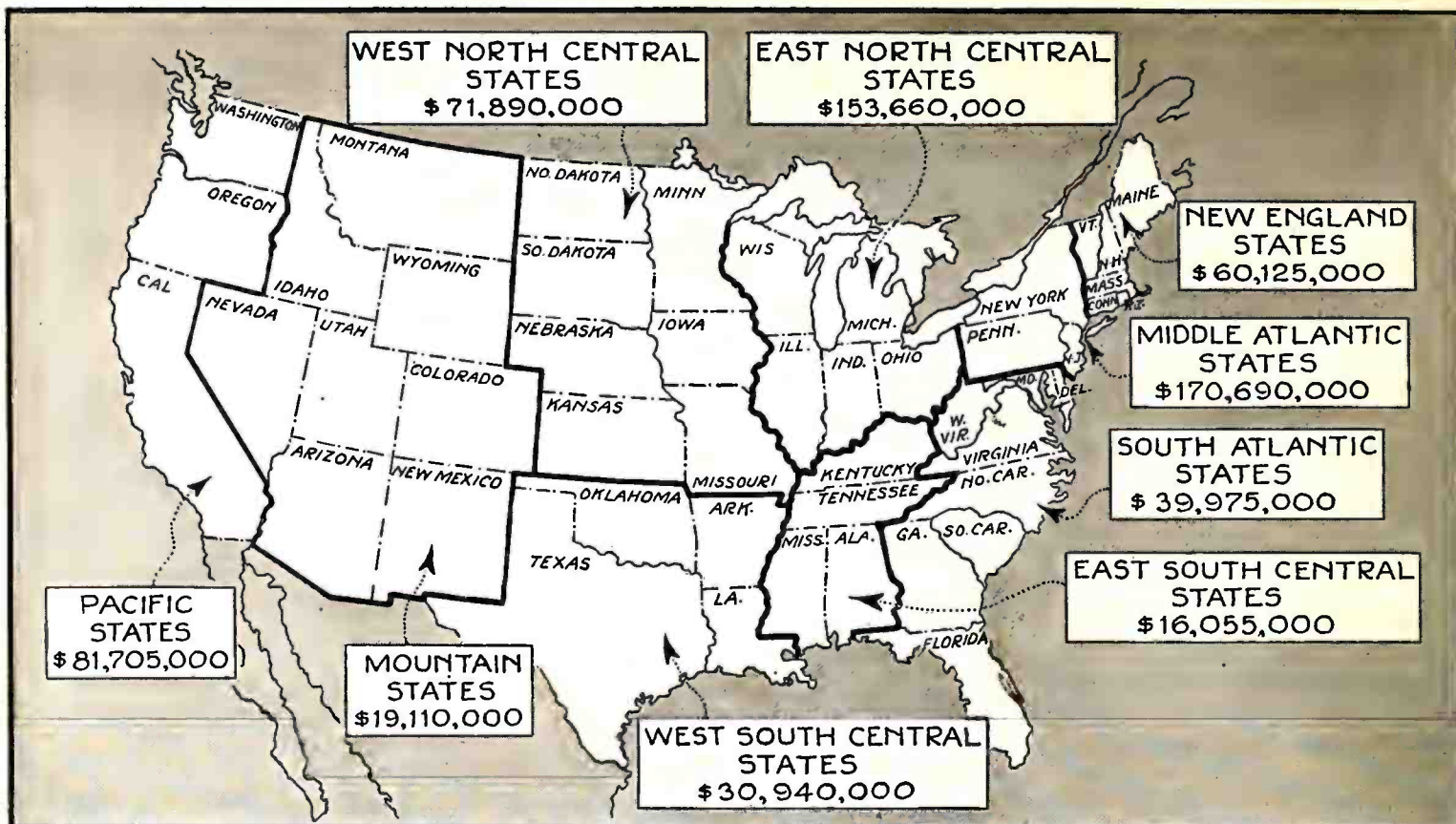

The figures on this map give an estimate of the total radio set sales for the radio year of 1928-29 (July-June).

# AN ESTIMATE OF SET SALES

By T. A. PHILLIPS

Manager, Research Division, Doubleday, Doran & Company, Inc.

**T**HIS is the last and concluding article analyzing the radio survey made by the Bureau of Foreign and Domestic Commerce, electrical equipment division, in cooperation with National Electrical Manufacturers Association. The first two articles discussed the most important phases of the survey. This article reports some of the other items covered that are of general interest.

The survey gives radio set sales by states July 1, 1928 to March 31, 1929, which presents the opportunity of making

an estimate of total set sales for the radio year (July 1, to June 30) by states. The radio year has passed but it will be many months before the totals are known. In the meantime, these estimates will help in determining the future business in light of past results. The NEMA estimates that set sales will reach a total of \$650,000,000. Taking that as a base we have made the estimate given in Table I. Note that New York, New Jersey, and Pennsylvania account for more than one-quarter of the total sales. The territory east of the Mississippi and north of the Ohio River accounts for more than

Table I: Estimate of Total Radio Set Sales for Each State for 1928-1929

State	Percent. of Total Sales	Estimated Total Sales in Dollars. Radio Year 1928-1929.	State	Percent. of Total Sales	Estimated Total Sales in Dollars. Radio Year 1928-1929.	State	Percent. of Total Sales	Estimated Total Sales in Dollars. Radio Year 1928-1929.
<b>NEW ENGLAND STATES</b>			<b>WEST NORTH CENTRAL STATES</b>			<b>WEST SOUTH CENTRAL STATES</b>		
Maine	0.89	5,655,000	Minnesota	2.04	13,260,000	Arkansas	0.59	3,835,000
New Hampshire	1.00	6,370,000	Iowa	2.58	16,770,000	Louisiana	0.42	2,730,000
Vermont	0.36	2,210,000	Missouri	3.55	23,075,000	Oklahoma	1.15	7,475,000
Massachusetts	4.39	27,690,000	North Dakota	0.38	2,470,000	Texas	2.60	16,900,000
Rhode Island	0.92	5,915,000	South Dakota	0.40	2,600,000	<b>Group Total</b>	<b>4.76</b>	<b>\$30,940,000</b>
Connecticut	1.94	12,285,000	Nebraska	0.11	715,000	<b>MOUNTAIN STATES</b>		
<b>Group Total</b>	<b>9.50</b>	<b>\$60,125,000</b>	Kansas	2.00	13,000,000	Montana	0.25	1,625,000
<b>MIDDLE ATLANTIC STATES</b>			<b>Group Total</b>	<b>11.06</b>	<b>\$71,890,000</b>	Idaho	0.30	1,950,000
New York	11.80	74,750,000	<b>SOUTH ATLANTIC STATES</b>			Wyoming	0.09	585,000
New Jersey	4.42	28,600,000	Delaware	0.28	1,820,000	Colorado	1.04	6,760,000
Pennsylvania	10.66	67,340,000	Maryland	1.20	7,800,000	New Mexico	0.04	260,000
<b>Group Total</b>	<b>26.88</b>	<b>\$170,690,000</b>	District of Columbia	0.91	5,915,000	Arizona	0.13	845,000
<b>EAST NORTH CENTRAL STATES</b>			Virginia	1.00	6,500,000	Utah	0.98	6,370,000
Ohio	7.75	50,375,000	West Virginia	1.22	7,930,000	Nevada	0.11	715,000
Indiana	3.16	20,540,000	North Carolina	0.37	2,405,000	<b>Group Total</b>	<b>2.94</b>	<b>\$19,110,000</b>
Illinois	5.90	38,350,000	South Carolina	0.49	3,185,000	<b>PACIFIC STATES</b>		
Michigan	4.39	28,535,000	Georgia	0.34	2,210,000	Washington	2.16	13,975,000
Wisconsin	2.44	15,860,000	Florida	0.24	2,210,000	Oregon	2.38	15,405,000
<b>Group Total</b>	<b>23.64</b>	<b>\$153,660,000</b>	<b>Group Total</b>	<b>6.15</b>	<b>\$39,975,000</b>	California	8.06	52,325,000
<b>EAST SOUTH CENTRAL STATES</b>			<b>EAST SOUTH CENTRAL STATES</b>			<b>Group Total</b>	<b>12.60</b>	<b>\$81,705,000</b>
Kentucky	0.79	5,135,000	Kentucky	0.79	5,135,000	<b>Grand Total</b>	<b>100.00</b>	<b>\$650,000,000</b>
Tennessee	0.69	4,485,000	Tennessee	0.69	4,485,000			
Alabama	0.74	4,810,000	Alabama	0.74	4,810,000			
Mississippi	0.25	1,625,000	Mississippi	0.25	1,625,000			
<b>Group Total</b>	<b>2.47</b>	<b>\$16,025,000</b>	<b>Group Total</b>	<b>2.47</b>	<b>\$16,025,000</b>			

L-3



# The MARCH

Putting Radio on the Front Page  
Let Dealers Suggest Advertising Copy

## Tying In With Aviation

**F**IVE YEARS AGO, radio occupied the same public attention and the same liberal space in the press that is to-day accorded to aviation. There was then no item of the broadcast studios or of the industry too insignificant to break into print and one who had a working knowledge of radio became automatically a social lion. The radio industry successfully established itself on a sound footing before its command of the front page wore off.

Radio is remarkably well adapted to associate itself with aviation in the news of the day. By such an alliance, it may share the limelight. Most broadcasting organizations have been too concerned with direct advertising to realize that, in aviation, they have an ally which may bring them once again to the front page of the newspaper and to the forefront of public interest. Consequently, they have made rather limited use of their opportunities restricting themselves to such events as the start of the recent transatlantic flights, the inauguration of the transcontinental air-rail service, and occasional talks by various aviation experts. These features are scheduled during obscure broadcasting hours when audiences are at their minimum.

If the newspapers had as little conception of news interest as the broadcasters, they would still be carrying aviation news in a half column on the fourth page. Why restrict aviation broadcasts to relatively unimportant hours?

Aviation also means opportunity to the dealer. The public is flocking in huge numbers to airports, particularly on Sundays and holidays. During May, 22,072 people paid admissions to visit Roosevelt Field, Long Island. Leisurely crowds at airports can be entertained by radio reception to the advantage of the radio dealer who capitalizes this opportunity. Open air demonstrations show up the capabilities of the modern receiver to the best advantage.

### Let Dealers Mould Advertising Policy

**R**ADIO MANUFACTURERS spend tens of millions annually in newspaper and magazine advertising to stimulate sales of radio receivers. The influence of that expenditure depends not only upon its magnitude and the skill used in selecting mediums, but also upon the directness and power of the appeals made in the advertising copy itself. One must go far from radio and the advertising profession to evaluate effectiveness of copy appeal upon those who are neither technically familiar with radio nor sufficiently interested in broadcasting to purchase a receiver. To pass judgment, one must consider advertising copy in the light of the questions asked by the prospects who visit the radio dealer's store for the first time and upon close observation of the influences which attract the new prospect and lead him to buy.



Advertising policies are usu-

ally determined by persons who have no real contact with buyers and prospects. They are based more upon theory than upon practice face-to-face with buyers. All sorts of methods are resorted to by the advertising agents to acquaint themselves with the new buyer attitude. But none have the opportunity of the average dealer to secure first-hand information as to the sales appeals arousing the greatest interest in the non-owning group, now by far the largest potential market. The dealer can help to mould advertising policies by practical suggestions made to the manufacturers whose products he handles, based on his selling experiences.



Radio manufacturers' advertising has an unconvincing uniformity to the average non-owner. The claims made by most makers are almost stereotyped, such phrases as "magnificent tone quality," "revolutionary in principle," and "new precision," appearing everywhere. Another favorite advertising technique is to coin an esoteric technical term to lend a veil of mystery to what is usually a perfectly ordinary design feature. This may captivate the dealer who gathers some glimmer of meaning from the verbiage, but it is doubtful whether a new prospect was ever won by the hocus-pocus appeal in advertising.

The disadvantages of being technically expert, when associated in the preparation of advertising, are usually not apparent to those who pay the advertising bills. Dealers use copy sent them by the manufacturer because of its convenient form and the prestige of those who prepare it. But many a dealer is better able to suggest copy themes which will bring people into his store than the manufacturer or his advertising agent. The dealer's idea of copy may violate all the principles of advertising which have been laid down so carefully by armchair experts, but it would be based upon an intimate knowledge of the buyer's attitude when he enters the radio store. For that reason, suggestions and conclusions based on careful observation should be welcomed. A dealer contest for advertising copy suggestions would be a productive source of copy ideas for any manufacturer.

### The WCFL Controversy

**C**ONSIDERING THE immense political agitation brought forward in behalf of WCFL, the Chicago Federation of Labor broadcasting station, one would derive the impression that its activities are of vital importance to the well-being of labor. We were, therefore, sufficiently interested to read the brief filed in reply to WCFL's appeal by the Federal Radio Commission with the Court of Appeals of the District of Columbia.

The Commission pointed out that the station, in the long period that it has had full time on its channel, had devoted only 30 to 65 minutes daily to programs of special interest to labor, that it has broadcast patent-medicine advertising and violated the order that phonograph records be identified. The Commission contends that labor unions as





# OF RADIO

Paramount Enters Broadcasting  
District Judges Become Commissioners

a class are no larger or more important than numerous fraternal and political bodies which could, with equal propriety, claim an exclusive channel on the basis of their numerical strength. By making the fate of WCFL a "cause," politically potent labor may force upon the Commission the necessity of granting it a clear channel. Such a decision would establish precedents which will encourage other groups to make pleas for exclusive channels on the same grounds.

There is no instrumentality which serves the public without discrimination on a broader scale than radio broadcasting. It is unfortunate to attempt to make this the tool of any class or grouping of society. WCFL should base its case on superior service to all the public and prove itself a better station from the program and service standpoint than other Chicago stations assigned clear channels. Dependence on service to labor unions rather than to the general public might indeed be construed as a realization that its case is weak from the public service standpoint. Any group, including organized labor, better able to serve than existing broadcasters, is entitled to the channel facilities of inferior broadcasters, but none deserve consideration on the basis of political threat or influence.

## A Fortune for a Feature

"AMOS 'N' ANDY" have captivated the radio public so successfully that numerous stations have been broadcasting special phonograph recordings released them each week. Recently, the services of these artists were purchased by the National Broadcasting Company from Station WMAQ for a sum reputed to be \$100,000, apparently the highest price to be paid to date for the release of a single broadcast act. The sum is not verified, but it is quite probably correct.

There is no shortage of good radio talent, but it is a matter of the utmost difficulty to secure real headliners whose merit and distinctiveness establish extensive and enthusiastic followings. It is probable that the National Broadcasting Company will be fully compensated for its purchase. No doubt, there is a great deal of scurrying around to find an advertiser to sponsor these two capable and expensive entertainers. One of these days, they will appear in the name of toothpaste, halitosis, or screen-grid tubes.

In this connection, it is interesting to learn the conclusions of Duane Wanamaker, advertising manager of the Grigsby-Grunow Company, sponsors of the "Majestic Theatre of the Air," after presenting Moran and Mack as a headline feature over the Columbia System. There has been no question about the popularity of this feature, he states in *Broadcast Advertising*, but headline artists win attention to themselves rather than to their sponsors.

This reasoning might justify the conclusion that an ordinarily good broadcast feature, not sufficiently outstanding to arouse great public interest in the artists presenting it, centers good will upon the sponsor and his product most effec-

tively. Therefore, such a program is a better paying broadcasting proposition than a "big-name" feature.

It is doubtful, however, whether an "average" feature can attract as large an audience as outstanding headliners. The average radio advertiser is no longer content to make his advertising secondary to good radio performance. Such reasoning, it seems to us, is fallacious because the first essential to successful radio advertising is to attract the largest possible audience through the program merit of the feature itself. The advertiser may secure the benefits of headliners by identifying them with names suggesting his products.

## Paramount in Broadcasting at Last

PARAMOUNT-FAMOUS PLAYERS have purchased a half-interest in the Columbia Broadcasting System, forming a combination somewhat similar to the Radio-Keith-Orpheum. The statement issued at the time of the merger set forth that it was brought about by Paramount's desire to associate itself with radio on account of the coming of practical television. It is our guess that this was simply publicity strategy because television has yet to reach a stage of development of interest to the general public and does not promise to do so in the immediate future. Paramount has been linked with the effort to start broadcasting chains for several years and this merely represents the consummation of their work in this direction.

## District Judges Become Commissioners

THE FEDERAL RADIO COMMISSION bids fair to be displaced in its most important functions by the District Court of Appeals of the District of Columbia. All the Commission's major high-frequency allocations in the continental and inter-continental channels have now been brought before that court by appeals. This amounts to placing the decision as to how the high-frequency allocations will be made with that judicial body. Attacks have centered upon the generous allotment of frequencies made to the Universal Wireless Communications Company. The Mackay Radio Corporation, Radio Communications, and Intercity Radio have appealed the Commission's decisions. The latter two fear no comparison with Universal Wireless Communications in experience in practical commercial radio telegraphy, their contender in high frequencies having had none to date.

It is all an extraordinary mess which has not been in the least simplified by the existence of strong prejudices against some of the interests involved. Radio communication is of such importance in national and international relations that it is well to consider decisions not only from the standpoint of how they affect the relative positions of various communication companies and the pet hatreds of some Senators and Congressmen, but primarily how they affect the economic future of the United States and its position in international communication.

—E. H. F.



# IN THE RADIO MARKETPLACE

*News, Useful Data, and Information on the Offerings of the Manufacturer*

## *New Receivers Announced*

**KELLOGG SWITCHBOARD AND SUPPLY Co:** Three new receivers, especially designed for use in districts supplied with 25-cycle current, have been added to the line of sets manufactured by this company. These new sets, models 526, 527, and 528, will use 224-type screen-grid tubes and an automatic volume control. The 526 and 527 have phonograph pick-up jacks.

**STERLING MANUFACTURING COMPANY:** This is the first season that this company has manufactured radio receivers although they have been in the electrical business for 23 years. Three sets are being made, the Stuart, the Avon, and the Oxford. The sets use screen-grid tubes and 245-type power tubes. The loud speaker is a 10-inch dynamic.

**STEWART WARNER CORPORATION:** The series 900 screen-grid receiver and the Stewart-Warner dynamic loud speaker are now available in a new console of 17th century English furniture design.

**TEMPLE CORPORATION:** The new receivers of this company are arranged so that either screen-grid or ordinary 227-type tubes may be used, the change over from one type to the other requiring about thirty minutes work. All models use the Temple 14-inch dynamic loud speaker. In converting a Temple set from 227 tubes to a screen-grid tube receiver, two radio-frequency transformers and two resistors must be changed. Then two 224-type screen-grid tubes are substituted for the 227 tubes in the r.f. stages and the job is done. The Temple Corp. feels that the possibility of using either 227- or 224-type tubes in their sets is a protection for their dealers in case of a screen-grid tube shortage.

**STROMBERG-CARLSON TELEPHONE MANUFACTURING COMPANY:** The model 846 receiver is a screen-grid set with automatic volume control. Two special features provide for quiet reception. One of these is a control which reduces the sensitivity of the set when powerful locals are being received or when there is considerable static. The second feature is the "silent key" operated by a push button, which enables the user to cut out background noises and station signals when tuning from one station to another. The set uses a linear detector and is tuned by means of a single dial in conjunction with a tuning meter. A phonograph pick-up jack is provided.

## *Miscellaneous New Apparatus*

**RADIO RECEPTOR COMPANY, INC:** Four new power amplifiers have been designed by this company. The PYP-245 is a three-stage amplifier with two 227-type tubes followed by two 245-type tubes in push pull, the PX-245 is a two-stage amplifier with one 245-type tube, the PXP-245 is a two-stage amplifier with 245-type tubes in push pull, and the PXP-250 amplifier contains three stages with 250-type tubes in push pull.

**JENKINS TELEVISION CORPORATION:** This company recently demonstrated a complete television receiver for home use. The complete receiver was contained in a cabinet measuring 18 by 18 by 24 inches and

the apparent size of the image was 6 by 6 inches. The set is operated by first turning on the neon glow tube by means of a snap switch and then tuning in the television signal. A crank on the set is turned to frame the picture properly. The interior mechanism consists of a synchronous motor and the scanning drum. A special distributor serves to flash in succession the four plates contained in the neon lamp. Two transmitters of the company, one at Jersey City, N. J., and the other near Washington D. C., are on a regular schedule transmitting television programs. Both stations are rated at 5 kw. and operate on 140 meters.

**JEWELL ELECTRICAL INSTRUMENT COMPANY:** The pattern No. 199 Set Analyzer is now available in a portable cabinet provided with a drawer and compartments for tools and tubes.

## *Personal Notes*

**C. J. CALLAHAN,** has assumed the duties of sales promotion manager of Colin B. Kennedy Corp. Mr. Callahan was for several years promotion manager of the Zenith Radio Corporation, of Chicago.

**AT A SPECIAL MEETING** of the Midwest Radio Trades Association held at the Electric Club of Chicago, E. J. Brennan was formally elected to the board of directors. Mr. Brennan is Chicago district radio sales manager for the Kellogg Switchboard & Supply Co.

**GEORGE MUCHER,** of the well-known family of Mucher brothers, who operate in the radio field under the name of the Clarostat Manufacturing Company, of Brooklyn, N. Y., has just joined the Clarostat engineering staff, following his graduation from the Rensselaer Polytechnic Institute.

**D. W. MCKINNON** has been chosen division manager for the Colin B. Kennedy Corporation, of South Bend. Mr. McKinnon will cover the Mid-West territory.

**DAVID GRIMES,** radio inventor, has been appointed chief research engineer of the Pilot Radio & Tube Corporation, it was announced by I. Goldberg, president of the firm. He has taken charge of the main Pilot laboratory, 323 Berry St., Brooklyn, New York, where he will conduct investigations along original lines.

**EDWARD STRAUSS** has joined the Brunswick national organization, and he will be succeeded by Frank S. Horning as the New York district sales manager.

**AMONG THE** recent additions to the Colin B. Kennedy Corporation executive personnel is G. H. Kratsch, divisional supervisor at the main office.

**O. H. ESCHHOLZ** has been appointed manager of the patent department of the Westinghouse Electric and Manufacturing Company, succeeding O. S. Schairer, who resigned to accept a similar position with the Radio Corporation of America. Mr. Eschholz's headquarters will be at the company's East Pittsburgh works.

**E. W. BUTLER,** for the past five years with the sales and engineering depart-

ment, San Francisco office, E. T. Cunningham, Inc., has been transferred to the New York executive offices of the company, it is announced by C. R. King, vice-president and assistant general manager of the company. Mr. Butler will devote his time in the same capacity at the company executive headquarters.

**THE STERLING MANUFACTURING COMPANY,** Cleveland, announces the addition to their staff of Geo. J. Eltz, Jr. Mr. Eltz will act in the capacity of manager of the Radio Division.

**A. A. TROSTLER** has just been made sales manager of the Radio-Panatrope Division of the Brunswick-Balke-Collender Company, of Chicago. This concern recently purchased the Bremer-Tully interests.

**KEITH SAUNDERS,** well-known figure in the New York radio sales field, has been appointed assistant sales manager for the Freed-Eisemann Radio Corporation. Mr. Saunders will handle all the shipment problems of the Freed concern and will contact with the Freed Radio distributors throughout the nation.

**EXECUTIVE PROMOTIONS** are announced by E. T. Cunningham, Inc. George K. Throckmorton, formerly vice-president and general manager, to the position of executive vice-president and general manager; C. R. King, formerly assistant general manager to the position of vice-president and assistant general manager; and M. F. Burns, formerly general sales manager, to the position of vice-president and general sales manager.

## *News from Distributors*

**W. E. DARDEN** has been elected vice-president and Hal Motor has been elected treasurer of Ernest Ingold, Inc., Atwater-Kent distributor of San Francisco.

**C. V. CHISHOLM,** manager of the Edison Distributing Corporation, of Boston, Mass., New England distributors of Edison radios, phonographs and records, recently announced the appointment of Guy P. Clement as their representative for the state of Maine.

**R. B. WOLFE,** sales representative of the Atwater-Kent Manufacturing Company assigned to the Sioux City distributing area, has moved to Sioux City and will serve in the territory embraced by the A. A. Schneiderhahn Company.

**THE BURR-TRUE CORPORATION,** Atwater-Kent distributors in Syracuse, N. Y., devised in connection with their annual Atwater-Kent Dealers Convention, a very novel and arresting announcement and reservation blank in the form of a check, making payable to the invited dealer "One Profit-ful Day and Enjoyable Evening," collectible at par at the Convention Headquarters. The lower part of the perforated double check, to be returned to the Burr-True Corporation, is detachable for the purpose of reservations.

## **NEW DISTRIBUTORS APPOINTED**

**THE KELLOGG SWITCHBOARD AND SUPPLY COMPANY** has appointed the Em-Roe Sporting Goods Company, 209 West Washington Street, Indianapolis, Indi-



## NEW CONSOLES

- (A) The new Victor receiver which has attracted considerable attention. The tuning control consist of a transparent indicator which slides over an illuminated dial.
- (B) A rather interesting cabinet houses this screen-grid receiver manufactured by the Sterling Manufacturing Company. The dynamic loud speaker is connected to a power stage using two 245-type tubes in push-pull.
- (C) This illustration shows the Jensen Imperial Model dynamic loud speaker. This model is available with either the Concert- or Auditorium-type dynamic units.
- (D) Automatic volume control and power detection is used in this model (No. 846) Stromberg Carlson receiver. The r.f. amplifier employs three screen-grid tubes.
- (E) The Stewart Warner series 900 screen-grid receiver in a 17th Century English Console. The receiver uses eight tubes including the rectifier.
- (F) An Atwater-Kent Screen-Grid receiver and dynamic loud speaker in a well-designed console. The receiver uses three screen-grid tubes and two 245-type power tubes.
- (G) Here is a picture of the Eveready Model 33 radio receiver. It is one of the ten models included in the Eveready line this year.
- (H) The Bosch Radio De Luxe Highboy. Sliding doors are used in this artistic piece of furniture. The receiver uses screen-grid tubes and a dynamic loud speaker.
- (I) Here is a unique cabinet design. No loud speaker grill is required for the loud speaker plays through an opening in the bottom of the cabinet. It is the Colonial Model 32.
- (J) The Radio-Victor Corporation of America makes this receiver, known as the Model 33. The legs are readily detachable making a table model receiver.

ana, distributor for the southern Indiana territory.

Western Missouri and the entire state of Kansas will be served by the Universal Equipment Company, 1201 Winchester Avenue, Kansas City, Missouri. Another distributor recently appointed by

Veer, Inc., Boston, Mass.; J. H. Blimline & Sons, Reading, Pa.; G. S. Means Co., Fort Wayne, Ind.; John Y. Parke Co., Philadelphia; and the Gertler Electric Co., New York City.

W. R. McALLISTER, sales manager of the Federal Radio Corporation, Buffalo, N. Y., announces the appointment of the Haas Electric Sales Company, Cleveland, Ohio, as a Federal wholesaler. The company's territory extends throughout about half of the state of Ohio and the tier counties in the southeastern portion of Michigan. The company contemplates opening a branch in Toledo in the near future, thereby giving immediate service to its trade in its western territory.

JOBBER-DEALER MEETINGS

DEALER MEETINGS during the summer were held by the following Atwater-Kent jobbers: Louis Beuhn Company (Philadelphia); Knerr & Company, (Harrisburg, Pa. territory); D. T. Lansing Company (Scranton, Pa. territory); Southern Wholesalers, Inc. (Washington D. C. territory); E. J. Edmond Company, E. B. Latham, and E. A. Wildermuth (metropolitan New York area); Bertram Motor Supply Company (Boise, Idaho, area); Sunset Electric Company (Washington state territory); Ernest Ingold, Inc. (San Francisco territory); Ray Thomas, Inc. (Los Angeles area); Albany Distributing Corporation (Albany, N. Y. area); Stiefvater Electric Company, Utica N. Y.; Columbus Ignition Company, Columbus, Ohio; C. L. Hartman Corporation, Rochester, N. Y.; Burr-True Corporation, Syracuse, N. Y.; Kurtzmann Company, Buffalo, N. Y.; Strevell-Patterson Hardware Company, Salt Lake City, Utah.

TEMPLE DISTRIBUTORS' dealer meetings were held during the summer by Bihl Brothers, Buffalo, New York, and by the Ackerman Electric Company in Grand Rapids, Michigan. At Pittsburgh, Pa., the Keps Electric Company gathered 315 dealers to hear the Temple story and a similar meeting was held for the West Virginia territory by the Front Company, Temple wholesalers in that territory.

News of the Industry

THE ACTIVE Pacific Radio Trade Association, with George H. Curtiss as secretary, has been sending out dealer window strips during the summer, plugging sum-

mer radio entertainment to be had over the West Coast networks. Window strips at other seasons for important broadcast events have also been sent out.

NINETEEN DEALER helps are listed in an illustrated catalogue recently sent to Atwater-Kent dealers. Among the sales helps available are the following: window sign; girl cutout, cardboard musical instrument group, name blocks, humorous cardboard cutouts, organ and disc cutouts, heraldic figures, color shafts, miniature posters, 24-sheet posters, bridge sets valance and window transparencies, cardboard letter, match folders, whistles, and balloons.

PARKS AND HULL, Atwater-Kent distributors in Baltimore, issue each week a folder giving highlights of local broadcast programs. The cover of the printed piece gives program features on the air at the same time every day as well as a list of regular attractive types of programs to be heard. The two inside pages are multi-graphed each week and refer especially to local programs of interest. *Highlights of Local Programs*, as Parks & Hull have named the sheet, is available to retail salesmen.

W. S. TAUSSIG, service engineer of Freshman-Freed Eisemann, believes that radio manufacturers should encourage cooperation with manufacturers of electrical and other devices which are, in operation, capable of setting up interference with radio reception. In this way, he thinks, these makers can be induced to cure the trouble at the source and in a great measure, relieve the industry of the onus of curing interference after it is created.

THE FRESHMAN COMPANY have contracted with the makers of electric flasher signs, electric pianos, elevators, telephone apparatus, street cars, electric refrigerators, etc., to furnish information about the parts of their products causing interference and to assist them in ways of removing the causes without altering the operation of the apparatus.

WALTHAL'S, New York radio chain, announce the appointment of Miss Nellie Brennan as manager of their New York City store at 142 East 86th Street. It is said she is the first woman radio store manager on record.

Walter Nussbaum, president of Walthal's, announces the opening of the 15th store in the system in Brooklyn. Another store was recently opened in New York City.

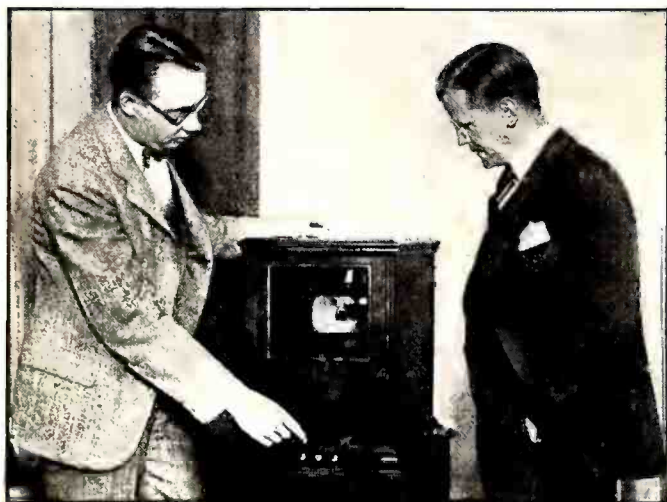

The television receiver pictured above has been developed for home use by the Jenkins Television Corp.

the Kellogg Switchboard and Supply Company is the F. D. Lawrence Company, Inc., 219 W. 4th Street, Cincinnati, Ohio, who will serve dealers in eastern Kentucky, southwest Ohio, and the southwestern portion of Indiana.

THE TRIAD MFG. COMPANY has appointed the Northeastern Radio, Inc. and John V. Wilson, of Boston, Triad wholesalers for the New England territory.

THOMAS A. EDISON, INC., maker of the Edison Radio, have completed negotiations with Morley Bros., of Saginaw, Michigan, for the distribution of Edison radios, phonographs, and records in that state, according to an announcement recently made by Roy S. Dunn, western sales manager of Thomas A. Edison, Inc. Michigan Edison dealers will now be served by two Edison distributors, the other distributor being E. A. Bowman, Inc., of Detroit, who is intensifying his Edison activities within the environs of Detroit.

THE COLIN B. KENNEDY CORPORATION, announce the appointment of the following distributors: Belknap Hardware & Manufacturing Company, Louisville, Ky.; Lindsay Electric Company, Rochester, N. Y.; Whiteemore, Bros., Worcester, Mass.; Narrangansett Radio Corporation Providence, R. I.; Tri-State Radio Co., Huntington, West Virginia; Ashton-Dc-



L. T. Breck



Crosley distributors and representatives of seven leading furniture manufacturers met in convention recently at the Crosley factory at Cincinnati, Ohio.

TEMPLE IS having 5000 feet of film taken which shows the process of receiver making. It will be put to good use beginning August 15 when a fleet of Temple sales-promotion autos starts on a tour of the United States.

There will be six machines, painted Temple blue and cream, in the caravan at the start. Each machine will be equipped to show films of the Temple plant and will be prepared to shoot new scenes along the way. A sales-promotion official, a radio engineer, and a window trimmer will be in each car, and, in addition, each auto will carry a Temple receiver.

THE NATIONAL ELECTRICAL MANUFACTURERS ASSOCIATION will hold its annual meeting at the Wardman Park Hotel, Washington, D. C., during the week of October 7. A large attendance, representing the entire electrical manufacturing industry, is anticipated as this is the only meeting attended by all the different product groups in the Association.

A SPECIAL STOCKHOLDERS' meeting has been called for the purpose of changing the name of the Chas. Freshman Co., Inc. to Earl Radio Corporation. The change in name was strongly urged by dealers and distributors who deemed this advisable, in order to identify more properly the company with the new C. A. Earl Radio which has been so enthusiastically received by the trade and the public.

HAROLD J. WRAPE and his business associates in the Benwood-Linze Company purchased outright the entire interests of the Trav-Ler Mfg. Co. stockholders. New officers of the company are Mr. Wrape, president; C. Hambuechen, vice-president; and C. R. Ogle, secretary and treasurer. W. A. Butler, formerly merchandising manager of the Benwood-Linze Company, is general sales manager for the Trav-Ler Mfg. Corp.



George K. Throckmorton

THE NEW *Better Radio Reception Manual*, published by R. M. A., gives detailed information as to the various types of electrical appliances which are liable to cause interference, how the cause of the noise can be located, and, finally, how the noises can be eliminated through the installation of various types of filters. The price of the Manual is 25 cents and copies can be obtained from the Radio Manufacturers Association, 32 West Randolph Street, Chicago, Ill.

AT A MEETING of the Board of Directors of the Grigsby-Grunow Company, the

regular quarterly dividend at the rate of \$4.00 per share per annum was declared. The Company's fiscal year ended May 31, and total sales for the fiscal year were \$49,275,990.97.

IN THE PRESENCE of more than 100 distributors and guests, the All-American Mohawk Corporation, manufacturers of Lyric radios, in June opened its new cabinet manufacturing plant at North Tonawanda, N. Y. This was one of the features of the fourth annual convention of the corporation's distributors.

Dr. Charles Lauritsen, chief engineer of the Colin B. Kennedy Corporation, has inaugurated a complete system of inspection to maintain production models of the sets equal in every respect to the laboratory models. The factory test bench is shown in an illustration on this page.

IN OPENING a new real estate development featuring a modernistic home, the Justin Matthews Company, developers, working with 555 Incorporated, Atwater-Kent distributor of Little Rock, Arkansas, equipped the home with a new Atwater-Kent screen-grid electrodynamic radio set.

RADIO AND FURNITURE MEN MEET

SEVEN LEADING manufacturers of fine furniture were asked to display cabinets to the distributors of Crosley radio receivers at a convention held recently in Cincinnati. Distributors from all parts of the country, with the exception of the West Coast, attended, while the latter group held a similar meeting at San Francisco at the same time.

The cabinets displayed by the furniture companies are designed to take the Crosley chassis and moving-coil loud speaker. Assembly may be made in a few minutes. Provision has been made to make permanent installation by placing two screws, one in the chassis and one in the loud speaker. Steel rails are placed in the cabinets to permit easy placing of the chassis.

The seven furniture manufacturers who displayed thirty cabinet designs, were: Berkey and Gay, Grand Rapids, Mich.; Sligh Furniture Company, Grand Rapids, Mich.; Showers Brothers, Bloomington, Ind.; Thomasville Chair Company, Thomasville, N. C.; Memphis Furniture Company, Memphis, Tenn.; Rockford Furniture Company, Rockford, Ill.; and

Doernbecker Manufacturing Company, Portland, Ore.

PRODUCTION PLANS FOR 1929

FROM ANNOUNCEMENTS of set manufacturers, referring to production plans for the current radio season:

*Kennedy:* 1000 sets per day on the



F. A. D. Andrea showing A. S. Hunter and J. Sieger, London radio engineers, the new Fada chassis. F. K. Rettenmeyer, chief engineer Fada, is on the right.

screen-grid chassis. "Estimates from orders on file place our production for 1929-30 at 150,000 sets."—F. W. Wellington, chairman of the board.

*Bremer-Tully:* 2200 complete radio sets per week. ("Before winter, the company expects to speed up production to 750 sets per day."—R. E. Smiley)

*Majestic:* 5100 sets per day.

*Temple:* 500 sets per day (July 15); production quota for 1929-30: 250,000 sets.

*Freshman:* 1200 sets a day; 1500 by August 1st.

RADIO ADVERTISING SERVICE

STANDARD RATE AND DATA SERVICE, 536 Lake Shore Drive, Chicago, are issuing a monthly radio supplement to their regular advertising media service. In addition to rate cards and information about each station, the monthly issue provides data on the following broadcast networks: National Broadcasting Company, Columbia Broadcasting system, American Broadcasting Company, and Trans-Canada Broadcasting Company.

KOLSTER ORGANIZES FIELD FORCE

THE KOLSTER RADIO CORPORATION has completed the reorganization of its field sales force into five districts covering the United States, according to sales manager L. T. Breck. The company has set (Concluded on page 303)



Dr. Charles Lauritsen, chief engineer, Colin B. Kennedy Corp., tries to keep production models equal in every respect to laboratory models. Above is pictured the elaborate factory test bench.

L-5

# THE TUBE BUSINESS

## HOW TO ADVERTISE TUBES

WE HAVE HEARD the belief expressed a number of times that tube advertising which suggests a test between two makes of tubes to determine which gives better tone quality, distance, etc., is certain of failure. We have heard of several of these tests, conducted according to the modern "blindfolded" fashion, which proved conclusively that one set of tubes in a given receiver was just as good as another set from another manufacturer. It is our belief that any test suggested by advertising which when carried out does not point conclusively to the superiority of the product being advertised is sure to be a boomerang.

Long tube life, uniform construction, freedom from hum, the sound judgment and financial status of the manufacturer, the superior engineering force as evidence of good design—these are the sources of copy which the advertising writer can use to the advantage of his client.

Some manufacturers feel that advertising which claims a tube "heats" instantly may be perfectly true but that it is misleading. No tubes "play" instantly, and even with d.c. tubes there is appreciable time lag between turning on the switch and the advent of sound from the loud speaker. We feel that such advertising harms the tube in question more than other manufacturers, who state plainly that their tubes produce music in from five to ten seconds, and therefore carries its own punishment with it. It is just the difference between a clear-cut statement and one that is cloudy—and it is here that a test will tell the truth. We should like to see and to recommend a tube of the 227 type that "plays" instantly.

## FACTS ABOUT SYLVANIA TUBES

IN A BOOKLET entitled *Business Facts about Sylvania Radio Tubes*, we find the following four reasons why the tubes identified by the "Flashing S on a Green Oak Leaf" are good tubes.

"First: Sylvania precision operations are handled by men trained for years. And we never rush them, because if you crack a whip over skilled workers they become nothing more than laborers, and the product is bound to suffer.

"Second: We will never let a Sylvania tube leave the factory unless it passes fifteen rigid inspections. That protects the product against rush and hurry because all tubes must pass those tests or go into the junk pile. And junk piles run into money.

"Third: Sylvania has contentment. No slot machines are on Sylvania's payroll. Our hundreds of employees are treated like human beings, given good wages and every consideration, from a com-

pletely equipped hospital and nursing staff to buses that take them back and forth.

"Fourth: Sylvania's up-to-the-minute plants at Emporium, Pennsylvania, are in the heart of the Allegheny Mountains—where the air is crisp and healthful, bodies rugged, eyes clear, and minds alert."

## TUNG-SOL ENTERS FIELD

Entry of Tung-Sol Lamp Works, Inc., Newark, N. J., into the radio tube industry has been announced. A new factory adjacent to the lamp factory in Newark will be built. It will have an operating space of over 82,200 square feet, a daily capacity of between 25,000 and 30,000 tubes, and will be in operation by January 1, 1930. Tubes will be made under R.C.A. license. The factory is to be built out of company earnings. Harvey W. Harper is president of the company.

## NEW TUBE TESTER

THE JEWELL ELECTRICAL INSTRUMENT COMPANY announces a new Pattern 199 a.c.-d.c. set analyzer designed to test the new a.c. screen-grid tubes. This instrument tests practically everything about a radio set except the kind of program the user tunes in, and, if there were any way in which the device could be made to censor loquacious announcers, we suppose Jewell would incorporate it into the instrument.

## CUNNINGHAM SALES

CUNNINGHAM SALES for the first five months of 1929 show an increase of more than 35 per cent. over a corresponding

period of 1928, according to M. F. Burns, vice-president and general sales manager. It is expected that the figures for the first half year will show a total number of tubes made exceeding the total number built during 1928.

Mr. Burns believes the 1929 tube market will be greater than any other in the history of radio. He believes the total production of tubes for the year will reach 110,000,000.

## MARVIN'S RADIO DEBUT

THE MARVIN MUSICIANS, sponsored by the Marvin Radio Tube Corp., of Irvington, N. J., will make their radio debut over the wjz network of the National Broadcasting system on Saturday, Aug. 31, at 8:30 p. m., New York Time. The series will continue for a period of 26 weeks.

Hugo Mariani, ace conductor of the NBC studios, assisted by a 25-piece orchestra, comprise the Marvin Musicians. Mariani has evolved a novel "musical-journey" idea which readily adapts itself to a flexibility in programs.

## RUMORS OF LARGE MERGER

RUMORS OF A merger of the manufacturers of Televocal, Magnetron, Sonatron, and Marathon tubes continue to float hither and yon. No one will deny or confirm these rumors which in themselves are a good indication that something is brewing. The latest rumor (July 25), published in New York papers, states that not only has such a merger been completed but that a license has been granted it by R.C.A. who has loaned the new company \$2,000,000 secured by an option on 50,000 shares of stock in the new company.

## TUBE SHORTAGE PREDICTED

AS LATE AS July 22, William J. Barkley, assistant to the president of the DeForest Radio Company, predicted a severe shortage in tubes of the -24 and -45 types, and encouraged all dealers to stock up on tubes in preparation for the fall trade when this shortage would become evident in the retailer's end of the business.

Certainly there are two serious aspects of any tube shortage. If a dealer cannot supply tubes he cannot sell sets, any more than he could sell an automobile on the promise of getting tires later on. Thus the dealer loses sales. On the other hand, a pronounced tube shortage makes it "pie" for inferior products to be dumped on the market and sold. These tubes either work but poorly, or fail prematurely and always breed dissatisfaction. As Mr. Barkley says, "Tubes in stock mean more than money in the bank."

(Concluded on page 303)

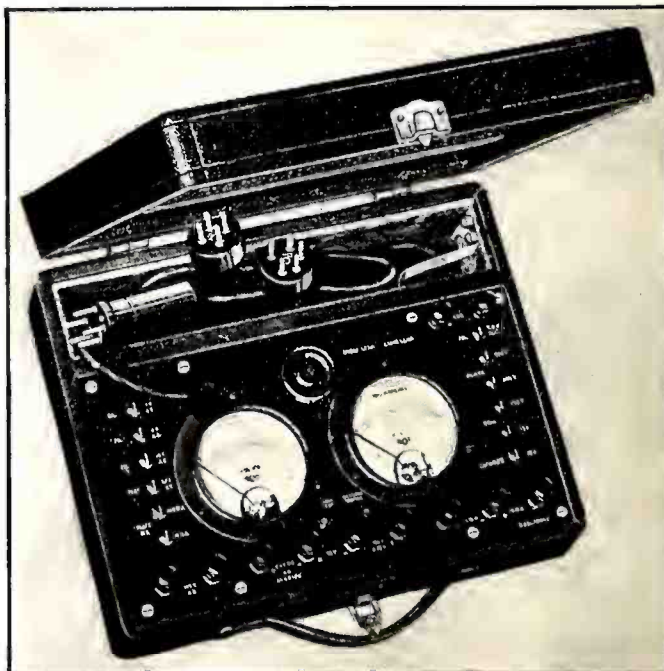

The New Jewell set analyzer tests a. c. screen-grid tubes.

L-6

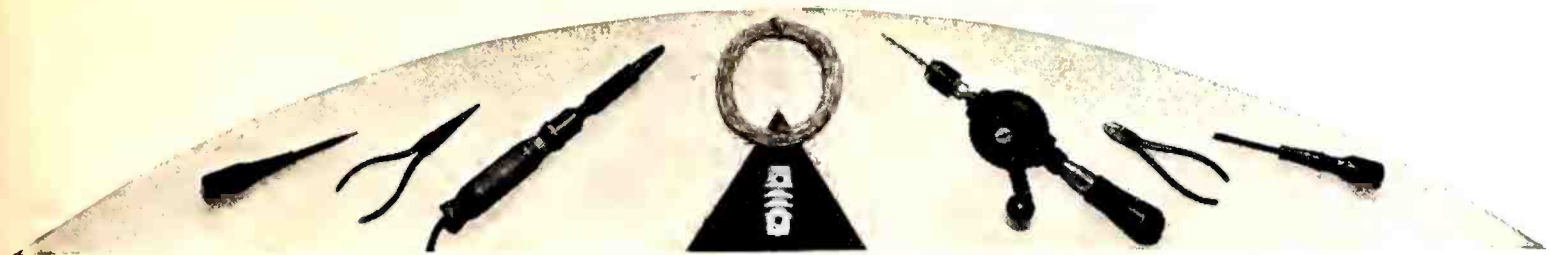

# THE SERVICEMAN'S CORNER

## Why Servicemen Go Home

**R**ADIO SERVICING has settled down for the greater part to the detection and solution of a few relatively simple troubles. But every once in a while, just to make life interesting, we run into a stumper, and HERBERT M. ISAACSON, service expert of Brooklyn, N. Y., describes two good ones in the paragraphs that follow:

"If your customer complained that a loud bong came from the loud speaker at every footstep of a person in the room, and that a howl, low in volume at first, but rapidly building up to tremendous loudness, occurred whenever the loud speaker was brought within ten feet of the set, you'd say that undoubtedly there was a very microphonic tube in the detector socket.

"Well, that's what I said, but—

"The set was a Garod electric, model E A. The detector is a 199, and because of the high audio gain, a tube that is only mildly microphonic manages to kick up quite a rumpus. Wherefore, I had selected a number of 199's that tested practically non-microphonic, feeling quite certain that the trouble could be due to nothing but a microphonic tube.

"A terrific howl was my greeting when I switched the set on. We'll fix that in a moment," I murmured confidently to the customer, and I slipped in a new detector tube. To my chagrin it too howled unmercifully. I tried the rest of my tested tubes with no greater success.

"The loud speaker had a 30-foot cord, so that it was possible to move it into the next room. This stopped the howl which was due, of course, to acoustic coupling between it and the set. However, the scraping of a chair across the floor, walking or the very lightest scratching of the set panel with the fingernail resulted in a noise of considerable volume from the loud speaker. With my mouth held close to the panel, every word I uttered was reproduced, badly garbled but still intelligible and with good volume.

"I tried tapping the set at different places in an attempt to localize the source of the trouble, but the noise in the loud speaker was equally loud wherever I tapped. An examination of the set did not indicate anything that might cause the trouble.

"Finally I sandpapered the brass end caps of the grid leaks and the trouble cleared up. Although the grid leak was held tightly between its mounting clips, tarnish on the end cap evidently caused a highly resistive contact that varied greatly under the stimulus of any slight vibration. The result was to affect grid circuit modulation in the detector.

\* \* \*

"On another occasion, I was called in to correct a trouble that the customer assured me I couldn't correct. 'No one could,' he said. All the local experts had tried to, and had failed. This fellow was fairly bursting with pride at being the owner of a radio that 'no one could fix.'

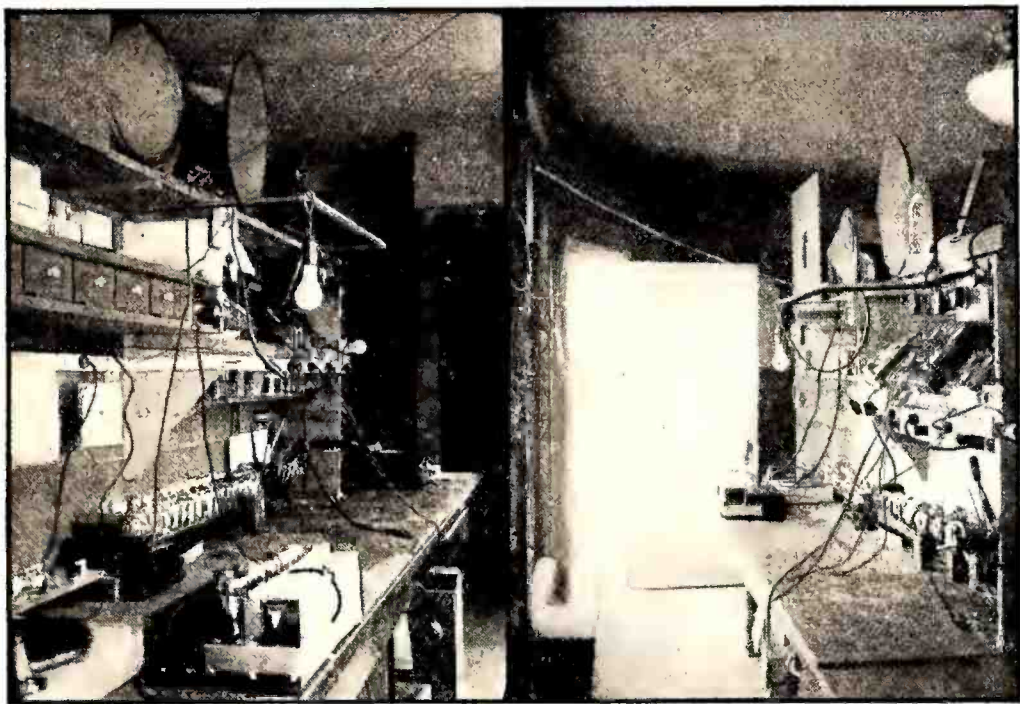

Two views of the radio service bench at the Bee Automobile Company, of Allentown, Pa.

"This customer had a Garod electric on which reception was perfect except for the annoying fact that all stations would fade in and out. This fading was gradual and very similar to that encountered when listening to a distant station. My first suspicion was that the antenna was at fault. I disconnected it and strung a few feet of magnet wire through the room instead. (The r.f. gain of these sets is

quite high so that good volume is obtained with very small antenna.) I disconnected the ground. But won't fade serenely in and out. My diagnoser showed that the voltages at the tubes remained steady while the fading occurred. A new set of tubes helped not at all. Jarring the set didn't seem to affect the fading.

"Then, during one of the periods when the station stayed 'out' for a few seconds, I found that I could bring it in again with full volume by retuning about 3 degrees. Here was a clew. Whatever was causing the fading was doing so by virtue of a tuning effect. I took off the shield cans—which were of brass and bolted to brass bed plates on which the apparatus is mounted—and inspected the tuning condensers. Seemingly, they were perfect. Careful examination of the r.f. coils showed them to be perfect, too. Everything appeared to be tight. I sandpapered the bed plates where they made contact with the shield cans and secured the cans back in place. The fading was gone.

"In all probability tarnish and dust were causing variable contact between the shields and the grounded bed plates, so that at times the shields were grounded and at other times they were 'floating' with a resultant tuning effect on the coils mounted inside them."

[These are only two of Mr. Isaacson's unusual experiences in servicing radio receivers. We are holding several others in type and they will be published in a future issue—Editor.]

### Tube Troubles

"The big joke was found in a brand new Tyrman a.c. Imperial 80 (beautiful job). The trouble: fading signal, no wallop, hum,

*We are publishing this month a collection of several contributions on radio service problems caused by faulty tubes. In the past we have given space to articles of a similar nature but these have by no means exhausted the subject, as it has been estimated by service experts that tube trouble is to blame for more service jobs than the failure of any other piece of apparatus or equipment. Fully fifty per cent. of radio difficulties—in many instances fading, distortion, lack of volume, noise, dead set, howling, insensitivity, and almost anything else that can happen to a radio set—can be traced to a tube in the process, past or present, of "going west."*

*We should like servicemen to tell us of the tube troubles they have run into, simple and complex, the common difficulties and the freaks. The more the merrier!*

—THE EDITOR.

and several minor afflictions. I made strict search for all defects possible and then put the little box of tricks to work. Well, the amplifier proved ok., plenty of pep and juice to spare, but when I hooked it all up I lost all plate voltage on the second detector. Well then it was the old process of elimination and the trouble was located as a direct short from the second i.f. transformer space charge to cathode. So watch your a.c.-21, they're tricky."

R. R. HESCOCK, Manager (Silver-Marshall Service). Associated Radio Engineers, Portland, Oregon.

GEORGE W. BROWN, radio service manager of the Motor Supply Company, Boston, Mass., reports the following:

"Here is a trouble which I have encoun-

tered often enough to deserve a space in the "Corner."

the serviceman will, no doubt, find that some have much more volume on the phonograph pick-up than others. This is usually due to the fact that some 181's have the pick-up unit connected ahead of the detector and some are hooked up ahead of the first audio tube. To ascertain this quickly, it is only necessary to pull out the detector tube and try the phonograph. If it plays with the detector out it is generally advisable to change the wiring.

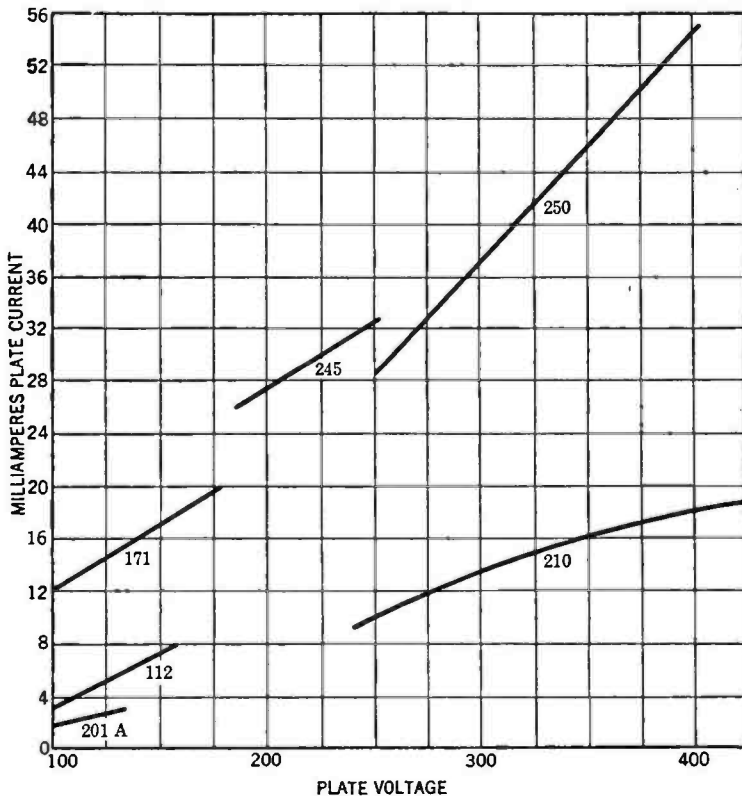

This graph indicates the correct plate currents for six popular types of tubes at various plate voltages, assuming a consistently correct C bias. These data should be pasted to the cover of your tube- and set-tester.

"I have been servicing Eveready sets. This set uses three stages of r.f. with 227 tubes. The detector and 1st audio are also 227's and two 171A's are used in the last audio. The volume control, a resistance in the cathode leads of the r.f. tubes, controls the C bias.

"The set in question after working for a short while suddenly developed full volume and the volume control had no effect on it. After a lot of testing and sweating I found that one of the 227 tubes in the r.f. end had developed a short from cathode to filament, thus shorting out the volume control completely.

"Shortly afterwards I had another set which after playing ok. for a while started to hum in an alarming manner—a regular 60-cycle hum. On testing this set I found there was no C voltage on the r.f. tubes. Here again it was due to a 227 being defective, and I imagine it was also a cathode to filament short."

It is reasonable to suppose that the possible tube troubles will be augmented considerably with the popular use of the a.c. screen-grid 224 tube.

Miscellaneous Kinks

Majestics, Fadas and Radiolas: H. P. ERICKSON, specialist in Fada, Majestic, and Atwater-Kent service in Ottumwa, Iowa, helps the cause along:

"Majestic 181 Combination: In the installation of a number of these machines,

With this chart one may determine the relationship between current, resistance, and wattage when two factors are known. A straight edge is laid across the two known factors and extended, if necessary, to include the third. The chart was prepared by R. C. Hitchcock.

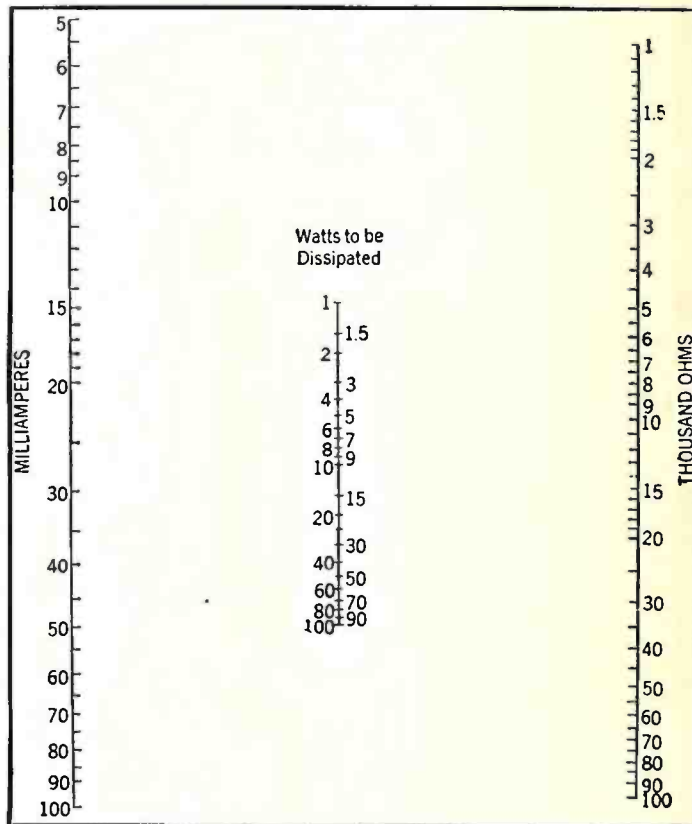

bypass in such a way that they will reach the switch and solder the ends of the lugs from which you have just removed the other two wires. Next clip the grid lead on the other side of the switch and solder it to the grid side of the detector grid-condenser. A substantial increase in volume will be the result.

"When a cable breaks on the tuning drum of a Majestic or other receiver, and you find that your stock of cables is completely exhausted, try this one. Get a three-foot cable fish-leader (who laughed?) about the same size as the drum cable. This is almost exactly the same length as is used on the Majestic sets. Remove the eyelets from the old cable and put them on the leader. You now have a cable that is just as strong and just as

efficient as a new drum cable, at, incidentally, a fraction of the cost of a new one.

"Fada 'Big Shielded Six' D.C.: Some of these models are equipped with grid leaks and condensers, and some are not. The next one you work on put in an 0.00025-mfd. condenser and a 2-meg. leak. You will notice about a 50 per cent. increase in general efficiency, in most cases.

"Fada Seven D.C.: A lot of these sets have been equipped with a dry ABC power unit by Fada. In my past experience I find that the only way in which to avoid trouble caused by excessive filament overload is to put fixed resistors in the filament circuit and use a variable high resistance across the first audio as a volume control.

"Pooley and Red Lion Cabinets: To search an hour in an attempt to locate mysterious noises and vibrations in a machine only to find that a loose board in the cabinet is causing it, is not as much of a novelty as it should be. A hammer and brads are indispensable to the serviceman in his everyday routine.

"Radiola 20 Receivers: If the volume is very poor and nothing but locals are being logged, though the filament, grid, plate voltages at the sockets are perfect, almost invariably you will find that the rotor connections on the condensers are bad. The substitution of some good cable pig-tail is recommended. In a case like this the set owner usually complains that the trimmers are not working which is a good indication of this kind of trouble."

Pepping Up the Set: "What causes a set to have 'no volume' when all the circuits test ok., all the parts appear to be, and test, in good mechanical and electrical condition, tubes of known performance are used, and a power supply furnishing standard operating voltage is connected?"

"It is the big question in radio service, as it fits those jobs which we often hear described as 'all right, just has no pep.' And the man working at radio service is measured in efficiency by just how many of these sets of reliable manufacture pass by him with no material good being accomplished toward correction. And the manufacturer, jobber, or dealer, as the case may be, suffers the consumer's loss of confidence, and the passing around of



advertising that sells no goods or makes no friends. Most every serviceman has had his share of these cases on sets known to be of reliable manufacture and to have a reputation for a high standard of performance.

"Some RCA 17's suffered from this trouble last summer in the territory along the Eastern coastal states and the cause and correction is now fairly well known over this territory. The forms on which the radio-frequency coils were wound, in some cases absorbed sufficient moisture to cause a high r.f. loss in the amplifier circuit. The popular remedy has been to remove the radio-frequency coil assembly and dry it out thoroughly in a moderately heated oven or to dry it out less quickly by placing the whole set in a warm dry place for a few days. In almost every case the original performance has been obtained after this treatment.

"Another group of 'no-volume' cases was found to exist in the variable tuning condensers of some models of A-K and other make sets using bolted-stator condensers.

"It was found that by loosening up on the bolts and turning the spacing washers a turn or two, a retightening resulted in a marked improvement in reception."

H. J. S. EMMERICH, Service Manager, Parks and Hull, Baltimore, Md.

Lack of pep in many single-control jobs is due to the fact that one or more of the condenser units have been thrown too far off resonance in stabilizing the receiver—as often happens with A-K's. The tuning circuits should be lined up until they are closer to the oscillation point.

**A Pocket Tool Kit:** "To the radio serviceman a few tools close at hand when needed are a great deal more valuable than a shop full of tools lying somewhere else.

"Since he is liable to be called on at any time to go almost anywhere, like a family doctor, he will likely have to go home first for his tools, like a plumber. This is not so good because the sick radio is liable to start playing again while he is gone. On the other hand, if the set starts while he is working at it everything is 'Jake' and he can collect his fee.

"I started early in the game to carry a small pair of pliers and a screw-driver in my coat pocket. This practice day after day soon wore holes in my pockets and coat-lining. Also, I found it necessary to buy tools quite frequently to replace those lost. Therefore, I bought a small leather pouch that was just large enough to hold the following:

One five-inch needle-nose, side-cutting pair of pliers.

One four-inch screw-driver, narrow enough to fit the set screws in radio switch knobs and dials, yet strong enough to loosen most of the screws about a radio set.

One No. 1020 Bonney CV double-end wrench that fits most of the hex nuts.

A few inches of rosin-core solder.

A short piece of insulated copper wire.

"The leather pouch is not cumbersome and can be carried any time unnoticed. The wire is often necessary to make a splice in the case of a broken connection. The rosin core solder needs only the application of heat which the ingenious serviceman will supply with a match, cigar-lighter, or a hot poker.

"I carry the kit with me whether I am on duty or not and it has prevented disappointment

in receiving radio programs many times, also possibly a reputation."

EDWIN J. BACHMAN, Bee Automobile Company, Allentown, Pa.

**Starting Nuts or Bolts with Rubber Tubing:** "The serviceman or set builder often finds times when it is next to impossible to start a nut or a bolt because of the narrow space in which he works. There have been many methods devised for doing this but all are more or less emergency devices and call for as much effort arranging the device as for doing the work. By using several eight- or ten-inch lengths of rubber tubing of varying internal diameters the work can be quickly and easily accomplished.

"Use fairly heavy walled tubing. To start a nut simply push one end of the tube over the nut and then insert that end in the space and give the tube a few twirls with the fingers. The nut will catch on the threads at once. Then pull off the tubing and finish with the necessary wrench. Bolt heads can be inserted in the tubing in the same way and thus started into any otherwise inaccessible threaded hole."

This idea, contributed by L. B. ROBBINS, veteran supporter of our departments, in Harwich, Mass., will appeal to every serviceman who has rubbed his knuckles against live stuff in trying to start an elusive nut or bolt—which makes it just about unanimous.

**The Ohm-Meter as a Service Instrument:** Reynolds W. Smith, authorized radiotriician, of Manchester, N. H., recommends the General Radio Company type 287-A portable ohm-meter as a most useful service device. The instrument consists of a 4.5-volt battery and a 7000-ohm meter in series with a variable resistor. The dial of the instrument is calibrated directly in ohms. It is portable, weighing only two and a half pounds, and rugged.

In checking circuits the ohm-meter gives a visual indication of continuity, and shows the resistance of the circuit, which, when compared with a table of standards which are easily prepared, is often significant. The resistance measurements provided by the meter are sufficiently accurate for all service work.

This G. R. ohm-meter sells for \$30.00

**Reducing Man-Made Static**

The Pacific Radio Trade Association makes the following recommendations in reference to reducing artificial static by means of a preferred ground connection:



H. J. S. Emmerich

1. Make the ground wire as short and direct as possible.

2. If a water pipe must be used make the connection to the pipe as near the earth as possible (remember that copper wire will always have a lower resistance than a water pipe).

3. Use only approved ground clamps for connection to water pipe or ground rod.

4. Never connect the ground wire to steam, gas, conduit, hot water or telephone grounds.

5. The ground wire must be insulated and treated in the same manner as the antenna.

6. To prevent ground pick-up keep the wire as far away from power wires and grounded metallic objects as possible.

7. Do not run the ground wire close and parallel to the antenna.

8. Before attaching a ground clamp to pipe or rod clean surface with sandpaper.



The G.R. 287A ohm-meter will give resistance readings directly without an external battery.

9. Wherever ground pick-up is had shield the ground wire.

10. Where an unusually low resistance earth contact is desired, or where the soil is dry and sandy, two or more pipes may be driven not less than six feet apart, nor more than ten feet apart, and the two or more pipes connected in multiple or parallel to form the ground for the receiver.



E. J. Bachman

**Service Managers Organize**

The Radio Service Managers Association, New York City, was recently organized with the following officers:

John S. Dunham, QRV Radio Service, Inc., president; Howard T. Cer-

vantes, Haynes-Griffin, Inc., vice president; James E. Shannon, Colonial Radio Corporation, corresponding secretary; C. P. Baldwin, The Aeolian Company, recording secretary, and O. Ramberg, R. H. McMann, Inc., treasurer. The three additional directors provided for and elected are: Wm. W. Heller, Gimbel Brothers; Henry C. Struckmann, American Bosch Magneto Corporation; and J. W. Wiegand, Factory Radio Service.

The principal objects of the Association, as set forth in the by-laws are:

1. To act as a forum for the interchange of ideas and experience relating to service.

2. To secure the coöperation of manufacturers and distributors in furnishing service information for dissemination to its members.

3. To provide a central source of service information for the use of its members.

4. To act as a free employment agency for servicemen and service managers.

5. To establish a system of examination and classification of applicants for service and managerial positions.

6. To coöperate with radio service schools or schools having such courses, for the purpose of improving the training available for men who desire to go into the service business.

All those who are interested in applying for membership, or who wish to be informed of future meetings, or desire more information, may address the Radio Service Managers Association at Room 406, 1400 Broadway, New York City.

We are anxious to publish names of local radio service organizations and will appreciate having secretaries send us the name of their organization together with other data, such as the address, number of members, activities, etc.—EDITOR.



H. P. Erickson

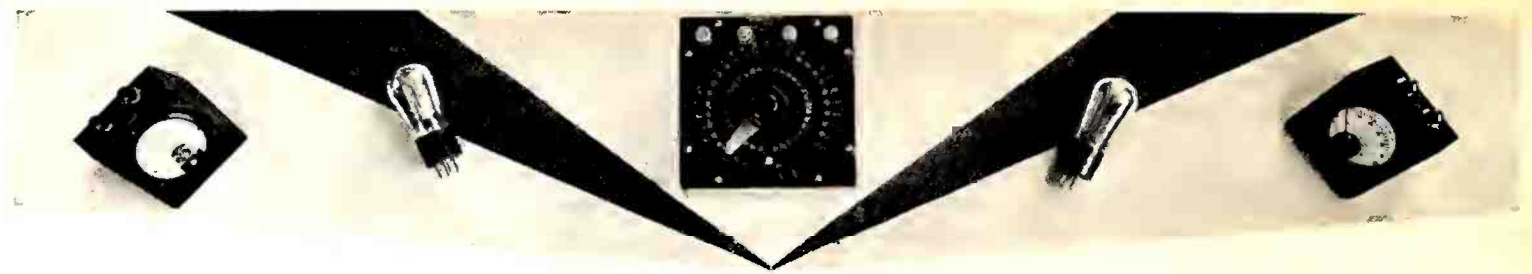

# STRAYS from THE LABORATORY

## Regarding Cross Talk

The screen-grid receiver has brought into the limelight a problem which has bothered engineers in the past and which assumes a major importance now. This is the problem of "cross talk." It is distinct from lack of selectivity, and, as a matter of fact, may have little to do with the selectivity of a receiver.

The latter is a function of the number of tuned circuits, their alignment, and the selectivity of these circuits. Cross talk occurs in the first tube circuit and is not confined to screen-grid receivers.

Any receiver which is connected to the antenna through an untuned or aperiodic circuit, such as a resistance or choke, may be subject to cross talk if it is in the vicinity of powerful stations. The strange fact is not that the receiver is bothered by local stations when its antenna is floating in the midst of an extremely heterogeneous field of signals of all frequencies, powers, and band widths, but that the receiver gets any one signal at all.

Cross talk may take place when there is some non-linearity in grid or plate circuits of the first tube, or it may take place even though the characteristics are essentially linear.

Suppose two voltages of equal amplitude at 600 and 700 kc. are impressed on the antenna and thence to an untuned input of a receiver. These signals may beat and produce a sum frequency of 1300 kc. If the following tuned circuits are tuned to 1300 kc. a signal may be heard in the loud speaker composed of the modulations of both the component station frequencies. It will be a *polpourri*, and undecipherable.

Suppose the receiver is tuned to a rather weak 700-kc. signal and that a strong 600-kc. voltage is impressed on the grid of the first tube. If this signal is great enough to cause the grid to draw current, or to cause any non-linear part of a characteristic to be traversed, demodulation will take place and the resultant audio voltages which will be present in the circuit may modulate the carrier of the desired station. Thus it may be possible to hear the studio program of a local station "riding in" on the carrier of a distant station. This carrier may or may not be completely modulated by the local station's signals.

If the volume control reduces the plate voltage of the r.f. tubes, or increases the grid bias of these tubes, a peculiar form of cross talk may result. If the volume is reduced sufficiently, the r.f. tubes become peak voltmeters and the peaks of strong local signals will "blurb" through the receiver and make intermittent loud speaker squawks and gasps that sound like regurgitations of undesired noise.

All of these evidences of cross talk can occur in screen-grid sets. In fact, they may appear often unless precautions are taken to prevent them. The amplitude of signal that can be applied to the grid of a screen-grid tube is distinctly limited by the curvature of the characteristics and the flow of grid current. A strong local signal

may overload the first tube and cause cross talk. If the volume control is on the control or screen grid and must be reduced too far to cut down a local signal to reasonable volume, cross talk may result.

The solution is to use a selective input circuit to the receiver. In some cases this may involve the use of band-pass circuits between antenna and receiver so that desired signals are admitted and passed while undesired voltages are attenuated. It seems almost certain that the volume control of the future will not only reduce the sensitivity of a receiver but at the same time must reduce the coupling of the receiver to its antenna, or increase the selectivity of the input circuit.

## The Berne Radio List

We learn from *Wireless World* (June 12, 1929) that the first part of the so-called Berne list of radio stations is ready. This section (there will be five in all) contains a list of the commercial and official fixed and land stations of the world, both long and short waves. The first section costs 7.5 francs (Swiss) and may be obtained from the International Bureau of the Telegraph Union, Berne, Switzerland. The sum in United States currency is about \$1.45.

Other sections of the list will be ready soon. They will list broadcasting stations, ship stations, special-purpose stations such as meteorological, air stations, etc.

## Municipal Radio Laws

Tobe Deutschmann, Inc. is distributing a pamphlet prepared by Paul M. Segal and Paul D. P. Spearman of the Legal Division of the Federal Radio Commis-

sion. It deals with "State and Municipal Regulation of Radio Communication," and is dated May, 1929. The laws relating to prescribing local licenses, limiting the operation of reception apparatus (radiating receivers), restricting hours of operation, etc. are considered in the pamphlet, as well as those relating to "man-made static."

## Comparison of Noise Intensities

The figures in Fig. 1 are taken from "Transmission of Sound through Wall and Floor Structures," by V. L. Chrisler and W. F. Snyder, *Bureau of Standards Journal of Research*, March, 1929. The units are logarithmic units like the dB. Thus, if the "threshold of feeling," where a sound becomes so intense it affects the nervous system as a pressure like that of a weight instead of a sound, is 108 units, the noise in an airplane is about 10-15 units below this figure. Note the high level of noise in a stenographic office.

## Grid Leak Condenser Detection

Several articles on detection, written by Professor Terman of Stanford University have been published in *RADIO BROADCAST*. Mr. Terman recommends grid leak and condenser detection for its greater sensitivity, better frequency characteristic, and greater linearity when operated at high input voltages. Some criticism of this type of detector been has made and it has not been used generally because of the "loading" effect on the previous circuit. Some experimenters feel that the loss in gain in the previous circuit makes up for any gain in the sensitivity of the detector. Other workers in this interesting field claim that the grid leak and condenser detector contributes too much distortion in the form of harmonics.

In a recent letter Mr. Terman cites the following data of a graduate student at his university who has measured the output of a detector with a harmonic analyzer. "With a 227-type tube, 33 per cent. modulation, 90 volts on the plate, the voltage across a 10,000-ohm load may be as high as 5 volts with only 5 per cent. second harmonic. This indicates that with 100 per cent. modulation and a high-quality 3-1 transformer, over 30 volts could be applied to the following power tube without excessive harmonic distortion."

After all the argument in favor of bias detection and against grid leak and condenser detection, it would be rather amusing if a majority of receivers were to go back to the older form of demodulation a year or so from now. If, as it seems is true, a grid leak and condenser detector has a high input which is linear, while the bias detector is linear over only a very small range and very near the overloading point, the former may be demanded by the search for better fidelity.

An article from the laboratory of E. T. Cunningham, Inc., giving quantitative comparisons of the two general types of detection, is scheduled to appear in October *RADIO BROADCAST*.

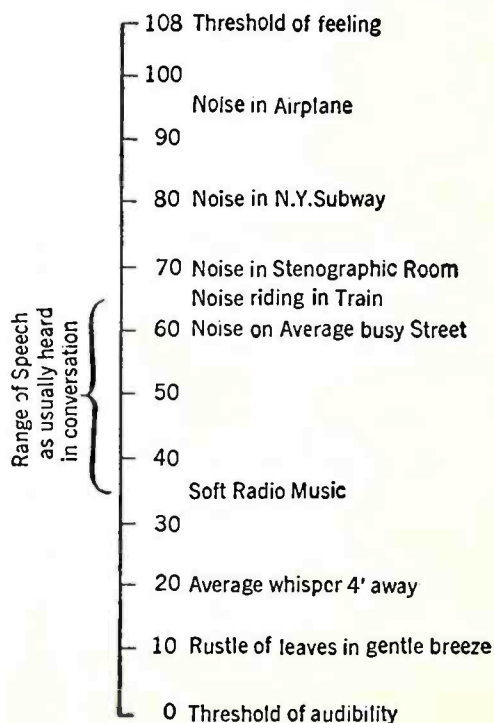

Fig. 1 — How sound intensities compare.



*In the Window*

# A new merchandising idea by MARVIN

**J**OBBERS are reducing stock investment, simplifying inventory and increasing turnover and profits by limiting their tube lines to one or two nationally known brands. If this is good business for the distributor it is an equally sound policy for the dealer.

With this new cabinet idea MARVIN makes it possible for every dealer to have a complete compact tube department that will give absolute stock control and show greater profits.

Sturdily built of steel and lithographed in full colors this cabinet displays and holds the number of tubes the average dealer should carry in stock.

Ask your MARVIN distributor how you can get this cabinet without cost, or write us.

**MARVIN RADIO TUBE CORPORATION**  
IRVINGTON, NEW JERSEY

Sales Offices: 225 Broadway, New York City

*Straight on the Counter*



*On the End of the Counter*



*Against the Wall*





**M**ARVIN colorful literature and display material tells and retells the story of the Master-Built tubes that *serve better and live longer.*

This advertising material effectively supplements MARVIN broadcasting programs and newspaper publicity and identifies MARVIN dealers everywhere.

There is an old saying that "goods well displayed are half sold." The MARVIN merchandising and stock cabinet, window lithography, window stickers and transparencies insure MARVIN dealers of maximum display value for the line.

Your MARVIN distributor will gladly furnish you with the advertising material illustrated on this page and explain the MARVIN Resale Help Plan in greater detail.





# The MARVIN MUSICIANS

**I**N their regular Saturday Night Concert Hour the MARVIN MUSICIANS are striving to please the great radio tube-using public.

MARVIN engineers are also trying to please this same audience by making radio tubes that *serve better and live longer*. The Master-Builder illustrated below symbolizes the many famous radio tube engineers who are responsible for MARVIN quality. These scientists have made contribution after contribution to the advancement of the radio art and their latest achievements are the new MARVIN MY-227 and MARVIN MY-224 tubes.



Strictly a product of MARVIN'S own laboratories this Master-Built MY-227 tube creates a new world's record for quick starting time by heating up in *five seconds flat*.

Dealers everywhere are finding this tube invaluable for demonstration purposes and easier and more profitable to sell. Complete information upon request.

**Marvin Radio Tube Corporation**  
Irvington, New Jersey



The instant approval of MARVIN MY-224 by dealers the country over is another testimonial to the Master-Builders.

This tube, on account of its ingenious construction, will not "short" even if dropped. Outer and inner shield-grids are doubly supported to prevent displacement or breakage and it maintains uniform electrical characteristics. Complete information upon request.

*General Sales Offices:*  
225 Broadway, Transportation Bldg.  
New York City

## COPPER-OXIDE RECTIFIER VOLTMETERS

By R. J. KRYTER

Radio Engineer, Prest-O-Lite Storage Battery Corporation

WHEN performing experimental work in the field of radio, the ability to make quantitative measurements is of utmost importance. It is quite essential that one have instruments which will tell him just what is going on in the circuits he is studying. The average experimental laboratory is equipped with d.c. instruments for measuring the voltages and currents involved in vacuum-tube networks. On the other hand, the measurement of the alternating voltages and currents in these circuits is not always as readily accomplished as the necessary instruments are too sluggish in their movement, or require too much power for their operation. Thermocouple instruments have the first two disadvantages, moving-iron instruments have the last two, and dynamometer instruments have the first and last drawbacks.

A.C. meters in general are more sluggish than d.c. meters and require a great deal more power to energize them. This last drawback is a very serious one in radio measurements, for it often works out that more power is required to swing the meter's needle than is available in the circuit being studied. We are accustomed to d.c. voltmeters requiring only 1 milliampere to produce a full-scale deflection (sensitivity of 1000 ohms per volt) and know that a voltmeter consuming 10 milliamperes has a limited usefulness in radio measurements. On the other hand, a.c. voltmeters of the moving-iron and dynamometer types generally require from 15 to 100 mA. in the higher ranges and from 100 to 500 mA. in the lower ranges. The power consumption is usually several watts! Even the expensive and fragile thermocouple instruments require 10 mA. to produce a full-scale deflection.

### Principle of Operation

When a d.c. instrument is placed in an a.c. circuit where the polarity is constantly reversing it merely reads the algebraic average of the reversals, which is zero. The customary method of measuring alternating currents is to design the meter so that its deflection is independent of the direction of the current flowing through it. The types of mechanism which will fulfill this requirement are limited, and are responsible for the shortcomings of a.c. instruments.

A second method of measuring alternating currents is to use a direct-current mechanism and to rectify the a.c. passing through the meter. This method is discussed in the present article and a simple and inexpensive arrangement is presented whereby the experimenter can use his d.c. instruments for a.c. measurements without materially impairing their sensitivity or their quickness of response.

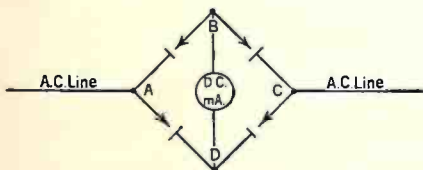

AC = A.C. INPUT TO RECTIFIER. B-D = D.C. OUTPUT OF RECTIFIER

Fig. 1

The method of measuring alternating currents by rectifying them and then passing the unidirectional product through d.c. meters is old, but in the past has been complicated and inefficient. For this method to be a practical success, we must have a rectifier which is compact, self-contained, and highly efficient. Such a device is found in the modern dry-disc electronic rectifiers, such as the Westinghouse "Rectox" unit,

*As every engineer knows, a.c. meters are both expensive and not universally useful. In this article is described a method of constructing a rectifier-voltmeter that will measure both alternating currents and voltages without many of the disadvantages experienced when meters of conventional type are employed.*

THE EDITOR

and it is around this rectifier that the following method of measurement has been arranged.

The method makes necessary connecting in series with the a.c. circuit where current is to be measured, the a.c. input terminals of a full-wave rectifier consisting of four Rectox discs, and connecting the d.c. output terminals of this rectifier to a suitable milliammeter, as in Fig. 1. If voltage is to be measured instead of current, the milliammeter used is of the lowest available range and a multiplier is placed in series with a.c. terminals of the rectifier. The device is then connected across the points where potential is to be measured.

The characteristics of the a.c.-operated rectifier-meter will depend upon those of the d.c. instrument which forms the actual measuring unit. In general, the sensitivity will be approximately the same, the "dead-beat" qualities will be unchanged, and when used as a milliammeter the scale range will be quite similar to that of the d.c. instrument used. The writer uses Weston Model 301 instruments for this purpose, because they are sensitive, yet very rugged and are nearly perfectly "dead-beat." Similar instruments, such as those made by Jewell, Westinghouse, etc., will be suitable.

Due to the geometrical properties of a sine wave, the d.c. output of a theoretically perfect rectifier working into a resistive load is 0.901 times the effective value of the a.c. being rectified. This being the case, if our rectifier were perfect, the d.c. meter would read 90 per cent. of the true a.c. flowing in the external circuit. Although no rectifier is perfect, a dry-disc rectifier when properly used in this service so nearly approaches the above ideal that its divergence is hardly greater than the errors in the d.c. meter itself and can often be neglected. Therefore, when once the proper adjustment is obtained, it is only necessary to multiply the reading of the d.c. meter by  $\frac{1}{0.901} = 1.11$ . Due to the fact that this constant proportionality exists between the reading of the d.c. meter and

the a.c. input, the scale of the resultant meter is practically uniform, rather than being of the inconvenient "square-law" type found in other a.c. meters.

### Accuracy

The instruments built by the writer are accurate up to about four-thousand cycles, but fall off gradually beyond this point, due to their inherent capacity. No attempt was made to prevent this effect in the writer's instruments and doubtless a material improvement in high-frequency characteristics could be made by proper design. In any case the rectifier will have enough capacity to render it useless at radio frequencies, in which field the vacuum-tube voltmeter has no rival.

At this point the reader may ask, "But will not the insertion of a rectifier in any a.c. circuit alter materially the wave form and other conditions in that circuit, and therefore render the measurement of doubtful value?" The answer is "No," and a careful inspection of the circuits will make the reason clear. Note that the rectifier feeds directly into the d.c. meter which absorbs the entire output. Since the meter used is a milliammeter without any multiplier, its impedance is low and consists almost entirely of resistance. The rectifier may be considered merely as a synchronous switch which reverses the current to the milliammeter in step with the reversals in the line. Therefore, the rectifier-meter as seen from its input terminals is merely a small resistance and this will cause no appreciable alteration in any circuit in which it may be placed. The effect of leakage in the rectifier is negligible when the instrument is arranged properly and the distributed capacity of the rectifier becomes apparent only at the high audio frequencies. When used as a voltmeter the rectifier is in series with a resistance multiplier, and the effect upon the circuit under test is merely that of shunting the circuit with a high resistance. It is interesting to note that the rectifier-meter has a smaller phase angle than commercial meters of the dynamometer or iron-vane type.

### Construction

The following directions apply to Westinghouse "Rectox" units of 0.6-amp. capacity such as are used in various trickle chargers. These directions also apply to other makes of rectifiers if proper modifications are made to compensate differences in construction and operation.

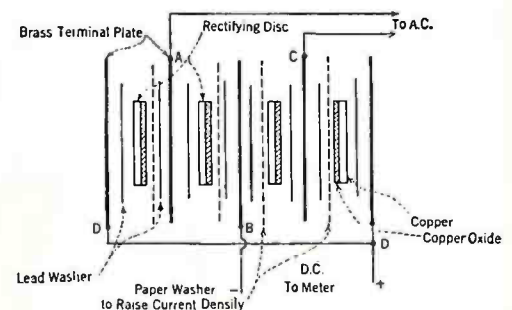

AC = A.C. INPUT TO RECTIFIER. B-D = D.C. OUTPUT OF RECTIFIER

Fig. 2

Before constructing the special rectifying unit, the experimenter must decide the approximate current ranges he wishes to cover, so that he may adjust his rectifier accordingly. One of the peculiarities of the copper-oxide valve is that its degree of rectification and its energy efficiency depend upon the current density. At low current densities the copper-oxide couple ceases to rectify; the completeness of rectification and energy efficiency increase with increasing current density until the density becomes high enough to cause local heating; at this latter point the degree of rectification and the efficiency rapidly fall off. The exact current density desirable for any particular service depends upon the arrangement of discs used, upon the voltage across each disc, and upon the cooling provided. For use with meters the minimum density is about 30 mA. per square inch, the normal density is about 100-1500 mA. per square inch, and the maximum density about 2000 mA. per square inch, although this last quantity is determined entirely by the radiating surface provided.

The method of adjusting the current density is to cover the copper-oxide surface with a paper disc, cutting out a sector thereof to expose the area desired. The working area of the original disc is about 1.1 square inches, and this disc is suited for rectifying currents of 100-300 milliamperes.

The area of the disc is arrived at as follows: Although the disc is 1 1/2" in diameter, the oxide film is usually chipped or worn down for a distance of approximately 1/8" from the edge, leaving the outside diameter of the useful surface about 1 3/8". Now the area of a circle is 0.785 d<sup>2</sup>, which, in this case, is 0.785 (1.375)<sup>2</sup> or about 1.48 square inches. The disc, however, contains a hole in the center whose area must be subtracted to get the actual area of the ring-shaped piece. This hole is 1/2" in diameter, but again the film is imperfect for about 1/8" from the edge, so that we must consider the hole as being 5/8" in diameter as far as the oxide film is concerned. The area of a 5/8" circle is 0.785 (0.625)<sup>2</sup> or about 0.31 square inch. Therefore, the maximum working area of the disc is 1.48 sq. in. - 0.31 sq. in. = 1.17 square inches. It will be noticed that the lead washers are made 1 3/8" in diameter and with a 5/8" hole to

allow for the above imperfections of the oxide film so that the washer itself has an area equal to that calculated above, thus definitely limiting the working area to this figure as a maximum.

Close inspection of the rectifying disc or the washer will reveal the fact that the washer seldom makes contact perfectly over its entire surface, there being small non-contacting areas due to imperfections in the oxide surface. This fact was allowed for in taking the working area as 1.1 square inches rather than 1.17 as calculated. Now suppose we wish to supply a 10 mA. d.c. meter, how will we restrict the working area? Since the normal current for the disc is 100 to 300 mA., and we wish to rectify only 10 mA., cooling by radiation will be excellent and we can use a moderately high-current density, say about 200 mA. per square inch. The area required will therefore be  $\frac{10}{200} = 0.05$  square inch of rectifying surface.

Since the total working area of the disc is about 1.1 square inches, we need expose only  $\frac{0.05}{1.1} = 0.045$  of this surface for the rectifying action, allowing the remainder to be covered by an insulating disc of paper. The simplest way of removing part of the paper disc is to cut out a sector or wedge, just as a slice is cut out of a pie. A complete circle includes 360° of angle, and, since we wish to expose only 0.045 of the circle, our sector will include  $360° \times 0.045 = 16°$ ; that is, we will cut out a wedge-shaped slice having a 16° angle at the point. Now it is not at all necessary for this angle to be accurate, hence the following approximate method of laying it out can be used. On the paper disc lay out two

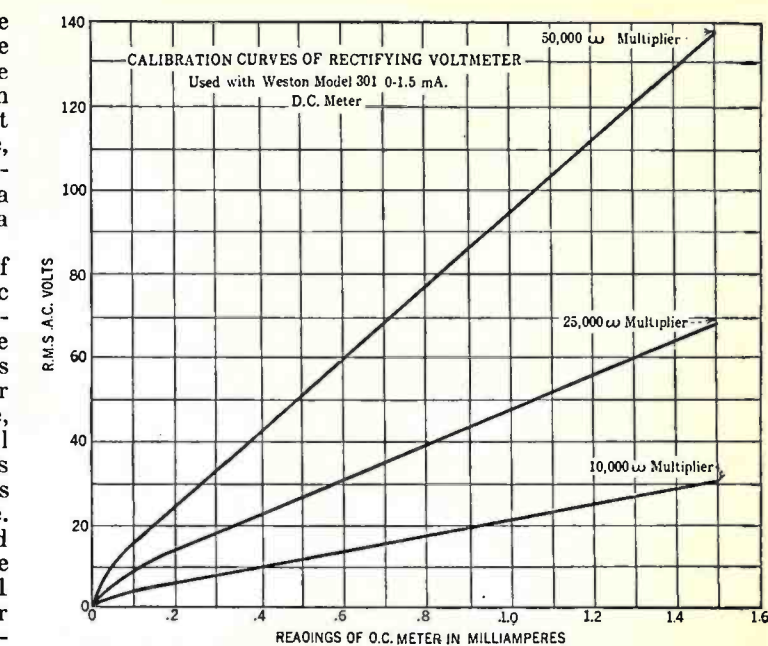

Fig. 4

below 50 mA. per square inch nor above 1000 mA. per square inch for efficient operation. Furthermore, this upper limit is allowable only when the total current through the stack is reasonably low, permitting good radiation of heat from the active surface. Applying these limits to the above design, we obtain current capacities as follows:

Minimum = 0.05 × 50 = 2.5 mA.

Maximum = 0.05 × 1000 = 50 mA.

Thus this instrument should operate satisfactorily over a current range of 2.5 mA. to 50 mA., a range of 20 to 1.

In general, this 20 to 1 ratio should not be exceeded; if it is desired to equip meters covering a greater range than this, several rectifying units of different working areas should be provided. However, if less accurate results were desired, the above meter could be worked over the maximum current density range described in a preceding paragraph, namely 30-2000 mA. per square inch, giving it a current capacity of 1.5 to 100 mA. Over such wide limits the constancy of calibration will be impaired and the deviation from straight-line calibration will be more marked. This is brought out in Fig. 3, showing the calibration curves of a single rectifier unit with four different milliammeters. The unit was designed for the 30-100 mA. range and it will be noticed that the curves for these two ranges are not only straight lines but practically coincide. The 10-mA. meter still gives a straight line, but with a different slope, while the 1.5-mA. meter gives a pronounced curve.

Assuming that the experimenter has decided upon the current range he wishes to cover and has calculated his working area accordingly, he is now ready to construct his special rectifier unit.

Adjusting the Rectifier

First disassemble the unit by unscrewing the two heavy clamping nuts with their lock washers and removing the central clamping bolts. It will be noted that the original rectifier unit consists of 16 rectifying discs arranged in two stacks of 8 each. Each stack is a complete four-cell full-wave bridge with 2 discs in each leg of the bridge, and the two stacks are connected in parallel by means of thin copper straps which also act as heat-radiating fins. Discard these connecting straps, and, using just one stack of discs, remove one of the two discs from each leg of the bridge leaving a full-wave rectifier composed of only 4 discs. Cover the copper-oxide surfaces

lines at right angles, each line passing through the center. This will divide the circle into quarters and each quarter will include  $360° \times \frac{1}{4} = 90°$ . Now divide the circumference of one of these quarters into five equal parts and draw lines from two of the adjacent dividing marks to the center (See Fig. 5). This forms a sector with an angle of  $90° \times \frac{1}{5} = 18°$ , which is close enough to the 16° calculated above.

Range of Operation

By the simple method described above, the working area of rectifying discs has been restricted so as to make the device most efficient for currents around 10 mA. Over what range may we expect satisfactory operation of this device? In general, it is not desirable to go

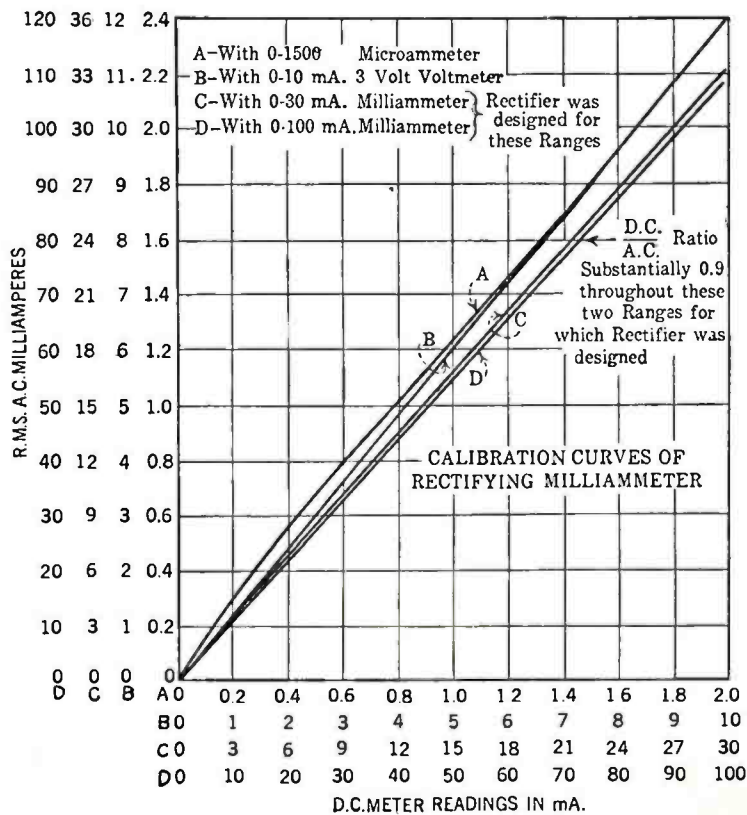

Fig. 3



with paper washers appropriate to the output desired, face each rectifier disc on both sides with lead washers, and insert the brass terminal plates between the discs. (See Fig. 2.) Cut off the central insulating sleeve to the proper length and cut the bakelite end-plates to circular form. See that the discs with their washers and terminal plates are arranged as in Fig. 2, the rectifying discs being arranged in two pairs with their oxidized surfaces in each pair facing the center. Then reassemble the stack, clamping it as tightly as possible by means of the central bolt and nut. The unit is now ready for trial.

Connect the central terminal to the negative post of a milliammeter and the two outside terminals of the positive post. The intermediate terminals form the a.c. leads. (See Fig. 2.) In case the unit is connected to a milliammeter of low range, say 5 or 10 mA. full scale, try the following experiment: Place the a.c. input of the rectifier unit in series with one of the leads running from the output-coupling device of your radio receiver to your loud speaker. Turn on your set and you will find that the d.c. meter will give a visual indication of the actual signal current flowing through the loud-speaker windings, the needle following the rhythm of the speech or music being received. Watch for the surges of current caused by drums or bass chords on the piano; also note the wide range of energy in speaking voice.

### Calibration

Next comes the item of adjustment and calibration. If the experimenter merely wishes to use his instrument to determine relative values, no calibration will be necessary. If it is desired, however, to have the instrument read in terms of actual milliamperes or volts, it must be checked against some kind of known standard.

The simplest thing, of course, is to compare the rectifier-meter with a standard indicating a.c. meter if such an instrument is available. By making such a comparison the rectifier-meter can be adjusted for most efficient operation. The reading of the d.c. meter should theoretically be 0.90 times the reading of the a.c. meter and in

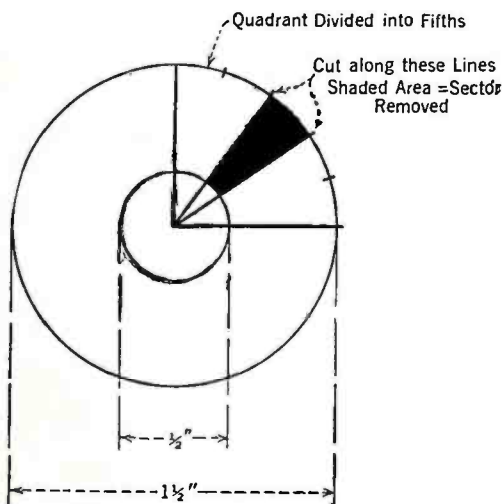

Fig. 5

no case need it fall below 0.83 times the a.c. value. If the d.c. meter reads lower than this, it is an indication that the current density is not right, that the stack has not been clamped tightly enough, or else the stack has been improperly assembled. A typical unit gave d.c.-a.c. ratios between 0.83 and 0.90 all the way from 1 mA. to 100 mA., even though it was used with 4 different d.c. instruments. This fact makes it possible to omit calibration if only approximately quantitative results are needed. After a little experience in con-

structing these devices, the experimenter should have no trouble in obtaining d.c.-a.c. ratios of 0.85 to 0.90 on the first trial, and, can assume, therefore, that the a.c. indicated by his instrument will be between 1.1 and 1.2 times the reading of his d.c. meter.

If it is desired to calibrate the instrument and no a.c. milliammeter is available but an a.c. voltmeter is at hand, the meter may be calibrated from a known voltage and a known resistance. If the experimenter desires only a rough check on his work and has no a.c. meter of any kind available, the 60-cycle house-current may be assumed as being 115 volts and the meter checked through known resistors. For example, a 10,000-ohm resistor will pass 11.5 mA. from a 115-volt line.

The range of a milliammeter can be extended by shunting, although this should be avoided if possible. The shunt should be placed across the a.c. input terminals to the rectifier. In the case of a voltmeter, the range of the instrument can be adjusted very conveniently by changing the value of the resistance-multiplier which is placed in series with the a.c. input. It is convenient to adjust the multiplier so that the volts applied will be some multiple of the reading of the d.c. milliammeter. Thus, if a 0-1.5-mA meter is used, the multiplier can be arranged so that full-scale deflection on the meter will be obtained with 15 volts or 150 volts applied.

Fig. 3 shows typical calibration curves of a rectifying milliammeter, the rectifier being used in conjunction with four different d.c. meters. Fig. 4 shows the calibration curves of a rectifying voltmeter. In this case multipliers of known fixed values were used, without making any attempt to produce an integral ratio between the voltage applied and the current read on the meter.

## THE DEALER AND THE FINANCE COMPANY

(continued from page 257)

carry your own. The reason for this is that it gives you a third-party alibi in making prompt collections. You can honestly tell a customer that the finance company demands the money, and that if he (the customer) does not pay same, you will have to. It is often desirable or good business to use this leverage in making collections. I think any dealer's motto should be, "Get the money, keeping the customer in good humor whenever it is humanly possible to do so; but if you have to do it, get him mad enough to pay." We must not forget that statistics show that the number of businesses going into bankruptcy because of poor credits (or poor collections—the meaning is the same) is more than four times that of businesses which fail because of lack of capital. I am sure that bad debts or poor judgment in extending credit is the greatest cause of failure. Watch your overhead expense; don't buy carelessly; don't let employees' dishonesty or carelessness rob you of legitimate profits; but above all, *watch your collections*—get the money promptly when due.

So far we have been looking at this dealer-finance company relation from the standpoint of what the dealer should do. Now let's look at the other side. What about the man who buys your paper? What should he do to hold up his end of things?

First of all, of course, he should pay you promptly for all contracts as fast as he gets them from you. I know of companies who hold their dealers' checks up

from two weeks to a month while they are "investigating." There is no reason for this. If you are dealing with an outfit who does this ask them to correct it, and if they fail to do so get another outlet for your paper.

Demand that you be notified promptly of a past due account. If the finance company expects you to be on the job helping them get their money, they certainly should notify you of delinquencies promptly. A radio dealer has to know a lot of things, but no one should expect him to include mind-reading.

### Regarding Rebates

A contract may often be paid out before maturity, and if so the finance company should rebate a portion of the total handling charge originally figured in the contract. This will not be exactly on a pro-rata basis because a certain amount of work must be done in "setting up" the contract on the finance company's books, regardless of how long the paper runs. But an unexpected two or three dollars promptly refunded to a customer when he pays out ahead of time will make him feel mighty good toward you.

As mentioned before, very few finance companies can afford to send a collector after small individual amounts from purchasers; but nearly all of them have what is called a "road-man," or "contact-man." As the name implies, this man calls on all dealers who deal with his company. Here is your chance to get some valuable in-

formation. Talk over general business conditions with him. Find out what other dealers are doing—probably he can tell you exactly how some successful radio merchant has solved a problem which may be bothering you; or he can tell you of an out-of-the-ordinary window display he has noticed; and dozens of other valuable pointers. These suggestions apply also to your talking to jobber's salesmen who call on you, but the finance company's man will probably be more fruitful of good ideas, and what he tells you will not be colored by a desire to sell you something.

In closing let me say that during this year many millions of dollars worth of radio merchandise is going to be retailed on the monthly installment plan; and I hope that each of you will be successful in getting your share.

### SCREEN-GRID SHRINKAGE SHRINKS

PRIVATE LAMENT among tube manufacturers regarding the abnormally high shrinkage in tubes of the 224 type continues, although it seems that shrinkage figures show a slight tendency to shrink themselves. We have heard of at least two manufacturers who can make such tubes with less than 45 per cent. shrinkage and of one manufacturer who has reduced the shrinkage to below 30 per cent.—which, we believe, is getting into the range at which profit begins. Such low shrinkage is a product of good mechanical design, independent research, and unceasing efforts to iron out small causes of trouble.

# DESIGNING R.F. CIRCUITS FOR THE 224

By **BENEDICT V. K. FRENCH**

*Radio Engineering Division, American Bosch Magneto Corporation*

**T**HE NEW Bosch radio line represents an example of the commercial application of many new developments in the rapidly changing art of broadcast receiver design. Of outstanding interest are the use of the new screen-grid a.c. tubes as radio-frequency amplifiers, the linear high-voltage detector, and the single stage of push-pull audio power amplification. These features are incorporated in an all-steel design of exceptional mechanical strength which consists of two units, the radio chassis and the power pack, the two being assembled on a ribbed-steel base. The receiver is licensed under patents of the Radio Corporation of America and under patents and patent applications pending of the Radio Frequency Laboratories, Inc.

The schematic is given in Fig. 1. It discloses the use of three screen-grid a.c. tubes of the 24 type, interposed between four tuned circuits, a linear high-voltage detector of the 27 type, and, following this, a single stage of push-pull audio amplification using the new 45-type tubes. Rectified power supply is obtained from a single full-wave rectifier tube which also furnishes the exciting current for the electrodynamic loud speaker.

The electrical design of the receiver as a whole required the utilization of the high amplification of three screen-grid tubes (tetrodes) with a view to the selective properties of four tuned circuits and the input voltage requirements of a linear high-voltage detector whose output is made capable of working to full power the single push-pull stage of audio amplification.

### *The R. F. Amplifier*

Several considerations make it advisable to compensate the inequality of voltage gain over the broadcast band which is an inherent property of capacitance-tuned radio-frequency amplifier stages. In the types of antenna input circuits heretofore employed, the effectiveness of voltage transfer from the antenna to the first grid decreased rapidly with increasing wavelength. The circuit employed in this receiver represents a distinct departure in that a reverse effect is obtained. This com-

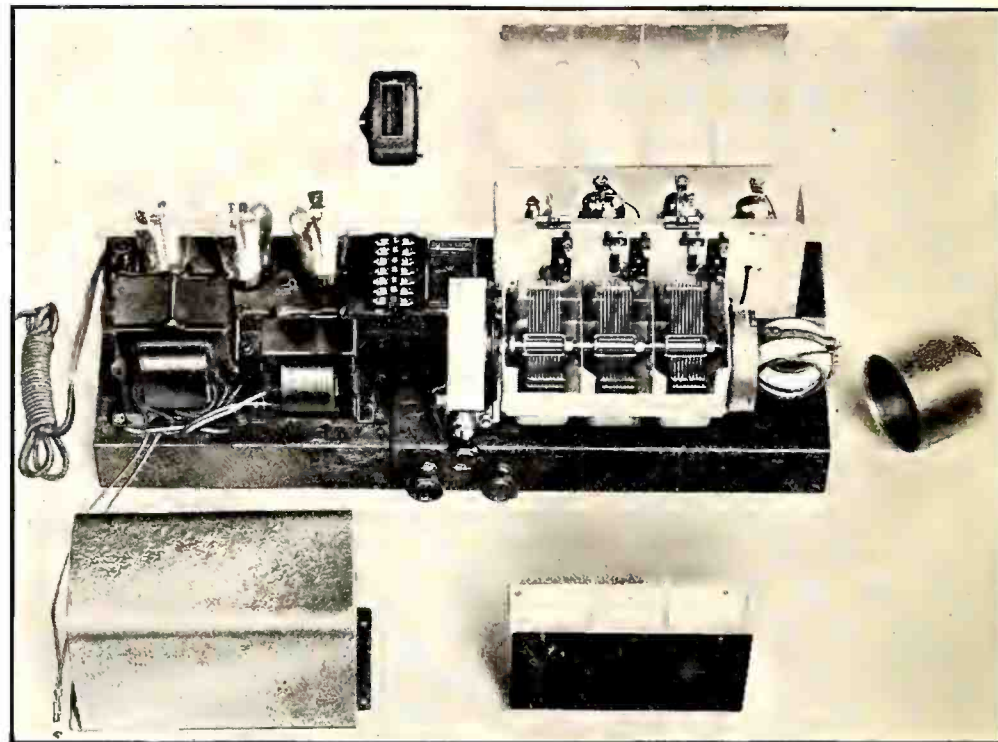

*This view of the Bosch screen-grid receiver shows the chassis with shield covers removed.*

prises a unique type of capacity coupling for introducing the antenna voltage into a tuned antenna circuit. The constants of this type of circuit are proportioned so that antennas of any size can be accommodated and, in addition, changes in effective capacity of an individual antenna over the wavelength band have only slight effect on tuning.

The main element of this circuit is a variometer driven from the main gang condenser shaft through a gear ratio which is proportioned so that the stage tuning for the average antenna follows closely the frequency settings of the main tuning unit. The essential property of this tuning system is such that it serves to equalize the overall sensitivity of the radio-frequency amplifier and allows a design for uniform

amplification over the entire waveband. The interstage transformers are of straightforward design comprising tightly coupled primary and secondary windings, the value of coupling being governed by a consideration of the sensitivity and selectivity requirement of the entire receiver. These are given in Figs. 2 and 3. For purposes of comparison, Curve A (Fig. 2) shows the sensitivity in terms of standards proposed some time ago by the I.R.E. This curve represents the field strength in microvolts per meter, in the vicinity of a four-meter antenna, necessary to produce a standard output level of 50 milliwatts. For measurement purposes, the antenna comprised a fixed capacitance of 200 mmfd. and a non-inductive resistor of 20 ohms. Practical considerations indicate the ad-

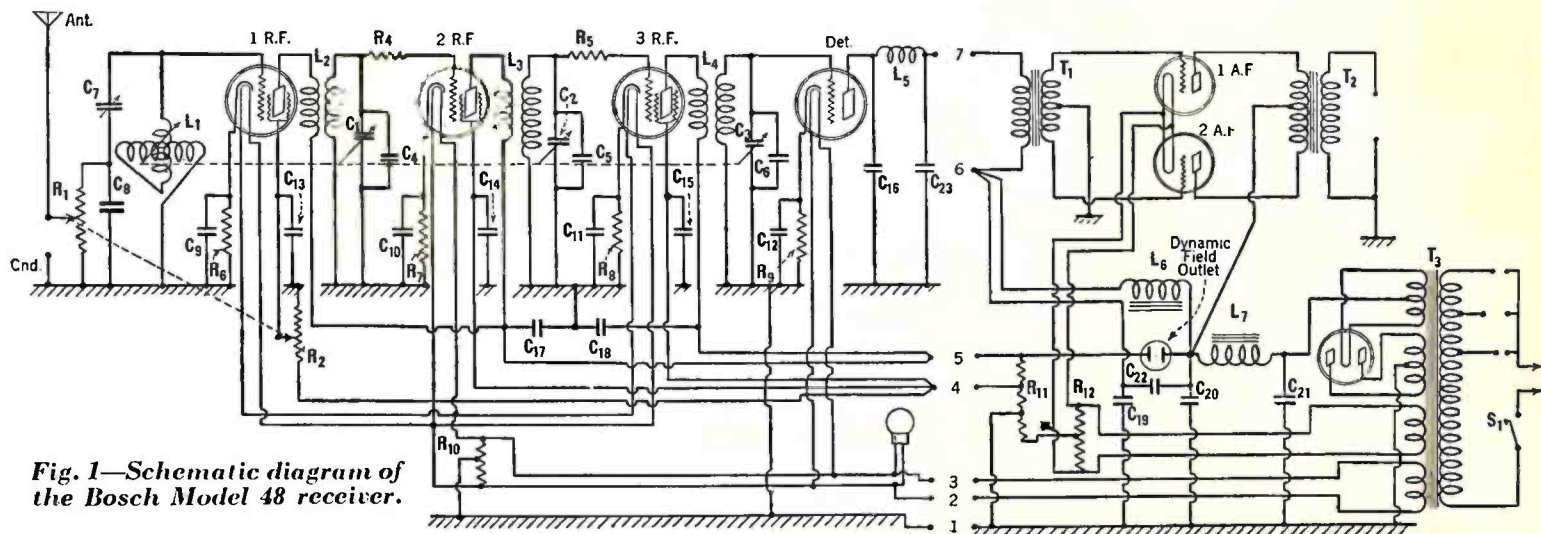

*Fig. 1—Schematic diagram of the Bosch Model 48 receiver.*

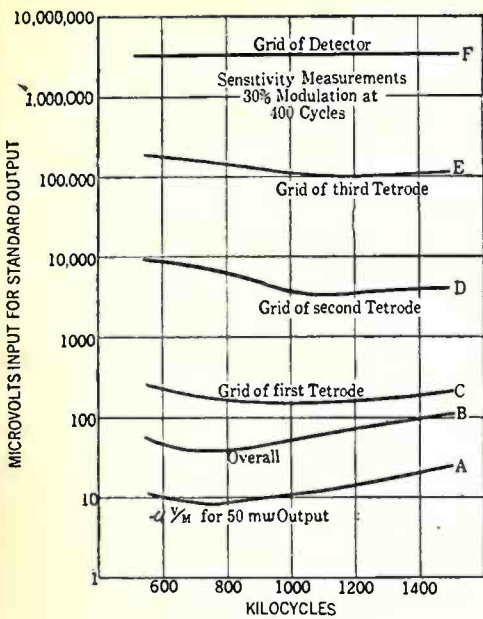

Fig. 2

visibility of expressing the sensitivity in terms of actual microvolts input at an output volume level more in accord with actual reception conditions, and in curve B (Fig. 2), therefore, is given an analysis of the Model-48 in terms of microvolts input to the dummy antenna for an output volume level of 100 milliwatts. Curve C of Fig. 2 shows the microvolt level necessary on the grid of first tetrode to produce the same 100 milliwatts in the output. A comparison of curves C and B illustrate the point made above relative to the functioning of the antenna input circuit. It will be seen that the voltage gain obtained at the longer wavelengths is over twice that obtained at the lower wavelengths.

Curves D and E of Fig. 2 represent the microvolt level applied to the second and third grids, respectively, to obtain standard output, and curve F gives the number of microvolts necessary on the detector grid to produce standard output. All of these measurements were taken with the carrier modulated to 30 per cent. at 400 cycles.

**Selectivity Characteristics**

In curve A of Fig. 3 is given a selectivity curve of the Model-48 receiver taken at 600 kc., and for purposes of comparison curve B of Fig. 3 shows the selectivity curve of last season's Model-28. This latter model was considered a very selective receiver. It employed four tuned circuits in conjunction with 26-type tubes. The increase in selectivity, due to the use of tetrodes with the same number of tuned circuits, is apparent. The method of measurement and the ordinates chosen for the curves are such that small selectivity dif-

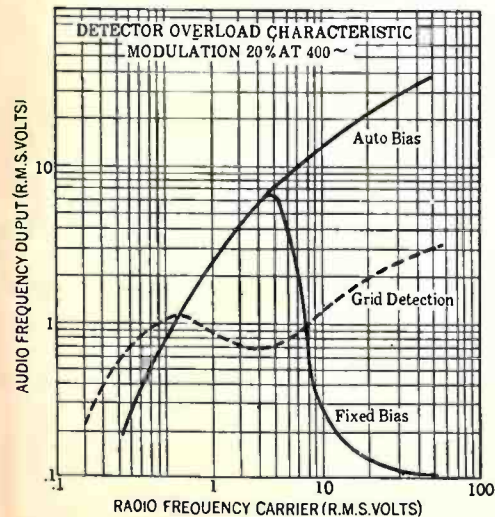

Fig. 6

ferences between receivers of the same class are clearly indicated. Possibly, this type of curve differs from the resonance curves usually shown to imply "knife-like" selectivity and "ten-kilocycle separation."

The problem of an adequate type of volume control for a high-gain tetrode receiver is a difficult one. Control of the screen or the grid-bias voltage, although effective in extinguishing the signal from the strong local station, introduces in its range of operation bad-quality distortion due to the non-linearity of the tetrode characteristic at high signal voltages. It is, therefore, necessary to reduce the applied voltage from the antenna simultaneously with the screen or grid-bias voltage.

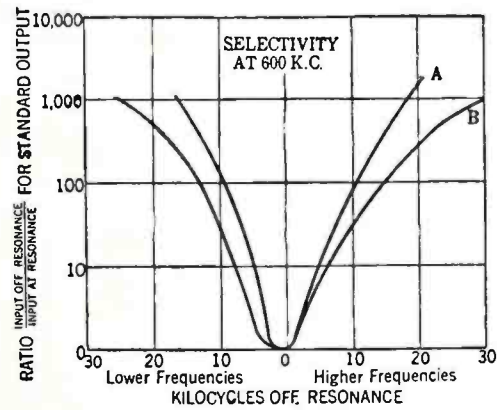

Fig. 3

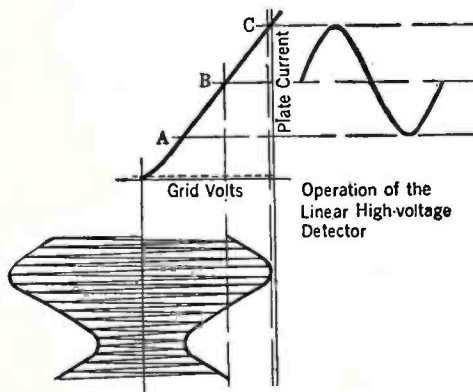

Fig. 4

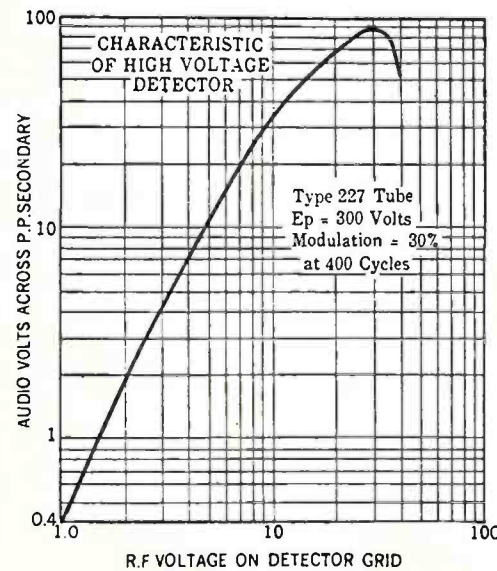

Fig. 5

Control of the antenna input voltage alone is inadvisable inasmuch as the receiver is allowed to operate always at full gain with a consequent possibility of a poorer signal-to-noise ratio as the signal input is reduced.

**The Linear Detector**

Vacuum-tube detectors in general use for broadcast reception may be classified as follows: the rectifying-amplifier, in which rectification occurs in the grid cir-

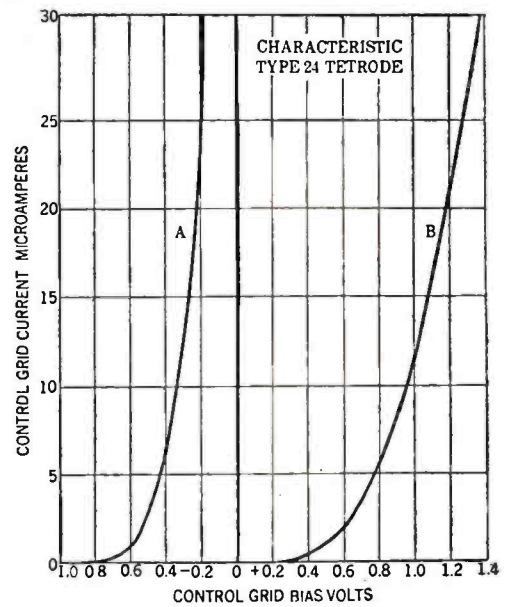

Fig. 7

cuit, and amplifying-rectifiers, in which rectification occurs in the plate circuit.

The first class is represented by the grid-condenser, grid-leak type, which is used primarily as a weak-signal detector. With the usual constants chosen for this type of detector, the maximum audio-frequency output is such that two stages of audio-frequency amplification are required to bring the signal to a satisfactory loud speaker level. Plate circuit rectifiers include the anode-bend detector and the linear high-voltage detector. The former, as its name implies, operates over that portion of its grid-voltage plate-current curve which gives an audio output proportional to the square of its modulated radio-frequency input. This type, as ordinarily operated, suffers from the same limitation of output that characterizes the grid-condenser grid-leak type.

The type of detector used in this receiver will be termed the linear high-signal-voltage detector rather than a "power" detector. The term "power detector" has been used indiscriminately to describe any type of plate detection. In the strict sense of the word, power detection refers to the use of a detector directly supplying the loud speaker load. The action of the linear high-voltage detector (see U. S. Patent No. 1,698,668) is best explained by reference to Fig. 4 which shows a modulated radio-frequency voltage of high amplitude impressed on the characteristic with the result that operation takes place along the straight-line portion, giving an audio-frequency output which is directly proportional to the modulated radio-frequency input. In Fig. 5 is shown

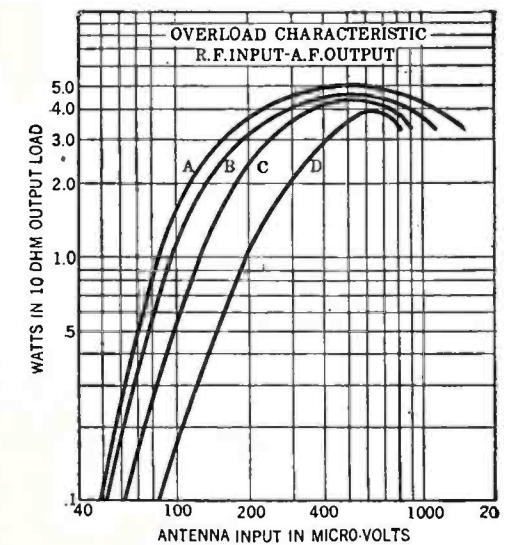

Fig. 8

the input-output characteristic of a typical case consisting of a 27-type tube with 300 volts applied between plate and ground, and a grid potential determined by the plate current flowing through an auto-biasing resistor of 15,000 ohms bypassed for audio frequencies by a 1-mfd. condenser. (Stuart Ballantine, "Detection at High Signal Voltages," *Proceedings I. R. E.*, July, 1929, Contributions from Radio Frequency Laboratories, No. 11)

*Automatic Grid Bias*

The action of this auto bias, in extending the working range of the detector, is shown in Fig. 6. This figure also shows on the same scale of ordinates the output obtainable from a grid-condenser grid-leak detector operating at the same plate voltage. This curve is abstracted from an article by F. H. Drake, "An Aircraft Radio Receiver for use with Rigid Antenna" (Contributions from the Radio Frequency Laboratories, No. 8A, and *Proceedings I.R.E.*, February, 1929.), and, although the data were taken on a different type of tube, it serves to show the relative performance of plate and grid detectors. The output obtainable is naturally a function of the modulation percentage, and the results in the instance shown were obtained with a thirty per cent. modulation. The curve illustrates the necessity of a high-gain radio-frequency amplifier since the proper operation of the detector is entirely dependent upon a high impressed voltage to the detector input. Mathematical analysis of detector action indicates that distortion incidental to

square-law rectification increases rapidly with an increase in percentage of modulation. The linear type detector, however, is free from distortion up to very high percentages of modulation. This fact is of importance in consequence of the trend

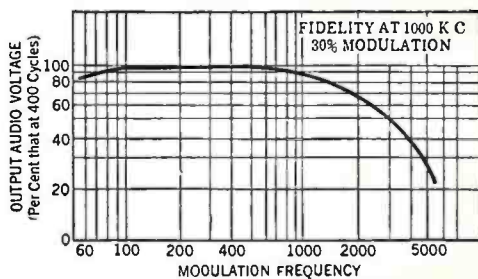

Fig. 9

toward higher percentage of modulation evident in modern broadcasting transmitters.

The design features of high-voltage detectors employing the 227- and 224-type tetrodes will be published shortly by P. O. Farnham. ("Contributions from the Radio Frequency Laboratories." No. 12)

*Overall Characteristics*

Sufficient output is obtained from the detector (Fig. 5) to operate the push-pull 45-type tubes to overload on stations of adequate field strength. Fig. 8 shows the relation between antenna input in microvolts and power output in watts. Curve A is taken for 40 per cent. modulation, curve B for 30 per cent. modulation, curve

C for 20 per cent., and curve D for 10 per cent. It may be observed that an output of over three watts is obtainable before distortion enters as a limiting factor.

In development work on the receiver, it was discovered that with the operating constants recommended by tube manufacturers for the 24-type tetrode, the maximum power output was seriously limited at low percentages of modulation. An investigation disclosed the fact that voltage levels on the third radio amplifier grid were high enough to cause an appreciable flow of grid current, even though the measured peak r.f. voltage was less than the grid-bias voltage. A detailed study of the static characteristics brought out the important fact that in certain tubes of the 24 type, grid current existed for negative values of grid-bias voltage. Typical characteristics are given in Fig. 7. This effect seems a characteristic of the equipotential cathode tube. Curves A and B represent the extremes of a large group and it is, therefore, necessary to design for operation with tubes of type A. To guard against any possibility of grid current, the grid-bias potential has been increased in this receiver from the recommended value to 2½ volts and the interstage transformers have been so proportioned that the decrease in stage amplification occasioned by the increase in plate resistance is compensated.

Fig. 9 gives the fidelity curve of the receiver. This is taken by introducing at the antenna post a 1000-kc. carrier of constant amplitude modulated to 30 per cent. The modulation frequency is changed through the audible range and the output noted.

**THE LITTLE RED SCHOOL HOUSE COMES TO MARKET**

(Continued from page 265)

effort, for example, the board members, after listening to the programs in their own homes, were quick to equip their schools as they realized that radio brings more in the way of education than can be purchased in any other way with the same amount of money. They discovered that for a fraction of a penny with the aid of radio a classroom can listen to men and women whom they could not bring to their school without an outlay of hundreds and sometimes thousands of dollars for the one session.

By far the larger share of sets, however, have been bought by organizations of parents, especially the Parent-Teacher Associations. Some sets have come from senior classes, athletic funds, dramatic societies, sales of a wide variety of articles, popular subscriptions, gifts from interested individuals and organizations such as Kiwanis, Rotary, Lions Clubs, Chambers of Commerce, lodges, and fraternities. Others have been donated by manufacturers, distributors, and dealers. Some have been provided by newspaper or magazine subscription campaigns, some by special festivals, pageants, plays, and even by Bunco parties. In many cases the funds have come from two, three, or even four sources. Everywhere the dealer has given special discounts and terms.

The fact that dealers are expected to give special discounts to schools may cause some to frown upon this "golden opportunity for radio." However, this is entirely the wrong attitude to take. Installing your radio in the school, even if you had to pay for the privilege, would probably prove to be an excellent investment when viewed from its advertising value. Also, it should be remembered that even though you grant a discount it does not mean that you

will lose money, or that you will not make a little.

*What Kind of Equipment*

There is no particular type of radio equipment which is designed especially for schools, nor will there be as the requirements in different schools are so different. In the 150,000 one-room country schools any receiver which is satisfactory for home reception would be satisfactory. On the other hand, in larger schools a more elaborate installation or several smaller installations would be required in order to give adequate coverage of all the pupils.

In a majority of the schools to-day the installations are rather crude, and the arrangement of the apparatus is seldom conducive to the best possible results. In general it has been found that the best results are obtained with radio when the loud speaker is located in the classroom, and at present the tendency is to make installations of this type wherever possible. In the classroom with a small orderly group of pupils the teacher can aid the class by adding explanations, taking notes on the blackboard, following with a pointer on the map, etc., and her time is not taken up with discipline. Therefore, in a number of large schools several portable receivers are used in place of a large set in the auditorium. These sets are mounted in special cabinets on wheels which may be moved easily from one room to another as required.

*Larger Installations*

The most modern and practical type of equipment for the large school is a combination public- and group-address installation and the trend to install appara-

tus of this type is growing every day. In this connection the following letter indicates the results which are being obtained with such equipment.

Dear Uncle Ben:

The gift of the class of 1929 to the high school is in perfect working order. It is "The Magnaphone," the Schoolmaster of the Air, purchased as the class memorial gift. It cost \$650 plus \$25 per room for installation and loud speakers.

With it our principal, P. Q. Freeman, without leaving his office, can speak his message to one, all, or any group of rooms in the high school building. In addition he can transmit phonograph records to any or all rooms, or he can broadcast any radio program to any, all, or a few selected rooms at will.

Every student at the high school can now listen-in, without leaving his seat in the classroom, to the "School of the Air" programs that the principal believes he should hear.

The Senior Class,  
Bellefontaine High School,  
Bellefontaine, Ohio.

The features of the combination public- and group-address installation are so clearly stated in the above letter that little need be said in addition. However, there is one great advantage which was not touched upon and that is the aid in preventing a panic in case of a fire. Instead of ringing a gong, which sets hundreds of little hearts palpitating with excitement, the principal can make his announcement to the rooms which he wishes to march out first, and in such a way they may be directed out of the building before they actually know there is a fire, thus avoiding any possibility of a panic.

BRANDES MODELS B-15 AND B-16

This receiver is of the conventional tuned radio-frequency type with grid resistors to prevent oscillations. A grid leak and condenser detector is followed by a two-stage audio amplifier with two 171A-

type tubes in push pull in the output. The volume control consists of a 25,000-ohm variable resistor connected across the antenna coil. Plate and grid voltages are obtained from a 280-type rectifier tube.

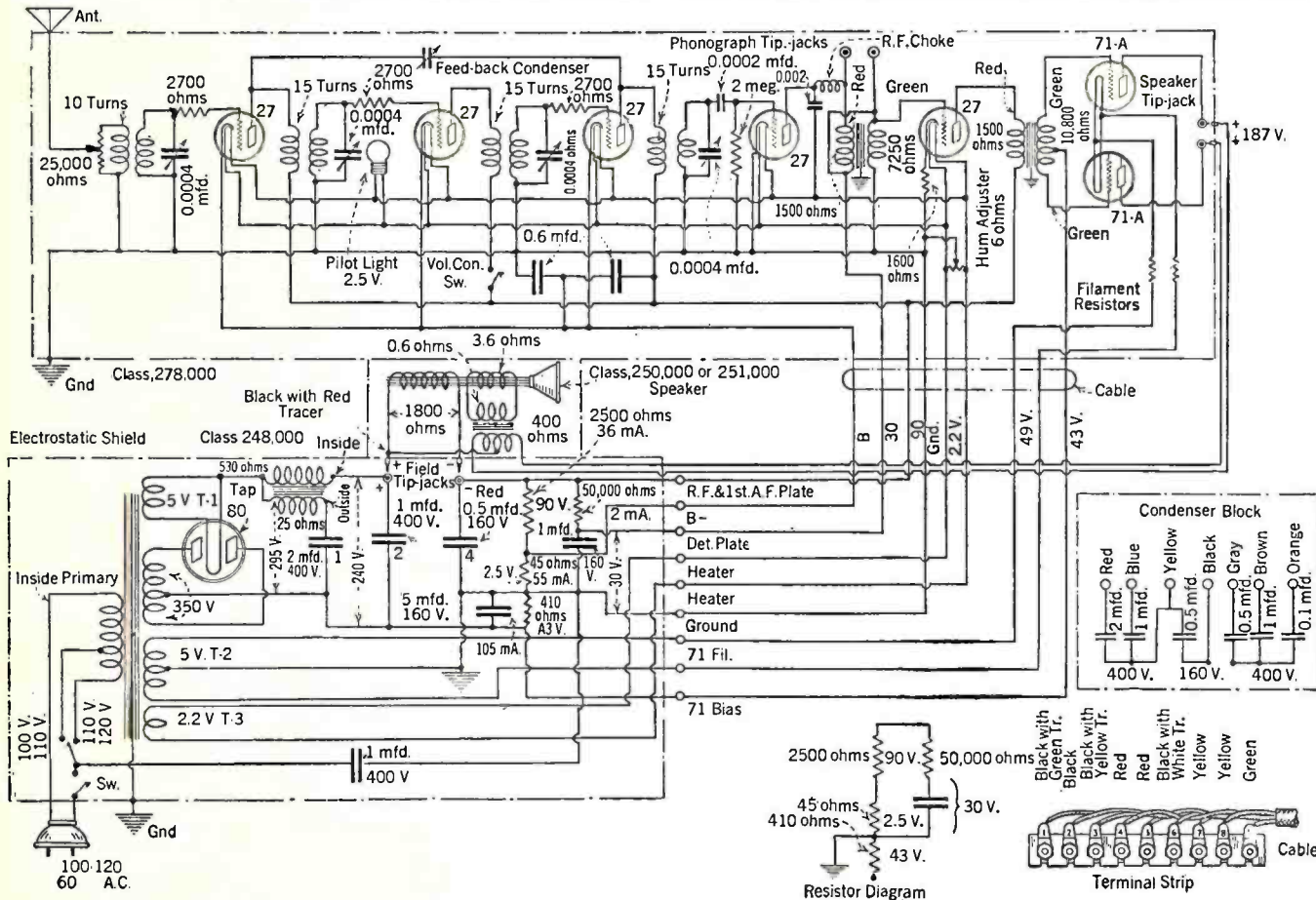

THE CONTINENTAL MODEL R-30

This receiver licensed under patents of the Technidyne Corporation contains several interesting features. The most important is the use of untuned r. f. stages between each tuned stage.

Volume is controlled by adjusting the coupling between the primaries and secondaries of the tuned interstage transformers. Only one stage of audio-frequency amplification is used.

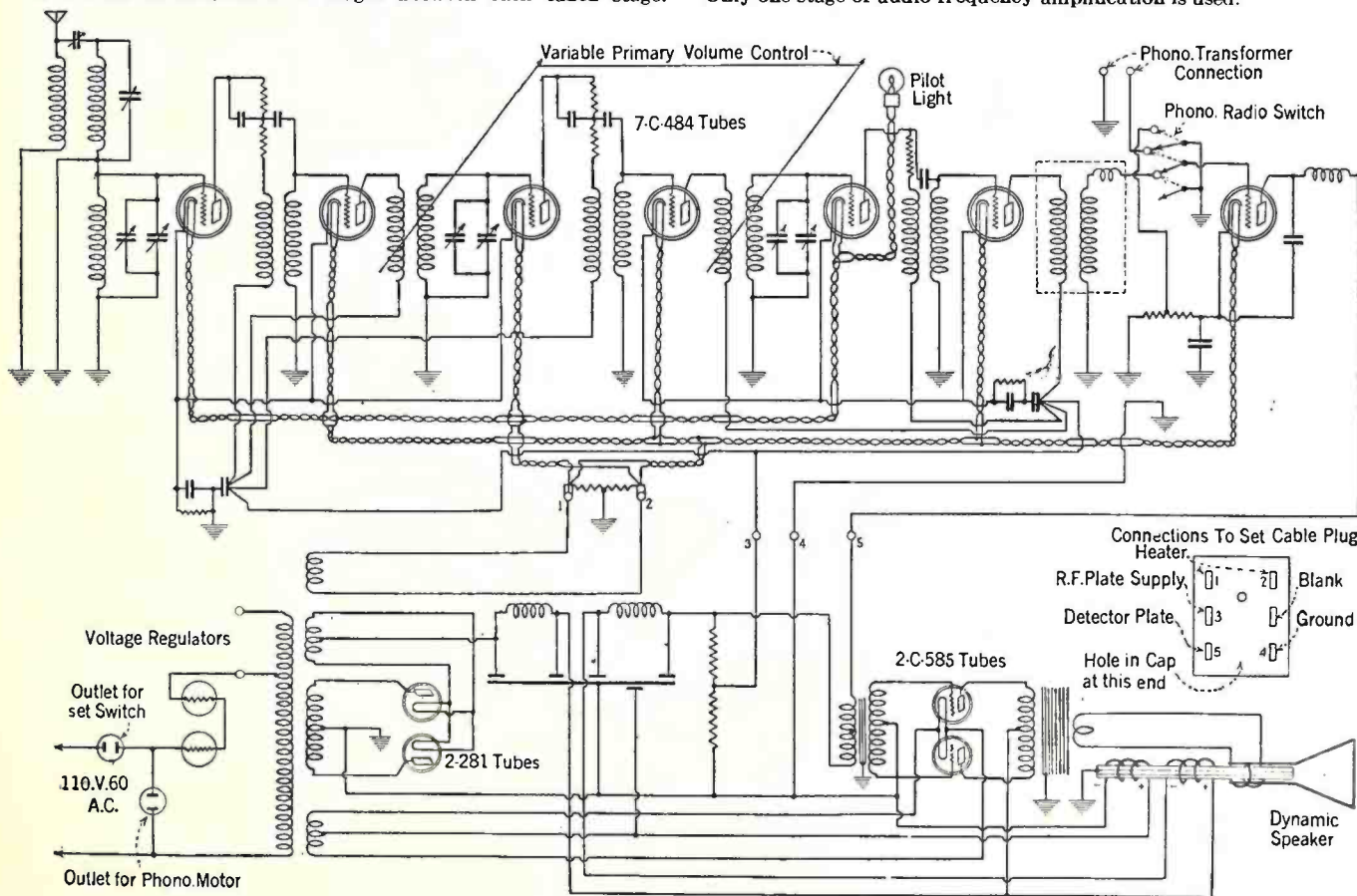

## QUALITY CONTROL OF RADIO PRODUCTION

By **DAVID SONKIN**

*Inspection Engineer, F. A. D. Andrea, Inc.*

**V**ERY LITTLE has been said of the modern methods of insuring a uniform and high-quality production in the manufacture of radio sets and auxiliary equipment. The application of inspection and test methods has long been used in high-speed production in the making of automobiles, electric motors, and the many other commodities manufactured and sold in large numbers. The application of the broad general principles used in these industries, when modified to suit the peculiarities of radio, produces interesting results.

Some years ago, when the manufacture of radio receivers began, the process was entirely along custom-built lines. Each receiver bore the earmarks and individuality of its builder. Often the same operator who milled the bakelite panels, drilled the holes, assembled the component parts into place (themselves elaborately built as separate entities) prepared each wire and soldered it into place, and even tested his finished product. Each completed set bore the builder's "fingerprints," his little personal idiosyncrasies.

It did not take very long for some of the more progressive manufacturers to realize that a more uniform product was necessary. How to obtain this uniformity and how to get it across to the manufacturing division was a problem. The producing department, free from a restraining influence and and partially uninitiated to the possibility that there could be any difference in performance of two units seemingly alike, had a natural antipathy towards anything that would tend to cut down the total figures of their day's production. The same parts were used in each set and the same wires were placed in the same places—how could there be any difference? The sets played, did they not? What could be wrong? The testers (originally drawn from the ranks of that interesting group, the "amateurs") passed them. (And did not amateurs have a reputation of being "tin-gods"?) Little was it realized that many times the tester had to revise the receiver and would introduce his very individual ideas in affecting the remedies. As we look back—how uncommercial they were!

The problem resolved itself into two distinct phases. First, how could we eliminate the disturbing factors which prevented a uniform product, and second, how could we combat that natural antagonism of one group of humans towards another criticizing group. At times, the latter was the more serious problem, for, in order to eliminate the disturbing influences, we had to find them—and to find them we had to utilize the very group that produced them. Research had to be conducted on a large scale, in a field not cognizant of what was desired and unskilled in the art of observation. Casual sampling,

and the slow, deliberate investigation in the laboratory were unsuited to the speed of modern production. If something was wrong, it had to be discovered, a remedy evolved and applied immediately. With large quantities of material to handle, any delay in production or a continuance of a faulty operation would rapidly run into a serious loss in both time and money—and often resulted in the throwing of a large group of workers into enforced idleness.

### The New System

Slowly, with studied care, an illustrative system of recording and noting the quality of one item after another was introduced. To begin with, those items which previous experience had indicated as most likely to give trouble were selected for the introduction of the system. Assignable causes, such as variations in the raw materials were soon discovered and better materials introduced. Better and improved methods of handling the product were insisted upon. It was very interesting at this time to notice a marked "toning-up" of the factory personnel—and appreciation of the value of the commodity handled was realized. Subconsciously, the operators ceased to handle the production of radio receivers roughly and began to take pride in their work and in passing along a good-looking product.

The control system indicated variations at times which could be traceable only to a deviation from the specified routine and sometimes to an influence assignable only

to a characteristic of the mechanical means used in fabricating the product.

In the drawing of Fig. 1 we have plotted the ideal production—each and every unit is identical, 100 per cent. of the units are alike—a condition never attained. The more normal occurrence and variation can be represented by the curve of Fig. 2. Here the greatest percentage of units simulate the standard, and, as we proceed equal distances above and below the standard, we find a lesser and lesser number of units of the same characteristics, until at some distance from the standard no units exist. Even this curve represents an ideal distribution of the variation among units.

Some of the actual distribution curves experienced in manufacture are shown in Figs. 3, 4, 5, and 6. Fig. 3 represents a normal production curve in which the average is somewhat offset from the standard. Such a condition might easily exist in the production of a coil where the specifications were read 19 turns instead of 18 through a blur in the copy or a typographical error.

Fig. 4 represents a production where the maximum performance was expected and where a deviation from the standard could be only in one direction. An illustration of this exists in the production of iron-core choke coils which may have been specified with a butt joint. Maximum inductance was probably required. The introduction of the slightest gap reduced the inductance. (An excellent case where the engineering division can and does learn of the difficulties of manufacture.)

In Fig. 5 we have represented a product made by two operators using the same equipment but working in two shifts. A confusing indicator was read differently though consistently by each. Here the remedy is accomplished by the use of a clearer instrument.

The result of selecting the better units of a given production to satisfy a critical customer, and of leaving the remainder for the indifferent and very often ignorant purchasers, is given Fig. 6. The dotted line completes the normal curve which indicates that originally there was good control of the product.

With an attitude of constructive criticism, whereby collective data is illustratively presented, it is not difficult to obtain the complete cooperation of the manufacturing group. The feeling that the Inspection Division is "out to get something" on the Manufacturing Department is replaced by free hearted desire by the latter to see and in more cases that one to actually demand some sort of control. "Let's see how the job is coming.—Build us a 'gadget' for checking!—That dope does show up that faulty machine!—Well, guess we'll have to replace the operator." Quality Control tells the story.

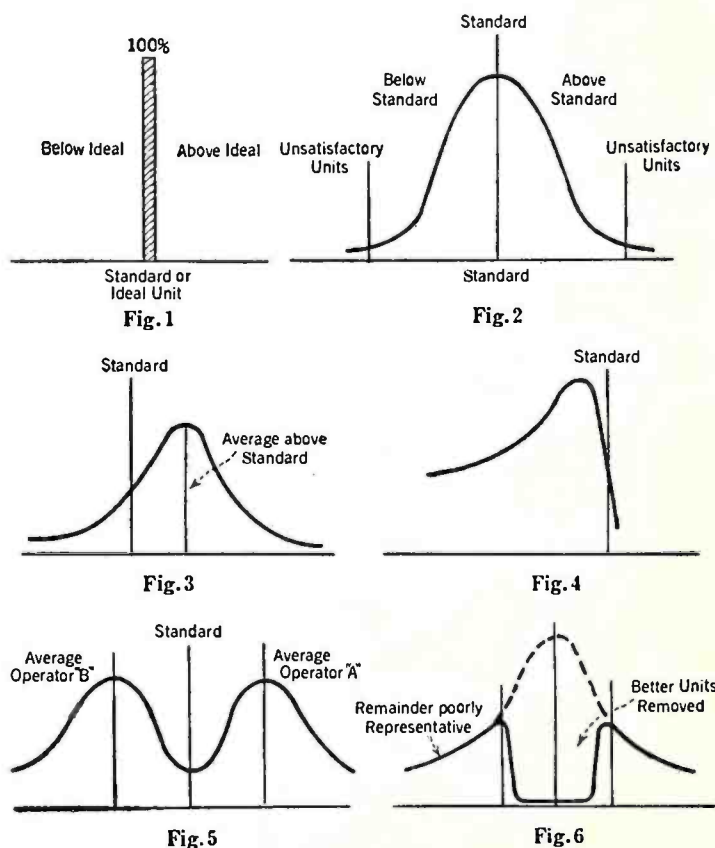

**Curves indicating efficiency of production**

## ADVANTAGES OF PRESELECTION

By JACOB YOLLES

Engineer, Technidyne Corporation



Jacob Yolles

THE IDEAL radio receiver must embody the following characteristics: (a) high amplification, (b) adequate selectivity, and (c) uniform reproduction of all tones in the acoustic range. These qualities are co-requisite—they must not vary throughout the broadcast band. The latter two must not be

affected by adjustments of the volume control. In this article an attempt will be made to describe the mechanism whereby the Technidyne Equase circuit conforms to these ideals.

Let us glance for a moment at the familiar academic diagram of Fig. 1. This shows the logical sequence of the operations upon an electromagnetic wave which are required for the successful reception of a program. This diagram is indeed old. It has been reproduced from text to text as a fundamental.

### Regeneration

Considerable progress had been made in the field of selectivity as a result of the work of John Stone Stone with coupled circuits. In order to conform with the scheme of Fig. 1, an amplifying apparatus was required. Thus far, the single-tube circuit had been employed.

De Forest and Armstrong greatly enhanced the utility of the single-tube circuit by the contribution of regeneration. Inductive feed-back and the ultra-audions had enabled a magnification of signals of from ten to fifty-fold to be realized. When programs were put on the air, however, it became apparent that non-regenerative receivers were needed for satisfactory reception. That multi-stage amplifiers were needed was also apparent. The problem then confronting the engineer was to find a suitable link for coupling amplifying tubes in cascade. The difficulty of securing a moderate degree of amplification was increased by the fact that relatively high frequencies (which are more difficult to amplify), had been allotted for broadcast purposes.

### Untuned Amplification

In endeavoring to follow the logical scheme of Fig. 1, the early investigators sought to develop an untuned amplifier. They were not concerned with other functions within this unit since the selectivity developed by Stone was available, as were also detectors and audio amplifiers.

The ideal untuned amplifier is one that, without any adjustment, amplifies to the desired extent any one of a chosen band of frequencies, as, for example, the allocated broadcast band. Since the amplifier is to be used in connection with a selecting apparatus, it must not react upon the tunable circuits and render them unstable, make them oscillate, or impair their selective properties. For many years this ideal seemed to be impossible of attainment.

Invariably, the early untuned amplifier oscillated and squealed, had inadequate and poorly distributed amplification, and reacted strongly upon the tuning system. Stability was sought even at a sacrifice of efficiency. Some amplifiers were developed in which the oscillations could be controlled. What performance could be realized from these was due to regenerative feed-back and was limited to a very narrow band of wavelengths. In summarizing this phase of the early work, it may be said that the trend was to follow the logical scheme of Fig. 1, but that a complication of troubles hindered this type of development. A field was open for the inventor!

### Tuned Radio Frequency

The next forward step taken by the receiving art was through the work of the Germans, Schloemilch and Von Bronk, and of Alexanderson. Their work laid the basis for tuned radio frequency. However, although they indicated the advantages that would accrue by the use of the tuned circuit itself as the coupling element, these advantages could not be realized in practice. The tuned circuit turned out to be extremely susceptible to regenerative feed-

back. In fact, it was most susceptible to any reaction, either that of the grid-plate capacity of the tube into which it worked or the reactions from distant stages. (In the course of his research on tuned-radio-frequency amplifying systems, Lester L. Jones coined the expressions "adjacent-stage" and "distant-stage" feed-back. The former refers to reaction via the grid-plate capacity of the tube, the latter designates feed-back from later stages and includes common impedance, external magnetic, and capacitive coupling.)

Lester Jones' Melco-Supreme made its appearance upon the market in 1923. The description of the unique features incorporated in the Melco-Supreme is beyond the scope of this article, but the reader is referred to several patents (Nos. 1,658,804; 1,658,805; 1,664,513, and 1,712-214) which are a mine of information on the design of receivers of the neutralized tuned-radio-frequency type. It was, however, but a short time later that the Equase system was invented.

### The Equase System

The Equase circuit arrangement is one that follows rigorously the scheme of Fig. 1. Selection is performed as a distinct, separate, and complete operation upon the signal before amplification and detection. This is known as *pre-selection*, and is an outstanding feature of the circuit. The following advantages are derived from this type of selectivity:

"Phantom" heterodyne whistles are greatly minimized. In the usual receiver all of these are not real heterodynes of the waves of stations. Some, which are called "Phantom" because they are not real beats in space, are produced in the plate circuit of the first radio amplifying tube. These "Phantom" whistles are of two distinct types. The simplest is an audio-frequency beat between a station wave and a harmonic of a local station, which harmonic is created in the plate circuit of the first r.f. tube. A single tuning circuit, even though adjusted to a short wavelength, will not reduce the amplitude of a powerful long-wave local station sufficiently to prevent this phenomenon.

Another "Phantom" whistle is of more frequent occurrence and is brought about by the fact that two long-wave local stations may be operating on frequencies whose sum can beat audibly with a desired higher-frequency station.

The phenomenon of "Phantom" heterodynes is not revealed by the ordinary selectivity characteristic. The additional information that is needed relates to the nature of the amplifying tubes employed (as regards the residual rectification), and to the distribution of the selectivity among the stages. In the Equase circuit, the selectivity is "lumped." The nature of condenser and coil circuits is linear as regard voltage and current amplitudes; in other words, they do not distort. The Equase selector reduces the interference to one part in a million whereas a single tuned circuit reduces it to but one part in a hundred.

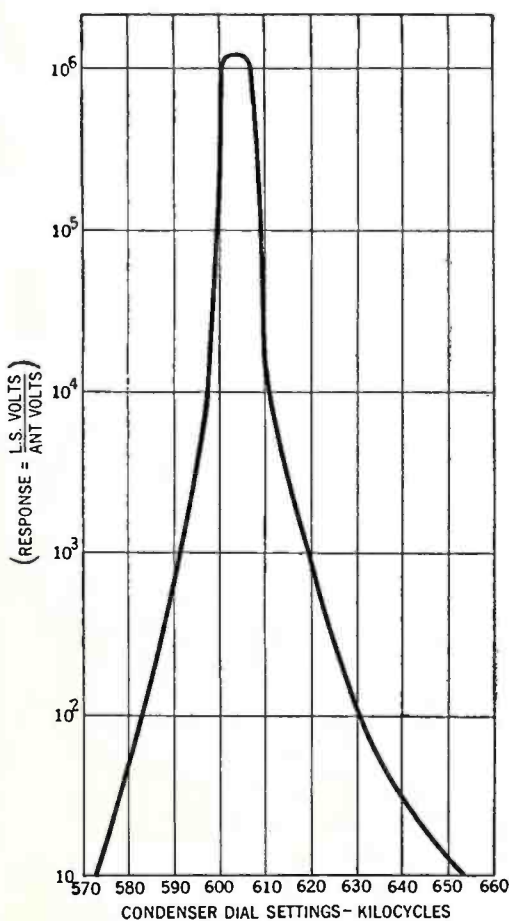
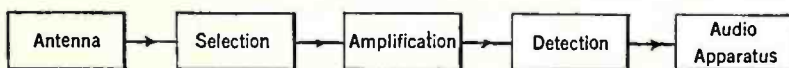

Fig. 2



LOGICAL SEQUENCE OF OPERATIONS IN RECEPTION

Fig. 1

### "Square-Top" Selectivity

Another advantage of Equase selectivity lies in the "square-top" nature of the tuning characteristic, over a single channel. With ordinary tuned radio-frequency systems, the high audio frequencies which contain the essentials of articulation, tone definition, and timbre, are not reproduced in their original intensity (relative to the low and middle register), due to distortion of the modulation envelope of the carrier by the "peaked-top" nature of the selectivity characteristic. Thus, amplitude distortion is introduced even before the signal reaches the detector.

The Equase selector uses four tuned circuits. This number is sufficient to provide a degree of selectivity that is adequate. In fact, our experiments indicate that it surpasses the selectivity obtained with an equal number of similar tuned circuits when used in a tuned-radio frequency receiver.

The selectivity characteristic shown in Fig. 2 was taken on the Sparton Equasonne (Sparks-Withington Co.), a receiver embodying the Equase circuit. It should be observed that the measurements were carried out to the extent of one part in one-hundred thousand, a practice that should be generally adopted. Even this degree of accuracy in estimating the shape of the selectivity characteristic does not reveal the whole selectivity, an air test being essential, as must become apparent when the phenomenon of "Phantom" heterodynes is regarded as interference.

The circuit diagram of the selector is given in Fig. 3. The four circuits are coupled as shown by a combination of capacitive, inductive, and direct couplings.

There are two criteria of the efficiency of a selector. One is the degree of selectivity available and the other is the attenuation, viz., the ratio of output voltage to input voltage. The selectivity of the Equase selector, taken in the real sense of being able to reduce all manner of interference to a minimum, is very good. The attenuation is less than with the old-time selectors of the Stone era, even though at that time, four tuned circuits were not even anticipated. In the Equase four-circuit selector, fully seventy-five per cent. of the voltage across the first tuned circuit is available for energization of the first r.f. amplifier tube. This is due to the maintenance of optimum coupling and efficient coil design.

### Amplification

The function of the untuned amplifier of the Equase circuit is to magnify the output from the selector to the degree necessary to operate the detector, audio, and loud speaker systems. The detector and audio amplifier as used in the Equase system require about ten volts for satisfactory loud speaker operation.

The Equase amplifier as embodied in the Navigator (The A-C Dayton Co.) has the amplification characteristic shown in Fig.

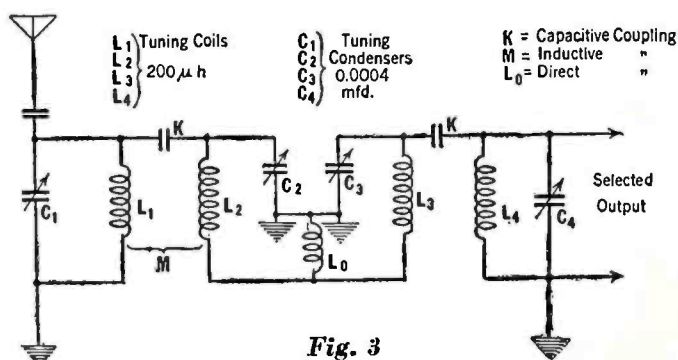

Fig. 3

4. Although the amplification increases rapidly as the wavelength increases, the response of the receiver as a whole is practically uniform over the whole band. The amplification characteristic in this case was purposely designed to increase with wavelength, since, on the longer wavelengths, the efficiency of capacitively tuned selecting circuits falls off and the ability of the antenna to absorb energy also diminishes. The response curve of the complete receiver is shown in Fig. 5.

### Resonance Maintenance

The design of the untuned amplifier is unique. The principle of operation upon which the amplifier is based is "resonance maintenance." A novel design of untuned coupling transformer further contributes to the success of the amplifier.

The "resonance maintenance" principle is described in Patent No. 1,673,287 issued to Lester L. Jones. It is based upon the fact that the load in the plate circuit of an amplifying tube can be designed so as to make the capacity between the grid and

cathode of the tube vary in a pre-determined fashion as the frequency of the impressed grid voltage varies. A typical curve showing how this capacity can vary automatically with the wavelength is shown in Fig. 6. The plate circuit loads are designed so as to make the input capacity approximate the variation of a tuning condenser over the broadcast band. By suitably proportioning the inductance of the coupling transformers, resonance is maintained to a considerable degree due to this automatic tuning effect. This feature provides high impedance

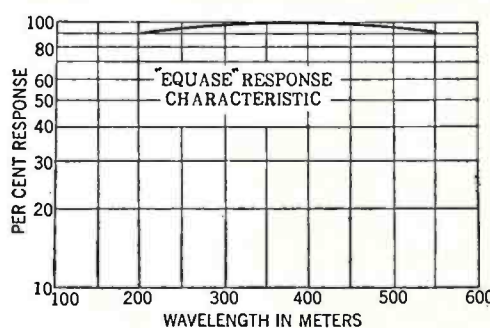

Fig. 5

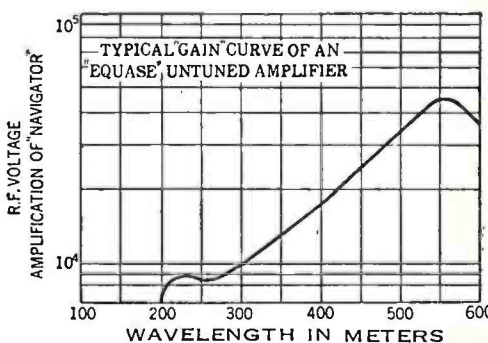

Fig. 4

loads in the plate circuits of the amplifying tubes and enables a high "gain" per stage to be obtained. Five stages of amplification are employed in present commercial receivers.

The interstage transformers are of practically one hundred per cent. (unity) coupling. The unity coupling contributes at once both to high efficiency and stability. Distant stage magnetic feed-back is neutralized by a "pie" type of winding which provides astaticism and keeps the self-capacity of the transformers at a very low figure.

### Stability

It has been mentioned that a reaction through the grid-plate capacity of a

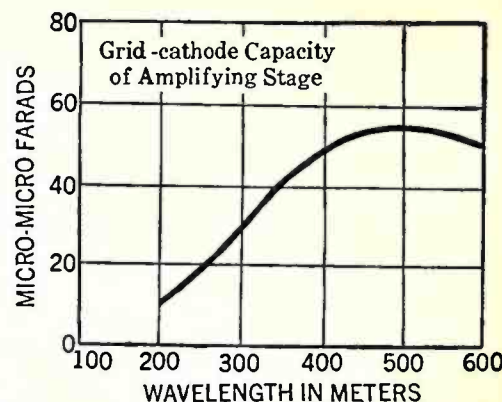

Fig. 6

tube may be one which tends to over-damp the input circuit rather than make it regenerative. In other words, a grid-plate capacity reaction may be one which either adds resistance to a circuit or removes resistance from it. In the former case stability results. In the latter case instability and oscillation may result.

In tuned-radio-frequency sets where the input circuits must be sharp and selective, the addition of resistance must be avoided with the same care that regeneration is avoided. In a broadly tuned amplifier, such as the Equase, the increase of resistance is relatively unimportant

as a damping factor, the function of selectivity being performed by the selector. The design accordingly is such as to maintain the non-regenerative reaction.

### Neutralization

The first tube of the amplifier has a novel output circuit. Since the last tuned circuit of the selector is connected to the input of this tube, especial design is necessary. The plate circuit of this tube is an impedance network which maintains a constant grid to cathode capacity for the tube, which is essential in order to avoid detuning of the selector, and it provides freedom from feed-back or over-damping reaction at all wavelengths. It is a method in which the over-damping and regenerative tendencies are both made to neutralize each other. This inherent-in-the-circuit type of neutralization has been named "feed forward" by Lester Jones. The stability of the amplifier can be appreciated from the fact that the tubes are placed as close together as is physically practical, almost touching. No metal shielding whatever is employed.

In the Sparton Equasonne, the Equase amplifier employed has the dimensions 8½ by 3½ inches. The A-C Dayton Navigator employs a different receiver layout in which a longer but narrower (2¼ by 12½ inches) amplifier is employed. Great flexibility in design is offered to the design engineer due to the isolation of the selective and amplifying functions, and the individual unit type of construction.

### Detection

If one stage of audio amplification is employed, it is, of course, the last and power stage. The burden of supplying the power tube with sufficient a.c. voltage falls upon the detector. Research upon methods of detection led to the development of the "anode-bend-power-detect"

(Concluded on page 303)



# THE LIGHT BULB—A HANDY RESISTOR

By WILLIAM H. WENSTROM

With the Laboratory Collaboration of William A. Morton, Jr.

**L**IGHT BULBS of various kinds are among the cheapest and most convenient resistors that we have. The difficulty attending their use has been that their resistances are far from constant. We often hear statements such as "the resistance of this bulb is about so-and-so." Actually the hot resistance of a bulb may be ten times its cold resistance. It is the aim of this article to take the guesswork out of light bulbs, and to place their use on some sort of scientific basis.

The use of light bulbs of course depends on Ohm's Law:  $E = IR$ , where  $E$  is the voltage drop across the bulb,  $I$  the current, and  $R$  the bulb's resistance at that particular current. The formula for bulbs in series is of course  $R_1 + R_2 = R_T$ ; and for bulbs in parallel  $1/R_1 + 1/R_2 = 1/R_T$ . The currents of bulbs in parallel are added:



*Banks of electric light bulbs are quite commonly used in laboratories, school laboratories particularly, as a convenient variable load in making all sorts of measurements. It is useful to know the characteristics of a lamp bank at various voltages other than normal and in this article Mr. Wenstrom gives some data from which lamp bank characteristics can be calculated readily.*

—THE EDITOR.

$I_1 + I_2 = I_T$ . For calculating the normal current of a bulb from its watts rating, we use the formula  $W = I^2R = IE$ .

### House Lighting Bulbs

Standard light bulbs are made with tungsten or carbon filaments. The older carbon bulbs are now practically obsolete for lighting purposes but are better than tungsten for most resistance purposes. The resistance of metals increases with increase of temperature; that of non-metallic elements decreases with increases of temperature. This means that the resistance of a tungsten filament increases as the current rises, while the resistance of a carbon filament decreases with a rise in current. The variation between hot and cold resistance is astonishingly large, particularly in the case of tungsten bulbs. General data on many standard bulbs appear in Table I. This table includes 115-volt, 32-volt, and 240-volt tungsten bulbs, and 110-volt and 220-volt carbon ones. Tungsten bulbs are also made in 110-, 120-, 220-, 230-, 250-, and 260-volt ratings. Any individual standard bulb listed in the table should test within 5 per cent. of the values given. "Cold resistance" is of course a relative term; the figures given are near enough to average zero current values for all practical purposes.

The resistance of a bulb not given in the table may be approximated. For instance, the resistance of a 120-volt bulb will be about 120/115 that of a similar wattage 115-volt bulb; the resistance of a 100-watt bulb will be about 50/100 that of a similar voltage 50-watt bulb.

### How Resistance Changes

Now let us see how the bulb resistance changes between extreme values. In Fig. 1 we follow the changing resistances of two typical bulbs—a 115-volt 50-watt tungsten and a 110-volt 50-watt carbon—from zero current up to normal current. The carbon bulb starts with high resistance which decreases rapidly at first, and then less rapidly as it heats up. The tungsten bulb starts with extremely low resistance which rises fairly uniformly with the current—the curve is almost a straight line. Where we wish a fairly constant resistance at normal current, therefore, carbon bulbs are best (they also prevent a

large initial current rush); where we wish a ballast action, or pronounced opposition to a rise in current, tungsten bulbs are best. Additional curves show how the voltage drop across each lamp varies with the current through it.

In constructing lamp banks we usually know beforehand the available voltage and the desired current. What we really wish to know, therefore, is the voltage drop across a given bulb or group of bulbs at a given current. In Fig. 2 we have curves from which this information can be calculated approximately for any tungsten or carbon bulb of any common voltage and wattage rating. For example, we wish to find the voltage drop across a 115-volt 100-watt bulb at a current of 0.5 ampere. Referring to Table 1, we find that the normal current of this bulb is 0.87

TABLE 1  
HOUSE LIGHTING  
BULB DATA

Bulb & Rating	Hot I	Hot R	Cold R
Tungsten			
115 V 10 W	.09	1280	140
115 V 25 W	.22	525	45
115 V 50 W	.44	260	23
115 V 100 W	.87	135	11
115 V 150 W	1.30	90	8
32 V 25 W	.80	40	5
32 V 50 W	1.60	20	3
240 V 25 W	.10	2400	205
240 V 50 W	.20	1200	125
240 V 100 W	.42	560	45
Carbon			
110 V 15 W 6 cp	.15	730	1250
110 V 50 W 16 cp	.46	234	415
110 V 100 W	.91	122	260
220 V 120 W	.55	400	700
	Mean of Calc. & Meas. Values	Calc. fm. Prec. Table	Meas. Values with small Currents

TABLE 2  
FLASHLIGHT AND AUTO  
BULB DATA

Bulb & Rating	Test E	Test I	Hot R	Cold R
Pilot 6 V	5	.15	35	10
Flashlight				
1.2 V	1.2	.50	2.4	.6
1.25 V	1.25	.75	1.6	.5
2.2 V	2.2	.25	8.8	1.8
2.5 V	2.5	.30	8.3	1.8
3.8 V	3.8	.32	12	2.5
$\frac{1}{2}$ C Ratio			4	1
Auto				
3 V 2 cp	3	.8	3.7	.9
6 V 3 cp	6	.6	10	1.7
6 V 6 cp	6	.9	6.7	1.0
6 V 21 cp	6	2.0	3.0	.5
12 V 3 cp	12	.3	40	6.0
18 V 3 cp	18	.2	90	12
Average Hot R-Cold R Ratio 6:1				

FILAMENT COLORS AT  
PROPORTIONAL CURRENTS

Cold R	Dull Red	Bright Yellow	White	X Normal I
Medium	$\frac{1}{2}$	$\frac{3}{4}$	1	"
Below 1 ohm	$\frac{2}{3}$	$\frac{3}{4}$	1	"
Above 5 ohms	$\frac{1}{3}$	$\frac{2}{3}$	1	"

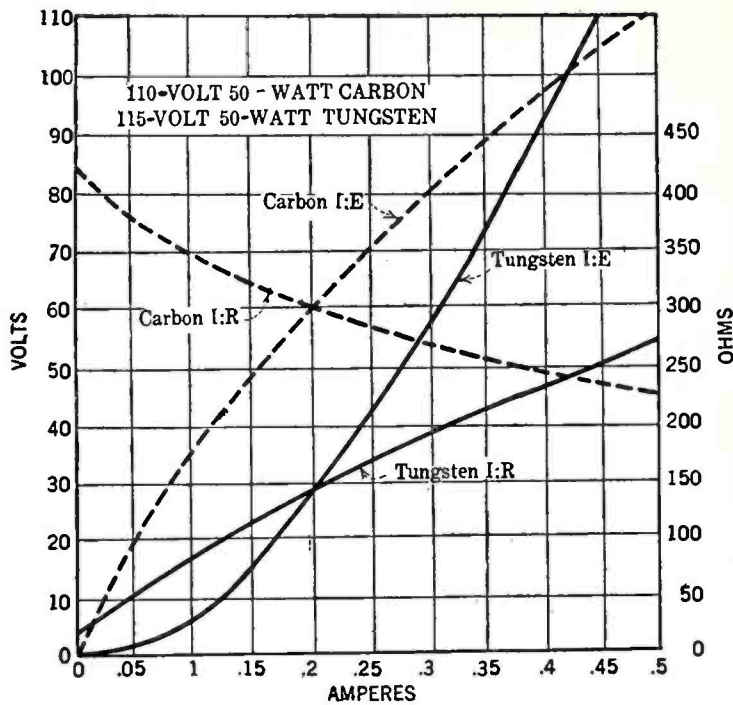

Fig. 1

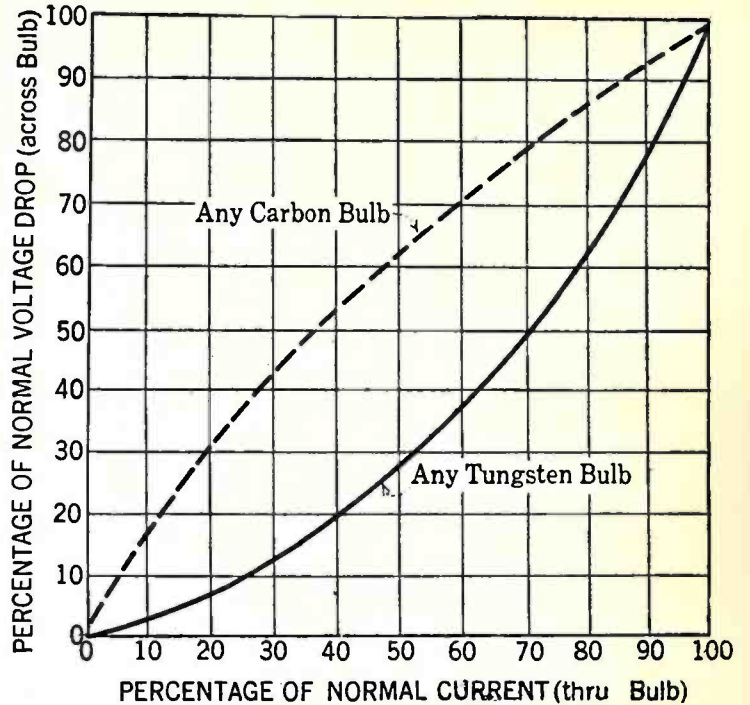

Fig. 2

ampere. Our given current is then 57 per cent. of the normal current. On Fig. 2 we project the abscissa corresponding to this current percentage up to the tungsten bulb curve. Then, projecting this point on the curve across to the ordinate or voltage percentage scale, we find that the voltage drop across the given bulb at the given current will be about 34 per cent. of its normal voltage drop, or 39 volts.

*Auto and Flashlight Bulbs*

Practically all auto and flashlight bulbs have tungsten filaments, so that their resistances increase with increase of current. Table 2 gives complete data on all bulbs in common use. Here again, any

standard bulb should test within 5 per cent. of the table. It will be noted that the hot resistance of a flashlight bulb is around four times its "cold" resistance, and that for auto bulbs this ratio is about six to one.

In addition to their use as resistors, these bulbs have possibilities as emergency ammeters and milliammeters for rough measurements of alternating or radio-frequency currents. A suitable bulb is placed in the a.c. or r.f. circuit; then a similar bulb, connected in series with a battery, rheostat, and d.c. meter, is placed near it for visual comparison. The d.c. circuit is adjusted until the two bulbs are alike in color, when the d.c. meter gives the effective value of a.c. or r.f. in the other

circuit. The bulbs should be interchanged to check their uniformity. One bulb may be used in first one circuit and then the other if desired, but this procedure introduces the inaccuracies of memory. The accuracy of the first method is probably better than  $\pm 10$  per cent.

For still rougher measurements we may use the filament color data at the end of Table 2. A medium resistance bulb, for instance, will show dull red at about  $\frac{1}{2}$  normal current, and bright yellow at about  $\frac{3}{4}$  normal current. While the accuracy of this method is not over  $\pm 20$  per cent. it may often be found useful. The accuracy of any method is greatest between filament colors of red and yellow.



Laboratory set-ups employed for determining the resistance of light bulbs under various conditions.

PROFESSIONALLY SPEAKING

(continued from page 269)

It seems to us that a receiver which selects a band of constant width would be somewhat better than one in which the amplification is constant. However, it must be admitted that the latter is an advance because it increases the "apparent selectivity" at high frequencies, and it makes the user think the set is more selective than it really may be.

We believe uniform sensitivity is desirable, provided that the sensitivity is great enough. We have seen some modern re-

ceivers in which the amplification varied over a very large ratio; we have heard that a prominent receiver has a gain curve that varies from something less than 10,000 at low frequencies to more than 200,000 at high frequencies. We do not believe such curves are desirable because of the poor apparent selectivity at high frequencies. Perhaps the designers feel that what the listener can get on the high-frequency channels is not worth listening to—and they may be correct. The tendency to de-

vote only a few degrees of the tuning dial to the channels above 1000 kc. decreases or increases the apparent selectivity depending upon whether the receiver separates such channels or not. In other words, the local area in which the receiver is to be used determines whether or not it is considered locally as a selective or a broad set.

If 1929 is a year in which uniform sensitivity gains in popularity, perhaps 1930 will be a year in which uniform selectivity is attained. If so, let us hurry it along.

## DESIGNING COILS FOR THE MODERN SET

By HUGH S. KNOWLES

Engineering Department, Silver-Marshall, Inc.



Hugh S. Knowles

SOMEONE IS credited with the observation that the difference between the work of a mathematician and an engineer lies in the fact that a mathematician has only one variable for his equations whereas an engineer has two—one of which is controlled by economic factors. We know of no

case in which the economic factors are of more importance than in the design of a modern inexpensive radio receiver.

The S-M 722 receiver was designed with the object in view of providing a receiver with modern performance to market at less than \$75.00. This meant that the receiver must have high gain in terms of this year's performance, a high degree of selectivity to make the increased gain usable as well as to keep the apparent selectivity up, and a good overall frequency characteristic which meant the use of at least one band-selector circuit.

This resulted in the use of a band selector or "siamese" circuit followed by two transformer-coupled screen-grid r.f. stages and a screen-grid detector followed by a transformer-coupled a.f. stage using a 227-type tube and a push-pull power stage using a 245-type tube.

### Selection of Coils

A very important part of the design of the r.f. end of the receiver lay in the selection of a suitable coil design. The data which were obtained in the design of two screen-grid receivers last year, and in the receiver described in July, 1929, RADIO BROADCAST, were available for this purpose. The results of measurements on nine representative coils are listed in Table I.

The test circuit was composed of a low-impedance supply source having a frequency of 550 kc. and a series-tuned circuit including a two-ohm thermocouple.

Instead of making two observations on each coil, such as would be required by the resistance-variation method of determining the coil power factor, an arbitrary figure of merit equal to the square root of the deflection divided by the capacity was used. The figure of merit,  $M$ , is tabulated in the eighth column. The test frequency of 550 kc. was chosen because the gain of a receiver of this type is always low at this point and the performance at this frequency is of prime importance.

Test transformers using secondaries Nos. 1 and 2 were available since this coil had been used previously. The interesting thing about the two coils is that the ratio of the selectivity factor (ratio of voltage at resonance to voltage 10 kc. off resonance)

from 5.22 at 550 kc. to 1.1 at 1300 kc., that of the smaller coil (No. 2) varied from 4.88 to 1.31 over the same interval. Coil No. 3 was selected because of its very good performance for a compact form.

Curves A, B, and C in Fig. 1 were run with a view to determining the possible gain in the antenna coupler using coil No. 3 as the secondary. Curve A uses a standard dummy antenna feeding a small primary winding (tapped for long antenna) Curve B was run with a 12.5-mmfd. condenser in series with the dummy tied directly to the grid. Curve C was run with the same circuit as B, except that it was coupled through the primary with a 25-mmfd. condenser. As a result of this test, the transformer shown in curve C was adopted because of the high gain obtained and because the gain ratio at the two ends of the broadcast spectrum was somewhat better than the other two. The high gain in the receiver makes it possible to use a low coefficient of coupling and an antenna which is sufficiently small to minimize detuning of the first condenser. With proper alignment the variation of the first tuning condenser is of the order of a quarter micro-microfarad.

### Band-Selector Needed

When it was definitely established that satisfactory alignment of the first stage could be maintained with an antenna coupled to it, it was decided to place the band-selector circuit ahead of the first tube. This is very desirable since the frequency discrimination which occurs ahead of the first tube minimizes the possibility of stations having a high field strength, other than the one to which the receiver is tuned, of impressing sufficient input on the first 224-type tube to give second order variations in the output circuit which might be amplified sufficiently by succeeding stages (when tuned to the harmonic) to cause objectionable interference. The overall gain from antenna to grid of the first tube is entirely satisfactory because

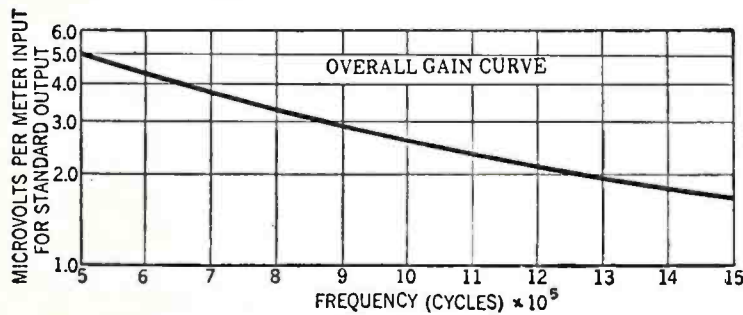

Fig. 3

at 550 kc. to that at 1500 kc. is more satisfactory on the smaller coil. This may be accounted for by the fact that the smaller coil was wound on an ungrooved tube resulting in a lower dielectric loss at the high frequencies. Placing coil No. 2 in a larger shield than No. 3 (No. 4) resulted in an improvement which was too slight to warrant the greater physical volume and cost of the latter. Whereas the selectivity factor of the large coil (No. 4) varied

Table I

Coil	Diam.	Turns	Wire	Spacing	Cmm+d.	Def.	$M = \sqrt{Def/C}$	Shield
1	2 1/2"	72	25	diam.	355	94	2.73	None
2	1 1/2"	124	29	close	285	54	2.58	None
3	Same	"	"	"	350	64	2.28	2 1/2 x 2 1/2
4	Same	"	"	"	300	56	2.48	3 1/2 x 5
5	2"	105	22	close	281	63	2.84	None
6	Same	"	"	"	361	80	2.47	3 1/2 x 5
7	1 1/2"	109	22	1/2 d	398	90	2.50	Same
8	Same	120	Same	Same	340	81	2.65	Same
9	Same	123	23	1 1/2 d	306	66	2.65	Same

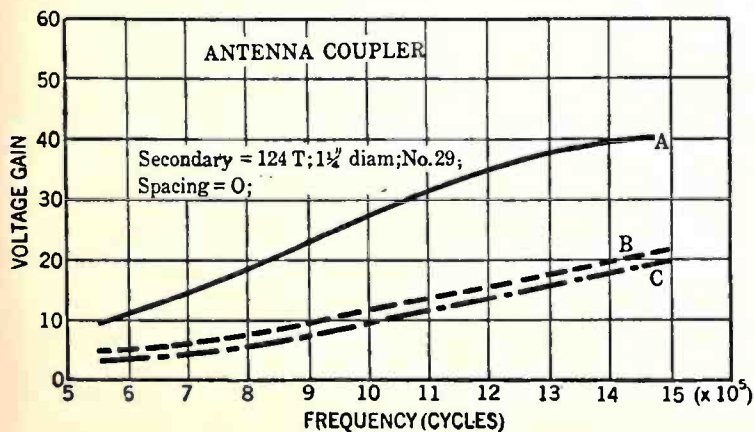

Fig. 1

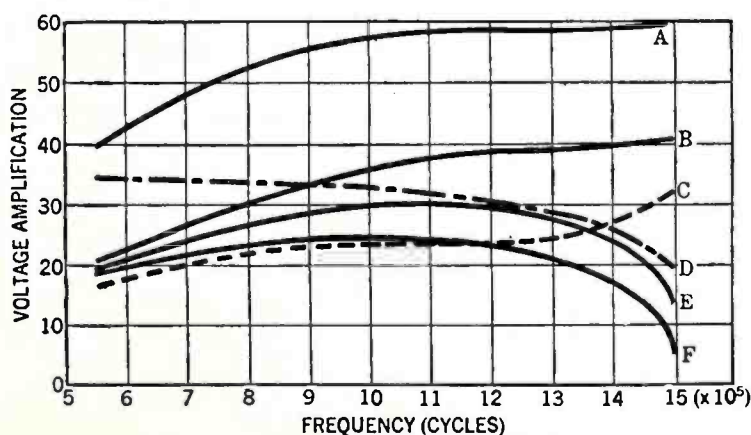

Fig. 2

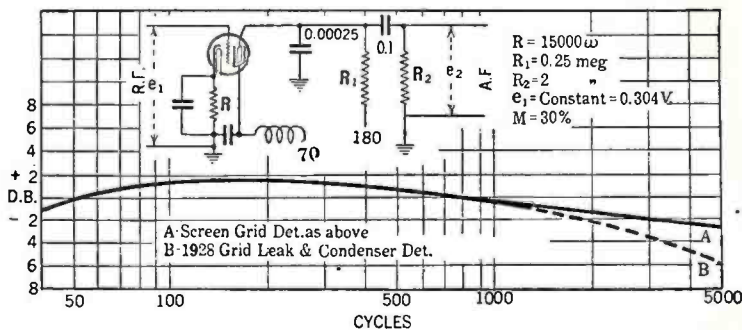

Fig. 4

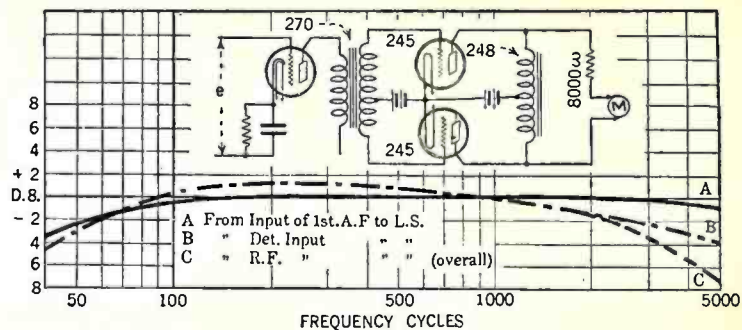

Fig. 5

of the fact that nearly optimum coupling relation exists over the whole frequency range; that is,  $\omega M$  must equal the product of the resistance in the two circuits ( $\omega M = R_1 R_2$ ). The frequency ratio is very nearly 3 to 1 and, since the resistance variation is of the same order, almost optimum coupling is obtained throughout the whole range.

Fig. 2 shows a characteristic group of transformer curves using the secondary No. 2 and various primaries, degrees of coupling, etc. The gain at 550 kc. varies almost directly with the primary impedance. The gain limiting possibilities at high frequencies of the primary to secondary capacitive coupling are shown in curves D, E, and F.

In curve D it would appear to be desirable to limit the high-frequency gain but the actual selectivity factor of coil B is superior, being 4.88 at 550 kc. and 1.31 at 1500 kc. as compared with 4.03 and 1.05 for coil D. The coil of curve A was adopted because of its high gain and the exceptionally good minimum-to-maximum gain ratio.

### Transformer Coupling

Transformer rather than impedance coupling was adopted because it is difficult to build a choke which will have a uniformly high impedance over the whole broadcast band and because of the difficulty of controlling the selectivity factor of the interstage coupling device. Whereas, in d.c. screen-grid tubes, the plate impedance is sufficiently high so that the resistance reflected into the tuned circuit is very low, in the case of a.c.

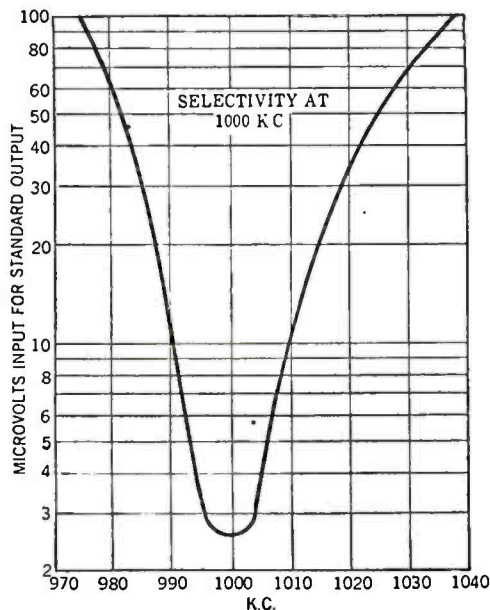

Fig. 6

screen-grid tubes with their lower plate impedance (particularly at high screen-grid potentials where the gain is great and the selectivity is actually needed) the reflected resistance, and hence the influence of the tube on the selectivity, is very considerable. Impedance coupled amplifiers also offer considerable alignment trouble and are apt to have a poor gain ratio.

The alignment problem is one of the most serious in receiver design, particularly where band-selector circuits which have to be symmetrical are concerned. Although the shielding problem is simplified by using two coils in one shield partition, and using the mutual as the

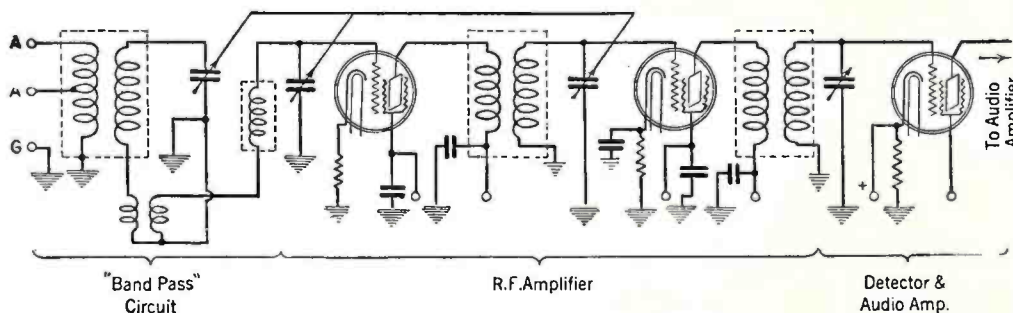

Fig. 8

"spacing" impedance, it is difficult to make the two circuits perfectly symmetrical because of the difference in the capacity to the two coils and possible differences in materials in the fields of the two.

In the first coil designs the maximum variation between stages (assuming identical condenser sections) was 3.35 micro-microfarads. In coils similar to D, Fig. 2, the variation ran as high as 7 micro-microfarads. The present design gives a maximum difference of 0.24 micro-microfarads. This is obtained by reducing the leakage reactance of the transformers to a minimum (maintaining high values of "K" for the inductance used) and yet keeping the primary to secondary capacity fairly low and constant.

The use of plate-circuit rectification is now generally accepted and needs little comment. The use of a 224-type tube in preference to a 227-type tube seems advisable for the following reasons:

1. Higher detection coefficient (greater audio output for given radio-frequency input)
2. Improved frequency characteristic (better than leak-condenser type and superior to numerous bias detector arrangements)
3. Larger undistorted output for moderate plate voltage.

Point No. 1 is clearly shown in curve A, Fig. 6 on page 162 of July, 1929, RADIO BROADCAST. The frequency characteristic of the detector alone is given in A of Fig. 4. Curve B is flat from 100 to 1000 cycles and down 6 dB at 5000 cycles and is representative of grid leak condenser detectors of a year ago (2-megohm leak). Curve A, Fig. 5, shows the curve from the

input to the first a.f. tube to the output of the 245-type tubes in push pull. Curve B shows the overall fidelity from detector to loud speaker. The improved detection coefficient makes it possible (with the same r.f. gain) to use a low-gain transformer with an exceptionally satisfactory transmission characteristic in working out of the first audio stage into the 245-type tubes. By using two audio stages with the transformer looking into the 245-type tubes working out of a low-impedance tube, such as the 227, the frequency characteristic is not made a function of the plate impedance which varies over wide limits in the conventional single audio stage detection arrangement and results

in a considerably improved frequency characteristic. The input impedance of the power tube is not only usually low but also varies greatly so that it is desirable to work out of a low-impedance tube through a low-ratio transformer to minimize the loading effect of the power tubes.

The overall gain curve of the receiver is given in Fig. 3.

The overall frequency curve given in curve C, Fig. 5, indicates an attenuation in the r.f. end of 3 dB at 5000 cycles, which is slightly more than given in the selectivity curve, Fig. 6. With the loud speaker with which the receiver is used the high-frequency response, even at 550 kc., is very good and frequently called excessive by those who are accustomed to the more common values of attenuation or sideband cutting.

As a final check on the overall performance the input was held constant and the percentage modulation varied.

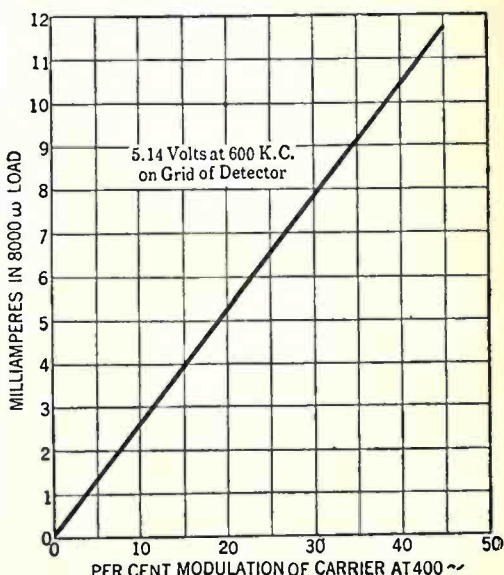

Fig. 7

# The Radio Broadcast LABORATORY INFORMATION SHEETS

By HOWARD E. RHODES

THE aim of the RADIO BROADCAST Laboratory Information Sheets is to present, in a convenient form, concise and accurate information in the field of radio and closely allied sciences. It is not the purpose of the Sheets to include only new information, but to present practical data, whether new or old, that may be of value to all those in the engineering branches of radio. In order to make the Sheets easier to refer to, they are arranged so that they may be cut from the magazine and preserved, either in a blank book or on 4" x 6" filing cards. The cards should be arranged in numerical order.

Since they began, in June, 1926, the popularity of the Information Sheets has increased so greatly that it has been decided to reprint the first one hundred and ninety of them (June, 1926-May, 1928) in a single substantially bound volume. This volume, *Radio Broadcast's Data Sheets*, may now be bought on the newsstands, or from the Circulation Department, Doubleday, Doran & Company, Inc., Garden City, New York, for \$1.00. Inside each volume is a credit coupon which is worth \$1.00 toward the subscription price of this magazine. In other words, a year's subscription to RADIO BROADCAST accompanied by this \$1.00 credit coupon, gives you RADIO BROADCAST for one year for \$3.00 instead of the usual subscription price of \$4.00.

—THE EDITOR.

No. 296

RADIO BROADCAST Laboratory Information Sheet

Sept., 1929

## Output Transformer Ratios

SOME INTERESTING curves which were published in a recent bulletin issued by the Ferranti Company are given on "Laboratory Sheet" No. 297. These curves show the transformer turns ratio necessary for use with power tubes of different plate impedances when used with dynamic loud speakers of various impedances. The chart covers tube impedances up to 15000 ohms and loud speaker impedances up to 55 ohms.

The charts are calculated on a basis that the tube is to work into an impedance equal to twice its own impedance. That is, for example, a tube with an impedance of 4000 ohms should work into an 8000-ohm load. Transformer ratios for output circuits are always calculated under this condition and the chart ought to prove quite useful.

The required ratio of a coupling transformer is determined by taking the square root of twice the tube impedance divided by the loud speaker impedance. Expressed as a formula,

the turns ratio of the transformer is equal to

$$T = \sqrt{\frac{2 R_p}{R_L}}$$

where  $R_p$  is the plate resistance of the tube  
 $R_L$  is the impedance of the loud speaker

$T$  is the required turns ratio of the transformer

As an example, suppose we have a loud speaker with an impedance of 40 ohms and that we were going to supply it from a push-pull stage using two tubes each with a plate impedance of 5000 ohms. Substituting in the above formula we obtain approximately 22.5 as the required turns ratio. Checking this on the curves we find that the line corresponding to 40 ohms and the line corresponding to 10,000 ohms (two 5000 ohm tubes in push-pull give a total impedance of 10,000 ohms) intersect at a point corresponding to the line giving a ratio of 22.5:1 which checks our calculation.

No. 297

RADIO BROADCAST Laboratory Information Sheet

Sept., 1929

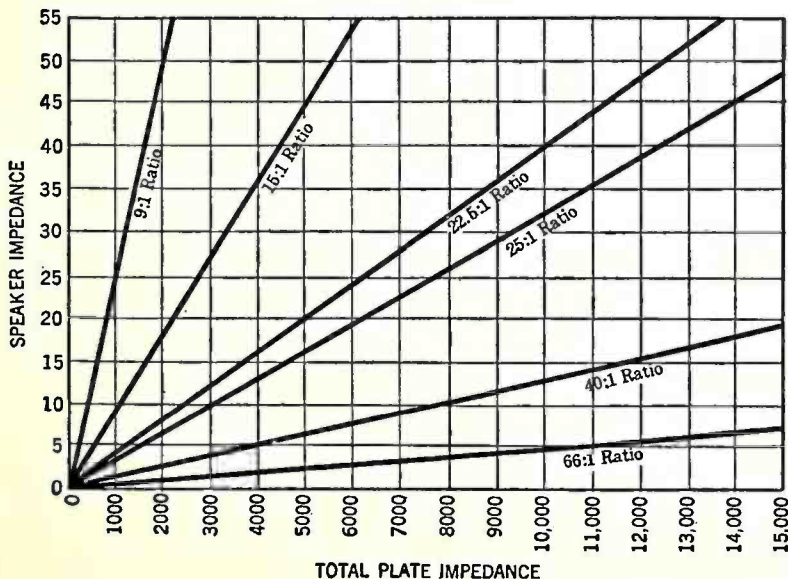

## HOW TUBE SALES GO

(Continued from page 260)

months for the last three years, and the illustration above indicates how sales vary during the average year. A table also gives exact tube sales in percentages by months for the last three years and for the average year. These figures are believed to be representative of the entire industry as they were prepared after examining carefully exact sales figures of several leading tube manufacturers.

An examination of the curves in the illustration below shows that sales during 1928 parallel more closely the average sales curve than the curves for the years 1926 and 1927. This may be explained by the fact that the outstanding special broadcasts during 1928 were more numerous and more evenly distributed throughout the year, and therefore, conditions were more nearly normal. On the other hand, 1928 has a higher peak during the month of October—sales for the month are 19.2 per cent. of the yearly sales—than either of the other years, which may be explained by the unusual interest displayed in the broadcasts of the political campaign.

In comparing the average curve with the three yearly curves the most interesting fact which will be noticed is that the peak of tube sales occurred at a different month in each of the three years. In 1926, sales were at a peak in November, which is considered normal as this is the height of the football season. The curve for that year also shows that sales in September were almost equal to those in October, which is unusual and which was probably caused by the great interest in the Tunney-Dempsey fight broadcast over a network of stations on September 23, 1926. In 1927, tube sales reached the peak of the year during September, and this unusual condition was unquestionably caused by the broadcasting of the second Tunney-Dempsey fight from Chicago on September 22, 1927. As already explained, the Presidential Campaign undoubtedly caused the shift of 1928's sales peak to the month of October.

Two interesting deductions may be drawn from the facts stated above. In the first place it may be assumed that tube sales would probably reach the peak of the year in November if they were not affected at an earlier date by some outstanding broadcast. This fact, however, is not proved by the average curve because the peak in October during 1928 had sufficient height to shift the peak in the average curve to this month. The second point of interest is that important broadcasts have a greater effect on tube sales to-day than in 1926. This is probably due to the fact that much greater areas are now covered by the large networks.

Strange as it may seem the sales curves also show that for the past three years tube sales have been decreasing during the first five months of the year—January to May. This tends to indicate that sales are affected more by important broadcasts than by the sale of new receivers. The increase in replacement sales in the fall naturally causes a decrease in sales during January, February, and March. If it is desired to flatten out the sales curve it is suggested that tube manufacturers inveigle Mr. Tunney to have a return bout with Mr. Dempsey sometime in March or April to be followed by a "barnstorming" trip between Al Smith and Senator Borah in May and June.

### MARVIN'S NEW SALES PLAN

IN ORDER to introduce its new 5-second heater tube to the trade, the Marvin Radio Tube Corporation has arranged a special offer to its jobbers. This offer is to supply sets of five standard tubes, the first tube, the 227, being given free and the others billed to the jobber at 40-10-2 per cent.

Circuits for the 245-type Tube

Most of the new radio receivers are using audio power amplifiers which employ either one or two 245-type tubes, the tubes being arranged in push pull when two are used. Because of the wide use of this tube we give on this sheet and sheet No. 299 some data on the various circuit arrangements generally used with the 245.

CIRCUIT A

Two 245-type tubes are indicated in circuit A on "Laboratory Sheet" No. 299. The plate voltage required is 300 volts, 250 of which is impressed on the plate of the tube and the remaining 50 supplying the necessary C bias. The filament is shunted by the 10-ohm resistance. The C-bias resistance is calculated by dividing the required C bias, 50 volts, by the plate current, 32 milliamperes, and dividing by two since there are two tubes. This calculation shows that the C-bias resistance should have a value of 750 ohms as indicated.

CIRCUIT B

This circuit shows a single 245-type tube with transformer output. The required plate voltage is 300 volts and the C-bias resistance is 1500 ohms. Since the a.c. current in the plate circuit must flow through the C-bias resistor to get to the filament, it is essential that the resistor be bypassed with a condenser of 1 or 2 mfd. The output transformer may be an ordinary one with a ratio of about 1:1, or it may be the transformer which couples the tube to the moving-coil system of a dynamic loud speaker, in which case, of course, it should have a step-down ratio.

CIRCUIT C

This arrangement is similar to that indicated at B except that a choke condenser output is used. With this arrangement d.c. current is kept out of the primary of the loud speaker or coupling transformer if one is required. Since one of the loud speaker terminals returns directly to the center-tapped resistor connected across the filament, it is not essential that any condenser be connected across this resistance.

THAT TRADE GOSSIP

(Continued from page 259)

other, and have worked together. Every difficulty as to harmonious action has been the breeder of some new form of distribution, the mail order house, the department store, the chain store, the manufacturer's own retailing system—and yet the independent dealer, in the aggregate, remains the principal retail factor. He and the manufacturer understand each other a little better than they did once—but not well enough yet, by far.

Welcome the wholesaler's salesman, make him your friend, make him work for you, tell you the news of how other dealers are making a success, but do not exchange cheap and unreliable gossip with him. You can give him much and he can give you much that is real and important.

To your customer you must always appear substantial and reliable. There is money in your pocket in having him respect you. In your business, your customer looks up to you as an expert in a mysterious business.

"The customer is always right?" Not always. He is not right when he wants to take your profit away from you and you should have a nice way of telling him so. There is a nice way to do this, also a nasty way. The customer is not right when he wants to trade-in a bum set for many times what it will bring as junk. He generally is not as up to date about radio as he likes to appear. No he is not always right but he is interested, and that is the thing for you to build on. He needs education, both in your merchandise and in the common rights of a merchant.

Remember this about customers. They have been catered to, flattered, made love to by advertising to such an extent that they are all puffed up with the importance of their own little dollars. They do not know how to treat a dealer fairly. They do not realize that if he gives up his profits he cannot continue to serve them. But they are human. Most of them are trying to make a living for themselves. They are quite capable of being educated into being profitable customers.

News vs Gossip

The distinction we have made between "news" and "gossip" is often a hair-line distinction. How can we get the "news," which is wholesome, and kill the bad effects of "gossip"?

The first step is to see the seriousness of what it means and act accordingly. The next is to fix the imagination on being a successful dealer and act accordingly, that will keep any man busy.

Simple and self-evident as all these things are, we are very apt to ignore them. We are very prone to help foolish gossip along, then wonder why the good will in our industry is no better than it is.

Everybody has a stake in this.

"Among the many things we talk about, what is dangerous gossip, and what is real and valuable news?"

The only answer I can give to that is—You generally know that difference yourself if you will stop to think. Broadly speaking, any display of real enthusiasm for radio and radio merchandise is promotive and valuable, while knocking of radio, knocks at people in radio, indications of fear for radio's future are taking money out of your own till and throwing it away.

[Another article by Mr. Dickinson will appear in the October RADIO BROADCAST. In this article the advertising problems of a retail radio store will be discussed from all angles—Editor.]

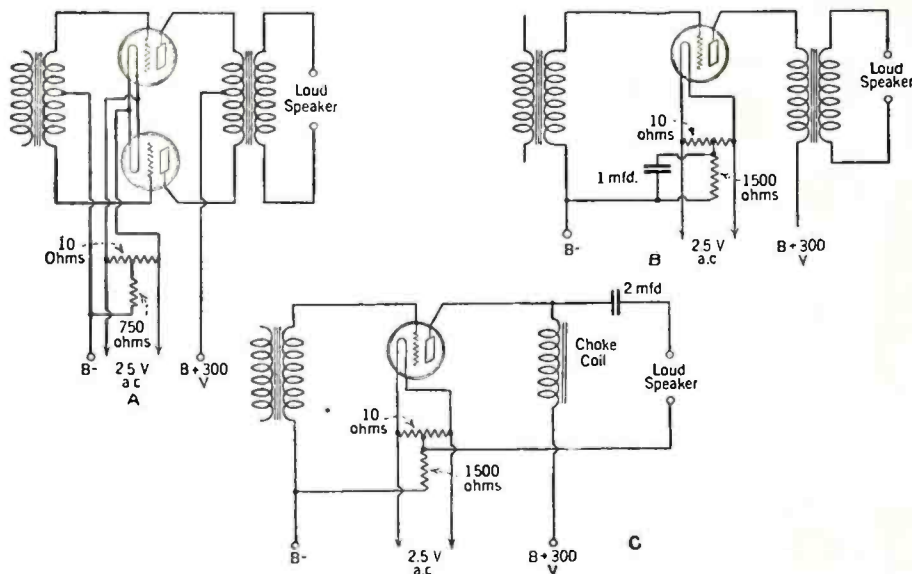

Center-Tapped Filament Resistors

SEVERAL READERS have written us requesting information on what determines the value of the center-tapped resistance connected across the filament of an a.c. tube. In some cases it is apparently felt that this resistance must have a definite value in order to produce a definite load on the transformer secondary supplying the filament. This is seldom, if ever, the case, however.

No hard and fast rules can be given for the value of the resistance used across the filament. In fact a wide range of resistances can be used with equally good results. The important point to consider is the resistance of the filament across which the center-tapped resistor is to be connected and to make sure that the latter's resistance is fairly high in comparison with that of the tube. For example, if a tube filament has a resistance of 1 ohm then the total resistance of the center-tapped resistor should be at least 10 ohms and might well be higher. Never use a center-tapped resistor of an ohmage comparable to that of the tube across which it is to be connected.

One other factor is of some importance, especially in connection with the resistors placed

across the filaments of power tubes. C bias for these tubes in a.c. sets is obtained by means of an additional resistor whose value is equal to the C-bias voltage required divided by the plate current of the tube. Actually, however, the center-tapped resistor also supplies some of the bias for the current in returning to the filament must flow through both halves of this resistance. In effect, therefore, the plate current flows through a resistor equal to one half the total value of the center-tapped resistance, since both halves of it are in parallel with the standpoint of the plate current. In calculating required values of C-bias resistance, it is wise, therefore, to subtract from the calculated results one half the value of the center-tapped resistance. For example, two 171A tubes in push pull draw 40 milliamperes and require a bias of 40 volts. The value of the C-bias resistor should, therefore, be 1000 ohms. If, however, a 200-ohm center-tapped resistor (values as high as this are frequently used) is placed across the filament of the tube, one half of this value (100 ohms) should be subtracted from the required 1000 ohms leaving 900 ohms. This value should then be used for the C-bias resistor.

## IN THE RADIO MARKET-PLACE

(Continued from page 277)

up district offices in each territory and the district sales managers are now busily engaged in conducting jobber and dealer meetings throughout their respective districts, cementing closer contacts between the manufacturer and the dealers and getting the field in order for a record year.

The five district managers are R. C. Hopkins, C. H. Griffith, J. G. Baquie, C. A. Lindevall, and J. A. Ramsey.

R. C. Hopkins is at the head of the Eastern District, with an office at 39 Broadway, New York. His territory includes such distributing points as New York, Boston, New Haven, Albany, Rochester, Philadelphia, Baltimore, Syracuse, Scranton, Nashville, Atlanta, Miami, and New Orleans.

The Eastern Central District with headquarters at 547 Leader Building, Sixth and Superior Streets, Cleveland, Ohio, has C. H. Griffith in charge. His distributing points include Cleveland, Cincinnati, Columbus, Toledo, Detroit, Muskegon, Pittsburgh, and Buffalo.

Chicago is the headquarters of the Central District, with J. G. Baquie in charge. Jobber headquarters in this district include Chicago, Milwaukee, St. Louis, Peoria, Indianapolis, and Elkhart. Central District offices are now located at 702 London Guaranty Building, 360 North Michigan Boulevard, Chicago, Illinois.

C. A. Lindevall is at the head of the Western Central District with offices at 550 Gates Building, Kansas City, Missouri. In his territory are Minneapolis, Mitchell, Omaha, Kansas City, Oklahoma City, Dallas, Houston, and Memphis.

The Western District, with J. A. Ramsey in charge, includes San Francisco, Los Angeles, Portland, Seattle, Spokane, Boise, Butte, Salt Lake City, and Denver. Headquarters are located at 625 Market Street, San Francisco.

### HAZELTINE PATENTS UPHOLD

THE DECISION of the Federal Court of Brooklyn in upholding the Hazeltine Corporation patents for eliminating undesirable generative effects in radio was affirmed July 2nd by the Circuit Court of Appeals.

The Corporation, as a test case, sued E. A. Wildermuth, a wholesale dealer in Atwater-Kent models, which, it was alleged, infringed on the corporation's patents, applied for in 1920, and issued a year later. It was indicated that an appeal might be taken to the United States Supreme Court as all the Atwater-Kent models of that type are involved. The new Atwater-Kent screen-grid tube set is not involved, in the suit, however, although a Hazeltine representative is quoted as saying that a move against that type of set may be taken later.

### EFFECTIVE RETAIL ADVERTISING

R. B. JOLLEY, Atwater-Kent dealer in Morristown, N. J., is going far and wide to advertise and promote his sales. This progressive dealer's latest stunt is to take full back-cover space in local motion-picture theatre programs.

"People who frequent movie theatres," says Mr. Jolley, "are red-hot prospects for the modern radio. That a definite part of their leisure time is devoted to entertainment—the more varied the better—is proved by their more or less regular movie attendance. I have found that this method of advertising is particularly effective, especially from a cost-versus-

coverage standpoint. The majority of the average local motion pictures programs are two or four page leaflets—easily and quickly read. Your radio message, covering one entire page at an extremely low cost, possesses immediate force and direct appeal."

### SPARKS-WITHINGTON INCREASES CAPITAL STOCK

WITH BUSINESS in hand to justify the promise of an unprecedented output of Spartan radios for 1929-30, and with the past season, a record year in profits the stockholders of the company authorized an increase in the capital stock from 400,000 shares to 2,000,000. At present there are outstanding 166,498 shares of common stock, and 7334 shares of preferred stock. Captain William Sparks, president of the company, states that booked orders starting after July 1 amount to double the business prospect of a year ago.

### MAKERS TO EXHIBIT RAW MATERIALS

FIFTY MANUFACTURERS of parts and raw materials have indicated their purpose to exhibit to the public at the forthcoming national radio expositions, the Radio World's Fair, in New York in September, and the Chicago Radio Show, in Chicago, in October. G. Clayton Irwin, Jr., general manager of the two shows, has completed details for a "Parts and Raw Materials Section" in the shows, and a "Parts and Raw Materials Directory" to be made available to all. Such a directory will fill a definite need. There is no single source to which radio manufacturers may turn for information regarding parts or raw materials which enter into set, speaker, tube, or apparatus construction.

## ADVANTAGES OF PRE-SELECTION

(Continued from page 296)

tor." This detector utilizes an ordinary heater-type tube such as is used in the amplifier. Suitable choice of operating voltages enable as high as 15 volts of modulated r.f. to be applied to the detector input without overloading.

In practice, the volume control is usually adjusted to provide sufficient amplification for raising the voltage of the received signal to a value of about 10 volts. The amplified signal is impressed directly upon the detector which is in the same container as the radio-frequency amplifier. The output of this detector when a 10-volt signal is impressed upon the input is sufficient to operate directly the largest power tubes employed to-day.

### Power Supply Apparatus

The single stage of audio-amplification employed in the Equase system has a gain of about  $\frac{1}{2}$  of the conventional two-stage audio amplifier. The demands upon the filter are reduced in like proportion. In fact, the resistance of the field coil in the dynamic loud speaker may be used in place of the choke coils usually employed, and but two filter condensers are needed; and the residual hum is inaudible! The saving in weight and size of power unit and the minimization of service troubles brought about by this simplicity, results in a great economy indeed.

## THE TUBE BUSINESS

(Continued from page 278)

### OF INTEREST TO WIRE EXPORTERS

WILL MANUFACTURERS who desire to export tungsten-filament wire, oxide-coated wire, molybdenum wire, nickel ribbon, and wire net write to V. Hirota, managing proprietor, The Sun Denchi Seisakujo, No. 18 Zengenjicho, Nichome, Osaka, Japan. On June 10 this company desired names of manufacturers who sold such material for the construction of radio tubes.

### SYLVANIA HAS NEW LAB

A "SALES ENGINEERING LABORATORY" has been established at the Sylvania plant to aid in "rendering the utmost in service to the user of Sylvania tubes." This laboratory, housed in a neat brick building some distance from the main factory, and equipped with modern measurement instruments, life-test racks, etc., is under the charge of Walter R. Jones. The main purpose of the laboratory is to maintain a "control" on the quality of Sylvania tubes; to maintain close contact with the field, and lend assistance in technical problems in regard to sales. In maintaining control on Sylvania output, tubes made at Emporium as well as at other tube plants will undergo constant life tests.

### REGARDING TUBE LIFE

ARCTURUS ENGINEERS believe that radio tubes receiving proper care in the average sets of to-day will last two years. If tubes need to be replaced at short intervals the A, B, and C voltages are probably wrong or fluctuate due to line-voltage variation. It would be interesting to have the experiences of a sufficient number of servicemen to answer the question, "in actual service how long do present-day a.c. tubes last?"

### KEEPING AHEAD OF THE TIMES

"A RADIO PLANT is no stronger than its engineering personnel," says Ernest Kaucr of CeCo. "No institution can keep moving forward unless it maintains the vigor and imagination of its engineering department. Frequently the engineer's tests demand a rejection of from 25 to 50 per cent. of the day's output. This is an awful blow for the head of a plant to have to accept—but there is no way out. High standards are more important than ever this year, for many institutions are seeking volume to such an extent that there is apt to be a careless attitude toward technical standards."

### NEW FILAMENT PREPARATION

A NEW PROCESS of coating the filament of a.c. tubes has been developed by Triad engineers. A non-oxide preparation is used which has proven highly effective in prolonging the life of the tubes. The Triad company, to quote Harry H. Stienle, sales manager, is a "new organization of old manufacturers." The company has floor space totalling something over five acres; has a daily capacity at present of 50,000 tubes which can be almost doubled when, and if, necessary or desirable; will spend more than a half-million dollars in advertising; will appoint only a limited number of jobbers.

The Executive Officers are George Coby, president, Ely Egnatoff, treasurer, Harry Steinle, vice-president and general sales manager, and William Cepck, secretary. Its engineering staff includes S. U. Marie, Ph.D., Roger Williams, Ph.B., A. S. Friedman, Sc.B., and George Rylsky, E.E. M.E.

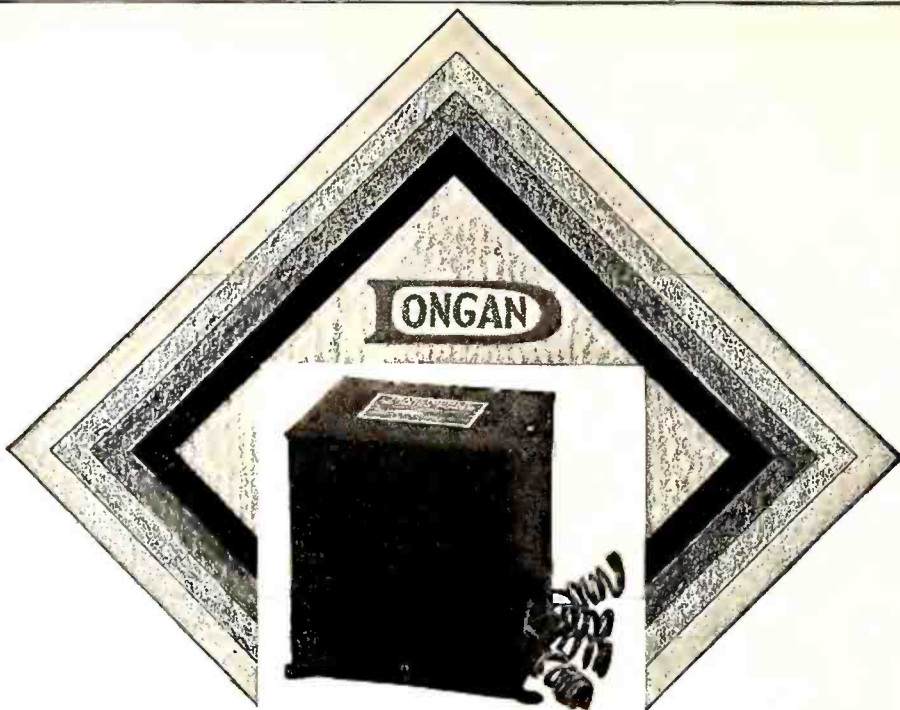

## START THE RADIO SEASON WITH A REAL POWER AMPLIFIER

USE either the UX-250 Tube or the UX-245 Tube as a basis for equipping your set with up-to-date power amplification. Programs this year will far exceed all previous broadcasting and you can get each one as realistically as anyone could desire, for a reasonable cost.

### POWER PARTS BY DONGAN

Designed especially for UX-245 Tube, the following Parts will build you the very latest and finest kind of Power Amplifier—the type used with the new high-priced receivers.

- No. 994 Power Amplifier Transformer - - - - - \$12.00
- either No. 2189 Push-Pull Output Transformer - - - - \$12.00
- with No. 2142 Push-Pull Input Transformer - - - - 4.50
- or
- No. 3107 Straight Output Transformer - - - - - 12.00
- with No. 2158 Audio Transformer - - - - - 4.50
- D-946 Standard Condenser Unit - - - - - 22.50
- No. 5554 Double Choke (use in Filter Circuit) - - - - - 11.00
- No. 2124 Transformer (for Push-Pull Radio and Phonograph Amplifier) - - 6.00

Get complete information on the new and approved types of Power Amplifiers using UX-245 and UX-250 Tubes and Dongan Approved Parts. For immediate delivery of any of these parts send check or money order.

### DONGAN ELECTRIC MANUFACTURING CO.

2991-3001 Franklin Street  
Detroit



## A Radio Parts Guide

THE NEW

# YAXLEY

Catalog

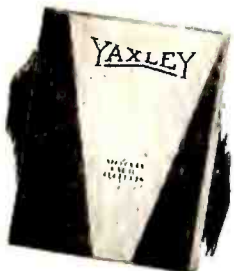

Send for it today for complete listings of Radio Convenience Outlets, Connector Plugs, Rheostats, Fixed and Grid Resistances, Jacks, Jack Switches, Phone Plugs, etc.

YAXLEY MFG. CO.

Dept. B, 1528W Adams St., Chicago, Ill.

the

most amusing of the new smart accessories found every month in the pages of *The American Home*. \$1.00 a year.

Garden City, N. Y.

ROBERT S. KRUSE

Consultant and Technical Writer

103 Meadowbrook Road, West Hartford, Conn.  
Telephone Hartford 45327

**There's Only One Audion**  
Radio tubes made in the laboratories of Dr. Lee De Forest, "The Father of Radio," are called De Forest Audions. The name on the base is your guarantee of getting the genuine.

DE FOREST RADIO CO.  
NEW JERSEY  
JERSEY CITY

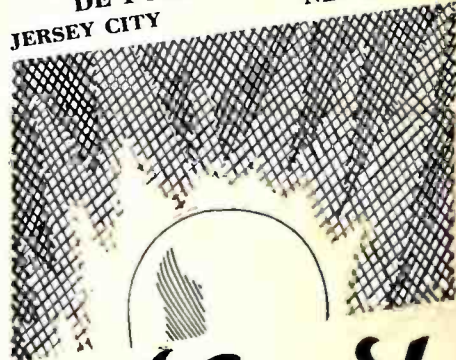

# de Forest

## AUDIONS



**NEW!** A. C. Line Voltage Control

For Radio Set Manufacturers

A remarkably convenient and efficient device which automatically handles A. C. line fluctuations over a broad range.

Does not add to chassis cost. For Details, Write Dept. RB9.

**Radiall Company**  
50 FRANKLIN ST., NEW YORK

Makers of the **AMPERITE**  
The "SELF-ADJUSTING"...

### HELPFUL TECHNICAL INFORMATION

A regular feature of RADIO BROADCAST is the series of Laboratory Information Sheets, which cover a wide range of information of immediate value to every radio worker, presented in a form making it easy to preserve them. To insure your having every issue, send your check for \$4.00 for one year's subscription to

Subscription Department  
Doubleday, Doran & Company, Inc.  
Garden City, N. Y.



# SM

## New S-M Custom Receiver Designs Shatter All Records

### Single Control

Perfect convenience in operation, with a tremendous gain in selectivity and sensitivity—that's what has been accomplished in the new S-M receivers. Newly developed shielded coils make possible, with straight single control, a degree of selectivity never before achieved, even with multiple controls or verniers. One tuning control, one volume control, an on-off switch—that's all. All these receivers have push-pull 245 output stages, and both broadcast receivers embody the latest band-selector tuning.

### All-A. C. Operation

These receivers are absolutely all-electric—even the 735 short-wave set, the first of its kind ever offered on the market. Power supplies are built into the receivers—not separate. The full advantages of the new a. c. screen-grid tubes are secured. The characteristic superior S-M tone quality, distance-range, and selectivity are in these receivers as never before, due not alone to band-selector tuning but also to still greater refinements of design and accuracy of manufacture.

### S-M Speakers and Power Amplifiers

Nothing more beautiful in sound reproduction has ever been heard than the new S-M dynamic speakers, when supplied from a powerful S-M push-pull audio amplifier—giving straight-line amplification from 5000 cycles down even to below 50. These new medium-voltage high-power two-stage amplifiers, using 245 tubes in push-pull are built into the 722 and 735, and an extra high-grade Clough-system amplifier is obtainable separately, as the 677.

### Beautiful Cabinets

The handsome new 707 table model shielding cabinet, finished in rich crystalline brown and gold, suitable for 722, 735, or 735DC, is only \$7.75. Special arrangements have been made whereby these receivers may be housed in magnificent consoles especially adapted to them. Be sure to send for the new Fall S-M General Parts Catalog, for details of these cabinets.

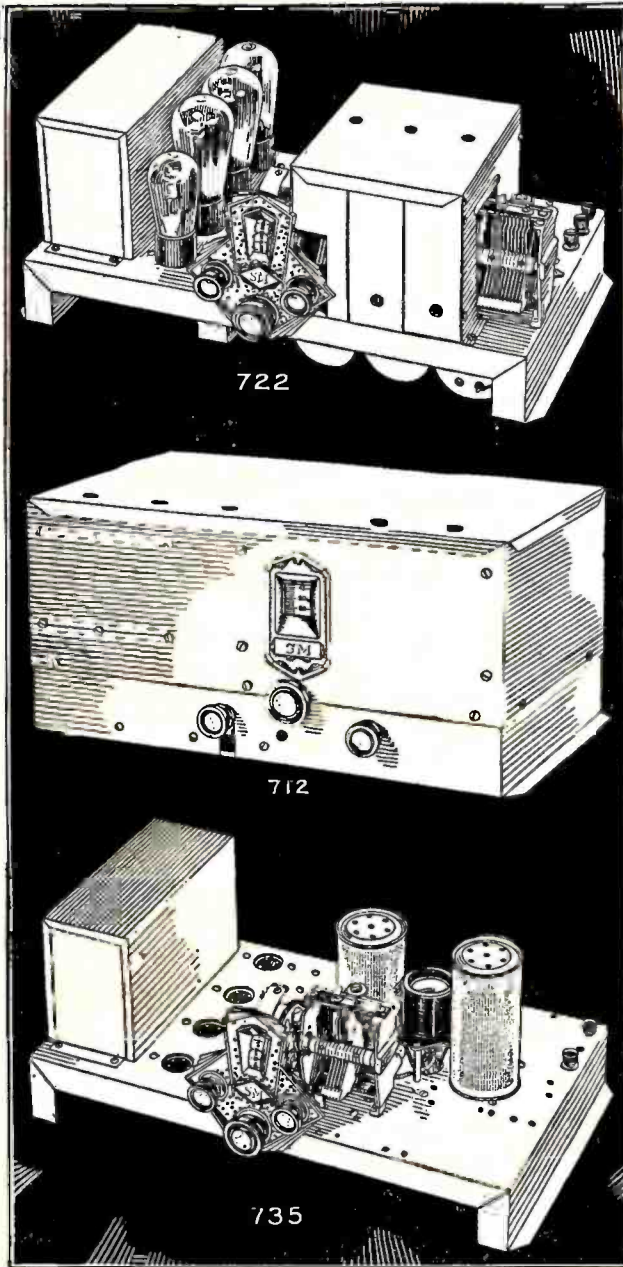

### 722 Band Selector Seven

Providing practically all 1930 features found in most new \$200 receivers, the S-M 722 is priced absurdly low in comparison. 3 screen-grid tubes (including detector), band-filter, 245 push-pull stage—these help make the 722 the outstanding buy of the year at \$74.75 net, completely wired, less tubes and cabinet. Component parts total \$52.90. Tubes required: 3—'24, 1—'27, 2—'45, 1—'80.

### 712 Tuner

Far more selective and sensitive even than the Sargent-Rayment 710, the new single-control 712 with band-filter and power detector stands far beyond competition regardless of price. Feeds perfectly into any audio amplifier. Tubes required: 3—'24, 1—'27. Price, only \$64.90, less tubes, in shielding cabinet. Component parts total \$40.90.

### 677 Amplifier

Superb push-pull amplification is here available for only \$58.50, less tubes. Ideal for the 712. Tubes required: 2—'45, 1—'27, 1—'80. Component parts total \$43.40.

### 735 Short-Wave Receiver

A screen-grid r. f. stage, new plug-in coils covering the bands from 17 to 204 meters, regenerative detector, a typical S-M audio amplifier, all help to make this first a. c. short-wave set first also in performance. Price, wired complete with built-in power unit, less cabinet and tubes, only \$64.90. Component parts total \$44.90. Tubes required: 1—'24, 2—'27, 2—'45, 1—'80. Two extra coils, 131P and 131Q, cover the broadcast band at an extra cost of \$1.65.

Adapted for battery use (735DC) price, \$44.80, less cabinet and tubes. Component parts total \$26.80. Tubes required: 1—'22, 4—'12A.

### Did You Get the Red-Hot News in the July RADIOBUILDER?

Keep up-to-date on Silver-Marshall progress; don't be without THE RADIOBUILDER. New products appear in it in advance of public announcements—all of the receivers and cabinets above were described in detail and illustrated in THE RADIOBUILDER for July. Many hints on operating and building appear in it. Use the coupon.

### It Looks Like a Big Year For S-M Service Stations

Custom-builders using S-M parts have profited tremendously through the Authorized S-M Service Station franchises. Silver-Marshall works hand-in-glove with the more than 3000 professional and semi-professional builders who display this famous insignia. If you build professionally, let us tell you all about it—write at once!

## SILVER-MARSHALL, Inc.

6403 West 65th St., Chicago, U. S. A.

Silver-Marshall, Inc.

6403 West 65th Street, Chicago, U. S. A.

... Please send me, free, the new Fall S-M Catalog; also sample copy of The Radiobuilder.

For enclosed.....in stamps, send me the following:

.... 50c Next 12 issues of The Radiobuilder

.... \$1.00 Next 25 issues of The Radiobuilder

S-M DATA SHEETS as follows, at 2c each:

- ....No. 3. 730, 731, 732 Short-Wave Sets
- ....No. 4. 255, 256, etc., Audio Transformers
- ....No. 5. 720 Screen Grid Six Receiver
- ....No. 6. 740 "Coast-to-Coast" Screen Grid Four
- ....No. 7. 675ABC High-Voltage Power Supply
- ....No. 8. 710 Sargent-Rayment Seven
- ....No. 9. 678PD Phonograph-Radio Amplifier
- ....No. 10. 720AC All-Electric Screen-Grid Six
- ....No. 12. 669 Power Unit (for 720AC)
- ....No. 14. 722 Band-Selector Seven
- ....No. 15. 735 Round-the-World Six
- ....No. 16. 712 Tuner (Development from the Sargent-Rayment)
- ....No. 17. 677 Power Amplifier for use with 712

Name.....

Address.....

# Precision manufacturing safeguards correct design

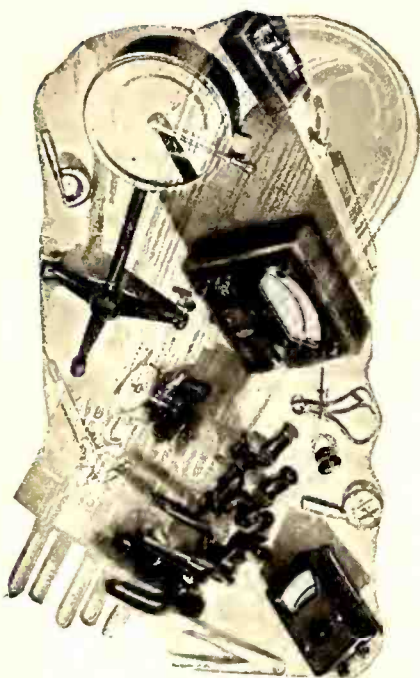

**T**HE most advanced principles of design, the most unique features of construction, cannot in themselves produce tubes of uniform characteristics. *Manufacturing accuracy must measure up to engineering skill in every respect.*

The unvarying excellence of Arc-turus Tubes is due as much to pains-taking production methods, rigidly adhering to accurate standards, as to unique design. This rare combination has gained widespread recognition for these exceptional tubes.

By inspecting every tube 137 times, approving only those tubes whose characteristics fall within the narrowest manufacturing limits, ARCTURUS has set a standard of uniform quality unsurpassed by any tube on the market today.

## ARCTURUS BLUE <sup>A-C</sup> LONG-LIFE TUBES

ARCTURUS RADIO TUBE COMPANY ~ Newark, N. J.



A  
Beautiful  
NEW  
Panel  
Plate



for the  
Famous

## HAMMARLUND DRUM DIAL

**R**ICHLY embossed, pebbled bronze in the modern mode. It has grace and charm appropriate to the superb dial mechanism back-panel that delighted thousands of set builders last season.

The control knob can be mounted *anywhere* on the panel. Illuminated scale.

Write Dept. RB9 for Details

HAMMARLUND MFG. CO.  
424-438 W. 33rd St. New York

For Better Radio  
**Hammarlund**  
PRECISION  
PRODUCTS

## TESTING SCREEN-GRID TUBES



The Type 443 Mutual-Conductance Meter tests triodes and screen-grid tubes with equal ease. Manufacturers, jobbers, and dealers are using this instrument to make inspection tests.

It is compact, easy to operate, and thoroughly reliable.

Send for Descriptive Literature

## GENERAL RADIO COMPANY

30 State Street  
Cambridge, Massachusetts

274 Brannan Street  
San Francisco, California

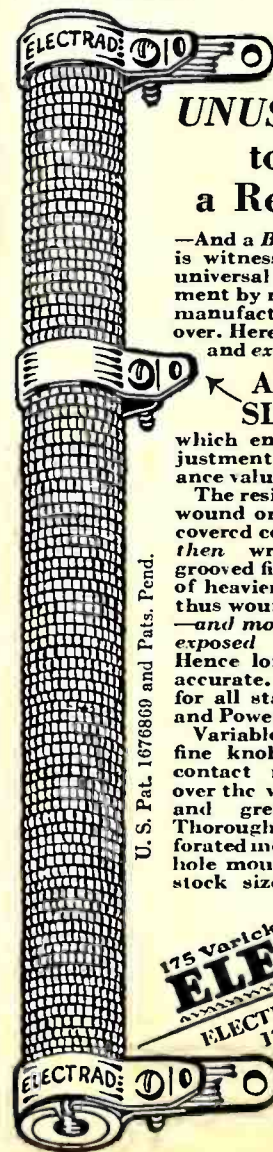

“What an  
UNUSUAL Way  
to Wind  
a Resistance”

—And a **BETTER** way too, as is witnessed by its almost universal use and endorsement by radio engineers and manufacturers the world over. Here's another unusual and exclusive feature, the

### ADJUSTABLE SLIDING CLIP

which enables instant adjustment to the exact resistance value desired.

The resistance wire is first wound on a small asbestos-covered copper core. This is then wrapped around a grooved fire-clay base. More of heavier resistance wire is thus wound in smaller space—and more of its surface is exposed and air-cooled. Hence longer-lasting—more accurate. Sizes and ratings for all standard Eliminator and Power Pack use.

Variable models also, with fine knob adjustment—the contact moving **ENDWISE** over the wire with less wear and greater smoothness. Thoroughly air-cooled. Perforated metal shield, one-hole mounting. 22 stock sizes.

U. S. Pat. 1,678,869 and Pats. Pend.

175 Varick St., New York, N.Y.  
**ELECTRAD**  
ELECTRAD, INC., Dept. R. B.-9  
175 Varick St., New York  
Please send TRUVOLT literature.

Name  
Address

# COMMAND

the ENTIRE WORLD  
with Pilot's Double Duty

# SUPER-WASP



### CUSTOM SET-BUILDER'S PRICE

A combination short wave and broadcast receiver covering all wave lengths from 14 to 500 meters. Price of kit includes two sets of five interchangeable plug-in coils, full-sized blueprint, and complete assembly data.

# \$29<sup>50</sup>

*Slightly higher west of the Rockies*

Why miss half the joy of radio? The Pilot Double-Duty Super-Wasp, designed by Robert S. Kruse internationally famous short-wave authority, will give you radio's greatest thrill for a few dollars and a single evening's "work" with screwdriver and pliers. Uses only four tubes—including the super-sensitive screen grid! Enthusiastic radio fans report nightly reception of Chelmsford, (England), PCJ Eindhoven (Holland), Costa Rica, Central and South America, Canada, Cuba, South Africa and Australia! Exceptional results because exceptionally engineered, and priced right because produced in the world's largest radio parts plant! Hear the Super-Wasp at any authorized Pilot Agency.

## PILOT Now Makes RADIO TUBES!

Pilotron tubes "Built for Professionals" are especially designed and constructed for the professional radio engineer, custom set-builder and amateur—an audience which is super critical—and has a right to be! Moreover Pilotron tubes are available many months before you can obtain them from the usual sources. This gives custom set-builders an opportunity to use new tubes long before they are available in manufactured receivers. You would think that because of this, Pilot tubes would cost more—but they don't! Pilot's self-contained manufacturing provides definitely superior tubes at the usual prices! Stocked by all Pilot authorized agencies.



BUILT for PROFESSIONALS

TRADE MARK



REGISTERED

**DEALER'S OPPORTUNITY!** The Pilot policy of encouraging individual experimentation and custom set-building is the greatest single factor in stabilizing and maintaining the parts and kit business. Technically qualified and financially responsible dealers are invited to write for details of our agency plan.

**HOW TO KEEP STEP WITH NEW DEVELOPMENTS.** Send 50c for four quarterly issues "Radio Design" and membership in the Radio International Guild, a world-wide organization of radio engineers, experimenters, and custom set-builders. Radio Design, Dept. A. 103 Broadway, Brooklyn, N. Y.

# PILOT RADIO & TUBE CORP.

## WORLD'S LARGEST RADIO PARTS PLANT

### 323 BERRY STREET

### BROOKLYN NEW YORK

### U. S. A.

**A Radiotron  
for every purpose**

- RADIOTRON UX-201-A  
*Detector Amplifier*
- RADIOTRON UV-199  
*Detector Amplifier*
- RADIOTRON UX-199  
*Detector Amplifier*
- RADIOTRON WD-11  
*Detector Amplifier*
- RADIOTRON WX-12  
*Detector Amplifier*
- RADIOTRON UX-200-A  
*Detector Only*
- RADIOTRON UX-120  
*Power Amplifier*
- RADIOTRON UX-222  
*Screen Grid Radio  
Frequency Amplifier*
- RADIOTRON UX-112-A  
*Power Amplifier*
- RADIOTRON UX-171-A  
*Power Amplifier*
- RADIOTRON UX-210  
*Power Amplifier Oscillator*
- RADIOTRON UY-224  
*Screen Grid Radio  
Frequency Amplifier  
(A. C. Heater)*
- RADIOTRON UX-240  
*Detector Amplifier for  
Resistance-coupled  
Amplification*
- RADIOTRON UX-245  
*Power Amplifier*
- RADIOTRON UX-250  
*Power Amplifier*
- RADIOTRON UX-226  
*Amplifier  
(A. C. Filament)*
- RADIOTRON UY-227  
*Detector Amplifier  
(A. C. Heater)*
- RADIOTRON UX-280  
*Full-Wave Rectifier*
- RADIOTRON UX-281  
*Half-Wave Rectifier*
- RADIOTRON UX-874  
*Voltage Regulator Tube*
- RADIOTRON UV-876  
*Ballast Tube*
- RADIOTRON UV-886  
*Ballast Tube*

The standard by  
which other vacuum  
tubes are rated



Look for this mark  
on every Radiotron



**MAJOR JAMES E. HAHN**  
President AMRAD CORPORATION, of BOSTON  
President DE FOREST CROSBY, LTD., of TORONTO  
Director (ROSLY) RADIO CORP., of CINCINNATI

Says:

**"Since the vacuum tube is the heart of any receiving set we are naturally very exacting in choosing tubes for the testing of AMRAD instruments. Our experience has taught us that RCA Radiotrons give the best results. Consequently we recommend their use in all radio sets bearing our name."**

*J. E. Hahn*

All radio engineers agree that after a year of average use the vacuum tubes in a radio set should be replaced throughout with new ones. Old tubes left in mar the performance of the others. For finer results completely reequip your set with RCA Radiotrons.

**RCA RADIOTRON**  
RADIOTRON DIVISION  
RADIO-VICTOR CORPORATION OF AMERICA · NEW YORK · CHICAGO · ATLANTA · DALLAS · SAN FRANCISCO

The national magazine advertisement reproduced at the left is one of the 1929 Radiotron series, each of which carries the signature of a leading radio manufacturer.

**Dealers enjoying the largest tube sales—and making the biggest profits—are those who carry the full line of RCA Radiotrons—and are never out of stock. Radio customers naturally choose the stores that have a reputation for always being stocked with the complete line of RCA Radiotrons.**

Superior resources of research and manufacturing guarantee to RCA Radiotrons the finest possible quality in vacuum tubes. They are the standard of the industry—and so accepted by both the trade and the public.



RADIOTRON DIVISION  
RADIO-VICTOR CORPORATION OF AMERICA · NEW YORK · CHICAGO · ATLANTA · DALLAS · SAN FRANCISCO

# RCA RADIOTRON

RADIOTRONS ARE THE HEART OF YOUR RADIO SET