

May
1926

35
CENTS

RADIO BROADCAST



HOW TO MAKE A SIMPLIFIED LOCAL RECEIVER
BUILDING AND USING TRICKLE "A" BATTERY CHARGERS

Easy Ways of Learning the Code

Shall I Use the New Type of Tuning Condenser? How Wire Lines Are Used in Broadcasting

Doubleday, Page & Co., Garden City, New York

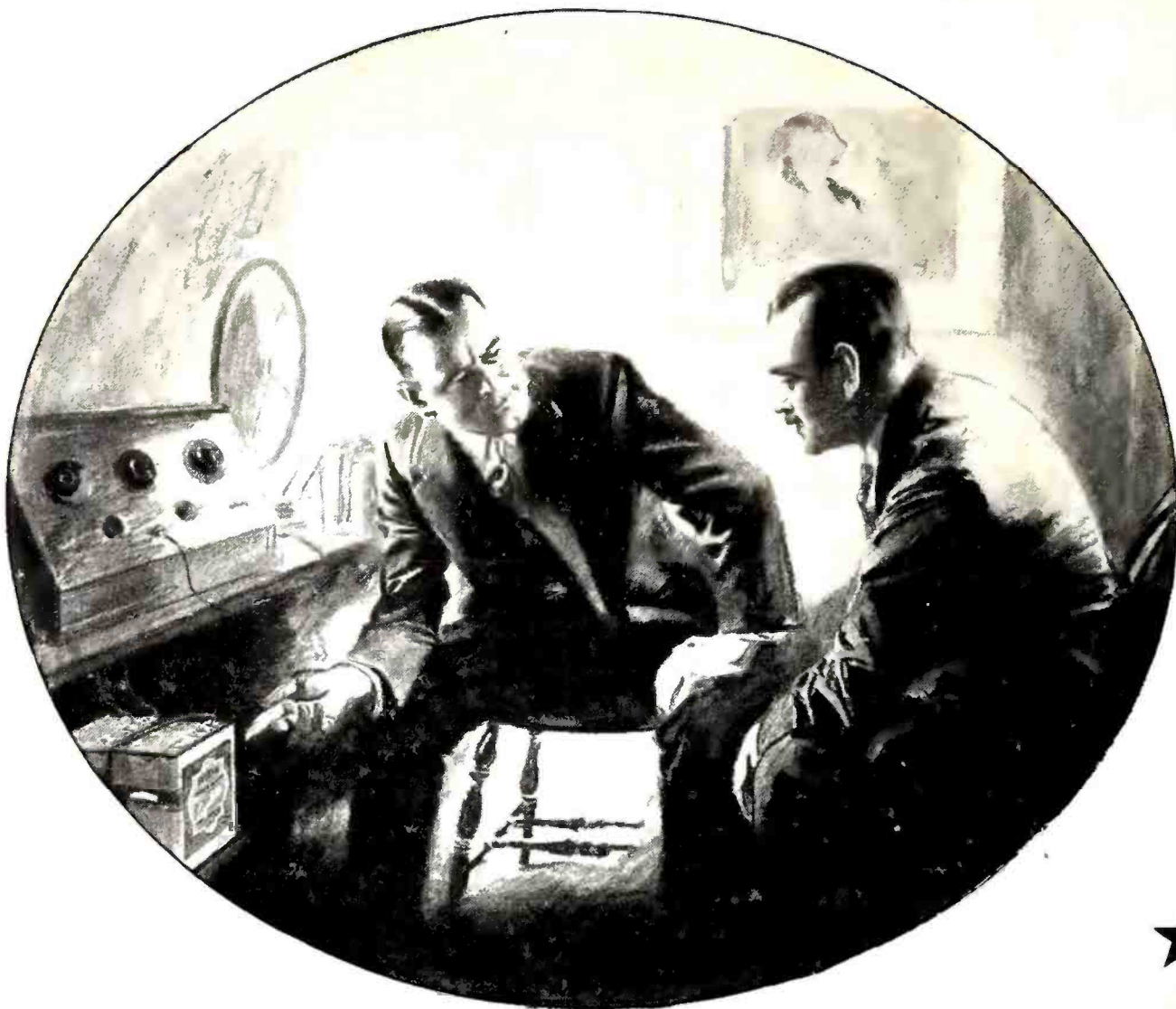

“The little wrinkle that makes my ‘B’ batteries last longer is using the right size Evereadys with a ‘C’ battery”

“I USED to think that because the Eveready ‘B’ Battery No. 772 cost less than either of the larger Heavy Duty Evereadys that I was saving money. As a matter of fact, on four or five tube sets, that was false economy.

“The right size Eveready ‘B’ Batteries to use depends on the number of tubes in your set. The life of the batteries depends on how much you listen in and on whether a ‘C’ battery is employed.”

To get the maximum of “B” battery life and satisfaction, follow these simple rules:

On 1 to 3 tubes—Use Eveready No. 772.

On 4 or more tubes—Use the Heavy Duty “B” Batteries, either No. 770, or the even longer-lived Eveready Layerbilt No. 486.

On all but single tube sets—Use a “C” battery.*

Follow these rules, and No. 772, on 1 to 3 tube sets, will last a year or more; Heavy Duties, on sets of 4 or more tubes, eight months or longer.

The average year-round use of a set is two hours a day. If you listen longer,

your “B” batteries will have a somewhat shorter life. If you listen less, they will last longer.

Our new booklet, “Choosing and Using the Right Radio Batteries,” is free for the asking. It also tells about the proper battery equipment for the new power tubes.

*NOTE: In addition to the increased life which an Eveready “C” Battery gives to your “B” batteries, it will add a quality of reception unobtainable without it.

Manufactured and guaranteed by
NATIONAL CARBON CO., Inc.
 New York San Francisco
 Canadian National Carbon Co., Limited
 Toronto, Ontario

Tuesday night means Eveready Hour—
 9 P. M., Eastern Standard Time, through
 the following stations:

WEAF—New York	WGR—Buffalo	WGN—Chicago
WJAR—Providence	WCAE—Pittsburgh	WOC—Davenport
WEFI—Boston	WSAI—Cincinnati	WCCO—Minneapolis
WTAG—Worcester	WEAR—Cleveland	WFL—St. Paul
WFI—Philadelphia	WWJ—Detroit	KSD—St. Louis

LEFT — No. 486, for 4, 5 or more tubes, \$5.50.

RIGHT — Eveready Dry Cell Radio “A” Battery, 1½ volts.

EVEREADY
Radio Batteries
—they last longer

★ Tested and approved by RADIO BROADCAST ★

THE COUNTRY LIFE PRESS, GARDEN CITY, NEW YORK

ERSL 24040

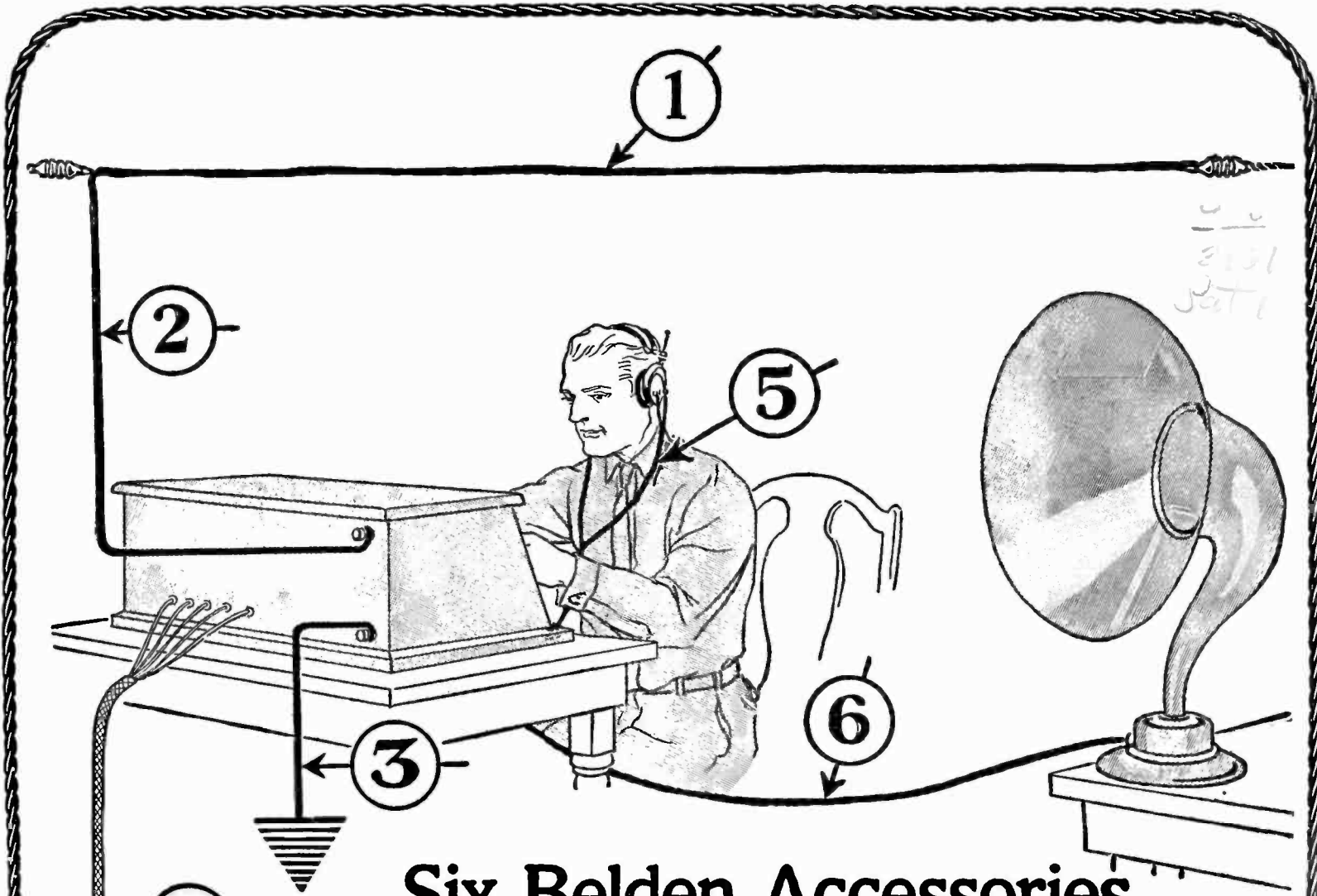

Six Belden Accessories that improve every radio set!

TUBES and batteries are not the only accessories that must be selected with care. Think of the aerial! A poor aerial will cripple your entire set, no matter how fine the set is. That's why you should always specify a Beldenamel Aerial, the aerial that lasts indefinitely.

And a Belden Radio Battery Cord makes a neat installation. It takes the place of a tangle of messy wires that frequently short-circuit and blow out tubes. And for ground wires, extension cords, receiver cords, and many other essential items, be sure to specify Belden. Every Belden product is distributed in a distinctive carton for your protection. An illustrated booklet, "Helpful Hints for Radio Fans" describes each product and its application. Send for it!

- 1 Beldenamel Aerial Wire, made of 7 copper strands, each coated with baked Beldenamel.
- 2 A continuation of No. 1 connecting aerial to set without joint.
- 3 Special Belden Ground Wire—Rubber covered.
- 4 The well-known 6-ft. Belden Battery Cord with five conductors enclosed in a brown braid.
- 5 Belden Headphone Cord
- 6 Belden 20-ft. Radio Extension Cord.

Mail the Coupon for Free Illustrated Booklet

BELDEN MANUFACTURING CO.
 2312G South Western Ave., Chicago

Please send me your booklet entitled "Helpful Hints for Radio Fans."

Name

Address

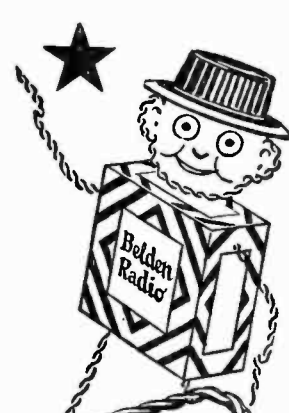

son 18/xi29

Belden

Speed RADIO TUBES

NEW tests, reported almost daily from all sections of the world, indicate that "SPEED" tubes excel in not only one feature, but in all characteristics.

- Standard types
- Power amplifiers
- Short or long prong bases

"SPEED" tubes are sold by wide awake dealers. If you cannot find them in your town, write us.



TYPE 201-A

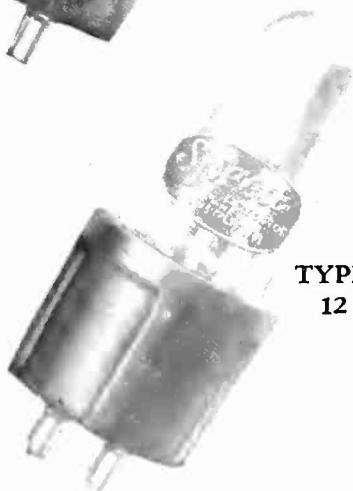

TYPE 12

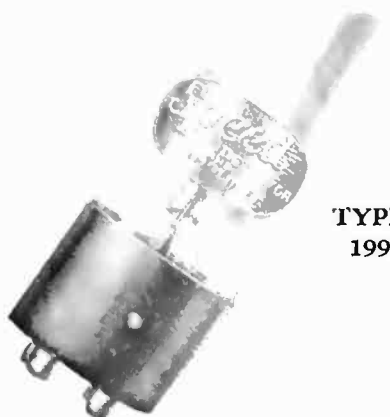

TYPE 199

JOBBERS DEALERS

An exclusive franchise on "SPEED" TUBES is valuable. A few territories are still available. Write for details.

Cable Supply Company

INCORPORATED

Sales Offices

907 BROADWAY
NEW YORK



This Remarkable Clock
Does the work of 12 Clocks **\$3.75** POST-PAID

Tells at a glance correct time in all parts of the world

This new time device is being used by DX fans everywhere—Frame may be removed and clock inserted in panel of your receiver—This radio clock girdles the globe—overcomes confusion in bringing in distant stations—A glance tells you the time anywhere. Most essential to the traveler in foreign countries or those motoring 'cross country—Guaranteed mechanically perfect Shipped promptly, postpaid, on receipt of check or money order for \$3.75. State time zone wanted.

O. L. ANDERSON COMPANY

12 Middlesex Road

Stoneham, Mass.

Why not subscribe to *Radio Broadcast*? By the year only \$4.00; or two years, \$6.00, saving \$2.40. Send direct to Doubleday, Page & Company, Garden City, New York.



No guessing, less wiring and—no grief—with AMPERITE. Eliminates hand rheostats. AMPERITE is the only perfect filament control. Specified in all popular construction sets. Price \$1.10.

Radiall Company

Dept. RB-5 50 Franklin Street, New York City



Write for FREE Hook-ups

AMPERITE
REG. U.S. PAT. OFF.
The "SELF-ADJUSTING" Rheostat

★ Tested and approved by RADIO BROADCAST ★

Silence the Thunder of the Near-by Station

And Bring in the Ones You Want
KFI WCCO WEAF

THE STATION YOU DON'T WANT — GROUND IT OUT

Easy to Install

The Filtrola has four binding posts: Connect two of them to your antenna and ground leads, and the other two to the antenna and ground posts on your set. There are no tubes, and no battery connections to be made.

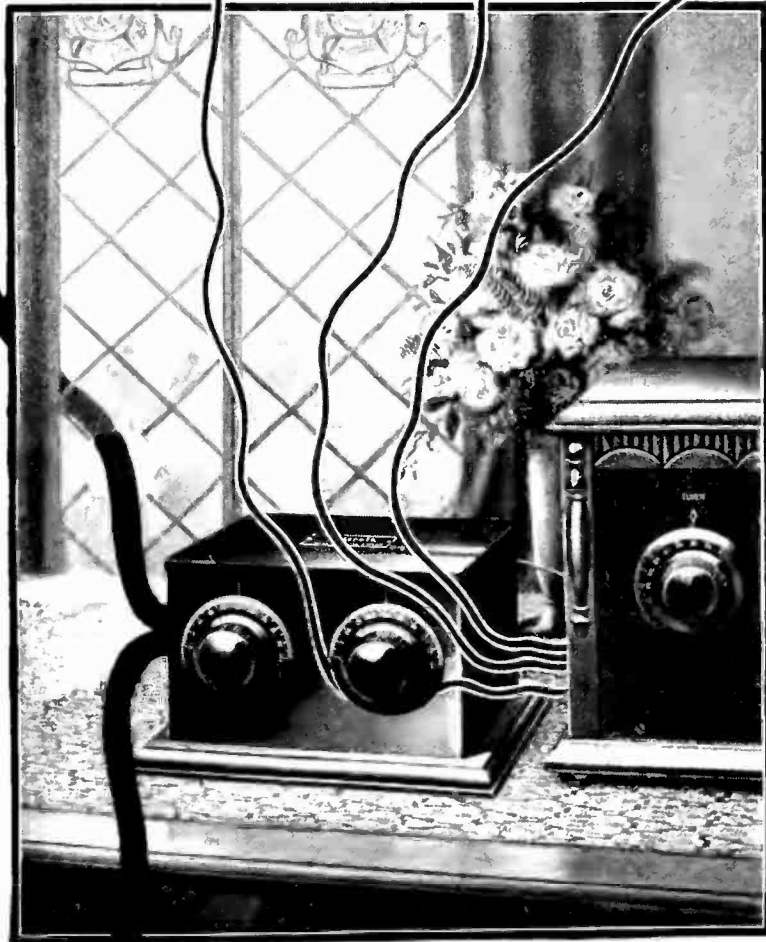

Easy to Operate

First tune in the interfering station on your own set. Then tune it out with the two dials of the Filtrola. Then tune in any station you want with the set — you need not touch the Filtrola again.

No longer need your radio set, if it is fairly selective, remain at the mercy of some near-by station whose signals are audible at all points on the dials. The Filtrola will "drop out" for you the station to which it is tuned, leaving the air as clear as though the near-by station had signed off.

Filtrola
 ALL-AMERICAN STATION ELIMINATOR

Price \$15.00
 ALL-AMERICAN RADIO CORP.
 Pioneers in the Industry
 Belmont, Tripp & Kenosha Aves., Chicago



OWNING AND OPERATING STATION WENR—266 METERS

ALL-AMERICAN

Radio Built for the Years to Come



★ Tested and approved by RADIO BROADCAST ★

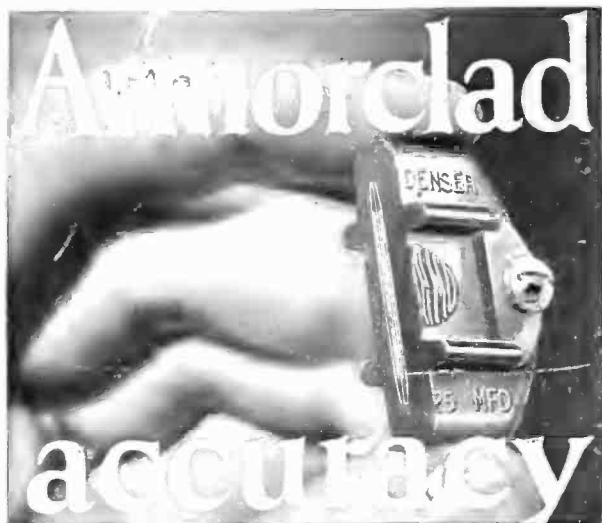

BE careful when choosing fixed condensers, if you want supreme results in radio. Look for *permanent* accuracy. These little valves must measure with perfect precision. If too much or too little energy is released at one time, the rest of the circuit chokes or starves.

SANGAMO ★

Mica Condensers

are accurate—and they *stay* accurate forever, being molded in an armor of bakelite that gives complete protection against heat, cold, moisture, corrosive fumes, or accidental contacts with tools. Not a crevice in the armor into which moisture can creep, for the accuracy of a condenser can be utterly ruined by dampness absorbed from the atmosphere.

The sustained accuracy of Sangamo Condensers makes an immense difference in the tone, range, volume and selectivity of any well-built receiver. There is no finer looking or more accurate condenser on the market—that's why Sangamos are used by so many professional builders of radio sets.



Approved by all nationally recognized radio laboratories

SANGAMO BY-PASS CONDENSERS

Surges won't break them down. Sizes to meet your requirements.



Sangamo Electric Company
Springfield, Illinois

6332-3

RADIO DIVISION, 50 Church Street, New York

SALES OFFICES—PRINCIPAL CITIES

For Canada—Sangamo Electric Co. of Canada, Ltd. Toronto.
For Europe—British Sangamo Co., Ponders End, Middlesex, Eng.
For Far East—Ashida Engineering Co., Osaka, Japan.

Radio Broadcast's "Theory" and "How to Make it" Books may be obtained from the Book Department for One Dollar each

1.—RADIO BROADCAST'S: Knock-out Four-Tube Roberts Receiver

Instruction Book with full-sized blue-prints showing how to make one of the best receivers of the year. Price \$1.00

2.—RADIO BROADCAST'S Knock-out Reflex Receivers

A book describing 9 or more efficient receivers, all reflexed. Fully illustrated and containing some of the best construction descriptions on home-made receivers. Price \$1.00

3.—How Radio Receivers Work

From beginning to end this book tells the beginner all about the function of the various parts of a radio receiver. The super-heterodyne, the neutrodyne, the reflex are all described in detail in this collection of valuable information
Price \$1.00

4.—RADIO BROADCAST'S Aristocrat Blue-prints

Three full-sized blue-prints give the home constructor that many selections for various types of Aristocrat Receivers which produce unapproachable tone quality Price \$1.00

ORDER YOUR COPIES NOW

RADIO BROADCAST,
Garden City, N. Y.

Gentlemen:

Please send me

- RADIO BROADCAST'S Knock-out Four-Tube Roberts Receiver @ \$1.00
 RADIO BROADCAST'S Knock-out Reflex Receiver @ \$1.00
 How Radio Receivers Work @ \$1.00
 Aristocrat Full-sized Blue-prints. @ \$1.00

for which I enclose dollars.

Name

Address

The CUP WINNER



PAUL C. VASEL
ROCKVILLE CENTER
NEW YORK

Mr. P. C. Vasel was awarded the silver cup for the best log. He used his Freed-Eisemann NR-7 six tube receiver.

GARDEN CITY NEW YORK LONDON CHICAGO BOSTON TORONTO SANTA BARBARA

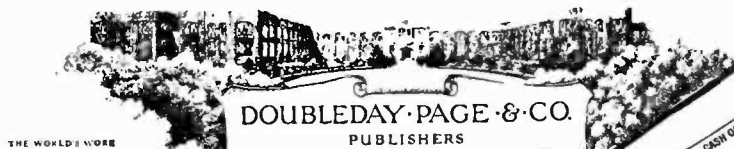

DOUBLEDAY PAGE & CO.

PUBLISHERS

THE COUNTRY LIFE PRESS
GARDEN CITY NEW YORK

THE WORLD'S MOST
COUNTRY LIFE
GARDEN & HOME OUTLIDER
RADIO BROADCAST
SHORT STORIES
THE FRONTIER
EDUCATIONAL REVIEW
LE PETIT JOURNAL
EL ECO

Freed-Eisemann
Manhattan Br
Brooklyn, N. Y.

WESTERN UNION TELEGRAM

NO.	CASH OR DRG
	CHECK
	TIME FILED

CLASS OF SERVICE DESIRED	
TELEGRAM	
NIGHT LETTER	
NIGHT MESSAGE	
NIGHT LETTER	

Received at 313 Fulton Street, Brooklyn, N. Y.
296N FTW 144 7 EXTRA COLLECT BLUE 1/60
MAR 16 1926

FRIED EISEMANN RADIO CORP
ATTENTION R R SMITH MANHATTAN BRIDGE PLAZA BRLYN N Y

ON THE OCCASION OF THE PRESENTATION OF THE SILVER CUP FOR THE
BEST RECEPTION OF A FREED EISEMANN RECEIVER DURING THE
INTERNATIONAL RADIO BROADCAST TESTS FOR NINETEEN TWENTY SIX
RADIO BROADCAST MAGAZINE HEARTILY CONGRATULATE MR PAUL C VASEL
OF ROCKVILLE CENTER AS THE HOLDER OF THE BEST RECORD STOP
THE INTERNATIONAL TESTS FIRST ORGANIZED BY RADIO BROADCAST
MAGAZINE IN NOVEMBER NINETEEN TWENTY THREE HAVE EACH YEAR
INCREASED IN INFLUENCE AND SCOPE AND WE BELIEVE THAT THEY HAVE
AND THE ENTIRE RADIO INDUSTRY BEEN A DISTINCT CONTRIBUTION TO
AMERICAN BROADCASTING HAS BROUGHT HARMONY AND UNDERSTANDING STOP
UNITED STATES CLOSE TOGETHER AND INTERNATIONAL BROADCASTING HAS
MADE IT NECESSARY AND INTERESTING FOR US TO GIVE A THOUGHT TO
OUR INTERNATIONAL XXXX NEIGHBORS

WILLIS K WING EDITOR RADIO BROADCAST 215P

WKK:H

International Broadcast
week record contest.

Official confirmation by Doubleday,
Page & Co., Publishers of Radio
Broadcast and other magazines.



FREED-EISEMANN

GET THIS 10-DAY FREE TRIAL INCREASE YOUR LOOP EFFICIENCY

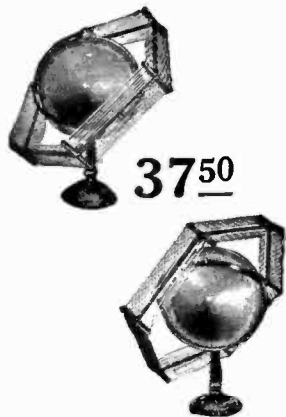
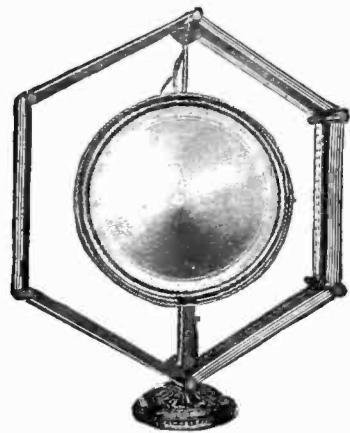

37⁵⁰

Let us prove to you that the VOGUE UNIVERSAL CONE LOOP can greatly increase the efficiency of your Set without any risk on your part—if you don't like it, send it back.

UNIVERSAL CONE LOOP

The UNIVERSAL CONE LOOP has both horizontal and vertical action. Your reception is clear—interfering stations are cut out entirely.

Aim the LOOP the same as you would a gun—the truer your aim, the better your reception. Static can be reduced to a minimum, signal strength greatly increased—the best LOOP made for fine tuning. A \$30.00 standard make Cone Speaker is used. Doesn't take up any more space than the regular Horn speaker—can't tip or fall—adjustable to every conceivable angle. If your Set isn't designed to work with an inside LOOP, ask how to change it over.

10 DAYS FREE TRIAL

This offer is for a limited time only. Send check or money order. If you aren't more than satisfied, return to us in ten days, and we will refund the full amount—provided, of course, the merchandise is received by us in good condition.

VOGUE HORN LOOP.....\$10.00
UNIVERSAL CONE LOOP.....\$37.50

RICHARD T. DAVIS

INCORPORATED

5254 BROADWAY

CHICAGO, ILL.

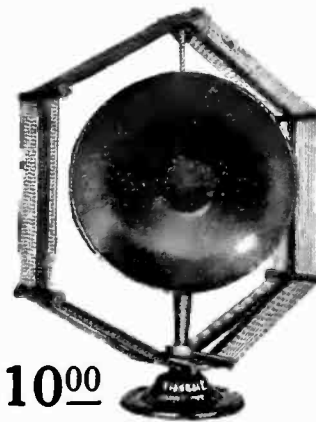

10⁰⁰

VOGUE HORN LOOP

Fits any regular Horn Speaker—can be installed in a few seconds. No adjustments necessary—makes two units into one—fits snug around base of Horn. 110 feet of 68 strand No. 36 silk covered wire used.

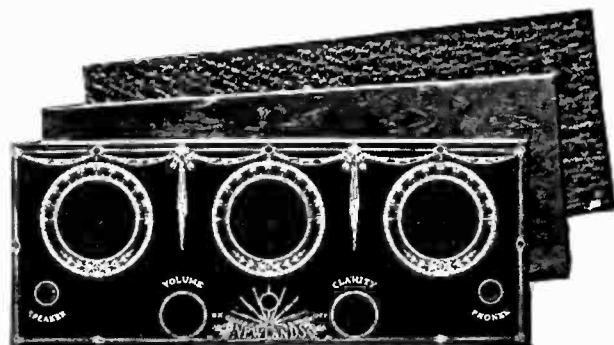

★ INSULINE THE PREMIER PANEL MATERIAL

"Sets that Jack and Dad Built," a 50-page manual for building the most popular circuits, sent for 25c. to cover cost of mailing and postage.

For the same reasons that Radio Broadcast Laboratories specified Insuline Panels for the Radio Broadcast "Aristocrat" and "Universal" you should make Insuline your choice in the building of that "home set." Insuline is the only panel material that combines all the qualities required by radio, including highest insulating efficiency.

Furnished drilled and decorated for all popular circuits; or in plain blanks, with full instructions for drilling and mounting. In three finishes as shown; top, Frieze finish; center, Mahogany finish; lower, Black.

At your dealer's or write us direct if he can't supply you. Also ask to see I. C. of A. complete Foundation Units for all popular circuits.



Branches in Principal Cities
INSULATING COMPANY OF AMERICA INC.
(RADIO PANEL & PARTS CORP.)
INSULINE BLDG. 59 WARREN STREET
NEW YORK

\$ DOLLAR VALUES \$

How RADIO RECEIVERS WORK

by Walter Van B. Roberts,
B. S., E. E., Ph. D.

The Up-To-Date Radio For the Radio Constructor
Easily Understandable and Experimenter

Profusely Illustrated

HERE are some of the topics discussed in this Book: Electrons, The Volt and The Ohm, Impedance, Transformers, Simple Receivers, Regenerative Circuits, Loud Speakers in General, The Reason for the Super-Heterodyne, Problems of "Super" Design, Radio Tubes, Etc.

This is a six-chapter book that deals with up-to-date apparatus, and modern circuits. 53 pages, 65 Illustrations.
Price, \$1.00

RADIO BROADCAST
Garden City, New York

Gentlemen:
Please send me a copy of W. Van B. Roberts Book, "How Receivers Work," for One Dollar, enclosed.

Name.....

Address.....

RB-F

★ Tested and approved by RADIO BROADCAST ★

Win \$100.00 in Universal Reception Contest



Thomas H. Butler

The Grand Prize of \$100.00 in the Radio Broadcast "Universal" Reception contest has been awarded to Mr. Thomas H. Butler, 427 St. Marks Avenue, Brooklyn, New York. The list of stations tuned in by his "Universal" include 120 stations.

The following extract from Mr. Butler's report expresses his views on the "Universal". "The Universal has given me more pleasure than any set I have owned. I am a DX fan. As my reward I am very thankful to Mr. Lynch to give me and any one a good receiver that I can be satisfied with. My opinion is that the Universal is 'The Ideal Receiver'".

Mr. Butler is 29 years old, married and a book binder by trade. He took home his first set of parts with which to build his first radio set just two years ago. Since that time he has constructed practically all of the popular circuits.

Mr. Butler, we congratulate you upon the splendid performance of your Universal and your success in winning the Grand Prize in the Radio Broadcast Universal Reception contest.

General Radio Co.
Cambridge 39
Mass.



An Unfailing Source of "B" Voltage



Build a Practical "B" Eliminator

WITH a properly built "B" eliminator constant worry whether the "B's" are run down and their continual replacement is a thing of the past.

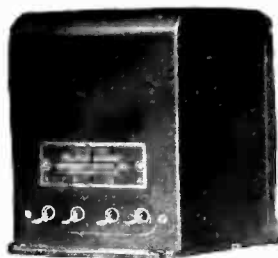

Type 365
Rectifier Transformer
Price \$10.00

For a dependable plate supply unit which will improve the operation of your set, and will require no attention other than its original installation build a "B" eliminator of General Radio parts.



Type 366
Filter Choke
Price \$10.00

Write to-day for descriptive data on the General Radio Rectifier Transformer and Filter Choke, and get our circular with full instructions for building a practical "B" eliminator.

GENERAL RADIO COMPANY
Cambridge, Mass.

GENERAL RADIO CO.

INSTRUMENTS

Behind the Panels of Better Built Sets



RADIO BROADCAST

WILLIS K. WING, Editor

MAY, 1926

KEITH HENNEY,
Director of the Laboratory

JOHN B. BRENNAN
Technical Editor

Vol. IX, No. 1

CONTENTS

Cover Design	From a Painting by Fred J. Edgars	
Frontispiece		
Breaking Into the Wireless Game	The Marconi Direction Finder on a British Ship	18
	James M. Baskerville	19
The March of Radio	J. H. Morecroft	23
Shall I Buy a Factory-Built Receiver?	Austin C. Lescarbourea	28
Will the New Type of Condenser Improve my Set?	Kirk B. Morcross	33
The Listeners' Point of View	John Wallace	37
The RADIO BROADCAST Local Receiver	John B. Brennan	42
The \$500 Short-Wave Receiver Contest		46
Trickle Chargers for Your A Battery	James Millen	47
Testing and Operating the "Aristocrat"	Howard E. Rhodes	52
Easy Ways of Learning the Code	Edgar H. Felix	56
As the Broadcaster Sees It	Carl Dreher	60
	Drawings by F. F. Stratford	
The Grid—Questions and Answers		70
	One Way to Sharpen Tuning	
	When to Change Storage-Battery Electrolyte	
	The Western Electric Cone—High or Low Impedance?	
	How to Eliminate a Singing Noise in the Receiver	
	Circuit Diagram for an Interference Finder	
	Eliminating a Buzzing Noise in the Receiver	
	Two-Point Tuning on the Super-Heterodyne	
	Correct Grid Bias Voltage	
	Determining the Best Grid Leak Connection	
"Now, I Have Found"		76
	Using a Cone with the Super-Heterodyne	
	Head Phones With the Roberts Reflex	
	Try Choke Coupling When your Audio Transformer Burns Out	
	Changing the Frequency Range of Your Set	
	A Treble Back-Mounted Tap Switch	
	A Simple Way of Switching from Tube to Crystal	
	Quarterly Prize Award Announcement	
A Key to Recent Radio Articles	E. G. Shalkhauser	79
Book Review	Edgar H. Felix	85
	Talks About Radio, by Sir Oliver Lodge	
The Wavelengths of Canadian Stations		87
Letters From Readers		88

BEHIND EDITORIAL SCENES

WITH this number of the magazine, RADIO BROADCAST begins its fifth year. The first copy was dated May, 1922. During the last four weeks, a large volume of correspondence has come in to the editorial offices, commending our policies, praising the quality of the general and the strictly technical articles which we have been publishing, and very decidedly expressing the hope that we will continue along the lines which we have been following. There will be no change of policy and, reviewing our editorial schedules for the next six months, we can promise to our readers some extraordinarily interesting material.

OLD timers and new timers of radio will find James M. Baskerville's "Breaking Into the Wireless Game" full of the charm that wireless—now radio—holds for all of us. Mr. Baskerville is especially well qualified to write of those early days, because there are not many who antedate him in point of practical experience. Another one of Austin Lescarbourea's articles about the development of the commercial broadcast receiver appears on page 28. Home constructors who build their own will read with interest of the many technical and manufacturing obstacles which must be overcome before the complete factory-built receiver reaches the hands of that much discussed person, the ultimate consumer. Those who are still weighing the advantages of using the new types of condensers recently developed will find Kirk Morcross' article on page 33 of real assistance. Mr. Morcross is a radio research engineer of excellent standing, and we feel that his article is more than usually complete.

ALTHOUGH we have no quarrel with the many enthusiasts whose chief radio pleasure is in pulling in stations at a great distance from their homes, there are still a great number of listeners who are interested chiefly in their local program. That is the reason for the design of "RADIO BROADCAST's Local Receiver." No claims whatever are made for its distance-getting abilities, but the receiver is simple to build and easy to operate, and delivers very excellent audio quality. James Millen, who has become known to readers of this magazine as an authority on current supply devices, has in this issue, another of his helpful articles, this time on trickle charging. Carl Dreher, whose comment about broadcasters and broadcasting, always informative and interesting, and frequently humorous, has had something to say recently in his department about the technical methods of broadcasting: how outside wires are rigged, the placement of the microphones, and other valuable notes for the broadcaster. This month he tells more about how the outside wire connections, so essential to every station, are "equalized," and some of the problems which must be solved in their use.

THE next RADIO BROADCAST will contain details of a circuit which, while not revolutionary in itself, does contain some very interesting ideas, many of which will provide food for thought and experiment to constructors for many months to come. The second of Howard Rhodes's articles on wavetraps and their use will appear in this number, as well as a report of some extremely interesting observations made by Dr. Greenleaf W. Pickard on radio transmissions in the broadcast band. Many listeners have wondered at the poor long distance reception during the last six months and Dr. Pickard's figures reduce generalities to actual data.

Doubleday, Page & Co.
MAGAZINES

COUNTRY LIFE
WORLD'S WORK
GARDEN & HOME BUILDER
RADIO BROADCAST
SHORT STORIES
EDUCATIONAL REVIEW
LE PETIT JOURNAL
EL ECO
THE FRONTIER
WEST

Doubleday, Page & Co.
BOOK SHOPS

(Books of all Publishers)

NEW YORK: LORD & TAYLOR BOOK SHOP
PENNSYLVANIA TERMINAL (2 Shops)
38 WALL ST. AND 166 WEST 32ND ST.
GRAND CENTRAL TERMINAL
ST. LOUIS: 223 NORTH 8TH STREET
4914 MARYLAND AVENUE
KANSAS CITY: 920 GRAND AVENUE
1306 WEST 47TH STREET
CLEVELAND: HIGBEE CO.
SPRINGFIELD, MASS.: MEEKINS, PACKARD & WHEAT

Doubleday, Page & Co.
OFFICES

GARDEN CITY, N. Y.
NEW YORK: 285 MADISON AVENUE
BOSTON: TREMONT BUILDING
CHICAGO: PEOPLES GAS BUILDING
SANTA BARBARA, CAL.
LONDON: WM. HEINEMANN, LTD.
TORONTO: ONFORD UNIVERSITY PRESS

Doubleday, Page & Co.
OFFICERS

F. N. DOUBLEDAY, President
A. W. PAGE, Vice-President
NELSON DOUBLEDAY, Vice-President
RUSSELL DOUBLEDAY, Secretary
S. A. EVERITT, Treasurer
JOHN J. HESSIAN, Asst. Treasurer

DOUBLEDAY, PAGE & COMPANY, Garden City, New York

Copyright, 1926, in the United States, Newfoundland, Great Britain, Canada, and other countries by Doubleday, Page & Company. All rights reserved.

TERMS: \$4.00 a year; single copies 35 cents.

Announcing
Ferguson
 J.B. INCORPORATED

The Gold Standard of Radio Receivers

Model TEN

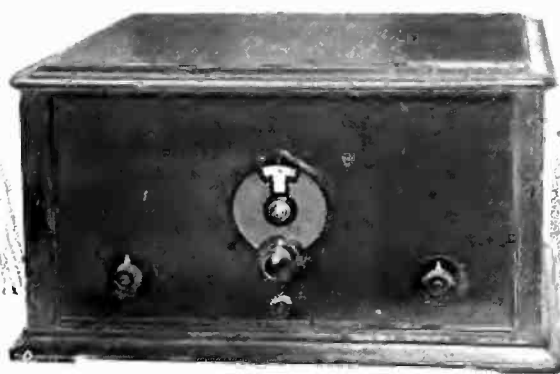

\$110



This 6-tube FERGUSON has two stages of balanced tuned r.f., non-radiating detector, and three stages of resistance—coupled amplification.

Being completely shielded, the tuning circuits are extremely selective. The tone quality—due to the distortionless characteristics of the resistance amplifier—is unsurpassed for absolute fidelity. A precision-built FERGUSON in every detail.

Investigate, at your Authorized FERGUSON Dealer's, or write us.

J. B. FERGUSON, INC.
 41 East 42nd Street, New York, N.Y.

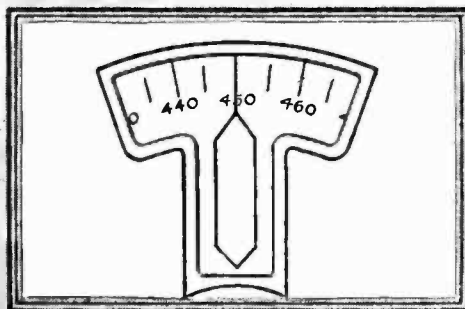

*One Tuning Control—
 Calibrated in Meters!*

*Select your program,
 turn up its wavelength
 and in comes your
 station.*

No Seasonal Models, Continually Developing Refinements

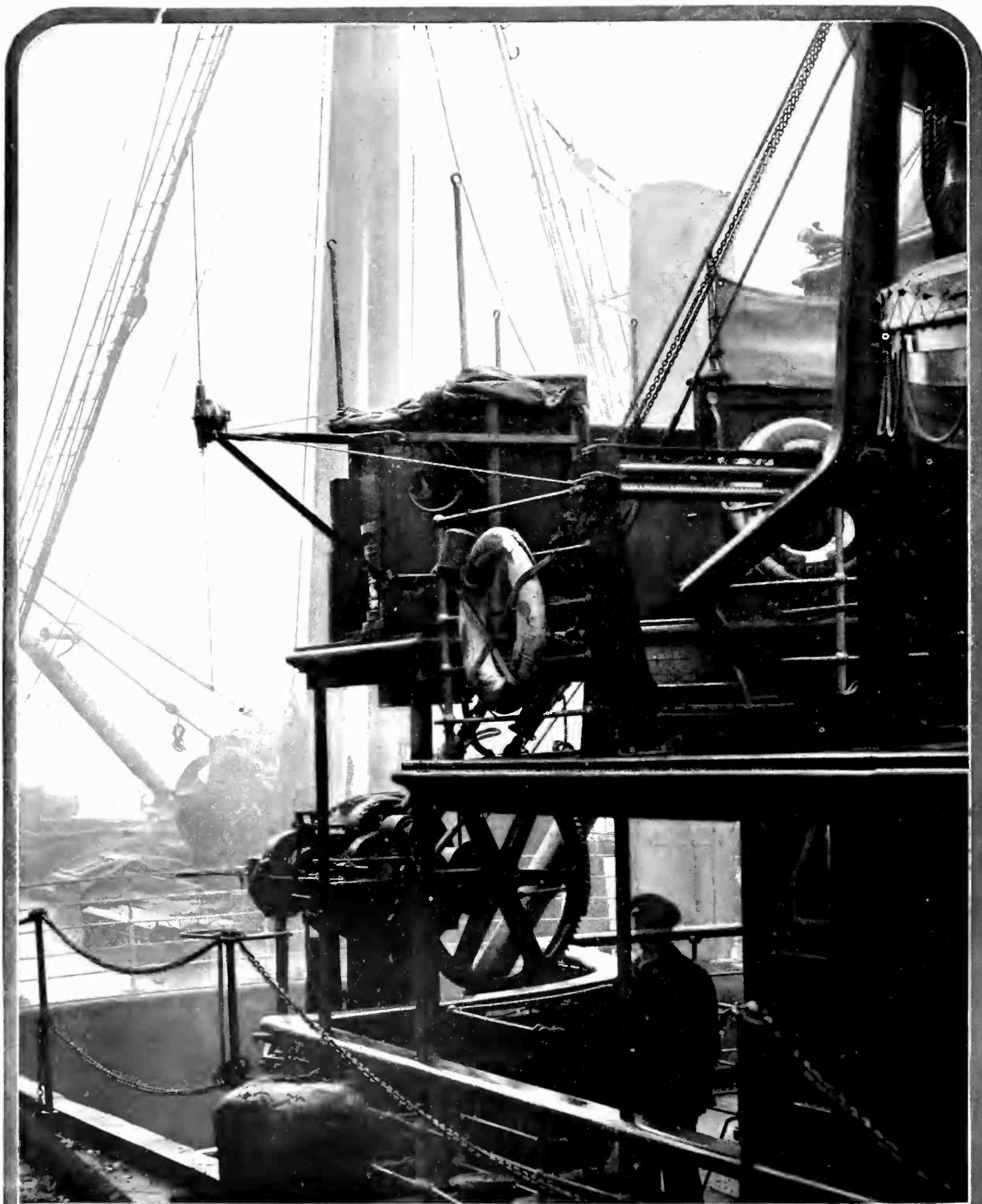

THE NEW MARCONI DIRECTION FINDER ABOARD A BRITISH SHIP

Senator Marconi's beam transmission has been experimentally applied to marine direction finding. South Forland Light, near Dover, is equipped with a transmitter, operating on 49,900 kc. (6.09 meters). The shore station sends signals in a beam 15° wide and a different Morse signal is sent as the beam points successively to different points of the compass. On the bridge of the ship, the observing officer listens on a simple receiver and notes the letters sent as the beam flashes past the ship from the shore station. The letters correspond to letters on a chart which show the beam's direction. The antenna in the illustration is the short wire at the end of the bridge

RADIO BROADCAST

VOLUME IX ✓



NUMBER 1 ✓

MAY, 1926 ✓

Breaking Into the Wireless Game

How Wireless Stations Were Installed and Operated Twenty Years Ago—When 200 Miles Was a DX Record and Amplifiers Were Unknown—How a Young Man Took Up Wireless in 1904

By JAMES M. BASKERVILLE

IN THE fall of 1904, a young man with no particular ambition and a roving disposition, left his home in the South and, proceeding to New York, became the first class helper to a second class electrician.

And by the time a few months had elapsed and winter had set in, I—for this young man was the writer—had considerably enlarged my electrical vocabulary and taken on a veritable load of self confidence. When it became real winter, however, my comfort-loving nature began to revolt at the daily labor of cutting pipe threads and lugging two tool kits usually up flights and flights of steps leading to exposed construction jobs. Blizzards raged endlessly, and the mercury lay low in the cold grip of true winter weather. The vagaries of New York winter climate did not exactly contribute to the desire for an outdoor job, and I, coming as I did from the South, felt the City's hurricane-like gusts keenly. Is it any wonder then, that I had an impelling desire to change my vocation?

My father had written of a Mr. McRae who had been down South selling stock for a "wireless telegraph" concern located at 42 Broadway, New York. Mr. McRae, it transpired, had claimed that it really had at last become possible to send telegrams many miles without any wires intervening. To a hard working wireman like myself, such a statement seemed truly and grossly exaggerated, to say the least. However, the twang of the phrase "wireless telegraph" caught hold of me—curiously mystified me, and I decided to investigate matters on my own.

On Friday, February 3rd, 1905 (this my diary tells me), I stepped over the threshold of Number 42 Broadway, with the avowed intention of convincing Mr. McRae that I was a born wireless man.

Mr. McRae was in but at the time, busy. He would grant me a short interview presently,

Shortly I was in his presence. Could I see the wireless outfit? Well, hardly to-day, for he had a lot to do. How did it work, and how far? Again he could hardly tell me offhand, but if I would care to call again in a few days when he was less busy, perhaps then I might be able to glean a little more

information. I confided that my real object in the visit was a job. That was impossible right away, he said. We did agree on one thing, however. He said he was sorry. So was I. And with a "Good day. Call again" ringing in my ears, I left the room which held so many interesting possibilities for me.

Perhaps I should have been satisfied with that, but as I stepped to the corridor the door of the "General Manager" loomed up ahead of me—a new and unexpected find that halted me. I stepped in without compunction and introduced myself to that genial gentleman, Mr. C. C. Galbraith, familiarly known to all oldtimers as "C. C. G." He asked what I could do, and I told him that I was a first class electrician and looking for a job installing wireless telegraph stations (I hadn't seen one yet, but that didn't worry a youth of twenty). He looked interested, and asked if I knew anything about wireless. "Not yet, but I'm going to take it on," I replied. So he wrote me a pass to the station on the roof and said, "Tell Birchard to post you up on the equipment and let me know how you like it."

Cornered on the elevator machinery deck, twenty-three flights above the street, was a little three-room construction—the laboratory, working office, and operating room of the De Forest Wireless Telegraph Company.

So cold was it when I entered the operating room that I at first thought the amiable gentleman there had on ear muffs, but, on closer inspection, they turned out to be, head phones. He was seated before a table on which was a large telegraph key, a three-pole knife switch, some delicate and peculiar looking instruments, and a piece of pie. I realized that it was lunch time, and in order to disturb no one during this important event, quietly backed out and started to size up the surroundings.

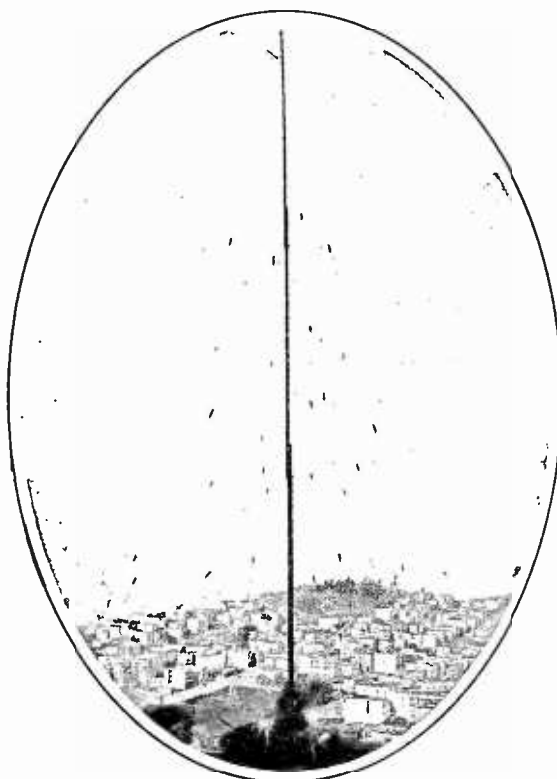

AN OLD-TIME RADIO TELEGRAPH STATION
The United Wireless Telegraph Company station at Russian Hill, at San Francisco which carried on a commercial ship-to-shore business. These early wireless stations were the marvel of their day. Many boys, mechanically and electrically inclined, fairly ached to learn the "wireless" just as boys do to-day. Mr. Baskerville's story tells how he started in the "game" when wireless sets were as rare as vials of radium

There was no one in the office or laboratory and I was upon the windy roof studying the mass of wires from the hundred-foot mast when Mr. Birchard called me from below. He appeared to be all set for the afternoon now, and in the pink of an agreeable humor.

THE FIRST LESSON IN WIRELESS

IF HIS explanations of the equipment fell short in lucidity, he made up for it in speed and brevity. He stated facts as so, and never risked a reason. The gist of his remarks was something like this:

Upon a little box a glass point dipped into a rubber cup—the electrolytic detector—most sensitive known. The head phones connected to this box. The oblong instrument was a three-slide tuner, boxed also, with the sliders protruding through slits. (In damp weather, try to move them). This was for tuning-in incoming signals. Manipulating these little sliders, up or down, did to the receiving circuit what tuning a violin string did to a violin, he said. Things grew clearer.

Having mastered the receiving side, we moved rapidly to the sending. In almost a breath and with a sweeping swing of the arm, Birchard followed the action from d. c. to a. c., to key, to transformer primary; from secondary to spark gap, to helix, to anchor gap, to antenna, and on to ships at sea. He particularly said that "juggling" the helix clips affected the sending side just as the sliders did the receiving.

We were now ready for practical demonstration. I hadn't absorbed quite all of the lesson, but was willing to wait. Birchard connected on an extra pair of phones, and I listened-in. Nothing on just now. "Yes. There's VN after a ship," he said.

But there was no sound in my phones. In fact, after the tuner-violin string talk, I half expected to hear some music. But none was there, and I doubted the presence of any sound.

Birchard laughed contentedly when I said I heard nothing. I measured agreeably up to his expectations as just an ordinary individual, while he of the wireless knowledge soared on high. "You know you have to have wireless ears," he confided. I didn't know, but agreed with him.

Under Birchard's insistent persuasion there developed a faint suspicion of something in my head phones. The faint something got stronger until I could distinctly hear the buzzes generated in New Haven. This wasn't music. These buzzes were telegraphic code, and appeared quiet different from the clicks of a telegraph sounder. Evidently I was beginning to develop "wireless ears." Birchard asked me if I could tell what VN was saying. No—but I thanked him for the compliment, anyway. After listening awhile, he suddenly looked around as if to see whether all was clear, and said, "He's after me." As he reached for the starting box, I moved in closer and took off the ear phones in order to miss nothing.

Mr. J. M. Baskerville, Dean of the Wireless Department, and whose photograph appears herewith, entered the wireless service in Feb., 1903, being among the pioneers in that field. Mr. Baskerville has had charge of some of the most important land stations on the Atlantic coast, including Callee, N. J., Charleston, S. C., Savannah, Ga., Atlanta, Ga., and the main office of the United Wireless Telegraph Company, 42 Broadway, New York. He has also served as aerographer and electrician on more than a score of ocean liners. He gained the distinction of holding the world's first long distance record in 1905 by holding communication for a distance of 1570 miles. He handled the first wireless communication between Chicago and New York in 1909. He saved a schooner in the Gulf of Mexico in 1906 by getting quick assistance from Havana. He also has the record of never having come into port with any wireless apparatus broken down. He has traveled over 300,000 miles as an aerographer (wireless operator). In 1908



Mr. J. M. BASKERVILLE,
Wireless Engineer.

AFTER "BREAKING" INTO THE BUSINESS

The start in wireless given to Mr. Baskerville by the De Forest Company led him far as an operator and practical man. The page reproduced here is from a circular of Dodge's Institute of Telegraphy and Wireless at Valparaiso, Indiana, where many radio men received training

When, with the key, he crashed that bare 2-kilowatt spark within two feet of me, certainly I missed nothing. On the contrary, I gained much! A steam siren, two fire engines, a fog horn and a couple of factory whistles all exploding at once will give you a shock similar to that which I got when that crashing open spark was let loose almost on top of my ear. I later learned that this was only a little joke of the smiling Birchard to impress upon greenhorn visitors that there was really something to this wireless after all. When he heartily laughed at his little piece of mischief, however, I pulled myself together and laughed with him, in a diplomatic way, for I had an axe to grind.

Leaving behind me this jargon of wireless terminology and still perhaps feeling a little unnerved from the effects of that inconsiderate 2-kilowatt spark, I again betook myself to the office of the general manager and made my report. Thereupon it was decided that I should spend all my leisure time in studying up this wireless system, while Mr. Galbraith promised that I should receive first consideration when an opening appeared in the construction gang.

During the ensuing weeks, I spent much time at the station, at the same time working my other job when the weather permitted. I became acquainted with such old timers as Lee De Forest, Henry Hughes, Jack Duffy, John Murphy, and many others who were in the wireless game right at the start, and who were constantly in and out the laboratory.

I entered thoroughly into the spirit of the wireless game and must even confess to bribery, so deep was my enthusiasm. To let me trace every inch of the wiring of the complete installation, I had to pay Birchard in pie and cigars. I had no idea at the

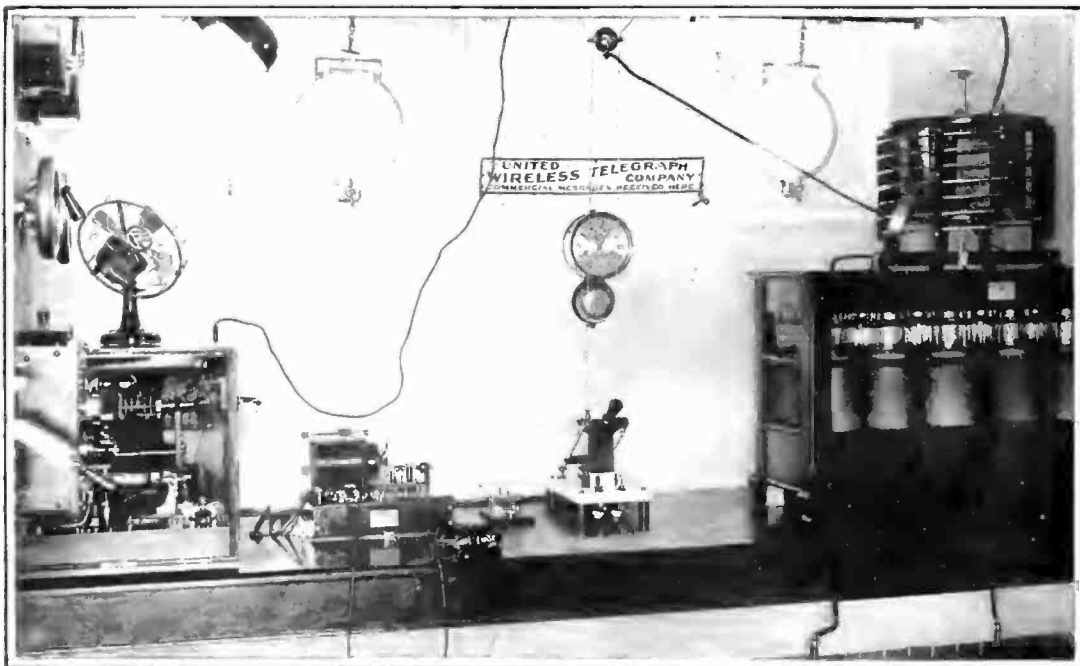

ONE OF THE TYPICAL SHIP WIRELESS INSTALLATIONS

Long before the days of the rotary spark gap, continuous waves, or vacuum tube wireless telephone and telegraph sets, outfits similar to this one were on use aboard ships. The shore stations had similar equipment, except that their power was about five kilowatts, whereas this installation is a 1-kw. one. The bank of condenser jars is shown on the table at the extreme right, the enclosed open spark gap inside the helix above it, and a lead connecting to an anchor spark gap to short-circuit the receiver while sending. The receiver was an inductively coupled crystal outfit, with a slider on the primary to vary the inductance. The emergency 10-inch spark coil is in the box at the left. It was operated from a 24-volt storage battery and was expected to transmit 100 miles in daytime

time what a gross offence this was on my part. Some time later, De Forest said to me of a man who had just been discharged, "Why, that man opened up the detector box and let curious people look into it." I afterward learned that the closest secrecy had to be maintained to prevent spies from other concerns learning our secrets.

theory about magnetic influence super-induced upon the compass. The debate between the ship's officers and John Murphy, one of the installers, was warm and enlightening, but eventually, to be safe, the set was put in a stateroom midships off the engine room—a nice noisy place, where the operator not only fought his natural handicaps, but also those wished upon him.

For several days we hugged the stove, ate Lockwood meals, and waited for the weather to moderate. The operator, Mr. Current, was recalled from Galilee. On the day of his departure, March 8th, during a lull of the storm, we got enough men together and hoisted the mast into place, an altogether unexpected accomplishment. Toward evening we had a complete wireless station ready for action but no operator. My diary says: "March 8. Galilee station finished. Sent first wireless message to New York at 7:22 P. M." This was one of the first stations ever to use a frequency above 60 cycles. We had 133-cycle supply from the local power house and our note was good.

SIGNS UP WITH DE FOREST COMPANY

ON FEBRUARY 27, 1905 (again my diary informs me thus), I started to work for the De Forest Wireless Telegraph Company. My job was to help equip the S. S. Caracas, of the Red D Line. The salary was \$15 weekly. I got more enjoyment out of that job than from any other and, I might as well admit it now, I would have been quite content to have worked for half the money I was given.

Our next job was the equipping of the Standard Oil tanker *Captain Lucas*, in the Erie Basin, Brooklyn, and after this, part of the construction gang and an operator were sent to Galilee, New Jersey, on March 3rd, 1905 to erect a station on the beach. It was not difficult to install the apparatus in the glassed-in front porch of Lockwood Cottage, but snow lay deep on the ground and a blizzard howled outside. The angry ocean creeping up our back yard rolled almost to the kitchen door, making it impossible to erect the 138-foot mast for the antenna.

While I belonged to the construction gang and didn't boast a first class telegraphic knowledge, I must modestly admit having at that time a little experience of telegraphy, for as a boy I often hung around the dispatchers' office on the Seaboard Air Line after school and "shot his stuff." Since taking up wireless, however, I had kept this knowledge to myself, but I listened-in whenever opportunity lent itself and could read signals providing they were clear and slow.

It was originally intended that the wireless equipment should be installed in the pilot house, but somebody advanced a

Now somebody had to put the Galilee station into service, and I felt that I was the one to do it now that the operator had been recalled. My fingers itched to get at the key and I finally succumbed to my

SS Finance

Only Edition The Ocean Tattler. Kindness Royal Mail SS ATRATO.

By ATLANTIC DE FOREST WIRELESS. AT SEA - April 7th. 1906.

Boston 5 - Mr E Swift, the Chicago meat packer died early today at the Quincy, after several days illness of pneumonia

Odessa 5 - The Governor General in an interview today declared he could not answer for Anti-Jewish disorders occurring at Easter and added he would not guarantee order beyond that time, as everything depended on results of election

Honolulu 4 - The steamer "Mona" reports persons were drowned during the hurricane recently swept over her.

Kingston, Jamaica 6 - We learn that a decree by President Amador of Panama prohibits landing in Panama of foreigners not at least \$1,700, unless they be under contract to work on the canal.

SEUL Natal Native Rising: Editorial.

Durban 10 - There is much irritation and impatience here at the disposition of certain home politicians, as shown by cables - to interfere in regard to the preventative measures against a possible spread of native disaffection in the colony. The press is making strenuous complaint against home interference, and a grave crisis unquestionably confronts Natal & South Africa. The natives are outnumbered to 10 to 1 and there is a general fear that the natives will yield to his savage impulses for rapine, murder and destruction.

We are sorry not to be able to give more news, and especially M/S news, but our means are limited, and we tender the foregoing for your perusal without a blush!

We are most pleased to note that Dr Leech has recovered from his recent sea-sickness

Vox Populi!

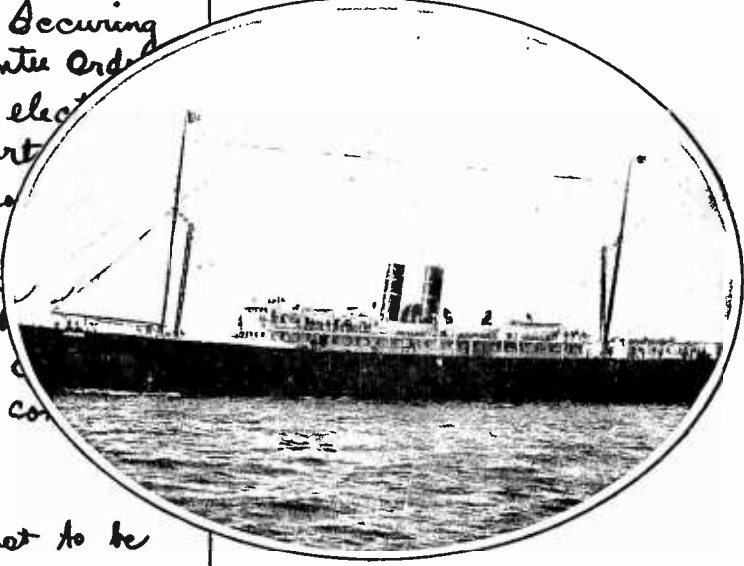

desires. I christened the station just plain G, gave New York a few calls, and listened. Immediately came Birchard's GGG GA (go ahead) 3 NY. The figure three was the sign off signal.

I keyed out something to which Birchard replied O. K. wo? (meaning who are you?). I gave him the necessary information and added, "Not so fast, you old speed demon." He seemed very much surprised upon my identifying myself, and we carried on a long conversation. He picked and chose the little first-grade words, and that probably accounted for the success of my first experience as a wireless telegraph operator.

I felt very elated, and more so when, shortly after, New York sent a congratulatory message to me personally from "C. C.

A DAILY "WIRELESS" NEWSPAPER

News the passengers aboard the Panama liner *Finance* received by the wireless set operated by Mr. Baskerville aboard this ship in April, 1906. The insert shows the Panama Railroad ship *Mexico* a vessel similar to the *Finance*, although several thousand tons larger. It is interesting to note that the news is as full of political difficulties as the paper you pick up this very morning

#1.

UNITED STATES OF AMERICA
 Department of Commerce and Labor
 NAVIGATION SERVICE

OPERATOR'S CERTIFICATE OF SKILL IN RADIOCOMMUNICATION

This is to certify that, under the provisions of the Act of June 24, 1910,

James M. Baskerville
 has been examined in radiocommunication and has passed in

(a) The adjustment of apparatus, correction of faults, and change from one wave-length to another;
 (b) Transmission and sound-reading at a speed of not less than fifteen words a minute American Morse, twelve words Continental, five letters counting as one word.

The candidate's practical knowledge of adjustment was tested on a condensative set of apparatus.* His knowledge of other systems and of international radiotelegraphic regulations and American naval wireless regulations is shown below

Excellent

[Signature]
(Signature of examining officer.)

Place New York, New York Date May 25, 1911

By direction of the Secretary of Commerce and Labor:

[Signature]
Commissioner of Navigation, Washington, D. C.

I, James M. Baskerville, do solemnly swear that I will faithfully preserve the secrecy of all messages coming to my knowledge through my employment under this certificate, that this obligation is taken freely, without mental reservation or purpose of evasion, and that I will well and faithfully discharge the duties of the office. So help me God

Date of birth Oct 11, 1884 Place of birth Charlotte, N.C.
 Sworn to and subscribed before me this 25th day of May, 1911

[Signature]
Notary Public

* It is not intended to limit the employment of the holder to a particular system, but merely to indicate the particular system in which he was tested for adjustment of apparatus.
 This certificate is valid for two years, subject to suspension or revocation by the Secretary of Commerce and Labor for cause. It should be kept where it can be shown to officers of the customs or other officers of the Government just before the ship leaves port.

WIRELESS LICENSE NO. 1

In 1910, an Act to Regulate Radio Communication was passed by Congress and, in addition to specifying "certain ships" which were required to be equipped with wireless telegraphy, provision was made for examination and licensing of operators. The present-day licenses are granted by the Radio Service of the Department of Commerce and require a thorough examination of the applicant in the Continental code and in radio theory and practise

G." First I fumbled it and if I had not been very familiar with that name, I don't believe I would have gotten it so easily.

The following morning, Gregg, my companion at Galilee, received his traveling orders, but I received instructions to stay as operator! I regretted this keenly, and was sorry for my spontaneity of the night before. I remonstrated with "C. C. G." (who stood beside Birchard in New York), insisting that I belonged to the construction gang and couldn't telegraph. He said I was doing fine, and would I stay for the present. So I stayed. There was also a little salary adjustment—from \$15. to \$12.,

which probably came nearer to my real worth as a wireless operator. But while I had secured what I had originally set out for—a change of job—the cold climate stayed with me.

Those days of being thrown entirely on my own had an effect similar to that of a boy thrown overboard and told to swim out. I copied—or tried to copy—everybody's business regardless of destination or speed, even to old Birchard when he unleashed himself upon New Haven, dis-

regarding all speed limits, as his snappy rhythmic Morse chopped its way through Navy and Marconi interference. Up to this time my pace had been fairly rapid, but now, settled down at Galilee, I had time for reflection. I was the sole employee and therefore the guiding spirit of the station. I carefully watched day and night for any of our few ships which might be within range. Promised relief from New York seemed as far off as it ever had been, and it certainly was not a one-man job to keep a twenty-four hour station in constant operation. Finally, however, relief did come, in the person of A. W. Dorchester.

A few days after Dorchester's arrival, at 3.30 A. M. one morning, we logged the SS *Bermuda* two hundred miles out at sea. That was considered quite an accomplishment then. A few days later, we exceeded this feat of DX by thirty miles, when, under extremely bad atmospheric conditions, we handled business with the SS *Concho* 230 miles away. In this instance, each word had to be sent three times, so bad was the static. From that time on, we continued reaching out, using all the time an electrolytic detector with, of course, no amplification. We entered into the spirit of the thing with probably as much confidence as the owner of a modern multi-tube set. If there is to-day such a creature as the DX hound, we must assuredly have been the original DX pups, blazing the trail as forerunners of the International Radio Broadcast Tests.

My stay in Galilee was not long. It proved to be the first of a long series of short stays and quick jumps that I indulged in as I journeyed from place to place—from the Atlantic to the Pacific, from the Great Lakes to the Gulf. Contracts for ship installations began to swamp the construction people, and I was called in during April to help out. The *Horatio Hall* was being equipped down at the docks, and was scheduled to sail on a certain evening before she was out of the hands of the construction gang. It was imperative that the sailing date should not be delayed, so something had to be done at once. Superintendent Henry Hughes arrived at the dock in the nick of time, and without further ado informed me, "Finish the job and work her."

This was the first of many sea voyages I have made during my career as a wireless operator. It was, in fact, a turning point in my life, for it marked the time when I first definitely established myself as a fully fledged operator, after having deliberately broken into the wireless game.

THE RADIO URGE STILL LASTS

Mr. Baskerville, although he has long since left active radio work and is now in a very different business, is shown here with a Roberts Knockout receiver he built from plans printed in RADIO BROADCAST



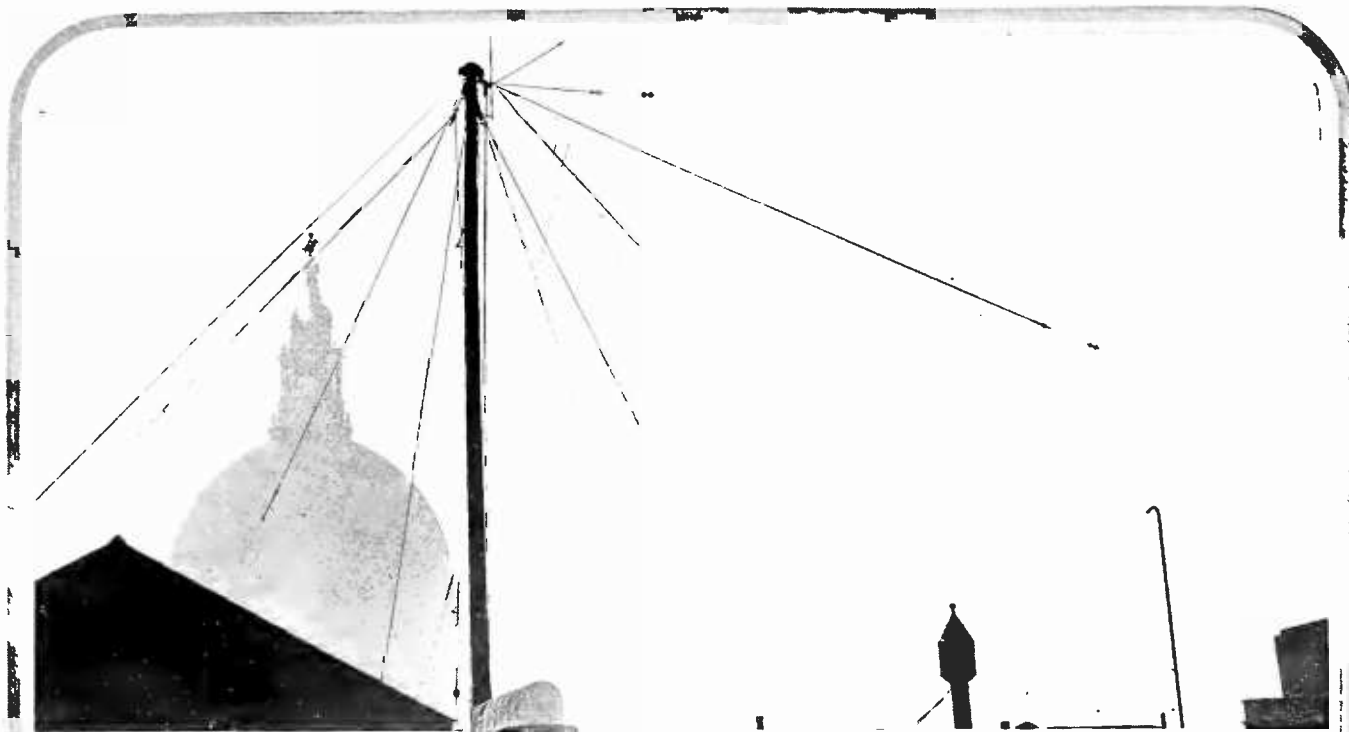

THE MARCH OF RADIO

By *J. J. Morecroft*
 Past President, Institute of Radio Engineers

Important Provisions of the New Radio Bill

RADIO legislation of importance, is now before Congress at this writing. The White Bill has been in the hands of the Merchant Marine and Fisheries Committee and that body has sent it to the House for consideration, where it passed on March 15, 218 to 124.

One of the new items added by the Committee provides that at least one broadcasting station in each state shall have a channel reserved for it. This assumes that Rhode Island has the right to a radio channel as much as New York. At present, of course, the available licenses have been granted on the basis of priority of demand; whatever state had the earliest and most insistent license seekers got the most channels. The wisdom of the "State's Rights" clause is not apparent on the surface. Few will deny that the apportioning of channels should be made in accordance with the best interest of most of the listeners and these interests have nothing to do with states' boundaries.

Another clause divides the United States into five radio zones, this idea also having to do with the allocation of the available channels. This item provides that

In considering application for licenses and renewals of licenses when and in so far as there is a demand for the same, the Secretary of Commerce shall make an equitable distribution of licenses, bands of frequency or wavelength, and power among the different zones.

The first zone is to embrace the New England states, New York, New Jersey, Delaware, Maryland, District of Columbia, Porto Rico, and the Virgin Islands. The second zone contains Pennsylvania, Virginia, West Virginia, Ohio, Michigan, Kentucky, etc. It is not at all evident that this division of the country into zones will have any considerable merit. It is certainly not to be expected that each zone should have the same number of channels allotted to it. The density of population is entirely different in these districts so that equal treatment as regards number of channels would not be equitable. The Secretary of Commerce would naturally apportion the licenses equitably between the various parts of the country even under the present condition. The zoning plan would be of no help to the Department.

An added feature, however, of this zoning clause has to do with the appointment of the commission. A commission of five members is to be appointed, one from each zone, to constitute an advisory body to

aid the Secretary in the apportionment of channels. These additions to the original White Bill, will probably do it no real harm, though it certainly is questionable that the Bill has been improved.

Groundless Fears About Poor Reception

AN IMMEDIATE investigation should be undertaken by the government to determine the cause of unusually poor radio reception throughout the country. This is the opinion of many listeners who are racking their brains to find some scientific theory to explain existing receiving conditions.

During the past month radio reception has been remarkably poor, in the opinion of some listeners. We hadn't noticed it because long ago the distance craze left us. The broadcasting from local stations is not subject to weather conditions. Ideal reception should not be subject to weather conditions. Our compassion goes out to those who complain that "reception was poor last night." One's enjoyment of a good radio program shouldn't be at all dependent on static or other disturbing influences.

Apparently listeners in Washington and vicinity have encountered more than usual

The photograph forming the heading for the March of Radio shows the receiving antennas at the British General Post Office, London, where commercial business is carried on with Continental stations. The dome of St. Paul's Cathedral is in the background

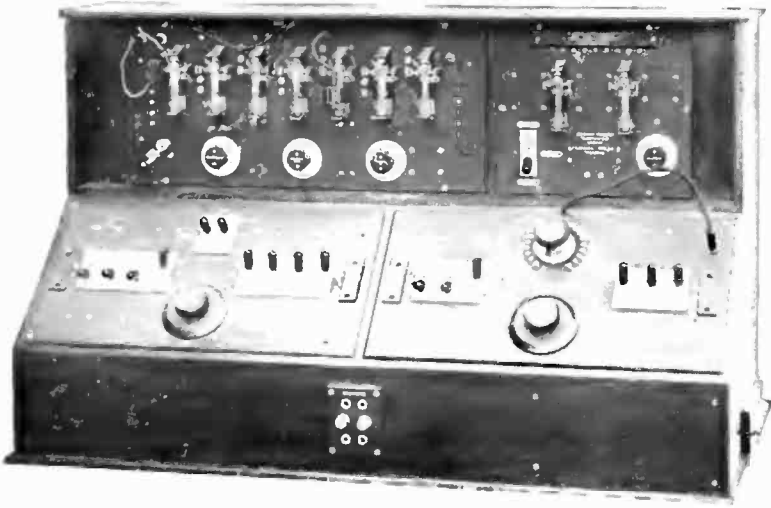

A BRITISH MARCONI RECEIVER

The type RG5 general utility set, comprising detector, audio amplifier, antenna tuning circuit unit and closed circuit tuning unit. It is designed to meet the requirements of those who need an efficient and selective receiver to cover a very wide range of frequencies, 1000 to 10 kc. (300-30,000 meters)

difficulty in hearing Northern and Eastern stations, and so have started the move to have the government investigate these atmospheric disturbances, perhaps with the hope that this attention from the government will prevent another such poor receiving cycle.

There have been some abnormally large disturbances on the sun lately and as it is now believed that sun spots are accompanied by the violent expulsion of tremendous clouds of electrons, it seems most likely that the earth did run into exceptionally bad electrical disturbances during the past month. The electrons in the upper atmosphere are credited with most of the abnormal behavior of radio waves and in fact when one takes these clouds of electrons into account that which we have heretofore considered as abnormal behavior seems reasonable and almost predictable. Fading and skip distances seem to be surely due to reflections from the electron-charged atmosphere a hundred or more miles up.

When extra electrons are shot off from the sun, our radio channels may be somewhat affected, but in spite of this fact it will probably do little good to have the Federal agencies investigate them. Radio transmission will always be subject to vagaries to some extent, as are the mariner's compass and the ocean cable. In periods when extensive sun spots occur, both the earth's magnetic field and the stray currents in the earth's crust are subject to rapid and irregular changes. It is not remarkable that radio transmission also shows sympathetic reaction with the sun.

The heads of the Radio Department of the Bureau of Standards and Chief Radio Inspector Terrell, have both been asked to conduct an examination. Both of these busy men, however, have their hands full in doing their present specified work without taking on a new and indefinite problem of this nature. It looks as if we had better accustom ourselves to taking radio weather as it comes, exactly as we do the common variety of weather.

was increasing in leaps and bounds, has become constant.

At the last radio conference, the conferees apparently convinced the Secretary of Commerce, that the public wanted him to stop issuing licenses. Mr. Hoover has heeded the call. But the fact that no new

licenses were being issued didn't at all deter the aspirants for radio channels. Each day brings appeals for permission to broadcast. Few of these will, or can, be satisfied unless the present broadcast band is extended, so it behooves the desirous ones not to invest too much money in their prospective stations.

Two of the applicants would use five thousand watts, one three thousand five hundred, one fifteen hundred, and eighteen want permission to put up one thousand-watt stations. Besides these expectant newcomers there are thirty-three of the present stations making requests for permission to increase their power.

Of the various radio districts, the Ninth, centering in Chicago, heads the list with requests for new stations totalling a hundred and forty-seven. Chicago alone would have nineteen new stations if every potential broadcaster had his desires fulfilled! Other districts do not seem to be afflicted with as strong a desire to "tell the world" as the Mid-Western ones. The Second district wants only twenty-five new stations although New York is included. The south-

Four Hundred and Twenty Eight Broadcast Licenses Refused

WITH five hundred and thirty-six stations actually broadcasting in the United States, there are four hundred and twenty-eight more anxious to serve the listening public. For some time now, we are glad to say, no new licenses have been issued by the Department of Commerce, so that the congestion, which a year ago

eastern district wants forty-eight new stations, most of them the extreme South, perhaps to boom Florida real estate. The northwestern district wants fourteen new channels, the southern district thirty-nine, the eastern, including Philadelphia, wants seventeen, and the Detroit district wants forty-one, as does the western district, including California.

It seems almost certain that these new licenses will never be issued. There is no equitable way to substitute new applicants for some of the present incumbents. If the station at present occupying a wavelength is fulfilling its obligations, why should it be forced to divide time or go off the air in favor of some other station, now demanding a license? The wisest move for the prospective broadcasters would be to first ask themselves if the material they have to dispense is worth while and if it is, to get in touch with some existing broadcasting station. By engaging a going station for a few hours a week, the reasonable needs of a new broadcaster would be satisfied and the programs of the stations used probably improved in quality. Furthermore, the prospective station owner would probably save himself a lot of money.

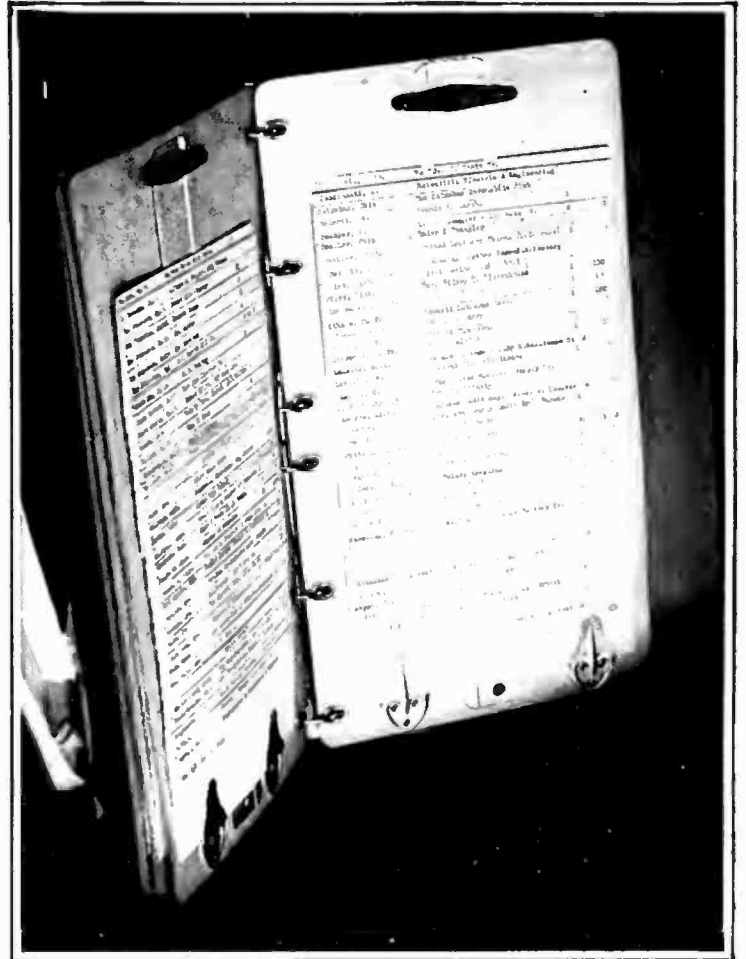

© Harris & Ewing

THE BOOK OF REGRETS

Applications for broadcasting licenses are recorded in this book, in the offices of the Department of Commerce at Washington. Up to March 1, 1926, the list totalled 428 applications, none of which have been granted because there are no more wavelengths left. Applications come from 45 states and the District of Columbia. Illinois leads with 47 who request a license, California is second with 40, and New York third with 28. The right hand page shows that The Columbus Automobile Club has applied, the Polish Alliance at Hamtramck, Michigan, the Toledo *News-Bee*, the *Pittsburgh Press*, and many churches and civic organizations



THE INTERFERENCE CAR

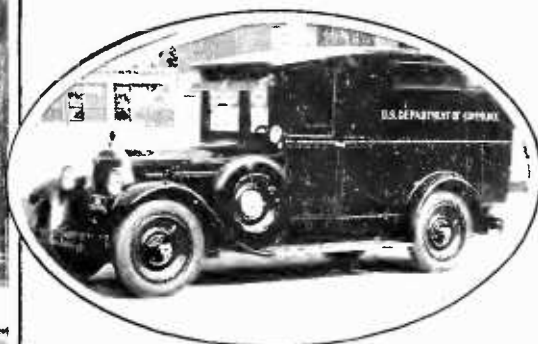

Packard Motor Company photographs

Equipped by the Radio Service, Department of Commerce, and at present attached to the Eighth District, with headquarters at Detroit. Complete trouble-finding apparatus is installed and many cases of interference have been tracked down with it. Lack of funds has prevented the building of similar cars for the other seven districts

Interference Eliminating Is a Local Matter

WITH improving quality of broadcasting, both programs and transmission, the nuisance from interfering noises of one kind and another becomes ever more noticeable. In the old days of Frank Conrad's phonograph concerts at East Pittsburgh (beyond the ken of most of to-day's listeners) the sputtering of a defective street car motor or humming of an electric elevator detracted but little from the quality of radiophone reception. The interference was nearly on the same level as the program itself, judged by musical values. But nowadays with high class transmitters, receivers, and loud speakers, and artists of the highest calibre, performing over the radio channels, the clicks and hisses and sputterings and squeals become downright objectionable. The public's appreciation of modern radio is such that no effort should be spared in clearing the air of objectionable interference.

The best way to eliminate interference from the railway or electric power company is to induce the president thereof to become a radio enthusiast. The best way to eradicate the whistling from a neighbor's regenerative set is to invite a member of that family to dinner with you, turn on the dinner music and let him hear his home set perform in the hands of the other part of the family. But there are many sources of interference where such strictly humanistic methods of attack are not available. Many sources of radio noise conceal themselves, so that only a methodical search will find them out and of course they must be found out before they can be eliminated. This "finding out" is apparently the *raison d'être* for the many interference committees springing up all over the country. Many listeners believe the radio department of the government should come to their aid, ferret out and

eliminate the causes of radio interference. What else is the Radio Service for?

The government's radio personnel was organized many years ago to supervise ship and shore traffic. With the tremendous increase in breadth and scope of radio communication within the last few years, the relative size of the government's radio staff has become almost insignificant. They do a vast amount of work in trying to keep up with their tasks, but it is manifestly impossible for them to take on the entire burden of interference prevention.

Local radio clubs must assume the task of eliminating interference in their neighborhoods and this is the solution which seems to be working itself out. We hear of many such clubs, and of their general success. Unless the interference is of the most persistent kind which does not give way to persuasion, the radio inspector should not be bothered with it at all; it really isn't his task.

Transatlantic Telephoning Is Progressing

THREE years ago we had occasion to congratulate the engineers of the A. T. & T. Company for establishing a radio telephone channel which spanned the Atlantic. With a transmitting outfit set up at the Rocky Point station of the Radio Corporation and a receiving outfit in England, reasonably successful telephony was carried across the Atlantic one way. Many measurements were made on signal strength, and the average of strength of atmospheric noises in England, so that engineering data was obtained as to how much power must be used in the transmitting antenna to get across a signal which is readily distinguishable over the noise. Thousands of measurements were made so that the American engineers were able to say that, with average atmospheric conditions in England, for reliable communication throughout,

say, sixteen hours of the day, the power used in America must be a certain number of kilowatts.

To be sure, eight years previously, these same engineers had achieved a much more remarkable result in telephoning from Washington to the west coast and to Honolulu. This feat, however, must be reckoned to some extent as accidental; the God of Progress was kind to the young engineers in rewarding their imagination and bold attempts. That was much more spectacular than the work of three years ago, but it is this more recent accomplishment that makes for engineering knowledge and advancement. The Honolulu miracle showed what was possible and it furnished the motif for the later arduous and difficult task of reducing the accidental to a certainty.

These tests three years ago brought out clearly the difficulties of spanning the Atlantic, but the difficulties were not insurmountable. The work was sufficiently promising for the British authorities to be encouraged to build a powerful transmitter at Rugby. The receiving station was set up near Swindon.

During the last two months the transmitters and receivers in both England and America have been at work, and on many occasions successful two-way conversations have been held. "The quality of speech in both directions was clear and free from distortion or fading and the voices of individual speakers were easily recognizable." So reads a report from London. Certainly no one need say that the age of miracles is over.

Behind the report of a successful test of this kind, one who knows sees days and nights of strenuous application by many able young engineers. When the test is made the President of the A. T. & T. Company talks perhaps to the British Postmaster General and they, as heads of their respective bodies, are lauded for the achievement. Well, really, they have had a

The Radio Corporation's Annual Report

THE annual report of the Radio Corporation makes very interesting reading to any one following the progress of radio.

The Corporation now has high-powered stations in the United States communicating directly with Hawaii and Japan, Dutch East Indies, Great Britain, Norway, Germany, France, Holland, Italy, Poland, Argentine, and Sweden. Such a network may well be styled world-wide. Early in 1926 Brazil will be added to the above list, as the transmitting and receiving stations at Rio de Janeiro are nearly completed. This station is being constructed, not alone by R. C. A. but by an international company designated as A E F G. These letters stand for America, England, France and Germany, we take it, because these four countries have united in developing South America's radio channels.

All of the marine stations of the Corporation have now been equipped with the latest types of vacuum tube transmitters. These are located at Chatham, Massachusetts, New York, Tuckerton, New Jersey, Galveston, San Francisco, and Los Angeles. At Chatham the power has been much increased by diverting to it some

of the power generated by the great Alexanderson alternator at Marion, and using it in the higher frequency tube transmitter.

The report states

A radio direction finder was developed and placed on the market. This device so demonstrated its value as an aid to navigation that your corporation received the largest single order ever placed by a shipping concern for direction finders.

Reference is made to the development of short-wave transmitters for long distance communication, but "this system," we learn, "while a useful supplement to your Corporation's long-wave, high-powered transmitters, is still regarded as in the experimental stage." This idea of short-wave, low-powered transmitters was only recently hailed by the Naval Radio Laboratories, it will be remembered, as spelling the doom of the present powerful transoceanic stations using very long waves.

Attention is called to the reduction in the price of radiotrons during the past year, namely, from four dollars to three dollars and then from three dollars to two fifty.

The research and development staff of the Corporation have been spending their efforts, "to increase the efficiency and per-



DAME NELLIE MELBA

Australia; In a farewell message given to the London press

"Amid the sadness of bidding good-bye to so many good friends of mine up and down the country, it has been a pleasure to note almost everywhere a quickening in musical appreciation. To-day there are gratifying signs that the British audience begins to hear as well as listen.

Mainly, so it seems to me, the secret of this new interest is to be found in the astonishing enlargement of the audience for music accomplished by the gramophone and broadcasting. Although I believe I was the first prima donna to make a gramophone record and the first to broadcast, I have not, whilst recognizing the possibilities of these devices, ever accepted either of them uncritically, and I am well aware of the flaws in wireless as that science is practised to-day. But, just as I have followed the gradual perfecting of the gramophone, so I think one may look forward to like improvements in wireless. Broadcasting and the gramophone are certainly the two most eloquent missionaries to the musical heathen in our midst."

very minor part to play. All these eminent gentlemen have to do is to exercise their imaginations sufficiently to see that the task is worth while, that the attempt is sufficiently promising to constitute a proper outlay of funds. Then after they have approved the program, it is the visionary, yet practical, engineers that complete the work. Many of them there are whose names are never mentioned, who have worked the night long to improve this piece of apparatus, to discover the trouble with that piece, to develop schemes for measuring and a thousand other developments on which an achievement of this kind rests. So homage we pay to the young engineers who remain in the background. On March 7, 1926, this channel remained open both ways for more than four hours. Many people on both sides of the water were able to use it with the same ease they do their ordinary telephones although a special high quality microphone was used in New York on these tests and so good was the transmission that voices on either side the ocean were clearly recognized.

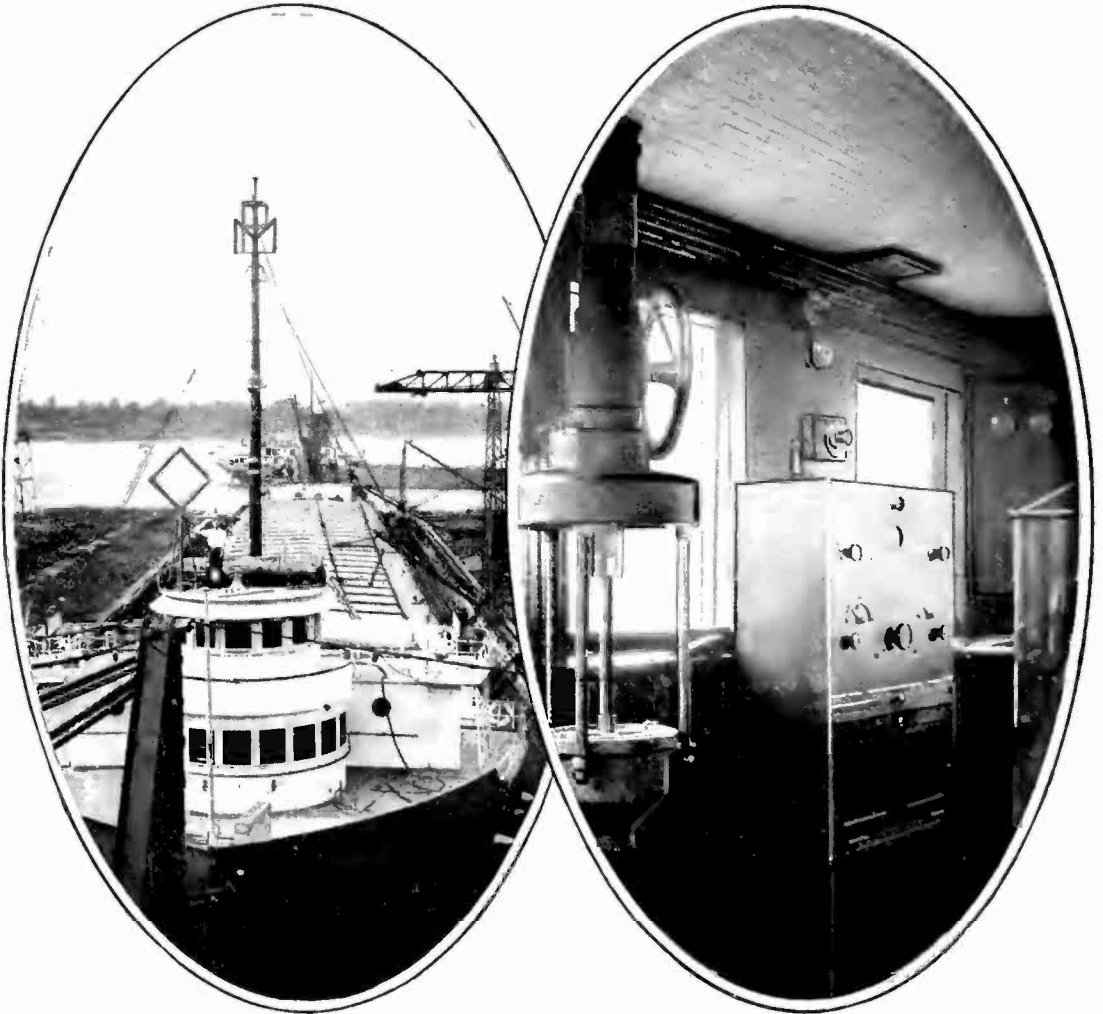

A RADIO COMPASS INSTALLATION ON A GREAT LAKES SHIP

The *J. A. Campbell* being equipped with a Radio Corporation radio compass at a dock in Toledo, Ohio. The left hand illustration shows the loop atop the pilot house and the other view shows the receiving equipment inside, with the indicator and wheel for adjusting the loop. Head telephones are used and the loop adjusted so that signals are loudest and then the reading on the indicator noted.

Forty ships on the Great Lakes are being equipped with this new protection for life at sea

formance of radio receiving equipment and to develop its broadcasting facilities and thus further contribute to the service upon which the industry is built."

Reference is made to the opening performances of the high-powered station at Bound Brook and it is stated that the daylight range of this station is about five hundred miles, and during the night it has been heard practically everywhere in the United States. The report states that comparatively few complaints were made by persons living in the immediate vicinity of Bound Brook that the operation of the new station interfered with their reception of other stations. There is no reference in the report to the action of municipal and state bodies seeking injunctions against the station. Intelligent work by the engineering staff of R. C. A. in actually helping the complainants to cut out the powerful signals should smooth over what looked like a radio tempest brewing around Bound Brook.

The essentially patent-holding character of the Radio Corporation is shown by the financial statement. Material assets in transoceanic stations, ship stations, broadcasting stations, etc., total less than \$14,000,000 investment, while the patent and good-will items in the assets column call for approximately \$16,000,000. An interesting entry in the liabilities statement is "Good-will written down" for \$1,500,000. Most of us would be glad to sacrifice quite a bit of good-will for that tidy sum. The net income for the past year was \$5,737,206.15, a decrease of about two million from the corresponding figure for the previous year.

The Importance of the Aurora

A RECENT display of Aurora Borealis stirred up again a discussion as to what effect this natural display of northern electrical disturbance has on radio transmission. We believe now that these northern lights are due to clouds of electrons shot off from the sun, causing ionization in the rare upper atmosphere, and possibly affected somewhat by the earth's magnetic field. Certain it is that the Aurora is generally accompanied by very large disturbing currents on the earth's surface, as ocean cables and many telegraph lines which use the earth as a return path are frequently put out of commission for many hours by these wandering currents. During the recent display of Aurora, some telegraph lines reported voltages, due to stray earth currents, as high as one hundred and fifty.

These effects, however, seem to be of such a low frequency, that we hear nothing of them in radio reception. One man who ought to know, better than any other, about the effect of northern lights on radio transmission is Donald MacMillan. He has gone right under the Aurora display, so that they became for him southern lights instead of northern lights, yet he says they have no effect on static.

Probably the electrical condition of that part of the atmosphere where the Aurora disports itself has a great deal to do with radio transmission, but this condition affects radio whether the Aurora appears or not. The Aurora may be, in so far as radio is concerned, merely an indication that the Heaviside layer is there.

The Month In Radio

WHY don't you tell us what kind of radio reception we are going to have tomorrow night? asks Gentle Inquirer, of Prof. C. F. Marvin, Chief of the United States Weather Bureau. Many times requests are made of the Bureau, says Professor Marvin, for a radio weather forecast.

It may well be that radio conditions and weather conditions have some very close connection. Several observers (see J. C. Jensen's article, RADIO BROADCAST for March) have tried to find just what the association is, but the problem is big and the work so far is not entirely conclusive. It is a fertile and fruitful field for investigation. Much interest has been aroused by Mr. Jensen's article which gave the results of experiments made over a period of several years.

A RECENT announcement reported that an inventor of Chicago, L. W. Skala, had accomplished what we had heretofore regarded as unfeasible, the transmission from the same antenna of several messages on the same frequency, which could be unscrambled in a receiver. Ever since Mr. Grindell Mathews announced his "death ray" and failed to make good, however, we have a tendency to claim residence in Missouri and wait to be shown. Far be it from any one with imagination to regard a radio feat of this sort as impossible, but it pays to be slow in becoming enthusiastic, for there are so many inventions that fail to work as the inventor claims.

Dr. A. N. Goldsmith, chief broadcast engineer of the R. C. A. said of Skala's announcement:

Radio listeners and engineers are interested in a method that proposes to reduce the present amount of interference between broadcasting stations. However, until they have full details from scientific publications or issued patents, they cannot well give any decision as to the value of any particular device. In order for a system for simultaneous transmission on the same wavelength without interfering to be useful, it must meet two requirements. The first is that two transmissions will not occupy more than the usual ten-kilocycle band which is used by ordinary broadcasting stations to-day and the second is that the receiving equipment shall be such that it can readily be used by the average broadcast listener.

THERE is apparently a move on foot in the Canadian Parliament which has all the flavor of being sponsored by our friends the A. S. A. C. & P. and radio fans and theater managers are up in arms against it. A bill is being fathered by L. G. Ladner, M. P., Vancouver, which aims to amend the copyright law of the Dominion in such a way that radio and theaters might be subjected to unreasonable and indefinite royalty demands. According to accounts in the press, the Montreal Theater Managers Association feel they run the risk of being victims of extortioners, who may ask so much royalty under the permission to be granted



DR. A. HOYT TAYLOR

Washington: Chief of United States Naval Research Laboratory

"It would appear from theoretical considerations that waves much shorter than 14 meters will not be of much use for really long distance work. Even in the band between 20 and 40 meters, a phenomenon occurs which we call the skip distance effect.

Under certain conditions, when operating in this band, stations at relatively near-by points, will be skipped over or missed entirely, whereas very intense signals will be received much farther on. This effect naturally was very puzzling before it was understood.

I can recall an occasion when I was in communication on the 20-meter band with a British station between 12 and 1 in the afternoon. At the same time, two American amateurs, one in St. Paul, Minnesota, and one in Connecticut, were listening-in for the test. The only way I could communicate with the man in Connecticut was to relay a message either through St. Paul or through London. He was unable to hear my signals, and I was unable to hear his. On the other hand, I was perfectly well able to work London. The St. Paul man, being outside the skip distance, which at that time of the year was about 600 miles for that wave, was able to communicate with both stations."

by this bill as to ruin the theater business. A similar association is being planned in Ottawa, and both societies, helped by the radio managers, will apparently conduct a vigorous campaign against this change in the present copyright arrangement.

Interesting Things Said Interestingly

W. SETON GORDON (London; in a letter to the *New York Times*): "Speeches broadcast by the British Broadcasting Company at public dinners, take well. The wireless fan soon gets to recognize and distinguish the voices of all public men. It is something worth while to listen to the actual voices of elder statesmen and to men who, in every department of public life, have done things and made history. At important ceremonies the King's voice is heard. He is a ready speaker.

Shall I Buy a Factory-Built Receiver?

The "Bought Set" Is Coming Into Its Own—Experimental Work Done in the Manufacturer's Laboratory and Not in the Buyer's Home—Simplified Wiring and Assembly Have Reduced Production Costs Without Impairing Quality—More and More Substantial Values for Buyers

By AUSTIN C. LESCARBOURA

THE conveyor belt moves along at the leisurely pace of three feet in one minute and ten seconds. At one end, a girl places a bare metal frame between each pair of cleats on the moving belt. At the other end, some two hundred feet down, a gantlet of busy hands and buzzing voices, another girl inspects the assembly, touched a joint here and there to flick off surplus solder, and initials a bright red ticket that carries the pedigree of a radio receiver just born into the broadcast world. So, in an hour's time, a multiplicity of odd parts have grown into an elaborate assembly called a radio receiver, with every last wire soldered in its proper place; with every adjustment carefully made, and with a thorough check on the wiring and the workmanship involved.

Typical of the manufactured radio receiver of to-day is this scene in a plant which turns out six hundred receivers each working day—receivers of the most elaborate type. In another part of the same plant the various radio components are manufactured in a similar efficient manner. Each component, as it is completed, is provided with its individual wiring in the form of flexible leads cut to predetermined length and with the free ends skinned and tinned, ready to be connected in their proper electrical position in the final assembly. And even the parts that go to make the radio components—screws, nuts, moulded pieces, punchings, and so on—are likewise produced in this vast self-contained radio plant. Is it any wonder, therefore, that some manufactured receivers can be sold at prices for which the parts themselves could not be bought by the home constructor?

How an intricate piece of apparatus like a radio receiver is reduced to a quantity production problem, is a long, long story. It starts in the laboratory of the conscientious manufacturer, where real radio engineers and indefatigable research workers are constantly engaged in working out new circuits and variations of old circuits. Set-up follows set-up. Test follows test. Out of a maze of radio components sprawled all over the laboratory table, and entangled in a veritable web of loose wires, there evolves a circuit which in the opinion of the laboratory staff and production staff alike—not forgetting the patent attorney—combines the necessary radio qualities with the refinements called for in manufacturing on a vast—and safe—scale.

DURING the past two years, radio receivers have come out of the trick circuit period and manufacturing has developed on an entirely different basis. We have not yet reached the ultimate in circuit efficiency, to be sure, but we have learned to produce receivers at fairly low prices which are extremely satisfactory. So far as the layman, on pleasure bent, is concerned, he has little to worry about in the purchase of a receiver. Most of those now offered by reliable dealers—except the bargain mark-downs, yet even some of these may be included—are good. The extent of their goodness is, as a general rule, dependent upon nothing but price.

Now the editors of RADIO BROADCAST cannot, in fairness to all, get down to a series of descriptions of individual receivers. We cannot take up valuable space with a detailed discussion of the operation and performance of a given receiver, since that very matter is amply covered by the manufacturer in his printed matter. But we can and, beginning with this article we shall present the trends and tendencies in radio receivers from time to time. Articles such as "What's New in Radio" (January, 1926, RADIO BROADCAST) written by Austin C. Lescarbourea, formerly Managing Editor of the Scientific American and author of the book, "Radio for Everybody," are, we feel more satisfactory. We shall publish similar articles from time to time, as the material becomes available. And so we offer at this time the first of a series on the trends and tendencies of radio receivers.—THE EDITOR.

After all, radio manufacturers to-day are agreed that the place for experimenting, so far as the manufactured radio receiver is concerned, is in the laboratory. The average purchaser of a manufactured radio receiver is not seeking a collection of experimental apparatus which may have to be arranged and re-arranged, added to and subtracted from, in order to secure the desired results, but a finished product which, with minimum effort, will satisfactorily bring in radio programs. The receiver is generally looked upon as a necessary evil by the average radio listener.

So with all leading radio manufacturers, a radio receiver begins its career back in the research laboratory, where the circuit is finally evolved. Then follow the mechanical considerations. Various arrangements of parts are assembled and tested until the receiver takes definite shape. Then comes the bench model,

which is virtually the prototype of the final receiver, even to the cabinet and panel engraving and finish. The bench model is an animated blueprint, so to speak. It must be passed on by the engineering staff, the production staff, the sales staff, and, in some instances, certain representatives of the public, who judge the contemplated offering. Bench models cost fortunes; indeed, a king's ransom would not suffice to purchase some bench models of well-known radio receivers. It is said that the first bench model of the well-known super-heterodyne receiver cost well over a million dollars to produce! But fortunately, radio receivers do not stop at the bench model stage.

At any rate, the bench model is eventually okayed, following which it is turned over to the tender mercies of the production staff whose

task is to make thousands and tens of thousands of copies at a cost within reach of all radio fans.

The bench model is literally torn apart, piece by piece, while production engineers analyze each piece that enters into the whole, even to the last screw and nut. In some instances, certain changes must be made to conform with production methods. Blueprints and specifications are prepared in great detail. Indeed, we have seen specifications for a well-known receiver, which were in the form of fourteen voluminous books and packets of blueprints. Even the cabinet of this receiver was covered by a specification book, stating the kind of wood to be used, how it should be dried, the finish and how it could be secured, the hardware, the glue, and so on. Every part, even to the modest washer, receives a number in the specification, for ready reference. Likewise with the wiring. Each wire is given a number and differentiating feature, such as a certain length, or colored braid.

And now for the multiplication process! The plant is arranged for the detail manufacture of the various components, in the case of the largest manufacturers, while in other instances contracts are placed with radio parts manufacturers. In the former event, suitable dies and moulds must be prepared. The detail manufacture arranged for, either within the organization or with outside coöperation, the progressive assembly process is now considered. Radio manufacture, these days, is generally a matter of having small parts grow into important parts, important parts into sections or sub-assemblies, and these sections

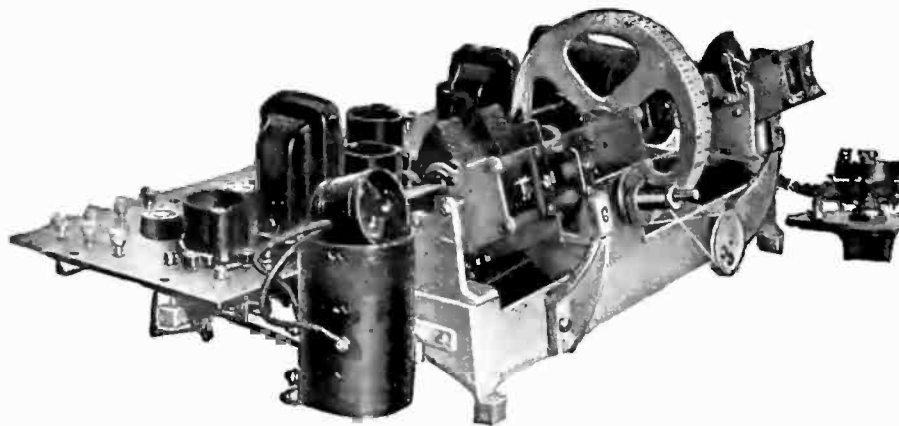

THE MECHANISM OF THE FERGUSON EIGHT

A remarkably efficient single-control receiver. The complete unit is mounted on a rigid aluminum frame, similar to an automobile chassis. There are three variable condensers tuning the grid circuits of the two radio frequency tubes and of the detector tube. Three stages of matched audio frequency amplification are incorporated in this circuit. A revolving drum is marked off in five-meter units, and is synchronised to turn in coöperation with the condensers

or sub-assemblies into the complete receiver.

Progressive assembly calls for marked organization ability. The steps must be planned so that the work will flow in the same easy manner as water flowing from the mountains to the sea, steadily increasing in volume from stage to stage. Jigs and fixtures must be designed and provided so that the girl workers can do their respective work in just one way—the right way. This ensures uniform workmanship. Following the installation of the necessary machinery, tables, chairs, help, must be secured. Materials must be ordered.

Then, at last, production starts, with engineers coaching the workers in their respective tasks. Certain changes may be made to meet unexpected conditions. Veritable bottle-necks appear—stages in the work which require more time and labor than was originally anticipated—and certain re-arrangements may have to be made. But finally, the radio receivers begin to pour out of the factory, with the precision of clockwork. The costly bench model is now excelled by the manufactured receiver which is offered at a price within the reach of all. How simple it all seems!

SIMPLICITY THE KEYNOTE OF EFFICIENCY

PROGRESSIVE assembly, as already described, makes for volume production which, of necessity, makes for low individual cost. Then, too, instead of employing skilled radio technicians for the assembly and wiring of each receiver, the work is ingeniously planned for girl workers, who, strange as it may seem, usually do not know the first thing about radio—and care even less! Girl No. 39 knows that her job is to mount jack type 3-H in the left hole of the sub-panel. Girl No. 62 is responsible for mounting condenser type C-4 in its allotted position. Girl No. 83 wields a soldering iron, seeing to it that wire No. 56, plain black, 6½ inches, with free end already skinned and tinned, is brought over to the third connecting lug on the terminal strip. And so it goes. Each girl has one duty to perform. She does it to her own satisfaction and that of the critical inspector.

There is a vast contrast between the manufactured receivers of to-day and those of yesteryear. The elaborate bus bar wiring so much in vogue in the manufactured as well as the home-built radio receiver, is becoming less and less evident in the manufactured offerings. Instead, the wiring is handled with flexible and insulated wires, as well as connecting cables. Truth to tell, the receiver mechanism does not present the neat appearance of former days, but from a purely radio standpoint the results are better than ever, so why worry!

In some instances the wiring is accomplished by means of thin strips of metal, which are actually eyeletted to the various parts joined together. Here is a method which saves a vast amount of



THE BREMER-TULLY COUNTERPHASE SIX

Here is a receiver which employs three stages of radio frequency amplification and yet there are only two main controls. A special method of oscillation control is incorporated in this set. The panel is of copper, this feature tending to increase selectivity and reduce stray noises

time yet serves just as well as the most elaborate bus bar job handled by an expert radio worker.

And what has been done by way of simplifying the wiring is likewise in evidence when it comes to other details. One well-known make of receiver, for instance, employs variable condensers which, at first glance, would seem altogether too crude to do their appointed work. There is virtually no finish to these components. In fact, these condensers, as we see them unmounted on the bench, even lack tension or balance so as to make the rotor plates "stay put" in any position. Still, these very same condensers, in combination with the unique drum controls provided with friction brakes, provide one of the most selective and efficient tuners now available.

So it goes. The trend and tendency in radio manufacturing to-day is to make the receivers as simple as possible, consistent with the best

radio results. No end of money and effort is put into the development of circuits and the combination of ideal components; but, on the other hand, if something can be simplified, if the wiring can be reduced, if a part can be eliminated or at least replaced by a less intricate and less costly part without sacrificing the quality of performance, it is done. After all the radio buyer should be interested in what issues from the loud-speaker, first, last and always. He is buying a seat in the radio broadcast auditorium, and it is up to the radio manufacturer who has sold the ticket in the form of the radio

receiver, to make sure that the radio "fan" gets a good seat.

FLIVVERS AND ROLLS-ROYCES OF RADIO

ALL OF this may be a rather long way of coming down to the simple thought that radio receivers can be produced at surprisingly low cost. Thus we have five-tube receivers now offered at prices even lower than the cost of the one-tube receivers of the early days of broadcasting. The quantity methods already mentioned, together with simplified mechanics and wiring, have made possible these really good receivers offered at prices within the reach of the modest pocketbook. The fan who could afford nothing better than a crystal detector set in 1921, now gets at least a three-tube receiver of infinitely greater value.

All manufactured receivers to-day, with but very few exceptions, are good. After five years of highly competitive effort, radio manufacturing has come down to a plain question of the survival of the fittest, so that manufacturers of radio junk have, for the major part, passed out of the picture. Those still remaining among us are rapidly mending their ways or, like the proverbial Arab, getting ready to fold their tents and disappear in the blackness of the night lest they be scalped or suffer whatever fate comes to the dishonest radio man at the hands of an outraged public.

So the problem of selecting a radio receiver to-day is no longer what it was a year or two ago. As a general rule, all manufactured sets to-day may be considered good. True, the advertising claims at times may be somewhat enthusiastic, but then, it should be remembered that the battle of superlatives has been going on since the advent of radio broadcasting. The goodness of a radio receiver, irrespective of the glowing tributes of the manufacturer himself, can generally be taken for granted.

The relative degree of goodness, on the other hand, is a quantitative proposition and therefore more difficult to estimate. However, it is a safe and sane rule to judge relative goodness by the selling price. Values are now fairly well standardized on all types of radio receivers, so that a given sum will buy just so much radio receiver and furniture. Occasionally



GLORIFYING THE AMERICAN CABINET MAKER

This is a Kennedy Spanish Desk receiver. There is no denying the fact that it would enhance the appearance of almost any room in which it might be placed. The cabinet is finished in either mahogany or American walnut



A BRITISH DELUXE
RECEIVER

This is a fine example of British workmanship, comparing favorably with the American sets illustrated on these pages. It is manufactured in Manchester, England, by the Metropolitan Vickers Company

the buyer will get a greater proportion of furniture, or ornate cabinet, than the radio feature. Furniture, like radio, costs money, and a given selling price will stretch over just so much of each. Too much of one may mean too little of the other, at a given price.

All in all, the price is a safe criterion, provided we are considering the offerings of established and reputable manufacturers.

Remarkable progress has been made in the way of multi-tube receivers selling at surprisingly low prices. There are now many makes of five-tube sets, with two stages of r. f., a detector, and two of a. f., selling at prices within the reach of the modest pocketbook. The average inexpensive radio receiver of this kind, which costs less than \$100 complete with batteries, loud speaker, vacuum tubes and installation, will provide satisfactory radio entertainment. Like the flivver of the highway, it serves the plain purpose intended; but it is useless to compare the performance with that of the radio Rolls-Royce. Both receive radio programs—but a noticeable difference in tone quality between the low-priced and high-priced radio offerings is generally apparent. The low-priced radio receiver, generally speaking, cannot operate a high-grade cone speaker with satisfactory results. Obviously, expensive transformers or other means of quality amplification cannot be included in a receiver which costs little more than the ingredients of such amplification. Again, the inexpensive radio receiver is limited to the simplest form of tuning mechanism—simplest from the manufacturing standpoint, but likewise the most complicated from the operating standpoint. The three-dial method of control is usually standard on low-priced five-tube receivers, since it is the cheapest to make. Then the components of the low-priced receiver must of necessity be plain, devoid of the refinements and precision found in the more expensive receivers. This, of course,

is reflected in the performance. Still, it is gratifying to find the latest type of variable condensers in some of the radio flivvers, as well as other recent improvements.

REGENERATION ON THE WANE

THE TREND of the past year or two in radio manufacturing has been toward stable circuits, rather than the super-sensitive but tricky circuits of several years ago, when one tube gave excellent volume of signal with head phones, and a three-tube receiver represented the standard loud speaker set-up. Thanks to the advent of economical vacuum tubes, requiring a fifth or less of the current formerly consumed by the tungsten filament tubes, radio manufacturers have found it possible and advisable to add tubes for handling the radio functions more in the way of the plodding and reliable day laborer rather than



THE RADIOLA 28

Is a desk model eight-tube super-heterodyne, working from a loop-antenna and using dry batteries. It is claimed that this receiver will give greater volume than that obtained with some storage battery operated receivers. The new RCA unicontrol tuning mechanism is incorporated, together with straight line frequency condensers, giving equal spacing of all stations on the tuning scale

the flashy and uncertain performance of the strong-arm man. Two additional tubes, performing as radio-frequency amplifiers, now serve to build up the radio energy in safe and sane manner, relieving the detector of that task formerly accomplished by means of so-called regeneration. A wonderful means of increasing sensitivity and volume, regeneration nevertheless did not belong in the home receiver. It is too unstable and difficult to handle, so far as the average layman is concerned. Hence it is best that this feature has been eliminated as the sole means of increasing sensitivity.

Going a step beyond regeneration, radio manufacturers have sought to control undesirable regeneration or oscillation in the radio set, by some inherent feature which might perform irrespective of the manipulations of the lay hand. Thus the squeals and groans so characteristic of early radio are no longer in evidence. In the less expensive receivers, oscillation is controlled by the simplest of means, namely, introducing certain losses which eliminate the possibility of oscillation. In the more elaborate receivers, this purpose is accomplished by various means which do not call for a sacrifice in efficiency.

One thing is certain: the elimination of the regenerative detector, at the expense of two more tubes, has made it possible for milady to operate the radio receiver. Furthermore, it has more or less standardized the service rendered by all receivers of a given make. Previously, regeneration was such a tricky thing that there was no telling just what might be accomplished with it. The skilled operator might tune-in San Francisco in his New York home. Next door, an average radio fan, with the same type of receiver, could do no better than a local station, and even then, the squeal just about drowned out the music. To-day, the non-regenerative receiver has virtually wiped out the advantage of the skilled operator. Once the dials are charted or logged for various stations, the ten-year-old child tunes just as well as Daddy who reads every radio magazine that comes along.

A similar observation is that the non-regenerative receiver has made it possible to put radio sets on a sort of miles-per-gallon basis somewhat approaching that of automobiles. With the operation of the set virtually reduced to a fixed standard, as compared with the widely separated extremes with the regenerative receiver, the performance of a given set is more or less accurately gauged in advance.

CUTTING DOWN CONTROLS

THE SUCCESS achieved with the multi-tube receiver has spurred radio manufacturers on toward less controls and simpler operation, which, in turn, means a more elaborate receiver. Whereas a year or two ago the radio public was content to set three dials to various numbers in order to tune-in desired stations, to-day that public wants to get away from such elaborate operation. Their ideal is thought by many to be the one-knob receiver, which is being closely approximated by some of the present offerings.

Electrically, there is no such thing as a



A DELUXE CONSOLE

A five-tube creation of the Electrical Research Laboratories (Erla), of Chicago. This is a fine example of exquisite craftsmanship, the cabinet being of quartered and matched figured walnut in the French Huguenot finish. Balloon Circloids, three of them, are used in the circuit, which employs two stages of tuned radio frequency amplification, detector, and two stages of audio

A KELLOGG RECEIVER

Is shown below. It is a highly sensitive, yet easy to control, seven-tube set, designed to furnish as closely as possible a satisfactory answer to the question, "What is the ideal form of radio for the home?" To the right is shown a beautiful example of loud speaker design, a product of the Seaman-Jones Fibre Products Company, of Chicago



QUALITY THE KEYNOTE

In this six-tube Air-Way tuned radio frequency receiver. The three audio stages employ the resistance-capacity method of coupling, and there are two stages of radio frequency amplification. This receiver is manufactured by the Air-Way Electric Appliance Corporation of Toledo, Ohio



THE BLAIR SIX

THE "NO DIAL"

THE RADIO FLIVVER

Employs three stages of resistance-coupled audio amplification. It gave very satisfactory results when tested in the RADIO BROADCAST Laboratory

An innovation in receiver design, produced by the Ohio Stamping & Engineering Company, of Dayton, Ohio. The unusual method of control, by rotating the lid, does not appreciably detract from the efficiency of the set

Alias, the Crosley 5-38 receiver. Despite their low cost, very excellent results are obtainable with this and other Crosley sets. A feature of the new Crosley model is the Crescendon, a volume control device exclusive with these sets

MILADY

Must be catered to as is evident after a glance at the two receivers to the left and right. The new Freshman Masterpiece has a real appeal to the women of the home. It is compact and has a built-in loud speaker, and sells for a few cents below the \$100 mark. On the right we have an Italian Renaissance Console, truly an exquisite example of cabinet work. It is a product of the Valley Electric Company of St. Louis, Missouri. It is to their credit that manufacturers have made it a point not to sacrifice either quality or sensitivity for beauty of appearance

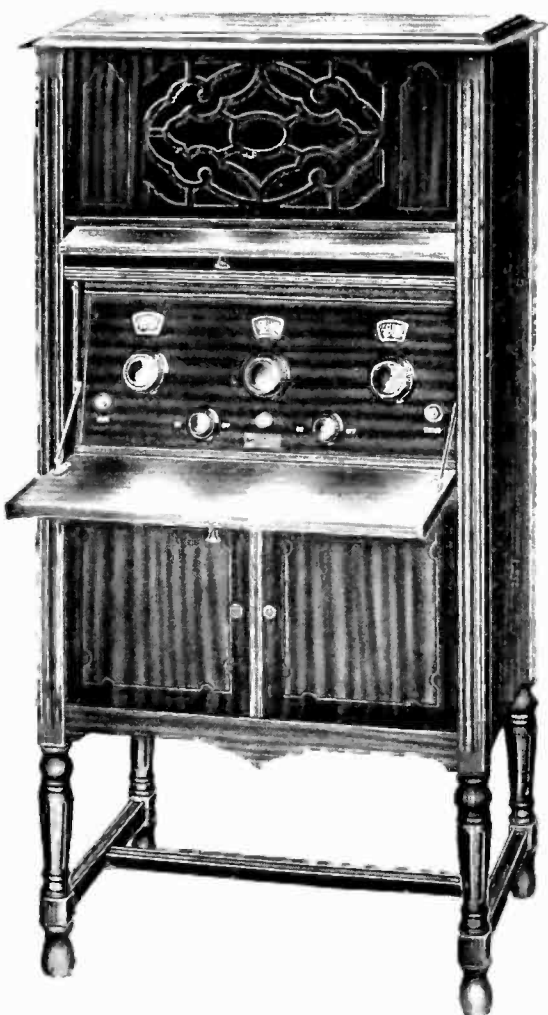

one-control set. The various tuned circuits of a radio receiver must be controlled individually by their respective tuners. However, by ingenious mechanical arrangements, it becomes possible to operate simultaneously the various tuners, generally variable condensers, with a single knob, thus simplifying the operation.

It is no easy matter to tune several radio circuits simultaneously. Mechanically, it seems simple enough. The variable condensers can be arranged in tandem—their shafts connected together in a straight line—for rotation in unison or, they can be joined together by gears, chains, or levers. But the real complication comes in the electrical or radio performance. Unfortunately, variable condensers will not run uniform throughout their capacity range and, while three condensers may match up very nicely for one wavelength or frequency setting, they may be 'way off at another.

As a consequence, the earlier one-knob receivers were of the crudest form from the radio standpoint. The various circuits were tuned to utmost efficiency at one frequency setting, at most. At all other settings the circuits were tuned so far apart as to impair the sensitivity and selectivity of the receiver. Manufacturers sought to correct this shortcoming by introducing supplementary condensers for the final sharp tuning of the individual circuits, but by so doing they immediately defeated the very purpose of the one-knob receiver.

As one radio engineer has so pertinently put it, any one can build a good single-knob receiver—provided there are sufficient supplementary controls! And any one can build a one-knob receiver, provided the results are not compared with a multi-knob receiver utilizing the same number of tubes. So the one-knob is either a misnomer, because it involves supplementary controls, or it is a wonderful achievement in radio engineering and precise manufacturing methods.

To-day, there actually are examples of the wonderful radio engineering achievements on the market. The design of such receivers has been worked out with infinite care, in the case of the best one-knob receivers, and as a consequence, these offerings are costly. In fact, certain one-knob receivers have been made possible only by an entirely different method of building the variable condensers, involving a precision heretofore not even thought possible in factory production.

The one-knob receiver is the ultimate in radio reception. There can be no doubt of it. Nothing provides a greater thrill, even to the hard-boiled radio man, than to turn the single knob or drum slowly from the low to the high numbers, while the various broadcasting stations fade in and out in a steady procession. It is positively uncanny. One of the present single-control receivers has its dial readings arranged to represent frequency separations of ten kilocycles, the standard separation of radio broadcast channels. Stations can be instantly tuned-in by turning the single drum control to the frequency setting.

But single control means an elaborate receiver, costly production, and high cost. Hence the multi-control receiver must remain with us for quite a while to come. It saves money for the radio buyer and manufacturer alike.

THE COST OF TONE QUALITY

THE greatest advance scored in radio receivers during the past few months has been in tone quality. Just so long as radio broadcasters were transmitting crude approximations of music, and just so long as loud

speakers were still following in the footsteps of the horn-type phonograph, tone quality did not receive much attention. In fact, the public was more than generous with radio acoustics, accepting the crudest performance willingly enough.

Then, the radio broadcasters began to move ahead in the matter of tone quality. Better equipment was installed, for the purpose of transmitting a wider band of musical frequencies and furnishing the subtle overtones and harmonics so essential to realistic rendition of music and speech. Meanwhile, loud speakers were being studied in laboratories, from the standpoint of sound. Soon the cone speaker made its appearance, providing a means of reproducing virtually all musical frequencies from the lowest to the highest. The problem then became one of furnishing the loud speaker with a true copy of the musical frequencies impressed on the broadcast wave. And the audio frequency end of the radio receiver heretofore, left alone in the more important quest for new circuits and other things, now came in for a cross-examination.

Under the concentrated efforts of the radio

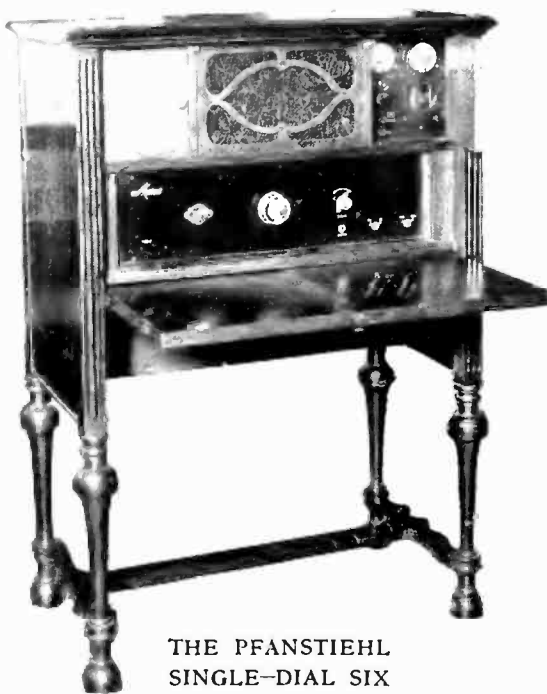

THE PFANSTIEHL
SINGLE-DIAL SIX

A novel feature of which is the built-in Tungsar charging rectifier of the 110-volt, 1½-ampere type. A circular window on the panel permits the reading of the charging indicator with the least possible inconvenience, no separate hydrometer being necessary to test the Philco glass contained storage batteries

fraternity, remarkable things have been done in audio frequency amplification in the space of months. Transformers have now appeared which are capable of amplifying a wide range of musical frequencies without distortion, or, to put it another way, with equal amplification for all musical frequencies from the lowest to the highest encountered in the average broadcast program. With a full realization of the limitations of even the best audio-frequency transformers, other methods of amplification have been investigated and developed, notably resistance- and impedance-coupled amplification.

Receiver manufacturers have not been slow to appreciate the importance of tone quality. In the better grade of offerings, tone quality is taken care of by present-day transformers—veritable giants compared with the little transformers of a year ago. Some offerings even include resistance-coupled or impedance-coupled amplification. While the lower priced sets

will not, as a rule, perform satisfactorily with a cone speaker, because of the limitations of their transformers, the medium priced and the higher priced receivers should operate a cone speaker very nicely. Unless a receiver is capable of rendering good quality amplification, it will work far better with a horn type speaker.

Another trend to-day among the better sets is toward the self-contained offering. Originally, there was the tuner, the detector unit, the amplifier unit, the loud speaker, the batteries, and the wave-intercepting system. Some time ago radio practice had come down to the tuner, detector and amplifier in one unit, with the accessories scattered about. Today, there is a definite move toward combining the loud speaker, batteries and even the wave-intercepting system with the receiver proper, all in one handsome piece of furniture. Whether or not this is good practice is for the buyer to decide. There are pros and cons in abundance. The matter seems to simmer down to one of personal preference.

Let us briefly review both sides: The self-contained receiver has the advantage of neatness, compactness, and the presumable balancing of the accessories with the receiver, so as to provide the best possible ensemble. The receiver with separate accessories has the advantage of perhaps lower first cost, since the buyer can secure the equipment as he wishes; while various combinations can be tried to meet individual taste and pocketbook, and anything new can be introduced in the receiver layout.

Many of the present-day offerings now include a built-in loud speaker, a battery with trickle charger, a B power supply, and a handsome cabinet. Loop receivers, of course, include the self-contained wave interceptor.

The development of the cabinet end of the radio set has been an interesting one to follow. Originally, the cabinet was little more than a protective case. Then, with the debut of the home radio from the attic or spare room into the living room, the cabinet took on better wood and better finish, but still remained plain enough. More recently, the console type of cabinet has appeared, so that the radio receiver can stand on its own feet in some desirable part of the living room or other convenient part of the home. And now, there seems no limit to the radio cabinet, ranging from the simplest case for the inexpensive radio receiver which is 95 per cent. radio and 5 per cent. cabinet, to the most elaborate offering which may be 95 per cent. cabinet and 5 per cent. radio. Furniture radio has been a wise move. It has done much to popularize radio, especially with the fair sex who judge so much by appearance. There is only one danger, and that is the sacrificing of radio to the furniture end. Here and there, among current offerings, one finds instances of furniture with a radio feature, rather than radio with a furniture feature. Too much furniture is as bad as too little, if it means the sacrifice of the radio end. This is especially true in some popular priced offerings which include an elaborate piece of furniture, with a corresponding retrenchment on the radio end. After all, it is radio that is being bought—a seat in the broadcast auditorium—and not a piece of furniture as furniture alone.

Decidedly, the manufactured radio set has come into its own. The radio fan can now purchase a receiver which will provide all the essentials of good radio reception, including sensitivity, selectivity, tone and economy. What is more, he is buying a finished product and not an experiment. And his radio dollars will bring him greater value to-day than ever before.

Will the New Type of Condenser Improve My Set?

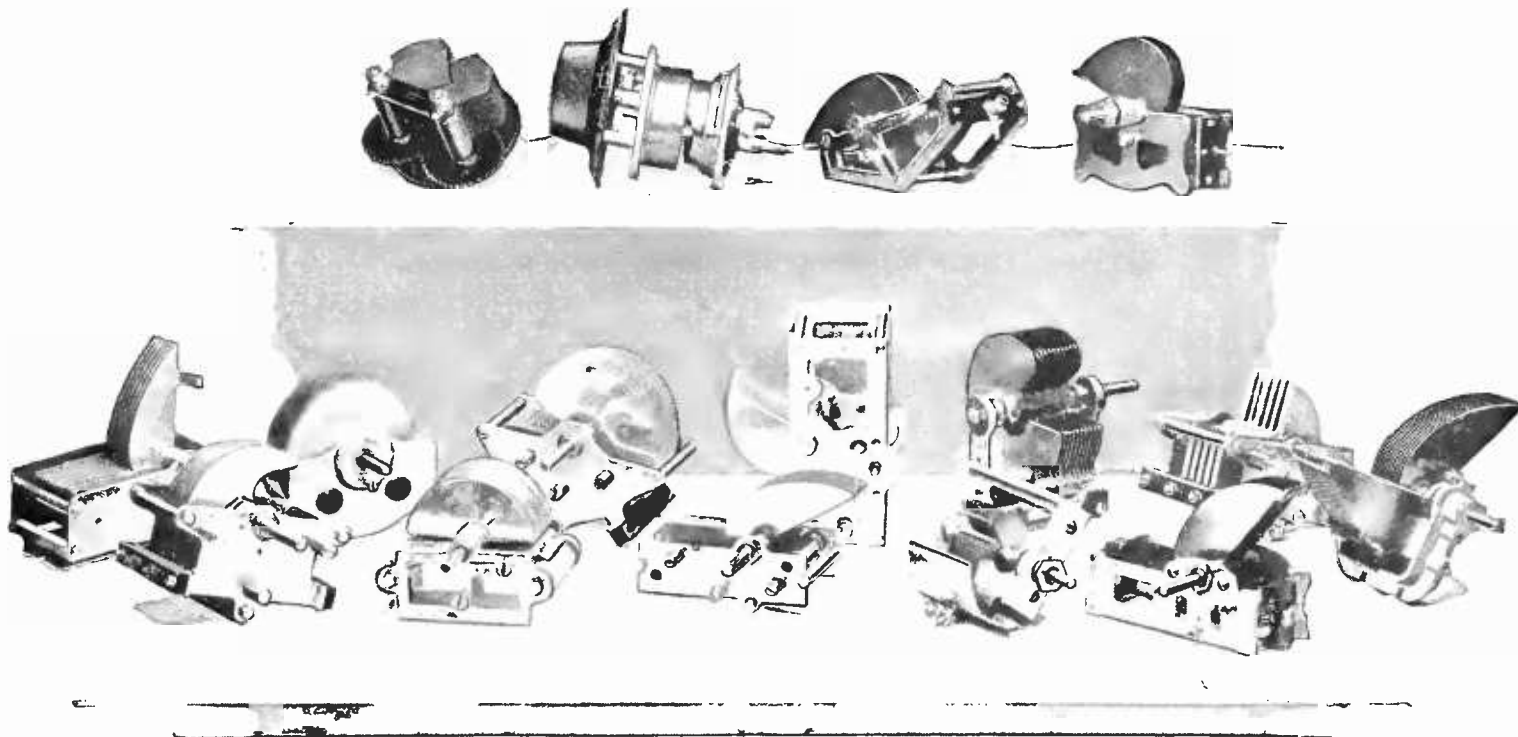

What the 10-kilocycle Separation of Stations Means and How to Decide the Best Condenser to Use—How Condenser Plates are Designed Advantages and Disadvantages of the Three Types

By KIRK B. MORCROSS

WHY are broadcasting stations crowded together at low settings of the dials of receiving sets? This question arises in consideration of the fact that frequency assignments to broadcasting stations give a uniform spacing of ten kilocycles between them. A little of this irregular spacing on the dials is due to deviations of some broadcasting stations from their assigned frequencies which are sufficient to cause a noticeable change in dial settings. Such irregularities are, however, slight. There would be essentially the same crowding even though each broadcasting station transmitted at *exactly* its assigned frequency.

One might say that this crowding on the dials occurs because the shorter wave stations have less wavelength separations. This is, indeed, true—at least for the majority of receiving sets. However if we try to solve the difficulty by looking at it from this point of view and apply what is apparently the natural remedy of uniform wavelength separation of broadcasting stations, we are going to get into trouble. Having thus allocated these stations, we would find it a simple matter to separate them equal distances on the receiver dials by using straight line wavelength condensers. However, in adopting this alloca-

tion a certain *minimum* separation in kilocycles would be required in order to prevent undue interference and the production of an objectionable beat note between carrier waves. This separation is found to be about ten kilocycles. If then, we assign wavelengths to the longest and next longest wave broadcasting stations so that

these stations have a ten-kilocycle separation (corresponding to a wavelength separation of 9.7 meters) and then give a uniform wavelength spacing of 9.7 meters to all broadcasting stations down to the shortest wave station, the kilocycle separation increases rapidly. At the lower end of the broadcast band it becomes approximately 70 kilocycles! In these days when every available radio channel is sorely needed, no argument is necessary to show the absurdity of such a method of allocation.

On the other hand, the allocation of stations by a uniform kilocycle separation gives the maximum number of radio channels. Hence, in order to reduce crowding on the receiver dials we must turn our attention to the shape of the plates of the variable condensers.

There is another alternative to changing the shape of condenser plates. One may take an ordinary condenser and apply to it a properly designed mechanism so that for a given angular rotation of the dial, the same *frequency* variation takes place regardless of whether the condenser is being adjusted at large or small capacities. Devices of this kind are now on the market and some broadcast listeners may prefer them to the purchasing of

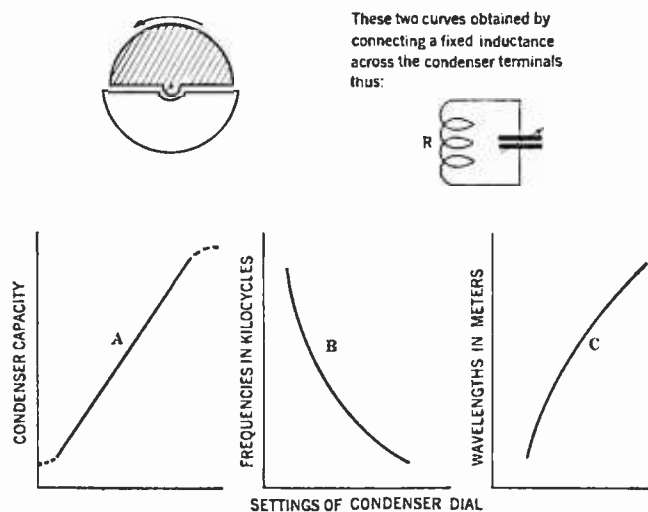
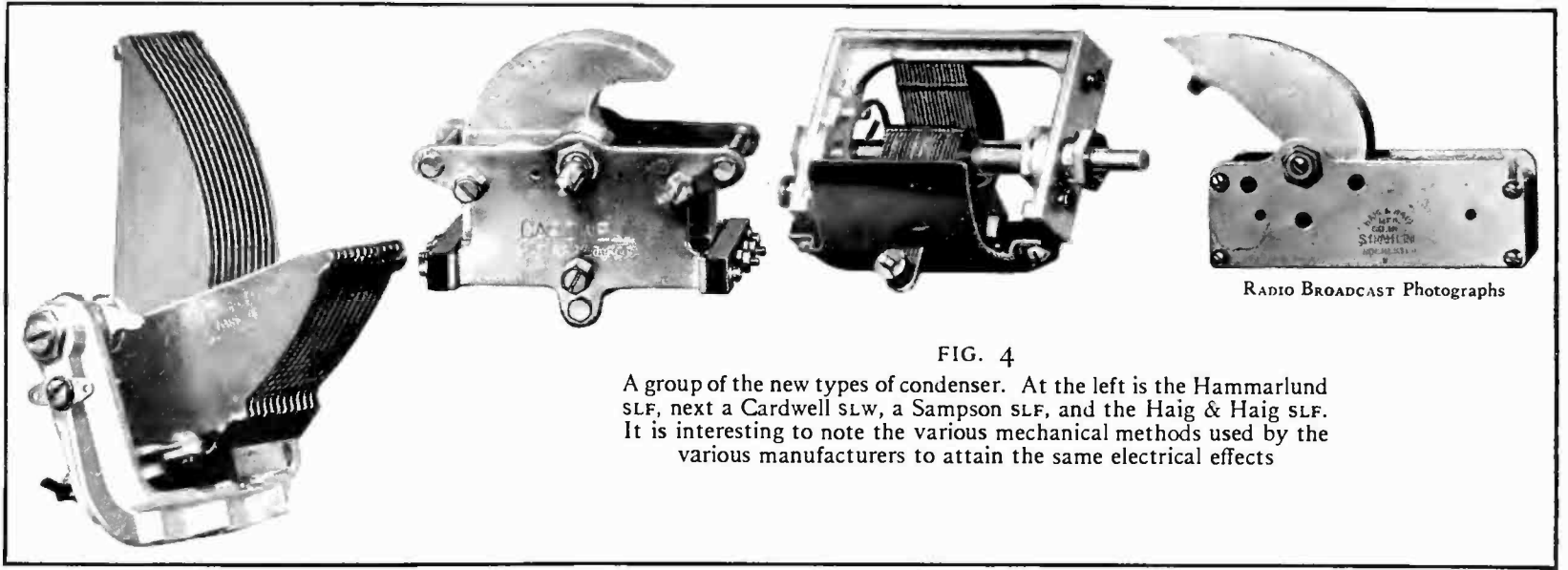

FIG. 1
The three curves indicating the tuning characteristics of a straight line capacity condenser show several things of interest. Curve A demonstrates that for a progressive similar increase in the condenser dial reading, the capacity of the condenser changes each time by the same amount. Curves B and C prove that if an equal separation in kilocycles or wavelength is desired, this is not the type of condenser to employ in your receiver



RADIO BROADCAST Photographs

FIG. 4

A group of the new types of condenser. At the left is the Hammarlund SLF, next a Cardwell SLW, a Sampson SLF, and the Haig & Haig SLF. It is interesting to note the various mechanical methods used by the various manufacturers to attain the same electrical effects

new condensers. The photograph Fig. 6, shows a well-known device of this sort.

The commonly used condensers are the so-called "straight line capacity," "straight line wavelength" and "straight line frequency" types (Hereafter called "SLC," "SLW" and "SLF"). The expressions SLF, SLW, and SLC, referring to condensers of straight line frequency, wavelength, or capacity characteristics are used in the rest of this article for convenience. The writer is not attempting to consider mechanical construction or "low loss" characteristics in this discussion; such properties are satisfactorily met in the majority of condensers on the market. The question that many broadcast listeners are asking is this: "What improvement in results will I get from my receiving set by substituting condensers giving more uniform spacing of stations?" It is in answer to this question that this article is written.

Before taking up a discussion of condenser construction it will be very useful to consider the function of condensers in receiving circuits. We will take an imaginary case of two receiving circuits identical in all respects except that one uses SLF or

SLW condensers while the other is provided with SLC condensers. Suppose both circuits are tuned to the same broadcasting station and let us also assume that other stations are broadcasting at or near this same frequency. Assuming that the condensers and associated coils in the two circuits have the same losses (which is a fair enough assumption) then each circuit will experience *exactly* the same amount of interference from stations of a frequency numerically quite similar.

This simple illustration serves to show that no particular type of condenser is superior at eliminating interference simply because it has plates of special shape. Nevertheless such condensers often assist indirectly in reducing interference because they give greater spacing of stations on the dials, permitting more accurate tuning to a particular station. It will be seen that this advantage becomes less in some of the larger cities where the receiving set is located near several broadcasting stations.

Practically all of the older types of receiving sets have SLC condensers (semi-circular rotating plates). Under what conditions should these be replaced by SLW condensers? The answer to this question will be made easier by a little consideration of the characteristics of the SLC and SLW condensers. The former type gives *linear* capacity variation with dial settings—that is, if the dial is rotated from say 80 to 90, the capacity is increased the same amount as when the dial setting is changed from 20 to 30. This is shown by a curve plotted with units of capacity along the vertical axis and dial settings along the horizontal axis, Fig. 1A. The curve is a

straight line except for deviations near the ends—particularly the lower end.

Now suppose we adapt this condenser to the usual condition in a receiving circuit by connecting it to a fixed inductance as shown at R, Fig. 1. What happens? When the capacity of the condenser is

These two curves obtained by connecting a fixed inductance across the condenser terminals thus:

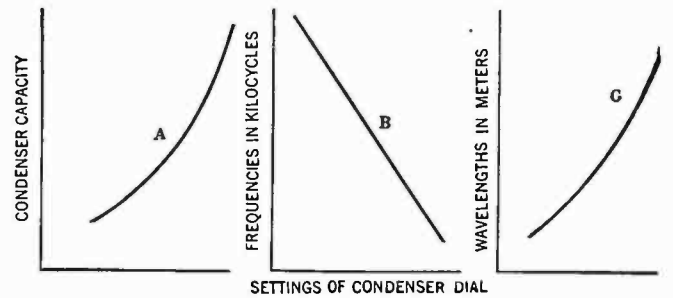
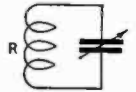

FIG. 3

Curves illustrating the peculiarities and advantages of the straight line frequency condenser. Since broadcasting stations are assigned to frequencies differing by 10 kc., then a condenser that would produce a definite rate of frequency response would be desirable. This the SLF condenser does

These two curves obtained by connecting a fixed inductance across the condenser terminals thus.

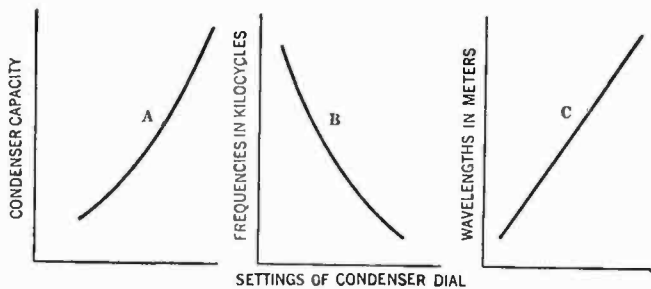
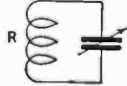
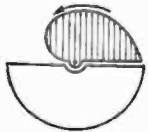

FIG. 2

Now we come to the straight line wavelength condenser whose tuning characteristics are depicted in the curves A, B and C, above. In C it is shown that for a definite successive increase in condenser dial reading there results a very definite change in wavelength, each change differing from the last setting by the same amount, in wavelength

varied, the circuit is tuned to the frequencies of various broadcasting stations. If we now plot a curve (Fig. 1B) using dial settings on the horizontal axis as before and frequencies in kilocycles along the vertical axis and another curve using wavelengths along the vertical axis, we find that neither curve is a straight line. They become steeper as the dial settings *decrease*. Hence a given rotation of the dial near the lower end of its scale produces a *much greater* change in frequency or wavelength. Therefore in tuning to broadcasting stations of high frequencies (short wavelengths) we find them crowded together on the condenser dials. In practice, this condition appears still worse because more stations broadcast at the higher frequencies.

To reduce this crowding, one may substitute SLW condensers for the SLC types.

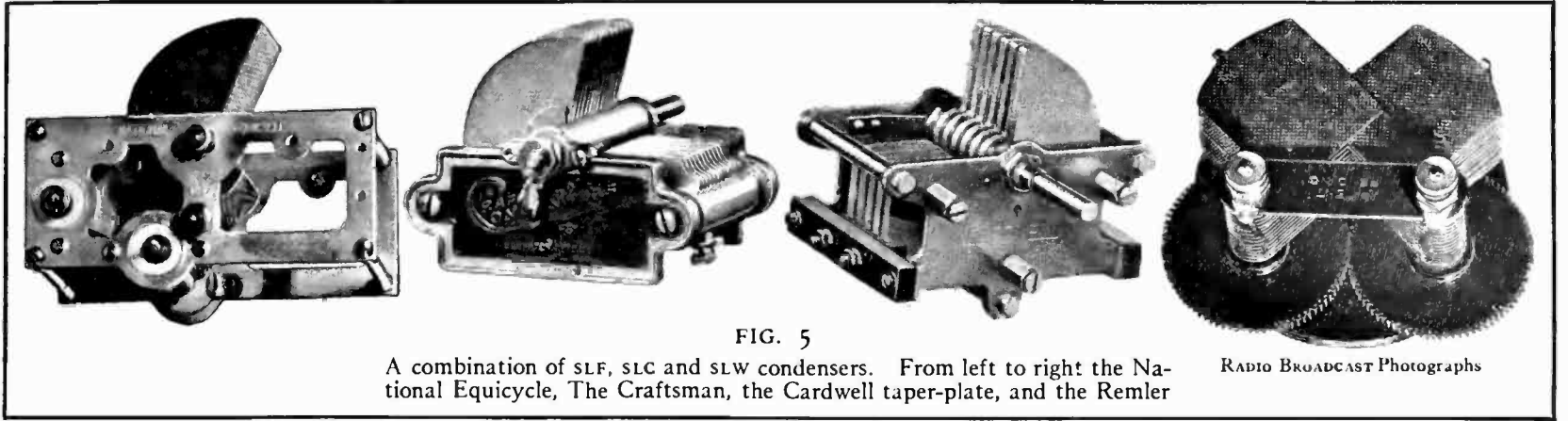
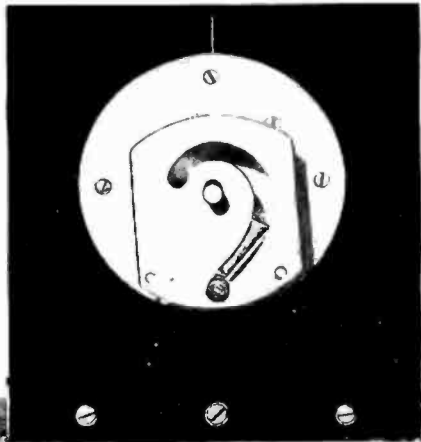

FIG. 5
A combination of SLF, SLC and SLW condensers. From left to right: the National Equicycle, The Craftsman, the Cardwell taper-plate, and the Remler

RADIO BROADCAST Photographs

FIG. 6
The Rathbun straight line frequency converter dial, and a view of its inner "works." For those who prefer to keep their straight line capacity condenser but desire the effect of straight line frequency tuning, this dial may be used



RADIO BROADCAST Photograph



(1) Is it difficult, with my present type of condenser, to set the dials accurately for the required wavelengths? (2) Is it difficult to predetermine the dial settings for a new wavelength? If the answers to these questions are affirmative then it should be worth while to substitute in your receiver SLW condensers for the SLC types.

STRAIGHT LINE FREQUENCY CONDENSERS?

OUR next question is, "When should one substitute the SLF condenser for the more conventional types?" In answering this question let us refer to Fig. 3 which shows curves for the SLF condenser. These should be compared with those in Figs. 1 and 2. Curve 3B shows the ideal characteristic of the SLF condenser—that of uniform spacing of broadcasting stations. This condenser, however, has the disadvantage of requiring much more space for the same maximum capacity than the

Curves for this condenser are shown in Fig. 2 and should be compared with Fig. 1. In discussing the capacity curve for the SLC condenser mention was made of irregularities near its ends. As one might expect, similar effects are present in curves obtained from condensers having plates of various shapes. These effects occur only at the extreme maximum and minimum dial settings and need not be discussed further.

The curve in Fig. 2C is a straight-line; hence a given change in dial setting *anywhere* will produce the same change in wavelength. Therefore if broadcast wavelengths were equally spaced in meters, the SLW condenser would give ideal separation. Actually, since the shorter waves are more closely spaced, the short-wave stations will likewise be more closely spaced on the dials, although better spacing is obtained than with the SLC condenser. If you are in doubt about changing to SLW condensers, ask yourself the following questions:

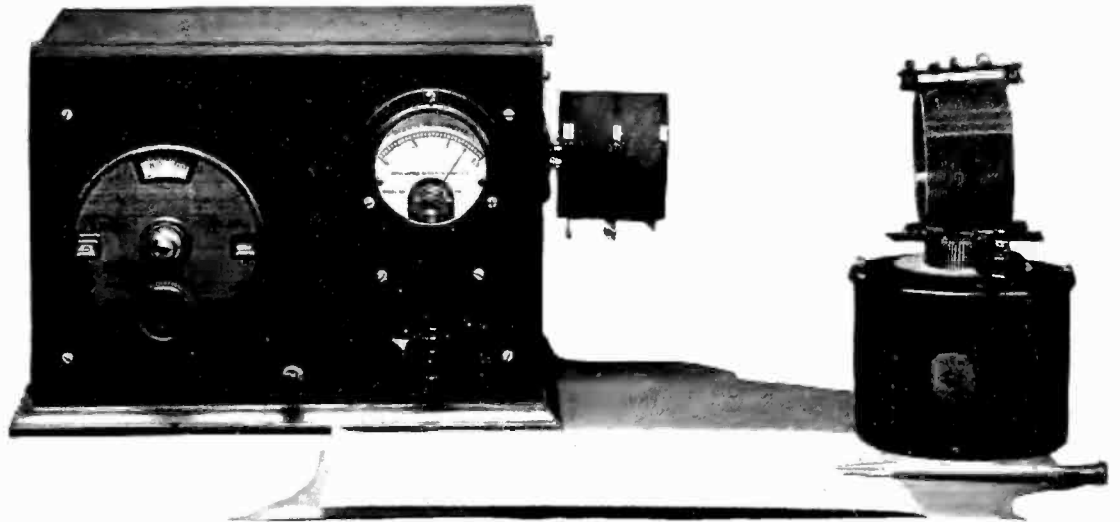

RADIO BROADCAST Photograph

FIG. 7

To plot curves showing the characteristics of various types of tuning condensers, it is necessary to have a calibrated source of radio oscillations which may be interpreted in terms of frequencies, wave lengths or capacities. Such an instrument is known as a driver or oscillator and one was described by Mr. Keith Henney for the Home Constructor in the September, 1925, RADIO BROADCAST. The coil and condenser located at the right of the photograph represent the circuit comprising a fixed inductance and a variable capacity and by tuning to settings of the oscillator, a series of readings are obtained, which, when plotted indicate the characteristic curve of the condenser and coil being tested

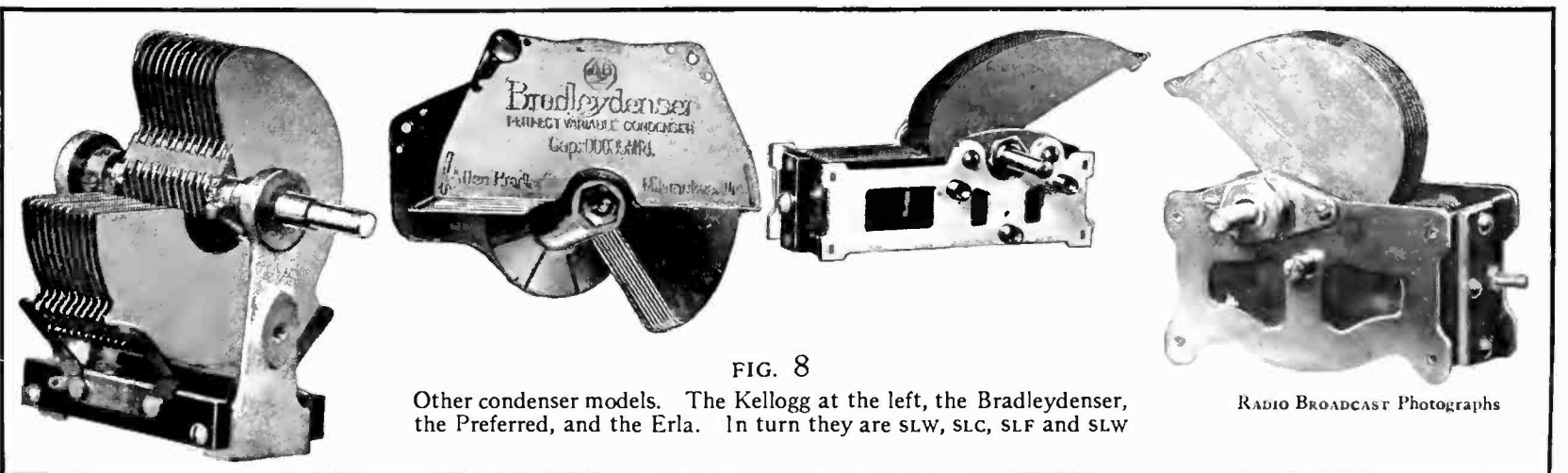

FIG. 8
Other condenser models. The Kellogg at the left, the Bradleydenser, the Preferred, and the Erla. In turn they are SLW, SLC, SLF and SLW

RADIO BROADCAST Photographs

SLC condenser and considerably more space than the SLW condenser. However, some new types now on the market are designed to fit in the same space as that occupied by the conventional SLC condenser found in so many radio sets. Another disadvantage of the SLF condenser is the difficulty of making it sufficiently small in zero capacity consistent with securing the desired maximum capacity. On the whole, these drawbacks are by no means serious and are largely overcome by proper design.

In considering the adoption of SLF condensers, make sure of these points: (1) Sufficient space for mounting. (2) Sufficient maximum capacity to suit the requirements of the receiving circuit. In addition, ask yourself these questions: (1) Do I have difficulty in adjusting the present type of condensers to the higher frequency stations? (2) Is it difficult to locate new stations?

These questions are similar to those for judging the SLW condenser; however they should be considered more from the view of the broadcast listener who is most interested in tuning-in a great many broadcasting stations, or separating a multitude of local ones.

Thus far nothing has been said of the theory of design of condenser plates. This subject is not uninteresting—even for the non-technical radio fan—and a little knowledge of this kind is a considerable help in determining the most suitable condenser for the receiving circuit. Owing to lack of space this discussion must be brief.

The shape of the plates of the SLF condenser can be determined from the formula:

$$R = \sqrt{\frac{K}{D^3} + r^2}$$

where R = distance from center of rotation of plate to the edge,
 r = radius of cut out portion of fixed plates,
 and K = a constant determined in designing the condenser.

Fig. 4 shows the shape of plate obtained

What Condenser Shall I Use?

Here are some questions to ask yourself as you consider which of the three available types to use.

If you debate using the straight line wavelength type:

- 1—Is it difficult, with my present type of condenser, to set the dials accurately for the required wavelengths?
- 2—Is it difficult to predetermine the dial settings for a new wavelength?

If the answer to these questions is yes, then the straight line wavelength type will meet your needs.

If you are considering the use of the straight line frequency condenser, ask yourself these questions:

- 1—Is there sufficient space available for mounting them?
- 2—Have the condensers in question, sufficient maximum capacity to suit the requirements of the receiving circuit?
- 3—Have I difficulty in adjusting my present condensers to the higher frequency (shorter wavelength) stations?
- 4—Is it difficult to locate new stations?

principally by computation from this formula. The formula has some interesting peculiarities. It shows that as R increases the dial setting decreases. Hence if in attempting to determine K, we assume the maximum value for R, D is zero and the equation is indeterminate. However we can determine K by assuming R at some other dial setting. For instance,

R = 4 centimeters when
 D = 20. Then if
 r = 0.8 centimeter,
 K = 122,900.

We can now place these values of R and K in the original formula and solve for various values of R corresponding to assumed values of D between 0 and 100. As D approaches zero R becomes enor-

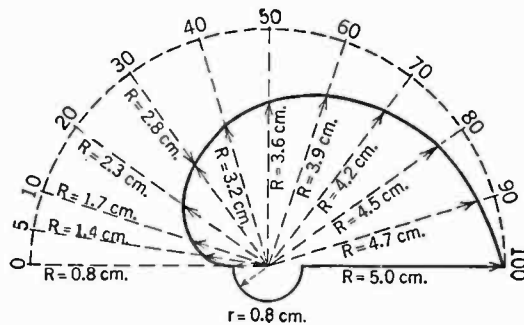

FIG. 9

The template for a SLW condenser rotor plate drawn to scale. The mathematics governing the computation of this odd-shaped plate are fully explained in the text

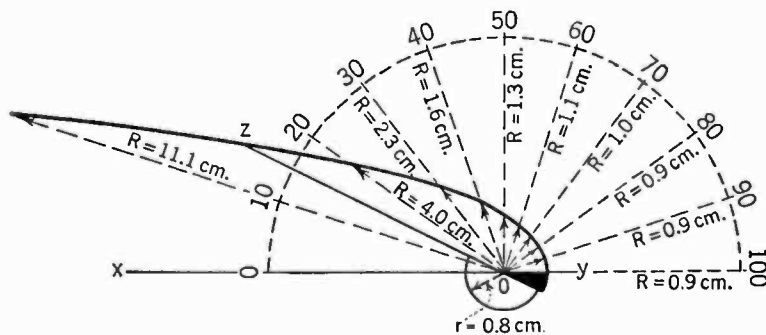

FIG. 10

The template for the SLW condenser rotor plate looks like this. Some condensers have variations of this general outline by providing changes in the stator plate to maintain the proper ratio of increase between rotor and stator plates

mous, and when D is zero R is infinite! Consequently the curve in Fig. 10 never reaches the zero line x-y. To overcome this difficulty, a point z is selected and a straight line is drawn through it and the point O. This produces an area shown in black which when added to the rest of the plate will complete its shape to give 180 degrees rotation. In actual practice, this long thin plate may be made somewhat "fatter" without greatly affecting its straight line characteristics.

The shape of the rotating plates of the SLW condenser is determined

from the formula:

$$R = \sqrt{KD + r^2}$$

Suppose we wish to design a rotating plate having

R (maximum) = 5 centimeters
 and r = 0.8 centimeter.

This means that

D = 100 (or 180 if the dial is marked in degrees).

We then substitute these values in the formula and solve for K thus:

$$5 = \sqrt{(K \times 100) + 0.64}, \text{ from which}$$

$$K = 0.24, \text{ which is now inserted in the original formula together with the value of } r^2 \text{ giving:}$$

$$R = \sqrt{0.24D + 0.64}.$$

Values of D, ranging from zero to maximum, are now assumed, the formula is solved for each corresponding value of R and a curve is plotted which gives the required shape of plate. There is not sufficient space to give these computations, but one can understand the method from Fig. 9 which the writer has drawn to scale.

Other shapes of rotating plates than those described in this article are used to secure straight line wavelength and frequency effects. Sometimes the stationary plates are given a special shape; again, some condensers are made with two sets of moving plates. In actual practice, a truly straight line wavelength or frequency curve is seldom obtained, but the curvature is generally so slight that it is of no practical consequence.

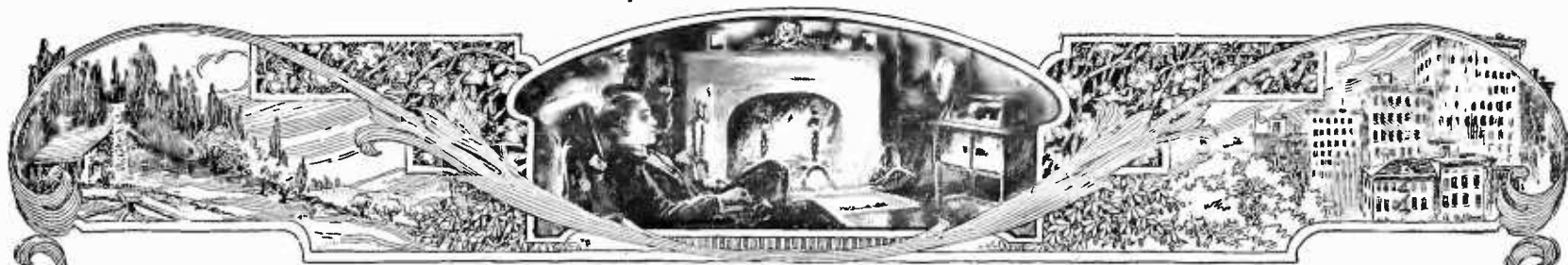

The Listeners' Point of View

Conducted by ----- John Wallace

The Announcer as an English Teacher

AMONG the functions attributed to radio by its more enraptured admirers is that of "cure-all."

Radio, the prize production of the twentieth century, is going to make the world safe for democracy, bring the heathen light, keep the boy off the streets, encourage home cooking, give wits to the witless, prevent war, and bring about an early Utopia.

Particularly clamorous are its devotees in proclaiming its cultural influence. It is the harbinger of the Super Man, the token of a new and greater civilization. In short, it is going to do everything that the printing press was expected to do—and didn't. Alas for the printing press: the widest circulating newspapers pay a bigger bill to the photo-engraver than to the typesetter. The yokel who isn't quite sure what m-u-r-d-e-r spells, at least knows what the big black X marks in the picture of South River Street.

Radio, as regards its educational probabilities, occupies a position slightly southeast of the tabloid newspaper. But in matter of making ladies and gentlemen of all of us, radio could be a factor in improving the native "polite" speech. Of course it isn't doing this. The large majority of persons behind microphones possess a vast ignorance of the English language as she is spoke.

Newspapers, even the worst of them, pride themselves on one unassailable standard i. e. accuracy in spelling—particularly of proper names. Any one who has witnessed the destructive antics of a Mr. Yjer J. Pheudlleski at the city editor's desk following his mention in print as Mr. Yjer J. Pheudllesky, will not wonder at this precaution. Pronunciation, however, is the least of a newspaper man's worries. The city editor probably called the above gentleman Mr. Fiddlestick, if, indeed, not something worse. Radio announcers, relieved of the worry of correct spelling, should, by way of evening the scales, be sticklers for exactness in pronunciation.

Now, to get to our "cure-all" point, reading right spelling in newspapers is not likely to make spelling champions of all of us, but hearing a word pronounced a certain way night after night is pretty certain to influence our pronunciation of that word. Hence radio's opportunity to play the rôle of reformer.

A reader writes in to complain of one announcer saying in swift succession: *jeopar'-die, vised for*

vi-sé, and the-a'-ter. We recall a *Meditation* from "*Thay-is,*" a Sampson and Delilah selection by "*Saynt Sayns,*" and . . . well why go on? Lest we sound too harsh, we will readily grant that we'd hate to try to pass an oral test on any five furrin' names. We wouldn't gamble on getting two right. (We haven't yet learned how to pronounce Chartreuse in a manner that will elicit response from a Parisian bar tender.) But all the same, if an individual sets himself up as announcer, and hence speaker to the millions, he has, we think, let himself in for a conscientious job of brushing up on his aspirants and liquid l's. And his vocabulary, as soon as he sets up in business as announcer, is a matter of public concern. His command of words should at least equal that of his average listener.

Once we were told we had been "listening to an ultra-cultural program of semi-classical songs played on the wonderful twin organ at superstation xxx." "Ultra" and "super" have been poohed at by better pooh-poohers than we. "Wonderful" is the delight of all illiterate enthusiasts. It is stretched to cover all manner of virtues, whether or not they inspire wonder.

We offer a fine bag of peanuts to the person who can prove there is any such word as "semi-classical." It belongs, we maintain, on the same shelf as "very unique" and "half dead." But that is a moot point. The radio expression that drives us into paroxysms of rage is that most detestable word: Kiddies. Why not, oh ye Uncle Charlies and Auntie Janes, call them

Children? That's what they are. The other appellation was coined by sweetly smirking old maids of both sexes. No one ever heard children refer to one another as "kiddies" so why attempt to foist the saccharine moniker on them. "Kids" is well and good; or, if that be too undignified, simply: Children.

The WLS Prize Play

THE Night Herd," the prize winning play in the contest conducted jointly by WLS and the Drama League of America, made its première last February before what must have been about the biggest first night audience in the history of play producing. And the occasion was made an auspicious one.

Mr. George Arliss, who was in Chicago playing in "Old English," made some well chosen introductory remarks; very gracefully pulled the inevitable pun about the play being "night heard"; and presented the Hoover Trophy Cup to the author, Levi Ballou.

And by way of adding further glamour to the event, two legitimate stage stars were pressed into service in the principal rôles. With all these fine trappings it was a bit unfortunate that the play itself didn't quite live up to its send-off.

The action of the play is laid in the Western cattle country. There are but three characters: "Tex", a cowboy who is playing night nurse to the herd (Holbrook Blinn, star of "The Dove"); "Lolita," the dissatisfied wife of another cowperson (played by Nance O'Neill) and "Jim" her husband (Harry Dean Saddler, WLS dramatic director.)

The station announcer simply read the list of players and stated that the scene was a ranch at two in the morning and that the principal character, Tex, was patrolling the herd on his horse. So much for the start—excellent in its brevity.

Then the play. First is heard the voice of Tex crooning a soft melody to his mount "Buck." The distant bay of the coyote, the occasional rustling of the moving herd, and the rhythmic sound of the horse's hoofs galloping over the plain constitute the only scenery.

By the clever device of having Tex talk to his horse, the author makes known the situation. Tex is in love with Lolita, whom he had known "down South" and who is now married to his fellow worker Jim. Then a crescendo of hoof



PROF. PAUL STOYE

Who is heard on the Monday program of WHO at 7:30 to 8 P. M.

beats announces the appearance of Jim. The two pledge their friendship. After Jim has left to attend to his own duties, up gallops Lolita, who ought to have been in bed long ago. This fickle corner of the triangle has discovered that it's really Tex she loves after all, and she launches forth on an impassioned plea that he take her back with him to the Rio Grande country.

This, of course, puts Tex in an awful jam, for he is thoroughly in love with the lady. But there is also his friendship for Jim to be considered. So being a denizen of the "great open spaces" and hence a Man, he breaks away from Lolita's amorous clutch, bids her be off, and rides slowly away, singing softly to himself. Finis.

The play was not a "wow," but it had so much to recommend it that the contest can be regarded as a success, and the author's efforts praiseworthy.

In the first place, the play was essentially radio drama, i. e. it was better adapted to radio than the stage, for the locale was shifting constantly as the horses galloped on. Secondly the "atmosphere" effects, such as the howl of the wolves, were convincing and suggestive. Thirdly there was never any doubt as to who was speaking.

But the story itself was trite and unconvincing. While the leads professed to be in the throes of dramatic mental anguish, their worries didn't quite secure our sympathy. And we were sorry that the play's unique feature—that the scene of the action was constantly shifting—wasn't made more of. As a matter of fact all the action could have taken place on one spot. Not a great play, but at any rate, a step in the right direction.

Poets as Broadcasters

JAMES STEPHENS, the Irish poet, gave a reading of his verse over WGN some time ago and we have since wondered why this radio possibility has not been further exploited. Poetry, if it be genuinely such, gains by being read aloud. And the opportunities for hearing poetry recitals are few and far between. Most contemporary poets undertake an at least occasional speaking trip to stimulate the sale of their volumes, but they only visit the larger cities, and never tarry for more than one public recital.

It has been paradoxically stated that no poet knows how to read his own work, but whether this be true or not, it is nevertheless interesting to hear his own interpretation of it. Besides, warrantable or not, there is always an interest



OPAL HEMLER

Soprano who has been heard from WTAM, at Cleveland. Her pleasing voice was heard by a listener in England who tuned-in WTAM last November. Mrs. Hemler was recently added to the staff of WTAM as assistant program director

added to a man's work if the man himself be known.

In the case of James Stephens (the only poet of any consequence we have yet heard by radio) his delivery of his own work was delightful, and we question if any reader could do as well by it. Mr. Stephen's persistent brogue is no small factor in his charm.

The days when ladies, dressed as Greek maidens, recited interminable poems to the accompaniment of a proscribed, and gymnastic, succession of gestures is happily over. No one, outside of high schools, reads verse any more, with any gesture other than that which is unconscious and uncontrolled. So the radio audience has nothing to lose in not observing the poet. (Though in the instance of Mr. Stephens, one who has never witnessed his intriguing appearance has missed a large share of his interesting personality).

Doubtless other poets have broadcast their works, but as we have happened on only this one instance we infer that poetry recitals are not, as yet, a frequent program feature.

The reason for this may be in the almost universal precaution exercised by program directors never to high-hat their audiences with anything too high-brow; or in the traditional timidity and modesty of the poets themselves; or in the failure of the publishing houses to realize that in radio lies their opportunity to clear their shelves of piles of dust gathering on "slim volumes."

Bring on the bards!

Shakespeare by Radio

THE considerable time that elapses between the writing of this material and its appearance in print occasionally results in our pleas being answered quite a while before they are even made known. Such a state of affairs is however, effective in preventing us from complacently imagining that our words brought about the desired reform.

As an instance of this, we urged in the March issue, that more attention be paid to the possibilities offered in Shakespearian production. In February, WEAf did that very thing. And we were pleased to note that the efforts were even more successful than we had hoped they would be. And WEAf started off its series of tabloid presentations of Shakespeares dramas with "The Merchant of Venice." From start to finish the performance was eminently successful. The

actors were intelligent and well versed in the tradition of Shakespearian production. Their interpretation of the lines was in accordance with the soundest judgment. Shakespearian lines, by the way, are no small task to read correctly; the slightest misplacement of stress may alter the whole meaning.

But perhaps the most praise should go to whomever it was, who "cut" the play to adapt it to a one hour presentation, for it was excellently done. All the sub-plots, with which "The Merchant of Venice" abounds, were eliminated, and only the thread of the principal narrative sustained. This made possible the elimination of all but eight characters, leaving, principally Antonio, Bassanio, Shylock, and Portia.

This "cutting" was not continued to the point of mutilating the text. Whenever a scene was given it was given in its entirety and (we followed the play with the book) only very occasionally was a word dropped out. The abridger managed to preserve most of the famous-soliloquies, for instance the "Quality of mercy" passage and Shylock's "Hath a dog money?" speech. Of course it will be protested, and with some reason, that we of the twentieth century should not seek to re-hash Shakespeare's immortal words, nor attempt to condense into one hour the material he wrote for three hours.

But such a protest is largely footless. Shakespeare constructed his plays with such nicety that it is possible to remove their joints and yet find their integral parts structurally intact. Besides, even if this be called a makeshift, and a lazy man's way of becoming acquainted with Shakespeare, it is better than no knowledge of him at all. Shakespeare's plays are more suited to reading than those of any other playwright in the entire history of drama. But he wrote them primarily for oral production, and in the very music of the spoken words is much that is lost in a mere silent reading.

WEAF presented as its second Shakespeare program, "Romeo and Juliet," which was followed later by "Hamlet" and others.

Communication

THE following letter, which we quote in part, was addressed to a commercial broadcasting station—the name of which is of no consequence—and a copy forwarded to us.

Broadcasting of any kind is advertising, be it religion, politics, or merchandise. Who benefits



©Drake Studio

JAMES STEPHENS

Irish poet and novelist who read some of his verse over WGN some time ago. Mr. Stephens is the author of *The Crock of Gold*



MME. ERNESTINE SCHUMANN-HEINK

Her concert proved to be one of the best and most popular in the Atwater Kent series which have been delighting radio audiences on Sunday nights for many weeks

from the broadcasting? The much-discussed Broadcast Listener receives entertainment—infrequently; you receive notoriety, which brings you hard, iron dollars—or you wouldn't do it. Who pays for the broadcasting? The Broadcast Listener!! Every penny of it! I am fed up with this ceaseless chatter about the "sponging" of the B. C. L.! Why are there nearly six hundred broadcasting stations on the air, and a waiting list of over four hundred? Are these persons so saturated with altruism that they rush into the spending of real money so they may uplift humanity with their various noises? Are these singularly philanthropic persons casting their golden bread upon the waters *hoping* to get some of it back? Hardly—to both questions; they haven't the slightest interest in humanity, and the results, financially, of this apparent disinterested largesse are figured out to the fraction of a cent.

I am tired hearing such persons as DeWolf Hopper sneer at the people who happen to be listening to a broadcast of which he may be a component; these same people have kept him in luxury for a lifetime. I resent the attitude of condescending tolerance with which the broadcasters view the rest of us. And if a lot of this silly cant doesn't cease there will be no listeners—and one wonders if broadcasting will continue in spite of that fact, if set manufacturers will keep on producing receivers even though they have no sales, if the radio combine will go on pouring out money on high powered stations to which no one listens. Again, hardly. When nine million persons like me are forced to feel that we are poaching and doing a discreditable thing every time we tune-in, right there we stop!

And the item of blatant advertising: no one objects to WEA's announcer telling us that we are indebted to the Goodrich Company for the excellent entertainment afforded by the Silver-town Cord Orchestra; or the Eveready Hour; or the Goldust Twins; or Roxie; or Atwater Kent. All advertising; all household words; but none of them insistent or in the least objectionable. How long do you think an audience would listen to the A & P Gypsies if every number were followed by a dissertation on the quality and price of their beans and pickles? A single, dignified announcement is quite sufficient.

You may have a meritorious article you wish to get before the public, but you overreach yourself when you go about it in the manner I objected to the other night. And if you spend six thousand dollars a week for advertising, please remember that it doesn't cost *you* a red farthing. I pay the bills when I buy Salicon, and if I didn't you would inevitably go out of business.

WILFRED TAYLOR.
Thompson, Connecticut.

Broadcast Miscellany

ADD to the opera companies at your beck and call, if such be to your liking, the Rochester American Opera Company which broadcasts Wednesday nights through WHAM and WGY. This company is an outgrowth of the Opera Department of the Eastman School of Music, University of Rochester, and is under the direction of Vladimir Rosing. The series has been tabloid in form, and rather well cut. Orchestral accompaniment is by musicians from the Rochester Philharmonic Orchestra.

BY WAY of showing off its not inconsiderable wire connections, WGY pulled an interesting stunt some time ago; for periods of fifteen minutes it sent out music from New York, Cleveland, Poughkeepsie, Albany, Schenectady, Syracuse, Rochester, Buffalo, and Washington.

This station recently celebrated its fourth birthday. Culled from the mass of proud statistics that always accompanies such an event are the following facts: WGY broadcast for the first time in this or any other country on 50,000 watts; it conducted a series of experiments using alternately horizontal and vertical radiation (maybe you know what that means—we don't); it perfected successful 250-mile radio relay on 1560 meters. It sometimes speaks with four different voices simultaneously, for its words and music may be picked up on 41 meters, 109 meters, 1560 meters, and 379.5 meters.

THE most interesting thing about the National Broadcast Listeners' League to our mind is the name of the president and vice-president. Introducing: Messrs. Luckey and Yockey!

MANIFESTO issued by KF1:
A positive belief that nothing of musical importance has ever or can ever come from a broadcasting station persists in the minds of certain people, even in the face of the many radio events of 1925 that would do honor to the greatest musical capitals. The instinct to decry and belittle broadcasting is laughably illustrated by the refusal of a Los Angeles music critic to listen, to the recent broadcasting of the complete Los Angeles Philharmonic Orchestra, conducted by Walter Henry Rothwell, on the ridiculous score that the concert couldn't be good if it were given in a broadcasting station. As an example of meritorious programs, KF1, a station representative of many, broadcast in 1925: Ernestine Schumann-Heink, Marcel Journet, Antonio Cortis, the Victor Recording Orchestra, Duci de Kerekjarto, Adolph Tandler's Little Symphony, the San Carlo Grand Opera Company, and other fine organizations and soloists of a more local nature. Compositions of every great composer,

modern and classic, were satisfactorily represented and rendered during the year, some of which were rescued from obscurity and introduced to a wide audience for the first time.

To attack broadcasting as an institution because of a percentage of unsatisfactory programs is like attacking literature because of the driveling books which flood the market, or the stage because of the inanities which appear on it, according to Earle C. Anthony, owner of KF1. He finds the bulk of the radio audience intelligently aware of the destiny of radio and content to accept the best efforts of broadcasters without unduly condemning those transgressions of good taste and quality that are primarily a result of the youth of the art.

PROPHETIC utterances by Mr. Powell Crosley, Jr., proprietor of WLW on the occasion of his station's fifth anniversary:

"I can safely prophesy reception of broadcast entertainment eventually from every nation on the globe. The only thing needed now is more power in the broadcasting station. I prophesy moving pictures and radio vision in homes within the next five years. This will be brought about by a vision microphone, set up to catch things you would like to see in various parts of the world—transmitted through a broadcasting station and received in your home on a moving picture screen. Another development that may come within a few years is the transmission of heat and energy by radio."

Willie, turn off the radio—the house has gone up to eighty!

KDKA having got off its chest a series of six weekly talks on public speaking, and a series of seven weekly lectures on "Chemistry and Human Progress" is now engaged in lading

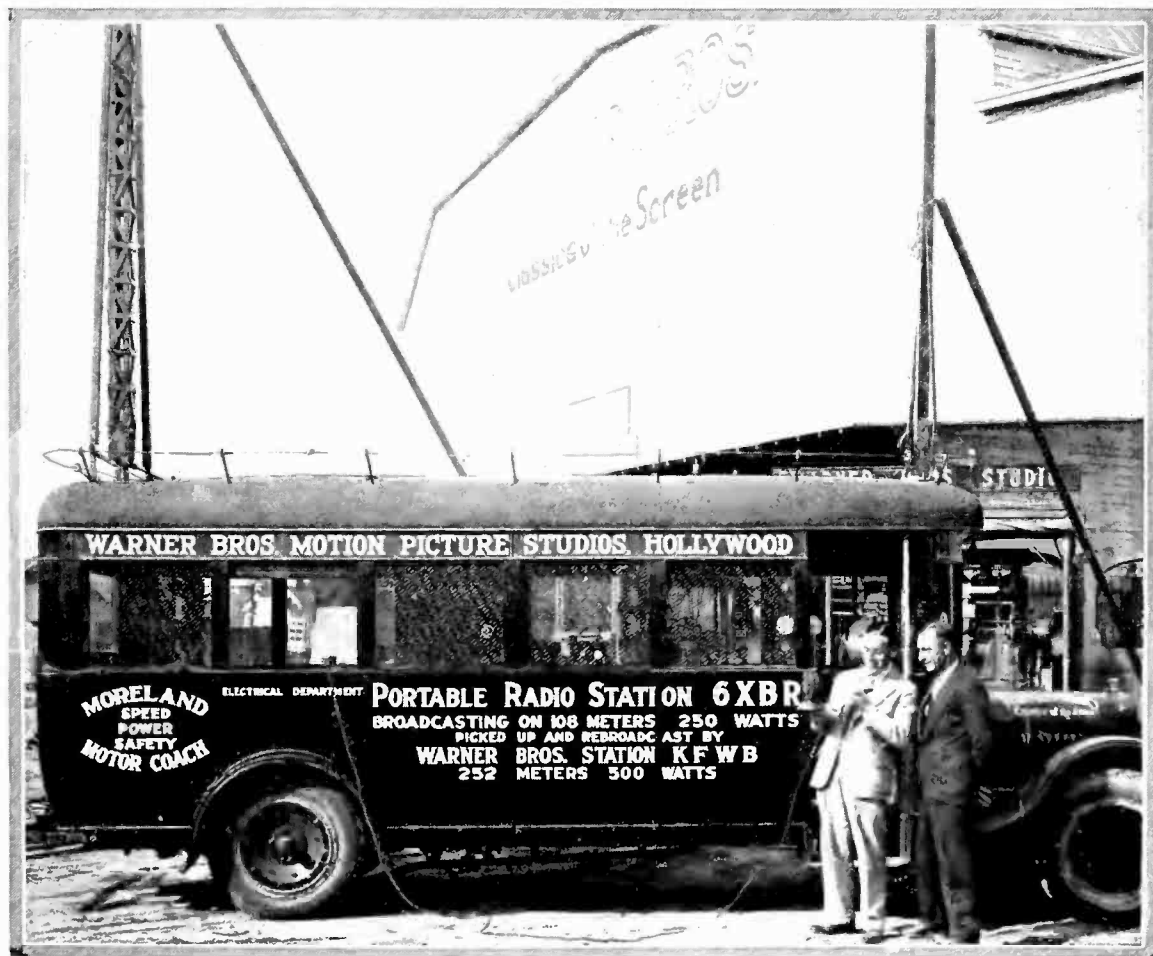

IN CALIFORNIA

The only important fact not told by the perfectly readable lettering on the portable radio station is that the two standing with possessive air near the door of the "studio" are Charlie Wellman, manager and announcer at KF WB, left, and Frank H. Murphy, chief electrician for Warner Brothers

out a "Science in the Home" series every Wednesday night at 8:15.

These educational features come from KDKA's University of Pittsburgh studio. While we are inclined to believe that information gleaned from reading is not as likely to go in one eye and out the other as radio'd information is prone to go in one ear and out the other, still there may be a slight permanent value in these lectures.

At any rate they are presented in an interesting manner, and in every instance by a capable lecturer, thoroughly familiar with, if not even an authority on the subject.

The Spring Science series listed such subjects as these: Food Values, Foods from the Sea, Selection and Care of Beds and Bedding, Fuel Economy in the Home, Home Disinfectants and Insecticides, Selection and Care of Textile Fabrics, Renovation of Wearing Apparel, Care of Tableware and Kitchen Utensils, Selection and Care of Flooring Materials, and so forth.

OUT of consideration for the radio audience of the United States Marine Band Orchestra, the Marine Corps has authorized the draping of the walls of the Marine Barracks in Washington from which the Marine's music is broadcast by WRC, WJZ, WGY. This draping should greatly benefit the acoustic properties of the auditorium and eliminate the slight echoes which have been noted in the past.

PRINTED announcement told recently of a "Hickey Game" to be broadcast by WJZ direct from Madison Square Garden. You may roll your own joke.

WGN is engaged in signing up a body of "official listeners" and now has over 1000 scattered throughout the country. They are expected to offer a regular channel through which worth while information on program and broadcast quality will reach the station, information which formerly had to be culled from the mélange of miscellaneous listeners' letters. Most of the larger stations, we understand, have a staff which analyzes the mail received. The new method makes it possible to grasp worth while information in a much quicker way.

Official listeners are being selected by WGN from points in all sections of the country, and their very distance from the station should be an admirable way of judging reception in their localities. All of the listeners are being furnished with blanks on which space is provided for marking the quality of the program, the volume of the station, for checking fading and objectionable atmospheric conditions.

WOR is presenting as a tri-weekly feature, on Monday, Wednesday, and Saturday evenings, George Tcherban's Katinka Gypsy Orchestra. This band was first formed by Tcherban in Constantinople and only recently came to America. Their work both in the general classic literature of music and in their native Russian and Gypsy airs is very good. To our own dance music they bring their innate sense of rhythm and an individuality of treatment.

WKRC at Cincinnati has built itself a new and very fancy studio in the Hotel Alms. Came to our desk copious pages from WKRC's publicity department foretelling the event and describing the opulent layout in detail. Therein we learned:

"When finished, the studios will be among the most lavish in the country. Here will be found the most artistic furniture from the Italian periods; gorgeous draperies for walls and ceilings. Rich rugs and artists will be engaged to decorate the walls and ceilings.

That last sentence leaves us guessing. We picture, on the one hand, a couple of long haired Persian carpets perched on the giddy heights of a scaffold busily engaged in painting cupids and blue clouds on the ceiling. Or on the other hand: an assortment of artists, neatly ironed out, and secured to the wall by thumb tacks in the manner of cow hides and bear skins. Neither picture is entirely convincing—besides artists aren't rich, even if the rugs are.

ADD to the now imposing list of first string artists who have appeared before the microphone the name of Mary Garden. She was heard, some time ago now, through WJZ. Miss Garden being one of the meager four or five opera singers worth seeing as well as hearing, and being by all odds the first of that four or five, it seemed to this listener a crime to limit her two-dimensional art to the single dimension of radio.

WE ARE glad to note the return of George Barrère's Little Symphony orchestra to WEAf. George Barrère, himself, recognized as one of the world's premier virtuosos of the flute, founded the "Little Symphony" in 1914, when it was called into being at a concert given in New York City for the benefit of the American Red Cross which carried on such important work during the war.

The "Little Symphony" consists of a choir of wind instruments, flute, oboe, clarinet, horn,

trumpet and bassoon combined with an adequate balance of the strong section and to the music lover and student offers an unusual opportunity to study the use of the more important instruments. It has often been called "The Miniature Orchestra," for it possesses all the qualities of the full symphony and at the same time a sweetness and subtle charm which is so often lost in a large orchestra.

WHT, Chicago, announces with pride that "if the particular number coming from WHT does not suit your fancy, wait three minutes and another will succeed it." Commenting on this new rule the station's program director said: "It will give the entire program more freshness and more variety. Moreover, the artists themselves are in favor of being limited to three minute selections, which will allow them to play but one number. It will allow them to concentrate on this number and give it "a more intense interpretation," as one of them put it. The only exception to this rule will be special speakers who will sometimes be allowed eight minutes, and dance orchestras who will be allowed about the same amount of time.

Which causes this listener, who has, as you know, ranted on at great length against the "kaleidoscope," program, to throw up his hands in holy horror and erase the letters WHT from his log.

WE KNOW of no concert on the entire Atwater Kent series concerning which we have heard more favorable comment than that of Madame Schumann-Heink. Added to the fact that the famous contralto enjoys the affection of the whole nation, her voice is admirably suited to radio transmission. She succeeded in making felt her personality quite as well as she does on the concert stage.

Another WEAf program that seems to have been greatly enjoyed was the third annual concert of the Associated Glee Clubs. Twenty-six Glee Clubs from New York City and several other cities near by, with a combined membership of 1200, took part. Miss Anna Fitzu of the Metropolitan and Chicago opera companies was soloist. Walter Damrosch directed the event.

THE Victor Hour programs, broadcast at intervals through WJZ, WGY and associates, continue to be *pièces de résistance* on the radio menu. WJZ has inaugurated the broadcasting of the Saturday morning (11 A. M.) Children's Concerts of the Philharmonic Society of New York from Aeolian Hall. And we trust they are being occasionally listened to, though the hour is most unseemly.

HOWARD THURSTON, the magician, has succumbed to the lure of radio, and filled a first engagement recently at WLW. Thurston is gratified at the success of transmitting photographs and the human voice through the air, and makes prediction that it may be possible to broadcast human beings—the dream of many scientists and inventors. Experiments are being



ADOLPH SCHOTTLER AT WAHG

A well known soloist on the bass viol. Mr. Schottler and his accompanist, Mita Weinzoff, composer-pianist, are frequently heard on Saturday afternoons over WAHG



RALPH FREESE

One of the announcers at KOA, Denver. Listeners to this station, in their correspondence, have hazarded guesses as to his personal appearance. Although his voice is low and mellow, he is not "tall and thin" as one letter-writer assumed. He is a lyric tenor and not a basso. The microphone voice, it may be added, is most deceiving

conducted by Thurston along the lines of broadcasting a human form through space. He carries some apparatus with him and has a greater part of it in his laboratory at Beechurst, Long Island.

We have a boundless faith in Mr. Thurston's ability to do any thing he pleases, and hereby earnestly entreat him to cease his experiments. Imagine the unwelcome shock of having your most hated announcer suddenly start to trickle through the loud speaker, jump lightly to the parlor floor and shout brightly "Well, here I am folks!"

WHAZ, the Rensselaer Polytechnic Institute station at Troy, New York, sends out a good program Monday evenings (its only time on the air). These programs are semi-highbrow in nature, well done, and prone to specialize in music's "best sellers."

AFTER all is said and done, it is the regular weekly features that constitute the best that radio has to offer. The various So-and-So Hours set a definite standard for themselves and attempt to live up to it. They use none but paid labor and come around every seven days at a fixed hour which makes them easy to locate. They maintain a more or less uniform type of program, so the listener knows what to expect. Those "Hours" you dislike you can carefully skip; those you like you can count on. So clearing our throat and noisily tipping over the gilded banquet chair, we arise and take this occasion to welcome the new Bakelite Hour, from WJZ, eight to nine P. M. Sunday nights.

WHEN in need of jazz try WSM, Nashville, Tenn., Monday, Wednesday, Friday, or Saturday nights between 6:30 and 8. Francis Craig holds forth at this time with his prom trotting band, and of them this eulogy, largely deserved, has been written: "They strike a happy medium between the spiritless, phlegmatic style of the mechanists whose souls are unmoved by syncopation, and the slambang, ear-splitting squawks of the amateur gatherings whose ecstasy resembles too closely idiocy, and fill the air with soft, tantalizing sounds of amazing sweetness."

Another jazz band that titillates our tympanum is Paul Specht's Original Orchestra which WJZ picks up from the Moulin Rouge in New York. They're good, in spite of the fact that they ponderously label themselves "rhythmic, symphonic, syncopators."

WGBS, ever faithful in tapping New York's theaters for what they may have, did a good job recently of broadcasting the "Charlot Revue" from the Selwyn Theater—as good, at least, as such pick-ups ever are. When a sketch came on the boards that couldn't be intelligibly listened to without aid of vision WGBS switched to its studio and filled in the interval.

THE KGO players, when last tuned-in, were engaged in the weighty task of broadcasting Sir Edward Bulwer Lytton's "Richelieu." Wilda Wilson Church, director of this organization, had her hands full, what with directing a cast of sixteen players. Considering the size of the cast, the length of the play (five acts), the fact that it wasn't written by Sir Edward for the radio, and likewise considering our usual hostility to radio plays, it was well done!

CHICAGO, every now and then, crashes through with something good. Jacques Gordon, violinist, offered a series of concerts through WGN that were especially fine. Mr. Gordon is concertmaster of the Chicago Symphony Orchestra and enjoys a well earned renown. He plays, if it be of interest, a Stradivarius violin called the "Clara Schumann Strad," which once belonged to the wife of the famous musician of like name.

WBAL has been broadcasting a series of "Musical Scenarios" that have proved an interesting novelty. They are arranged by Broughton Tall, musical writer and dramatist, and a member of WBAL's staff, and are narrated by Harry Welker.

The first of the series was "The Evolution of American Popular Song." It traced the history of song in America from the days of the Revolution, 1776, when "Yankee Doodle" was the popular piece of the day on down through the many "periods" that have featured the centuries, concluding with George Gershwin's famous "Rhapsody in Blue."

America's song history, as presented by Mr. Tall's scenario, is intriguing, to say the least. Following the vivid, colorful Colonial period when lovely crinolined ladies in powdered wigs flirted over lace fans with velvet clad gallants, on through the war of 1812 with its "President's



"UNCLE JOHN," OF KHJ, LOS ANGELES



AT KSL, SALT LAKE CITY

State Senator Herbert S. Auerbach is shown feeding Teddy Grizzly Bear after his (the bear's) broadcast over KSL. At KSL, they say that the bear's broadcast was highly popular with listeners, although how the deuce the grizzly could be distinguished from thunderstorm static, we don't claim to say

March," the slave songs that have colored many later important musical works, until in 1850 we come to Stephen Foster's quaint songs, including "Massa's in de cold, cold ground," "I Was Seeing Nelly Home," and other pieces that had a great vogue during the days just prior to the outbreak of the Civil War. This conflict brought "Tramp, Tramp, Tramp, the Boys Are Marching" and then came the Southern songs, "Dixie," "Old Oaken Bucket," "Silver Threads Among the Gold," etc.

Continuing, the scenario depicts the days of Tony Pastor's theatre which made famous "Rosie O'Grady," and "On the Banks of the Wabash." And then we see George M. Cohan's cake-walk, the two step, and hear "It's a Grand Old Flag." The Spanish war ushered in another patriotic "period" punctuated by "Good-bye Dolly Gray," "There's a Hot Time in the Old Town To-night"; came next such songs as "In the Good Old Summer Time," "Wait Till the Clouds Roll By," "Back, Back, Back to Baltimore," "In the Shade of the Old Apple Tree."

Finally, we come to the modern song period illustrated by Irving Berlin's "Alexander's Ragtime Band" and later, the outburst of patriotic songs—"Over There," "Joan of Arc," etc.—that accompanied the World War which led directly to the jazz period of which George Gershwin's "Rhapsody in Blue" is perhaps the most serious and noteworthy contribution.

AN INTERESTING item on WLW's programs is the Burnt Cork Review. This is an organization of instrumentalists, singers and comedians, who provide an hour of favorite songs and stories Tuesday evenings at eight o'clock. Louis John Johnen, director of the station, is interlocutor.

KGW, the *Oregonian*, at Portland, Ore., will install a 1000-watt broadcasting station of Western Electric manufacture, to replace the 500-watt equipment now in use. The station with its new equipment will probably be ready to go on the air about the middle of April.

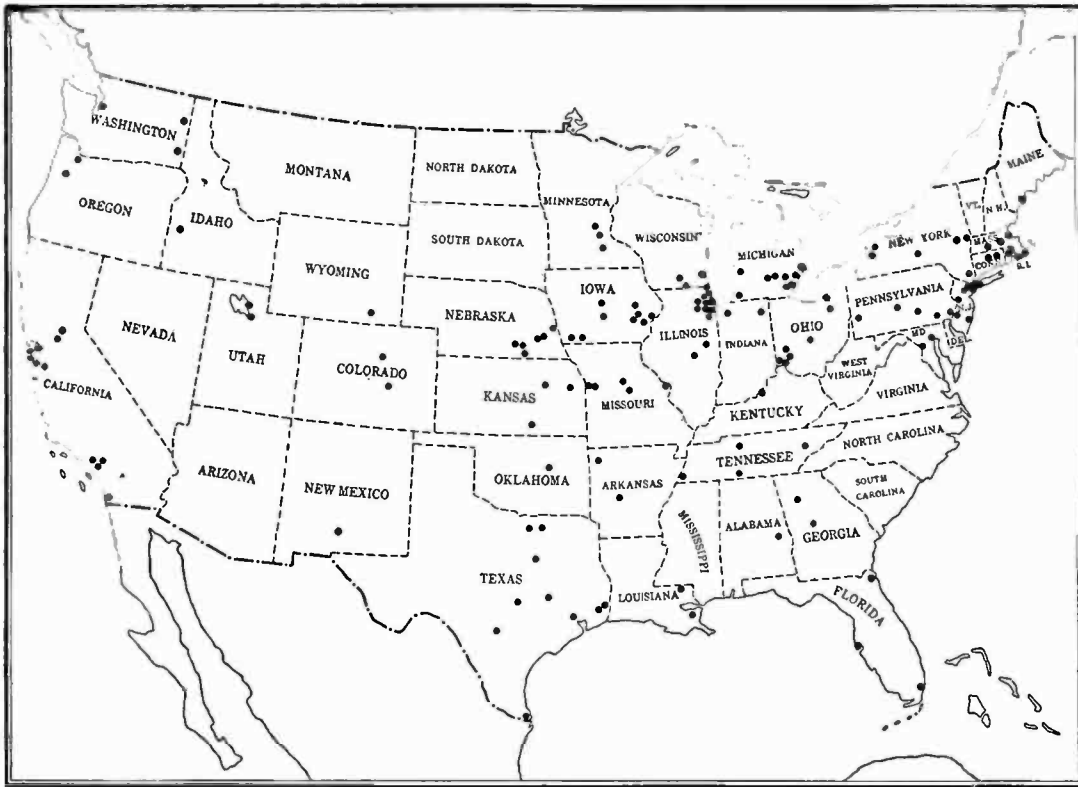

WHERE THE LOCAL RECEIVER WILL BE MOST EFFECTIVE

The dots indicate locations in the United States which have broadcasting stations of at least 500 watts power. The set described in this article should be most effective in at least a twenty-five mile radius of the dotted localities

The "Radio Broadcast" Local Receiver

Constructional Details for a Simple Five-Tube Receiver Designed Specifically for Local and Not Distance Reception with the Highest Quality of Reproduction as a Goal

By JOHN B. BRENNAN

WHEN the radio constructor considers the building of a radio receiver sometimes he is after distance reception, sometimes merely to putter around, but nine times out of ten what is really desired, whether seriously considered or not, is good quality of tone from the loud speaker. It is surprising too, to note the increasing number of people with five-tube sets sold to them for their wonderful distance qualities, listening with much satisfaction to the local program.

All this points in a certain degree to the prominence of the local station in the life of the American citizen. In reception he wants quality. His local station, because it is local, is more apt to supply it than a station at a distance.

No elaborate receiver is needed to bring to his home the quality of music and speech to which he would like to listen. There are several requirements that must be fulfilled. The receiver must be turned on and off without disconnecting wires; it must have a dial to tune from station to station, and lastly there must be a volume control. Simplicity itself.

The receiver described here fits in very nicely with these requirements, having been designed to embrace these general specifications. Five tubes—one tuned radio-frequency amplifier, a regenerative detector, a transformer audio amplifier, and two stages of resistance audio amplification—insure for the receiver a suitable signal pick-up and tone amplification that puts it in a class where tone quality and simplicity of tuning are prime requisites. The tuning of the radio frequency and detector stages is obtained by employing a "gang" condenser—one with two stator sections insulated from each other and a common section of rotor plates.

To suppose that in a home-made receiver the

tuning points for both tuning condensers would be exactly the same would be too much. Even assuming that both tuning coils have the same number of turns of the same size wire, the chances are that the connections from coil to condenser to tube socket would not be the same for each tuned circuit and accordingly would introduce differences in the value of each circuit sufficient to cause a detuning effect. This effect would manifest itself in such a way as to prevent a signal, impressed on the grid of the first tube, from being passed along to the second tube.

To offset this possibility of difference in tuning for each tuned circuit, that section of the duplex condenser which tunes the detector circuit is shunted with a midget condenser to serve as a vernier adjustment and allows both circuits to be brought into resonance with each other. Many may prefer to employ this midget condenser as an auxiliary volume control when exceptionally strong locals are being received.

The output of the detector is passed along into an audio transformer purposely designed for high quality amplification. By its use, a greater



RADIO BROADCAST Photograph

FIG. 1

First appearances and impressions often deceive. The dial located in the center of the panel, viewed here, is used as the main tuning control. The others do not complicate the operation of the receiver, that to the right being a volume control and that at the left, an auxiliary tuner

amplification in signal is gained than if all resistance amplifier stages were employed.

THE AUDIO CHANNEL

TWO resistance audio amplifier stages follow the transformer amplifier stage and in the last socket, a type 112 tube provides an efficient power amplifier, necessary properly to operate any good horn or cone loud speaker.

On this last stage, the plate voltage is 135 with a grid bias of 9, or 180 volts with a grid bias of negative 13.5, or 225 volts with a negative 18 volts bias. On the first two audio and the radio stage, the plate voltage is 90. For the detector, 45 volts will be found suitable. At least nine volts C battery is necessary for a 112 tube and not more than three volts should be applied to the grids of the first two audio amplifiers. Where greater volume is desired from the receiver, the B battery voltage for the radio frequency stage should be increased to a point just below where the r. f. stage will oscillate.

All the filaments are in parallel and are controlled by one filament ballast so designed that it will pass $1\frac{1}{2}$ amperes of current and allow 5 volts on the filament terminals. Those satisfactory for this purpose are the Brach, the Elkay, the Amperite, and the Daven filament ballasts. Where one ballast of the correct size is not obtainable, any two that total $1\frac{1}{2}$ amperes may be employed in parallel, or a separate ballast may be used for the 112 tube.

From Figs. 1 and 2, the panel layout will be seen to be quite simple. The large dial in the center commands immediate attention and is the main tuning control. To its right is the volume control, otherwise the regeneration control, and at

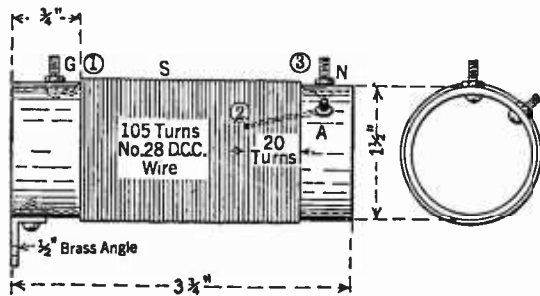

ANTENNA COIL UNIT

FIG. 3

The construction of the antenna coil unit is fully shown here. Cardboard tubing may be used to wind the coils, but hard rubber or micarta tubing is more to be desired

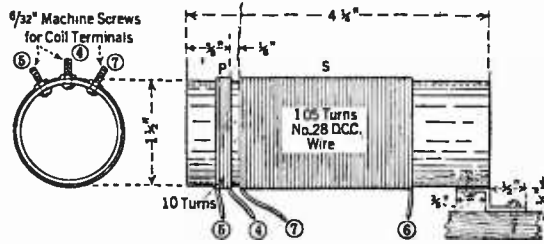

DETECTOR COIL UNIT

FIG. 4

The detector coil unit is quite similar to the antenna coil unit except that a plate coil is provided. The numbered terminals coincide with the connection shown in the circuit diagram, Fig. 7

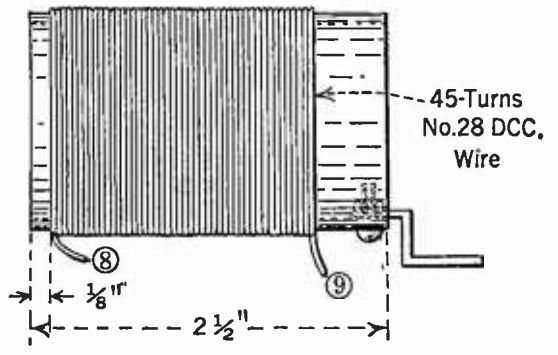

TICKLER COIL UNIT

FIG. 5

The tickler coil is wound on the same size tubing as the antenna and detector coil units. It is supported by a small brass bracket similar to that supporting the detector coil unit

the left end of the panel the vernier tuner, sometimes used as an auxiliary volume control is located. Filament switch and loud speaker jack are placed to either side of the main tuning dial and directly below it.

Inside the receiver the audio amplifier tubes are arranged along the back edge of the baseboard while on either side, and to the rear of the tuning condenser, which is the central object, are placed the two sockets, one for the radio stage, the other for the detector. The two

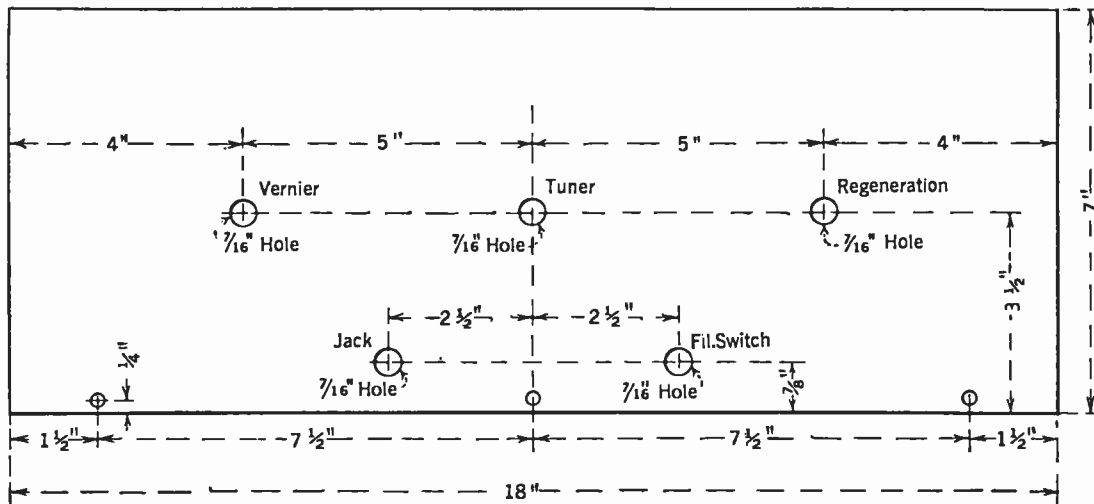

FIG. 2

In this panel layout the main mounting or shaft holes are all of the same size, i. e., $\frac{7}{16}$ ". The holes through which are passed the wood screws which fasten the panel to the baseboard are drilled with a No. 18 drill and countersunk if flathead screws are used. The actual mounting holes for the condensers are not shown as their positions will differ for the several types of condensers which may be employed

The Facts About this Receiver

In the circuit diagram, Fig. 6, the values of the lettered parts are:
 C1—.000375 mfd. C6—.002 mfd. R1—.665 ohms (to pass $1\frac{1}{2}$ amps)
 C2—.000375 mfd. C7—.00025 mfd. R2—3 megohms
 C3—.000016 mfd. C8—.1 mfd. R3—100,000 ohms
 C4—.00025 mfd. C9—.1 mfd. R4—1 megohm
 C5—.002 mfd. L1 } Construction de- R5—100,000 ohms
 L2 } scribed in text. R6—1 megohm

The other parts used in the model built in the Laboratory are:

- 1 Marco Vernier Dial
- 1 Panel 7" x 18"
- 1 Baseboard 12" x 18"
- 1 Open circuit jack
- 1 Filament Switch
- 5 Sockets
- 1 Rauland Lyric audio transformer
- 9 Binding Posts or Fahnestock clips
- Miscellaneous: screws, brackets, wire, etc.

OTHER PARTS THAT MAY BE USED

Tuning Condensers
 Gardiner-Hepburn
 Bremer-Tully
 U. S. Tool
 Hammarlund
 Lombardi
 Bruno

Audio Transformers
 Rauland-Lyric
 Patent Superaudioformer
 Federal
 Erla Concert-Grand
 Amertran De-Luxe
 Thordarson

Resistance Coupling Units
 Daven
 Mountford
 International
 Amisco
 Muter
 Brach
 Electrad
 Aerovox

TUBES

R. F. and Detector
 201-A
 199

1st and 2nd Audio Stages
 201-A
 or
 HIGH-MU

Last Audio Stage
 SEMI-POWER TUBE
 SUCH AS 112
 or
 W. E. 216-A

tuning coils are directly behind the condenser and between the two tube sockets.

It is obvious that, in a receiver of this kind, where one condenser control adjusts two tuned circuits, these two circuits must be very similar in electrical and physical dimensions so that as the condenser plates are rotated, the two circuits keep in step with each other over the entire scale of the dial. An approximate similarity is the most that can be hoped for in the coil units, and any slight difference is compensated for

in the vernier condenser adjustment. To make coils that are similar is the immediate problem.

DETAILS OF THE COILS

ON A piece of bakelite or cardboard tubing $3\frac{3}{4}$ inches long and $1\frac{1}{2}$ inches in diameter, 105 turns of No. 28 d. c. c. wire are wound, the

first turn starting $\frac{3}{4}$ inch in from one end. See Fig. 3. This end connects to the grid of the radio frequency tube and to those stator plates of the two-gang condenser that are to be used for the radio frequency stage. The last turn is common to both ground and negative A battery line and also connects to the rotor shaft of the two-gang condenser. Twenty turns from this end, a tap is taken which connects to the antenna post. At the grid end of the coil a $\frac{1}{2}$ -inch brass angle piece is

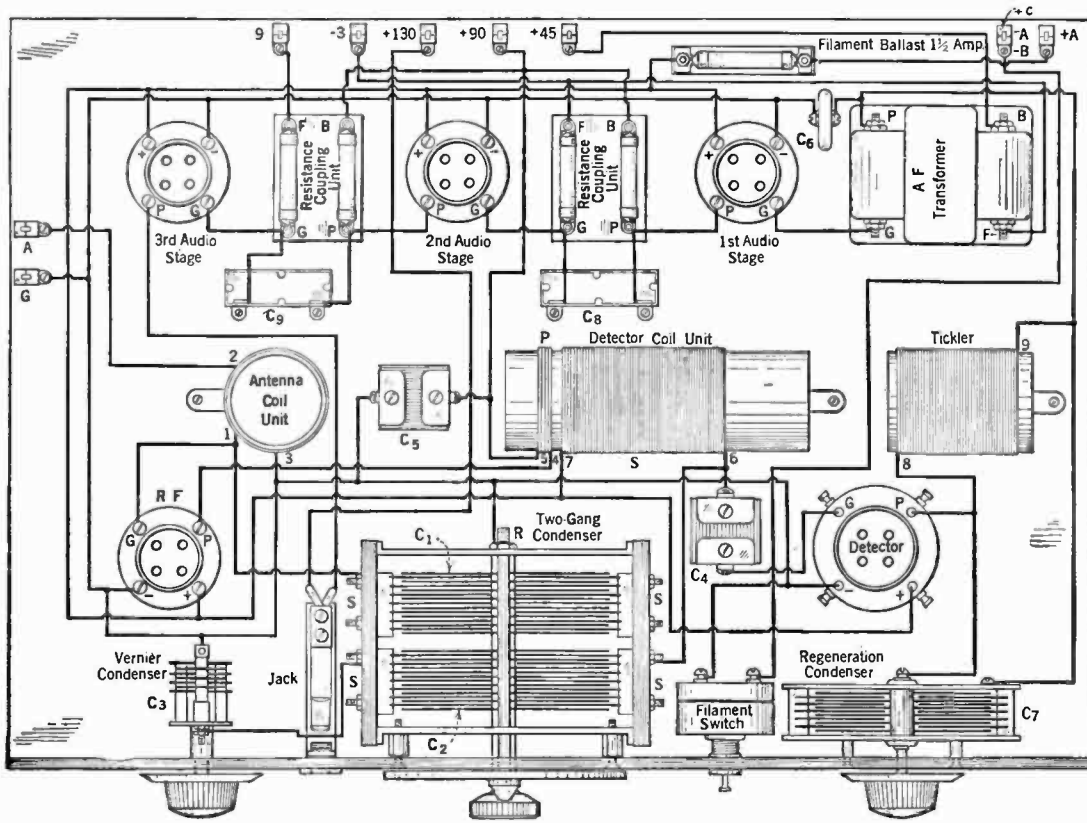

FIG. 7

This illustration, besides showing the actual wiring of the receiver, shows the placement of all the parts and makes the job of assembly and wiring quite simple

amplifier, connects to the B+90 terminal. The last turn of this plate coil connects to the plate of the r. f. tube. The first turn of the secondary connects directly to the positive terminal of the detector socket and *does not* connect to the condenser as usual. One hundred and five turns are also wound for this secondary, the last turn connecting to the grid leak and condenser and also to the stator plates for the detector.

The tickler coil consists of 45 turns of the same wire wound on the same diameter tubing $2\frac{1}{2}$ inches long. It is fastened to the baseboard by a brass angle piece in the same manner as



RADIO BROADCAST Photograph

FIG. 8

This shows clearly the type of duplex or gang condenser used in constructing the local receiver. Two sections of stator plates, insulated and opposite from each other, and one shaft having two sets of plates thereon make up this condenser which is employed simultaneously to tune the antenna and detector circuits

fastened by which the coil is mounted in place on the baseboard.

The same diameter tubing is used for the detector coil unit and tickler coil shown in Figs. 4 and 5. For the former, 10 turns of the same wire are wound, the first turn beginning $\frac{5}{8}$ inch from one end of the tubing. In the sketch Fig. 5, the dimension $\frac{5}{8}$ inches indicates the space from

the edge of the coil form to the last turn of the 10-turn coil. This should show the $\frac{5}{8}$ -inch space from the edge to the first turn. After the ten turns have been wound the wire is cut and an $\frac{1}{8}$ -inch space is left between this coil and the first turn of the next winding which is the detector secondary. The first turn of the ten-turn coil, otherwise the plate coil of the radio-frequency

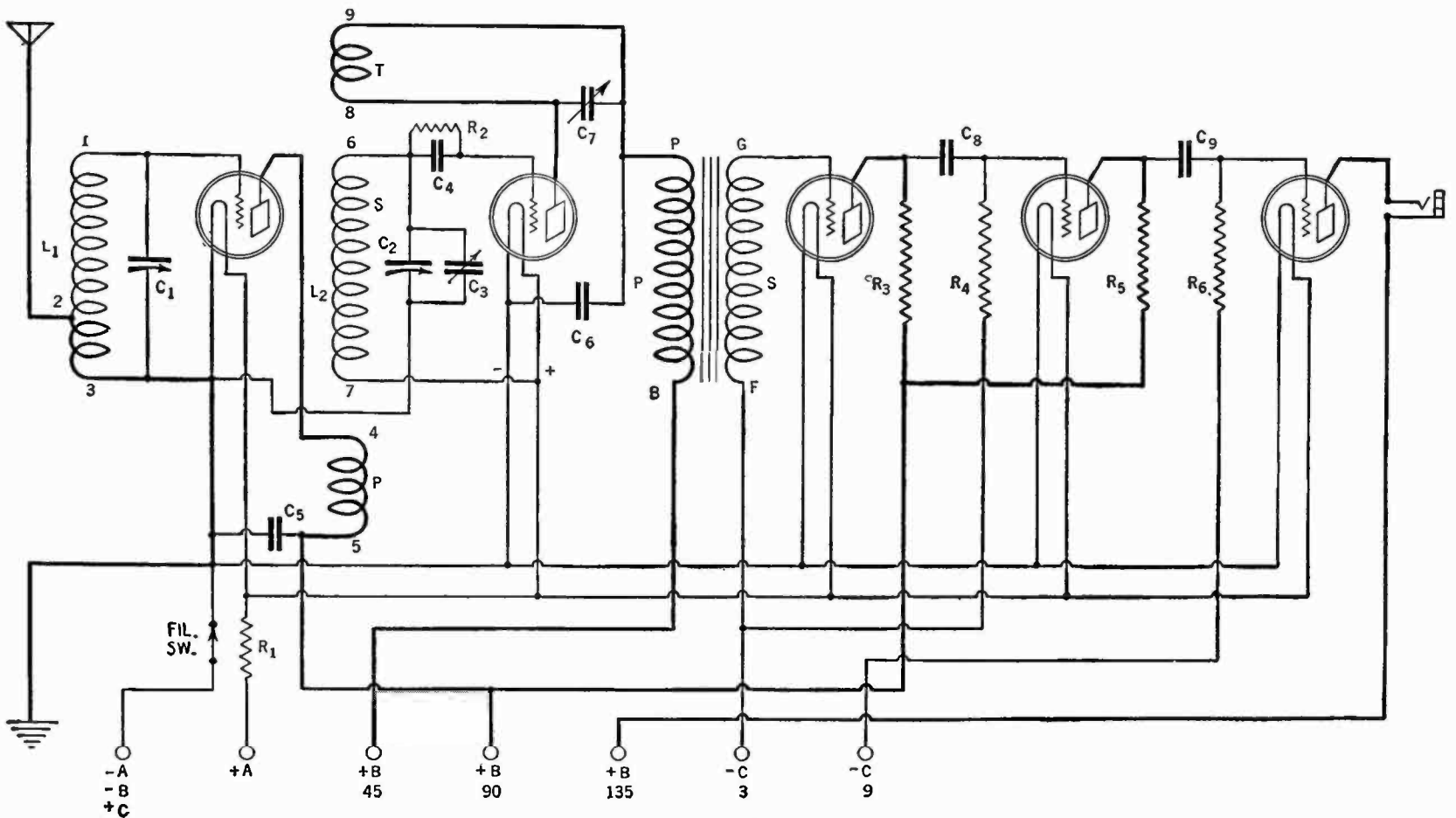
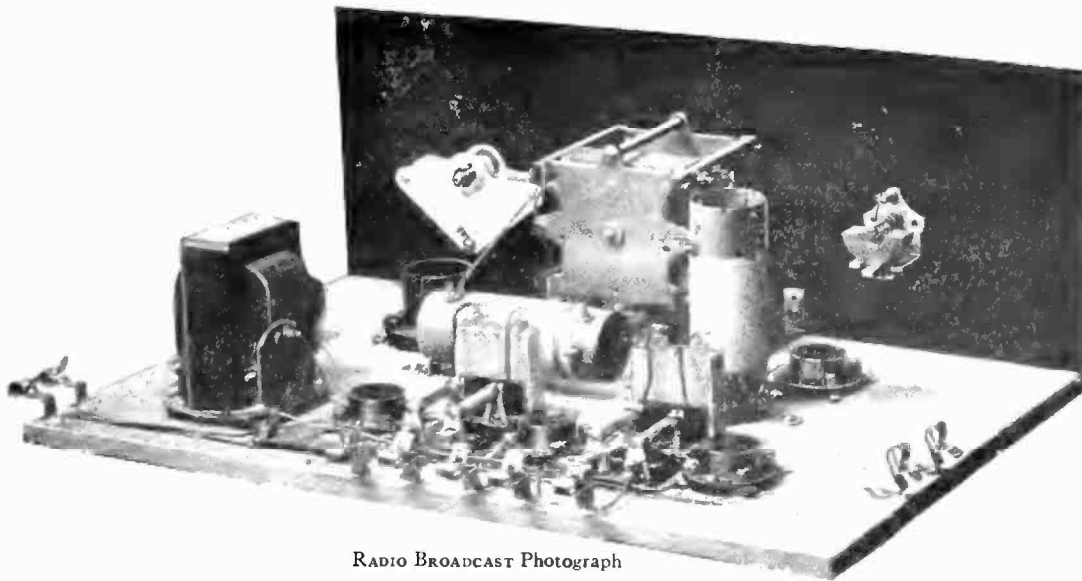

FIG. 6

The circuit diagram for the Local Receiver is not complicated, although there are several features involved that are somewhat new. The values for the various parts are contained in the text



RADIO BROADCAST Photograph

FIG. 9

A general view of the local receiver partly wired. To the ingenious and energetic set-builder the possibilities for making use of a sub-panel assembly are evident

the detector coil unit. This coil is wound in the same direction as the turns on the detector coil unit.

Small holes drilled into the tubing with a No. 57 drill allow the constructor to pass the coil end-leads down through these holes and through the center of the tube to several 6-32 machine screws which have been previously fastened at the end of the tubing to act as terminals. This facilitates wiring and insures against breaking delicate coil wires.

The peculiar connections of the return side of the detector secondary are evident from a glance at the circuit diagram for the receiver in Figs. 6 and 7. For proper detection it is better that the return side of the detector secondary be

connected to the positive filament terminal of the detector socket rather than to the negative. Since for a radio-frequency amplifier, the opposite holds true, then if the rotor shaft of the gang condenser, which is common for both condenser sections, be connected to the negative side, it is not possible to connect the detector return to the rotor shaft and to the positive side of the filament terminal because such a procedure would cause the A bat-

tery to become short-circuited. Therefore, this difficulty is evaded by connecting the return side of the detector secondary not to the rotor shaft but direct to the positive terminal of the detector socket.

A TUNING CHART

AFTER the receiver has been assembled and wired it is worth while in operating it to prepare a chart or curve to enable the operator to tune to stations without having to fish for

FIG. 11

If the detector oscillates too violently the tickler coil may be turned on its pivot screw so that its turns are at right angles to those of the detector secondary. The photograph here incidently shows the line up of the coils to minimize inter-coupling effects

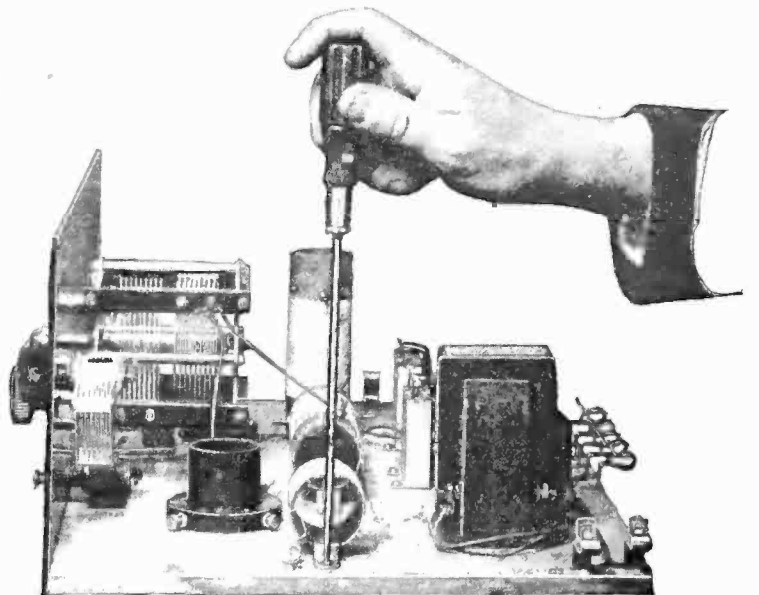

RADIO BROADCAST Photograph

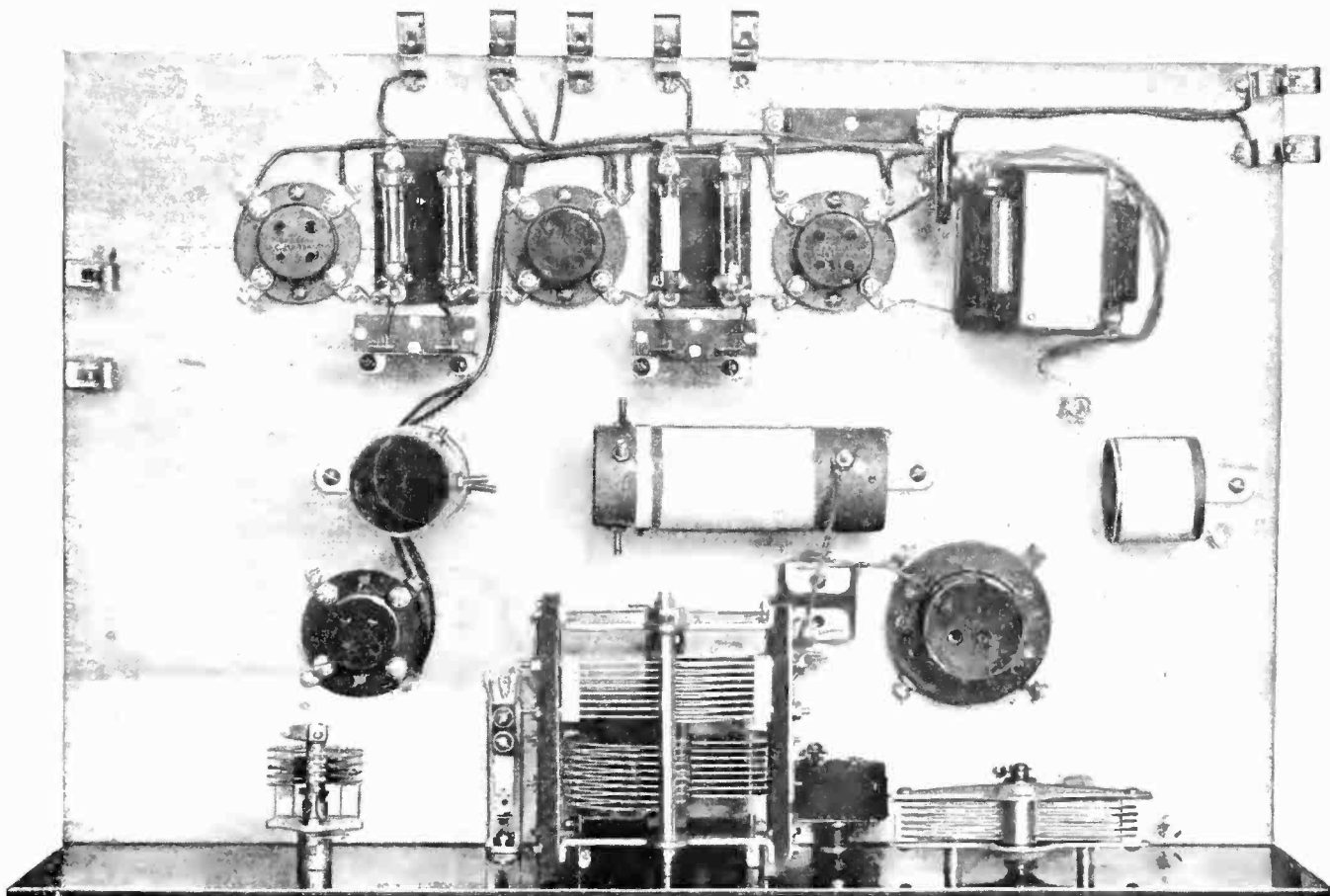

RADIO BROADCAST Photograph

FIG. 10

Cross reference and comparison with this and the other photographs accompanying this article make the understanding of the assembly and disposition of the parts not difficult. A wider base-board than those usually employed in receiver construction makes the wiring and assembly easy

FIG. 12

Several types of gang condensers which are used for simultaneously tuning several grid circuits. Directly below is the condenser manufactured by the Lombardi Company—that at the lower center is the product of the U. S. Tool Company

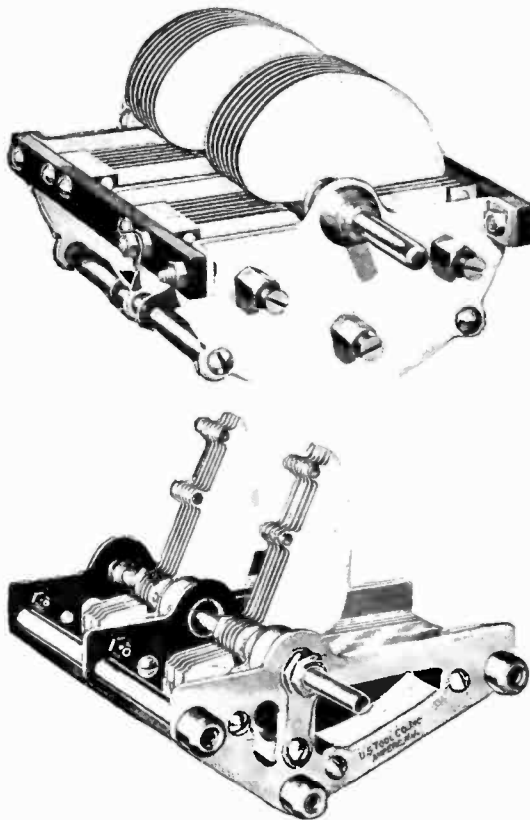
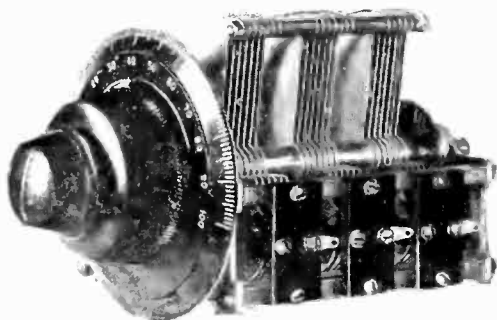
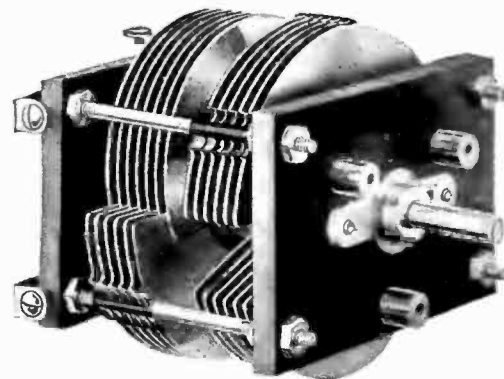

FIG. 13

Two more gang condensers, the Gardiner Hepburn to the left, above, and the General Radio directly below add to the many makes of condensers of this type which may successfully be employed in the receiver described



them. Several minor adjustments on the inside of the receiver may be found necessary, to make it function satisfactorily over the entire wavelength range before this chart can be prepared. For instance, if the detector oscillates violently, the tickler may be swung on its pivot so that the direction of the turns are at right angles to those of the detector coil unit. If this does not suffice, then turns should be removed from the tickler coil until a satisfactory point is reached where the receiver will not oscillate at the lowest position on the main tuning dial, with the rotating plates of the regeneration condenser turned fully out.

The coil specifications given apply when a two-gang tuning condenser is used whose sections are each .000375-mfd. capacity.

The condenser employed in the construction shown here is the Cardwell type 217B. Other makes that may be used are listed in the Parts List.

Of course, other values of condensers, too, may be employed for the tuner unit. If its capacity is greater than that specified above, then it

will be well to wind the same number of turns as specified, and on both coil secondaries simultaneously reduce this number, the while making tests on the receiver, until the highest wavelength which one desires to receive is located on a high point on the dial. For this test it would be simpler to connect the antenna and ground to the plate coil and disconnect the radio-frequency amplifier from any B battery leads to prevent short circuits. Then by tuning-in on the detector alone, the approximate coil turns for the particular condenser employed may be found by the cut and try method described. Once the proper number of turns for the detector coil is determined, the same changes may be made for the antenna coil unit and the receiver re-connected as shown in the circuit diagram. Where a condenser is employed whose capacity is lower than that stipulated, more turns will have to be wound on the coil form than the 105 turns which are satisfactory to cover a tuning range from 545 kc. (550 meters) to 1500 kc. (200 meters). However, for single control of this nature it is unusual

to employ very small condensers due to the corresponding increase in the size of the coils necessary in such an arrangement.

Volume is controlled by the regeneration condenser, but at no time should this adjustment be advanced to the point where the receiver oscillates. In such a position clear reception is impossible for the listener. To prevent radiating disturbing squeals, the plate voltage to the r. f. amplifier should not be made so high that the r. f. stage will oscillate.

Very little explanation is necessary for the audio amplifier unit. In the position as shown, exceptionally short grid and plate leads are obtained, and it is possible to cable the B battery and filament leads so that there is little chance for large closed loops so detrimental to the proper operation of a receiver.

For tone quality, the use of a type 112 tube in the last stage is absolutely essential. It is only necessary that at least 135 volts of B battery and 9 volts of C battery be applied to this tube for distortionless reproduction.

The Short-Wave Receiver Contest

AMONG many interesting points that have come up in connection with the RADIO BROADCAST-Eveready contest for a non-radiating short-wave receiver, there are several that seem to be particularly worthy of mention.

In the first place, the contest closed April 1 after an extension of one month had been made to enable foreign receivers to arrive in Garden City in time to be judged with those produced in this country. Interest was awakened in England by announcements in *Popular Wireless* that such a contest was waging in America so time had to be allowed for European entries.

Many manuscripts have been received. Some of them obviously cannot be considered, for they describe nothing but the ordinary Reinartz circuit which seems to be used in about 90 per cent. of present short-wave amateur stations. Several others used foreign tubes, or devices that no one could purchase or build without extensive

gear and one of the conditions of the contest was that standard apparatus was to be used.

All receivers in the Laboratory by March 8th were exhibited at the Second District annual Convention and Radio Show at the Hotel Pennsylvania, New York City, March 8-13, where they attracted considerable attention. This was but natural, since it was the first time that a new series of short-wave receivers had appeared since the Reinartz capacity feedback circuit. For years the "ham" has used this circuit which has proved to be sensitive and easy to handle, but a persistent feeling has been in the back of his head that somewhere there might be an improvement on the old faithful.

In fact this contest was started with just that idea in mind, to find out if the regenerative tube working directly from an antenna was the best possible receiver for short waves, and to ascertain if there was not some simple means of pre-

venting the oscillations from such a detector from getting out into the ether.

RADIO BROADCAST has always frowned on receiving circuits that were liable to disturb nearby listeners, and this meant "thumbs down" on the familiar Reinartz and its cousins. For that reason the Editors have refused to publish complete details on such receivers, feeling that it would be folly to entice the many RADIO BROADCAST's readers into the short-wave bands with receivers that would contribute to the squeals and howls on the short-wave channels.

Now it is not the purpose of this announcement to state who won the prizes, for that has not as yet been decided nor are any of the secrets of the circuits used to be given away here. There will be given in the July issue after the judges have had time to go over each contestant's manuscript and to listen to his receiver compared with all of the others.

Trickle Chargers for Your A Battery

Installing and Using the Commercial Types—How to Make an A. C. Trickle Charger—The Circuit for Trickle Charging from a Direct Current Supply—Care and Use of the Storage A Battery

By JAMES MILLEN

EVER since the advent of the radio B current-tap devices, there has been what appears to be a fairly insistent demand by the public for the elimination of the A battery. The tube manufacturers brought out dry-cell tubes to do away with the storage A battery but it was not very long though, until the dry cells were being replaced in many instances by storage batteries.

The storage batteries first used for radio work were merely automobile batteries. No thought had been given by the manufacturers to make them spray-proof and neat in appearance. To-day, however, radio A storage batteries have been developed to the point where they may be placed permanently inside the radio cabinet itself without any danger of corrosion due to acid spray when charging. And now some manufacturers are going so far as to build charge indicators right into the battery so that its condition may instantly be observed at any time without the inconvenience of an acid-dripping hydrometer.

Then improved noiseless and economical chargers were developed which made it merely necessary to turn a switch at night and in the morning practically all the energy that had been drawn from the battery in the preceding week was replaced. But still some of the public was not satisfied, so the trickle charger was developed. Now we do not even have to think about letting the regular charger run overnight once or twice a week. By means of special switches, the trickle charger runs night and day, whenever the set is not in use, so that the small storage radio A battery is always in the best of electrical condition. The next step was to combine the special switch, trickle charger and special spray-proof storage battery into a neat and compact unit that could take its place along side of the B substitute on the shelf under the radio table in the living room.

WHAT THE RADIO POWER UNIT IS

REDUCED to its simplest terms, the radio power unit part of which is shown in Fig. 1., is a storage battery of low capacity directly connected to an efficient charging device which is kept at all times connected to the ordinary house current. A compact metal housing, finished in a rich mahogany color, accommodates both battery and charger, making a most attractive unit, that will fit in the space provided for the average battery equipment. It must be remembered that the storage battery used in one of the new radio power units receives altogether different treatment than the regular storage battery. Ordinarily there is an advantage in using a battery of large capacity. It means fewer recharges. A 100-ampere-hour battery, for instance, will heat the filament of a tube which consumes one ampere, for 100 hours before it needs a recharge. Or it will supply current to four one-quarter ampere tubes for the same length of time.

THE trickle charger method of maintaining the storage A battery of the receiving set in a charged state is not the final answer to the problem, but it is a highly convenient and usually simple method and one which has found wide favor. This unusually complete article describes the commercially available types and also gives constructional details for making one's own charger. The trickle charger is about as efficient electrically as the standard, full-rate types with this added advantage, that it maintains the battery more nearly charged constantly and so is better for the storage cell. Care should be used lest the battery fall below the point where it cannot be brought up by the trickle charger. The charger in some instances can be used while the set is in operation, but, that is not always possible.—THE EDITOR.

Except when the receiving set is actually in use, this battery is being charged at a low rate, technically known as a trickle charge—normally sufficient to replace what has been withdrawn from the battery, yet insufficient to harm it.

NEW TYPE OF BATTERY USED

THE small batteries used in radio A power units of this type have been especially designed for the purpose. An unusually large space is provided above the tops of the plates for excess electrolyte to compensate for that lost by evaporation and charging. In these cells it is only necessary to add water three or four times a year. The rectifying or changing over of the usual

alternating house current to direct current (necessary in charging a battery) is accomplished by means of a rectifier tube of the Tungar type, in the power units made by Exide and Philco. Tube rectification is quiet in operation and causes no electrical interference with other receiving sets in the neighborhood.

Fig. 2 shows the Gould A power unit. This unit employs a trickle charger of the Balkite type instead of the Tungar tube as used in the Exide radio A power.

The special switch is not mounted on the case of the unit but provided with a flexible extension cord so that it may be conveniently placed on the table alongside of the radio set.

Provision is made so that this switch also controls the B supply unit when such a device is employed.

Water must be added to both the storage battery cells and the rectifier cell about every two months. The electrolyte in all cells is dilute sulphuric acid and, in the action of the Unipower, water is evaporated. Distilled water only should be used to replace it. If the user fails to add water when necessary, the Unipower will cease to charge until water has been added.

Still another unit of this general type is shown in Fig. 3. These units may be obtained with either the tube type or aluminum anode chemical rectifier type of trickle charger.

Many radio set owners who now have storage batteries may obtain the advantages of the A power supply units just described by the use of a trickle charger and "master" switch.

The Balkite trickler charger and Brach control switch make a very fine combination that is economical to operate, low in first cost, and without renewal costs. The average operating cost is but one tenth of a cent per hour.

CARE OF THE TRICKLE CHARGER

THE only attention the Balkite trickle charger requires is the addition of water to replace that evaporated from the electrolyte by the gassing action. It is very important that the cell be maintained with sufficient liquid. It should not be permitted to fall below the low level mark indicated on the cell (Fig. 4). When adding water, fill to the "high" level as indicated. Distilled water is preferable, but if this is not available, any pure water may be used. Water from melted ice or clean snow is good.

The charging rate of any trickle charger for radio use must be adjusted so that over a given period of time the charger will return to the battery an amount of electrical energy equal to that withdrawn from the battery by the radio set, plus from 20 per cent. to 30 per cent. in addition, to compensate for the internal losses in the battery. Thus the rate of charge needed will depend upon the kind of tubes used, their number, and the number of hours per day, week, or month that the set is used. For example: A set using five 201-A tubes is operated on the average of twenty

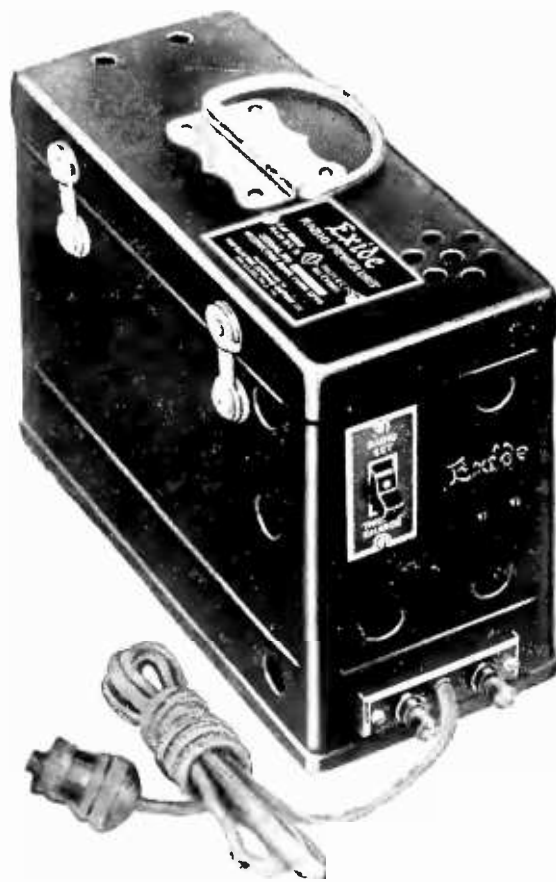

FIG. 1

A commercial unit for trickle charging. The Exide A Power Unit contains a .2-ampere Tungar type trickle charger

hours per week. As each 201-A tube draws $\frac{1}{4}$ ampere, the total number of ampere-hours withdrawn from the battery per week is $\frac{1}{4} \times 5 \times 20$ or 25 ampere-hours. The number of ampere-hours that must be returned to the battery each week, including internal battery losses, is $25 \times \frac{100}{75}$ or about 33 ampere-hours. As the battery is in use for twenty of the 168 hours in each week, the 33 ampere-hours will have to be returned to the battery in 148 hours at the rate of about .225 amperes.

As it is extremely difficult to estimate to just what use any given set will be put, it is a good plan to look occasionally at the charge indicator in the battery (if it has one) and note whether or not the battery is being kept up to charge. A regular hydrometer will give the indication desired if the cells have no built-in indicator.

heated to the point where it might ignite any inflammable material coming into contact with it.

Many readers, however, prefer to make the complete charger. Tantalum, the valve metal employed in the Balkite trickle charger is not obtainable in small quantities, so the construction of a chemical trickle charger of the lead-

FIG. 3
The Philco A Power Units are made in two different types. One has a Tungar trickle charger and the other an electrolytic trickle charger

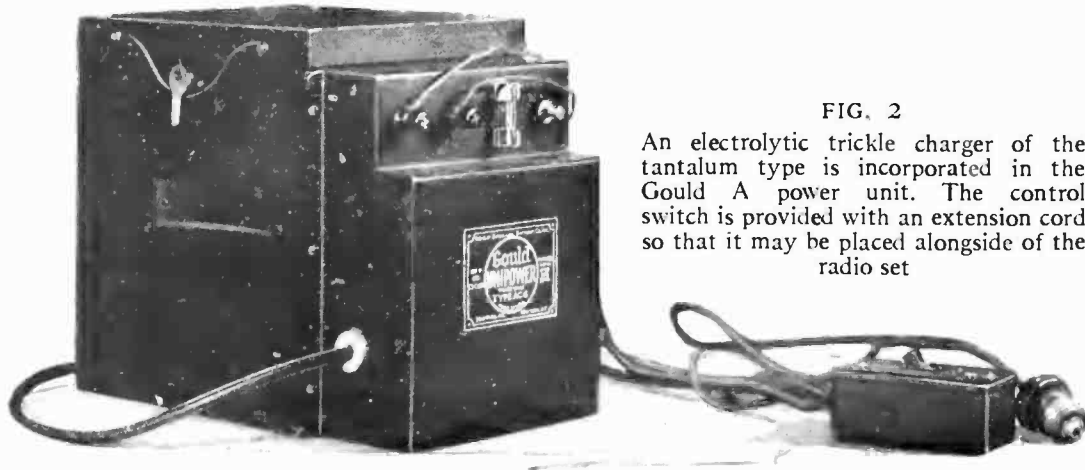

FIG. 2
An electrolytic trickle charger of the tantalum type is incorporated in the Gould A power unit. The control switch is provided with an extension cord so that it may be placed alongside of the radio set

aluminum type will be described. A home-constructed charger of this type, if carefully made from good materials will give very satisfactory results. It will, however, require more attention than the commercial chargers of this type. Two or three times a year it will be necessary to clean the electrodes and change the solution. Distilled water must also be added occasionally unless a very large jar is employed for the rectifier. The frequency with which water must be added and replacements of solution made will depend very largely upon the charging rate employed. The correct charging rate in turn depends upon the type and number of tubes used in your set.

If they are not fully charged, then slightly increase the charging rate. Likewise, if you think the battery is being overcharged, slightly decrease the charging rate. This latter operation although advisable, is not essential as the charging rate is so low in any event that the battery will not be harmed by over-charging.

Provision is made in the complete A power units such as the Gould and the Philco so that the charging rate may be readily varied. There are two general ways by which the charging rate of the Balkite trickle charger may be varied. A resistance may be inserted in one of the 110-volt primary leads or in one of the low voltage charging leads from the charger to the battery. The most convenient resistance to put in the primary circuit is an ordinary electric lamp. This lamp can most easily be placed in the circuit by cutting into the lamp cord from the charger and connecting a socket as shown on Fig. 5. The proper lamp to use under different conditions may be determined from Table A.

It is recommended that only a lamp resistance be used in the primary circuit, and in general a resistance connected in the secondary is preferable. Resistance is connected in the secondary circuit between the charger and the battery as shown in Fig. 5. The proper value of resistance to obtain the charging rate necessary for any certain number of tubes, can be obtained from Table B.

A good 25-ohm filament rheostat having a current carrying capacity of $\frac{1}{2}$ ampere (300 mils.) or more makes a very handy unit to use for resistance in the secondary. The number of ohms of resistance placed in the circuit by such a rheostat can be figured from the portion of the rheostat winding that is cut in. For example, if the contact arm of the rheostat is moved around halfway from the "full on" position, half of 25 ohms, or $12\frac{1}{2}$ ohms, will be cut in.

Any such resistance should have enough current carrying capacity so that it does not become



FIG. 4
The Balkite trickle charger enables any one to use his present A battery as a power unit. The photograph shows Balkite B Supply, trickle charger and Brach power control switch. The insert view shows the inside of the trickle charger and the chemical rectifier

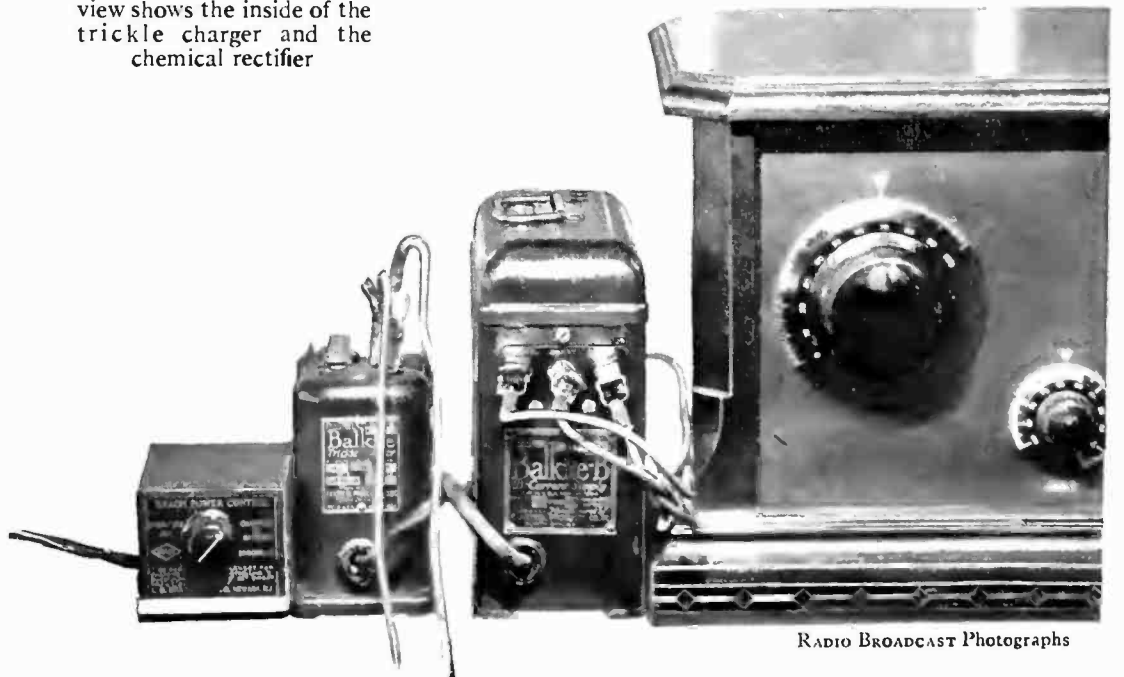

RADIO BROADCAST Photographs

TABLE A

The size lamp to be connected in series with the primary leads of a Balkite trickle charger as shown in Fig. 5.

Size of Lamp in Watts	10	25	40	50	60	75	100	none
Rate of Charge 4-Volt Battery	.11	.25	.34	.39	.44	.49	.52	.52
Rate of Charge 6-Volt Battery	.09	.20	.27	.32	.35	.38	.40	.43

TABLE B

Resistance to be connected in series with secondary (charger to battery lead) of Balkite trickle charger as shown in Fig. 5 to give varying rates of charge.

Resistance in Ohms	0	2	4	6	9	15	25	50
Rate of Charge 4-Volt Battery	.52	.43	.35	.30	.25	.19	.13	.07
Rate of Charge 6-Volt Battery	.42	.34	.30	.25	.20	.15	.10	.04

The Construction of a Chemical Rectifier Type Trickle Charger

A CHEMICAL rectifier type of trickle charger consists of the following parts: a transformer, a chemical rectifier, and a suitable switch.

The transformer is preferably made at home if the constructor is able to secure the necessary core. If the constructor does not want to make the transformer, he may use a so-called "toy transformer" such as is used to run toy electric trains, operate Christmas tree lights, and any number of other such things. A transformer should be selected that is made by a reliable manufacturer. It should not consume excessive power at no load.

The transformer shown in Fig. 6 is the 40-watt Lionel transformer with the case removed.

CONSTRUCTION OF A TRANSFORMER

FOR the benefit of those readers who have the facilities for making a transformer, the following data is given:

Magnetic circuit

Mean length 9 inches.
Sectional area 60 cycles, 1 square inch, 25 cycles 2 square inches.
Material 10 to 17 mil silicon steel. Shellac each lamination before assembling.

Primary

800 turns No. 26 enameled copper wire, layer wound and layer insulated.

Secondary

No. 20 d. c. c. copper well insulated from primary. Take taps at 109, 131, 153, 175, 196, 218 turns corresponding approximately to 15, 18, 21, 24, 27 and 30 volts a. c. total turns 218.

Intermediate charging rates to be obtained by rheostat.

The "40-watt" rating of a transformer does not, as in the case of some other electrical appliances such as bulbs, flat irons, heaters, etc., mean that it consumes 40 watts of electrical energy, but that 40 watts of electrical energy may safely be taken from it without causing it to overheat. The transformer itself consumes very very

little power (if well made) and merely serves to take electrical energy from the lamp socket at one voltage (usually 110 volts) and deliver most of it out again at some other voltage. It is in this case, about 20 volts.

MAKING THE RECTIFIER

THE rectifier is made from a quart size Mason jar. The porcelain lining is removed from the top. A large round opening is then made in the metal top as shown in Fig. 7. The electrodes are fastened to a hard rubber disc cut from a piece of radio panel. A soft rubber gasket such as ordinarily used for sealing Mason jars, is placed on the lower side of the hard rubber disc before fastening in place as shown in Fig. 8.

High and low solution level marks may be indicated on a small strip of paper pasted to the side of the jar. The illustration shows how that can be done roughly.

Two electrodes are employed in the rectifier.

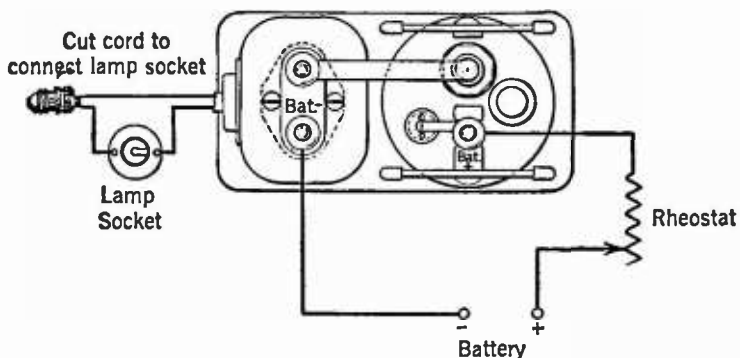
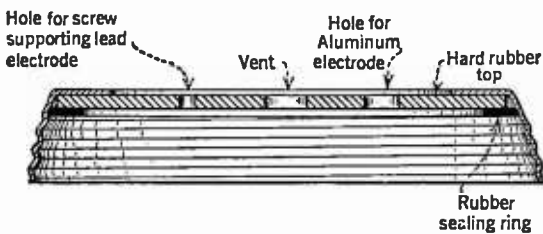

FIG. 5

Either different size lamps in the 110-volt line or a rheostat in the battery line may be employed to vary the charging rate of the Balkite trickle charger shown in Fig. 4



FIGS. 7 AND 8

Constructional details of the rectifier shown in the photograph to the right Fig. 6

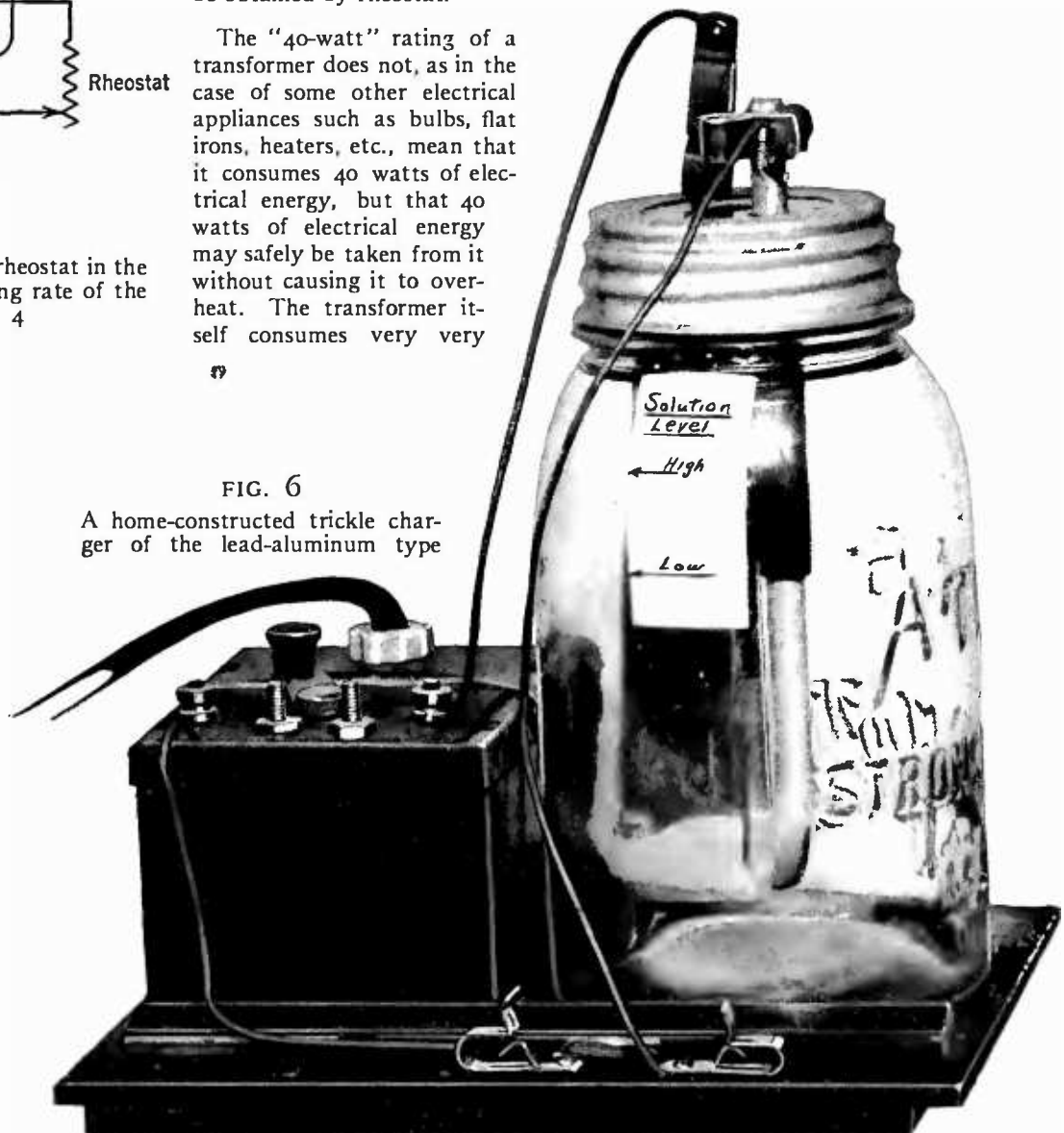
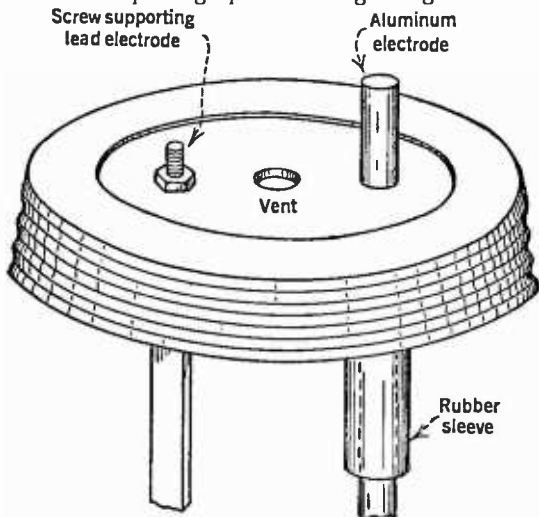

FIG. 6

A home-constructed trickle charger of the lead-aluminum type

RADIO BROADCAST Photograph

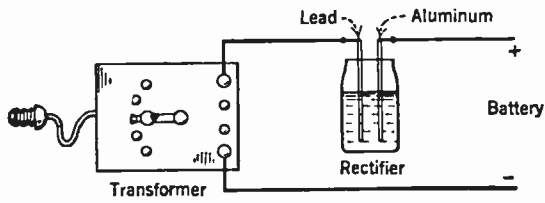

FIG. 9

The trickle charger connections are few and simple. A good quality flexible No. 18 rubber covered wire is well suited to the purpose

One of these electrodes is a rod of pure aluminum. The aluminum electrode is the valve electrode and the success of the rectifier depends largely upon its purity. All grades of aluminum cannot be used. The chemically pure aluminum rods sold by chemical supply houses are generally very satisfactory, although occasionally an unsatisfactory rod will be obtained. Some rods may be very good at one end and quite poor at the other end. Commercial aluminum cannot generally be used for rectifier electrodes. Sheet aluminum is, as a rule, less satisfactory than rod stock.

The diameter of the rod is of no great importance so long as the desired active surface area is obtained. The rectifier shown in Fig. 6 has a $\frac{5}{8}$ -inch diameter aluminum rod with an active length of 7 inches. If a larger size rod is employed, its length should be such that the same area is exposed as for the $\frac{5}{8}$ -inch rod.

An important part of the aluminum electrode is the rubber insulating sleeve. This sleeve is made of heavy walled "live" rubber tubing, which is stretched over the upper end of the rod so as to keep the active area of the electrode constant regardless of the height of the solution. (between the "high" and "low" level marks). Another important function of the sleeve is to prevent arcing at the surface of the solution.

The other electrode is generally made of lead. Carbon rods, if the proper kind are used, are more satisfactory than lead rods. Suitable carbon rods are, however, rather difficult to obtain. Old battery carbons cannot be used. The best material to use, if one can secure it is a high-silicon iron rod. The silicon content must be high enough to prevent oxidation.

The lead may either be pure or contain antimony. Its purpose is merely to make electrical connection to the solution. Pure lead is very soft, and for this reason the harder lead-antimony alloy is to be preferred. Lead containing antimony is used in the manufacture and repair of storage batteries. It can be obtained from any

storage battery service station. Ordinary sheet lead may be obtained from any plumber.

The lead electrode may be either round or flat. Its size and shape is of no importance as long as its active area is about equal to or greater than the active area of the aluminum electrode. The two electrodes should be placed as close together as possible without being closer than one half inch at any point. Both electrodes must be rigidly supported by the cover so that there will be no danger of them touching.

Sandpaper or scrape the lead until it is bright and clean. Then assemble the rectifier and use it for several days or until the lead electrode has turned a dark red color. Then remove the lead electrode and hammer it so as to force the dark brown coating into the surface of the lead. This treatment, although not essential, will greatly prolong the active life of the rectifier as it will prevent the lead electrode from slowly disintegrating.

THE SOLUTION FOR THE RECTIFIER

THE solution is made by dissolving as much secondary ammonium phosphate, $(NH_3)_2 HPO_4$, as will dissolve (about one ounce) at room temperature in sufficient distilled water to fill the rectifier cell to within 2 inches of the top. The solution before using should be shaken every ten or fifteen minutes for about an hour. Tap-water should not be used. After the excess crystals have settled to the bottom, pour off the clear solution. Add to this solution 1 oz. $(NH_3)_2 HPO_4$ plus (after an hour) $\frac{1}{8}$ oz. $K_3 PO_4$, tertiary potassium phosphate.

After the solution has been poured into the rectifier cell, add enough of any mineral oil, such as castor oil, to make a layer about $\frac{1}{8}$ -inch thick on top of the electrolyte.

The transformer, rectifier, and switch are connected as shown in Fig. 9. They should be mounted on a small base board as shown in Fig. 6 rather than in a box, so as to facilitate heat radiation. The charger leads are permanently connected to the battery. When the set is to be used, the 110-volt switch is turned off and the filament switch on the panel of the set turned on. By using a standard double-pole enclosed switch of either the "push" or "toggle" type, using the set is reduced to one operation. If a B supply unit is also employed, then one of the Brach switches referred to in connection with the Balkite trickle charger may be used in order to reduce the "starting and stopping" of a set to one operation.

OPERATION

AS EXPLAINED in connection with the Balkite trickle charger, the charging rate at which to set a trickle charger depends almost entirely upon the number and type of tubes employed in the radio set and the average number of hours per day that the set is used. Due to variations in different home made recti-

fiers it is not possible to make a table showing what adjustments to make for different charging rates. The only practical way in which to tell at what rate the battery is being charged is with a movable coil type of d. c. ammeter. One having a range of from 0-500 milliamperes is excellent. The charging rate is varied by changing the transformer voltage. The proper transformer voltage will be between 15 and 25 volts a. c., depending upon the rate desired and the characteristics of the rectifier. Rates in excess of $\frac{1}{4}$ ampere are hardly advisable, as with the higher rates it becomes necessary to renew the rectifier solution more frequently.

Distilled water must be added to the rectifier cell every month or so, in order to prevent the level of the solution from falling below the bottom of the rubber insulating sleeve on the aluminum electrode. Two or three times a year it will be necessary to clean the electrodes and renew the solution.

LIST OF PARTS

Aluminum rods, C P, may be obtained from most any large chemical supply house. Also from:

- Empire Lab. and Supply Co.,
218 East 37th Street, New York City.
- Straus Aluminum Co.
48 Franklin Street, New York City.

The chemicals may also be obtained from any large chemical supply house, or in many instances, through your local druggist. They must be free from more than a trace of chlorides, iodides, or bromides.

- Empire Lab. and Supply,
218 East 37th Street, New York City.
- Schaar and Co.,
556 West Jackson Boulevard,
Chicago, Illinois.

A DIRECT CURRENT TRICKLE CHARGER

THE Balkite trickle charger and the home-constructed chemical trickle charger just described must not be used when the house current is d. c. In the business districts of some cities, the power supplied is d. c. In New York City, there are sections in which d. c. is supplied and still other sections where a. c. is supplied. This also applies to some of the residential districts within the city limits. In many other cities, the downtown districts have a d. c. supply, while the residential sections have alternating current. In order to determine whether your home is supplied with a. c. or d. c., and if a. c. the frequency, it is merely necessary to look at the name plate on your electric meter.

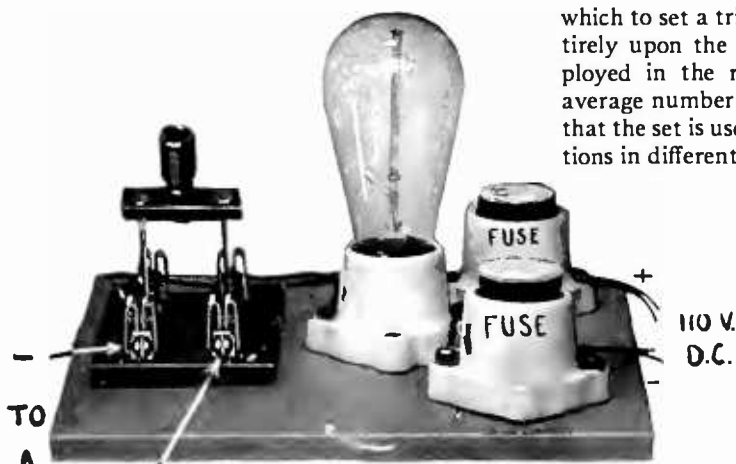

FIG. 10

A trickle charger where the current supply is direct current is extremely simple and can be built up in about a half hour. The illustration shows the necessary apparatus

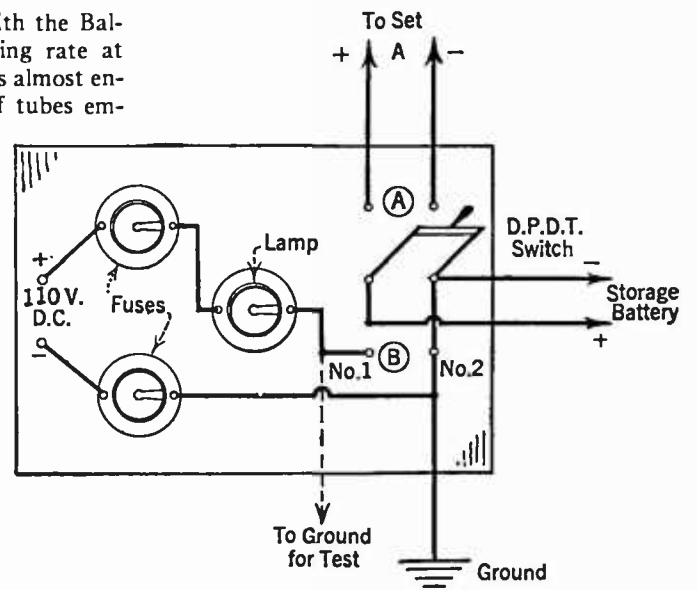
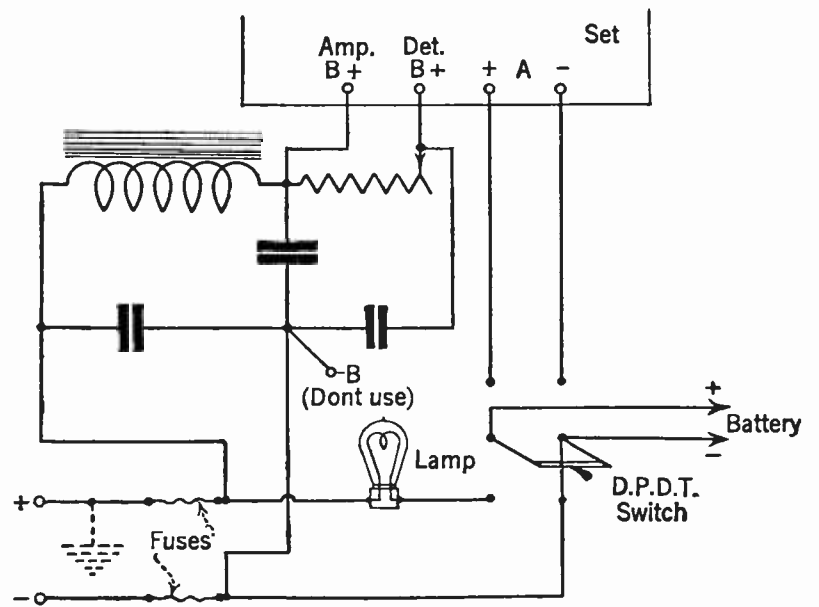
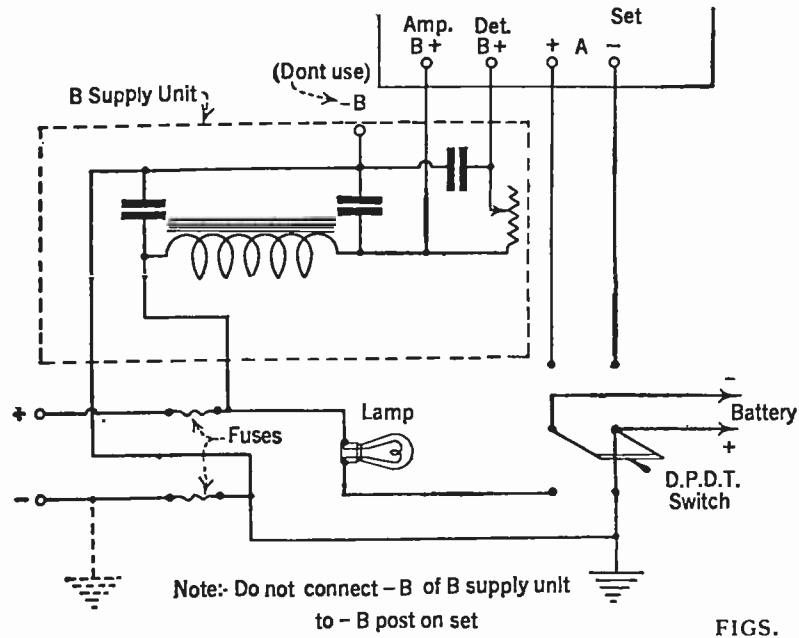

FIG. 11

Circuit diagram for the charger shown in Fig. 10



FIGS. 12 AND 13

In all receivers the minus B lead connects either to the minus or plus A leads. Also in most B supply units the negative side of the output is grounded. Since, when using a trickle charger with such a B supply the negative B will connect to the set through either the minus or plus A leads it is well, to prevent short-circuits, *not to connect the minus terminal* (marked don't use) as shown above, to the receiver

A trickle charger to work with a d. c. supply is a much simpler device than for a. c., as neither rectifier nor transformer are required. All that is necessary is a lamp cord, for connecting to the lamp socket, a lamp to regulate the charging rate, and some fuses.

A convenient way of mounting the essential parts is shown in Fig. 10. The following material is required:

- 3 Porcelain lamp sockets
- Flexible lamp cord and plug
- Double-pole double-throw switch
- Baseboard

When the apparatus has been mounted and wired up, screw the plug into the lamp socket or outlet in which it is to be used later on in charging the battery. The plug had better be one of the non-separable type, as once the proper connections are determined, reversing the plug would cause considerable trouble.

Insert the necessary fuses (5-ampere, or smaller if you can get them) and any convenient lamp, say 25-watt size in their proper sockets. Then from the post marked No. 1 in Fig. 11, run a wire to the radiator, water pipe or other ground. Note whether or not the lamp lights. If it does not, then reverse the connections from the lamp socket. The lamp should now light. After arranging the lamp cord connections so that the lamp on the charger panel burns when post No. 1 is grounded, determine the polarity of post No. 1.

The simplest way of determining the polarity is by connecting two bare wires to posts No. 1 and No. 2. Dip those wires into a glass of water to which has been added some ordinary table salt. Bubbles will soon start to rise from the negative wire. Mark post No. 1 plus or minus as the case may be.

The regular ground wire must now be removed from the set and connected as shown in Fig. 11. If your set is of the type in which there is no connection between the antenna coupling coil and the filament circuit, then it will be necessary to retain the regular ground connection to the set, but in that case, for the sake of safety, put a .002-mfd or larger condenser in series with this ground wire.

The switch at the lamp socket must at all times be turned on. So must the filament switch on the radio set. To use the set, throw the switch to position A, Fig. 11, and when the set is not in use, to position B, which puts the battery on trickle charge. If the set is not to be used for some time, then the charger and set are both dis-

connected by leaving the switch in the up position. A much neater and better way is to use an enclosed type switch, in place of the knife switch.

When all connections have been made, throw the switch to the "charge" position. The lamp should burn just a trifle less bright than when in an ordinary lamp socket. It may be difficult.

LAMP WATTAGE	APPROXIMATE CURRENT IN AMPERES
10	.086
15	.13
25	.21
40	.34
50	.43
60	.51
75	.64
100	.86
150	1.3
200	1.7

however, to notice the difference in brilliancy. If you should notice that it burns a trifle brighter, then it is clear that there is a mix-up in polarities. The circuit should be carefully checked at once and the error rectified.

After all is functioning properly, it is necessary to adjust the rate of trickle charge, so that just about as much or a little more current is put back than is taken out of your battery in a day. The charging rate is varied by using different size lamps. It is especially important to note that the battery should be at least three-fourths or

more charged (as indicated by a hydrometer) before it can be put in the trickle charge circuit and forgotten about (except, of course, for the occasional addition of distilled water).

Suppose, for example, that we have a five-tube neutrodyne equipped with 201-A tubes each of which takes $\frac{1}{4}$ ampere. The total current drawn is thus $5 \times \frac{1}{4}$ or $1\frac{1}{4}$ amperes. Now, if we use the set on an average of four hours per day, $4 \times 1\frac{1}{4}$ or 5 ampere hours is drawn from the battery. The average efficiency of a storage battery is about 75 per cent. We must then return to the battery $5 \times \frac{100}{75}$ or $6\frac{2}{3}$ ampere hours per day. If the set is in use for 4 hours, then we have 20 hours in which to charge the battery. $6\frac{2}{3}$ amperes divided by 20 is $\frac{1}{3}$ amperes, the hourly rate at which the battery must be charged. By referring to Table C, it will be seen that by using a 40-watt lamp, this charging rate is obtained.

By applying this same line of reasoning, the proper size lamp to use for any condition can be readily determined.

As the lamp will burn at but very slightly less than full brilliancy (104 volts instead of 110 across the lamp in case of 110-volt supply), it is quite feasible to put an extension to the lamp socket and use it as a cellar light, night light, reading light or any other such purpose. Remember though, that it only burns when the radio set is *not* in use.

When a d. c. B-supply unit is to be used with the d. c. trickle charger just described, care must be used to secure the proper connections.

In cases where the negative side of the line is grounded, use the connections in Fig. 12. When the positive side of the line is grounded, then a B unit cannot be used with the trickle charger connected as shown in Fig. 11, but the trickle charger must be rewired and connected with the B unit in the manner shown in Fig. 13. It will be noticed in this case that the lamp resistor is in the grounded side of the line. Disregard the negative B terminal of the B supply unit, as connection to it will be made through the trickle charger. Connect the negative detector B post in the usual manner.

To determine which set of connections is applicable to your case, use a lamp for locating the grounded side of the line, and a glass of salt water for determining the polarity, as previously described.

Don't get discouraged if the fuses blow. Just check things over again and you'll have no trouble finding the error.

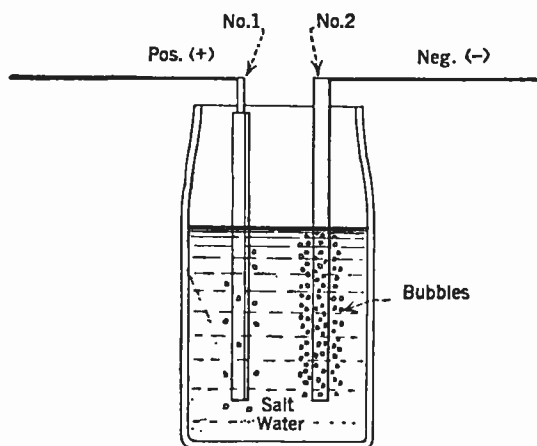

FIG. 14

A glass of water in which some table salt is dissolved, is useful in determining the polarity of a direct current line

Testing and Operating the "Aristocrat"

How to Use a C Battery—A B-Substitute with Resistance Amplifiers
—Modifications in the Audio Output—Details of Home-Made Coils

By HOWARD E. RHODES

IN THE November issue of RADIO BROADCAST there appeared the first of several articles describing the RADIO BROADCAST "Aristocrat", a five-tube receiver designed to give excellent quality of reception, combined with selectivity and sensitivity. It consisted of a stage of tuned radio frequency, regenerative detector, and a resistance-coupled audio amplifier. It appealed greatly to home constructors because of simplicity of construction and its exceptional tonal fidelity. The circuit is a remarkably efficient one and meets the requirements of the DX fan in a highly satisfactory fashion. Some of the models used a Hanscom single-control tuning unit so that the utmost simplicity of operation was had, while other models used dual control, preferred by many people. The "Aristocrat" has proved extremely popular and there have been many requests for further information concerning batteries, tubes, home-made coils, B substitutes for use with the set, the best method of assembly, etc. In this article we are going to discuss some of these interesting questions. Constructional data appeared in the November, 1925, RADIO BROADCAST and will not be repeated here.

In the first place, there is something to be said about assembly. Whether or not a sub-panel is used depends upon personal preference. The set will, of course, give

satisfactory operation with any good electrical assembly. The various methods of construction can readily be seen by reference to the accompanying photographs and those in the November, December, and April issues. The sub-panel layout illustrated in Fig. 4 uses a Bruno Bracket and makes a very neat job. The base board assembly will appeal to others and it is well illustrated in the photographs in the issues mentioned above. The "Aristocrat" is an exceedingly simple circuit to put together—not at all tricky—and any standard procedure can be successfully followed.

MAKING YOUR OWN COILS

THERE are a great many radio home constructors who like to build their own coils and Table 1 presents complete data for the construction of various types of coils which can be used in this circuit. There are also a large number of manufactured coils that can successfully be used in the "Aristocrat" hook-up. Excellent manufactured coils are made by the following companies;

Hammarlund, Eastern Coil Corporation, American Mechanical Labs Inc. (Clartuner), F. W. Sickles Company, Perfection Radio Mfg. Company (Supercoils), Victoreen Radio Products, and several others.

There have also been some questions concerning batteries to be used with the

circuit. Particularly with regard to the C battery, there seems to be some confusion as to just what factors determine its value. The bias voltage should be determined by the strength of the signal that is to be handled. A UV-201A should not have much more than $4\frac{1}{2}$ volts of C battery when used in the output stage with 135 volts on the plate. Increasing the grid voltage beyond negative $4\frac{1}{2}$ volts will result in decreased power in the plate circuit. Actually, the power in the output circuit of a UV-201A is not sufficient properly to operate a loud speaker and it is always best to use a semi-power tube in the last stage. These tubes will be able to handle a stronger signal and this change will also result in better operation of the speaker at a power level more nearly correct. Table 2 gives the correct value of C battery to use on each stage of a resistance-coupled amplifier when 135 volts is used on the plates of all the tubes. Practically, not much difference will be noticed if the first two tubes are operated at a lower C voltage, since the lower voltage need not necessarily result in distortion if the signals being handled are not very great, but will only produce a slight decrease in amplification, not detectable by the ear. The important point that should come out through this discussion is: Don't make your C battery voltage much greater than is necessary

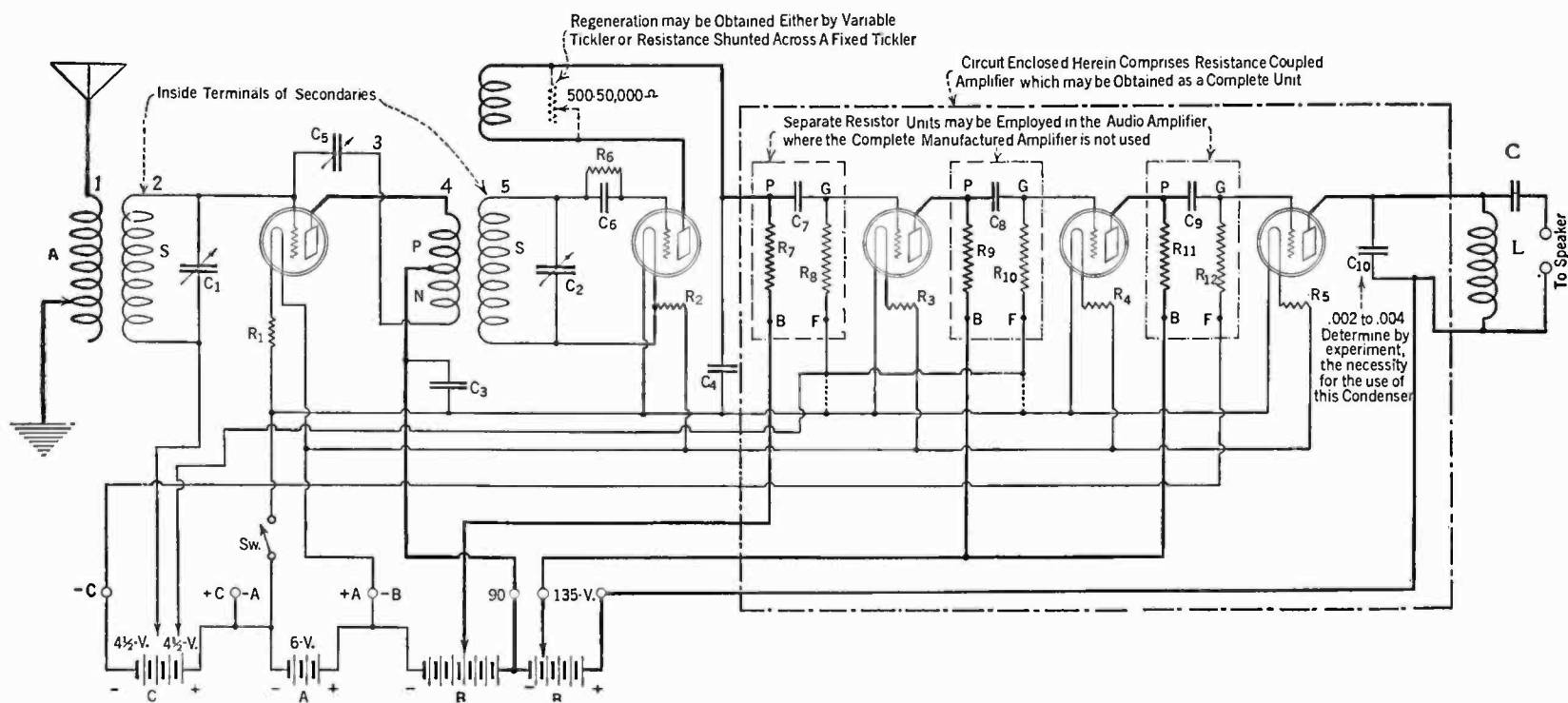

FIG. 1

The circuit diagram of the "Aristocrat" incorporating the modifications mentioned in this article. Note how the C battery is connected and also the addition of a choke and condenser at the output, so as to keep the battery current out of the loud speaker windings. This diagram will be useful for those wishing to use a C battery on all the amplifiers

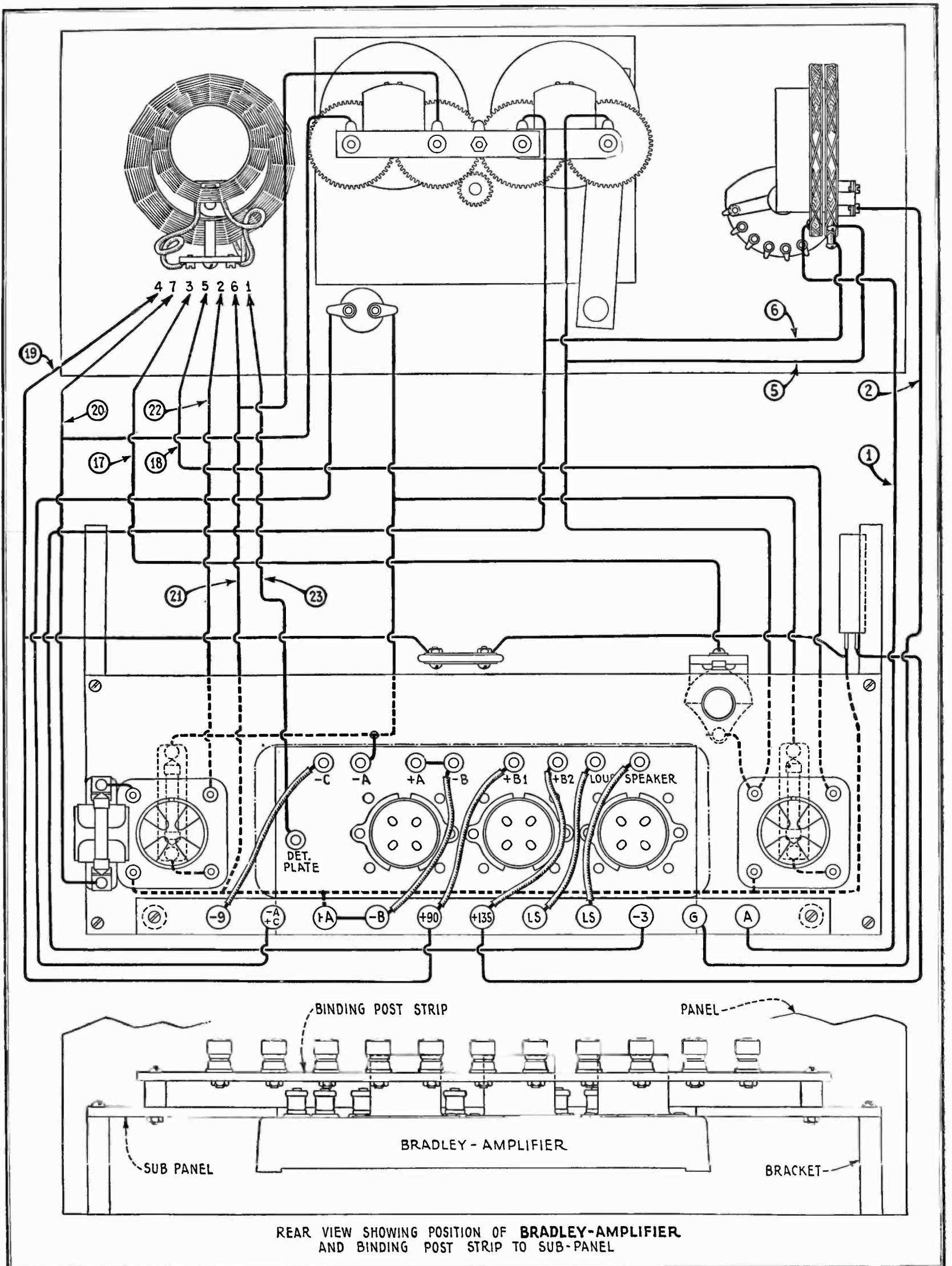

FIG. 2

Here's a simple way in which a manufactured resistance-coupled amplifier unit may be used in an "Aristocrat." Note how the sub-panel has been cut away

to handle the signals. Too much voltage may give distortion, decreases volume to a slight degree, and if the excessive potential is impressed on the grid of the output tube it results in operation of the loud speaker at a lower power level than that required for best results.

THE C BATTERY IN RESISTANCE COUPLING

MANY receivers have been made using a resistance-coupled amplifier purchased as a complete unit. An amplifier of this type is the Allen-Bradley, which is illustrated in the accompanying full page diagram. These units are not wired for the use of a C battery on the first two tubes and if it is desired to use one, it will be necessary to get inside of the unit and take off a tap at the correct point. This can be determined by reference to the circuit diagram shown in Fig. 2. As shown on the drawing, it is necessary to break the connection to the filament end of the grid leaks on the first two tubes and then bring out a lead to a binding post. The dotted lines in Fig. 2 indicate the connections that have been removed.

Many readers have tried to use a B battery substitute for supplying the plate voltages for the various tubes in the resistance-coupled amplifier and have found that when this is done it sometimes produces a loud hum. This hum is caused by the impedance of the B battery eliminator, which feeds back energy into the first tube of the amplifier. If moving the eliminator further away and using twisted leads to be B binding posts on the set does not eliminate the hum, it becomes necessary to use dry batteries for supplying the plate voltage for the amplifier tubes. The eliminator can, of course, be used to supply the various other plate voltages required for the receiver. It will actually be necessary to use ordinary B batteries on only the first two tubes of the resistance-coupled amplifier.

In the interest of good quality, it is also wise to use the method of connection to the loud speaker that is indicated on the circuit diagram, Fig. 1. L is a choke coil having a very high inductance and C is a large fixed condenser with a capacity of about 2-4 mfd. This connection results in the elimination of the battery current from the windings of the speaker so that the only current flowing through them is that current which produces sound. For the choke coil L it is possible to use the secondary of an

audio transformer. Excellent units for just this purpose are made by the General Radio, Acme, Thordarson, Amertran, and several other companies.

THREE-VOLT TUBES IN THE R. F. STAGE

THERE is another circuit variation in which there is considerable interest, and that is whether or not satisfactory operation can be had using a 199 type tube in the radio



RADIO BROADCAST Photograph

FIG. 5

The "Aristocrat" in a cabinet. Space is provided below the set for all necessary batteries. The cabinet is made by the Detroit Woodcraft Corporation



FIG. 3

The "Aristocrat" with dual control. Dual control has the advantage that it does not require the accurate matching of coils that is essential if single control is to give satisfaction. It will also enable those who have their own condensers and dials on hand to use them

frequency stage. The amplification obtainable with this type of tube will, of course, be somewhat less than that of a 201-A but a compensating advantage is that neutralization, using a 199, is an exceedingly simple matter. The change from a 201-A type to a 199 type tube is very simple. It is merely necessary to remove the filament control resistance in the radio frequency stage and substitute a new fixed resistance designed for use when a 199 tube is to be supplied from a 6-volt battery. See "The Use of the Filament Resistance,"

RADIO BROADCAST for April, 1926. If the set is well constructed, it will still be necessary to neutralize it but the job is not at all difficult.

And now we come to the final point—location of trouble. Unfortunately, every receiver does not operate perfectly when it is first put together and so a few pointers with regard to trouble hunting should prove useful. In making these tests, the receiver should be completely connected, exactly as it would be under ordinary circumstances.

In testing a newly made receiver, the first unit that should be looked over is the audio amplifier. The simplest way in which to test this unit is to listen-in on the output, using a pair of head phones, and then lightly tap the detector tube. A loud microphonic ring should be heard and this noise is a quite certain indication that the audio amplifier is functioning satisfactorily. If the test fails to give any response we may be sure that at some point the amplifier is at fault and it is wise to make whatever additional tests are necessary in order to localize the defect. In a resistance-coupled amplifier, a common cause of failure is defective grid or plate resistances. A systematic electrical test of the various parts of the amplifier should show up the trouble and it can then be repaired.

The next part to be tested is the detector circuit. A good check on this unit can be made by connecting the antenna to point No. 5, Fig. 1, on the secondary coil in the

detector circuit. The radio frequency tube can be removed from its socket and under these conditions the set should function as an ordinary three-circuit regenerative set and results should be equal to those obtainable with that type of receiver. If, on the other hand, very poor or no reception is obtained, trouble should be looked for some-

TABLE I

KIND OF COIL	NO. OF SPOKES	INSIDE DIAMETER	PRIMARY		SECONDARY	
			SIZE WIRE	NO. OF TURNS	SIZE WIRE	NO. OF TURNS
Spiderweb	17	2"	20	14	20	46
	15	1 3/4"	24	16	24	52
	11	1 1/4"	24	15	24	50
Basketweave	13	2 1/2" between peg centers.	18	18	18	58
	14	4 1/4" between peg centers.	18	20	18	60
	15	2 1/2" between peg centers.	24	20	24	64
Diamondweave	15	2 1/2"	26	18	26	57
	21	2 1/4"	20	10	20	36
	15	2 3/4"	24	14	24	44
Solenoid		2 1/2"	24	20	24	59

where in the detector circuit. Examine all the coils and be sure connections are tight since this is a common cause of trouble. Various grid leaks should be tried and that one used which gives the smoothest regeneration. Try different tubes, making sure that the socket contacts make good connection with the tube prongs. After this part of the circuit is made to function properly, the antenna can be connected to point No. 3 and then on point No. 4. If good results are had up to this point, any further trouble can be looked for in the radio-frequency amplifier.

To test the radio-frequency amplifier, the antenna can be connected to point No. 2. With the antenna at this point, the signals should be very loud and if this is not the case it indicates either

TYPE OF OUTPUT TUBE	C BATTERY VOLTAGE			B BATTERY VOLTAGE	
	FIRST HIGH MU TUBE	SECOND HIGH MU TUBE	OUTPUT TUBE	HIGH MU TUBES	OUTPUT TUBE
201A type	1½	1½	4½	90	135
112 type	1½	3½	9	90	135

a defective tube or a defective coil. Try a new tube and if results are the same it is likely that the fault will be found in the coil or in the wiring connecting it in the circuit. When best results are obtained at this point, the antenna can be connected to the antenna binding post and the receiver should now function in the proper manner. In order to obtain

best operation, various plate voltages and grid voltages (on the radio frequency tube in particular) should be tried. Be sure not to put too much grid voltage on the r. f. tube (see Table 2) because it will tend to make this tube act partly as a rectifier and results will then be very poor. The usual troubles can ordinarily be found after systematic search and, in general, will be quickly and easily located.

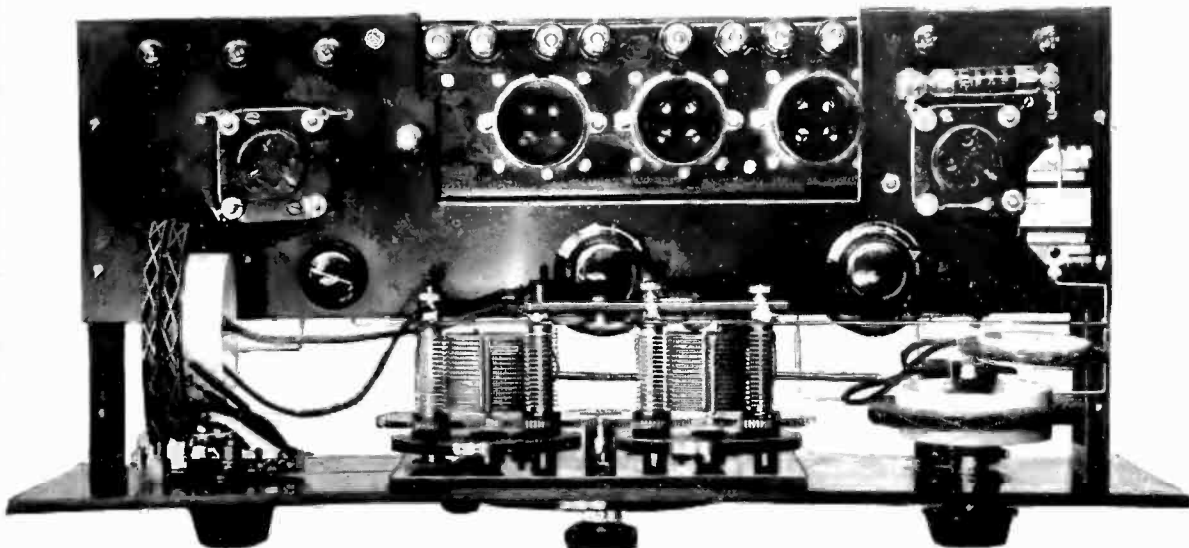

RADIO BROADCAST Photograph

FIG. 4

This receiver was assembled using a Bruno bracket. It should be noted that the sockets extend far enough beneath the sub-base to allow wiring to be done at approximately the level of the socket prongs

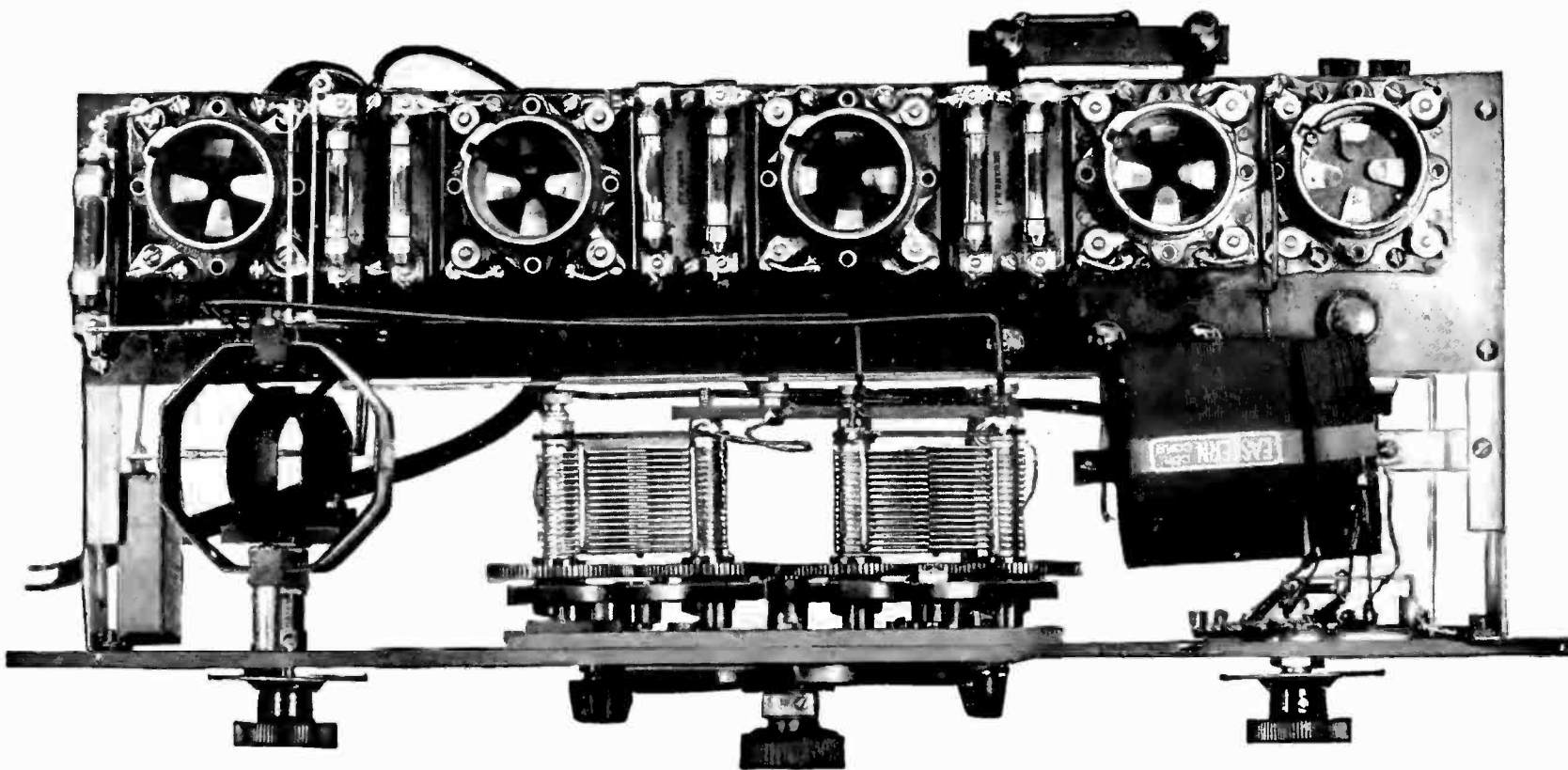

FIG. 5

Another model of the "Aristocrat." Any standard parts may be used and it will be found easy to revise the position of the wires so as to produce a well-designed set irrespective of what parts are used. The actual wiring of an "Aristocrat" is a very simple matter. Some readers might want to duplicate the model shown above so below appears a list of the apparatus used. Left to right on the sub-panel we have the Daven Leakandenser, Benjamin socket, Sangamo .004-mfd. bypass condenser, Daven resisto-coupler with .1 and 1 meg resistors, socket, resisto-coupler with .1- and ½-meg resistors, socket, resisto-coupler with .1- and .25-meg resistors, socket. The .1 mfd. condensers are within the resisto-couplers. The two Eby posts on the upper strip are for the loud speaker. The three posts on the lower side are for the C battery, and the small knob is for the Hammarlund variable neutralizing condenser. Left to right on the main panel are the Benjamin bracket, Dubilier .5-mfd. bypass condenser, Eastern Knockout r. f. coupler with Apex knob, Hanscom single control unit with Marco dial, Yaxley filament switch, Eastern Knockout antenna coupler with Carter antenna switch.



THE GOVERNMENT EXAMINATION

Applicants for Government commercial or amateur operator's licenses must take the examination set by the Department of Commerce. For a first grade amateur license, a speed of 10 words per minute is required. The test is given by a mechanical transmitter which sends for five minutes

Easy Methods of Conquering the Radio Code

Short Cuts to Learning the Code and a Word About the Fascinating Fields Opened Up to the Listener Who Can Translate the Dots and Dashes

By EDGAR H. FELIX

FOR the benefit of those who were asleep at the conclusion of our last lecture," said the Professor, looking directly at me, "I will repeat several of the points which I made."

Naturally, all eyes were focused upon me as the class indulged in a hearty laugh at my expense. The Professor had his revenge and I immediately plotted mine. Then and there I determined to make him a slave to radio, which had been the cause of my undoing. Not only did I achieve my purpose in a few short weeks, but also secured the aid of a capable psychologist in perfecting a simplified method of learning the code, into the bargain.

My first step was to inveigle the Professor into an evening of listening. First, we listened to ships along the coast calling various shore stations all the way from Cape Race to Guantanamo Bay, Cuba. Then we stepped up to the 800-meter mark and heard a number of compass stations giving bearings to ships. I copied the messages as they came through and I could see the Professor trying to make out dots and dashes, of course without success. At a thousand meters we heard radio beacons and continued up the scale through commercial, naval, and military stations until we were away up on the long wavelengths with their chorus of international high power stations in all parts of the world.

But the thing that really clinched the

matter was an sos call, which accomplished its usual disruption of ether communication. A yacht had collided with a passenger steamer. I copied messages from all the ships and shore stations concerned, none of which were more than 100 miles away. There was nothing which appeared particularly exciting to me about the accident; both ships were safe and no one was hurt. But the Professor was thrilled!

One hour at the phones had done its deadly work. A week later I had the satisfaction of following the Professor, walking to College one morning, whistling in the dots and dashes of the Continental code, the name of a hand laundry as he passed its sign; then he walked by a barber shop and Tony's name was broadcast in dots and dashes for the first time. It would be only a matter of time, I gloated, before he would fall asleep at his desk in front of the entire class.

Any one who has listened for an hour to the traffic passing through the ether by the dot and dash method is certain to make an attempt to learn the code. Now that it is possible to hear and communicate with amateurs in all parts of the world on short-wave, low power transmitters, the profit and pleasure resulting from a knowledge of the code is still greater than it was at the time of the Professor's downfall; certainly any one will be repaid if he succeeds

in mastering the language of dots and dashes.

THE VIVID WORLD OF CODE TRANSMITTING

TO THE trained ear, the dots and dashes are much more than just letters of the alphabet. Every operator has his own style of sending which reveals his personality more faithfully than does his handwriting. Men and women in every walk of life are represented in the amateur ranks. Here may be an Argentinian millionaire holding dot and dash converse with a New Zealand farm hand. A slight turn of the dial may bring you a Hawaiian sending a message of friendship to a London cockney. Another readjustment of the controls may bring you the commercial station sending its mathematically correct dots and dashes by machine. After a few months of listening you can often judge of the character of the man behind the key by the manner in which he sends the code.

A simple and efficient one-tube long-wave receiver can give you, in the course of two minutes, signals from many of the commercial and military high power stations, perhaps in England, France, Italy, Argentina, Hawaii, Japan, or Java. In the last analysis, the broadcasting band, although familiar to the largest number of people, is a relatively small part of the radio world. The code listener never complains about the similarity of the program because

he has a constant variety of message traffic and may shift the scene from place to place over distances which makes the mere broadcast listener envious.

Some people have great difficulty in learning the code; to others it comes quite easily. Learning the code is greatly facilitated by a natural aptitude for remembering a succession of sounds. There are some people who can whistle a melody which they have heard but once. Others have to hear it a hundred times to repeat the first bar successfully. The chances are that the former can learn the code in a few hours, while the latter may have a tedious struggle unless he uses the correct method in acquiring it.

The mistake most frequently made in attempting to learn the code is that the would be operator tries to "memorize" the Continental Morse alphabet. He may be able to repeat fluently, after some study, the entire alphabet, beginning with "A, Dot Dash," "B, Dash Dot Dot Dot," and so on. But when he begins to listen to radio signals he will not be able to distinguish a single letter. He has simply learned words *about* the code rather than learning the code itself.

A much more successful method is to whistle the sounds of each letter so that a connection is formed between the center of hearing and the letter which you are trying to represent by sound. The other method is equivalent to trying to learn the playing of a musical instrument by talking about it.

LEARNING THE CODE AT HOME

BBETTER yet, obtain a buzzer and key and learn to "pound out" the alphabet. The photographs show the most accepted way to hold the key, with the thumb underneath and the first and second fingers on top if it. The finger grip is easy and light, practically no effort being required to press the key. Note how high the wrist is held. The impulse for pressing the key is obtained from the arm muscles and not from the fingers. If you conceive the fingers and hand up to the wrist joint to be a part of the key itself, you are most likely

*T*HERE is no system for learning the radio code which will permit that achievement overnight, but there are ways of making the job easier, and Mr. Felix's article gives some valuable suggestions of that sort. So much of interest goes on over the ether channels which the broadcast listener never hears because he is practically deaf to the dots and dashes. The short-wave amateur channels afford the best place to start because the transmissions are slow, and next come the commercial long wave intercontinental circuits. Those who do become proficient in the code should remember that the radio law is very specific in stating that no communication by radio shall be divulged except to the authorized addressee. Licensed operators are required to take oath to this effect. If the DX fiend gets throbs from the voice of an announcer on the other side of the Continent, consider the thrill before him when he can read the key of a station on the other side of the world, or the nervous "fist" of an operator sending an SOS aboard a ship in distress!—THE EDITOR.

to the key itself. If he were to use his fingers instead of his wrist, he would soon have telegrapher's paralysis or a "glass arm," in the lingo of the radio cabin.

Mechanical devices are available which automatically send messages, for instruction purposes. Usually these employ a spring motor rotating a disc which operates a contact switch. On the periphery of this disc, indentations spaced according to letters and words of the Continental Morse code, actuate the contact switch, controlling a high-pitched buzzer. Mechanical senders such

as the omnigraph are used widely in schools because the government examinations for commercial licenses use the omnigraph to test the applicants. Experienced operators usually find it difficult to copy from the omnigraph because it lacks the free swing of hand sending. But it is valuable in learning to read the code because the speed may be regulated to fit the student's progress. A mechanical sender is a part of the equipment furnished students of most correspondence schools which teach the radio code by mail. The correspondence school method, aided by the use of a simple long wave receiver is one excellent way [to learn the code. In various cities, there are schools which teach the code and practical radio operating as well. These schools are of great value for the individual who is eager for supervised code or theoretical and practical instruction.

The first step, then, is to memorize the *sounds* representing the letters of the alphabet by actually sending them with a key and high pitched buzzer. This process is facilitated by grouping letters and becoming thoroughly familiar with each group one at a time. For the first group, learn the "dot" letters:

- e .
- i ..
- s ...
- h
- 5

When you can send any of these instantly, smoothly and easily, ask someone to read different combinations of three or four of these letters. Send each combination twice until your hand forms each letter automatically and your ear

INTERNATIONAL MORSE CODE AND CONVENTIONAL SIGNALS	
1. A dash is equal to three dots.	3. The space between two letters is equal to three dots.
2. The space between parts of the same letter is equal to one dot.	4. The space between two words is equal to five dots.
A . —	Period •• •• ••
B — ••••	Semicolon —• —• —•
C — •• —•	Comma • —• —• —•
D — •••	Colon — — —•••
E •	Interrogation •• —• —••
F •• —••	Exclamation point — —•• —• —•
G — —••	Apostrophe — — —• —• —••
H •••••	Hyphen —•••• —•
I ••	Bar indicating fraction —••• —•
J • — — —•	Parenthesis —• —• —• —• —•
K —•••	Inverted commas • —•••• —•
L —• —••	Underline •• —• —•• —• —•
M — —	Double dash —••• —•
N —•	Distress Call ••• —• —• —• —• —• —•
O — — —	Attention call to precede every transmission .. —••• —• —•
P •• —••	General inquiry call —•••• —• —• —• —•
Q — — —•	From (de) —•••
R ••••	Invitation to transmit (go ahead) —• —• —•
S ••••	Warning—high power — — —••• —• —•
T —	Question (please repeat after)—interrupting long messages •• —• —• —••
U •• —	Wait •••••
V ••• —	Break (Bk.) (double dash) —••• —•
W • — —	Understand •••• —•
X — — —•	Error ••••••••••
Y —• —• —	Received (O. K.) • —•
Z — —••	Position report (to precede all position messages) —• —• —•
Ä (German) • —• —• —•	End of each message (cross) •• —• —• —•
Á or Å (Spanish-Scandinavian) •• —• —• —•	Transmission finished (end of work) (conclusion of correspondence) •••• —• —• —•
CH (German-Spanish) — — —• —•	
É (French) •••••	
Ñ (Spanish) — — —• —•	
Ö (German) — — —• —•	
Ü (German) •• —• —• —•	
1 • — — —• —•	
2 •• —• —• —•	
3 ••• —• —• —•	
4 •••• —• —• —•	
5 •••••	
6 —•••••	
7 —• —••••	
8 — — —•••	
9 — — —• —• —•	
0 — — —• —• —•	

recognizes each letter instantly. If you have no one to read off combinations to you, write down a series of them and then send them, as follows:

sie hesi she
 5 hies isee sees
 esih sesh his
 sees hehe sis
 hihi

Next, learn the dash group, as follows:

t —
 m — —
 o — — —
 o — — — —

Note that there is no letter represented by four dashes. Each dash is three times as long as a dot. Master this group, then send combinations of it such as tom, moot, motto, O tom, tomo, and so on. Next, combine the dot group with the dash group. Already you can send simple sentences; such as, "I see Tom," "Tom hit his sis," "50 shots hit Tim."

Pursue the same course with each set of combinations, first mastering the letters and numbers in succession, then forming combinations of these letters, and finally combin-

TABLE A		
I. DOTS	II. DASHES	III. Dot-DASHES
e .	t —	a . —
i ..	m — —	w . — —
s ...	o — — —	j . — — —
h	o — — — —	1 . — — — —
5		
IV. DASH-DOTS	V. DOTS-DASH	VI. DASHES AND DOTS
n — .	u .. —	g — . — .
d — ..	v ... —	z — — ..
b — ...	4 —	7 — — — ...
o —		8 — — — — ..
		9 — — — — .
VII. DOT-DASH-DOT COMBINATIONS	VIII. DASH-DOT-DASH COMBINATIONS	IX. PUNCTUATION
r . — .	k — . —	Period
p . — — .	x — . — —	Comma . — . — . — .
l . — ..	c — . — .	Fraction — . — . — .
f .. — .	y — . — — —	
	q — — . — .	



AN AMATEUR OPERATOR AT HOME

A knowledge of the code, acquired in a few months of intensive study, and apparatus as simple as that shown here, will give the radio experimenter, who has known nothing but broadcasting, some fascinating hours of experience. The transmitting set is on the shelf at the left below which are cards from stations all over the world. The receiver is on the shelf at the right

ing these with all the groups you have previously learned.

After learning the alphabet so that you can send any letter instantly, and without mental effort, practice sending from a newspaper until you can do it steadily and smoothly. Be sure the correct proportion between dots and dashes is maintained, that is, a dash should be three times as long as a dot. Leave ample spacing between words. Listen to your own sending, and correct any halting quality until you can send smoothly and evenly. No one can send readable code if the spacing is irregular and the individual code characters are given improper time values. Don't try to send fast until you can send every letter perfectly and with full confidence of what it should sound like.

If two people attempt to learn the code together they can greatly expedite the process. While one is learning to send the letters of the alphabet, the

HOW TO HOLD THE KEY

The illustrations at either side, top, shown how *not* to use the key. In the first position, the key is grasped too strongly by the thumb. In the second, the grasp all around the knob makes the muscles of the hand too taut. The three lower photographs show three different ways to hold the key, all satisfactory. The wrist must be above the table, and arched. The motion which operates the key should come from the muscles of the upper arm and the second joints of the fingers be easily flexed. In this way the effort is reduced to the minimum and it is easy for the operator to get a free "swing" to his copy

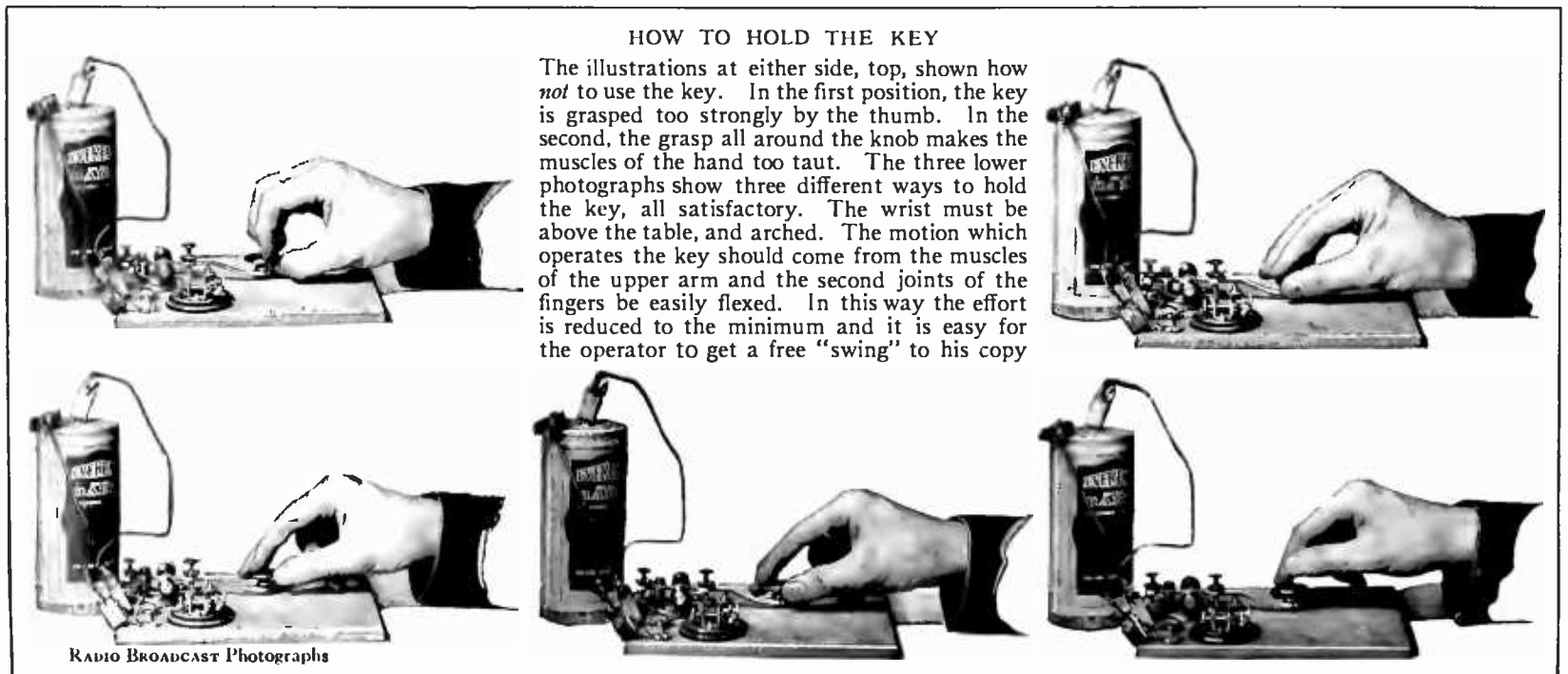

RADIO BROADCAST Photographs

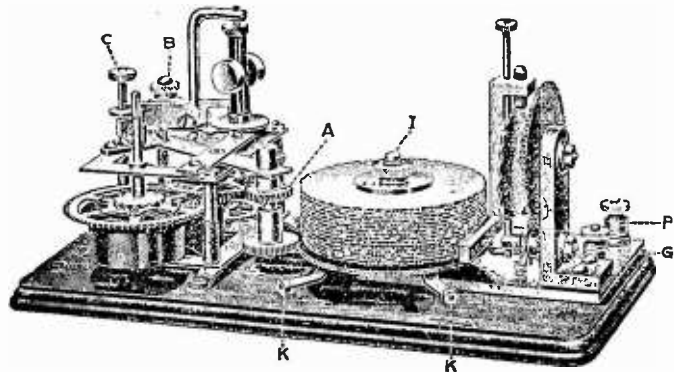

THE OMNIGRAPH

A well known mechanical device for code practise. The clockwork at the left turns the record table, I, where aluminum records bear the characters of the code. Numberless combinations are possible with this system. The records break the circuit to a buzzer or similar device used to make the signals audible

THE NATROMETER

An automatic code teacher developed and patented by the National Radio Institute Washington. With a device of this sort, a battery and buzzer, plus some ambition it is not hard to learn the code after a reasonable amount of application

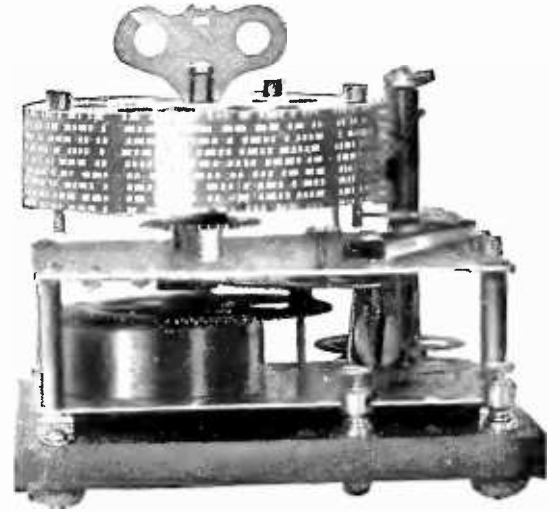

other can attempt to receive it. By reversing position at the key and the listening post, it should not take long to read entire sentences. The receiving operator can correct the sender if his spacing is not good.

INTERNATIONAL EAVES-DROPPING

AS SOON as the alphabet has become familiar, the next step is to listen to some of the long-wave transmitting stations. Usually you can find one of these sending very slowly and repeating each word twice.

The construction of a long-wave receiving set, useful in securing code practice at moderate speeds, is very simple. Usually the experimenter has, in his stock of

Station	Call letters	Frequency	Wave length	When sent
Annapolis, Md.....	NSS	Kilo-cycles 17.5	Meters 17,130	Daily at 11.55 a. m. to noon and 9.55 to 10 p. m., eastern standard time.
Arlington, Va.....	NAA	113	2,653	Do.
Astoria (North Head), Wash.	NPE	110	2,726	Daily at 11.55 a. m to noon, Pacific standard time.
Balboa (Darlen), Panama...	NBA	45	6,663	Daily at 3.55 to 4 a. m. and 11.55 a. m. to noon, central standard time.
Cavite, P I.....	NPO	57	5,260	Daily at 10.55 to 11 a. m. and 9.55 to 10 p. m. 120th meridian east time (Philippine standard time).
Colon, Panama.....	NAX	165	1,817	Daily at 3.55 to 4 a. m. and 11.55 a. m. to noon, central standard time.
Eureka, Calif.....	NPW	95	3,156	Daily at 11.55 a. m. to noon, Pacific standard time.
Great Lakes, Ill.....	NAJ	64.0	4,685	Daily, except Sundays and holidays, at 11.55 a. m. to noon, eastern standard time.
Key West, Fla.....	NAR	151	1,986	Daily at 11.55 a. m. to noon, eastern standard time.
Pearl Harbor (Wailupe), T. H.	NPM	205	1,463	Daily at 11.55 to noon, 180th meridian time.
San Diego (Challas Heights), Calif.	NPL	26.1	11,490	Daily, except Sundays and holidays, at 11.55 a. m. to noon, Pacific standard time.
San Francisco (Mare Island), Calif.	NPH	133	2,254	Daily at 11.55 a. m. to noon and 9.55 to 10 p. m., Pacific standard time.
		30.6	9,798	
		195	1,538	
		62	4,836	
		225	1,333	

SCHEDULE OF TRANSMISSIONS OF LONG-WAVE TIME SIGNALS

By setting up a long wave receiver, the amateur listener can hear the time signals and weather reports and forecasts. Frequently they are sent slowly, which affords good practise to the learner

the code is acquired, to the time when you become an operator of your own transmitting station. Thousands of broadcast listeners are being won over to the hobby of amateur transmission. The principal factor that has deterred most people is that they believe that an elaborate and expensive equipment is needed. But with only a simple receiving tube and a bank of heavy duty B batteries, messages have been sent halfway round the world. The RADIO BROADCAST-Eveready short wave experiments, conducted for the purpose of developing short-wave low power transmission, have done much to stimulate interest in this new and increasingly popular field.

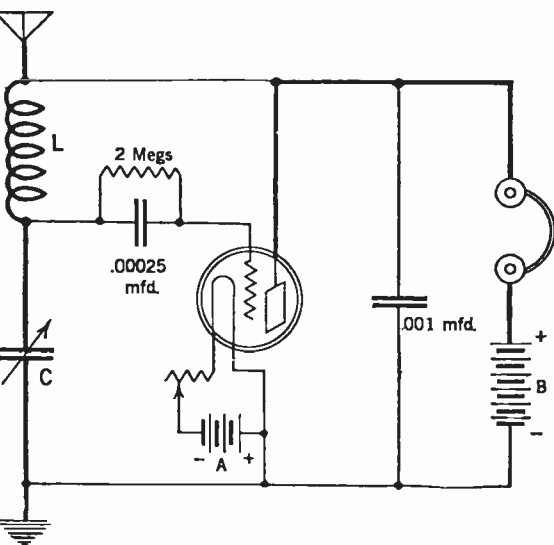

600 Meter Traffic, L=100 to 150 Turn Honeycomb Coil
1200-2600 " " L=300 to 400 " "
2600-5000 " " L=750 " "
5000-15,000 " " L=1500 " "

A SIMPLE LONG-WAVE RECEIVER

By using plug-in honeycomb coils, a one-tube outfit such as this shown, will bring in long-wave stations from great distances. On some circuits, traffic is sent slowly and repeated several times which makes grand practise for the beginner

discarded instruments, practically all the essentials required to make the outfit shown in the drawing. Through the use of interchangeable honeycomb coils, any wavelength range desired may be covered. The table to the left shows the correct honeycomb inductance required for covering the wavebands in common use.

The secret of learning to copy long-wave stations or code sending from any source is to continue copying no matter what you have missed or skipped. Usually you can supply from the context any letters or words which have been skipped.

It is a characteristic of a skillful operator that he writes his message down several seconds after the letter has been sent, keeping two or three words of the text in his mind all the time. In the parlance of operators they call this "copying two or three words behind." The result is a neat looking blank with any missed words or letters supplied by the context of the message.

It is not a tremendous step forward once

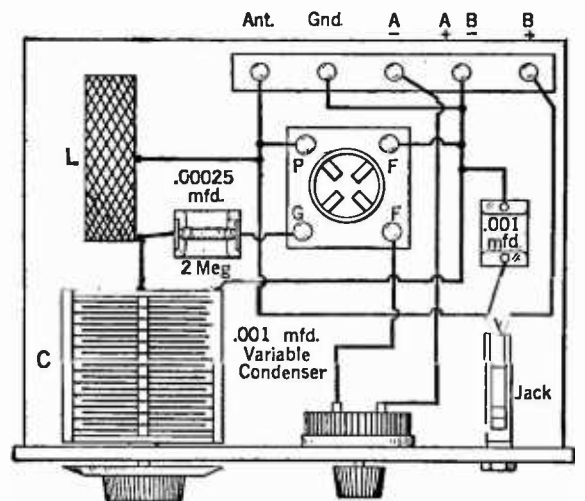

THE LAYOUT FOR THE LONG-WAVE RECEIVER

It should take perhaps an hour to do the assembly work on such a receiver. The novice will be surprised to note how many distant long-wave, high power stations such a set will bring in. Besides learning the code by copying their signals, he will hear a great deal of interesting, sometimes almost romantic, traffic

AS THE BROADCASTER SEES IT

by CARL DREHER

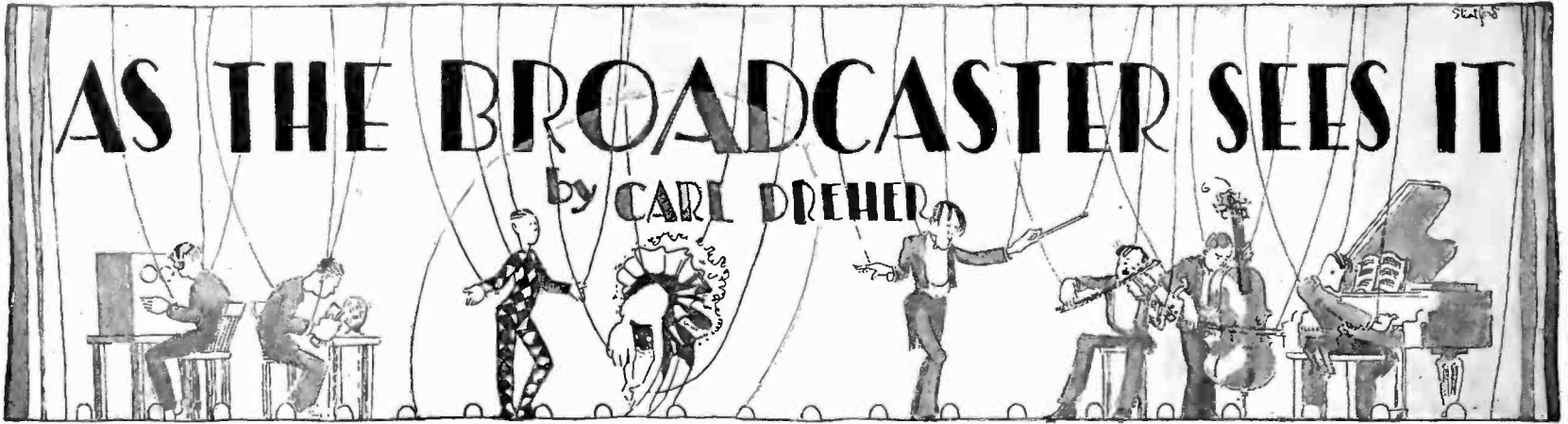

Drawings by Franklyn F. Stratford

What Constitutes Fair Dealing in Radio Matters?

THE problems of ethics are by no means as definite and soluble as those of algebra, even in fields where ancient usages have standardized the ethical values involved. But in these cases there is reasonable unanimity as to what constitutes fair dealing. In banking, for example, a man knows quite accurately what his rights and duties are. But when it comes to a young industry, like radio, which is at once an art and a general source of perturbation, ethical values are all up in the air, so to speak. Men of normal good will, moderate, well-intentioned men, frequently do not agree at all as to what constitutes fair dealing in radio. Moreover, they frequently cease to be men of good will when they dispute in this field. And not only are precedents and crystallized sentiment lacking, but in radio, probably more than in any other occupation of man, activities overlap and interact to a bewildering extent.

Take, for example, the erection of a new broadcasting station. It is not feasible to locate it in the desert, and inevitably some radio listeners will be near it. Some of these people may have receiving sets which were adequate for their purposes before the new station was planted in their midst. Four years ago a friend of mine wanted a single-circuit regenerative set with two-stage audio amplifier, during the great radio boom. The set cost \$150, but actually, none was to be had on the retail market. I did him a great favor by going to the president of one of the large distributing firms and enabling the fellow who had to have a radio set to get rid of his \$150. At a moderate distance from broadcasting stations, and close to none, it is still a usable receiver. If he is not too critical of quality, a man might be satisfied with it. He might not be ready to write off the cost of his equipment after the four years he has used it. Why should he, since it is still giving him the grade of service he requires? But someone comes along and plants a broadcasting station

three city blocks away. And now, on this once costly set, only this near-by station can be enjoyed. And the owner of the receiver does not want to listen to that station. It is an anti-vivisectionist station, say, and the listener, a surgeon doing research work in cancer, kills two hundred rats every month. There is the situation. It is by no means a purely hypothetical one.

Who is wrong? No one, apparently. The anti-vivisectionists have a right to their station if they can persuade the Department of Commerce to grant them a license, and if they have the funds to pay for the equipment and operation. They must put the station somewhere. The manufacturer of the set, and the dealer who sold it in 1922, acted in good faith. They turned out the best product that the state of the art then permitted, and sold it at a price that people were willing to pay, and which they did pay eagerly. If that was wrong, the whole commercial structure is wrong, and we must

deliver ourselves into the hands of M. Trotsky. Since then, the art has progressed, which is also good. Well, you say that the listener must progress with the art, and buy himself another \$150 set. This one may last for eight years, and \$300 as a capital outlay for twelve years of radio entertainment is not much. But the listener is not in the mood for progress which, just at this time, is to cost him money. Bear in mind that he was satisfied before the anti-vivisectionists came. His satisfaction has been taken away from him. Why should he suffer? Go ahead, apply your ethics. I will side-step, if you don't mind.

Or, suppose that the anti-vivisectionist brethren want to broadcast, and have the money, but can't get a license because there are no wavelengths left? Isn't that a hardship, in a world where publicity is everything and the inarticulate go under? Already flour mills, vaudeville theatres, public service corporations, colleges, cabarets, Christian Scientists, Zionists, and the Y. M. C. A. have stations on the air, and why should not the anti-vivisectionists, who consider their cause vastly important, be given a wavelength? They would have got one, if they had come a little earlier. Let them divide time with an existing station, it is proposed. But the existing stations are filling their time, and want to hold on to it. Half time on the air is worth much less than full time. If a man or a firm has invested \$100,000 in a broadcasting station, taking away some of its time may cut the value of the investment 50 per cent. or more. That is confiscation, and not ethics. But should a vaudeville house be allowed to broadcast its frivolities every day, when its primary motive is profit, while the fervent moral crusaders of the anti-vivisection cause remain gagged, just because the vaudeville crew got there first? That must also be painful to the professors of ethics. For it may not be anti-vivisection which is left out in the cold, it may be religion or education or the League of Nations or what



IT IS NOT EASY FOR JUSTICE TO WEIGH RADIO MATTERS

worthy or unworthy cause you will. Let the followers of the cause hire time somewhere, you say. But that does not give one as free a hand as when one owns a station. The cause may not be popular to-day, and how shall it become popular if it cannot get a hearing, even with the merit which its proponents assert it possesses. Well, the listeners should decide. A referendum must then be held of all the listeners within range of the existing and proposed stations. Who shall pay for this plebiscite? And will not the existing stations have an unfair advantage? They will certainly plead their cause on the air. They have invested their \$100,000 apiece for the privilege of doing so. The problem, you see, becomes complicated. What with conflicting interests, many of them irreconcilable, and the shortage of wavelengths, we have wandered into an ethical morass.

Some musicians are hired to play for a hotel, to assist the salivation and digestion of the guests in the dining room. They are paid a certain sum for their services. The hotel management arranges with a broadcasting station to radiate this dinner concert for the benefit of all and sundry. The musicians claim extra payment for their work, which now performs two functions instead of one. The broadcasters and hotel management deny the claim, maintaining that the musicians play exactly as before and are not entitled to additional compensation. A nice question in equity is here presented.

The copyright question fairly bristles with such problems. If you consider broadcasting as merely an extension of range of sounds already audible to persons assembled at the place of performance, then a license from the copyright owner to play his composition in that place may be construed as implying the right to broadcast. It is equivalent to employing amplifiers and loud speakers in order that the music may be heard clearly by people in remote parts of the hall. But if broadcasting is a separate and distinct operation, then the broadcaster must obtain a license covering his functions. Here the problem is legal rather than ethical, for ethically it will probably be conceded that broadcasting is a separate operation and should be dealt with independently. But if the broadcasting interests are to pay for the copyright privilege, how much should be exacted? And why should the broadcaster pay it all, since the listener enjoys the music?

Some radio manufacturers broadcast. Others do not, but sell apparatus on the broadcasting of the first class. The manufacturers who broadcast are in effect subsidizing their competitors. There is nothing very ethical about the distribution of handicaps in this race, but what are you going to do about it?

There are also many practices in broadcasting which are clearly unethical, but hardly important enough to give rise to lawsuits or assault and battery. A small station is struggling to maintain itself by toll broadcasting. It assigns periods which remain uncovered to volunteer artists. When the station lands another contract it promptly throws off the program any amateurs who are in the way, perhaps offering them another date, perhaps neglecting even this act of decency. In this case the station has clearly violated the principles of fair dealing. But amateur artists do not always live up to their obligations either. They promise to be at the studio at a given time, and fail to appear. This is a double lapse, offending both the station and the audience. Yet it is very common.

Personally, I have no cure for these evils, such as they are. We must wait for the gradual accumulation of ethical standards. Then everything will be sweet, and all the oscillating re-

ceivers will disappear. In the meantime, some preacher hunting for a new subject for his Sunday sermon might take an excursion into radio.

Clubless Radio

THE following is a list of professional groups maintaining club quarters in New York City:

- | | |
|------------------------------|--------------------------------|
| Adventurers | Journalists |
| Advertising Men | Lawyers |
| Aeronauts and Aviators | Machinery Men |
| American Dramatists | Merchant Marine Officers |
| Army and Navy Officers | Merchants |
| Artists | Modern Drummers |
| Authors | Musicians |
| Bakers | National Vaudeville Artists |
| Bankers | Newspaper Men |
| Bellevue Nurses | N. Y. Hospital Graduate Nurses |
| Business Men | N. Y. Newspaper Women |
| Chemists | Paper Hangers |
| Clergymen | Physicians and Surgeons |
| Colored Vaudeville Comedians | Professional Chauffeurs |
| Dining Room Workers | Pullman Porters |
| Drug and Chemical Men | Railroad Men |
| East Harlem Workmen | Soldiers and Sailors |
| Engineers | Speakers |
| Explorers | Swedish Chauffeurs |
| Fabric Men | Telephone Men |
| Film Players | Thespians |
| Garment Men | Wool Men |
| Hardware Men | |
| Jewish Writers | |

These are all genuine. I have omitted all groups, such as Fakirs, Friars, Lambs, Jockeys, Lions, American Jersey Cattle, and Warriors, where I had reason to believe the members were going under an assumed name.

And where are the radio men? They have no club, strange to relate. There is, of course, the Radio Club of America, which has the name and the membership, but it is a learned society, a sort of younger brother to the Institute of Radio Engineers. Neither of these organiza-

tions maintains quarters where one can go to talk business, recline on plush chairs, get away from one's wife, or take a drink, while remaining in the atmosphere of one's profession.

There are already so many near-bankrupt clubs in the metropolis that there is probably no sense in starting another, and yet it is probable that by and by a radio club will appear. The founders will have their bewhiskered images done in oils and hung on the walls for all eternity. Their descendents will say. "There are the old fellows who steered the ship when the trans-Atlantics flivvered in 1926." I do not know that I aspire to this immortality, if it is going to cost me much money, but I have been asked to send up a trial balloon, to ascertain whether there is any interest in such a project. I will be glad to enter into correspondence on the subject.

S O S Publicity

IN PROPOSING the establishment of a central observation station to supervise the frequency adjustment and 600-meter watch of a group of New York broadcasters, the engineer of one plant suggests that a different station be designated each week to give the public information about the sos.

Not a bad idea, but there is a legal stumbling block in its path. No operator's license is valid until the applicant has subscribed to the following oath:

I, _____, do solemnly swear that I will faithfully preserve the secrecy of all messages coming to my knowledge through my employment under this license; that this obligation is taken freely, without mental reservation or purpose of evasion; and that I will well and faithfully discharge the duties of the office: So help me God.

There is no exemption in this for sos material or anything else. Thus, theoretically, the operator of a broadcasting station may not divulge what he hears on the air during an sos shutdown, although the material is of public interest and there is no good reason why it should not be broadcast when the telephone sta-

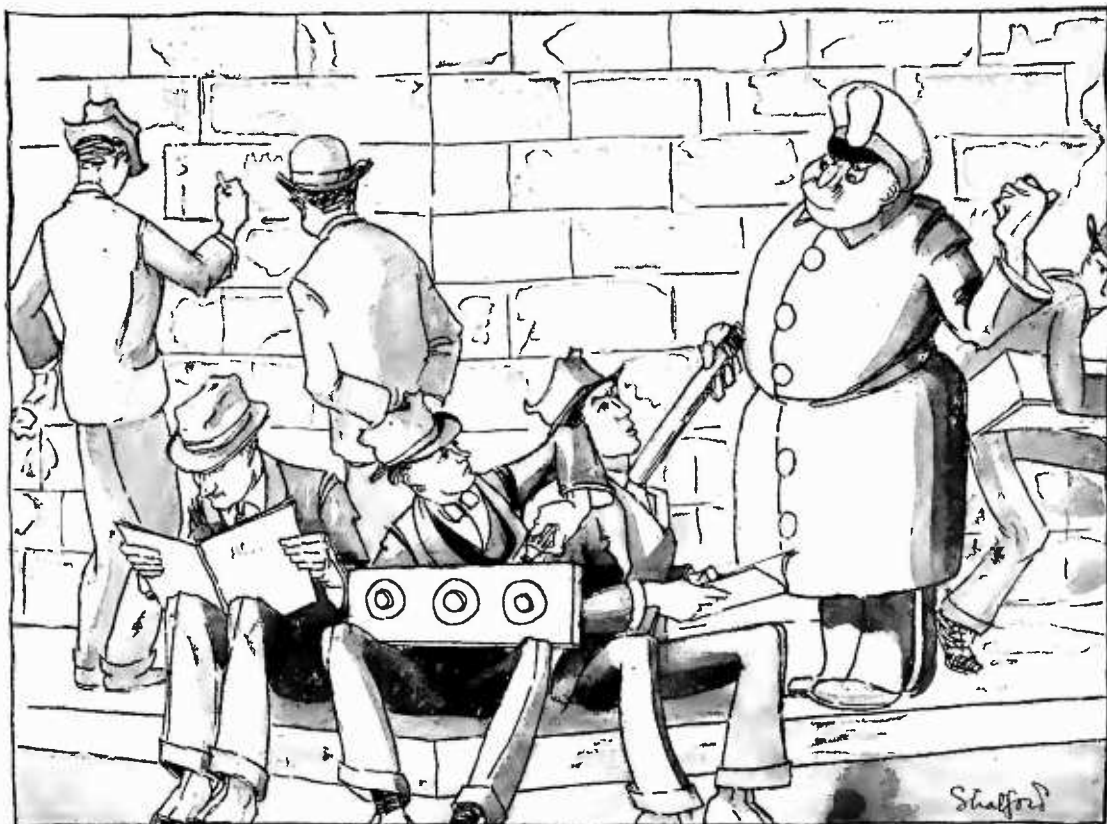

THE POOR RADIO MEN IN NEW YORK HAVE NO CLUB AT ALL

tions get back on the air. Actually, many of the stations ignore this prohibition. The newspapers, also, secure the desired information, no doubt through wireless operators in some instances. This situation is one which should be brought before the legislative committees now pondering over radio regulation. My suggestion is that the oath be modified to exempt sos calls and traffic directly pertaining thereto.

Technical Operation of Broadcasting Stations

5. Equalization

IN GENERAL it may be said that the low notes in speech and music impart roundness and volume, while the high notes give brilliancy and intelligibility. The high notes, which electrically are in the form of alternating currents of from 3000 to 10,000 cycles per second, are readily lost through the bypassing effect of shunt capacities. See Fig. 1. Here we have an alternating current generator *G* which is assumed to produce currents of various frequencies in the acoustic range, say from 100 cycles per second to 10,000, and to have an internal impedance of 500 ohms, independent of frequency. The output of *G* goes to a line of standard cable, assumed to have a capacity of 0.054 mfd. per loop mile, and to be ten loop miles long. We have no time here to work out the problem in detail, so we shall represent the cable by a lumped capacity of 0.5 mfd., *C*. The line terminates in a fixed absorbing circuit of 500 ohms impedance. This circuit represents, in a rough way, the combination of a field amplifier, a line, and the input to the audio frequency amplifiers of a broadcasting station.

The reactance of the capacity *C* of the ten miles of cable is given by the usual formula for the reactance of a condenser

$$X_c = \frac{1}{C \omega} \quad (1)$$

where *X_c* is the reactance of the condenser in ohms

where *C* is the capacity in farads
where ω is the angular velocity of the alternating current, equal to $2\pi n$, *n* being the frequency in cycles per second.

For a low note, *n* = 100 cycles per second, we find that the capacitive reactance of the line is about 3200 ohms. In other words, the line will pass low notes on to the terminating transformer with little loss. But it is clear from (1) above that the reactance varies inversely as the frequency of the applied e.m.f., so that at 1000 cycles the reactance of the line considered as a pure condenser is only 320 ohms, while at 5000 cycles, a frequency which it is very necessary to transmit for good broadcast quality, the capacitive reactance is only of the order of 64 ohms. Under these conditions the 500-ohm absorbing circuit is practically short-circuited for the higher notes, from 4000 cycles up, while receiving the low tones strongly. A pair of high impedance telephones at the absorbing end of the circuit will accordingly give a very "drummy," muffled response. Before this stuff can be broadcast, something must be done to "equalize" or "correct" it.

There are various ways of accomplishing this "equalization" of the different frequencies, some very intricate and effective, others relatively simple and good enough for the ends in view.

In the first place it is clear that the capacitive bypassing characteristics of a line are not as serious if the output impedance of the field amplifier at the pick-up end is kept low, inasmuch as the loss of high frequencies depend inversely on the ratio of the output impedance to the capacitive reactance in shunt. That is, when the terminal impedances are low, the line capacity has that much less influence in the determination of the over-all transmission characteristic of the system, since one has to get down lower effectively to shunt a low impedance than a high one. Hence, if instead of working with end impedances of the order of 500

ohms, as is common in telephone practice, we wind the output transformer of the amplifier feeding the line to, say, 50 ohms, the lowering of tone caused by a given line will be much less pronounced. On the other hand, energy is lost by this measure. However, practically all forms of equalization in use by broadcasters lose energy, which must be regained by extra amplification, so we might as well be resigned to that.

The same thing may be done at the receiving end of the cable. The formula for the reactance of a pure inductance is

$$X = L \omega \quad (2)$$

We see, therefore, that the tendency of an inductance, employed, as a shunt, is to cut down the low frequencies, as a capacitive shunt cuts down the high. Some lines may therefore be

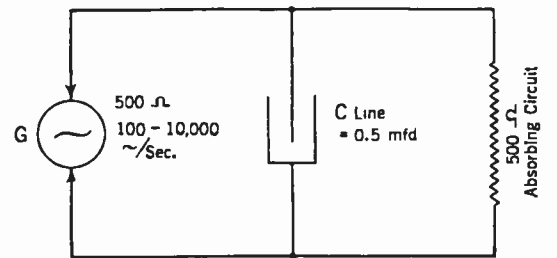

FIG. 1

Shunt capacities in wire lines for broadcasting can bypass the necessary high frequencies

roughly equalized by connecting a small inductance, such as a 60-ohm telephone receiver, across the receiving end, or the field amplifier output, or both. In the latter two cases the ability of the field equipment to ride over line noise is of course reduced. However, in some cases it might be advantageous to provide the field crew with low impedance phones to take advantage of this influence on the transmission characteristic. This effect is also noticed when one listens across a line with a low impedance telephone.

Another simple scheme is to provide an amplifier which is deficient in magnifying the low frequencies, such as a choke coil amplifier in which the coupling inductances are below the values normally used for "flat" transmission. The usual practice, when one wishes to retain the low notes, is to provide a choke whose impedance, at the lowest frequency which one wishes to retain, will be of the order of three times the tube impedance. If the tubes run around 10,000 ohms, for example, inductances with an impedance of 30,000 ohms at 100 cycles will be required. From (2) above, this corresponds to about 47 henrys. Usually values of the order of 100 henrys are preferred. To balance lines, an amplifier might be built with chokes having sliding iron cores, like those of induction coils built to give a shock of adjustable severity, to give a range from, say, 10 to 50 henrys. At 10 henrys, for example, 500 cycles and up would receive practically full amplification with 10,000-ohm tubes, but below 500 cycles the amplification would tail off. Such an amplifier, in combination with a "flat" amplifier with gain which can be regulated, would constitute an adjustable equalizer. The "flat" amplifier would be required to compensate for the varying efficiency of the equalizing amplifier as the inductance values were changed. The two instruments may be combined in one, by the use of a stage or two of "flat" amplification, either transformer, inductance, or resistance coupled, and a stage of low-inductance coupling to get rid of the excess of low frequencies.

In our next issue more elaborate methods of equalization will be taken up.

Embarrassment of Riches

THE broadcaster is often in the unfortunate situation of getting too much of a good thing. Take the case of one engineer. He started listening at 6:00 p. m. one Sunday to a concert by the small but excellent symphony orchestra of George Barrère, broadcast by WEAf. It was an excellent job, and the engineer enjoyed it. Then came the Waldorf Astoria Concert Orchestra, led by Joseph Knecht, one of the field pick-ups of wjz. He listened to that also, and liked it, particularly because part of the Rimsky-Korsakoff Scheherazade suite, one of his favorites, happened to be included. This ended at 8:00, and was followed by an hour of chamber music by the



A USE FOR JAZZ: IT PEPS UP FATIGUED BROADCAST ENGINEERS

Philharmonic Chamber Music Society, led by Ernest Schelling, the same station broadcasting. This was also admirable, but at about 8:45 the listener began to feel satiated. He had been listening unintermittently for two and three-quarter hours, and his appetite was beginning to give out, although he testifies that he loves music and considers it the most fundamental and naturally appealing of all the arts. Furthermore, he was trying to compare the Barrère hour with the Schelling hour, and as nearly as he could judge they were of equal merit technically (from the station transmission point of view) and musically, but he now felt that he should have skipped Knecht in order to start on Schelling with fresh ears, so to speak.

From 9:00 to 10:00 it was his duty to listen to Bernard Levitow's Hotel Commodore Ensemble, and by this time it really was a duty. The pleasure had largely gone out of it, although normally an hour of Levitow's broadcasting would be decidedly a treat to this observer. At 10:00 P. M. Mr. Godfrey Ludlow went on at WJZ for his regular Sunday night half-hour. Although our engineer is a friend and admirer of Mr. Ludlow's, and had promised to report to him on reception, he now quit and hunted around for some jazz. He felt like a low-brow and a scoundrel and all that, but he just couldn't listen to any more good music, and Mr. Ludlow, being an artist, could be depended upon to provide nothing else. Then why didn't the observer quit altogether? For this reason: after he had listened to some pretty ragged and sassy jazz for fifteen minutes, he was able to go back to Ludlow, restored, and to listen to his last twenty minutes with pleasure. If he had merely taken a lay-off for those fifteen minutes, the degree of recuperation would have been less. Thus a use has been found for jazz, aside from its function in dancing. It peeps up fatigued broadcast engineers. Stravinsky serves the same purpose, but he is too rare to be of practical use. I can say myself that there are times when I would pay \$6.60 to hear that fireworks piece of his, amid the appalling amounts of homophony which we technical broadcasters are paid to radiate and listen to.

Have you ever watched the people behind the counters in candy and ice cream stores? They never touch a sundae or a piece of chocolate candy. Such things are enjoyed most by the infrequent consumer. Similarly radio. What ails us professionals is not a paucity of good music, but an excess of the same. For our sake, some station should take to broadcasting dog-fights.

Memoirs of a Radio Engineer: XI

CAN you imagine an experimenter writing an article on single wire antennas for receiving, getting a prize for it from a radio magazine, having the article published, and then engaging in a lengthy controversy over the question of whether such antennas were to be preferred to the multi-wire type with spreaders? That is hardly a probable situation nowadays, when single-wire antennas outnumber all others in this country, probably in the ratio of one hundred to one, as a result of their adoption by the broadcast listeners. But in 1914 the inverse ratio held, almost all antennas, amateur and commercial, being of the four-wire flat top type, both for receiving and transmitting. Hence when I printed an article, in the January issue of the *Wireless Age* of that year, advocating the use of long single-wire antennas, and giving the results of experiments with that type, my conclusions were immediately challenged.

The multi-wire flat top antenna had come into practically universal use on ships, it being the most convenient type for combination receiving and transmitting in the space afforded by the average vessel. And, in fact, it has retained its position in the majority of marine cases, although the cage type has displaced it many instances. Early amateur radio was largely copied from marine practice, hence the early part of the second decade of the century was one in which four-wire flat tops held the lead unchallenged, even where the only object was reception of commercial signals, by amateurs. In fact, most amateurs hardly knew that a single wire would receive. If they got a present of one hundred feet of wire for Christmas or a birthday, they proceeded up to the roof and, as a matter of course, erected a 25-foot four-wire antenna. If Providence yielded two hundred feet of the necessary material, then a fifty-foot antenna was put up. But, in the case of those amateurs who wanted to hear the ship-to-shore traffic on 600 meters and other traffic, such as Cape Cod (wcc) and Sayville (wsl) up to about 3000 meters, these antennas were too short for maximum signal strength, however suitable they may have been for 200-meter transmission. This was a fact which some of my friends and I discovered before long, and we took advantage of it by erecting long single-wire antennas between conveniently located apartment houses. Most of us lived in two- or three-story frame houses, and by swinging single wires between two six-story brick apartments, from two hundred to four hundred feet apart, we gained the advantages of both height and length. Of course it was a vital matter for us to get as much energy out of the air as possible, inasmuch as we were limited to crystal reception, and whatever the antenna didn't pick up strongly enough to be audible in the phones after rectification, we had to do without. And the single wire had one other advantage—it was not so apt to be detected by the janitors, our natural enemies. However, in writing up the idea I stressed only the electrical advantages. Of course there was nothing original in the article; I knew Marconi had used single wires before 1900. Nor, even in my group of amateurs, had I made the discovery. A number of my friends were using long single-wire spans, and I believe they copied the idea from Mr. Fred Parsons. Where he got it I don't know.

Anyway, a controversy raged in the columns of the *Wireless Age* through the July issue, and the method of argument was the same that the broadcast listeners use now. One fellow testified that with a single wire 500 feet long, he had heard the United States Naval station at Guantanamo, Cuba, on such and such a night, so and so loud, whereas with a 100-foot four-wire antenna he had never heard this station, using the same receiver. Another scientist, using a different receiver, had achieved better results with a short multi-wire antenna, and he defended it fiercely, extolling its virtues with poetic fervor, and denouncing the long single wires as frauds. The editors injected some theory into the controversy, and we were all very happy; we saw our names in print each month, our DX records were chronicled and set down for posterity, and we were sure we were right. On this point I was particularly confident, for, early in the debate, I had gone to Doctor Goldsmith, laid the case before him, and received his assurance that, other things being equal, a single 400-foot wire would pick up more and louder 600-meter signals than the same amount of wire in four parallel strands.

In our magazine argument, to be sure, other things were not equal. To this day, however,

John Smith argues that he has a better set than Bill Jones, because in a different neighborhood, on a different antenna, on a different night, he heard some broadcast station better (or so he says) than Jones heard it last March. So we were no bigger fools than our successors.

Microphone Miscellany

The Sweet Listeners. Letter received from a cash customer by a well-known station after a wire failure during a field broadcast:

Having tuned-in on your star number every night for the last fortnight and in the midst of the broadcast, heard a series of crashes followed by periods of silence, think it would be better to stick to studio work until your staff learns something about broadcasting. After my experience to-night during _____'s program, I wonder why your staff permits such a butchery of an artist's efforts. If they don't know how to do it, why not experiment with amateurs?

Announcer's Bull. Some time last year we offered valuable prizes for reports of striking verbal bulls by members of the announcing fraternity, but the announcers suddenly became respectable and the prizes went begging. Here, however, is a healthy entrant, from WGBS, New York, Jan. 3, 1926, 4:40 P. M.:

"I am sorry that the Crystal Palace orchestra will not have time to play all the numbers requested. Of course you understand there is a limit both to time and to human endurance." It was a good orchestra.

Marvelous Invention Announced for Twenty-First Time. A. P. dispatch from Washington, D. C., Jan. 16, 1926:

A discovery whereby the sharpness of tuning and selectivity of radio crystal receiving sets is greatly improved was announced to-day by the Department of Commerce.

E. B. Judson, expert in the radio laboratory of the Bureau of Standards, who discovered the improvement, declares that shunting the crystal detector across one-half the inductance coil, causes sharper tuning and greater selectivity.

Moral Effects of Radio. From Baltimore comes another A. P. report, printed in the *New York Times* of Jan. 15, 1926, under the headline, "Forbids Radio at Goucher. President Guth Says It Causes Girl Students to Lose 'Pep.'" The text is as follows:

To-day was bargain day for radio sets at Goucher College. No more will loud speakers or ear phones aid in whiling away the hours between supper time and breakfast. President William Wesley Guth has banned them.

Radio is responsible for late hours and consequent loss of efficiency and "pep," Dr. Guth told the students. In the business world, he said, it is easy to pick out the men who own radios. In the morning their faces tell. Therefore the radio ban, "for the physical as well as the mental welfare" of Goucher girls.

On the other hand, valuable moral lessons are taught over the radio, which may balance the deleterious effect of loss of sleep. An instance from a Japanese newspaper: "Man Attempts Suicide After Lecture by Radio."

After listening to a radio lecture on the horrors of drunkenness and its effects on descendants, Tetso Yashiro, 28 years old, an artist living in Sakurada-cho, Azabu, attempted to commit suicide Tuesday by drinking poison at the Omura restaurant in Imado, Asakusa.

Before drinking the poison the artist drank two bottles of beer and two bottles of sake.

If Mr. Yashiro had bethought himself to get some American bootleg liquor, he might have foregone the poison. That, however, is beside the point. The thing for Dr. Guth to do, obviously, is to re-install the radio sets, and not only that, but to put in a broadcasting station at Goucher. (Heaven will provide a wavelength.) This transmitter will radiate lectures against hip-flasks, the Charleston, cigarette smoking, and petting parties. The girls, attending to these exhortations, will either become good or commit suicide. There will thus be nothing left for Dr. Guth to worry about, and he will have the distinction of presiding over the only collection of chemically pure collegiate women in all Christendom.

Historical Example of Some Record DX Work by Nature

THE energy of most of the sounds to which we are accustomed, is quite feeble, and we are likely to conclude that no sound disturbances exist in nature which are capable of propagating themselves over distances comparable to those of radio or other electrical transmission. Under phenomenal conditions, however, unaided nature is capable of sending sounds, and even material particles, over terrestrial distances as great as those spanned by submarine cables and radio circuits. Sir Ray Lankester, in his book, *Secrets of Earth and Sky*, gives some well authenticated data on the volcanic explosion of Krakatoa in 1883. This volcano is on an island in the Strait of Sunda between Java and Sumatra. The eruption, lasting two days, blew the island high into the air. Some of it, in the form of pumice particles, ascended 30 miles, whence it was carried all over the world by the currents of the upper atmosphere, causing the exceedingly red sunsets of 1884. Over Batavia, a hundred miles distant, the sky became completely dark during the cataclysm. The sea wave which was set up, swept over part of Java and other islands in the East Indies, drowning 36,000 persons. Where it was unimpeded it swept on and was recorded at Cape Horn, 7800 miles distant. At Mauritius, 3000 miles from Krakatoa, the explosions were distinctly audible! Can radio do more?

Radio may not be able to go farther, but it gets there sooner. Inasmuch as sound travels about 1100 feet per second in air it must have

taken the noise four hours to reach Mauritius from Krakatoa, whereas a radio wave would cover the 3000 miles in about $\frac{1}{8}$ second. It follows that electricity is the only known solution to the problem of long distance communication, for if sound had to be used directly over a 3000-mile circuit, one would have to wait eight hours for the reply to a question. Two-way conversation, therefore, would require more patience than the human race possesses, judging by the experience of telephone operators. Of course, when it comes to light waves, that part of nature outside of man equals his radio waves in speed and far transcends them in magnitude. Light waves come to us over inconceivable distances, scarcely to be expressed even in such astronomical units as light years—the distance traveled by a light wave, moving 186,000 miles a second, in one terrestrial year. Our little toy radio waves reach their destinations in trifling fractions of a second, because their energy dies down to insignificance after they have gone a few thousand miles, a distance scarcely worth mentioning to an astronomer.

Radio Lingo

Broadcasting Transmitters' Cant

A NEW terminology is growing up in the broadcasting stations. The operators say, "How's the pick-up?" referring to the placing of microphones. "You're on the air" goes over the wire line to a remote point as a warning that broadcasting of an outside event is to begin. They say, "Give him the air," and "Take him off the air," "Did that go out?" and many other phrases along these lines.

A broadcasting engineer, listening critically to the reproduction of an orchestra, may make the remark, "The violins are down ten miles." "Down" means "weak" in telephone phrasology. "Ten miles" denotes the degree of weakness—telephone engineers speak of amplification in terms

of miles of standard cable. He means, then, that the violins in the orchestra are as weak as if they had to go through a line ten miles longer than the rest of the orchestra, and that this must be corrected.

Terms Derived from Physics and Engineering

RADIO is high speed acoustics. Speed up a sound vibration to a hundred times, let us say, and you have a radio oscillation. It is only natural, therefore, that many of the technical terms and inventions of radio have originated in the field of acoustics.

The fundamental concept of "tuning" is an instance. Musical instruments were "tuned" long before radio was dreamed of. We speak of electrical "resonance" nowadays when its only indication may be the silent movement of a pointer across a scale, but the origin of the word is obvious: "re-sound," to respond sympathetically and audibly when tuned to the same period, as a pair of properly adjusted violin strings. The quality of a broadcasting station's "modulation" is discussed; the term is an old one to students of singing and voice formation—"quality" itself is an expression used in music and the physics of sound. As for inventions, Fessenden's heterodyne, for example, came directly from acoustics. Everyone is familiar with the fuzzy quality of two discordant notes on a piano. This roughness is due to "beats" or periodic building up and neutralization of the energy of the two waves. In radio an inaudible oscillation may be detected with the aid of a local oscillation set to "beat" with the incoming frequency at an audible rate. Thus we speak of "beat-reception," "beat-frequency," and "zero-beats" in radio, the last named being the method by which a lot of distance records are more or less reprehensibly made by novice listeners, since with this condition re-radiation and interference with other listeners is bound to result.

"Microphone" is a telephone term. "Cross-talk," which is supplanting the vague expression "interference" in broadcasting, is also of telephone origin. "Loading coils," used in radio to tune to a higher wavelength than the normal range of a set, receive their name from Professor Pupin's contribution to long distance telephony—the placing of inductances along the line to improve speech quality and loudness.

Many radio fans have wondered why a gas-content vacuum tube is called a "soft" tube, while the highly evacuated bulbs are termed "hard." These expressions originated with the X-ray folk. A highly exhausted X-ray tube was found to give out "hard" or highly penetrative rays, while in the presence of gas, "soft" or less piercing radiation resulted.



WE WERE PROUD OF OUR ARTICLES
PUBLISHED IN RADIO MAGAZINES

B-POWER

By

NOE H. TYAR



HEWYWOOD BROUN writes an interesting, witty, and occasionally instructive column for the *New York World* and other papers. He might have been persuaded to do this one. But it would have been a trying experience for even the versatile and clever Heywood.

Not so with the present author, however. He feels an advantage over Broun that would put even that seasoned veteran in the shade; if any shade can be found to hide a man of his reputed dimensions and admitted luminosity.

To Broun the Raytheon B-power supply is a sort of hazy entity which he heard one of his friends mention at luncheon yesterday. He thinks that his radio set is naturally whimsical, and while the music isn't just what one is accustomed to from a good press seat on the aisle, it is about what one expects from a radio. Of course it's a little bit flat and tinny sometimes, but if friends are coming in one can always pep it up with a new set of B-batteries.

What a handicap! Not even if Broun spent a whole week-end investigating the advantages of central station power over inefficient B-battery power would he be competent to write convincingly for this column. Nor would any literary person, however talented, unless he

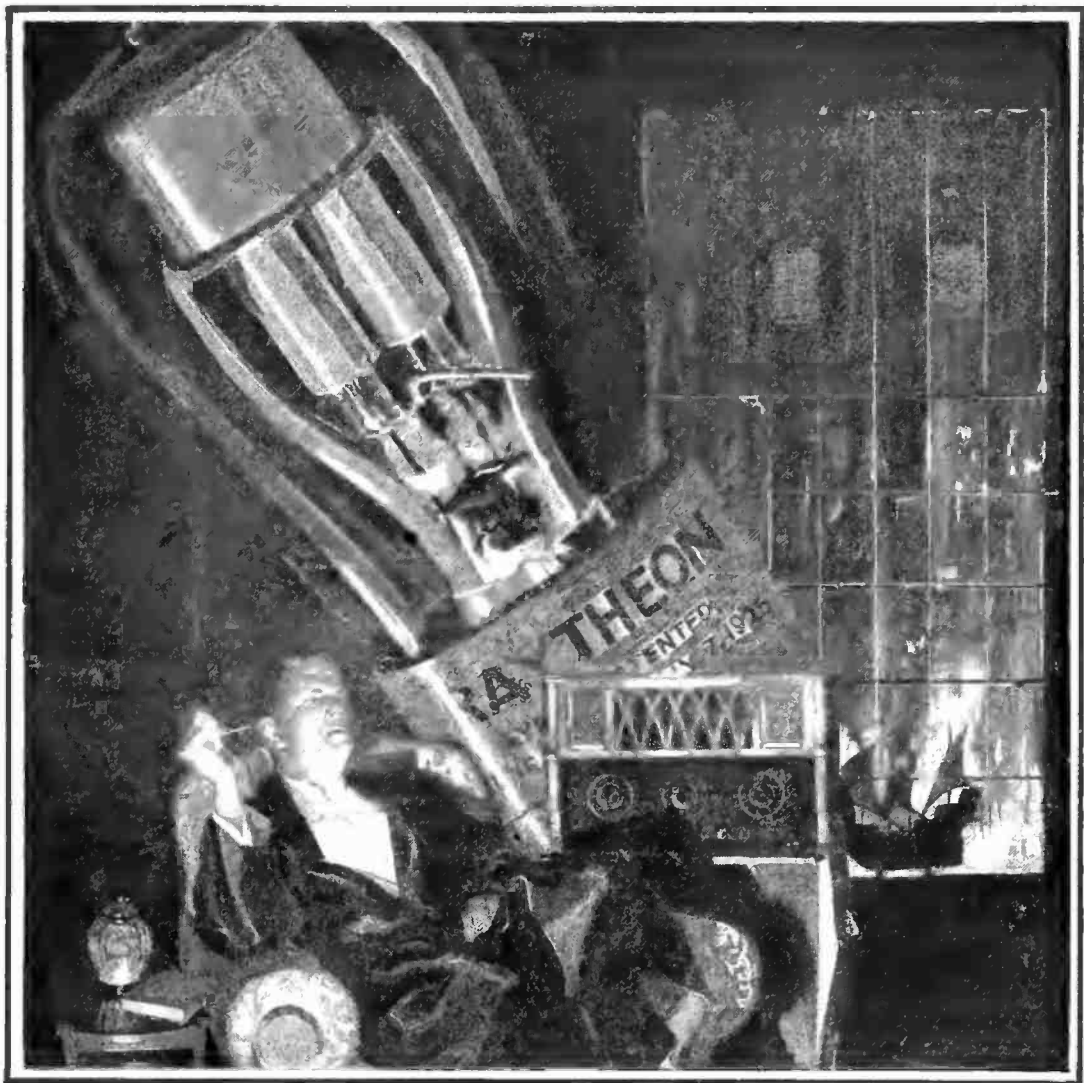

CONTENTMENT— Many people do not realize the contentment and honest pride that comes with the nightly operation of a Raytheon powered receiver.

DO YOU KNOW why RAYTHEON makes the piano seem more real? Do you know why you will ultimately obtain your radio power from the Central Station, just as you do your lights?

DO YOU REALIZE that a good B-power unit is better than the best B-battery—and why its every advantage continues without the slightest change from night to night and month to month?

We merely suggest that you investigate so that you will be prepared when your present set of B-batteries runs down. Let the accompanying article be your introduction.

RAYTHEON, TYPE B, is a full wave rectifying tube of ample capacity to eliminate B-batteries on even the largest ten-tube set.

RAYTHEON B-power units are manufactured by the companies shown on the following pages.

★
RAYTHEON

RAYTHEON MANUFACTURING COMPANY

CAMBRIDGE, MASSACHUSETTS

RAYTHEON

★ Tested and approved by RADIO BROADCAST ★

TOBE

"A Better Condenser" ★

Thousands will build or buy B-Eliminators this spring and summer. If you build your B-Eliminator, be sure to use TOBE Condensers in it. THE TOBE B BLOCK combines in a single silvered case unit all of the filter condensers required, sells at \$11.00, and saves you \$2.50 over the cost of separate condensers, and saves space and saves wiring. If you buy a B-Eliminator, make sure it uses TOBE Condensers for lasting satisfaction.

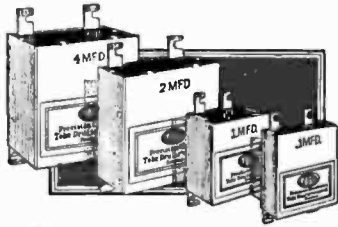

Tobe Deutschmann Co.
CORNHILL BOSTON, MASS.

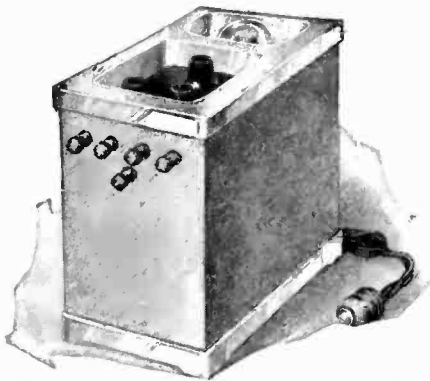

Mayolian

B SUPPLY

★ *The "B" Without a Buzz*
Highest "B" Voltage Output

Mayolian produces a "B" voltage up to 180, insuring great volume, sharp selectivity and distortionless amplification. The detector voltage is variable from 0 to 60 volts, the radio frequency or medium voltage is variable from 40 to 110 volts.

Raytheon Rectifier

No filament tubes, chemicals or liquids of any kind are used in the Mayolian. As a full wave rectifier, it employs the Raytheon long life rectifier, the life and efficiency of which is practically indefinite.

Guaranteed

Mayolian is backed by the established reputation of the Mayolian Radio Corporation and is absolutely guaranteed.

Type 609—\$55

Alternating current, 110 volts, 60 cycles, complete with tube.

Type 607—\$25

Direct current 110 volts.

Yes—Mayolian costs more than other "B" eliminators, but—it does more. If your dealer cannot supply you send us your order direct.

Regular discounts to jobbers and dealers. Write for the Mayolian circular.

Mayolian Transformers, Chokes and Resistances

for building Raytheon Plate supply
Transformer No. 201 List price \$7.00
Chokes No. 202 " " 5.00
Resistances " " " "
Types 5 and 7 " " 1.80
Raytheon Tubes " " 6.00
Mayolian resistances and other products are especially designed for "B" supply units.

MAYOLIAN RADIO CORPORATION, 1991 Broadway, New York City

GENERAL RADIO

Type 365
Rectifier
Transformer
Price \$10



Type 366
Filter Choke
Price \$10



Modernize your Radio Set—
Build a Practical "B" Eliminator

The popular topic of discussion among radio experimenters today is "B battery Elimination." Constant worry whether the "B's" are run down—and their continual replacement will soon be a thing of the past in radio. A "B" Eliminator never runs down and never has to be replaced.

For a dependable plate supply unit which requires absolutely no attention other than its original installation, build a "B" Eliminator of General Radio parts.

Write today for full data on General Radio Rectifier Transformers and Filter Chokes, and get our circular with full instructions for building a Practical "B" Eliminator.

GENERAL RADIO CO. Cambridge 39, Mass.

possessed that magic touchstone of enthusiasm which we (editorially speaking) are privileged to enjoy.

And that touchstone is no happy bent for the technical details which prove the superiority of the Raytheon B-power units. Far more important, far more convincing than that is the honest pride of ownership, the simple joy of throwing the switch that turns on the power. This is the daily revelation that has made every Raytheon B-power owner a more enthusiastic booster than a newspaper columnist would dare to be, even over his own college football team.

Evolution Crops Out Again

But let us digress since we are surely to be allowed the license and freedom from coherence which is the implied right of all who write "columns."

Have you ever thoughtfully considered the evolution of the candle? Yes, the candle, the kind great-grandfather used during those long winter evenings to teach grandfather his sums. (Little boys brought their lessons home in those days.) Do you know it was surprising the amount of light folks could get out of one of those old tallow dipped wicks. To be sure, it sputtered and flickered and had a habit of burning dim and dimmer just as great-grandfather reached the interesting part of the piece he was reading aloud to the assembled family. But that old tallow dip played its part in brightening the small corner where it stood.

Manufacturing methods soon made possible the candle mold so that a dozen or more could be made at one time. This reduced the cost somewhat and increased their reliability and brightness. It wasn't long until they were made in larger,

RAYTHEON

★ Tested and approved by RADIO BROADCAST ★

long-burning sizes for the big living room. Folks had pretty sound ideas of how to get the most out of things in those days. The wiser ones even put a reflector back of the flame to conserve what energy there was and use it to the best advantage.

But candles had their drawbacks, and while they were handy for lighting a pipe, they were apt to set curtains or carpets afire, to say nothing of the never-ending replacement problem. So when the oil lamp came along it was immediately adopted by the better homes as the last word in illumination. Surely such a steady glow combined with the ease and economy of re-filling the bowl with lamp oil was all anyone could wish.

Yet the lamp rapidly became obsolete in all except the farthest rural districts, and to-day we have illumination that is limited in its intensity only by the power of the equipment we see fit to install. Surely no one who has known the satisfaction of the steady glow that is now available at the turn of a switch would consider for a moment the uncertain old candle.

Now About B-Power Units

But the history of the candle is of interest to us at this time only as it sheds light on its successor to fame—the B-battery. Does not the evolution of the candle, the oil lamp and the modern electric light parallel the development of the dry B-battery, the storage B-battery, and the modern B-power unit to a remarkable degree?

To be sure dry B-batteries, like candles, can be conserved by judicious use, and the storage type B-batteries do improve the quality of reception. But to the owner of a Raytheon B-power unit it is no more a B-battery eliminator than

MODERN "B" Power Supply

THE Modern "B" Power Supply is a perfected unit behind which is our unconditional guarantee of satisfaction.

It is an electrically correct unit. Into it has been built every element that makes for practicability. It can supply 150 volts, thereby permitting the use of big power tubes. An extra 90 volt tap provides for the use of peanut tubes. Possible moisture seepage is absolutely eliminated; electrical depreciation of elements is totally absent; several additional microfarads eliminate oscillation where oscillation is part of the inherent design and each unit is tested at 2500 volts.

In short the Modern "B" Power Supply will operate any receiver satisfactorily, even improving in most instances tone and quality.

Try it and be convinced!



"It's Better Because It's Modern"

MODERN ELECTRIC MFG. CO.

Toledo, Ohio

CLAROSTAT

O. K.'d by
RAYTHEON—

because CLAROSTAT passed with flying colors the most searching tests Raytheon had ever given a variable resistance.

CLAROSTAT has no equal for voltage control in "B" Battery Eliminators. Only CLAROSTAT gives you a wide range of control and a current carrying capacity greater than that of any other variable resistor.

P. S. A host of other nationally known eliminator makers have also approved and endorsed Clarostat.

If your dealer cannot supply you, write direct

AMERICAN MECHANICAL LABS. INC.

285-287 North Sixth St., Brooklyn, N. Y.

Special types for "A" and "B" Battery Eliminators for Manufacturers.



\$2.25

Raytheon B-eliminator is the first "B" plate supply unit Thordarson has approved. Even on the modern all-frequency amplifiers it operates without hum, when built with the specially designed



Thordarson Transformers and Chokes are Standard on the B-eliminators of leading makers

THORDARSON "Raytheon-type"

Transformers and Chokes

Transformer R-195 Larger in capacity—Will not heat up in continuous service. Separable plug, 6 foot cord attached. Unconditionally guaranteed. Price, at dealers, or by mail, \$7.00.

Choke R-196 Completely shielded and mounted in large steel case. Binding posts at base for neat assembly. Capacity 60 milliamperes. Unconditionally guaranteed. Price, at dealers, or by mail, \$5.00.

Write for Hook-up Bulletin

THORDARSON ELECTRIC MANUFACTURING CO.

Transformer specialists since 1895

WORLD'S OLDEST AND LARGEST EXCLUSIVE TRANSFORMER MAKERS

Chicago, U.S.A.



RAYTHEON

★ Tested and approved by RADIO BROADCAST ★



- W-B-3 Two Voltages—
Detector and Amplifier . . . \$47.50
One variable resistance
 - W-B-4 Three Voltages with
power tube tap 50.00
Two variable resistances
 - W-B-D For 110-125 D. C.—
Three Voltages 25.00
- Prices slightly higher in Canada and West of the Rockies

★ Webster SUPER-B

THE Webster Super B with Raytheon tube makes radio reception better because—

It supplies steady, noiseless flow of plate current and thereby clarifies signals and builds up volume. It forever eliminates noises from run down "B" batteries and the expense of replacing them. It reduces cost of operating set to minimum. Just connect it to light socket and it will keep your "B" power always ready, full efficiency—costs less than $\frac{1}{10}$ of a cent per hour. Has ample power to operate any set and is adjustable for any voltage requirement. Model W-B-4 is especially designed to operate sets using power tube in last audio stage.

All leading radio distributors can supply you. Write us to-day for full information and Free booklet, "Improving Your Radio."



Compact—5 $\frac{1}{2}$ " high, 4 $\frac{3}{4}$ " wide
10" long—overall

THE WEBSTER COMPANY

3506 West Lake Street

Chicago, Ill.

Tested and approved by the Raytheon Mfg. Co.,
for use in the Raytheon "B" Eliminator

Filter Condensers for all "A" and "B" Supply Units

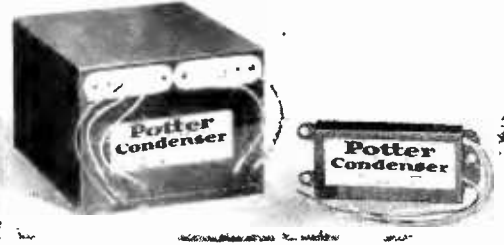

Special Models for the Raytheon "B" Eliminator

In building your "A" or "B" Eliminator it is absolutely necessary to use the finest condensers to obtain good results.

Made in 3 types: Type A, tested 300 volts D. C.; Type B, tested 500 volts D. C.; Type C, tested 1000 volts D. C. Each type comes in all capacities. There is a Potter Filter Condenser to fit every specification. Special models (shown above) for the Raytheon "B" Eliminator.

Potter Filter Condensers are made with the best foil, best insulation and best impregnating compounds obtainable. They take the kinks out of current, remove all traces of A. C. impulses, eliminate all hum. They have unusually long life under continuous use.

Potter ★ FILTER Condensers

(An American-Made Product)

POTTER MANUFACTURING COMPANY, NORTH CHICAGO, ILLINOIS

At your dealers. If he cannot supply you write direct to us



Transformers

Chokes



509 Full Wave
\$7.00 List
Manufactured in
25, 40, 50 and 60
cycles



514 20 Henry
\$5.00 List
Raytheon Tubes
\$6.00 List

Fans easily build their own B-Eliminators with Dongan B-Power Units, used with the Raytheon Tube. Dongan B-Power Units assure you definite results.

Special unmounted B-Power Units furnished to manufacturers. Our engineers will co-operate with you.

DONGAN ELECTRIC MANUFACTURING CO.

2991-3001 Franklin Street

Detroit, Mich.

TRANSFORMERS of MERIT for FIFTEEN YEARS

the Mazda lamp is a candle eliminator. The Raytheon B-power unit marks a new era in radio, a distinct advance in the art that is immediately evident to those who have had the foresight to install one.

Is There a Reason?

Why is Raytheon B-power better? Folks have an odd trait of wanting to know the whys and wherefores of things. In the days when electric street cars were replacing the old horsecars children had the embarrassing habit of looking up into their papas' faces and demanding, "What makes it go?" And many a proud father floundered miserably in the vain struggle for an explanation.

But here the answer is not far to seek. A Raytheon B-power unit gives better reception principally because it supplies ample voltage, a higher voltage and more power than you would find economical to obtain from B-batteries. This reserve power, which is as steady from night to night as are your electric lights, is made possible by the new rectifying tube, Raytheon type B.

And people are becoming more and more critical in their judgment of quality. We once heard a music lover say that if he were seated blindfolded in a room and some one in that room struck but one chord on the piano, he could tell positively whether or not that person was Paderewski. Those who know the unique quality of Paderewski's touch will not be inclined to doubt the possibility. But how many of the best music critics could listen to a piano concert over the average radio and judge whether it was being played by a master or by a student from the local conservatory? Even the best receivers, with the latest model loudspeakers,



RAYTHEON

★ Tested and approved by RADIO BROADCAST ★

often lack the final touch of realistic quality.

The Second Reason

And that final touch will usually be found in the B-power supply. Not only must the voltage and power be ample, but the power must be fed to the receiver through the right circuit. Here we have the second reason why Raytheon B-power units are better. They use a filter circuit which is scientifically balanced to allow all the notes to be uniformly amplified. The low notes come through in their normal volume.

The third, and not least important, reason for the high quality of Raytheon B-power units is the group of manufacturers who sponsor them. These companies, of long established reputation for square dealing, stand back of their products and they could ill afford to come on the market until they had taken every precaution to make sure that the new product was right. Some of the interesting laboratory work that is done to safeguard this quality will be discussed in a future article.

As for you, Mr. Broun

Oh, yes, we nearly forgot about our columnist friend who is struggling along with his B-batteries. Well, Mr. Broun, if you'll let by-gones be by-gones and give us a fair chance to prove that you *are* slightly behind the times, we'll just ask you to install a Raytheon B-power unit to-night. If it isn't all that has been claimed, drop a postal to us care of RADIO BROADCAST and we'll buy the darn thing back, spot cash, no questions asked. The office boy has been snooping around for a second-hand one, anyway.

Majestic Super-B

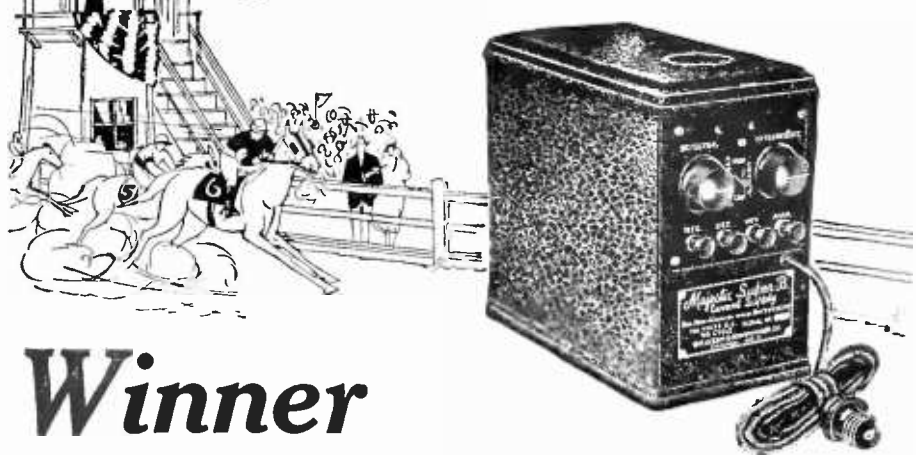

Winner in Performance!

On the racetrack there is always a winner! One whose stamina is greatest of all contestants—so it is with Radio. Your set, when equipped with the new Majestic Super-B, will literally outperform at *all* times, the records made previously by your receiver in its best temperamental moods.

The Majestic Super-B not only improves the volume and quality of tone, but spares you the constant annoyance of depreciating B-batteries. Also, it reduces the cost of operating your set to less than one-eighth cent an hour.

Two chokes of 41 Henrys each and 20 micro-farads of capacity are used in the Majestic Super-B filter circuit. Winding the chokes and transformer with 30 gauge wire of low resistance, also allows voltage regulation of better control. The unusually large condenser bank smoothes out every trace of ripple with a wide safety factor to spare.

Majestic Super-B Current Supply Complete with Raytheon Tube, Capacity 1 to 12 tubes including the use of new 135-150 volt power tubes.

110 volt, 60 cycle. Price \$39.50

The Majestic Standard-B is a smaller B current supply unit, designed for sets having not more than 6-201A type of tubes or 5-201A, plus one 112 type of 135 volt power tube.

Majestic Standard-B Current Supply Complete with Raytheon Tube.

110 volt, 60 cycle. Price \$32.50

GRIGSBY-GRUNOW-HINDS CO.

4540 Armitage Ave., Chicago, Illinois ★

RAYTHEON

★ Tested and approved by RADIO BROADCAST ★

THE GRID

A Department Devoted to Solving the Problems of our Readers

QUERIES ANSWERED

1. MY RECEIVER TUNES BROADLY. HOW MAY I CORRECT THIS?
W. A. S.—Cincinnati, Ohio.
2. HOW OFTEN SHOULD I CHANGE THE ELECTROLYTE IN MY STORAGE BATTERY?
M. B. L.—New Orleans, Louisiana.
3. YOU SAY THE WESTERN ELECTRIC CONE IS A LOW IMPEDANCE SPEAKER AND THE WESTERN ELECTRIC COMPANY SAYS IT'S A HIGH IMPEDANCE CONE. WHO'S RIGHT?
P. J. F.—Philadelphia, Pennsylvania.
4. I AM BOTHERED WITH A PERSISTENT SINGING NOISE IN MY RECEIVER. HOW CAN IT BE ELIMINATED?
T. S. L.—Baldwin, Long Island.
5. MAY I HAVE A CIRCUIT DIAGRAM FOR AN INTERFERENCE FINDER?
B. J. S.—Brooklyn, New York.
6. THERE IS PRESENT IN MY RECEIVER A CONTINUAL BUZZING NOISE, EVEN WHEN GROUND AND ANTENNA ARE DISCONNECTED. CAN YOU HELP ME TO ELIMINATE IT?
C. E. E.—Toledo, Ohio.
7. I CAN RECEIVE ONE STATION ON TWO POINTS ON MY SUPER-HETERODYNE'S OSCILLATOR DIAL. WHY?
B. F. D.—New York City.
8. IN FIG. 8 ON PAGE 455 OF THE FEBRUARY RADIO BROADCAST, YOU SHOW A NINE-VOLT C BATTERY ON THE LAST TUBE WITH ONLY 90 VOLTS ON THE PLATE. IS THIS CORRECT?
K. H. S.—Miami, Florida.
9. THERE ARE SEVERAL METHODS OF CONNECTING THE GRID LEAK. WHAT DETERMINES WHICH CONNECTION TO USE?
R. S. J.—Detroit, Michigan.

1. SHARPER TUNING

UNDOUBTEDLY there are many constructors who, after completing a receiver consisting of a stage of tuned radio frequency amplification, a detector, and audio amplifier, have noted that the dial of the condenser tuning the secondary coil of the antenna circuit usually logged twenty or so degrees different than the condenser dial used to tune the r. f. transformer secondary.

This condition may be caused by a number of things but usually it is because the antenna coil is too closely coupled to the secondary. This close coupling not only shifts the tuning point but broadens the tuning because the resistance of the secondary is increased, due to the absorbing effects of the closely coupled primary circuit.

The remedy, of course, is to loosen the coupling between primary and secondary. Where maximum selectivity is desired, a .0001-mfd. fixed condenser may be inserted in the antenna lead. Fig. 3 A shows how this is done, while B shows how the antenna may be directly connected to the secondary for sharp tuning.

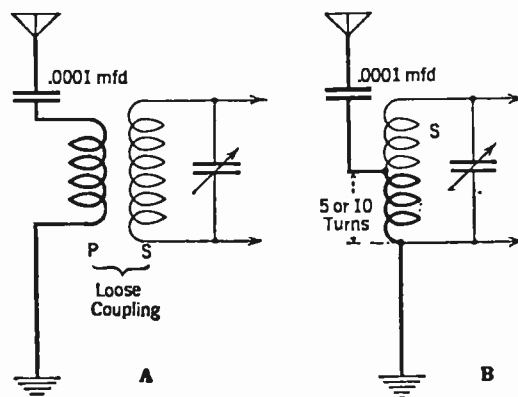

FIG. 1

energy by a chemical change which takes place within the cells comprising the battery.

The three fundamental parts which go to make up a generator of electrical energy, such as the storage battery, are the positive plates, the negative plates, and the electrolyte. The first two are fixed elements encased within the cell container, and therefore are, for all practical purposes, non-renewable. The electrolyte is a combination of water and sulphuric acid (for lead type cells). The specific gravity of this combination changes during the discharge of a battery, and during the recharge is restored to its original value. Now, during this charge and discharge, the water mixed with the acid evaporates more quickly than the acid; therefore, to keep the

level of the electrolyte at such a point as to be effective over the whole surface of the other two plate elements, more water must be added to compensate for that lost through evaporation. Distilled water should be used for this operation. Also, about once a year, it is wise to have your battery thoroughly cleaned out and refilled with a new solution of fresh acid and water.

The cleaning process is necessary because, after constant use (and when a too high charging rate is used) partial disintegration of the plate elements takes place. That is to say, the active material which is compressed into the meshed plate forms during manufacture, becomes loosened, and frequently falls to the bottom of the container. If enough material falls, there is the possibility that it will reach up to a level with the bottom of the plates and in time cause short-circuits from plate to plate. A certain amount of dust is also liable to fall into the battery when the vents are removed during

2. STORAGE BATTERIES AND ELECTROLYTE RENEWALS

WHEN one buys a radio receiver and its accessory equipment, it is expected to function with as little care or trouble as possible. If the set is one run on dry batteries, these will require replacement more frequently than will a storage battery because the latter has the property of being rechargeable to its former state of usefulness. Storage batteries function on the principle of a liberation of electrical

Control Volume with this Modulator Plug

WITH your radio set operating under full power, you can now regulate tone and volume to suit your mood, by simply turning the knob on this *Centralab Modulator Plug!* Replaces ordinary loud-speaker plug. Provides perfect control of volume from a whisper to maximum, without touching the tuning dials or rheostat. *Cuts down powerful local stations, and brings through programs sweet and clear—improves reception wonderfully!*

\$2.50 at your radio dealer's—or sent direct if he can not supply you. Write for literature describing this and other Centralab controls.

★
Central Radio Laboratories

22 Keefe Ave., Milwaukee, Wis.

Centralab

Four New Radios

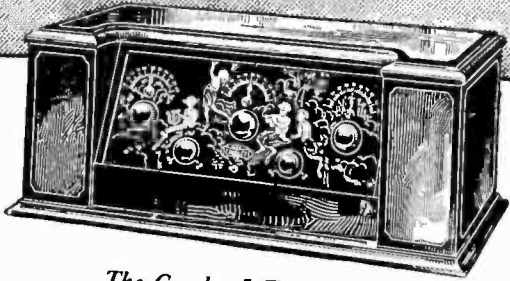

The Crosley 5-Tube RFL-75
 Absolutely balanced radio frequency amplification. Non-oscillating under any handling. Exquisite two-tone mahogany cabinet—satin finish. Decorated panel with rose-gold metal fittings. Cabinet holds necessary dry cells
 Price without accessories **\$75**



The Crosley 5-Tube RFL-60
 Same as RFL-75 but in compact cabinet only 17 1/2 inches long. Truly marvelous selectivity, sensitivity and purity of tone. Art panel—solid mahogany cabinet—rose gold fittings. Price without accessories **\$60**

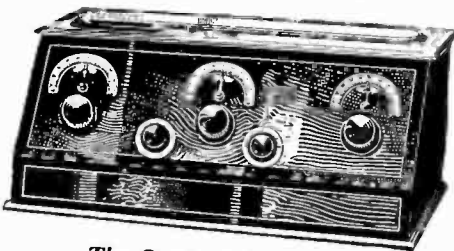

The Crosley 5-Tube 5-38
 All the volume, selectivity, sensitivity and fine tone in the best 5-tube set you've heard—plus the CRESCENDON. Two toned mahogany finished cabinet—daintily striped in gold. Price without accessories **\$38**

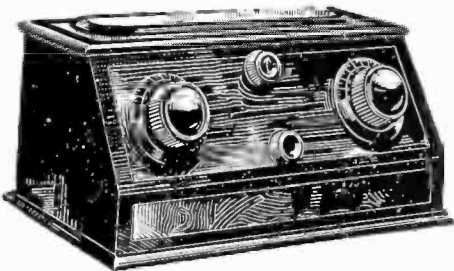

The Crosley 4-Tube 4-29
 A beautifully designed set—both to ear and eye. Crescendon equivalent to one or more additional tubes of radio frequency amplification. Two toned mahogany finished cabinet. Price without accessories **\$29**

West of the Rockies add 10% to all prices

“If inexperienced in radio, be sure your first set is a Crosley”

It takes neither practice nor mechanical skill to tune in stations all over the country. Children and old people operate Crosley radios easily.

They are fool proof.

They are inexpensive. They don't tie up a lot of money.

They have proven their efficiency over a period of years. Thousands of letters report remarkable demonstrations. Hundreds of thousands of sets sold substantiate all claims to excellence.

They are made by a reliable, well known and financially strong concern, that guarantess them . . . absolutely.

The easy operation, tone and volume of these four new Crosley sets delight, not only the expectant beginner; they arouse the most confirmed radio lover to realization that Powel Crosley, Jr., has again made a revolutionary improvement in radio.

And the RFL sets possess true cascade amplification. For Crosley has utilized an entirely new patented circuit which achieves cumulative amplification, actually approaching the theoretical maximum efficiency per tube.

The Crescendon

In the 4-29 and the 5-38, the introduction of the Crescendon enables these two highly efficient radios to give almost unbelievable results and has lifted them away and beyond all competition.

The Crescendon is an exclusive Crosley device for increasing the weak signals of distant stations to full volume tones without distortion. Yet with these sets, loud nearby stations can always be softened practically to whispers.

Their striking beauty will please your eye, and your ear will introduce to you new qualities in radio, which you are sure to pronounce a revelation.

See the new Crosley sets at your dealer's or write Dept. 20 for literature.

Crosley manufactures radio receiving sets which are licensed under Armstrong U. S. Patent No. 1,113,149, or under patent applications of Radio Frequency Laboratories, Inc.

THE CROSLLEY RADIO CORPORATION
 Powel Crosley, Jr., President
 CINCINNATI, OHIO

Owning and Operating WLW, first remote control super-power broadcasting station in America

CROSLLEY RADIO

BETTER—COSTS LESS FOR THE ENTERTAINMENT CORNER

★ Tested and approved by RADIO BROADCAST ★

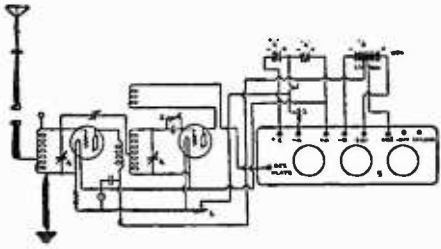

**Improve the Browning-Drake
with a
Bradley-Amplifier**
Resistance-Coupled
PERFECT AUDIO AMPLIFIER

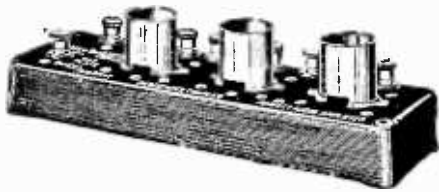

THE Bradley-Amplifier is a ready-built, ready-to-install audio-amplifier. It contains no transformers, but is equipped with Bradleyunit resistors which amplify without distortion.

The quality of the Browning-Drake receiver, like any other selective radio set, can be improved by substituting the Bradley-Amplifier for audio-frequency transformers. Try the Bradley-Amplifier with the Browning-Drake receiver and be assured of amplification without distortion.



There are six Bradleyunit resistors mounted in the base of the Bradley-Amplifier. These compact units are of solid, molded material, baked under terrific pressure and fitted with silver-plated terminal caps. Bradleyunits do not deteriorate with age nor are they affected by temperature or moisture. They are permanently soldered into the Bradley-Amplifier, thereby assuring an amplifier which is permanently adjusted for maximum efficiency.



ALLEN-BRADLEY CO.,
278 Greenfield Avenue,
Milwaukee, Wisconsin

Please send me your literature on the Bradley-Amplifier and other Allen-Bradley products.

Name.....

Address.....

the charging process, etc. A few general hints for the maintenance of a storage battery are as follows:

Keep the level of the electrolyte about $\frac{1}{4}$ inch above the tops of the plates.

Don't charge your battery at a higher rate than that specified by the manufacturer (usually around 5 amperes.)

Renew your electrolyte once a year.

During charge, remove the vents from the cells to liberate and dissipate the gases formed during the charge period.

Keep the lead terminals of the battery well greased with vaseline.

Keep the tops of the containers and the wood retaining box dry. If this is not done, the action of the acid upon the wood will cause rot.

If acid spills upon anything, cleanse the object with household ammonia. This will insure against burns, rotting, and the other injurious effects of sulphuric acid.

3. CONE LOUD SPEAKER IMPEDANCES

SOME time ago RADIO BROADCAST showed how the mechanism of the cone loud speaker, such as the Western Electric 540AW, could be altered so as to improve tone quality, etc. It was stated then that this particular cone was a low impedance one. The Western Electric Company says that its 540AW cone is a high impedance cone, however. In comparison to the old 10D horn type loud speaker manufactured by the Western Electric Company, the 540AW cone is a high impedance unit, its resistance being approximately 4000 ohms. The impedance of the former is about 2000 ohms. But when compared with other loud speakers of the cone variety now obtainable, the 540AW is a low impedance cone since all the others have a higher impedance.

To use the Western Electric cone in a circuit correctly and efficiently, where UV-201-A tubes are used throughout, a 9 to 1 output transformer should be employed to compensate for the difference in impedance between the tube and the cone. When one of the 112 type tubes is employed in the output position, no output transformer is required, for the cone and this tube very nearly match, thus insuring satisfactory tone quality.

4. ELIMINATING AUDIO AMPLIFIER NOISES

WHEN there is present in your loud speaker or phones a steady, unchanging, singing noise, you may be sure that the trouble is somewhere in your audio-frequency amplifier.

By grounding the minus A terminal of the storage A battery, this noise may often be eliminated. Sometimes this is not sufficient, so other means for eliminating the noise must be employed.

If the transformers in the audio amplifier have metal cases, connect them together, and then run that connection to the grounded terminal of the receiver. If these transformers have no metal cases, connect their cores together with a wire and lead this to the ground binding post.

Often, by wrapping a wire around the cord to the loud speaker or phones, and grounding the lower side of this wire, the singing noise may be prevented from entering into the loud speaker.

The wrong way to control the volume of your signal in the loud speaker is to turn down the rheostat which regulates the audio tubes. When the voltage to the audio tubes is lowered beyond the rated operating point, the impedance of the tube is increased. This creates an unbalance between tube and transformer with the result

that the lower audible frequencies are discriminated against. The reasoning behind this statement is clearly explained in the articles by Keith Henney in the December, 1925, and February, 1926, issues of RADIO BROADCAST.

It is well for the operator of a receiver to see to it that not only does he control his volume output in some other way, but that his A battery is not allowed to drop considerably in voltage.

One of the best types of volume control is that where a high variable resistance shunts the secondary of one of the audio transformers.

5. AN INTERFERENCE FINDER

THE recent articles in RADIO BROADCAST on the subject of interference, which were supplied through the courtesy of the Canadian Government, have caused considerable interest and a demand for a circuit satisfactory for use in a receiver designed to locate radio disturbances.

We print herewith the circuit diagram for a simple portable affair which is exceedingly successful for this type of work.

It consists of a tuned loop radio-frequency amplifier and a crystal detector, the latter feeding into a pair of phones. The circuit, Fig. 2, is self-explanatory. Standard broadcast coils are satisfactory for the coupling unit between the r.f. stage and detector. If a gang condenser is employed to tune the loop and detector secondary, then the number of turns on the loop

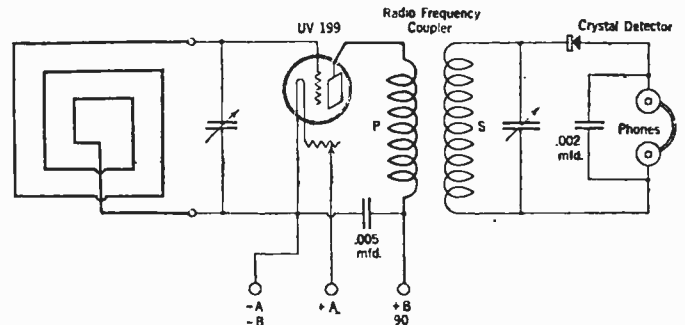

FIG. 2

must be adjusted so that the dial readings, had separate condensers been employed, would be the same for both loop and r.f. secondary. It is advisable to employ a UV-199 tube so that dry cells may be used for the A battery supply. This makes for better portability.

6. RECEIVER NOISES AND BYPASS CONDENSERS

USUALLY it is not a difficult job to locate and remedy the noises caused by a receiver if systematic search for the trouble is instituted. However, there are some cases that prove baffling. In general, the search may be classified into three groups, i.e., noises coming into the set from without; noises generated in the receiver; and noises caused by the batteries.

By disconnecting the antenna or ground, or both, while the set is in operation, the noise will usually cease if it comes from the outside. A noise inside the receiver may be usually attributed to defective parts, poor wiring, or incorrect location of the apparatus. All this can be determined by a sensible test. Now noises not located by the above observations are not necessarily caused by defective batteries as the following instance will show.

Every possible test had been made. Wiring checked, new tubes tried, new batteries, but still the noise, one of a crackling intermittent nature, persisted. After trying every test, the fixed bypass condensers were inspected and subjected to a circuit test. Here it was found that evidently one had become punctured causing an intermittent spark-over of the B

Cardwell

Acclaimed!

By Every prominent engineer who has seen them, Taper Plate Type E Condensers represent the foremost step in condenser design since the original low-loss metal endplate, first made by Cardwell five years ago.

CLAYTON—Cockaday—Lynch—Best—Wing—Neely—the list of those who specify Taper Plate Cardwells reads like a roster of the greatest Technical Editors of Radio.

The Taper Plate Type E Receiving Condenser is designed to be practical rather than theoretically perfect. Its tuning characteristic is straight frequency over the lower part of the scale, tapering to approach straight wave-length at the top. Full size plates, far heavier than ever used before, assure positively permanent calibration.

The Type C approaches straight frequency on the very low portion of the scale only; changing to a modified straight wavelength as capacity is increased.

Type "C"	Type "E"	Capacity (Mmfds.)	Price
168-C	167-E	150	\$4.00
170-C	168-E	250	4.25
171-C	169-E	350	4.75
172-C	192-E	500	5.00

The Allen D. Cardwell Mfg. Corp.
81 PROSPECT STREET, BROOKLYN, N. Y.

5c. in stamps brings this booklet on the Best Super-Heterodyne. If your dealer can't supply you, order direct. Write for illustrated catalogue and handbook.

5c. in stamps brings this booklet on the Best Super-Heterodyne. If your dealer can't supply you, order direct. Write for illustrated catalogue and handbook.

The Type "C" has a modified straight wave length tuning curve

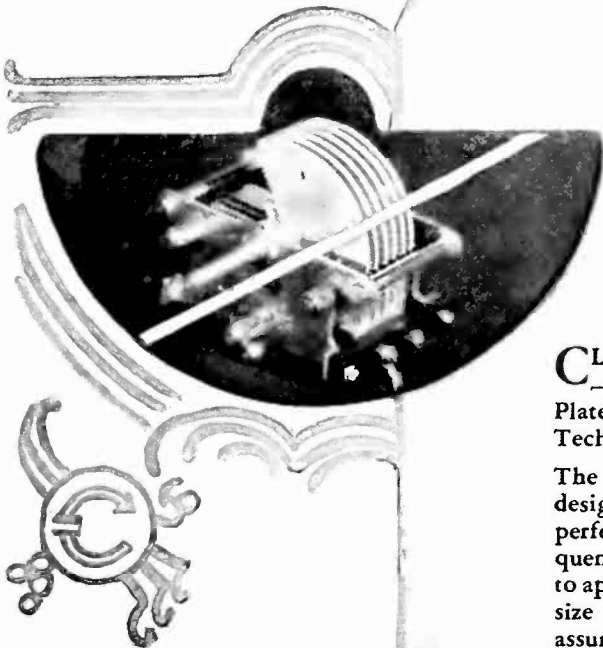

The Taper Plate Type "E" with straight frequency tuning characteristics

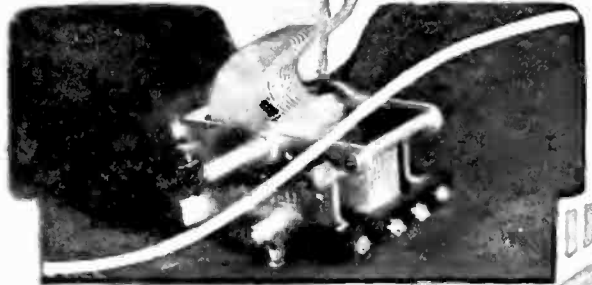

Condensers

"THE STANDARD OF COMPARISON"

★ Tested and approved by RADIO BROADCAST ★

Here's Work That is Almost ROMANCE!



Many EARN \$50. to \$250. a Week in RADIO

Get into the great new BIG-Pay Industry—Radio. If you're earning a penny less than \$50 a week, clip coupon now. Send for AMAZING FREE BOOK. Be A Radio Expert, and draw down big money for the easiest and most fascinating work in the world. Positions everywhere. Need for Radio Experts in every community. Short hours. BIG PAY. Free book gives all the facts.

Learn Quickly And Easily At Home

Master Radio Engineers will show you how to qualify, quickly and easily at home, for Radio's fine jobs. We guarantee to train you successfully. Every day N. R. I.-trained men are taking good places in the Radio field. Thousands of openings now awaiting the trained man. FREE EMPLOYMENT SERVICE. Many other big features. Get the facts—CLIP COUPON.



"My charges for consultation \$2.50 per hour. All success due to you!" R. W. Blackhill, Brooklyn.



"Radio a gold mine—your course worth thousands." A. R. Herke, Winnipeg.

Get This FREE Book!

Send coupon below for FREE BOOK—"Rich Rewards in Radio." Read for yourself. No previous experience needed. Common schooling enough. WRITE NOW.



You get all these sets

Receiving sets, from simplest kind to thousand mile receiver, included to help you learn. AN UNEQUALLED OFFER. Other special features for limited time only, so ACT QUICK!

National Radio Institute
Dept. EU-5, Washington, D. C.

MAIL COUPON

NATIONAL RADIO INSTITUTE
Dept. EU-5, Washington, D. C.

Without obligating me in any way, please send me your free book "Rich Rewards in Radio," also complete information on your practical, home-study Radio course.

Name

Address

Town..... State.....

Age.....

battery potential which it directly shunted. After a new bypass condenser was installed, there was no further trouble.

7. TWO POINT TUNING WITH A SUPER-HETERODYNE

QUESTION after question is received from owners of super-heterodynes who wish to know why it is that a station may be received on two places of the oscillator dial. To provide an easily understandable answer requires a review of the principles of operation of a super-heterodyne.

An incoming signal as in A, Fig 3, first passes through the detector or mixer tube. An oscillator capable of generating a signal whose frequency is greater by a definite amount than that of the tuner unit of the super-heterodyne, sets up a signal which is also passed into the detector tube, as in B, Fig. 3.

There are then, two signals being passed to the detector tube which combine, or beat, and set up a third signal, C, Fig 3. This third signal is equal to the difference of the first two signals mentioned. As an example, let us assume that a signal of 1000 kc. (300 meters) is being received on the loop of the super-heterodyne. Now, if the oscillator is adjusted so that its frequency is either 990 kc. or 1010 kc. it will differ with the 1000-kc. signal by 10 kc. This 10-kc. difference is equal to 30,000 meters, and the radio-frequency amplifier, otherwise termed the intermediate-frequency amplifier, in this instance should be so designed as to pass signals slightly more or less than 30,000 meters. The reason that the intermediate amplifier is not tuned sharply to exactly 10 kc. in this case is to prevent cutting off of the side bands of the carrier. A 5000-cycle leeway should be allowed on either side of the determined frequency. Thus, the intermediate amplifier should be capable of covering a frequency band of from 5000 to 15,000 cycles in what is known as a 10-kc. super-heterodyne.

The reason, then, for being able to listen to a station at two places on the oscillator dial is obvious because, with the loop tuning control set at the station desired to be heard the oscillator can be tuned to a frequency either 10 kc. less or more than this incoming frequency.

8. CORRECT GRID BIAS VOLTAGE

IN OPERATING a receiver it is essential that all the tubes be used with the correct voltage of grid bias. This is particularly true of the output tube of a receiver. The various other tubes in the audio amplifier should be operated as voltage amplifiers, whereas the last tube functions as a power amplifier. The power depends upon the amount of current available in the plate circuit of the tube and, with decreasing C battery, the plate current, and therefore the power, increases. It therefore becomes essential that the lowest value of C battery be used as is possible without overloading the tube. The tube will overload if the peak value of the signal voltage becomes greater than the voltage of the C battery.

Since it is seldom that a signal of more than 4½

volts is impressed upon the grid of the last tube, a 4½-volt C battery is generally sufficient, and this is about the largest signal that a UV-201 -A type tube can handle and still give an undistorted output. It is commonly supposed that the value of C battery depends upon the amount of plate voltage, but this is not especially true of power amplifiers. It would be truer to say that the value of plate voltage depends upon the C battery. In other words, the C voltage should have a value equal to the peak value of the signal voltages and then sufficient plate voltage should be placed on the tube so as to handle satisfactorily the signal that is being impressed on the grid.

For all ordinary cases these conditions are fairly constant, so that average values can be used. For a receiver of the type mentioned in this question, a value of 4½ volts on the last tube would give quite satisfactory results.

9. GRID LEAK CONNECTIONS

THERE are two common methods for connection of the grid leak. One is to connect this resistance directly across the grid condenser, while an alternate method is to connect the resistance from the grid of the detector tube directly to the positive side of the filament. The former connection is used in most circuits but for some hook-ups it cannot be used.

An example of the type of receiver where this connection cannot be used is the RADIO BROAD-

CAST "Universal," and it becomes necessary to connect the resistance directly from the grid of the tube to the positive filament. In this circuit, if a leak were placed directly across the condenser, the high plate voltage used on the r. f. amplifier would be impressed on the grid of the detector tube, and would prevent this unit from operating.

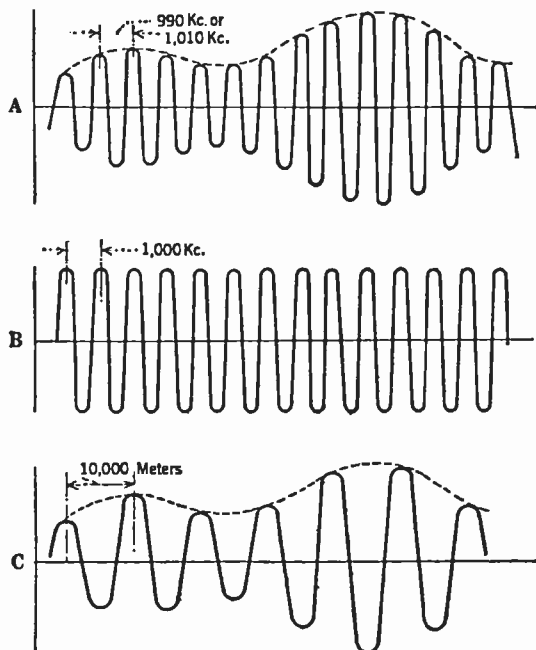

FIG. 3

GRID INQUIRY BLANK

Editor, The Grid
RADIO BROADCAST
Garden City, New York

DEAR SIR:

Please give me the fullest information on the attached questions. I enclose a stamped envelope.

I am a subscriber to RADIO BROADCAST and therefore will receive answers to my queries free of charge.

I am not a subscriber and enclose \$1.00 to cover cost of answers.

NAME

ADDRESS

G. M.Y.

NATIONAL TUNING UNITS for Amateur Set Builders

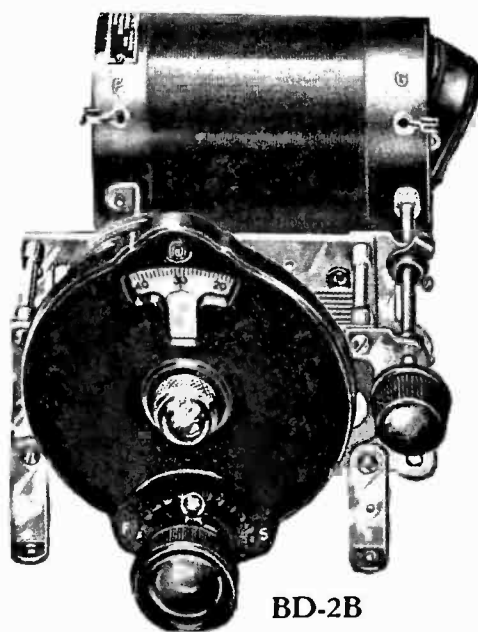

BD-2B

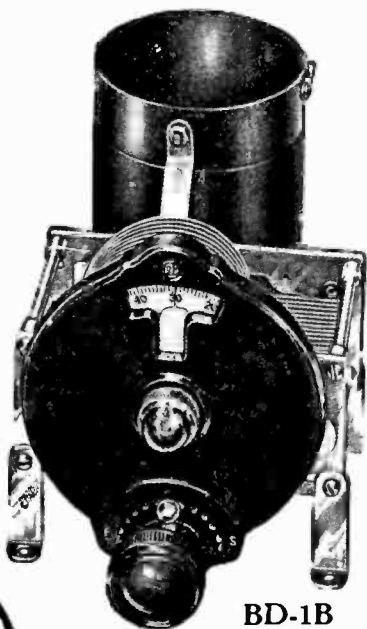

BD-1B

These New NATIONAL Tuning Units include the genuine BROWNING-DRAKE Space wound TRANSFORMER and the NATIONAL Equicycle (S. L. F.) Condenser are now in the hands of your dealer.

Their efficiency and beauty will greatly surprise you.

See them at your dealer's.

Send for Bulletins 105 and 110 RB

NATIONAL COMPANY, Inc.

W. A. Ready, President

110 Brookline St., Cambridge, Mass.

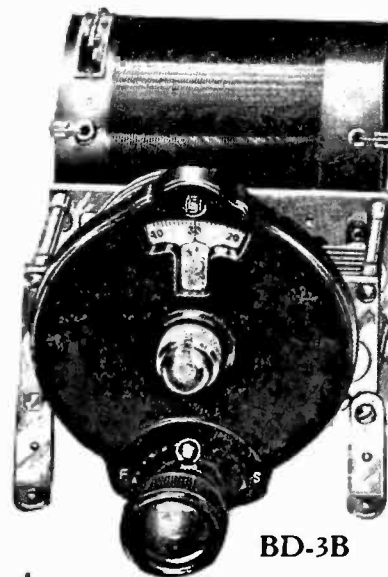

BD-3B



ELECTRAD

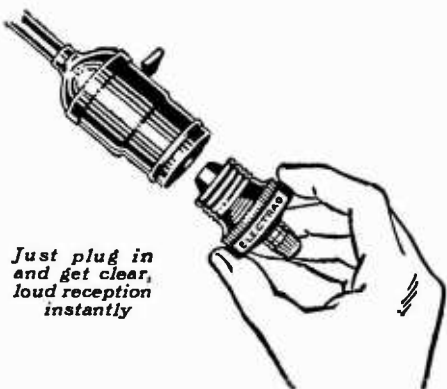

Just plug in and get clear, loud reception instantly

Minimizes Static and Interference — Ends Summer Worries

HERE is the quick, easy way to good summer reception—the

ELECTRAD LAMP SOCKET ANTENNA

Just screw it into any lamp socket or outlet in the house, and you have loud, clear reception, with a minimum of static and of interference from neighboring sets.

The Electrad Lamp Socket Antenna helps you get distance. It does away with all lightning worry. Uses no current. Absolutely safe.

Every one tested and certified electrically. U. S. price 75c, Canada \$1.10, at good radio stores and counters. For safety's sake insist on Electrad.

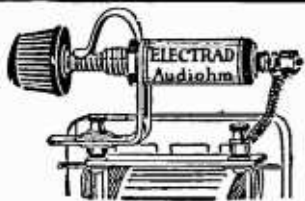

For Clearer, Purer Reception, Do This

Place an ELECTRAD AUDIOHM across the secondary of your audio-transformer. Then you will enjoy your radio. Kills distortion, eliminates squeals and howls. Fits all audio-transformers. Easy to attach. For sale at all good radio stores and counters. U. S. \$1.50, Canada \$2.10.

For perfect control of tone and volume use the Electrad 500,000-ohm Compensator. For free hookup write 428 Broadway, N. Y. City.



ELECTRAD Inc. New York City

“NOW, I HAVE FOUND . . .”

A Department for the Exchange of Ideas and Suggestions of Value to the Radio Constructor and Operator

CONTRIBUTIONS to this department are welcome and those used will be paid for at the usual rates, that is, from two to ten dollars each. A prize of twenty-five dollars is given for the best idea used during each three-month period. The prizewinner for the last period is announced at the foot of page 78. Manuscripts intended for this department should not exceed about three hundred words in length, and should be typewritten. Little consideration can be given to manuscripts not typewritten. Envelopes should be addressed to this department, RADIO BROADCAST, Garden City, New York.

WESTERN ELECTRIC CONE WITH A SUPER-HETERODYNE

WHEN I purchased a Western Electric cone speaker for my Silver-Marshall portable super-heterodyne, I was disappointed with the results. The cone gave a very sweet, pure tone when operated at low volume, but rattled and distorted if the set was tuned in to a volume loud enough for an ordinary living room.

By installing one of the new UX-120 tubes in the second audio stage, and making suitable wiring changes, I have been able to eliminate this trouble and to realize the tone possibilities of this speaker at full volume.

This cone is designed for use with its companion amplifier using tubes whose

Here, 1 marks the last audio transformer of the set, preferably one which gives uniform amplification over a wide range. Disconnect the leads to the secondary and hook up as shown. The 22½-volt C battery should be provided with taps so that its voltage can be adjusted to obtain the best tone, particularly if less than 135 B volts are used. The C plus lead is on the filament side of the rheostat.

Best results are obtained with the Western Electric cone when only alternating current passes through its windings. The secondary of an audio transformer is therefore connected as shown at 2, to bypass the direct current, and a 1-mfd. condenser is placed in the output lead.

If, by chance, the A and B minus terminals of your set are connected together, don't forget to modify your connections to avoid shorting your A battery.

An adapter is available for mounting the UX-120 in a 199 socket, if there is room inside your set. Some may prefer, however, to build a separate power amplifier unit, in a separate ten-inch cabinet, which makes a neat arrangement and avoids making permanent changes to the set. The apparatus in this unit is shown inside the dotted lines.

Although greater volume can, of course, be obtained by using a larger power tube and 350 B volts, the arrangement described permits the unusual clarity and sweetness of tone to be realized while still using dry cells as a source of current.

J. T. LANSING,
Montclair, New Jersey.

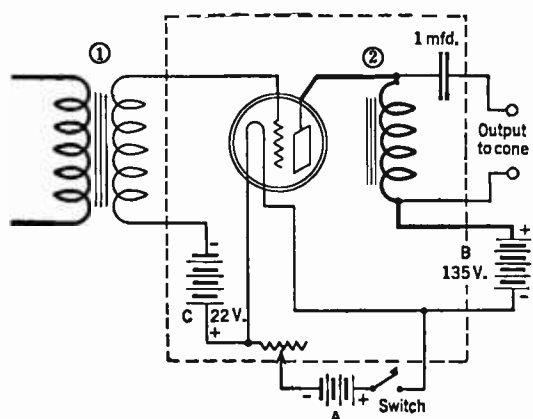

FIG. 1

plate-filament impedances are in the neighborhood of 6000 ohms, and with which it will give wonderful results, particularly when used with the higher plate voltages. Best results are not to be expected with average sets using UV-201-A or 199 tubes which have impedances of 12,000 to 15,000 ohms. Until recently the answer has been to install a power tube in the last audio stage, such as the UV-202, 216-A, or VT-2. These tubes operate at relatively high A and B battery current, however, so that the user of 199's would have to give up the use of dry cells as his whole current source, and make a considerable battery investment.

The new UX-120, however, operates on .125 amps at 3 volts, and is rated as having an impedance of 6,600 ohms. Some alterations are required in the installation of this tube, which should be brought to notice with reference to the accompanying diagram, Fig. 1.

USING HEAD PHONES WITH THE ROBERTS RECEIVER

THE only criticism that might be lodged against the Roberts reflex circuit is that the volume of sound produced by this excellent receiver is too great for those listeners who do not wish to employ a loud speaker always, but prefer to use head phones. However, this defect is easily remedied. It is only necessary to place a double-circuit jack in the

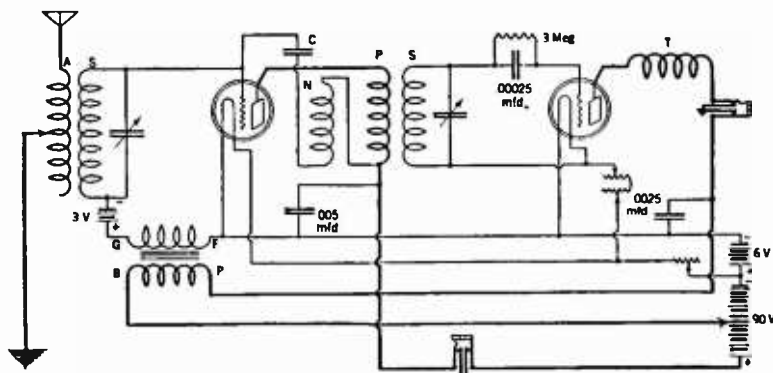

FIG. 2

★ Tested and approved by RADIO BROADCAST ★

plate circuit of the detector tube, as shown in Fig. 2. No other change is necessary in the three- or four-tube set, but in the two-tube set the regular jack, which is single, will need to be replaced with a double-circuit jack so that the plate circuit of the amplifying tube will be closed when the plug is pulled out.

When the phone plug is inserted in the jack in the plate circuit of the detector tube, the reflex feature of the Roberts set is automatically eliminated.

This arrangement affords an easy and accurate method of neutralizing the radio-frequency amplifying tube as explained by Mr. M. B. Whitney in this department for August, 1925.

In this connection it might be well to add that the neutralizing condenser should be a first-class article. It has to stand the pressure of the entire B battery voltage, and the slightest leakage or arcing across it will be the cause of much trouble. Unless the amplifying tube is accurately neutralized, energy will be fed back when the tickler is advanced up to the secondary coil, and signals will become mushy or distorted. It would be poor economy to use a make-shift neutralizing condenser.

W. C. LANE,
Sanford, North Carolina.

replace that transformer, but that I shall also convert the first stage to impedance coupling.

C. O. SOUTHARD, M. D.,
San Francisco, California.

INCREASING THE FREQUENCY RANGE OF YOUR SET

BROADCAST listeners have, for some time now, been troubled by the crowding of stations at the higher frequencies of from 1500 kc. to 1000 kc. (200 to 300 meters). This may be avoided by using straight line frequency condensers or dials. But if you are the user of a two circuit tuner, as shown in Fig. 3, the stations between 1500 kc. and 1000 kc. may be separated very easily by simply placing a 30-turn honeycomb coil across X and Y. With this arrangement my set now tunes from 1000 kc. to above 2000 kc. (150 to 300 meters), and the stations between 1500 kc. and 1000 kc. come in at the top of the condenser scale, and are widely separated.

Using an "Uncle Sam" tuner in the circuit my set tunes from 545 kc. to 1500 kc. (550 to 200 meters). By shunting a 25-turn honeycomb coil across the secondary (across X and Y), the set tunes from 1200 kc. to 3000 kc. (250 to 100 meters), and with a 10-turn honeycomb coil, it tunes from 2400 kc. to 5500 kc. (125 to 50 meters).

By putting condensers of .00025, .0005, and .001 mfd. across X and Y, the set tunes from 545 kc. to 300 kc. (550 to 1000 meters). The 300 kc. frequency band (1000 meter wavelength) is obtained by shunting both the .001 and .0005 mfd. fixed condensers across X and Y. Note the 10-megohm grid leak. The set will not oscillate over the entire 300 kc. to

3750 kc. (1000 to 80 meters) band if a lower resistance is used here. Although I use a WD-11 tube, the set will work just as well with any of the other types. I use an outdoor aerial 140 feet long and 30 feet high, but when receiving the frequencies above 2000 kc., a 20 feet indoor aerial works just as well as the large one. I have the three condensers and two coils attached

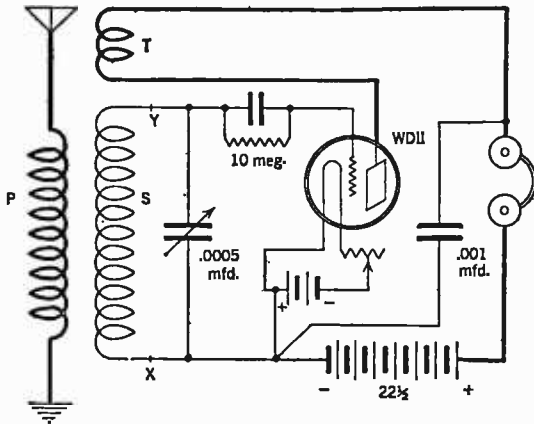

FIG. 3

AN EMERGENCY REPAIR WITH IMPROVED RESULTS

ONE evening my set, which had been developing some curious noises, suddenly ceased operating. A little investigation showed that the primary winding of the second audio transformer was broken. This was annoying as there was a program on the air that we wished to hear. The loud speaker was plugged into the first stage. This gave fair volume, but not enough for the deaf member of the family, so I decided to change the second stage to impedance coupling, meanwhile leaving the set in operation.

The primary of the damaged transformer was disconnected, and the secondary was hooked up as a choke coil, one terminal being joined to the plate of the preceding tube, the other terminal to the B plus.

A blocking condenser of .001 mfd., the only one in the house, was connected between the plate end of the choke and the grid of the following tube. There being nothing in the shape of a grid leak around, I fell back on the good old pencil mark on a small strip of fibre board to connect the grid to C minus. All this took about fifteen minutes.

With a c-299 tube in the socket, 90 volts of B and 4.5 of C battery, the loud speaker was then plugged into this makeshift second stage. The result was absolutely astonishing. The volume was almost as great as from the undamaged transformer. The music could be heard in rooms on the second floor of the house. The quality of the reproduction was far ahead of any transformer I have ever heard. It is needless, perhaps, to say that I shall not

ed to battery clips and mounted on my panel so that they may be easily attached to X and Y. Using the coils and condensers mentioned, the set will tune higher than 3750 kc. and lower than 300 kc., but it will only oscillate over the frequency band mentioned.

It will be seen that, when putting the coils or condensers across X and Y, no other changes than a change in frequency range takes place in the set. The primary and tickler coils both feed into the old secondary.

By fixing one's set in the manner described above, many stations other than broadcasting stations may be heard. Ship stations, commercial stations, amateur stations, and short-wave broadcast stations, may be heard. Station 2 XI, rebroadcasting WGY's programme on 2700 kc. (109

ELECTRAD

Certified Radio Essentials Specified for "THE BEST 5-TUBE SUPER"

Endorsed by Gerald M. Best, Technical Editor of RADIO

Electrad Certified Mica Condensers

This is the famous "Six-Point Pressure" Condenser, without an equal for consistent performance. Uniform pressure insured by rigid binding at six points. Sheet copper—not tinfoil—soldering iron can't hurt it. Certified electrically and mechanically. Guaranteed to remain within 10% of calibration. Standard capacities—all types. In sealed packages, list 30¢ to 75¢—in Canada, 45¢ to \$1.50.

Electrad Certified Filament Switch

When it's on, it's 100% on; when its off, it's 100% off. A better switch. Solid brass construction. Tinned soldering lugs, placed to make good connections easy. Neat design, genuine Bakelite knob. Requires less than 1" behind panel. Price, 40¢—in Canada 60¢.

Electrad Royalty 50,000-ohm Variable Resistance—Type C

Note these important features: Wire-wound. Genuine Bakelite base. No parts to wear, break or lose electrical efficiency. Resistance remains constant at every point. Made in various types and ranges. Write for circular and special hook-up diagram, sent free on request. Price \$1.50—in Canada \$2.10.

Electrad Certified Single-Circuit Jack (Open)

The jack you can depend on. Positive acting spring of phosphor bronze. Tinned soldering lugs, placed to make good connections easy. Requires less than 1" behind panel. Certified and guaranteed electrically and mechanically. Price 25¢—Canada 35¢.

Electrad Metallic Grid Leaks

Clearer reception with greater signal strength. No carbon, paper, varnish or fiber. The metallic resistance element is fused to the inside of a glass tube. Noiseless, non-inductive, constant under any weather, temperature or working conditions. Permanently accurate. Non-hydroscopic. Paraffined under high vacuum. Capped with the exclusive Electrad ferrule. Sizes 1 to 10 megohms, price 60¢—in Canada 85¢.

For perfect control of tone and volume use the Electrad 500,000-ohm Compensator. For free hookup write 428 Broadway, N. Y. City.

ELECTRAD Inc. New York City

MAIL THIS COUPON NOW

Electrad, Inc., 428 Broadway, New York, Dept. C Send me complete instructions and working data on how to build "THE BEST 5-TUBE SUPER" for which I enclose 5 cents in stamps.

Name _____
Address _____
City _____ State _____

★ Tested and approved by RADIO BROADCAST ★

Men needed in RADIO



Wonderful opportunity for ambitious men to win success in this fast-growing profession

THE Radio industry is expanding so rapidly that trained men are at a premium. There is a constant, urgent demand for operators—factory superintendents—engineers—service men—designers—salesmen who know radio.

There is no better way for you to succeed in this fascinating business than to study the Radio Course of the International Correspondence Schools. This course is new, complete and up-to-the-minute, and it was written by practical authorities in this field. Leading radio manufacturers endorse it. Scores of men have found it of great help in securing better positions and larger salaries.

You, too, can get in on the ground-floor if you act quickly. Mail and mail the coupon today and let us tell you all about this new I. C. S. Radio Course and what it can do for you.

Mail the Coupon for Free Booklet

INTERNATIONAL CORRESPONDENCE SCHOOLS
Box 8300-E, Scranton, Penna.
Without cost or obligation, please tell me how I can qualify for the position or in the subject before which I have marked an X:

RADIO

- | | |
|---|--|
| <input type="checkbox"/> Electrical Engineering | <input type="checkbox"/> Architect |
| <input type="checkbox"/> Electric Lighting | <input type="checkbox"/> Architects' Blueprints |
| <input type="checkbox"/> Mechanical Engineer | <input type="checkbox"/> Contractor and Builder |
| <input type="checkbox"/> Mechanical Draftsman | <input type="checkbox"/> Architectural Draftsman |
| <input type="checkbox"/> Machine Shop Practice | <input type="checkbox"/> Concrete Builder |
| <input type="checkbox"/> Railroad Positions | <input type="checkbox"/> Structural Engineer |
| <input type="checkbox"/> Gas Engine Operating | <input type="checkbox"/> Chemistry |
| <input type="checkbox"/> Civil Engineer | <input type="checkbox"/> Automobile Work |
| <input type="checkbox"/> Surveying and Mapping | <input type="checkbox"/> Airplane Engines |
| <input type="checkbox"/> Metallurgy | <input type="checkbox"/> Navigation |
| <input type="checkbox"/> Steam Engineering | <input type="checkbox"/> Agriculture and Poultry |
| <input type="checkbox"/> Pharmacy | <input type="checkbox"/> Mathematics |
-
- BUSINESS TRAINING COURSES**
- | | |
|--|---|
| <input type="checkbox"/> Business Management | <input type="checkbox"/> Salesmanship |
| <input type="checkbox"/> Industrial Management | <input type="checkbox"/> Advertising |
| <input type="checkbox"/> Personnel Organization | <input type="checkbox"/> Better Letters |
| <input type="checkbox"/> Traffic Management | <input type="checkbox"/> Show Card Lettering |
| <input type="checkbox"/> Business Law | <input type="checkbox"/> Stenography and Typing |
| <input type="checkbox"/> Banking and Banking Law | <input type="checkbox"/> Business English |
| <input type="checkbox"/> Accountancy | <input type="checkbox"/> Civil Service |
| <input type="checkbox"/> (Including C. P. A.) | <input type="checkbox"/> Railway Mail Clerk |
| <input type="checkbox"/> Nicholson Cost Accounting | <input type="checkbox"/> Common School Subjects |
| <input type="checkbox"/> Bookkeeping <input type="checkbox"/> Spanish | <input type="checkbox"/> High School Subjects |
| <input type="checkbox"/> Private Secretary <input type="checkbox"/> French | <input type="checkbox"/> Illustrating <input type="checkbox"/> Cartooning |

Name.....
Address.....

IF you like this magazine with its coated paper and enlarged size—then why not subscribe and get it regularly—by the year, \$4.00, Six months, \$2.00.

Doubleday, Page & Co.
Garden City New York

meters), is often heard louder than the wgy broadcast program.

WILLIAM G. TALLEY,
Richmond, Virginia.

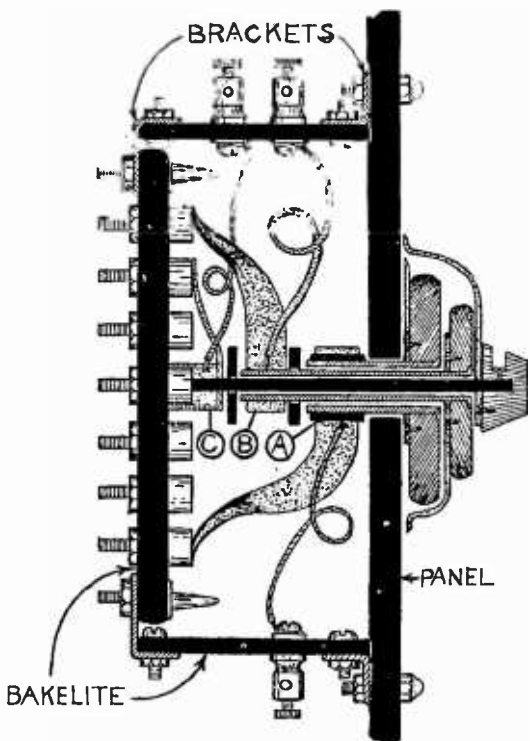

FIG. 4

A TREBLE BACK-MOUNTED TAP SWITCH

SOME people use the Reinartz hookup because it is easily constructed by the home builder. However, the trend is now toward nice bare panels without even bezels, so one can watch the genie of the tube get in his work, and the Reinartz certainly has a bunch of knobs and dials, as illustrated in Figs. 4, 5, and 6, is an innovation and improvement with this or any other hookup requiring two or more sets of taps.

The necessary taps and stops are mounted on a disc of bakelite 2½ inches in

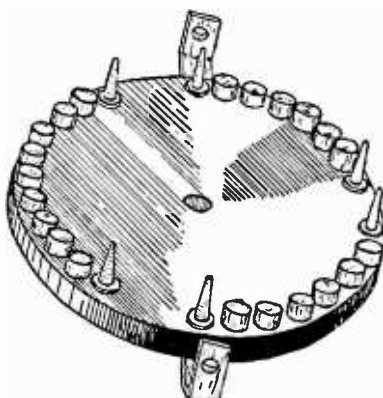

FIG. 5

diameter. The brass shaft for A in Fig. 4 is 5/16-inch in diameter and 3/4-inch long. The brass shaft for B is 1/8-inch in diameter and 1 1/2 inches long. The bakelite shaft for C is 1/8-inch in diameter and 2 3/4 inches long.

The shafts fit tightly in A and B, and are swaged in with a punch. A strip of heavy paraffin paper or varnished cambric insulates the switch lever from the shaft on A. The switch lever on C was taken from

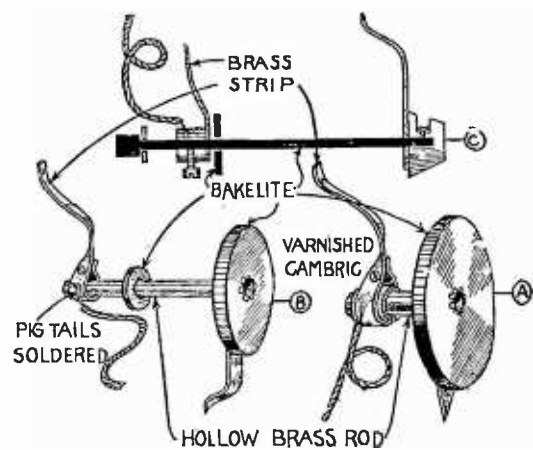

FIG. 6

an old rheostat. The pigtailed are soldered to the levers.

Markings with white ink on the front of the panel indicate the position of the levers on the points.

The diagram clearly shows the method of mounting the assembled unit on the panel.

J. T. GARVER,
Huntington, Tennessee.

AN AUXILIARY LISTENING-IN KINK

THE cover of your March, 1925, issue, certainly expresses my sentiments, but rather than use a separate crystal set, I included it as a part of my two-tube Roberts. The only extra parts needed are a jack and a crystal detector. The diagram, Fig. 7, is self-

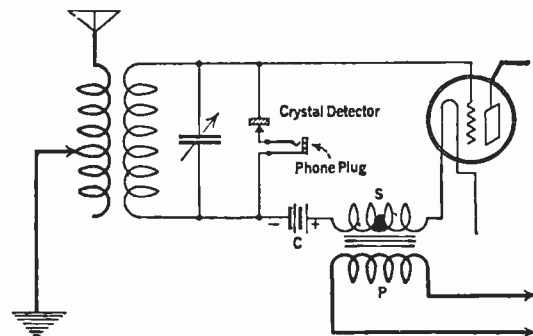

FIG. 7

explanatory, and the system may be applied to practically any circuit.

To use the crystal set, merely plug the phones in the jack and adjust crystal.

WALTER SENTER,
Omaha, Nebraska.

[The cover in question shows a smiling radio fan contentedly listening-in with a crystal set and headphones while in the background is a tube set which evidently cannot be coaxed to function. Presumably our correspondent intends to switch in the crystal set when the batteries run down, or in other emergencies.—The Editor.]

AS ANNOUNCED in this department every month, a prize of twenty-five dollars is awarded to the person who submits what is adjudged to be the best idea during each three-month period. The award for the period just concluded goes to Mr. John L. Lee, of Washington, District of Columbia, whose idea, "How to Make Balloon Coils," was printed in the March RADIO BROADCAST.

THE BEST IN CURRENT RADIO PERIODICALS

The Seventh Installment of a Useful Classified Survey of Material Appearing in the Radio Press

By E. G. SHALKHAUSER

How This Survey Can Help You

HOW often have you looked for information contained in some article which you recall having read months ago—the description of the Browning-Drake receiver, or the measurement of losses in inductance coils, for example? After looking through probably several issues of a dozen different publications, you either give up or become interested in something altogether different.

When data is wanted on some particular subject, a systematic file of subjects and titles becomes a real radio encyclopedia. Instead of having merely the title of an article given, which often is misleading, a summary of the contents gives all the information. These surveys cover the radio field as gleaned from material in to-day's periodicals. They will always serve as a future reference-guide to all who are interested in the science of radio, whether engineer, manufacturer, dealer, experimenter, or listener.

To be of practical value and easily accessible, these surveys should either be pasted in a scrap book, or, better still, be pasted on individual cards and filed according to numbers, or alphabetically. In the matter of classification of articles, the Bureau of Standards circular No. 138 has been followed. This may be obtained from the Government Printing Office, Washington, District of Columbia, for ten cents. In addition, each abstract has certain key-words placed at the upper right, which may be used for the purpose of filing articles alphabetically.

With this series of surveys we hope to aid our readers and help them through many difficulties which they no doubt have often experienced. The writer is prepared to give information and references to articles previously surveyed upon receipt of a stamped and self-addressed envelope.

Following is the series of headings, made up according to the Dewey Decimal System used in the Bureau of Standards circular No. 138:



R000 RADIO COMMUNICATION IN GENERAL.

Under this heading will appear all subject matter pertaining to laws, regulations, history, publications, etc., which deal with radio in a general way.

R100 PRINCIPLES UNDERLYING RADIO COMMUNICATION.

Here will be given the phenomena of radio waves, their underlying theory of propagation, the principle of antenna and counterpoise, design and characteristics of vacuum tubes and their behavior in circuits, types of circuits, transmitting and receiving apparatus and their principles of operation.

R200 RADIO MEASUREMENTS AND STANDARDIZATION METHODS.

The various known methods which have been used in measuring frequency, wavelength, resonance, capacity, inductance, resistance current, voltage, dielectric constants, and properties of materials, will be mentioned here.

R300 RADIO APPARATUS AND EQUIPMENT.

A description of various types of antennas and their properties, the use of the electron tube in various types of receiving and transmitting sets, other methods of transmission of signals, various detecting devices used in reception, instruments, and parts of circuits, come under this heading.

R400 RADIO COMMUNICATION SYSTEMS.

The spark, modulated wave and continuous wave systems in transmission, beat and other methods of reception, wired wireless, automatic printing, the buzzerphone and Fullerphone, will be given here.

R500 APPLICATIONS OF RADIO.

To aviation, navigation, commerce, military, private, and broadcasting, and the specific information under their headings, are referred to here.

R600 RADIO STATIONS.

The operation, equipment, and management of radio installations, both transmitting and receiving, the testing, the rules and regulations concerning stations, the reports and bulletins issued will follow under this heading.

R700 RADIO MANUFACTURING.

Data relative to costs and contracts of radio equipment from raw material to finished product, including factories, tools, equipment, management, sales and advertising, follows here.

R800 NON-RADIO SUBJECTS.

The matter of patents in general; the mathematics and physics, including chemistry, geology, and geography; meters of various kinds; all information not strictly pertaining to radio but correlated to this subject, will be found under this heading.

R900 MISCELLANEOUS MATERIAL.

A Key to Recent Radio Articles

R343. ELECTRON TUBE RECEIVING SETS. RECEIVER.
Radio News, Feb. 1926, pp. 1142ff. *Browning-Drake*
 "The Browning-Drake Regenerator," V. D. Hurd.
 The Browning-Drake receiver depends for its sensitivity upon the maximum transfer of energy through one r. f. stage to the other, the capacity coupling between primary and secondary being relatively small compared to the coefficient of coupling, which is made large through a unique slot winding. With most other r. f. transformers used as couplers and designed to give an amplification factor of about eight, a factor of only about three or less is actually obtained, says the writer. The transformer described is said to have an efficiency of better than 90 per cent. The outline here presented includes the theory of the receiver and constructional data on a four-tube set of the writer's own design.

R384.1. WAVEMETERS. WAVEMETER.
Popular Radio, Feb. 1926, pp. 181-182. *Calibration of*
 "Calibrating an Oscillating Wavemeter," S. G. Taylor.
 Use is made of the standard frequencies sent out by station WWV, of the Bureau of Standards, Washington, District Columbia twice each month, in calibrating a wavemeter. Method of procedure during an actual test evening is related, using four coils of different sizes and an oscillating receiver to cover a definite waveband.

R134.4. REGENERATIVE ACTION. REGENERATION.
Multiple.
RADIO BROADCAST, March 1926, pp. 563-567.
 "What Multiple Regeneration Can Do for Your Tuned R. F. Amplifier," V. D. Landon.
 The basic principles of multiple regeneration in receiving sets, and the application of this control system to existing receivers, is outlined. In the circuits shown, the Roberts, the Browning-Drake, and the neutrodyne, an extra tube with a tickler coil or other regenerative system gives greater selectivity and volume to the receiver. Facts about the operation of the circuit are given.

R200. RADIO MEASUREMENTS AND STANDARDIZATION. STANDARDS OF L, R, C.
RADIO BROADCAST, March 1926, pp. 573-576.
 "Standards for the Home Laboratory," Keith Henney.
 This third of a series of articles for the home laboratory discusses measurements of inductance, resistance, and capacity. With standards for making measurements which may be obtained at a nominal cost from several companies here listed, the constructor may build and compare intelligently any of the variables entering into a radio circuit. Equations of inductance, capacity, and resistance, are given, including several bridge arrangements for measuring unknown values.

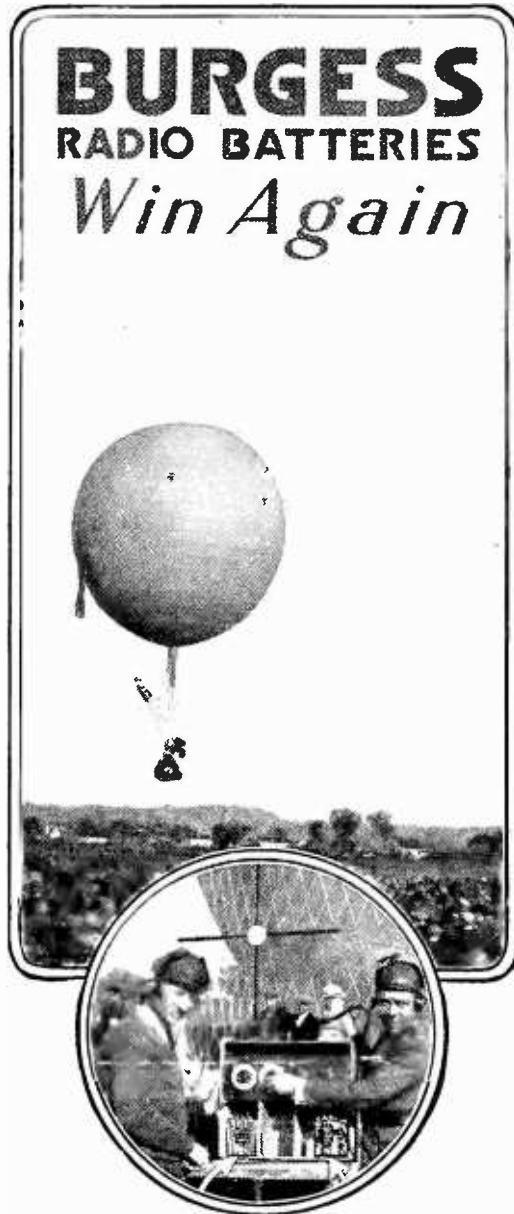

The illustration pictures the take-off of the winning flight and in the insert is the radio equipment carried. (Burgess 'A', 'B' and 'C' Batteries furnished the electrical energy to operate the set.)

When the Goodyear III won the right to represent the United States at Belgium, Burgess Radio Batteries supplied the electrical energy for the operation of the balloon's radio equipment.

Almost every day from somewhere in the world news comes to us of new Burgess adventures.

And that Burgess Batteries have contributed their bit in so many interesting events of sport, commerce and science reflects the esteem in which they are held.

"Ask Any Radio Engineer"

Your own radio dealer down the street sells Burgess Batteries. He probably sells the famous Burgess Flashlights, too.

BURGESS BATTERY COMPANY GENERAL SALES OFFICE: CHICAGO

Canadian Factories and Offices:
 Niagara Falls and Winnipeg



★ Tested and approved by RADIO BROADCAST ★

You can use any combination of tubes in the same set with the

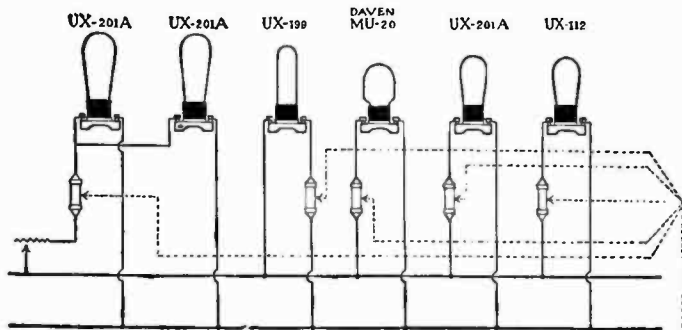

TUBE EQUALIZER SYSTEM

THIS System comprises a wide range of preadjusted filament control Equalizers, which slip into spring clips. Equip a set with these clips and ANY TUBE + THE CORRECT EQUALIZER = 6 VOLTS. You can change instantly from dry-cell tubes to big tubes, UX power tubes, or any others, simply by inserting a different Equalizer. This System does away with all rheostats and their controls, except for one in the R. F. side. Equalizer, 50c; with clip 75c. Write for complete Equalizer folder.

MANUFACTURERS! With this System you can eliminate at least one adjustment, perhaps two and make a saving per set that will surprise you. Write for low quantity prices.

ELKAY FIVE-TUBE SUPER SELECTOR, \$80



Equipped with ELKAY TUBE EQUALIZER SYSTEM. Compares favorably in appearance, selectivity, volume, distance and tone quality with sets at twice its price. Has one stage R. F., detector, one stage of transformer coupled amplification and two resistance coupled. Only two dials. A R. F. choke permits same smooth operation on low or high wave lengths. Selectivity control a distinct departure, an ELKAY invention.

The Langbein-Kaufmad Radio Co., Dept. R, 511 Chapel St., New Haven, Ct.



This is a good time to subscribe for

RADIO BROADCAST

Through your dealer or direct by the year, only \$4.00

DOUBLEDAY, PAGE & CO.

GARDEN CITY, NEW YORK

Hammarlund

PRECISION PRODUCTS

Write for Descriptive Literature

HAMMARLUND MANUFACTURING CO.
424-438 West 33rd Street New York City

Holtzer-Cabot



REPRODUCING UNIT

Many Receiving Set Manufacturers who supply built in speakers are now using this high grade unit.

QUALITY AT A PRICE

with a factory back of it able to take care of any quantity required is what Holtzer-Cabot has to offer you.

SPECIFIED DELIVERIES ASSURED

Manufacturers write for full particulars

THE HOLTZER-CABOT CO. ★

Manufacturers of signal apparatus for fifty years
125 Amory St. Boston, Mass. 6161-65 S. State St. Chicago, Illinois

Send for Latest RADIO CATALOG and GUIDE



Sets - Parts - Kits Radio's Newest

You need this big FREE book. A practical guide to success in set building. Gives advanced hook-ups. Shows all newest parts and kits, built up sets ready for use, battery eliminators, radio's newest creations. Write for Copy free, also send name of radio fan. Send to-day

BARAWIK CO.
102-109 S. Canal St., Chicago

\$75 A WEEK BUILDING RADIO SETS

In Your Spare Time



Join the Radio Association of America. Learn how to build and repair sets. The Association will train you—start you out in business, if you wish. Be the radio "doctor" of your community. \$3 an hour upwards easily made.

EARN \$500 IN SPARE HOURS

"I have at last found myself," writes Lyle Follick, Lansing, Mich. "I have already made over \$500." Werner Eichler, Rochester, N. Y. writes, "...have made over \$50 a week in my spare time." Our members are starting radio stores, increasing their salaries, securing better positions, passing radio operator examinations, earning big money in spare time.

JOIN ASSOCIATION NOW!

Are you interested in radio for pleasure or profit? Join now because we have a Special Plan whereby your membership need not cost you a cent. Only limited number of these memberships acceptable. Write now for details—before it is too late.

MAIL THIS COUPON

Radio Association of America,
Dept. B-5, 4513 Ravenswood Ave., Chicago.
Send me details of your Special Radio Association Membership Plan.

Name.....
Address.....
City..... State.....

R132. AMPLIFYING ACTION. DISTORTION IN
Popular Radio. Feb. 1926, pp. 112-123. AMPLIFICATION.
"How to Reduce Distortion in Amplification,"

H. S. Knowles,
In a preliminary discussion dealing with distortion in audio amplifiers, the author refers to the inter-electrode capacities and resistances found in vacuum tubes. The information covers: 1. The relation of grid voltage to grid current; 2. The determination of grid potential to prevent distortion; 3. A discussion of a series of curves, static and dynamic, showing effect of resistance in the plate circuit; 4. A theoretical and actual determination of amplification per stage (with examples worked out for illustration purposes); 5. A determination of the relation of B Battery voltage to amplification constant of the tube (the μ value); 6. A discussion on the correct capacity for coupling condensers between stages, and the value of leak resistance in connection with the capacity. In the appendix, the author makes reference to information of a similar nature found in other books and publications.

R250. CURRENT MEASUREMENT. B BATTERY
Popular Radio. Feb. 1926, pp. 134-141. CURRENT.

"How to Cut Down Your B Battery Bill," E. H. Felix.
B Battery current used in most receiving sets may be reduced in several ways without loss in volume and usually with an increase in selectivity. Three methods of doing this are mentioned and discussed; 1. By the use of C battery or utilization of drop across the rheostat; 2. Employment of lower plate voltages; 3. Regulation of filament current. The method to use depends upon the circuit, the power to be handled by the tubes, and the number of tubes used, according to the writer. Detailed references are made to several typical circuits, such as the super-heterodyne and neutrodyne. A summary application of the principles discussed is given in conclusion.

R343. ELECTRON TUBE RECEIVING SETS. RECEIVER,
Popular Radio. Feb. 1926, pp. 142-155. Orthophase.
"How to Build the New Orthophase Radio Receiver,"

R. J. Griffith.
A four-tube receiver, the "Orthophase", embodying a new radio frequency amplifying principle, is presented. Crystal detection is used with apparently good results. Quality of tone and selectivity are said to be characteristics of the receiver. One stage of transformer-coupled and one resistance-coupled amplifier constitute the audio circuit. A detailed account of the features of this receiving circuit is given. Constructional details are complete, including photographs and diagrams, panel drillings, and list of parts.

R110. RADIO WAVES. RADIO WAVES,
Popular Radio. Feb. 1926, pp. 165-167. Theory of.
"Rolling Hoops Through the Ether."

The two outstanding theories of ether waves, the ether wave theory and the quantum theory, are compared. Here Sir Oliver Lodge discusses the possibility of both theories being in part correct, and suggests a possible hoop form of ether waves, which are pictured in a diagram.

R710. FACTORIES. FACTORY,
Radio News. Feb. 1926, pp. 1110-1111. Atwater-Kent.
"Radio Receivers By Production Methods," J. A. Fern.

A trip through the Atwater-Kent daylight factory reveals the magnitude of present-day radio manufacturing, as told by the author. Views are shown depicting the departments devoted to construction and assembly of parts. The immense machinery used in shaping the steel for the loud speaker bells, and the extreme precision required of other machines, is spoken of. Each set is inspected many times before final delivery.

R110. RADIO WAVES. RADIO WAVES.
Radio News. Feb. 1926, pp. 1126-1127.
"More About Radio Waves," J. Riley.

A further discussion on the principles of radio waves (continued from the January issue), is given. Included are details covering electric and magnetic fields and their relation to each other. Graphic illustrations help in bringing out the points under consideration. Doctor Fleming's explanation of these two fields is given, and the writer states that much experimental work must be done in order to verify the statements made.

R344.3 ELECTRON TUBE GENERATORS; TRANSMITTER,
TRANSMITTING SETS.

Radio News. Feb. 1926, pp. 1128-1129. Crystal Control.
"Calibrating Receivers with Crystals," J. L. Reynolds.
The application of a quartz crystal oscillator in calibrating receiving sets, is outlined. From the diagram presented, the writer shows how various definite frequencies can be fed into a common antenna wire which in turn is connected to the receiver under test. Trap circuits prevent all but the desired frequency from entering the receiver. The method of mounting the crystal and cabinet used for the entire layout, is pictured.

R113. TRANSMISSION PHENOMENA. TRANSMISSION.
Radio News. Feb. 1926, pp. 1130 ff. PHENOMENA.
"Facts and Fallacies of Radio Wave Transmission,"

Dr. J. H. Dellinger.
Prevailing ideas and theories concerning wave propagation on low and high frequencies are discussed by the Chief of the Radio Laboratory of the Bureau of Standards. The Heaviside-Kennelly layer theory, the Larmor theory, and the experiments by H. W. Nichols and J. C. Shellen on fading, may all lead to some definite conclusion on the real nature of radio wave transmission. At present we are far from a definite solution, says the writer.

R343.5. HETERODYNE SETS. SUPER-HETERODYNE
DETAILS.

RADIO BROADCAST. March 1926, pp. 580-592.
"Super-Heterodyne Construction," H. C. Weber.
The writer discusses the various component parts of the super-heterodyne in turn. The function of the first detector tube is important, regeneration and proper high frequency bypass condenser being necessary for best results. The oscillator coils must be correctly built, a good tube and comparatively low plate voltage being necessary in this unit. Concerning the intermediate-frequency amplifiers, the writer mentions the respective advantages of air, and iron-core transformers, preference being given to the latter. Data on an air-core transformer for tuned input and output circuits are given. The second detector tube should have a comparatively low value of grid leak.

American Transformer Company

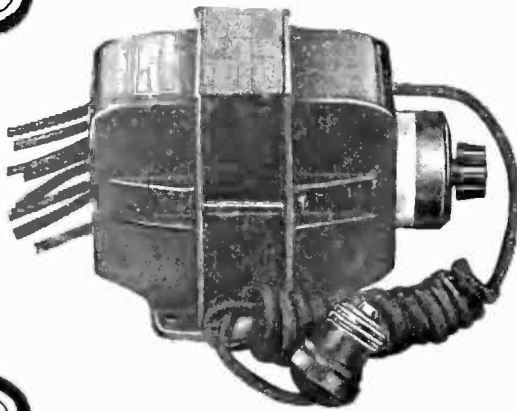

AmerTran Power Transformer
Type PF-52



AmerChoke, Type 854.

A REPUTATION for fine transformers that has been maintained for over a quarter-century! Today this high standard of manufacture is more apparent than ever—for radio has adopted each of the advanced, dependable AmerTran Products as the leader of its field.

The new AmerTran DeLuxe Audio Transformer actually puts the development of the "audio side" ahead of existing acoustical devices. Faithful amplification with natural quality over the entire audible range is consistently obtained with this audio transformer. The new tubes, cone speakers, and clear signals from the detector tube bring the most satisfactory results in combination with the AmerTran DeLuxe.

It is significant that in 1926 the AmerTran DeLuxe is an essential unit in the finest set designs. One of these is the *Best 5 tube Super*. Before building this Receiver write us for complete information.

As the receiving set of the future is destined to be power operated the American Transformer Company is now offering two units of the finest type—especially adapted to the use of the new

7½ volt power tubes in the last audio stage. These are the AmerTran Power Transformer and the AmerChoke which are strictly up to standard, and may be depended on in the type of audio amplifier required. The Power Transformer, also has filament supply windings for the power tube in the last stage and for the rectifying tube, and supplies sufficient plate current, after rectification, for the operation of the set.

- AmerTran DeLuxe 1st Stage . . . \$10.00
- AmerTran DeLuxe 2d Stage . . . 10.00
- AmerTran AF-7 (3½-1) . . . 5.00
- AmerTran AF-6 (5-1) . . . 5.00
- AmerTran Power Trans. PF-45 . . . 15.00
- AmerTran Power Trans. PF-52 . . . 18.00
- AmerChoke Type 854 . . . 6.00

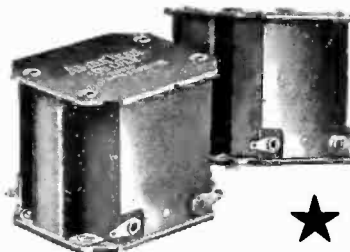

AmerTran DeLuxe two types for first and second stages.

Whether or not you are actually building a set, our booklet "Improving the Audio Amplifier" will prove decidedly interesting. It costs nothing and includes the most advanced information made practical for your use by our engineering staff.

AmerTran Products Sold Only At Authorized AmerTran Dealers

HOW TO BUILD Gerald M. Best's 5 TUBE SUPER 5c
Complete Instructions with Additional Working Data. Reprinted from: April 1926 RADIO
AMERICAN TRANSFORMER CO., 178 Emmet St., NEWARK, N. J.

Transformer Builders for Over Twenty-Five Years

FOR THE FIRST TIME—

A transformer that really matches the characteristics of the tube.

CERTAINLY—A General Instrument Product



The G. I. Variable Audio Transformer

(Type 101)

Is without a doubt the most important radio development since the industry became generally popular.

It is easily adjustable—merely turn the knob until reception is clearest and sharpest—the result is perfect co-ordination between transformer and tube; positive absence of any signs of squeals and howls, perfect reproduction.

Designed for use in any set—in the detector circuit, and any or all stages of amplification. Now for the first time can more than two stages of Audio Amplification easily be used by even a novice.

PRICE

\$10.50

At any dealers otherwise send purchase price and you will be supplied postpaid



GENERAL INSTRUMENT CORP.

Manufacturers of "Bureau of Standards" Variable Primary Condensers

477 BROADWAY

NEW YORK CITY

This is a good time to subscribe for

RADIO BROADCAST

Through your dealer or direct, by the year only \$4.00

Doubleday, Page & Company

Garden City, New York

HOMMEL DEALERS BENEFIT FROM OUR SERVICE AND REPAIR DEPARTMENT — WHY NOT YOU?

WHOLESALE **LUDWIG HOMMEL & CO.** EXCLUSIVELY

929 PENN AVENUE  PITTSBURGH, PA.

Catalog 466-B is free to dealers.

Stop Shifting Tubes

NO TUBE will do equally well all the things that must be done to give perfect reception. Special characteristics are essential for Detectors, Radio Frequency Amplifiers, Audio Frequency Amplifiers, Hi-Mu Amplifiers and Oscillators.



Myers Tubes are made and marked specifically for the function they are to perform, therefore they increase distance, improve quality and enlarge the volume.

Don't Guess—Don't Match

Order the Exact Tubes You Want.

Made by Pioneer Designers and Builders of Radio Tubes

Type 01-A \$2.00
Type 99 - 2.25

At your dealers, or we will ship, postpaid

Myers Radio Tube Corporation
Cleveland, Ohio



MYERS

Best Buy on the Market

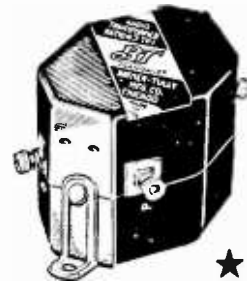

J. E. Owen, Bureau of Tests and Measurements University of Oklahoma and Radio Digest Technical writer says, "I find your apparatus very excellent indeed. To my mind there is no better audio transformer buy on the market than your 2.2 to 1 ratio EUPHONIC at anything near the price."

Better Tuning, the B-T booklet 10c

2.2 to 1 \$5.00
4.7 to 1 5.75

BREMER-TULLY MFG. CO.
532 So. Canal St., Chicago, Ill.

 **75c**

Micamold

All Weather LIGHTNING ARRESTERS

Listed as Standard by Underwriters Laboratory

MADE OF MICA and MOULDED IN BAKELITE SAFE—INDESTRUCTIBLE—RAINPROOF

A positive safeguard against static accumulation or lightning. Can be instantly attached to your set by means of Phosphor bronze snapover clamps, or out-doors directly to your aerial or casement window, for which purpose a suitable brass strap is furnished.

If your dealer cannot supply you, write direct to Department B

MICAMOLD RADIO CORP.
Flushing & Porter Aves. Brooklyn, N. Y.

R388. CATHODE RAY OSCILLOGRAPH. OSCILLOGRAPH,
Radio News. Feb. 1926, pp. 1132 ff. Cathode Ray.
"Special Cathode Ray Oscillographs," C. B. Bazzoni.

The cold and hot cathode ray oscillograph tube is discussed as to its practicability in analyzing high frequency currents. In the cold cathode tube, voltages of 10,000 or more are needed to produce an electron stream. A 110-volt a. c. rectifier circuit to supply this voltage, is shown. Due to the very great speed of the oscillations in a high frequency circuit, it is impossible to see the line traced on the fluorescent screen unless the end of the beam retraces its exact path many times. Substituting a photographic plate means considerable complications in the operation of the tube, since it must be inside the tube. The French scientist, Dufour, designed the oscillograph here described, with film and screen within a hollow chamber attached to the tube, and with provision for exhaustion while the tube is in operation. The author discusses the functioning of this tube. The hot cathode tube oscillograph is also discussed and shown, it being more sensitive than the cold cathode tube according to the writer, because the velocity of the electrons is much less at the applied voltage of about 400. Other uses can be made of this tube, some of them being listed.

R160. RECEIVING APPARATUS. TESTING THE
Radio. Feb. 1926, pp. 22ff. RECEIVER.
"How to Test Radio Receivers," H. Diamond.

A circuit used for testing the relative performances of radio receiving sets consists of a radio frequency oscillator and modulator, an audio frequency oscillator, and an indicating device to determine the magnitude of the received signal in the set under test. The circuit diagram is shown. The following tests can be made: Measuring distortion; obtaining variation of signal strength with wavelength; and determining selectivity. The method of operating the equipment is described. A typical curve shows the variation of signal strength with wavelength.

R113.5. METEOROLOGICAL WEATHER AND
PHENOMENA. RADIO CONDITIONS.
RADIO BROADCAST. March 1926, pp. 558-562.
"Can We Forecast Radio Reception From the Weather,"
J. C. Jensen.

Evidence is presented to prove some definite relationships between weather conditions and radio reception. The general conclusions arrived at by the writer may be summarized as follows: 1. Signal strength will be greatest with settled weather conditions and transmission parallel with the isobars; 2. Good reception may also occur at right angles to the isobars unless a storm center intervenes between sending and receiving stations; 3. Static is most noticeable as a storm area approaches, the crashing noises being audible for several hundred miles, and the hissing noises prevailing only in the immediate vicinity of a "low"; 4. Fading is much less troublesome in daylight than at night; 5. Fading is much more noticeable in unsettled weather than when transmission is parallel with the isobars along the ridge of a "high". Charts and curves are presented to substantiate the above statements.

R113.9. WAVE FRONT ANGLE. WAVE PROPAGATION.
QST. Feb. 1926, pp. 9-17.

"Horizontal Reception," R. S. Kruse.
Measurements made by Dr. G. W. Pickard on horizontal and vertical field intensities of waves in the 3.5-4 and 7-8 megacycle band (80 and 40 meter bands), show that the wave after traveling some 20 to 30 miles, becomes horizontal, the vertical component giving a relatively small intensity when compared with the horizontal component. The author presents the fundamental theory of electro-magnetic and static fields and the operation of the original Hertz oscillator. He gives data on the ratio of horizontal to vertical intensities of the short waves, collected from a great many observations made during the summer of 1925. The earth's magnetic field apparently had no effect on the measurements as stated. The horizontal type antenna, as pictured and described, is recommended for short-wave reception. Other types of antennas tried, and circuits used, are also shown, with remarks as to their effectiveness in these particular tests.

R343. ELECTRON TUBE RECEIVING SETS. RECEIVER,
QST. Feb. 1926, pp. 18-22. Short-Wave.
"Short-Wave, Plug-in-Coil, Receiver Design,"
F. J. Marko.

A short-wave regenerative receiver of the plug-in-coil type, is described in detail. Three coils are used to cover the three bands commonly used by the amateur stations at present, although the coils have overlapping wavelength curves when used with the condensers specified. The coils are wound on skeleton frame forms thus reducing the dielectric losses. The operation of the receiver and detailed analysis of the various parts that govern good reception, such as proper grid leak and condenser values, r. f. chokes, size of wire, antenna characteristics, etc., are described. Three calibration curves of the receiver show location of stations on the dial settings.

R343.7. ALTERNATING CURRENT SUPPLY. ELIMINATORS,
QST. Feb. 1926, pp. 23-32. B Battery.

"Battery Substitutes," R. S. Kruse.
B battery substitutes may be more economical, more convenient, or give superior performance than dry or wet batteries, according to the author. Using five different types and makes of receivers, many B battery eliminators were tested. The results are given here. Circuit diagrams and photographs of these eliminators tested, are shown, and information is presented concerning the particular behavior and operating characteristics of each.

R386. FILTERS. FILTERS.
QST. Feb. 1926, pp. 35-36.

"Filtering the Synchronous Rectifier," Chauncy Hoover.
A brief description of a filtering problem encountered in connection with a synchronous rectifier, is presented. Several arrangements of condensers and coils were tried by the writer and are shown in the diagrams. The finally adopted system was chosen since it gave very good filtered direct current when measured with an oscillograph.

R343. ELECTRON TUBE RECEIVING SET. RECEIVER,
Radio. Feb. 1926, pp. 15ff. Non-oscillating.

"A Non-Oscillating R. F. Circuit," Charles H. Smith.
A five-tube tuned r.f. receiver, using split wound coils to reduce interstage coupling, and high resistance wire for the primary, is illustrated and described. Constructional details, and method of operating the set, are outlined.

RADIO PEP

B-BATTERY ELIMINATOR

NO TUBES NO HUM



Buy no more B-batteries!

USE the unlimited supply of cheap, dependable electricity right at hand in your household lighting circuit.

This can be done with *permanent* satisfaction with RADIO PEP.

RADIO PEP is the FIRST eliminator to completely solve the problem, as it is the only one made with EIGHT PERFECTED ELECTROLYTIC CELLS, replacing tubes and doing away with all the familiar tube troubles.

Two or four cells *overloaded* will not give PERMANENCE and POWER—the outstanding characteristics of RADIO PEP.

135 VOLTS are called for by the modern sets and tubes; here you get it year after year without weakening.

For 110-125 volts, 60-cycle alternating current.

Send for particulars and name of our nearest dealer. Price \$38.
Money back guarantee.



PEP MFG. CO., Inc.

33 West 42nd Street

New York

screw machine products —brass



For plugs, jacks, clips, condenser and transformer parts, etc., BRASS assures economy in quantity production. It also gives the right electrical conductivity and the mechanical accuracy essential to proper operation of radio sets and parts.



COPPER & BRASS RESEARCH ASSOCIATION

25 Broadway, New York



No. 135-A

SEND FOR
New No. 739 Circular describing special voltmeters for Radiola, Victor and Brunswick sets
Order from Dealer

Jewell Electrical Instrument Co.
1650 Walnut St. Chicago
"26 Years Making Good Instruments"

R345. AMATEUR RADIO. AMATEUR RADIO, *Experiences in.*
RADIO BROADCAST. March 1926, pp. 547-551.
"A Man and His Hobby," E. E. Horine.
The ever interesting and fascinating hobby of the "ham" who constructs his own inexpensive transmitters and receivers with which he communicates to fellow amateurs everywhere on earth, his language, his philosophy, his quick adaptation to new developments in radio as they are made, are graphically portrayed by the writer in giving the story of Colonel Foster's experiences as a "ham." Photographs of several short-wave transmitters are shown.

R384.1. WAVEMETERS. WAVEMETER, *Calibration of.*
QST. Feb. 1926, pp. 39ff.
"Calibrating Your Wavemeter From a Quartz Crystal," J. M. Clayton.
A crystal oscillator circuit, shown and described, is used for purposes of calibration. While the crystal is oscillating, the frequency of the oscillations is said to remain constant, irrespective of capacity values, the watts output, however, varying. A large number of harmonics are generated, and these may be detected either using an oscillating receiver, or better, an auxiliary Hartley generator circuit with grid milliammeter indication. The method used in calibrating a wavemeter, using whole and fractional harmonics, is described in detail. Companies furnishing quartz crystals are listed.

R070. EDUCATION; TRAINING. ENGINEERING, *Radio.*
QST. Feb. 1926, pp. 44-45.
"Entering Radio Engineering," R. S. Kruse.
The writer gives his personal opinion of radio engineering as a profession. His views are shared by other engineers who are prominent in radio, as stated. A general engineering course supplemented by specialized study and research in high frequency phenomena, are requirements for the grade of radio engineer, according to the writer.

R402. SHORT-WAVE SYSTEMS. SHORT-WAVE, *Eiffel Tower.*
Radio. Feb. 1926, pp. 10ff.
"The Eiffel Tower Short-Wave Transmitter," L. Jaquet.
The short-wave transmitter (3333-1874 kc. or 90-160 meters) used at the Eiffel Tower, Paris, is described. It employs a new circuit designed after the principle of the push-pull amplifier. It is stated that parasitic oscillations, which would necessitate the use of choke coils, are not encountered, thus making the circuit very stable when in operation. A schematic circuit diagram, and photographs of the station, are shown.

R592. DEVELOPMENTS IN GREAT BRITAIN. BROADCASTING, *IN ENGLAND.*
Radio. Feb. 1926, pp. 11ff.
"Broadcasting in The British Isles," H. de A. Donisthorpe.
A list of high and low powered broadcasting and relay stations of the British Isles, including locality, call letters, wavelength, is given. The system employed in England in operating these stations for the benefit of the public, is described. A map is given showing the distribution of these stations.

R342.5. POWER AMPLIFIER. POWER AMPLIFIER, *Radio.*
Radio. Feb. 1926, pp. 17ff.
"A High Quality Power Amplifier," H. W. Armstrong.
In the author's opinion, there is room for improvement in the audio stages of most amplifiers when the question of distortionless amplification is considered. A two-stage amplifier, utilizing choke coil and resistance coupling, with rectified a.c. as a source of power for the plates, is shown. The first stage employs a high-mu tube, the second a power tube which feeds the output energy to the loud speaker through a transformer. A complete list of parts necessary for construction is added. When connected to any good receiver, distortionless amplification with considerable increase in volume is promised by the author.

R333. ELECTRON TUBES. THREE ELECTRON TUBES, ELECTRODE. TRANSMITTING.
Radio. Feb. 1926, pp. 19-21.
"Transmitting Tubes," Lieut. J. B. Dow.
General Electric and Western Electric transmitting tubes of various sizes and output values, are depicted. The G. E. tubes normally employ thoriated filaments, whereas the W. E. tubes have oxide coated platinum filaments. The W. E. tubes are more critical as to filament temperature and therefore not as safe because of release of gases within the tube at the higher temperatures; but they have a longer life, when properly burned, than the thoriated filament tubes, according to the writer. Grid-plate characteristics of several of the tubes, and data of most of the transmitting tubes manufactured by these two companies, are given. Several G. E. kenetron rectifier tubes and data covering these, is also included in the article.

R134.75. SUPER-HETERODYNE ACTION. SUPER-HETERODYNE.
Radio. Feb. 1926, pp. 29-31.
"Super-Heterodyne Suggestions," L. W. Hatry.
The super-heterodyne, although only six of the tubes are actually used in the eight-tube variety for amplification purposes, is superior to a six-tube tuned r.f. receiver, because it is more selective, more stable, and easier to operate, states the author. A large loop is recommended as an energy collector rather than a small one. Questions regarding regeneration, addition of intermediate-frequency transformers, proper bypass condenser values, proper use of the energy from the oscillator tube, shielding of the set to prevent undesired pick-ups, etc., are discussed at length.

R113. TRANSMISSION PHENOMENA. POLARIZED WAVES.
Radio. Feb. 1926, pp. 34ff.
"Polarization of Radio Waves," E. F. W. Alexanderson.
Tests on three types of radiators to explore the propagation characteristics at different wavelengths of radio waves, have been in progress at the General Electric Company's experimental plant. The three types of radiators are—1. The straight vertical antenna oscillating at a harmonic frequency; 2. The horizontal antenna with an overall dimension of one-half wave fed in the middle through a transmission line; 3. The series and horizontal loop. The radiation from these antennas is projected at a high angle. From the data obtained through an extended series of tests, it appears that horizontally polarized radiation is superior to vertical radiation. With the aid of a unique laboratory model, which the writer describes, the theory of wave propagation, vertical, horizontal, and elliptical, may be shown. A difference in velocity of these waves probably causes many hitherto unexplained phenomena.

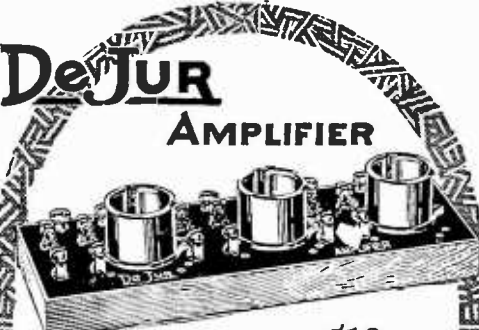

De JUR AMPLIFIER

\$10

DISTORTIONLESS AMPLIFICATION

Equip your set with a De Jur Amplifier and enjoy REAL radio. Get tone, clarity and volume you never thought possible. Fits in the audio side of any set.

Equipped with De Jur Parts

Sockets of Genuine Bakelite and take standard or new UX tubes. Built with .01 Bakelite Impregnated Mica Condensers and De Jur Resistors.

No bus in bar wiring. All metal strip connections are riveted. No screws, nuts or bolts to work loose.

*Sold by all Dealers
Get the Genuine* ★

Write for Catalog of De Jur Parts

De JUR PRODUCTS CO
The World's Largest Manufacturers of Rheostats
197 LAFAYETTE ST. NEW YORK CITY

Make any Good Receiver BETTER



CC TUBES

C.E. MFG. CO.
Providence R.I.



ACCUSTI-CONE SPEAKER

FROM FACTORY TO YOU

Full floating 19 inch cone powerful unit, worth \$25 in a store; save by getting it direct from manufacturer for only 7.50

Superior to any Speaker, at any price

MONEY BACK IF WE DO NOT PROVE IT ON YOUR SET

Reproduces all high and low tones, true and natural.

Beautiful cone, dust proof wall unit. Packed to go anywhere. Remember you have a free trial. We take all the risk. You don't. Fully guaranteed.

Accusti-Cone Laboratories ★

96 Church Street, New York, N. Y.

BOOK REVIEW

A Book for Both Radio Enthusiast and Engineer

TALKS ABOUT RADIO. *By Sir Oliver Lodge. Published by Hodder & Stoughton, in London; in New York by George H. Doran and Company. 259 pages. \$2.50.*

HAVE you ever visited a huge industrial plant, accompanied by a well informed and interesting guide? At one point, the guide goes into considerable detail about a particular operation in the plant which seems to interest him especially. Other parts of the factory are hurriedly skipped over through lack of time. But altogether, a two-hour visit is very interesting and profitable.

Sir Oliver Lodge's treatment of the subject of radio in his recent book, *Talks About Radio*, is in somewhat the same manner. Here and there, Sir Oliver makes clear as crystal certain phases of radio communication which most writers neglect, and he neglects those things which most writers treat in detail.

The spirit in which the book is written is indicated in the writers preface which states: "This is a friendly rather than an ambitious book. It is a message of greeting to the great army of wireless amateurs and experimenters, from one who—always enthusiastic about ether waves—did some pioneering work; and who now admires the remarkable progress that has been made by others. May they all take it as conveying the author's good wishes, combined with a hope that, in the diversity of these gossipy chapters, each may find something acceptable, something worthy, of his or her interest."

The publisher's statement, appearing on the paper cover, to the effect that "Sir Oliver Lodge puts at the command of the amateur and professional alike all the benefits of his study and research in the science of the air," seems quite inaccurate and exaggerated. We doubt whether all the salient points of Sir Oliver Lodge's vast knowledge of radio are presented in the book's 259 pages of text, and we question the accuracy of the statement that the book deals with the science of the air.

The book is divided into three parts, each consisting of about ten chapters. The first part deals with radio in general, the general phenomenon involved in the propagation of electromagnetic waves, radio's early history, and with the contribution of physicists and scientists whose work is appreciated by only a few, and deplorably forgotten by the many. Sir Oliver Lodge reveals himself as much philosopher as scientist. His text is steeped with appreciation of the social significance as well as the scientific importance of the radio art. He deals frankly with his contemporaries, as indicated by the following quotation:

"Before 1896, the public knew nothing of its (radio's) possibilities; and for some time after 1896, in spite of the eloquence of Sir William Preece and the demonstrations by Signor Marconi, the public thought it mysterious and almost incredible; and still knew nothing about the early stages. Indeed, I scarcely suppose that Signor Marconi himself really knew very much about them."

Maintaining aloofness from considerations of circuit design, the second section of the book, under the title, "Details that Make for Efficiency," discusses with a clearness of presentation the factors of capacity and inductance, the proportioning of coils, phase differences in coupled circuits, and the use of iron in transformers. The studiousness with which constructional details are avoided is indicated by the fact that

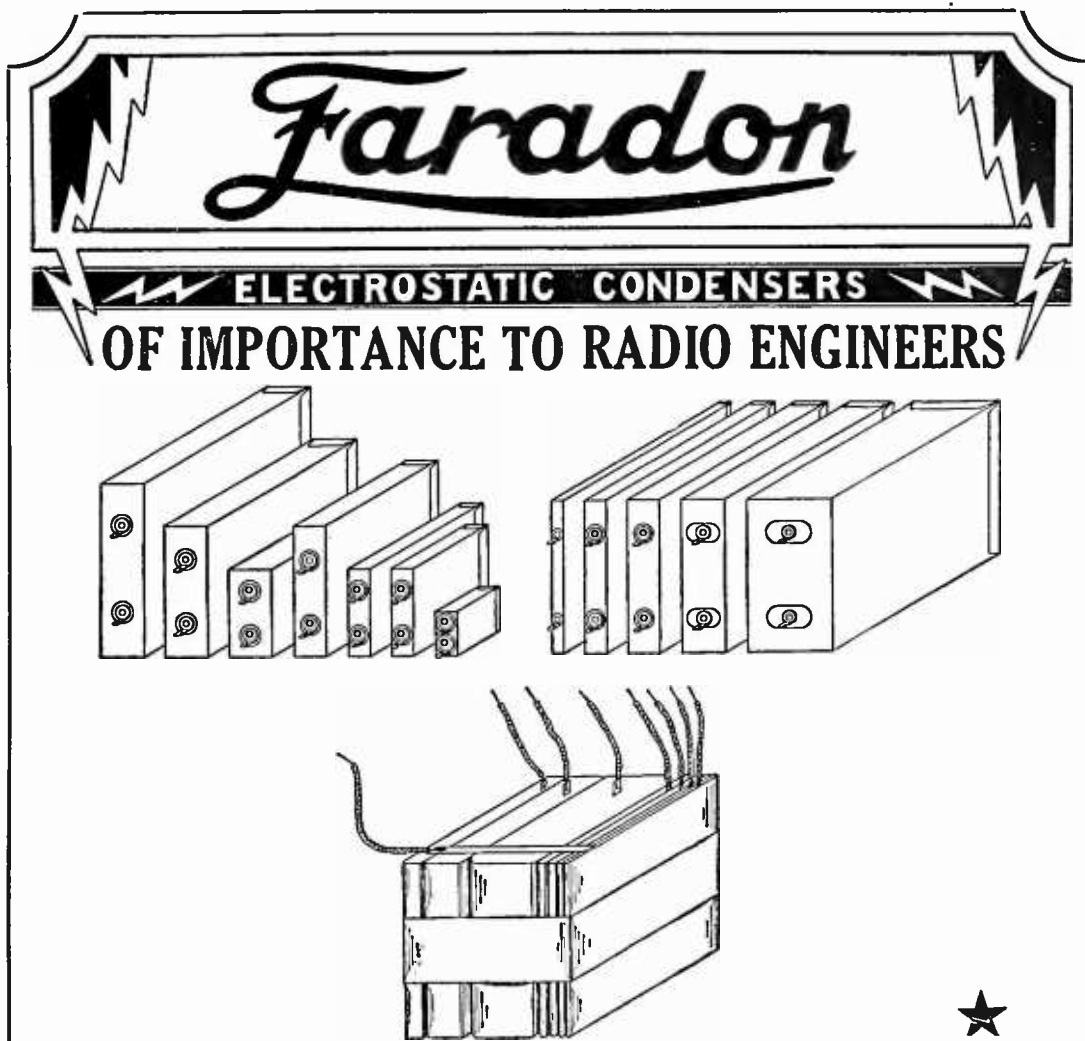

Faradon

ELECTROSTATIC CONDENSERS

OF IMPORTANCE TO RADIO ENGINEERS

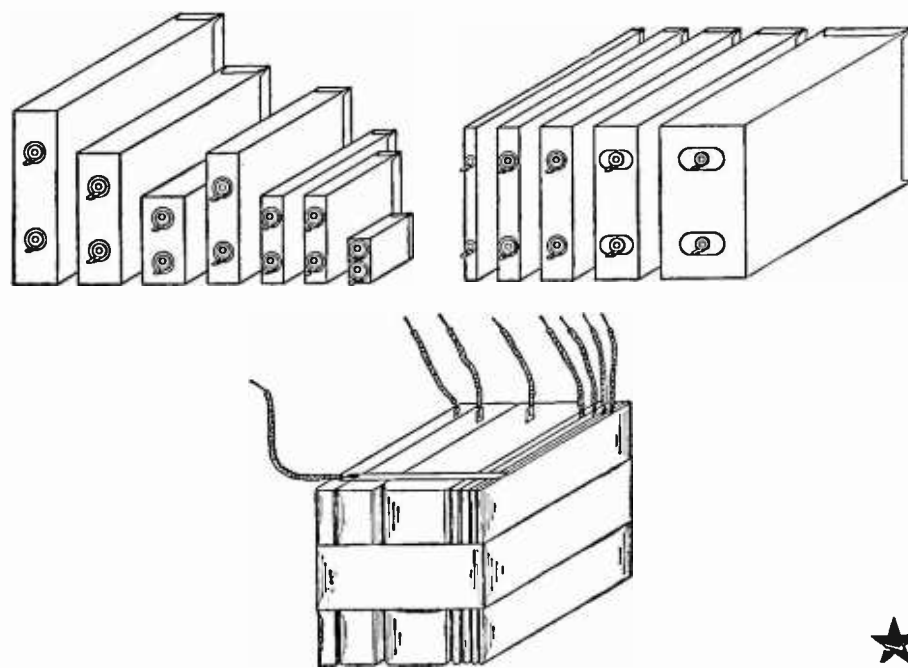

The Wireless Specialty Apparatus Company, following extensive specialized development, presents a complete group of condensers of

FARADON QUALITY

for BY-PASS, FILTER, BLOCKING, and INTERFERENCE ELIMINATION application. Design and Manufacturing Equipment permits meeting

SET MANUFACTURERS' SPECIFICATIONS

In both capacitance and voltage requirements. Regularly Produced. In units and in gangs, incased or plain, with fixed terminals or flexible leads to suit particular equipments.

Complete data and quotations will be furnished promptly upon receipt of advice as to just what is desired. Inquiries are requested.

19 YEARS SPECIALIZATION IN THE RADIO FIELD

Wireless Specialty Apparatus Company

Jamaica Plain—Boston, Mass.

Why not subscribe to *Radio Broadcast*? By the year only \$4.00; or two years, \$6.00, saving \$2.40. Send direct to Doubleday, Page & Company, Garden City, New York.

BAKELITE for Radio Parts



The use of Bakelite parts in the set you buy or build, will insure you against inferior reception through defective insulation. Write for booklet 29.



BAKELITE CORPORATION

247 Park Ave., New York, N. Y. Chicago Office: 636 W. 22nd St.
BAKELITE CORP. OF CANADA, LTD., 163 Dufferin Street, Toronto, Ontario, Canada

★ Tested and approved by RADIO BROADCAST ★

DIAMOND-WEAVE

(TRADE-MARK REGISTERED Aug. 4, 1925)

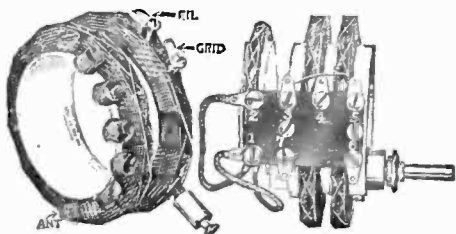

Sickles Coil Set No. 18A for Roberts Circuit, containing our new center-tapped N-P Coil. Price \$8.00.

Sickles Coils for the "Aristocrat" Circuit, designed upon new scientific discoveries, set highest standards of efficiency.

COIL PRICES

No. 18A Roberts Circuit	\$ 8.00 set
No. 24 Browning-Drake	7.50 set
No. 20 Craig Circuit	4.50 set
No. 19 Acme Reflex	4.50 set
No. 8 Knockout Reflex	4.00 set
No. 21 Hoyt Circuit	10.00 set
No. 25 "Aristocrat" Circuit	8.00 set

SICKLES COILS

For the "Aristocrat," Browning-Drake, Roberts, Craig, and Hoyt Circuits

(Patented Aug. 21, 1923)

Our Coil Set No. 25 is specifically designed for the new "Aristocrat" Circuit, already very popular.

Compactness of form, rigidity of construction, and the supremely efficient Diamond-Weave method of winding are well-known characteristics of Sickles Coils.

These refinements of design and construction result in low distributed capacity, low dielectric losses and large range of frequency with small variable capacity.

There are Sickles Diamond Weave Coils for all leading circuits.

Send for descriptive catalog

The F. W. Sickles Co. ★

132 Union Street
SPRINGFIELD, MASS.

there are only three illustrations in this section of the book.

The third section deals with calculations for amateur constructors. For a mind accustomed to reasoning with mathematics as its foundation, this section is a real pleasure. Lodge has the happy faculty of carrying the imagination along with his figures so that the significance of each formula, and how it is derived, is conveyed to the reader. To the non-mathematical mind, the section would have at least greater interest than the usual mathematical treatment because his conclusions are frequently crystallized in such basic expressions as "A remarkably simple expression for the inductance of a coil so as to give that inductance a maximum value for a given length of wire . . . is . . . that it equals the length of wire employed multiplied by three times the number of turns" and, "We can estimate the capacity of an antenna by eye. Expressed as a length, the capacity of a vertical wire is just about one-twentieth of the height of the wire."

Obviously Sir Oliver Lodge is speaking down to his audience when he reaches a conclusion of this kind, but, in each case, he follows up with much greater accuracy and detail, presenting all the essential calculation for efficient coil sizes, antenna capacity, and damping in oscillatory circuits.

Throughout these pleasant excursions into the radio art, Sir Oliver Lodge clothes his thoughts in a delightful, unadorned, and crystal-clear style of writing. We believe he accomplishes his objective in creating a friendly and familiar contact, but, beyond this, it is doubtful just exactly what his general purpose is. No radio enthusiast can read the book without profiting, and no engineer will fail to find sections which express his understanding of one point or another more aptly than he has seen it expressed before. On the other hand, if you attack the book with a more definite objective, it is quite possible that you will be unsatisfied.

EDGAR H. FELIX.

CUBA'S SUGAR-MILL BROADCASTER

BROADCASTING station 7 SR of Elia, Cuba, transmits test programs every Tuesday and Thursday evenings at 8:30 P. M., Eastern Standard Time, according to a letter received by RADIO BROADCAST from Salvador C. Rionda, the licensee of the station. The power used by the Cuban station is 500 watts, and request has been made by the owners that listeners who hear this station write and inform the engineers whether it interferes with the transmissions of any American broadcaster, which, of course, is contrary to the wishes of all concerned. The Cuban Government has authorized transmissions from 7 SR to take place on a frequency between 833 and 1500 kilocycles (200 to 360 meters). At the time of writing, the frequency decided upon was between 1000 and 1034 kilocycles (290 and 300 meters). This station is located at Central Elia, Elia, Cuba, in a sugar mill that produces 75,000 tons of sugar a year; "In a sugar mill," as Salvador C. Rionda puts it, "that is at present helping the consumers in the United States in receiving cheap sugar, notwithstanding the duty of 1 1/8 cents per pound that is paid to your Government for every pound of Cuban sugar entering the United States."

By referring to the list of Cuban broadcasting stations in RADIO BROADCAST'S booklet of foreign broadcasting stations in the February number of the magazine, it will be seen that very few employ as much power as does 7 SR. The majority in fact, employ considerably less than 100 watts.



Radio Battery Chargers

Best by Test ★

\$ 8⁵⁰ minus bulb

east of Rockies

Your dealer can get it for you

THE ACME ELECTRIC & MFG. CO.

1410 Hamilton Avenue Cleveland, O.

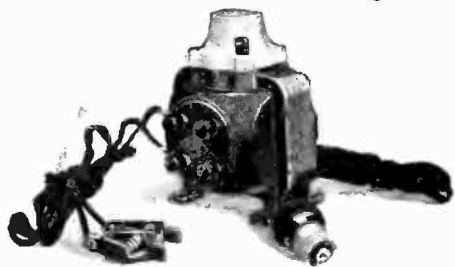

LEARN THE CODE AT HOME with the OMNIGRAPH

"Just Listen—The Omnigraph will do the teaching!"

THE OMNIGRAPH Automatic Transmitter will teach you both the Wireless and Morse Codes—right in your own home—quickly, easily and inexpensively. Connected with Buzzer, Buzzer and Phone or to Sounder, it will send you unlimited messages at any speed, from 5 to 50 words a minute.

THE OMNIGRAPH is not an experiment. For more than 15 years, it has been sold all over the world with a money back guarantee. The OMNIGRAPH is used by several Depts. of the U. S. Govt.—in fact, the Dept. of Commerce uses the OMNIGRAPH to test all applicants applying for a Radio license. The OMNIGRAPH has been successfully adopted by the leading Universities, Colleges and Radio Schools.

Send for FREE Catalogue describing three models. DO IT TO-DAY.

THE OMNIGRAPH MFG. CO., 13K Hudson St., New York City

If you own a Radio Phone set and don't know the code—you are missing most of the fun

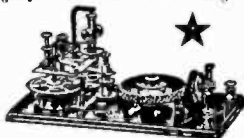

Are You a Radio Dealer?

WE want Radio Dealers to get in touch with us as we have an interesting proposition for them in connection with *Radio Broadcast Magazine*.

Radio Broadcast is read by a class of readers who have money to spend on radio. The majority of them are radio constructors, they are buying parts and building sets all the time. They are always experimenting because radio is their hobby. Write us for our Dealer's proposition and information on how *Radio Broadcast* will create sales for your store.

Radio Broadcast, Garden City, N. Y.

★ Tested and approved by RADIO BROADCAST ★

CANADIAN STATIONS USE THESE WAVE-LENGTHS

THE following list of frequency bands employed by the Dominion Government is compiled from a list recently printed in a report of the Radio Division of the Department of Marine and Fisheries. It includes those bands used for broadcasting purposes in addition to those employed for ship work, commercial purposes, etc.

AMATEUR EXPERIMENTAL AND EXPERIMENTAL—

	METERS	KILOCYCLES
C. W. . . .	4.69 to 5.35	64,000 to 56,000
" . . .	18.7 to 21.4	16,000 to 14,000
" . . .	37.5 to 42.8	8000 to 7000
" . . .	75.0 to 85.7	4000 to 3500
(c) 120	—	2500 —
I.C.W. and Phone . . .	150 to 200	2000 to 1500
	170 to 180	1,750 to 1,665

(c) For Trans-Canada Amateur Relay Work Only.

BROADCASTING—

METERS	KILOCYCLES
200 to 545	1500 to 550

SHIP SERVICES—

	METERS	KILOCYCLES
Phone . . .	200	1500
Other . . .	600 to 1,200	500 to 250
(Includes Radio Direction Finding, Radio Beacons)		
	2100 to 2800	142 to 107

COMMERCIAL—

	METERS	KILOCYCLES
Beam work . . .	21.2 to 103.3	14,000 to 2850
Point-to-point work . . .	940 to 1900	319 to 158
Point-to-point, long range and trans-atlantic work . . .	2850 to 3400	105 to 88
	4000 to 25,000	75 to 12

To show the activity of the direction service carried on by the Dominion of Canada, the above mentioned report tells us that the number of radio compass bearings given during the year 1923-24 was as follows:

STATION	BEARINGS
Chebucto Head, Nova Scotia . . .	2875
Canso, Nova Scotia	2923
Yarmouth, Nova Scotia	1804
St. Paul Island, Nova Scotia	1547
Cape Race, Newfoundland	4101
St. John, New Brunswick	1145
Pachena Point, British Columbia	3050
TOTAL	17,445

Our own Naval Communication Service furnished during the past year 137,592 compass bearings to 64,497 vessels.

★ Tested and approved by RADIO BROADCAST ★



Oh boy

KESTER Rosin Core Radio SOLDER

Sure! is Safe and Simple

Approved by
Radio Engineers
A Genuine Solder

CHICAGO SOLDER COMPANY

4222 Wrightwood Ave., Chicago, U. S. A.

Originators and
World's Largest Manufacturers of
Self Fluxing Solder

YOUR DEALER
CAN SUPPLY YOU

To Roberts Knockout Fans

Do you know that we have published two books on the Roberts Knockout Receivers? One is a treatise containing all the articles printed, and the other is just one article with complete blue prints on how to build this wonderful receiver. Price one dollar each. Write to Booklet Dept., Radio Broadcast, Garden City, N. Y.

LATEST "COAST TO COAST" FULLY GUARANTEED

RADIO'S 10 DAYS FREE TRIAL

SAVE 1/3 TO 1/2

Users everywhere report Miraco Radios get programs coast to coast on loud speaker; outperform sets three times as costly. Many hear foreign countries. Radio's most amazing values in unconditionally guaranteed, factory-built long distance sets—let testimony of users convince you.

Powerful New Multi-tube Miraco gets long distance on loud speaker. Set, ONLY \$27.35 retail

FREE! Literature on latest improved 1 to 5 tube models, new low prices, testimony of users and SPECIAL OFFER. Write: **MIDWEST RADIO CORP'N**
Pioneer Builders of Sets
406-W.E. 8th St. Cincinnati, O.



AGENT USERS WANTED Write for discounts.

SM

S-C KIT



The famous S-C Receiver is now offered exclusively by Silver-Marshall, Inc., as a complete, Armstrong licensed kit, including all parts necessary to build this remarkable set in a few hours time.

Behind the S-C Receiver is the reputation of Popular Radio—Laurence Cockaday—McMurdo Silver. And behind each and every part stands the pick of radio manufacturers—Belden Mfg. Co.—Central Radio Labs.—Polymet Mfg. Co.—Poster & Co.—Silver-Marshall, Inc.—Thordarson Elec. Mfg. Co.—Yaxley Mfg. Co. and the S-C Merchandising Co. What better guarantee could be demanded—or offered?

PRICE S-C Kit \$ 59
No. 620

Licensed under Armstrong U. S. Patent No. 1113149, Manufactured by Tresco. Exclusive Distributing Agents: Silver-Marshall, Inc.

SENSITIVITY MEASUREMENT?



The Silver-Marshall Laboratories have perfected a new and radical method of transformer measuring that insures an unbelievable degree of selectivity and sensitivity to weak signals. All 210 long wave interstage and 211 tuned transformers are now measured by this remarkable system. Priced singly or in matched groups. \$6.00 each.

For those experimenters desiring to avail themselves of this special service, S-M transformers will be measured and matched at 50c each. All other makes at \$1. each, when returned accompanied by remittance.

See S-M Parts at Your Dealers

SILVER-MARSHALL, Inc.
846 West Jackson Blvd. Chicago

RADIO FANS, a one-year's subscription to Radio Broadcast will cost you four dollars, two years six dollars. Consider this expenditure as being a necessary investment on your part for the future development of your own knowledge of Radio.

You Can Play It

If It's a Buescher Saxophone

We give 3 free lessons with each new instrument. They start you. Teach yourself. It's great fun practicing because you learn so quickly. Even though you have failed with some other instrument, you can learn the Buescher Saxophone. And it will make you the most popular person in your set. 6 days' free trial in your own home, any instrument. No obligations. Easy terms if you decide to buy. Send now for beautiful free literature. A postal brings liberal proposition. Address:

Buescher Band Instrument Co. (1)
1522 Buescher Block Elkhart, Indiana



The S-C SILVER COCKADAY
"All Wave Receiver"

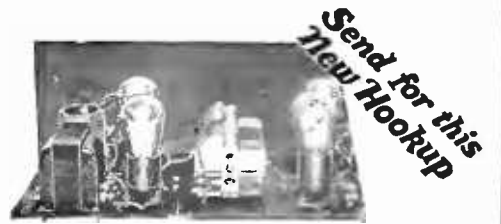

4-Tubes—Single Control

Designed by Silver, Cockaday, and the engineering staffs of the seven manufacturers listed below. . . . Sponsored by Popular Radio Magazine. . . . Endorsed and described by Radio News, Radio Engineering, Radio, On The Air Magazine, Christian Science Monitor and Newspapers throughout the country. . . . The new S-C Receiver is presented to the Set-Builder with an astounding introduction that is his best assurance of a performance that will live up to promise.

New S-C Features

Perfected single control—Unlimited wavelength range—Extraordinary volume—Quality unsurpassed and hair-line selectivity. The S-C is adapted to any standard cabinets, tubes, batteries or eliminators, and to practically all installation conditions.

Easily Assembled

S-C assembly is a marvel of simplicity. A special, multi-color wiring harness eliminates soldering, unless desired, and prevents error. With only a screw driver and a pair of pliers, even an absolute novice can assemble the S-C perfectly in a few hours.

Represented Manufacturers:

- Belden Mfg. Co.—S-C Wiring Harness
- Central Radio Laboratories—Centralab Resistance
- Polymet Mfg. Corporation—Fixed Condensers, Leak, and Leak Clips
- Poster & Co.—Drilled and Processed Front Panel and Drilled Sub-Panel
- Silver-Marshall, Inc.—Variable Condensers, Coil Sockets, Coils, Tube Sockets, Vernier Dial, Mounting Brackets
- Thordarson Elec. Mfg. Co.—R200 Power Transformers
- Yaxley Mfg. Co.—Rheostat, Jacks, Switch

Get the hand-book at your radio dealer's, or clip the coupon and send 25 cents to

S-C Merchandising Company
65 E. Jackson Blvd. Chicago

S-C Merchandising Company
65 E. Jackson Blvd., Chicago

Herewith please find 25 cents for which send me the hand-book of the new S-C Four-Tube Receiver

Name.....

Address.....

WHAT OUR READERS WRITE



Arthur Burrows on the International Tests

ALTHOUGH our thoughts are probably more inclined toward the next International Radio Broadcast Tests than to those of last January, we feel sure that this letter warrants publication in these columns so long after the conclusion of the Tests. The series of local tests Mr. Burrows refers to in the early part of his letter are those which have been conducted to find some plan whereby interference may be mitigated in the European ether. There are now well over a hundred broadcasters in Europe with about half as many separate wavelength channels, most of the stations being in the western half of the continent, and interference by heterodyning, etc., is causing much trouble. Possibly some system will have been put into operation to improve the chaotic condition on some wave bands by the time these remarks appear.

*Editor, RADIO BROADCAST,
Doubleday, Page & Company,
Garden City, New York.*

SIR: Many thanks for the advance proof of the article for the April issue of RADIO BROADCAST and for your kind remarks regarding our efforts on this side. We did all within our power to make the tests successful particularly as our European stations had already committed themselves to a series of local tests.

In future tests, the American organizers may rely upon our hearty collaboration, provided there is evidence that all concerned will take the matter seriously. In other words, we are keen in helping forward all organized effort to widen broadcasting knowledge, but we have no time for mere stunts.

My own personal view is that the greatest factor of all, in the relative failure of this year's tests, is the multiplication of freak sets in which distant reception, irrespective of quality, is the sole object. Many of these sets are not only a public nuisance by reason of the distressing howls which they radiate, but, collectively, screen their localities against favorable reception by the radiation of inaudible frequencies.

I am not a radio mathematician and, therefore, these personal comments should be treated with reserve, but I do know definitely how much easier it is to receive distant European stations which are transmitting specially for test purposes at hours when the possessors of radiating receivers are in bed.

I employ no reaction (regeneration) for our work here.

Very truly yours,
A. R. BURROWS,
Director,
Office International de Radiophonie,
Geneva.

Radio and the Weather

MR. JENSEN'S article entitled "Can We Forecast Radio Reception from the Weather," in the March RADIO BROADCAST, was the cause of considerable comment all over the country. Many prominent newspapers reprinted much of Mr. Jensen's material so interesting was it

★ Tested and approved by RADIO BROADCAST ★

Hoyt Radio Rotary Meter



Price \$24

This is a unique 5-range precision, moving coil voltmeter, made specially for the Radio Service Man, Dealer and Owner. It will make all tests necessary on Radio Receiving Sets, tubes, batteries and battery eliminators. It is rugged and will last a lifetime, yet will retain its extreme accuracy. Operation is simple and accident-proof.

BURTON-ROGERS CO.
26 Brighton Ave. Boston, Mass.
National Distributors
HOYT makes a complete line of Radio Meters.
Send for booklet "HOYT Meters for Radio"

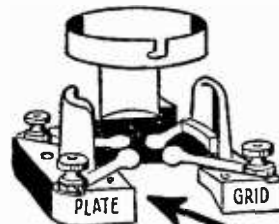

"It gets that last mile"

The AIRGAP SOCKET

Will rid your set of those squawks, howls and frying noises. They prevent closed circuit absorption of current, inter-coupling of circuits, feedback and undesirable capacity. **THEY MAKE ANY CIRCUIT** more stable and sharpen tuning, resulting in purer and clearer tones with more volume particularly on distant stations.

At all dealers 75c each
Sent direct if your dealer cannot supply you.

AIRGAP PRODUCTS CO. MFR.
188 N. J. R. Rd. Ave.,
Newark, N. J.

SEE THAT GAP? ★

This is a good time to subscribe for
RADIO BROADCAST
Through your dealer or direct, by the year only \$4.00
DOUBLEDAY, PAGE & CO. GARDEN CITY, NEW YORK

MRC—STATION LOG AND WAVE LENGTH FINDER

Now you can easily adjust your set to exactly the wavelength of the station you want to hear. Greatly simplifying tuning.



Can be placed either above or below any dial not over 4 inches in size. Very simple to attach; no tools needed.

MADE OF HIGH GRADE BRISTOL BOARD
Sent Postpaid—25c each or 3 for 50c—Stamps not accepted
MUELLER RADIO COMPANY
533 Bush St. Toledo, Ohio

\$35 Cone Speaker

for \$10

If you will assemble it yourself

(All parts supplied)

Don't pay \$35 for a cone speaker when you can assemble one yourself for only \$10 and a few hours time. We send you all the parts including special complete cone unit; also a blue print and directions for assembling. Everything is made as simple as A B C. Any one can set up this splendid, supersensitive loud speaker in a few interesting hours and actually save \$25. And there's absolutely no risk. You can get

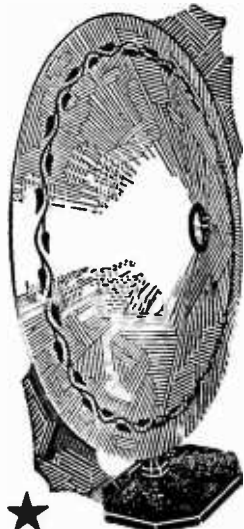

your money back instantly if you are not completely satisfied.

Stands 18 inches high

This speaker stands 18 inches high, complete in every detail. It gives a wonderfully natural tone, not to be compared with the tinny, megaphone sound of the ordinary horn speaker. With this new cone speaker you can shut your eyes and believe it's real. The only reason we are able to make this astonishing offer is because we save the labor costs and dealers' profits by dealing with you direct.

Send no money

Simply send name and address for the complete outfit. When postman brings package, deposit only \$10.00 in full payment. If not entirely satisfied simply return parts within ten days and your money will be instantly refunded. Never before has a better radio bargain been offered. These speakers are selling fast. Write at once if you want one.

SCIENTIFIC RADIO LABORATORIES

Dept. 25 254 West 34th St. New York City

RUDYARD KIPLING



The finest of all gifts—a complete set of Kipling. (In cloth or leather.)

AT ALL BOOK STORES

TRUTH

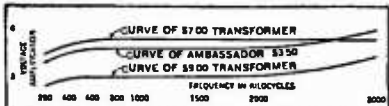

AMBASSADOR

Perfect Radio

TRANSFORMERS

By the most careful laboratory tests give as good or better results than transformers costing two and three times as much. Test them in your set and be convinced of the TRUTH.

FREE Four page booklet in colors, "The Truth About Transformers" and hook-ups.



AMBASSADOR SALES CO.
110 Greenwich St., Dept. 551 New York

considered. Professor Eugene Van Cleef, who is well-known to RADIO BROADCAST readers by virtue of his contributions to this magazine, disagrees with Mr. Jensen on one point. Here is his letter.

Editor, RADIO BROADCAST,
Doubleday, Page & Company,
Garden City, New York.

SIR:

I was very much interested in Mr. Jensen's article in the March RADIO BROADCAST. With some of his points I am in accord, but in his opposition to my theory relative to right-angled crossing of isobars versus strong reception, I am inclined to believe that he is misinterpreting weather maps. It will not be possible for me to run a series of observations at once to show the validity of my assertions, but I may be able, through the cooperation of the Storm-O-Guide Club, to carry the matter further.

Very truly yours,
EUGENE VAN CLEEF.
Worcester, Massachusetts.

Radio in Canadian Hospitals

THE first hospital to be fitted up with radio as a result of the drive in Toronto to provide for such equipment, is the Christie Street Hospital in that city. Considerable impetus was given to the drive by the special appeals of Roxy on behalf of the Disabled Soldiers' Fund during the recent visit of himself and his Gang up there. This letter gives some interesting details of the Christie Street equipment.

Editor, RADIO BROADCAST,
Doubleday, Page & Company,
Garden City, New York.

SIR:

Thinking that readers of RADIO BROADCAST will be interested in the installation here, I submit the following particulars. The master receiving sets are of Westinghouse manufacture, and are located in the basement. Jack boxes are located at the head of each bed in the hospital wards, and these are so wired as to give the patient the choice of a local or out of town broadcast. In all, there are 350 sets of head phones, and the equipment is valued at \$7,000.

The fund has reached \$12,000 to date, and subscriptions are still coming in. The amount aimed at is \$30,000. The Mowat Sanitarium at Kingston, Ontario; the Byron Sanitarium at London, Ontario, and the Hamilton Sanitarium at Hamilton, Ontario, are next to be equipped. After that, it is the intention to supply every shut-in veteran with the means of listening-in. The boys really do appreciate getting in touch with the outside world, and the concession granted by the medical supervisor permitting the radio to be operated until midnight, helps greatly to shorten some sleepless nights.

Sincerest thanks to Roxy.

Very truly yours,
H. TAYLOR.
Ex-Chief Petty Officer.

He Tried the Short Waves

IT APPEARS that more and more fans are tiring of being confined solely to listening to broadcast programs and are devoting more time now to code, especially on the shorter waves. This is not due to any fault of the broadcasting stations, but rather is it a credit to them. They have whetted the appetite of the really ardent fans and have converted many of them to veritable "DX Hounds." Opportunities unconfined await the fan who develops the symptoms of a DX-er on the short

ANNOUNCING The New FROST-RADIO GEM-JAC

The Jewel of all Radio Jacks

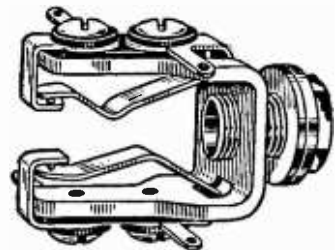

List:
50c

FROST-RADIO

No. 951 Double Circuit Gem-Jac

THE NEW FROST-RADIO GEM-JAC is ready!

It is the smallest and most compact radio jack made. An entirely new principle in spring design. The GEM-JAC projects only 1 inch back of panel. Has extremely low capacity effect, self-cleaning contacts, Bakelite insulation, sterling silver contacts, nickel plated brass frame. FROST-RADIO GEM-JAC gives you more room in your set for other parts. Order from your dealer now

No. 953 Open Circuit type, 40c
No. 954 Closed Circuit type, 45c
No. 951 Double Circuit type, 50c

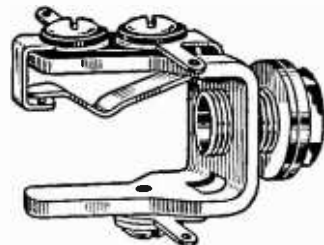

FROST-RADIO
No. 954
Closed
Circuit
Gem-Jac
List:
45c

FROST-RADIO
No. 953
Open
Circuit
Gem-Jac
List:
40c

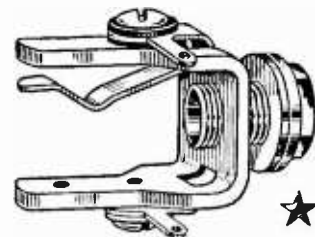

HERBERT H. FROST, Inc.
314-324 WEST SUPERIOR ST., CHICAGO
New York City Cleveland Kansas City
Los Angeles
Export Office: 314 W. Superior St., Chicago

RADIO FANS, a one-year's subscription to Radio Broadcast will cost you four dollars, two years six dollars. Consider this expenditure as being a necessary investment on your part for the future development of your own knowledge of Radio.

RADIO PANELS

OF GENUINE BAKELITE

Cut, drilled and engraved to order. Send rough sketch for estimate. Our New Catalog on Panels, Tubes and Rods—all of genuine Bakelite—mailed on request.

STARRETT MFG. CO.

521 S. Green Street

Chicago, Ill.

Thorola Receivers and Speakers Must Outperform

Reichmann Company, 1725-39 W. 74th St., Chicago

It's Easy to Build a Powerful Set

Using the New and Improved FRESHMAN "TRF" Low Loss Kit



Straight Line Wave Length Condensers With Low Loss Self Balanced Coils

These are the identical units which have made the FRESHMAN MASTERPIECE factory built Receivers the World's Greatest Radio Sets.

\$9.50

Complete instructions for building this powerful five tube receiver, written in plain everyday English, together with actual size schematic wiring diagram, are furnished with every FRESHMAN "TRF" Kit.

Sold by Authorized **★**
Freshman Dealers Only!

CHAS. FRESHMAN CO., Inc.
Freshman Building, New York
2626 W. Washington Blvd., Chicago

FOR CLEAR, QUIET "B" POWER



RADIO Storage "B" Battery

12 Cells 24 Volts Lasts Indefinitely—Pays for Itself
Economy and performance unheard of before. Recharged at a negligible cost. Delivers unflinching power that is clear, pure and quiet. Approved and listed as Standard by leading Radio Authorities, including Pop. Radio Laboratories, Pop. Sci. Inst., Standard, Radio News Lab., Lo-fax, Inc., and other important institutions. Equipped with Solid Rubber Case, an insurance against acid and leakage. Extra heavy glass jars. Heavy rugged plates. Order yours today!

SEND NO MONEY Just state number of batteries wanted and we will ship day order is received. Extra offer: 4 batteries in series (96 volts), \$10.00. Pay expressman after examining batteries. 5 per cent discount for cash with order. Mail your order now!

WORLD BATTERY COMPANY
1219 So. Wabash Ave., Dept. 78 Chicago, Ill.
Makers of the Famous World Radio "A" Storage Battery
Prices: 6-volt, 100 Amp. \$11.25; 120 Amp. \$13.25; 140 Amp. \$16.00.
All equipped with Solid Rubber Case.

World STORAGE BATTERIES
Set your Radio Dial at 210 meters for the new 1000 watt World Storage Battery Station, WSHU, Chicago. Watch for announcements.

waves. There is no limit to the distances that may be covered with the simplest of receivers. Here is a letter from a recent convert.

Editor, RADIO BROADCAST,
Doubleday Page & Company,
Garden City, New York.

Sir:

I have been interested in radio for about two years and, after tiring of the broadcasting stations, I started listening-in to the code on the 600-800 meter band. A few weeks ago I constructed a one-tube Reinartz set to cover the 50-200 meter band. With this set and one stage of audio amplification, I have already copied six of the amateur districts (the 1st, 2nd, 3rd, 4th, 8th, and 9th; fifty-seven stations in all). At present I can read and send code at about ten words per minute and am going to try for an amateur license soon. I think that there is a great deal more fun in listening to the code on the short waves than there is in listening to broadcasting programs.

Very truly yours,
STANLEY C. ALLEN,
New Bedford, Massachusetts.

Daylight Reception

MOST fans are aware of the fact that reception at night time is much better than during the hours of daylight, and many theories of this phenomenon have been advanced. An interesting letter reached us the other day from a reader giving some particulars of daylight reception in his locality, El Dorado Springs, Missouri. The fact that he was using an eight-tube super-heterodyne accounts to a certain extent for his extraordinary good results, although he states that all stations were received with good volume on the speaker.

Editor, RADIO BROADCAST
Doubleday, Page & Company,
Garden City, New York.

Sir:

As I have been very much interested in daylight radio reception, I was pleased to see the article on this subject by Mr. Alexander Sheridan in a back issue of RADIO BROADCAST. I consider the daylight range of a receiver a true test of its quality, and if a receiver is sensitive enough to bring in the DX stations during the daylight hours, many enjoyable programs may be received when static and other troubles interfere at night. Beginning last November, and using an eight-tube super-heterodyne receiver with an outdoor antenna, I decided to divide all stations into three classes, those received in winter and summer, those in winter only, and the third group, those received only occasionally. By daylight reception I mean at a time when the sun is shining both at the sending and receiving end; at midday for example. In all cases reception was on a loud speaker and was audible in a large room. In the first group the following stations were heard—all over a hundred miles; WHO, WOAW, WOS, KSD, WOC, WHAA, WHT, WNC, KTHS, WFAA, WBAP, KFRU, KFAB, KYW, KSAC, WSB, and WHAS. In the second group, that including stations heard only during the winter months, are the following stations; WCCO, WTAS, WLS, WMAQ, WQJ, WCX, WWJ, WHA, WTAM, WOAI, WSMB, CKY, and WCBD. Included in the group of stations only received occasionally are KGO, KDKA, WEAJ, CFCA, CFCN.

Yours very truly,
D. M. CRAIG,
El Dorado Springs, Missouri.

★ Tested and approved by RADIO BROADCAST ★

AMPLION

Product of nearly 40 years' Experience

For Better Radio Reproduction

Hear this creation of the originators and oldest makers of loud speaking devices, Alfred Graham & Co., England. Clear, life-like tone, supreme sensitivity and broad musical range explain its world-wide leadership in popularity. Six models, including phonograph units, with cords and panel plugs, at \$12 up. Write for "Amplion Pedigree."

THE AMPLION CORPORATION OF AMERICA

Suite L, 280 Madison Avenue, New York
Chicago Branch: 27-29 North Morgan St.
Amplion Corp. of Canada, Ltd., Toronto

Big FREE RADIO Catalog & Guide

PARTS, HOOK-UPS, SETS and KITS

Send now for this valuable FREE book. Full of advanced hook-ups, parts and kits. A real guide. Shows factory built sets and the new ideas in radio. Send at once. No charge. No obligation. Please include name of radio fan.

BARAWIK CO.

102-109 S. Canal St., Chicago

See That Screw

A screw-driver adjusts an X-L in crowded places

X-L VARIO DENSER

RESULTS in easier tuning, more distance, volume and clarity—greater stability. Indorsed by leading radio authorities.

Model "N"

A slight turn obtains correct tube oscillation on all tuned radio frequency circuits. Neutrodyne, Roberts two tube, Browning-Drake, McMurdo Silver's Knockout, etc., capacity range 1.8 to 20 micro-microfarads. Price \$1.00

Model "C"

With grid clips obtains the proper grid capacity on Cockaday circuits, filter and intermediate frequency tuning in heterodyne and positive grid bias in all sets. Capacity range .00016 to .00055 and .0003 to .001 microfarads. Price \$1.50

X-L Push Post

Push it down with your thumb, insert wire, remove pressure and wire is firmly held. Releases instantly. Price 15c.

Information on request ★

X-L RADIO LABORATORIES
2424 Lincoln Avenue Chicago, Ill.

FREE!

12-Cell — 24-Volt Storage 'B' Battery

Positively given free with each purchase of a WORLD "A" Storage Battery. You must send this ad with your order. WORLD Batteries are famous for their guaranteed quality and service. Backed by years of successful manufacture and thousands of satisfied users. Equipped with *Solid Rubber Case*, an insurance against acid and leakage. You save 50 per cent and get a **2-Year Guarantee** ★

Bond in Writing WORLD Battery owners "tell their friends." That's our best proof of performance. Send your order in today.

Solid Rubber Case Radio Batteries
 6-Volt, 100-Amperes . . . \$11.25
 6-Volt, 120-Amperes . . . 13.25
 6-Volt, 140-Amperes . . . 14.00

Solid Rubber Case Auto Batteries
 6-Volt, 11-Plate . . . \$11.25
 6-Volt, 13-Plate . . . 13.25
 12-Volt, 7-Plate . . . 16.00

Send No Money Just state battery wanted and we will ship day order is received, by Express C. O. D., subject to your examination on arrival. **FREE "B" Battery** included. **Extra Offer:** 5 per cent discount for cash in full with order. Buy now and get a guaranteed battery at 50 per cent saving to you.

WORLD BATTERY COMPANY
 1219 So. Wabash Ave., Dept. 24 CHICAGO, ILL.

World STORAGE BATTERIES

Set your Radio Dials at 210 meters for the new 1000 watt World Storage Battery Station, WSRC, Chicago. Watch for announcements.

WKA • WEA • WGN • WJ • KHL • KGO • KF • WJ • KOP

A Letter from Italy

WE ARE proud to present the new RADIO BROADCAST which, in quality of appearance and contents, speaks for itself." Thus read the opening sentence of our presentation of the first new RADIO BROADCAST, that of November, 1925. We don't like patting ourselves on the back too much, but it seems as though the magazine really has spoken for itself, judging from the many laudatory letters we have received. It has a pretty lusty voice too, and reaches out for plenty of DX.

Editor, RADIO BROADCAST,
 Doubleday, Page & Company,
 Garden City, New York.

SIR:

Please accept my sincerest congratulations on the new form, and especially the new cover, you have chosen for RADIO BROADCAST. The name "Aristocrat," which you have given to the single control set described in your November number, is the name by which RADIO BROADCAST should be defined too. I have always liked your magazine in whatever form it appeared, and have constantly maintained that it was, without doubt, a straight, serious magazine. Actual conditions of exchange make it almost impossible for me to realize my great wish to be the owner of one of RADIO BROADCAST's receivers. It is difficult for me to send for the necessary components or for a completed set, and what makes it harder is the knowledge of their absolute superiority over any we have over here. Had it not been for the fact that I am a war invalid, I should certainly have come over to see for myself and admire radio conditions in America. But this cannot be, and the only way out is by reading your first rate magazine.

Very truly yours,
 CAPTAIN PESARO, M. C.,
 Varese (Province of Como), Italy.

From a User of the Four-Tube Knockout

IT IS hard to choose any one letter from the great group which we have received about the Knockout four-tube receiver which has been variously described in this magazine beginning with April, 1924. The one printed below, hot from the radio fields of Nebraska, probably will interest those now using this Knockout receiver and those who have not yet constructed one too.

Editor, RADIO BROADCAST,
 Doubleday, Page & Company,
 Garden City, New York.

SIR:

Just a word about your four-tube Knockout set. I read your article in the September, 1924, issue in which you mentioned the fact that a good many fans had spent large sums of money on different hook-ups without getting good results and had decided to quit radio. I happened to be in that class, and on reading your article, decided to give it just one more whirl before quitting for good.

After getting the Knockout all hooked up and working, I just felt that I owed it to you to tell you that it is the best set I ever got my fingers on. It is very selective, and has enough volume to satisfy a deaf man when you want to use it, or you can use headphones and plug in on the two tubes and adjust it just the way you want it. I have tried all the known reflex circuits in existence, but none of them has the volume on three tubes that yours has on two.

I am sure that for the money involved and the number of tubes used, you have the best hook-up yet.

C. E. B.,
 York, Nebraska.

AEROVOX



By-Pass Condensers

"Built to be Better"

Tested and approved by M. I. T., Yale, Radio News, Popular Radio and Popular Science. Used by over 200 of America's leading set manufacturers.

Aerovox Wireless Corporation

489-491-493 Broome Street
 New York City

Branch Offices:

Chicago, Ill., 53 W Jackson Blvd.
 Boston, Mass., 104 Portland St.
 Cincinnati, Ohio, 304 Palace Theatre Bldg.
 Los Angeles, Cal., 324 N. San Pedro St.

RADIO FANS, a one-year's subscription to Radio Broadcast will cost you four dollars, two years six dollars. Consider this expenditure as being a necessary investment on your part for the future development of your own knowledge of Radio.

MORE PROFITS for the PROFESSIONAL SET BUILDER

WE have an unusually interesting proposition to make to the man who is now building (or has the ability to build) radio receiving sets for resale.

This is a real opportunity. Write today for full information.

Gearhart-Schlueter Radio Corp.
 716 Voorman Ave. Fresno, California

Why not subscribe to *Radio Broadcast*? By the year only \$4.00; or two years, \$6.00, saving \$2.40. Send direct to Doubleday, Page & Company, Garden City, New York.

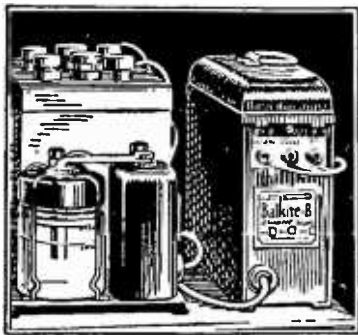

★ **Convert your present radio receiver into a light socket set with a Balkite Trickle Charger and Balkite "B"**

FANSTEEL PRODUCTS CO., Inc.
 North Chicago, Illinois

Blue-Print for The Radio Broadcast "Aristocrat"

A third full-sized blue-print, showing how to build a complete "Aristocrat" Receiver employing the Allen-Bradley type 3-stage resistance-coupled audio amplifier, has been added to the two original full-sized blue-prints showing the baseboard and sub-panel "Aristocrat" Receiver. The new blue-print also shows the use of other types of coils.

The "Aristocrat" Receiver

designed in RADIO BROADCAST'S Laboratory has found immediate favor with thousands of home constructors because it combined all the desirable features of simplicity of tuning control, sensitivity, and a purity of tone and volume difficult to associate with some of the year's best receivers.

These Plans

show you every step in the construction, together with a complete picture diagram of the actual wiring of every part employed.

The circuit, around which the receiver is built, is a modification of the well-known Roberts of well earned popularity. It combines a tuned, neutralized radio-frequency amplifier of high gain, a regenerative detector, and three stages of resistance-coupled audio frequency amplification, insuring selectivity, sensitivity, and clarity of volume unequalled in many of the present day receivers.

The dollar blue-prints show you how to build any one of three "Aristocrats". Send your dollar now, using the coupon below.

RADIO BROADCAST

Garden City, N. Y.

Gentlemen:

Please send me, prepaid, the set of 3 full-sized "Aristocrat" Blue-prints for which find One Dollar, enclosed.

Name

Address

R. B. My

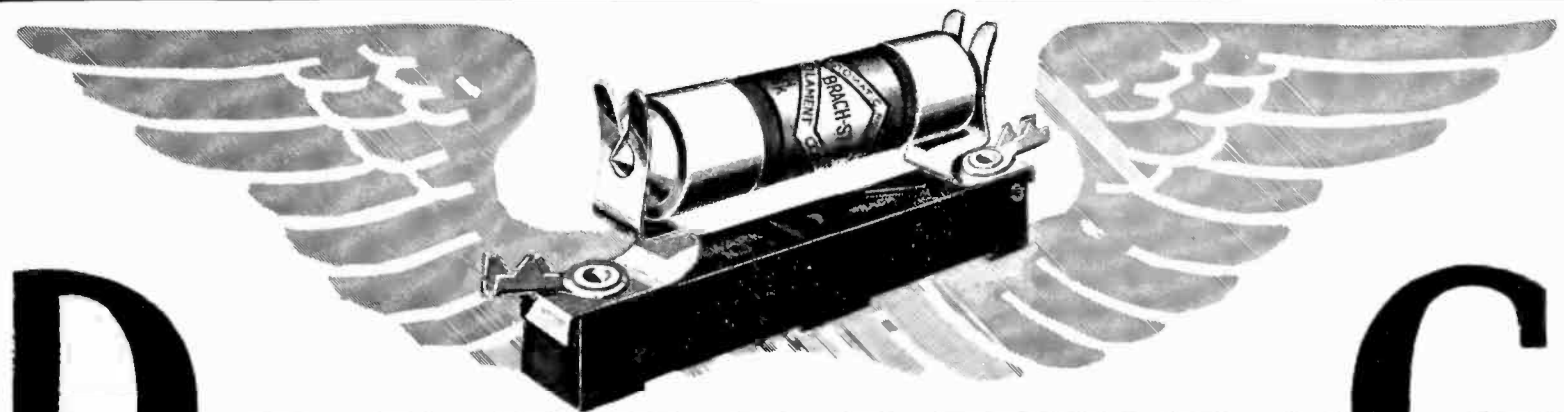

DOMINATING ITS FIELD BECAUSE OF SUPERIOR MERIT BRACH-STAT - THE AUTOMATIC FILAMENT CONTROL ★

We are prepared at any time to prove Brach-Stat superiority over any other form of filament control ballast. The life of a radio tube is materially shortened when even slightly overloaded. Leading set makers and discriminating engineers insist upon Brach-Stats because they positively prevent overloading and provide perfect filament control.

L. S. BRACH MFG., CO. - - **NEWARK, N. J.**

BRAIDED
COPPER
RIBBON

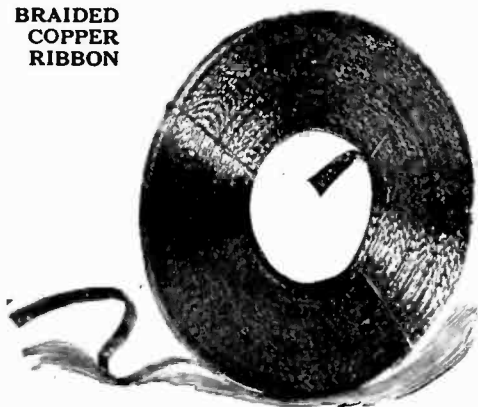

Increases
Range

Clearer
Tone

Greater
Volume

Note the
many strands



Shown here
exact size

No. 25 Copper Web

BRAIDED RIBBON

Indoor or Outdoor
ANTENNA WIRE

—is made of 25 strands of copper wire braided into a strong flexible ribbon aerial three-eighths inch wide, and containing in each 100 feet nearly one-half mile of single copper strands. This gives greatest possible capacity and conducting surface.

Made in copper, tinned copper and enameled copper, and put up in coils of 50 ft., 100 ft., 150 ft. and on spools of 500 ft.

We also make round, braided and stranded antenna wires—all metals.

Litz Wires—Cotton Covered Wires—Springs

ROSS WIRE COMPANY ★

69 Bath Street

Providence, R. I.

Goodrich Silvertown

The Radio Panel Supreme!

- 1 Easier to drill and machine.
- 2 Better color, lasting lustre.
- 3 Lower free sulphur—no discoloration.
- 4 Higher softening point—no warping.

Goodrich V. T. Sockets

Spaghetti Tubing

Radiophone Ear Cushions



Battery Mats

Hard Rubber Tubes for Coils

The B. F. Goodrich Rubber Company

Established 1870

Akron, Ohio

★ Tested and approved by RADIO BROADCAST ★

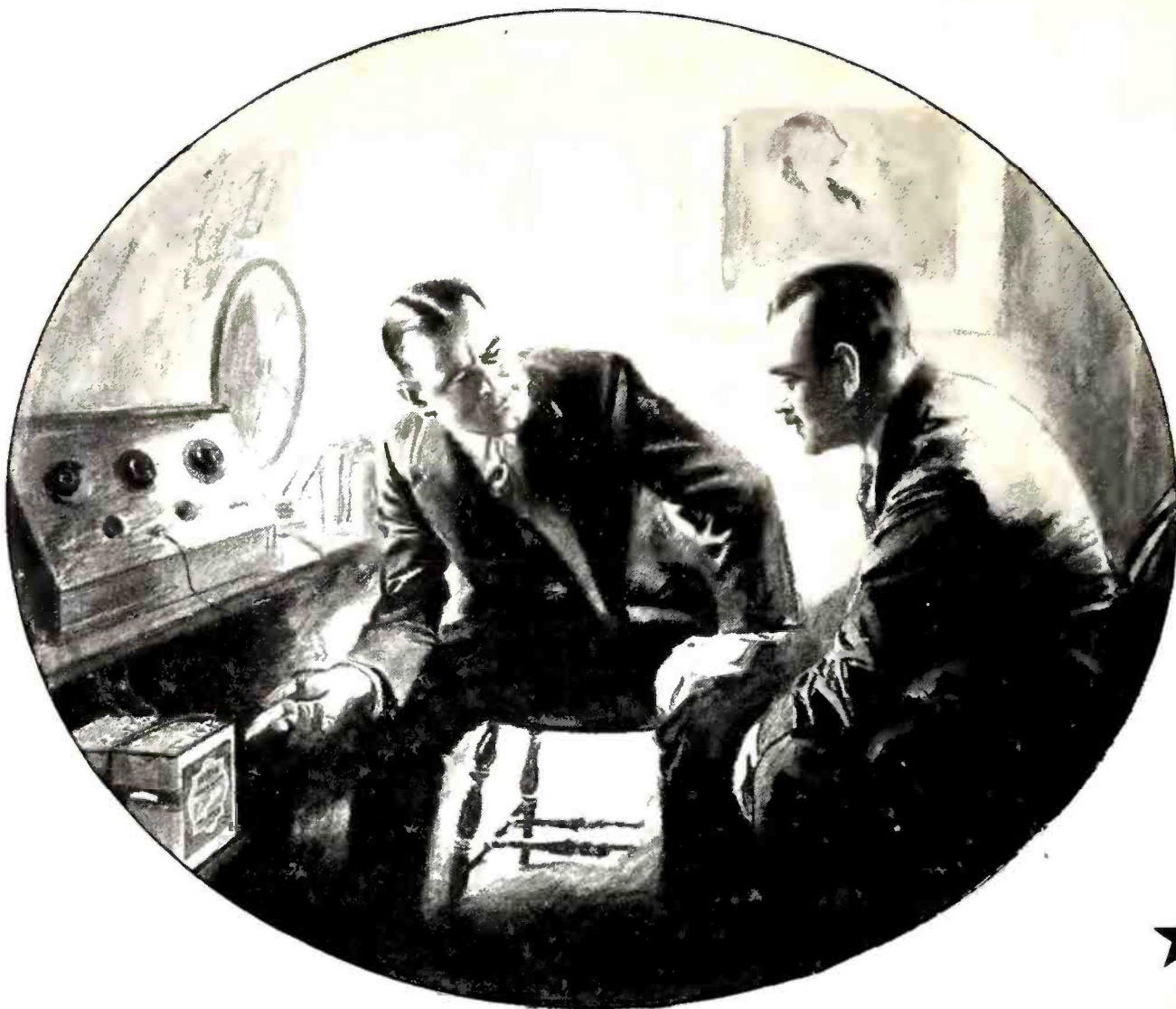

“The little wrinkle that makes my ‘B’ batteries last longer is using the right size Evereadys with a ‘C’ battery”

“I USED to think that because the Eveready ‘B’ Battery No. 772 cost less than either of the larger Heavy Duty Evereadys that I was saving money. As a matter of fact, on four or five tube sets, that was false economy.

“The right size Eveready ‘B’ Batteries to use depends on the number of tubes in your set. The life of the batteries depends on how much you listen in and on whether a ‘C’ battery is employed.”

To get the maximum of “B” battery life and satisfaction, follow these simple rules:

On 1 to 3 tubes—Use Eveready No. 772.

On 4 or more tubes—Use the Heavy Duty “B” Batteries, either No. 770, or the even longer-lived Eveready Layerbilt No. 486.

On all but single tube sets—Use a “C” battery.*

Follow these rules, and No. 772, on 1 to 3 tube sets, will last a year or more; Heavy Duties, on sets of 4 or more tubes, eight months or longer.

The average year-round use of a set is two hours a day. If you listen longer,

your “B” batteries will have a somewhat shorter life. If you listen less, they will last longer.

Our new booklet, “Choosing and Using the Right Radio Batteries,” is free for the asking. It also tells about the proper battery equipment for the new power tubes.

*NOTE: In addition to the increased life which an Eveready “C” Battery gives to your “B” batteries, it will add a quality of reception unobtainable without it.

Manufactured and guaranteed by
NATIONAL CARBON CO., Inc.
 New York San Francisco
 Canadian National Carbon Co., Limited
 Toronto, Ontario

Tuesday night means Eveready Hour—
 9 P. M., Eastern Standard Time, through
 the following stations:

WEAF—New York	WGR—Buffalo	WGN—Chicago
WJAR—Providence	WCAE—Pittsburgh	WOC—Davenport
WEFI—Boston	WSAI—Cincinnati	WCCO—Minneapolis
WTAG—Worcester	WEAR—Cleveland	WFL—St. Paul
WFI—Philadelphia	WWJ—Detroit	KSD—St. Louis

LEFT — No. 486, for 4, 5 or more tubes, \$5.50.

RIGHT — Eveready Dry Cell Radio “A” Battery, 1½ volts.

EVEREADY
Radio Batteries
—they last longer

★ Tested and approved by RADIO BROADCAST ★

THE COUNTRY LIFE PRESS, GARDEN CITY, NEW YORK