

April
1926

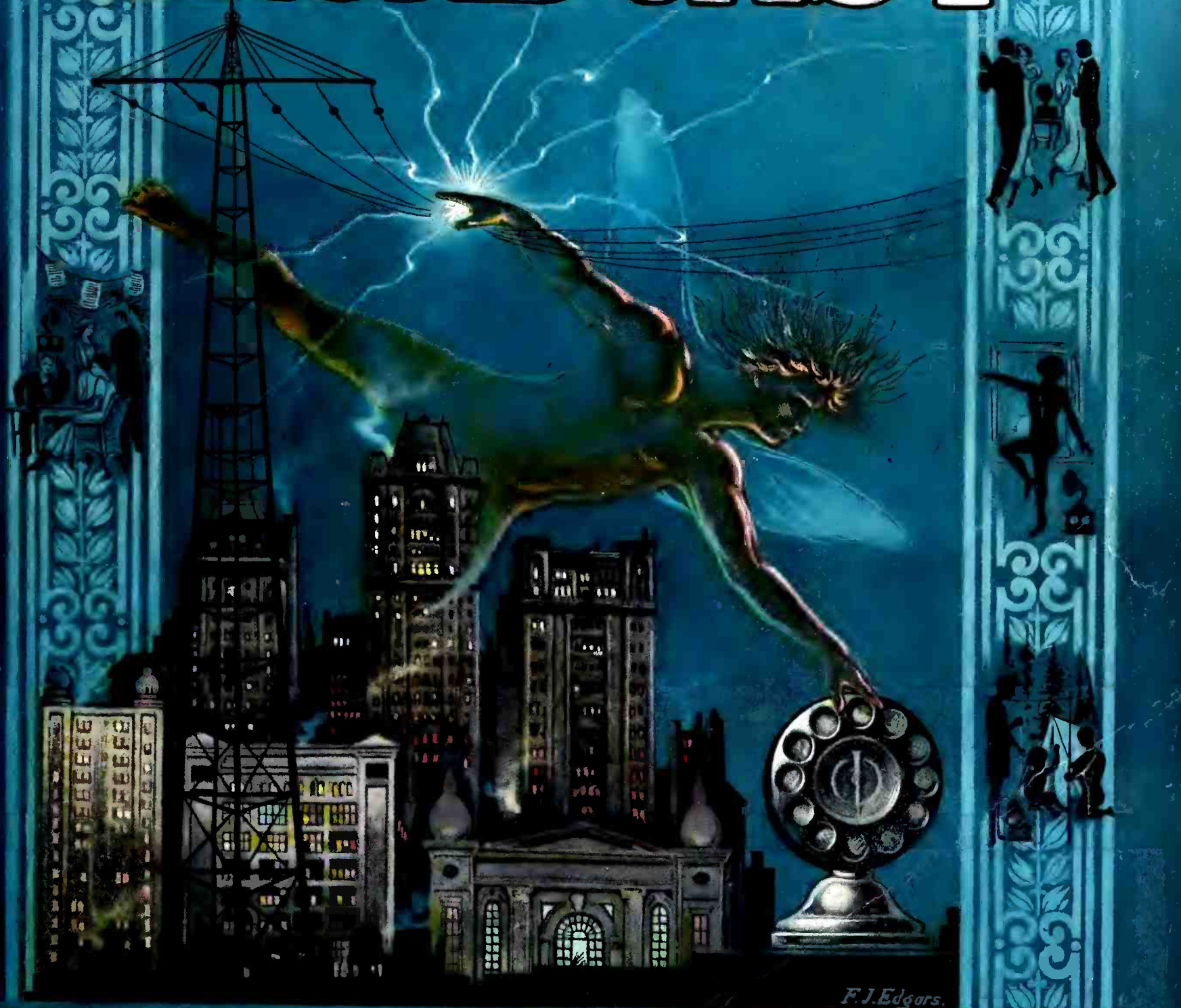

35
CENTS

RADIO BROADCAST



F.J. Edgars.

WHAT HAPPENED DURING THE INTERNATIONAL TESTS
ROBERT H. MARRIOTT ON EARLY RADIO DAYS

Additional Announcement on the Contest
for a Short Wave Receiver

The Proper Resistance to
Control Your Filament

Doubleday, Page & Co., Garden City, New York

Cunningham

RADIO TUBES



Confidence in a Name

KNOWLEDGE derived from his own experience soon convinces the radio recruit that all radio tubes are *not* alike--no matter how similar their appearance. And from his own experience he

reaches the conclusion of millions --that the best guarantee of hidden value and unseen protection in a radio tube is in the name Cunningham, with a reputation zealously guarded since 1915.



E. J. Cunningham Inc.

Chicago

San Francisco

New York

★ Tested and approved by RADIO BROADCAST ★



for DISTANCE Use a Beldenamtel Aerial

Interesting Facts About Beldenamtel Aerial Wire

Made in 100 and 150 feet lengths to avoid splicing for lead-in wire.

Furnished in distinctive striped carton that is a safeguard against substitution.

Endorsed by leading radio engineers as the best and most efficient aerial.

THE reason for the unusual efficiency of a Beldenamtel Aerial is the great care exercised in its construction. Beldenamtel Aerial Wire is made of several strands of pure copper, each coated with many layers of baked Beldenamtel. The enamel coating prevents corrosion of the wire surface, and thereby offers a low resistance to the antenna current.

Ordinary bare copper aerials corrode, and the volume and range of the set decreases. A Beldenamtel Aerial never corrodes, and therefore the volume and range are not diminished by corrosion. Try a Beldenamtel Aerial, in place of your old aerial, and hear the difference.



*Mail the Coupon
for Free Illustrated
Booklet*

BELDEN MANUFACTURING CO.
2312M South Western Ave., Chicago

Please send me your booklet entitled "Helpful Hints for Radio Fans."

Name.....

Address.....

Belden

Speed RADIO TUBES

SUPREME
IN
PERFORMANCE

If it's in the air
"SPEED"
TUBES
will bring it in
loud and clear

"SPEED" TUBES are sold by a large number of wide awake dealers. If you cannot find them in your town, write us.

Sold with a Worthwhile Guarantee

DEALERS AND JOBBERS

An exclusive franchise on "SPEED" TUBES is valuable. A few territories are still available. Write for details.

Cable Supply Company

INCORPORATED

Sales Offices

907 BROADWAY
NEW YORK



TYPE
201-A

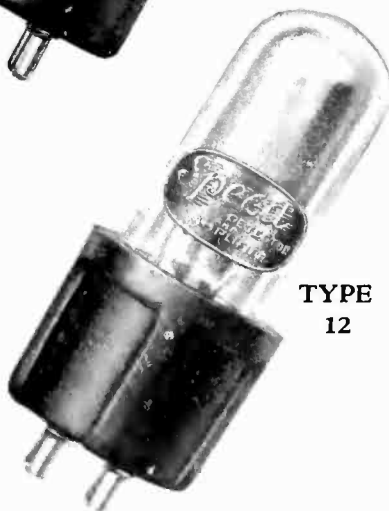

TYPE
12



TYPE
199

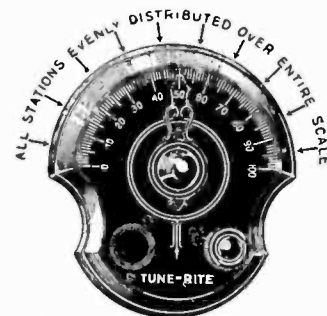

N
O
W

Complete Separation of
Low Wave Stations

Perfectly accomplished with Tune-Rite, the straight line frequency dial. A marvel in scientific construction, it instantly converts any set to straight line frequency. Bring your present set up-to-date by replacing your old dials with Tune-Rite. Beautiful in appearance. Easily mounted without drilling.

Price, \$3.50

Write for instructions

Radiall Company

Dept. T.R.B.-3, 50 Franklin St., N.Y.

TUNE-RITE
The Straight Line Frequency Dial
Made by the makers of Amperite, the Self-Adjusting Rheostat

MORE PROFITS
for the **PROFESSIONAL**
SET BUILDER

WE have an unusually interesting proposition to make to the man who is now building (or has the ability to build) radio receiving sets for resale. This is a real opportunity. Write today for full information.

Gearhart-Schlueter Radio Corp.
716 Voorman Ave. Fresno, California



100% Value
From Each Tube

What's the use of buying good tubes if you don't get their full value? Individual, automatic tube control is the answer. Amperite alone gives it. That's why it is specified in every popular construction set. Offers precision regulation—automatically. No hand rheostats to regulate. Eliminates all errors of human judgment. A special type for every style and strength of tube. Price \$1.10.

Write for free hook-ups

Radiall Company

Dept. R.B.-4 50 Franklin St., N.Y. City

AMPERITE
REG. U.S. PAT. OFF.
The "SELF-ADJUSTING" Rheostat

★ Tested and approved by RADIO BROADCAST ★

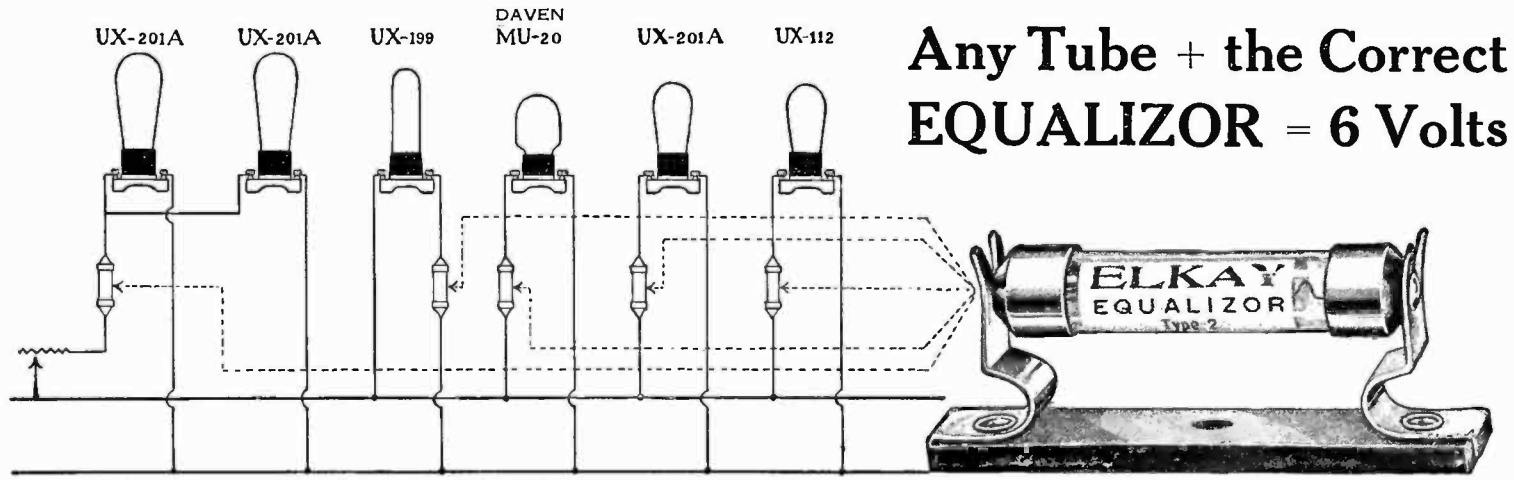

Filament Line of Standard Two-Stage Tuned R.F. Circuit

**Any Tube + the Correct
EQUALIZOR = 6 Volts**

**Use any combination
of tubes with the**



ELKAY TUBE EQUALIZOR SYSTEM

(PRE-ADJUSTED RHEOSTAT)

THIS System comprises a wide range of pre-adjusted filament control EQUALIZORS to slip into spring clips. Equip your set with this system and you can use any combination of tubes you wish, making the change instantly without touching the wiring. You can change from dry-cell tubes to the large tubes, for instance, in a few seconds; and, in these days of UX tubes, the System is ideal. Any tube + the correct Equalizor = 6 volts!

The Elkay Equalizor is really a pre-adjusted rheostat. It replaces the regular rheostat in all except the R. F. stages, where it is used in series with a rheostat for volume control.

Your set can easily be equipped with the Elkay Tube Equalizor System by a few simple changes in wiring, which you or your dealer's service department can make. Full directions for this are enclosed with the Equalizor.

Following is a table of Elkay Equalizors with the values required for the different tubes.

Tube Type	Equalizor Type
201 A	4
2-201 A	2
112	2
199	50
199 plus rheostat	35
2-199	25
MU-20	0
MU-6	0
200 plus rheostat	0

Price per Equalizor, 50c; with clip mounting, 75c.

New Equalizors will be made from time to time as newer tubes come out. Send for complete folder on the Elkay Tube Equalizor System.

ELKAY SUPER-SELECTOR, \$80.

(Equipped with Equalizor System)

Compares favorably in appearance, selectivity, volume, distance and tone quality with sets at twice its price. Has one stage R. F., detector, one stage of transformer coupled amplification and two resistance coupled amplifiers. Only two dials. A radio frequency choke permits same smooth operation on low or high wave lengths. Control



Resistance Coupled

over selectivity a distinct departure—an ELKAY invention.

Manufacturers—

Equip your sets with this System. It makes a more flexible, more salable job, and cuts your costs by eliminating rheostats and controls. Write for low-priced quantity offer.

The Langbein-Kaufman Radio Company, Dept. R, 511 Chapel Street, New Haven, Conn.

Originators and Pioneers in the Manufacture of Tube Equalizor Systems



★ Tested and approved by RADIO BROADCAST ★

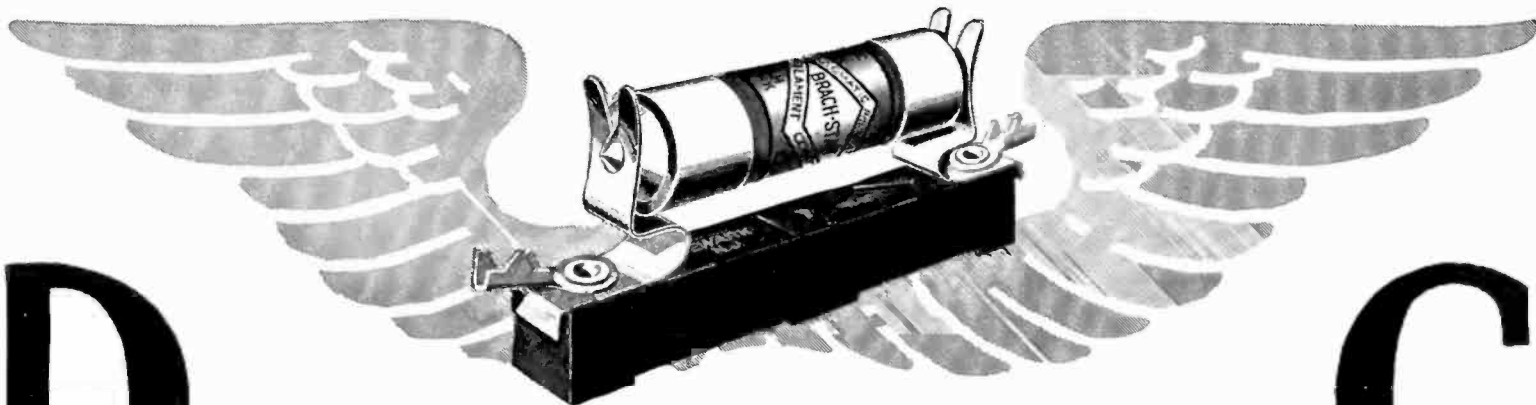

DOMINATING ITS FIELD

BECAUSE OF SUPERIOR MERIT

BRACH-STAT

- THE AUTOMATIC FILAMENT CONTROL ★

We are prepared at any time to prove Brach-Stat superiority over any other form of filament control ballast. The life of a radio tube is materially shortened when even slightly overloaded. Leading set makers and discriminating engineers insist upon Brach-Stats because they positively prevent overloading and provide perfect filament control.

L. S. BRACH MFG., CO. - - NEWARK, N. J.

Radio Broadcast's Knockout Four-Tube Roberts Receiver IS STILL IN GREAT DEMAND

More Than 20,000 Constructors
Have Built This Receiver
From
Radio Broadcast's
Full Sized Blue-Prints

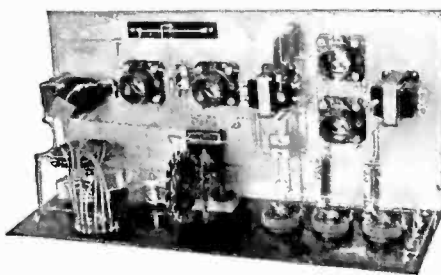

Build it with
BLUE-PRINTS

- 1—Tuned Neutralized Radio Frequency Amplification.
 - 2—Regenerative Detector.
 - 3—Reflexed Detector Output Through Radio Amplifier.
 - 4—Push-Pull Audio Amplifier.
- These are the features that make construction of this receiver worth-while.

Use this coupon if your local dealer cannot supply you with

Radio Broadcast's Knockout Four-Tube Blue-Prints

RADIO BROADCAST
Garden City, New York

Gentlemen:

For one dollar (enclosed) please send me Radio Broadcast's Four-Tube Knockout Roberts Receiver Blue-Prints, which are full-sized.

Name.....

R. B. A.

Address.....

★ Tested and approved by RADIO BROADCAST ★

The UNIVERSAL

Standards of Quality



Type 277-D
Coupling Coil
Price \$1.50

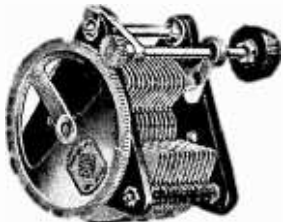

Type 247-H
Geared Condenser
Price \$5.00



Type 368
Micro Condenser
Price \$1.25

In building a radio receiver remember that its performance depends primarily upon two things; an efficient circuit, and the use of good parts.

Wherever you find a popular circuit you will invariably find General Radio Parts.

The General Radio Company has contributed more in scientific apparatus for laboratory use than any other one Company in the history of radio.

The same outstanding craftsmanship and materials are embodied in General Radio parts for use in the construction of broadcast receivers.

Through the merits of design, performance, and price, General Radio instruments for the scientist or set-builder are universally recognized as the Standards of Quality.

Every instrument made by the General Radio Company is thoroughly guaranteed.

The General Radio Company has endeavored to make it possible for the experimenter to obtain its products with a minimum of effort. A careful selection of distributors and dealers has been made. They are best fitted to serve you. If, however, you are unable to obtain our products in your particular locality they will be delivered to you, postpaid, direct from the factory upon receipt of list price.

Write for our latest parts
catalog 924-B

GENERAL RADIO Co
Cambridge 39 Mass.



Type 285
Audio Transformer
Price \$6.00



Type 301
Rheostat
12 ohm and 25 ohm
Price \$1.25



Type 349
UX-Tube Socket
Price 50c.

GENERAL RADIO



INSTRUMENTS

“Behind the Panels of Better Built Sets”

COMO

VARIABLE-RATIO AUDIO-TRANSFORMER

Price \$6.00
Send for
descriptive
Pamphlet
R

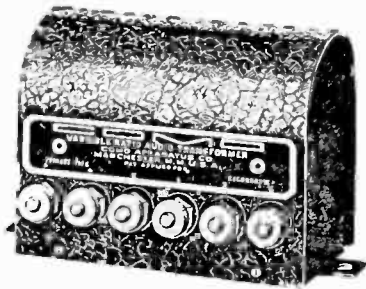

3 Ratios
4-1, 6-1,
8-1,
all in one
transformer

This new unit, made by a pioneer manufacturer of high-grade Radio equipment, gives three ratios in one transformer—4 to 1, 6 to 1 and 8 to 1. It permits varying primary impedance to secure the best results in each stage of audio. It may be used as a high-grade impedance in impedance-coupled audio.

At all good dealers. Price \$6.00

COMO APPARATUS COMPANY, Inc.
Kelley Street Manchester, N. H.
★ Send for pamphlet R

See That Screw

A screw-driver adjusts an X-L in crowded places

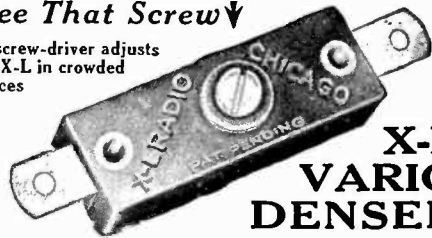

X-L VARIO DENSER

RESULTS in easier tuning, more distance, volume and clarity—greater stability. Indorsed by leading radio authorities.

Model "N"

A slight turn obtains correct tube oscillation on all tuned radio frequency circuits. Neurodyne, Roberts two tube, Browning-Drake, McMurdo Silver's Knockout, etc., capacity range 1.8 to 20 micro-microfarads. Price \$1.00

Model "C"

With grid clips obtains the proper grid capacity on Cockaday circuits, filter and intermediate frequency tuning in heterodyne and positive grid bias in all sets. Capacity range .00016 to .00055 and .0003 to .001 microfarads. Price \$1.50

X-L Push Post

Push it down with your thumb, insert wire, remove pressure and wire is firmly held. Releases instantly. Price 15c.



Information on request ★

X-L RADIO LABORATORIES
2424 Lincoln Avenue Chicago, Ill.

"HOW RADIO RECEIVERS WORK" by WALTER VAN B. ROBERTS

B. S., E. E., Ph. D.



W. VAN B. ROBERTS
Originator of the famous Roberts Circuit

THE name "Roberts" stands for efficiency and clear reception to thousands of our readers who have employed the Roberts circuit in their home-constructed receivers.

The originator of that circuit, Walter Van B. Roberts, has answered all the questions that have been put to him ever since his circuit was first shown in RADIO BROADCAST regarding the technical family history of radio in writing his book entitled "HOW RADIO RECEIVERS WORK." He explains the functioning of every part, in a clear and concise manner.

The contents include information on how electrons work, the use of condensers and transformers, suggestions as to the best antennas to be used for receivers and transmitters, descriptions of the vacuum tube as a detector, oscillator and amplifier, the method of feed-back and push-pull amplification, with additional explanations of the infinite electrical variety of all radio vacuum tube circuits. Mr. Roberts has covered the entire field of radio in a very unique way. Here is a text book, a guide book even, to radio, written without the professional manner. Mr. Roberts tells you what you have always wanted to know about radio, in a fascinating way. This is not "just another radio book."

As to the book itself: It contains 53 pages of reading matter, with 65 illustrations; it is cloth bound; and it is 7"x10 3/4" in size. The title is stamped in gold on the cover, and the text is printed on dull finish book paper and therefore is not a strain on the eyes if read under an electric lamp.

This is RADIO BROADCAST's Book No. 3. A dollar and the accompanying coupon will make you the possessor of Mr. Roberts' book, "HOW RADIO RECEIVERS WORK."

DEALERS! Let us outline to you the attractive discounts which we will allow you on these new and easy selling books, to be sold at a popular price. Do not delay, write us at once.

DOUBLEDAY, PAGE & CO.
Garden City, New York

Enclosed find my dollar for Radio Broadcast's new book by Walter Van B. Roberts, "How Radio Receivers Work." It is understood that my dollar will be returned if the material sent me does not come up to my expectations.

Name.....

Address.....

A

Make Your Own Cone Speaker

—and Save \$25

(All parts supplied)

Why pay \$35 or more for a cone speaker when you can easily assemble a splendid supersensitive one with the complete parts we send you—and save \$25?

We include a special cone unit, blue print and simplified directions for assembling. Directions are so clear anyone can easily set it up in a few hours. It's a big cone, eighteen inches high, complete in every detail. Unmatched for beauty, and reproduces music and voice with faultless accuracy. The cost is amazingly low—only \$10 complete for the most approved form of loud speaker known. Big saving is due to elimination of labor in assembling and packing and because we save jobbers' and dealers' profits.

Send No Money

Simply send name and address for the complete outfit. When postman brings package, deposit only \$10.00 in full payment. If not entirely satisfied, simply return parts within ten days and your money will be instantly refunded. Never before has a better radio bargain been offered. Write at once.

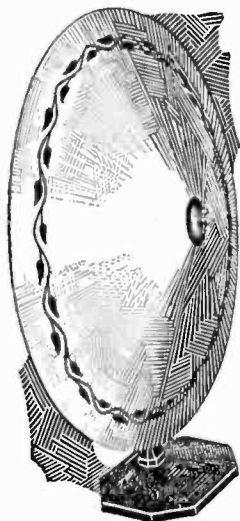

★ **SCIENTIFIC RADIO LABORATORIES**
254 W. 34th St., Dept. 24 New York City

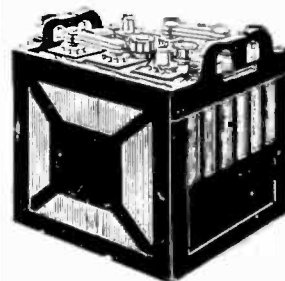

CHICAGO Radio BATTERIES

Auto

Solid One Piece RUBBER CONTAINERS

GUARANTEED FOR 2 YEARS FAMOUS

for unexcelled quality, guaranteed long-lived service and unvarying dependability. Chicago Batteries offer the Radio fan an "A" Power that is backed by years of experience and master workmanship with the finest materials available. Endorsed and approved by leading Radio and Automotive authorities. Chicago Batteries in their new non-leak, solid rubber cases represent an amazing value at lowest cost.

PRICES

Solid Rubber Case RADIO Batteries			
6 volts,	100 Amps.	\$ 8.79
6 volts,	120 Amps.	10.79
6 volts,	140 Amps.	13.50

GUARANTEED 2 YEARS

Solid Rubber Case Auto Batteries			
6 volts,	11 plates	\$ 8.79
6 volts,	13 plates	10.79
12 volts,	7 plates	13.50

SAVE MONEY—ORDER DIRECT

Buy Chicago Batteries direct from the manufacturer. Batteries you order will be shipped the same day. Express C O D or 5% discount cash with order.

CHICAGO BATTERY WORKS
1206 So. Peoria St. Chicago, Ill.



Report of the Laboratory

RADIO BROADCAST
Doubleday Page Co. Company Garden City, New York

UNITED RADIO & ELECTRIC COMP'Y.

Type 201-A Tubes

	F1	F2	F3	F4	F5
Filament Current	.25	.25	.24	.25	.25
Plate Current	4.3	6.5	4.3	3.95	6.55
Plate Impedance	8,500	7,400	8,400	9,050	8,600
Ampl. Constant	7	7	7	7.7	7.0
Mutual Conductance	824	745	853	855	814

Average Characteristics

Fil Current	Fil. Watts	Plate Current	Miles per Watt	Plate Impedance	Mutual Cond.	Amplification Coef.
.25	1.25	4.3	3.64	8,500	854	7.1

Conditions

Filament Volts	Plate Volts	Grid Volts
5	90	-4.5

Keith Henney,
Director of the Laboratory.

January 27, 1926

For Mutual Conductance

WHEN you want best results from *any* set—greatest range, volume, and clearness—select your tubes with care. COMPARE! For a radio authority has said: “The tubes are the heart of the set.”

And Mr. Keith Henney, leading radio tube authority and Director of “Radio Broadcast” Laboratories, points out in the October, 1925 issue of that publication that in order to secure best results with a radio tube *“the mutual conductance . . . should be as high as possible.”*

This “Radio Broadcast” Laboratory Test Tells the Story

THAT’S one reason why URECO Radio Tubes give such amazingly superior results. They grade highest in mutual conductance—and here are the facts to prove it.

In an impartial test of practically every make of Radio Tube, Mr. Keith Henney, Director of “Radio Broadcast” Laboratory, found the Mutual Conductance of URECO 201A Tubes to be 854, while the *highest* Mutual Conductance shown by any other tube tested was 745—a *Mutual Conductance superiority of 109 in favor of Ureco.*

ARE you enjoying the superiority of URECO Tubes? If not, make this comparative test. Tune in on any station. Then take out your present tubes and put in URECOs. Listen again. Note the greater volume and clearness.

URECO Tubes are made to sell on *performance*—not *claims*. Tests in the laboratory or the home *prove* them superior on every count. That’s why the URECO slogan is “COMPARE.” Every comparison means a new URECO booster.

UNITED RADIO & ELECTRIC COMPANY
418 Central Avenue - - Newark, New Jersey



"He didn't need new tubes!"

SANGAMO

Accurate Condensers

(Solidly molded in impervious Bakelite)

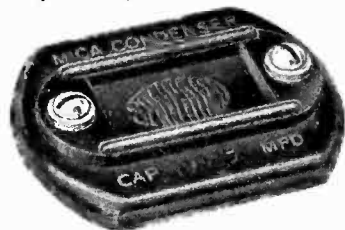

saved
\$15

FOR several weeks his receiving set had been disappointing. Previously, it had been a constant delight, but now programs came in so weak his family had to use headsets—they couldn't hear the loud-speaker clearly. Nothing but local stations. Friends said he needed new tubes, new batteries, new aerial, new this-and-that; all with a fine friendly disregard for the cost.

Then a *real* radio expert gave him good advice. "Trouble may be in your fixed condensers. Moisture creeps in at exposed edges and changes their capacity. This upsets the electrical balance; there is resistance where there ought to be exact capacity, and your reception is spoiled, both in quality and volume.

"Try Sangamo Mica Condensers. Their accuracy is guaranteed, and the solid, seamless bakelite jacket prevents the capacity from ever being affected by moisture, fumes, soldering heat, or any other cause of condenser troubles."

Putting in these accurate Sangamo Condensers increased volume, cleared up reception, brought in DX and saved a waste of money for new accessories. Such a little, inexpensive part—but tremendously important! Any real expert will tell you so.

APPROVED BY ALL NATIONALLY
RECOGNIZED RADIO LABORATORIES

Sangamo By-pass Condensers are also accurate—and surges will not break them down. They last longer.



★
Sangamo Electric Company
6332-2 Springfield, Illinois

RADIO DIVISION, 50 Church Street, New York

SALES OFFICES—PRINCIPAL CITIES

For Canada—Sangamo Electric Co. of Canada, Ltd. Toronto.
For Europe—British Sangamo Co., Ponders End, Middlesex, Eng.
For Far East—Ashida Engineering Co., Osaka, Japan.

BRAIDED
COPPER
RIBBON

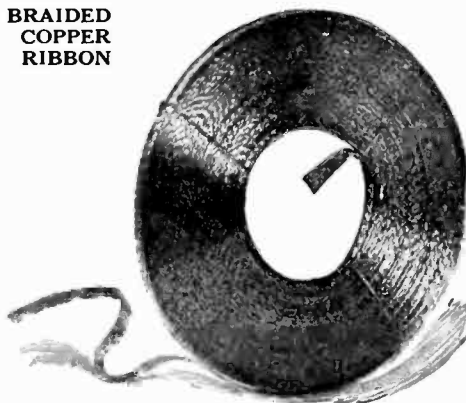

Increases
Range

—

Clearer
Tone

—

Greater
Volume

Note the
many strands

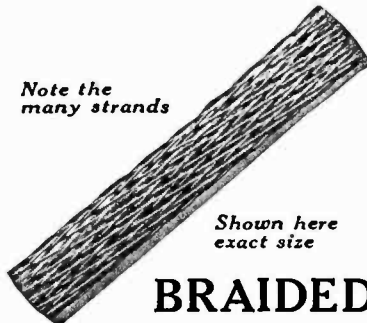

Shown here
exact size

No. 25 Copper Web

BRAIDED RIBBON

Indoor or Outdoor
ANTENNA WIRE

—is made of 25 strands of copper wire braided into a strong flexible ribbon aerial three-eighths inch wide, and containing in each 100 feet nearly one-half mile of single copper strands. This gives greatest possible capacity and conducting surface.

Made in copper, tinned copper and enameled copper, and put up in coils of 50 ft., 100 ft., 150 ft. and on spools of 500 ft.

We also make round, braided and stranded antenna wires—all metals.

Litz Wires—Cotton Covered Wires—Springs

ROSS WIRE COMPANY

69 Bath Street

Providence, R. I. ★

Goodrich Silvertown

The Radio Panel Supreme!

- 1 Easier to drill and machine.
- 2 Better color, lasting lustre.
- 3 Lower free sulphur—no discoloration.
- 4 Higher softening point—no warping.

Goodrich V. T. Sockets Spaghetti Tubing

Radiophone Ear Cushions

★ Battery Mats

Hard Rubber Tubes for Coils

The B. F. Goodrich Rubber Company

Established 1870

Akron, Ohio

COUNTERPHASE SIX

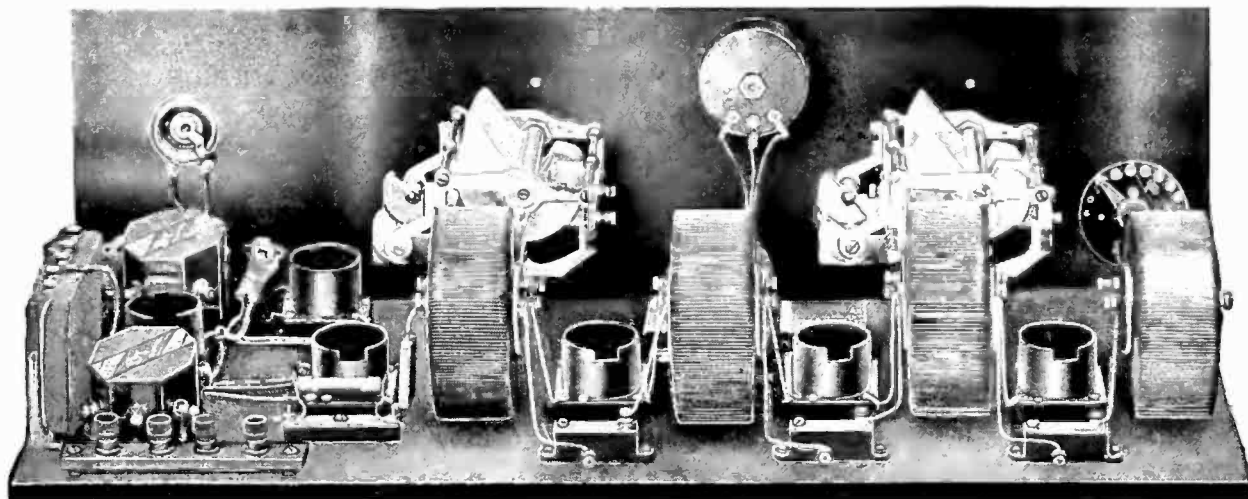

B-T Counterphase Six (Built from Kit)

The season's outstanding development in radio—

In the short time that Counterphase has been offered to the Radio public, its fame has spread to all parts of the U. S. and Canada, to say nothing of foreign countries. Unsolicited letters from users all over the country attest its unparalleled popularity and success—Mr. M. E. K. of Indiana Harbor, Ind. writes, “—had *KFI* (Los Angeles) too

loud on six tubes and *WCAP* (Washington, D. C.) was broadcasting on nearly same wave length at the same time—.” EMW's letter from Minneapolis contains an interesting fact, “—got *WKAQ* San Juan, Porto Rico, using 25 foot indoor aerial picked up on loud speaker—.” And so the letters come in every day in an ever-increasing number.

Counterphase Leadership

The public has elected the Counterphase the season's leader. The right to leadership was acquired by giving to the Radio fan quality parts and a REAL circuit.

The momentum gained is bound to increase and the

Counterphase bids fair to maintain the head position for many seasons to come.

All quality dealers can supply you with the Counterphase Kit. The nine-color wiring diagrams leave no room for errors in building the set.

FOR BEST RESULTS—

use B-T products throughout—B-T AUDIO TRANSFORMERS,
B-T SOCKETS, and B-T TUNING CONTROLS

To those who have not read any of the technical articles on the Counterphase, let us say that it is a patented circuit, developed by B-T engineers and uses the B-T Torostyle transformers (also Patented). The six tube set employs three stages of R.F., the 5 tube 2 stages of R.F., and the 4 tube, 1 stage of R.F.

B-T Tandem Condensers simplify tuning by reducing the number of tuning dials. The feature of the circuit is the special method of balancing the circuits. For more information on the Counterphase and other hook-ups, write for the 9th edition of “*Better Tuning*,” price 10 cents.

BREMER-TULLY MFG. CO.

Pioneers of Better Tuning

532 SO. CANAL ST.

CHICAGO, ILL.



COUNTERPHASE SIX

For Best Results Use B-T Parts Throughout

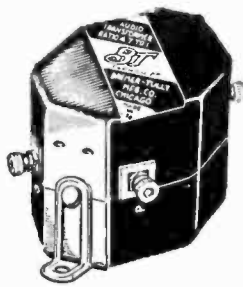

2.2 to 1 \$5.00
4.7 to 1 5.75

Audio Transformers

The B-T Euphonic Audio Transformer was designed by the inventor of the Counterphase circuit. His experience is your best guarantee. The mechanical design permits mounting in the best position for short direct leads. The beautiful tone quality possible when using B-T Euphonics will surprise you.

Tuning Control

The B-T Tuning Control combines excellent appearance with the utmost mechanical efficiency. It reads in degrees, station wave lengths or station call letters and fits condensers turning either way. Ratio 12 to 1—the original window dial—black and gold finish.

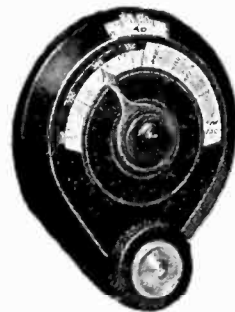

Price \$2.50

Tube Socket

The B-T Universal socket takes either the old or new tubes with equal efficiency. Loose contacts are impossible. Made of genuine bakelite—compact and requires little room. The best socket insurance you can buy.

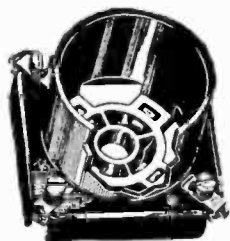

Type U. L. Socket \$.75
Silent Socket - 1 25

Condensers

B-T Tandem condensers are furnished in the Counterphase kits. A very important part of any set, B-T condensers play no small part in the widespread success of the Counterphase. B-T condensers were the choice of Lieut. Schnell in his short wave experiments with the Pacific Fleet. You can't go wrong on B-T condensers.

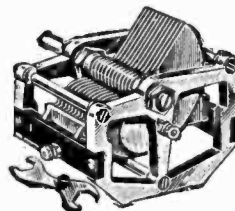

Made in 5 sizes from .000125 to .00075 and priced from \$4.25 to \$6.50 each. Also made in tandem style—and S. L. F. type. Send for circulars.

BREMER-TULLY MFG. COMPANY ★

532 South Canal Street

Chicago, Ill.

Bremer-Tully Recommends

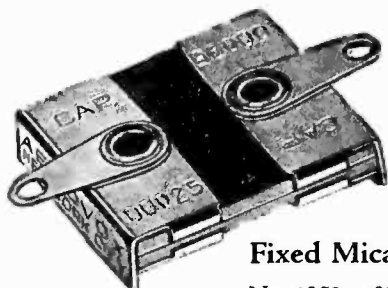

Fixed Mica Condensers

No. 1250 .001 Mfd. \$.40
" 1250 .00025 Mfd. .35

AEROVOX

Fixed Condensers and Grid Leaks

FOR THEIR FAMOUS CIRCUIT



By-Pass Condensers

No. 1200 1.0 Mfd. \$.90
(2 required in B-T Circuit)



No. 1090 Fixed
Grid Leak 2 Megohm \$.20
No. 1046 Bakelite
Grid Leak Mounting \$.15

In doing this, Bremer-Tully have associated their name with those of the most eminent engineers and scientific leaders in the world.

AEROVOX FIXED CONDENSERS AND GRID LEAKS have been tested and approved by Massachusetts Institute of Technology, Yale University, Radio News, Popular Radio and Popular Science.

AEROVOX FIXED CONDENSERS AND GRID LEAKS are used by over 200 of America's leading set manufacturers.

AEROVOX WIRELESS CORPORATION
489, 491, 493 BROOME STREET, NEW YORK CITY

BRANCH OFFICES:

Chicago, Ill. 53 W. Jackson Boulevard Boston, Mass. 104 Portland Street
Cincinnati, O. 304 Palace Theatre Building Los Angeles, Cal. 324 N. San Pedro St.

★ Tested and approved by RADIO BROADCAST ★

Bremer-Tully Counterphase

Six Tube Receiver

List

Price

\$165.00

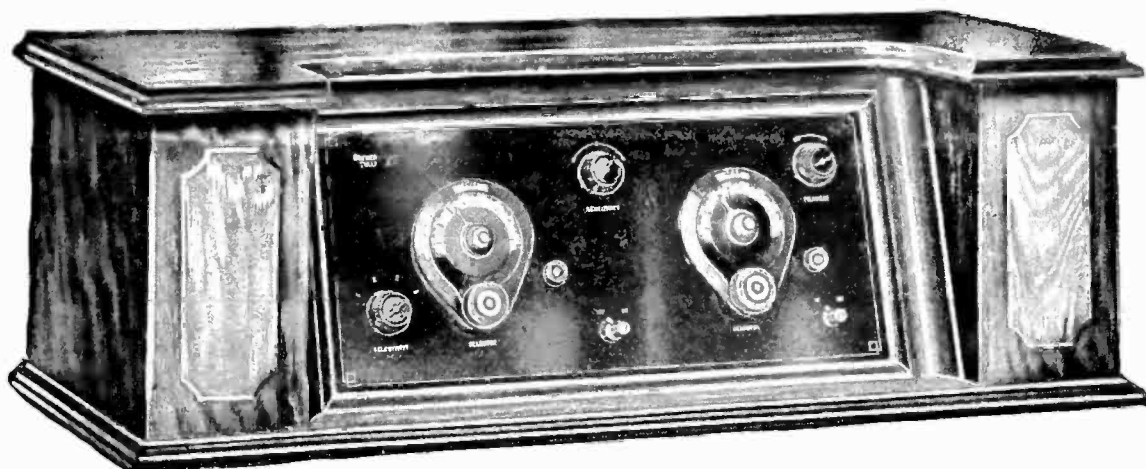

The
Sensation
of
Chicago

THE B-T COUNTERPHASE SIX is housed in a beautiful Walnut Cabinet with "B" battery compartment and a multiple plug is used for all "A" and "B" battery connections. The panel is of burnt walnut finish with specially finished tuning controls to match.

In order to secure the highest degree of practical selectivity, as well as improvements in tone quality and to reduce stray noises, the cabinet is completely copper-lined and shielded throughout. The design of the Torostyle coils allows the use of this shielding method without loss in efficiency which would follow in the case of open coils. As a result, the set can be operated with great satisfaction in congested districts where interference from broadcasting stations or other nearby receivers would cause great difficulty with any unshielded sets.

A special form of radio transformers has enabled the manufacturer the use of a third radio frequency tube which secures maximum results without a long cumbersome aerial, something which many are unable to erect. Also is tuned with only two controls. Uses B-T Tandem Condensers.

Radio frequency circuits generally have a distinct weakness, they either oscillate violently or if any of the usual means of stopping this

tendency is employed, the receiver will not respond reasonably except on certain stations.

The B-T Counterphase Six is the only factory-built receiver of this type available to-day that provides the means of securing the maximum efficiency possible from all stations, whether they are on the lowest or highest broadcast wave lengths. This result is secured by the exclusive B-T patented Counterphase method.

The capacity of a receiver to bring in distant stations is a measure of its efficiency. The B-T Counterphase recognizes no equal in this respect.

The sensitivity and volume control is another exclusive B-T invention. All the operator needs to know is that the panel knob is turned in one direction to increase and in the other direction to decrease either sensitivity or volume.

The B-T Counterphase Six is the most practical, selective and generally efficient radio receiver made.

Immediate shipments to any genuine Radio Dealers in the United States made from our large Warehouses here

B-T Counterphase Kits — B-T Nameless Kits
"Crowe Panels for above B-T Kits"

"WE SHIP FAST" IN ANY QUANTITY

B-T "Lifetime" Condensers — B-T Euphonic Transformers

B-T Tuning Controls — B-T Universal Sockets

Some of the Famous Lines we Distribute:

CROSLY
CUNNINGHAM
EVEREADY
KING
FROST
VALLEY

BREMER-TULLY
BALKITE
REMLER
TRIMM
ACME
JEWELL

JEWETT
CARTER
DUBILIER
MORRISON
ALL-AMERICAN
BELDEN

PREMIER
HARKNESS
SAMPSON
HAMMARLUND
WESTON
BLANDIN

Dealers only write for our New Catalog RB 1007

RADIO DIVISION

WAKEM & McLAUGHLIN

INCORPORATED

DISTRIBUTORS OF

STANDARD RADIO SUPPLIES AND EQUIPMENT

"WE SHIP FAST"

225 EAST ILLINOIS STREET

CHICAGO

For Utmost Efficiency Equip Your B-T Counterphase-Six with a CROWE METAL PANEL

The Crowe metal panel obviates the necessity of separate metal shielding of panel—eliminates “body capacity”—aids in the elimination of inductive disturbances—insures maximum selectivity under the most trying conditions. Crowe panels used in conjunction with metal shield illustrated below provide complete metal shielding.

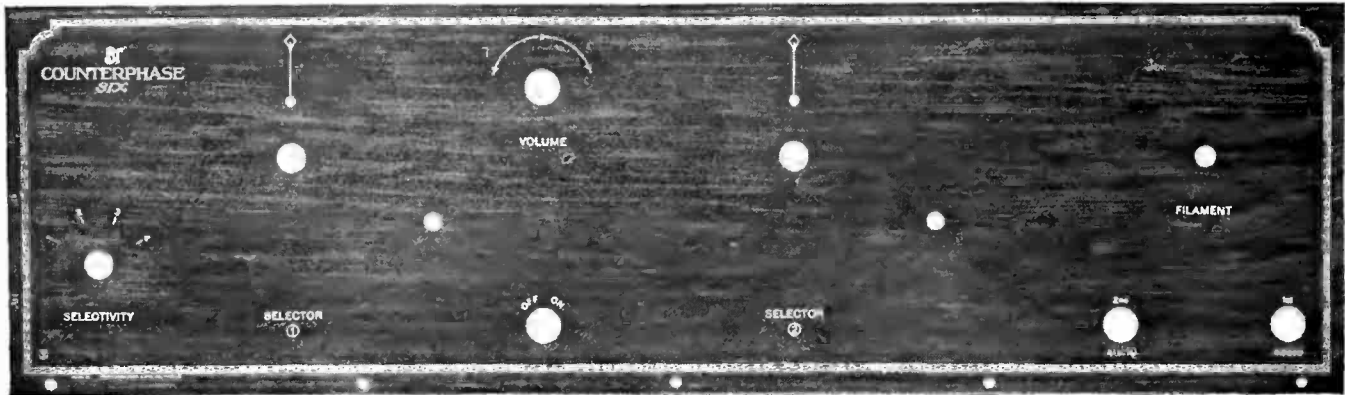

Crowe Panel for B-T Counterphase-Six, Size 7 x 24, Accurately Pierced, Ready for Use.
(Packed in Individual Containers, with Insulation and Directions)

Crowe Metal Panels and Shields For Sale by Leading Dealers

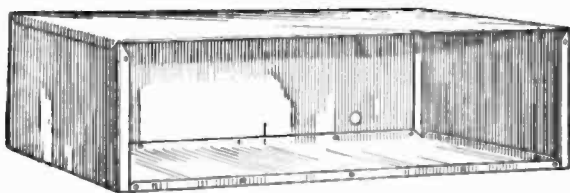

★ CROWE METAL SHIELD for B-T Counterphase-Six



Write for instructive folder, explaining why your receiving set should be paneled with a Crowe metal panel.

C R O W E
NAME PLATE & MFG. CO.

1749 Grace Street CHICAGO

To Get the Best Results from the Bremer-Tully Counterphase “6” Kit

Use **CARTER** Parts

as specified in the Bremer-Tully “Hook-up” Sheets

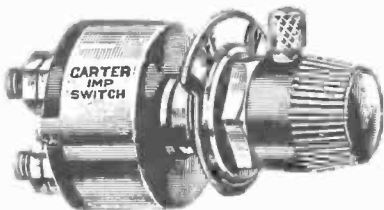

Pat. 1-30-23

Full Size

CARTER “IMP”
Battery Switch 65c



Half Size

CARTER “IMP”
Inductance Switch \$1.00

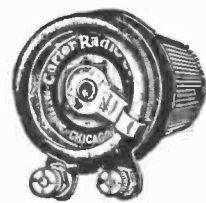

Pat. Pend.

Half Size

CARTER “IMP”
Rheostat \$1.00

3 to 50 Ohms. All Resistances

Manufacturers of Kits and Sets realize how important it is to have only the best parts in their circuits. Carter radio products are the choice of the big majority. Bremer-Tully have specified in their “Hook-up” Sheets Carter parts. Your dealer can supply them.

Carter Radio Parts specified by Bremer-Tully for B-T Counterphase “6”

- 1 Carter “IMP” Switch \$.65
- 1 “IMP” Inductance Switch 1.00
- 1 Carter “IMP” Rheostat (3 ohms)..... 1.00
- 1 Carter “HOLD-TITE” Jack No. 10170
- 1 Carter “HOLD-TITE” Jack No. 10390

Send for folder on complete line of Carter quality radio products.

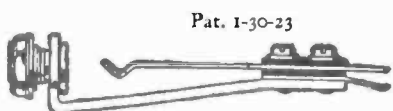

Pat. 1-30-23

70c

Carter HOLD-TITE Jack No. 101. Each
One spring. Open circuit.



In Canada: Carter Radio Co., Limited, Toronto



★

90c

Carter HOLD-TITE Jack No. 103. Each
Three springs. No local make contact. Single filament control.

COUNTERPHASE SIX

Quick Service on

Bremer Tully Counterphase Kits and Parts
available to Pacific Coast through

Radio Supply Co.
LOS ANGELES

The instant popularity enjoyed by the B-T Counterphase is well deserved. Remarkable, almost unbelievable reports of long distance reception are coming in daily—Pacific Coast fans especially appreciate an efficient long distance receiver because they are far removed from the center of our great country. Their thrill how-

ever is greater when Atlantic coast stations are received.

The Counterphase is the product of B-T engineers who designed the famous Nameless Circuit. This fact alone is a guarantee that the Counterphase is all that is claimed for it. It is the only new and noteworthy development in radio this year.

Counterphase Kits

The essential parts for the five- and six-tube Counterphase are available in kit form. Each kit contains a full-size nine-color wiring diagram and wires cut to length and colored like the diagram. Wiring the set is simple.

No. 6 Kit for Six-tube Sets

No. 5 Kit for Five-tube Sets

B-T Euphonic Audio Transformers produce best tone quality; B-T Universal Sockets insure the Counterphase against socket trouble—B-T Tuning Controls will permit "Better Tuning" and greatly add to the appearance of the receiver.

Use B-T Parts Throughout

Dealers—Write or Telegraph

RADIO SUPPLY CO.

Wholesale Distributors B-T Kits and Parts

920 So. Broadway Street

Los Angeles, California

Complete list of
GUARANTEED PARTS FOR
Silver - Marshall
 Model 1926

**“MODERN BROADCAST
 6-TUBE RECEIVER”**

When building this receiver be sure you use only the parts specified and you will have the satisfaction of possessing the finest receiver yet developed.

- 3—S-M 311 .00035 S. L. F. Condensers
- 3—4 in. Kurz Krasch Moulded Dials
- 3—S-M 515 Coil Sockets
- 2—S-M 112A Inductances
- 1—S-M 110A Inductance
- 6—S-M 510 Sockets
- 2—Carter 6-ohm imp. Rheostats
- 1—Central Laboratory 500,000 ohm Modulator
- 3—Daven Resistance Couplers complete
- 1—Carter 101 Jack
- 1—Carter 102A Jack
- 1—Carter On-Off Switch
- 1—.002 M. F. Condenser
- 2—Dubilier .5 M. F. By-pass Condensers
- 1—7 x 24 Drilled, Sanded and Engraved Bakelite Panel
- 1—7 x 23 Oak Base Board, Bus-bar, Screws, Lugs, etc.
- 1—Belden 5-lead color cable

Complete Parts \$49.50
 as Specified, Only . .

Wired and Ready to Use \$8. Extra

S. C. Receiver

Standard Parts

	Total
2 S-M antenna coils; Nos. 110A and detector coil No. 114A equipped with 2 No. 515 coil sockets	\$ 7.00
2 S-M SH variable condensers No. 316, equipped with 1 vernier dial No. 801	13.75
4 S-M tube sockets, type 510	2.00
2 Thordarson S-C power transformers	16.00
1 Polymet mica fixed condenser, .002 mfd.	.40
1 Polymet mica fixed condenser, .005 mfd.	.60
1 Polymet gridleak, 2 megohms	.25
1 Polymet mica fixed condenser, equipped with gridleak clips, .10005 mfd.	.45
1 Yaxley rheostat, No. 16K, 6 ohms	1.35
1 Yaxley battery switch No. 10	.50
1 Yaxley jack, type No. 1	.50
1 Yaxley jack, type No. 2	.60
1 Centralab variable resistance, 25,000 ohms	1.50
1 S-M midget condenser, No. 340, .000025mfd.	1.50
2 S-M mounting brackets	.70
1 Belden S-C connecting harness	4.00
1—7 x 18 Drilled and Engraved Panel } \$7.00	
1—6½ x 17 Drilled Sub-Panel	

Complete Parts \$55

Cabinet for this set \$9.50 extra

Big Demand for New Circuits

The New S. C. Receiver Orthophase Receiver
 L. C. 26 Broadcast Receiver General Radio Universal Receiver

We Have All the Hard-to-Get Complete

STANDARD PARTS

Either in Kit Form or Separately for All Popular Circuits

SEND YOUR ORDER NOW!

ABOVE SETS WIRED TO ORDER \$10. EXTRA

We guarantee immediate Delivery

HEINS & BOLET
 46 PARK PLACE, NEW YORK

Hear Ye Radio Fans

At Last a Radio Tube that's
 Different

With a set of these tubes you don't need a power tube. The first quarter ampere five-volt coated filament tube and at a popular price. And they are efficient down to three volts, with great volume and purity of tone.

We will gladly send you a set of these tubes and with our money back guarantee in five days if they don't improve your set.

Dealers write for list of types and discounts.

Type C. F. 500, List \$2.50, *Armor Brand*

★
The Armstrong Electric and Mfg. Co.

Factory selling agents

Armor Sales Co., 351 Halsey St., Newark, N.J.

IF YOU like this magazine with its coated paper and enlarged size—then why not subscribe and get it regularly—by the year, \$4.00, Six months, \$2.00.

DOUBLEDAY, PAGE & CO.
 Garden City .: New York

*When you think
 of perfect electrical contact
 —as being permanent—
 think of the*

Lastite
it locks!



The Standard, tubular Soldering Terminal for making radio Circuits mechanically strong
A refinement that saves time and material

Manufactured by
William Stevens Co. ★

27 Hammatt Road, Roslindale Mass.



Oh boy

KESTER
Rosin Core
Radio SOLDER

Sure! is Safe and Simple

Approved by
Radio Engineers
A Genuine Solder

CHICAGO SOLDER COMPANY

4222 Wrightwood Ave., Chicago, U.S.A.

Originators and
World's Largest Manufacturers of
Self Fluxing Solder

YOUR DEALER
CAN SUPPLY YOU



A&B Battery \$2
Charger ONLY

SATISFACTION GUARANTEED

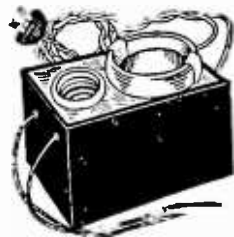

Charges any type of storage A or B battery, or auto battery, using a few cents worth of ordinary house current. Cannot injure battery and lasts for years. Complete directions enclosed—anyone can operate. No "Extras" to buy.

Why pay \$10.00 to \$18.00 for a charger when you can get this splendid GUARANTEED R. B. Charger by mailing us two dollars (bills, money order, check, or stamps). Charger will be sent postpaid. Act at once. TO-DAY.

R. B. MANUFACTURING CO.

308 East Third Dept. 19 Cincinnati, Ohio

RADIO PEP

B-BATTERY ELIMINATOR
NO TUBES NO HUM



Buy no more B-batteries!

USE the unlimited supply of cheap, dependable electricity right at hand in your house-lighting circuit.

This can be done with *permanent* satisfaction with RADIO PEP.

RADIO PEP is the **FIRST** eliminator to completely solve the problem, as it is the only one made with **EIGHT PERFECTED ELECTROLYTIC CELLS**, replacing tubes and doing away with all the familiar tube troubles.

Two or four cells *overloaded* will not give **PERMANENCE** and **POWER**—the outstanding characteristics of RADIO PEP.

135 VOLTS are called for by the modern sets and tubes; here you get it year after year without weakening.

For 110-125 volts, 60-cycle alternating current.

Send for particulars and name of our nearest dealer. Price \$38. Money back guarantee.



PEP MFG. CO., Inc.

33 West 42nd Street

New York

RADIO BROADCAST

ARTHUR H. LYNCH, Editor
 WILLIS K. WING, Managing Editor
 JOHN B. BRENNAN, Technical Editor

APRIL, 1926
 Vol. VIII, No. 6

CONTENTS

Cover Design	From a Painting by Fred J. Edgars	
Frontispiece	Listening-in at Pekin	642
How Radio Grew Up	Robert H. Marriott	643
What Happened During the 1926 International Tests	Willis K. Wing	647
The March of Radio	J. H. Morecroft	652
The \$500 Short-Wave Receiver Contest		657
The Tube and Its Best Uses	Keith Henney	658
The "Aristocrat" Receiver		664
Radio Sets for Light Keepers		666
The Listeners' Point of View	John Wallace	667
As the Broadcaster Sees It	Carl Dreher	672
	Drawings by F. F. Stratford	
How a Portable B Battery Transmitter Works	By the Laboratory Staff	678
The Use of the Filament Resistance	John B. Brennan	682
Cutting out the Locals	H. E. Rhodes	686
The Grid—Questions and Answers		696
	Coil Dimensions for the "Universal" Receiver Eliminating the Reflex in the Roberts Circuit How to Calculate Capacity in Series or Parallel A Three-Tube R. F. Circuit with Impedance Amplification	
"Now, I Have Found"		702
	Improving Reproduction in Cone Speakers How to Provide a Counterpoise System The Silver "Model 1926 Receiver" A Coil Winder for Diamondweave Coils A Battery Throw-over Switch Economical Sub-panel Brackets	
Short Wave Stations of the World		708
A Key to Recent Radio Articles	E. G. Shalkhauser	710
What Our Readers Write Us		716

BEHIND EDITORIAL SCENES

ROBERT H. MARRIOTT is one of the "old men of radio" in the United States and his articles about "How Radio Grew Up" seem to please both old and new radio folk. The first article in the series he is writing for RADIO BROADCAST appeared in December, 1925. However much we may marvel now at the accomplishments of the amateur in throwing a faint short-wave signal half way around the world with his simple apparatus, there is still much of the remarkable in the accomplishments of the early radio workers, and there is no one better able to tell about it than Mr. Marriott. There are other articles to follow by him.

ALTHOUGH the International Tests are considerably behind us in this rapidly moving radio world, the correspondence from radio listeners all over the United States and from foreign countries still continues to bombard the office. For those who listened in vain for a peep on a foreign wavelength, the review of the results of the Tests on page 647 of this issue should attract attention. A letter just received from a woman in Iowa is especially interesting. "To settle an argument with my husband," she writes, "will you please tell me whether or not the following program came from any foreign station?" The program in question came from Bournemouth, and since that station was added to the list at the last minute, she, among many listeners, did not know they were on. We settled the argument.

THE third in the series of Keith Henney's valuable articles on tubes appears in this number. The previous two appeared in the December and February issues of RADIO BROADCAST. "The Tube and Its Best Uses" is specially designed to answer all sorts of questions on the practical use of the tube in radio circuits, and it was written in a large measure, to answer definite inquiries which came to our office.

COMING numbers of RADIO BROADCAST will have much of interest to every sort of reader. One wishes that space limitations did not prevent us from including in this issue some of these articles which have been omitted for that reason. In an early number, there will be another of the home laboratory articles, describing a very useful wavemeter with complete instructions on how to use this valuable device in the home laboratory. Then there is another article by H. E. Rhodes on wavetraps, describing a number of valuable types, which will be a great help to those who are having their own difficulties with a receiver which is not selective enough. There will be more information on short-wave transmitters—that subject which has proved widely popular with our readers. Edgar H. Felix has written a very helpful article on how to learn the code which many a mystified struggler with the Continental dots and dashes will find of great value. The article by J. C. Jensen in the April number, "Can We Forecast Radio Reception from the Weather?" has stirred up no end of interest and discussion. Shortly after the magazine appeared, the Associated Press carried a story about Mr. Jensen's conclusions. Mr. Jensen's article has inspired other investigators in the same field to tell us of their work and we hope soon to print the conclusions of some of these men.

MANUSCRIPTS on the \$500 short-wave receiver contest are piling into the office, and those who have not yet become actively interested in the problem should turn at once to page 657 and set their brains to work.—W. K. W.

Doubleday, Page & Co.
 MAGAZINES
 COUNTRY LIFE
 WORLD'S WORK
 GARDEN & HOME BUILDER
 RADIO BROADCAST
 SHORT STORIES
 EDUCATIONAL REVIEW
 LE PETIT JOURNAL
 EL LEO
 THE FRONTIER
 WEST

Doubleday, Page & Co.
 BOOK SHOPS
 NEW YORK: LORD & TAYLOR BOOK SHOP
 PENNSYLVANIA TERMINAL (2 SHOPS)
 38 WALL ST. AND 166 WEST 32ND ST.
 GRAND CENTRAL TERMINAL
 ST. LOUIS: 223 NORTH 8TH STREET
 4914 MARYLAND AVENUE
 KANSAS CITY: 920 GRAND AVENUE
 306 WEST 47TH STREET
 CLEVELAND: HIGGEE CO.
 SPRINGFIELD, MASS.: MEEKINS, PACKARD & WHEAT

Doubleday, Page & Co.
 OFFICES
 GARDEN CITY, N. Y.
 NEW YORK: 285 MADISON AVENUE
 BOSTON: TREMONT BUILDING
 CHICAGO: PEOPLES GAS BUILDING
 SANTA BARBARA, CAL.
 LONDON: WM. HEINEMANN LTD.
 TORONTO: OXFORD UNIVERSITY PRESS

Doubleday, Page & Co.
 OFFICERS
 F. N. DOUBLEDAY, President
 A. W. PAGE, Vice-President
 NELSON DOUBLEDAY, Vice-President
 RUSSELL DOUBLEDAY, Secretary
 S. A. EVERITT, Treasurer
 JOHN J. HESSIAN, Asst. Treasurer

DOUBLEDAY, PAGE & COMPANY, Garden City, New York

Copyright, 1926, in the United States, Newfoundland, Great Britain, Canada, and other countries by Doubleday, Page & Company. All rights reserved.
 TERMS: \$4.00 a year; single copies 35 cents.



Ferguson

J.B. INCORPORATED

The Gold Standard of Radio Receivers

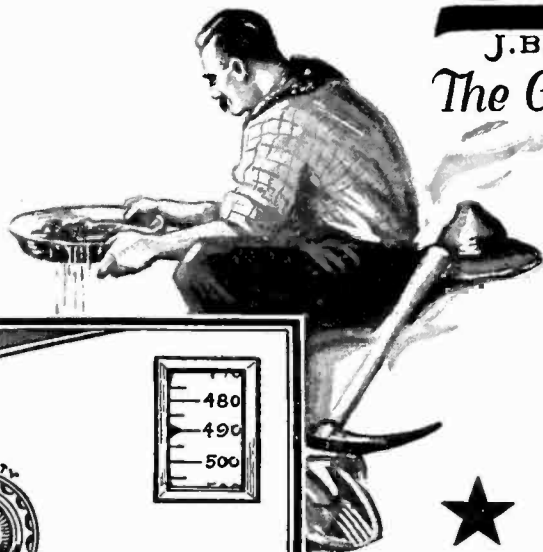

AS THE "FORTY-NINERS" washed out for the hidden particles of gold, so, today, the wise buyer—sifting through a confusion of extravagant claims and choosing on performance alone—finds Ferguson, "The Gold Standard of Radio Receivers."

Readily piercing through the maze of local broadcasters, the Ferguson unfailingly finds the more remote stations. Its three stages of *Matched Audio* give ample volume so that you may not only hear but enjoy their programs. Its life-like reproduction is true as gold.

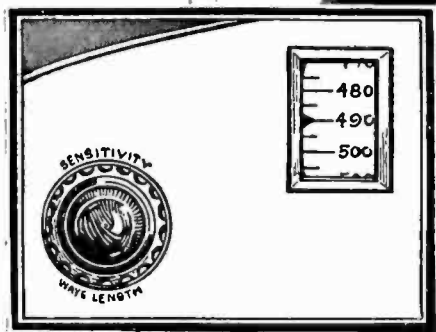

**One Tuning Control—
Calibrated in Meters!**

Select your program, turn up its wavelength and in comes your station. In accomplishing this feat in radio design, there has not been the slightest sacrifice in electrical efficiency.

*Arrange with the nearest Authorized
Ferguson Dealer for a demonstration
in your own home, or write us.*

J. B. FERGUSON, Inc.
41 East 42d Street
NEW YORK, N. Y.

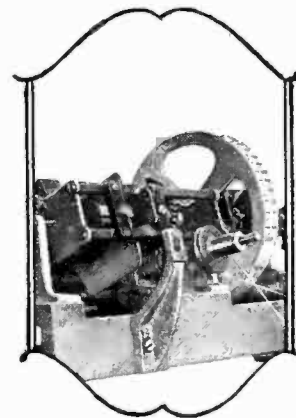

The single tuning knob revolves the shaft by means of a split gear that eliminates all backlash. A pivot bearing gives this control its velvet-smooth ease. The Receiver is mounted upon a rigid aluminum chassis.

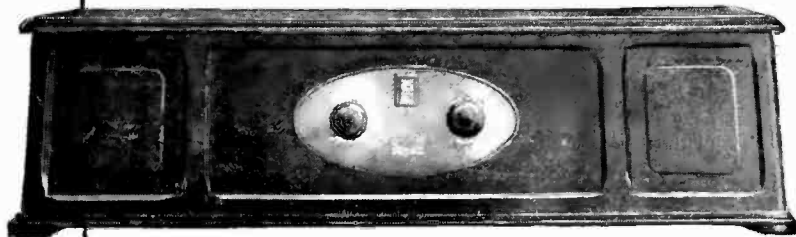

CABINET MODEL EIGHT
A Six-tube Tuned r. f. Receiver, \$226



© American Museum of Natural History and *Asia*

LISTENING-IN AT PEKIN

Although radio broadcasting has already made its debut in some Chinese centers, most of the natives listening-in here were doing so for the first time. The sets are those of the scientific expedition headed by Roy Chapman Andrews, which was sent to Mongolia through the cooperative efforts of the American Museum of Natural History, and *Asia* magazine. The upper picture shows one of the expedition mystified by the voice in the box, while the other retainers are shown listening to a program from Tientsin in the lower picture

RADIO BROADCAST

VOLUME VIII



NUMBER 6

APRIL, 1926

How Radio Grew Up

The Period 1872 to 1897—Hughes, Dolbear, Hertz, Branley, Lodge, Tesla, Popoff—Marconi's Early Life—Wireless is First Put on a Commercial Basis

By ROBERT H. MARRIOTT

First President, Institute of Radio Engineers

IN CHAPTER I of "How Radio Grew Up" we rapidly traced the growth of radio science from its earliest stages—from the time when Luigi Galvani conducted his researches in 1790, probably knowing little about what he was actually doing, through the researches of De Salva, of Morse, and of Maxwell. The electro-magnetic induction experiments of Faraday were also described, and the story concluded with one Loomis, who, in 1872, took out a patent for a special apparatus designed to utilize electricity collected from the atmosphere for transmitting purposes. Taking up our story at this point (where it was dropped in the December, 1925, RADIO BROADCAST,) the first new name in the series is that of Professor D. E. Hughes, who, in 1872, managed to transmit and receive intelligible signals over a distance of a quarter of a mile, using, for receiving purposes, both coherers and microphonic detectors.

He described his devices before the Royal Society on May 8, 1878. During his experiments, he walked up and down Great Portland Street in London with his microphonic detector and telephone receiver, and it was at this time that he got signals up to a quarter of a mile or more from his transmitter. Had he persisted with his apparatus, and if it had been possible to employ at that time a present day publicity agent, radio might have gone into public service many years earlier than it did, for some of the accounts indicate that his apparatus was every bit as efficient as apparatus used seventeen years later. In this country we quickly abandoned the later

coherer method of reception and went back to the telephone and detector method.

Hughes made his demonstrations to fellow scientists who appeared to be bent on discouraging him, and years later he said, "I was so discouraged at being unable to convince them of the truth of these aerial electric waves that I actually refused to write a paper on the subject—."

In 1882, Professor A. E. Dolbear, of Tufts College, built a transmitter and a receiver, with antenna and ground, that apparently must have operated according to the electro-magnetic theory. On October 5, 1886, he was granted United States patent number 350,299. He described

his invention as a mode of electric communication, and said in the description, "Communication may thus be established between points certainly more than half a mile apart; but how much farther I cannot now say."

It looks now as though both Hughes's and Dolbear's devices were pretty fair radio devices for that time; but apparently those equipments were not deliberately designed and operated on the basis of the now accepted electro-magnetic wave theory of Maxwell.

Following Hughes and Dolbear, we next come to the exponents of the earlier Maxwell theory. The first of these is Henrich

Hertz, a German scientist, who, in 1886, proceeding on Maxwell's theory, built and used a carefully tuned radio transmitter and receiver. However, it could not be heard enough to do much more than serve as proof of the Maxwell theory, because the detector was insensitive. Sir William Crookes, in discussing Hertz's apparatus, said, quoting from the *Fortnightly Review*, London, February, 1892, "Here, then, is revealed the bewildering possibility of telegraph without wires, posts, cables, or any of our present costly appliances."

HERTZ THE FATHER OF RADIO?

SOME scientists and other folk who have studied the history of radio and who are not biased by nationality or by some company's pay roll, are inclined to say that radio is a product of evolution; while others prefer to say that radio was invented. As a rule, those unbiased ones who prefer to say it was invented, give the credit to Hertz.



EDOUARD BRANLY

A French scientist who made a very valuable contribution to wireless telegraphy in designing a detector known as a coherer. It was later improved by Sir Oliver Lodge



NIKOLA TESLA

Was born in Austria-Hungary in 1857, Serbian by race. It was originally intended that he should be trained for the clergy, but he developed scientific tendencies instead. He came to America in 1884 and immediately entered the Edison works, afterward starting out on his own. In 1893 he invented methods of wireless transmission

In 1891, Edouard Branly, a French scientist, made a more sensitive detector than that used by Hertz, intended for use in the latter's receiver. This detector was called the Branly coherer. It consisted of particles of metal that would stick together when affected by radio currents and would then pass a battery current. Sir Oliver Lodge used the Hertz-Branly combination, but added a tapper that automatically de-cohered the coherer after a signal.

In 1893, Nicola Tesla proposed that high antennas and a ground connection be used at the sending and receiving instruments to get the greatest possible distance.

In 1895 Vladimir Popoff, a Russian, added antenna and ground to the Hertz-Branly-Lodge combination, and gave demonstrations to students and scientific people. The distances covered grew with these successive steps.

By 1894, wireless, that is the induction system like that Faraday had used, and the conduction system which Morse had demonstrated, had been successfully and repeatedly used to telegraph over distances up to three miles or more. The Hertz-Branly-Lodge-Tesla-Popoff combination apparently worked best. It was

the product of German, French, English, American, and Russian scientists, arrived at by sticking to the Scotchman's (Maxwell's) theory.

MARCONI'S EARLY LIFE

WHILE this radio development was going on in the scientific circles of the world, young Marconi had been taking a course under science teachers at Leghorn and Bologna, and became interested in radio in 1895, when about twenty-one years old. He had means and influential connections in both Italy and Great Britain. He came from Italian ancestry on his father's side, and Irish ancestry on his mother's side.

In 1896, Marconi went to England and filed a patent in which he described the Hertz-Branly-Lodge-Tesla-Popoff devices and a special form of spark gap that had been designed by the Italian scientist Righi, which gap was not necessary but could be used as a substitute for the one used by Hertz. Then he commenced demonstrating what was actually known about radio up to that time, to government representatives and to business men, to newspaper and magazine writers. His demonstrating extended radio from college environment to political, military, and mercenary circles. By the middle of 1897, business men had become sufficiently interested to form a £100,000 company for exploiting radio.

Marconi played the part of a salesman, and, as is still often the case where scientists and salesmen are involved, the salesman got money out of it while the scientists



GUGLIELMO MARCONI

Whom Mr. Marriott describes as a sales engineer. He studied and conducted his early experiments at the University of Bologna in Italy. In 1899 he succeeded in communicating across the English Channel for the first time, and in 1901, across the Atlantic Ocean. He was awarded the Nobel Prize for Physics in 1909

didn't. Also, as part of the promotion scheme for getting money, Marconi was advertised as deserving the honor for what the scientists had done, making him appear as a profound scientist and almost supernatural inventor.

The scheme was to make it appear that Marconi had invented radio and thereby get a world wide radio patent monopoly. That was the beginning of many duplicated attempts to advertise inventions and inventors for the purpose of getting a monopoly of radio, or to sell stock. It has

been tried more or less right up to this very minute. In the United States, however, the patents were shown up for what they were worth, or avoided by making other devices that would serve the same purpose.

The virtue of the Marconi Company's advertising was in the publicity it gave to radio and not in the claims they made for themselves. That publicity started quite active development of radio in several countries. It put more money and people into the developing of this so-called new science.

The advertising brought radio to the attention of people in all walks of life, including numerous unattached young would-be scientists and engineers, who,



THE CATALINA SENDING STATION

Located at Avalon, about twenty-five miles from the California Coast station. Until Mr. Marriott erected this station there was no means of communication with the mainland except by means of the boat service which was not at all reliable, especially in bad weather. One of the first uses to which this wireless was put was to receive the result of a big fight which took place in San Francisco. Skeptics doubted the authenticity of the wireless reports and even after they were confirmed, various theories as to how the messages were actually received were advanced. Some said that carrier pigeons were used. Others said they saw a man in a small boat land on the Island with the news. Another theory was that signals by means of powerful lights were sent from the mainland to Catalina

like Marconi, as yet had no scientific or engineering reputations to lose, and therefore, could take a chance in this new field.

It became obvious to many that radio could be useful if properly applied. Its apparent possibilities made it an easy thing for stock jobbers to sell stock in radio companies. They were inclined to depart very widely from the kind of rules laid down in Christian Sunday schools in disposing of their stocks, however. Radio was an obviously fertile field, but without immediate returns in it. It contained some more or less

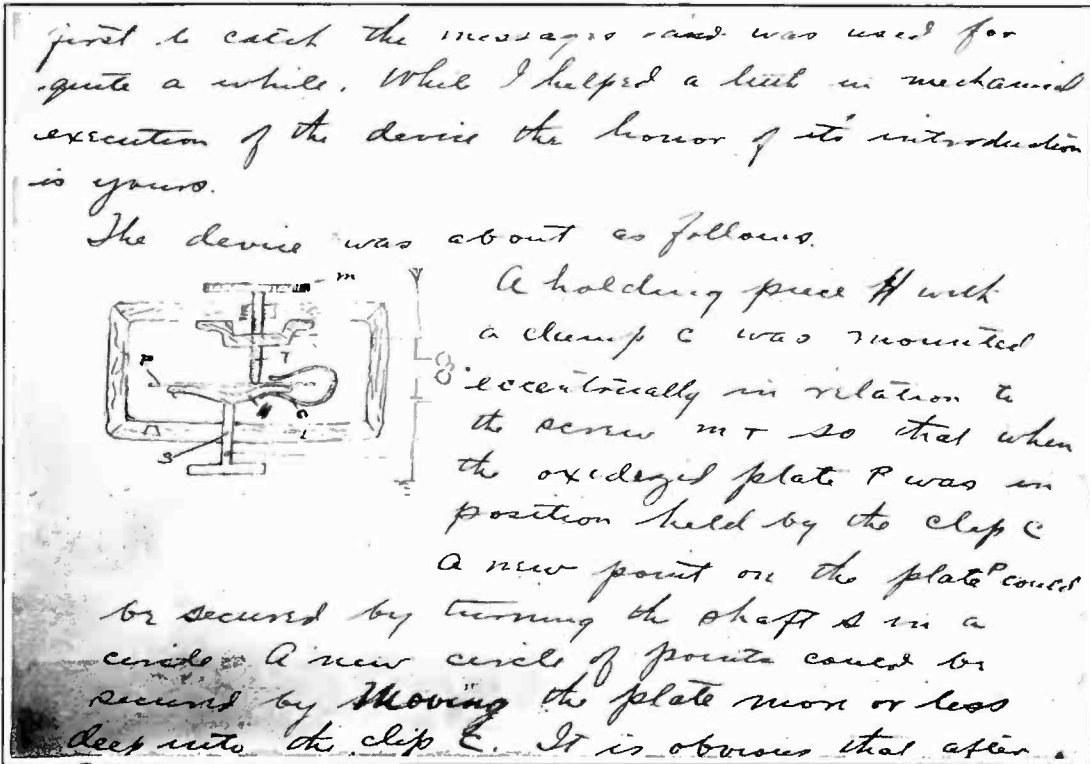

AN EARLY DETECTOR

Is shown in this photographic reproduction of the sketch and description of those made by Mr. Swenson (Mr. Marriott's able assistant) to Mr. Marriott's specifications. These were used in the California-Catalina Island circuit for several years. They consisted of converted spherometers

dangerous Indians. Scientists, with reliable incomes and reputations that might get sunk naturally were afraid to go into radio. However, there were quite a number of young men who had been given scientific training, and who had not made any scientific or engineering reputations that could be lost. Some of them were adventurous enough to go into radio then, and a few still survive. The writer is one of these young men.

After 1897, the works and workers became so increasingly numerous that only some of the essence of them can be

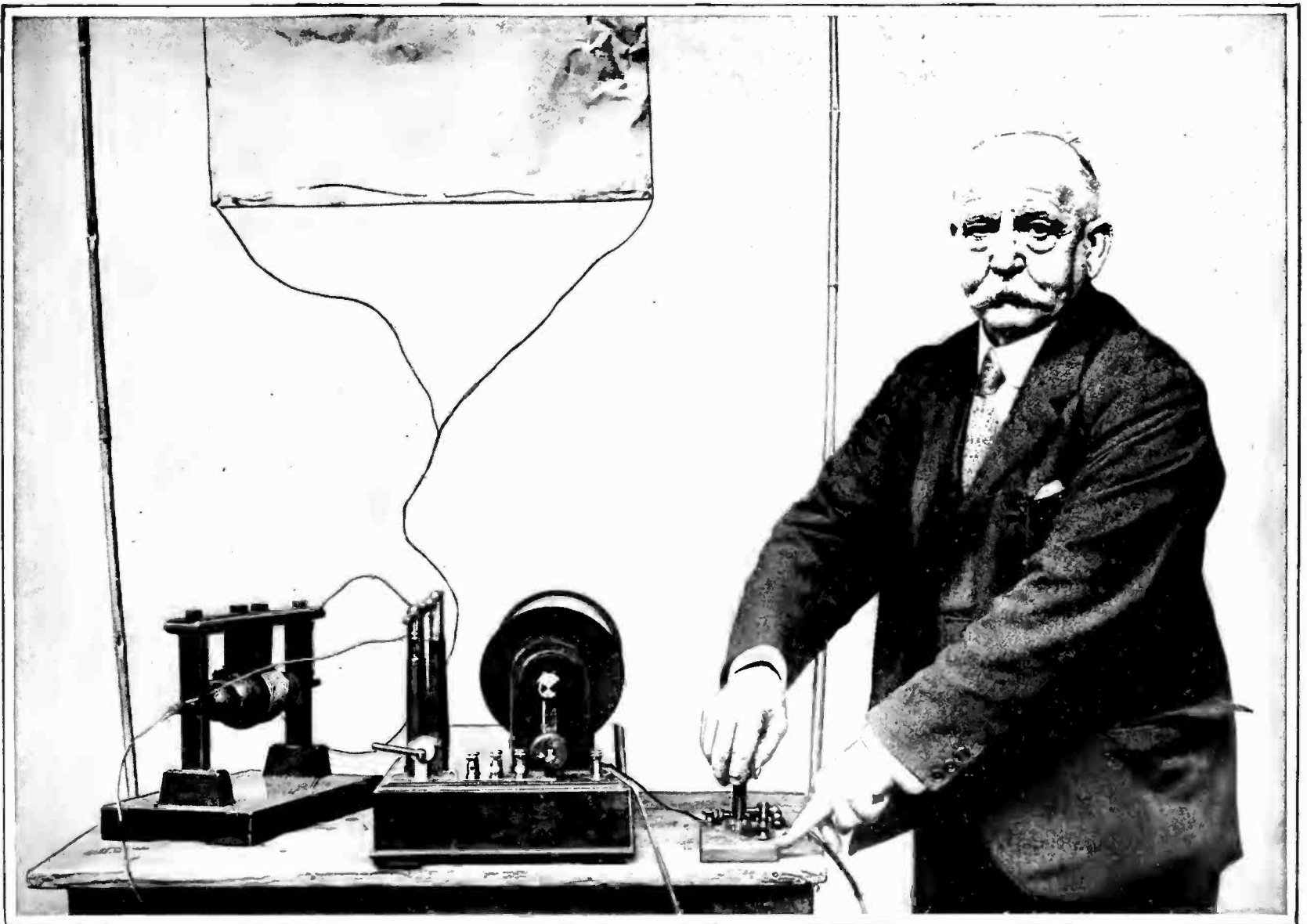

C. S. KEMP, AN EARLY ASSISTANT OF SENATOR MARCONI

Photographed in England with the apparatus used by Mr. Marconi in his experiments at Bologna, Italy, in 1895. The copper plate at the top is the antenna used for short distances, while for greater distances, kite balloons ten feet in diameter with a copper antenna wire attached, were employed. The telegraph key is at the right, the large induction coil shown in the center operating from batteries, furnished the high-frequency energy

given here. Radio stations began to bob up in various parts of the world like mushrooms, and like mushrooms, they did not last long in any one place; as a rule because they didn't pay expenses, and also because a great many of them were temporary stations erected purely for demonstration purposes, devoted to showing the possibilities at that place, or to sell stock. In 1902, the writer succeeded in establishing a radio circuit between Catalina Island and the mainland of California, the first in the United States that stayed put, although several circuits had been tried before that. That circuit continued for twenty-one years, becoming a radio telephone circuit in its later days. The use of telephony killed it, for too many uninvited folks were able to listen-in.

The steamship companies were slow to install radio on their ships. The directors of the companies had too many other places where they wanted to put their money. The captains likewise did not want it because, without it, they were kings between docks, but with it, the owners might play king and give them orders. A large proportion of the first ship radio stations were established on board free of charge to the steamship companies.

The United States law which compelled ships to be equipped with radio, took effect in 1912, and caused a large increase in radio on vessels, and also resulted in some of the old captains recalling for service all the cuss words they had mentally vocabularized during, perhaps, forty years at sea. The writer had intimate contact with this aspect of radio, because, when the law went into effect, he helped enforce it at New York as United States Radio In-

spector. After a captain's big noisy kick was divested of its profane trimmings, about all it amounted to was a statement to the effect that he had sailed the seas ever since the time when vessels were pushed along by the wind, and that he had

gotten along without wireless up to date so why shouldn't he and everybody else continue to get along without it. All the radio inspector had to say was, "Maybe so, but if your radio isn't in proper working order before you leave port I will have to report it, and you will be liable to a fine of five thousand dollars." Not many words, but they were effective.

The value of radio as a protection against the loss of life and property, and the failure of steamship companies to avail themselves of it, made the law necessary. Had there been a radio monopoly, this law would probably have been all the more necessary because the monopoly would have undoubtedly held up the prices, and steamship owners would have fought harder against its enforcement.

The United States took the lead in the production of the best detectors and receivers; Germany took the lead in the production of the best transmitters. Receivers and detectors were inexpensive to build, as compared with transmitters. This was what probably caused the various workers in the United States to advance rapidly in making the best detectors and receivers. By the time the European War started in 1914, however, the United States was catching up with Germany in making first class transmitters.

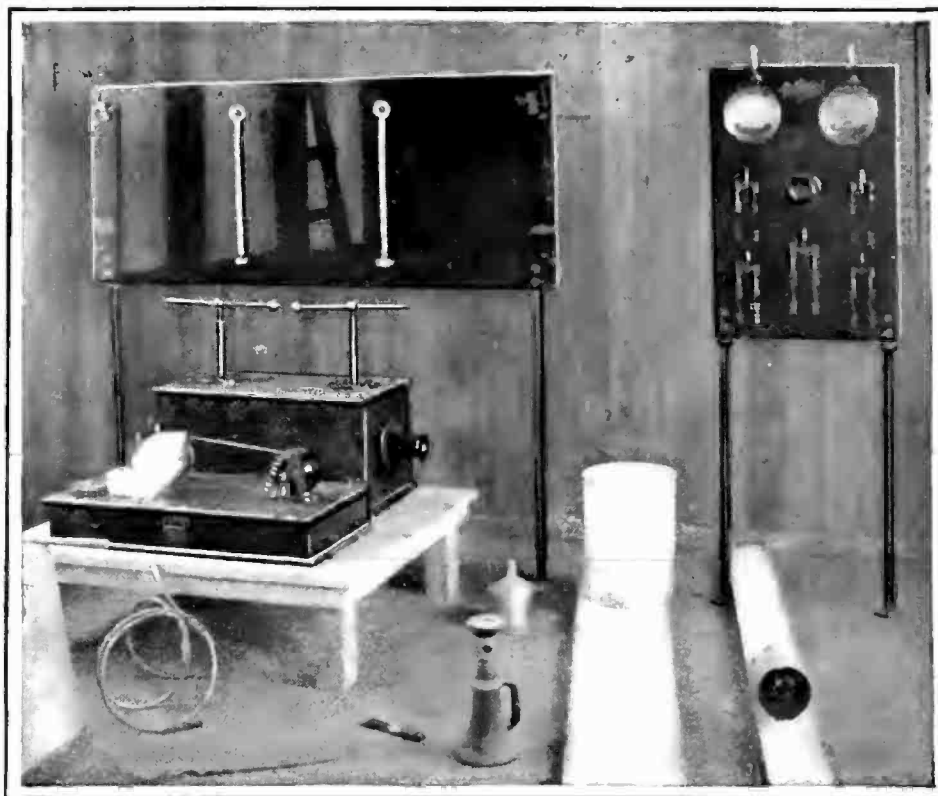

A 1902 COMMERCIAL RADIO CIRCUIT

The wireless telegraph installation at Catalina Island, made by Mr. Marriott and his assistants. The switchboard at the right controlled the dynamo circuits for light and transmitter power. The switchboard in the back carried two remote control switch arms which switched the antenna from "send" to "receive". The box bearing the spark rods is a large induction coil capable of giving a 20-inch spark but actually delivering a $\frac{3}{8}$ -inch spark when connected to the antenna. The piece of paper covers a mechanical interrupter, which, at the time the picture was taken, was a secret

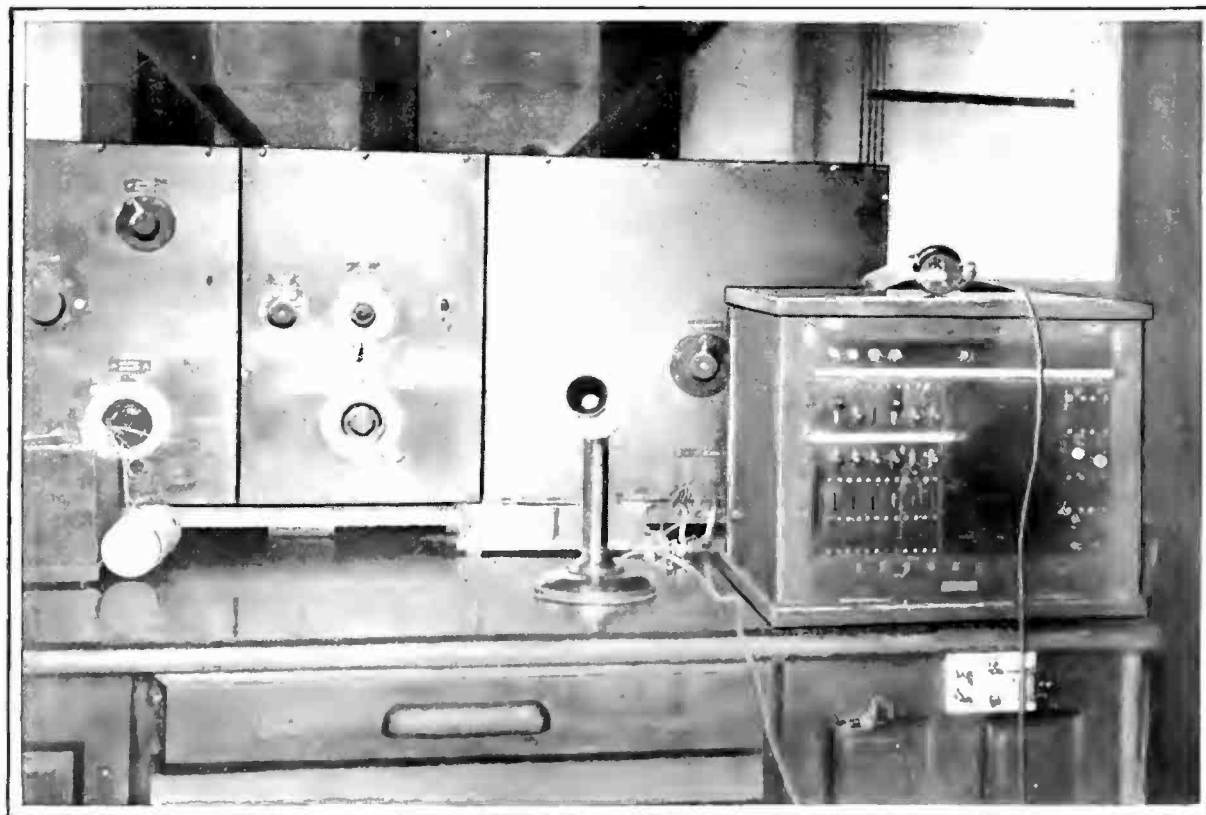

THE RECEIVING EQUIPMENT

Of the last Santa Catalina public service station, which was closed in July, 1923, as its traffic was listened-in to by many outsiders. The receiving loop may be detected in the background. A submarine cable was substituted for the radio link

What Happened During the 1926 International Tests

A Complete Report of the Plans, Their Progress and Success—What Stations Were Generally Heard—How Bloopers Spoiled Reception—The Great Popularity of the Regional Broadcasting Experiment

By WILLIS K. WING

MANY old wives' tales are common knowledge about events which occur in the dark of the moon. And by the same token, things which happen during the full moon must take their chances of success. The third of the International Radio Broadcast Tests took place during the fullest of full moons, we remind the superstitious, and if that be any comfort to those who failed to hear signals from the foreign broadcasters, all of that gentry are free to make the most of that celestial condition. For to review the Tests briefly, a comparatively small number of American and Canadian listeners heard broadcasting stations on the other side of the Atlantic. If that is the only measure of failure, the Tests were a failure. However, the Tests this year, lasting for an hour for seven days, included but five days of transmission from transatlantic stations. The other two days, as everyone knows, were devoted to distance receiving trials on the North and South American continents. And in those two days, the average listener probably heard more stations on this continent than he had ever heard before. The genuinely new feature of the Tests proved a great success.

The plans for the Tests were published so completely in newspapers in this country and in Canada, that there is no point in completely reviewing them here, for no monthly magazine can hope to compete with a newspaper. But the 1926 Tests were the third to be held. The first Test was held in November, 1923, and involved only the stations of the British Broadcasting Company, abroad. The second occurred in November, 1924. In that, the British stations and broadcasters in Spain, Italy, France, and Belgium took part. The third annual Test was to have been held in November, 1925, but was postponed to January, 1926 in order to take advantage of what was fondly supposed to be better weather conditions.

There is always plenty of enthusiasm for international broadcasting from this side of the Atlantic, but the desire for a special Test of this sort is not so great on the other side of the water, and especially in England, where there are probably more active listeners than in any of the Continental countries. Owing to the difference in time, it is possible for any European listener to sit up a bit after twelve at night, and if he has a sensitive receiver, tune in an occasional American station. So that when the special International Tests are arranged, with listening periods for American stations at from three to four o'clock in the morning, European time, the desire on the part of foreign fans for

special long distance tests is apt to be less ardent than here, where the listening period has never been later than midnight, Eastern time.

LARGE NUMBER OF STATIONS INVOLVED

BUT in spite of these handicaps, the foreign arrangements for the Tests went forward with great completeness and more foreign stations were listed in the schedules this year than have ever taken part before. John Scott-Taggart, editor of the British Radio Press publications was appointed foreign director of the Tests, and through his good offices and those of his able assistant, Percy W. Harris, editorial manager for those publications, the work went forward. On the Continent, the arrangements were in charge of Dwight K. Tripp, a former member of the editorial staff of RADIO BROADCAST, who is now residing in Paris. Mr. Tripp worked in close coöperation with Arthur Burrows, head of the newly formed Bureau International de Radiophonie at Geneva.

Although the engineers of all the Continental broadcasting stations have, for the past few months, been conducting some special late broadcasting tests of their own, in the effort to solve the problem in international heterodyning between stations which is now very serious, they entered into the spirit of the plan and assumed the additional burden of broadcasting for an hour several nights of the Test at the unpleasantly early hour of four o'clock in the morning, their time. It was chiefly through the fortunate official influence of Mr. Burrows that the Con-

tinental coöperation was as general and complete as it was. And Mr. Tripp was untiring in his efforts to make the many complicated arrangements necessary.

On this side of the Atlantic, the greatest number of broadcasting stations ever to take part in a concerted plan of this sort were on the schedule. There were the 37 Canadian broadcasting stations, some 550 American broadcasters, 16 Mexican stations, 36 Cuban broadcasters, one station in Porto Rico, one in Lima, Peru, and three in Argentina taking part. The coöperation of the Cuban stations was secured by Mr. Frank H. Jones, owner of station 6KW at Tuinicu. The coöperation of the American broadcasting stations was practically complete with the exception of several of the California stations, notably KNX at Hollywood and KF1 at Los Angeles. The operators of KF1 it was announced, felt that their individuality would be greatly limited by participation in the Tests and confidently undertook to analyze the desires of all the radio listeners within range of their five kilowatts, and decided, to the tune of wide publicity, that they would remain on the air during the silent periods. They stated that the chances of California listeners for hearing foreign broadcasting was very slim, and to that confident assertion was added the confession that theirs was in part a commercial station, devoted to selling time on the air, and that they saw no reason for making any financial sacrifice.

Our records show that a number of listeners in Oregon and Washington did hear fragments of the foreign programs, a remarkable receiving record. A very large number, comparatively speaking, heard OAX at Lima, Peru and several of the Buenos Aires stations. The sentiment quoted from the letter printed below is similar to that contained in a great many letters and telegrams which came into the office of RADIO BROADCAST both during and after the Tests.

*Editor, RADIO BROADCAST,
Doubleday, Page & Company,
Garden City, New York.*

SIR,

I am a radio dealer and a fan as well. May we not in some way enter protest against California stations remaining on the air during the quiet hour Sunday night (January 24th) during the Tests? I think I picked them all up. I like California, but I like them to shut up at least once a year and I am sure I speak the sentiments of many more of your readers and fans in this locality.

Very truly yours,
W. M. CURTRIGHT,
Flat River, Missouri.

No purpose would be served in



THE SHORT-WAVE OUTFIT IN USE AT 2GY

During the International Tests, a 40- and an 80-meter transmitter were used constantly in checking receiving conditions with amateur operators in this country and in Europe. Many reports of reception were handled by this short-wave link

embroidering this controversy, except to add, in fairness to the Pacific Radio Trade Association, who failed to cooperate positively in the national United States arrangements, that they finally agreed to recommend silence for the West coast stations even though they were in highly active opposition to the plan. And during the first few nights of the Tests, some of the Pacific coast stations did not keep silence, but in the main, their insurgent tactics caused no national radio calamity. Our judgment that radio listeners there, and elsewhere, wanted the Tests to go through as planned, whether or not the individual felt he had a chance of hearing Europe, has certainly been vindicated if our heavy correspondence is any criterion.

HOW THE TESTS WERE ADMINISTERED

THE Tests were managed this year by a representative organization, drawn from all branches of the radio industry. A committee was chosen from the National Radio Trade Association, with Powel Crosley, Jr., as chairman and L. A. Nixon executive secretary. There were other cooperating committees from the National Association of Broadcasters and the Radio Manufacturers' Association. The editors of RADIO BROADCAST felt in planning the test this year, that the interest caused by the first two Tests, which were almost entirely managed from this office, had made the affair so important that the entire radio industry should be represented in its management.

The Test Committee at its headquarters in New York managed the American side of the affair and furnished the newspapers and press associations with daily and hourly bulletins. Certain newspapers in representative cities were furnished with the official programs as received from the foreign representatives of RADIO BROADCAST. This made the task of checking foreign reception vastly easier and far more accurate than in the previous two Tests. Busy long distance wires, and piles of telegrams at the New York office made the scene there dur-

ing the Test Week one of the most active we have ever witnessed, and we have been in more than one metropolitan newspaper office at World Series time, or on the occasion of a big disaster.

A large number of official listening posts were appointed by RADIO BROADCAST and their reports, sent in by mail, telegraph, and by the short wave amateur radio link with our experimental station 2 GY was of constant help in determining how receiving conditions were in all parts of the country. Many radio manufacturers had special receiving stations. The National Association of Broadcasters appointed a listening committee, headed by Paul F. Godley, of Upper Montclair, New Jersey. Mr. Godley, it will be recalled, about five years ago was successful in hearing American amateur transmissions, the first across the Atlantic, from a special receiver he established at Androssan, Scotland. The Boston *Herald-Traveler* established a listening station at Baker's Island near Boston, manned by several operators, and a meteorologist. F. R. Hoyt, of Stamford, Connecticut set up his interesting radio recording apparatus at Shippan Point, Connecticut, and reported that he succeeded in making partial records of foreign programs. R. P. Worden, radio editor of the *Cleveland News* sent especially complete reports of receiving conditions and success in the Cleveland area which were very helpful.

In addition, RADIO BROADCAST had several receivers in operation at Garden City, and two operators were constantly on watch at station 2 GY using the 40- and 80-meter transmitting bands simultaneously. During the Test periods, 2 GY received frequent reports from all parts of the United States on receiving conditions, and on several occasions, communicated directly with Europe to discover weather and receiving conditions at the time. An article on another page of this number describes in part some of those arrangements with short wave communication. Receiving conditions are never especially favorable at Garden City for extreme long dis-

tance work, so several members of the staff took sensitive receivers to Riverhead, Long Island, where it was thought that the air would be free from radiating receivers and their havoc. Even there, miles from the nearest house, the bloopers got in their furious work.

THE BUSINESS OF VERIFICATION

REPORTS from listeners in this country went chiefly to the local newspapers, to the broadcasting stations, and to radio manufacturers. Many newspapers furnished verification cards to successful listeners. Telegrams sent to RADIO BROADCAST for verification of reports were answered the same day they were received, which was no small chore, considering their number. Letters with details of reception have come in to our office by thousands and are being checked and verified as rapidly as possible. An official verification card is being mailed to all listeners who write to RADIO BROADCAST whose report can be verified.

This task of verification is not easy, but its onus is frequently broken by conscious or unconscious humor. "While listening last night," reads a sample letter, "I picked up a lady singing on 360 meters, but she soon faded out. Can you tell me who it was?" This achievement, if it is a radio affair at all, is worthy of note, and a curiously large number of letters read just like that. Verification from such meagre information is out of the question and there are probably many disappointed listeners whose letters were equally bare of facts who still wonder why "the coveted pasteboard" was not sent them. Still others sent in confident letters announcing that they heard 2 LO, or Madrid, or whatnot, "very clearly," but failed utterly to specify their success in detail. Reports like that were not considered. But many others mailed reports that were more than complete and very accurate, making our task almost easy.

The question that everyone wants to have answered is: What success did listeners have generally, and what foreign stations were heard? There is not space enough at our disposal to list the listeners whose reports have been verified, but it is possible to tell what stations were most generally heard. Station OAX at Lima, Peru, was heard by more listeners than any other, and that is no mean accomplishment, from the point of view of distance and can be pointed to with as much pride as the electrical bagging of a European broadcaster. Reports on English stations were few and far between, but all of the English stations participating were heard in various parts of the United States. Almost no Canadian listeners heard British broadcasters. The Madrid and Barcelona stations got through to the United States very well also. Prague, Munich, Berlin, Hamburg, Brussels, and Munster were also widely reported during their transmission times. Hamburg signed off in code with the letters "h a" and one faithful reporter although he did not know the Continental code, related that he heard the name of the city and the code sign, four dots, dot dash.

NO RECEIVING LOCATION PERFECT

THERE were spots of fair reception, although in no locality did any of the transmitting stations come in with any laudable volume. In parts of New England there were a number of successful listeners who heard both Europe and South America. There were a few, similarly fortunate, in eastern Pennsylvania, New Jersey, and New York. A listener in Bermuda heard Madrid and he reported that many other Bermudians heard LOX, and numbers of European stations. Moving farther west, there were a considerable number of listeners in southern



NEWS HEADQUARTERS FOR THE TESTS IN NEW YORK CITY

With L. A. Nixon, Secretary of the International Radio Week Committee, wearing the telephone receiver. During the Test Week, an office was set up in the Hotel McAlpin, New York, where official programs were given to the Official Radio Week newspapers; the United Press, and the Associated Press were given hourly bulletins as to the progress of events. This left the wires freer at Garden City for communications from our official listening stations

Ohio and Kentucky who heard fragments from the Continent and more than that from the South American stations. Missouri seemed to be fortunate in having more favorable receiving conditions than some of her neighbor states. Reports from the Middle and Far West were scattering, but in these localities, OAX at Lima, and the Buenos Aires stations seemed to get through quite consistently.

The unfortunate atmospheric conditions affected reception on the other side of the ocean and only four American stations were reported heard by our foreign aides. Mr. Tripp, in Paris, reported that KDKA was heard there and Mr. Harris, in London radioed that WGY, WJAZ, and WLW had been heard in England. Other reports may yet come through by mail. It was reported by the Associated Press that WFAF and WJZ had been heard in Moscow and in Germany, but no further verification could be obtained.

Mr. Paul Godley, whose reputation as a radio authority is of long standing, reported some very interesting conclusions from his listening post at Barnegat, New Jersey. He had a special antenna and about eight sensitive receiving sets under his direction. On every evening of the Tests, it was his experience that receiving was much better in a north and south direction than east and west. This condition, he avers, has always held good in the United States, but was particularly noticeable during the Test week. As an example, on one evening, he was able to hold the entire program of OAX at Lima, with fair volume, while not even a carrier wave could be heard on any of the European frequencies. Other careful observers noted the same condition and it is unfortunate that there is not room to quote from their reports.

It is interesting to note that practically all of those who listened during this Test and during the two which preceded it, accepted the challenge of the thing in the sporting spirit in which it was conceived. All realized that there was no absolute certainty of hearing any of the foreign stations, but made their best receiving efforts and took their chances of success. Even a casual glance over the mass of mail which has been sent to Garden City about the Tests from radio enthusiasts in every section of the country, shows that no listener is childish enough to think that because his receiver failed to bring in a foreign program on the loud speaker that therefore radio is all wrong, overestimated, and a failure.

PRINTABLE REMARKS ABOUT BLOOPERS

THERE is something to be said about radiating receivers, although indications are that a wide variety of remarks, mostly unprintable, have already been made about the subject during the Tests. "International radio week," says the Hamilton, Ontario, *Spectator* editorially, "is proving to be just a howl, instead of the howling success it was hoped it would be." And with this terse opinion about oscillating receivers everyone seems to agree. Says the Kansas City *Star*:

Whatever conclusion may be drawn by the committee in charge of the International Tests as to the success of transoceanic broadcasting, it can be definitely stated that the Tests demonstrated to radio listeners the menace of the radiating receiver and the ignorance of many persons in the operation of such sets.

The silent hour for the hundred of licensed broadcasting stations was only the signal for thousands of unlicensed bloopers to fill the air with such howling, squealing, and sputtering as to make it a miracle indeed that any listeners were able to pick up foreign broadcasting. . . . Such a situation is a hangover from the early

days of radio when no thought was given to the matter of radiation; when single circuits and regeneration were the vogue with builders whose chief object was distance. In the last two years, these circuits have been gradually junked in favor of the more advanced sets. . . . Reports of foreign reception have been frequent, yet not at all in proportion to the number of receivers capable of the distance jump to Europe. Those that were not prevented by interference, probably gave up where the repulsion against squeals was stronger than the lure of dx.

The *Star's* radio writer has well put the case for the whole country. There is not a community in the United States where the blooping receiver did not make distance reception nearly impossible. Those who were successful in getting through were either fortunate in their neighbors, or fortunate in an especially good location, or both. One imaginative listener, in describing his experience to us said, "It was like trying to pick out the buzz of one bee through the sound made by an entire hive, when I tried for Europe through the barrage of squeals."

Our correspondents have been eloquent on the subject of the radiating receiver and it is hard to refrain from quoting indefinitely. Mr. Charles Temple of Waltham, Massachusetts, wrote:

For three nights now, my wife and I have sat for one hour with the head phones on, taking the punishment that is meted out to us by the thousands on thousands of bloopers. It is



January 24, 1926

January 30, 1926

INTERNATIONAL RADIO BROADCAST TEST

Under the Auspices of RADIO BROADCAST Magazine

This Certifies That

M^r. Charles Ellis,
Clark Island, Maine

Located at
Has assisted and participated in the International Radio Test, and that information received and checked at Radio Broadcast Laboratory (Headquarters of the Test) indicates successful reception of test programs from cooperating European Stations.

6 Bm.
Garden City, New York
Bournemouth

284

Arthur H. Lynch
Chairman International Tests
Editor Radio Broadcast

THE VERIFICATION CERTIFICATE

The successful listeners who heard European or South American stations received an official verification card from RADIO BROADCAST similar to this one issued to Mr. Charles Ellis of Clark Island, Maine

absolutely past description the noise that we get from these radiating sets, and I want to say in capital letters that man has never made a set that will distinguish even a local station, to say nothing of foreign ones, through the din that they set up.

It is our suggestion and the suggestion of all other radio lovers who get pleasure from the air and who are interested in the future of radio that you spend the next season in efforts for legislation against these bloopers who are a hindrance to the whole future of radio. I am not a chronic kicker, either, but I'm only one of thousands who have been standing by and watching this nuisance increase rather than diminish for the past two years. I am not in the radio business, but am simply an ordinary citizen who likes to stay at home nights and get some pleasure out of the air without listening to the sound of fire sirens ripping up the atmosphere.

Mr. Temple adds another word, which, al-



THE STUDIO OF STATION SBR AT BRUSSELS

SBR was one of the European stations very generally heard in this country and succeeded also in pushing its signals to the United States during the Tests in 1924



© Barratt's

WHEN 5XX WAS UNDER CONSTRUCTION

The Daventry station of the British Broadcasting Company, using 25 kilowatts input now furnishes good program service to a very large number of British and Continental listeners. But during the Tests, the signals of 5xx were not reliably reported in this country, despite the fact that a 1601-meter wavelength was used, a frequency which wgy has reported to be most satisfactory for general relay work

though perhaps not applying directly to the subject in hand, is a graceful bit of praise:

I want to thank you (RADIO BROADCAST and the International Test Committee) and let you know that I certainly appreciate the time, money, and effort that you have spent in the months past in an endeavor to give American radio listeners an interesting week, and perhaps the thrill that comes once a year in hearing music from across the Atlantic.

RADIO BROADCAST has been working for the better part of its magazine career against the

(London) of the 1924 Tests:

The second International Radio Week was held in November, 1924, and although agreements had been made with all the American broadcasting stations to "keep off the air" during the periods of the European transmissions so as not to interfere with these transmissions, the results were not, on the whole, very satisfactory, as atmospheric conditions during the week of the tests were remarkably unfavorable. It was just a matter of bad luck that this was so, because reception during the week before and during the week after was very good.

radiating receiver, has never described a receiver that will radiate, and frequently, at a severe financial disadvantage, has refused to publish advertisements featuring radiating sets. But the fight is apparently a losing one, and our own weapons not strong enough to combat a menace of this size.

RECEIVING CONDITIONS

THE weather conditions were even less favorable than they were during the Tests of 1924. Here is what Captain A. G. D. West, assistant chief engineer of the British Broadcasting Company, wrote in an article in the *Radio Times*

Very few of the reports of reception could be verified.

Reports from all over this continent showed that reception was bad, not only on the foreign programs, but also on American stations. "KFI and KGO are, under average radio weather conditions, easily picked up in this locality," writes W. W. Muir, of Lockport, New York, "and under extremely favorable conditions, are heard with great volume and clarity. For the last four or five nights, it has been impossible to pick up even the carrier wave from either of these stations with a very sensitive receiving set." And Wilfred Taylor, at Thompson, Connecticut says: "Atmospheric conditions, with the possible exception of those in evidence on Wednesday (January 27), were unspeakably bad. Western United States stations were entirely blank, and none but the large Eastern stations could be heard. On Wednesday, I got through to KGO with fair speaker volume, and on that night code and bloopers were heard all over the lot."

And from far off North Dakota, Professor E. W. Bollinger, of the University of North Dakota, at Grand Forks writes:

The failure to receive foreign stations was undoubtedly due to the extremely poor weather conditions, it being impossible to receive United States stations with sufficient volume, and in some instances, it has been impossible to receive a single station. This condition has prevailed during the larger part of the winter and is perhaps the poorest reception we have ever experienced.

Receiving conditions can not be guaranteed in advance, and in choosing January, we thought that a great improvement would be noticed. Receiving conditions in the first year of the Tests were rather good, and as Captain West of the British Broadcasting Company writes:

The first Test Week gave rise to a great interest in transatlantic broadcasting, in fact, this can be referred to as the beginning of interest by the general public in receiving and transmitting broadcast programs across the Atlantic. Conditions during this week were, on the whole, fairly good and a very large number of amateurs in Great Britain were able for the first time to hear on their own sets some of the broadcasting stations of the United States. Also, the reports of reception of British stations by amateurs in America were very many, of which some thousands were verified.

THE POPULAR REGIONAL TESTS

ASIDE from the correspondence and invective by the bloopers' performance during the Tests, the innovations of the North and South and East and West test of the last two nights of the Tests appeared to create the most interest during the period. It suggested to many listeners that here was a national arrangement which might be well continued in the future. Listeners on the Pacific coast rarely hear Eastern United States stations, owing to the difference in time. And stations in Mexico and South America are infrequently heard because stations here operate simultaneously on similar frequencies. During the silent period for American stations, the sonorous call of CZE of Mexico City was heard all over the United States, and the announcer at that station made many friends by his thoughtfulness in frequent announcements.

"I think it would meet with the approbation of thousands of radio fans," writes Henry B. Newhall of New York, "if perhaps not this winter, but possibly during next season, regional broadcasting, preferably during two hour periods similar to those of the last two nights of the Tests, could be arranged to take place every



THE "RADIO BROADCAST" EXPEDITION ON LONG ISLAND

Setting up the short wave transmitter and receiver near Riverhead, Long Island. The short wave link connected the listeners with headquarters at Garden City. What with blooming receivers and unfavorable receiving conditions nothing more definite than strong carrier waves could be heard at that location. In the photograph, left to right: Arthur H. Lynch, editor of this magazine; Keith Henney, director of the Laboratory; John B. Brennan, technical editor

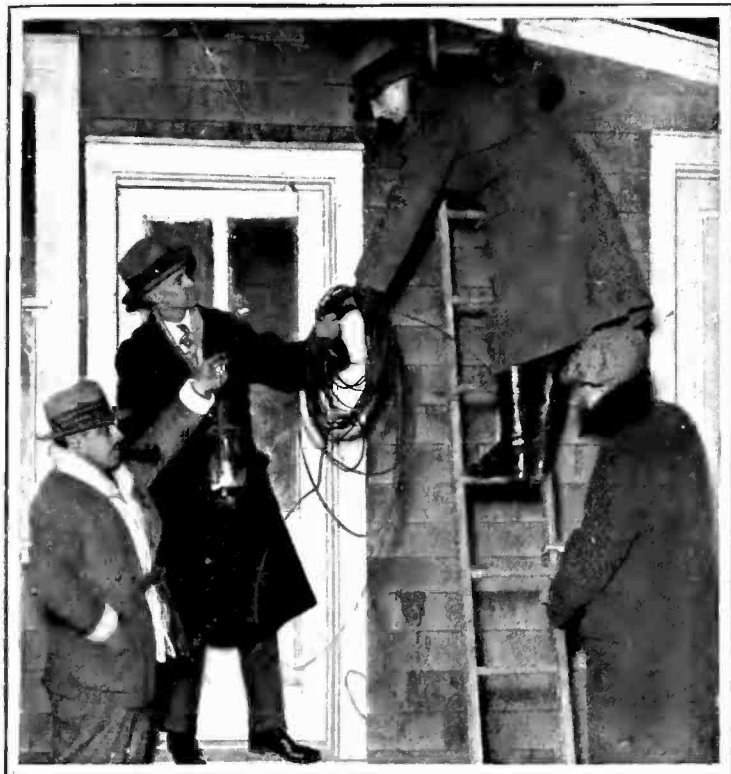

MANY LISTENERS MADE SPECIAL PREPARATIONS FOR THE TESTS

The photograph shows a special antenna being put up at a good receiving location on Long Island. Practically every listener overhauled his set, steamed up his batteries, and tightened connections, all to hear the foreign signals. The overhauling is not such a bad idea regardless of the Tests. It is a good plan to go over a set at least every six months



A SPECIAL LISTENING STATION IN MASSACHUSETTS

Samuel Curtis, Jr., and Leslie Barnard of the Boston *American* at their receiving station at Pembroke, Massachusetts. In all parts of the country, deeply interested listeners took an assortment of receivers to the best location near by they knew of and did their best to pull in the foreign signals. Mr. J. L. Snyder, of Patton, Pennsylvania, for example, set up a receiver on the side of a mountain and reported very successful reception

two weeks or every four weeks. I should think it would not seriously interfere with the programs of the regular broadcasters if the tests were arranged for the mid-week so that they would not break in on Saturday and Sunday programs. Such an arrangement is really about the only chance now we have to give our sets tests for distance. The only other way I can get California, for instance, is to rise up out of my warm bed at two o'clock in the morning. My bed has usually looked better than California."

There is a great deal of interest in the question of regional broadcasting, with silent periods for the other groups, and it may be that this may point to a solution of that always debated

question of silent nights. It might be wise, for instance, instead of silencing all the stations in one city, so that listeners could hear programs from other cities, to arrange for silent periods for all stations in one time belt to be silent, either for several hours, or for an evening. We suggest this, knowing full well that it will start a storm of protest in some quarters. Our own feeling in the matter is quite neutral; after all

the matter is for the majority of listeners to decide. We believe pretty firmly in the sovereignty of the local station. It should be able pretty generally to meet the wishes of the majority of its listeners in most instances. If it fail, then the listeners ought to become vocal and state their feelings.

And so we write "Finis" on the 1926 Tests. Better luck next time!

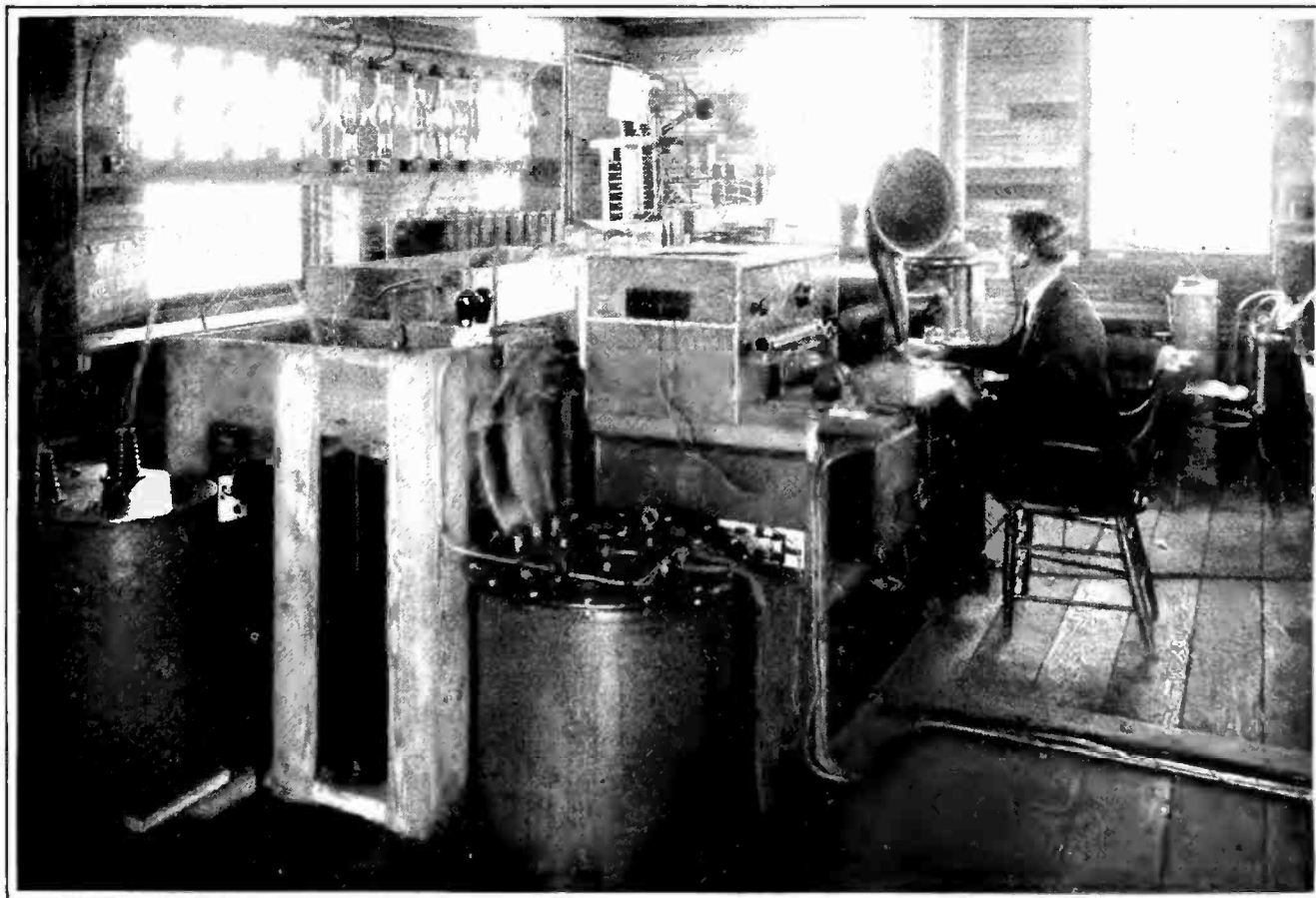

A CORNER OF THE EXPERIMENTAL LABORATORY AT WGY

With a monitoring operator at the desk. This is a part of the short wave, high power transmitter installation. During the Tests, WGY used its usual power, although on the intersectional transmitting periods the last two days of the Tests, 50 kw. was employed. The station was heard in England and on the Continent

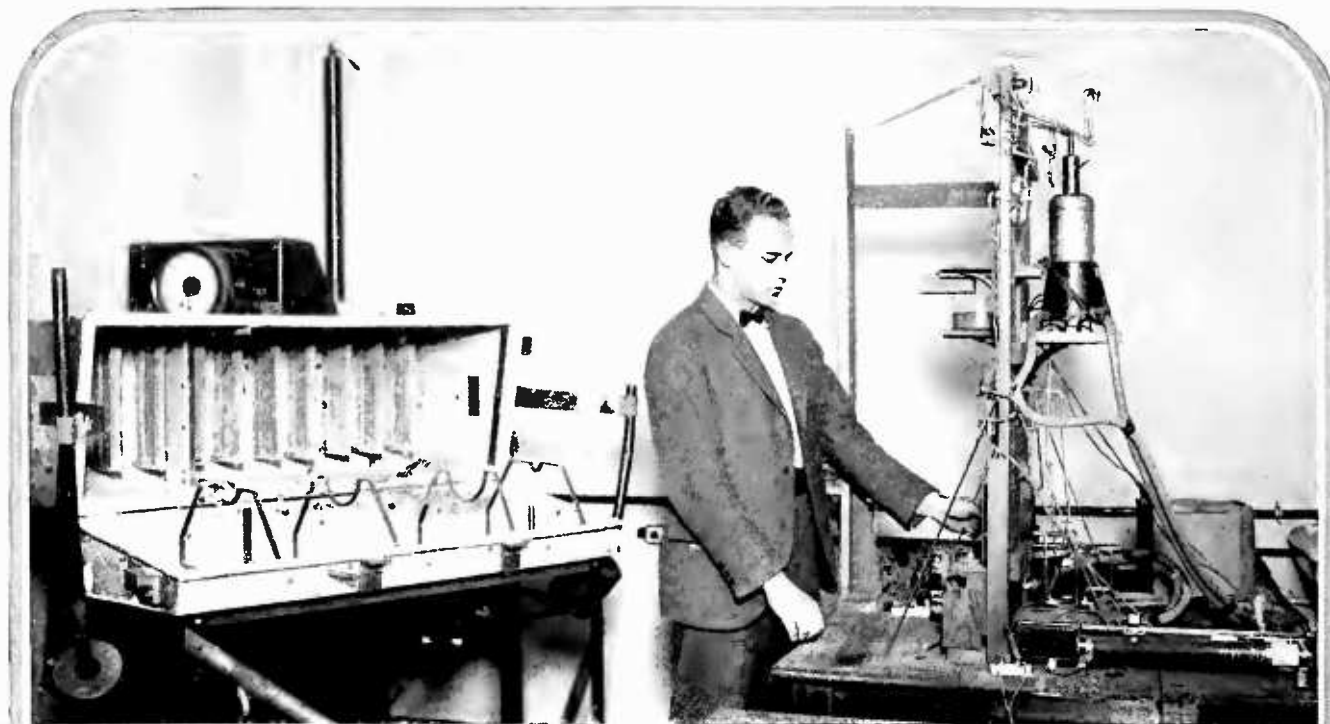

THE MARCH OF RADIO

By *J. J. Morecroft*

Past President, Institute of Radio Engineers

A Legal Test Case For Our Radio Laws

THE government, it appears, is engaged in testing the legality of the present regulations of radio broadcasting stations and the outcome of this test case will be followed with profound interest by all of those operating broadcasting stations and by many of us who merely listen.

Station WJAZ in Chicago has questioned the authority of the Department of Commerce to regulate its broadcasting assignments. This station is owned by the Zenith Radio Corporation and the issue is created by Mr. E. F. McDonald, Jr., who has much to say about "the freedom of the air." Well, we hasten to comment that there is no such thing as freedom of the air in the sense that Mr. McDonald uses it. The tactics he has pursued in forcing legal action on the part of the Department of Commerce are unfortunate.

Some time ago, apparently at Mr. McDonald's request, his station was assigned to operate on the same frequency with KOA, the General Electric station at Denver. Only two hours a week were free, so WJAZ was given these two, a small share of the time, we do admit. Not being content with this allotment, the Chicago sta-

tion searched for another channel and found a neighboring one frequently free.

This new frequency selected by this active philosophy of force had been reserved, by mutual agreement, for the Canadian stations. Of the ninety-five available frequencies in the present broadcast band, we have appropriated eighty-nine and left only six for Canada. Now a "freedom of the air" exponent finds it necessary to step into one of these six Canadian channels. This presents not only a national, but an international radio problem of serious proportions.

Mr. McDonald has given a statement of his case to the press and we can easily see his reasons for feeling aggrieved. He has invested a deal of money in his station and now finds it practically valueless. He feels that he has been discriminated against—that he has as much right on the air as any other broadcaster. After having spent several weeks in Washington trying to get an assignment from the Department of Commerce and not having achieved the success he expected, he evidently felt that he was entitled to go back home and try other means. Perhaps the course was justified, but why bring Canada into the fray? Certainly her meagre share of the ether could be left alone.

Why didn't Mr. McDonald start to

operate on KOA's time? He felt, according to his statement, that stations such as KOA had been assigned a disproportionately large part of the total time—166 hours a week to two for WJAZ. Of course the General Electric Company could reply that they had been using the channel regularly and possession being nine-tenths of the law, they are entitled to keep the channel.

The question of division of time between the stations operated by the Radio Corporation group and "independent" stations is suggested in Mr. McDonald's press statement and we think it brings up a very important point. Someone should compare the R. C. A. group "channel-hours" to the independent "channel-hours" and let us see where we stand on this question. We have twice legislated that the ether is inalienably the property of the citizens of the United States so we had better take inventory and see whether it is or not.

Even if the combine controls 75 per cent. of our broadcasting time we are not at once ready to denounce it. Are the people more pleased to listen to the combine stations or the independent stations?—that is the thing that really counts. The people of the country are the ones who have "the freedom of the air" and not the owner of any special broadcasting station.

The photograph which forms the heading for this month shows H. I. Rothrock, Jr., of the radio laboratory, Bureau of Standards, Washington, testing the high vacuum pump used for exhausting tubes. © Harris & Ewing.

The Institute of Radio Engineers Convention

THE first national convention of the Institute of Radio Engineers recently closed and even the most modest commentator must declare it was an unexpected success. Not only did the attendance justify the opinion that there is a host of capable engineers working in the radio field to-day, but the fact that so many of them should come long distances at considerable expense speaks well for the past year's prosperity in the radio business. Enthusiastic as radio workers may be, without a materially prosperous business behind them backing up their plans and ambitions, the engineers could not have turned out in the numbers they did.

The Institute is not yet fifteen years old but the membership already totals about three thousand. Probably in no other national engineering society is there such a preponderance of young men, and it is the presence of young men in an association of this kind that promises much for its future. The older societies with their venerable and bemedalled members of the engineering profession may well point with pride to the accomplishments of these well-known figures, but their work is in general in the past. It is in the hands of the younger and almost unrecognized members that the future of the profession lies.

It was with some doubt that the Board of Direction of the Institute started their plans for this first convention but the out-come well justifies their judgment that it would be worth while. Such a call a decade ago would not have gathered more than a dozen men, but so great has been the recent demand and the resulting supply for technical radio men that several hundred attended this meeting. The convention did not attempt the ambitious programs carried through by some of the other engineering bodies, yet there were some valuable papers presented and interesting and profitable trips were planned to the Bell Telephone Laboratories, to the high-powered station wjz at Bound Brook and to the factory of the A. H. Grebe Company operating station wAHG. The session closed with a most successful banquet and we must admit that never before had we believed that so many radio workers could attend a five-dollar dinner, but there were hundreds of them there to testify to radio's prosperity. Jewett, Nally, Alexanderson, Langmuir, Fessenden, and other noted workers in the radio field gave brief talks, all of them bringing out the tremendous strides radio is sure to make in the coming decade. (The modest writer of these editorials was also among the speakers.—Editor.)

RADIO BROADCAST announces with regret that Mr. Arthur H. Lynch, who has edited the magazine from its third number to the present one has decided to leave editorial work and go into manufacturing.

The managing editor, Mr. Willis K. Wing, will succeed him, and the rest of the staff will remain the same, with Mr. John B. Brennan as technical editor, and Mr. Keith Henney as director of the Laboratory. The policy of the magazine will continue along the lines set during Mr. Lynch's editorship. Professor Morecroft will continue to write "The March of Radio" and the other departments will be continued by the same writers.

DOUBLEDAY, PAGE & COMPANY.

What the Australians Think of Their Broadcasting

NO POSITIVE methods of comparing foreign broadcasting with that in the United States exist, but it is always to note what outsiders say. A. W. Watt, editor of *Wireless Weekly* (New South Wales), writes:

The broadcasting in Australia is excellent. This is the well-considered opinion of an official of one of the largest British wireless concerns. This opinion coming from one who has, if only from a business point of view, intensively studied the quality of British broadcasting which is conceded even by our cousins in America to

be the finest in the world is worth having.

When did we concede audibly that British broadcasting was better than ours?

And further—a Sidney trader, after a trip to the United States, said:

I went over there to admire American broadcasting but I came back with the full conviction that taken all around our Australian broadcasting was better. More boost has been put into American broadcasting than into any other thing and it becomes natural for us to associate everything that is good in broadcasting with the country whence that boost emanates. . . . We blink at the fact that America . . . is now up against a serious problem of extricating the broadcasting situation from the chaotic condition under which it labors. . . .

And then to make sure that we are down for the count of ten—"if we must pattern ourselves after somebody else let it be after the British system which, built up on a solid foundation, stands out as preëminent." This is criticism indeed, from one of our most respected neighbors. Are we really as good as we have been telling ourselves we are?

"An Official Indiscretion"

UNDER this caption, the editorial writer of the *Wireless World* takes to task that admirable British engineer, Captain Eckersley, Assistant Con-

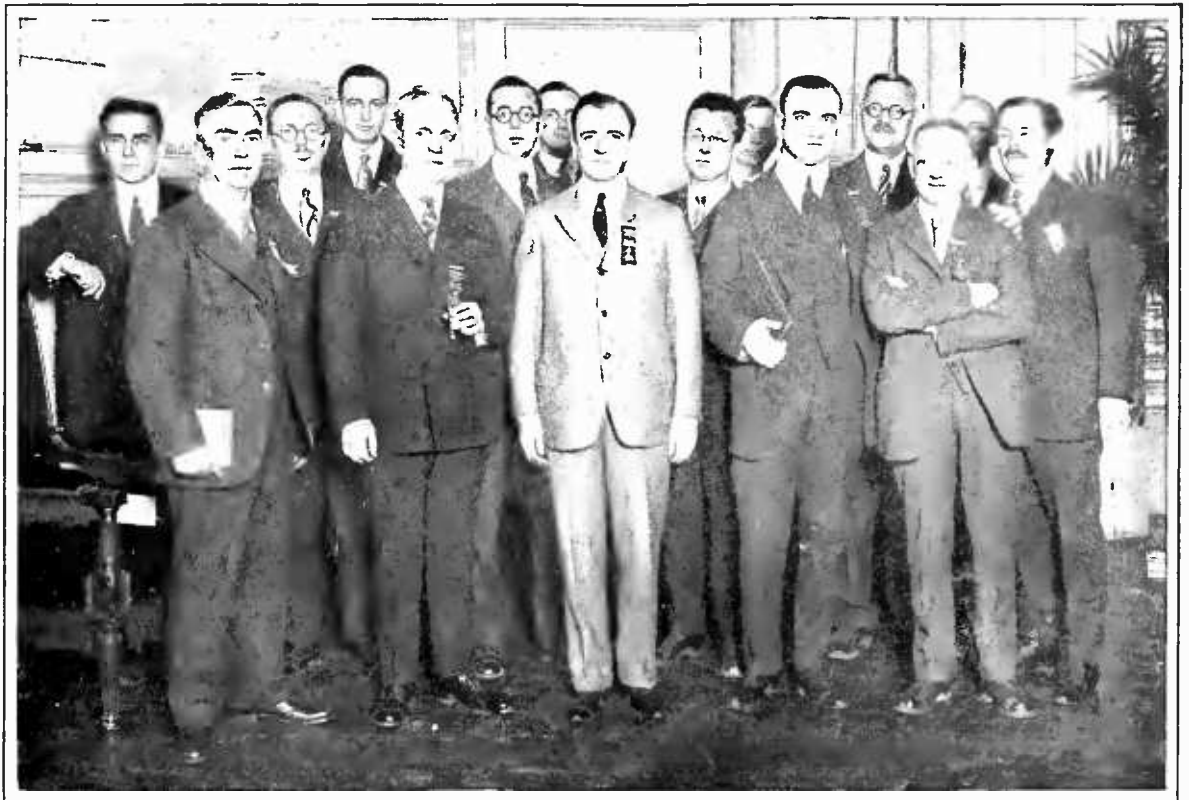

SOME OF THE LEADING MEMBERS OF THE INSTITUTE OF RADIO ENGINEERS

Photographed during the recent convention of that organization in New York. In the front row, reading left to right: Frank Conrad, assistant chief engineer of the Westinghouse Company, who received the 1925 \$500 award of the Institute for his work in short wave broadcasting; Donald McNichol, president of the Institute; Dr. J. H. Dellinger, director of the radio laboratory, Bureau of Standards, and retiring president; Dr. A. N. Goldsmith, chief broadcast engineer, Radio Corporation of America; R. H. Marriott, first president of the Institute; second row, left to right: W. H. Hubley; John V. L. Hogan; C. W. Horne, manager of radio for the Westinghouse Company; Lloyd Espenschied; A. H. Grebe; Professor J. H. Morecroft of Columbia University and member of the staff of RADIO BROADCAST; Melville Eastham, president of the General Radio Company; Dr. G. W. Pickard, research engineer, Wireless Specialty Apparatus Company; L. E. Whittemore, and Dr. E. F. W. Alexanderson of the General Electric Company

troller and Chief Engineer of the British Broadcasting Company.

In an interview entitled "A Talk to Homemakers" he saw fit rather severely to criticize the enthusiast who buys parts and assembles them into the well-known home-made set. Not only did he tell the radio "tinker" that he was generally wasting his time and money but further intimated that the home builder was actually doing an unethical thing: that he was using ideas which had cost the manufacturer thousands of pounds to develop and for which the manufacturer was entitled to believe that the radio listener would buy his sets and thus help pay for the cost of research. "If home making simply means copying what some one else has taken pains to design, may I suggest that mental indigestion may result, and more, might I point out that a new and great industry is being hampered"?

The home builder is one of the important

vitamines of the radio industry. He really learns a lot about radio, he spends much money for parts; he spends his time at home, contented and enthusiastic about his task, he occasionally lets his family actually listen to a whole selection from some distant station before he tunes to another, and in many instances he also buys a manufactured set. So actually instead of cheating the set manufacturer from his legitimate profit he generally does contribute his bit and in addition creates a healthy demand for "parts."

The Recent International Radio Broadcast Tests

THIS year's international tests ran into difficulties with a vengeance. It seems as though nature, as well as the bloopers, were making all efforts to keep America for Americans. It probably pleased many of our short-sighted senators

to think that circumstances were doing so well to keep us from being contaminated by touch, even over an ether channel, with our transatlantic fellow men. Rapidly changing weather conditions, which always bring plenty of static, resulted in violent Atlantic storms, and as soon as the static had partially abated, the transocean channels were required for more important service than that of friendly intercourse. Radio was being used to locate the men who were fighting against death in the ocean storms, and no one of us has ever begrudged giving up his radio hours for such a cause.

The law of compensation played its part in the ocean tragedy, however; one of the benefits of these International Tests which some of us had continually urged is that arising from the better understanding between nations. This must result from our repeated attempts, always more successful, to get in radio touch with those in Europe and South America. When peoples are in

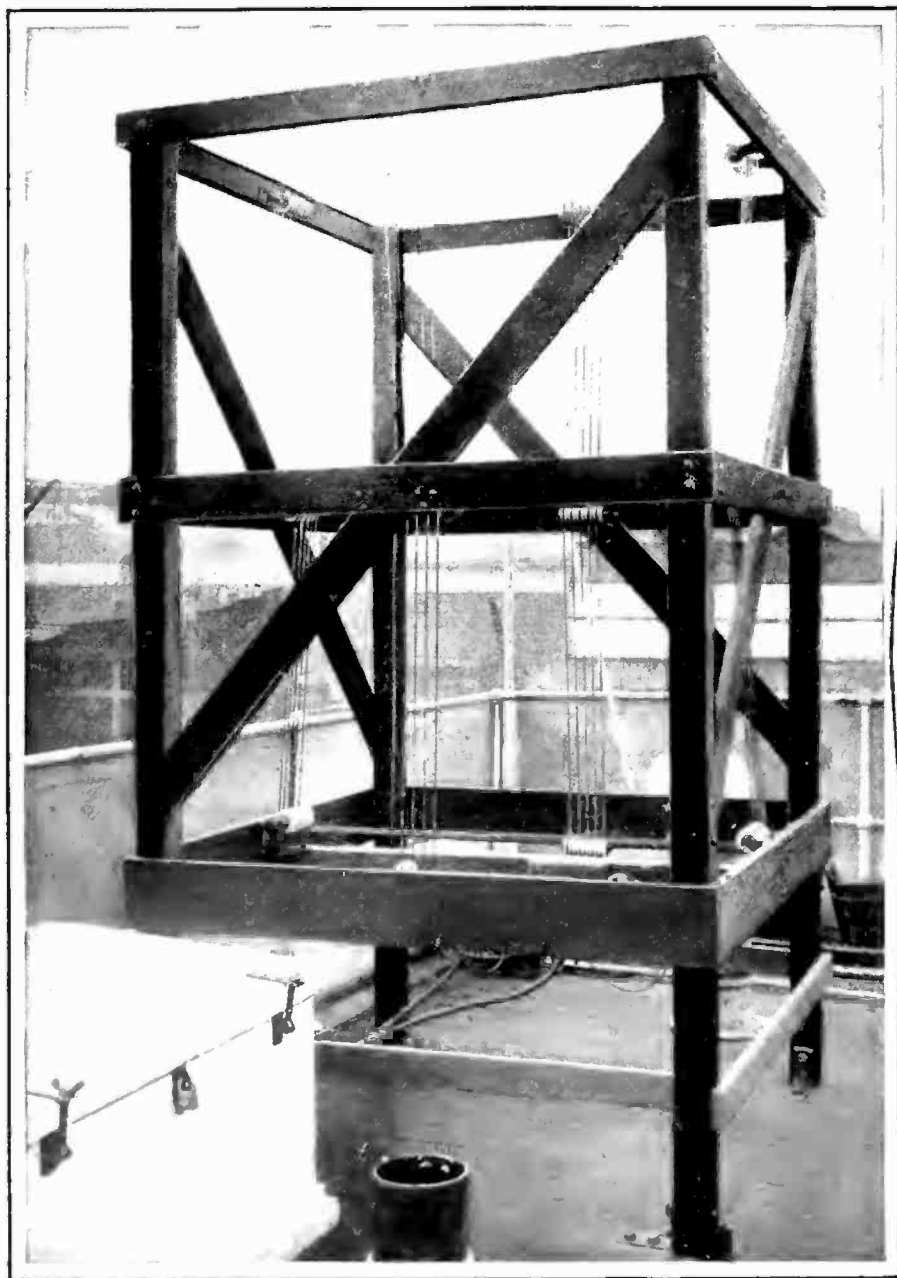

MARINE RADIO DIRECTION FINDERS

Three nations have recently joined to honor the Captain and crew of the S. S. *President Roosevelt* on their rescue of the crew of the British steamer *Antinoe*. It was radio which brought the rescue ship and the radio compass which guided the *Roosevelt* to the drifting *Antinoe* after the American ship had drifted more than 100 miles out of her course during the night. The large illustration on the right is the Kolster radio compass installed on the bridge of the S. S. *President Harding*, a sister ship of the *Roosevelt*. The wheel operates a loop above, which leads to the receiver at the right of the operator. The view at the left is the antenna of the British Bellini-Tosi direction finder, installed on the bridge of an English merchant ship. Its principle of operation is somewhat different from the Kolster system used on American vessels

close communication with each other, many sources of friction and causes of discord will disappear. Now the time used for the sos calls during the International Test schedule resulted in American crews and German crews risking their lives for British crews, certainly an international episode of as much importance as the exchange of the "Star-Spangled Banner" for the strains of "God Save the King."

This year's Tests further emphasized the undesirable character of the regenerative receiver in the hands of unskilled or careless users. Much of the time when the air was otherwise clear and the chances of having European and South American radio channels end in our homes, was rendered useless to us by the howling receivers. As soon as we located one of the transatlantic channels and were endeavoring to copy the program, a flock of howling receivers would start to work around, trying to locate the same station. It is high time that common decency to our neighbors prohibit the use of such equipment and especially on such an occasion as the long-distance tests.

How They Run Radio in Canada

IN CANADA the radio activities of the government are carried out in the Department of Marine and Fisheries, a logical place for it when we remember that radio served the marine service long before it was used for broadcasting entertainment. We have commented before on what seemed to us the very reasonable and sane course the Canadian officials take in developing radio—in fact, we have also previously expressed the opinion that the work was done in a manner somewhat superior to that which our officials display in attacking radio questions. It is good to find the quality of directness of attack for which the Canadians won a reputation during the war, shown in the annual report of the Canadian radio service.

The total number of stations coming under government supervision is 93,049, apparently a prodigious number, but we hasten to recall that all receiving sets are classed there as receiving stations and come under government supervision. There are 92,000 of these receiving stations in the dominion which pay to the government \$1.00 a year for their operation. After reviewing the compass service and the twice daily weather report to shipping, the probable development of radiophone service to certain classes of shipping is discussed. The ordinary weather and compass reports are of course sent out in code and the receiving ship must have a trained operator on board. But it is thought that harbor shipping might use radiophone channels and thus get the benefit of radio without the expense of a specially trained man. A frequency of 1500 kc. is to be used so as not to interfere with broadcast channels. It seems to us that such a scheme is only practical when the shipping is not dense. Around New York harbor, such an attempt would be unwise indeed.

Strange as it may seem to those in control of our governmental attitude, the Canadian government has a definite policy by which broadcasting licenses are issued. "One wavelength is issued to each city or area and three stations are licensed to use it, one station at a time. In case the licensees are unable to arrive amicably at a division of time, the department itself divides the time on an equitable basis." This is different from the Cincinnati row we had when the Department of Commerce officials said it was none of their business and left the stations to fight it out. In the larger Canadian cities, a second wavelength is assigned but the station operating on the second wave must be at least ten miles out from the city!

For the past two years, licenses issued by the Department have permitted indirect advertising without restriction and direct advertising before 6 p. m. In spite of the permission, practically all direct advertising has been abandoned, the stations apparently having reached the same conclusion that direct advertising fell on "deaf" receiving sets.

In 1923 the United States assigned to its numerous licensees all of the broadcast bands available for this continent, a not very neighborly action. Ninety-five channels to be properly proportioned between Canada and ourselves so we use all of them! "As a result, the transmission of practically every one of our stations was subject to severe interference." The United States Department of Commerce finally agreed to regard six of the ninety-five channels as exclusively Canadian and also to use certain of the other channels for our southern stations only, that is, these channels might also be used by our northern neighbor. Taking into account the unlikelihood of

West Coast stations interfering with her eastern stations, Canada counts on 19 available channels.

Continues the report:

Every Canadian station is checked each night by some specified inspector and offending stations are at once ordered back to their specified wavelength. Should the offending station be under the jurisdiction of the United States, the Supervisor of Radio for the area in which the offending station is located is advised by telegraph and in all cases promptly and effectively attends to the complaint.

The report speaks of the surrender of the 1000- and 660-kc. channels by the shipping approaching our shores. They are not used by ships of Great Britain, United States, Belgium, Denmark, and Sweden when within 250 miles of our shore. "Unfortunately France has not seen her way to accede to our request and we still have a prolific source of interference in the coast station operated by that government at St. Pierre Island, south of Newfoundland." Under the caption "Regenerative Whistles" we learn that "We have as a matter of fact, considered getting all the Canadian radio manufacturers together with a view to having them mutually agree to stop the manufacture of the regenerative type of apparatus. But as there is no legislation available to compel any manufacturer to abide by the same, etc.—"

With comparatively few broadcasting stations (only nineteen channels), Canada has thirty-eight inspectors. "Generally speaking," the Commissioner modestly concludes, "the Canadian broadcast listener would appear to receive at least as much, if not more, service than the listeners in any other part of the world, whether licensed or not, and we have not as yet really got into our stride!"



RADIO HEADQUARTERS OF THE SIGNAL CORPS

At Washington, all the official business of the Signal Corps of the Army which is transacted by radio through the network of Army stations is received at this central office. General Saltzman, Chief Signal Officer, reported recently that radio was the means of saving a large sum over the usual telegraph tolls paid by the Army for official communication. This radio central is located twenty feet below large receiving loops on the roof of the building



REGINALD A. FESSENDEN

Chestnut Hill, Massachusetts
at the Institute of Radio Engineers
Dinner, New York

"There are in existence to-day, fully developed and tested, wireless methods for operating substantially without disturbance from static or interference, and these means have been tested with large capacity high antennas between Boston and Panama, in summer.

"There are also in existence to-day, fully developed and tested in all essential details, wireless methods for operating direct, without exchanges, by setting direct to the subscribers' numbers, between bodies of subscribers as large as those comprising the New York exchanges.

"The wireless pheroscope has been developed from the first crude apparatus of 1906 to a device capable of putting wireless vision into every house in the United States, and was tendered to the United States Navy under guarantee in 1921, and to others. Its success depends upon two inventions—the multiple valued function method, as it is called, and the shutter which has been operated by independent engineers at a frequency of 400,000 per second and is capable of more. I have pleasure in showing you the shutter, a photograph showing its general arrangement in action, and a sample of the wire used, of which it takes 900 twisted together to make the size of a single hair; and of presenting these historical exhibits to the archives of the Radio Engineers."

The Month In Radio

THE large station at Rocky Point (Radio Central) has for some time been able to send telephone messages across the Atlantic to England where a receiving station has been set up at Chedzoy; this, it is expected, will be the English receiving station for the transatlantic radio-telephone channel. The British have been at work on a transmitting station for their end of the channel and a cable to the *New York Times* says that the station is now complete and has been taken over by the British Postoffice, which will operate the communication scheme.

The English news puts the price of a three-minute talk to America at five dollars. This seems like an unreasonably low price for the

service and certainly cannot be based on the idea of earning a reasonable return on the investment.

NOTHING more indicative of the emancipation which Turkish women have experienced in the last decade has occurred than the broadcasting of a speech by the wife of the Curator of the Evkaf Museum in Constantinople. Only a few years ago the face of the Turkish women could be seen by her master only, and never could she talk to other men. Now she not only shows her face as other women do but addresses an audience numbered in the hundreds of thousands by the most modern of our scientific achievements. Mme. Aly addressed the British radio audience on "The Turkish lady of Yesterday and To-day." The topic certainly seems to offer opportunities for some striking contrasts.

FROM wgy, the radio audience had a chance to listen recently to a most striking experiment. Professor Wold of Union College, gave a series of talks on the electron and its activities and during one of his lectures he let his listeners actually hear an electron as it splashed its way through a cloud of gas particles. Some substances, said to be radio-active, are continually shooting off positive and negative electrons, and as these, traveling at high speed, bump their way through a small air chamber and so affect the air particles they bump that the air becomes partially conducting. This change in the conductivity of the air is made to affect a vacuum tube amplifier and thus modulate the carrier wave of the broadcast station. The noise is scarcely more pleasing than static noise, but it will be certainly more interesting when one realizes that each noise represents the collisions caused by one electron, the smallest thing in the universe of which the scientist knows to-day.

Interesting Things Said Interestingly

GENERAL J. G. HARBORD (New York; president Radio Corporation of America): "The world leadership of the United States in the development of the radio art and industry has won for our manufacturers and engineers a dominant position in the radio affairs of South America, where to-day the greater percentage of the total business is carried on by Americans. In spite of foreign competition, our products and methods remain the most acceptable to South Americans. Our four years of experience in the development and production of broadcasting devices both for transmission and reception, has stood us in good stead in Latin America. Americans are contributing a full measure of this experience toward the development of radio in South America and we have the hearty cooperation of local South American radio interests."

E. F. W. ALEXANDERSON (Schenectady; Chief Consulting Engineer, Radio Corporation of America): "The great problems in radio are static, interference and fading. The trend of the radio art in the past has been determined by improvements that have been made in overcoming these difficulties. The practical solutions of these problems to-day are; directive reception for reduction of static; continuous waves



CAPT. A. G. D. WEST

London; Assistant Chief Engineer
British Broadcasting Company; in an
interview before the recent
International Tests

"The tests will not give such a unique opportunity to European listeners because they can listen on any night to American stations without fear of interruption from broadcasting stations on this side of the Atlantic. American stations usually take very great care with regard to maintaining their wavelengths and their power constant over long periods of time, so that amateurs on this side who want to do serious experimental work on long distance reception on various wavelengths, can do so throughout the winter season, but there are not many experimenters who would have time and opportunity and also inclination to listen in the early hours night after night for American stations to obtain data that will be valuable from a scientific point of view, and it is during Radio Week that a more useful opportunity is given to those who want to try occasional American reception.

"Even now it is not advisable for listeners with sets containing less than two valves to attempt to pick up these (American) programs, and it is certainly most important to make sure that the sets do not oscillate and cause local interference. Even just a few oscillators playing around the wavelength of a distant station can completely spoil the reception of that station by listeners situated many miles around."

to minimize interference; and the use of long waves to minimize fading. The future answer to these problems may be different. At least we have reason to think that the new knowledge which we have gained regarding wave propagation will furnish us additional methods of discriminating between signals and disturbances. Wave polarization will undoubtedly be one of the important factors in this new development."

PROF. A. M. LOW (London; from an article in *John Bull*): "Before many years are passed we are sure to have the radio serial story, and we are sure to have plays acted by radio with various incidents leading up to exciting passages which are always 'to be continued in our next.'"

News of the \$500 Short-Wave Receiver Prize Contest

Entries May Be Made Up to April 1, 1926, Instead of March 1—Conditions and Further Information of a Contest to Interest Amateurs Everywhere

THE short-wave receiving set contest, announcement of which was made in the February issue of RADIO BROADCAST, has won the enthusiastic response of numerous experimenters in the short-wave field, judging from the correspondence which has come in since the announcement was made. So many complaints were received that there was not sufficient time for some of the experimenters to finish their sets for submission before the contest closes, that it has been decided to extend the time limit from March 1st to April 1st, 1926. A request by the New York representative of *Popular Wireless*, London, that the receivers of entrants shipped from Europe not later than April 1st should be considered, has been granted. It is probable that the extension date will also enable Australian short-wave enthusiasts to compete.

One of the interesting things which the contest has brought forward is the fact that up to this time there has been little or no novelty in the design and construction of short-wave receivers. The conventional types have given satisfactory results and consequently, prior to this contest, the stimulation to designing better receivers has been lacking.

According to present indications, among the contenders for the prize money will be super-heterodynes, regenerative neutrodyne and even the much neglected super-regenerative receiver. Certainly something worth while should be brought forward. In practice, however, Reinartz receivers are being used almost to the exclusion of other types. Attention is called again to the basis of points upon which the prize is to be awarded. Contestants should observe that a paramount requirement is that the receiver shall be adapted by its design and construction to practical amateur relaying. The only circuit limitation imposed is that *radiation be reduced to a minimum*. Otherwise, any type of receiver which will function with the utmost sensitiveness, stability, and reliability, is eligible for consideration.

The extension of the contest, which has been widely announced, will give contestants opportunity to do additional work, which should not be overlooked.

The basis of points is as follows:

Workmanship	15
Simplicity of handling	20
Ease of Calibration	
Freedom from hand capacity	
Independence of tuning and regeneration	
Low Cost	10
Use of standard or easily constructed parts	5

Performance	25
Overall amplification of signals	
Use in relaying	
Ability to use break-in	
Ability to cover foreign amateur bands	
Appearance	15
Method of avoiding radiation	10
Total	100

Much comment has resulted from our insistence on the non-radiating feature. Certainly we are aware that there are differences between continuous wave reception and broadcast reception. The enjoyment of a broadcast entertainment can be completely ruined by a near-by radiating receiver but continuous wave reception is not necessarily impossible within range of a radiating receiver. Continuous wave reception is not the only thing to consider, however. Short waves are also used for rebroadcasting purposes and for supplying programs to broadcasting stations from remote points. A few hundred radiating receivers on short wavelengths, used for rebroadcasting purposes, would be sufficient to make these short wave radio telephone links practically inoperative. In anticipation of this problem, RADIO BROADCAST adheres to its fixed policy to discourage the use of radiating receivers on any and all wavelengths.

We have been invited to exhibit receivers entered in the short-wave contest at the Sixth Annual Radio Show and Convention held at New York under the management of the Executive Radio Council of the Second District. If a sufficiently interesting exhibit can be assembled so early in the contest, there will be an opportunity to see some of the latest designs in the short-wave art.

We have sought to make the board of judges a composite one, which will be thoroughly capable in considering all of the qualities of a receiver. You will observe that it includes practical amateurs, who have extensive experience in short wave relay work; scientists and mathematicians, who know how to measure and appraise in impersonal quantitative terms, and writers and commercial engineers who are able to judge the simplicity of workmanship and ease of construction from the point of view of the average home constructor. There are many names which we would have liked to include in the Board who were perforce omitted, lest it become too large to be efficient in its work, but we are sure that each member has a specific and definite contribution to make which should result in a fair decision from every standpoint.

That public interest and attention is turning toward short waves is no longer a debatable question. The announcement of this contest, the RADIO BROADCAST-Eveready short-wave experiments conducted with the coöperation of the National Carbon Company, the long-distance records of 2 GY have, individually and collectively, aroused so much attention that we are inclined to predict that the number of enthusiasts in short-wave transmission and reception will continue to increase with the marked rapidity of the last few months for some time yet. After all, your receiver may respond to signals coming in for distances of thousands of miles, but until you, yourself, have mastered the ether by making it subservient to the will of your own transmitter, your conquest is not complete. It is our hope that through the disclosure of a better short-wave receiver, RADIO BROADCAST may be the means of introducing you to a new phase of radio entertainment—the mastery of the ether through the use of the short waves.

THE CONTEST

OBJECT: The object of this contest is to aid in the development of improved short-wave receiving apparatus, so that the possibilities of high frequencies may be more effectively studied.

PRIZES: First prize, \$250; Second prize, \$150; Third prize, \$100. Only one prize to a contestant.

ELIGIBILITY: Anyone interested in short-wave reception is eligible to compete, though no prizes will be given to manufacturers making short-wave receivers or parts therefor.

CONDITIONS: Each contestant must submit a complete description, photographs, and hook-up of a short-wave receiver which does not radiate. The receiver should be adapted to the entire short-wave band from 8566 to 1999 kc, although this may be accomplished by interchangeable coils. RADIO BROADCAST is permitted to request that the most promising receivers be sent to its laboratories, in order that the final award of the prize may be determined, after exhaustive tests. In addition to the prizes, RADIO BROADCAST is to be permitted to use descriptive matter, either in whole or in part, submitted by any contestant, at its regular rates.

BOARD OF JUDGES: The following constitute the board of judges: Boyd Phelps, Prof. Louis A. Hazeltine, Zeh Bouck, G. C. Furness, Arthur H. Lynch, Edgar H. Felix, Dr. Lawrence Dunn, and Dr. A. Hoyt Taylor.

The Tube and Its Best Uses

Explanations of Some General Instructions on How Best to Use Tubes—How Characteristics are Measured and Their Importance—Relative Merits of Amplifier Connections—The Facts About Tube Rejuvenation

By KEITH HENNEY

Director, Radio Broadcast Laboratory

RADIO receivers arrive in American homes at the present time in one of two ways, either the home buys a completed receiver or someone in the home builds it, assembling material that some manufacturer has designed and constructed.

In either case, the receiver is a static thing until the listener buys the tubes and turns on the A battery. From the moment that this final act is completed, the receiver ceases to be a mere assembly of electrical apparatus and becomes, for the time being at least, a stage upon which many interesting things happen.

Few builders, or purchasers, of radio receivers seem to realize that the tube is about the only part of the complete installation over which they have any control. The purchased set comes "without tubes" and the final contribution to the home made receiver must be tubes. These tubes must be chosen with considerable discretion and operated with care.

It is sufficient for the average listener if his set works, and under this happy condition a tube is a tube, an ingenious device that fits into a socket. Yet let something happen, a mix-up in A and B battery leads, a broken connection, a dropped tube, and the user realizes without delay that the tube is the vital thing, and that upon its proper functioning depends the success of the receiver.

For this reason this article, with those published in the December and February RADIO BROADCAST, endeavors to explain some tube information and some tube idiosyncrasies. Such information, in the words of a certain college professor "is in all the books" but many that should have noted it, have not. To judge from the enthusiastic reception given the first two tube articles, this field is a profitable one for study.

Among other things about tubes that are frequently mentioned in radio magazines and newspaper radio sections is the fact that an amplifier grid should never be allowed to go positive, and this seems a logical point of attack for the present article.

It is also stated that the characteristics of tubes as ordinarily measured are "static" and have little to do with the tube under actual operating conditions. At least one manufacturer of tube testers claims that his device measures the "dynamic" characteristics of tubes giving the lie to others whose products measure tubes statically. This particularly efficient instrument, so the manufacturer says, measures tubes dynamically because it uses a source of alternating current for the measurements, and everyone knows that tubes are alternating current amplifiers. And there you are!

Naturally, what the average listener wants is information that will aid him in operating his tubes intelligently; it matters little to him by what name you call tube characteristics, or how they are measured. He wants the "cold dope." And the experimenter—how many there are who

have requested tube data from RADIO BROADCAST Laboratory—wants to know how to measure tubes in the most approved fashion. The present article may be of interest to both of these types of readers.

With regard to static and dynamic characteristics, there is this to be said—a difference does exist between them; both are important; neither is difficult to measure. And it is doubtful if the dynamic tube tester mentioned before has anything to do with the so-called dynamic characteristics of vacuum tubes.

WHAT IS NEEDED TO TELL TUBE CHARACTERISTICS

ASIDE from the tube and its accessory batteries, all that is necessary to measure static characteristics of tubes, which show in the form of curves the relations between grid, plate, and filament voltages and the corresponding currents, is a good voltmeter of double range, 0-10 and 0-100 volts, and a good milliammeter, and any one in his home laboratory can have many hours of enjoyment studying tubes by means of these instruments. With such apparatus diagrammatically represented in Fig. 1, let us carry out the following procedure:

- Measure the B battery voltage.
- Set the filament at proper voltage.
- Vary C voltage in convenient steps, measuring with voltmeter.
- Note plate current at each different C voltage.
- Plot the results similar to Fig. 2.

For 199 and 201-A tubes, the normal plate voltages are 45, 90, and 135. The C voltage may be varied in steps of 2 volts from minus 10 to plus 10. Semi-power tubes normally use 135 volts on the plate but as many as 180 may be safely used. On some tubes of this type—not of

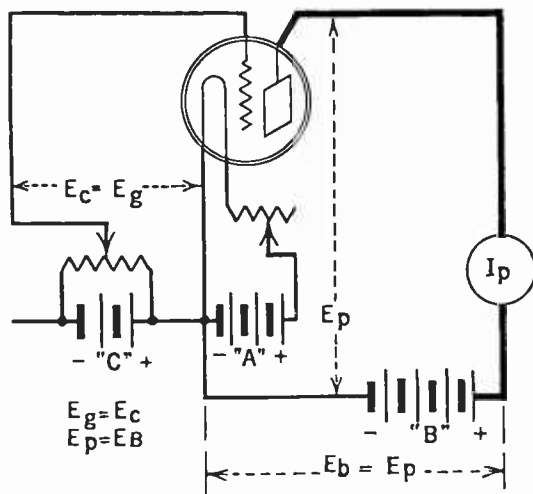

FIG. 1

Apparatus required for measuring static characteristics of tubes. A double-range voltmeter can be used to measure A, B, and C battery voltages

the oxide coated filament type—plate voltages up to 400 have been used in the Laboratory with complete success. The C voltage on these tubes of the 112 type may be varied in steps of 5 volts from minus 35 to plus 5.

Now it is a common statement in published tube information that only the straight—comparatively speaking—part of this grid-voltage-plate-current-curve should be used for distortionless amplification. Any one can see that the curve is not straight at the bottom, and on page 458 of the February RADIO BROADCAST, the effect of using this part of the curve is shown. But any one can see that the curve continues to be straight beyond the zero grid line. In other words, there seems to be no reason why the grid should not be allowed to go positive. There must be a catch somewhere.

The catch lies in the fact that the method of discovering the relation between I_p and E_g (plate current and grid voltage) illustrated above does not tell us exactly what the tube will do under actual amplifying conditions. For instance, an amplifier tube always works into a load of some kind; as the telephone engineers say, the tube "looks" into a transformer, a resistance, or a pair of telephones, and the grid circuit, in the same language "looks back into" a transformer secondary, a resistance, or some combination of resistance, inductance and capacity.

Therefore, if we insert into the grid and plate circuits of the tube under test, a resistance approximating the impedance into which the tube normally looks we shall have the conditions of test more nearly like those occurring in practice. Fig. 3 contrasted with Fig. 1 shows these additions, and Fig. 4 the method of calculating the input and output resistance. The tube normally looks back into the output impedance of a similar tube which is "stepped up" by the square of the turn ratio of the connecting transformer. Fig. 5 shows how two differing impedances may be coupled together by means of a transformer. In this case Z_1 may be the output impedance of a semi-power tube and Z_2 the impedance of a loud speaker. If the turn ratio of the transformer obeys the formula

$$Z_2 = \left(\frac{N_p}{N_s}\right)^2 Z_1$$

or

$$Z_1 = \left(\frac{N_s}{N_p}\right)^2 Z_2$$

the maximum amount of power will be transferred; in other words, quality reproduction will result.

In connection with this formula it is well to remember that the voltages appearing on primary and secondary of transformers vary directly as the turn ratio, while the impedances which the transformer connects vary as the square of the turn ratio.

In the case of a first stage amplifier working from a detector tube—whose impedance will be

about 30,000 ohms—and coupled to it by means of a 3:1 ratio transformer, the tube looks back into approximately $30,000 \times (3)^2$ or $30,000 \times 9 = 270,000$ ohms. If the tube is the second of a two- or three-stage resistance amplifier employing high-mu tubes, the tube looks back into three impedances in parallel as shown in Fig. 4. In the case of the last tube in a set which works into the loud speaker, its output impedance will be approximately matched by the impedance of the

plate voltage is less than the B battery voltage by the drop in the load impedance. The plate current will be less naturally. When the grid goes positive it begins to draw current so that variations in grid voltage are no longer as effective in changing plate current; then these variations only produce more or less grid current.

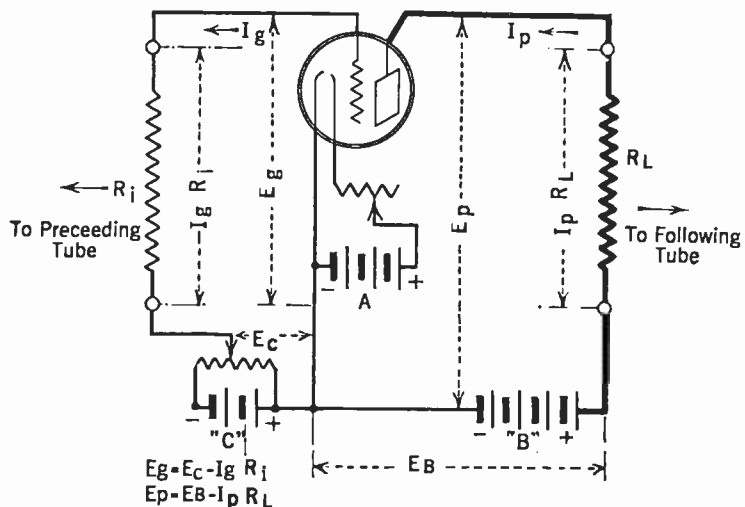

FIG. 3

To obtain the curves shown in Fig. 2 it is necessary to add resistances in the input and output circuit of an amplifier tube. These resistances simulate the impedances of the preceding and following tubes together with accessory coupling apparatus

speaker, but in intermediate stages, the primary impedance of the coupling transformer should be at least three times the output impedance of the tube at the lowest audio frequency which it is required to amplify. This means that the primary of the transformer must have 50 henries inductance at 100 cycles when working from a 201-A tube with an output impedance of 10,000 ohms. If the transformer has a "flat" characteristic at 100 cycles, the higher frequencies will be taken care of by a complicated combination of capacity and core loss in the transformer.

In other words in the first amplifier the factor R_L will be about 30,000 ohms, while in the last amplifier this factor will be about 10,000 for a 201-A and 5000 for a 112 tube.

In Fig. 3 R_L and R_i represent the combined impedance of the tube and the connecting apparatus looking away from the tube under test.

Under these conditions, shown in Fig. 3, somewhat different curves result when one plots plate current against change in grid volts. In this case the plate voltage is not the B battery voltage but is less by the drop in the load resistance, and the voltage actually applied to the grid is not the same as the C battery but is less by the drop in the input resistance—when the grid goes positive.

As soon as the grid goes positive, current flows in the grid circuit, depressing the input voltage, and the plate current curve flattens out or actually drops. Distortion is inevitable because the plate current no longer is an exact replica of the applied voltage. The tops of the waves are completely obliterated and the plate current jumps about when incoming signals force the grid positive. What comes from the loud speaker differs widely from what leaves the transmitting station. Curves which show this flattening are in Fig. 2 in which the load impedance is 12,000 ohms, and many excellent curves of this nature may be found in a recent article in *Popular Radio* by Hugh S. Knowles.

What actually happens is the following: the

a tuning inductance and condenser. When the grid takes current, however, power is required, the input impedance becomes very low, effectively shunting the tuning circuit and making tuning broad.

As a matter of fact, the above experiment has not as yet measured what vacuum tube experts know as "a.c. dynamic characteristics" which show the relation between alternating plate current values as related to alternating grid volts. Some excellent curves of this type may be found in the December, 1925, *Proceedings of the Institute of Radio Engineers*. What we have measured are known as "d.c. dynamic" characteristics. Since we have used pure resistance loads, the curves for d.c. and a.c. will be the same. This would not be true had we used an inductance in the plate circuit. But the fact has been clearly demonstrated that amplifier grids should not be permitted to go positive—they should not be overloaded. The remedy, naturally, is increased C battery and this in turn necessitates greater B battery.

It seems to be a psychological fact that the average listener

TABLE 1

TUBE	μ	R _p	G _m	$\frac{\mu^2}{R_p}$	$\sqrt{\frac{\mu}{R_p}}$	CONDI-TIONS
199	6.5	22,400	304	19.8×10^{-4}	4.45×10^{-2}	a
201-A	8.2	12,700	660	55.3	7.37	a
12	5.6	14,000	400	15.0	3.87	a
120	3.3	6600	500	12.8	3.58	b
112	7.0	6150	1140	80.0	8.95	c
210	7.65	5100	1500	107.0	10.35	d
Mu 20	20.00	33,000	600	121.0	11.00	e

	CONDITIONS	
	E _g	E _p
a	-4.5	90
b	-22.5	135
c	-9.0	135
d	-27.0	350
e	0.0	90

u = amplification constant
R_p = Plate impedance in ohms
G_m = mutual conductance in micromhos

wants louder and louder signals—he becomes radio deaf. For example the first stage in the average listener's radio life is that of a single tube which delivers its output to the listener through head phones. After a time he wants a loud speaker and he adds one or two stages of audio amplification to his one-tube set. He is satisfied with 90 volts on the plate and negative 4.5 on the grid. Then he finds that signals do not seem as loud as they did at first. So he uses 135 volts on the plate and negative 9 on the grid and installs a semi-power tube. Then he finds after a time that signals might be louder. So he goes to 180 volts on the plate and negative 15 on the grid, or to two tubes in parallel or push-pull, or to the final stage where he uses a power tube with 350 volts on the plate and about negative 25 on the grid. The more the listener gets, the more he wants. In another

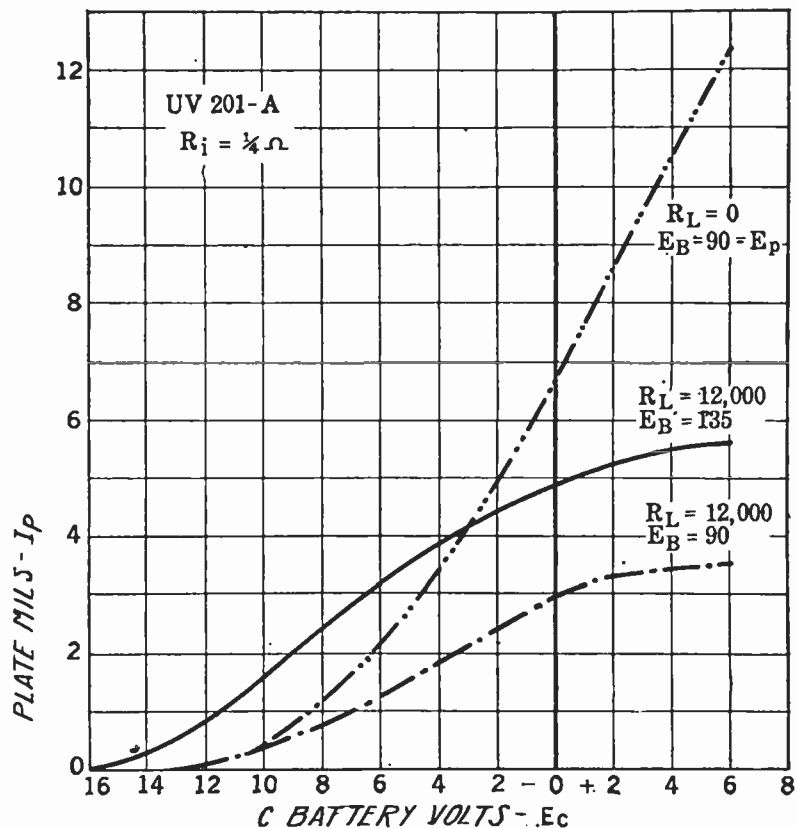

FIG. 2

What one gets by measuring tube characteristics with and without a load in the plate circuit. Note how the curve of plate current flattens out when a load is included. This is due to the fact that the effective voltage on the plate has been reduced. It shows why people get into trouble when they use resistance amplifiers with low mu tubes and with low plate voltages

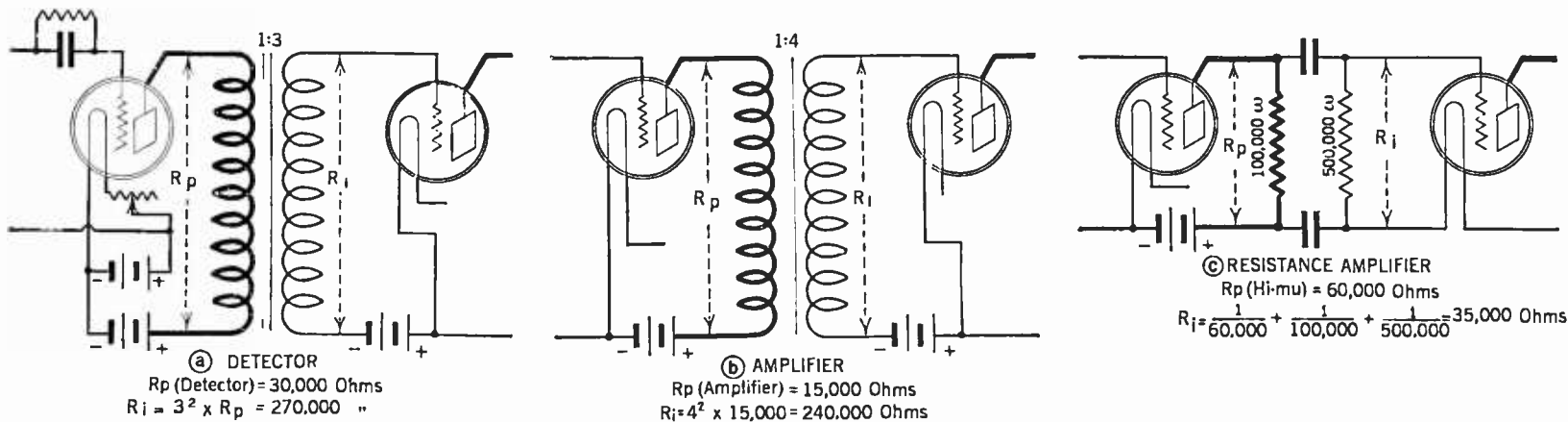

FIG. 4
Methods of calculating R_i and R_p for three general amplifier cases

direction there is an analogy—rouge blindness! The more rouge, the more . . . but perhaps we had better not go into that.

So much for distortion owing to positive grids. Too much C battery, however, will force signals to use too much of the lower part of the characteristics and will cause distortion. A load in the plate circuit, however, has the tendency to straighten out the I_p - E_g (plate current-grid voltage) curve, so that the bottom of the curve is not so bad as it looks from the static characteristics.

Consideration of the curves in Fig. 5 and those in *Popular Radio* already mentioned show that the greater the impedance in the plate circuit the straighter will be the characteristic. Some loud speakers have very little impedance at low frequencies so that the curve worked over is not straight but curved and a peculiar distortion results when bass viols, or kettle drums are played. The remedy lies in a lower impedance tube, say one of 4000 ohms, and some tube manufacturers are making preparations to supply such tubes. They will necessarily have a low amplification factor and will draw considerable plate current but will be capable of delivering considerable power. Output transformers useful in overcoming this type of distortion are manufactured by the General Radio Company, and are designed to couple low impedance speakers of the cone type to 201-A tubes and to low impedance power tubes.

Among other things that are often discussed by those interested in tubes is the importance of producing and using tubes with a high value of mutual conductance. In preceding articles of this series, methods of measuring this important tube constant have been shown. Tables were given showing the value of mutual conductance of tubes recently tested in the Laboratory.

Let us examine this term and see what it

means in relation to proper tube operation. Tubes are most frequently called upon to perform one of two functions, voltage and power amplification. It is important then to know how useful a given tube will be when used as a

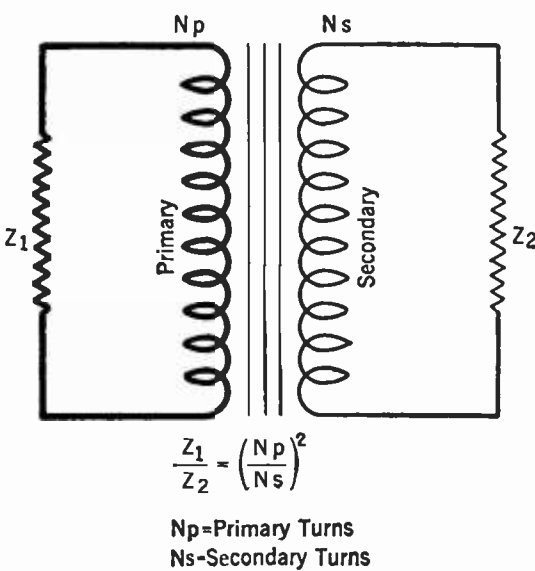

FIG. 5

How a transformer may be used to couple two impedances. As a matter of fact, such transformers in the telephone industry are called "repeating coils" since they repeat into a second circuit what goes on in a first circuit which may be of widely differing impedance characteristics

voltage or power multiplier. It is also important to know the power in watts that a given tube will deliver to a loud speaker.

It can be shown by mathematics that voltage and power amplification, and power output are related to the mutual conductance, usually

abbreviated to read G_m and defined as the amplification constant divided by the plate impedance.

The same mathematics, however, shows that these functions are related in the following manner:

$$\begin{aligned} \text{Voltage Amplification} &= \frac{1}{2} \sqrt{R_i} \times \frac{\mu}{\sqrt{R_p}} \\ \text{Power Amplification} &= \frac{R_i}{2} \times \frac{\mu^2}{R_p} \\ \text{Power Output} &= \frac{E_g^2}{8} \times \frac{\mu^2}{R_p} \\ \text{Mutual Conductance} &= \frac{\mu}{R_p} \end{aligned}$$

The mutual conductance, then, is a measure of a tube considered without regard to the circuit in which it works, while the other facts outlined above depend upon these external conditions.

For example, the values in Table 1 are for $\frac{\mu^2}{R_p}$

and $\frac{\mu}{\sqrt{R_p}}$ and knowing the input impedance as figured in Fig. 4 and the voltage that is being placed on the grid of an amplifier, it is a simple matter to compute the power and voltage amplification and the actual power output in watts delivered to a loud speaker. It has already been mentioned that a reasonable amount of power to require from an amplifier is .06 watts which will give a good comfortable signal from an average loud speaker of the cone type without overloading distortion.

When one is interested in oscillators and modulators, for example, in a transmitting circuit, the mutual conductance of a tube is a valuable measure, but it is believed that in amplifier practice some other factor such as $\frac{\mu^2}{R_p}$ is a better figure of merit by which to rate tubes. In England such a factor has been used for some time.

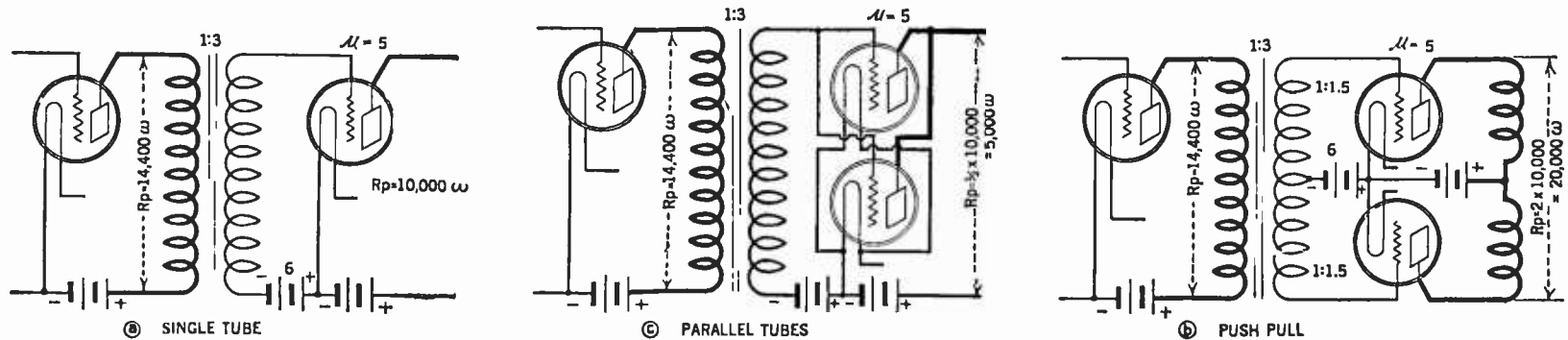

FIG. 6

Methods of calculating the important factors of three commonly used amplifier connections. One point worth noting is the fact that the push-pull input coil divides the voltage so that the effective step-up to each grid is only one half the total turn ratio of the transformer. In the push-pull circuit, the two tube impedances are in series; in the parallel case they are cut in half

THE MERITS OF VARIOUS AMPLIFIER CONNECTIONS

Now with these facts in mind let us settle a few arguments about the relative merits of a single tube compared with a push-pull amplifier or with two tubes in parallel, each working into a loud speaker designed to match approximately the output impedance of the amplifier. In Fig. 6 these three amplifiers are shown and the values of $\frac{\mu^2}{R_p}$, voltage amplification, and power output given. The factor $\frac{1}{2}$ which is included in the above expressions for voltage and power amplification has not been used in these computations since in these cases a high impedance open circuit secondary is used.

It will be noted that the push-pull and parallel tube amplifier will deliver twice as much power to a loud speaker as a single tube with the same input voltage, but that the push-pull amplifier is behind the others when it comes to voltage amplification. Now, in any amplifier, the tubes, with the exception of the last one, are primarily acting as voltage amplifiers, boosting the voltage as much as possible without distortion so that the last tube whose power output is expressed as $\frac{(\text{input voltage} \times \mu)^2}{8R_p}$ gets as much voltage input as possible. The push-pull amplifier should be used to feed power into the loud speaker, and practically any tube can be used up to that point, that is a 199, 12, or 201-A. These preliminary tubes are not required to handle much power since they are functioning primarily as voltage multipliers.

The Electrical "Shorthand" Terms Used in This Article

- Ep = Plate Voltage
- Eb = B Battery Voltage
- Eg = Grid Voltage
- Ec = C Battery Voltage
- Ef = Filament Voltage
- Ip = Plate Current
- Ig = Grid Current
- μ = Amplification Constant
- Rp = Plate Impedance
- Gm = Mutual Conductance

There is one other consideration when investigating the merits of the three amplifiers mentioned above. Owing to the electrical symmetry of the push-pull amplifier, each tube has supplied to its grid only one-half of the total input volt-

age. In other words, one can apply greater input voltages to a push-pull amplifier than to a single or parallel tube arrangement. Owing to this same symmetry, certain harmonics, due to curvature of the characteristic, are balanced out so that about 25 per cent. more overloading can be tolerated.

The parallel tube arrangement has the only advantage that its output impedance is lower than the single tube, due to the two plate impedances connected in parallel, and for this reason greater power can be delivered to a loud speaker of low impedance. Practically all loud speakers now on the market are comparatively high in impedance so the advantage in the parallel tube arrangement is not usually realized.

Since the output impedance of the push-pull amplifier is the sum of the tube impedance, a high impedance speaker must be used. If a low impedance speaker is used such as the Western Electric 540-AW, an output transformer should be used. The push-pull amplifier has both advantages and disadvantages, and at the present time it is impossible to get input transformers that compare in quality with the best of the single-tube transformers. With power tubes of low impedance and capable of delivering relatively large amounts of power, the usefulness of the push-pull amplifier is not so great as it has been.

TABLE 2

	$\frac{\mu^2}{R_p}$	POWER OUTPUT = WO	VOLTAGE AMPLIFICATION = N
Single tube	$\frac{5^2}{10,000} = .0025$	$\frac{6^2}{8} \times .0025 = .0125$ watts	$\sqrt{14400 \times 3^2 \times \sqrt{.0025}} = 18$ times = 25.1 T. U.
Push-pull	$\frac{5^2}{20,000} = .00125$	$\frac{(2 \times 6)^2}{8} \times .00125 = .0225$ watts	$\sqrt{14400 \times 3^2 \times \sqrt{.00125}} = 12.7$ times = 22.1 T. U.
Parallel tubes	$\frac{5^2}{5,000} = .005$	$\frac{6^2}{8} \times .005 = .0225$ watts	$\sqrt{144000 \times 3^2 \times \sqrt{.005}} = 24.5$ times = 28.1 T. U.

THE EAR AS A MEASURING INSTRUMENT

AND while we are speaking of impedance matching and voltage amplification, one should not lose

MEASURING THE TUBE'S HEARTBEATS

Apparatus necessary for laboratory tests of tubes is shown here. The diagram of connections controlling this set-up of apparatus was given on page 459 of February Radio Broadcast, and involves the use of accurate resistance standards, a source of a.c. voltage, accessory batteries and switches, and several meters

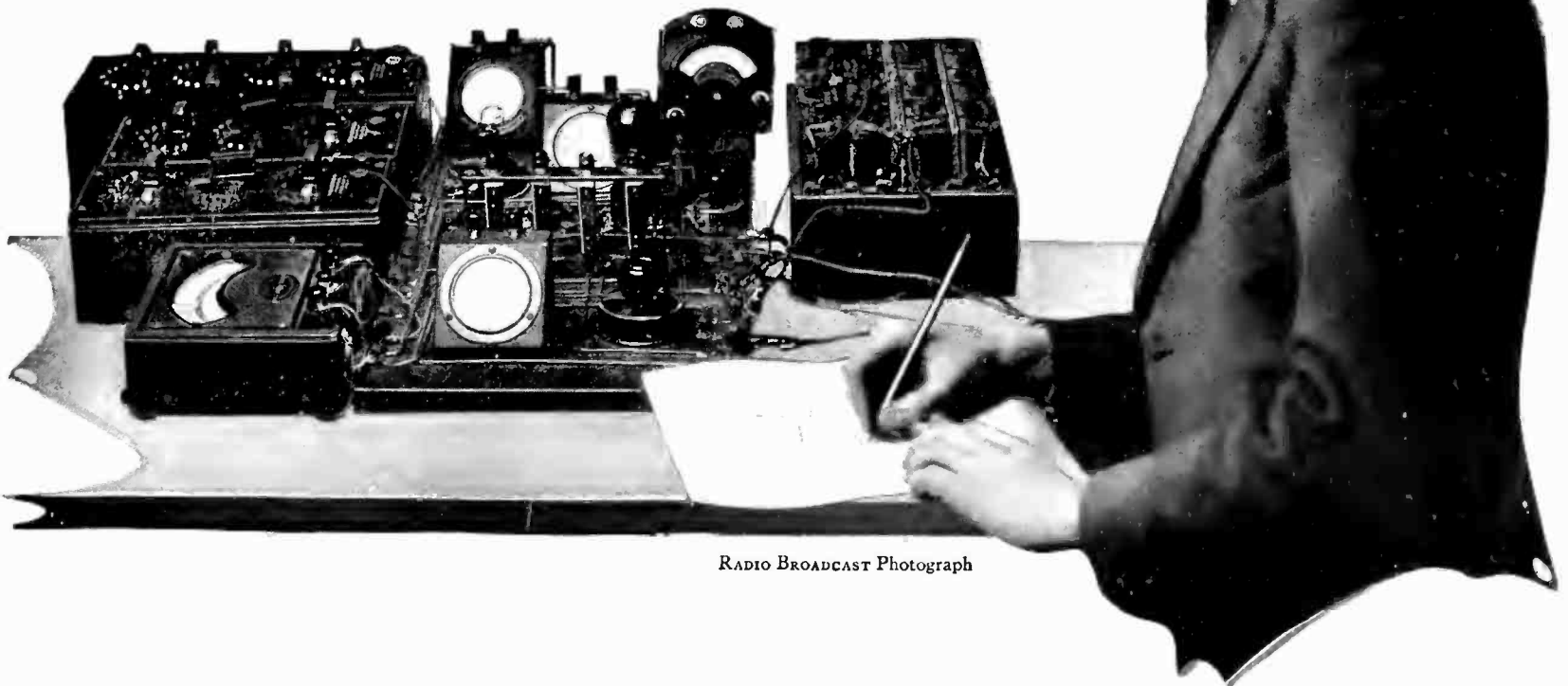

RADIO BROADCAST Photograph

sight of the fact that the ear is a deceptive measuring instrument. It hears according to a logarithmic scale, that is, a signal with one hundred times the power of another signal will sound only twice as loud. For that reason, the difference between a 3:1 and a 4:1 transformer in an audio amplifier is scarcely noticeable. For example, the parallel tube amplifier compared to a single tube has 1.4 times the voltage amplification and twice the power output. This difference in logarithmic "transmission" units is only three units, and it takes a trained ear to detect such small differences.

For the same reason the fact that it is not possible to "match" a loud speaker to a tube at every frequency in the useful audio range should not worry a listener too much. Any one can tell the difference between a terrible loud speaker of ante-quality days and a fine one, or with the latter the difference between running it from a 199 tube and a 112, but in general any one should be satisfied with an amplifier that uses two of the modern high grade transformers, or a resistance or impedance amplifier properly constructed and operated, with a semi-power tube in the last stage and proper B and C batteries, especially if this amplifier delivers its output to a cone type speaker that is properly made.

At this point it seems fair to point out that a speaker that merely uses a paper cone is not necessarily better than a speaker of the horn type. Much depends upon the element that drives the cone and upon the methods of construction and mounting. The only test is to listen to it compared with other speakers in which the listener is interested. Comparisons should be made both as regards fidelity (quality) and efficiency (volume with a given input). Some cones are remarkably inefficient.

HOW NOT TO CONTROL VOLUME

IT IS well too, to point out the fallacy of controlling volume by regulating the filament voltage of audio frequency amplifiers. As soon as the voltage is reduced to the point where volume is reduced, the impedance of the tube is increased, resulting in the dropping out of the low notes. If the low notes seem to have been lost, or the amplifier has a tendency to howl, charge the battery. Much distortion can be laid to a detector or amplifier filament that is run at too low a voltage. Reduced emission due to too low filament voltage results in distortion due to the inability of the plate current to follow the peak input voltages. Low B battery voltages also result in poor quality due to increased plate impedances.

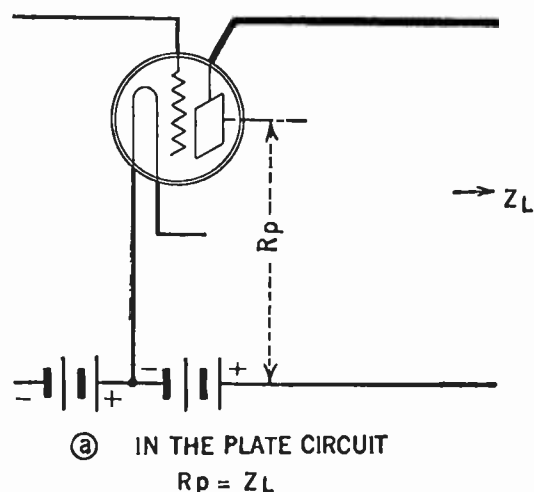

201-A		199	
PLATE CURRENT @ 90 Ep, 0 Eg		PLATE CURRENT @ 90 Ep, 0 Eg	
Before	After	Before	After
3.0	3.0	0.0	4.0
.5	5.0	0.0	3.0
1.0	9.0	0.3	4.0
0.0	6.5	0.2	3.4
0.0	2.0	0.4	4.0
0.0	1.0	2.0	3.8
3.5	2.0	0.2	0.9
4.0	1.3	0.1	3.2
2.0	5.8	1.0	4.2
0.5	5.0	0.5	3.0
0.4	4.8	2.4	4.0
3.9	4.8	2.4	dead
1.8	5.0	2.2	4.2
3.2	5.6		
4.9	4.7		
3.6	4.8		
2.0	5.5		
2.6	5.0		
1.0	4.4		
2.8	dead		
1.2	6.0		
0.2	dead		
1.5	5.0		
1.6	7.0		

Number of 201-A tubes	24
" 199	13
Average increase in 201-A Ip	2.4 mils.
" 199 Ip	2.2 "
Average Ip of new 201-A	6.5 "
" 199	3.5 "

Some question has been raised regarding the proper method of coupling a good loud speaker to a high quality amplifier. In Fig. 7 are shown three common systems. In any case there are two primary considerations; will the d.c. plate current of the power tube harm the loud speaker, and will the impedance of the speaker match the tube? If one uses a power amplifier as was described by James Millen in the November RADIO BROADCAST in which the plate current is of the order of 30 milliamperes, the speaker should certainly be protected.

When the loud speaker is directly in the plate circuit it looks directly into the tube impedance. This is also the case with the condenser-choke

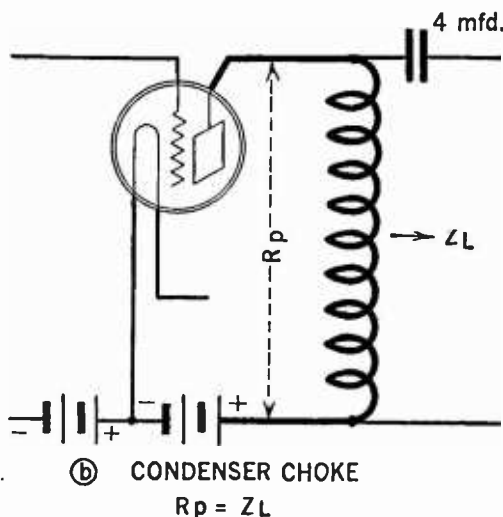

FIG. 7

Methods of coupling a loud speaker to a power tube. When the impedances of speaker and tube are approximately the same, either "a," or "b" may be used. When they differ, an adjusting coil should be used—commonly called an output transformer. Its turn ratio as controlled by the impedances is given by the above formula

system since the choke and condenser are so large that they have no effect upon the audio frequency output, and in both of these cases the loud speaker and tube impedances should be of the same order. In case of the output transformer, the impedances can be anything, pro-

vided the primary of the transformer matches the tube and the secondary matches the speaker. Either the condenser-choke or the output transformer will keep the direct plate current out of the speaker.

THE MEANING OF THE "SQUARE LAW" DETECTOR

IT HAS been stated that distortion in radio reception arises from the use of detectors which function according to a "square law." In other words the output current varies as the square of the input voltage. This statement may be discussed in the following manner. If the detector acted according to a linear law, i. e., output current directly proportional to input voltage, there would be no detection—only amplification. In other words our detector, which is inherently a distortion device, would amplify.

At the transmitting station a modulator is used which functions according to a complicated law, approximating a square law. This is distortion at the very start of the whole radio circuit. At the receiving station a detector is employed as a "demodulator" which brings the distorted signals back to their original form. The detector is

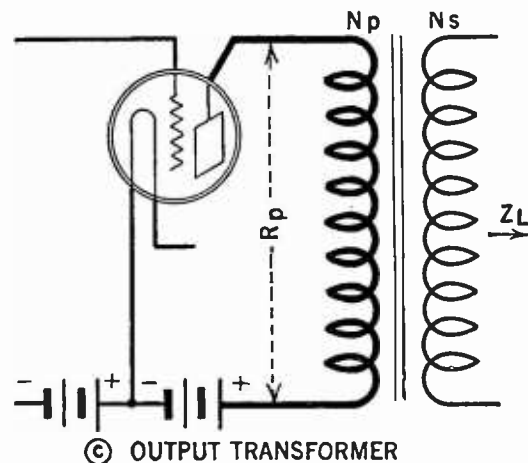

© OUTPUT TRANSFORMER

$$\frac{N_p}{N_s} = \sqrt{\frac{R_p}{Z_L}}$$

Rp = Plate Impedance
ZL = Loud Speaker Impedance
Rp not equal to ZL

the reverse of the modulator and may be said to introduce approximately complementary distortion. Neither would work at all unless there were a bend in the characteristic curve. As a matter of fact a crystal detector does not follow a linear law but approximates a square law. Fig. 8 shows the curve of a crystal detector and its similarity to a three-element tube curve is apparent at once. Detection takes place on the bend of the curve. If an amplifier is operated on the bend of its characteristic it acts as a detector (distorts). Recent research on detectors by F. M. Colebrook in England, shows that tube detectors are more efficient at low frequencies than at high, say 100 cycles compared with 5000, and some distortion results. The extent of this distortion may be considerable.

USE OF "HIGH-MU" TUBES

QUESTIONS are frequently asked regarding the use of tubes with a high amplification constant. These tubes are primarily designed for use in resistance and impedance amplifiers. As a matter of fact a low mu tube will not "load up" a power amplifier unless coupled to it by means of a transformer. For example, the average amplifier to deliver .06 watts power requires

at least 9 volts variation on its grid. A tube with a mu of 8 coupled by means of resistance or impedance to the amplifier cannot produce a variation of voltage greater than 8 volts and probably not over 6, so that the amplifier will not deliver its rated quota of power. On the other hand a tube with a mu of 20, or a tube with a mu of 5 coupled by means of a 2:1 transformer, can easily produce the desired change in input voltage. High mu tubes can be used as detectors and hence are useful in vacuum tube voltmeters. Their use in resistance and impedance amplifiers makes the latter practical without increasing the B battery voltage beyond reason. It must be said here that the mu of such tubes is not the only important constant. The plate impedance must be considered and, like all other tubes, the usefulness of high-mu tubes increases as their impedance decreases.

REJUVENATING TUBES

THERE are many rejuvenating devices on the market at the present time. These cannot be used with any tubes except those which have thoriated filaments. They will be of no service with the old tungsten filament 201 or 200 type tubes, or with the new UX-112, or with Western Electric tubes. On the other hand they are very efficient when worked with thoriated filaments of the 199, 201-A, 120, 210 and certain 112 type tubes. The data in Table 3 gives the result of recent rejuvenating in the Laboratory showing the plate current in milliamperes at 90 volts on the plate and zero grid



FIG. 9

A few of the tube rejuvenators now on the market. Those illustrated here are the Jefferson, the Sterling, the Burton and Rogers and the "Socket" tube reviver. The device with two meters is to measure the plate current of a tube so that one can tell if the reviving process had any effect. Another rejuvenator which is not shown here but which has been used in the Laboratory is the Hemco

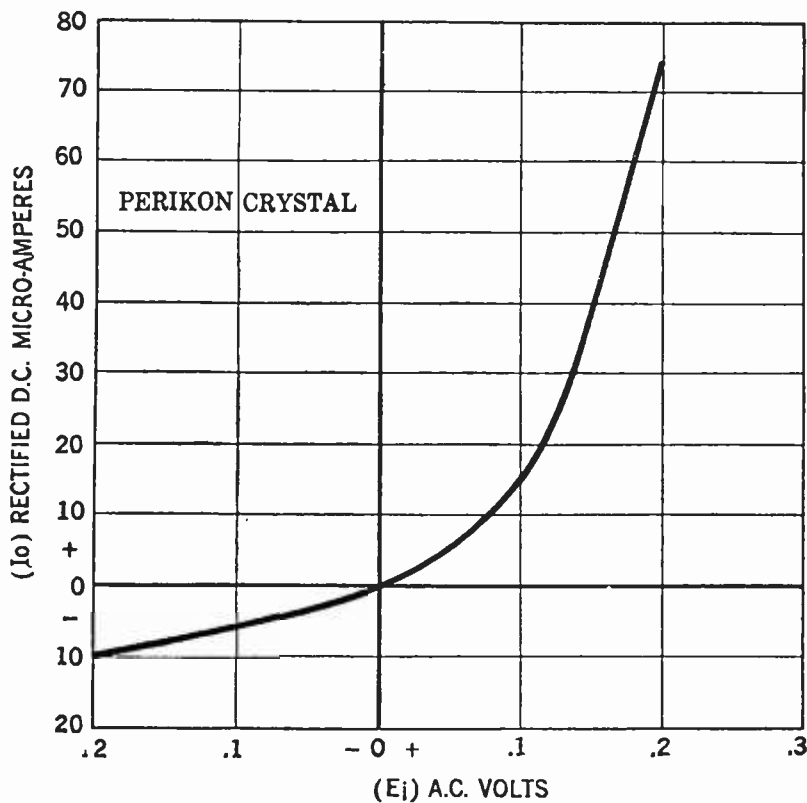

FIG. 8

This curve shows that the crystal detector follows a complicated curve—not a straight line—differing but little from the grid voltage-plate current or grid voltage-grid current curve of a vacuum tube. The apparent increase in quality when using a crystal detector is probably due to lack of tube noise introduced by a grid condenser-grid leak detector

before and after the process. Fig. 9 shows several tube flashers that have been tested in the Laboratory. It will be seen that some tubes went dead in the flashing process while many gave increased plate current. At any rate the user has everything to gain, nothing to lose in the process. If his vacuum tube is no good before, it cannot be worse after the rejuvenating

process. Tubes can often be revived by burning the filament for several hours without the B battery.

WHAT "IMPEDANCE" MEANS

FOR the many readers to whom the term "impedance" is something of a mystery, the following explanation may be of aid—it is not intended for engineers. In direct current circuits—vacuum tube filament circuits, for example—the resistance controls the flow of current. In alternating current circuits, for example, the plate circuit of a tube in which there is an inductance coil, an additional factor comes into play. There is resistance and inductance, both of which tend to limit the flow of current. These two factors may be combined into a single term called impedance. If there is no inductance or capacity in an a.c. circuit, the impedance is the same as the resistance; if these other factors appear in the circuit, the resistance must be combined with them to calculate the impedance.

The impedance between the filament and plate of a vacuum tube is practically pure resistance, and its d.c. plate circuit resistance may be figured knowing the plate voltage and the plate current. As an example: If the plate voltage is 90 and the plate current 6 milliamperes, the d.c. resistance is 15,000 ohms. The impedance of the tube, however, as measured on an alternating current meter differs from this value, and since tubes are used in alternating current circuits it is not correct to use the above figure when calculating the amplification, etc., as has been done in this article.

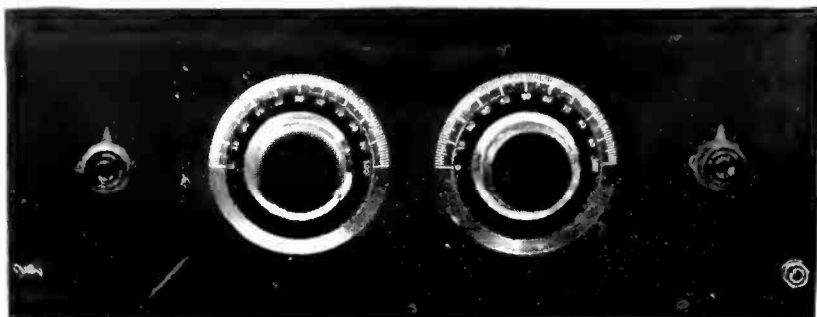

RADIO BROADCAST Photograph

WHERE TWO CONDENSERS ARE EMPLOYED

To tune the RADIO BROADCAST "Aristocrat," a very symmetrical layout may be had. In the receiver illustrated here, Silver straight line frequency condensers have been used. The panel size is 7 x 18 inches

The "ARISTOCRAT"

Some Variations of this Popular Quality Circuit which Originally Was Described in the November, 1925, "Radio Broadcast" —the Application of Dual-Control Tuning

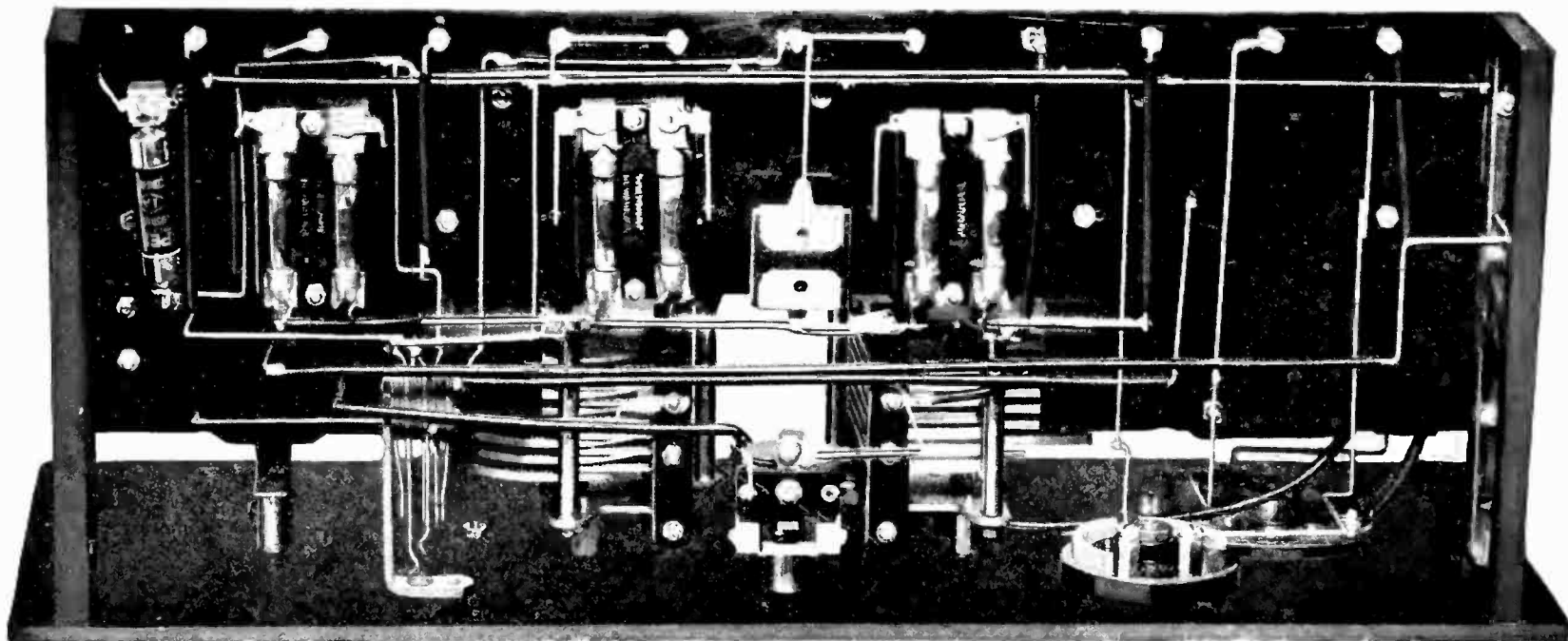

RADIO BROADCAST Photograph

UNDER THE SUB-BASE

Showing most of the wiring and the method of mounting of Daven resisto-couplers and Amperite filament control. Moulded hard rubber brackets have been used to hold the panel and sub-panel together, and to act as rests for the completed receiver. This receiver and other models of the "Aristocrat" were designed by Arthur Lynch

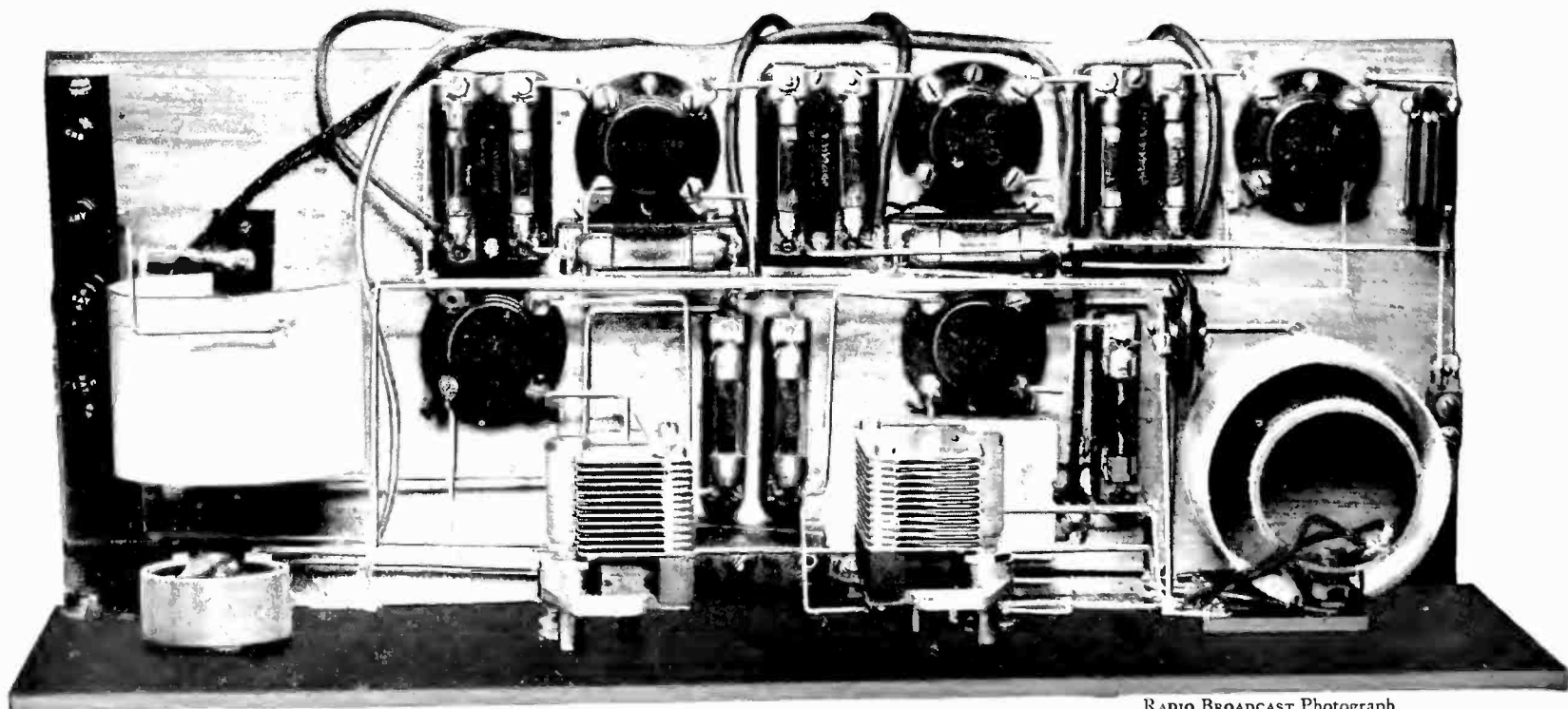

RADIO BROADCAST Photograph

A TOP VIEW OF THE TWO-CONTROL "ARISTOCRAT"

The layout, on an ordinary baseboard, and simplicity of wiring, make for compactness without stray capacities or the necessity of shielding. In this receiver the single General Radio 20-ohm rheostat is in the filament circuit of the r.f. tube. Daven $\frac{1}{4}$ -ampere ballasts are used in all the other filament circuits save the extreme right, where the size of ballast depends on the output tube used. The plate voltage arrangement found best with this receiver was 90 on the r.f. and a 4.5 negative bias; 45 on the detector, and 135 on all three audio stages with 4.5 bias on the first two and between 9 and 11 volts on the last. The parts employed in this model are Formica panel, Kurz-Kasch dials, Silver SLF condensers and Knockout coils, Daven ballasts, fixed resistors, and resisto-couplers, Silver ux tube sockets, Tobe-Deutschmann bypass condenser X-L neutralizing condenser, Eby binding posts, Sangamo condensers, Carter switch, and Pacent jacks

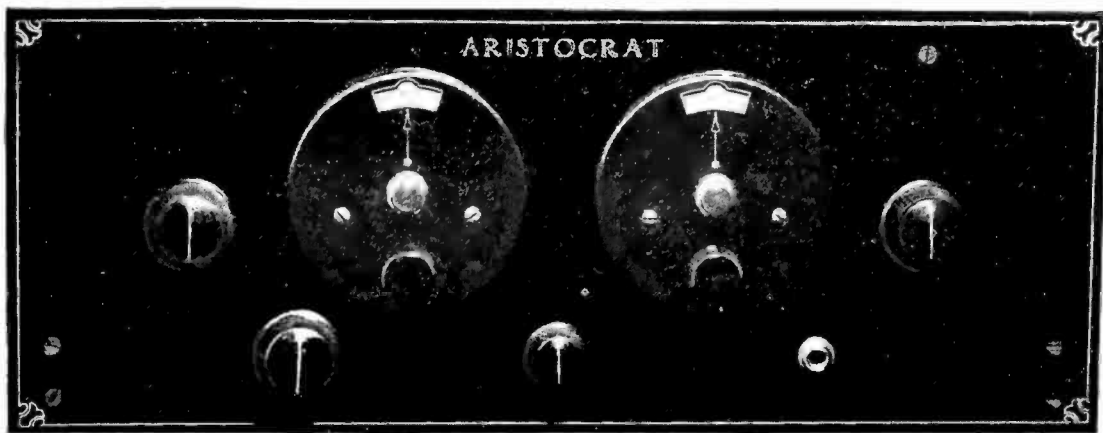

ARISTOCRAT

RADIO BROADCAST Photograph

ANOTHER TWIN-CONTROL
"ARISTOCRAT"

In this model the layout is altered somewhat by the use of a sub-base. This receiver is identical to the original RADIO BROADCAST "Aristocrat" for which working drawings in blueprint form are available. Amsco vernier dials, whether black, silver, or gold, show up nicely on the Insuline panel. The other knobs, left to right, are Carter antenna switch, Royalty r.f. rheostat, Hammarlund neutralizing condenser, and Eastern tickler control

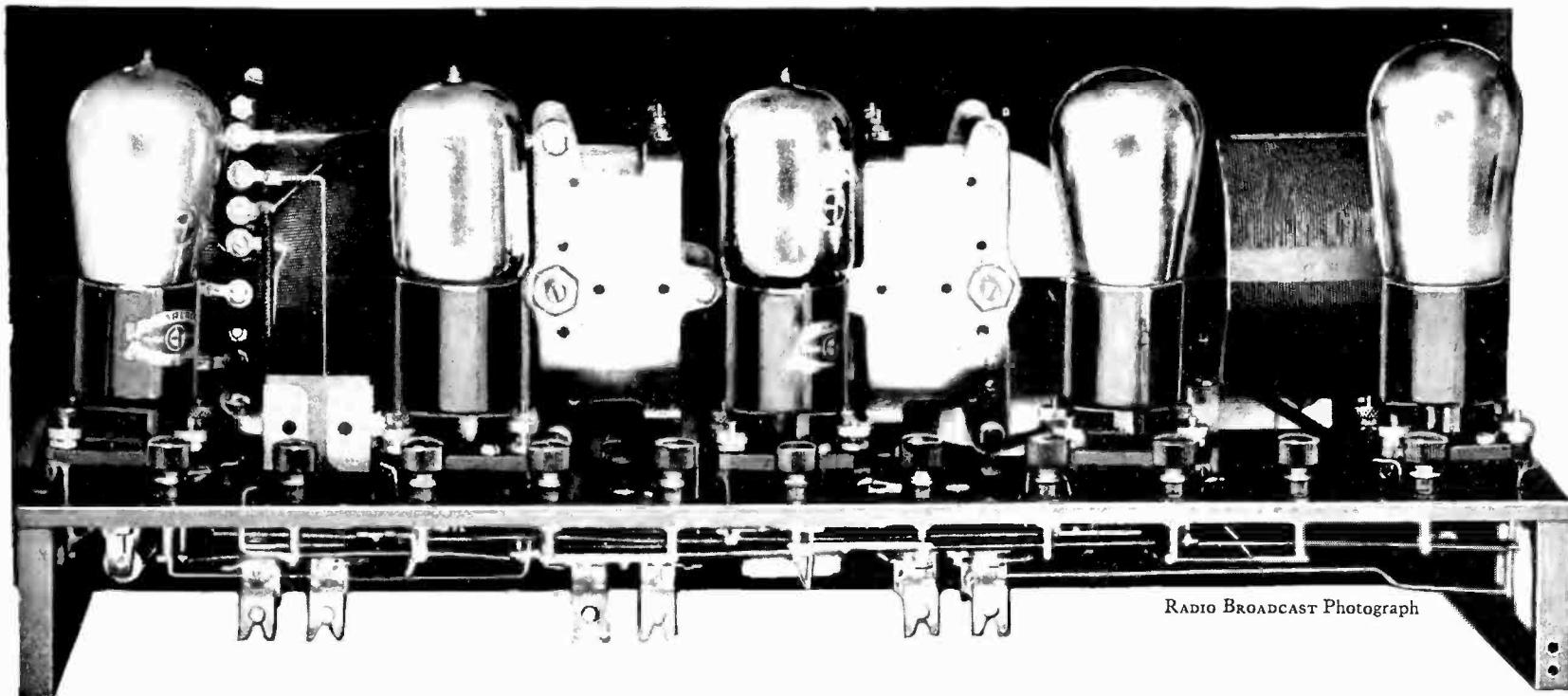

RADIO BROADCAST Photograph

A REAR VIEW OF THE SUB-BASE RECEIVER

Furnishing a general idea of the complete assembly. The tubes, left to right, are Cleartron CT-201-A Detector; two Cleartron Hi-Constron CT-101-A high-mu amplifier tubes; ux-112 Radiotron power tube; and ux-201-A radio-frequency amplifier. In this layout the resisto-couplers are hung below the sub-base rather than mounted on it as shown in some of the original models

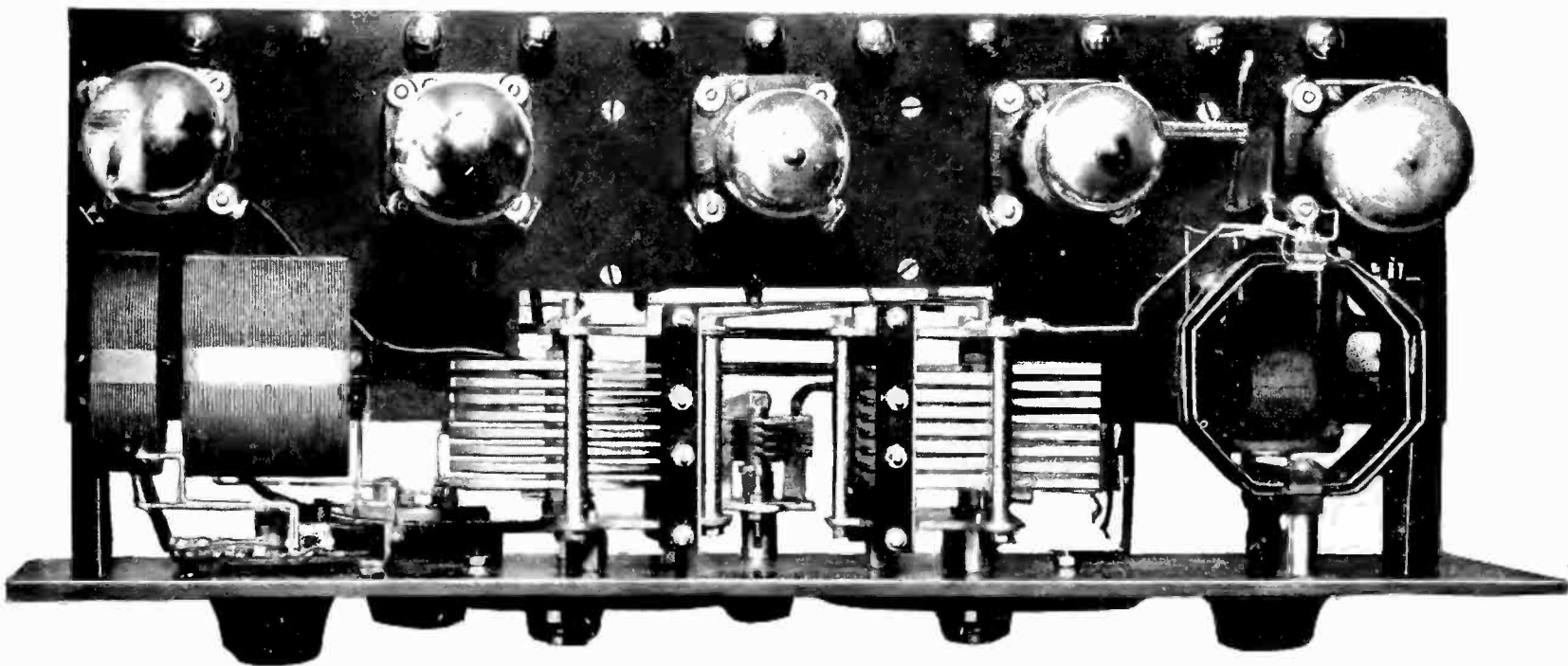

RADIO BROADCAST Photograph

A BEHIND-THE-PANEL VIEW

Of the set shown above, the layout above the sub-base, and the freedom from visible wiring this form of construction makes possible, is distinctly shown. The use of the Cardwell SLF condensers and Eastern Coils, resulted in both dials reading the same for any given station throughout the broadcast range. Benjamin cushioned sockets for ux-base tubes were found very satisfactory. In this receiver Dubilier fixed condensers were used

Radio Sets for Light Keepers

SECRETARY of Commerce, Herbert Hoover's letter, reproduced on this page, is quite self-explanatory. There are without question, many radio receivers in working condition which are idle, and which would be of inestimable service to the lighthouse keepers at their lonely posts. We believe that readers of RADIO BROADCAST, if they know the service they can render by the donation of good receiving sets, will not be slow in rendering the aid they can so easily offer.

Readers of this magazine who have multi-tube sets which they are willing to donate to the lighthouse keepers, should pack them carefully and ship them to the Commissioner of Lighthouses, Washington, D. C., together with an explanatory letter to that official, who will see that the set is delivered to a keeper who could best use it. It is well to keep in mind the fact that the set should be capable of long distance reception,

for as every marine traveler knows, lighthouses are necessarily located at lonely and out-of-the-way spots, often far from any broadcasting station.

There are few more worthy causes than this, which RADIO BROADCAST is glad to present, and we are sure that our readers, who best know the pleasure that a broadcast receiver can bring, will not be slow in showing their generosity.

DEPARTMENT OF COMMERCE
OFFICE OF THE SECRETARY
WASHINGTON

January 29, 1926.

Mr. Willis K. Wing,
Associate Editor,
Radio Broadcast,
Garden City, N. Y.

Dear Mr. Wing:

It is certainly very kind indeed of you to offer your help in securing radio sets for the use of lighthouse keepers.

I am sure that it is not generally realized that approximately 1400 men are employed at 700 light stations and depots to safeguard navigation. The stations extend from Unimak Pass at the entrance to Bering Sea to the extremities of United States territory in Maine, Florida, Porto Rico, and the Hawaiian Islands. Many of these stations can be reached only when the weather is favorable. At Tillamook Rock, off the Oregon coast near the mouth of the Columbia River, there have been intervals when the lighthouse tender has been unable to reach the station for seven weeks at a stretch. At Cape Sarichef, Alaska, a few years ago, the keepers were unable to receive any mail during a period of ten months.

At the best many of these men are forced to lead a dreary, lonely existence shut-off from practically all of the ordinary amusements of the average citizen. They are faithful servants of the American Government employed in most necessary work wherein inattention to duty might end in serious disaster. Their pay is very small, averaging a little more than \$100 a month. With this many of them must maintain families. Some of the better equipped keepers have put together homemade radio sets to help relieve the monotony of passing days, but others who possess the mechanical knowledge to make their own cannot afford to buy the materials. Then too, the patched together home product is not usually conducive of good results in the out of the way places where lighthouses are found.

A recent donation of twenty-five tube sets by a public spirited woman has led me to believe that perhaps there are other liberal citizens who might be in a position to help a good cause along. The Commissioner of Lighthouses will be very glad to see that any sets donated are immediately placed at the stations where they are in the greatest need, and the keeper of the lighthouse to which each set is sent will write a letter acknowledging its receipt, and this letter will be forwarded to the donor.

Yours faithfully,

HH-M.



LEAVING A LIGHTHOUSE

Heavy weather often makes relief for the keeper uncertain and infrequent. There are many lonely marine outposts such as this where radio would bring much comfort and pleasure. The gift of a sensitive radio receiver would be a welcome one indeed



Conducted by — John Wallace

Radio and the Taste of the Nation

Comes now radio, stalking in like the proverbial last straw, to put on the complete kibosh the few straggling remnants of good taste that have managed to linger on in this Land of the Cretin and Home of the Depraved.

—words taken from the utterances of any one of several of God's private secretaries, expressed editorially in any one of several pastel colored periodicals on the occasion of that sage's discovery of the existence of radio.

THE text of most of this pious pessimism is that the taste of the American nation is lower than that of any other similar body of men on this sphere, and that, among the agents engaged in undermining it, radio promises to be one of the most effective.

Nor is the custom of unfavorably comparing the *kultur* of America to that of any other nation confined to the so-called intelligentsia. The habit is so widespread as to constitute almost a Dulcism. That America, in respect to its appreciation of the "higher things" is an infant among nations is, in fact, one of the cardinal planks in the American credo. It finds place in our code of national convictions along side of such sacred tenets as "We must avoid all entangling alliances," "The French do not know how to make coffee," "Success is always the reward of effort," "Newspaper men are conscienceless scoundrels," "Abraham Lincoln was the incarnation of all virtue," and "The Japs are a dangerous little people."

It seems unfathomable on the face of it that this nation of 100 per cent. boosters should be so clamorously insistent upon deprecating the aesthetic consciousness of its citizenry. But it needs no Freud or Jung to explain this seeming paradox.

Try saying aloud; "Why, my dear, you know our people have simply no taste at all. Why any French workman, or Italian ditch digger, or German peasant, or heathen Chinese, has ten times as much appreciation of good art and good music as the average American. *They* seem to take naturally to the bettah things."

There now, doesn't that give you a delightful glow; doesn't that tickle your superiority complex; doesn't that neatly, though not too obviously, set you aside as one of the chosen few who appreciate the bettah things; doesn't it give you a cosmopolitan and world traveled air? That at any rate is our explanation of the national delusion that the taste of the average American is inferior to the taste of the average Anything-else.

At risk of appearing to make ourself out to be very widely traveled, we assert that this theory is pure and undiluted bunk. The "man in the street" in Naples or Shanghai or Buenos Aires or Berlin or Paris is every bit as much of a dumb-bell as "the man in the street" in Janesville, Wisconsin. In fact if any difference in their stupidity exists we should be inclined to give the American an edge more of appreciation.

Paris—the cultural capital of the world! There is more inferior and ridiculous statuary lining the boulevards of Paris for the delectation of the Parisian "man in the street" than could ever be found in a thousand miles of our Main Streets.

"Ah, but the Italians," the self abasing Amer-

icano cries out, "see how they appreciate music. It is born in them. It is part of them!" We are urged to ascend to the garlic saturated heights of the galleries of our local opera houses, and find there the Latins, the true appreciators of operatic music. And we find them there. But when? When the silly melodramas of Guiseppe Verdi or Donezetti are being yawped forth from the stage beneath.

The tired business man of Milan goes out in the evening to have his spirit refreshed by some cafe or street corner band doling out dolorous and sentimental tunes garnered from the jam pots of the "classics." The tired business man in Pittsburgh takes his musical stimulus in the form of a program of jazz. And we are inclined to attribute a superior discrimination to the Pittsburgher. His taste savours less of the maudlin and more of the virile and lusty.

We are told that the European instinctively knows a good picture when he sees it, and at the same time we find on the walls of his home, even as we do in Texas, color prints of "Aurora" or of one of Carlo Dolci's sickly saints.

But it is the man in the streets of ancient Athens who is most frequently held up to our gaze as the supreme example of the artistic cultivation of the masses. And without pausing to examine any of the numerous reference books on the golden age of Greece, we venture to guess that though civic art at that time reached a perfection never to be approached it was no doing of *boi polloi*. The politicians of the time happened to be gentlemen of artistic leanings, so they put up public buildings that seemed to them good—and they were good. The bourgeois Athenian accepted these exquisite edifices because they were there, no whit realizing that they were supreme examples of architecture. Doubtless he admired the Parthenon, but not so much for its purity of form as for the gaudy colors with which it was then daubed.

In brief, we hold that there is no evidence to support the contention that the American taste is on a lower level than that of other countries (speaking always of the "average man's" taste.)



CECILIA HANSEN AND DR. WALTER DAMROSCH

Two artists recently heard on Sunday evening Atwater-Kent radio hours. Miss Hansen presented a violin program splendidly played, although the program numbers were hackneyed. Doctor Damrosch led his New York Symphony orchestra in a special program for the International Tests, which was unfortunately cut short on some of the stations of the "chain" by an sos call in mid-Atlantic

But let not our impassioned defense of the aesthetic discrimination of our fellow citizen lead you to suspect that we consider his taste worth a row of pins. Our argument is entirely relative; we simply believe he is no worse off than any foreigner of the same intellectual strata.

For the taste of the American nation is incontrovertibly low. It could adorn itself with a parasol and still walk under a dachshund to the small discomfiture of the beast. Our newsstands are loaded with printed rubbish, our theaters are decadent and demented, our music is punk in proportion to its popularity, and our movies . . . ah, there is exhibit A . . . fifteen years of almost unrelieved drivel.

However picture us not as sitting here gnashing our hair or tearing our teeth over the fact. On the contrary it disturbs us not a bit. If the magazines on the stands and the movies at the theaters actually represent what the great mass of the people want, so be it, and well and good. One book read for enjoyment is worth three books read for uplift.

Yet our peace of mind is occasionally disturbed by the suspicion that perhaps this nefarious fare doesn't exactly reflect the desires of the masses. Perhaps they, or some of them, could be getting a bit more entertainment out of something a little better. If so it would seem an economic waste for them to be content with inferior substitution. Which brings us back to the subject on hand—the influence of radio on the taste of the nation.

Radio, we conclude after some pondering, will have no vast and far reaching effect on the nation's taste. But far from lowering it, as has been prognosticated by the pious pessimists, it will, if it reacts upon it at all, more likely improve it. And for several good reasons.

Taste in art, like taste in anything else, is the index of our ability to enjoy the more highly civilized forms of entertainment or stimuli. Our friend Mr. Mulligan gets an immense kick out of a prize fight. Our friend Mr. Van Peyster gets an immense kick out of a George Bellow's picture of a prize fight. And though we are inclined to suspect that Mr. Van Peyster's enjoyment is a bit more acute, there is no way to prove it. More power to both of them in their varied pursuits!

But perhaps Mr. Mulligan might likewise get a kick out of Bellow's prize fight paintings if he were ever exposed to one. And then what a desirable state of affairs would have been reached: Mr. Mulligan could spend his days enjoying fisticuffs and his evenings enjoying pictures of fisticuffs and thus be assured of sixteen hours a day of happiness.

But all fooling aside, it is in just this way that radio is likely to prove of service. It is exposing the American nation nightly to better things in music than it has been accustomed to hear. Among the millions thus exposed to good music are certainly some few who were not vaccinated against it at birth, and they will, as they have been doing, "catch" it.

To say that good music is not heard by radio—as has been said by some critics—is simply to confess an utter ignorance of what is being broadcast. For good music is being broadcast, indifferently performed in many instances no doubt, but nevertheless good music.

The man in the street, like the man in the jungle, has a tremendous fear of the Unknown. Offer him an artichoke and he will bristle at the brow and foam at the mouth. Conduct a nationwide advertising campaign with the slogan,

ARTICHOKES FOR HEARTY FOLKS
and he will deposit his pennies in the Piggly Wiggly for dozens of them.

Such names as Beethoven, or Moussorgski or Debussy formerly filled our lowbrow with wide eyed fright, gave him the blind staggers, lashed him into a frenzy of terror. And now he has found that his fears were groundless; that even the baby can listen to these names as they come in via the family receiving set, perhaps even to the tunes themselves, without dying of some mysterious blight.

His curiosity is piqued. Who were these men? Did they ever run for alderman? Could they stand a show against Irving Berlin? And lo and behold! if he has not been too thoroughly inoculated against them by heredity, he finds himself actually enjoying them. *Voila!* The deed is done! Our lowbrow has found a new source of amusement. He has not been "uplifted." He has not been "cultivated." He has simply stumbled upon something as effective in another way as a bag of peanuts, or a game of pinochle, in assuaging the griefs of this world.

And radio will be a tremendous boon to those who imagine they are already possessed of a polite and enviable taste for music. More often than not, an imagined appreciation of music is at bottom simply an appreciation of all the fripperies and gew-gaws that deck it. The cut of the soprano's gown, the twirl of the violinist's moustache, the presence of the "400", and so forth, are of greater interest to a large proportion of concert goers than the music itself.

Attention to the concert is frittered away through the eye. What with attending to the gymnastics of the conductor, the foot work of the tympanist, and the amazing alertness of the piccolo player, small part of the cerebral hemispheres is available for following the music.

The remedy, in the case of concert halls, is to darken the auditorium. But this, few impresarios have the temerity to attempt. Their business is to fill the seats, and plenty of light wherewith to peruse the programs is the demand of their clientele. Individuals feeling more rabid on the subject than we have gone so far as to protest that "no executive artist should ever be visible to the audience." We vaguely recollect that a concert hall in London made the experiment one time of screening the stage.

Radio is, of course, the complete answer to this problem. The listener, of necessity, does naught but listen. So we can not help but believe that in the long run this training in listening exclusively will have a demonstrable effect on the mass of musically inclined people.

The WGBS Prize Play

COMES to our desk a copy of *Sue 'Em*, the radio play which won first prize in the contest recently conducted by WGBS and which was acted over the air for the first time some months ago by members of the Provincetown players.

The title page makes known that the author is Nancy Bancroft Brosius, that it is published by Brentano's, and is the first radio play printed in America.

Unfortunately (or fortunately?) we didn't hear the play presented, but we have just read it through two times—the second trip being attributable only to our burning desire to discover, if possible, why it won the prize. That discovery we have yet to make. We dismiss the most ready answer—that it was the best one submitted—as a rather too unkind reflection on the other contestants.

The characters are four: Mrs. Dorn, "middle aged and of settled disposition," her henpecked husband, the "flapper" daughter Effie, and the son Bill. The family is sitting around waiting

to go to the movies when pa finally puts in a belated appearance. Ma gives pa a good bawling out and is not at all appeased by his explanation that he was delayed by a cop who wanted to arrest him for jay walking. Pa, it seems, tried to walk into a truck which brushed by his leg.

But suddenly it is suggested to ma that the truck drivers might be sued! Then pa is quickly shifted from the rôle of doddering jay walker to that of martyr.

In a few moments he is quite dead and buried, the suit is set at \$2000 and the receipts budgeted out and all but spent. Pa is now a wounded hero and the truck driver indicted as a criminal menace to the safety of honest citizens. The dialogue working up to this right-about-face on the part of Mrs. Dorn is well written and humorous in a broad fashion.

Then the twist is introduced: Bill, the son, enters the room, disheveled of appearance and terror stricken of mien. He announces that he has been out driving in the family Ford; that a man walked right in front of his car, that he struck him, and probably killed him! The consternation of the family is augmented when Bill says they will probably be sued by the man's widow and four orphans. Ma then executes another right-about-face and discourses at length about the carelessness of pedestrians and the injustice of the widow's presuming to sue her innocent little Bill.

An amusing situation, we grant, but how was it arrived at: Bill, after witnessing his family's absurd shift of ground, breaks into merry laughter and announces that it's all a joke, he never hit anyone. This announcement, which is supposed to constitute a climax, is, as a matter of fact, a silly let down, and takes away whatever merit the play hitherto had. It is irritating as it discloses the author as trying to put one over on the audience. In other words the situation is not *developed* but *forced*. It is like killing off the husband in the third act to solve the unsolvable triangle problem.

A Plea for More Novelties on First Class Programs

CECILIA HANSEN, violinist, sharing a program with Florence Austral, soprano, was heard in the third of this year's Atwater Kent concerts. Miss Hansen's contribution to the concert was as follows:

- a. *Poem* Fibich
b. *Valse Bluette*. Drigo-Auer

- a. *Meditation, "Thais"* Massenet
b. *Caprice Viennois* Kriesler
c. *Serenade* Arensky

- a. *Humoresque* Dvorak
b. *Ave Maria* Schubert-Wilhelmj

Now suppose you, gentle reader (if such there be!), help us finish this article. Turn to your nearest neighbor and ask him to "name five solos for the violin that have been massacred more often than any others by radio performers." Done? Well now we'll just bet you our Hyper-whichomodyne against your thirteenth tube that your five numbers are included in the above program.

Who was responsible for Miss Hansen's dishing out such an assortment of trite tunes we don't know, but we are willing to be quoted as saying it was a stupid move. Cecilia Hansen is in the first rank of her profession. Her skill as a violinist is not even exceeded by her good looks (a considerable tribute that). So why,



WILLIAM DIEFENDORF

A well known performer on the musical saw who was heard during the recent International Tests from WHAZ, at Troy

oh why, couldn't we have heard something a little less threadbare from her?

Dvorak's *Humoresque*, Massenet's *Meditation*, and the rest of the above pieces have become hackneyed for the very good reason that they are beautiful tunes. So charming in themselves that they defy the efforts of the vilest cat gut scratcher to completely disguise their beauty. Ever assured of an enthusiastic reception, they have become fixtures on the repertoires of every fourth rate vaudeville or radio fiddler.

But hackneyed they nevertheless are. Of course any alert musical theorist can furnish proof beyond contradiction that a great composition can never get old, no matter how often it is heard. But, aside from theory, the facts of the case are we do get tired of hearing the same thing over and over again.

And for this reason we regretted that an artist of Miss Hansen's ability allowed these musical banalities not merely to encroach on, but to completely monopolize her program. On the strength of her skillful interpretation she could have made just as enjoyable a program of less familiar, though equally worthy, selections—and thus enriched our musical acquaintanceship, leaving these sure-fire-hits to her weaker sisters.

We ramble on at such length not because this concert alone would seem to warrant it, but because it is typical of many other offenses in kind. The John McCormack concert, for instance, was made up largely of the ditties that you, as do we, sing so effectively in the bath tub. And we are not entirely convinced that John sang them a bit better than we have ourselves under the stimulus of fragrant soap suds. Doubtless there are some more difficult tenor airs that Mr. McCormack could do more justice to than we, but they were, in the main, lopped off his program. Which seems to us somewhat of a waste—rather like using a nice shiny silver cocktail shaker to mix up the baby's barley water.

* * * * *

After writing the above the information below came to our attention. The novelty week referred to was inaugurated last January.

Banning all musical selections that

have been "played to death" on the radio, the eight directors of the concert orchestras whose programs are featured weekly by station WRC, at Washington, will for one week include in their programs only those new-old compositions which are seldom, if ever, heard on the concert stage or on the air.

Working in cooperation with Ralph Edmunds, Program Manager of station WRC, the eight directors will search their libraries for musical compositions whose melodies lie half-forgotten on their shelves, and will eliminate from their programs any numbers that they themselves have played in radio concerts in the past year or any which they may have heard played by some other orchestra. This innovation was decided upon following numerous requests from listeners for "new" music, instead of the almost continual repetition of selections which in many cases have become prevalent during the past six months.

So far, a list of more than a hundred such compositions has been compiled by Mr. Edmunds and submitted to the directors for their consideration. Included in the programs for the "music revival" week will also be a number of original compositions which are being written by the directors and members of their orchestras. A second list of more than one hundred and fifty selections has been made, all of which are placed definitely under the radio ban for the week.

Is It too Early for the Burlesque Program?

SOME time ago it occurred to us that radio had attained of sufficient age and accumulated enough foibles in the ageing for some intrepid station to undertake a burlesque program, poking fun at the broadcasting game and possibly effecting some reform through the medium of mild satire. As we rotated the idea in our mind we were struck by the limitless number of opportunities for screamingly funny burlesque that are offered. In fact we had almost reached the point of writing to some station director and imploring him to hazard such a program when we ran across the following article in the *New York Times*, whereupon we decided 'twere better not.

LONDON, Jan. 17.—Great excitement and fear were caused here and in all parts of Great Britain and Ireland last evening when radio listeners-in, by a comedy of errors, heard on the air the announcement that a revolution had broken out in London.

Among other things they were told that the National Gallery had been laid in ruins by an army of unemployed; that the Savoy Hotel had been blown sky high,



FRED SMITH

Formerly program director of WLW at Cincinnati, and lately the guiding spirit behind the splendid and entirely unique civic music programs sponsored by the Cincinnati Chamber of Commerce and broadcast through WSAI. Business men of that city have subscribed more than \$15,000 to support twenty monthly programs which have featured such artists as Fritz Reiner, and the Cincinnati Symphony Orchestra, Marguerite Lizsniewska, Mieczyslaw Munz, Francis McMillan, and Paul Althouse. Edward J. Hoff, of the Chamber of Commerce, is Chairman of the Broadcasting Committee

that the interior of the House of Commons had been bombed, and that there had been a massacre of people in St. James's Park. A realistic touch was given to the terrifying details by sounds as though of distant explosions, the tumult of terror-stricken crowds and the crash of falling buildings.

The listeners-in spread the news and soon the newspaper offices everywhere were bombarded with telephone calls from people anxious to get further details. These offices were kept busy all day today reassuring frightened inquirers, for the rumors were still circulating in country towns and villages, and the fact that bad weather delayed the arrival of the morning papers was taken by many persons as confirmation that the worst had happened.

It was learned later that Father Ronald Knox had been broadcasting from the Edinburgh wireless station a series of burlesque "news items" and it seems that many in the radio audience had failed to tune-in soon enough to hear a preliminary announcement warning that the stories should not be taken seriously.

But the British Broadcasting Company is being severely criticized for what is described as a bad joke and has found it necessary to issue an explanation to the public. It regrets that any listeners should have been "perturbed by this purely fantastic picture," but points out that preliminary warning was given that the entertainment was not to be taken seriously.

Father Knox's burlesque news bulletin was given with so many touches of humor that it seems incredible that what he said could have been taken literally, yet at least one woman fainted when she heard it.

The Listeners Speak for Themselves

THE following statistics should be of interest. They were arrived at by a canvass of 2800 radio fans scattered through 48 states. The poll was undertaken by A. Atwater Kent of Philadelphia and its result catalogued by Carl H. Butman of Washington.

Practically all listeners agreed that there are far too many small broadcasting stations operating in the lower wave band, and that there is too little high-class entertainment, although many believe that the chain broadcasters are giving excellent service.

Lack of variety in programs and poor announcing from many stations, are given as constructive



THE CAST OF THE WGBS PRIZE PLAY, "SUE 'EM"

Recently presented at the New York station. Last year, a contest was conducted by the station and the prize for the best manuscript for the group was given to Miss N. B. Brosius, of Cleveland. In the photograph, left to right: John Huston, Eugene Lincoln, Marion Berry, and Jeanie Begg. All are members of the Provincetown Players of New York

criticisms by radio denizens of over five hundred cities and towns. "No, there is not too much classical music," 2400 reports out of 2600 state. On the other hand, there is too much jazz, according to 1420 replies out of a total of 2534 answers. Short talks and timely speeches also appear to hold fan interest, the survey shows.

Interference from various sources is noted by more than half the correspondents; only about nine per cent. of the writers claim they have no interference. Static is blamed by more than seventy per cent. of those having reception difficulties, and seventy-five per cent. of them admit that their local or near-by stations come in the best. This is believed partly due to the static handicap. Code reception still causes some interference; about a third of the fans reporting interference, say this form bothers them.

A large number insist most of the interference is due chiefly to the fact that so many stations are crowded into the wavelengths between 300 and 200 meters. A Pennsylvania listener wished three-fourths of them would sign off for good. Some say they never try to tune-in below the wavelength of KDKA. The use of a selective set and careful tuning seems to bring in lots of little fellows pretty well, and some of them offer unique programs. This fact is pointed out by another fan, who asserts he likes some of the smaller, independent stations better than the high-powered broadcasters due to their individuality and unusual features.

One correspondent, an old time listener from Cleveland, states boldly that, although some of

the larger stations which frequently hook up on national programs with WEAJ or WJZ are fine, he believes ninety per cent. of all the programs are not worth while. The ideal conditions will only be realized, he declares, when there is but one local in a city or town, and one or two good continental chains. More broadcasting of international events, conventions and really good speakers will make for greater understanding and contentment in radio land, he adds. Many of the smaller stations, he points out, put on artists from cheap vaudeville shows, whose acts and lines of patter are often offensive and sometimes obscene. His statement that the programs handled by linked stations are usually good, is borne out by approximately eighty-five per cent. of the replies filed, which endorse this type of entertainment.

A pertinent suggestion is offered by a fan who says he can't see why these chain hook-ups always work one way, that is out of New York; He would like something from Detroit, Chicago, Philadelphia and other cities broadcast over a series of stations for a change, believing there is also good talent available in those cities.

A feminine fan is willing to listen to dance music and jazz when there is some semblance of melody to be heard, but objects to tuneless selections which sound as if they were written for noise alone. She also makes a plea for variety, pointing out that a whole evening of classical music is boring while a solid program of jazz is worse.

The ears of careless operators of regenerative

sets would certainly burn if they could read some of the caustic complaints regarding oscillating receivers. This type of set should not be manufactured, one letter protests, while another listener claims all should cooperate to suppress them or teach the owners how to handle them. Semi-technical talks on operation would help remedy this condition, he believes.

Just after Christmas for about three months, one writer says he never tries to listen-in, because the kids trying to operate their cheap "radiators" make the nights hideous until they run their batteries down or break up their sets. Another fan expresses disappointment that Secretary Hoover hasn't put a stop to the use of oscillating sets, adding that it now looks as if radio was doomed to failure in this country where it should be the best in the world. An Ohio listener says he quits in disgust every night about eight when the howlers and squealers begin. "I would gladly pay a national tax on my antenna or set," this man declares, "if we could be guaranteed from the interference of these nuisances." This man seems to have spoken for a large number of listeners.

Some of the suggestions for improving the programs call for humorous talks sprinkled in with miscellaneous matter, touching on the general request for novelties and variety, which of course make it harder than ever for the over-worked station managers. One man wonders why practically all stations open up at almost the same hour and suggests that some start earlier, say at dinner time and carry on through



THE FLONZALEY QUARTET

Heard in a recent Victor Hour, broadcast over WJZ, WGY, WRC, KDKA, and WBZ. This group of musicians is internationally conceded to be one of the most perfectly balanced chamber music organizations on the concert stage

the early evening, while others come on a little later. Perhaps they would interfere less if they operated on staggered schedules. A train dispatcher is evidently needed if they all want us to ride with them. After all, we can't ride on more than one train or listen-in on more than a single wave at a time satisfactorily.

Thoughtful members of the listeners' clan, point out that more instruction on reception is necessary; that dealers should be particular to sell correct accessories and, particularly, suitable length antennas, designating the proper installation of antennas and grounds for new comers. Incorrectly erected and poorly insulated antennas are the cause of a great amount of poor reception, several correspondents hold. Faith in fairly long outside antennas is evidently still strong, as 83 per cent. of the fans listed use them, nearly half of them being between 75 and 100 feet in length.

A few listeners admit they would prefer one or two good programs a week rather than a continuous nightly performance by mediocre talent or even fair entertainment. Many offer to pay for better broadcast programs if it is necessary, so as to eliminate the amateur and inferior stations.

The calls for silent nights were not missing, but most of the fans reporting seem able to get at least a few outside stations when they want to do so. This is perhaps because a large percentage of those writing in own three-, four-, or five-tube sets. Out of 2660 fans replying to the question, 40 per cent. operate five-tube sets, while 22 per cent. own three-tube receivers, and 13 four-tube sets. Very few boast of more tubes and even less seem content with single tubes or crystals. This would indicate that listeners are slightly better equipped than a year ago. Most of them get loud speaker volume on some station as 85 per cent. of their sets are equipped with loud speakers. Of these, horns seem still most prevalent, although the more modern types are coming into use gradually.

These folk who wrote in about their sets, appear to prefer wet A batteries, but dry B batteries, although a few have installed eliminators.

Complaints against barefaced advertising and sales talks were also registered, while protests against the conduct of announcers would make a story in itself.

Broadcast Miscellany

A NOTABLE contribution to recent radio offerings was the series of Free Chamber Music Concerts by the Lenox String Quartette broadcast through wjz from the Music Library in New York City.

These concerts were made possible through the courtesy of Mrs. Elizabeth S. Coolidge, who has taken a great interest in the development of musical appreciation in the American people and has spent large sums of money in the advancement of the education of the people along these lines. She is the founder of the Coolidge Chamber Music Festival, which is an annual event of three or four days duration in Washington each Autumn. It is Mrs. Coolidge's aim to institute free music concerts in every city in the United States and make the public libraries the seat of musical as well as literary education. It was she who paid for these concerts and her only stipulation was that the works of at least one American composer be played at each concert.

The Lenox String Quartette is composed of



HENRY FORD'S OLD FASHIONED DANCE ORCHESTRA

Composed of cymbalom, sousaphone, "fiddle," and dulcimer, which recently broadcast an interesting program of old time dance music over WEAJ, WJAR, WEEI, WOO, WCAP, WCAE, WTAG, WGR, WWJ, WOC, WEAR, WCCO, WGN, and KSD

Wolfe Wolfensohn, first violin; Edwin Ideler, second violin; Herbert Borodkin, viola; and Emmeran Stoeber, violoncello.

A WELCOME addition to the Chicago district's dinner music programs is the offering of the KDKA Little Symphony concert through KYW. This is effected through KDKA's short wave relay system which connects that station also with WBZ and KFKX.

AMONG the novelties recently introduced was the Henry Ford Old Fashioned Dance Orchestra broadcast through WEAJ and Associates. Besides the still up-to-date violin this quartette boasts of a cymbalom, sousaphone, and dulcimer.

ONE of the best of the permanent features on KGO's program, is the concert by the station's Little Symphony Orchestra every Sunday afternoon at 3:30. The orchestra is conducted by Carl Rhodehamel. Explanatory remarks are made by Arthur S. Garbett.

TO STIMULATE a greater interest in the operations of governmental machinery and national problems, the Minneapolis League of Women Voters has arranged a series of 20 weekly talks from WCCO. These are to be given at 2:00 P. M. every Tuesday. Each week the speaker will devote five minutes to answering questions which the listeners have sent in. The subjects to be discussed are: "Is Woman Suffrage a Failure?"; "Why Vote?"; "How Can Women Help in Bringing Universal Peace?"; "How Does My Vote Affect the Home?"; "City Government?"; "State Government?"; "National Government?"; "Women in Industry?"; "Women in Professional Life?"; "The Child at Play."; "The Child at School."

OF THE stations we receive regularly on our set, we know of none that flaunts its call letters and location more frequently and persistently than WJAX at Jacksonville, Florida. Since it is a municipal station, the explanation lies, probably, in its desire to impress the name of the village on the world at large. Personally, we're over-impressed.

THE custom in Europe, we are told, is to announce the name of the station at the commencement of the program, and then to

make no subsequent reference to it. The only exceptions are Toulouse, Oslo, Rome, and Munster, where the announcers state the station's name with every single announcement throughout the program.

PROBABLY the most irritating mode of announcing in present use is that employed by WBBM, Chicago. An oh so cheery, oh so democratic voice greets the listener before each number with a "Yes sir! Yes ma'm! This is the so-and-so Company station!!!"

IN NOTING the recent high spots in radio programs we first take occasion to welcome again the Victor Hour. The series started out auspiciously with John McCormack and Lucretia Bori, on whose heels quickly followed Titta Ruffo and the Flonzaley Quartette.

BUT what we consider the best news since last writing is the winning over of the Boston Symphony Orchestra to broadcasting. For the first time in its history it has undertaken to broadcast its regular winter series of twelve concerts Saturday evenings through WEEI.

The fact that season ticket holders have completely filled Symphony Hall for the last two seasons, to the exclusion of the general public, was a determining factor in causing the trustees to authorize the broadcast.

Communications

Mr. John Wallace,
RADIO BROADCAST,
Garden City, New York

SIR:

I have been hoping that someone would take a crack at those announcers who urge us to "write in." Why always "in?" Can't they say "out" or even "round about" once in a while?

Also something about the announcers who only have "little" songs, "little" compositions, etc. Why not have something of a fair size or perhaps even large now and then?

I grow somewhat tired, too, of the announcers who are so sure we are enjoying their programs.

BEECHER OGDEN.
Pleasantville, New York.

AS THE BROADCASTER SEES IT

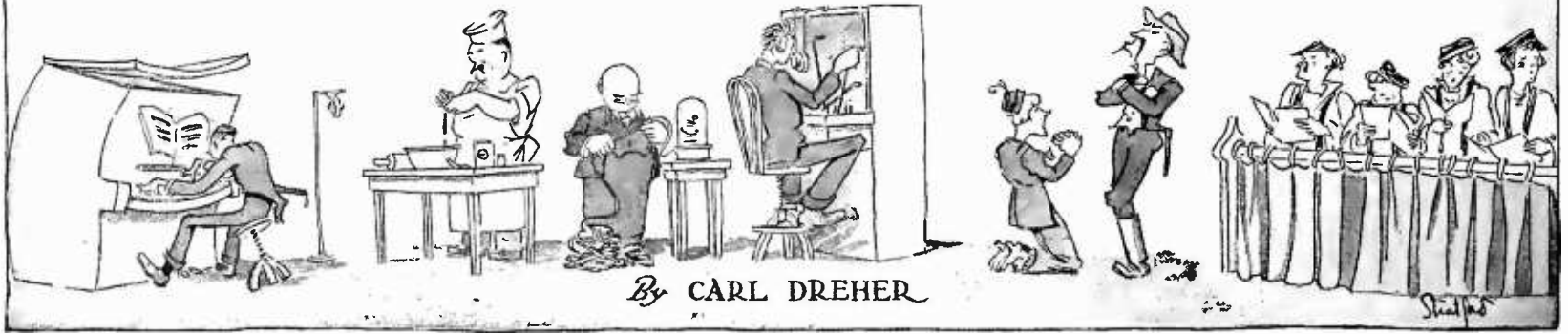

Drawings by Franklyn F. Stratford

How Radio Has Progressed

WE ARE so constantly bombarded with the idea of "progress," nowadays, that we are apt to conclude that it is a notion of universal validity, which has always existed. This is an error. Progress, as a matter of fact, was first boomed in earnest by the late Victorians. No doubt it existed before, but it was taken for granted, and no one got excited over it. Presumably a civilized Greek of the BC's realized that he was housed and fed better, and more comfortably situated in general, than his remote ancestors, but he did not feel the urge to deliver lectures on the subject. As for the mediaeval mind, the idea of progress was as remote from it as oil circuit breakers.

The reason for this deplorable lack must lie in the fact that these people were not blessed and burdened with machinery. Their main concern, after the primal comforts had been taken care of, was with the things of the spirit. Hence they did not believe in progress, probably never even thought of it. For it can hardly be denied that as far as spiritual comfort is concerned, one age is no better off than another. If we assume that happiness is the aim of life—an assumption which holds good for me, and you are free to accept it or to make your own assumption, as you please—then certainly a man of this age has made no progress over a man of the age of Pericles or even Rameses. Or, if you like, go back further. These men were as free to learn, and to make love, and more free to get drunk, than we are, and they had less to worry about. I doubt if I am happier than they were, all the way back to *Pithecanthropus Erectus*. So much for progress in that sense.

But when it comes to machinery, we face a different situation. As soon as machinery enters the door, progress breaks in at the window and sits down in the best chair. There are no perfect machines, and few good ones. Some, however, are better than others. As soon as you start

in on that line, you must follow it to the grave. If you build one machine, you must shortly build another and better one, or some one else will. And so Progress has you by the neck. Progress, therefore, is a specialized and narrow thing, valid only in certain applications. To us it seems universal, because we are interested only in the things to which the concept of progress is applicable.

Of these things radio is one. Here is a field, taken by itself, in which the advances are evident to any one who has not been traveling in Tibet for the past five years. (The qualification may not be an apt one; by the time this gets into print, radio may have invaded Tibet.)

Let us go back those five years. That, of course, is an arbitrary figure. As we have often emphasized in this place, radio was very much alive before 1921; even radio telephony was not a novelty to those "in on the know," and there had been stations properly describable as broadcasting stations before that time. But it was toward the end of 1921 that radio became a subject for public participation, rather than the esoteric preoccupation of a few engineers, operators, and amateurs. And, entirely aside from the "I did it first" claimants, that is when broadcasting as we know it had its beginning.

Toward the end of 1921 I was living up on Cape Cod in Massachusetts, not far from the beach where, in his day, Henry Thoreau paced the sands and declaimed Homer to the ocean waves; but my occupations were more prosaic. I was engaged in my trade of wireless telegraphy, together with about forty other men at a transoceanic-and-marine station. Some of the operators, at their homes in the evening, listened to broadcasting from Newark, New Jersey, and spoke to me about it. I was not much impressed, having often heard wireless telephone transmission before. The trouble with it, they said, was the interference; various ship and shore stations broke in continually

while the children were listening to the bedtime story, and set them to yowling instead of putting them to sleep, and hashed up the phonograph music, which was otherwise grand. Reception, of course, was on headphones. The sets were one- and two-tube affairs, inductively coupled, with tickler regeneration. These sets were decidedly better than the average, having been built by professional operators with all the controls necessary to achieve the best results, and perhaps a few in addition. They were not selective enough, however, to achieve freedom from interference, aggravated by the distance of the broadcasting station (some 200 miles), and the relative nearness of the spark transmitters of ships rounding the Cape and sending on 300 and 450 meters.

At this time a majority of the listeners were probably still in the skilled class mentioned above—commercial or amateur wireless telegraph operators having a little fun with telephone reception. Their number was limited, while the number of potential unskilled listeners was enormous. The latter were rapidly catching up and passed the first group very early in 1922. The receivers offered for sale to the lay public at this stage were very crude. Most of them were built for only one wavelength (360 meters), and the only variable element was to enable reception of signals of this frequency with various sizes of antennas. The best known of them was a single-circuit crystal receiver in a small box, with switch taps for varying the inductance of a single-layer solenoid. The tuning was so broad that with a large antenna—and everyone tried to get as large an antenna as possible—it did not matter much where the switch was set; everything from 175 to 500 meters came through, more or less. Then there were some better sets, also of the single-circuit type, but with a variometer adjustment and a more scientific connection of the detector circuit to the antenna inductance (through a suitable tap arrangement on the latter)

so that the tuning was as good as one could expect of such a simple arrangement. Of course the more complicated three-circuit, four-control tube receivers favored by the amateurs were available, but bold indeed was the novice who essayed to operate one right off the bat. A three- or four-control receiver nowadays usually has most or all of the dials lined up so that for a given setting of one, the others should be adjusted to about the same numbers on the scales. Besides, in the meantime the public has been educated by radio periodicals, trade catalogs, and comparison of notes on the 8:13 into town. But in 1921-22 the more complicated receivers were still operated by intuition rather than figuring, and if you lacked the intuition you had to fall back on the crystal receivers, which were therefore in the vast majority. The typical radio fan was a slightly deranged but harmless fellow who sat all evening with a pair of headphones on his ears, tinkering with a wire which he called a "catwhisker" wherewith he gently prodded a "crystal," muttering at intervals, "Maybe I can find a better spot on this d—d piece of galena." So much for the technical equipment.

And what did he hear? Mainly phonograph music riding on top of great splashes of telegraph code. Although, for a time, very respectable artists broadcast for the sheer novelty of the thing, and a ride to Newark in a Packard with a lively party at the Robert Treat following. Then, when the cute little fish began to grow up and threatened to attain the dimensions of a whale, they found it better to stay away from its aquarium. Also the music composers, and the custodians of their copyrights, began to oil their six-shooters and to sharpen the tips of their harpoons. There followed some lean years, judged by the artistic standard, but the marvel of getting voices, and a species of music, out of the air, kept the new art, not only going, but growing.

As for the broadcasting stations themselves, they were good for their day, even though they would give a modern broadcast engineer, i.e., one practicing four years later, convulsions and suicidal impulses. Their audio frequency bands were too narrow and had a great number of humps and dips, most of the tubes overloaded, the microphones had joyfully responsive resonance peaks and were addicted to blasting; the wire lines carried almost as much sixty cycle hum and telegraph clicking as modulating energy for the broadcasters who leased them. It was a grand old time, and I myself grow sentimental over it after a few drinks of ginger ale—but let us thank God that we do not have to listen to its effusions again, with our sensitized and critical ears. (We prodigies who did not know, five years ago, whether a 373-W "mike" had one button, or two, or as many as a vest.)

Let us now regard the present. We have receiving sets so selective that they clip the side-bands off the transmitted wave,

if we are not careful, and they operate on one or two tuning controls. They are a thousand times as sensitive as they need to be for anything but extreme long distance reception, and are used most of the time with the volume control near its minimum position. The output can be made as loud as the original performance in the studio or concert hall, without noticeable distortion. The users of such sets need not be cautioned to hold down the volume in order to keep the quality decent; they can get all the output the window panes can stand, without hashing up anything. As for headphones, most radio listeners no longer associate them with radio sets at all. Modern loud speakers transmit all the frequencies from 70 to 7000 per second, and if they have serrations they are not as high as a cathedral door, nor as close as saw teeth, so that the human ear, which is no precision instrument itself, takes little note of them. These sets not only work well, but they look well. The programs, in large part, are on the same level. More and more they are being supported by professional musicians, and, among the greatest artists and aggregations of artists, there are now more who have broadcast, and are going to do it again, than those who still fight shy of the microphone. Scarcely an event of public importance is run off without that little instrument in the foreground, and half of them are planned as much for the "invisible audience" as for the people physically present. As for the broadcasting stations, it is not fitting for a professional broadcaster to point publicly to their many excellencies. Nor is it prudent, because whenever he gets that way all the modulators immediately go soft, the cat gets tangled up with the ten thousand five hundred, and the breakers go out and won't go back while Lucrecia

Bori takes a top note. Still, it may be said that there are ten or twenty stations in the States which are pretty good, considering that their whiskers are not yet beginning to sprout. They are connected by quiet and well equalized lines, their frequency characteristics are satisfactory, their power is fairly adequate, their staffs know something about music and practical acoustics. All in all, the look backward is flattering, and the prospect encouraging. What with static, forced sales, copyright disputes, and lack of wavelengths, we are certainly not out of the woods, but one does not have to be a member of the Kiwanis sodality to recognize the fact that we are on intimate terms with the goddess Progress.

Among the Broadcasters

WBAL

THIS new 5 kw. transmitter at Baltimore, Maryland, uses the "mixing panel" idea in solving its studio pick-up problems. Instead of employing one microphone, which must be moved to the proper position for proper balance on vocal solos with instrumental accompaniment, orchestras, and the like, WBAL utilizes three microphones with separate controls which are under the hand of the supervising operator. The electrical energy fed to the set from each of these microphones may be increased or decreased at will, without noise or other complications, so that one microphone may be cut out altogether, and another cut in, during a musical number. In other words, microphones may be changed at any time, without disturbance, the only precaution necessary being that the cutting out and swinging in must be accomplished in inverse proportion, so that the over-all volume resulting remains about constant.

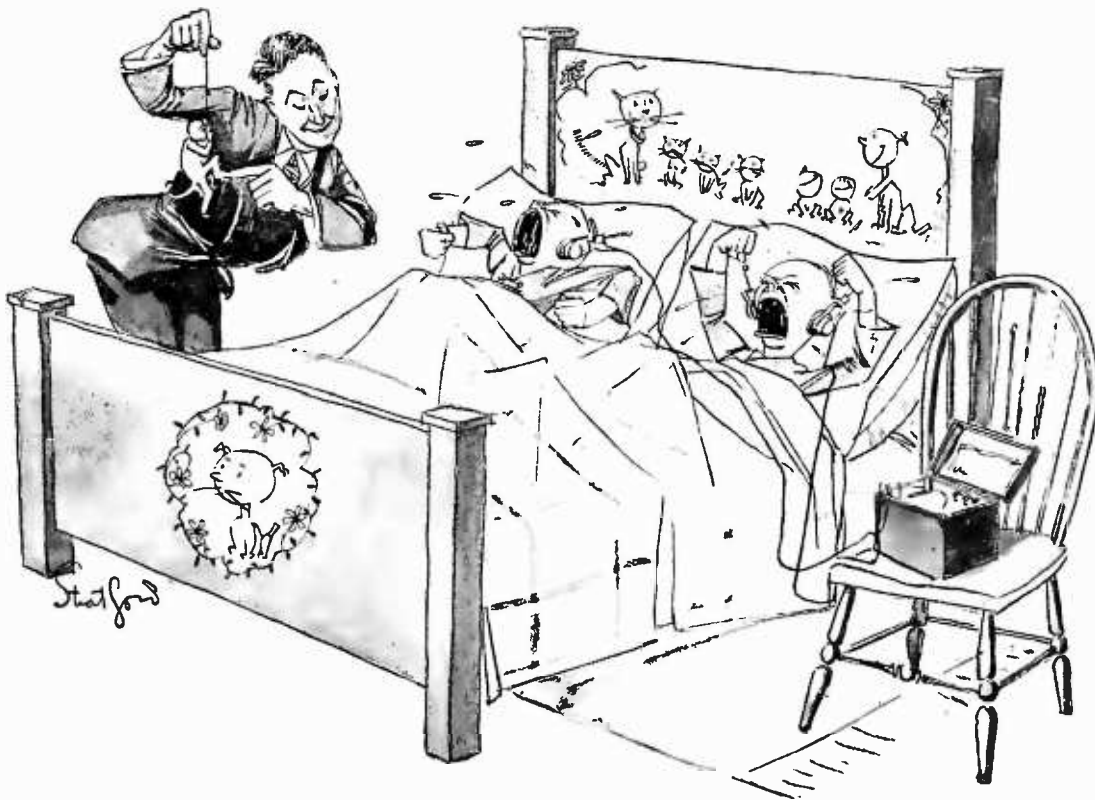

IN 1921, THE SPARK INTERFERENCE ON 360 METERS MADE THE CHILDREN HOWL

Or, the pick-up of the three microphones, or any two of them, may be "mixed" to produce a musical balance better than can be secured on one (assuming no physical movement of the microphones). I insert this last qualifying clause because it is my opinion that in a studio of moderate size with experience and reasonable control in placing of musicians, one can do as good a job with one microphone as with a dozen. One microphone, properly placed, will give as satisfactory results on small ensembles, as any combination. The advantage of the multiple pick-up arrangements is the flexibility in adjustment secured when it is found during the first number of a performance that no one microphone is properly placed. If there is only one microphone, the choice is between entering the studio during the number and moving the transmitter, which always disturbs the artists and may cause a noise on the air, and letting it ride for that number, i.e. doing a bad job for five or ten minutes, and fixing things up during the first interval. In other words, the broadcaster has to choose between the electrical devil and the deep sea. But if he has a number of microphones independently mounted and controlled, his life is made a little easier. Suppose he encounters a soprano of unknown potentialities, with the usual piano accompaniment. If she sings very loud, it may be well to place her five feet from the microphone, say, while the piano

is two feet to one side. (See Fig. 1, position A). But if she sings softly, the piano will predominate with this set-up. Well, all you have to do is place your microphone B say three feet from the lady. As soon as she starts you will know which transmitter to use, and as you have control of both it is the work of only an instant to swing in the right one. Or, it may be convenient to combine the outputs of the two microphones. This, in brief, is the system used at WBAL. With it there is much less excuse for poor musical balances, blasting, etc., than when only a single pick-up unit is available.

The WBAL announcement which has reached us merely explains the purpose of the system described, without giving the technical *modus operandi*. One way of doing it would be to use separate amplifier systems with individual gain controls of the type described in this department in the March issue ("Technical Routine in Broadcasting Stations: Monitoring"), the outputs being combined after two stages of low power amplification. This has the advantage of including a number of parallel chains: microphone plus amplification up to the five watt level, say; and if anything happens to one of the amplifiers or microphones, that particular system is cut out as a unit, leaving one or two others still functioning. It has the disadvantage of complexity. A method of using a multiplicity of microphones, individually controlled, "inputting," as Zeh Bouck says, to a single amplifier, is shown below under "Technical Operation of Broadcasting Stations: Multiple Pick-Up."

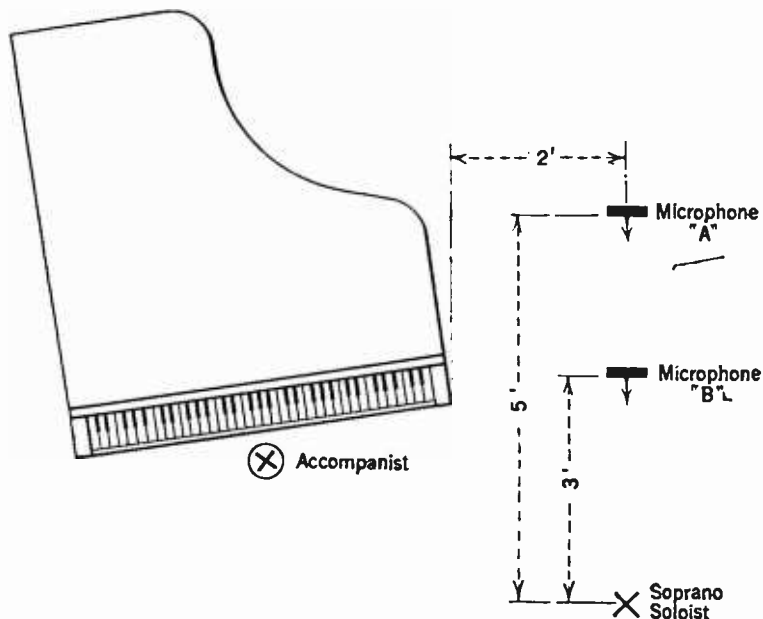

FIG. 1

within range of the microphone. The stunt is to place a small rug at the best pick-up location. After ten months' trial Alfred Thomas, the resident engineer in charge at KOA, has this to say about his device:

Not once has our magic device failed to turn the trick. Most any type of rug fills the bill if it is soft and of contrasting color with the floor. It should, however, be of small dimensions, say three or four feet. It is placed a few feet from the microphone, the distance depending wholly upon the voice of the person to be heard.

Unconsciously, the speaker assumes a position on this rug before the microphone and there remains until his remarks are concluded. Subconsciously he regards this piece of floor-covering with its imaginary boundaries, as an island of safety, and he is disinclined to venture elsewhere about the stage. As a result, broadcast listeners are enabled to hear the talk in full. Otherwise, some of the speaker's comments would be lost to the invisible audience.

Ministers, it is further stated, are the best behaved subjects before the microphone, while political speakers are the worst. How about the Rev. Billy Sunday? I have my doubts about the rug remedy if that acrobat-evangelist should be persuaded to broadcast.

Dr. D. E. Phillips, a psychologist of the University of Denver, makes the remark that "KOA's plan to prevent a speaker from taking gymnastic exercises on the lecture platform is indeed novel." With a heavy heart I must take issue with the eminent scholar of the U. of D. The stunt is a good one, but it is neither novel nor original. Public address operators in various parts of the country have been using it for years. In fact, if I am not mistaken, and I'm not, it was mentioned in the paper on public address systems by Green and Maxfield in the *Journal of the A.I.E.E.* for April, 1923.

WJJD

THE sketch shows the layout of the new Chicago studio of WJJD, with transmitter at Mooseheart, Illinois. The new quarters consist of eight rooms—the

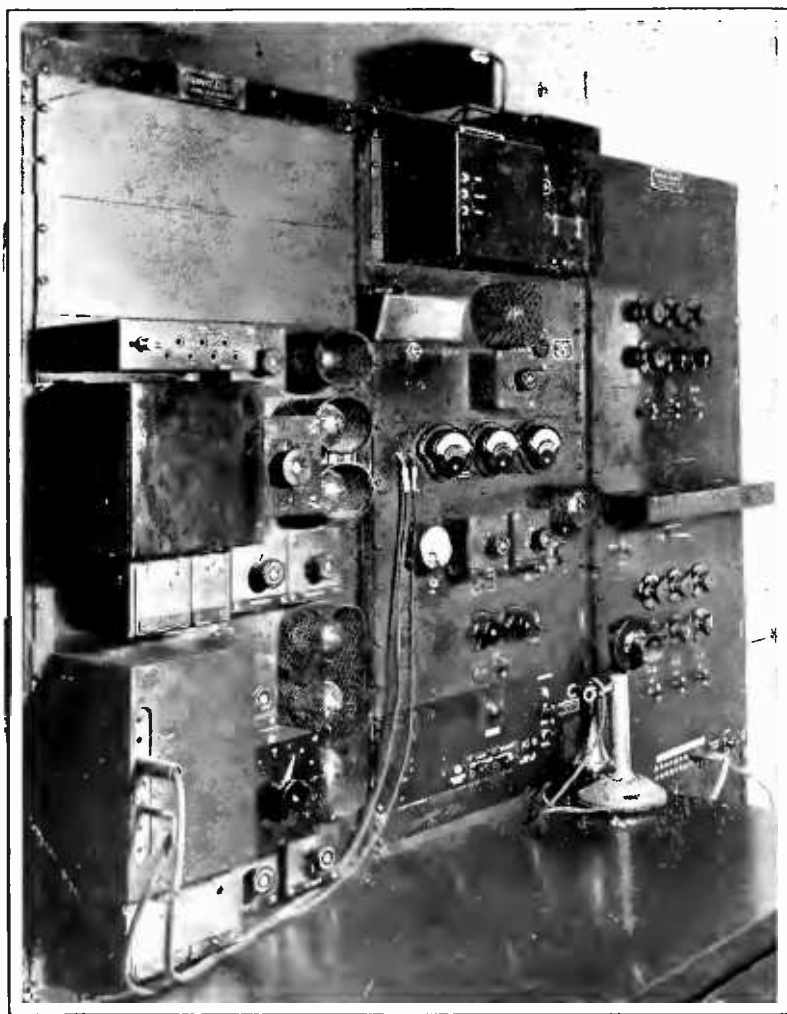

THE MIXING PANEL AT WBAL

Part of the standard 5000-watt equipment at that station. The mixing panel for various studio microphones is that at the extreme right of the illustration

KOA

FROM KOA, the big fellow in Denver, comes the news that the technical staff at that station are utilizing a "magic rug remedy" to keep public speakers

"Radio Suite"—on the twenty-fourth floor of the Palmer House, which, when the second section is completed, is expected to be the largest hotel in the world. The director of WJJD is Jack Nelson, one of the pioneer broadcasters of the Middle West.

The new studio arrangement was not thrown together haphazardly, but was carefully planned by Mr. Nelson and the architects of the building. Under these conditions, the people in charge had a relatively free hand in arranging things as past experience indicated they should be. No doubt in the future many new buildings will include broadcasting facilities in the plans; Mr. Rothaphel's New York theatre, now in process of construction, is an example of this evolution.

At WJJD there are two studios, to facilitate rehearsals and avoid delays in running off the programs. No one who has not tried to get a thirty-piece band out of a moderate sized room, with the air blank or desperately "plugged" until they could be got out and the next number set up, can appreciate what a help an auxiliary studio is to the program and operating staffs of a station. By means of buzzer and light signals the operator in the room between the studios keeps control of the proceedings. The artists in the studio are directed by means of electric signs reading, "Get Ready," "Broadcast" (in red), and others like "Too Loud," "Too Soft," "Too Much Piano," etc.

A motion picture booth is provided for taking pictures of celebrities who broadcast. Here the necessary cameras and lights are stored, ready for use and out of the way, and cables leading direct from the main power switchboard of the hotel furnish the currents necessary.

Microphone stands are considered *passé* at WJJD. Instead, the transmitters are suspended from eight-foot decorative wrought iron arms adjustable to any height and position. This eliminates microphone wires trailing around the floor, with the possibility of people tripping over them.

Loud speakers placed in the Studio Parlor, each of the rest rooms, the Director's office, and the Control Room, permit the program to be followed at all of these points. The reception parlor is furnished on the style of a well furnished living room, with chairs and lounges for waiting artists and guests. The windows between the studios and the reception room are so draped that the guests can see into the studios, but the artists, while on the air, cannot be disconcerted by a view in the opposite direction. This arrangement gets around the difficulty encountered when the studio is glass enclosed on one side, of causing the artists to feel as if they were in an aquarium.

A twenty-pair cable connects the control room of the WJJD suite to the public address control room of the hotel, so that public address service can be provided in any portion of the hotel on radio programs, and, conversely, the station can pick up broadcast material from any of the ballrooms,

dining rooms, and other points reached by the public address system. For example, any one of the five orchestras which will play regularly in the Palmer House will be available in this way.

One important item that is frequently neglected in broadcasting studios has not been overlooked in this instance. This is the matter of ventilation. It is stated that more than \$10,000 was spent for ventilation in the new quarters of WJJD.

WFBG

WFBG is a 100-watt outfit at Altoona, Pennsylvania, owned and operated by the William F. Gable Company and the Times-Tribune Company of that city. Walter S. Greevy is the director; the chief operator is William K. Aughenbaugh.

WFBG broadcasts regularly from eighteen remote control studios, over leased wires, and about once a week they pick up a special program, using portable equipment. The shortest loop is 3000 feet and the longest about 4 miles, not counting central office wiring. A. T. & T. circuits are used in the main.

The transmitter is a Western Electric 2A, with 100 watts output, fed by a 24A speech input amplifier and equipped with the 3B receiver and KS2253 power panel. There is also a set of storage batteries for plate and filament supply. The set reaches out 600 miles on evening programs.

In making some pleasant remarks about this department in its relation to broadcasters, Mr. Aughenbaugh comments on the lack of books about land line broad-

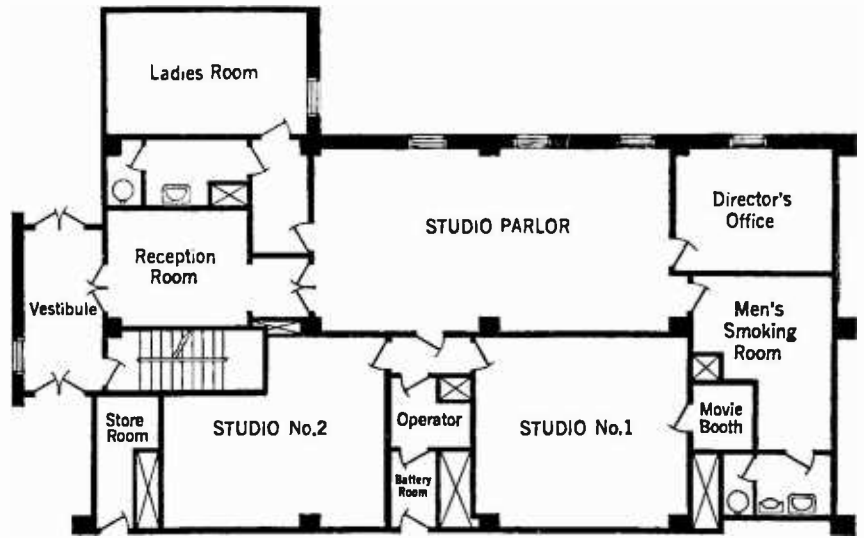

THE CHICAGO STUDIO OF WJJD

It is located in the New Palmer House and especially designed for the station

cast transmission and broadcasting in general. There is certainly a paucity of such works. However, many valuable papers have appeared in the *Journal of the A.I.E.E.* and the *Proceedings of the I.R.E.* A list of the more conspicuous ones was given in this department in the April 1925 RADIO BROADCAST. Every broadcast engineer and operator should read the articles therein named, if nothing else. However, a complete file of the journals mentioned for 1923, 1924, and 1925 would be a good investment. There are also valuable papers in the *Bell System Technical Journal*, *G. E. Review*, and other technical periodicals. We are thinking of summarizing one such article each month, in its practical aspects, for technical broadcasters who are so situated that the originals are inaccessible to them. But we can do that only if we have reason to believe there is a decided demand for such material among our readers. How do you feel about it? You can have what you like, but you must let us know what it is.

WLS

IN A town with an ancient and Mediterranean name, Crete, Illinois, there is situated the new 5000-watt transmitter of

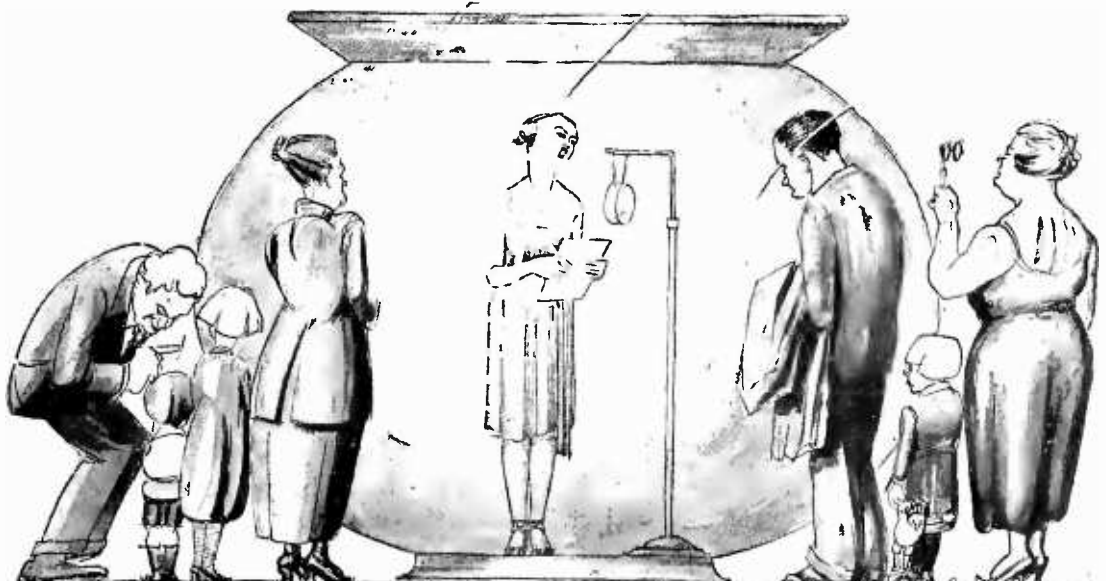

"THE ARTISTS FEEL AS IF THEY WERE IN AN AQUARIUM"

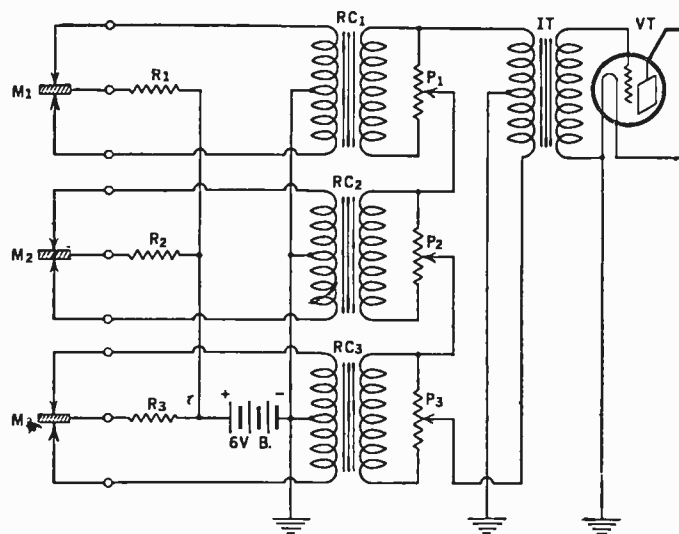

FIG. 2

wls, with studio in the Hotel Sherman Annex in Chicago. This well-known station is maintained by the Sears-Roebuck Agricultural Foundation. Curtis D. Peck is the chief operator.

The power plant is located on a two-and-a-half acre plot on the Dixie Highway, just south of Crete. The site is landscaped, with ample drives and parking space for visitors. The lawns cover some fifteen miles of ground wire, plowed in during the period of construction of the station.

The building contains a large operating room, an office, a reception room for visitors, generator and battery rooms, switch closets, and an entrance hall. The construction is up to date in every respect, including factors affecting radio transmission. The layout and joining of metal lath, for example, is such as to minimize radio frequency losses. An elaborate water cooling system for the tubes, with provision against freezing during the winter, has been provided. The towers, measuring forty feet at the base, and two hundred feet high, are visible from the Indiana state line.

The transmitting set is a product of the Western Electric Company. The wavelength is 344.6 meters, corresponding to 870 kilocycles. The Army experimental call letters are A Z 3.

The studio on the sixth floor of the Hotel Sherman Annex was fixed up by a well-known interior decorator with the aim of expressing the radio motif (on the nature of which there may not be perfect agreement). According to an announcement, "Every piece of equipment and furniture, the walls, ceiling and lighting fixtures . . . emanate the speed, intensity, and universality of the mysterious forces of the air." Black, red, and silver are the colors, with representations of sound waves on the walls and ceilings, giving the visitor the impression that "he has stepped inside of Einstein's brain." Well, at last someone understands Einstein.

There are two studios. One is 55 feet long and 20 feet wide, for orchestras, bands, and dramatic productions; a smaller studio accommodates soloists. Separated from the larger studio by a plate glass

window is a miniature theatre which is to be open to the public. It seats about 50 people, who hear the program through loud speakers while watching the broadcasting. The usual reception room, offices, operating and battery rooms are of course included.

Broadcast Transmitters and Tuning

COMMENTING orally on the substance of my remarks on "Broad Waves and Sharp," in the March issue, in which I let loose a few growls at the broadcast listeners and operators

who labor under the delusion that a c.w. telephone station can "sharpen" its wave in some recondite manner, Mr. John V. L. Hogan, the well-known consulting engineer and Past President of the Institute of Radio Engineers, points out that there is one case in which a broadcasting station may contribute to broadcast tuning at the receiving end. That is when the carrier frequency fluctuates with modulation. This malady is probably a rare one among broadcasting stations worth listening to, but it may occur among some of the loose and flapping small time agitators of the ether, so let it be included for the sake of completeness. Mr. Hogan discussed this complaint in the September and October, 1924 numbers of *Popular Radio*. If the fluctuations are rapid enough, such a carrier will not only tune broadly, but it will be noisy. I think even in this case we should not apply the terms "sharp" and "broad" to the carrier, but should refer to its "steady" or "fluctuating" nature, as the case may be. The term "broad" should be reserved for the tuning of receivers, and the radiation of spark transmitters, with their adjustable decrement.

For that matter, the broadness of tuning of every c.w. transmitter varies with modulation. The carrier, the carrier plus the modulating frequency, and the carrier minus the modulating frequency, are the three frequencies radiated. Hence when emitting a note of high musical pitch a station should tune somewhat broader than when its carrier is modulated down in the bass. Whatever broadness of tuning is introduced in that way is a consequence of the fundamental function of the station. Again, there is a practicable form of radiation, called "single side band transmission," in which the carrier and one side frequency are suppressed at the transmitter. A substitute carrier is introduced at the receiver, and the modulation reproduced by the use of the single side frequency which is radiated. This method is very economical in that it requires a much narrower frequency band per station, and consequently allows more channels to be crowded between given

frequency limits. It has not yet been introduced into broadcasting, so this is as far as we shall let it worry us for the present.

Radio Lingo, Past and Present

Miscellaneous Influences: The Novice

BEGINNERS in the radio art, and the public in general, say, "My radio" where initiates refer to "my receiver," or "my receiving set" or, more loosely, "my radio set." The broadcast listener is interested only in receivers, so a receiver is a "radio" to him.

The same slackness is evident in the "23-plate" nomenclature for condensers. The beginner is not interested in capacitance, which is a concept and takes some experience and thought to grasp, but he can see and count, and so condensers are sold by the number of plates rather than by the essential factor of capacity. We may expect a widening gap between the engineering and selling terminology of radio, for the engineering interests will certainly not give up their ways of calculating and designating, and the public cannot be expected to take up the engineers' way of looking at things.

Among other influences that have formed radio terminology is that of the sea. We have all heard the announcer say, "Please stand by for the next feature on our program." Now, "stand by" is a general term meaning "to be near," "to be present." As a nautical term it means "get ready," as "Stand by to launch the boats." This phrase entered radio apparently by the nautical route, but had to undergo a change in meaning to "Wait a minute; I'll be with you shortly." When two ship stations called a coast station, the land operator would tell one of them to "stand by." The early tuners had a "stand-by circuit"—a broadly tuned circuit, picking up any signal within a wide range of wavelengths. Many an old operator remembers the musical swing of Cape Race's "std bi" in the dim romantic spark days. And now the broadcast announcers have it. An honorable and manly phrase of deep salt water, it has become a prefix to jazz orchestras.

Past, Present, and Future

SO RADIO has passed from the backyard-spark coil-coherer stage to the universal communication level, and ways of speech have changed with it. In the early telegraph days the note or tone of the signals was anything. The object was just to get a sound through. The Marconi spark coils, with their gastric growling, were supplanted by the sixty cycle spark, because sixty cycles happened to be handy. Gradually aspirations for a musical note took form and the question arose, "How's his note?" when one was speaking of a station. A decade later the question is, "How is their quality?"

when people discuss the merits of a broadcasting station—quality being the effect of a great complexity of notes and their faithful reproduction. Behind the change in phrase there is an evolution from the relatively simple to the relatively complex.

And the end is not yet. If radio movies become a reality, will radio fans be asking, "How's the visibility?" a decade or two hence?

Technical Operation of Broadcasting Stations

4. Multiple Pick-Up

FIGURE 2 shows the layout of what is commonly known as a "mixing panel" for combining the outputs of several microphones. The transmitters M_1 , M_2 , M_3 , are of the carbon type, and they are fed in multiple from a single battery B , each having its own resistance R_1 , R_2 , or R_3 , in series, to limit the d.c. through the microphone to the proper value. Each microphone feeds its audio output into a repeating coil, which is simply a 1:1 transformer, usually with a torodial winding on an iron core, much used in wire telephone practice. This repeating coil is marked RC , with the appropriate numerical suffix. Also, the secondary of each repeating coil is paralleled by a potentiometer, P_1 , etc. The variable terminals of these potentiometers are connected in series, as shown in Fig. 2. One extreme terminal goes to one terminal of the low side of the input

transformer IT ahead of the first tube; the other extreme terminal of the potentiometer chain goes to the other side of the input transformer primary. The secondary winding of the transformer goes to the tube. In the output of this tube there may be an over-all gain control, as described in the March issue, supplementing the individual gains afforded by the potentiometers.

The value of the impedances will now be given roughly. For a 6-volt battery, R will be of the order of 200 ohms, which with the 100 ohms impedance offered by each button of the microphone limits the d.c. per button to the appropriate value of 20 milliamperes. Since, for audio frequencies, the buttons are in series, a normal carbon microphone has an output impedance of about 200 ohms. This matches such a repeating coil as the Western Electric 77-A. The impedance does not change in the repeating coil (the windings being alike) hence the potentiometer across each secondary may also be of the order of several hundred ohms total resistance. The primary of the input transformer has an impedance at low frequencies of 500 ohms, stepped up to about 50,000 ohms in the secondary to match the input impedance of the vacuum tube. This transformer has, it will be seen, an impedance ratio of 100:1, corresponding to a turns ratio of 10:1, the impedance varying as the square of the number of turns.

It is important that the potentiometers should be smoothly variable, to avoid abrupt changes in the output of the indivi-

dual microphones, and that a true zero be obtainable, so that any microphone on the panel may be cut out completely if desired. Usually telephone keys are provided, so that after the gain on a transmitter has been set at zero, its circuit may be opened entirely by means of a key or switch.

The diagram shows the operation of this system with carbon microphones, but a condenser type may be used equally well provided that its associated amplifier has a step-down transformer whose output matches a carbon microphone approximately (200-500 ohms.) This output is then connected to the two outside posts of one of the sets of three, the middle post, to which the frame or diaphragm terminal of a carbon microphone goes, being left unconnected. The output of the condenser may then be mixed with a carbon microphone output, if desired. In fact, there is no reason why the outputs of several transmitters of differing frequency characteristics may not be mixed in this way, for the purpose of securing an over-all output superior to any of the component pick-ups. Or, in the more usual situation, several more or less identical microphones have their outputs mixed, combining pick-ups which differ owing to the physical positions of the respective microphones with reference to the source of sound. Finally, any microphones may be swung in or taken out at will, to suit changing conditions during a concert. All these operations are noiseless, inasmuch as the variation is carried out in a circuit carrying nothing but audio frequency currents.

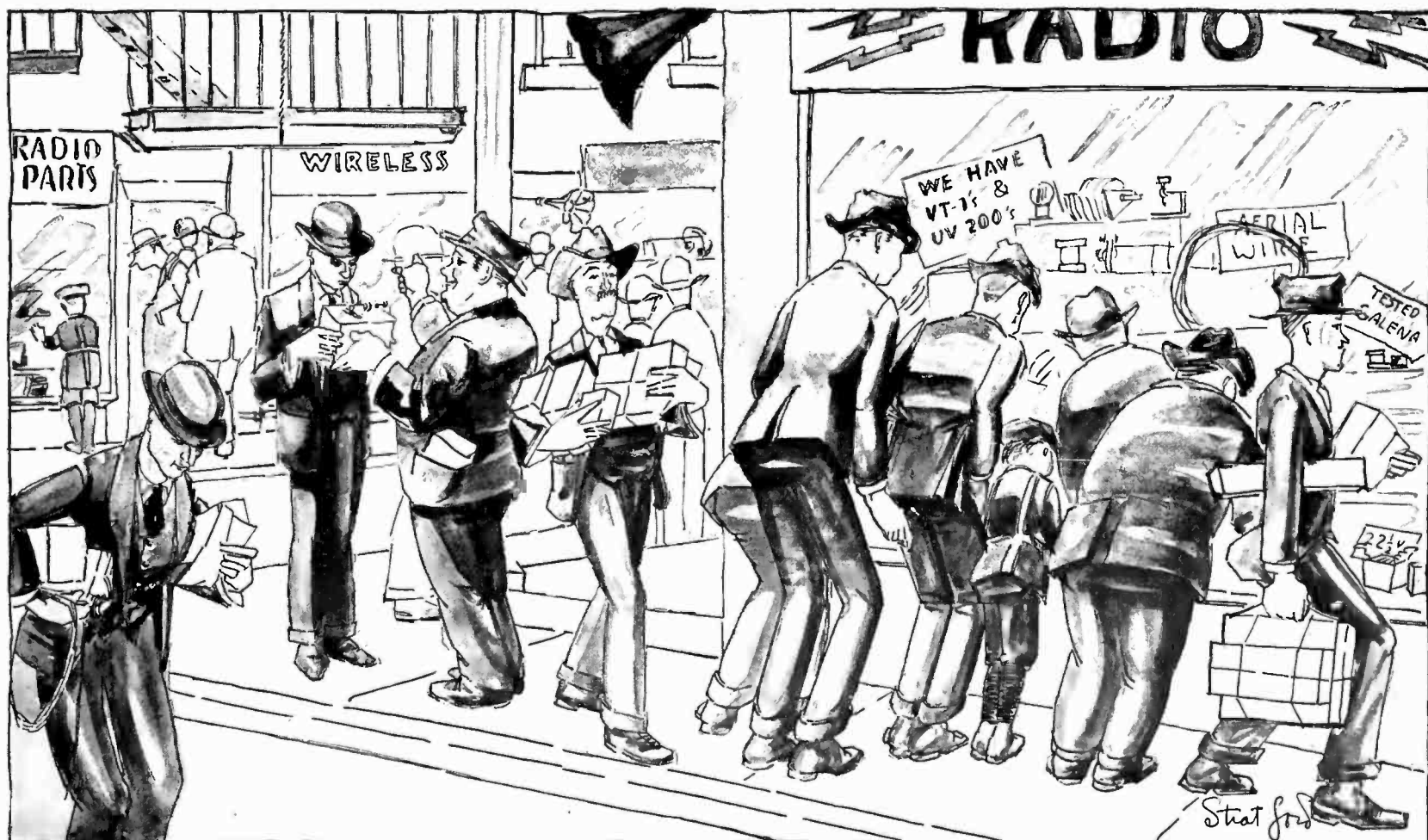

RADIO GRIPPED THE FAN AS EARLY AS 1921

How a Portable B Battery Transmitter Works

Details of Actual Operation of a Forty- and Eighty-Meter Transmitter Using B Batteries for Plate Supply—How the Record of Twenty-Six Thousand Miles Per Watt Was Attained

By THE LABORATORY STAFF



STATION 9ECC AT MINNEAPOLIS
Note the chemical rectifier on the floor and the businesslike transmitter arrangement

WITH the approach of the International Tests and receiving conditions in Garden City nothing to brag about, it became necessary to make arrangements for an expedition to the wilds of some "bloopers" land. The problem of communication with Headquarters was a serious one indeed, for there was no telling where the expedition might lead. There seemed but one solution—amateur radio. What the Test committee needed was a light, easily portable transmitter and receiver that could be transported with its power to points unknown with the assurance that pressing the key in the wilds would awake activity in Garden City.

For some time the Experimental Station 2 GY operated by RADIO BROADCAST Laboratory and the National Carbon Company had been the scene of much activity on short waves and low power. A circuit described in the January magazine by Niklaus Hageman had proved quite successful but secured a perfectly steady note at the expense of greater plate currents, and for hauling a transmitter to distant points, a foolproof, and especially a very economical circuit was essential.

The transmitter shown in Fig. 1 is the result. The circuit is the simplest possible, the Hartley, and is shown at Fig. 2. In construction or operation there is nothing easier. A coil made of No. 8 soft copper wound on a dry cell tube and allowed to expand until the required diameter of four inches is reached constitutes the closed circuit inductance the ends of which are attached to the grid and plate of the oscillator tube. For the 40- and 80-meter bands, 10 turns are required when a .00025-mfd. condenser is used for tuning. Another coil of four turns of the same construction couples the antenna to this circuit.

radio shack at 2 GY with the operators, about to try the new transmitter. It is to get its power from batteries; storage battery to light the filament of the tube, B batteries for plate supply, for it is obviously impossible to carry generators to the country and who can predict the kind of power available from the lighting mains of Podunk?

It is 8:00 p. m. on the night of December 11th and Operator Mann (Mn) is at the key with Bob Blanchard standing by to throw switches and be generally helpful. The air is filled with 40-meter stations and among them is 9 DDE, John Wilcox, Chicago

So much for the construction for the present. Let's imagine for a few minutes that you are sitting out in the

whom we call without result. Then at 8:15 we send out a "CQ" which is answered by 9 ECC, Floyd E. Wilkins, at Minneapolis. At that time the transmitter tube, a UX-210, was drawing 22 milliamperes at 400 volts. For an hour 2 GY conversed with 9 ECC, reducing the power with the following results:

CURRENT	VOLTAGE	WATTS	SIGNAL STRENGTH
22	400	8.8	R4
16	300	4.8	R3.5
6	130	.78	R3.3
3.8	90	.342	R1 - R3

Not bad for a start! 1000 miles on .342 watts—less power than is taken by the average receiving set.

On the 15th at 9:32 p. m. E. S. T., the same stunt is repeated. 2 GY connects with 8 BZK, Paul Roth, Cleveland, using 40 mils. at 500 volts and power is reduced as follows:

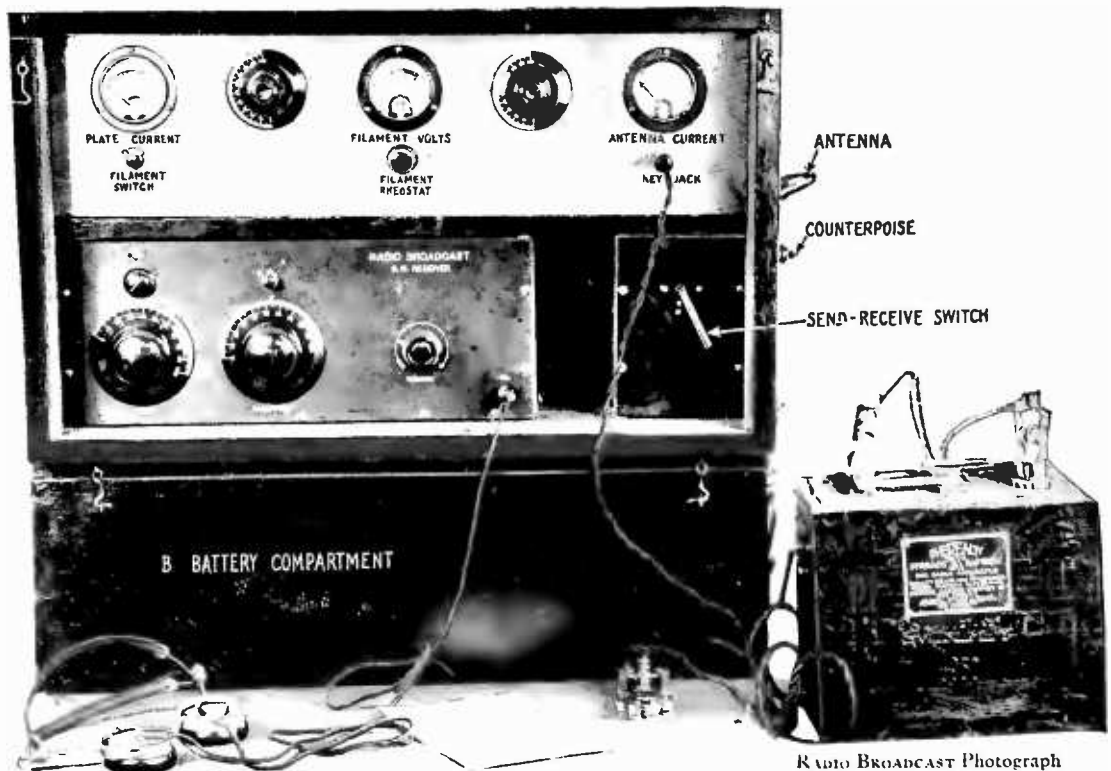
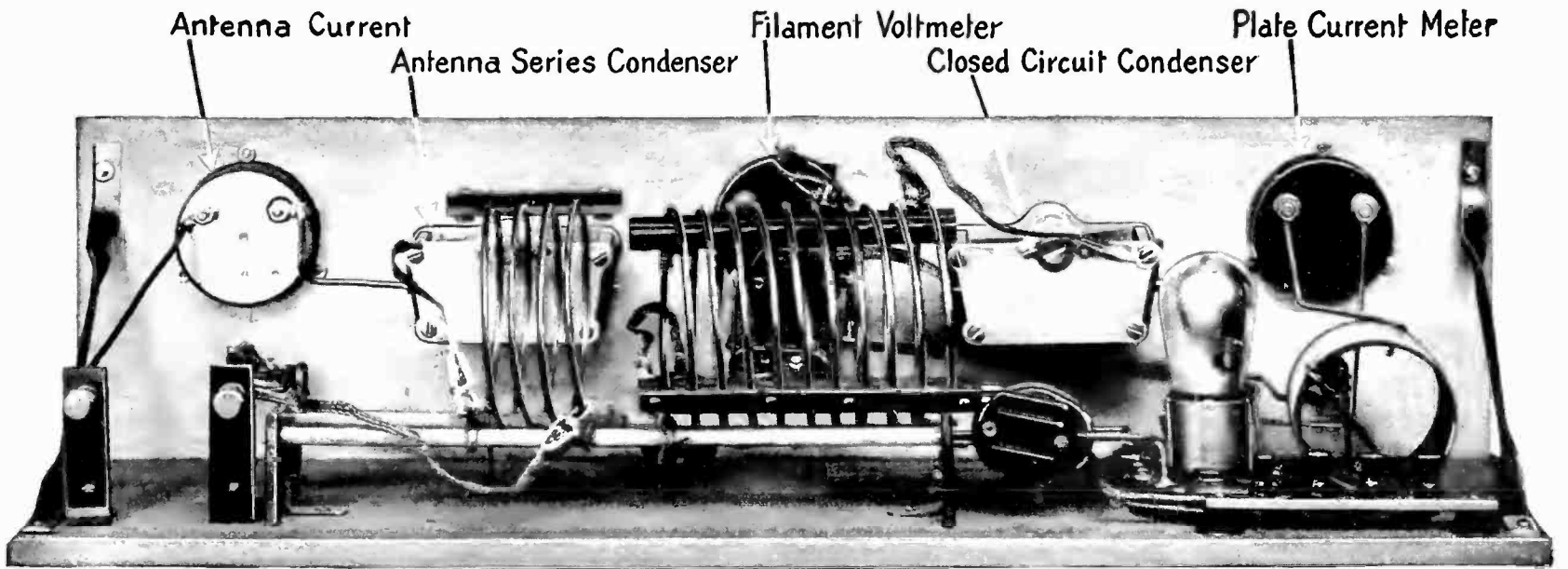

FIG. 1

Transmitter receiver and B battery compartment complete. Space is provided for ten standard receiving B batteries totalling 450 volts. The throw-over switch is unnecessary if an additional antenna is provided for receiving. The same batteries can be used on both transmitter and receiver if proper precautions are taken

RADIO BROADCAST Photograph



RADIO BROADCAST Photograph

FIG. 2

A rear view of the transmitter showing location of component parts. The inductance coils are strapped to two dowel rods and kept away from metallic objects

CURRENT	VOLTAGE	WATTS	SIGNAL STRENGTH
40	500	20	R6
30	400	12	R6
15	320	4.8	R4
8	130	1.4	R3

At this point, local interference prevented going lower in power, but the meters on the transmitter could not read much lower anyway!

On December 16th at 8:18 p. m., 2 GY connected with 9 DCG, Frederick G. Braig, Rockford, Ill., and with an input of 1.8 watts (10 mils. at 180 volts) he said signals were audible all over the room.

At 10:05 p. m. on the night of December 17th, communication was established with 9 CCQ, Vere Davis, at Braymer, Missouri and the first of a long series of tests was carried out. That night 2 GY was using a Sea Gull 201-A tube as follows:

CURRENT	VOLTAGE	POWER	SIGNAL STRENGTH
19	290	5.5	R3
13	200	2.6	R3
7	120	.84	R2
4	75	.3	R2
1	40	.04	R1

A message was given to 9 CCQ at .3 watts which he received perfectly. Arrangements were made by wire to communicate nightly on low power. He was using three 201-A tubes with 250 volts of B batteries, no meters or any other means of indicating resonance in the antenna.

Beginning December 21, a nightly schedule was maintained with 9 CCQ except when weather conditions prevented, until January 5th when it was necessary to test the transmitter in the field. During this time communication was held many times with other stations with a maximum input at 2 GY of 20 watts. Schedules with 9 CM, Edward N. Fridgen, L'Anse, Michigan and 9 ECC proved conclusively that battery operated sets could be depended upon for consistent work.

INSTALLING THE PORTABLE TRANSMITTER

AT PATCHOGUE, Long Island, 40 miles from Garden City, the transmitter was installed in a hotel room with the antenna against a metal building

and parallel with a metal roof not more than 20 feet from the ground. Strong signals were received at 2 GY in the daytime and at night until 10:00 p. m. when interference and the skip distance made further communication impossible on 40 meters. At 80 meters, however, communication was easily accomplished. During the International Tests, the receiver and transmitter, set up in a farmhouse miles from anywhere, provided the only means of communication with Test Headquarters.

Now all of this low power work was done without special arrangements. After communication had been established, the power could be reduced, and often 2 GY got into communication directly on low power. The antenna system was amusing—a single wire poorly insulated, neither vertical nor horizontal and only about 35 feet long. The single wire counterpoise ran in a direction opposite to the antenna and likewise was not insulated. Antenna currents were never over .3 amperes.

All of which shows that on 40 meters,

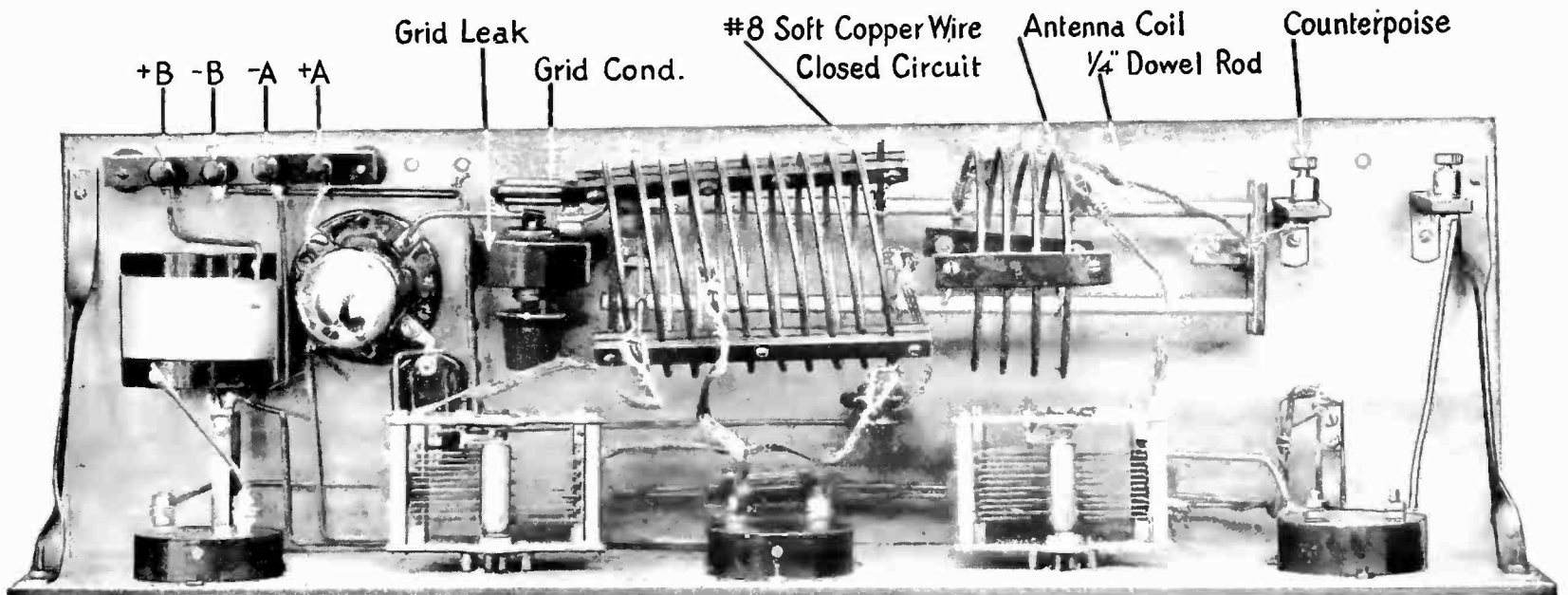

RADIO BROADCAST Photograph

FIG. 3

Another view behind the front panel giving an idea of how simple the whole transmitter is

there is no reason why any one cannot be in communication with any one else without a lot of expensive apparatus. Witness the fact that with 9 CCQ, a power input of .04 watts was successful in maintaining communication over a distance which represents a record of 26,500 miles per watt. It required less power to transmit the messages than it did to receive them.

The photographs of the transmitter should give all the constructional details that are necessary and the simplicity of the antenna throwover switch is shown in Fig. 3. The plate batteries are contained in the lower compartment as shown in Fig. 4 and the whole outfit can be set up for operation in less than five minutes. All that is necessary is to remove the front board which has on it the key, plug in the A and B battery cables, throw a wire over a tree and spread on the ground the counterpoise—or use the automobile as a counterpoise—tune the antenna and closed circuits by means of the proper condensers until maximum current is obtained on the wavelength desired. The current on inputs up to 20 watts should not be high, at least not over one half ampere.

DATE	TIME	STATION	DISTANCE	WATT INPUT	MILES PER WATT
11/13	9:35 P.M.	4 DO	745	14.4	51.6
11/13	11:55 P.M.	9 DZN	970	6.7	145.0
11/14	12:35 A.M.	9 AJI	750	6.7	112.0
11/23	9:45 P.M.	9 DSL	860	10.8	80.0
11/23	10:00 P.M.	9 TJ	1080	10.8	100.0
11/23	10:10 P.M.	9 DXX	860	10.8	80.0
11/24	1:10 A.M.	9 ECL	1080	10.8	100.0
12/11	8:15 P.M.	9 ECC	1030	3.42	3000.0
12/15	9:32 P.M.	8 BZK	600	1.04	580.0
12/16	8:20 P.M.	9 DCG	740	1.80	410.0
12/17	8:40 P.M.	9 CBZ	700	.21	3500.0
12/17	10:00 P.M.	9 CCQ	1060	.04	26500.0
12/24	9:00 P.M.	9 CCQ	1060	.11	9650.0
12/29	8:40 P.M.	9 DIB	860	17.0	50.5
12/29	9:40 P.M.	9 BAL	860	17.0	50.5

If the current is higher than .5 amperes, more wire should be added to the antenna to increase the radiation resistance. Quite often it is impossible to raise any one on .5 amperes, but adding ten feet to the antenna will decrease the current to .2 with the result that good distance can be worked.

Sangamo condensers will stand voltages up to 1000 volts, provided of course that the currents are not high. Ordinary receiving condensers will serve as tuning capacities. Practically any tube will do. At 2 CV excellent results have been obtained with the standard 201-A tube of various manufacturers. A Ureco 112 tube

is practically the equal of the UV-210 tube which requires more filament current.

The center tap to the closed circuit inductance which completes the Hartley circuit is variable and should be near the grid end of the coil for maximum efficiency. Moving it toward the plate end will increase the power taken by the tube without much increase in the power taken by the tube and with little increase in antenna current. Only two meters are essential and one of these can be avoided if a small flash-

light bulb is used to indicate antenna resonance. This was explained in the January article in RADIO BROADCAST by Nicklaus Hageman. If a 201-A or 112 tube is used, the filament voltage should be only high enough to insure that the maximum efficiency is being obtained. This can be obtained by watching plate or antenna current meters and varying the filament rheostat. If a 210 tube is used, it may be run on 6 volts without a rheostat—and naturally no filament voltmeter is necessary.

Regardless of the fact that no especial insulation has been used at 2 CV, the antenna-counterpoise system should be as

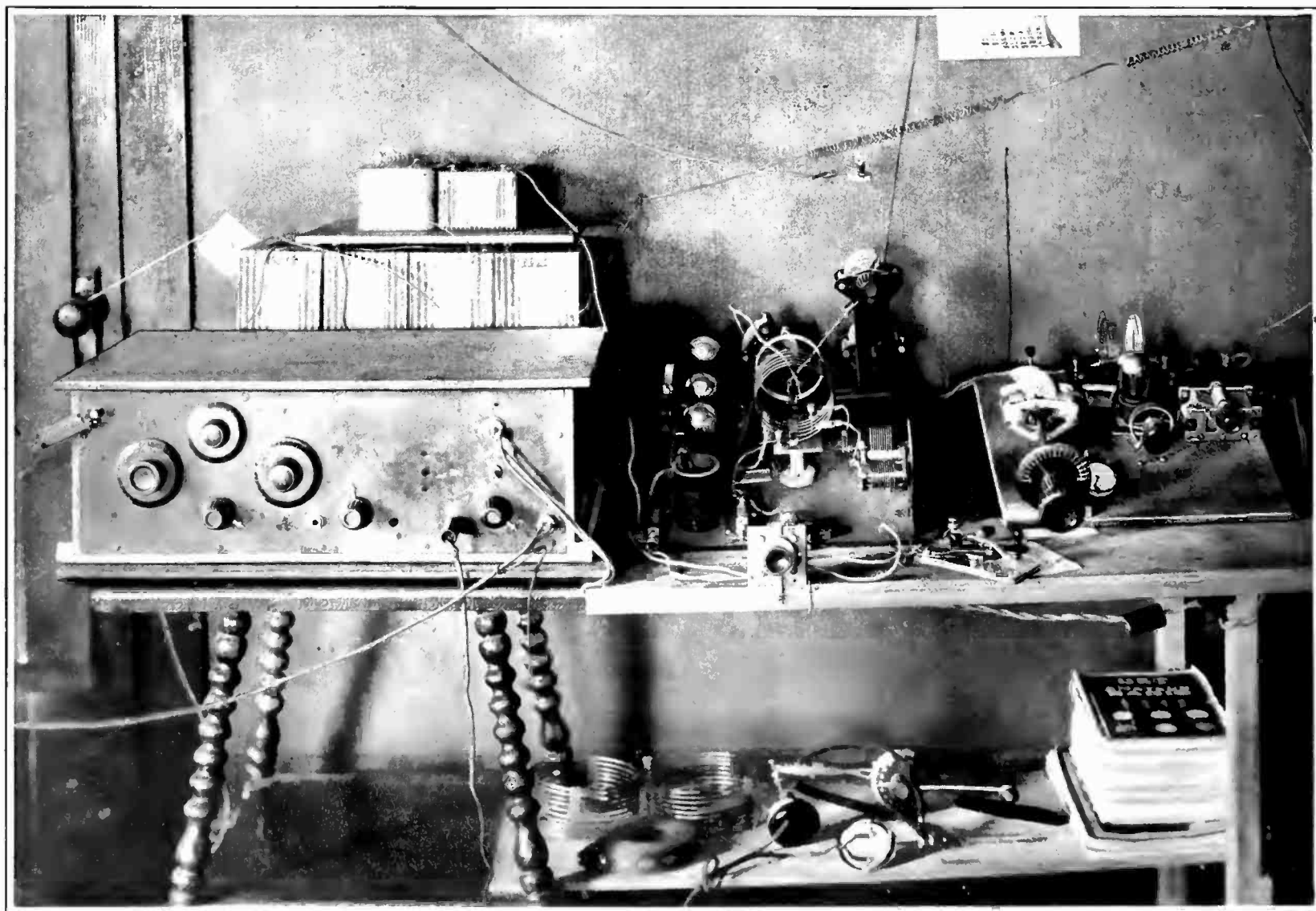

FIG. 4

A photograph of 9 CCQ at Braymer, Missouri. The three 201-A tubes with their elements in parallel, the calibrated short wave receiver, and the compendium of amateur information—*QST*—are worthy of notice. We suspect the big box at the left is a broadcast receiver

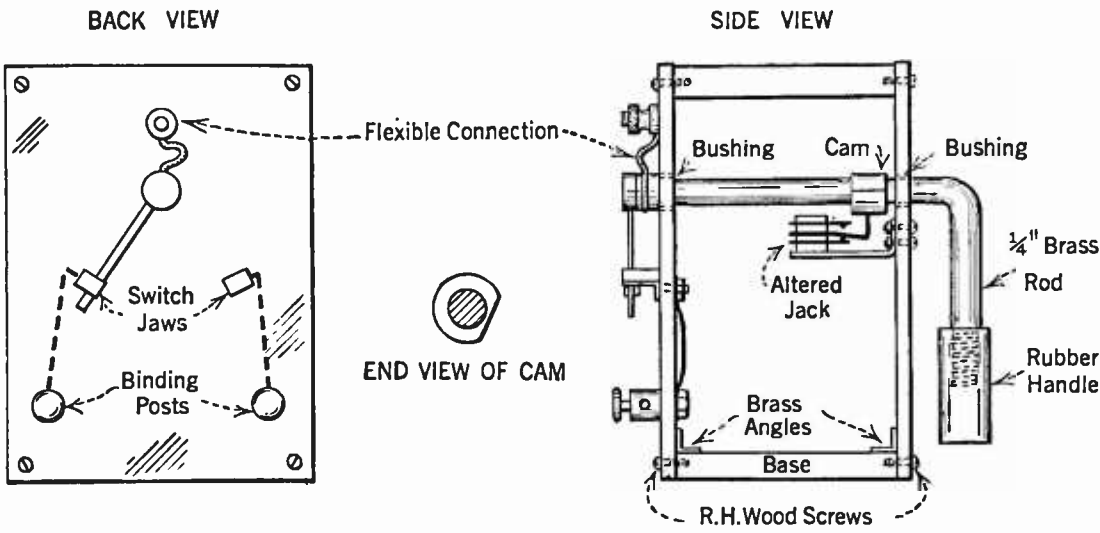
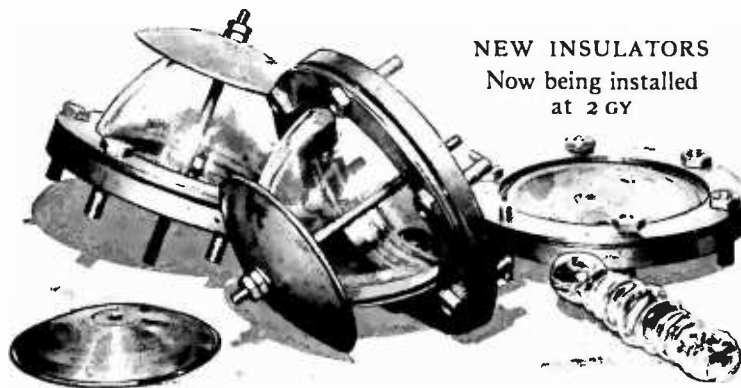

FIG. 6

Details of the throw-over switch which changes the antenna and batteries from sending to receiving



RADIO BROADCAST Photograph

TABLE OF AUDIBILITY SIGNS	
R1	Faint signals, just audible
R2	Weak signals, barely readable
R3	Weak signals, but readable
R4	Fair signals, easily readable
R5	Moderately strong signals
R6	Strong signals
R7	Good strong signals. Would be readable through heavy QRN and QRM
R8	Very strong signals. "Several feet-from-phones signals"
R9	Extremely strong signals

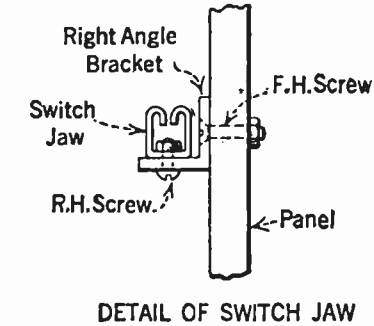

DETAIL OF SWITCH JAW

well insulated as possible, and an accompanying photograph shows some Pyrex insulators made by the Corning Glass Works which are now being installed at 2 GY.

Coupling to the antenna should be loose enough so that the tube continues to oscillate under all conditions. If coupling is too close, the wavelength will jump about and no listening operator can read what you are trying to send.

On 40 meters, reception is erratic, fading is bad, but phenomenal distances can be attained with low powers. On 80 meters transmitting distances are not so great, but steady signals, good traffic handling, and the possibility of phone transmission make it a very interesting band in which to work.

A few words about 9 CCQ may not be amiss to show that the work done between that station and 2 GY is not due to unusual conditions but rather to the great carrying power of transmissions on 40 meters with pure d. c. plate supply. Station 9 CCQ is operated by Mr. Vere Davis at Braymer, Missouri, about 1080 miles from Garden City. Braymer is 60 miles East of Kansas City and 20 miles southwest of Chillicothe in rolling country which is still blessed with considerable timber.

Mr. Davis says he "became interested in broadcast radio about three years ago and it's just a case of drifting from bad to worse, I guess. Have had an amateur's license now about four or five months and have been active about two and one-half. I became interested in amateur radio just about the same way most anybody of my age and interests does. I've always read radio magazines when I got the chance

and of course couldn't help seeing short wave circuits and the marvelous things they were supposed to do. I made my first successful short wave receiver last spring, a little less than a year ago, with the intention first of listening to the short wave broadcasts and was very disappointed when KDKA came in strong but with bad fad-

ing and distortion. So another fan, now 9 CJD, and I began practicing the code, and to our surprise passed the amateurs' examination. My first communication was with 9 WQ at Elmhurst, Illinois (40 meters), at about 4 o'clock p. m. November 1st. Next was 9 BV at Council Bluffs, Iowa, and the third was 8 CJM, Elyria, Ohio, but I found trouble raising stations. I could get a large current in the antenna but it wasn't effective. In a month or so I got time to improve the system and although I don't get the current I did, reports are better now. Have been reported at 5 AQI, Meridian, Mississippi, R 6 at about noon. Plate voltage 220, mils., 33."

Since the International Tests, this simple transmitter has been in operation at 2 GY with complete success, reports indicating that the pure d.c. note penetrates much better than our "high powered" outfit, for distances up to 1000 miles. The operators at 2 GY welcome reports of reception and will be glad to advise any of RADIO BROADCAST's readers who are interested in low power, short wavelength amateur work.

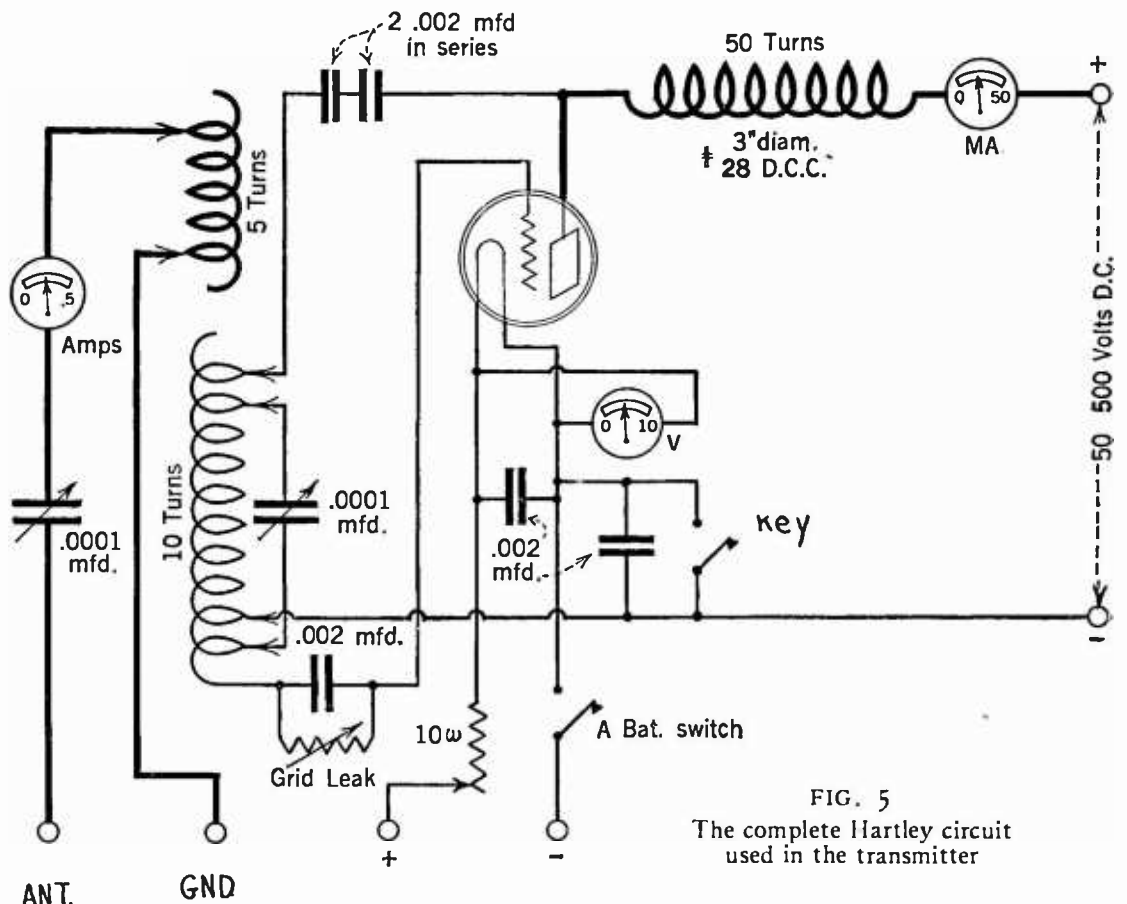
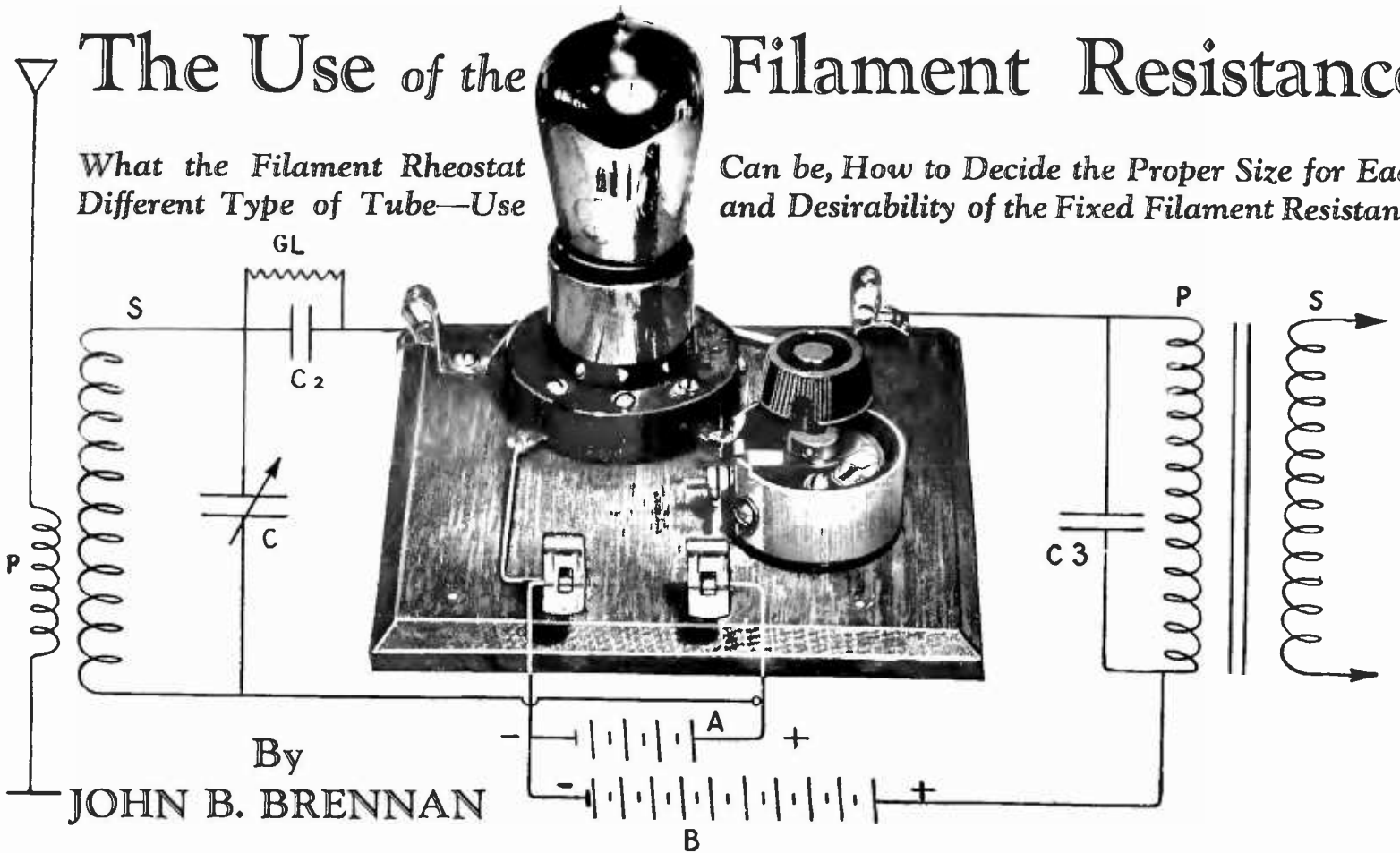

FIG. 5
The complete Hartley circuit used in the transmitter

The Use of the Filament Resistance

What the Filament Rheostat Different Type of Tube—Use

Can be, How to Decide the Proper Size for Each and Desirability of the Fixed Filament Resistance



By
JOHN B. BRENNAN

THE vacuum tube, that indispensable unit of the radio receiver, which transforms unintelligible radio signals into sounds that we can hear has been dealt with at length admirably by Keith Henney in the December, 1925, and February, 1926, issues of RADIO BROADCAST. In these articles, Mr. Henney dwelt upon the selection, use, and function of the vacuum tube in radio circuits and described in detail the parts played by the three elements of the tube, the plate, grid, and filament.

It is the last named, which is taken as the subject for this article. We shall try to show how this filament performs its task efficiently by the use of suitable control devices which adjust or regulate the current and voltage applied to it.

The filament is the thing that lights up when the A battery is applied to its terminals and emits electrons at a given rate. The grid is the regulator or shutter which stops or lets flow the electronic stream to the plate, the third element. In this way, feeble radio impulses impressed on the grid release a stronger impulse in the plate and its attendant circuits.

Manufacturers of the early tubes found it necessary to employ a control in the filament circuit of the tube so that the tube might be adjusted to its most efficient point of operation. Naturally they could not use a six-volt filament energized by a six-volt battery because the regulation so necessary would not be obtained. The five-volt filament, energized by the six volt storage battery, allowed for an adjustment

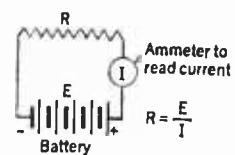

FIG. 1

A simple circuit comprising a source of voltage (battery) a resistance (R) and a means for reading the current flowing through the circuit. This arrangement is comparable to a tube circuit where the resistance R is represented by the tube filament and the external control device

$$R = r^1 + r^2 + r^3$$

Or if all r values are the same
 $R = r^1 \times N$
 Where N=Number of resistance units

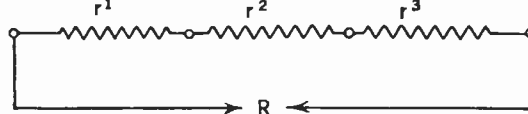

FIG. 3

Resistances in series retard to a greater extent the flow of current in a circuit than where only one resistance unit is used. The total resistance of a series-resistance circuit is equal to the sum of all the resistances employed. In a circuit of this kind it is possible to employ two 3-volt tubes energized from a 6-volt source

presumably from zero to six volts by means of a variable resistance. Soft tubes, as they were known not so long ago, required critical filament adjustment and to obtain this end, a rheostat had to be used. Sometimes the best operating voltage was found to be five but most times not. Each tube had its own peculiarities.

Now, the manufacturers have advanced the design and manufacture of the tubes to such a point that the filament adjustment is not critical.

Keith Henney has pointed out in RADIO BROADCAST that with the present tubes, a decrease in filament voltage below five is usually accompanied by a falling off in signal tone quality. Also, a slight increase above the rated filament voltage always causes a surprising decrease in filament life. To prevent this it is obvious that the old six-volt storage battery, borrowed from the automobile days, must still be retained so that a regulation of one volt in the rheostat may be had to maintain the filament at five volts.

When the battery is newly charged, more resistance of the rheostat will be in the circuit to maintain it at five volts. However, when the battery voltage drops off then this resistance is cut out of the circuit to compensate for the drop

in voltage at the battery terminals. Theoretically this is true but in actual practise, the battery maintains its full charge over the major portion of a single charge life. Toward the end it does drop in voltage but its energy has been expended to the point where the rheostat is useful, in maintaining the tube voltage at 5 only for a few hours. Then the battery may be considered in need of recharging.

Some tubes require 1.1 volts, others 3 volts and still others 5 volts. Therefore, it is essential that we adjust each of these filaments economically and efficiently. To make this clearer, it would not be strict economy or efficiency to control a 1.1-volt tube filament with a 60-ohm rheostat where only 1.6 ohms are required, only unless the battery voltage was much higher than $1\frac{1}{2}$. Even this is an unusual case.

SELECTING THE PROPER RESISTANCE

FOR the radio set constructor then, there arises a problem in selecting the proper size of rheostat for the tube or tubes he is going to use. To understand what is happening in a circuit where voltage, resistance, and current are present, it is necessary to review the law governing the use and application of resistances in a circuit. Ohm's Law says that where a pressure of one volt is exerted in a circuit whose resistance is one ohm, then one ampere of current will flow. Now if the resistance is reduced to one half, the voltage

FIG. 2

When several resistances, such as tube filaments are connected in parallel as is the case in the majority of receivers, the total resistance of the circuit offered to the flow of current is less than were only one resistance unit used in the circuit because several paths are provided for the flow of current

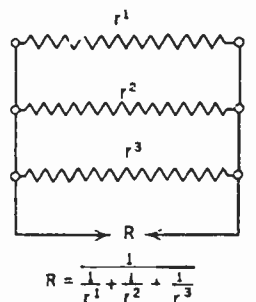

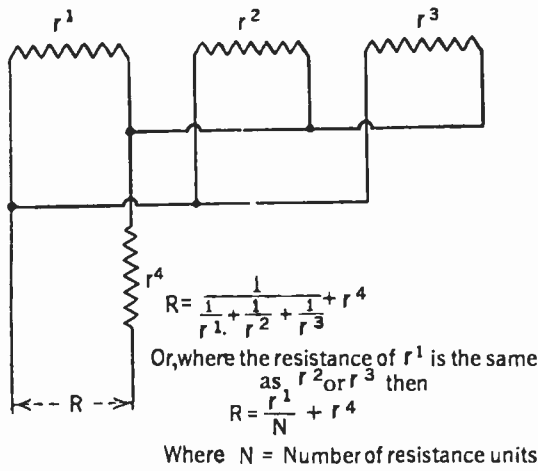

FIG. 4

A series-parallel circuit. The total resistance of the circuit is determined by first calculating the parallel circuit resistance of r^1 , r^2 , and r^3 and adding that total to r^4

remaining constant, then double the current will flow. This gives rise to the equation $I = \frac{E}{R}$ where I is the current in amperes, E is the pressure in volts and R the resistance in ohms. From this equation it is possible by transposing, to find any one value where the other two are known. That is to say $E = I \times R$ and $R = \frac{E}{I}$. A circuit comprising these three factors is shown in Fig. 1.

If a resistance is paralleled by another of the same value, then two paths are provided for the flow of current so the total resistance to this flow is cut in half. If the resistances are added to each other, that is, connected in series, then the current flow is retarded because the total circuit resistance has been increased. To determine the total resistance of a circuit where resistances are in parallel the formula $R = \frac{1}{\frac{1}{R_1} + \frac{1}{R_2} + \frac{1}{R_3}}$ is employed, as shown in Fig. 2.

Where the resistances are in series, the total resistance is equal to the sum of all the resistances or where the resistance per unit is the same, then the total is equal to the value of one unit multiplied by the number of units employed. Expressed algebraically $R = r_1 + r_2 + r_3$, etc. or $R = r_1 \times N$ where R = total resistance r = resistance per unit and N = number of units. This is illustrated in Fig. 3.

It is possible to combine resistances in a circuit so that a series-parallel arrangement is produced. This is the case where it is desired to know the total resistance of a circuit comprising several tubes in parallel with a single rheostat in series with the tubes and battery. To calculate this total resistance, it is first necessary to find the resistance of all the tubes in parallel. Then when this value is known it is added to the value of the resistance of the rheostat. This is illustrated in Fig. 4.

In the matter of determining the resistance of the tube filament Ohm's Law is employed first and then where it is desired to know the total resistance of a circuit, where such an arrangement exists as in Fig. 4 then the formula for resistances in series is employed.

Take, for example, a five-volt tube. Its filament should be energized by the battery so that .25 ampere of current flows in the circuit when the voltage at the tube terminals is 5. With these two known factors it is possible to determine the resistance of the circuit. Since the resistance of the battery and wire for the circuit is negligible, therefore the resistance computed will be purely tube resistance. Applying Ohm's Law $R = \frac{E}{I}$ where R = resistance of

the tube, E = rated voltage of tube, I = rated filament current in amperes. Then $R = \frac{5}{.25} = 20$ ohms.

WHY RESISTANCES ARE NEEDED

NOW if six volts is applied to a filament, the current will be correspondingly greater than with five volts. In order to keep the current at that point stipulated by the tube manufacturer, it is necessary to decrease this voltage by adding resistance to the circuit.

Until a short while ago the one means for regulating the current flow and voltage in a filament circuit was by means of the rheostat but lately there has been placed on the market the filament ballast, otherwise termed filament regulator. That is, they automatically decrease the battery voltage to the correct point for application to the filament terminals.

It is a known fact that the battery voltage remains quite constant over the major portion of its discharge life but at the end takes a decided and sudden drop. A curve illustrating this is shown in Fig. 5. It is because of this voltage life-retaining property of the battery that filament ballasts have proved satisfactory for use as filament controls. For those who desire simplicity of control, the filament ballast will commend itself.

Writers of radio articles have differed widely for years concerning the correct value of rheostat to be used in a filament circuit. The best possible advice, and the easiest to follow is that our old friend Ohm's Law be used. Where two factors or values of this equation are known, the third can be determined by the application of the formula.

Let's look over a typical filament circuit consisting of tube, rheostat and battery, such as that in Fig. 6 B. The filament R of the tube is considered as a resistance and, therefore, its value may be rated in ohms. The battery E is the source of the energy which lights the filament and has a certain voltage, usually six. The rheostat r , has a variable external resistance whose total resistance we do not know, but wish to ascertain. If there were no rheostat r , in the circuit and the voltage of the battery were 5, then the total resistance of the circuit would be 20 ohms. If the battery voltage were raised to 6 then .3 amperes of current would flow in the circuit instead of the rated .25 amperes.

Now by introducing a resistance in the form of the rheostat r , not only is the current reduced but the voltage at the filament terminals is accordingly diminished. By applying the formula $R = \frac{E}{I}$ then $R = \frac{6}{.25} = 24$ ohms which is the total resistance of the circuit. How much

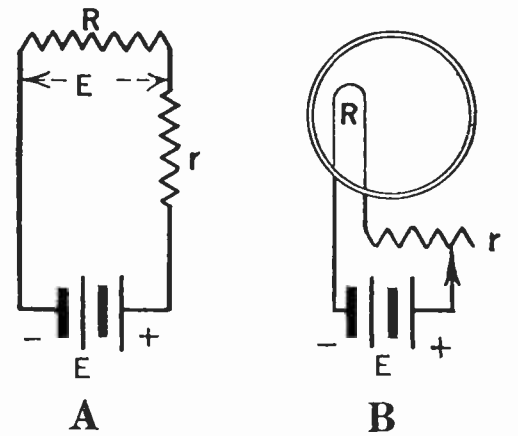

$$r = \left(\frac{E}{I} \right) - \left(\frac{E_1}{I} \right)$$

Where r = Rheostat resistance
 E = Battery voltage
 E_1 = Filament terminal voltage
 I = Filament amperes

Example:

$$r = \left(\frac{6}{.25} \right) - \left(\frac{5}{.25} \right) = 4 \text{ Ohms}$$

FIG. 6

Determining the resistance value of the unit 'r' in the circuit above involves the use of the formula as shown. The battery voltage, the tube resistance and the current are usually known; from these values it is possible to calculate the unknown

resistance is necessary in the rheostat? The answer may be found by subtracting the circuit resistance at 5 volts from the circuit resistance at 6 volts i. e. $24 - 20 = 4$ ohms as shown in Fig. 6A. From this we see that with 4 ohms in the circuit where a fully charged 6-volt storage battery is employed, .25 amperes of current will flow. Theoretically, as the charge in the battery decreases, the voltage decreases; therefore, to keep the circuit characteristics at their rated level, it is necessary to cut out part of the external resistance to compensate for the corresponding drop in battery voltage.

Now the main rub comes in the advocacy of rheostats larger than 4 ohms where only one tube is to be controlled by it. Of course, if one rheostat controls more than one tube, the proper resistance value may be calculated since usually the tube filaments are in parallel and as such the total resistance of these filaments is figured from

$$\text{the formula } R = \frac{1}{\frac{1}{r_1} + \frac{1}{r_2} + \frac{1}{r_3}} \text{ etc.}$$

To use a rheostat of 4 ohms means that when the movable arm touches the first turn of the wire

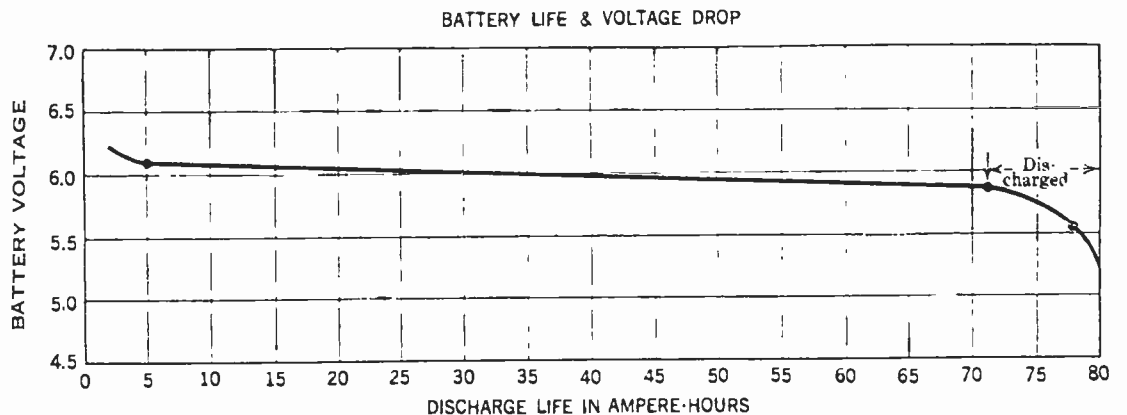

FIG. 5

When a fully charged battery is first used, its voltage is slightly above six volts. The major portion of its life, however, is at a fairly constant voltage level, the gradual drop being from 6 to 5.7 volts. When this low point has been reached, the battery is considered discharged and is in need of recharge. As the 5.7 point is reached the rheostat in a filament circuit is of greatest use because as the rheostat arm is advanced the voltage at the tube terminals is maintained at its highest point

Table I
Various Types of Tubes and Their Respective Rheostats

UV-200		UX-112	
NUMBER OF TUBES IN PARALLEL	MAXIMUM RESISTANCE OF RHEOSTAT IN OHMS	NUMBER OF TUBES IN PARALLEL	MAXIMUM RESISTANCE OF RHEOSTAT IN OHMS
1	1.0	1	.5
2	1.0	2	1.0
UV-201		TYPE 199	
1	1.0	1	25.0
2	.5	2	12.5
3	.33	3	8.33
4	.25	4	6.25
TYPE 201A		TYPE 120	
1	4.0	1	12.0
2	2.0	2	6.0
3	1.33		
4	1.0		
WD-12			
NUMBER OF TUBES IN PARALLEL	MAXIMUM RESISTANCE OF RHEOSTAT IN OHMS		
1	1.6		
2	.8		
3	.53		
4	.4		

on the rheostat, the required amount of resistance is immediately introduced in the circuit. Then as the battery voltage drops off toward the end of its ampere hour capacity this arm can be advanced over the entire periphery of the rheostat surface to keep the filament voltage constant. Where a 20-ohm rheostat is employed, four-fifths of the rheostat is unused as only the last 4 ohms is required in the circuit. Then as the battery voltage drops, the regulation is over only one fifth the surface as compared to the entire surface of the 4-ohm rheostat.

Various diameters and textures of resistance wires have different current carrying properties. In the case just cited, assuming that the 4-ohm, and 20-ohm rheostats are of the same physical dimensions, then the space in which the resistance unit is placed is the same for each. Now if on one, there is to be wound resistance wire totaling 20 ohms, while on the other there is to be only 4 ohms, then the both must be wound with such a diameter of wire as will fill up the whole space. The 20-ohm rheostat will be

wound with thinner wire so that the full 20 ohms are accommodated on the same size form. The thinner wire is used because per inch it has more resistance than that used on the 4-ohm rheostat. Less current can be carried by small wires than by larger wires. So, by forcing too great a current through a small wire, heat is produced, and in its dissipation sometimes warps or otherwise injures the forms of the rheostat wound with small wire. This is especially true in the case of 20-ohm rheostats where it is intended to use only 4 ohms. This means that one-fifth of the entire wire is used where if a 4- or 6-ohm rheostat were used in the first place, it would be safer because the wire would be larger, insuring ample current carrying capacity and also any desired variation in current would be finer since the change in resistance produced by a movement of the contact arm would be less per unit of change than if the same movement were made on the 20-ohm rheostat.

THE FILAMENT BALLAST

THE only point that may be raised in objection to the use of filament ballasts is that they do not permit of detector filament regulation for regeneration control as the rheostat does. However, now as ticklers, feedback condensers and variable plate circuit resistors are generally used for oscillation control, that objection is not serious.

Examine the curve in Fig. 5, showing the voltage of a battery over a period of discharge hours. The battery practically maintains its voltage until very near the end of its charged life, then rapidly falls. The use of the rheostat or filament ballast is helpful only up to the point where the sudden drop occurs. When past this point the battery must be recharged and rheo-

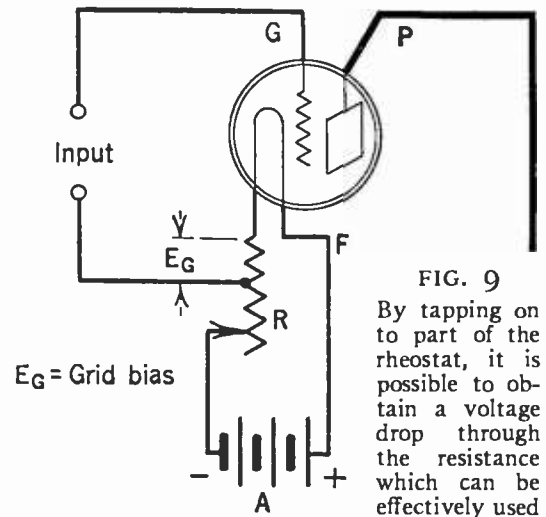

FIG. 9
By tapping on to part of the rheostat, it is possible to obtain a voltage drop through the resistance which can be effectively used for biasing the grid of a tube with the same result as a C battery. However, this practice is not to be recommended as the difficulties of soldering and unsoldering the lead necessary to obtain the correct grid bias for a tube is great compared to the ease and simplicity of providing a C battery for this purpose

stats and filament ballast will not assist for long in maintaining the tube voltage at 5.

Look at the curve for a filament ballast in Fig. 7. From 6 volts, the charged state of the battery, to 5.7 volts when the battery is considered discharged, there is only a change of .006 amperes from the rated .25 amperes of filament current, surely not enough to be seriously considered as affecting the proper and efficient operation of the tube in a radio circuit.

In the case of dry cell tubes, there is not this constancy of voltage in dry cell batteries as compared with the storage battery unless many batteries are connected in parallel so, therefore, it is essential that a variable resistor be used to maintain the tube filament voltage at a constant level even though the battery does drop in voltage from 4.5 to 3 volts as is the case where 199 type tubes are employed. When the battery voltage falls below 3 then tone quality will probably suffer and it is wise to replace with new batteries.

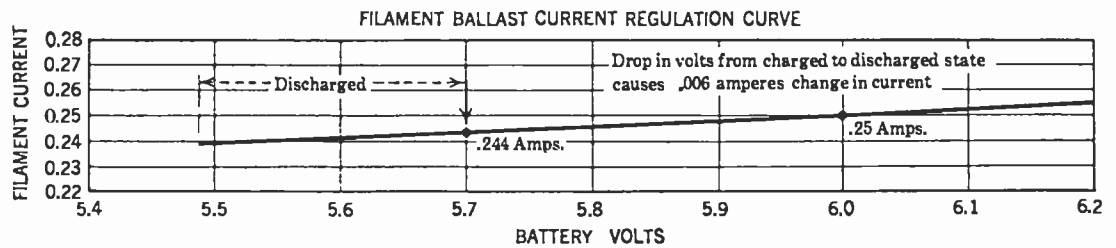

FIG. 7

Filament ballasts are used to regulate the flow of current in a tube circuit. Their purpose is to maintain this current value at a constant point as the battery becomes discharged. From the above it will be seen how successfully this purpose is accomplished. As the battery fell off in voltage, the filament ballast caused a change in the current in the tube circuit from .25 amperes to .244 amperes—.006 amperes, not enough to be seriously considered as affecting the proper operation of the tube at its rated filament characteristic

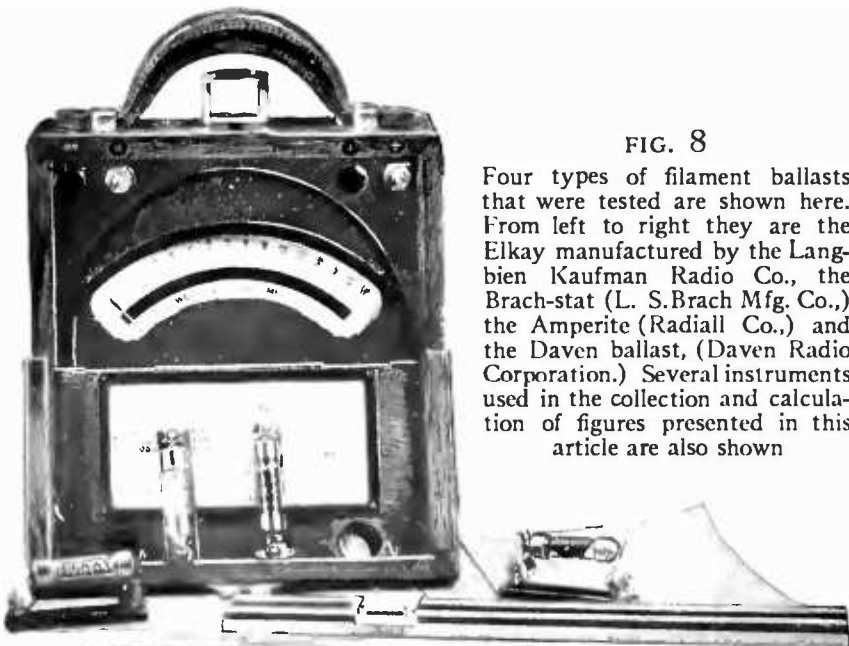

FIG. 8

Four types of filament ballasts that were tested are shown here. From left to right they are the Elkay manufactured by the Langbien Kaufman Radio Co., the Brach-stat (L. S. Brach Mfg. Co.), the Amperite (Radiall Co.), and the Daven ballast, (Daven Radio Corporation.) Several instruments used in the collection and calculation of figures presented in this article are also shown

Table II
Tube Operating Characteristics

TYPE OF TUBE	FILAMENT CURRENT IN AMPERES	FILAMENT VOLTS	BATTERY VOLTS	FILAMENT RESISTANCE
201A	.25	5	6.	20
199	.06	3	4.5	50
120	.125	3	1.5	24
112	.5	5	6.	10
12	.25	1.1	1.5	4.4
UV-200	1.0	5	6	5
UV-201	1.0	5	6	5

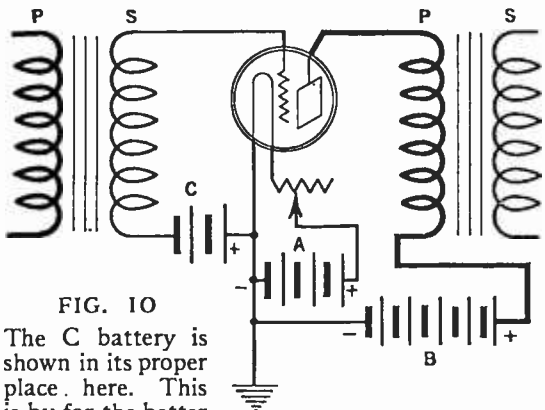

FIG. 10

The C battery is shown in its proper place here. This is by far the better way to obtain grid bias for receiving tubes since if it is desired to vary the grid bias voltage, more or less C battery may be placed in the circuit

Rheostats are variable resistances with which an accurate control of the filament voltage and current is obtained. The selection of a rheostat for one tube has already been explained and the radio experimenter should not become confused where more than one tube is controlled by a single rheostat. As it has been said, in a radio circuit it is usual to connect several tubes in parallel, the path for the flow of current will become greater hence there will be less resistance to the flow of this current. In tube circuits it is customary to employ tubes all of one nature, that is, all 5- or all 3-volt tubes. The total resistance then, of a circuit, is equal to the resistance of one tube divided by the number of tubes in the parallel arrangement. See Fig. 4. For instance, 201-A's have a resistance of 20 ohms. Where four are connected in parallel the total circuit resistance is 5 ohms. Therefore, to cut down the battery voltage so that five volts are applied to the filament terminals, 1 ohm of external resistance must be added to the circuit. Before, the method by which the rheostat value was ascertained was to subtract the circuit resistance at 5 volts from the circuit resistance at 6 volts. Another method, also very good, is to employ the formula $R = \frac{E - E_x}{I}$ where R = resistance of rheostat, E_x = filament voltage, E = battery voltage and I = total current of circuit. This last factor, total current, is obtained by multiplying the current rate of one tube by the number of tubes to be controlled by the rheostat. Again, using four tubes, the total current would be $4 \times .25$ amperes = 1 ampere. Then, applying the formula $R = \frac{6-5}{1} = 1$ ohm.

WHERE SHOULD THE RESISTANCE GO?

INDEPENDENT tube manufacturers as well as the pioneers in tube production advocate the use of the rheostat in the negative side of the A battery lead. The writer became convinced that this procedure was proper only where the rheostat was to be employed to provide a grid bias of a few volts. This usually was supplied by tapping on to a portion of the rheostat so that a voltage drop through that portion of the resistance employed would provide the necessary few volts for grid biasing.

In Fig. 9 the circuit shows how this tap is arranged. This manner of obtaining grid bias is unusual inasmuch as it entails first, a calculation as to the necessary amount of resistance wire to be included in the tap-off circuit so as to supply the necessary grid voltage. Secondly, it is sometimes desirable to vary the grid bias and when the connection is soldered to the rheostat a change in voltage is impossible unless the tap-off be unsoldered.

The use of a C battery provides the more convenient and simpler way to obtain grid bias and with this change it is possible to place the rheostat in the positive side of the A supply lead so that all the negative leads are at ground potential as in Fig. 9. The use of the rheostat in the positive side instead of the negative side of the A battery supply makes for more accurate wiring, clearer understanding of circuit diagrams, and the surety that one part of the complete wiring circuit will be at ground potential insuring shorter leads from other units in the circuit which of necessity must be connected to the ground line.

Among the rheostats tested because of the difference in design and principle was the Bradleystat, and the Filkostat. Both these devices insure a continuous, even increase in voltage differing from the wire-wound rheostat which provided the increase in steps as more turns of wire was cut out of the circuit. Voltage regulation is secured by the change in resistance of the device as carbon discs are compressed by means of a thumb screw.

Table III
Filament Ballasts for Various Tubes

TUBE	ELKAY EQUALIZOR	RADIALL AMPERITE	DAVEN BALLAST	BRACH BRACHSTAT
1 type 199	No. 50 for 6 volt source	No. 6V 199 for 6 volt source No. 4 V 199 for 4 or 4.5 volt source		1 C for 4 volt source 1 D for 6 volt source
2 type 199's	No. 25	No. 120		2 C
1 type 120	No. 25	No. 120		2 C
1 type 201-A	No. 4	No. 1-A	No. 1	1 B
2 type 201-A's	No. 2	No. 112	No. 2	2 B
1 type 112	No. 2	No. 112	Use No. 3 for 3 type-201 A's and No. 4 for 4 type 201A's	2 B
MU 20	No. 0			
MU 6	No. 0			
WD 11				
WD 12				
WX 12				
C 11		D 11		1 A
C 12				
CX 12				

If you intend to build a super-heterodyne and control eight tubes with one rheostat then that rheostat should be of the power variety capable of carrying from 2 to 3 amperes of current. This is especially necessary where the new power tubes are to be employed in the audio end since they take more current than the ordinary 201-A type of tube. Fortunately, filament ballast makers have kept up with the development of the power tubes and today it is possible to purchase special ballasts designed solely for use with these new tubes.

The total watts consumed in a filament is 1.5, of this, .25 watts is dissipated in the rheostat or other filament resistance. This means that there is a 16 2/3 per cent. loss of power in the filament resistor and only 83 1/3 per cent. of the power being utilized in the filament directly.

Outstanding are these several not-to-be ignored facts:

A 4-ohm rheostat is satisfactory for controlling a single 201A.

A variable resistance may be used for detector filament regulation but for other tubes fixed resistances are satisfactory.

Filament ballasts may be used successfully in all tube filament circuits except detectors.

Dry cell tubes need variable filament control.

Where grid biasing is desired, use a C battery.

Tone quality suffers when the filament or plate voltage is reduced.

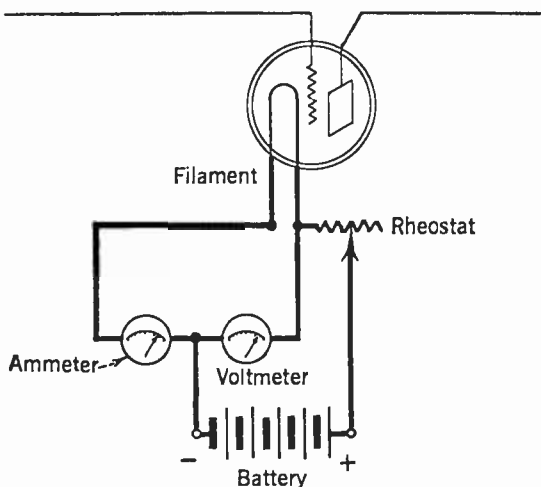

FIG. 11

Voltmeters and ammeters indicate the amount of voltage and current in a circuit. This is the circuit of the test set actually employed in checking the regulation properties of rheostats and filament ballasts described in this article

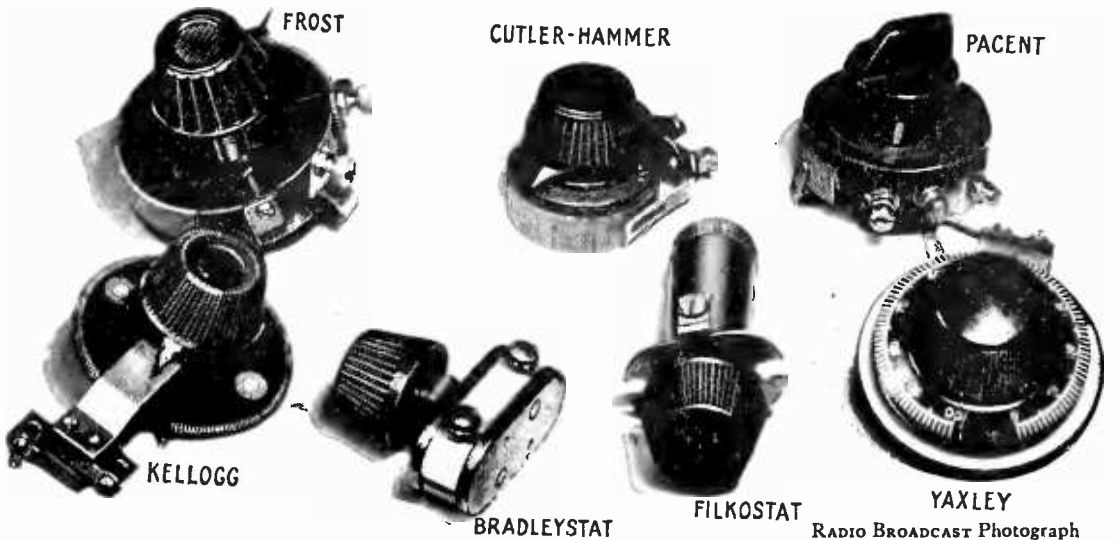

FIG. 12

Only a few of the many rheostats that were tested are shown here. The Kellogg type of resistance unit has its circular form, with the resistance wire thereon as the rotating unit. The same is true of the Cutler-Hammer rheostat. Two carbon-pile type of resistance units are represented in the Filkostat and Bradleystat

Cutting Out the Locals

Simple and Efficient Wave Traps to Eliminate Interfering Near-by Stations

By HOWARD E. RHODES

THE trend in broadcasting for some time has been toward the use of higher powers, wherever that is possible, and this, combined with the concentration of many stations in large centers, has made the problem of selectivity a serious one for many listeners. It is easy to remedy most of the trouble encountered in the average receiver by simply adding a wave trap of good design, and the accompanying article reviews the subject in a very helpful fashion. The present article is concerned with types which can be made very easily, and a second article, to be printed soon, will describe a radio-frequency amplifier and detail how it functions as a wave trap.—THE EDITOR.

WITH the increase in power of a great many of our broadcasting stations, listeners find need of some efficient method whereby undesired signals may be eliminated. These signals sometimes are caused by direct pick-up by the coils of the set so that its natural selectivity is of no avail in eliminating them. This occurs when the set is being operated in proximity to a broadcasting station with the result that the field strength in the vicinity is great enough to induce currents directly in the various coils of the receiver. Under these conditions it will be found possible to hear the program with the antenna disconnected.

The only practical methods to be used in eliminating this type of interference are either shielding of the receiver or using some form of close field coil, such as a toroid. If the set is to be shielded, it is necessary to line the entire

inside of the cabinet, including the cover and the panel, with thin copper. Any joints in the copper sheet are soldered together and connection is finally made between the shield and the minus A terminal which should, in this case, be connected to ground. This puts the entire shield at ground potential, thereby excluding from the coils any external electrical fields. It should also be pointed out that this shielding will also eliminate any interference caused by power lines, motors, etc., provided they are causing trouble by setting up currents directly in the coils. However, if this interference is reaching

curve of Fig. 10 which represents the resonance curves of a fairly good receiver. For ordinary reception this degree of selectivity is satisfactory, but under some unusual condition, even greater selectivity might be required. For instance, the receiver might be operated at a location quite close to a powerful broadcasting station so that the signal strength from this station, in comparison with the strength of the signals that it is desired to receive, is so great as to produce considerable interference, even though the receiver is considerably detuned from the interfering signal. It is apparent then that in some way this powerful signal must be impeded so as to decrease its strength.

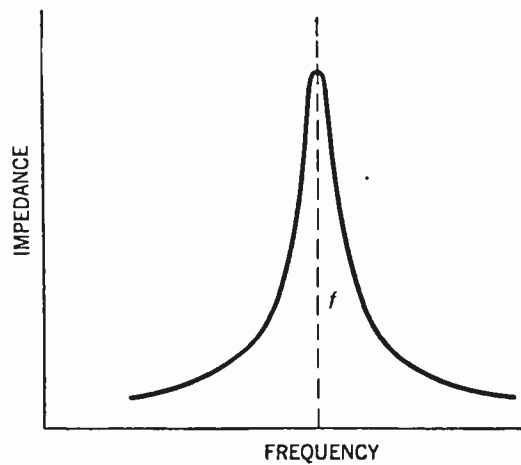

FIG. 1

The impedance curve of a well-made wave trap

the set by way of the antenna system, shielding will be of no aid.

A second and rather recently developed method of eliminating this type of interference is by the use of toroid coils. This type of coil is now being widely employed in instances where there is need of an inductor that is unaffected by external fields. The reason why toroids are not sensible to magnetic fields is easy to understand. Suppose such a coil is placed in a magnetic field. Then a voltage is induced in practically every turn of the coil. However, the voltage induced in one half of the coil is exactly equal and opposite to the voltage produced in the other half of the coil. These two voltages react against each other and the resultant effective voltage is therefore zero. This type of winding can be placed in comparatively strong magnetic fields without having any appreciable voltage produced in it. Toroids are, therefore, very useful in eliminating that type of interference caused by some form of direct pick-up by the coil units of a receiver. These two methods which have just been outlined, first, shielding of the set, and secondly, using Toroid coils, are practically the only methods of eliminating this type of interference.

There is a second type of interfering signal that also causes considerable trouble, and against this type the two methods so far described are useless. If the signals being induced in the antenna are sufficiently strong, it is possible that a receiver may not have a selectivity sharp enough to eliminate them completely, although its selectivity under ordinary conditions may be perfectly satisfactory. Take, for example, the

THE SIMPLICITY OF A WAVE TRAP

THE most common piece of apparatus for use in this connection is the so-called wave trap which is actually a filter circuit tuned to absorb the interfering signals. These wave traps are very easily constructed, and cost little. They consist merely of an ordinary coil and a condenser. The traps are connected in the antenna circuit and are adjusted so that at the frequency of the interfering signal they have a very high impedance, the exact value depending on whether the unit is connected in series or parallel with the antenna. This high impedance prevents the signal from passing down through the primary of the antenna coupling and so into

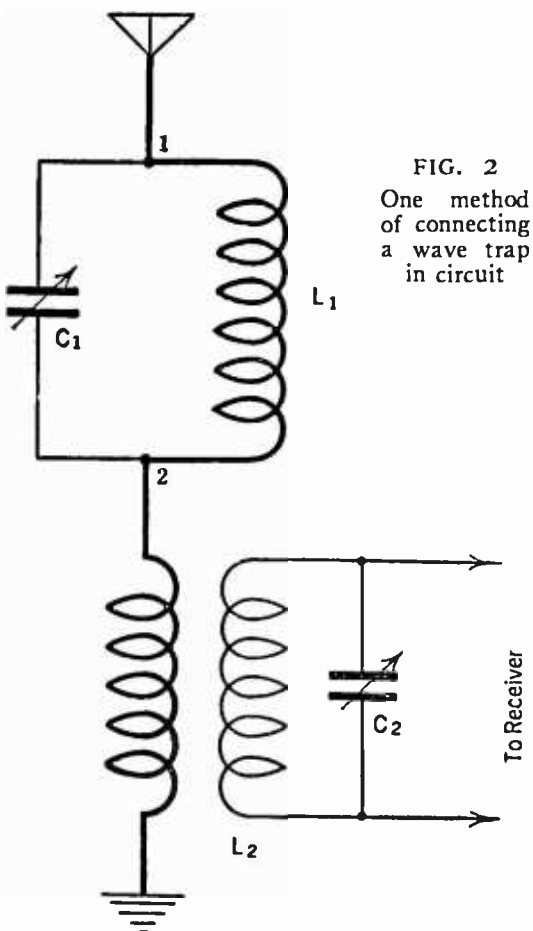

FIG. 2
One method of connecting a wave trap in circuit

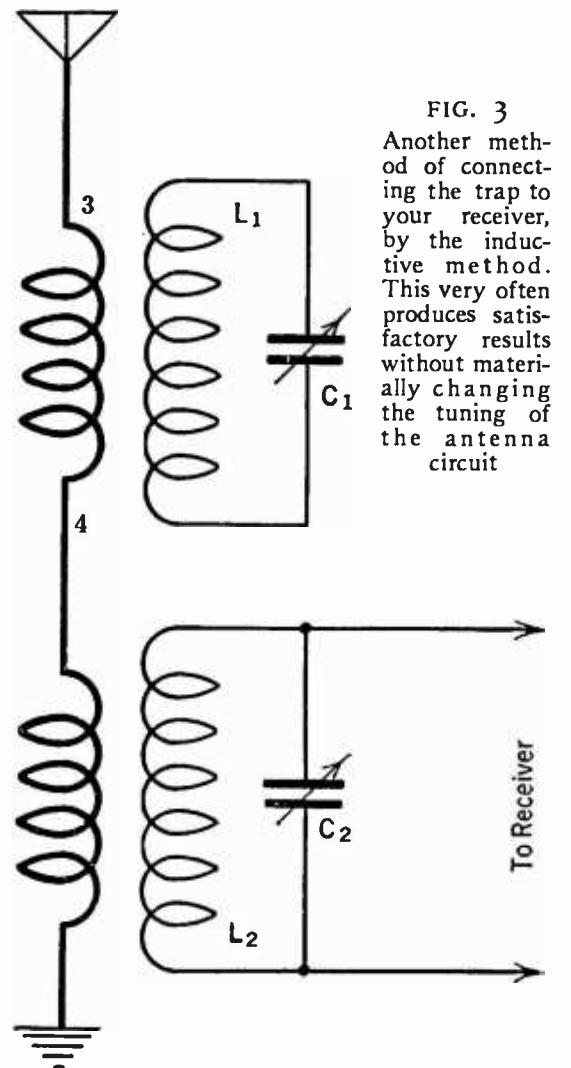

FIG. 3
Another method of connecting the trap to your receiver, by the inductive method. This very often produces satisfactory results without materially changing the tuning of the antenna circuit

the receiver. At the same time, these wave traps offer a very low impedance to all other frequencies. In Fig. 1 there has been plotted the change in impedance of a wave trap as the frequency is varied, and this gives a good idea how a wave trap functions. At the frequency marked f on the diagram, the impedance as read on the ordinate of the curve is very high and since this circuit would be connected in the antenna system of a receiver, it is evident that at this frequency the impedance of the antenna system to this particular frequency would be very high, and for that reason practically no energy could be received at this frequency. At the same time, the impedance of the trap to any other fre-

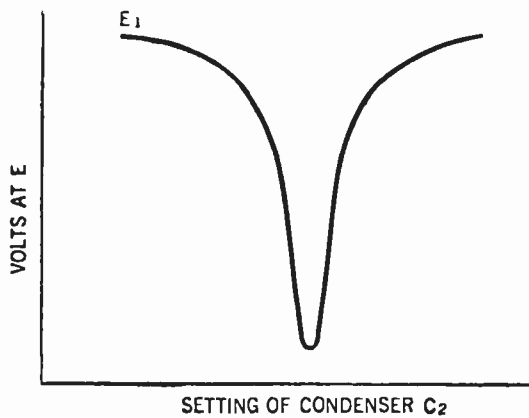

FIG. 5

A curve showing the decrease in interference obtained by the use of a wave trap

quencies, either above or below the frequency f , is very low. The efficiency with which the trap operates depends upon the steepness of the sides of the curve, and in order to obtain satisfactory operation, it is essential that a sharp resonance curve be obtained.

This idea of high impedance at resonance may

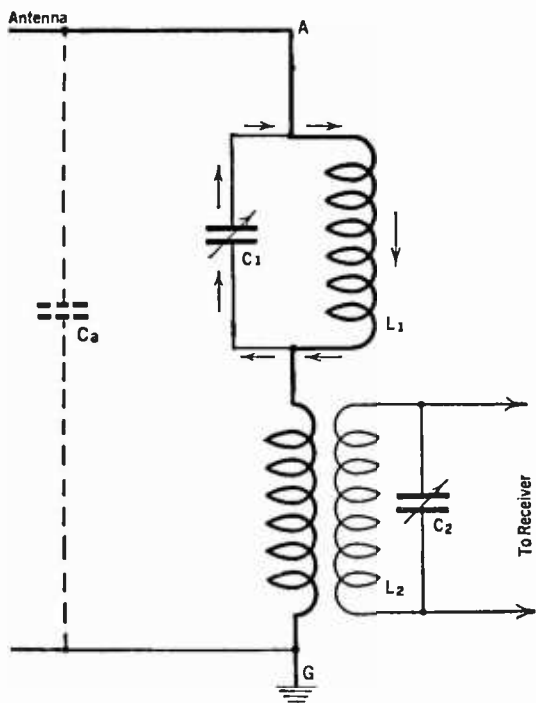

FIG. 6

The small arrows indicate the circulating current set up in the wave trap by the interfering signal

require some explanation since we are accustomed to think of resonant circuits as having a low impedance. At resonance, a circuit consisting of a coil and a condenser has a low impedance to the flow of current around the path

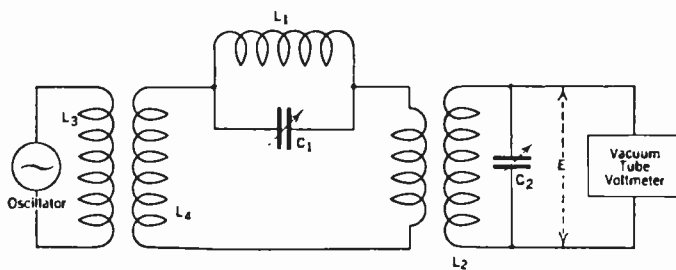

FIG. 4

The circuit diagram of the test apparatus used to obtain some of the data given in this article

indicated in Fig. 6, by the small arrows. This is important current with regard to the various tuned circuits of a receiver. In a wave trap, however, we wish to impede the flow of current in the circuit AGCa, and at resonance, the trap circuit offers high impedance to the flow of current in this circuit.

There are several methods of connecting these traps. Fig. 2 shows the most common method. In this drawing $L_1 C_1$ constitutes the trap circuit, and $L_2 C_2$ the antenna coupler and tuning condenser of the receiving set. It is seen that the trap is connected between the antenna post of the receiver and the antenna lead-in. Fig. 3 represents a slightly different method of connecting the trap in the circuit. In this latter method, the wave trap is inductively coupled to the antenna. This inductive coupling is obtained by winding a few turns of wire about one end of the coil L_1 . One end of this new winding connects to the antenna and the other to the antenna post of the receiver. This circuit is practically equivalent to that of Fig. 2 with the difference that somewhat sharper tuning is obtained.

WHY THE CIRCUIT PREVENTS INTERFERENCE

IN ORDER to give an idea of the effectiveness of these traps, a series of experiments were carried out in the RADIO BROADCAST Laboratory to illustrate how interfering signals are eliminated by the use of such a filter. The circuit illustrated in Fig. 4 was excited by means of an oscillator. The output of the oscillator was fed into the coil L_3 which was inductively coupled to coil L_4 . This coupling was very loose so that variation in the test circuit caused no change in the oscillator output. $L_1 C_1$ is the trap circuit and $L_2 C_2$ represents the input circuit of the receiver. As shown in the diagram, a vacuum tube voltmeter was placed across the $L_2 C_2$ circuit so as to measure the voltage induced across this circuit. This would be the voltage that would ordinarily be applied to the grid of the first tube of a receiving set and the extent to which this voltage is reduced by the wave trap is a measure of the trap's efficiency.

With the trap circuit $L_1 C_1$ detuned from the incoming frequency produced by the oscillator, the condenser C_2 was adjusted until maximum voltage was read on the vacuum tube voltmeter. This indicated that this circuit was adjusted to resonance. The frequency of the oscillator was then changed by 10,000 cycles but no change was made in $L_2 C_2$.

This circuit was, therefore, tuned to a wave 10,000 cycles (10 kc.) different in frequency from that being supplied by the oscillator. However, a certain amount of voltage was still to be measured on the vacuum tube voltmeter

but since the circuit was not tuned to the oscillator frequency, the voltage which was measurable represented an interfering signal. This voltage read on the vacuum tube voltmeter under these conditions is represented as E_1 in Fig. 5. The trap was then adjusted and as condenser C_1 was varied, the voltage across $L_2 C_2$ was recorded and a curve Fig. 5, plotted, showing the variation of voltage as the trap condenser C_1 was changed. This curve shows a large decrease in voltage as the trap circuit is brought into resonance with the incoming frequency. With the trap in resonance the voltage decreased to about 15 per cent. of its former value.

This whole test was analogous to the case of a



RADIO BROADCAST Photograph

FIG. 7

Space-wound solenoid coils can be used to construct a very efficient wave trap

receiver tuned to a particular station and at the same time receiving a certain amount of energy from another station differing in frequency by 10 kilocycles (10,000 cycles). Under such conditions, the use of a trap would have caused a decrease of about 85 per cent. in the strength of the interfering signal. Let us take a numeri-

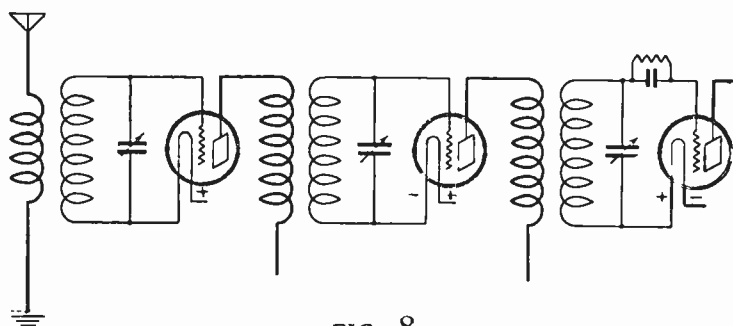

FIG. 8

A simplified diagram of a receiver employing three stages of radio frequency amplification, really successive wave traps

cal example of such a case. Suppose it is desired to receive a signal having a frequency of 500 kilocycles and to eliminate the interference from another station operating on 510 kilocycles. The antenna circuit of the receiver would be

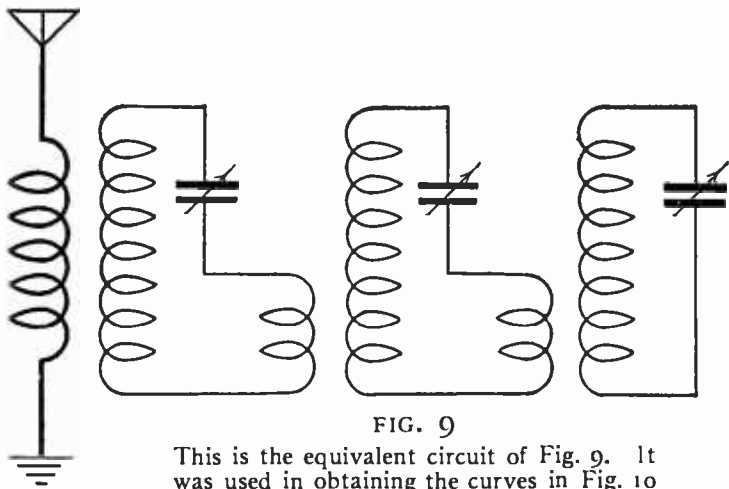

FIG. 9

This is the equivalent circuit of Fig. 9. It was used in obtaining the curves in Fig. 10

tuned to 500 kilocycles and then the wave trap would be tuned to 510 kilocycles with the result that the interfering signal of 510 kilocycles would be decreased to 85 per cent. of the value it would be without the trap. Under some conditions, it will be found that the type of connection used

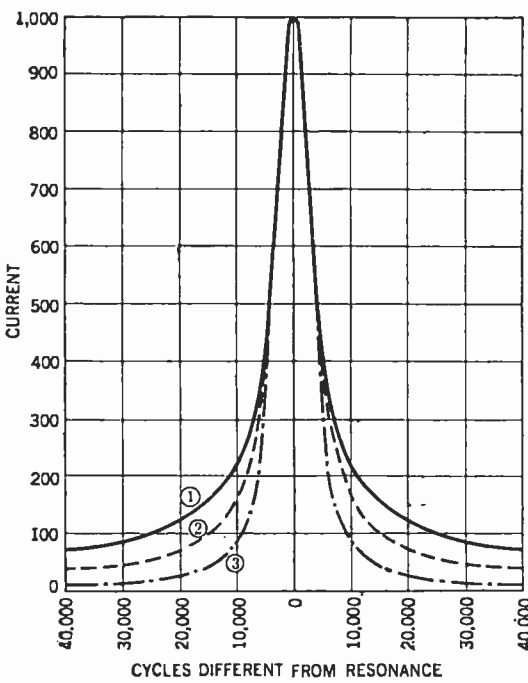

FIG. 10

Here's a curve that shows the effect of using several stages of tuned radio frequency

in the test suppresses too much of the main signal and it will be best to change over to the hook-up shown in Fig. 3. With the trap inductively coupled to the antenna circuit, the tuning is usually very much sharper but at the same time it is generally found that the interference is not as completely suppressed. Since the operating characteristics of the trap depend to some extent on the conditions at which the receiver is being operated, it is best to try both types of connection and determine which method gives the most satisfactory results. Sometimes the frequency separation between the signals it is desired to receive and the signals it is desired to suppress is very much greater than 10 kilocycles, and under such conditions the trap will operate even more efficiently.

WHICH CONNECTION TO USE

WHETHER the trap circuit of Fig. 2 or that of Fig. 3 is used depends to a considerable extent upon the characteristics of the antenna system. A well insulated antenna with a short lead-in and a short ground wire to a good ground, such as the cold water mains, gives

best results with the inductively coupled circuit. Every effort should be made to have as good a ground and antenna as possible, but if it is necessary to use a long ground lead to a rather poor ground system, the direct coupled wave trap will probably give most satisfactory operation.

When using the latter method of direct coupling as illustrated in Fig. 2, some small change in the tuning of the antenna condenser will be noticed whereas with inductive coupling practically no change in tuning takes place. This represents a slight advantage in favor of inductive coupling, since it will be possible to continue to use the same old dial readings after the trap has been installed.

In designing a trap circuit, the difficulty arises in making one that will do its work well when the frequency separation is only 10 kilocycles. If the trap is poorly made it may eliminate the interfering signals but will also decrease the strength of those signals we desire to receive. The most common cause of poor results with wave traps is due to the use of high resistance coils and low grade condensers.

It is therefore essential that the trap operate efficiently, and in order to obtain such operation, it is generally best to use a fairly small coil and a large condenser. With a large coil the elimination is usually more complete but the neutralized band is larger so that the trap interferes with reception on wavelengths adjacent to that wave on which the interfering station is operating. Most satisfactory results are obtained when low loss coils are used.

Any type of multiple-stage tuned radio frequency receiver is actually a series of traps or filters coupled together. The circuit shown in Fig. 8 is really equivalent to the circuit of Fig. 9. The tubes function as amplifiers and do not alter the resonance curves to any considerable extent. Fig. 10 shows a set of resonance curves obtained from a circuit connected as in Fig. 9. In a one-stage r. f. amplifier a resonance curve like 1 would be obtained. Adding two and then three stages give us curves 2 and 3 respectively.

In order to obtain maximum benefit from such an r. f. amplifier, it is essential that the various tuning units be constructed as efficiently as possible and if this is done it will not be necessary, under ordinary circumstances, to use a wave trap in conjunction with this type of receiver. Nevertheless, under some conditions, for instance when a set is being operated very close to a broadcasting station, the currents induced in the antenna might be strong enough to override the selectivity of such a receiver, and it will be necessary to use a wave trap.

In order to aid the home constructor in building up his own wave traps, the accompanying table has been compiled.

For those wishing to duplicate the model constructed in the Laboratory, the following material should be secured: one 36-turn Hammarlund Roberts 3-inch coil, one Cardwell .001-mfd.

TYPE OF COIL	SIZE WIRE	NO. OF TURNS	DIAMETER OF COIL	NO. OF PEGS
Spiderweb	20	40	2½"	13
Diamondweave	20	30	2"	17
Solenoid	20	28	3½"	—

variable condenser, one 3-inch dial, one panel 7 x 8 inches, and necessary binding posts, screws, etc. The apparatus layout is shown in Fig. 11. It is obvious that similar capacities and inductances, of any make, or home made, will be just as satisfactory.

The antenna winding consists of 10 turns of No. 20 wire wound directly over the Hammarlund Roberts coil and fastened with a small amount of collodion. If the trap is to be connected as in Fig. 2, the antenna goes to binding post No. 1 and the antenna terminal of the receiver to terminal No. 2 on the wave trap. For inductive coupling as in Fig. 3, the antenna connects to No. 3 and terminal No. 4 goes to the antenna binding post on the receiver.

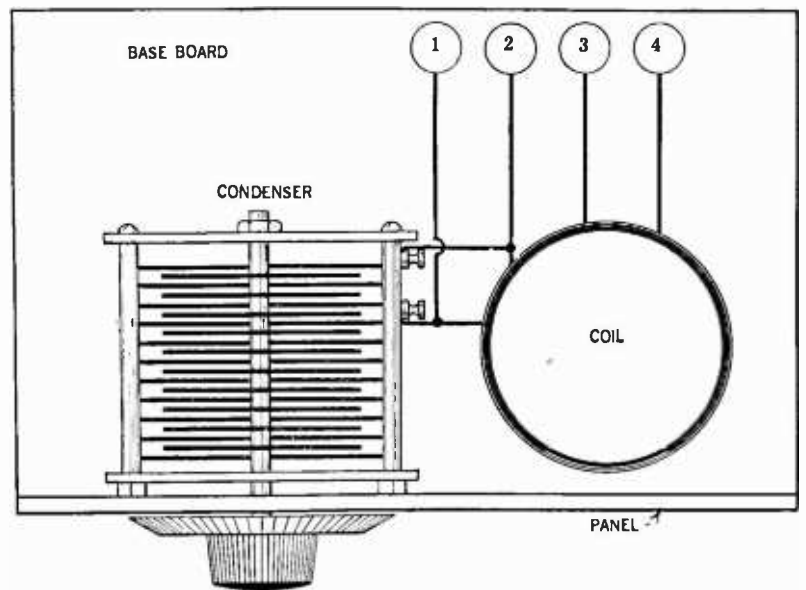

FIG. 11

The layout of apparatus for a wave trap. Note how simple the construction is

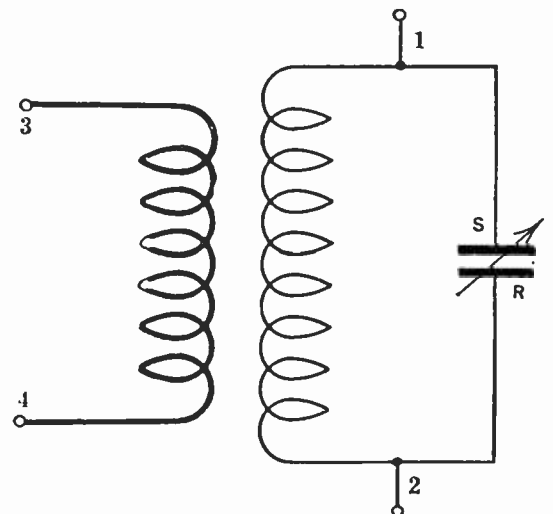
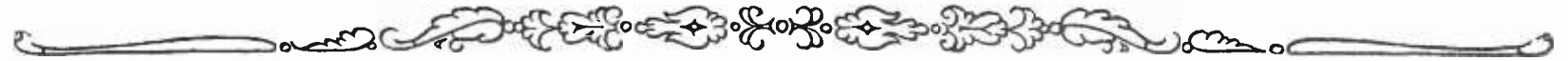

FIG. 12

Circuit diagram of the wave trap shown in Fig. 11. The notation on the binding posts in Fig. 12 correspond to the numbers on this diagram



Why Eliminators!

by

ROLAND F. BEERS



THE outstanding difference between receivers that grace American homes to-day and those of ante-quality days lies in the naturalness of the reproduction now possible. It seems to be the tendency among all reputable manufacturers to improve the audio-frequency amplifiers in their receivers to the greatest possible degree, and those who build receivers at home are not far behind.

Regardless of the type of amplification employed, whether transformer-, resistance-, or impedance-coupled, there are a number of claims made upon the B voltage supply that cannot be slighted or overlooked. One is an unfailing source of voltage, and for high quality reception with plenty of volume, high voltage is required. This voltage must be a quiet voltage, not full of noises or variations or flutters that annoy the listener. In other words, the B voltage supply is a sort of silent partner, always supplying his share of what is necessary in the form of power.

One of the important developments in the realm of high quality reproduction has been the Raytheon tube which, with accessory apparatus, takes current from your house lighting system, converts it to a voltage sufficiently high to operate the new semi-power or power

RAYTHEON

The tube that perfects the B-eliminator

RAYTHEON is more than the name of a new type rectifier. It is the symbol of a research laboratory, the mark of an organization of engineers. Radio manufacturers, radio editors and radio dealers appreciate the value of *Full Wave Rectification, No Filament, No Chemicals, Ample Voltage and a Sixty Milliampere output.* Price six dollars.

RAYTHEON B-eliminators or specially designed parts for home-built units are made and sold by these and other well-known manufacturers:

Acme Apparatus Co.
 All-American Radio Corp.
 American Mechanical Laboratories, Inc.
 Dongan Electric Mfg. Co.
 General Radio Co.
 Grigsby-Grunow-Hinds Co.

Jefferson Electric Mfg. Co.
 Mayolian Radio Corp.
 Modern Electric Mfg. Co.
 Potter Mfg. Co.
 Thordarson Electric Mfg. Co.
 Tobe Deutschmann Co.

Webster Co.

RAYTHEON MANUFACTURING COMPANY
 Cambridge, Massachusetts



tubes which are now available and which have been described in RADIO BROADCAST by Keith Henney. This voltage is then filtered by the necessary apparatus, so that what actually arrives at the plate of the power amplifier is clean, unvarying, noiseless power.

The importance of high voltage in connection with faithful reproduction has been emphasized by Mr. George C. Crom of the American Transformer Company in the October, 1925, RADIO BROADCAST, and other points which are worthy of note will be published from time to time in a series of articles by engineers of the Raytheon company. They will acquaint the readers with the many interesting things that result from research in the Raytheon Laboratory, and it is believed that the intelligent application of the principles explained will result in many receivers in American homes that from the standpoint of beauty of reproduction will not be surpassed in the world.

The principles upon which absolute fidelity of reproduction are founded have been explained many times in radio publications, and all that has been necessary has been the development of apparatus of the proper nature, and its distribution so that anyone could purchase and use it. The Raytheon tube in the few months it has been on the market has proved itself to be of the utmost importance in connection with power amplifiers and their necessary voltage supply. Because we are particularly careful concerning the dealers with whom we make arrangements to handle our tube, and the manufacturers of devices for use with it, and because we can honestly endorse the products of

GENERAL RADIO

Type 365
Rectifier
Transformer
Price \$10



Type 366
Filter Choke
Price \$10



Modernize your Radio Set— Build a Practical "B" Eliminator

The popular topic of discussion among radio experimenters today is "B battery Elimination." Constant worry whether the "B's" are run down—and their continual replacement will soon be a thing of the past in radio. A "B" eliminator never runs down and never has to be replaced. For a dependable plate supply unit which requires absolutely no attention other than its original installation, build a "B" eliminator of General Radio parts. Write today for full data on General Radio Rectifier Transformers and Filter Chokes, and get our circular with full instructions for building a Practical "B" Eliminator.

GENERAL RADIO CO. Cambridge 39, Mass.

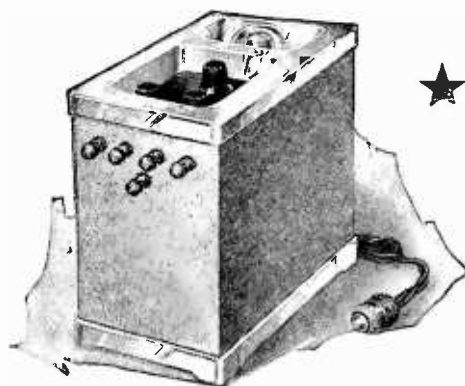

It's a Beauty

The Mayolian "B" Supply is encased in a beautiful mottled blue-gray metal cabinet, 5 inches wide, 10 inches long, and 9½ inches high, with a satin finish aluminum base and top, and engraved Bakelite panel. It harmonizes with any receiver and the furnishings of any room.

Write for Complete Information

MAYOLIAN RADIO CORPORATION, 1991 Broadway, New York City

Mayolian

"B" SUPPLY

The "B" Without a Buzz

Pioneers In Battery Elimination!

The Mayolian "B" Supply assures to any radio set, regardless of make and under all conditions, a continuous, uninterrupted, noiseless, and uniform "B" supply direct from the light socket. Perhaps the most outstanding characteristic you will find in the trial tests of your Mayolian is that it improves the tonal quality of your receiver. This is obtained in the Mayolian "B" supply by the use of the Raytheon Rectifier plus three years of constant experimentation on the part of our own engineers. All voltages in the Mayolian are variable because our engineers have found that variable voltage for the detector and radio frequency tubes is absolutely necessary to insure highest efficiency. The total amplification voltage is controlled by a three-way switch. By this means, you obtain the correct voltages, necessary to get the best results. It is possible to obtain with your Mayolian a high "B" voltage up to 130 volts. This produces great volume, sharp selectivity, and orthotone amplification. On second thought, it is but natural that the whole industry should look to Mayolian for a correct "B" Supply Unit for we are "Pioneers in Battery Elimination." Write for complete information on the Mayolian Unit or complete list of Mayolian parts. This list of parts includes the Mayolian variable resistance for controlling detector and R. F. voltages.



"A Better Condenser"

See Page 715 of RADIO BROADCAST Advertiser, this number, for official proof that the TOBE Condensers are the better condensers for use in the improved Raytheon Plate Supply Unit.

Write us for full particulars and prices of separate condensers and of the new TOBE B BLOCK.

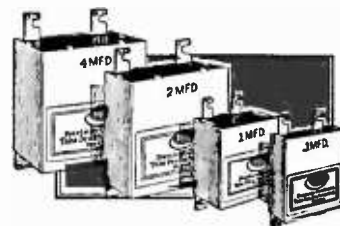

Tobe Deutschmann Co.
CORNHILL BOSTON, MASS.

RAYTHEON

CLAROSTAT

O.K.'d by RAYTHEON—

and a host of other nationally known battery eliminator manufacturers.

—because CLAROSTAT has no equal for voltage control in "B" Battery Eliminators.

—Only CLAROSTAT gives you a range from practically zero to 5,000,000 ohms and a carrying capacity of 200 milliamperes—a capacity ten times greater than that of any variable resistor.

To insure smooth functioning of your eliminator, go to your dealer and get a CLAROSTAT. It will give you absolute noiseless operation.

If your dealer cannot supply you, write direct.

American Mechanical Labs., Inc.,
285-287 North Sixth St., Brooklyn, N. Y.

Special types for "A" and "B" Battery Eliminators for manufacturers.



MODERN "B" Power Supply

It's Better Because It's Modern

THE Modern "B" Power Supply is a perfected unit behind which is our unconditional guarantee of satisfaction.

It is an electrically correct unit. Into it has been built every element that makes for practicability. It can supply 150 volts, thereby permitting the use of big power tubes. An extra 90 volt tap provides for the use of peanut tubes. Possible moisture seepage is absolutely eliminated; electrical depression of elements is totally absent; several additional microfarads eliminate oscillation where oscillation is part of the inherent design and each unit is tested at 2500 volts.

In short the Modern "B" Power Supply will operate any receiver satisfactorily, even improving in most instances tone and quality.

Try it and be convinced!

MODERN ELECTRIC MFG. CO.

Toledo, Ohio

these manufacturers we feel confident that the purchaser of any of these devices will find complete satisfaction from them—provided of course they are properly used.

To point out to the users of Raytheon tubes and accessory apparatus the proper methods of operation, the series of articles mentioned above will appear from time to time. These articles will present as much technical information as we believe will be of interest to home constructors as well as to dealers who handle our products. The experimental work in our laboratory as well as that conducted elsewhere will be digested and brought to the attention of those most interested in these articles, so that the products of the many manufacturers associated with the Raytheon tube will be used as intelligently and as successfully as possible.

It should be borne in mind that wherever possible new developments or improvements in the application of the Raytheon tube will be such that they will not entail changes in existing apparatus. Naturally, what the home constructor or the manufacturer who uses or sells Raytheon tubes wants, is something new that will increase the usefulness of his device without any changes, and every effort will be made to carry out this natural and defensible desire.

One of the first tasks to which the Raytheon manufacturers confronted themselves was the development of apparatus with sufficient power. The result has been possible through concerted effort, and now one can be assured that a receiver equipped with a Raytheon B eliminator will have adequate

RAYTHEON

★ Tested and approved by RADIO BROADCAST ★

power at all times. At every instant, no matter what the demand may be, there is an instantaneous response to the call for the power required to handle those peak voltages that ordinarily are dulled and fogged by a supply that is worked too near its limit. In other words, there is a reserve of power available from a Raytheon B-supply and when a soprano touches those elusive high notes, the receiver will respond; when the Symphony leader calls for the maximum of effort from his musicians, the receiver will not fail to register the enormous change in volume. All of this means fidelity and naturalness, both in tone and in volume.

The easy control of a power supplied by a Raytheon eliminator lends itself to the distance seeker. To bring a receiver to its most sensitive condition requires a simple and yet delicate control of voltages. The Raytheon B power supply enables the user to control oscillations by a casual turn of a knob. "Spilling over" and the resultant distortion is prevented by the gradual manner in which the detector B voltage may be changed. When all tuning operations are complete this voltage may be increased and the voice of the announcer will come through clear and with full volume.

The importance of good loud speakers has been mentioned in radio magazines, descriptions of high quality and comparatively high power amplifiers have been published.

In connection with these high quality speakers and amplifiers the use of power tubes is highly important so that there is always available a reserve of power. These power tubes make possible the am-

DONGAN

TRANSFORMERS and CHOKES



509 Full Wave
\$7.00 List



514 20 Henry
\$5.00 List

Use Dongan B-Power Units for assured results with the Raytheon Tube. Build your own B-Eliminator. Easy to construct and of lasting endurance. Details upon request.

Special unmounted B-Power Units furnished to manufacturers. Our engineers will cooperate with you. ★

DONGAN ELECTRIC MANUFACTURING CO.

2991-3001 Franklin Street

Detroit, Mich.

TRANSFORMERS of MERIT for FIFTEEN YEARS

Potter FILTER Condensers

(An American-Made Product)



BUT four prime features enter into the determination of the relative merits of the microfarad units employed in the construction of the Raytheon "B" Power Supply: weight, capacity, thickness of material, and dielectric constant. Potter 1 microfarad, 1,000 volt condenser unit employed in Raytheon group weighs 153 grams per microfarad is composed of 3 laminations; insulation between foils.

Each unit, furthermore, in these groups has been thoroughly tested for a break-down voltage of not less than 1,000 volts D. C. Of full capacity, they remove every vestige of A. C. impulses. They eliminate hum. They give a continuous discharge service without leakage because they are far more highly insulated than ordinary condensers. Potter microfarad units insure the highest possible resistance and longest life under continuous use.

Compare with others. Write for complete information.

POTTER MANUFACTURING CO.

NORTH CHICAGO, ILL.

W-B-3	Two Voltages— Detector and Amplifier	\$47.50
W-B-4	Three Voltages with power tube tap	50.00
W-B-D	For 110-125 D. C.— Three Voltages	25.00

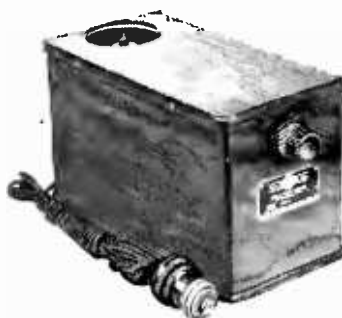

★ Webster SUPER-B

THE Webster Super B with Raytheon tube makes radio reception better because—

It supplies steady, noiseless flow of plate current and thereby clarifies signals and builds up volume. It forever eliminates noises from run down "B" batteries and the expense of replacing them. It reduces cost of operating set to minimum. Just connect it to light socket and it will keep your "B" power always ready full efficiency—costs less than $\frac{1}{10}$ of a cent per hour. Has ample power to operate any set and is adjustable for any voltage requirement. Model W-B-4 is especially designed to operate sets using power tube in last audio stage.

All leading radio distributors can supply you. Write us to-day for full information and Free booklet "Improving Your Radio."

THE WEBSTER COMPANY

3506 West Lake Street

Chicago, Ill.

RAYTHEON

★ Tested and approved by RADIO BROADCAST ★

Majestic Super-B



A Triumph in Better Radio Reception

AS the Prima-Donna is to the opera—so compares YOUR receiver to ordinary radio when equipped with a MAJESTIC SUPER B.

Tonal quality and volume alone are not only improved, but the annoyance of constantly depreciating B batteries is permanently eliminated. Also, the cost of operation of your set is further reduced to an infinitesimal tenth of a cent per hour.

Engineers and technical experts will appreciate the efficiency of the MAJESTIC SUPER-B to know that two chokes of 41 Henrys each and 20 micro-farads of capacity are used in our filter circuit! The chokes and transformer are wound with number 30 Gauge wire of low resistance which results in voltage regulation of better control. The exceptionally large condenser bank smoothes out every trace of ripple with a wide safety factor to spare.

Majestic Super-B Current Supply Complete with Raytheon Tube Capacity 1 to 12 tubes including the use of new 135-150 volt power tubes.

110 volt, 60 cycle. Price \$39.50

The MAJESTIC STANDARD-B is a smaller B current supply unit, designed for sets having not more than 6-201A type of tubes or 5-201A, plus one 112 type of 135 volt power tube.

Majestic Standard-B current supply Complete with Raytheon Tube

110 volt, 60 cycle. Price \$32.50

GRIGSBY-GRUNOW-HINDS CO. ★

4540 Armitage Ave.

Chicago, Illinois

plification of the low bass notes that mean so much toward enriching the sound output of a good radio receiver.

These power tubes, however, cannot be run efficiently from the ordinary B-power supply since greater voltages and greater currents are required. The use of high voltage is necessary to operate the tubes at their greatest efficiency, and these tubes require more B current than others which are used as detectors and preliminary amplifiers.

It must not be supposed that because the Raytheon B-supply units will furnish the requisite power for semi-power tubes that they will not be effective on lower powered sets, for this is not the case. What the Raytheon does is to have available the maximum amount of power that any set will require, and whether it is used at all times or not it is always ready at an instant's notice.

Installing a Raytheon B-supply will make available in a silent, efficient form the power that is necessary for the clang of cymbals, the zoom of the viol, the trill of the piccolo and the touch of the famous virtuoso and make one's receiver a source of perpetual delight. Owners of receivers which have been cramped for power, or which have been fed from noisy critical sources of voltage will be amazed at the change which takes place when a source is substituted which has sufficient voltage and sufficient current. In other words the receiver will at last have sufficient power.



RAYTHEON

★ Tested and approved by RADIO BROADCAST ★

Has Radio Broadcast's "Aristocrat" Receiver—

- 1. Good Volume
- 2. Good Selectivity
- 3. Good Sensitivity
- 4. Good Tone Quality

? ? ?

This is one of
the many

UNSOLICITED
LETTERS
RECEIVED

that will
Settle Definitely These
Questions

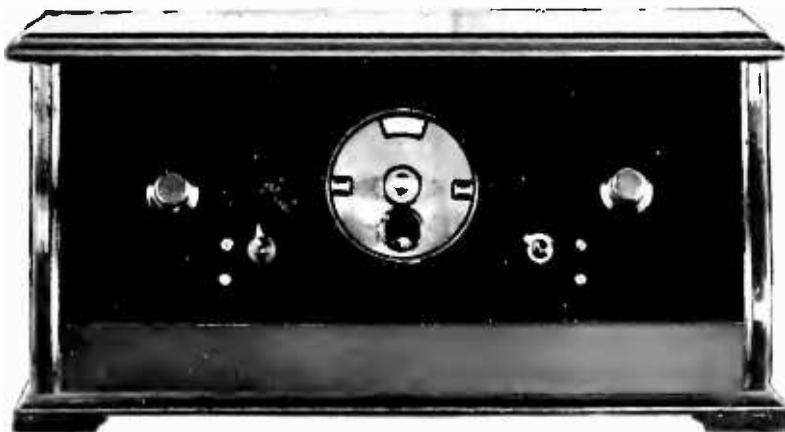
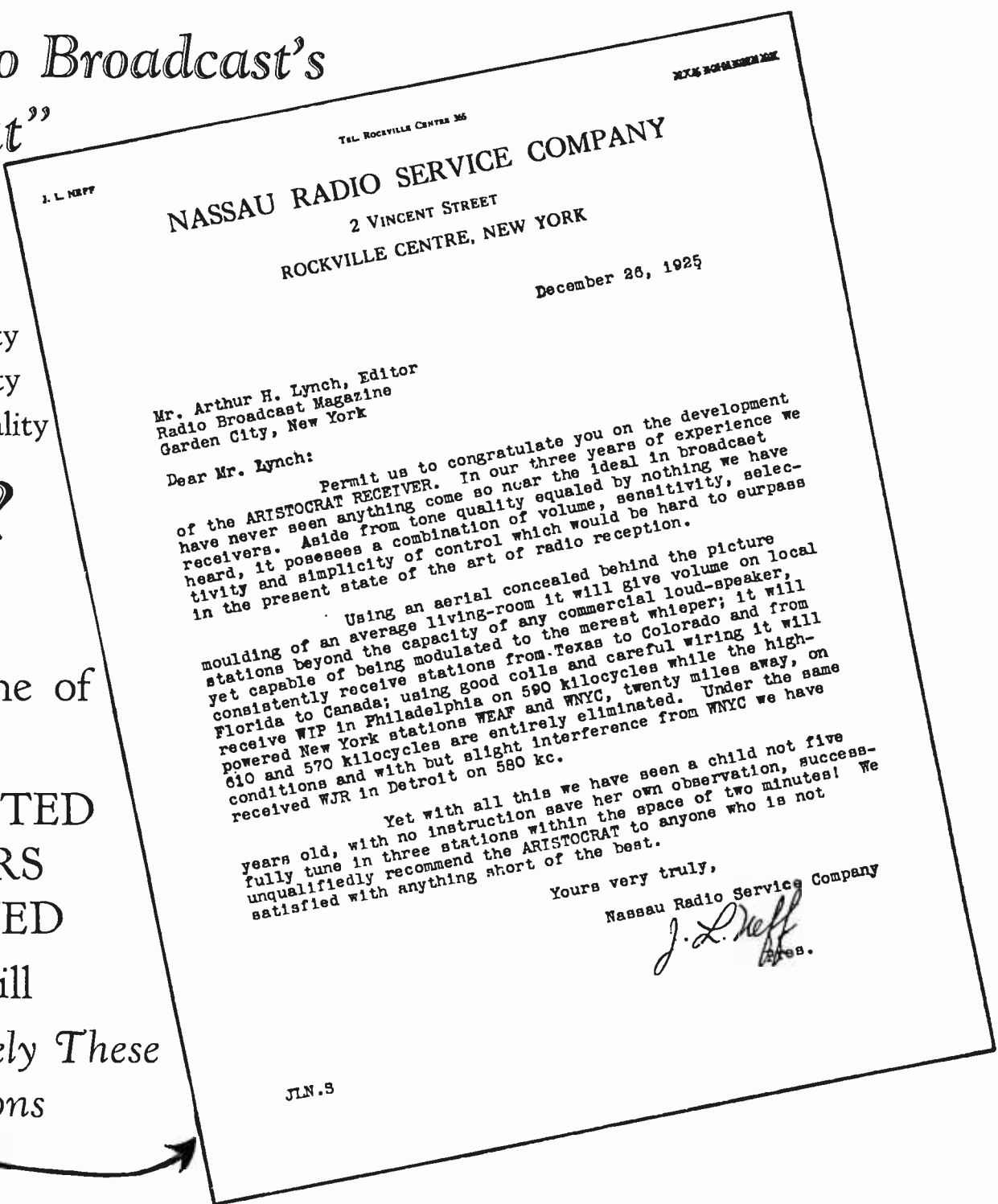

One Dollar Brings To You

A Set of

Full-Sized Blue-Prints

That Show You How to Construct
Two Models of

"ARISTOCRAT" RECEIVER

USE THIS COUPON WHEN SENDING YOUR DOLLAR

RADIO BROADCAST
GARDEN CITY, NEW YORK

Gentlemen: For One Dollar (enclosed) please send to me your Radio Broadcast "Aristocrat" Blue Prints.

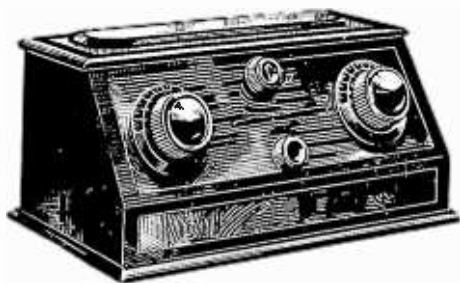

The Crosley 4-tube—4-29
in which the Crescendon is equal to one or more additional tubes of tuned radio frequency amplification . \$29



The Crescendon
—an amazing new volume control exclusive to Crosley sets. Hear it!

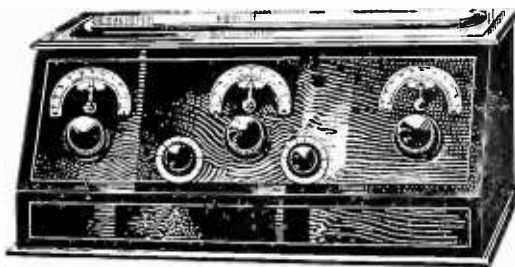

The Crosley 5-tube—5-38
All the volume, selectivity and purity of tone available in the best 5-tube set—plus the Crescendon . . . \$38

Widespread Popularity Marks Another Great Success

Spectacular as has been each stride in radio achieved by Powel Crosley, Jr., never before has a Crosley success received such prompt and widespread recognition. Here in the radio plant which has made more radios than any other factory in all the world, every man and machine is going at top speed, every hour is a crowded hour, every night a working day, as the result of orders for the four new Crosley sets.

Even the sweeping success of the Crosley Musicone did not match this merciless demand upon an organization tuned to mass production. With the first demonstrations by Crosley dealers, public approval was expressed in orders that have increased in volume day by day and show no inclination to relax.

This popularity is distributed quite evenly between the four new 4- and 5-tube sets. Thousands who had formerly believed that

worth while reception was exclusive to high priced sets, have found in Crosley 4-29 and 5-38 all that they could ask of radio. The accurate selectivity and pure tone of these instruments would be enough. That magnificent volume achieved through the *Crescendon* is the final touch.

And in Crosley "RFL" types there is a revelation for all. For here true cascade amplification makes its first appearance. Here what was considered *impossible* in expert opinion has been achieved by amplification closely approaching theoretical maximum efficiency per tube!

What a joy to find, and in a low priced set, rare beauty, rich tone, volume subject only to your desire, and no howling at any pitch by any mishandling under any conditions.

Each instrument delights the ear, fires the enthusiasm of the lay technician, converts the staunchest skeptic to love of radio.

See the new Crosley receiving sets at your dealer's or write Dept. 20 for descriptive catalog

Crosley manufactures radio receiving sets which are licensed under Armstrong U. S. Patent No. 1,113,149, or under patent applications of Radio Frequency Laboratories, Inc.

THE CROSLEY RADIO CORPORATION, CINCINNATI, OHIO
 Powel Crosley, Jr., President

Owning and Operating WLW, first remote control super-power broadcasting station in America



The Crosley 5-tube—RFL-60
A set of marvelous performance and beautified by the artistic decorative panel \$60

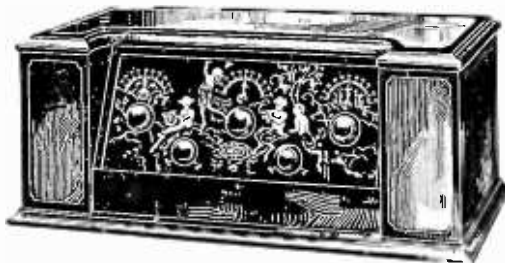

The Crosley 5-tube—RFL-75
Simplicity and speed in tuning, fidelity of tone and decorative beauty, enhanced by the art panel \$75

Add 10% to all prices west of the Rockies

CROSLEY RADIO

BETTER—COSTS LESS

FOR THE ENTERTAINMENT CORNER

★ Tested and approved by RADIO BROADCAST ★

and now more stations come in distinctly

A UX Power Tube

will increase the clarity and volume of YOUR set

REWIRING UNNECESSARY

NOTE: The UX-120 tube for dry battery sets and the UX-112 for storage battery sets reproduce more perfectly the excellent broadcasting of to-day. These tubes handle the powerful signals of nearby stations so that the quality of the tone is preserved without distortion. You can easily obtain this increase in clarity without rewiring your set. A complete line of Na-Ald Adapters and Connectoralds have been made to meet this purpose. Their scientific design insures a nicety of operation. Below are given three efficient and easily made applications of the new power tubes. For complete details covering these and other applications of the new tube mail the coupon below.



No. 920 Connectorald

How to improve storage battery sets

Clarity and volume can be increased in storage battery sets by using the UX-112 tube in the last stage. Easily fitted to the UV-201A socket by means of the Na-Ald No. 112 Connectorald which provides cables for attaching necessary extra B and C batteries. Price \$1.25. Mail coupon below for complete adapter information covering use of new tubes in all sets.

How to improve sets equipped with UV-199 tubes

To increase volume and clarity in sets using UV-199 tubes, use the UX-120 tube in the last stage. Easily fitted to the UV-199 socket with a Na-Ald No. 920 Connectorald which also provides cables for attaching necessary extra 45 volts B battery and 22½ volts C battery required for the UX tube. Price, \$1.25.

How to switch to dry batteries without sacrificing volume or quality

The combination of a UX-120 tube for the last stage with UX-199 tubes in the other sockets provides, with dry cells, results previously obtained only with storage batteries. Fit UX-120 tube to the UV-201A Socket with Na-Ald Connectorald No. 120. Cables provided for attaching extra B and C batteries. Fit UX-199 tubes in all other sockets with Na-Ald No. 419-X Adapters. Price, No. 120 Connectorald, \$1.25; No. 419-X Adapter, 35c.



No. 120 Connectorald

ALDEN MANUFACTURING COMPANY
Dept. B 17 Springfield, Mass.

All Na-Ald Sockets, Dials and Adapters are protected by patents. Many patents Pending



ALDEN MFG. CO.,
Dept. B17, Springfield, Mass.

Please send me complete information on how to increase volume and clarity in any set by the use of the new tubes.

Name.....
Address.....
City.....State.....

THE GRID

A Department Devoted to Solving the Problems of our Readers

QUERIES ANSWERED

1. WHAT ARE THE DIMENSIONS AND NUMBER OF TURNS FOR THE COILS USED IN THE "UNIVERSAL" RECEIVER RECENTLY DESCRIBED IN RADIO BROADCAST?
L. T.—Flushing, New York.

2. HOW MAY I ELIMINATE THE REFLEX PART OF THE ROBERTS CIRCUIT?
G. C.—Altoona, Pennsylvania.

3. WHAT ARE THE SIMPLE LAWS GOVERNING THE CALCULATION OF CAPACITY IN SERIES OR PARALLEL?
J. C.—Chicago, Illinois.

4. PLEASE PUBLISH A GOOD THREE TUBE R. F. CIRCUIT FOR A RECEIVER EMPLOYING ONE STAGE OF IMPEDANCE-COUPLED AUDIO FREQUENCY AMPLIFICATION.
H. H. McC.—Dayton, Ohio.

"UNIVERSAL" RECEIVER COILS

THE coil units employed in the "Universal" receiver may very easily be made by winding on a 2¼ inch diameter cylindrical form, 59 turns of No. 24 d.s.c. wire in the manner shown in Fig. 1.

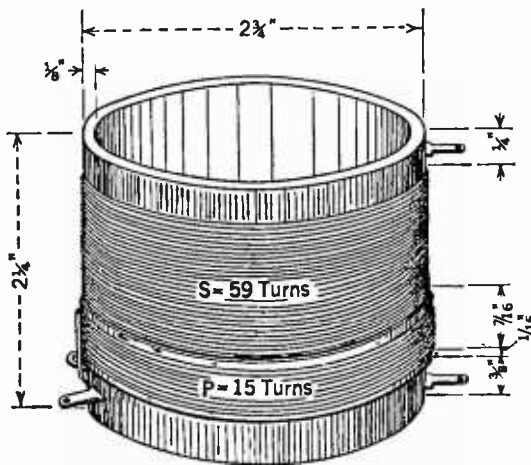

No 24 D.S.C. Wire

FIG. 1

The first winding put on the coil form is the secondary, and over it, at one end of the form, is wrapped a piece of insulating material, such as

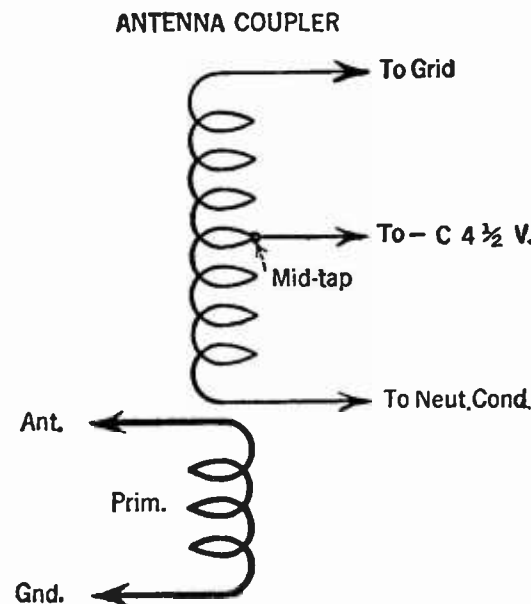

FIG. 2

paper, cambric cloth, etc. The width of this piece is about 1/8 inch, and over it is wound 15 turns of the same wire for a primary. For the interstage coupler, located between the radio frequency and detector tubes, the coil unit has

a tap at the 20th turn from the grid end of the secondary. The antenna coil unit has its secondary tapped at the center turn. The circuit connections are shown in Figs. 2 and 3

ELIMINATING THE REFLEX IN THE ROBERTS CIRCUIT

THE RADIO BROADCAST Knockout four-tube receiver has enjoyed widespread popularity for more than a year, and is still going strong. For many it has proven to be the "par excellence" circuit.

In such a highly specialized circuit where each branch has its own important rôle to play, there is bound to be trouble when constructors disregard the simple fundamental rules of receiver design, or where cheap parts are substituted for those recommended.

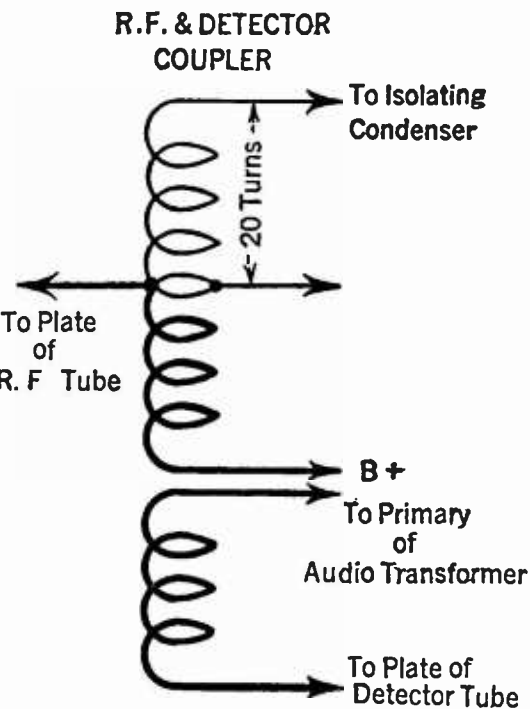

FIG. 3

Reflex, at its best, is a system of dual amplification that must be handled with utmost consideration and, when installed properly in a receiver, offers advantages, economically and electrically, that cannot be seriously disregarded.

However, there are those who, in attempting to rid their receiver of the troubles caused by an inefficient reflex system, desire to eliminate the reflex feature entirely and substitute for it a stage of straight audio frequency amplification.

The circuit-changes necessary to make-over a four-tube receiver are few, and are shown in Figs. 4 and 5. In Fig. 4 the regular four-tube circuit is shown. Fig. 5 shows the new circuit,

The *New* NATIONAL EQUICYCLE Condenser

The latest development in straight line frequency control as applied to NATIONAL Condenser design. Increases range of rotation from 180° to 270°, permitting more precise adjustment and sharper separation of stations, and accomplishes this WITHOUT GEARS, CAMS, OR LEVERS.

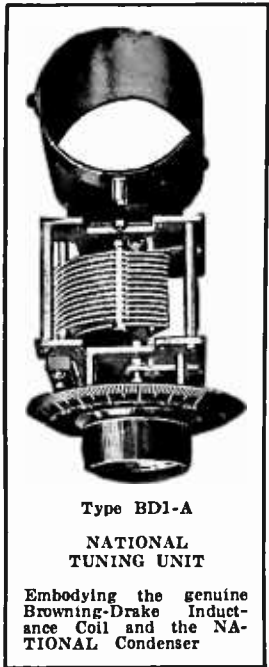

Type BD1-A

NATIONAL TUNING UNIT

Embodying the genuine Browning-Drake Inductance Coil and the NATIONAL Condenser

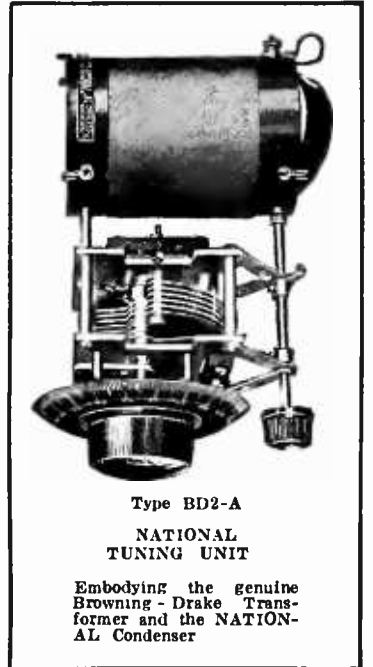

Type BD2-A

NATIONAL TUNING UNIT

Embodying the genuine Browning-Drake Transformer and the NATIONAL Condenser

It changes a mob into an orderly procession

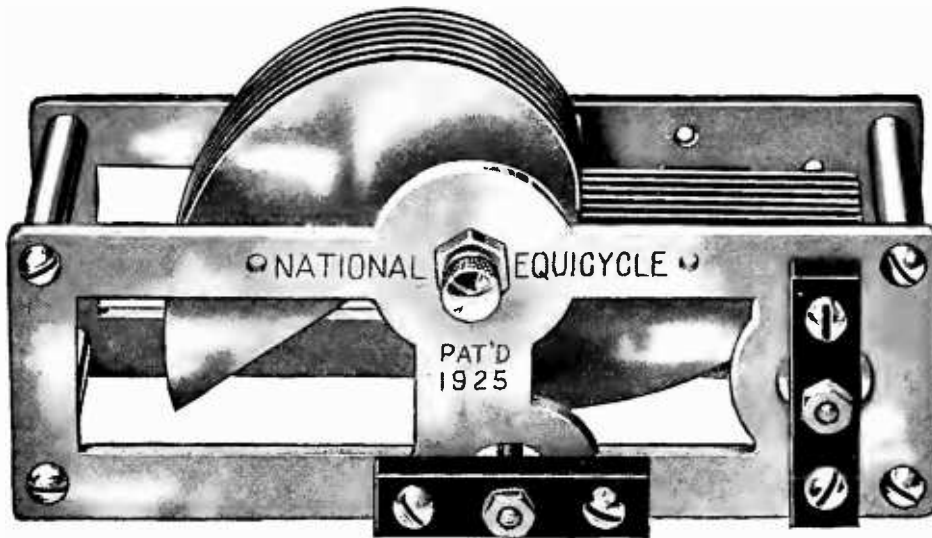

(Patented February 10, 1925)

and lengthens the line of march!

Tests Conducted at Harvard University, by Prof. Field, give characteristics of the new Equicycle Condenser as indicated by the following graph:

—The novel shape of the plates spaces the station groups at equal intervals of 10 kilocycles (as specified by the U. S. Department of Commerce) in a true straight frequency line.

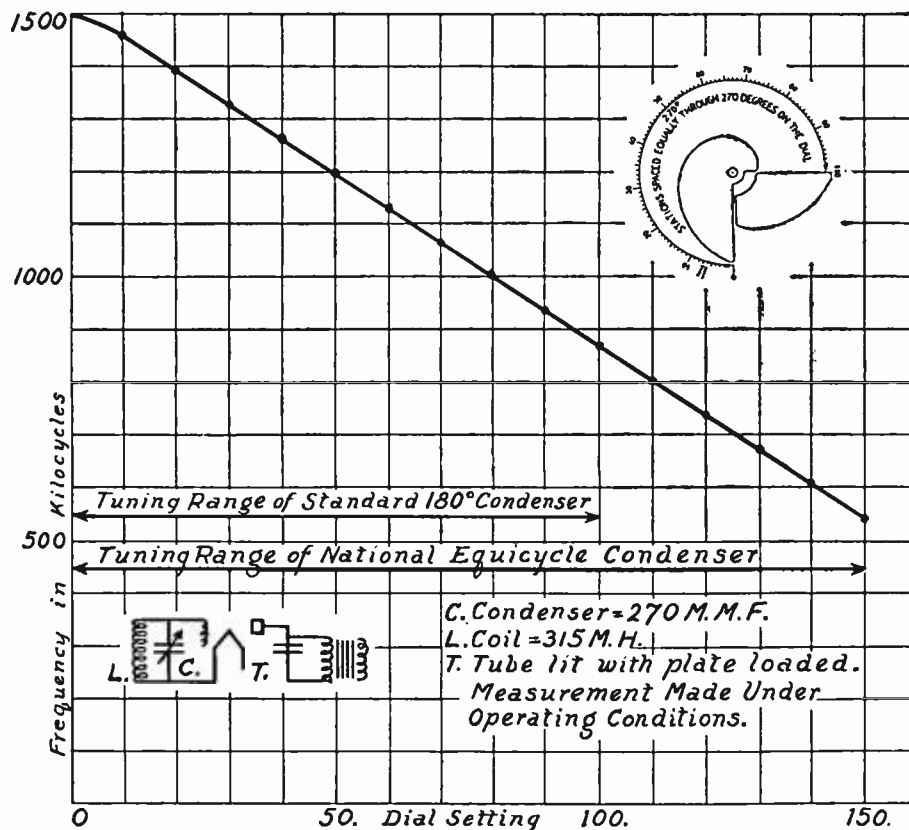

—The same electrical efficiency and mechanical ruggedness that have always characterized NATIONAL DX Condensers have been embodied in the *new* NATIONAL EQUICYCLE Condenser.

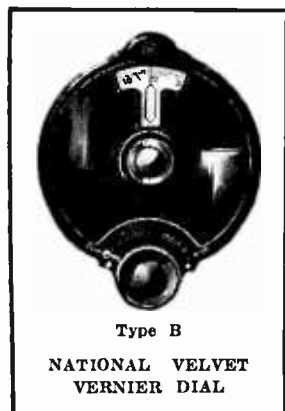

Type B

NATIONAL VELVET VERNIER DIAL

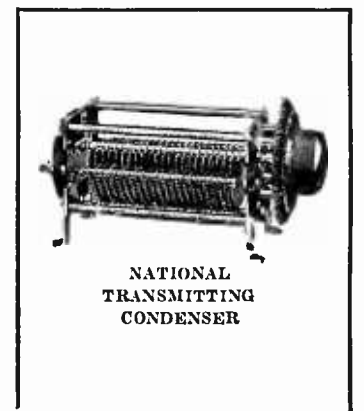

NATIONAL TRANSMITTING CONDENSER

Get the Genuine. Insist upon NATIONAL COMPANY'S RADIO Products. Your dealer appreciates your patronage and will gladly get them for you. Write for Bulletin III-RB

NATIONAL COMPANY, Inc.

W. A. READY, PRESIDENT

110 Brookline St.

Cambridge, Mass.

★ Tested and approved by RADIO BROADCAST ★

A BETTER LEAD-IN

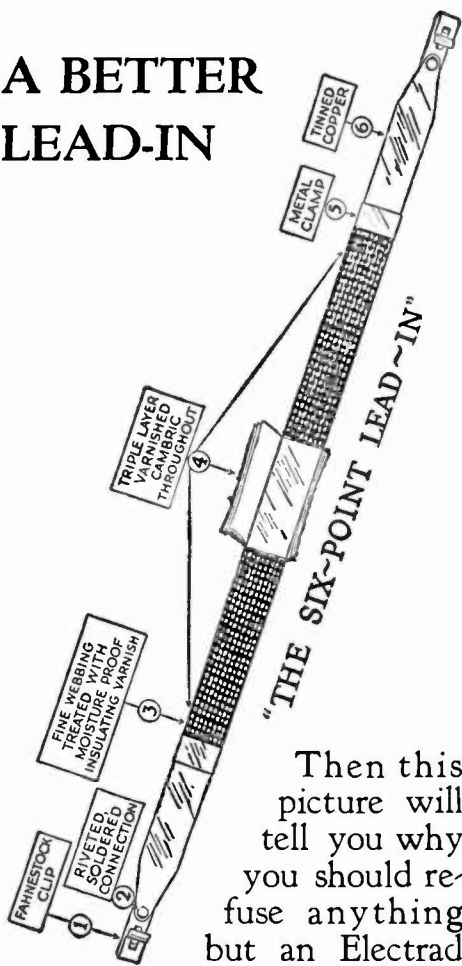

Then this picture will tell you why you should refuse anything but an Electrad Certified Lead-In.

Saves marring your window or door frames. Fits under locked windows. Bends to any desired shape. Imitations do that too, but they stop there. Notice what else you obtain in this Electrad Lead-In. Insulation, 10 inches long, waterproofed and protected entire length. Riveted and soldered Fahnestock clips.

Sold at all good radio stores and counters. Price 40c. Canada 60c. Ask for it by name. For safety's sake refuse imitations.

For Clearer Purer Reception Do This

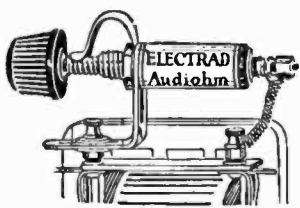

Place an Electrad Audiohm across the secondary of your audio-transformer. Then you will enjoy your radio. Kills distortion, eliminates squeals and howls. Fits all audio transformers. Easy to attach. For sale at good radio stores and counters. \$1.50. Canada \$2.10.

ELECTRAD INC.

428 Broadway New York
Makers of Certified Radio Essentials and Accessories: Grid Leaks, Fixed Condensers, By-Pass Condensers, Variobias, Resistances, Rheostats and Potentiometers, Jacks, Switches, etc. Write for catalog.

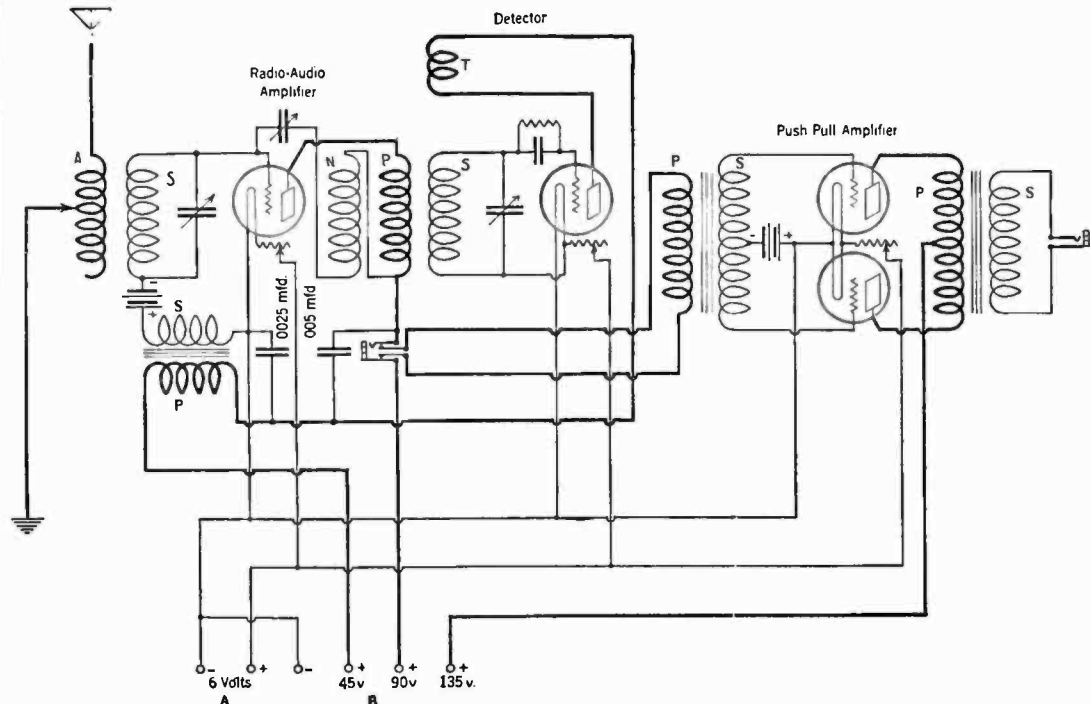

FIG. 4

the dotted lines indicating that part of the former circuit which was reflexed.

It may be observed from these two circuit sketches that the audio transformer employed as the reflex agent is merely eliminated from its position and re-located as the transformer for the first straight audio amplifier. The primary

but has not the correct size, as recommended, on hand.

It is quite a simple matter to get over this, however, by the combination of a variable and a fixed condenser.

For example, suppose a condenser of .001 mfd. is desired. By shunting the usually handy .0005 variable condenser with a fixed .0005 mfd. condenser, the desired capacity is obtained.

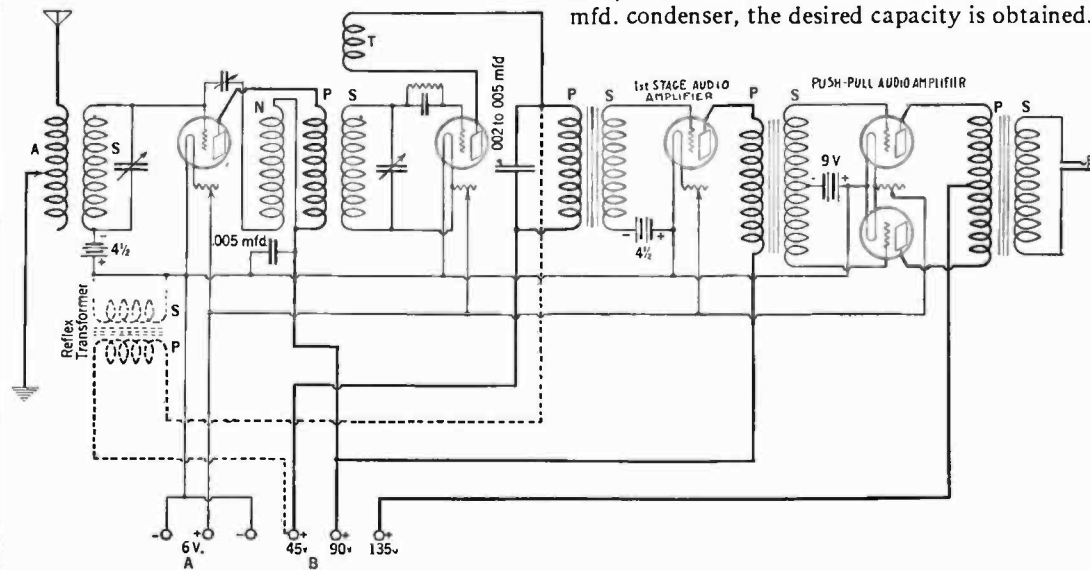

FIG. 5

of the push-pull input transformer, instead of being in the plate circuit of the radio frequency tube, is in the plate circuit of the new audio stage.

With the new circuit, where UX-112 tubes are used in the push-pull amplifier, well-nigh perfect reproduction will result. With the use of this type of tube, it is essential that 9 volts C battery be employed as a grid bias for the push-pull amplifier, with 135 volts plate potential.

If, with this same variable condenser, it is desired to lower the total capacity in a circuit to which it is applied, then a condenser in series with it will produce the desired result.

In the first case—the fixed condenser in parallel arrangement—the minimum capacity that can be obtained with the plates of the variable

condenser completely unmeshed will be greater than when only the variable condenser alone is used, by a capacity equal to that of the fixed condenser used. If the minimum capacity of the variable condenser is .000025 mfd., the total minimum capacity of the two condensers is .000025 plus .0005 mfd. See Fig. 6. If the condensers are arranged in series, as in

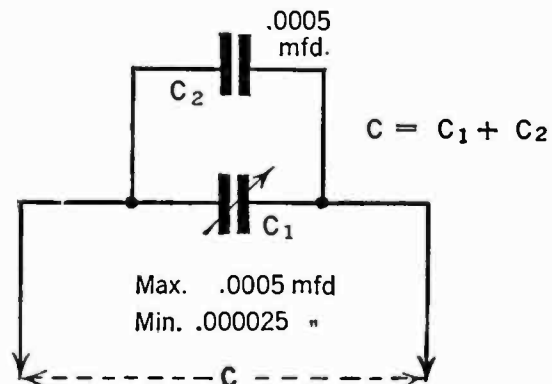

FIG. 6

CONDENSERS IN SERIES AND PARALLEL

IT IS often the case that the radio man will require a condenser of a certain specified capacity when experimentally hooking up a new circuit



*“Your radio is always top notch.
What do you do to keep it so full
of pep?”*



KEEPING your “B” batteries full of pep, without frequent renewals, is simply a matter of using the right size Evereadys for your particular set with a “C” battery*.

The rule which determines the right size “B” batteries to use is so simple no one can make a mistake, and once learned it definitely settles the question of “B” battery service and economy.

On 1 to 3 tubes — Use Eveready No. 772.

On 4 or more tubes — Use the Heavy Duty “B” Batteries, either No. 770, or the even longer-lived Eveready Layerbilt No. 486.

On all but single tube sets — Use a “C” battery.

When following these rules, No. 772, on 1 to 3 tube sets, will last for a year or more, and Heavy Duties on sets of 4 or more tubes, for 8 months or longer.

These life figures are based on the established fact that the average year-round use of a set is 2 hours a day.

A pair of Eveready No. 772's for a 5-tube set

instead of 2 Eveready No. 770's or 2 Eveready Layerbilts No. 486—looks at first glance like an economy because of lower first cost. But in a few months the 772's will be exhausted and have to be replaced. After the same length of time the Eveready No. 770's or the Eveready Layerbilts No. 486 will still be good for many more months of service.

We have prepared for your individual use a new booklet, “Choosing and Using the Right Radio Batteries,” which we will be glad to send you upon request. This booklet also tells about the proper battery equipment for use with the new power tubes.

*NOTE: In addition to the increased life which an Eveready “C” Battery gives to your “B” batteries, it will add a quality of reception unobtainable without it.

Manufactured and guaranteed by
NATIONAL CARBON Co., Inc.
New York San Francisco
Canadian National Carbon Co., Limited
Toronto, Ontario

Tuesday night means Eveready Hour — 9 P. M., Eastern Standard Time, through the following stations:

WEAF—New York	WSAI—Cincinnati
WJAR—Providence	WEAR—Cleveland
WEEI—Boston	WWJ—Detroit
WTAG—Worcester	WGN—Chicago
WFI—Philadelphia	WOC—Davenport
WGR—Buffalo	WCCO { Minneapolis
WCAE—Pittsburgh	{ St. Paul

KSD—St. Louis
Pacific Coast, Eveready Program,
KGO—San Francisco, 8 to 9 P. M.



LEFT—No. 486,
for 4, 5 or more
tubes. \$5.50.



RIGHT—Ever-
eady Dry Cell
Radio “A” Bat-
tery, 1½ volts.

EVEREADY

Radio Batteries

—they last longer

★ Tested and approved by RADIO BROADCAST ★



The AmerTran DeLux is made in two types, a first and second stage. Price, either type, \$10.00.

A New Standard of Excellence in Audio Amplification

The realism of this new audio transformer is outstanding. Realism of this kind results from the uniform amplification of the fundamental tones of the lower register. The AmerTran DeLux makes possible the natural reproduction of not only the Overtones, but *all* of the transmitted Fundamental tones.



AmerTran Power Transformer type PF-45, Price \$15.00, type PF-52, Price \$18.00.

The AmerChoke type 854 is a choke coil or impedance of general utility. Price \$6.00.



A Good Audio Amplifier

Requires enough plate and grid bias voltage on its tubes to prevent them from being overloaded by the signal voltage.

The AmerTran PF-45 or PF-52 with the half wave high voltage rectifying tubes now available and suitable condensers and resistances—together with three AmerChokes Type 854 will furnish these proper voltages. This combination will give real quality loudspeaker volume. AmerTran Power Transformers also supply A. C. filament current for the last audio tube.

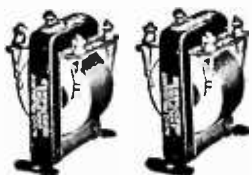

AmerTran Audio Transformers type AF6 (turn Ratio 5) and AF7 (turn ratio 3½) are the leaders in their class. Price, either type, \$5.00.

Write for booklet describing these and other AmerTran Products—with recommendations on their use. It's free on request. All prices are F. O. B. Newark, N. J.

AMERICAN TRANSFORMER CO.
178 Emmet Street, Newark, N. J.
"Transformer builders for over twenty-five years"
Sold Only at Authorized AmerTran Dealers.

Fig. 7. then the minimum capacity of the circuit is calculated by the following formula:

$$C = \frac{1}{\frac{1}{C_1} + \frac{1}{C_2}}$$

where C_1 equals the minimum capacity of the variable condenser (.000025 mfd.) and C_2 equals

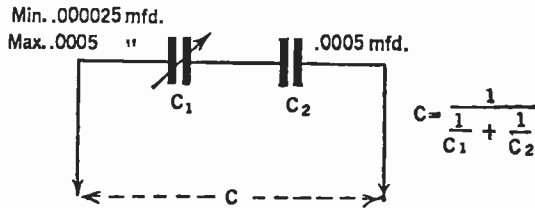

FIG 7.

the capacity of the fixed condenser. By substitution in this formula, we get:

$$C = \frac{1}{\frac{1}{.000025} + \frac{1}{.0005}} = \frac{1}{.00024} = .000024 \text{ mfd.}$$

The same formula may be applied for finding the maximum capacity of the arrangement, the maximum capacity of the variable condenser being substituted for C_1 .

AN IMPEDANCE-COUPLED AUDIO AMPLIFIER

FOR a means of amplifying audio frequencies, the impedance method is commendable because of its simplicity of connection, and also because use can be made of discarded transformers or other coils. From the circuit in Fig. 8 it will be seen that all that is necessary for a coupling agent between the regenerative detector tube and the first audio tube, is a coil having an iron core. Of course, this

coil unit should have certain definite dimensions for most efficient functioning, but it has been found that such coil units as the secondary of a transformer which has been rendered useless by a burned-out primary, or the wire-wound bobbins of discarded head phones, are satisfactory make-shifts for an amplifier unit. The connections for an entire receiving circuit, showing the application of an impedance or choke coil to it, are clearly indicated in the accompanying circuit diagram.

The two tuning units in this circuit are standard coupler units. In the antenna unit, the secondary coil is tapped at the mid-turn for the filament return connection. Rice neutralization is employed. The neutralizing condenser is connected between the plate of the radio frequency tube and the lower end of the first coil-unit secondary. These connections are clearly shown in the diagram. The value of the neutralizing condenser is .000016 mfd. The tuning condensers are both about .0005 mfd.

The similarity between impedance and resistance audio amplification is apparent from a glance at the circuit diagram. In resistance amplification a resistor of approximately 100,000 ohms is substituted for the impedance coil, and there is a B battery voltage drop across the plate resistance. Any variation in voltage causes a corresponding voltage variation in the resistor, and these voltage variations are applied to the grid of the succeeding tube, and magnified by the latter's action. For an impedance amplifier, the general action is much the same, with the exception that, instead of utilizing the voltage drop across a resistance, the variation in voltage across an inductance is used. It is essential that the isolating condenser C, should be of the highest quality, one of mica dielectric being recommended.

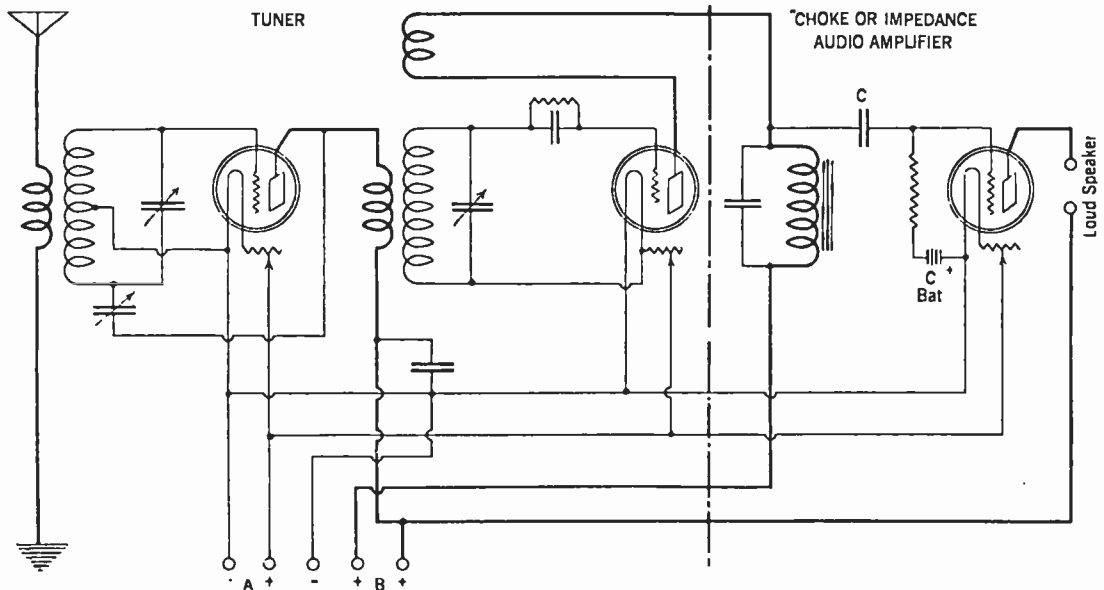

FIG. 8

GRID INQUIRY BLANK

Editor, The Grid
RADIO BROADCAST
Garden City, New York

DEAR SIR,

Please give me the fullest information on the attached questions. I enclose a stamped envelope.

I am a subscriber to RADIO BROADCAST and therefore will receive this information free of charge.

I am not a subscriber and enclose \$1 to cover cost of answers.

NAME.....

ADDRESS.....
G. A.

Hammarlund Roberts

Acclaimed from Coast to Coast



Testimonials on the Hammarlund-Roberts Receiver

1
Grandview, Washington
 Last night I received PWX at Havana, Cuba on the loud speaker. Other stations that I get regularly are: WFGB at Atlanta, Georgia; WSM, Nashville, Tenn.; WGY, Schenectady, N. Y.; WSMB, New Orleans, Louisiana; CZE, Mexico City, Mexico. Ready to back your set against any other of the same size. Logged over 100 stations the first week.
 R. F.

2
Butte, Montana
 During tests the Hammarlund-Roberts was installed in the Butte Radio Club Headquarters and this set for 2LO. Immediately we were able to get through for a few moments, long enough to hear announcements made in English, German, and Spanish. This was followed by both instrumental and vocal music.
 M. R. C.

5
Wheeling, W. Va.
 On January 25th, 1926, I picked up 7EAJ of Madrid, Spain. Reception was so loud and clear from the cone speaker, it was desirable to cut the volume considerably. I have received CZE of Mexico City and PWX of Havana, Cuba; both of these stations I have received before these tests however. I have logged over 90 stations and more are coming in all the time.
 N. E. C.

7
Washington, D. C.
 Each evening during the tests, I logged in no less than a dozen stations. However, regenerative sets absolutely ruined reception. I was able to make out only partly some station in South America operating at 300 meters. From results obtained I am sure that Hammarlund-Roberts is capable of Trans-Atlantic Reception. I feel that Hammarlund-Roberts is one of the best buys in radio today.
 G. J. A.
 Electrical Engineer

9
Williamport, Pa.
 We have tested the Hammarlund-Roberts and find it to be exactly as you recommended. Surprising volume and very clear and deep tone, exceedingly selective.
 H. B. S.

10
Lansing, Mich.
 On the first night of the Trans-Atlantic Tests, I had PWX, Havana, Cuba, on the loud speaker, so loud that it could be heard at times all over a six-room house. Have not heard of anyone beating this record. I have ten witnesses to this reception.
 J. R.

13
Morristown, Tennessee
 I assembled the Hammarlund-Roberts Receiver in one day's time. The set is highly efficient and up to all claims made by you. I have owned many factory built sets and will say that the Hammarlund-Roberts is superior to them all. This set is capable of building up tremendous volume without distortion and behaves like a thoroughbred. I get New York, Atlantic City, Jacksonville, San Francisco, Montreal, Havana, Cuba, and Mexico City.

Thousands Have Built It!

SIMPLICITY of assembly is an outstanding feature of the Hammarlund-Roberts receiver. Thousands of amateur builders in all parts of the country testify enthusiastically to the ease of assembling this circuit and express their delight at the results secured by their own handiwork.

The secret of their success lies in the flawless technique of every part entering into the assembling of this set. The Hammarlund-Roberts receiver represents the composite achievement of ten leading engineers, backed by ten of the best known manufacturers of radio parts. Every part is the work of a specialist and has been chosen because it meshes easily and yet efficiently with every other related part in the set.

After you have assembled this receiver you will want your friends to call around and judge for themselves your ability as a radio engineer. And your pride will be justified. The Hammarlund-Roberts receiver combines remarkable volume and sensitivity with an unusual degree of selectivity and tone quality. As for distance—you have on either side enthusiastic testimony by users of the Hammarlund-Roberts in all sections of the country. A perusal of these comments will revolutionize all your previous ideas of five-tube performance. Should you desire to verify any of these reports we will be glad to furnish you with full name and address on request.

Hammarlund Roberts ★

Hammarlund-Roberts 1182-A Broadway, New York City

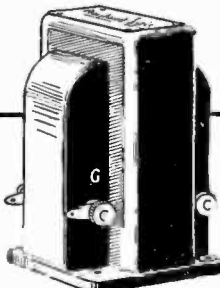

This famous instrument and other parts shown here are some of the quality units in the Hammarlund-Roberts.

Carter



RHEOSTATS



DURHAM RESISTORS

AMPERITE



UNION PHONE TIP JACKS

NA-ALO



DIALS and SOCKETS

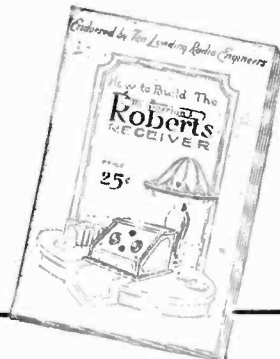

SEND FOR THIS BOOK

Contains step-by-step instructions on the assembly, wiring and operation of the Hammarlund-Roberts. Fully illustrated; most complete "How to Build It" radio book ever published. 25c.

Send for this
New Hookup

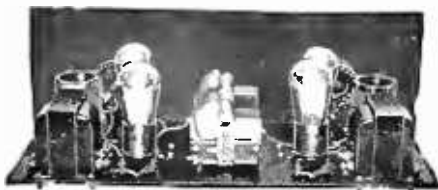

The outstanding receiver development of the season, in which is combined the genius of two of the most distinguished radio engineers. A receiver for the home builder that will represent for several seasons to come a far greater value than any other design available. Several outstanding features place the design in a position far in advance of anything available or contemplated. Unlimited wavelength range, with interchangeable antenna and detector coils; marvelously improved audio transformers; a special self-contained wiring harness; but one tuning or station selector control, are special features. Over-all design is rugged and solid. Adapted to practically any standard cabinet, any standard tube, any battery or eliminator source of supply, outdoor antenna or loop. Only a screw driver and pair of pliers necessary. The set can be built at an extremely low cost and parts are readily available at all radio dealers.



Represented Manufacturers:

Belden Mfg. Co.—S-C Wiring Harness

Central Radio Laboratories—Centralab Resistance

Polymet Mfg. Corporation—Fixed Condensers, Leak, and Leak Clips

Poster & Co.—Drilled and Processed Front Panel and Drilled Sub-Panel

Silver-Marshall, Inc.—Variable Condensers, Coil Sockets, Coils, Tube Sockets, Vernier Dial, Mounting Brackets

Thordarson Elec. Mfg. Co.—R200 Power Transformers

Yaxley Mfg. Co.—Rheostat, Jacks, Switch

Get the hand-book at your radio dealer's, or clip the coupon and send 25 cents to

S-C MERCHANDISING COMPANY

65 E. Jackson Blvd. Chicago

S-C Merchandising Company

65 E. Jackson Blvd., Chicago

Herewith please find 25 cents for which send me the hand-book of the new S-C Four-Tube Receiver

Name

Address

“NOW, I HAVE FOUND”

A Department for the Exchange of Ideas and Suggestions of Value to the Radio Constructor and Operator

CONTRIBUTIONS to this department are welcome and those used will be paid for at the usual rates, that is, from two to ten dollars each. A prize of twenty-five dollars is given for the best idea used during each three-month period. The prizewinner for the last period was announced in the February RADIO BROADCAST. Manuscripts intended for this department should not exceed about three hundred words in length, and should be typewritten. Little consideration can be given to manuscripts not typewritten. Envelopes should be addressed to this department, RADIO BROADCAST, Garden City, New York.

BETTER REPRODUCTION IN CONE SPEAKERS

AN EASY way to eliminate the jingle in the high notes and reproduce the bass notes more faithfully in a cone loud speaker, taking as an example the Western Electric No. 540 AW, is as follows:

Loosen the set screw in front which holds the pin, then remove the screws in the back thus allowing the metal ring, fibre ring, and screen to be removed.

This exposes the telephone unit held to the frame by three screws. First, mark the frame where the unit is held to it so that it can be put back in the same place, and then remove the screws and carefully lift out the unit.

Remove the screw holding the pin to its support and insert a piece of electric tape between these two members, first making a hole through the tape for the screw to go through. Replace the screw.

Then slip over the pin a rubber tube $\frac{1}{8}$ inch or more in thickness reaching from the base of the pin to just short of the parchment, and having its bore slightly smaller than that of the pin, so as to grip it tightly. With the use of this system, the possibility of bending or otherwise injuring the pin by loading it with rubber tape is avoided. See Fig. 1.

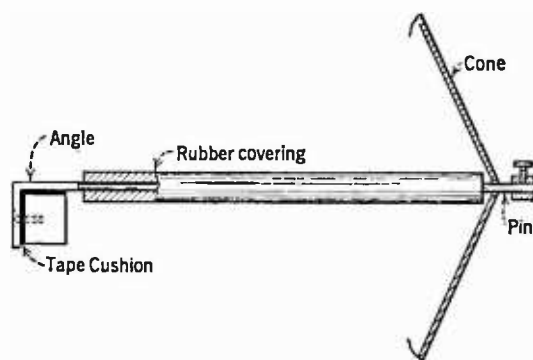

FIG. 1

Re-assemble, taking care to have the pin straight and to put the telephone unit back in the same place on the frame as marked. Tighten the screw in front to the pin.

Before replacing the screen, tune in on some good station and test out the speaker. If there is any jingle leave the set screw in front secured to the pin, loosen up the screws holding the telephone unit to the frame, and move the unit until the jingle disappears and the best reproduction is obtained. Then tighten up the screws.

Replace the screen and rings, thoroughly tightening up all screws.

WILLIAM C. MORRILL, E. E.
New York.

HOW TO PROVIDE A COUNTERPOISE SYSTEM

THOSE who use the Roberts or Browning-Drake circuits and are troubled with broad tuning antenna couplers, might well use the single inductance with a conductively coupled antenna, placing the antenna tap about one third up

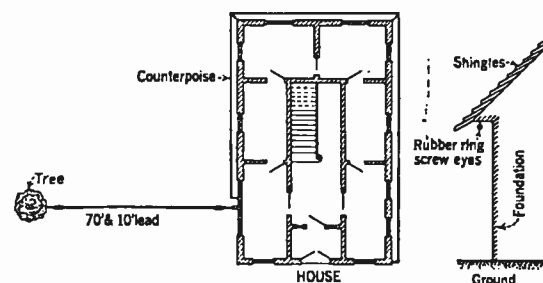

FIG. 2

from the filament end of the inductance, and grounding the negative A battery line.

For those who have the space or who live in shingled houses, the substitution of a counterpoise for a ground (entirely eliminating the ground will materially sharpen the tuning and in my case was found to produce much clearer signals, with greater intensity, than with the ground. The lower edge of the shingles generally stops about 3 feet from the ground and overhangs the foundation wall by several inches. Small insulated screw eyes placed under the shingle-overhang all the way around the house will hold a good counterpoise. If the shingles go all the way to the ground, a row of screw eyes about the height of the doorways will work almost as good. See Fig. 2.

My antenna combination is now an 80-foot antenna and a 100-foot counterpoise.

J. B. GREENMAN,
Montclair, New Jersey.

SOME NOTES ON SILVER'S MODEL 1926 RECEIVER WITH CHOKE AMPLIFICATION

VARIATIONS on the theme of McMurdo Silver's "Model 1926 Broadcast Receiver," introduced to its readers in the November, 1925, number of RADIO BROADCAST, were presented by E. R. Pfaff in the January, 1926, number. Before the appearance of the latter article, the writer had constructed a receiver of this type using Thordarson Autoformer audio amplification. As the set was constructed for experimental purposes, and this circuit is peculiarly adapted to this end, one or two wrinkles used may be of interest.

As described, the set has no binding

Faradon

ELECTROSTATIC CONDENSERS

19 YEARS OF SPECIALIZATION
IN THE RADIO FIELD

are behind each Condenser Trade Marked

Faradon



In Radio Receiving Sets

The Biggest Little Things Are

The FIXED CONDENSERS

The MODEL T FARADON is furnished in all usual sizes to meet the requirements of Quality Performance.

Quotations covering quantity requirements furnished

to

SET MANUFACTURERS

promptly upon request.

Some Important FARADON Users:

- | | |
|----------------------------------|--------------------------|
| U. S. Army | General Electric Co. |
| U. S. Navy | Radio Corp. of America |
| U. S. Signal Corps | Western Electric Company |
| U. S. Bureau of Standards | Tropical Radio Tel. Co. |
| Westinghouse Electric & Mfg. Co. | |



TYPE I TERMINALS

For Soldered Connections in Any Portion of Circuit

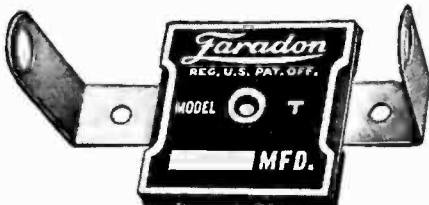

TYPE II TERMINALS

Holds Standard Cartridge Grid Leak— Also Takes Soldered Connections



TYPE III TERMINALS

For Transformer or Other Binding Post Mounting Also Takes Soldered Connections

WIRELESS SPECIALTY APPARATUS COMPANY
JAMAICA PLAIN — BOSTON, MASS.

★ Tested and approved by RADIO BROADCAST ★



Seven Years of Superiority

KNOWN as the original HI-MU tubes before the days of BCL;

Preferred by amateurs and experts before the first popular receiving set was sold;

Progressively improved in construction and performance;

Made in the newest and best equipped plant in America.

Get the World on Your Dial With Myers Tubes

Low impedance, high amplification constant, high mutual conductance. Best results in any circuit — impedance, resistance or transformer coupled.

At Your Dealer's
Myers Radio Tube Corporation
Cleveland, Ohio

Attractive, compact, correct inside and out, no clumsy materials. Made by pioneer designers and builders of Radio Tubes.

Marvelous Clarity and Distance

Use Myers Tubes in any set and get better results in volume, tone, range and ease of control.

Made with standard four prong base, or double-end, in types Myers 01 A, Myers 01 X, Myers 99, Myers 99 X.

List Price
Type 01 \$2.00
Type 99 2.25

At Your Dealers

JEWELL

No. 135-A

SEND FOR New No. 739 Circular describing special voltmeters for Radiola, Victor and Brunswick sets

Order from Dealer

Jewell Electrical Instrument Co.
1650 Walnut St. Chicago
"26 Years Making Good Instruments"

posts, the ends of a Belden battery cord being attached directly to various terminals, transformer, switch, etc., in the set. For experimental purposes, it is handier to use binding posts, however. Choke amplification may be used with either 90 or 120-135 volts of B battery. In case 90 volts of B battery is used, the 90 volts go to both r.f. and a.f. amplifiers, while the detector receives 45 volts. If, however, it is desired

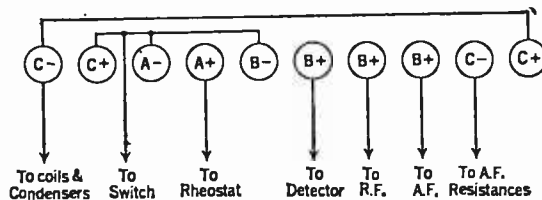

FIG. 3

to employ 120-135 volts of B battery on the last audio stage, then the r.f. amplifier and the first two stages of audio receive 90 volts. There are three separate units to be provided for, the r.f., 1st and 2nd a.f. amplifiers, the detector, and the last a.f. amplifier stage. If three B plus binding posts are used, one for each unit, the a.f., r.f., or the detector may be quickly connected at the binding posts to facilitate the use of various values of B potential without tearing the set apart.

The December, 1926, RADIO BROADCAST contained two very interesting articles on the use of high-mu tubes, one by Keith Henney and the other by Glenn H. Browning. The latter describes the use of Daven

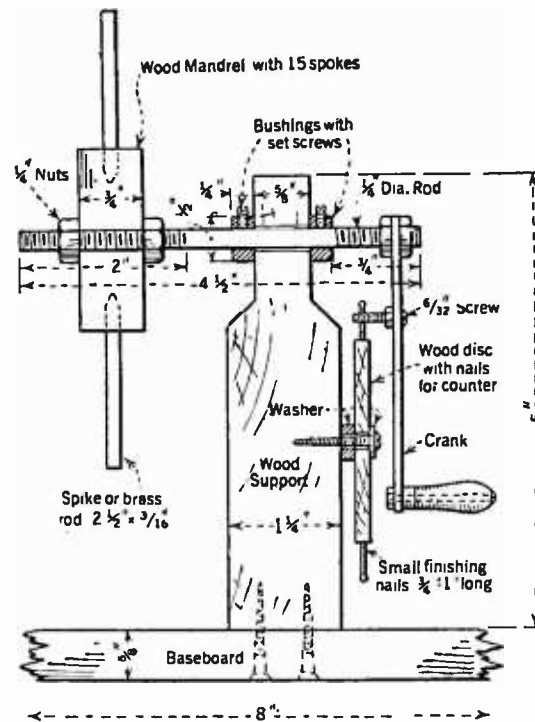

FIG. 4

high-mu tubes in conjunction with National chokes, using 90 volts of B battery. When two Daven mu-20 and one Daven mu-6 (in the last stage) are used in the "Model 1926 Receiver" with Thordarson chokes on 90 volts, an appreciable gain in volume is experienced. When, however, 120-135 volts of B battery are used in the a.f. circuit, as suggested by Mr. Henney, the receiver talks right out. Furthermore, quality is not sacrificed.

When Daven tubes are used, the rheostat lead to these tubes may be disconnected from the rheostat and connected directly to the current supply, as these tubes operate

directly from a 6-volt battery. A switch of the midget type mounted inside the set makes this change simple.

To care for added C battery (6 to 7 1/2 volts) to the a.f. circuit, an extra pair of C binding posts may be used to advantage, as indicated in Fig. 3.

DAVENPORT HOOKER,
Pittsburgh, Pennsylvania.

A HOME-MADE COIL WINDER FOR DIAMONDWEAVE COILS

THOSE preferring to "roll their own" will find in the accompanying sketches, Figs. 4, 5, and 6, sufficient instructions to build an efficient coil winder for diamondweave coils. It consists of a wood mandrel and metal spokes for a coil form, mounted on a shaft; also a counter and a wire guide made of small thread spools, and a small screw eye to give correct tension to the wire.

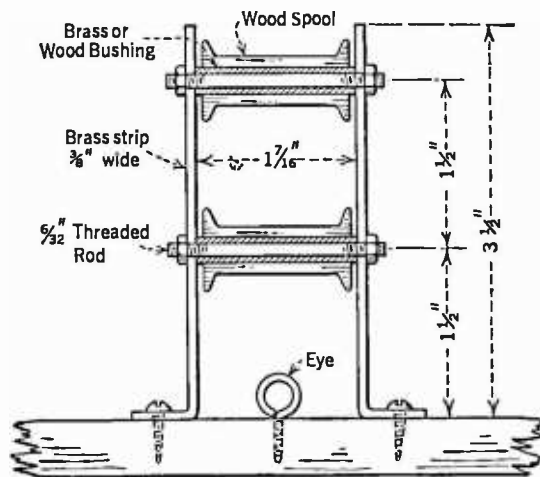

FIG. 5

Care must be taken in marking and boring to the correct size, the holes in the mandrel to take the spokes. Place the spool or wire guide in an upright position, and far enough away from the winder proper to allow easy handling of the wire with the hand (about five inches from the shaft support). To wind, run the wire through the eye and under first spool, then between the two and over the top spool; set counter and begin winding. With a little practice one can soon learn the "swing" of "over two, under two," done with the left hand.

After winding, remove the mandrel from the shaft, pull the spokes just out of the wood, but leave them engaged in the wire until sewn. About twenty nails in

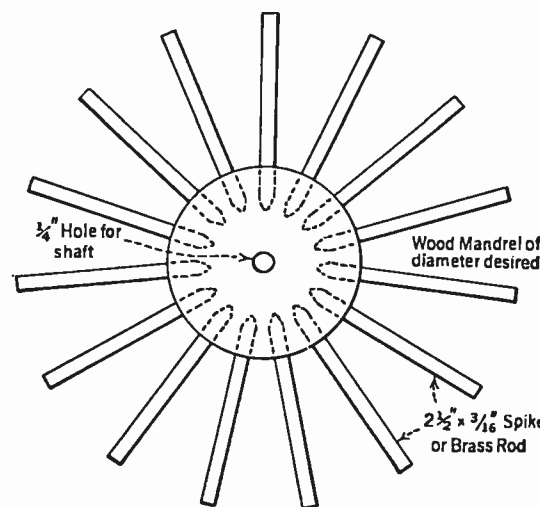
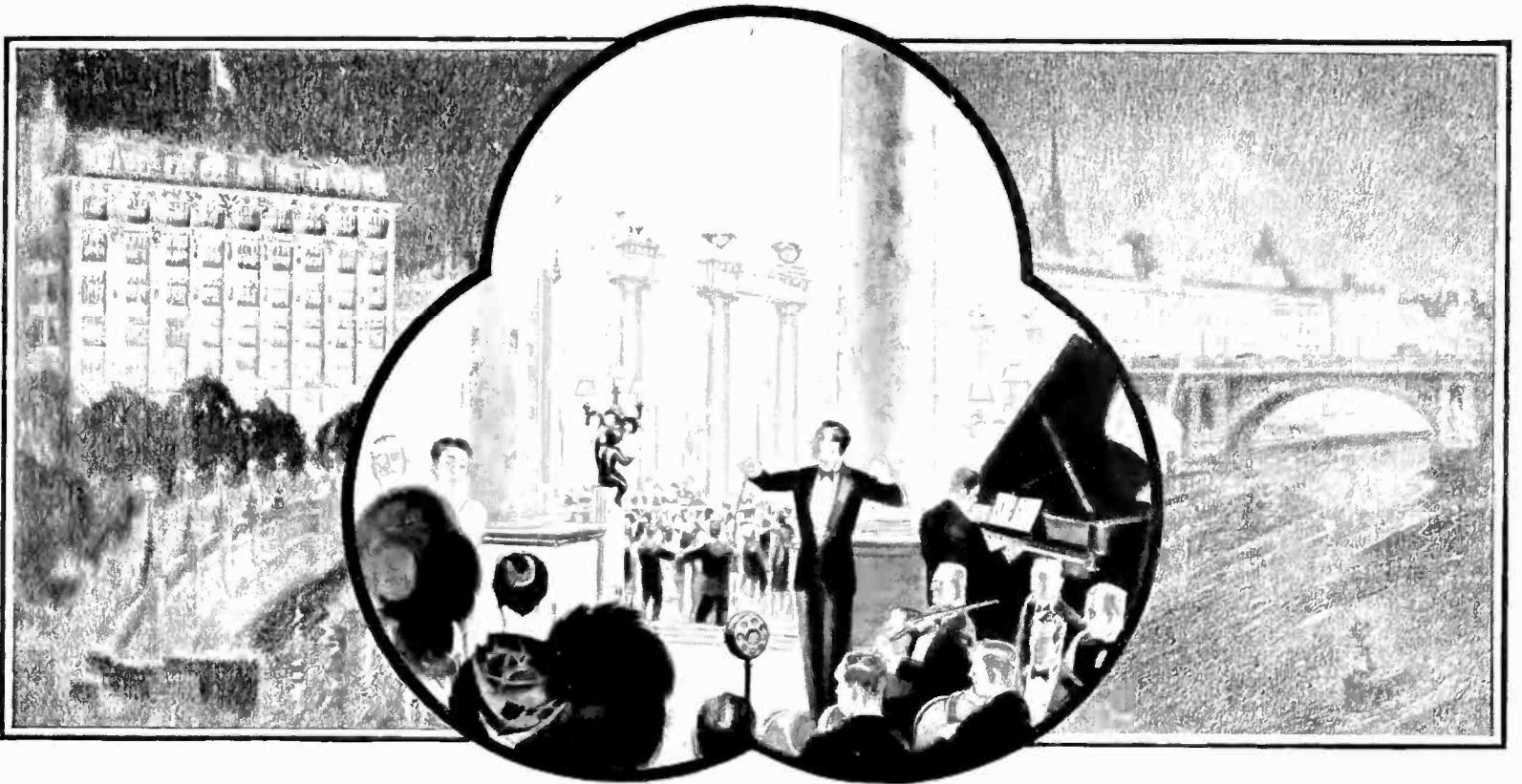

FIG. 6



“This is Station 2-L.O. London,—12 Midnight”

WHEN listeners-in on this side of the Atlantic first heard the voice of the British announcer, and then a program of music from the famous Savoy in London, they experienced one of the real thrills of radio.

To get everything that is on the air—the faint signals as well as the strong ones—effective insulation of all radio parts is a prime essential. The best way to make sure that a radio set or parts are well insulated, is to buy those in which Bakelite is used.

Bakelite is used by 95% of radio set and parts manufacturers. It is the standard material for front and base panels, dials, knobs, tube sockets and bases, fixed and variable condensers, rheostats, plugs and other radio accessories and parts. Write us for a copy of Booklet No. 29, “Bakelite in Radio”—it’s a helpful guide in buying radio equipment.

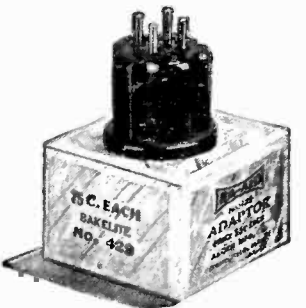

BAKELITE CORPORATION

247 Park Avenue, New York, N. Y.
Chicago Office: 636 West 22nd St.

BAKELITE CORPORATION of CANADA, Ltd.
163 Dufferin Street, Toronto, Ontario, Canada.



BAKELITE

REGISTERED U. S. PAT. OFF.



THE MATERIAL OF A THOUSAND USES

“The registered Trade Mark and Symbol shown above may be used only on products made from materials manufactured by Bakelite Corporation. Under the capital “B” is the numerical sign for infinity, or unlimited quantity. It symbolizes the infinite number of present and future uses of Bakelite Corporation’s products.”

★ Tested and approved by RADIO BROADCAST ★

screw machine products —brass



For plugs, jacks, clips, condenser and transformer parts, etc., BRASS assures economy in quantity production. It also gives the right electrical conductivity and the mechanical accuracy essential to proper operation of radio sets and parts.



COPPER & BRASS
RESEARCH ASSOCIATION

25 Broadway, New York

KILL STATIC!
Without Loss of Volume

ELIMINATE STATIC

Enjoy perfect reception regardless of weather conditions. The Static Eliminator—the newest and most startling thing in Radio—cuts out practically all static without loss of volume! And in addition it will help increase selectivity, tune out local stations, sharpen signals, remove noises, lessen interference, and prevent re-radiation!

Use it with any receiving set—simply hook up according to our simple instructions and enjoy perfect reception unmarred by static. Satisfaction absolutely guaranteed—Money back if Eliminator is returned within 5 days. Mail your order Today.

\$1.00 Postpaid

STATIC ELIMINATOR COMPANY
627 United Bank Bldg. Cincinnati, O.

the counter disk is correct for a two-inch disk. By means of the screw on the crank, and the counter, each turn of the crank registers one complete turn of the coil. It is easier to use two rings of heavy cardboard tubing of given diameter and half an inch in width, clamped on each side of the spokes with two pieces of heavy sheet metal, than to make various size wood mandrels. In this way, one mandrel serves for all diameter coils. Take care to center these properly on the form before winding. An excellent coil can be wound in this way. These coils give fine results in a RADIO BROADCAST "Knockout" receiver.

MATERIAL REQUIRED

- 1— $4\frac{1}{2}$ -inch x $\frac{1}{4}$ -inch metal rod for shaft (60 penny spike will do).
- 1—Piece of hard wood $\frac{3}{4}$ -inch wide and of diameter desired.
- 1—Piece of hard wood 5 inches x $1\frac{1}{4}$ inches (support for shaft).
- 1—Piece of heavy sheet metal 3 inches x $\frac{5}{8}$ inches for crank.
- 15— $2\frac{1}{2}$ -inch x $\frac{3}{8}$ -inch spikes for spokes (with heads cut off).
- 2—Pieces of brass bushing, $\frac{1}{4}$ -inch inside diameter, $\frac{1}{4}$ -inch wide, with set screws.
- 1—Baseboard about 15 x 8 x $\frac{5}{8}$ inches.
- 1—Small wood disk about 2 inches diameter $\frac{1}{4}$ -inch thick for counter, with some small fishing nails to go around periphery.
- 2—Wood spools of same size (thread spools.)
- 2—Pieces of $\frac{3}{8}$ threaded rod 2 inches long.
- 2—Pieces of brass or wood tubing (pipe stems) $\frac{1}{8}$ inch longer than spools.
- 2—Pieces of metal strip 4 x $\frac{3}{8}$ inches wide to hold spools.

R. S. HART,
Pisgah, Kentucky.

A HANDY BATTERY THROW-OVER SWITCH

WHEN a vibrating magnetic rectifier, such as the "Homcharger," is employed to charge the storage battery, it is necessary to observe the following procedure:

To charge:

1. Disconnect battery from receiver.
2. Connect charger to line supply (110 volts a.c., 60 cycles).
3. Connect battery to charger.

To discharge:

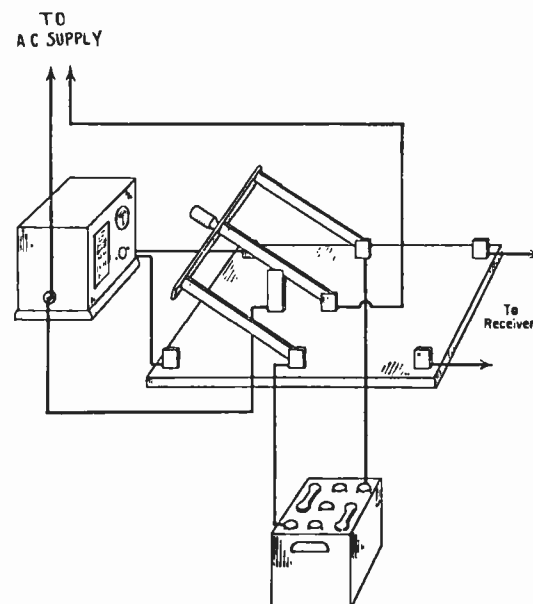

FIG. 7

1. Disconnect battery from charger.
2. Disconnect charger from mains.
3. Connect battery to receiver.

To eliminate the clumsy connection and removal of clips, the author has devised a simple arrangement whereby the complete process of connection necessary to the proper charge and discharge of the battery is controlled merely by the movement of a double-throw switch.

The switching device is illustrated in the accompanying diagram, Fig. 7. The dimensions of the switch itself are unimportant, so long as the extra contact which connects the charger to the line supply is made large enough so that the switch blades connected to the battery are entirely clear of their contacts before the line supply is cut off.

BERNARD SALZBERG,
New York City.

ECONOMICAL SUB-PANEL BRACKETS

BEING suddenly faced with the necessity of making a pair of brackets for a sub-panel, I tried the following: Get from a good hardware or plumbing supply store, a piece of $\frac{1}{8}$ -inch channel brass, $\frac{1}{2}$ -inch wide. This will be shaped as shown in 1, Fig. 8.

Measure how far the bracket must project back from the front panel and add about two inches for support to fasten on to the front panel. At the point where you wish to bend the strip make a cut, perpendicular and square across, with a hack saw, merely cutting through the side walls as illustrated in 2, Fig. 8.

Then, with a three-cornered file, widen the saw cut to a "V" shaped notch, as in

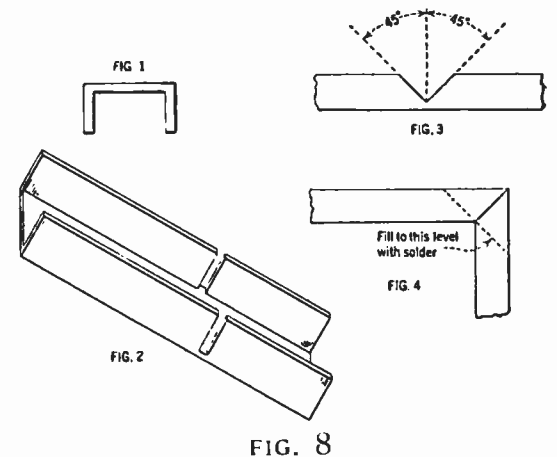

3. Be sure the angle at the bottom of the notch is one of 90° and that it is pretty accurately placed 45° on each side of the perpendicular. The bracket is now bent, as shown in 4. If your angle is correct, the top piece will project from the panel exactly square, and the weight on the sub-panel will be supported nicely by the side walls of the notch as they come together.

Of course, by regulating the angle of the filed notch, you may make a bracket that projects from the panel at any angle of more or less than 90° as you wish. This idea could be used in making sets with a sloping panel.

To finish the bracket, fill the corner where the brass was bent, with solder. This prevents the bracket from bending back under pressure from beneath, such as is exerted when the foot on the sub-panel rests on a table or the bottom of the cabinet.

R. L. DOUGLAS,
Huntington Park, California.

ATWATER KENT RADIO

“Are you running a store
or a museum?”

THAT'S what the caustic stranger said to the radio merchant.

The merchant started to flare up, but thought better of it. Instead, when the visitor departed he spent a profitable half-hour with his own thoughts.

Had he taken on too many lines? Had he selected them indiscriminately? Didn't unsalable reminders clutter his shelves? Obsolete models, discontinued by the manufacturer in the middle of the year? Orphan sets—maker gone out of business?

Those job lots he had bought to “move quickly”—weren't they still hanging around? Yes, and good sets, but without the necessary advertising to make people want them? And sets that looked good but ate their heads off in service calls? Sets that had come in with drums beating—and stayed while the parade passed on?

“It is a museum,” said the merchant. “I only *thought* it was a store.” Whereupon he cleared out the relics as best he could, concentrated on two lines his customers really wanted, and lived happily ever after.

* * *

Has the Radio *you* handle commer-

cial value? Is it a good product, nationally advertised, and fairly priced? Has it a record of consistent sales and assurance of permanence? Does it sell easily—and *stay sold*, enabling you to turn your capital often with a minimum of overhead? In short, is it *profitable*—over a period of time?

If April is your month for mental stock taking—for figuring what you have been doing, where you stand and whither you are bound—isn't this a good time to look around, see what the Atwater Kent Radio merchants have done and what *they* think of the radio business?

Perhaps you would fit into the picture, too.

EVERY SUNDAY EVENING

The Atwater Kent Radio Hour brings you the stars of opera and concert, in Radio's finest program. Hear it at 9:15 Eastern Time, 8:15 Central Time, through:

WEAF New York	WFI Philadelphia
WJAR Providence	WOO } alternating
WEEL Boston	WCAE Pittsburgh
WSAI Cincinnati	WGR Buffalo
WCAP Washington	WOC Davenport
WCCO Minn.-St. Paul	WTAG Worcester
WEAR Cleveland	KSD St. Louis
WLIB Chicago	WWJ Detroit

Write for illustrated booklet of Atwater Kent Radio.

ATWATER KENT MANUFACTURING CO.
A. Atwater Kent, President

4726 WISSAHICKON AVENUE, PHILADELPHIA, PA.



Short-Wave Stations of the World

THIS list, containing more than a hundred short-wave stations situated throughout the world, is about the most completely accurate one yet to be printed. The Traffic Department of the Radio Corporation of America coöperated in its compilation. Included in this list are stations known to be operating on the wavelengths given, stations licensed for operation, and stations which have been in operation to any considerable extent during the past year, and which are not definitely discontinued.

FROST-RADIO

No. 530 Socket

for all new type tubes

The new No. 530 FROST-RADIO Socket takes ALL of the new type tubes. It is made from black polished Bakelite, and has sturdy contact springs which hold the tube prongs for almost their entire length. Price 40c at your nearest dealers.

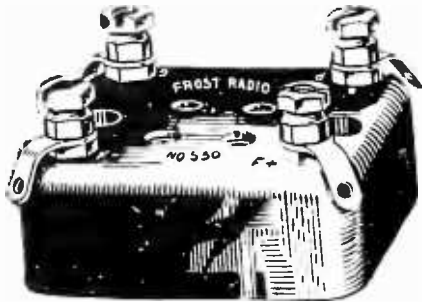

The No. 530 is a rich-looking socket because it is made from real Bakelite. Takes all the new type tubes. Price 40c

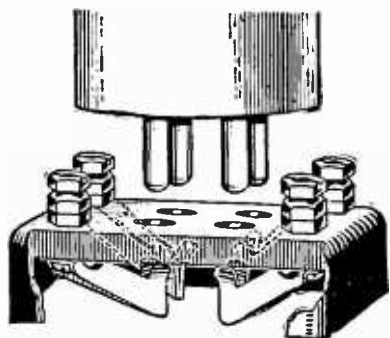

Note the spring construction as revealed by this cut-away view. These sturdy springs are held between cast bosses, and stay put.

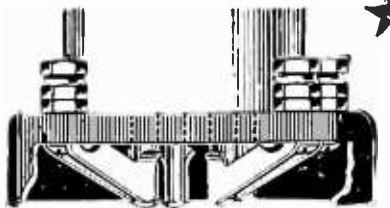

When the tube is inserted each prong is gripped the full length on two sides and held in a vice-like grip. Dirt cannot remain on the springs or prongs here.

HERBERT H. FROST, Inc.
314-324 WEST SUPERIOR ST., CHICAGO
New York City Cleveland Kansas City
Los Angeles

Export Office: 314 W. Superior St., Chicago

★ **RADIO CLAMP Blackburn Ground Clamps**

Telephone companies using MILLIONS. Adjustable — fits any size pipe. Requires no pipe cleaning—screw bores through rust and scale. Send 12 cents for sample and postage.

Blackburn Specialty Company
1960 E. 66th St. Cleveland, O.

Burns

PERFECT REPRODUCER

Loud, Pleasing tone. Handsome material. Distinctive design.

Horns, \$22.50 to \$30.00
Units, 10.00 to 12.00

American Electric
COMPANY
State & 61th Sts. Chicago

CALL SIGNAL	LOCATION	FREQUENCY IN KC.	WAVELENGTH METERS
POF	Nauen, Germany	22209	13.5
2XS	Rocky Point, New York	20082	14.93
2XAW	Schenectady, New York	19988	15
2BR	Chelmsford, England	19988	15
POF	Nauen, Germany	18738	16
NKF	Anacostia, District of Columbia	18738	16
2BR	Chelmsford, England	17636	17
POF	Nauen, Germany	16657	18
2XAD	Schenectady, New York	14991	20
KFVM	SS <i>Idalia</i>	14991	20
POF	Nauen, Germany	14991	20
NAL	Washington, District of Columbia	14991	20
NEPQ	USS <i>Relief</i>	14991	20
NKF	Anacostia, District of Columbia	14414	20.8
WIK	New Brunswick, New Jersey	13628	22
2 YT	Poldhu, England	11993	25
POY	Nauen, Germany	11993	25
FW	Sainte Assise, France	11993	25
NKF	Anacostia, District of Columbia	11758	25.5
AGA	Nauen, Germany	11532	26
PCMM	Kootwijck, Holland	10903	27.5
POW	Nauen, Germany	10708	28
2 XI	Schenectady, New York	9994	30
NAL	Washington, District of Columbia	9798	30.6
2 YT	Poldhu, England	9369	32
ANE	Malabar, Java	9369	32
NAJ	Great Lakes, Illinois	8630	34
WQO	Rocky Point, New York	8560	35.03
PCMM	Kootwijck, Holland	8328	36
PCUU	Kootwijck, Holland	7890	38
KFVM	SS <i>Idalia</i>	7496	40
NAS	Pensacola, Florida	7496	40
NAJ	Great Lakes, Illinois	7496	40
NPG	San Francisco, California	7496	40
NRRL	USS <i>Seattle</i>	7496	40
NQW	USS <i>New Mexico</i>	7496	40
2 XAC	Schenectady, New York	7496	40
NKF	Anacostia, District of Columbia	7260	41.3
2 XAF	WGY—Schenectady	7160	41.88
5 XH	New Orleans, Louisiana	7139	42
FW	Sainte Assise, France	7139	42
WIZ	New Brunswick, New Jersey	6970	43.02
WQO	Rocky Point, New York	6814	44
KZA	Los Angeles, California	6814	44
KZB	Los Angeles, California	6814	44
PCLL	Kootwijck, Holland	6518	46
WHD	Sharon, Pennsylvania	6119	49
NPM	Honolulu, Territory of Hawaii	6119	49
2 XAD	Schenectady, New York	5996	50
SAJ	Karlsborg, Sweden	5996	50
WQN	Rocky Point, New York	5822	51.5
NPU	Tutuila, Samoa	5657	53
NBA	Balboa, Canal Zone	5552	54
NKF	Anacostia, District of Columbia	5511	54.4
WQN	Rocky Point, New York	5501	54.5
KFKX	Hastings, Nebraska	5354	56
ANF	Malabar, Java	5354	56
1 XAO	Belfast, Maine	5354	56
WQN	Rocky Point, New York	5260	57
KDKA	East Pittsburgh, Pennsylvania	5100	58.79
KDC	Casper, Wyoming	5082	59
2 YT	Poldhu, England	4997	60
KDKA	East Pittsburgh, Pennsylvania	4759	63
8 XS	East Pittsburgh, Pennsylvania	4475	67
NPO	Cavite, Philippine Islands	4409	68
WRB	Miami, Florida	4383	68.4
WRP	Miami, Florida	4383	68.4
2 XAO	Belfast, Maine	4283	70
POX	Nauen, Germany	4283	70
NPO	Cavite, Philippine Islands	4283	70
NERM	USS <i>Los Angeles</i>	{ 4283 3548	{ 70 to 81.5
NQC	San Diego, California	4253	70.5
NKF	Anacostia, District of Columbia	4205	71.3
NPL	San Diego, California	4182	71.7
WIR	New Brunswick, New Jersey	4052	74
SFR	Paris, France	3998	75
NUQB	USS <i>Pope</i>	3998	75
NIRX	USS <i>Canopus</i>	3998	75
NAJ	Great Lakes, Illinois	3945	76
NFV	Quantico, Virginia	3874	77.4
JIAA	Iwatsuki, Japan	3795	79
KFVM	SS <i>Idalia</i>	3748	80
NEL	Lakehurst, New Jersey	3748	80
2 XK	Schenectady, New York	3748	80
NPC	San Francisco, California	3748	80
NKF	Anacostia, District of Columbia	3701	81
RDW	Moscow, Russia	3679	81.5
NKF	Anacostia, District of Columbia	3612	83
SFR	Paris, France	3569	84
NQC	San Diego, California	3527	85
KIO	Kahuku, Territory of Hawaii	3486	86
2 YT	Poldhu, England	3331	90
KEL	Bolinas, California	3190	91
8 XS	East Pittsburgh, Pennsylvania	3156	95
POX	Nauen, Germany	3123	96
NAM	Norfolk, Virginia	2998	100
WGH	Tuckerton, New Jersey	2998	100
WHU	SS <i>Big Bill</i>	2911	103
2 XK	Schenectady, New York	2855	105
KFVT	SS <i>Eloise</i>	2751	109
KFHV	SS <i>Facile</i>	2726	110
KFWJ	SS <i>Gallivant</i>	2726	110
1 XAO	Belfast, Maine	2726	110
FL	Paris, France	2677	112
KFWK	SS <i>Nirvana</i>	2607	115
KFVB	SS <i>Bridget</i>	2607	115
		2600	115.3

★ Tested and approved by RADIO BROADCAST ★

Cardwell

Old Friends

With New Faces

are far more dependable than strangers.

The logical plate shape of a rotary variable condenser is semicircular, and to use these plates to the proper advantage, neither rotor nor stator should be cut away to any extent.

Cardwell Taper Plate Type "E" condensers have the old familiar plate shape, but have a straight frequency tuning characteristic.

Authorities agree that these condensers are the finest instruments ever produced. Mr. Arthur H. Lynch, Editor of "Radio Broadcast," selected them as ideal for use in the "Aristocrat" and other receivers. Mr. Gerald M. Best, Editor of "Radio," uses them in his new "Super."

The Type "C" approaches straight frequency at minimum but gives more separation at maximum.

They are priced the same—the .0005 mfd. capacity lists at \$5.00, and others, proportionately.

The Allen D. Cardwell Mfg. Corp.

81 PROSPECT STREET
BROOKLYN, N. Y.

5c. in stamps brings this booklet on the Best Super-Heterodyne.

If your dealer can't supply you, order direct. Write for illustrated catalogue and handbook.

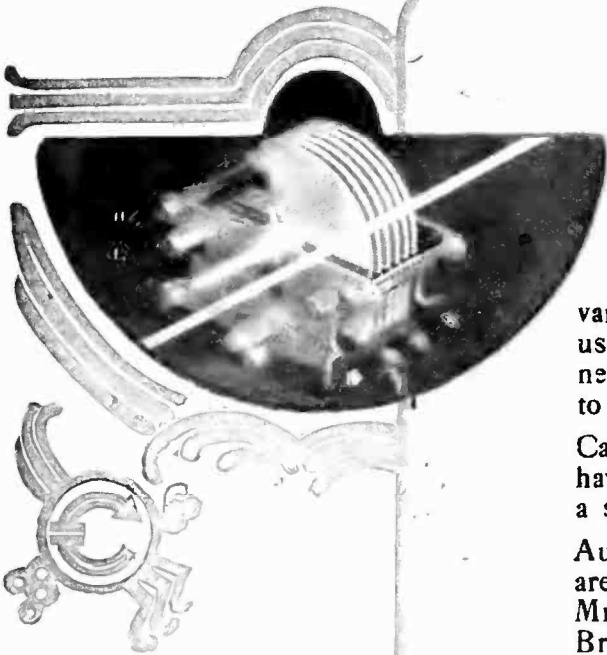

The Taper Plate Type "E" with straight frequency tuning characteristics

The Type "C" has a modified straight wave length tuning curve

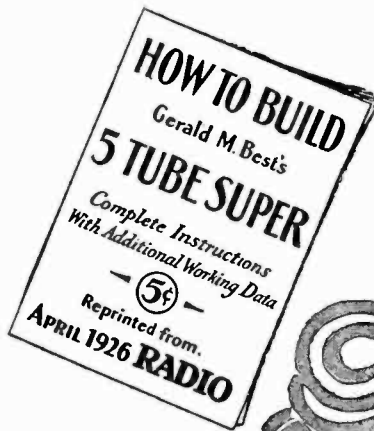
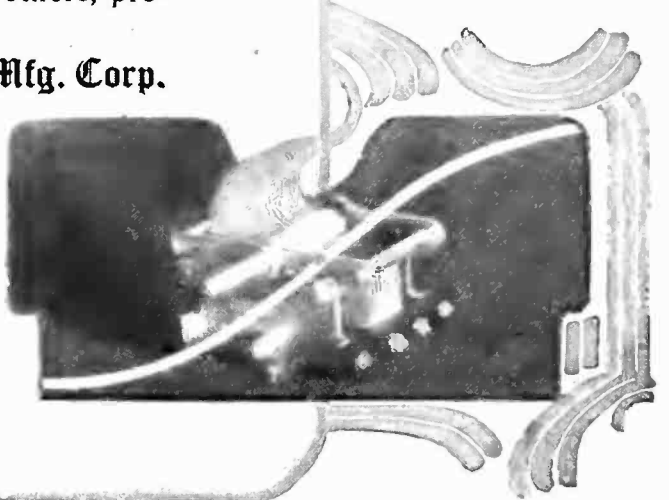

Condensers

"THE STANDARD OF COMPARISON"

★ Tested and approved by RADIO BROADCAST ★

www.americanradiohistory.com



PARTS

THE SC RECEIVER

In this new, single control, all-wave, 4-tube receiver, designed by eight eminent, engineering staffs, SM PARTS were used wherever possible. Their unquestionable excellence and dependability made SM Parts the logical selection for this advanced receiver. That is why in almost every successful receiver design of past and present seasons you will find SM Products—depended upon, and dependable.

THE "SIX"

Type 600 KIT Includes all parts necessary \$53.00
 Type 610 KIT Essentials only, including 3 condensers, 3 inductances and 3 inductance sockets \$27.75

SM THORDARSON RAYTHEON B-ELIMINATOR

The SM Type 650 Kit includes Thordarson Transformer, Choke, Tube Condensers, genuine Ratheon Tube, Bradleyohms and all necessary parts \$34

This Eliminator will deliver from 20 to 200 volts at three different adjustable voltages with maximum current of 50 milliamperes—more than enough for the largest receiver. Send for Assembly Instructions by McMurdo Silver 10c

SEE SM PARTS AT YOUR DEALERS OR SEND FOR CIRCULARS

Silver-Marshall, Inc.

103 S. Wabash Ave., Chicago

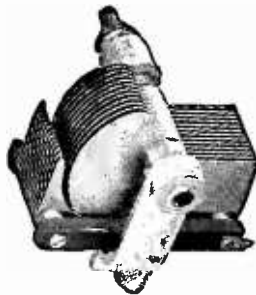

Type 316 Condenser, .00035 Mfd. for single or gang control. Brass plates, die cast frame. Price, \$5.75.

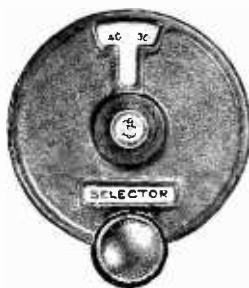

Type 801 Universal Vernier Dial, Ratio 14.5:1. Fits any standard condenser right or left, 180 or 360° movement. Price, \$2.50.



Interchangeable Coils for any wavelength. Standard Sizes. \$2.50. Type 515 Coil Socket, \$1.00.

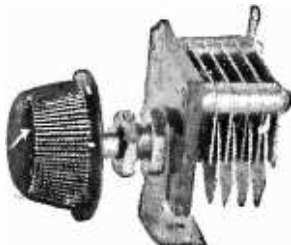

Type 340 Compensating Condenser, .000025 Mfd. with knob, \$1.50.



Type 510 All-Bakelite Socket for UX Tubes, 50c.



A KEY TO RECENT RADIO ARTICLES

By E. G. SHAULKHAUSER

THIS is the sixth installment of references to articles which have appeared recently in various radio periodicals. Each separate reference should be cut out and pasted on cards for filing, or pasted in a scrap book either alphabetically or numerically. An outline of the Dewey Decimal System (employed here) appeared in the November and January RADIO BROADCAST, and will be reprinted in an early number.



R113.4. IONIZATION; HEAVISIDE LAYER HEAVISIDE LAYER.
Popular Radio. Jan. 1926, pp. 61-63.
 "Up and Down Movement of the Heaviside Layer," Dr. E. E. Free.

A short outline covering the research in high frequencies carried on at the Naval Research Laboratory by Dr. A. H. Taylor and Dr. E. O. Hulbert, is reported. Most of the phenomena observed are explained on the basis of the Heaviside Layer movements. Skipped distances and fading apparently depend upon the height of this layer and its position during day and night.

R382. INDUCTORS. INDUCTION COILS.
Popular Radio. Jan. 1926, pp. 80-83.
 "Some Methods for Determining the Distributed Capacity of Coils," H. S. Knowles.

A discussion covering several methods which may be used in measuring the distributed capacity of coils, is presented. Mathematics and graphs are used in giving the information.

R382. INDUCTORS. INDUCTION COILS.
Radio Broadcast. Feb. 1926, pp. 436-438
 "Design of Radio Inductances," W. W. Harper.

Inductances, whose efficiency is high, must be designed to have a low high frequency resistance compared to inductance, twenty-five or more microhenries per ohm being considered a good coil in the opinion of the writer. Such a coil results in sharp tuning when combined with good condensers, although pick-up action of coils and crowding of apparatus in sets may make tuning broad. The standards of coil design are given as follows: (1) Low resistance over the broadcast frequency spectrum combined with as high a value of inductance as is permissible under the circuit conditions; (2) Effective confinement of electrostatic and electromagnetic field; (3) Consistent mechanical and electrical characteristics; (4) Small physical dimensions so as to permit compact construction. Experiments and tests have shown that space-wound solenoids are best for radio frequency purposes. With proper copper shielding and grooved space winding, the new so-called Metaloid coil was designed and built. Its L R value is 320/9.5, equal to 33, as given in the data.

R343. ELECTRON TUBE RECEIVING SETS. RECEIVERS.
Radio Broadcast. Feb. 1926, pp. 439-444 *Grimes Reflex*
 "How to Build a Grimes Inverse Duplex," F. J. Fox.

Constructural details of a four-tube Grimes Inverse Duplex receiver are given. The set is considered very sensitive and selective, and is easily built by the home constructor. Photographs, circuit diagrams, details of coil construction, panel layout, and method of locating audio, radio, or overload howl, which might be found in the completed receiver, give the necessary information desired when building such a receiver.

R800 (621.353) BATTERIES, PRIMARY. BATTERIES.
Radio Broadcast. Feb. 1926, pp. 452-455. *Life of B.*
 "How Long Will My B Batteries Last?," G. C. Furness.

A discussion on the life of B batteries in all sets from one to eight tubes or more, leads the author to the conclusion that the life of B batteries depends entirely upon current drain and size of cells in the battery. Charts and figures are presented, verified experimentally, showing how a definite time limit of six, eight, or twelve months can be set on the average life of B batteries when these are chosen properly for the receiver in question.

R131. Characteristic Curves; General Properties. VACUUM TUBES.
Radio Broadcast. Feb. 1926, pp. 456-461. *Characteristics*.
 "How to Use Vacuum Tubes," Keith Henney.

In this article, the elementary principles of vacuum tubes and their characteristics are discussed, a clear meaning of such terms as amplification constant, mutual conductance, plate impedance, of tube characteristics in general, etc.; being included. Data covering a great many makes and varieties of tubes are presented. Circuit diagrams show how this information was obtained. The proper use of C batteries and correct amount of filament current, are essential in good tube operation, according to the author.

R620.068. TESTING. TESTS OF BROADCASTING
Radio Broadcast. Feb. 1926, pp. 462-464
 "The 1926 International Radio Broadcasting Tests," W. K. Wing.

An outline of the plans and the transmitting schedule for the 1926 International Radio Broadcasting Tests are given. Many foreign stations lent their full cooperation and support to the success of this undertaking sponsored by RADIO BROADCAST.

R210. FREQUENCY; WAVELENGTH. FREQUENCY TO WAVELENGTH.
Radio Broadcast. Feb. 1926, pp. 471-472
 "Taking the Complexity Out of Wavelength-Frequency Conversion," H. S. Davis.

A simple full-page frequency-wavelength conversion chart is presented together with information on how to use it. The author emphasizes the fact that the term frequency and not wavelength is the proper term to use, and gives definite reasons.

Why not subscribe to *Radio Broadcast*? By the year only \$4.00; or two years, \$6.00, saving \$2.40. Send direct to Doubleday, Page & Company, Garden City, New York.

For Better Radio Hammarlund PRECISION PRODUCTS

Write for Descriptive Literature

HAMMARLUND MANUFACTURING CO.
 424-438 West 33rd Street New York City

Join the Leaders at RADIO CENTER!

Radio Center is the big move of the year in radio. It provides sound-proof offices and demonstration rooms of special construction where radio manufacturers and distributors can enjoy year-round sales facilities of unusual attractiveness.

Radio Center occupies two floors of more than twenty thousand square feet in the famous Bush Buildings New York in the heart of the world's greatest radio market. This real opportunity demands action now. Don't delay—call in person at Radio Center or wire for space reservations.

RADIO CENTER, Inc.

S. Herbert Mapes, President

Bush Building

130 W. 42nd St. New York City

22½ Volt
un-acid
everlasting
rechargeable
"P"

Storage Battery

\$2.95

includes
chemical



45 volts \$5.25, 90
volts \$10.00, 112½
volts \$12.50, 135
volts \$14.75, 157½
volts \$16.80.

Truly the biggest buy today. Easily charged on any current including 32 volt systems. Any special detector plate voltage had. Tested and approved by leading authorities such as Popular Radio Laboratories. Over 3 years sold on a non-refundable 30 day trial offer with complete refund if not thoroughly satisfied. Further guaranteed 2 years. Knock-down kits at greater savings. Complete "Hawley" "B" Battery Charger \$2.75. Sample cell 35c. Order direct—send no money—simply pay the expressman cost on delivery. Or write for my free literature, testimonials and guarantee. Same day shipments.

B. Hawley Smith, 312 Washington Ave., Danbury, Conn.

TRUTH

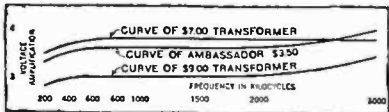

AMBASSADOR Perfect Radio TRANSFORMERS

By the most careful laboratory tests give as good or better results than transformers costing two and three times as much. Test them in your set and be convinced of the TRUTH.

FREE Four page booklet in colors, "The Truth About Transformers" and hook-ups.

★
AMBASSADOR SALES CO.
110 Greenwich St., Dept. 451 New York



These Instruments FREE of Extra Cost

All instruments shown here and others—SIX BIG OUTFITS—sent to all our students free of extra cost under short-time special offer. Clip coupon now—find out all about this big unequalled offer while you still have time to take advantage of it. Our training is intensely practical—these instruments help you learn to do the practical work. Receiving sets, from simplest kind to thousand-mile receiver. Many other big features.



J. E. SMITH,
President

My Radio Training is The Famous "Course That Pays For Itself"

Spare time earnings are easy in Radio when you know it the way we teach you. Increase your income almost from the start of your course through practical knowledge we give you. We show you how to hold the job, then our big Free Employment Department helps you get one. Free Book "Rich Rewards in Radio" tells how.

Howard B. Luce of Friedens, Pa., made \$320 in 7 weeks during his spare time. D. H. Suitt of Newport, Ark., writes, "While taking the course I earned in spare time work approximately \$900." Earl Wright of Omaha, reports making \$400 in a short time while taking his course—working at Radio in his spare time only! Sylvester Senso, 207 Elm Street, Kaukauna, Wis., made \$500.

And when your training is completed you're ready to step into a real big Radio job like C. C. Gielow, Chief Operator of the Great Lakes Radio Telegraph Company; E. W. Novy, Chief Operator of Station WRNY; Edward Stanko, Chief Operator of Station WGR; and hundreds of other N. R. I. Trained men. The National Radio Institute, Originator of Radio Home-Study Training, established 1914, today offers you the same opportunity these men had, under a bond that guarantees you full satisfaction or money refunded. It's your big chance to get into Radio—mail coupon for FREE Book and proof!

"MEN! Here's the 'dope' you've been looking for-

How TO GET INTO THE RADIO BUSINESS"

J.E.S.

**\$50 to \$250 a Week
in Work That is
Almost Romance**

If you're earning a penny less than \$50 a week, clip coupon now for FREE BOOK! New book, profusely illustrated, tells all about the Radio Profession, thousands of openings—in work that is almost romance! YOU can learn quickly and easily at home, through our tested, improved methods, to take advantage of these great opportunities. Why go along at \$25 or \$35 or \$45 a week, when you can pleasantly and in short time learn to be a Radio Expert, capable of holding the big jobs—paying \$50 to \$250 a week?

Clip Coupon For Free Book

Don't envy the other fellow who's pulling down the big cash! Our proven home-study training methods make it possible for you, too, to get ready for a better job, to earn enough money so you can enjoy all the good things of life. Most amazing book ever written on Radio tells how—thousand of interesting facts about this great field, and how we can prepare you, quickly and easily in your spare time at home, to step into a big-pay Radio job. You can do what thousands of others have done through our training. GET THIS NEW FREE BOOK. SEND COUPON TO-DAY.

V. E. SMITH, President

NATIONAL RADIO INSTITUTE

Dept. DU-5 Washington, D. C.



Dept. DU-5
National
Radio Institute
Washington, D. C.

Dear Mr. Smith:
Without obligating me in any way, send me your big FREE BOOK, "Rich Rewards in Radio," and all information about your practical, home-study, Radio Course.

Name.....

Address.....

SEND THIS COUPON TODAY

★ Tested and approved by RADIO BROADCAST ★

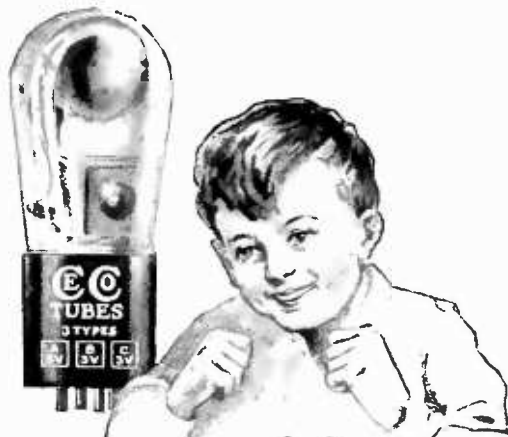

-it's in the Tube

A receiving set is no better than its tubes.

With other parts and connections *right* a set may be as good as its tubes—no set can be better.

That's why you want CECO Tubes. They stand up and deliver. With them your set works at its maximum. Clarity of tone, rich volume, long life—CECO has them all to a superlative degree.

Our charted tests (results confirmed by laboratories of national reputation) PROVE CECO TUBE SUPERIORITY—whether used as detectors, audio or radio frequency amplifiers.

CECO Tubes make a Good Receiver BETTER. Try them and you'll BUY them always—for results.

Now Ready! CECO Tubes with new type Long PRONG BASES. Also, Power Amplifier Tubes, E (Dry Cell Type), F (Storage Battery), for last stage of Audio Frequency.

Dealers write giving jobber's name.

C. E. Mfg. Co., Inc.

702 Eddy Street, Providence, R. I.

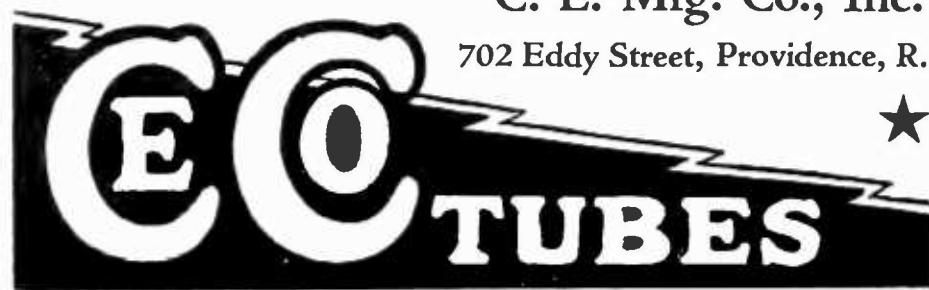

RADIO PANELS OF GENUINE BAKELITE

Cut, drilled and engraved to order. Send rough sketch for estimate. Our New Catalog on Panels, Tubes and Rods—all of genuine Bakelite—mailed on request.

STARRETT MFG. CO. ★

521 S. Green Street

Chicago, Ill.

RADIO FANS. a one-year's subscription to Radio Broadcast will cost you four dollars, two years six dollars. Consider this expenditure as being a necessary investment on your part for the future development of your own knowledge of Radio.

LEARN THE CODE AT HOME with the OMNIGRAPH

"Just Listen—The Omnigraph will do the teaching"

THE OMNIGRAPH Automatic Transmitter will teach you both the Wireless and Morse Codes—right in your own home—quickly, easily and inexpensively. Connected with Buzzer, Buzzer and Phone or to Sounder, it will send you unlimited messages, at any speed, from 5 to 50 words a minute.

THE OMNIGRAPH is not an experiment. For more than 15 years, it has been sold all over the world with a money back guarantee. The OMNIGRAPH is used by several Depts. of the U. S. Govt.—in fact the Dept. of Commerce uses the OMNIGRAPH to test all applicants applying for a Radio license. The OMNIGRAPH has been successfully adopted by the leading Universities, Colleges and Radio Schools.

Send for FREE Catalogue describing three models. DO IT TO-DAY.

THE OMNIGRAPH MFG. CO., 13K Hudson St., New York City

If you own a Radio Phone set and don't know the code—you are missing most of the fun



To Roberts Knockout Fans

Do you know that we have published two books on the Roberts Knockout Receivers? One is a treatise containing all the articles printed, and the other is just one article with complete blue prints on how to build this wonderful receiver. Price one dollar each. Write to Booklet Dept., Radio Broadcast, Garden City, N. Y.

R343. ELECTRON TUBE RECEIVING SETS. RECEIVERS.

QST. Jan. 1926, pp. 17-20.

"A New Reflex Circuit", L. W. Hatry.

A reflex circuit using good high primary-impedance audio transformers and proper bypass condensers, is described. Distortion is prevented also by reflexing through a radio frequency tube with a shunt rather than a series audio frequency connection. The method and circuit arrangement in a two- and three-tube set are discussed in some detail.

R344.3 TRANSMITTING SETS. TRANSMITTERS.

QST. Jan. 1926, pp. 21-25.

"Practical Crystal Controlled Transmitters",

A description of crystal controlled transmitters operating from a d.c. as well as a c. source of supply is submitted. Complete constructional details of the crystal controlling station at 4 XE are given. It operates from a d.c. source using an UX-210 and three 204-A tubes. The a. c. crystal controlled set described operates, with two UX-210 and two 203-A tubes.

Method of mounting the crystals and certain precautions are necessary in handling them, according to the author.

R402. SHORT WAVES. SHORT-WAVE

QST. Jan. 1926, p. 28.

"Getting Down Below Five Meters", H. Lyman.

Several circuit diagrams with constants of transmitters suitable for the very high frequency bands used by amateurs, are given.

R007. REGULATIONS. CONFERENCE,

QST. Jan. 1926, pp. 33-36.

"The Fourth National Radio Conference", K. B. Warner.

A survey of the transactions and recommendations made by the various committees at the Fourth National Radio Conference, is given. Several changes in the allocation of frequencies were proposed, including amateur phone operation on the 3500-3600 kc band (85.7-83.3 meters). Broadcasting conditions are to be placed on a higher plane than heretofore, through elimination of some of the stations and adoption of new regulations governing their operation. The new frequency assignments from 550 kilocycles up (5.45 meters down) are also published in this summary.

R610. EQUIPMENT; STATION DESCRIPTION. STATIONS,

Radio. Jan. 1926, pp. 10-11.

"The Radio Detective".

A car, completely equipped with necessary transmitter and receivers for use in connection with the radio supervisor's work in the 8th district, is described and illustrated. A Kolster direction finder, short- and long-wave receivers of various types, a 50-watt transmitter, and equipment for giving license examinations anywhere, make this portable radio station a modern radio supervisor's office on wheels. The diagram of the field strength measuring set is shown, and constants of the circuit given.

R343. ELECTRON TUBE RECEIVING SETS. RECEIVER,

Radio. Jan. 1926, pp. 12ff.

"An Exceptional Four-Tube Receiver", E. E. Turner.

A four tube receiver, r. f. stage, regenerative detector, and two stages of audio amplification, is described. The wiring diagram shows several unique features, which are also taken up in the general discussion. Among these is the method of controlling oscillations in the regenerative circuit. Data on coil construction and panel layout, serve as a guide to building the set. An ABC eliminator may be used with the set, the wiring diagram of the complete circuit being shown. This set is a modification of the LC circuit described in the October, 1925, issue of *Radio*.

R531.2. STATION CALL LETTERS. STATIONS,

Radio. Jan. 1926, p. 22.

"Short-Wave Stations".

A complete list of short-wave stations both, limited commercial and general public, operating in the United States, is given. There are forty-six in all. The inclusion of class, frequency, wavelength, owner, power, and call, makes this table a most complete reference guide.

R376.3 LOUD SPEAKING REPRODUCERS. LOUD SPEAKERS,

Radio. Jan. 1926, pp. 24ff.

"Hornless Types of Loud Speakers", Dr. J. P. Minton.

The author enters into a detailed discussion concerning the general types of loud speakers now used. The new cone type speakers make use of large vibrating surfaces. Flat surfaces may be used to obtain good sound vibrations over a large frequency range, but shaping such surfaces into the form of a cone gives greater rigidity and less natural resonance, at the same time rendering also better acoustic radiation. Three types of driving units have been employed in the commercial cone speakers; electro-dynamic, balanced armature, and bipolar unit. These are discussed in detail.

R383. RESISTORS. RESISTORS,

Radio. Jan. 1926, pp. 25ff.

"Vacuum Tube Resistors", G. F. Lampkin.

Vacuum tubes, in addition to being used as detectors, amplifiers, and oscillators, may be used as variable resistors to very good advantage. As such they have several advantages not found in grid leaks or regular resistances. They are especially good as a grid leak in an oscillator to control keying and phone transmission. Data on actual tests made with 201-A and 202 tubes, and information concerning their uses as grid leak resistors, are given.

R148. MODULATION. MODULATION,

Radio. Jan. 1926, pp. 31-32.

"Speech Modulation Methods", Lieut. J. B. Dow.

Three methods of speech modulation, the variable absorption method, grid voltage variation method, and the plate power variation method, are taken up. Several circuits, including the Meissner and a combination Heising and Colpitts, are shown, and an account of their performances discussed in some detail.

R343. ELECTRON TUBE RECEIVING SETS. RECEIVERS,

Radio. Jan. 1926, p. 33.

"A Good Short-Wave Receiver", F. C. Jones.

For use on the very high frequency stations, a receiver must be capable of sharp yet not too sensitive tuning. Herein is described a two-tube receiver operating on the capacity feedback principle, the tube capacity being large enough for this purpose. Oscillations are controlled by means of a tuned-plate circuit. Constructional data and circuit diagram are given.

★ Tested and approved by RADIO BROADCAST ★

R343. ELECTRON TUBE RECEIVING SETS. RECEIVERS, Reflex.
Radio, Jan. 1926, pp. 29ff.
 "Proper Reflex Circuit Assembly," L. W. Hatry.
 Some very good points on the construction of a three-tube reflex receiver are contained in this article. The use of condensers and choke coils, and valuable suggestions pertaining to the circuit layout, accompany the article.

R553. METEOROLOGICAL SIGNALS. EARTHQUAKE RECORDING.
Radio, Jan. 1926, pp. 35ff.
 "Radio as an Aid in Recording Earthquakes," G. M. Best.
 An account is given of a method of recording earthquake tremors automatically and accurately. Both the horizontal and vertical components of such tremors can be recorded, the exact time of such tremors being received from some naval time-signalling station and recorded on the same chart. A circuit diagram of the apparatus is shown.

R800 (533). SOUND. PHONOGRAPH REPRODUCTION.
Popular Radio, Jan. 1926, pp 3-9.
 "The New Wave-Transmission Phonograph," H. C. Harrison.
 Principles developed in the mechanical reproduction of sound by Bell Telephone engineers, have been applied to the phonograph, with the result that now five and one-half octaves are faithfully reproduced instead of three, as was the case in the old type of phonograph, according to the article. The construction of the new reproducer is described and shown in a diagram. Comparison is made between electrical and mechanical constants, the similarity being very evident.

R343. ELECTRON TUBE RECEIVING SETS. RECEIVER, LC-26.
Popular Radio, Jan. 1926, pp. 10-23.
 "How to Get the Most out of Your LC-26 Set," S. G. Taylor and L. M. Cockaday.
 Information is given concerning the theory and operation of the LC-26 receiver described in the December issue of *Popular Radio*. Details pertaining to antenna and ground connection, tubes and batteries to be used, installation, equipment, and operation of the receiver, are given. A shunt-plate feed unit, which keeps the d. c. out of the loud speaker, is a feature of this circuit.

R800 (530) PHYSICS. ATOM.
Popular Radio, Jan. 1926, pp.24-29
 "The Atom," Sir William Bragg.
 The place that the separate atoms take in forming crystals, is outlined. Most substances crystallize in very orderly and regular fashion. X-Rays are used in analyzing transparent solids of crystalline structure to determine their arrangement. Examples and illustrations are given to show how atoms may arrange themselves and how X-Rays detect this arrangement.

R382. INDUCTORS. INDUCTION COILS.
Popular Radio, Jan. 1926, pp. 30-39.
 "Some New and Useful Facts about Coils," D. R. Clemons.
 A discussion pertaining to distributed capacity of induction coils, employing various types of windings and materials for mountings, is given. The distribution and strength of the fields of magnetic and electrostatic forces, depending upon the kind of insulation used about the wire, is illustrated by means of graphs and diagrams. A lot of experimental data is given.

R381. CONDENSERS. CONDENSERS FOR TUNING.
Popular Radio, Jan. 1926, pp. 48-55.
 "The Part That Your Condenser Plays in Tuning," H. J. Harries.
 Condensers of the circular plate, the square-law plate, and the straight line frequency plate, are compared. The effect each one of these condensers has on sharpness or broadness of tuning covering the present broadcast band, is shown by curves, data, and discussion. A low minimum condenser is really not what is desired in the opinion of the writer, but rather a condenser having a low resistance path at high frequencies.

R380. PARTS OF CIRCUITS; INSTRUMENTS. TONE METER. QST.
Jan. 1926, pp. 37-39.
 "The Tone Meter," L. J. Wolf.
 A device indicating the condition of the plate supply current of vacuum tube transmitters, is described. Any source other than a high voltage storage battery will give a more or less fluctuating power supply which necessitates filtering. An a. c. voltmeter is used in series with a condenser, the condenser preventing the d. c. from getting through the meter and acting also as a multiplier. The multiplying factor depends on the frequency, the capacity of the condenser, and the resistance of the voltmeter. Its value can be determined, as described. The entire arrangement is called a Tone Meter.

R375. DETECTORS AND RECTIFIERS. RECTIFIER, Epom.
QST, Jan. 1926, pp. 41ff.
 "The Epom Rectifier and Filter," R. S. Kruse.
 The new Epom rectifier tube uses no filament but operates on the principle of ionization of a gas at low pressures within the tube. Argon gas is used for several reasons. The construction of the tube, and the circuit diagram are described. The tube may be used as a d. c. source of plate supply in transmitting tubes if properly loaded.

R281.71. QUARTZ. QUARTZ CRYSTAL CONTROL.
Radio News, Jan. 1926, pp. 952 ff.
 "Quartz Crystals Control Wavelengths of Broadcasting Stations," S. R. Winters and I. F. Byrnes.
 The use of quartz crystals in the control of frequencies in broadcasting stations is growing, as is evidenced by the decision of the Westinghouse Company, and the General Electric Company, i. e., to equip all of their stations with this piezo-electric mineral, according to the authors. Its properties, operation in circuits, the use of harmonics produced by such an oscillating crystal, methods of mounting, and results obtained by the Navy and others, indicate that the quartz crystal will be in general use among transmitting stations before long.

R402. SHORT-WAVE SYSTEMS. HIGH FREQUENCY SYSTEMS.
Radio News, Jan. 1926, pp. 954ff.
 "Navy Investigates Ultra Frequencies," Dr. A. Hoyt Taylor.
 The investigation carried on by the Naval Research Laboratory with ultra frequencies is presented in graphic and systematic form. Night and day range, comparison of phenomena at various frequencies, and directional effects, show that certain bands of frequencies should be chosen for definite transmission schedules depending upon time, distance, and season.



INSULINE

No matter what circuit you are building, the final results will be better if you select Insuline for the panel—the material chosen by Radio Broadcast Engineers for the "Universal."

Laboratory tests prove Insuline to be highest in dielectric strength and other properties conducive to clear reception. Also the most easily worked panel material. Doesn't chip or crack. Doesn't warp. Holds its lustre for all time.

Insuline Panel for the "Universal," engraved by our exclusive Etch-O-Gravure Method, in gold and white or combination; drilled ready to set up: black or mahogany \$3.50; "Frieze" finish, \$4.00.

Insuline panels, drilled and decorated, are furnished for all popular circuits. Also supplied in all standard size blanks. Insuline Sub-panels, drilled and mounted with metal sockets for UV and UX tubes for all circuits. Bakelite Brackets for Sub-panel mounting, etc., etc.

★ *If your dealer can't supply you write us direct. Send to-day for Free Booklet and price list.*

The best panel for Radio Broadcast's "Universal"—the best panel for YOUR set



"Sets that Jack and Dad Built," a practical 50-page book for building the most popular circuits, with diagrams and instructions for hook-up, sent for 25 cents to cover cost of mailing and postage.



Branches in Principal Cities

INSULATING COMPANY OF AMERICA INC.

(RADIO PANEL & PARTS CORP.)
 INSULINE BLDG., 59 WARREN STREET
 NEW YORK

Why not subscribe to *Radio Broadcast*? By the year only \$4.00; or two years \$6.00, saving \$2.40. Send direct to Doubleday, Page & Company, Garden City, New York.

LEARN RADIO

Become a big-pay man in the greatest industry of all time. Quickly, easily and right at home, you can fit yourself for highest salary positions, or you can cash in on your spare time. The call is urgent for mechanics, operators, designers, inspectors. Unlimited, fascinating opportunities on land or sea

I WILL TRAIN YOU AT HOME TO BE A RADIO EXPERT

Under my practical, easy to understand, instruction—you qualify in an amazingly short time. No previous experience is necessary. Every branch of radio becomes an open book to you. You learn how to design, construct, operate, repair, maintain and sell all forms of Radio apparatus. My methods are the latest and most modern in existence.

FREE Wonderful home construction tube receiving set of the latest design: **Write Today** "Radio Facts" **FREE**

A. G. Mohaupt, Radio Engineer, RADIO ASSOCIATION OF AMERICA, Dept. 2484, 4513 Ravenswood Ave., Chicago

★ Tested and approved by RADIO BROADCAST ★

every reader of this magazine needs

G.I. Static Reductor

TRADE MARK



Practically eliminates normal static—reduces excessive static to a minimum. Eliminates necessity of outside aerial with any set—makes a squealing receiver absolutely non-radiating—increases selectivity—improves tone quality.

Elevates an inexpensive receiving set to the dignity and quality of a high-priced receiver.

Enables a good set to bring in far-distant stations with a full, clear, smooth tone not before dreamed possible.

Ask your dealer—or send purchase price direct and you will be supplied.

Price, \$28.50.

GENERAL INSTRUMENT CORPORATION

423 Broome St., New York City

Order your copy of *Radio Broadcast* from your news dealer or radio store. Make sure that he reserves a copy for you each month. If your favorite radio store does not stock the magazine write us giving name of radio dealer and address.

Send for Latest RADIO CATALOG and GUIDE

Sets—Parts—Kits
Radio's Newest

You need this big FREE book. A practical guide to success in set building. Gives advanced hook-ups. Shows all newest parts and kits, built up sets ready for use, battery eliminators, radio's newest creations. Write for Copy free, also send name of radio fan. Send to-day.

BARAWIK CO.
102-109 S. Canal St., Chicago

R113. TRANSMISSION PHENOMENA. FADING AND DISTORTION. *Radio News*. Jan. 1926, pp. 956 ff. "Unraveling a Broadcast Enigma", A. Van A. Summers. Many data on fading and distortion of signals from broadcasting stations, which were accumulated by the American T.&T. Company are presented. Conclusions arrived at indicate that the ether is not a perfect carrier of electromagnetic waves, especially when these waves are near large masses of iron and steel. Refraction and absorption are probably the causes for most of the distortion observed. The author discusses at some length the conclusions arrived at through these experiments.

R114. STRAYS. AURORA BOREALIS. *Radio News*. Jan. 1926, pp. 964 ff. "New Facts About the Aurora Borealis", C. L. Davis. An experiment relating the effect of the Aurora Borealis on a telephone line, and the subsequent conclusions drawn from this phenomenon, are described. A frequency of one cycle for fifteen minutes was noted on a voltmeter.

R110. RADIO WAVES. RADIO WAVES. *Radio News*. Jan. 1926, pp. 966 ff. "What Are Radio Waves?", J. Riley. An elementary explanation of the nature of radio waves, is given. Stress and strain, displacement of fields, electrostatic and electro-magnetic fields of force, questions on radiation, current and voltage relations in antennae, are some of the subject discussed.

R134.45. SUPER REGENERATIVE ACTION. SUPER-REGENERATIVE ACTION. *Radio News*. Jan. 1926, pp. 976 ff. "Super Regeneration and the Future", A. K. Laing. The original Armstrong super regenerative circuit, modified somewhat, is presented, with points on construction and operation given. These, it is claimed, will make this type of amplification as popular as the super-heterodyne. The drawbacks of the circuit are enumerated and taken up in detail. The circuit is said to give much more amplification on the higher frequencies than on the low ones.

R134.75. SUPER-HETEROODYNE. SUPER-HETEROODYNE. *Radio News*. Jan. 1926, pp. 982 ff. "An Improved Laboratory Super-Heterodyne", F. R. Pfaff. A seven-tube super-heterodyne covering the frequencies from 550kc. to 5000kc. (550 to 50 meters) using plug-in coils, is described. The oscillator is connected ahead of the first detector in this circuit. Complete constructional data are given.

R382. INDUCTORS. INDUCTION COILS. *Radio News*. Jan. 1926, pp. 986 ff. "Which Type of Coil is Best?". An exhaustive study of various types of coils, dealing with their overall efficiency, is presented. Circuits used in the measurement of resistance at high frequencies, graphs showing the efficiency and distributed capacity of coils and the result obtained through experimental hookups, are discussed. The best all around coil, according to the writer, consists of ordinary bell wire wound on a bakelite tube in the regular fashion.

R201.7 USE OF HIGH-FREQUENCY OSCILLOGRAPH. TUBES, OSCILLOGRAPH. *Radio News*. Jan. 1926, pp. 988 ff. W.E. "The Cathode Ray Oscillograph In Radio Work", Dr. C. B. Bazzoni. The author reviews the elementary principles concerning electric waves and their forms, referring to pitch and quality of sound as an analogy. To study these wave forms, the cathode ray tube, illustrated, is of great importance in high frequency circuits. The tube used here was developed by the Western Electric Company. Electric and magnetic deflections of the electron stream through plates and coils near these electrons, picture the resulting wave forms for closer analysis. Lissajou figures produced, enable the experimenter to synchronize circuits or adjust them to many different ratios of oscillations.

R343. ELECTRON TUBE RECEIVING SETS. RECEIVERS, DERESNADYNE. *Radio Progress*. Dec. 15, 1925, pp. 13 ff. "Revamping a Popular Radio", H. J. Marx. An analysis of the five-tube Deresnadyne receiver is given, showing the wiring diagram and method of operation. This receiver is equipped with a B-eliminator, and trickle charger for the A battery; the speaker is built in the cover, thus making this set complete. Oscillations are prevented in the tuned radio frequency stages by controlling the plate voltage on the tubes through a series resistance. The coil angle may also be varied, depending upon the type and characteristic of the tubes used. Other details of operation are mentioned.

R342.7. AUDIO-FREQUENCY AMPLIFIERS. AMPLIFICATION, RADIO BROADCAST. Jan. 1926, pp. 308-312. *Audio Frequency*. "The Requirements for Better Audio Amplification", K. Clough. An analysis of the various instruments used in sound production show that a good amplifying device should respond equally well to frequencies from 32 to 8192 cycles or more. A full logarithmic scale is considered best in plotting characteristics of amplifying units. Of considerable importance are the characteristics of the tubes used in audio amplifiers, and good results are obtained only when the entire amplifying unit is tested as one device. It is stated that in the present type of resistance-coupled units, the lower notes are somewhat suppressed. Transformers having a cruciform core construction seem to give best results. Reference is made to Mr. Crom's article on audio amplification in the Oct., 1925, *RADIO BROADCAST*.

R342.6. RADIO-FREQUENCY AMPLIFIERS. R. F. AMPLIFIERS, RADIO BROADCAST. *Radio Broadcast*. Jan. 1926, pp. 350 ff. "Methods for Controlling Oscillation in R. F. Circuits", J. Bernard. Many methods are used in r. f. amplifiers to prevent tubes from oscillating or to control oscillations. Some of these are discussed briefly by the author. A somewhat novel method is employed in the "Counterphase" circuit, diagrammed and described here. This scheme makes use of a combined resistance and capacity control, and is considered very effective over the entire range of frequencies to which the receiver is tuned.

FOR CLEAR, QUIET "B" POWER



RADIO Storage "B" Battery

12 Cells 24 Volts Lasts Indefinitely—Pays for Itself Economy and performance unheard of before. Recharged at a negligible cost. Delivers unflinching power that is clear, pure and quiet. Approved and listed as Standard by leading Radio Authorities, including Pop. Radio Laboratories, Pop. Sci. Inst. Standards, Radio News Lab., Lefax, Inc., and other important institutions. Equipped with Solid Rubber Case, an insurance against acid and leakage. Extra heavy glass jars. Heavy rugged plates. Order yours today!

SEND NO MONEY Just state number of batteries wanted and we will ship day order is received. Extra offer: 4 batteries in series (96 volts), \$10.50. Pay expressman after examining batteries. 6 per cent discount for cash with order. Mail your order NOW!

WORLD BATTERY COMPANY
1219 So. Wabash Ave., Dept. 78 Chicago, Ill.
Makers of the Famous World Radio "A" Storage Battery
Prices: 6-volt, 100 Amp. \$12.50; 150 Amp. \$15.25; 140 Amp. \$14.00.
All equipped with Solid Rubber Case.

World STORAGE BATTERIES

Set your Radio Dials at 210 meters for the new 1000 watt World Storage Battery Station, WSBG, Chicago. Watch for announcements.

KDKA - WEAZ - WGN - WJS - KHJ - KGO - KFAF - WOP - 3

M R C Station and Meter Log

Now you can easily calibrate your dials in meters.



A convenient station log and wavelength scale — Very simple to attach and is a permanent log.

SOLD BY MAIL ONLY

PRICES—1 for 15c, 2 for 25c or 3 for 35c.

MUELLER RADIO COMPANY

533 Bush St. Toledo, Ohio

S-C PARTS AT WHOLE-SALE PRICES

Dealer-Set Builders and Radio Parts Dealers write for FREE description, list of parts and wholesale prices for Silver-Cockaday Single Control 4-Tube Receiver. Catalogue of nationally known radio equipment sent free. Write today. Address Dept. S

SHURE RADIO CO., 19 S. Wells, Chicago

Gets Everything but Noise!

Amazing new Aerial guaranteed to eliminate all power noises such as leaky transformers, generators, motor hums, Dulco Plants, etc. Cuts static, regeneration howls and squeals 1-2. Dr. Gehrig, Oakland, Cal., says improves reception 50%. Hundreds of other testimonials. Wonderful results. Mr. Boeck, Grand Haven, Mich., heard 3 foreign stations during tests with Kane Antennae. Easy to install.

\$1.00 Bring BLUE PRINT—Working Drawings—Complete Instructions for Erecting. Just send dollar bill (or check), limited quantity. Send TODAY.

KANE ANTENNAE CO., Dent. 982, 3333 W. Monroe, Chicago

This is a good time to subscribe for
RADIO BROADCAST
Through your dealer or direct, by the year only \$4.00
DOUBLEDAY, PAGE & CO. GARDEN CITY, NEW YORK

Be the Jazz King Of Your Town!

Be popular. In demand everywhere. Have fun Earn your welcome. Charm your friends with your

BUESCHER True Tone

SAXOPHONE

Teach yourself, 3 free lessons give you quick easy start. Try any instrument in your own home 6 days free. See what you can do. Easy terms if you decide to buy. Send now for beautiful free literature. A postal brings details.

Buescher Band Instrument Co. (4)
1221 Buescher Block Elkhart, Indiana

CORBETT CONSOLE
for Hammarlund Roberts

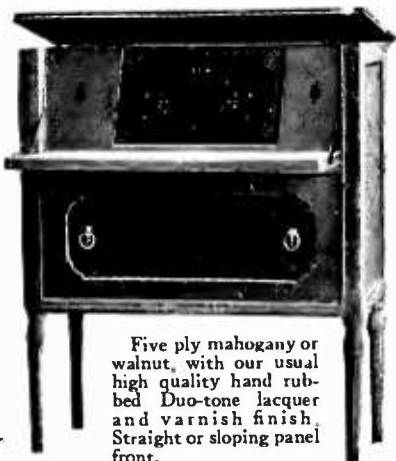

Five ply mahogany or walnut, with our usual high quality hand rubbed Duo-tone lacquer and varnish finish. Straight or sloping panel front.

The "Corbett Console" is adapted to any of the popular receivers, including LC-26, and Broadcast Universal.

WITHOUT HORN (as illustrated) \$40.00

WITH BUILT IN HORN (Large Miller hard rubber horn at left of panel with silk backed grill). Shipping charges prepaid. \$4.00

WRITE FOR BOOKLET showing attractive models for all sizes of radio cabinets consoles and tables.

Jobbers and Dealers write for discounts

CORBETT CABINET MFG. COMPANY
St. Marys Pennsylvania

LATEST "COAST TO COAST" FULLY GUARANTEED

RADIO'S-10 DAYS FREE TRIAL
SAVE 1/3 TO 1/2

Users everywhere report Miraco Radios get programs coast to coast on loud speaker! outperform sets three times as costly. Many hear foreign countries. Radio's most amazing values in unconditionally guaranteed, factory-built long distance sets—let testimony of users convince you.



MIRACO RADIO GETS 'EM COAST TO COAST
Powerful New Multi-tube Miraco gets long distance on loud speaker. Set, ONLY \$27.35 retail

FREE! Literature on latest improved 1 to 6 tube models, new low prices, testimony of users and SPECIAL OFFER. Write: **MIDWEST RADIO CORP'N**
Pioneer Builders of Sets
406-W E. 8th St. Cincinnati, O.

AGENT USERS WANTED
Write for discounts.

RADIO FANS, a one-year's subscription to Radio Broadcast will cost you four dollars, two years six dollars. Consider this expenditure as being a necessary investment on your part for the future development of your own knowledge of Radio.

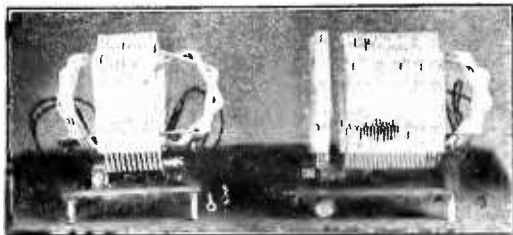

LOW LOSS Tuners and Coils for all circuits

- 3 Circuit Amateur and Broadcast tuners \$7.00
- Tuned R. F. Transformers (each) \$2.00

NEW COILS

- Diamond of the Air
- Browning Drake Coils \$7.00
- Superdynco Coils 7.00
- Roberts Coils 7.00
- Superheterodyne Oscillator and Antenna Coupler 6.00

Basket Weave coils to order. Write for literature.

Davenport Radio Laboratories 1711 W. Locust Street, Davenport, Iowa

Big FREE RADIO
Catalog & Guide
PARTS, HOOK-UPS, SETS and KITS
Send now for this valuable FREE book. Full of advanced hook-ups, parts and kits. A real guide. Shows factory built sets and the new ideas in radio. Send at once. No charge. No obligation. Please include name of radio fan.

BARAWIK CO.
102-109 S. Canal St., Chicago

"The Better Condenser"

Maintains its Leadership

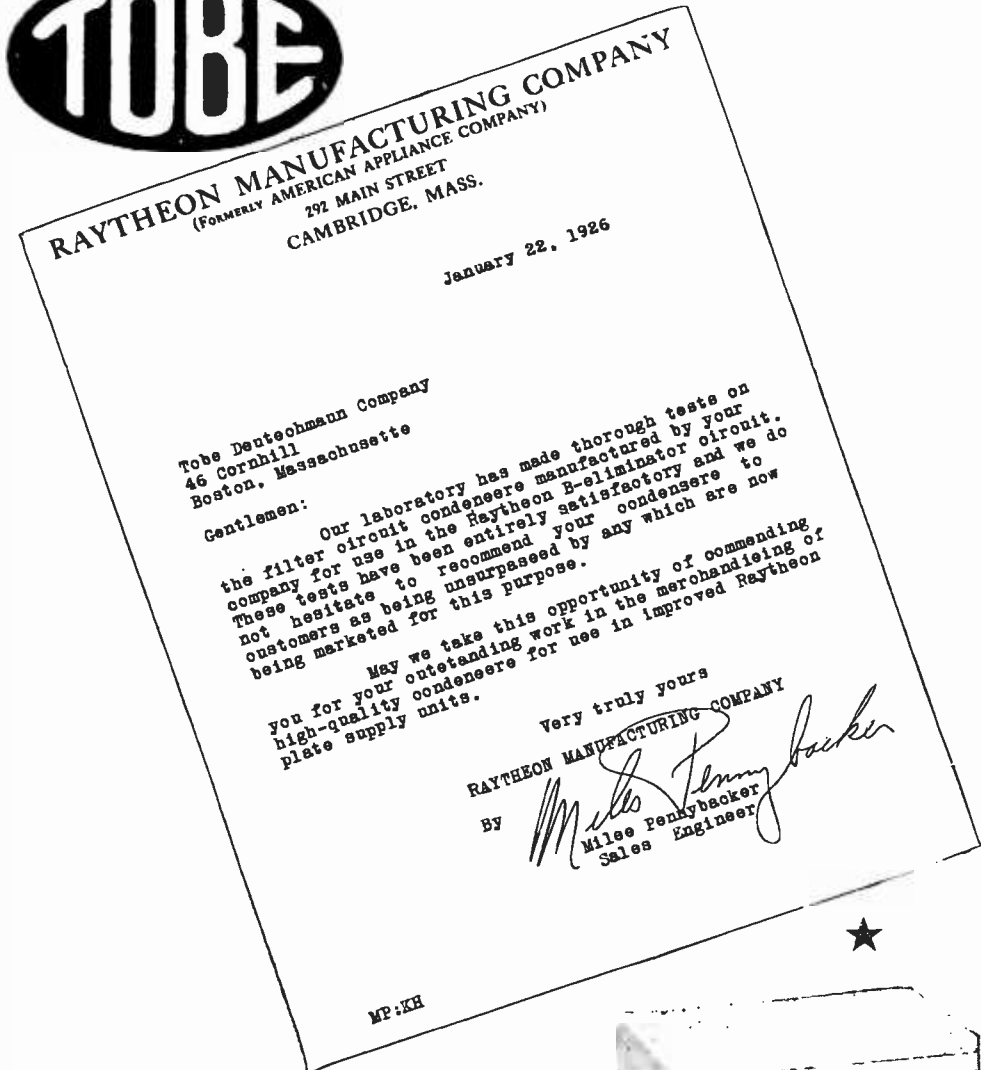

Make sure that you get the OFFICIALLY APPROVED RAYTHEON Filter Condenser Block

The TOBE Condensers have been tested in the laboratory of the Raytheon Manufacturing Company and as a result, they have written the letter reproduced above. It speaks for itself.

The new TOBE B BLOCK contains in one compact silvered metal case the three filter and two bypass condensers required for the Raytheon B-Eliminator; one 8 Mfd., two 2 Mfd., two 1 Mfd. It saves \$2.50 in the cost of parts—saves space—saves wiring.
Price \$11.00

Ask your dealer for "The Better Condensers."
Send for free circuit diagrams of B-Eliminators.

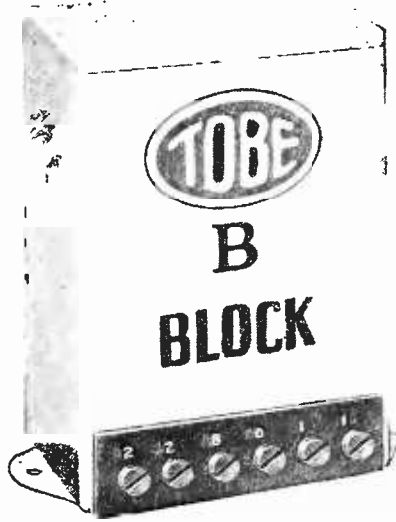

Tobe Deutschmann Co.
CORNHILL BOSTON, MASS.

This is a good time to subscribe for

RADIO BROADCAST

Through your dealer or direct, by the year only \$4.00

Doubleday, Page & Company

Garden City, New York

ACME Radio Battery Chargers
Best by Test ★
\$8.50 minus bulb
east of Rockies
Your dealer can get it for you
THE ACME ELECTRIC & MFG. CO.
1410 Hamilton Avenue Cleveland, O.

Modernize Your Radio Set!

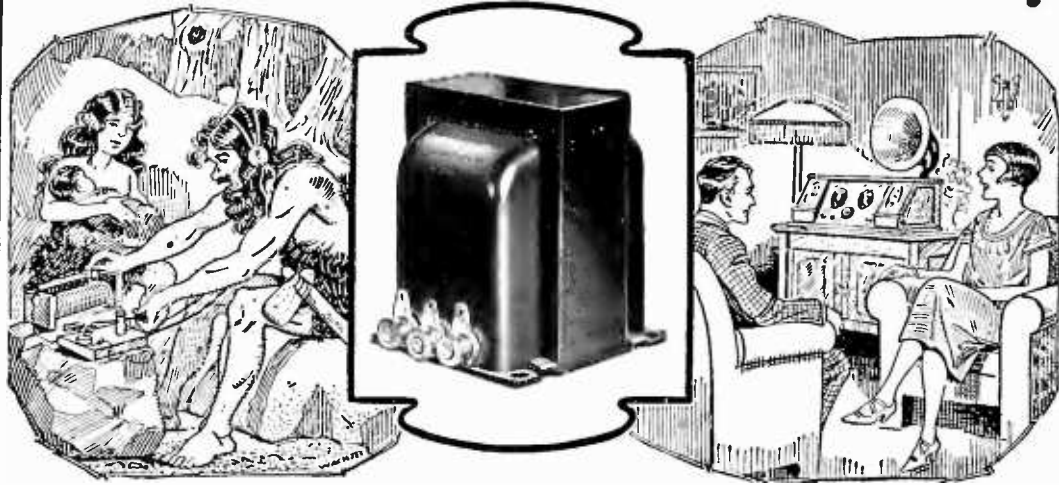

THORDARSON Autoformer

Trade-Mark Registered

All Frequency Amplifier

Write for free
descriptive circular

Price \$5.00

Are you still using primitive methods of amplification? Why not make your receiver an up-to-date model by installing Autoformer amplification—the ultimate in reproductive equipment?

The Autoformer, a step up impedance amplifier, reproduces with full volume those bass notes lost in ordinary transformer amplifiers.

The Autoformer provides the unrestrained flow of distortionless music. It records everything from the slightest shading to the greatest extreme of volume, intensity, and timbre.

★ Better volume control
More volume on distant stations
Full bass note amplification
Greater clarity on all signals

OTHER THORDARSON TRANSFORMERS

R-200 Amplifying Transformer
Standard Amplifying Transformer
Power Amplifying Transformer
Interstage Power Transformer

B-Eliminator Transformer
B-Eliminator Chokes
Battery Charging Transformers
Transmission Equipment

THORDARSON ELECTRIC MANUFACTURING CO.
Transformer specialists since 1895
WORLD'S OLDEST AND LARGEST EXCLUSIVE TRANSFORMER MAKERS
Chicago, U.S.A.

Now is the time to subscribe for RADIO BROADCAST
Through your dealer or direct, by the year only \$4.00

DOUBLEDAY, PAGE & CO.

GARDEN CITY, NEW YORK

Immediate Shipment from Stock
**HAVE MERCHANDISE
WHEN YOU NEED IT**
Catalog 466-B is free to dealers

WHOLESALE

EXCLUSIVELY

LUDWIG HOMMEL & CO

929 PENN AVENUE



PITTSBURGH, PA.

WHAT OUR READERS WRITE



The International Tests

AS MIGHT be expected, we were simply inundated with letters from all quarters of the country and abroad, after the recently concluded International Tests. Space limitations permit the publication of only three or four here, but these convey the sentiment expressed in the letters of many other correspondents.

Editor, RADIO BROADCAST,
Doubleday, Page & Company,
Garden City, New York.

SIR:

I hear over KGO's news items that California was silent during the test period. I wish to refute this statement for I distinctly heard KNX, Hollywood, on two different occasions while trying for British stations. . . . I think KNJ was on the air too, for I heard a station at a setting on my dials where this station usually comes in, but I could not be positive about this. There is nothing too small for California to do.

Very truly yours,
F. W. DALLEY,
Lyons, Colorado.

Editor, RADIO BROADCAST,
Doubleday, Page & Company,
Garden City, New York.

SIR:

Just a line in appreciation of last week's silence tests, especially those of Friday and Saturday evenings. Is it possible to have an arrangement for regular zonal silence periods, thus allowing uninterrupted sectional exchanges of programs? Here is one unsolicited vote in favor of such a scheme.

Very truly yours,
R. M. BOULDEN,
Los Angeles, California.

Editor, RADIO BROADCAST,
Doubleday, Page & Company,
Garden City, New York.

SIR:

Organize an anti-bloop club with a big turnout at first meeting. What are the other cities doing along this line?

Very truly yours,
E. M. RAY,
Rochester, Minnesota.

Editor, RADIO BROADCAST,
Doubleday, Page & Company,
Garden City, New York.

SIR:

I am a regular reader of your excellent magazine, and am also a confirmed radio fan, being interested in the reception of both broadcast matter and code. I was greatly interested in the International Tests, although they were a failure as far as I am concerned. In 1924, I received British stations with a modified three-tube Reinartz set. This year, nothing but interference, static, bloopers, and almost everything injurious to satisfactory radio reception. One thing that has come to my attention is that during the period from half-moon until the moon begins to wane, radio reception is not what it should be—it is noisy. At other periods, when there is no moon, reception is much better, I have found. During Test Week, the moon was pretty well full. I have been watching this phenomenon since last July. I wonder if any one else has noticed it. Wishing you continued

★ Tested and approved by RADIO BROADCAST ★

AMPLION

For Better Radio Reproduction



**Hear this
World-Wide
Favorite**

Creation of Alfred Graham & Co., England, 38 years experienced in producing loud speaking devices, Amplions lead in sales throughout the world. Hear an Amplion—in comparison! Six models, including phonograph units, equipped with cords and plugs, \$12 up. Write for "Amplion Pedigree."

**THE AMPLION CORPORATION,
OF AMERICA**

★
Suite L, 280 Madison Avenue, New York
Chicago Branch: 27-29 No. Morgan St.
Burndept of Canada, Ltd., Toronto

Send for Latest RADIO CATALOG and GUIDE

Sets — Parts — Kits
Radio's Newest

You need this big FREE book. A practical guide to success in set building. Gives advanced hook-ups. Shows all newest parts and kits, built up sets ready for use, battery eliminators, radio's newest creations. Write for Copy free, also send name of radio fan. Send to-day.



BARAWIK CO.
102-109 S. Canal St., Chicago

Hoyt Pocket Meters

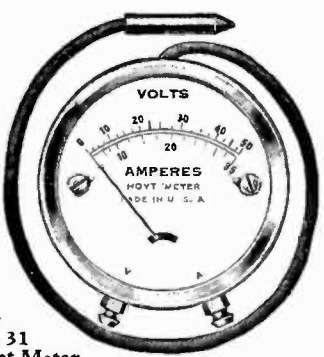

**Hoyt
Type 31
Pocket Meter**

The indispensable pocket instrument for Dealers and Radio-Owners for checking the condition of A and B batteries. Reads up to 50 volts or 35 amperes. All scales are hand-calibrated, resistance of meter is unusually high for this type, accuracy does not vary in extreme heat or cold.

Finished in polished nickel, of small size, convenient for handling.

Price, complete with lead \$3.00 ★

BURTON-ROGERS CO.
26 Brighton Ave. Boston, Mass.

National Distributors

HOYT makes a complete line of Radio Meters.
Send for booklet "HOYT Meters for Radio"

New! Tone and Volume Control



ESSENTIAL to thoroughly enjoy present day broadcasting. New high-priced sets feature tone control as their greatest improvement. You can have this new feature in your old set by attaching a *Centralab Modulator Plug* in place of the old phone plug. Takes a moment—no tools required.

Gives any degree of tone volume from a whisper to maximum by simply turning the small knob on plug. Static interference is reduced and programs come in clear and true with just the volume you most enjoy.

Order from your dealer, or mailed direct on receipt of the price \$2.50.

CENTRAL RADIO LABORATORIES
22 Keefe Ave. Milwaukee, Wisconsin

Centralab Radiohms or Modulators are standard controls on sixty-six well-known sets.

Centralab

DIAMOND-WEAVE

(TRADE-MARK REGISTERED Aug. 4, 1925)

SICKLES COILS



*For the "Aristocrat,"
Browning-Drake, Roberts,
Craig, and Hoyt Circuits*
(Patented Aug. 21, 1923)

Sickles Coil Set No 18A for Roberts Circuit, containing our new center-tapped N-P Coil. Price \$8.00.

Sickles Coils for the "Aristocrat" Circuit, designed upon new scientific discoveries, set highest standards of efficiency.

COIL PRICES

No. 18A Roberts Circuit	\$ 8.00 set
No. 24 Browning-Drake	7.50 set
No. 20 Craig Circuit	4.50 set
No. 19 Acme Reflex	4.50 set
No. 8 Knockout Reflex	4.00 set
No. 21 Hoyt Circuit	10.00 set
No. 25 "Aristocrat" Circuit	8.00 set

Our Coil Set No. 25 is specifically designed for the new "Aristocrat" Circuit, already very popular.

Compactness of form, rigidity of construction, and the supremely efficient Diamond-Weave method of winding are well-known characteristics of Sickles Coils.

These refinements of design and construction result in low distributed capacity, low dielectric losses and large range of frequency with small variable capacity.

There are Sickles Diamond Weave Coils for all leading circuits.

Send for descriptive catalog

The F. W. Sickles Co.

132 Union Street
SPRINGFIELD, MASS.

FREE!
12-Cell — 24-Volt Storage 'B' Battery
 Positively given free with each purchase of a WORLD "A" Storage Battery. You must send this ad with your order. WORLD Batteries are famous for their guaranteed quality and service. Backed by years of successful manufacture and thousands of satisfied users. Equipped with Solid Rubber Case, an insurance against acid and leakage. You save 50 per cent and get a **2-Year Guarantee** ★

Bond in Writing WORLD Battery owners "tell their friends." That's our best proof of performance. Send your order in today.

Solid Rubber Case Radio Batteries
 6-Volt, 100-Amperes . . . \$11.25
 6-Volt, 120-Amperes . . . 13.25
 6-Volt, 140-Amperes . . . 14.00

Solid Rubber Case Auto Batteries
 6-Volt, 11-Plate . . . \$11.25
 6-Volt, 13-Plate . . . 13.25
 12-Volt, 7-Plate . . . 16.00

Send No Money Just state battery wanted and received by Express C. O. D. subject to your examination on arrival. FREE "B" Battery included. Extra Offer: 5 per cent discount for cash in full with order. Buy now and get a guaranteed battery at 50 per cent saving to you.

WORLD BATTERY COMPANY
 1219 So. Wabash Ave., Dept. 24 CHICAGO, ILL.

World STORAGE BATTERIES
 Set your Radio Dials at 210 meters for the new 1000 watt World Storage Battery Station, WSBC, Chicago. Watch for announcements.

WJZ WEAF WGN WJS KRL KGO KFAF WYV KQZ

Big FREE RADIO
Catalog & Guide
PARTS, HOOK-UPS, SETS and KITS
 Send now for this valuable FREE book. Full of advanced hook-ups, parts and kits. A real guide. Shows factory built sets and the new ideas in radio. Send at once. No charge. No obligation. Please include name of radio fan.

BARAWIK CO.
 102-109 S. Canal St., Chicago

"It gets that last mile"

The AIRGAP SOCKET

Will rid your set of those squawks, howls and frying noises. They prevent closed circuit absorption of current, inter-coupling of circuits, feedback and undesirable capacity. **THEY MAKE ANY CIRCUIT** more stable and sharpen tuning, resulting in purer and clearer tones with more volume particularly on distant stations.

At all dealers 75c each
 Sent direct if your dealer cannot supply you.

AIRGAP PRODUCTS CO. MFR.
 188 N. J. R. Rd. Ave., Newark, N. J.

SEE THAT GAP! ★

success, and next year—or whenever you decide to have another week of international tests—let's hope that there will not be so many bloopers. If they all make sets described in RADIO BROADCAST, there certainly will not be.

Very truly yours,
 G. JOHNSON.
 Bloomington, Illinois.

A Setback to the Florida Boom

IN MANY districts code interference has been materially reduced through a general coöperative campaign of the newspapers and magazines which circulate in those areas, in which pressure was brought to bear on the offenders. There are still too many districts, however, where broadly tuned transmitters are a source of constant annoyance to listeners of both local and distant broadcasting stations. The Florida peninsula, it would appear, from this letter suffers badly from coast to shore interference.

Editor, RADIO BROADCAST,
 Doubleday, Page & Company,
 Garden City, New York.

Sir:
 Ship to shore transmission is responsible in this locality for the worst form of interference encountered. "Sparks" will sit on the key at just about the time the broadcast program is at its best, and often it seems as if he had held up his work to fill the air between then and twelve o'clock. The wonderful New Year's treat from wjz was perfect as regards volume and modulation, but all through the stellar offering of McCormack and Bori there was only one brief song not ruined by code.

Very truly yours,
 FREDERIC B. HYDE,
 Miami, Florida.

A Letter from the Philippines

TAKING Horace Greeley's "Go West" thoroughly to heart, apparently irrespective of any human element, one copy of RADIO BROADCAST has monthly wended its weary way right out to the Philippines, there, we presume from that so enthusiastic letter following, to be eagerly read by at least one "satisfied customer." The letter:

Editor, RADIO BROADCAST,
 Doubleday, Page & Company,
 Garden City, New York.

Sir:
 I have already received the new size November and December numbers of the RADIO BROADCAST. I want to congratulate you on the progress and success your magazine is making. It is the best magazine of its kind that I have ever yet seen and so cheap that anybody can afford to subscribe. Its articles are very interesting and highly instructive. Its hook-ups are all "knockouts."

Before I subscribed to this magazine I hadn't an inkling of radio; now I am proud to say that I am the first home-constructor in this province. The department "For the Radio Beginner" should be continued as it is always very instructive to the novices and fans.

Wishing you a prosperous year for RADIO BROADCAST.

Very truly yours,
 JUAN CARBALLO.
 La Carlota, Philippines.

★ Tested and approved by RADIO BROADCAST ★

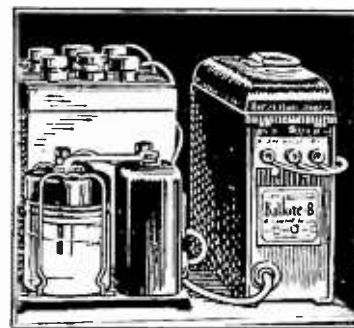

★
Convert your present radio receiver into a light socket set with a Balkite Trickle Charger and Balkite "B"

FANSTEEL PRODUCTS CO., Inc.
 North Chicago, Illinois

Thorola Receivers and Speakers ★
Must Outperform

Reichmann Company, 1725-39 W. 74th St., Chicago

A Laboratory Product ★

CRESCENT LAVITE RESISTANCES
for Distortionless Amplification

Insure distortionless amplifications and a clarity of tone not obtained through any other resistance. All capacities 12,000 ohms and up. List price \$1.50. Special sizes to order. Write for full information.

Crescent Radio Supply Co. 1-3 Liberty St., Jamaica, N. Y.

\$6.50
APOLLO
Parlor Model

Stands 22 inches high, has a ten inch bell, gives faithful reproduction and may be varied from a whisper to a torrent of sound by the adjustable unit control without the least loss of the sweet mellow, clear tones that are found in the Apollo Speakers. Mail orders promptly filled. Send no money, just pay the postman.

HARD RUBBER PANELS

Size	Black
7 x 10	.32
7 x 12	.39
7 x 11	.42
7 x 18	.56
7 x 21	.64
7 x 24	.75
7 x 26	.85
7 x 30	.96

Rix Radio Supply House, Inc.
 5505 Fourth Ave. Dept. 45 Brooklyn, N. Y.

INDEX TO ADVERTISERS

IN THIS ISSUE

A

Acme Electric Mfg Co., The715
Aerovox Wireless Corp.634
Airgap Radio Products Co.718
Alden Mfg. Co.696
Allen-Bradley Co.720
All-American Radio Co.3rd Cover
Ambassador Sales Co.711
American Electric Co.708
American Mech. Lab.691
American Transformer Co.700
Amplion Corp.717
Armstrong Elec. & Mfg. Co., The638
Atwarter Kent Mfg. Co.707

B

Bakelite Corp.705
Barawik Co., The714-715-717-718
Belden Mfg. Co.625
Blackburn Specialty Co.708
Brach Mfg. Co., L. S.628
Bremner-Tully Mfg. Co.633-634
Buescher Band Inst. Co.714
Burton-Rogers Co.717

C

C. E. Mfg. Co.712
Cable Supply Co., Inc.626
Cardwell, Allen D.709
Carter Radio Co.636
Central Radio Lab.717
Chicago Battery Co.630
Chicago Solder Co.639
Como Apparatus Co.630
Copper & Brass Research Ass'n.706
Corbett Cabinet Mfg. Co.715
Crescent Radio Supply Co.718
Crosley Radio Corp.695
Crowe Name Plate & Mfg. Co.636
Cunningham, Inc., E. T.2nd Cover

D

Davenport Radio Lab.715
Deutschmann Co., Tohe690-715
Dongan Electric Mfg. Co.692

E

Electrad, Inc.698

F

Fansteel Products Co.718
Ferguson, Inc., J. B.641
Freshman Co., Charles4th Cover
Frost Co., Herbert E.708

G

Gearhart-Schlueter626
General Instrument Co.714
General Radio Co.629-690
Goodrich Co., B. F.632
Grigsby-Grunow-Hinds Co.693

H

Hammarlund Mfg. Co.710
Hammarlund-Roberts701
Heins & Bolet638
Hommel Co., Ludwig716

I

Insulating Co. of America713

J

Jewell Elect. Inst. Co.704

K

Kane Antennae Co.714

L

Langbein-Kaufman Radio Co.627

M

Mayolian Radio Corp.690
Midwest Radio Corp.715
Modern Electric Co.691
Mueller Radio Co.714
Myers Radio Tube Corp.704

N

National Carbon Co.699
National Co.697
National Radio Inst.711

O

Omnigraph Co., The712

P

Pep Mfg. Co.639
Potter Mfg. Co.692

R

R. B. Specialty Co.639
Radiall Co.626
Radio Ass'n. of America713
Radio Centers, Inc.711
Radio Supply Co.637
Raytheon Co.689
Reichmann Co.718
Rix Radio Supply House, Inc.718
Ross Wire Co.632

S

S-C Merchandising Comm., The702
Sangamo Electric Co.632
Scientific Radio Lab.630
Shure Radio Co.714
Sickles Co., The F. W.717
Silver-Marshall710
Smith, B. H.711
Starrett Mfg. Co.712
Static Eliminator Co.706
Stevens Co., William638

T

Thordarson Elect. Mfg. Co.716

U

United Radio & Electric Co.631

W

Wakem & McLaughlin635
Webster Co.692
Wireless Specialty Apparatus Co.703
World Battery Co.714-718

X

X-I. Laboratories630

The Bradleyohm is used as standard equipment on the Acme B-Power Supply and most other B-Battery eliminators provided with voltage control. Silent voltage control is thereby assured.

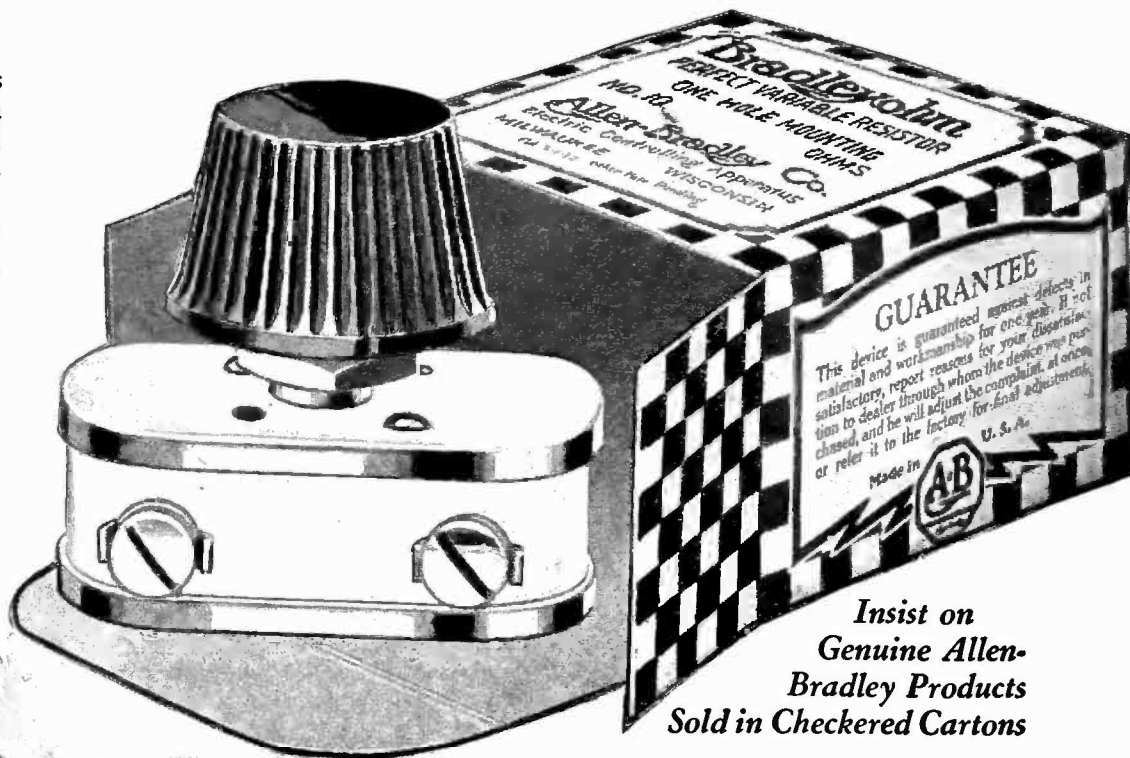
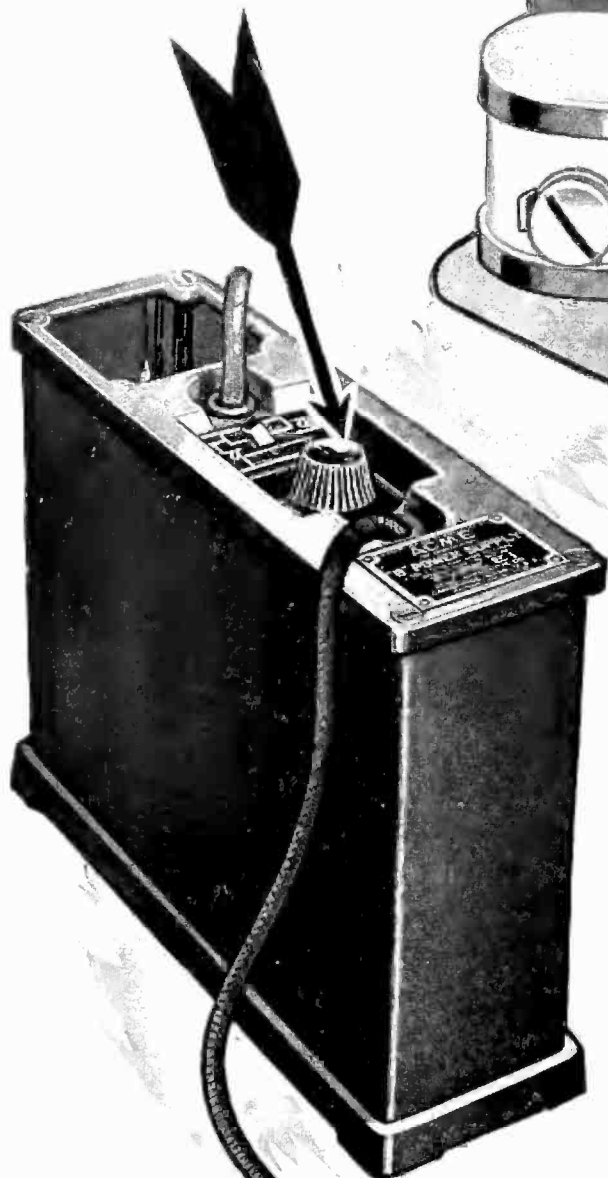

*Insist on
Genuine Allen-Bradley Products
Sold in Checkered Cartons*

How to Get Extra Voltage Taps from Your B-Eliminator

MANY radio receivers are provided with several B-battery terminals for detector, amplifier and radio frequency tubes. To provide the extra voltage taps from B-battery eliminators, such as the Acme B-Power Supply unit, is a simple matter. The diagram below shows the method of connecting the necessary Bradleyohms and condensers.

A Bradleyohm No. 10 for the 67-volt connection and a Bradleyohm No. 5 for the 90-volt connection provide marvelously smooth control over a wide range for these terminals. The condensers may be larger if desired, especially when used with audio-frequency taps. The standard Bradleyohm in the eliminator gives sufficient range for the detector plate voltage. Your dealer can supply you with Bradleyohms and condensers. Try these connections tonight and improve your receiving set.

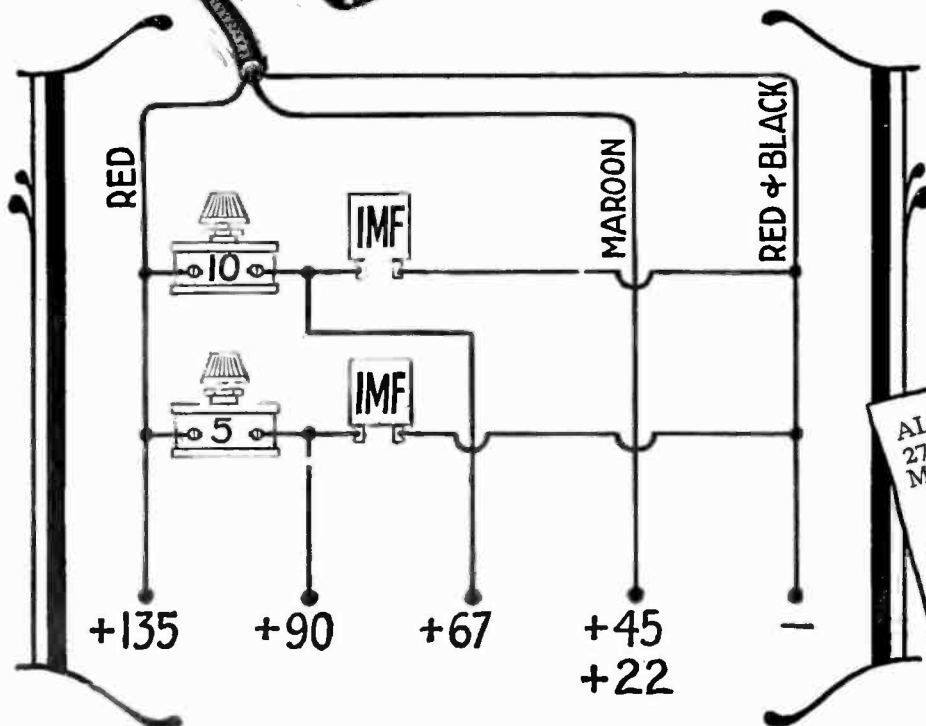

*Mail the Coupon
for Literature*

★

ALLEN-BRADLEY COMPANY
278 Greenfield Avenue
Milwaukee, Wisconsin

Please send me literature on Allen-Bradley radio products including the Bradleyohm.

Name

Address

THE *Dependable* B-POWER

Constant-B

Replaces Your "B" Batteries Permanently

AFTER installing the All-American "Constant-B" you need only snap the electric switch to have permanent and constant plate power for your radio, direct from the light socket. With it there is no ruinous acid, no hum—nothing but the pure, full tone that is only possible when the "B" voltage is constantly up to standard. Write for descriptive folder showing how to use "Constant-B" with any set.

Price \$45 COMPLETE WITH RAYTHEON TUBE

ALL-AMERICAN RADIO CORPORATION

Pioneers in the Radio Industry

4213 BELMONT AVENUE, CHICAGO, U. S. A.

Complete instructions for building a similar "Permanent Plate Supply Unit" may be had free upon request. Specify Bulletin B-82.



★ Tested and approved by RADIO BROADCAST ★

FRESHMAN

Announces
Another SENSATION!

Model 6-F-1

New and Improved
**FRESHMAN
MASTERPIECE**

**The World's Greatest
Radio Receiving Set**

Freshman's latest sensation has a real appeal to the women of the home. It is built of five-ply genuine mahogany; a handsome piece of furniture that fits in any corner of the room. It is compact and comparatively small, giving it preference over clumsy consoles. Contains an especially large tone chamber.

**With Built-in Loud Speaker of
Great Volume and Superb Tone**

When not used as a radio it can be entirely closed. The top is stationary and provides an attractive resting place for vases and other ornaments. Spacious compartments afford ample room for all batteries, etc.—not a single wire being visible.

**THE RADIO RECEIVER WOMEN
HAVE BEEN WAITING FOR—**

Prices slightly higher Denver and West and Canada



\$ **99** ⁵⁰
★

Sold on Convenient Terms by Authorized Freshman
Dealers Who Also Install and Service Them

CHAS. FRESHMAN CO., Inc. Freshman Building, New York
2626 W. Washington Blvd., Chicago

★ Tested and approved by RADIO BROADCAST ★

1 R 8 0 '29

THE COUNTRY LIFE PRESS, GARDEN CITY, NEW YORK
www.americanradiohistory.com