

FEB.
1926

35
CENTS

RADIO BROADCAST



Getting Maximum Efficiency from Your B Batteries
How to Judge and Use Vacuum Tubes

HOW TO CONSTRUCT THE
INVERSE DUPLEX RECEIVER

LAST INFORMATION ON THE
INTERNATIONAL TESTS

Doubleday, Page & Company, Garden City, New York

Cunningham

RADIO TUBES



SINCE 1915 - STANDARD FOR ALL SETS **PRICE \$2.50 EACH** IN THE ORANGE AND BLUE CARTON

GOOD MEN TO KNOW—

The tens of thousands of **RADIO DEALERS** who sell and recommend
CUNNINGHAM RADIO TUBES

They consider the ultimate satisfaction of their customers of the utmost importance.

They want your business not only to-day and to-morrow but next month and next year.



Your confidence is the foundation of their success.

Types CX-301A, C-299, CX-299, C-11, CX-12, CX-300, CX-220, CX-112, CX-310, CX-316B, CX-313

**Cunningham dealers are good men to know, good men to trust,
 good men to patronize**

E. J. Cunningham Inc.

Home Office 182 Second Street
 SAN FRANCISCO

CHICAGO
 NEW YORK

★ Tested and approved by RADIO BROADCAST ★

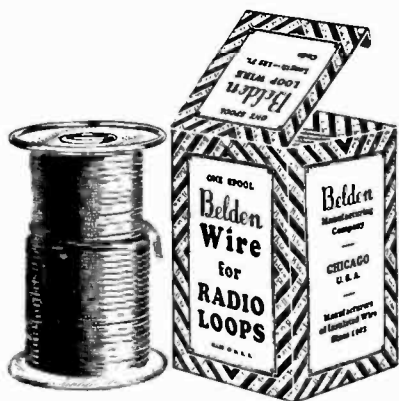
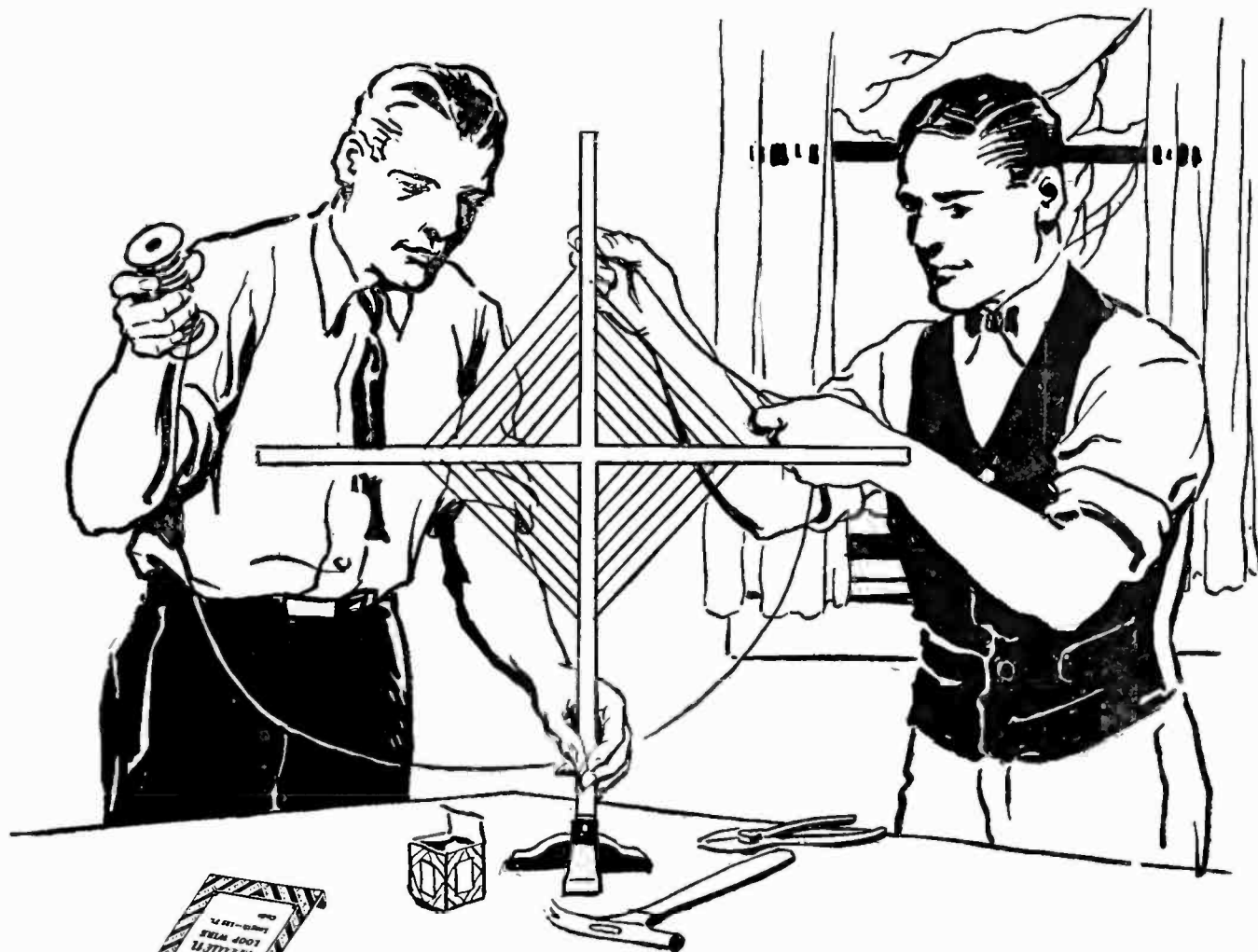

Look for the distinctive Belden Striped Carton. Furnished in maroon cotton or braided with brown or green Rayon (artificial silk).

A Good Loop is Easy to Build if You Use Belden Loop Wire

WHEN you build your new loop antenna, obtain maximum efficiency by using the special loop wire prepared by Belden engineers for standard loops. The Belden loop wire is made of sixty strands of No. 38 copper wire combined with five strands of No. 36 copper wire which has been treated to prevent stretching. All strands are insulated with a double wrap of cotton or with a Rayon braid. This unique construction provides a non-kinking, non-stretching, non-sagging conductor that will make a splendid loop, and one that will keep taut.

Ask your dealer for Belden loop wire!

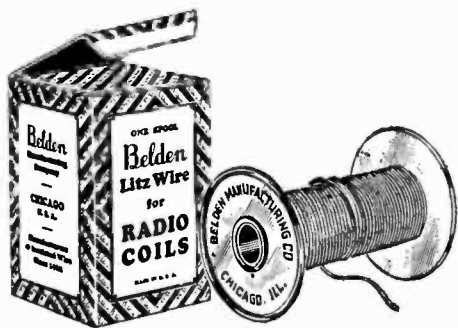

Belden Litz Wire is a special high-frequency conductor, ranging from 20 to 48 strands of Beldenamel. Furnished in 100-ft. spools for winding high-frequency coils and apparatus.

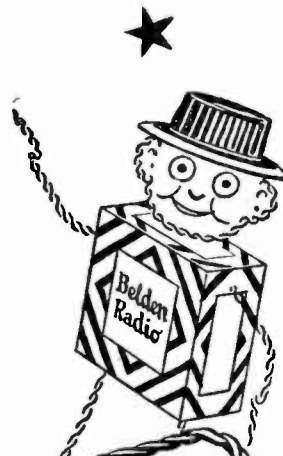

Mail the Coupon for Free Illustrated Booklet

BELDEN MANUFACTURING CO.
 2312-J South Western Ave., Chicago

Please send me your booklet entitled "Helpful Hints for Radio Fans."

Name.....

Address.....

Belden

★ Tested and approved by RADIO BROADCAST ★

The New NATIONAL EQUICYCLE Condenser

The latest development in straight line frequency control as applied to NATIONAL Condenser design. Increases range of rotation from 180° to 270°, permitting more precise adjustment and sharper separation of stations, and accomplishes this WITHOUT GEARS, CAMS, OR LEVERS.



Type BD1-A
NATIONAL
TUNING UNIT

Embodying the genuine Browning-Drake Inductance Coil and the NATIONAL Condenser

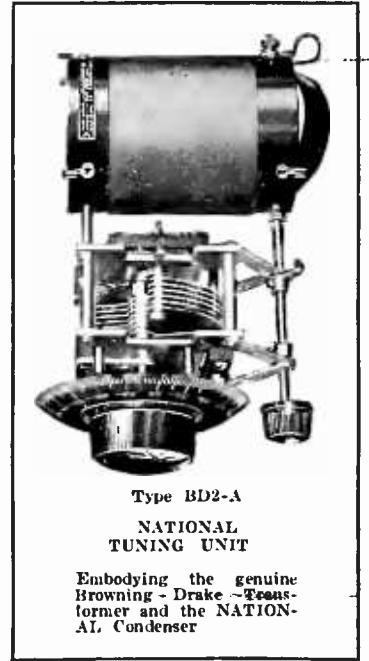

Type BD2-A
NATIONAL
TUNING UNIT

Embodying the genuine Browning-Drake Transformer and the NATIONAL Condenser

It changes a mob into an orderly procession

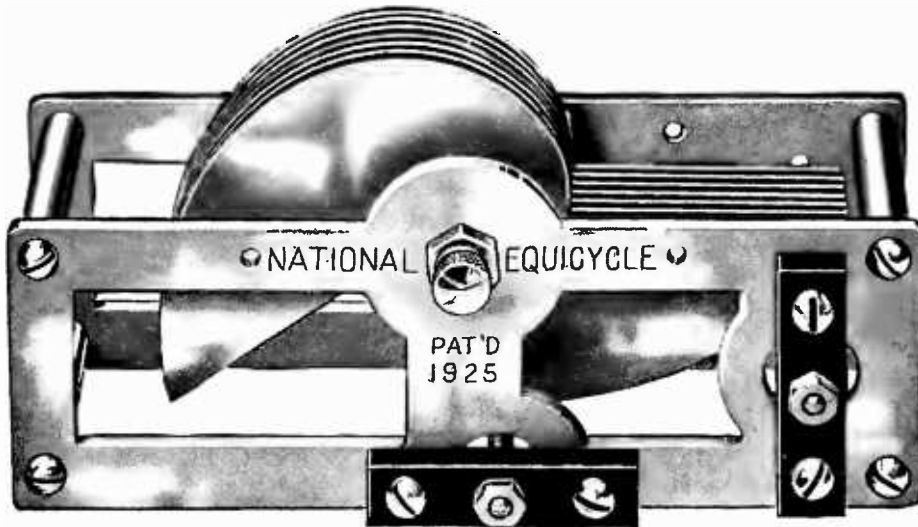

(Patented February 10, 1925)

and lengthens the line of march!

Tests Conducted at Harvard University, by Prof. Field, give characteristics of the new Equicycle Condenser as indicated by the following graph:

—The novel shape of the plates spaces the station groups at equal intervals of 10 kilocycles (as specified by the U. S. Department of Commerce) in a true straight frequency line.

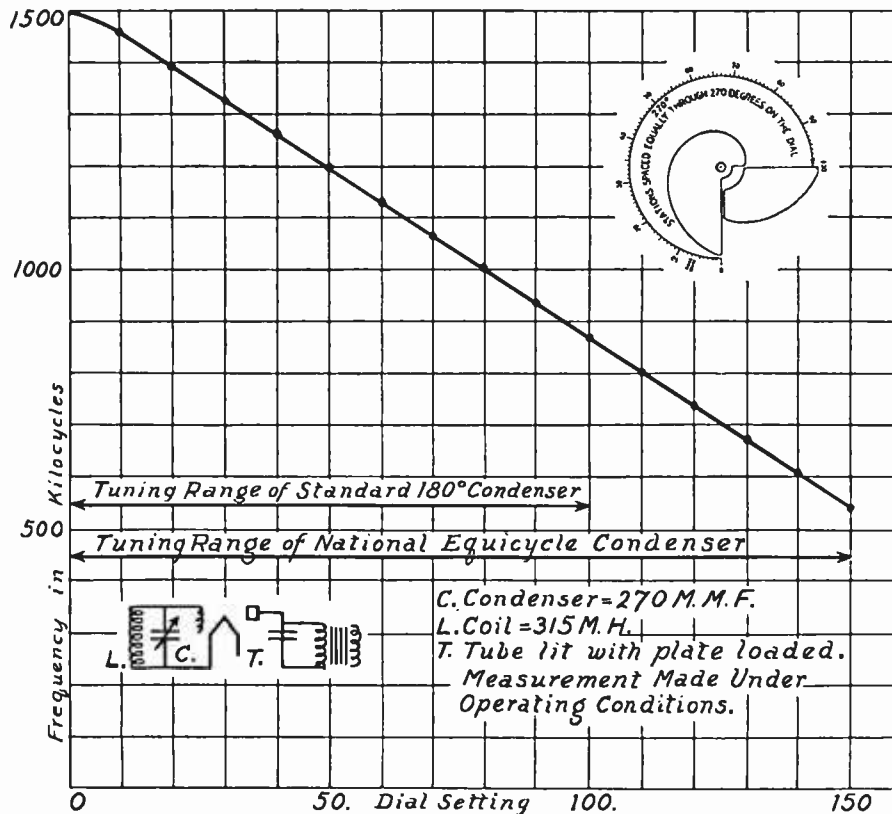

—The same electrical efficiency and mechanical ruggedness that have always characterized NATIONAL DX Condensers have been embodied in the new NATIONAL EQUICYCLE Condenser.

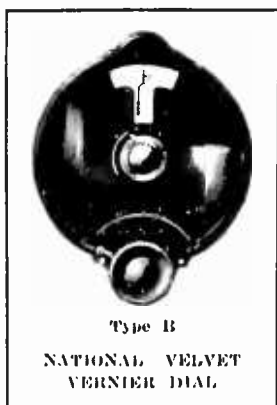

Type B
NATIONAL VELVET
VERNIER DIAL

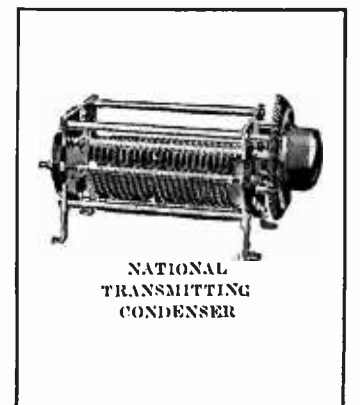

NATIONAL
TRANSMITTING
CONDENSER

Get the Genuine. Insist upon NATIONAL COMPANY'S RADIO Products. Your dealer appreciates your patronage and will gladly get them for you. Write for Bulletin 111-RB

NATIONAL COMPANY, Inc.

W. A. READY, PRESIDENT

110 Brookline St.

Cambridge, Mass.

★ Tested and approved by RADIO BROADCAST ★

They All Tried It—but it took a Ferguson to bring the Chicago-Dartmouth game to Concord, N.H.

YOU can always count upon a Ferguson to win, especially when the phenomenal is to be accomplished.

This letter, like many others that have come to us unsolicited, shows that in radio, as in everything else, "the proof of the pudding is in the eating."

J. B. FERGUSON, INC.
41 East 42nd St., New York

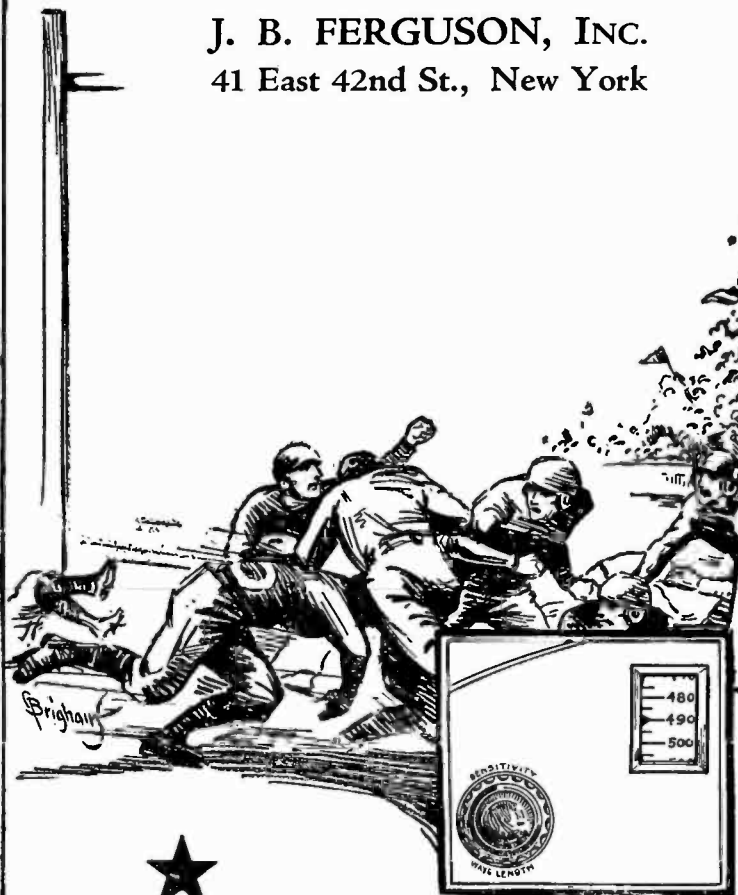

★
One Tuning Control—
Calibrated in Meters!

Choose your program,
turn to its wavelength and
in comes your station.

Ferguson

J.B. INCORPORATED

The Gold Standard of Radio Receivers

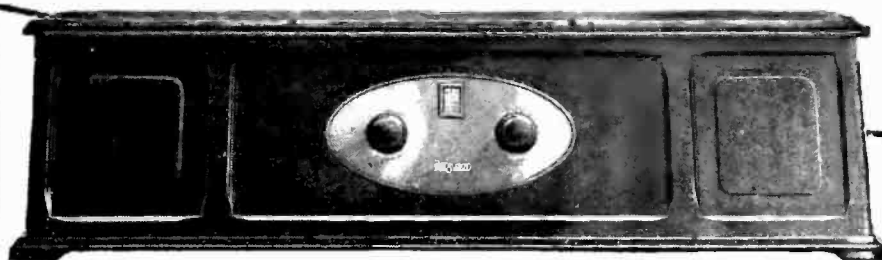

Witness a comparative demonstration at your Authorized Ferguson Dealer's and learn why Ferguson is recognized as "The Gold Standard of Radio Receivers."

ROBERT A. GEORGE
AUTHORIZED DISTRIBUTOR OF
BOSCH AND FERGUSON RADIO
SIXTEEN RIDGE ROAD
CONCORD, N. H.

November 17, 1925.

J. B. Ferguson, Inc.,
41 East 42nd Street,
New York City.

Gentlemen:

You might be interested to learn that I was successful in bringing in the Dartmouth-Chicago football game broadcast last Saturday afternoon by KYW and as far as I can learn the Ferguson was the only set in the city that got it although I think everybody who owned a powerful set tried very hard to get it. Had it not been for considerable interference I would have had the whole game but as it was I missed the first and third quarters. There were about thirty-five on hand to hear it and although they were disappointed not to get it better when they found that no one else even found KYW they were very enthusiastic about the set.

Thanking you for past favors and wishing you every success, I remain,

Robert A. George

Straight-Line-Frequency Tuning Without the Brakes!

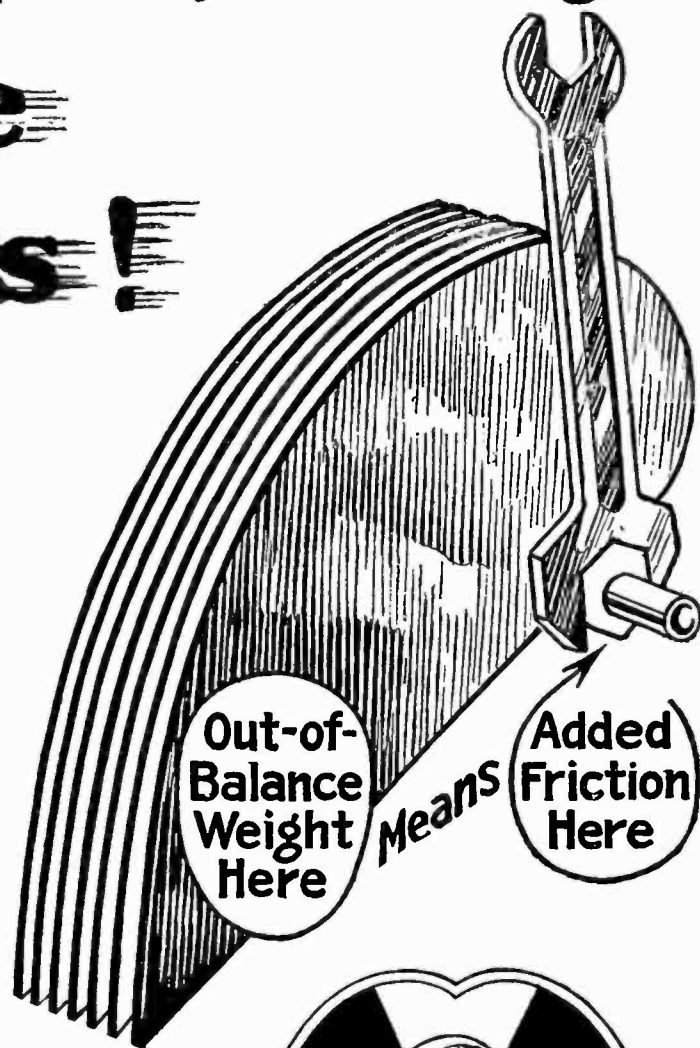
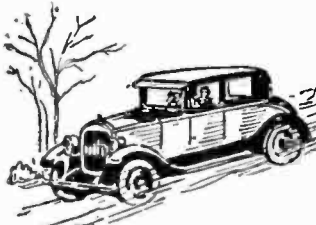

ALL-AMERICAN Condensers, with their smooth-sliding plates, (see sketch at left) require no tensioning. There is no sensation of raising a weight or letting it fall. Compactness, also, far exceeds that of rotor types. (See dimensions on sketch.) Efficient shielding prevents the touch of the fingers from affecting the tuning, and protects the plates permanently from dust or damage.

Taking full advantage of the 360° rotation, there is an ALL-AMERICAN Dial with two scales, both on the upper half, where they are always visible.

Used with the ALL-AMERICAN Toroid Coils, these Condensers space out equidistant on the dial all wave-frequency channels from 550 meters down even to 175 meters. Power and selectivity are greatly improved through the absence of stray magnetism.

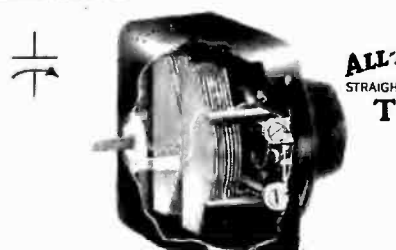
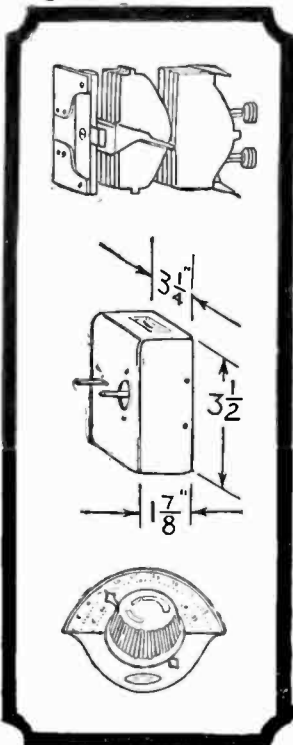

**ALL-AMERICAN
Straight-Line-Frequency
CONDENSERS**

Type C-35 Max. 350 micro-microfarads (Min. 10.5 mmf. at 400 meters) . . . \$4.50

Type C-50 Max. 500 micro-microfarads (Min. 11.8 mmf. at 400 meters) . . . \$5.00

Type C-40, 360° Dial . . . 1.00



**ALL-AMERICAN
TOROID COILS**

Type T-1 Antenna Coupler. \$3.50

Type T-2 R.F. Transformer. 3.50

Set of 3 coils complete. . . . 10.50

The R. F. Transformer has a small primary, closely coupled to the secondary, entirely air-insulated. The coupler has taps for long and short antenna. All bases are of bakelite.

ALL-AMERICAN
TRADE MARK
**Famous Audio
Transformers**

**Standard Audio
Transformers**

3 to 1, R-12 \$4.50

5 to 1, R-21 4.75

10 to 1, R-13 4.75

**Power Amplifying Transformers
(Push-Pull)**

Input Type R-30 \$6.00

Output Type R-31 6.00

Rauland-Lyric

A laboratory-grade audio transformer for music lovers. R-500 . . . \$9.00



ALL-AMERICAN RADIO CORPORATION, 4213 Belmont Avenue, Chicago, Illinois
E. N. Rauland, President

OWNING AND OPERATING STATION WENR-266 METERS

ALL-AMERICAN

Pioneers in the Radio Industry

★ Tested and approved by RADIO BROADCAST ★



The RADIO BROADCAST

UNIVERSAL

FOUR TUBE RECEIVER



Build

the circuit that has won the

Nationwide Approval

of Radio Engineers, Magazine and Newspaper Radio Editors, Dealers, and Set-Builders by

PERFORMANCE

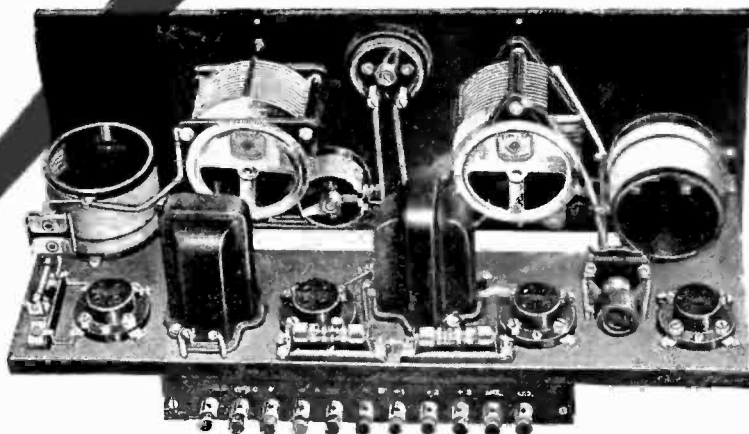

The RADIO BROADCAST

UNIVERSAL ★

FOUR TUBE RECEIVER

Read the Following Pages



The RADIO BROADCAST

UNIVERSAL

FOUR TUBE RECEIVER

Chosen from Circuits as BEST PRACTICE IN



GENERAL RADIO
Type 277-D Coupling Coil
Price, \$1.50

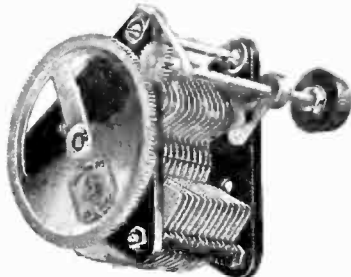

GENERAL RADIO
Type 247-H
Geared Variable Condenser
Price, \$5.00



GENERAL RADIO
Type 368
Micro-Condenser
Price, \$1.25



Panel View of UNIVERSAL

In selecting the Radio Broadcast "UNIVERSAL" our aim has been to single out one particular circuit which from a standpoint of performance, simplicity and economy of construction and operation would meet the most rigid requirements of amateur set-builders under all reasonable receiving conditions.

Every conceivable type of circuit worthy of consideration has been investigated. Comparisons were made under a wide variety of receiving conditions by competitive tryouts with other receivers of creditable performance.

We found that the Radio Broadcast UNIVERSAL out-rivaled the other circuits in all-around achievement.

Build

The

RADIO BROADCAST

UNIVERSAL

FOUR TUBE RECEIVER

Behind the Panels

The RADIO BROADCAST

UNIVERSAL

FOUR TUBE RECEIVER



More than 200

Representing the

RECEIVER DESIGN

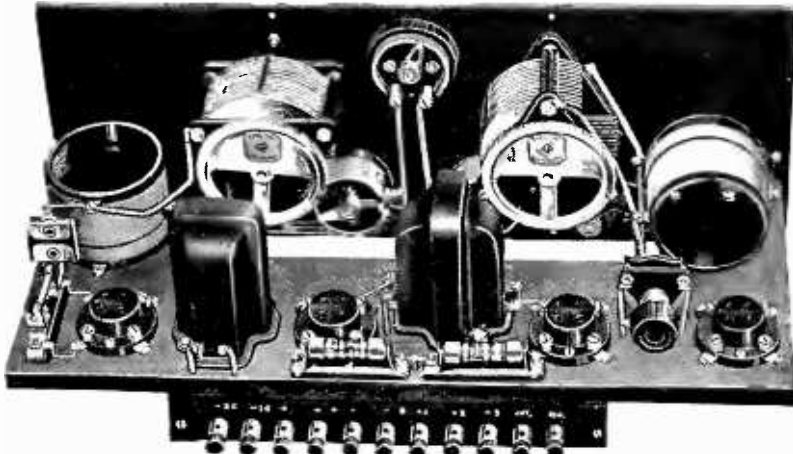

Inside View of UNIVERSAL

While the circuit itself is not new in principle its efficiency can not be doubted—the best proof of this being its performance.

To the set builder who expects real results from his set and wants advance assurance that he will get them we recommend the "UNIVERSAL" as the circuit to build.

We have prepared a booklet which contains all information necessary to the home construction of the UNIVERSAL. These booklets are available FREE to all set-builders who are looking for a reliable circuit built of reliable parts.

Ask your dealer or write for our booklet "Complete Construction Details for the Radio Broadcast Universal Four-Tube Receiver."

GENERAL RADIO CO.

Cambridge 39, Mass.

with

GENERAL RADIO

INSTRUMENTS

of Better Built Sets



GENERAL RADIO
Type 285
Audio Transformer
Price \$6.00



GENERAL RADIO
Type 301
Rheostat
Price, \$1.25

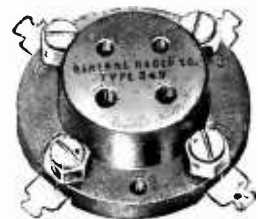

GENERAL RADIO
Type 349
UX Tube Socket
Price, 50c



The RADIO BROADCAST

UNIVERSAL

FOUR TUBE RECEIVER

WIN A \$100 PRIZE



Enter the International Reception Contest

JAN. 24 to 30

All Radio Broadcast "UNIVERSAL" Four-Tube Receivers built of General Radio parts by the owners according to the circuit as described in the January, 1926, issue of *Radio Broadcast*, or the booklet "Complete Construction Details for the Radio Broadcast 'UNIVERSAL' Four-Tube Receiver," are eligible to enter the International Radio Week Reception Contest January 24 to 30.

A \$100.00 cash prize will be awarded the receiver which shows the best performance by identifying the greatest number of stations during International Radio Week in accordance with the conditions specified by the Radio Week Committee.

Cash prizes of \$10.00 each will be awarded the next one hundred receivers which show the best performance by identifying the greatest number of stations during International Radio Week in accordance with the conditions specified by the Radio Week Committee.

Upon receipt of the entry blanks, entrants will receive reporting blanks on which to report the performance of their "UNIVERSAL" receivers during the contest. Reporting blanks must be received by the General Radio Company not later than 5 P. M., February 15, 1926.

The official judge to make prize awards in the International Reception Contest will be Mr. Arthur H. Lynch, Editor of *Radio Broadcast*.

Further information on International Radio Week may be obtained on request from *Radio Broadcast*, Garden City, New York, or the General Radio Company, Cambridge 39, Mass.

All contestants are required to fill out their entry blanks in detail, and to mail them, not later than January 30, 1926, to Department "UNIVERSAL," General Radio Company, Cambridge 39, Mass.

*Ask your dealer or write for an Entry Blank for the International Radio Week Reception Contest
Jan. 24 to 30*

GENERAL RADIO CO.

Cambridge 39, Mass.

GENERAL RADIO

Behind the Panels of Better Built Sets

★ Tested and approved by RADIO BROADCAST ★

The RADIO BROADCAST **UNIVERSAL** FOUR TUBE RECEIVER



GENERAL RADIO

*INSTRUMENTS
for the Scientist or Set-Builder*



*are
the*

UNIVERSAL Standards of Precision

LABORATORY APPARATUS

- Precision Condensers*
- Precision Wavemeters*
- Capacity Bridges*
- Capacity Meters*
- Decade Bridges*
- Standards of Resistance*
- Standards of Inductance*
- Piezo Electric Oscillators*
- String Oscillographs*
- Ratio Arm Boxes*



For over a decade General Radio instruments have been universally recognized as the standards of excellence.

They are manufactured by a company which has contributed more laboratory equipment for radio research than any other one company in the history of radio.

Nearly all the leading commercial and technical school laboratories throughout the world are equipped with General Radio scientific apparatus.

The same outstanding craftsmanship and materials are embodied in all General Radio parts for use in the construction of broadcast receivers.

Through the merits of design, performance, and price General Radio instruments for the scientist or set-builder are the accepted standards of quality.

GENERAL RADIO Co
Cambridge
Mass.



INSTRUMENTS FOR THE SET BUILDER

- Variable Condensers*
- Coupling Coils*
- Transformers*
- Rheostats*
- Potentiometers*
- Variometers*
- Vario Couplers*
- Wavemeters and Filters*
- Sockets*
- Dials*



Behind the Panels of Better Built Sets



The RADIO BROADCAST **UNIVERSAL** FOUR TUBE RECEIVER



Electrad Parts Recommended For R.B.'s New Universal Receiver

IN the new Radio Broadcast Universal Receiver, an improved method of regeneration control has been presented. It offers decided advantages over the usual methods in common practice.

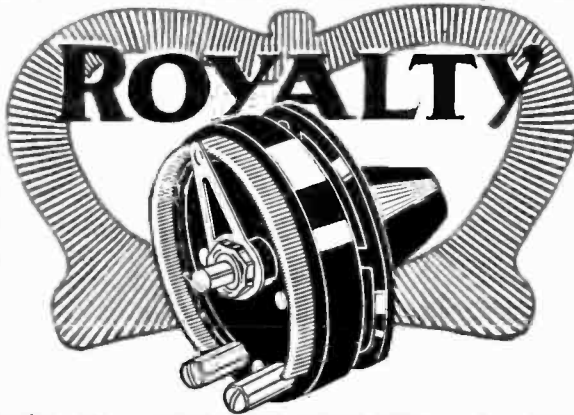

THE Electrad Royalty Variable Resistance Type C—is especially adapted to the new type of Regeneration control, because of its fine, gradual adjustment and the wide range of resistance, 500 to 50,000 ohms, exactly as specified for this set.

ELECTRAD Royalty Variable High Resistance

Type C—As used for regeneration control in Universal Receiver

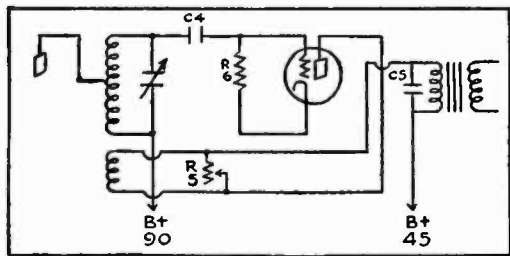

- R-5—Electrad Royalty Type C—500 to 50,000 ohms.
- R-6—Electrad Certified Grid Leak—2 megohms
- C-4—Electrad Fixed Condenser .00025 Mfd.
- C-5—Electrad Fixed Condenser .002 Mfd.

Type E—Transformer compensator for volume control—\$2.00

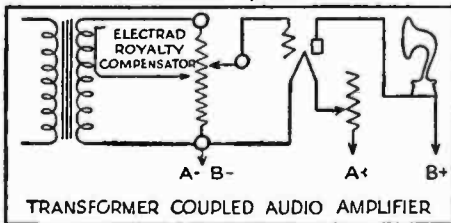

TRANSFORMER COUPLED AUDIO AMPLIFIER

THE Electrad Royalty Variable Resistance is wire wound. It is unaffected by atmospheric or temperature conditions, and is absolutely non-inductive. Resistance value is always the same at the same point on dial. This permits an accurate and positive control of regeneration.

Constant adjustment does not impair the efficiency of the resistance—it does not deteriorate with use.

Electrad Royalty Variable High Resistances, Type C, 500 to 50,000 ohms. Price, \$1.50.

Other types of Royalty Resistances are: Type A—Variable Grid Leak, 1/10 to 7 megs. \$1.50. Type B—Variable Resistance, 1,500 to 100,000 ohms \$1.50. Type D—for B-Eliminator Control of Detector, 10,000 to 100,000 ohms. \$2.00. Type E—Compensator, 500,000 ohm Potentiometer. \$2.00.

Electrad Six-Point Pressure Condensers and Electrad Grid Leak Resistors—are also recommended for use in this set.

On sale at all good radio stores with other guaranteed Electrad Radio Accessories:—Lead-Ins, Lamp Socket Antennas, Lightning Arresters, Aerial Kits, Variohms, Audiohms, etc.



Electrad Certified Grid Leaks
Accurately calibrated. Perfect conductivity. Permanent in value and noiseless. 1/4 to 10 megohms. 50c each.

Recommended By Mr. Arthur Lynch For Use In The Universal Receiver

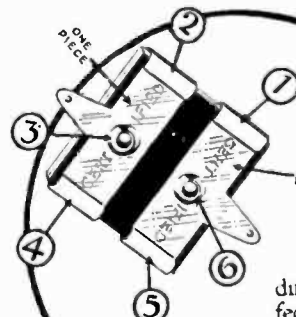

Electrad "Six-Point Pressure" Condenser

Ingenious, rigid binding and firm riveting fastens parts securely at six different points. Perfect electrical contact.

Value guaranteed within 10% of calibration. Standard capacities. Price, 30c to 75c.

ELECTRAD

428 Broadway

New York City



The RADIO BROADCAST

UNIVERSAL

FOUR TUBE RECEIVER

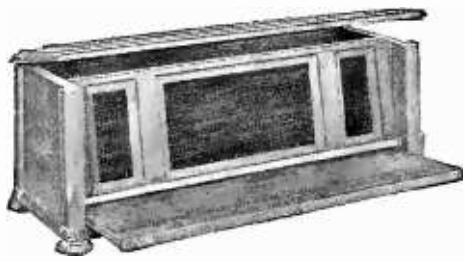

RADIO-ENCLO
(Open Front)

THE NEW
Woodcraft

STANDARDIZED — ADJUSTABLE

RADIO

(Broad Patents Pending)

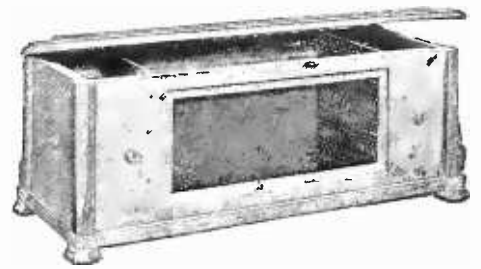

RADIO-ENCLO
(Closed Front)

ENCLOSURES, CONSOLES, TABLES,

with

Built in Loop Speakers, Etc.



(BABY) CONSOLETTTE

THE
Universal - Enclosures

for all panel sizes up to 30" long x 10" wide, instantly adjusted to tilted or upright position and variable sizes, in each enclosure or console model.

No Cutting or Screws Required

THE WOODCRAFT
Is Not a Makeshift

Built in genuine dark walnut with 5 coats of Lacquer and rubbed to fine satin piano finish. Panels are full $\frac{7}{8}$ " bevel encircled in two-tone with many beautiful hand carved and in-laid wood effects and all at

A Very Popular Price

SEE OUR OTHER MODELS
(in High Grade)
CONSOLES, SPEAKERS, Etc.



RADIO-ENCLO
CONSOLETTTE
(Unison)



CONSO-ENCLO
In-door Antenna (on rear)

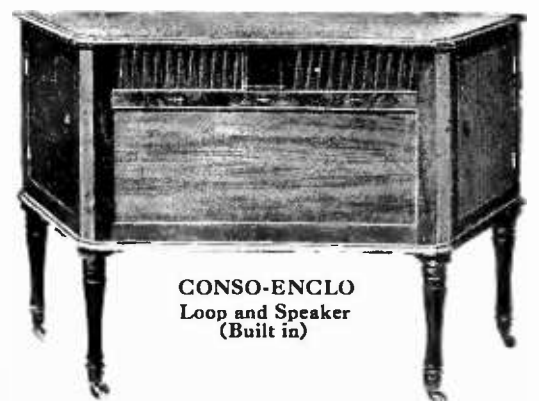

CONSO-ENCLO
Loop and Speaker
(Built in)

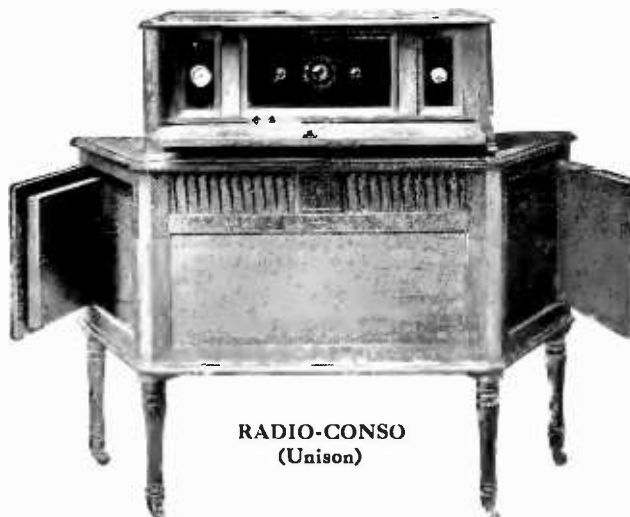

RADIO-CONSO
(Unison)

Write for Illustrated
Literature, etc.

Make Your Set Up-to-Date



Built by the
**DETROIT WOODCRAFT
CORPORATION**

Sales and Adv. Dept's
4611 Woodward Avenue
Convention Hall

Detroit

Mich.



ONLY the best panel material is good enough for the "Universal." In signifying its approval of Insuline for this circuit, Radio Broadcast Laboratories accord it a tribute that speaks volumes.

Insuline is *made specially for radio*—to meet its exacting requirements! It has greater dielectric strength than any other panel material. It is moisture-resistant and moisture-repellent. It does not warp or crack. Its beautiful high-lustre surface remains unimpaired throughout the years.

Add the perfections of an Insuline Panel to the perfections of the "Universal" and you have a set that represents the last word in efficiency.

Insuline Panel for the "Universal," beautifully engraved in a combination of white and gold and drilled ready to set up; Black, \$3.50; Mahogany, \$4.00; "Frieze" finish, \$4.00.

Insuline Panels, drilled and engraved for all popular circuits, including the following, can be obtained from all good radio dealers.

Hammarlund Roberts
Radio Broadcast Aristocrat
Radio Broadcast Universal
Citizen's Radio Call Book 45 Kilo-
Cycle 9-Tube Super Het.
B.-T. Counterphase, 5 and 6 Tube
Browning-Drake

B.-T. Nameless
Cockaday 7 Tube Super Het.
Roberts Knockout.
Freshman Type TRF
Ambassador
Eastern Classic
The New Yorker

If your dealer can't supply you, write us direct. Don't take a substitute for Insuline. Insuline sub panels, completely drilled and mounted with Metal Sockets for both UV and UX tubes are available for all of the above circuits.

Write for free booklet and price lists

INSULATING COMPANY OF AMERICA, INC.
(Radio Panel & Parts Corp.)

Insuline Building 59 Warren Street
NEW YORK CITY



INSULINE—THE PANEL FOR BETTER-BUILT SETS

★ Tested and approved by RADIO BROADCAST ★



The RADIO BROADCAST

UNIVERSAL

FOUR TUBE RECEIVER



"One More Touch of Refinement"



Our Panel

—The Front Door of the Universal Set

Make the front door of *your* new Universal Set worthy of the mechanism within. Then—to all your friends the first impression will be lasting!

The illustration above shows the new panel that we have designed expressly for this new wonder set. It is made of the finest material—Spaulding Bakelite! Whether in black or in walnut, it has the most durable and lasting lustre. It is engraved in gold or in silver, and so drilled that it has the harmony of balance.

At all Good Dealers. Size 7" x 18". Price \$4.75

To Every Universal Set Builder

We have devised a sub-panel—designed in a way new to radio. Made of Spaulding Bakelite to match our panel. It is engraved

with full directions. No blue print is necessary and you can assemble your set in *an hour and a half*. You can't go wrong!

Price \$4.50. Our "Combination No. 2" includes both panel and sub-panel. Price \$9.00

A Special Cabinet

If your dealer cannot supply you, write us direct. We are authorized manufacturers.

The Carlson Cabinet shown in the illustration was specially made to fit our panel for the *Universal* set. It is made of re-inforced mahogany with a full length nickel plated piano hinge and stop. A beautiful creation.

Price \$14.00—Type B—Deluxe Cabinet with Space for all Batteries \$18.00

Distributors:—Write to us for literature regarding discounts and other data.

**BOSTON RADIO
MANUFACTURING COMPANY**

Precision Made Products

117 Water St. Boston, Mass.



★ Tested and approved by RADIO BROADCAST ★



Hommel is a Helpful Jobber

- ☞ He maintains close contact with his dealers at all times.
- ☞ He carries ample stocks of reliable radio apparatus only so that his dealers are assured prompt deliveries.
- ☞ All user inquiries, resulting from his national advertising, are turned over to his dealers.
- ☞ A dealer repair and inspection department is maintained so that all sets needing minor repairs can be fixed up im-

mediately—thus saving the time and trouble of sending them to the factory.

- ☞ And last, but not least, he issues a complete catalogue of the Radio Sets and Apparatus he carries—known as the "Hommel Encyclopedia of Radio Apparatus" that Hommel dealers find invaluable in ordering and dealing with their customers.

Write to-day for Hommel's Encyclopedia No. 466-B

WHOLESALE

EXCLUSIVELY

LUDWIG HOMMEL & CO

929 PENN AVENUE



PITTSBURGH, PA.

TUBE SERVICE

*Your set is no better than your poorest tube
They must be uniform*

A good tube must have:

1. Good Tone Quality.
2. Impedance not too high.
3. Low filament consumption.
4. Long life.



Pingree Tube Characteristics

- Plate impedance 8500—10,000 ohms.
- Amplification factor 8-9.
- Filament consumption .25 amp.
- Filament voltage 5.0 volts.
- Plate voltage 16v-90v.

A—TYPE \$2.00

Especially adapted for multi-tube Sets where uniformity is required.

PROTECTION

Each tube submitted to rigid tests using Superadio Dynamometer before shipment.

TRIAL OFFER

Try these tubes 10 days at our expense. If they are not what we claim, we will gladly refund your money.

PINGREE RADIO SERVICE, INC.

170 Summer Street

Boston, Mass.

Dealer inquiries solicited



PRECISION BI-PASS and FILTER CONDENSERS

Every good radio-set needs by-pass condensers. Use a TOBE .002 Mfd. around the primary of the first audio transformer, thus by-passing the radio frequency currents out of the audio end and improving the tone.

On resistance or impedance-coupled amplifiers, the coupling condensers should be TOBE, not less than 0.1 Mfd., to pass all the low notes and secure really truthful reproduction.

TOBE Condensers are standard for smoothing and filter work in the Raytheon Plate Supply Unit.

TOBE Condensers are ACCURATE, durable, SILENT, dependable, and REASONABLE in price.

"A BETTER CONDENSER"

In the silver case and the silver carton

AT YOUR DEALERS

TOBE DEUTSCHMANN CO. ★

CORNHILL

BOSTON, MASS.

★ Tested and approved by RADIO BROADCAST ★



Great names become real folks

The President, the Secretary of Commerce, and scores of leaders in politics, science and industry are no longer mere "names". Through radio they speak direct to you. The very tones of their voices are known to millions.

In bringing Radio broadcast reception within the reach of everyone, Bakelite has had a major part. You will find it in receiving sets, speakers and accessories, for it improves both appearance and performance.

Bakelite is the most widely used material for panels, dials, knobs, tube bases and sockets, rheostats,

variable and fixed condensers and other parts requiring lasting insulation.

In speakers Bakelite is used for magnet spools, housings and diaphragms, as it is unaffected by temperature and atmospheric changes. Because of its resonance it is also used for speaker "bells" and "cones".

It is a fact that over 95% of radio set and parts manufacturers use Bakelite, for they know that its electrical properties, as well as its beauty of color and finish are permanent, unimpaired by time or service.

Write for Booklet 29, a helpful guide when buying a radio set or parts.

BAKELITE CORPORATION
 247 Park Avenue, New York, N. Y.
 Chicago Office: 636 West 22d Street



Shaw Insulator Co.
 Binding Posts and
 mounting and Connewey
 Elec. Laboratories, Baka-
 lite Tube Base.

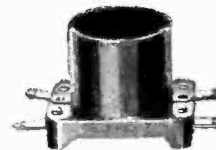

Shaw Insulator Co.,
 Tube Socket



Daven Radio Corp.,
 Resisto Coupler



Mica Mold Radio Corp.,
 Grid Condenser and Leak



Carter Radio Co.,
 Flat Plug

BAKELITE

REGISTERED U. S. PAT. OFF.



THE MATERIAL OF A THOUSAND USES

"The registered Trade Mark and Symbol shown above may be used only on products made from materials manufactured by Bakelite Corporation. Under the capital "B" is the numerical sign for infinity, or unlimited quantity. It symbolizes the infinite number of present and future uses of Bakelite Corporation's products."

★ Tested and approved by RADIO BROADCAST ★



Accurate
and stay accurate

helps your DX record

LUCKY nights happen when a set built out of fence wire by rule of thumb can get DX. But the surest way to get the utmost in radio performance is to have all parts in correct electrical balance. Especially the fixed condensers, for they must release the incoming impulses at exactly the right time, or there is discord. This is where accuracy counts most.

The accuracy of Sangamo Mica Condensers is doubly assured. They are tested individually for accuracy, and guaranteed to be within 10 per cent. of marked capacity. They are solidly molded in bakelite, absolutely impervious to any outside influence. There are no exposed edges. You can boil them, freeze them, expose them to acid fumes or heat the terminals with a soldering iron, but their capacity remains unchanged.

Sangamo Mica Condensers are made in all standard capacities, with or without resistor clips. They can be easily installed in any set, old or new.

Also available: Sangamo By-Pass Condenser
1 MFD. \$1.25. $\frac{1}{2}$ MFD. .90



All progressive dealers have Sangamo Condensers in stock, or will quickly secure them if you insist.

Sangamo Electric Company

1421-7

Springfield, Illinois

RADIO DIVISION, 50 Church Street, New York

SALES OFFICES—PRINCIPAL CITIES

For Canada—Sangamo Electric Co. of Canada, Ltd., Toronto.
For Europe—British Sangamo Co., Ponders End, Middlesex, Eng.
For Far East—Ashida Engineering Co., Osaka, Japan

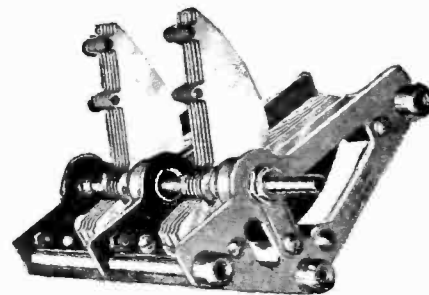

Made under Hogan Patent No. 1,014,002
Jan. 9, 1912

Simplified Tuning!

DIAL crowding has been responsible for blurring radio reception. You can now get new pleasures from your radio. Just as each note on the piano has its tone, so each degree on the dial will have its station. U. S. Tool Straight Line Frequency Condensers make this possible. These condensers spread the stations uniformly round the dial, each degree has its station and *one station only*.

The U. S. Tool New Straight Line Frequency Condensers

are the latest product of skilled engineers, designed and manufactured in a factory that for years has specialized in the making of precision instruments.

When you use the U. S. Tool S. L. F. Condenser you will know the real joys of radio performance.

Write for booklet

U. S. TOOL COMPANY

INC.

AMPERE, N. J

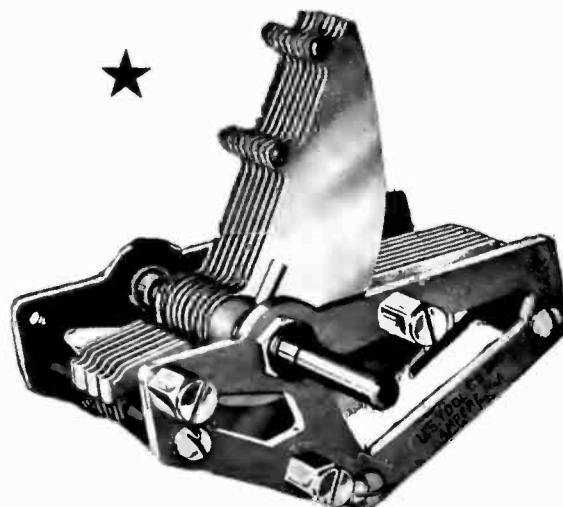

★ Tested and approved by RADIO BROADCAST ★

HAMMARLUND



ROBERTS

AS long as human ingenuity progresses, there will never be an "ultimate" radio receiver. But of one thing you may be sure—that for a long time to come, there will not be evolved a more efficient circuit arrangement than is employed in the new Hammarlund-Roberts Receiver.

Ten leading radio engineers, each an expert in the design of some particular unit, devised the Hammarlund-Roberts Receiver as their composite ideal. The result of this co-ordination of ideas is a receiver which, although operating on only five tubes, possesses the sensitivity of any standard eight-tube receiver, plus a high degree of selectivity which insures reception of distant signals without interference from strong local stations.

HAMMARLUND MFG. CO.

Tuning is simplicity itself. The volume and tone quality are exceptional, the receiver being designed to operate on the new cone type of speaker.

And best of all, without any previous experience, you can construct it yourself, from the finest parts known to radio, and with results worthy of any professional builder.

The cost, \$60.80 (cabinet extra) is only about one-third of the price of any factory-built receiver of equal quality.

Your dealer sells the famous Hammarlund parts pictured below, and can supply you with all the other parts specified in the "How to Build" book, which will be mailed to you on receipt of 25 cents.

424-438 W. 33rd St., NEW YORK

For Better Radio
Hammarlund
PRECISION
PRODUCTS

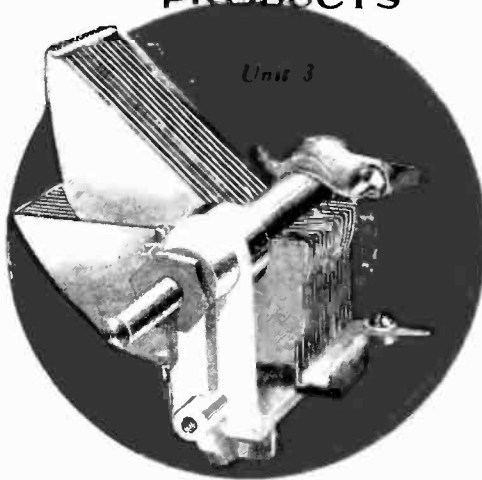

Unit 4

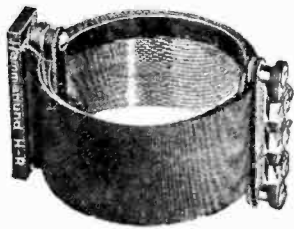

Unit 2—"Hammarlund, Jr." The Precision Mid-gate Condenser.

Unit 3—The New Hammarlund Straight-Line Frequency Condenser.

Send 25 cents for illustrated book, giving complete instructions for assembling, wiring and operating the Hammarlund-Roberts Receiver.

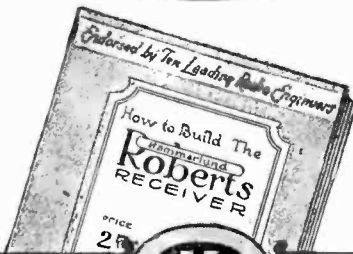

Unit 4—The New Hammarlund Low-Loss Space-Wound Coils.

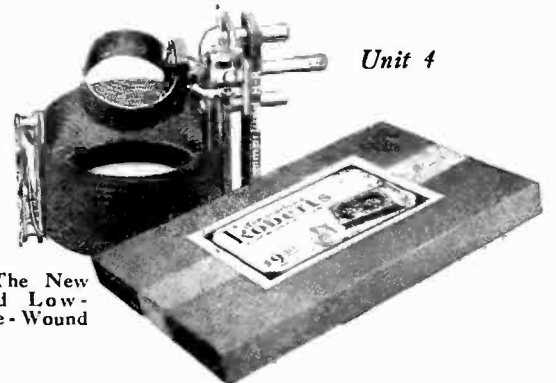

The Foundation Unit contains all special parts needed to build the Hammarlund-Roberts Receiver, including drilled and engraved panels, brackets, wire, screws, etc.

RADIO 'RITHMETIC



© 1926,
W. E. & M. Co.

How to Prove this Result

Complete your set with a Rectigon! Keep your batteries so full of life that every turn is a tune, every adjustment of the delicate knobs a means of furthering your radio joys.

It's a simple thing with a Rectigon. Just snap the leads into place and your "A" and "B" batteries—also your automobile bat-

tery—will surprise you with their old-time pep.

There's no muss or fuss with a Rectigon. No acids or chemicals. No moving parts and no noise. It's a handsome, bright, maroon-enameled helper that will get the best out of your radio—and continue to do so.

No storage-battery radio is complete without a Rectigon.

WESTINGHOUSE ELECTRIC & MANUFACTURING COMPANY

SOUTH BEND, INDIANA

Westinghouse manufactures, also, a complete line of Micarta radio panels, Micarta tubes and instruments.

The **Westinghouse** ★
Rectigon Battery Charger

★ Tested and approved by RADIO BROADCAST ★

www.americanradiohistory.com

MICARTA & KDKA

REG. U. S. PAT. OFF.

Big Names in Radio

Building your own set? Take a tip from KDKA and use Micarta panels. Build right.

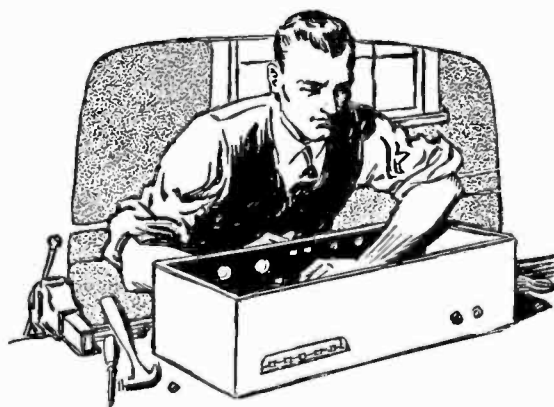

Won't dull, fade or wear off.

Very strong and rigid. Easily and neatly drilled, too, with no worries

Match your set with mahogany, black, walnut grain or burl, all the popular effects with beautiful gloss surfaces.

about chipping, cracking or breaking out. Be particular; Micarta is worth asking for by name.

WESTINGHOUSE ELECTRIC & MANUFACTURING COMPANY

Offices in Principal Cities—Representatives Everywhere

Tune in sometime with KDKA—KYW—WBZ—KFKX

Westinghouse manufactures, also, a complete line of Micarta tubing, instruments, and Rectigon Battery Chargers



PAUL GOLDSTEIN & CO., Inc.
54-56 Franklin Street
New York, N. Y.

[Fabricators of Micarta
for the Radio Trade]

CALVERT SPECIALTY CO.
141 North 11th Street
Philadelphia, Pa.

Westinghouse



© 1926, W. E. & M. Co.

★ Tested and approved by RADIO BROADCAST ★

www.americanradiohistory.com

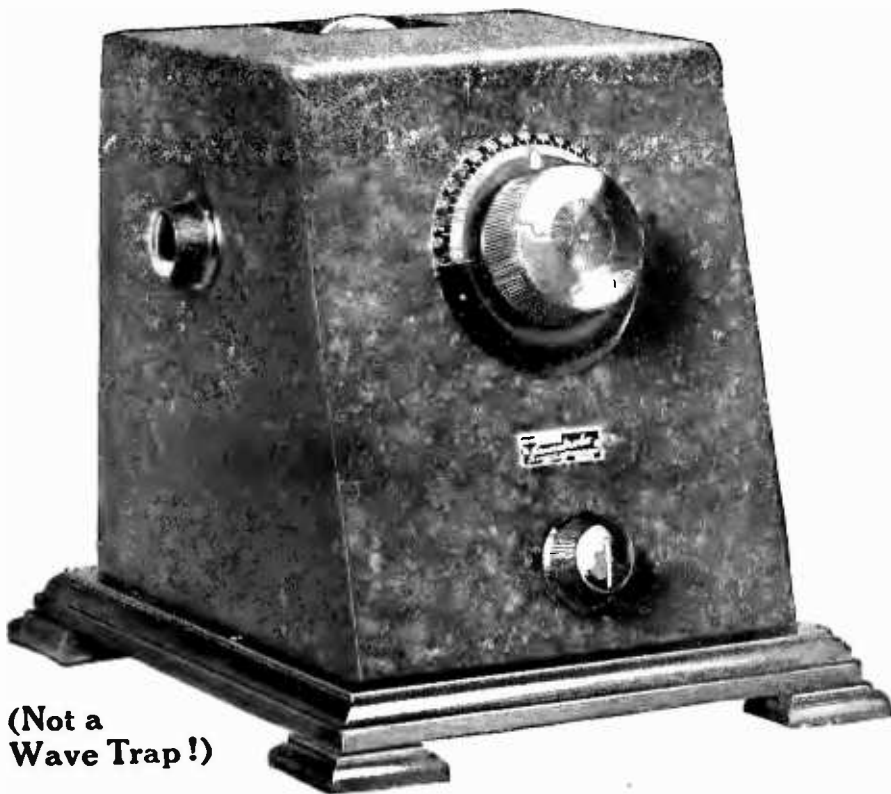

(Not a Wave Trap!)

It *IS* true!

188 times the energy... and there is absolutely nothing else at all like

P E N E T R O L A

Without Penetrola the signal intensity of WOAI was 11, on the Audibility Meter—an impartial precision measuring device. With Penetrola the signal intensity of WOAI jumped above 2000—188 times the signal strength!

Without Penetrola the scientifically measured signal intensity of WCAL was 35, scrambled with WCBD at 29. With Penetrola WCAL went to 2000+ and WCBD to zero—*selectivity with a vengeance!*

This is just exactly the sort of thing any Penetrola demonstration will show you on any set with any number or arrangement of stages. The wanted station is immensely intensified; interference is overwhelmed by Penetrola. There is so much volume available for the most distant signals that a shorter aerial may be used, curing excess static. Your set is stopped from radiating, and is stabilized. It is needless to operate near the oscillation point. And dial readings stay substantially the same.

Radio principles known to be of immense promise, but hitherto elusive, are now successfully applied by Walbert Penetrola. The widely heralded Isofarad Circuit, latest development of Walbert engineers, is the foundation of Penetrola performance. Here is one radio appliance literally unduplicated in any way by anybody, because there is no other Isofarad circuit. Nor is there any substitute for Penetrola action, which amplifies *ahead* of the detector entirely, strengthening signals which would otherwise never be detected! Remember, signals too weak to detect cannot be amplified by any means placed *beyond* the detector.

In a few moments any receiver, however costly, can be transformed with Penetrola. Or anyone can quickly assemble the Penetrola kit and obtain amazing Penetrola results most economically. The Penetrola price buys performance which cannot be obtained with any amount of investment in a receiver alone.

1st
Walbert
Made It
FIRST

For the sensation of the European tests note Penetrola Reception!

Penetrola in beautiful Black Crystallite, \$35
for Instant Attachment

Penetrola Kit with Complete, Simple \$15
Instructions



If your dealer is not stocked, remit purchase price direct to factory and you will be promptly supplied. State whether you wish Penetrola for outdoor aerial or for loop receiver.

W A L B E R T

Manufacturing Company, 923 Wrightwood Avenue, Chicago

★ Tested and approved by RADIO BROADCAST ★

RADIO BROADCAST

ARTHUR H. LYNCH, Editor
 WILLIS K. WING, Associate Editor
 JOHN B. BRENNAN, Technical Editor

FEBRUARY, 1926
 Vol. VIII, No. 4

CONTENTS

Cover Design	From a Painting by Fred J. Edgars	
The Hamilton Rice Expedition	Frontispiece	426
Radio: The Jungleman's Newspaper	John W. Swanson	427
The March of Radio	J. H. Morecroft	431
Design of Radio Inductances	W. W. Harper	436
How to Build a Grimes Inverse Duplex	Florian J. Fox	439
Prize Contest Announcement		444
The Listener's Point of View	John Wallace	445
"Radio Broadcast's" Universal Receiver		450
"How Long Will My B Batteries Last?"	George C. Furness	452
How to Use Vacuum Tubes	Keith Henney	456
The 1926 International Radio Broadcasting Tests	Willis K. Wing	462
"Radio Broadcast's" Booklet of Foreign Broadcasting Stations	Lawrence W. Corbett	465
As the Broadcaster Sees It	Carl Dreher	467
Wavelength-Frequency Conversion	Homer S. Davis	471
Wavelength-Frequency Chart		472
The Grid—Questions and Answers		482
An Explanation of Tuning How to Obtain Better Regeneration Protecting the Loud Speaker C Batteries in the Detector Circuit		
"Now, I Have Found"		488
Quarterly Prize Award Announcement Using a Voltmeter as a Milliammeter Coil Design Data A Simple Long-Wave Receiver A Good Audio Amplifier Improving the Volume of the Two-Tube Roberts Winding Spider Web Coils		
What Constitutes a Radio Patent?	Leo T. Parker	494
A Key to Recent Radio Articles	E. G. Shalkhauser	504
Book Review		514
"ECONOMICS OF THE RADIO INDUSTRY"		
What Our Readers Write		518

BEHIND EDITORIAL SCENES

PROBABLY one of the most interesting numbers of RADIO BROADCAST presented to our readers in a long time is this February magazine. To start it off, Mr. John W. Swanson, who is now a radio inspector for the Department of Commerce, with headquarters at Norfolk, Virginia, tells of the unusual experiences he and his comrades had on their trip to the headwaters of the Amazon and shows how short waves saved the day. Mr. W. W. Harper, who wrote "Design of Radio Inductances" on page 436, is a consulting radio engineer in Chicago who has practically lived with coils in his laboratory for the past year. His conclusions should excite considerable comment and, in addition, prove very valuable to every home constructor. Florian J. Fox, who prepared the very complete constructional article on the four-tube model of the Grimes Inverse Duplex Receiver, is chief engineer of the Grimes Radio Engineering Company. The reader will notice that on page 441 appears a complete chart of the set being described. The same terse description was applied to the short wave transmitter in the January magazine. It would interest us to know whether readers like this feature well enough for us to continue it. Write us and let us know.

THE \$500 prize contest for the design of a non-radiating short-wave receiver indicates one of the most unusual steps taken in the short-wave communication field. Amateur experimenters have already shown that they will try hard to meet the challenge to their ability. The four receivers shown on pages 450 and 451 follow those models of the "Radio Broadcast Universal Receiver," so completely described in this magazine for January. The Universal has jumped into more than immediate popularity, not merely because RADIO BROADCAST and others say it is good—that, by the way is certain, for it was developed in our own laboratories—but chiefly because others have found it to be good. Mr. Henney's article on how to use vacuum tubes on page 456, lives up, we are certain, to all the promises made for it in this space last month. The transmitting schedule for all stations in the International Tests during the week of January 24th will be found on page 463, together with all late information on the Tests in the article which accompanies it.

ERRORS, when they occur, should be corrected and not glossed over. In Roland F. Beers's article, "An Improved Plate Current Supply Unit" in our December number, it was stated on page 190 that "one lug of the single-pole double-throw switch goes to the full secondary terminal at 1250 turns." The phrase should read "primary" for "secondary." The proper placement of the tap and its circuit connections are evident from the wiring layout and circuit diagram accompanying the article.

NEXT month we expect to print details of the design of a very interesting receiver, from the pen of a well known radio man, whose talents entitle him to be mentioned in the same breath as Dr. Walter Roberts. The third of the "Home Radio Laboratory" articles, prepared by Keith Henney, will appear in March also. This should please many constructors who have reached the "end of their string" and who have shown such great interest in the possibilities opened up by these articles. Mr. J. C. Jensen, who has spent much time in research on the subject, will have a fascinating and stimulating article on how radio reception can be calculated from known weather conditions. It is worth waiting for.—W. K. W.

Doubleday, Page & Co.
 MAGAZINES

COUNTRY LIFE
 WORLD'S WORK
 GARDEN & HOME BUILDER
 RADIO BROADCAST
 SHORT STORIES
 EDUCATIONAL REVIEW
 LE PETIT JOURNAL
 EL ECO
 THE FRONTIER
 WEST

Doubleday, Page & Co.
 BOOK SHOPS

NEW YORK: LORD & TAYLOR BOOK SHOP
 PENNSYLVANIA TERMINAL (2 Shops)
 38 WALL ST. AND 166 WEST 32ND ST.
 GRAND CENTRAL TERMINAL
 ST. LOUIS: 223 NORTH 8TH STREET
 4914 MARYLAND AVENUE
 KANSAS CITY: 920 GRAND AVENUE
 306 WEST 47TH STREET
 TOLEDO: LASALLE & KOCH
 CLEVELAND: HIGBEE CO.
 SPRINGFIELD, MASS.: MEEKINS, PACKARD & WHEAT

Doubleday, Page & Co.
 OFFICES

GARDEN CITY, N. Y.
 NEW YORK: 120 WEST 32ND STREET
 BOSTON: PARK SQUARE BUILDING
 CHICAGO: PEOPLES GAS BUILDING
 SANTA BARBARA, CAL.
 LONDON: WM. HEINEMANN LTD.
 TORONTO: OXFORD UNIVERSITY PRESS

Doubleday, Page & Co.
 OFFICERS

F. N. DOUBLEDAY, President
 A. W. PAGE, Vice-President
 NELSON DOUBLEDAY, Vice-President
 RUSSELL DOUBLEDAY, Secretary
 S. A. EVERITT, Treasurer
 JOHN J. HESSIAN, Asst. Treasurer

DOUBLEDAY, PAGE & COMPANY, Garden City, New York

Copyright, 1926, in the United States, Newfoundland, Great Britain, Canada, and other countries by Doubleday, Page & Company. All rights reserved.
 TERMS: \$4.00 a year; single copies 35 cents.

give your radio set more power with one new Radiotron



Drive a car uphill beyond its power—and the motor knocks. Drive a radio set beyond its power—and the last tube chokes. But change one single tube in the set—and you have the power you need for *greater volume and finer tone.*

The new RCA power tubes add about fifty per cent greater efficiency to any radio set. They cost but \$2.50, and need only an inexpensive adapter and a little extra current. Change the tube of the last audio stage to a new power tube, as any dealer will show you—and in ten minutes you have a new set.

RADIOTRON
UX-112
\$6.50

RADIOTRON UX-112
The new storage battery power Radiotron UX-112 may be used in sets that use Radiotron UV-201-A.

RADIOTRON UX-120
The new dry battery power Radiotron UX-120 may be used in sets that use Radiotron UV-199.



RADIOTRON
UX-120
\$2.50

You would not use any but a Mazda lamp in your lighting circuit. Why use any but an RCA Radiotron in your radio set? They are made by the same skilled workers, backed by the same research laboratories. But the Radiotron is far more delicate to make.

RADIO CORPORATION OF AMERICA — NEW YORK · CHICAGO · SAN FRANCISCO

★
RCA Radiotron

MADE BY THE MAKERS OF RADIOLAS

★ Tested and approved by RADIO BROADCAST ★

KARAS Parts Are Intended Only for the Few Who Demand Finest Quality and Workmanship

IT takes many manufacturers to supply the tremendous demand for condensers and transformers in this vast radio market of ours. If all home set builders were ready to pay the price which *real* quality commands, a big proportion of them would necessarily be disappointed—the Karas factory could not begin to take care of all. Karas parts are designed and built for the select few—you builders who want the utmost in quality, in quiet operation, in appearance. You who take pride in your workmanship—whose sets have that “professional” appearance which is the envy of all your radio friends.

Just as water quickly finds its level, so did Karas Harmonik Transformers and Orthometric Condensers quickly find the exclusive market for which they were intended.

The most skillful radio set builders the country over, discovered Karas Harmonik Transformers soon after they were placed on the market in 1924. When Karas Orthometric Condensers appeared a year later they were snapped up far too quickly for our own comfort. Perhaps it was because they were the first to meet the demand for a Straight Frequency Line tuning instrument. More likely it was because of the

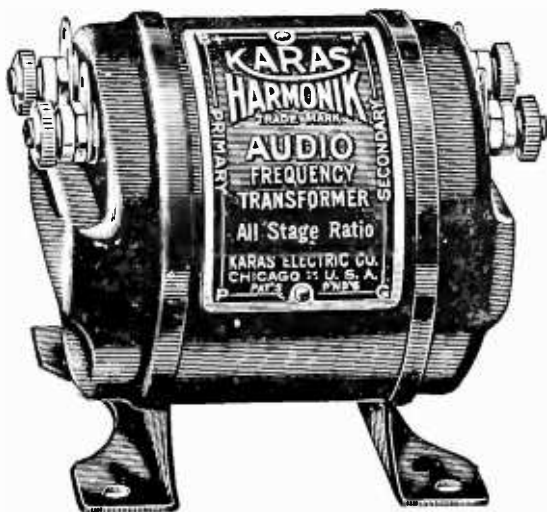

THE KARAS HARMONIK "ALL-STAGE" RATIO AUDIO FREQUENCY TRANSFORMER

Price \$7 each. Shipped direct where dealers cannot supply, cost plus a few cents postage paid to postman on receipt. Parcel post is prepaid where payment accompanies order. Our 30-day Money Back Guarantee applies, wherever and however purchased.

enviable reputation created the year before by Karas Harmonik Transformers. At any rate, it was months before we could fully supply the insistent, clamorous demand that came to us from all sides.

We begin to think now that the number of set builders who want the very "Best that Money Can

"How Many Jewels?"

The Question was not asked about a watch. It was a Karas Orthometric Condenser the man held in his hand. He was an enthusiastic radio man of Columbus. He had just been shown a Karas Orthometric Condenser for the first time.

He was speaking humorously, no doubt. But his reaction was only that which any admirer of fine workmanship cannot help but have when he first sees this masterpiece of radio instruments.

Buy" is far greater than we first imagined. Our production has been greatly increased to provide for the growing numbers who demand Karas parts and will accept nothing else.

In many places, good dealers who wanted a stock of Karas products could not be supplied. If *you* are still unable to find them in your local stores, tell your dealer that we are now able to take care of his requirements. Or, if you wish to get Karas parts in the quickest possible time, we will be glad to send them to you direct.

However you buy Karas Harmonik Transformers or Orthometric Condensers, you do not run the least risk of their not performing up to your highest expectations. If there is the slightest cause for disappointment during a thirty days' test, you are invited to return the parts to the dealer from whom you bought them, or to us if you buy direct. Your money will be promptly refunded without question or quibble.

23 plate, .0005 Mfd., \$7.00
17 plate, .00037 Mfd., 6.75
11 plate, .00025 Mfd., 6.50
5 plate, .0000972 Mfd., 6.50

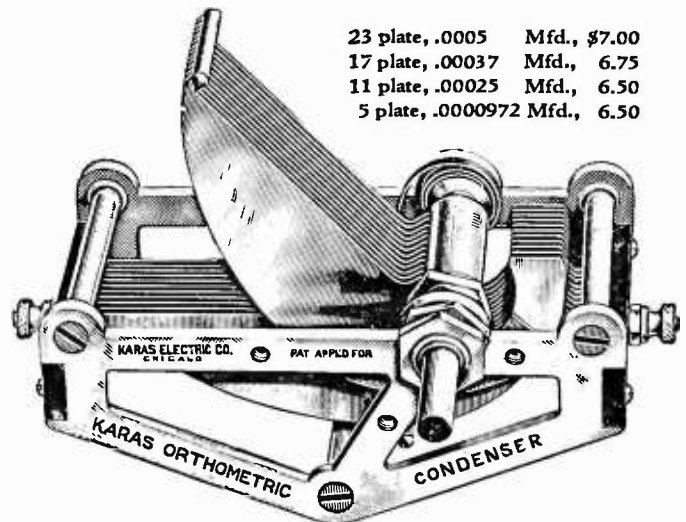

THE KARAS ORTHOMETRIC (STRAIGHT FREQUENCY LINE) CONDENSER

Prices and sizes above. Shipped direct where dealers cannot supply. No money in advance. Pay the postman price plus a few cents postage. Or send cash with order and we prepay parcel post. 30-day Money Back Guarantee.

Karas radio parts are the pride of an organization that has been making precision electrical apparatus for more than thirty years. We believe we are making the finest transformers and condensers possible to produce and we are glad to back them up with this, the strongest guarantee we know how to write.

KARAS ELECTRIC COMPANY
4042 NORTH ROCKWELL ST. CHICAGO

"Counterphase Six"

The only new circuit in radio this year

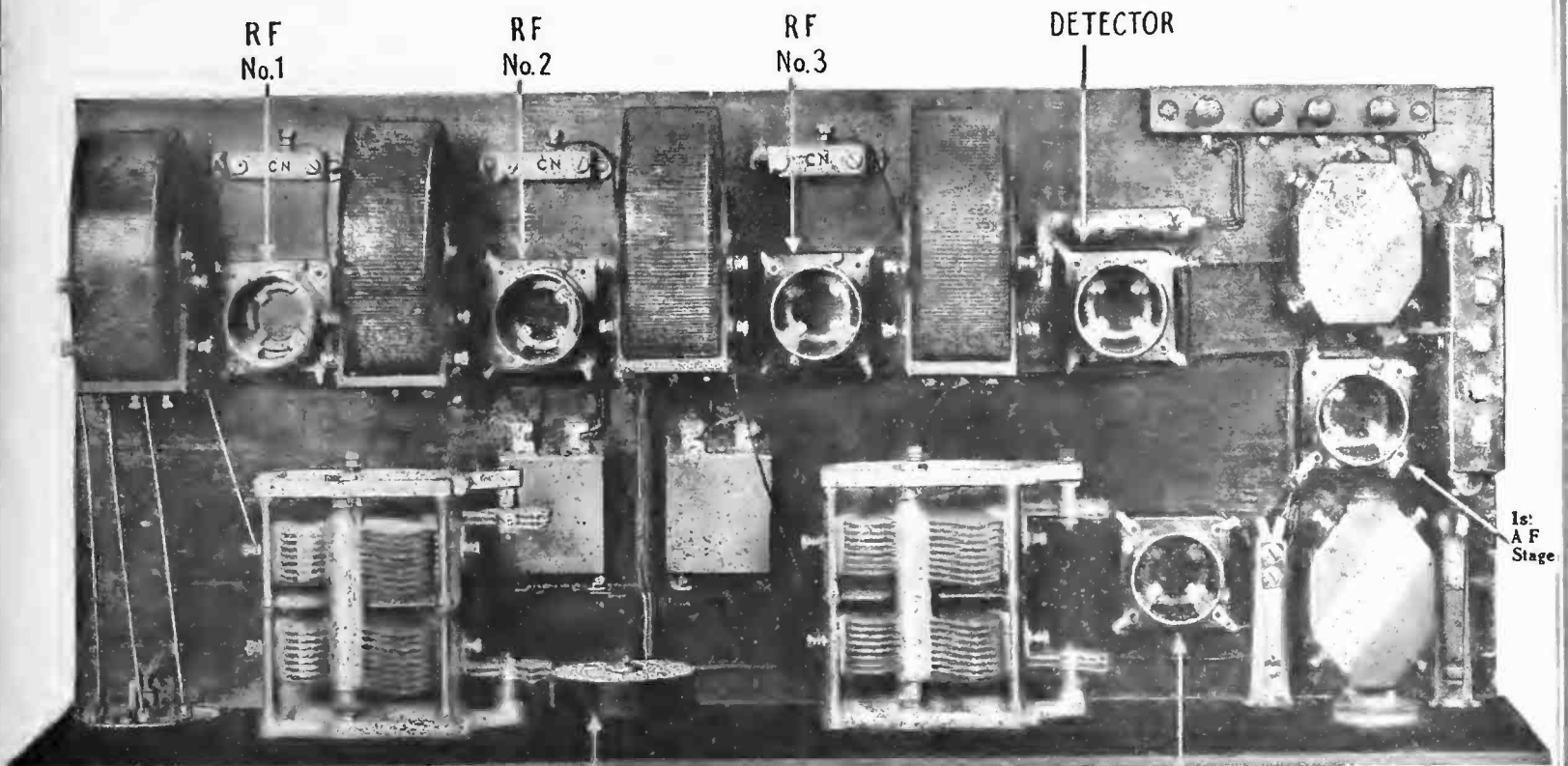

DUAL
RESISTANCE

2ND
AF
STAGE

RADIO BROADCAST Photograph

A base-board layout of the Bremer-Tully "Counterphase" receiver. The rectangular blocks shown above the tube sockets and between the toroidal coils are the condensers, by means of which the tubes may be adjusted to the correct oscillating point. Note also the extra midget or trimming condensers, which are a part of the large tandem tuning condensers

THE NEW BREMER-TULLY PATENTED CIRCUIT

as described in January Radio Broadcast, and as built from Bremer-Tully Kit

Advanced Design

The "Counterphase Six" is primarily a Radio Receiver of advanced design rather than merely a decorative piece of furniture housing just another circuit of mediocre parts. The "Counterphase" represents the engineering talent and genius of the Bremer-Tully Organization which has built for itself a national, if not a world-wide, reputation for quality products and sound sense.

The "Counterphase" is a scientific balancing of synchronized parts. In the "Counterphase" you will find a set of parts superior in quality, better in construction, and higher in production costs than any other kit or complete receiver made to-day, regardless of selling price.

The "Counterphase" developments include a special form of radio transformer which accomplishes two distinct improvements of great value.

The first is the use of a *third radio frequency* tube. Most six tube sets have the sixth tube in the output or audio end which in our opinion is wrong. Using three stages of radio frequency secures maximum results without using the long and cumbersome antenna or unsightly loop.

Simplified Tuning

The second very marked advantage is efficient tuning with but

two controls. It is our strong conviction that two controls are the correct and proper tuning control method.

Bearing in mind the fact that all B-T products are designed to give first of all permanent satisfaction, has led us to this conviction.

The Greatest Feature of All

The most general weakness of radio frequency circuits is violent oscillation, which, if any of the usual means of stopping such action are employed, will not respond reasonably except on certain stations. The patented B-T means of controlling this, heretofore characteristic weakness, provide the means to you of securing maximum efficiency on both high and low wave lengths.

To the operator, this method of control is simplicity itself. This sensitivity and volume and control are one. It is possible to tax on loud speaker by this one control or to reduce your reception to a point where even local stations cannot be heard.

Distance Getter

Distance getting ability is the measure of any receiver's efficiency. The "Counterphase" recognizes no equal in this respect. It is the most practical, selective, and generally efficient receiver made.

"PIONEERS OF BETTER TUNING"

Bremer-Tully Manufacturing Co.

532 South Canal St.

Chicago, Ill.



The B-T Parts for the "Counterphase Six"

B-T Tandem Condenser

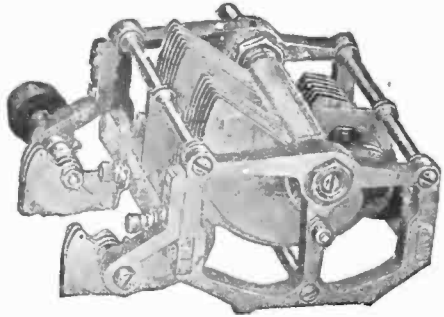

has all the efficiency and finish of design that characterizes the "Lifetime" Condenser plus the added advantage of a dual control from a single dial. A shielding plate, furthermore, prevents interference between the stators. Small trimming condensers fastened securely to the frame provide a close balance between the units. The effectiveness of this is easily determined by comparing results with some of the more unique arrangements. (L.D.—17 (Capacity each unit .00035) 17 plate 9.50)

B-T Torostyle Transformer

for easy wiring

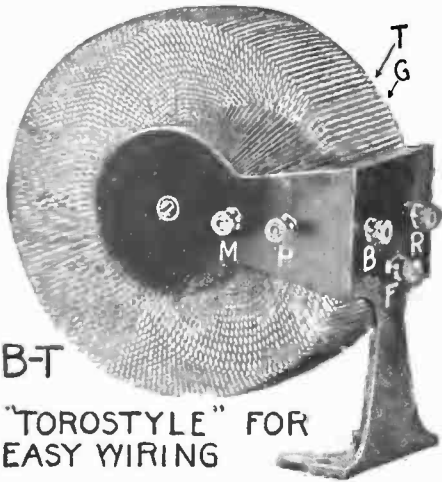

B-T
"TOROSTYLE" FOR
EASY WIRING

The principle of "toroid" or "closed" field inductances has been used by telephone engineers for years. But the adoption of this distinct telephone feature to radio frequencies is a very real triumph. Every conceivable difficulty confronted the B-T laboratories in their original work on this elusive subject. So many obstacles were experienced that seemed almost unsurmountable. Gradually, these were overcome until a coil that could measure up to B-T standards was finally produced. This took, however, over two years of intensive research and unremitting effort. The B-T Torostyle Transformer reduces local pick-up to a negligible minimum and inter-magnetic-coupling and stray feed backs are eliminated. In three styles, T.A. Antenna Coupler, T.C. Intermediate, T4 for one stage radio, \$4.00 each.

B-T Mikro-Mike Condenser

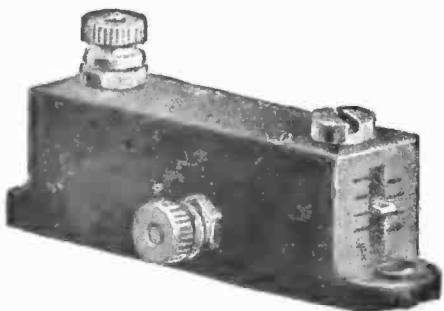

gives accurate permanent adjustment with uniform change in capacity over complete range from 1/2 to 30 M.M.F. The indicator shows relative adjustment. The Mikro-Mike straight Line Capacity Condenser is used in the B-T patented circuit or wherever a highly accurate capacity capable of fine adjustment is needed. Type M.M. Condenser, \$0.90.

B-T "Euphonic"

"Pleasing to the Ear"

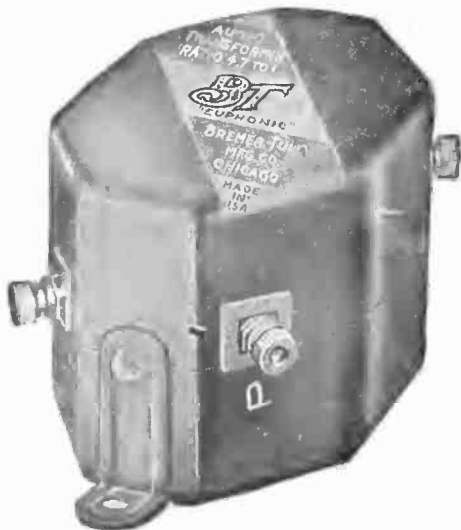

The Euphonic is a scientifically designed and practical transformer that is not oversize in iron. But it has been greatly increased in both the primary and secondary by the utilization of the much more expensive element than iron—copper.

Besides being an audio amplification unit of the customary B-T merit, the inherent design of the Euphonic eliminates all possibility of *crossed wires* (cause of distortion and howling). This is accomplished with the Euphonic by ingeniously constructing its legs so that they are movable. The Euphonic can be built into any circuit so that its wires will not be crossed.

The legs snap easily into place in either position. This permits mounting the Euphonic *upwards*, above or below the panel.

- Type 210 Ratio 2.2 to 1.....\$5.00
- Type 410 Ratio 4.7 to 1..... 5.75

This is what they say:

Chicago.

"November 9th, outside of the usual run of distant stations the following were picked up from Chicago Heights: Miami Beach, New Orleans, New York, Denver, Springfield, and FOUR DIFFERENT STATIONS IN CALIFORNIA.

C. B. M.

Cincinnati.

"Summarizing tests on Counterphase Set I can safely say it has more volume, greater selectivity, greater sensitivity and produces higher quality of reproduction than any receiving set I have ever heard."

A. C. H.

Kansas City.

"The Counterphase is in every particular by far the most efficient receiving set that I have owned or heard in operation. One stage of audio is quite sufficient for ample loud speaker reception in five rooms of all class B stations in the U. S., and many class A."

J. E. M.

The B-T Counterphase Kit

Kit for building "Counterphase" Six, includes two B-T Type LD-17 Tandem Condensers, one TA, B-T Torostyle, three TC Torostyle Transformers, three Mikro-Mike neutralizing condensers, one B-T Dual Resistance, blue prints and instructions and easy wiring cable. Price ..\$38.00 Total cost of parts purchased separately ..\$42.45

Kit for building "Counterphase" Five, contains one B-T Type L-17 Condenser, One B-T Type LD-17 Tandem Condenser, One TA Torostyle, two TC Torostyle Transformers, two B-T Mikro-Mike Condensers, One B-T Dual Resistance, easy wiring cable and blue prints and instructions. Price, \$28.50 Total cost of parts purchased separately ..\$32.80

Hundreds of thousands have read it. Write to-day for your copy of "Better Tuning."

"PIONEERS OF BETTER TUNING"

Bremer-Tully Manufacturing Co.

532 South Canal St.

Chicago, Ill.



For the "Counterphase Six" A Cabinet of

Character

Sound
Construction

Lasting
Beauty

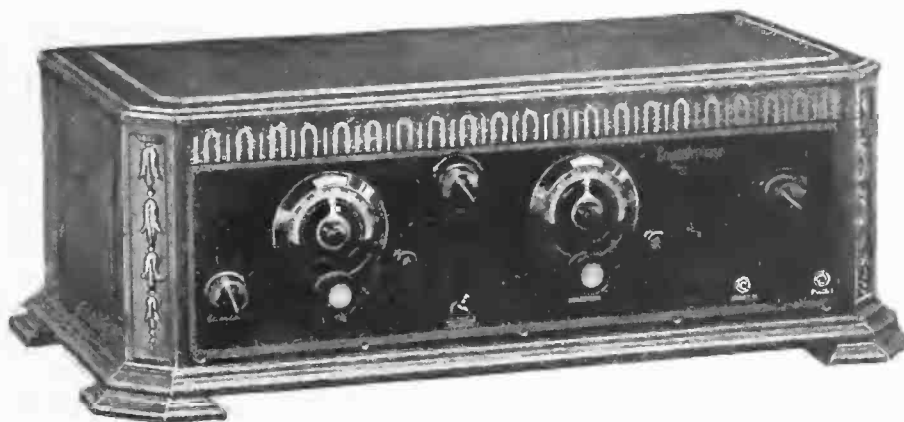

Solid
Walnut

Varnished—
Water-rubbed

Italian
Chest type

A FINE CABINET for a FINE RECEIVER

THE Fritts Super cabinet provides a highly appropriate housing for the B-T "Counterphase Six." The dignity and quality setting that this excellent receiver deserves, is properly supplied in the Fritts Cabinet.

This Cabinet is of sturdy four post construction, Italian Chest type in motif, and in SOLID WALNUT. The finish is the best known to quality furniture manufacturers; i.e., varnished and water-rubbed.

The Fritts Super cabinet is very attractive and is a beautiful addition to

any setting, one that will last indefinitely. Ordinary usage will not affect its stunning appearance.

Its inherent character of design and craftsmanship warrants the attention of those who understand first quality.

A stained baseboard of correct dimensions (23 1/2" x 10") for the Counterphase is supplied with each Cabinet.

PRICED at \$24.00.

D. H. FRITTS & CO.

R-621 Hearst Square

★
Chicago, Ill.

For Utmost Efficiency Equip Your B-T Counterphase-Six with a CROWE METAL PANEL

The Crowe metal panel obviates the necessity of separate metal shielding of panel—eliminates "body capacity"—aids in the elimination of inductive disturbances—insures maximum selectivity under the most trying conditions. Crowe panels used in conjunction with metal shield illustrated below provide complete metal shielding.

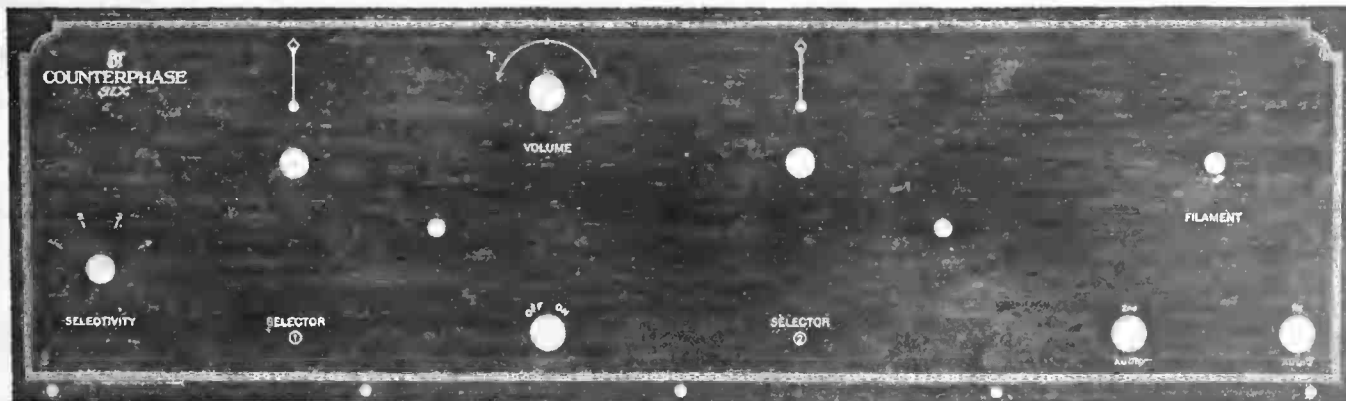

Crowe Panel for B-T Counterphase-Six, Size 7 x 24, Accurately Pierced, Ready for Use.
(Packed in Individual Containers, with Insulation and Directions)

Crowe Metal Panels and Shields For Sale by Leading Dealers

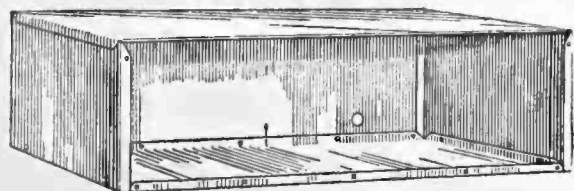

★ **CROWE METAL SHIELD**
for B-T Counterphase-Six



Write for instructive folder, explaining why your receiving set should be paneled with a Crowe metal panel.

C R O W E
NAME PLATE & MFG. CO.

1749 Grace Street

CHICAGO

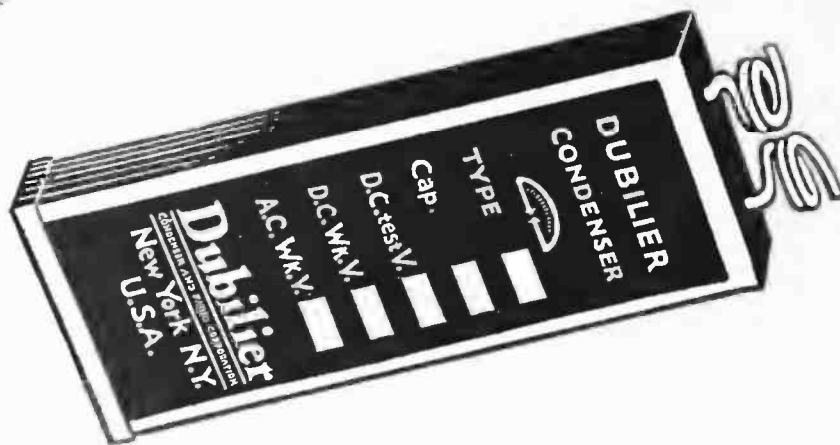

Be sure to use the right condenser for the job

IF you are building a "B" battery eliminator, be sure to use the right type of condenser in the filter circuits. The usual type of "By-Pass" condenser is not designed for the high voltages required.

Dubilier Filter Condensers are especially designed for use in the filter circuits of "B" battery eliminators. Their working voltage is very conservatively specified. That is why they give a permanent life of efficient service at voltages up to their maximum working ratings.

Remember that, *with no load*, the D.C. voltage impressed on the condenser in your filter circuit is 1.4 times the secondary terminal voltage of the A.C. transformer.

Use the right condenser for the job—made by the pioneer manufacturer of radio condensers. ★

Dubilier

CONDENSER AND RADIO CORPORATION

AMERTRAN

TRADE MARK REG. U.S. PAT. OFF.

DeLuxe

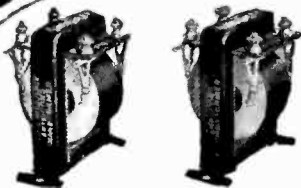
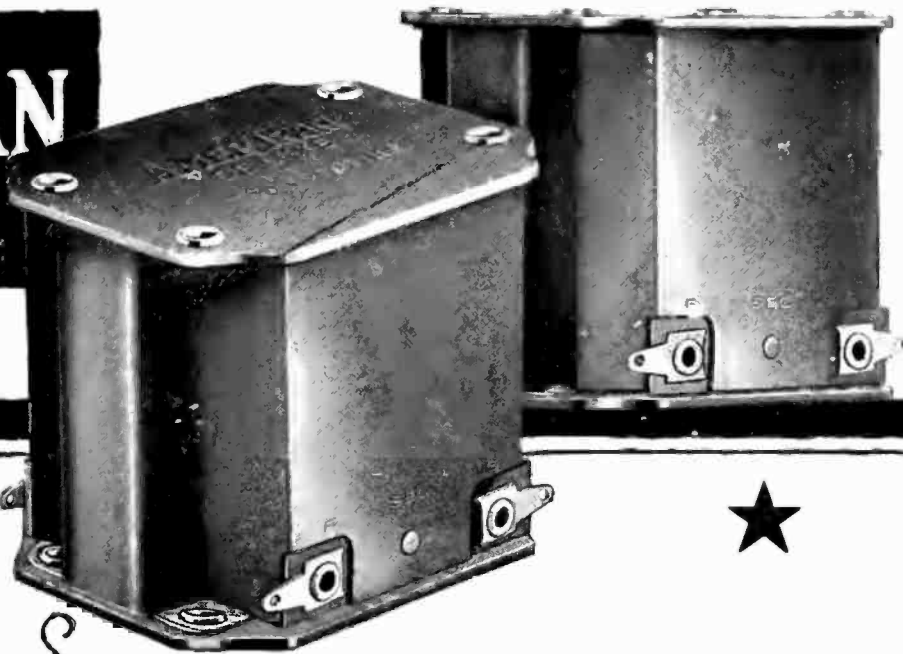

AMERTRAN
Types AF-7 and AF-6

AmerTran audio transformers Types AF-7 and AF-6 have been considered for years among the leaders in audio amplification. These popular and efficient models may now be purchased at a considerable saving in cost. Types AF-7 (ratio 3½:1)—AF-6 (ratio 5:1) . . . \$5.00 each



The
AMERTRAN Power Transformer

Type PF-45, 65 Va-60 cycles 110 volts primary, 450-8/4-8/4 secondary

Type PF-45 is intended for use on the standard 110 volt, 60 cycle house lighting circuit. It has three separate well-insulated secondary windings. These are enclosed in a strong metal case provided with mounting feet. The secondary leads are standard code flexible wires left long enough to reach the terminals in the average set without splicing. This transformer is well suited for supplying AC power for filter circuits, and is designed with the usual margin of safety . . . \$15.00 each

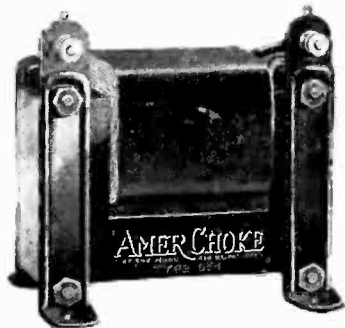

The New **AMERCHOKE**
Type 854

Type 854 is a scientifically designed impedance or choke coil of general utility, designed primarily for use in filter circuits. As an output impedance for by-passing direct current from the loudspeaker it is just as efficient and more economical than an output transformer. When used with a 1 mfd. (or greater) fixed condenser, the tone quality equals that of the best output transformer. DC saturation is prevented by two adjustable butt joints in the core. \$6.00 each



A New Standard of Excellence in Audio Amplification

THIS new audio transformer has been developed for those who are satisfied only with the utmost in quality. It possesses an unusually straight line frequency characteristic extending the range below the lowest note now being broadcast, and actually shows a gain of about three octaves below that previously obtained.

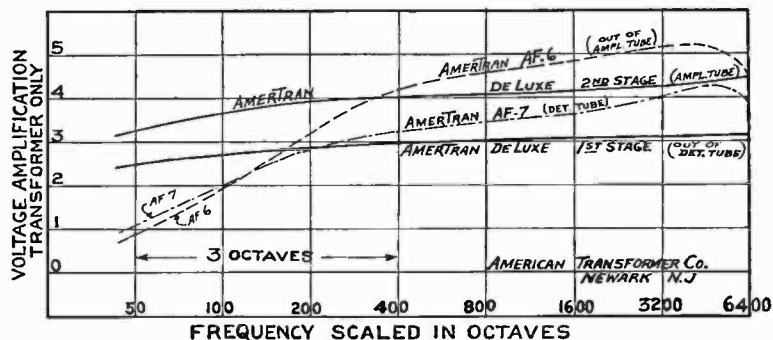

The AmerTran De Luxe is a transformer of moderate size and weight, enclosed in a strong metal case with mounting holes at both top and bottom so that it may be inverted, affording simplified connections. While the AmerTran De Luxe will improve any set, appreciation of its uniform amplifying qualities can best be realized when operated in conjunction with straight line frequency loudspeakers, such as the best cone and disc types, and with a tube in the last stage capable of handling the output.

The AmerTran De Luxe is made in two types, one for the first stage and one for the second stage, and plainly marked as such. The chief difference between these two types is that the first stage transformer has approximately 50% greater primary inductance than the second stage transformer, thus more nearly corresponding to the operating impedances of the tubes out of which they work. For this reason it is advisable to purchase and operate these transformers by the pair!

PRICE, EITHER TYPE, \$10.00

Write for descriptive booklet on AMERTRAN Radio Products

American Transformer Company

178 Emmet Street, Newark, N. J.

"Transformer builders for over twenty-four years"

**SOLD ONLY AT
AUTHORIZED AMERTRAN DEALERS**



RADIO AND THE HAMILTON RICE EXPEDITION TO BRAZIL

The country conquered by men, flying machines, and radio. The large photograph, taken in the expedition's advance airplane piloted by Walter Hinton, was made by Captain Albert W. Stevens of the United States Army Air Service whose photographs are world renowned. The expedition proceeded up the Rio Negro 500 miles from Manaus, Brazil. Manaus is 1500 miles from the ocean, and the base of the explorers was set up at Boa Vista. The Rio Negro at the point photographed is about three and a half miles wide and appears a veritable archipelago of curious shaped islands. The photograph above shows the short wave transmitter and receiver used to maintain communication with the outside world. The natives, after they gained courage enough to wear the phones, showed little surprise at the "white man's magic" when they heard the short wave broadcast signals from KDKA and WGY through the head set

RADIO BROADCAST

VOLUME VIII



NUMBER 4

FEBRUARY, 1926

Radio: The Jungleman's Newspaper

How the Rice Expedition in the Jungle Maintained Communication with the Outside World
—A Triumph of Short Waves and Low Power When Long Waves and Higher Power Failed

By JOHN W. SWANSON

Chief Radio Operator of the Expedition

NOT so many months ago the public was thrilled to read in its morning newspapers an account relating how radio amateurs all over this and other countries had established two-way communication with the Rice exploration party, then in South America. Receiving apparatus only had been carried on the two previous expeditions, which was used for reception of time signals, necessary in accurate topographical surveying, and of press dispatches, which were, to the members of the expeditions, what the London *Times* is to King George's subjects. Radio's capable handling of these assignments led Dr. A. Hamilton Rice, vice-president of the American Geographical Society, when his third expedition was being organized at New York, to allot a more important task to the writer, who had been radio operator on the preceding Brazilian ventures.

Where radio had been acting the part of a listener, a masculine part, if you please, it was to be given a tongue on the third expedition and, now cast in a feminine rôle, was, if its abilities were not overestimated, to keep the advance exploration party in touch with the base party, and the base party, through stations of the Brazilian government, on speaking terms with the rest of the world. It must be admitted that this mission assigned by Doctor Rice was regarded with a certain amount of doubt and misgivings on the part of the radio personnel. The advance party, in the

first place, could only carry featherweight apparatus and an insufficient source of power supply, while the erection of efficient antennas would present a big problem. The interior of South America, experience had taught, bred static as it did fever, while venomous insects and rank vegetation were not the least of their troubles.

How far radio's performance exceeded expectations; how "it might" became "it did," is a tale which deserves a paragraph or two in the history of short-wave communication. Called on to bridge one hundred—two hundred miles of jungle, the Rice Expedition's transmitters night after night, months on end, laughed at the 3000-odd miles of space between upper Brazil and the United States. Naked, half-savage Indians were the explorers' neighbors while the operators whispered into the ears of amateur radio men over half the civilized world.

To the American amateur is due a large share of the credit of the success of the Rice Expedition's employment of radio in the Amazon valley. Playing for love of the game alone, they handled the cards as if the stakes were gold and mountain high. Hats off to 2 AG, 2 BR, and 2 CVS, of New York City, 1 COT of Braintree, Massachusetts, 3 ATE—Baltimore, 8 ES—Akron, 5 SK—Fort Worth, and the others! Radio is a game at which one cannot play a lone hand and Thomas S. McCaleb, former inspector for the Independent Wireless Telegraph Company, of New York, was the writer's capable assistant and fellow burden bearer in the tropics.

The expedition's radio history begins at New York City where, previous to taking ship for Para, at the mouth of the Amazon, \$6000 was expended upon a stock of radio material which ran up and down the list from binding posts to generators, fifty-watt tubes to bus bar. Variable condensers are conspicuous by their absence on the store shelves of small Brazilian towns, and no explorer has yet discovered a jungle palm tree which bears milli-volt meters. Once in the jungle there was continual construction and destruction of transmitters and, to some extent, of receivers.

AMERICAN BROADCASTING
HEARD

INITIAL tests of the radio apparatus were made at Manaus, an Amazon town of 5000 inhabitants, 900 miles from the ocean, and the jumping-off place for



LISTENING TO KDKA

From the midst of the jungle. WGY was another short-wave station heard. When the short-wave apparatus was first tried out at Manaus, only three stations were heard. Two of these, curiously enough, were broadcasters, while only a single code station was heard

these who probe the uncharted interior of the great southern continent. Here the expedition's 400-watt transmitter was set up temporarily and put in operation on 200 kc. (1500 meters). With this set the Para station, 850 miles distant, was "raised" without difficulty.

Tests of short-wave receiving equipment at Manaus did little to bolster the confidence of the radio detachment. Nights of dial-twisting and ear-straining brought in but three short-wave stations, two of them broadcasters. Hearing KDKA and WGY with regularity on high frequency was, it is true, a distinct contribution to the expedition's entertainment, but reception of a lone code station—it was 8 XI—was discouraging. The road ahead appeared as dark to the radio men at this stage as the native tobacco they were smoking.

Radio work at Manaus was drawing to a close when a political tidal wave engulfed the town. Making merry in the Hotel Grande on July 23, at a gathering to welcome others of the party who had just come up the river to join their fellows, the radio men were thrust into box seats at a South American revolution.

Zero hour came without warning. From the restaurant windows the explorers were gazing idly, between drinks, at a detachment of olive-skinned soldiers shuffling down the Broadway of Manaus. Troops in movement are so frequently encountered in South America that the military exhibition awakened no interest until the infantrymen halted, took interval quickly, and sent a steel-jacketed shower in the direction of the governor's palace. A bullet in motion is not a desirable neighbor, no matter who fires it. There is small comfort in the knowledge that marksmanship is bad when brick dust begins to fly. There was a great slamming and barring of doors and windows within the Hotel Grande restaurant, and a scramble for safe places behind thick walls as the government of Manaus began to totter.

Soon a panting revolutionary wormed the news through a crack in the hotel door that *right* had triumphed. "Long live the revolution," in its equivalent Portuguese, came between gasps.

Screwing up courage after a time, the Americans filed out upon Rua 28 do Setembro to find all quiet. They stole softly down dark thoroughfares where the arc lights had gone on the casualty list. Carefully they trod to avoid slipping on the blood which, they judged from the wholesale expenditure of powder, must have showered the rough pavements. Their guess was wrong; no blood or dead. Even the martyred donkey, the usual accompaniment to tropical internecine strife, was not encountered. Thousands of brass cartridge shells underfoot and the white flag flying above the governor's palace alone lay in the wave of the revolution. Next morning, commercial Manaus was doing business at the same old stand.

Rebel rule imposed strict surveillance upon foreigners, but the upheaval little

hampered the expedition's work, though it brought an end to radio tests. The interdiction of ether communication at Manaus by the de facto government was followed by a laughable incident, the humor of which registered even upon the officials who called the Americans to account when it was reported to them that antennas had been erected by the explorers on the outskirts of the town.

Without much difficulty, official Manaus was convinced that what had been described as "radio wires" were baited fish lines set to catch turkey buzzards, the blood of which was being analyzed by the medical branch of the party. When the time came to move upriver, an old stern wheel steamer transported the party to Vista Alegre, on the Rio Branco, where the first semi-permanent camp was established. Ascertaining that Vista Alegre was a poor radio location, the two operators put their equipment aboard a batalao (a barge towed by a steam launch), and proceeded further upstream to Boa Vista, which was to be the expedition's base during the time the advance party was in virgin territory.

During the batalao's slow ascent of the river, the radio men slept in filthy quarters, foggy with mosquitoes. McCaleb went down with high fever the day of his arrival at Boa Vista. Two weeks he lay ill at the small mission, attended by the kindly padres, a casualty of the never-ending conflict between man and the insect life of the Brazilian river country.

The anthem of the Amazon valley is the whining, petulant song of the mosquito, chief of a happiness-blighting clan which includes the pium, a smallish black fly with a red-hot snout and others whose names would carry nothing to American readers but whose blood-sucking operations would shame even a radio gyp dealer.

Against these barely visible foes the expedition fought. They were its unwelcome guests at meals, its bedfellows; many a radio message sent by LR, the portable station set up at camps and bivouacs beyond civilization's frontier, was dispatched by operators whose right hand tapped the key and whose left repulsed an insect onslaught.

Larger insect enemies included several species of the ubiquitous ant, whose acquaintance was made at Manaus, and hornets encountered in the jungle. They attacked apparatus as well as operators.

Anti-ant measures became a regular part of radio routine after the short-wave receiver, opened one day for inspection, was found to be full of very live radio bugs. A blow torch, in McCaleb's hands, did for the most of them. Those escaping cremation perished under the huge feet of Chico, native servant of the radio detachment.

Hornets, of a species which build a mud dwelling, took possession of LR one day upriver. The operator found that all crevices in the apparatus had become hornet home-sites. Their mud huts shorted the grid and plate terminals of one transmitter tube and a veritable firework display resulted when the current was turned on.

ESTABLISHING THE BASE STATION

WHILE McCaleb convalesced, the erection of a station at Boa Vista went forward, the main trouble encountered in putting it up being inability to secure timber for masts in a treeless country. Four days' journey from the camp mast material was found, cut and floated. With the help of natives, most of them Indians, three masts went up, eighty, seventy-five, and forty feet high. An antenna for long-wave work was suspended between the two highest; a short-wave antenna was hoisted between the shorter sticks. There was an elaborate ground system for long-wave work and a litzendraht cable counterpoise for the high-frequency set.

There followed six days of calling and listening while static alone caused the head-phone diaphragms to vibrate. Two operators were deep in the dumps, half-sick and nearly played out when a woman's voice floated in on the sixty-meter wave. The song, ironically enough, was "Happy Days." KDKA's short-wave set did a physician's work at Boa Vista that night.

An American amateur, 4 SA, shattered the silence with a readable signal the next night, but failed to respond when called repeatedly. This was a disheartening chapter and the events of the next few days produced more gloom.

McCaleb, sent down the river to join the expedition proper at Vista Alegre, took with him the twenty-five-watt transmitter, hoping to effect communication with the base station WJS at Boa Vista, as the expedition moved along. The attempt failed dismally.

The only silver lining during these days of discouragement was that another American amateur was heard, and WSC, an American coastal station of the Radio Corporation, boomed in. They could not be made to hear us, however. Then things brightened for Manaus, called in vain for days, one morning responded with a snappy "O. K." This was a slice of bacon where a whole side of meat was needed.

The base party having established itself at Boa Vista, and McCaleb in charge of WJS, the advance party early in December set out on the jungle trail, the twenty-five-watt transmitter, under the wing of the writer, accompanying it. Communication between the two parties was established without difficulty after the advance party had made some progress, and radio stock soared. Equipment overlooked when the advance party set out, and needed urgently by the scientists, was ordered dispatched in pursuit from Boa Vista. The portable set was demonstrating its usefulness.

At this juncture, with things going swimmingly, partial failure suddenly loomed in the radio detachment's path. Short waves and the American amateur saved the day.

The rock on which the radio plans threatened to wreck was the heavy tube mortality at WJS. The fifty-watters expired in such numbers that not enough remained to

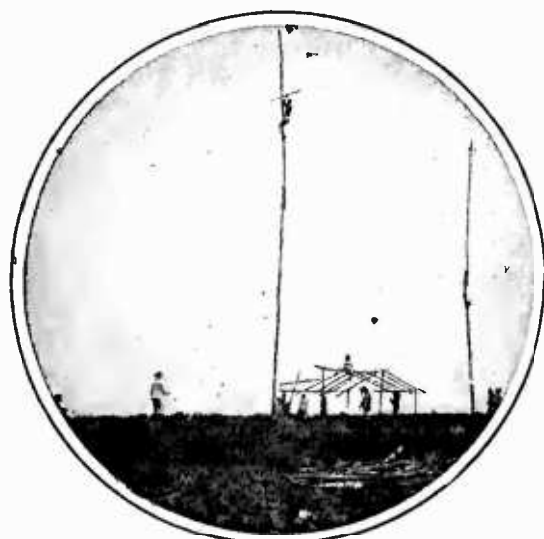

ERECTING WJS'S MASTS

The wood for which had to be brought from a point four day's journey away as no suitable trees were found at Boa Vista

power the long-wave base transmitter. The Boa Vista-Manaos link broke and the expedition's communication with the outside world was disrupted.

Now McCaleb's short-wave experiments bore fruit. During the months since the expedition's sailing, the great amateur migration to the 40-80 meter band had taken place. So, unable to work Manaos which was, as radio distance is measured, but a step away, wjs began shooting Rice Expedition traffic almost daily to American amateurs. First two-way communications was effected with 2 cvs, New York City. This success was followed by the transmission of long and important messages to dozens of other amateurs in the United States, two in England, one at Buenos Aires, and to sj, the United Fruit Company's efficient station at San Jose, Costa Rica.

JUNGLE RADIO ADVENTURE

SOME of the traffic was destined to American points but much of it was addressed to Manaos. Consider what this meant: Manaos was 400 miles from wjs but could not be reached direct during the tube shortage days. A message for Manaos went 3000 miles by ether to the United States, 3000 miles by cable from the United States to Para, then by radio, a matter of nearly 1000 miles, to Manaos. Costly? No end. Subject to delays? Yes, frequently. But the messages, many of them of utmost importance to the party, reached those to whom they were addressed, and that was the object of the game.

The advance party, with its portable set, had now penetrated well into the dense forests it had come to explore and map, its canoe fleet daily engaging the rapids of the turbulent stream, which the Indians who live beside it have appropriately named "The Poison River."

In a clumsy, heavy, spoon-billed craft, more scow than canoe, radio made its fight against the angry river, its guardians being Weld Arnold, jovial topographer of the expedition; an Indian boatman of the region; Antonio, in whose veins ran mixed negro and Indian blood; and the writer.

There were many rapids up which the canoes could be pulled by ropes, but some, more waterfalls than rapids, would stop a salmon's upstream rush. Encountering these, the canoe fleet was forced to portage. This meant heart-breaking labor under an unrelenting sun. It meant more than carrying equipment and canoes on the backs of men to navigable water above the obstruction, because, in order that this could be done, a trail must first be hacked with machetes through the jungle, which came down to the river banks. On a day when the river seemed set to baffle the canoeists, the party gained, with infinite labor, an advance of one-half mile. Camp was made that night within sight of the camp of the night before.

Beau Brummels of the advance party fought the river in B. V. D's and bathing suits.

From day to day the program varied little: During daylight a contest with the river; in late afternoon selection and clearing of a camp site, pitching of fly tents and preparation of the evening meal, which, if the hunters had made a kill, might include a venison steak sweet and juicy enough to tempt an epicure; at night, work by the map-makers, the scientists and the radio man, each with his specialty.

Erection of an antenna was the first step in establishment of radio stations at



LR'S POWER SUPPLY

Which consisted of a dynamotor operated by storage batteries. The batteries, in turn, were charged by an auto generator belted to an outboard motor which in turn did canoe duty at other times. The plates of the two fifty-watt tubes received 500 volts

the jungle camps. Trees were the masts, and the vegetation for some distance about the antenna trees was cleared away to give the wires breathing space. Obtaining an efficient ground was no problem; a length of antenna wire thrown into the river served well. The receiving antenna was usually a thirty-foot length of wire, suspended one foot off the ground. The low antenna reduced signal strength materially but reduction in static more than compensated for this loss. In a tropical region, where every night is a static night, LR thumbed its nose to atmospherics.

The portable station's short-wave receiver, put together in the wilds out of camp odds-and-ends, including two empty sugar tins procured from Kwong, the Chinese cook, was a thing to bring a blush of shame to the cheek of the radio constructor who likes to see things shipshape. That its appearance was not a measure of its sensi-

tiveness was demonstrated when it picked up amateur signals from every radio district of the United States, and from several foreign countries. A simple Armstrong circuit was used.

The transmitter, designed for 100-meter work, was revamped upriver after its operator became convinced that better results were obtainable lower down the scale. Alterations fitted this set for eighty and forty meter work. The lack of a wavemeter at the portable station was met one night when the operator had the good fortune to pick up the standard frequency



A CABOCLOS VILLAGE IN THE MIDST OF THE JUNGLE

They are a Portuguese-Indian people, and, after being presented with a few cigarettes, proved most hospitable. The flying boat, which was piloted by Lieutenant Walter Hinton and used to survey the country ahead of the expedition, made a forced landing at this point. The walls of the thatched house were covered with pictures cut from various magazines, among which were some of the 1922 New York-Rio de Janeiro flight. The natives became wildly excited on being informed that Lieutenant Hinton was the pilot on that trip

signals emitted by wwv, the Bureau of Standard's station at Washington. Utilizing the system of harmonics, a hastily assembled, but accurate instrument, was calibrated.

The portable station's power supply was a dynamotor operated by storage batteries, which were charged by an auto generator belted to an outboard motor, which in turn did canoe duty at other times. The plates of the two fifty-watt tubes received 500 volts.

Both outboard motor and generator threatened frequently to give up the ghost but were nursed along to a remarkable performance by the gas engine experts of the party who lent a hand to the radio operator when failure of the power supply loomed.

Jungle days and nights were crammed with incidents. Among them there was an encounter with tucandera ants whose sting, which carries a long-lived pain, the natives dread more than that of any other insect.

The operator's carelessness in lashing one end of his hammock to a dead tree, which gave way in the night, made him food for the tucanderas. Extricating himself in the darkness from the fallen hammock he rolled into their nest. He remained there but a moment—there is a limit to man's endurance—but the tucanderas which had crawled into his clothes emerged from the ant hill with him. Before all were routed the radioman's skin, from head to foot, burned with the fire to which the wicked are headed.

More pleasant recollections are those of the visit to one of the river camps of four naked Guihibo Indians, shy but not unfriendly savages of the country traversed by the explorers. Their call on the white men, the natives of the party learned from them, had been made at some difficulty. It appeared that enemy country lay between their village and the explorers' camp, and the enemy had sought to block their route. It had been necessary for them to slay four hostile tribesmen. Arrows, as long as spears, were their main weapons; a dugout canoe their means of getting about.

There were few nights spent in camp when traffic was not exchanged between wjs and LR and scarcely a night when signals from American amateur stations were not heard on the crude short-wave receiver. Due to the necessity of conserving power, the portable station's messages destined to the outside world were habitually shot to the base station, which relayed them north-

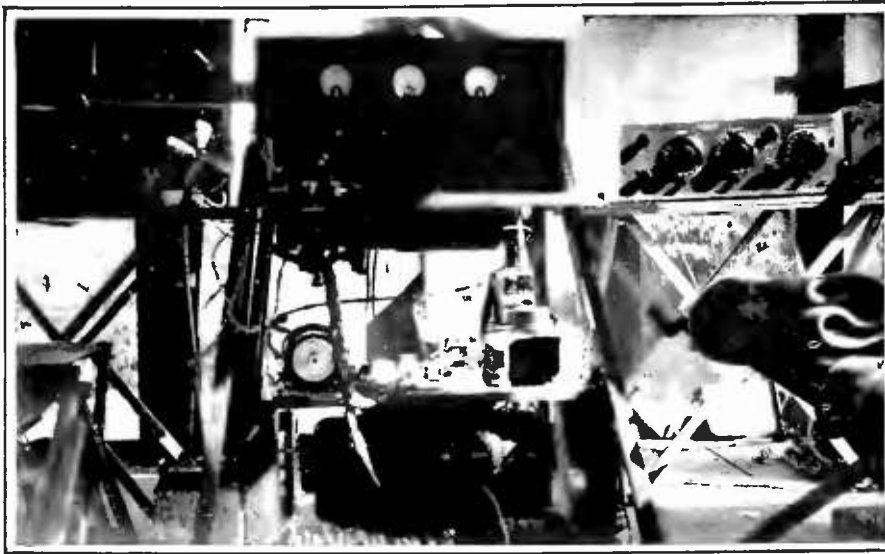

THE EXPEDITION'S RADIO APPARATUS

The upper picture is of the interior of the base station at Boa Vista. It was intended that wjs (the base station) should be employed for communication with the station at Manaus, a distance of about four hundred miles, but heavy tube mortality at Boa Vista brought long-wave medium power work with Manaus to an end. Short-wave communication was then established with amateur stations in the United States, using low power and smaller tubes, the supply of the latter being plentiful. Messages for Manaus reached their destination by a round-about route, often going to New York first. The advance party's short-wave station, LR, provided the connecting link with wjs. The second picture shows LR's "shack" at one of the camps. Below: Natives listening to code signals on the short-wave receiver

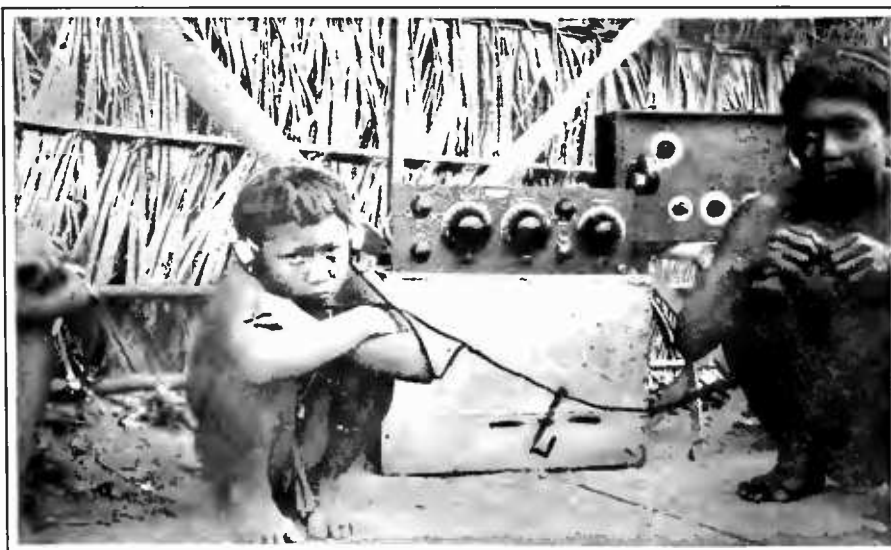

ward. This was, however, no insult to the twenty-five-watt set at LR for, on one occasion, when the operator's curiosity to learn how the low power equipment would reach out got the best of him, he passed with ease a message direct to station 4DO, of M. M. Burns, at Atlanta, Georgia.

Radio operations during the final months of the expedition's work in the tropics followed the lines established during the period with which this article deals. On February 23, 1925, the writer returned to Boa Vista by

means of an aeroplane used mainly in mapping from the air. His leave from the Department of Commerce expired, so he came back to the States. McCaleb took over the portable station and capably handled his task until early summer, when the explorers came home.

There were times when, unsuccessful in "raising" wjs on eighty meters, a shift to the forty-meter wave brought immediate results. Even after nights when signals carried poorly, when static was terrific, there was a short period just following sunrise when the world could be heard. Sometimes this fruitful interval lasted two hours; often not longer than fifteen minutes.

The amount of power used in transmission appeared not to be a factor of much importance. Many of the amateurs heard in the forest were using sets with as little as ten watts of power. McCaleb reported that he was often warned that LR was about to call, by a clearly audible sound which could only have been occasioned by a minute amount of radio frequency energy leaking into the antenna when the tubes were lighted but when the key contact points were not actually meeting.

Elevation above sea level was important, the ease with which traffic could be handled apparently varying almost directly with the elevation. During early evening the short waves gave poor results. It was a rare night when much work could be done before 9 o'clock.

On the whole, while transmission on high frequencies proved to a certain extent freaky, communication was established over such long distances, with so little power that the conclusion seems unescapable that short waves will come to be used extensively in long range work. We have not yet solved many of the mysteries of their propagation but we have opened the gate wide enough to enable us to see that there is much inside the field we hardly realized, until recently, was ours to explore and to use.

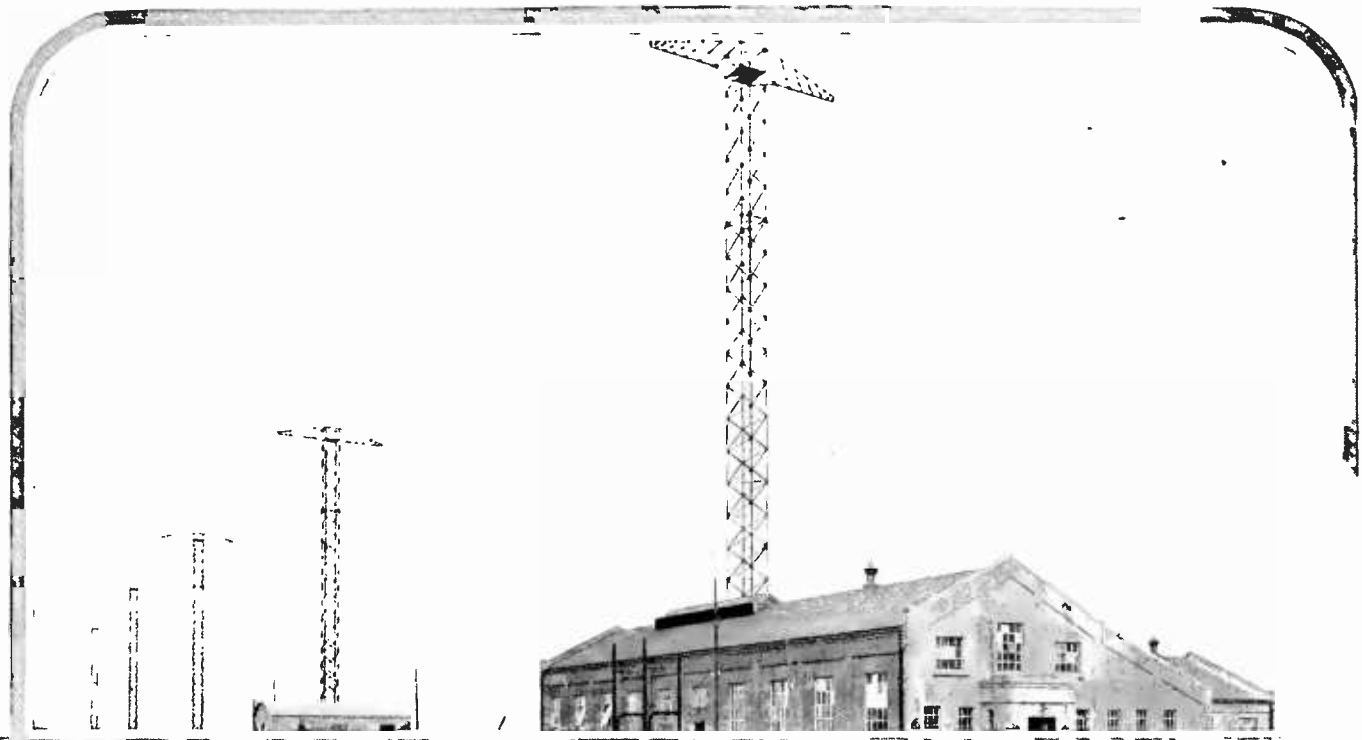

THE MARCH OF RADIO

By *J. J. Morecroft*

Past President, Institute of Radio Engineers

What Happened at the Fourth National Radio Conference

THE radio industry is to be congratulated upon the outcome of the deliberations of the 1925 Radio Conference, and this seems to be the burden of the average editorial comment throughout the country. The spirit in which the various questions were approached and the remarkable display of reasonableness on the part of the many conferees augurs well for the healthy development of our industry.

The radio industry can well get along with no governmental interference or help—that was the keynote of Secretary Hoover's opening address and that was the natural conclusion to be reached from the deliberations of the conference. Many people are too ready to ask the government to regulate something or other, somehow or other, so that it is remarkable that no action was taken along this line.

To legislate away the regenerative receiver, to subject the advertising question to federal legislation, to pass laws closing down the super-power stations, even before they had started; many such questions were in the air waiting to be settled by government action of some kind and yet the conference actually put through no such resolution.

The one action of the conference which

The photograph above shows the towers of the beam station at Dorchester, England, which will communicate with New York.

stands out more than any other was the stand taken on the number of broadcasting stations. The opinion of the conferees was almost unanimous in favor of positively limiting the number of licenses issued. We have advocated the limitation of the number of stations for a long time and certainly it is gratifying to hear the voice of the conference so unanimous in settling this question. The conference recommended that the number of stations is not to be increased, but is actually to be diminished. No new licenses are to be issued and those licenses which become forfeited because of disuse are not to be reissued to another station unless there is a demand from the public. The pleasing thing about this action is that the question was settled with the purpose of satisfying the radio listener instead of the station owner. The public is surely to be congratulated upon this stand taken by the conference. It all simply means that the radio listener's interests are to be paramount in guiding the future licensing of stations and matters of similar import.

"It is a piece of hard luck," remarks one commentator, "for the would-be station owner who has his station built and paid for, to be told that no license is available and his investment is valueless." How-

ever, unless the broadcast listeners in his neighborhood show unmistakably their desire for the new station it should remain silent. No one has a right to intrude into ether channels where he is not wanted and those who know whether he is wanted or not are the neighboring listeners.

Coöperation between various branches of the radio industry, no governmental regulation or censorship, settlement of interference troubles entirely in the interests of the broadcast listener—these three features stand out as real accomplishments of the Fourth National Radio Conference so well directed by Secretary Hoover.

A Praiseworthy Bit of Radio Research

IN NOVEMBER, 1925, a most remarkable paper was presented to the Institute of Radio Engineers by a group of three researchers of the American Telephone and Telegraph Company, Messrs. Bown, Martin, and Potter. To those of us who look upon radio primarily as a branch of electrical engineering rather than simply a scheme of communication, the paper seemed to be the best which has been presented in years. Of all the divisions of engineering, electrical is the most accurate and scientific. Of the branches of elec-



RADIO ON MOVING TRAINS

Passenger trains of the Canadian National Railways making the transcontinental run are all equipped with broadcast receivers. The installation of a receiver to give regular service has been entirely successful. On one trip of the "Quebec," the following stations were logged by operator N. Bonneville, who is seen in the view here: WBZ, KDKA, WFI, WGBS, WOR, WAAF, CKAC, WGR, WGN, WJAS, WCAE, CNRO, WTAM, WAAF, WGY, and WCX

trical engineering, that dealing with radio phenomena contains the most intricate and interesting problems. To the student who has a keen imagination, a reasonable grasp of mathematical relations, and an intense desire to penetrate into the unknown, there is today probably no more attractive field than that in which Bown, Martin, and Potter have been working for the past two years and about which they reported in their recent paper.

There are three general subdivisions in radio engineering which offer opportunities to the experimenter. The receiving set is being made the subject of intensive study by thousands of keen experimenters. The cost of suitable laboratory facilities is comparatively little and the reward for a worth while discovery is ample and sometimes fabulous. The transmitter can be made the subject of development work by comparatively few. Expensive apparatus is required and only a small group of engineers of the large companies can possibly work on the improvement of transmitters.

There is another field of radio investigation, however, which apparently offers no financial return for successful endeavor, that is the question as to how radio energy is actually carried from the transmitter to the receiver. Even a complete answer to this question may bring with it no material reward of any kind. One says "may" because there have been several cases in the past in which an apparently useless scientific research has yielded tremendous financial returns to those who developed the idea. We think of the work of Richardson and

other "pure scientists" who studied the evaporation of electricity from metal, working simply to discovering the truth, then we consider the profits of the Radio Corporation of America last year on tubes, which utilized the result which these scientific workers gave to the world for nothing.

The question of how radio waves are transmitted can be tackled only by the best trained engineers we have today. Not only must they be able experimenters, but to make any reasonable progress based on the interpretation of their results, they must be conversant with many allied branches of science. The electro-magnetic theory of light (the bugaboo of many a student of college science), must be thoroughly understood and the laws of reflection and refraction of such waves be sufficiently familiar that their occurrence is at once recognized.

In the experiments reported to the I. R. E., the engineers used many thousands of dollars worth of the most modern electrical apparatus; the experiments were such that only one or two of the most prosperous companies could afford to finance them. The American Telephone and Telegraph Company really felt the need to investigate the question because of the very poor quality of WAAF's signals throughout Westchester County, only a short distance from the transmitter. Not only was the signal unexpectedly weak but the quality also was poor. So began a most exhaustive study to discover just what happened to WAAF's radio waves as they traveled the fifty or more miles up Long Island Sound.

These experiments showed conclusively that the signal received in these defective localities is produced by waves arising from two directions. One wave comes along the ground and is greatly weakened as it travels through New York's forest of steel skyscrapers. The other goes apparently up in the air and is reflected after going up perhaps one hundred miles and comes down again to combine with the other wave which has arrived via earth. These two waves add their effects to give the actual signal and, unfortunately for the dwellers in these districts, the combined wave frequently looks entirely different from the wave which started out from the transmitting station. The length of the extra path continually varies with atmospheric conditions and thus the amount of interference of the two waves with each other continually changes. The result of this interference is to make the signals so badly distorted as to be sometimes unrecognizable. A photograph of the signal current received close to WAAF, and another photograph of the signal current received in Westchester County, only a few miles away, are so different that one cannot be identified with the other.

An explanation of the extraordinary distortion which this radio current suffers, which Bown and his co-workers offer us, does but little at present to make the transmission better. Their work did show, however, that certain improvements are possible at the transmitting station which will make the distortion somewhat more constant that it is at present, but that won't help the broadcast listener very much. It appears to be a fact that certain districts will get bad transmission from certain stations and there is at present no apparent remedy for it.

Radio Control for Railroads

IT HAS been recently announced that radio was doing much to accomplish automatic train control, which the Interstate Commerce Commission has ordered installed on all of the principal railroads. The scheme required by the Commission must automatically apply the brakes of a train which runs into a danger zone so that even if the engineer ignores the danger signals set against him, his train will be stopped before a wreck occurs.

Among the schemes which give promise of success is that which uses the two rails to carry high frequency currents. These currents, acting on a coil carried on a locomotive, will apply brakes, shut off steam, or whatever other operation is necessary. Tuned circuits are used on the locomotive so that different operations are carried out on the locomotive according to the frequency of the current in the track.

To be economically successful, it should not be necessary to feed the high frequency energy into the tracks at too many points, preferably only at one point in each block. But very high frequency currents will not travel far along the railroad tracks, for they waste away too rapidly. The radio

engineer trying to use this scheme must employ frequencies very low compared to those in which the listener is ordinarily interested. About 20,000 cycles (15,000 meters) is as high as is generally useful in the continuous train control scheme. The amount of power radiated from the tracks with such current is practically negligible. The tracks are really acting as the two wires of a power transmission line and there is no real radiation of power in the scheme at all. This "radio" system would probably operate as well or even better if there was no radiation, so that the scheme can scarcely be hailed as an application of radio. The frequencies useful are those used by the telephone engineer in carrier telephony, they are so low that even if there was appreciable radiation, no broadcast receiver, as used by the average listener, could possibly pick it up.

Detroit Has a Good Radio Supervisor

WHEN the recent radio conference convened there appeared on the scene a real radio inspector properly equipped to do his job. Probably the most pressing duty of the government radio inspector today is to locate sources of interference and to do this with any degree of ease requires a portable receiving set. Supervisor S. W. Edwards, of the Detroit district saw the need some time ago and by shrewd application of the meagre funds furnished to the inspection service was able to buy and equip a portable radio laboratory. An enclosed truck was fitted up with all kinds of receivers, frequency measurers, and the like, so that wherever the truck may be, measurements of frequency, direction from which interfering

signals are coming, and so forth, can be readily made.

When complaint of interference comes into his office, Supervisor Edwards at once dispatches his portable laboratory to the scene and by direction finding apparatus, wavemeters, etc., locates the source of the trouble. He reports that in no case so far investigated has he failed to locate the source of interference.

Is the Loop or Antenna Receiver More Popular?

A RECENT bit of propaganda by one of the manufacturers of loop sets, states that fifty-three per cent. of the public prefer loop sets to those operated from an antenna. Just where these figures came from is not stated but we were surprised at the conservative claims of this loop-set manufacturer. Why not say one hundred per cent. of us prefer loop sets—it would not be contradicted provided the qualifying clause were added "other things being equal."

Naturally people prefer loop sets. They don't have to bother with outdoor antennas coming down in a country snowstorm or with the obdurate city janitor when trying to put one up. Further the loop has directional qualities (except in some steel buildings) and this offers the possibility of cutting out undesired stations. Why then don't we all use loops? Because we can say in general that a set requires between one and two extra stages of radio frequency amplification to give as strong a signal with a

loop as with an ordinary antenna. Tubes cost money to buy and maintain. Furthermore tubes themselves give noise due to electrical irregularities in their behavior and when excessive amplification is used in a multi-tube set, these noises become quite apparent and sound much like static. Sets having eight or more tubes at times give a lot of noise even if the input circuit is shorted so that no static can get in. Until very quiet tubes are available at low cost the loop set actually works against quite a handicap when compared to the antenna set.

A New Short Wave Ray Is Discovered

AT A recent meeting of the National Academy of Sciences, Dr. R. A. Millikan of the California Institute of Technology reported the discovery of some new rays of the greatest power. Doctor Millikan's name should be known to all radio enthusiasts because of his wonderful work in measuring the size and charge of the electron, the thing that evaporates from the filament of the vacuum tube and makes its operation possible. And when Doctor Millikan's announces a new ray the public may rest assured that he has one. Such an announcement is not to be confused with that of such exploiters as Grindell-

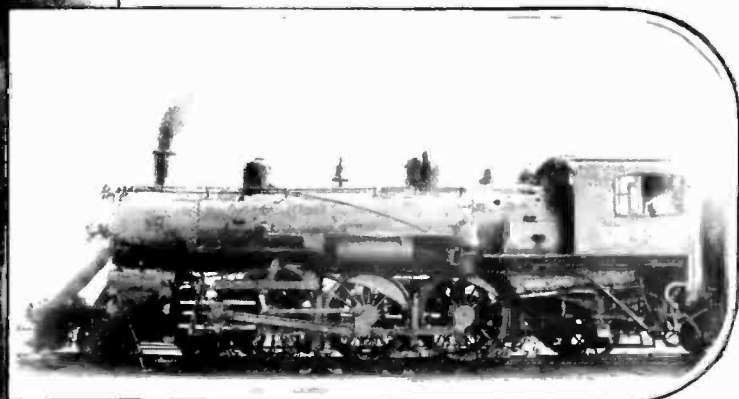
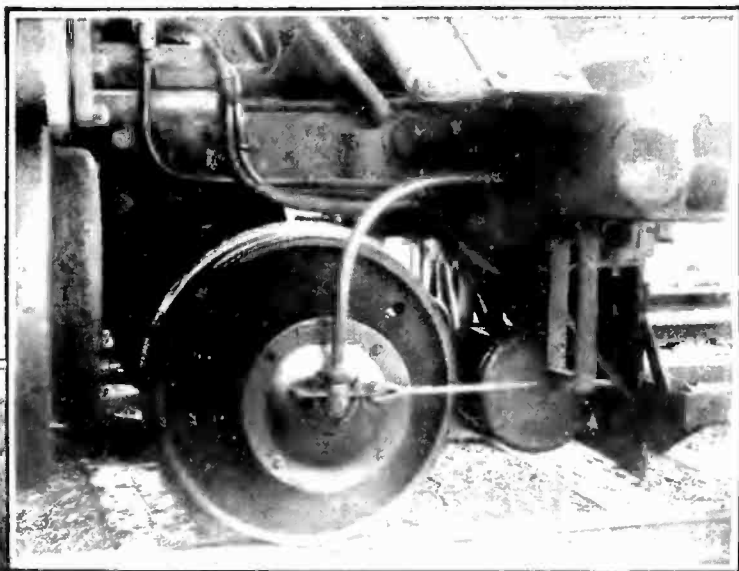
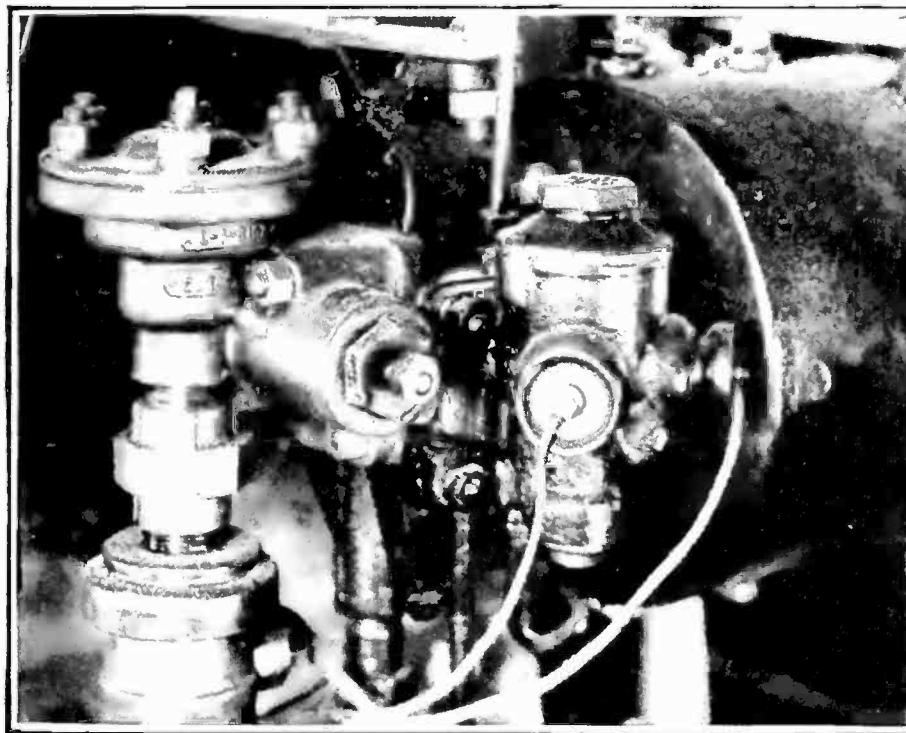

A RADIO TRAIN CONTROL SYSTEM

Developed by Thomas Clark of Detroit who, in the early days of wireless telegraphy headed a "wireless" company of his own. The control system is really not wireless but rather, "wired wireless," for high frequency currents are sent along the rails and used through the proper combination of apparatus to control danger signals in the engine cab and valves which will stop the locomotive. The view at the lower left shows a close-up of the valves which are worked by this "radio current" to stop the engine when desired. Above is shown the control device applied to the drive wheel of the locomotive.

The smaller view shows a typical locomotive on the Pere Marquette Railroad which is experimenting with the system

Matthews, who gave to his fellow Englishmen the bad attack of ague some time ago when he announced his "death ray" which was to be sold to the French if his country wouldn't pay his price. This death ray, it will be remembered, was never proved to be at all valuable or effective.

Millikan has already received the Nobel prize for his scientific researches which marks at once any announcement he makes with the stamp of reliability. The new rays are of the nature of X-rays, he says, but perhaps one thousand times as powerful. They are discovered only at great height; he sent his measuring instruments up in balloons and only at ten miles height were the new rays found with intensity great enough to be recorded.

These rays fall in with the tendency of the times, by the way. The radio engineer every day hears of the increasing reliability of short waves. The shortest waves of radiation which the scientist has known until now are the X- or Roentgen rays. These new rays, christened Millikan Rays by the discoverers' fellow scientists, have a wavelength only one thousandth that of X-rays. Whether we shall ever be able to produce them on earth or use them after they are produced, is problematical, but the probable answer to the question is "Yes."

The Ethics of Radio Advertising

SURELY when a novice looks over the radio advertisements with the idea of purchasing a receiving set, he must be greatly confused and misled as to what the different sets will do. Most extravagant claims are made for radio apparatus of any kind and price. Everything is the very best and when one adviser hits upon some

extravagant word with which to brand his goods all of its synonyms are sure to appear in the next issue of the periodical. Now, no matter what the manufacturer may say, we cannot believe that a forty dollar set is as sensitive, selective and as good in quality of reproduction as the hundred and fifty dollar set—yet the advertisements all say so.

Mr. E. H. Jewett, recently commented on the situation in the following way.

It (the radio advertising competition) has reached the stage where it is practically interchangeable, really almost cancellable. The race in superlative claims is so intense that most advertisements almost duplicate one another. One could interchange the corporate names and hardly destroy the purpose of the advertisement.

The majority of radio manufacturers are much concerned about the good name of their industry. It is essential to their purposes that when Mr. Ultimate Consumer shoves his money across the counter he gets value received. So the old admonition about letting the buyer beware is very apropos nowadays. Every radio purchase deserves personal investigation. Personal inquiry is the best checkup on too effusive advertising.

The Month In Radio

LAST month saw the passing of two of our most promising radio engineers. Returning from the Fourth Radio Conference, G. Y. Allen, technical assistant to the manager of the radio department of the Westinghouse Company, was killed in a train wreck near New Brunswick on November twelfth. He was a

graduate of Stevens Institute, a member of several technical societies and was highly appraised by his company. "Mr. Allen's death means a great loss to the Westinghouse Company," said E. B. Mallory, his superior in the Westinghouse organization. "Brilliant as an engineer, indelible as a worker, and of charming personality, it will be impossible to replace him."

Dr. H. W. Nichols, research engineer of the Bell Telephone Laboratories, died at his home recently after a brief illness. After getting his Ph.D. degree at the University of Chicago, Dr. Nichols joined the research staff of the Bell Laboratory and was



CAPTAIN E. P. ECKERSLEY

London

Chief Engineer, British Broadcasting Company; in a statement especially written for RADIO BROADCAST

"Based on our previous experience, the International Radio Broadcast Tests in January, 1926, should mark a distinct advance. It should be possible to secure with the assistance of the International Bureau de Radiophonie, more definite and accurate data on the programs of the broadcast stations on our side of the water than ever before. It is especially important to communicate to all listeners to the programs in these tests that there is five hours' difference in time, for example, between New York and London. The tests will start Sunday, January 24 at 10 P. M., Eastern Standard, or New York Time: that will be 3 A. M. Monday, January 25th, London time. The stations on our side of the water will begin their test programs at 4 A. M. London time, or 11 P. M. the night before, New York time. Our European schedule of transmissions is being settled at a conference in Brussels. We believe radio intelligently developed in the public interest is destined to become a potent auxiliary to international coöperation in bringing closer together broadcast listeners and wireless enthusiasts all over the world. Radio should perform invaluable work in establishing common points of interest and in consolidating conscious world citizenship without which there can be no assurance of permanent peace between nations.



Courtesy New York Evening World

"HOW IS YOUR RADIO RECEPTION HERE?"

largely responsible for the radiophone development carried on in this laboratory during the past few years. He was a member of several scientific societies, on the Board of Direction of the Institute of Radio Engineers and had been nominated for President of the Institute at the time of his death.

THE Western Union Telegraph Company is not suffering much from the air mail and radio competition, as had been predicted; radio, the air mail, and the telephone, it has been claimed, constitute a real menace to the telegraph companies, but Newcomb Carleton, President of the Western Union, says they are allies of the

telegraph rather than competitors. The business of his company was three times as great last year as in 1914 and the profits have so increased that a three million dollar salary increase is to be granted to the employees and a fifty per cent. stock dividend probably declared.

IN A previous paragraph we spoke of the effusiveness of the radio advertiser and how slightly his claims are influenced by the truth. A recent advertisement of the Radio Corporation of America, under the attractive caption "How important is vacuum?" claimed for its engineers that they have succeeded in reaching a vacuum "ten million times greater than the vacuum of the high exhaust incandescent lamp"; the rest of the copy suggests that all of the R C A triodes are thus exhausted.

We think that Thomas F. Logan, Inc., the advertising agency concerned, will find upon inquiry that the engineers, capable as they may be, have succeeded in doing no such thing. The vacuum claimed is nearly a thousand times as great as the research men have succeeded in attaining unless some remarkable discovery, not yet disclosed, has been recently accomplished.

A BRITISH mail plane recently en route from Croyden to Paris encountered trouble, and anticipating a forced landing, called to both English and French stations for its bearings. These were promptly given and so the plane located itself. It had to come down on the water but was able to send its location with sufficient accuracy that after a few hours floating on the Channel it was picked up by one of the searching vessels. This is in contrast to the radio service the *PN-9 No. 1* secured from its own equipment and the destroyers placed in the Pacific to help guide it.

THE Amsco Products, Inc. was recently sued by the Westinghouse Company and R C A for putting out sets which, it was claimed, infringed the regenerative patent.

The set was supposed to be neutralized, but, as the neutralizing condensers were adjustable, and instructions were given as to how the set might be made to regenerate, the judge decided that infringement had been accomplished and found for the plaintiffs. A special master has been appointed to assess damages.

DURING a recent talk in England, Senator Marconi stated that he and his engineers have not only found it possible to communicate with Argentina, from England, with only one-fifth of a kilowatt of power at 20,000 kilocycles (15 meters), but that he had actually found the communication more reliable in the daytime than in the night time. This is an entirely unexpected result as night time transmission has always heretofore established the long distance records.

*Interesting Things
Said Interestingly*

A. H. MORSE (in *Radio: Beam and Broadcast*, published by D. Van Nostrand Company): "Unquestionably there is much that Britain and America may learn from each other in the matter of broadcasting, and it is certain that it would be an advantage if announcers in North America were required to satisfy a central authority as to the purity and standard quality of their diction, as they do in Britain. This done, there would soon be no point in the announcement of the facetious German shopkeeper, 'English spoken, American understood,' and the New York Eastsider might learn to articulate an 'r'."

MAJ. HERBERT H. FROST (Chicago; president of the Radio Manufacturers Association): "Listeners in America will never be called upon to pay a tax of any kind to support broadcasting, as is the case in some European countries. This will never happen in the United States for the reason that there are enough broadcasting stations owned and operated by the radio manufacturers to reach every part of the country. The manufacturer will, if necessary, pay for broadcasting, for his business depends on it."

GEN. J. G. HARBORD (New York; president of the Radio Corporation of America): "Broadcasting in South America is at present chiefly confined to the few large cities. Buenos Aires boasts of four stations. There are two stations in Rio de Janeiro, two in Sao Paulo, while smaller stations operate occasionally, one in Bahia and one in Pernambuco. In Chile there are two stations operating at Santiago. These stations, while perhaps not as powerful and well-organized as those of the United States, give a very fair degree of service in each instance though for the most part, the sched-



CHARLES GRAY SHAW

New York

Professor of Philosophy, New York University, in an address "The Philosophy of Radio," through station wjz

"Our interest in radio is as great a mystery as radio itself. There is no real reason why we should listen to sounds which come to us from afar, but we have our radio sets by the million and tune-in on anything. We listen-in without regard to the character of what is being broadcast. It may be an inferior soloist or a cheap minstrel singer, a bedtime story, or a college professor. If these artists were to hire halls they would perform before empty houses. But radio somehow makes it all different.

"How we love to listen-in. A pious old lady was found sitting enchanted listening to the report of a prizefight, round by round. A profane gambler boasted that on the previous Sunday he had caught a dandy prayer. These individuals would not have taken prizefight and prayer in any way but the uncanny one of radio. How shall we explain this mad interest in the "air"?"

ules are well interspersed with phonographic music. In Buenos Aires excellent broadcasting is given the people during the operatic season when the opera is broadcast direct from the Teatro Colon.

"It is interesting to compare the 'radio coverage' in the countries, Argentine, Brazil, and Chile, with that of the United States. Here one station serves an area of roughly 6000 square miles, while in South America one station serves more than 300,000 square miles. From these figures, it is obvious that the South American broadcasting service is wholly inadequate, even in view of the fact that large sections are not extensively populated."

BENNO MOISEWITSCH (London; following his recent recital from 2 LO): "Alone in my room, sitting at the piano without coat, collar, or tie, with nothing whatever to distract my thoughts, I believe I can play better than on the platform. It was the same in the broadcasting studio. I found when I arrived there that a number of people were in the room, but, at my request, they were asked to leave. Then I took off my collar, tie and waistcoat and abandoned myself to my task.

"I was completely happy. There was no one near me save the operator, and the thought that, in my own way, I was entertaining an unseen audience of, perhaps millions, supplied me with all the inspiration I needed.

"It is a remarkable experience."



©Henry Miller News Pictures, Inc.

JOHN OCHACKI, JR. AND GEORGE SEEBER

Chief and Assistant Radio operators of the Clyde liner *Lenape* which caught fire off the Delaware Capes recently and was burned to the water's edge. Only one life was lost and passengers and crew numbering 367 were rescued

RECENT conditions in radio broadcasting have resulted in new requirements for the design and construction of receiving equipment. The new frequency allocation of transmitting stations, and their increased numbers, have created the need for receiving systems capable of yielding a very high degree of selectivity. It is probable that the necessity will never be less.

Further refinements in mechanical detail and physical appearance of receivers have also made imperative the most compact internal construction. The radio set builder, confronted with the problem of selecting suitable elements for a receiver to meet the above requirements, has encountered many difficulties. Parts available for purchase have not been designed to overcome the handicaps to reception brought into being by these new conditions.

Radio inductances for commercial broadcast work have undergone only slight improvements in recent years and the purpose of this paper is to point out the need for advancement in this specialized field and to relate some developments which are thought to be new.

A tuned radio frequency transformer, or "coil" as it is often referred to, is recognized as being of great importance in any receiving system. Let us consider some of the characteristics of a radio coil which play an important rôle in the proper functioning of a receiving system in which it is used.

The efficiency of the coil has a very direct and significant bearing upon the receiving results obtainable. It has been stated many times that a coil should be designed so as to permit sharp tuning inherently; that is, its resistance to the frequencies for which it is intended should be as low as possible. Reduction in coil resistance is the fundamental design problem where selectivity is wanted.

Various engineering texts have defined coil efficiency in terms of the ratio of inductance to resistance. A coil, to be highly



Design of Radio Inductances

Why the Conventional Inductances Do Not Meet the Electric and Mechanical Ideal—How an Electrically and Mechanically Desirable Shielded Inductance Was Designed and a Suggestion of Its Possibilities

By W. W. HARPER

efficient, should have as much inductance per unit of resistance as possible. There are certain limitations to the magnitude of this ratio, but it is reasonable to say that a radio coil for broadcast reception should be designed so as to permit an inductance of 25 or more microhenries per ohm.

NECESSITY OF FIELDLESS CHARACTERISTICS

THE need for efficient coils has been recognized for many years, but it is only recently that we have been forced to con-

broad in their tuning. At any rate, under conditions such as described, the receiver will appear to be just as broad as the broadest circuit. A non-regenerative detector input circuit in the ordinary tuned radio frequency amplifier system is an example of a broad circuit. It is possible, in many cases, to have other circuits equally broad, however.

So we see why it is necessary to design a coil which will not function as a "collector" or antenna. The logical solution of the problem seemingly resolves itself into a matter of confining the magnetic and electric fields of the coil. It is through these agents that this "pick-up" action occurs. The effect of unconfined fields is also detrimental from other standpoints.

Very compact construction of receivers many times necessitates the placing of other instruments in close proximity to the coil. Penetration of these bodies by electrical fields of the coil is usually accompanied by resistance increases within the coil. This is equivalent to saying that these adjacent objects have caused energy to be absorbed from the coil. This disadvantage will be eliminated if effective confinement of the coil fields is attained.

RELATIVE MERIT OF RADIO COILS
EXPRESSED IN MICROHENRIES PER OHM

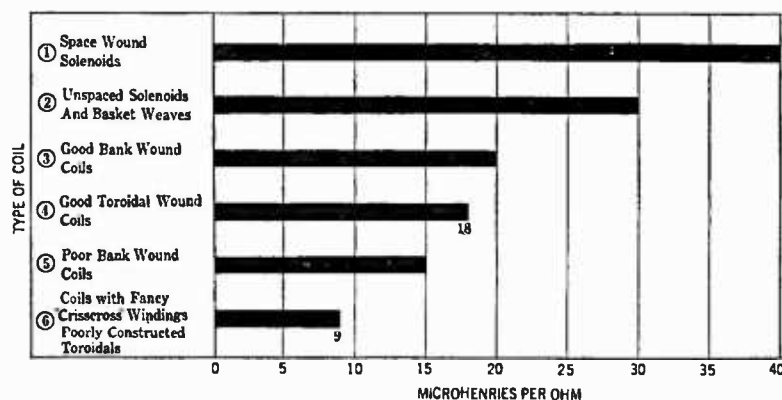

FIG. 1

One of the requisites of a good coil is that it have a large value of inductance per ohm. From this chart, showing graphically the results of tests conducted by Mr. Harper, it will be seen that some types of coil have distinct advantages in this respect over others. This chart should help to answer the question, "What is a good coil?"

Inter-stage coupling phenomena has also been a drawback with the old type coils when attempts were made to construct receivers of small size. Effects of this kind also have their source in the electrical fields surrounding the coils.

The mechanical characteristics are also worthy of consideration. They should be of such nature that the inductance, resistance, and other electrical characteristics will be invariable whatever the minor mechanical stresses the coil is subjected to. This feature is doubly important in tandem control receivers where it is almost imperative to match successive coils so as to get identical characteristics in each circuit. The usual method of coil building where the insulation on the wire is relied upon for spacing of turns, is an example of constructional methods which must be discarded. Variations in the thickness of insulation produces similar variations in pitch of winding. This results in unfortunate variations in inductance and other electrical properties.

STANDARDS OF COIL DESIGN

IT SEEMS possible from the foregoing generalized considerations to set down definitely certain axioms of efficient radio receiving coil design. These may be stated as follows:

- (1) Low resistance over the broadcast frequency spectrum combined with as high a value of inductance as is permissible under the circuit conditions.
- (2) Effective confinement of the electromagnetic field.
- (3) Effective confinement of the electrostatic field.
- (4) Consistent mechanical and electrical characteristics.
- (5) Small physical dimensions so as to permit compact construction. (Points 3 and 4 also assist in this connection, for with the coil fields confined it is obvious that they may be mounted in closer proximity without harmful coupling.)

The first consideration is that of coil efficiency in terms of low resistance combined with maximum inductance. It is necessary to select the most desirable type of coil in this respect before any attempts at solution of the remaining factors are

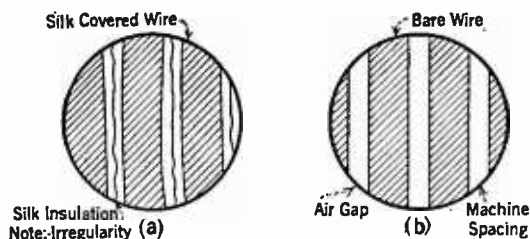

FIG. 3

The separation afforded between turns of a coil by silk insulation is apparently uniform, but when examined under a magnifying glass, its irregularities manifest themselves. In comparison, note the uniformity of spacing when a coil is wound by the aid of a machine which places each turn in position correctly. Uniformity of spacing of turns insures accurate calibration of coils on a quantity basis. Furthermore, by eliminating the silk or cotton insulation from the wires and employing a grooved cylinder, there is not the possibility of adding to the total of losses due to hygroscopic effects

made. Satisfactory results in any receiving system may only be anticipated when this requirement of maximum inductance per unit of resistance is reached.

In Fig. 1 is shown a statistical chart compiled from numerous tests conducted on various types of coils commercially available. The reader should not incorrectly interpret the significance of this data. It is well known that solenoid type coils can be so constructed that they offer greater values of microhenries per ohm than given on this chart. The same applies to all the types mentioned. The impressive point relative to the chart in question resides in the fact that the figures given are the results of averages made on measured observations of the characteristics of coils picked at random from the commercial market. The outstanding merit of the solenoid type coil is clearly apparent. This data in combination with other published works by various investigators seems to indicate emphatically the superiority of the solenoid inductance.

The fulfillment of the first requirement is therefore gained by the adoption of the solenoid type of coil, and if this were all, our problem would be a comparatively simple one. The further requirements, as listed, however, prevent such an easy solution.

The second and third points stated above

require that the two field components be confined in order to eliminate or reduce "pick-up" effects and eddy current losses arising from too compact construction, as well as serious and unuseful coupling phenomena. It is therefore necessary to cast aside the usual solenoid and attempt to devise something more effective.

It is known that confinement of the electromagnetic field may be satisfactorily ac-

complished by the use of a toroidal winding. A step in this direction appears to be distinctly undesirable, however, for it is seen from the first chart that toroidal type coils inherently are less efficient than some other types. It would therefore seem that the satisfactory solution of one requirement which imposed a very noticeable loss upon another equally important one could hardly be considered the totally best solution.

It is also evident that the toroidals are incapable of meeting the entire problem of field confinement, since this form of winding has little or no effect upon the electrostatic field. The toroidal coil, is difficult to construct with the aim of satisfying the fourth requirement of electro-mechanical consistency.

NEW CONSTRUCTIONAL METHODS

THE desirability of the space-wound solenoid in respect to efficiency and the possibility of shielding it metallically suggested a much more satisfactory method of fulfilling the requirements we desire to attain.

It was reasonably safe to assume that a metal container could be used as both housing and shield for an efficiently designed solenoid. This belief, having been verified by experiment, led to the design of an inductance which is called the Metaloid.

Preliminary attempts to "screen," electrically, solenoid coils by metallic cans met with many misfortunes. A solenoid which had a very low resistance unshielded, would

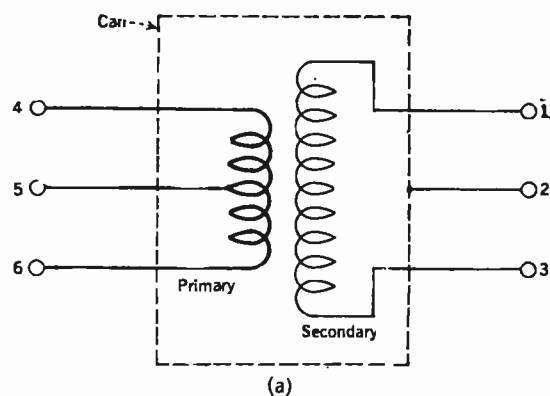

FIG. 4

The connections of the Harper coil unit. Below, the finished coil with "can" removed. The dimensions:

Primary: Form: 1 1/8" diameter, 3 1/2" long. Turns: 22, No. 28 D S C wire. Winding: Started 1/8" from top of form. Tap at 14th turn. Secondary: Form: 2" diameter, 3 1/2" long. Turns: 115, No. 28 Enamel covered wire in grooves separated by thickness of wire. Winding: Started 1/8" from top of form. Can: Size: 3" x 3" x 5". Cubic Volume: 45" cubic inches. Material: 12 oz. copper. General: Secondary-320 microhenries. Average resistance-9.5 ohms. Approximate inductance per ohm: 33 microhenries. Coil Form: Hard Rubber.



COMPARATIVE MAGNITUDE OF COIL LOSSES
DETERMINATIONS BASED ON SMALL SOLENOID COILS
Expressed in terms of Percentage increase in Total
Coil loss Averaged over Broadcast Spectrum

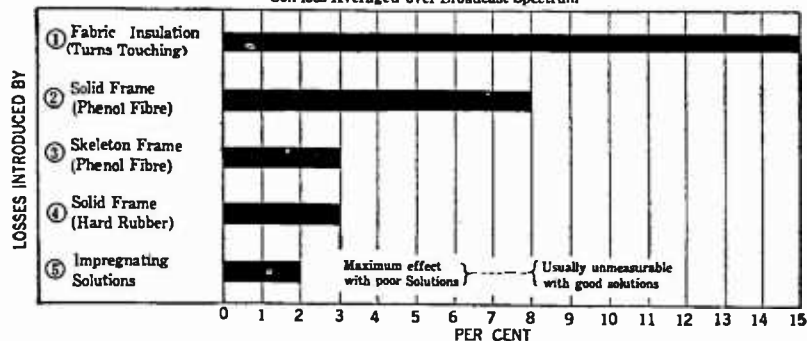

FIG. 2

From this chart it can be seen what effect the various factors entering into the winding of a coil have upon the finished product insofar as introducing losses in the coil and in the circuit in which it is used are concerned

undergo tremendous resistance increase when "canned."

There are two obvious reasons for these failures. It was almost a radio legend that good solenoids could not be efficient if they were made smaller than, say, three inches in diameter. And true, when the diameter was reduced to two inches, the resistance increased at an enormous rate. The larger coils, however, could not be easily encased by a metal can. When the can was made of convenient size, the coil characteristics were harmed and by making the can of correct size to avoid this difficulty, it became of tremendous dimensions.

The second reason was due to lack of knowledge regarding the shielding characteristics of various metals.

Elimination of the first difficulty led to a careful analysis of the various sources of losses in small solenoid coils. The results of this investigation are depicted in the chart of Fig. 2, compiled after numerous measurements of various coil losses had been made.

The magnitude of losses introduced by insulation averaged as high as 15 per cent. and in some instances ran as high as 20 per cent. The loss effect in the framework and impregnating solutions, which have been thought to be of vital importance, dwindle to inconspicuous factors in view of insulation losses.

Insulation losses, of course, are reduced to a very low value by space winding so that an air-gap exists between successive turns.

The experiments leading to this discovery yielded the data necessary to proceed with the design of a small solenoid without the customary resistance increase. Eliminating the insulation immediately suggested the use of bare or enameled wire wound on a threaded hard rubber tube. Following in a fortunate sequence came the elimination of impregnating solutions, which are undesirable from both the standpoint of manufacturing and electrical efficiency.

It was also apparent that the framework

tubing could be machine threaded with great accuracy, thereby attaining electrical and mechanical constancy in every coil.

The Metaloid secondary is constructed along the lines mentioned above. It is approximately two inches long and two inches in diameter, space wound with bare or enameled wire in a machined groove. The inductance is approximately 320 microhenries and the average resistance is 9.5 ohms. This gives approximately 33 microhenries per ohm. These figures are based upon measurements made on the secondary coil encased in the metal can, which will be described later.

In Fig. 3 is shown a magnified comparison between coils in which the insulation is depended upon to give spacing and those in which the wire is space wound by means of an accurately machined groove in the supporting framework. Fig. 3A indicates the variations which arise because of variations in the thickness of fabric insulation. Fig. 3B shows the remarkable accuracy possible where the wire is spaced by a machine cut groove.

The second difficulty, that of selecting the proper metal as well as the determinations of the optimum dimensions for the can, was found to be more involved than one might anticipate, and a detailed *résumé* of the work done is not possible within the limits of this article.

It was found, however, that with the small solenoid previously mentioned, a four-sided metallic can approximately three inches square and five inches high, of ordinary 12-ounce copper sheet was satisfactory in all respects.

This arrangement apparently affords very effective confinement of both field components. Direct signal "pick-up" is very materially reduced as compared to other coils. It is understood, of course, that, due to pick up by other elements, this difficulty cannot be totally eliminated, unless the receiver is completely screened.

Audio-frequency transformers, sockets, and any metallic objects may be mounted directly against the can and no measurable eddy current losses occur.

Grounding the individual cans to the low potential secondary terminals of their respective coils entirely obliterates electrostatic potential gradients between successive coils. The four-sided can is also effective in nullifying inter-stage electromagnetic coupling.

The cubic volume of the can is approximately 45 inches. It should be remembered that this space houses the coil as well as its associated fields. While the actual physical size of the Metaloid is *larger* than average coils, it really takes up *less space* electrically, and may therefore be mounted more compactly.

The winding, which is seen in the photograph, is the secondary. The primary is mounted concentric and inside the secondary framework.

Fig. 4A is a schematic drawing of the Metaloid windings and connections. The primary is tapped as shown at 4, 5, and 6. This permits the use of large and small tubes as well as special circuit arrangements.

Contact to the can is independent of other connections and is made at terminal 2. In this way, the shield may be used either "grounded," or "floating." It is customary, however, to connect this terminal to the low potential end of the secondary winding.

The secondary terminals are indicated at 1, and 3. It was stated that the secondary inductance is approximately 320 microhenries. A variable air condenser having a maximum capacity of 250 picofarads (.00025 microfarads) will therefore be necessary to tune the coil to broadcast frequencies.

A new coil of this type appears to open up a broad field to the receiving experimenter, and in its correct application to receiver problems, many handicaps have already been met.

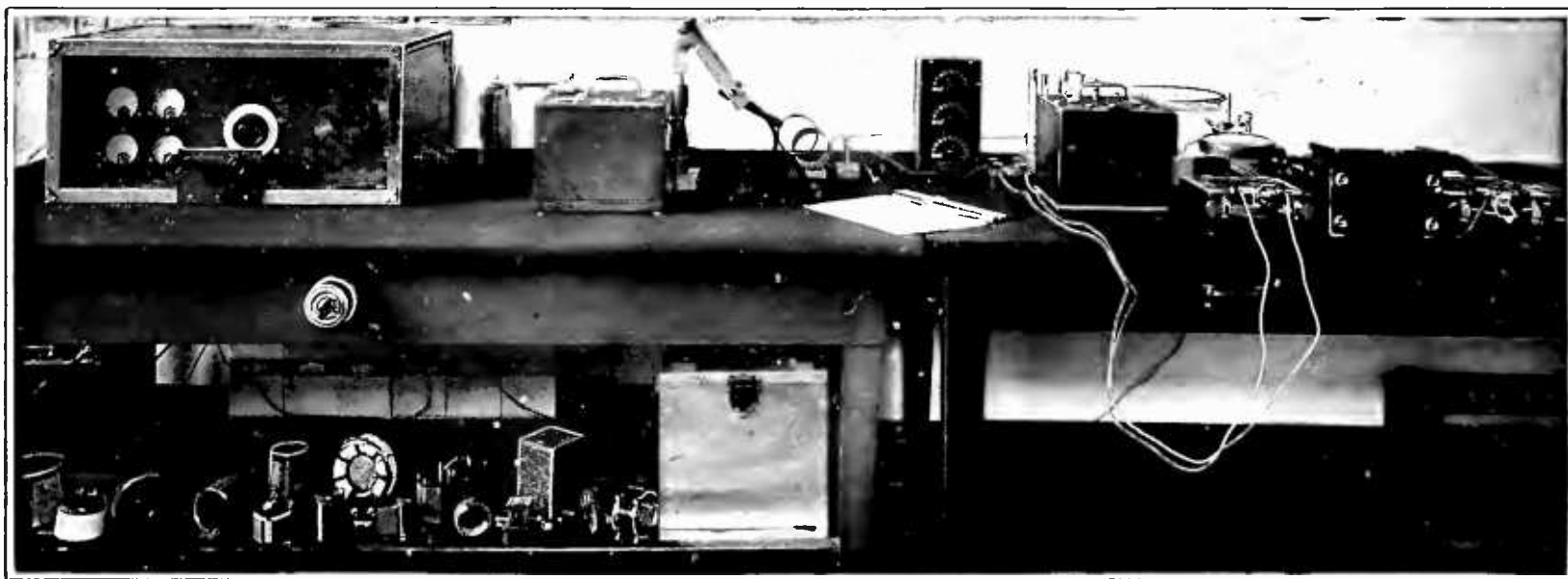

FIG. 5

This view shows the layout of apparatus used by Mr. Harper in making radio frequency resistance measurements of coils. At the extreme left is the radio-frequency oscillator, next in line is the wavemeter used to determine the frequency of the oscillator, and next the coupling coil. The coil being measured is the one resting on the block. It is connected to the resistance box and then to a microammeter through a thermo-couple. Note the magnifying glass suspended above the microammeter for precision readings. Other coils which have been tested are shown on the shelf in the lower left side of the photograph. The Harper coil is the high one to the left of the wooden box

How to Build a Grimes Inverse Duplex

Constructional Details of a Four-Tube Receiver Which is Highly Selective, Built of Standard Parts, and Which Produces Signals of Irreproachable Quality

By FLORIAN J. FOX

LET us say in the beginning that the Inverse Duplex is not a specific circuit—it is a system which can be applied to any circuit in which both radio and audio frequency amplification are to be found.

Reflexing, which is the foundation of the Inverse Duplex system, permits one tube to function as both radio and audio frequency amplifier, and where it is employed in a

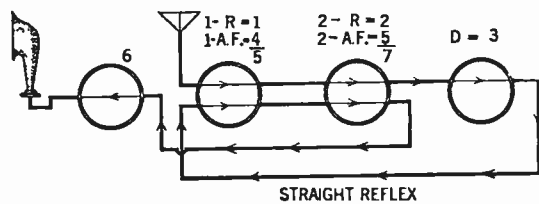

FIG. 1

Schematic diagram of a "straight reflex," circuit. The figures above show how the several tubes are employed to provide more than one kind of amplification

circuit, special attention must be paid to the function of various parts under differing conditions for instance, small condensers offer very little impedance to high frequency radio currents, but their impedance to current flow at the relatively low voice, or audio, frequencies is extremely high. In the case of inductances (transformer windings, choke coils, etc.) exactly the reverse is true. Circuits can therefore be so arranged that they discriminate against low frequencies in favor of the radio frequencies and vice versa. These principles are used in reflexing. Radio and audio frequency voltages are applied simultaneously to a tube, and since tubes work practically as well at radio frequencies as at audio frequencies, both the applied component voltages are amplified. By means of an appropriate circuit arrangement of coils and condensers, these amplified components are separated in the output circuit of the tube. In a properly designed reflex system, the presence of the audio system has no harmful effect upon the efficiency or "sharpness" of the radio circuit.

The Grimes Inverse Duplex is really an inverse reflex system. By that we mean

that the reflexed audio signals are passed through the amplifiers in a direction opposite to that of the incoming radio signals. The simple sketches, Figs. 1 and 2, illustrate this point.

The Inverse Duplex system is superior to the straight system in several ways. It is more stable because any radio frequency energy which may pass the detector and first audio transformer through capacity coupling will only be impressed on the input of the stage ahead of the detector, instead of two or more stages ahead of it as in the case of the straight reflex. In the latter case, oscillation due to feedback would be almost beyond control. In a

greater output volume level before overloading begins. In the sketch, Fig. 2, we have assumed that each stage has an amplification of one unit. The sum for any one tube will represent the load that it carries.

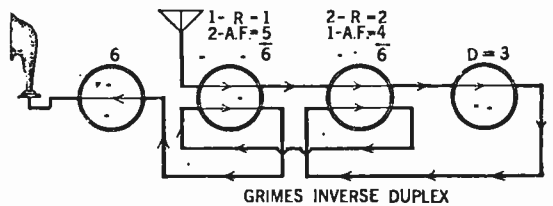

FIG. 2

A sketch which shows schematically how the Grimes Inverse Duplex system works. The tubes are shown in the order in which they are employed in the set and the figures above indicate their functions

FOR those constructors who are interested in building a receiver which is efficient and very sensitive, which employs no regeneration, the Grimes Inverse Duplex receiver described so completely in the accompanying article should appeal very strongly. This set is selective, a virtue not present in many simple reflexed receivers, and delivers tone quality of a high order, because the transformers selected for use in the audio channel are of excellent quality and the design makes best use of them. The filament and plate current drain with four storage battery tubes suggested for the circuit is fortunately low. Every part of the circuit can be made by the home constructor, for complete details of the coil construction are given, an important point, since many experimenters desire to make their receiver, as far as possible, with their own hands.

—THE EDITOR.

straight reflex receiver the first radio tube is usually also the first audio amplifier. Therefore if any audio frequency noises, such as hum from power lines, are induced

One of the greatest advantages of the Inverse Duplex system is its economy of tubes and battery power. This is especially apparent if the receiver is to be operated by means of dry batteries, either in part or entirely. In the set to be described, if 201-A tubes are used throughout, the A battery drain is only 1 ampere. If a 90-volt B battery is used in connection with a 4½-volt C bias, the total B drain from the amplifiers will be only about .009 amperes (9 milliamperes). Since the drain

on the detector battery will be less than 2 milliamperes, even a small battery should last about a year at this point. This set properly handled will enable the user to get results equal to that of a six-tube set. This should have a strong appeal to those fans who like to get greater distances on less tubes or "more miles per ampere."

Looking into the set in the normal manner the tube arrangement

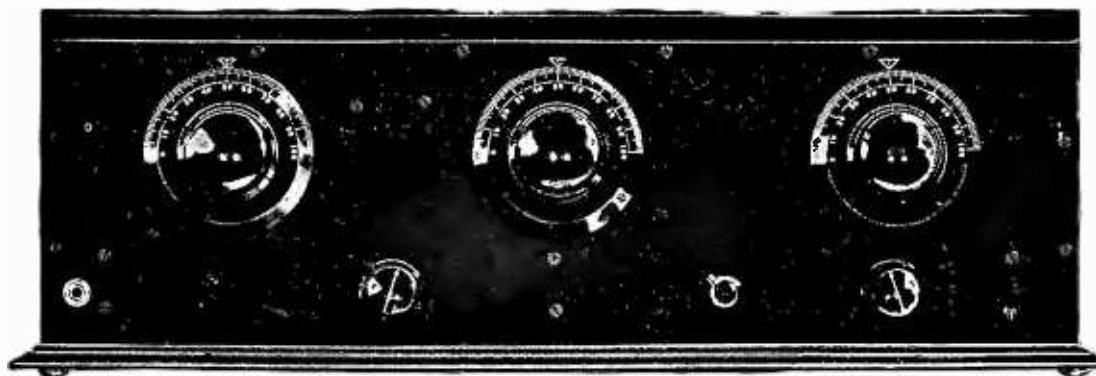

RADIO BROADCAST Photograph

FIG. 3

How the Inverse Duplex Model receiver looks from the outside. Three main tuning controls, which read almost the same for each station tuned-in, take up the major portion of the panel. On the lower portion of the panel, from left to right may be seen the output jack, series antenna resistance for controlling volume, audio amplifier switch, and rheostat. In the accompanying article it is explained how the series antenna resistance is eliminated from the circuit and in its place is substituted the antenna tap-switch which is shown in other photographs

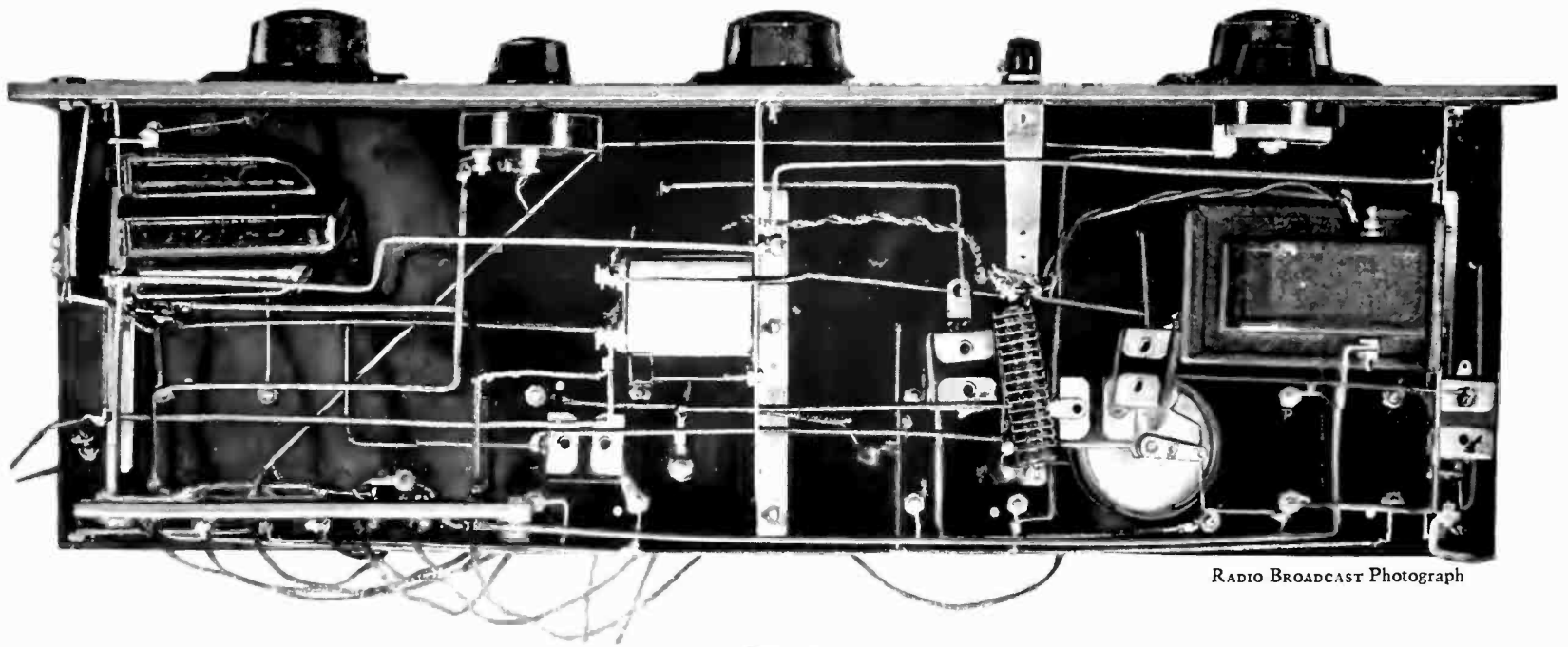

RADIO BROADCAST Photograph

FIG. 4

In this bottom view of the sub-panel, the important feature to observe is the location and distribution of the three audio transformers. Three brackets support both sub-panel and transformers. The variable resistance unit located directly below the Rauland Lyric transformer is the stabilizer

is as follows: (from left to right) 1. Third audio, or power amplifier; 2. First radio and second audio; 3. Second radio and First audio; 4. Detector.

The table printed with this article contains a list of the parts used in the construction of this model.

If a certain amount of good judgment

is used in the selection of the materials, parts made by other reliable manufacturers may be substituted. For good results one must use dependable parts.

Since most experimenters know how to build sets, we shall not spend too much time in describing constructional details.

Fig. 8 shows the general panel layout. The dimensions given should be followed rather carefully, otherwise considerable difficulty may be experienced later when the set is to be mounted in its cabinet. Only the holes for the condenser shafts are shown because the mounting holes will be different for different makes of condensers.

Fig. 10 shows the layout of the inside sub-panel. On account of their height, it will be necessary to remove the bases of the Benjamin sockets. The base is then used as a template for drilling the four spring terminal holes. The sockets may then be mounted on the sub-panel as shown in Fig. 12.

As for mounting the vernier dials, directions are generally given by the manufacturer of the dial. If Hammarlund condensers and National Velvet dials are used, it will be necessary to remove the friction drags supplied with the condensers and to cut off a half inch or more of the condenser

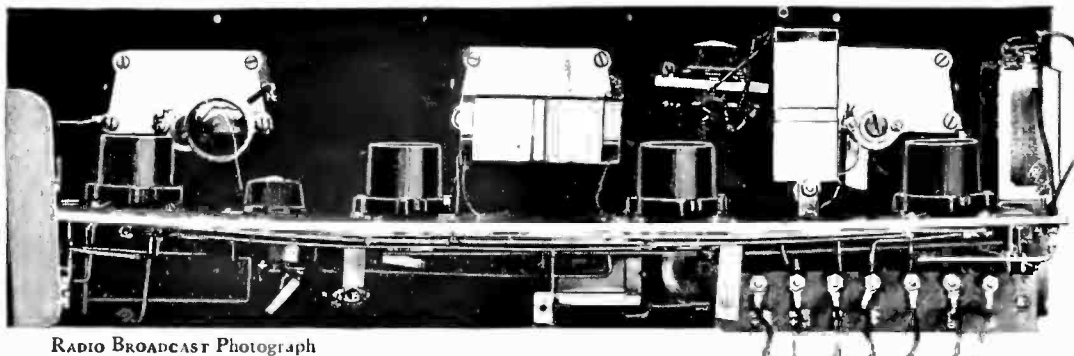

RADIO BROADCAST Photograph

FIG. 5

The coil units located in front of each tuning condenser are mounted so that their axes are aligned at right angles to each other. On the extreme left may be seen part of the grid leak which is shielded by the copper strip

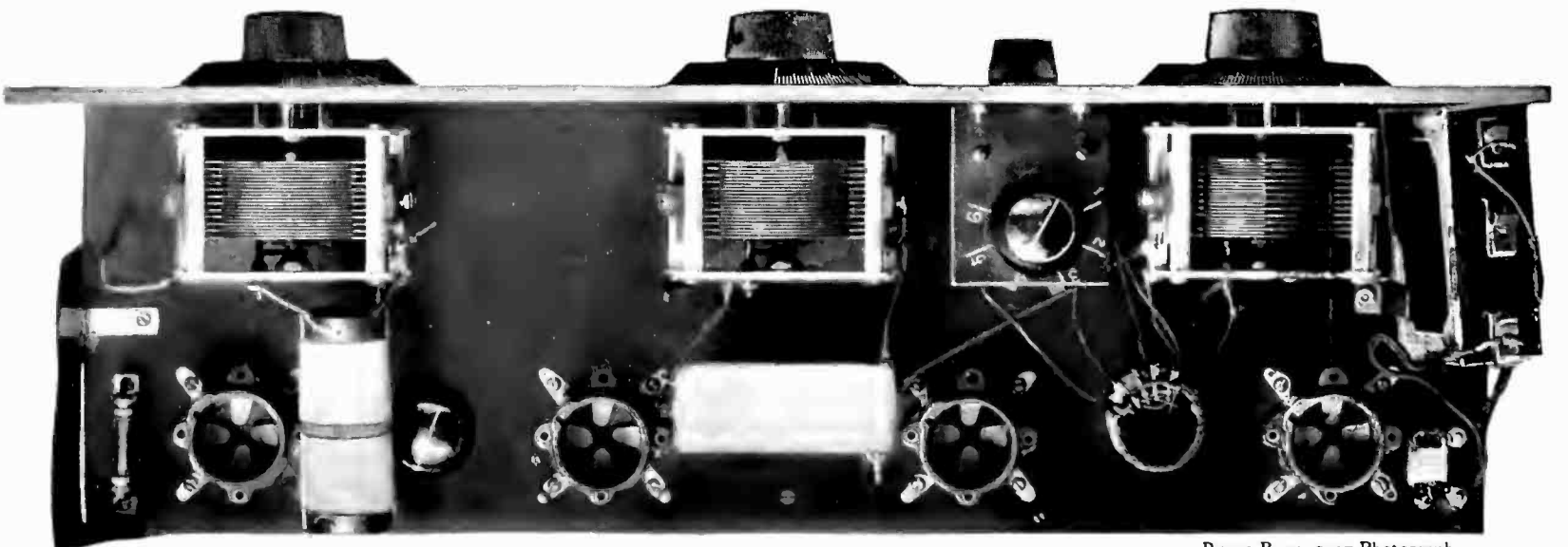

RADIO BROADCAST Photograph

FIG. 6

A top view of the receiver which will be of further aid to the constructor in placing the parts mounted above the sub-panel. As explained elsewhere, the antenna coil tap-switch situated between the two tuning condensers at the left is placed in the regular model directly on the main panel

shaft. It would probably be easier to buy National condensers complete with dials. There are, of course, other good vernier dials on the market which the constructor may favor. We suggest that the builder consider the purchase of a set of straight line frequency condensers for this circuit for they help to spread the tuning points of the higher frequency (short wave) stations, found at the lower end of the dial.

There are quite a large number of concerns that make radio-frequency transformers for use in tuned radio frequency circuits. Since it is difficult to advise the builder how to choose between them, we suggest that he copy the coils that we have designed. The diameter of these coils is small. This concentrates the magnetic field and thus reduces magnetic feed-back. Also, since the voltage per turn is low, the distributed capacity is very low. The resistance is not appreciably increased and the result is a coil which tunes very sharply. Let us now describe its manufacture.

The winding form is a bakelite or formica tube $3\frac{1}{2}$ inches long and $1\frac{3}{4}$ inches in diameter. A $\frac{1}{2}$ -inch space is left in the center of the secondary winding. In this space the primary is wound. Before winding, drill all necessary holes for mounting-brackets, terminals, and anchor holes for

the ends of the windings. Then make a cut with a hack saw in the middle of the tube, and at an angle of about 45 degrees to the axis of the coil. Now begin the secondary winding in such a direction that this saw cut can be used for leading the wire across the $\frac{1}{2}$ -inch space reserved for the primary. The secondary is wound with No. 28 d.c.c. wire. The total winding length is $2\frac{1}{4}$ inches or the equivalent of 90 turns. The primary is now wound in the same direction as the secondary and consists of 15 turns of No. 32 or 34 d.c.c.

wire. Two such coils are made. The remaining, or antenna coil, has a primary of 25 turns (same size wire as the other primaries) tapped as follows: 2 turns, 4 turns, 8 turns, 15 turns, 25 turns. The beginning of this winding is connected to ground, and the taps are connected to points on the inductance switch. This arrangement provides both a volume and selectivity control. Decreasing the number of turns by means of the switch will decrease the volume and increase the selectivity of the receiver. See Figs. 6 and 9.

The Facts About This Receiver

No.	NAME OF PART	MAKE OR KIND	OTHERS RECOMMENDED
3	.0005 mfd. Variable Condensers	Hammarlund	Any good make
3	4" Vernier Dials	National Velvet	} Any good make
3	Radio Frequency Transformers	Home made	
1	6:1 Audio Trans.	General Radio	Amertran, Karas high ratio
1	2:1 Audio Trans.	Thordarson	Jefferson $1\frac{1}{2}$:1
1	Rauland Lyric Audio Trans.	All Amer. Trans. Co.	Amertran $3\frac{1}{2}$:1
1	Panel 7" x 24"	Formica	} Any good make
1	Sub-panel 7" x 22 $\frac{1}{4}$ "	Formica	
3	Panel Mounting Brackets	Benjamin	
1	Open Circuit Phone Jack	Carter Radio Co.	Any good make
1	Inductance Switch	J. W. Jones	Any good make
1	6-ohm Rheostat	United Scientific Laboratories	Bradleystat, or any good make
1	Double-pole double-throw Jack Switch	Carter	Any good make
3	.00025-mfd. Mica Condensers	Dubilier	} Any good make
3	.002-mfd. Mica Cond.	Dubilier	
4	Standard Sockets	Benjamin	Any good make
1	R. F. Choke Coil	Home made	
1	1000-ohm. Non-ind. Var. Resistance	Central Radio Laboratories	} Any good make
1	Radio Cabinet	Jewett Parkay	
	Wire, Screws, etc.		To suit builder

NAME OF RECEIVER: Grimes Inverse Duplex.
 TYPE OF CIRCUIT: Two tuned radio amplifier stages, detector; two audio stages reflexed through the two radio stages; and one straight audio stage.
 FREQUENCY RANGE: 512-1330 kc. (225-585 meters)
 NUMBER OF TUBES: Four.
 KIND OF TUBES: All UV-201A's.
 FILAMENT CURRENT: 1.1 ampere at 5 volts.
 TOTAL PLATE CURRENT: 9 mls.
 APPLIED B VOLTAGE: Amp—90 V—Det. 22 $\frac{1}{2}$ V.
 APPLIED C VOLTAGE: 4 $\frac{1}{2}$ volts.
 SELECTIVITY: Sharp.
 REPRODUCTION QUALITY: First Audio Good; last Audio Fair, with some distortion—controllable.
 NUMBER OF CONTROLS: Three for tuning, one for filament, one for volume, one for quality.
 PARTS EMPLOYED: contained in article.
 CONSTANTS OF CIRCUIT: contained in article.

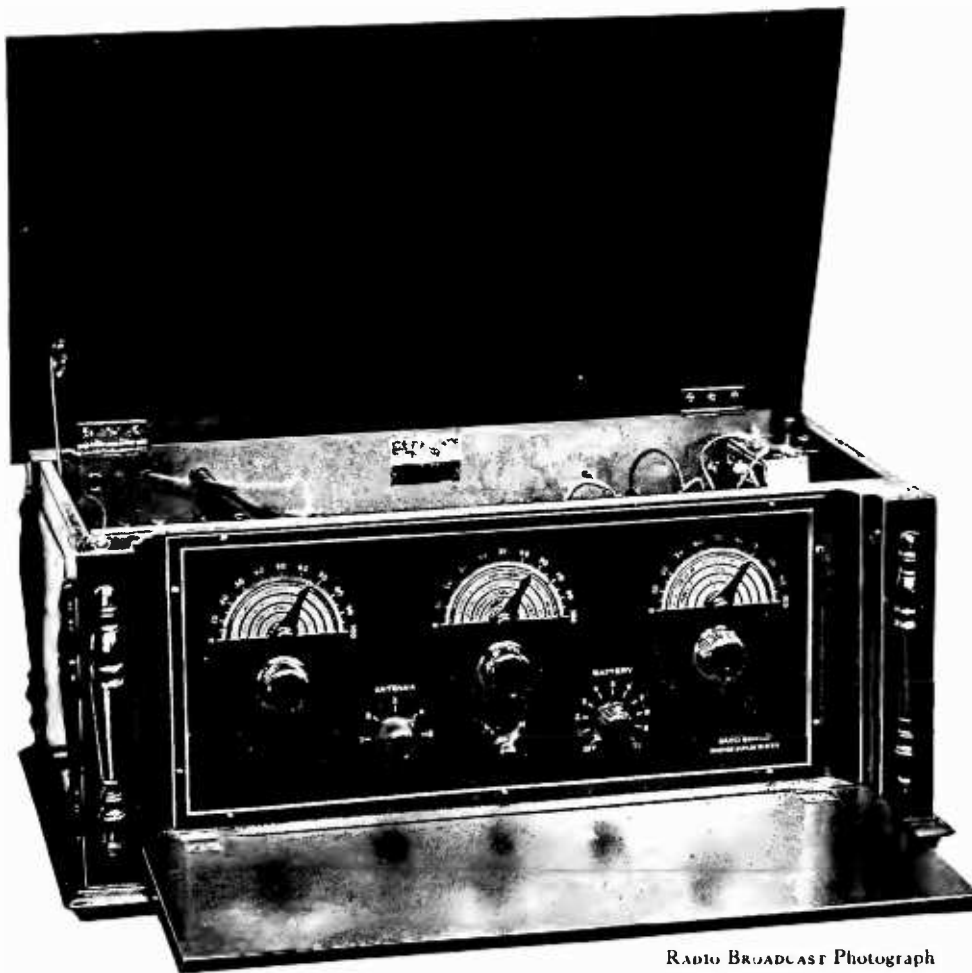

RADIO BROADCAST Photograph

FIG. 7

An external view of the commercial model of a receiver employing the Inverse Duplex system. The dial indicators are engraved on the panel with pointers revolving over a semi-circular scale

BUILDING THE R.F. CHOKE COIL

THE radio frequency choke coil shown in the wiring diagram of the receiver is absolutely necessary. Since there are none available on the market, this piece of equipment will have to be made. The choke coil described is the best we have been able to devise. It consists of about 20 separate windings all connected in series. Spacing the windings in this manner lowers the distributed capacity to such an extent that its presence across the tuned circuit does not affect the setting of the tuning condenser.

If the builder has no lathe, he can have the form made in a machine shop, or by a hard rubber turning company. The form is a piece of hard rubber, hard wood, or bakelite, 3 inches long and $\frac{1}{2}$ to $\frac{3}{4}$ inches in diameter. Slots $\frac{1}{8}$ of an inch wide are cut to a depth of $\frac{1}{8}$ -inch. The slots are spaced $\frac{1}{8}$ -inch apart. This will enable the cutting of about 20 slots altogether. A saw cut is now made along the form parallel to its axis. This will be used for leading the wire from a filled slot to the next empty one. Fill each slot with No. 36 d.c.c., or better, d.s.c. wire. The ends of the wire may be later soldered to lugs that can be screwed to the ends of the form. An easy way to wind a choke coil is to drill into the dead center of one end of the form for a distance of about one inch and leave the form on the drill. Then clamp the breastdrill in a

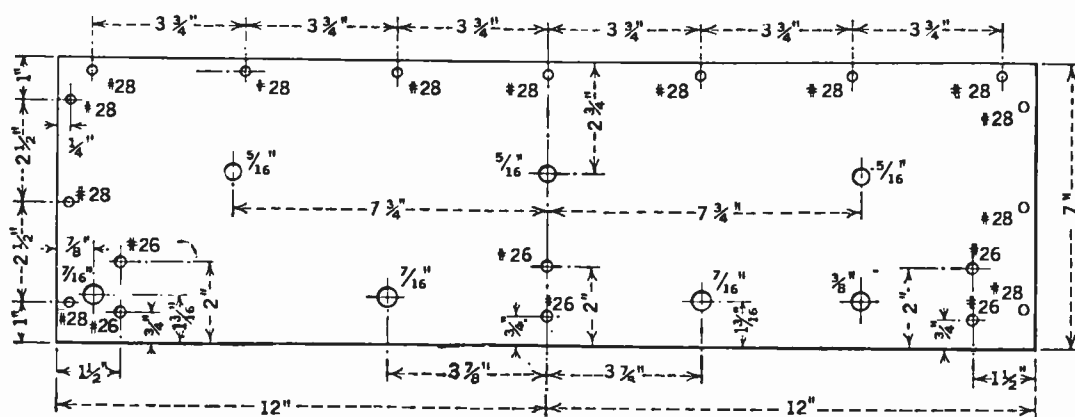

FIG. 8

The layout for the main panel

wise in such a way that by turning the crank, the wire can be easily and rapidly wound on. Fig. 9 shows a sketch of the winding form.

If it is impossible to obtain the above form, some makeshifts may be devised. A dowel could be used and the windings spaced by means of heavy cardboard washers. It might even be possible to get fair results by using a long thread spool filled with wire. Fill the spool up as the winding advances, do not wind in layers. No mounting brackets will be necessary because the finished coil can easily be supported by the wires that connect to it.

The illustrations show the inductance switch mounted inside of the panel. This arrangement has been changed since the photographs were taken. The switch may be better placed where the small knob appears on the panel to the left of the middle dial. The unsymmetrical arrangement of the panel, as the photographs show, was due to a fear when this model was designed that the parts would be too crowded when the receiver was assembled. The fears were not well founded. However, the following change from the photographed model is suggested: Do not mount the rheostat under the third dial. Install a Bradleystat in the extreme lower right corner of the panel, in a position corresponding with that of the jack in the lower left hand corner. Do not change the position of the double-pole double-throw jack switch. The increased length of the audio transformer might cause the set to howl.

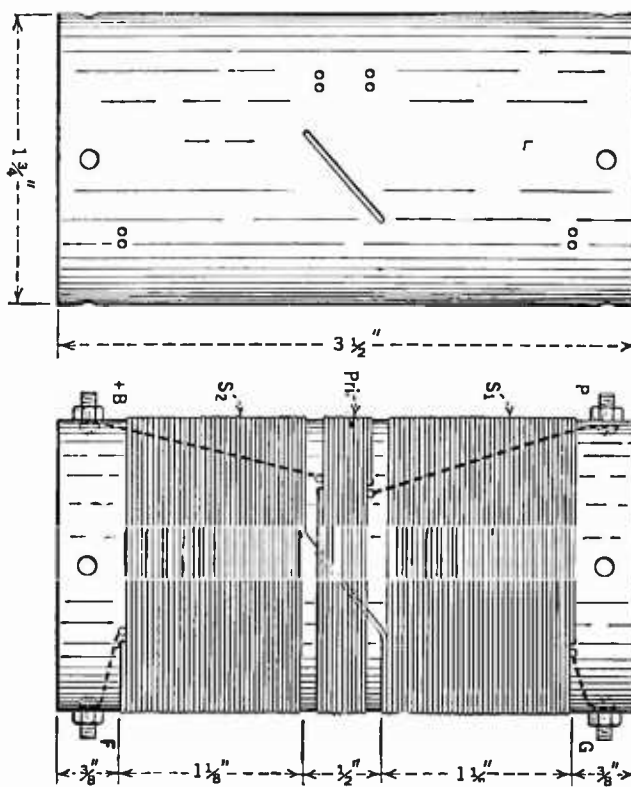

FIG. 9

A detail drawing showing how the coil forms for the radio-frequency transformers are prepared and wound

Before using the sub-panel brackets, drill holes in the sides in such a way that an audio transformer can be mounted to each one. Study the photographs carefully in order to get the correct order and approximate position of each transformer on the brackets. Notice that the General Radio transformer is at the left, the

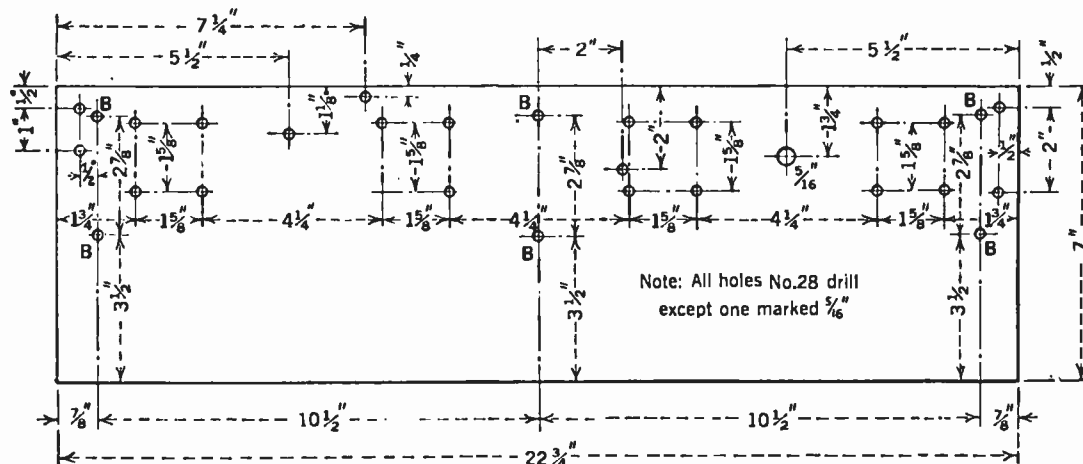

FIG. 10

The sub-panel dimensions

Thordarson in the center, and the Rauland Lyric at the right of the receiver. Before drilling the bracket holes in the sub-panel (marked B in Fig. 10.) check the distances between holes and between holes and panel.

DETAILS OF CONSTRUCTION

Holes will also have to be drilled, before wiring, in the sub-panel to allow for the passage of the condenser and coil leads through it. The location of the holes is not shown. These may be drilled where convenient. Wherever possible, use one of the coil mounting brackets for bringing one of the coil leads through the sub-panel.

The brass brackets which are used to support the coils are shown in Fig. 11.

The grid leak mounting clips used in this model were obtained from a Daven grid leak holder. This is perhaps an unnecessary expense, because these parts can be easily made from a piece of spring brass. The clips are fixed to the top of the sub-panel in order that the grid leak be easily accessible. If this feature is not desired, a grid leak and condenser may be mounted beneath the sub-panel, where it is out of sight.

Notice also in the photographs that a brass bracket is made to support the end of the binding post strip that is not supported by the left hand panel mounting bracket.

The C battery and its terminals are placed at the extreme end of the sub-panel. In the model of the Inverse Duplex shown a small spring brass bracket was used to hold the battery against the cabinet. The hole for this is not shown.

The 1000-ohm variable stabilizing resistance, since it is not to be considered a control, is mounted on the sub-panel where it is accessible for adjustment. In order that this stabilizer

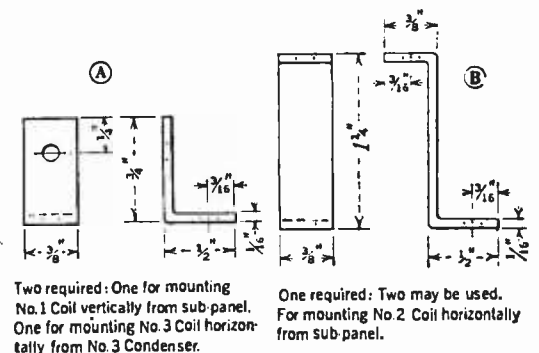

FIG. 11

Details of the coil mounting brackets

may work properly, the primary of the second radio frequency coil *must* be reversed as shown in the wiring diagram. If this is not done, the stabilizing resistance will make the set oscillate badly.

The double-pole double-throw jack switch changes the set from a six-tube to a five-tube outfit (theoretically) by cutting in or out one of the audio-frequency stages.

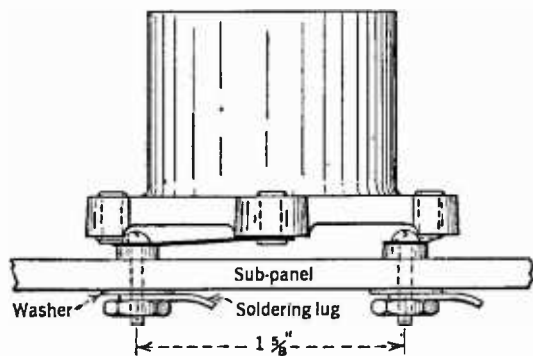

FIG. 12

The assembly for the Benjamin sockets

A switch that has a fibre cam should be used if possible.

If other makes of audio transformers are chosen, insist on two low ratio transformers for the two reflexed stages. Use a high ratio in the last free audio stage. This will insure good quality in this circuit.

Because of the sub-panel construction it is not necessary to waste time in fancy wiring. This will appeal to a large number of home builders. Avoid large closed loops in the wiring of the audio circuits. Wherever possible, twist the wire with its return. That is, in the case of the wires connecting an audio transformer, twist the plate wire with the plus B wire and the grid wire with its minus filament wire. This helps to reduce the tendency for audio feedback which is very great with three stages of audio amplification. Notice also that the third audio tube is placed as far away from the detector tube as possible.

Do not allow the output wires from the third audio stage to run anywhere near the detector tube or its grid leak and condenser. The grid leak and condenser should be mounted as close to the detector grid as possible. This is very important in a set employing this circuit. In the set described, a grounded metal shield has been placed near the grid leak and condenser and the detector tube. This helps considerably in shielding these parts which are extremely sensitive to induction from various sources, such as electric light wires, trolleys, small motors, and so on. It is also desirable

to ground the brackets which support the sub-panel and the audio transformers.

For best results in Inverse Duplexing, there is a certain definite way of poleing the primaries of audio transformers. A technical explanation of this statement is not necessary in this article. The circuit shows the best arrangement for the transformers used. If transformers of a different make are used some experimenting will perhaps be necessary in order to determine whether the primaries are to be connected as marked or reversed. All transformers do not have their primaries marked in the same way.

For local, or perhaps moderate distance reception, it is possible to dispense with the antenna and substitute for it a loop. The loop is connected in the circuit in place of the first secondary tuning coil. It can be so arranged that by means of a double-pole double-throw switch, the loop is connected in the circuit in place of the antenna system. By no means can it be expected

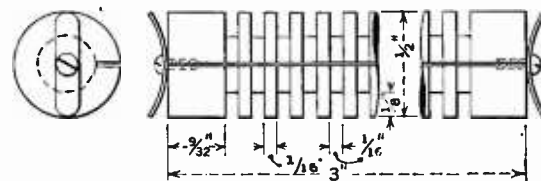

FIG. 13

Specifications for making the choke coil forms

that the loop will prove as satisfactory as the antenna where only distance reception is to be considered, but the constructor will note that with its use there will be a freedom from the usual collection of noises that find their way into a receiver via the antenna.

The circuit is quite stable in operation when UV or UX-199 tubes are substituted, but when this is done, it is well to employ a power dry-cell tube such as the UX-120 in the last audio stage to prevent overloading which results in distortion.

Builders often experience a certain amount of difficulty in constructing a set of entirely new design. We shall outline some of the troubles that may be experienced, and how to locate and correct them.

HOW TO LOCATE AND REMEDY TROUBLE

THE first indication of trouble is usually a howl of some kind. These can be divided into three main classes.

1. AUDIO HOWL. This is a steady high pitched sing which is absolutely independent of dial settings. It may be caused by: (a) audio feedback due to wiring; (b) audio feedback due to common resistance in old B batteries; (c) use of a common detector B battery.

In this set, a separate small 22½-volt battery must be used for the detector tube except when storage B batteries are used; (d) long detector grid lead; (e) the proximity of a loud speaker or loud speaker cord to the detector tube, or to its grid leak and condenser; (f) improper shielding of audio transformers; (g) open grid circuits. Look the set over carefully and check everything except (a) and (f). If the howl still persists, there are only two things to be done; rewire the set, or load the secondaries of the audio transformers. Try placing ¼-meg. or 1/10-meg



FIG. 15

The three dials on this panel seem to be similar to those on any number of sets, especially those of the two-stage tuned radio frequency receiver. Actually this is a panel view of the new Kurz-Kasch E-Z Toon Group Control. By means of the center dial, all three tuning condensers may be rotated simultaneously. All three dials have verniers, permitting each condenser to be finely adjusted independently

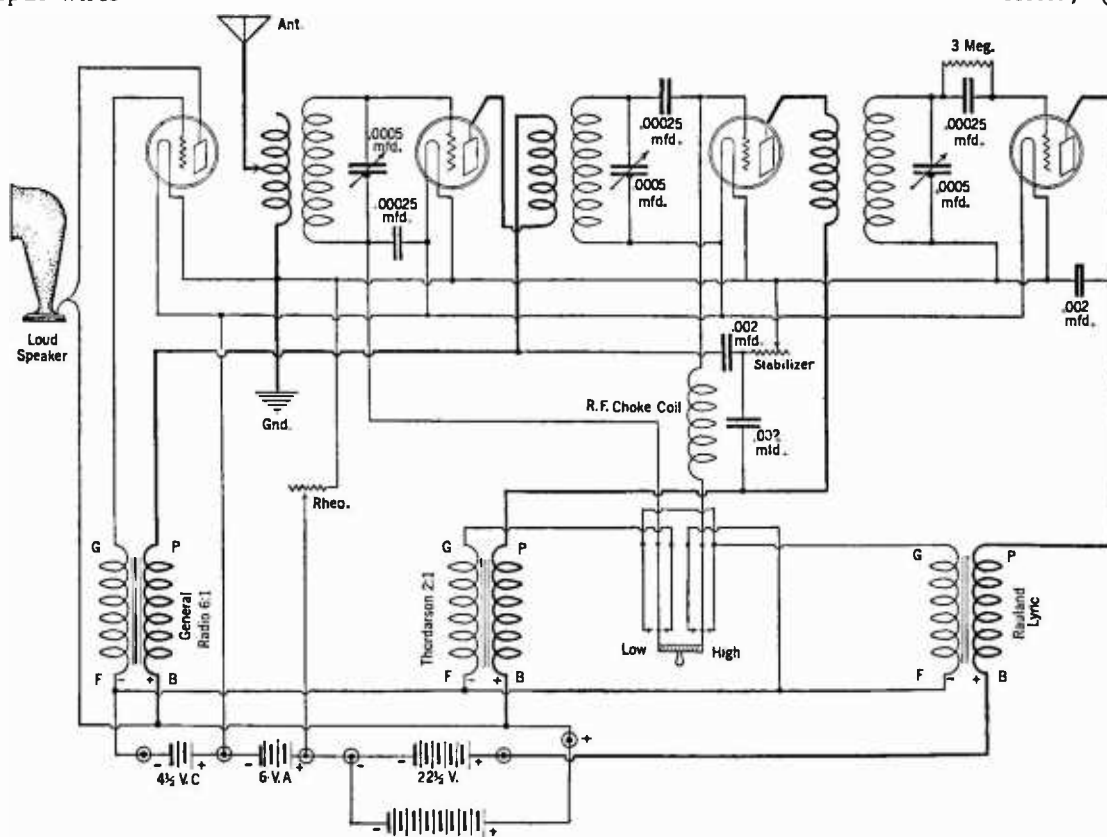

FIG. 14

The circuit of the Grimes Inverse Duplex. The first and last tubes are 3rd audio and detector tubes respectively. The other two are both radio and audio amplifiers

grid leaks across one, two or all three of the secondaries. This should certainly kill the howl. If it does not, the author would be glad to hear in detail by letter from constructors and we shall try to help you. The addition of these leaks, while it reduces the amplification, tends to improve the quality.

2. RADIO HOWL.

This is usually a very low pitched buzzing noise. It only occurs when two or three of the dials are set alike. Removing the antenna and ground tends to make it even worse. Radio Howl is caused by radio oscillation in the receiver. Radio oscillation, in turn, is caused by either electrostatic or electromagnetic feed-back between the radio-frequency stages. It may also be due to capacity feed-back within the tube. In any case, first make sure that the pri-

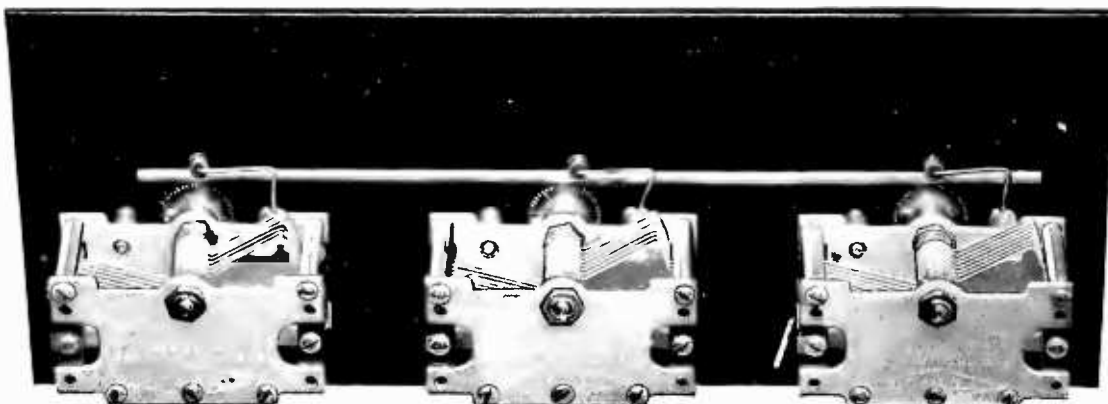

FIG. 16

RADIO BROADCAST Photograph

How the Kurz-Kasch arrangement works. By means of the rack and gears, one dial controls three condensers, an advisable simplification of the tuning of any set employing three condensers. This arrangement can be applied without difficulty to the Inverse Duplex set, and to many other types of receivers employing two stages of tuned r. f. amplification

mary of the second r.f. transformer has been reversed. Next cut in some of the stabilizing resistance, retune carefully, and repeat until no oscillation can be produced, even at the low dial settings. If the stabilizing resistance has no effect, the primary of the second radio coil probably has not been connected according to instructions.

3. OVERLOAD HOWL. The pitch is generally higher than that caused by Radio Howl. It occurs only when all three dial

readings are the same and when antenna and ground leads are connected. The removal of these leads stops it at once. Overload Howl is produced when the set is tuned-in to a very powerful local station. If the pitch is rather low and occurs before the volume reaches the overload point of the free audio tube as indicated by distortion, the audio transformer primaries are poled wrong. Try reversing them in various combinations until the Overload Howl is of rather high pitch. This is the condition for least overload. The receiver should now be capable of delivering volume up to the limit of the tube in the third audio stage. To avoid Overload Howl always cut out one audio stage when tuning-in to local programmes. The third audio stage should only be used when extra volume is desired.

A PRIZE CONTEST FOR THE DESIGN OF A NON-RADIATING SHORT WAVE RECEIVER

SO GREAT has been the interest in the RADIO BROADCAST-Eveready experiments carried out at station 2 GY, and so many inquiries have come from readers who want to listen on the short waves, that the contest outlined below will serve many purposes. In the first place it will indicate that up to the present time there is no receiver which the Editors of RADIO BROADCAST feel that they can recommend. It will also indicate what these Editors, and the judges of the contest, believe an ideal short wave receiver should be. And finally, it will serve to awaken interest among the thousands of amateurs toward developing real honest-to-goodness receivers.

Perhaps a few words on the reason for the first statement will not be amiss. It may be remembered by many readers of RADIO BROADCAST that the clearest cut and longest standing policy of that magazine has been to frown on radiating receivers. It has consistently refused to publish how-to-make-it articles on receivers that were liable to interfere with nearby receivers, and it has endeavored in many ways to show owners of such receivers how they can make them innocuous and more efficient.

The second important point in this connection is the fact that there are at present about 20,000 amateur operators listening-in on the short waves, and practically all of them use very simple two- or three-tube sets, which are of the "blooper" variety. To encourage thousands of broadcast listeners to go down to the short waves with similar receivers would be contrary to our long established policy, and would result in a hopeless medley of meaningless parasitic signals on the higher frequency bands.

At 2 GY, the experimental station of RADIO BROADCAST-Eveready, a receiving tube with 180 volts on the plate has transmitted signals to Philadelphia, 100 miles away, under favor-

able conditions. Of course no receiver regularly uses 180 volts, but with 90 volts, there has been no difficulty in communicating over distances of ten miles and at that distance the 90 volt set produced very strong signals.

What is wanted is a non-radiating short wave receiver, preferably one that will cover all of the amateur bands, but most certainly the so-called 40, 80, 150 meter bands.

To aid possible contestants, the following schemes are suggested. A receiver with such loose coupling that the single oscillating tube cannot radiate; a simple receiver of the present type with a stage of neutralized radio frequency ahead of the oscillating detector; a super-regenerator with a blocking tube ahead of it; some simple form of super-heterodyne, such as the O'Connor frequency-changer described in RADIO BROADCAST for June, 1925. Such a receiver should be as efficient as present receivers, preferably it should be better. That is, it should go down to the noise level in places where a single oscillating tube will not do it.

The conditions of the contest are outlined below. In order to appear in the May issue of RADIO BROADCAST, complete specifications, photographs etc., of the receivers will have to be in the editorial office by the first of March, 1926, in order to be considered.

THE CONTEST

Object: The object of this contest is to aid in the development of improved short wave receiving apparatus, so that the possibilities of high frequencies may be more effectively studied.

Prizes: First prize, \$250; Second prize, \$150; Third prize, \$100. Only one prize to a contestant.

Eligibility: Anyone interested in short wave reception is eligible to compete, though no prizes will be given to manufacturers making short wave receivers or parts therefor.

Conditions: Each contestant must submit a complete description, photographs and hook-up of a short wave receiver which does not radiate. The receiver should be adapted to the entire short wave band from 35 to 150 meters, although this may be accomplished by interchangeable coils. RADIO BROADCAST shall be permitted to request the most promising receivers sent to its laboratories, in order that the final award of the prize may be determined, after exhaustive tests. In addition to the prizes, RADIO BROADCAST shall be permitted to use descriptive matter, either in whole or in part, submitted by any contestant, at its regular rates.

Determination of Prizes: The winning receiving sets will be judged on a basis of points as follows:

Workmanship	15
Simplicity of handling	20
Ease of Calibration	
Freedom from hand capacity	
Independence of tuning and regeneration	
Low Cost	10
Use of standard or easily constructed parts	5
Performance	25
Overall amplification of signals	
Use in relaying	
Ability to use break-in	
Ability to cover foreign amateur bands	
Appearance	15
Method of avoiding radiation	10
Total	100

Board of Judges: The following constitute the board of judges: Boyd Phelps, Prof. Louis A. Hazeltine, Zeh Bouck, G. C. Furness, Arthur H. Lynch, Edgar H. Felix, Dr. Lawrence Dunn, and Dr. A. Hoyt Taylor.

The contest positively closes March 1 so that prizes may be announced in the May issue, appearing April 15. All correspondence and prize manuscripts must be addressed: Director of the Laboratory, RADIO BROADCAST, Doubleday, Page & Company, Garden City, New York.



The Listeners' Point of View

Conducted by — John Wallace

What Radio Programs Chiefly Need

WAS it Irvin Cobb who described in whimsical fashion the dire results of his attempt to reduce, by taking alternate steaming hot and icy cold baths? Whoever it was, he attests that it resulted in his developing a set of highly trained, trick pores, capable of opening or closing at the slightest provocation, or at no provocation at all. This double action, hair-trigger arrangement, he further averred, was no unmitigated joy, inasmuch as said pores used absolutely no discretion as to the proper time to do their stuff, being prone, nay even fain, to open wide on a brisk, six-below zero morning, or shut up, like offended clams, in a stuffy telephone booth.

Another disease, similar in causation, threatens at any moment to sweep across the continent, sparing Mr. Cobb perhaps, but reducing to mild insanity a large army of listeners-in. This scourge we dub *Radio-Emotionalis*—or perhaps better *Radio-Super-Emotionalis* (medical term for an insidious neurotic condition).

The hapless victim of the epidemic may be readily recognized. He will greet you

right cheerily enough, perhaps laughing boisterously the while. But a second later he will be weeping copiously on your shoulder only to relapse quickly into the belligerent, defiant attitude of one resolved to crush out the little white menace. This may, like as not, be followed by a period of calm, whilst the victim, with gently heaving chest, gazes off into space, a where-have-you-been-all-my-life look in his eye. Then he will cackle hideously and start tuning-in the buttons on your coat, whereupon you will take to your heels, unless, as is probable, you have by that time caught the disease, in which case you will make it a cackling duet accompanied by Miss Blaughk on the mighty Baldwin.

Which is reason enough for the Government to establish a colony on some isolated island and confine thereon, as menaces to the public health, sixty per cent. of all existing radio program directors.

The "bigger and better" radio stations have, in response to the nowise concealed wishes of the listeners, largely got away from the kaleidoscopic type of program. But a large majority of the jerk-water

stations, keeping abreast, as is their wont, with the times now three years passed, still persist in this nerve-racking offense. An extra-horrible example of the kaleidoscope program runs something as follows:

- 8:00 P.M. Announcement. Name of station. Its street address and telephone number. List of pickle manufacturers and dance halls it represents. Name of announcer. Color of his eyes. Call letters of station. Slogan of station. Bright remark. Vaise Triste *Sibelius* (Same as 8:00 P.M.)
- 8:07 Itchy Foot Rag *Joe Goose*
- 8:10 (Same as 8:00 P.M.)
- 8:13 Elegy *Massenet*
- 8:20 (Same as 8:00 P.M. and repeated hereafter as frequently as possible)
- 8:23 Reading: "The Shooting of Dan McGrew"
- 8:29 Quartette: "Oh Lord Where Art Thou?" *Larch*
- 8:36 Quartette: "Where's My Sweetie Hiding?" *Ed Ock*
- 8:41 Solo: "Fly With Me" *Verdi*
- 8:46 Address: "Swat the Fly" by Ald. Skink
- 8:51 And so forth.

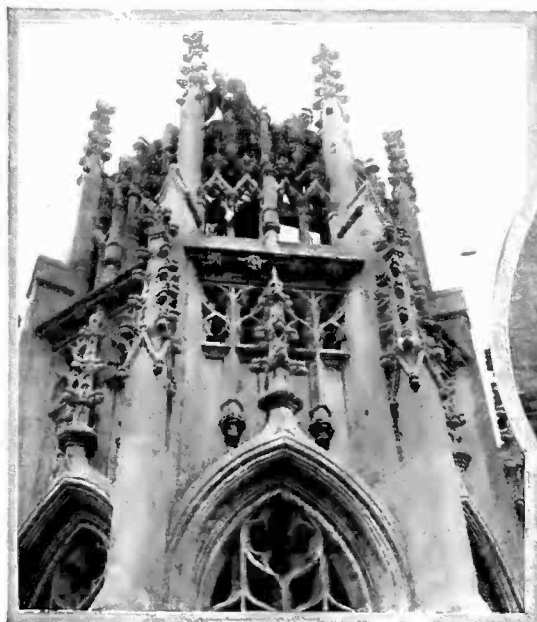

BROADCASTING A CARILLON AT WJZ

On Sunday nights at 7 P. M., Eastern Standard Time, the carillon recently installed in the Park Avenue Baptist Church, through the generosity of John D. Rockefeller, Jr., is broadcast. The chimes sound much better on the air than they do to listeners nearby. There are many high buildings near the belfry and unfortunate sound reverberations occur. The view at the left shows engineers of wjz experimenting with the location of the microphone. Anton Brees, formerly assistant carillonneur of the famous Antwerp Cathedral, and now in charge of the New York chimes, is shown at the manual in the center view. The photograph at the right shows H. B. Glover, of wjz, installing the microphone above the bells

Well, yes, we'll admit that this is a slightly exaggerated example, but the inconsistent program, even in its mildest form, is very annoying. Unity is a quality inseparable from anything that is well constructed, whether it is a watch or play or a sermon or a railway station. We don't always consciously note the force that unifies an otherwise heterogeneous collection of miscellany but we quickly and instinctively sense its absence.

Of course even a che-ild (that hypothetical youngster who, as shown in numberless illustrated advertisements, spends its infant years at pushing pianola pedals, running vacuum cleaners, operating Blum Bros. Cross Index Files, and cranking Tripco Trucks) could tell you that the above program was decidedly lacking in unity. But with the less flagrant offenders, the problem becomes a less evident one and its solution rests

finally on the taste and sense of the fitness-of-things of the program director. If he already lacks this sense the chances are he won't acquire it, and it would be better for the station to throw him out and get someone else.

Appreciation of Sibelius' *Valse Triste* requires that we be in a certain frame of mind. Likewise thorough enjoyment of *The Shooting of Dan McGrew* presupposes our being in a certain frame of mind. And the two frames are as dissimilar as passe-partout and carved ebony. The desirability of an audience being in receptive mood is so evident that it hardly needs to be stated. The overture that commonly precedes an opera constitutes a recognition of this truism. Containing as it does inklings of all that is to happen, it prepares the auditor for the three or four acts to follow and effectively bridges the gulf that exists between listening to music

and the previous occupation of the listener, be it clipping coupons, or punching a typewriter.

Even the movies take cognizance of this device. If, in one of the larger palaces, the feature film "Why Shoot Your Husband?" is shown, it will inevitably be preceded by an "opulent stage presentation" showing a chorus of bored wives engaged in target practice.

If the *Valse Triste* and *Itchy Foot Rag* are put on the same program, one or the other, or both, is going to suffer from the juxtaposition. The difference in mood between the two is greater than we can be reasonably expected to bridge.

But giving unity to a radio program does not, by any means, imply making it monotonous. Variety and unity are not necessarily antagonistic. Shakespeare, who was no ham at play construction, and who was a stickler for unity, didn't hesitate



IN THE STUDIO OF WRNY, NEW YORK

What probably is called a motley crew, peering through the plate glass window of the studio, inspecting Jerome Lama playing on the musical saw, an "instrument" capable of curious and unearthly melodies—as many radio listeners know from their own experience



DR. EDMUND A. WALSH

Vice President and Regent of the School of Foreign Service at Georgetown University who inaugurated the first radio school of international relations at station WRC, Washington. Conferences in this school are broadcast weekly by WRC, and test periods have been arranged for examination of listeners who enroll for the course

to introduce variety into his tragedies. He occasionally made use of the most sudden and violent contrasts. For instance the execrable pun pulled by Othello as he blows out the candle preparatory to smothering his wife, which, in 1926 version amounts to: "I'll douse this glim, and then, douse that one!"

If it's a joke it's a rather dismal one, and quite in keeping with the tragic mood. Thus Jarnefelt's *Praeludium* could be sandwiched in along side of the aforementioned *Valse Triste* with no disconcerting effects. For, though the one is riotously funny and the other mournfully sad, they are united by a common bond: both are music.

Mixing in a lot of fundamentally different things in the same hour's broadcast simply means that the edge is going to be taken off all of them. We can only give such a program the most superficial sort of attention and consequently derive a most superficial sort of enjoyment. If we were to try to get the most out of it by changing our mood as fast as the program director's whims we would expose ourselves mercilessly to the dread disease described above—*Radio-Emotionalis*.

The mixed program is doubtless the program director's honest effort to reach and entertain the maximum number of people of widely varying tastes. But in his attempt to please everybody he pleases nobody. Moreover, in considering it his duty to please everybody, he is flattering himself as to his indispensability; forgetting he is only one of the ten or twenty, or more, stations at the listener's command.

He performs no valuable service in offering variety, since it is the simplest thing in the world for the listener to get the variety himself, if he wants it, by tuning from one station to another. But if the listener, on the other hand, wants a uniform program, with no jarring inconsistencies, his only recourse is to tune-in on those few progressive stations on which he can count to deliver such a program.

And that is exactly what the listener does. Which is well. For in the long run it will mean that the hodge-podge program station will either come around to some sort of an organized presentation or simply waste its vaudevillian offerings on the thin air—which would not be economically advantageous.

So we would seem to have been tilting with a wind mill for the last several hundred words since all will right itself in time. But the sooner the better. The ideal state of affairs will have arrived when each station adheres to one type of offering for at least sixty minutes on end. Then,

but not till then, we will be able to regard the faint snatch of something or other we hear flickering across our dials, as a fair sample of what that station is offering. Under present conditions, we have more than once been fooled into patiently tuning-in a station because we heard a bit of a Brahms symphony (which, now that it is no longer the fashion to do so, we will admit we crave inordinately) and have been rewarded by the clear and perfect reception of *Palpatin' Mamma*.

In Defence of the DX Fishers

THE Chicago district is, at present writing, engaged in a fearsome battle on the question of silent nights. One station has lingered on through months of warfare and refused to shut down on the specified night. Hence the fracas. While the recalcitrant station frequently asserts, with an air of injured righteousness, "We are considering the interests of the thousands of fans who, if no local station were in the air, would be



HOW WGY IS REBROADCAST AT WCAD, CANTON NEW YORK

Left to right: Harold K. Dergman, radio operator in charge at WCAD; Ellis L. Manning, announcer at WCAD, and instructor in physics at St. Lawrence University; S. E. Barber; Charles Geyh, control room assistant, and Prof. Ward C. Priest, chief announcer. The WCAD station is maintained by the students and faculty of St. Lawrence University and broadcasts on Wednesday evenings between 8 and 11 P. M., Eastern Standard Time, on a frequency of 1140 kc. (263 meters). The main features of the WCAD programs are rebroadcast from WGY at Schenectady, 175 miles away. The illustration shows the staff at the receiving station, picking up the WGY signals on their 192.2-kc. (1560-meter) wave

entirely deprived of radio on Monday nights, and the multitude of owners of large sets who can get outside stations, but who prefer to tune-in on local programs" it is transparent enough that it is playing the martyr for publicity purposes.

And, of publicity, it has received plenty in the controversy in the newspapers. One of the most amusing communications to the press was that of a lady who said "Indeed we do not want silent nights. We want to listen to the good programs in Chicago."

Any one familiar with the general run of Chicago programs should get a large ha-ha out of that!

But while we have not been inflamed by the controversy to the point of contributing to the symposium of nasty letters, it seems to us that were we questioned we'd advocate a silent night. Why not?

The thousands of fans who "would be entirely deprived of radio on Monday nights" could doubtless find something else to do. They didn't sit around thumb twiddling in the Before-Radio age.

We can't see why there should be any gnashing of teeth over the fact that the capital tied up in a station lies idle on silent night. There's many a large factory, representing an investment equivalent to a gross of broadcasting stations, that grinds forth no goods of a Sunday.

Moreover, why isn't the station's force entitled to a bit of a vacation at least once a week? Perhaps for some stations a two-, or even three-day vacation might be desirable. Who knows but that the program director, freed for the nonce from his duty of filling up the programs, might, during the enforced idleness, give birth to an original thought concerning said programs!

DX fishing has been pooh-poohed quite a bit by those who claim that it is a hold-over from radio's infant days. Its chief thrill they protest is merely (powerful word that "merely") the satisfaction gained in conquering vast distance. This, they go on to say, is silly; a perversion of radio's purpose, which is not to furnish geographical gymnastics, but to entertain.

Granting the fact that the largest use to which radio is put is to furnish entertainment in the home, and granting likewise that this will doubtless continue to be its chief attraction, we still maintain that its faculty of entertaining is not radio's greatest attribute. Its greatest potentiality is the conquering of distance.

Entertainment in the home is no new thing. We have always had Cards and Conversation. Pianos abound. Then there is always Charades or Post Office, to say nothing of Photograph Albums. Add to all these boons the Talking Machine and what more could you ask! Surely if radio's claim to admission to the Hall of Fame is on the ground that it has brought entertainment into the home, its argument is a feeble one. Cross Word Puzzle books could with as much right demand a pedestal. The unique feature of radio is not that it entertains, but, that it conquers distance. Every seeker after glory must pursue that chimera in his own line—not in the other fellow's. Hence it is in the conquering of distance that radio must achieve its laurels.

When we get a string quartette from Omaha we are getting nothing that we couldn't get out of a talking machine. But when we get an opportunity to sit in, by radio, on a national political convention, in session perhaps halfway across the continent, we are getting something we

never got before and couldn't get any other way. When (if ever) we are able to listen to some important history making event in a distant country, we are experiencing something undreamed of a generation ago. It is in service such as this that radio achieves its greatest purpose.

So to us the most potent argument for a silent night is that it encourages DX fishing. And by stimulating DX fishing it is stimulating designers and manufacturers to greater efforts toward perfecting long distance receivers. In short it is a step toward the development of radio's greatest and most valuable potentiality.

Readings in Foreign Languages

AMONG the very few things that radio is actually capable of doing in the educational line is to assist in the teaching of foreign languages. Time and again we hear someone moaning "If I could only get someone to talk to me in French I could learn the language, but you know you can't get it all out of a book. You've got to hear it spoken."

We seem to remember that some years ago the broadcasting of lectures and readings in foreign languages enjoyed a brief vogue. But of late we have combed our dials assiduously and discovered a paltry few such offerings, generally in the form of lessons. In New York, WEAJ broadcasts a twenty minute French conversational lesson on Tuesday evenings conducted by Dr. Thatcher Clark of Columbia University and WNYC gives an hour on Monday, Wednesday and Friday evenings to elementary lessons by V. Harrison Berlitz in German, Spanish, and French. In Denver KOA contributes forty-five minutes a week to a conversational Spanish lesson on Mondays at 8 P. M. There are doubtless several other stations we have overlooked, but in all there is very little attention paid this excellent educational possibility.

There may be some question in the minds of program directors as to how widespread an appeal such an offering would have. Certainly it is true that there is no universal desire in this country to become bi-lingual. What if the most disreputable little newsboy in Rome can hawk his wares in three languages? He needs to. We don't.

But with the constantly increasing ease and decreasing cost of transportation to foreign strands, we, of America, are gradually going to find it more convenient to know other tongues. Moreover, the time is not centuries off when communication, via broadcasting, with foreign countries will be an everyday occurrence.

Besides there are already a goodly number of persons who would be interested in having an opportunity to listen-in on French or Italian or Spanish from time to time—persons who have struggled through Mr. Woman's or Otto-Onion's estimable grammars in their school days and have a foundation of knowledge which needs only exercise to become useful.



DOC HOWARD'S WKRC BROADCASTERS

Who are heard every Monday night from station WKRC at Cincinnati as a part of the "Kodel Mid-night Frolic." The entertainment includes this jazz orchestra, a male quartet, a whistler, and character monologists

Such an educational program might take the form of a lecture on some current topic, given perhaps by an attaché of a consulate or by some first rate pedagogue. Or perhaps better it might consist in readings from some of the standard classics in the foreign tongues. Then the radio scholar would be able to sit with the book in hand and supplement with his eyes what he could not get with his ears.

The desirability of such readings or lectures being given by someone to whom the tongue is native, and who is possessed of the most perfect enunciation, is evident.

Announcers as Automatons

SEVERAL readers have taken the trouble to inform us, and in no uncertain terms, that we are all wrong in advocating that the radio announcer be an automaton. We were assured that "no one wants to hear the plot of the opera to be broadcast read in the same monotonous voice that is used for stock market quotations." And we make haste to agree heartily.

When we urged that the announcer be an automaton rather than a personality-plus salesman of the radio station's wares, we had reference only to the announcer engaged in the routine business of labeling the next number and citing the name of the performer. We still think he should sink unobtrusively into the background.

The individual whose duty it is to comment at length upon the program (where absolutely necessary), to explain the music (where absolutely necessary), or to prepare us with some historical background (where absolutely necessary), is not, in the strict sense of the word, an "announcer." Call him a public speaker, if you will, or an "artist."

Of course he should have free rein to do his job in the best possible manner; though, unless he is the author, he should see fit to read the interpolations with only the inflection necessary to make them clear, spritely, and pleasant, and with no attempt to put his own personality forward.

But if, on the other hand, his observations are his own, he has a perfect right to put them across any way he pleases—just as he would do in ordinary conversation.

Broadcast Miscellany

ACALL has been sent out by KF1 to its receptionists to send in lists of old music dating from the Civil War period up to 1900. Plans are on foot in the Los Angeles station to review American music in a thorough and painstaking manner. Request is also made for copies of the old songs, songs such as "Climbing Up the Golden Stairs," "I'll Meet Her When the Sun Goes Down," or "We'll Paint the White House Green."

And, WKRC at Cincinnati performed a similar service in ferreting out folk songs

that have been preserved in the mountain fastness of Kentucky and are still played and sung in the cabins that are found in the clearings atop the mountains. This station arranged with the Cincinnati *Post* and the Rudolph Wurlitzer Company to send a musician on a trip through the hills to listen to, and record, the tunes—most of them unpublished. Among the songs, many of them two hundred years old, that were gathered together to form a broadcast program were: *Brother Green*, *Frog Went A-Courting*, *Lady and the Glove*, *Sourwood Mountain*, and the *Hangman's Song*.

H. V. Kaltenborn, associate editor of the Brooklyn *Daily Eagle* is on the air again Monday evenings from eight to eight-thirty through station WOR. His Current Events talks have been a popular feature of radio programs for the past three seasons. Mr. Kaltenborn interrupted the series last spring to make an extensive journey through Europe and the Near East in search of new material.

WITH the addition to its program of a new feature entitled "Things Talked About," which is presented every Friday afternoon by Mrs. Nina Reed, station WRC at Washington is now covering the weekly trend of current events for both its masculine and feminine audiences. Mrs. Reed's new series of weekly talks takes up the important events of the world that are of particular interest to women, and reviews those questions that are not covered by Frederic William Wile in his excellent weekly discussions of the political situation in Washington every Tuesday evening.

THE Uncle Charlies and other bed-time boys who persist in calling their juvenile listeners "kiddies" are, we suspect, some kin of the coy word-coiners who attempted to label the American soldiery in the late fracas "Sammies."

WHAT ho! we thought, there is much talk of how Music is insinuating itself into the Radio World. Let us see, vice-versa, how much of a ripple Radio is creating in the Musical World.

So we hied ourself to the public library and surrounded ourself with seven of the current musical publications. This, thought we, should be a fair enough index of the interest aroused among bonafide musicians by radio. Well, we shall chronicle the result of our research without comment: nowhere in the music trade journals did we find the word "radio" as much as mentioned. Which may or may not prove anything.

AN INTERESTING variation of the traditional ritual of announcing is that employed by WEBH, Chicago. For some time this station has been announcing only the "next number," omitting reference to the preceding one. Recently this

system was reversed and the practice now followed is to announce only the number just completed, after which the next number starts without any introduction. Either practice is commendable since it results in cutting the announcer's time on the air in half—and announcements, like subtitles in the movies, are best when brief.

Of the two methods, the one finally adopted by WEBH as a permanent practice has the most to commend it; for frequently a listener tunes-in during a number and is perhaps curious to know what he has heard.

This rule of omitting introductions is subject to exception. Where the importance of the artist, or the novelty of the offering, warrants it the announcement is made both before and after—for routine studio offerings the "back announcement" alone suffices.

SOME attention-caller, amateur or professional, ought to take it upon himself to inform these enthusiastic and breezy announcer-persons that g-e-n-u-i-n-e is not pronounced genuine. Concerts "broadcast direct" from some place or other, also leaves us exceeding cold. The logic of this last statement is positively astounding. Everyone is of course familiar with indirect concerts, and knows that the direct brand are vastly to be preferred.

THE editor of this department is pleased to hear from readers who agree or dispute his opinion. Those who write should address their letters to "John Wallace, Conductor, Listeners' Point of View, RADIO BROADCAST Magazine, Garden City, New York," and sign their communications.

IN TAKING stock of recent noteworthy additions to the broadcast listener's fare, we discover that the Radio Corporation of America stations have been responsible for at least two of the outstanding features on the winter's programs.

First in importance was the series of recitals from Steinway Hall, sponsored by Steinway and Sons. Such important musicians as Josef Hofmann, Guy Maier and Lee Pattison, pianists; Walter Damrosch and William Mengelberg, conductors; and Paul Kochanski, violinist, were heard in this series of one and one-half hour concerts broadcast through, WJZ, WRC, WGY, and WBZ.

Also of interest to many have been the Lewisohn Free Chamber Music Concerts broadcast from Hunter College, New York, every Wednesday night. The Chamber Music Series was founded by Dr. Henry Fleck and is still under his direction. They comprise the first course in musical appreciation offered to the public. In arranging the concerts, Doctor Fleck devoted the first part of the program to the classical school of writers, presenting them in chronological order. The second part has been reserved for modern works, however radical. Several excellent quartettes and trios have been heard in this series.

FOUR RECEIVERS

Each of Which Were Experimented With In Developing the "Radio Broadcast Universal"—Showing How Variations in Panel and Sub-Panel Arrangement Can Be Used to Advantage

DUE to space limitations, it was not possible to show the readers of RADIO BROADCAST all the models of the popular RADIO BROADCAST "Universal" Receiver completely described in this magazine for January, 1926. A great many of these models were constructed while we were experimenting with the circuit in search for the final receiver. Several of the models which were not illustrated in our January number are shown here and it is possible for the reader to ascertain for himself the wide scope of application of this circuit to other designs. Other coil units, different panel and base layouts may be employed. On these two pages are shown several views and a circuit diagram of an excellent receiver which has points in common with the "Universal." We believe that many of our readers are

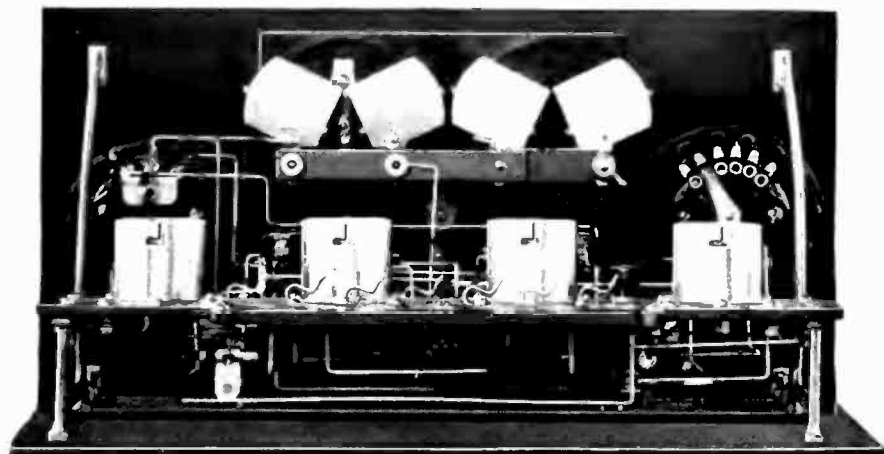

RADIO BROADCAST Photograph

FIG. 1

Rear view of the Phonograph model. Note the compactness of the unit which is made possible by using the Clarotuner coils and Hanscom single control unit

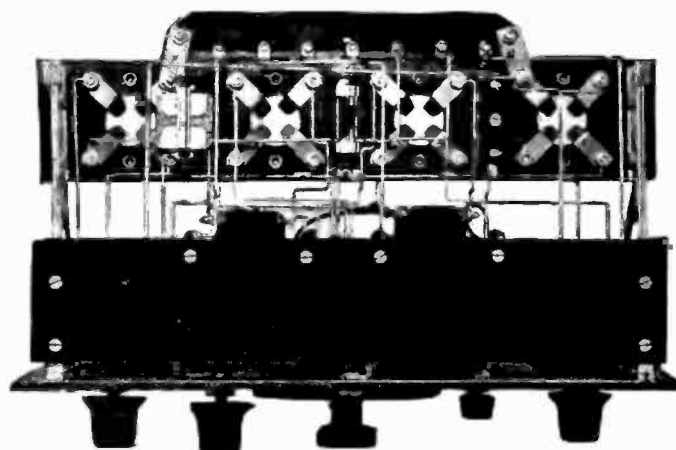

RADIO BROADCAST Photograph

FIG. 2

Bottom view of RADIO BROADCAST's Universal made to fit in a phonograph cabinet. This design is due to the engineers of the American Mechanical Laboratories and employs several departures from our original model to good advantage, including the Bruno Brackets which make for great rigidity in a compact receiver of this kind

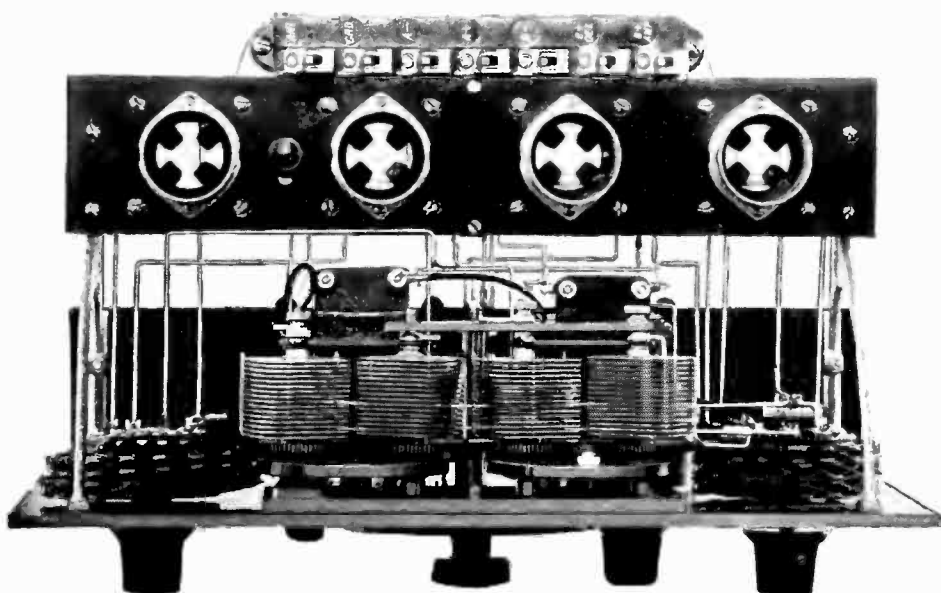

RADIO BROADCAST Photograph

FIG. 3

Top view of the same receiver illustrating the ease of assembly and wiring as well as the particularly neat appearance this form of assembly makes possible

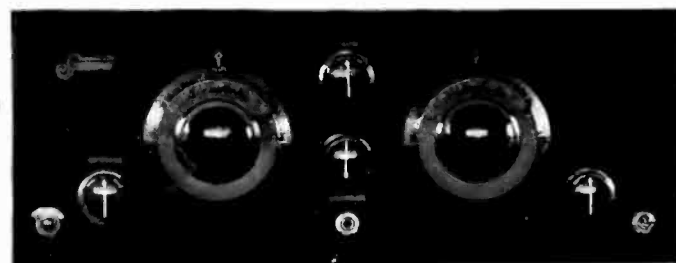

RADIO BROADCAST Photograph

FIG. 4

A front view of the Sampson T C Receiver which has been developed by the Sampson Electric Company of Canton, Massachusetts, after a design of J. K. Clapp of M. I. T. This set is a very good example of the design adaptations possible in the Universal Receiver. The changes in the circuit employed are briefly covered in an accompanying illustration

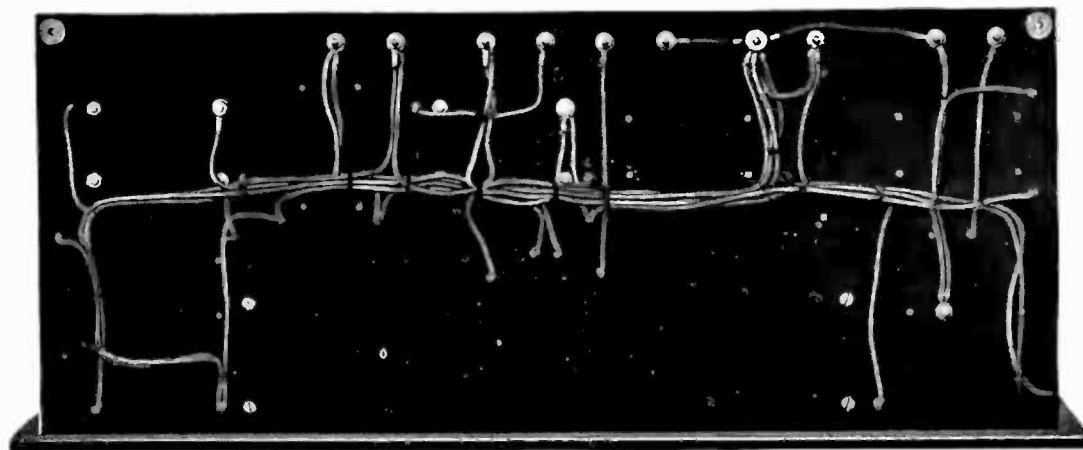

RADIO BROADCAST Photograph

FIG. 5

Cabling the wiring—when it is done intelligently—is advisable. Here is the base of the Samson and is a very good example of how it is done

undoubtedly familiar with this receiver, the Sampson T C, and for those who are not, it is shown here by illustration and circuit diagram.

The circuit diagram for the "Universal" Receiver is found on page 331 and the six pages following of RADIO BROADCAST for January, 1926.

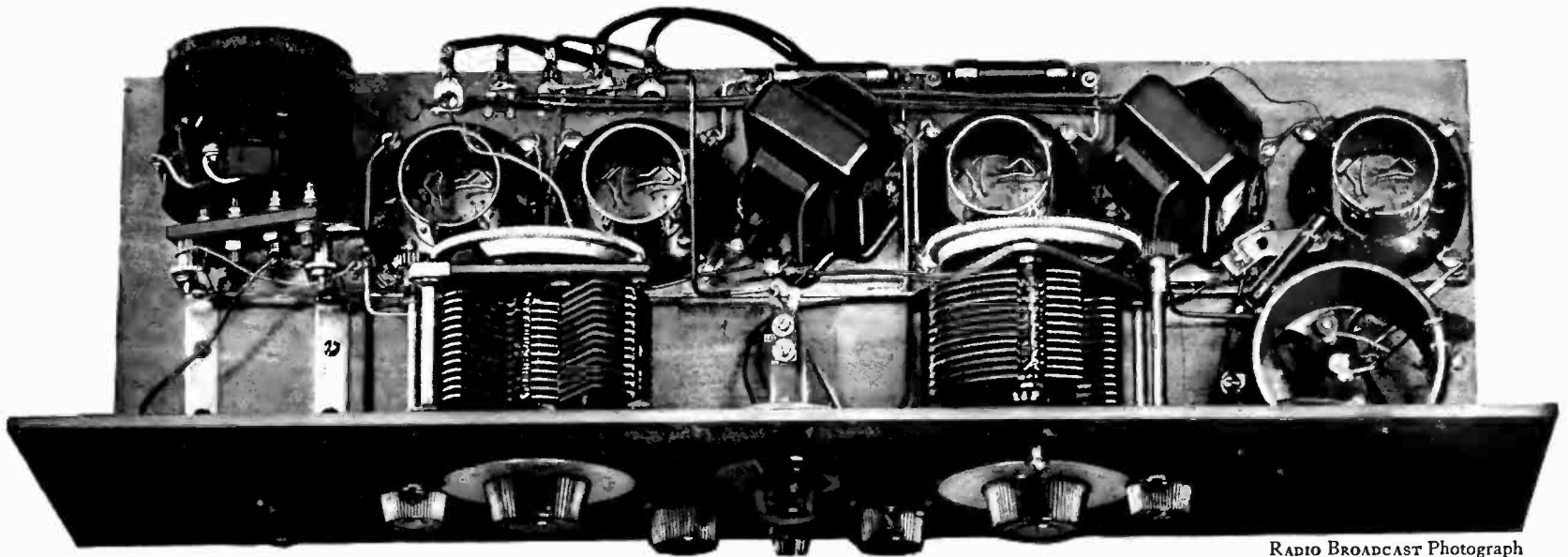

RADIO BROADCAST Photograph

FIG. 6

One of the early models of the Universal which was abandoned because of wiring and electrical feedback difficulties

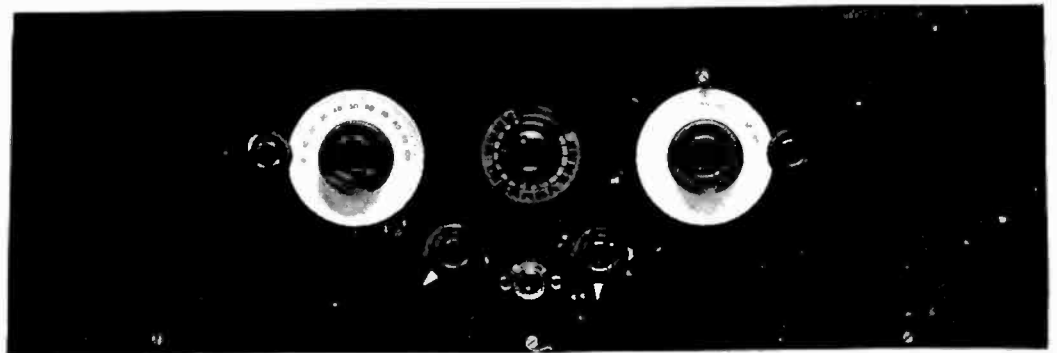

RADIO BROADCAST Photograph

FIG. 7

A very symmetrical panel may be had by bringing the volume control resistor to the center as shown here

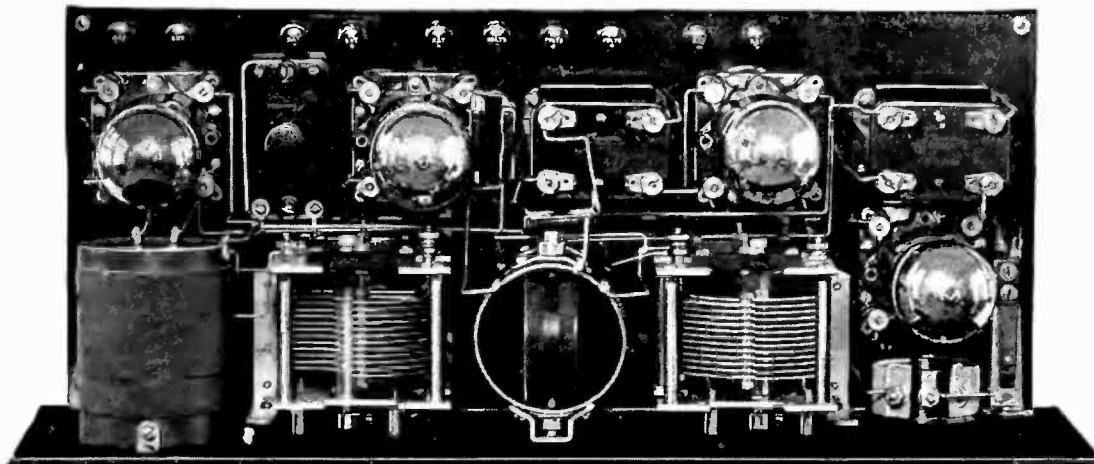

RADIO BROADCAST Photograph

FIG. 8

Looking down on the Sampson T C Receiver. So much equipment in so small a space is in itself an accomplishment. This layout is a little difficult to approximate, but when you have it finished it is a real receiver. The tests run on it in our Laboratory revealed it to be one of the best we have ever had submitted for test. It is compact, easy to handle, economical to use, and the tone quality is far above the average. On the second stage audio it performs very well with a cone speaker which is saying much for a transformer-coupled audio receiver

FIG. 9

The circuit used in the Samson receiver is our old stand-by—the stage of neutralized, tuned radio frequency amplification, a regenerative detector and two stages of high quality transformer coupled audio amplification. The neutralizing system is particularly simple to handle and but few improvements in the circuit could be made. Some reduction in plate current consumption may be had by placing a 3 to 4½ negative bias on the first tube and better performance may be had from the audio, without complicating either the building or operation, if the R. F. stage rheostat is confined to that tube and ballasts are used in the filament circuits of the first and second audio tubes. If a 201-A type tube is used in the first stage, a ¼-ampere ballast may be used and where the new 112 type tube is used, a ½-ampere ballast will serve very well. In this last case, raising the plate voltage on the last tube to 135 volts and increasing the grid bias to minus 9 volts will be found worth while

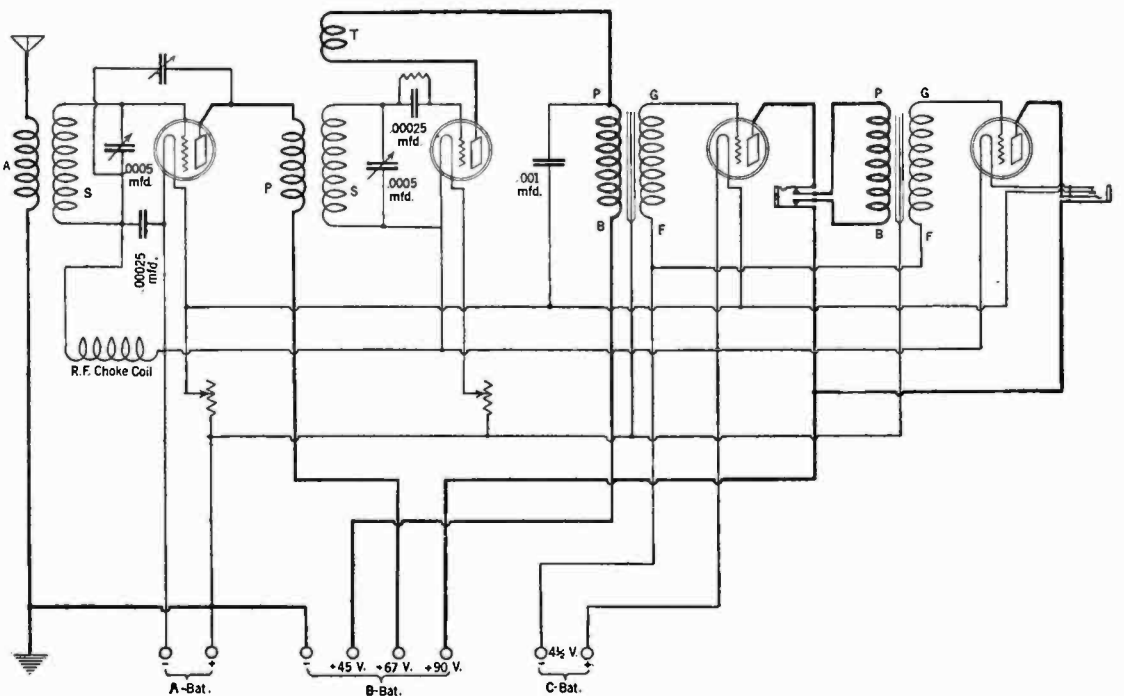

“How Long Will My B Batteries Last?”

New Thoughts on an Old Question—How to Choose the Proper Unit for the Proper Use—The Economic Importance and Use of the C Battery



By GEORGE C. FURNESS

Manager, Radio Division, National Carbon Company

THE question “How Long Will My B Battery Last?” was old when radio broadcasting began, and from then until now, the answers have rarely been satisfactory. If the question were asked of a radio battery expert, the answer would consist of a cross-examination of the user as to the kind and size of battery, number of tubes, the B battery voltage, the C-battery bias and so on, world without end, until the inquisitive child appears dumb in comparison. If the question were asked of an unreliable clerk in the radio store, who had become an expert over night and who, knowing little, feared less, the answer would be whatever figure the clerk thought would most please the questioner.

Both types of answers are equally unsatisfactory to the radio user. In the one case, he is not generally interested in a discussion of the many factors which affect the life of his battery, and in the second case, he does not want an incorrect answer.

Although the laws of physics and chemistry continue to operate as formerly, thus bringing in just as many factors as of old in affecting the life of a B battery, conditions have become sufficiently standardized with respect to broadcast receivers so that we can now *fix* many of what formerly were *variable* factors. Common practice thus enables us to simplify a complex subject and give results which are in close approximation to actual performance.

This article is written by a student of radio batteries who still finds it impossible entirely to get over the old habit of severe cross-examination and discussion of every factor. We are therefore unable to come to the consideration of battery life under simplified conditions without first explaining the basis on which simplification is accomplished.

Here then are the assumptions on which the simplified story is built:

1. That the battery is of reliable, high grade manufacture.
2. That 90 volts of B battery is used on both radio and audio frequency amplifier tubes.
3. That 45 volts is used on the detector tube.
4. The battery is considered as discharged when each $22\frac{1}{2}$ -volt section drops to 17 volts. This is the conventional “cut-off” voltage. Experience has shown that many users continue to obtain satisfactory results and do not discard their B batteries until long after they have passed this 17-volt point.
5. That the grid bias on all radio frequency tubes is zero.
6. That the grid bias on the audio amplifier tubes is either zero (no C battery) or is $4\frac{1}{2}$ volts negative when a C battery is used.

7. That the tubes are burned at normal filament brilliancy.
8. That the receiving sets employ tubes which have the electrical characteristics of the UV-199 or UV-201A.

HOW MUCH IS THE AVERAGE RECEIVER USED?

WHEN a user asks “How long will my B battery last?” he wants to know how long it will be before he will have to buy another battery. He does not want to be told how many hours of operation he will get from his battery because he does not know how much he is going to use his receiver, and therefore he cannot tell how soon he will have to renew his batteries. The other horn of this dilemma is that the life of a B battery, in terms of elapsed time, rises and falls with the extent to which it is used. Therefore, a satisfactory answer forces us to a consideration of the average hours of use of a radio receiver. This is a fertile subject for discussion among radio fans and, in general, one man’s opinion has been as good as another’s because they have all been opinions rather than facts drawn from extensive investigation. We are fortunate in having available a considerable amount of data which warrants the conclusion that average year-around use is in the close neighborhood of two hours daily. We have, therefore, based all of our battery life figures on a two-hour daily use. Any reader who feels that his use is more or less than two hours per day, should decrease or increase the figures given, accordingly. In those rare instances where the average use exceeds three hours daily, the battery life should be somewhat more than proportionately decreased. Similarly, if the average use is less than one and one-half hours’ use daily, the battery life should not be increased in full proportion.

Experience has shown that the drain on



FIG. 1

The cylindrical cells which go to make up two types of B battery. That at the left is for light duty batteries, that at the right for heavy duty batteries. A zinc cylinder encloses a compound in which is located centrally, the carbon rod. The carbon is the positive pole of the battery cell, the zinc can the negative

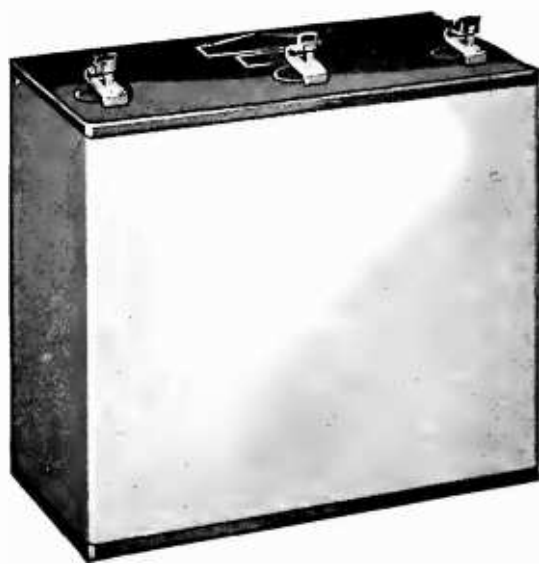

FIG. 3

This is a heavy duty battery designed for use with receivers where the current drain is 14 milliamperes or over

storage battery tubes at 90 volts and without bias is 6 milliamperes per tube, and when using the proper C battery, this figure is reduced to 2 milliamperes. The drain on this tube when used as a detector is also 2 milliamperes.

The difference between the B battery current drain of dry cell and storage battery tubes is not great enough to warrant separate figures or calculations for dry cell tube sets.

We have been clearing out underbrush all this time, so that we can see one of the two things which we must always know to determine how long a B battery will last that is, the current drain on the battery. This is now merely a matter of arithmetic, knowing the number of tubes and how they are used. For example: here is a three tube set without a C battery. Its drain is twice 6 for the two audio tubes, plus 2 for the detector, a total of 14 milliamperes. A C battery would change the story to twice 2 plus 2, or 6 milliamperes. (We never work out one of these examples of the B battery drain with and without a C battery, that we don't marvel afresh at the saving involved.)

Once we know the current drain of a battery, all that we have to do to determine its life is to put it on test *at that drain* and see how long it lasts. It doesn't suffice, how-



FIG. 2

Several types of B batteries, varying both in voltage and size. All are for light duty

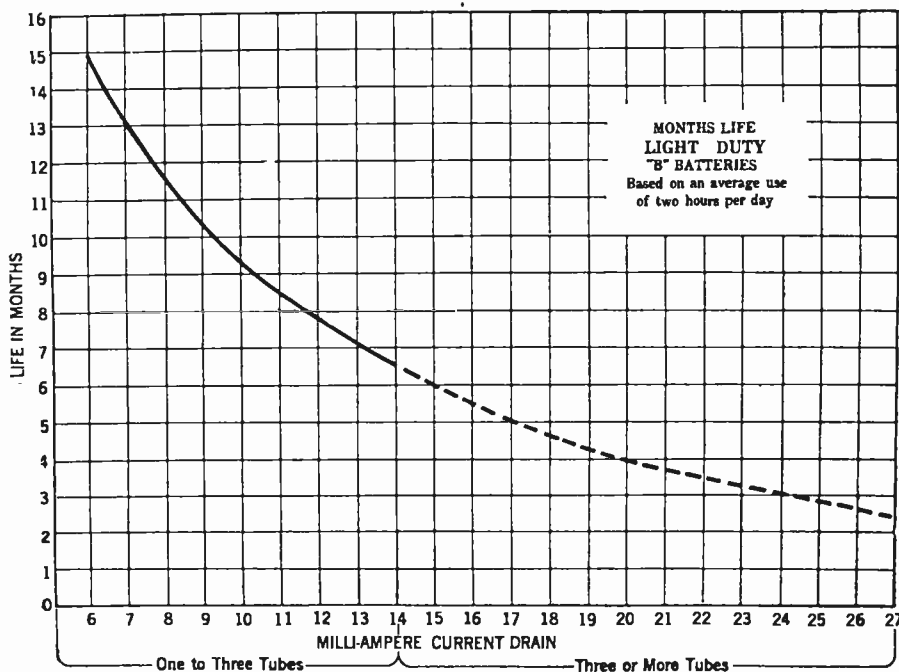

FIG. 4

All the curves shown on these pages are based on the results obtained from a test conducted to determine the average number of hours of use of a receiving set. The unbroken part of the curve indicates the life of a battery when used with a receiver employing one to three tubes where the total milliampere drain does not exceed 14 milliamperes. Where more tubes are used the drain is greater and the battery correspondingly lasts over a shorter period

ever, to test a battery at one drain and then calculate the life at other drains, for the electrical capacity varies somewhat with the drain. If a battery lasts 1000 hours at one drain, it probably will not last a full 500 hours at twice the drain. Therefore, the only way to determine how long a battery will last at different loads is to test it at those loads. This has been done.

The drains chosen were 4, 8, 16, 24, and 32 milliamperes, which covers the entire range of load ordinarily encountered. Several tests were made for each drain at different periods and each test represents the performance of several batteries.

The entire series of tests were made on two sizes of batteries, designated as the Light Duty and the Heavy Duty. The illustrations in Fig. 1 show the size of the

cells used in the Light Duty and in the Heavy Duty battery. The illustrations in Fig. 2 show the three common forms of the Light Duty battery—the 22½-volt unit which is sometimes referred to as the “5-pound battery” and the vertical and horizontal forms of the 45-volt unit.

The size of the cells in a battery determines its electrical capacity, not the number of cells and the voltage. The 22½-volt and 45-volt units shown in Fig. 2 are all Light Duty batteries, even though one is twice the weight and dimensions of the other.

Fig. 3 shows the Heavy Duty battery which is generally made only in a 45-volt unit.

One of the results of the elaborate series of tests on the two sizes of batteries has been to enable us to determine the field, i.e., the drain, where each is best suited. The answer is this:—Use the Light Duty on *all* drains below 14 milliamperes and the Heavy Duty on all drains above 14 milliamperes. An approximate rule, in terms of the number of tubes, is:—The Light Duty battery should be used on sets of one to three tubes; the Heavy Duty size on sets of four or more tubes. Let it be noted with all possible emphasis that the rule makes no mention whatever of the smaller size batteries. This is because the Light Duty size is more economical than any of the smaller size batteries *however low the drain*. The justification for the smaller size batteries lies entirely in their portability, never in their economy.

When we tell how to fit the right size battery to a receiver in terms of the milliampere drain of that receiver there are practically no exceptions, for we are dealing with a fixed electrical unit: the milliampere; when, however, we talk in terms of number of tubes, a simple unit, under-

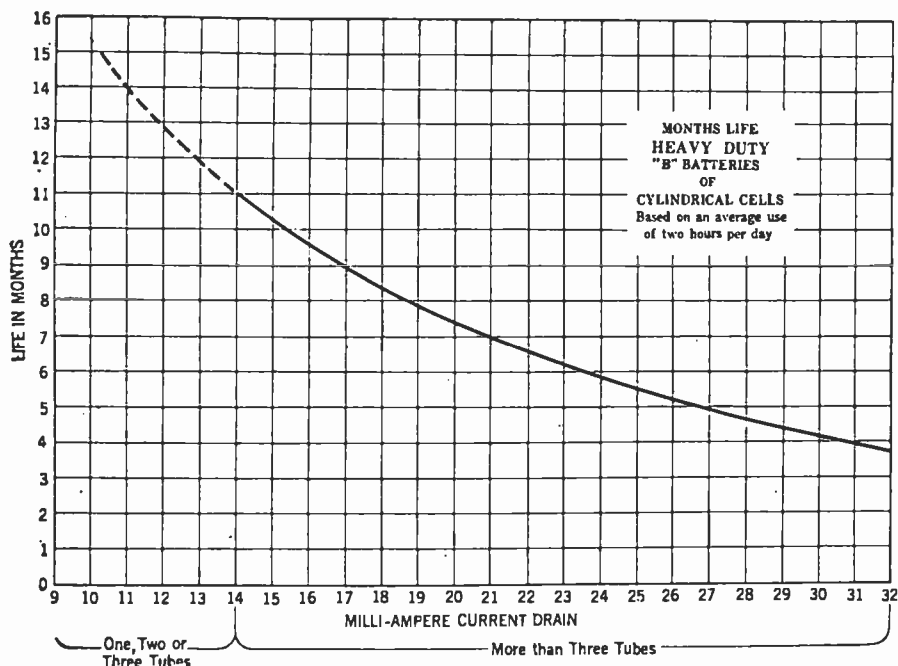

FIG. 5

Where the ordinary heavy duty battery is employed for receivers having more than three tubes, the period of life is greater as can be seen by the above curve, than if light duty batteries were employed

standable to all, we obtain a simple rule, but, like most simple rules, there are exceptions.

"One to three tubes" covers most sets below 14 milliamperes, and "four or more tubes" covers the great majority of sets whose drain is above 14 milliamperes. One exception is that of one model of the Radiola super-heterodyne, which is so designed that, although it employs six tubes, the drain is only 12 to 13 milliamperes. Another exception is the four- and five-tube receivers, recently described in RADIO BROADCAST, which are so constructed that their drain is much less than 14 milliamperes. There are, therefore, certain exceptional cases where the Light Duty battery is the proper size for sets of four or more tubes.

Practically no one uses the Heavy Duty battery when the Light Duty battery should be used. A recent survey has indicated, however, that a large proportion of the radio users are making the rather serious mistake of using the Light Duty when they should be using the Heavy Duty battery. The use of the Heavy Duty battery on sets of four or more tubes is not only much more economical, but also raises still further the high convenience factor of dry cell B batteries.

At last we have come to the point where we can discuss B battery life, for we know now the two essential factors, the current drain, and the correct size of battery to use for that particular drain. The rest is clear sailing.

THE LIGHT DUTY BATTERY ON ONE- TO THREE-TUBE SETS

THE curve in Fig. 4 is derived from the data furnished by the tests on the Light Duty battery. To "work" the curve is easy. Take the three-tube set about which we have already spoken. The drain without a C battery was 14 milli-

amperes. Reference to the curve shows that at this load, the life is 6.4 months.

With the set pulling only 6 milliamperes when a C battery is used, the life is just fifteen months. "Too long," you say. You don't believe it? Very well, we won't quarrel. You and I both know that Niagara Falls is very, very high, but neither cares whether it is actually 250 or 400 feet from top to bottom. Let's say "more than a year" for the life of the battery and let it go at that.

The curve does not show battery life for drains of less than 6 milliamperes because there is little interest in a life of over fifteen months, and also because we do not wish to overtax the reader's credulity.

We have said that the Light Duty bat-

tery should not be used on drains in excess of 14 milliamperes but we have extended the curve in a dotted line up to 27 milliamperes. This makes it possible to determine the life of the Light Duty battery even when wrongfully used on excessive drains.

Another way of expressing the same data given by the curve in Fig. 4 and of avoiding the necessity of even thinking milliamperes, is shown in the following table:

LIFE OF LIGHT DUTY B BATTERY
(Based on average use of two hours per day)

NUMBER OF TUBES	WITHOUT C BATTERY	WITH C BATTERY
1	More than a year	
2	11 months	More than a year
3	6 months	More than a year

The shortest life in the table is six months, i.e., two renewals a year. The Light Duty story then comes down to this: When properly used, this battery will not require more than two renewals per year for two hours' use per day.

THE HEAVY DUTY BATTERY ON SETS OF FOUR OR MORE TUBES

THE life of the Heavy Duty battery under various drains is shown in Fig. 5. In this case the curve is dotted below 14 milliamperes—the field of lower drains where the Light Duty battery is better suited, as previously discussed.

The life of this battery on a five-tube neutrodyne with a C battery on the audio stages is worked out thus: Two radio frequency stages at 6 milliamperes each is 12; the detector at 2 and each audio stage also at 2—totals 18 milliamperes. The curve shows the life to be 8 months.

A substitute for the curve is given in the following table:

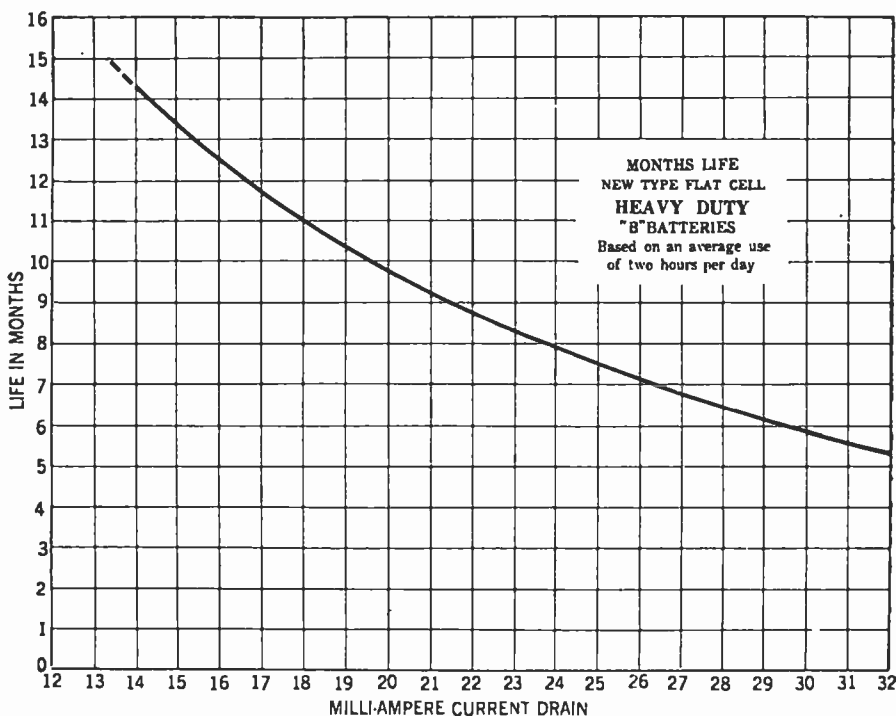

FIG. 6

This curve of a newer type of heavy duty B battery shows conclusively that where high drain is to be experienced and where long life is to be expected, the flat type cell unit approximates, more than the other types, the ideal condition

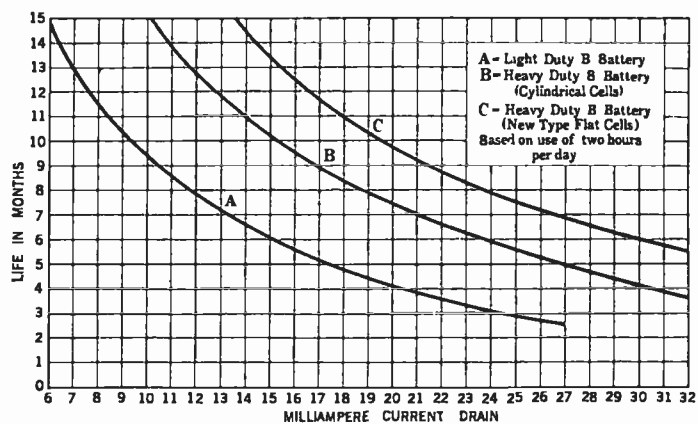

FIG. 7

This composite curve illustration shows very definitely the comparative longevity for three types of batteries, where the current drain is the same in each case

LIFE OF HEAVY DUTY B BATTERY

(Based on average use of two hours per day)

NUMBER OF TUBES	WITHOUT C BATTERY	WITH C BATTERY
4	7	Over a year
5	*6	8 mos.
6		6 mos.

*This figure is slightly higher than is shown by the curve when using the calculated current drain. Experience has shown, however, that six months' life is generally obtained. This longer life results from operating the receiver at lower drains in order to avoid the distortion which accompanies high volume in the absence of a C battery.

The space for the battery life on a six-tube set without a C battery is left blank for we are not familiar with any six-tube, factory-made set now being produced which does not use a C battery.

Here again it will be noted that the *minimum* life to be expected from the Heavy Duty battery is six months, or two renewals per year, based on 2 hours' use per day.

The new type of dry cell battery, consisting of flat cells piled on each other layer by layer, instead of the conventional cylindrical cells soldered together, is a special case under our discussion of the Heavy Duty size battery. The external dimensions and general characteristics of this new type of battery are the same as those of the Heavy Duty battery. The difference lies in the higher capacity and longer life of the new battery. The flat construction results in the use of more of the active chemical ingredients per unit of volume because it avoids the waste of space between the cells in the cylindrical type of battery.

The curve in Fig. 6 shows the life of this flat cell, Heavy Duty battery at various drains.

POWER TUBES

WE MUST also consider the effect of the new, highly important power tubes, UX-112, UX-120, and others on B battery life. The situation is a bit complicated technically, but is most simple from the standpoint of results, particularly when we confine our attention to those cases where

practically all the power tubes will be used, i.e., in sets of four or more tubes.

The new power tubes must be used with a C battery. Therefore it is necessary to provide C battery connections in order to use either of these tubes in sets which were formerly without a C battery. The net result of the change will be a decrease in B battery drain, and hence longer battery life.

The drain of these power tubes when properly biased averages around 5 or 6 milliamperes. This is 3 or 4 milliamperes more than that of the biased tube which it replaces. The use of either of these power tubes on a set already equipped with a C battery will therefore increase the total drain about twenty per cent.

In selecting the proper size batteries for multi-tube sets employing either of the new power tubes, one point should be kept in mind. The Heavy Duty size will, of course be chosen to supply the original 90 volts, but the battery which furnishes the "top 45 volts" to supply 135 volts to the power tube should be of the Light Duty, not the Heavy Duty, size. This "top" 45 volt battery carries the 5 or 6 milliamper drain of the power tube only, and will therefore last "more than a year."

Articles on "How to Build a Radio Receiver, How to Erect your Antenna," in fact all the "How to" articles on radio generally have a paragraph near the end on "How to look for trouble," as though it were necessary to search for it. But the

precedent is too strong to break. We shall therefore include the customary paragraph of warning and advice.

The figures on the B battery life are based on proper radio equipment and normal operating conditions. They will *not* apply under such conditions as:

- (1) Leaving the set turned on for a week and then forgetting that you did so.
- (2) Use of tubes which have an abnormally high B battery drain (an occasional misfortune.)
- (3) A faulty by-pass condenser or any form of short circuit which continuously drains the B battery.
- (4) Chronic over-burning of the filaments.
- (5) When using old exhausted tubes which need renewing or re-activating.
- (6) Failure to renew an exhausted C battery.
- (7) Leaving the shears resting on the battery terminals over night.

The next time any one asks us how long his B battery will last we shall not ask a single question, but immediately reply, "Six months at least, generally eight months and often a year or more." Then if the combination of a New England conscience and an engineering training gets in its deadly work, we will be forced to add "Of course you understand that this answer is based on your using batteries of proper size and of a reliable make and also on an average use of your receiver of two hours per day."

We might also go on to explain that there would be occasional, rare cases where the battery life would be only four or five months but that for every such case there would be literally thousands of instances, even with multi-tube sets, where the battery life would be in the nine- to twelve-month range.

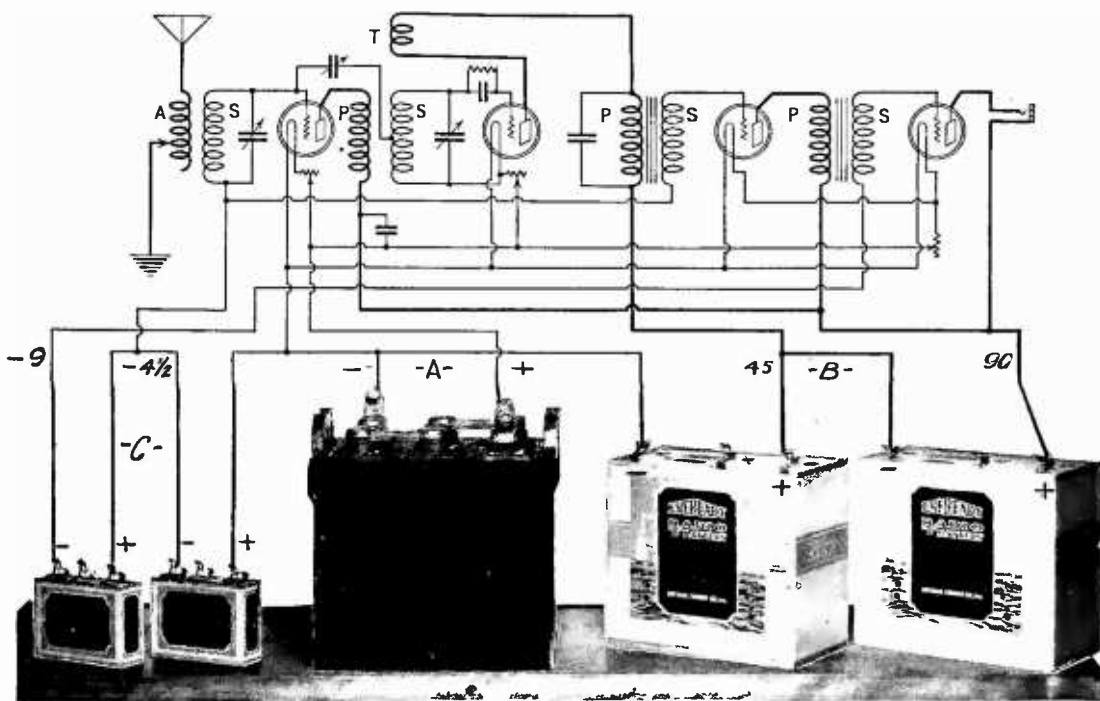

FIG. 8

It is usual in depicting the circuit diagram of the Browning-Drake receiver described in the December, 1924, issue of Radio Broadcast, to represent the batteries employed, symbolically. Here is the diagram showing actual illustrations of batteries connected in the circuit. The reader, however, will do well to become accustomed to the symbolical representation of batteries and other parts of radio circuits

How to Use Vacuum Tubes

A Clear Explanation of How and Why Tubes are Rated as to Amplification Constant, Mutual Conductance, Plate Impedance, Etc.—How to Make and Use a “Characteristic Curve”—Answers and Explanations for the Most Commonly Asked Questions About the Use of Receiving Tubes

By KEITH HENNEY

Director, Radio Broadcast Laboratory

OF ALL the various instruments that go to make a radio receiver, there are none that approach the vacuum tube in importance. In the majority of receivers to-day the tube is the most essential accessory, and upon its proper operation depend all of the qualities of which the owner of the receiver brags. The sensitivity of the receiver, the volume and quality of reproduction, the economy of operation, all rest upon the tubes that are used and the manner in which they are operated.

Therefore, it behooves the owner or builder of a radio receiver to become as well acquainted as possible with the various functions which his tubes perform, and to know what happens when he does this or that to those small bits of glass and metal.

In the December RADIO BROADCAST, the use of new semi-power tubes was discussed and the connection between undistorted audio output and the operating conditions of tubes was outlined. Data on the amount of power necessary to operate a loud speaker properly and the power obtainable from various tubes were given. It was pointed out that the purchase of high quality audio transformers, or cone type loud speakers was futile unless one used a tube with an output of about .06 watts to operate the loud speaker; that sufficient power was not obtainable from a single dry-cell tube to operate a cone type speaker without distortion; and that the “scratching” in cone speakers was due, in the vast majority of cases, not to the speaker but to the amplifier which was overloaded.

In this article some of the other important



THIS is a most unusual article in many ways. For one thing, it contains the most up-to-date presentation of information on the use of commercially available vacuum tubes which has so far been presented. The curves and tables in this article are the result of tests on more than 250 tubes and show the amount of work which has gone on recently in the Laboratory. The data given here shows, for example, what C battery potential to use with a given B battery voltage, and what the effect of varying either or both is. The curves show also, the proper filament potential which should be applied to many types of tubes for greatest efficiency. All in all, this is in reality a semi-technical guide book to radio tubeland. The first article in this group appeared in this magazine for December, and another will be published in an early number which will conclude this series, prepared by Mr. Henney, director of the RADIO BROADCAST Laboratory.—THE EDITOR



aspects of vacuum tube operation will be discussed, and an attempt will be made to clear up some misunderstanding with regard to what is generally considered as complex tube terminology.

For example, nearly everyone will say that a tube should have a high value of mutual conductance. But what does nearly everybody understand by this high sounding phrase? And what is a characteristic curve, how is it made, and after one has it, of what use is it? What of amplification constant, “high mu,” plate impedance, etc. What do these terms mean?

It must be understood, first of all, that a tube is a complex creation, that its actions are always controlled by certain boundary conditions which surround it, and that everything that it does is a product of not only one external cause, but of several. It will be possible to treat of but few of the important aspects of vacuum tube theory and practice in this article, or to more than scratch the surface of those few. Readers are referred to Professor Morecroft's excellent book, *Principles of Radio Communication*, which has nearly half of its 1000 pages devoted to vacuum tubes, and to the standard 385-page text of Van der Bijl, *Thermionic Vacuum Tubes*.

SOME FACTS ABOUT THE FILAMENT

A TUBE consists of a glass container into which are sealed three metallic elements, after which the air and gas sealed into the tube are pumped out. The most important of these elements is the filament. It is the thing that lights up when the A battery is placed across its ends; and which blows up when the B battery is accidentally connected to the terminals. When the filament is dead the tube might as well be buried. And when the filament wire is poor, the tube is poor. And that's that.

In general there are three types of filament now being sealed into glass containers for radio use, the tungsten filament, the thoriated filament and the oxide filament. The tungsten is represented in the detector tube, UV-200, thoriated filaments are in the newer types, the 201-A, the 199, the 120, and similar tubes, and oxide filaments are used in Western Electric tubes as well as the WD-12, and the UX-112.

The pure tungsten filament and the oxide coated filaments are the oldest of the present types. Pure tungsten must be heated to a much higher temperature than either the thoriated or the oxide filament before it emits sufficient electrons for ordinary operation. In other words it is not so efficient, for more electrical “filament power” must be expended to get a given number of electrons. The data in Table 1 represents the filament efficiency of several tubes under average operating conditions and shows the plate current in milliamperes per watt expended in heating the filament.

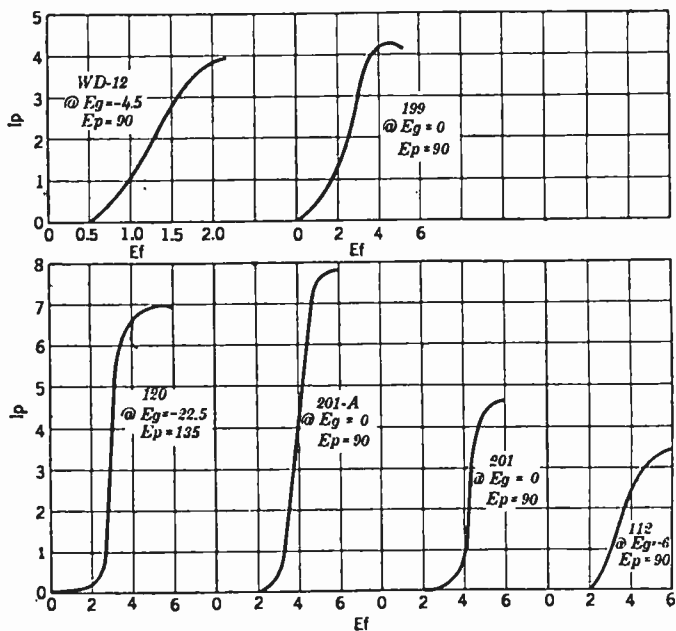

FIG. 1

These curves show the relation between the filament voltage and the plate current, giving plain evidence that it is useless to run filaments above their rated voltage. Attention is called to the plate and grid voltage conditions under which these curves were made

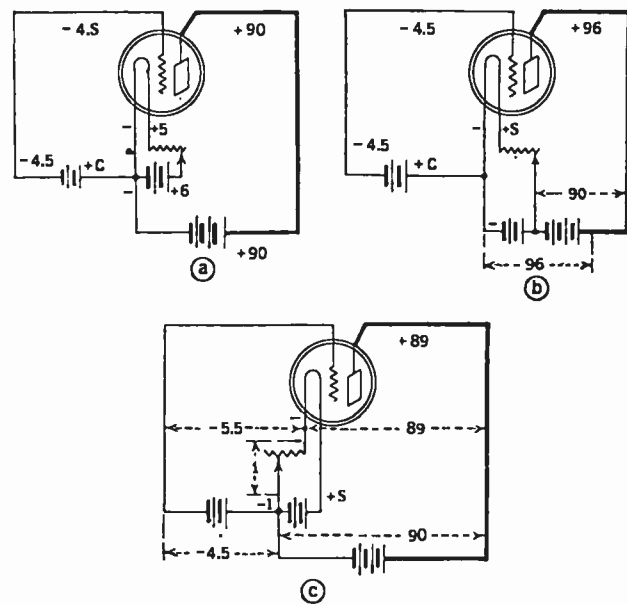

FIG. 2

Many questions are asked this magazine concerning the proper method of connecting A, B, and C batteries together. These diagrams give three possible connections, giving in each case the resultant filament, grid, and plate voltages. It has become standard practice to connect negative A, negative B, and positive C together

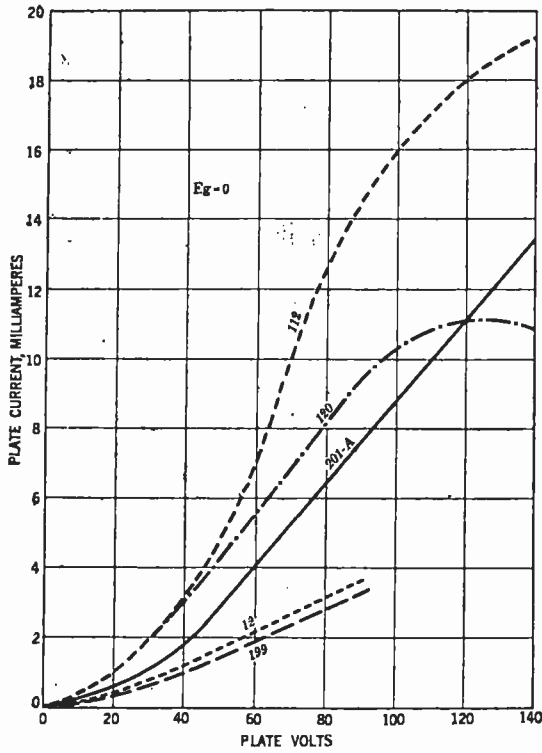

FIG. 3

The effect of increasing the plate voltage on various standard tubes is shown in this Figure. Data for these curves was made at rated filament voltage and at zero grid voltage.

Oxide filaments are made by a complicated process of baking on to the surface of a platinum, or other metallic wire the oxides of strontium, barium, and calcium, which emit electrons at a low temperature. In Europe such tubes are known as "dull emitters" since they are operated at a dull red heat and never as bright as the tungsten or the thoriated wire. Thoriated filaments are the result of a fortunate accident in the laboratories of the General Electric Company. A certain run of tubes was found to be very efficient, much more so than usual. It was found that the filament wire had come from a container in which thorium had been treated. The tungsten had combined with some of the thorium which like the oxides of the elements mentioned above emits electrons at a low temperature.

The result of this important discovery, that thorium mixed with the filament wire would increase the filament efficiency, was the production of the tubes with which everyone is now familiar. Instead of a tube filament that needed one ampere at 5 volts to get the proper number of electrons, present day tubes require but one fourth of this current. Four of the thorium tubes can be run at the same expense as one of the old ones. It may be interesting to those who still use the soft detector tube, UV-200, to know that it requires more current than three of the 201-A type.

The charts in Fig. 1 show the plate current in milliamperes of several important tubes for various filament voltages. They show the futility of burning tubes beyond their rated voltage, for above that point there is slight increase in plate current. Furthermore, pushing up

the filament voltage is one of the most certain methods of decreasing the life of the tube. For this reason a filament voltmeter is an important and economic addition to any existing receiver.

THE PART PLAYED BY THE GRID AND PLATE

THE other elements in the orthodox tube play important parts in the operation of this remarkable device. The plate has been mentioned already. It is maintained at a positive voltage with respect to one end of the filament by means of the B battery. The electrons coming from the heated filament are attracted toward the plate, because they are negative quantities of electricity. Each electron that arrives at the plate represents a certain flow of electric current, and the sum total of this electronic flow makes up the plate current. The plate battery supplies the energy for this transfer of electrons as shown in Fig. 2.

The number of electrons that flow to the plate depends upon at least two factors, the filament temperature, and the plate voltage. Under ordinary conditions the filament is heated to the point where further increase in temperature has no effect on the plate current. In other words the tube is operated under the condition of "filament saturation."

Under this condition the plate current is a function of the plate voltage, and Fig. 3 shows the effect of varying the B battery voltage while a constant A voltage is applied to the filament and a constant voltage is on the grid.

The grid is a mesh of wires placed between the filament and the plate. It, too, has control over the flow of electrons toward the plate for when negative it repels the negative electrons; when it is positive it draws more electrons out

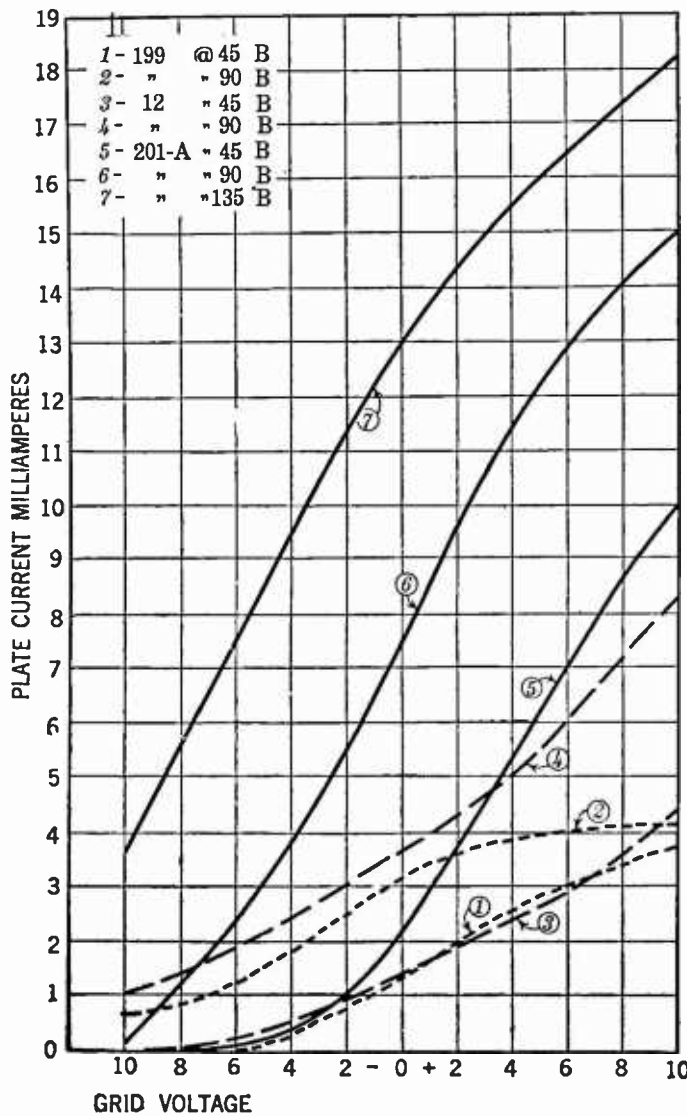

FIG. 4A

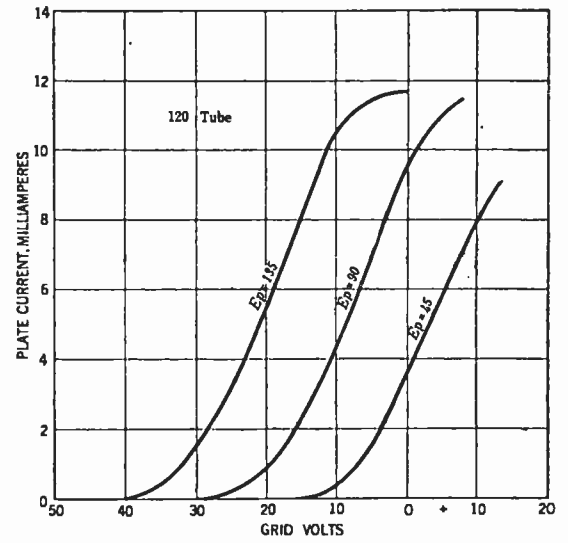

FIG. 4B

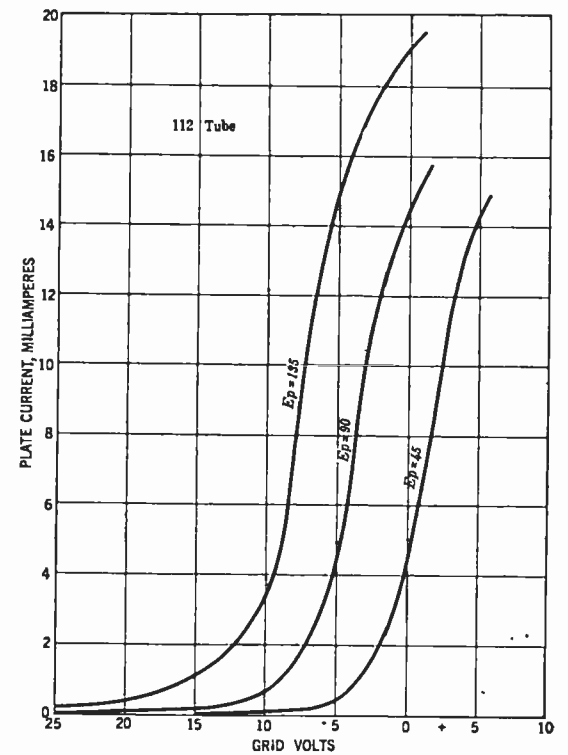

FIG. 4C

Characteristic curves, plate current vs. grid voltage, are shown here. Increasing the plate voltage on amplifier tubes makes it possible to use much greater C voltages, with the result that greater input voltage may be used without distortion due to "overloading." The lower curve of the 201-A tube at 45 plate volts is an indication of an excellent detector. The long straight portions of the 201-A curves are the parts that are useful for amplification

into the space between the elements, and the plate current increases—provided the filament temperature is up to the required point.

It is a matter of great importance that the voltage of the grid has more effect on controlling the plate current than has the plate voltage. It is for this reason that the tube amplifies, and carries out its other multitudinous functions. If the grid has ten times the effect that the plate voltage has upon the plate current the amplification factor of the tube is said to be ten, and so on.

The manner in which the grid controls the plate current may be seen in Fig. 4A which is a "characteristic curve" of an average 5-volt receiving tube of the 201-A type. There are several curves on this plot, each one representing the effect of the grid voltage and each taken at a different value of plate voltage.

There are, then, three factors which control the plate current of a vacuum tube, the filament voltage, the plate voltage and the grid voltage.

TUBE	MILS PLATE CURRENT	FIL. WATTS	MILS PER WATT	MILS PER WATT PER DOLLAR
199	3.2	.18	17.8	7.10
201	7.6	5.00	1.52	()
201-A	7.6	1.25	6.1	2.44
120	7.0	.375	18.7	7.45
112	14.4	2.5	5.75	.89
12	3.6	.275	13.10	5.24

the plate or grid of an average tube. Let us connect it first across the filament of a 201-A type tube, regulate the rheostat, as shown in Fig. 5 until we have the required 5 volts on the filament. Then the meter should be placed across the B battery. Now we know that the tube is operating under the proper conditions and all we need to make a characteristic curve is a plate

ammeter such as a zero to 5 or 10 milliammeter, Weston or Jewell, which is placed in the circuit between the plate of the tube and the plate battery as shown in Fig. 5. A potentiometer placed across a C battery will give us variations in grid voltage which may be measured as in Fig. 5 and placed on the grid of the tube. As a matter of rough measurement, the potentiometer is not necessary, and indeed our C battery will last considerably longer if the potentiometer is not used.

The low range part of the voltmeter is now placed across the grid and filament to show what voltage is being placed on the grid. The grid voltage is then varied and each change in plate current noted as shown in the data for Fig. 4A. It will be found that for large negative values of grid voltage the plate current will be small, and that for less negative grid voltage the current increases. This is one reason why a C battery on a modern five-tube receiver is quite essential. It reduces the plate current of a single tube from about 7 milliamperes to about 3. After zero grid volts is reached, the C battery must be reversed in order that positive voltages may be supplied. Care must be taken in this process, or the milliammeter will be injured, since a positive grid permits a large plate current to flow.

For this reason a tuned radio frequency receiver which uses a potentiometer to stabilize the radio-frequency amplifier is an expensive proposition. In order to keep the amplifiers from oscillating, the grids must be kept positive by a certain amount. This means that two amplifier tubes will draw considerable current from the B battery

Now that we have collected this data on the relation between grid voltage and plate current,

As stated before, tubes are usually operated under the condition of filament saturation, that is, the conditions are stable with regard to the filament voltage. This leaves only two factors which control the plate current, and since a tube is usually operated with a fixed value of plate voltage, it is only the fluctuating grid voltage that varies the plate current.

WHAT CHARACTERISTIC CURVES MEAN

NOW let us see how these characteristic curves are made, and what they mean. Suppose that in our home laboratory we have a double range voltmeter, such as the one made by Weston Electric Instrument Company, or the Jewell Model 55, or Hoyt type 17. Such a meter will read from zero to about 10 volts and from zero to about 100 volts. Thus it will measure the voltage across the filament and on

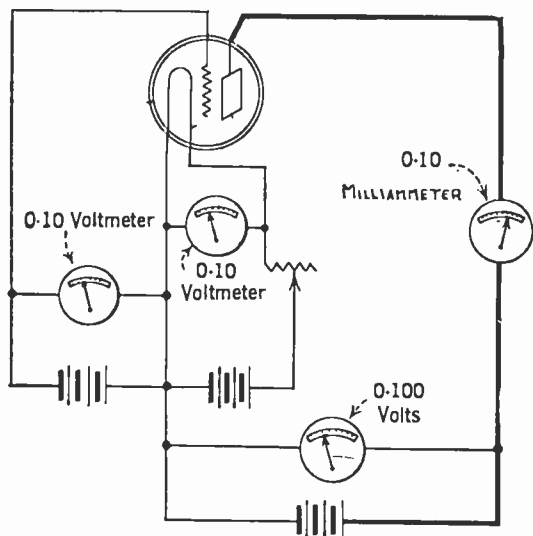

FIG. 5

A simple arrangement of apparatus by means of which characteristic curves of Fig. 4 may be taken. With proper switches, two meters will suffice for this experiment, a milliammeter and a double-range voltmeter

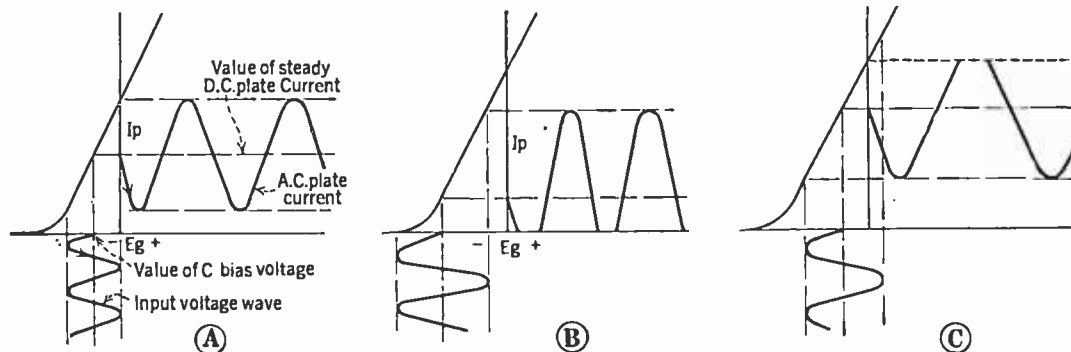

FIG. 6

Three curves showing the effect of proper and improper C bias are shown in this illustration. It will be noted that when the grid goes negative, the plate current decreases. In (a) the correct C voltage is used so that the plate current is a perfect reproduction of the incoming wave. When the C bias is too negative, the lower parts of the plate current curve are cut off. In other words the plate current is actually brought to zero at times. On the other hand in (c) when there is not enough C battery used, the grid goes positive at times, and the tops of the curves are cut off. Both of these latter cases produce distortion of the worst type, most easily detected by watching a milliammeter in the plate circuit. If the needle jumps about, one of the two latter cases is in effect

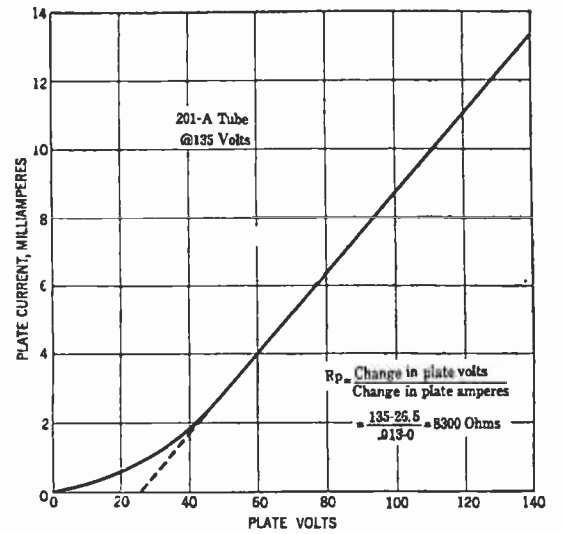

FIG. 7

A method of obtaining the plate impedance of a tube. Only the straight part of the curve is to be used, and the proper values of plate current and plate voltage may be obtained from the curve. To simplify the calculation, the straight part of the curve is prolonged to the zero current line. In mathematical language, the plate impedance is the slope of the plate current-plate voltage line

TABLE 2. 201-A TYPE TUBES

TUBE	NO. TESTED	PLATE CURRENT	AMP. CNST.	PLATE IMPEDANCE	MUTUAL CONDUCTANCE
Arion	4	1.9	9.2	14,400	638
Kismet	3	2.60	7.75	13,250	590
Ureco	8	2.62	8.15	12,300	660
Gold Seal	6	2.43	8.13	13,000	630
Duotron	9	1.83	10.00	16,000	615
Van Horne	12	2.64	8.63	12,800	677
Sylfan	6	3.00	6.90	12,800	542
Sylvania	6	2.63	8.29	11,350	735
Sturdy	2	2.90	8.20	12,500	678
Magnatron	6	2.75	8.00	12,250	652
Goode	3	2.50	7.90	12,000	658
Empire-Tron	2	1.80	9.50	16,500	581
CcCo	9	2.2	8.48	14,300	592
R. C. A.	6	3.40	7.53	10,100	745
Marathon	2	2.60	8.20	11,500	712
Supertron	3	2.00	9.50	14,600	680
Sea Gull	12	3.60	6.70	10,600	640
Boehm	4	3.62	7.10	9,740	734
Speed	5	3.82	7.35	9,950	734
Ken Rad	5	2.78	8.24	12,400	677
Cleartron	6	4.2	6.75	9,450	715
Perryman	6	3.98	6.53	9,750	670
AVERAGE	125	2.59	8.2	12,700	660

CONDITIONS		
FILAMENT VOLTS	GRID VOLTS	PLATE VOLTS
5	-4.5	90

we may try another value of B battery and repeat the experiment. In this manner data for the three curves shown in Fig. 4A, B and C were taken. The only thing that remains is to plot the data in a curve which gives a complete picture of what happens to the plate current under variations of the grid and plate voltages. They are called "static" characteristics because they were made under static conditions, that is not under the exact operating conditions, for in actual practice there is a load of some kind, in the plate circuit, such as a pair of receivers, a transformer primary, or a large resistance, whose characteristic, when alternating voltages are applied, differs from its direct current characteristic.

Now to see what these curves tell us, let us look at them rather closely. It will be seen that increasing the plate voltage increases the plate current. For instance let us look at the curves in Fig. 4A at the exact center of the picture at zero grid volts. With 45 volts on the plate, the

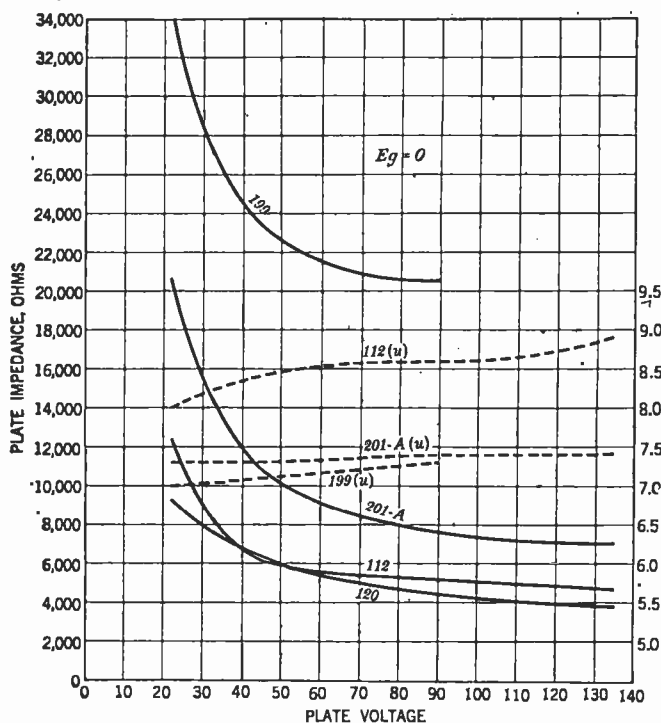

FIG. 8

The three important tube factors, plate impedance, amplification constant, and mutual conductance all vary with plate voltage and with grid voltage. This curve shows how these factors vary with plate voltage

plate current of the 201-A is 2.2, with 90 volts, the current is 7.6, and with 135 the current is 13.

Also it will be noted that increasing the grid voltage increases the plate current. For example let us take the 90-volt curve. At negative 2 grid volts, the plate current is 5.6 milliamperes and at positive 2 the plate current is 9.7. It will be seen at once that the grid voltage has greater effect than has the plate voltage. The ratio of these effects is known as the amplification constant of the tube. For example it

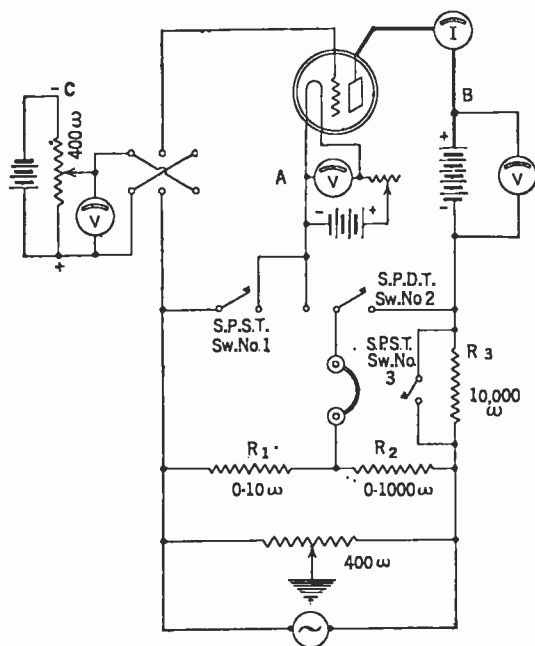

FIG. 9

A diagram of the bridge used in RADIO BROADCAST Laboratory for determining tube characteristics. The resistances R_1 and R_2 may be a simple slide wire bridge or they may be decade resistance boxes. To measure amplification constant, open switch No. 1, throw No. 2 to the left, close No. 3. Then when silence is obtained in the phones, $\mu = R_2/R_1$. To measure plate impedance, close No. 1, throw No. 2 to the right, open No. 3. Then $R_p = \frac{R_1 \times 10,000}{R_2}$. The potentiometer across the input with the variable arm grounded is useful in obtaining a balance

will be found from this data that it requires only 5.5 volts change in grid potential to produce the same change in plate current that 45 plate volts change produced. In other words the amplification factor is $\frac{45}{5.5}$ or 8.2.

This may be stated as follows:

$$\text{Amplification factor} = \frac{\text{change in plate volts}}{\text{change in grid volts}}$$

to produce the same change in plate current.

PROPER USE OF THE C BATTERY

UNDER actual operating conditions, the plate is maintained at some definite value, say 90 volts, and the grid is biased negative by a definite value, say $4\frac{1}{2}$ volts. The incoming signals which are impressed on the grid are alternating in value, and they cause the actual voltage on the grid to vary from $4\frac{1}{2}$ as a mean value. For instance, let us suppose that the tube is the second audio amplifier tube and that fluctuating voltages of a maximum, or peak, value of one volt are coming from the previous audio stage. When the impressed alternating voltage is positive the actual negative grid voltage is $4\frac{1}{2}$ minus 1 volt or $3\frac{1}{2}$ and when this a.c. voltage is negative, the negative bias on the grid has been increased to $5\frac{1}{2}$ volts. In other words the voltage actually on the grid varies from $3\frac{1}{2}$ to $5\frac{1}{2}$ volts.

We may see how the plate current varies with these changes in grid voltage by noting the proper values from the characteristic curve. Fig. 6 gives a picture of the process showing that small changes in grid voltage produce large changes in plate current.

Now for distortionless amplification, only the straight part of the curve may be used, and the grid must never be permitted to become positive. This limits the input grid voltages to certain definite values. The characteristic curves shown above indicate the proper value of C battery that is to be applied to an amplifier tube with a given value of B voltage. For example it will be seen that if the grid of the tube shown in Fig. 4A at 90 volts B battery goes negative by 4 volts it will be approaching the lower bend in the curve while if it goes beyond $4\frac{1}{2}$ volts positive, the grid will actually be positive with respect to the filament and distortion is inevitable.

To find from the curve the proper C voltage it is only necessary to measure the length of the straight part of the curve. For example at 90 volts the length in volts is about 9 volts. Then the C bias is about half this or $4\frac{1}{2}$. At 135 volts B, about 9 volts C battery may be used.

In an article by Mr. George Crom in RADIO BROADCAST for October the effect of improper C and B batteries was discussed. A consideration of the characteristic curves shows what actually happens when incorrect values are used. For example, when the grid is forced too negative by input voltages, the curved part of the characteristic will be used with the result that harmonics are added to the original sounds coming from the broadcasting microphone. If

TUBE	NO. TESTED	PLATE CURRENT	AMP. CNST.	PLATE IMPEDANCE	MUTUAL COND.
Arion	5	2.00	6.8	19,650	346
CeCo	3	2.33	6.1	16,900	361
Jove	6	1.87	6.0	22,800	268
Gold Seal	3	1.50	6.3	35,400	207
Sylvania	6	1.87	6.0	19,600	305
Perryman	2	1.80	6.35	21,475	296
Van Horne	5	2.66	7.35	24,500	305
Magnatron	6	2.60	6.3	18,500	350
Empire-Tron	2	1.70	7.1	23,400	303
Speed	3	2.2	6.0	19,500	310
Ken Rad	5	2.0	6.76	22,800	300
R. C. A.	5	2.5	6.3	18,600	332
TOTAL	51	2.00	6.5	22,400	304

FILAMENT VOLTS	GRID VOLTS	PLATE VOLTS
3	-4.5	90

still greater negative values are impressed on the grid, or if the grid is biased too negatively, the lower parts of the waves will be cut off as shown in Fig. 6 resulting in still greater distortion. As mentioned in Mr. Crom's article, a milliammeter in the plate circuit of such a tube will show an upward deflection under such conditions. The remedy lies in increasing the plate voltage to the values he specified.

Fig. 6 also shows the effect of too little C battery. In this case a strong signal will force the grid positive at times which again results in distortion, though of a slightly different nature. In this case the plate current will decrease as Mr. Crom pointed out. Increasing the C battery negative potential will eliminate this difficulty.

An amplifier that is working properly, with correct B and C batteries will turn out a distortionless output—as far as the tubes are concerned—only when a milliammeter in the plate circuit remains steady. This is the best method of investigating the conditions under which an amplifier works. In a great many cases the C battery value is much too low to take care of loud signals. Increasing the C battery, however, without making corresponding changes in the B voltage is fatal, as Fig. 6 indicates.

Fig. 4 shows the effect of increasing the B battery voltage. The straight part of the characteristic is much longer, a fact that has important consequences. Greater values of C bias may be used, greater input voltages may be applied without distortion, and the tube will have a lower plate impedance. This latter fact is explained later in the present article, and the value of a low plate impedance was mentioned in the article on tubes in the December RADIO BROADCAST.

The curves in Fig. 4, known as the static characteristics of the tubes in question, reveal many interesting facts. For instance the method of calculating the amplification factor

TUBE	PLATE CURRENT	AMPLIFICATION CONST.	PLATE IMPEDANCE	MUTUAL COND.	POWER OUTPUT
Daven Mu-6	8.7	6.35	5,350	1,190	.076
Cleartron	6.0	6.35	5,340	1,190	.076
CeCo	5.8	7.0	6,700	1,050	.060
Ureco	8.0	6.8	5,570	1,235	.084
UX-112	5.8	7.9	6,000	1,315	.105
216-A	7.4	6.0	6,000	1,000	.060
Van Horne	4.7	8.65	8,050	1,075	.0936

FILAMENT VOLTS	GRID VOLTS	PLATE VOLTS
AS RATED	-9	135

of the tube has been mentioned. It is only necessary to measure along the zero grid line the number of milliamperes change in plate current produced by varying the plate voltage from 45 to 90, and to take any of the three curves and find out how many grid volts change are required to produce the same change in plate current.

THE MEANING OF "PLATE IMPEDANCE" AND "MUTUAL CONDUCTANCE"

NOW there are two other important tube factors, known as the plate impedance, and the mutual conductance. The plate impedance is defined as the change in plate current a given change in plate voltage produces. This may be expressed as below

$$\text{Plate impedance} = \frac{\text{plate voltage change}}{\text{plate current change}}$$

and using the values ascertained for calculating the amplification constant, the plate impedance of the tube under question is

$$\frac{90 - 45}{.0076 - .0022} = 8330 \text{ ohms}$$

This value may be obtained directly from the plate current—plate voltage curve, Fig. 3. Fig. 7 shows how this may be done. This second method is more accurate, since the plate impedance varies with each change in plate or grid voltage. For that reason it should be calculated for small changes and only over the straight part of the characteristic.

The mutual conductance of the tube is an important factor, since it is an expression for the value of the grid voltage in controlling the plate current. It is defined as

$$\text{mutual conductance} = \frac{\text{change in plate current}}{\text{change in grid volts}}$$

For example from Fig. 4A we see that a change of ten volts on the grid, from plus 6 to minus 4 of the 135-volt 201-A curve produced a change of 6.9 milliamperes. Therefore

$$\text{mutual conductance} = \frac{.0069 \text{ amperes}}{10} = .00069 \text{ mhos.}$$

or expressed in the usual units of micromhos the mutual conductance of the tube under question is 690.

This may also be obtained from the interesting relation between amplification constant and plate impedance,

$$\text{mutual conductance} = \frac{\text{amplification constant}}{\text{plate impedance}}, \text{ or } G_m = \frac{\mu}{R_p}$$

showing that the best tube is one with a high amplification constant and a low plate impedance—but in popular language "try and find one."

All three of the tube factors, μ , R_p , and G_m vary with grid voltage and plate voltage as the curves in Fig. 8 show. For purposes of power amplification a low plate impedance is of importance, and the effect of increasing the plate voltage to produce this lowered impedance is clearly indicated. For voltage amplification, a high amplification constant is important.

The effect of tube impedance on the characteristics of an audio-frequency amplifier was shown in Curve 2 in the article by Kendall Clough in the January RADIO BROADCAST.

Anyone can verify the improvement in signal quality with the use of low plate impedance tubes by noting the difference when substituting a high impedance tube, say a 199, or a tube designed for resistance-coupled amplifiers for the final tube in a transformer-coupled set. The low notes of the viols and horns will be lost in the latter case but will suddenly reappear when the low impedance tubes are again replaced. Characteristics of these tubes were discussed in the December RADIO BROADCAST, page 163, and were found to be an extremely important advance from the standpoint of quality.

The methods outlined above for obtaining the important tube characteristics required only two meters, a milliammeter and a double range voltmeter. The method is not so accurate as that employed in well equipped laboratories, but is sufficient for all practical purposes provided small changes of plate and grid voltage are used.

In the RADIO BROADCAST Laboratory a special bridge is used which places an a.c. voltage on the grid and measures the factors of the tube under conditions that are closer to actual operating conditions. A diagram of connections is given in Fig. 9 and by the proper use of switches, only two meters are necessary. The source of a.c. tone may be obtained from a buzzer or from a

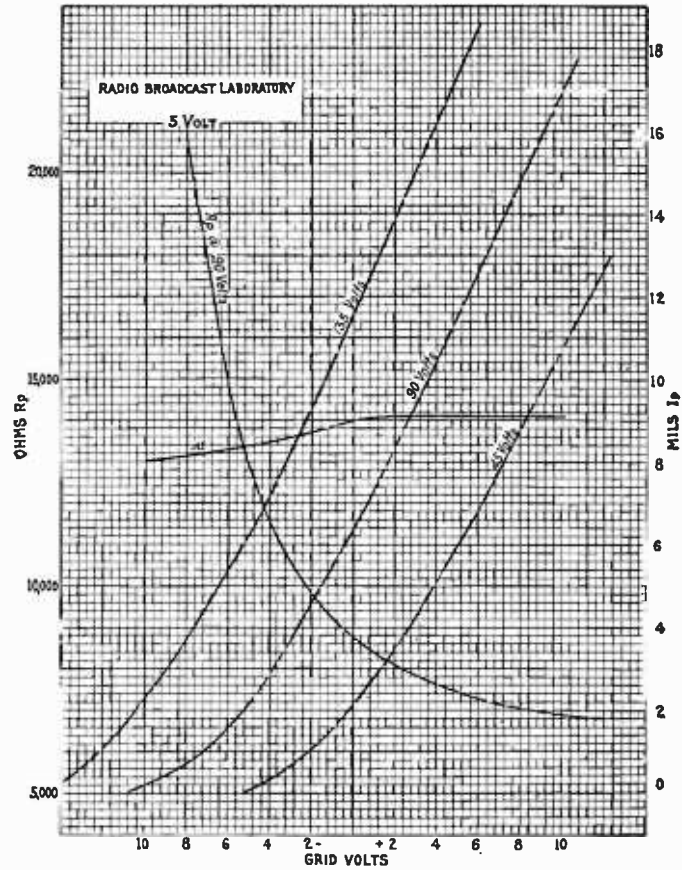

FIG. 11

The effect of grid voltage is clearly shown in this figure. Plate current, plate impedance and amplification constant all vary with changes in grid voltage. Mutual conductance may be obtained by dividing the amplification constant by the plate impedance. These curves were made from 201-A type tube

modulated oscillator as described in RADIO BROADCAST for September.

HOW TUBE VALUES ARE FOUND

IN PRACTICE the tube is lighted at its rated voltage, the switches are thrown as indicated, and at silence in the phones, the values are as shown in the Figure. The accuracy of the method is such that one can repeat measurements to within a few per cent. depending upon the accuracy with which the meters can be read and readjusted to proper value. All of the data in Table 3 were taken by means of such a bridge.

Several machines are on the radio market which are useful in measuring the tube constants, but attention must be paid to the methods in which they are used. For instance, one meter submitted to the Laboratory measured the plate impedance by an Ohm's law method. It was argued that from Ohm's law,

$$\text{current} = \frac{\text{voltage}}{\text{impedance}} \text{ or } \text{impedance} = \frac{\text{voltage}}{\text{current}}$$

and from the data used above, impedance = $\frac{90}{.0076} = 11840$ while the actual impedance as measured on a bridge = 7600 ohms.

The error in using such a meter is explained on page 424 of Prof. Morecroft's Principles of Radio Communication.

In connection with tube constants and their measurements, the question naturally arises, at what values of grid and plate voltage should tubes be measured and rated. At the present time there are several points of view, to judge from the printed matter sent out by tube manufacturers. All tubes rated in the Laboratory are measured under the conditions under which they are usually operated. For example an

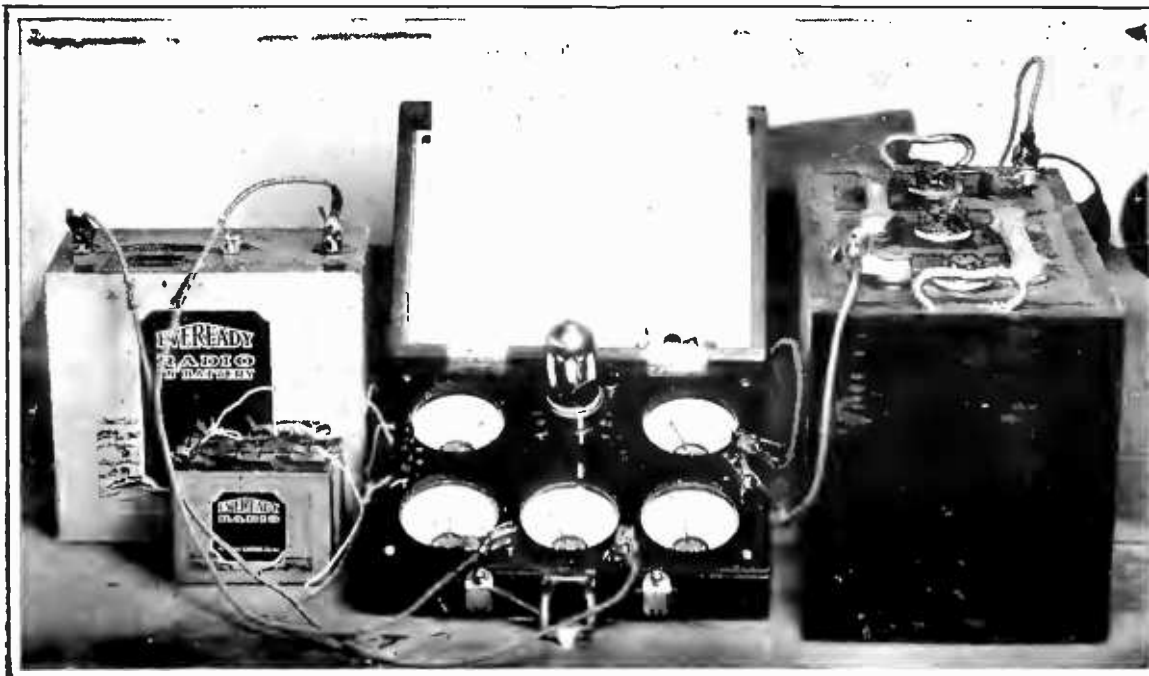

FIG. 10

A laboratory set-up for making characteristic curves of tubes. The group of instruments is a Jewell test set and is made up of plate, grid, and filament voltmeters, and plate and filament ammeters

amplifier is usually operated at 90 volts on the plate and negative 4.5 volts on the grid. The plate current, the amplification constant, the mutual conductance, and the plate impedance will all be different under these conditions than at zero grid voltage. For this reason Laboratory measurements are made under these conditions, notwithstanding that the fact that many tube testers now on the market, and in the hands of tube dealers, have no provision for adding C batteries.

It is to be noted in this connection that the circulars recently sent out by the Radio Corporation give values for these important constants under standard conditions, namely 90 volts plate and negative 4.5 volts grid. To state tube constants at zero grid is to give no indication of what these tubes will do under actual conditions, and for this reason the table of tube data included in this article gives values at the proper C bias.

The reader who is interested in tubes and the proper conditions under which they should work would do well to study the booklet published by the Radio Corporation which gives tube constants for all of the well known detectors and amplifiers. The reader should see that tubes that he buys measure up to these standards,

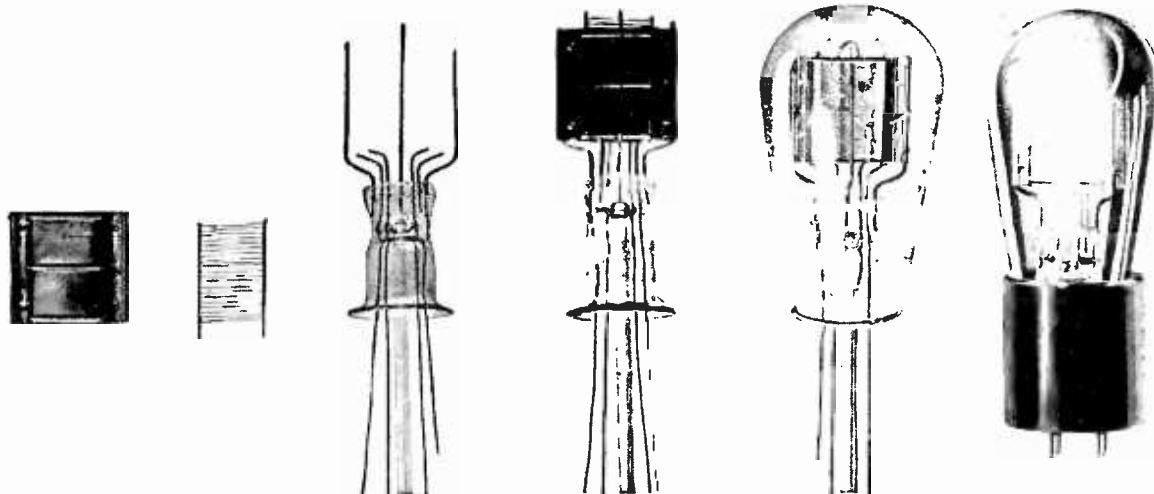

FIG. 12
The main elements of a standard UV-201A tube

and should not let dealers give him tubes that the dealer has used in his own receiver—for sad to relate, reports come frequently of this nefarious practice.

And the data in the table of tube constants must be considered with the proper respect for what the ear actually hears. For instance a tube with a mutual conductance of 650 will differ but little—as far as the ear is concerned—from one with a conductance of 675 or even greater. It is probable that any of the tubes in this table will give identical results as is pointed out in an interesting manner by a recent booklet on tubes published by the Radiofax Company. The point to be noted is that the average of all those tubes listed is about 650 and that tubes that one buys should be of this order, and not of only 400 or so. Having a tube with a high plate current is no disadvantage, for this current may be reduced

first audio amplifiers, but that for operating a loud speaker without overloading larger tubes must be used with greater values of B and C voltages. It is here that the 112 type tubes of the R.C.A., Cleartron, Sea Gull, Golden Tone, the Daven Mu 6, the 216-A, and others are most useful. The reader is referred to the table in the November RADIO BROADCAST which gives the output of these tubes in undistorted power.

For resistance and impedance-coupled amplifiers, there are several tubes with higher amplification constants that are useful and curves will be found of these tubes in this number. Such tubes are Daven, Cleartron, Golden Tone, and there are doubtless others which have not yet been submitted to the Laboratory.

Tubes are the important items in present day receivers, they make the wheels go 'round—but they must be operated intelligently, and with care.

NOTE

THE data in Table 4 represents the average of at least four tubes of each manufacturer. It will be noted that it differs in some respects from similar data published in December RADIO BROADCAST. This is due to the fact that some manufacturers, at least, have not decided definitely upon the desired characteristics. It is probable that another month will see other changes and additions to this table. When this article was written (December) this data was the best obtainable from existing tubes.

Throughout this article and in other texts which deal with the subject of vacuum tubes, their characteristic curves, etc., reference is made for convenience's sake to letters and signs intended to represent some constant or value. The

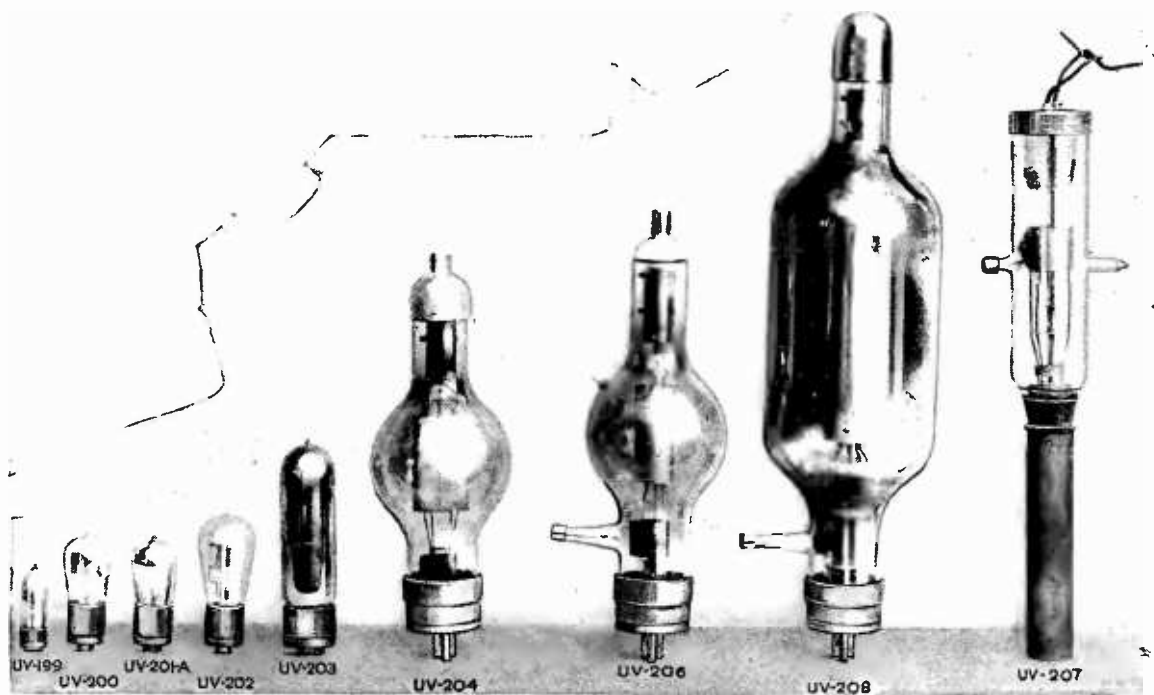

FIG. 13
The Radiotron family from the little 199 to the big water cooled fellow that is being used at the new WJZ and other stations

derivation of these symbols is originally from Ohm's Law where volts is represented by E, amperes by I and resistance by R. The elements of a vacuum tube, the filament, grid and plate are represented by the letters F, G, and P respectively. Now by combining these and

the letters of Ohm's Law, we can denote a value such as plate voltage by writing Ep. Filament current or amperes would be IF and so on.

The symbols designating amplification constant was borrowed from the Greek alphabet and is represented as μ . Mutual conductance is usually represented by Gm since G is a symbol for a "conductance," and the term "mutual conductance", μ_m , was coined by Prof. Hazeltine.

Following is a list of letter symbols most commonly used, with their meaning.

- Ef. . Filament Volts
- Ep. . Plate Volts
- Eg. . Grid Volts
- Ip. . Plate Current
- If. . Filament Current
- μ . . Amplification Constant
- Rp. . Plate Impedance
- Gm. . Mutual Conductance

The 1926 International Radio Broadcasting Tests

What Radio Listeners Everywhere May Expect in the Most Comprehensive International Tests Ever Arranged—The Final Transmitting Schedules

By WILLIS K. WING

BASED on previous experience, the January International Radio Broadcast Tests should mark a distinct advance over the others held," says Captain Eckersley, chief engineer of the British Broadcasting Company, in a radiogram just received by RADIO BROADCAST. "It should be possible," he continues, "with the coöperation and assistance of the International Bureau de Radiophonie recently organized at Geneva, to secure more definite and accurate data on the test broadcasting of all the European stations than in the Tests of November 1924. All listeners should remember the differences in time, in order to avoid confusion and disappointment. Our council meeting at Brussels during the second week of December, at which representatives of all English and Continental broadcasters took part showed a most commendable spirit of coöperation on the part of all concerned.

"We believe that radio, intelligently developed in the public interest is destined to become a potent auxiliary of international coöperation in bringing closer together broadcast listeners and wireless enthusiasts all over the world. Radio should perform valuable work in establishing common points of interest and in consolidating conscious world citizenship without which there can be no assurance of permanent peace between nations," concludes Captain Eckersley.

The idea of the International Tests originated with Mr. F. N. Doubleday, president of Doubleday, Page & Company, on his return from a trip to England in 1923, during which time he had made a detailed study of radio broadcasting there. Mr. Doubleday felt that it would be extremely interesting and stimulating both to the progress of radio and to international friendship were it possible for RADIO BROADCAST to arrange a program of broadcasting from this country to England. So it was arranged that a two-way test should be held. And during the last week in November, 1923, the first International Tests took place, between the broadcasters of England and America. The plans were not extensive, but the success of listeners on both sides of the water, in logging broadcasters at great distances was really extraordinary. And the second series of tests, during the last week of November, 1924, more ambitious than the first, since Continental

broadcasters were invited to participate, boasted a huge total of listeners in the United States and in England who received stations foreign to them. This is all the more remarkable because in both years, atmospheric conditions were certainly not all that could be desired. In addition to the mere DX features of the first two Tests, there was the side, perhaps not so evident, but really none the less important, that radio enthusiasts on both sides of the water were bending their thoughts toward a kind of international radio unity. To the American listeners, the English and Continental peoples seemed closer, as indeed they were, than ever before. And the same may be said of the English listeners.

EUROPEAN PARTICIPATION GREATER

THE 1924 Tests inaugurated the broadcasting of European stations, and the Tests of 1926 will see the European and the British stations in fuller coöperation



"FOR SERVICES RENDERED"

In arranging the International Test. Presented to the editor of this magazine at the recent New York Radio Show

than ever before. This increased coöperation is due to the recent organization of the International Bureau de Radiophonie, with headquarters in Brussels, headed by Arthur Burrows, formerly chief program director for the British Broadcasting Company. The European broadcasters have realized that broadcasting is not a sectional or national matter, and that they must arrange their affairs so that all listeners may benefit, and the international bureau, which attempts to settle wavelength allotments and allied problems, is the logical result.

The success of the International Tests depends entirely on the coöperation of all the broadcasters, because silent hours, allowing for the uninterrupted reception of stations outside national boundaries is essential. And in this respect, the American and Canadian stations have definitely demonstrated their feeling that the Tests meant enough to radio for them to make special sacrifices. These sacrifices have been greater for the American and Canadian stations than they have for those of the other nationals, because these Tests have come on this side of the water during the regular evening hours of broadcasting, while the difference of time between the American continent and Europe has called the foreign broadcasters from their more or less downy couch at three o'clock in the morning, and no paraphrase of a once popular song meant.

But what is going to happen this year? The editors of RADIO BROADCAST felt that the International Tests had grown too big for any one organization in this country to assume entire charge. So the matter of the Tests was put up to many organizations, including the Radio Manufacturers Association and the National Radio Trade Association who felt that so important an event to the radio world should not continue without their active support. The result has been that about eighteen organizations devoted to furthering the interests of radio have aligned themselves with this movement. So in the United States this year, the International Radio Broadcast Tests are not supported and supervised by RADIO BROADCAST alone, but by all the influential organizations in radio. And in Europe, the aid of the three most powerful radio groups has been enlisted, the British Broadcasting Company, the International Bureau de Radiophonie, and



RECEIVING FOREIGN STATIONS

During the International Tests of 1924, at Mitchel Field, New York. This Army radio truck was driven to the center of the field, and a super-heterodyne set up and many stations were heard. Light was furnished by lanterns and flashlights

Radio Press, the latter controlling a circulation of radio readers in England totalling more than a million. Mr. Scott-Taggart, the editor-in-chief of all the Radio Press publications has been appointed, jointly with Captain Eckersley, chief engineer of the British Broadcasting Company, as heads of the European broadcasting program during these Tests.

In the United States and Canada, the broadcasters, at a considerable sacrifice, have arranged their programs so that silent hours are provided. The activities during this test week also involve Mexican and Cuban and South American stations. Among the South American stations participating is OAX, at Lima, Peru, owned by the Peruvian Telephone Company, operating on a wavelength of 380 meters (789 kc.). The Cuban broadcasters are directed by Frank H. Jones, owner of the famous Cuban station 6 kw. Canadian broadcasters are operating under the direction of Jacques Cartier, director of station CKAC, *La Presse*, Montreal.

UNUSUALLY INTERESTING PROGRAMS

A GREAT number of American stations are arranging special programs for the American test period, which is from 10 to 11 P. M., Eastern Standard time. Mr. A. Atwater Kent, whose excellent radio programs through the WEAf chain of stations are so popular, expects to present a program of more than usual interest to listeners on both sides of the water. This program will be broadcast the first night of the Test Week, Sunday, January 24, 1926. Those in charge of work at Newark admit that their program for the Test week will offer some genuine surprises. This station was heard abroad in both the previous tests. Station WJL, the Detroit *News*, is planning features of unusual interest during their transmitting period for over-seas listeners. This is true of practi-

cally every broadcast-station on this side of the water, and to list all the special plans of all the broadcasters would take far more space than can be spared in RADIO BROADCAST. Every individual and organization in any way connected with International Radio Week realizes that this year there is an opportunity to share in an international party of huge proportions.

The Tests were scheduled this time for the last week in January, instead of the last week in November, because receiving conditions are much better in January

than in November. This was found to be true by the experience gained in the first two Tests and we firmly believe that receiving conditions will give a greater number of

listeners a better chance to hear foreign stations. Tests recently conducted by the Bureau of Standards on the transmissions of KDKA at Pittsburgh, seemed to show that the worst atmospherics were found in June, and the least in February, with the next best months in the following order: March, January, November, December, May, October, April, August, July, and September. The worst fading was encountered in October and the least in February. Fading increased in the months in the following order: April, July, March, June, January, May, November, December, August, and September. These results, while not conclusive, certainly point to the last week in January as a very favorable time to schedule the Tests.

The final schedules and latest information about the Tests will of course appear in the daily newspapers. This is written some weeks before the Test Week and while the main features of the schedules are settled, there are many details which cannot be announced until a few days before the first night of the Tests.

Wavelengths and call signals of the European stations have been subject to many changes since the organization of the International Bureau de Radiophonie and

Schedule of Transmissions International Radio Broadcast Tests of 1926

All the Times in This Table are Eastern Standard

DAY	TIME	STATIONS PARTICIPATING
Sunday, 24th January	10—11 P. M.	Canadian, United States, Mexican, Porto Rican, Cuban
Sunday, 24th January	11—12 P. M.	Foreign (British, French, German, Dutch, Spanish, Italian, Austrian, Czech, Polish and South American stations)
Monday, 25th January	10—11 P. M.	American Continent (as shown above)
Monday, 25th January	11—12 P. M.	Foreign (as shown above)
Tuesday, 26th January	10—11 P. M.	American
Tuesday, 26th January	11—12 P. M.	Foreign
Wednesday, 27th January	10—11 P. M.	American
Wednesday, 27th January	11—12 P. M.	Foreign
Thursday, 28th January	10—11 P. M.	American
Thursday, 28th January	11—12 P. M.	Foreign
Friday, 29th January	11—11:15 P. M.	American Eastern Standard Time Zone stations
	11:15—11:30 P. M.	American Central Standard Time Zone stations
	11:30—11:45 P. M.	American Mountain Time Zone stations
	11:45—12 P. M.	American Pacific Time Zone stations
Saturday, 30th January	11—11:15 P. M.	All Canadian stations
	11:15—11:30 P. M.	Northern half United States stations
	11:30—11:45 P. M.	Southern half United States stations
	11:45—12 P. M.	All stations south of the United States

It will be noted that this schedule will not only give American listeners a chance to hear stations in this country never heard before because of the station operating on a frequency used by some near-by station, but this arrangement will also give the overseas listeners a chance to pick up some American stations that are more distant from them than the stations almost on the edge of the Eastern seaboard. The arrangement of the American tests so that on the first night (Friday, American time) the stations will progressively transmit from east to west, and on the second night of those tests (Saturday, American time) transmit north and south, will give American listeners a chance to experiment with DX reception such as they have never before had.

The Continental and British stations, if they follow the same plan for their territory, on the last two nights of the test, will be on the air just one hour earlier than the American stations. This will keep the air clear for the American transmissions which follow. The British and Continental broadcasters will undoubtedly appreciate this arrangement, for it will give them a chance to get a bit more rest. Since the transmissions from abroad come at from four to five o'clock in the morning, London time, the physical strain on the various station staffs is bound to be quite heavy by the end of the test week.



CUP PRESENTED TO ARTHUR H. LYNCH

At the recent Chicago Radio Exposition for organizing and arranging the International Tests

so most of the listed frequencies of those stations are not now accurate. On pages 465-6 of this magazine appears as complete and accurate a list of English and Continental broadcasters as is possible to secure.

The main outline of the entire transmitting schedule for all the stations is printed elsewhere in this article and it would be well for listeners to clip that schedule out for reference during the Test Week. As Captain Eckersley suggests in his radiogram quoted above, all listeners should remember that there is a great difference in time. For the convenience of listeners in the United States and Canada, the schedule is made out entirely in Eastern Standard Time. Conversion to the time of the other zones in this country is not difficult. Five British stations including 5 xx, the high power station of the B. B. C., will be on the air for three nights of the test. Although no list is at present available of the European stations participating, the leading continentals will be on the air.

Without any major exception, all the broadcasters in the United States, Canada, Mexico, Cuba, and Porto Rico will be on

the air during their allotted periods. And, a matter of great interest, at least one station on the west coast of South America will be heard, OAX 789 kc. (380 meters) at Lima, Peru. A number of the broadcasters on the east coast of South America are also expected to join in the test broadcasting.

Copies of the Radio Week programs of all the American stations which take part are being forwarded to Mr. Scott-Taggart of Radio Press in London. Radio Press will undertake to verify American programs heard by English and European listeners during the week. And in the United States and Canada, the verification of foreign programs heard will be in charge of the official International Radio Week newspaper in each city. The official programs will be printed the day after they are sent so that all listeners can themselves check their reception.

It is probable that there will be many listeners who will not see the printed newspaper programs and who prefer a verification direct from RADIO BROADCAST. Listeners who want a verification direct may address their telegrams, letters, and long distance calls to International Radio Broadcast Test Committee, RADIO BROADCAST magazine, Garden City, New York. Our long distance telephone number is Garden City 800. Those who wish to address the Committee by amateur radio may do so by filing a message with some amateur operator in their locality and asking him



"BIG BEN"

The famous clock atop the Houses of Parliament whose chimes are frequently broadcast from 2 LO and other stations in the British Broadcasting Company chain. If the English plans work out, listeners on this side of the water may have an opportunity to hear the deep bells of these chimes over their own sets during the January 1926 Tests

to forward it to the above address. The call letters of our amateur radio station are 2 GY, and the station is tuned to 7496 kc. (40 meters).

Good going to you all during the Tests!



THOSE IN CHARGE OF CANADIAN COÖPERATION

The staff of station CKAC, *La Presse* at Montreal. J. N. Cartier, the director of the station, fourth from the left in the illustration, has had charge of the arrangements with all Canadian broadcasters for their part in the Tests. In the back row, from left to right are Arthur Dupont, assistant announcer; Adrien Arcand, radio editor of the paper; Leonard Spencer, technician; J. N. Cartier; A. Lebeau, master of ceremonies; front row: J. P. Calligan, "Father Radio"; Mary Brotman and Nora O'Donnel, stenographers

Distance Computation Chart

MILES TO ↓	FROM →							
	BERLIN	LONDON	MADRID	MOSCOW	NEW YORK	PARIS	ROME	SAN FRANCISCO
Aberdeen	700	400	1180	1514	3280	600	1220	5880
Amsterdam	400	220	940	1350	3300	260	820	5900
Barcelona	950	720	300	1900	3200	540	520	5800
Berlin	—	580	1560	1020	3700	540	740	6300
Bilbao	990	600	200	1980	3050	480	770	5650
Bremen	210	400	1060	1170	3580	400	800	6180
Breslau	190	720	1230	900	3850	650	680	6450
Brunn	280	740	1150	1000	3800	630	540	6400
Brussels	500	200	830	1420	3240	160	730	5840
Buda Pesth	430	880	1200	1000	4000	750	500	6600
Cadiz	1460	1110	310	2420	2900	970	1050	5500
Cardiff	700	140	780	1680	3000	300	1020	5600
Chicago	4400	3900	3800	5400	750	3800	4700	1820
Cleveland	4000	3550	3500	5100	400	3500	4400	2140
Copenhagen	280	600	1310	1000	3700	640	950	6300
Daventry	600	80	850	1780	3200	290	1190	5800
Dresden	100	590	1110	1050	3650	520	640	6250
Dublin	820	300	930	1760	3000	500	1170	5600
Geneva	700	460	630	1500	3300	250	430	5900
Glasgow	760	340	1100	1650	3150	580	1230	5750
Habana	4500	3580	3250	5000	1350	3700	3900	3950
Helsingfors	700	1160	1860	570	4300	1210	1390	6900
Lausanne	520	460	660	1460	3550	260	430	6150
Lisbon	1840	1020	300	2450	2800	940	1140	5400
London	580	—	800	1580	3200	220	880	5850
Los Angeles	6300	5700	5600	7280	2560	6000	6300	5160
Lyons	610	460	580	1560	3200	250	460	5800
Madrid	1560	800	—	2130	3100	670	830	5500
Mexico City	6000	4300	4100	5900	2200	4400	4400	1270
Milan	530	590	730	1430	3800	390	300	6400
Moscow	1020	1580	2130	—	4600	1540	1490	7300
Newcastle	640	260	1040	1540	3400	460	1110	6000
New York	3700	3200	3100	4600	—	3350	3700	2600
Oslo	540	720	1510	1060	3900	850	1260	6500
Paris	540	220	670	1540	3350	—	680	6000
Prague	180	620	1100	1040	3700	530	580	6300
Reval	660	1130	1810	550	4300	1160	1330	6900
Rome	740	880	830	1490	3700	680	—	6400
San Francisco	6300	5850	5500	7300	2600	6000	6400	—
Toulouse	830	570	330	1790	3150	380	560	5750
Vienna	330	750	1140	1060	3900	620	480	6500
Warsaw	320	890	1410	720	4000	850	830	6600

Eight

RADIO BROADCAST'S

Booklet of

European
South American
Mexican
and
Cuban

Broadcasting Stations

January 15th, 1926

Compiled by

LAWRENCE W. CORBETT

LOCATION	CALL SIGNAL	FREQUENCY IN KC.	WAVELENGTH IN METERS	POWER IN WATTS
NORWAY				
Oslo	OSLO	785	382	1000
PERU				
Lima	OAX	789	380	1500
POLAND				
Warsaw	—	779	385	1000
Warsaw	—	779	385	300
PORTO RICO				
San Juan	WKAQ	882	340	500
PORTUGAL				
Lisbon	P1AA	937	320	—
Lisbon	—	750	400	1500
Montesanto	—	122	2450	1500
RUSSIA				
Moscow	—	821	365	1000
Moscow	—	666	450	1000
Moscow	—	297	1010	1000
Moscow	—	207	1450	12,000
Nijni-Novgorod	—	2998	100	1000
SPAIN				
Barcelona	EAJ 1	923	325	1000
Barcelona	EAJ 13	652	460	1000
Bilbao	EAJ 9	999	300	1000
Bilbao	EAJ 11	923	325	1000
Bilbao	—	723	415	1000
Cadiz	EAJ 3	833	360	1000
Cadiz	EAJ 10	909	330	1000
Madrid	EAJ 2	967	310	3000
Madrid	EAJ 4	983	305	1000
Madrid	EAJ 6	765	392	3000
Madrid	EAJ 7	735	408	6000
Madrid	EAJ 15	612	490	1000
San Sebastian	EAJ 8	867	346	3000
Seville	EAJ 5	857	350	1000
Valencia	EAJ 14	750	400	1000
SWEDEN				
Boden	SASE	219	1370	1500
Goteborg	SASB	769	390	500
Joenkoepping	SMZD	1131	265	1000

Six

LOCATION	CALL SIGNAL	FREQUENCY IN KC.	WAVELENGTH IN METERS	POWER IN WATTS
CUBA—Continued				
Habana	2 HP	1016	295	100
Habana	2 JP	1110	270	20
Habana	2 XX	1999	150	5
Habana	2 CX	937	320	10
Habana	2 AB	1276	235	10
Habana	PWX	7496	400	500
Habana	2 JL	1090	275	5
Habana	2 EP	845	355	400
Habana	2 CG	857	350	15
Habana	2 BB	1176	255	15
Habana	2 MG	1071	280	20
Habana	2 OK	833	360	100
Habana	2 OL	999	300	100
Habana	2 RY	1764	170	5
Habana	2 TW	1304	230	20
Habana	2 UF	1131	265	10
Habana	2 RK	967	310	20
Habana	2 PK	1538	195	10
Matanzas	5 EV	833	360	10
Nueva Gerona	8 JQ	1333	225	20
Puerto del Rio	1 AZ	1090	275	5
Sagua la Grande	6 HS	1499	200	10
Santiago	8 FU	1333	225	15
Santiago	8 BY	1199	250	100
Santiago	8 HS	1499	200	20
Santiago	8 IR	1578	190	20
Santiago	8 JQ	2306	130	20
CZECHO SLOVAKIA				
Brunn	OKB	167	1800	1000
Prague-Strasnice	OKP	584	513	5000
DENMARK				
Copenhagen	—	973	308	1000
Hjorring (relay)	—	240	1250	—
Lyngby	—	387	775	500
Lyngby	OXE	125	2400	2500
Odense (relay)	—	316	950	1000
Ryvang	—	261	1150	1000
ESTHONIA				
Reval	—	857	350	—
FINLAND				
Helsingfors	—	810	370	—
Skatudden	—	714	420	1000
Tammerfors	3 NB	999	300	250

Three

LOCATION	CALL SIGNAL	FREQUENCY IN KC.	WAVELENGTH IN METERS	POWER IN WATTS
ARGENTINE				
Buenos Aires	LOR	750	400	500
Buenos Aires	LOV	857	350	500
Buenos Aires	LOW	917	327	500
Buenos Aires	LOX	800	375	500
Buenos Aires	LOY	923	325	500
Buenos Aires	—	705	425	1000
Mendoza City	LOU	790	380	500
AUSTRIA				
Graz	—	742	404	500
Vienna	ORV	566	530	2000
BELGIUM				
Brussels	Radio Belgique	1131	265	2500
BRAZIL				
Bahia	—	857	350	—
Bahia	—	—	—	500
Bello Horizonte	SPH	961	312	500
Bello Horizonte	—	810	370	500
Pernambuco	—	857	350	—
Porto Alegre	RSR	787	381	80
Recife	—	967	310	300
Rio de Janeiro	SPE	790	380	500
Rio de Janeiro	SPE	961	312	500
Rio de Janeiro	SQE	750	400	—
Sao Paulo	—	750	400 (approx.)	100
Sao Paulo	—	857	350	10
CHILE				
Santiago	CRC	779	385	350
Santiago	RC	857	350	30
Santiago	—	833	360	1200
Santiago	ORC	697	430	—
Valparaiso	ACB	750	400	50
CUBA				
Caibarien	6 EV	1200	250	50
Camaguey	7 AZ	1333	225	10
Camaguey	7 SR	857	350	500
Central Tuinicu	6 KW	882	340	100
Central Tuinicu	6 JK	1090	275	100
Camajuani	6 YR	882	200	20
Ciego de Avila	7 BY	1280	235	20
Cienfuegos	6 JQ	1090	275	10
Cienfuegos	6 BY	999	300	100

Two

LOCATION	CALL SIGNAL	FREQUENCY IN KC.	WAVELENGTH IN METERS	POWER IN WATTS
SWEDEN—Continued				
Norrkoeping	SMVV	1153	260	1000
Malmo	SASC	1110	270	1000
Stockholm	SASA	702	427	1000
Stockholm	—	681	440	1000
Sundswall	SASD	550	545	1000
SWITZERLAND				
Berne	—	993	302	500
Geneva	HB 1	273	1100	1500
Lausanne	HB 2	353	850	500
Zurich	RGZ	582	515	500
URUGUAY				
Montevideo	—	857	350	—
VENEZUELA				
Caracas	—	750	400 (Approx.)	—

Instructions

TO ASSEMBLE this eight-page booklet of foreign broadcasting stations, first cut the sheet on which the call signals are printed, from the magazine. It is best to employ a razor blade for this operation. Then trim the sheet along the outside border line. Do not cut down the center vertical lines. These are used as a folding guide only. The sheet is next cut in two, across the center horizontal line. The two pieces (each consists of four booklet pages, of course) are then folded down their vertical centers and inserted into each other so that the numbered booklet pages run concurrently.

The distances given in the chart on page eight of the booklet are only approximately correct, but are sufficiently accurate to serve a useful purpose.

Seven

LOCATION	CALL SIGNAL	FREQUENCY IN KC.	WAVELENGTH IN METERS	POWER IN WATTS
FRANCE				
Agen	—	943	318	250
Grenoble	—	357	840	150
Lyons	—	1086	276	300
Lyons	YN	631	475	300
Marseilles	—	857	350	300
Paris	SFR	168	1780	4000
Paris	5 NG	869	345	500
Paris	FPTT	655	458	500
Paris	8 AJ	168	1780	100
Paris (Eiffel Tower)	FL	113	2650	4000
Toulouse	—	109	274	2000
Toulouse	MRD	952	315	250
Tours	YG	120	2500	500
GERMANY				
Berlin	—	594	505	4500
Berlin	—	520	576	2000
Bremen (relay)	—	1075	279	1000
Breslau	—	717	418	1500
Brunswick	—	1176	255	1500
Cassel (relay)	—	1041	288	1500
Dortmund	—	1059	283	500
Dresden (relay)	—	1027	292	1000
Eberswald	—	1071	280	1000
Elberfeld	—	1204	249	500
Frankfort	—	638	470	1500
Gleiwitz	—	1195	251	1500
Hamburg	—	759	395	1500
Hanover (relay)	—	1013	296	1000
Königsberg	—	648	463	1500
Königs wusterhausen	—	231	1300	5000
Leipzig	—	663	452	1500
Munich	—	618	485	1000
Munster	—	731	410	1500
Nuremberg (relay)	—	882	340	1000
Stuttgart	—	677	443	1500
GREAT BRITAIN				
Aberdeen	2 BD	606	495	1500
Belfast	2 BE	681	440	1500
Birmingham	5 IT	626	479	1500
Bournemouth	6 BM	777	386	1500
Bradford	—	967	310	200
Leeds	2 LS	867	346	200
Cardiff	5 WA	849	353	1500
Daventry	5 XX	187	1600	20,000
Dundee	2 DE	906	331	200
Edinburgh	2 EH	914	328	200
Glasgow	5 SC	711	422	1500

Four

LOCATION	CALL SIGNAL	FREQUENCY IN KC.	WAVELENGTH IN METERS	POWER IN WATTS
GREAT BRITAIN—Continued				
Hull	6 KH	895	335	200
Liverpool	6 LV	952	315	200
London	2 LO	821	365	3000
Manchester	2 ZY	793	378	1500
Newcastle	5 NO	742	404	1500
Nottingham	5 NG	920	326	1500
Plymouth	5 PY	887	338	200
Sheffield	6 FL	996	301	200
Stoke on Trent	6 ST	980	306	200
Swansea	5 SX	622	482	200
HOLLAND				
Amsterdam	PCFF	154	1950	1000
Amsterdam	PX 9	280	1070	400
Amsterdam	—	140	2125	1000
Bloemendaal	—	869	345	5000
Hilversum	HDO	286	1050	2500 up
Utrecht	—	273	1100	2000
HUNGARY				
Buda Pesh	—	549	546	2000
IRISH FREE STATE				
Dublin	2 RN	769	390	1500
ITALY				
Milan	SITI	550	545	500
Rome	IRO	705	425	1500
Rome	—	167	1800	500
MEXICO				
Chihuahua City	CZF	923	325	250
Mazatlan	CYR	631	475	250
Merida	CYY	546	549	100
Mexico City	CYA	999	300	500
Mexico City	CYB	1090	275	500
Mexico City	CYH	800	375	100
Mexico City	CYL	750	400	500
Mexico City	CYO	705	425	100
Mexico City	CYX	923	325	500
Mexico City	CZE	857	350	500
Mexico City	CZI	666	450	—
Puebla City	CYU	961	312	100
Tampico	CYE	833	360	—
Tampico	CYQ	931	322	100
Vera Cruz	CYC	999	300	—
Vera Cruz	CYD	1199	250	—

Five

AS THE BROADCASTER SEES IT

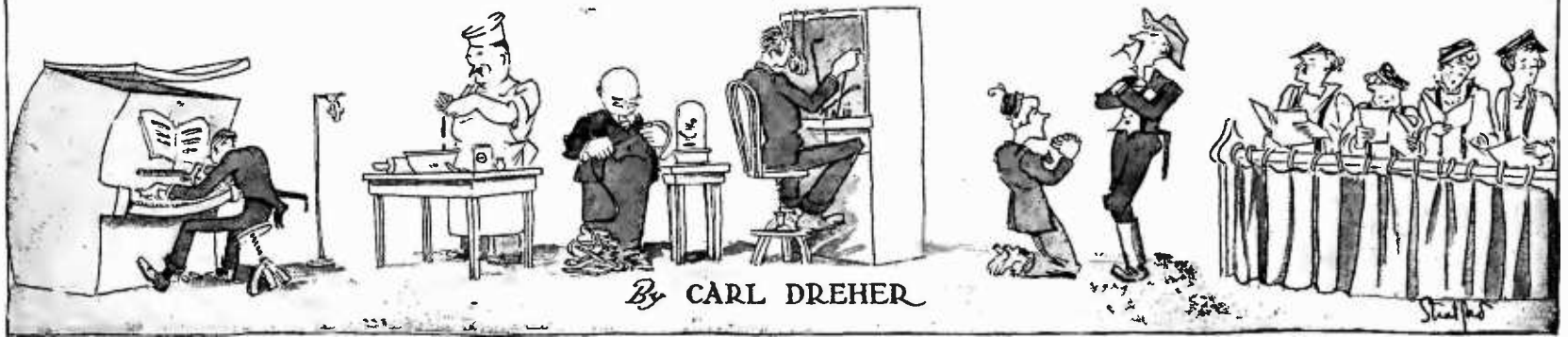

Drawings by Franklyn F. Stratford

What the Institute of Radio Engineers Does for Radio

THE Institute of Radio Engineers is a learned society devoted to the advancement of radio communication in all its aspects, theoretical and practical. The term "radio communication," it must be understood, includes a great deal besides broadcasting. To old radio telegraph engineers, broadcasting is only the frothy comedy of radio. What does it matter, they ask, whether the ether is burdened with all these pretty tunes and smart talks; no one is going to die if they fail to reach the receivers waiting for them. An SOS call on the high seas is another matter. So they stick to their dots and dashes.

The Institute, however, keeps pace impartially with the developments in radio telegraphy and telephony. As a matter of fact, the two arts rest on the same principles and most of the articles appearing in the *Proceedings*, published six times a year by the society, are of equal interest to specialists in both fields. If an engineer makes some experiments on field intensity of a transmitter at various points, the presence of shadows, dead spots, etc., the results are equally applicable to telegraph transmitters and broadcasting stations in or near the frequency bands covered. The differences between wireless telegraphy and telephony, important as they are, are much fewer than the similarities.

Practically every technical radio man of prominence in the United States, and many in other countries, are members of the Institute of Radio Engineers. But membership is not confined to these eminent figures. The total membership is in the neighborhood of 3000, divided into four grades according to experience and professional standing. At the head are about 100 Fellows, followed by some 500 full Members. These are very largely professional radio engineers and administrators. The 2400 Associate Members comprise the body of the membership. There are also approximately 150 juniors under 21 years of age.

It is not generally known that any responsible person who is seriously interested in radio, in either an amateur or professional capacity, is welcomed to associate membership in the Institute, as long as he or she can pay the dues of \$6.00 per year assessed in this grade. As a matter of fact, the Associate gets as much for his \$6.00 as the Fellow for his annual payment of \$15.00. He may attend meetings. He may contribute to the *Proceedings* if he has something worth while to say. He can't be President,

but his vote counts as much as any one else's. If he makes a great invention he is just as eligible for the gold medal or the Liebmann Memorial Prize of \$500, both awarded yearly. Above all, he gets his six copies of the *Proceedings* every year. In 1924 the volume ran to 864 pages of reading matter, printed in admirable format with full illustrations and charts, making a thick book of information absolutely indispensable to anyone whose interest in radio is above the twelve-year-old level. How the Institute does it I don't know, although the fact that a number of \$20,000-a-year men give a portion of their time to running it, free, gratis, for nothing, as they say in the backwoods, must have something to do with it. Anyway, there's the book. The subscription price to non-members is \$9.00, and it is worth that.

Members of the Institute in any grade must be passed on and elected by the Board of Direction. Application blanks may be secured from the Secretary, at 37 West 39th St., New York, New York. If the application is for one of the two top grades it must be accompanied by the recommendation of five members in that grade, and the Board goes over it very exactly. There are rigid constitutional requirements which must be met. A Fellow must be not less than thirty years of age; he must have been in the active practice of his profession for at least seven years, including three years of responsible charge of important radio work—and "important" does not mean running a peanut roaster broadcasting station or designing still another receiver which is called a uni-control because you have to move six knobs, one big and five small, in order to tune it. A Member-applicant's record is also subject to critical scrutiny; but the section of the constitution referring to Associates states merely that "An Associate shall be not less than twenty-one years of age and shall be: (a) a radio engineer by profession; (b) A teacher of radio subjects; (c) A person who is interested in and connected with the study or application of radio science or the radio arts." That lets in everyone who wants to join and who pays his debts and does not throw bombs at the constituted authorities, invent perpetual motion machines, or sell pill-box static eliminators. Through affiliation with the Institute, one is definitely known as a person active in the development of radio communication, and, aside from the tangible advantages realized, it is about the most practicable means

of testifying to a genuine interest in the art. Not without reason, some employers in technical radio pursuits consider membership in the Institute of Radio Engineers as one evidence of serious devotion to the problems of advancing and establishing radio communication.

The principal section of the Institute is in New York City, where the attendance at meetings is such that it is necessary to hold them in the large Engineering Societies Building auditorium. However, good-sized sections have also been organized in Washington, District of Columbia, Boston, Massachusetts, Seattle, Washington, San Francisco, California, Philadelphia, Pennsylvania, Chicago, Illinois, and Toronto, Canada. These bodies hold meetings, usually each month, in their respective towns. Important engineering papers are presented and discussed at these gatherings. It is no exaggeration to say that no important radio achievement of a technical nature has appeared without being introduced to the engineering fraternity in this way. Foreign engineers, as well as Americans, contribute to the material presented at these meetings and later published in the *Proceedings*, thus giving the papers and discussions an international flavor in keeping with the nature of an art which knows no national boundaries or artificial limits in its mechanism.

The Institute maintains various committees which systematize forms and procedure in their various fields. For example, there is a Standardization Committee which has the job of keeping technical nomenclature and terminology abreast of the times, so that everyone interested may know the correct and accurate use of the various terms. This committee and its subcommittees issue detailed standardization reports every few years.

The officers of the Institute of Radio Engineers for 1926 are Donald McNicol (President); Ralph Bown (Vice-President); Alfred N. Goldsmith (Secretary and Editor of Publications); Warren F. Hubley (Treasurer); Edward Bennett, Lloyd Espenschied, Louis A. Hazeltine, John V. L. Hogan, John H. Morecroft, A. H. Grebe, Melville Eastham, and A. E. Reoch (Managers). The Past Presidents are R. H. Marriott, G. W. Pickard, L. W. Austin, John Stone Stone, A. E. Kennelly, M. I. Pupin, G. W. Pierce, J. V. L. Hogan, E. F. W. Alexanderson, Fulton Cutting, Irving Langmuir, J. H. Morecroft, and J. H. Dellinger. Doctor Kennelly is also a Past President of the American Institute of Electrical

Engineers, with which the Institute of Radio Engineers maintains close and cordial relations; and Doctor Pupin, the President of the A. I. E. E. at this time, is the second engineer to hold these two important offices during his career.

I do not go in much for exhorting the populace or inflicting advice on my fellow citizens, but I will say to any technical broadcasters who happen to read this, as well as any one seriously interested in radio work, amateur or professional, that they are very definitely getting off on the wrong foot if they have neglected to affiliate themselves with the Institute of Radio Engineers. Personally, I have never joined any fraternities, lodges, churches, sodalities, temperance societies, police reserve organizations, *turn vereine*, unions, or pacifist brotherhoods. I declare, with several thumps on my chest, that I am as little inclined toward joinery, in the large, as an Anatole France or a Rémy de Gourmont. But I have belonged to the I. R. E. since considerably before the time when I became eligible to vote, and intend to remain in it until I become too weak to earn \$10.00 a year. The sixty or seventy dollars which I have paid in in dues during that decade have been among the best investments I have ever made, and if you are a radio engineer, operator, amateur or experimenter still on the outside, permit me to give you this tip and to urge you to send for the application blank, as the correspondence schools say, NOW.

Technical Routine in Broadcasting Stations. II. Control Work

THIS is the sixth of a series of practical articles for professional broadcasters. Articles previously published are three on microphone placing (September, and October, 1925; and January, 1926); one on personnel and organization in a typical large station (November, 1925); and one relating to wire lines as employed in broadcasting (December, 1925). This last-named paper was the first of a number under the general heading of Technical Routine in Broadcasting Stations, and this discussion will now be continued with a consideration of the functions and problems of broadcast control work.

Essentially the control room is a small telephone exchange. We have a radio telephone transmitter to which various places—studios and a variety of field points—are to be connected in a pre-arranged order and for more or less

definite periods. The control room makes these connections. It (meaning the men in the control room) also "lines up" the various field points, making sure that each will be ready to broadcast when the program is handed over to it. The control room supervises the output, and adjusts the over-all amplification of the station to appropriate levels, as required by changing inputs and the characteristics of the equipment. And when the station in question is connected to other stations, hundreds or thousands of miles away, "feeding" them a portion of its own animating energy, the work of the control men is further increased. These operators, therefore, are highly trained technicians, not, like wire telephone operators, automatons mechanically doing the bidding of the people who use the telephone facilities. The work of local telephone operators can be done, and is being done better by machine switching equipment than human beings can do it. When it comes to long lines and toll telephony, the procedures become somewhat too intricate for successful mechanization. The control room of a broadcasting station contains most of the complications of long distance wire telephony, plus complexities of its own. If we are to see the day when machinery takes the place of the control operators, we shall have to get a good deal older.

One of the essential elements in good control work, nevertheless, is an almost machine-like uniformity in procedure. In putting the station on the air, in changing from the studio to the field or vice-versa, in interrupting a field event when necessary, a definite routine should always be followed, to be varied only when it is obviously advantageous for some special reason. Mistakes are less apt to be made when the various steps are always taken in the same order. For example, when the control operator changes over from the studio to an outside point it is generally necessary for him to light a separate amplifier to the input of which the line is connected at the proper time. Unless there is some fixed rule on the subject, there will be occasions when the amplifier is not lighted when the change-over is made. The result is that the opening announcement from the remote point is lost while the control operator rushes madly around tracing the signal and finds he has no voltage on his filament. If, however, it is a regular procedure to light this tube at the beginning of the last studio number, this sort of thing is less apt to occur.

Such instances may be multiplied. It is

found that some specific formula must be used in putting a field event on the air. The control operator should say to the field man: "You're on the air," and wait for the word "Right!" before closing the switch. If various phrases are used the station will inevitably get into trouble. There will be a misunderstanding and some wire talk will go out on the air. Such mishaps occur in most complicated ways. Recently I heard of one which came about through a curious combination of circumstances. A chorus was being broadcast from an opera house, with no audience present. It was a first-class aggregation of sixty trained voices, achieving unusual and very beautiful symphonic effects. After starting the concert the field operator decided he was not getting quite enough bass, and as he was set up near that section of the chorus he ran out his own microphone, which he had been using for communication with the studio before the wire was turned over to the air, some twelve feet, adding it to the two or three concert microphones already set up. Half-way through the program the control operator had occasion to give a brief message to the announcer, something about signing off one of the stations on the chain, and, no extra pair being available, he opened the broadcasting line at what seemed like an opportune moment and called, "Hello." The field operator heard him and made a dash for his microphone. In order to get it he had to take off his phones, which were on the usual six foot cord. It took him a few seconds to get back with the microphone, and in this interval the control operator gave him the message, which the field man missed, of course. Then the control operator said, "You're on the air," just as the field man was putting on the phones in more or less confusion and excitement. The control man waited for a reply, and heard some noise which he interpreted as "Dit-Dit"—the Continental code for "1," frequently used as an acknowledgment by this particular field man, who had been a ship operator in his day. So the control put the opera house back on the air. An instant later the field man cried, "What d'you say?" and this went out to Canada and Mexico while the engineers and program managers listening on the outside tore their hair and smashed mirrors without being able to bring it back. The line was immediately opened again and the mess straightened out, but the damage was done. A single slip like that, coming after a majestic oratorio, dispels the dramatic illusion like a half



"IMPORTANT PAPERS ARE PRESENTED AND DISCUSSED AT THE I. R. E."

ton of gun cotton exploded in a haystack. Yet the four or five individual mistakes made by the technical men might occur singly without causing a break. In this case the fates bunched them in such a way that all hands made a show of themselves on the air. A better organized routine procedure would have saved all this.

In most stations, even of the half and one-kilowatt size, all the technical equipment—switchboards, amplifiers, and transmitting set, is found in one room. This is fundamentally wrong. The only advantage is in enabling the station to be run with a small staff, since one or two men are enough to watch the oscillators and modulators, regulate the gain, take care of necessary switching, and keep a 600-meter log. It also means that these men have too much to do, especially when the station gets into trouble, and I have yet to see one which is exempt. At the very least the line switchboard, amplification controls, and first few stages of amplification, should be in one room (the control room) with the heavy machinery elsewhere. The tendency now is to subdivide even further. Thus, there may be a line control room where the various local and out-of-town wires terminate in suitable switchboards. Here the appropriate connections are made and telegraphing over simplex circuits is handled. The noise involved in these operations is in this way kept away from the second control room, where the amplification is adjusted and the output of the station monitored in relative peace and quiet. The men in this division are not responsible for switching; their responsibility is to take what the preceding technicians send them and pass it on to the transmitter with the best possible acoustic quality. The men in the first division take care of the switching and corollary adjustments. The steps then become:

1. Field operators at remote pick-up points;
2. Control operators (switching);
3. Control operators (Amplification and radio quality);
4. Power operators.

The 600-meter watch is best kept, in the majority of cases, by the men in the power plant. It should be kept out of the control room whenever possible; if it must be handled there, a separate operator listening with headphones should be assigned for this purpose. If this job is taken care of in the transmitter plant, a loud speaker may be used and no additional staff is required for this important detail.

The Memoirs of a Radio Engineer.

IX

I WENT to the College of the City of New York for two reasons; one was that I had none too much money, and the tuition at the College was free. This, however, was not a major factor; it would not have been an insurmountable difficulty to raise the money for a course at one of the other institutions of learning around town. The principal force which drew me to the City College was the presence in the faculty of physics of a famous radio engineer, Dr. Alfred N. Goldsmith, now Chief Broadcast Engineer of the Radio Corporation of America. As early as 1910 or 1911 the Doctor's renown had spread to the far corner of the Bronx in which I struggled with insensitive pieces of galena, hard visaged janitors who were as ready to cut down an antenna as to step on a cockroach, ten-cent store tools, my own ignorance—all the animate and inanimate obstacles in the path of the young wireless experimenter of that benighted time. Of these

handicaps my lack of knowledge was the greatest, and I hoped to sit at the feet of this preceptor and learn from him the theory and practice of the wireless art.

A prominent college president, in a recent commencement address, advised graduate students not to attend a professional school at random, but to select one at which some outstanding scholar taught the subject in which they were interested, for contact with such a figure would be of incalculable value to aspirants in his specialty. At the mediaeval universities, also, a celebrated professor attracted students, sometimes in enormous numbers; some of the universities, in fact, grew up around such figures. Thus my course in picking a college had ample historical precedent, a fact of which I was probably unaware; all I knew was that I wanted to learn radio, and Doctor Goldsmith could teach me if he desired. In this hope I was not disappointed. If I did not learn radio, the fault was not in my training.

During his teaching years, Doctor Goldsmith instructed, inspired, and in most cases got jobs for some thirty radio engineers, among whom may be named Julius Weinberger, William Priess, Joseph D. R. Freed, Lester Jones, and numerous others. He gave what was probably the first regulation radio engineering course in this country, and certainly one of the best anywhere. His students were picked men, senior students specializing in physics or engineering, who showed special qualifications for an advanced course in radio technique and theory. The classes ran from three to six men in number, an ideal condition in which a "course" ceases to be what is usually meant by the term—something to be "taken" and forgotten. The first class was in 1913, the last in 1918, when the pressure of other responsibilities became too great, and the Doctor was no longer able to devote a considerable portion of his time to a handful of men in this one course. It was not until the end of 1924, however, that he gave up active teaching entirely. He was then an Associate Professor, in charge of the Department of Electrical Engineering at the College of the City of New York.

While teaching physics, electrical engineering, and radio at the College, Doctor Goldsmith was editor of the *Proceedings of the Institute of Radio Engineers*, a position which he still holds, and has held since the Institute was founded in 1912. Since 1918 he has also been Secretary of the Institute. He is, accordingly, one of the charter members and founders of the Institute, and a Fellow from the beginning, with activities dating back to the Society of Wireless Telegraph Engineers and the Wireless Institute, whose combination formed the Institute of Radio Engineers.

Readers who are unfamiliar with these primordial days of organized radio, and its outstanding figures then and now, will probably imagine Doctor Goldsmith as a man of at least sixty. He is in fact thirty-eight years old. In 1913, when I first met him, he was in his twenty-sixth year, already a Ph.D. of Columbia University, and an instructor in physics at the City College. And while he was engaged in all the activities enumerated above, he was also, from 1914 on, Consulting Engineer, and later Director of Research, for various commercial radio companies.

The course in radio engineering was neither my first nor last contact with Doctor Goldsmith. Long before I was qualified for this study, I was one of his students in physics, and a member of the City College Radio Club, founded in 1914, of which the Doctor was the Faculty Advisor, and which he supported liberally, not only with advice, but also with donations of valuable apparatus, so that shortly it became one of the most affluent amateur radio clubs of the city. At the meetings he would frequently appear and lecture for a half hour on some interesting phase of radio to the fifteen or twenty members present. In this way, by virtue of the fact that the Doctor was Chairman of the I.R.E. Committee on Papers, and Editor of the *Proceedings*, the students frequently received summaries and elucidations of important engineering literature soon after presentation. This early contact with first-rate engineering exposition was of course inestimably valuable to the young men in the club.



"THE PROGRAM MANAGERS AND ENGINEERS LISTENING ON THE OUTSIDE TORE THEIR HAIR"

In 1913 I was in the graduating class of Townsend Harris Hall, the preparatory school of the College, across the campus from the other college buildings. It was the custom to give these "subfreshmen," during the last semester of their preparatory course, College instructors, space in the Main Building, and other facilities of the university. Accordingly my class in what was known as Physics 2, an elementary course in light, heat, magnetism, and electricity, received its tuition from Doctor Goldsmith. I had seen pictures of him, and recognized him as soon as he came into the room. He was smooth shaven, and it became clear to me immediately that a man could look very much the scientist without the pointed beard which invariably characterizes the profession in the movies. His manner was brisk and businesslike, not at all hurried, but giving the effect of getting to the objective without any delay or vacillation. He knew just what he was doing, and my classmates, who were not above indulging in various monkeyshines if they thought the instructor would let them get away with it, realized, appraising a firm chin and executive-looking eyes, that they would get kindly treatment, but that it would not do to throw chalk, roll dice under the seats, or bring pet fauna into the recitation room. With sinking hearts they resigned themselves to the thought of work.

I got along well enough in this course, having gone over the electricity and magnetism part in my private studies, and in the other branches I studied diligently in order to impress the instructor with my serious intentions. So did a number of the other lads, who also had their eyes on the radio field, although not obsessed by it to the extent I was. We knew of the radio engineering course, P 17, which was that year being given for the first time, and from the lowly position of P 2 we gazed up at the heights with vast curiosity and longing. The radio laboratory, a large room on the ground floor, was always kept locked. One made application to get in after ringing a bell. On a certain day, as three of us were passing the room, the Doctor came by, nodded to us as we touched our hats in accordance with the punctilio of the College,

and went in. Walking nervously up and down the hall, we began to debate as to whether he might show us the laboratory if we could get up courage enough to ask him. Finally one of us pumped up resolution and pressed the push-button for about a quarter of a second. When the door opened we almost turned on our heels and ran, but it was not Doctor Goldsmith. We explained to the College senior who appeared that we were preparatory school students of the Doctor's, and suppliants for a view of the laboratory. In a moment Doctor Goldsmith appeared, received us cordially, and invited us in. This was the first time that I had ever seen commercial radio telegraph equipment and precision radio measurement apparatus, and I was dazzled. The neat ebonite bases, shiny brass fittings, the carefully spaced turns of helical inductances, and all the other marks of good design and workmanship, were fascinating to one used to wooden bases and cheap construction. Of especial interest was a 3 kw. Poulsen arc, presented to the College by Mr. Gano Dunn.

It was a laboratory afternoon for the radio engineering students and they were engaged on the various experiments assigned to them. One squad was measuring the voltage of a quarter kilowatt transformer with an electrostatic voltmeter; another was working with wavemeters; another was taking antenna characteristics, and so on. It would all seem fairly commonplace to me to-day—I mean, I like radio as much as ever, but the magic is no longer there; it is the difference between having a crush on a girl and marrying her. Radio to me to-day is a matter of hiring men, o'k'ing bills, arguing with orchestra leaders, worrying about wire lines, maintenance, costs, and technical bugs; and so on. But on that day, when Doctor Goldsmith showed us around his laboratory, it was pure glamour.

Having introduced Professor Goldsmith into my narrative at this point, I shall have many more occasions to refer to his influence and good will, which were so great an aid to these young men eager to enter the radio field. They were fortunate that for some years before executive functions took over all the Doctor's time, he was able to devote a part of his plentiful energy toward giving them a start. As for me, I feel the obligation to acknowledge my indebtedness to Doctor Goldsmith at this point in my autobiographical sketches. Perhaps this is in bad taste. Perhaps, with the reserve or inarticulateness considered proper in a country of Anglo-Saxon traditions, I should wait until the object of my acknowledgments is dead. But he shows no signs of disintegration, on the contrary, he is in vigorous health, and it might well turn out that when he is dead I shall be in the same state, which would interfere seriously with my eulogizing. So I speak my piece now.

Resurrection

AMONG the oral and written comments which we have received on points of ancient history taken up in the "Memoirs of a Radio Engineer" series, is one from Mr. James M. Baskerville of Patchogue, Long Island. He deposes and says:

I installed and operated the Plaza Hotel station, call letters fs (not P) after Mr. Fred Sterry,

Manager. Harry Shoemaker designed the "Ice Box" for the spark gap, to reduce the complaint of patrons who desired to sleep nights. Some day I'd like to tell you how I fought it out with the *Lusitania* (incoming) and Sea Gate, from fs, before there were any laws governing good wireless conduct. No doubt the Plaza station, aggressively manned, was the air boss around New York, though frequently the Waldorf Astoria (wa) station disputed this fact with fs.

It is a good thing that Mr. Baskerville added that last qualifying statement, or Jack Pickerill would be coming out to Patchogue with an elephant rifle. The boys have never got over those days. There were no church services on the air in 1908.

The Lingo of Radio

Artificial Terms and Trade Names

A NEW thing requires a new name, and when a good word does not happen to be at hand, an attempt is sometimes made to build one out of Greek or Latin roots. "Heterodyne" is an example. "Hetero" is from a Greek prefix meaning "other" or "different," as in "heterodox," "heterogeneous." "Dyne" means "force"; in physics the "dyne" is in fact the unit of force. The name was applied to the reception of a radio oscillation by causing it to beat with a local oscillation of somewhat different frequency—the local oscillation being the "other" or "different" force. Similarly with such terms as "homodyne," "autodyne," etc. With the exception of "heterodyne" and a few others, such terms do not usually attain a great vogue; their artificiality appears to be against them. For example, "diode" for a two-electrode tube, and "triode" for a three-electrode bulb, have not come into very wide use, logically constructed as they are.

Trade names are sometimes built up in the same way and frequently gain currency. For example, "Audion," "Pliotron," "Kenotron," "Radiotron," "Radiola." Sometimes words with this origin push out of use the more general names of academic origin. "Graphophone" and "gramophone" are correct synonyms for "phonograph," but they are certainly less widely known and used than "victrola," although "victrola" has no dictionary standing at all. With a generous advertiser behind it, a word may go a long way.

Misnomers: Inappropriate Terms, Etc.

"Static" is an ambiguous term as generally used. Its derivation is from "static electricity" in the sense of a bound charge on some insulated object, as distinguished from the electricity in motion of an electric current. The charge on a piece of sealing wax or a Leyden jar or a metal ball on an insulating stand was called "static" appropriately enough. In radio the word came to be used indiscriminately to denote the various disturbances picked up by receivers affected by lightning storms. These are highly dynamic effects, and it is glaringly inappropriate to speak of them as "static." The 1922 report of the Committee on Standardization of the Institute of Radio Engineers limits "static" to "conduction or charging current in the antenna system resulting from physical contact between the antenna and charged bodies or masses of gas." The term "strays" is applied to irregular electromagnetic waves or impulses originating from lightning or other sudden electrical changes, whether natural or artificial.

One word that has fallen into deserved disrepute is "undamped" for "continuous wave." We might as well speak of a girl as "unplain" when we want to say she is pretty.

(To be continued)



"JACK PICKERILL WOULD BE COMING TO PATCHOGUE WITH AN ELEPHANT RIFLE"

Taking the Complexity Out of Wavelength-Frequency Conversion

How the Term "Wavelength in Meters" First Came Into Being and Why It Should Be Discarded—Why Broadcasting Stations Are Given a Definite Frequency Separation

By HOMER S. DAVIS

EVER since the old broadcasting channels of 360 and 400 meters discarded nearly three years ago, the use of the expression "frequency in kilocycles," rather than "wavelength in meters," has been constantly advocated. The reason for this is that the broadcasting stations are now spaced according to frequency instead of wavelength. But, like a bad habit, the use of the term wavelength is proving a difficult one to drop.

Now light, radio, heat, and sound forms of energy, are similar in one respect; they all are transmitted by wave motion. When the quiet surface of a pond is disturbed by dropping a stone into it, waves are formed which spread out in ever-widening circles. This is a classical example of wave motion. These waves travel outward with a definite velocity, and contain energy sufficient to set in motion any small floating objects that they might pass. In applying this analogy to radio waves, consider the stone as replaced by a radio transmitting station, the floating objects by radio receivers, the water by the ether, and an idea may be had of the transmission of radio energy, except that radio waves travel forward at a much greater velocity than water waves.

Every wave has a length, which is conveniently defined as the distance from the crest of one wave to the next. This is easily observed in the case of water waves, but the alternate crests and troughs, though present, are invisible in radio and light forms, and must be measured indirectly. Each wave travels with a definite velocity, defined as the distance it moves in one second. The number of times per second that a new crest passes a fixed point is called the frequency. The relation between these three properties of length, velocity, and frequency, is that the velocity, or distance one wave travels per second, when divided by the length of each wave, gives the frequency, or number of waves per second.

The early scientists who experimented with radio phenomena, were able to demonstrate that radio waves are transmitted with the same velocity as light waves, and that the two are the same kind of waves, differing in frequency. They travel with the enormous velocity of more than 186,000 miles per second, or 300,000,000 meters (the meter being a little longer than the yard) per second. As the frequencies

of light waves are almost too great to comprehend, that of yellow light being six hundred trillion per second, it was found more convenient to classify them by their wavelengths. In view of their similarity, the same practice was adopted for radio waves, and proved entirely satisfactory in those early years, long before broadcasting stations, not to mention interference between them, were even dreamed of.

But when the old 360 and 400 meter channels became jammed, and the problem of spacing the stations over a wide range of wavelengths presented itself, it became evident, for two chief reasons, that they must be spaced on a frequency basis rather than of wavelength. The first reason was that the energy radiated by a broadcasting station consists of not only the principal, or "carrier" frequency, but other, or "side" frequencies, differing from the carrier by amounts equal to the audio frequencies. Since the useful audio frequencies range up to about 5000 or more cycles per second, the energy radiated by the station is distributed from at least 5000 cycles below to 5000 cycles above the carrier frequency, a band of 10,000 cycles. To prevent overlapping, it is evident that adjacent stations should not use frequencies closer together than 10,000 cycles per second. The second reason was that if two stations use frequencies very close together, an audible "beat note" or whistle will be produced, its pitch being equal to the difference in the frequencies of the two stations. As this difference is increased, the pitch of the whistle increases until it can no longer be heard by the human ear; this occurs at a minimum of about 10,000 cycles per second.

Thus broadcasting stations are now allotted frequencies differing by 10 kilocycles (or 10,000 cycles, "kilo" meaning thousand), and although many stations use the same frequency in common, they are located in sufficiently remote parts of the country as to cause a minimum of interference.

HOW TO USE THE CHART

THE present time marks a period of transition from the old custom of speaking of wavelengths to the new one of frequencies. It is a rather trying period, for the old custom has not yet been fully abandoned, and both are in general use, resulting in a great deal of confusion. To assist the reader in converting meters into

kilocycles, until the time when the term wavelength is put back on the shelf of the scientific library whence it was first borrowed, the chart on the next page has been prepared for reference use. On the right is a scale of wavelengths from 10 to 10,000 meters, placed alongside a scale of corresponding frequencies in kilocycles. To use, merely read the desired frequency opposite the wavelength in question. For example 200 meters corresponds to 1500 kilocycles, 300 meters to 1000 kilocycles, 1000 meters to 300 kilocycles, 5000 meters to 60 kilocycles, and so on. It may be seen from the chart that the frequencies are closer together at the shorter wavelengths than at the longer ones; to take a specific case, the hundred meters between 100 and 200 correspond to a frequency range of 1500 kilocycles, or 150 station channels, whereas the hundred meters between 500 and 600 comprise a range of only 100 kilocycles, or only 10 channels. Everyone who has used the old style circular plate condenser is familiar with this crowding of stations at the shorter wavelengths.

On the left is a pair of similar scales covering a more limited range; namely, the broadcast band. It is used in the same manner as the other pair of scales; for example, station KDKA uses a wavelength of 309.1 meters, which is seen from the chart to equal a frequency of 970 kilocycles. Here the frequency scale has been spaced uniformly, suggesting the spacing of dial readings when a straight line frequency condenser is used. This clearly shows how a properly designed condenser of this type spreads out the short wavelength, or high frequency, stations, relieving the critical tuning formerly required at the low readings. (This function should not be mistaken for selectivity.)

That the adoption of this custom of speaking of frequencies is fully justified may be seen by summing up its advantages; it is in keeping with the station assignments made by the United States Department of Commerce; it replaces clumsy wavelength numbers, such as 483.6 meters, with useful frequency values, such as 620 kilocycles; it gives a direct indication of the possibility of interference between stations; it is especially convenient when straight line frequency tuning condensers are used; and its general use aids the movement toward simplifying our every-day terminology.

WAVELENGTH FREQUENCY CONVERSION CHART

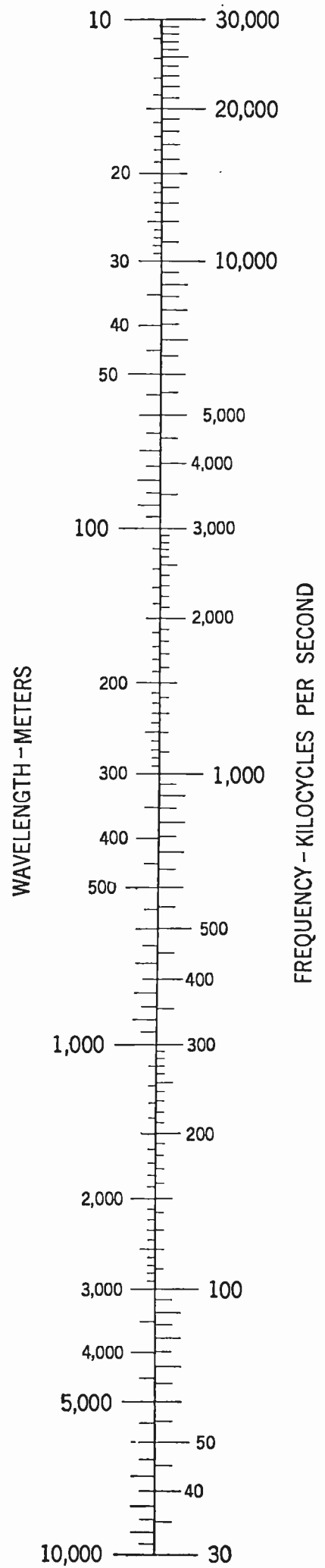
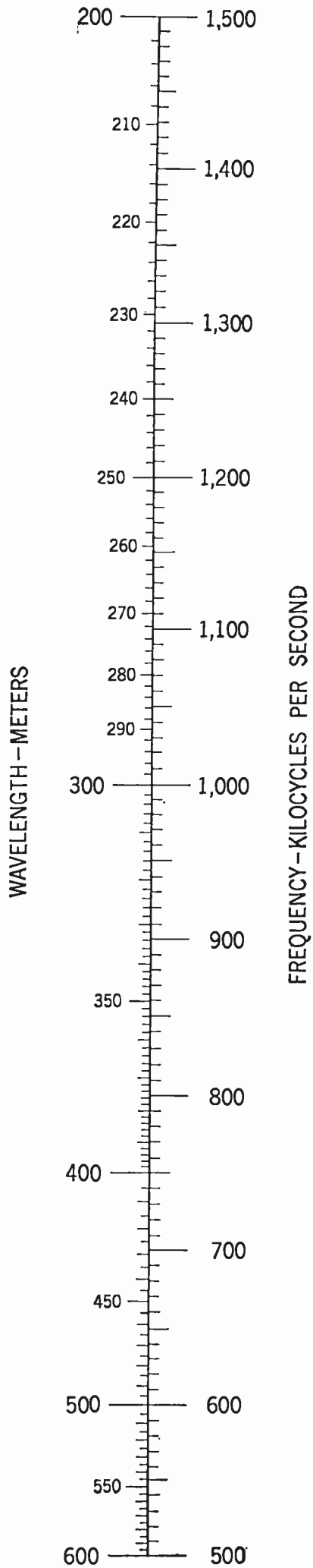



Not so long ago

There was a man who found radio fascinating because it required constant attention and tinkering. Locating the source of noises or weak signals was an adventure.



But today

This same man expects flawless reception at the touch of a finger. He wants to feel that his receiver will always be at its best—even when turned on by his wife at the children's bedtime hour.

And tomorrow

Our friend will have learned (as have thousands of others already) that the finest and most reliable reception comes from the use of that smooth and unvarying power furnished by a high-grade B-eliminator. In short, he will obtain lasting satisfaction only from the type of eliminator that the long life Raytheon rectifier makes possible, whether he buys it complete or assembles it himself.

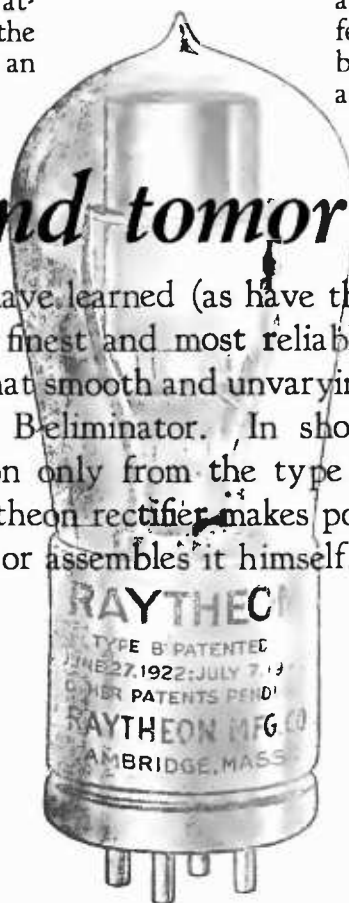

RAYTHEON

is more than the name of a new type of rectifier. It is the symbol of a research laboratory, the mark of an organization of engineers. Radio manufacturers, radio editors and radio dealers appreciate the value of Full Wave Rectification, No Filament, No Chemicals, Ample Voltage and a Sixty Milliampere Rectifier for Six Dollars.

RAYTHEON MANUFACTURING CO. ★
Cambridge, Mass.

RAYTHEON

★ Tested and approved by RADIO BROADCAST ★

www.americanradiohistory.com



Transformers of Merit for Fifteen Years

DONGAN

Builds complete, including winding of coils, in Dongan Plants.



Transformers

No. 509 Full Wave
\$7.00 List



Chokes

No. 514 20 henry
\$5.00 List

Raytheon Tubes

\$6.00 List

Set Manufacturers

Rely on Dongan Transformers and Chokes for all types of B-Eliminators. 42 Set Manufacturers use Dongan Audio Transformers.

Perfected B-Eliminators

Assure Better
More Economical
Reception

Easy to Build Your Own
Using Raytheon Tube
and

DONGAN

B-Power Units

Up-to-date radio means clear, true reception, without hum and without B-Batteries. You will never go back to the old way once you have used the new and perfected type B-Power Supply with the Raytheon Tube and Dongan Transformers and Chokes.

Full instructions for building this remarkable B-Eliminator can be obtained from your dealer or direct from us at your request. Costs little to build, is an economy to use and will serve you for years.

Order from your dealer or send check or money order to us direct.

*Other Dongan Products
Audio Transformers and Voltmeters*

Dealers

Ask your Jobber or write to us for information and discounts on the year's best merchandise.



DONGAN ELECTRIC MANUFACTURING CO.

2991-3001 Franklin St. Detroit, Michigan

RAYTHEON

★ Tested and approved by RADIO BROADCAST ★

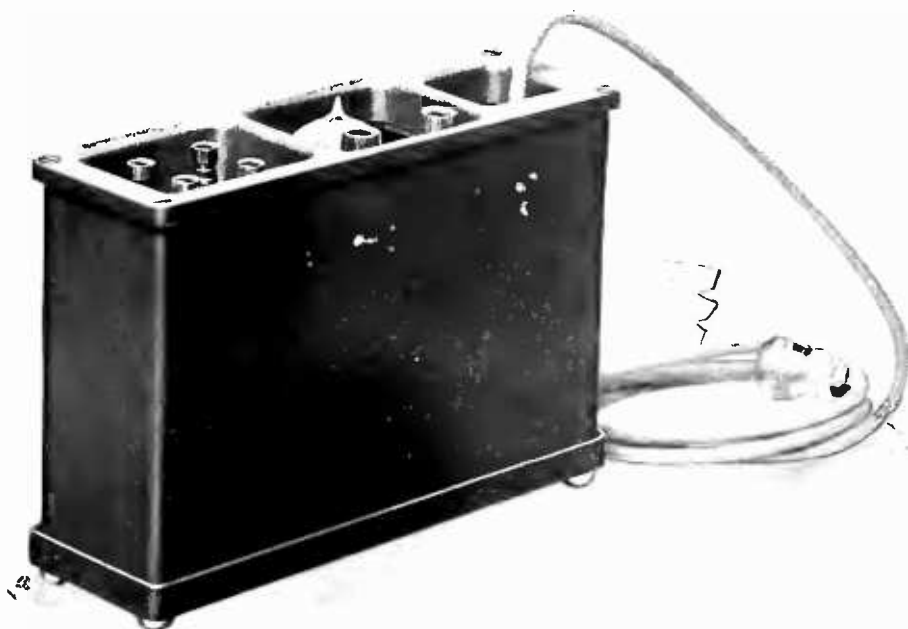

The MODERN "B" Power Supply Solves Your Battery Problems!

MODERN

"B" Power Supply Unit
will operate any receiver

MODERN

"B" Power Supply Unit
is economical. It pays
for itself

MODERN

"B" Power Supply Unit
improves reception

MODERN

"B" Power Supply Unit
is ideal for DX

MODERN

"B" Power Supply Unit
is scientifically constructed

MODERN

"B" Power Supply Unit
is unqualifiedly guaranteed

MODERN

"B" Power Supply Unit
is bought on competitive
tests

The Modern "B" Power Supply Unit was developed, tested, and perfected in our laboratories. It goes to you as a finished product. It is unqualifiedly guaranteed.

It will operate any receiver satisfactorily, even improving in most instances the tonal quality. All types and designs of receivers, from the "super" to the neutrodyne have been operated from it. The four-tube Reflex, which is the stumbling block for the ordinary power supply unit, performed beyond all expectations from the Modern.

Ask your dealer to perform this test: Disconnect your ground and aerial; turn on your receiver; and then hold a Western Electric Speaker close to your ear. If your power supply unit is a Modern you will *not* be able to tell the difference; if your power supply unit is not a Modern you will perhaps hear a hum.

The Modern "B" Power Supply Unit can supply 150 volts, thereby permitting the use of the big power tubes. It has an extra 90-volt tap for peanut tubes. Optional connections are provided. The customary difficulties that beset the average power supply unit are totally absent from the Modern. Moisture seepage is prevented; electrical depreciation of the elements is completely overcome; several additional microfarads permit oscillation in the receiver that is designed to oscillate; each Modern "B" Power Supply Unit is thoroughly tested at 2,500 volts; and it is housed in an attractive, highly polished steel cabinet.

Furthermore, the Modern "B" Power Supply Unit is built by radio manufacturers of national reputation, manufacturers of standard equipment.

Ask your dealer or write direct for complete information.

MODERN ELECTRIC MFG. CO.

Manufacturers of Standard Radio Equipment

TOLEDO, OHIO



RAYTHEON

★ Tested and approved by RADIO BROADCAST ★

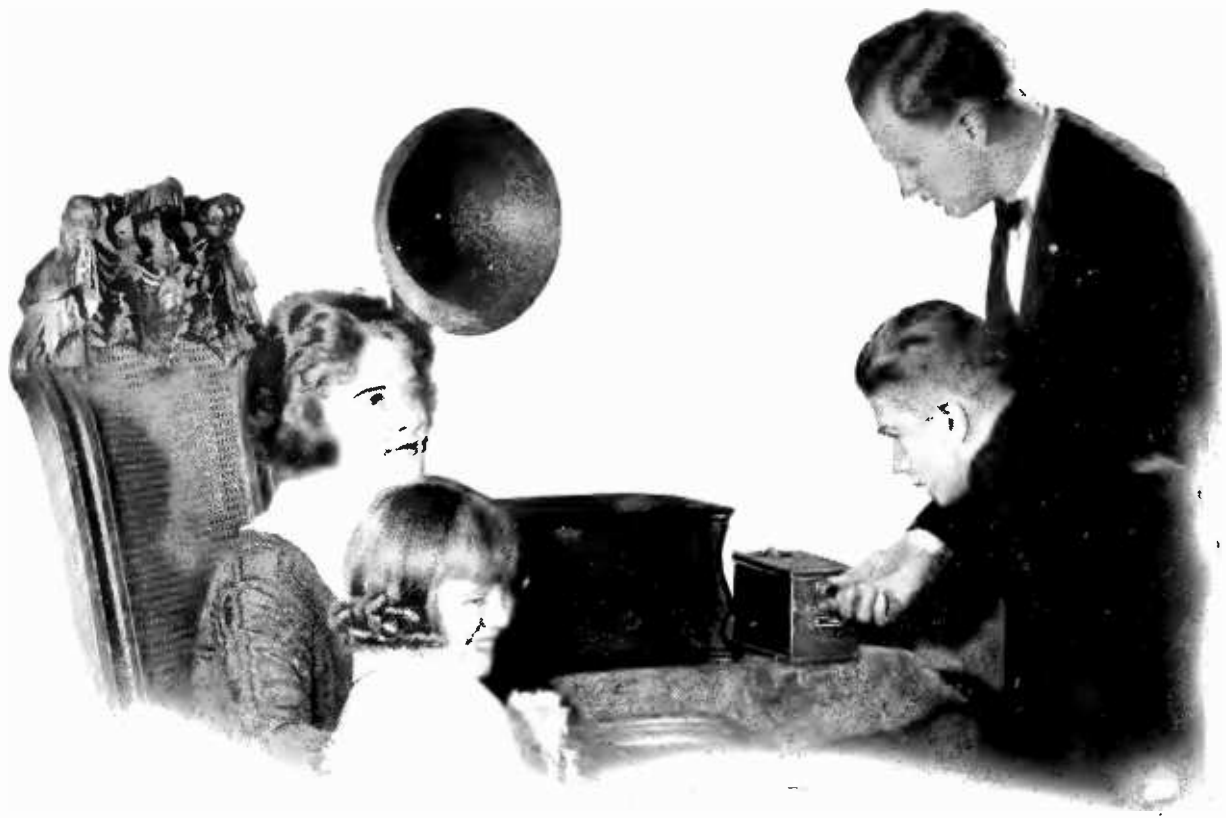

Makes Any Radio Better!

Hook up a Webster Super-B to your receiver. Plug the cord into a light socket or a wall receptacle. Then, sit back and really enjoy your radio.

Reach out for distant stations. You'll get volume you never dreamed of. You'll have tonal quality you never thought possible from your set.

The reason? Steady, undiminishing, noiseless B power, as dependable as your electric light,—power of a smoothness and strength that only a central station can give. The Webster Super-B, using the Raytheon tube, does all this, and more. It saves you money. It has nothing to wear out, to burn out, to spill out or to replace. It is permanent. Its operating cost is less than one-tenth of a cent per hour,—many, many times cheaper than B batteries. It

eliminates forever the noise of run down B batteries and the bother and expense of battery replacement.

The Webster Super-B pleases the eye, too. It is a beauty, handsomely finished in grain walnut enamel. Operates from 110 volt, 60 cycle alternating current.

Write for free booklet "Improving Your Radio"

Ask your dealer to show you a Webster Super-B. If he does not have one in stock it will pay you to wait till he gets one. Or write to us, mentioning his name.

THE WEBSTER COMPANY

3508 West Lake Street

Chicago

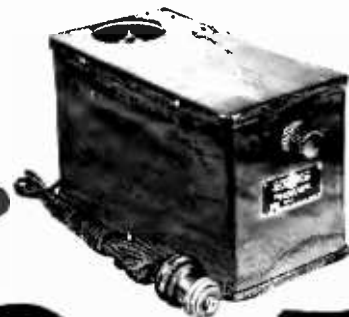

Webster SUPER-B

RAYTHEON

★ Tested and approved by RADIO BROADCAST ★



Tested and approved by the manufacturers of the Raytheon tube for use in the Raytheon "B" Eliminator

The Only Condensers *especially* designed for the Raytheon "B" Eliminator

Complete in two groups — Tested 1000 Volts D. C.

The two Potter Condenser Groups shown above constitute a complete condenser equipment for building the Raytheon "B" Eliminator. They are the only condensers specially designed in groups for this use. They are specially developed to stand up under the high voltages used with the Raytheon tube.

Each unit in these groups has been thoroughly tested to a break-down voltage of not less than 1000 Volts D. C. They are of full capacity. They remove every vestige of A. C. impulses. They eliminate all hum. Being far more highly insulated than ordinary condensers, they will give continuous discharge service without leakage. They insure highest

possible resistance and longest life under continuous use.

The larger of the two groups shown is the Filter Unit, tapped for 8, 2, 2, and .5 Mfds. This unit is also made with smaller capacities as listed below. The smaller unit shown is the Transformer Condenser Unit, used across the secondary of the transformer. Both units have strong metal jackets. They occupy minimum space and make for quick assembly.

These two units provide a complete and ideal condenser equipment for the Raytheon "B" Eliminator, yet cost practically no more than would the cheapest condensers if bought separately. Ask for them at your dealer's today. If he cannot supply you write direct to us.

- No. 350 Raytheon Filter Unit—Tested 1000 Volts D. C.—Tapped 8 Mfds., 2 Mfds., 2 Mfds. and .5 Mfd. \$12.00
- No. 375 Same as 350, but tapped 6 Mfds., 2 Mfds., 2 Mfds. and .5 Mfd. 11.00
- No. 385 Transformer Condenser Unit—Tested 1000 Volts D. C. 1.50



Potter FILTER Condensers (An American-Made Product)

POTTER MANUFACTURING COMPANY . NORTH CHICAGO, ILLINOIS

RAYTHEON

★ Tested and approved by RADIO BROADCAST ★

TONE

Full, sweet, mellow and natural, without the slightest indication of distortion, is another achievement that is making the APEX SUPER FIVE the most popular of all receiving sets.



VOLUME

That supplies dance music or entertainment without any loss, is a feature for which the APEX SUPER FIVE is world famed.



DISTANCE

Lends added enjoyment to radio with an indescribable fascination of tuning-in far away stations, which is always possible with the APEX SUPER FIVE.

Ask your dealer for a demonstration. Your eyes and your ears will tell you that APEX stands at the high point of perfection in both performance and appearance. \$80 without accessories.



SUPER 5

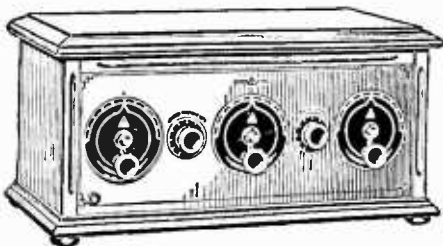

APEX ELECTRIC MFG. CO.

1410 W. 59th Street

Dept. 204

CHICAGO

THE GRID

A Department Devoted to Solving the Problems of our Readers

QUERIES ANSWERED

1. WHAT IS MEANT BY "TUNING"?
F. B. F.—Topeka, Kansas.
2. THE CONTROL OF REGENERATION IN MY RECEIVER IS NOT SATISFACTORY. WHAT CAN I DO TO IMPROVE IT?
E. W. P.—Chicago, Illinois.
3. IS THE USE OF AN OUTPUT TRANSFORMER, FOR A LOUD SPEAKER, OF ANY BENEFIT IN OBTAINING GOOD QUALITY SIGNALS?
A. C. B.—Gloucester, Massachusetts.
4. HOW IS A C BATTERY USED IN A DETECTOR CIRCUIT TO OBTAIN RECTIFICATION?
T. C.—Newark, New Jersey.

AN EXPLANATION OF TUNING

IN A circuit consisting of inductance and capacity (coil and condenser), it is possible to alter the value in meters of this circuit by variations in value of either the inductance or capacity.

If a generator of an alternating current is connected with a coil and a variable condenser,

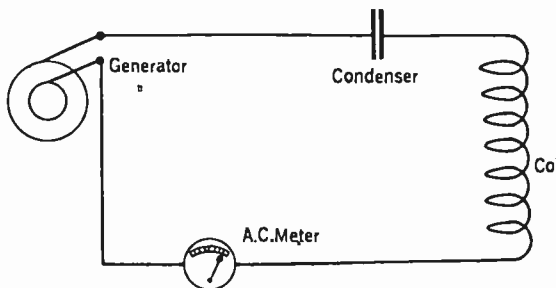

FIG. 1

then by varying this condenser it is possible, by noting the maximum deflection of a meter which is in the circuit, as in Fig. 1, to arrive at a setting of the condenser where the coil-condenser part of the circuit will be resonant with the frequency of the current set up by the generator.

We now have a new term "resonant" or "resonance," and as defined by Hogan this means "Agreement or harmony in frequency: the condition under which the natural frequency of an oscillating circuit equals the frequency of an applied alternating electromotive force."

In the circuit A, Fig. 2, we have a frequency generator whose frequency can be varied by the variable condenser C1.

Now, to bring the circuit B in "resonance," or "tuned" to A, it is necessary to rotate the condenser C2 until maximum deflection is noted on the meter. Any change in the adjustment of the frequency of the generator will necessitate an adjustment for the circuit B.

Now suppose, instead of the generator circuit A, a signal from a broadcasting station is substituted. Since broadcasting stations are as-

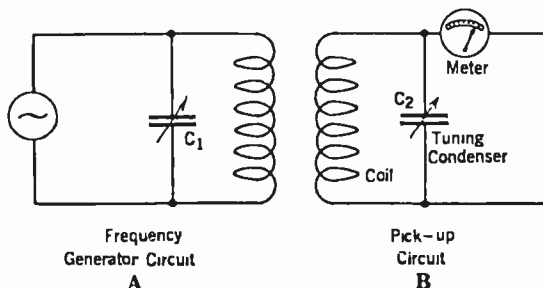

FIG. 2

signed to a definite frequency (wavelength), then it is possible to adjust the circuit B, or "tune it," by means of the condenser C2, until it is in resonance with the transmitted wave. To

change over to another station transmitting at a different frequency (wavelength) it is only necessary to re-adjust the receiving condenser C2 until the circuit is in resonance with the new signal.

As was previously stated, variation in value of a circuit may also be obtained by varying the inductance value of the coil. This may be done by a switch tap arrangement as in Fig. 3A, or by the variometer method in B. The switch-taps allow the use of more or less of the coil turns which, at its best is only a rough control. In the variometer arrangement, the total inductance value is governed by the coupling of the fields of the two parts of the coil. They are wound so that when at right angles to each other the fields oppose each other and the inductance value is low. When parallel,

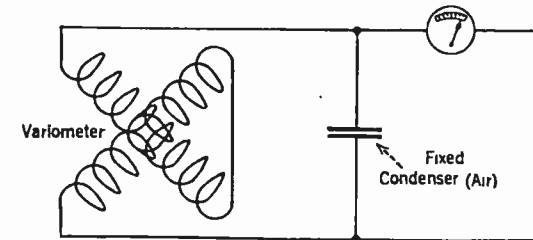
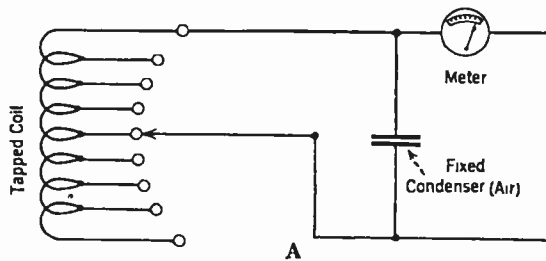

FIG. 3

the fields aid each other and the inductance value is high.

HOW TO OBTAIN BETTER REGENERATION

WHEN a receiver of the regenerative type goes into oscillation with a "plop" instead of gradually doing so, as the tickler coupling is increased, it is impossible to tune-in distant stations satisfactorily and steps should be taken to rectify this condition.

Often smoother oscillation can be obtained by decreasing the B battery voltage applied to the detector tube plate, but when this does not alter conditions, it is then necessary to employ other means for obtaining the desired results.

If the tickler coil produces regeneration, then by reducing the number of turns on this coil, one at a time, a point may be reached where, upon advancing the tickler, there is an even, smooth, production of oscillation.

POWELL CROSLLEY

JR.

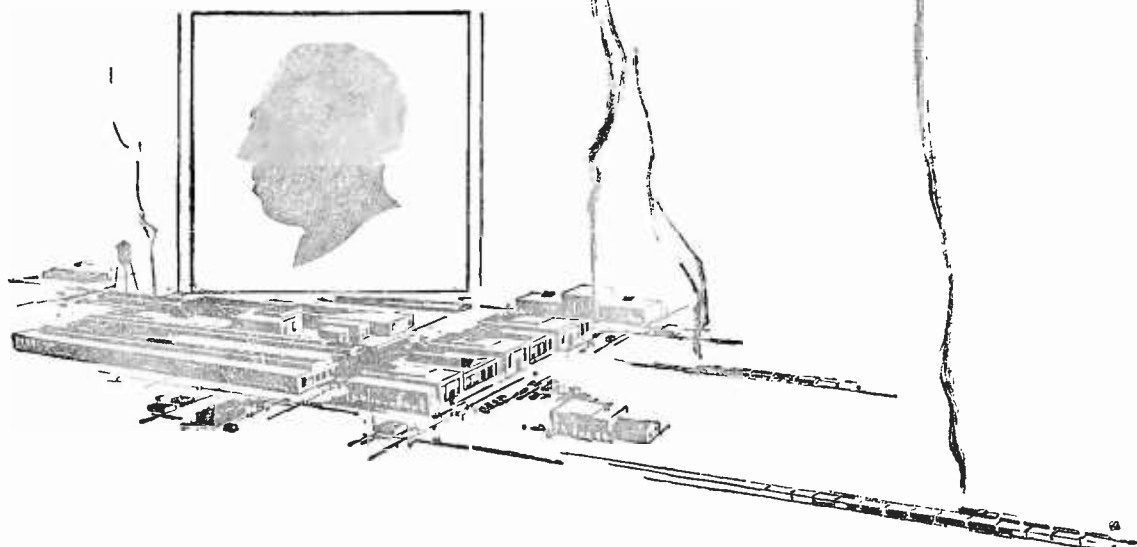

INDUSTRIALIST *Pioneer Radio Builder*

At a time when products of his manufacturing genius were already known to millions, Powell Crosley, Jr., boldly diverted his energies to the development of radio reception, then scarcely known beyond the laboratory walls.

Pioneering both in engineering trends and manufacturing practices, Mr. Crosley has been a vital factor in making radio and broadcasting as much a part of American life as motion pictures and the motor car.

There is scarcely a milestone in the development of popular radio on which his shadow has not been the first to fall. And his announcement of December 26th concerned a milestone that dwarfed all others in its importance—*four entirely new radio receiving sets:*

- The Crosley 4-29 (4-tube) . . . \$29.00
- The Crosley 5-38 (5-tube) . . . 38.00
- The Crosley R. F. L.-60 (5-tube) . . . 60.00
- The Crosley R. F. L.-75 (5-tube) . . . 75.00



These are now being demonstrated by Crosley dealers and will be completely described in a forth-coming issue.

★ Tested and approved by RADIO BROADCAST ★



135-C is furnished with leads and phone tips for plugging into Radiola Models 20, 25, 26 and 28 **\$10.00**

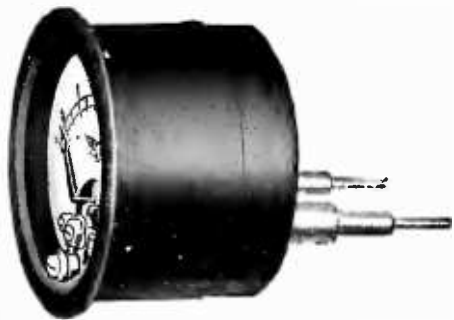

135-A has prods for plugging into Radiola Models 25 and 28 **\$7.50**



\$12.50

107 Junior Tube-Checker makes the testing of tubes in the home easy.

NEW

Write for copies of Circulars 735 and 739 describing these three new Jewell Radio Instruments for Set owners.

★ ORDER FROM DEALER

JEWELL ELECTRICAL INSTRUMENT CO.

1650 WALNUT ST. CHICAGO

26 years making Good Instruments

Variometers which are employed to produce regeneration, should be so placed that no permanent coupling effects between them and other coils used in the receiver are obtained.

Replacing the small by-pass condenser which shunts the primary of an audio frequency transformer, will often improve matters. A too high value of grid leak sometime causes this inefficient condition while even the grid condenser's value may be improved upon.

PROTECTING THE LOUD SPEAKER

WHEN a power amplifier is used in a receiver, it is well to consider just what is taking place in the loud speaker. Unless the action is visualized and understood, the user cannot hope to obtain maximum efficiency from his apparatus.

Most of the loud speakers on the market are merely elaborations of head phones, so constructed that a large diaphragm is actuated by the impulses surging through the magnet windings of the loud speaker reproducer unit. Also the majority employ a type of mechanism where the armature, pin, or diaphragm, is pulled toward the pole pieces of the magnet by the strong magnetic field set up by the permanent magnet.

Now, when signals are received and passed along through the vacuum tubes in the form of impulses, the diaphragm is alternately released and gripped as the impulses first neutralize then aid in the gripping of the diaphragm. While such a system is satisfactory, where normal B battery voltage is employed, it is not at all to be desired in cases where high B potential is applied to the plate of the last audio tube.

The reason here is that the heavy current coursing through the windings of the loud speaker tends to paralyze the diaphragm, thereby causing imperfect reproduction.

Now, if some arrangement could allow the diaphragm more freedom of action, then the objection to the use of high B battery potential would automatically become void.

Such a device is simple to construct and efficient in operation.

It consists of a large fixed condenser, of 1 mfd. capacity, and an iron-core coil with high impedance and low resistance. One having an inductance value of 350 henries is highly satisfactory.

The parts are connected in the circuit as shown

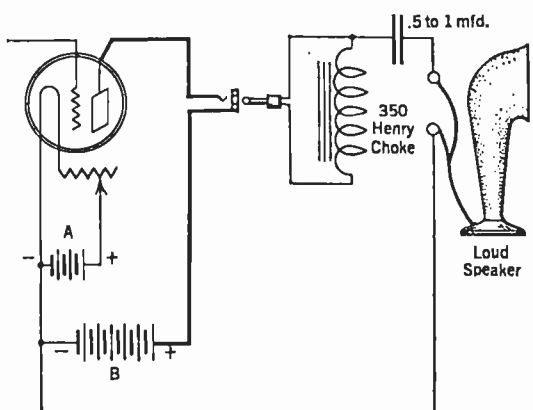

FIG. 4

in Fig. 4. Three wires, instead of the conventional two from the loud speaker, lead to the set. The lower side of the speaker connects to the minus side of the filament, while the impedance

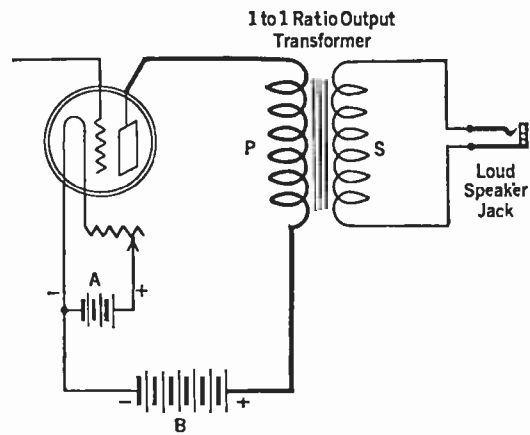

FIG. 5

coil connects one side to the plate of the last tube, the other side to the high voltage terminal of the B batteries. The upper side of the loud speaker connects to the large fixed condenser, the other side of which terminates at the plate lead of the impedance coil.

A glance at the circuit will show that now the heavy B battery potential is circuited through the choke coil instead of through the loud speaker windings. The variations in the electro-magnetic field set up in the choke coil, cause a charging of the large condenser which in turn produces an a.c. signal in the loud speaker.

Another type of unit which will do much the same thing is an output transformer. It will be recalled that such a transformer is employed in push-pull amplifiers, with the exception that the primary has a middle tap. Where the output transformer is used in a single stage power amplifier, the primary and secondary each have two terminals. The ratio of the windings is 1:1. A circuit diagram is shown in Fig. 5.

C BATTERIES IN THE DETECTOR CIRCUIT

LAТЕLY the C battery has come in for its bit of attention because of its use as a satisfactory substitute for the usual grid leak and condenser in obtaining rectification in a tube detector circuit.

The use of a C battery as a grid bias in amplifiers, has been an accepted practice for years, but little has been generally known about its function in a rectifying circuit.

The Model 1926 receiver, described by McMurdo Silver in the November, 1925, RADIO BROADCAST, employed this system of detection very successfully.

Those who have had the opportunity to compare this and the old grid leak and condenser system have, no doubt, noticed that while the former produces a healthier signal, the latter is more to be desired where sensitivity and selectivity are the prime considerations.

In this system the tube is acting as a distorting amplifier, and the C battery is the agent which produces the distortion because it shifts the



The Eveready Hour



LIKE the fabled ship in which Jason brought home the enchanted fleece of gold, the Eveready Hour brings a rich treasure of entertainment to charm the harbor-homes of its hearers.

Inaugurated two years ago, the Eveready Hour was an adventure in broadcasting—an hour of connected entertainment, uninterrupted by the frequent injection of the name of the broadcaster.

Many of these programs have become famous. Thousands of letters voice the appreciation of our audience and ask for repetition of favorites. We make no requests for these letters, but they mean much to our artists and to us, and are of great value in helping us in

our efforts to arrange programs of a distinctive nature and pleasing to the vast audience.

Radio has already become a highly specialized art worthy of the most scrupulous code of ethics, and the Eveready Hour represents a sincere effort to pioneer in providing the most acceptable form of radio entertainment.

Eveready programs cover a wide range of entertainment and human interest, transporting us to periods of wholesome simplicity; to barren islands where marooned sailors meet adventure, starvation and death; to battle-scarred France with singing doughboys; to emotional heights by telling with music the stories of the seasons; and to memories of yesteryear aroused by old ballad and musical comedy favorites.

Eveready Hour begins at 9 p. m. each Tuesday night, Eastern Standard Time.

Tuesday night means Eveready Hour —9 p.m., Eastern Standard Time, through the following stations—

- | | |
|------------------|--------------------|
| WEAF—New York | WSAI—Cincinnati |
| WJAR—Providence | WWJ—Detroit |
| WEEL—Boston | WOC—Davenport |
| WTAG—Worcester | WEAR—Cleveland |
| WFI—Philadelphia | WCCO { Minneapolis |
| WGR—Buffalo | WCCO { St. Paul |
| WCAE—Pittsburgh | WGN—Chicago |
| | KSD—St. Louis |

EVEREADY
Radio Batteries
—they last longer

NATIONAL CARBON CO., Inc.
 New York San Francisco

Canadian National Carbon Co., Limited
 Toronto, Ontario



He was amazed—
 he had been sure
 it was static—

MANY fans are blaming static for noises which are not static at all. They are noises which can be eliminated. For example, unless you keep your contacts between tube and sockets clean at all times, corrosion is going to cause disturbing noises which you may lay to static.

It is easy to keep these contacts clean with the Na-Ald No. 400 De Luxe Socket. Just a turn or two of the tube in the socket cuts away all corrosion from tube terminals and clears up the voice of your radio instantly. No need to take the tube out and sandpaper each terminal with this socket. When the tube is turned in the socket, the exclusive side-scraping duo-contacts scrape away all corrosion and the terminals come to rest on the scraped portions. The Na-Ald No. 400 De Luxe Socket is the only socket that eliminates noises due to corrosion. Meter tests have proved this action sure and positive.

And our No. 400-S socket (the regular No. 400 on spring mount) also eliminates microphonic noises due to vibrations.

Both the No. 400 and the 400-S sockets are made of Alden-processed Bakelite which conserves all the current energy. Laboratory tests proved Na-Ald Sockets most efficient in low loss and low capacity. Na-Ald Socket No. 400 was selected by ten famous radio engineers as best for the famous Hammarlund-Roberts set. It is part No. 6. List prices: No. 400 and No. 400-S, 75c.

The New socket that takes all the new tubes

THE new Na-Ald Socket No. 481-X takes all the new tubes without adapters. Sure, Positive Contact. Alden Processed Bakelite for lowest losses. List price, 481-X, 35c.

★ Write for full information on the complete line of Na-Ald Sockets, Dials and Adapters.

ALDEN MANUFACTURING COMPANY

Dept. B-15 Springfield, Mass.

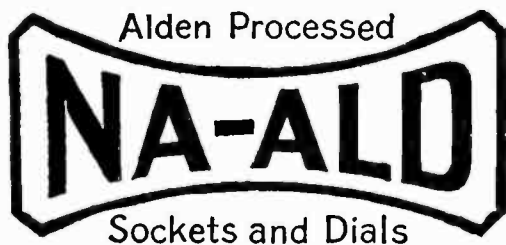

operating point on the characteristic curve of the tube to the curved portion. See Fig. 6. Here one half cycle of the incoming signal is reproduced, greater in proportion to its other half. This is because that section of the curve below

In A, practically the same circuit is shown as that in B, but the C battery is shunted with a potentiometer of 200 or 400 ohms. By means of this potentiometer, it is possible to apply a readily regulated C voltage ranging from

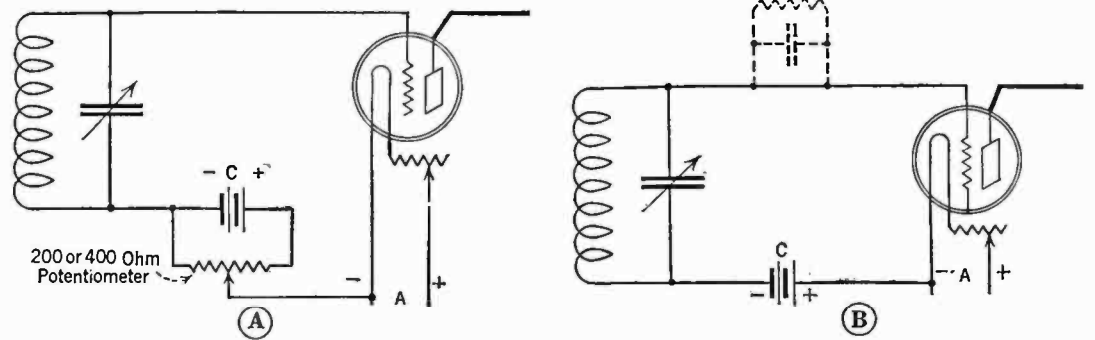

FIG. 7

Showing the position for a C battery in a detector tube circuit. In A, the grid battery is shunted with a potentiometer to control the voltage bias. A potentiometer is not essential, as B shows

the mid horizontal line of the distorted wave form, flattens out more than the part above it.

In Fig. 7B, the C battery is shown connected in a detector circuit, replacing the more standard grid leak and condenser. Note the polarity of the C and A battery leads.

0 to 4½ volts, or whatever the full value of the C battery may be. Such an arrangement aids in shifting the working point of the tube to that position where most satisfactory distortion-detection is to be obtained. With only the C battery, as in B, the variation is mainly in steps of 1½ volts.

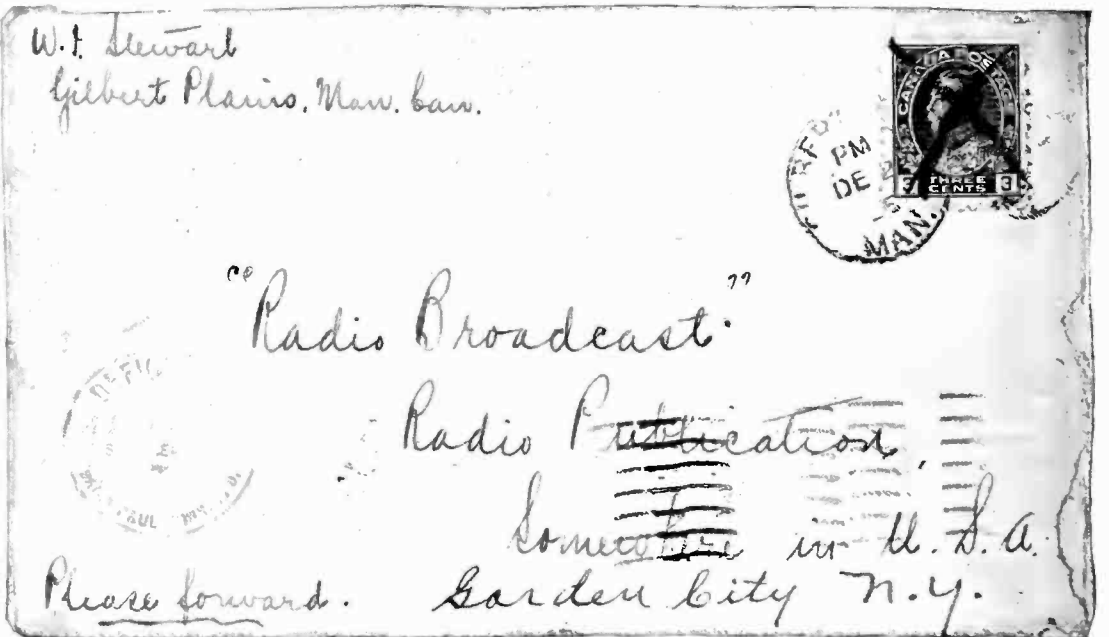

DON'T ADDRESS YOUR GRID DEPARTMENT LETTERS LIKE THIS
 Originating in Manitoba, Canada, this letter was forwarded by the postal authorities to St. Paul, Minnesota, and there was re-addressed to Garden City as shown

GRID INQUIRY BLANK

Editor, The Grid
 RADIO BROADCAST
 Garden City, New York

DEAR SIR:

I am a subscriber to RADIO BROADCAST and therefore will receive answers to my queries free of charge.

I am not a subscriber and enclose \$1 to cover cost of answers.

NAME

ADDRESS

G. F.

WHEN WRITING TO THE GRID—

A TYPEWRITTEN letter, written on one side of the paper only, is to be preferred, as it aids in the quick formation of a satisfactory reply.

Don't fail to send a stamped addressed envelope with your inquiry.

Don't send a second inquiry about the first.

Don't include questions on subscription orders or inquiries for other departments of Doubleday, Page & Company.

In asking questions give us all the information that will aid in advising you. If the question relates to apparatus described in RADIO BROADCAST, give the issue, page number, and figure number of the circuit diagram, etc.

Be explicit yet brief.

★ Tested and approved by RADIO BROADCAST ★

FANSTEEL
Balkite
Radio Power Units

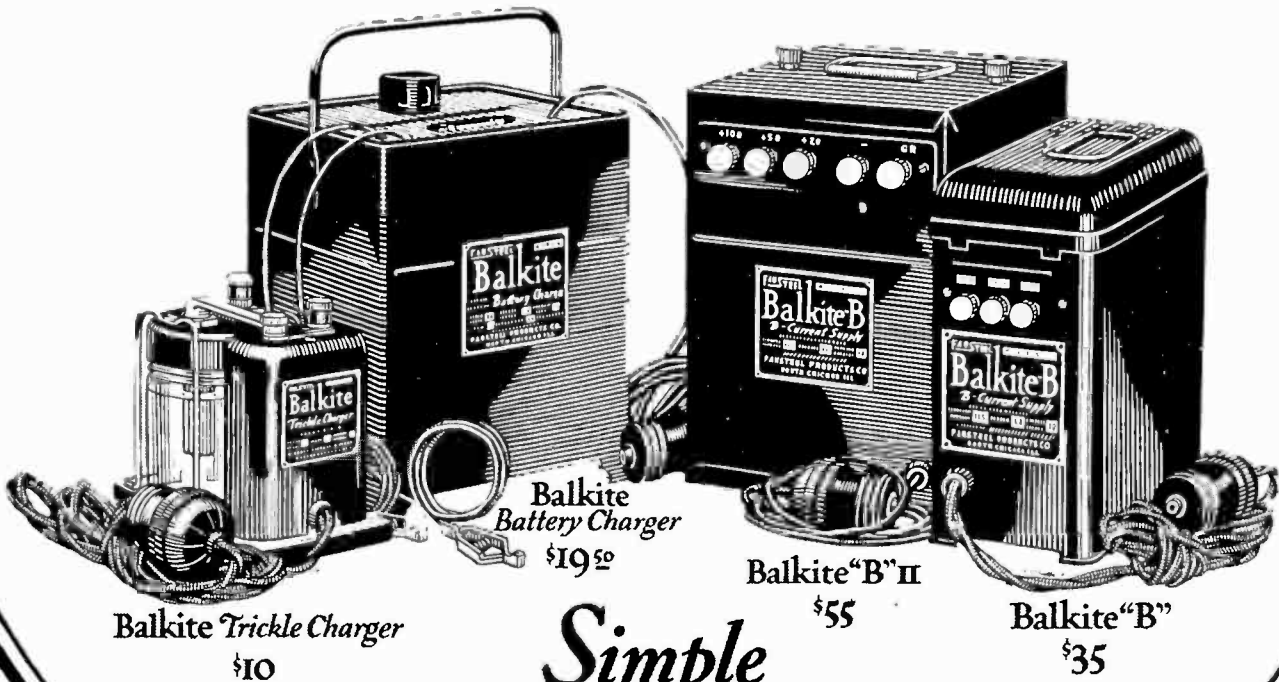

*Simple
 Entirely Noiseless
 Permanent*

Manufactured by FANSTEEL PRODUCTS COMPANY, Inc., North Chicago, Illinois

**Convert your present receiver into
 A LIGHT SOCKET SET
 with
 Balkite Radio Power Units**

Ask your Radio Dealer

Manufactured by FANSTEEL PRODUCTS COMPANY, Inc., North Chicago, Illinois
 Sole Licensees in the United Kingdom:
 Messrs Radio Accessories Ltd., 9-13 Hythe Rd., Wellesden, London, N.W. 10



★ Tested and approved by RADIO BROADCAST ★

TONE

Full, sweet, mellow and natural, without the slightest indication of distortion, is another achievement that is making the APEX SUPER FIVE the most popular of all receiving sets.

VOLUME

That supplies dance music or entertainment without any loss, is a feature for which the APEX SUPER FIVE is world famed.

DISTANCE

Lends added enjoyment to radio with an indescribable fascination of tuning-in far away stations, which is always possible with the APEX SUPER FIVE.

Ask your dealer for a demonstration. Your eyes and your ears will tell you that APEX stands at the high point of perfection in both performance and appearance. \$80 without accessories.



SUPER 5

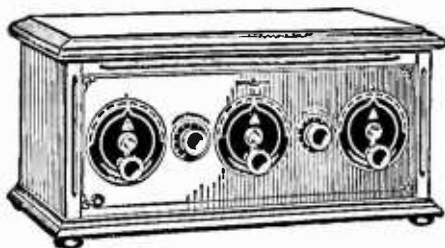

**APEX ELECTRIC
MFG. CO.**

1410 W. 59th Street
Dept. 204
CHICAGO

"NOW, I HAVE FOUND . . ."

A Department for the Exchange of Ideas and Suggestions of Value to the Radio Constructor and Operator

CONTRIBUTIONS to this department are welcome and those used will be paid for at the usual rates, that is, from two to ten dollars each. A prize of twenty-five dollars is given for the best idea used during each three-month period. The prizewinner for the last period is Mr. J. T. Garver, of Huntington, Tennessee, whose description of a home-made loud speaker appeared in the last (January) RADIO BROADCAST. Manuscripts should not exceed about three hundred words in length, and should be typewritten. Little consideration can be given to manuscripts not typewritten. Envelopes should be addressed to this department, RADIO BROADCAST, Garden City, New York.

USING A VOLTMETER AS A MILLIAMMETER

IN LOOKING for trouble in a receiving set, it is often convenient to connect a milliammeter in the negative B battery lead. Thus, as each tube is plugged in or turned on, the change in plate current, and thus the current drawn by this tube, may be readily observed. A tube that is worn out will draw very little plate current. If there is an open plate circuit (caused by a burned-out transformer, loud speaker or defective jack, etc.) it will be readily detected as there will be no increase in the milliammeter reading when the tube with the open plate circuit is turned-on.

If a milliammeter is not available for this use, a voltmeter may be employed as a substitute. The deflection of a good voltmeter is directly proportional to the current passing through it. The current required for full-scale deflection may generally be obtained from the manufacturer of the meter.

For example, a Weston 301 eight-volt meter has a full scale deflection of 16.12 milliamperes, and there are 40 divisions on the scale. As the reading is in proportion to current, the reading in scale divisions multiplied by 16.12 and the quotient divided by 40, gives exactly the current passing through the meter in milliamperes. For this particular meter it figures number of divisions times .4 approximately. Thus a reading of six scale divisions would indicate $6 \times .4$, or 2.4 milliamperes plate current.

CLAUDE SCHUDER,
Sumner, Illinois

COIL DESIGN DATA

IT HAS been generally acknowledged in radio circles that d.c.c. wire is very satisfactory for radio purposes, and most designers, accordingly, specify this type of wire in the construction of their coils.

The main reason for this preference seems to lie in the fact that the comparative thickness of double cotton insulation is instrumental in producing low distributed capacity, which is, as is well known, a very desirable quality.

The majority of the present day variable condensers with air dielectric, possess exceedingly high maximum to minimum capacity ratios, and naturally, very low minimum capacity values. Such condensers, coupled with really efficient radio coils of low distributed capacity, tend to extend the lower limit of our wavelength range, thus permitting us to tune-in more of the low power, high frequency, Class A, broadcasting stations.

Unfortunately, a coil made of double cotton covered wire is quite inefficient in moist weather because cotton is highly hygroscopic, which means that it will absorb moisture from the air. Not only is the efficiency of such a coil variable, but it is often variable to such an extent as to make long distance reception in moist weather practically impossible.

To eliminate the undesirable hygroscopic characteristic of d.c.c. coils, it has been suggested that such coils be painted with a light coat of thin shellac. True enough; such precautions protect the coil from moisture without adding greatly to its distributed capacity. However, even this increase in distributed capacity, when added to other losses inherent in construction of the coil, causes diminished efficiency and a shorter radius of reception.

It is for this reason the writer suggests that celluloid cement be substituted for shellac in coating d.c.c. coils. Celluloid cement will:—

1. Add less than shellac to the distributed capacity of the coil.
2. Decrease dielectric losses by making the coils self supporting, as the winding form may be removed when the cement dries.

Note: When such a coil is removed from

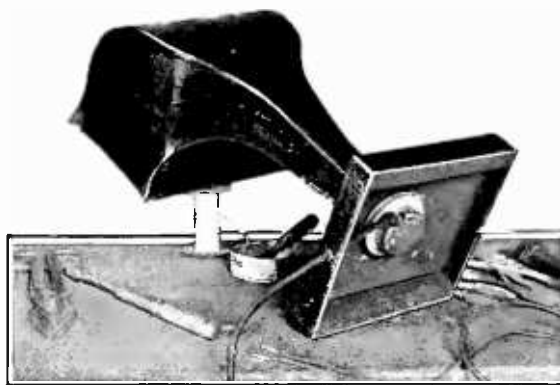

A PRIZE-WINNING IDEA

The home made loud speaker described by Mr. J. T. Garver in this department of the January RADIO BROADCAST, was awarded the quarterly \$25 prize offered by this magazine for the best contribution published in the "Now, I Have Found . . ." Section. Complete constructional data on the construction of the speaker appeared in the January number. The winner of the next prize, that offered for the February, March, and April period, will be announced in the May RADIO BROADCAST. All manuscripts for this department should be prepared and sent according to the conditions given at the top of this page. Special consideration is given to typewritten manuscript.

ATWATER KENT RADIO

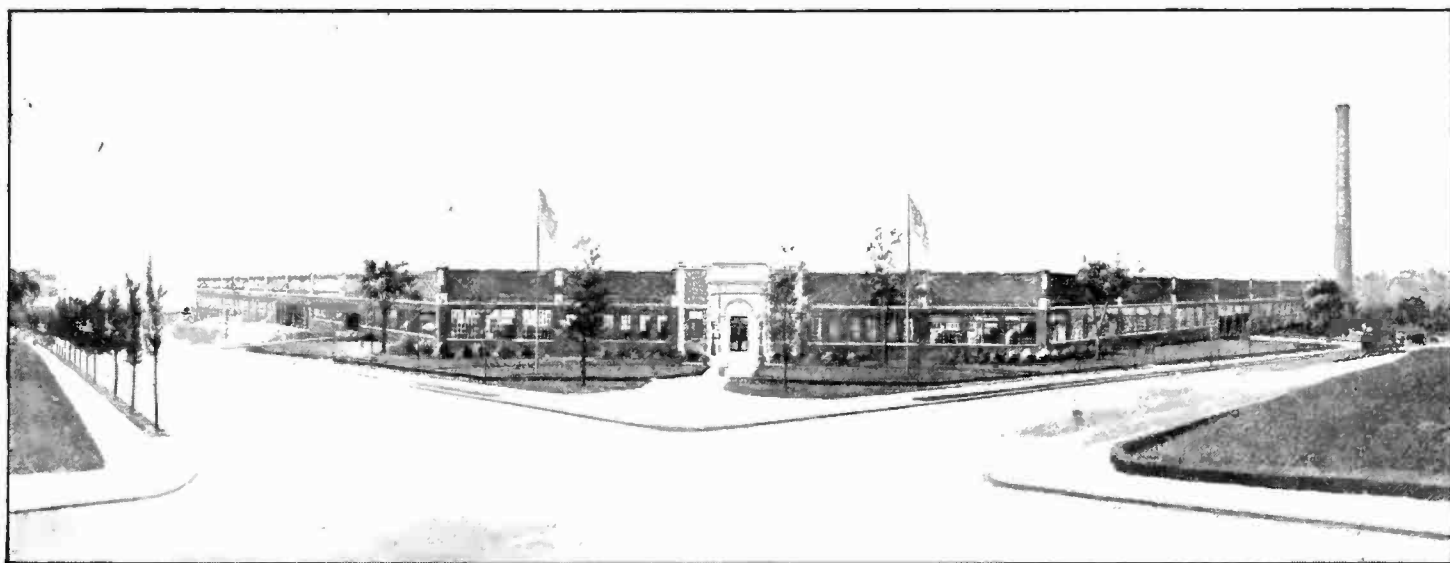

Fifteen acres of radio

What does it mean to you?



Radio Speaker
Model H, \$22

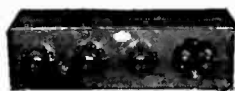

Model 20 Compact,
\$80

*Prices slightly higher
from the Rockies west,
and in Canada.*

Every Sunday Evening
The Atwater Kent Radio Hour brings you the stars of opera and concert in Radio's finest program. Hear it at 9:15 Eastern Time, 8:15 Central Time, through:

- WEAF New York
- WJAR Providence
- WEEI Boston
- WCAP Washington
- WSAI Cincinnati
- WCCO Minn.-St. Paul
- WFI } Philadelphia
- WOO } alternating
- WCAE Pittsburgh
- WGR Buffalo
- WOC Davenport
- WTAG Worcester
- KSD St. Louis
- WWJ Detroit
- WEAR Cleveland
- WLIB Chicago

LOOK at this building. It is the factory where Atwater Kent Receiving Sets and Radio Speakers are made.

To every dealer this picture tells a story of Stability.

Already the largest radio factory in the world, our plant is still growing. The demand for Atwater Kent Radio has proved that we didn't have room enough.

By May, a three-and-one-half acre addition will be completed. The main building will then cover nearly fifteen acres.

If this isn't enough, we shall go on building, for we have the ground.

Think of it! Fifteen acres of radio—and every part of every Receiving Set and Radio Speaker made from our own designs by our workers in our own way. And every set and speaker constructed with as much

care as if this were the smallest factory in the world and we had a reputation yet to win.

Thus we prove our confidence in Radio now and in Radio five, ten, twenty years from now—indefinitely.

Look at this picture again and let it remind you that

1. A sound product, rightly designed, carefully manufactured, and sold at a sensible price made possible by large production and modern methods, has become so popular that it takes a fifteen acre plant to meet today's demand.
2. The Atwater Kent Manufacturing Company has invested its money in this plant because it is in the radio business to stay.

Is not this something to think about?

Write for illustrated booklet telling the complete story of Atwater Kent Radio

ATWATER KENT MFG. CO.
A. Atwater Kent, President
4726 WISSAHICKON AVE. PHILADELPHIA

The Loud Speaker Sensation!



The KODEL MICROPHONE LOUD SPEAKER

You can't tell the KODEL MICROPHONE LOUD SPEAKER from the microphone the broadcasting stations use—they are exactly alike in size and appearance.

The efficient Kodol Sound Unit, with an ingenious new snail-shell horn, mounted inside the microphone case, produces a remarkably clear, full-toned volume. Non-vibrating tone chamber absolutely eliminates distortion.

\$15 model incorporates Kodol, Jr. unit equipped with large Kodol unit \$20

\$15.00

Radio dealers everywhere have them.



THE KODEL RADIO CORP.
505 E. Pearl St. Cincinnati, O.

RECEIVERS :: SPEAKERS
HOMCHARGERS

WKRC

Owners of Kodol Broadcasting Station WKRC. Send for program

Books by Telegraph

between

New York

Cleveland

Kansas City

Springfield

Toledo

St. Louis

Doubleday, Page Book Shop

the winding form, it is necessary to paint the inside of the coil in order to render it absolutely non-hygroscopic.

Now a few words about the preparation of the celluloid cement. Obtain a wide-mouthed bottle of acetone and small pieces of celluloid, the quantity to be determined by experiment. The latter does not have to be purchased, as old photographic films can be used after the emulsion has been removed in hot water.

Into the acetone throw a quantity of celluloid, taking care that the pieces are small. Leave the bottle overnight and in the morning it will be found that the celluloid has been dissolved. The consistency of the solution should be that of a thin syrup. By adding to the solution, either more acetone or celluloid, you will obtain the right consistency.

Apply the cement with a brush, and keep the bottle well stoppered at all times, as the acetone has a tendency to evaporate and leave the cement too thick.

BORIS S. NAIMARK,
New York City.

A SIMPLE LONG-WAVE RECEIVER

THE radio fan who has not built himself an ultra audion set to play with when his regular equipment fails to function, just doesn't know how much fun he is missing.

The expense of a set of this sort is quite modest and its performance is certainly wonderful. The transoceanic code stations come booming in on almost any frequency band from 300 down to 20 kilocycles (1000 to 15,000 meters)—and on even longer waves. The big fellows give excellent code practice for nearly all of them send very slowly, and repeat each word.

I wish I could radiate some of the pleasure and enthusiasm I get from the little

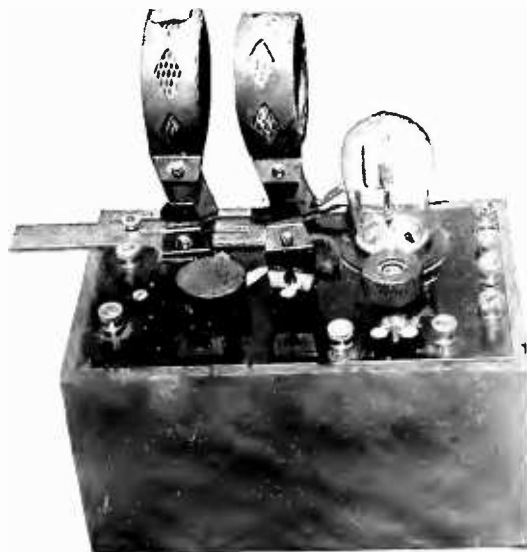

FIG. 1

The completed ultra audion receiver. Not the slotted strip of bakelite which permits variable coupling between the two coils

ultra audion set pictured above. There must be thousands of others, who, like myself, want to get a little vacation from the broadcasting territory on those occasions when the programs just don't seem to fit one's mood. There are all sorts of strange and mysterious territories to explore where whistling treasures may be picked up. The big European stations talk with the Americans, and Panama sends up tones from the tropics.

I have built a number of ultra audion circuits, and all functioned very nicely.

But there are drawbacks; the annoying instability of the circuit for example, and the squeals and howls from body capacity. Many times I have found it essential to sit perfectly still to hold a very distant station. Finally I made a discovery. By connecting the metal case of the head phones with the ground, the set immediately settles down to steady work. I have a six-foot piece of silk-covered tinsel cord with a test clip on each end. I clip one end to the headband adjustment and the other to the ground post. It is not well to twine the cord around the phone cord but permit it to hang loosely.

Strange as it may seem, another improvement that has been decidedly satisfactory is the addition of a tickler. The illustration, Fig. 1, shows how a coil mounting

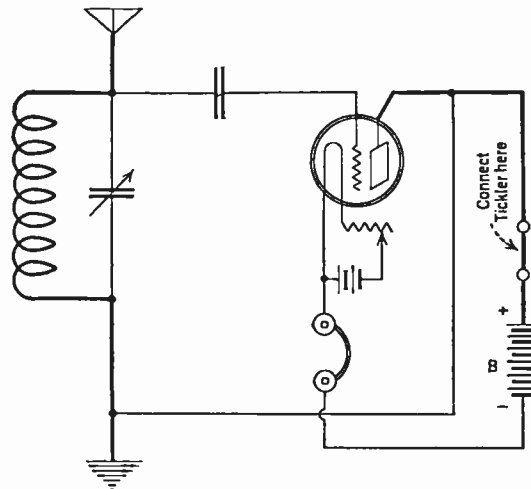

FIG. 2

The circuit diagram of the ultra audion. A tickler coil arrangement can be included as shown

is attached to a sliding strip of bakelite, and held in place with a thumb nut. This coil is inserted between the positive B binding post and the plate connection on the socket. The condenser has a capacity of .0005 mfd. Any tube may be used but I seem to get best results with a standard UV-200 or C-300 with about 22 volts on the plate. For an antenna for the transoceanic stations, with a coil of 1000 to 1500 turns, I have a stretch of about 125 feet of single copper wire, thirty feet high. The tickler for the very large coils should increase in size in proportion. For instance, with 1500 turns I seem to get best results with a 500-, or 750-turn tickler.

Other than adding the tickler and the grounding of the phone caps, the hookup is exactly the same as shown in the DeForest catalogues of seven or ten years ago. The circuit is shown in Fig. 2.

H. H. BUCKWALTER
Denver, Colorado.

A GOOD AUDIO AMPLIFIER

BEING convinced that the cone type of speaker does not do itself justice on the standard two-stage audio amplifier, I am giving the wiring diagram of an amplifier which in my opinion will really give the volume and true reproduction which we all strive for. See Fig. 3. Used with a three-circuit tuner and tube detector, it will furnish the most perfect quality I have yet heard.

The parts may be assembled to suit the fancy of the constructor, remembering only the standard precautions about short grid leads, transformers mounted at right angles and non-parallel leads. Although there are three stages of audio, the amplifier

Sixteen radio publications have saved you the work of trying out various B battery eliminators—



They have put their official okay on the

TIMMONS *B-Limiter*

We would like to tell you something about the tests to which these publications subject the B-Limiters. For this purpose we have prepared a folder which we will send. All of these tests were more severe than conditions the B-Limiter will ever meet on your set.

In this folder you will also find quoted in the exact words of publications just what the tests showed.

B-Limiters operate on 110 volts, 60 cycle alternating house current and completely eliminate all B batteries

The Timmons Laboratories, which produced the B-Limiter, have now developed the
Timmons Cone Talker

Price, \$25.00

14-inch Cone



There are years of experience in acoustics behind this new Timmons Cone Talker. However, as most of the adjectives have been exhausted in describing other loud speakers, we'll just ask you to hear the new Timmons Cone. If you wish, we'll first send you a folder telling you all about it. Your dealer handles both the Timmons B-Limiter and Timmons Cone Talker—or we'll tell you one who does.

MEMBER
RMA



Timmons Radio Products Corporation
Germantown, Philadelphia, Pa.

TIMMONS *Radio Products*

★ Tested and approved by RADIO BROADCAST ★

STUDY RADIO!

Radio, the field of unlimited opportunity, calls for more trained men.

Prepare yourself for a high salaried position by using your spare time to study radio at home.

Radio Institute of America, the world's oldest radio school, has graduated more than 7,000 students. The value of RIA training is universally recognized—and graduates readily secure positions.

This coupon will bring you a wealth of important and interesting information.

RADIO INSTITUTE OF AMERICA

Formerly Marconi Institute
Established in 1909

328 Broadway
New York City

TEAR OUT

Radio Institute of America
328 Broadway, New York City
Please send me full information about your Home Study Course of radio instruction.

- I am interested in the complete course, including code instruction, which qualifies for the U. S. Gov't Commercial or Amateur Radio License.
- I am interested in the technical course for radio dealers, jobbers and salesmen.

Name

Address

will not howl or distort, and there is no necessity for grounding the transformer frames.

If the amplifier is to be used in connection with a radio frequency set, it is advisable to use either two tubes in parallel in each half of the push pull, making four tubes in the last stage, or use two power tubes, as the volume to be handled will overload two of the 201-A type tubes.

A list of material is given below, and although it is not necessary to adhere strictly to the list of manufactured parts given, it is essential to use good transformers.

- 2 Amertran transformers, ratio 5:1.
- 1 set of Western Electric or Como push-pull transformers.
- 2 Bradleystats.
- 1 single-circuit jack.
- 4 General Radio sockets.
- 1 "Turn-It" grid leaks.
- 1 2-mfd. fixed condenser.
- 2 .002-mfd. fixed condensers.
- 2 .001-mfd. fixed condensers.

Only one jack is used, as I find that better tone quality is obtained by using all the tubes and controlling the volume by the

besides. How to eliminate them, and not reduce the volume to the two-tube level was at first a problem.

Connecting a resistance across the secondary of the additional transformer efficiently eliminated the squeals and the volume also. It was found that varying direct and reversed grid biases had much the same effect.

While disconnecting one of the various unsuccessful arrangements, the dulcet tones of a local station suddenly half deafened the operator! Upon said operator's springing back in surprise, the old familiar medley of horrible sounds came back in full force. In short, placing the hand of a human ground on the grid terminal of the second transformer accomplished what nothing else had done. The trail now being clearly blazed, a variable resistance of 25,000-100,000 ohms was connected between this point and the ground.

Using this arrangement, a signal which is audible on a cone speaker with two tubes, when the ear is placed very close to the instrument, is magnified sufficiently to fill comfortably quite a large sized room. Signals from WBZ at a distance of about one

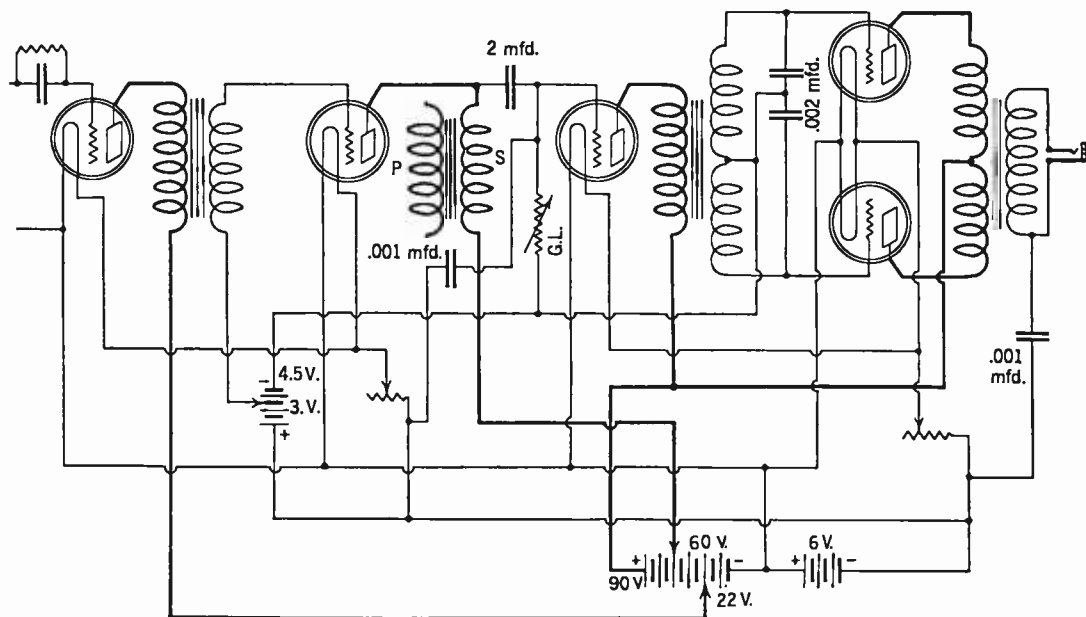

FIG. 3

The connections for the quality audio amplifier from the output of the detector tube are shown in this diagram. There are three stages of audio but four tubes are employed

regenerator, or if the set is non-regenerative, by the detector and first amplifier rheostat.

Due to the high amplification obtained, it will often be found that unless exceptional volume is desired, the tubes may be operated at four volts, thus lengthening their life and compensating for the additional tubes used. For those who do not use a voltmeter, I would suggest that the tubes be turned up to normal brilliancy while tuning-in, and then turned down as far as possible without destroying the tone quality.

EDWARD T. WERDEN
Mount Vernon, New York.

IMPROVING THE VOLUME OF THE TWO-TUBE ROBERTS CIRCUIT

DESIRING more volume than that obtained from the usual Knock-out two-tube set, and not wanting to change the whole arrangement of the apparatus, I added one step of orthodox transformer-coupled audio amplification. Using a G. R. Type 285 audio transformer gave enormous volume—and a thousand raucous squeals, noises, and howls

hundred miles are rather too loud for comfort in a large room.

As an important afterthought, I should like to emphasize the fact that the quality obtained—both transformers being of the type mentioned—is good enough to have caused surprised comment from a large number of people.

J. W. TEALE,
Boston, Massachusetts.

WINDING SPIDER WEB COILS

I HAVE found that two empty thread spools, together with a bolt of sufficient length, a nut, and washer, are of much help in quickly and accurately winding spider web coils.

The bolt is passed through one spool, then through the hole in the center of the coil form, and then through the other spool, after which the washer and nut are placed on the bolt and the nut tightened.

This gives a firm and convenient handle for holding the form during winding, greatly facilitating that process.

H. EDWARD KNIES,
White Haven, Pennsylvania.

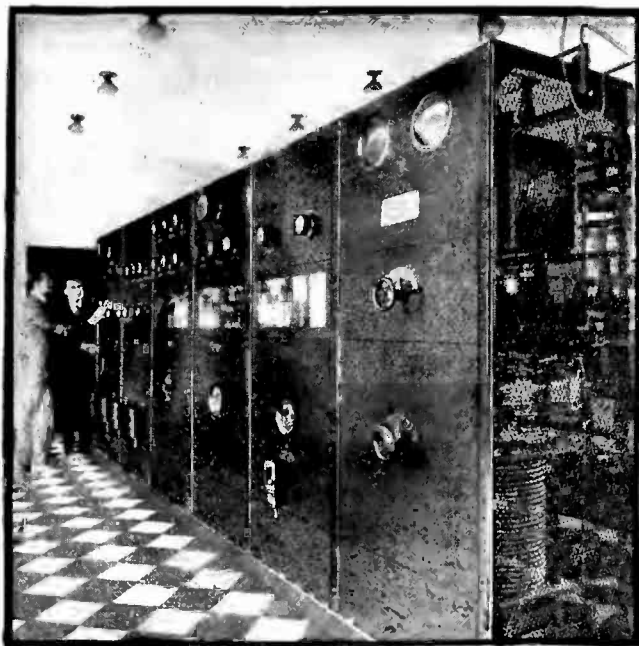

\$50. to \$250 a week IN WORK THAT IS ALMOST ROMANCE

Be a Radio Expert



Get into the great new Big-Pay Industry—Radio. If you're earning a penny less than \$50 a week, **clip coupon now.** Send for **AMAZING FREE BOOK.** Be a Radio Expert and draw down big money for the easiest and most fascinating work in the world. Positions everywhere. Thoroughly-trained men are in big demand. Need for Radio Experts in every community. Short hours. **BIG PAY.** Free book gives all the facts. Astonishing opportunities—thousands of them! Every day N. R. I. trained men are taking good places in the Radio field. Free book tells all about their success. Send for it now!

Learn Quickly and Easily AT HOME

Master Radio Engineers will show you how to qualify quickly and easily at home, for Radio's fine jobs. We **guarantee** to train you successfully. Lack of experience no drawback—common schooling all you need. Our tested, clear methods make it easy for you. Send coupon now for free proof.

Instruments Given with Course

All instruments shown here and many others given to students for practice work while learning. Receiving sets, from simplest kind to thousand mile receiver. An **UNEQUALLED OFFER.** Many other big features for limited time only.

Famous Training That "Pays for Itself"

Spare-time earnings are easy in Radio. Increase your income almost from the start through practical knowledge we give you. This is the famous **practical** training that **pays its own way.**

Get this Amazing Book

Most amazing book on Radio ever written—full, interesting facts about this great field and how we prepare you and help you start. You can do what others have done. **GET THIS BOOK.**

SEND COUPON

Send coupon to-day for special limited offer, including all instruments—you'll get full particulars by return mail.

National Radio Institute

Dept. BU5, Washington, D. C.

You get
all of
these

MAIL THIS NOW

NATIONAL RADIO INSTITUTE

Dept. BU5

Washington, D. C.

Without obligating me in any way, send me your free book, "Rich Rewards in Radio," and all information about your practical, home-study Radio course.

Name.....Age.....

Address.....

Town.....State.....



Operates WMAQ

"Accepted a position with Chicago Daily News—Station WMAQ. My income practically doubled thanks to your fine course."

KEITH KIMBALL, Chicago.



Gets Big Job

"Just been made Sales Manager of this Radio concern—a big raise in pay. Regret I did not take course sooner."

R. E. JONES, Bay City.



LARGEST RADIO SCHOOL IN THE WORLD

ORIGINATORS OF RADIO HOME-STUDY TRAINING

best for condensers —brass

As plates and columns BRASS has the right temper to preserve alignment with small clearances. BRASS is readily soldered in making proper electrical contact and its easy machining qualities give economy in production.



COPPER & BRASS
RESEARCH ASSOCIATION

25 Broadway, New York

22½ Volt
un-acid
everlasting
rechargeable
"B"

Storage Battery

\$2.95

includes
chemical



45 volts \$5.25, 90
volts \$10.00, 112½
volts \$12.50, 135
volts \$14.75, 157½
volts \$18.80.

Truly the biggest buy today—easily charged on any current including 32 volt systems. Any special detector plate voltage had. Tested and approved by leading authorities such as Popular Radio laboratories. Over 3 years sold on a non-refundable 30 day trial offer with complete refund if not thoroughly satisfied. Further guaranteed 2 years. Knock-down kits at greater savings. Complete "Hawley" "B" Battery Charger \$2.75. Sample cell 3c. Order direct—send no money—simply pay the expressman cost on delivery. Or write for my free literature, testimonials and guarantee. Same day shipments.

B. Hawley Smith, 312 Washington Ave., Danbury, Conn.

What Constitutes a Radio Patent?

By LEO T. PARKER

Patent Attorney

MANY radio experimenters overlook opportunities of obtaining the protection afforded by the patent laws, simply because they are unfamiliar with the rules by which to determine the kinds of radio inventions that present patentable possibilities. Others of these inventors and experimenters do not understand the essential requirements of an invention in order that a good patent may be obtained on it.

There are at least two very important things about which all experimenters should be familiar. One is what the word "invention" really means when it is construed in relation to radio circuits. The other is how the United States Courts have dealt with important radio patents in the past.

In the first place, the word "invention" really means any newly discovered thing or method which, when put to a practical test, will produce useful results. It makes no difference if the various parts or elements of which the invention consists are old and well known. The important requirement is that these old elements co-act to accomplish new and beneficial results. So, therefore, merely changing a wire in a radio circuit may effect an entirely new and patentable circuit, because the signals are received with improved tone quality, or the volume of the incoming signals is increased, or greater selectivity is effected, or any other of the many desirable results is attained.

Many individuals believe Marconi was the first person to discover wireless telegraphy. But he was not. Others had accomplished this result many years before him.

Going back to 1905, we find the first United States adjudicated radio patent was that of Marconi's reissue No. 11,913. The validity of this patent, after lengthy litigation, was upheld. His original patent was dated July 13, 1897, and related to apparatus used in transmitting electrical impulses and signals, particularly related to spark telegraphy. This original patent, however, did not protect the invention as he thought it should, so he cancelled it and had another patent issued in its stead.

During the legal controversy, various patents and experiments were brought to the attention of the court in an attempt to have Marconi's patent declared invalid, and considerable money was spent toward this end. Nevertheless, Marconi was declared to be the first inventor of wireless telegraphy.

One of the first methods to be utilized for the purpose of sending wireless messages was the Dolbear System. A conductive principle was employed on the banks of a body of water, and comprised primary and secondary circuits suitably positioned on the opposite banks, while wires were stretched along both banks and connected with the ground. By means of this improvised arrangement together with the assistance of batteries, galvanometers, and either telephone or telegraph instruments, the currents of electricity in the primary, generated by the batteries, were passed across the body of water to the terminal of the secondary circuit, thereby making and breaking the connections of the receiving apparatus, corresponding to the intermittent changes of the current set up in the primary circuit. However, the greatest distance covered by the Dolbear System was about two miles.

Another method of transmitting wireless messages had been used, consisting of the

principle of induction, and based upon the theory of an arrangement of primary and secondary circuits. A battery was connected with the primary which was positioned parallel with the secondary. By actual test it was found that a current made or broken in the primary circuit induces a transient current in the secondary circuit. This wireless system was successfully demonstrated prior to 1887, with the utilization of elevated conductors, vertical wires, and ground conductors, and messages were sent through the air for short distances. Also, in 1865, Professor Maxwell discovered that electricity, made manifest in the form of a spark, will spread out in waves or undulations similar to sound waves and he produced the effect by means of a special radiator.

However, the important difference between Marconi's invention and the prior ones was that Marconi realized his messages were sent through the ether by means of high frequency currents of electricity and, therefore, he was enabled to devise suitable instruments with which to increase the distances over which he could communicate, thus rendering the invention highly useful, and not a mere experiment.

In the patent specification Marconi referred to his invention as "Electrical signals, actions or manifestations, which are transmitted through air, earth, or water, by means of oscillations of high frequency."

Marconi, therefore, has been said to be the discoverer of the fact that high frequency currents are essential in the successful sending of wireless messages. He also invented instruments particularly adapted to send and receive this type of current. Although other persons before him had accomplished similar results through accident, they did not know why the phenomenon took place. In one sense of the word, all Marconi did was to adopt, improve, and elaborate upon existing theories, and put the various principles on a substantial working basis.

It should be remembered that, irrespective of how old or well known the elements of a new radio circuit or other invention may be, if by means of this new combination or arrangement the old elements are caused to co-act to perform new and different results, such an arrangement is a patentable invention. It does not matter how old or common the various parts or elements are, the important thing is whether, when acting together, they effect a new and unitary result or function.

THE HETERODYNE PATENT

ALMOST every inventor knows that a basic patent is construed broadly in favor of the patentee, but many persons do not know that an invention need not relate to an entirely new science to be basic. It may relate merely to a new application of a well known thing, as is verified by a very recent United States Court decision on the validity of the heterodyne patent, which was declared to also cover the super-heterodyne principle.

Two patents were obtained by Mr. Fessenden on his invention of the heterodyne; one for the method of accomplishing the results and the other for the apparatus itself. The numbers of these patents are, respectively, 1,050,441 and 1,050,728, and any person desiring to examine the patents may secure them (and any others for that matter) merely by addressing The Commissioner of Patents, Washington, District

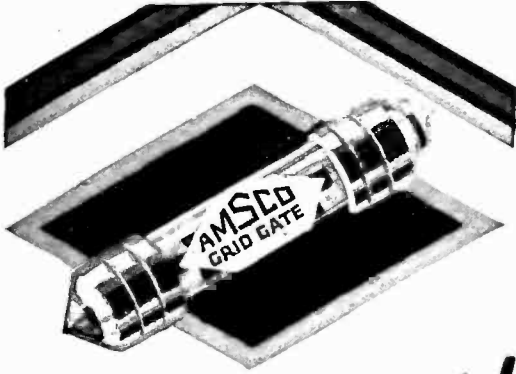

Amsco's Newest!

Grid Gates, Resistors and Resistance Couplers

Grid Gates are the Amsco improvement on "leaks." They provide measured and exact control of the current flow. Extra large for noiseless service. Fit all mountings. Insist upon Amsco Grid Gates, Amsco Resistors, Amsco Resistance Couplers. The latter are made with .006 condenser in genuine Bakelite base with mountings for two Resistors.

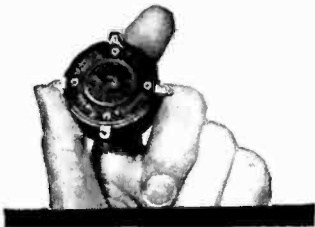

The New Amsco Universal Sockets

Especially designed to fit all the new types and sizes of U. X. and C. X. radio tubes. Clicks into contact—making positive wipe connection. Most compact and fool-proof socket made. One hole mounting. The Ultimate Socket—will be 1926 standard. Ask your Dealer.

AMSCO PRODUCTS, Inc.
Broome and Lafayette Sts., N.Y.C.

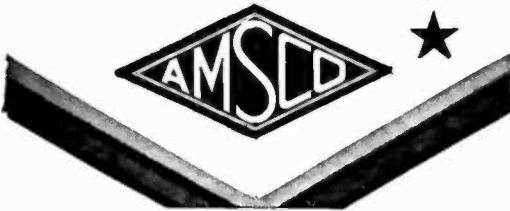

This is a good time to subscribe for
RADIO BROADCAST
Through your dealer or direct, by the year only \$4.00
DOUBLEDAY, PAGE & CO. GARDEN CITY, NEW YORK

**MORE PROFITS
for the PROFESSIONAL
SET BUILDER**

WE have an unusually interesting proposition to make to the man who is now building (or has the ability to build) radio receiving sets for resale.

This is a real opportunity. Write today for full information.

Gearhart-Schlueter Radio Corp.
716 Voorman Ave. Fresno, California

Speed RADIO TUBES



**SUPREME
IN
PERFORMANCE**

The one outstanding Tube in radio betterment.

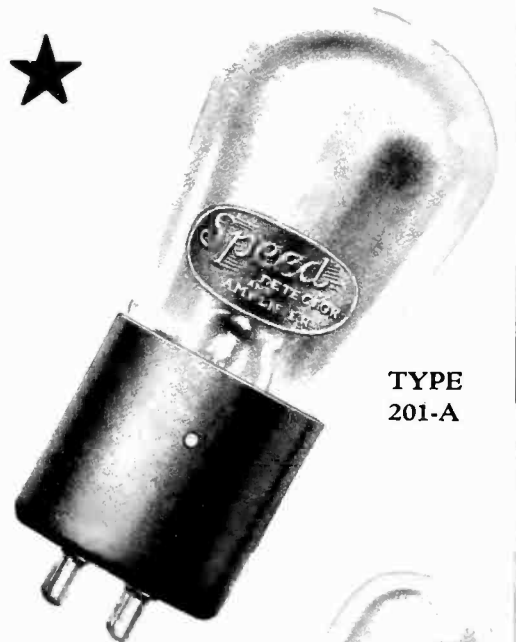

TYPE 201-A

No station too distant for "SPEED" Tubes. They bring in voice and music as broadcasted.

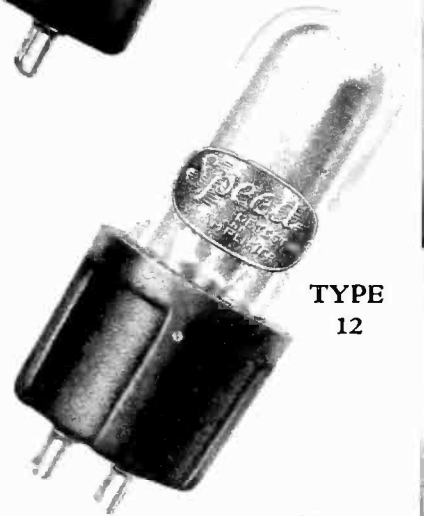

TYPE 12

The latest charted tests from Radio Broadcast Laboratories prove "SPEED" Tubes are superior in quality and performance. Send for a copy.



TYPE 199



CABLE SUPPLY CO.
INCORPORATED

Sales Offices

907 Broadway, New York City

★ Tested and approved by RADIO BROADCAST ★

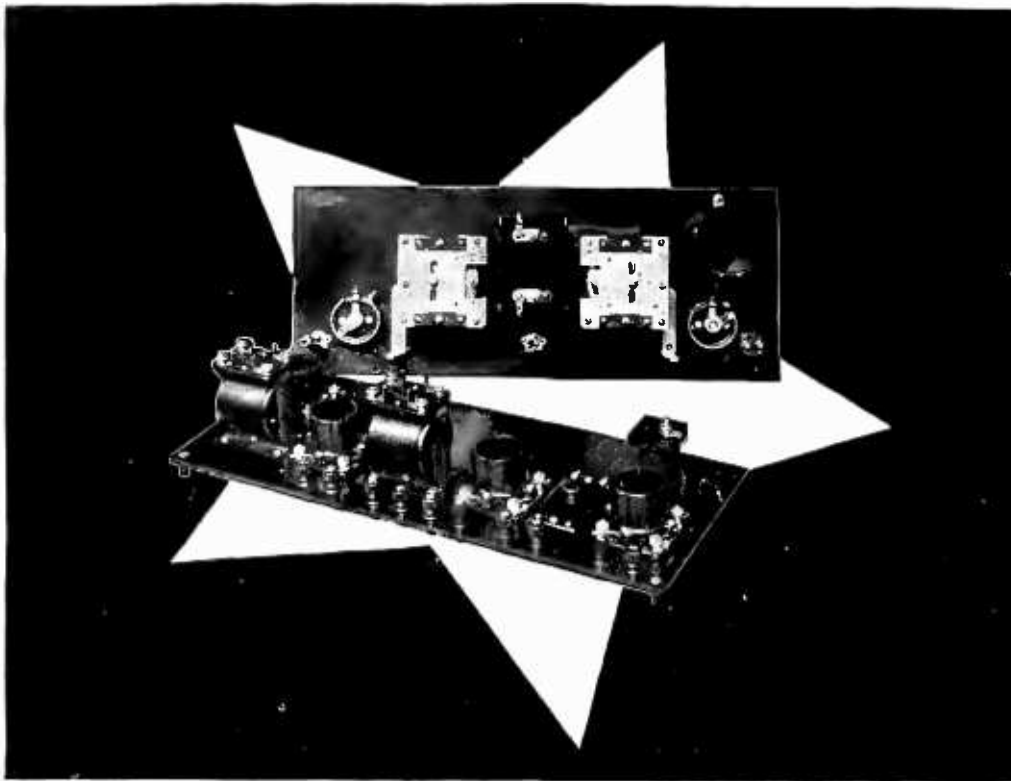

Hitch Your Radio Wagon to the Brightest Star of 1925-6

LAST year's most popular circuit has been greatly improved, and made the basis of the Samson TC Assembly—a four tube outfit that easily outperforms the average five tube set.

Almost overnight the Samson TC Assembly won the enthusiastic support of radio engineers and others who knew.

They saw it was made up exclusively of highest grade standard parts plus such refinements as a radio frequency choke, new type quick acting balancing condenser, new uniform frequency condensers of superlative efficiency, and Samson Audio Frequency Transformers with patented helical windings to assure practically uniform amplification over entire audible range.

When these experts tested out a set wired from the Samson TC Assembly they found supreme tone quality—selectivity adjustable to suit the owner—and sensitivity for transcontinental reception. There's no substitute for such quality.

When you have a few hours to spare wire up a set from a Samson TC Assembly which comes complete except for the wiring for only.....\$65.00

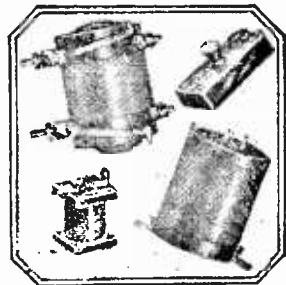

For Changing Over Your Present Set

Purchase the Samson Transcript Kit which contains all the special new parts needed—Antenna Coil, Double Rotor Coupler, Radio Frequency Choke and Neutralizing Condenser, all for.....\$14.75

SAMSON ELECTRIC COMPANY Canton, Mass.

Manufacturers Since 1882

Sales Offices in Thirty Leading American Cities



Are You a Radio Dealer?

WE want Radio Dealers to get in touch with us as we have an interesting proposition for them in connection with *Radio Broadcast* Magazine.

Radio Broadcast is read by a class of readers who have money to spend on radio. The majority of them are radio constructors, they are buying parts and building sets all the time. They are always experimenting because radio is their hobby. Write us for our Dealer's proposition and information on how *Radio Broadcast* will create sales for your store.

Radio Broadcast, Garden City, N. Y.



Burns SPEAKER with CONCERT UNIT

The Heart of the Speaker

Large size and scientific construction of the Concert Unit gives the remarkable tone values which combined with the special amplifying properties of the BURNS horn produce remarkable results.

Burns horn is of distinctive design with pyralin flare in several handsome finishes.

Manufacturers

American Electric Company

STATE AND 64TH STREETS
CHICAGO, U. S. A.



LATEST "COAST TO COAST" FULLY GUARANTEED

RADIO'S-10 DAYS FREE TRIAL SAVE 1/3 TO 1/2

Users everywhere report Miraco Radios get programs coast to coast on loud speaker; outperform sets three times as costly. Many hear foreign countries. Radio's most amazing values in unconditionally guaranteed, factory-built long distance sets—let testimony of users convince you.

MIRACO RADIO GETS 'EM COAST TO COAST Powerful New Multi-tube Miraco gets long distance on loud speaker. Set, ONLY \$27.35 retail. FREE! Literature on latest improved 1 to 5 tube models, new low prices, testimony of users and SPECIAL OFFER. Write: **MIDWEST RADIO CORP'N** Pioneer Builders of Sets 406-W.E. 8th St. Cincinnati, O. AGENT USERS WANTED Write for discounts.

To Roberts Knockout Fans

Do you know that we have published two books on the Roberts Knockout Receivers? One is a treatise containing all the articles printed, and the other is just one article with complete blue prints on how to build this wonderful receiver. Price one dollar each. Write to Booklet Dept., Radio Broadcast, Garden City, N. Y.

Steinite

Interference Eliminator



LOW LOSS
\$1 Postpaid
Amazing Results, Better Reception
Guaranteed or We Refund Your Dollar

ORDER TODAY
Dollar Bill Will Do
TWO BIG BANKS Testify To Our Reliability.

No Radio Complete Without It!

NOW you can select stations at will, cut out interference and undesired stations—tune in loud and clear. Wonderful results with any tube or crystal set. Over 150,000 sold. Partially absorbs static.

Select Stations At Will

Try this Radio Wonder at our risk. Nothing to add—attach in 2 minutes to aerial. No tools—no extra tube or battery—Doesn't disturb present log. Order today—money back if you say so.

FREE Complete Steinite Literature.
Steinite Famous 1500 Mi. One-Tube Set \$6; Crystal Set \$6; Crystal 500-3 for \$1; 5-Tube Set—\$29.75.
STEINITE LABORATORIES
305 Radio Building
Atchison, Kans.

SM

SILVER

SIX

SM COILS

The SM Interchangeable Coils used in Radio Broadcast's new receiver make it truly universal in wave length range.

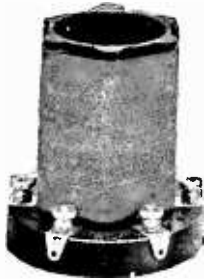

SM Low Loss Inductances

All-bakelite Low Loss Interchangeable Coils for 50-550 meters. These new coils may be used as oscillators, antenna adapters and R F transformers in standard circuits. Price of all types, Each.....\$2.50 Sockets for any size Coils. Each..... 1.00



SLF CONDENSERS

SM Condensers are particularly adapted for short wave reception because of their extremely low dielectric and eddy-current losses. They are the smallest SLF Condensers made. Supplied with special attachment for single control.

Price No. 310 .0005..... \$6.00
No. 311 .00035..... 5.75



SM 210 and 211 Transformers

Designed so that maximum amplification will be obtained at 60 Kilocycles. Both types in bakelite housings, hermetically sealed. No. 210 is iron-core type while No. 211 is of the air-core type supplied with measured tuning condenser. Each transformer is furnished with individual laboratory curve chart. Price: Both Types..... \$8.00 each

SM VERNIER DIALS

The SM Type 801 Vernier Dials are of all bakelite construction. Zero to 100—clockwise—counter-clockwise or 360 degrees (for Remler Condensers) in a single type. In appearance and operation the SM is the finest vernier dial on the market. Price each..... \$ 2.50

McMURDO SILVER'S NEWEST RECEIVER

This amazing receiver has everything that makes for perfect reception. Thousands of builders report its startling performance—enthusiasm over its marvelous selectivity and sensitivity—marvel at its extraordinary volume. You will find Mr. Silver's description of the "Six" very interesting. Send for it today.

ANYONE CAN BUILD THE "SIX" AND OBTAIN MARVELOUS RESULTS

Type 600 KIT includes all parts necessary to built the "Six"..... \$53.00
Type 610 KIT essentials only, including 3 condensers, 3 inductances and 3 inductance sockets \$27.75

THE IMPROVED RAYTHEON-THORDARSON B-ELIMINATOR

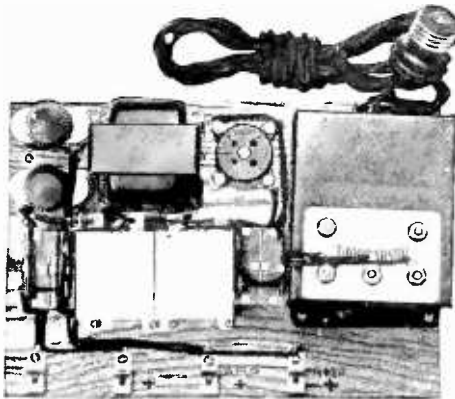

The SM Type 650 Kit includes Thordarson transformer, choke, Tube condensers, genuine Raytheon tube, Bradleyohms and all necessary parts. Price \$34.00.

This eliminator will deliver from 20 to 200 volts at three different, adjustable voltages with maximum current of 50 milliamperes—more than enough for the largest receiver. Send for Assembly Instruction by McMurdo Silver..... 10c

THORDARSON POWER TRANSFORMER

This new audio power transformer has been endorsed by McMurdo Silver, who says it is the very finest obtainable. Its curve is a straight line—its quality cannot be improved on. Price each..... \$8.00

SEND FOR CIRCULARS ON SM PRODUCTS



SEE THEM AT YOUR DEALERS

SILVER-MARSHALL, Inc.

103 S. WABASH AVE., CHICAGO

THE BIG LITTLE THINGS OF RADIO



The DAVEN LEAK-ANDENSER—the new combination grid leak and grid condenser all in one! For any detector tube circuit.

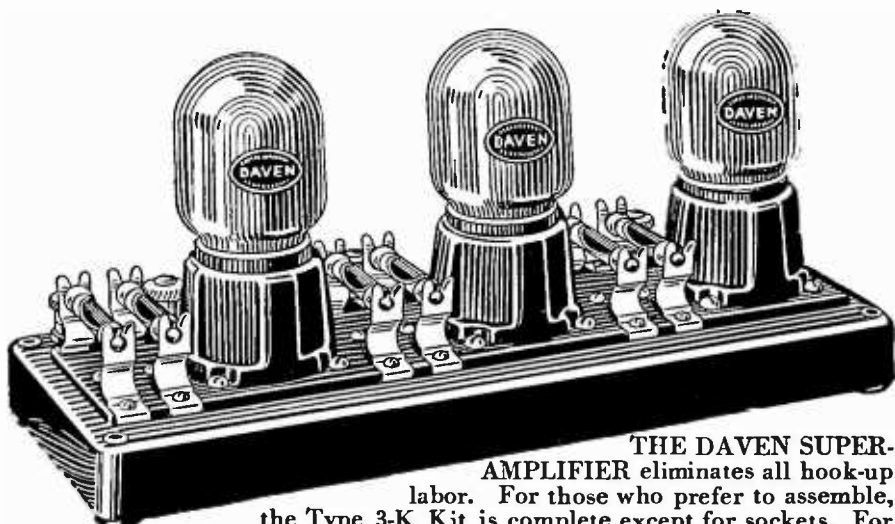

THE DAVEN SUPER-AMPLIFIER eliminates all hook-up labor. For those who prefer to assemble, the Type 3-K Kit is complete except for sockets. For 50% more volume use the new Daven Tubes Type MU-20 with the Daven Super-Amplifiers. Daven Power Tube Type MU-6—for the last stage of any set.



The biggest of all the little things—THE DAVEN GRID LEAK. Made in 29 standard values from 2500 ohms to 10,000,000 ohms.

Volume and Quality

As an owner of a radio set you should demand two things: (1) Volume on the weakest signal, (2) Tone quality that makes criticism impossible and excuses or qualifications unnecessary. Why sacrifice one for the other? Demand both. Today it is a simple matter to have both.

It is easy to get volume but there is only one way to get both quality and volume. Use Resistance Coupled Amplification in the audio end of your set. We have made this very simple by developing the Daven Super-Amplifier. Or, if you prefer self-assembly, couple up Daven precision-built resistances and mountings as contained in the 3-K Kit. Then you will hear radio at its best.

Three new Daven Products were announced this Fall. The Daven Leakandenser is a Daven grid leak of permanent and constant value, combined with a grid condenser of fixed capacity, correct for all makes of detector tubes. Precision-built, simple, effective, uniform and very handsome. A pair of mounting clips included.

The new Daven High MU Tube Type MU-20, used with the Daven Super-Amplifier, is designed to give 50% more volume—6 volt, 1/4 ampere. The Daven Power Tube Type MU-6 is for use in the last or output stage of any set regardless of the method of amplification used—6 volt, 1/2 ampere.

The new Daven Special Type "A" Condensers are the latest development of Daven Engineers. Their use in Resistance Coupled Amplifiers gives you more volume than ordinary condensers.

The Resistor Manual is the "A.B.C." of Resistance Coupled Amplification—a complete handbook for designers and builders. Send for it.



Clip Mounting No. 50—suitable for single Resistor or Grid Leak.

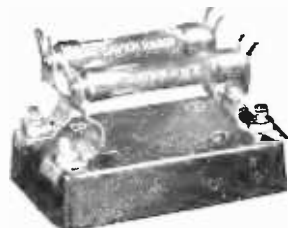

Resisto-Coupler No. 42, with special Daven Type "A" Coupling Condenser hidden in the base—the original and most popular resistance coupling unit.



Daven Ballast Resistors—for use with amplifying tubes in place of rheostats. There are five sizes, for one to five tubes. Soldered with mounting only.



New Daven Special Type "A" Coupling Condenser increases volume with Resistance Coupled Amplification. Sold separate, and also included in all Resisto-Couplers, Super-Amplifiers and Kits.



A practical handbook on Resistance Coupled Amplification. At your dealer's 25c. By mail postpaid 30c. Dealers send for free sample.

DAVEN PRODUCTS ARE SOLD ONLY BY GOOD DEALERS

"The Sine of Merit"

DAVEN RADIO CORPORATION

Resistor Specialists

Newark

Reg. U.S. Pat. Off.

New Jersey

CLIP THIS COUPON

The Resistor Manual

DAVEN RADIO CORPORATION, 154 Summit Street, Newark, New Jersey. Please send me the following on Resistance Coupled Amplification:—

Check One
 Resistor Manual. 30c is enclosed. Complete Catalog (free)

Name Address

To Dealers: May we have our nearest distributor communicate with you?

MAIL ORDER HEADQUARTERS

READY TO SHIP

The Silver-Marshall "Six"

All parts as recommended by McMurdo Silver in Radio Broadcast with the addition of the Daven 3-S Super-Amplifier.

Type 600—Special \$61.00
Type 600—Regular \$53.00

Silver 610 essential kit . . . \$27.75
Silver 210-211 transformers . . . 24.00
Silver plug in coils 2.50

The Silver-Marshall Raytheon B-Eliminator Kit

Includes Thordarson Transformers and Chokes, bypass Condensers, genuine Raytheon Tube, variable resistances and all necessary parts. This eliminator will deliver from 20 to 200 volts with maximum current of 50 milliamperes.

\$34.00

Silver "Super" Kit \$82.00
Silver S L F .00035 MFD 5.75
Silver Coil Sockets 1.00

The "See Ess" Coil Winder with Counter \$13.00

Dealers write for Complete Catalogue

MAIL ORDER HEADQUARTERS

Hammarlund Roberts

For the Trans-Atlantic Tests

Build it and then try to beat it!

Guaranteed by Ten Manufacturers and Ourselves

WIRELESS ELECTRIC

206 Stanwix Street

Pittsburgh, Pa.

DISTRIBUTORS

SERVICE

ENGINEERS

Tear off coupon and send with remittance

WIRELESS ELECTRIC COMPANY

206 Stanwix Street, Pittsburgh, Pa.

Gentlemen: I enclose for which please send me the following parts for the HAMMARLUND-ROBERTS Receiver.

2 Rauland Lyric Transformers \$ 1.80	5 prs. Union Phone Tip Jacks 1.25
1 Hammarlund "Midget" Condenser 18.00	1 Carter 25 ohm "Imp" Rheostat 1.00
2 Hammarlund .0005 mfd. Model C or S. L. F. Condensers 10.00	1 Carter Single Circuit No. 101 Jack70
1 Set of Hammarlund-Roberts Coils 6.00	1 Carter "Imp" Battery Switch 1.65
2 Na-ald Super de Luxe 4" Dials 1.50	1 Dubilier Type 640-G .00025 mfd. Grid Condenser50
5 Na-ald de Luxe Sockets 3.75	1 Dubilier Type 640 .002 mfd. Fixed Condenser45
1 Na-ald K-3843 1 3/4" Dial25	1 Dubilier Type 640 .006 mfd. Fixed Condenser65
4 Amperites No. 1-A 4.40	1 Durham Resistor40

ONLY PARTS SPECIFIED by Hammarlund-Roberts are furnished. We do not substitute.

Name Address



The Most Complete Radio Value Book Published!

From cover to cover, every one of the 96 pages is crammed full of exceptional radio values made possible by our tremendous buying power. It has been compiled by experts, containing all the newest and finest in radio parts, apparatus, and equipment. Efficient little, compact 1-tube sets to the finest multi-tube outfits, and SPECIFIED PARTS for EVERY popular circuit—complete kits or ready built sets.

24 HOUR SERVICE

SATISFACTION GUARANTEED

Your order is packed, checked and on its way to you within 24 hours after we receive. We carry the most complete stock, we guarantee this prompt service.

Your money is still your money until you are thoroughly satisfied in every way. All merchandise set in stoutly constructed containers to insure perfect delivery.

WE ARE NATIONAL HEADQUARTERS FOR

**Hammarlund
Roberts
RECEIVER**



- Parts Used By H-R Engineers**
- 2 Rauland Lyric Transformers
 - 1 Hammarlund Midget Condenser
 - 2 Hammarlund .0005 mfd. Straight Line frequency Condensers
 - 1 Set Hammarlund Roberts Coil
 - 2 Alden "Super DeLuxe" Sockets
 - 5 Alden DeLuxe Sockets
 - 1 Alden K-3843 1 1/2-inch Dial
 - 4 Amperites No. 1-A
 - 5 Prs. Union Phone tip jacks
 - 1 Carter 25 ohm "Imp" Rheostat
 - 1 Carter Single circuit No. 101 "Hold-tite" Jack
 - 1 Carter "Imp" Battery Switch
 - 1 Dubilier Type 640-G .00025 mfd. Grid Condenser
 - 1 Dubilier Type 640 .002 mfd. Fixed Condenser
 - 1 Dubilier Type 640 .006 mfd. Condenser
 - 1 Durham Resistor
 - 1 Hammarlund-Roberts Foundation Unit

The newest circuit to flash across the radio horizon. Winning thousands of new friends and adherents daily because of its unequalled results. Our new catalog contains a page devoted exclusively to this new set—lists complete information about the authorized parts, diagram of hook-up and other essential data.

A Postal Brings You Our Catalog

If you are planning to build any of these circuits, be sure to get our radio guide before you buy elsewhere. In this book you will get full information as well as interesting prices! FREE.

**GET OUR CATALOG
For Parts and Information**

**New SILVER
MARSHALL**

WRS is earliest with the latest. We carry in stock—FOR IMMEDIATE DELIVERY—EVERY specified part used by the engineers who perfected this standard circuit. The catalog contains authorized data about the circuit with illustrations and other important information.

Write For Your Copy NOW

Parts For All Circuits

IN STOCK	McLAUGHLIN'S SINGLE-CONTROL SUPERHETERODYNE
24 HOUR DELIVERY	COCKADAY'S LC-26 RECEIVER
	<i>Browning-Drake</i>

DEALERS Write for details of our interesting proposition. Complete information, price lists and discounts furnished upon request.

WHOLESALE RADIO SERVICE Co.

Manufacturers and Distributors of Radio Parts and Apparatus

6 Church St.

Dept. 2602

New York City

**Complete list of
GUARANTEED PARTS FOR
Silver - Marshall
Model 1926
"MODERN BROADCAST
6-TUBE RECEIVER"**

When building this receiver be sure you use only the parts specified and you will have the satisfaction of possessing the finest receiver yet developed.

- 3—S-M 311 .00035 S. L. F. Condensers
- 3—4 in. Kurz Kasch Moulded Dials
- 3—S-M 515 Coil Sockets
- 2—S-M 112A Inductances
- 1—S-M 110A Inductances
- 6—S-M 510 Sockets
- 1—Carter 6-ohm imp. Rheostat
- 1—Central Laboratory 500,000 ohm Modulator
- 3—Daven Resistance couplers complete
- 1—Carter 101 Jack
- 1—Carter 102A Jack
- 1—Carter On-off Switch
- 1—002 M. F. Condenser
- 2—Dubilier .5 M. F. By-pass Condensers
- 1—7 x 24 Drilled, Sanded and Engraved Bakelite Panel
- 1—7 x 23 Oak Base Board, Bus-bar, Screws, Lugs, etc.
- 1—Belden 5-lead color cable

**Complete Parts \$49.50
as Specified, Only . .**

Wired and Ready to Use \$8. Extra

EXTRAS

Daven MU-20 Tubes	\$ 4.00
Daven MU-6 Power Tube	5.00
Western Electric 540-A.W. Cone Speaker	24.50

WE ALSO CARRY ALL THE PARTS FOR THE

**Radio Broadcast
UNIVERSAL RECEIVER**

This is the simplified 6 tube circuit described in detail in the January issue of this magazine by Mr. Arthur H. Lynch. Diagrams and complete instructions can be found in January issue—it's easy to build and easy to operate.

**COMPLETE OR SEPARATE PARTS CAN BE ORDERED
AS DESIRED**

1 Bakelite Panel, drilled and engraved	\$ 6.00
1 Wood sub base	1.00
2 Sub base mounting brackets, per pair	1.00
2 Detector coil supports, per pair20
1 Antenna coil support05
1 Neutralizing condenser support25
1 Drilled binding post strip25
2 Binding post support brackets per pair20
1 Royalty 500 to 500,000 var. resistor	1.50
1 Each of .00025, .002, .0005 Sangamo condensers	1.30
2 General Radio Type 277 D. coils	3.00
2 General Radio Type 247 P Ver. Condensers	9.50
2 General Radio Type 310 Dials	1.20
1 General Radio Type 368 Neut. Condenser	1.25
2 General Radio Type 285 L Audio Transformers	12.00
4 General Radio Type 349 sockets	2.00
8 General Radio Type 138 Z binding posts80
2 General Radio Type 301 10 ohm Rheostats	2.50
1 General Radio Type .5 condenser90
1 Carter Filament Switch65
1 Carter 101 Jack70
1 Daven 2 meg. leak resistor50
1 Daven No. 50 mounting35
1 Each Amperite 3/4 and 1/2 ampere	2.20
		\$49.30

EXTRAS

1 Jewett Parkay Cabinet for above set	\$ 7.95
1 UX112 Power Tube	5.95
1 Belden Battery Cable lead75

**We Also Have Specified Parts For The New
Lawrence Cockaday 1926 MODEL RECEIVER**

HEINS & BOLET, 46 Park Place, New York



ARBORPHONE

What You Expect of Your Set

THERE are several thousand men and women, owners of Arborphone Receivers, who will tell you—

“You cannot equal my Arborphone—It’s all you could ask of a radio.”

Anyone can tune in enough stations to satisfy the most ambitious air-adventurer. From stations near or far there is a delightful ease of tuning and purity of tone quality unsurpassed in radio.

Arborphone gives you permanent radio. Like any good musical instrument your pleasure in Arborphone will be measured in years.

Housed in a really beautiful cabinet Arborphone lends a new charm to your prettiest room.

You cannot buy better radio—at any price. Ask any Arborphone owner or dealer.

Most interesting radio facts—written for everyone to understand—are described and illustrated in Arborphone Catalog. A copy sent free at your request.

\$55⁰⁰

\$60.00 in Rocky Mt. and Pacific Coast States.

MACHINE SPECIALTY COMPANY
ANN ARBOR, MICHIGAN

This is a good time to subscribe for
RADIO BROADCAST
Through your dealer or direct, by the year only \$4.00
DOUBLEDAY, PAGE & CO. GARDEN CITY, NEW YORK

Radio Dealers WANTED!

If you are the type of dealer who hustles after business, who isn't content to wait for trade to come in but who takes sets out to demonstrate, can talk and sell quality merchandise, and knows Radio values, we have a big proposition for you. Are you that dealer?

50% Discount to Dealers

We manufacture a complete line of high grade receivers and sell to dealers at 50% discount. We are distributors for more than 225 Nationally advertised lines.

FREE Write today for amazing offers, new 112-page catalog and regular monthly catalogs quoting below-the-market prices on latest merchandise—all free. Everything in Radio for less.

AMERICAN RADIO MFG. CO.
1426 McGee St., Kansas City, Mo.



BUY ALL YOUR FUTURE B-CURRENT NOW!



RADIO PEP B-BATTERY ELIMINATOR

is unique in that it stops ALL the hum by using EIGHT perfected electrolytic cells and NO TUBES.

Plugged into the standard AC house lighting circuit RADIO PEP gives a silent, strong, dependable plate current that *improves the performance of your set* due to the effect of its huge condensers.

ECONOMY! No more drain of buying new batteries; and RADIO PEP takes so little current that you see no difference in your electric bills.

135 VOLTS are called for by the modern sets and tubes. RADIO PEP delivers 135 volts year after year without weakening.

Send for particulars and the address of the nearest dealer who can supply you. Money-back guarantee. Price, \$38.00.



PEP MFG. CO., Inc.
33 West 42nd Street

New York

★ Tested and approved by RADIO BROADCAST ★

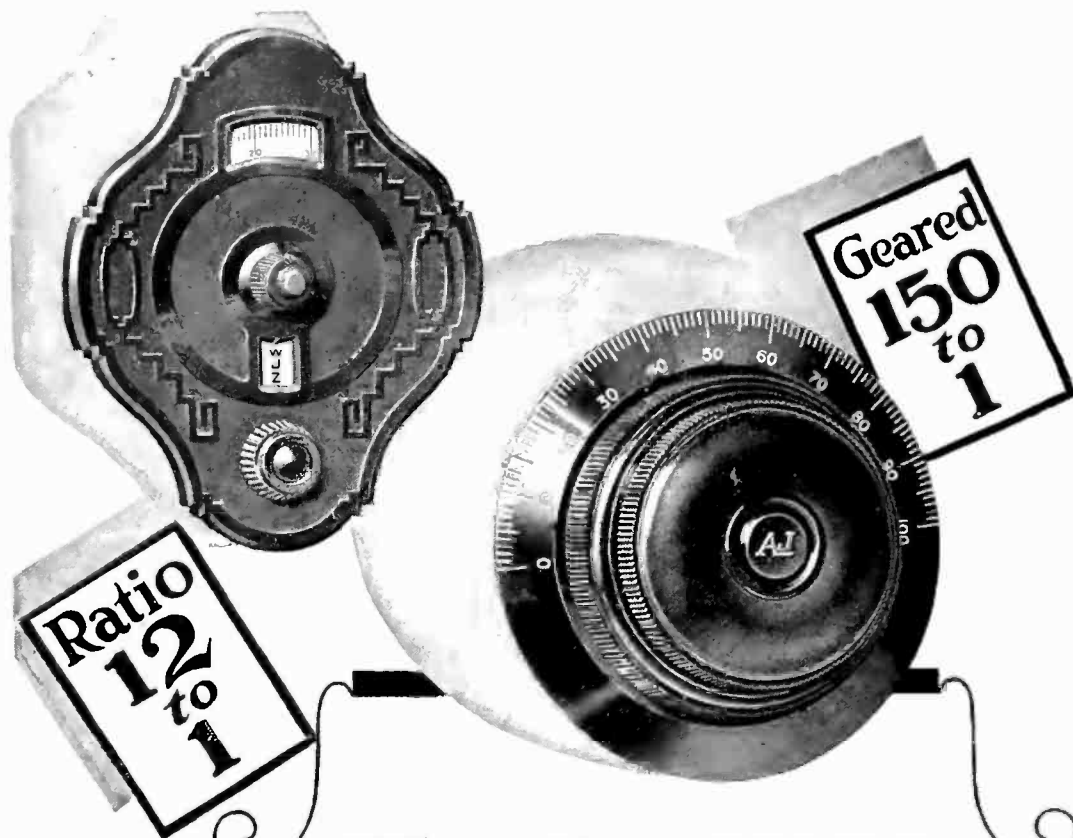

What You COULD Get From Your Set

IT isn't what you're getting now. It's how much more you could get from your present set.

Your set may be one of the finest in the world but it can be no better than its dials.

The human hand cannot tune ordinary dials sufficiently accurate to bring in all the stations within scope of your set. That's where Science has stepped in with the two dials shown above.

MYDAR Recording Dial shown at the left above, offers a degree of tuning efficiency not usually associated with this price. Ample space for call letters insures permanent logging of all stations. Genuine Bakelite, handsomely embellished—12 to 1 Ratio. Price \$1.75.

The A. J. (Vernier) shown at the right above, geared at 150 to 1, brings tones into sharp focus like a fine camera lens. Beautiful, dignified. Genuine Bakelite. A master product of master craftsmen.—Price \$2.25.

Accuratune (not shown) geared 80 to 1 is admirably suited to every type of tuning requirements.

No panel drilling necessary to substitute any one of these dials.

★ **MYDAR Radio Company**
3 CAMPBELL STREET
NEWARK, N. J.

of Columbia, and enclosing ten cents for each copy specified by the numbers.

Heterodyne, as applied to radio, is a method by which signals are produced by beats, whose frequency is equal to the difference between that of a transmitted frequency and that of locally produced oscillations. This accomplishment was the important consideration for which Mr. Fessenden was granted patents.

Broadly speaking, the method of generating local oscillations, as performed by Mr. Fessenden, was a beat system, old and well known in acoustics. The same results have been produced many times by means of various musical instruments, such as tuning forks, pianos, etc. In other words, he simply applied a well known scientific principle to a different purpose whereby new and beneficial results were accomplished—an absolutely safe foundation upon which a highly valuable and valid patent may be obtained.

The courts regard the heterodyne invention as one of the highest order and entitled to a very broad scope, because it was the first application of the old beat system in radio apparatus.

Another important thing to remember is that Mr. Fessenden's patents do not infer or suggest that his invention is intended for voice or concert reception. Notwithstanding this, the court refused to limit the patent and sustained it as a basic patent which covers any kind of beat system of radio reception, including the super-heterodyne receiving set.

At a later date a Mr. Vreeland applied for certain super-heterodyne patents but the courts decided that although his patents Nos. 1,239,852 and 1,245,166 on the super-heterodyne circuit doubtless improved Mr. Fessenden's invention, he could not build his circuit without infringing. This decision brings out another important point, namely, that an improver of a valid patented radio circuit cannot proceed to build his improvement, in which is incorporated the original circuit, without paying a royalty to the original patentee.

Mr. Vreeland contended that, while his patent may infringe Mr. Fessenden's patent, it goes beyond it and makes a substantial contribution to the original patent. In spite of obvious differences between the heterodyne and super-heterodyne circuits, the heterodyne patents are broadly construed, in favor of the inventor, to cover the super-heterodyne principle of receiving incoming signals, even though the beat system is old in acoustics, and Mr. Vreeland's claim could not be sustained.

IMPORT DUTY ON RADIO GOODS FOR AUSTRALIA

A CONSIDERABLE amount of American and British radio apparatus is now on the market in Australia, and there is keen competition between these two importing countries. Contrary to general opinion, even Britain is charged duty on her imports, but the percentage is not so high as it is for American apparatus. Radio sets imported into Australia from this country are chargeable at the rate of 55 per cent. ad valorem, while British set manufacturers are required to pay a duty of only 35 per cent., according to the *Broadcaster and Wireless Retailer* of London. An intermediate figure of 50 per cent., is applicable to certain countries. British tubes were allowed into Australia duty free until January 1st of this year, but a 27½ per cent. duty is now levied. American tubes are taxed at the rate of 40 per cent. ad valorem. The general tariff on tubes was only 15 per cent. until recently. There is an intermediate tariff of 35 per cent. on tubes from certain countries. A general revision of duties on radio apparatus came into force on January 1st.

CHELSEA

Super Five \$50.00



The Ideal Receiver!

ADVANCED engineering and years of production experience by one of the oldest radio manufacturers in the country produced the new Chelsea Super-Five—a Receiver with performing features and refinements found in much higher priced sets.

Fine mahogany finish cabinet with graceful sloping panel and large dials for easy tuning. Convenient cord leads (no unsightly binding posts). Foolproof, dust-proof inside panel to protect delicate parts. Rugged bus-wiring, hand-soldered connections and other refinements. This Set delivers wonderful tone quality and volume and is one of the most selective sets on the market.

Choose Chelsea and save the difference

Write us to-day for New Descriptive Folder

CHELSEA RADIO CO.
Chelsea, Mass. ★

RADIO FANS, a one-year's subscription to Radio Broadcast will cost you four dollars, two years six dollars. Consider this expenditure as being a necessary investment on your part for the future development of your own knowledge of Radio.

MOUNTFORD

FITS ANY MOUNTING

PLUNGER TYPE VARIABLE GRID LEAK

50¢

Perfect graduation, obtains all fractions of a megohm from 1/4 to 20 inclusive. Increases selectivity and sensitivity. Unaffected by heat or cold. Maintains accuracy of range and consistency of resistance. At your dealers or postpaid upon receipt of price.

We also manufacture the Mountford Resistance Coupled Kit, Price postpaid \$6.50

C. E. MOUNTFORD ★
409 Greenwich St.
New York City



Super C, \$30

The New SUPER UNIT

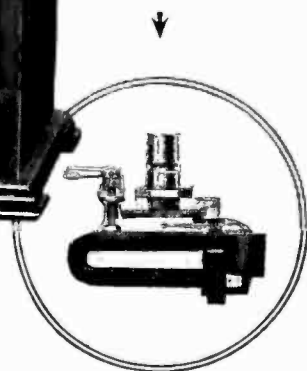

This Speaker



Has the NEW VOICE!

THE small diaphragm commonly used reproduces the middle and upper notes of the musical scale well enough, but it leaves much to be desired from the middle down. Verify this yourself. Listen to almost any speaker and you will be amazed at the muffled sound of the middle and lower registers of voice and instrument.

The Bristol Speaker is equipped with that latest discovery in tone reproduction, the SUPER-UNIT. This unit contains an unusually *large diaphragm* which brings in the full range of tones from deep bass to high treble.

The rumble of the tympani, the roll of the snare drum, the low tones of the viols, tuba, organ, saxophone and voice—notes you've never before heard in radio—notes which are even more vital in reproduced music than in an actual concert—are clearly and naturally audible.

The cabinet is highly polished mahogany, 17 x 10 x 10 1/4 inches in size, with long, freely vibrating sound chamber. The price is \$30. Ask your dealer for a demonstration and at the same time.

Send for FREE BOOKLET

entitled, "How to Select Your Loud Speaker." It tells how to look for and find tone quality in a speaker.

BRISTOL SPEAKER

(AUDIOPHONE)

The Bristol Company

Radio Div. AH, Waterbury, Conn.

For 36 years makers of the highly sensitive and accurate Bristol's Recording Instruments

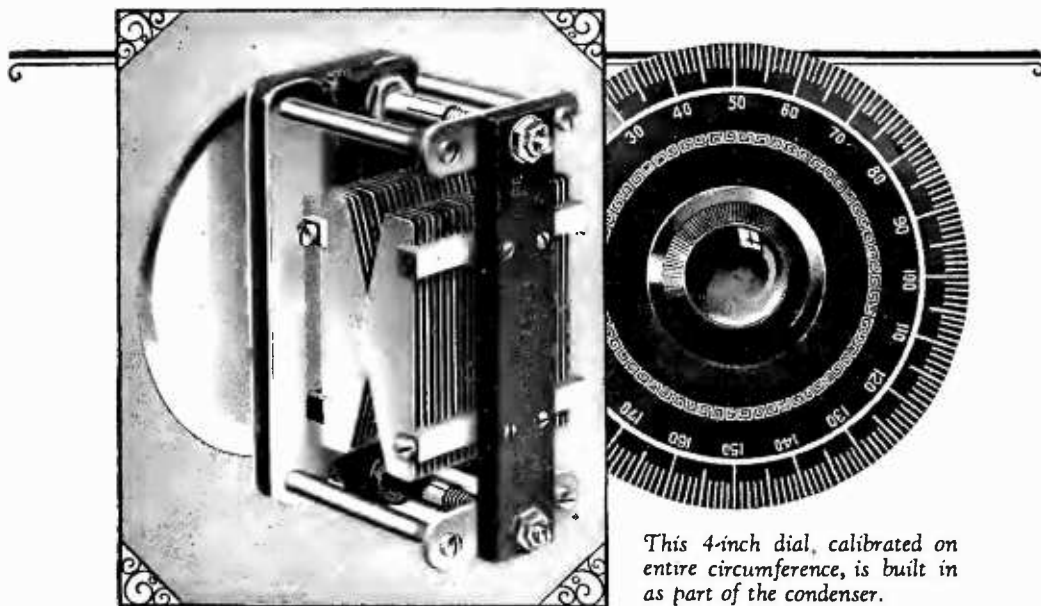

This 4-inch dial, calibrated on entire circumference, is built in as part of the condenser.

"Spreads" Stations All Over the Dial

Wade Tuning Unit Including Condenser and Dial

The Wade Condenser Tuning Unit consists of a Wade Condenser geared to a four-inch 360 degree vernier dial of 16 to 1 ratio. Prices are for the complete unit.

Capacity	.000125 mfd.	\$6.00
Capacity	.00025 mfd.	\$6.25
Capacity	.00035 mfd.	\$6.35
Capacity	.0005 mfd.	\$6.50



The Viking Tool and Machine Co. Inc. 745-A 65th Street, Brooklyn, N. Y.

No Body Capacity Effects

A separately grounded frame, insulated from both sets of plates, shields the condenser from all body capacity effects—an important feature, exclusively in Wade Condensers.

STATIONS won't overlap one another when you use the Wade Condenser Tuning Unit. This unique condenser is geared to a dial that is graduated all the way around—from zero to 360 degrees. This means twice as much space between stations for close tuning adjustment; even wider separation of stations than the rotor plate types of straightline frequency condensers using standard 180 degree dials. If you are one who is tuning now with only "half a dial" you are in for a pleasant surprise when you try Wade Condenser Tuning Unit. It covers the whole broadcast range and down below 200 meters.

Dealers

Dealers and jobbers, as well as the radio public, will be interested to note the addition of a .00035 mfd. capacity model to our regular line. We have had many calls for this capacity and it will beyond doubt meet with popular favor.

Why not subscribe to *Radio Broadcast*? By the year only \$4.00; or two years, \$6.00, saving \$2.40. Send direct to Doubleday, Page & Company, Garden City, New York.

ELDREDGE PANEL METERS **\$5.00**

Why pay more? Eldredge meters are accurate and long-lived.

If dealer can't supply you, write us direct

Dept. B

Eldredge Electrical Corporation

Springfield

★
Mass.

Established 1892

A KEY TO RECENT RADIO ARTICLES

By E. G. SHAULKHAUSER

THIS is the fourth installment of references to articles which have appeared recently in various radio periodicals. Each separate reference should be cut out and pasted on cards for filing, or they may be pasted in a scrap book either alphabetically or numerically. A brief outline of the Dewey Decimal System (employed here) appeared in November and January RADIO BROADCAST.



R800(535.3) PHOTOELECTRIC PHENOMENA. PHOTOELECTRIC
Radio News. Oct. 1925, pp. 436ff. CELL.

"The Luminotron," T. H. Nakken.
The description of a new type of photoelectric cell, and its application to many unsolved problems, is outlined by the inventor in this article. The cell is of the potassium plate type. Its fundamental working principles, and some of the results obtained with the tube, make this cell very reliable.

R550. BROADCASTING. BROADCAST RANGE,
Radio News. Oct. 1925, pp. 446ff. Covering the.

"Extending the Broadcast Range," S. Harris.
A possible expansion of the present broadcast band will necessitate changes in most radio receivers to cover the entire range. The difficulties encountered and the best solutions are presented in an excellent discussion by the author, who comes to the conclusion that tapped coils will most likely be necessary.

R343. ELECTRON TUBE RECEIVING SETS. RECEIVER,
Radio News. Oct. 1925, pp. 448-449. 2000-600 kc.
(150-600m).

"Another Three-Range Receiver."
Anticipating an expansion in the broadcast band of wavelengths, the receiver here described and illustrated uses a novel scheme in covering the range. Sets of coils of three sizes are built, and mounted to fit into an ordinary tube socket. The receiver is of the regular two-stage radio frequency type, using three tuning dials.

R113.8 ECLIPSES. ECLIPSE, SOLAR.
Proceedings I.R.E. Oct. 1925, pp. 539-569.

"The Effect of the Solar Eclipse of Jan. 24, 1925, on Radio Reception," G. Pickard.
A complete résumé of the observations made under the direction of the author, is presented, with diagrams and illustrations. The data collected lead to certain conclusions and put us several steps ahead in our search for information concerning the behavior of ether waves in space.

R331. CONSTRUCTION OF VACUUM TUBES. VACUUM TUBES.
X-L filament.

Proceedings I. R. E. Oct. 1925, pp. 589-609.
"The Application of the X-L Filament to Power Tubes," J. C. Warner and O. W. Pike.
The properties of the X-L or thoriated tungsten filament, are discussed, with particular reference to the suitability of this material for use in power tubes and its advantages over other materials. Comparisons are given between pure tungsten and thoriated tungsten filaments in electron emission characteristics and effect on tube design, and performance. Several power tubes containing X-L filaments are described in detail. The improvements due to the use of the X-L filament are illustrated by comparison of these tubes with older types of tubes containing pure tungsten filaments.

R375. DETECTORS AND RECTIFIERS. RECTIFIER,
QST. Nov. 1925, pp. 38-40. Raytheon.

"The Raytheon Rectifier," M. Pennybacker.
A theoretical discussion of a new rectifier tube, the Raytheon, is given by one of the manufacturer's engineers. The tube is a full-wave rectifier, and has many new features which make it exceptionally well adapted to B battery eliminator operation, according to the author. The curve in Fig. 5 shows the relation of output voltage to output current. A completed rectifier unit is shown in a photograph.

R350. GENERATING APPARATUS; TRANSMITTER,
TRANSMITTING SETS. Crystal-Control.

QST. Nov. 1925, pp. 41-44.
"Navy Developments in Crystal Controlled Transmitters."
A detailed account of the developments of crystal controlled transmitters at the Naval Research Laboratory, Bellevue, District of Columbia, is given, beginning with the first experiments, May 1st, 1925. Most of the research has been done on short waves, according to the account given. Various types of sets tested, results obtained on different frequencies, and power input, are described, and photographs shown for the benefit of the experimenter who desires this information. The data presented is all of an experimental nature.

R343. ELECTRON TUBE RECEIVING SETS. RECEIVER,
Radio. Nov. 1925, pp. 25-26. Loop.

"An Improved Loop Receiver," R. L. Rockett.
A five-tube loop receiver, employing three stages of radio frequency amplification, is presented, with data on construction and assembly. One audio stage is reflexed.

R343. ELECTRON TUBE RECEIVING SETS. RECEIVER,
Radio. Nov. 1925, pp. 27ff. Short-Wave.

"Building for the Future," H. A. Nickerson.
Many stations can be heard broadcasting programs on very high frequencies (wavelengths below 100 meters) with a receiver designed for that purpose. Such a receiver is described in this article. It is a simple regenerative arrangement.



Oh boy!

KESTER
Rosin Core
Radio SOLDER

Sure! is Safe and Simple

Approved by
Radio Engineers
A Genuine Solder

CHICAGO SOLDER COMPANY

4222 Wrightwood Ave., Chicago, U. S. A.

Originators and
World's Largest Manufacturers of
Self Fluxing Solder

YOUR DEALER
CAN SUPPLY YOU

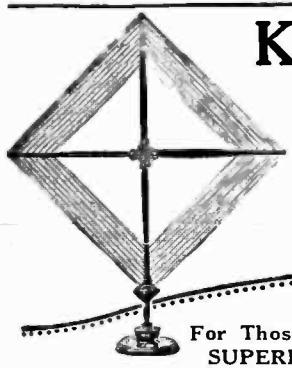

KORACH

- Tuned Loop
- Multiple Switch
- Board Tuner
- Directional
- Base Compass for
- Logging
- Collapsible

For Those Who Demand
SUPERIOR RESULTS

Leads the march towards perfect radio reception under all conditions. Not merely a "loop" but an ingenious arrangement of mechanical skill designed for superior results. L. M. Cockaday, using this loop, reached out across the Atlantic to audibly hear many trans-continental stations. Selectivity Plus Distance unheard of with common loop aeriels. The Korach excels on all sets designed for loop reception. Priced at \$12.50. and for sale by all good dealers. Full particulars sent for 2c stamp and name of local dealer.

KORACH RADIO CO. ★

20 E. Jackson Blvd., Dept. 8, Chicago, Ill.
Dealers and Jobbers: Write today for attractive proposition.

The Korach Junior
A modification of
the "Senior" but possess-
ing all its important features—\$10.00.

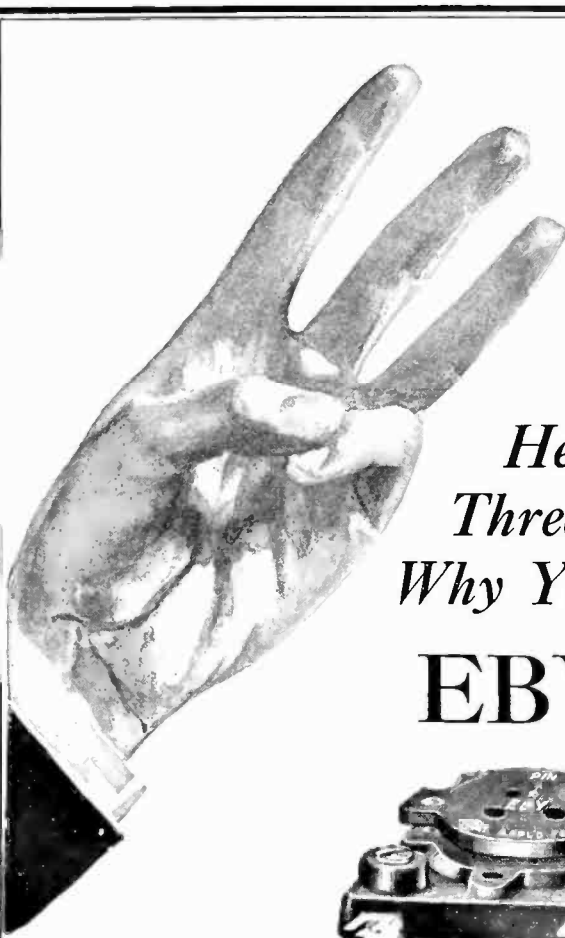

Here Are
Three Good Reasons
Why You Should Use

EBY

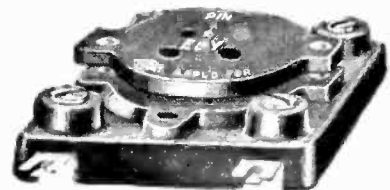

SPRING SOCKETS

- 1** A three point wiping contact that insures a positive contact at all times regardless of the size of the prong or amount of solder on the prong tip.
- 2** Its ingenious design permits the tube to "float" when in service. This feature reduces microphonic noises to a minimum and prevents tube damage.
- 3** All the advantages of interchangeability of the new UX, CX, and UV tubes for 6oc. Don't take chances on twenty loose connections in a five-tube set. Use the new EBY positive contact sockets for better reception.

*If you dealer can't supply you
write to us sending his name.*

H. H. EBY MANUFACTURING CO.
4710 Stenton Ave., Philadelphia



This is the EBY Binding Post that is standard equipment on eight out of ten of the radio receivers made in America—your dealer has all of the 27 different markings.

★ Tested and approved by RADIO BROADCAST ★

Now you can hear ALL notes!

A Thordarson Autoformer Amplifier built in accordance with instructions and diagrams furnished with each Autoformer

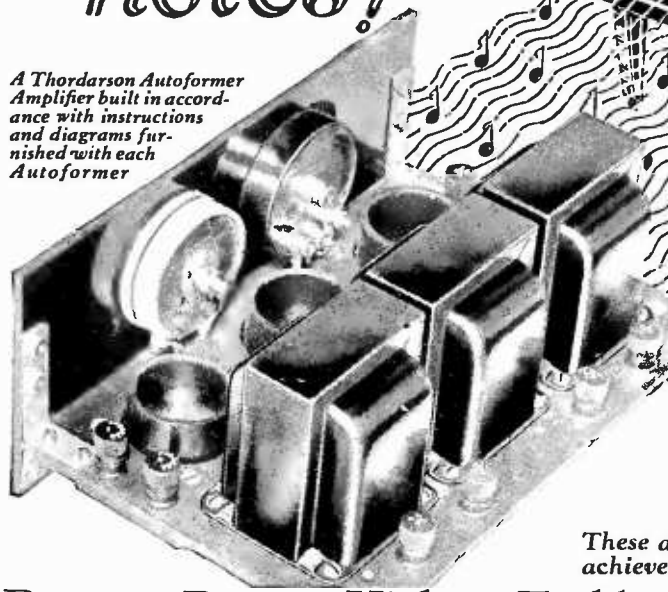

- 1 Full amplification of those bass notes hitherto largely "lost."
- 2 Greater clarity on all notes.
- 3 Improved reception of distant programs.
- 4 Better volume control.

These are the four great improvements achieved by Autoformer Amplification

Deepest Bass to Highest Treble Brought Out Clearly

The Thordarson Autoformer is not "another transformer." It is an all-frequency amplifier, an entirely new instrument developed and built only by Thordarson. Autoformer Amplification is step-up impedance coupled with capacities and resistances. Write for fully descriptive literature. Autoformers, \$5 each. Dealers everywhere.

THORDARSON
Autoformer

Trade-Mark Registered
All Frequency Amplifier

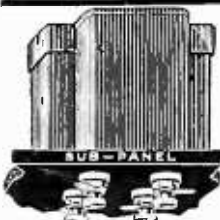

Other Thordarsons

Thordarson Super Audio Frequency Transformers in either sub-panel or top mounting type. Three ratios: 2-1, \$5; 3 1/2-1, \$4; 6-1, \$4.50. Thordarson Power Amplifying Transformers, \$13 the pair. Thordarson Interstage Power Amplifying Transformers, \$8 each. All Thordarson products are unconditionally guaranteed.

THORDARSON ELECTRIC MANUFACTURING CO.
Transformer specialists since 1895
WORLD'S OLDEST AND LARGEST EXCLUSIVE TRANSFORMER MAKERS
Chicago, U.S.A.

ZENITH
KENNEDY
w/ **Radiodyne**
Planstiehl
Howard
Thermodyne
OZARKA
Deresnadyne
ADLER-ROYAL
MURDOCK
MU-RAD
Valleytone
LEICH
Silver-Marshall
GLOBE
McNewark
Newport
BUCKINGHAM
NUNN-LONDON
KUSTOMBILT and many others
use Thordarson Super-Amplifying Transformers

Also choice of the MacMillan Arctic Expedition

R800(535.3) PHOTOELECTRIC PHENOMENA. PHOTOELECTRIC CELLS. *Popular Radio*. Nov. 1925, pp. 397-404. "The Photoelectric Cell," E. E. Free. The development of photoelectric cells is an outgrowth of radio progress. This cell is used to convert light beams into a stream of electrons. Their efficiency, at present, is very low, and the most modern cells still use as active metal either potassium, sodium, lithium, caesium, or rubidium. The action taking place within the tube is vividly described.

R375. DETECTORS AND RECTIFIERS. RECTIFIER, *Popular Radio*. Nov. 1925, pp. 405-414. "Raytheon Plate Supply Unit," L. M. Cockaday. This article describes the new B battery eliminator unit using the Raytheon tube. Cost of parts is given at about \$45.00. The tube has no filament and will last practically indefinitely. A detailed description covering the operation of the unit, and method of constructing, wiring, and testing, is given.

R800(621.314.3) TRANSFORMERS. TRANSFORMERS, *Popular Radio*. Nov. 1925, pp. 444-452. "Practical Pointers About Transformers," F. E. Nimmcke. This article gives practical information concerning the design, construction, and operation of small transformers, as used in radio engineering. Mathematical equations and reference examples serve to help the radio engineer in comprehending the problems in question.

R110. RADIO WAVES. RADIO WAVE THEORY. *Popular Radio*. Nov. 1925, pp. 461-464. "Alexanderson's Theory of Twisting Waves," E. F. W. Alexanderson, is illustrated by diagram, and discussed. The phenomenon of polarization, and the effect of the magnetic field of the earth on such polarized waves, is taken as a probable explanation of fading signals, and so called "dead-spots."

R333. THREE-ELECTRODE VACUUM TUBES. VACUUM TUBES, RADIO BROADCAST. Dec. 1925, pp. 163-166. "Tubes: Their Uses and Abuses," Keith Henney. The condition under which present-day vacuum tubes must be operated to get best results, are related. A brief but very practical discussion on theory and operation of the detector tube, regeneration in the detector circuit, audio and radio amplification where voltage as well as power amplification must be considered, importance of matching output impedance of last tube with loud speaker impedance, transformer ratios, resistance-coupled audio amplifiers, are questions receiving attention. The author gives considerable information concerning the new power amplifier tubes, UX-120, UX-112, Daven MU-6, Cleartron 112, WE-216-A, and others.

R343. ELECTRON TUBE RECEIVING SETS. RECEIVER, RADIO BROADCAST. Dec. 1925, pp. 172-176. "A Five-Tube Receiver of Dual Efficiency," G. H. Browning. The receiver described is an improvement of the one previously described in RADIO BROADCAST (December, 1924.). Three stages of impedance coupling are used in the audio circuit. The construction of the tuned radio frequency stages is very important. From the curve it appears that when frequency is plotted against voltage amplification, the Daven MU-20 and MU-6 tubes, with impedance coupling, will give greatest amplification without distortion when compared to other methods of amplification. Parts listed, and diagrams covering constructional details, enable the builder to follow instructions without difficulty. The author lays stress on the careful construction of the Regenerator, and gives a very simple method of balancing the r. f. stage, using a small disc of metal brought near the coil winding.

R545. AMATEUR RADIO. SHORT WAVES FOR AMATEURS. RADIO BROADCAST. Dec. 1925, pp. 182-184. "Short Waves—A New Paradise for the DX Fan," E. H. Felix. The great interest manifested in high frequency telegraph transmission by the so-called radio amateur, is depicted in this article. Short-wave stations communicate by code generally using small power transmitters (5 watts being a common output). Such apparatus can be constructed for sums of \$20.00 and up. The receivers are very simple and rarely use more than two tubes. The thousands of dyed-in-the-wool "hams" are at their game day and night and their work constitutes a most important link in the progress of radio.

R375. DETECTORS AND RECTIFIERS. RECTIFIER, RADIO BROADCAST. Dec. 1925, pp. 186-190. "An Improved Plate-Current Supply Unit," R. F. Beers. The operation of the Raytheon rectifier tube in B battery eliminator circuits, is discussed. The tube is rated at 60 milliamps. at 150 volts d. c. output; is very quiet in operation, and has good characteristics as shown by the curve. Back currents are not detectable in the tube, and consequently all filtering problems are simplified. There is no filament in the Raytheon tube. Data is given enabling the constructor to build his own transformer and choke coils.

R113.6 REFLECTION; REFRACTION; REFLECTOR. PARABOLIC. *Radio*. Nov. 1925, pp. 13ff. "Short Wave Reflectors," R. C. Hunter. Method of constructing a parabolic reflector for the range from 400,000 kc. to 401,000 kc. (7406-7477 meters) is given. This information can be used for building larger reflectors to operate on lower frequencies. The size here described can be placed in a small space in a laboratory, dimensions being about 66 x 30 x 18 inches. Diagrams and illustrations supplement the article.

R312.7 AUDIO-FREQUENCY AMPLIFIERS. AMPLIFIERS, *Radio*. Nov. 1925, pp. 16-18. "An Ideal Audio-Frequency Amplifier," E. W. Pfaff. A three stage impedance-coupled amplifier, for which unusual amplification quality is claimed, is described. The theory of the circuit, and the construction of the set, including list of parts, are presented in detail.

This is a good time to subscribe for
RADIO BROADCAST
Through your dealer or direct, by the year only \$4.00
DOUBLEDAY, PAGE & CO. GARDEN CITY, NEW YORK

Send for Latest RADIO CATALOG and GUIDE

Sets - Parts - Kits
Radio's Newest

You need this big FREE book. A practical guide to success in set building. Gives advanced hook-ups. Shows all newest parts and kits, built up sets ready for use, battery eliminators, radio's newest creations. Write for Copy free, also send name of radio fan. Sent today.

BARAWIK CO.
102-209 S. Canal St., Chicago

The LATEST HOOK-UPS & RADIO Catalog

Attention Dealers
SEND FOR OUR 200 PAGE CATALOG

SCHNEITERS
RADIO SUPPLIES
ST. JOSEPH, MO.

The finest and largest exclusive Radio Catalog in the United States
SCHNEITZER RADIO COMPANY
Dept. 10 St. Joseph, Missouri

This RADIO BOOK will save you money

514 PAGES ONLY \$1

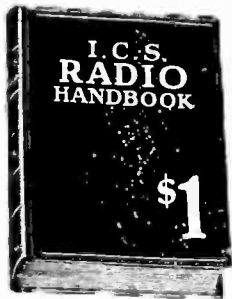

Compiled by HARRY F. DART, E.E. Formerly with the Western Electric Co., and U. S. Army Instructor of Radio. Technically edited by F. H. Doane. THE I. C. S. Radio Handbook will help you to get more enjoyment out of radio. It clears up the mysteries—tells you just what you want to know. Written by nationally known radio authorities in language that you can understand. An absolute necessity for every radio fan. A wonderful bargain at \$1. Note this partial list of contents—Electrical terms and circuits, antennas, batteries, generators and motors, electron (vacuum tubes), many receiving hook-ups, radio and audio frequency amplification, broadcast and commercial transmitters and receivers, super-regeneration, licenses, etc.

Send \$1 today and get this 514-page I. C. S. Radio Handbook—the biggest value in radio today

International Correspondence Schools
Box 8298-E, Scranton, Penna.

I enclose One Dollar. Please send me—post-paid—the 514-page I. C. S. Radio Handbook. It is understood that if I am not entirely satisfied I may return this book within five days and you will refund my money.

Name.....

Address.....

Check here and enclose \$1.50 if you wish the edition bound in Leatheroid

IF you like this magazine with its coated paper and enlarged size—then why not subscribe and get it regularly —by the year, \$4.00, Six months, \$2.00.

Doubleday, Page & Co.
Garden City New York

RADIO OWNERS

who can twirl a dial can renew their old tubes without chance of error with this instrument. It is built so that it cannot be mis-operated.

YOU CAN DO IT YOURSELF WITH A

BURTON & ROGERS TUBE FLASHER

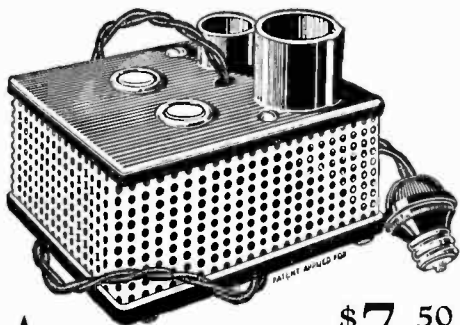

\$7.50

One Model for D. C. or A. C. all cycles For tubes with thoriated filaments.

BURTON & ROGERS MFG. CO.
755 Boylston Street Boston, Mass.

ACME WIRE RADIO PRODUCTS

Celatsite Battery Cable

For connecting A and B Batteries (or current supply) to radio set. Silk braid covering 5 flexible Celatsite wires —5 feet long—a different color for each terminal. Prevents messy wiring and “blown” tubes. Adds greatly to the appearance of your set.



Stranded Enameled Antenna

The best outdoor antenna you can put up. 7 strands of enameled copper wire; maximum surface for reception. Enameling prevents corrosion and consequent weak signals. 100, 150 or 200 foot coils, boxed.



Loop Antenna Wire

You can make a good loop with Acme wire made of 65 strands of fine copper wire, green silk covered. Flexible; non-stretching, neat.

The Original Celatsite Wire

Celatsite is a tinned copper bus bar wire with a non-inflammable “spaghetti” insulation in five colors. Supplied in 30 inch lengths.



Flexible Varnished “Spaghetti”

A perfect insulation tube for all danger points in set wiring. Costs little more and is worth a lot more than the cheaper substitutes offered. Black, yellow, red, green, brown, for wires No. 10 to No. 18. 30 inch lengths.

Flexible Celatsite Wire

Flexible stranded wire for “point to point” and sub-panel wiring—latest method of wiring sets. 5 colors, black, yellow, green, red and brown, one for each circuit. 25 ft. coils.



Send for Folder

THE ACME WIRE CO., Dept. B
New Haven, Conn. ★

Make your set a Super-Het

THE circuit described in Radio Broadcast for June and August will change any set into a super-heterodyne. It is particularly applicable to five-tube neutrodyne and tuned RF sets. It changes these two circuits into super-heterodynes as good as most, and considerably better in some respects than any super-heterodyne circuit ever devised.

Stations come in at but one point on the oscillator dial. There is mathematically no possibility of harmonics. Full scale blue prints with reprint of article \$1.00.

- Eastern Coil antenna coupler..... \$6.00
- O'Connor oscillator coupler..... 4.75
- Special fixed condenser..... .60
- Complete parts including panel, drilled and engraved, special formica bushings, screws, and wire, blue prints and reprint..... 37.50

★ A. O'CONNOR & COMPANY
Super-Heterodyne Headquarters Since 1923
9702 Euclid Avenue Cleveland, Ohio

The moustache, the beard and the bustle are hopelessly out of date. But no more so than the obsolete slow 2-ampere battery charger!
Buy nothing but an up-to-date 5-ampere charger!

The New Improved
5 AMP. A & B
GOLD SEAL
HOMCHARGER
\$19.50



Over 500,000 already in use

Modern-Fast-Efficient!

NOW you don't have to wait for days while your battery charges. The new 5-ampere GOLD SEAL HOMCHARGER charges A or B batteries three times as fast as last year's slow chargers - - - it fully charges the average radio battery OVERNIGHT!

This year when you buy a battery charger, be sure it is a modern fast charger - - - one that charges at 5-amperes. To be absolutely sure, insist on the 5-ampere GOLD SEAL HOMCHARGER.

Free Write for new edition of our interesting 16-page booklet "The Secret of Distance and Volume in Radio." ★

THE KODEL RADIO CORPORATION
 505 EAST PEARL ST. CINCINNATI, OHIO

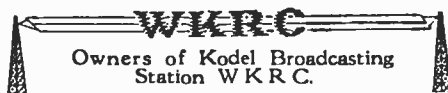

This is a good time to subscribe for
RADIO BROADCAST
 Through your dealer or direct, by the year only \$4.00
 DOUBLEDAY, PAGE & CO. GARDEN CITY, NEW YORK

Play Jazz
 in a week

on your **Buescher Saxophone**
 You can do it—easy. 3 lessons free with each new instrument give you a quick start. Practicing is fun because you learn so fast. And it will make you popular, in demand, the center of attraction everywhere you go. Always a hit. Even if you have failed with some other instrument, you can learn the simplified Buescher Saxophone. Don't delay. Get into the big fun. Any instrument sent for 6 days' free trial. Easy terms if you decide to buy. Write now for beautiful, free literature. Address:



Buescher Band Instrument Co. 111
 1219 Buescher Block Elkhart, Indiana

If Your Set Won't Percolate

write us about it. RADIO BROADCAST is establishing a special repair department to assist set builders in getting the best out of the receivers they build from plans published in the magazine. Write for complete information about this new department established for your benefit.

★ Tested and approved by RADIO BROADCAST ★

R380. PARTS OF CIRCUITS: INSTRUMENTS. METERS, RADIO BROADCAST. Dec. 1925, pp. 198-200.

Use in Receivers.
 "How to Use Meters in Your Receiver," James Millen.
 A voltmeter for the filament circuit, and one for the B batteries, is recommended. A plate milliammeter gives the plate current drain and shows when audio amplifiers are properly "modulating." Method of connecting meters, and the various uses to which they can be put otherwise, is given; several "meter circuits" are shown.

R344. ELECTRON TUBE GENERATORS. OSCILLATORS, RADIO BROADCAST. Dec. 1925, pp. 201-204. *Modulated*
 "New Fields for the Home Constructor," Keith Henney.

For those who have accumulated radio apparatus and tools, and really want to know more about radio science and what is going on in the laboratory, this second article of a series is given. A method of testing open circuits in audio transformers by means of 1000-cycle oscillator, and obtaining transformer characteristics with the same oscillator, is described. Other uses of the oscillator are suggested, and taken up in some detail. The previous article in this series appeared in the September, 1925, RADIO BROADCAST.

R115. DIRECTIONAL PROPERTIES. BEAM TRANSMISSION. "Marconi Radio Beams," H. de A. Donisthorpe.

The advent of beam transmission will relieve ether congestion, and make obsolete existing high-power long range stations of to-day, according to the writer. Beam transmission will give minimum interference, due to marked directional effects. Early experimental work is discussed, and modern improvements made, due to the invention of vacuum tubes, are described. The size and method of constructing reflecting surfaces have given rise to new theories of wave transmission. Parabolic and flat reflectors have been used, the latter with marked results. A flat network of wires set horizontally, serves as an antenna, while another similar network, placed 1/4-wavelength back, serves as the reflector. This system will concentrate energy within 10°, making possible thirty-six times the transmitted energy otherwise obtained at a point.

R342.6 RADIO-FREQUENCY AMPLIFIERS. AMPLIFIERS. RADIO. Nov. 1925, pp. 14-15. *Radio-Frequency*

"A Universal Radio-Frequency Amplifier," A. J. Haynes. A radio-frequency amplifier, which can be used ahead of any receiving set, is described. Careful construction is emphasized. The circuit employs an effective means of controlling oscillations. This is done through the use of a tuned choke coil, as is evident from a study of the circuit diagram. Sufficient data is presented to enable the experimenter to construct this set. Unusual sensitivity and volume are supposed to be the prime features incorporated in this amplifier.

R097. BIOGRAPHICAL. BIOGRAPHY. RADIO. Nov. 1925, pp. 19ff. *M. Latour.*

"Marius Latour," W. Emmett. A short biographical sketch of M. Latour, the French scientist and philosopher, is presented. Mr. Latour is not only known as a student of science, but his writings in the field of sociology and psychology are widely read. He has many patents to his credit, some of which are discussed in this article.

R145.3 INDUCTANCE. INDUCTANCE COILS. RADIO. Nov. 1925, pp. 24ff. *J. E. Anderson.*

"Comparative Efficiencies of Coils," J. E. Anderson. The L/I ratio of inductance coils is regarded as a measurement of the efficiency of coils at low as well as high frequencies. From this standpoint, the author makes a comparison of various forms and types of coils, including two and three layer banked coils, single layer coils of various shapes, Lorenz coils, spiderweb coils, toroidal coils, etc. The conclusions arrived at are summed up at the end of the discussion.

R133. GENERATING ACTION. ELECTRON TUBE GENERATORS. RADIO. Nov. 1925, pp. 29ff. *Lieut. J. B. Dow.*

"The Vacuum Tube as a Generator," Lieut. J. B. Dow. A theoretical as well as practical analysis of the fundamental principles of vacuum tubes, is presented, for the benefit of the amateur building his own transmitter. Information is given of the effect of gas in the tube, on the grid, the internal resistance, the amplification factor, the dynamic characteristics, the mutual conductance, the generator action, etc. Schematic circuit diagrams illustrate the discussion.

R375. DETECTORS AND RECTIFIERS. RECTIFIER. RADIO. Nov. 1925, pp. 35-36. *Raytheon.*

"The Helium Tube Rectifier," E. E. Turner. The Raytheon tube rectifier and its use in B battery eliminators, is discussed. Complete description on building a practical eliminator, including list of parts required and diagram, is given. No hum of any kind is heard in the loud speaker, even when the outfit is delivering 37 milliamps. on a ten-tube super-heterodyne set, according to the writer.

R350. GENERATING APPARATUS. TRANSMITTING SETS. QST. Nov. 1925, pp. 15-19. *Ship.*

"KFUH," Ralph M. Heintz. The transmitter aboard the ship *Kaimiloa*, call KFUH, consisting of two 250-wattors, is discussed in detail. Circuit diagrams and photographs give a clear idea of the set, and how it has been constructed. The results obtained have been very gratifying.

RR342.6. RADIO-FREQUENCY AMPLIFIERS. AMPLIFIERS. QST. Nov. 1925, pp. 21-24. *Radio-Frequency.*

"The One-Stage Radio-Frequency Amplifier," P. L. Pendleton. While designing a one stage radio-frequency amplifier, results of a nature different to the conventional, were obtained. They pertained to the control of oscillations in the radio frequency circuit over the broadcast band of frequencies. With the layout of Fig. 1 (circuit diagram Fig. 2), and the array of coils shown in Fig. 3, considerable information was gathered on the actual operation of such a setup. The final arrangement adopted as giving the best results, is shown in Fig. 4.



FREE!

To Each Purchaser of a **WORLD 6V. Auto or Radio BATTERY**

12-Cell — 24-Volt Storage 'B' Battery

Positively given free with each purchase of a WORLD "A" Storage Battery. You must send this ad with your order. WORLD Batteries are famous for their guaranteed quality and service. Backed by years of successful manufacture and thousands of satisfied users. Equipped with *Solid Rubber Case*, an insurance against acid and leakage. You save 50 per cent and get a **2-Year Guarantee**

Bond in Writing — Approved and Listed as Standard by Leading Authorities including Radio News Laboratories, Popular Science Institute of Standards, Radio Laboratory, Broadcast Laboratories, Radio in the Home, and Lefax, Inc.

WORLD Battery owners "tell their friends." That's our best proof of performance. Send your order in today.

Solid Rubber Case Radio Batteries
 6-Volt, 100-Amperees . . . \$11.25
 6-Volt, 120-Amperees . . . 13.25
 6-Volt, 140-Amperees . . . 14.00

Solid Rubber Case Auto Batteries
 6-Volt, 11-Plate . . . \$11.25
 6-Volt, 13-Plate . . . 13.25
 12-Volt, 7-Plate . . . 16.00

Send No Money — Just state battery wanted and we will ship day order in received, by Express C. O. D., subject to your examination on arrival. **FREE "B" Battery** included. **Extra Offer:** 5 per cent discount for cash in full with order. Buy now and get a guaranteed battery at 50 per cent saving to you.

WORLD BATTERY COMPANY
 1219 So. Wabash Ave., Dept. 24 CHICAGO, ILL.

World STORAGE BATTERIES

Set your Radio Dials at 210 meters for the new 1000 watt World Storage Battery Station, WSBK, Chicago. Watch for announcements.

WDBK - WFAF - WGN - WJS - KHJ - KGO - KFAF - WJY - KOP

Why not subscribe to *Radio Broadcast*? By the year only \$4.00; or two years, \$6.00, saving \$2.40. Send direct to Doubleday, Page & Company, Garden City, New York.

HOYT "SUPER" CONTROL METER



FOR PRECISION CONTROL of Radiola Superheterodynes No. 25 and No. 28. Instantly attached without any change in wiring to jacks already installed for this purpose. Permits setting rheostat for exact filament voltage for best reception and longest tube life. A HOYT moving-coil voltmeter, type 17, with bronze rim, wood case to match set, non-scratch base and cord.

Price \$8.50 ★

BURTON-ROGERS CO.
 26 Brighton Ave., Boston, Mass.

"The enchantment of distance, the joy of clearness, with **FROST-FONES**"

New! Better!

Two useful new items of **FROST-RADIO** now ready

A new **FROST-RADIO** socket that fits all new type tubes

This new socket takes ALL tubes with the new type bases. Has perfect spring construction which grips each tube prong full length with self-cleaning, sliding contact. We believe this socket to have the most satisfactory contacts of any socket made. All terminals plainly marked. It is equipped with soldering lugs. Genuine black Bakelite in high lustre finish. Order from your dealer today.

FROST-RADIO
 No. 530 **FROST-RADIO** SOCKET . . . 40c

Convert your present standard sockets to UX199—CX299, or UX120—CX220 with this adapter

With this handy, inexpensive adapter you can instantly fit the new CX299 or UX199, and the CX220 or the UX120, into your present standard base sockets.

No need to rebuild your set to take the new tubes. Genuine black Bakelite—high lustre finish. Ask your dealer to supply you.

FROST-RADIO
 No. 540 **FROST-RADIO** ADAPTER . . . 25c

HERBERT H. FROST, Inc. ★
 314-324 WEST SUPERIOR STREET, CHICAGO
 NEW YORK CITY CLEVELAND KANSAS CITY LOS ANGELES
 Export Office: 314 West Superior Street, Chicago

IF you like this magazine with its coated paper and enlarged size—then why not subscribe and get it regularly—by the year, \$4.00, Six months, \$2.00.

Doubleday, Page & Co.
 Garden City New York

RADIO FANS, a one-year's subscription to Radio Broadcast will cost you four dollars, two years six dollars. Consider this expenditure as being a necessary investment on your part for the future development of your own knowledge of Radio.

Big FREE RADIO
Catalog & Guide

PARTS, HOOK-UPS, SETS and KITS

Send now for this valuable **FREE** book. Full of advanced hook-ups, parts and kits. A real guide. Shows factory built sets and the new ideas in radio. Send at once. No charge. No obligation. Please include name of radio fan.

THE LATEST HOOK-UPS RADIO Catalog

BARAWIK CO.
 102-109 S. Canal St., Chicago

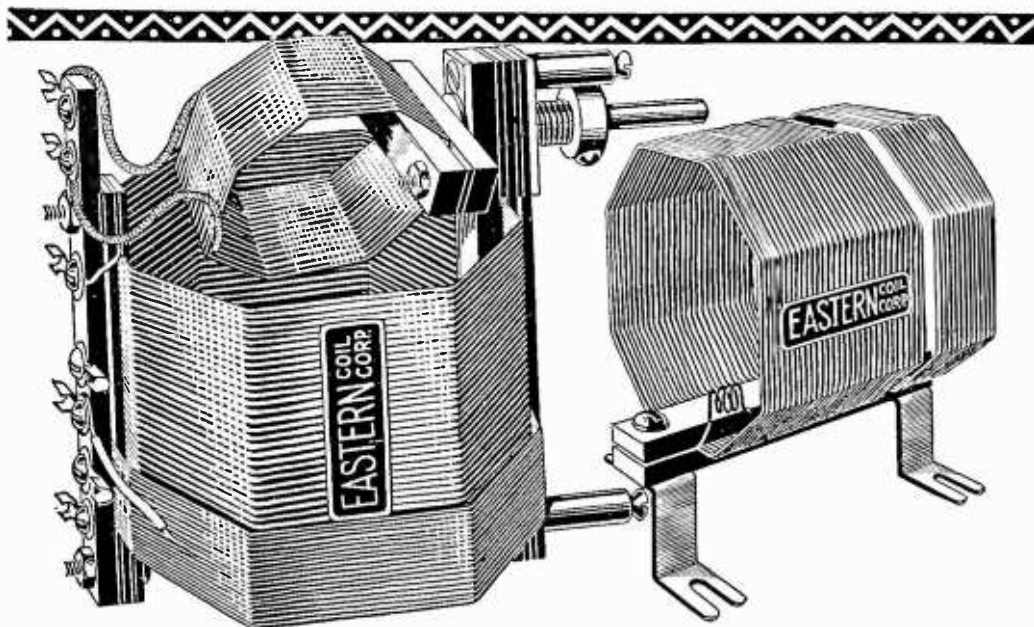

EASTERN KNOCKOUT COILS (TYPE R)

Specified
by
RADIO
BROADCAST
for the
"Aristocrat"
Set.

for the EASTERN KNOCKOUT CIRCUIT (The original unreflexed ROBERTS.)

Designed in strict accordance with latest Radio Broadcast specifications and guaranteed perfect for the "Aristocrat" and for all Roberts Knockout Circuits.

Minimum of capacity between N. P. winding and secondary; mid-tap on single-layer wound N. P. coil—simplifies neutralization and tuning, and brings in the lower wave length stations with a heretofore unequalled efficiency.

Price, \$8.50 per set.

EASTERN Pickle Bottle COILS

TRADE MARK

Ever Increasing in Popularity

No matter what the circuit, they guarantee the best possible results from it because they incorporate every feature essential to low loss coil design, in conformity with every known radio engineering principle.

Highest in ductance, combined with lowest distributed capacity and dielectric losses, least insulating material in the field, wires free of *any injurious substance—no celluloid or collodion binders used.* These are some of the advantages of this extremely efficient pickle bottle form of winding.

Elimination of losses keeps the high frequency resistance at the minimum, insuring increased selectivity, volume, and natural tone quality.

Eastern Pickle Bottle Coils may also be had for the following popular and leading circuits—

"EASTERN CLASSIC" circuit, the latest achievement in non-regenerative, efficient tuned R. F. reception—makes the ideal five-tube set. Hook-up free on request.

EASTERN CLASSIC COILS (Type EA, for use with .0005 condensers), set of 3.....\$6.00

EASTERN CLASSIC COILS (Type EB, for use with .00035 condensers), set of 3.....\$6.00

BROWNING-DRAKE (Type B-D) \$8.00

THREE CIRCUIT (Type 3 C) \$6.00

M. B. SLEEPER RX-1 \$6.00

DX SUPERDYNE (Type S) \$8.00

At your dealers or direct postpaid

EASTERN COIL CORPORATION

22 Warren Street

Dept. R. B.

New York

R386. FILTERS. FILTERS.
QST. Nov. 1925, pp. 31-32. Key-Thump.

Practical suggestions on where to and where not to connect a key in a transmitter to avoid key-thumps, are presented. Six possible locations for a key are shown in Fig. 7. Only one of these locations is good. The cure for key-thumps is found in a proper filter circuit. Analysis of various filters brings the author to the best possible arrangement of parts, shown diagrammatically in Fig. 5.

R350. GENERATING APPARATUS. TRANSMITTING SETS. KLUTH SYSTEM.

Radio News. Nov. 1925, pp. 60iff.
"Plastic Radio by the Kluth System," Dr. A. Gradenwitz.

A method used for producing stereophonic effects at the receiving station is described. By means of a special high inductance variometer, two circuits are so arranged that the telephone current of one is slightly out of phase with that of the other, thus producing different acoustic effects, and giving a perfect plastic impression. Circuit diagrams are shown and described.

R343. ELECTRON TUBE RECEIVING SETS. RECEIVERS.

RADIO BROADCAST. Nov. 1925, pp. 36-40.
"A Model 1926 Broadcast Receiver," M. Silver.

The receiver described by Mr. Silver has, for its fundamental requirement, wavelength flexibility. By using interchangeable coils a much larger frequency band can be covered. The matter of condenser size, regeneration, amplification, assembly, and testing, is covered in great detail. A list of parts required to construct the set is given. The receiver has three control dials, although, as explained, single control is possible by belting condensers together.

R610. EQUIPMENT; STATION DESCRIPTIONS. STATIONS.

RADIO BROADCAST. Nov. 1925, pp. 41-44.

"Radio Central-Conqueror of Time and Distance," F.J. Turner.

A graphic description of "Radio Central," the largest telegraph transmitting station in the world, is given. This station is located on Long Island, was built in 1920, and is owned by the Radio Corporation of America. It carries on transmission with all foreign countries, handling commercial messages throughout the year, twenty-four hours per day. Photographs show the immense towers and the station proper, interior and exterior.

R540. PRIVATE STATIONS. STATIONS.

Private

RADIO BROADCAST. Nov. 1925, pp. 54-56.

"What Do We Know About Short Waves?" K. Henney.

The experimental short-wave station operated by RADIO BROADCAST, call letters 2 GY, is conducting experimental work to determine the results of short waves versus distance, using different values of power input. The station desires to cooperate with other experimenters in its efforts to arrive at some conclusion regarding some of these high frequency wave problems.

R343-7. ALTERNATING CURRENT SUPPLY. A.C. RECEIVER AND AMPLIFIER.

RADIO BROADCAST. Nov. 1925, pp. 57-62.

"An A. C. Receiver and Power Amplifier," J. Millen.

The design and assembly of a four-tube receiver using a.c. power supply, is given. A new high efficiency power amplifier is developed for use in the audio stages. Care in choosing parts for this set, especially for the power amplifier, is considered important. The construction of a power unit to supply B current from a 60 cycle source is detailed, giving circuit diagram and a list of parts. Considerable valuable information concerning the use of tubes in a.c. circuits is found in this article.

R570. DISTANT CONTROL BY RADIO. AUTOMOBILE.

Radio News. Nov. 1925, pp. 592 ff. Radio-Controlled

"Radio-Controlled Automobile," H. Green.

By means of two 10-watt transmitters, an automobile was controlled up Fifth Avenue, New York City, the operator following some few hundred feet in another car. The controlling mechanism operated everything necessary in starting and running a car. Two frequencies were used, one to set the selector switch, the other to close the relays for the battery current. The wiring diagram shows the method used, photographs of the cars and the transmitters are also shown.

R545. AMATEUR RADIO. AMATEUR

REC. & TRANS.

Radio News. Nov. 1925, pp. 605ff.

"A Crack 40-80 Meter Set," E. W. Thatcher.

The construction and operation of a simple but efficient transmitter and receiver, to operate round about 7500 kc. (37-43 meters) and 3750 kc. (75-86 meters), is described. According to the diagram, one 50-watt tube is connected in the Meissner circuit for transmission purposes. Both receiver and transmitter are considered in detail for the benefit of those who have had very little experience in the construction of radio sets. A table, showing the relative merits of the various wave-bands assigned to the amateurs, is given.

R343. ELECTRON TUBE RECEIVING SETS. RECEIVER.

Radio News. Nov. 1925, pp. 610-611. Two-Range.

"A New Two-Range Receiver," S. Harris.

A receiver is described, using tapped inductances, capable of covering a range from 500 to 2000 kc. (600 to 150 meters). A single lever changes the inductances of each coil through a switch arrangement. This is a five tube set; two radio-frequency amplifiers, detector, and two audio frequency stages. Three tuning controls are required. Photographs are shown, giving constructional details.

R375 DETECTORS AND RECTIFIERS. RECTIFIER.

Radio News. Nov. 1925, pp. 613ff. Raytheon.

"The Raytheon Rectifier," J. Riley.

The theory and characteristics of a new rectifier tube used in B battery eliminators is presented. Helium gas is used in this rectifier. It differs from other rectifier tubes mainly in the means taken to reduce the effective anode area, and in the selection of design for insuring steadiness of action. Two anodes are contained in the tube, the circuit diagram showing how this rectifier is connected to rectify both halves of the wave.

This is a good time to subscribe for

RADIO BROADCAST

Through your dealer or direct, by the year only \$4.00

DOUBLEDAY, PAGE & CO. GARDEN CITY, NEW YORK

RADIO AGENTS WANTED

You Can Now Earn a 5 Tube Demonstrator FREE!



In addition to \$25 to \$100 a week, part or full time. Everyone a prospect. Complete line standard sets and accessories, \$5 to \$90. Write today for illustrated catalog and exclusive selling plan for live dealers and community agents. 20TH CENTURY RADIO CO., 1045 Coca Cola Bldg., Kansas City, Mo.

If Your Set Won't Percolate

write us about it. RADIO BROADCAST is establishing a special repair department to assist set builders in getting the best out of the receivers they build from plans published in the magazine. Write for complete information about this new department established for your benefit.

★ Tested and approved by RADIO BROADCAST ★



To-day-in every good set

**Less wiring—
Fewer losses**

Full, clear, rich tone depends on more than on just good apparatus. It depends, first of all, upon careful, compact wiring. AMPERITE eliminates complicated wiring, avoiding leaks and losses. Requires no attention. Controls the filament perfectly, bringing the utmost out of each individual tube. Permits use of any tubes or combination of tubes. Used in all popular construction sets. Price, \$1.10.

There is an AMPERITE for every tube

Write for free hook-ups ★

Radiall Company

Dept. R.B-2 50 Franklin St., N. Y. City

AMPERITE
REG. U.S. PAT. OFF.

The "SELF-ADJUSTING" Rheostat

RADIO PANELS

OF GENUINE BAKELITE

Cut, drilled and engraved to order. Send rough sketch for estimate. Our New Catalog on Panels, Tubes and Rods—all of genuine Bakelite—mailed on request.

STARRETT MFG. CO. ★

521 S. Green Street Chicago, Ill.

RADIO BROADCAST

For March

will be a better magazine than this. Make sure of it by telling your newsdealer to hold one for you—or better still, subscribe through him or direct.

RADIO BROADCAST

Garden City New York

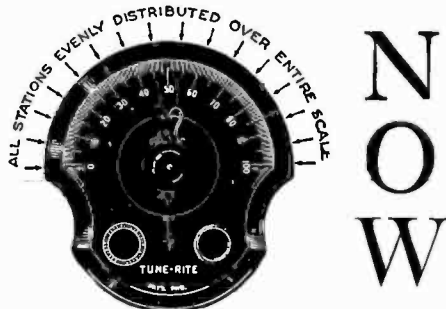

**Complete Separation of
Low Wave Stations**

Perfectly accomplished with Tune-Rite, the straight line frequency dial. A marvel in scientific construction, it instantly converts any set to straight line frequency. Bring your present set up-to-date by replacing your old dials with Tune-Rite. Beautiful in appearance. Easily mounted without drilling.

Price, \$3.50

Write for instructions ★

Radiall Company

Dept. T.R.B.-1, 50 Franklin St., N. Y.

TUNE-RITE

The Straight Line Frequency Dial

Made by the makers of Amperite, the Self-Adjusting Rheostat



"Now We Can Enjoy Radio"

"WE NEVER knew what joy and entertainment radio could bring into the home until we bought our Mu-Rad. Now, with a slight movement of the Single Dial we can tune in any station that is broadcasting, so clear that it seems the music and artists are right here in our home. It is a comfort to me during the day and a relaxation to you after a busy day at the office."

The **MU-RAD**
Transcontinental Receiver

can bring joy and entertainment into YOUR home. Ask your nearest dealer for a demonstration of this wonderful Radio—in your home.



Write for Booklet E-6

MU-RAD RADIO CORPORATION

Asbury Park, N. J.

This is a good time to subscribe for

RADIO BROADCAST

Through your dealer or direct, by the year only \$4.00

Doubleday, Page & Company

Garden City, New York

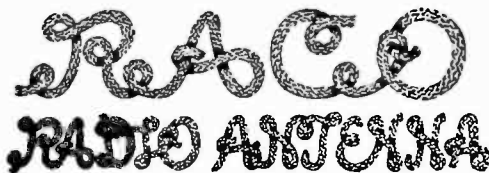

RADIO WIRES

We manufacture all types.

- Round braided antenna wires
- Flat braided antenna wires
- Round stranded antenna wires

- Above types in copper—tinned copper—enameled copper—tinned bronze.
- Loop wires in silk or cotton covered.
- Litz wires.
- Enameled wires.
- Antenna supporting springs.
- Cotton and silk covered wires for set wiring.

Write us for descriptive catalogue. ★

ROSS WIRE COMPANY

69 Bath St., Providence, R. I.



-it's in the Tube

A receiving set is no better than its tubes.

With other parts and connections *right* a set may be as good as its tubes—no set can be better.

That's why you want CECO Tubes. They stand up and deliver. With them your set works at its maximum. Clarity of tone, rich volume, long life—CECO has them all to a superlative degree.

Our charted tests (results confirmed by laboratories of national reputation) PROVE CECO TUBE SUPERIORITY—whether used as detectors, audio or radio frequency amplifiers.

CECO Tubes make a Good Receiver BETTER. Try them and you'll BUY them always—for results.

Now Ready! CECO Tubes with new type Long PRONG BASES. Also, Power Amplifier Tubes, E (Dry Cell Type), F (Storage Battery), for last stage of Audio Frequency.

Dealers write giving jobber's name.

C. E. Mfg. Co., Inc.

702 Eddy Street, Providence, R. I.

CECO TUBES

Why not subscribe to *Radio Broadcast*? By the year only \$4.00; or two years, \$6.00, saving \$2.40. Send direct to Doubleday, Page & Company, Garden City, New York.



If Your Set Won't Percolate

write us about it. RADIO BROADCAST is establishing a special repair department to assist set builders in getting the best out of the receivers they build from plans published in the magazine. Write for complete information about this new department established for your benefit.

R343. ELECTRON TUBE RECEIVING SETS. RECEIVERS. RADIO BROADCAST. Nov. 1925, pp. 28-31. "The RADIO BROADCAST 'Aristocrat,'" A. H. Lynch. The author describes in detail the construction and operation of a five-tube receiver having one stage of radio frequency amplification, regenerative detection, and three stages of resistance coupling. The circuit diagram, with list of parts, is reviewed to cover many kinds of radio parts now available. According to the author care should be exercised in mounting resistances for amplifier to prevent leakages. Photographs of several five-tube receivers, including the RADIO BROADCAST "Aristocrat," are shown.

R620.065. REGULATION AND CONTROL. CRYSTAL CONTROL. QST. Nov. 1925, pp. 8-13. "Crystal Control for Amateur Transmitters," John M. Clayton.

Rochelle crystals, when placed between two charged metal plates, change in shape. The fact, however, that they absorb moisture readily makes their use impracticable for the purpose here designated. Quartz crystal are far more satisfactory. Because of their electrical properties, crystals will oscillate when placed between two metal plates which are charged. A discussion concerning the axes of crystals and method of cutting and grinding them, follows. Ready cut crystals may be purchased from optical companies. Their use in practical circuits, precautions to observe, and results that can be obtained, are outlined in detail.

R350. GENERATING APPARATUS; TRANSMITTER. TRANSMITTING SETS. QST. Nov. 1925, pp. 26-30. "The Pacific Coast Standard-Frequency Station," H. H. Henline.

A complete description of the two standard-frequency stations located at Stanford University, California, 6XBM, is given. A circuit diagram of the 125-1500 kc. set, with a detailed list of parts and construction data of coils, etc., make possible the duplication of such a transmitter by experimenters. The 1500-6000 kc. set is simpler in construction, as indicated in the accompanying figure. A list of parts is also given.

R800. (533.85) VACUUM APPARATUS. TUBES. Radio News. Nov. 1925, pp. 604 ff. Gas Filled.

"Hot Cathode Metal Vapor Tubes," Dr. C. B. Bazzoni. It is desired to obtain a detector tube with a sensitivity so high that regeneration, with its complications, will not be necessary. For this purpose, tubes employing ionization are considered as being much better than pure electron discharge tubes. The use of metal vapors is therefore tried and found superior to gas vapors for this purpose. The author describes how tubes are filled, and what results one can expect when connecting such a vapor filled tube into a receiving circuit.

R800 (534) SOUND RECORDING. SOUND PHOTOGRAPHS

Radio News. Nov. 1925, pp. 614 ff. "Sound Photographs and Their Reproduction," T. H. Nakken.

A method of recording and reproducing sound waves on a film, by means of a special tube called the Gehrke tube, is described. Two types of records may be made, one called by the writer the qualitative (step-ladder) type, the other the quantitative (saw-tooth) type. The latter is considered to be the better from several standpoints. Different types of microphones used to convert sound waves to electric energy are also mentioned in the discussion. A circuit diagram of a special amplifier for the weak currents is shown and explained.

R343. ELECTRON TUBE RECEIVING SETS. RECEIVER. Radio News. Nov. 1925, pp. 616-617. Counterphase.

"The Counterphase Circuit," J. T. Carlton. The much discussed "Counterphase" circuit, having three stages of radio frequency amplification but only two controls, has many advantages over ordinary radio frequency sets, says the writer. First, the causes of oscillation in sets is taken up, then the principle embodied in this circuit is explained. Of particular interest seems to be the fact that no kind of losses are introduced in the grid circuit, which remains at a low resistance. Circuit diagrams and photographs are shown.

R342.7. AUDIO-FREQUENCY AMPLIFIERS. AMPLIFIERS. Radio News. Nov. 1925, pp. 620-623. Audio-Frequency

"The Four Types of Audio Amplifiers," S. Harris. In receiving sets of today four types of audio amplifiers are in common use, namely transformer, impedance, resistance, and push-pull. Diagrams of these four types, with detailed discussion concerning use, characteristics, and advantages, are given. A breadboard layout of each type is also shown. Comparison by the author shows some interesting results concerning the particular type of amplification method to be used, especially in the many kinds of receiving sets now being constructed. Each amplifier arrangement has its specific advantages.

First International Meeting of Radio Engineers

FOR the first time in the history of radio, the scientists and engineers who made radio telegraphy and radio broadcasting a reality will convene in an International Meeting and Convention in New York City, January 18th and 19th. Notices have been sent by the Institute of Radio Engineers, under whose auspices the meetings are being held, to its members both here and abroad. Included in its membership roll are such illustrious names as Guglielmo Marconi, Edwin H. Armstrong, Louis A. Hazeltine, E. F. W. Alexanderson, George O. Squier, Lee de Forest, Thomas A. Edison, Michael Pupin, Irving Langmuir, Reginald Fessenden, John Stone, David Sarnoff, and John V. L. Hogan.

★ Tested and approved by RADIO BROADCAST ★

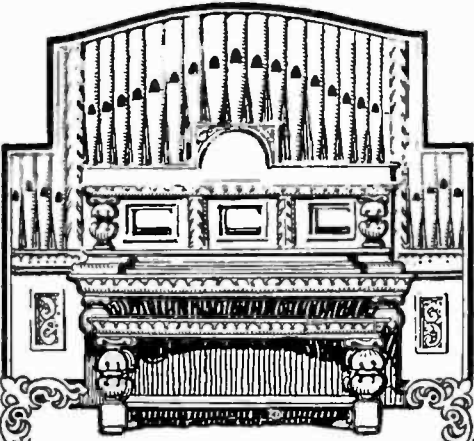

**“Even the organ
crescendo
was perfect”**

A VETERAN set-builder recently remarked about the purity of tone at tremendous volumes that he got through the Super-size Precise No. 480 Audio Transformer. In particular was he impressed with a recent organ recital which he had received. “Why,” he said, “even the organ crescendo was perfect.”

The big Precise No. 480 (shown below) is truly a master transformer, designed for radio reception in a concert hall if necessary. It brings forth the deep rich tones or the high clear tones with magnificent volume. The ratio of voltage amplification to frequency is practically a straight line, assuring uniform amplification over the entire range of useful audio frequencies.

Made in two ratios, 2½ to 1 and 5 to 1.

Price, \$7.50 either ratio.

Ask your nearest radio dealer to show you the complete Precise Line.

PRECISE MANUFACTURING CORPORATION

Rochester, N. Y.

Branch Offices:

126 Liberty Street New York City	1127 Pine Street St. Louis, Mo.
205 W. Harrison Street Chicago, Illinois	701 A. O. U. W. Bldg. Little Rock, Ark.
821 Market Street San Francisco, Cal.	454 Builder's Exch. Minneapolis, Minn.

Canadian Distributors:
Perkins Electric, Ltd.
Toronto, Winnipeg, Montreal

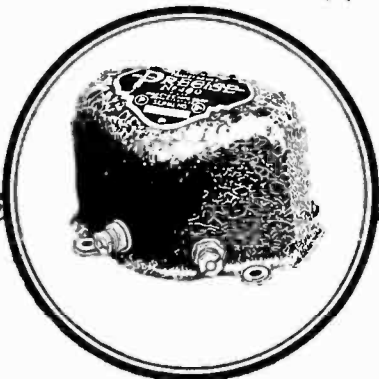

Improved S. L. F. Condenser \$2.75

A scientific instrument house of international reputation offers for the first time direct to the radio fan an improved S.L.F. Variable Air Dielectric Condenser.

Due to over production on orders from prominent set manufacturers whom we have been supplying for years!

Type offered has a maximum capacity of 315 M. M. F. with a minimum of 8 M. M. F. especially adapted to Neutrodyne, Tuned Radio Frequency, and Radio Broadcast Hook-Ups for home construction.

Made of the best materials obtainable, of highest grade aluminum and brass; workmanship that of precision instrument maker!

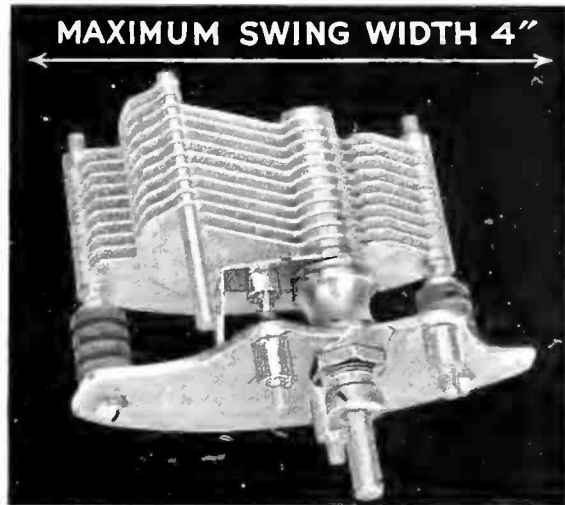

Ordinary “Straight line frequency” calibration gives too rapid a capacity variation near maximum capacity to permit convenient tuning for the longer wave lengths. Radio Engineers will appreciate the nicely balanced compromise we have obtained in equal spacing broadcasting stations and equal facilities of tuning over the entire frequency band. Compact; no narrow pointed rotor plates of small area to crowd the other parts of the set, but eccentric semi-circular plates of adequate area.

The low minimum capacity (7 to 8 micro-microfarads) reaching down to 200 meters, necessary for new Department of Commerce allocations.

Losses are negligible.

The bearings are individually reamed to fit, with no side or end play and are mechanically correct with dissimilar metals on all rubbing surfaces.

Good electrical bonding between plates, due to our highly developed crimping process. Good centering of plates, resulting from high standards in assembly and adjustment and rigid inspection and test.

General sturdiness of construction and cleanness of workmanship.

Due to our large production for set manufacturers, we are enabled to offer extremely reasonable prices on these high grade condensers.

Sold only on a cash with order basis, money returned if you are not more than satisfied that they are exactly what you want and none equalled electrically or mechanically.

Price \$2.75 each. Set of three, \$8.00

Sent by paid parcel post anywhere in U. S. A.

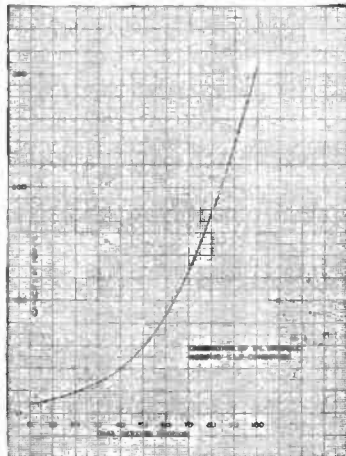

THOMPSON-LEVERING COMPANY

RADIO DIVISION



353-357
North 57th Street

Philadelphia, Pa.,
U. S. A.

Trade Mark Registered

At Last! A Real Panel Engraving Machine at a Price you can afford.

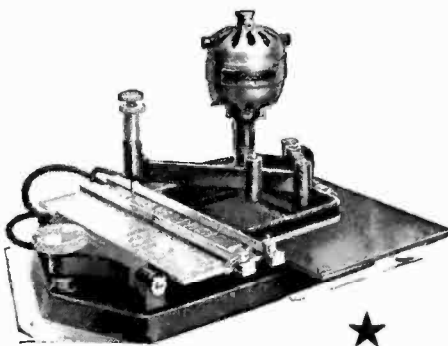

Capacity 14 x 40"

LOW in price because it is designed for panel engraving only.

For engraving your own Panels, or panels for others with any marking desired, including Trade-marks, special designs and serial numbers.

Being designed particularly for panel engraving, it is the most rapid and accurate machine for engraving panels. Simple to operate.

Price of machine with full equipment including master letters and characters, \$135.00.

f. o. b., Forestdale, R. I.

Wire or write

BRANCH TOOL CO., Dept. G
Forestdale, Rhode Island

Centralab Radiohm

for oscillation control

The Centralab Radiohm gives you perfect oscillation control—enables you to get full efficiency from your radio set.

By controlling oscillation with this little unit, you can hold that sensitive regenerative position which immediately precedes the oscillation point, without distortion or loss of selectivity. Think what a boon to clear, true-tone reception this is!

The Radiohm provides smooth variation of resistance from zero to 200,000 ohms. Ideal for plate circuit control of oscillation. Used as a standard unit in many leading commercial sets. Price: \$2.00.

Centralab Modulator

for volume control

This improved type of potentiometer takes the "rough spots" out of volume—smooths out powerful "locals" as well as difficult "DX." It provides noiseless control of tone volume without in any way affecting the tuning of your set. Has a maximum resistance of 500,000 ohms, specially tapered to give smooth, even control from a whisper to full volume—or vice versa—without de-tuning.

Used in the "Silver Six" set! also in audio circuits with any transformers or with Thordarson "Autoformers." Price: \$2.00.

CENTRAL RADIO LABORATORIES
22 Keefe Avenue Milwaukee, Wis.

Mail the coupon



BOOK REVIEW

The Economic Background of Radio

ECONOMICS OF THE RADIO INDUSTRY.
By Hiram L. Jome, Ph. D. Published by A.W. Shaw Company, New York, Chicago, and London. 332 pages. \$5.

THIS work by the Professor of Economics at Denison University is said by the publishers to be the pioneer book on the subject. It is a good beginning, and marks a transition from the state of affairs which was epitomized, about six years ago, by a prominent electrical manufacturing executive called on to manufacture radio telegraph equipment. "Radio isn't a business!" cried this gentleman in a moment of confessional anguish, "It's a disease!" What is more, at the time he said this he was right, as he was also when he declared vacuum tube manufacture to be "a nice toy for the lamp works." But times change. In 1924 the tube business alone, according to Mr. Babson, amounted to about \$50,000,000, which is a good-sized toy for anyone. In fact, it was able to swallow a few dozen lamp works as an entrée.

Economics of the Radio Industry is written in four parts, with an appendix. Part I, concerned with "Development and Extent of the Radio Service," is largely a technical and financial history of the whole wireless art, both telegraphy and telephony, from the days when the coherer was a great and indispensable invention, down to this era of super-heterodyne and balanced radio frequency receivers calibrated in kilocycles, receiving antennas nine miles long, transmitters which put one thousand-plus amperes into antenna systems which in themselves constitute engineering feats, and radio technicians who are engineers, telephone experts, publicists, musicians, and diplomats, all in one. The four chapter headings in this part of the book give some idea of the range covered: "Beginnings of Wireless"; "Early Organization for Service"; "The Radio Corporation of America"; "The Radio Industry of To-Day."

Part II, under the somewhat vague heading of "Bringing Radio Service to the People," is principally a discussion of marketing, retailing, and financing problems in receiving set manufacture, but at the end there is a chapter on "Handling of Traffic," which includes an elementary discussion of oscillation and vacuum tube theory, preliminary to an analysis of traffic conditions in long distance radio telegraphy.

In Part III, "Problems of Efficiency in Radio Service," the growing pains of broadcasting, copyright and patents as property problems in the radio field, and the extent to which sound public policy requires federal and international control of the various services, receive about seventy-five pages of discussion. This is followed by Part IV, "The Future of Radio," in which the author cautiously ventures into the domain of prophecy, having in mind the rash remark (which he quotes) of Mr. Marconi's youth: "As soon as my wireless system succeeds, the vast network of cables and wires will become useless, and the money invested in the old system will be simply thrown away," a forecast which has turned out to be so incorrect that it should evermore serve as a warning to even the greatest inventors, sales "engineers", and promoters. The wireless system has succeeded, and there are more wires and cables than ever. But Dr. Jome plays safe, and in gazing into

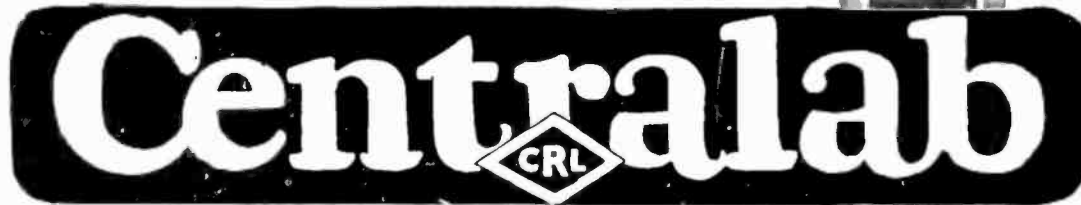

CENTRAL RADIO LABORATORIES 22 Keefe Ave., Milwaukee, Wis.
() Send me literature describing Centralab controls. Enclosed find \$..... for which please send me the following:
() Centralab Modulator, at \$2.00 each. () Centralab Radiohm, at \$2.00 each.

Name
Address

This is a good time to subscribe for
RADIO BROADCAST
Through your dealer or direct, by the year only \$4.00
DOUBLEDAY, PAGE & CO. GARDEN CITY, NEW YORK

RADIO CATALOG
DEALERS!
Send for our big new live Catalog. Contains hundreds of standard nationally advertised sets, kits and parts.
Use your letterhead
Western Radio Co.
134-136 W. Lake St. Chicago, Ill.

400 CENTS RESISTANCE

is the subscription price to Radio Broadcast for one year. This is less than the cost of a good low loss variable condenser. Let us enter your subscription to begin with the next issue.

Send \$4.00 with your name and address to Radio Broadcast, Garden City, N. Y.

★ Tested and approved by RADIO BROADCAST ★

REMEMBER!

WHEN BUILDING THE ROBERTS' KNOCK-OUT AND ARISTOCRAT

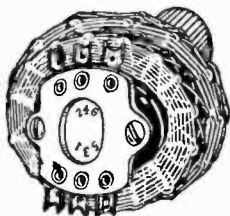

Receivers that CLAROTUNERS are easier to mount, easier to hook-up, and that a more even approach to the point of MAXIMUM AMPLIFICATION is effected with CLAROTUNERS.

DO YOU KNOW

that CLAROSTAT is the perfect variable resistor and that it is the only logical resistor for the UNIVERSAL receiver?

Send Stamp for Hook-ups



American Mechanical Labs., Inc. ★

285 North Sixth Street
Brooklyn, New York

Antiques

interiors, houses, gardens, travel, sports, horses, dogs, blooded cattle—

all these are in

Country Life

A Doubleday, Page Magazine
Limited Supply at Newsstands

Superadio Receiver

5
Tubes
—
2
Dials

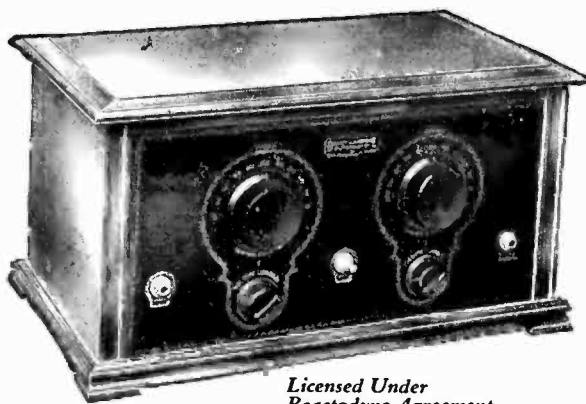

Licensed Under
Reactodyne Agreement

Many
New
Fea-
tures
—
\$56

MATCHLESS tone quality is obtained in the Superadio Receiver due to the Reactodyne System of R. F. Amplification by which automatic control of oscillation is effected over the broadcast range. As the result of exhaustive development work, each tube performs the maximum amount of work assuring greater volume and greater distance. Housed in a handsome, compact, solid walnut cabinet with black bakelite panel, engraving in deep gold. Very easy to operate. Economical upkeep. Truly marvelous results.

Ask your dealer or write us

Superadio Dynamometer



Superadio Dynamometer equipped with phones and plug. Price \$120. (Patents Pending)

Remember—you can now buy TESTED tubes—where the Superadio Dynamometer is on the job. This meter is direct reading. Measures Amplification Factor, Plate Impedance and Mutual Conductance of any tube. No Curves—No Calculations.

Jobbers and dealers

The Superadio is direct reading and tests 3 tubes per minute. Write for discounts.

SPECIAL MODEL S-2 AMPLIFIER \$30

To be used with Dynamometer and loud speaker in place of phones

Just out—The new Superadio B-Battery Eliminator.

De WITT-La FRANCE CO., Inc. ★

54 Washburn Ave., Cambridge, Massachusetts

Boston Representative:
Martin, Hartley & Dewitt Sales Co., 99 Bedford St.

Chicago Representative:
William A. Welty & Co., 36 So. State St.

LEARN THE CODE AT HOME with the OMNIGRAPH

"Just Listen—The Omnigraph will do the teaching!"

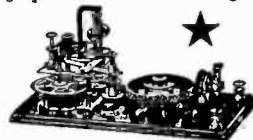

THE OMNIGRAPH Automatic Transmitter will teach you both the Wireless and Morse Codes—right in your own home—quickly, easily and inexpensively. Connected with Buzzer, Buzzer and Phone or to Sounder, it will send you unlimited messages at any speed, from 5 to 50 words a minute.

THE OMNIGRAPH is not an experiment. For more than 15 years, it has been sold all over the world with a money back guarantee. The OMNIGRAPH is used by several Depts. of the U. S. Govt.—in fact, the Dept. of Commerce uses the OMNIGRAPH to test all applicants applying for a Radio license. The OMNIGRAPH has been successfully adopted by the leading Universities, Colleges and Radio Schools.

Send for FREE Catalogue describing three models. DO IT TO-DAY.

THE OMNIGRAPH MFG. CO., 13K Hudson St., New York City

If you own a Radio Phone set and don't know the code—you are missing most of the fun

Order your copy of *Radio Broadcast* from your news dealer or radio store. Make sure that he reserves a copy for you each month. If your favorite radio store does not stock the magazine write us giving name of radio dealer and address.

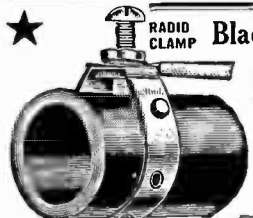

Blackburn Ground Clamps

Telephone companies using MILLIONS. Adjustable—fits any size pipe. Requires no pipe cleaning—screw bores through rust and scale. Send 12 cents for sample and postage.

Blackburn Specialty Company
1960 E. 66th St., Cleveland, O.

Gosilco Super Aerials

Heavy burnished silver plate on 14 copper sheathed with 24 karat gold. Permanently efficient. O t-distance all others. Sets re-wired with Gosilco show 35% increase volume, range. K N X lab. test. Approved Popular Radio, Radio News All American Radio Corp. 4½¢ per ft., round bus wire 12¢ per length, postpaid. C. O. D.

American Luminous Products Co. ★

Patent Applied for
Huntington Park California

The AIRGAP SOCKET THE BEST TEST

Listen in on your detector, replace old socket with an AIRGAP SOCKET. Note the wonderful improvement. You will then use no other.

Sent direct if your dealer cannot supply you. 75 cents each. ★

AIRGAP PRODUCTS CO. MFR.
188 N. J. R. Ave. Newark, N. J.
"Yes, It's Bakelite"

You must protect the circuit against leaks and losses

RADION

The Supreme Insulation
does it!

RADION offers the *utmost possible protection* against leaks and losses. Designed exclusively for radio purposes, it is the most efficient insulation as indicated by authoritative, impartial tests. Radion Panels reduce surface leakage to a minimum. Their beautiful surface finish adds to the attractiveness of any set. Radion Dials match their beauty of fin-

ish and help to get close tuning. Radion Sockets eliminate capacity effects; they are made both for new UX tubes exclusively and with collar adapters for old-type tubes.

Radion dealers have the complete line of Radion low-loss parts. Manufacturers will find it to their interest to write us for prices on moulded parts. Send for catalog.

FREE Booklet, "Building Your Own Set" mailed on request

AMERICAN HARD RUBBER COMPANY

Dept. C 14, 11 Mercer Street, New York City. Chicago Office: Conway Building
Pacific Coast Agent: — Goodyear Rubber Company, San Francisco—Portland

the future he does not relinquish the sober and unpyrotechnical style with which he writes of the past. As to the future of broadcasting, he apparently favors a modification of the British system, combining the order and symmetry of the latter with some of the advantages of the American *laissez-faire* structure, which admittedly begins to lean at an alarming angle.

In preparation for writing this book Dr. Jome has very obviously talked to a great many people and consulted a raft of documents and authorities. There is scarcely a page without one or more footnote references. The author has done a thorough job at an opportune time, and his book deserves wide reading among people to whom radio is more than a song and dance. Leaving aside the advent of broadcasting, which brought up the gross sales of the Radio Corporation of America, for example, from \$1,468,920, or 35 per cent. of the total business, in 1921, to \$50,747, 202, or 92.5 per cent of the whole, in 1924, practically swamping, as far as magnitude goes, the communication activities of the company—even omitting consideration of this shift, the changes have been remarkable. In transoceanic communication, not much over ten years ago the practice was to build a line of 400-foot masts for reception—vacuum-tube amplifiers were not yet taken seriously—and large stone hotels were erected for the occupancy of operating staffs of sixty men or so off on the seashore somewhere. These men copied the messages and re-transmitted them over wire lines to the metropolis, adding another link to the chain with that much more chance of errors creeping in. A few years later this whole system was changed. None of the engineers of 1914—and they were good engineers—were able to foresee this development. In a business which turns such somersaults, there is certainly room for an economic treatise like that which Professor Jome has given us.

A few errors and omissions may be pointed out. On page 86 we encounter the statement that "Consumers now looked for apparatus which would enable them to tune-out a larger number of stations, thus eliminating interference and eliminating static." Doctor Carson has proved that sharp tuning will not eliminate or reduce static in any way, shape, or manner. The footnote on page 166, discussing the question of the pioneer broadcasting station, does not mention the later work of De Forest (in 1916) at High-bridge, New York. On page 167, Doctor Jome trustingly states it as his opinion that a large number of broadcasters "have begun the broadcasting game for no ulterior motive at all." So they say. Possibly Munchausen wasn't a liar either. Page 170: "The act of reception itself does not weaken radio signals, just as the human voice, carried by means of sound waves, can be heard by all within range without loss of strength." This is not true in the case of a number of receiving antennas close to each other and tuned to the same signal, and there is reason to believe that the field strength of a transmitter may be pulled down somewhat in urban reception by a great number of outdoor antennas tuned to it. On page 203, discussing the motives of Heinrich Hertz, the author of *Economics of the Radio Industry* fails to mention the most probable reason why Hertz omitted to take out a patent, to wit: that he wasn't interested in making money. And some of the aviators may be amused at the statement on page 235 about what damage an aviator flying far up above New York could do. If he went that high he would probably have all he could do to take care of himself. The high estimate of beam transmission (Page 269) is possibly somewhat too sweeping. And Professor R. A. Fessenden's name is not found in the index. Such little points can be corrected in later editions.

RADIO STUDY AT HOME
EXPERT
Radio, the wonder of all ages, has grown with gigantic strides. Radio experts are needed to keep pace with the growth. Thousands of good-paying positions are open to trained men. Be a radio expert—earn big money—travel—get into the limelight. There's romance, power and fortune ahead for men with vision now just as there was when Henry Ford got started on his auto. The ground-floor opportunity is here.
YOU EARN WHILE YOU LEARN
Our home-study course in practical radio can be mastered by you in 3 months. Become a radio engineer. Write for free booklet. "Millions Untouched."
FREE TWIN if you enroll now. Send letter or postal to **RADIO SET**, 1 1/2 Months—learn how to make \$100 wk.
AMERICAN RADIO ENGINEERS
Dept. 16 Hearst Bldg., Chicago, U. S. A.

NO MORE LOOSE CONNECTIONS
X-L PUSH POST
A Binding Post that really does excel, looks, action, service and convenience. Push it down—insert wire—cannot jar loose from vibration. No screwing or danger of shearing off wires. Furnished attractively plated with soldering lug and necessary markings.
★ **Price Each, 15 Cents**
X-L RADIO LABORATORIES
2424 Lincoln Ave. CHICAGO

RADIO FANS, a one-year's subscription to Radio Broadcast will cost you four dollars, two years six dollars. Consider this expenditure as being a necessary investment on your part for the future development of your own knowledge of Radio.

FOR CLEAR, QUIET "B" POWER

RADIO Storage "B" Battery
12 Cells 24 Volts Lasts Indefinitely—Pays for Itself
Economy and performance unheard of before. Recharged at a negligible cost. Delivers unfailing power that is clear, pure and quiet. Approved and listed as Standard by leading Radio Authorities, including Pop. Radio Laboratories, Pop. Sci. Inst. Standards, Radio News Lab. Leafax, Inc., and other important institutions. Equipped with Solid Rubber Case, an insurance against acid and leakage. Extra heavy "in-a-jars." Heavy rugged plates. Order yours today!
SEND NO MONEY Just state number of batteries wanted and we will ship day order is received. Extra offer: 4 batteries in series (96 volts), \$10.90. Pay exp. salesman after examining batteries. 5 per cent discount for cash with order. Mail your order now!
WORLD BATTERY COMPANY
1219 So. Wabash Ave., Dept. 24 Chicago, Ill.
Makers of the Famous World Radio "A" Storage Battery
Prices: 6-volt, 100 Amp. \$11.25; 120 Amp. \$13.25; 140 Amp. \$14.00.
All equipped with Solid Rubber Case.
World STORAGE BATTERIES
Set your Radio Dials at 210 meters for the new 1000 watt World Storage Battery Station, WSBG, Chicago. Watch for announcements.
KDKA—WEAF—WGN—WJS—KHJ—RGO—KFA—WJY—KOB

DURHAM ★
Variable Leaks
And Tube Makers Data
Standard Type 75c
Instruction sheets say that you should try different values. With a DURHAM this is done with a smooth running plunger. Fits your present clips.
New Panel Mount
Short lead to grid \$1 Note patent plunger
Durham convenience and accuracy brought to your fingertips. This type makes shortest path from socket to condenser or coil. Fits in 1/4" hole.
There's a DURHAM for every need
No. 100—1,000 to 100,000 ohms (audio)
No. 101—0.1 to 5 megohms (for UV-200 and W-12 tubes)
No. 201A—2 to 10 megohms (for UV-199 or 201A tubes)
DURHAM & CO., Inc.
1936 Market St., Philadelphia

★ Tested and approved by RADIO BROADCAST ★

New Roberts' "Supercoils" using Capacity Feed Back



Higher Amplification with Zero Coupling for "The Aristocrat" and "Universal"

Per Set Complete **\$7.00**
P. P. C. O. D. if desired

Mail postcard for details

PERFECTION RADIO MFG. CO.
24th & Race Streets Philadelphia, Pa.

A Laboratory Product

CRESCENT LAMITE RESISTANCES

for Distortionless Amplification

As transmitting Grid leaks, they are made in special sizes and are not afraid of power. Dissipate 10 watts. Four standard sizes \$1.50 each. Special resistances \$2.50 each.

Crescent Radio Supply Co. 1-3 Liberty St., Jamaica, N. Y.

RUDYARD KIPLING



Who is able to reach you, talk to you in your own language, portray your own emotion, convulse you with laughter or hold you spellbound before pathos or power . . . like Kipling? Buy his books.

AT ALL BOOKSTORES

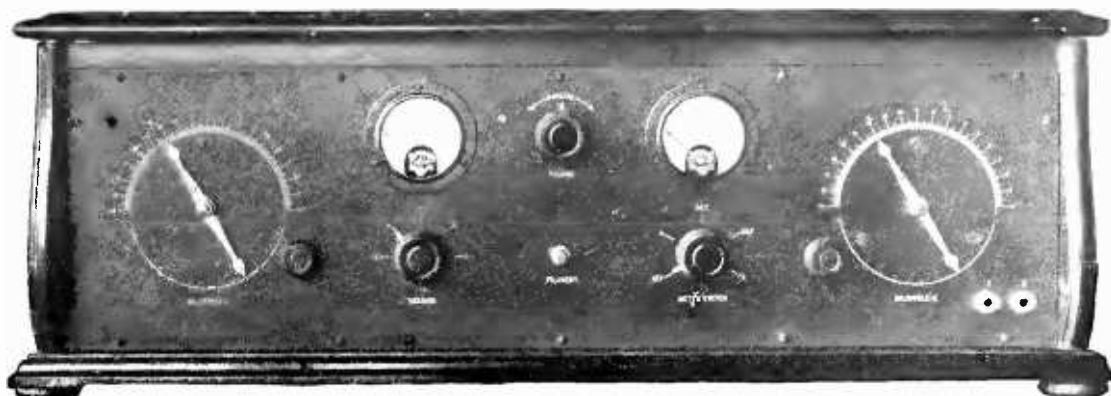

The Best in the World

No Batteries

are required even to operate the most powerful 10-tube receiver pictured above, if you use the new laboratory type

Model A Power Unit

One Customer Telegraphs:

"Receiver assembled, performing like a thorobred."

The Amateur or Experimenter with his ultra-modern high-powered receiver is years ahead of Commercial Radio.

It is significant that unsolicited testimonials are constantly being received from even the far corners of the earth, where Norden-Hauck Engineers have furnished the finest radio apparatus known to the art today.

Quotations gladly furnished on radio parts and apparatus having non-infringing uses.

Write for Literature

NORDEN-HAUCK, Inc.
Engineers

1617 Chestnut Street, Philadelphia, Pa.

Why not subscribe to *Radio Broadcast*? By the year only \$4.00; or two years, \$6.00, saving \$2.40. Send direct to Doubleday, Page & Company, Garden City, New York.



Radio Battery Chargers

Best by Test

\$8.50 minus bulb

east of Rockies

Your dealer can get it for you

THE ACME ELECTRIC & MFG. CO.
1410 Hamilton Avenue Cleveland, O.

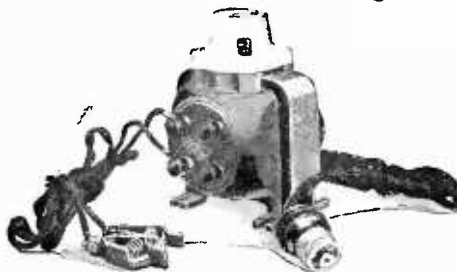

★ Tested and approved by RADIO BROADCAST ★

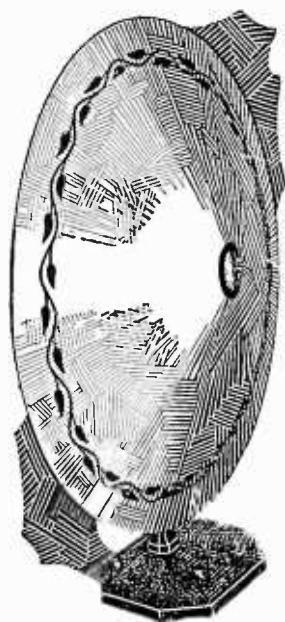

Make Your Own Cone Loud Speaker —and Save \$25⁰⁰

(All Parts Supplied)

Why pay \$35 for a cone loud speaker when you can easily assemble a splendid super-sensitive one at home with the complete parts we send you—and save \$25?

We include a special complete cone unit, blueprint and simplified directions for assembling. You can easily set up this wonderful speaker in a few interesting hours. Large size, stands eighteen inches high, complete in every detail. Not only unmatched for beauty but reproduces both music and voice with faultless accuracy. Yet the cost is amazingly low—only \$10 for the most approved form of speaker known. You make this big saving because we save the cost of assembling and packing and you save all jobbers' and dealers' profits.

SEND NO MONEY

Simply send name and address and the complete outfit will be sent you by return mail. When postman brings package, deposit with him only \$10.00 in full payment. If you aren't more than delighted—if you are not absolutely convinced that you have a cone speaker equally as fine as any \$35 cone sold—simply return the parts within ten days and your money will be instantly refunded. Never before has a better radio bargain been offered. You would pay at least \$35 for a cone speaker of equal quality anywhere. Act at once. Write NOW!

SCIENTIFIC RADIO LABORATORIES 254 West 34th Street, Dep't 22
New York City

WHAT OUR READERS WRITE

Chain Broadcasting an Economy

DUE to the fact that we go to press a number of weeks before publication and to heavy demands upon our space, we have not been able to print this interesting letter which came to our desk some time before the last Washington Radio Conference. Those would-be broadcasters whose hopes were cast to the ground by the statement that very few more stations would be licensed, should consider the possibilities of the use of the chain system as an alternative to erecting their own stations. The following letter is representative of several we have received on this subject.

Editor, RADIO BROADCAST
Doubleday, Page & Company,
Garden City, New York.

SIR:
Permit me to call to your attention a field which your magazine might cover with advantage to the radio public. It is a campaign to educate the prospective broadcasting station builder into a realization of the fact that his yearnings for fame and publicity may be attained by means other than supplying the radio audiences with a quantity of programs such as are now available to all.

We have been discussing the question of who pays for broadcasting. That, of course, is easily answered, as easily as the question of who pays for the full pages of advertising in the *Saturday Evening Post* and our daily newspapers. Does broadcasting pay well? That question also is easily answered, for take note of the fact that we are to have about forty new Class B stations and that many of the older Class B stations are scrambling to double and triple their present power output.

Now the thing that puzzles me is why we, the radio listeners, need these 40 new stations when the air is so congested now that one can generally hear two programs on one wave channel to the accompaniment of a beautiful heterodyne whistle. To which wave channels will these new stations be assigned without increasing this annoying interference?

My suggestion is this. Educate the prospective broadcasting station builder into spending his money on good programs put on the air once or twice a week through a chain of stations such as are now connected with the American Telephone & Telegraph system. The simultaneous broadcasting from several stations of exceptionally fine programs is far better advertising and creates more good will than the continuous broadcasting of mediocre or poor programs such as we now have from many stations. More people would be reached and at the same time the cost of such fine programs, although expensive, would not equal the cost of equipping and maintaining a broadcasting station.

I firmly believe in interlinking broadcasting stations for indirect advertising by means of superfine programs of education and music. Such a system will force the other stations to produce equally fine programs or lose the good will of the radio public. Two very fine examples of indirect advertising by the system of chain broadcasting are the programs of the National Carbon Company and the Victor Talking Machine Company. Let us have more programs like these with fewer Class B stations using more power.

Yours very truly,
F. L. W.,
Philadelphia, Pennsylvania.

**ALMOST TOO GOOD TO BE TRUE
X-L VARIO DENSERS**
INSTALL THEM IN YOUR SET AND LEAVE THEM SPEAK FOR THEMSELVES

Endorsed and Used by the Foremost Radio Engineers

MODEL N—Capacity range 1.8 to 20 micro-microfarads, for balance in Roberts two tube, Brownings-Drake, McMurdo Silver's 4-tube set, Neutrodyne and tuned radio frequency circuits. Price, \$1.00

MODEL G—For the Cockaday circuit, filter and intermediate frequency tuning in super-heterodyne and positive grid bias in all sets.

G-1—.00002 to .0001 Mf. G-10—.0003 to .001 Mf. G-5—.0001 to .0005 Mf.

Price each with Grid Leak Clips \$1.50

X-L RADIO LABORATORIES 2424 Lincoln Avenue, CHICAGO

**Books by Telegraph
between**

New York
Cleveland
Kansas City
Springfield
Toledo
St. Louis

**Doubleday, Page
Book Shop**

WRITTEN 2-YEAR GUARANTEE

Battery Prices SMASHED!

To Consumers Only
Here is a real battery quality, guaranteed to you at prices that will astound the entire battery-buying public. Order Direct From Factory. Put the Dealer's Profit in your own pocket. You actually save much more than half, and so that you can be convinced of true quality and performance, we give a *Written 2-Year Guarantee*. Here is your protection! No need to take a chance. Our battery is right and the price is lowest ever made. Convince yourself. Read the prices!

Auto Batteries	Radio Batteries
6 Volt, 11 Plate, \$9.50	6 Volt, 100 Amp, \$9.50
6 Volt, 13 Plate, 11.50	6 Volt, 120 Amp, 11.50
12 Volt, 7 Plate, 13.00	6 Volt, 140 Amp, 13.00

Buy Direct—Send No Money
We ask no deposit. Simply send name and address and style wanted. Battery will be shipped same day we receive your order Express C.O.D. subject to your examination on arrival. Our guarantee accompanies each battery. We allow 5% discount for cash in full with order. You cannot lose! Send your order today—NOW!

ARROW BATTERY CO.
Dept. 10, 1215 So. Wabash Ave., Chicago

**FREE BLUE PRINTS
To Set Builders**

TO PROVE THE SELECTIVE AND SENSITIVE COMBINATIONS OBTAINABLE WITH

Werner Transformers
(Radio Frequency Type)

which cover the entire broadcasting wave range and have been used by the best radio engineers for the past 2 years, we will furnish a full size Blue Print of a selective 6 tube Loop Receiver FREE if you order from us direct.

Werner Radio Frequency and Audio Frequency Transformers are fully guaranteed and tested, on actual broadcast reproduction. Guaranteed damp and moisture proof and will give perfect reception in any climate.

MADE IN TWO TYPES
Tuned and untuned for any standard type of vacuum Tube

Radio Frequency \$4. Audio Frequency \$6.

Werner Loop Antenna

Used with any type of loop receiver. Adjustable to a fine degree of clearness. Can be folded or extended without tools. Approved by POPULAR RADIO.

PRICE POSTPAID \$14.00

Send for free circuit diagrams and descriptive literature.

Book of Up-to-date, practical R. F. circuit diagrams and treatise on R. F. amplification postpaid **25c**

Ask Your Radio Dealer
WERNER MFG. CO.
204 Ninth St. Brooklyn, N. Y.

★ Tested and approved by RADIO BROADCAST ★

FIXED RESISTORS

Micamold
 REG. **FIXED CONDENSERS**

"Made of Mica and Moulded in Genuine Bakelite."

With Micamold Resistors and Condensers you need no clips or mounts—just solder direct to the terminals, thus eliminating point or loose contact and accidental dislodgement of the units. Micamold Products are moulded in genuine Bakelite and guaranteed within 5% of calibrations and constant in value. They are noiseless, moisture-proof and indestructible.

At all good Radio Stores.

MICAMOLD RADIO CORP.
 Flushing & Porter Aves.
 BROOKLYN, N. Y. ★

 **ACCURACY GUARANTEED**
 —VALUES REMAIN CONSTANT

 MOULDED UNDER PRESSURE OF 50 TONS

AMPLION

ALFRED GRAHAM & CO.
 LONDON, ENGLAND
 Patentees

Product of Over 30 Years' Experience

Bring in those distant programs clear and loud!

THE actual originators and world's oldest makers of loud speaking devices have created in The Amplion a long distance radio reproducer so clear and powerful that many users say it can be used instead of another tube in a set. Hear The Amplion—in comparison!—and you will understand the reason it leads in sales throughout the world—is the choice of the Royalty and Nobility abroad, and of the musically critical everywhere. Write for the "Amplion Pedigree."

THE AMPLION CORPORATION OF AMERICA
 Executive Offices: Suite L, 280 Madison Ave., New York City
 Canadian Distributors: Burndept of Canada, Ltd., Toronto ★



Supreme clarity of tone caused Amplions to be chosen for use in St. Peter's, Rome, to reproduce important papal ceremonies.

All Amplions are completely equipped with cords and panel plugs.

Speakers and console units
\$12 to \$4250

The January RADIO BROADCAST

Like a gilt edged bond issue was over subscribed and sold out almost before the ink had become dry. If you have difficulty in getting February number send us your subscription at once. One year Four Dollars, Two years Six Dollars.

Jones MULTIPLE-PLUG

THE STANDARD SET CONNECTOR

"For Battery, Antenna and Ground Leads"

HOWARD B. JONES ★

614-18 S. CANAL ST. CHICAGO, ILL.

Why not subscribe to *Radio Broadcast*? By the year only \$4.00; or two years \$6.00, saving \$2.40. Send direct to Doubleday, Page & Company, Garden City, New York.

HAMMARLUND-ROBERTS CABINET



Built exactly to specifications with fancy panel effect line grooves, full length piano hinge and lid stay. In stock for prompt shipment.

LIST PRICES:
 GENUINE AMERICAN WALNUT... \$14.00
 GENUINE MAHOGANY... 14.00
 MAHOGANY OR WALNUT FINISH. 11.50

Shipping charges prepaid

"CORBETT'S CABINETS" have been preferred for several years by quality set builders and are unquestionably superior in design and finish. They are backed by our guarantee to please you. Carefully hand-rubbed piano finish. Well packed for shipment.

WRITE FOR CATALOG showing attractive models for all sizes of radio cabinets, consoles and tables. ★

Jobbers and Dealers write for discounts.
CORBETT CABINET MFG. COMPANY
 St. Marys Pennsylvania

A \$60 Receiver for \$25

Fit for the home of a king manufactured for the home of moderate means



7" x 18"
 Solid mahogany cabinet

ONLY \$25

The Gold Medal 5-tube tuned radio frequency receiver "that stormed the country!" Manufactured to sell at \$60, now \$25.

Distance, volume, and good tone quality. Guaranteed to operate or money refunded. Send \$25 by money-order or certified check and this fine receiver will be sent express prepaid. Tubes, batteries and speaker extra. "Picks" 2000 miles.

EUREKA OUTLET CORP.
 1030 Longwood Ave. New York City

★ Tested and approved by RADIO BROADCAST ★

INDEX TO ADVERTISERS

IN THIS ISSUE

A

Acme Electric & Mfg. Co., The..... 517
 Acme Wire Co., The..... 507
 Airgap Radio Products Co..... 515
 Alden Mfg. Co..... 486
 All-American Radio Corp..... 412
 Allen-Bradley Co..... 528-3rd Cover
 American Electric Co..... 496
 American Hard Rubber Co., The..... 516
 American Luminous Products Co. 515
 American Mechanical Lab..... 515
 American Radio Engineers..... 516
 American Radio Mfg. Co..... 501
 American Transformer Co..... 525
 Amplion Corp..... 519
 Amsco Products Co..... 495
 Apex Electric Mfg. Co..... 482-488
 Aristocrat, The..... 521-522-523
 Arrow Battery Co..... 518
 Atwater Kent Mfg. Co..... 489

B

Bakelite Corp..... 413
 Barawik Co., The..... 506-509
 Belden Mfg. Co..... 409
 Blackburn Specialty Co..... 515
 Boston Radio Mfg. Co..... 412-I
 Branch Tool Co..... 513
 Bremer-Tully Mfg. Co..... 421-422
 Bristol Company, The..... 503
 Buescher Band Inst. Co..... 508
 Burton-Rogers Co..... 507-509

C

C. E. Mfg. Co..... 512
 Cable Supply Co., Inc..... 595
 Central Radio Lab..... 514
 Chelsea Radio Co..... 503
 Chicago Solder Co..... 505
 Cook Plate Co., Edward N..... 416
 Copper & Brass Research Ass'n..... 494
 Corbett Cabinet Mfg. Co..... 519
 Crescent Radio Co., Inc..... 517
 Crosley Radio Corp..... 483
 Crowe Name Plate & Mfg. Co..... 423
 Cunningham Co., E. T..... 2nd Cover

D

Daven Radio Corp..... 498
 Detroit Woodcraft Co..... 412-G
 Deutschmann, Tobe C..... 412-J
 De Witt-La France Co..... 515
 Dongon Electric Mfg. Co..... 474
 Dubilier Condenser & Radio Corp..... 424
 Durham & Co..... 516

E

Eastern Coil Co..... 510
 Eby Mfg. Co., H. H..... 505
 Eldridge Electrical Corp..... 504
 Electrad, Inc. 412-F
 Eureka Outlet Corp..... 519

F

Fansteel Products Co..... 487
 Ferguson, Inc., J. B..... 411
 Fritts Cabinet Co..... 423
 Frost Co., Herbert E..... 509

G

Gearhart-Schlueter..... 595
 General Radio Co..... 412-A-B-C-D-E

H

Hammarlund Mfg. Co..... 414-A
 Hanscom, Allan T..... 527
 Heins & Bolet..... 500
 Hommell Co., Ludwig..... 412-J

I

Insulating Co. of America..... 412-H-524
 (Radio Panels & Parts Corp.)
 International Corres. Schools..... 507

J

Jewell Electrical Inst. Co..... 484
 Jones, Howard B..... 519

K

Karas Electrical Co..... 420
 Kodel Radio Corp, The..... 490-508
 Korach Radio Co..... 505

M

Machine Specialty Co..... 501
 Martin-Copeland Co..... 526
 Micamold Radio Corp..... 519
 Midwest Radio Corp..... 496
 Modern Electric Co..... 475
 Morrison Elec. Supply Co..... 416
 Mountford Co., C. E... :..... 503
 Mu-Rad Radio Corp..... 511
 Mydar Radio Co..... 502

N

National Carbon Co..... 485
 National Co..... 410
 National Radio Inst..... 493
 Niagara Metal Stamping Corp..... 512
 Norden-Hauck..... 517

O

O'Connor Co., A..... 507
 Omnigraph Co., The..... 515

P

Pep Mfg. Co..... 501
 Perfection Radio Mfg. Co..... 517
 Pingree Radio Service, Inc..... 412-J
 Potter Mfg. Co..... 481
 Precise Mfg. Co..... 513

R

Radiall Co..... 511
 Radio Corp. of America..... 419
 Radio Inst. of America..... 492
 Radio Panels & Parts Corp.... 412-H-524
 (Insulating Co. of America)
 Raytheon Mfg. Co..... 473
 Reichmann Co..... 4th Cover
 Ross-Wire Co..... 511

S

Samson Electric Co..... 496
 Sangamo Electric Co..... 414
 Schneitter Radio Co..... 506
 Scientific Radio Lab..... 518
 Sickles Co., F. W..... 525
 Silver-Marshall..... 497
 Smith, B. H..... 494
 Starrett Mfg. Co..... 511
 Steinite Lab..... 496

T

Thompson Levering Co..... 513
 Thordarson Elect. Mfg. Co..... 506
 Timmons Radio Products Co..... 491
 Twentieth Century Radio Co..... 510

U

U. S. Tool Co..... 414

V

Van Horn Co., The..... 416
 Viking Tool & Machine Co..... 504

W

Walbert Mfg. Co..... 417
 Webster Co..... 476
 Werner Mfg. Co..... 518
 Western Radio Mfg. Co..... 514
 Westinghouse Electric & Mfg. Co. 414-B-415
 Wholesale Radio Service Co..... 500
 Wireless Electric Co..... 499
 World Battery Co..... 509-518

X

X-L Radio Laboratories..... 516-516

RESISTANCE COUPLING

RADIO BROADCAST
Aristocrat
A Resistance Coupled Receiver

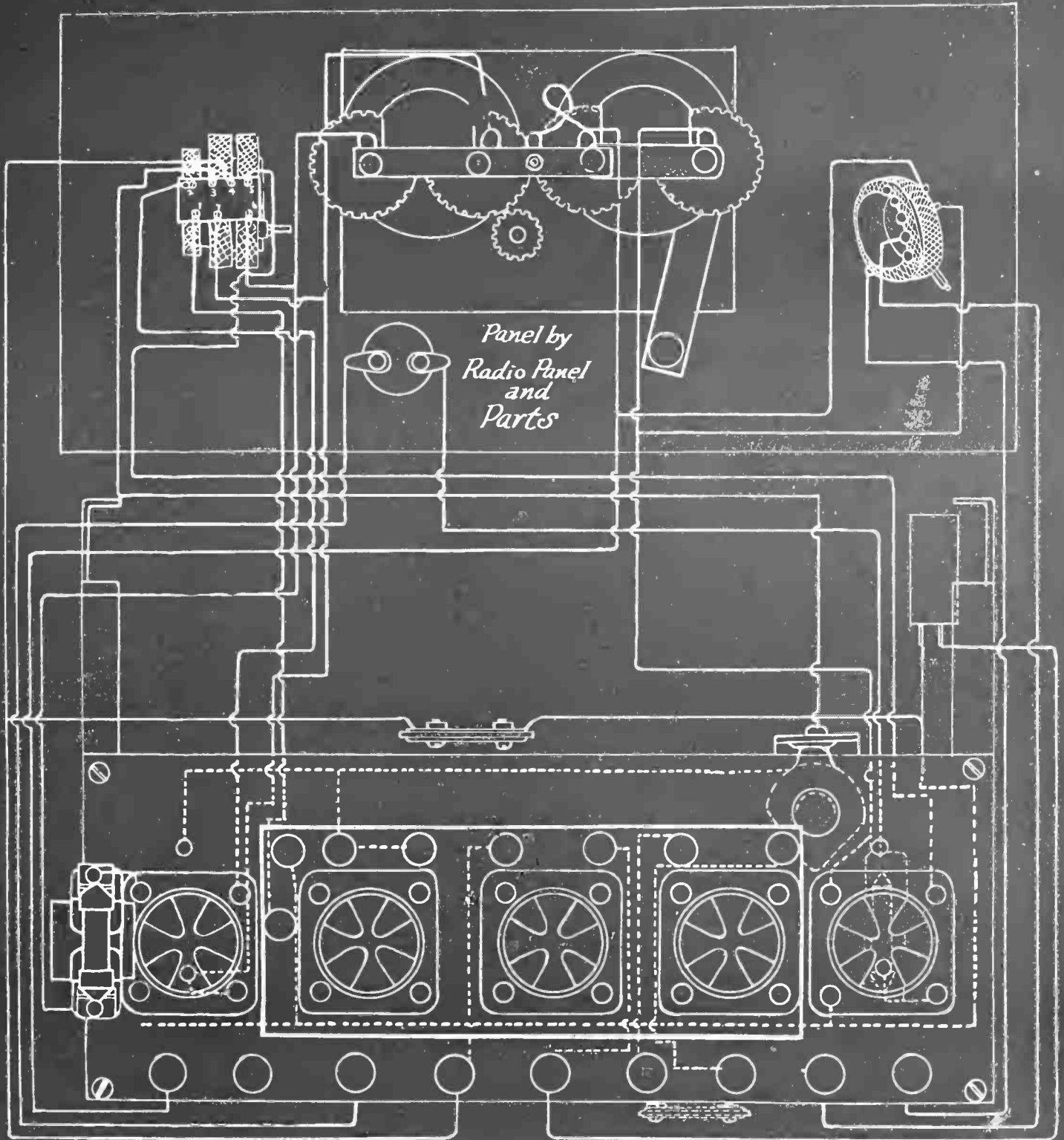

DESIGNED BY
ARTHUR H. LYNCH

The Aristocrat

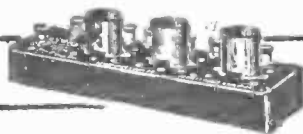

The Aristocrat

RESISTANCE COUPLING

The Aristocrat

A Receiver Employing Resistance

INSULINE



Insuline panels, sub-panels and foundation kits are made specially for both models of the Aristocrat—for complete information see page 524



Insuline moulded UX sockets are provided with the sub-panel for the 7 x 18 inch model and they will carry either UX or UV based tubes without adaptors or changes of any kind. They are particularly heavy and durable.

HANSCOM

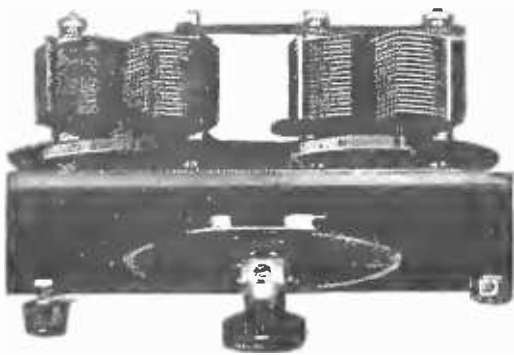

The Hanscom Single Control Unit is one of the distinctive features of the Aristocrat. By the mere turning of a single dial it enables stations from the lowest to the highest broadcast range to be heard. See page 527

CORRECT acoustics are coming to be recognized as one of the most important requirements of the modern receiver, and it is not a far call to hark back to the phonograph for a parallel.

Countless families have been satisfied with their phonographs until they were heard in direct comparison with the newest models. Doubt as to merit is instantly removed; the decision is overwhelmingly with the latter. This really great stride in acoustics—in fact, the greatest in phonograph history—on the part of the phonograph is the application of what radio investigators have learned.

And what these newer ideas have done for phonograph acoustics, resistance-coupling has done for radio. It is natural, therefore, that the modern resistance-coupled receiver is capable of better reproduction than even the latest model phonograph. Unless you have heard such a receiver, you have not heard radio at its best.

Radio Broadcast's "Aristocrat" is such a receiver.

A Popular Fallacy

Most radio receivers are entirely deficient in producing bass tones. The next time you tune in on some dance music, listen for the bass drums. Many who have performed this test, are quite sure that they are hearing all the bass of the orchestra until an analysis of what they hear is made. Imagination, it has been found, ordinarily supplies the bass.

Try also this simple but conclusive test for quality of reproduction. Tune in one of your local stations with some real volume. Connect, then, into your circuit a Western Electric Cone. If it rattles as though it were about to fall apart the fault is not with the cone but with the receiver. Quite contrary to general but erroneous ideas, the W. E. Cone will carry heavy volume without rattling.

Strange as it may seem, resistance-coupling is not new. On the contrary, it is rather old. But it is only now coming to be recognized by responsible engineers that a resistance-coupled receiver will deliver the most faithful reproduction known, regardless of whether it be the new phonograph or the much heralded "new circuit." In fact, it is agreed upon by radio and acoustic authorities that resistance coupling is the satisfactory method of retaining the bass notes that are so necessary for musical reproduction of tone proportion. This is particularly true now that the new tubes and especially designed parts are available.

The Aristocrat



The Aristocrat

RESISTANCE COUPLING

Aristocrat

Coupling developed by Radio Broadcast

Long Experience is Your Protection

Radio Broadcast has come to be recognized not only by the engineer but by the layman as a disseminator of sound engineering practice. Since its inception, it has been carrying on a campaign for better tonal quality, a campaign in which we as manufacturers are glad to participate. Arthur H. Lynch, the editor, has made a thorough study of the various methods of improving tone fidelity. His engineering staff, as well as many of the best authorities in America, have co-operated with him in giving to radio a receiver which, for tone reproduction, has no peer. He has co-ordinated many of the ideas of the outstanding radio inventors into the Aristocrat. This receiver has, through sheer merit and performance, come to be recognized by those who know as one of the most practical combinations of proven radio engineering that the art has yet produced. It has already been described by more than two hundred newspapers.

It, too, is a significant fact that Mr. Lynch in his four years editorship of Radio Broadcast has directed the work of many authors whose contributions to the radio art have made them famous. But in all that time he has never permitted any receiver built in his laboratory and described in his magazine to carry his name as the designer until he perfected Radio Broadcast's Aristocrat. Hear this receiver and you will hear radio at its best.

Home Folks and Engineers Agree

Engineers have heard the Aristocrat reproduce famous symphonies with a tone fidelity and volume that was amazing. With a power tube in the output circuit, the total drain on the B batteries is less than half the drain of the average five tube receiver using an ordinary tube. These same engineers marvelled at its compactness and simplicity and economy of construction as well as its handsome appearance.

Home folks who have found other receivers difficult to use, express pleasant surprise and delight at the ease with which stations are brought in by the turning of a single dial. They delight in varying the volume of a local band to a mere whisper or in filling the average room with a violin solo from a distant station.

Your Ten Foot Rule

The two five-foot blue prints for the 7 x 21 and 7 x 18 models of the Aristocrat which have been prepared by Radio Broadcast, are perfect working drawings. They combine the wiring diagrams arranged in progressive order with life size pictorial layouts. These diagrams, which are the most complete and comprehensive we have ever seen, are accompanied by a descriptive booklet. This combination makes the building of the Aristocrat a simple and interesting undertaking. Radio Broadcast's background of experience in bringing to the attention of the home constructor the receivers which have proven most popular because of satisfactory performance has enabled its staff in the Aristocrat to excel itself.

SICKLES



Sickles Diamond Weave Coils for the Aristocrat are of special design. They are compact, easy to mount and make the operation of the completed receiver a very pleasant pastime. See page 523

Allen-Bradley Co.



Bradleystat

"Bradleystat" means everything necessary when you are seeking a perfect filament control



The Allen-Bradley, 3 stage, resistance-coupled amplifier is a compact, complete, unit which makes the building of the Aristocrat a very simple matter because it is all wired and ready for use.

Note the carefully concealed wiring, Bradleyunits, and condensers. Nothing exposed except tube sockets which will accommodate the new UX tubes

Can be installed within radio cabinet. UX as well as old tubes can be used

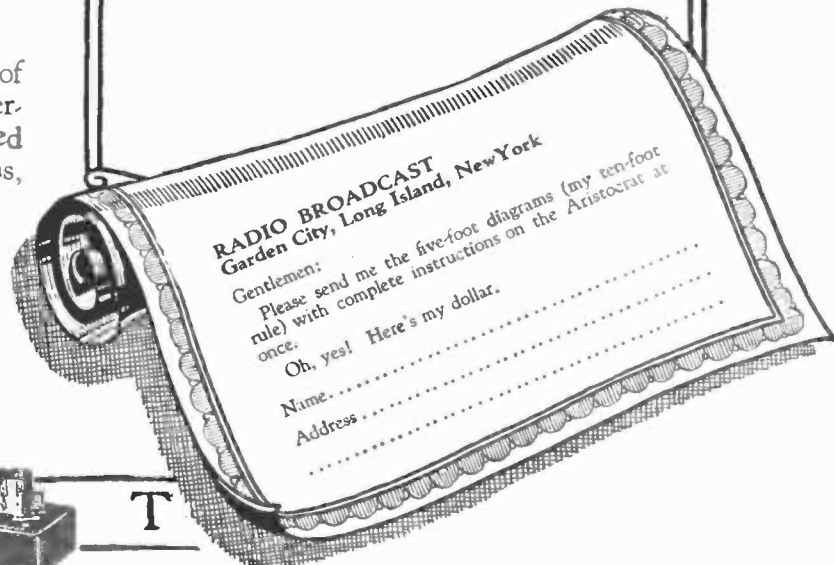

RADIO BROADCAST
Garden City, Long Island, New York

Gentlemen:
Please send me the five-foot diagrams (my ten-foot rule) with complete instructions on the Aristocrat at once.
Oh, yes! Here's my dollar.

Name.....
Address.....

The Aristocrat

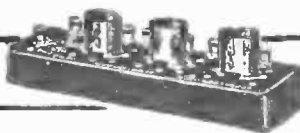

T

RESISTANCE COUPLING

ASK FOR INSULINE



and You Get the Best!

Insuline panels, sub-panels and foundation units for the Radio Broadcast Aristocrat are now available in either the 7 x 18" or the 7 x 21" size. If your dealer cannot supply you, write direct. They are drilled and engraved according to Radio Broadcast's specifications and are all ready for use in conjunction with the other high grade units shown in this piece of co-operative advertising.

Insuline, the Aristocrat of panel materials may be had in the following sizes and finishes for this remarkable receiver:

This receiver performs like an Aristocrat; Insuline makes it look like one.

3/16 x 7 x 18" Front Panel Drilled and Engraved
 Black Finish.....\$3.50
 Mahogany Finish..... 4.00
 Frieze Finish..... 4.00

Special Sub-Panel assembled with two universal sockets to take the old UV or the new UX base tubes for use with the Allen-Bradley 3-stage, resistance coupled-amplifier, complete.....\$3.00

3/16 x 7 x 21" Front Panel
 Black Finish.....\$4.00
 Mahogany Finish..... 5.00
 Frieze Finish..... 5.00

Complete foundation unit No. 1 consisting of drilled and engraved front panel and sub-panel with 2 UX sockets, 11 binding posts, brackets, screws, nuts, filament switch, bus wire and spaghetti for the 7 x 18 receiver.. \$9.85

Complete foundation unit No. 2 consisting of drilled and engraved front panels, 7 x 20 wood base board, drilled and engraved bind post strip with 11 binding posts, 2 panel brackets, 3 instrument brackets, 1 insuline condenser bracket with supporting tubing, filament switch, bus wire, spaghetti, all machine and wood screws for the 7 x 21 receiver.....\$9.25

Write for Radio Broadcast's Five Foot Diagrams

Insulating Company of America, Inc.

RADIO PANEL and PARTS Corp., Insuline Building, 59 Warren St., New York City

Branches in Principal Cities

The Aristocrat



The Aristocrat

★ Tested and approved by RADIO BROADCAST ★

www.americanradiohistory.com

RESISTANCE COUPLING

COILS

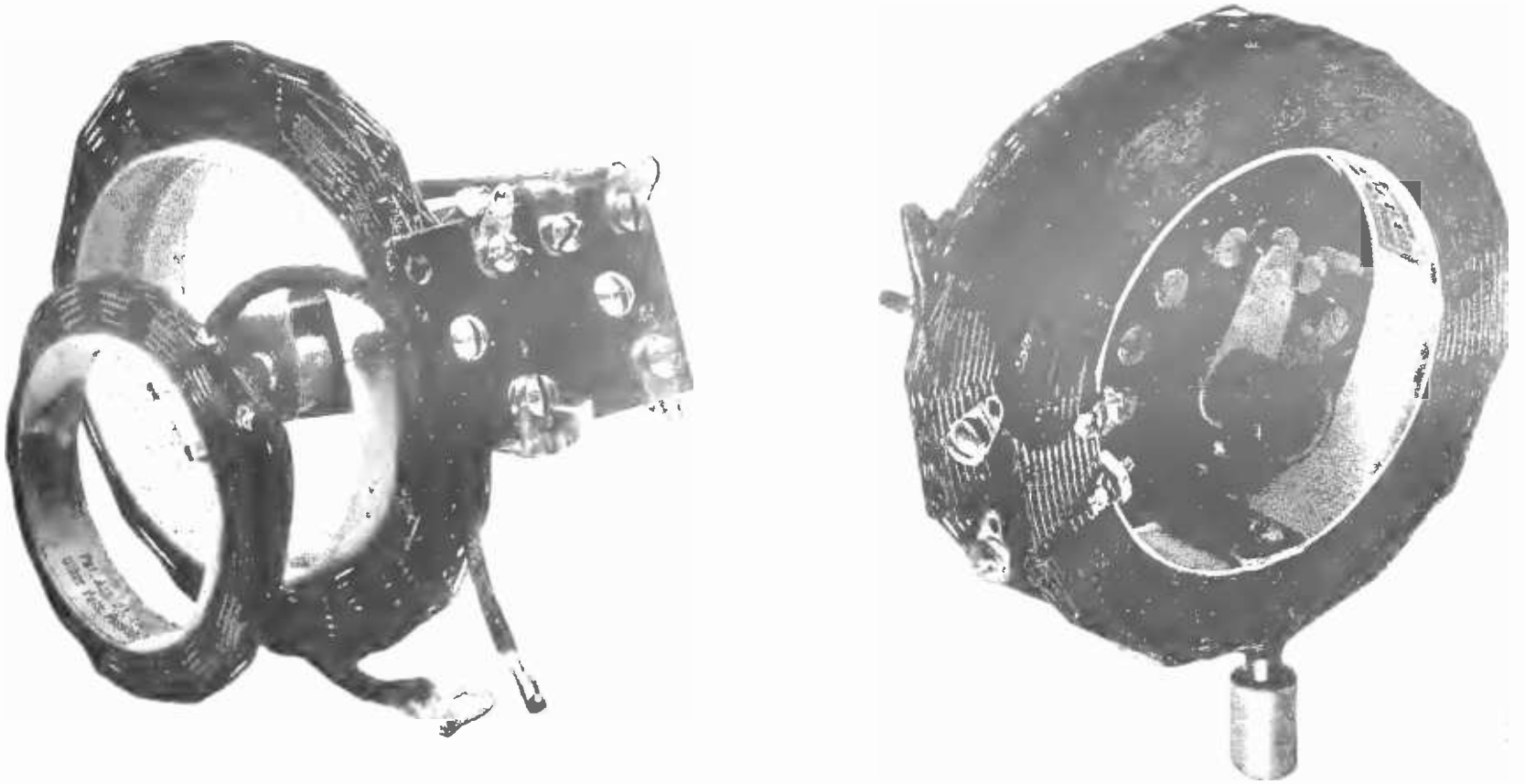

by SICKLES

developed exclusively for the Aristocrat

THE F. W. Sickles Co. felt strongly that a receiver so advanced in design as the "Aristocrat" deserved coils just as advanced in order to give to the home constructor the inherent benefits of this receiver.

As a consequence Mr. Sickles, who is the developer of the proved "Diamond Weave" principle in coils and who is chief engineer of the F. W. Sickles Co., set to work. The result of his engineering ability backed by thoroughly-going and practical research, is being enthusiastically welcomed by laboratories everywhere in America. The "Aristocrat" Coil by Sickles is based upon scientific facts, not wishes nor fancies. And these facts were determined by an exhaustive and conclusive series of tests upon highly sensitive and calibrated electrical instruments.

The "Aristocrat" Coil is unquestionably the best coil ever produced by Sickles.

Write for Radio Broadcast's Five Foot Diagrams.

THE F. W. SICKLES CO.

132 Union Street, Springfield, Mass.

The Aristocrat



The Aristocrat

★ Tested and approved by RADIO BROADCAST ★

RESISTANCE COUPLING

Turn this dial, once—

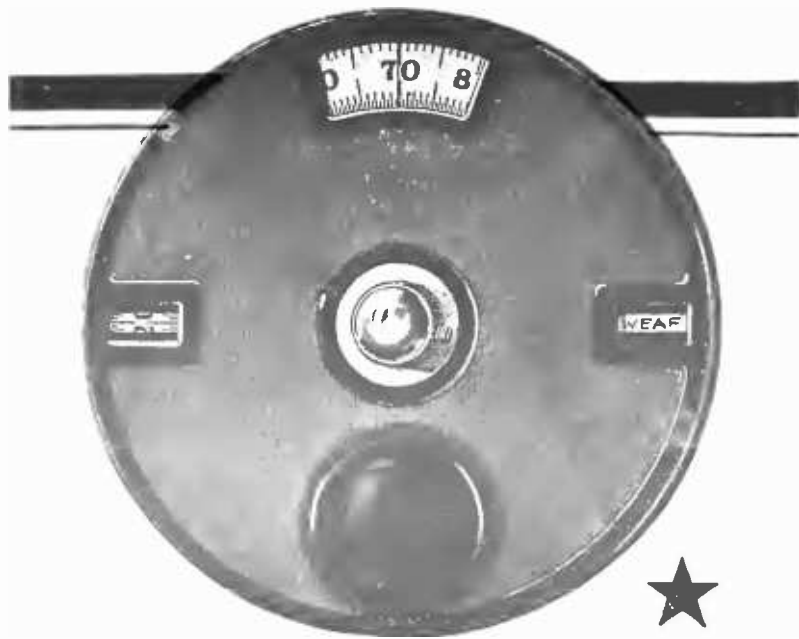

and You'll know why it is in the Aristocrat

THE fact alone that this dial was used in the experimental models of the "Aristocrat" is, to thousands, sufficient endorsement of its merits.

Smooth, precise, handsome, it is just the dial for your Aristocrat or any other receiver. It has that proper combination of qualities that sets it apart and marks it as a leader. In fact, the approval that was accorded this instrument was so immediate and widespread that the Mar-Co Dial is to-day regarded as one of the season's outstanding successes.

Ask your dealer to show you this big improvement in tuning controls. Feel for yourself its easy and natural responsiveness, its hair-line accuracy. Note, too, the complete absence of backlash.

Once you try the Mar-Co, no other dial will do.

Write for Radio Broadcast's Five Foot Diagrams.

MARTIN-COPELAND CO.

Providence

Rhode Island

MAR-CO
RADIO PRODUCTS
Vernier Dial

Join the Ranks of the Satisfied

AND BUILD WITH THE AID OF FULL-SIZE BLUE-PRINTS

RADIO BROADCAST'S ARISTOCRAT RECEIVERS

THE BUILDER has his choice of two types of Aristocrat Receivers and the blue-prints, which are full-sized, show complete wiring, location, and constructional details. These prints are accompanied by an instruction pamphlet prepared by Arthur H. Lynch, Editor of RADIO BROADCAST.

The receivers embody the most modern features of circuit design such as a neutralized radio-frequency amplifier, regenerative detector, and three-stage resistance-coupled amplifier. Provision is made for the use of high-Mu tubes with high voltage and proper grid bias on the last audio amplifier.

Tuned, Neutralized Radio Frequency Amplification

Three Stages Resistance Coupled Audio Amplification

Single Tuning Control

Regenerative Detector

Blue Prints and Booklet Price, \$1.00

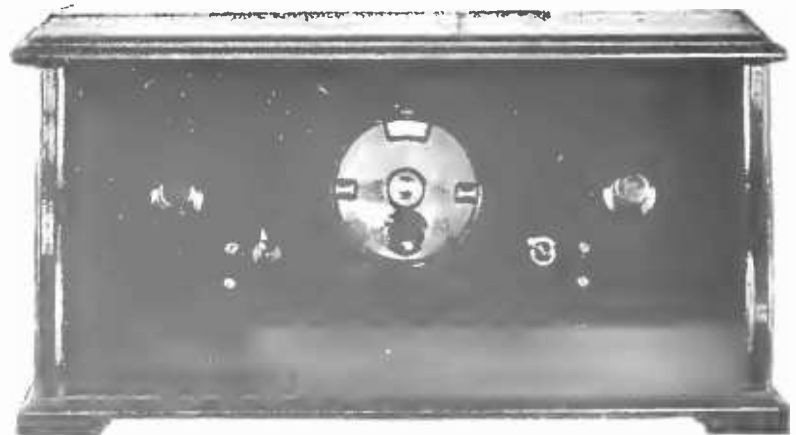

USE THE COUPON IF YOUR LOCAL DEALER'S SUPPLY IS EXHAUSTED

DOUBLEDAY, PAGE & Co.,
Garden City, New York

Enclosed find my dollar for the Blue-Prints and Instruction Book for building RADIO BROADCAST'S Aristocrat Receiver. It is understood that my dollar will be returned if the material sent me does not come up to my expectations.

Name

Address

RB-F

The Aristocrat



The Aristocrat

★ Tested and approved by RADIO BROADCAST ★

RESISTANCE COUPLING

The Feature of the Year

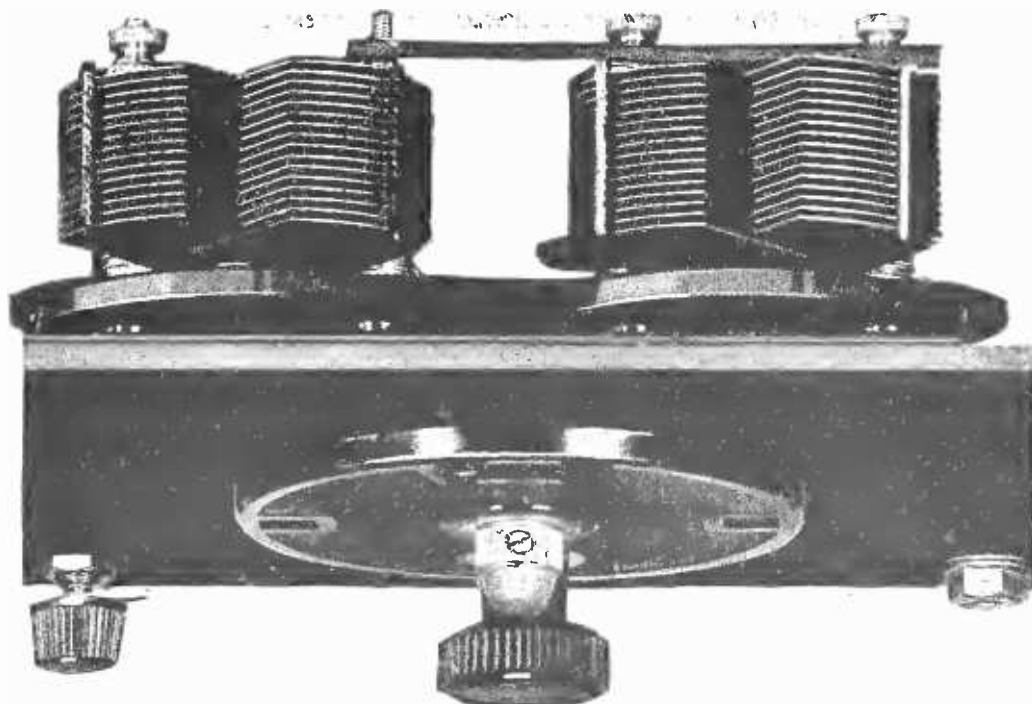

the Hanscom Single Control Unit

ARTHUR H. LYNCH, editor of *Radio Broadcast*, in describing the Hanscom single control unit in October *Radio Broadcast* pointed out quite specifically that it was against the policy of his publication to describe completely manufactured units, but he went on to say that this unit was, in his estimation, of such value to the readers of *Radio Broadcast* that it would be unjust not to describe it.

Mr. Lynch's judgment in this has been thoroughly vindicated. The Hanscom Uni-control unit is recognized to-day as a real contribution to the problem of uni-control in a practical form. It achieves what many have endeavored; it encompasses all the advantages of the average single-control unit with none of the customary disadvantages. It is positively proof against error; it is adaptable to any receiver.

The ingenious vernier of the Hanscom single-control unit permits of fine adjustments impossible in others. Simplicity in mounting, ease of making connections, sufficiency of performance are obvious characteristics. The finished engineering and workmanship inherent in it, places it on the verge of craftsmanship.

In short, it is a good, serviceable unit that has been endorsed by all radio authorities of any importance.

And it is incorporated in the Aristocrat.

Write for *Radio Broadcast's* Five Foot Diagrams

Hanscom Radio Devices

Woonsocket

Rhode Island

The Aristocrat



The Aristocrat

★ Tested and approved by RADIO BROADCAST ★

RESISTANCE COUPLING

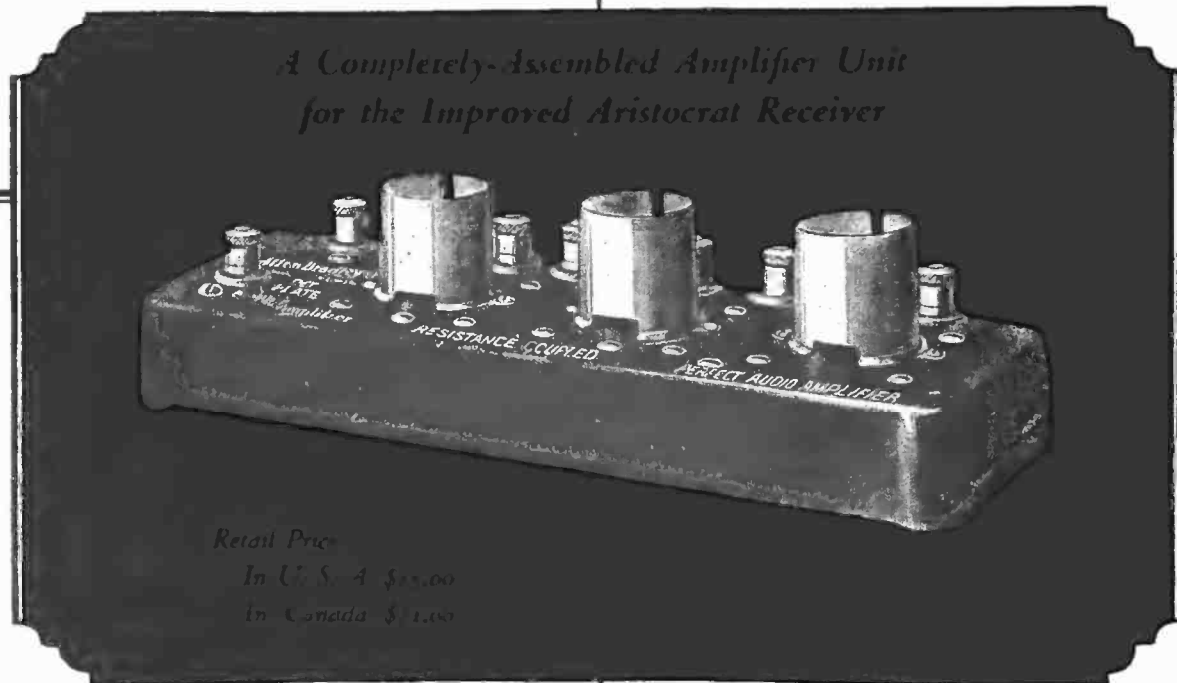

Why You Should Use
A Resistance-Coupled
Audio Amplifier

THE tone quality of a radio receiver is vitally affected by the construction of its audio amplifier. Poor, overloaded audio transformers are the most frequent cause of distortion, because they are unable to amplify equally all the tone frequencies of a musical program. Some tones are over-amplified, while others are subdued, or entirely eliminated. Harsh, unnatural tones are therefore produced by the loud speaker, and the quality of rendition is extremely unsatisfactory.

The better type of audio amplifier uses no transformer whatever. It is called the Resistance-Coupled Amplifier, because small fixed resistance units take the place of the bulky transformer of earlier models and they produce amplification without distortion. For clarity and purity of tone, nothing has excelled the resistance-coupled amplifier.

Why You Should Choose
Bradley-Amplifier
Resistance-Coupled
PERFECT AUDIO AMPLIFIER

THIS compact resistance amplifier is easily installed by any one in any type of radio receiver. Convenient terminals make the Bradley-Amplifier as easy to connect as a B-Battery. The sockets will hold old or new tubes without adapters, and a C-Battery connection is provided for the new tubes.



The distinguishing feature of the Bradley-Amplifier is the use of Bradleyunit Resistors. These small, solid, molded units cannot break, deteriorate or change with age. They are soldered into place and require no attention. For amplification without distortion be sure to ask your dealer for a Bradley-Amplifier. Try one tonight!



Allen-Bradley Co.

278 Greenfield Ave.,
Milwaukee, Wisconsin

Please send me your latest booklet on the Bradley-Amplifier.

Name.....

Address.....



The Aristocrat



The Aristocrat

The New **S.L.F. Bradleydenser**

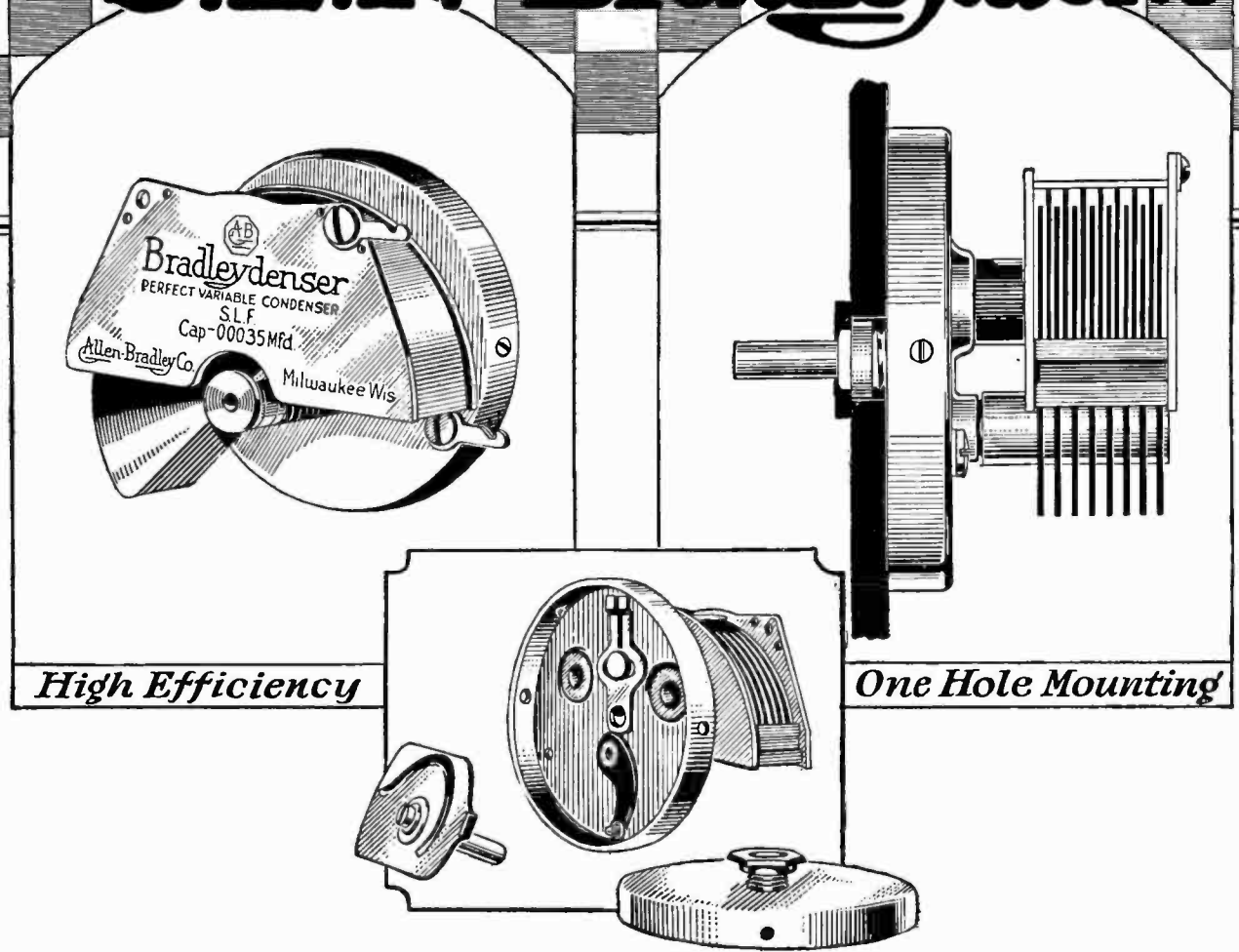

A Compact Straight-Line-Frequency Condenser

THE new S. L. F. Bradleydenser is the outcome of long, careful research in condenser design. It provides straight-line-frequency tuning over the entire circumference of a 360-degree dial. Stations are widely and evenly spaced over twice the dial-spacing of ordinary condensers. This unique control is obtained by using a special cam on the condenser shaft which provides the straight-line-frequency tuning now demanded by all set builders. The efficiency of the condenser is extremely high, due to the unique construction that practically eliminates insulating material in the condenser.

ANOTHER outstanding feature of the new S. L. F. Bradleydenser is the compact design which eliminates entirely the long eccentric rotor plates, ordinarily used with straight-line-frequency condensers. The Bradleydenser can be substituted for any condenser in a set without interfering with other parts on the panel. The one-hole mounting also simplifies installation. The S. L. F. Bradleydenser is the latest Allen-Bradley contribution to better radio. Be sure to bring your set up-to-date by getting a set of S. L. F. Bradleydensers from your nearest dealer.



OTHER Allen-Bradley Devices

Use the Bradleystat, Bradleyleak, Bradleyometer, and Bradleyohm in your next set. For resistance amplification, use the Bradleyunit Resistor.

Mail the Coupon

Allen-Bradley Company,
278 Greenfield Avenue,
Milwaukee, Wisconsin.

Please send us your latest literature on the new S. L. F. Bradleydenser and other items of the Allen-Bradley line.

Name.....

Address.....

★ Tested and approved by RADIO BROADCAST ★

Must Outperform

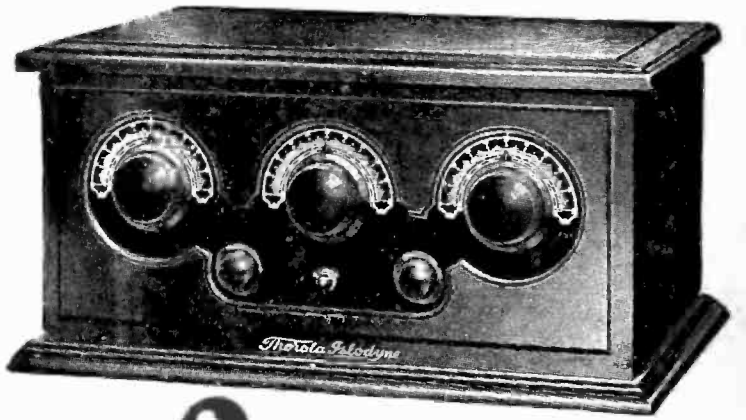

*The Most Positive Radio Statements
You Have Ever Read*



Thorola Islodyne receivers must outperform any other set you listen to, regardless of price, tube-power or circuit. Any Thorola merchant lets you challenge this in home or store.

Thorola outperforms with Thorola Low-Loss Doughnut Coils, the basis of the exclusive *Isolated Power* principle. Interference, excess static, maddening "pick-up" are *designed out* of this receiver. Full, undissipated power behind the one sharply selected station, wells up the volume, far extends range, and keeps out tone impurities.

Thorola outperforms by *several times the efficiency*, in many cases, on the difficult

higher wave lengths. Thorola outperforms with truest "straight-line" characteristics. Thorola outperforms with lower internal resistance. That's Thorola design and construction—great steps ahead.

Creating and manufacturing our own products in our own great plant, far ahead in experience and technique, we are able to give you super-radio at the price of average receivers!

OUTSELLING
Several Times Over

Thorola Loud Speakers outsell every other kind—even 2 or 3 to 1 in many great radio centers. Thorola Speakers, foundation of Thorola reputation, express the superiority of the entire Thorola line.

Take us at our word. You cannot know what radio should be—you do not know what magnificent radio you can afford—until you hear a Thorola Islodyne receiver.

REICHMANN COMPANY, 1725-39 W. 74th St., CHICAGO

5-tube Thorola Islodyne Receivers, Walnut Cabinet	\$100	5-tube Thorola Islodyne Console	\$225	Thorola Low-Loss Doughnut Coils (set of 3)	\$12 Each \$4
5-tube Thorola Islodyne Receivers, Thorooco Cabinet	\$85	Thorola Loud Speaker Model 4	\$25	Thorola Low-Loss Straight Line Frequency Condensers	\$5.50 and \$6
5-tube Thorola Islodyne Receivers, Mahogany Cabinet	\$85	Thorola Jr. Loud Speaker	\$15	Thorola Golden Audio Reproducing Transformer	\$4.50

Thorola Islodyne

★ Tested and approved by RADIO BROADCAST ★

THE COUNTRY LIFE PRESS, GARDEN CITY, NEW YORK