

JULY 1925 **RADIO** 35 CENTS
BROADCAST

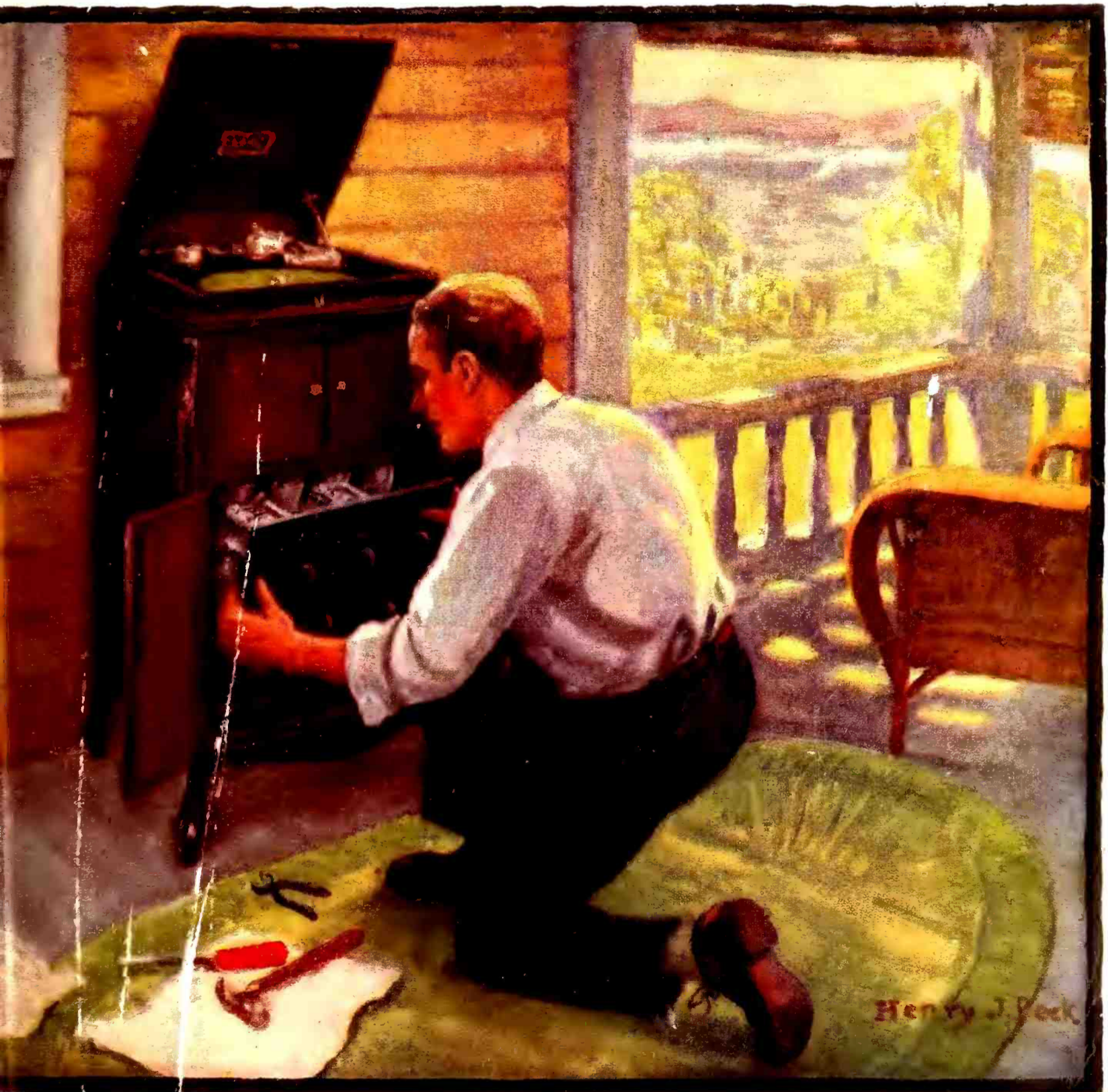

Marconi Writes of His Latest Experiments
A Compact Six-Tube Super-Heterodyne
How to Build the Phonograph Receiver

DOUBLEDAY, PAGE & COMPANY

GARDEN CITY, NEW YORK

Cunningham RADIO TUBES

Since 1915—

Standard for all Sets

Types C-301A : C-299 : C-300 : C-11 : C-12

In the orange
and blue carton
Price \$3.00 Each



**Sensitive as a Bare Nerve
Delicate as a Spider's Web
Enduring as the Brute**

A single inferior tube in any socket of your receiver and you might just as well try to get a resonant, clear-ringing tone from a cracked bell.

When you neglect the tube, you endanger the entire performance of your set. In millions of American homes—where radio rules supreme—perfect reception is made a certainty by Cunningham Radio Tubes.

Home Office:
182 Second St.,
SAN FRANCISCO

A. J. Cunningham Inc.

CHICAGO
NEW YORK

Patent Notice: Cunningham Tubes are covered by patents dated 2-18-12, 12-30-13, 10-23-17, 10-23-17, and others issued and pending.

★ Tested and approved by RADIO BROADCAST ★

The Old Way

The BELDEN Way

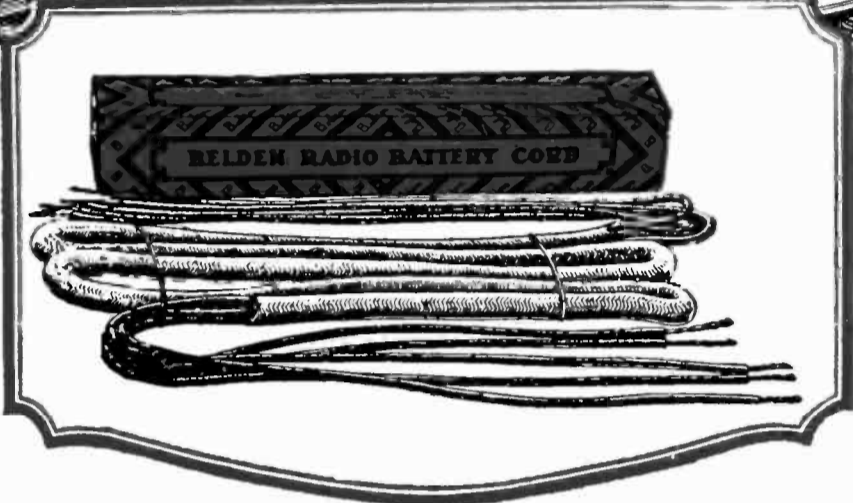
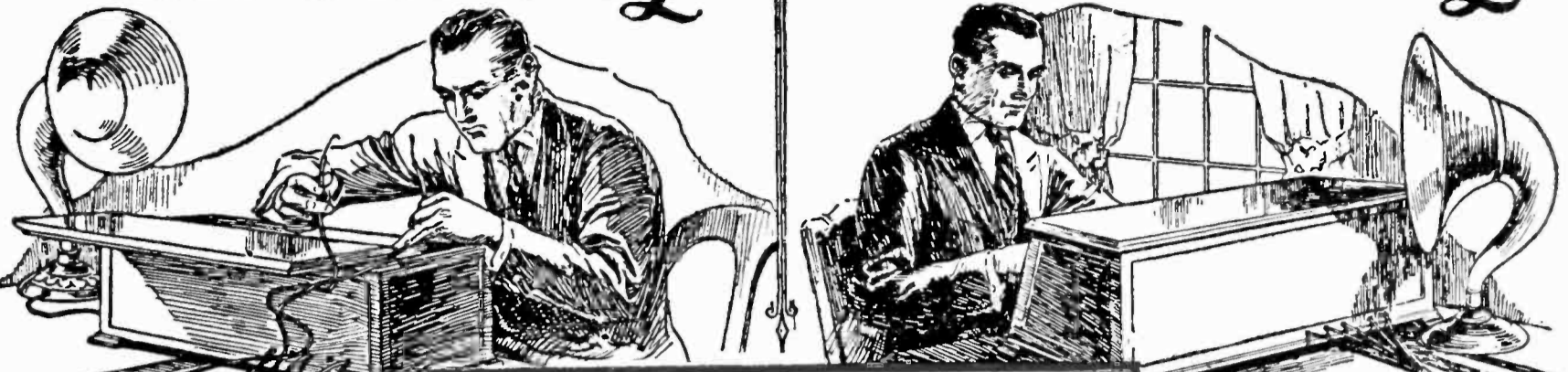

Save Tubes, Time and Trouble with a Belden Radio Battery Cord

The old, crude way of connecting batteries to your radio set with a mess of tangled wires never was satisfactory. There was always the danger of crossed wires, discharged batteries, and burned-out tubes.

Today, the Belden Radio Battery Cord provides a neat, compact installation. Each conductor is oversize, and color-coded to simplify A and B battery connections. The handy 6-foot Belden Cord is used in thousands of homes, because one cord replaces the unsightly array of loose wires that formerly detracted from the appearance of the set, and invariably caused trouble.

Buy Belden Cord, Today!

Belden

Manufacturing Company
2312A So. Western Ave.
CHICAGO, U.S.A.
Manufacturers of Electrical Wire
Products since 1902

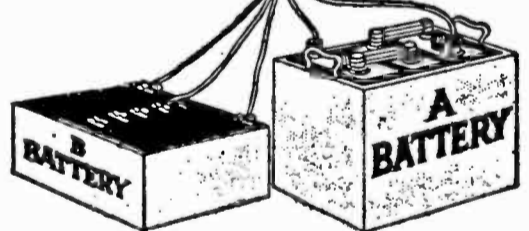

MAIL THIS COUPON
FOR FREE BOOKLET



Belden Manufacturing Company,
2312A So. Western Ave., Chicago, Ill.

Please send me your booklet—Helpful Hints for Radio Fans.

Name _____

Address _____

*Specify
Belden*

Ask your dealer about Belden Magnet Wire on small spools, if you wind your own radio coils. Also inquire about Belden loop wire, Litz wire, terminals, hook-up wire, solder, tape, and dozens of other radio items. The coupon will bring a booklet about them

★ Tested and approved by RADIO BROADCAST ★

Sickles Diamond Weave Coils Were Used in the New Roberts Knock-Out Phonograph Receiver

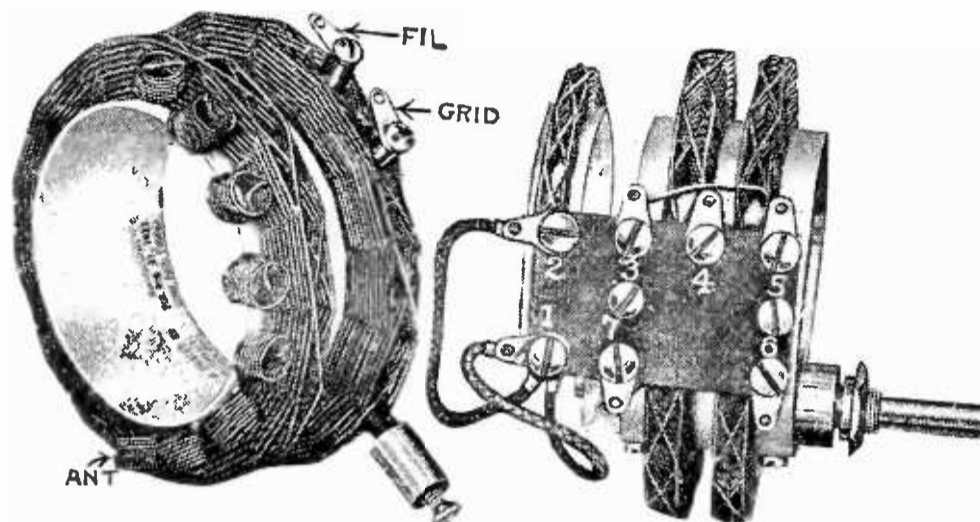

New No. 18A Coils for any Roberts Circuit

Price \$8.00

Patented August 21, 1923

Improved One Hole Panel Mounting Unit New N and P Coil

Designed in our laboratory and gives maximum amplification with perfect neutralization over both **Low** and **High** wave lengths, also added selectivity.

The new N and P Coil can be substituted for the present one in any No. 18 Sickles Diamond Weave Coil at a cost of \$1.50.



The F. W. Sickles Co.

335 Worthington St.

Springfield, Mass., U. S. A.

★ Tested and approved by RADIO BROADCAST ★

GENERAL RADIO

Transformers bring out all the refinements of tone quality



TYPE 285
5.9 to 1 for first stage

TYPE 285-L
2 to 1 ratio for second stage

By specially designing the core, and adjusting the coil turns, the very low and very high notes are sustained to approximately the same degree as all other notes over the entire musical range. The amplification curves are high and flat over the full extent of audio tones common to speech, instrumental, and vocal music.

They are real "super" transformers—greater in volume, better in quality.

The better loudspeakers to-day are capable of reproducing music with all its truest refinements of tone quality. Consequently a higher standard of transformer design is necessary to deliver to the loudspeaker the desired volume with a purity of tone that makes radio reception delightfully natural.

In designing the General Radio Type 285 transformers great stress has been laid upon tone quality—yet volume has been increased to a very marked degree.

In spite of the pronounced superiority over other transformers it sells at a popular price.

Enjoy music in its unmodified form—use type 285 transformers in the set you build or substitute them in the set you already have.

Price, \$6.00 each



"Behind the Panel of well built sets"

GENERAL RADIO CO.
Cambridge Mass.



★ Tested and approved by RADIO BROADCAST ★

A Tribute to
NEW ENGLAND'S RADIO CRAFTSMEN

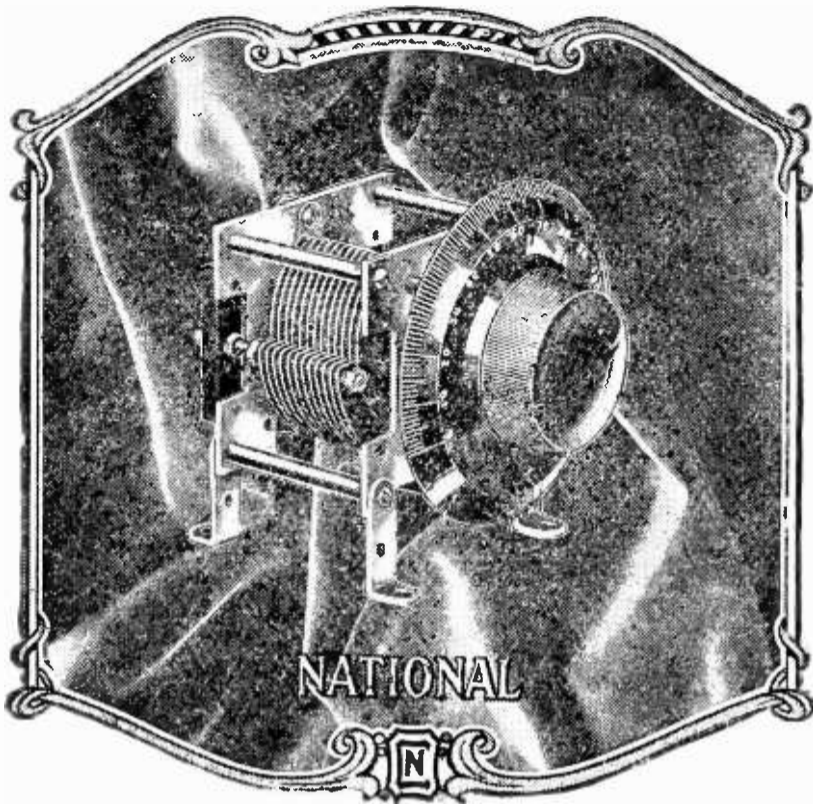

*The
 product*
 ←
*The
 tribute*
 ↓

*Specified
 For Control
 of the
 Ultra-Selective
 Radio
 Broadcast
 Phonograph
 Receivers*



Write for
 Bulletin 106 R.B.

National Company
 110 Brookline Street
 Cambridge - - Mass.

C
 a
 CaPaC
 a
 C
 —————

Central Peat Corporation

CAPAC, MICHIGAN

Telephone 6s

March 19, 1925.

National Company, Inc.,
 Cambridge, Mass.

Gentlemen:-

When a company turns out an honest article of great merit that company deserves the thousands of compliments it is sure to receive.

You don't know me from Adam. But everytime I sit down to the old music box and turn those Velvet dials you have my blessing. I built three Roberts Knockouts and installed all 4" Velvet dials. Perfection is the word that describes them. The reduction ratio is exactly right and the smooth-running mechanism makes the dial a joy to handle. If you asked \$10.00 each instead of \$2.50 I would still be a "Velvet" user.

I crack up the "Velvet" to every radio fan I know, and so you have been getting a lot of advertising you didn't know about.

Yours very truly,

A. B. Curtiss
 A. B. Curtiss

ABC/L

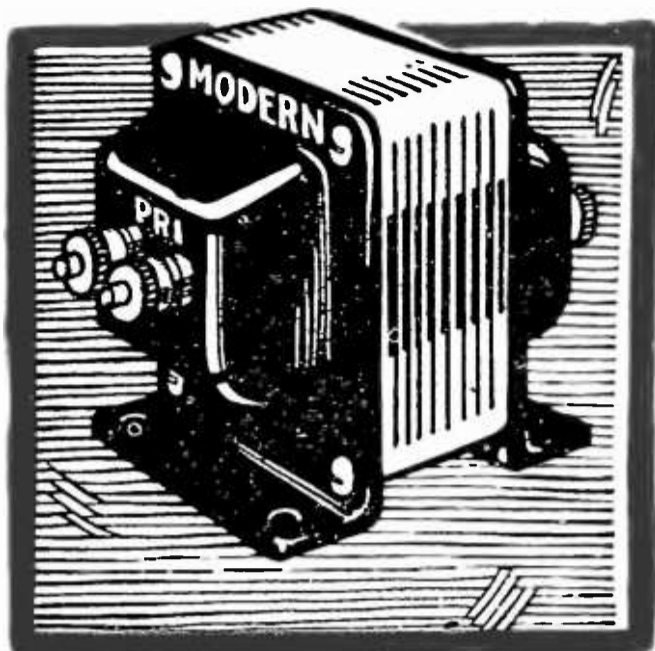

Authorities Use MODERN Transformers for Push-Pull Amplification!

It is significant that the best brains in the radio industry choose Modern Transformers.

This is not the result of whim, wish or guesswork. It is the result of careful experiments spread over a sufficient period of time to actually determine the real merit of Modern Transformers.

★ The original experiment models of the Roberts "Knock-Out" Receivers were equipped with Modern Push-Pull Transformers. RADIO BROADCAST'S Phonograph Receivers are equipped with Modern Transformers.

MODERN ELECTRIC MFG. CO.

TOLEDO, OHIO

4 to 1	\$5.00
10 to 1	\$5.50
Push-Pull (per pair)	\$12.50

★ Tested and approved by RADIO BROADCAST ★

B-T for "Better Tuning"

Since the beginning of broadcasting the name "B-T" has been the radio public's guarantee of quality products.

Radio Broadcast's Phonograph Receiver, in fact any set, will be improved by the use of the typical B-T parts shown below.

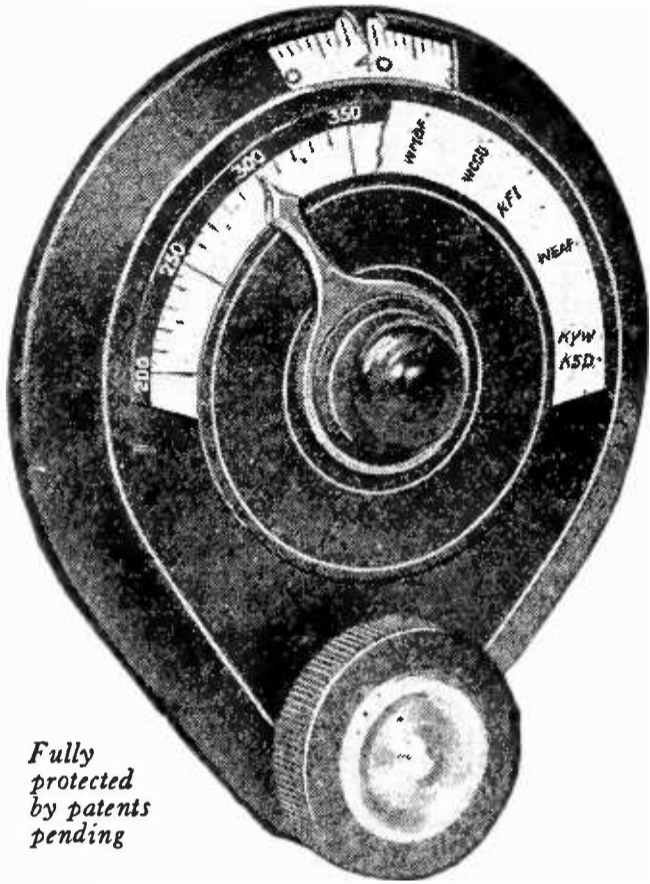

Fully
protected
by patents
pending

The "Better Tuning" Control

The new "BETTER TUNING" Control answers an insistent demand for a tuning instrument of better appearance as well as greater precision.

Reads in dial numbers, wave lengths, or call letters, as you prefer—all on one dial;

No side strain or pull on condenser or tuner shaft;

Smooth, flowing action;

Hairline Control;

Absolutely no backlash;

A rich, beautiful finish that improves the appearance of the panel.

Readings, 0 to 100 and 100 to 0, works with right or left hand instruments.

The B-T Condenser

Chosen by Those Who Know

B-T "Lifetime" Condenser efficiency is attested by acknowledged radio authorities.

Lieut. Schnell, A. R. R. L., chose it for his famous 12 meter set used in Pacific naval maneuvers.

Prof. G. H. Wilcox, Armour Institute, *found it has less resistance than a "laboratory standard."*

Don C. Wallace, Hoover Cup Winner, whose two-way communication with New Zealand from Minneapolis for two and one-half hours, sets a record says: "I feel sure the ease of tuning, low minimum and absence of losses in the B-T Condenser contributed largely to the success of this experiment."

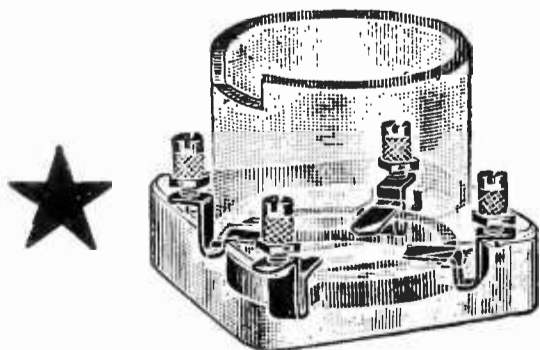
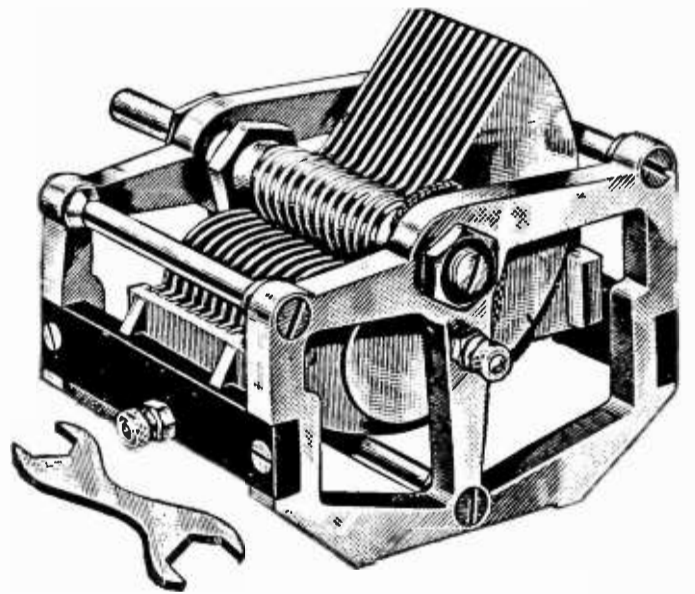

The New B-T Socket

Something new and different coming in sockets. Features you hadn't thought of but will appreciate on sight.

Watch for further announcements on this new B-T development.

532 S. Canal St., Chicago

BREMER-TULLY MFG. CO.

★ Tested and approved by RADIO BROADCAST ★

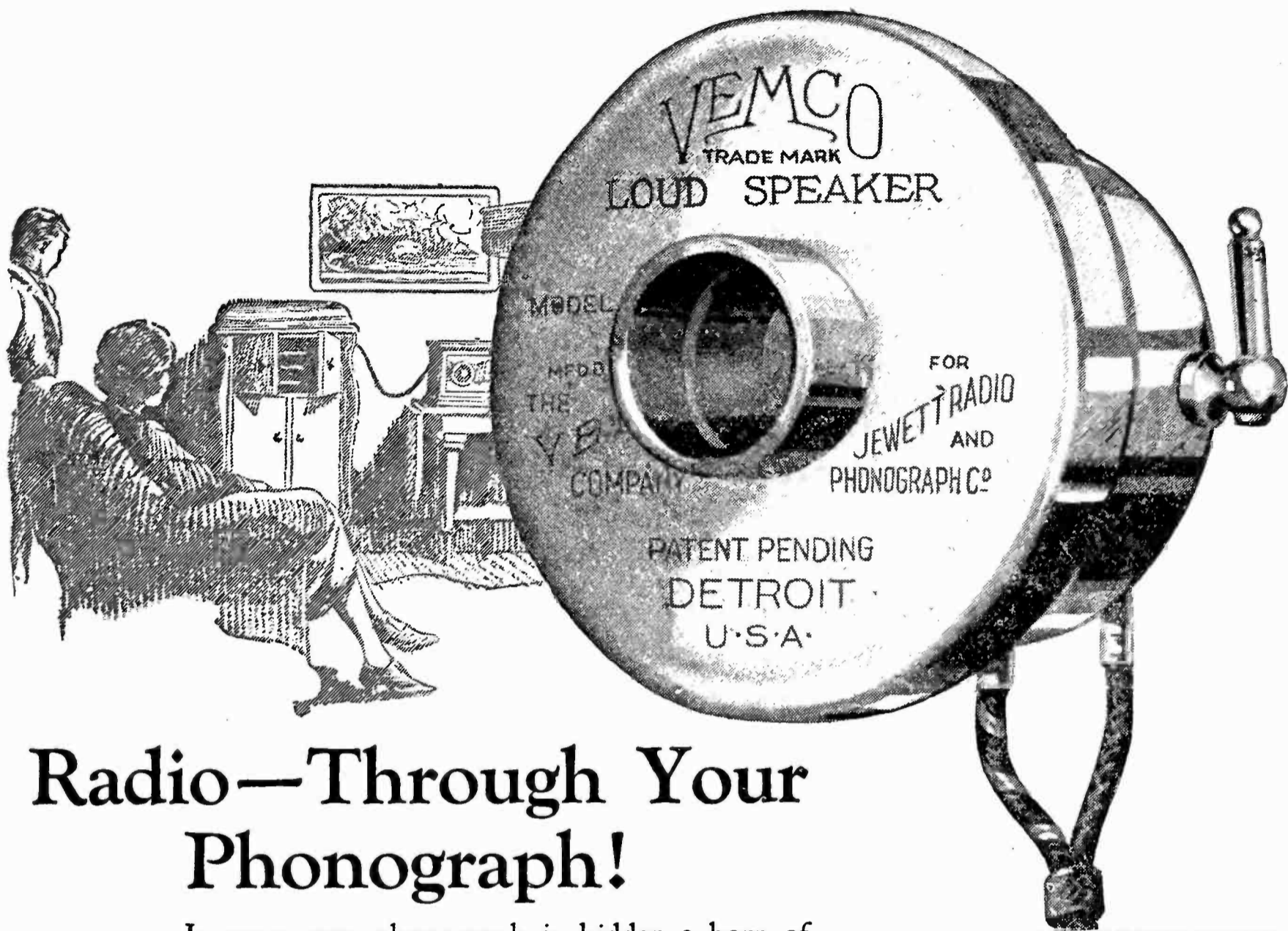

Radio—Through Your Phonograph!

In your own phonograph is hidden a horn of proved acoustical merit.

With a Jewett Vemco Unit, this horn can provide excellent Radio reproduction—reproduction so loud, so clear, and so accurate as to rival that of the best phonograph record you have ever heard.

But be sure that the Reproducer is a Vemco! That is the secret of accuracy, volume and tone.

No tools, no changes—Slips easily on or off the tone arm of a Victrola—We supply simple adapters for other phonographs. Volume control develops distant broadcasting to amazing strength. Above cuts show actual size. The same reproducer used in the famous Jewett Super-speaker. Price \$12; West of the Rockies, \$12.50. Adapter, when needed, slight addition. At your dealers or use the coupon.

“THERE IS NO SUBSTITUTE FOR THE BEST”

JEWETT RADIO & PHONOGRAPH CO.
5672 DIXIE HIGHWAY PONTIAC, MICHIGAN

The Jewett Vemco Unit

★ Tested and approved by RADIO BROADCAST ★

SEND NO MONEY—
Just Fill In The Blanks!

Jewett Radio & Phonograph Co.
5672 Dixie Highway, Pontiac, Mich.

My dealer is not yet supplied so please send me, carrying charges prepaid, a Vemco Unit with adapter if needed. I will pay the postman. My Phonograph is a

(make)

(Name)

(Address)



Erla Push Pull Transformers Give Amazing Volume

---Yet prevent distortion

*Used with splendid success
in the Roberts reflex circuit
described in this issue.*



This phenomenal invention brings in the faintest long distance signal on the loud speaker with volume enough to fill an auditorium. Gives results not possible with standard audio transformers.

THE push-pull circuit is in no way a substitute for standard methods of audio amplification. It is used as the third stage following two straight audio stages to get extraordinary volume. Audio currents so heavy that they would overload ordinary transformers are easily handled without the slightest distortion. The carrying capacity of Erla push-pull transformers is more than ample for handling the output of five watt power tubes, using as high as 200 to 300 plate voltage.

All danger of overloading or damaging the loud speaker is eliminated because the method of wiring used in these transformers does not permit the plate current to enter the loud speaker windings.

3 reasons why ordinary transformers should not be used in push-pull circuits

1—There is loss of efficiency because impedance values of the transformers are not

properly proportioned to the tube circuits under these conditions. 2—Distortion occurs because there is no neutralization of plate currents to eliminate saturation of transformer cores such as push pull transformers give. 3—Power transformers have an altogether different ratio from the ordinary audio transformer.

Write for literature and diagrams

Get this remarkable product at your dealers today or write direct. Simply send your name and address and receive by return mail new literature describing these amazing transformers. Also free circuit diagrams showing various applications. See what surprising results you can obtain. Performance guaranteed where Erla audio transformers are used. Write immediately.

Electrical Research Laboratories
2500 Cottage Grove Ave. Chicago, Ill.

Dealers—Exclusive franchises are available to high class dealers in localities still open. Write or wire immediately.

ELECTRICAL RESEARCH LABORATORIES, Inc.
2500 Cottage Grove Ave., Chicago, Ill.
Send me your booklet "Scientific Audio Amplification" and diagrams.
Name.....
Address.....
City..... State.....

**SUPER
PARTS**

SM

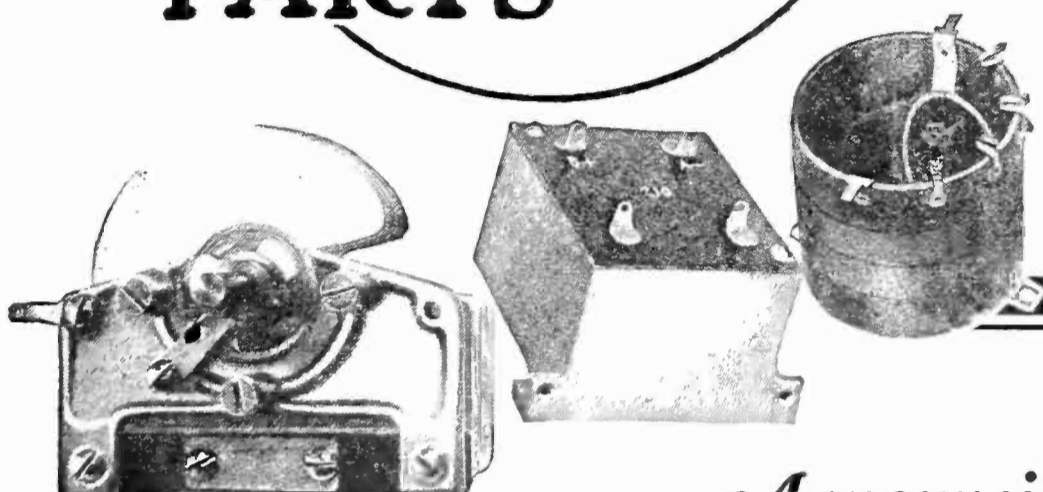

Announcing—

A New S-L-W Condenser

Again S-M Engineering leads the field, this time with a Straight-Line-Wavelength Condenser that sets new standards of mechanical and electrical excellence. Every current-carrying surface is heavily silver-plated. A long cone bearing gives wonderfully smooth control. The plate shape (S-L-W) gives *real* and not imaginary separation of stations—and selectivity. The design and appearance will delight the discriminating lover of fine instruments.

No. 305
.0005 Cap.
\$5.00

No. 306
.00035 Cap.
\$4.75

No. 307
.00025 Cap.
\$4.50

A Perfect Combination for Your Super

S-M 210 and 211 matched and charted intermediate transformers are the choice of experts, for they give the highest amplification with the greatest selectivity ever obtained practically. And the famous S-M 101B coupling unit is but another example of the basic correctness of S-M Design. You'll find these parts in the ultra-sensitive sets of men who know. In stock with better dealers and recommended by editors and engineers everywhere.

S-M Two-Ten and Two-Eleven Transformers—Each, \$8.00
S-M 101B Oscillator Coupler— " 2.50

Construction Plans for the "Super-Autodyne"—50c.

Midwest Headquarters for Roberts "Knockout" Parts for Radio Broadcast Phonograph Receiver

Silver-Marshall, inc.

103 S. Wabash Ave.
Chicago, Ill.



★ Tested and approved by RADIO BROADCAST ★

Mayolian
NEW YORK

B-Battery Supply for A.C. or D.C. That Can Be Built at Home!

The **Mayolian B-Battery Supply** is a practical, guaranteed B-Battery supply that is simple to construct, that is inexpensive to operate, and that is highly efficient. The **Mayolian** can be assembled and working in 45 or 50 minutes. To construct the **Mayolian B-Battery supply** requires only:



1 Mayolian Input Transformer, \$8.00

Type No. 601

1 Mayolian Filter Unit, \$21.00

Type No. 602

2 Standard Sockets. 1 Resistance.

Nothing else is required to build the **Mayolian**.

1. The **Mayolian** operates on either A. C. or D. C. with equal efficiency.
2. The **Mayolian** delivers 180 volts on open circuit when A. C. is employed.
3. The **Mayolian** has a Detector Variation of from 0 to 80 volts.
4. The **Mayolian** operates either 200 or 201-A tubes as detectors with equal efficiency.
5. The **Mayolian** delivers 50 milliamperes on closed circuit.
6. Your tubes cannot be burned out when a **Mayolian B-Battery Supply** is used.
7. The **Mayolian** is a new filter circuit that chokes the "hum" out of both sides of the line.
8. The **Mayolian** may be assembled in your cabinet. It requires no more space than your B batteries.

Write for **Mr. Mayo's** descriptive and construction booklet.

Orders shipped anywhere. Remit with order or pay your Postman on delivery. Money refunded if not satisfactory

Easy to Construct—Practical—Efficient—Economical

M A Y O L I A N

R A D I O C O R P O R A T I O N

1991 Broadway

New York City

Eastern Factory Representative: 20th CENTURY RADIO CORP.
102 Flatbush Ave. Brooklyn, New York



WJS Brazil on One BRIGHTSON *True Blue* ★ Tube!

BRIGHTSON LABORATORIES, Inc.
Waldorf Astoria Hotel
New York City

Gentlemen:—

This is to advise you that I have tested the True Blue Tube which was submitted to me and that I am pleased to be able to praise it most highly.

At my station I am able to receive the signals from the Rice Expedition, WJS, in Brazil, on a single tube, and changing to the True Blue Tube gave it an excellent chance to make good.

It did. If anything the signals were louder. Keep up the good work.

Yours very truly,

P. C. OSCANYAN, Jr.
Managing Editor,
Amateur Radio.

Whether you buy one True Blue Tube or three, six or eight, in a safety case, they are all alike, and all sold on approval.

10 Day Return Privilege

Unless True Blue Tubes prove interchangeably uniform, noiseless, crystal clear in tone and the handsomest, finest quality tubes you have ever seen, you can return them in ten days for refund.

60 Day Guarantee

Whether you buy one True Blue Tube or a set of three, five, six or eight in a safety case, each individual tube is covered by its own Brightson guarantee. If within sixty days a mechanical defect prevents any True Blue Tube from operating perfectly, you can return it for replacement.

BRIGHTSON LABORATORIES, Inc., 16 W. 34th St., NEW YORK, N. Y.
Philadelphia Office. 50 N. Eleventh St., Philadelphia, Pa.

Boston Representative: Wm. C. Oakes
832 Park Square Bldg., Boston, Mass.

Jersey City Representative: Triad Sales Co.
Trust Co. of N. J. Bldg., Jersey City, N. J.

Detroit Representative: H. C. Schultz
2831 Gratiot Ave., Detroit, Mich.

Milwaukee Representative: Yahr & Lange
207 E. Water St., Milwaukee, Wis.

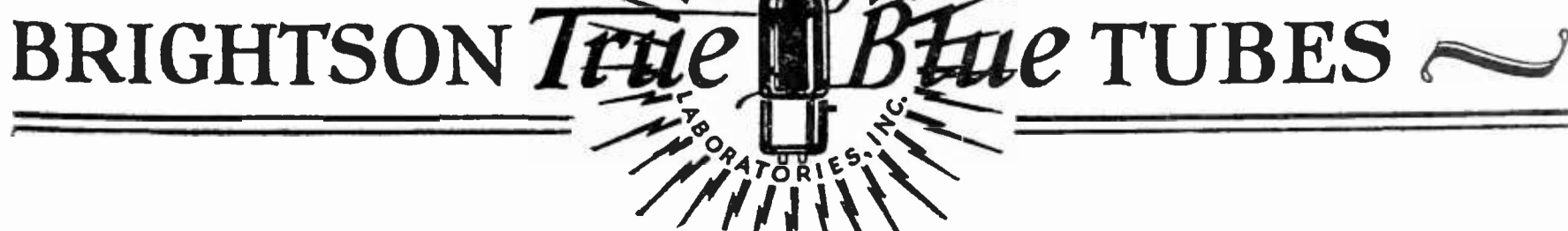

★ Tested and approved by RADIO BROADCAST ★

The DAVEN SUPER AMPLIFIER

A 3-stage RESISTANCE COUPLED UNIT which gives you that perfect tone-quality you are seeking. It is already wired and may be made a part of your set with a minimum of assembly labor. The merits of this modern form of amplification are so appreciated that progressive set builders are adopting the SUPER AMPLIFIER for perfect results. It costs less to install and adds greatly to the life of your "B" Batteries.

The DAVEN AMPLIFIER KITS are for those who desire Resistance Coupled Amplification, but who would rather assemble their own amplifier. Sold in three or four stage kits with complete instructions for assembly.

The Sine of Merit
DAVEN RADIO CORPORATION
Resistor Specialist.
 NEWARK, N. J.

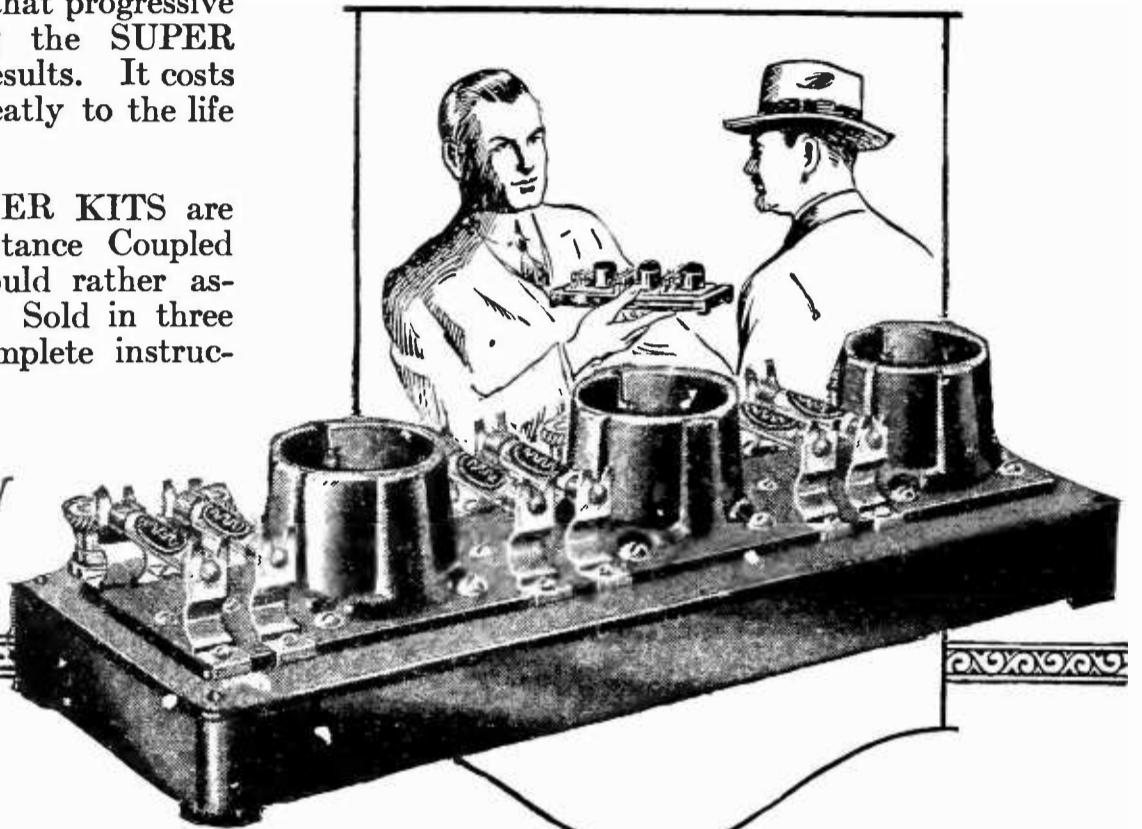

Obtain from your Dealer the "RESISTOR MANUAL," our complete handbook on Resistance Coupled Amplification. Price 25c. Postpaid 35c.



Make your set a Super-Het

The circuit described on page 254 of June Radio Broadcast will change any set into a super-heterodyne. It is particularly applicable to five tube neutrodyne and tuned RF sets. It changes these two circuits into super-heterodynes as good as most, and considerably better in some respects than any super-heterodyne circuit ever devised.

Stations come in at but one point on the oscillator dial. There is mathematically no possibility of harmonics. Full scale blue-prints with reprint of article \$1.00.

Eastern Coil antenna coupler	\$6.00
O'Connor oscillator coupler . . .	6.00
Special fixed condenser60
Complete parts including panel drilled and engraved, special formica bushings, screws, and wire, blue prints and reprint	37.50

A. O'CONNOR & COMPANY
 SUPER-HETERODYNE HEADQUARTERS SINCE 1923
 9702 Euclid Avenue, Cleveland, Ohio

THE SILENT FRANCE MULTI-DUTY SUPER-CHARGER

Proven
Superior!

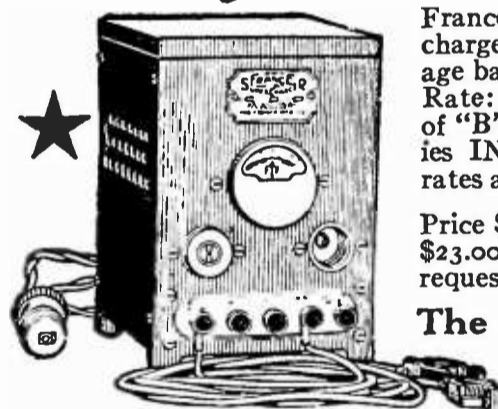

France Silent Super Charger charges 2, 4, 6 or 8 Volt storage battery at 5 to 7 Ampere Rate: charges 20 to 120 Volts of "B" Radio storage batteries IN SERIES at varying rates as desired.

Price \$22.00; West of Rockies \$23.00. Canadian prices upon request.

The France Mfg. Co.
 10327 Berea Road
 Cleveland Ohio

PEERLESS TWIN-AUD



List Price \$9.50

AT ALL GOOD DEALERS

—Buy a TWIN-AUD TO-DAY—

PEERLESS RADIO CORPORATION
 Newton Lower Falls Boston, Mass.

may be substituted in any circuit in place of any two audio transformers regardless of specifications or price with the assurance that the result will be *Greater Volume and Clearer Reproduction* because of its two stages of *balanced* audio amplification.

★ Tested and approved by RADIO BROADCAST ★



Now
Only
\$28

The
speaker with
*seven superior
features*

1. **PERMANENT MAGNET.** Sensitivity and volume depend on a magnetic field maintained constant by a permanent magnet. The magnet in the Thompson Speaker is about four times as large as the magnets used in the ordinary "loud-speaker."

2. **ACTUATING COILS.** Of generous size, wound of wire heavy enough to withstand currents needed to produce great volume. Insulated to withstand higher plate-voltages than the small coils used in the "telephone type" loud-speakers.

3. **LAMINATED POLE-PIECES.** More costly than solid pole-pieces, but they add to sensitivity and permit a wider range of sound-vibrations.

4. **DRIVING ARMATURE.** Fixed at one end and fastened to the apex of the conical diaphragm at the other end. Movement at diaphragm twice that at

pole-pieces, permitting reproduction of very loud sounds with a narrow air-gap, insuring *both* volume and sensitivity.

5. **CONICAL DIAPHRAGM.** Effective area 50% greater than flat diaphragm of same diameter. Entire cone moves. Sound created for given movement 100% greater than for equal movement in a flat diaphragm. Result: Better tonal quality and greater volume.

6. **VOLUME REGULATOR.** In one turn around, varies air-gap from zero to maximum. Permits regulation for varying strength of near and far stations.

7. **THE THOMPSON HORN.** Moulded composite horn delivers sound-waves from diaphragm without adding distorting waves of its own. Double bend gives effective horn-length of 27 inches, in an instrument which (including base) measures only 23 inches high over all.

R. E. THOMPSON MANUFACTURING CO., 30 Church Street, New York

★ **THOMPSON
SPEAKER**

Thompson Tone Stands Alone

★ Tested and approved by RADIO BROADCAST ★

For Good Summer Radio Reception use

JEFFERSON★

TUBE REJUVENATOR

keeps tubes like NEW

DON'T blame the weather for all summer radio troubles. . . . How are the tubes? All tubes, remember, grow weak with use—especially in summer when operated at higher voltage. Bring them back to full efficiency with the Jefferson Tube Rejuvenator! Takes only 10 minutes; attach to a convenient electric light socket. Used once a month, it **DOUBLES** and **TREBLES** the life of tubes! Quickly pays for itself in saving of tubes and batteries. It's wasteful to be without one; it's economy to own one. *Fully guaranteed.* At leading stores selling radio supplies. If your dealer can't supply you, send \$7.50 to

Jefferson Electric Mfg. Co., 501 So. Green Street, Chicago, Ill.

Makers of Jefferson Radio, Bell Ringing and Toy Transformers; Jefferson Spark Coils for Automobile, Stationary and Marine Engines; Jefferson Oil Burner Ignition Coils and Transformers.

For Home Use



Patent Pending

\$7.50
\$10 in Canada



Takes large or small tubes—
201-A, 301-A, UV-199, C-299

BIG MONEY!

\$3,000 to \$10,000 a year

Want to make big, easy money? Learn how to install, operate, repair, construct and sell Radios. Write now for facts about the amazing opportunities for Radio experts, and our special offer of a **FREE 1000-mile receiving set**, and how you can quickly train at home by mail.

Be a Radio Expert

No previous experience necessary. Anyone with ordinary education can now learn Radio quickly under our simplified home-study plan. We need men right now to represent our Association. Be the Radio expert in your neighborhood. Get your share of the big profits. Hundreds about you want Radios and advice how to operate. You can earn enough money right from the start to pay for course. Nothing difficult about it, Low cost and easy terms.

FREE 1,000-MILE Receiving Set

Don't miss this big special offer to supply **FREE** all parts necessary to construct a high-grade 1000-mile receiving set. You can sell this set alone for practically the entire cost of the course. Send for the facts now. Find out all about this big-pay field. Address

Radio Association of America
4513 Ravenswood Ave., Dept. B-7 Chicago, Ill.



Be a RADIO EXPERT

EARN \$50 to \$200 a Week

Free Book Send for my big **FREE RADIO BOOK** right now! See how many wonderful money making opportunities are waiting for you as a Trained Expert in the liveliest, fastest growing Big Pay field in the world—**RADIO!**

Superdon Radio Set FREE
Long distance super-powerful selective radio set **FREE** to every student who acts now! Not a cent extra charge.

Write Today for full particulars and proof that you can succeed quickly in the big pay business of Radio; also how to get the wonderful Twin Superdon set without cost. Write at once—Now! No obligation.
I. J. Mendels, American Radio Engineers
646 N. Michigan Ave., Dept. 80 Chicago

Send for it millions untouched

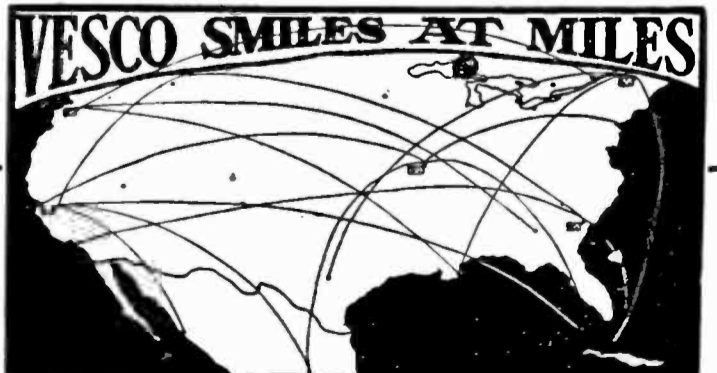

VESCO SMILES AT MILES

ON ONE TUBE

BIG FREE BOOKLET tells the story. California users of **CROSS COUNTRY CIRCUIT** hear Atlantic Coast, Canada, Cuba, Mexico, and Hawaii. Atlantic Coast users hear England to California. Our new plan makes this set easiest and cheapest to build. One hour puts in operation. One tuning control. No soldering. Any Novice can do it. **BIG BOOKLET FREE** or complete instructions for 25c stamps or coin.

VESCO RADIO CO. Box RB-117 Oakland, California

★ Tested and approved by RADIO BROADCAST ★

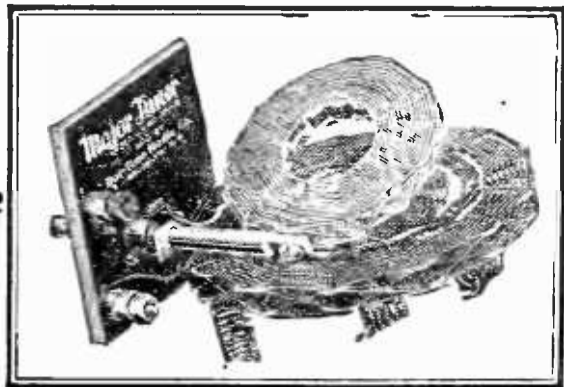

Have you met

Major Tuner

REG. U.S. PAT. OFFICE

MAJOR TUNER will end those "interference blues." A set built with the MAJOR TUNER gets only one station at a time—the one you want to get and no other.

MAJOR TUNER is the most advanced form of three circuit Low-Loss tuner. It is packed with complete picture wiring diagrams and full instructions.

(If your dealer cannot supply you, write us)

BEL-TONE RADIO CO. \$4
161 Jamaica Ave., Brooklyn, N. Y.

HOW ABOUT YOUR JOBBER ?



- Does he wholesale exclusively?
- Does he refer all customers' inquiries to his dealers?
- Does he carry reputable apparatus that is nationally advertised and in demand?
- Does he carry ample stock to insure prompt delivery?
- Does he sell all his stock to dealers—even when material is scarce?

HOMMEL DOES!

Write to-day for Hommel's Encyclopedia of Radio Apparatus 266-B. It's free and will help you

LUDWIG HOMMEL & CO

929 Penn. Ave. Pittsburgh, Pa.



A safeguard against current leakage

THOSE faint electrical impulses picked out of the ether by your antennae must be led along through the circuit of your set with the least possible chance of escape. To guard this path is the prime function of insulation.

Any leakage due to poor insulation has a marked effect on the character and volume of the current delivered to the phone or loud speaker. The insulating material proved most efficient in guarding against such leakage is Radion made to order exclusively for radio purposes.

Radion Panels are the easiest to work with simple home tools and are regarded as the best-looking, best-finished panels made. There are 18 standard sizes in black and Mahoganite. Radion Dials (in all regular sizes) match Radion Panels.

Send for booklet "Building Your Own Set." It contains complete, clear directions for building the most popular circuits; gives wiring diagrams, front and rear views, shows a new set with slanting panel, etc. Mailed for ten cents. Use coupon.

AMERICAN HARD RUBBER COMPANY
Dept. C7 11 Mercer St. New York City

RADION

The Supreme Insulation

PANELS

Dials, Sockets, Binding Post Panels, etc.

AMERICAN HARD RUBBER COMPANY
Dept. C7, 11 Mercer St., New York City

Please send me your booklet, "Building Your Own Set" for which I enclose 10 cents.

Name

Address

ATTENTION SET MANUFACTURERS

Our special "Selector" variable condenser with self-balanced coils attached is the equipment you have been waiting for—at a price you can afford to pay.

To enable you to successfully manufacture a five tube, popular priced radio receiver consisting of two stages of tuned radio frequency, detector and two stages audio, combining selectivity, volume, true tone, distant reception and simplicity.

OUR "SELECTOR" LOW LOSS GROUNDED ROTOR VARIABLE CONDENSER "THE MANUFACTURERS' SPECIAL" answers the demand for a ruggedly constructed efficient instrument at an exceptionally low price.

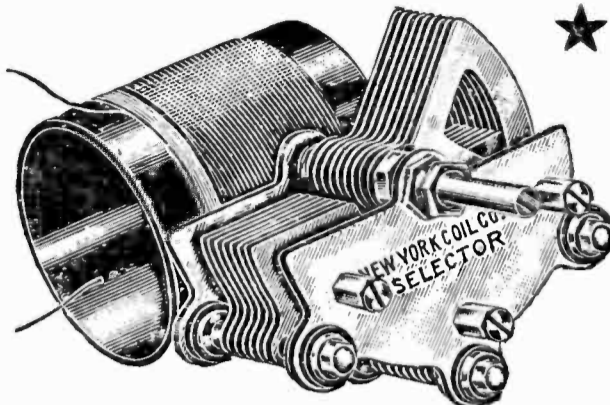

Condenser and Transformer as shown, List Price \$3.75

Get manufacturers' price and descriptive literature
List Price \$2.75 .0005 (23 plate) — \$2.50 .00035 (17 plate)

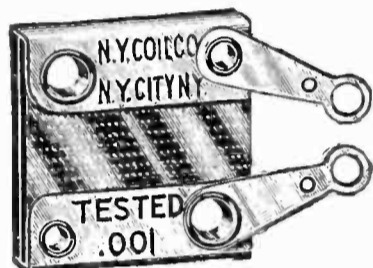

NEW YORK PRECISION MICA FIXED CONDENSERS—CHOICE OF LEADING MANUFACTURERS AND RADIO ENGINEERS.

"High Grade Large Cap. Paper Condensers for B Battery Eliminators."

NEW YORK COIL COMPANY

338 Pearl Street

New York City, N. Y.

Pacific Coast — Marshank Sales Co., 926 Insurance Exchange Building, Los Angeles, Calif., also San Francisco, Portland

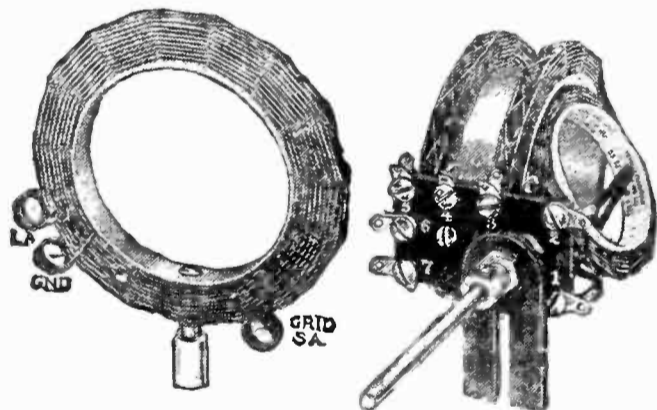

★ SICKLES DIAMOND-WEAVE COILS

(Patented Aug. 21, 1923)

For Browning-Drake, Craig, and Hoyt Circuits

Sickles Coils for the famous Browning-Drake Circuit are the latest Sickles achievement in efficient design for a particular use. They are priced at \$7.50 a set. When ordering specify set No. 24.

Coil set No. 20, at \$4.50, is for use specifically with the New Reflex Receiver designed by Albert G. Craig, using the Sodian detector.

Coils for the Hoyt Circuit at \$10.00 a set, for the Knock-out Reflex Circuit at \$4.00 a pair, the Tuned Radio Frequency coils at \$2.00 each and Coils for the Acme Reflex circuit at \$4.50 a set are other standard Sickles Coils. We manufacture also for manufacturers' special requirements.

Send for descriptive catalog

The F. W. Sickles Co.
335 Worthington St., Springfield, Mass.

A Laboratory Product CRESCENT LAYITE RESISTANCES

for Distortionless Amplification

12,000, 48,000, 50,000, 100,000 Ohms. List \$1.50 each. Special Sizes to Order \$2.50 each. Dealers write for discounts. When Better Resistances are made they will be Crescents.

Crescent Radio Supply Co. 1-3 Liberty St., Jamaica, N. Y.



\$3.25 RADIO Storage "B" Battery

12 Cells 24 Volts Lasts Indefinitely—Pays for Itself
Economy and performance unheard of before. Recharged at a negligible cost. Approved and listed as Standard by leading Radio Authorities, including Pop. Radio Laboratories, Pop. Sci. Inst. Standards, Radio News Lab., Lefax, Inc., and other important institutions. Equipped with Solid Rubber Case, an insurance against acid and leakage. Extra heavy glass jars. Heavy, rugged plates. Order yours today!

SEND NO MONEY Just state number of batteries wanted and we will ship day order is received. Extra Offer: 4 batteries in series (96 volts), \$12.75. Pay expressman after examining batteries. 5 per cent discount for cash with order. Mail your order now!

WORLD BATTERY COMPANY
1219 So. Wabash Ave., Dept. 78, Chicago, Ill.
Makers of the Famous World Radio "A" Storage Battery
Prices: 6-volt, 100 Amp. \$11.25; 120 Amp. \$13.25; 140 Amp. 14.00.
All equipped with Solid Rubber Case.

World FOR RADIO STORAGE BATTERIES

WDKA - WEAF - WGN - WJS - KHJ - KGO - KFAF - WJY - KOP

Getting Concerts Whole

It soon dawns on the owner of a Bristol Speaker that he is listening in on entire concerts.

That roving disposition to tune in every station on the map is due, much more than is generally supposed, to a yearning for really sweet music.

One reason radio music does not always sound sweet is that certain of the tones are out of tune.

Coming through a Bristol Speaker, all the tones are evenly in tune. The result is an arresting sweetness that "invites" you to stay through a concert to the end.

For \$25 and \$30 you can get a Bristol Speaker; and there are others as low as \$12.50. Ask your dealer to send one out. Write us for Folder No. AH-3022, telling why the Bristol is such a delight to the ear.

THE BRISTOL COMPANY, WATERBURY, CONN.
For 36 years makers of BRISTOL'S RECORDING INSTRUMENTS. Ask any technical engineer. ★

BRISTOL MADE IN U.S.A. REGISTERED TRADE MARK DESIGNED BY OFF **AUDIOPHONE** **LOUD SPEAKER**

NO MORE B BATTERIES!

The Molliformer B Current Unit is the type of B Eliminator described in the June issue of this magazine. When you buy a B Current Supply Unit be sure to get one that is powerful enough for the larger receiver you may eventually build.

The Molliformer B Unit is powerful enough for even the largest receivers. Here are some of its salient features:

Shell type transformer with only 3 watt core loss amplifier voltage adjustable from 80 to 130 volts. Detector tap can be used with soft or hard tube as well. Every individual part designed especially for the Unit. Very easy to assemble, no skill or knowledge required.

Price per kit of essential parts, including rectifiers with purest materials \$22.50

Send for free descriptive folder.

Dealers write for exclusive agency proposition on your letterhead.

C. E. JACOBS
Designer & Manufacturer

2804 N. Kedzie Ave.

Chicago

Better Contact

An easy way to get distant stations clearly

IT'S important at all times—but *doubly important in summer* when static is apt to be troublesome—to have clean, perfect contact between tubes and sockets. If you don't, the almost unnoticeable films of corrosion act as barriers for the delicate current; magnified, they cause annoying noises.

"It's the contact that counts"

NA-ALD Sockets remove those barriers. The exclusive side-scraping contacts (not just side pressure) of Na-Ald De Luxe Sockets cut the corrosion from the sides of tube terminals. A turn or two of the tube and the tube terminals are clean.

The Alden-processed Bakelite conserves all the current energy. Laboratory tests proved Na-Ald Sockets most efficient in low loss and low capacity.

Na-Ald Adapter No. 429 and Na-Ald Socket No. 499 are especially made for use with UV-199 and C-299, and No. 411 for WD-11 tubes, all of which are used with dry batteries. They are a big aid to the highest tube efficiency.

Use Na-Ald Sockets not only in the set you build but also install them in the set you buy. At all dealers.

Mail coupon for free booklet, "What to Build," giving tested, selected circuits.

ALDEN MANUFACTURING CO.
Also makers of the famous Na-Ald Dials
Dept. B8 Springfield, Mass.

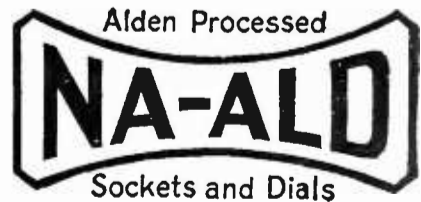

Na-Ald Socket No. 499, 50c.



Na-Ald Adapter No. 429, 75c.



Na-Ald De Luxe Socket No. 400, 75c.



Na-Ald Small Space Socket No. 401, 35c.



Na-Ald Socket No. 411, 75c.

ALDEN MANUFACTURING CO.
Dept. B8, Springfield, Mass.

Send me free booklet, "What to Build."

Name.....

Address.....

C-10

Navy Model ★

Super-Heterodyne

The supreme achievement in receiver design, setting a new high standard of efficiency not even contemplated heretofore.

**A High Powered Receiver
employing 10 tubes**

Simple tuning

Compact (size only 28x8x8)

*Wave length range 50-600
meters*

*Selectivity far in advance
of others*

*Total amplification almost
2,000,000 times*

*Perfect tone reproduction
and volume*

In actual tests the C-10 completely outclasses any other receiver in all respects.

Illustrated descriptive matter gladly mailed upon request.

Write direct to

NORDEN-HAUCK, Inc.
Engineers

Offices and Laboratories:

**1617 Chestnut Street,
Philadelphia, Pa.**



Oh boy!

KESTER

Rosin Core

Radio SOLDER

Sure! is Safe and Simple

APPROVED BY
RADIO ENGINEERS

A GENUINE SOLDER

CHICAGO SOLDER COMPANY

4222 Wrightwood Ave., Chicago, U. S. A.

Originators and World's Largest Manufacturers of Self Fluxing Solder

YOUR DEALER CAN SUPPLY YOU



Get this great new

MAP of THE AIR

A MARVELOUS new way to chart your radio exploits—beautiful Air Map, printed in three colors, with every station clearly marked and Time zones outlined! Size 28 x 34 inches.

There's no limit to the useful and amusing ways you can use Collier's new Radio Map of the U. S. and Canada. With its help—

**You can find out INSTANTLY
how far any station is**

If you use a directional aerial, you can point the loop exactly toward the station you want to get. The map also outlines the radio districts, and gives an alphabetical list of all stations and their operators.

Thousands have already been sold. Get yours *to-day!* At your news-stand or radio dealer's, only twenty-five cents—only just mail a quarter to us.

P. F. COLLIER & SON COMPANY
254 Park Avenue, New York City, R. M. B. 3300

★ Tested and approved by RADIO BROADCAST ★

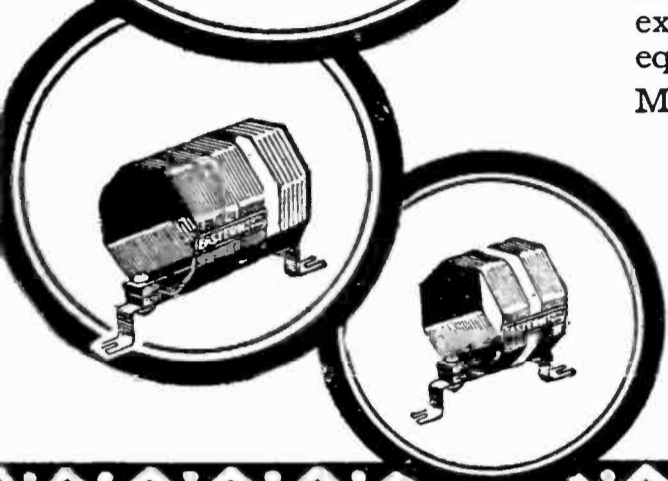
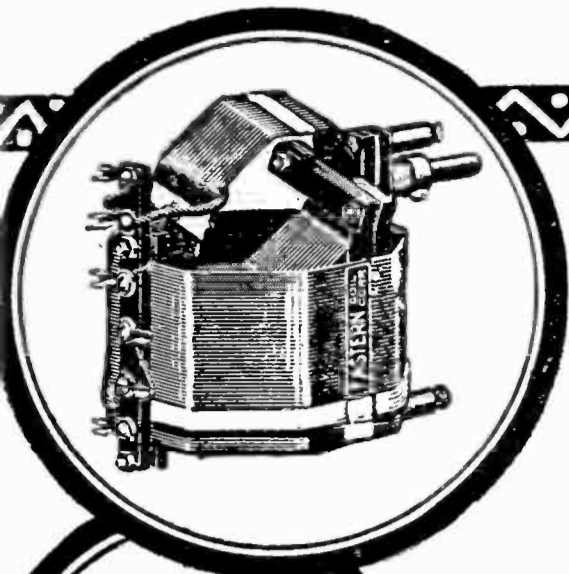

EASTERN

Make your set a Super-Het!

by adding the *new, revolutionary* O'Connor Frequency Changer as described in the June issue of Radio Broadcast. Only one extra tube is necessary. It's easy to build and the results obtained equal the best Super-Het.

Mr. A. O'Connor has *specified* the EASTERN PICKLE BOTTLE COUPLER (Type FC) for use in his remarkable Frequency Changer. Type FC Coupler, price \$6.00

EASTERN PICKLE BOTTLE COILS are also designed for perfect performance in the Roberts Circuit (\$8.50 per set), DX Superdyne, (\$8 per set), 3 Circuit (\$6) and for Tuned R. F. for .0005 or .00035 condensers (\$2 per coil).

At your dealers or direct, postpaid.

EASTERN COIL CORPORATION
22 Warren Street Dept. R. B. New York



pickle bottle COILS

**PROFESSIONAL
SET BUILDERS!**
*and
dealers who build sets*

WE will shortly begin a series of newspaper advertisements featuring the work of individuals and dealers who build sets using Cardwell Condensers.

If you build to specification or from original design, it will be to your interest to communicate with us immediately.

Ask for details of plan. Be sure to give name of your jobber.

★ ALLEN D. CARDWELL
MANUFACTURING CORP.
81 Prospect Street, Brooklyn, N. Y.

Summer Static *now overcome by volume*

Static is diminished in proportion to the amount of volume which a radio set delivers, experts agree.

Kellogg transformers give volume with added clarity of tone.

The Kellogg radio frequency transformer is of the low loss type, having many important features. It will operate at all wavelengths with .00035 to .0005 variable condensers. For best results, use the Kellogg .0005 low loss variable condenser. Kellogg R. F. Transformers at all dealers \$2.35.

Kellogg Audio frequency transformers give greater volume with clearer reproduction, due to the high quality materials and expert workmanship, used in the Kellogg process of manufacture. Kellogg audio frequency transformers are made in both shielded and unshielded types ranging in price from \$3.50 to \$4.50

Kellogg transformers can be obtained at all radio dealers

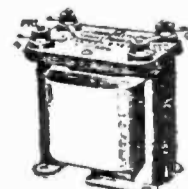
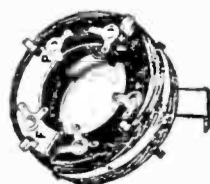

KELLOGG SWITCHBOARD & SUPPLY CO.
1066 W. Adams St., Chicago, Illinois

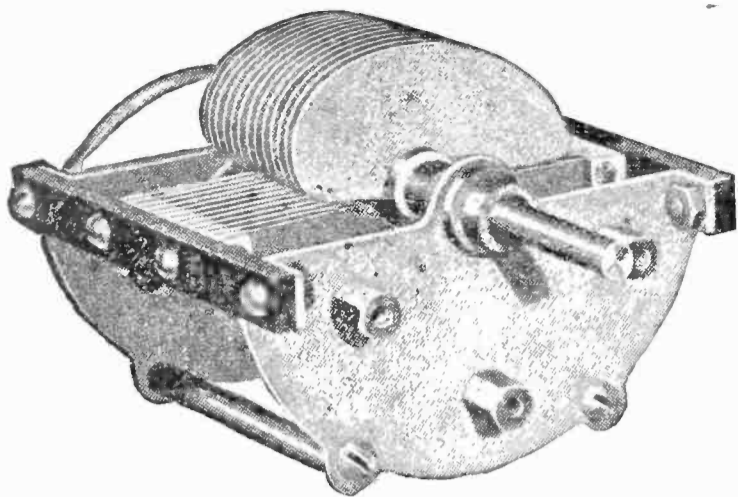

CONTINENTAL

LO LOSS

SEPARATOR

*Having a Little Trouble Tuning
in the New Wave Lengths?*

It's Your Condensers!

THEY were made when there was a wide difference between stations. Now, you need more than a condenser—you need a *Separator* to successfully cut out the overlap of two stations sending on wave-lengths only a fraction of a meter apart.

The *Continental Separator* is all that its name implies—a rigidly built low loss condenser, designed to make your set receptive over the full range of broadcast wave lengths from 0 to 1500 meters.

Sold with the new *Continental Junior* (the perfect vernier) at the price of any high grade condenser.

Plate	Capacity	Price
13	.00025	\$4.50
18	.00035	4.75
25	.0005	5.00
45	.001	6.00

If your dealer can't supply you, write Condenser Headquarters

GARDINER & HEPBURN, Inc.
611 Widener Bldg. Philadelphia, Pa.

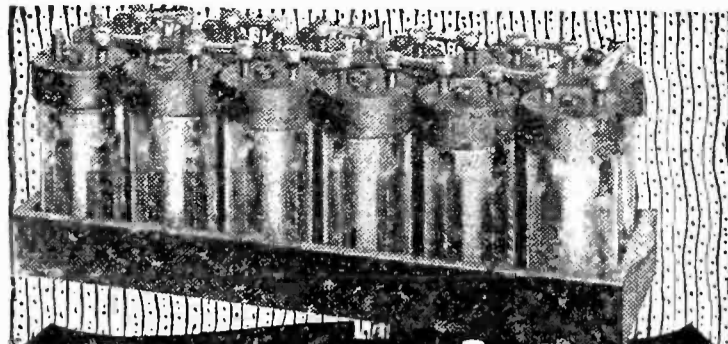
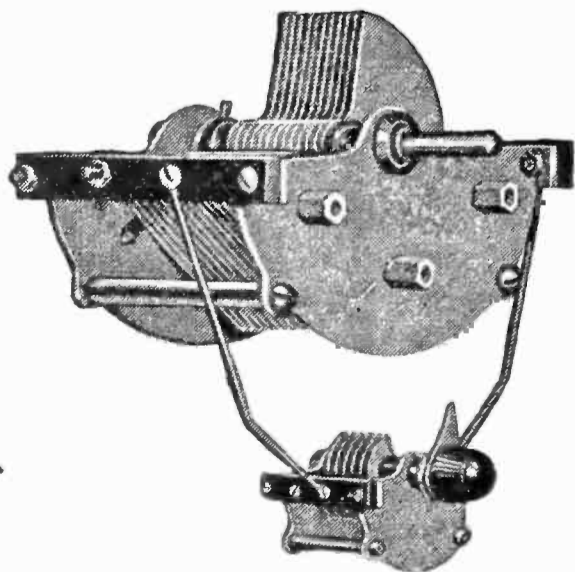

FREE!

**12-Cell — 24-Volt
Storage 'B' Battery**

Positively given free with each purchase of a WORLD "A" Storage Battery. You must send this ad with your order. WORLD Batteries are famous for their guaranteed quality and service. Backed by years of successful manufacture and thousands of satisfied users. Equipped with *Solid Rubber Case*, an insurance against acid and leakage. You save 50 per cent and get a

2-Year Guarantee

Bond in Writing WORLD Battery owners "tell their friends." That's our best proof of performance. Send your order in today.

Solid Rubber Case Radio Batteries

6-Volt, 100-Amperes \$11.25

6-Volt, 120-Amperes 13.25

6-Volt, 140-Amperes 14.00

Solid Rubber Case Auto Batteries

6-Volt, 11-Plate \$11.25

6-Volt, 13-Plate 13.25

12-Volt, 7-Plate 16.00

Send No Money Just state battery wanted and we will ship day order is received, by Express C. O. D. subject to your examination on arrival. **FREE "B" Battery included.**

Extra Offer: 5 per cent discount for cash in full with order. Buy now and get a guaranteed battery at 50 per cent saving to you.

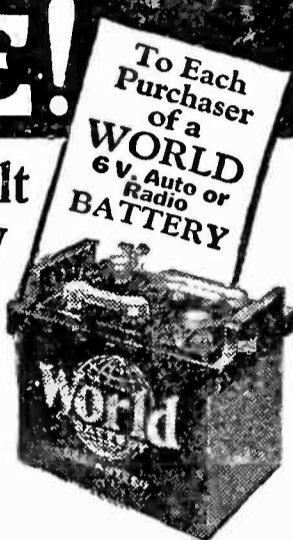

Approved and Listed as Standard by Leading Authorities

including Radio News Laboratories, Popular Science Institute of Standards, Popular Radio Laboratories, Radio Broadcast Laboratories, Radio in the Home, and Lefax, Inc.

WORLD BATTERY COMPANY
1219 So. Wabash Ave., Dept. 24 CHICAGO, ILL.

World For **AUTO** and **RADIO**
STORAGE BATTERIES



KDKA - WEA - WGN - WJS - KHJ - KGO - KFAF - WJY - KOP

Harkness Scores Another Knock-Out

Kenneth Harkness, originator of the famous "Knock-Out" Harkness Reflex, has developed a new and better circuit—a 3-tube Counterflex. By a new method of varying neutralization for different frequencies, Mr. Harkness has obtained greater amplification per stage with this circuit than was hitherto thought possible.

Write to-day for 16-page illustrated booklet "How to build the Harkness Counterflex" with complete building instructions and step by step wiring diagrams. Also ask for full details on our complete Counterflex kit containing all parts to build this remarkable receiver. Enclose 25c to cover cost of handling and mailing. Write now!

KENNETH HARKNESS RADIO CORP.
727-739 Frelinghuysen Ave.
Newark, N. J.



**Building
Better Service
into RADIO PARTS**



Aside from recognized radio uses in which no other metals can be substituted, COPPER and its alloys help you to make good radio sets *better* sets.

For instance, binding posts are superior posts, and battery nuts give best service and satisfaction when made of dependable free-cutting BRASS rod. And—

★ their speedier production makes labor costs lower.

**COPPER & BRASS
RESEARCH ASSOCIATION**
25 Broadway, New York

**Actual
Performance
Is the real test
Of any Condenser.**



**Judged
On this basis
The RATHBUN
Is the equal
Of any — and
At any price.**

**There is
No Better Value.**

RATHBUN MANUFACTURING CO., Inc.
Jamestown New York

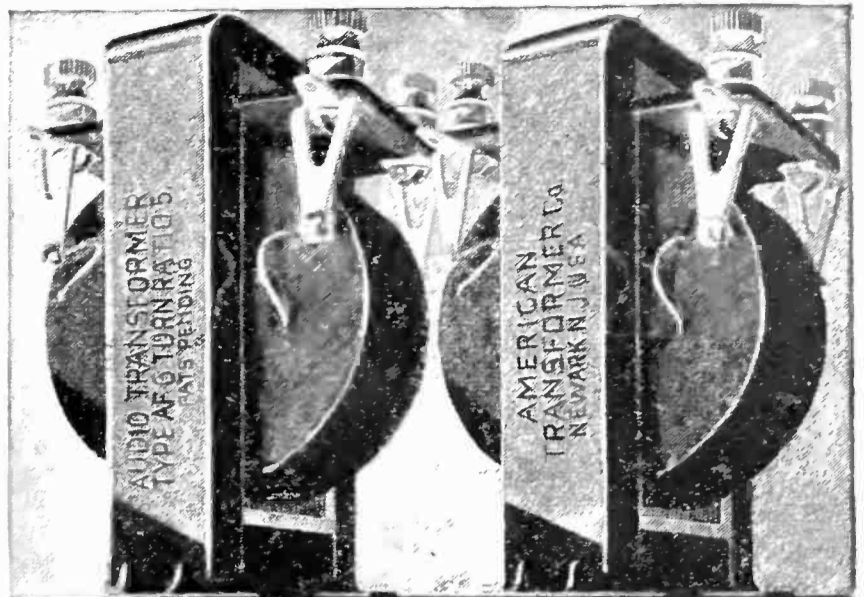

Quality

Good materials and honest workmanship go far in transformer efficiency.

Add to these the experience gained in 24 years of transformer building and you have the facts behind the quality of the AmerTran—a transformer hard to beat from any angle.

Among the better audio transformers AmerTran ranks high—higher than most by actual test.

Buy AmerTrans by the Pair!

AmerTran is made in two types, one quality—A F 6, ratio 5:1, and A F 7, ratio 3½:1. Price either model, \$7.00 at your dealer's.



AMERICAN TRANSFORMER
COMPANY

181 Emmet Street, Newark, N. J.

“Transformer builders for over 24 years”

AMERTRAN
TRADE MARK REG. U.S. PAT. OFF.

★ Tested and approved by RADIO BROADCAST ★



The
Book-Cadillac
DETROIT'S FINEST HOTEL

1200 Rooms with Bath

\$4 and up

475 rooms at \$4 and \$5

Parlor Suites \$14, \$16, \$18 per day

Sample Rooms \$5 and \$8 per day

Three Main Restaurants
*Cafeteria Service in Coffee Shop
on Ground Floor - 18 Shops and
Broker's Office in Building*

*Special Luncheon Served
Daily in English Grill and
Blue Room \$1.25*

*Dinner De Luxe in Blue
Room and English Grill \$2
(Except Sunday)*

Venetian Room a la Carte

THE BOOK-CADILLAC
HOTEL COMPANY - DETROIT
ROY CARRUTHERS, *President*
WASHINGTON BLVD. AT MICHIGAN AVE.

FROST-RADIO

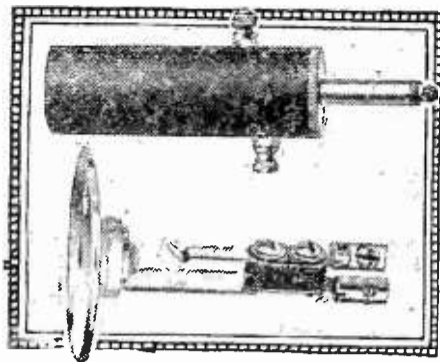

Loop Aerial
Plug and Jack

A NEW wrinkle that has been eagerly awaited—a plug and jack designed especially for loop use. Has sturdy jack, fitted with nicked flush plate and plug for taking loop. List price, complete, \$1.50.



HERBERT H. FROST, Inc.
314-324 WEST SUPERIOR STREET, CHICAGO
NEW YORK CITY CLEVELAND KANSAS CITY LOS ANGELES

Burns The Perfect
Reproducer

Tone loud and pleasing
Handsome material and design
Black—\$22.50 Shell—\$25.00

AMERICAN ELECTRIC COMPANY
State & 64th Sts. Chicago



The **Andrews**
Deresnadyne

RADIO RECEIVING SET

combines tone quality and selectivity with distance and volume. De Luxe Model \$165 without accessories. Write for literature
ANDREWS RADIO CO. Tribune Tower, Chicago

Bel-Canto Speakers

Volume and mellow, brilliant tone quality—truly "beautiful singers." Best workmanship—solid wood—beautifully finished. All adjustable.

Horns, \$10.00 and \$15.00. Cabinet \$17.50.

JOBBERs—Write us to-day about out-of-town territory.
BEL-CANTO RADIO AND TELEPHONE EQUIPMENT CO., Inc.
872 Broadway New York City

NEW IDEAS WANTED

Well known Radio Manufacturer whose products are nationally advertised and sold everywhere, wants new Radio device to sell. Will pay outright or royalty for idea or invention which is really new and salable. Address:

Mr. R. F. DEVINE
116 West 32nd St. Room 1101 New York, N. Y.

Let the non-directional
Thor Speaker Lamp
[Patents Pending]

bring in your Radio programs and furnish light at the same time. Many models—many styles—parchment or any color silk shades.

Table lamp models \$35.

At your dealers—or delivered.

★ **THOR Radio Division**
of the Golden Gate Brass Manufacturing Co.
1239-1243 Sutter St., San Francisco, Cal. (125)

Tower

The
Greatest Values
in Radio History



The Tower Meistersinger Loud Speaker represents the heart's desire of every radio enthusiast who is satisfied with nothing less than the best. Equipped with the famous Tower adjustable unit, the wonderful tone quality is amplified to the maximum degree without distortion through the full throated goose neck and scientifically proportioned bell. An object of beauty, the Tower Meistersinger, with soft tone golden lacquer base and dark mahogany finish bell, is the outstanding value in radio to-day.

On sale at all good
Radio Dealers



\$15⁰⁰

The
Meistersinger
Speaker

(The Greatest Singer)

\$3.95

TOWER SCIENTIFIC
PHONOGRAPH ATTACHMENT

\$4.95

LITTLE SPITFIRE
LOUD SPEAKER

\$2.95

TOWER
SCIENTIFIC
HEAD-SET

\$8.50

TOWER
SCIENTIFIC
LOUD SPEAKER

THE TOWER MFG. CORPORATION
98 BROOKLINE AVE
BOSTON MASS

WORLD'S GREATEST LOUDSPEAKER VALUES

★ Tested and approved by RADIO BROADCAST ★

Radio Broadcast

WILLIS K. WING
ASSOCIATE EDITOR

ARTHUR H. LYNCH
EDITOR

JOHN B. BRENNAN
TECHNICAL EDITOR

JULY, 1925

COVER - - - - -	<i>From a Painting by Henry J. Peck</i>	
SUMMER-TIME RADIO - - - - -	<i>Frontispiece</i>	322
WILL BEAM STATIONS REVOLUTIONIZE RADIO? - - -	<i>Guglielmo Marconi</i>	323
THE MARCH OF RADIO - - - - -	<i>J. H. Morecroft</i>	332
OBITUARY NOTICE OF MISS JENNIE IRENE MIX - - -		343
WHAT ARE THE ROYAL ROADS TO RADIO? - - - - -	<i>Keith Henney</i>	344
"AS THE BROADCASTER SEES IT" - - - - -	<i>Carl Dreher</i>	350
HOW TO BE A GOOD RADIO NEIGHBOR - - - - -	<i>Hogan-Goldsmith</i>	359
FOR THE RADIO BEGINNER - - - - -	<i>Zeh Bouck</i>	366
How to Make a Receiver for \$1.82		
How to Make a Simple Low-loss Coil		
WHAT OUR READERS WRITE US - - - - -		374
THE SUPER-AUTODYNE - - - - -	<i>McMurdo Silver</i>	376
A NEW METHOD OF RADIO-FREQUENCY AMPLIFICATION	<i>C. L. Farrand</i>	387
HOW TO BUILD RADIO BROADCAST'S PHONOGRAPH RECEIVER	<i>Arthur H. Lynch</i>	393
"NOW I HAVE FOUND . . ." - - - - -		406
THE GRID - - - - -		411
Something about Loops		
What Wavelength Means		
The High Mu Receiver Versus the Roberts Knockout		
Selecting a Storage Battery		
The Four-tube Crystal Reflex Receiver		
A Neutrodyne Circuit		
Tools for Radio Construction		
The Lynch Lead		
NEW EQUIPMENT - - - - -		420

Copyright, 1925, in the United States, Newfoundland, Great Britain, Canada, and other countries by Doubleday, Page & Co.
All rights reserved. TERMS: \$4.00 a year; single copies 35 cents.

F. N. DOUBLEDAY, *President*
ARTHUR W. PAGE, *Vice-President*

NELSON DOUBLEDAY, *Vice-President*
RUSSELL DOUBLEDAY, *Secretary*

S. A. EVERITT, *Treasurer*
JOHN J. HESSIAN, *Ass't. Treasurer*

Doubleday, Page & Co.
MAGAZINES

WORLD'S WORK
COUNTRY LIFE
GARDEN MAGAZINE & HOME BUILDER
RADIO BROADCAST
SHORT STORIES
EDUCATIONAL REVIEW
LE PETIT JOURNAL
EL ECO
THE FRONTIER

Doubleday, Page & Co.
BOOK SHOPS

NEW YORK: LORD & TAYLOR BOOK SHOP
PENNSYLVANIA TERMINAL ARCADE
LONG ISLAND TERMINAL ARCADE
AND 38 WALL ST.
ST. LOUIS: 223 NORTH 8TH STREET
4914 MARYLAND AVENUE
KANSAS CITY: 920 GRAND AVENUE
TOLEDO: LASALLE & KOCH
CLEVELAND: HIGBEE CO.
NEWARK: 34 PARK PLACE
SPRINGFIELD, MASS., MEEKINS, PACKARD & WHEAT

Doubleday, Page & Co.
OFFICES

GARDEN CITY, NEW YORK
NEW YORK: 120 WEST 32ND STREET
BOSTON: PARK SQUARE BUILDING
CHICAGO: PEOPLES GAS BUILDING
SANTA BARBARA, CALIFORNIA
LONDON: WM. HEINEMANN, LTD.
TORONTO: OXFORD UNIVERSITY PRESS

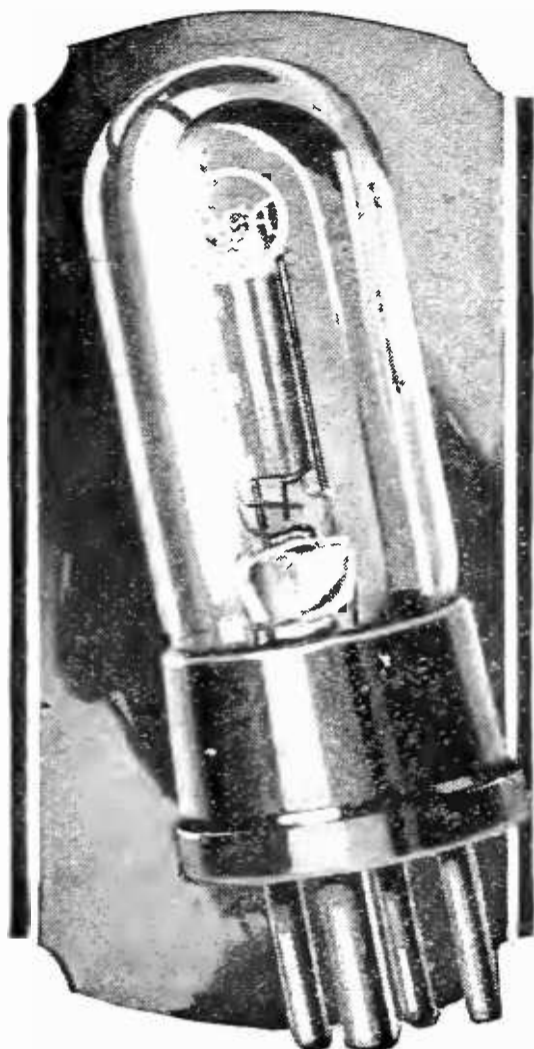

WD-11
 WD-12
 UV-199
 UV-200
 UV-201-a

Radiotrons with these model numbers are only genuine when they bear the name Radiotron and the RCA mark.

Do you believe in Names?

Do you buy things by name because the name tells the quality? Do you ask for a RADIOTRON, instead of just a "vacuum tube"—demand the standard by the name that marks it as genuine?

The most important part of a radio set is the tube, and you can't get the best out of any set without putting the best tubes into it. There's a Radiotron for every use, in every kind of set. Look for the name—and the RCA mark—and be sure it is *genuine*.

Radio Corporation of America

Sales Offices: Suite 37

233 Broadway, New York

10 So. La Salle St., Chicago, Ill.

28 Geary Street, San Francisco, Cal.

Radiotron

REG. U.S. PAT. OFF.

PRODUCED ONLY BY RCA



★ Tested and approved by RADIO BROADCAST ★

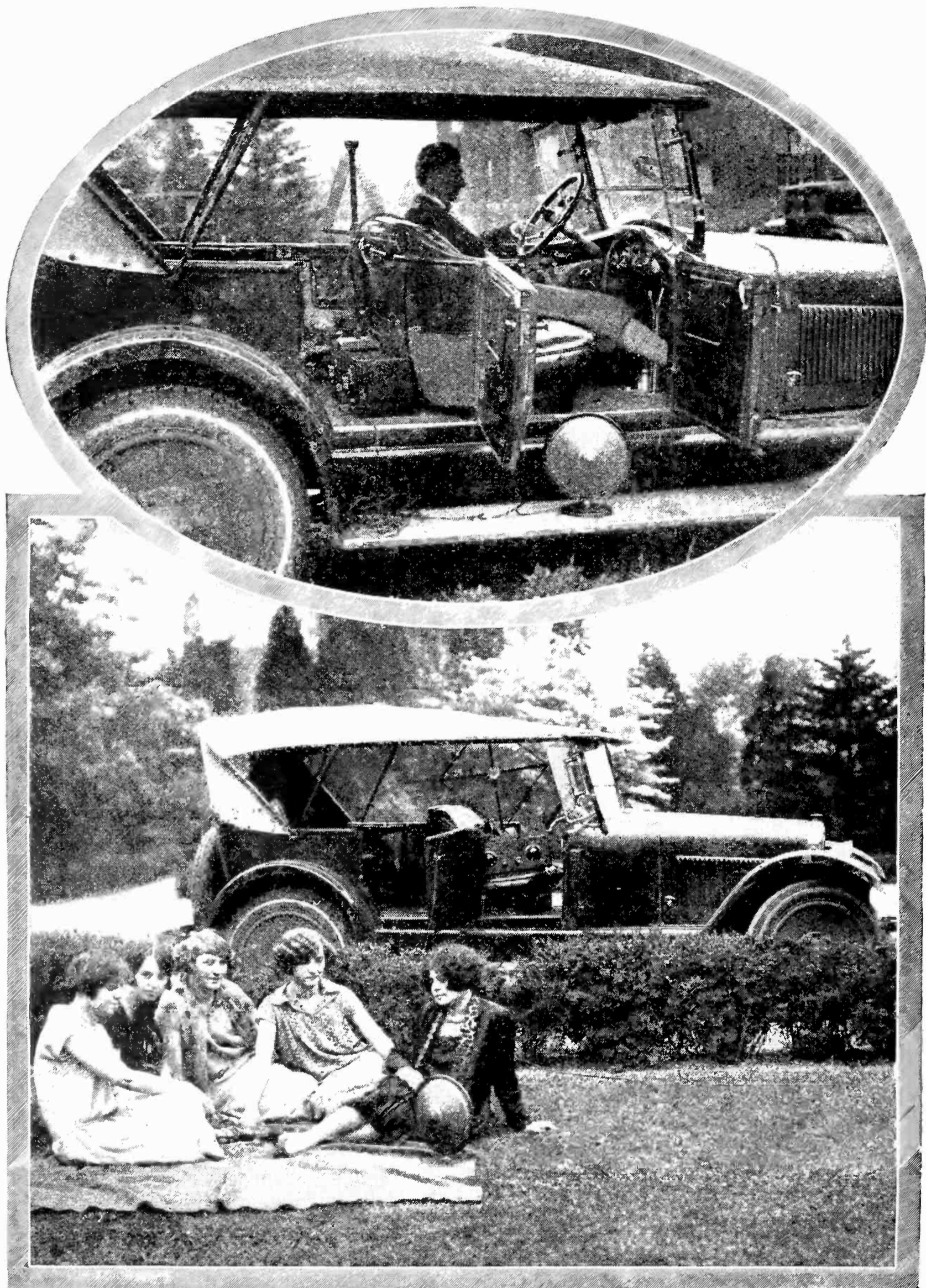

SUMMER-TIME RADIO

The super-autodyne described in this issue is made portable by use of the Lynch Lead which connects the filaments to the automobile battery. The Crosley "Musicone" is connected by a long cord so that the receiver may be left in the car and the speaker taken to any convenient spot nearby. It is growing more and more fashionable to make a portable set a part of motoring and camping equipment

JUN 22 1925

© C18661063

RADIO BROADCAST

Vol. 7, No. 3



July, 1925

Will "Beam" Stations Revolutionize Radio?

Senator Marconi's Own Story of His Experiments with Short Waves—Increased Efficiency and Greater Sending Speed Made Possible by Focussed High-Power Short Waves

By *GUGLIELMO MARCONI*

THE art of radio communication might well adopt as its motto, paralleling a well-known Roman saying about Africa, "*Ex radio semper aliquid novi,*" or, to put it in the vernacular, "Out of radio we are always getting something new."

For many years, all the important radio communication enterprises of the world have been engaged in building larger and more powerful stations, employing many hundreds of kilowatts in order to be able to send forth into the ether more powerful and longer electric waves, which have, in some cases, reached a length of about 15 miles. But had a little more time been devoted to a systematic investigation of short waves, produced by a power equal to only a fraction of that used in all of the big stations in the world, the discovery might have been made that a modest 100-foot wave, utilizing only some 15 kilowatts or 20 horse power, could successfully travel from England to Australia and South America, even during daylight, and there reproduce easily decipherable telegraphic signals.

But most experts, relying on theories which had not been thoroughly tested or on insufficient experimental data, had made up their minds as to what short electric waves could or could not do. It was reserved for the years 1923 and 1924 to show conclusively that such short waves could, and did, perform efficiently and reliably most of the things which the experts had considered until then either impossible or impracticable.

I think I am justified in saying, as a result of the experiments which I have carried on for a number of years and which culminated in 1923 and 1924, that a combination of short electric waves with what is known as the Beam System, is likely to bring about what amounts to nothing less than a revolution in the methods of commercial long-distance radio communication.

SHORT WIRELESS WAVES ARE HISTORICAL

THE use of short electric waves is as old as the discovery of the waves themselves. Hertz made use of them in his first classical experiments, and he proved that they obeyed the same laws as the infinitely shorter light

waves in regard to the speed of propagation, reflection, refraction, and diffraction. Some twenty-nine years ago in my own first experiments, in Italy, and shortly afterward in England, I used short waves in combination with metallic reflectors and, curiously enough, I was then able to transmit signals with them over a distance of a mile and three quarters, while with the elevated antenna and much longer waves, i. e., using the same system that is used to-day in all the high-power stations of the world, I could only manage to communicate over a distance of half a mile.

It is perhaps regrettable that the subsequent rapid development of the long-wave system, which in three or four years achieved such spectacular results, drew away the attention of most of us not only from the possibilities of the short waves, but also from the use of suitable reflectors to concentrate them into a beam in a definite direction, which is possible only with short waves. I never quite abandoned the idea, however, of utilizing the latter and, in addition, I always realized the importance of evolving a practical directive system of radio communication.

I believe it is generally admitted now that electric waves are far too valuable to be always allowed to spread out in every direction when it is desired to communicate with only one particular place. If a station in Great Britain wishes to communicate with one in the United States, for example, there seems to be no good reason why, if it can be helped, what it has to say should be heard in Siberia, and Egypt, as well as in Nicaragua and India. Naturally, non-directional stations, which scatter their waves in every direction, are of great utility for many naval and war purposes,

and of course for broadcasting, where the very soul of the process lies in the fact that the waves are scattered all around to be picked up by any one with a suitable receiving set. But it has always seemed to me that, if possible, the right thing to do would be to concentrate the whole of the radiated energy into a beam directed toward the locality with which it is desired to communicate, just as the beam of light waves from a searchlight is thrown in one direction by means of reflectors.

Such a result is greatly to be desired on many grounds, such as the low cost of installation and economy of upkeep entailed by the much lower amount of energy required, the reduction of interference with other stations, and the comparative secrecy which can be obtained.

Economy of energy is a matter which is instantly translatable into pounds, shillings, and pence. If we consider a high-power station similar to the one recently built in the Argentine for communication with Europe over a distance of about 6000 miles, every time the operator depresses the key and sends a signal flashing through the ether, some 800 kilowatts (about 1100 h. p.) is expended, although in the case of

these long waves, only a small fraction of the power is radiated from the antenna, which, in this case, is supported by ten steel towers each 690 feet high. It is evident that if a signal as easily readable can be sent with 30 or 40 kilowatts (about 50 h. p.) and by means of an antenna supported by much lower and fewer masts, there will be not only a greatly decreased cost of installation of the station, but also a great reduction in the cost of maintaining the station.

With regard to the question of interference

What Senator Marconi Is Doing

ON HIS last trip to the United States, Senator Marconi presented a paper before the Institute of Radio Engineers describing various radio experiments being conducted under his direction. That paper was read June 30, 1922, and dealt to a large extent with experiments with short radio waves.

It should not be thought that short wave radio transmission is new, simply because experiment in this field has lately received a good deal of attention from amateur and commercial engineer alike. Senator Marconi's earliest experiments with wireless waves in 1895 and 1896 used waves not more than a few inches long. And now, after radio stations have been built to use waves as long as 20,000 meters, the cycle of radio investigation swings back to something very similar to that of the first radio experiments. But in these experiments, the aim is to do away with the fading and absorption of signals, interference by natural electric waves, and to make transmission directional. In this article, Senator Marconi himself tells of what he and his engineers have lately done to revolutionize radio.—THE EDITOR

with other stations, it should be remembered that the number of available wavelengths is, after all, far from being unlimited, and if Brazil wishes to let New York know the prices of coffee and rubber on a certain wavelength, it would seem useless and, in certain cases, perhaps, undesirable, to broadcast the same information over Africa, Europe, the Pacific Ocean and probably a large part of Asia.

BEAM RADIO TRANSMISSION IS MORE SECRET

AS REGARDS secrecy, the beam system possesses a considerable advantage because only places situated within a certain angle or sector of the beam are able to receive a signal sent out by this method. This comparative secrecy or privacy, which cannot be obtained with any other system of radio communication, might prove of the greatest possible value in war time and, moreover, as has already been said, by reducing mutual interference, it will increase the number of stations that can be operated within a certain area.

During the early stages of the War, I became convinced that we had per-

mitted ourselves to get into a rut by allowing our attention to be monopolized almost exclusively by long waves, and I decided to take up the systematic study of short waves in combination with arrangements for directing them in any given direction. My first experiments along these lines in Genoa and later in Livorno in 1916, showed me that good directional working could always be obtained with properly constructed reflectors, and with the apparatus then available a range of six miles was attained.

Further experiments, carried out by my assistant, Mr. C. S. Franklin, between Carn-

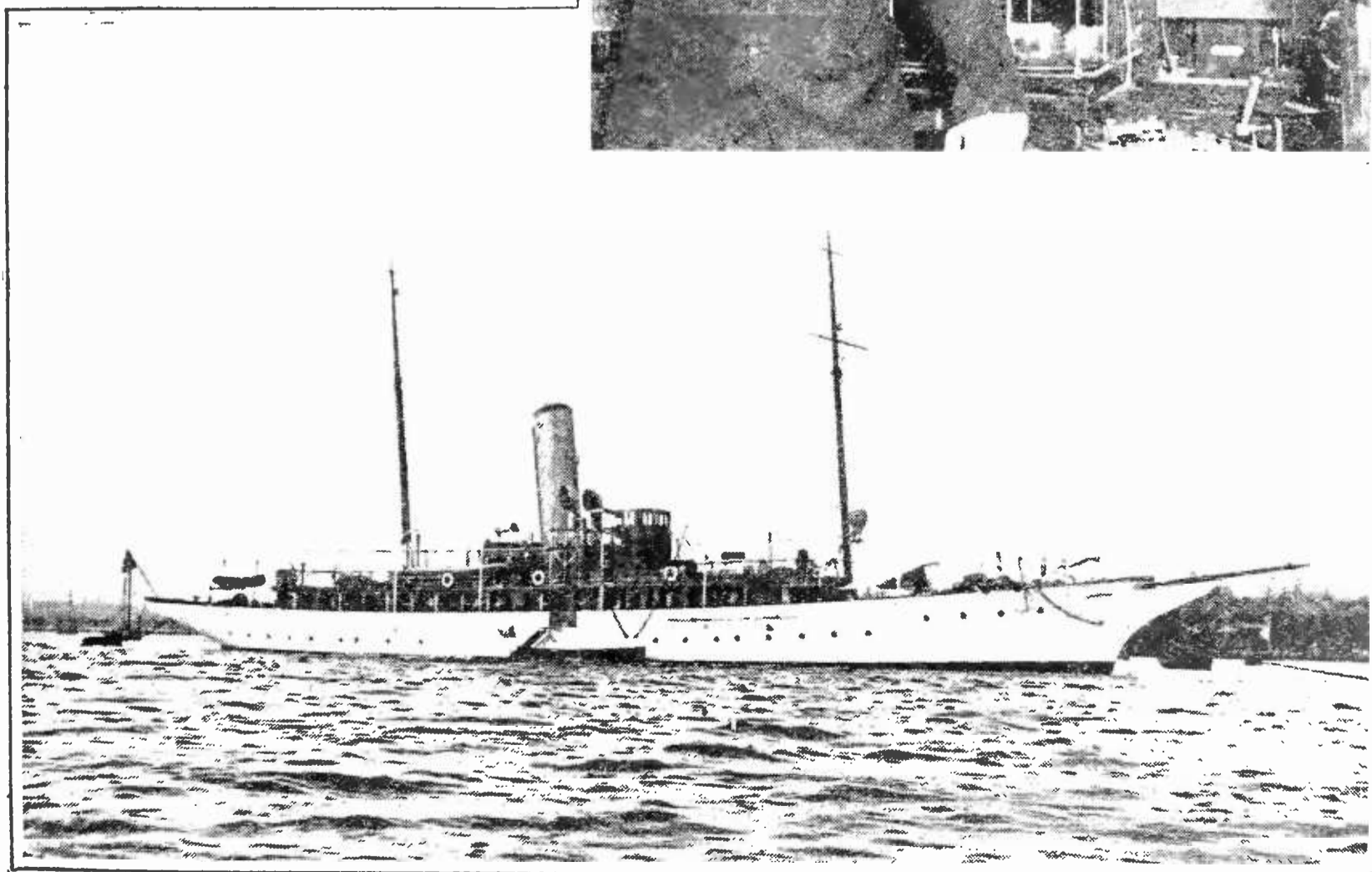
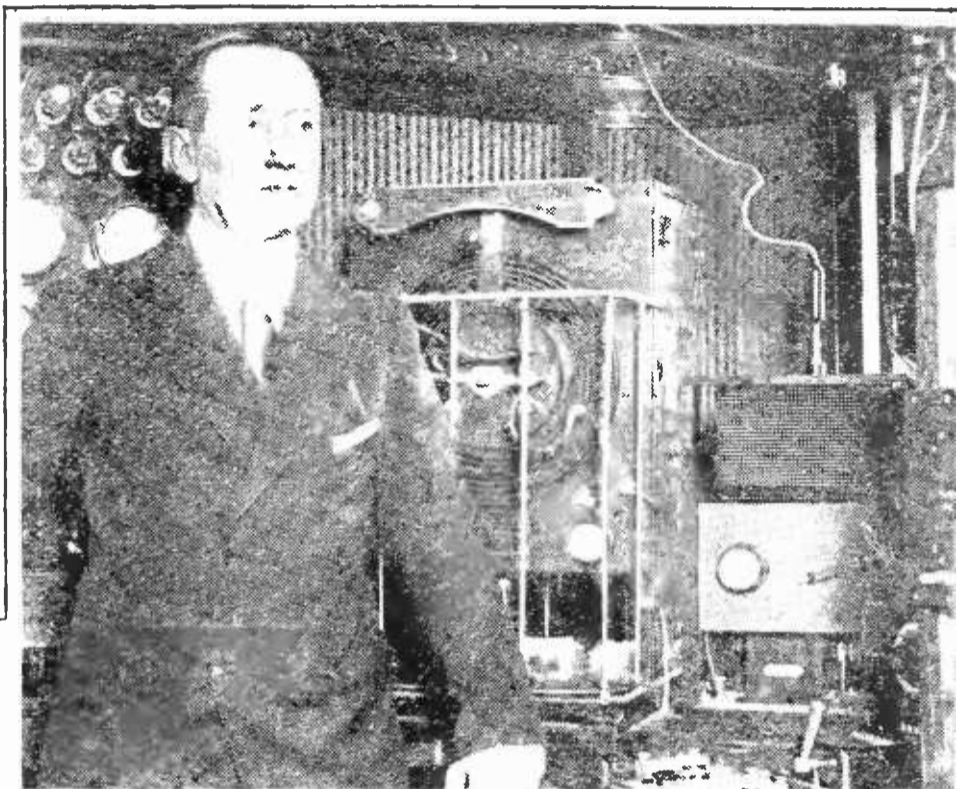

© Kadel & Herbert

THE "ELETTRA"

Senator Marconi's floating radio laboratory and pleasure yacht. Much of this great investigator's most important work has been done aboard his yacht. Some of the experiments described in this article were made on the *Elettra* while she was in the Mediterranean, communicating with the station at Inchkeith, shown in the cut on page 327. The insert shows Senator Marconi in his radio cabin

arvon, in Wales, and Ireland, and subsequently between Hendon, near London, and Birmingham, increased this range to nearly a hundred miles and strong radio-telephonic speech was received with the use of a power of only 700 watts (less than 1 h. p.). One very important experiment led to the knowledge that, when suitable reflectors were used at both ends, that is, one reflector to concentrate and project the waves in a beam and the other to focus them at the receiving end on the receiving antenna, the received energy was some 200 times greater than when no reflectors were used.

The success of these experiments led me to carry out a series of tests between a small experimental transmitting station at Poldhu in Cornwall, and a receiver installed on my yacht, the *Elettra*, which would enable me to vary the distance between the transmitting and receiving ends at will. Until then, most technicians were under the general impression that the range of short waves during daytime was variable and short, and that though their night range was, as a rule, much greater, it was far too unreliable to be of any use for practical commercial work. In addition it was thought that any considerable mass of land, especially if it were of a mountainous nature, would very materially reduce the working range with them. My experiments, which were carried out chiefly with waves of about 100 meters in length, and with about 12 kilowatts (about 16 h. p.), served to disprove a considerable portion of these beliefs and theories.

I knew, of course, like every other experimenter, that short waves, or at any rate short waves of the length I was then using, had much shorter ranges during daytime than at night. This fact was first observed by me in February, 1902, and my subsequent discovery that waves of the order of several thousand meters would, on the average, work as well by day as by night, was one of the main contributory causes to the development of the use of long waves for long-distance communication.

In the 1923 experiments with the *Elettra*, however, I found that the day ranges were reliable and of a quite respectable magnitude, that the night ranges were much greater than any one, including myself, had expected, and that intervening land and large portions of continents, mountainous or otherwise, did not prove any serious obstacle to the propagation of short waves. I found also, which was extremely interesting and important, that

“day-range” is not an accurate term as the strength of the signals received varies definitely and regularly in proportion to the mean altitude of the sun over the space between the two communicating stations. That is to say, the “day-range” depends on the particular time of day.

A TEST AT SEA WITH SHORT WAVES

WE STARTED off from Falmouth, and even when we reached Seville and were anchored in the Guadalquivir River, a very unfavorable position for reception, as the banks of the river were high and covered with trees and buildings, we found that the night signals were almost as strong as they had been in Falmouth Harbour, 12 miles from Poldhu, although at Seville, the whole of Spain, consisting of over 300 miles of high and mountainous land intervened between the sending and receiving stations.

When we reached the Moroccan coast at Casablanca, I gave instructions that the reflectors at Poldhu should be set up and we then proceeded to the Island of Madeira, and finally to St. Vincent, in the Cape Verde Islands where, at a distance of 2230 nautical miles, we continued to receive the night signals with such strength that it was nearly always possible to do without an amplifier or to disconnect the antenna or put it out of tune. In fact the signals were so extraordinarily strong that we never experienced the slightest trouble in consequence of static. The power then being used at Poldhu was about 12 kilowatts, and the reflector so concentrated the energy in the direction of the Cape Verde Islands that the strength of the signals was such that it would have required 120 kilowatts at Poldhu without the use of reflectors.

Because I was obliged to return to England without going any farther, I gave instructions to diminish this power gradually and found that with only 1 kilowatt (about $1\frac{1}{3}$ h. p.), the signals were still stronger than would have been required to carry on commercial work at night at that distance. It is interesting to note that these night signals, received at St. Vincent, even when Poldhu was using only 1 kilowatt, were much stronger than those which could be received from the high-power station at Carnarvon or the British Government station at Leafield (using 200 to 300 kilowatts) or from any of the other European or American high-power stations.

In view of these rather encouraging results, further tests were made early in 1924 between Poldhu, using some 17 kilowatts of power and

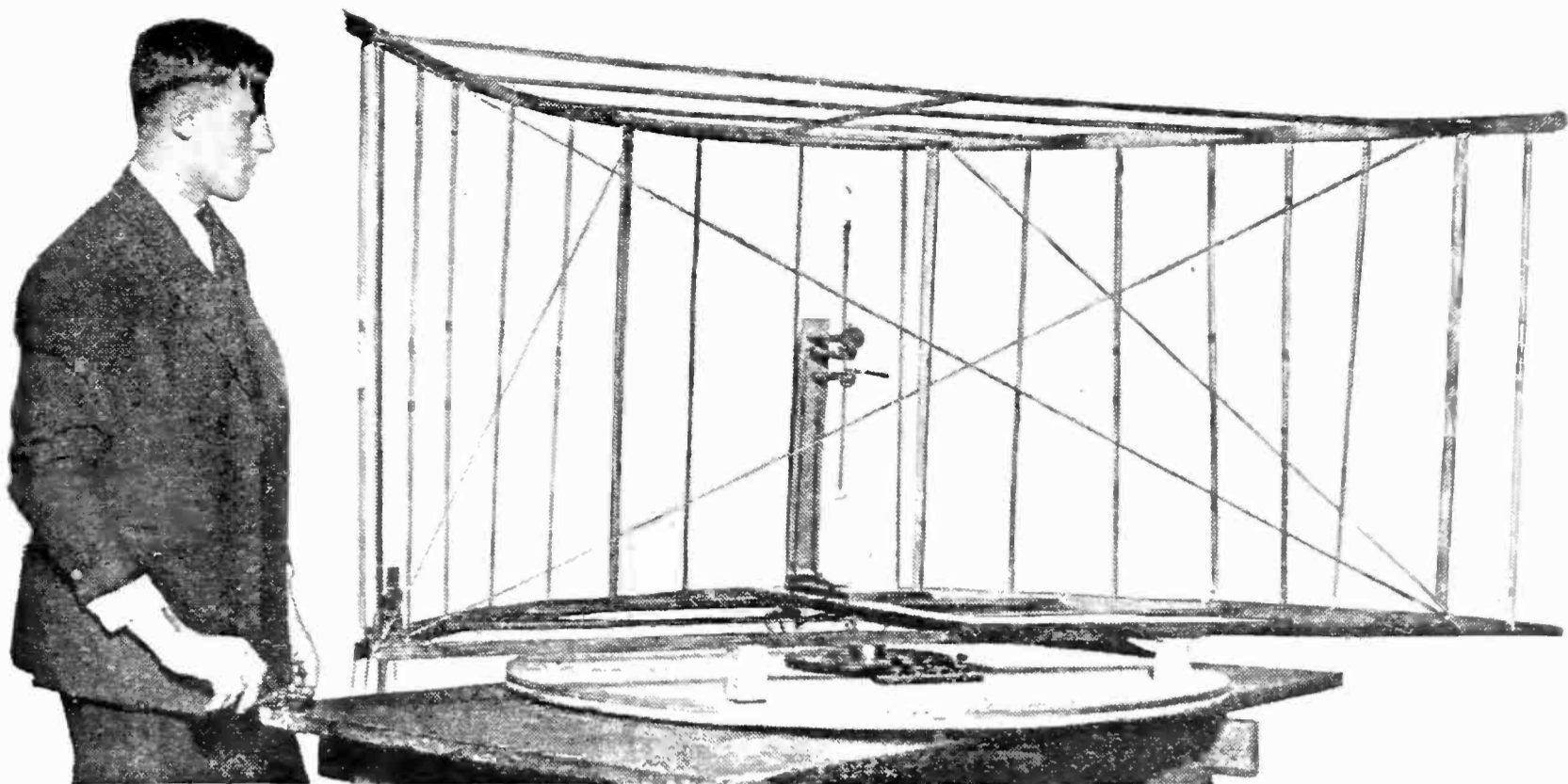

© Underwood & Underwood and Marconi's Wireless Telegraph Company

A REVOLVING BEAM TRANSMITTER AT INCHKEITH, ENGLAND

One of the experimental transmitters of directed radio energy used by Senator Marconi in his experiments between his yacht *Elettra* and England is shown in the photograph below. The main rigging on the towers is used as the reflector, while the transmitting antenna is very short and can be seen just above the two blocks at the outside of the circle at the base of the mast. This reflector can be moved so as to "mirror" signals in any desired direction. The photograph above shows a model of the beam transmitter used by Senator Marconi when he read a paper before the Institute of Radio Engineers at New York several years ago, explaining his beam experiments. The transmitting antenna is the short vertical wire at the center of the wire "mirror"

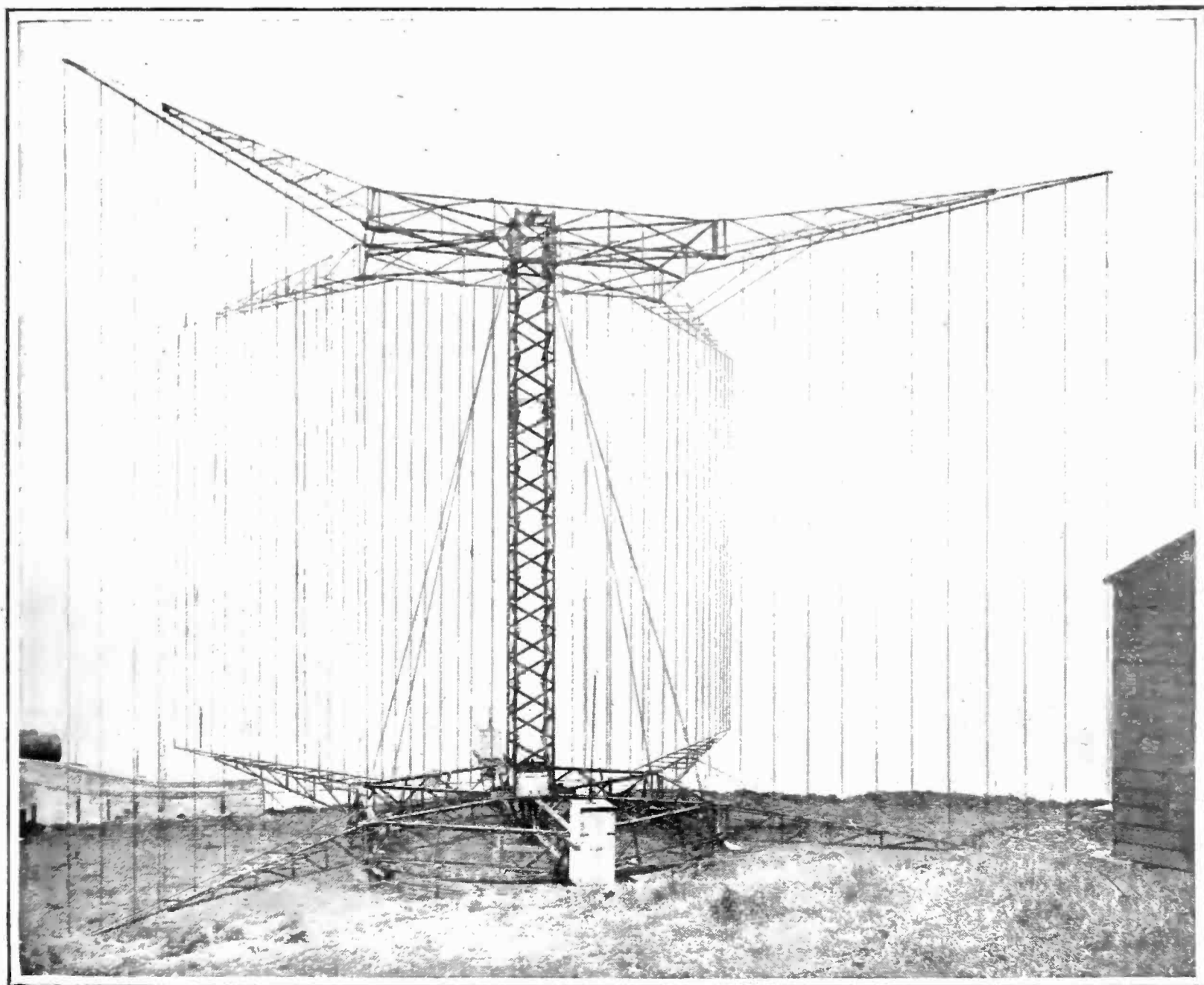

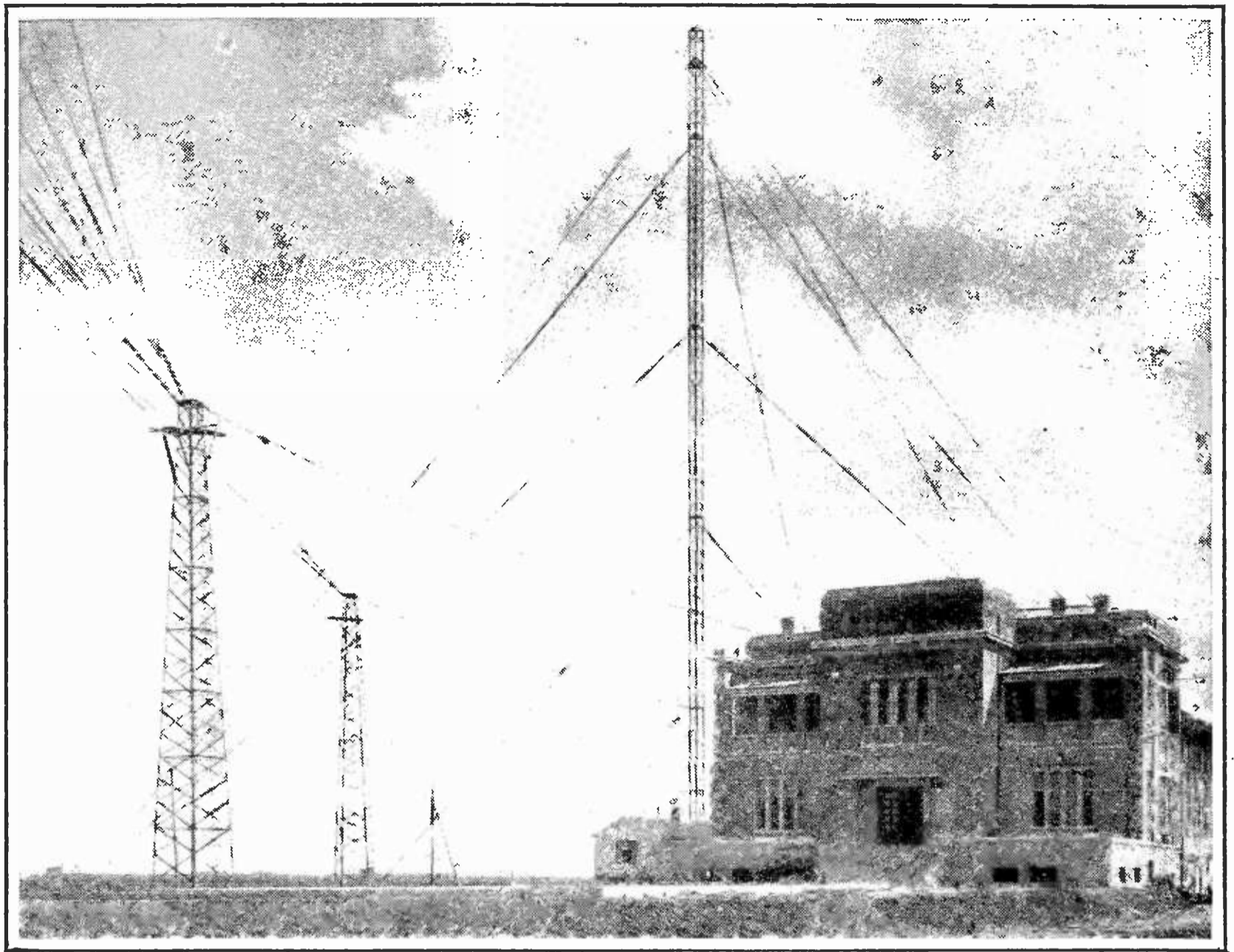

TRANSRADIO

The imposing towers of the new international station at Monte Grande, Argentina. The power house and masts are the center of the largest international radio telegraph station ever erected in South America. The towers are about 690 feet high. The smaller towers in the left foreground form an anchorage for the down-leads from the antenna. This station is for communication on long wavelengths and high power. The beam method of transmitting has not been applied to this station

waves of 92 meters and a special receiver installed on the White Star Liner *Cedric*. The result showed that during the daytime signals could be received up to 1400 nautical miles and confirmation was obtained that their intensity was dependent on the mean altitude of the sun at all times.

Advantage was taken of these tests to ask engineers of our associated companies in Australia, Canada, and the United States to attempt to listen to these transmissions from Poldhu and, rather to my surprise, it was reported to us from Australia, that they could be heard distinctly every day in Sydney, from 5 to 9 p. m. (Greenwich time) and again from 6.30 to 8.30 a. m., and this with what might be called an improvised receiver. If we consider the position and the altitude of the sun, the preference of short waves for traveling over regions not illuminated by the sun was made manifest, for it appeared quite obvious, that during the morning period, the

waves traveled over 12,000 miles between England and Australia in a westerly direction across the Atlantic, America, and the Pacific, while during the evening period they must have traveled in an easterly direction across Europe and Asia, over the shortest distance, which is about 9380 nautical miles.

I was, however, by no means satisfied, for one of the essentials of a good telegraph system, whether it be with or without wires, is to be able to transmit the messages as soon as they are handed in and, therefore, the limitation of the period of working to practically the night hours constituted an undoubted disadvantage. That this was so, admitted of no doubt, so far as I had gone. For example, although the signals sent from Poldhu were received with great strength at New York, Rio, and Buenos Aires when darkness existed over the whole or the greater part of the track followed by the waves, no signals at all were received when the same

track or the greater part of it was exposed to the light of the sun. Even an increase of power or the use of reflectors augmented the working hours very slightly. I had the impression of being faced with conditions analogous to those produced by a fog on the transmission of light. If the fog be thick enough, no matter how much the luminous intensity is increased, the light waves fail to penetrate it for any considerable distance.

DISCOVERIES ABOUT SHORT WAVES IN DAYLIGHT

I THEREFORE resolved to make further experiments between Poldhu and the *Electra*, to see if some means could not be found

to overcome the limitation of working hours imposed by daylight. I tried the effect of still further decreasing the wavelength, reducing it to 60, 47, and, finally, to 32 meters and I found that the opaqueness of space in the daytime diminished rapidly as the wavelength decreased. During these tests, which were conducted in August and September of last year, the 92-meter wave could not be heard for many hours in Madeira—a distance of 1100 miles entirely over the sea. At Beyruth, in the Mediterranean, the 32-meter waves were regularly received all day, although the distance was 2100 miles, practically all over mountainous land.

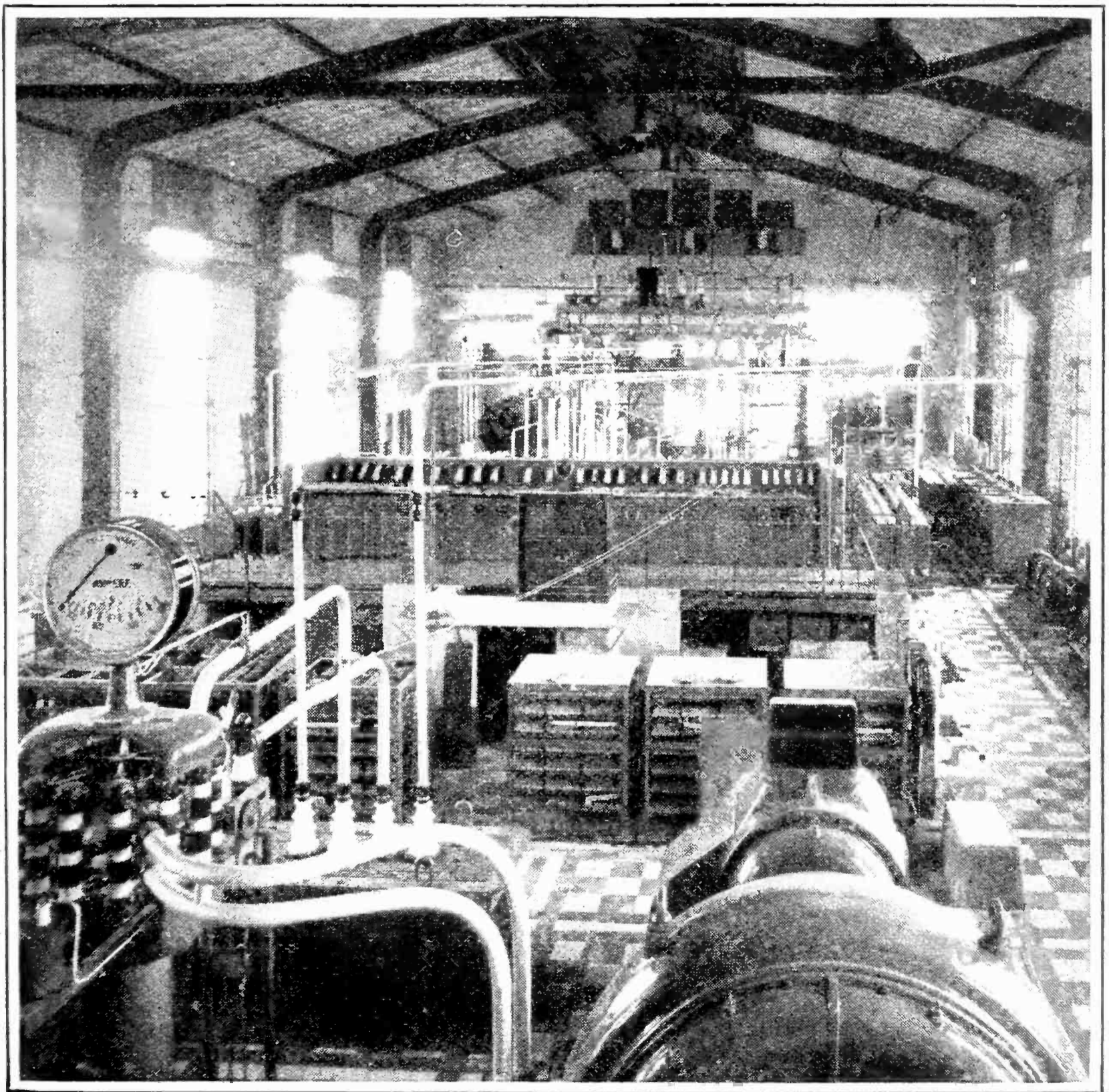

THE POWER HOUSE AT TRANSRADIO

The most interesting thing in this photograph is the antenna radiation meter which registers up to 1200 amperes. Energy from large radio telegraph stations such as this is radiated in every direction and much of it serves no useful purpose. Senator Marconi believes that beam transmission of radio signals on short waves will do much to alter the whole course of long distance radio communication

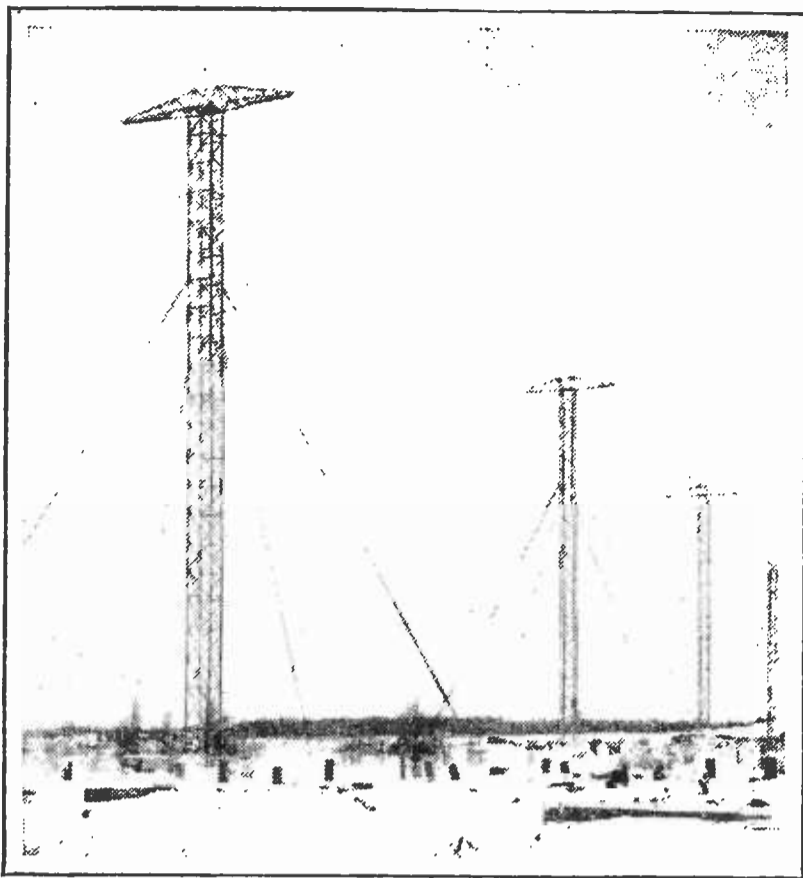

© Marconi's Wireless Telegraph Company

A CANADIAN MARCONI TRANSMITTING ANTENNA

Note the high towers in process of erection. Present international stations use wavelengths of from six to seven miles, while the beam transmitting stations will use wavelengths of about 120 feet. Poldhu at Nauen, Germany is carrying on long distance communication on high power on a wavelength of about 40 meters, while the stations of the Radio Corporation of America are being equipped to use short waves as an auxiliary to their regular long wave equipment. Short wave transmitters do not require nearly the elaborate antenna installation that the present long wave stations do. Senator Marconi contends that reflected short waves are much less subject to unfortunate fading effects than are the long waves

This discovery was so interesting and satisfactory that I thought it wise to confirm it over longer distances and, in October and December of last year, with only 12 kilowatts of power, it was immediately found possible to transmit signals and messages from Poldhu to New York, Rio de Janeiro, and Buenos Aires when the whole of the track separating these places from Poldhu was exposed to daylight. Poldhu was also able to communicate with Sydney, in Australia, for a period of $23\frac{1}{2}$ hours out of 24.

To sum up my impressions of all these experiments, I can say that I am now firmly convinced that the day is fast approaching when beam stations, using short waves, and employing only a fraction of the power utilized in the present high-power stations, and with much lower and fewer masts, will be able to carry on communication at practically any time between any two points of the earth's surface and at much higher speeds than are

now possible. It should be mentioned here that very high speeds appear to be possible only with short waves and, therefore, even if only a portion of the 24 hours were utilized, a much greater number of words could be transmitted than would be possible with a slow-speed, long-wave service, even should it be found capable of working during the whole of the 24 hours. It should also be borne in mind that, although communication at great distances has been obtained without the use of reflectors, still I am of the opinion that these will be found to be essential for the carrying on of commercial, high-speed services, because, apart from their directive effects, they enormously increase the effective strength of the signals, thus minimizing the effects of what is known as "fading." Reflectors, I find, also increase the margin of readability of the signals.

WE DON'T KNOW MUCH ABOUT THE LAWS OF SHORT WAVES

NATURALLY a good deal remains to be done in connection with a further and still more systematic study of these short waves and the conditions and laws which regulate their propagation through space. For some time, the practical technical side of radio has been far in advance of the theory of the subject. We have known a great deal about the methods of producing electric waves and about the various methods of receiving such waves, but our knowledge of the conditions that govern their propagation through space is far from exact. Otherwise, as I have said, we might have known long ago that it was possible to send messages to Australia throughout the 24 hours on a 30-meter wave with only 10 or 12 h. p. of energy in the antenna.

However, now that this has been ascertained and confirmed by numerous experiments, I have no doubt that the development of short-wave beam stations will be more rapid than that of the old super-power stations, and it is my firm personal opinion that these latter will, sooner or later, be found to be uneconomical and comparatively inefficient so far as long-distance commercial communication is concerned.

One final point remains to be mentioned in connection with these newly discovered properties of short electric waves. We may be on the threshold of a day when broadcasting, that application of radio which interests the whole of the civilized world, will have its range enormously increased. Within a year

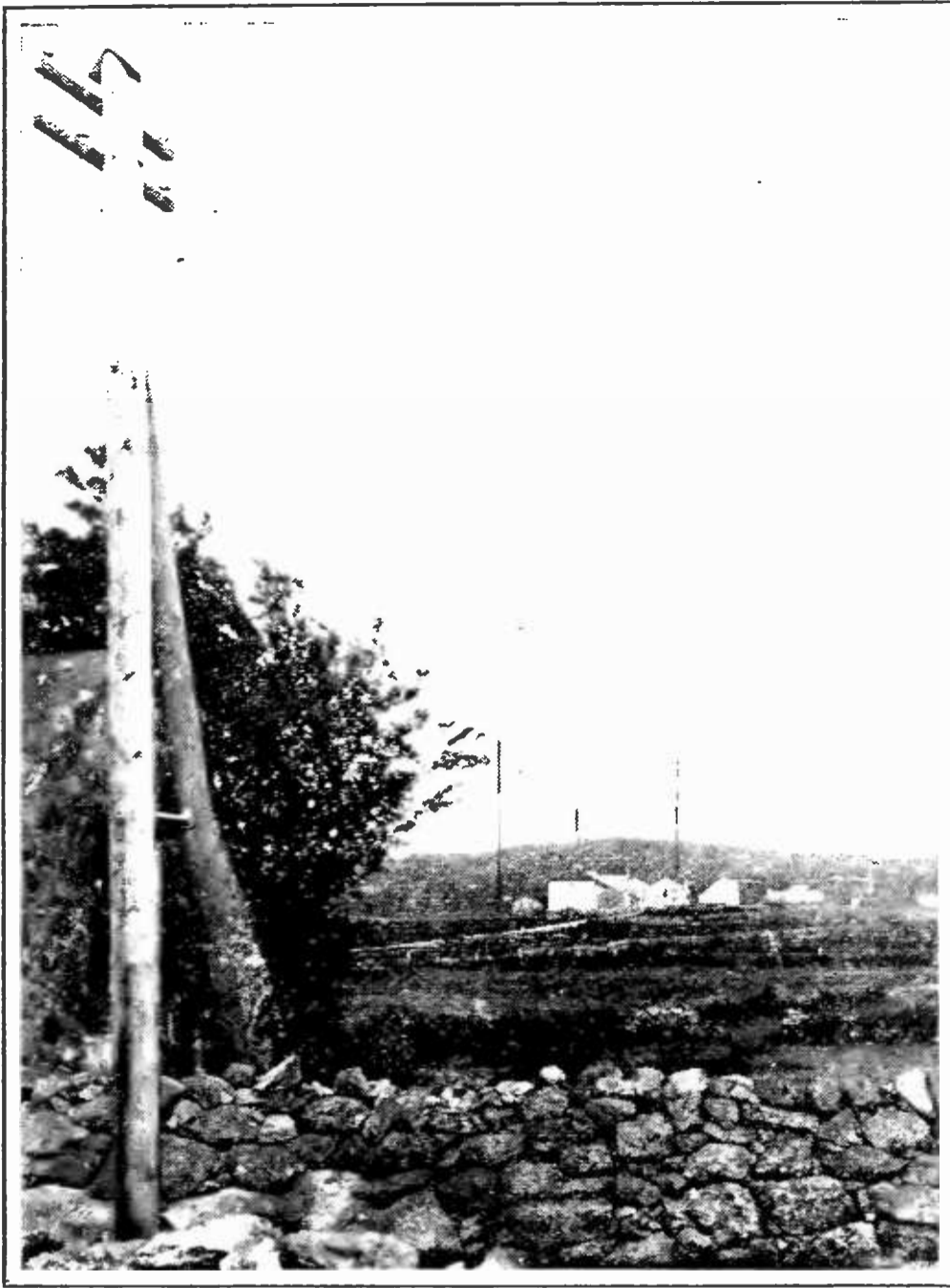

or two, the voice of the King of England, for example, may be easily and clearly heard by millions of his subjects in places as far apart as India, Australia, Canada, and South Africa. A service in Westminster Abbey, with its sermon, choral and organ music, may be clearly heard in Capetown. It may become as easy to listen-in for the Philharmonic Orchestra in London, as it would be now in Philadelphia.

Perhaps the voice of the short wave will be able to accomplish for human brotherhood and our common civilization what has not yet been done by the better-known long wave, although radio is already one of the most powerful agents in the linking of mankind into one great whole.

MASTS AT THE CARNARVON, WALES STATION

Of Marconi's Wireless Telegraph Company. These tall masts help to conduct the high power long wave radio telegraph signals into the ether. Compare the size of the power pole with

that of the radio masts. This transmitter spreads its energy in practically every direction while the beam station, illustrated below, directs its energy in a beam

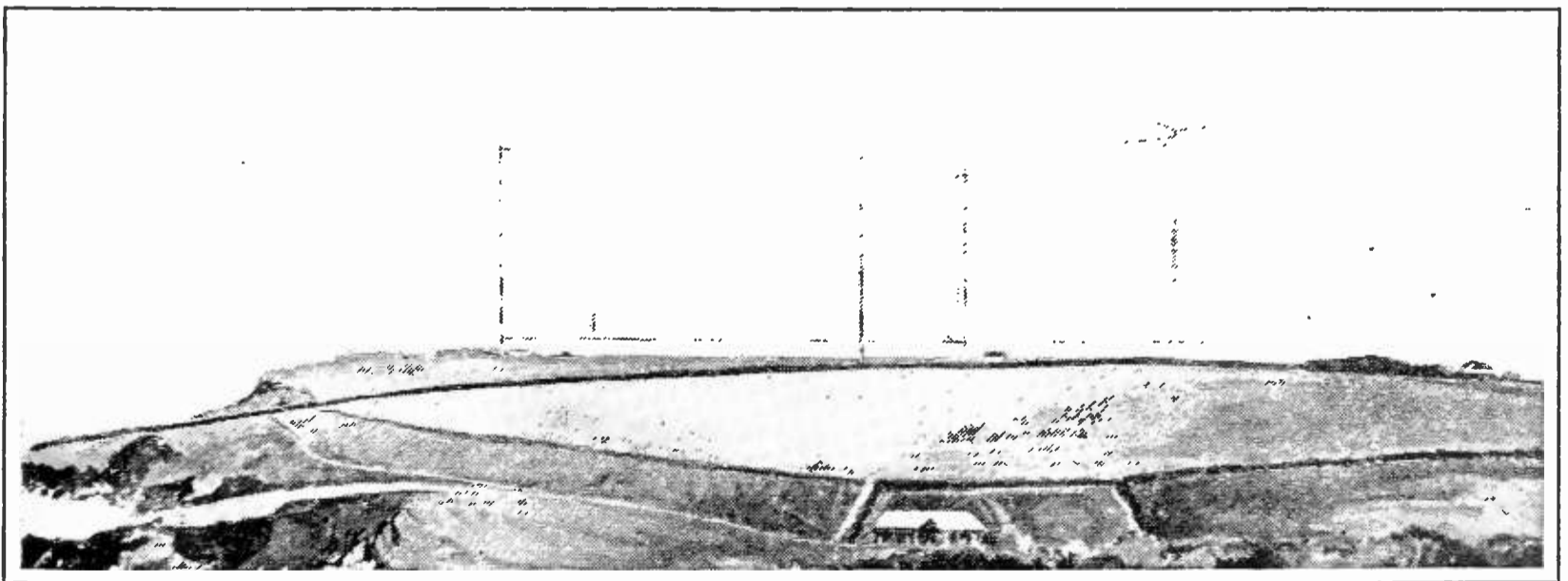

© Marconi's Wireless Telegraph Company

HOW THE POLDHU BEAM STATION WILL LOOK

High towers support the reflecting antenna while the very short sending antenna is in the exact center of the whole structure. The English Marconi Company recently announced that it planned to erect beam transmitting stations which will link England with all her colonies. The English Company expects to establish surer and more efficient communication, using the methods developed by Senator Marconi, which may, perhaps, replace the extensive installations now necessary for radio telegraph communication over very long distances

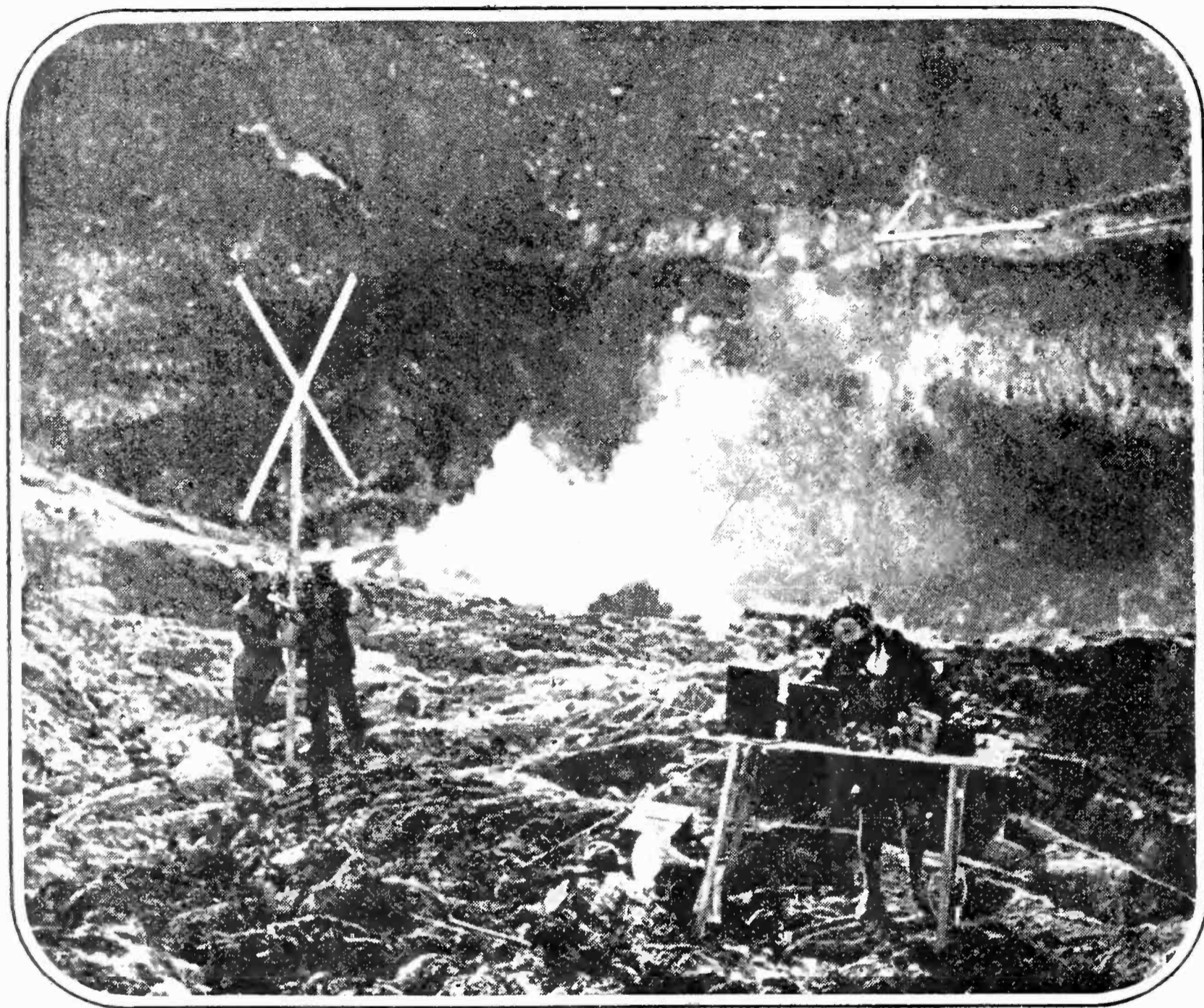

INSIDE THE CRATER OF MT. VESUVIUS

Professor Rogotti of Milan, with two assistants, transported a radio receiver inside the crater of this famous old volcano to test the radio receiving qualities of this somewhat sparsely populated area. The tests seem to prove that there was no radio reception near the eruptive cone of the volcano, while at a distance of 300 feet from the cone, reception was rather poor. The experimenters, as the photograph shows, wore masks as a protection against the stifling gases from the erupting cone

THE MARCH OF RADIO

By *J. J. Morecroft*
Past President, Institute of Radio Engineers

How the Propagandists Work in Radio

UNDoubtedly there are millions of people in the United States to-day who have a real interest in radio broadcasting. Discounting many times (as any sensible person unconsciously does) the figures given out by over-enthusiastic

broadcasting managers, we still must place the number of these radio folk at some millions.

The purchasing power of such a number of people is tremendous, and is measured, of course, in the hundreds of millions of dollars. It is natural that some of the radio manufac-

turers have reached the conclusion that the employment of professional propagandists—"public relations counsel" is a kinder phrase—would be greatly to their advantage. These gentlemen, honorable, no doubt, draw their pay for creating in the minds of the public a favorable impression for the man or product they write about. Stories at regular intervals come from these rather undesirable publicists in which their employers are favorably featured. These stories frequently find their way into the daily press and so appear as unbiased news to the casual reader.

By sheer repetition, one is frequently convinced that the repeated statement is fact, even though no proof has been given. This is illustrated by the current belief that four people out of five have a certain malady, whereas the prevalence of this trouble is undoubtedly greatly exaggerated in the well known advertisements. If one reads enough stories, each beginning with, Mr. A. B. C., the well-known radio engineer and inventor, one is quite likely to think that the man in question is a radio engineer and inventor, when that may not be the case at all. Then if the story gives Mr. A. B. C.'s ideas on a certain radio subject one is likely to think that an authoritative, unbiased opinion is being presented, when as a matter of fact, the gentleman in question is simply succeeding in a bit of indirect advertising.

So prolific are the writers of this type that the radio editors of our

newspapers never lack material with which to fill their daily columns. One of our friends recently offered to write for a certain paper a series of popular articles dealing with the relative merits of different receivers on the market, showing how they worked, why one was more selective than the other, another good only for local reception and still another preferable for distant stations, etc. He was told by the radio editor, however, that instead of paying for radio articles, he had quite a task in selecting his stories from material which was sent in voluntarily.

To the best of our knowledge, there are very few men writing stories (even radio ones) to-day for the mere love of writing. We should like to suggest that when next you read

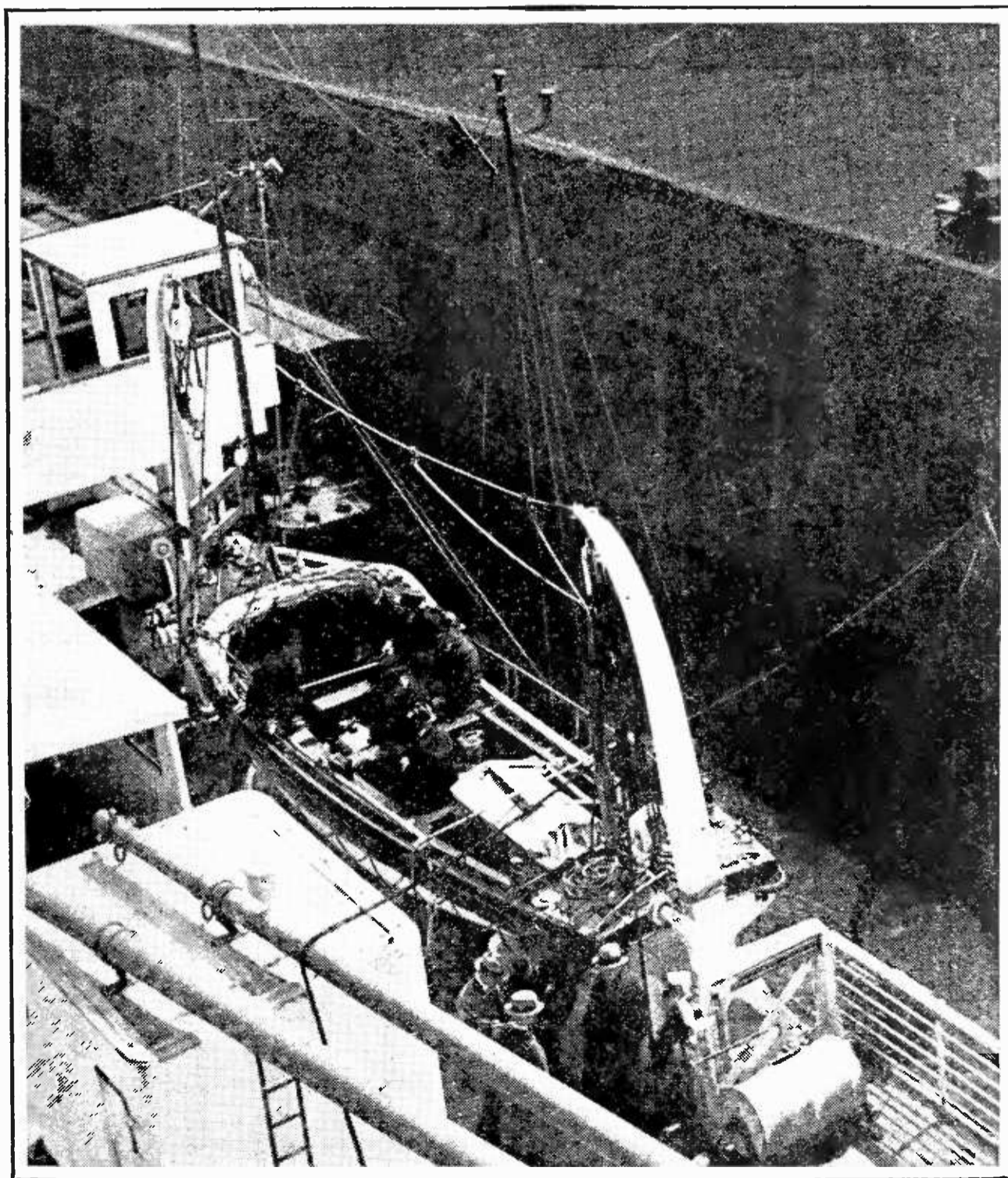

A WIRELESS-EQUIPPED LIFEBOAT

Aboard the *S. S. Orbita*. The British Board of Trade has ruled that to every ten lifeboats aboard large passenger ships, there shall be one lifeboat with radio transmitting and receiving equipment. The operator has a small cabin 'way up fo'ard. The transmitter has a range of about 100 miles. A small two-wire antenna is used. In the bow of the boat is the rectangular loop used in the direction-finder equipment

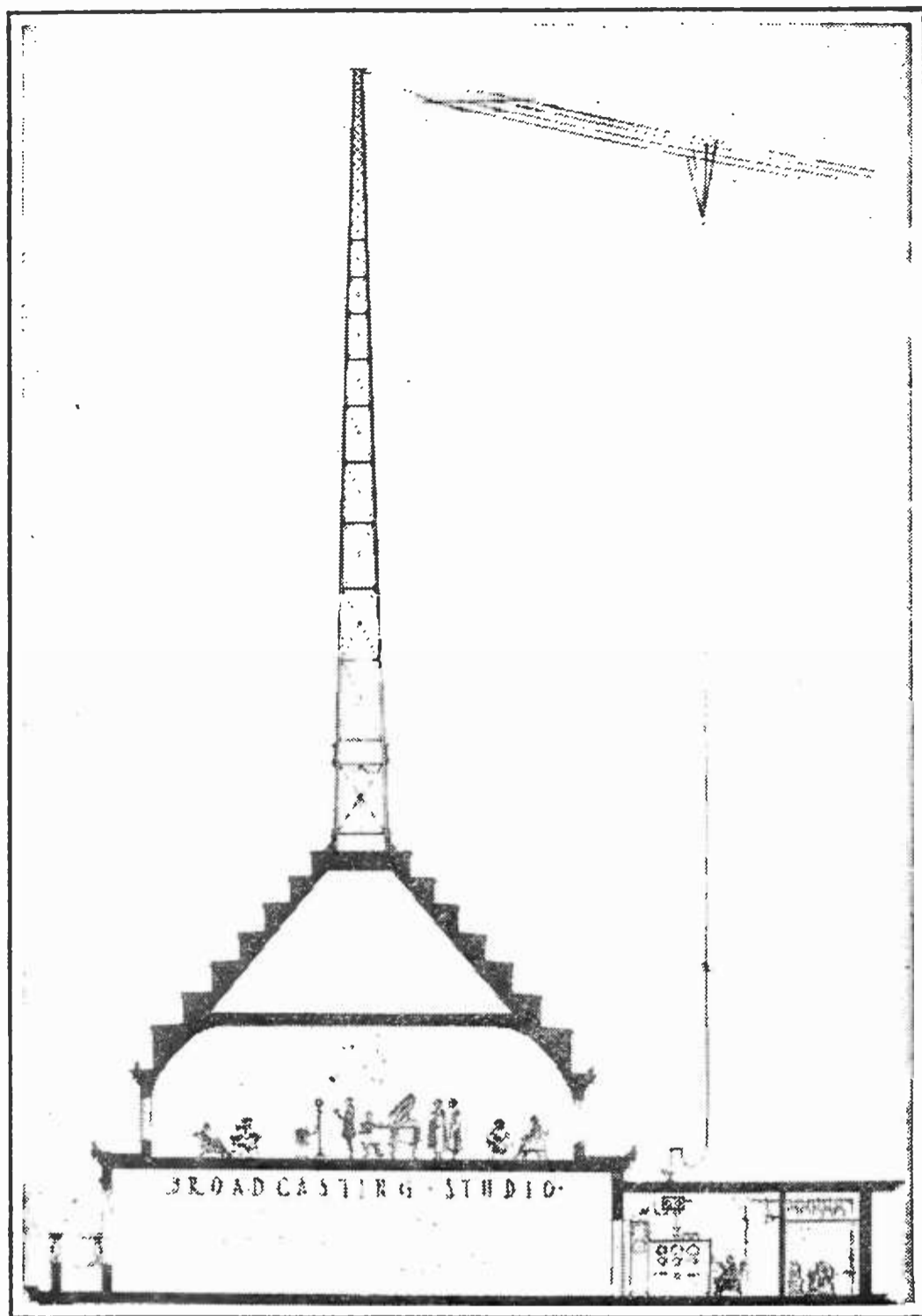

ARCHITECT'S DRAWING OF A PROPOSED
BUFFALO STATION

Which incorporates some new ideas in station design. The towers rise 60 feet above their pyramidical pedestals, whose design was suggested by a pyramid built in Guatemala many thousands of years old. The broadcasting station has been designed especially for the new Liberty National Bank building at Buffalo. Alfred C. Bossom, of New York is the architect

one of those interesting interviews with "Mr. A. B. C. the well-known radio engineer and inventor," you ask yourself first whether he really is such a well-known engineer and next why he said that a crystal was better for a detector than a tube, etc. Just possibly his revenues will be increased if you direct your purchases along the line he suggests.

Super Power Is Almost Here

ALMOST as soon as this magazine appears, the new broadcasting venture of the Radio Corporation will be launched. At Bound Brook, New Jersey, the Corporation has erected its first high-powered

broadcasting station, and we understand that, opening some time in June with a moderate power output, this station will gradually increase its power until its full output of forty to fifty kilowatts is reached. Familiar wjz, which was first berthed in Newark, New Jersey and was later transferred to the heart of New York City, is now to migrate to Bound Brook, the while with greatly increased output.

It is our belief that the operation of high-powered stations such as this, is one of the real solutions for static. This ever-present disturbance does not greatly bother those of us who are within perhaps twenty-five miles of a low-powered station, but for those more than a hundred miles away from one of our present 500-watt stations, the pulses of static are at least as strong as the signal during parts of the year. During a few of the summer months, the static noises are so loud that they make a program from the distant station unsatisfactory.

As the various static eliminators come forward and then quietly retire from the radio stage, we can find no evidence of defeat or even fatigue in our atmospheric disturbances. The only evident remedy to circumvent nature in her pernicious interference is to greatly increase the strength of the radio signals, to drown out static. That will require a great many kilowatts

of power, as wjz anticipates using. We shall all watch with great interest the public's reaction to the new venture.

Again it is to be pointed out that those radio listeners near the high-powered station will naturally have some difficulty in tuning it out sufficiently well to hear distant stations of nearly the same wavelength. This tuning difficulty will be true of the average set as used to-day. It will be possible, however, to build special rejector circuits which will greatly cut down the wjz signals even for those in its immediate vicinity. Undoubtedly a rejector circuit for a reasonable price will be put on the market.

The Crime of a Radio Manufacturer

JUST as we had thought the single-circuit regenerative receiver was beginning to disappear from the market we learn from a most reliable source that an order for about one hundred thousand of these receivers is being put through the shops of one of the largest radio manufacturers. One hundred thousand more potential squealers from one manufacturer is a frightful stop to radio progress. This is no step forward in the march of radio. It looks as though this manufacturer was more interested in dividends than in the advancement of the art.

What Is a "Bootleg" Tube?

AS ONE after another of the vacuum tube patents expire, it becomes increasingly difficult to say just what is a bootleg tube and what isn't. While Fleming's valve patent and De Forest's three-electrode patent were still running their seventeen-year life, it was an easy matter to distinguish between genuine and counterfeit tubes. But now with the fundamental three-electrode idea thrown open to all, (the patent expired in February) one has to look more carefully to see if a tube is infringing those design patents and others which still have some time to run.

Before a manufacturer invests much money in the business of tube making, he would do well to consult some patent attorney who is closely in touch with this particular field. There are many patents on the details of construction which may still be infringed. The sensitized tungsten which is used in the modern tube is a patented product. It is

probably not possible for any manufacturer but the Radio Corporation to make tubes whose filaments are made electronically active by the addition of thorium. There may be other ways of making even better tungsten. It seems quite possible that European tubes are made sensitive by some other process, and if so, such a process may become available to independent manufacturers here. Schemes used for attaining this high vacuum are fully patented. The difficulties of properly exhausting tubes frequently are so great as to cause the downfall of the inexperienced manufacturer. There is one very interesting phase of the tube situation which has still to be settled. Years ago, the American Telephone and Telegraph Company and the General Electric Company were involved in a very seriously contested suit having to do with the question of degree

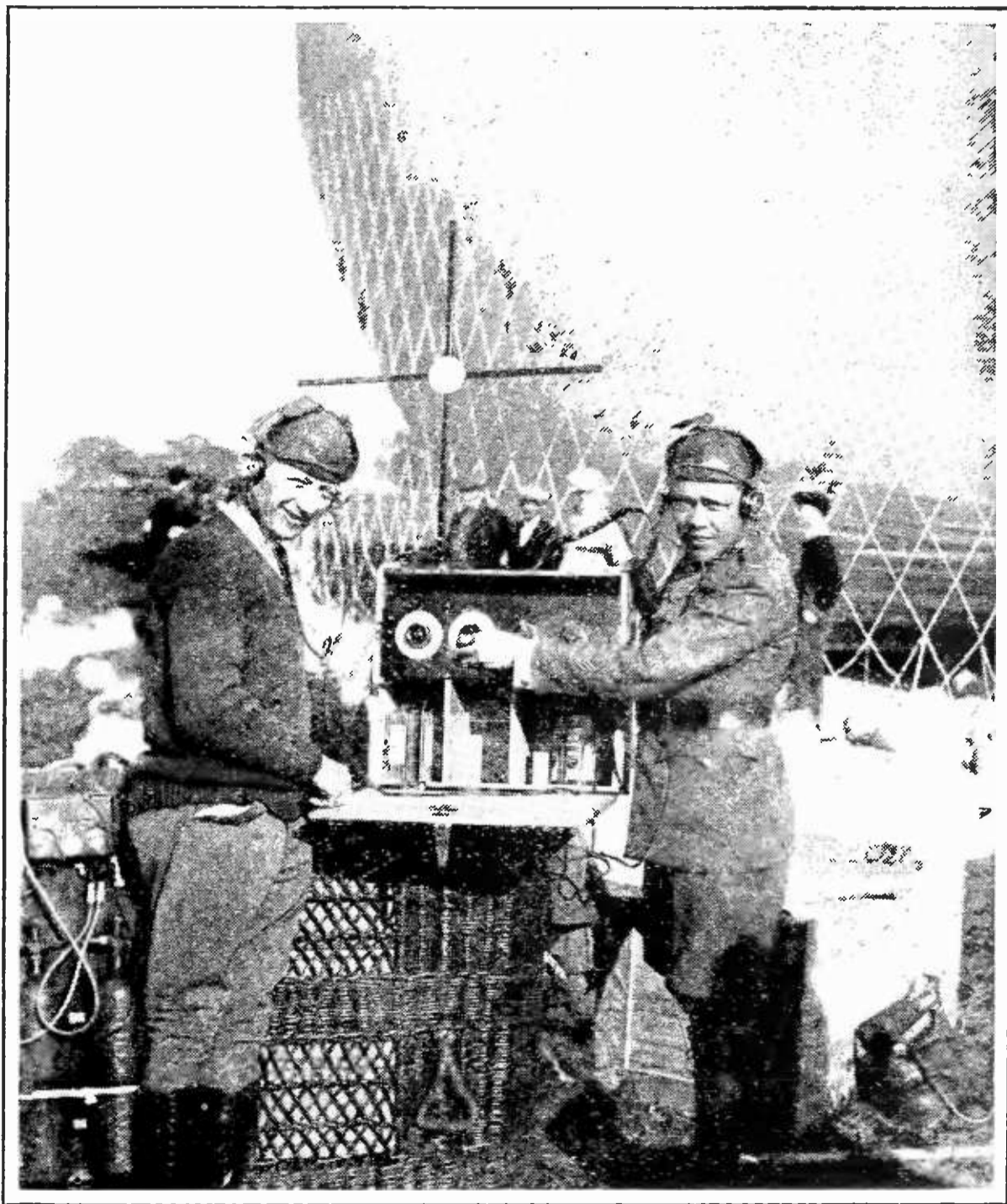

LIEUTENANTS MCCORMICK AND FLOOD

United States Army, looking over their receiving apparatus which was of considerable aid during the recent national balloon elimination race. The race was won by Ward T. Van Orman. Broadcasting stations near the air course broadcast special weather instructions and meteorological information to the racers

of vacuum used in triodes. Doctor De Forest, several times, apparently, had admitted the advantage of some gas in his audions so that the question of a tube having very high vacuum was still unsettled. Doctors Langmuir, of the General Electric Company, and Arnold, of the Western Electric Company, both had patent applications for high vacuum tubes whose vacuum was so high that whatever gas was present played no important rôle in the functioning of the tube, as it generally did in the De Forest audion. Most extensive testimony was taken and intricate experiments were performed before the court to illustrate the effect of small amounts of various gases in vacuum tubes.

On a case like this, a judge has a hard time in reaching a reasonable decision, and in this case no decision at all has yet been reached. The court has first to determine whether a high vacuum of this sort is patentable, and then if it is, to whom the patent should issue. And this question of high vacuum is not as easy as one might think. The "gas" tube, for ex-

ample, might be claimed as high vacuum because there is only about one hundred millionth of the original amount of gas left in the tube. But the high vacuum expert comes along and tells the judge that although only one hundred millionth of the original gas is left in the tube there are still ten thousand million gas molecules per cubic centimeter left in the tube! In such a dilemma, what was the judge to conclude?

This high vacuum patent, if it should ever be granted, would most seriously affect the independent manufacturer. In fact, should the court decide to grant a patent of this kind for seventeen more years, the Radio Corporation or the American Telephone and Telegraph Company would completely control the tube situation. We regard that control as lamentable because we still remember the \$6 we used to give for Radio Corporation tubes until the De Forest patent was about to expire when bootleg tubes appeared more plentifully with the resultant cut in selling price of 3 to 1.

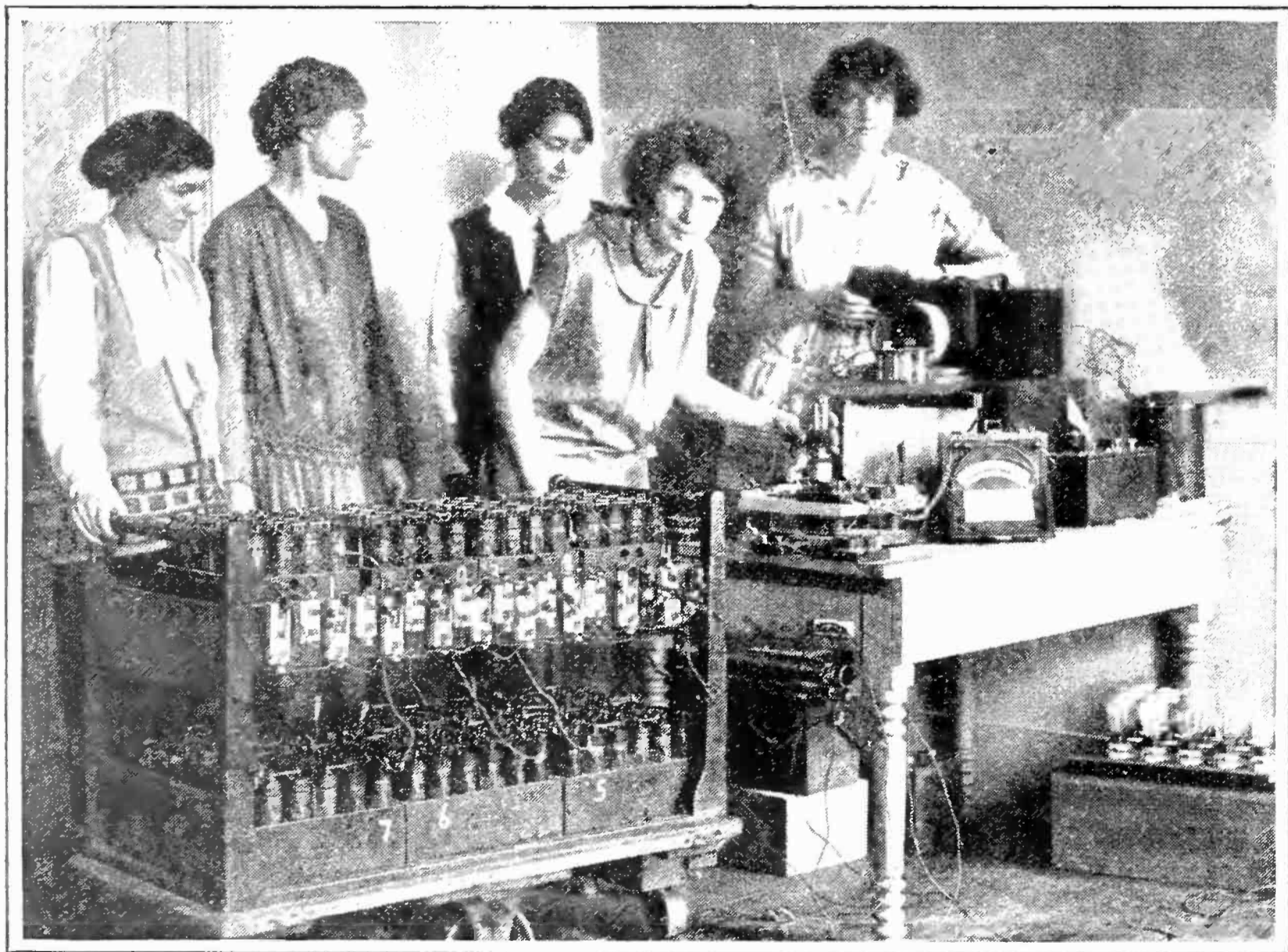

AT WELLESLEY COLLEGE

Wellesley, Massachusetts, some of the advanced students in the Physics Department are learning something about radio. Left to right: Miss Lucy Begeman and Miss Louise McDowell, instructors of radio in the Physics department of the College; Miss Truko Nakamura, Tokyo, Japan; Miss Jane Whigham, Pittsburgh; and Miss Ruth Lovejoy, Boston. The essentials of a fifty-watt continuous wave transmitter are being assembled



K. INUKAI

Japanese Minister of Communications, listening to a Tokio radio program with members of his family

Radio Sets Must Meet the Claims Made for Them

A MOST commendable decision was recently handed down by Judge Woester in the Municipal Court of Cincinnati. A radio supply house had sold a five-tube set with the guarantee that it would "get" all the stations from coast to coast. The user claimed that the set did not bring in every broadcaster and he refused to pay for it and was subsequently sued.

The Judge ruled that if the set was guaranteed to do certain things it must live up to its guarantee. If the claims were not met, the purchaser was not obliged to pay the price specified. It was argued that the purchaser didn't have a good ground or antenna; the plaintiff evaded the obvious confession, that his claims for the operation of the set were extravagant. It would be a good thing to have a few more decisions of this nature on record. We think that then dealers and salesmen might be more careful about their enthusiasms. It may be that the ruling of the Municipal judge will be reversed when the case is carried to the higher courts, but we hope not. Absurd and extravagant claims of radio salesmen have far too often resulted in the disappointment of the purchaser.

The Associated Press Recognizes Broadcasting

DURING the recent annual meeting of the Associated Press in New York this conservative organization yielded to the pressure of the modernists within its ranks and decided to make radio broadcasting one of its many allies. The great national interest in the broadcasting of the last presidential election was the lever used to upset the conservatives. By a vote of 130 to 10, the Association decided to permit its dispatches to be used over radio channels when the items can be regarded as of "transcendent importance."

The resolution which admits radio as a friendly arm of the Association was as follows:

Whereas, the tremendous and continuing growth of radio broadcasting is presenting many new problems not contemplated when the existing by-laws and rules of The Associated Press were adopted; and

Whereas, the great public interest in the result of Presidential elections and other events of nationwide importance has repeatedly raised the question of the advisability and wisdom of permitting the limited and restricted use of Associated Press matter in the broadcasting of such special and outstanding events; therefore be it

Resolved, That the Board of Directors be authorized to adopt the necessary rules and regulations

which shall permit the broadcast of such news of the Association as it shall deem of transcendent national and international importance and which cannot by its very nature be exclusive, provide adequate safeguards, and require that proper credit in each and every instance be accorded the Associated Press.

The great activity of the Associated Press, with its 1195 newspaper members, is indicated by the treasurer's report which showed an income during the past year of more than seven million dollars.

At about the time that the "A. P." was taking this action on radio, the American Newspaper Publishers' Association was also taking cognizance of this newest method of communication, endeavoring to eliminate propaganda and direct advertising from the radio channels conducted by the newspapers. The resolution passed by the publishers was as follows:

Whereas, direct advertising by radio is likely to destroy the entertainment and educational value of broadcasting and result in the loss of the good-will of the public, therefore be it

Resolved, that members of the A. N. P. A. refuse to publish free publicity in their news columns concerning programs consisting of direct advertising; also that they eliminate from program announcements the name of trade-marked merchandise or known products obviously used for advertising, and that newspaper broadcasters eliminate all talks which are broadcast for direct advertising purpose.

The Victor Company Joins the Radio Ranks

THE phonograph companies have, one by one, yielded to radio. The recent annual report of Eldridge P. Johnson, president of the Victor Talking Machine

Company, announces the future radio activities of this company. "Plans carefully and deliberately developed toward meeting the conditions confronting the industry are rapidly nearing maturity, and are anticipated to maintain your company in its position in the van of the entertainment field." These "conditions" of course, are the effects of the popularity of radio receivers on the sales of talking machines. We may expect the Victor organization to make an excellent impression on the public when they do enter the radio field. The wonderful entertainment their artists gave us last winter through WEAJ, and other stations, would permit nothing else.

There is a fine opportunity for the marketing of an artistic high quality loud speaker. Rumor has it that the Victor Company has secured the patent rights to a loud speaker developed and patented in France. Some European engineers have spoken of this talker as better than anything we have in America, and if this is true, we certainly

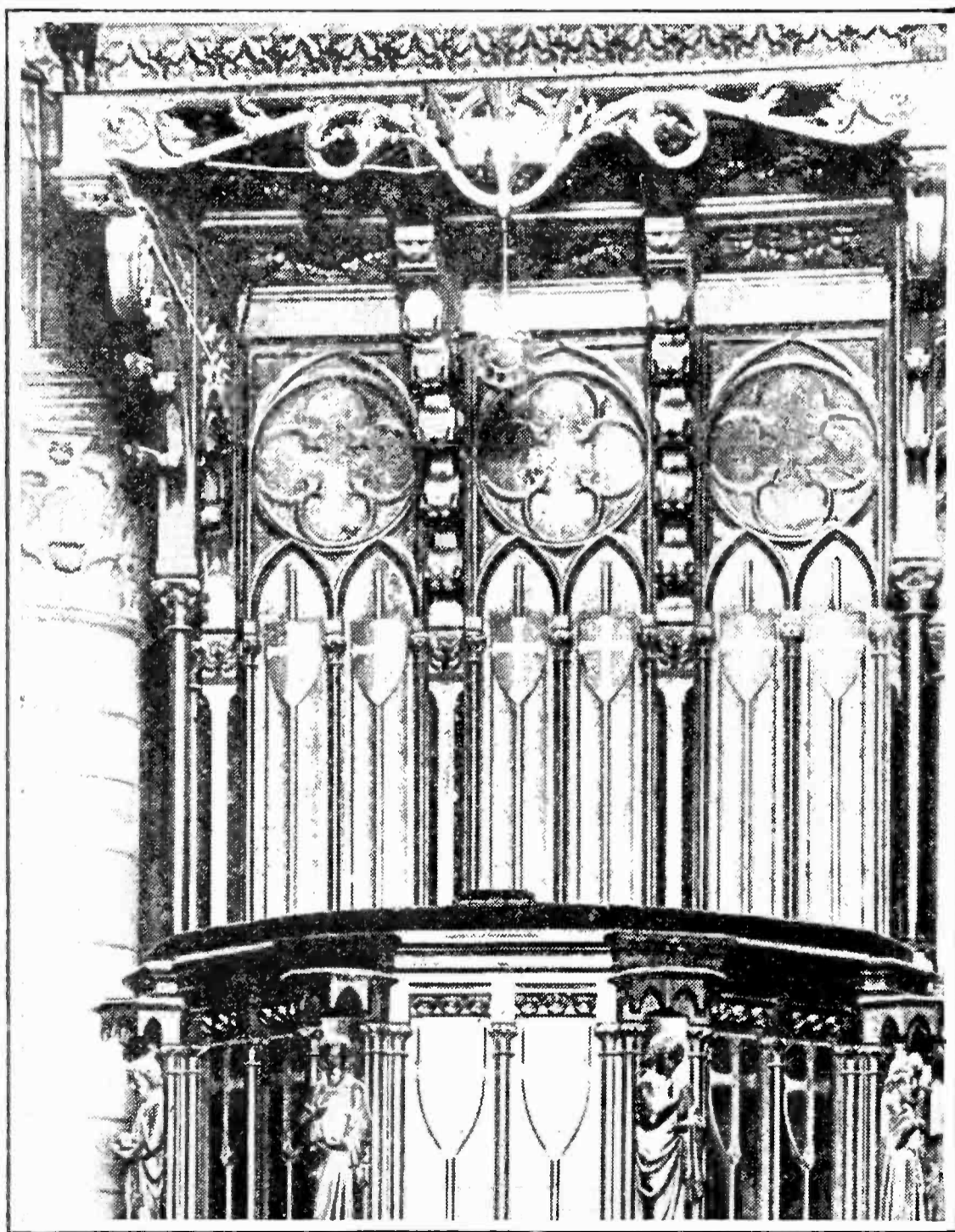

SCIENCE INVADES THE CHURCH

The microphone an excellent symbol of modern progress suspended over the famous carved pulpit of Notre Dame de Paris. The pulpit was designed by Viollet-le-Duc. The microphone is not for broadcasting but for the public address system which has just been installed in this famous old cathedral

would like to see it put on the market here.

We sincerely hope that the new policy of the company will not interfere with continued concerts by their artists, as it is impossible at this time to imagine a better combination than the artistic talent of the Victor performers and the technical excellence of the broadcasting apparatus of the American Telephone and Telegraph Company engineers.

There Are So Few American Radio Tubes

IN A recent issue of the *Wireless World* (London), editorial dissatisfaction is expressed with the number of tubes now on the English market. So many experimental and war type tubes as well as more standard recent ones are available to the radio experimenter, that many times he buys tubes entirely unsuitable for his work. Improvement would be brought about, according to Hugh S. Pocock, the editor, if most of the types were withdrawn from the market, leaving only two or three standard types.

If we in America have any difficulty of this sort, it is rather on the opposite side. We really have only two types of tubes for receivers on the market; the quarter-ampere 5-volt filament, and the sixteenth-ampere 3-volt filament. The latter is hardly to be regarded as a success because of its fragility and short life. In Holland, a Dutch engineer recently told us, the Phillips Lamp Works is putting on the market a tube which he regards as the equal, if not the superior, to any of our tubes. The Dutch tube uses in its filament circuit a sixteenth of an ampere at one volt. that is, just one third the power which ours uses. We would welcome this Dutch tube to our present small assortment. The tube which uses alternating current in its filament and operates from a light socket, is surely on its way. The so-called McCullough A C tube built on this principle, has recently been announced and just as sure as the public takes to this tube, the Radio Corporation will put out one to equal or possibly surpass it.

We sincerely hope that the McCullough tube has been so carefully built that it will not fail, and thus give this desirable type of tube a bad reputation before it has been even well tried out. In a new development of this kind it is very easy to make technical and manufacturing errors, and so give a product a bad name when more care and study would have made it a complete success. We certainly extend



©Harris & Ewing

W. E. DOWNEY

Technical radio expert of the Bureau of Navigation, Department of Commerce. On Mr. Downey's shoulders fall much of the technical advisory work which is a constant necessity in the administrative branch of government radio control

to this first alternating current tube our very best wishes.

The World Conference of Amateurs

THE first world conference of amateurs has just come to a close. And thinking of this world union, the amateurs may well feel that progress is being made. Ten years ago, the American Radio Relay League was just starting; now its members are numbered in many thousands and they assume a commanding rôle in any international question having to do with radio amateurs.

The conference recommended wavelength assignments for the amateur channels as follows: United States, 85 to 70 meters and 41.50 to 37.50; Canada and Newfoundland, 120 to 115 and 43 to 41.50; Europe, 115 to 95, 75 to 70, and 57 to 43; other countries, 95 to 85 and 37.50 to 35. These short wave channels, of course, must be approved by the respective governments concerned before becoming the official domain of the amateurs.

It is interesting to note how important the short wave channels are becoming. American, British, and German commercial companies are all carrying on intensive experimentation in the development of transmitters and receivers for these nearly ten million-cycle currents. The German station poz, for example, is working to Argentine with a 41-meter channel, and it won't be long before the five-

or ten-turn coil, a couple of inches in diameter, becomes recognized as a regular tuning coil.

We cannot urge too strongly that the amateurs get busy with their short wave receivers. As this issue goes to press, Donald MacMillan is leaving the country for his next polar trip. In view of the fine showing made by short wave communication on his last trip, Mr. MacMillan has decided that his outfit this time will be short wave equipment altogether, and he has indeed chosen a short wave expert to accompany him, in John L. Reinartz of South Manchester, Connecticut.

Plans for the expedition include the transmission of a daily *resumé* of their activities and findings, sent out at noon on a 20-meter wave. Recent successful daylight transmission with these extremely high frequency currents lead to the belief that the signals will be picked up at Washington where the government services will be listening, and thus permit a rebroadcast on ordinary wavelengths.

Work for Hoover's Third Radio Conference

SECRETARY HOOVER is again contemplating calling in the best radio minds in the country for a third annual conference.

The possibility of such a call was considered by the conference of the Radio Committee of the League of Nations which has been in session in Geneva. It was anticipated in Geneva that the Washington call would not come until the spring of 1926 at the earliest. This committee decided to call to the attention of the Washington conference the necessity of elaborating the international regulation of radio communication concerning security at sea and the protection of navigation. It has not been apparent that commercial radio has seriously interfered with the channels reserved for navigation and distress messages, but it may be that the problem in European waters is more serious. If this is so, the Washington Conference would do well to consider it.

The Month in Radio

IN GERMANY it is a crime to listen-in on broadcast programs unless the government fee has been paid, and according to a press dispatch, there are more than 550,000 obedient citizens who pay the Post Office Department

about fifty cents a month for their radio entertainment. At present the government receives more than three million dollars annually from the radio enthusiasts.

MORE than three years ago, in fact in our very first editorial, we suggested that philanthropists should leave money for equipping and endowing high class broadcasting stations. This movement had its inception at the University of Notre Dame and the University of Illinois, both of which are to be given modern stations as memorials to Roger C. Sullivan, a well-known Democratic leader of Illinois who died five years ago. The stations are gifts from his son, B. H. Sullivan. This is a fine beginning of a worth-while enterprise.

THE Radio Corporation's quarterly report shows its gross earnings for the quarter ending March 31st to be more than \$15,000,000. This indicates a total for the present year at the same rate of \$61,000,000 or about \$6,000,000 in excess of last year's business.

LAST month saw the exportation of some of America's good radio capital. Dr. Marius Latour, a French scientist, owns many patents on details of radio receivers, some of which have been used promiscuously by American radio concerns, who were apparently all oblivious of his patents. In a suit which he brought against the Hazeltine Corporation, Latour was successful in sustaining his claims, so this radio company, and several others decided to capitulate and buy him out. One of his patents covers the use of iron cores in radio transformers. No sensible engineer ever thought of using anything but iron cores insofar as we know, yet Latour was able to get a patent on the idea. Most of his other patents are of similar import, but, lacking as they may be in scientific merit, they were sufficiently important to cause our American companies to part with several hundred thousand dollars.

ACCORDING to newspaper stories, the General Electric Company recently demonstrated the operation of a loud speaker from a crystal set. From the layman-writer's description it appears that the instrument is a cross between the large paper cone speaker and a French type using a small, flexibly supported, rigid cone. Needless to say a crystal set must be very close to a transmitting station if a loud speaker is to be operated by it, because at any appreciable distance, the receiv-

ing antenna cannot pick up enough power to give audible sounds in any loud speaker. With tube sets, the local B battery gives the energy to operate the loud speaker. The received signal merely serves to control this energy.

SOME interesting figures on the income of broadcasting stations were given out recently by the Radio Artists' Association. According to their report, some stations are actually making money. WHN of New York, for example, has a reputed income of \$300,000 a year and expenditures of not more than \$50,000 a year. WFBH in the same city, has contracts which bring in \$90,000 a year with an annual expenditure of \$35,000, it is reported.

The stations in present Telephone Company network charge as follows:

WEAF \$500 per hour, \$195.35 per quarter hour; WEEI, WJAR, and WCCO \$250 each per hour; WOO, WFI, WCAE, WGR, WSAI, and WWJ \$200 each per hour; WCAP, WEAR, and WOC \$150 each per hour. For the "facilities" of all these stations, the gross charge is \$2600 per hour. To give a ten minute talk over this wire-radio network would cost \$1300, or about a dollar per word.

The manager of WHN, when shown the report characterized it as a gross misstatement, and similarly, WFBH's manager claimed that his income was only just sufficient to meet expenses.

Interesting Things Interestingly Said

DAVID SARNOFF (New York; vice-president and general manager of the Radio Corporation of America): "At present it cannot be said that advertising over the radio is parallel in effectiveness with advertising in periodicals and newspapers. The standards of periodical and newspaper advertising should also apply to the standards of the air and no advertisement should be broadcast without the plain advertising label."

HARRY M. WARNER (New York; president, Warner Brothers, a motion picture company): "My attention has long been directed to a general tendency to fight radio within the amusement field. The identical arguments used only a few years ago in an effort to minimize the popularity of motion pictures are being dragged out and pointed at an entertainment which now, roughly, has 20,000,000 supporters in the United States. . . . The cry of 'the pictures will ruin the theatre,' is within easy memory. But they didn't, although there is no doubt that the pictures inflicted considerable dam-



POWEL CROSLY, JR.

Cincinnati; Radio Manufacturer

"I am looking forward to the day when first class broadcasting stations will use from 50 to 100 kilowatts. I believe that this is as essential as it was for the commercial companies figuratively to boost the power of the original 1/2 kilowatt used by Marconi when he sent the famous letter "s" across the Atlantic Ocean to 50 kilowatts and later, to 200 kilowatts, for satisfactory transoceanic communication. The high power broadcasting stations of the future must be located away from large centers of population so as not to cause undue local interference.

"The quality of service rendered by the higher powered stations should be recognized by the Department of Commerce in assignment of wavelengths, and this recognition should necessarily have coupled with it, certain requirements as to quality of service. . . . There must be more recognition of quality of service and priority than there has been heretofore. First class stations should not be asked to divide time with third class ones. . . . Though still untried, I believe more strongly than ever in super-power"

age to the cheaper theatrical attractions. . . . To this has been added the alarm, 'the radio will ruin the theatre and pictures.' It will not, provided it is used intelligently. . . . The radio is here to stay just as the theatres and pictures are here to stay. They all have their followers, and just as the picture audience is a theatre audience, so is the radio audience largely a picture audience. . . . To my mind, any effort to fight an entertainment that



© Underwood & Underwood

CAPTAIN A. W. STEVENS

New York; Aerial Photographer with
the Rice Expedition in Brazil

"Although we worked with portable radio apparatus in the heart of the world's greatest forest, we established a record in short-wave communication with England. Long-wave communication was carried on between the expedition and Manaus and short-wave communication to many parts of the world, including New York, San Francisco, London, Rio de Janeiro, and New Zealand. The signals were reported as very strong, both in New York and London. Part of the apparatus was designed and assembled on the job by the operators, John W. Swanson and Thomas M. McCaleb.

"The antenna system was often erected by sawing down a number of large trees in the forest and stringing the wires between other tall trees on the edges of the roughly cleared space. A wire was usually strung from the folding table that held the instruments to a ground loop."

has the backing of 20,000,000 people is sadly misdirected and will react harmfully on the entire industry. If radio has had an effect on motion pictures—as those exhibitors who should know what they are talking about claim—my idea is not to wage a useless fight against it, but to use radio to the best possible advantage."

N. P. VINCER-MINTER (London, England; in an article in the *Wireless World*): "From a point of view of artistic appearance, American-made radio sets show a marked superiority over those

made in England. In this respect we are not referring to the hundred-guinea type of cabinet set, whose artistry cannot, of course, be denied, but to the ordinary type of good quality set which sells at prices ranging from £20 to £40 or thereabouts. . . . One has only to glance through the advertisement pages of any of the American radio journals to note the large number of really efficient and attractive-looking sets at not unreasonable prices, to be acutely aware of how much greater is the range of choice accorded to American purchasers. Although, of course, some of the claims made in these advertisements are typically American, it must be admitted that on the whole the sets are highly efficient."

BRUCE J. A. M. ELDER (Sydney, Australia; Commissioner for Australia in the United States): "Production costs have increased enormously, until now wages in the tailoring trade are 300 per cent. above the pre-war level. Factory expenses have also doubled. . . . But there are other factors equally important. In the United States, there are more than 17,000,000 motor cars, which exceeds the number of telephones. These cars are bought on time payment as are also the majority of wireless sets in the country. I am of the opinion that the purchasers of cars and radio sets meet obligations by saving on clothing for themselves, their wives and families. Radio causes people to stay in their homes, thus lessening the demand for clothing. American bankers go further and say that people do not wear good clothes in motor cars and consequently purchase new clothes less frequently."

EDWARD H. JEWETT (Detroit, Michigan; president of the Jewett Radio and Phonograph Company): "Time was when open cars were all the rage and most autoists stored their cars during the winter. . . . Radio has developed similarly. From a purely winter instrument it has been brought to the point in development—thanks to the fine engineering talent in the radio industry—where it affords the radio enthusiast a full year's pleasure and utility. . . . Mighty few vacationists will be without their radio this summer. Modern portable sets are as easily taken along on a summer journey as the ordinary suitcase. The summer camper may pick the wildest, loneliest spot for his vacation and yet be in touch with the world through his radio."

S. H. MAPES (Chicago, Illinois; vice-president and general sales manager, Joseph W. Jones Radio Manufacturing Company): "Is the possibility of extensive improvements in radio sets affecting sales? The answer is an emphatic no. For the improvements that will come will be those of 'evolution rather than revolution.' . . . Radical changes will not be made, but refinements will continue to appear as they have in the automobile and other industries. The more noticeable changes will be made in transmitting and not in receiving sets."

The Listeners' Point of View

JENNIE IRENE MIX, who has written "The Listeners' Point of View" since April, 1924, died suddenly after a short illness at her home in Toledo, Ohio on April 26th.

When "The Listeners' Point of View" started it was the first attempt to present sound radio program criticism in any magazine. Miss Mix was probably better qualified than any other writer who could have been selected for the task. For many years she had been writing music, thinking music, and almost living it. She was well known in the musical life of Pittsburgh. From 1904 to 1918 she was music critic of the Pittsburgh *Post*. During many music seasons she covered important musical events in Boston, Philadelphia, Cincinnati, Cleveland, Ann Arbor, and Chicago.

Miss Mix spent some time abroad, where she furnished music correspondence to a number of prominent American newspapers from such centers as Paris, Berlin, Munich, Dresden, and Bayreuth. In 1920, Henry Holt and Company published a novel from her pen, *At Fame's Gateway*, which deals with the life of a young music student in New York. Comment on this book was very favorable and very widespread. Several years before, Miss Mix had turned her talents in another way and *Mighty Animals*, published by the American Book Company, presented in an entirely new fashion the story of prehistoric animals. The preface to this

volume was written by Dr. Frederick A. Lucas, director of the American Museum of Natural History. The book is used as a supplementary reader in public and private schools.

A woman of striking personality, Miss Mix had a peculiar talent for transferring her personal charm to her work, which was one reason for her great popularity with the readers of RADIO BROADCAST. It is interesting to note, also that, in the newspapers, her writings were almost as widely quoted as those of Professor Morecroft in "the March of Radio."

Miss Mix felt that, since the greater part of radio broadcasting was music, helpful criticism and comment about radio music would be welcomed by interested radio readers everywhere. She had a wide acquaintance among musicians throughout the country, and she spent many a musical season in New York covering the events for newspapers in various parts of the country. In "The Listeners' Point of View,"

she was singularly successful in presenting comments about radio broadcasting programs which could be found nowhere else. Her remarks on programs and personalities, her news and comment on the new world of radio, made for her and for RADIO BROADCAST many firm friends.

The Listener's Point of View will be continued in the magazine as before, and the new conductor of the department will take up Miss Mix's duties in the August number of RADIO BROADCAST.



Jennie Irene Mix

April 26, 1925

What Are the Royal Roads to Radio?



An Interesting Answer to the Question, "How Can I Learn More About Radio?"—What the Colleges Offer—The Place and Value of the Commercial Radio School—Some Help and Suggestion for the Earnest Student Who Works at Home

By KEITH HENNEY

OF ALL the many questions that come to RADIO BROADCAST there is one that causes the Editors more than usual thought. The query of "How can I become a radio engineer?" seems to worry a great variety of people. High school students contemplating their college courses, mature engineers, mechanical, electrical, civil, chemical or mining, and professional electricians; all want to know how to fit themselves to enter the radio engineering field. And aside from those who actively plan a dash into the land of radio there are many who would like to know more about this fascinating subject than most of the present day radio books tell them. They are doctors, lawyers, ministers, and the great army of tradespeople who are interested in radio, and who are interested, incidentally, in the whole vast field of science, for its own sake.

And while it is not the purpose of the writer to argue the point here of whether there is or is not a future for a man fitting himself to be a radio engineer, it is well to call attention to two conflicting statements appearing in the press within the last year.

According to Colonel Percy E. Barbour,

Editor of *Mining and Metallurgy*, the engineering field is already overcrowded, and he takes exception to the press report that colleges and universities are falling behind in their output of capable engineers.

The other statement may be found in some radio school advertisements wherein the marvellous salary of \$10,000 a year appears in large type, and one gets the idea that such a munificent sum may be commanded within a few months after completing some particular course which the school offers.

It is very difficult to judge the truth of the first statement, but it is certainly true that any capable wide-awake engineer may find a position if he has the qualifications mentioned later in this article. The engineering profession, like all other walks of life, needs big men, and this means those who have fitted themselves with all of the modern educational equipment.

As for the \$10,000 year salary, it is again largely a question of the man. No student who follows any radio course, whether in college or by correspondence can hope to attain this sum unless he has the most extensive experience behind him. And that entails work, several years of it at least.

WHAT IS A RADIO ENGINEER?

IN THE first place, as Professor Morecroft pointed out in RADIO BROADCAST in July, 1924:

"To the best of our knowledge, none of the good technical schools of this country confer the degree of 'radio engineer.'"

The nearest approach is that given by Harvard University and other large institutions which have a number of courses grouped under the title of "communication engineering" but here, as in other branches of electrical engineering, the first degree given after four years of study is "bachelor of science in engineering."

The degree of electrical engineering "E. E." is usually won only after the bachelor's degree has been taken and after at least two years of commercial experience.

A real radio engineer will probably be proud of the fact that he has had a technical training, but he will hesitate to admit that he is a radio engineer, so thickly populated has the radio profession become with self-labelled authorities without training or experience beyond that of any boy who has assembled radio apparatus.

The field of radio engineering is simply a branch of electrical engineering. A power engineer, a telephone, or a telegraph engineer must first of all be an electrical engineer, and a good one too. In nearly every case, one must have a general engineering training before he can specialize in any of its many branches.

THE STRAIGHT AND NARROW PATH

THE young man who is anxious to fit himself best for the radio world, should learn all he can from elementary books which he can secure in the public library, and from actual ex-

perience with radio apparatus. This experience should include both transmitting and receiving apparatus, and here is where the "amateur" has the advantage over his brothers who casually decide to enter the radio world.

It is probable that the greatest number of our future radio authorities will come from the ranks of these so-called amateurs, youths who construct and operate apparatus that enables them to converse with other amateurs across unbelievable distances.

It is surprising what an advantage these amateurs have when they go to college for their further training. They have the "feel" of radio equipment; they are already familiar with laboratory apparatus, and they have acquired first-hand knowledge that gives them a great advantage over their classmates. These relatively inexperienced men who are not so fortunate require some considerable time to gain equal familiarity.

The student should pay as much attention to his mathematics and physics as possible during high school, for all that is learned here will save time in college. If he has time for

French in high school, several years of that language will be a great help. Or French and German may be learned in college, and if the student has a fair reading knowledge before his arrival there he will find it a distinct advantage. These two languages have become important adjuncts to an engineer's training, for so much good work is being done on the Continent that a well posted expert must keep in touch with what goes on there. One ought to follow the work of foreign investigators in their own language.

After arrival in college, the student may approach radio from one of two angles, either through the conventional electrical engineering department or through

There Isn't Any Formula—

FOR success in any line of activity. Not very long ago, someone set down three rules for mental progress. They are: "1. Sit down in front of a blank wall. 2. Ask yourself difficult questions. 3. Answer them." And so with radio. The best way to learn more about radio is to learn it. However, there are so many who really want helpful and definite suggestions about how they may improve their radio knowledge, where good college courses in radio are to be had, and what books to read, that it seemed that a helpful discussion of the entire subject would be read with great interest. Boys in high school, preparing for college, want to know what subjects to study so they may progress as fast as possible; older men, out in the whirl of daily existence are eager to know what books will help them to get a good technical foundation in radio theory; and radio salesmen want to learn the technical facts about the merchandise they are selling. This article does not pretend to present complete instructions for success for any of these interested persons. But there is information here which should be of genuine aid. Mr. Henney, who is director of the RADIO BROADCAST Laboratory, is a graduate of Western Reserve, and of Harvard University which granted him the degree of Master of Science. —THE EDITOR

the physics department. For the first year the courses studied will be much the same whether the student is in engineering school or in the "arts" college where he will elect scientific subjects.

A continuation of his higher algebra, trigonometry, analytical geometry and an introduction to the calculus will complete his mathematical background for the more serious work to follow. He will go through the usual Freshman English which is aimed to give him practice in writing. He will continue his foreign languages, and probably learn something of history, sociology, or economics.

In the second college year, the student engineers continue to study more mathematics and they begin to branch out and to concentrate in their various fields. Both the engineers and the physics students learn something of the several branches of physics. Electricity appeals to the embryo radio expert, but he should not forget that acoustics has become a very important part of radio engineering, and his course on sound will prove valuable in his future work.

The third and fourth years are given to more specialized courses. The study of vacuum tubes, and their properties of amplifying, detecting, and oscillating, will be begun, and for the radio enthusiast, this course will prove to be more than interesting as will the study of oscillations and electric waves.

Should all this time and work seem unnecessary to the budding engineer, he should remember that he will be forced to compete with other engineers, and that the better trained will have the better chance of success. The attendance at colleges and technical schools increases each year, and it seems that the youth who passes up a college training without good cause will find himself somewhat handicapped.

THE WIDE SWEEP OF RADIO

RADIO is perhaps the broadest of the various related fields of electricity, for it requires knowledge and practise derived from engineering, from physics, from chemistry, and from mathematics. For this reason, the radio man who is being trained for radio, should have as broad a scientific education as he has time to accumulate.

The radio engineer must know the fundamentals of electricity, and there is no royal road to this knowledge. He must understand the principles of the various branches of physics, such as light, heat, electricity, mechanics, and sound. He must be able to

design apparatus that can be made by ordinary machine practices, for a device that cannot be manufactured might as well not be invented, from a practical point of view.

All of these subjects require a knowledge of mathematics, and the more a man is at home with his algebra, and his trigonometry and his calculus, the better is he able to visualize the electrical and mechanical problems that come to him.

At the present time, there are surprisingly few really outstanding radio experts in this country. Among them are college professors whose training and experience has been so extensive—not necessarily in engineering—that they can speak authoritatively on radio theory and radio practises. There are others whose training has not had the formality of any college at all, but they have learned their profession in the more arduous one of experience. It is probable that none of these men hangs out his shingle as a "radio engineer." It is probable that few of them can copy "twenty words a minute" of Continental Morse code.

A real engineer then, is one who understands electricity, who can design apparatus, not merely building it by the cut-and-try method, and who by the aid of his mathematics can arrive at preliminary solutions to important problems without the necessity of long laboratory experiment.

"COMMUNICATION" COURSES

SOME technical schools are recognizing that the field of communication is a distinct entity within the larger one of electrical engineering. As a result, their communication courses include more about vacuum tubes, for example, than about power machinery. Included in such courses is work on telephone lines and their associated apparatus, the methods of signalling under water, telegraph, and, naturally, radio.

"MAN SPECIFICATIONS"

AN INTERESTING statement was made some time ago by John Mills, a prominent educator and engineer who hires the technical men for the Western Electric Company and indirectly men for the American Telephone and Telegraph Company. In this statement he said:

I look for six characteristics, without regard to the engineering course in which the student has been trained; and I accept for the same opportunity men who as arts college students have had no engineering courses whatever.

In the first place I look for "intellectual curiosity." Unquenched and unquenchable intellectual curiosity is to my mind the first requisite for growth in our rapidly progressing age. The second requisite is the ability to study. It is perhaps the one real aim in education. The percentage of population which has the ability to study is much less than the percentage of degrees and other evidence of learning would indicate. Learning looks to the past, while study looks to the future.

The third requirement is the habit of study.

The three remaining requirements have nothing to do with the content of engineering courses, but they have a great deal to do with the natural

water, but he was curious to know how, and to-day his intellectual curiosity has got him much farther than his fellows who were not particularly thrilled by the fact that "H₂O" was the chemist's shorthand symbol for one of nature's grandest explosions.

WHAT TRAINING IS VALUABLE

IT IS surprising when one looks over the names of those who appear in the *Who's Who in Engineering* to see the great number of prominent men who have had general college training and who are, technically speaking, not engineers at all. On the other hand one should not forget that President Emeritus Charles W. Eliot of Harvard University was a

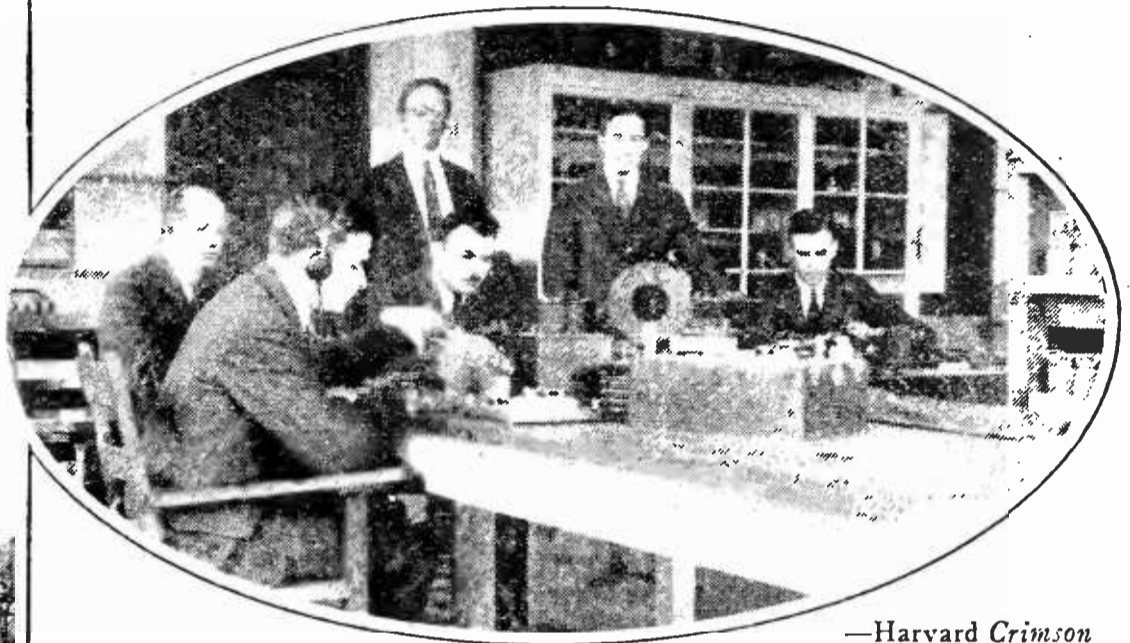
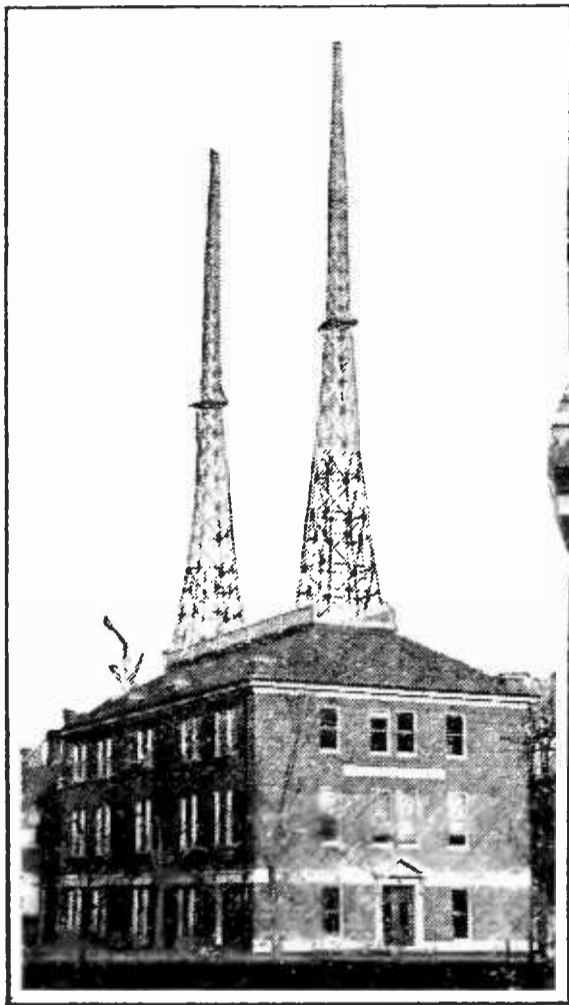

—Harvard *Crimson*

CRUFT HIGH TENSION LABORATORY

At Harvard University. This building is one of the few university buildings in the country devoted exclusively to radio work. The oval shows students at work in one of the laboratories. Dr. E. L. Chaffee is standing at the extreme left. Most of the students who are taking work in this building are graduate students, many

of them from other universities than Harvard. Professors George W. Pierce, A. E. Kennelly, and Dr. E. L. Chaffee give courses and supervise radio research at the Laboratory

characteristics of the student and his general training; they are: first, the ability to learn from men; second, the ability to cooperate with men; third, a promise of the ability to lead men.

In connection with the first requirement, intellectual curiosity, the writer remembers distinctly a fellow student in freshman chemistry. A young instructor was lecturing at some length upon the simple fact that two molecules of hydrogen and one of oxygen combine to form the well known "H₂O", and this chap wanted to know "how." Such a heretical question apparently astonished the instructor, for he struck up the usual attitude of a young teacher who finds himself in deep water.

But that freshman who was not satisfied by knowing that hydrogen and oxygen did form

professor of chemistry, or that Herbert Hoover is a graduate mining engineer.

It seems that aside from the intrinsic value of a technical education, there is much to be said in favor of general training. It is probable that the best-known doctors, lawyers, and educators are those who have studied many subjects not directly related to their particular interest.

Here again it is "intellectual curiosity" and the ability to study that counts, for a man trained in one field may find himself thrust into another. It is probable that the executive engineers who become presidents of corporations are those who have had the widest possible training outside of their narrow technical study.

Benjamin Franklin was "craftsman and

tradesman, philosopher and publicist, statesman, patriot, and diplomat." Yet, too, he was a scientist.

Good radio courses are given by many state universities, and the work that is done at Harvard University under Professors Pierce and Chaffee, at Columbia by Professor Morecroft, and by Professor Hazeltine at Stevens is well known. There are a number of technical schools like Rensselaer or Massachusetts Institute of Technology that give highly specialized work in radio subjects in connection with their departments of electrical engineering.

The student who cannot go to one of these large institutions should not feel discouraged, for any well taught engineering course will give him the background for research or graduate work in radio subjects. It must be remembered that a radio engineer may be a physicist, and there are few colleges that do not have physics departments. The principal thing for the student to remember is to get the fundamentals of electricity and mathematics well in hand; the value of the superstructure of one's training depends entirely upon how well the ground work has been laid.

COMMERCIAL RADIO SCHOOLS

THOSE who are interested in radio and who cannot go to college can learn a great deal about radio. It is probable that the greater number of workers in this fascinating study fall into this class, for they are those who are now working with radio equipment and have neither the time nor the inclination to go through the somewhat lengthy process of becoming thoroughly trained.

The point is that any one can be well posted on radio, and can become well acquainted with radio phenomena at home, or by attending some radio school. Before the day of broadcasting such schools confined their activities to preparing men for the government commercial license examinations. To-day the picture has changed and presents a much broader aspect. Experts are needed for salesmen, for operators, for broadcasting duties, for inspectors in manufacturing plants, and for designers of radio apparatus. Each of these particular positions requires somewhat different training, but the fundamentals of radio should be understood by all. And it is these fundamentals that can be learned at home, or in day or night school, or by correspondence.

The Department of Engineering Extension of Pennsylvania State College gives two courses by correspondence. One of these is an elementary course for those who know little

about radio; the other is more technical and complete in its scope and uses as its text, the book *Principles Underlying Radio Communication* prepared by the Bureau of Standards.

These schools draw their students from all walks of life, there are few professions that are not enrolled. A statement from one of the large radio schools is significant:

An analysis of last year's enrollment showed that 134 distinct and separate professions were represented in our student body, and among them were doctors, lawyers, electrical, mechanical, and civil engineers, postmasters, building contractors, dentists and men of similar occupations.

CHOOSING A RADIO SCHOOL

THE task of choosing a radio school is no simpler than that of choosing a college; there are the same questions to be answered. One should decide what one is to expect from such a school and to find out whether it offers the course that is wanted. Some schools are offering courses in radio research for the advanced student, but there is no reason why the enthusiast cannot perform the experiments included in such a course at home—provided he has the apparatus.

It is surprising how many of the fundamental facts of radio may be discovered by reading and by simple measurements that any radio hobbyist may do. In future issues of RADIO BROADCAST will be found descriptions of apparatus and experiments that will teach much about the characteristics of tubes used as amplifiers, detectors, and generators; of the theories of resonance and tuning; of the effects of resistance in circuits, and of similar work in high frequency alternating current circuits.

Those who have had technical training should get acquainted with their mathematics again, specially the major operations in algebra, trigonometry and calculus. They should master alternating current theory, especially the effect of inductance and capacity in tuning. Technical articles appearing in the radio publications, especially in the *Proceedings of the Institute of Radio Engineers* may be read with much profit. Here are descriptions of modern radio stations, amateur, ship, broadcasting, and high power, complete with technical data and methods of operation. Here, too, are descriptions of new applications of existing apparatus.

The correspondence and day or night schools have much to offer for those who want to know more about radio, and the good that can be done in this direction is incalculable. Radio

is suffering from a lack of first hand information.

The stores that are doing the largest business are those that employ trained radio salesmen, and it seems reasonable to suppose that those that will continue to exist in these days of competition will be those that are best posted on radio facts. The buying public likes to feel that the salesmen know what they are talking about.

RADIO BOOKS

MANY books have appeared on radio since the advent of broadcasting. Some of these appeal to some people, but seem sketchy and stupid to others. It is impossible to recommend a book unless one knows the background of the reader. A book that is too technical for some is too simple for others; and there you are.

Books are a reservoir of knowledge and those that are listed below are not all that have been printed by any means. Two that may be obtained from the Superintendent of Documents, Washington, D. C., should be part of every radio man's library. They are the *Principles Underlying Radio Communication*, which costs one dollar, and the Bureau of Standards *Bulletin No. 74*, which costs sixty cents.

Books written for the laymen are *Radio Communication* by E. W. Stone, *An Outline of Radio* by John V. L. Hogan, and *Dunlap's Radio Manual* by Orrin E. Dunlap, Jr. John Mills' book *Letters of a Radio Engineer to his Son* presents the fundamentals of radio science in an unusual and interesting manner.

Among the more technical books, there are

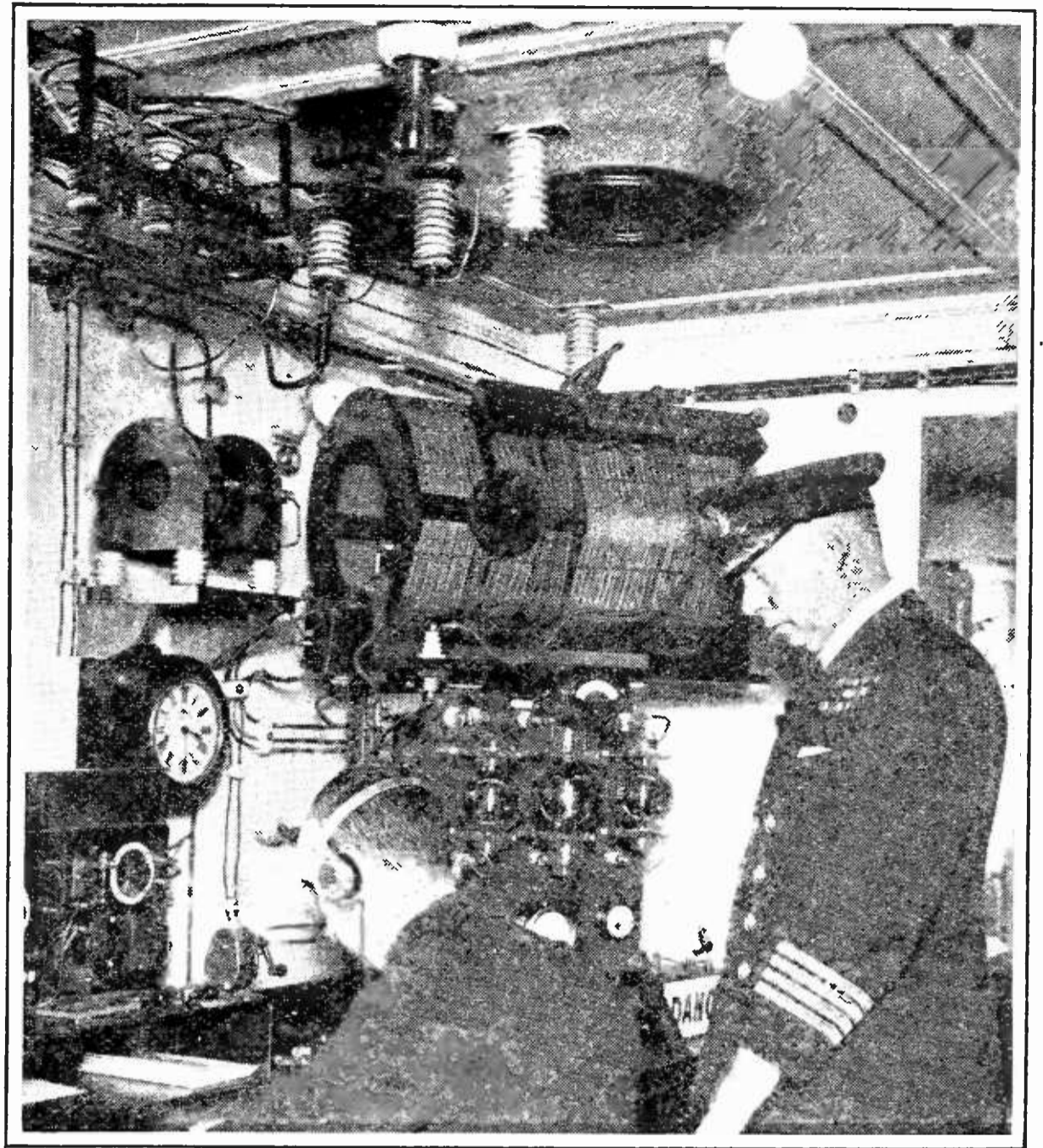

A MARINE RADIO OPERATOR AT WORK

Senior operator J. T. Williams, and Captain John Roberts of the S. S. *Homeric*. Part of the tube transmitter is visible. Those who want to gain as much radio experience as possible often spend several years or more as a marine radio operator. Operators, when they are granted their government licenses, are thoroughly examined on their knowledge of radio theory and practise. Practical experience aboard ship is very valuable to the man who wants to have a thorough knowledge of radio. Great numbers of prominent radio men have graduated from the marine operator class to positions of considerable radio success. The amateur radio operator learns much about the fundamentals of radio without leaving his own home. He can gain much from a study of good radio text books and magazines, and more by practical experiments with radio. The study of radio at home, as the author points out in this article, although it cannot substitute for study at a technical school or college, can do much toward building a radio groundwork

none that are as complete and as useful as Professor Morecroft's *Principles of Radio Communication*. *Thermionic Valves*, by Van der Bijl is useful to the vacuum tube student, but this book is highly technical and was written from the point of view of the telephone engineer. The mathematically inclined reader and those who crave exact proofs of statements will enjoy Professor Pierce's *Electrical Waves and Electrical Oscillations*—which, by the way, contains some excellent material on electric lines and filters, a subject that is treated very sketchily in other publications.

as the broadcaster sees it

by Carl Dreher



Drawings by Franklyn F. Stratford

High Power and Elimination of Strays

THE only reason that static is bothersome, even occasionally, in radio reception, is that the amount of energy normally picked up from a distant station is almost incredibly minute. Dr. W. R. Whitney of the General Electric Company, is reported to have calculated recently, that the energy expended by a house fly in climbing one inch up a wall, is equal to the total energy which would be picked up by a one-foot loop at Schenectady, New York, from a normal broadcasting station in San Francisco, *over a continuous period of 35 years.* Yet we know that, given a suitable receiver, reception of KGO on a one-foot loop at Schenectady is not an extraordinary feat. It is the amplification required—and available in a good set—which is extraordinary.

When amplification is raised to this level, it is to be expected that any natural or artificial electrical forces which may happen to be hanging about will also make themselves heard in the loud speaker. Leaving aside the relatively rare periods of local lightning, static interference is not caused by the strength of the static, but by the weakness of the signal. The static is not particularly vicious, but we stick our hands into its cage, in DX reception, and invite it to bite us. Or, to change the metaphor, we look for needles in a haystack, and then complain of the hay. Archimedes said that given a long enough lever, and a place at the fulcrum to rest it on, he could move the earth. The modern radio engineer can paraphrase Archimedes with the declaration that, given enough stages of r. f. and a. f. amplification, he can sit in California and hear all the x-ray machines in Maine; or, since we are talking

about static, he may hear all the lightning flashes in Korea and all the meteorites hitting the Heaviside layer, assuming that this cosmic bombardment gives rise to certain varieties of static, as has been alleged by some specialists in the subject.

In discussing static interference in radio it is necessary to differentiate between interference with program service and interference with distance reception. Static frequently interferes with distance reception, particularly in the summer, because the received signal requires great amplification. Interference with program service is relatively rare. When the signal from a given station in a given locality is strong enough to ride over the usual disturbances, this ability being taken as the criterion of program service, it will be found that periods of abnormal disturbance are not as unusual as railroad wrecks or tornadoes, but neither are they more common than "rotten" pictures at the movies, or automobile tire punctures, or arguments with one's wife. In other words, as regards static, radio is in the position of other public utilities and domestic conveniences with reference to their peculiar difficulties; it is imperfect, but good, and not to be appreciated until one has to do without it.

While we are thus attempting to view the problem in its true proportions, it is not to be denied that a compact, cheap, simple static eliminator would be of great utility, especially to people who live several hundred miles from the nearest broadcasting station, and of even more value to listeners in the tropics, where static is at its worst. A nice little tube, to be connected in the antenna lead, which

would stop the static and let the signals go on down, would be just the thing. I would go to the five-and-ten-cent store myself to buy one. Unfortunately, while many good men have attempted to invent some such device, and have brought great ingenuity and assiduity to bear, the job remains to be done. Very successful means of static reduction have been devised, but all are complicated and costly. They are used only in long distance radio telegraph circuits, where the plant investment is in any event great and where profits are more or less proportional to ability to ride over static disturbances. Most of these successful methods operate on the directional principle. The signal comes from only one direction, and the static may come from a different direction. If you can confine your reception within as narrow an angle as possible, pointing in the direction of the approaching waves of the desired station, you may be able to shut out an appreciable proportion of the static. This is the principle of the barrage receivers of Alexanderson, the loop-vertical combinations of Pickard, some of Weagant's devices, and the "wave antenna" of Beverage, Rice, and Kellogg. The latter employs antennas nine miles long for trans-oceanic reception. The antenna is supposed to be about a wavelength long, so even for broadcast reception one needs about a quarter of a mile. As yet no one has put up a wave antenna on Riverside Drive or Michigan Boulevard! In any case, for broadcast reception, the direction of all such telescopic receivers must be variable, since one will generally want to listen to stations in any direction.

Many aspiring anti-static gladiators come forward periodically with vest-pocket eliminators which do not work, but which add to the gayety of the industry. Recently the ancient device of two circuits, one tuned to the wavelength of the desired station, the other to some other frequency, followed by rectification in each branch, and an a. f. balance in a differential transformer, was once more revealed. This method was in its first flush of youth in about 1916; it was described in a paper by

Dr. Cornelis J. DeGroot, "On the Nature and Elimination of Strays," (*Proc. Institute of Radio Engineers*, Vol. 5, No. 2, April, 1917.) Whosoever is interested can also discover, in the printed discussion following the article, some of the reasons why this plausible method will not work.

Another exhibit is found in an issue, early this year, of a trade paper advertising one of those five tube stabilized radio frequency sets, with three big knobs and two or three little ones, which is an imitation of an imitation of a five tube stabilized radio frequency set, but no doubt just as good. There is the usual cut, with captions on either side detailing the virtues of the set, and heading all the other claims is the bald statement, "It Eliminates Static." Of course it doesn't.

However, although the ordinary broadcasting receiver is not a static eliminator, it is important to note that when improperly used it may show a much less favorable signal-to-static ratio than when properly handled. The output of a vacuum tube is of course a limited quantity. If it is pushed too hard, a point is reached at which the signal volume can no longer be increased, while minor disturbances are still swinging the grids over the steep portion of the curve. This results in bringing up static or inductive interference or whatnot, to the disadvantage of the desired modulation, which is incidentally distorted. Not infrequently one sees receivers which are capable of delivering a clear, relatively disturbance-free output of moderate volume, pushed to a point where a mushy signal, full of squeaks, crashes, and hisses, but loud enough to be heard in the next county, is duly brought forth. A radio receiver of the usual design cannot be expected to do the work of a public address

system, any more than a billy-goat can drag a five-ton load. If more people would form the habit of holding down the amplification to a comfortable level, complaints of radio noise interference would be greatly reduced.

Finally, freedom from static and other extraneous sounds is a matter of transmitting power. Given the power, we can ride over

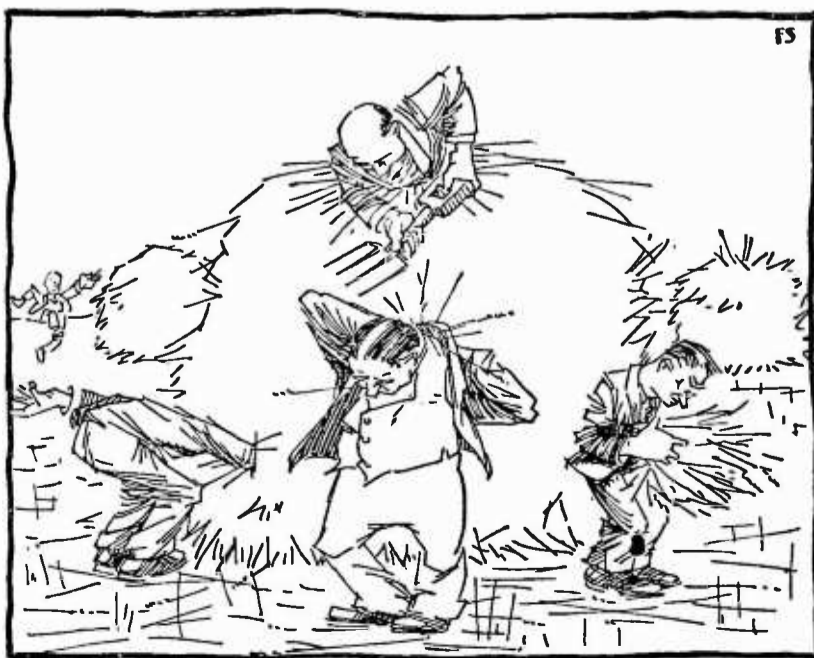

they hunt for needles and object to the hay

anything within reason. With inadequate power, one is in the position of a man talking in a whisper in any crowded place. Radio communication is inherently a problem in amplification. In the studio one starts with energy of the order of microwatts—millionths of a watt. This is enormously magnified—to the level of say 500 watts in the transmitting antenna, but the method of distribution is such that the receiver gets only a few microwatts to work with. Once more this is amplified, until it is strong enough to actuate a loud speaker reproducing the original sounds. But here is the rub: where amplification at the transmitter brings up only the desired sounds, as amplification at the receiver magnifies these and all other impulses that happen to be flying around. The former is selective amplification; the latter is general, indiscriminating amplification, except in the one particular of frequency selection.

Thus even the engineer who is skeptical about static elimination at the receiver, sees no reason why static cannot be substantially eliminated by perfectly feasible increases of power at the transmitter. Largely, in fact, this has already been accomplished. People who live within a few miles of a powerful station hardly know that static exists. Farther out, they hear it occasionally, but it is hardly as annoying as the coughing at a symphony concert—a form of disturbance which, incidentally, is effectively eliminated for radio listeners by close microphone placing. With the constant increase in power of broadcasting stations, the area of practically interference-

free reception increases in proportion. The time is not so far off when the area subject, more or less, to radio disturbances, will disappear entirely, just as the frontier of the United States disappeared, through the increase and distribution of the population, toward the end of the last century.

Among the Broadcasters—Howard E. Campbell

MR. CAMPBELL was a radio man in the days when "broadcasting" was not yet in a radio man's vocabulary. He is now chief radio engineer and director of broadcasting for the Jewett Radio & Phonograph Company of Detroit, which is about to put into operation a 5-k. w. station at Pontiac, near that city.

Leaving the University of Indiana in 1909, Mr. Campbell enrolled in the Naval Electrical School at Brooklyn, New York, where trembling amateurs and professional aspirants, a few years later, were summoned for their operator's license examinations, before the Department of Commerce took over that function. But that examination Mr. Campbell did not take until in 1912, after spending most of the intervening period as a Naval Radio Electrician in Atlantic waters, for the simple reason that until 1912 there was no examination to take. With his first grade ticket he made one trip as a marine operator in the coastwise service, before being transferred to the Marconi Company's installation force early in 1913. Ultimately he became chief radio inspector at the port of New York for the Marconi Company, and no doubt held down many a key while squeezing the last milliamperes out of the old quenched spark set. He also installed sets on sealing vessels in Newfoundland.

By this time, apparently, Mr. Campbell felt that he had graduated from marine radio, for, following a brief period as technical assistant at the Aldene, New Jersey, plant, he is next discovered as engineer-in-charge of the 300-k. w. New Brunswick, New Jersey, transatlantic station, which was a timed-spark outfit of the type still being used at Stavanger, Norway (LCM), for communication with the United States. New Brunswick was under test at this time, and soon after that job was in a stage of completion Mr. Campbell went out to Bolinas, California, to assist in the installation of a similar outfit for communication with Hawaii and Japan. All this, of course, was

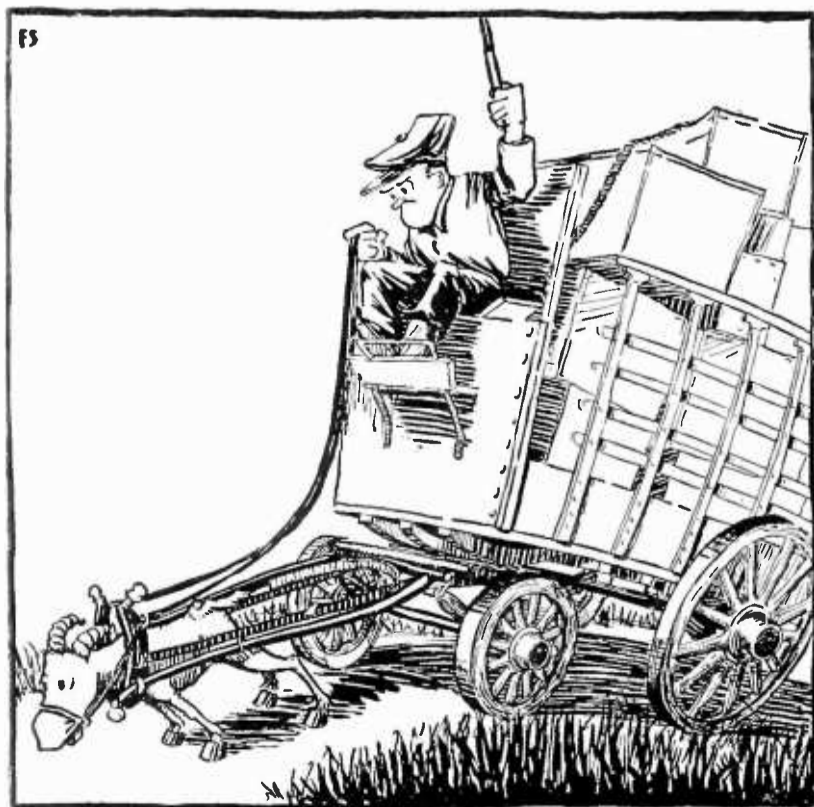

no more can a billy-goat pull a 5-ton load

in the dot-and-dash business; radio telephony was still in the incubator.

In February, 1917, Mr. Campbell was engineer-in-charge at Bolinas, and then the war came along. The day after the United States declared war against Germany, the station and all of its personnel were taken over by the Navy, Mr. Campbell remaining in charge with the rank of Radio Gunner. When the armistice was signed he was officer-in-charge of the Naval Radio Training School at Marshall, California, following which he went back to Bolinas, as Chief Radio Gunner, to recondition the station before it was turned back to the Marconi Company by the Navy. In May, 1919, Mr. Campbell was detailed as Radio Communication officer on the staff of the Pacific Coast Communications Superintendent, and this turned out to be his last assignment in the service, for in September he received his discharge and returned to his home in New York City, in plenty of time to participate in the broadcasting boom which started in the East in September, 1921.

As soon as Mr. Campbell reached New York he made a connection with the Western Electric Company as radio designing engineer, and in that capacity he had much to do with the design of the first 500-watt radio telegraph and telephone transmitter, from which the present standard 500-watt broadcasting outfit was developed with comparatively unimportant modifications. Having been in intimate touch with the design, Mr. Campbell was ready to operate this equipment when he became chief engineer of station wwj in Detroit early in 1922, and his success may be judged by the fact that this station was shortly cited by the Bureau of Standards as one of the few standard frequency stations of the country, varying from its assigned frequency less than one-tenth of one per cent. over a period of seventeen months. From wwj, Mr. Campbell passed over to his present connection.

Mr. Campbell has been a full member of the Institute of Radio Engineers since 1914.

Radio Is Too Urban

FROM Miami, Arizona, comes a comment by Mr. W. H. Mayfield relative to the discussion of DX vs. Programs in our April issue. Mr. Mayfield points out, pertinently enough, that some listeners are DX hunters through necessity. "The closest station of any size," he writes, "is 450 miles, air line, whereas a 450-mile circle drawn around Mr. Dreher's listening post would undoubtedly include a hundred stations. We necessarily have to be 'DX hounds' here, if we are to get anything, and to listen to stations for selection after selection without announcement, and when the announcement is made to have it entirely unintelligible, or 'down in the trough,' as he puts it, is discouraging, to say the least."

Mr. Mayfield suggests that the announcer have a key and buzzer handy, and give the call signal in Continental Morse. There are numerous objections to this method. Here in

New York only one of the announcers in my acquaintance knows the code well enough to learn to send even a simple combination of letters. Announcers are not chosen for telegraphic ability, but for a ready tongue, a pleasant voice, knowledge of music and showmanship, good manners and a measure of good looks. (The last to put female artists into a pleasant frame of mind, so far as possible). In the second place, nine-tenths of the listeners know as little code as the announcers. Thirdly, code signals, almost as much as key words like Watch George Yoke, would be out of atmosphere. At one station in the East there was a device for chopper-modulation of the carrier whenever the microphone was off, giving a characteristic monotonous note of musical pitch for listeners to tune to. It sounded pretty nasty on test, and was never put on the air.

The answer to the problem is twofold:

(1) Frequent announcing with modulation not below the mean level of the music. We shall be glad to hear from listeners about stations which

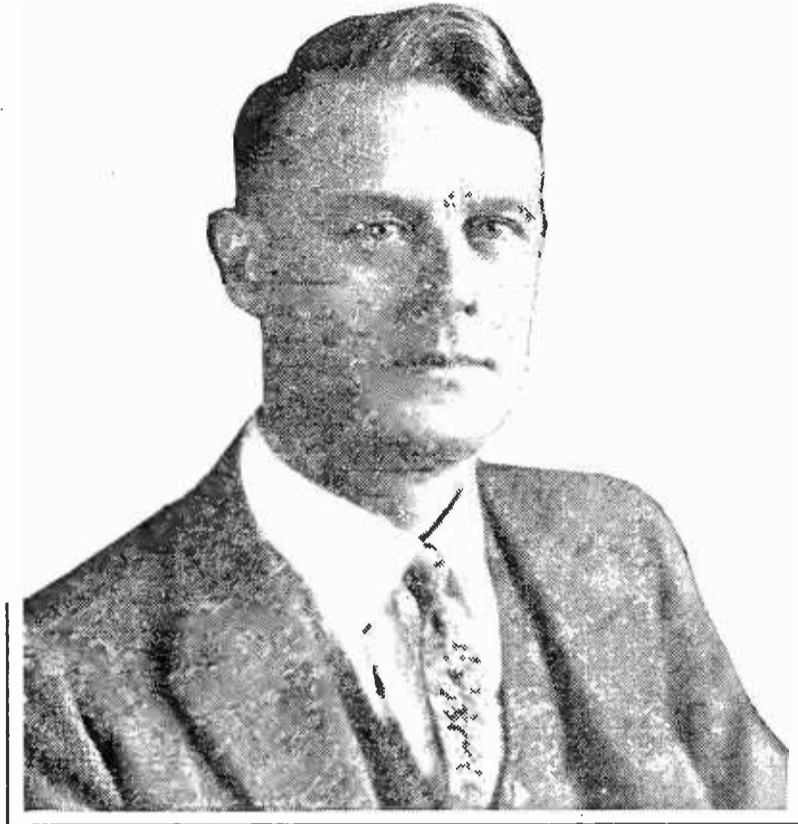

HOWARD E. CAMPBELL

neglect to give their call letters at reasonably frequent intervals, it being borne in mind, however, that on some types of programs, such as church services and theatrical features, frequent cut-in announcements may not be feasible.

(2) Adequate power to reach the backwoods. Radio is at present too much an urban proposition. The people out on the plains and up in the hills need it as much, and more, and they will buy the sets when the service is offered them. One of the kings of France—Henry was his name, but I don't recollect his number offhand—who had a great zeal for the welfare of his subjects, declared his ambition was that every French peasant should have a fowl in his kitchen pot on Sunday. Well, every American farmer must have a radio signal field strength of 1.0 millivolt per meter in his front yard on Sunday and every other day. When all announcements made are certain to reach the listeners, then the determination of the proper frequency of call-letter repetitions will be a trifling problem indeed.

Is Government Action Needed on the S O S Question?

ON MARCH 21st there was another east coast sos, and Mr. John S. Dunham, of Larchmont, New York, kept a log of the proceedings, sending a copy to Mr. Arthur Batcheller, United States Supervisor of Radio in the second district, and one to us. The record is very complete and covers from 7.46P, when the alarm was first given, to 8.27, when NAH (Brooklyn Navy Yard) sent out the "Resume traffic" message.

WEAF apparently got the original sos, or an immediate relay, for it is in this instance in the honorable position of going off the air first, at 7.46. WJZ, WNYC, WOR, WGBS, KDKA, and others kept right on broadcasting. At 7.57, NAH, the naval control station in this district, sent out a QRT (Stop Sending). Thereupon WJZ took off its carrier, followed within a few minutes by WNYC, WGBS, and WOR (8.01). The inland broadcasters continued their programs, and WIP, Philadelphia, 508.2 meters, likewise failed to break its carrier, until 8.22, when Mr. Dunham's log states, "WIP at last off."

Mr. Batcheller, in a communication to Mr. Dunham, commented as follows:

"Class B stations only, which are on the coast and capable of interfering on 600 meters are required to cease transmission during the transmission of an sos and signals relating thereto. Inland Class B stations and all Class A stations are not required to cease transmission."

That puts the sos situation substantially on the basis we advocated in our first article on

the subject in RADIO BROADCAST. (We do not mean to imply that that brought about the readjustment, which had probably been in contemplation for some time.)

However, Mr. Dunham feels that all stations above 300 meters should cease broadcasting when an sos goes out, on the ground that damage to antenna or apparatus might necessitate the use of a lower wavelength than 600 meters, the standard distress call wavelength. He calls attention, also, to the case of WIP, which is Class B, near the coast, and not so far from 600 meters. There may be a difference of opinion on the first question, and evidently the Department of Commerce, having liberalized the rules, considers the low-wave distress call contingency remote. But, whichever way you look at it, there is little to be said in favor of WIP if Mr. Dunham's log is correct.

Dr. Frank W. Elliott, Manager at WOC, also contributes to this discussion, pointing out that the Department of Commerce has never seen fit to enforce the regulations as regards inland broadcasters, and that it would be difficult to pick up sos calls on either coast at points in the Central states. He writes further:

"If some way could be developed to give information to the stations inland by telephone or telegraph I am sure that all would be willing to cooperate. I know that we would."

It was not our intention to criticize the inland broadcasters in this regard. We were calling attention to a general condition, using particular stations merely for illustration. The fact remains that some of the sos calls which take the coast broadcasters off the air originate several thousand miles out at sea. A powerful inland station on one of the higher wavelengths might conceivably interfere with the traffic following such a call. The argument in the March issue was for a formula or some equivalent means of differentiating dangerous stations from the others. This still seems a rational procedure. It is merely one of a number of radio problems which could stand scientific investigation as a basis for appropriate action.

Receiving equipment exists which could give an adequate sos service to those broadcasters, however, far from the coast, who might be designated to stand an sos watch. Or, as Doctor Elliott points out, a wire service might be organized.

We are glad to hear from WOC, not only for their specific addition to what has been said on the sos question, but because the exchange-

ing and debating of different points of view among the broadcasters is exactly what this department is here for.

The Memoirs of a Radio Engineer. II

BESIDES constructing an electrophorus, from which, when the weather was not too wet, sparks could be drawn, my companions and I built several detecting devices, or electroscopes. These were of two general types, which used metal foil and pith balls, respectively. The latter form consists very simply of two small sheets of gold-leaf or other very thin metal foil, suspended from a metal rod so that they will separate on the approach of an electric charge, owing to the repulsion effect between two similarly charged bodies. In our case, we stuck a fairly heavy copper wire through the cork of a pickle bottle, or any bottle of diameter uniform over the entire length, bent it over at the lower end, and hung pieces of aluminum foil over the horizontal part of the wire. The object of the bottle was to shield the apparatus from air currents. The proud operator of the electroscope would demonstrate it, before a gaping congregation of children, by running an ebonite comb, very likely stolen, through his hair, and bringing it close to the upper end of the metal rod or wire. Promptly the leaves would separate, standing stiffly apart at an angle of about forty-five degrees. For a small consideration, the spectators were permitted to rub the comb, each in his own hair, and by performing the experiment personally to satisfy themselves that there was no fraud. Many of them believed that the electricity was drawn out of the head, that some individuals had more than others, and that there was a peculiar virtue in having a great deal; arguments arose as to who had the most, and in the more acute cases led to fist-fights and neighborhood feuds. One boy in particular vaunted himself on his remarkable virility; for he was able to make the pieces of foil leap apart so violently that they reached the sides of the bottle and clung there. His enemies maintained, probably not without truth, that he was able to do this because his mother never made him wash his head. They caught one of the stray cats of the neighbourhood, rubbed its back with the comb, and proved that it yielded an even more striking effect on the electroscope than the hair of the champion, who stood near by, surrounded by his adherents, sneering. Finally one of them threw a

rock, smashing the electroscope; the cat escaped, all the contestants, abandoning science, rushed to arms, and in the ensuing mêlée I received a bloody nose, neither the first nor last injury of that nature which I sustained.

The other type of electroscope worked on the same principle, but utilized pith balls suspended by threads. The pith we obtained by hunting for the dried stalks of weeds, which abounded in the vacant lots of the Bronx. Pith ball electroscopes were cheaper, and hence more common. One could be bought from the manufacturers, if I recollect, for about five marbles of the type known as "immies," while the aluminum foil product sold only for cash. As much as ten cents changed hands in some transactions.

These experiments were successful and profitable, but many other adventures in static electricity failed. For example, we were never able to build a static machine, or generator of static electricity with moving parts. Our greatest ambition was to own what is known as a Wimshurst machine, which consists of two glass disks revolving in opposite directions, with brushes and combs for drawing off a continuous charge. This was beyond our constructional ability, and we had no more chance of buying one, with the money derived from snow shovelling, running errands, and begging from our parents, than we had of buying a railroad or an automobile. Yet we yearned for one, hopelessly and yet pleasurably, as a farm-hand longs for a Follies girl or a case of Scotch. Always there is something beyond one's reach, and one must accept substitutes. We tried to build a simpler electric machine, using a revolving glass cylinder rubbing against a silk pad, and we did succeed in mounting a bottle



they proved that there was no fraud

on a shaft turned by a crank, but no amount of turning and sweating got us an appreciable static charge, presumably because the glass was not the right kind. We fell back on the electrophorus as a generator.

Another great diversion was collecting or accumulating charges in condensers, which were known to us only in the form of Leyden jars. These we manufactured out of glass test tubes, coated on the outside with tinfoil, and filled with salt water for the inside electrode. By imparting about fifty charges from the electroscope to the ball of the Leyden jar, one could get a fairly severe shock on discharging the jar. This was far more entertaining than the comparatively feeble, painless, and less noisy sparks of the electrophorus. The spark of the Leyden jar was blue and loud, and by combining a number of test tubes one could get it to jump as much as a quarter of an inch. We persuaded one innocent youth to hold such a battery in his hand, and to present his tongue to the brass ball which was connected to the inner coating; the shock knocked him down, and in falling he broke the four condensers of the battery. Thus we were justly punished for our cruelty.

This incident marked the limit of our progress in electrostatics. We now turned to experiments with electric currents, as distinguished from static charges, and numerous galvanoscopes and galvanometers—devices for detecting and measuring electric currents—were built and torn apart. Our raw material was mainly in the form of old electric bells, which we bought from the neighborhood electricians for ten cents apiece. Some of them had been incapacitated by a coat of kitchen paint, others concealed a dead cockroach in their vitals, many had simply failed from old age, but they were all precious to us for the two electromagnets which they contained. Some of these we unwound from the core and rewound on cardboard forms, within which a magnetized sewing needle, suitably suspended, twitched violently when a dry battery was connected to the terminals of the coil. We attached scales to these instruments, but we had no means of calibrating them and so they never really measured anything. However, I do recollect building a tangent galvanometer, on which I worked for some months, the frame consisted of one of those small wooden hoops which are used in embroidering, which I got from my sister, by either force or stealth. The scale was correctly laid out, and probably the instrument was capable of fairly accurate measurements,

but at the time I built it I did not know what a tangent was nor what part it played in the operation of the galvanometer.

Our great problem was a source of current supply, for when our dry cells ran down we frequently had no money with which to buy new ones. A dry cell cost a quarter, equivalent to five strawberry frappés or the same number of visits to the nickelodeon, as the then primitive movie theatres were called. Sometimes we were able to get more or less exhausted cells, from garages or electricians, at a much reduced rate, and various householders in the neighborhood, sympathizing with our endeavors, gave us their worn-out batteries. These we attempted to rejuvenate with injections of vinegar, salt water, and on one occasion I was inspired to try beer (5 per cent. alcohol in 1909) but the improvement was not worth the beer.

And now, at the age of about thirteen, we became telegraphers. Our communication was neither by radio nor over a wire, for at first we had only one instrument, which was communally owned and operated. The key and sounder were separate, and constructed mainly of wood, with a few screws and wires for the current-carrying and sounding parts. For example, the lever and the anvil of the sounder were both of wood, whittled from a cigar box, but screws were provided at the proper points in order to obtain the proper clicking sound. The sounder magnets were taken from a bell, of course, and likewise the armature. The difficulty of learning the Morse code dampened the ardor of all except some four of the group of urchins who had originally started out to become electricians. There was no drama in sitting in a cellar and making stupid clicking noises for hour on hour. We were considered to be obsessed by a dull and malignant spirit, and in fact we did go around telegraphing to each other by mouth signals of the dah-dit-dah variety, and many people took us for idiots incapable of intelligible speech. Even in school we practised in solitude by clicking pencils between our teeth or portions of the desks. Occasionally we would go down to a near-by railroad station and hang around the ticket office, listening to the sounders of the railroad telegraph, but the speed was much too great for us and we only caught a letter now and then. We looked with envy at the station master and wondered if we should ever own a real telegraph sounder of shiny brass, mounted in a mahogany resonator, with a tin tobacco can jammed between the anvil and the wood to give each sounder a

characteristic tone. As yet all we were able to get was the tobacco can.

It was not long before we were able to secure a few hundred feet of annunciator wire, and to build additional wooden keys and sounders, enabling us to connect our several homes and to spend our evenings telegraphing instead of doing our lessons. By that time we were good for about 12 words a minute in American Morse, with its spaced characters. Continental Morse, save perhaps in cable traffic, was not yet recognized in the United States. Even radio, in this country, started in American Morse and continued so for several years. As yet we were not interested in radio. We were aware that such a thing existed—"wireless," it was called, but no one knew anything definite about it. It was unknown, remote, nebulous, no doubt costly; we regarded it somewhat as a grocer thinks of celestial mechanics—not very pertinent to the practical business in hand.

(To Be Continued)

Microphone Miscellany

"Irate Listener"

ON MARCH 14th, early in the evening, wjz in New York was rebroadcasting a concert from 2LO, London, the stuff going from the Savoy to 5XX, Chelmsford, by wire line, thence over the Atlantic on 1,600 meters, to be picked up at the Radio Corporation experimental station at Belfast, Maine, retransmitted on 112 meters, picked up again at the laboratories adjacent to Van Cortlandt Park, New York, amplified, and sent down to Æolian Hall on 42nd Street by wire line, where finally it modulated its last carrier and could be heard by any one within range of wjz.

While the congratulatory telegrams were pouring in, a listener called up on the telephone, gave his name, and with unrestrained indignation spoke his mind, as follows:

"I listen to your station often and enjoy your programs . . . but your quality seems different. It isn't my set, other stations sound all right. There must be something the matter with your microphone. Why don't your engineers get on the job? Don't they know what they're sending out?"

Finally the studio attendant who had answered the telephone managed to get in a word, a great light burst on the complaining

BCL, and with a single *Ob!* he hung up the receiver.

THINGS I AM TIRED OF ON THE RADIO

VIOLET ray machines.

Hearing middle aged sopranos coyly singing "The Lilac Tree," and, worse, seeing them do it.

Publicity stunts in which some self-styled musical genius broadcasts on 200 watts to his loving wife and children seated at the receiver in Tibet, 8,000 miles away.

Radio critics who turn out stuff like this:

Nature, in a melting mood last night, was not generous to radio. Languorous air made thick the voices of soprano and barytone and injected squeaks



we hung around the telegraph office

into the tender violin. Though they brightened as the night waxed cooler, the effects were most lugubrious early in the evening.

THOSE ELUSIVE TH'S

THE best broadcasting station in the world, and the finest receiving set and loudspeaker, can't as yet reproduce the consonant combination *th* to perfection. Thus when the announcer of a New York station, broadcasting from the annual radio show and convention at the Hotel Pennsylvania, told the radio audience, "The grand ballroom is all filled with *booths*, that innocent word came out on the air as *booze*, an altogether unintended indictment or compliment.

EVERYBODY BELIEVES IT, BUT IT'S NOT SO

SOMEBODY—probably Artemus Ward—said that it isn't the things we don't know that hurt us, but the things we know that aren't so. A few examples in the radio art:

That a coupled circuit receiver cannot radiate.

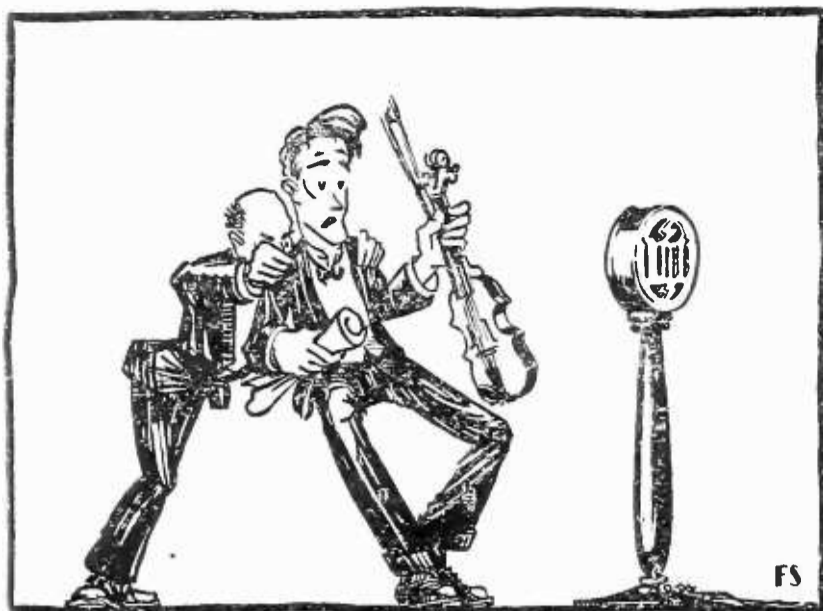

“at their début all artists are panicky”

That broadcasting stations have a decrement.

That generators in a broadcast transmitter always result in a noisy carrier and that the only remedy is to buy a bank of storage batteries.

That artists appearing before the microphone for the first time are all in a very panicky state and about ready to faint with fright.

COMFORT FOR THE ANNOUNCERS

EVERYBODY, including myself, takes pleasure in harassing the announcers for their lapses, mistakes in diction, and whatnot, in spite of the knowledge that they have to make up what they say as they go along, admittedly no easy task. One would think, sometimes, that only announcers make mistakes. To disprove that theory, may we not present the first sentence of an announcement sent out by the wealthy and influential New York section of a national electrical organization

“There *has* been procured for our next meeting two speakers of prominence in the engineering and business world, who will talk. . . .”

Have the stenographer of the honorable secretary of the section no knowledge of Eng-

lish grammar? Have she no proof-reader? Have”

What About a Broadcasters' Association?

IN THE United States and Canada there are about 600 broadcasting stations, with staffs numbering from one person up to sixty. Probably the average personnel is around four. That would make a total of about 2400 professional broadcasters.

There were not that many radio engineers in the world when the Institute of Radio Engineers was founded in 1912, and that was antedated by five years by the venerable Society of Wireless Telegraph Engineers. The technicians among the broadcasters are largely affiliated—and those who are not, should be—with the Institute of Radio Engineers. But broadcasting, after all, is a special occupation, and it is probable that before long the broadcasters, both program officials and technical men, will feel the need for some form of association of their own. In two or three or five years broadcasting will have got over its growing pains, and the energy for founding such a body will become available. Some of the owners of broadcasting stations already have an organization, but what we are thinking of is an association of the men who actually book the programs, make the announcements, and turn the knobs, and whoever may be interested in their work.

In the meantime, our hope is that this department of RADIO BROADCAST will serve as a broadcasters' forum, where all the practitioners and friends of the art will have a chance, not only to watch the general flux of projects and ideas, but also to express thoughts, contribute opinions, and to vent feelings which, in the present adolescence of the industry, frequently require such relief.

AN EFFICIENT RECEIVER FOR SHORT WAVES

ONE of the best known experimenters in the country, George J. Eltz, Jr., is developing a receiver for use on very short waves. The circuit employs super-regeneration—a highly efficient receiving method on the very high frequencies. Broadcast listeners who want to hear the short wave broadcasting now taking place at several large American stations, and transmitting amateurs will find Mr. Eltz' receiver an excellent addition to their equipment. It will be described in an early number

How to Be a Good Radio Neighbor

PART ONE: WHY YOUR RECEIVER SQUEALS

Helpful and Informative Discussion by Two Radio Authorities on the Menace of Squealing Receivers—How to Tell What Receivers Oscillate into the Antenna and How to Prevent that Oscillation—Practical Instruction on How to Operate Your Receiver Without Annoying Your Radio Neighbors

By JOHN V. L. HOGAN

Consulting Radio Engineer

GENERALLY speaking, there are two types of whistling interference heard in radio receivers. One type is the result of two broadcasting stations sending simultaneously at wave frequencies (wavelengths) that are too close together. Their waves react on each other and produce a more or less uniform whistling note, often of very high pitch, in all the radio receivers within range. This sort of interference is somewhat bothersome when listening-in on the present thickly populated broadcast wave bands. It is daily growing of less importance, and for the moment we need not consider it further, although it will be discussed in a future article of this series.

The second type of whistling interference is caused by radiating receivers, or, in other words, by receiving stations that are so designed and so operated that they act as small radio transmitters. This kind of interference is exceedingly troublesome and breaks

up a great deal of broadcast reception. It is particularly a nuisance in localities where there are many radio receivers close together, as in the cities; but even in the country this squealing and whistling interference often prevents satisfactory receiving.

It is safe to say that nearly every broadcast listener has heard the chirp or whistle of rapidly varying pitch that is the mark of this kind of

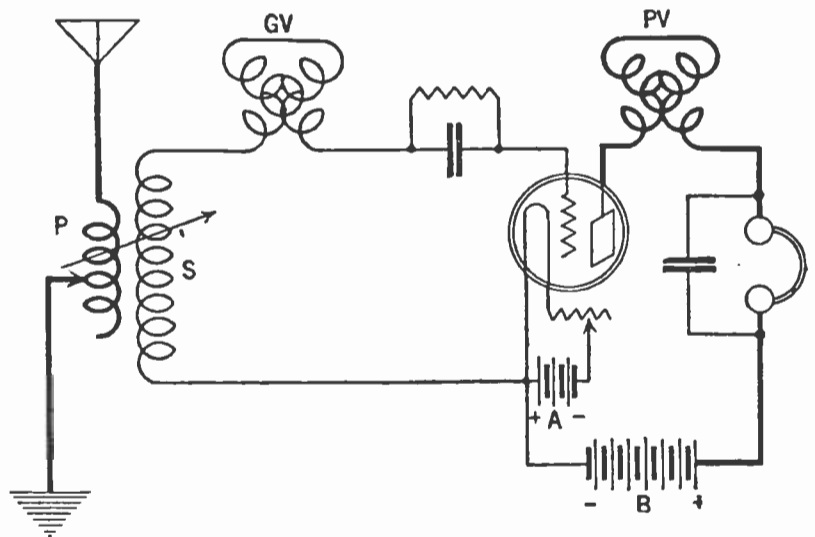

FIG. 2

The variocoupler-variometer circuit also is a generator of squeals. When in an extremely sensitive oscillating condition it possesses the ability to pass energy into the antenna circuit which creates interference in neighboring receivers

interference. Many listeners, however, do not know what causes the troublesome whistles and many do not know that their own receivers may be adding somewhat to the nightly din of squawks and squeals.

WHY WHISTLES OCCUR

THE reason for these chirps and whistles is not known to many radio listeners, although the scientific basis of the action is not complicated. It is merely another mani-

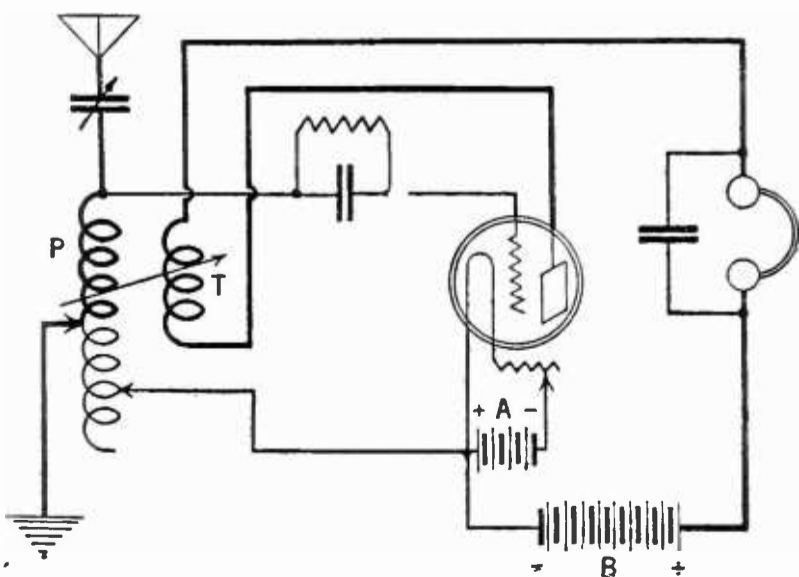
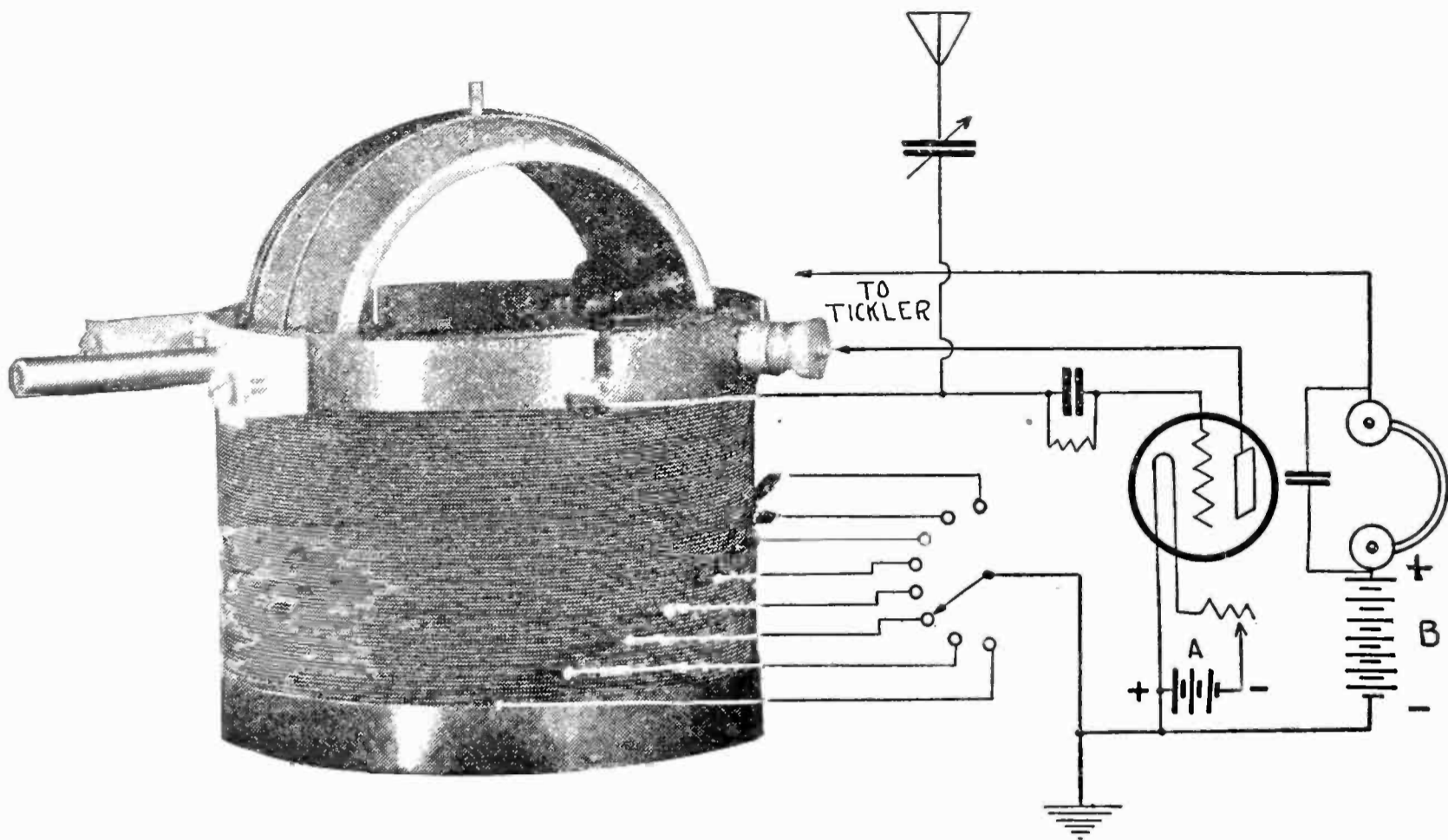

FIG. 1

The old time single-circuit regenerative receiver which is the worst offender where radiation is concerned. When in an oscillating condition this circuit is a very effective transmitter



THE INCORRECT WAY

Of connecting a variocoupler. Here the coupler is connected to a detector circuit with the rotor coil used as a tickler to produce regeneration. While this circuit is more sensitive than the one illustrated below, it is quite broad in tuning and is an excellent transmitter of squeals

festation of the common phenomenon of "beats" that is frequently noted in acoustics. You may have observed that when two musical tones of neighboring pitch are sounded simultaneously, the combined tone flutters in intensity. This happens because the two sound-waves interact or "beat" together, and the

rapidity of the flutter is always equal to the difference in frequency of the two sounds. Thus, if two organ pipes of 32 and 36 vibrations per second, respectively, are blown at the same time, the sound heard will grow strong and weak (or flutter in strength) four times per second.

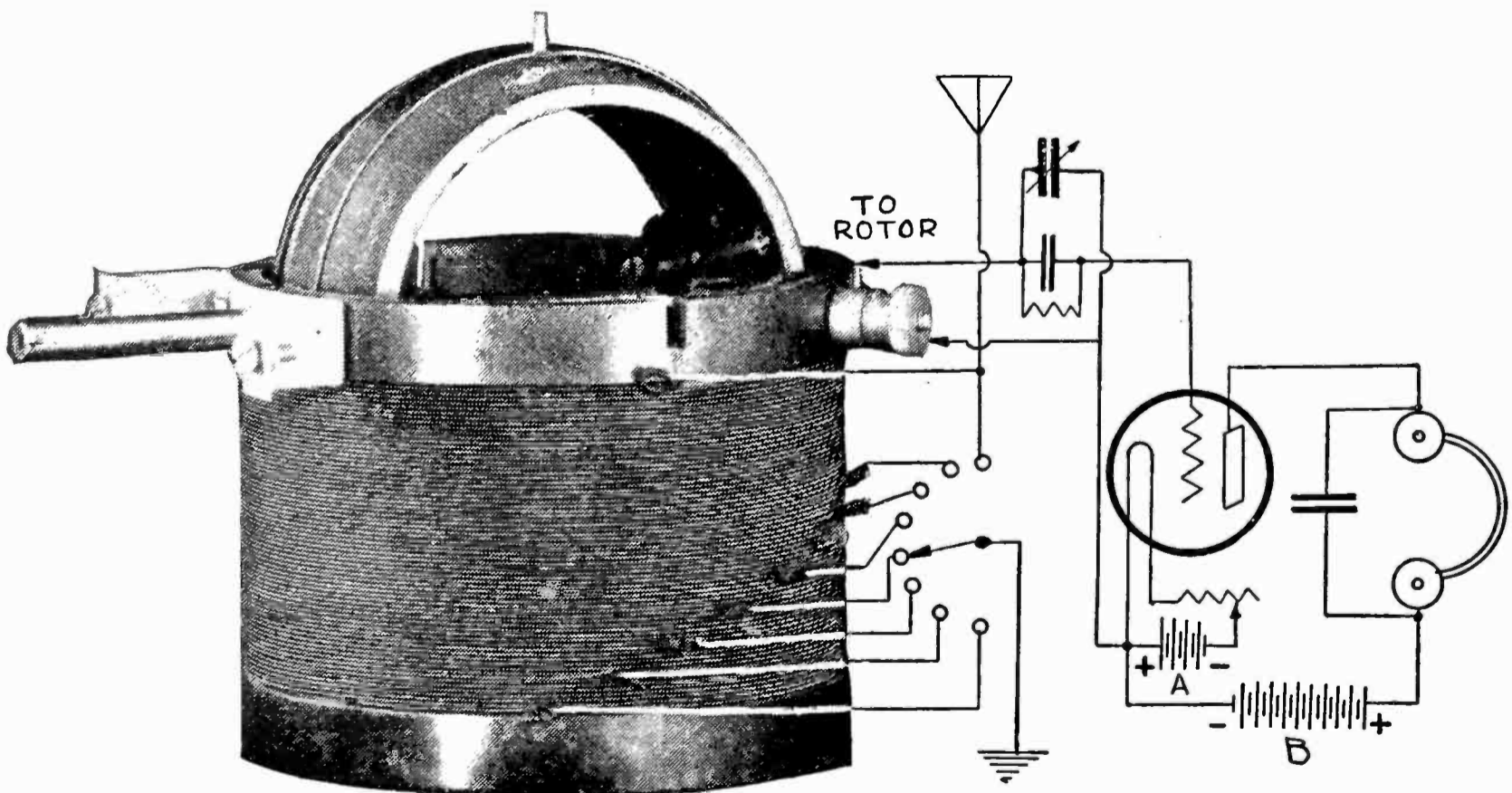

THE CORRECT WAY

A standard variocoupler consisting of a primary and secondary winding connected to the other essentials of the circuit in a way that will not cause the outlawed radiation. Tuning is accomplished by the variable condenser and the switch making contact with the switch points indicated

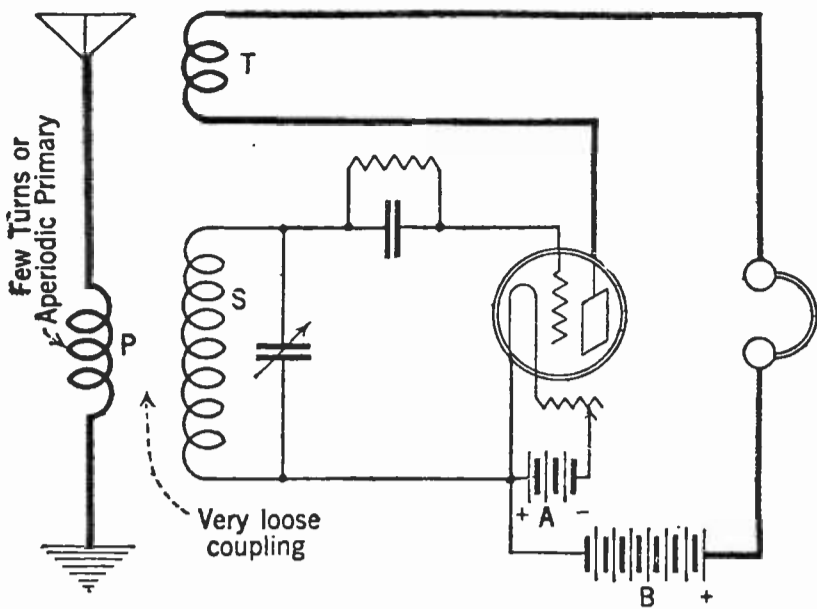

FIG. 3

The three-circuit tuner consists of primary, secondary, and tickler coils. Radiation may be somewhat diminished by employing a primary coil having only a few turns, loosely coupled to the secondary

In the same way, if two radio waves or two radio frequency currents of somewhat different frequencies are allowed to interact upon each other they will produce beats. Thus a carrier wave from station WEAf, at the frequency of 610,000 cycles per second, might interact with the carrier wave from another transmitter at 611,000 cycles per second to produce 1000 beats per second. When picked up and rectified, such beating waves would produce, in the listening telephones or loud speaker, a note of 1000 per second pitch, corresponding approximately to the second C above middle C on the musical scale. Any change in frequency of either beating wave would produce a change in the pitch of the beat note, since this must always equal the difference in the two wave frequencies.

In the same way, a carrier wave from any broadcasting station will beat with waves or currents produced by any self-oscillating receiving set. The frequency of the oscillations

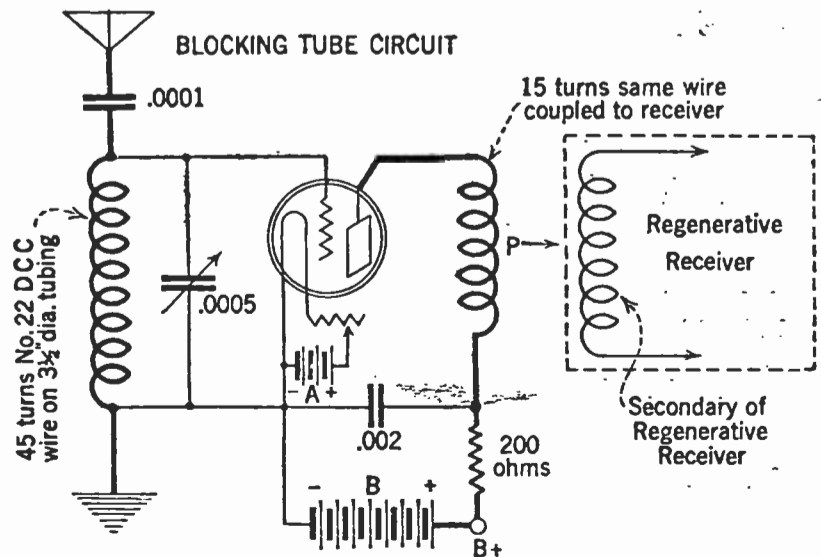

FIG. 4

A blocking tube circuit which was fully described in the March and May, 1924, issues of RADIO BROADCAST.

in the receiver, and of the waves that those oscillations will send out if they are allowed to get into the receiving antenna, depends upon the tuning adjustments of the receiving set. As the tuning knobs are turned, the frequency changes. Consequently the pitch of the beat-note produced also changes, and this is what gives rise to the bird-like chirps and whistles that are so often heard.

If you have a radio receiver of any of the types that can be made to cause oscillations in the antenna circuit, your set is one that may interfere with your radio neighbor's reception. The receivers that can be made to generate antenna circuit oscillations, and thus to interfere with receiving throughout the neighborhood, are probably made and used in larger

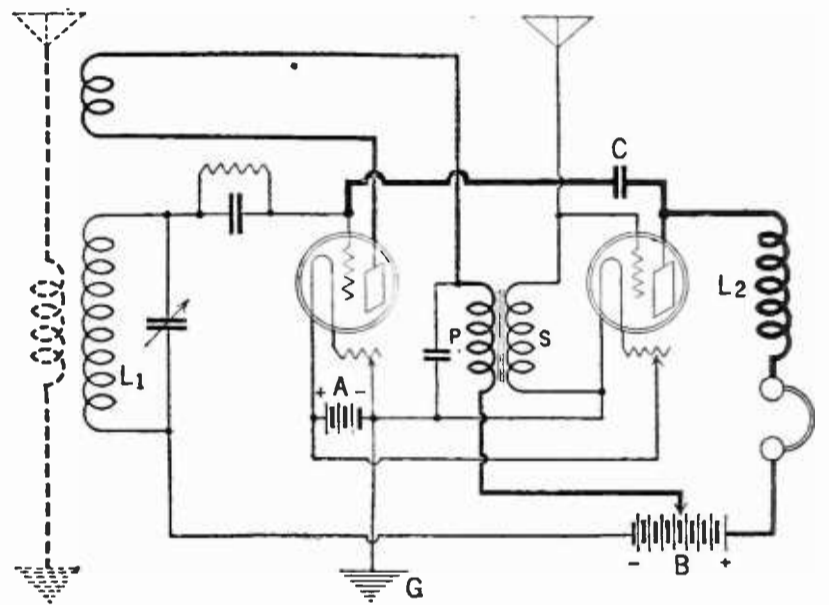

FIG. 5

Is the recent circuit contribution to radio by Roy A. Weagant. A description of the additional apparatus and its method of use is contained in the text

numbers than the non-radiating and hence non-interfering sets.

TYPES OF RADIATING RECEIVERS

NEARLY, if not absolutely, all of the interference-producing receivers are of the simple regenerative type, though more complicated outfits such as the super-heterodyne, when used with an antenna, may cause this trouble. They may be of single-circuit double circuit, triple-circuit or of any other design; the offending set may be of the unneutralized radio-frequency amplifier or reflex type. Many of these will generate oscillations in the antenna circuit and produce interference if not specifically designed otherwise, particularly when they are not correctly handled by the user.

There are only two ways to stop the whistling interference produced by oscillating receivers. The first and simplest way is simply

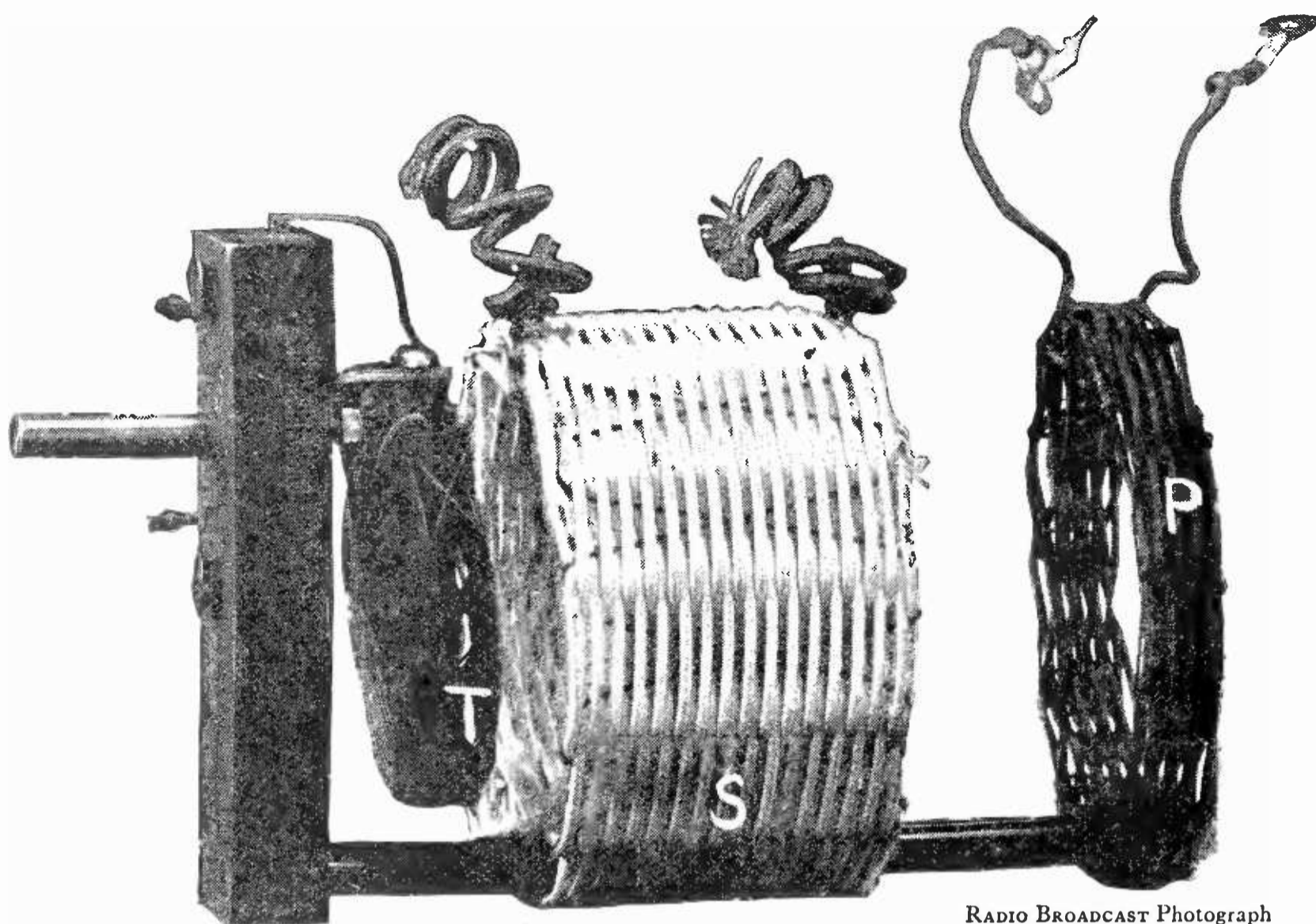

RADIO BROADCAST Photograph

A THREE-CIRCUIT TUNER

Which illustrates very well the method of obtaining very loose coupling between primary and secondary to reduce the possibilities of radiation. The parts are labelled respectively T, tickler, S, secondary, and P, primary

to tune and manipulate your own receiver properly, and to teach your radio friends to do the same with theirs. A little work among your near-by radio listeners will produce wonderful results, for no one wants to trouble his friends. Ordinarily, by a little coöperation, a neighborhood can be relieved of the strongest receiver-produced whistles quite easily. The second and more difficult method is to arrange your receiver so that it cannot produce oscillations, or so that when it does oscillate, the currents will not reach the antenna. By preventing the generation of oscillations in your antenna you prevent the radiation of interfering waves.

IS MY RECEIVER OSCILLATING?

MANY of you are perhaps wondering how you can tell whether or not your own receiver is ever a source of neighborhood interference. There is one simple rule that answers this question: *If, when turning your wavelength or tuning-control knob, you hear a whistling note in your telephone or loud speaker and if, also, you can change the pitch of that note by turning the tuning knob, you are making interference for all the listeners who live near you, unless your*

receiver is so designed that it will keep the oscillations out of the antenna circuit. Whistles whose pitch you cannot control do not come from your set, and you need not blame yourself for causing them. On the other hand, if you have no blocking tube in your set, whenever you hear a whistle and find that you can vary its pitch by moving your tuning control, you may be sure that all your neighbors who are listening to the same station are hearing the same whistle. Thus you are not only spoiling your own reception but also theirs.

Unless you use a blocking tube, the wise and considerate thing to do is to keep your receiver adjusted so that it is *not* in an oscillating condition. Whenever you hear a whistle of this kind, stop your set from oscillating. If you will follow that rule and will impress its importance upon your radio friends, you will find that great reductions in the amount of whistling interference can be made.

The article which follows, by Dr. A. N. Goldsmith, gives a detailed description of how to tune without permitting your receiver to radiate and so show you how to protect your neighbors from interference caused by the oscillations of your set.

PART TWO

Operating Your Radiating Receiver Without Squeals

BY DR. ALFRED N. GOLDSMITH

Chief Broadcast Engineer, Radio Corporation of America

EVERY time your receiver produces a squeal in your own telephones or loud speaker, or every time it is in what is called the "oscillating condition," you are spoiling your neighbor's enjoyment of his concert and annoying people who have done you no harm. (There is but one exception to this rule, and that is the new non-radiating regenerative and non-radiating super-heterodyne receiver, which is specially built at the factory so that it will not radiate appreciably when used in accordance with the manufacturer's instructions. The definite "non-radiating guarantee" of a reputable manufacturer relieves the user of worry relative to this point). May I make an earnest plea to you, to apply the best possible rule of conduct, and to do to other broadcast listeners only what you would like them to do to you? Would you like to be interrupted by a loud noise while you were listening to a beautiful selection on the fine receiver which you bought or built

recently, and which represents toil and expense? Would you want an evening's party ruined, after your guests had assembled to hear a particular concert which they were enjoying, by some inconsiderate outsider who, instead of being a good neighbor, is really a neighborhood nuisance? Surely you would not want either of these things. Then remember that it is up to you to consider other people.

HOW TO TUNE YOUR RECEIVER

BUT," you may rightly ask, "how am I to avoid bothering my neighbor? What must I do? No one has yet given me definite

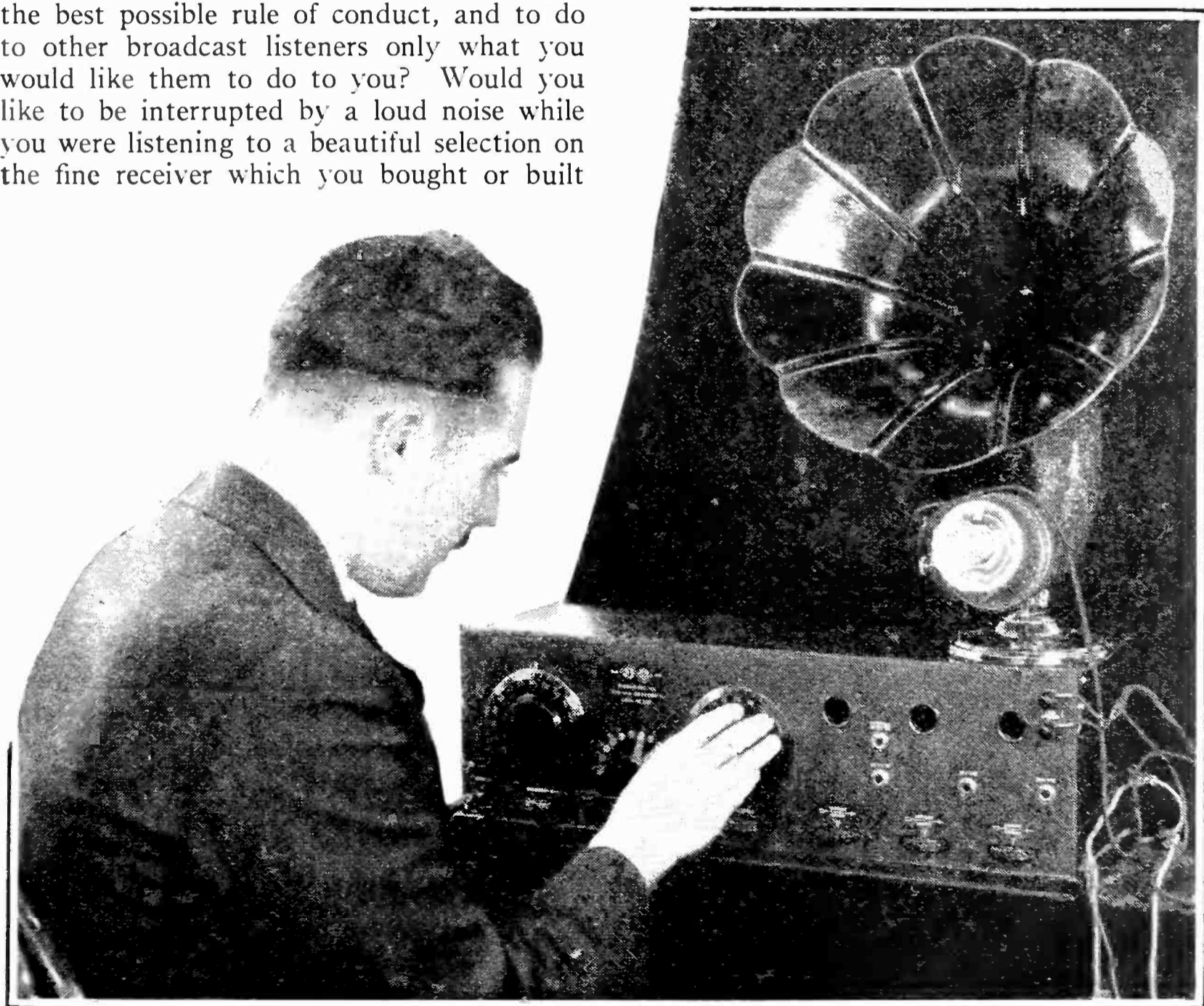

RADIO BROADCAST Photograph

THE INCORRECT WAY OF TUNING

A regenerative receiver. Rotating the tickler or regenerative dial causes bird-like tweets to be radiated from your antenna. The effect on the neighbors is well known

instructions.” And it is to give you a partial answer to your proper and reasonable questions that this article is written. In it, a few simple rules are set forth, which, if consistently followed, will make your neighborhood cleaner and quieter in the radio sense, and enable you and everyone else to be reasonably sure of an evening’s entertainment whenever you want it by radio. Of course, the best and simplest way is to use a guaranteed non-radiating receiver. The following rules apply, however, to receivers which can radiate.

1. Find out what adjustment, or adjustments, on your set make it oscillate. By this I mean, turn the knobs of your set experimentally until you find that knob (or those knobs) which, as you turn them past a certain point, cause the well known squeal or tweeting birdlike sound in your telephones or loud speaker. Usually this knob is labeled Tickler, or Amplification, or Volume Control, or Loud-Soft or some such term. In some sets it is even marked Potentiometer. In other sets, there will be several knobs which cause the trouble of squeals, including the filament current control knob.

In all this, I assume that you are not using an ordinary super-heterodyne or super-regenerative set on an antenna. If you are, all I can say is, please don’t. Put that set on a loop right away. If it does not work on a loop, it is so badly designed and built that it had best be replaced by some other set. Any one who deliberately uses a set which is continually oscillating—like the ordinary super-heterodyne or super-regenerative sets—on an antenna, is either ignorant of what he is doing or devoid of consideration for his neighbor. In the radio sense, he is a public nuisance.

Assuming, then, that you have found the knobs which cause your set to squeal, try to carry out the next suggestion.

2. a) Get a clear idea of the settings of each of these knobs where the squealing begins, for the stations to which you generally listen.

b) Then mark with a pencil the point on the scale of each knob where the trouble begins.

c) To make it still clearer, a small piece of white paper may be pasted next to the scale with its left hand edge at the point marked by the pencil.

d) The pencil or paper mark on the scale then represents the danger mark. Whenever you approach it, you are coming nearer and nearer to making trouble for others, and you should proceed with the utmost caution in so doing. (There are some sets for which this

plan will not work because the settings of the knobs are too complicated and too variable. But it will work particularly well for many of the simpler sets.)

3. In using your receiver, develop the habit of slowing up the knob-turning process as you get near the danger mark. There are people who twist the Tickler knob around until they are sure that the set will produce squeals, and then they throw the wavelength control knobs for selecting a station, back and forth rapidly, thus producing a multitude of howls in other people’s receivers. This is a vicious way of picking up a station. If such people knew what their neighbors thought of them, they would be astonished. Why store up ill will and discourage other people in their attempts to listen? Don’t do it, but give them a chance by picking up only such stations as you can get **WITHOUT HAVING THE KNOBS IN THE POSITION WHERE SQUEALS CAN BE PRODUCED**. I know that this means very careful work in handling the set at times, particularly for receiving other than local stations, but it is truly worth while. Get into the habit, and you will be astonished how easy it will soon become.

4. If you have the kind of a set which produces squeals (and too many people have), be content with a little less distance rather than making so much trouble in the air. If getting a very remote station means a great deal of fussing and adjustment and a lot of squeals, you had better let it go, and listen to nearer stations. You will be a neighborhood blessing if you do.

INSTRUCTIONS FOR NEIGHBORLY RADIO

TO PUT it differently, don’t overwork your set. Keep away from burning the filaments of the tubes too brightly or increasing the plate battery voltage or altering the set construction as received from the factory, or doing any of the other things which may possibly give a little more distance, but, on the other hand, make you a pest. If you have a receiver which does not radiate (and there are some excellent varieties now on the market), leave its construction severely alone. It left the factory in proper shape and if you meddle with it, you are bound sooner or later to put it out of order.

It is hoped that there is not too much of the sermon in this article. But it is so simple a matter to avoid producing squeals that refusing to take the slight trouble necessary to avoid them is like throwing banana peels on the sidewalk. It may be a natural and thoughtless

act, but the man whose leg is broken when he slips and falls, knows that you have been guilty of criminal carelessness. The person who produces radio interference deliberately is not only violating the law of the land but is also devoid of the spirit of community helpfulness. Broadcast listeners of the United States, give an extra minute and a little thought to your neighbors when tuning your set, and urge them to do the same for you.

THE WEAGANT RADIATION ELIMINATOR

Early this year Roy A. Weagant, Chief Engineer of the Deforest Radio Company, released to the public the circuit diagram showing the use of a small choke coil and condenser in regenerative receivers for eliminating radiation. The circuit is that of Fig 5. The heavy lines show where these two pieces of apparatus are inserted in such a circuit. The usual antenna circuit consisting of the antenna, primary coil, and ground is not employed, the antenna coil being eliminated with the antenna connected to the grid of the audio-frequency tube and the ground connected to the negative side of the A battery.

The theory of operation as explained by the Deforest Company is as follows:

It will be seen from the circuit that the incoming signal is impressed upon the grid of the audio-frequency tube instead of the grid of the detector tube. This audio-frequency stage acts as a radio-frequency amplifier resulting in radio-frequency variations in its plate circuit. The insertion of the choke coil L_2 produces a radio-frequency potential which is passed to the grid of the detector tube through the condenser C . Inasmuch as this condenser has a small value of capacity and the grid and plate capacity of an audio-frequency is very small, any oscillation of the detector tube causes only a negligible amount of radio-frequency current to be passed into the antenna. The capacity of condenser C is .000025 mfd. and the choke coil has a very high inductance. It is composed of many small coils connected in series. Each coil has a natural wavelength some place in the broadcast wavelength.—THE EDITOR

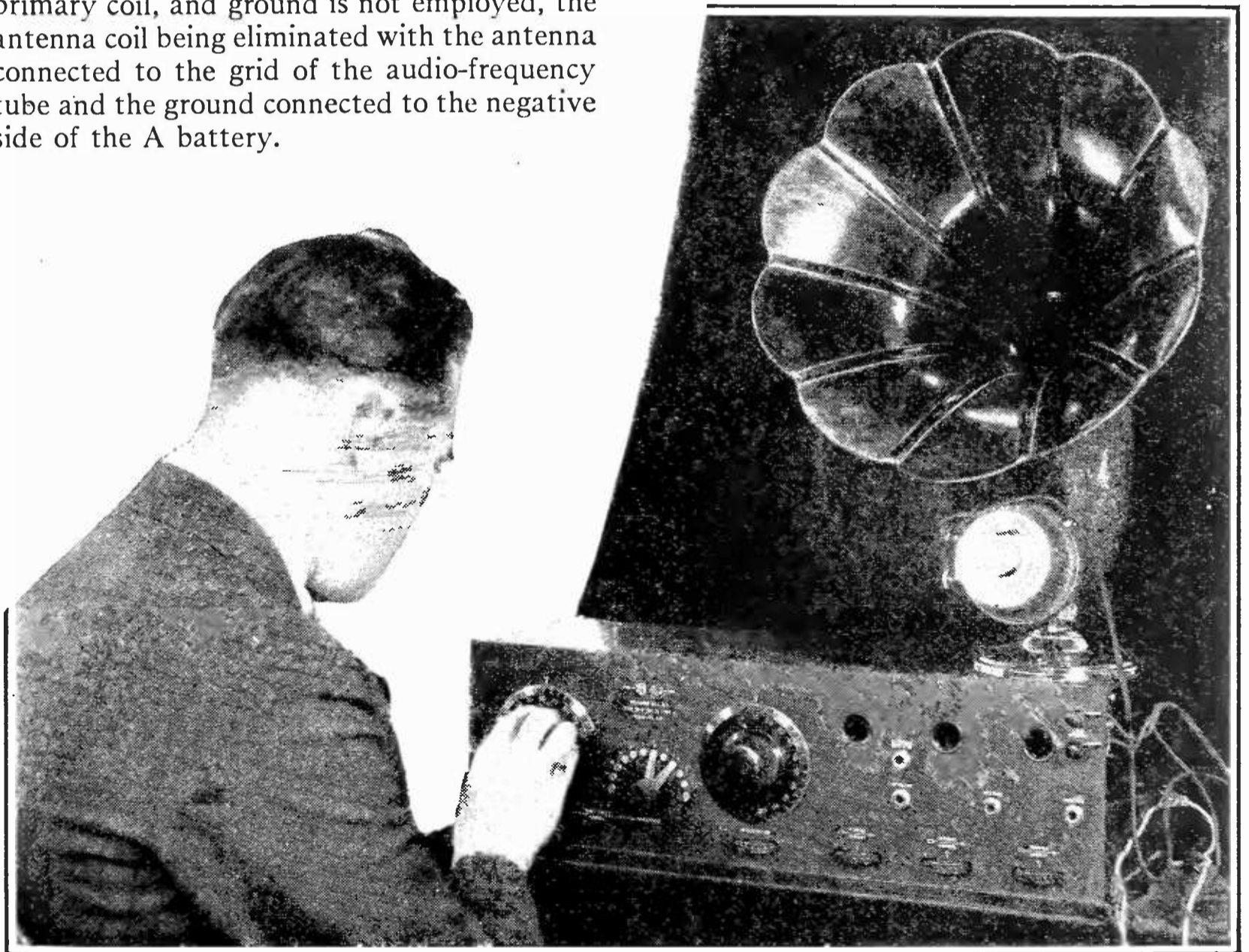

RADIO BROADCAST Photograph

THE CORRECT WAY OF TUNING

A regenerative receiver. Here, the tickler dial is turned nearly to zero. The tuning is mainly accomplished with the condenser dial, the first one on the left. Once a station has been received, the regenerative dial may be advanced, but not beyond the point where squeals are produced. In some receivers, the left dial is the tickler and the right the antenna tuning dial. A glance inside the cabinet will usually make this point clear

For the Radio Beginner

How to Make a Radio Receiver for \$1.82

WE WHO have played and worked at radio for many years are perhaps prone to neglect the thousands that every month approach their first radio experiments. Beginners are apt to be discouraged by the complexities which are life and nourishment to the average fan, and to which, as a popular radio magazine, we have given the most attention. We have, however, published an occasional article for the less advanced enthusiast, and the reception which has been tendered them, has encouraged us to inaugurate a department, devoted to the education and interest of the radio beginner. He will find here articles on the construction of simple apparatus built from inexpensive material. Particular attention will be paid to the possibilities of five-and-ten-cent store parts.

The editor will be pleased to hear from readers to whom this department is dedicated, telling him what they would like to see in it, the problems they would like discussed, and the sets they wish to build. We shall gladly consider manuscripts and short notes dealing with the design and construction of simple apparatus and shall pay for acceptable material at our usual rates.

—THE EDITOR.

RADIO to-day is neither an expensive nor a complicated proposition, unless the enthusiast himself desires to make it so. The advent of the five-and-ten-cent store into the radio field has cut the cost of almost all parts, and these, arranged into simple circuits, present the logical start for the radio beginner's first experiment.

The crystal receiver we are describing was constructed entirely of such items. They can be duplicated in almost any of the five-and-ten-cent stores scattered throughout the United States and Canada, for one dollar and eighty-two cents.

THE PARTS FOR THE CRYSTAL RECEIVER

THE parts used in the construction of this receiver are photographed before assembly in Fig. 1.

No. 1	Eleven plate variable condenser, built up of parts; totalling	\$0.77
No. 2	Dial	.10
No. 3	Crystal detector stand	.10
No. 4	Fixed condenser, .001 mfd. capacity	.10
No. 5	Crystal for detector (shown in detector stand)	.25
No. 6	Lightning arrester	.10
No. 7	Switch lever with knob and bushing	.10
No. 8	Four binding posts	.10

No. 9	Winding form cut from pasteboard	
No. 10	Spool of No. 24 enameled wire	.10
No. 11	Switch taps (3 for 5c.)	.10
	Cigar Box	
	Total	\$1.82

The lettering beside some of the parts, indicates the abbreviation by which they are designated on the diagram Fig. 2.

Extra equipment, if not on hand, may be added to the above list as follows:

Antenna Wire	\$.40
Insulators	.30
Telephone receivers	3.00

This brings the grand total for complete receiving equipment to \$5.52.

If it is desired, a panel and cabinet can be substituted for the cigar box. This adds considerably to the cost. The writer preferred the box arrangement because it simplified construction, both in the drilling or working of the panel material and in the elimination of more or less elaborate fittings. The cigar box can be stained if desired, but when merely cleaned and sand-papered, it presents a not unpleasing appearance.

Following the accumulation of the parts, it is well to make sure that the necessary tools

are on hand. While this simple set can be constructed with no other implements than

- A pair of scissors,
- A jack-knife,
- A screw-driver, and
- A gimlet

a neater and quicker job can be made if these elementary tools are supplemented by

- A brace,
- A $\frac{1}{4}$ " drill,
- Countersink,
- No. 18 drill,
- No. 27 drill,
- Hand-drill,
- Reamer,
- A pair of wire-cutting pliers and
- A compass or dividers

THE PANEL

THE cigar box should be of average size—about eight or nine inches long, five inches high and two and one half inches deep. The paper can be removed by soaking in hot water for one half hour. It should be sand-papered, dried, and sand-papered again. The hinged

top of the box is discarded, unless it is attached with metal hinges.

Fig. 3 shows how the "panel" or bottom of the box is drilled to receive the mounted parts. A horizontal pencil line is drawn across the box half way between top and bottom of the panel. On the left hand side, a vertical line is drawn $2\frac{1}{2}$ inches in. This line will cross the horizontal line at A, at which point a quarter-inch hole is bored to pass the variable condenser shaft. The screw holes for the condenser are drilled according to the pattern or "template" furnished with the condenser, and are countersunk.

Two and one quarter inches from the other end of the panel, a second perpendicular line is drawn. Holes for the detector, the exact placing of which will vary with different obtainable detectors, are drilled on the upper part of this line. The switch lever and tap holes are located on the lower portion of this line as shown. The tap holes are drilled with the No. 27 drill, and the lever hole, B, with the quarter-inch size and thus reamed to fit the bushing. The radius of the taps

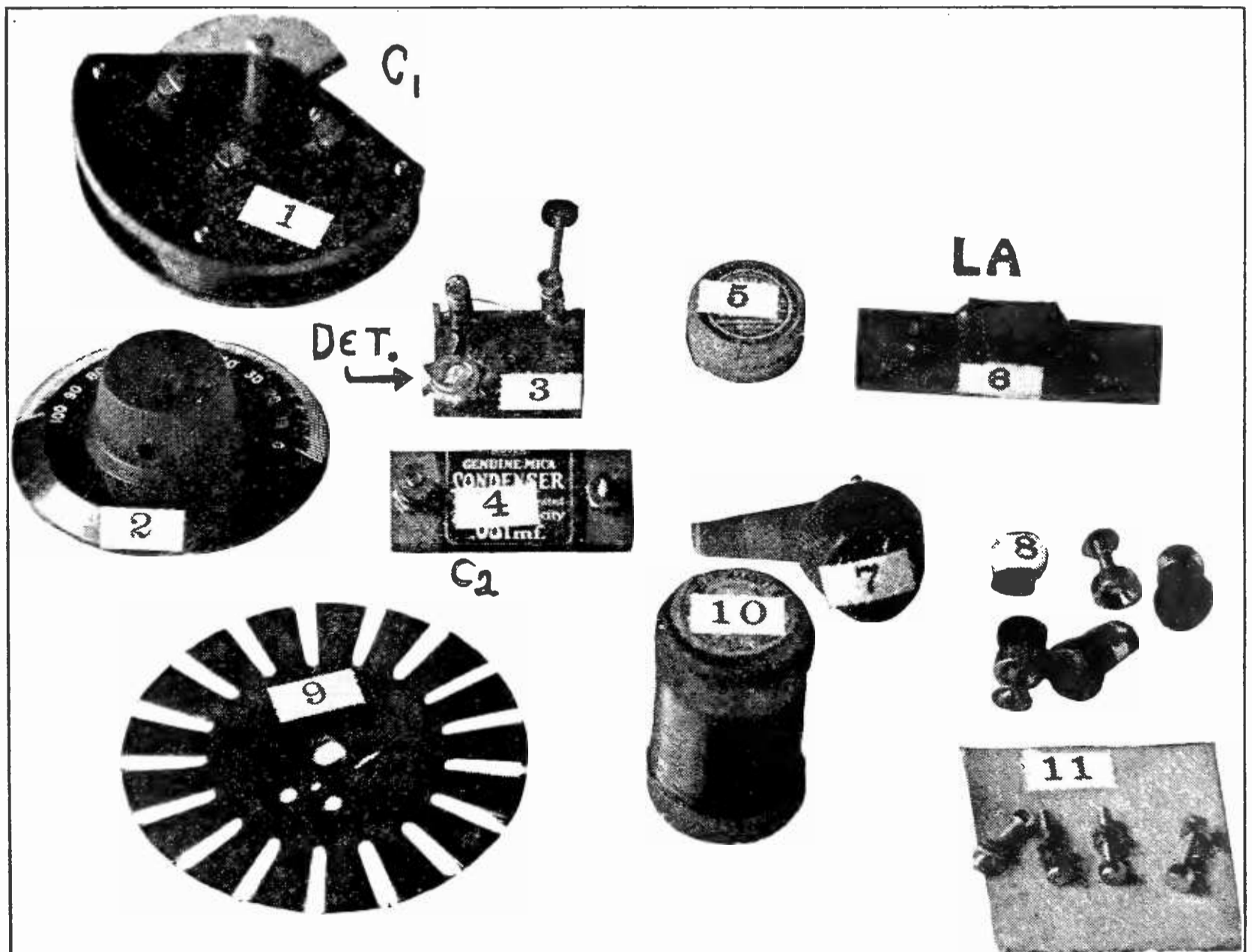

FIG. 1

These parts, which altogether cost \$1.82, can be built into a simple but efficient receiver. All parts, excepting the lightning arrester, item 6, are included in the receiver proper

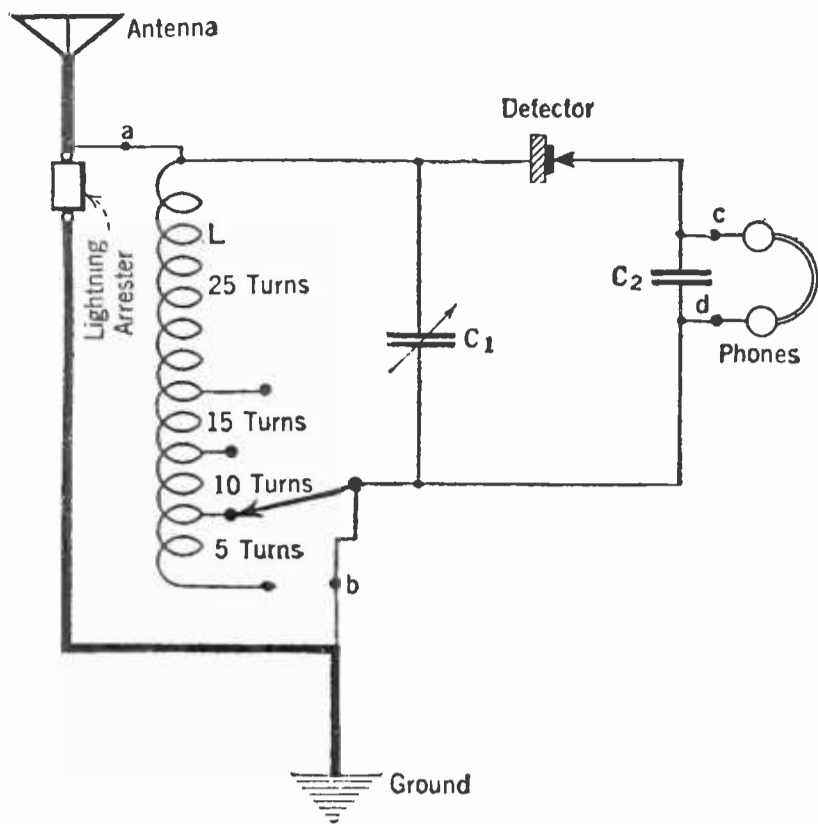

FIG. 2

How the different parts of the receiver are connected. The heavy wire in the antenna circuit should not be smaller than No. 14

will be determined by the length of the switch arm.

Each end of the box is drilled according to the right hand sketch in Fig. 3. These holes are for the binding posts.

Care should be exercised in drilling the box in order to avoid splitting. The metal drills are much preferred to the gimlet. The drills should be sharp and turned rapidly but with little pressure. This procedure will result in clean, unchipped holes.

After the required holes are drilled, the pencil lines should be erased by sandpapering

and a coat or two of stain can be applied if desired.

THE COIL

WHILE the stain is drying—or, perhaps while the paper is being soaked from the box—the coil can be wound. If the builder prefers, the winding form can be bought for a few pennies from the same ten-cent store that supplied the rest of the parts. But it is easily cut from stiff card-board in exact duplication of the drawing in Fig. 4. It is wound with 45 turns of wire, over three, under three, with taps taken with 7th, 14th, and 21st turns. Over three under three means over three spokes of the spider-web form, and under three spokes, as illustrated in Fig. 5. The turns are wound tightly. After seven turns are wound, a loop about three inches long is twisted forming a double lead. This constitutes the first tap. The winding is continued, additional taps being made, as directed, at the 14th, and 21st turns.

In connecting the set, looking at the panel from the rear, the start or lower terminal of the coil leads to the first switch point (from left to right), the 1st tap to the second switch point, the 2nd tap to the third switch point and the 3rd tap to the four or right hand point. The outer end of the coil leads to the antenna post. Loops are made in the tap leads, and the enamel scraped off, so that contact will be made with the nuts on the switch points under which they are placed.

Fig. 6 shows how the taps are twisted and connected to the switch points.

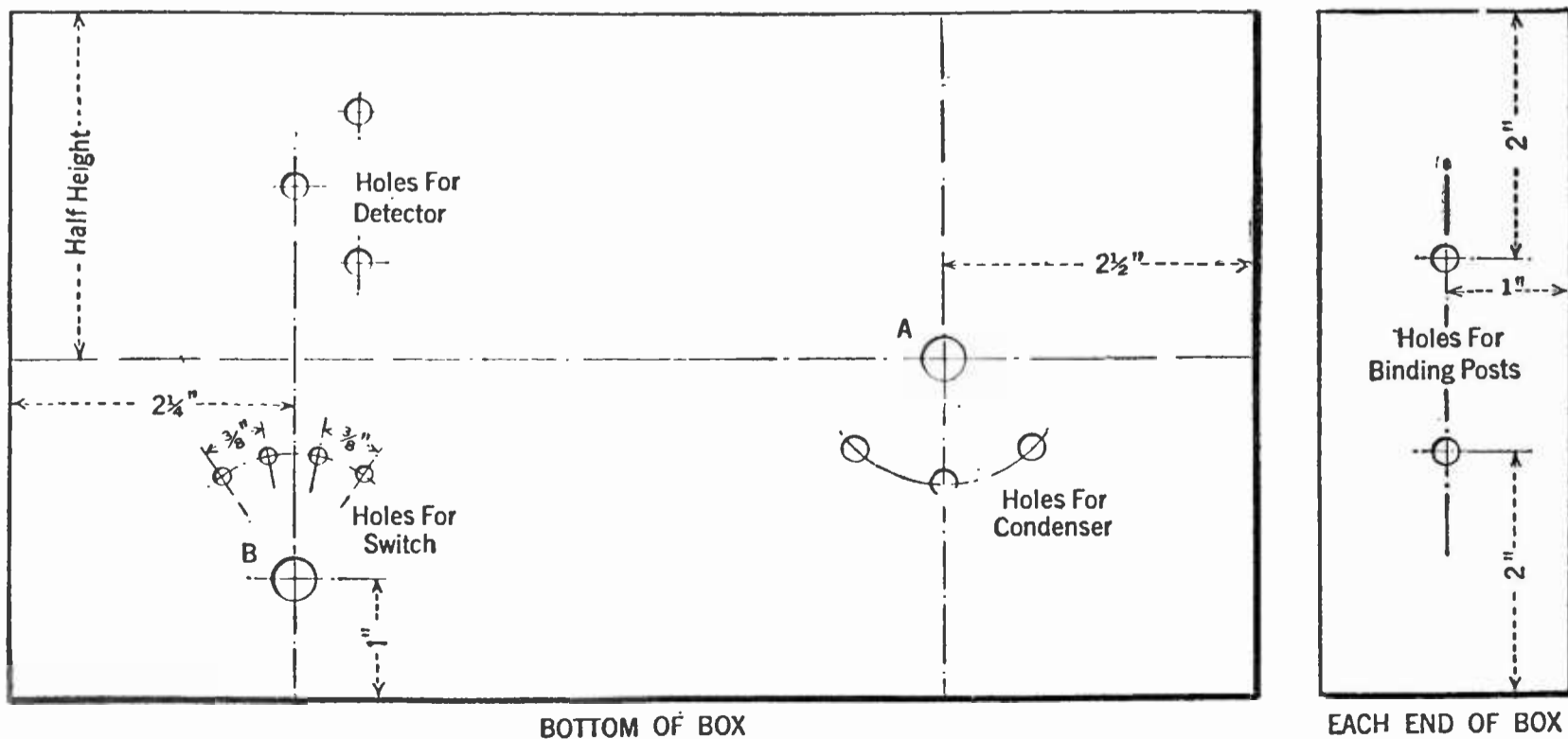
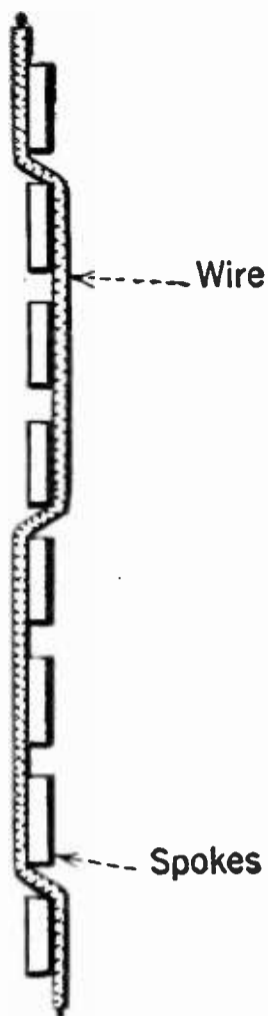

FIG. 3

“Panel layout.” How the holes should be drilled. The condenser and switch point holes are most easily placed with a pair of dividers or a compass. Two binding-post holes are drilled in each end of the box

MOUNTING



AFTER the eleven plate condenser has been assembled (in many cases it can be bought complete for the total cost of its parts), it is mounted on the panel by the three screws provided for this purpose. If the holes in the panel are not quite properly spaced, they can be reamed slightly to compensate for any discrepancy. The dial is adjusted so that zero is at the top of the panel (at which point an indicating line may be inked in) when the rotary plates are entirely out.

The bushing for the switch lever and the four switch points are secured in their proper places. The crystal detector stand is mounted with a single screw through

the center, two small holes on the right hand side being provided for the leads.

The remaining parts of the receiver, the fixed condenser and the coil, are supported by the wiring in back of the panel.

WIRING THE SET

THE internal connections of the set are shown in the diagram Fig. 2. Small "a" is the antenna post (upper left from the front) running to the top of coil L, to one side of the condenser, and to the crystal detector. The lower terminal and taps of the coil are connected as described. The bushing of the switch lever is wired to the ground post "b" (lower left) and to the variable condenser

and telephone receiver post (lower right) "d". The upper telephone post runs to the crystal detector. The fixed condenser, C2, is connected across the phone binding posts, "c" and "d." Figs. 7 and 8 are rear and front views of the completed receiver. The connections within the set may be made with what wire is left over after winding the coil. The writer, however, had some No. 18 bell or annunciator wire, which, being larger and stiffer, was a bit better for this purpose. Using the parts photographed and described, no soldering was necessary.

THE telephone receivers are connected to the posts provided for them. The antenna is connected to "a" and the ground to "b." The lightning arrester, LA, is connected between antenna and ground as shown. The lightning arrester is conveniently mounted on the windowsill. The antenna wire should not be smaller than No. 14 B & S gauge, or its equivalent in stranded wire, and this same large wire should be used for the heavy leads shown in Fig. 2.

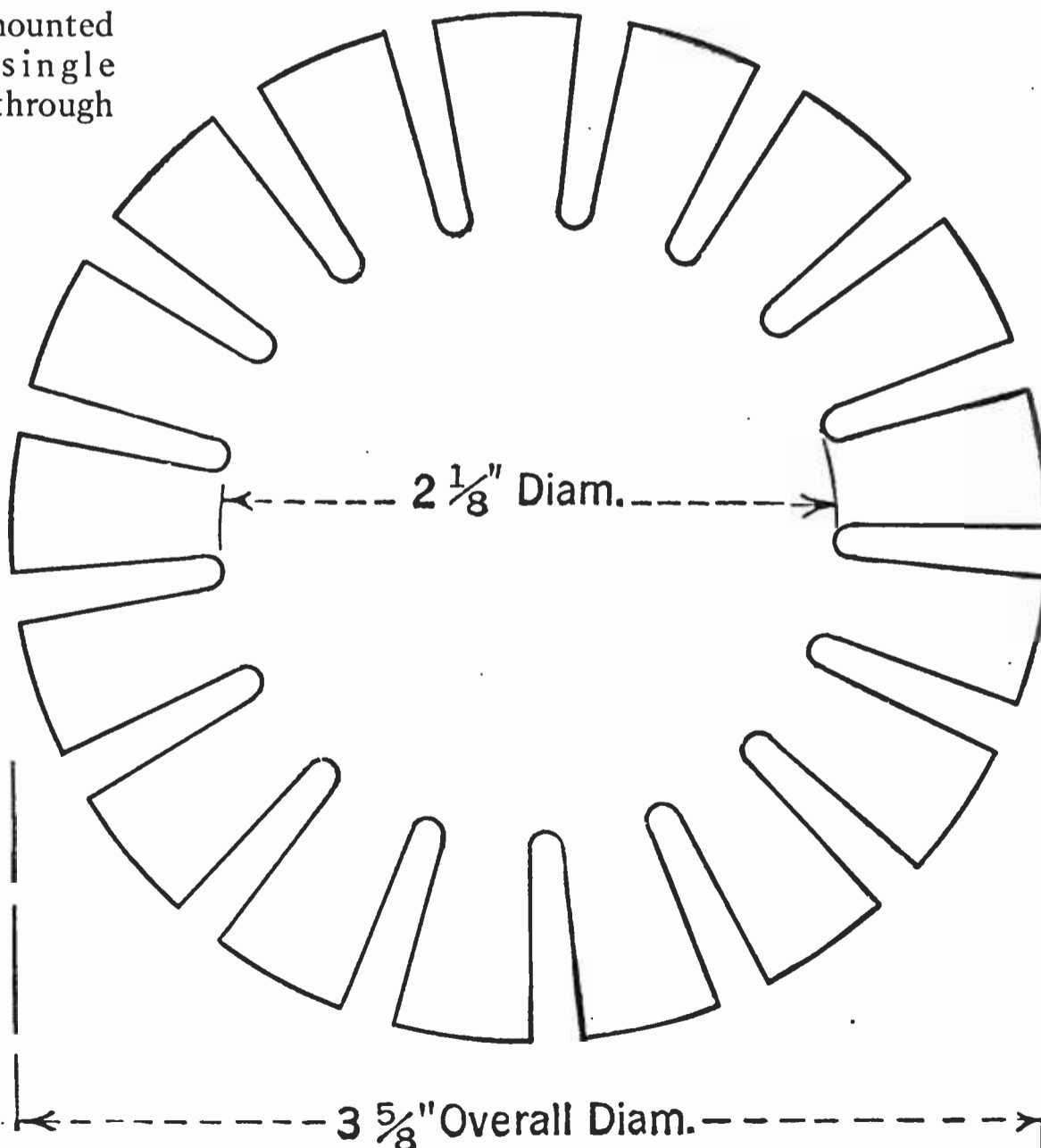
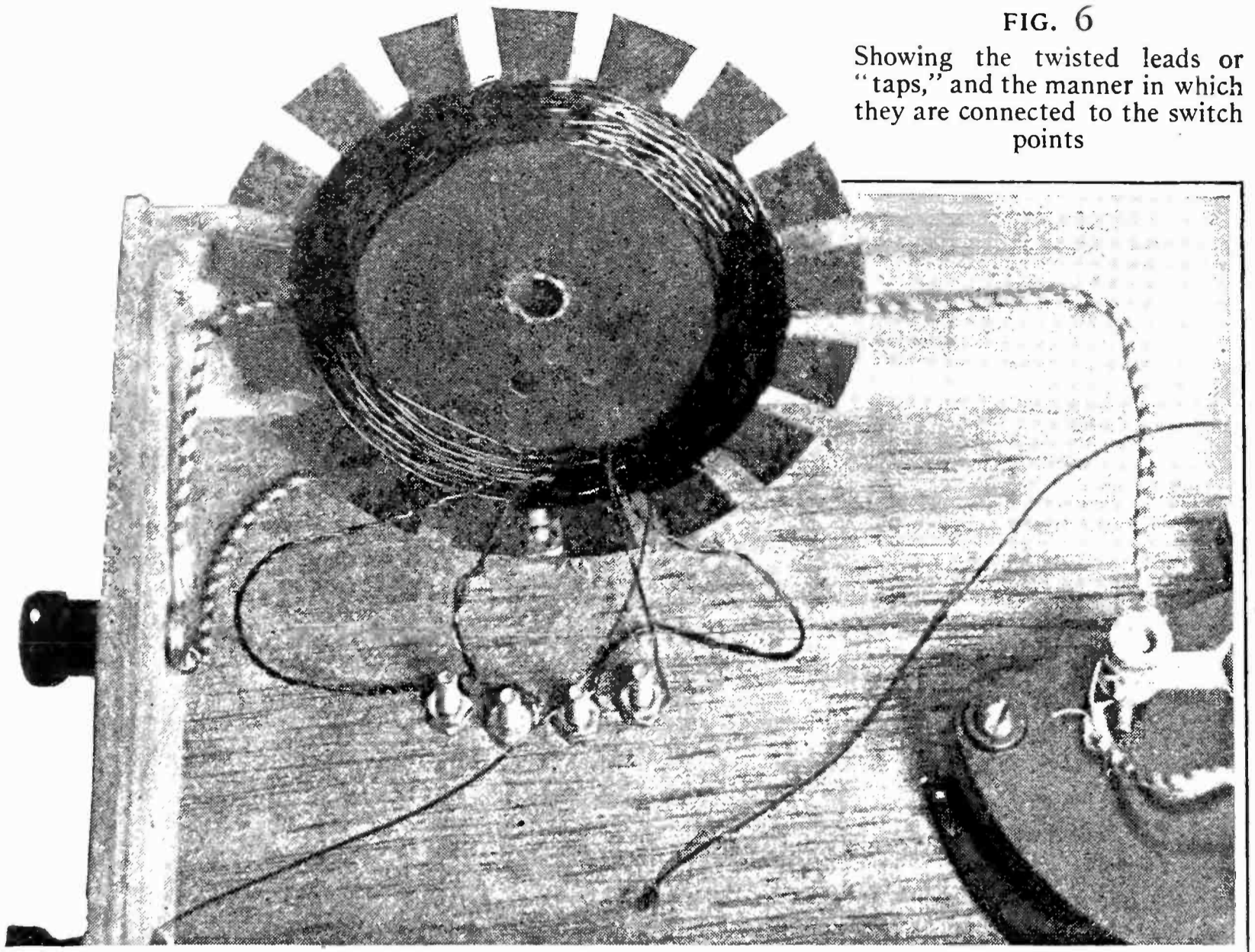

FIG. 4
A pattern for the coil form. This may be cut out and pasted on cardboard so that it can be duplicated exactly

FIG. 6

Showing the twisted leads or "taps," and the manner in which they are connected to the switch points



RADIO BROADCAST Photograph

WHAT ANTENNA TO USE

THE crystal receiver will operate on an indoor antenna, but will give much more satisfactory results on an outdoor system.

For an indoor antenna, it is advisable to run a single stretch of wire through rooms and hall as far as possible without doubling back upon itself. No particular precautions need be taken for insulation, nor is a

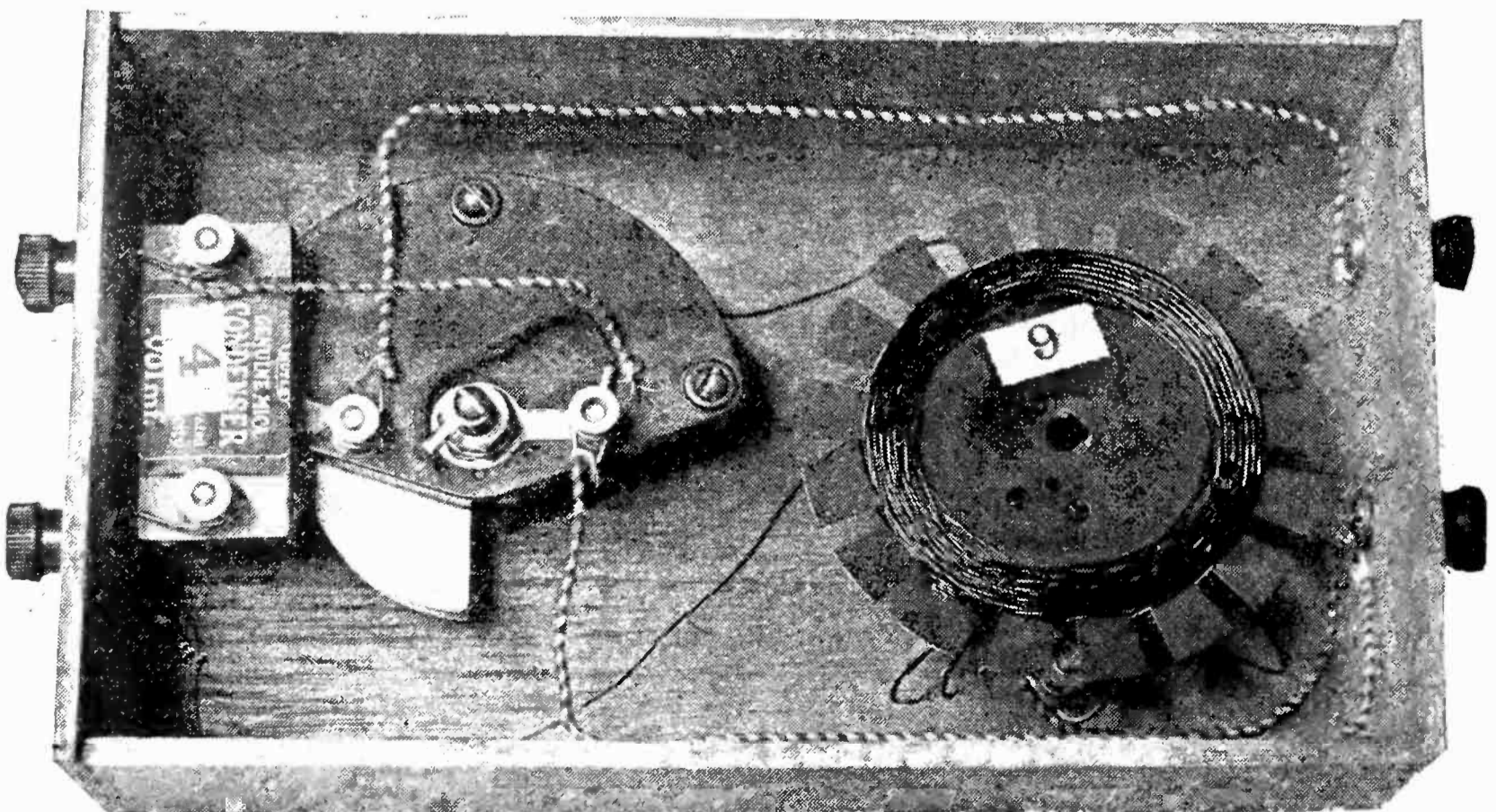

RADIO BROADCAST Photograph

FIG. 7

Rear view of the crystal set. No soldering has been necessary in connecting the different parts

lightning arrester necessary with an indoor antenna.

A horizontal length of about seventy-five feet is best with an outdoor system. A longer antenna, while increasing volume and distance, generally boosts up interference in the same proportion. The antenna should be swung as high and clear as is conveniently possible. Low antennas and antennas surrounded by houses and trees will work, but efficiency will increase almost in proportion with the height and the absence of near-by dumbwaiter shafts, tin roofs, trees, and other absorbing obstructions.

The antenna should be insulated at each end, and, if possible, the horizontal and vertical (which means the lead-in) parts should be one long piece of wire, as suggested in Fig. 9. If two lengths of wire are used, they should be soldered at the joint. As a rule more than one wire for receiving is unnecessary.

The lead-in should be guyed away from walls if necessary, and should be heavily taped or otherwise insulated wherever it comes in contact with fire escapes, windows, etc. Remember, the crystal receiver depends altogether upon the energy the antenna system picks up, and it must be conserved by every practical care. There is no radio

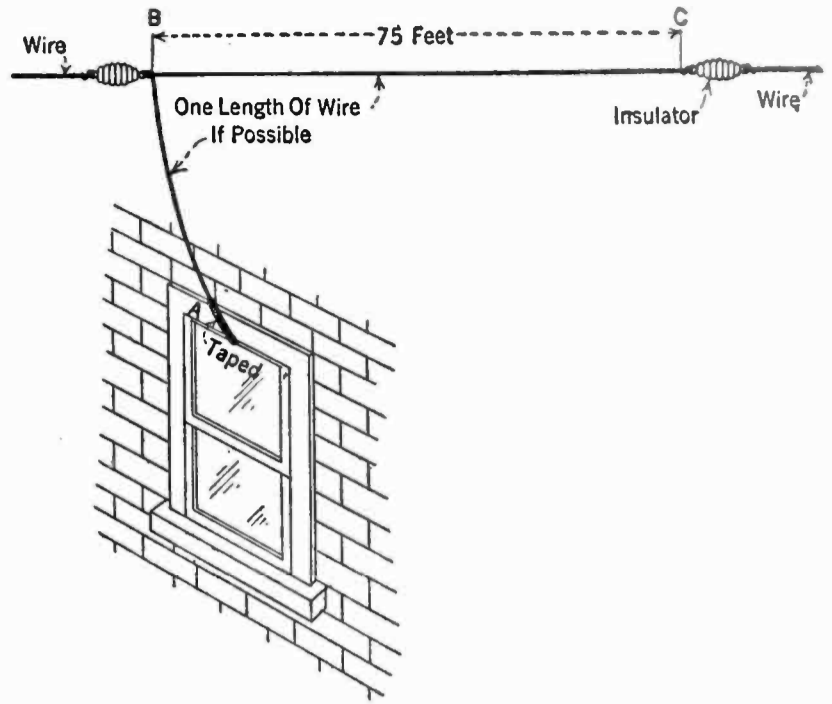
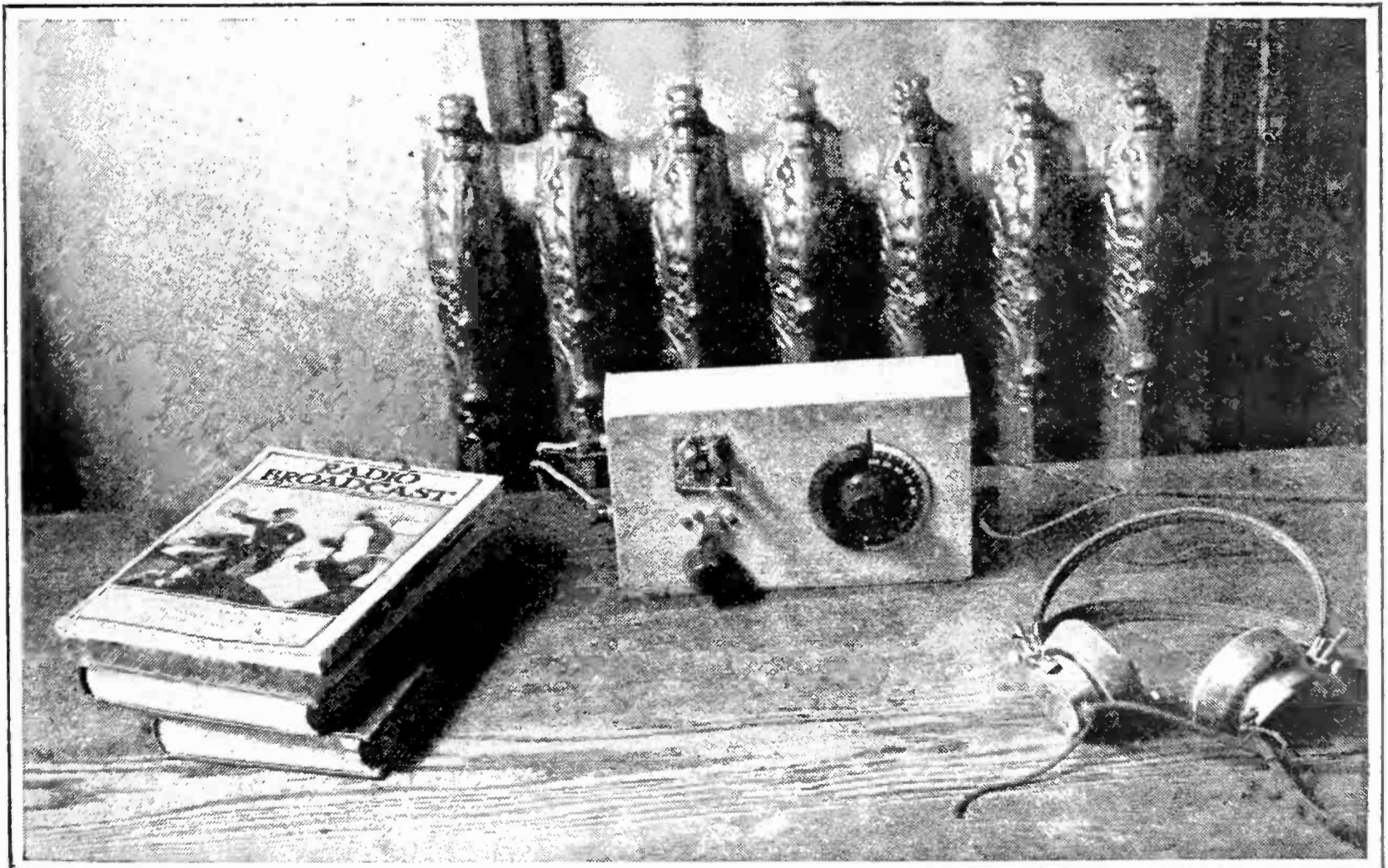

FIG. 9

A simple but efficient antenna system. If conveniently possible, the stretch A, B, C should be a single length of wire

frequency amplification, or local batteries, and the telephone receivers are actuated by the minute currents induced by the radio wave.

The lead-in may be brought through the top of the window with the usual precaution of taping. Or, any of the several lead-in devices may be employed if the experimenter so desires.



RADIO BROADCAST Photograph

FIG. 8

The complete receiver, connected to antenna and ground, and ready for action. No batteries of any kind are necessary or desirable

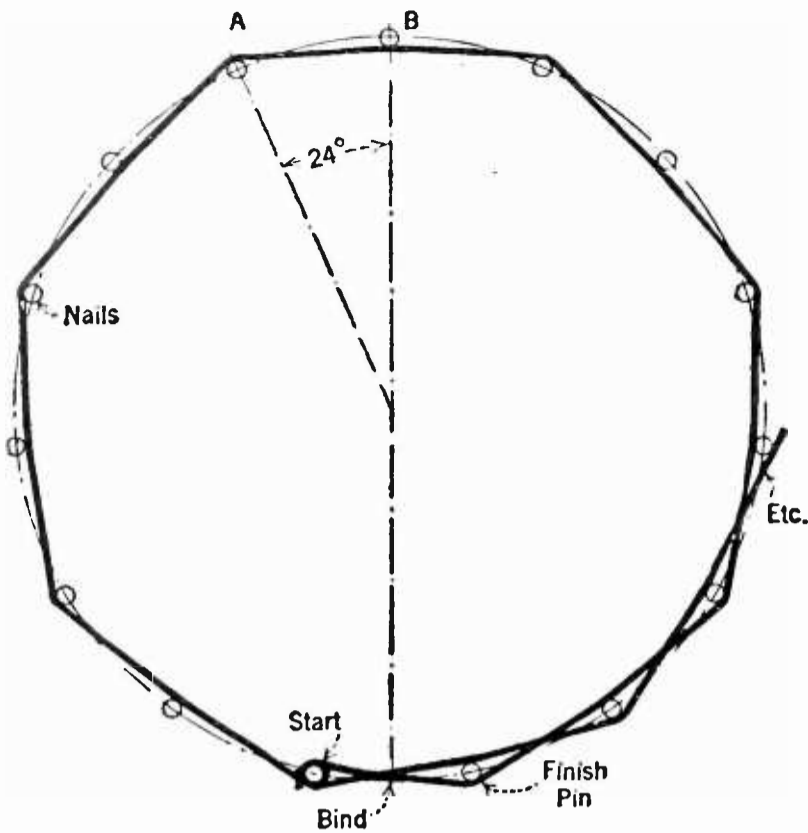

FIG. 10

The layout of the studs or nails, and the method of winding the simple low loss coils

THE GROUND

THE water-pipe or radiator make equally satisfactory grounds. The wire need only be wrapped tightly around a scraped portion of the pipe and taped. Such a ground, however, should be renewed every six months or so. A more permanent ground is secured by soldering or by using the common ground clamp. A ground wire can often be clamped under a valve nut on the radiator, forming a lasting and satisfactory connection.

HOW TO OPERATE THE RECEIVER

THE operation of even a simple receiver is a matter best taught by individual experience. A good starting point on our crystal receiver is to set the switch on the second tap, and tune for stations with the condenser while the detector is being adjusted.

The process of adjusting the detector consists of moving the catwhisker lightly over the surface until a sensitive spot is found. It is a simple matter on most crystals obtainable to-day where the entire surface is comparatively sensitive. An occasionally difficult adjustment can be expedited by having someone ring the doorbell while the catwhisker is being moved. A rough buzz will be heard in the 'phones when a sensitive spot is discovered.

The highest waves will be tuned-in with the switch lever set on the right, the lowest waves on the left and the intermediate lengths in between.

HOW FAR CAN I HEAR ON A CRYSTAL?

THE probable range of broadcast receiving apparatus is little more than a matter of guess. It depends too much on individual conditions. Crystal sets have received distances over a thousand miles on many occasions. Using a short indoor antenna, stations fifteen miles away have been enjoyably received in our New York laboratory. Using an average outside antenna, the crystal set as we have described it should not be depended on for consistent reception of pleasurable loudness over distances in excess of 25 miles.

HOW TO MAKE A SIMPLE LOW-LOSS COIL

THE trouble with most low-loss coils, from the amateur's point of view, is the difficulty in executing the generally eccentric windings. The Lorenz, or basket-weave coil is an exception to the rule, and it is probably more easy to wind than the straight solenoid. Like most low-loss coils at broadcast frequencies, losses are lowered, not so much by the type of winding itself but by the

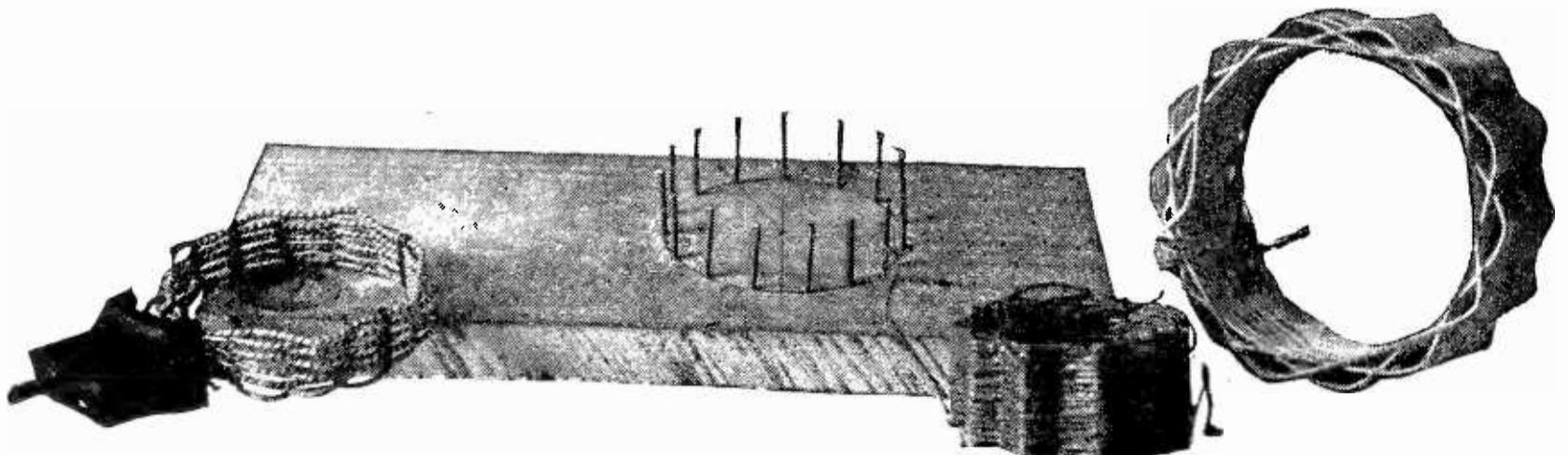

FIG. 11 RADIO BROADCAST Photograph

The winding form and three Lorenz type coils. The left hand coil has been mounted on a standard honeycomb base

fact that the inductance (coil) is self-supporting. This eliminates much of the metal and insulating supports with their attendant inefficiencies and mechanical problems. Combined with the simplicity of construction, this added desirability recommends the Lorenz coil to the inexperienced experimenter.

A piece of scrap board and a handful of two or three inch nails represent the winding equipment. The heads should be cut from the nails. A circle the size of the desired coil is circumscribed on the board, and *an odd number* of nails driven into equally spaced points on the circumference. The arrangement of the points is best laid out with a protractor and dividers. Fifteen nails were used by the writer, which represents a spacing of 24 degrees of arc. Twenty four degrees are measured from the diameter with the protractor, and the same distance (A, B, in Fig. 10) is marked off on the circumference with dividers or compass.

The length of the nails is governed by the height of the contemplated coil and they should be driven firmly into the board.

The manner of winding is illustrated by the sketch, Fig. 10. Two turns are placed around the starting nail, and the winding commenced over one under one. The desired number of turns is wound and the coil completed by winding the wire twice about the finishing pin, which is one nail farther on than the starting pin. The coil is laced or bound before it is lifted from the nails. Thread is generally used for this purpose, tying in four places beginning with the crossing between the start and finish pins. The coil can be pried up with a knife or screw-driver sufficiently to pass the binding thread under the inductance. The black thread binding can be discerned on the left hand coil in Fig. 11, in which is shown the simple winding machinery and three of its products.

The Lorenz coils can be mounted in a variety of simple ways. The left hand coil in Fig. 11 has been soldered to the terminals of the standard honeycomb coil base. A more general form of mounting is to clamp the coils between strips of wood or bakelite as suggested in Fig. 12.

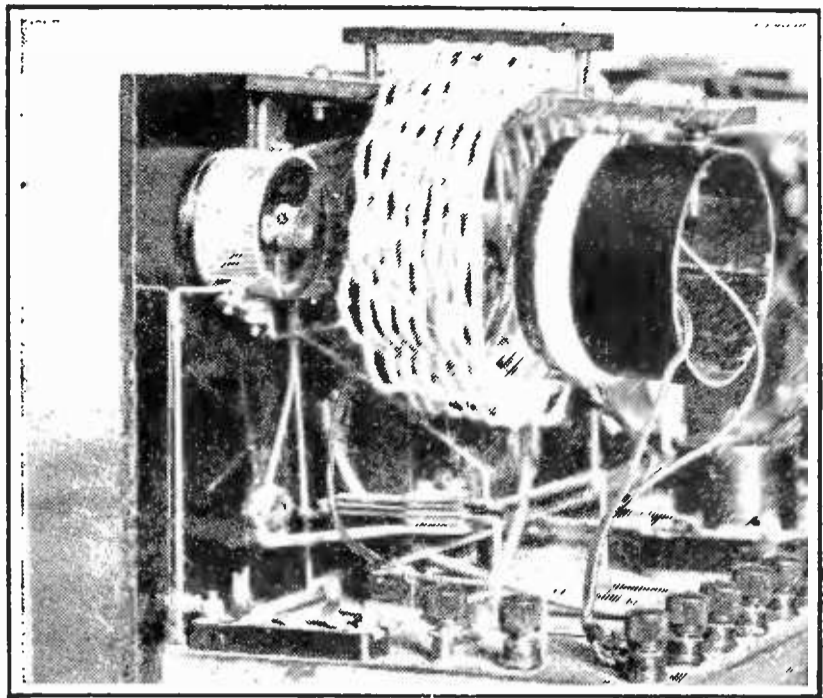

RADIO BROADCAST Photograph
FIG. 12

A simple way of mounting Lorenz coils is to clamp them between two strips of wood or bakelite

Primary and secondary coils can be wound alongside of each other as is occasionally done in the case of solenoids. It is a good idea, however, to overlap two turns in order to insure strength in the unit. The secondary should be started two turns before the completion of the primary. After one turn of the secondary, the next to the last turn of the primary is wound over the secondary turn. The second turn of the secondary is next made over the primary turn and the last turn of the primary over the second turn of the secondary. The secondary is then continued by itself. The two coils are so interlocked that their self-supporting quality is not weakened. However, little is ever gained electrically by the winding of primaries in low-loss fashion.

Low-loss secondaries for broadcast wavelengths can be wound, of course, on various diameters. On a three-inch diameter, fifty turns should be wound and on a four-inch diameter, thirty turns. Shunted by a .0025 mfd. variable condenser, such coils will cover the broadcast band. If the reader desires, the inductance for the simple receiver completely described on another page of this Department can be wound Lorenz fashion in preference to the spider-web. Either of the two coils just suggested can be wound, and taps taken at $\frac{1}{8}$, $\frac{1}{3}$, and $\frac{1}{2}$ the total number of turns.



WHAT Our Readers Write Us

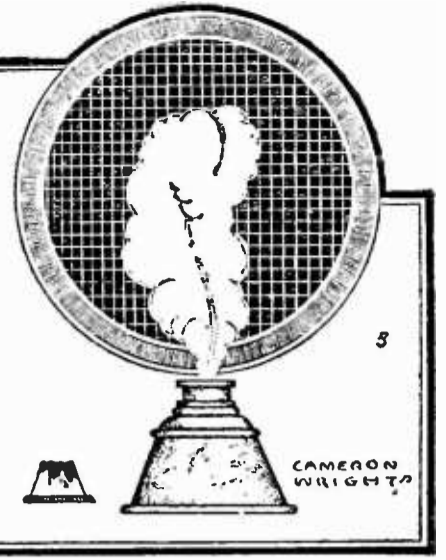

Line Voltages Supplied by Power Companies

THE following letter was received the other day from the Brooklyn Edison Company, Incorporated, taking issue with a statement, in an article by Phil Fay, "Selecting a B-Battery Eliminator," which appeared in the March issue of this magazine.

Editor, RADIO BROADCAST,
Doubleday, Page & Company,
Garden City, New York.

SIR,

The first paragraph at the top of page 858 of your March 1925 issue, states that there are wide variations in voltage at different hours of the day and night on power circuits ranging between 100 and 120 volts. We believe this statement, as a definite statement, as made in your magazine, is incorrect and does electric supply companies an injustice.

While it is true that in some cases such a variation as you mention may take place on lines of some companies occasionally, it is not the usual practice and we believe that the statement would have been more correct if it had been stated that a variation in the amount of the proportions given may occasionally occur. The practice of this company is to permit a voltage variation of 4 volts either above or below the normal voltage of 120 volts which we supply. In other words, the range in voltage we undertake to supply is from 116 to 124 volts.

I hope that you will be able to make some correction of the statement referred to above in your magazine.

Very truly yours,
R. A. Paine, Jr.
Outside Plant Engineer

The paragraph referred to above is as follows:

"There are many differences between one power circuit and another. First, there are wide variations in voltage at different hours of the day and night, ranging between 100 and 120 volts. These are not noticeable in the brilliancy of electric lights or in the operation of ordinary household equipment, largely because this apparatus, unlike radio equipment, is not especially sensitive to voltage variations of this amount. In a current tap supplying a set line, voltage differences are of the utmost importance."

What Do the Roberts Knockout Users Think?

THE list of radio constructors all over the United States, Canada, and foreign countries who have written enthusiastic letters about their experience with the Roberts Knockout Receiver would fill many lines of type indeed. There have been a number of these correspondents who wanted to get in touch with others in their own vicinity to talk about their mutual experiences with the circuit and to discuss their various experiments with it. Keith Henney's article "Progressive Experiment With the Roberts Circuit" which appeared in RADIO BROADCAST for April, 1925, in especial excited a great deal of interest. "Can't you put me in touch with other radio fans in my city who have been experimenting with this remarkable circuit?" was the question we received in more than one letter after that article appeared. As a matter of fact, similar requests, differently phrased, have come in the offices ever since the publication of the original article about this circuit by Doctor Roberts in the April, 1924, RADIO BROADCAST. The suggestion in the letter printed below is therefore not new, but it expresses very concisely what a lot of correspondents have been suggesting. RADIO BROADCAST will publish a list by cities and states of the names and addresses of Roberts Knockout users providing those users who are interested in taking up the suggestion outlined below will send us their names and addresses.

Editor, RADIO BROADCAST,
Doubleday, Page & Company,
Garden City, New York.

SIR,

About a month ago I wrote a letter to Mr. Zeh Bouck, partly personal and partly asking some advice regarding some trouble I was having with a Roberts Four-tube set I had built. I had hardly mailed my letter when the April number of the magazine came and informed me that Mr. Bouck was away on a vacation. The purpose of

this note is to have you, if you please, tell Mr. Bouck when he returns that I have since been able to settle my difficulties quite satisfactorily by changing the tubes. I wonder if this suggestion is any good? Let RADIO BROADCAST offer to print the names of some fans in each of the large cities who have built say two or three Roberts outfits and are willing to share their experiences with others. The Roberts circuit is so good that unless you treat it right in construction, you'll have trouble. A few *don't's* from one who has *done* only to his sorrow, may save perplexities later on. This is offered for what you think it worth.

Very sincerely yours,
(Rev.) Robert E. Holland, S. J.

What Doctor Pickard Thinks About Fading

THERE have been many interesting arguments presented of late upon the effect of weather conditions upon radio transmission. Doctor Pickard, Consulting Engineer of the Wireless Apparatus Company of Boston, has made an intensive study of fading in transmission extending over a period of several years and which has brought out much valuable information. His most important work probably has been his study of the eclipse of the sun in January, 1925. His observations during the period of the eclipse were reviewed in a paper which was read before the Institute of Radio Engineers in April, and dealt rather conclusively with this very interesting subject.

Doctor Pickard's reaction to Professor Van Cleef's article, which appeared in RADIO BROADCAST for May, is therefore, of especial interest. Mr. Van Cleef reviewed in his article the factors which influenced the transmission and reception of radio waves. There have been many theories put forth to explain the peculiar condition of fading. The most popular theory is, perhaps, that of the Heaviside Layer, which, in part, assumes that the various ionized layers of the upper atmosphere refract, absorb, or aid the waves in their passage. Doctor Pickard's letter follows:

Editor, RADIO BROADCAST,
Doubleday, Page & Company,
Garden City, New York.

SIR,

I am indeed indebted to you for the galley-proof of Professor Van Cleef's interesting article. We certainly need the aid of the meteorologist in the correlation of weather and radio transmission.

Few radio engineers who have specialized on transmission phenomena still retain the original or reflecting Heaviside Layer hypothesis. Not only did this hypothesis involve a grotesque amount

and arrangement of atmospheric ionization, but to-day we realize that to act upon waves by conductivity would damp them out more rapidly than it would bend them. It is therefore refreshing to find a writer who pays no attention to the Heaviside Layer.

For nearly a quarter of a century it has been recognized that those happenings below the isothermal layer, which we call weather, were related to radio transmission. Some five or six years ago a Frenchman, whose name has temporarily escaped me, made a very similar analysis to that of Professor Van Cleef, although he came to somewhat different conclusions.

However, I do not share the author's assurance that reception conditions can be forecast with the same degree of accuracy as the weather, because I know several other factors profoundly affect transmission. But there is little that I can criticize in Professor Van Cleef's article.

The principal factor in radio reception is not the electric field at the receiving point, because this can be discounted by increased amplification. The principal factor, is, however, the height of the disturbance level or noise background. The fact that winter reception is better than summer reception is really due to two things. First, there is less static or noise background, and second, there is less sunlight, and therefore less ionization of the lower levels of the atmosphere.

Sincerely yours,
GREENLEAF PICKARD.

On Our Anniversary

IT IS a pleasure to receive letters of the sort reproduced below. Such expressions make us feel that our earnest endeavors to present to the radio public a magazine of the highest grade have not been wasted. But our efforts for the last three years have not been confined to the dissemination of the best in radio alone. In November, 1923, RADIO BROADCAST inaugurated the first International Broadcast tests. The tests were repeated in 1924 as they will be in 1925, and the data obtained from these tests as well as in many other and different researches conducted by RADIO BROADCAST has been invaluable to the radio field. Mr. Rice is Manager of Broadcasting for the General Electric Company.

GENERAL ELECTRIC COMPANY

Editor, RADIO BROADCAST,
Doubleday, Page & Company,
Garden City, New York.

SIR,

In looking over the May issue of RADIO BROADCAST I find that it is an anniversary number. I congratulate you on the high grade and interesting magazine which you have edited for the past three years.

Very truly yours,
MARTIN P. RICE.
Manager of Broadcasting.

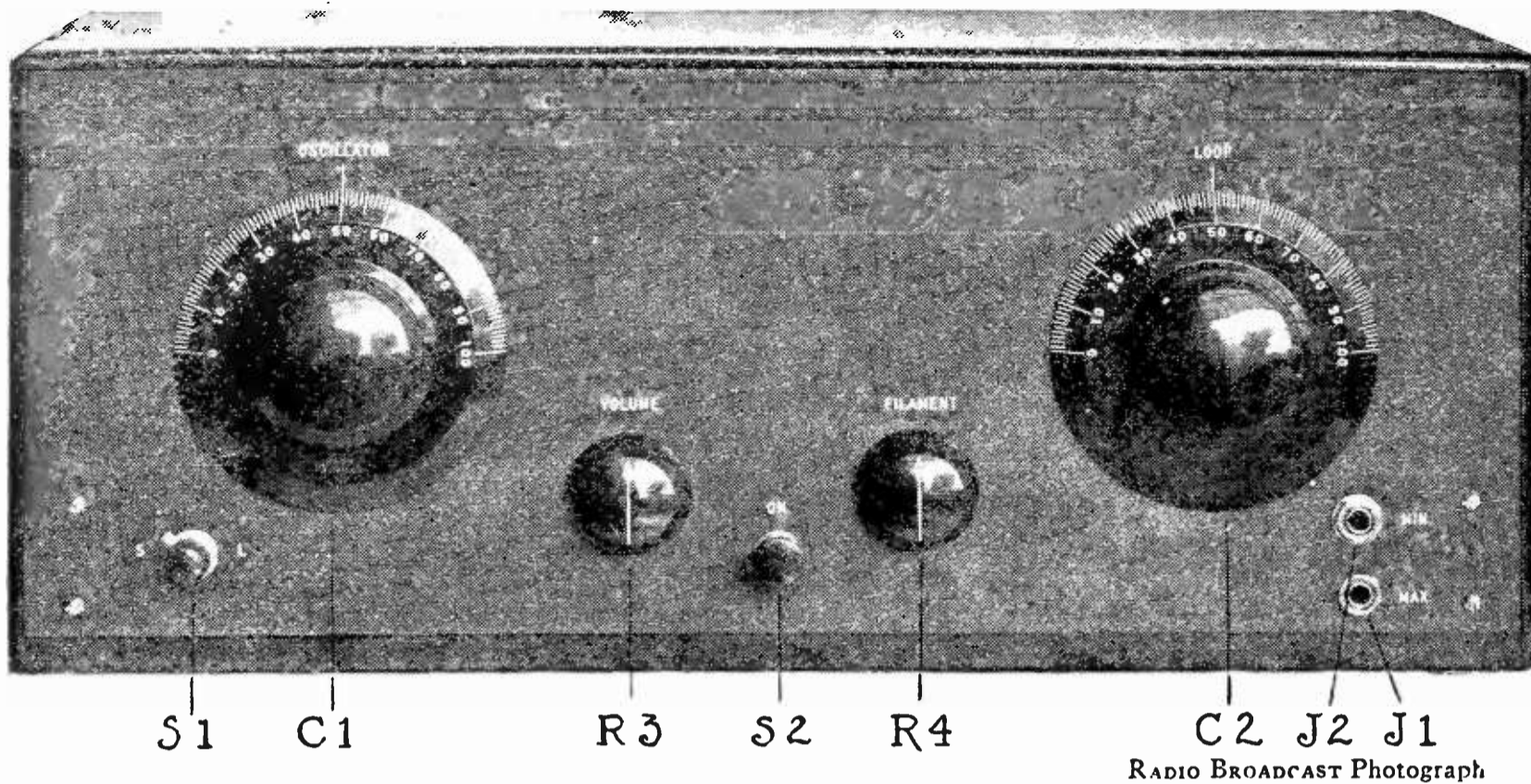

FIG. 1

Front view of the super-autodyne receiver, assembled on a standard 7 x 18 x 1/4-inch bakelite panel. The knob at the lower left is the wavelength change switch which controls the loop. The designation letters in this Figure coincide with those in the list of parts, and in the remainder of the illustrations

The Super-Autodyne

Complete Data for Building an Improved Type of "Super-Autodyne" Using But Six Tubes for Portable or Home Use

By McMURDO SILVER

THE super-heterodyne described in this article has a number of features which commend it to the radio constructor. In the first place, it uses six tubes, with a total plate current consumption of 12 milliamperes. As for actual mechanical arrangement and layout, we feel that the author has done a very good bit of design, for the set is exceptionally easy to wire, and if the constructional outline is carefully followed there should be no difficulties from this source. The entire receiver has been concentrated in a 7 x 18-inch panel, a vastly more compact arrangement than one finds with most super-heterodynes. No reflexing is used. The quality of tone we believe excellent. It is somewhat difficult to tune this receiver, as the dial functions differ from those in the common types of super-heterodyne. The interested constructor will, however, find that this is not merely "another super-heterodyne." Many radio enthusiasts, old and new, are looking for a portable loop receiver to use in vacation trips this summer; this receiver should satisfy their summer requirements as well as giving them a set for all-around home use.—THE EDITOR

THAT it possess features which definitely lift it above the class of the best receivers heretofore developed—is the first requirement of any new receiving system in order that it may, in a measure, justify that age-old human cry of "something new under the sun." And if for purposes of differentiation it is elected to call this new receiver by a name which includes the word

"dyne," then there must certainly be something to recommend it other than that its designer has managed to unearth some new prefix or suffix for that word. The receiver to be described in this paper has but two basic claims to the first of these requirements and one to the second—it uses but six tubes, and its name is as logical as that of the super-heterodyne.

Essentially, the receiver is a super-

heterodyne, employing an autodyne detector-oscillator, and what the writer believes to be an exceptionally efficient intermediate amplifier. Because of the use of the autodyne frequency-changer, the circuit has been called a "super-autodyne," which seems to be a more logical name than "super-heterodyne." It might be argued that the usual interpretation of the word "heterodyne" implies the use of a separate detector and oscillator to produce a beat note, whereas in this system but one tube is used (autodyne). The name at least serves to distinguish this system from the conventional ones.

THEORY OF THE AUTODYNE CIRCUIT

THE autodyne circuit, which is the most interesting feature, is worthy of explanation. The difficulty which has heretofore prevented the use of one tube for both detector and oscillator has been that of isolating the loop or pickup circuit from the local oscillator circuit. It has been impossible to couple a tuned pickup circuit to a tuned oscillator when the two are to operate but fifty or sixty kilocycles apart throughout the broadcast wavelength range, and not have the tuning of one section react on that of the other. Armstrong and Houck developed the second harmonic system, whereby the oscillator, working at double the desired wave, did not react greatly upon the loop circuit. Then, a harmonic of the oscillator was used for hetero-

dyning. This meant two waves of sufficient power to cause radiation were being produced by the oscillator, which necessitated the use of a muffler tube ahead of the detector-oscillator to prevent radiation. Thus, two tubes were still used, though the gain in signal strength was equal to or slightly better than that obtained with a good regenerative detector and oscillator. At best, this system is not entirely satisfactory for home assembly.

Then came the development of the balanced autodyne circuit, by J. H. Pressley, a Signal Corps engineer, which performs the required function with one tube.

The actual first tube circuit is shown in Fig. 9. The coils L₂, L₃ are theoretically equal, as are the condensers C_X, C_X. Actually they cannot be made fixed and equal, so C_X, C_X are made adjustable, to obtain substantially a condition of equality. These units make up a bridge circuit, shown by the heavy lines. Since L₂ equals L₃, the potential across them is equal, so that it is also equal between points 3, and 4, and 5 and 6. Likewise, the potential across C_X and C_X is equal. Since the potential across 3 and 6 is the same for both inductance and capacity, then point 4, 5 and the connection between C_X, C_X are at equal potential, and are also theoretically at zero potential, since these points are neutral with respect to 3 and 6. Then, circuit B₁, C₂, B₂, may be connected at these neutral points with substantially no reaction on the

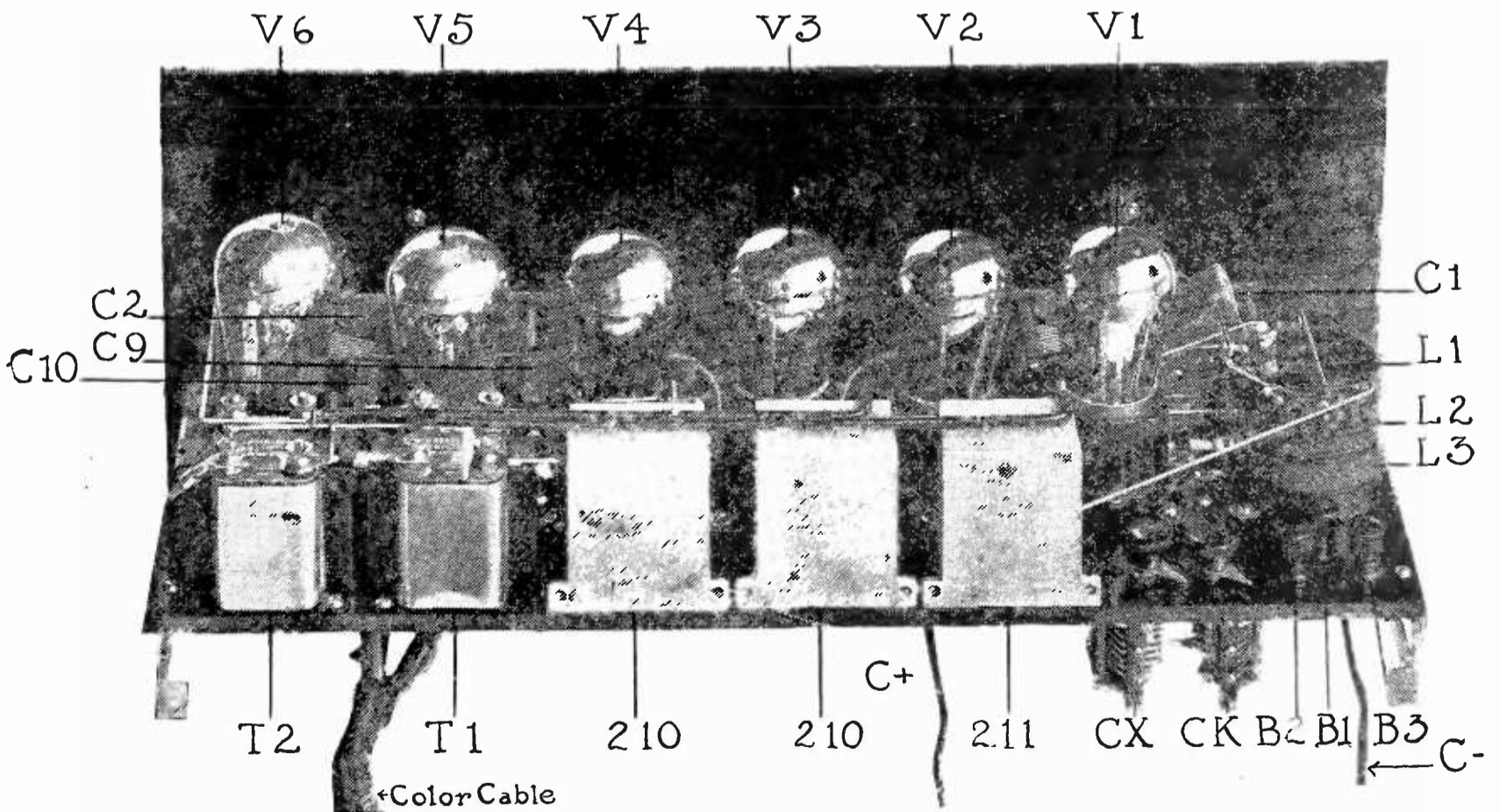
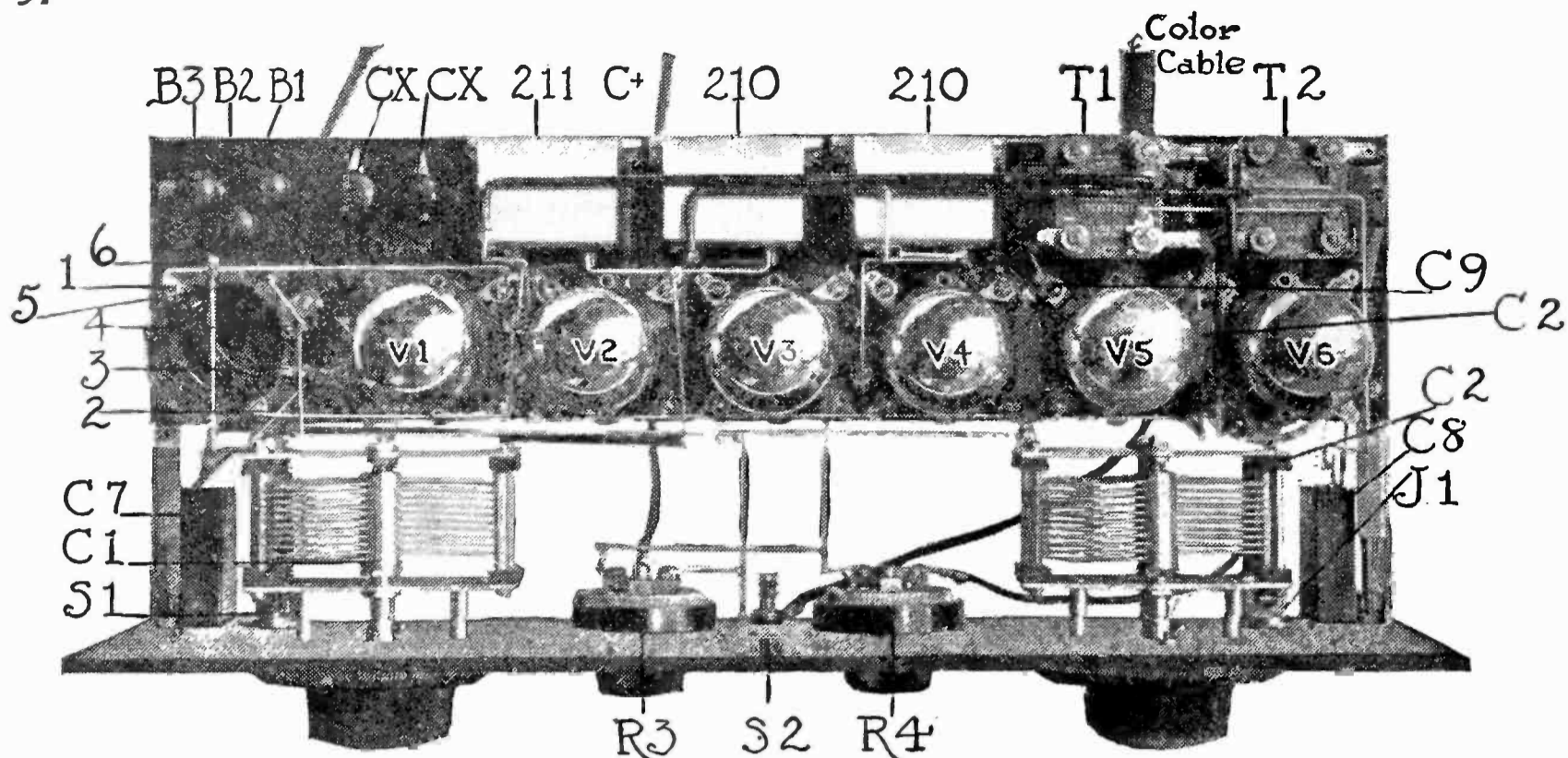

FIG. 2

RADIO BROADCAST Photograph

The completed receiver from the rear. Note how the color cable runs into the assembly, and how two of its leads terminate on the rear left posts of transformers T₁ and T₂. Condensers C₉, and C₁₀ should be fastened to the under side of the sub-panel, using holes provided in this socket-panel



RADIO BROADCAST Photograph

FIG. 3

Details of the finished receiver from above. Note how the five leads of the color cable separate: one to the rheostat R3, one to the switch S1, two to T1, and one to T2. The gang-socket used in this particular model of the set is a home-assembly, and the springs are held by screws. In the factory product, the springs are held by hollow rivets which permit connections to be made from either above or below quite simply

frequency of the bridge circuit. Further, as these points are neutral with respect to 3 and 6, no energy in the bridge circuit can get into B1, C2, B2, since there is no potential difference across these points of the bridge. Therefore, the frequency adjustment of the bridge circuit cannot react upon that of the B1, C2, B2, circuit, and vice versa.

Since the signal is fed from the loop and its tuning condenser to the oscillator, it will divide equally across the bridge arms. If a tube detector is connected across one capacity CX, the drop in potential may be used to cause rectification. The coil L1, coupled to L2, L3, causes the bridge circuit to oscillate at a frequency determined by these coils,

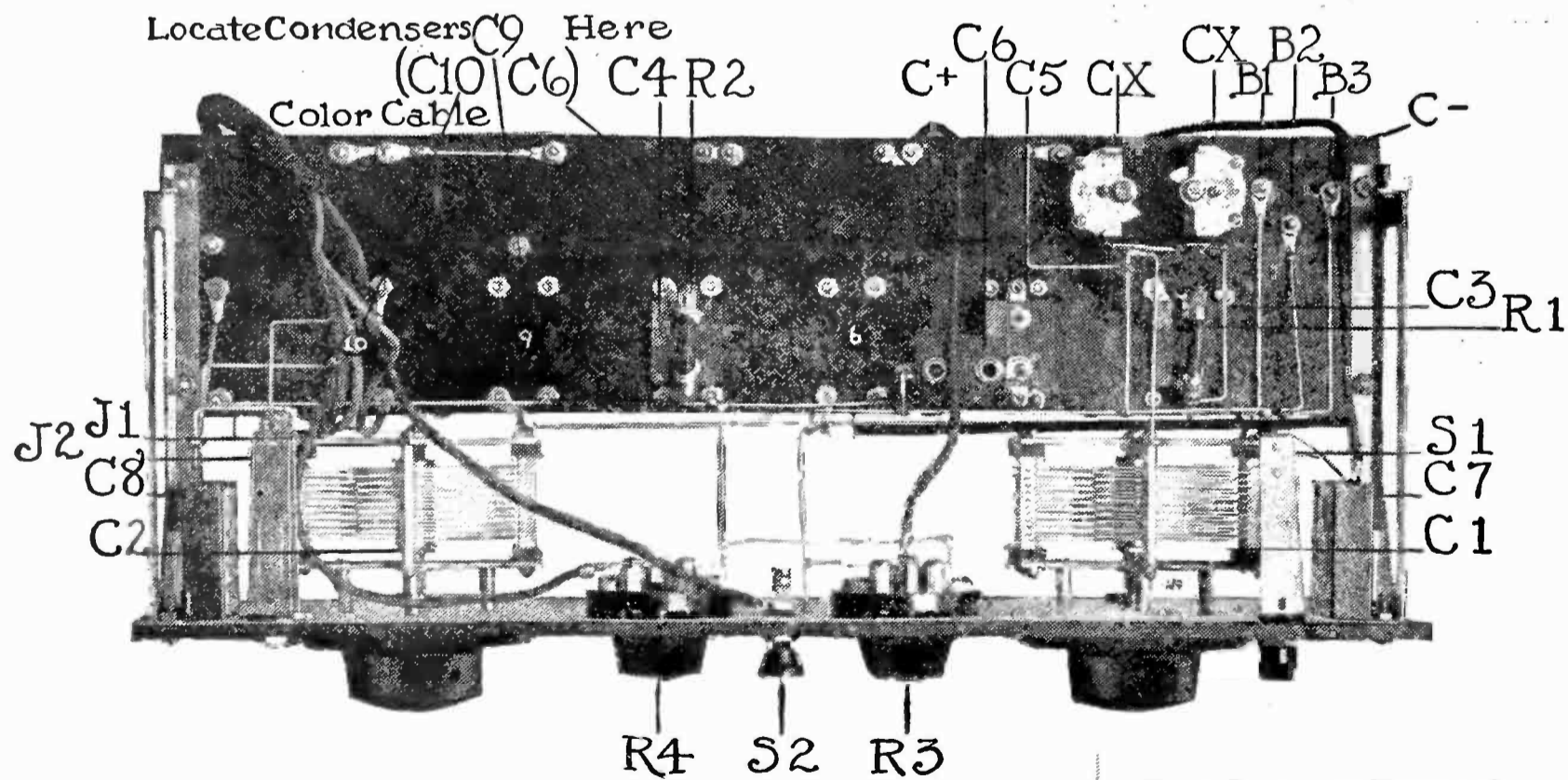

RADIO BROADCAST Photograph

FIG. 4

Bottom view. Condensers C6, C9, and C10 should be fastened to the sub-panel at the points shown, similarly to C3, C4 and C5. The proper hole locations are given in Fig. 7. Connections from C3 and C4 to the socket grid terminals are by means of lugs, just visible between the condensers and the nuts to the rear left. This view shows quite clearly how the bypass condensers are held by the same screws holding the mounting brackets

CX, CX, and C₁ which is made variable for the purpose of tuning the oscillator circuit. As previously explained, this energy cannot get into the loop circuit, so radiation is confined to what may be experienced from the oscillator coil system itself—a negligible amount.

It is desirable that the losses in these circuits be kept low, particularly in C₁, C₂, CX and CX. Further, CX and CX should be quite small so as not to lessen the tuning range of the circuits, and in order that maximum voltage may be impressed upon the detector terminals. In some cases, it has been found possible to use the tube capacity for one condenser CX, while a very small variable was used for the other capacity.

INTERMEDIATE AMPLIFIER

THE intermediate amplifier is the only other unusual feature of the receiver. It employs but two stages and is on the order

of those described by the writer in RADIO BROADCAST for October 1924, and January, 1925. It differs, however, in that it employs transformers which are a compromise between the extreme selectivity of properly designed air-core coils, and the great stability and amplification of good iron core transformers. But two core laminations are used in each transformer, of 7-mil silicon steel, one in the shape of an "F" and one an "L".

CONSTRUCTION OF THE SET

THE material required to build this receiver is listed below, with the designation letters used in the diagrams and cuts following the quantity of each item required. It is entirely permissible to substitute any other standard parts for those listed. The actual space available is such that if in some instances parts of larger or different dimensions are substituted, considerable difficulty will be encountered in making the units fit in the

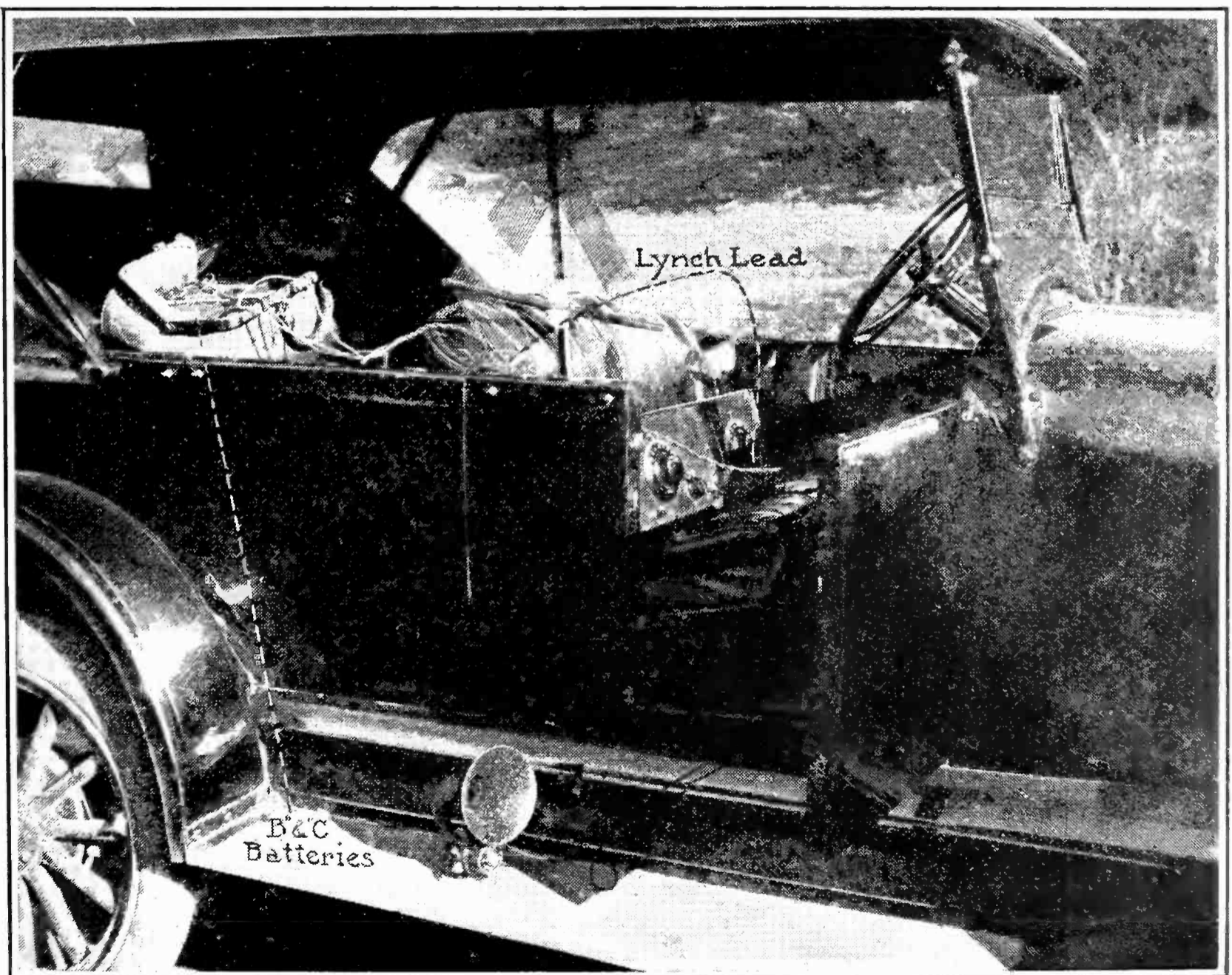

RADIO BROADCAST Photograph

FIG. 5

The receiver in an automobile. The A battery supply comes from the automobile by using the Lynch Lead. The rather dilapidated bag in the rear holds the B and audio amplifier C batteries. The Amplion loud speaker and the folding loop also go in this bag when not in use. Blanket-roll straps provide a convenient means for carrying the set itself

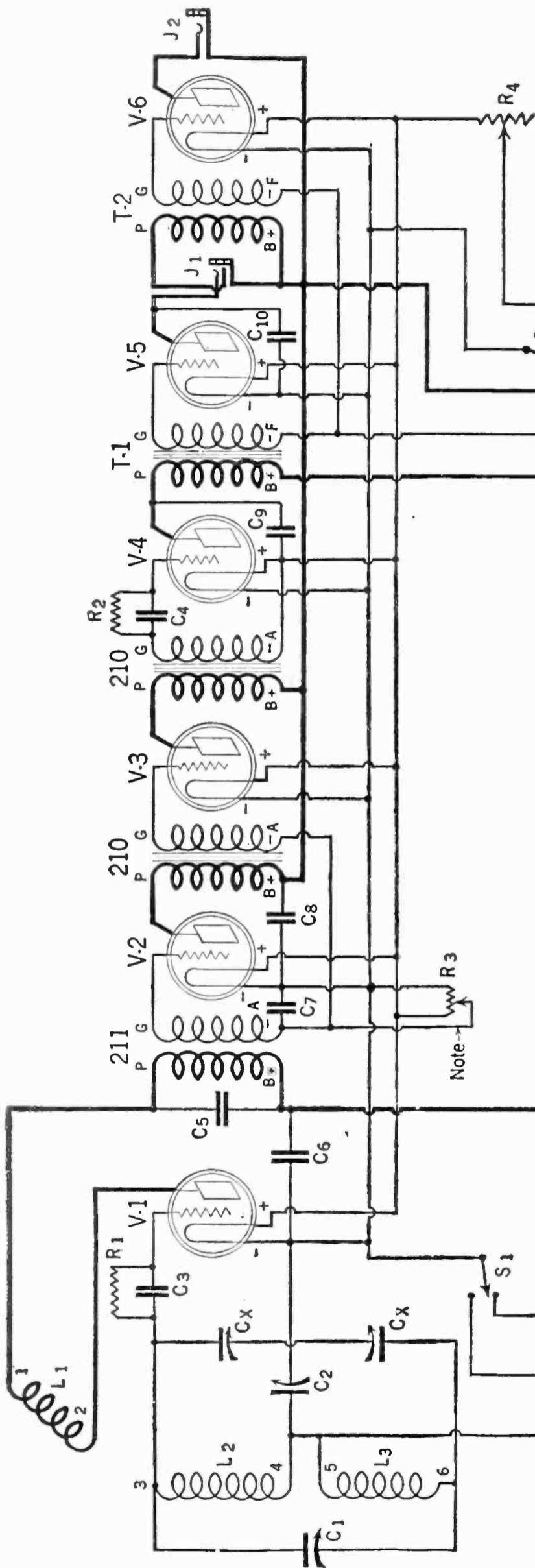

space provided. In the case of the r. f. transformers, it would be inadvisable to substitute, since the results of the receiver depend in a large measure upon the use of the types recommended.

2 C1, C2 S-M 301-A (or 305-A S. L. F.) Condensers

2 4" Moulded dials, vernier type preferably

1 R4 U. S. L. 6 ohm rheostat

1 R3 U. S. L. 240 ohm potentiometer

3 B1, B2, B3 Insulated top binding posts

1 J2 Carter 101 jack (1-spring)

1 J1 Carter 102-A jack (3-spring)

1 C-5, 211 S-M 211 filter with matched tuning capacity

2 210, 210 S-M 210 charted intermediate transformers

1 L1, L2, L3 S-M 101-B coupling unit

1 S-M or Benjamin 6 gang socket shelf (536-201A, No. 537-199)

2 T1, T2 Thordarson 3 1/2:1 or 2:1 transformers

2 C7, C8 S-M or Dubilier .5 mfd. Condensers

2 C3-C4 Muter .00025 mfd. condensers with 2 clips

2 C9, C10 Muter .002 mfd. condensers

1 C6 Muter .0075 mfd. condenser

2 CX, CX Continental .000025 mfd. condensers

1 R1 S-M or Muter .5 Meg. leak

1 R2 S-M or Muter 2 meg. leak

1 S1 Carter No. 3 jack switch (s. p. d. t.)

1 S2 Benjamin 8630 switch (s. p. s. t.)

1 S-M No. 701 color cable (5 leads)

1 pair Benjamin No. 8629 shelf brackets

1 Bakelite Panel, 7 x 18 x 1/4 inches

1 Small parts: 29 6/32 R.H. N. P. machine screws 3/4 inch

2 6- R.H. N. P. machine screws 1 1/2 in.

31 6/32 nuts

1 spaghetti

10 strips bus-bar

25 lugs

FIG. 6

Complete wiring diagram of the super-autodyne receiver. If this diagram is used in connection with the picture layout diagram, an error in connections is impossible

Tools required: 1 hand-drill with drills and countersink, 1 soldering iron with rosin-

core solder and non-corrosive paste, 1 side-cutting pliers, 1 screw-driver, hammer, and centerpunch.

THE OSCILLATOR COUPLER AND GENERAL ASSEMBLY

THE oscillator coupler may be made by winding two sections separated $\frac{1}{16}$ -inch apart on a $2\frac{1}{4}$ -inch bakelite or condensite tube; each section containing twenty-eight turns of No. 28 d.s.c. wire. The rotor coil also consists of twenty-eight turns of the same size wire on a $1\frac{1}{2}$ -inch tube rotatable within the stator tube.

As soon as the materials have been procured, each item should be carefully examined to see that all screws and nuts are tight, and lugs placed as shown in the photographs, so that those on the various instruments will point in the best directions for short leads. Socket springs should be bent up to make good contact with tube pins. Condenser bearings should be adjusted to give the desired tension.

If the builder already has Benjamin sockets, the socket-shelf may be made up by drilling a piece of bakelite $17\frac{1}{4} \times 4\frac{1}{4} \times \frac{1}{4}$ inch in accordance with Fig. 7. The bases should be removed from the Benjamin sockets so that they may be fastened directly to the sub-base with their original screws. On each terminal will be found a round knurled nut, a hexagonal nut, and a round-headed screw. The screw should be put through the hole in the spring, pointing downward. The knurled nut is turned up on the screw under the spring, the screw pushed through its hole in the shelf, a lug placed over it if necessary, and the "hex" nut tightened up on the under side of the shelf. Care should be taken to prevent the spring from twisting as the nut is tightened, due to rotation of the screw. If this occurs, the socket will not ride evenly on its spring. Details of these operations may be obtained from Figs. 2, 3, and 4. Either UV-109 or standard UV-201A sockets may be used. They should be arranged so that their grid terminals come out at the left rear, as in Fig. 3.

The front panel may be laid out in accordance with Fig. 8, using a rule and scribe after which the hole locations should be punched with a center-punch or nail, and a hammer. After drilling the holes, the panel may be grained with fine sand-paper and oil, rubbing in one direction until the original polished finish has disappeared. After wiping the panel off with alcohol, indicating marks for the dials may be scratched as in Fig. 1, and filled with Chinese white. The sub panel should not be grained.

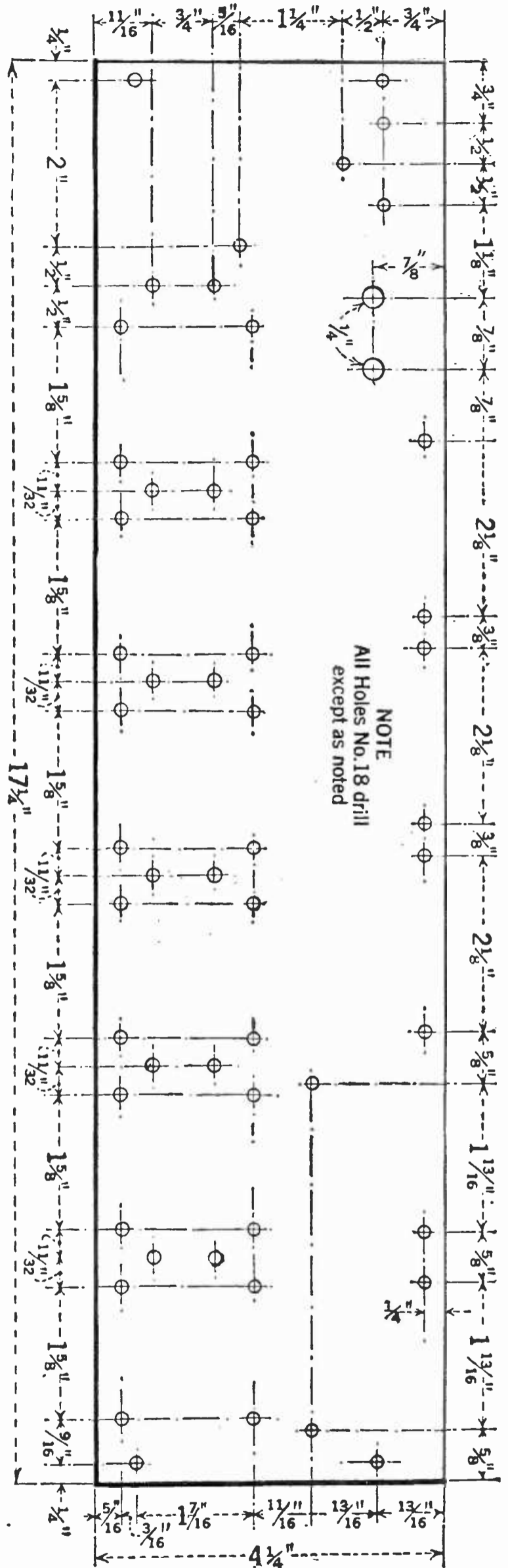

FIG. 7
Drilling dimensions for the sub-panel

ASSEMBLY OF PARTS

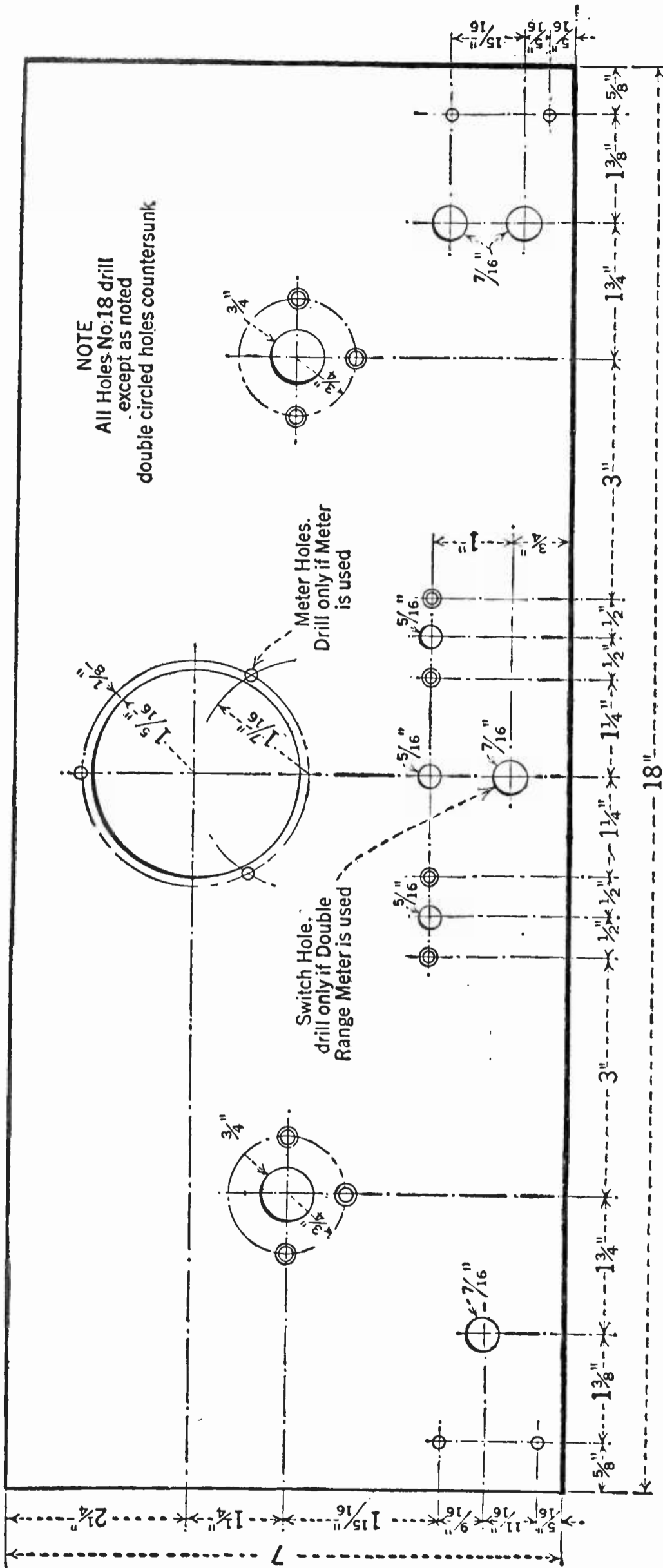

FIG. 8

Panel drilling dimensions. If a meter is used with this set, which is strongly advised, the holes indicated should be drilled. The Weston double range voltmeter type 301, which may be used on the panel requires the additional switch hole indicated

BEFORE starting with the assembly, the photographs should be very carefully studied, to see just how each part is put on, and just where each of the different parts go. If the S-M or Benjamin shelf is used, it will be unnecessary to drill any additional holes, as these shelves are supplied completely drilled for the parts recommended.

Figs. 1, 3, and 4 should be examined to see how the parts are arranged on the panel. The condensers C1 and C2, the Carter jacks and jack-switch and the Benjamin switch should be put on the panel, followed by the rheostat and potentiometer. The posts of these latter instruments should be on the bottom, and their contact arms should point upward when their indicating arrows do likewise.

All parts should be put on the sub-panel as shown in the various photographs. In these C6, C9 and C10 are shown inconveniently located. They should be placed in the positions indicated in Fig. 4, on the under side of the shelf. They are held to the sub-panel by machine screws and nuts. Lugs placed between these condensers and the sub-panel may be soldered directly to the socket terminals in the case of C9 and C10, since they run to plate and F of sockets V5 and V6. Condensers C3 and C4 may have one of their contacts connected to the grid terminals of sockets V1 and V4 respectively in the same manner. Lugs for C5 should be placed on the upper side of the shelf, as well as on one terminal each of C3 and C4, since some of the condenser connections will be made from above.

WIRING THE RECEIVER

IN WIRING the receiver, a well-tinned iron should be employed in conjunction with rosin-core solder. A small amount of paste may be used on each connection if desired; but not on any of the fixed condensers. Here, connections

may be soldered to lugs, or to the condensers directly.

Only two connections can be put on the panel alone. These are a connection between the rheostat and potentiometer, and one between the potentiometer and S1. (See Figs. 3 and 4.) Bus-bar should be used, straightened, carefully cut, and bent to proper length before any attempt is made to solder it in place. A long piece of bus-bar should not be soldered to a lug, and then bent and twisted until it reaches the other lug to which it is to be soldered. Each piece should be bent to fit properly, cut to size and then soldered in place.

ASSEMBLING ON THE SUB-PANEL

STARTING on the sub-panel, all the wiring visible on it in Fig. 3 should be put on, the shelf then turned over, and the wiring necessary on the bottom put in place. All of the r.f. and a.f. transformer cases are connected together, and in turn connected to the negative filament line, which joins the minus lugs of all sockets, just as the positive line joins all the plus terminals of the six sockets.

The Benjamin brackets should be fastened

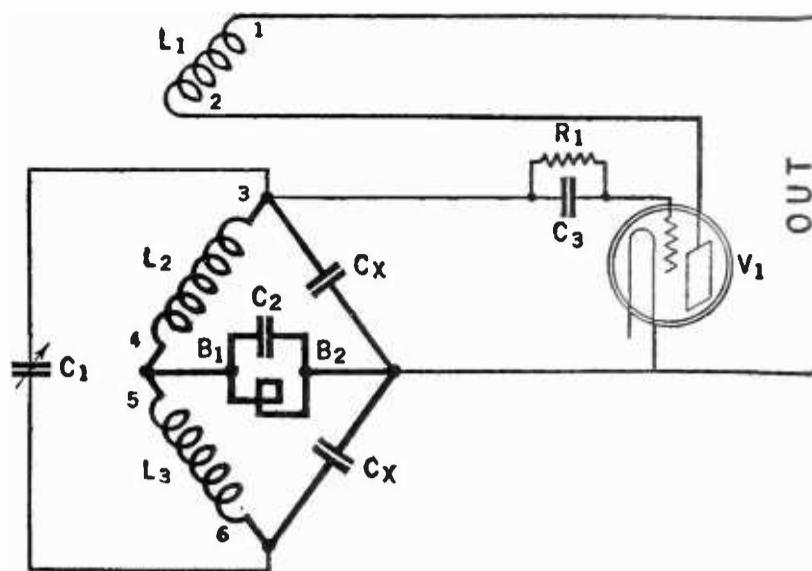
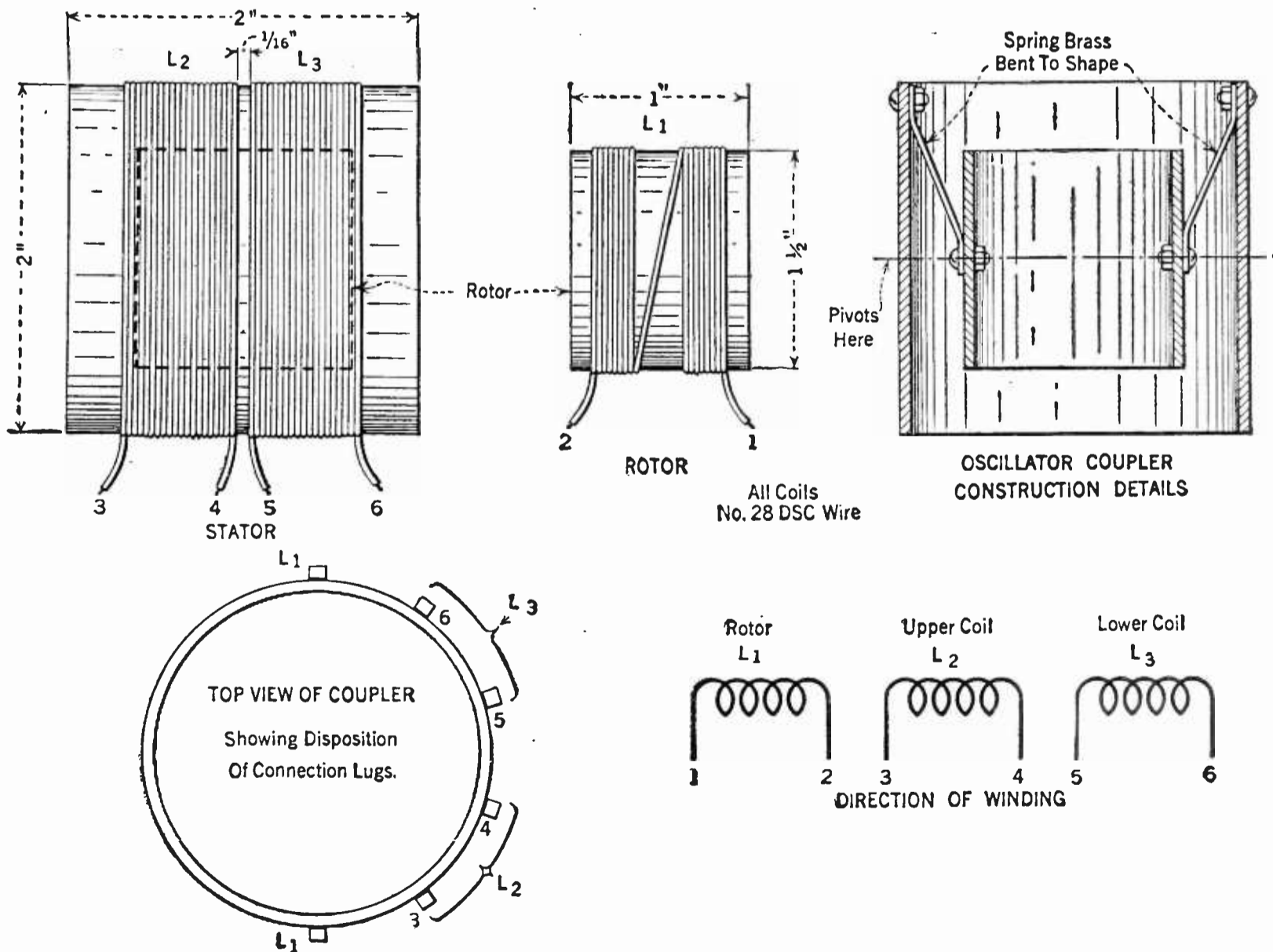

FIG. 9

to the sub base, and in turn loosely fastened of the panel. The lugs of the bypass condensers C7 and C8 are bent at right angles, and slipped in between the brackets and fastening nuts, as in Fig. 4. This makes a solid mounting for these condensers, after the screws are tightened, as well as for the shelf-brackets. The balance of the wiring is then put in, running between the parts on the sub-shelf and those on the panel. This will not be found difficult, particularly if spaghetti is used only where there is danger of two wires shorting, or a wire shorting on an instrument.



DETAILS OF CONSTRUCTION OF THE OSCILLATOR COUPLER

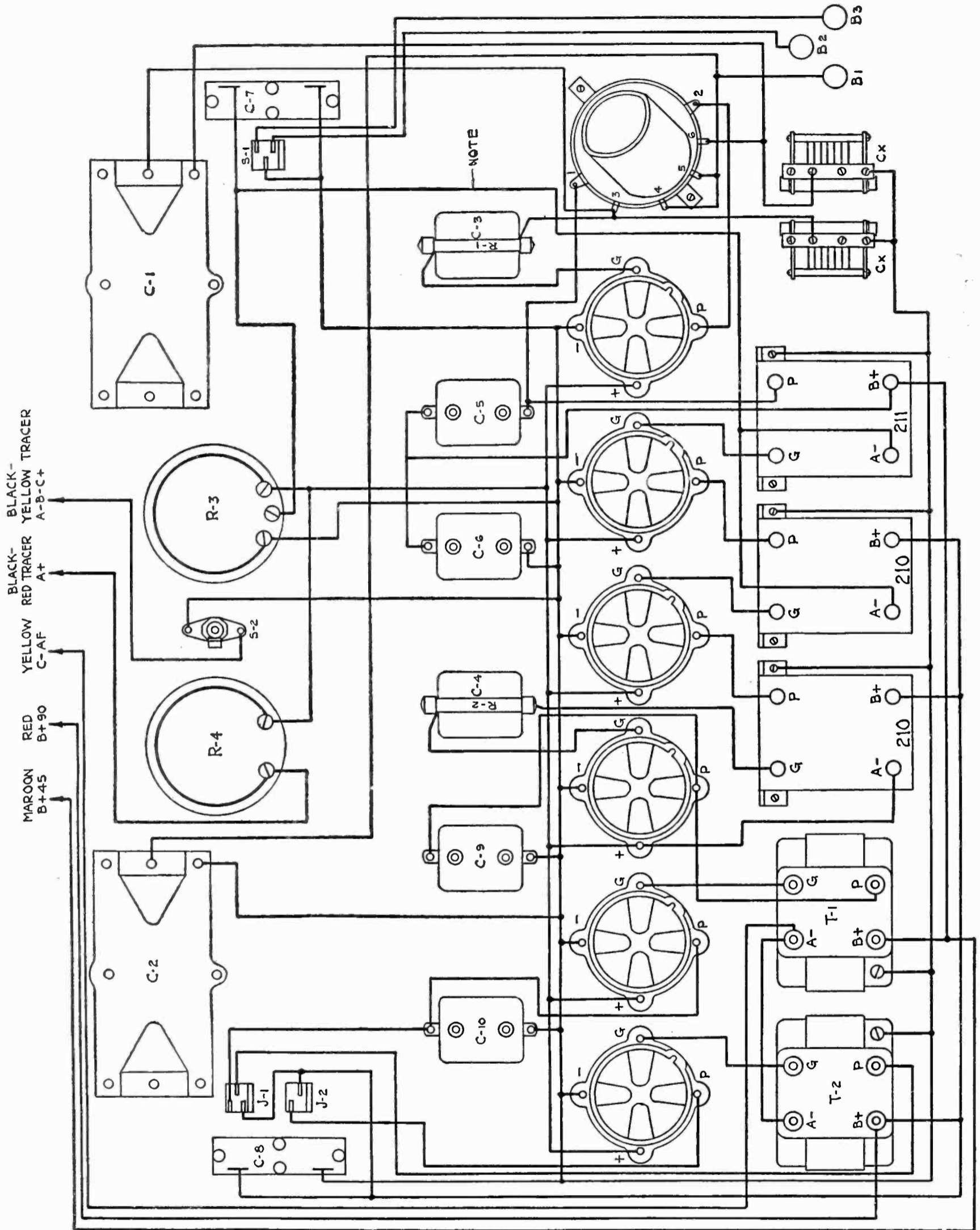

FIG. 11

A picture wiring diagram of the super-autodyne. The location of every wire in the circuit is shown. This should be used in connection with Fig. 6

A C battery is used on the r.f. amplifier. It connects to the two flexible leads marked C minus and C plus in the photographs. No provision is shown for it in the diagram, except the point marked "Note." At this

point, the wire is broken, and a ten-inch lead of lamp cord soldered to the potentiometer arm for the C plus lead and another similar wire soldered to the joint between C7 and the A minus lugs of the 211 filter and

its adjacent 210 transformer. This C battery is 3 volts, and may be placed in the cabinet under the sub-shelf, since its leads should be short. It had best be wrapped in paper to prevent shorting on any of the wiring. For UV-201A tubes, these leads may be shorted and the battery eliminated entirely if the amplifier will oscillate without it.

The remaining battery leads are brought out through a color cable, which should be coded in accordance with the data presented on page 1034 of the April RADIO BROADCAST. Unfortunately, there are a few manufacturers who have not yet adopted this coding for their cables. In Fig. 6, the colors of the various wires in the cable used for different voltages are given. This was for one particular make of cord, used on an experimental set. It will be noticed that the black lead with red tracer is used for three connections, which are made between the batteries themselves by means of other wires.

ACCESSORIES AND TESTING

ASSUMING the receiver to have been wired, it is ready for test. The additional material required is as follows:

6 Radiotron tubes, UV-201A, or UV-199. DV-3 De Forest tubes may be substituted for 199's, but will require a standard-base socket shelf.

1 A-battery. This may be a storage battery, 6 volts, 90 ampere hours for UV-201A's, or it may be the battery used in an auto, tapped by means of Lynch Leads. For dry cell tubes, three dry cells may be used, or, better yet, for home installation six in series-parallel.

1 B-battery. For permanent installation 90 volts, of large size 22, or 45 volt batteries should be used. For portable work, 67½ volts will be sufficient, of medium or small-size batteries, since the current drain is but 12 milliamperes for 201A tubes, and 9 milliamperes for 199s. (90 volts will give only slightly more volume than 67½, so it is hardly worth while to carry around the extra 22-volt battery.

2 C-batteries. One 3-volt battery required in the set box for the r.f. amplifier, and one 4½-volt battery for the a.f. amplifier.

1 Loop with center tap. Any good tapped loop may be used, or one may be made by winding 16 turns spirally on a form about 24 inches square, tapped at the center, with ¼ inches between turns. This loop with eighteen turns, ⅜ inches apart, may be wound on the back of a cabinet large enough to hold the set, with the batteries beneath if desired.

1 Loud speaker. The small Amplion is recommended for portable work as it is a most excellent speaker, and delivers very good volume and quality. For home use, the Western Electric cone speaker is best, with its leads shunted by a .0075 mfd. condenser.

1 Phone plug.

1 Set Lynch Leads if the set is to be operated in a car, using the starting and lighting battery. The Lynch Lead may be made up from any double conductor wire. Several types of wire can be used, but the flexible, rubber covered lead is recommended. The wires, which should be colored for ease in identification, should be scraped on one end, for connection to the filament posts on the receiver. The other end of the lead should be connected to a plug which will fit into the dashboard connection to the automobile storage battery.

1 7 inch x 18 inch x 7 inch mahogany cabinet.

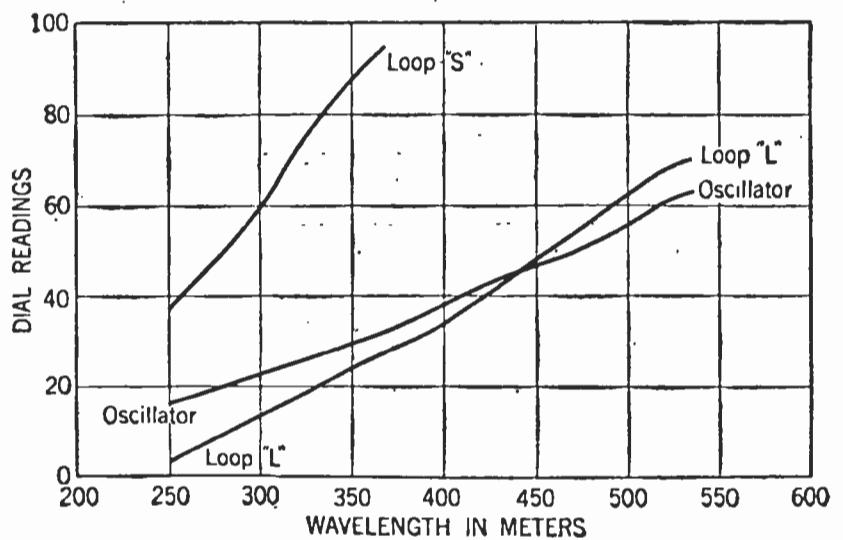

FIG. 12

Typical tuning chart of a super-autodyne. The curve marked "Loop S" is for the loop condenser with the switch in the "L" position. Only one curve is shown for the oscillator. The curve embracing the upper heterodyne points would parallel the one given, starting about four degrees higher at 250 meters and ending about thirty degrees higher at 530 or 540 meters

CONNECTIONS

THE A battery should be connected to its leads, one tube inserted in a socket, switch S2 closed, and rheostat R4 just turned on. If the tube lights, it should be moved from socket to socket to see that all A connections are correct. The positive battery lead should then be connected to the B45 and B90 posts. If the tube lights, the wiring or assembly is faulty and should be checked. The tube should only light when the A battery is connected to the A leads.

The remaining batteries may be connected, and the loop leads run to posts B1, B2, and B3. If the loop is spiral, B1 goes to the outside

lead, B₂ to the center and B₃ to the inside. When switch S₁ is to the left, or short position, only half the loop is used. When it is to the right, the whole loop is used. This means all low wave stations up to 380 meters will come in on dial C₂ from 0 to 100 degrees. Stations from 350 meters up will come in on C₂ with switch S₁ thrown to the right, or long position. This means that in the long position, C₂ will read about 20 for 345 meter stations, and about 70 for 536 meter stations. On the short position, C₂ will read about 85 for 345 meter stations, and about 45 for 270 meter stations. These figures are approximate, but show that to cover the entire wavelength range, C₂ must be varied from 0 to 100 degrees to go up to 370 meters with S₁ to the left, then S₁ turned to the right and the remaining wavelength range secured by varying C₂ again from 0 to 100, allowing, of course, for over-lapping. C₁, the oscillator, starts around 18 for 270 meters, and brings in the lower heterodyne point for 536 meters at about 70. Two points can be found for each station on this dial, which will help in tuning, as when interference is experienced on one point, the other may be used.

TUNING AND TESTING THE COMPLETED RECEIVER

THE first test should be to check tube V₁ for oscillation. Insert only tube V₁, set R₄ just on and connect the phones in series with the B₄₅ lead. Then touch lugs 3, or 6 of the coupler. If a plucking sound is heard, this tube is oscillating. If not, adjusting the rotor coil will cause it to oscillate. When this rotor winding is in the same plane as the stator windings, turning it 180 degrees around will either start or stop oscillation. When once set to produce oscillation, this coil should never be touched. If the tube squeals at low settings of C₁, reduce R₁ to .25-megohms, or try another

.5 megohm leak. Use the highest value of leak possible—(up to 1 meg). The receiver will probably squeal below 10 degrees on C₁ in any case. R₂ is not critical and may vary from 1 to 3 megohms.

With tube V₁ oscillating constantly, insert the remaining tubes in the set, turn the rheostat seven-eighths on for 201A tubes, or on one-third for 199's, and rotate the potentiometer from positive to negative. If both C₁ and C₂ are set at 100 degrees, a plunk will be heard at some point as R₃ is adjusted, indicating amplifier oscillation. If C₁ is adjusted, squeals will be heard. R₃ should be set with its arm just positive of the point where squeals can be heard, and either left set at this point, or used to control volume. Now, with S₁ to the right, and C₁ set at 50, rotate C₂ over its entire range. A click will be heard near the center of its scale. The condenser CX connected between terminals 3 and 4 of the coupling unit should now be slowly turned out in small steps until rotating C₂ fails to produce a click. The receiver is now balanced and CX, CX should never be touched unless tube V₁ is changed.

In tuning, C₂ will appear rather broad, which is correct, while C₁ will be extremely sharp. This permits of extremely easy logging, since C₂ need only be set approximately correct, and C₁ rotated in order to find a station. The chart printed on page 385 will help in preliminary tuning. The set will log definitely, and a station once heard may be brought in again at the same settings of S₁, C₁ and C₂, providing CX, CX have not been tampered with.

Due to the sensitivity of the circuit, a small amount of hand capacity may be noticeable on C₁. This may be overcome by grounding the negative filament line to a piping system, or it may be compensated for by tuning-in a station, increasing C₁ slightly until the volume begins to decrease, and removing the hands from the set. The signal will then return to full intensity. It will be evident in those few cases where it may be encountered, only on weak, low wave stations, and is seldom bothersome.

An Explanation

THE similarity in name of Dr. Walter Van Braam Roberts and J. E. Roberts has led to some confusion among the readers of RADIO BROADCAST. Doctor Roberts, of Princeton University, is responsible for the inception and the design of the Roberts Knockout receiver. Doctor Roberts wrote two articles describing this receiver which appeared in the April and May, 1924, RADIO BROADCAST.

Immediately after the publication of these two articles, a great deal of interest was shown by radio constructors all over the country in the design and operation of the set. Many investigators started building the receiver, making additions and alterations according to their own ideas. One of these enthusiasts was J. E. Roberts, of Cleveland, Ohio, who prepared an article describing how to build the original two-tube circuit in a cabinet with an additional stage of audio amplification, making three tubes.

We have received many letters from residents of Cleveland and vicinity who have taken issue with what they regarded as an unfortunate use of the similarity of last names of these two men. The situation which drew the protest was in Cleveland and other cities. And in especial, a number of our correspondents did not like printed matter which was distributed by a Cleveland radio shop.

Mr. J. E. Roberts has no connection with RADIO BROADCAST other than that of a former contributor to its pages. The only approved models of the Roberts Knockout circuit have been described in the magazine. We can take no responsibility for any printed matter or representations of individuals relative to this circuit released by other sources than this magazine except that of approved manufacturers of parts which may be used in the Roberts circuit.



A New Method of Radio Frequency Amplification



The Theory of Various Arrangements for Neutralizing Tube Capacity in Radio-Frequency Amplifier Circuits and a Discussion of a New Method—An Arrangement for the Measurement of Amplification Constant and Impedance

BY C. L. FARRAND

T HIS paper of Mr. Farrand's was presented before a meeting of the Radio Club of America, in New York, and involves an interesting history and discussion of neutralizing methods in radio frequency amplification. Toward the end of the paper, the author also describes a method for connecting and using a vacuum tube voltmeter which should be particularly interesting to many readers. In a later number we shall print another article by the same author, dealing with his later investigations. The papers presented before the Radio Club appear from time to time in this magazine. The editor assumes no responsibility for statements made by the authors of the papers, but is very glad indeed to present them to the readers of RADIO BROADCAST.—THE EDITOR

IT IS the purpose of this paper to present a new method of radio frequency amplification, together with the necessary data for the design and construction of the circuits. Tuned radio frequency amplification is not new. See Schloemilch and Von Bronk, United States Patent No. 1,087,982. This method has been used with considerable success, more difficulty being experienced as the number of stages were increased. These difficulties were due to incipient couplings in the amplifier circuits, either between the input and output circuits of a single tube or between the input and output circuits of more than one tube. These couplings are either electro-magnetic or electro-static, as in a good design, resistance couplings are eliminated. The magnetic couplings can best be taken care of by disposing the transformer windings so that their axes are at right angles, and on the same center line, with reasonable distance between windings.

Static couplings between the input and output circuits of the tubes can be eliminated by shielding in all cases excepting the inherent capacity coupling of the tube itself. From general considerations it is apparent, having been brought out before, that there are three capacities in a three-electrode vacuum tube, two of which act in shunt to the input and output circuits respectively, and the third which is the grid to plate capacity, acts as a coupling between the input and output circuits. See

Fig. 1. To eliminate this coupling, it is necessary to resort to balancing arrangements or to additional circuits which will nullify the influence of the coupling current flowing through this capacity. The coupling increases with frequency, and, it is in the broadcasting range and shorter waves that the most difficulty is experienced.

Various methods have been suggested for neutralizing or balancing the tube coupling. Hartley (R. V. L. Hartley, United States Patent No. 1,183,875) has suggested a magnetic balance, which is the equivalent to a reverse tickler coil. See Fig. 2.

By this method, the coupling effect of the grid-to-plate capacity of the tube is balanced by an equal and opposite magnetic coupling between the input and output circuits. This condition holds for only one wavelength. In the Figure shown, the static tube-coupling increases with frequency, while the magnetic coupling remains constant.

THE RICE METHOD

RICE (C. W. Rice, United States Patent No. 1,334,118) has suggested a capacity balance which is in effect Fig. 3. By this method, the coupling effect of the grid-to-plate capacity is balanced by a capacity of equal value connected between the plate and an input coil being opposite potential to the grid.

Hazeltine (L. A. Hazeltine, United States Patent No. 1,450,080) has suggested a

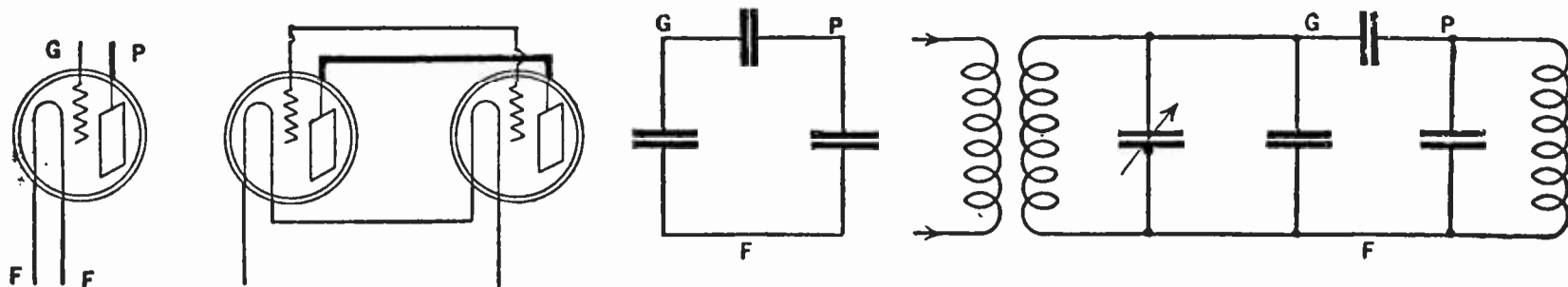

FIG. 1

capacity balance wherein the effect of the grid to plate capacity of the tube is balanced by means of an output transformer. Fig. 4.

Here the coupling effect of the grid-to-plate capacity is balanced by a capacity connected between the grid and an output coil having a potential opposite to the plate.

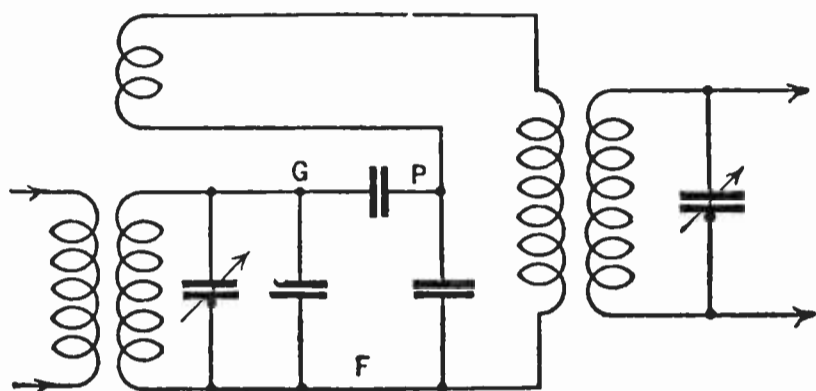

FIG. 2

The output coil is the secondary of the transformer supplying the next tube and has a ratio of turns greater than unity to satisfy the impedance relation, so that it is necessary that the value of the balancing capacity be chosen to equal the grid-to-plate capacity divided by the voltage ratio of the output transformer.

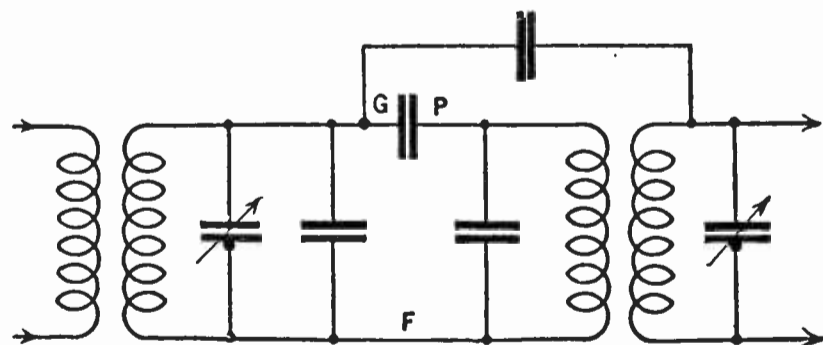

FIG. 3

The disadvantages of the above methods are that, particularly on short wavelengths, it is very difficult to maintain a balance when more than one stage of radio frequency amplification is used. This is due to stray capacities, which tend to upset the balance of the circuit. Oscillations then result. Difficulty of this sort is also brought about by the variation of grid-to-plate capacity of commercial tubes, which vary so much that

a balance obtained for one tube may not hold for another.

A NEW NEUTRALIZING SCHEME

THE method of nullifying the effect of the grid-to-plate capacity of three-electrode vacuum tubes described in this paper does not depend upon a capacity balance and is free from the disturbing effects described above. The method involves a resistance connected between the grid and plate of the tube as in Fig. 5.

The effect of this arrangement is to change the phase of the coupling current flowing between the input and output circuits, thereby reducing the energy transfer or feed-back between these circuits and causes the remaining energy to be absorbed as quickly as it is transferred or fed back. The value of resistance necessary to nullify the grid-to-plate coupling is dependent upon the design of the tube, as

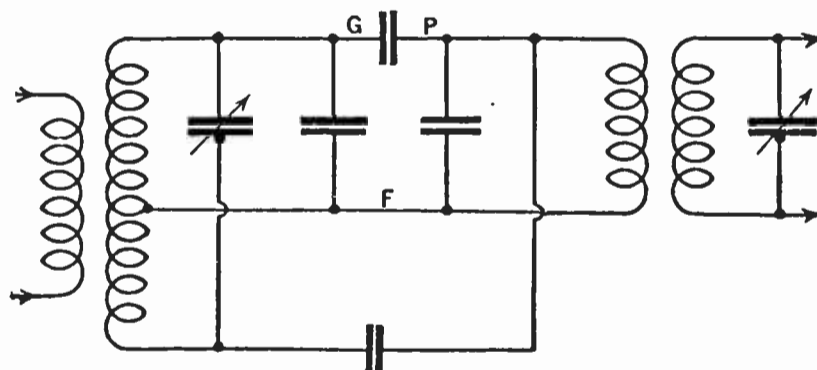

FIG. 4

well as the circuits. This resistance value is not critical. For the storage battery tubes now in commercial production, a resistance ranging between twenty-five and thirty-five thousand ohms gives satisfactory performance for multistage operation. The value for multistage operation is slightly lower as it is possible to take care of the stray overall coupling by a slight reduction of resistance. One hundred thousand ohms is a satisfactory value for the present dry cell tubes and may vary between ninety and one hundred and twenty thousand ohms.

The resistance should preferably be non-inductive and of low capacity. Present forms of conducting coated-paper resistances, and

carbon filament wound lavite resistances are satisfactory.

The circuit for a two-stage amplifier is shown in Fig. 6.

It will be noted that a condenser is inserted in series with the resistance between grid and plate to prevent the plate battery from flowing through it to filament. The con-

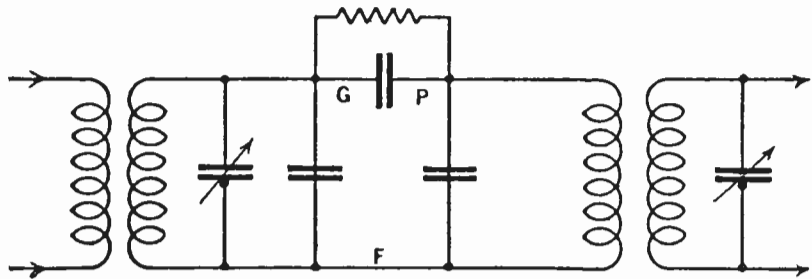

FIG. 5

denser is purely a blocking condenser and may range in value between one microfarad and one one-thousandth of a microfarad, and is only needed to permit the amplifier tubes to be operated from a common plate battery.

The transformer windings should preferably be tightly coupled, although this is not necessary as long as a suitable voltage ratio is maintained between primary and secondary. A suitable design consists of one hundred turns of No. 26 B & S gauge wire on a cylindrical tube, two inches in diameter and about two and three quarter inches in length. This is the secondary winding. The primary should be wound with about twenty-five turns of the same size wire on a concentric cylindrical tube of about one and three quarter inches in diameter. It is preferable to have the primary winding the same length as the secondary winding. This arrangement gives the tightest coupling, although the same result may be secured by using more primary turns and less coupling. This will be discussed more in detail later. The primary is, in practice, wound opposite to the secondary. That is to say, if the secondary is wound clockwise, the primary is wound counter-clockwise, or vice versa. The end of the primary winding directly under the grid end of the secondary should be connected to the plate battery. The other terminals follow as usual. The secondary tuning condenser should have a capacity of approximately two hundred and fifty micro-microfarads. The increase in intensity produced by each stage of radio frequency amplification as outlined above is nearly as much as that produced by each stage of audio frequency amplification. This is a very general statement but holds

fairly closely for radio stages up to three or four before the detector when compared one stage at a time with one and two stage of audio after the detector, although the voltage amplification of the radio stages were only about twelve each while the audio amplifiers gave approximately twenty per stage.

This indicates that while the detector characteristic is not linear it is far from a square law.

REGENERATIVE AMPLIFICATION IN THIS CIRCUIT

IN ADDITION to the radio frequency amplification of each stage, it is possible to obtain a regenerative amplification which is equivalent in increased volume to the addition of two audio stages on a signal of average intensity. Fig. 7 shows the circuit of a receiver consisting of three stages of radio frequency amplification, a detector and two audio stages.

The regeneration here shown is provided for by omitting the nullifying resistance of the third radio stage, and controlling the feed-back due to the tube coupling by means of a potentiometer on the grid of this same

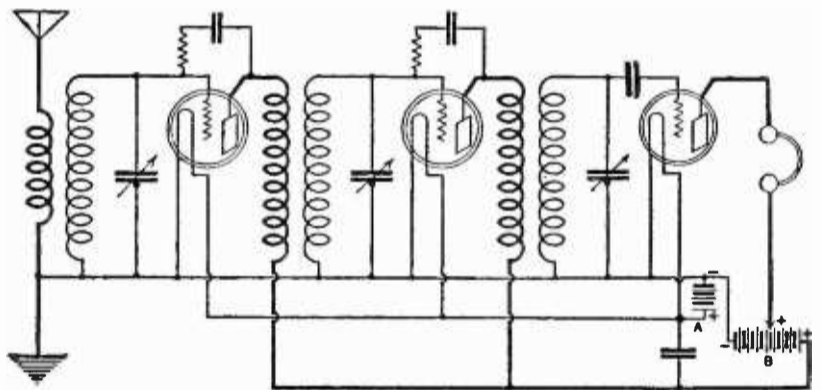

FIG. 6

tube. This gives very satisfactory operation. Equally satisfactory operation may be had by the use of a variometer in the plate of the detector tube in the usual manner. In this case the nullifying resistance must be used across the grid and plate of the third tube as well as across the first and second. In the use of three stages of radio frequency amplification without regeneration it is not necessary to take any particular precautions except to dispose the transformer windings at right angles and to use care to provide for short grid leads, and that the grid lead of one tube does not run close to the grid lead of another tube. If such precautions are not taken, the amplifier may regenerate and oscillate at the lower wavelengths. It will be found that when the regenerative feature is added to the amplifier or detector, better control of the regeneration will be obtained if the receiver

has first operated satisfactorily without regeneration. This means that the interstage coupling has been reduced to a minimum and that this provides for the localization and better control of the regeneration. In the operation of a receiver as outlined above using two or three stages of radio frequency amplification in addition to regeneration, the local oscillations produced during the adjustment of the regenerative amplifier or detector tube do not radiate from the antenna in any noticeable degree sufficient to cause interference with near-by receivers. As a typical example of this, a receiver has been operated on an outdoor antenna approximately forty feet from an adjacent antenna which is paralleled for approximately twenty feet. Both antennas were approximately forty feet high and had a total length of about one hundred and twenty five feet. The beat produced by the receiver was noticeable on the receiver of the adjacent antenna only on reception from stations nearly one thousand miles distant and then was not particularly objectionable.

Due to the low input impedance of the present commercially produced tubes and the consequently large damping effect produced thereby, the tuning of transformers is broader than would be anticipated. While objectionable in single-stage operation, the tuning sharpens considerably with the addition of several stages until very reasonable selectivity is obtained. It is also possible and extremely

practicable to tune the transformers by means of condensers on a common shaft as suggested by Hogan. (J. V. L. Hogan, United States Patent No. 1,014,002). This has been done very successfully with three stages of radio frequency amplification using an aperiodic antenna input by means of four condensers on a common shaft and with six stages of radio frequency amplification by means of eight condensers on a common shaft. In the latter case one condenser was used to tune the antenna separately which was loosely coupled to the amplifier input circuit. The condensers were electro-statically shielded from each other, and the tube coupling capacities were nullified by means of the resistances of values given above.

Additional improvements in selectivity have been made, which, unfortunately cannot be disclosed at the present time and will have to form the subject of a later paper. It might be mentioned that by these means, reception without regeneration of five hundred and nine-meter stations in Philadelphia, through a local four hundred and ninety two-meter station, is entirely practicable.

MEASUREMENTS OF AMPLIFICATION CONSTANT AND IMPEDANCE

A METHOD of measuring the voltage amplification of radio-frequency amplifiers during the writer's experiments became very desirable. After various methods were

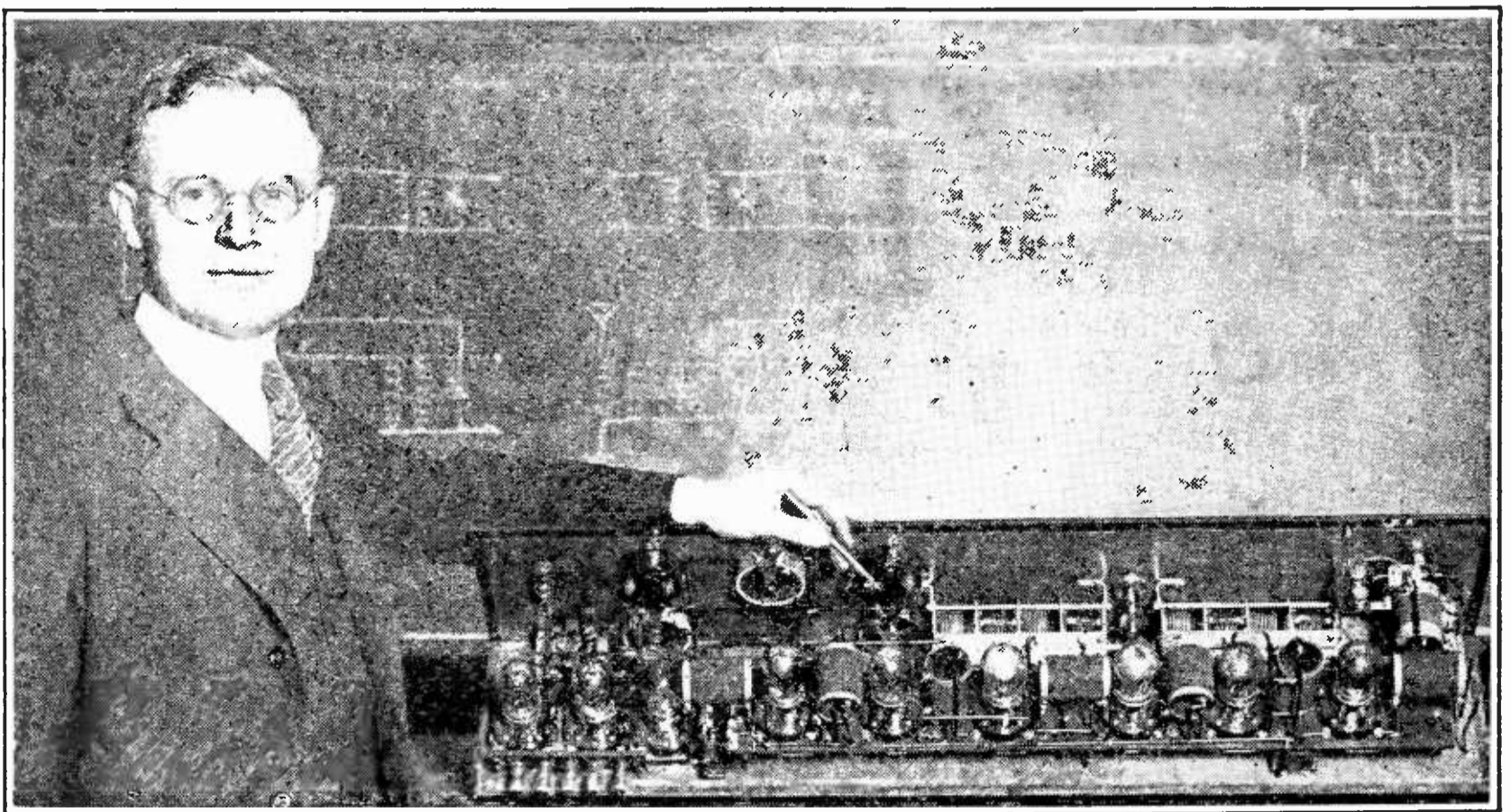

MR. FARRAND DEMONSTRATING HIS RECEIVER

Before a meeting of the Radio Club of America in New York. The entire back of the panel is shielded, as can be seen from the photograph. The condensers are all tuned by one knob which controls a gear arrangement. Nine tubes are used in this model

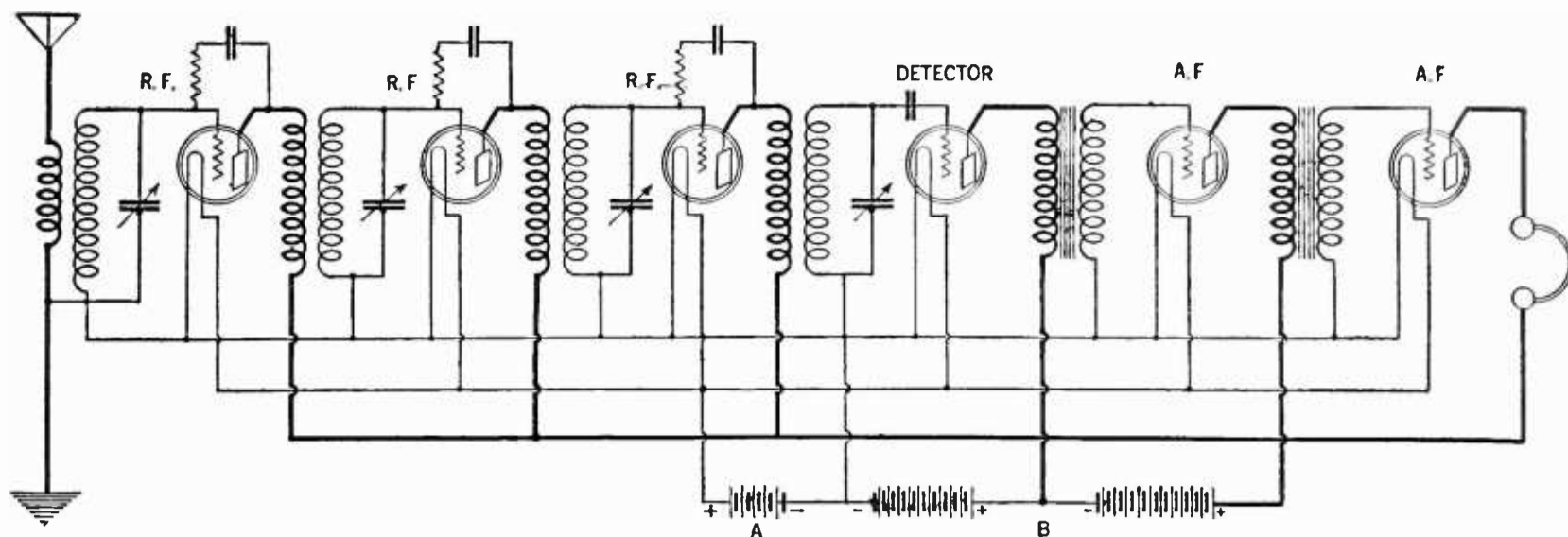

FIG. 7

considered and used, the peak volt-meter was selected as giving most promise. This method consisted in determining the actual voltages of the grids under working conditions by use of a three-electrode vacuum tube. The use of three-electrode tubes as volt meters is well known and has been described before.

The voltmeter was calibrated as follows: A UV-201A tube was used with approximately 67 volts on the plate and about 12 volts negative on the grid. The plate current was then normally about 10 micro-amperes. A known radio frequency voltage was applied to the grid and the grid negative voltage was increased until the plate current reached a known value which was the 10 micro-amperes. The increment of negative grid voltage was recorded. It was found that the tube would always reproduce these conditions with the same voltages. In this manner the voltmeter was calibrated in terms of increments of negative grid voltages vs. applied root mean square values. To save interpolation the measurements of impedance and voltage amplification were made with the same r.m.s. value of voltage applied to the voltmeter. This value was set at .5 volts and the input voltage of the preceding tube changed until this value was produced.

The following is a diagram of the voltmeter and circuit used for these measurements:

The capacity of the voltmeter is very small, since it is only the grid-to-filament capacity of the tube plus small lead capacity which would approximate 10 to 20 micro-microfarads. This capacity is connected in parallel to the tuning condenser and therefore does not affect the result. The impedance of the voltmeter can be considered as purely resistance in nature and very high, probably several megohms, as the grid has in excess of 10 volts negative applied.

MEASUREMENTS WITH THE VACUUM TUBE VOLTMETER

THE voltage amplification per stage is the voltage of the grid of the second tube divided by the voltage of the first tube. It was necessary to determine that the impedance of the plate circuit of the second tube would not affect the impedance of its grid, as in multistage operation the plate circuit of the second tube would be tuned by a transformer to supply the grid of the succeeding tube, and if this high impedance caused by the plate tuning of the second tube affected its grid to filament impedance, the measurement as outlined would not hold. Non-inductive resistances of 10,000 ohms were inserted in the plate circuit and the plate voltage was maintained constant by adding sufficient battery to take care of the resistance drop, and at radio frequencies this was found to affect the input impedance of the grid very considerably. This corresponded somewhat to the results obtained by Weinberger. (J. Weinberger, *Proc. I. R. E.*, page 584, sec. 1919.) It was thought that this change of impedance might be due solely to capacity coupling of the tube causing feed-back action, therefore the applied frequency was reduced to 1000 cycles and it was found that at this frequency, the grid-to-filament impedance was independent of the plate load impedance. It followed, therefore, that any influence of the plate load on the grid impedance was due to regeneration and would disappear when the regeneration was nullified.

The measurements of voltage ratio by this method would hold and give the true radio frequency amplification without feed-back as long as the amplifier was non-regenerative.

The voltage ratio was determined for a tuned radio-frequency transformer as shown in the Figure and the radio frequency ampli-

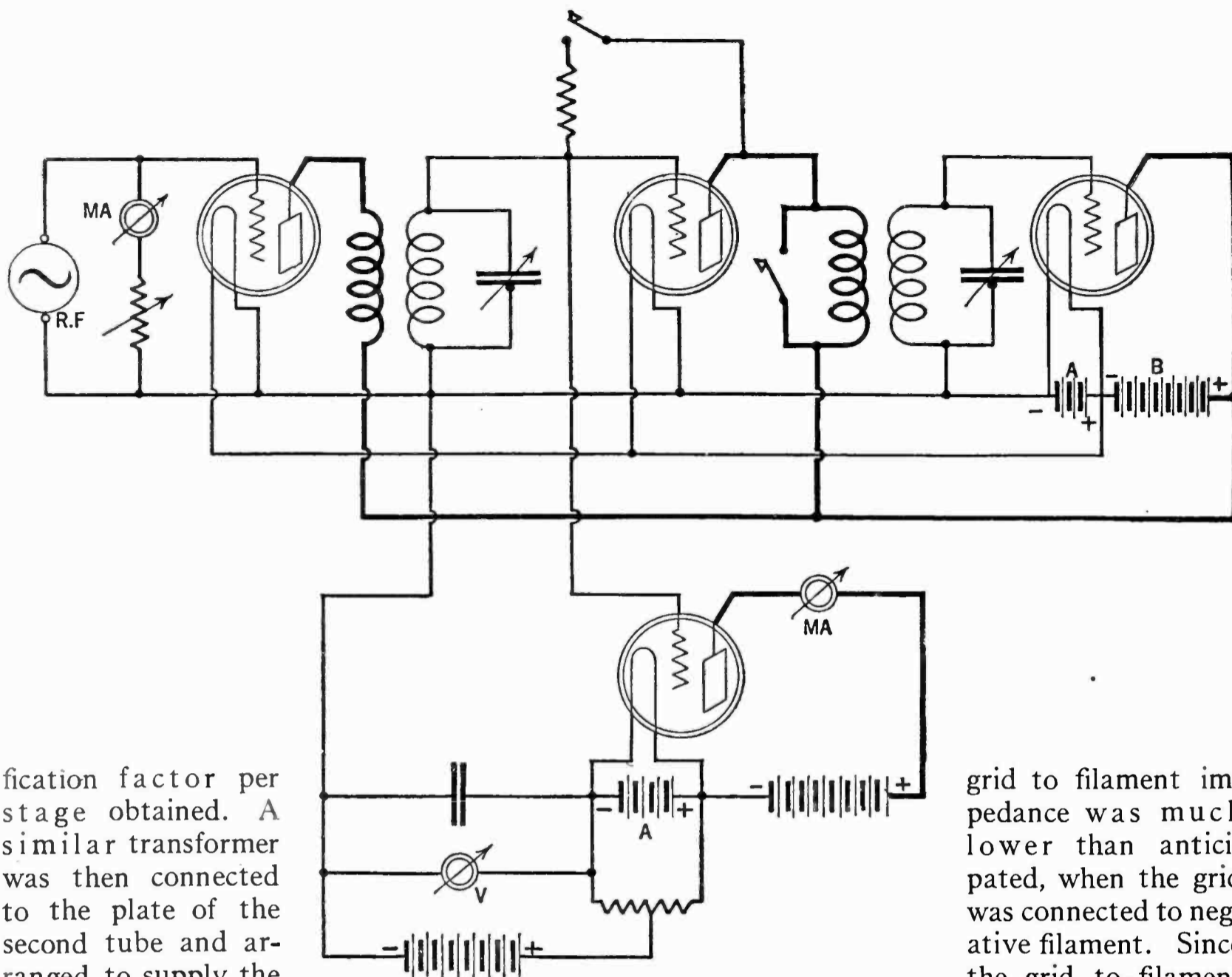

FIG. 8

fication factor per stage obtained. A similar transformer was then connected to the plate of the second tube and arranged to supply the grid-to-filament circuit of a third tube

which was connected as the second tube had been in the first case. The voltage on the grid of the second tube was found to be decidedly higher due to feed-back action. A nullifying resistance was then connected from grid to plate of the second tube and adjusted until the voltage of its grid equalled the original voltage as given when the output of the plate was shorted by switch "S." The resistance had then nullified the feed-back action due to the natural capacity between the grid and plate of the tube and the voltage amplification obtained was the original non-regenerative radio frequency amplification. The value of nullifying resistance thus obtained was found to be between 30,000 and 50,000 ohms for UV-201A tubes and between 80,000 and 120,000 ohms for UV-199 and WD-11 tubes. The values of resistance approximate the capacity coupling reactance of the tubes, i. e., the grid to plate capacity in ohms at the operating frequency.

IMPEDANCE VALUES OF COMMERCIAL TUBES

THE maximum voltage amplification determined and the turn ratios for maximum amplification lead to the conclusion that the

grid to filament impedance was much lower than anticipated, when the grid was connected to negative filament. Since the grid to-filament impedance was always shunted with a

secondary tuning condenser, it could be considered as purely resistance in nature. It was decided to determine this impedance value for commercial tubes. The peak voltmeter method was very well suited to this measurement as it was only necessary to substitute a known non-inductive resistance for the tube, retune to compensate for the reduction of capacity of the grid-to-filament and adjust the resistance until the voltage of the grid of the second tube was at its original value. The resistance thus determined was then equal to the resistance of the grid-to-filament path of the tube. These values for UV-201A tubes with grid connected to negative filament were found to be between 120,000 and 150,000 ohms with 130,000 ohms as a fair average. This accounted for the broadness of tuning of non-regenerative radio-frequency amplifiers, as with a circuit using a condenser of 250 micro-microfarads maximum, for the broadcasting range, the condenser reactance at 400 meters is approximately 1800 ohms and the effect of 130,000 ohms in shunt to such a circuit is the same as if approximately 25 ohms had been inserted in series with the condenser and inductance, and consequently produces very large damping.

How to Build Radio Broadcast's Phonograph Receiver

By ARTHUR H. LYNCH

IN THE June RADIO BROADCAST we described a receiver which has been designed to fit in any phonograph. This article, the second of the series describing this receiver, deals with the actual construction of the apparatus and indicates by illustrations what has been done in RADIO BROADCAST'S Laboratory to apply this unit to a number of phonographs.

It may be seen from the illustrations accompanying this article, that it is not necessary to use one specified unit in building this receiver. For example, any good audio transformer will function satisfactorily in the reflex stage, and any good push-pull transformer will work in the amplifier arrangement. In the diagrams shown in Figures 23-A and B, the panel and sub-base arrangements have been designed to accommodate practically any .0005 mfd. condenser, and almost any tube sockets and other units which make up the assemblage.

RADIO BROADCAST'S Phonograph Receiver has not been designed to satisfy the demand for the ultimate in radio reception. It will, however, bring in excellent quality with very good volume and at the same time cover a

very reasonable wavelength range. With a similar set operated here on Long Island during the month of April, and using but two tubes, the following log was made in one hour and twenty minutes:

DIAL SETTINGS

12-12
15-15
19-19
21-21
22-22
28-28
31-31
32-32
34-34
39-39
41-41
42-42
45-45
46-46
49-49
52-52
57-57
60-60
62-62
64-64
69-69
80-80

CALL LETTERS

WCAD
WEAN
WTAS, WPG
KDKA
WGBS
WLS
CFCA
WHN
WGN
WTAM
WLIT
WOR
CHYC
PWX
WLW
WOS
WJZ
WCAE
WCAP
WEEI
WEAF
WNYC

When this log was made, the set was tuned with but two controls. The rheostat and

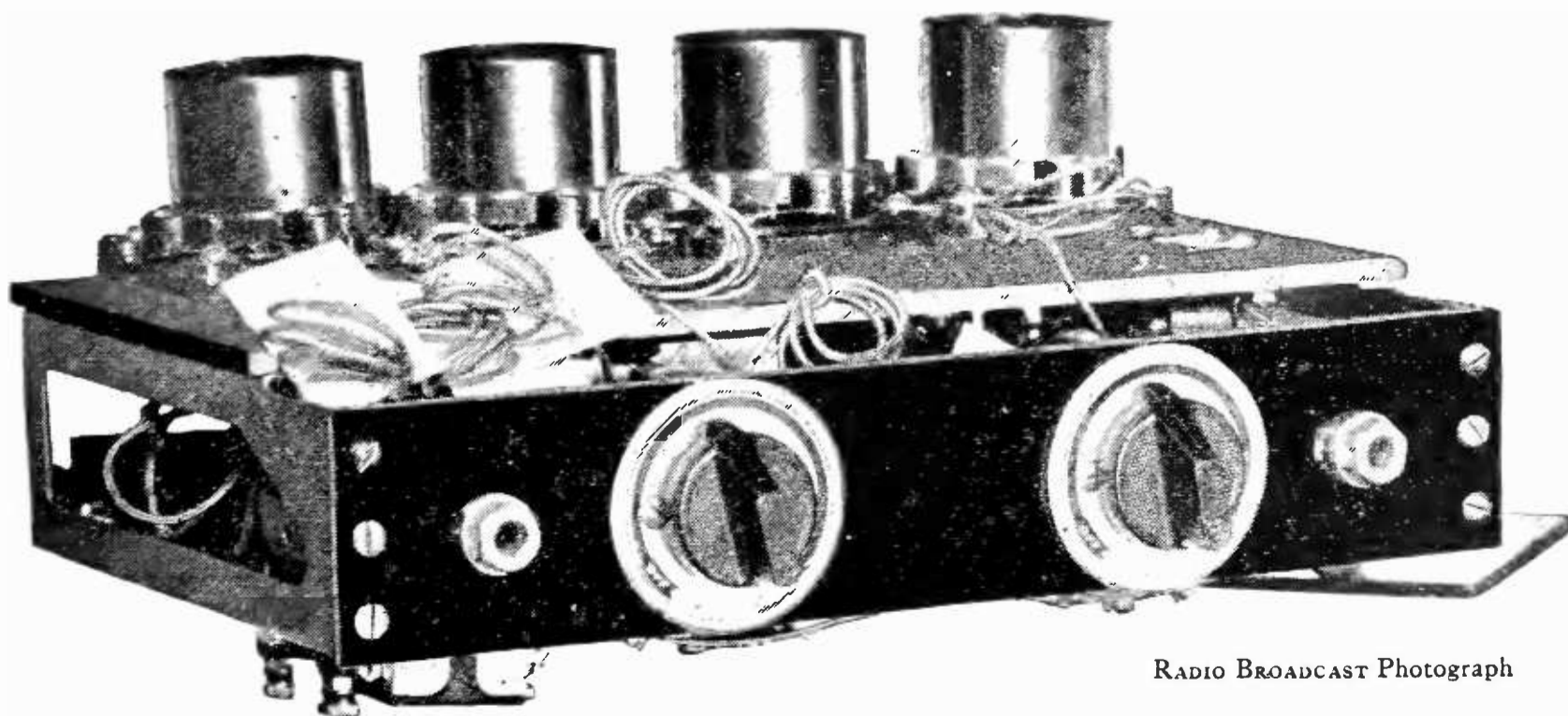

RADIO BROADCAST Photograph

FIG. 1. SUB-PANEL ASSEMBLY

The photograph illustrates how the rheostat panel and tube sockets are mounted upon the brackets. All connecting leads to the main panel are temporarily coiled and labeled until this assembly is ready for further use. This is the "Robert-Unit" made by the Radio Research Laboratories

tickler controls were not used. It will be noted that the positions of the two dials throughout this log coincide over the entire broadcast range.

HOW TO ASSEMBLE AND WIRE THE SUB-PANEL

BEFORE drilling holes in the sub-panel for mounting the various units it must hold, it is advisable to place the sub-panel itself upon the brackets which are going to support it on the main panel. Then place

the tube sockets in their proper places and if necessary, secure them with a few pieces of string. Then turn the sub-panel upside down and mark off the positions to be occupied by the transformers, but make certain that there is plenty of space surrounding each unit to permit the wiring to be done easily.

It is good practise to do as much wiring on the sub-panel as possible before permanently attaching it to the panel as shown in Fig. 1.

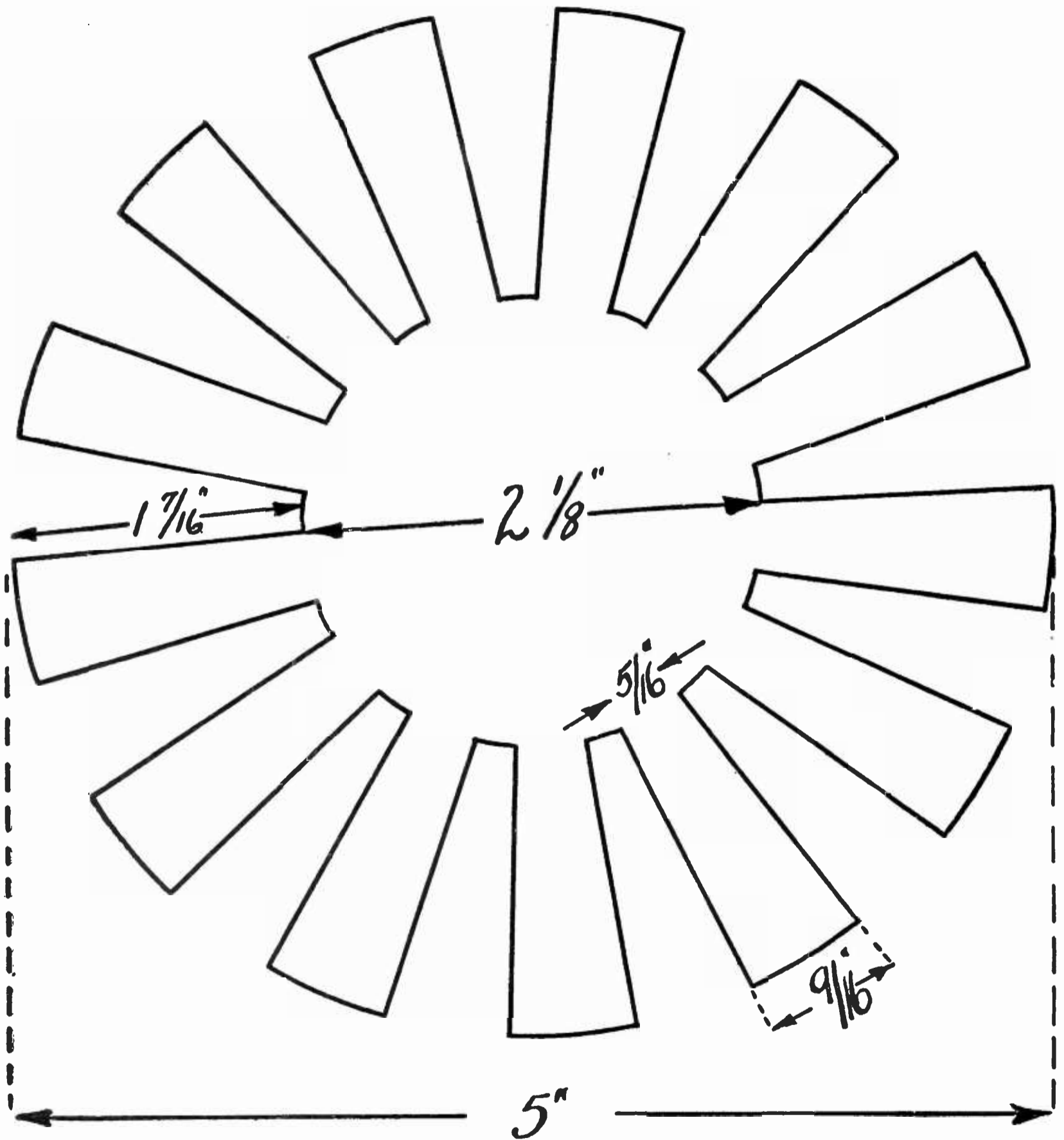
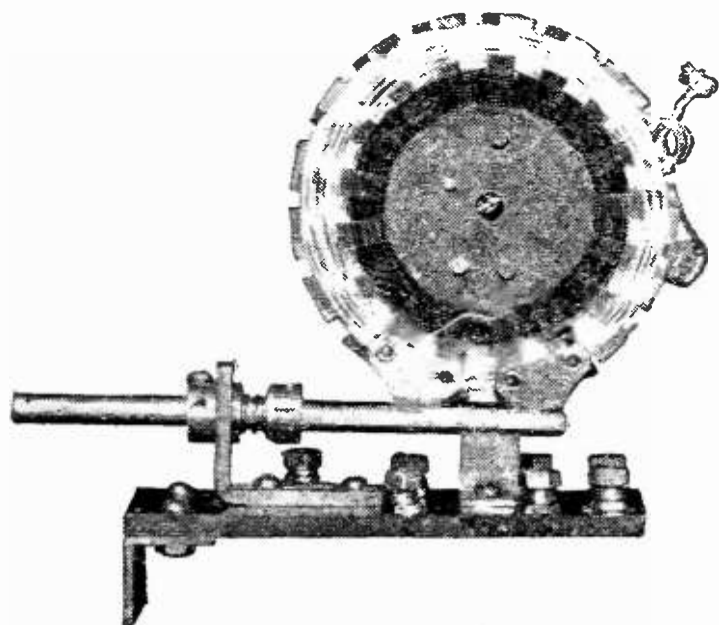

FIG. 2. A TEMPLATE FOR THE SPIDER WEB COILS

Exact size. The windings for these coils, as used in various parts of the Roberts circuit and indicated by the letters are as follows: A (antenna coil): 40 turns No. 22 dcc wire tapped 1-2-5-10-20-30-40; S1: 44 turns No. 22 dcc wire; N: 20 turns No. 26 dcc wire; P: 20 turns No. 26 dcc wire (two wires of N and P are wound parallel as a pair); S2: 44 turns No. 22 dcc wire; T: 18 turns No. 22 dcc wire. Coils A, S1, S2 and T are each individually wound under two and over two spokes of the form. The NP coil is wound under one and over one spoke



RADIO BROADCAST Photograph

FIG. 3A-B. A HOME MADE COIL UNIT

Constructed from odds and ends around the laboratory. The binding posts to which flexible leads from the coils are attached are mounted on bakelite supports. Coupling between the primary and secondary is obtained by loosening the hexagon nuts and shifting the position of the primary coil

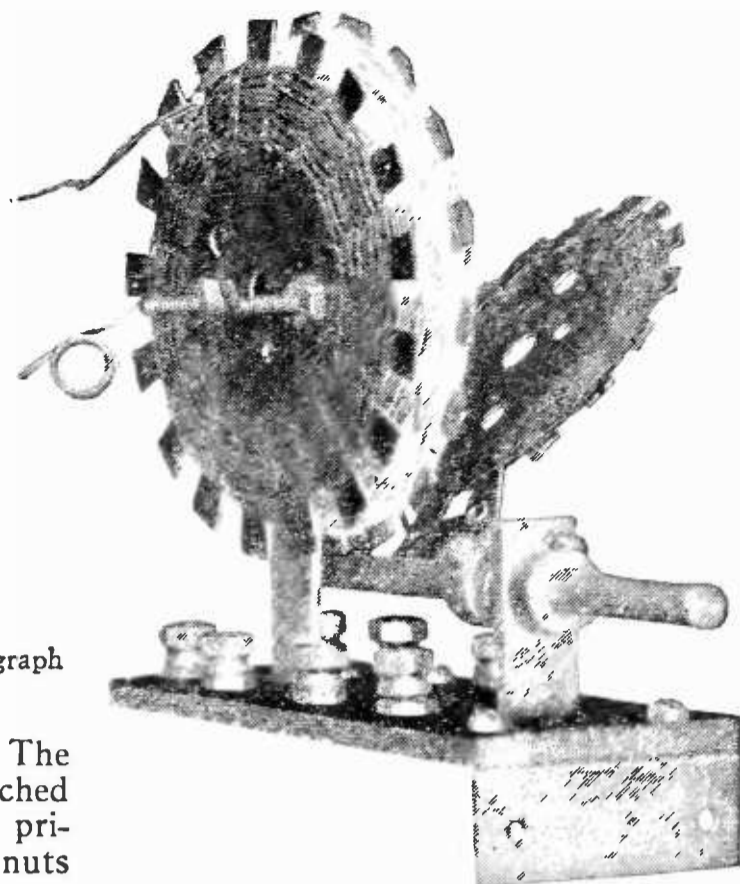

THE PANEL

IN ARRANGING the units on the panel the layouts in Figs. 21-A and B will be found very helpful. Then, too, it is good practise to wire as much of the panel as possible before the sub-panel is attached. If this plan is followed the balance of the wiring will be brought to

a minimum and the attendant work will be much simplified.

HOME-MADE COILS

ONE of the simplest forms of coil for home construction and which may be used in this receiver is the spider-web coil. The form dimensions are given in Fig. 2. The various wire sizes, and the number of turns to be wound on each coil are indicated in the caption of Fig. 2 on page 394.

A simple and good method of mounting and coupling home made coils has been designed by John B. Brennan, Technical Editor of RADIO BROADCAST. This system is illustrated in Fig. 3A-B.

ANTENNA SWITCH

IN ORDER to compensate for the use of antennas of various lengths, a switch is placed in the antenna circuit to alter the



RADIO BROADCAST Photograph

FIG. 4. THE TAP SWITCH

The antenna coil sections may be included in the primary circuit by means of this switch which is mounted upon a piece of bakelite supported within the coil unit as shown above. This is a control which need not be varied once the correct adjustment has been obtained. Therefore, it is not necessary to mount the switch upon the panel proper

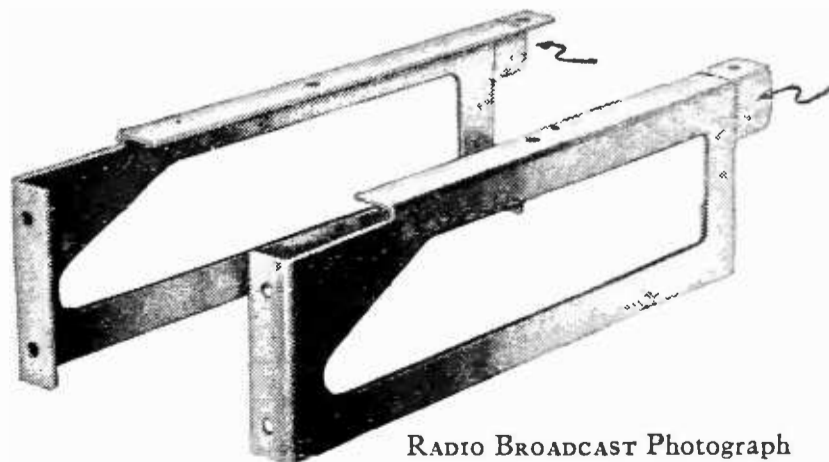

RADIO BROADCAST Photograph

FIG. 5. THE BRACKETS

For supporting the sub-panel upon which is mounted the transformer, etc. The arrows indicate the points at which the projected parts of the brackets are removed

number of turns in the primary of the antenna coupler. By the proper adjustment of this switch, the two main control dials, the antenna and the radio-frequency tuning dials, will be found to read approximately the same for given stations within the tuning range. This feature is particularly valuable when the receiver is used by an inexperienced person. In order to make the layout of our phonograph model more symmetrical we have placed this switch behind the panel as shown in Fig. 4. When the receiver has been completed it should be tested before it is placed in its cabinet and the proper setting for the antenna switch should be determined.

RUBBER BUSHINGS

WHERE cushion sockets are not used, sponge rubber, which may be procured from many dealers, or from several radio mail order houses or rubber companies, is ideal for

FIG. 6. THE BUSHINGS

Note that the sub-panel is raised up from the brackets by means of the knurled nuts taken from the socket terminals and which are used as bushings. This is necessary so that the bottom of the audio reflex transformer—mounted out of sight in this photograph at the far end of the sub-panel—does not project beyond the bottom of the panel

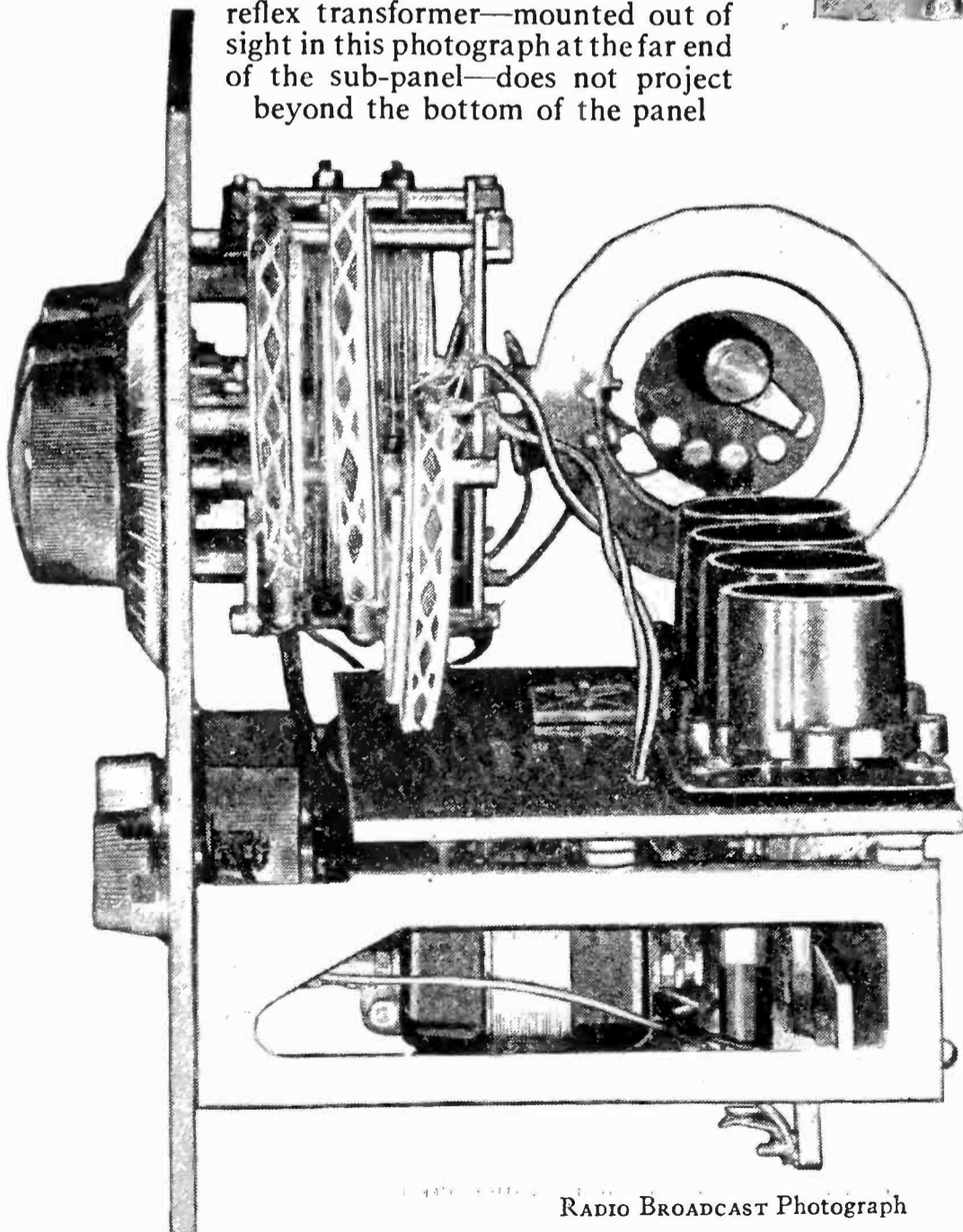

RADIO BROADCAST Photograph

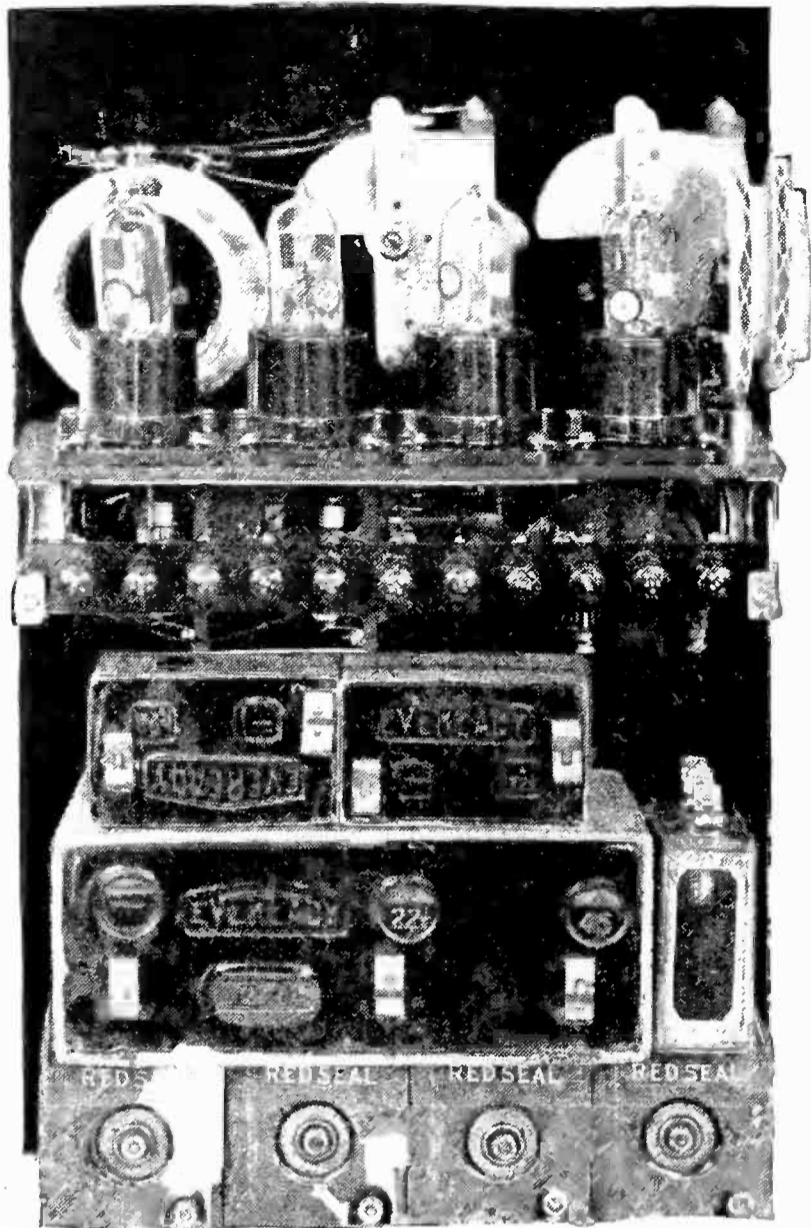

RADIO BROADCAST Photograph

FIG. 7. THE BATTERIES

Are here shown stacked up to fit underneath the sub-panel. This receiver may be used as a portable outfit. $1\frac{1}{2}$ -volt dry cell tubes are used

cushioning the tubes to prevent microphonic noises which are sometimes noticed where rigid construction is used. Flexible wiring is employed between the main and the sub-panels. This is necessary to insure the success of the cushioning. An ideal system for applying bushings of this kind is shown in Fig. 6.

TUBE IRREGULARITIES

TUBES, particularly those which have been in use for some time, are often found to be anything but uniform in performance. A tube which may do very well as a radio or audio amplifier may not function properly as a detector and vice versa. Therefore, the tubes must be tried in various positions until the best combination is found.

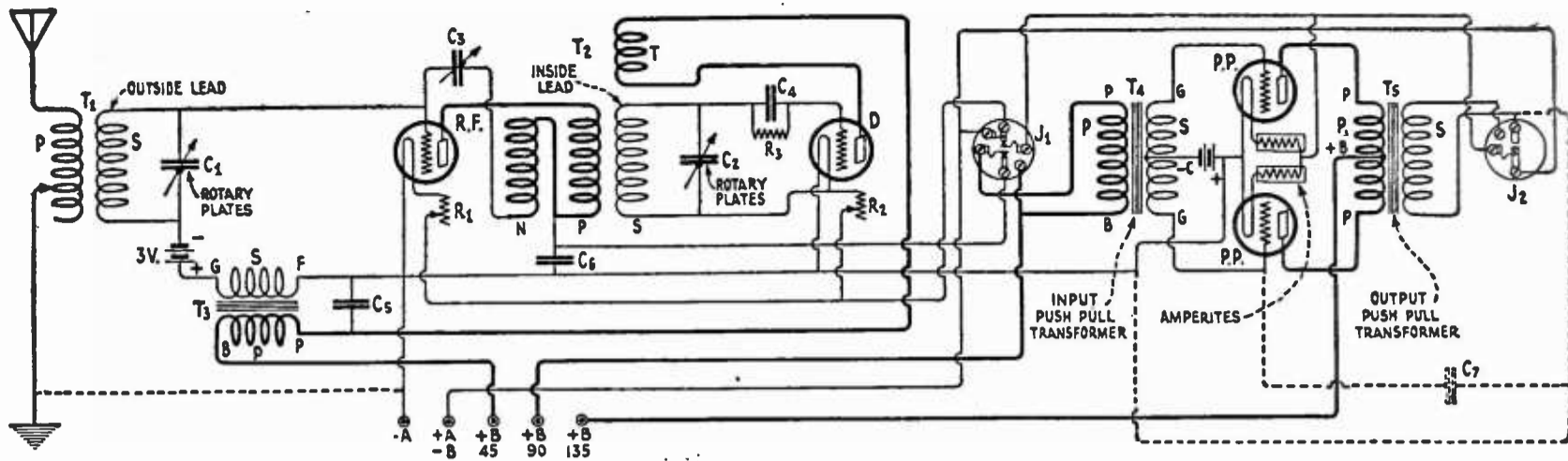

FIG. 8. THE WIRING ARRANGEMENT

From this circuit it will be seen that the push-pull amplifier circuit differs from the original four-tube hook-up. The balance of the circuit, however, remains the same. In this illustration Amperites have been substituted for the rheostat controlling the two push-pull tubes. Also a condenser C7 has been added in the circuit. This condenser will effectively prevent the amplifying transformer from singing

ABOUT PLATE AND GRID VOLTAGES

THE plate voltage on the radio and audio-amplifier tubes is not critical and for practical purposes in the home we have found 90 volts to be ideal. It is unnecessary, unless great volume is required, to use more than 90

volts in any part of the circuit, and it has been found that a jumper between the two last terminals on the binding post strip, as indicated by the dotted line in Fig. 10-A, serves to

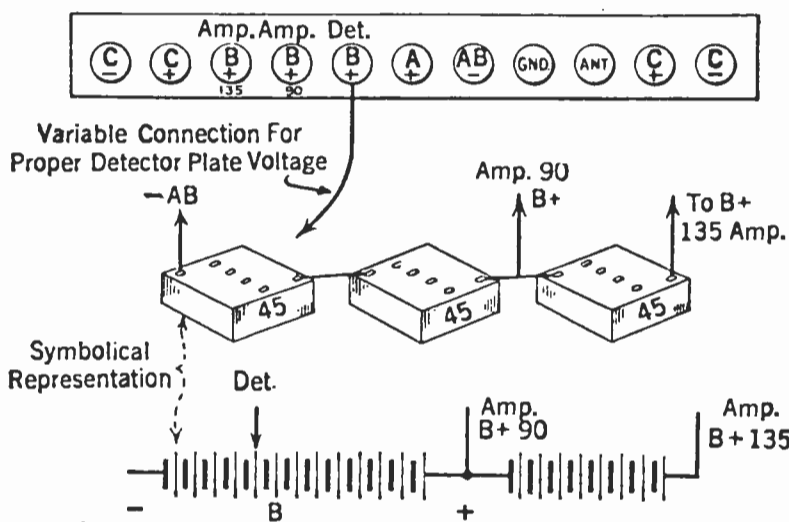
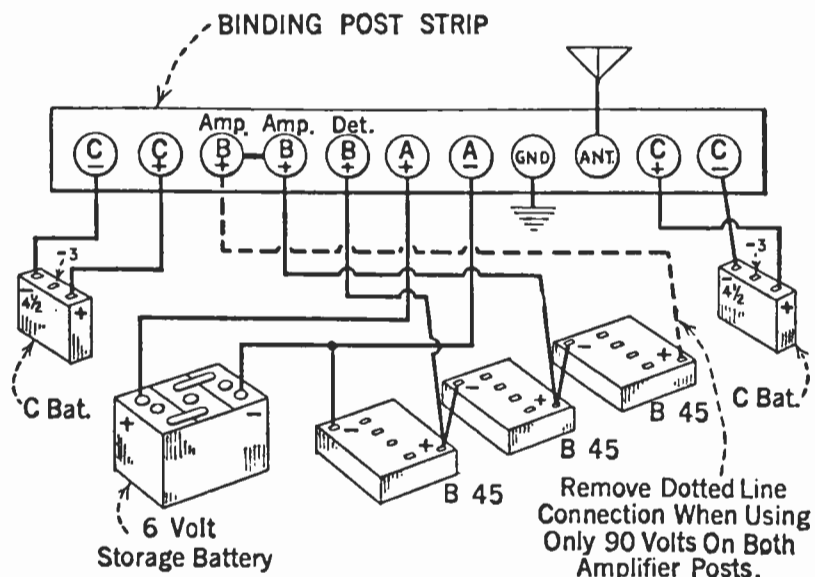

FIG. 9. TESTING PLATE VOLTAGE

When it is desired to use but 90 volts upon the amplifier tubes the connections to the B batteries must be changed as shown in Fig. 10-A. The connection represented by the dotted line is removed and a jumper connection is fastened between the amplifier B plus binding posts. Fig. 10-B shows the connections when the full 135 volts are used

For some detector tubes it is necessary to employ a definite plate voltage which must be ascertained by actual test. The pointed lead attached to the B plus binding post may be touched upon the several taps of the first 45 volt B Battery until the desired value of plate voltage is obtained

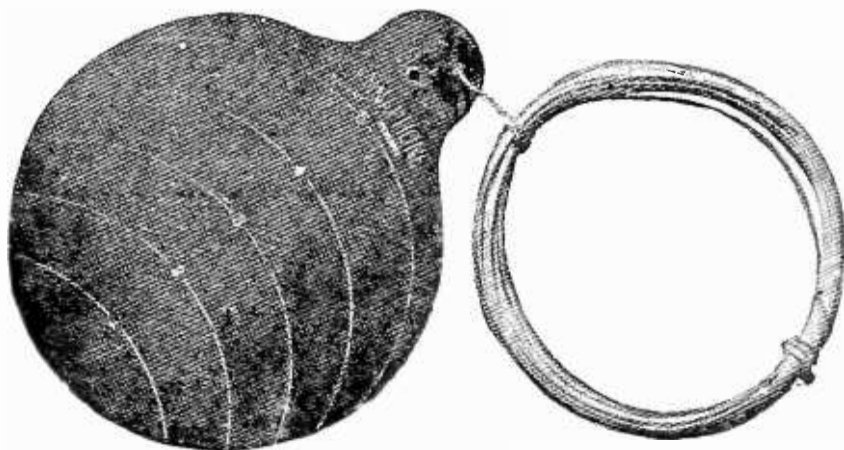
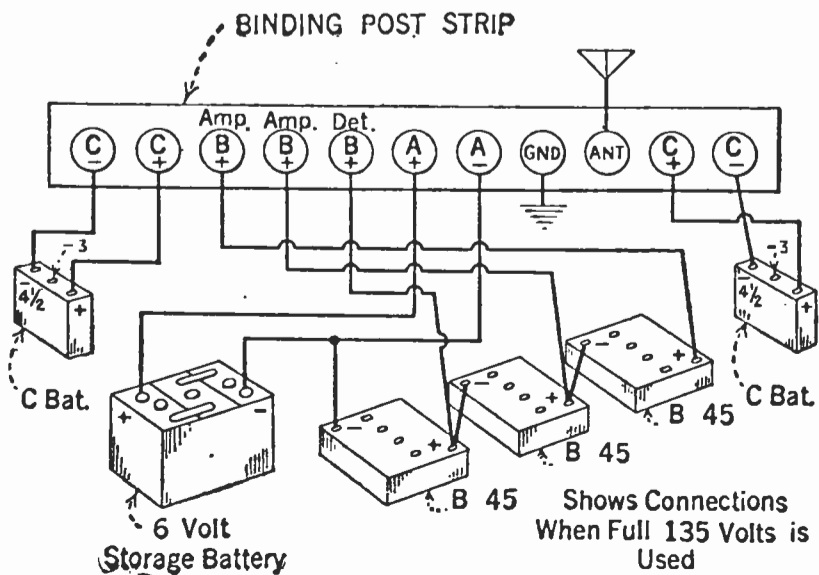
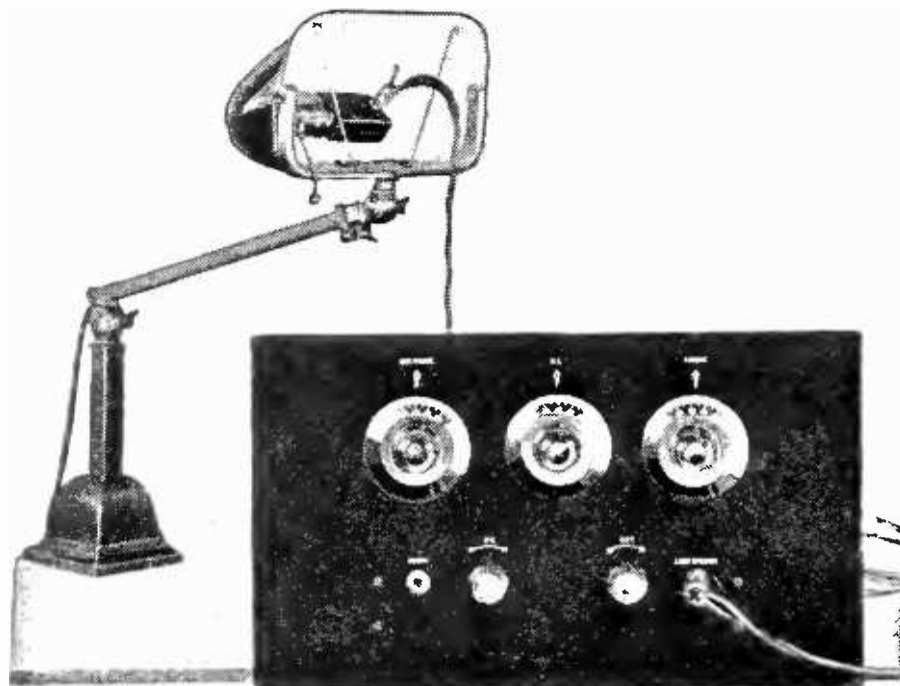

FIG. 11. ANTENNA SUBSTITUTE

For an outside antenna called the Antennaphone. It is only necessary to place a metal disc under a desk telephone to obtain an antenna installation. The disc is then connected to the antenna binding post on the receiver. Wire is supplied for this purpose



RADIO BROADCAST Photograph

FIG. 12. ANOTHER ANTENNA SUBSTITUTE

This unit is merely plugged in to any electric light lamp socket. Several methods of use are shown in Fig. 13

bring this voltage into play on all tubes but the detector.

Caution: When using the jumper between the terminals in the diagrams marked minus 90 and minus 135, as indicated by the dotted lines, make sure that the 135-volt connection to the B battery is taken off. Otherwise the

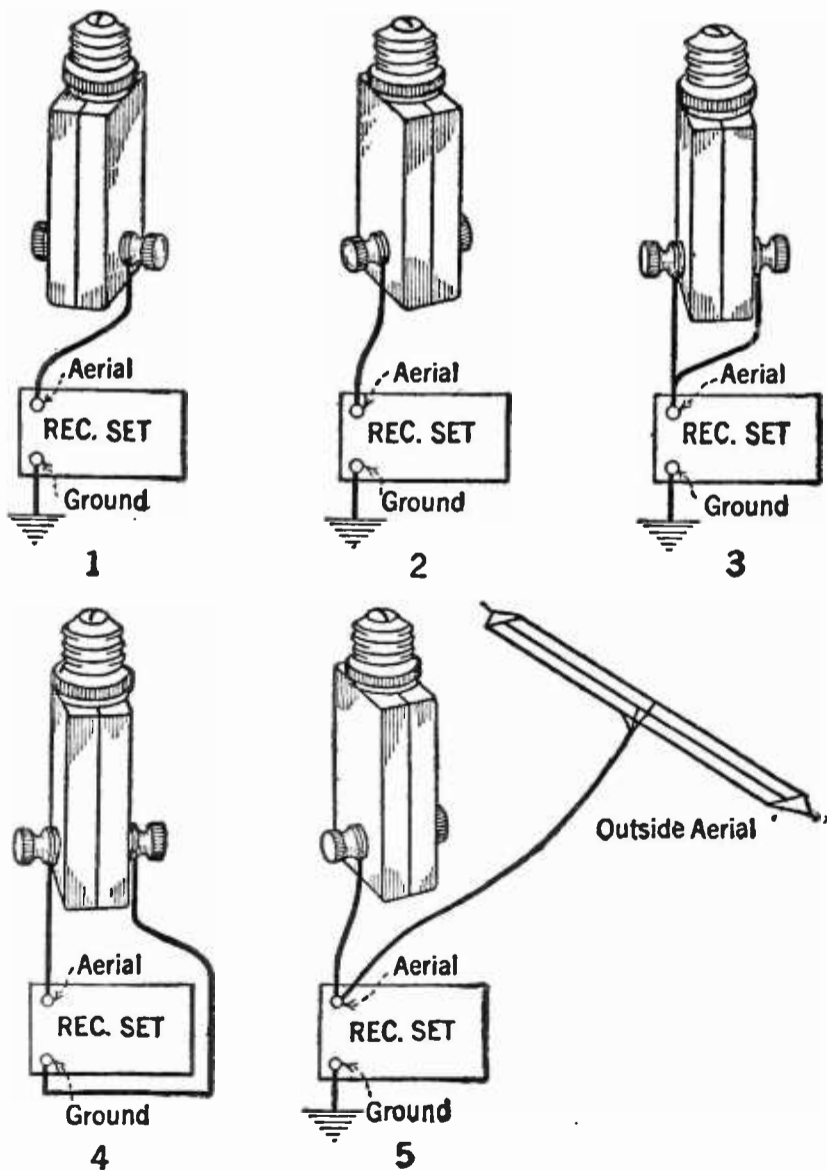

FIG. 13

The several ways in which the Ducon lamp-socket antenna may be connected to the receiver



RADIO BROADCAST Photograph

FIG. 14. AN ELABORATE PIECE OF RADIO FURNITURE

A Jewett Highboy loud speaker-radio cabinet in which has been combined a loud speaker, a battery cabinet and receiver housing. The sliding doors have been so arranged that any standard-sized receiver may be fitted within the housing. There is still ample room for the installation of a home-made or portable phonograph

last section of the battery will be ruined. This is also shown in Fig. 10-A.

The regeneration of volume of this receiver must be controlled smoothly, and we have found that much depends on the type of detector tube used. The 45 volts indicated in the diagrams is a very flexible standard, and various voltages from 8 to 90 have been employed successfully with various tubes. The detector connection in Fig. 9 is therefore variable.

CENTER HOLES ONLY

TEMPLATES for drilling accompany all modern parts, and to avoid giving the impression that particular units must be employed, we have merely indicated the center holes for condensers, coils, rheostats, jacks, and the filament switch mounting in the panel-layouts.

MAKING A PORTABLE OF THE RADIO BROADCAST PHONOGRAPH RECEIVER

IN FIG. 7, we illustrate a receiver which was made to fit in a console phonograph. By removing the entire unit from the console



RADIO BROADCAST Photograph

FIG. 15. A STANDARD FORM OF RADIO-PHONOGRAPH

In this cabinet, manufactured by the Sonora Phonograph Company, has been built a Roberts four-tube receiver. The compartment underneath the receiver contains all the necessary batteries for its operation

and placing it in a wooden carrying case, or other container, and using dry cell tubes we have an ideal portable for use on automobile trips, boat rides, and other summer activities.

FIG. 16

The rear view of the Sonora cabinet illustrating the ample space which has been provided for the installation of even larger types of storage B battery. The removable back-panel is shown at the right of the main cabinet

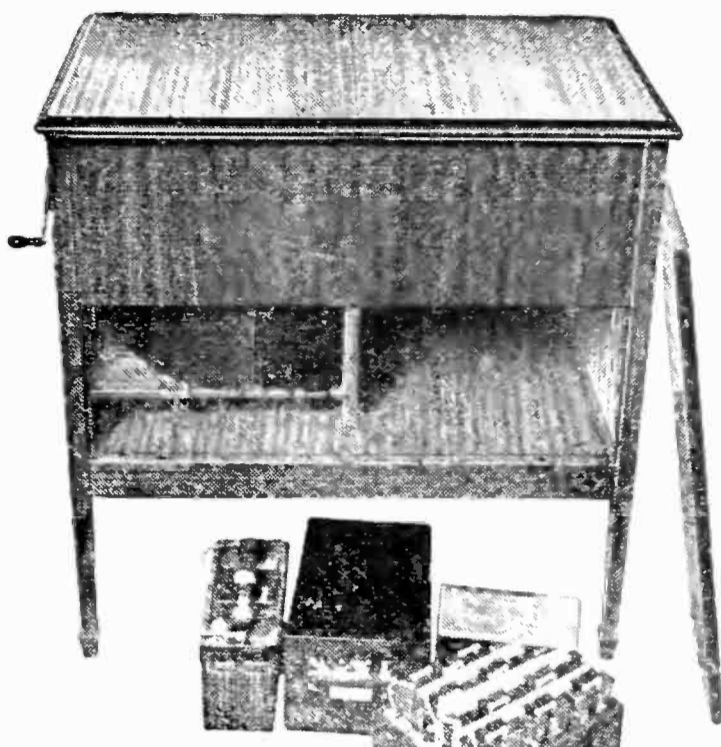

RADIO BROADCAST Photograph

For use of this sort we have found that WD-12 tubes are very satisfactory and that either three or four standard dry cells connected in parallel work very nicely. If the receiver is not to be used as a portable for more than a few weeks, three dry cells will suffice, but for periods longer than a month

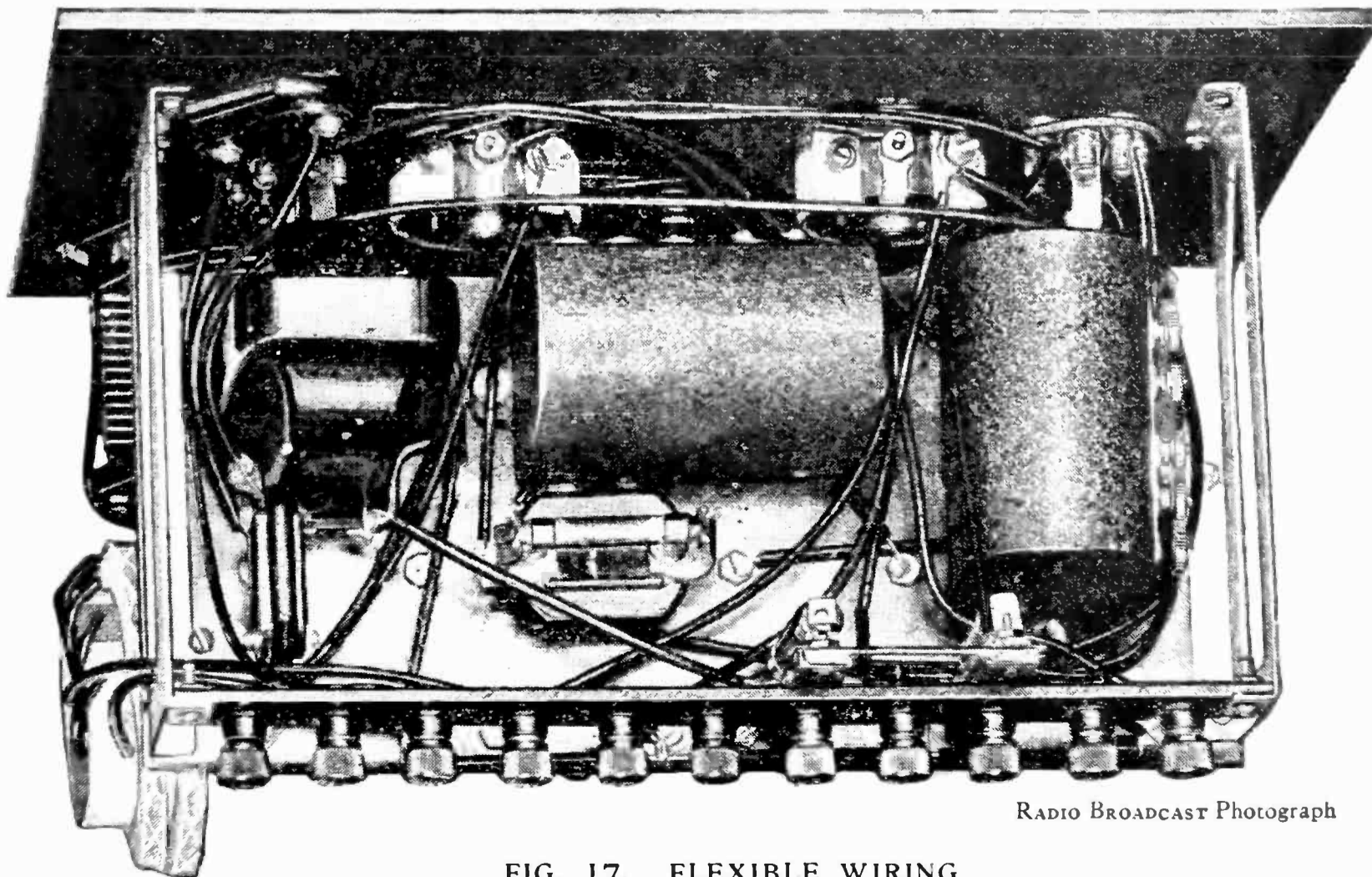

RADIO BROADCAST Photograph

FIG. 17. FLEXIBLE WIRING

A receiver employing the new type of Como push-pull amplifying transformers. It will be seen from the photograph that direct wiring has been employed to connect the various units

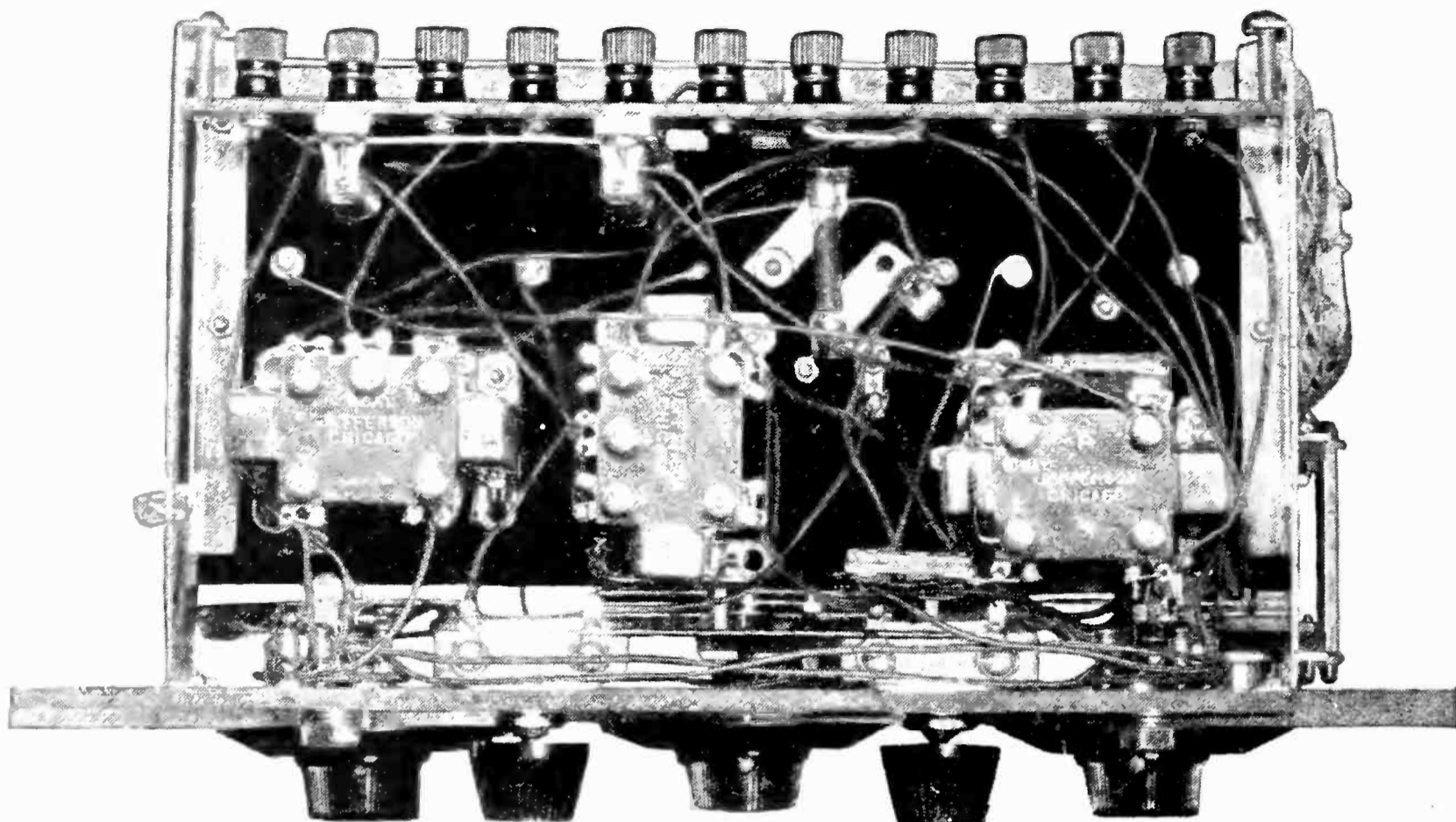

RADIO BROADCAST Photograph

FIG. 18. THE SUB-PANEL

Another view of the bottom of the sub-panel illustrating the use of Jefferson push-pull transformers. The same make of audio transformer has been employed for the audio-reflex stage

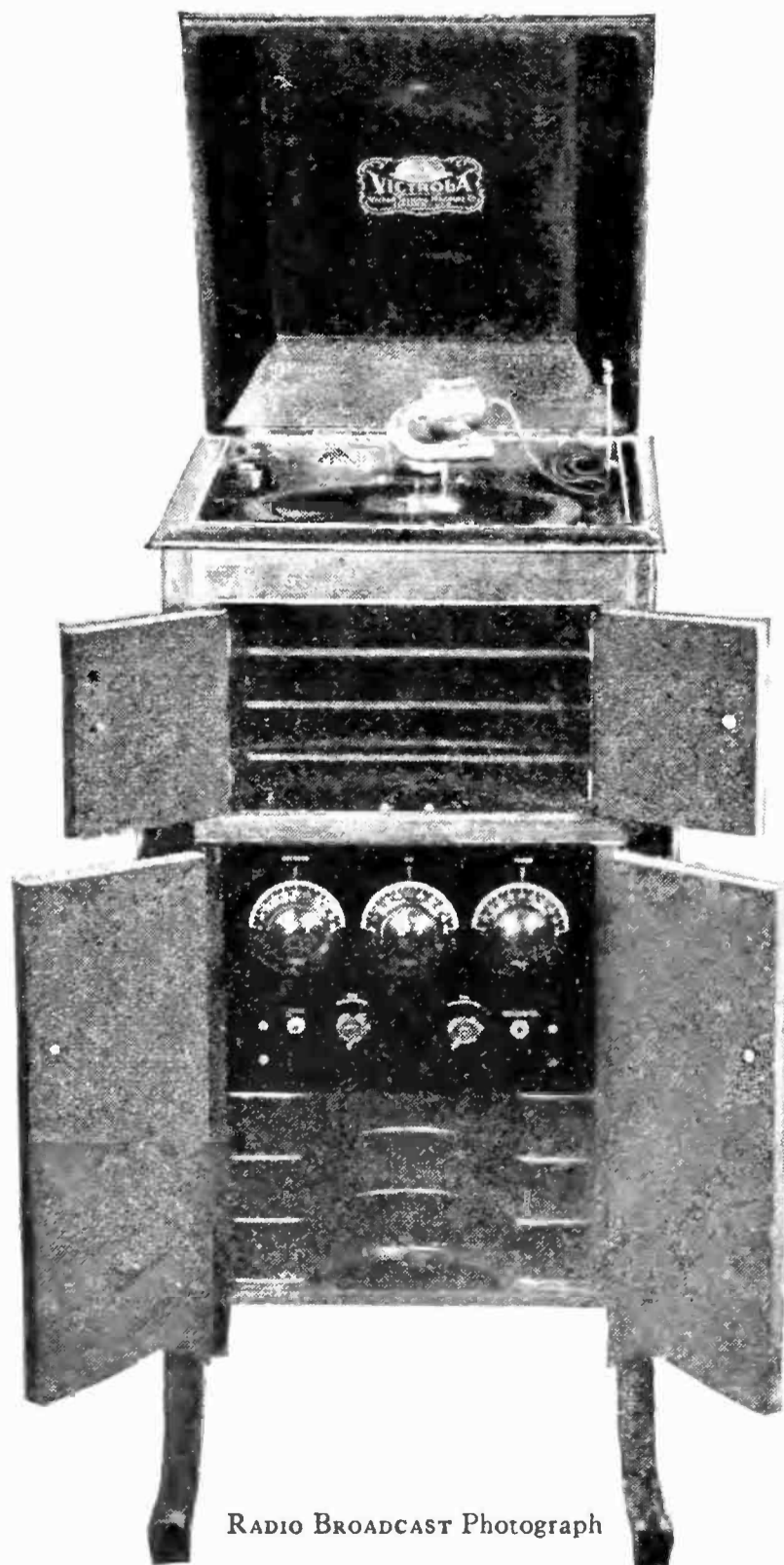

RADIO BROADCAST Photograph

we recommend the use of four cells. The connections are shown in Fig. 10-B. The plate current drain with dry cell tubes is very low and for this reason the very small B batteries may be used. When operating the receiver about two hours a day, these batteries will last a month or more. There is room enough for the sky-scraper type, however, and they will last much longer and are more worthwhile where weight is not the primary consideration.

THE SUMMER TIME ANTENNA

THERE are many methods for the provision of antenna for use with this receiver in the open. No doubt there is a good market for an antenna made in the form of a reel, similar to a fishing reel. Several antenna reels have been brought to us in an unfinished condition, but we know of none now on the market. This type of radio specialty offers a very attractive field, and we believe that the

FIG. 19. IN PLACE OF RECORDS

Here is illustrated a method of mounting the RADIO BROADCAST Phonograph receiver unit in that part of a Victrola cabinet ordinarily used for the storage of phonograph records. Several shelves have been removed to make room for the unit and some shelves for records still remain. A loud speaker unit has been mounted on the tone arm thereby making use of the Victrola sound box mounted within the cabinet

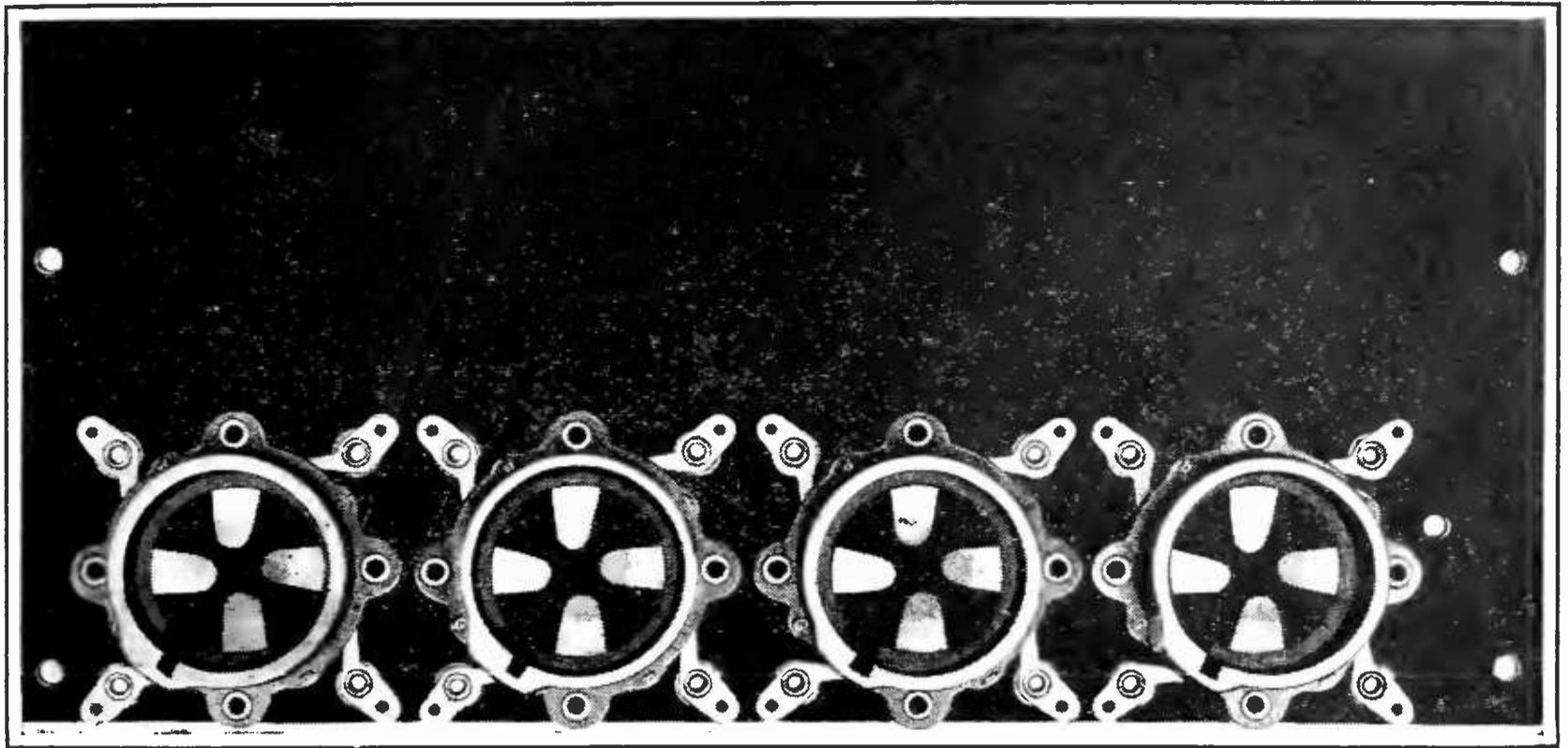

RADIO BROADCAST Photograph

FIG. 20. THE CUSHION SOCKETS

The photograph illustrates how the Benjamin spring cushion sockets may be mounted directly on the sub-panel. A manufactured unit of this type is being marketed by the Benjamin Company

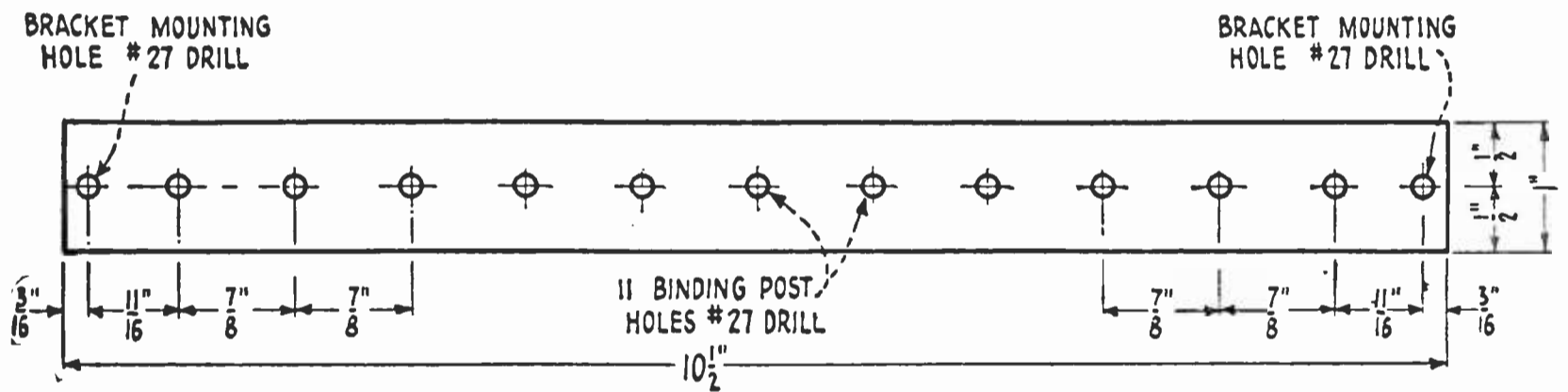

FIG. 21. THE BAKELITE BINDING POST LAYOUT

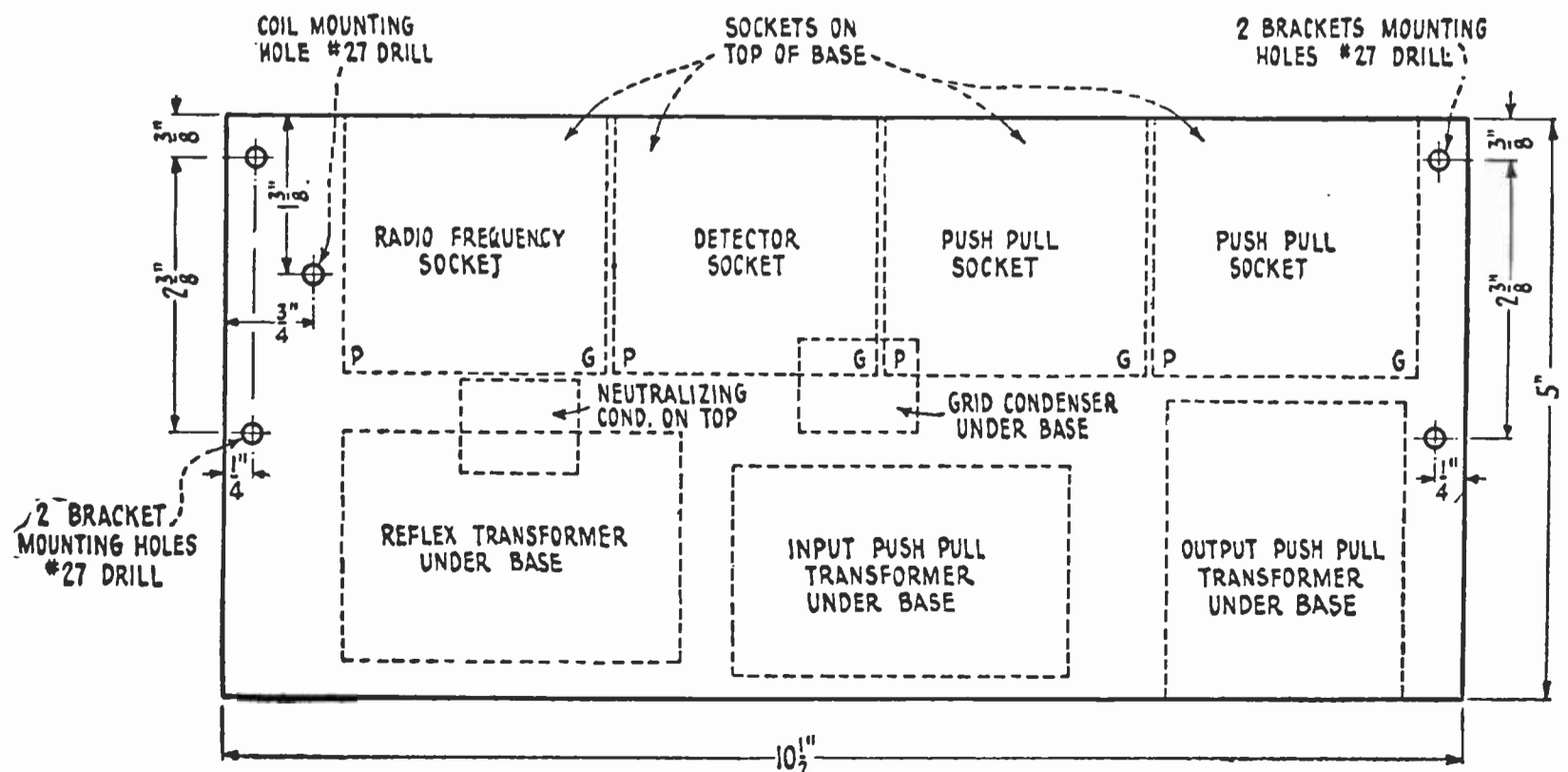

FIG. 22. THE SUB-PANEL LAYOUT
Showing how the parts are placed underneath the base

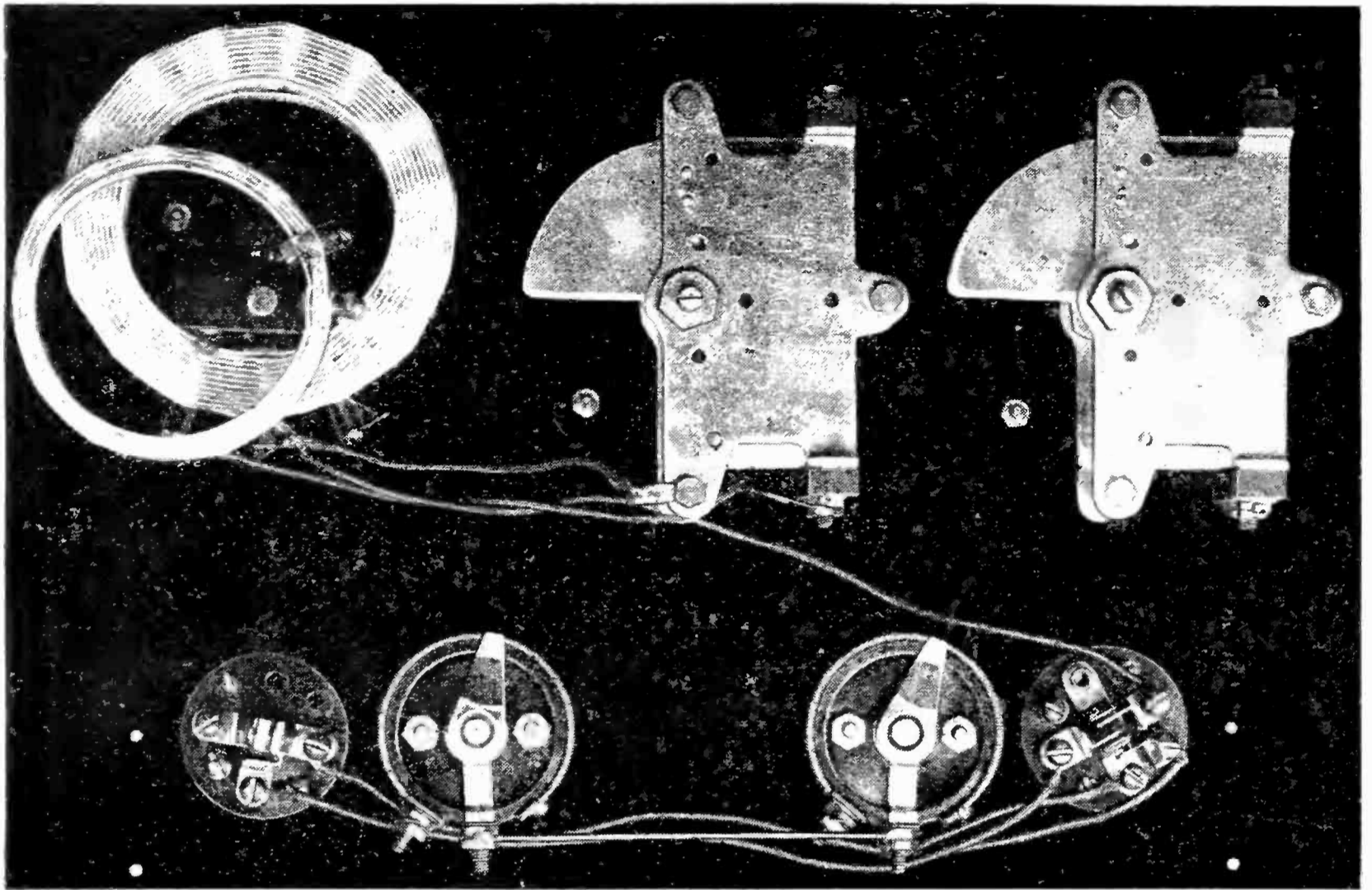
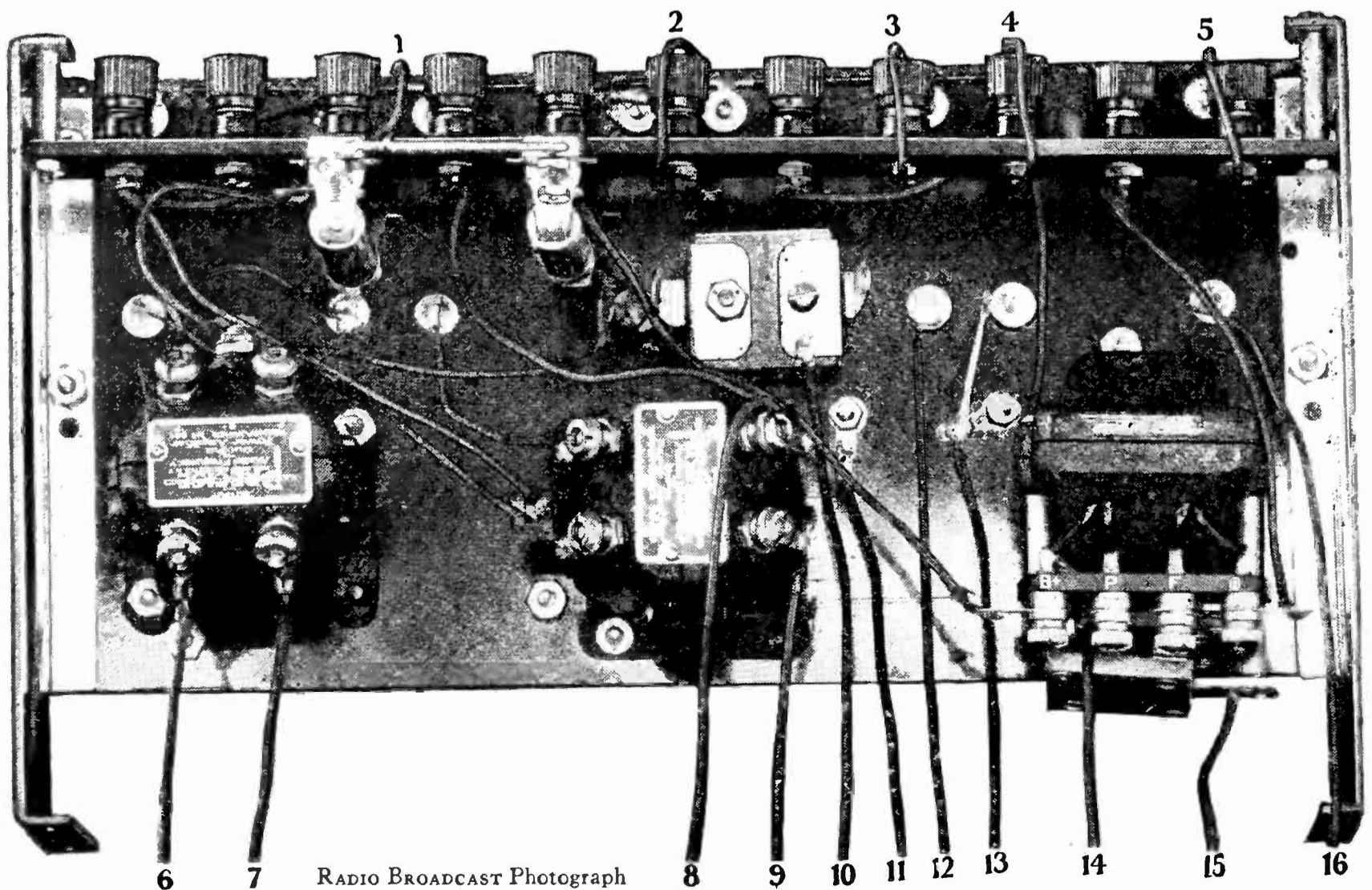

FIG. 23A-B. THE MAIN PANEL

RADIO BROADCAST Photograph

And sub-base with most of the wiring completed. A circuit diagram is shown in Fig. 8. The numbered leads are connected to the following terminals; they may be traced directly to the apparatus in the Figure above. No. 1 goes to the single circuit inside jack. No. 2 connects to the outside filament circuit and double circuit jack. No. 3 goes to the ground lead and the switch arm. No. 4 leads to the antenna coil τ -1. No. 5 connects to the inside secondary τ -2 and to the rotary c-1. Nos. 6 and 7 go to the output jack, single circuit. No. 8 goes to the inside jack, double circuit. No. 9 to the outside jack, double circuit. No. 10 goes to stationary plate c-2 inside τ -2 secondary. No. 11 goes to the N-P coil neutralizing condenser. No. 12 connects to the tickler coil detector plate. No. 13 goes to stationary plate c-1 and outside secondary τ -1. No. 14 is connected directly to the tickler. No. 15, to the center tap N-P and No. 16 to N-P coil plate



RADIO BROADCAST Photograph

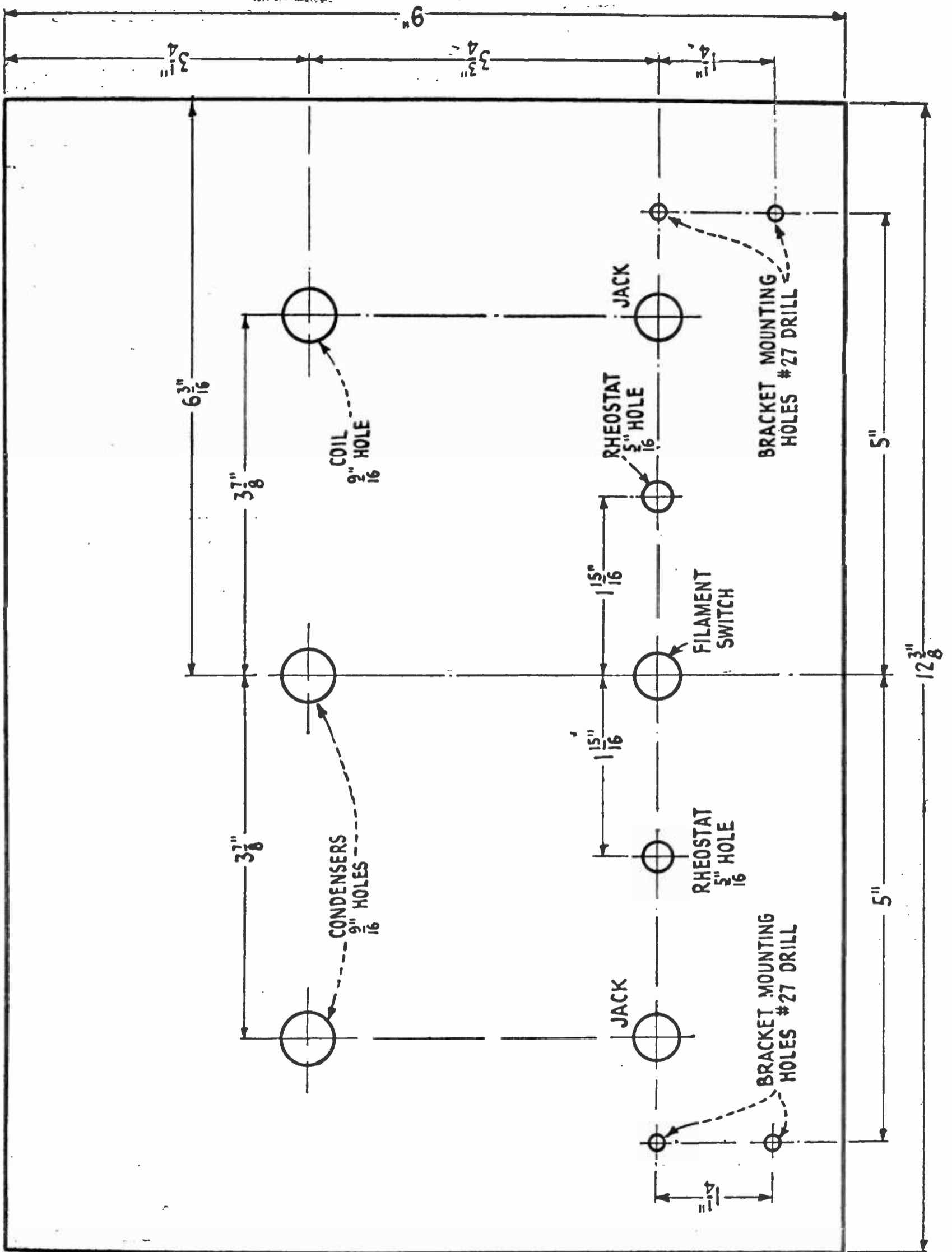

FIG. 24. THE MAIN PANEL LAYOUT

Showing drill sizes and dimensions. No condenser mounting holes are indicated because this depends upon the type of condenser used



RADIO BROADCAST Photograph
FIG. 25

Shows a very fine addition to any radio and phonograph combination. The use of the ephonograph horn for either radio or phonograph purposes may be had by turning the knob shown in the direct center of the illustration. The loud speaker unit is mounted upon the cap of the Selectron unit. The tone arm fits on the right side and the speaker unit on the left

concern that will manufacture such an antenna will have no trouble in marketing this product.

There are several other antenna devices for use in connection with electric light circuits and telephone lines which make a regular antenna unnecessary. Where there is a portable receiver and a small loud speaker at hand that may be put in the car, it is becoming increasingly popular for the radio enthusiast to take his "music box" with him when visiting friends. This makes comparison of results obtained in various locations with different types of receivers possible and frequently makes an otherwise boresome visit a really pleasant one.

The antennaphone, which is illustrated in Fig. 11, is a very simple device and is in no way connected to the telephone. It is laid on a table or other convenient place and the telephone is set down on it. This makes the use of a regular antenna unnecessary.

The antenna attachments for use with the light sockets are illustrated in Fig. 12 and the various methods for employing them are illustrated in Fig. 13. It is impossible to tell in advance just which connection will be best. Each should be tried. Devices of this kind have been found of little value in some places but better than a regular antenna in others. Radio products of reliable manufacture are sold on a money-back-guarantee basis. They are well worth trying for those whose problem of antenna erection is difficult and often impossible.

ANY STANDARD PARTS MAY BE USED

THERE is little necessity for reviewing the havoc caused by the new and novel features which have attracted the buying public from time to time. Buyers have spent large sums of money in the purchase of new equipment, spuriously advertised, only to find that their money had been grossly misspent and that their purchases were neither new nor revolutionary. Quite probably many individuals have grown to think that the manufacturers desired only to sell parts regardless of the satisfaction that they might otherwise give.

After all, there is but one basis upon which a parts business can exist and that is to give the home builder at least some value for the money he has expended.

For example, there once was heralded a revolutionary super-heterodyne which employed nine tubes. As a result of the publicity it received many of the parts specified for use in it were sold to jobbers and dealers in comparatively large quantities. But it did not last long; it was too unreliable for that. As an example of its "efficiency" it consumed 73 milliamperes in the plate circuit—a good super-heterodyne should not use more than 20, and many require much less—the Hanscom six-tube receiver described in RADIO BROADCAST for June, 1924, for instance. Now, 73 milliamperes means that dry cells are out of the question and even battery eliminators can not be used. There is then nothing left but storage B battery operation. When equally satisfactory results may be obtained—and this is stating the case conservatively—from one of the receivers employing the Roberts circuit and four tubes drawing less than 10 milliamperes, it is not difficult to understand what we are talking about when we say we are trying to show how good radio parts can be bought by the interested constructor, and real service be secured from their use.

RADIO BROADCAST's Phonograph Receiver may be constructed by the use of any good standard parts, but we strongly oppose the use of parts which have not become standard.

After all, it is the consumer who eventually pays the piper and we can but hope that he, in making his purchase, will choose only those products which he knows to be sound. Eventually this practice will lead to a market unencumbered by the "gyp" parasites which at times even now defile it.

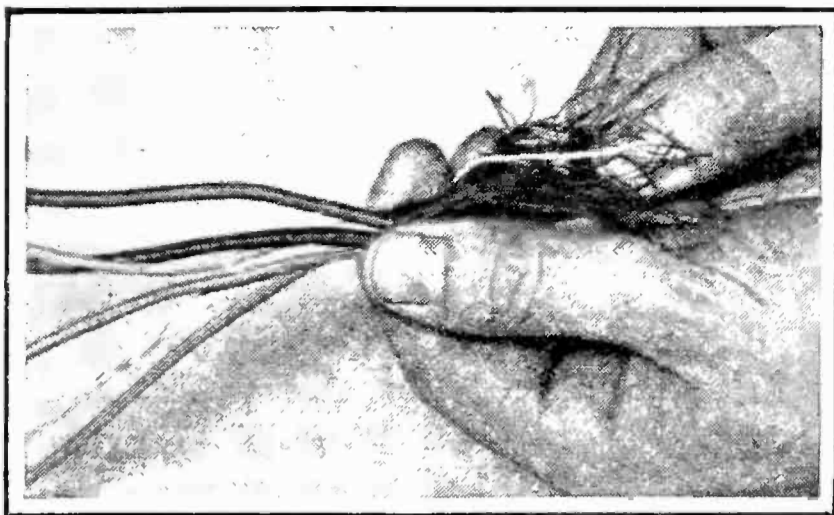

FIG. 1

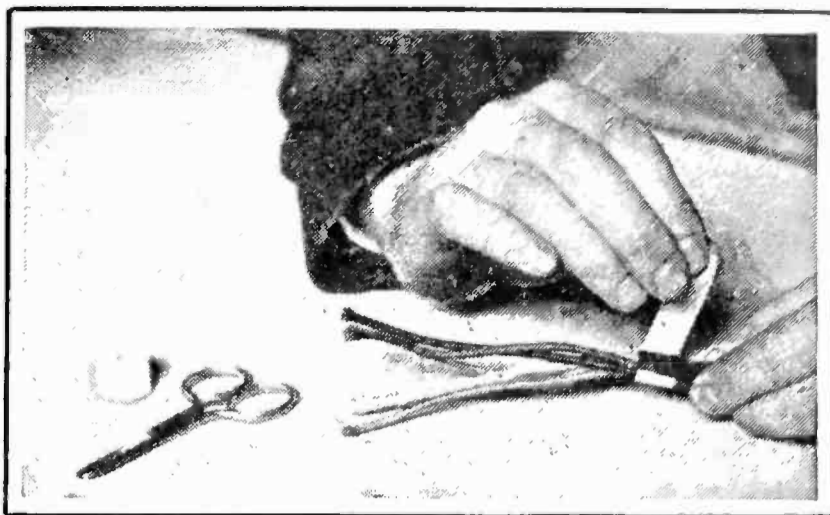

FIG. 2

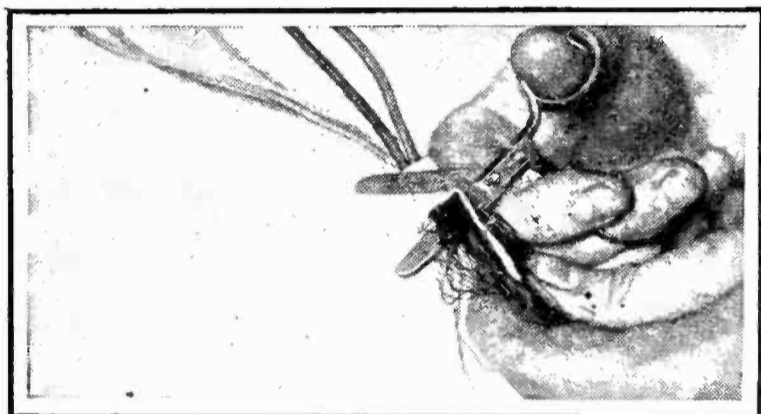

FIG. 3

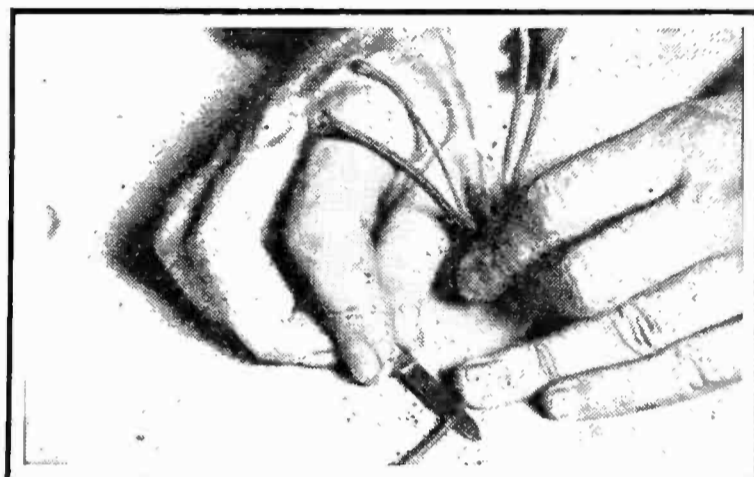

FIG. 4

A CONNECTION CORD FOR OUTSIDE LEADS

In the Phonograph receiver. Figs. 1 to 4 show the processes in preparing the wires for attaching at both ends. The cable, composed of two No. 16 and three No. 20 conductors is used to connect the batteries to the set. The conductors are each rubber insulated and each of a different color. First shirr the outer braid back about six or eight inches, or as far back as is necessary to make connections. Next fold the loose ends back over the cable and finish off neatly by wrapping a piece of half-inch adhesive tape around the cable as shown in Fig. 2.

With scissors, trim off the frayed edges as shown in Fig. 3. In preparing the individual conductors, slice the insulation at three or four points around the wire about one inch back, permitting the insulation to be removed very easily. The finished ends may be wrapped with a quarter-inch strip of adhesive tape for neatness. If some shellac is available, the ends might be dipped in it and dried before the insulation is removed. The copper wire should be scraped brightly and twisted tightly to prevent the wires from spreading. Fig. 5 shows one end of the completed lead. In the Phonograph Receiver, the top lead is plus B 120 volts, the next to the left is plus B 90 volts, the third plus B 45 volts, the next plus A, and the last minus A and B. This does not provide for C battery connections, which should be made with separate leads. The C battery itself can well be included inside the set. Considerable importance attaches to proper C battery potential in this receiver. This cord is available on the market as R-1360 and made by the Belden Manufacturing Company.

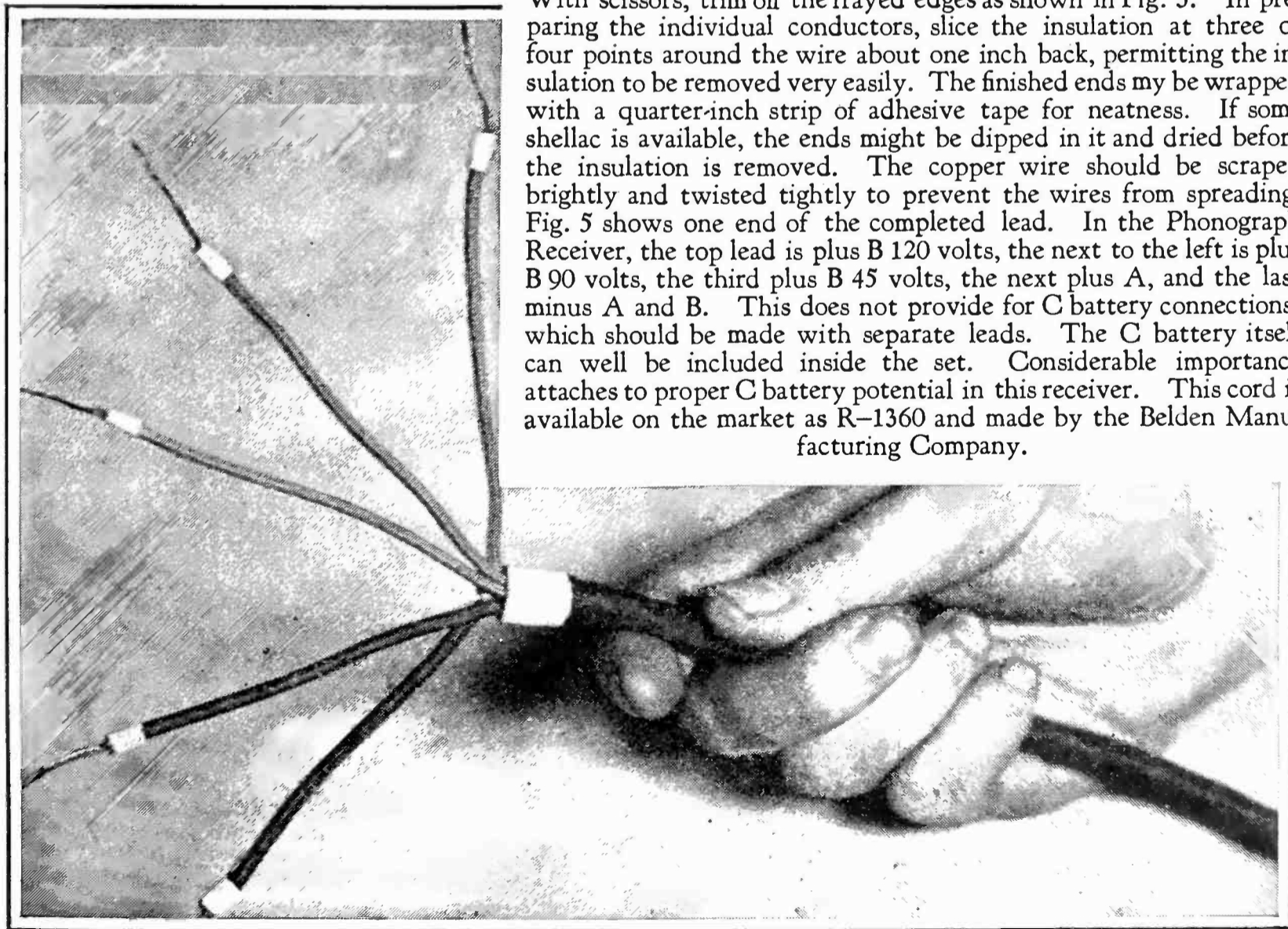

FIG. 5

“NOW, I HAVE FOUND . . .”
A Department Where Readers Can Exchange Ideas
and Suggestions of Value to the Radio Constructor and Operator

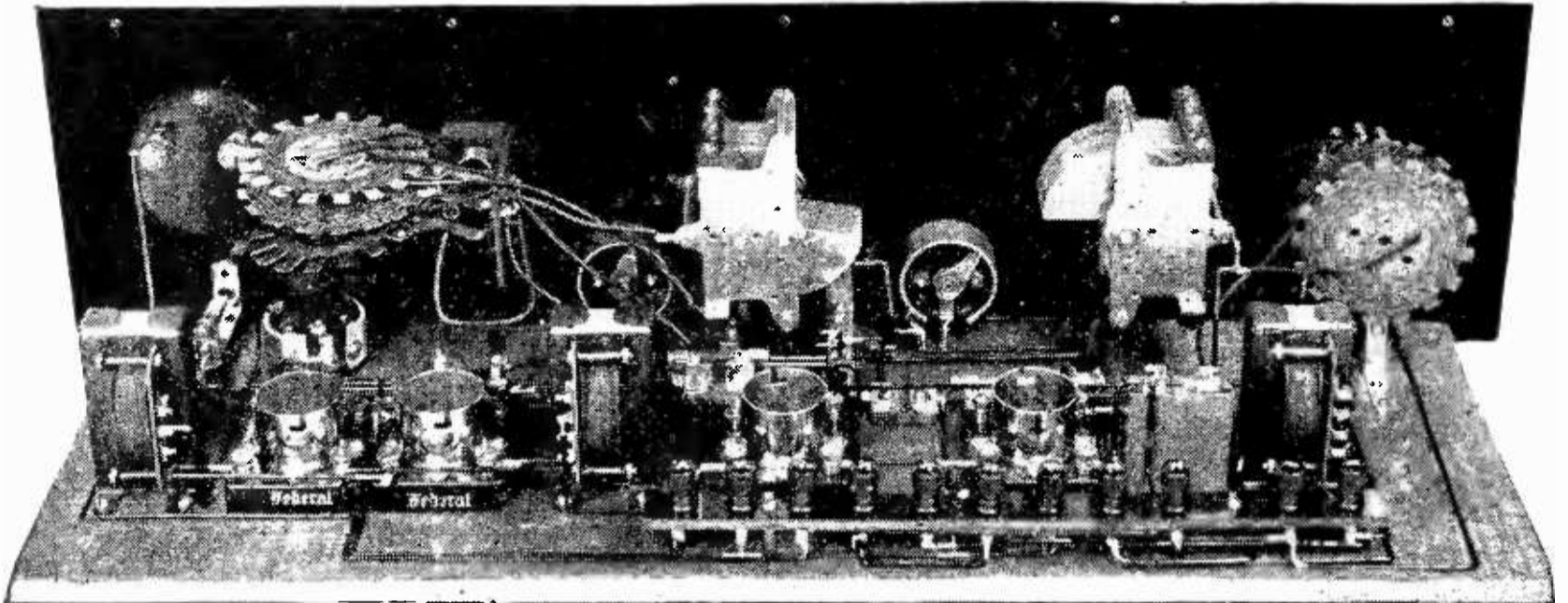

FIG. 1

A FOUR TUBE ROBERTS RECEIVER

THE outfit shown in the photograph, Fig. 1, represents one of the highest types of receivers embodying the Roberts circuit. Of several hundred various Roberts sets made by the writer and Mr. S. Schneider, it was selected as the best of the lot as far as tone quality and ease of volume control were concerned.

The feature of the set is its employment of a brace of Western Electric push-pull transformers removed from a 7-A amplifier unit. The tapped input transformer is connected in the circuit as the reflex transformer, feeding the audio component of the detector plate current back into the grid circuit of the first tube. The secondary winding is the tapped one, there being five taps in all. The switch arm is connected to the positive side of the C battery, and the negative pole of the latter is then carried to the lower side of the antenna coupler secondary.

The actual switch and contact points are mounted on the panel at the extreme left. They are not visible in the photograph because they are covered by the antenna coupler coils. This switch directly controls the volume obtainable from the receiver.

The push-pull transformers are wired to a pair of tube sockets in the standard arrange-

ment. These parts occupy the section of the baseboard to the right of the detector tube socket.

Two automatic filament control jacks allow the use of either two or four tubes. Individual rheostats are provided on the panel for the r. f. and detector tubes, while another rheostat, screwed to the baseboard near the second phone jack, regulates the less critical audio bulbs. This third rheostat is turned to the best position for amplifier operation, and can then be entirely neglected. The filament jacks take care of all switching.

The unusual transformer system does not alter the operating characteristics of the circuit in the slightest. The set tunes exactly like other Roberts sets.

In active service this receiver is truly a “knockout.” It is being used by a resident of Washington Heights, New York City, and under the adverse local conditions has brought in Pacific Coast stations on only two tubes. The reproduction, thanks to the excellent transformers, is as perfect as the modulation of the broadcasting stations permits. The volume with UV-201A tubes, or others of similar constants, is more than sufficient for the large apartment in which the set is used. And the appearance, it might be stated, is quite commensurate with the electrical efficiency.—H. Q. HORNEIJ, New York City.

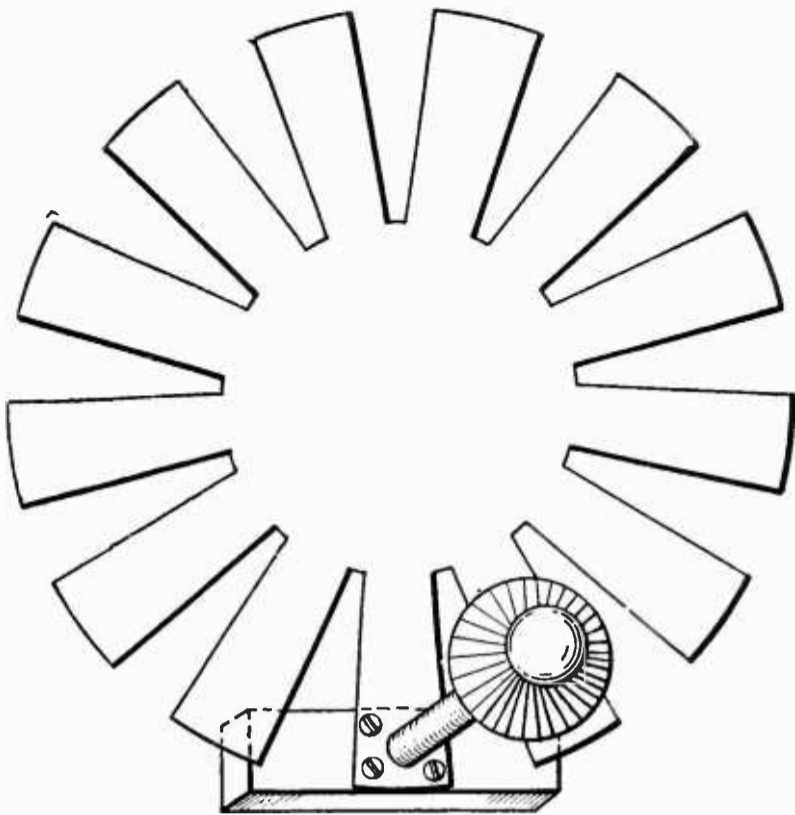

FIG. 2B

A COIL MOUNT FOR THE ROBERTS COILS

A SIMPLE variable mounting for the antenna inductance of the Roberts receiver may be a practical suggestion which will interest the readers of RADIO BROADCAST.

The several Figures are as follows: Fig. 2 A—the assembled coils, cross section view; Fig. 2 B front view of secondary, unassembled; Fig. 2 C—cross section view of antenna coil, unassembled.

The blocks of wood which hold the coils are $\frac{1}{2}$ inch thick. The constructor may use his own judgment as to the width but $1\frac{1}{2}$ by $1\frac{1}{2}$ by $\frac{1}{2}$ inches has been found satisfactory for the secondary mounting and 1 by $1\frac{1}{2}$ by $\frac{1}{2}$ inch for the antenna mounting.

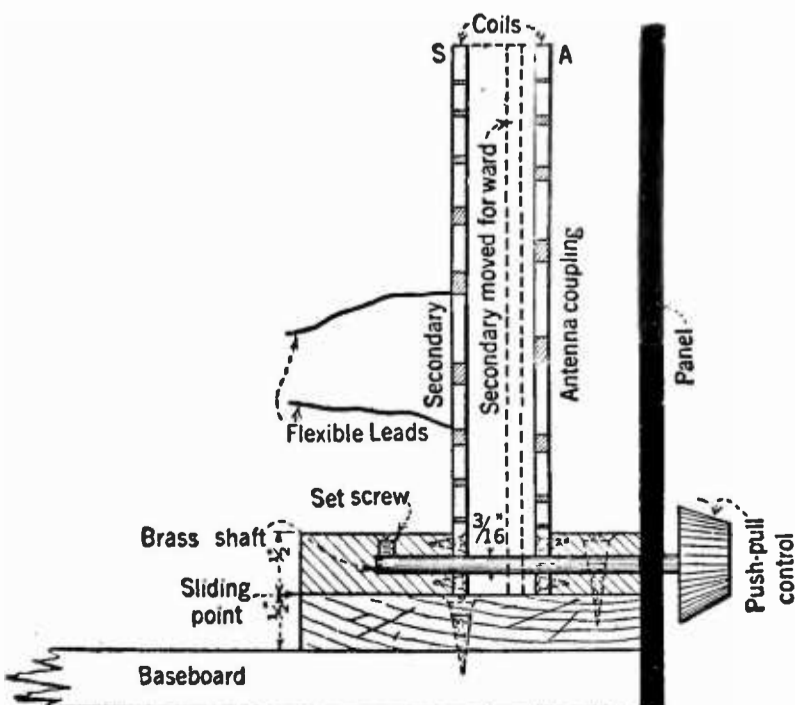

FIG. 2A

The base which supports the sliding secondary and the stationary antenna coil is $\frac{1}{2}$ inch thick, $1\frac{1}{2}$ inches wide and 4 inches long.

This base may be set back a distance from the panel, and the control rod cut to the proper length accordingly.

The antenna coil is fastened to the block by small screws. This block is permanently fastened to the base. It has a hole drilled in it to allow the shaft which moves the secondary to pass back and forth through it.

With this arrangement, very fine variable coupling between the primary and secondary coils may be obtained.

The sketches show very clearly the mechanical features involved in the construction of these mountings.—H. BATCHELDER, Yakima, Washington.

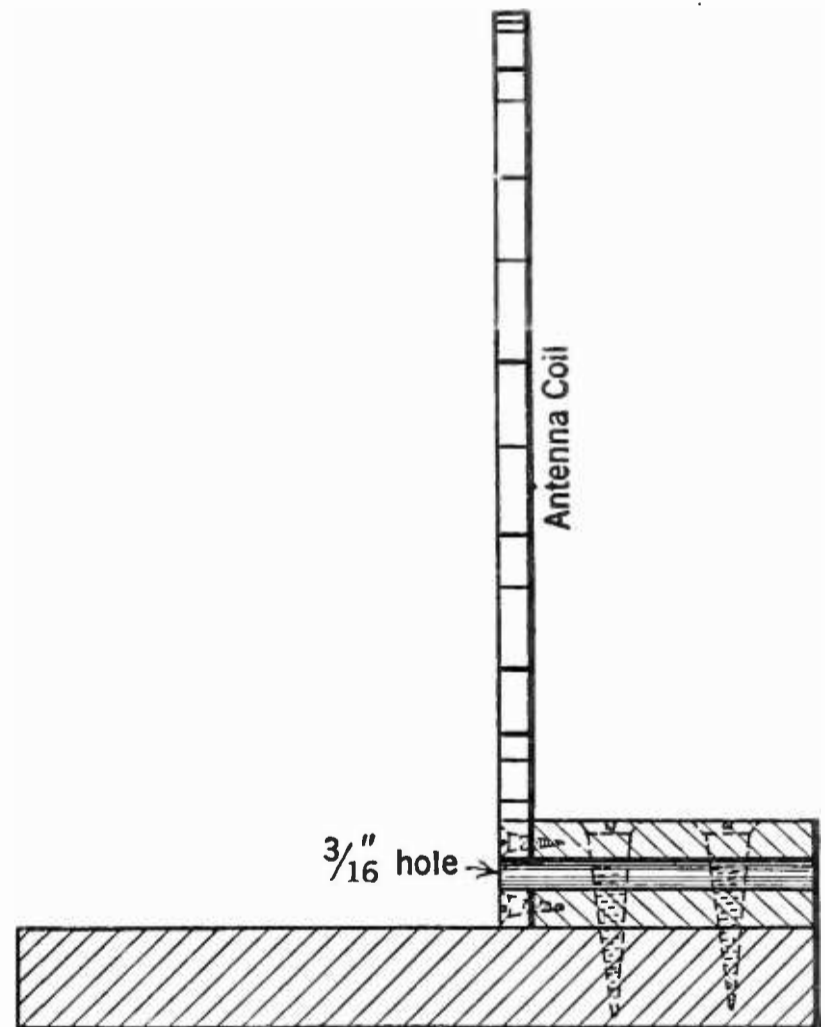

FIG. 2C

HOW TO MAKE A LOW MELTING POINT SOLDER

WHAT radio fan has not found, when soldering, that some of the work got so hot that either the appearance or utility of the soldered part was affected?

While in many cases it may be true that sufficient experience would have allowed the constructor to avoid the trouble, still any method of soldering with less heat would be greatly appreciated by many of us. The answer is simple. Use solder that melts at a

lower temperature than that ordinarily sold on the market.

Solder is made of a mixture of lead and tin. Since tin is much more expensive than lead, the manufacturer is inclined to put in more lead and less tin. Probably no solder available to the radio fan is more than half tin, in spite of the fact that the melting point of solder becomes lower and lower with the increase of tin until a combination of about three fourths tin is reached. Such solder, with a low melting point, is known as "soft solder."

Soft solder may easily be made in the home by adding tin to ordinary solder. Small quantities of tin are available in every home in the form of ordinary tin-foil. One must notice that not all of the "tin-foil" is really made of tin. The genuine article may be recognized by its softness and bright finish. Tin-foil which comes around eatables will really be made of tin if it comes into direct contact with them. One may be certain that foil which is separated from the eatable by waxed paper is not pure tin and can not be used for this purpose.

To get the tin into usable shape, put the foil into a metal cover, such as a baking powder can cover, and add to it about as much rosin, by bulk, as you have foil, and then heat over a gas stove or other fire. Stir with the end of a match stick. Presently the tin will appear as a bright puddle with a lot of black dirt over it.

Now, to make the extra soft solder, add to this tin, ordinary solder about equal in amount to the tin recovered from the foil and heat until the two melt together.

The resulting compound may be left in the cover to be picked up by the soldering iron, or it may be made into "wire" solder either by pouring into a groove gouged out of a piece of wood or by pouring into a soda straw with the lower end pinched shut.

By using a soldering iron just hot enough

to cause the solder to flow freely when using this soft solder, work may be done with appreciably less heating than usual.

This solder is not quite as strong as the ordinary solder, but, in radio work, joints are soldered for good electrical contact rather than for mechanical strength.—G. D. ROBINSON, Annapolis, Maryland.

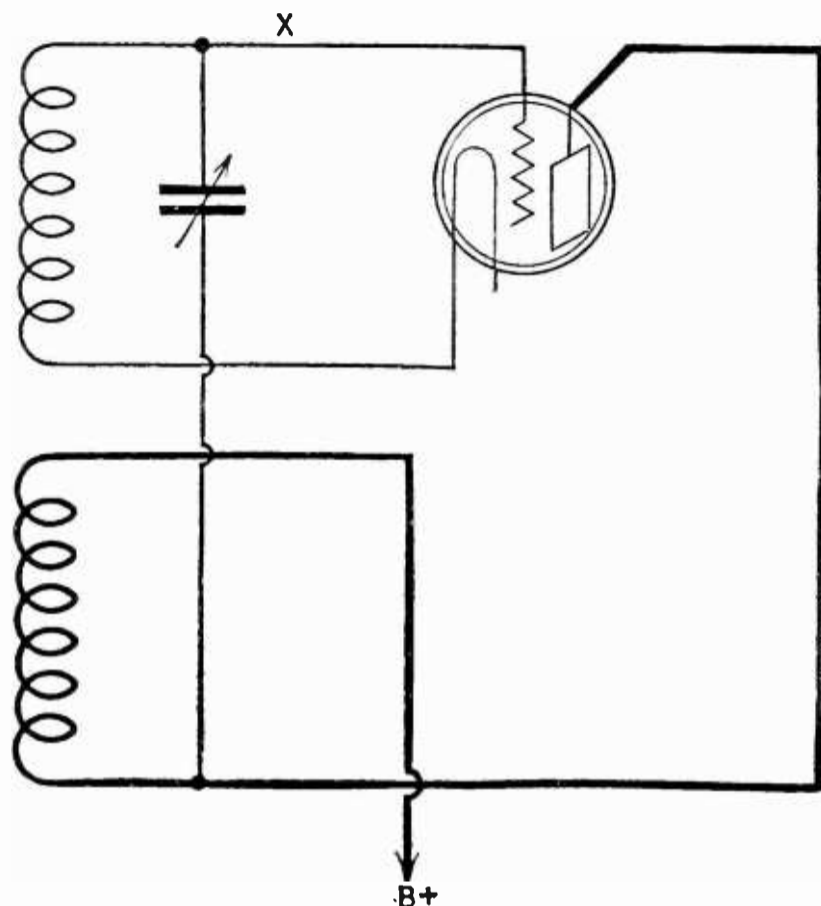

FIG. 3

THE OSCILLATOR IN YOUR SUPER-HETERODYNE

IT IS not the purpose of this article to extol the super-heterodyne but to show you how to make yours more efficient. By efficiency I mean output divided by input. It is obvious that with a given input we can increase the efficiency of a set by increasing the output. Or if with a smaller input the output is the same in both cases then we have increased the efficiency. The average radio listener is more or less familiar with the action of a vacuum tube as an amplifier. He probably has less understanding of the tube's action as a detector and unless he is a transmitting amateur he has practically no knowledge of an oscillator.

There are several oscillating systems in popular favor with the amateur for transmitting purposes, but of these only one, the Hartley, is satisfactory as an oscillator in a super-heterodyne. There are three forms of the Hartley. The one shown in, Fig. 3 is used almost universally, and this is the one we are about to consider.

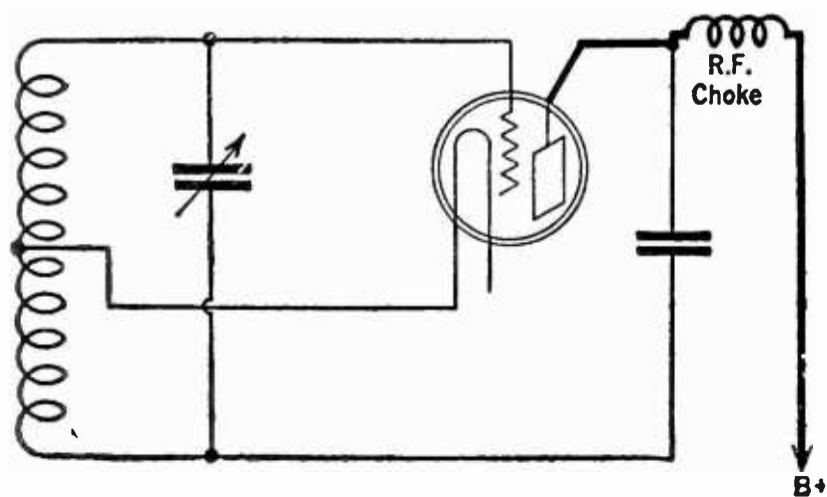

FIG. 4

As a generator of alternating current this form of oscillator is above reproach. In fact it does that too well, for it generates a lot more current than we can possibly use, and in the matter of squeals it is almost as great an offender as those receivers we know as bloopers. This is perhaps the most serious charge that can be brought against it. Used in its present form it is not as efficient as it might be.

Such an oscillator, with 5 volts filament supply and 90 volts plate supply, will draw about .025 amperes (25 milliamperes.) If we stop the tube from oscillating by short circuiting the grid coil, the plate current drops to 6 or 7 milliamperes.

If we cut the plate voltage down to 20 volts, the tube, oscillating, will draw about 5 milliamperes. But this is not good enough.

There is no advantage in using a 201A tube as an oscillator. A UV-199 is suitable for all of our purposes. By using a UV-199 in the circuit in Fig. 3, with 20 volts on the plate, the B battery drain will be but 3 milliamperes. This is better since we have also reduced our A battery current. A UV-199 can be used in the same set with UV-201A tubes by using a separate rheostat, or better an amperite.

Fig. 4 is a form of Hartley oscillator in common use among amateurs for transmitting purposes but there is nothing in particular to be gained by its use.

A third form of Hartley oscillator is shown in Fig. 5. This is the ideal form for our purposes. The plate current for a UV-199 oscillator with the constants shown, will be from .0001 to .00015 amperes (100 to 150 microamperes). If you are using 45 volts on the detector plate and do not want to provide a separate B battery connection for the oscillator, you will have to use a somewhat lower resistance grid leak. This oscillator will give you all the output that you can use to advantage. However, it is not strong enough to radiate seriously and it will oscillate smoothly

and evenly over the entire broadcasting wavelength range.

A tube will often oscillate in this circuit when it will not in the first one shown here, because the filament emission is not great enough to sustain oscillations in the former.

If the tube is stopped from oscillating in the circuit shown in Fig. 5 the plate current rises to about .4 milliamperes. If the filament emission is great enough to supply a plate current of 0.2 milliamperes, it will oscillate in this circuit.

The insertion of a grid leak and condenser at the point marked X in Fig. 3 will result in a greatly improved oscillator—almost as good as that shown in Fig. 5. However, for those who already have a "super," it offers less changing in wiring and will do very nicely.

There are several schemes for using the so-called first detector as an oscillator. Examples of this are the second harmonic oscillating system and the Pressley method. I do not recommend any of these because the added impedance in the grid circuit of this first tube more than offsets any advantage gained by using this tube—especially when a really good oscillator consumes only 60 milliamperes of A battery, and 15 microamperes of B battery, current.—F. W. HUTTON, Woodhaven, New York.

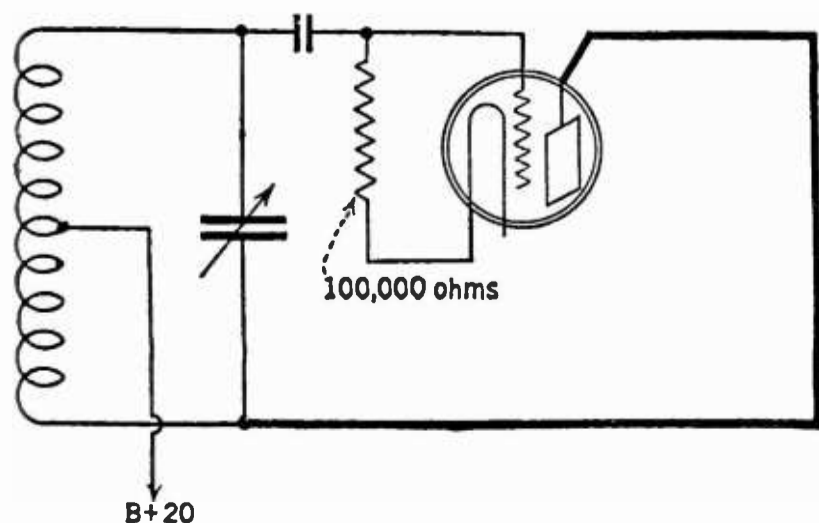
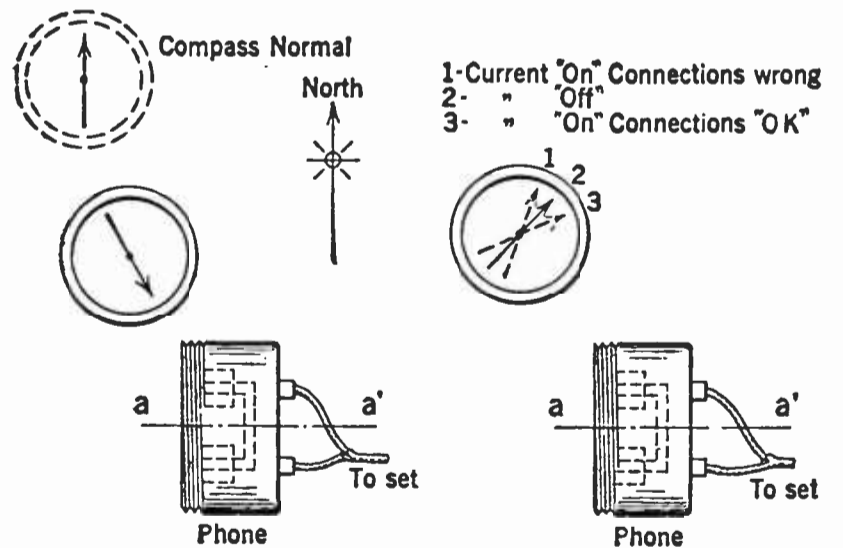

FIG. 5



FIGS. 6 AND 7

A PHONE CIRCUIT TEST

IT IS quite commonly known that to insure long life to the permanent magnets of phones, the field produced by the plate current flowing through the phone windings should assist and not buck that set up by the permanent magnets. Relatively few experimenters know how to determine which condition exists.

The object of this article is to give an experimental method for such determination involving no more elaborate apparatus than

a pocket-compass, which should, however, be fairly sensitive. No knowledge of electricity is needed, although of course it would help the operator understand the "why" of the method.

First unscrew the cap from the receiver and remove the diaphragm (unless the receiver be of the Baldwin type which has a mica diaphragm). The phones and compass should then be placed in the relative positions shown in Fig. 6, paying attention to the fact that the compass should be north of the receiver. The north-seeking pole should point toward the phone when brought near it. If such is not the case, the receiver should be revolved about the axis a-a, bringing the other pole nearest the compass.

The compass, which may be placed on a safety match box or anything not having iron or steel in its construction to facilitate movement, is then shifted to a position approximately as shown in Fig. 7. The exact spot is determined by finding where the needle starts to swing to its normal north-seeking position. Just before it has left the influence of the phone magnet, which is when further slight movement causes the needle to swing abruptly toward the north, the plate current should be allowed to flow through the phones, preferably when a strong signal is coming through. If the needle swings toward the phones, the fields are mutual and the connections correct. If the needle swings to the north, the phone connections to the plug or the binding posts, whichever are used, should be reversed. The deflection will be slight but unmistakable.—L. T. PHELAN, Washington, District of Columbia.

TO-DAY, there is small necessity for "matching tubes". The fact is, for most purposes tubes are so similar in their characteristics that they may be considered as being matched. The notable exception is in the super-heterodyne, where juggling tubes around in the intermediate stages is usually necessary to secure satisfactory reception. Howling, instability (uncontrollable oscillations with beat whistles) at normal plate voltages are evidence of poor or improperly balanced tubes in the intermediate amplifier.

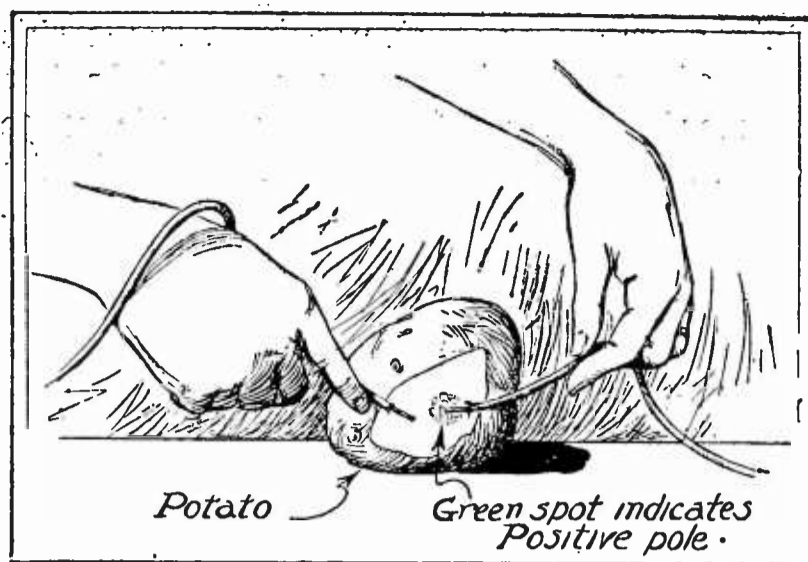

FIG. 8

DETERMINING THE POLARITY OF A BATTERY WITH A POTATO

THERE are devices on the market for finding the polarity of an electric battery. That is, to find out which is the negative pole and which is the positive pole. This is always necessary when connecting up an automobile or a radio battery or in making electrical experiments. But did you know that all this could be done with the aid of a common white potato?

Choose a potato with nice white meat and shave off a section of skin about the size of a half dollar so that the inside is exposed. Then turn on the current from your source of electricity and grasp one of the wires with bared ends in each hand. Touch the wire ends to the potato about $\frac{1}{8}$ inch apart and watch the result. In a few seconds the potato under one of the wires will be found to turn a shade of green. The section of the potato which the other wire touches will remain clear and white. See Fig. 8.

The wire causing the greenish hue on the potato is connected to the *positive* pole of the battery. Therefore the other wire must be connected to the negative pole. This experiment will not work on alternating current of the house lighting circuit. It is a good test, however for storage or dry batteries or small, direct current generators such as are found in cars and power boats.—L. B. ROBBINS, Harwich, Massachusetts.

THE "Now I Have Found . . ." department in this magazine is planned to furnish an outlet for the many excellent ideas dealing with various features of radio construction and operation which reach our office. If you have an idea about a valuable and useful new circuit, some new device, or a construction or operating suggestion, we should like to have it. We do not want simple or obvious suggestions, and material to be acceptable for this department must offer something of definite value to the constructor; mere novelty is not desired. Payment from two to ten dollars will be made for every idea accepted. Manuscript should not be longer than 300 words and typewritten. An award of twenty-five dollars will be paid for the best article published in every three-month's period.

Address your manuscript to this department, RADIO BROADCAST, Garden City, New York



See the Announcement on Page 418

QUERIES ANSWERED

CAN A LOOP BE USED WITH ONE-TUBE SETS?

P. B.—Canton, N. Y.

WILL YOU EXPLAIN THE MEANING OF WAVELENGTH?

F. C.—Lansing, Mich.

HOW DOES THE HIGH-MU RECEIVER DIFFER FROM THE ROBERTS?

E. L. J.—Berkeley, Calif.

HOW SHALL I BE GUIDED IN THE SELECTION OF A STORAGE BATTERY?

A. M.—Brooklyn, N. Y.

IS THE FOUR-TUBE CRYSTAL REFLEX CIRCUIT IN

THE JUNE, 1924, ISSUE OF RADIO BROADCAST CORRECT?

J. N. T.—San Antonio, Texas.

WILL YOU PUBLISH A CIRCUIT SHOWING A NEUTRODYNE RECEIVER EMPLOYING PUSH-PULL AUDIO FREQUENCY AMPLIFICATION FOR THE LAST STAGE?

L. J. T. Portland, Me.

WHAT TOOLS ARE NECESSARY FOR GOOD RADIO CONSTRUCTION?

K. W. J.—Marion, Ohio.

HOW MAY I PROCURE THE LYNCH LEAD DESCRIBED IN THE JUNE, 1925, RADIO BROADCAST

R. B.—Albany, N. Y.

LOOPS

THE energy transmitted by a broadcasting station must be collected or absorbed by some collective or absorbing agency so that a receiver may be actuated to produce results. Upon the size of this agency depends the efficiency at which the receiver operates, all other things being equal. However, this agency, which is the antenna, also is affected by other electrical disturbances in the ether, i. e., atmospherics, artificial static like motor commutator sparking, sparking trolley lines, defective power lines, and similar disturbances.

On one-, two-, and three-tube sets, an outside antenna is connected to the detector tube through a coupler unit. A loop will not be satisfactory for such a receiver because the feeble impulses which it receives will not actuate the detector tube sufficiently to produce energy which may be transformed into an audible signal.

A loop can only be used on receivers employing one or more stages of radio frequency amplification or in super-heterodynes which tend to magnify these feebly received impulses so that they are strong enough to be heard after being rectified to an audible signal in the detector tube.

While an antenna has directional effects, it is not practicable to move it about so that signals from all directions may be received with comparatively equal strength.

A loop can be rotated without much effort, for directional effects. The larger, physically, a loop is the greater its energy pickup will be. However, for most practical purposes its size is limited by individual requirements.

then we have the equation

WHAT WAVELENGTH MEANS

RADIO waves travel through space at the same velocity as light, roughly 186,000 miles per second. Rather, the wave motion is propagated at that velocity, which, when spoken of in meters equals 300,000,000 meters per second. That is a fixed value. Now if we vary the length of one wave, the frequency or number of times it will repeat itself, will vary. As represented in a formula

$$\text{Frequency} = \frac{186,000 \text{ miles (300,000,000 meters)}}{\text{length of wave}}$$

If N equals the frequency or number of oscillations occurring, V (300,000,000) indicates velocity of waves in meters, and L equals length of wave form then we have the equation.

$$N = \frac{V}{L}$$

L, the length of one wave depends upon the adjustments of the tuning elements to produce an oscillation which repeats itself in a propagated wave

form at a certain frequency. We can term this the number of oscillations produced by an adjustment which gives each oscillation a definite length in meters.

Reduced the formula is

$$N = \frac{V}{\lambda}$$

To deal with round numbers let us suppose we start with a wave 1 meter long. Then the number of oscillations (waves or cycles) occurring during the one second it takes to travel 186,000 miles (or 300,000,000 meters) is exactly 300,000,000.

Supposing we wish to determine the frequency (N) of a wave 600 meters in length then

$$N = \frac{300,000,000}{600} = 500,000 \text{ oscillations}$$

If it is a wave 300 meters long then

$$N = \frac{300,000,000}{300} = 1,000,000 \text{ oscillations}$$

If it is a wave 150 meters long then

$$N = \frac{300,000,000}{150} = 2,000,000 \text{ oscillations}$$

Therefore from this we can judge that while the speed at which the wave travels remains constant, any change in wavelength will alter the number of oscillations (waves) occurring over that distance of 186,000 miles. This is explained in Fig. 1 A, B, and C.

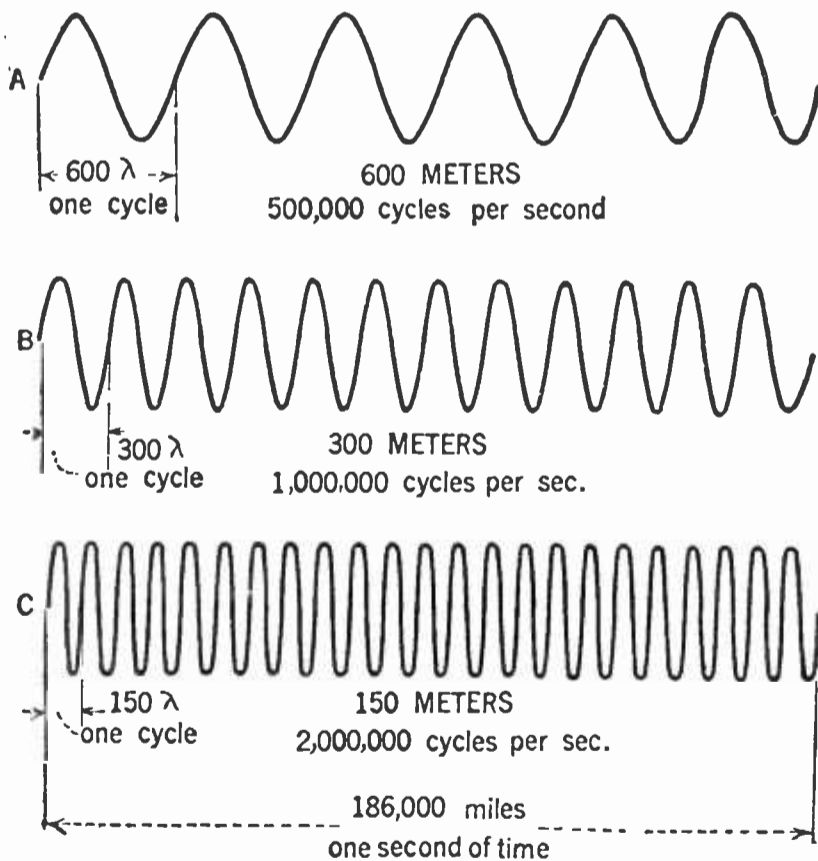

Since the space covered by the wave forms is 186,000 miles then for each one there occurs a different number of waves in that space.

Assuming that the same power is used in all three cases to produce the same amplitude then in A (600 meters) there will be 500,000 oscillations or cycles each 600 meters long from start to finish. In B there will be 1,000,000 and in C there will be 2,000,000,

Summing up we can say that the length of one cycle determines the number of cycles occurring during one second of time or covering 186,000 miles.

In broadcasting, a station transmits a wave called the carrier wave, which has a constant amplitude. This wave, occurring at a frequency to which the transmitter has been adjusted, is inaudible to the ear. Now by super-imposing an audio frequency wave on it, it is modulated into varying amplitudes but still inaudible until rectified by the detector tube.

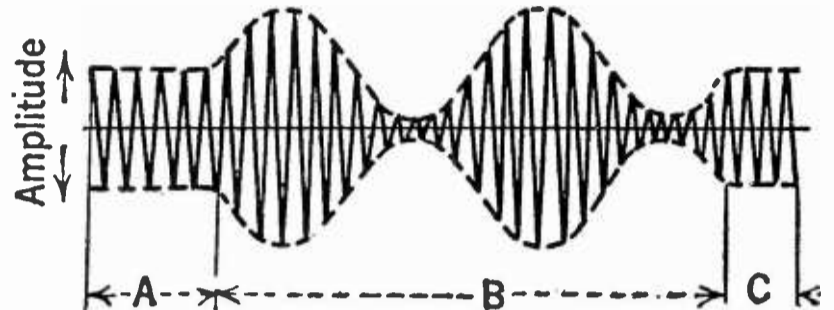

FIG. 2

Fig. 2 shows how the modulated wave, to conform to the voice and music variations, is produced. At A we have the constant amplitude of the carrier wave but between A and C (B) the wave is of a continually varying amplitude. This is due to the audio wave being super-imposed on the carrier wave.

THE HIGH MU AND THE ROBERTS

THE question arises "how does the High-Mu Browning-Drake receiver differ from the Roberts Knockout?" Well fundamentally both circuits are similar, each employing a stage of radio frequency amplification before a regenerative detector circuit. However, in the Roberts Knockout, the first tube circuit contains a reflex audio transformer providing an additional stage of audio amplification. Also, the neutralization methods are not alike. The novel Roberts system is quite different in principle to that employed in the High-Mu receiver which is similar to the standard Hazeltine neutralizing scheme.

The High-Mu receiver was designed for use with UV-199 tubes but UV-201A's may be employed, without any changes other than supplying the correct filament and plate voltages. This is borne out in the description of the "Good Four Tube Receiver" in this magazine for March, 1925, which is very similar to both the Roberts and High-Mu sets.

HOW TO SELECT A STORAGE BATTERY

WHEN selecting a storage battery, every owner of a receiving set desires one of sufficient capacity to make frequent recharging unnecessary, yet small enough to reduce the first cost to a minimum. The owner's ideas about what

Music Master
Resonant Wood
Insures
Natural
Tone
Quality



Connect Music Master
 in place of headphones.
 No batteries.
 No adjustments.

Prices of all models
 slightly higher
 in Canada.

Music Master Makes any good set **BETTER**

Music Master transforms mere radio reproduction into artistic re-creation. Mere assertion? No! Plain fact—because:

THE piano's sound board, the violin and 'cello, and Music Master's amplifying bell are all of wood—because wood produces *natural* tones.

Heavy cast aluminum eliminates over-vibration, develops sound without distortion and imparts a *unique* tonal brilliance.

This balance of resonant wood and non-resonant metal preserves, reproduces and re-creates the natural qualities of instrument and voice—and makes

Music Master the Supreme Musical Instrument of Radio, for which there IS no substitute.

Buy Music Master and be safe—buy Music Master and improve your set—buy Music Master and exchange mere radio receiving for the artistic enjoyment of radio re-creation.

Music Master Corporation

Makers and Distributors of High-Grade Radio Apparatus
 Tenth and Cherry Streets

Chicago PHILADELPHIA Pittsburgh
 Canadian Factory: Kitchener, Ontario

★ Model VI, 14" Wood Bell \$30
 Model VII, 21" Wood Bell \$35

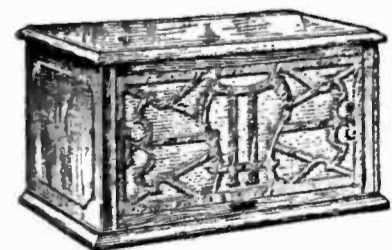

Model VIII, Mahogany Cabinet with *full-floating* Wood Bell \$35

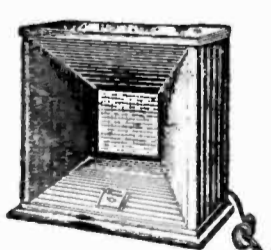

Model V, Metal Cabinet, Mahogany Finish, Wood Bell \$18

Music Master RADIO REPRODUCER

to specify, in order to obtain this highly desirable combination may be somewhat hazy, but he is never in doubt as to the result he seeks.

Various types of storage battery selection charts have been developed in the past, which were intended to assist the owner of a receiving set in making a proper selection. Generally speaking, these charts recommended certain types and capacities of batteries for certain tubes. The Prest-O-Lite Storage Battery Laboratories have just developed a chart which takes into consideration the numbers, types, and combinations of tubes in a way that makes the selection of a satisfactory battery a simple matter.

Voltage of tubes, number of tubes, type of tubes, the rated ampere drain and the recharging interval are treated in the chart in such a way that the receiving set owner has a choice of two recharging periods. For instance, for a set using one UV-200 and three UV-201A tubes, with a rated ampere drain of $1\frac{3}{4}$, and an A battery of 115 amperes (at a one ampere

Voltage of Tubes	No. of Tubes in Set	Type of Tubes (see foot-note)	Total Rated Ampere Drain	Storage "A" Battery Size Recommended		
				Amp. Hours at 1 Amp. Drain	Days between Chargings	
5-Volt Tubes C-300 and UV-200 are interchangeable C-301A, DV-2 and UV-201A are interchangeable	1	UV-200	1	65 or 47	22 16	
	2	UV-201A	$\frac{1}{2}$	47	33	
	2	1 UV-200 1 UV-201A	$1\frac{1}{4}$	80 or 65	22 17	
	3	UV-201A	$\frac{3}{4}$	65 or 47	29 22	
	3	1 UV-200 2 UV-201A	$1\frac{1}{2}$	95 or 65	21 14	
	4	UV-201A	1	65 or 47	22 16	
	4	1 UV-200 3 UV-201A	$1\frac{3}{4}$	115 or 80	22 15	
	5	UV-201A	$1\frac{1}{4}$	80 or 65	22 17	
	5	1 UV-200 4 UV-201A	2	115 or 80	19 13	
	6	UV-201A	$1\frac{1}{2}$	95 or 65	21 14	
	8	UV-201A	2	125 or 95	21 15	
	For sets using current at a rate higher than 2 amperes.			$2\frac{1}{4}$	140 or 95	22 13
				$2\frac{1}{2}$	140 or 125	19 16

Copyright, 1925
The Prest-O-Lite Co., Inc.

For combinations of tubes not listed: Use the same battery combinations recommended for tubes having voltage and current requirements similar to the tubes you have.
NOTE: If you use a loud speaker operated from your "A" Battery, add $\frac{1}{2}$ ampere to the total rated current drain of your tubes and then select a battery giving this total current consumption.

drain) will give 22 days of service without recharging when used daily for an average of three hours; while with the same tube combination, a battery of 80 amperes will have a recharging interval of 15 days. Similarly, for a set having three UV-201A tubes at a $\frac{3}{4}$ -ampere drain, a battery of 65 amperes insures 29 days of service while the smaller 47-ampere battery gives 22 days of service between rechargings.

By recalling attention to the types of tubes that are interchangeable, it will be noted that the accompanying chart, Fig. 3, gives practically every combination of 5-volt tubes in general use.

FIG. 3

CORRECTIONS IN THE FOUR-TUBE CRYSTAL REFLEX RECEIVER

IN QUESTIONING the accuracy of the four-tube Knockout crystal reflex circuit appearing in Fig. 3 page 103 of the June, 1924, issue of RADIO BROADCAST and also in Fig. 3 page 41 of our Knockout Series Booklet, it has been brought to our

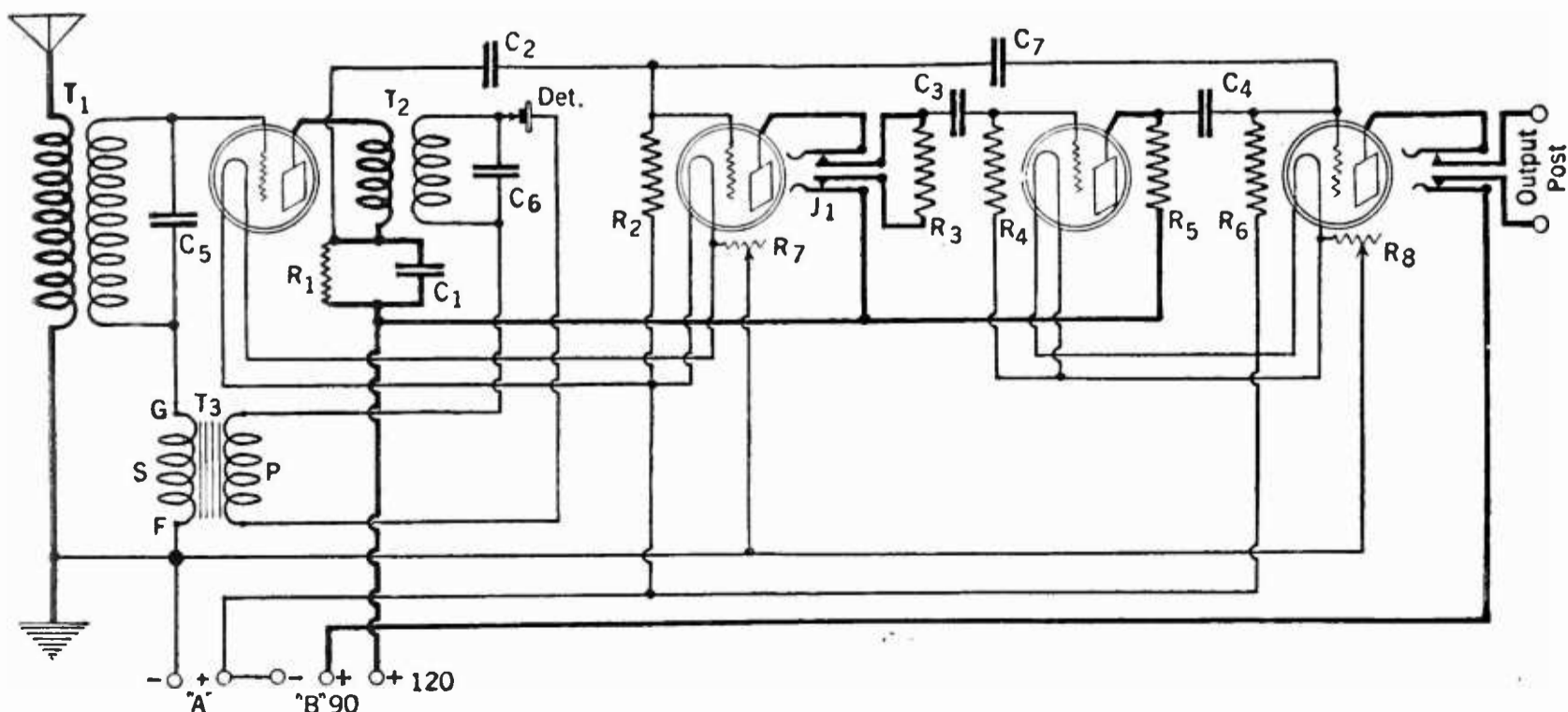

FIG. 4

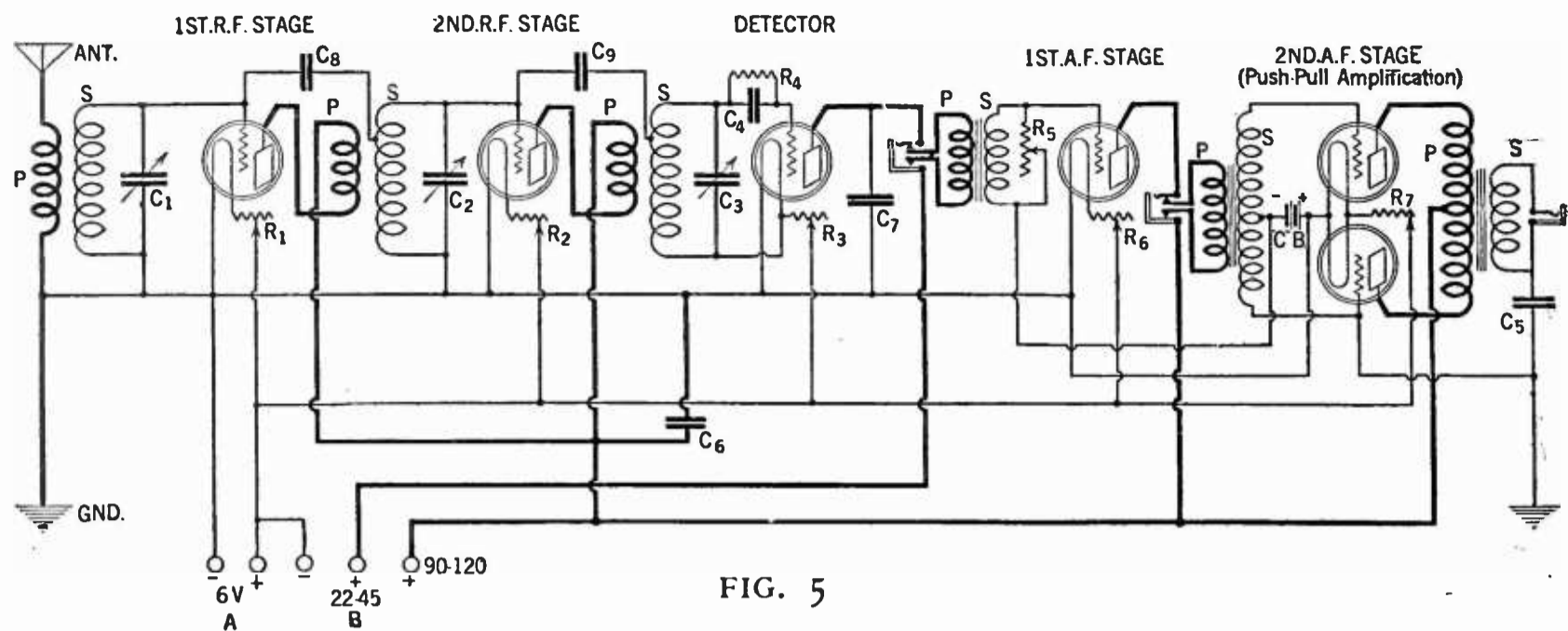

FIG. 5

attention that in its present form the A battery would short-circuit itself through the rheostat R7 when that rheostat is turned on. The defect in the circuit diagram is in making the connection of the lower side of R2 to that lead of the filament circuit connecting to the upper end of the rheostat R7.

The correct connection should be made to the line just below where the connection is now made, or in other words, to that lead running from the left hand side of each of the filaments of the first two tubes.

The corrected circuit diagram appears in Fig. 4.

A NEUTRODYNE CIRCUIT

MR. D. C. asks for a neutrodyne circuit employing a push-pull amplifier as the second audio stage. The complete circuit is shown in Fig. 5.

The values of the various parts are:—

- R1, R2, R3, R6, and R7—20-ohm Rheostats
- R4—3-megohm grid leak.
- R5—Variable resistance 25,000 to 100,000 ohms.
- Cb—C Battery $4\frac{1}{2}$ to 9 volts.
- C1, C2, C3—Variable condensers—.00035 mfd.
- C4—Grid condenser—.00025 mfd.
- C5—Stabilizing condenser—.0005 mfd.
- C6, C7—Bypass condensers—.006 mfd.
- C8, C9—Neutralizing condensers.

The several radio frequency coil units consist of primary and secondary coils wound on $3\frac{1}{2}$ inch bakelite or cardboard tubing. The secondaries are wound with 60 turns of No. 22 DCC wire and the primaries, situated at the lower end of the coil, that is, the end which connects to the negative side of the filament, consist of about 6 to 10 turns of the same wire.

Any standard neutralizing condenser may be employed.

Information relative to the proper neutralization and to the operation of push-pull amplifiers has appeared in past issues of RADIO BROADCAST.

RADIO TOOLS

THE need for good tools in radio construction is paramount where one wants good work to result. The ordinary tools usually to be found around the house are not of very much use.

The well-planned radio kit should contain:

- 2 screw drivers one with $\frac{1}{4}$ inch and another with $\frac{5}{16}$ inch blade.
- 1 pair of wire cutting pliers.
- 1 " " side " "
- 1 " " duck bill " "
- 1 " " round nose " "
- 1 centerpunch
- 1 ball peen hammer
- 1 scriber
- 1 adjustable square
- 1 6-inch scale
- 1 pair dividers
- 1 set of socket wrenches
- 1 soldering iron
- 1 hand drill and set of drills
- Countersink
- Brace and wood bits

The scale, square, scriber, centerpunch, hammer, etc., all aid in the laying out and marking of panels, brass and other work, while the hand drill, drills, countersink, etc., are used to do the actual work in the drilling of these materials. Round nose pliers are indispensable for bus wire bending and duckbill pliers may be handy for loosening and tightening nuts, bolts, etc. Side cutting pliers are usually employed for cutting wire and stripping off insulation.

In the use of drills special care should be used when large holes are drilled. It is much easier to drill a $\frac{1}{2}$ -inch hole by first using a No. 28 drill in a hand drill and then enlarging it by redrilling with a $\frac{1}{2}$ -inch drill inserted in the chuck of a brace, than to drill with a $\frac{1}{2}$ -inch drill at the very beginning. Furthermore, this practice tends toward accurate drilling because the point of a larger drill becomes displaced from the centermark easier than a small drill.

A set of socket wrenches or ordinary S wrenches helps the constructor greatly in insuring secure assembly work. It is well to remember that not too much strain should be placed upon nuts and bolts because, due to their soft brass composition, it is easy to strip the threads.

Every constructor ought to have an ample supply of bus wire, lugs, nuts, bolts, washers, and wood screws.

Get a good set— and Evereadys

**EVEREADY HOUR
EVERY TUESDAY
AT 8 P. M.**

(Eastern Standard Time)
For real radio enjoyment
tune in the "Eveready
Group." Broadcast through
stations

WEAF	New York
WJAR	Providence
WEEI	Boston
WFI	Philadelphia
WGR	Buffalo
WCAE	Pittsburgh
WEAR	Cleveland
WSAI	Cincinnati
WWJ	Detroit
WCCO	Minneapolis
WOC	St. Paul
	Davenport

To ENJOY radio for the rest of your life, get the best set you can afford. There are receivers at all prices, made by reputable manufacturers; it isn't necessary for anyone to get 'round-the-corner, unproved, unreliable merchandise at any price. That applies to batteries too. Eveready Radio Batteries are made in so many sizes and prices that there is a correct, long-lasting Eveready for every receiver and for every radio home, ship or commercial station. Specify Evereadys for your new radio set. It is false economy to buy nondescript batteries at any time. In the long run you'll find it most economical to buy either the large or extra large Evereadys. Always buy Evereadys and enjoy the knowledge that no one can get any more in batteries for the money than you. There is an Eveready dealer nearby.

Manufactured and guaranteed by
NATIONAL CARBON CO., INC.
New York San Francisco
Canadian National Carbon Co., Limited, Toronto, Ontario

EVEREADY Radio Batteries

-they last longer

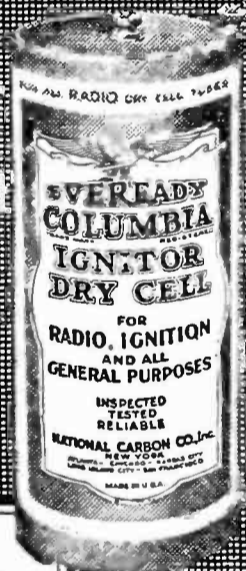

Eveready
Columbia
Ignitor
the proven
Dry Cell
for all
Radio
Dry Cell
Tubes
1½ volts



No. 772
45-volt
Large
Vertical
Price
\$3.75



No. 766
22½-volt
Large
Horizontal
Price
\$2.00



No. 771
4½-volt
"C"
Battery
improves
quality,
saves
"B"
Batteries
Price
60c

★ Tested and approved by RADIO BROADCAST ★

The following is a suggested list of what the supply should be:

	SIZE	LENGTH
Bolts — Round and Flat Head (Brass)	No. $\frac{6}{32}$ No. $\frac{8}{32}$	$\frac{1}{2}'' - \frac{3}{4}'' - 1''$ $\frac{1}{2}'' - \frac{3}{4}'' - 1''$
Nuts — (Hexa- gon Brass)	No. $\frac{6}{32}$ & $\frac{8}{32}$	
Wood Screws— Round—Flat & Oval Head (Brass or Nickel Plated)	No. 3 No. 5	$\frac{3}{8}'' - \frac{1}{2}'' - \frac{3}{4}''$ $\frac{1}{2}'' - \frac{3}{4}'' - 1'' - 1\frac{1}{2}''$
Washers	—size to fit screws	

LONG CORDS

INQUIRIES have been received asking where the Lynch Lead may be procured. This lead, described in the June 1925 issue of RADIO BROADCAST and illustrated in the frontispiece of this issue of RADIO BROADCAST, making possible the use of an automobile storage battery by plugging in to the lamp socket on the dashboard of a car is manufactured by the Belden Manufacturing Company, Chicago, Illinois, and the Crescent Braid Company, Providence, Rhode Island.

The extra length loudspeaker cord also illustrated in the frontispiece of this issue may be obtained from the Alden Manufacturing Company, Springfield, Massachusetts.

Before You Write to the Grid

THOUSANDS of you are writing the Grid for technical advice every month. The expense of framing a complete and exhaustive reply to each letter is very high. The editors have decided that the benefit of the questions and answers service will continue to be extended to regular subscribers, but that non-subscribers, from April 15, on, will be charged a fee of \$1 for each letter of inquiry which they send to our technical department. Very frequently, our technical information service proves of definite money value to you who write us, for we are often able by a sentence or two of explanation, to put you on the right path before you have made a perhaps expensive mistake.

The occasional reader of RADIO BROADCAST will be charged a fee of \$1 for complete reply to his questions, and the regular subscriber can continue to take advantage of the service as before. In that way the non-subscriber will help share the cost of the technical staff whose service he gets. Every letter receives the benefit of the experience of the editor and the technical staff and every correspondent may be sure that his questions will receive careful consideration and reply.

When writing to the Grid, please use the blank printed below.

GRID INQUIRY BLANK

Editor, The Grid,
RADIO BROADCAST,
Garden City, New York.

Dear Sir:

Attached please find a sheet containing questions upon which kindly give me fullest possible information. I enclose a stamped return envelope.

(Check the proper square)

I am a subscriber to RADIO BROADCAST. Information is to be supplied to me free of charge.

I am not a subscriber. I enclose \$1 to cover costs of a letter answering my questions.

My name is _____

My address is _____

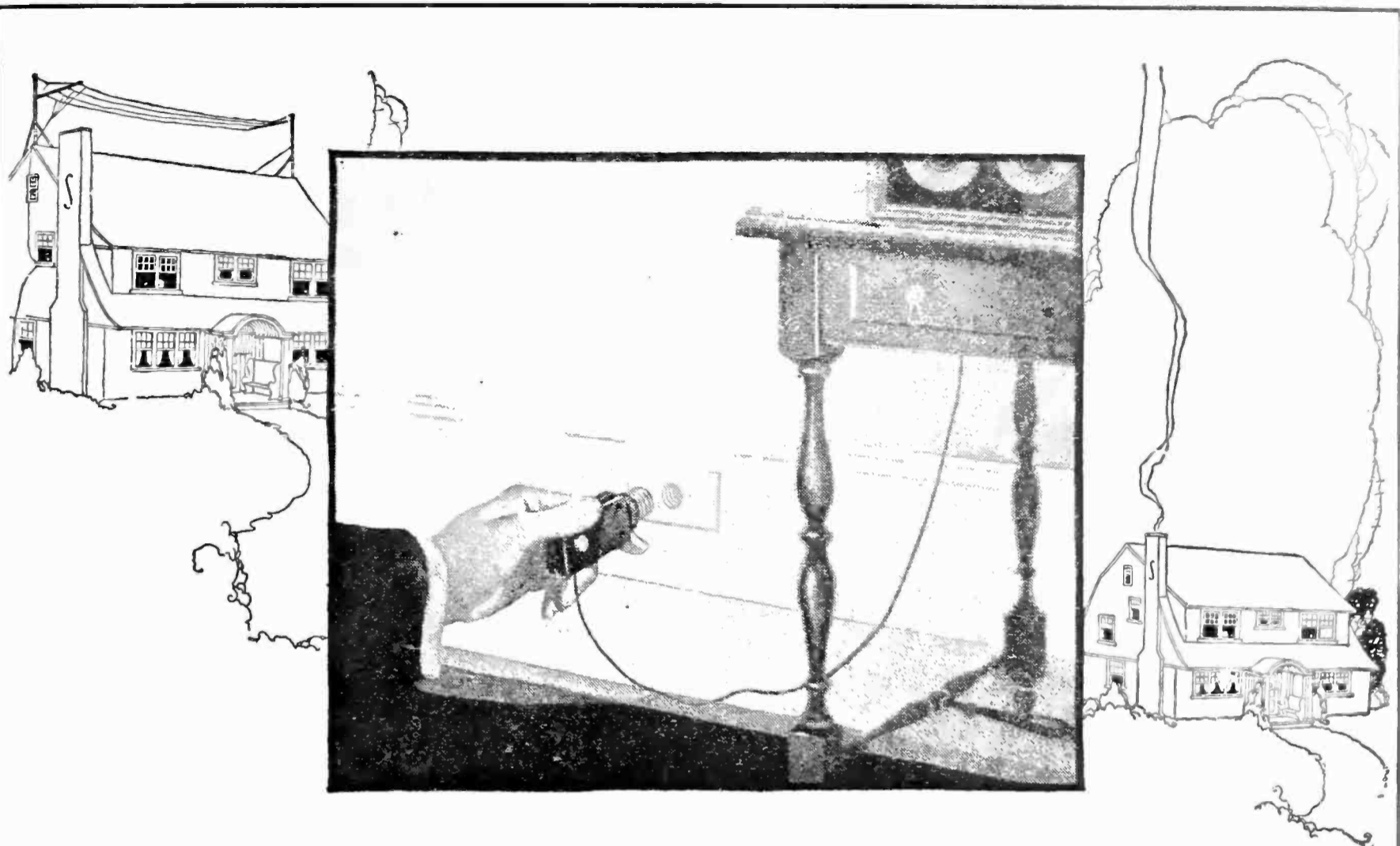

The \$1.50 Ducon and no antenna!

A small Ducon screwed into a light socket—
or a cumbersome, unsightly aerial? Surely
the Ducon! It's so inexpensive—so easy to
use—so sure in its results.



Take home a Ducon to-day—and hear to-
night's best programs!

*The Ducon is sold by all reliable dealers. Try one
for five days. If it is not thoroughly satisfactory,
your money will be refunded.*

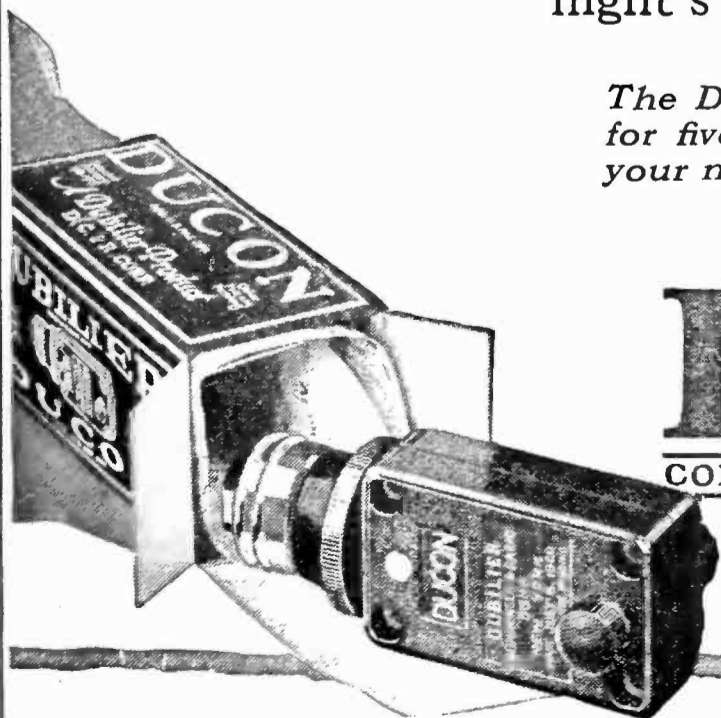

Dubilier

CONDENSER AND RADIO CORPORATION

New Equipment

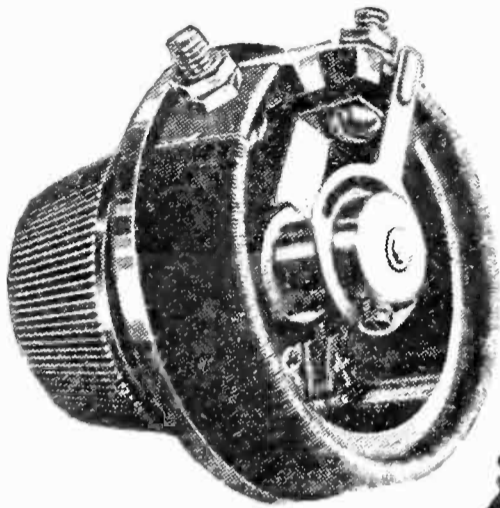

ERLA RHEOSTAT

Designed to require a minimum of room behind the panel and yet it does not sacrifice the good qualities of larger rheostats. The split contact arm facilitates its operation over the resistance winding. It is secured to the panel by a one-hole mounting, a constructional feature now becoming quite popular. Made by the Electrical Research Laboratories, 2505 Cottage Grove Ave., Chicago, Illinois

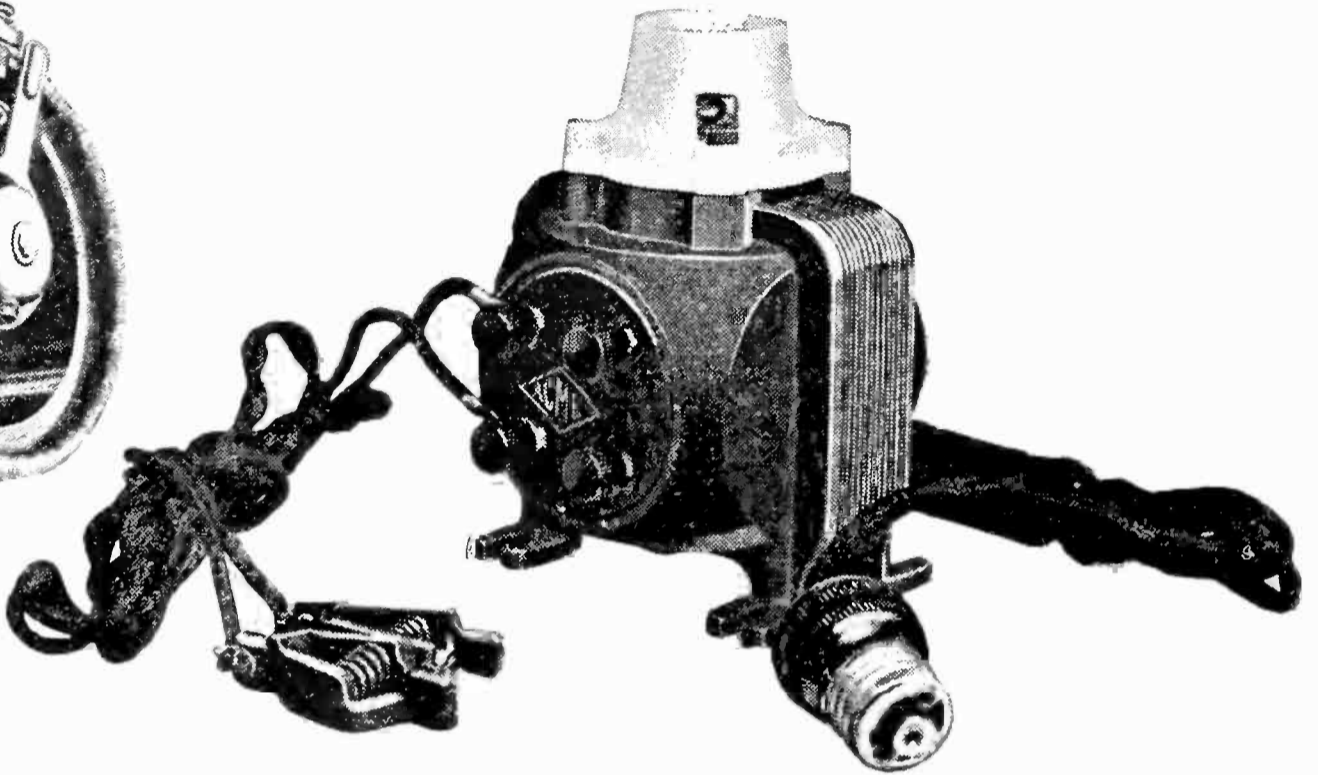

ACME BATTERY CHARGER

This battery charger is one of those units employing a Tungar rectifying tube. It does its work very well, whether it is charging A batteries or high voltage B batteries. The unit is composed of the necessary transformer and connections so that it may be connected directly to the power mains. Made by the Acme Electric and Manufacturing Company, Cleveland, Ohio

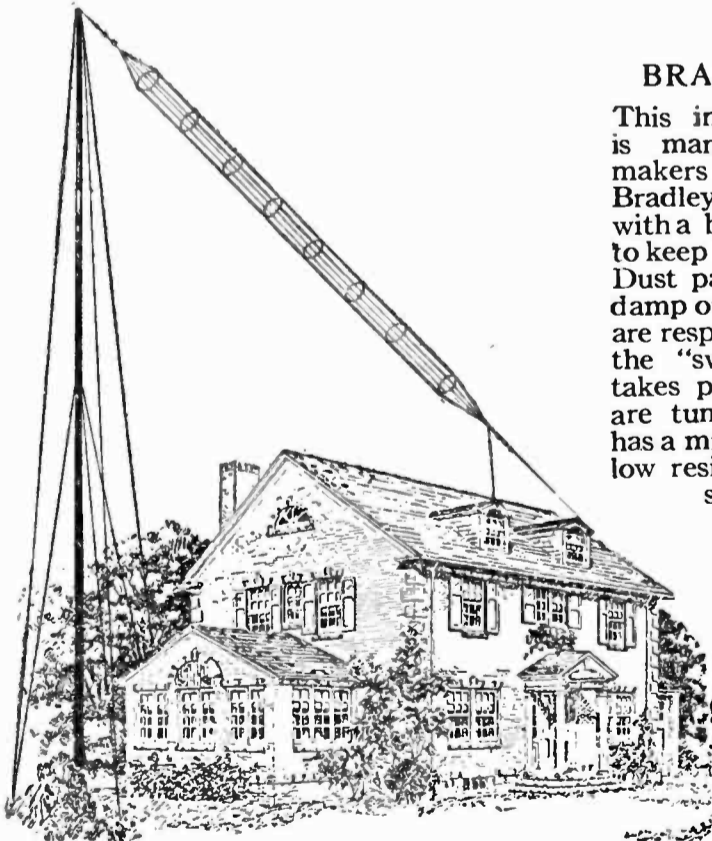

HERCULES AERIAL MAST

The above illustration shows how an efficient and good looking mast may be erected for your antenna. S. W. Hull and Company, 2048 East 79th St. Cleveland, Ohio, make these masts in three standard lengths—20 ft., 40 ft., and 60 ft., all steel construction. They are of a special angle construction that gives great strength and light weight, each of which is a decided advantage. When erected these masts will stand a five hundred-pound pull at the top

BRADLEYDENSER

This interesting condenser is manufactured by the makers of the well-known Bradleystats. It is equipped with a brass shield designed to keep dust from the plates. Dust particles that become damp or electrically charged are responsible for much of the "swishing" noise that takes place when receivers are tuned. The condenser has a minimum of dielectric, low resistance plates and a smooth action

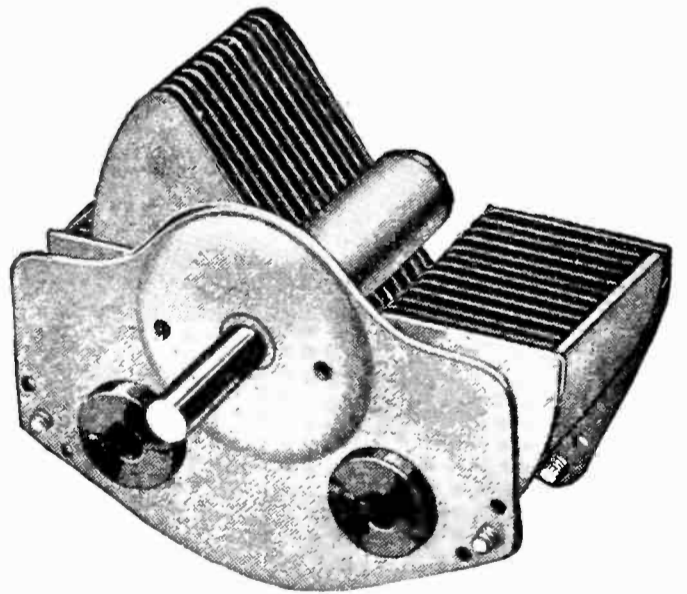

SANGAMO FIXED CONDENSERS

These condensers, made by the Sangamo Electric Company of Springfield, Illinois, makers of the well known Sangamo meters, are a distinct addition to the condenser market. They may be thrown on a cement floor without breaking, heated with a soldering iron without changing their capacity, and soaked in water without absorbing moisture. Their capacity is indeed "fixed"



ATWATER KENT RADIO



A glimpse of the studio of HARRISON FISHER, the artist, where the Model 20 is installed

EVERY Atwater Kent owner knows that his set is exceptionally well built.

If he should take it to pieces he would find every part, down to the smallest hidden screw, soundly and conscientiously made.

In twenty-four years of experience in the manufacture of electrical instruments of precision we have done it in no other way.

The result of this policy is that those who can choose *any* radio set are apt to

EVEN THE PARTS YOU DON'T SEE

prefer the consistent, satisfying action of Atwater Kent Receiving

Sets and Radio Speakers.

For tone, volume, distance, selectivity, appearance—you can be absolutely sure that better designed Radio Sets and Speakers cannot be found.

And your dealer knows how little attention they require after reaching your home. For they have received more attention than they need before they left our factory.

ATWATER KENT MFG. CO. • PHILADELPHIA, PA.

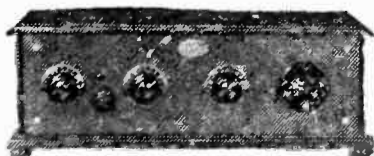

DE LUXE MODEL



MODEL 20 COMPACT



MODEL 10

The McCULLOUGH A-C ★ RADIO TUBE

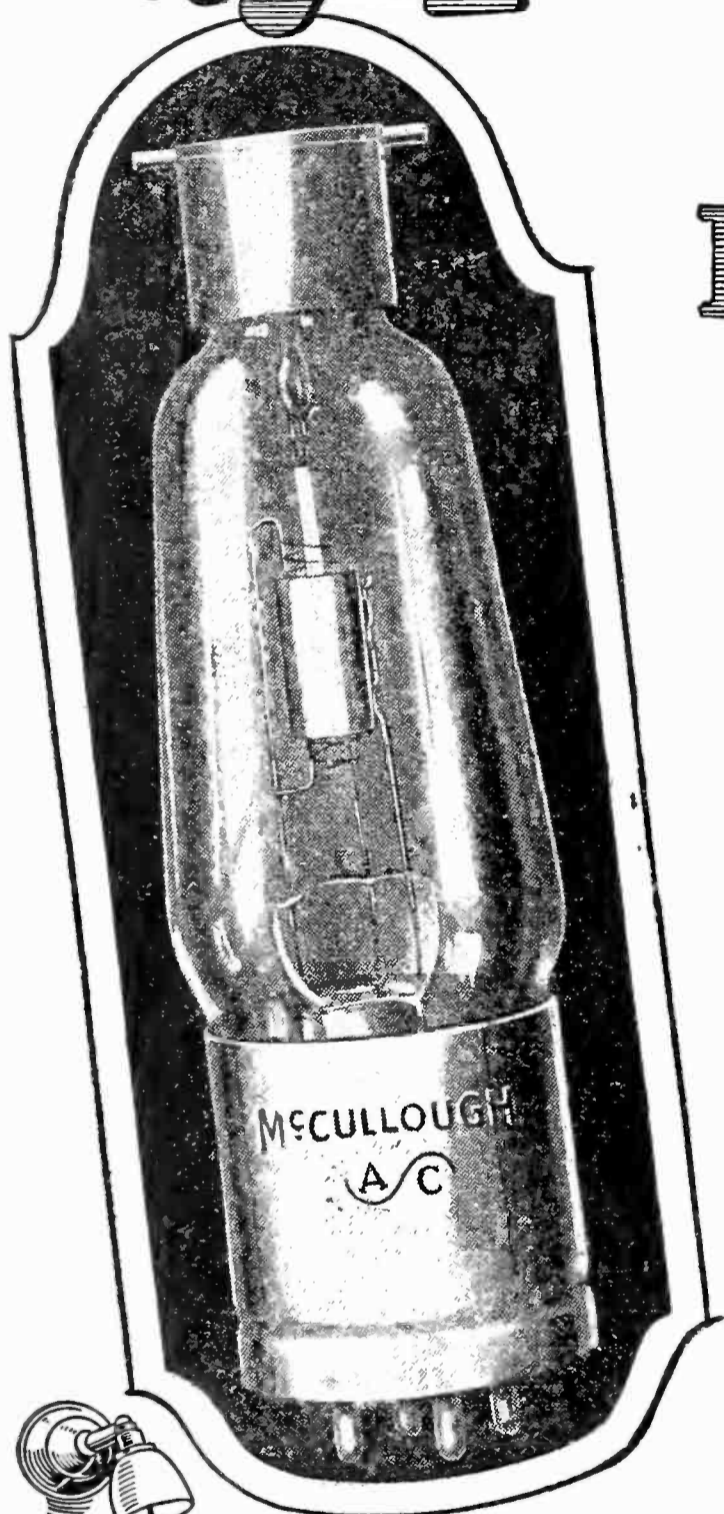

**SIMPLY PLUG INTO THE
A-C LIGHTING SOCKET**
(through small step-down
transformer) and Set is ready to
operate.



**—the Tube that
Eliminates A Batteries
From Radio—**

The elimination of the storage A battery with its
periodic recharging—

The elimination of battery chargers—

Elimination of rheostats—

Lower impedance; greater electron emission and
increased signal response—

No alternating current hum—

No microphonic action—

Low operating cost—

The longer life tube—no filament to burn out—

**THE RUGGED TUBE OF LONGER LIFE,
GREATER EFFICIENCY AND BETTER
QUALITY—**

List Price \$6

Jobbers—

**WRITE FOR
PROPOSITION**

McCullough Sales Company

Distributors McCullough A-C Tubes

963 Liberty Avenue

Pittsburgh, Pa.

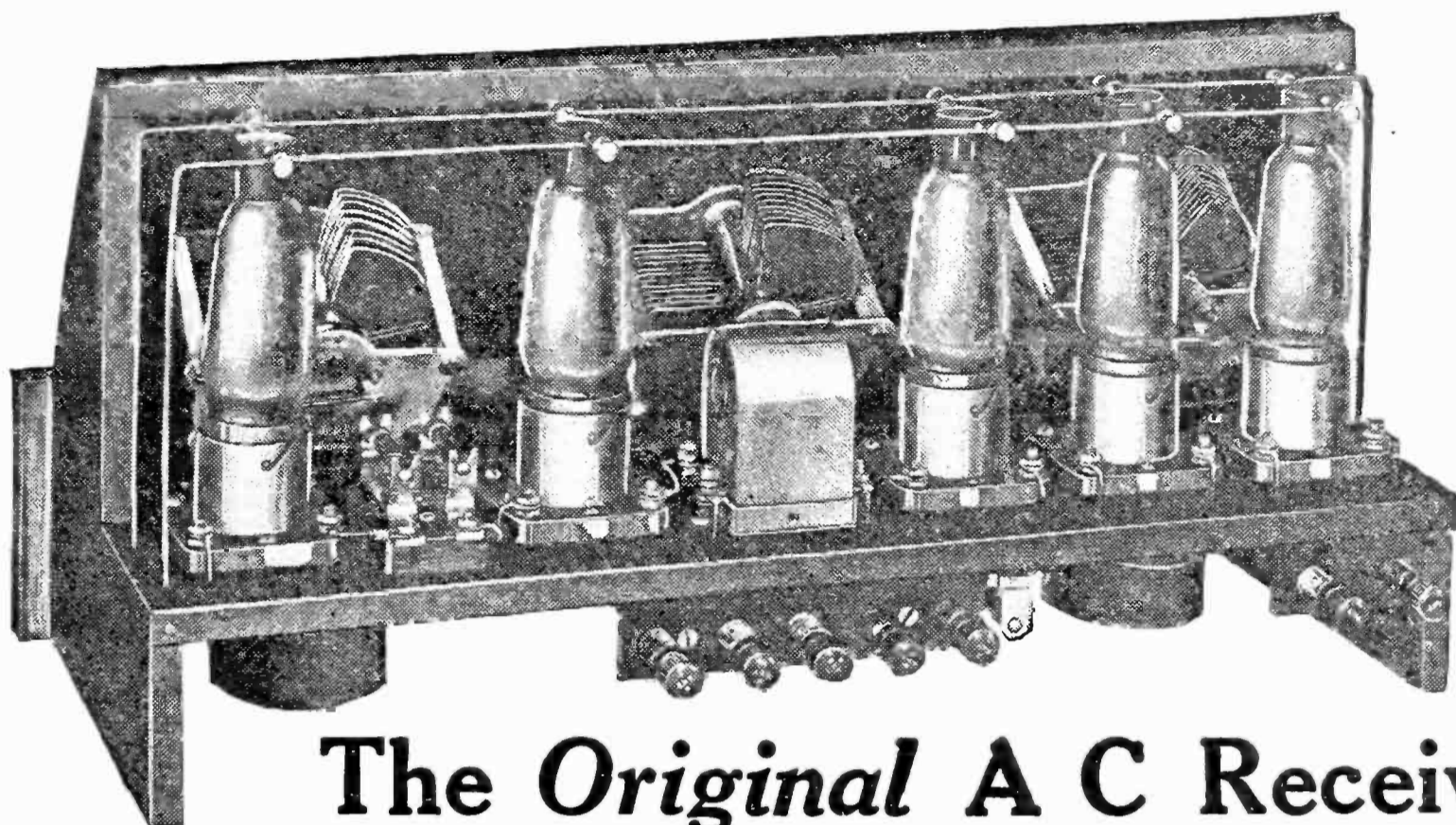

The Original A C Receiver—
MCCULLOUGH
A C

The Receiver built EXPRESSLY for the McCullough A C Tube.
 The Receiver that "came along" with the A C Tube — evolved step by step with the A C Tube to ultimate perfection. Not an overnight makeshift, but the result of the same ingenuity, research and effort that created the McCullough A C Tube.

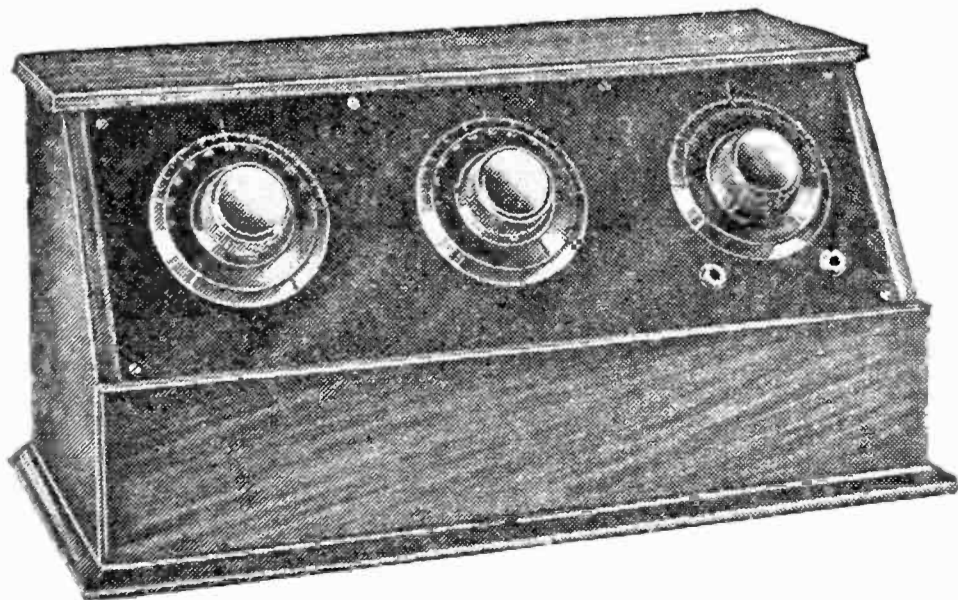

Great distance range—
 Exceptional selectivity—
 Easily logged—

Economically priced and economical to operate.

THE GREATEST THING IN RADIO!
 JOBBERS, WRITE FOR PROPOSITION

PITTSBURGH RADIO SUPPLY HOUSE

Manufacturers of the McCullough A C Receiver
 963 Liberty Avenue, Pittsburgh, Pa.

Also manufacturers of "PRS" A C Leads for the McCullough A C Tube

Radio Broadcast

Made for you by the original designers!

THE remarkable 4 tube Radio Broadcast Phono-Unit, described in the June and this issue, can now be had completely wired and assembled; A few minutes—the connecting of several wires—and this wonderful little circuit stands ready to get everything in the air.

Everything thoroughly tested and subjected to most exacting tests; nothing to go wrong. Together with complete wiring diagram **\$60**

If your dealer cannot supply you, write

RADIO RESEARCH LABS.—Schneider-Horneij
154 Nassau Street New York City

★ Phono Unit

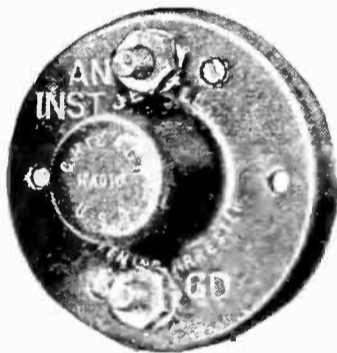

USE A
Jewell

Lightning Arrester

It is approved by
the National Board
of Fire Underwriters

★ Price \$1.10 *Buy from Dealer*

Jewell Electrical Instrument Co.
1650 Walnut St. - Chicago

Our 5-Tube Radio Frequency Set for \$35

will bring in the following stations while KPO is on the air:
Denver, Salt Lake, Seattle, KFI, the first night tried out;
\$65 complete, batteries, tubes, and horn.

HOMESIDE RADIO SHOP
233 Scott St. San Francisco Cal.

The FRENCH BINDERS

*An artistic binding will make a rare
gift for your best friend—your book.*

Country Life Press—Garden City, N. Y.

Sales Manager and Follow Up Man Wanted

by a manufacturing concern, located in New York City who for twenty years have been manufacturing automotive equipment and during the past three and a half years are well known and established in the radio industry. Applicant must have made good as a sales manager and be conversant with radio manufacturing and jobbing trade. Give present or past connections. Salary in exact proportion to ability. State salary and full particulars in first letter, addressing "Opportunity" % Radio Broadcast.

FAHNESTOCK CLIPS

The Perfect Radio Connectors—Are Used



★ *Reg. U. S. Patent Office*

By manufacturers of standard sets and parts, makers of wet batteries and exclusively on all Batteries manufactured by the National Carbon Company.

Their Sure Patented Grip is recognized universally by enthusiastic users.

FAHNESTOCK ELECTRIC CO. Long Island City

LEARN THE CODE AT HOME with the OMNIGRAPH

"Just Listen—The Omnigraph will do the teaching"

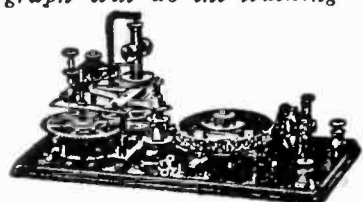

THE OMNIGRAPH Automatic Transmitter will teach you both the Wireless and Morse Codes—right in your own home—quickly, easily and inexpensively. Connected with Buzzer, Buzzer and Phone or to Sounder, it will send you unlimited messages. at any speed, from 5 to 50 words a minute.

THE OMNIGRAPH is not an experiment. For more than 15 years, it has been sold all over the world with a money back guarantee. The OMNIGRAPH is used by several Depts. of the U. S. Govt.—in fact, the Dept. of Commerce uses the OMNIGRAPH to test all applicants applying for a Radio license. The OMNIGRAPH has been successfully adopted by the leading Universities, Colleges and Radio Schools.

Send for FREE Catalogue describing three models. DO IT TO-DAY.

★ **THE OMNIGRAPH MFG. CO., 13K Hudson St., New York City**

If you own a Radio Phone set and don't know the code—you are missing most of the fun

★ Tested and approved by RADIO BROADCAST ★

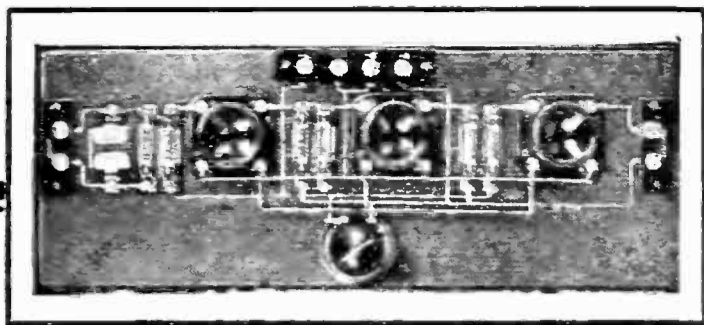

NEW! ★

Resistance-Coupled
Amplifier Kit \$5.00
for only - - - \$5.00

Electrad 3 stage
Resistance-Coupled
Amplifier Kit No. 1.
Price - - - \$5.00

Write for free diagrams
and instructions

ELECTRAD, Inc.

428 Broadway

New York City

Advertising a Fact



THE service of this Burgess Radio "A" Battery is and has been its greatest advertisement; its present recognition and world-wide use is one of the most outstanding tributes paid to a quality product in the radio field.

To date we are widely sustained in our opinion that no other dry cell Radio "A" battery approaches the combined electrical efficiency and economical service of the especially designed Burgess Radio "A."

Use the Burgess Radio "A." Test it. Compare its service in any manner you wish.

"ASK ANY RADIO ENGINEER"

BURGESS RADIO BATTERIES

BURGESS BATTERY COMPANY
Engineers - DRY BATTERIES - Manufacturers
FLASHLIGHT - RADIO - IGNITION - TELEPHONE
General Sales Office: Harris Trust Bldg., Chicago
Laboratories and Works: Madison, Wisconsin

In Canada: Niagara Falls and Winnipeg

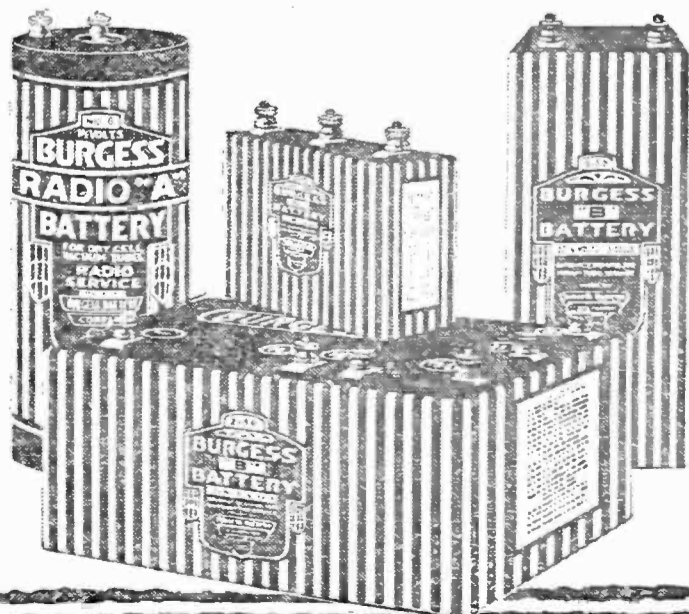

The Red Stripe A Radio Guide Line

For your protection, throughout the center of every Dilecto radio panel is a Red Stripe. You can see it along the edge of every panel.

If you buy or build a set look for the Red Stripe—and you'll be sure of the finest, strongest radio panel that can be made. Dilecto is a Phenolic condensation material.

THE CONTINENTAL FIBRE COMPANY
Factory: Newark, Delaware

Service on Dilecto, Conite, Contex and Vulcanized Fibre from:
New York, 250 Park Ave. Chicago, Wrigley Bldg.
San Francisco, 75 Fremont St. Los Angeles, 307 S. Hill St.
Seattle, 1041 Sixth Ave., South
Pittsburgh, Farmers Bank Bldg.

Dilecto ★



WRITTEN 2-YEAR GUARANTEE

ARROW BATTERY

Battery Prices SMASHED!

To Consumers Only

Here is a real battery quality, guaranteed to you at prices that will astound the entire battery-buying public. **Order Direct From Factory.** Put the Dealer's Profit in your own pocket. You actually save much more than half, and so that you can be convinced of true quality and performance, we give a *Written 2-Year Guarantee*. Here is your protection! No need to take a chance. Our battery is right—and the price is lowest ever made. Convince yourself. Read the prices!

Auto Batteries	Radio Batteries
6Volt, 11 Plate, \$9.50	6Volt, 100 Amp. \$9.50
6Volt, 13 Plate, 11.50	6Volt, 120 Amp. 11.50
12Volt, 7 Plate, 13.00	6Volt, 140 Amp. 13.00

Buy Direct—Send No Money

We ask no deposit. Simply send name and address and style wanted. Battery will be shipped same day we receive your order Express C.O.D. subject to your examination on arrival. Our guarantee accompanies each battery. We allow 5% discount for cash in full with order. You cannot lose! Send your order today—**NOW!**

ARROW BATTERY CO.
Dept. 10. 1215 So. Wabash Ave., Chicago

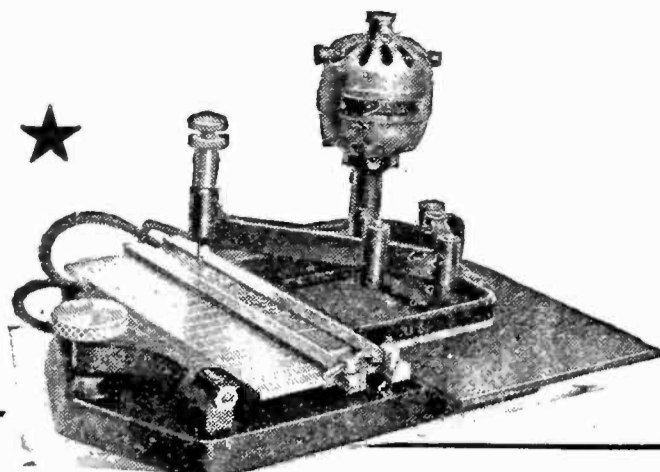

Engrave Panels for Radio Builders!

Keep Busy This Summer When Retail Sales Are Quiet

Every radio amateur who builds his own set wants engraved on the panel his name, trademark, dial markings, etc. You can do it for him if you own a Rapid Engraving Machine, and make several dollars an hour doing it. Complete equipment, \$135. Usual prices are several hundred dollars.

Be first to own one and coin money

Branch Tool Co., Dept. H, Forestdale, R. I.

FORMICA RADIO PANELS TUBES AND RODS

WRITE TO-DAY for your copy of our new catalog listing and pricing 3384 different sizes and kinds of Formica Radio Panels, 126 different sizes of Formica Tubes, and 21 different sizes of Formica Rods.

DRILLING—ENGRAVING

Lowest prices consistent with good work.

STARRETT MFG. CO.

521 S. Green St. - Chicago, Ill.

\$2.95 Out at last. "The Hawley." An unacid rechargeable "B" storage battery of 22½ volts. Runs any set with more than ample power up to 8 tubes. Easily recharged. This is not a parts battery but ready to use—no putting together or buying any extras. Chemical included and shipped separate. Closed top, heavy shock-proof glass cells. any special detector or amplifying voltage easily had. Patent Pending. Special offer 4 22½ volts (90 volts) \$10.00; 112½ volts, \$12.50; 135 volts, \$14.75; 157½ volts, \$16.80. Knock-down kits may be had at still lower prices. Every battery and kit sold on direct understanding it may be returned in 30 days if clearer and better reception is not had and money plus transportation refunded. No ifs, ands, or buts to this offer. Further guaranteed 2 years. Send no money—simply pay expressman their cost on arrival plus the small transportation. Same day shipments. Write for my guarantee, testimonials, and literature. It's free and it's interesting.

B. F. SMITH 31 Washington Ave. Danbury, Conn

RADIO LOUD SPEAKING
FACTORY GUARANTEED SET only \$29.50



SEND FOR testimony of users and SPECIAL OFFER. **MIDWEST RADIO CORP'N** Pioneer Builders of Sets 406-Y, E. 8th St., Cincinnati, O.

AGENTS DEALERS WRITE

MIRACO GETS 'EM COAST TO COAST

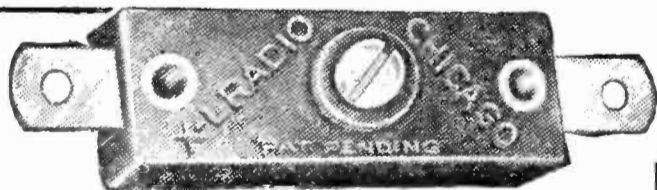

FOR GREATER DISTANCE, VOLUME AND CLARITY USE

X-L VARIO DENSERS

Endorsed and Used by the Foremost Radio Engineers of the Country

MODEL N—Capacity range 1.8 to 20 micro-micro-farads, as used in Radio Broadcast's Phonograph Receiver in this issue, for balance in Roberts two tube, Browning-Drake, McMurdo Silver's Knockout, Neutrodyne and tuned radio frequency circuits.

Price \$1.00

MODEL G—Two capacity ranges, .00016 to .00055 and .0003 to .0015 Microfarads, for the Cockaday circuit, filter and intermediate frequency tuning in super-heterodyne and positive grid bias in all sets.

Price \$1.50

X-L RADIO LABORATORIES

2426 Lincoln Ave. CHICAGO

If your dealer cannot supply you write direct

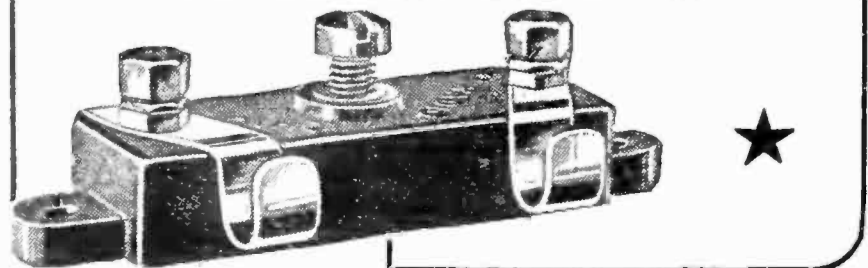

MU-RAD RECEIVER

The Last Word in Radio ★

Write for Literature

MU-RAD LABORATORIES, Inc., 801 Fifth Ave., Asbury Park, N. J.

Why Fuss with "B" Batteries?

Use the Rhamstine "B" RECTIFIER

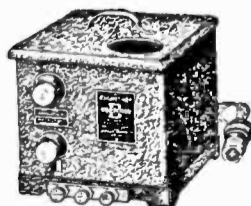

Plugs into any electric light circuit of 110 volts 60 Cycles AC. Cannot burn out tubes; has no acid; no hum nor distortion. Operates on any 1 to 8 tube set. Detector voltage 0 to 50; Amplifier voltage 0 to 110.

Only \$25 ★

Write to-day for circular.

J. THOS. RHAMSTINE*

506 E. Woodridge St. Detroit, Mich.

INSULINE PANELS

READY DRILLED
AND ENGRAVED
FOR ALL
POPULAR CIRCUITS

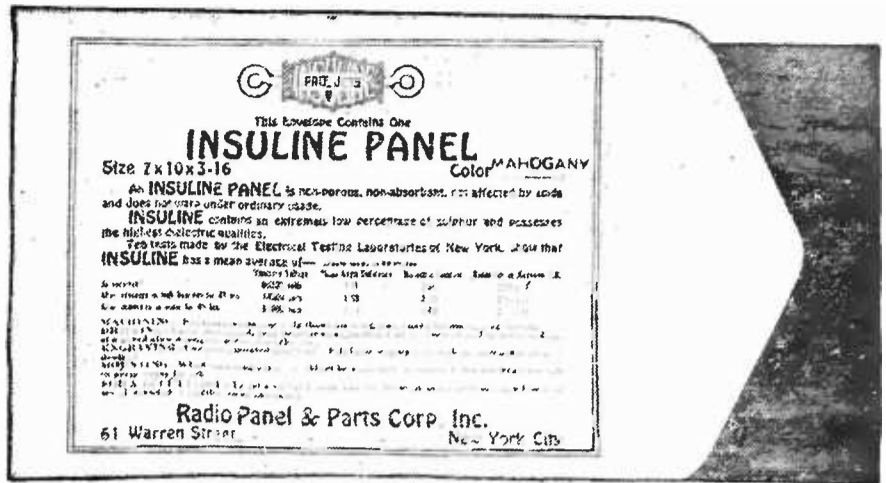

The Panels listed are made up to the same high standard specifications as are required by prominent set manufacturers. Every panel is made according to

the layout and blue prints supplied by the inventor of the individual circuits. They represent the greatest value in panels on the market to-day.

Drilling and Engraving on Insuline to Specification

★	Fada 5 Tube Neutrodyne, 7"x26" x3/16"	Fada 5 Tube Neutrodyne, 7"x24" x3/16"	Ambas- sador 3 Tube, 7"x18" x3/16"	Ambas- sador 4 Tube, 7"x21" x3/16"	B. T. Name- less 7"x26" x3/16"	Freshman Master- piece, 5 Tube 7"x18" x3/16"	Resla Reflex 3 Tube, 7'x18" x3/16"	Gennwin Low Loss 3 Tube, 7"x18" x3/16"	Cockaday Sup. Het. 7"x24" x3/16"	Roberts Knock- out 4 Tube, 7"x21" x3/16"
Black	\$5.00	\$4.80	\$3.50	\$4.00	\$5.00	\$3.50	\$3.50	\$3.50	\$5.00	\$4.50
Mahogany . .	6.00	5.70	4.00	5.00	6.00	4.00	4.00	4.00	6.00	5.50
Frieze Finish	6.00	5.70	4.00	5.00	6.00	4.00	4.00	4.00	6.00	5.50

Sub Panel for 5 Tube T. R. F., 7"x17"x3/16", \$4.00—Write for complete list of prices.
Standard size panels in stock—Insuline and Bakelite

RADIO PANEL AND PARTS CORP.

(INSULATING COMPANY OF AMERICA)

59 WARREN STREET

INSULINE BUILDING

NEW YORK CITY



★ **KORACH**
Tuned Loop
Tuning Feature
Directional
Can Be Logged
Collapsible

Patent Applied For

Approved! Recommended and used on the famous COCKADAY 8-TUBE SUPERHETERODYNE REFLEX. The Editorial on page four of Feb. POPULAR RADIO tells how Cockaday, using the Korach Loop, logged the following Foreign Stations: 2BD, Aberdeen, Scotland; 5NO, Newcastle, Eng.; 2PY, Plymouth, Eng.; ESP, Paris, France; 2LO, London, Eng.; PTT, Madrid, Spain; WKA2, Porto Rico and CYC, Mexico City. Positively the last word in loop construction. Exclusive features give you selectivity and distance unheard of before with loop aeriels. Operates successfully on all sets designed for loop construction. If your dealer cannot supply you, order direct from us. Price \$16.50. Send \$2.00 as good faith deposit with your order, balance C. O. D. Satisfaction guaranteed.

KORACH RADIO COMPANY
309 So. LaSalle St. Dept. 8 Chicago, Ill.

Full Particulars on Request

Dealers and Jobbers: Write at once for attractive proposition

ACH TUNING INSTRUMENT

Using Expensive WORM GEAR

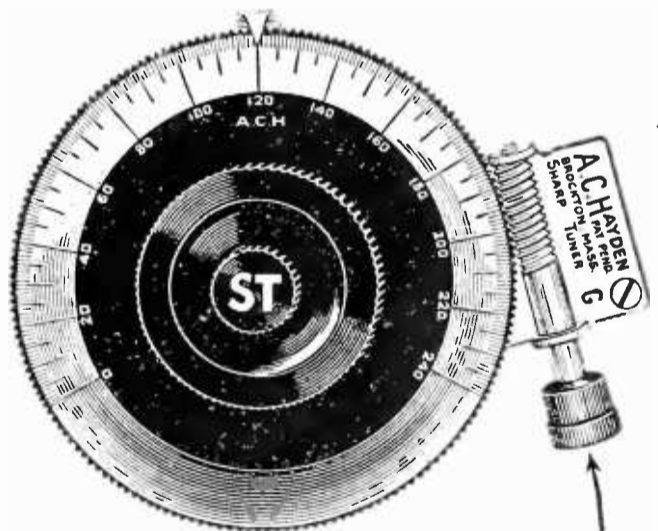

Why the A.C.H. is different

3 in. DIAL → ACH → 156-t0-1

4 in. DIAL → ACH → 215-t0-1

Price 3-inch size.....\$2.50 Price 4-inch size.....\$5.00
Regular fitting 5/16 shaft. 1/4 and 3/16.....5c each extra

The expensive worm gear is a type of gear in a class by itself. Ask for the

WORM GEAR

A new way to spell
SELECTIVITY—WORM GEAR
A WORM GEAR HAS NO SUBSTITUTE OR OTHER NAME

Mail orders—prepaid U.S.A.—if not at dealers

A. C. HAYDEN CO.
BROCKTON - - - MASS., U. S. A.

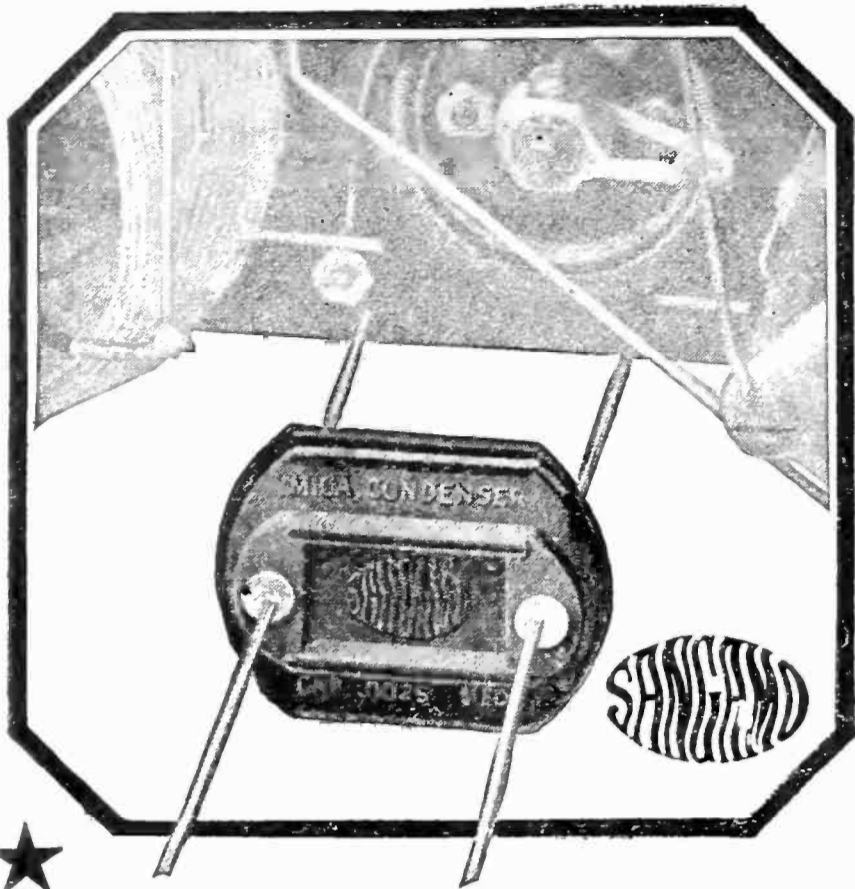

★
You can do this best with Sangamo Mica Condensers

You can use the new Sangamo Mica Condenser to support long busbars, instead of using the busbar to support the condenser. Simply slip the bus through condenser terminals and solder. No cutting of leads. This is merely one feature demonstrating the wide flexibility of connections possible with Sangamo Mica Condensers.

You can rely upon the capacity of this condenser being within ten per cent of marked value and remaining permanently at that value. Temperature or humidity changes, or even rough usage will not change it. You can freeze it in ice or boil it; keep it immersed in water for days, and the capacity will remain constant. Soldering has no effect whatever upon the capacity—there is nothing to melt or burn.

This feature of permanent accuracy is necessary to bring out the highest efficiency of any circuit—especially in reflex hook-ups.

Solidly molded in smooth brown bakelite, the Sangamo Mica Condenser sets a new standard of neat compactness. It looks finished and actually improves the appearance of the set.

Made in all standard capacities with or without resistor clips. Prices are very reasonable.



Sangamo Electric Company
 Springfield, Illinois

RADIO DIVISION, 50 Church Street, New York

SALES OFFICES—PRINCIPAL CITIES

For Canada—Sangamo Electric Co. of Canada, Ltd., Toronto.
 For Europe—British Sangamo Co., Ponders End, Middlesex, Eng.
 For Far East—Ashida Engineering Co., Osaka, Japan

1320-1

Send for FREE Bulletin 94

Whether you plan to build or to buy a receiving set, it will pay you to know something about the "insides" of radio. This booklet gives you the "inside dope" on some of the recent inventions embodying the latest ideas of radio engineers. In this bulletin is full information about the

Premier "HEGEHOG" Audio Transformer
 Ratios 1 to 3, 1 to 4, and 1 to 5, \$3.50
 Ratio 1 to 10 \$4.50



This light weight audio transformer has earned a place in the very front rank for its remarkable volume and pure, natural tone. It is 100% self-shielded against foreign noises. Its small size is a surprise to everyone. It cuts the space requirements for audio transformers in two. This is a big advantage in portables and makes it ideal for neat and compact wiring. FREE HOOKUP DIAGRAMS also sent on request. All popular types. Address

PREMIER ELECTRIC COMPANY
 3812 Ravenswood Avenue Chicago

PREMIER Quality Radio Parts

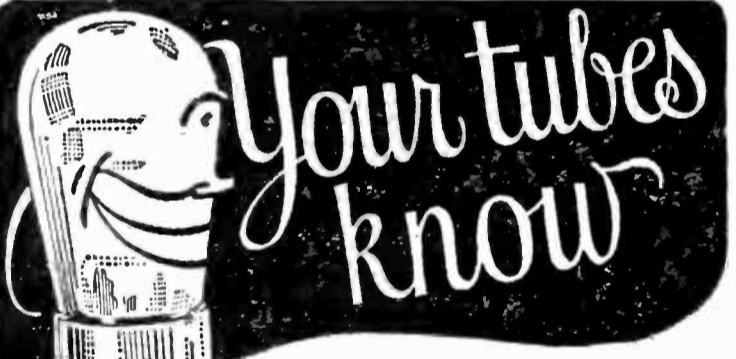

The Difference— When Using AMPERITE

AMPERITE the "self-adjusting rheostat", automatically controls the flow of current, and makes hand controlled rheostats obsolete.

Permits the use of any type of tubes or any combination of tubes. Specified in every popular construction set.

★ For perfect results you must use AMPERITE for filament control. Price \$1.10 everywhere.

RADIALL COMPANY
 Dept. R. B.-8, 50 Franklin Street, New York City



Write for FREE Hook-ups

★ Ferguson

SIX

It is a Mark of Distinction to Own or Handle This Remarkable Receiver

It is not our purpose to saturate the market with FERGUSON receivers, but rather to manufacture only for that class of dealer or owner who demands the finest possible reproduction of radio broadcast.

The quality of materials, expert designing, painstaking workmanship and thoroughness of testing—and also because of our new theory of operation—we admit of no equal for pureness of reproduction, power, selectivity, and all wanted characteristics that go with a radio receiver that is truly “years ahead” in both results and appearance, regardless of type or number of tubes.



Ferguson Six—Console Model

Complete with special built in loud speaker, with Amplion unit, compartments for “A” and “B” batteries and battery charger. Cabinet work the finest, genuine walnut, finished in latest high light styles. Plenty of room for books and radio literature. Top panel drops down when receiver is in operation, providing a handy desk arrangement.

Price, \$290

Batteries, tubes, and charger extra

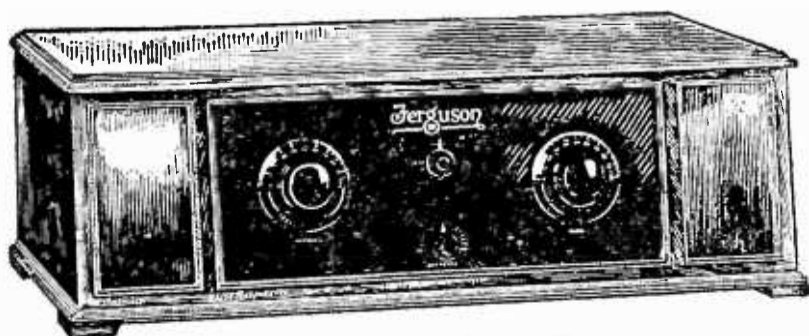

Ferguson Six—Cabinet Model

Employs two stages of balanced tuned radio frequency oscillating detector (equal to regeneration for added volume, but without radiation or effect on tuning); three stages of perfectly matched audio frequency. De Luxe high light walnut or mahogany cabinet with separate compartments for “B” batteries.

Price, \$180

Tubes and batteries extra

With the extreme care in design and manufacture goes also an extreme care in the selection of our dealer representation, and our policy of limiting our distribution consistently to those who handle quality products on a legitimate basis will be maintained as a measure of protecting our customers and our regular dealers against misrepresentation and unfair competition.

For these reasons purchasers of and dealers in FERGUSON receivers are assured of a permanent and tangible *investment*, one that will give *lasting* satisfaction and pride of possession through the years to come.

Illustrated catalog on request

Investigate if You Want the BEST

We still have valuable territory for the better class of radio jobber and dealers. As we challenge comparison with any receiver regardless of type or tubes, we welcome requests to show what the FERGUSON will do and how it operates on any antenna—from 15 ft. indoor to 200 ft. outdoor.

J. B. FERGUSON, Inc.

Manufacturers of High Class Radio Receivers

Executive offices and showrooms:

41 East 42nd Street

New York



Geared 80-1

Replaces your present dials without alterations to your set

Patented April 21, 1921
Other Pats. Pending

on super-hets!
-improves selectivity-

Just where you need the finest adjustment—a highly geared, absolutely accurate Tuning Control. Accuratune Controls give sharper tuning and improves any set. Particularly valuable for sensitive receivers where sharp tuning is essential. Equipped with patented friction clutch. Requires no set alterations. Your set deserves the best!

\$3.50

Write for descriptive folder.



At your dealers otherwise send purchase price and you will be supplied—postpaid.

MYDAR RADIO CO., 9-D Campbell St., Newark, N. J.



**MATCHED
DUPLIX
CONDENSERS**

*Always Read Alike
Because They Are ~ ~* ★

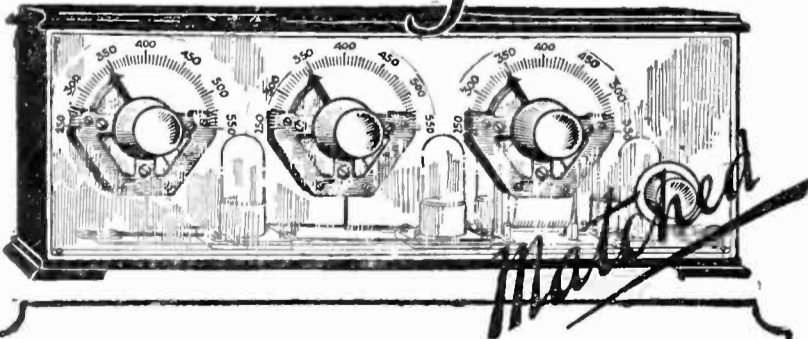

Just one number to log—or eliminate logging and dial by wave-lengths. Made as Bureau of Standards specifies, and guaranteed. Rugged, with wear-proof bearings. Built for accuracy. Packed in matched sets. Sealed, to remain untouched until used.

DUPLEX Matched condensers assure you the most out of your radio set. Ask your dealer.

Interesting illustrated folders on request.

DUPLEX CONDENSER & RADIO CORP.
46 Flatbush Ave., Extension Brooklyn, N. Y.

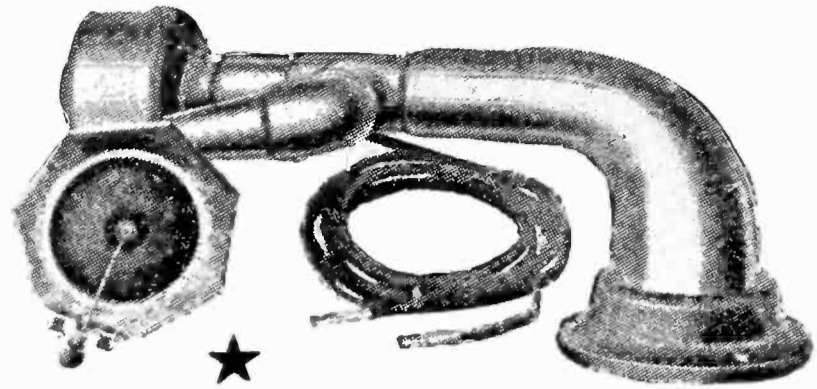

**Use the Empire Phone Arm
in Your Phonograph Receiver**

The Empire Phone Arm is a scientifically constructed combination phonograph reproducer and radio loud speaker unit that has been tested and approved by experts.

It is easy to mount, and is simplicity itself in operation. The Empire Phone Arm is a highly polished nickel unit that is distinctly attractive in appearance.

These reasons combined with the fact that it produces more than satisfactory results, is why it was used in the original experimental models of RADIO BROADCAST's New Phonograph Receiver.

Complete, Nickel Plated, \$12.75

THE EMPIRE PHONO PARTS CO.
2261 East 14th St. Cleveland, Ohio

RADIO

MASTS	MASTS	MASTS
60 ft. \$20.00	40 ft. \$10.00	20 ft. \$5.00

We pay the freight anywhere in U. S.

At last a reasonably priced mast is on the market, made from select tamarack and pine poles. To facilitate shipping, they are cut in 20 ft. lengths; wire and staples to wrap the joints included; the masts should last 20 years. No circulars or dealers, order direct from this ad. Send money order to

RADIO MAST COMPANY
Big Falls Minnesota

HEATH ★
CONDENSERS

For Real Radio Reception

Write for Literature

HEATH RADIO & ELECTRIC MFG. CO.
206 First St., Newark, N. J.

Wire-Nuts for joining

radio antenna and lead-in wires in one minute without solder, tape or tools.

Many other uses. A million perfect joints have already been made with these new Wire-Nuts.

Listed by Underwriters' Laboratories. Booklet free. Ask your dealer for Wire-Nuts.

We will send 3 Wire-Nuts post paid on receipt of 25c. B. TORK COMPANY, 8 W. 40 St., New York

Why Building a Portable Is so Easy with the



CASE

For a small cost and little effort you can now build a portable radio in a Karryadio Case, the like of which you could not buy for twice the sum.

Greatest Value Ever Offered Portable Set Builders

\$15.00

Three Portable Requisites for the Price of One

Pivoting Loop-Cover—the cover contains a low loss loop with center tap and is so designed that it can be turned in any direction—to pick up different stations.

Collapsible Horn—when closed it occupies only a space an inch thick and can rest on top of batteries—opened it measures six inches square, giving wonderful volume and tone. This collapsible feature of the horn permits for adequate battery supply in a compact case.

Compact Design—the conservation of space is the first essential in building your portable—Karryadio is the final word in compactness—yet this has not been accomplished at the expense of essentials. Only the above exclusive features of this portable case have made it possible in such a compact case to allow ample room for both a powerful radio set and good battery supply. The sturdy black leatherette case measures 18½" long, 14¾" wide, and 5¾" thick—no larger than a week end case

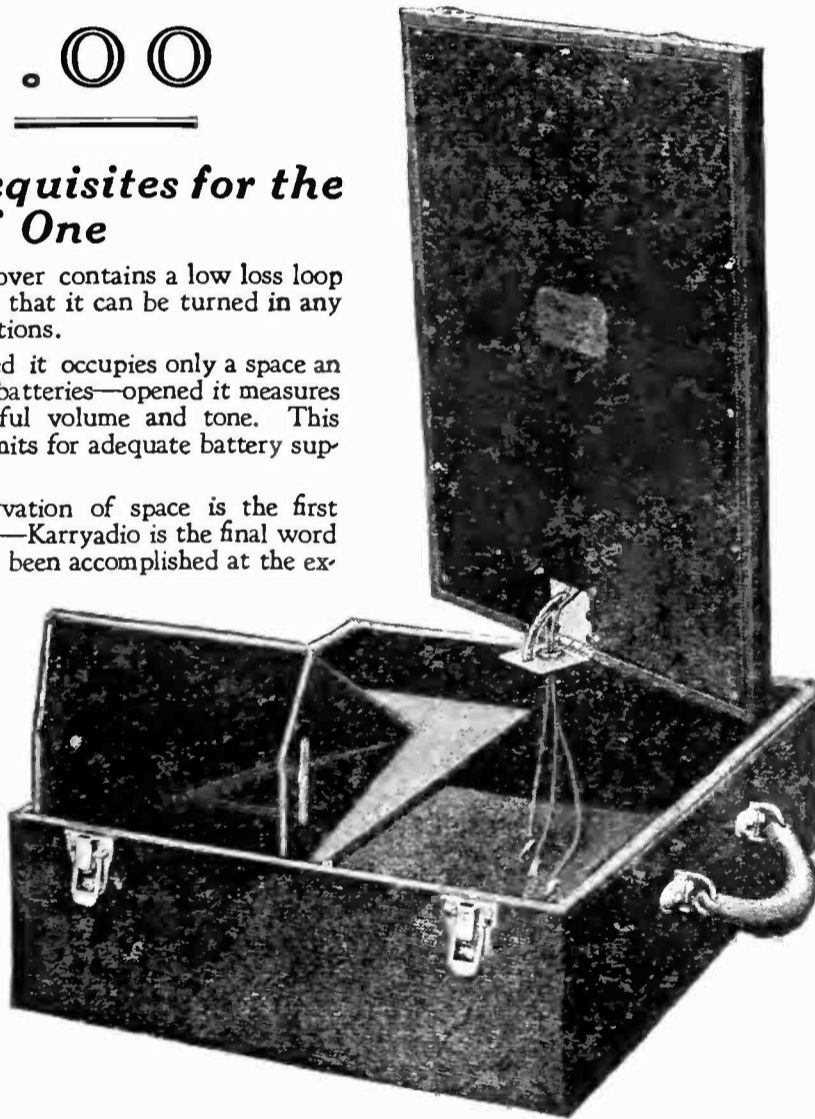

Now it is easy to build your portable. No problems as to how to make it self-contained. No shopping for this accessory or that to fit a certain case. You can build your radio in a truly portable case—portable, because once you close the cover your radio set is complete in one unit when you open the cover it is ready for instant operation. No assembling of a loop needed with Karryadio's pivoting loop-cover.



Build A Portable this Summer

Enjoy radio broadcasting wherever you happen to be. All you need to do is to build your set on a standard 18" panel—set it in the Karryadio Case and you are the possessor of a marvelous portable radio. Write to-day.

Armley Radio Corporation

68-70 Fleet Street, Jersey City, N. J.

At Your Dealer's or Mail Coupon Below

Armley Radio Corporation, 68-70 Fleet Street, Jersey City, N. J.

Gentlemen: I am enclosing \$15.00 for which send me without further charges one "Karryadio Case" with pivoting loop and collapsible horn.

Name..... City.....

Address..... State.....

My Dealer's Name is.....

Address.....

Bradleystat

PERFECT FILAMENT CONTROL
 The result of more than twenty years' research and experience in the manufacture of graphite disc rheostats for radio, mines, mills, etc.

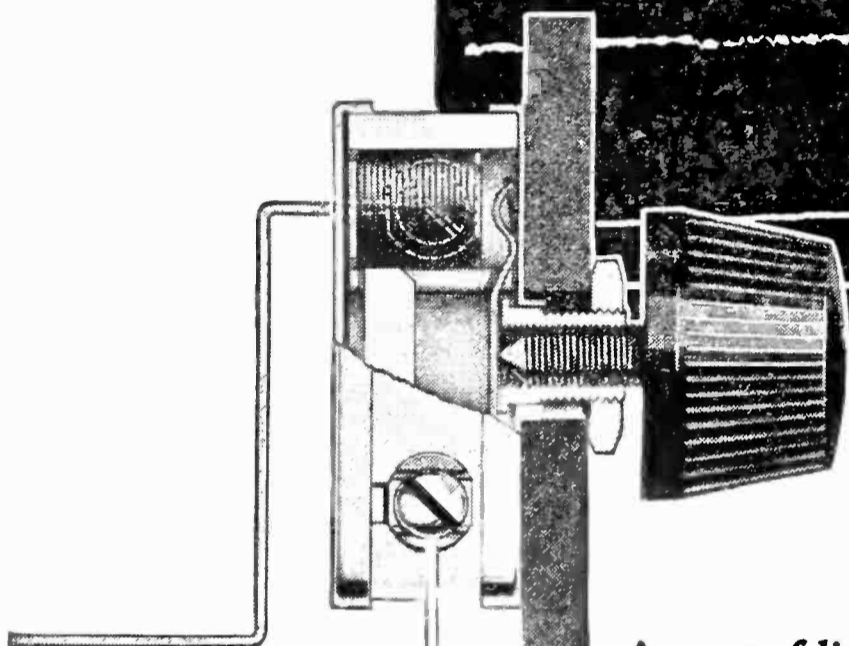
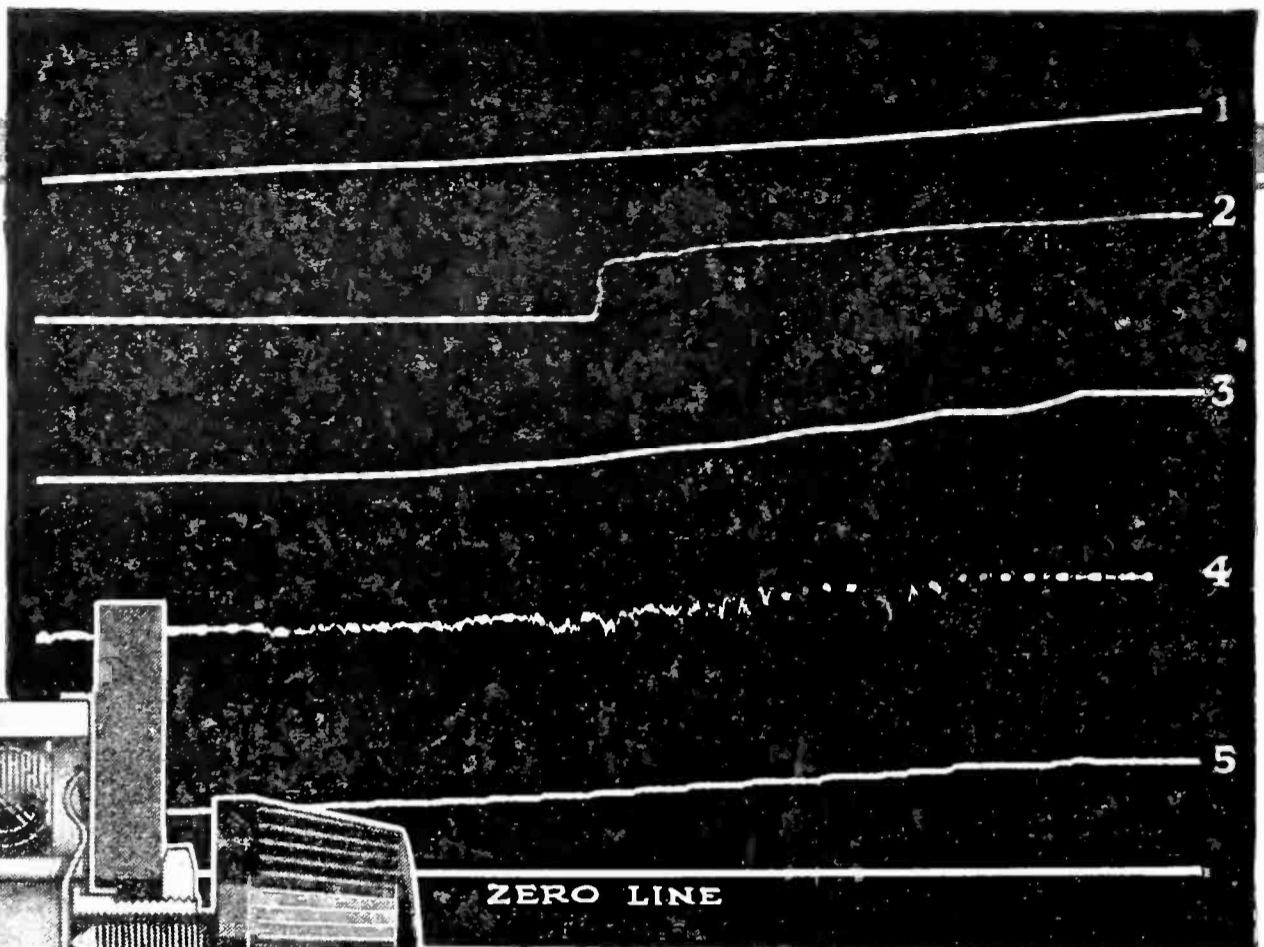

Only Graphite Discs provide noiseless filament control

A spot of light, silently guided by an automatic electric oscillograph, traced the above curves on a moving photographic film. The test, made at the University of Wisconsin, was impersonal and impartial. The result, however, proves beyond a doubt the superiority of the Bradleystat for radio filament control.

The first line (No. 1) shows the silent, stepless variation produced by the Bradleystat. The following curves (Nos. 2, 3, 4, and 5) were produced by other types of rheostats, some using loose powder instead of graphite discs. See the scratchy, noisy control. Every jog in the white lines means a distracting noise in the loud-speaker.

Is it any wonder that Bradleystats are being substituted for ordinary rheostats by thousands of set owners? Try one, yourself, and hear the difference!

Use the same Bradleystat for ALL Radio Tubes without changing connections.

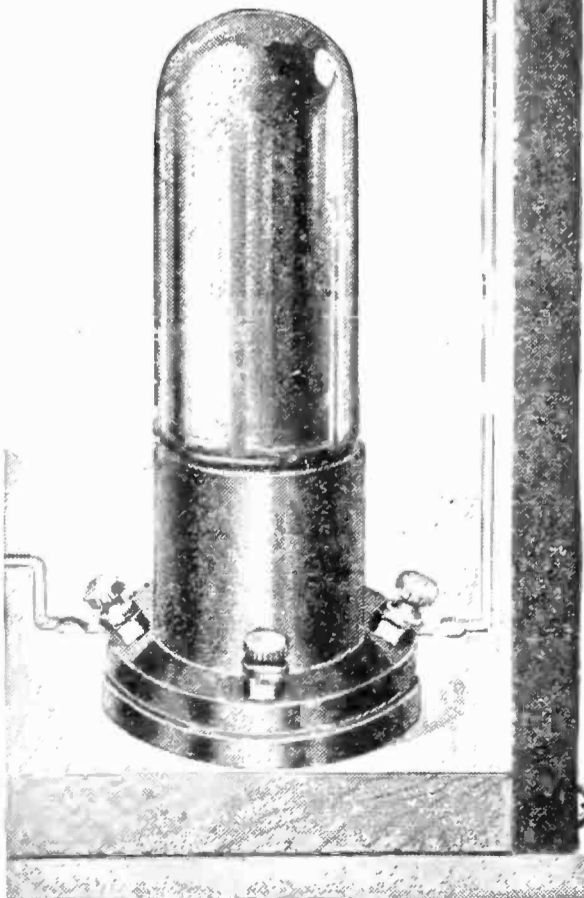

Mail the Coupon for Literature

Allen-Bradley Co.
 Electric Controlling Apparatus

278 Greenfield Ave.  Milwaukee, Wis.

Mfrs. of graphite disc rheostats for over twenty years.

★

Allen-Bradley Co.
 278 Greenfield Ave., Milwaukee, Wis.

Please send me your latest literature on the Allen-Bradley line of radio devices.

Name.....

Address.....

★ Tested and approved by RADIO BROADCAST ★