

JANUARY, 1923

PRICE 25 CENTS

V. 2 # 3

RADIO BROADCAST

“THIS IS A RADIO CHRISTMAS”

A Kingdom for More Wavelengths!

By Paul F. Godley

The First Amateur Radio Club
in America

Famous Radio
Patents

How Far Have
You Heard on One Tube?

Herbert Hoover on Radio
Legislation

Transmitting With Your
House Current

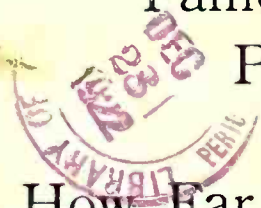

6347
Winnipeg
1922



AT A TIME when the Radio market is overflowing with unscientific and unreliable apparatus, the dealer as well as the public naturally seeks equipment of proved efficiency and recognized superiority.

As distributors of the standardized quality equipment of the Radio Corporation of America and Adams Morgan Co. (Paragon), and for such manufacturers of parts as Atwater Kent Mfg. Co., Magnavox Co., Callophone Co., C. Brandes, Inc. and others, we are in a position to render service which is dependable and satisfactory as well as prompt and economical.

Dealers are invited to write for our new price list specifying the latest discounts on all radio apparatus.

20th Century Radio Corporation
565 Fifth Avenue, New York City

That Satisfying Pride in Your Radio Set

You know how it is when you own anything that is really fine. You're proud of it and jealous for it and want others to appreciate it as you do. You'll feel in full measure that satisfying thrill of pride in your radio set when you own Kennedy equipment. Even such friends of yours as are not radio "fans" will admire the handsome appearance and perfect finish of your Kennedy installation. And those who are radio experts will be even more enthusiastic over its splendid performance.

KENNEDY EQUIPMENT

The Beautifully Finished and Wonderfully Efficient

KENNEDY

Short-wave Regenerative Receiver, Type 281

(All Kennedy Regenerative Receivers are licensed
under Armstrong United States Patent No. 1,113,149)

An ideal set for general use. Highly sensitive, selective and efficient—easy to operate—finely made in every detail. Meets the requirements of keen radio students who recognize and demand the best. Yet it is so simple to use that perfect results can readily be obtained by novices. Ask your dealer to show you the Kennedy Type 281 Regenerative Receiver, and *write* our nearest office for latest Kennedy Bulletin C-3.

THE COLIN B. KENNEDY COMPANY

INCORPORATED

— SAN FRANCISCO — U. S. A. — ST. LOUIS —

KENNEDY
EQUIPMENT

Radio Broadcast

ARTHUR H. LYNCH, EDITOR



CONTENTS FOR JANUARY, 1923

<i>Radio Club of America's Station in 1915</i> - - - - -	<i>Frontispiece</i>
THE MARCH OF RADIO - - - - -	179
BROADCASTING BY REMOTE CONTROL - - - - -	R. W. KING 187
A KINGDOM FOR MORE WAVELENGTHS! - - - - -	PAUL F. GODLEY 191
WHEN THE "CARLOS" SANK - - - - -	A. HENRY 194
HOW YOUR TELEPHONES WORK - - - - -	B. G. CROUSE 197
MINING THE MAKINGS - - - - -	PHILIP S. RUSH 201
TO MR. HOOVER, FROM THE POSTMASTER AT BOONE STOP, MO. - -	HOMER CROY 205
FAMOUS RADIO PATENTS - - - - -	CHARLES H. KESLER 207
THE URGENT NEED FOR RADIO LEGISLATION - - - - -	HERBERT C. HOOVER 211
DOWN ON THE FARM IN 1923 - - - - -	W. A. WHEELER 212
LONG DISTANCE AMATEUR WORK IN AUSTRALIA - - - - -	F. BASIL COOKE 215
FROM KEYBOARD TO TAPE THROUGH SPACE - - - - -	JOHN B. BRADY 219
THE FIRST AMATEUR RADIO CLUB IN AMERICA - - - - -	222
HOW FAR HAVE YOU HEARD? - - - - -	228
GETTING THE BEST FROM ONE TUBE - - - - -	P. B. CRONK 235
UP BEFORE THE MICROPHONE - - - - -	237
THE NEW WAY TO MAKE AMERICANS - - - - -	J. M. MCKIBBIN, JR. 238
AMERICAN AVIATION RADIO IS ROTTEN - - -	BRIGADIER-GENERAL WILLIAM MITCHELL 239
Reported by Donald Wilhelm	
HOW DOES THIS RECEIVER WORK? - - - - -	ARTHUR H. LYNCH 241
ON THE JOB ALL WINTER IN THE HIGH SIERRAS - - -	CHARLES HESTON PEIRSON 244
TRANSMITTING WITH YOUR HOUSE CURRENT - - - - -	ZEH BOUCK 246
AVOIDING THE JAM IN SOUTHERN CALIFORNIA - - - - -	F. W. CHRISTIAN 252
CONCERNING MY INVENTION—THE AUDION - - - - -	LEE DE FOREST 253
PRACTICAL POINTERS ON CABINET WOOD-FINISHING - - - -	W. S. STANDIFORD 254
WESTERN ELECTRIC BROADCASTING STATIONS - - - - -	256
THE GRID—QUESTIONS AND ANSWERS - - - - -	258
ADDITIONAL BROADCASTING STATIONS IN THE UNITED STATES - - - - -	262
NEW EQUIPMENT - - - - -	264

Copyright, 1922, by Doubleday, Page & Co. All rights reserved

TERMS: \$3.00 a year; single copies 25 cents

F. N. DOUBLEDAY, Pres.

RUSSELL DOUBLEDAY, Sec'y.

ARTHUR W. PAGE, Vice-Pres.

S. A. EVERITT, Treas.

NELSON DOUBLEDAY, Vice-Pres.

JOHN J. HESSIAN, Asst. Treas.

DOUBLEDAY, PAGE & CO.

THE WORLD'S WORK COUNTRY LIFE THE GARDEN MAGAZINE SHORT STORIES EDUCATIONAL REVIEW

CHICAGO: People's Gas Bldg.

GARDEN CITY, N. Y.

NEW YORK: 120 W. 32nd Street

BOSTON: Tremont Bldg.

LOS ANGELES: Van Nuys Bldg.



"He is rich," said Confucius, "who knows when he has enough!"
Would you find the richest man?
Look for the owner of a
Grebe Receiver.

Doctor Mu

The whole world is at your fireside when you own a Grebe Receiver.

Ten years of radio manufacturing experience has taught us the importance of simplicity. Recommended by most good dealers because they know the shortcomings of ordinary apparatus.

Ask your dealer for a demonstration. Get your copy of "Musings of Dr. Mu"—the story of the development of the Perfect Receiver.

GREBE RADIO

A. H. GREBE & CO., Inc.
Richmond Hill, N. Y.



Licensed under Armstrong
U. S. Pat. No. 1113149



THE SET INSTALLED IN 1915 IN THE HOTEL ANSONIA, NEW YORK

By the Radio Club of America. This station was used by Admiral Fletcher to communicate with vessels of his fleet at anchor in the Hudson River. Over one thousand messages were sent and received in ten days. President Wilson sent a congratulatory message to the Club from the Mayflower, for the efficient service it had rendered

RADIO BROADCAST

Vol. 2 No. 3



January, 1923

The March of Radio

WHEN WINTER COMES

BY THE radio man the flight of the summer months is not viewed entirely with regret. A vacation in the woods or at the ocean has its attractions, but to the real fan an equal joy is found in getting ready for a winter's efforts to improve the performance and records of his receiving set.

The increased interest in radio with the coming of winter is due not to the lack of the summer's entertainment alone, but largely to the better reception made possible as the summer disappears, taking most of the static with it. On a hot summer's day the atmosphere is intensely active, electrically speaking; electric charges form and spread more rapidly in proportion as the rate of evaporation and condensation taking place in summer increases. Every motion of an electric charge means radiation of energy, and thus a certain amount of static for the listener.

But in the cold, quiet winter nights little electromagnetic radiation other than that sent off by stations is taking place. We have no proof, or reason to believe, that radio waves travel with more efficiency in winter than in summer. A signal of such strength that it cannot be heard even above the summer's hissing and crackling, may in the winter time be perfectly clear and several times as loud as required for good audibility. This is due to the fact that the ear automatically adjusts itself to the loudest sounds coming to it; with heavy static, the

ear becomes so insensitive that the radio signal, plenty loud enough to be distinctly heard by itself, is lost in the crackling noises in the phones.

One of our neighbors now reports that he hears, nightly, stations from 1,000 to 1,500 miles away, although in summer two or three hundred miles is his limit. His outfit is not extraordinary, consisting of a single wire, 30 feet high, and a three-tube receiver, one radio-frequency amplifier, a detector, and one step of audio-frequency amplification. Another experimenter reports that a single-tube set, with regenerative connection, located in New York City, consistently hears a station in Iowa over a thousand miles away. Such instances will multiply during the winter months as atmospheric conditions improve and by next spring there will be many people who, for the first time, will appreciate why the early workers in radio always established their records for long distance at night during the winter.

Of course these long-distance records with comparatively low-powered transmitting sets do not serve to indicate the power of apparatus required by a commercial company to maintain a regular transatlantic service; guaranteed service, through the day as well as the night, requires a transmitter at least one hundred times as powerful as those used in most present broadcasting stations.

That Big Problem—Interference

AT a recent meeting of the Institute of Radio Engineers, the society having in its membership the best radio talent in the country, the topic of interference due to the simultaneous operation of neighboring broadcasting stations on 360 meters and 400 meters was discussed. The "general public," it seemed, was well fed-up with the signal hash that is served every evening. One man having "several hundred dollars invested in his receiving equipment" was so bothered by the simultaneous operation of the two stations that the evening's entertainment which he had promised to some friends gathered around his set proved to be an unappetizing mixture of jazz from one station and opera from the other. He was ready to give up radio in disgust, according to the letter he sent to the local radio inspector.

The attempt to give the public better radio service by allotting different wavelengths to neighboring stations was mentioned in our last issue. The two wavelengths chosen, 360 and 400 meters, it seemed, were surely far enough apart to permit of tuning in one signal and completely tuning out the other, unless the listener was very close to one of the transmitting stations. But reports proved it otherwise; many of the listeners were unable to get rid of the undesired station by manipulation of their sets, and, according to the radio inspector, felt that an injustice had been done in permitting the two stations to operate at the same time. Some even went so far as to threaten the removal of the inspector by personal appeals to their congressmen.

Now it is really time for the public to be educated in the elements of radio communication. Undoubtedly many people have invested in radio with no knowledge at all of what the set they bought had in it or what it was supposed to do, and these people will be much disappointed until they learn the capabilities of the apparatus. Some who have purchased cheap sets, poorly designed and inadequately constructed, will remain disappointed, but those having sets built by reliable concerns will find it the easiest thing in the world to adjust their apparatus so that either the 360- or the 400-meter programme can be heard at will, with no interference from the other.

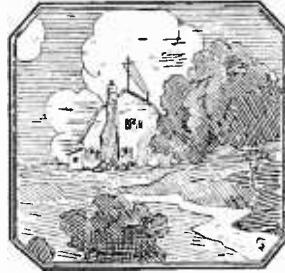

This margin of 40 meters between stations will probably be cut in two before long, so that sets will have to tune signals only 20 meters apart. This will not be difficult with efficient apparatus.

The relative merits of the single-circuit tuner and the two-circuit tuner was under discussion when one of the advocates of the latter type put forth the claim that a good set of this kind could sift out signals differing by only one meter! This seems like a rather extravagant claim because two signals differing by only one meter would have frequencies within 2,000 cycles per second of each other and for speech or music we should have more separation than this if one ether channel is not to encroach upon the other.

It seems likely, however, that the public should soon be able to separate two signals differing by not more than ten meters; such a margin will provide sufficient channels for all demands likely to be made on the broadcasting service in the near future. This means that people have to learn about tuning, coupling, etc., and at the same time they must get rid of some of the extremely poor sets that the fly-by-night companies have been foisting upon them as well as most of the "oatmeal box" sets made in accordance with the specifications of some Sunday supplement.

Furthermore, the public must learn to be content with smaller antennas where interference is troublesome. Small antennas, used with well designed and well built sets of two or three tubes and manipulated with reasonable skill, will soon prove that interference between stations separated by 40 meters is entirely unnecessary and that a lesser separation is feasible without causing any appreciable trouble.

Radio Central to Change Its Transmitting Apparatus

LESS than a year ago the opinion was offered that the installation at Radio Central, the Radio Corporation transmitting station on Long Island, would never be completed, as the machines would probably be superseded by tubes before the Alexanderson alternators could be put in. An announcement of the Radio Corporation just given out states that an experimental tube transmitter has been in successful operation for sixteen hours contin-

uously, sending out sufficient power to transmit perfectly as far as Germany. Instead of the 200-KW alternator ordinarily used, six pliotrons, rated at 20 KW each, were used to generate the high-frequency power required to excite the antenna. A 15,000-volt supply of continuous current power is required for the plate circuits of these tubes and here also the electron evaporation idea of Richardson is utilized. Two-electrode tubes, plate and filament

or even 1,000-KW whenever the demand for them will justify the expense involved.

Neckties, Soap, and Radio Sets for Sale

WITH the tremendous popular interest in radio, and possible profits in catering to the demands for apparatus, manufacturers and jobbers have placed radio apparatus in practically every place where

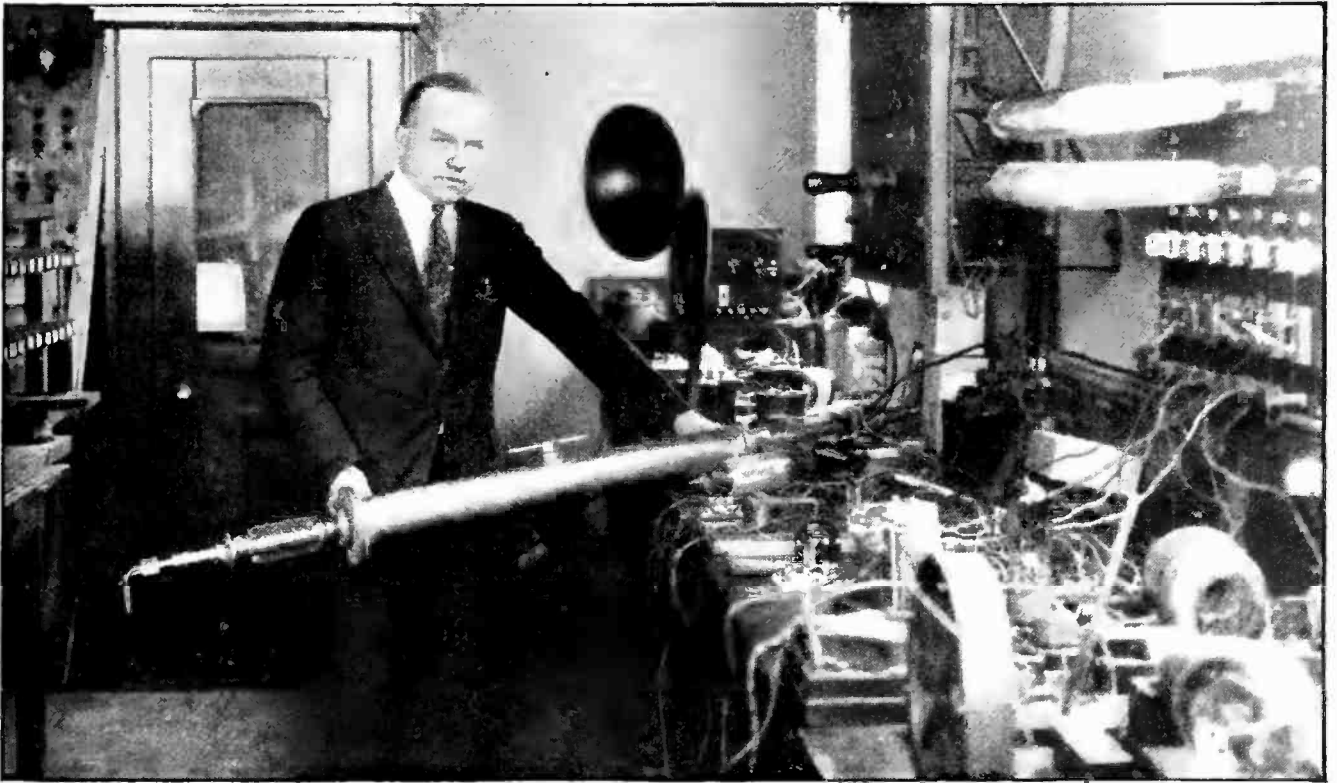

THE LARGEST VACUUM TUBE IN THE WORLD

This 1,000,000-watt tube, developed in the research laboratory of the General Electric Company by Mr. J. H. Payne, Jr., is designed for power purposes rather than for radio use. Its electrical output, expressed in terms of the incandescent lamp requirement, give some idea of its power. It will supply energy equivalent to that required to light 40,000 25-watt lamps, or the electrical energy required by 1,500 average homes. The tungsten filament in this tube is so large that if drawn into filament of the size used in the household incandescent lamp it would supply filaments for 175,000 such lamps

only, are used as rectifiers, to change the high voltage alternating-current supply available at the station into suitable continuous-current power.

The installation of these tube transmitters is so simple and the operation so reliable that it seems safe to predict that the life of all other high-frequency generators is already measured. The tubes used in this first large installation have about five thousand times the power of the small transmitter tubes used by amateur broadcasters, but the research men who are responsible for the development of these 20-KW tubes are ready to build tubes of 100-KW

people congregate. Drug stores, music stores, cigar stores, even men's furnishing stores have radio sets for sale. Can any good come from this method of merchandizing radio sets?

It seems to us that the practice will undoubtedly result in many disappointments for the purchasers, and consequent disgust with radio. If a store has apparatus for sale, the clerical force will naturally do its best to sell it, and if the customer seems doubtful about buying, unreasonable and foolish claims will be made regarding the reception to be expected from the sets. And because of ignorance of radio, both of purchaser and salesman, mis-



EDWIN H. ARMSTRONG

Goes down on this tire company's book of history as inventor of the feed-back circuit and native of Yonkers, N. Y.

understandings are sure to occur. How can it be expected that the haberdasher's clerk will know the relative merits of single-circuit and two-circuit tuners, regenerative and non-regenerative sets, soft tubes and hard tubes? And these are just the things the customer has a right to know before making his purchase.

Even some large department stores fail to have trained men in charge of their radio departments; only yesterday, we had explained to us in one of these stores the difference between a "single-current tuner" and a "double-current tuner"! The most extravagant claims are made for the reception distance of the apparatus, the clerks themselves not realizing the exaggeration in their statements.

What is to be done? It seems that here is an opportunity for the National Radio Chamber of Commerce to try a little missionary work in convincing the jobber and manufacturer that the only legitimate and worth-while outlets for their products are the regular electrical stores, having clerks trained in the elements of radio, who understand the relative merits of various types of sets. Every radio sale should be made in such a manner that the customer understands the merits of the article he has purchased and how properly to manipulate it. Hence he can get results which satisfy him, which lead to further purchases, and which help to keep alive and increase his interest in the radio game.

Public Health Service Talks

WE ARE glad to note that the Public Health Service recently resumed the broadcasting of talks from the Navy's Anacostia station, on a wavelength of 360 meters. Early in the year these brief talks were broadcasted from this station but, as there was some question as to the propriety of the Navy carrying on such work, it was suspended. One of the first acts of the Inter-departmental Committee, referred to in a recent issue, was to clear up this point, with the result that short lectures are being sent out three times a week. In the words of the officer in charge of this branch of governmental activity, "We try to make these talks as simple and direct as possible so that they will do the largest possible good and be understood by the largest possible number—not only those in the cities but those in rural districts as well."

Is a Radio Set a Musical Instrument?

THE State Convention of Music Dealers of Illinois, we hear, has under discussion the musical status of the radio set; if it can be classed as musical, they will consider it on an equal basis with other instruments and help in developing it. Of course, the instrument the music dealers are interested in is the loud-speaking horn; that there could be much

discussion on this question we are much surprised. For if there is any one thing of which the telephone engineer and manufacturer cannot afford to boast, it is this very instrument.

Musical? Yes, with a quality all its own—a quality fitting it more for an Indian war dance than for association with musical instruments. The raucous, throaty noises which emanate from the average horn should eliminate it from any discussion of instruments classed as musical.

It is not apparent just how much help the music dealers can render in improving the loud speaker but it certainly is time someone came to its aid; it is the one part of a radio set which, more often than any other, brings forth expressions of disgust from anyone with even the rudiments of musical appreciation.

Receiving in Steel Railway Cars

SIGNALING by wireless to moving trains has always seemed a remarkable feat; although, as we have pointed out before, it is really no more difficult for the signal to

reach a moving train than a stationary one. Compared to the speed of the radio message, the speed of our most rapid "flier" is negligible. Recent tests carried out on the Pennsylvania system have shown that it is possible to get a fair signal even inside a steel car. Now, it is a well-known fact that metal structures tend to keep out radio waves. In the laboratory when it is desired to shield a piece of apparatus from radio waves we build a metal cage or box around it and are thus able to protect it from high-frequency signals.

To be sure this shielding is only partially effective. It would take an immense amount of sheet copper to eliminate completely the radio waves from the inside of the shielded box. As an illustration it is found that a box made of copper (of about the thickness used for roofing) around a piece of apparatus cuts down the received waves to about 10 per cent. of their strength without shielding. The success of the reception in steel railway cars is due to this imperfection of the shielding action. A loop is used inside the car for an antenna, and this, in combination with an amplifier con-



THE KNIGHTS OF COLUMBUS FREE RADIO SCHOOL
In New York, where some hundred odd students, most of them ex-service men, are learning the theory and operation of radio apparatus

sisting of three radio-frequency tubes, a detector, and two audio-frequency tubes, was successful in picking up signals from points as far as 200 miles from the train. It seems certain that radio will have important use for

engine sparks, and the balloon was completely wrecked. Fortunately all the crew, including some aviation experts were able to get away by jumping, as the bag was still close to the ground when it exploded.



MR. L. W. MEEKINS BROADCASTING FOREIGN INQUIRIES

From WGI, Medford, Mass: "A Swiss firm wants to buy 10,000 electric light sockets," is the report. Next morning the U. S. Bureau of Foreign and Domestic Commerce has scores of applications for the name and address of the Swiss importer

train operation and passenger service in the future.

The C-2 Meets Its Fate

IN OUR last number we had a picture of the ill-fated Roma, the huge American dirigible wrecked by a hydrogen explosion; the illustration was accompanied by the query as to why the Army dirigible C-2 had been sent up with defective wireless apparatus and filled with hydrogen, when there was, as we understand, sufficient helium stored somewhere for its inflation. The helium had been taken out of the Roma just before its disaster, for experiments of some kind or other.

The C-2 "got away" with its trip to New York and back, in spite of the failure of its radio, but there was ever present the likelihood of explosion of hydrogen, from engine sparks, lightning, or similar causes. After successfully crossing the continent, however, this same C-2 came to the fate predicted for it; it was ripped open, the escaping hydrogen caught fire from

After the Roma disaster, Congress appropriated an extra \$400,000 to both the Army and Navy; the \$800,000 thus available was turned over to the Bureau of Mines for further development of the helium extraction process, and according to a report from Aviation Headquarters, future lighter-than-air machines of both Army and Navy will be filled with the non-explosive rival of hydrogen—inert helium.

Transmitting Pictures by Radio

SEVERAL announcements have recently appeared, some of them undoubtedly premature, of the success of radio transmission of pictures. Even though these accounts may be greatly exaggerated when seen through the optimistic eyes of the inventor, the handwriting on the wall predicts early success. A conservative announcement from London puts forth the claim that

one of the English radio companies has succeeded in transmitting pictures said to be "generally recognizable." Such conservatism from a promoting company leads us to believe that they really have something.

These first attempts will of course be crude as with any new development—witness Bell's telephone or Edison's talking machine, or the first flickering, jumpy, movie films. Progress in such a case is very rapid after the first steps have been taken, however, and it is not beyond our imagination to conceive the transmission even of colored photographs within the next few years. Why not? It is no more improbable than many developments of science which, ten years ago, were regarded as impossible!

The N. R. C. C. Acts

DURING the Chicago radio show a movement was started by the National Radio Chamber of Commerce to gather information on all phases of the broadcasting situation, with the idea of later making sug-

gestions to the proper government authorities as to how the situation may be improved. We are glad to note the spirit in which the Chamber is attacking the problem. In the words of its President, Mr. W. H. Davis, it appears that "the only scheme of broadcasting which can prevail in any real sense is one in which the end to be attained reconciles all the conflicting elements, even to the submerging of private interests." We hope that, in weighing these conflicting interests, however, the stress will be put where it belongs; the interest of the listening public must be the dominant factor upon which a decision is reached. What solution will give to the radio listener the best programmes, most excellently rendered—that is the test which will be applied in all cases coming before the Chamber.

Saved by Radio

UNDER this caption a recent editorial in the *Times* pays tribute to the service rendered by radio when the steamer *City of Honolulu* was burned at sea. In this instance there was plenty of time for the boats to be lowered, and as the sea was smooth, no immediate danger threatened the shipwrecked passengers and crew. But there was much to be done before they were saved; being adrift in the Pacific in small boats, with no other boat within perhaps a hundred miles, is far from being rescued. The Pacific often belies its name in the suddenness with which storms arise, and without the help of radio the small boats had but little chance of surviving until a steamer happened to pass by. As it was, the operators were able to notify other ships—one of which happened to be within fifty miles—as well as coast stations. The shipwrecked people were picked up by an outbound freighter, which, again by radio, arranged for their transfer to an inbound transport, permitting the freighter to proceed on her way to the Dutch East Indies whither the shipwrecked passengers would probably have gone

with her, had not radio been able to call the inbound vessel. The story is one to make us profoundly thankful to those who have invented and perfected radio.

Lightning and the Receiving Set

A SHORT time ago, the metropolitan press featured a fire which had started in a room equipped with a radio receiver, after lightning had apparently struck the antenna and burned up a part of the apparatus. The set was equipped with lightning protection in accordance with the requirements of the National Board of Fire Underwriters, having a ground to the water-pipes and an approved type of lightning arrester.

It is to be expected, of course, that as the number of antennas increases some of the houses having them will be struck by lightning and generally the trouble in such cases will centre about the radio apparatus. But in most of the cases the house would have been struck even had the antenna and set not been there—and probably greater damage done. As the number of radio stations increases, it is evident that the proportion of houses struck, which do have radio sets, must increase, and

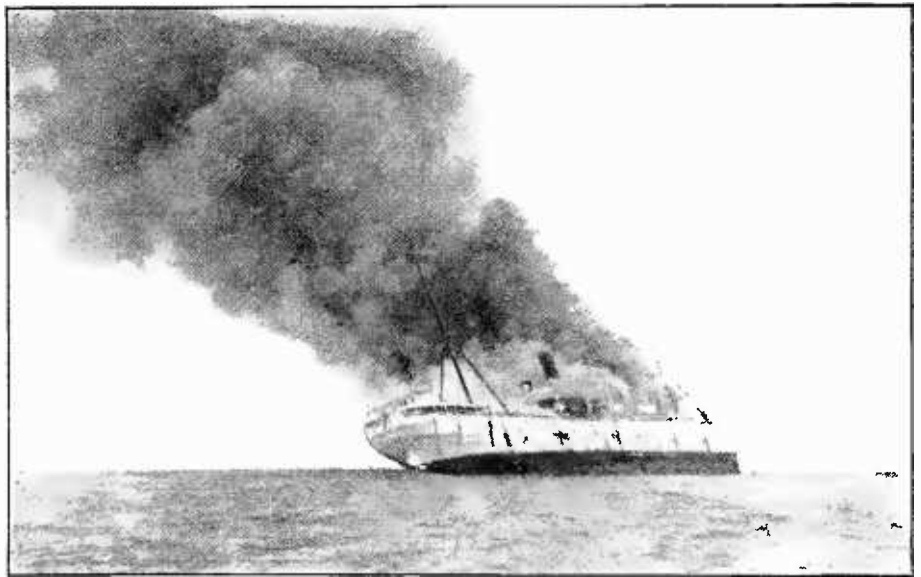

THE "CITY OF HONOLULU" BURNING IN MID-PACIFIC
Another ship, summoned by radio, rescued all the passengers and crew

this increase will have nothing to do with the lightning risk of radio sets.

Illustrating this point of view, we note that a few days after the occurrence cited above, the newspaper headlines announced "many

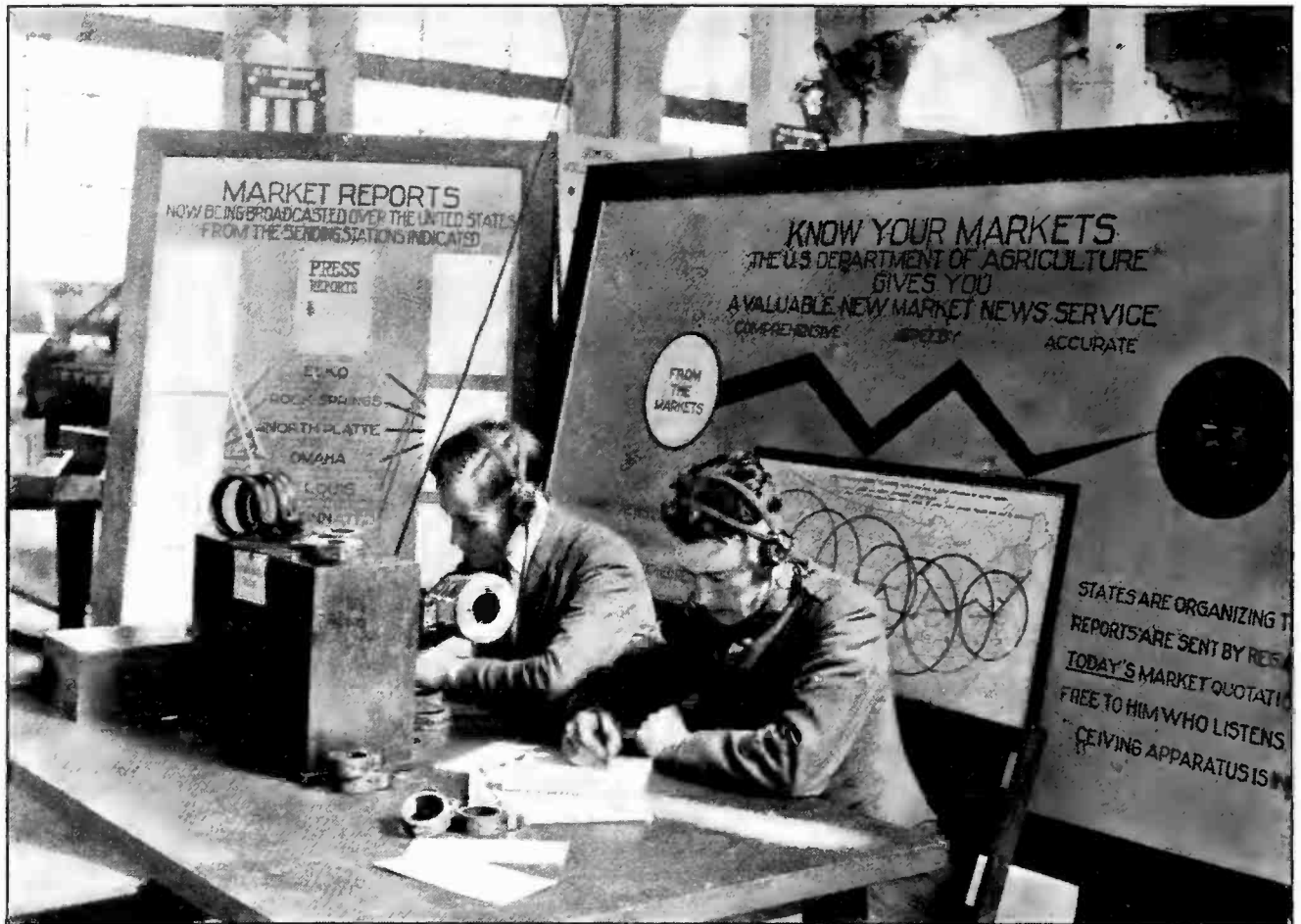

THE DEPARTMENT OF AGRICULTURE EXPLAINS ITS RADIO SERVICE
Showing how people living on farms or in remote districts can profit from the crop and market reports

lightning hits in a severe electrical storm," and although many of the hits were described in detail, there was no mention of one in a building where an antenna was installed! With more logic than was used by those who tried to prove that the first storm showed radio sets to be a lightning menace, we might use the second announcement to show that radio sets

constitute a protection against this very thing! Before the radio sets can be considered as extra lightning risks, it will be necessary to have statistics showing that of the number of houses set on fire by lightning those having radio sets form a disproportionately large share. This, we very strongly suspect, will never prove to be the fact. —J. H. M.



Broadcasting by Remote Control

By R. W. KING

American Telephone & Telegraph Company

PRINCETON was playing at Chicago. It was Princeton's ball on her one-yard line, and the score was much against her. Then the unexpected happened. A forward pass advanced the ball forty yards, a kick to Chicago, a fumble. Princeton's ball again, and a forty-five yard run for a touchdown. So was defeat turned, in a fraction of a minute, into victory.

As the applause swelled to its height, the door of a little booth in the press stand opened and the face of a man, tense with responsibility, was thrust out. With an attempt at a smile he said, "Here's where I turn my job over to twenty thousand rooters."

But it was only for an instant. The teams were already lining up for the goal. The door closed, the speaker was again in his little sound-proof booth, and with a hurried sweep of his hand over the moisture-covered window in front of him and his eyes riveted on the play, he again began his task of describing it step by step to his huge, invisible audience.

Before him stood a microphone transmitter which joined him telephonically to radio station WEAF in New York City, 900 miles away, and as he spoke, his words were immediately broadcasted to the hundreds of thousands of radio listeners within the station's range. With so vast an audience hanging on every word he uttered, it is small wonder that he felt a heavy responsibility.

Now what significance is there in the fact that a great football contest is followed throughout its course by so many thousands of rooters of both sides who are scattered through half a dozen states?

Consider for a moment certain important stages through which broadcasting has passed. In the beginning, we find here and there an amateur, particularly enthusiastic and resourceful, rigging up a transmitter which we would now consider most diminutive, but which in its day was the marvel of his community, and for the amusement of a few neighbors occasionally placing a phonograph in front of his transmitter. By this arrangement, his little audience could hear snatches of ethereal music at very irregular intervals. Such was radio broadcasting not so long ago.

Another and very important stage began with the opening of the celebrated WJZ by the Westinghouse Company. In the two years which have elapsed since that time some five hundred other broadcasting stations have sprung up over the country and a small army of radio experts and musicians are busy every

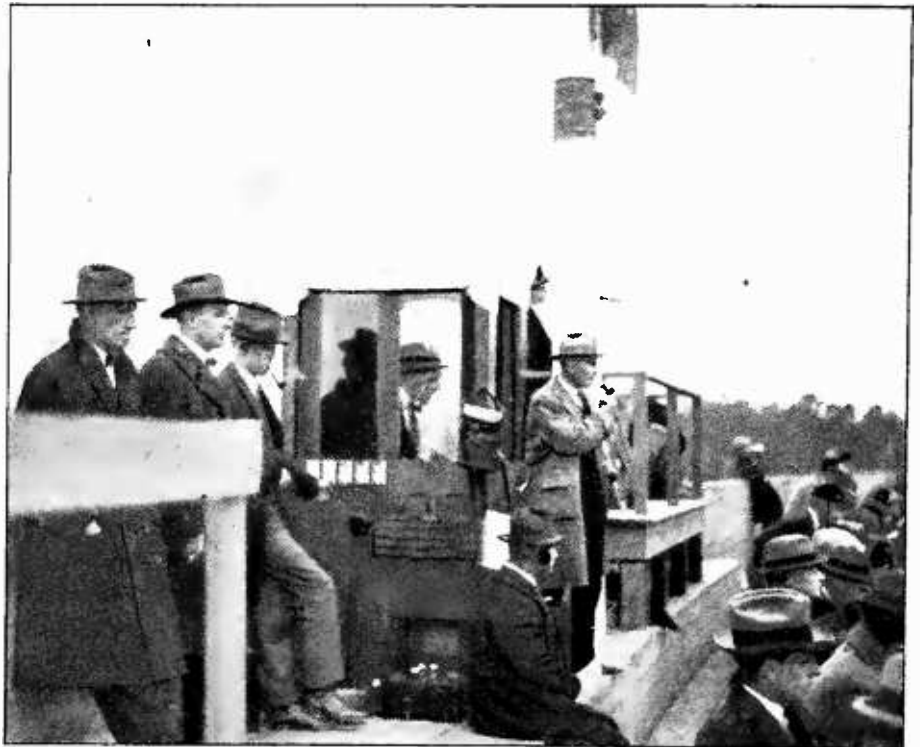

THE ANNOUNCER'S BOOTH

Installed by the engineers of the American Telephone and Telegraph Company. On the flag pole just above the booth will be noticed one of the microphones used for picking up cheering. The amplification which the output of these cheering microphones undergoes can be varied at will. When the announcer is silent the volume of cheering can be run up, and then diminished before an announcement is made

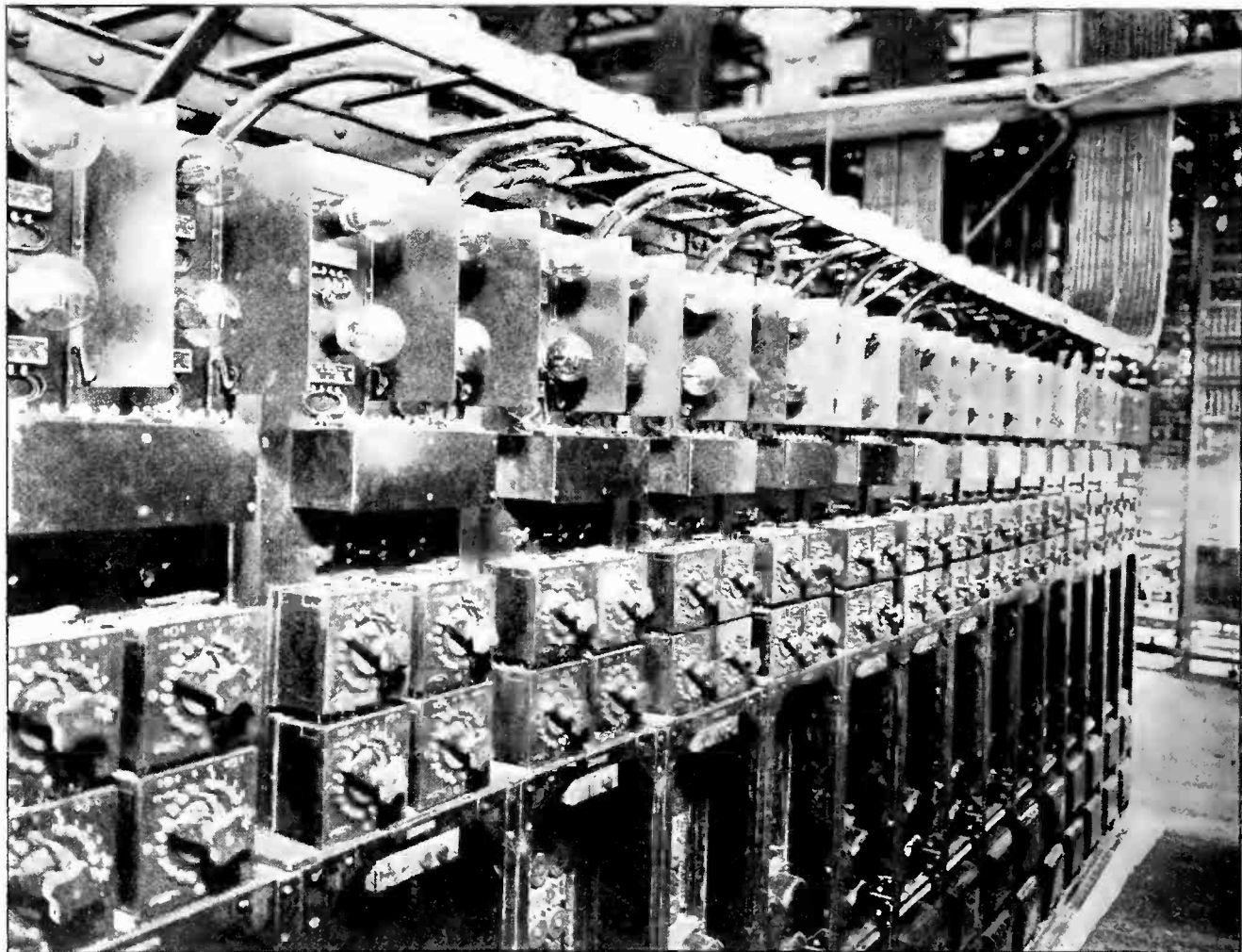

A TYPICAL TELEPHONE REPEATER INSTALLATION

As used on long distance telephone lines. Repeaters such as are here shown were also used for the remote control of W E A F when broadcasting the games between Brown and Yale, Princeton and Harvard, Yale and Princeton, and Harvard and Yale

day and evening putting on programmes. Moreover, the radio audience has grown from hundreds to hundreds of thousands and is today a body of people which, for enthusiasm, breadth of interest, and size, could not be gathered together by any other agency than the radio telephone.

This fact means that even greater stress must be placed upon the quality of the radio programmes. From where will they come? The only answer is that they will come from everywhere. Just as broadcasting replaced the amateur's phonograph programme, so it is reaching beyond the programme which originates in the radio "studio." The studio is not to be supplanted, but it is not enough. The time is rapidly approaching when the radio audience should have available a nation-wide, *even a world-wide, programme!* From boxing contests to grand opera, from church services to

great political mass meetings, from football and baseball games to international yacht races, from the inauguration of the nation's president to the dedication of great engineering achievements, there is a wealth of radio programme material which even the imagination can scarcely compass. But these events cannot be brought to the broadcasting station; *the station must, in effect, go to them.*

The purpose of this article is to discuss some of the technical developments by which this end is being accomplished.

Since broadcasting involves transmission of the voice or other sounds in only one direction, the problem of attaching a long-distance telephone circuit to the radio apparatus does not involve the use of such equipment as a hybrid coil and balancing network that are necessary whenever a two-way radio link is associated with a two-way telephone circuit. On the

other hand, the telephone circuit itself is of a special character designed to transmit without distortion the wide range of frequencies required for the accurate reproduction of speech and music. Two devices characterize the long-distance telephone line which is connected to broadcasting station: the electric wave filter and the telephone repeater.

Everyone appreciates the fact that music consists of sounds whose pitches range over a wide interval of frequencies. This interval extends from about 100 to about 5000 cycles per second for both instrumental and vocal music. It is not generally known that the normal speaking voice contains in it just as wide a range of frequencies as is used in music. The speaking voice consists of very complex sounds, in which the characteristic of pitch is not apparent. However, were one of these complex sounds to be carefully analyzed, we

would find it to consist of pure tones ranging in frequencies all the way from about 100 up to 5000 cycles per second. If it is desired to transmit the voice electrically either by radio or over a telephone circuit, and at the same time to preserve its individuality, we must therefore use an electrical system which will carry electric currents of frequencies from 100 up to 5000 with equal efficiency.

It is in this connection that a special form of the electric wave filter known as an equalizer performs a very important function. The filter is the invention of Dr. G. A. Campbell of the American Telephone and Telegraph Company, and, as its name implies, will separate currents of different frequencies somewhat as a screen will separate gravel of different sizes. In one sense, every long telephone circuit consisting of two parallel wires is a filter. It tends to transmit certain frequencies more readily

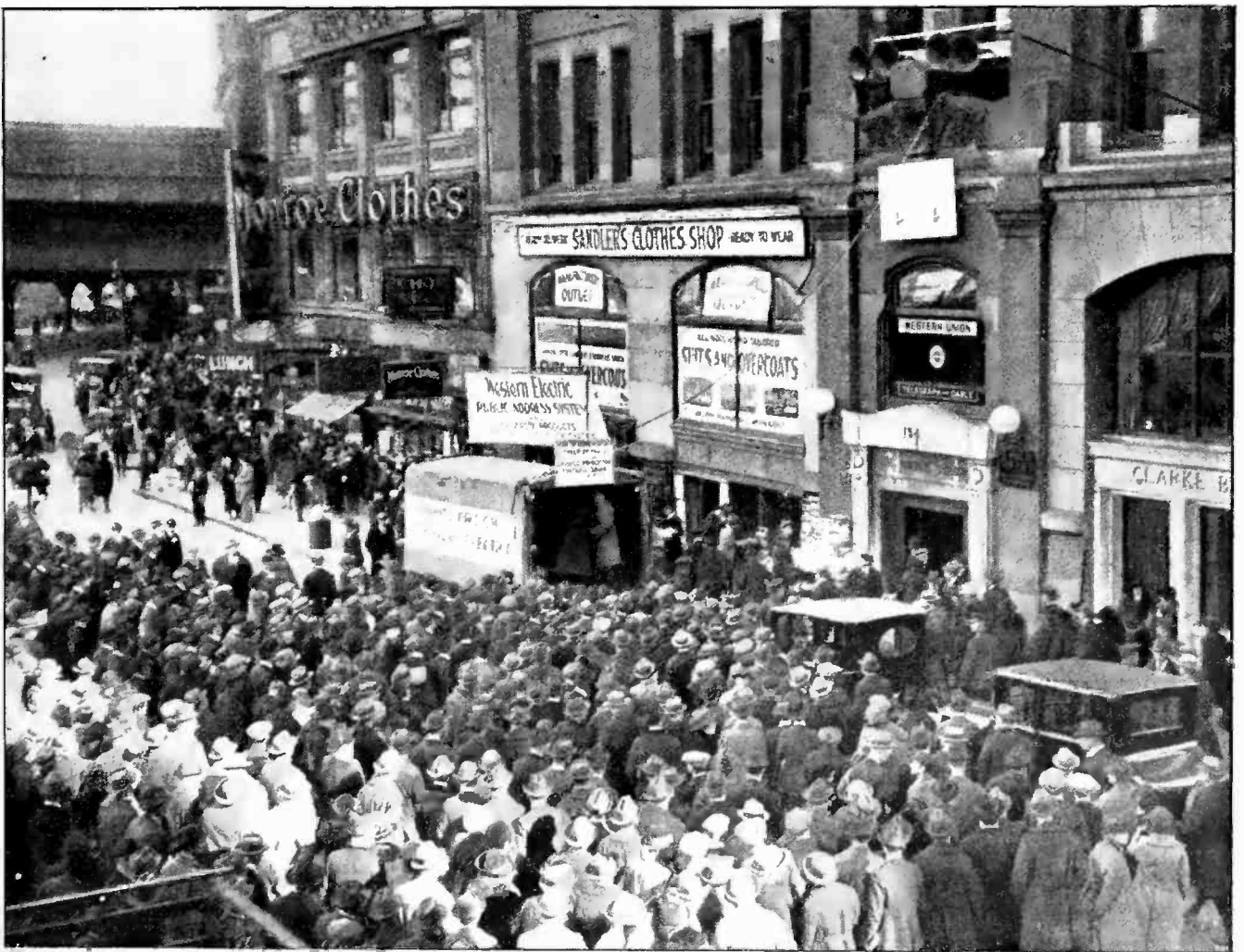

GETTING THE GAME PLAY BY PLAY

A crowd gathering around a loud speaker stand in Park Row, New York City. The input of the loud speaker was supplied from a radio receiving set located on the truck. On the upper left-hand corner of the truck may be seen a small loop antenna for receiving

than others, and this condition is particularly noticeable in cables, for there the two wires are twisted together with merely a thin paper insulation between them. Such a cable carries the lower frequencies with less alternation than the higher frequencies, and therefore distorts the speech currents sent through it. If it is necessary to use more than a few miles of cable in a long telephone line, and it was in the New York-Chicago line which was used to broadcast the game between Princeton and Chicago, this distorting effect must be counterbalanced. The use of equalizers accomplishes this. These special networks are introduced into the line at proper intervals and are so designed as to transmit most readily the frequencies which the line tends most to attenuate. The result is a conducting path for the speech currents which passes all the essential frequencies equally.

It is apparent that the use of equalizers will reduce the strength of the speech current which a line delivers, for, in effect, the transmission of the line for every frequency is reduced to the value it has for the least readily transmitted frequency. This difficulty, which at first sight might appear to be serious, is easily removed by the proper use of telephone repeaters. The repeater is a special form of vacuum-tube amplifier and can be installed at various points in a long telephone line to amplify the speech current and give it its original or an even greater value. In the New York-Chicago line, these amplifiers were installed at the football field in connection with the microphone transmitter, at Morrell Park, Illinois, at Beaver Dam, Ohio, at Pittsburgh and at Harrisburg, Pennsylvania.

As already indicated, the function of the telephone line is to deliver to the preliminary amplifier of the broadcasting station a speech current of about the same strength as it would receive were the transmitter at the station.

In accomplishing this, the spacing of the telephone repeaters at approximately equal in-

tervals along the line is a most important factor. The alternative to such an arrangement would be to introduce enough energy at the sending end so that, without amplification at any point along the line, there would still remain the amount required by the radio apparatus. This would necessitate an enormous power input and is not at all practicable. To take a concrete case, suppose that the speech current energy entering the preliminary amplifier at WEAJ (New York) should be 0.01 watt. The attenuation of the New York-Chicago line is such that at Harrisburg, the nearest repeater station, the speech energy present in the line should be 0.14 watt. If there were no repeaters, then at Pittsburgh the line energy needed would be 2.9 watts, at Beaver Dam 41 watts, at Morrell Park 860 watts, and at the field 200,000 watts.

While it would not be impossible to-day to construct an amplifier with an output of 200 kilowatts, it cannot be regarded as a practical alternative to the five amplifiers which were used and none of which was required to give an output of more than a watt. Nor is this an extreme case. Were it a question of using a telephone line twice as long as that between New York and Chicago, the initial energy needed without intermediate repeaters would be the enormous figure of 20,000,000 kilowatts.

This comparison between the use of repeaters spaced along a line and providing all the necessary energy at the sending end gives rise to the question of how many intermediate repeaters it may be practicable to use successfully. While it is not possible to set a definite upper limit, it may be pointed out that an artificial telephone line, the equivalent length of which was 24,000 miles or the circumference of the earth, and containing thirty-six repeaters, has been successfully demonstrated. The area over which a broadcasting station may "reach out" for its programmes is therefore practically unlimited.



A Kingdom for More Wavelengths!

By PAUL F. GODLEY

JUST twenty-four hours before the time that I start this, the November elections were concluded. Directly, the elections have nothing to do with what is here set down. But there is little doubt that these same elections had considerable to do with the limbering-up exercises given to radio machinery by every broadcaster and radio listener in these United States. After last night most broadcast listeners have new impressions and I should like to know them. Information at hand shows that throughout that entire section of the country East of the Rockies reception conditions were very good. Note carefully! I mean by this that whether one wished to listen to the Fort Worths or the Bostons, to the Atlantas or the Chicagos, the New Yorks or the Denvers made little difference. They, and dozens more were all present with about equal pep, and *all together!*

An unruly Schenectady had been lulled into a state of coma. And, as swells of music from Detroit accompanied Atlanta's presentation of a great Senior, I remember—very distinctly I remember offering up a fervent prayer for those simple-souled missionaries who might be demonstrating the wonders of a one-lunged "radio" to open-mouthed gatherings of their townfolk. If ever they needed expert radio aid, it was last night. If ever Santa booked an order for the receiver selective, it was last night. If

ever I wished that I might give to "fans" and manufacturers and editors and legislators and other sundry folks an earful, it was last night. I seemed to look out over a considerable tract of faces as the wish took form. A great wonder crept upward within me and turned to panic. No amazement was there. Open mouth after

open mouth was but registering expression—a collectively subconscious *though no less sincere* expression of a great desire to relieve the "gathering" in the ears.

What of it? Ah! but let me ask of you who have experienced this—let me ask you what of it! Can you not remember the universally heralded Conference of Radio Experts at Washington last spring who, called together by Herbert Hoover, finally made their recommendations? And, providing your interest survived, do you not remember the tenor of those recommendations? They assuredly promised that the much needed authority would be given the Department of Commerce in order that a *proper* founda-

Mr. Godley, well known as one of America's foremost radio experimenters, recently made an investigation in Washington of the sentiment on radio legislation. Addressing a conference of radio editors and business men in New York on November 6th, he summed up the results of his talks with Secretary Hoover, Chief Radio Inspector Terrill, Congressman White, Senator Kellogg and others, in these words:

"The entire personnel of the Department of Commerce, and some of the men in the Bureau of Standards with whom I talked, realized the great need for legislation. They all wanted it badly. They had been thinking about broadcasting, and what it is coming to, for a good many months, but they had the idea that the country as a whole—that radio folks as a whole—are not behind them in wanting legislation. . . . I was practically given to understand that the intention of the administration down there was to allow the radio people to stew in their own juice until they came to their senses sufficiently to decide definitely what they wanted and to get together and push that thing."

Meantime, the ether jam grows steadily worse. Mr. Godley's plea for a country-wide expression of the necessity for broadcasting legislation will surely stir to action those who have "suffered in silence" during recent months.—THE EDITOR.

tion might be laid for the soft-pedaling of chaos in radio. What of that? Here is the answer. These recommendations were drawn up in the form of legislative measures and presented to both legislative branches of our government and—*there they lie!* And there they will continue to lie as long as you and I who are interested in, and want the things which should be available to us now, permit it.

Even as this is written there is but slight chance that the proposed legislation will get action in time to permit of changed conditions *prior to the fall of 1925!* But, there is a *slight* chance, and that chance hinges entirely upon *your* interest and *your* effort *now!* If you don't know your Representatives at Washington you ought to. In any case do not disappoint them by failure to let them know what *you* think about radio and radio's mission in America.

The populace has tasted of radio and made a wry face. And yet, the great benefits to be derived from radio, unique as they are, completely overshadow in possibilities anything we have ever previously secured. Picture yourself as the chief executive of a mighty republic, able as you stand in your great office, to speak through radio directly to 100,000,000 souls. What contact! What inspiration to a nation! What uniformity of purpose during peril! Or, if

you will listen, no matter where you are, to Grand Opera, to famous orchestras, to stirring strains of military bands, to the thunder of the bleachers punctuated with play-by-play reports; to the roar of flood and fire and the cries of stricken cities, to news, news, news, and—if you live long enough—to the voices of other lands, voices with smiles and voices with tears! What contact! What annihilation of time, and space, and misunderstanding! Is that worth while? Every single bit of it is now possible. Some of it has already come to pass in limited areas. And, *if you want it*, a linking of super-landline and radio will secure nearly all of it within a few short months.

But legislation must come first. Radio laws of 1912, now sadly obsolete, placed certain bands of wavelengths solely at the disposal of the Army and the Navy. Between 600 and 2000 meters there are many wavelengths which must be made available to broadcasting

before a National Broadcasting System can be given birth. Both Army and Navy wish to keep them. For what purpose they do not seem to know. Suffice it to say that the Army now smears the ether with inter-departmental traffic of no apparent consequence which should long ago have been forced onto land wires. This traffic is all overland and land wires were built to carry such traffic. The rather lame excuse that its handling by radio serves to keep the personnel in training will not suffice. Any amateur operator will tell

you who did the very largest part of signal work during the late war, and he will also tell you that the Signal Corps personnel would get far more practice of the sort which is valuable during hostilities if that personnel were "boarding out" with the 30,000 amateur operators who, in spite of almost insurmountable interference, handle large quantities of "make believe" radiograms nightly. Amateurs would welcome signal



PAUL F. GODLEY

corps posts in their 200-meter band, and because of their greater resources as to equipment, would be inclined to class them, tentatively, as star relay stations.

One of the principal handicaps under which broadcasting is now struggling results from the great variation of any station's range in daylight and darkness. Other things being equal, the shorter the wavelength the more marked is this variation. At 200 meters, a station having a normal daylight range of but 40 miles may be depended upon to cover over 3500 miles during certain periods—a ratio of 90 to 1! Broadcasting stations now operating on 360 and 400 meters and having a normal daylight range of 75 to 100 miles may and do cover distances of 1500 miles at night—a ratio of 15 to 1. Stations having a wavelength of 1000 to 1500 meters whose daylight range reaches a limit of 150 miles may be expected to average a night range of approximately 2.5 times this figure. Thus, as wavelength is



"THE POPULACE HAS TASTED OF RADIO AND MADE A WRY FACE"

increased, complications which now exist, owing to the over-riding of one station by another, become markedly less. Because of the limited number of wavelengths available in the radio band, over-riding will have to be in some manner prevented. Too frequently, now, stations several hundreds of miles away may completely mar the programmes from a station two or three hours' train journey distant.

For fullest realization of its inherent benefits, broadcasting must be made dependable. Legislation must be secured as a start. Having secured it, its importance must immediately be forgotten. There is a vast amount of educating to be done. The very best that radio has to offer in the way of truly selective receiving equipment must be made popular. Even with the most highly specialized equipment in use to-day it is impossible to cut out interference of every kind. But the great majority of folks now struggle along with inferior equipment which represents in most cases initial expenditures equal to those necessary where the best available equipment is secured. This is due mainly to ignorance, and to what has been a misguided conception on the part of many manufacturers that the American public is incapable of handling a tuner which has more than one adjusting control.

Drawn up at the suggestion of Secretary of Commerce Hoover, the pending legislation is the result of recommendations made by a thoroughly representative body of the country's foremost radio engineers, amateurs, manufacturers, and editors. It provides for the establishment of an agency (the Department of Commerce) charged with the responsibility

of getting radio on the right track and keeping it there. By way of guiding this agency, a committee of twelve men is also provided for, each of these men to be chosen from one of the departments of the government, and six from among radio engineers of standing. Amateur station owners are taken care of through the allotment of all waves between 150 and 275 meters to their use under certain proper circumstances. The Secretary of Commerce is given power to stipulate what wavelengths are to be used for the various classes of radio services; to say how these services shall be conducted; to stipulate the nature of broadcasting programmes, time of operation of broadcasting stations, and power to be used; to penalize station owners who do not play the game; and to make changes in regulations as they become necessary. *He does not however have control over radio service operated by the government for the carrying on of official business.* Wavelengths for government stations are to be assigned by the president.

In this compromise with Army and Navy there lies potential friction which may produce a totally unsatisfactory state of affairs. Circumstances might very well arise, during peace times—should wavelength bands be assigned to a government branch without regard to the scheme of operations of the Department of Commerce which would find the public—you and me—in the rôle of bag-holder. It is hoped that in the hearings before the committee in whose hands these measures now lie, this one fly may be lifted from the ointment. You can be of assistance there too—if you will but speak.

When the “Carlos” Sank

The Unfortunate Predicament of a Radio Operator on a Sinking Vessel

By A. HENRY

IN DAYS gone by, the “call of the sea” was an annual event with me and my visit to the sanctum sanctorum of the Marconi Wireless Telegraph Company of America was as sure as the rising of the rent or the setting of the sun. Some folks have attributed my wanderlust to an abhorrence of hard work, others to a dislike for warm weather. I have never investigated thoroughly enough to decide which was correct.

Two or three trips were generally sufficient to satisfy me for the nonce and, because my duties as a radio operator permitted me to absent myself from the vessel, in port, I was frequently able to fill my erstwhile empty pockets or replenish a good, though elderly wardrobe from the commission I made selling phonographs or vacuum cleaners in Porto Rico or Nova Scotia—but that is another story and is merely brought in to show you that I had no business being on any steamer, especially one in distress. I was a vacationist with insufficient capital to vacation as I liked, and radio happened to be one of a few possible solutions.

The *Carlos* was a first-class American passenger steamer which plied between New York and several Porto Rican ports. She was in every way a fine vessel and was a particularly attractive berth for radio men. I was always a little fussy concerning the vessels upon which I sailed and had many disputes with the Superintendent over this matter, and must admit that he was very considerate as a rule. After a rather extended and heated discussion, which centred upon the fact that I had carried on regular communication with a certain amateur station on the last vessel he had assigned me to, and that I had no reason to expect assignment to so good a vessel, he finally gave in and let me down easily by reducing me to “junior” operator.

The man who was my senior—there were only two of us—happened to be an old friend with whom I had shared a very inferior berth on an assignment several months before. He seemed pleased to have me with him and I was

very well satisfied—for my heart was set on making another trip to Porto Rico.

One very fine day in June we sailed and I waved farewell to one who must have wondered: “Is it to be next June, or the next, or never?”

The trip was as most such trips are. There were travelers of all kinds—the shy little thing who runs away with the hearts of the bachelors, and the would-be shy little flower of forty-five or so, from whom the bachelors bend every effort to escape; the diplomat, plantation owner and the chauffeur traveling with a family of nouveaux riches. There were the usual poker games with rock and rye in the smoking room for the men, with bridge and Panama punches in the Social Hall for the ladies, while the younger set sought secluded sections of the upper deck to whisper sweet nothings and sip claret lemonade between observations of the tropical moon above a tranquil sea.

On the night of the fifth day out I was deep in slumber, after having partaken of a rarebit and a glass of beer in the smoking room at ten, when we came within sight of the light at the entrance to San Juan harbor. At one in the morning, which was the hour for me to arise and go on duty, my “partner”—juniors always like to use that term in speaking of their immediate superior—came in and shook me until I came to.

“We’re riding at anchor now,” he said, “and the light is just off the port quarter. Get up and see to it that nothing runs into us before morning.”

My only answer was a pillow, hurled at him as he began washing his face in the basin we shared. As he prepared for sleep and I for duty, he told me of the happenings of the evening and we checked up the profit accruing from the sale of the radio paper we published twice a day.

Then he fell into his bunk and I went into the radio room through the door which joined our quarters. We enjoyed two rooms on the upper deck, away from all the passengers and the other officers.

There was nothing important for me to do

in the radio room so I strolled about the deck and, finding everything serene, ambled down to the pantry in quest of the night watchman, a cup of black Java, a couple of sandwiches, and some olives. The watchman and I lingered over

loaned me by a manufacturer, and copied several messages from Germany as they were going to the station at Sayville, L. I.

After a half hour of eavesdropping on the world and smoking many cigarettes I began to

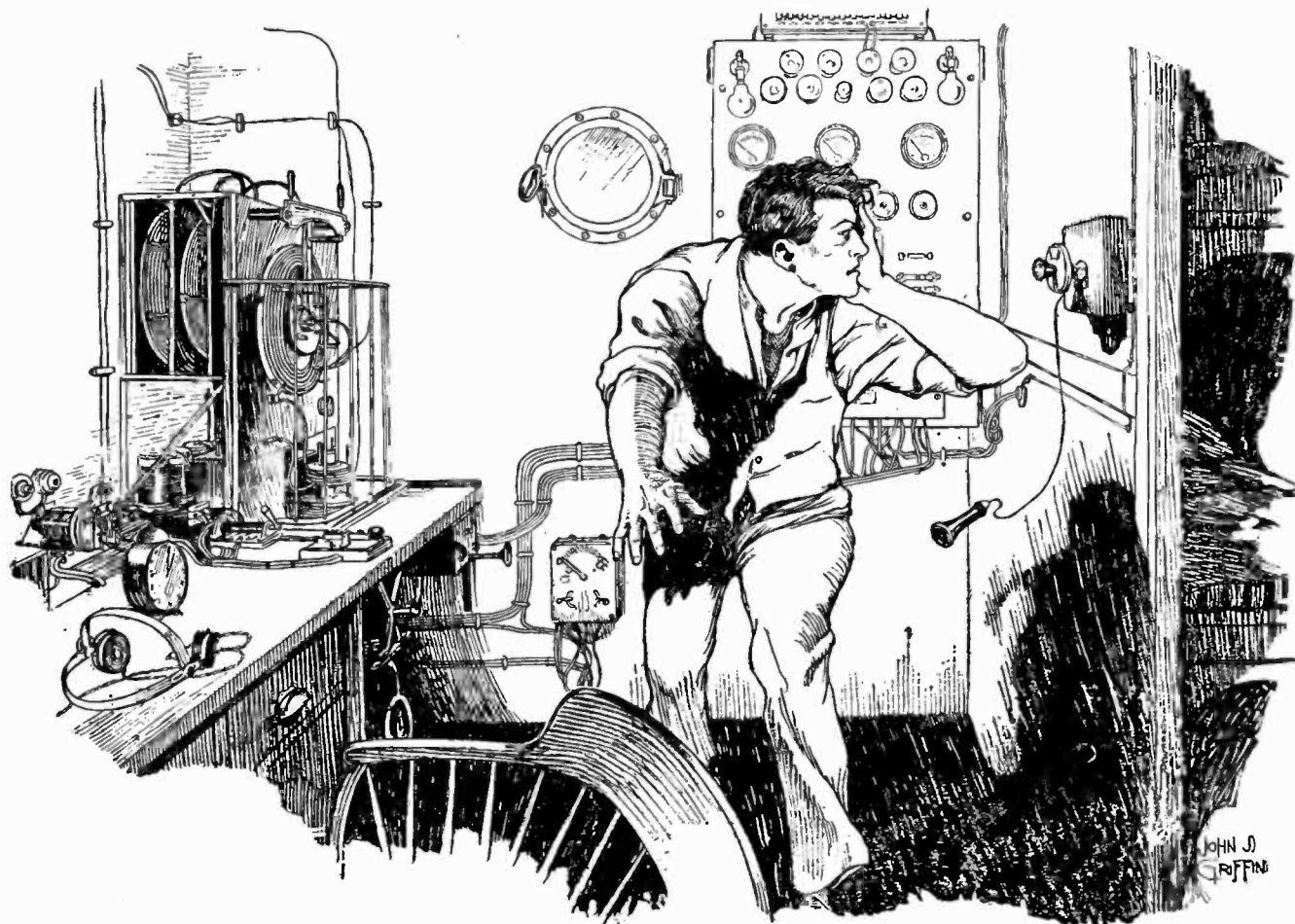

THE TELEPHONE STOPPED RINGING BEFORE I REACHED IT

A million thoughts flashed through my brain accompanied by a million different sounds from the deck below. Had we been rammed? Had a boiler blown up? Did our anchor drag and let us strike a rock? What to do to save the lives of those aboard?

our nocturnal meal, swapping jokes and tales of experiences on other packets—"wagons," as ships are called in deep-sea parlance.

At three o'clock I went back to the radio shack and listened-in. The Naval Station at San Juan was working an arc set and having difficulty clearing his traffic through Charleston, S. C. The station at Miami was carrying on his regular business with the vessels on the coast and in the Gulf of Mexico. The station at Morro Castle, Havana, was having some difficulty in getting a message from the Isle of Pines and the high-powered station of the United Fruit Company in New Orleans was sending a bunch of code messages to the Swan Island station for relay to the company's steamers.

For a short time I listened on a long-wave set,

grow weary. I fought off the increasing drowsiness for a time by trying new circuit arrangements. When, making a connection between a receiver and one of the "B" batteries, I fell over and struck my head on the corner of the bookshelf, I decided then and there that our vessel was entirely safe; that we were within a stone's throw of port and that I would go to bed.

The law requires that a passenger vessel carrying fifty or more persons maintain a continuous radio watch from port to port. I had absolutely no misgivings regarding our safety, for the deck officers were on duty and it was merely a matter of waiting for dawn before we would heave anchor and proceed to dock. However, I did feel as though I should be on

duty when we got under way and estimated the hour of daybreak.

I set the alarm clock at "repeat" for that hour, put it on the table in the radio shack, and turned in. I was so drowsy that sleep overtook me in a minute or two.

My sleep, however, was not very sound, for I subconsciously kept thinking of the alarm. It seemed as though I had just fallen asleep—though it was actually several hours later—when, like a thunderclap, came a crash—the vessel swayed to and fro and then settled. I woke with a start but merely waited, tensely apprehensive.

Then came a sudden, impatient ringing, and as I hastily climbed out of my bunk to answer the telephone, I heard the shuffling of many feet on the deck below, followed by the shrill shriek of the boatswain's whistle and several short verbal orders.

The telephone stopped ringing before I reached it and a million thoughts flashed through my brain accompanied by as many different sounds from the deck below.

Had we been rammed? Had a boiler blown up? Did our anchor drag and let us strike a rock? What to do to save the lives of those aboard?

"Hello, hello," I bellowed into the telephone transmitter. "Hello—this is the radio shack, what's the matter?"

But the telephone was both deaf and dumb. Not a sound came from the receiver.

I rushed out to see if the line from the bridge had been cut and fell on the dew-covered deck. As I got up the order "Over the side with 'er'" followed by the deafening whistle and the

shuffling of many feet told me they must be launching the life-boats.

The telephone rang impatiently and I rushed back into the shack, repeating the vain attempt to get an answer from the bridge.

As I stood there yelling—words I can't remember—my entire life passed before my eyes in an overwhelming instant. I saw my boyhood and the succeeding years, some of my pleasant moments and all my faults. And here was the end—on a sinking vessel—a disgrace to my family and myself—a "ne'er-do-well" meeting well-deserved fate.

With the passing of that instant came consciousness and reason. I was about to run up to the pilot house when the telephone rang again, but by this time I had become cool and collected, so instead of shouting, I merely said in as near a natural tone as I could command, "Yes, Sir, this is Radio, junior operator speaking." But there was no response and I lost my nerve again. The activity on the lower deck became greater and more orders and more whistling droned in my ears.

I made a dash for the door when the telephone rang again and I stopped in my tracks about to yell for my partner when I heard him impatiently exclaim, "Say, you nut—turn off that alarm clock and quit that foolishness!"

The realization of it all dawned on me in a flash. I had forgotten all about the alarm clock; the boatswain was getting the booms and hatches ready for unloading when we should get to dock, and I had made a fool of myself.

From that day on, I never slept on watch and radio has meant something more than an opportunity to enjoy myself.

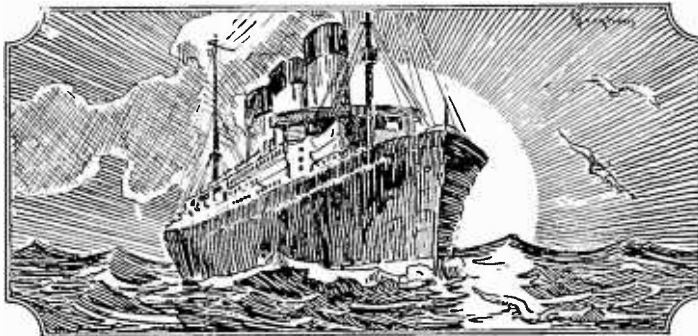
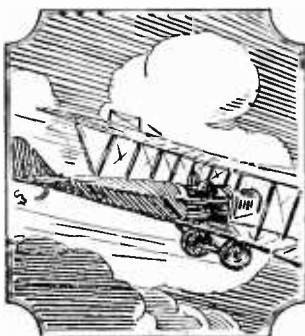

How Your Telephones Work

An Explanation of the Nature of Sound in Relation to Radio Telephone Reception

By G. B. CROUSE

Chief Engineer of The Connecticut Instrument Co.

GREATER acoustic excellence — more faithful reproduction—is becoming a necessity in radio just as it became a necessity in the development of the phonograph. Through the use of the electrostatic transmitter it is now possible to obtain practically perfect modulation in transmission, but it still remains to improve the receiving sets and especially the loud speakers and telephone head sets to the end that the waves received be perfectly reproduced.

One way of stimulating improvement is to show people what an interesting and important subject this is. In this article we shall describe briefly some of the most interesting phenomena involved in the reproduction of sounds by means of the telephone.

All sound waves consist of alternate expansions and compressions of the air. If we could cut through a cross section of air through which a sound is passing, and could see the arrangement of its particles at any particular instant, it would look somewhat like Figure 1.

When a train of such sound waves falls on the ear, the condensed portions push the ear drum in and the rarefied portions pull it out. This motion of the ear drum is transmitted to the nerves of the inner ear and a sound is heard.

When we hear a sound, we distinguish a number of different things about it. In the

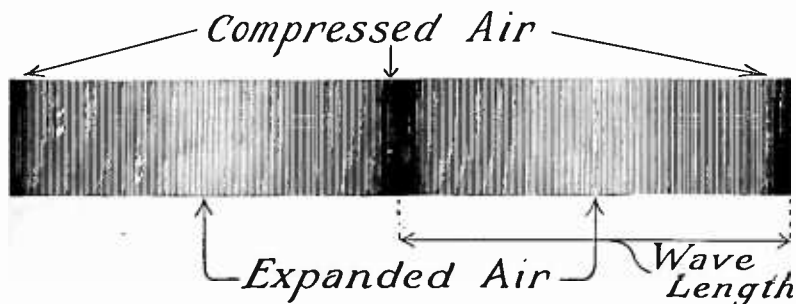

FIG. 1

first place we know that it is loud or soft; that is, we distinguish volume. We also know that the sound is deep or shrill; in other words, we distinguish pitch. Thirdly, we distinguish quality; that is, we can tell a violin from a tin whistle, even though they are both sounding notes of the same pitch and of the same loudness.

Let us examine the nature of these three characteristics of sound. In regard to the loudness of a sound, it is almost self-evident that it depends on the amount of motion of the ear drum, and thus on the amount of compression and expansion of the air which falls



Loud Sound



Faint Sound

FIG. 2

upon it. We therefore say that the loudness of a sound is dependent upon the amplitude of the air wave. The appearance of a loud sound is compared with the appearance of a soft sound in Figure 2.

The pitch of a sound wave depends upon the number of alternate compressions and expansions which strike the ear drum in a second. The greater the number per second, the higher the pitch of the sound. The pitch is determined by the distance from the centre of one condensation to the centre of the next. The wavelength is the distance A — B in Figure 3, where two sounds of different pitch are represented, the lower sound being one half the wave length and twice the pitch of

the upper one. In musical terms this difference is called an octave.

WHAT IS QUALITY OF SOUND?

THE explanation of quality is more complicated. When we say that sound consists of alternate compressions and expansions of the air, or which is the same thing, of alternate to and fro motions of the air particles, we have said nothing about the manner in which they execute these motions.

In general, a particle may have a periodic or to-and-fro motion, and yet execute this motion in a variety of ways, and we are at once led to suspect that the quality of a musical tone is dependent in some way on the manner in which the air particles vibrate. Von Helmholtz discovered that the manner in which the particles of air vibrate is the result of combinations of a number of simple or elementary vibrations from which all sounds are made up.

In hearing words, we very seldom hear the simple sounds by themselves. A tuning fork used in music for giving the pitch to piano tuners, when lightly struck gives a pure tone, and some musical instruments, such as the pipe organ, give almost pure tones in some parts of their scales, but the pure tone is dull, uninteresting and very tiresome to the ear. All pleasing musical tones are made up of quite a number of simple tones, all combined to make one sound.

THE COMPOSITION OF A PIANO TONE

IN FIGURE 4 we have shown the keyboard of a piano. When we strike the key marked middle c, we hear a compound tone whose pitch is middle c, but this compound tone is

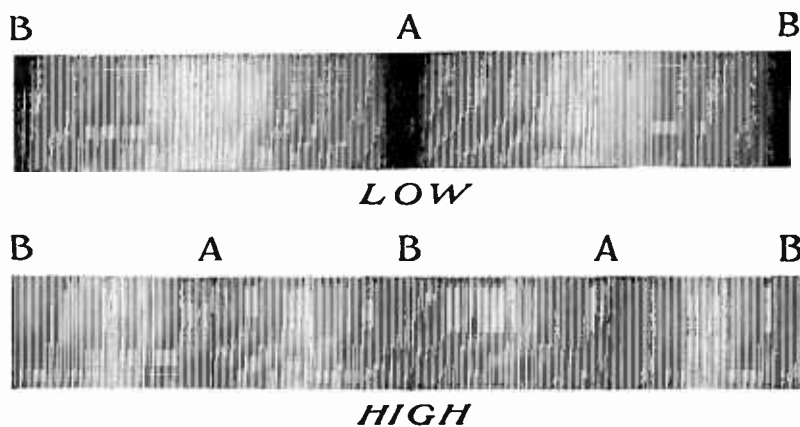

FIG. 3

made up of a number of simple tones, the lowest one of which is a simple tone of middle c pitch. But in addition to this, we hear also what is known as the second harmonic, another simple tone whose pitch is twice middle c, or an octave above, as shown. And in addition to this, we hear the third harmonic, which is a simple tone

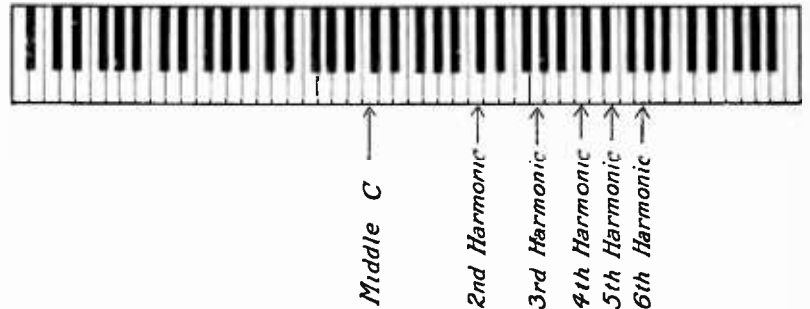

FIG. 4

of three times the pitch of middle c, or in musical terms is an octave and a fifth above the fundamental middle c. We also hear the fourth harmonic, or two octaves above middle c, and so on. We may hear simple tones of five, six or more times the fundamental which we struck.

Almost all tones which we are accustomed to think of as pure are in reality composed of quite a number of pure tones combined to form one compound tone.

Most of us are familiar with the method of representing music on paper, by means of notes placed on a "staff," the lines of the staff representing different pitches. For instance, in our experiment above, we struck the note middle c, and if we wished to write this in music, it would be represented as in Figure 5.

Now if we let our notes on the staff represent the various pure tones that were produced when the player struck this note, what the ear hears is indicated by Figure 6.

Now if this note, instead of being played on the piano, were played on a violin, we would at once recognize the difference, although the pitch would be the same. Upon analysis, it is found that while the tone we hear is made up of a number of simple tones, or harmonics, the *relative loudness* of these harmonics differs in the violin and the piano. If in our music, we let the size of the note mark represent its loudness as compared to the other harmonics, the

analysis of a violin note would be correctly represented by Figure 7. A flute playing the same note would be represented by Figure 8.

Thus we see that the quality of a tone depends entirely upon the number and relative loudness of the harmonics which are present. The ear always determines the pitch of the compound tone from the pitch of the lowest simple tone present, but it determines the quality solely from the composition. In some cases, the lowest simple tone, or "prime tone," or "fundamental" as it is variously called, may only represent as little as 5 per cent. of



FIG. 5

the total volume of the compound tone, as for instance in the split tone on the French horn, whose sound is represented by Figure 9.

So far, we have discussed only musical sounds, i.e., in which the harmonics, or overtones, were two, three, four, etc. times the fundamental in pitch. However, the overtone may not be an even number of times the pitch of the fundamental, in which case the compound tone is generally jangling and unmusical. This is true, for instance, in the cymbal, and indeed in all metal plates. For instance, the sound heard upon striking a metal plate may be represented as in Figure 10 in which the proper position for the harmonics is shown by the shaded notes, while the actual overtones as produced by the plate are shown in white as in the other figures. We have there an overtone which is two and one fifth the pitch of the prime tone and another which is three and one seventh times the prime. This sound will be

unmusical and discordant and all sounds containing these odd overtones we say are harsh and metallic in character.

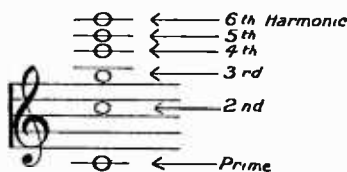

FIG. 6

We are now in a position to see what an ordinary telephone receiver does to the quality of a sound. If you take a diaphragm of steel, or indeed of any thin hard material, say the diaphragm from an ordinary telephone, and holding it to the ear, tap it lightly with the blunt end of a lead pencil, you will find that the diaphragm emits a clear metallic note, having a very definite pitch. In other words we say that the diaphragm has a definite natural period of vibration. Therefore it will vibrate at this pitch much more easily than at any other pitch.

Thus when the telephone is called upon to respond to this note (which is generally from one to two octaves above middle c in most receivers), it will respond loudly, whereas all other notes will be suppressed. Further than this, when the overtone of any note lies near this diaphragm period in pitch, it will be amplified at the expense of the other overtones, and from what has been said above, it is clear that this change in the relative loudness of one of the harmonics will change the quality and make it unnatural and less pleasant to the ear. In some cases it will make it difficult to recognize the instrument or voice which is sounding. This is one of the effects which is included in the term distortion. For instance a piano reproduction by radio often sounds more like a harp, due to distortion in some forms of receivers, and this is even more noticeable when

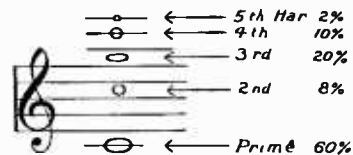

FIG. 7

certain kinds of loud speakers are employed. Therefore, reviewing briefly, we will represent a note played upon a violin in Figure 11 and beside it the same note when heard in the ordinary telephone, Figure 12.

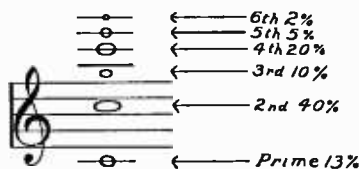

FIG. 8

In this case the second harmonic is made very much louder, because it is close to the natural period of the diaphragm. The characteristic tone of the violin is therefore partially lost.

UNMUSICAL OVERTONES AND TRANSIENTS

IF THIS were the worst effect in distortion, we should indeed be fortunate, for due to this cause alone, while the quality would not be the same as that of the instrument at the transmitting end, it would at least be musical.

There is, however a second effect of distortion which is distinctly unmusical and harsh. Since, as was shown above, the ordinary diaphragm note is always sounded along with whatever sound the telephone is reproducing, and this diaphragm sound is only very rarely an even

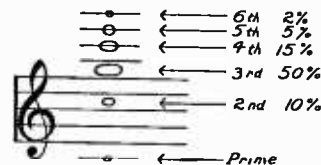

FIG. 9

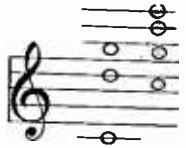

FIG. 10

harmonic of the note which is being sounded, we have added to the musical sound, a number of overtones which are not an even number of times the pitch of the prime tone, with a resultant harsh metallic jangling quality. We have seen, in Figure 11, c as played on the violin, and Figure 12 shows the distortion of the overtones due to the natural period of the diaphragm. Now, in Figure 13 we see the harsh, inharmonic diaphragm over-tones in black and the other tones in white.

The ringing of the diaphragm caused by the diaphragm overtones tends to persist after each syllable, thus not only distorting the individual sound but carrying over from one sound to the next with a blurring effect.

PROBLEM OF ELIMINATION OF DISTORTION

THE elimination of distortion in a telephone receiver resolves itself into the elimination of the natural period of the diaphragm, and while thus stated the problem sounds simple, it is in fact extremely difficult. It is only by the most careful acoustic, magnetic, and electric investigation that the problem can be solved. At present, an effort to find the solution is being made by a well-known instrument company. In this telephone, a diaphragm of special material is employed of such a nature that there is a great deal of friction between its molecules so that it cannot vibrate freely by itself and thus has no natural period which can be distinguished.



FIG. 11

NOISE FILTERING EFFECT OF NON-METALLIC DIAPHRAGM

THE freedom of this kind of diaphragm from free vibrations has another advantage for telephone receivers employed in radio work, in that it reduces the unpleasant effects of tube noises and static. In the ordinary re-

ceiver the noises produced by the tubes and static discharges set the diaphragm ringing strongly, and sometimes drown the useful sound. In the telephone mentioned these disturbances are partially filtered out, with the result that a dull sound is produced which does not produce as great a noise or tend to set up distortion of the desired sound.

In conclusion we will summarize the principal points that must be remembered when dealing with this subject of reproduction of sounds without distortion.

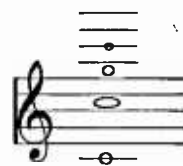

FIG. 12

1. Tone quality (the characteristic which distinguishes one musical instrument or voice from another) is the result of the combination of simple tones. For any given note on a given instrument this combination is always the same.
2. In order to be harmonious the resultant sound must be made up of simple tones which bear an even relation to each other, as 3 to 2, 1 to 3, 1 to 2, etc., and not an odd relation, as 7 to 11.
3. The introduction of any element which changes the values of the harmonics which make up a given sound will change the quality of that sound and may, for example, make a flute sound like a violin.
4. The introduction of any sound which does not bear an even relation to the fundamental tone will produce a jangling, unmusical effect.



FIG. 13

Listening to the radio telephone is not like using the ordinary telephone where it is simply necessary to understand the words spoken. To enjoy radio broadcasting it is generally necessary to sit down and listen for a half an hour or more. It is then that the full effect of distortionless reproduction is appreciated.

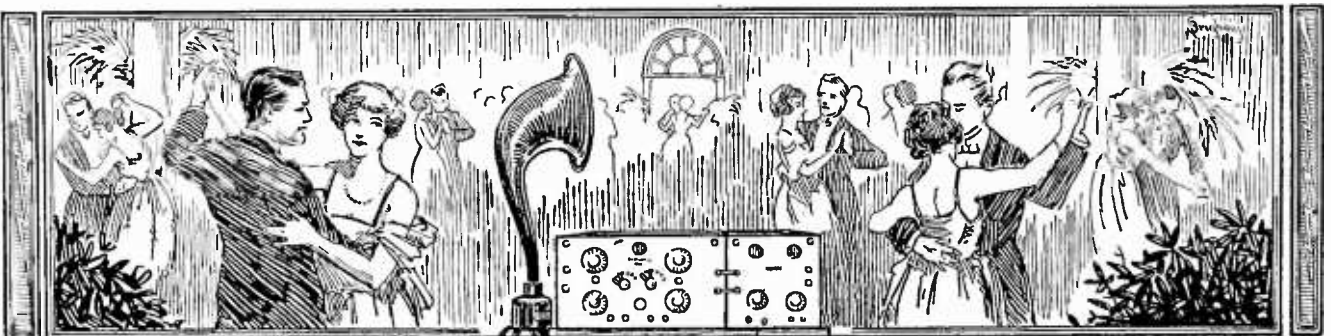

Mining the Makings

By PHILIP S. RUSH

IT'S a far cry from the dark and dangerous passageways of a copper mine, half a mile below the surface of the earth, to the bright and happy sitting room where your radio set reproduces the concerts sent out from a distant broadcasting station. And there isn't the slightest similarity in appearance between the huge masses of copper ore-bearing rock and the tiny wires that make possible the wonderful achievements of radio. Yet, the first step in the development of the wireless outfit, whether it be the largest and most powerful or the smallest and crudest, is mining the ores from which the metallic parts of the apparatus, the filling for the dry cells or the plates of the storage battery, and the crystals for the detector, are obtained.

The metals used in the manufacture of the parts of a radio outfit are obtained almost entirely from mines of great depth, located west of the Mississippi River. Even though your headphone or variometer may be labeled "Made in Germany," the chances are ten to one that the ores from which the metal was extracted came from the Western part of the United States, were exported to Europe as bars, ingots, slabs, or pig metal, there manufactured into delicate parts, and finally reshipped to America for use. Thousands of miners are employed in digging the ores, other thousands operate the smelters and refineries; in fact, an unseen and unknown army works day and night to produce the bits of metal which are necessary to the successful operation of large and small radio stations all over the world.

First in importance, in point of volume of metal used in electrical work, is copper—the "red metal," as it is called by mining men. Arizona, Montana, Utah, and Michigan furnish most of the copper output of the United States, and, incidentally, they export to Germany nearly half their product. In these states are some of the largest mines, smelters, and refineries in the world, and here new feats in mining and metallurgy are continually being performed. In Michigan, copper was mined first by a race of people whose history is lost in the centuries that preceded the discovery of

America, yet to-day many of the most productive copper mines in the world are located around Calumet, Hancock, and Houghton, where copper was dug from open pits in prehistoric times. Some of the present mines are sunk 8,000 feet into the earth, where copper in almost pure metallic state is found.

Very different are the mines of Bingham, Utah, and certain properties in Arizona and Nevada. At Bingham is located the Utah Copper Company which owns one of the greatest copper mines in the world. It consists of a mountain of low grade copper ore, upon which tracks have been built in terraces. Twenty-five giant steam shovels load the ore and rock into long strings of waiting ore-cars; the mountain is gradually being carted away to the smelters, a trainload at a time. Some of the properties in Arizona and Nevada are worked in the same manner, but most of the copper mines in Arizona, and all those of Montana are operated through shafts sunk deep into the earth. From the shafts extend

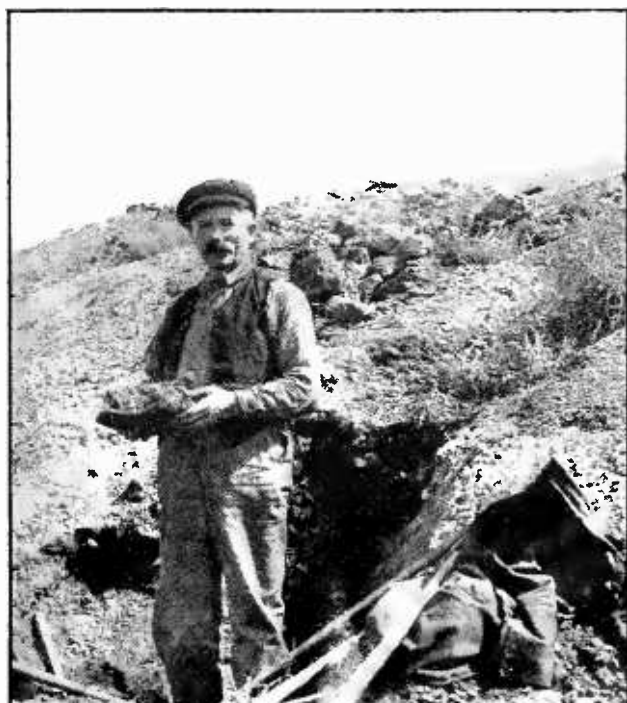

THE MOST OPTIMISTIC MAN IN THE WORLD
The Western prospector, who is always hoping that the next blow of his pick will turn up mineral riches

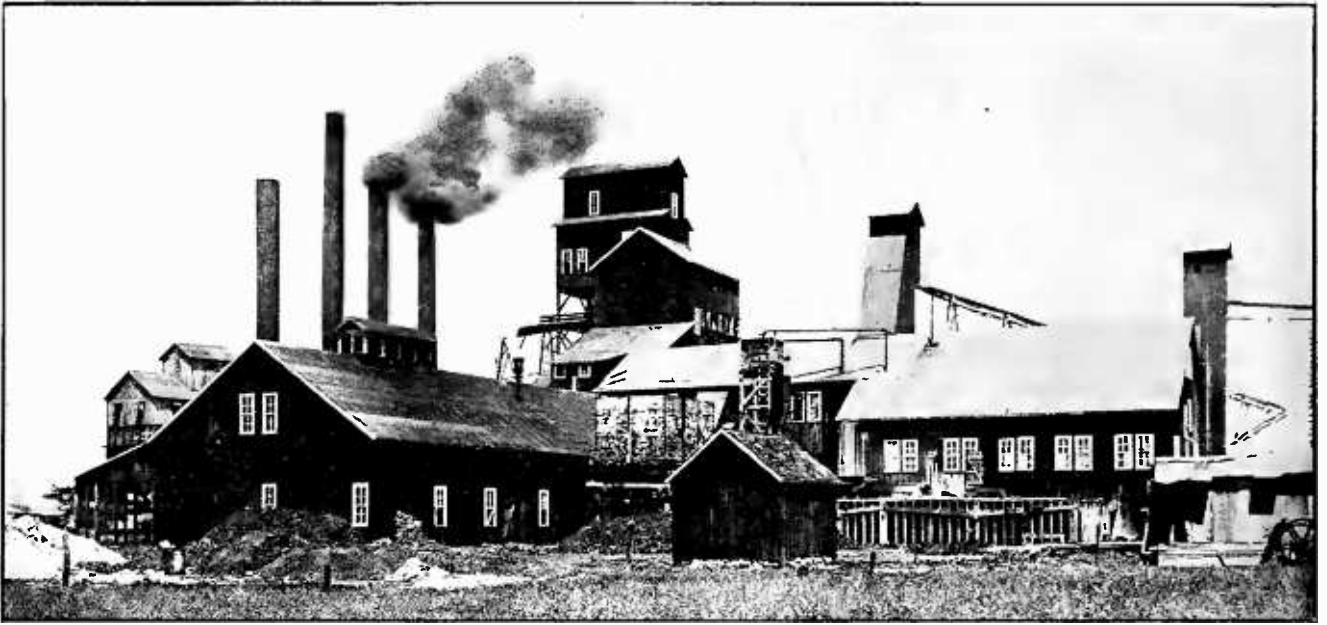

ONE OF THE PRINCIPAL LEAD MINES

Located in the Joplin, Missouri, district. Perhaps the galena crystals in your detector came from this mine

tunnels, or cross-cuts as they are called in the West, in every direction, honeycombing the ore-bearing rock for the desired metallic content. While the ores of northern Michigan are almost pure metal—"native copper"—and those of the Utah Copper Company contain much rock and little mineral, the mines of Montana and many of the Arizona copper properties carry their ores in veins set in solid granite walls. The veins vary in width from a few inches to great pockets many feet wide and deep, and in some instances the ores assay 50 or 60 per cent. copper, with a certain amount of gold and silver thrown in for good measure.

The small mining area at Butte, Montana, contributes more than just copper to the wireless equipment of the world, for in addition to some of the richest copper mines yet discovered, there is the largest single zinc mine in the world. The most valuable manganese deposit in the United States lies about seventy miles west of Butte, at Phillipsburg, and it is from the Phillipsburg mines that most of the high grade manganese used in dry cell batteries is obtained.

New Jersey is the one Eastern state that competes strongly with the West in zinc production, but the greatest zinc-mining field in the world is in the neighborhood of Joplin, Missouri. The ores underlie a wide area, extending into Oklahoma and Kansas, and during the last four years Oklahoma mines, all relatively close to Joplin, have produced far more

zinc than the mines of any other state in the Union. Unlike Butte, the Oklahoma-Kansas-Missouri field is shallow, and the ore is found in pockets and blanket formations, somewhat like the coal beds of the central states.

Zinc is, of course, a vital element in batteries and alloyed with copper it becomes brass, which is used in a hundred ways in radio equipment.

The preëminence of the zinc fields about Joplin is a matter of only the last few years, but for a long time Joplin and lead mining have been almost synonymous terms. It is, in fact, not at all unlikely that the galena crystal in your newest detector is a product of the mines about Joplin. The Coeur d'Alene district of the Idaho panhandle, while a most different geological area, also abounds in galena or lead ore, and there are extensive mining properties centring about Wallace and Mullin, producing vast quantities of lead, silver, and zinc. Montana, Colorado, Utah, Nevada, Arizona and a few other states produce lead. A marked difference in the value of the galena crystals obtained from different mines has been noted in experimenting with radio detectors.

The tungsten filaments in your bulbs may come from the mines of California, Colorado, or Nevada, but by far the greater part of the tungsten used to-day is produced in China and neighboring countries and exported to Europe or America for treatment and manufacturing. The United States is also a small producer of

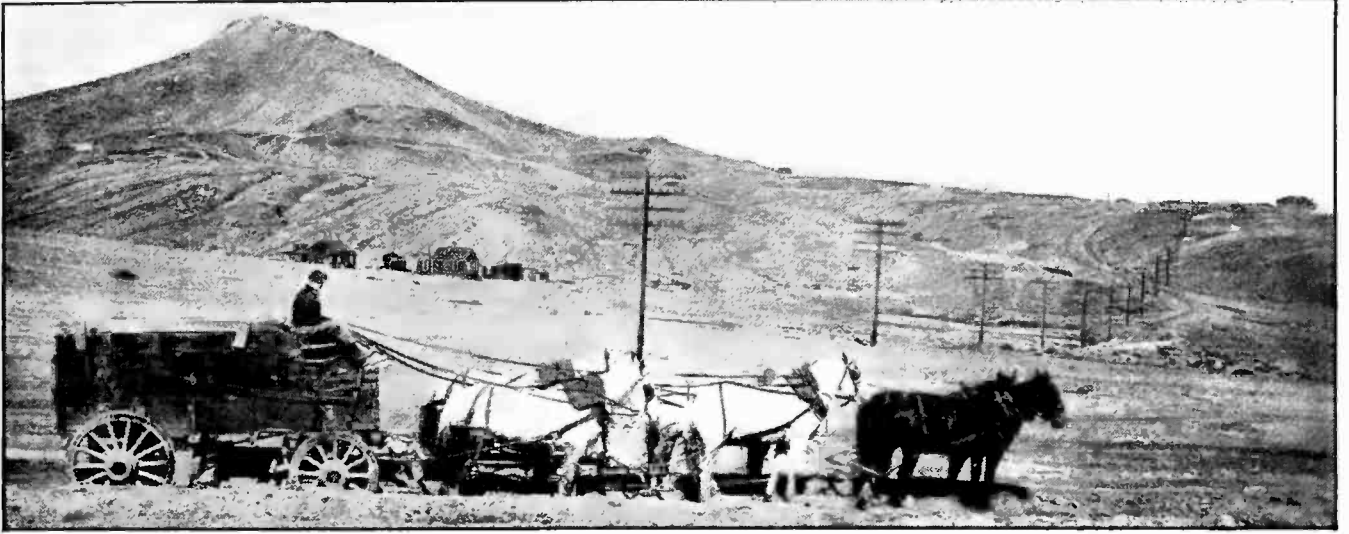

HAULING ORE IN THE WEST

Six-horse teams like this pull the heavily laden wagons along the deeply rutted roads of plain and mountain

platinum, but the Ural Mountain district of Asia, and Colombia, South America, export far more of this valuable metal than the total mined in Alaska, California, Oregon, and Arizona.

Nature distributed iron ore more generously than she did most of the other metals. The tall masts of the antenna of a great station, or the tiny core of an electromagnet, may have come from ores mined in almost any section of



GEOLOGISTS AND MINERS EXAMINING A VEIN

Just after a dynamite blast has brought down a lot of rock and ore. This flashlight was taken many hundreds of feet below the surface of the earth



MILES AND MILES OF WIRE

Are made from ore in this monster plant of the Anaconda Copper Co., at Great Falls, Montana

the United States. Deposits of iron ore exist in more than half the states of the Union, but in only a few is extensive commercial mining carried on; the fields of northern Minnesota alone produce more than fifty per cent. of the tonnage of the United States. Michigan is second, Alabama third, but a great deal of iron also is mined in Wisconsin, New York, New Jersey, and Pennsylvania. In the Lake Superior region, where most of the ore is mined, there is no coal or natural gas, consequently the ores are shipped to the coal fields, to Pennsylvania, Ohio, Illinois, Indiana, and Alabama, where are located the greatest blast furnaces and factories. Some iron mining is carried on in open cuts, with steam shovels, other ores are obtained by underground mining. Steel is, of course, derived from iron and finds its greatest appli-

cation to radio in masts rather than in the receiving or transmitting units themselves.

The West yields to the East in two minerals very important in the manufacture of wireless equipment: the aluminum for your condenser plates is mined chiefly in New York, North Carolina, and Tennessee, and the thin sheets of mica, used in insulation, are mined in North Carolina, New Hampshire, Georgia, and Virginia. The total American output of mica, however, is small in comparison with the product of the mines in British India where most of the world's supply is obtained. The one metal extensively used in radio equipment not commercially mined in the United States is nickel, used for plating the many bright knobs and screws. This we obtain chiefly from our Canadian neighbors.

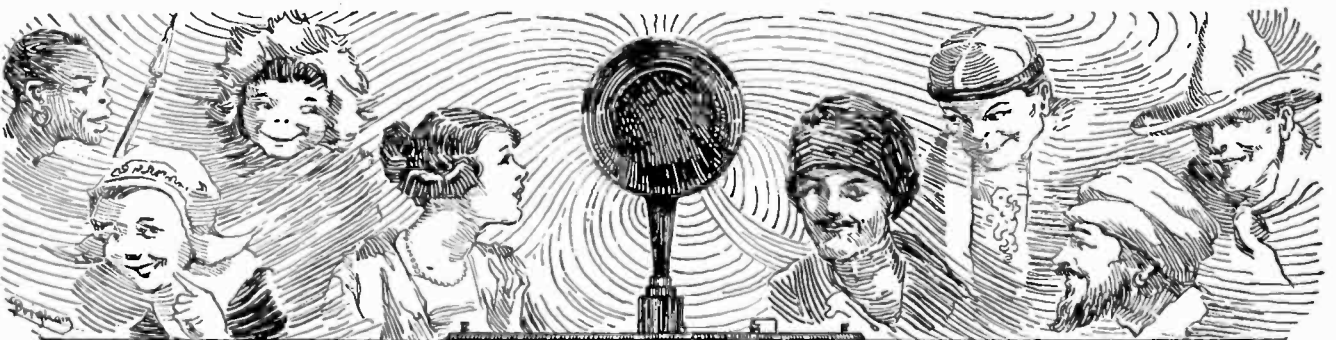

To Mr. Hoover From the Postmaster at Boone Stop, Mo.

By HOMER CROY

Boone Stop, Mo.

While waiting for
the 1:15 to come in.

THE HON. HERBERT HOOVER,
Department of Commerce,
Washington, D. C.

HONORED SIR:

I understand that you are head of the wireless telegraph of the country and that what you say is law, so I take my pen in hand to help you straighten things out, as no doubt you sometimes run up against knotty problems that are about all you can handle and make you wish for somebody to advise you who has had practical experience in wireless, such as the writer has.

As you can see from my letter head, I am also a part of the United States Government, being the postmaster in Boone Stop, Mo., which got its name because Daniel Boone stopped here. I have held the post under three consecutive administrations regardless of their politics, as I make it a principle to let each new postmaster-general do as he likes, as I find that is the best way to handle them. However, it seems to me if Will Hays has cleaned up the movies that he has kept it to himself, because when I put the duties and responsibilities of my office aside and go down to our theatre for a few minutes' recreation they are just about like they always were. But that is not the matter I wanted to take up with you, as no doubt you are more familiar with the intricacies of radio and haven't time for thought along other lines than what you are paid for. Nor do I blame you because I, too, know what the cares of public office are. It is only by closing the window that I can get any time to myself to take up these important matters with you. You may not know it, Mr. Hoover, but I was one of the first persons in Boone Stop to take up the wireless telegraph, or radio as it is often called. I have always been in the forefront of new ideas and as soon as I was convinced that the thing was sound, I threw my weight into it. I was also one of the first supporters of Bryan, and when prohibition came along I

again put my shoulder to the wheel so you can see that I am not a person afraid to use his brains. I have always done my own thinking, and have never been the pawn of clicks and parties. From what I have read of you, I judge you to be something of the same, so we should be able to work well together. It is said that Andrew Carnegie, the late millionaire, now deceased, attributed his success in life to his ability to pick brains in other men. But no doubt you already know this and are planning the same kind of career for yourself.

I have often thought that it was a pity that Mr. Carnegie did not make a trip out through the Missouri River Valley section of our country because it probably would have opened his eyes to the fact that there was some other place besides Pittsburgh where he got most of his talent, because he could have saved himself a good deal of money on the payroll by getting men who would have been willing to split the salaries he offered and yet work just as hard. But of course it is not too late, unless the same was carried into effect in official circles in Washington. If you chose me head of your radio work, or something that I am familiar with, you could rest assured that I would not slight my duties. I understand that there has been a good deal of complaint about our civil service system in Washington and that the employees work only when there is not a baseball game, or a new feature picture in town, but this would not be true of the writer. He would not walk down to the depot to see Babe Ruth and Judge Landis become personal, and as for features, the only difference that I can find is that there are more names of photographers and assistant photographers and assistant-photographers on features than on the kind that don't cost so much.

I see that you are puzzled about giving out wavelengths to the different people who want them. Of course I do not want to butt in on your domain, but you must recognize that this is a very important matter, because if they get into the hands of unscrupulous people what will they do with them? If I were in your place

I would select a good man in each community that I could trust and then have him report as to who was the most worthy person to let have them. This person would be your confidential man. At any time you wanted to know anything about the radio situation in a certain district, all you would have to do would be to call Boone Stop 67-R.

I will explain my ideas to you because I know how busy you are, going to dinners and things that way that you can not very well get out of without hurting somebody's feelings. But there is one thing that I would not allow and that is the use of radio by politicians. It seems to me, Mr. Hoover, that this is too much of a good thing. What we need less of than anything else is too much politics. For my own part, if, as I said, you selected a good man for this district I would make it a first degree offense to mention politics over the wireless telephone. If a person wants to read it in the papers it is his own lookout, but think of having company that you like in to dinner and you want to give them a good time before they go home, and you take down your radio and there is somebody talking about what he would do if you elected him to office. Marconi is a good man, and I am not one to belittle him, but if that is going to be the sum total of his invention it would have been better if his parents had guided him along some other channel before it was too late. There are plenty of good inventions needed by the human race, let alone something that will make them worse off than before they were born.

A thing that comes to my mind is something to keep pens from rusting in a post office. This would be a help to everybody who has ever picked up a pen, dipped it into the ink, thought of something to write and then started and found it didn't have but one nib—and the only other pen is being used by a girl who is writing to a boy who isn't good enough for her. Besides, such an invention as this would not

only be of help to struggling mankind but would be of service to a busy postmaster who has ideas outside the routine of his work.

Another thing that we ought to deal with with a firm hand is the growing prevalency of people telling how far they have been able to receive. This may seem a small matter to you, because you have your nose to the grindstone and do not know what the country as a whole is thinking of, but more and more people are beginning to boast how far they have been able to establish communication. If the first person says that he has heard WMPO and that is 400 miles, then the second person says he has heard KNKM and that is 700 miles if it is a foot. And then the third person raises him a thousand. It is tending to make us a nation that does not have the proper regard for the truth. We should act together at once, Mr. Hoover, to discourage this before it permeates to other channels or our whole public life will be honeycombed with it. You will recall the case of the boy who stayed the waters by putting his thumb in the hole in the dike. Mr. Hoover, one of us must put our thumb in the opening. I know that you are busy and need every hand you have and probably more, so I will make the sacrifice.

These are only a small part of the things that have occurred to me. If you will send for me, so that we can talk it over face to face as I like to do on such occasions, then you can get a better idea of what is in my mind. Then I will collect my expenses, return and set about getting my affairs into shape. The only delay will be while Mr. Work is trying to get somebody to try to take my place.

Yours till radio conquers all,

AMOS MILLER, P. M.
(Postmaster)

P. S. If you telegraph, please send it prepaid, as the agent here says that it makes him less work.



Famous Radio Patents

By CHARLES H. KESLER

Member of Bar of District of Columbia, and of New York Patent Law Association

From the very beginning of radio, patents have formed the legal battleground upon which many theories have been proved and disproved. Conflicts over patents have been the stepping stones or stumbling blocks in many radio careers. They are important to every radio investigator and should interest every radio enthusiast. Humor, pathos, jealousy, revenge, and the cold facts of science are found aplenty in these legal battles and it is but natural to assume that the story may best be told by a warrior who has tasted both defeat and victory.—THE EDITOR.

RADIO as we know it to-day is the result of the work of thousands of men, some of them scientists interested in knowledge as an end in itself; others practical inventors whose goal is a product that will sell. The inventions which have contributed to make modern radio possible are many; but we shall discuss merely the most important inventions which are covered by patents which the courts have decided are valid.

The patent system of the United States is unique among the patent systems of various nations, and our industrial progress has been due in no small measure to it. The Constitution of the United States gives Congress power:

“To promote the progress of science and useful arts by securing for limited time to authors and inventors the exclusive right to their respective writings and discoveries.” (Art. 1, Sec. 8.)

Such rights are granted by patents. A patent is a contract or agreement between the inventor and the United States in which the government agrees to give the inventor or patentee the exclusive right to make, use, and sell the invention for the term of seventeen years and the inventor agrees to make a full, clear, concise, and exact disclosure by description and drawing of the invention, such that after the expiration of the patent to which the description and drawing are attached, anyone of average skill in the art may be able to construct, make, or use it. The words, “exclusive right” means the right to exclude others from using the invention. The inventor has the right to use his invention himself, provided he does not infringe other patents.

Patents are granted for apparatus for doing a thing, or for methods or processes for doing a thing. A principle of nature cannot be

patented, as, for instance, the broad idea of using electromagnetic or radio waves for communication. Furthermore, the patent system is for the purpose of promoting “the progress of science and useful arts,” granting the exclusive right to a patentee being merely a means to that end.

A patent when granted is presumed to be valid unless found invalid by a Federal Court.

In a patent suit, facts are mustered by both sides, for and against the patent. The defendant or alleged infringer attempts to show that he does not infringe or that the patent is invalid. From the contested facts the court decides what was granted by the patent and how far one can go without infringing it. In a well conducted patent suit, earlier patents and publications showing similar constructions are reviewed, the question being: Has anything been contributed by the inventor, which promotes science and the useful arts, not covered by previous inventions? Technical experts testify and the counsel for each side argues the case.

ADJUDICATED RADIO PATENTS

THE patents which have so far stood the test of litigation and are now in force cover three phases of radio: the vacuum tube, beat reception, and the Armstrong regenerative or feedback circuit. Certain crystal detector patents, alleged to cover selective contact, a crystal embedded in a fusible metal, the “cat-whisker” and other features owned by the Wireless Specialty Apparatus Company have been recently before the court, the Wireless Specialty Company having brought suit against several companies for infringement.

The patents covering the vacuum tube are by far the most important because in practical applications of beat reception and regeneration, tubes are used.

The basic and dominating tube patent was the Fleming patent No. 803,684 (expired November 7, 1922) owned by the Radio Corporation of America, the successor of the old Marconi Company.

The device described and illustrated in this patent is shown in Fig. 1, and comprises a glass

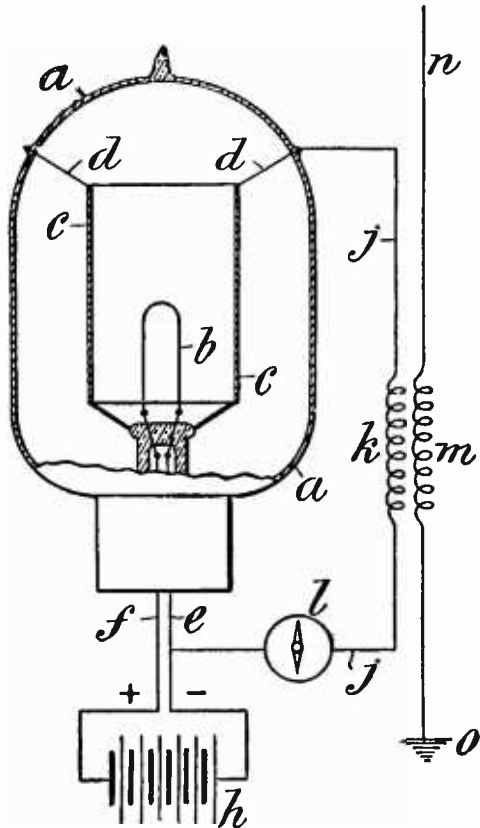

FIG. 1
The original Fleming valve arrangement

bulb *a*, a carbon filament *b* (the hot conductor), and an aluminum cylinder *c* (the cold conductor), which surrounds but does not touch the filament. The lead wires *f*, *e*, are sealed in the glass and are in circuit with a filament battery *h* for heating the filament to a high temperature and incandescence. The two electrodes are connected by an external circuit comprising the wires *d* and *j*. The circuit *j* includes an indicating device *l*, shown as a galvanometer, and is inductively coupled to the serial *no* through the coupling *mk*. The bulb *a* is highly exhausted to give a vacuum.

The invention relates to devices for converting alternating currents, and especially high-frequency alternating currents, or electric oscillations into continuous electric currents for the purpose of making them detectable by ordinary direct-current instruments. The device rectifies alternating current, that is, sup-

presses the electric current in one direction or changes the current so that the flow is in one direction only.

Fleming, in his patent, states:

"I have discovered that if two conductors are enclosed in a vessel in which a good vacuum is made, one being heated to a high temperature, the space between the hot and cold conductors possesses a unilateral electric conductivity, and negative electricity can pass from the hot conductor to the cold conductor, but not in the reverse direction."

That is, the oscillations set up in the aerial by the electromagnetic waves are transformed in the circuit *j* into direct pulsating currents of a form capable of actuating the galvanometer or other recording instrument.

This, in brief, is what Fleming shows in his patent and claims as his invention. Nothing is said in this patent about amplifying or oscillating tubes, two electrodes only being shown. We shall later see how the courts construed this patent.

Dr. Lee De Forest, the inventor of the "Audion" or three-electrode tube improved upon Fleming's work by making the vacuum tube practical. His inventions cover the three-electrode tube for all uses, as for detectors, amplifiers, and oscillators.

The first De Forest tube Patent No. 841,387 expires Jan. 15, 1924. The title of the invention is: "Device for Amplifying Feeble Electric Currents." In Fig. 2 is illustrated one form of the invention which shows how it is applied to a receiving circuit. The device is a glass bulb *A*, which has been exhausted or

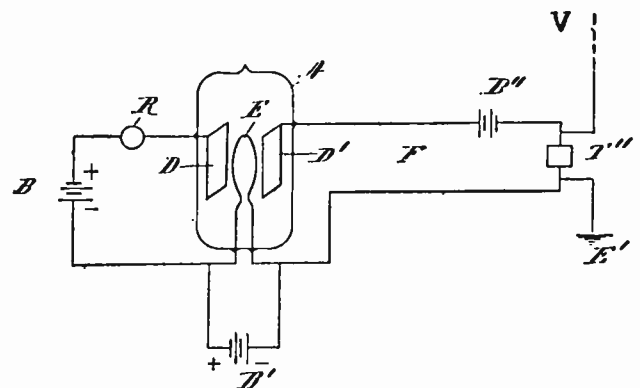

FIG. 2
One form of the De Forest patent No. 841,387

evacuated and in which are located the wire filament *E* with the spaced electrodes *D* *D'* upon opposite sides. The filament *E* is heated to incandescence by means of a battery *B'*,

and this use is described in the patent as follows:

"In Fig. 2 the current to be amplified may be impressed upon the medium intervening between the electrodes D and E, and thereby alter, by electrostatic attraction, the separation between the electrodes. In this case D' may be a strip of platinum-foil, and the slightest approach thereof toward the filament will act to slightly cool the gaseous medium, and thereby alter the current in the local circuit, or, if D' is rigid, the increase in electrostatic attraction between D' and E will cause E to recede from D, and thereby alter the current in the local circuit."

This patent covers, broadly, an evacuated vessel, that is, a vessel from which the air has been removed, three electrodes sealed within the vessel, means for heating one of the electrodes, a local receiving circuit, including two of the electrodes, and means for passing the current to be amplified between one of the electrodes of the receiving circuit and the third electrode.

In De Forest "grid" Patent 879,532, which expires Feb. 18, 1925, is found the culmination of the work on vacuum tubes, the form which is now standard and which is called the audion (the ion hearer).

The invention is illustrated in Fig. 3 and comprises a vacuum bulb D having sealed therein three electrodes, the heated filament F, the grid *a*, and plate *b*.

The filament F is heated by the battery A. The incoming oscillations are received by the aerial VE and are transferred across transformer M to the secondary inductance I_2 having a condenser C. The inductance I_2 is connected at opposite sides of condenser C with filament F at 2 and with grid *a* at 1, forming the input circuit. The now well-known grid condenser, C', is shown in this circuit. The output circuit,

including the telephone T and battery B, is connected at 3 to plate *b* and at 4 to filament F, the positive end of battery B being connected to plate *b* and the negative end to filament F. Fig. 3 is shown in the patent. Apparently the lettering used in the patent was adopted to describe the batteries shown, as these are now generally known as the A battery and the B battery.

The "hook-up" shown is for the use of the audion as a "detector" of electromagnetic waves, although the device also amplifies at the same time.

The invention covered in this patent is the grid located between filament and plate and broadly the use of a condenser C' coöperating with the grid in a manner now well-known.

The three patents above described were first considered in the Federal Court for the Southern District of New York in *Marconi Company vs. De Forest Co.* (236 Federal Reporter 942). Suit was brought upon the Fleming patent by the Marconi Co. on

the ground that the Audion (shown in Fig. 3 above) infringed it. A counter suit was brought by the De Forest Co. alleging infringement by the Marconi Co. of the two De Forest patents and others.

The Marconi Company, before trial, admitted that it infringed claims 4 and 6 of the above De Forest Patent 841,387 and the claims in issue of the above De Forest Patent No. 879,532, and also admitted that the claims infringed were valid. This is called "confessing judgment." The court then had to consider the Fleming patent only. Is the Fleming Patent valid and if valid, does the audion, the three-electrode type, infringe it?

Everything which had been accomplished before Fleming's invention was considered by the court, especially the detectors previously used in radio, such as the coherer, microphone, and

Time and Inventions

"The Edison lamp is an example of an invention," says Mr. Kesler, "which was made at the wrong time to reap material benefits therefrom. The patent was granted at the time Hertz was making his experiments which led to the discovery of the electromagnetic waves which bear his name. The Edison patent expired four years after the basic Marconi patent was granted but four years before Fleming secured his patent. Had Mr. Edison's invention been opportune, doubtless he would have dominated the audion vacuum tubes with his patent."

Scientific investigators frequently reason along similar lines and time becomes a very important factor in securing patents. Armstrong, De Forest, Hogan, Langmuir, Meissner, Waterman, Weagant and others independently observed that the vacuum tube would oscillate. Mr. Kesler will describe the resulting complex patent situation in an early number of RADIO BROADCAST.—THE EDITOR.

the magnetic, electrolytic, and crystal types. All these had some defect. Then came Fleming with his detector, and after him De Forest and the wonderful and rapid progress, not only in radio, but also in telephony and telegraphy.

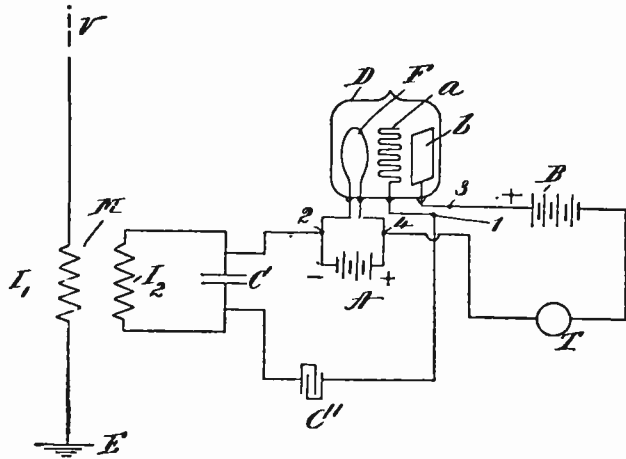

FIG. 3

The famous De Forest "grid" patent which expires in 1925

But the tube which Fleming proposed as a detector in radio was old. The wizard Edison, whose magic hand has touched almost every phase of modern development, had already noticed that a circuit including two spaced electrodes in a vacuum, when one is heated, has unilateral conductivity. This is called the "Edison effect." The Edison device was covered in patent 307,031 granted Oct 21, 1884 and is shown in Fig 4. For ten years or more the Edison device was known yet none thought of using it as a detector in radio. Fleming repatented it for use in radio. The Court said:

"What Fleming did was to take the well-known Edison hot and cold electrode electric lamp and use it for a detector of radio signals. Cohering filings, magnets, electrolytics, and sensitive crystals, at that time, failed to give any hint of the utility in this art of the Edison lamp."

The Edison lamp is an example of an invention which was made at the wrong time to reap material benefits. The patent was granted when Hertz was making his experiments which led to the discovery of the electromagnetic waves which bear his name. The Edison patent expired four years after the basic Marconi patent was granted, but four years before Fleming secured his patent. Had Edison's invention been opportune, doubtless he would have dominated the audion vacuum tubes with his patent.

In view of the Edison patent, which was used for low frequencies only, Claim 1 of the Fleming patent which was alleged to be infringed but was too broad as issued, was limited for use with high frequencies or oscillations of the order used in radio. This limitation was secured by filing a statement to that effect in the patent office, called a "disclaimer." The filing of the disclaimer enabled the court to hold Claim 1 of the Fleming patent valid and patentable over the Edison patent.

Fleming called the operation of his valve "rectification." His explanation of its operation, given in a 1905 lecture, is as follows:

"In the incandescent carbon there is a continual production of electrons or negative ions by atomic dissociation. Corresponding to every temperature there is a certain electronic tension or percentage of free electrons. If the carbon is made the negative electrode in a high vacuum, these negative ions are expelled from it but they cannot be expelled at a greater rate than they are produced."

The electron theory is the one now in vogue to explain the operation of the vacuum tube. To speak of "atomic dissociation" (the breaking up of atoms) to those of us who learned our chemistry in former days is enough to make agnostics of us all. As Chesterton says, "modern science has knocked the atom to atoms."

Then, after considering the prior art (what had been done before) the court said: "The contribution of Fleming was clearly invention and is entitled to liberal interpretation and consideration." The court decided that nothing which De Forest had done prior to

Fleming's time could be considered of sufficient importance and value to invalidate the Fleming Patent. The court was referring to what the plaintiff, Marconi Company, called the "Bunsen burner patents," which were either inoperative or differed in principle.

Now as to infringement. De Forest and his experts contended at the trial that the Audion operated according to a different principle from that of Fleming, that is, it was a "relay," its products being currents of audio frequency and of the local energy (the B

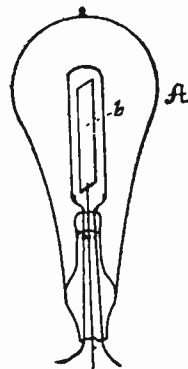

FIG. 4

The Edison patent which could have altered the entire radio industry had it been brought out at a later date

battery) and not of the input energy. Fleming's theory was that of rectification. It was the contention of the defendant De Forest that the radio impulses in the input circuit, causing potential variations on the grid, varied the resistance of the output circuit so as to cause a pulsating current in the latter due to the B battery. This is one way of looking at it.

It was shown by the plaintiff, however, that the use of a battery, such as B, had been used before Fleming and De Forest with detectors of different types to make them more sensitive. The court, relying on the testimony of Waterman and Armstrong and others, took the view that the grid and plate and the two circuits of the audion were the equivalent of the single plate and single circuit of Fleming and that the audion operated on the principle of rectification, the battery B assisting this action. The Court therefore decided that the three-electrode audion of De Forest, when used as a

detector, as an amplifier in radio, and as an oscillator infringed the Fleming Patent.

Although the two-electrode device of Fleming is seldom used in practice, yet the court felt that any real contribution which De Forest made was based on what Fleming did, crude as it was. Fleming made the first step and De Forest completed it.

The decision of the lower court just described insofar as it relates to a detector was affirmed later by the Circuit Court of Appeals, Second Circuit (243 Federal Reporter 560).

A pioneer invention does not deserve the name which does not blaze the way for future development, and as to De Forest's contribution to the art, the court said: "De Forest in his three-electrode audion has undoubtedly made a contribution of great value to the art, and by the confession of judgment in respect thereof, defendant company may enjoy the just results of this contribution."

The Urgent Need for Radio Legislation

By HERBERT C. HOOVER

U. S. Secretary of Commerce

THE present radio telephone situation in the United States is simply intolerable to those who have at heart the full value of radio broadcasting. Yet there is absolutely no adequate solution of the problem open to the Department of Commerce until pending legislation makes available to the public the use of the wave-band, 1600 to 600 meters, which is reserved for governmental purposes.

The reservation of this band was made by law in 1912, eight years before the radio telephone came into its amazing popularity. In February, the Radio Conference, which was made up of representatives of manufacturers and all other groups concerned, urged the necessity of making this band of waves available to the public, since it comprehends the logical range of any extension of available waves practicable, in the present stage of development of the art, for public use. Accordingly, bills were formulated and introduced into both the Senate and House looking to the amending of the law and the enlargement of the authority of the Secretary of Commerce to meet current

emergencies without the delays more or less inevitable in legislative action.

In the meantime the Radio Division of the Bureau of Navigation has utilized its ingenuity and resourcefulness to the full to make the most of the allocation of such wavelengths outside, but by no means including all outside, the governmental band. Thus, to make the most of the 400-meter wavelength, with an eye to the enjoyment of the greatest number, a new classification of broadcasting stations, Class B, was set up, with special requirements designed to make each broadcasting station using the 400-meter wavelength of the largest possible service to those having receiving sets.

The passing of the bills now before Congress will not of course constitute a panacea that will entirely do away with the necessity, for instance, of improving the selective power of receiving sets in general use. But until the existing law is amended certainly no considerable improvement in the situation can be looked for. Then a re-allocation of wavelengths can be made such as will, at least, make the most of existing potentialities.

Down on the Farm in 1923

By W. A. WHEELER

In Charge, Radio News Service, United States Department of Agriculture

THE lights in the living room went out. Conversation ceased. Only the ticking of the clock on the mantel could be heard. Presently the tiny wall bulbs came on and bathed the room in a rosy glow. There was something uncanny about it; it was like a seance.

Suddenly a voice spoke:

"Less fuel is required to cook the cheaper cuts of beef than is required to broil a thick steak properly."

The guests stirred uneasily. Someone laughed. Then the voice continued:

"Recipes for the proper preparation of stews, boiled beef, and braised beef have been prepared and are now ready for distribution on application."

Puzzled, Mrs. Baker switched on the centre lights. Something had gone wrong. Nothing wrong with the customary dramatic setting she had contrived for her radio concert, but she had not expected the beef stew. Again the message was coming:

"Less fuel is required to cook the cheaper cuts. . . ."

At the close, it was announced:

"This is the new 'Agriogram' service of the United States Department of Agriculture."

"Agriogram?" No need to look in the dictionary—you won't find it. "Agriogram" is a newly coined word, denoting the messages of a newly instituted radio broadcasting service. Secretary of Agriculture Henry C. Wallace is its author.

Jed Connors's crop of spring hogs had not yet been sold. This worried Jed, as he was hoping to start on a motor trip with his family. To delay the sale until his return might mean a heavy loss, because prices had been dropping steadily, and he had been holding out for an advance. He regretted now that he had not kept in closer touch with the market. Most of the information he had was several days old.

He heard a footstep on the walk, and looked up to see his friend Tuniper approaching.

"Well, I got it!" Tuniper announced jubilantly.

"Got what?"

"The radio. And say, guess what hogs did today. Jumped clear up to nine dollars."

"What!" shouted Jed. "Who told you that?"

"Came by radio. Come on over at 11 o'clock and we'll get the final report."

Half an hour later Tuniper and Connors were seated before a radio set, receivers over their ears. At 11 o'clock the market message came:

"Chicago live stock market: Hogs opened strong to 15 cents higher, light and medium weights closed firm at advance. Bulk of sales \$9.30 to \$11.60. Better grades beef steers . . ."

"Hurrah!" shouted Connors. Ten minutes later a sale was closed by telegraph—and the family was advised that the motor trip was "on."

These instances are not the product of imagination. They are actual occurrences reported to the United States Department of Agriculture. It is all part of the Department's Radio News Service. By radio, farmers nowadays get market news while it is hot. Distance from market means nothing. The hog raiser in the Corn Belt, or the fruit grower in California, can be as closely informed on markets hundreds of miles away as the operators in the individual markets. Through the Department's Agriogram service, city people are beginning to learn something about agriculture. Housewives are being taught home economics. The big facts about agriculture in their relation to national life are being brought into city homes.

More than six and a half million dollars' worth of business is transacted daily in the large livestock markets of the country. A thousand cars of wheat go into our ten largest markets each day. If farm products are to be distributed where and when they are needed, if overstocked markets that result in high prices to the consumer and low prices to the producer are to be prevented, producers must have up-to-the-minute news of market conditions. To get this news to farmers quickly, the Depart-

ment of Agriculture maintains a market reporting service unparalleled anywhere else in the world. Several hundred market reporters located at the various consuming centres and in large producing sections report daily crop and market conditions to branch offices, and by using a leased telegraph wire system, complete information of local and national agricultural marketing conditions is made available the day it is gathered.

Radio is the only agency that can get this market information to farmers everywhere immediately after the markets close. For farmers cannot daily pay tolls on telegraph messages, the press does not publish the market news until the next morning, and mail delivery of newspapers or mimeographed market reports is slow. By radio, the reports on fruits and vegetables, livestock, meats, grain, dairy products, hay, feed, seed, and cotton are flashed instantly, on regular schedule, to unlimited numbers of people. More than sixty Federal State and private broadcasting stations, covering practically the entire country, regularly send out the messages of the markets. Recently the Great Lakes and Arlington stations of the Navy Department were added to the list.

When the Department of Agriculture first suggested that radio be used to dispatch market reports about the country, the idea was received with good-natured tolerance. All right to send out the messages, it was agreed, but did the Department expect farmers to become wireless experts? At that time the radio telephone had not been perfected for popular use, and it was seen that to receive the reports direct, farmers would need to study the Continental code. But the Department replied that the country was filled with radio amateurs, and that farmers would simply need to get in touch with them to receive the messages. America's radio amateurs rose to the opportunity, toying with radio was discontinued, and they soon became an important agency in getting to farmers the market information so vitally needed in the intelligent conduct of the farm business.

The experiment started with the broadcasting of a daily market report from the Washington wireless station of the Bureau of Standards. The station covered a radius of 200 miles. Correspondence from amateurs in the territory soon began to pour in on the Department. One of the first of these was from a railroad telegrapher who stated that farmers in his com-

munity were "going wild" over the service, and kept him continually on the telephone calling off the news. The station was a junction point, and copies of the report posted on the bulletin board were eagerly read by local travelers. Similar letters were received from other operators.

The practicability of broadcasting market reports by radio having been demonstrated, agricultural interests throughout the country began to urge the Department to expand its radio service. Funds were lacking to do this, but the Post Office Department, through its Air Mail Service, jumped into the breach and offered to place some of its stations, at designated hours each day, at the disposal of the Department of Agriculture. Within three months of the beginning of the original experiments, market news was being dispatched from Post Office radio stations at Washington, Cincinnati, Omaha, North Platte, Neb., Rock Springs, Wyo., Elko and Reno, Nev.

When the science of radio telephony had reached a point of general utility, the possibil-

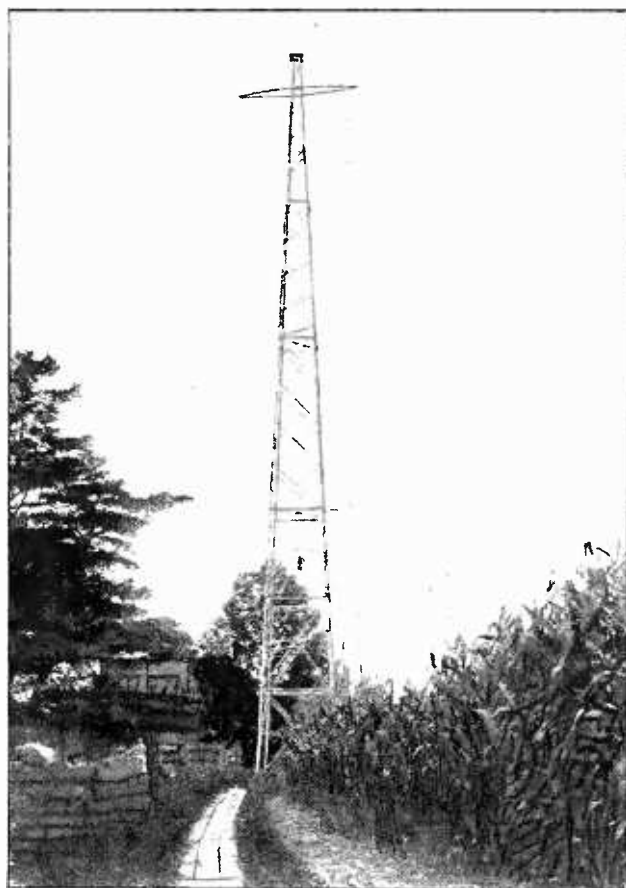

WAY DOWN YONDER IN THE CORNFIELD
Where radio has "entered the field of agriculture."
This station, built by the Connecticut Agricultural College, Storrs, Connecticut will be used for broadcasting information of an agricultural nature

ity of sending out market reports by radio telephone direct to farmers was investigated. It was seen that this was the ideal system to use, as reception of the messages involved no technical knowledge of radio, and with the use of simple receiving equipment farmers could get the reports themselves. Successful experiments along this line were conducted at Washington, and soon a chain of private radiophone broadcasting stations were granted permission to include market news in their programmes. Farmers and other agricultural interests began to install receiving sets. Agricultural colleges and market departments in a number of states installed broadcasting apparatus and through county agents and boys' and girls' clubs began to develop state-wide methods of receiving and disseminating the news. The number of farmers served with radio market news cannot be estimated, but reports from Federal and State agricultural representatives attest universal use of the service. The farm sky everywhere is dotted with antennas.

The "Agriogram" service is a more recent innovation. It consists of the preparation of brief agricultural news items for the general

public, broadcasted Monday and Thursday each week. The reports cover every field of agricultural activity; and although as this is written the service has been in existence only a few weeks, numerous letters of commendation have been received. Of particular interest to housewives are the matters pertaining to home economics, the selection, preparation, and cooking of foods. More than twenty-five broadcasting stations are now sending out the reports, and the list is growing daily.

The use of radio in broadcasting market news is one of the most progressive steps in the history of American agriculture. There are more than 32,000,000 people on farms comprising nearly one third the total population of the United States. Most of these people are located where they are practically cut off from immediate contact with the outside world. Radio is the only means of giving them quickly and at small cost the economic information necessary in the proper conduct of the farm business. In my opinion, there is therefore no single use of radio, except for marine and aerial purposes, that should take precedence over its utilization for the benefit of agriculture.

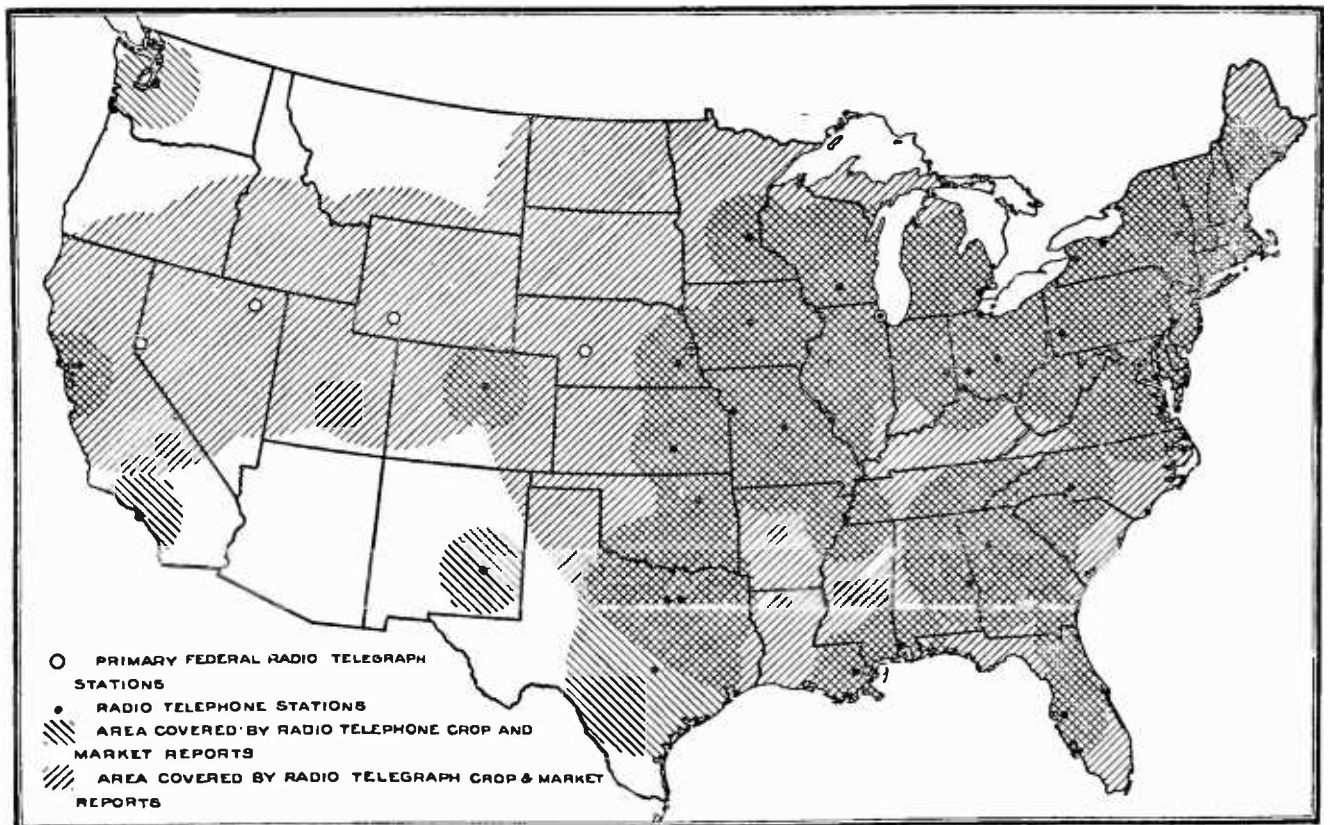

THE RADIO CROP AND MARKET NEWS SERVICE
Operated by the United States Department of Agriculture

Long Distance Amateur Work in Australia

By F. BASIL COOKE, F. R. A. S.

In Australia, as here, the tendency in amateur transmitting is toward reduction in the power accompanied by increase in the distance covered. In this account of an Australian amateur's station there are several features which may well be taken advantage of by Americans. Operating power tubes below their rated filament voltage, for instance, is a practice not usually found in this country. Transmitting 450 miles on 3.8 watts is quite an achievement, and we find that our confreres in Australia are using such highly developed receiving arrangements as the "reflex" circuit. We should like to hear more from Australia.—THE EDITOR.

MR. CHARLES MACLURCAN of Strathfield, near Sydney, has been devoting his energies with remarkable results to low-power transmission, throughout all his tests never exceeding 9 watts. He has designed every unit of his apparatus to contribute to a maximum efficiency to allow him to transmit farther than other experimenters have been able to do with the same power.

In order that his results may be fully appreciated, the writer wishes to give here a brief description of his station. A glance at the accompanying diagram shows that the circuit employed is a well-known one and reveals that the modulation is brought about by direct grid control. This method has been practically abandoned by many experimenters in favor of the valve system of modulation. It is therefore of interest to know that Mr.

Maclurcan has demonstrated that, for low power, this simple and inexpensive means of producing voice currents is at least as efficient as the elaborate and expensive valve system.

The transmitting valves are Radiotron 5-watt power tubes of which three are employed. The filament is supplied with only 6 volts instead of 7.5 in order that the tubes may have a longer life. The plate current exciting the tubes is drawn from a generator, developing 300 volts and passing 30 milli-amperes, giving a maximum input current of 9 watts.

The aerial and earthing systems deserve special mention. The aerial consists of four 18-gauge copper wires equally spaced round wooden hoops $2\frac{1}{2}$ feet in diameter. The hoops are placed 15 feet apart. The two spans are each 100 feet. The centre is fixed to an 80-foot mast while the two ends are supported by 25-foot masts. The feeder (lead-in) con-

MR. MACLURCAN'S TRANSMITTER

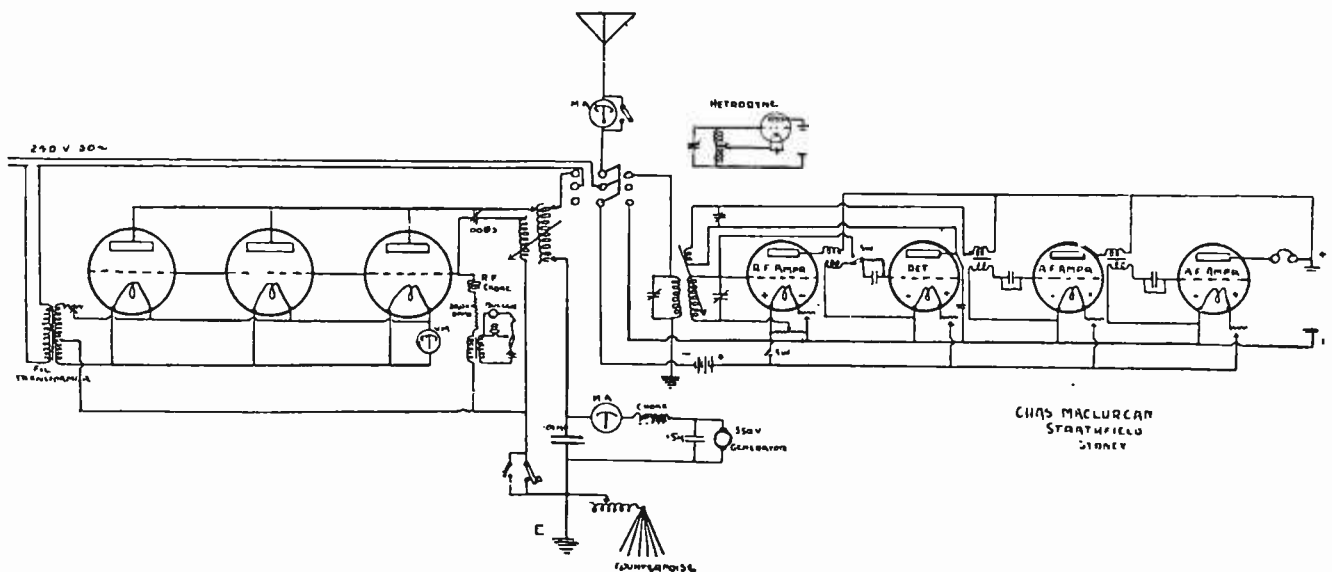

sists of four 18-gauge copper wires on 12-inch hoops. The natural wavelength of the aerial is 325 metres.

The earth system consists of a connection to a water pipe, together with a balanced counterpoise. The aerial-counterpoise is very carefully tuned to the same wavelength as the aerial-earth system. With the inclusion of the counterpoise, the radiation is increased by 33 per cent., giving a total radiation of from 1 to 1.2 amperes.

This description would not be complete without mention of the receiving apparatus of the station. As will be seen from the diagram, there are four valves grouped so that one valve acts as a radio-frequency amplifier passing the increased antenna current into the second valve, where it is rectified and detected. From here the received signals are coupled back with a tickler so as to use the regenerative effect and passed into the third valve which acts as an audio-frequency amplifier. The fourth

valve is a second stage of audio-frequency amplification. In practice, however, one valve only need be used to receive Nauen, Bordeaux, New York, etc.

Another feature of the receiver is the inclusion of an independent oscillator which acts as a heterodyne. In this manner much greater control can be attained with increase in signal strength and correspondingly greater selectivity.

On the night of May 21st last while conducting some tests in wireless telephony with the Sydney Observatory, using only 9 watts input, Mr. Maclurcan was heard in Melbourne 450 miles away. A telegram was received the following day stating that a Mr. J. Reed and several amateurs in Melbourne had heard the carrier wave on the previous evening.

Mr. Maclurcan then arranged to try to establish definite communication with Mr. Reed, with results entirely satisfactory.

Encouraged with the Melbourne success, Mr.



THE STATION AT STRATHFIELD, NEAR SYDNEY

From which Australians are getting their first broadcasting. Although the transmitter is never operated above 9 watts, it has been heard 2100 miles overland on a single-tube receiver

Maclurcan made arrangements with Mr. Dixon, the wireless operator on the S. S. *Montoro* while this boat was proceeding north from Sydney. Mr. Dixon wired back the following:

"10 P. M. June 3rd. 420 miles, telephone strength 6; continuous wave and tonic train strength 8."

"10 P. M. June 4th. 705 miles, continuous wave strength 6." Mr. Dixon was using one valve with standard ship's equipment.

Brief mention was made of these results in the daily press, and amateurs in the country and operators at sea immediately took the keenest interest, with the result that Mr. Maclurcan commenced broadcasting every Sunday evening. Amateurs all over Australia are now receiving these concerts, and reports are daily coming in from farther and farther afield. Music is being enjoyed from experimenters as far as 600 miles away and considering that Mr. Maclurcan is using only 8.25 watts, the results, to say the least, are very encouraging.

An extract from a letter received from Mr. Hull in Melbourne, 450 miles southwest of Sydney, is of interest in this connection.

"Was not able to listen for you until 8:40 P. M. and my accumulator was on its last legs.

"Upon switching on, however, reaction at zero, your music was excellent, readable at arm's length, to my intense surprise. At this stage of the proceedings the accumulator began to "peter," and I was obliged to switch off to give it time to pick up.

"At about 8:55 the record 'Mon Homme' was of similar strength to the above and I enjoyed almost the whole of it. Toward the end of the piece the accumulator gave up all hope."

In order to appreciate fully these results of Mr. Hull's it should be known that his receiving aerial consists of two wires 30 feet long supported at the eaves of the house 20 feet high and brought down to the edge of the workshop 10 feet above the ground. The whole aerial is below the level of the house and according to our ancient ideas he should be completely screened from anywhere. Instead of which Mr. Hull on this very inefficient aerial receives music and speech from a transmitter hundreds of miles away using less than 9 watts.

The writer is appending the circuit employed by Mr. Hull as it presents several novel features. By referring to this diagram it will be seen that only two valves are used and made to function



MR. CHARLES MACLURCAN

One of Australia's leading experimenters who has been doing remarkable work on low power transmission

as radio-frequency amplifier, detector, and audio-frequency amplifier thus doing the work of three. The writer has carefully tried out this circuit and finds it the best 2-valve circuit he has yet used, so some of you will doubtless be interested in trying it also.

Mr. Maclurcan has just completed some tests with the object of ascertaining how far his speech and C. W. could be heard. He made arrangements with Mr. Tuson, the operator of the S. S. *Ulimaroa* to listen-in while proceeding from Sydney to Auckland, New Zealand. Mr. Tuson's report discloses that he could read the C. W. at the wharf at Auckland (strength 4) and heard snatches of speech (strength 2). The distance of Auckland from Sydney is 1400 miles. One of the New Zealand land stations also confirmed Mr. Tuson's reports. This reception, by the way, was with a single valve.

Several weeks ago, Mr. Maclurcan received a telegram from Mr. Dixon on the S. S. *Montoro* from Thursday Island requesting him to transmit. Accordingly, signals were sent and a telegram was received stating that C. W.

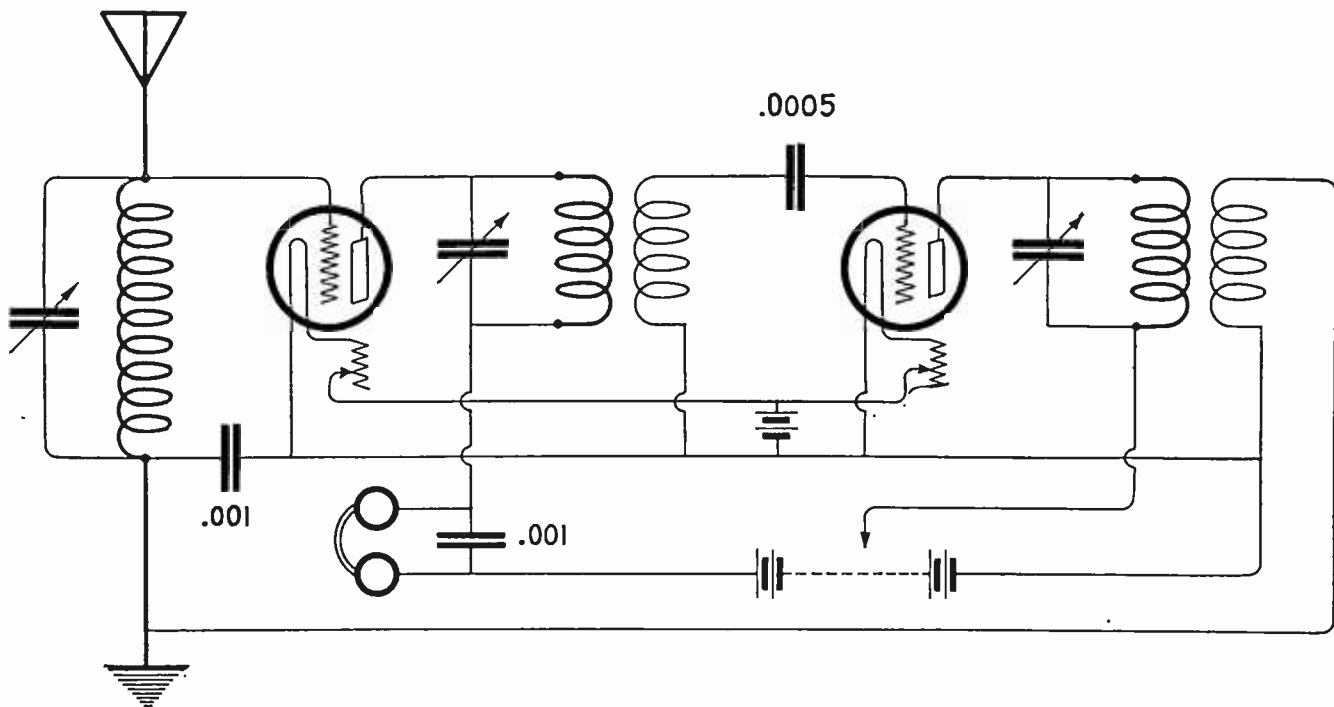

MR. HULL'S "REFLEX CIRCUIT" RECEIVER

In which two tubes are used to function as radio-frequency amplifier, detector, and audio-frequency amplifier, thus doing the work of three

signals were heard at Darwin, 2100 miles from Sydney. Mr. Dixon was receiving with one valve and standard ship's equipment.

It should be noted that Darwin is 2100 miles overland from Sydney which makes the test all the more remarkable. The power used in this test was very carefully measured and found to be 8.25 watts.

The results of Mr. Maclurcan's latest tests have just been received by telegraph, and state

that Mr. Hull at Melbourne (450 miles away) heard Mr. Maclurcan transmitting specially arranged code signals at noon yesterday, September 10th. Only one transmitting bulb was used and the input power 3.8 watts.

From the foregoing remarks, we might feel justified in thinking we can peep into the future and see ourselves talking to friends in distant lands with no more trouble than pushing a button.

If You are Thinking

Of submitting an article to RADIO BROADCAST, you may save yourself and the editors time and trouble by considering the following notes as to what we want:

WE WANT: True accounts of the uses of radio in remote regions.

Short, true stories of adventures in which radio played an important part: unusual and interesting occurrences to you or your acquaintances.

Clear explanations of new or especially effective circuits or uses for apparatus.

Concise and logical discussion of some important problem or phase of radio, whether in the field of broadcasting, constructing, operating, buying or selling; or of reading or writing that has to do with radio.

True accounts, of some particular interest, relating "What Radio Has Done For Me."

Humor, when the object is not merely to appear funny, but to present some phase of radio in an attractive, amusing way. The same applies to drawings.

Clear, unusual photographs are always in order, as are good circuit diagrams.

A liberal rate is paid for material used.

From Keyboard to Tape Through Space

By JOHN B. BRADY

THE Navy Department is enthusiastic over the results of experiments conducted during the past year with a system of printing by radio, whereby an operator can manipulate a keyboard resembling that of a typewriter and transmit radio signals automatically, which, received at a distant radio station, are set down simultaneously in print. The messages come through clearly and accurately, as can be seen by the reproduction of one of the first messages transmitted by this system.

The achievement of radio printing has been brought about by the coöperation of the Morkrum Company of Chicago with the Bureau of Engineering, Navy Department at Washington. The Morkrum Company manufactures the Teletype (Figs. 1 and 2), the invention of C. L. and H. L. Krum. It is a simple keyboard transmitting machine and printer unit, originally developed for operation in wire telegraphy. The levers of the keyboard are arranged to control the lateral movement of a set of five selector bars within the base of the machine. These selector bars are so notched that certain of them will slide endwise when a particular key is pressed and con-

trol the position of locking latches and contact levers mounted upon the base of the unit. A motor, driven from a generator or a storage battery and mounted on the unit, has a driving shaft which rotates a set of cams against contact leaf springs pushed forward by the depression of a particular key. In operation, the contacts close in sequence according to the letters to be transmitted. Each contact gives a brief

interval of complete circuit connection, causing an impulse to be radiated from the antenna. The sequence of impulses distinguishes the letters of the alphabet. Mounted on the base of the keyboard, the printer unit, a small mechanical brain in itself, is controlled by the operation of an armature attracted in a sequence of intervals by Teletype magnet coils. The operation of the armature results in the positioning of a type wheel opposite a

Many of you who have read that printing by radio is a practical reality may be curious to know just how this "radio typing" is accomplished. Pressing letter *a* on the keyboard causes a letter *a* to be typed on a paper strip at a radio receiving station miles away: it sounds almost too easy. Modern efforts in the field of mechanics are making processes continually simpler: (whether life in general is made simpler or more complicated as a result is another matter), and although any real radio amateur would find more satisfaction in caressing a "bug" than in using the Hunt & Peck system on a typewriter transmitter, the Teletype gives an element of precision to radio communication which should be exceedingly important, as Mr. Brady shows, to such departments as our Army, Navy, and Air Mail Service.—THE EDITOR.

paper tape for printing a character represented by the impulses received by the Teletype magnets.

Two sets of Teletype equipment were loaned by the Morkrum Company to the Navy Department for research on the printer system. Commander S. C. Hooper, Head of the Radio Division, Bureau of Engineering, Navy De-

NOW LETS SEE HOW IT COMES THROUGH IT SEEMS TO

HITTING PRETTY FAIR NOW

A STRIP OF TAPE

Showing how clearly these words, sent during the first experiments, were automatically printed by the Teletype

partment, recognized the importance of adapting printing to radio and made available for this work the facilities of the Navy radio laboratories. Much skepticism was expressed

frequencies. The selectivity is so marked that three different stations transmitting on the same wavelength, but with different tone frequencies, may be copied simultaneously. The relay is adjusted to pick out the signal desired and the other tones do not interfere. The relay at the receiver controls the circuit passing through the Teletype magnet coils. The armature of the magnets sets into operation selective mechanism resulting in the printing of the character represented by the sequence of the impulses transmitted.

When transmitting by Teletype and listening in with any ordinary type of broadcasting receiver, the signals sound like a confused jumble of noises and are absolutely unreadable. In this way, the system may be said to allow perfect secrecy. A quick change of the arrangement of

the letters on the keyboard, with a corresponding change of the type-wheel at the receiver would make it practically impossible for an outsider to make anything out of the signals.

Having obtained the successful results described, with operation between shore stations, Commander Taylor suggested the application of the system for transmission from aircraft to ships or to shore stations. At the present time one of the big problems in the Navy is to transmit accurately directions from

by experts in the government service as to the feasibility of operating printers by radio, but this was replaced by enthusiastic praise shortly after the beginning of experiments. A complete Teletype installation was made at the U. S. Naval Radio Research Laboratory, Bureau of Standards, and another complete outfit installed at the U. S. Naval Aircraft Radio Laboratory at Anacostia, D. C.

At the Anacostia Air Station, the transmitter was arranged so that the contacts on the Teletype keyboard controlled the radiation of impulses from the antenna system in groups of five impulses for each character, the sequence of the impulses distinguishing the characters. Throughout this work the usual code was entirely abandoned and the impulse code employed.

At the Bureau of Standards Radio Laboratory the Teletype was connected to a tuning arrangement in which a receiver with a local heterodyne detector and two stages of audio-frequency amplification were used. The relay employed was that developed by Mr. F. W. Dunmore, Physicist of the Bureau of Standards. The Dunmore relay in its different forms is illustrated on page 221 and is characterized by selectivity to tones of particular



FIG. 1

The Morkrum light-weight keyboard control, designed for transmitting from an airplane



FIG. 2

The Teletype equipped for both transmission and reception

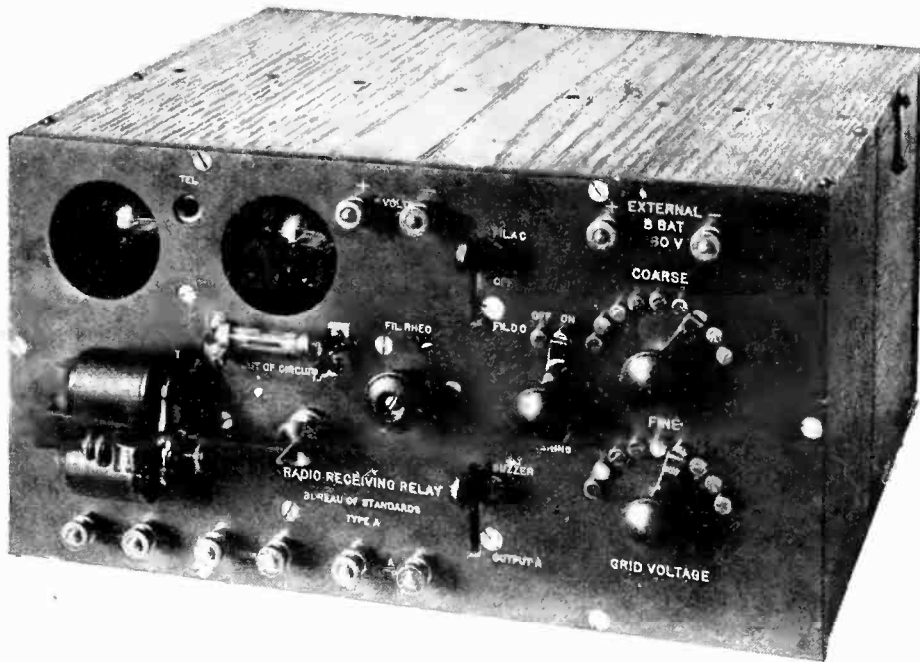

THE DUNMORE RELAY

For use with batteries in receiving Teletype messages

an observer in an airplane to stations on the ground, to give the fleet officer gunnery ranges, for instance, on an enemy fleet.

The Morkrum Company designed a special light-weight keyboard shown in Fig. 1 to be carried aboard aircraft and operated by the observer, by which energy could be radiated from the aircraft antenna system to a ship or shore station operating a Teletype printer. The tests conducted have been highly gratifying, making the practicability of the method of transmission assured.

This achievement in radio printing has numerous applications besides its use in enabling a spotter in the Navy to fly an observation plane over a shelled area and type-write back to the gunnery officer on shipboard information about the dropping of shells. The many human elements entering into conveying information by radio rapidly and accurately which have heretofore caused confusion were greatly reduced by this means of automatic transmission.

In the Post Office Department, the twelve radio stations used for communication with the mail-carrying planes can keep in direct touch, "in writing," with each other and with the Postmaster at Washington.

In commercial flying, the absence of a trained radio operator, in cases where the Teletype apparatus is used, means that one person less may be carried on each trip. The keys, however, are depressed more slowly than the usual typewriter keys, so that anyone without a knowledge of type-writing can employ the "hunt and peck" system

to operate the transmitter. A system like this is bound to prove valuable in such commercial aircraft routes as between Florida and Cuba or in communicating from Catalina Island to the coast of California.

THE DUNMORE RECEIVING RELAY

Developed by the Bureau of Standards for use with alternating current

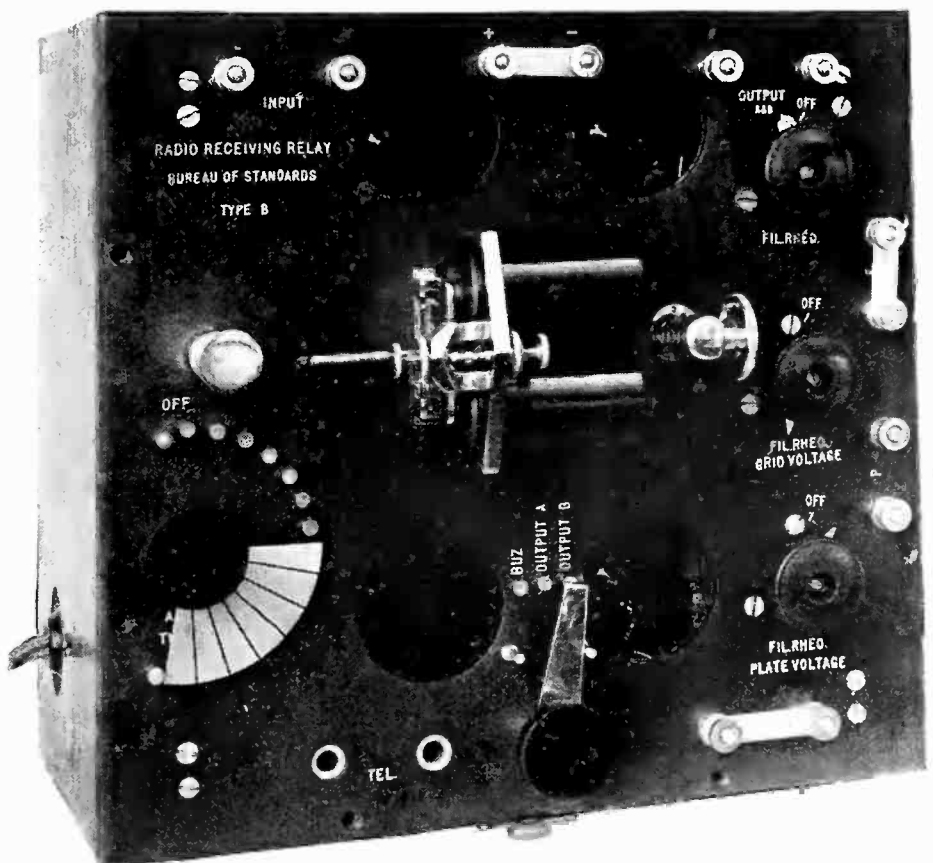

The First Amateur Radio Club in America

A Club That Dates from 1909 and Has Among Its Members
Men Who Have Helped to Make Radio Broadcasting Possible

PIONEERING in any field is in itself as valid a claim to fame as producing something of lasting good. Sticking to an ideal over a period of years, through the dark days when the very ideal itself seems to be threatened with extinction—that, too, deserves recognition.

With this in mind, we shall review the Radio Club of America's claim to lasting fame in the annals of radio. First of all, the Club dates back thirteen years—thirteen long years of the formative period of radio. This organization has stood for and has bitterly fought for amateur radio, even during those days when sinister wireless bills in the hands of unscrupulous and misinformed legislators were being discussed with the avowed intention of smothering amateur activities. This organization brought about an interchange and exposition of constructive ideas long before the founding of the present radio journals which serve that purpose so well. It has at every turn encouraged progressive steps and can, with pardonable pride, point to many names on its roster which have come to have real meaning in the first ranks of radio. That, in brief, is the background of the Radio Club of America.

It was in 1909, when amateur radio was just beginning to be taken up by a few pioneer experimenters that the Radio Club of America came into existence. Under the name of the Junior Wireless Club of America, it was founded through the efforts of W. E. D. Stokes, Jr., Frank King, George J. Eltz, Jr. and others as the first association of amateur experimenters in the land. At first, the headquarters of the

organization was in the Hotel Ansonia, in the residential heart of New York City, but soon the monthly meetings were held at Mr. King's house, 326 West 107th Street, at about the same time that the name was changed to the Radio Club of America. The reason for the change of name was that it was desired to have the organization national in its scope, with various branches in different parts of the country.

Perhaps the word "club," in this case, is unfortunate. A club is a place for good fellowship, true; and that describes the Radio Club of America, which has already stimulated good fellowship in radio and more specifically among its members. In that sense, the word stands.

But in the case of this group of young men, there has been something more than a club

atmosphere. With the serious intentions of its members, the thoroughness of the papers and discussions marking its meetings, and the scientific value of its experiments and tests, the word "club" is almost a misnomer. This organization might well call itself a scientific society, although it does retain that spirit of fellowship which goes with the usual meaning of club.

The papers prepared and read by members during those first few meetings of the young Radio Club of America were quite crude, and a family gasoline chariot was often called into service to carry long-wave receivers or "coffin" type transformers from the Long Island or Jersey residence of the speaker for the evening, in order to illustrate his "paper" by actual demonstration. Among the early papers were: "A Square Law Variable Condenser," by George J. Eltz, Jr., which by the

The story of the Radio Club of America and its members who were among the pioneers and are to-day leading the advances in radio, has never before been published. We greatly appreciate the valuable assistance given us by officers and members of the club in preparing this account of what we believe to be the first amateur radio club in America. It is doubtful that any other group of young men, banded together for the purpose of lending each other assistance in radio as well as the betterment of the art itself, can point to a record in any way comparable to the enviable record of the Radio Club of America.—THE EDITOR.

way, disclosed this type of condenser for the first time; and it is interesting to note that a long while afterward a condenser of this character was placed on the market by several companies and is used in several well-known wavemeters.

Another paper, "A Telephonic Relay Amplifier," was prepared and read by that ardent amateur, Dr. Walter G. Hudson, who has since died. Doctor Hudson also prepared a paper on the oxide filament for vacuum tubes, and this idea of his has since become an important factor in the construction of efficient vacuum tubes. It was tubes with oxide-coated filaments which our Army and Navy used to so great an extent during the war. They are widely known under the designations "J" and "E", the former being used for detecting and amplifying, and the latter in low-power radio telephone and continuous-wave telegraphy. At present, they are also employed in what are termed "power" amplifiers.

Still another of the early papers was "The Wavemeter, Its Operation and Uses," by Louis G. Pacent. This paper marked the first attempt to disclose to radio amateurs the mysteries of the wavemeter and the measuring of radio waves. Before then, the wavemeter was used only commercially.

Again, there were papers entitled: "Ground Antennae," by Walter S. Lemmon; "Radio Telephony," by Frank King; "A Radio Equipped Automobile," by Paul F. Godley; and "Audio Receiver System," by Edwin H. Armstrong.

The membership of the Club grew and grew and has kept on growing. Its serious character attracted the attention of early radio workers, so that aside from papers prepared by its own members, it was soon honored with ad-

resses by such well-known radio men as R. H. Marriott, Dr. A. N. Goldsmith, J. V. L. Hogan, F. Lowenstein, Dr. J. Zenneck, F. Conrad, W. C. White, and others. Subsequently, all of these men became members.

In order that one may have a better appreciation of what the pioneering work of the Radio Club of America meant, it is well to sketch a true setting by way of contrast with the conditions of to-day. Turn back to 1909, and you find a very few young men, here and there, fascinated by the newspaper accounts of wireless attempting to receive and send radio messages. Wireless, it was then called, although the founders of the club had the vision to choose the word "radio" for their club name. Little or no real information on the subject was available. With a scant description of Marconi's experiments as a basis, the amateur of that day started to construct his set. There were no journals to guide him. He constructed his set through ingenuity of his own, and as often as not

the finished product would not work. Occasional articles on the commercial stations appeared in newspapers and magazines, and each new idea, gleaned from various sources, was added piecemeal to the experimenter's stock of knowledge.

It should be borne in mind that there were no radio manufacturers to turn to for complete sets and units. All the apparatus had to be constructed by the amateur. The success of each experiment was passed along by word of mouth to other amateurs and eagerly picked up. The coherer was then used as a detector; some of the more ambitious amateurs procured the Marconi magnetic detector. Later came the microphone, crystal and electrolytic types. All tuning was accom-



© Bachrach

GEORGE BURGHARD
President of the Radio Club of America

plished by means of sliders on coils of wire wound on the handiest block of wood obtainable, often a broomstick or a bread roller. The use of variometers and variable condensers was then unknown to amateurs.

For transmitting, we find a conglomeration of small spark coils, usually home-made. These coils were operated with a mechanical interrupter and battery current, but later the electrolytic interrupter and lighting current came into use. A distance of 100 miles with an amateur transmitter was considered a remarkable achievement. To-day, with a continuous-wave transmitter at one end, and a regenerative receiver at the other, an amateur spans one thousand miles with ease and thinks little or nothing of it!

One amateur, desiring to erect the best possible aerial, came across an article describing the Cape Cod aerial as used by the Marconi Company for transatlantic work. It was in the shape of a huge square funnel, the upper ends or rim of the funnel being insulated. A carefully built miniature copy of the aerial only four feet on one side and six feet high was built, with little realization of the change in the electrical constants between the Cape Cod aerial and the miniature copy. Needless to say, the miniature copy did not work very well, and it was only by chance that the amateur discovered that a stretch of telegraph wire worked far better.

The Radio Club of America, a gathering of progressive amateurs for the purpose of exchanging ideas and experiences and avoiding the repetition of mistakes, was a necessity. The meetings, at which important papers were read, served, as nothing else could, to stimulate improvement in amateur radio.

Experiments were made with different types of aerials. It must be understood that the technical knowledge of the amateur in those days was very limited. He merely had the idea presented to him and would go ahead and experiment on any possible improvement that came to his mind. Some experiments were made with kites flown by a wire in place of the customary string. Those who tried this were sometimes surprised when, the kite having reached a height of several hundred feet, they received a good shock. This furnished considerable amusement. One member proudly announced that he would not get shocked from the wire because he had on O'Sullivan's, and walked about the tin roof

with his toes in the air. The manipulator of the kite-string rather doubted the insulating qualities of rubber heels against static charges, and at a favorable moment brought the kite wire very close to the boastful young man's ear. Said boastful young man received a distinct shock despite his O'Sullivan's, which then, as now, were intended for something more practical than insulating their wearer against static electricity. But the kite aerial gave excellent results.

Things were once far from cheerful for experimenters. In 1910, the legislators at Washington, urged by certain radio factions, turned their axes towards amateur radio. For a while everything seemed quite gloomy; amateurs in general felt that the death knell of their hobby had been sounded. There was to be no more listening-in or "talking" via radio. There were many protests and discussions, but no concerted action was brought to bear against the proposed measure until the Radio Club of America by promptly applied efforts, prevented the passage of the Depew Bill. If it had been passed, it would have terminated the art, as far as amateur radio is concerned.

Two years' respite followed, and then came the Alexander Wireless Bill, in 1912. This dangerous piece of proposed legislation was killed in committee by the quick work of the Club. Not long after the Armistice the bill was definitely buried by concerted action and immediate pressure brought to bear by the Radio Club of America through several members who had served with distinction in the Army and the Navy, and others who had helped in civilian capacities. T. Johnson, Jr., Lieut. Harry Sadenwater, U. S. N., Ensign Frank King, U. S. N., Ensign George Eltz, U. S. N., John Grinan, Ensign George Burghard, U. S. N., L. G. Pacent, Ensign T. J. Styles U. S. N., Capt. E. V. Amy, U. S. A. and others convinced the legislators that amateur radio was a constructive and necessary study.

But we are ahead of our story. In 1913, two of the members, Frank King and George J. Eltz, Jr., installed one of the first radio telephone *broadcasting* stations in the United States, at 326 West 107th Street, New York. The apparatus was all home made, and naturally crude. Successful transmission was obtained, however, and phonograph records were played for the benefit of several battle-ships swinging at anchor a short distance away in the Hudson River. An arc, burning in

hydrogen, with an improvised syphon cooling arrangement, was used. The hydrogen was supplied by vaporizing alcohol, and several amusing incidents occurred when the mixture in the arc chamber became explosive and the operators were forced to beat a hasty retreat.

It was during July, 1915, that the Club installed a model radio station in the Hotel Ansonia, the headquarters of Admiral Fletcher and his staff, enabling the visiting admiral and his men to keep in communication with the vessels of the fleet, anchored in the Hudson River. The station was operated by members of the Club for a period of ten days and handled over one thousand messages during that period. Because of this commendable work an interesting radiogram from President Wilson, who had reviewed the fleet on the last day from the deck of the *Mayflower*, was received

by the Club. Furthermore, a large banner was awarded the Club by the Navy League as a token of its patriotic activities.

When, in 1917, we found it necessary to become a warring people virtually overnight, the Radio Club of America was fortunately a going concern with a corps of highly trained members. The first business then being the winning of the war, the Club proceeded to devote its energies toward that end. Many of its members, through their training and experience, soon found important work to perform with the uniformed and civilian forces. Space does not permit of a full account of the Club's war record but we cannot refrain from mentioning the notable work done by Major Edwin H. Armstrong in the Signal Corps of the A. E. F. Also the flight of Lieut. Harry Sadenwater as radio officer in the NC1, during the attempted transatlantic flight at the close of the war. The

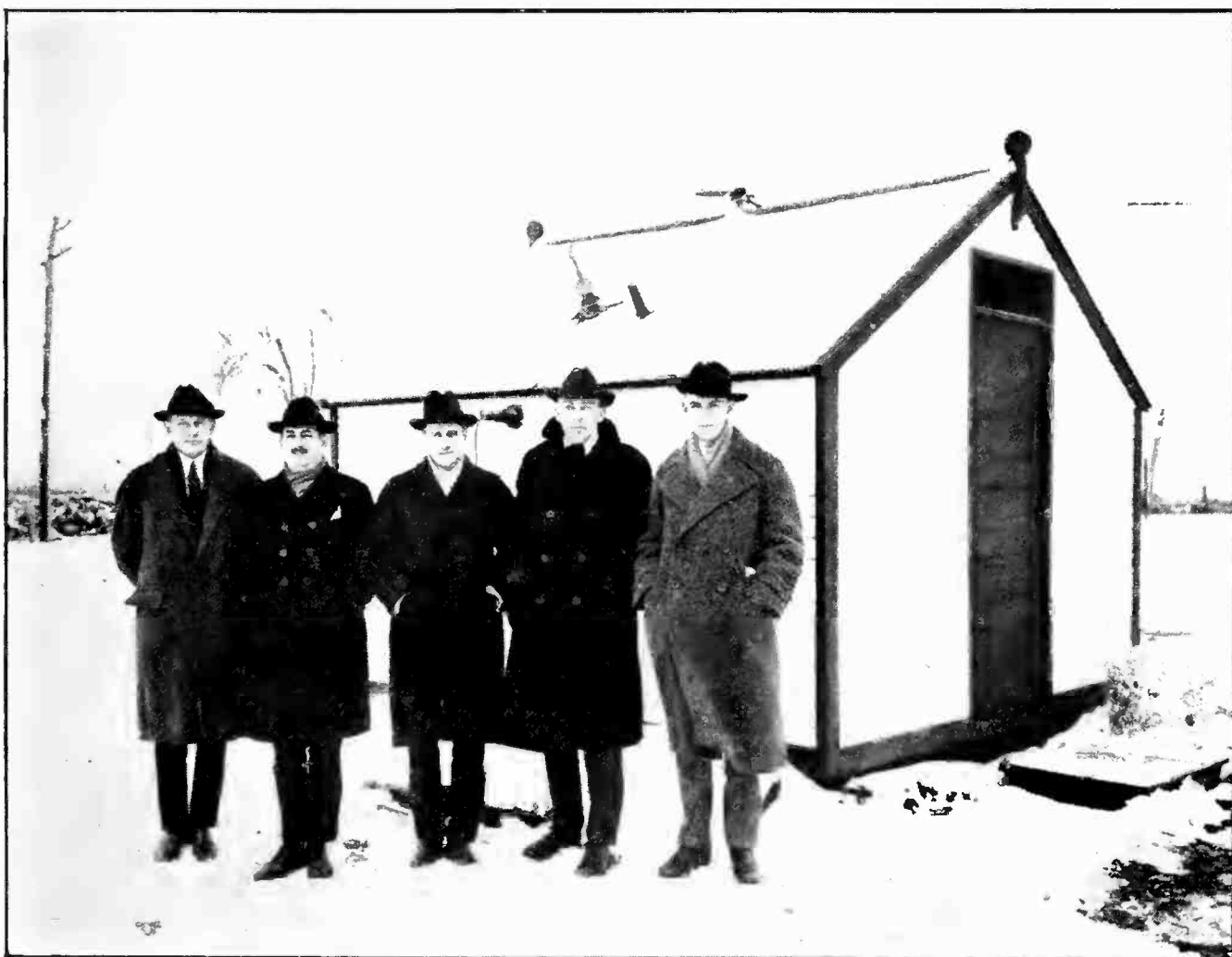

THE FIRST AMATEUR TRANSATLANTIC STATION

It was built in less than two weeks and operated by (left to right) E. V. Amy, John Grinan—the first amateur to send directly across the U. S.—George Burghard, E. H. Armstrong, inventor of regeneration and super-regeneration, and Minton Cronkrite

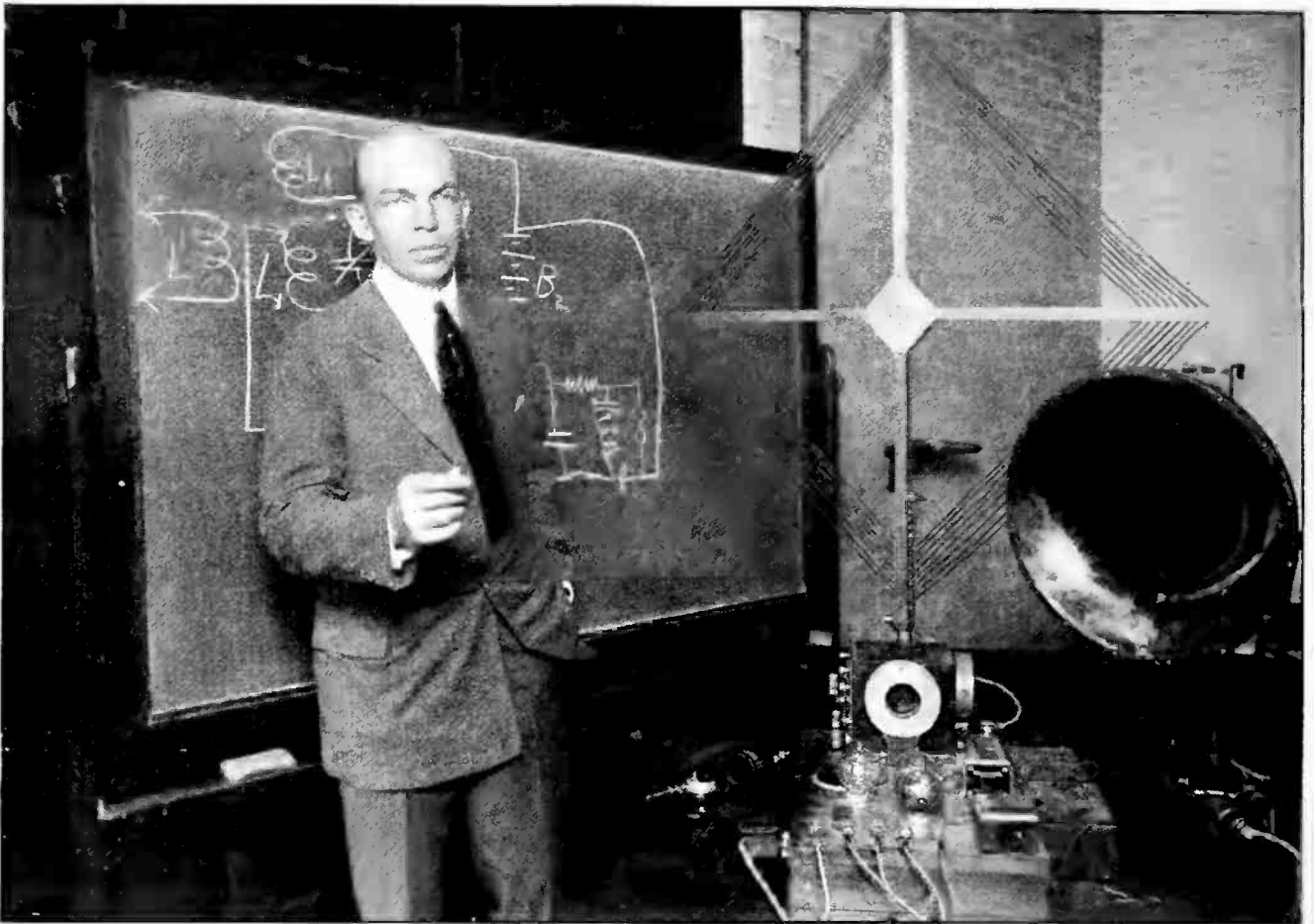

© and courtesy of Hearst's International Magazine

EDWIN H. ARMSTRONG

Explaining the principles of his latest invention, "super-regeneration" at a meeting of the Radio Club of America, held in Columbia University, New York City

NC₁ was forced to abandon the attempt at the Azores owing to a forced landing caused by uncertain bearings, while the sister craft, NC₄, made the entire flight.

In November, 1919, a banquet was given to Major Armstrong at the Hotel Ansonia, the scene of the Club's early efforts. All of the prominent local radio engineers were present to join with the members in paying homage to Armstrong. His work is so well known that nothing more need be said of it here. Sufficient to state that he made radio broadcasting of the vacuum-tube variety possible.

One eventful evening one of the Club members, Mr. John F. Grinan of New York, saw an opportunity to transmit a relay message to the Coast. He did so and received a reply from California. This was the first amateur transcontinental message and was not pre-arranged. About a week later, Mr. Grinan performed the remarkable feat of transmitting to California direct.

Another member of note is Jack Binns, the

operator who startled the world with the first C. Q. D. message from the sinking *Republic*.

Shortly after the war Mr. L. G. Pacent suggested the first transatlantic radio test with amateur transmitters and receivers. At that time the suggestion may have seemed fantastic—but it was carried out only two years later. When this first message was sent in the winter of 1921, from station 1BCG located at Greenwich, Conn., operating on 200 meters and 900 watts input, the messages were received by Paul F. Godley, a member of the Club, in Ardrossan, Scotland. The messages were also heard in Hamburg, Germany, and Catalina Islands, Cal. Thus 1BCG covered more than one fourth of the earth's circumference. It is interesting to note that the station was installed in two weeks' time, the Club having decided to enter the contest at the eleventh hour.

Although a period of thirteen years has elapsed since the formation of the Club, practically all its original members are still active, a fact which in itself is a tribute to the

fascination of radio. Thus we trace its history from a mere handful of interested experimenters, lacking in knowledge but filled with enthusiasm, to a well-organized body of three hundred members.

The present officers include: President, George E. Burghard; Vice-President, E. V. Amy; Recording Secretary, L. C. F. Horle; Treasurer, John Di Blasi; Corresponding Secretary, R. H. McMann, 380 Riverside Drive, N. Y. C.; Board of Directors, E. H. Armstrong, P. F. Godley, L. G. Pacent, J. F. Grinan, Minton Cronkhite, W. S. Lemmon, A. A. Herbert, Frank King, J. O. Smith and Nelson Dunham.

A branch has been started in Chicago, where many of the pioneers of that city and the vicinity are enrolled as members. The Affiliation Committee is working on plans to open other branches in Schenectady (N. Y.), Cambridge (Mass.) and Pittsburgh (Pa.) while plans are well under way to establish other branches throughout the country.

Since their high school and college days, most of the members have made radio their life work. The boys who used to climb to the topmost branches of trees or scale roofs, to the horror of their parents and landlords;

the boys who delighted in erecting antennas in forbidden places and who broke many a window with slings used to carry wires from apartment houses on opposite sides of the street; who built their transmitters and receivers in wood-sheds or barn lofts with tools taken from their dads' chests; who sat up into the wee hours of the morning much to the discomfort of solicitous parents, in order to add a few more miles to a distance record or pick up stations they had not "worked" before; whose deep-throated spark transmitters or musical rotary gaps kept whole neighborhoods awake; the boys who dimmed the lights of their community every time they pressed their keys; who fought the power companies tooth and nail; who succeeded in putting radio on the map and in thousands of homes—these boys, grown up, are now doing the same thing in business, in a less spectacular manner, no doubt, but as full of life and enthusiasm as before. They have left their original rôles to the beginner of to-day and have taken up the more important work in the radio field: they are pioneers, inventors, manufacturers, lawyers, lecturers, engineers, sales managers, editors and authors—and they are still boys.

BANQUET GIVEN IN HONOR OF MAJOR E. H. ARMSTRONG

Many of those present are famous in radio, and include W. F. Diehl, Harry Styles, John Styles, Thomas Styles, Jack Shaughnessy, H. Scutt, H. Houck, A. Herbert, Dr. C. C. Godfrey, C. E. Braden, C. R. Runyon, C. Calm, E. V. Amy, Paul F. Godley, A. Aceves, C. Cushman, A. H. Grebe, Walter Lemmon, Minton Cronkhite, A. Miesner, F. Humers, Prof. Hazeltine, W. Davis, E. J. Simon, L. R. Krumm, Prof. M. I. Pupin, E. H. Armstrong, T. Johnson, Jr., J. V. L. Hogan, Dr. A. N. Goldsmith, George Clark, J. A. White, L. G. Pacent, D. Sarnoff, W. Dubilier, C. Marshal, C. Hunt, C. Estey, C. Kaliant, E. Meyers, B. H. Noden, S. A. Barone, J. Di Blasi, H. Silversdorff, C. Burche, A. P. Morgan, C. Thomas, L. Spangenburg, E. Glavin, Joe Stanley, George Crouse, and others

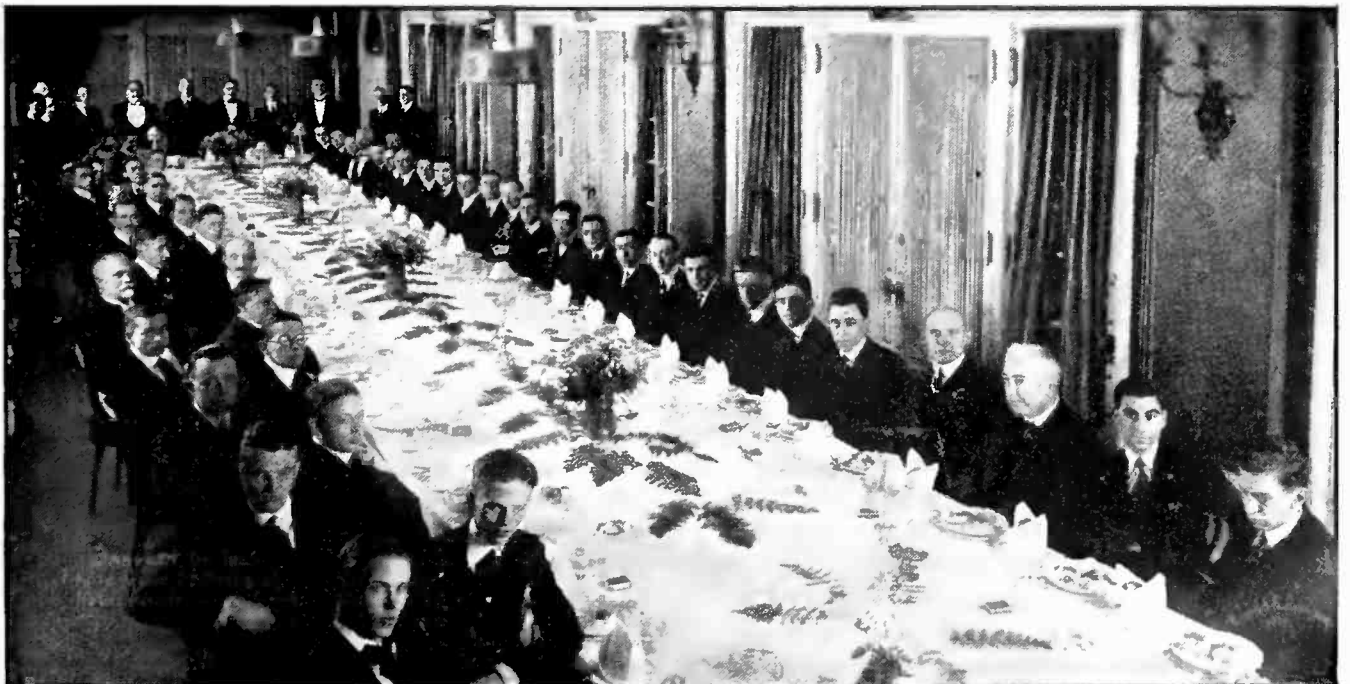

How Far Have You Heard?

Theodore Bedell, Jr., Has Made an Enviably Record
with a Receiver which He Built for Ten Dollars

RADIO BROADCAST fans throughout the country are showing great interest in our "How Far Have You Heard" contest, which was announced in the November number. It is impossible for us to keep pace with the letters which every mail brings and many of them, unfortunately, cannot even be considered because the authors have not paid enough attention to the conditions of the contest. As has been explained in our December number, the aggregate mileage covered by a single tube receiver will count fifty per cent. in the final judgment, the other fifty per cent. will be divided among such factors as the cost of the receiver; whether or not the design or circuit is new; practicability for general use; simplicity of the circuit; ease of adjustment, etc. Clear photographs should accompany each description as well as a comprehensive diagram.

Up to a few short months ago Theodore Bedell, Jr., of Freeport, New York, tells us that he knew nothing more about radio than most of us do about antediluvian reptiles. He had heard several loud-speakers operating in radio stores, but never heard one of them that he could understand or would care about having in his home. Radio to him was just one of those things he was satisfied to let the other fellow tinker with and produce all the howls and unmerciful noises he had heard coming from the loud-speakers.

Toward the end of the summer a friend made him a present of a radio book which in addition to describing the uses to which radio was being

put by the Army, Navy, commercial companies, and amateurs, gave complete instructions for the building and operating of a receiver from parts which could be purchased at retail for \$10.

Like many others, he decided that ten dollars would not ruin him if he lost, and it would be a good investment if he was able to make the set half as useful as the book claimed it could be made.

It did not take him long to complete the receiver and the results he has obtained are really remarkable. It may be well to study some of the salient features of the circuit employed in this receiver. This is especially interesting in view of the rapidly increasing need for receivers which in addition to being sensitive must be selective if they are not to be subject to interference from several stations operating at the same time on

approximately the same wavelength and the interference caused by several receiving sets of the single circuit regenerative variety oscillating simultaneously in the same neighborhood. The circuit employed by Mr. Bedell is shown in Fig. 2.

WHY THE THREE-CIRCUIT RECEIVER

VERY few question the fact that a regenerative receiver is more responsive to weak signals than a non-regenerative receiver, whether the latter be of the vacuum tube or the crystal type. Nor is there much controversy over the fact that a regenerative receiver will tune more closely than most other receivers in general use, but opinions differ concerning the type of circuit one should employ in order

More About the Contest

Next month we expect to publish several more circuits which are proving valuable in long distance broadcast reception with a single tube. Letters are arriving so rapidly that only those of exceptional interest can be considered and preference will be given those accompanied by clear photos and well-prepared diagrams. Many readers who report excellent reception have failed to include diagrams, which reduces the possibility of full consideration of their letters. If a circuit similar to the one you use has already been published in RADIO BROADCAST do not bother to send in another; simply mention the page on which the diagram appeared. Let us have a list of the stations you hear, accompanied by the distance each one is from your receiver.—
THE EDITOR.

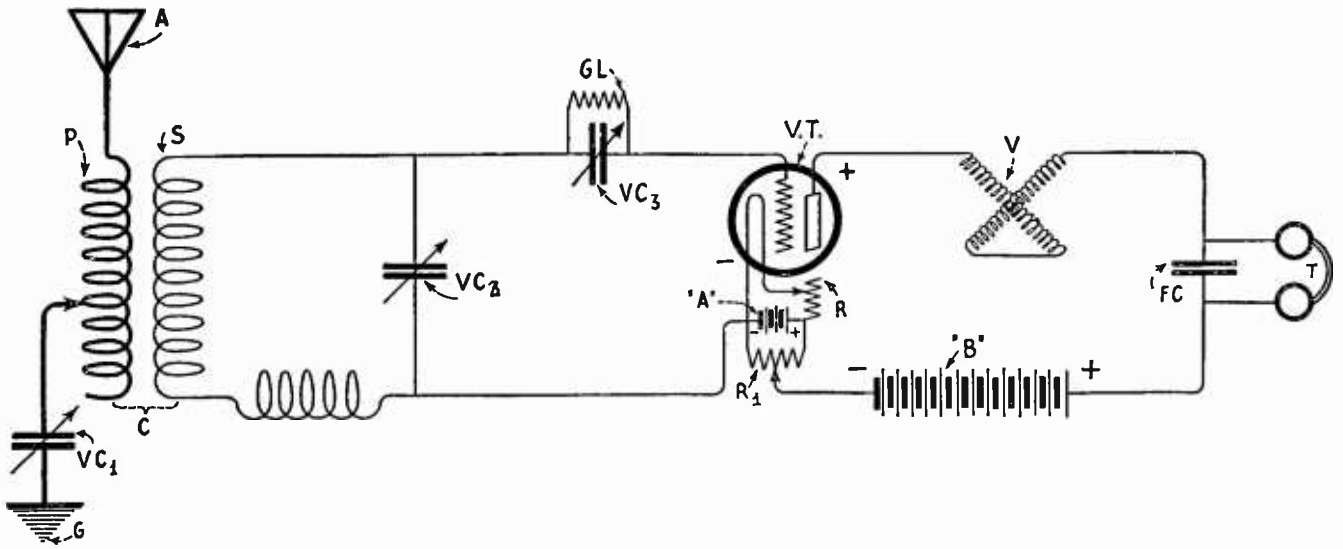

FIG. 1

In this circuit we have the secondary of the variocoupler, S, shunted by a variable condenser, V. C. 2

to get the most satisfactory results from regenerative receivers.

In its original form the regenerative receiver was merely a loose-coupled circuit, employing a vacuum tube for the detector, with what came to be called a "tickler" coil connected in series with the "B" battery and the plate of the vacuum tube and placed in inductive relation to the secondary of the receiving transformer or "loose coupler," as it was then commonly called.

Since that time various circuits have been developed for use as regenerators and various methods have been developed for tuning the primary, secondary, and tickler circuits. There is quite a difference of opinion concerning the most suitable way to take advantage of regener-

ation as well as the control of the secondary circuit wavelength. In the latter instance, some favor tuning the secondary by a condenser connected directly across the secondary of the receiving transformer as in Fig. 1 while others prefer the circuit shown in Fig. 2. The use of variable condensers is not necessary in the variometer type receiver and it is therefore easier and cheaper to make. The principal difference in opinion, however, is found in the supporters of the so-called "single circuit" receiver and the three circuit, whether the latter be of the character in Fig. 1 or Fig. 2.

It is claimed for the single circuit receiver, that simplicity of operation is brought about without reducing the selection power of the receiver—that is, it is claimed that it is just as

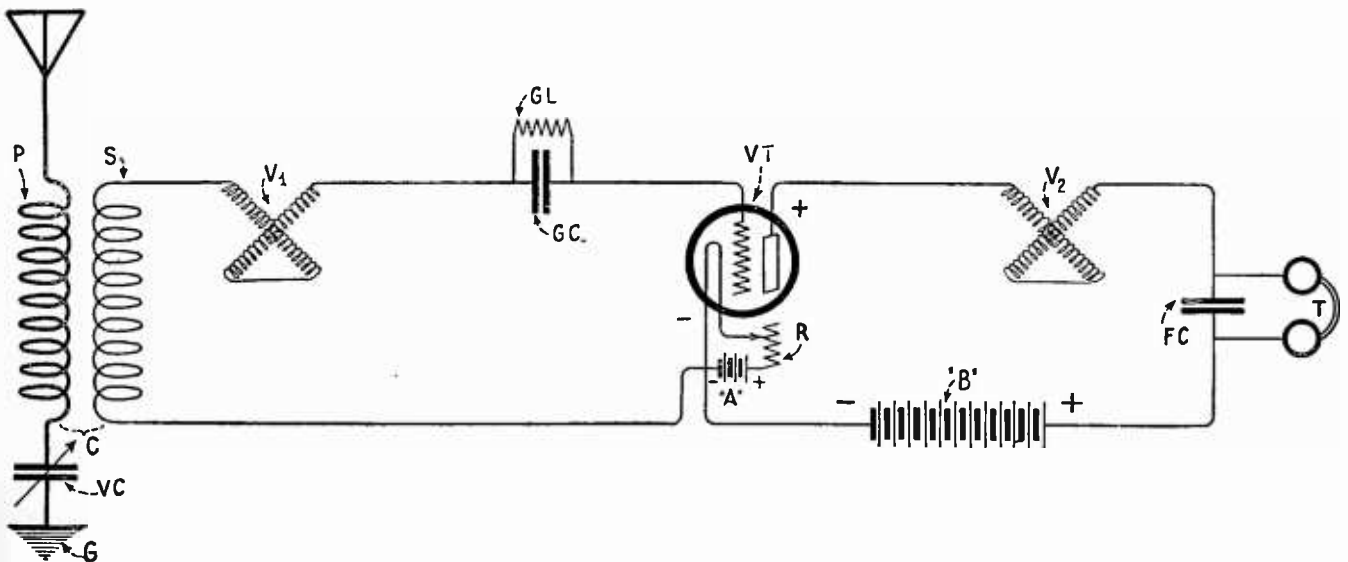

FIG. 2

Mr. Bedell uses this type of circuit but requires no variable condenser, VC, in the antenna circuit because his tuning is done by two switches—one for adjustment in steps of 10 turns and the other in steps of two turns

effective as an instrument for bringing in desired stations and cutting out undesired stations as the three-circuit receiver—and that it is certainly just as responsive to weak signals if not more responsive than the other types.

Whether it is possible for the person who had never operated a regenerative receiver before to get better results from the single circuit, than from the three-circuit receiver is not entirely a one-sided argument, especially now when there are so many broadcasting stations operating on approximately the same wavelength. It is not at all unlikely that the variation of the coupling between the primary and secondary circuits may spell the difference between an evening's entertainment and an evening spent in listening to howls. Nor is there any questioning the fact that the single-circuit regenerative receiver was subjected to some rather severe criticism at the conference held in Washington last February, for the interference it can cause other receivers when improperly operated. It is true that even a three-circuit receiver can produce a certain amount of interference, but not over any such distance as is possible with the other type, due to the fact that the coupling between the primary and secondary may be altered, greatly reducing the tendency to permit the current from the secondary circuit inducing a current in the antenna circuit, even though the latter may be tuned to the same wavelength.

The three-circuit arrangement may be a little



A NEW POTENTIOMETER

Of the carbon compression type is now available in 200- and 400-ohm resistances. By moving the knob through 180 degrees the plate voltage may be materially altered

more difficult to operate, but the results obtained are generally worth the trouble. Mr. Bedell seems to have proved this rather conclusively.

PAINTING THE LILY

PERHAPS after receiving music and speech directly from the broadcasting station located at Havana, Cuba (PWX) and the other distant stations on his list, with a receiver which cost ten dollars, Mr. Bedell should be satisfied, but if he is like most radio fans of our acquaintance that will not hold true, and it is to enable him to get even better results that we suggest some possible improvements in his circuit.

There is no questioning the fact that proper adjustment of the plate voltage on a vacuum-tube detector causes a great increase in the sensitivity of a receiver and to a certain extent aids in prolonging the life of the filament of the vacuum tube because the filament need not be

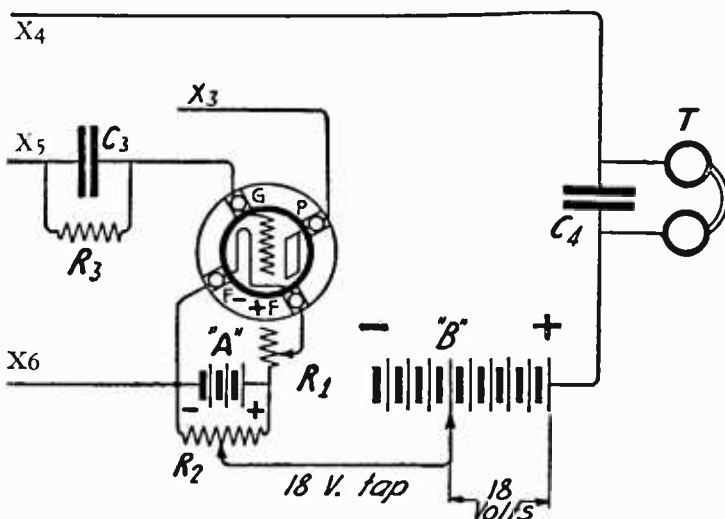
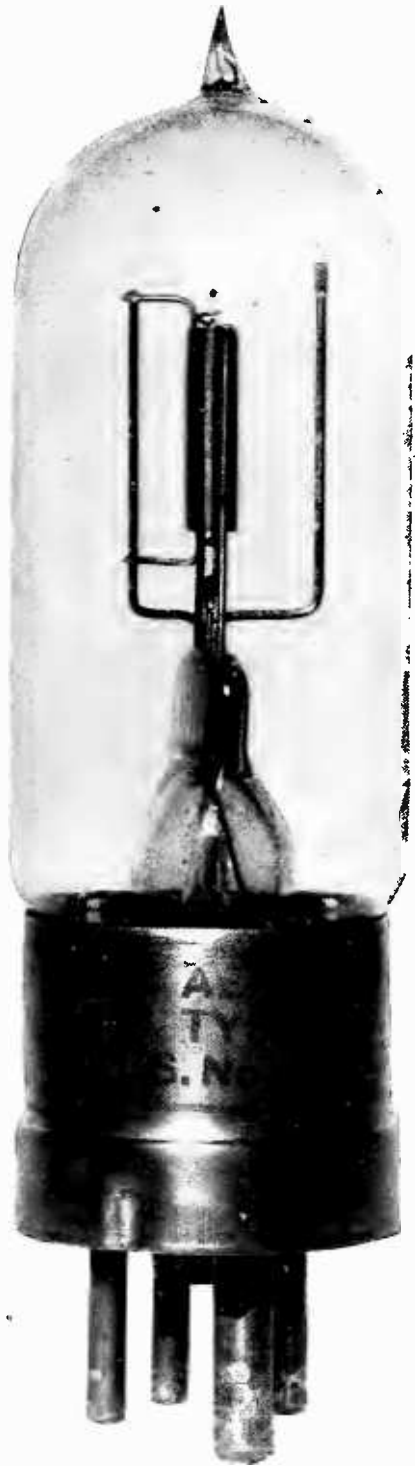

FIG. 3

This circuit shows some of the refinements which may be added to make any vacuum-tube receiver operate more satisfactorily. The potentiometer, R_2 and the variable "B" battery are very desirable. This arrangement was described in detail in "Paris and Honolulu are Calling You," in the December RADIO BROADCAST



A ONE-AND-A-HALF VOLT TUBE

Capable of bringing in music and speech over long distances. The filament of this tube may be operated by a single dry cell

burned as brightly. With some particularly "gassy" tubes even the $1\frac{1}{2}$ -volt variation, made possible by a tapped "B" battery, is not sufficiently delicate and the ideal arrangement is found only when such a battery is used in conjunction with a potentiometer connected directly across the "A" battery. A satisfactory form of potentiometer is shown in an accom-

panying illustration and the necessary changes in the circuit arrangement are shown in Fig. 3.

Since a vacuum tube has been developed which may be operated by a single dry cell, of the type commonly used for doorbells and such purposes, it is quite likely that the use of the six-volt storage battery, which has been the standard for vacuum-tube reception, will become less general.

Many of those who have put off procuring receivers because of the expense entailed in procuring the storage battery, can now avail themselves of vacuum-tube reception at nominal cost. Those who already own receivers, fitted with standard vacuum-tube sockets may use the new type tube without in any way altering their layout, by employing one of the adapters, shown here, and replacing their storage battery by a single dry cell.

In using these new tubes great care should be taken to see that no voltage in excess of $1\frac{1}{2}$ is permitted to get into the filament circuit or disaster will result. (The price of the tube is \$8.00). Unlike the vacuum tubes in common use, these tubes function best when the filament is a dull red. The adjustment of the filament temperature (brilliancy) is an important consideration and it is doubtful that a rheostat of the wire variety, will give the satisfaction to be had from the employment of one of the type employing carbon elements under a variable pressure, controlled by a knob.

THE USE OF VERNIERS

ALTHOUGH the receiver used by Mr. Bedell was designed specially for broadcast reception and arranged so as to permit more than the average movement of the tuning



AN ADAPTER

For using the $1\frac{1}{2}$ -volt tube with the ordinary vacuum-tube socket. Several have recently been put on the market

controls for adjusting the wavelength of the secondary and the regenerative action, the use of vernier controls is highly recommended for these circuits. A vernier attachment, which may be applied to any receiver fitted with dials, is shown in an accompanying illustration. There are other types on the market, but we have not seen any which are any more effective or can be applied more readily, or—and this is an important item to most fans—are as cheap.

INCREASING THE WAVELENGTH RANGE

IT IS quite likely that some of those who use this form of receiver would like to tune to six hundred or even longer wavelengths. In order to do this it is but necessary to connect a small fixed condenser directly across the secondary circuit, although a variable condenser would permit more delicate adjustment. If a short antenna is used it may also be necessary to connect a variable condenser directly across the antenna and ground terminals of the receiver, though this is not required with an antenna of normal size. If a fixed condenser



A VERNIER ATTACHMENT

This simple device, which may be applied to any receiver fitted with dials, has recently made its debut. It is effective, convenient and cheap and should prove very popular

is employed it may be fitted with a switch so as to be thrown in or out of the circuit at will.

Mr. Bedell's letter follows:

Freeport, N. Y., Oct. 31, 1922.

MR. ARTHUR H. LYNCH,
Editor, "RADIO BROADCAST,"
Doubleday, Page & Co.,
Garden City, N. Y.

DEAR MR. LYNCH:

Undoubtedly it will interest you to know that I have had great reception with the one-tube receiver that I made from your book of "The How and Why Radio Broadcasting." Please find listed below stations other than those near by:

KDKA	Westinghouse Electric & Mfg. Co	350
	East Pittsburgh, Pa.	
WBAA	Purdue University	750
	West Lafayette, Ind.	
WBAG	Diamond State-Fibre Co.	200
	Bridgeport, Pa.	
WEY	Casradia Co.	1350
	Wichita, Kans.	
WFI	Strawbridge & Clothier	150
	Philadelphia, Pa.	
WFO	Rike-Kumler Co.	600
	Dayton, Ohio.	
WGM	Atlanta Constitution	825
	Atlanta, Ga.	
WGY	General Electric Co.	150
	Schenectady, N. Y.	
WIP	Gimbel Bros.	150
	Philadelphia, Pa.	
WOH	Hatfield Electric Co.	675
	Indianapolis, Ind.	
WOO	John Wanamaker,	150
	Philadelphia, Pa.	
WSB	Atlanta Journal	825
	Atlanta, Ga.	
WGI	American Radio & Research Corp.	200
	Medford Hillside, Mass.	
WOC	Palmer School of Chiropractic Davenport, Ia.	925
WDAP	Midwest Radio Central	750
	Chicago, Ill.	
WHAM	School of Music	225
	Rochester University, Rochester, N. Y.	
WNAC	Shepard Stores	200
	Boston, Mass.	
WHAL	Phillips, Jeffrey & Derby	600
	Lansing, Mich.	
WHAS	Courier-Journal & Louisville Times	700
	Louisville, Ky.	
WHAZ	Rensselaer Polytechnic Institute, Troy, N. Y.	150

PWX Havana, Cuba 1350
 Aggregate mileage 11,275
 Yours very truly,
 (Signed) THEO. BEDELL, JR.

OTHERS WHO ARE BATTING WELL

NOR is Mr. Bedell alone in his good work, for Mr. Chas. Hodge of Baldwin, L. I., using a similar circuit with a set he made for ten dollars, informs us that he hears Davenport, Iowa, Havana, Cuba, and many other long distance stations, though he has not yet sent us in his statistics.

Mr. A. R. Lewis of Wichita, Kansas, who also uses this circuit, merely reports one station, Schenectady, N. Y., 1,350 miles distant. May we have your list, Mr. Lewis?

Mr. Harry C. Kisscaden, 4819 Ogle St., Manayunk, Pa., sends a partial list of the stations he hears with this circuit. There are 12 of them in all ranging from 150 to 1,050 miles with an aggregate of 4,450 miles.

Duane D. Karges of Wichita, Kansas, has had a set of this type for but three days and it is his first radio outfit, nevertheless he reports hearing 7 stations between 200 and 900 miles distant and has already piled up an aggregate of 4,300 miles. That is good work!

Mr. M. Davidson of Valley Cottage, N. Y., uses a condenser in the ground lead of his receiver and reports 10 stations of 325 to 925 miles distant with an aggregate of 6,400 miles.

Mr. Daniel W. Ingersoll of Chestertown, Md., reports hearing Davenport, Louisville, Schenectady, Atlanta, St. Louis, Shreveport, Peoria, Kansas City, Indianapolis, Birmingham, and Detroit, all more than 250 miles distant but none more than 975. Mr. Ingersoll's aggregate is 7,925 miles.

One of the most striking reports came from a letter unsigned but initialed W.B.M. and

headed 129 North Broad St., Cedartown, Ga. The circuit diagram accompanying the letter is identical to Fig. 2 except for the addition of a 43-plate variable condenser in the ground lead from the primary of the vario-coupler. Eight hundred miles is claimed for daylight reception and 3000 miles by night both of which are remarkable. The list of stations heard in the daytime is very commendable and the night

list bids fair to take first place in our contest if someone is not playing a joke on us.

We are endeavoring to have this contest carried on in a sportsmanlike manner with all the contestants "playing the game." If the letter from W. B. M. is a hoax, we are sorry to have a blight placed upon the efforts of those who are working so seriously. If, on the other hand, the letter is bona fide, we take off our hats to W. B. M.

SOME MORE GOOD WORK

WE ARE glad to learn so many of our readers are securing wonderful re-

sults from the circuit published in our December number which was brought to our attention by Mr. Edwin H. Parker. For instance, Mr. John Hoyt of Box 285, Rifle, Colorado, reports hearing 28 stations, the nearest being 225 miles distant, Denver, Colo., and the farthest being 975 miles, St. Louis, Mo. Mr. Hoyt has rolled up an aggregate mileage of 19,650. Mr. Hoyt holds first place, thus far.

Frank E. Williams, 1420 Euclid Ave., Cleveland, Ohio, reports hearing 62 broadcasting stations in two months and 27 stations from ten to twelve-thirty in a single evening. On the list of stations entered in the contest he has included but 19 stations and the shortest distance is 575 miles while the longest is 1290. He lists four stations each of which are more than 1000 miles distant. His aggregate mileage is 15,165 miles. Mr. Williams reports his

The Reflex Circuit

Frank M. Squier, Chief Engineer of the De Forest Radio Company and President of the Radiocraft Company has designed a receiver which uses three vacuum tubes and a crystal detector. The tubes function as 3 radio-frequency amplifiers and their output is rectified by the crystal detector and the rectified current is passed through two of the vacuum tubes a second time—in this instance they act as audio-frequency amplifiers. A two-foot loop which may be rotated easily projects through a hole in the top of the receiver cabinet. Mr. Squier demonstrated this new receiver for us at our plant and in several other places. Stations more than of 1000 miles away were picked up without difficulty. There are many novel features about this new receiver including its compactness, ruggedness, great sensitivity, and simplicity of operation. The first exclusive and complete description of this new development will appear in RADIO BROADCAST for February and will be written by Mr. Squier himself.—THE EDITOR.

tuning in the following manner: Set inductance switch so as to include nearly all the primary of variocoupler, leaving secondary parallel to primary. Turn condenser in to a point just beyond where the carrier wave is heard; then swing secondary of coupler around until almost at right angles with the primary. This makes for greater selectivity. Fine work!

Mr. L. B. Robinson of 537 Hillside Ave., Glen Ellyn, Ill., has recorded 18 stations, the farthest being 1720 (Los Angeles, Calif.) and the nearest 370 miles (Minneapolis, Minn.). His aggregate is 13,735 miles, which we judge to be conservative, for he has heard two other stations 700 and 800 miles distant which are not included in his report for the reason that he has only heard them for brief periods. Mr. Robinson says he has no difficulty in listening to any of the stations he has listed even though KYW, the Westinghouse Station in Chicago, is but 23 miles from his station. It is a pleasure to get a report like this.

Professor Frederick E. Croxton of the Department of Economics, Ohio State University, Columbus, Ohio, employs a modified single-circuit receiver and, because he can only listen at night, has listed only stations more than 500 miles distant. The eleven stations listed aggregate 7,545 miles. The longest single step is 975 miles. Professor Croxton makes the suggestion that some consideration be given the power employed at the transmitting station in judging the performance of a single tube. We should very much like to do this were it not for the fact that our contest is already assuming proportions which tax us to the utmost.

Mr. Edward Fox of 211 West 108th St., New York City, reports nine stations from 150 to 1,500 miles distant with an aggregate of 7,270 miles.

Mr. W. S. Wyman of Rome, N. Y., reports 7 stations 675 to 1650 miles distant and aggregates 6,850 miles.

Mr. Otis Maher of the Prendergast Company, Marion, Ohio, uses a single-tube, single-circuit regenerative set, the only unusual feature of which is a specially wound vario-coupler. He has heard 9 stations from 500 to 1,350 miles distant with an aggregate of 6,150 miles.

Mr. Edw. H. Schlader, 7754 So. Union Ave., Chicago, Ill., has listed 11 stations from 250 to 900 miles away with an aggregate of 5,275 miles. He has made a few slight changes in the circuit by using a load coil in the antenna circuit and two variable condensers.

Mr. C. K. Jones of Springfield, Mass., lists 12 stations between 175 and 975 miles with an aggregate mileage of 5,440.

Mr. Oscar Peterson of Youngstown, Ohio, reports 8 stations between 300 and 900 miles distant with an aggregate of 4,825 miles.

Mr. Walter E. Larsen, 4517 33rd Ave., So. Minneapolis, Minn., recorded six stations of 375 to 925 miles distant and aggregates 4,625 miles.

Mr. E. W. Benedict, R. D. 4, Waterbury, Conn., has heard five stations distant enough for entering our contest and all between 525 and 925 miles. His aggregate mileage is 3,750.

Mr. Harris C. Harvey of 1318 Kenmore Ave., Buffalo, N. Y., records 8 stations, the nearest being 225 and the most remote being 900 miles. His total mileage is 3,425.

Mr. Howard Sorey of 107 North Pecan St., Nowata, Okla., has heard six stations all between 225 and 825 miles distant with an aggregate of 3,225 miles.

Mr. C. F. Clarkson, 206 Victoria St., Amherst, Nova Scotia, Canada, reports three stations 600 to 675 miles distant with an aggregate of 1,950 miles, in spite of the fact that he is but a short distance from one of the Canadian



EDWARD FOX

With the receiver he made and used to pick up broadcasting from Omaha, Nebraska, 1,500 miles from his receiving station in New York

commercial stations which operates on C.W. using high power.

STANDARD REGENERATIVE RECEIVER

THE following results have been reported with a standard three-circuit regenerative receiver shown on page 58, Fig. 1, November RADIO BROADCAST:

Edward Howard, 76 High St., Waterbury, Conn., reports hearing nine stations 250 to 1,725 miles distant. His aggregate mileage is 8,650.

Mr. Hugh E. Woodward, 194 Kingsley St., Buffalo, New York, reports 16 stations from 200 to 900 miles distant with an aggregate of 7,650 miles. The total cost of Mr. Woodward's receiver was \$41 and he has had only five months' experience in radio.

Mr. M. J. Cleary, North Sidney, Nova Scotia, in spite of considerable interference from ships and the nearness to two high-power C.W. stations at Glace Bay fifteen miles away, has heard eight stations all of which are more than 550 miles distant but none more than 1,000 miles. His aggregate is 6,625.

Mr. A. D. Straussman, 601 Asbury Ave., Asbury Park, N. J., reports eight stations 375 to 900 miles distant with an aggregate of 4,100 miles.

Reports from contestants who are using Aeriola Senior receivers, operated by a single dry battery are very satisfactory. John Clum of Kensington, Md., who is only twelve years old, heads these contestants. He records 15 stations ranging from 150 to 1,050 miles distant and his aggregate mileage is 9,105.

Mr. Wm. J. Mincer, 53 Pine St., Mt. Holly, N. J., has received 10 stations from 225 to 1,500 miles distant. His aggregate is 7,025.

Mr. Edgar T. Anderson, East Mauch Chunk, Pa., reports hearing 5 stations from 750 to 1,050 miles distant and aggregates 4,475 miles.

Mr. John Int-Hout, Maurice, Iowa, has heard 5 stations 225 to 900 miles distant aggregating 3,150.

So much for this month. We are wondering what new hook-ups and new records you experimenters are going to spring on us during the next few weeks!

GETTING THE BEST FROM ONE TUBE

By P. B. CRONK

Few there are who question the assertion that music and speech received on a crystal set are clearer than when a vacuum tube is used. This receiver, which originated in the Bureau of Standards, combines the long range which the tube makes possible with the tone clarity of the crystal detector.—THE EDITOR.

THE diagram shows an electron-tube amplifier with a crystal detector. Any one already possessing an electron-tube receiver may construct this set with very little additional expense. It should be of particular interest to the many radio enthusiasts who now have single-tube sets and are not ready to go to the expense of adding a stage of amplification and still are not satisfied with the results obtained from a single tube.

The antenna circuit is variable and in the set described was tuned by a ten-point switch and a variable condenser in series-parallel. The oscillating circuit LC is tuned to the frequency of the incoming waves. The alternations of voltage between the terminals of the coil L are applied between the filament and the grid through the B battery, which is adjusted experimentally until the best value is obtained.

The amplified oscillations in the plate cir-

cuit are communicated to the oscillating circuit L₁ C₁, which is coupled to the plate circuit by the coil M. The circuit L₁ C₁ is also tuned to the frequency of the incoming waves.

The alternations of voltage between the terminals of the coil L₁ are rectified by the crystal detector and cause an audio-frequency current to pass through the phone receivers.

There are certain paramount advantages of this arrangement: first, the reception is pure and clear without the distortion accompanying the ordinary tube receiver. Second, static is greatly reduced and tube noises absolutely eliminated, although the set operates best with a very bright filament. Third, there is hardly any interference from "spark" stations, which is a point of considerable importance to most of those owning sets at this time. *This feature alone makes the set superior, for broadcast reception, to the Armstrong regenerative receiver.* And last, but most important—it is not finicky.

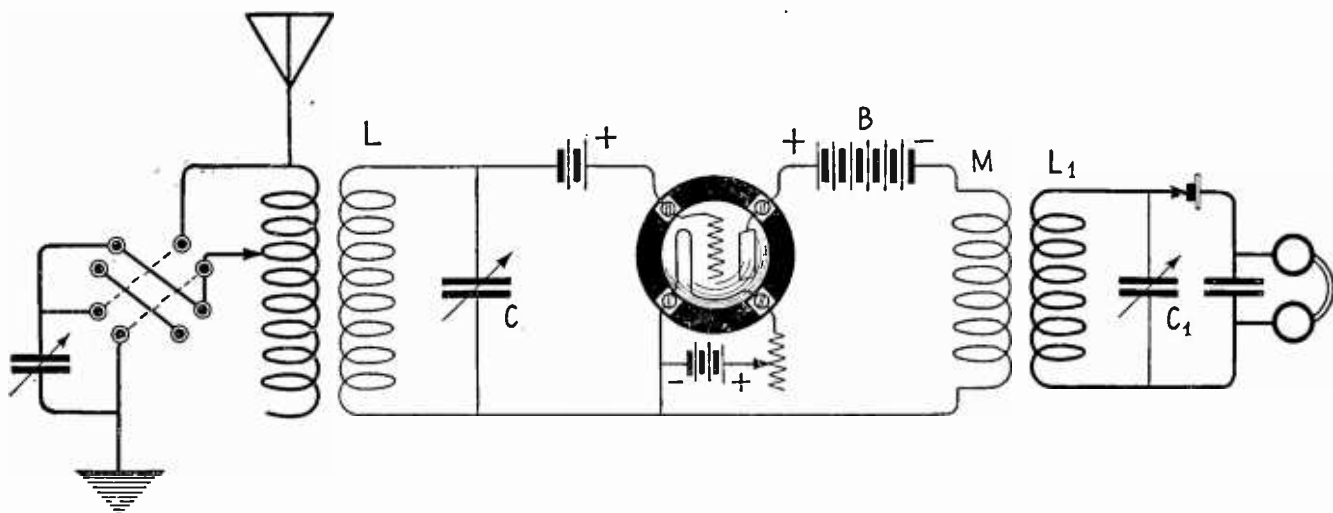

A VACUUM TUBE AND CRYSTAL COMBINATION

This circuit is being employed by Mr. Cronk with very satisfactory results

Except over long distances, you can use any tube, cross or parallel wires, take out the rheostat and C battery, disconnect the grid entirely, and the crystal alone will carry on the programme better than a crystal ever does independently. Tuning is the essence of simplicity.

One disadvantage which presents itself is the universal objection to the crystal detector, i. e., the difficulty of finding the proper contact. In receiving long distances the contact must be delicate and on a sensitive spot, using a first grade piece of mineral. However, the writer has found that this circuit gives better results than any other "hook-up" using only one tube, and in point of quality it is superior to any tube set now in common use, whether of one or more tubes.

The values are as follows: L is the secondary of a variocoupler or loose coupler of ordinary design; C and C₁ are .0005 mfd. air condensers; M and L₁ are wound on the same tube, M having 50 turns of No. 22 D. C. C. wire and L₁, 80 turns of No. 26 D. C. C. wire. M is wound first on about a 3½ inch tube and L₁ is banked over it. The coupler so made is placed in inductive relation to the antenna circuit.

The transformer ML₁ was arranged so that it could be placed in inductive relation similar to a "tickler," with good results. No marked effect was noticed from the closeness of the transformer coupling as long as the variable condensers were regulated carefully.

The detector may be of any design of galena detector, as long as a light contact can be maintained.

Individuals, no doubt, will devise many variations of the coupling arrangement and perhaps evolve something better, but it must be remembered that the principle here is not the same as that of a transformer coupling, where two circuits of different frequencies are closely coupled and the voltage ratio is about the ratio of the number of turns on the two coils. Here, there being no potential in the crystal circuit, the resistance of a transformer more than offsets any "step-up" effect which might take place. In the arrangement here described, both circuits are tuned to the same frequency.

No claim to originality is made by the writer for this "hook-up." It may be found in Bureau of Standards circular No. 40, which, however, is obtained with some difficulty. But the values have been carefully worked out by experiment, and the writer evolved the idea of putting the coupler in inductive relation to the primary of the antenna coupler.

The set described is giving perfect satisfaction to the writer, and in view of the fact that "a real amateur will try anything once," owners of single tube sets are urged to give this a try before paying good money for D. L. coils or transformers. The cost of the addition should be well under a dollar.

Up Before the Microphone



EDDIE CANTOR

Entertains about two thousand people a night when he appears before Broadway audiences. In a single evening before the microphone he entertained more people than he did in an entire season on the stage



MAY PETERSON

The noted soprano of the Metropolitan Opera Company has favored the invisible audience with her singing and we may say with no fear of contradiction that she has been heard by more than 100,000 people in a single evening, when she sang at WJZ



MRS. W. E. McADAMS AND MISS MYRTICE

Well known in Georgia before radio broadcasting became so popular as an indoor sport, now have made many friends among the listeners-in in almost every state in this large country of ours, through WSB



V. A. RANDALL

Is one of those men of mystery who tell you what the next number is to be and who is going to perform. Mr. Randall is Studio Manager of WEA and his voice has been heard in thousands of homes

The New Way to Make Americans

By J. M. MCKIBBIN, JR.

WHERE will radio stop? When will its present rate of growth slacken? When will its ultimate maturity and standardization be reached?

Such questions are asked alike by fans and those responsible for the present development of radio.

The consensus of opinion is that we have merely scratched the surface, in spite of the astounding beginning that has been made. The record of KDKA at East Pittsburgh, Pa., in broadcasting its diversified programmes to places as far away as South America, some 4000 miles distant, is splendid, but it is mere pioneer work. Some day, and that not remote, we shall probably realize accomplishments which will eclipse in importance all present performances. Will not radio become international in its scope? What influence, educational, social, and economic will such daily communications have upon mankind at large? Who can at this time measure the effect of a radio appeal, universally made?

To-day this nation of ours is slowly but surely being conquered, not by a single enemy in open warfare, but by a dozen insidious (though often unconscious) enemies in peace. We are not facing the question of taxation without representation, state rights, or slavery, but we must deal with a situation that, if unnoticed, will gradually undermine our national unity. From that little nucleus of government in 1783, we have grown to a mighty nation, wielding a power and influence over the whole earth. In our beginning, unity was essential, the people were bound closely together for common protection. Without it, there was a possibility of extermination; therefore it existed. But a kindly Nature has showered so many gifts upon the United States that the growth has been very rapid. With this growth came the assurance of national strength. Millions of foreigners were received into the country, with little or no thought being given to their assimilation. What is the result? To-day we see it everywhere, in Little Italy, Chinatown, Slovakia, etc., each retaining, as far as possible, the customs, language, and traditions of its mother

country. Each is a parasite living upon the natural resources and under the protection offered by America, yet giving little or nothing in return. It is this process of nationality isolation within one country which is ruinous.

Our problem is evident. It is the problem of assimilation, not only of the foreign-speaking people (who compose but a small part of our population), but of millions of people who enjoy the privileges of American citizenship, yet who secretly cherish and adhere to the traditions and customs of their mother country. Perhaps, as a nation, we are at fault. We have showered the blessings of liberty upon all—gratis. Too often this priceless gift of freedom has been mistaken for license.

We have a long list of national heroes—men who seem to have been predestined to lead this nation through its periods of national crisis. Success was theirs and the American public showered honors upon them. National success and power gained by such leadership has made us, as a people, the most optimistic in the world. Until recently, we have given little thought to the assimilation of the foreign element within our shores. But now the crisis is upon us; and we must face it without a great leader. Perhaps no man could mould these one hundred and twenty millions of people into a harmonious whole, bound together by a strong national consciousness; but in place of a superhuman individual, the genius of the last decade has provided a force—and *that force is radio*.

If properly employed, radio will cause the indifferent or antagonistic American unconsciously to become familiar with our government, its people, and their ideals. Now, familiarity causes interest; developed interest creates desire; desire leads to action, and action will make a positive 100 per cent. American citizen. After two years of broadcasting, we find approximately one million receiving sets in North America, the result of the universal appeals of radio novelty and music. We can see, when we consider the vast reach of radio, what a tremendous influence it can be made.

Radio is too large a force to deal with the many petty social and political differences of

American Aviation Radio Is Rotten

village and town—it deals with matters of state and nation, with matters of international importance. The “listeners-in” are lifted from that common plane of trivial interests and unconsciously made to realize that they are (collectively speaking) responsible for the guidance of this nation; that its troubles are their troubles, and that its achievements are due, in part, at least, to the conscientious fulfillment of their duty. Only through the appreciation by each person of his responsibility to his country and his fellow men can come the realization of Tennyson’s prophecy:

The common sense of most shall hold a fretful realm
in awe,
And the kindly earth shall slumber, lapt in universal
law.

Let us teach the newcomer correct English. English correctly heard is English correctly spoken, and the foreigner landing on a strange shore is almost as imitative as a child. Let us offer the foreigner coming to our land more than mere-opportunity: let us combine with this opportunity coöperation, which will enable him to become an intelligent citizen, working with us, instead of against us, making this people one and inseparable.

American Aviation Radio Is Rotten

By BRIGADIER-GENERAL WILLIAM MITCHELL

Reported by DONALD WILHELM

IN RELATION to aviation American radio is rotten, as compared with radio abroad. Even if we have the technical talent here, the airman doesn’t get the service that he gets over there. The fact is, the European nations—England, France, Germany, Italy, for instance—have us beat a mile in the

application of radio to aviation. That’s a fact that means a lot to airmen in days of peace. In time of war domination of air, land, and sea might turn on it.

On the other side they take these things seriously, even in peace-time, and make radio count in the development of aviation. They



BRIGADIER-GENERAL MITCHELL—AN INTREPID PILOT
General Mitchell knows the value of radio to airplanes from his own experience

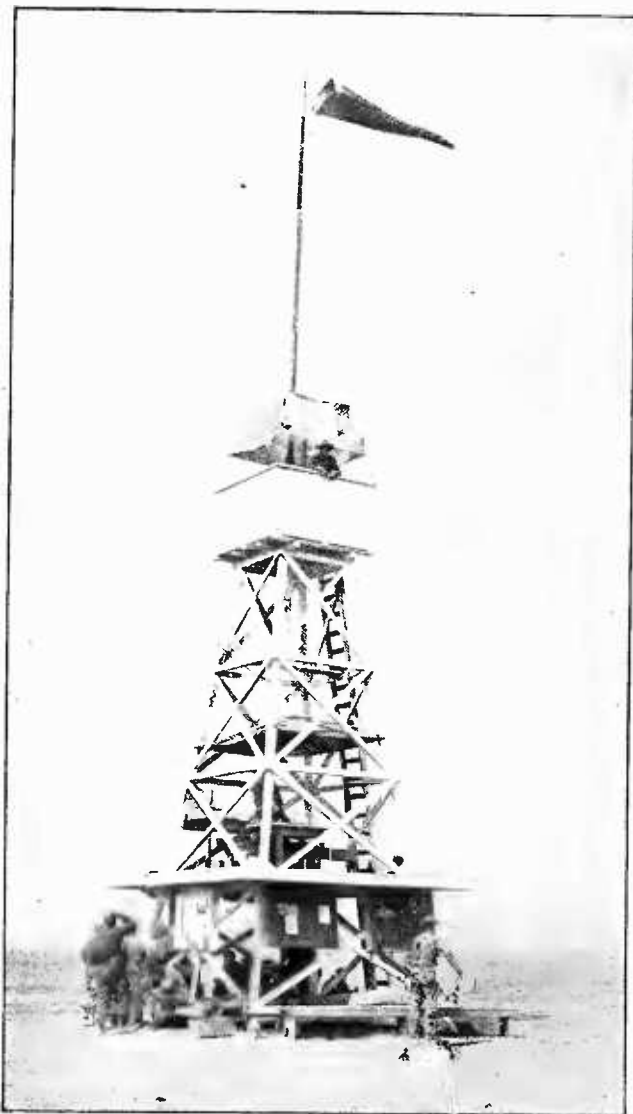

SIGNAL STATIONS

Like this are valuable in communicating with planes in flight and for instructional purposes. There isn't anything "rotten" about stations of this sort other than that there are too few of them

can do that because each nation is organized. For instance, meteorological service via radio

is organized under the same head as aviation—at the fields and in the air the pilot can rely on weather information and storm warnings. A pilot needs that information a lot more even than the farmer—with passengers on board, for instance, when he's driving ahead at the speed of a hundred miles an hour, it's important to know whether he's driving into a storm or not. That's one reason why meteorological service ought to be extended by radio in every direction in which a plane is apt to fly. Here in America at the present time, neither aviation nor radio is organized—when the pilot is flying, he misses like anything an organized system of airways and fields, and if he's looking for weather information and radio guidance, he finds that everything is being handled by someone else. There's nothing new in all that; it's the old story of not enough money, mainly. We haven't enough fields. We haven't enough radio equipment. We haven't enough stations, and most of those we have aren't powerful enough, are undermanned or working only half the time. And we haven't enough trained personnel. All hands, no doubt, are doing their best in their respective little spheres with a lot to do and not much to do it with.

But the point I want to hammer home is this:

It isn't a far cry from these easy-going days of peace to the emergency of war. It's as plain as the nose on your face that in any crisis the planes will be the first over the top. And any one can see that a nation with its landing fields, and radio equipment, and planes schooled to using radio for the spread of meteorological information, can use that combined service just as well for other purposes, and, with all things equal, would have us beat a mile.

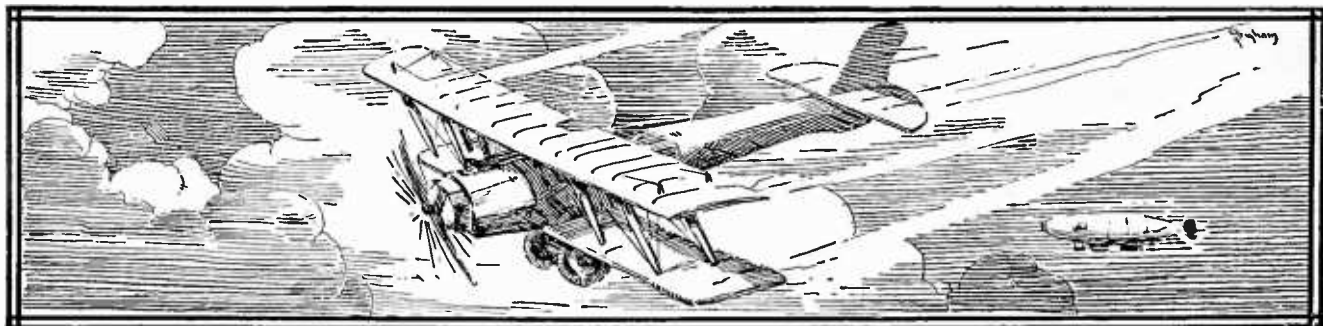

How Does This Receiver Work?

Dr. Francis Le Roy Satterlee, Who Invented It, Has His Own Theory, but Some Radio Engineers Dispute His Deductions. Do You?

By ARTHUR H. LYNCH

THERE is something more than amusement to be had from radio. Its manifold applications have been discoursed upon at length by many authors who did and many who did not know what they were writing about. Radio has recently come to be a subject of dinner table discussion and some very ambitious attributes have been credited to it by zealous though sometimes misinformed conversationalists. After listening to or reading an account of a young wizard who has success-

fully developed a marvelous "radiophone" or a loud speaker or a transmitter, it is a relief to learn of the efforts of a sober-minded scientist who has spent many of his years in fighting a brave fight against the most serious of human diseases. He tells but little of the story himself.

But before telling you of the receiver he has developed, may we tell you something of the man himself? His story is a most interesting one and he is a unique person, not only in radio, but in this work-a-day world of ours.

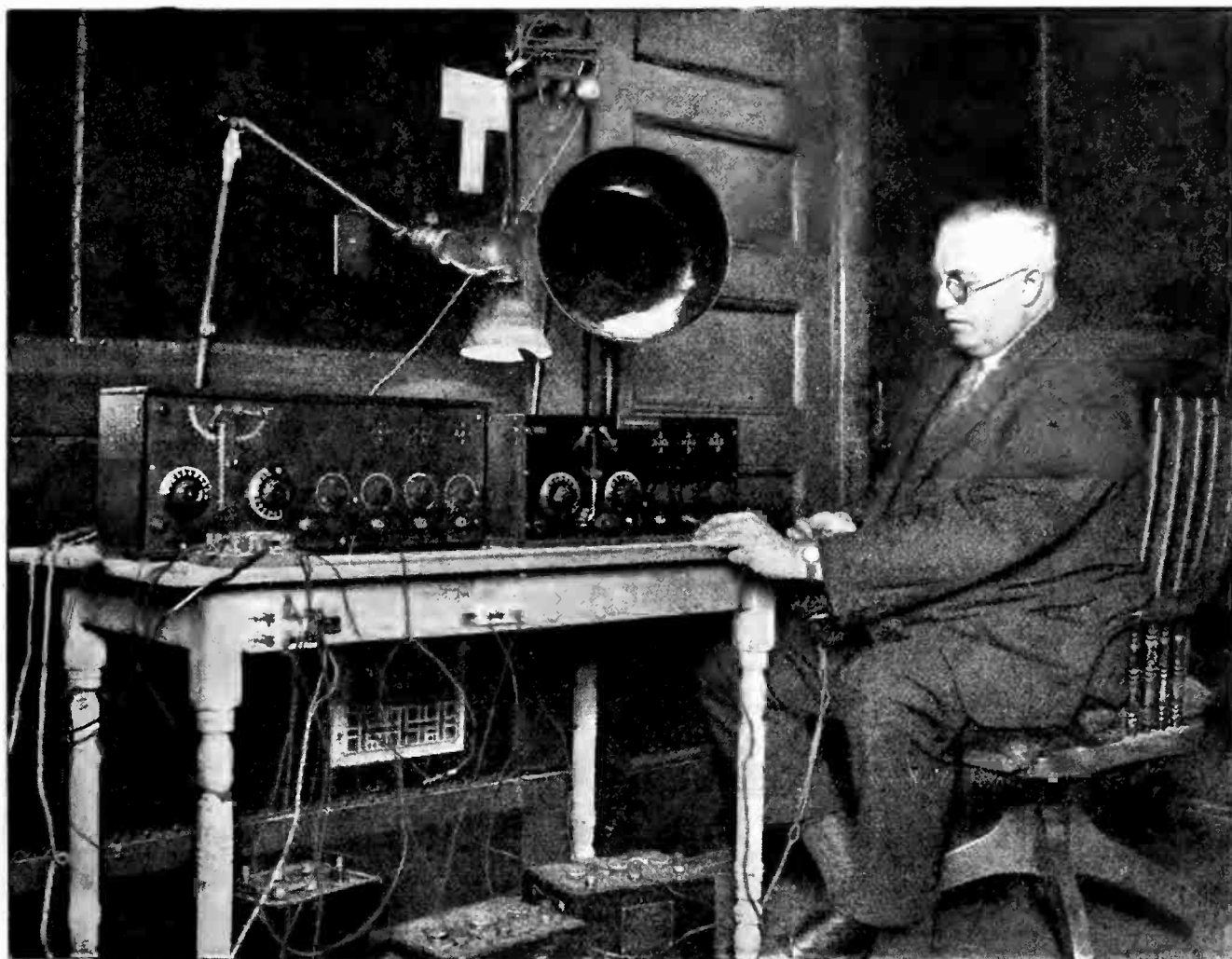

DR. SATTERLEE OPERATING HIS RECEIVER
Which is remarkably free from interference of any kind

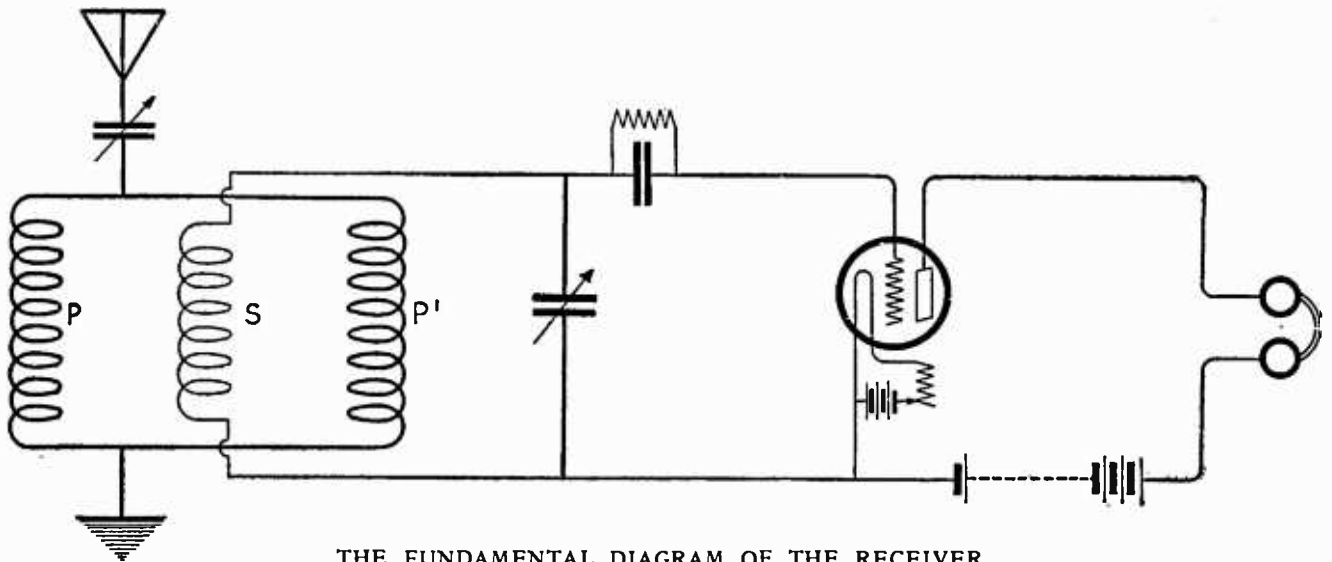

THE FUNDAMENTAL DIAGRAM OF THE RECEIVER

The double primary in this circuit is the principal point of difference between it and the ordinary loose-coupled circuit

He is one of those men who has fought death for others and is now fighting in order that he himself may live.

Dr. Francis Le Roy Satterlee has spent twenty-five years in X-ray work, which is a profession that undermines the health in a serious and painful manner. He is one of the half dozen survivors of the pioneers in Roentgen Ray work. He owned the second Crookes tube in America and had much to do with development work which led to the perfection of the lead glass screen used to safeguard X-ray operators to-day.

He is credited with making the first dental X-ray photograph and was laughed at by dental experts and physicians who claimed the X-ray could never be applied to practical use in dental work, though this same system is now used universally in modern dentistry.

Dr. Satterlee is truly a martyr to science and humanity. His forearms are covered with X-ray cancers which usually follow prolonged work with these helpful though sometimes fatal rays. Half his right hand has been amputated and specialists have recommended the amputation of his right arm. He has stubbornly refused to submit to this operation because it would handicap him in his research work.

The day before we visited his laboratory, Dr. Satterlee was ordered to go to bed for six weeks by his physician in order to offset the heart trouble he has developed as a result of his Roentgen Ray work. Finally, he compromised by agreeing to spend three days a week in bed over a considerable period.

As far back as 1909, Dr. Satterlee had some very positive theories on high-frequency alter-

nating current and one of his lectures appears in the *Medical Record* for 1902. His health has made it necessary for him to give up his X-ray work and he has been devoting his knowledge and time to radio for the past few months.

THE THEORY BEHIND THE RECEIVER

AMONG other things, the doctor maintains that radio waves and light waves are much alike, though the latter are of a much higher frequency and shorter wavelength, and claims that electromagnetic waves (radio) may be reflected and refracted by properly arranged units just as light waves may be controlled by mirrors, prisms, and lenses. In the last instance his argument is very well borne out by the work being done by C. S. Franklin, in England, which Marconi¹ himself dwelt so forcibly upon in his lecture before a joint meeting of the Institutes of Radio and Electrical Engineers on his last visit to America. Franklin's work, however, deals with a system for directing the waves sent from a transmitter while Dr. Satterlee has devised a method for directing the waves within a receiver in order that they may be properly focussed upon the unit used in the secondary circuit.

THE FIRST MODEL

IT WAS not until he had given the subject a great deal of thought and had proved his theory to himself time and again that he began building his first receiver. In April, 1922, Dr. Satterlee began to build his first crude model. When it was partially completed he told a

¹See "Radio Telegraphy," by Guglielmo Marconi, RADIO BROADCAST, August, 1922.

friend who was dubious about its success that he knew it must receive radio messages successfully because he had gone over the theory and circuit so many times in his mind and on paper that he was convinced he was on the right track.

A few days later the same friend was in the doctor's laboratory and saw the last connection made. To his utter surprise the receiver functioned almost immediately. The quality of reception was nearly as strong and clear as is obtained with the more carefully made sets he has built since then.

In spite of the fact that the original receiver performed satisfactorily, its inventor admits

that certain of the principles of its operation are still not fully known to him and several radio engineers who have seen the device have offered various theories.

Major General George O. Squier, Chief of the U. S. Signal Corps, motored to Dr. Satterlee's home in Flushing, N. Y., to see the receiver shortly after its completion. He said he could stay only fifteen minutes. The General, however, spent a long time in examining and adjusting the receiver and commented enthusiastically upon the strength of the received signals, the very fine tuning, and unusually clear tone of the music and voice which were heard.

During our own visit to Dr. Satterlee's

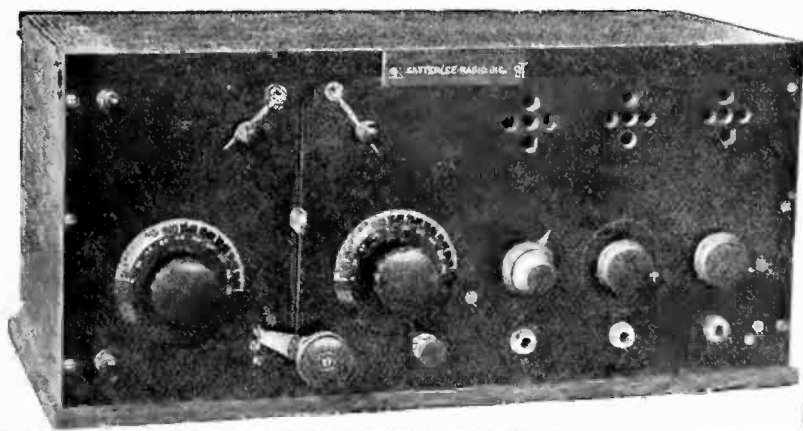

THE LATEST MODEL

Showing the control levers for the double primary and the secondary handle, which moves in the vertical slot. This unit comprises the tuning circuits, vacuum-tube detector, and two-stage audio-frequency amplifier

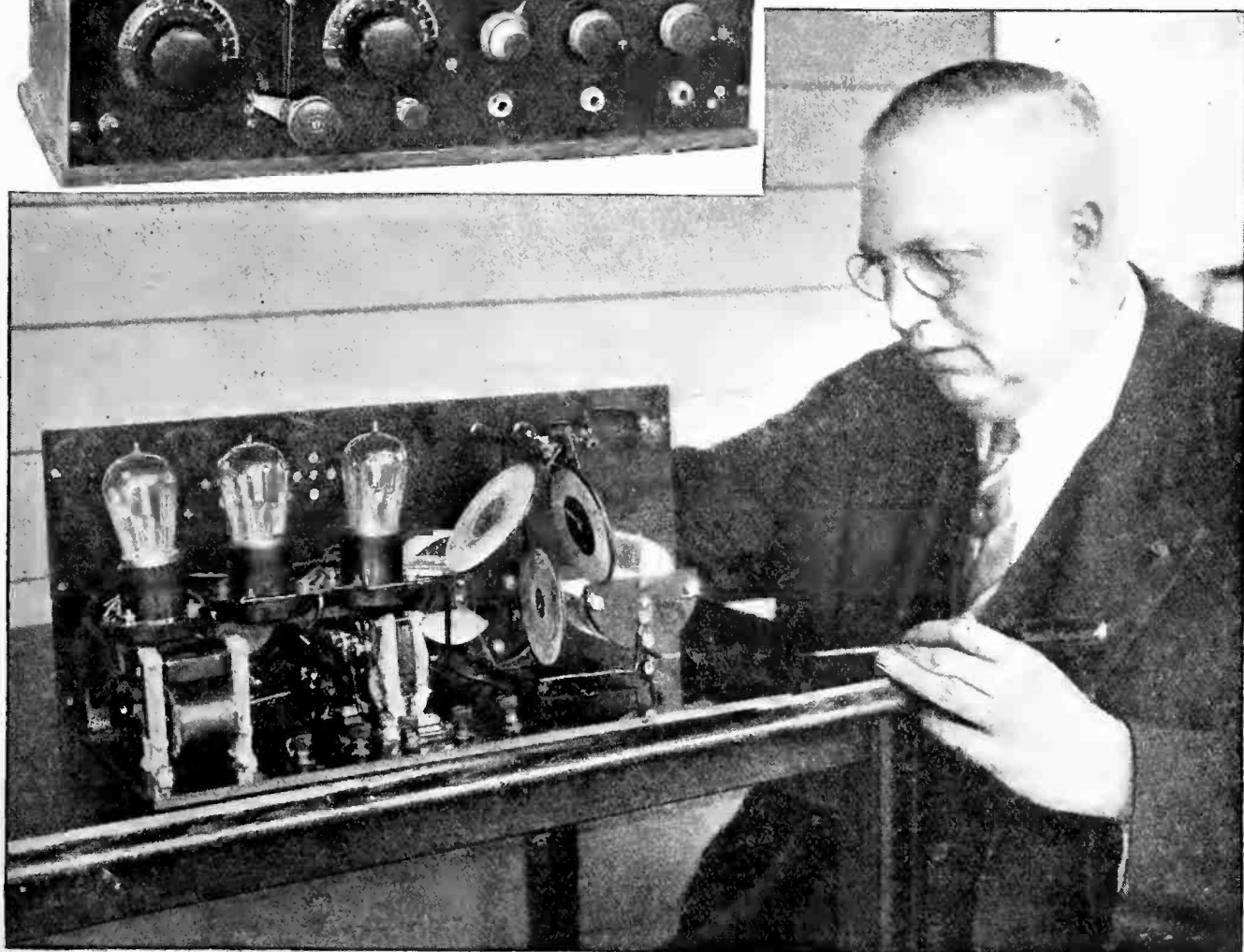

DR. SATTERLEE

Showing how the double primary is "focused" upon the movable secondary

laboratory, which, by the way, was on an evening when there was quite a little static, we heard a detector and two stages of audio-frequency amplification, operating Dr. Satterlee's own loud-speaker, produce music which it would be hard for any phonograph to duplicate. Not a scratch or a whistle or a howl or a single burst of static—not even a spark signal, though there were many amateurs in the neighborhood.

Dr. Satterlee has operated his receiver out at Montauk Point, L. I., which he says is carried on the Government radio maps as a "dead spot" for all radio from the West. In Maine, during mid-summer, he has received radio broadcasting from Denver, Colo., Louisville, Ky., New York, N. Y., Philadelphia, Pa., Newark, N. J., Boston, Mass., Chicago, Ill., Schenectady, N. Y., and many other points. The doctor says that he has heard San José, California, in his laboratory in Flushing, and he is now working on a system for receiving over long distances without an antenna.

A study of the fundamental diagram of Dr. Satterlee's receiver shows that the only way in which it differs from the conventional two-circuit receiver lies in the double primary. In the original arrangement three spiderweb inductances with their conventional mounting were employed but in the newer types the formation of the coils themselves has been changed and they are in the form of flat spirals, made with Litz wire after the manner of the French variometers used for aircraft work.

The centre coil, which acts as the secondary and is tuned to various wavelengths by a variable condenser shunted directly across its terminals, is mounted upon a shaft so that its position with relation to the two primary

coils—one being located on either side—may be altered. This is done by moving the shaft either up or down.

The primary coils are also moveable in the same way as the two external coils on a honeycomb mounting. The construction of the Satterlee coils and coil mounting, however, are considerably lighter than the usual spiderweb or multi-layer coil arrangements.

Within a short time this type of receiver is to be put on the market by one of the largest electrical manufacturers in this country. It is not to be sold, essentially, as a long distance receiver, though long distances have been heard with it. One of the greatest claims Dr. Satterlee makes for his receiver in addition to the clarity of tone is that, even with the best of material and workmanship, it will be possible for his outfit to sell at a price far below the price of others now available and there is surely room for a high grade product at a moderate price.

That is his story, or as much of it as he will permit us to make public just yet. Dr. Satterlee's work, however, has not been entirely confined to developing his receiver, for he is now working on inductances made without wire, which we may be able to tell you about later.

Here, indeed, is a new rôle for radio. Here we find it the playground for the highly trained scientific mind of one who has been compelled to relinquish an active interest in his life's work. And there is something fascinating about this genial man who is the picture of good health but is actually fighting death for himself, now, as he fought it for others for twenty-five years. Perhaps his grit may serve to stir us to greater achievement. Can you offer a concrete theory for the operation of Dr. Satterlee's receiver?

On the Job All Winter in the High Sierras

By CHARLES HESTON PEIRSON

IN THE dizzy altitudes of the Sierra Madre Mountains in Fresno County, California, radio will be used this winter to direct the activities of 500 men who will go into camp behind thirty miles of impassable snowdrifts to push forward during the winter one of the greatest pieces of tunnel construction now in progress in the Western Hemisphere. This

tunnel is a part of the gigantic hydro-electric project of the Southern California Edison Company, which is carrying on a program for the development of a million and a quarter horsepower of water-power electricity derived from the San Joaquin River and Big Creek and other mountain torrents.

The superiority of radio over the telephone

was so thoroughly demonstrated last winter, not only in directing the work of the men who were beyond wire communication, but in communicating with the general offices of the company in Los Angeles—270 miles from the outposts of operation—that, in preparation for this winter's work, new and expensive apparatus has been put into service. The work

territory, it was necessary to do considerable experimenting before satisfactory results were obtained. Portable radio telephone sets which had worked satisfactorily in the vicinity of Los Angeles were first taken into these mountains. Tests showed that to communicate a given distance, it was necessary to use about *twenty-five times more power* than was needed near Los Angeles!

The three transmitters rated at $\frac{1}{2}$ kilowatt were built on special order in about twelve days. One oscillion tube is used in each set. They were designed originally for continuous wave telegraphy, but have been successfully adapted for telephony or buzzer-modulated telegraphy, as well.

Involved in the work of developing the full electric potentiality of the streams of the

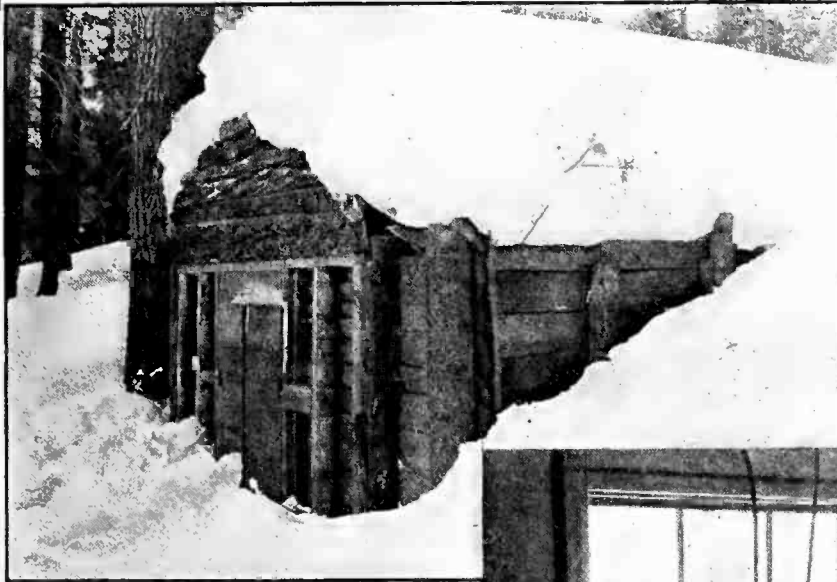

THE KAISER RANGE STATION
7300 feet above sea level
and "miles from anywhere"

of 4500 men, not including the 500 marooned on the upper end of the long tunnel over the crest of Kaiser Range, will be largely regulated by radio.

The headquarters station at Cascada is at an elevation of 5,000 feet, in a canyon approximately 2000 feet deep, with abrupt walls on three sides. The second station is located at a construction camp on the shore of Florence Lake, which is the south portal of the great Florence Lake tunnel, at an elevation of 7000 feet, and about seven and one-half miles in an air line northeast of Cascada. The third is located at a construction entrance camp, over the Kaiser Range, about eight miles in an air line north of the south portal on Huntington Lake. This is only about 300 feet higher than the portal station, but there is a mountain pass about 2000 feet high between them.

Owing to the fact that little was known regarding radio communication in mountainous

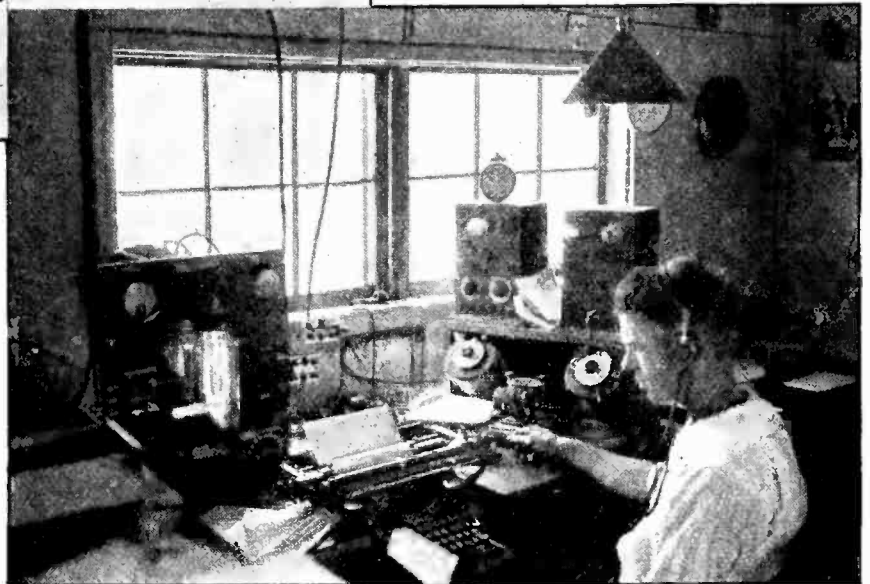

THE REMOTE STATION IN THE SIERRA MADRE MOUNTAINS
Which will keep the workers in touch, all winter,
with headquarters and the outside world

High Sierras and conserving their flow for irrigating lands in the San Joaquin Valley are many more daring engineering problems, which will necessitate the drilling of other tunnels, the erection of enormous storage dams in the mountain ranges far beyond lines of transportation and the constant employment of thousands of men for several years to come. It is not hard to appreciate the extent to which this work depends upon radio, nor to see that, by its use, vaster projects may be carried out than ever before in the history of engineering.

Transmitting with Your House Current

The Third Article in the Series on Simple Bulb Transmitters

By ZEH BOUCK

THE broadcasting enthusiast of yesterday, who has worked out his radio novitiate on simple low-power transmitters such as those described in the last two issues of RADIO BROADCAST, is now ready to QRO (increase power), and reach out with a 5-watt set.

The 5-watt installation is the lowest class of the power sets. But it is a power set, and in constructing and operating it, the experimenter will note many differences from the simple oscillators, using amplifying tubes, with which he is familiar. The 5-watt apparatus is built on a power basis, with more massive construction designed to stand up under greater strain. The panels are of heavier and less conductive material, well braced and capable of supporting comparatively heavy meters and shelves weighted with choke-coils, transformers, sockets and C batteries. Receiving parts, excepting sockets, can rarely be used. Rheostats are of special current-carrying capacity, the fixed condensers of a mica-foil construction, and the sockets well built and proof against insulation breakdown under the higher potential. The wiring cannot be carelessly insulated, with grid,

even the lowest power set from the quasi transmitters of our early experiments, the fundamentals and the theory remain the same; and the knowledge gained through our attempts will be of value in the intelligent operation of more complex apparatus.

The power source is the first and foremost consideration, and should be provided for, perhaps even prior to the actual building of the set. The B battery plate potential, and the 6-volt storage A battery, are no longer adequate. The filament of the UV 202, a typical 5-watt tube, draws 2.35 amperes at 7.5 volts, which may, of course, be supplied by an 8-volt battery. Nevertheless, such a battery is an expensive proposition, both in initial expense and in charging, while a step-down transformer with a specially wound secondary is much cheaper and prolongs the life of the tube.

The filament lighting transformer can be purchased, and it is generally provided for as a separate winding on power transformers for rectified A. C. transmission. However, the life of a radio enthusiast is one transformer after another, and so he is advised to gain the experience of building one as early as possible.

The core is first built up of 1"x6" soft iron strips, which may be purchased, cut to size, from a dealer in sheet metals. The core is constructed in the form of a 7-inch square; alternately overlapping the strips (Figure 1) until the core is one inch high. The sides are then taped, and the core knocked apart into four bundles, two opposite sides being selected for primary and secondary. These are prepared for winding by extra layers of tape, and by fitting the cores with heavy cardboard end pieces which serve to keep the wire within the winding area. The secondary is wound in two sections or "pies," and therefore three "end" pieces will be required, placed as indicated in Fig. 2, A. In addition to the original taping, a dozen 18" strips of tape are laid along the core with the adhesive surface outward, and are held in place by the end pieces and a few turns

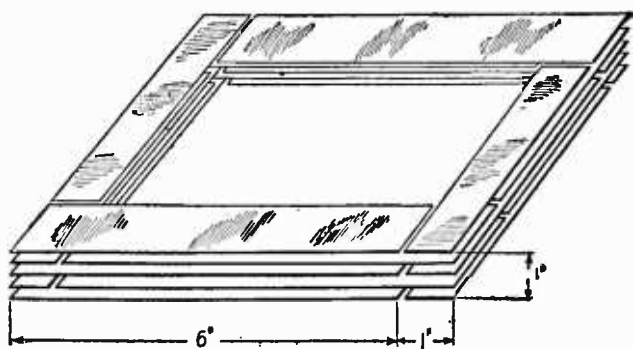

FIG. 1

Indicating dimensions and method of building up the soft iron core

plate and filament leads criss-crossing indiscriminately; for a short, or a blown tube is of far greater consequence with power apparatus. But in spite of these changes, which distinguish

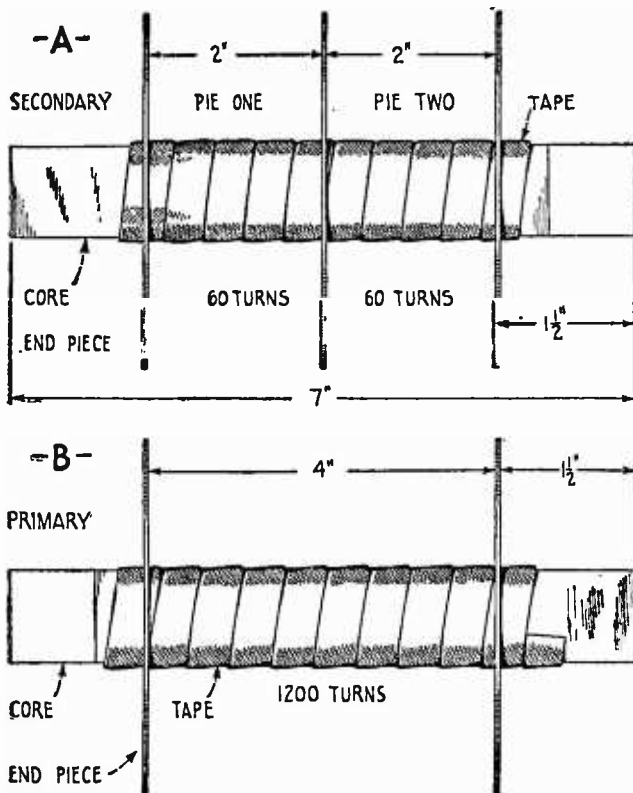

FIG. 2

Showing sides of core partially prepared for winding

of wound tape. The ends of these horizontal strips, extending six inches from each extremity of the core, are bunched together to facilitate winding. These strips are omitted, for the sake of clarity, from Figure 2.

The primary is wound with No. 22 single cotton covered wire, and every other layer wrapped with tape or empire cloth, giving an even surface for the next layer of wire. Wind the primary *very carefully*, five times across in each direction (ten layers), and allowing for a slight unevenness, this will approximate 1200 turns. After cutting the end pieces down to the size of the winding, the parallel strips of tape are unbunched, and brought up and over the winding, making the primary a neat and compact piece of work (Figure 3, A).

The secondary is wound with 120 turns of No. 12 single cotton covered, *soft drawn* wire. Pie No. 1 is first wound to 60 turns. The end is then brought out and over the middle "partition," given a few twists, and Pie No. 2 is wound as a continuation of the first. The secondary is finished up in the same manner as was primary, i. e., the cardboard guides cut down to the level of the winding, and the tape brought over.

The transformer is then dovetailed together, a rather difficult task accomplished by first

starting the ends, and gently hammering the sides into place. The assembled transformer is shown in Figure 3, B. The transformer may be mounted as the experimenter's ability and industry direct, but it is, perhaps, most simply disposed of by boxing. In any event there will be five leads, two from the primary, and three (the terminals and the middle tap) from the secondary. The outside leads of the secondary are connected *only to the filament*, and will give from 5 to 7 amperes at 10 to 11 volts without overheating. The centre tap runs indirectly to the grid, and it is the only wired connection between the filament and the remainder of the set. As it is at all times neutral, being simultaneously positive and negative to the filament, it neither adds nor subtracts from the effective plate voltage, nor varies the charge on the grid, thus eliminating the alternating current hum. The transformer will draw a current from the house lines equivalent to one or two 50-watt lamps, depending on the load or the number of filaments it lights.

THE HIGH-VOLTAGE SUPPLY

RECTIFIED A. C. and the motor generator are the two systems in general use for supplying the high-voltage direct-current plate potential requisite in power radio telephones. The rectification method, as its name implies,

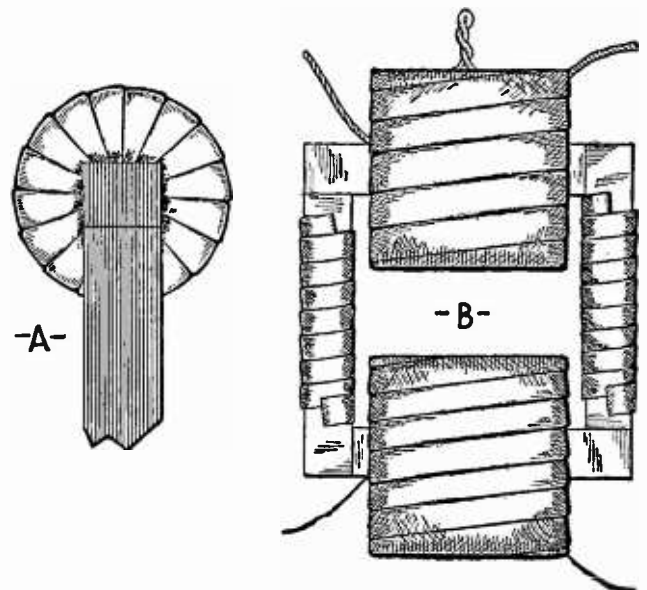

FIG. 3

Transformer construction

changes stepped-up alternating current into pulsating D. C. by virtue of the property of passing a current in one direction only possessed by some chemical solutions and the two-



FIG. 4
The commercial type motor-generator

element valve. While the initial expense of rectification is somewhat less than that of a new motor-generator, the latter is probably the more economical in the long run, and certainly more satisfactory. Due to an almost unavoidable hum, the 60-cycle A. C. systems require more complex and expensive filters, and the renewals of chemicals or bulbs are not a negligible expense. The purchase price of a direct-current generating system (Figure 4) is practically the only expense, and from the standpoint

of both economy and simplicity, it will be indicated throughout this article as the high-voltage source.

The dynamotor is somewhat similar to the motor-generator combining two fields and armatures in single stationary and revolving units, and is economical and efficient where D. C. is available for driving, Fig. 9. The dynamotor is of special advantage in isolated districts not wired for commercial lighting, where they may be had in models operating from a 6-volt storage battery, and delivering from 350 volts up. The price of a dynamotor averages three quarters the cost of an equally powerful motor-generator.

The Radiotron UV 202 and the Western Electric E tube, both five-watt oscillators, are designed to operate on a plate voltage of 350 to 400. 20- to 40-watt machines of this voltage can often be purchased second hand for as low as thirty dollars. However, the experimenter will find it desirable to increase power at times, and may later augment his equipment with more powerful tubes, such as the Singer, so, if the probable fifteen dollars difference in price is not prohibitive, he is advised to purchase a 500-volt machine. By the inclusion of a field rheostat or resistance across terminals provided for

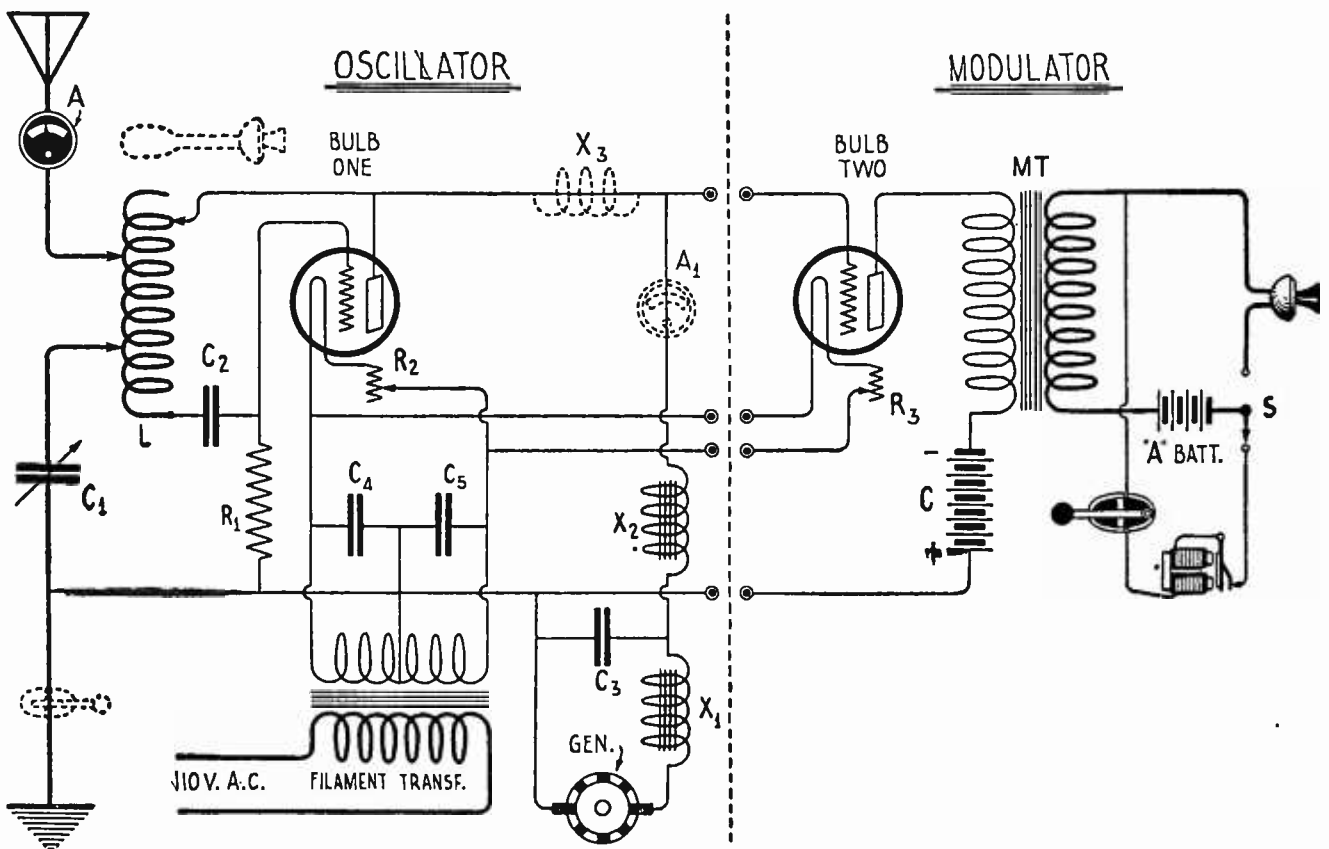

FIG. 5

this purpose, any desired voltage may be obtained.

If the amateur is in possession of a one-sixth to one-quarter horse-power motor, it will be but necessary to obtain the generator, several reliable makes of which are being marketed in the neighborhood of twenty-five dollars.

A very serviceable motor-generator can be built up by employing a 220-volt shunt-wound motor, driven as a generator at double its motor speed. A 220-volt motor of the type used to drive ceiling fans, when driven by a seventeen hundred R. P. M. induction motor, makes an excellent generator and delivers approximately 400 volts. In choosing a motor to be thus converted, the experimenter should select one having, if possible, not less than 24 commutator segments, and the bearings and insulation should be examined by one thoroughly familiar with motor construction. Two motors, one to be turned as a generator, are most easily procured second hand, and their combined cost should not exceed twenty-five dollars. It is occasionally necessary to include a 6-volt battery in series with the fields of such motors when they are first used as generators, in order to boost up the low residual magnetism.

The current from a motor generator, due to the commutator

action, is slightly pulsating, and the resulting ripple or hum should be filtered out. The filter generally consists of two choke-coils and one or more high-capacity condensers. It is advisable to purchase the condensers, but the chokes are easily wound. The core is of the same material used in constructing the filament lighting transformer, but preferably in larger strips about ten inches long, and built up until the core has a cross section of approximately one and a half square inches. Two cores should be made, and two and a half

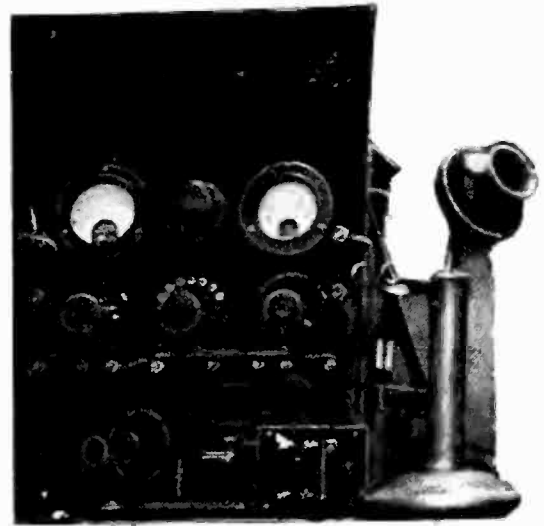

FIG. 6

A convenient panel arrangement

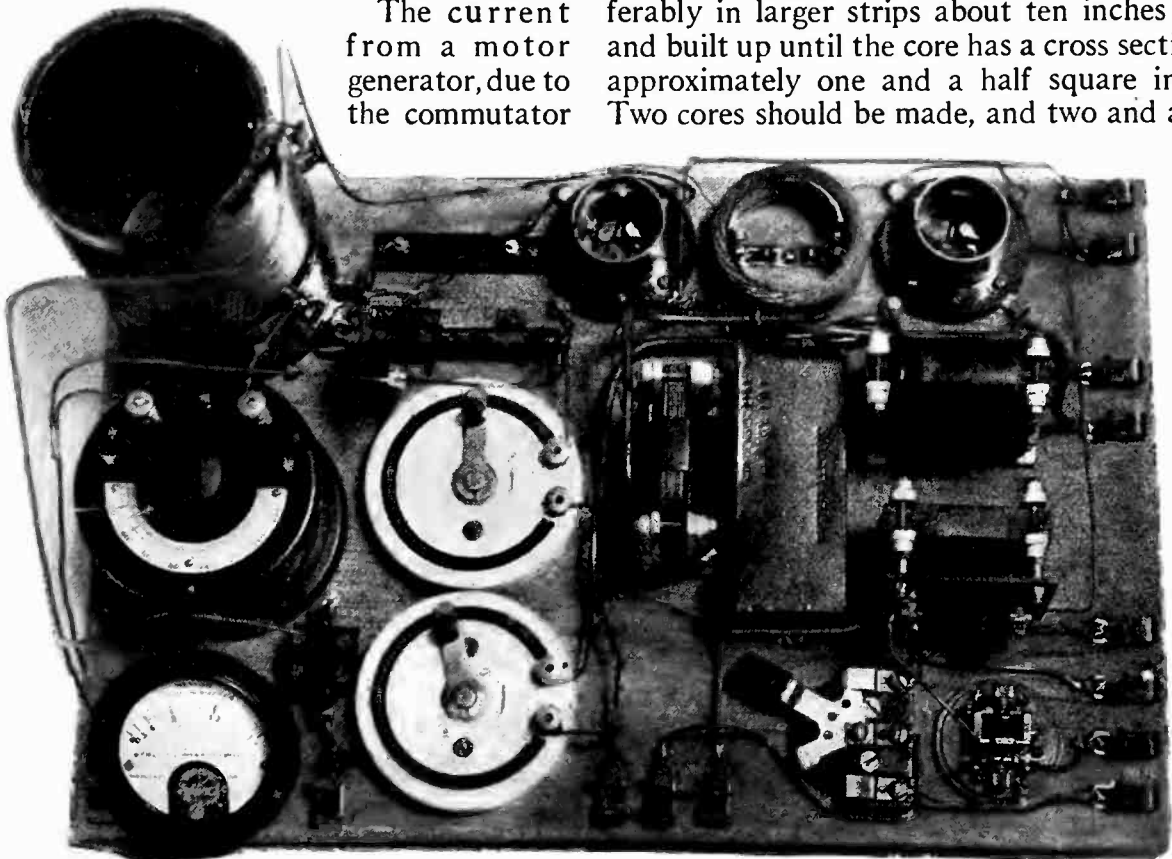

FIG. 7

It may be found convenient to experiment with your apparatus on a baseboard at first, and later to arrange it on a panel

pounds of No. 25 to No. 28 single cotton covered wire wound on each. The condensers, tested for breakdown at 600 volts, should aggregate at least .005 microfarads. The connections of the various units in the filter system are shown as part of the circuit in Figure 5.

The action of the filter is to counteract any fluctuations in the supply current caused by commutation. As the voltage rises above the average, the condenser is charged; and when, in the next instant, the generator voltage drops, the discharging condenser tends to keep the line E. M. F. normal. A similar effect is achieved in the choke-coils by the current of self induction, *which is always in such a direction as to oppose any change in the inducing current.*

THE CONSTRUCTION OF THE SET

THE radio-telephone circuit may be one of several oscillating systems, and if the experimenter is already transmitting on a well-built B battery set, he may merely modify it for power purposes. However, the Colpitts circuit is probably the best adapted to experiment with 5-watt bulbs, and if the results do not justify one's expectations, or the amateur wants to experiment further, it is quickly altered to the British airplane or other circuits.

The set may be built up in the form of a panel transmitter (Figure 6), or laid out systematically on a baseboard (Figure 7). As the

amateur is likely to make various alterations before constructing his more permanent equipment, this latter plan is, perhaps, the better.

The diagram (Figure 5), in its entirety, combines the Colpitts oscillating circuit (on the left hand side of the dotted line) with the Heising modulating system, this last being, without doubt, the most satisfactory method of superimposing the voice frequency on the outgoing wave. However, the oscillating circuit may be modulated by the absorption system (Cf. November, 1922, RADIO BROADCAST, pp. 16 and 17). The absorption loop is a single turn of wire about the inductance L, shunted by a microphone, and it is indicated by dotted lines in Figure 5. When the set is modulated in this manner, X₃, a radio-frequency choke, generally a honeycomb L₂₀₀ coil, may be omitted. If the oscillator is built up in the panel form, the Heising modulator may be constructed later with a similar outward appearance, and connected to the oscillator by four conveniently placed binding posts.

Inductance L may be either bought, or wound by the experimenter with No. 12 or No. 14 single cotton covered, soft drawn wire. For the Colpitts circuit the purchased inductance is more satisfactory (unless its design can be duplicated), as it admits of finer adjustments. A homemade inductance should be wound to 40 turns of wire on a 3-inch tube, or 30 turns on a 5-inch diameter, tapping every other turn in either case.

C₁, a variable feed-back condenser, should be of a reliable make, such as illustrated in Figure 8, tested for breakdown at 500 volts, and having a maximum capacity of at least .001 microfarads. The grid condenser, C₂, approximates .0015 mfd. and may be built up of six sheets of tinfoil, each having an active area of two square inches, and separated by a mica dielectric a hundredth of an inch thick. (By "active area" is meant the overlapping portion of each plate, exclusive of the remainder which merely acts as a lead.) C₃ is the filter condenser previously described, while C₄ and C₅ are paper-foil condensers of the type shunted across spark-coil vibrators. The purpose of these last is to reduce the positive reactance of the transformer secondary to radio-frequency variations of the plate current which must pass through half of it in going from the generator to filament.

R₁ is a non-inductive grid-leak of 5000 ohms resistance. Radiation ammeter A may be of

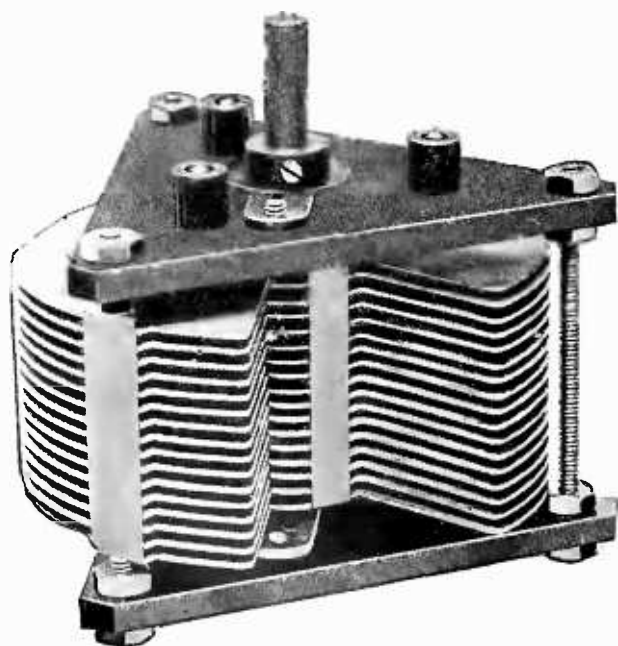

FIG. 8

A strongly built receiving condenser may sometimes be used for low-power transmitting

the hot-wire or thermo-couple type, preferably the latter, reading from zero to one ampere. X_1 and X_2 are the filter reactances (choke-coils). The rheostat R_2 (also R_3 in the modulating circuit) is especially designed for transmitting tubes and will carry 2.5 amperes. The resistance of these rheostats is just more than sufficient to lower the voltage of the transformer secondary to the filament operating potential, and will therefore be used with most of the resistance "in."

Tuning the set consists of adjusting the plate, antenna and condenser taps on L , and the capacity of C_1 . From 215 meters upward, the circuit oscillates best with the upper side of C_1 connected directly to the lower terminal of the inductance. However, it is possible to QSY (shift wave) unusually low, and still maintain good radiation, by tapping C_1 on the tenth turn of L as shown in Figure 5; then, by adjusting the antenna tap above the tenth turn, the wave may be brought down to well under 200 meters. On a similar set, radiation at three different wavelengths, 178, 192 and 200 meters was .3, .4, and .5 amperes respectively!

Radiation will drop when the modulating loop is in the circuit, and all adjustments should be made with it disconnected. Straight C.W. may be transmitted by including a key in the ground lead.

THE HEISING MODULATOR

THE "constant current" system of modulation may be added to any oscillating circuit with little, if any, modification. The bulb should be the same make or size as the oscillator, or, more accurately, the tube or tubes in the modulating circuit must be capable of dissipating an equal amount of energy as quickly as the bulbs in the oscillating circuit. If the oscillator is a single 5-watt Radiotron, the modulator should be of the same power. If two UV 202's are employed as oscillators, they may be modulated by a single 10-watt tube, and vice versa.

MT is a standard modulation transformer, which had best be purchased, though a Ford spark-coil often gives satisfactory results. The key and the single-pole double-throw switch for changing from microphone to buzzer are of conventional design. The 6-volt battery may be four dry cells or the receiving storage battery.

In adjusting the modulating circuit it is best to include in the common lead to the plates, a

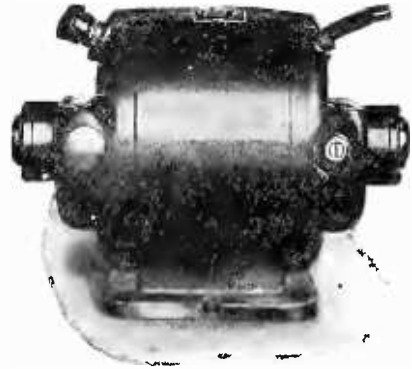

FIG. 9
A dynamotor used for
low-power transmission

milli-ammeter reading from 0 to 250. Guided by the plate meter readings, battery C (*negative to the grid*) is adjusted until the modulating tube draws the same current as the oscillator—in the neighborhood of 50 milli-amperes. The plate current varies inversely with the potential of the C battery, and as it need only approximate that of the first tube, a single 22.5 volt block-type battery will generally suffice.

In the Heising system, the chokes X_1 and X_2 act not merely as a filter, but also as a necessary part of the constant current system, by maintaining a current of unvarying strength through the ammeter A_1 . Thus the sum of the plate currents of the two bulbs is always the same, regardless of individual fluctuations; and it is due to this constancy that modulation is effected. As words are spoken into the microphone, the grid charge of bulb two is varied with each voice vibration, and, necessarily, the modulator space current. Assume that at a certain instant the constant plate current through meter A' of 110 milli-amperes, is equally divided between the two circuits, each tube drawing 55. At the next instant, with a different sound vibration, the space current of the modulator drops to 45 milli-amperes, and due to the choke maintaining the aggregate space current, 65 milli-amperes will be forced through the oscillator (45 plus 65 = 110) with a proportionately greater output. When the modulator plate current drops, the effect is reversed, the oscillating output always varying in perfect accordance with the sound.

The Heising system (which is used by practically all broadcasting stations), modulates perhaps twice the power controlled by the absorption method, and with the correct adjustments gives a permanently high quality of speech.

Avoiding the Jam in Southern California

By F. W. CHRISTIAN

WITH fifteen broadcasting stations in active service within twenty-five miles of Los Angeles, and only one wavelength to operate on, the question naturally arose, recently, as to who should have the best hours, conceded by all to be from 12 noon until 9 P. M. There are more people listening-in between 7 and 10 P. M. than at any other time, and the problem was to select stations having the best modulation and entertainment for these periods. Here, however, one difficulty presented itself: each broadcaster thought his programme was the best and that he had the best instrument.

Finally an association was formed composed of the managers of stations in and near Los Angeles and the president of the amateurs' association, who was elected president also of the broadcasters. Only one man from each station was to have a vote. They met, and have continued to meet once a month to allot hours to the various stations.

A percentage scheme was worked out whereby each station was voted on by the other members and rated, character of programme counting 50%, audibility 30%, and quality of modulation 20%. Then various stations were put up one by one and voted on conscientiously, each man stating what percentage of each of the three points the station was entitled to. After an average had been taken, the stations were classified according to the order of their total percentage of efficiency. The first half in rank were designated as class A and the other half as class B stations. The stations were next allowed to take their choice of hours, according to their rank in the percentage list, the A stations having double the time of the B stations. All A stations had an equal amount of time, as did all B stations. The schedule was to take effect the first of each month. Thus if a station in class A should fall down, either in the character of its entertainment or its modulation, it would be voted back into class B the next month. On the other hand, if a station in class B should surpass the A stations in the

three requirements, the people would be given a chance to hear more of its entertainment. This method resulted in assurance to the public that they would hear the best programme available at the times they would be most likely to listen-in.

As an example, during the month of June, a new station in Los Angeles, which had been heard only a few times, was put in the lower class. For the month of July, however, this station was voted second best of all the stations and put in class A, while one of the A rank of which the power had been increased but the modulation ruined, was voted back into class B. Had there been no changes made, the people would have been compelled to hear this station just when the best quality would be desired. As it was, however, they were allowed to hear a fine entertainment, sent out through a low-powered, well-modulated radiophone. Thus the people had an absolute guarantee of good entertainment and there was little or no interference under this scheme. But, as might be supposed, some of the managers were dissatisfied and demanded a change of methods.

At the July meeting, a set of by-laws was proposed, and, after much discussion, was finally granted a period of trial. It called for actual tests to be made at remote points by a Bureau of Standards instrument, and the stations reclassified according to these tests.

This arrangement was tried out during the month of August. Tests were made at various points by a committee which proceeded to reclassify the broadcasters on a basis of audibility, modulation and character of programme. There was some disagreement and dissatisfaction after the re-assignment of schedules because the two stations that were rated best took all the best hours, leaving no time for the others during the evening. This was changed at the August meeting, when the larger stations agreed to give up some of their time, allowing the smaller ones a chance to show during the evening, what they could do.

Then new difficulties arose. The stations classified as the best in the July-August tests

seemed to have fallen off in their programmes, sending mostly phonograph music. None of their transmitters were standardized products, and they seemed to have great trouble in maintaining good modulation. Commutator hums, ripples, blasting microphones, etc., were very troublesome. It was found that the by-laws called for a 90-day lapse of time before the results of a new classification would be felt. A station must give 30-days notice of its demand for reclassification, thirty days would be allowed for the classification committee to report, then another thirty days for the new classification to go into effect. This seemed to spell

doom for the radio listeners-in, until the new "Class B" licenses were announced by the Department of Commerce.

One newspaper, an automobile house, and a religious institute have applied for this license, which calls for rigid examination of the instruments used, a minimum power of 500 watts, and careful selection of programmes. The newspaper has completed the installation of a Western Electric Company 500-watt set and had its grand opening November 2nd. The others will also be ready soon. These three stations will operate independently of the Association and must divide the time equally.

Concerning My Invention—The Audion

By LEE DE FOREST

October
Twenty-fifth
1922.

EDITOR, RADIO BROADCAST,
Garden City, Long Island.

DEAR SIR:

My attention has recently been called to an article published in the RADIO BROADCAST by Professor J. H. Morecroft under the title "What Every One Should Know About Wireless and Its Makers." In this article I find mention of my invention of the Audion and several references to the Audion which are by no means in accord with the facts. I am persuaded that Professor Morecroft in no way intended to do an injustice to me or your readers, and will himself in all fairness welcome a brief statement on the genesis of the Audion.

From time to time the statement has appeared, as in the case of the Morecroft article, in effect that in my invention I contributed the grid to a rectifier or two-element vacuum tube, and thereby created the Audion or the three-electrode vacuum tube, the present heart and soul of radio communication. What could be more simple in the way of an explanation? What at the same time further from the truth and still further from a knowledge of the simple facts of radio principles?

Professor Morecroft says: "It seems strange that Fleming did not at once jump to the idea

of the Audion, but the history of science is full of just such occurrences—a worker on the point of making an important discovery, yet missing it by the merest chance."

Had Fleming thought of the grid, had he inserted it in the Edison Valve, he would have had exactly what he did have, a rectifier—but with a grid-shaped anode—nothing more. Had I come to this stage by the route Fleming followed, I should have done exactly as Fleming did—missed it exactly as he missed the Audion.

To recognize that the anode battery circuit is as essential a feature of the Audion as is the third electrode, that by virtue of this local energy alone is the Audion a relay device and therefore an amplifier of transcendent value, instead of a mere rectifier of received alternating current—seems such a simple proposition, so self-apparent, that I have always been at a loss to understand why any one should fail to grasp it. Yet such is the very common position of many writers: "The Audion is the Fleming valve with a third electrode." "Its inventor improved the Fleming valve merely by the addition of the grid." I doubt if such misleading stupidities were elsewhere ever preached in the history of the electrical art.

Add a third, or any number of electrodes to the Fleming valve and it remains the Fleming valve—a mere rectifier, possessing the utility of the rectifier and nothing more.

The evolution of the Audion patent claims marks, in a general way, the evolution of the Audion—first it was a gas effect in the open air, then in an enclosed vessel, then in an exhausted vessel, exhausted like an incandescent lamp—then to higher and higher degrees of vacuua (as early as 1912 I employed an X-ray vacuum) But always it was a relay. Always the “B” battery was employed. The control electrode idea even preceded the enclosed vessel. And never was the Audion “the Fleming valve with merely a grid added.”

Professor Morecroft continues: “The thing which he (De Forest) actually did, namely, the insertion of the third electrode into a Fleming valve, was a most wonderful contribution to the radio art.” It was not. Remember that a mere valve with three electrodes is still only a valve—with one electrode too many.

Unfortunately, prior to the year 1917, very little, indeed scarcely anything at all, appeared in radio history concerning the Audion art, although nearly a decade had elapsed since my first patents were granted on the Audion. It

was in this period of bitter commercial rivalry that certain British radio interests first saw fit to attempt to discredit an American invention and put forth the suggestion, altogether at variance with the truth, that an American had simply put another electrode in the two-electrode tube. There is no excuse, however, why, at this late day, such an untruth should persist in American radio history, above all, when the whole world is making use of the Audion in radio communication as well as in long distance wire telephony and the successors of these same English commercial rivals are now operating under the original De Forest Audion patent licenses. In fact, their entire radio system, outside of the generators and aeriels, is built around the three-electrode-anode-voltage vacuum tube.

Very truly yours,



Practical Pointers on Cabinet Wood-Finishing

By W. S. STANDIFORD

ELECTRICAL experimenters can make neat-looking cabinets, but often fall down in their finishing work. It is too bad to get so far along with the construction of a set and then omit those finishing touches that make it a pleasure to look at and to operate. As crudely finished apparatus is generally the result of a lack of knowledge of the processes and materials needed rather than to lack of interest or carelessness, a few practical pointers may prove helpful.

At the outset, it cannot be emphasized too strongly that a clean, smooth exterior is necessary in order to get a first-class finish, whether the wood is to be painted, enameled, oil-finished in natural-colored woods, or varnished. The first thing to do is to decide what kind of wood the box is to be made of, whether it is open- or close-grained, and also whether it contains any sap, as such conditions will make necessary different methods of working.

Open-grained woods include: Oak, ash, chestnut, walnut, mahogany, and butternut. These require fillers.

Close-grained woods include: Pine, cherry, maple, birch, cypress, whitewood, poplar, sycamore, beech, and redwood. These and others like them do not need fillers, but can be finished in natural colors or stained, as preferred. Five operations in wood finishing are needed: sandpapering, staining, filling, varnishing, and polishing.

First, plane the wood as smooth as possible. Then tack a piece of No. 00 sandpaper on a level block of wood and rub with the grain, using moderate pressure and taking care when working near the edges, not to round them. Wipe all dust from the surface with a cloth; if any remains, rough spots in the finished product will result. Staining comes next, if pine or poplar are used to imitate the appearance of more costly woods. By using pine or poplar, radio cabinets can be made which will

look as if an expensive natural-colored wood were used. In wood finishing, much trouble in working will be avoided by the purchase of the *best* stains and materials obtainable. There are two kinds of stains on the market: water and oil stains, each having their good points. Oil stains are those in which the coloring pigment is dissolved in linseed oil or turpentine; water is the solvent for the other. As pine wood in some cases has more or less sap, this wood, after being colored with an oil- or water-stain when dry, should have two coats of white shellac varnish applied, each coat to be lightly sandpapered after drying.

This shellac coating effectually keeps any sap from discoloring the finish; varnishing, rubbing down, and polishing can then follow. The best way to use water- or oil-stains is to apply them with a brush and then rub them into the wood with a piece of cheese-cloth. This distributes the color evenly and absorbs surplus moisture (which in the case of water-stains is apt to raise the grain of wood, thus making more sandpapering necessary) and also makes a uniform color tone. If the first application does not give as deep a color as is desired, give it another one. If you want to use an open-grain wood, such as mahogany or walnut, and use a stain to make it deeper in color, the pores will have to be filled after staining. Otherwise staining can be omitted; but the filling is necessary. Supposing that such a wood has been stained; get a paste filler of a color to match the stain as nearly as possible; put some filler on a small piece of cotton cloth and rub it on the wood. As soon as this filler has dried a little (don't let it get hard) continue to rub the surface until all pores have been filled up, rubbing off the surplus, the idea being to have nothing but the pores contain filler.

After it is dry and smooth, give it a coat of white shellac varnish. This should be rather thin, and may be diluted with alcohol if desired. All surplus varnish must be wiped off the brush before applying it to the surface, for if too thick a coating is applied, it will not

be clear enough to allow the stain to show. The first coat of shellac will take about three hours to dry, after which you should apply another one. Rub the dried surface with fine sandpaper until the wood is smooth. Don't rub it too hard or you will cut through the shellac. Varnishing comes next. Good brushes should be used as cheap ones are generally coarse and shed their bristles. The varnish must not be too cold as this prevents it from flowing freely. Have only enough varnish on the brush to give

a level coating when it is brushed across the grain. Finish off by rubbing lightly, *with the grain*, letting it dry thirty hours, or until thoroughly hard.

Purchase some FF grade pumice stone at a paint store; likewise a rubbing felt. Dip the latter into linseed

oil, then into pumice stone which will now adhere to the felt. Rub the varnished surface lightly along the grain. Continue this process until all small depressions have disappeared. This may be ascertained by looking diagonally over the surface when it is held to the light. All hollow places will now show as dark spots. The surplus pumice stone should be carefully removed with a soft cloth.

Give it another coating of varnish and let it dry, then repeat the operation with the pumice stone. The cabinet will have a dead, non-glossy finish. Those who prefer a shining polish can easily obtain it by dipping a piece of felt into linseed oil and into powdered rotten stone (to be bought at a paint store) and going over the surface in the same manner as with the pumice stone. A higher polish can be obtained on the last coat by giving it the rotten stone treatment, and then rubbing the hard varnish with a soft cloth dipped into linseed oil, using plenty of "elbow-grease" until a high polish is obtained. The surplus should be wiped off with a chamois skin. The above gives a durable finish; one that will not scar easily. If all the work has been done carefully, you will have a neat-looking cabinet that will be envied by your friends who have not learned polishing work, which is quite easy when you know how to do it.

During National Radio Week, December 23rd to 30th, special concerts and addresses will be put on by broadcasting stations throughout the country, and everyone will have a chance to hear exceptionally fine programmes. Get your set in shape well in advance, so that you will be able to reach out and provide entertainment for yourself and your friends from many miles away during these Christmas holidays.—THE EDITOR.

Western Electric Broadcasting Stations in the U. S.

A glance at this list and map may give you some data on stations you have been hearing. Most of these are class B stations, transmitting on 400 meters.

STATION NAME	INPUT TO ANTENNA IN WATTS	CALL SIGNAL	CLASS OF STATION
Detroit (Mich.) <i>News</i>	500.	WWJ	B
Detroit (Mich.) <i>Free Press</i>	500.	WCX	B
Kansas City (Mo.) <i>Star</i>	500.	WDAF	B
Atlanta (Ga.) <i>Journal</i>	500.	WSB	B
St. Louis (Mo.) <i>Post Dispatch</i>	500.	KSB	B
Rochester (N. Y.) <i>Democrat & Chronicle</i>	100.	WHAM	A
Louisville (Ky.) <i>Courier Journal</i>	500.	WHAS	A
L. Bamberger & Co., Newark, N. J.	500.	WOR	B
Amer. Tel. & Tel. Co., N. Y. City	500.	WBAY-2XY	B
Shepard Stores, Boston, Mass.	100.	WNAC	A
John Wanamaker, Philadelphia, Pa.	500.	WOO	B
Union Trust Co., Cleveland, Ohio	500.	WJAX	A
Palmer School, Davenport, Iowa	500.	WOC	B
Western Electric Co., New York	500.	WEAF-2XB	B
Sweeney Automobile School, K. C., Mo.	500.	WHB	B
Mo. State Marketing Bu., Jefferson C., Mo.	500.	WOS	A
Rensselaer Polytechnic Inst. Troy, N. Y.	500.	WHAZ	B
Round Hills Radio Corp., South Dartmouth, Mass.	100.	WMAF-1XV	A
W. S. Harris, Minneapolis, Minn.	500.	WLAG	A
Fort Worth (Texas) <i>Star Telegram</i>	500.	WBAP	B
Chicago <i>Daily News</i> , Chicago, Ill.	500.	WMAQ	A
Dallas (Texas) <i>News</i>	500.	WFAA	B
Gimbel Bros., Philadelphia, Pa.	500.	WIP	A
<i>Times Mirror</i> , Los Angeles, Cal.	500.	KHJ	B
Oregonian Pub. Co., Portland, Ore.	500.	KGW	B

Class A—operating on 360 meters.
B — " " 400 "

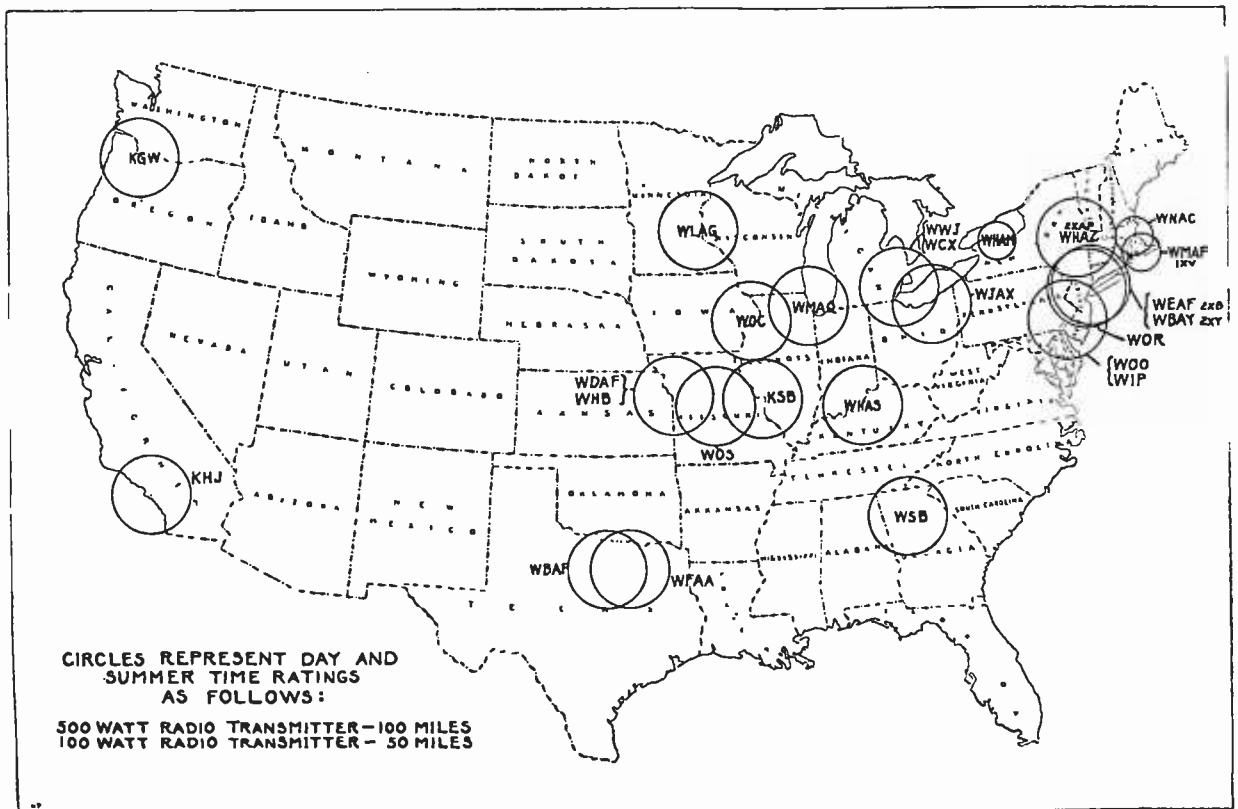

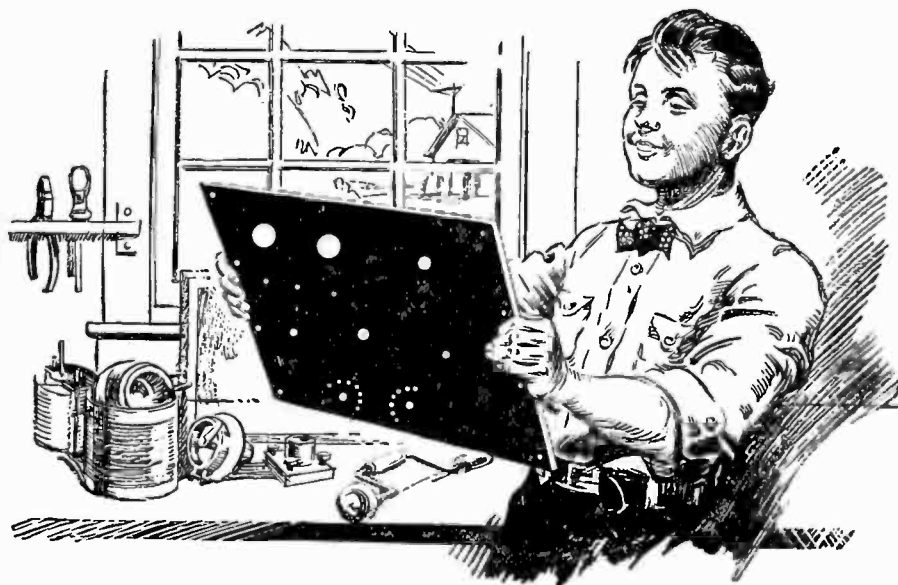

This Panel Will Improve Your Set

CONDENSITE CELORON

THE best panel made is none too good for your set. Dependable insulation is vital because it has a direct bearing upon the clearness and sensitivity of both transmission and reception.

Every thinking radio enthusiast certainly wants the highest type panel he can obtain and the surest way to get it is to insist upon Condensite Celoron.

This strong, handsome, jet-black material is not merely an insulating material—it is a radio insulation made to meet high voltages at radio frequencies. That is why it will give you greater resistivity and a higher dielectric strength than you will ever need.

Make your next panel of Condensite Celoron. It machines readily, engraves with clean cut characters and takes a beautiful polish or a rich dull mat surface.

An Opportunity for Radio Dealers

Condensite Celoron Radio Panels and Parts offer a clean cut opportunity to the dealer who is keen on building business on a quality basis. Write us to-day. Let us send you the facts. You'll be interested.

Diamond State Fibre Company

Bridgeport (near Philadelphia), Pa.

Branch Factory and Warehouse, Chicago.

Offices in principal cities

In Canada: Diamond State Fibre Co., Ltd., Toronto.

The Grid

QUESTIONS AND ANSWERS

The Grid is a Question and Answer Department maintained especially for the radio amateurs. Full answers will be given wherever possible. In answering questions, those of a like nature will be grouped together and answered by one article. Every effort will be made to keep the answers simple and direct, yet fully self-explanatory. Questions should be addressed to Editor, "The Grid," Radio Broadcast, Garden City, N. Y. The letter containing the questions should have the full name and address of the writer and also his station call letter, if he has one. Names, however, will not be published.

Technical Terms Used in This Month's Grid

Accumulator: A storage battery.

Zero-center meter: A direct-current meter having the zero at the middle of the dial, and reading to both right and left. In the case of a battery ammeter, one side will indicate the charging amperage and the other the rate of discharge.

Gassing: The "boiling" or excessive bubbling of a battery during the last period of charge.

Open circuit: Tested when the charging current is off, and no current other than that actuating the meter is being drawn from the battery.

Hydrometer: An instrument for measuring specific gravity.

Flux (in electricity): An energetic field of magnetic lines of force such as move the armature on a door-bell or the diaphragm of a telephone receiver.

Inductance: The property of a circuit which determines its ability to build up a flux. A coil of wire is also frequently referred to as an "inductance."

STORAGE BATTERY CHARGING

I have a 120-ampere-hour "A" battery. 110 volts D. C. is available.

How can I charge the battery?

L. A. H., LAINSBURG, MICHIGAN.

STORAGE batteries are very readily charged from 110 volts, direct current, by placing a resistance in series with the battery and line. This resistance should be of such a value that it will reduce the current flowing through the circuit to the amperage designated as the charging rate, which is generally specified on the name plate of the battery by the manufacturers. The charging rate varies with the capacity of the cells, from three or four amperes for the 40-ampere-hour accumulator, to ten or fifteen amperes and higher with the larger batteries. For a 120-ampere-hour battery, an 8-ampere charging rate should be maintained from 15 to 20 hours, depending on the original degree of discharge.

The most convenient form of resistance is probably the electric light bulb, and 50-watt Mazdas, or 16-candle power carbon lamps should be used, except in the case of large batteries where doubling the power of the lamps will halve the number. One 50-watt bulb should be used for each half ampere—or a 100-watt lamp for each ampere. Thus, charging a 120-ampere-hour battery, at an 8-ampere rate, will require 16 50-watt bulbs.

The lamp sockets, and at least two switches, should be mounted on a hardwood panel, which is most conveniently installed close to the battery. The necessary switches are the line switch with fuses, and the battery, double pole double throw, charge-discharge switch. Two additional switches which add to the utility of the panel and facilitate operation are indicated in the diagram, Figure 1. An ammeter of the automobile zero-centre type, reading up to fifteen amperes in both directions is also desirable.

Switch B makes it possible to halve the charging rate,

as should be done during the last two hours of charge, without unscrewing eight uncomfortably hot lamps. With switch A open, the filament battery is placed on "trickle charge," to which the battery should be occasionally subjected, and which will compensate for surface leakage during comparatively long periods of disuse. It must also be born in mind that, while it is theoretically possible to dissipate all of the energy put into the battery, some of the energy is not available for useful purposes, a fact that necessitates a slight overcharge which is most safely effected by frequently placing the battery on an overnight trickle charge.

Also, with the charge-discharge switch open, or in the discharge position, the "B" battery, up to an 80-volt potential, may be charged from the binding posts X and Y at the half-ampere rate. Charging of the "A" and "B" batteries must be accomplished separately, but either may be charged while the set is in operation, *if the receiver is of the inductively coupled type*, i. e., with no wired connection between the antenna-ground circuit and the audion. In all other hookups, the batteries must be disconnected from the set during charge, a precaution most conveniently accomplished by charge-discharge switches.

In charging, the positive of the line must be connected to the positive pole of the battery, so it will be probably necessary to test for polarity. Four methods are in general use, and are indicated in order of their simplicity:

1. By feeling for shock.
2. By an electro-chemical polarity indicator.
3. By a direct current, magnetic type voltmeter
4. By the decomposition of salted water.

In almost every case the negative of the 110-feed is grounded. Therefore if the fingers of one hand are placed on the positive wire, and those of the other hand grounded on the steam or water pipe, a *gentle* shock will be felt. Contrary to general supposition, a 110-volt shock through *dry hands* is very mild, and a pleasant sensation rather than otherwise.

No Wireless Receiving set complete without it



PALS AGAIN
Never a dull evening in the home



No matter what the weather, you can enjoy the world's best music and news in the comfort and privacy of your home by using

MAGNAVOX
Radio
The Reproducer Supreme



When you purchase a Magnavox product you possess an instrument of the highest quality and service.

R-2 Magnavox Radio with 18-inch horn: this instrument is intended for those who wish the utmost in amplifying power; for large audiences, dance halls, etc. \$85.00

R-3 Magnavox Radio with 14-inch horn: the ideal instrument for use in homes, offices, amateur stations, etc. \$45.00

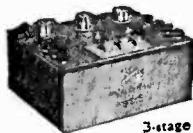

3-stage

Model C Magnavox Power Amplifier insures getting the largest possible power input for your Magnavox Radio.
2 stage AC2-C . \$80.00
3-stage AC3-C . 110.00

Magnavox products may be had of good dealers everywhere. Illustrated booklet on request.

IT was in 1913 that the Magnavox electro-dynamic receiver made its first public demonstration, when telephone communication was held by means of it between Denver and New York—a revolutionary advance.

The rise in radio broadcasting found Magnavox apparatus already fully developed to make possible the reproduction of wireless music and speech in ample volume and marvelous clearness.

The facilities and experience back of each piece of equipment bearing the Magnavox trade mark are unrivaled anywhere in the world.

THE MAGNAVOX COMPANY

Home Office and Factory: Oakland, California
New York Office: 370 Seventh Avenue

Chemical polarity indicators are made in the form of armored glass tubes with terminals at each end. They contain a solution of starch and iodide of potassium which, decomposed by the passage of current, turns blue at the plus terminal.

Direct current voltmeters, with a magnetic, motor movement, have the terminals marked + (positive) and - (negative). If they are improperly connected (the positive lead to the minus post) the needle will swing to the left of zero; and a reading will only be obtained when connected positive to plus and negative to minus.

Wires carrying direct current, carefully separated in slightly salty water, will decompose the solution into its composite gases, Hydrogen and Oxygen. As water, H₂O, contains twice the amount of hydrogen (H₂) as of oxygen (O), the greater number of the hydrogen bubbles, which rise about the negative wire, indicate its polarity.

A battery should be placed on charge when its voltage, under a normal load, drops to 1.7, and it may be considered fully charged when the current has been kept on for an hour and a half after it commences gassing freely, if, during that period, there is no further rise in either the voltage or the specific gravity. The voltage during the last hours of charge will vary, depending on the age of the battery from 2.3 to 2.5 (on open circuit 2.2 volts) and the specific gravity from 1.280 to 1.300.

The specific gravity is the density or weight of one cubic centimeter of the electrolyte as compared with a similar quantity of chemically pure water. Sulphuric acid, of which the electrolyte is a twenty to twenty-five per cent. solution, is heavier than water, and during discharge some of it is absorbed into the plates, leaving the solution so much lighter. Charging is fundamentally a process of

forcing the acid out of the plates back into the solution, boosting up the specific gravity until the electrolyte regains every bit of its original strength. Hence, the only loss in the electrolyte is occasioned by the evaporation of water, which should be replenished (preferably distilled water) from time to time, maintaining the level of the solution one half to three quarters of an inch above the top of the plates. All changes in the electrolyte should be made in accordance with hydrometer readings, and only when the battery is fully charged.

Directions for the maintenance and care of different batteries are furnished by their respective manufacturers, and the experimenter should be thoroughly familiar with those covering his own battery.

VACUUM TUBES

What are the structural differences that make some vacuum tubes more suitable for radio frequency amplification, and others suitable for audio-frequency amplification and for detection?

—G. K., NEW LONDON, CONN.

THE only structural differences between types of modern vacuum tubes are those differentiating power or transmitting tubes from low power receiving bulbs. The transmitting bulbs have larger elements in proportion to the amount of energy they control, with different spacing suited to the requirements of insulation, and a higher vacuum.

In low capacity receiving tubes (capacity in the condenser sense), which include practically all the present day bulbs used for detection and amplification, the structural details may be identical, whether used for radio or audio-frequency amplification. However, until a few years ago, when tube construction became a more exact science, all tubes possessed a comparatively high capacity, due principally to the design and placing of the elements and leads. As the tubes were imperfectly evacuated, it is also possible that the presence of air or gas, with the corresponding dielectric constant, may have increased this capacity.

Due to this condenser effect, pre-war tubes could not be used for radio frequency transformer amplification on short waves. The capacity of a tube is virtually shunted across the primary of the amplifying transformer, which, if the transformer is of the radio frequency type, will boost the wave, as will any condenser across an inductance. Thus, on short waves, where the addition of even small capacities has a comparatively large effect on wavelength, radio-frequency amplification was very inefficient, for little transference of energy could be effected on the few turns of wire to which the resonant transformer was limited.

As mentioned above, there is to-day no structural difference between radio-frequency and audio-frequency amplifying bulbs. However, detector tubes have a lower vacuum than those designed for amplification.

Several effects combine to make the low-vacuum audion more sensitive to weak grid impulses, and they are therefore more

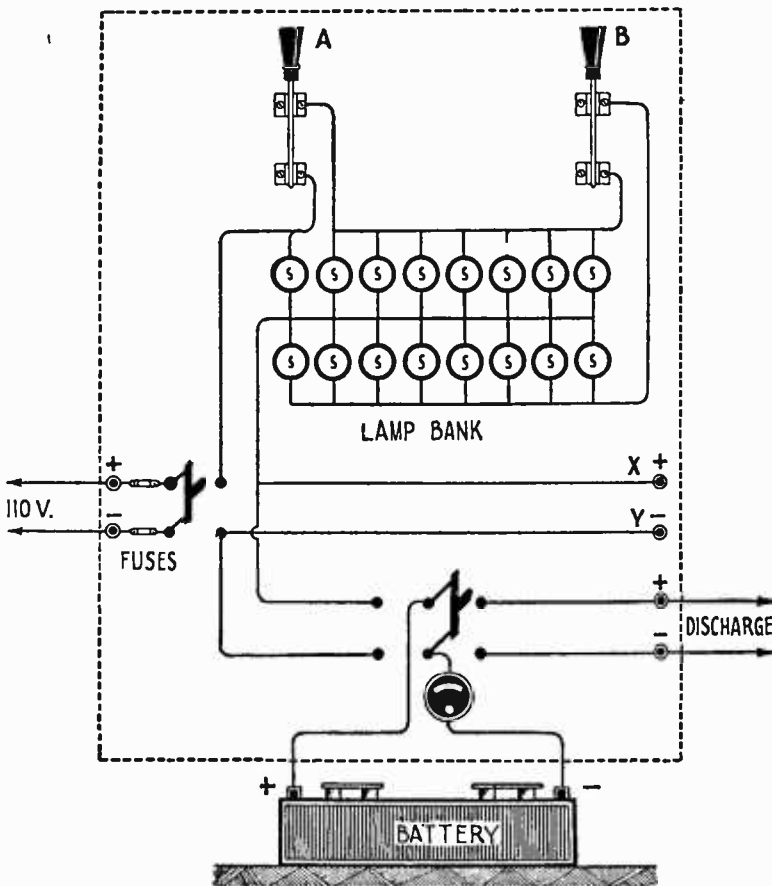

FIG. 1



Find this out

before you choose your radio frequency transformer

DOES it have marked depressions and peaks in its amplification range curve between 200 and 600 meters (indicating absence of amplification at the depressions)—or does it keep the amplification range curve uniform with its maximum efficiency around 360 meters—the place you need it most.

A test

THE two charts above tell a graphic story of tests made on radio frequency transformers in the laboratories of a well known concern. The chart at the left plots the amplification range curve of 12 Acme R-2's taken from stock. The chart at the right represents a composite plot of the curves of 6 ordinary types of different makes taken from stock. The superiority of the Acme R-2 is self-evident. Note its steadily increasing amplification curve with its maximum at 360 meters—just where it is most needed.

Getting greater distances

EQUALLY important is the greater distances over which you can get broadcasting when using the

Acme R-2. The R-2 used in a radio frequency amplifier builds up wave energy before passing it on to the detector. You hear signals that would ordinarily be inaudible. Even the simplest and most elementary type of set, either vacuum tube or crystal receiver type, will have its range tremendously increased when the Acme R-2 is employed in conjunction with a vacuum tube.



Acme R-2 Radio Frequency Amplifying Transformer. Price \$5. (East of Rocky Mountains.)

The best method

TO SECURE maximum results over long distance use both Acme Radio and Acme Audio Frequency Transformers. This insures maximum sensitivity and intensity, quietness in operation and freedom from distortion. A small indoor antenna or loop may

be used and sufficient intensity obtained to operate the Acme Kleerspeaker, providing perfect entertainment for a roomful of people.

You can get these and all other Acme Products at radio, electrical and many hardware stores. Write for booklet R-2 showing proper hook-ups and other information.

THE ACME APPARATUS COMPANY, Cambridge, Mass., U. S. A.
New York, 1270 Broadway

Pioneer transformer and radio engineers and manufacturers

ACME ~ for amplification

efficient in the original detection of signals. However, in succeeding steps of amplification, the impulses become stronger and stronger, and are capable of controlling a more powerful stream of electrons, or plate current, than was possible before, due to the inertia of the electron. (Inertia is a quality possessed by everything having mass, which resists any attempt to vary its relative state of motion.) The idea will be made more clear by analogy. It is an easy matter for a ball player to catch a baseball traveling fifty feet a second, but it would require a giant (no pun intended), comparable to a *larger grid impulse*, to control or stop a cannon ball moving at the same velocity! Thus a higher plate potential, which in part determines the strength of the electron flow, may be applied to the plates of successive steps of amplification, with a correspondingly greater response in the receivers or loud speaker.

Working back to the differentiation between detector and amplifying tubes, it is necessary to evacuate the bulb more completely when a heavier current is to be passed through it, owing to the fact that the partly gaseous content of a low-vacuum tube would be ionized by the electron stream. Ionization is the breaking up of the atoms of gas into their component positive and negative charges, a condition which is indicated by a blue or purple haze surrounding the elements of the tube, and which greatly affects the negative charges, electrons, given off by the filament, generally rendering the tube inoperative.

A very interesting example of ionization in a partial vacuum is the northern lights or Aurora Borealis. This phenomenon is caused by the passage of electrons thrown off by the sun, through the rarified upper strata of the polar atmosphere, where they are apparently concentrated by the earth's magnetism.

SUPPLEMENTAL LIST OF BROADCASTING STATIONS IN THE UNITED STATES FROM OCTOBER 6
TO NOVEMBER 22 INCLUSIVE

CALL SIGNAL	OPERATED AND CONTROLLED BY	LOCATION	WAVE LENGTH
KFCK	Colorado Springs Radio Co.	Colorado Springs, Colo.	360
KFDC	Radio Supply Co.	Spokane, Wash.	360
KFED	Billings Polytechnic Institute	Polytechnic, Mont.	360
KFFA	Dr. R. O. Shelton	San Diego, Calif.	360
KFGH	Leland Stanford University	Stanford University, Calif.	360
KYQ	Electric Shop	Honolulu, Hawaii	360
WNAQ	Charleston Radio Electric Co.	Charleston, S. C.	360
WNAV	People's Telep. & Teleg. Co.	Knoxville, Tenn.	360
WNAW	Peninsular Radio Club	Fort Monroe, Va.	360
WNAX	Dakota Radio Apparatus Co.	Yankton, S. Dak.	360
WNAV	Ship Owners Radio Service	Baltimore, Md.	360
WOAF	Tyler Commercial College	Tyler, Tex.	360
WOAH	Palmetto Radio Corp.	Charleston, S. C.	360
WOAJ	Ervins Electrical Co.	Parsons, Kans.	360
WOAK	Collins Hardware Co.	Frankfort, Ky.	360
WOAL	William E. Woods	Webster Groves, Mo.	360
WOAM	Arthur F. Breisch (temporary-1 day)	Bethlehem, Pa.	360
WOAN	Vaughn Conservatory of Music	Lawrenceburg, Tenn.	360
WOAO	Lyradion Mfg. Co.	Mishawaka, Ind.	360
WPAC	Donaldson Radio Co.	Okmulgee, Okla.	360
WPAD	W. A. Wieboldt & Co.	Chicago, Ill.	360
WPAL	Superior Radio & Telep. Equipment Co.	Columbus, Ohio	360
WPAM	Auerbach & Guettel	Topeka, Kans.	360
WRAA	Rice Institute	Houston, Tex.	360
WRAY	Radio Sales Corp.	Scranton, Pa.	360
WTAC	Penn. Traffic Co.	Johnstown, Pa.	360
WTAU	Ruegg Battery & Electric Co.	Tecumseh, Nebr.	360

What Would You Like to Have in Radio Broadcast ?

The editors would be pleased to hear from readers of the magazine on the following (or other) topics:

1. *The kind of article, or diagram, or explanation, or improvement you would like to see in RADIO BROADCAST.*

2. *What has interested you most, and what least, in the numbers you have read so far.*