

Popular Radio

JULY · AUGUST · 1927 *

25¢

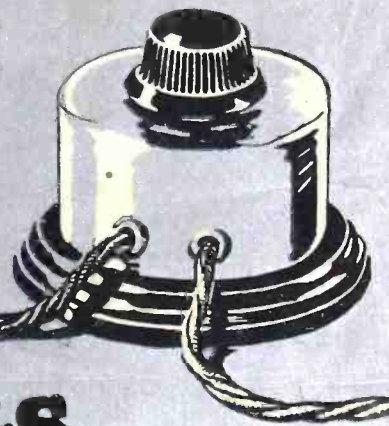

THE NEW 1928 MODELS
of RADIO RECEIVERS · LOUDSPEAKERS
and **ACCESSORIES**

put clear glass power tubes

*in every
socket*

*"A" batteries last
twice as long with
Z-P-201-A
power tubes*



WHAT you want most in radio is smooth, well-rounded tones with just enough volume to make reproduction *real*.

The new $\frac{1}{4}$ amp. oxide filament ZP 201 A all-socket Power Tubes now contribute this missing quality to radio. ZP 201 A power tubes take just enough current from your battery to assure smoothness of tone. Differing from the majority of other tubes, there is no excess—no "crowded" current active in ZP 201 A's to set up the blasting microphonic noises that distort true tone and

give volume an artificial rasp. ZP 201 A's in every socket—*installed without re-wiring*—give you music rich and clear, with as much power as you'll ever need.

The extremely conservative operating characteristics of ZP 201 A power tubes effect an appreciable economy in "A" power—reduces recharge bother and expense. And through elimination of magnesium coating, they perform at topmost efficiency . . . actually improving with service.

*A better, longer life power tube at only \$2.50 each.
Ask for a demonstration at your nearest dealer.*

ZETKA LABORATORIES, Inc., 73 Winthrop St., Newark, N. J.

ZETKA
The Clear Glass Tube

Presenting

a NEW

BROWNING-DRAKE

MODEL 7-A

SINGLE DIAL SEVEN TUBES
 COMPLETELY SHIELDED
 ILLUMINATED DRUM CONTROL
 SUPER-SELECTIVITY

AFTER several years of intensive research by G. H. Browning and Dr. F. H. Drake, the laboratories of the Browning-Drake Corporation have brought to commercial form an entirely new conception of the world-famous Browning-Drake receiver.

Ability to cut through the strongest local interference, and remarkable distance performance, even superior to previous accomplishments, give this new receiver an unmistakable appeal, although Browning-Drake receivers have a record of seven successive nights of transcontinental reception. The first Browning-Drake to use more than five tubes, this new receiver embodies many mechanical refinements, including complete shielding and a highly efficient and novel tuning drive system.

As the culmination of nearly five years of study and progress, and backed by the reputation of the Browning-Drake Corporation, this receiver, we believe, will occupy a paramount position in radio this year. High grade dealers throughout the country are prepared to offer several models of these new Browning-Drake sets, as well as the official Browning-Drake kit for home assembly, which has won wide-spread popularity.

Every fan knows Browning-Drake. Thousands own the factory-built receivers. And more fans are building the official Browning-Drake kit sets than any other type of kit assembly.

DEALERS: Browning-Drake now offers a complete line of receivers and kit parts. Sales of Browning-Drake parts during the past season were more than twice those of any other. Inquiries will receive prompt attention.

BROWNING-DRAKE CORPORATION
 CAMBRIDGE MASS.

BROWNING-DRAKE
 **RADIO** 

Popular Radio



FOUNDED 1911

VOLUME XII

July-August, 1927

NUMBER 1-2

CONTENTS

(Cover design by Frank B. Masters)

- The Wedding of the Radio Receiver
and the Talking Machine
FRONTISPIECE.....PAGE 10
- The New Prospects of
Transmitting Power by Radio
Will power be transmitted some day by means of
luminous beams of air made conductive by radio
waves? Here are some interesting speculations in
this new field of radio science
By Thomas Elway.....PAGE 11
- How to Add the
New Radio Amplification Units
to Your Phonograph
Here, at last, is an electrical device by means of
which you can give that old phonograph a tonal
quality and range equal to the best radio set
By Laurence M. Cockaday....PAGE 14
- How to Assemble the New Unitune Receiver
A receiver designed with the idea of simplicity and
low cost—the needs of the average listener
By Joseph Calcaterra.....PAGE 18
- The New "Exponential Horn"
Mathematical theories of sound have given radio
this latest method of lifelike reproduction
By David Lay.....PAGE 22
- A New Amplifier for Your Old Set
How to build an amplifier that employs resistance
and transformer coupling
By the Technical Staff.....PAGE 25
- The New 1928 Models in Radio Receivers
Advance information to the readers of POPULAR
RADIO on what will be offered in the radio market
for the next year
By the Technical Staff.....PAGE 28
- What's New in Radio
By the Technical Staff.....PAGE 34
- The Latest Radio Valves
The new valves mark one of the most distinct
advances that radio has made in its history. Here
is valuable information for both the fan and the
experimenter
By the Technical Staff.....PAGE 42
- A New Kink for Keeping Your Log-Book
By W. Penn Lukens.....PAGE 52
- How to Build the Capacidyne Receiver
Details for building a receiver that embodies new
ideas in high-frequency amplification
By Herbert Snead.....PAGE 54
- The Coming of the New LC-28 Receiver
PAGE 58

DEPARTMENTS

- With the Experimenters.....S. Gordon Taylor..... 60
- In the World's Laboratories....E. E. Free..... 62
- How the New Television Works Radio Waves Make New Chemistry Possible
What Noises Annoy? Noises from Northern Lights
- Star Program Features of the Month..... 64
- Broadcast Listener.....Raymond Francis Yates.... 82
- Broadcasts..... 88
- The Beginner in Radio.....Armstrong Perry..... 94

VOLUME XII

July-August, 1927

NUMBER 1-2

Published monthly by Popular Radio, Inc., 627 West 43rd St., New York, N. Y.; telephone number, Chickering 1906; Douglas H. Cooke, President and Treasurer; Kendall Banning, Vice-President; Laurence M. Cockaday, Secretary; Emma A. Harm, Asst. Treasurer. Price, 25 cents a copy; subscription, \$3.00 a year in the U. S., Canada and all countries within the domestic postal zone; elsewhere, \$3.50 a year, payable in advance. The International News Company, Ltd., No. 5 Bream's Bldg., London, E. C. 4, sole distributors in England. Entered as second-class matter April 7, 1922, at the Post Office at New York, N. Y., under the act of March 3, 1879. Additional entry at Jamaica, L. I., N. Y. Copyright 1927, and title registered as a trade-mark by Popular Radio, Inc. Copyright in Great Britain by Popular Radio, Inc., 6 Henrietta St., Covent Garden, W. C., London, England. For advertising rates, address Popular Radio, Inc., 627 West 43rd St., New York; or 225 North Michigan Ave., Chicago. Printed in U. S. A.

LAURENCE M. COCKADAY, Technical Editor

KENDALL BANNING, Editor

E. E. FREE, Ph.D., Contributing Editor

The True Magic of Music From Your Radio and Phonograph With These New Alden Devices

Amazing New Invention Makes it Possible to Obtain Radio Quality and Realism of Radio From Phonograph Records

Any radio engineer will admit that the improvements that have been made in radio reproduction during the past three years have been confined largely to audio-frequency amplifiers. The set of yesterday—of 1925-26—is antiquated, not because of its sensitivity or selectivity but because its audio-frequency apparatus *does not pass all the frequencies of the musical scale*. The mellow and rich low notes are practically absent and the absence of these frequencies gives to the music a colorless, nasal nature.

Any Set Modernized With Truphonic Amplification

Through the development of the marvelous Alden Truphonic Amplifier, an amplifier based on the very latest engineering discoveries, any radio set, *regardless of its age or manufacture*, may be brought up to the 1928 standard of reproduction through the simple expedient of making a few connections. For one-twentieth of the price of a new receiver, any novice, regardless of his experience in radio, can bring his old receiver to a point of audio-frequency efficiency where it will match and even surpass many of the high-priced sets of today. Music with a quality never before believed attainable is made instantly available through the quick and convenient attachment of an Alden Truphonic Amplifier.

Perfect Realism With Truphonic

A Truphonic Amplifier is simply this: A small, compact instrument which, when attached to your receiver, changes entirely the amplification of your set. As if by magic, it brings out the true musical qualities that have heretofore been distorted by old-fashioned and hopelessly antiquated audio-frequency systems. A Truphonic Amplifier also has the decided advantage that for those who want exceptional volume with the same pure quality of reproduction, may have it by the simple addition of a power tube. No other changes are necessary, no additional "A" or "B" battery being required.

The Wedding of the Phonograph and the Radio

Through the use of the Alden Truphonic Amplifier and the new Alden electrical phonograph reproducer, the wedding of the phonograph and the radio has been successfully brought about. Using these two devices, it is possible for the radio fan, for the first time, to enjoy phonograph concerts. The Alden electrical phonograph reproducer is attached immediately to any phonograph, regardless of its type or age. This device converts the delicately recorded impressions on the record into minute electrical currents which are perfectly amplified through the Truphonic unit. Thus, by a quick and simple change, the radio fan may use his radio or his phonograph.

A Matchless Combination

These two new Alden devices make of any phonograph a reproducer equivalent to the high-priced electrical phonographs being sold at the present time. For a few dollars the

owner of an old radio receiver and an old phonograph may enjoy this matchless combination and the new thrill of true musical reproduction. By the addition of these units, you not only bring your radio set up to date, but you bring your phonograph up to the new standard of electrical reproduction along with it.

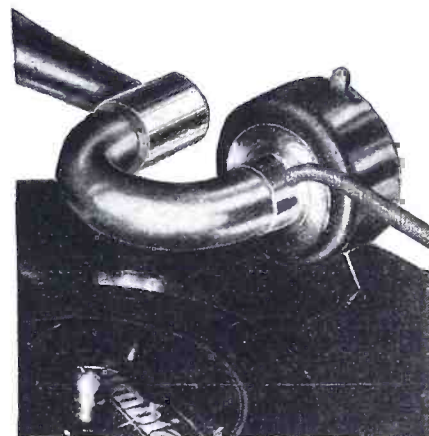

The Alden Electrical Phonograph Reproducer

The Alden unit is attached to any phonograph by a simple twist of the wrist, converting the instrument at once into a fine electrical reproducer of music. Although best results are had when used with the Alden Truphonic Amplifier, the unit may be permanently attached to any standard radio receiver by making a few simple, quick connections.

Price Complete with cord **\$10.00**

No. Other Phonograph Unit Has These Features

The Alden electrical phonograph unit is a masterpiece of acoustical engineering, having features that cannot be claimed by any other device of its kind. Nothing in a phonograph record eludes its searching needle. These new features make possible a realism of reproduction that is perfectly amazing.

The Alden unit requires nothing from a phonograph but a turn-table. It replaces the old sound box and may be attached in a twinkling of an eye. Embodied with the Alden unit, there is a volume control which makes possible music from a whisper to the full blast of a jazz band. There is also incorporated in this unit the new Alden feature that entirely eliminates all needle scratch. This needle-scratch filter is a distinct Alden feature and is not available on any other device of this nature.

The Alden Manufacturing Company makes many other radio necessities, and radio fans are invited to send for a complete catalog of sockets, dials, adaptors and loudspeakers.

ALDEN MANUFACTURING CO., SPRINGFIELD :: :: MASSACHUSETTS

The Alden Truphonic Amplifier

This unit comes complete in a beautifully finished case with labeled leads for ready attachment to any receiver, regardless of its type. A volume control is also provided, together with phone tip-jacks. Comes packed with full instructions for quick, easy attachment.

Price **\$25.00**

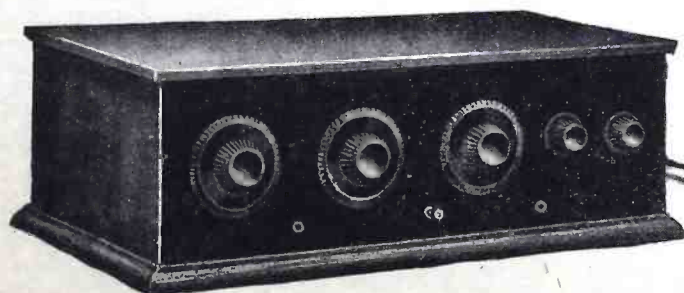

A PAGE WITH THE EDITOR

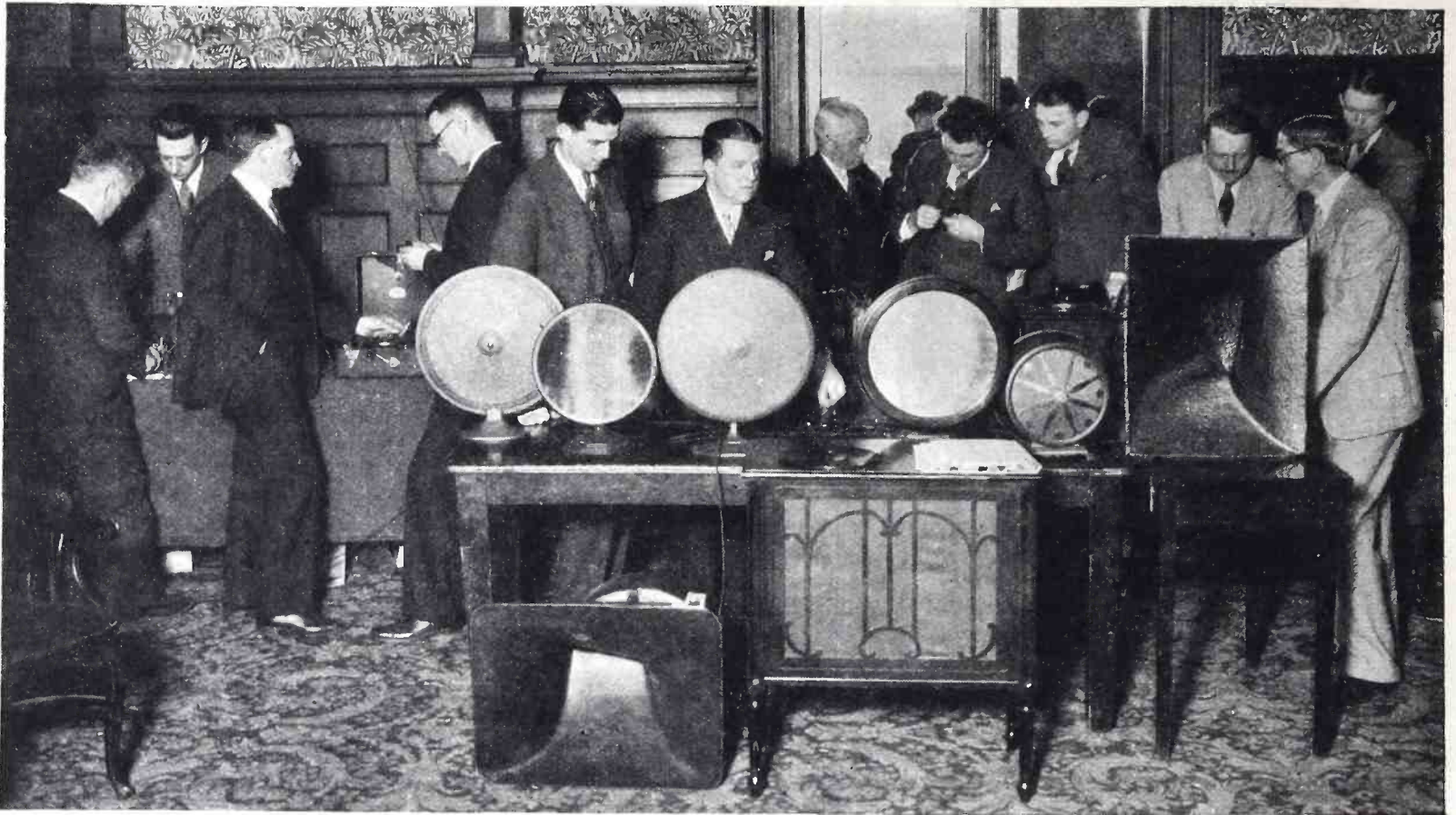

From a photograph made for POPULAR RADIO

A Practical Demonstration of the Electrical Pick-up Apparatus by the Technical Staff of POPULAR RADIO

The results of many months of experimental work in the radio laboratories of several manufacturers and inventors, supplemented by independent experimentation and research in the POPULAR RADIO LABORATORY, were revealed to various groups of engineers, manufacturers, radio and phonograph dealers and to the press in a series of highly successful demonstrations held at the Hotel Astor, New York, from May 20 to 24, inclusive. Some of the various electrical pick-up apparatus and loudspeakers that were here given an impressive demonstration are described on pages 14, 15, 16 and 17 of this issue.

THIS issue of POPULAR RADIO is devoted practically in its entirety to "what's new in radio."

* *

New applications and uses of radio apparatus, new types and models of radio receivers and accessories, new inventions in the field of radio, new demonstrations of radio phenomena—indeed, all that is of most timely interest to the radio experimenter and to the broadcast listener—are here presented to POPULAR RADIO readers, as evidence of what the coming season has in store for them.

* *

AND it may truthfully be said that never before in the history of radio have so many advances been made in a single season.

* *

ASIDE from the progress made in the development of apparatus, this coming 1928 season is marked by two inventions that are of outstanding significance:

* *

FIRST: the "electrical pick-up," by means of which radio apparatus can be successfully used for amplifying and

beautifying the reproduction of phonograph records, and;

* *

SECOND: the "exponential horn," which has been in the course of development for three years, but which is only just about to be placed at the disposal of the radio public.

* *

BOTH of these instruments are substantial contributions to the radio world—and the articles on pages 14-17 and 22-24 of this number contain authoritative information that has, until now, been guarded as confidential.

* *

AN excellent constructional article that tells exactly how to build one of the new exponential reproducer horns that give a quality of reproduction superior to practically any other type will be a feature of the coming month's issue of POPULAR RADIO. The details of size, shape and methods for building the forms to make the horn are clearly told for the special benefit of the radio experimenter who wants to get the best reproduction possible.

THE inauguration of the department "Star Program Features of the Month" in the April issue of POPULAR RADIO made an instant hit with our readers—if the large number of congratulatory letters are any criterion.

* *

HERE, for example, is a representative commentary concerning this new feature; it comes from Dr. R. du Valle Sarraga, of San Juan, Porto Rico:

* *

"I CONGRATULATE you for your innovation in publishing a list of star program features. You are rendering a distinct service to the public. The policy of the newspapers in omitting mention by name of these features, in order to increase their incomes through forced advertisements, has received a tremendous blow. The readers of POPULAR RADIO (and I am an old one), are willing to pay the subscription price more than ever, now that they have *real* programs."

Kendall Banning
Editor, POPULAR RADIO.

You Can't Carry a Load of Hay on a Wheelbarrow

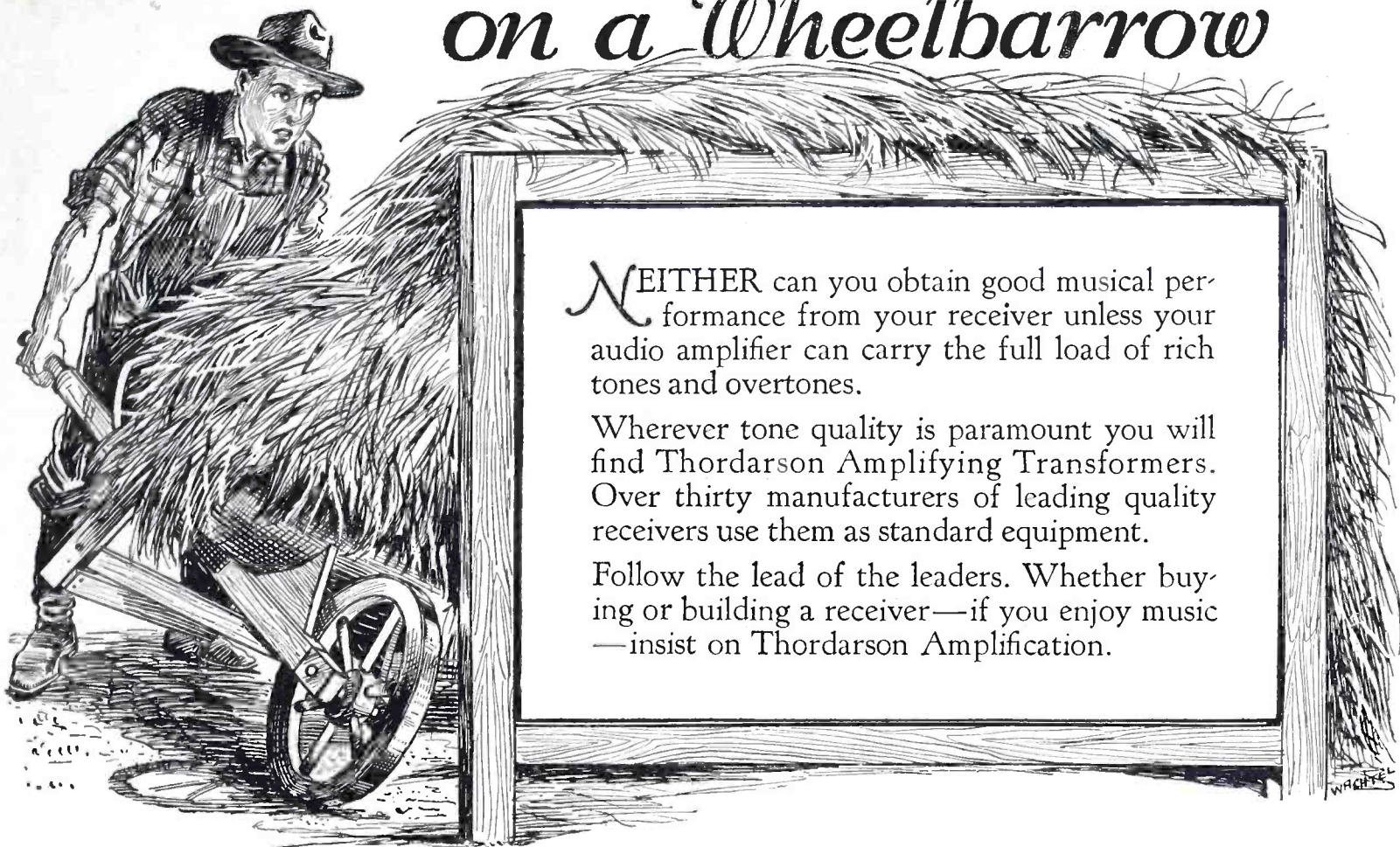

NEITHER can you obtain good musical performance from your receiver unless your audio amplifier can carry the full load of rich tones and overtones.

Wherever tone quality is paramount you will find Thordarson Amplifying Transformers. Over thirty manufacturers of leading quality receivers use them as standard equipment.

Follow the lead of the leaders. Whether buying or building a receiver—if you enjoy music—insist on Thordarson Amplification.

You don't have to be water boy to the

THORDARSON BATTERY CHARGER

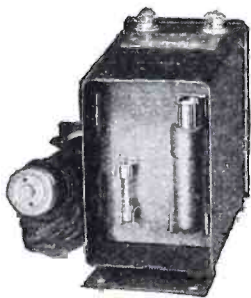

DRY—As dry as they make them. In fact the rectifying element is contained in a moisture-proof cartridge.

SILENT—No vibrating parts. Current is rectified through a patented electro-chemical process.

SAFE—There is no hazard to rugs or woodwork for there is no acid to spill. The tubes of the set are safe, even if turned on when the charger is in operation.

COMPACT—Fits into battery compartment easily. Only 2 $\frac{3}{4}$ " wide, 5 $\frac{3}{4}$ " long and 4 $\frac{3}{4}$ " high, overall.

EFFICIENT—This charger is always ready for service. No overhauling required. Rectifying element is held in spring clips and can be replaced in thirty seconds.

LONG LIFE—The Raytheon rectifying unit used in this charger is guaranteed by its manufacturer for 750 hours of full load operation, or approximately one year's service. The transformer will last indefinitely.

CHARGING RATE—2 amperes.

Price \$12⁵⁰



THORDARSON Power Compact

The only complete foundation unit for home-built power amplifiers. Contains power supply transformer, 2 30-henry choke coils, 2 buffer condensers and center tapped filament supply—all in one compound filled case. Supplied in two types: R-171 for Raytheon rectifier and UX-171 power tube, and R-210 for UX-216 B rectifier and UX-210 power tube.

Type R-171, \$15.00

Type R-210, 20.00



THORDARSON R-200 Amplifying Transformer

A transformer designed for the musical epicure. The large core of finest silicon steel and the high inductance primary winding combine to give this instrument the most perfect transformer reproduction obtainable. Has a remarkably wide range of amplification. Ideal for use with cone type speakers. Designed for both first and second stage amplification. Weight, 2 lbs.

Price \$8.00

THORDARSON

RADIO TRANSFORMERS

Supreme in Musical Performance!

THORDARSON ELECTRIC MANUFACTURING CO.
Transformer specialists since 1895
 WORLD'S OLDEST AND LARGEST EXCLUSIVE TRANSFORMER MAKERS
 Chicago, U.S.A.

The Warford Electrical Reproducer Literally Brings Your Favorite Phonograph Records to Life

Amazing Realism and Greater Volume Possible by the Use of Your Present Receiver



New Thrills from Your Set

The Warford Reproducer is a device that replaces the regular reproducer with which the talking machine is equipped and transmits and amplifies the record through the loud speaker of any radio set. The Warford unit may be easily and quickly attached to any phonograph or any standard radio receiver. Thus, for the first time, the thrilling realism of radio, the life-like reproduction of broadcasting, may be had from the phonograph record. For the first time it is possible to enjoy the full charm of Caruso's voice or the enchanting music of the New York Philharmonic.

The Renaissance of the Phonograph

The Warford Reproducer marks the Renaissance of the phonograph; music from the plaintive whisper of a violin to the full swell of a great organ, with a fidelity of tone never dreamed possible by acoustic engineers. Once more the phonograph becomes a source of potential entertainment through the employment of radio equipment.

Attached Instantly

The attachment of the Warford Reproducer requires no tools. For its installation, it is only necessary to remove the mechanical reproducer from the phonograph and replace it with the Warford electrical pick-up. The detector tube is removed from the radio receiving set and replaced by a special plug supplied with each Warford unit. No additional wires or equipment is required.

Eliminates Record Noise

This amazing new invention not only makes available radio reproduction from phonograph records, but also eliminates the annoying needle scratch and record noises. The age or manufacture of the phonograph used is immaterial, for the phonograph is called upon only to turn the record. Anyone owning a phonograph may now enjoy the marvel of electrically produced music as supplied by the newer phonograph creations.

Warford Reproducer for Phonographs

The Warford Unit comes supplied with volume control and 12 ft. cord for attachment to any radio receiver. Cord is equipped with special plug for quick change from radio to phonograph reproduction.

Price \$16.00

The New Warford Power Unit

The tone quality of your set is far more satisfactory when the tubes are not "pushed." But to afford adequate entertainment you are inclined to force the tubes, with the resulting distortion of tone. The further this is carried, the more unpleasant this lack of purity becomes, until many people believe that volume in itself is unpleasant.

Secret of Pure Tone

Yet the music from a good orchestra is equally pleasing whether you are nearby or in the far corners of an auditorium. This is because the tone is pure, and consequently, carries. The Warford Power Unit will give you this adequate volume to be heard at a distance, and, not only will not distort, but will purify and smoothe out the tone qualities of the set. It will make it possible to enjoy your set without the necessity of "huddling" in the immediate vicinity. In fact, it will give a volume that will fill an auditorium or hall and make it possible to dance by radio.

The WARFORD POWER UNIT operates off 120 volts A.C. 60 cycle current, and requires no batteries.

In addition it contains a "B" eliminator that will furnish adequate B current for your set.

This unit is designed to use interchangeably either Donle, R. C. A. or Cunningham Tubes.

It is furnished complete for use including both rectifier and power tubes. It has an 8 ft. cord and plug for connecting to house lighting circuit. Also has attached a 6 ft. cord fitted with tips for connection to speaker terminals on set. It is equipped with terminals for speaker connections and for "B" battery leads from set.

Modernize Your Old Set

The Warford Power Unit will bring your radio set up to date and make reproduction from your phonograph records still more enjoyable, bringing out the full, rich, round tone that you have heretofore been missing. The Warford Power Unit will make even the most modest radio set the equivalent in reproduction to the highest priced radio sets on the market today.

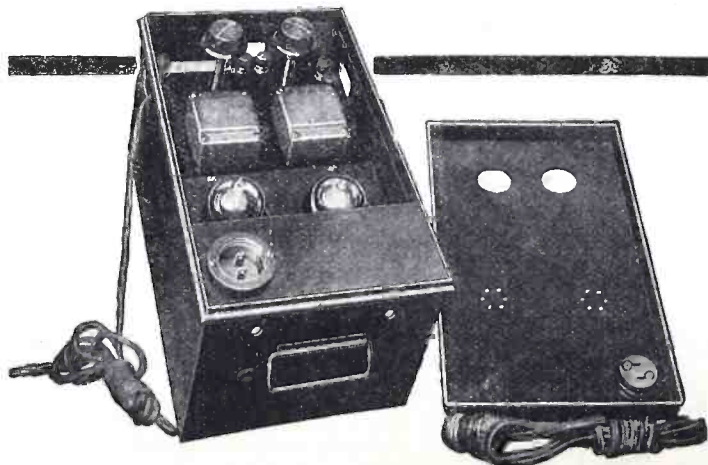

Warford Batteryless Power Amplifier and Eliminator

The Warford Power unit comes in a beautifully japanned metal case with 8 ft. cord, speaker extension and terminals ready for immediate attachment to 60 cycle lighting circuit. Uses either Donle, RCA, or Cunningham tubes, DR 4, UX 213 or CX 313 rectifier tubes or Donle DP 10, RCA, UX 210 or Cunningham CX 310 amplifier tubes.







Price \$54.50

Music lovers, dealers and jobbers are invited to write for further information and literature.

WARFORD ELECTRIC, Inc.
42 WHITEHALL STREET
NEW YORK, N. Y.



The RADIO ALMANAC

D.M.	D.W.	Notable Events and Anniversaries	August, 1927	 Full Moon, 12th Day 1 h. 5 m., evening, E
1	M.	1892: EDOUARD BRANLEY devised an appliance for detecting electromagnetic waves; it was known as a "coherer."		 Rather warm!
2	Tu.	1907: The first paid press dispatches were sent across the Atlantic by radio.	<i>Be sure that your lightning arrestor is in working order.</i>	
3	W.	1896: The first demonstration of directional wireless was given in England, with the aid of reflectors.	<i>Hot spells and thunderstorms will mar distance radio reception during this month.</i>	
4	Th.	1903: First International Radiotelegraphic Conference was held in Berlin. 1903: VALDEMAR POULSEN patented the improved arc oscillation generator, using a hydrocarbon atmosphere and a magnetic field.		
5	Fr.	 1924: Station KDKA established communication with the ship <i>Aetia</i> within 11 degrees of the North Pole, thus establishing a record for farthest north reception.		
6	Sa.	1904: The first commercial business to be transacted by radio was conducted through the United States Signal Corps station in Alaska.		
7	S	1923: Radio broadcasting was first used as a paid advertising medium. 1922: The Sainte Assize radio station was opened.	<i>Take in on church services.</i>	
8	M.	1915: During this month F. A. KOLSTER maintained experimental work on his radio compass, which was more effective than any used up to that period.		
9	Tu.	1837: The first patent for an electric telegraph was taken out by COOKE and WHEATSTONE, of London, and by SAMUEL F. S. MORSE, of the United States.		 Fair and warm.
10	W.	1888: RAYMOND A. HEISING, creator of the Heising system of modulating radio currents for radio broadcasting, was born.	<i>Begin now to plan for the new radio receiver.</i>	
11	Th.	1923: A Federal Court ruled that the broadcasting of the song, "Mother Machree," copyright by M. Whitman & Son, by Station WOR, owned by L. Bamberger & Co., constituted "a performance for profit."		
12	Fr.	 1847: DR. O'SHAUGHNESSY succeeded in passing intelligible signals without metallic conduction across a river 1,200 feet wide.		
13	Sa.	1912: An act was approved by the United States to license radio operators and transmitting stations.	<i>This is a good time to experiment with the new tubes.</i>	
14	S	1919: The first successful non-stop transatlantic flight of ALCOCK and BROWN, as well as the transatlantic flight of the British dirigible R34, pointed out the inestimable value of radio equipment in aviation work.		
15	M.	1904: The wireless telegraph act of Great Britain was passed.	<i>About this time a new crop of "wire-free static eliminators" will be encountered.</i>	
16	Tu.	1884: STANFORD C. HOOPER was born. Among his inventions is the radio compass system now used in the United States Navy.		
17	W.	1827: SAVARY found that a steel needle could be magnetized by the discharge from a Leyden jar.	<i>Bring the portable receiver along on the picnic!</i>	
18	Th.	1908: At about this period DR. REGINALD A. FESSENDEN reported successful radiophonic communication between his station at Brant Rock, Mass., and Washington, D. C.—a distance of 690 miles.		
19	Fr.	 1889: SIR JOSEPH J. THOMSON suggested that electric waves were particularly suitable for the transmission of signals through fogs and material objects.		
20	Sa.	<i>If all the users of interference-producing violet ray and other machines were laid end to end, they would form a line reaching from the prison at Sing Sing to the asylum at Matteawan—and it is suggested that they be laid that way.</i>		
21	S	1920: The first official radio message was transmitted from the Lafayette radio station at Bordeaux; it was addressed to the Secretary of the United States Navy.	<i>Hot as! U. K. K.!</i>	
22	M.	1921: The first town in the United States to be named Radio (Virginia) was given to the community where the Arlington radio station is located.		
23	Tu.	1914: The Lackawanna Railroad conducted its first tests of radio reception on moving trains.		
24	W.	1907: During this month ARTHUR KORN, the German radio expert, began his experiments in the radio transmission of pictures, which later came into commercial use.		
25	Th.	1919: The Franklin Medal, awarded by the Franklin Institute of Pennsylvania, was this year given to Major General GEORGE O. SQUIER for his contributions to telephonic, telegraphic and radio communication systems.		
26	Fr.	1873: DR. LEE DE FOREST, inventor of the audion valve, was born.	<i>Pep up your receiver occasionally with new valves.</i>	
27	Sa.	 1910: The first successful American attempt at radio transmission from a plane in flight to a ground station took place at Sheepshead Bay, Long Island, N. Y.		
28	S	1843: LINDSAY suggested that if it were possible to provide stations not more than 20 miles apart across the Atlantic there would be no need of laying a cable.		
29	M.	1870: VON BEZOLD discovered that oscillations set up by a condenser discharge in a conductor gave rise to interference phenomena.		
30	Tu.	1921: The American Radio Relay League opened its first convention in Chicago.		
31	W.	1923: AUGUSTE GUSTAVE FERRIÉ, a general in the French army, was at about this time awarded the Franklin Medal "in recognition of his successful researches in the field of radio transmission of intelligence."		

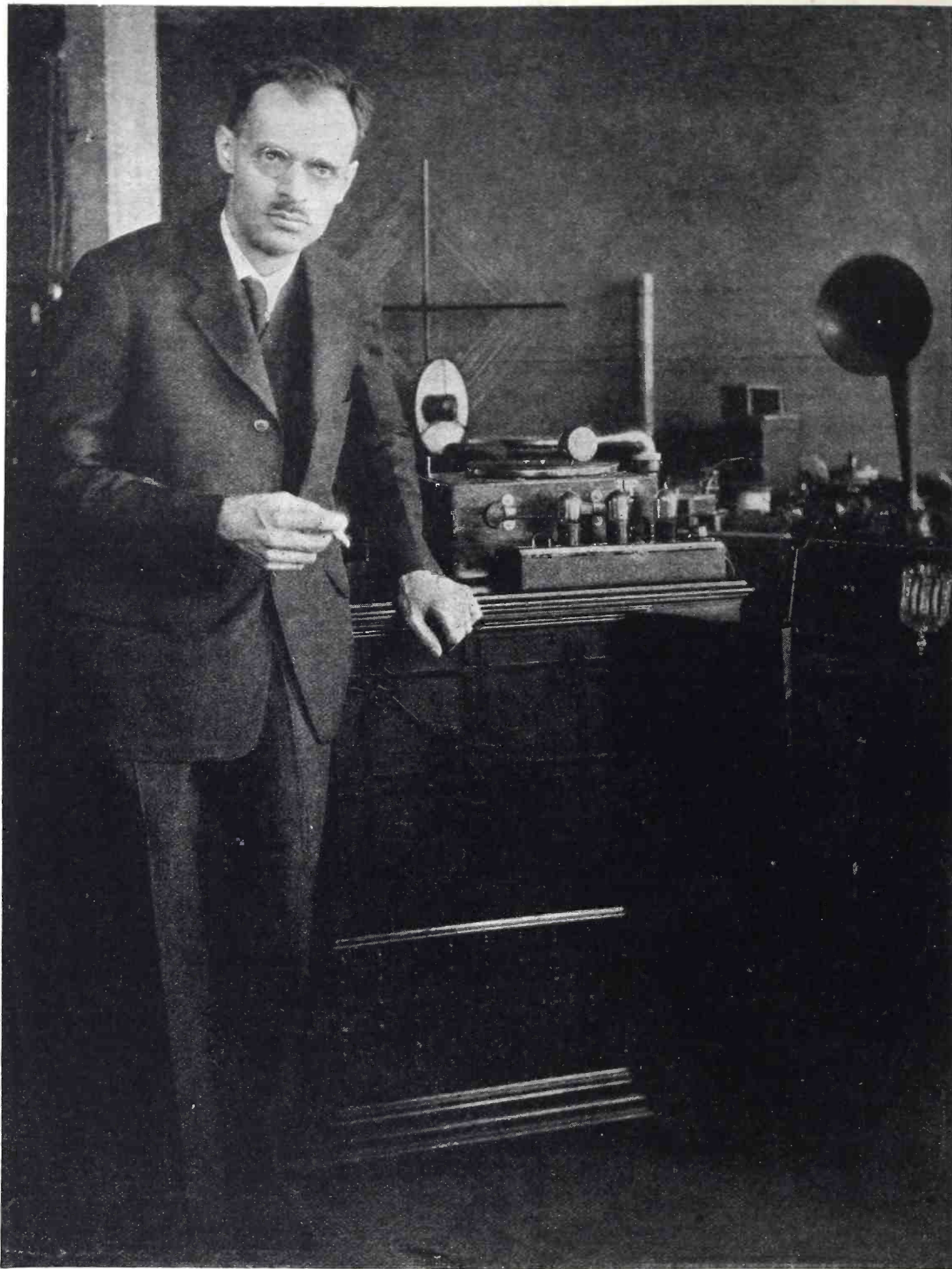

From a photograph made for POPULAR RADIO

The Wedding of the Radio Receiver and the Talking Machine

One of the most important advances made in the field of radio during the past few months has been in low-frequency amplification. The new apparatus known as the "electrical pick-up" now makes possible this form of amplification of talking machine records. Mr. H. P. Donle (who developed one of the methods described in the article beginning on page 14) is best known as the inventor of the famous sodion detector tube and of the system of truhphonic amplification.

Popular Radio



VOLUME XII

July-August, 1927

NUMBER 1-2

THE NEW PROSPECTS OF TRANSMITTING POWER BY RADIO

Years ago Nikola Tesla, imaginative genius of electrical engineering, predicted that power would one day be sent from place to place *without wires*. With each year the hope grows stronger. In this article Mr. Elway describes some remarkable experiments and predictions of power by radio recently presented at a gathering of scientists.

By THOMAS ELWAY

MEN have been dreaming for twenty years of sending power by radio. It is still a dream but it grows solidier. Like Jules Verne's imagined submarine, it seems more and more apt to come true.

On a recent evening in New York City the staid and sober and matter-of-fact New York Electrical Society devoted one of its famous meetings to a discussion of the possibilities of radio power and to demonstrations of some of the things that already are realities.

Dr. Philips Thomas, Research Engineer of the Westinghouse Electric and Manufacturing Company, already well-known to the radio public through his invention a year or two ago of the "glow transmitter" microphone,* was one of the speakers. He painted a picture of what practical radio power might mean:

"We may visualize," he said, "a parallel beam of radiation ten centimeters or four inches across, along which is being sent ten kilowatts of energy. What sort of effects shall we find? Will this be a means of delivering energy for heat and light to individual houses? Tesla had a similar idea many years ago. Later improve-

ments in the radio art make it interesting to consider such a possibility once more.

"We may imagine each house furnished with a half-wave oscillator in line with a parallel beam from a sending station, so that heat and light may be obtained very much as at present, by simply turning a switch, but without the costly transmission wire equipment now required."

What Dr. Thomas foresees, not as a certainty but at least as a possibility, are thousands of beams of radio power crisscrossing the roofs of a city or the farms of a countryside, like the beams of searchlights from a fleet of mighty battleships. He is thinking of power lines, carrying power as our great towers and wires do now, but which nobody will have to build because they will not be material structures. They will be created, when necessary, from the substance of the air itself and by the action of the same electric forces which it will be their duty to carry.

Dr. Thomas spoke first of the mere generation and use of radio waves concentrated into beams, something which he agrees with other engineers in believing quite possible so soon as we can generate waves of sufficiently short wavelength and in sufficient intensity. But that is not the only possibility nor the most significant one.

"Suppose," Dr. Thomas continued, "it should happen that this four-inch beam of highly concentrated energy should render conducting the air through which it passes. Then ordinary electric power could be sent along the beam as though the beam were a transmission line. The beam could be directed to any desired spot, with dire results to the target. It would constitute the so-called 'heat ray' employed with such deadly effect by the Martians in H. G. Wells' well-known story of their descent on earth."

This is no mere empty imagining. Granted that it will probably prove possible to make the short-wave radio beams at all, it is more than probable that they could be made to render the air at least partially conducting for other varieties of electric current, possibly even for direct current although the familiar sixty-cycle alternating current is perhaps somewhat more likely.

Such power-carrying beams of conducting air would probably be self-luminous, shining with the same clear bluish light which every radio amateur has seen once in a while in soft transmitting tubes and which is called the "blue glow." Probably the light produced would not be bright enough for any use. Otherwise one might imagine a beam of the rays passing down the center of the street, its own glow serving

* "The Remarkable New 'Glow' Transmitter," by David Lay. POPULAR RADIO for April, 1923, pages 290-294.

for the street lighting while it carried power to the subscribers along the route. It would be as though the power wires were themselves white-hot all the time and lit the streets without any lamps being necessary.

This is probably too much even for a Jules Verne to hope for in the near future, but the glow of Dr. Thomas's imagined radio power beams would be a considerable advantage in another way. If such beams are ever used they will not be pleasant things to run into unexpectedly. Their effects would probably be not unlike those predicted by Mr. Grindell-Matthews and others for the various varieties of "Death Ray" that have been conceived and proposed. Power rays criss-crossing the housetops would have to be high enough above them so that careless radio fans, fixing antennas on dark winter nights, could not thrust either the antenna pole or an incautious head into the powerful and destructive beam. If the beam were

utterly invisible, the danger would be greater than if it glowed dimly, as it is probable that it would.

Dr. Thomas did not predict, nor is it probable, that beams of this kind would be used at first in distributing power in cities or for any similar purpose. Wires work very well for such duties, and there would be no object in displacing them. On the contrary, the first use of the radio power beams, if they become possible at all, will probably be in places and under circumstances which render wires unsatisfactory.

An example which Dr. Thomas cited to the Electrical Society is that of a contractor who finds it necessary to take electric power up the side of a mountain or to some similarly inaccessible spot to begin digging a tunnel or preparing for a bridge or carrying out some other engineering work. Wires may be hard to place and to maintain. Perhaps the operation is a temporary or a movable one, so that the wire installation would

be no more than installed until it would be necessary to remove it again, the removal being almost as difficult as the installation.

Such situations would be opportunities for radio power. Imagine a beam-forming transmitter, perhaps mounted on a motor truck or a boat, and easy to set up and operate at some accessible point near the mountain-side which must be fed with power. The contractor wheels his beam-gun into position, starts his oscillator, trains the ray on the spot desired and turns on the power. With no more trouble than he has now with the light rays of his searchlights for night work, he carries the needed electric power to any peak or cliff where his men must cling precariously to do the job the engineers have set.

There are probably uses for the power-carrying radio ray, also, in crossing rivers or harbors where wires are impossible or difficult to place. The span which can be bridged by any reasonable

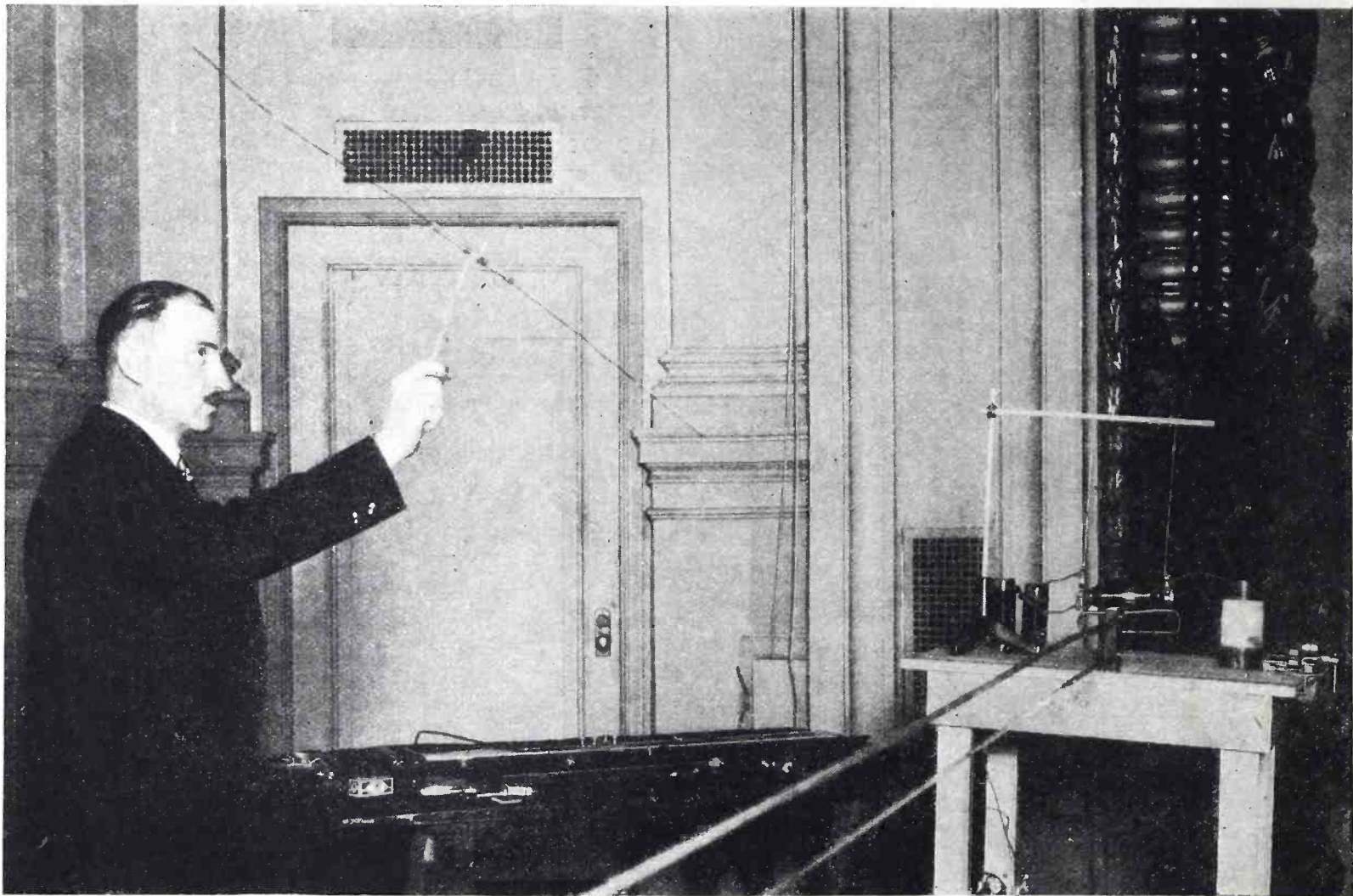

New York Electrical Society

How Dr. Thomas Pulled Radio Power Out of the Air

The vacuum-tube oscillator mounted on the table at the right produced radio waves of 2.4 meters wavelength. These filled the surrounding space. By holding in this radio field a stiff copper wire one-half wavelength long, operating as a Hertz antenna, Dr. Thomas picked up enough radio energy to make the small lamp at the center of the antenna glow brilliantly. The lamp glowed only when the copper wire pointed in the proper direction, thus proving that the waves were partly polarized, as are the waves now used in short-waved broadcasting. The flat aluminum ribbons were used instead of ordinary wire for the Lecher wires in the foreground, so that these were visible to the audience, a device which other lecturers using such wires will doubtless hasten to imitate.

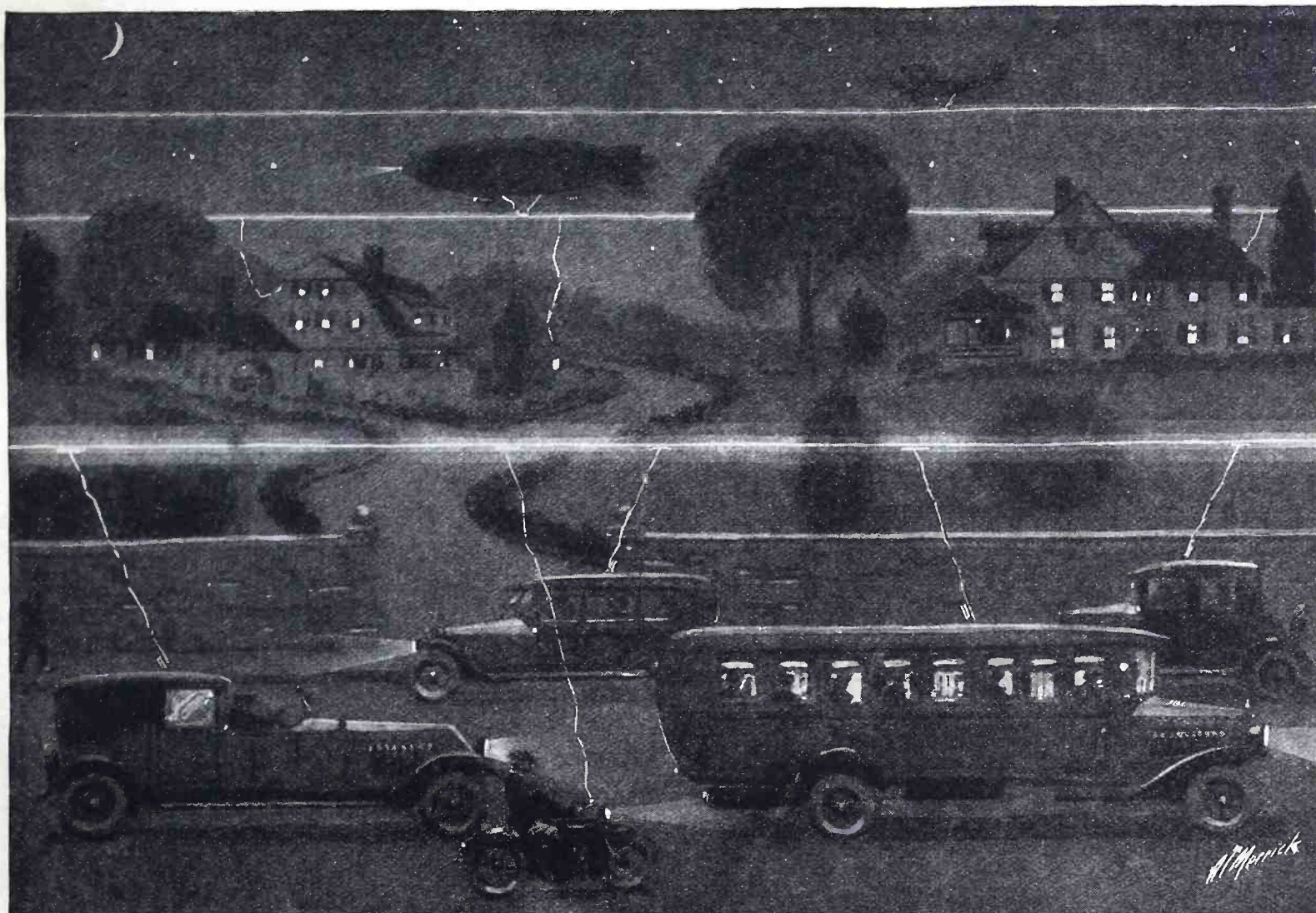

From a drawing by Arthur Merrick for POPULAR RADIO

When Power Is Drawn from Shining Radio Beams

In the future of radio power, which Dr. Thomas visualizes, power for automobiles, for dirigibles and airplanes, for households, and for many other purposes, may be carried by self-luminous beams of radio waves. Such concentrated radio beams might render the air conductive, so that ordinary power could pass along these beams as it now passes along wires.

variety of power wire is not unlimited. To put high-tension power cables under the ground or beneath the waters of a river or estuary is an expensive task at best and is not always a possible one. A tower on one side of the barrier with a set of generators for powerful radio beams; a receiving tower on the other side similarly equipped, both raised well above any danger to passing vessels from the beam, and the trick would be turned. Possibly something of this kind, to solve many such problems which now puzzle the power engineers here and there in the world, would be the first practical use of power by radio if it becomes an actuality.

There are possibilities, also, in radio power transmission over relatively short distances near great powerhouses and around power-producing machinery. Sometimes enormous amounts of power have to be carried between bus bars or from the terminals of a dynamo or other machine to some other piece of apparatus. Massive bars or sheets of copper or aluminum are now used for such purposes. They work well enough, but perhaps a beam of conducting air

would be better. At least it would have the advantage of not burning out so readily as copper. Even if the air did "burn," more air is cheap and no harm would be done.

All these possibilities depend, of course, upon just what the properties of the imagined radio beams will be if they are produced. It is possible, as Dr. Thomas told the Society, to predict some of these properties.

The chief secret of producing the imagined beams will probably lie, Dr. Thomas said, in generating very short radio waves at very high power.

Short radio waves, even as short as a few centimeters in wavelength, are no novelty. Some of the first waves produced by Professor Heinrich Hertz, when he still did not know that he had discovered radio, were extremely short ones, although badly mixed, as we know now, with waves of many other wavelengths. The writer of these lines constructed, just thirty-one years ago, a spark-coil and wave receiver that produced and received some of these then-mysterious sparks which Dr. Hertz was so excited about.

Quite early in these private experiments the electric-light transformer on the outside of the house unaccountably burnt up; producing a gorgeous spectacle, the volunteer fire department and a great black smudge on the side of the house. At the earnest solicitation of the electric light company, the fire department and the family, the experiments were discontinued. But not until they had proved—as did the more skillful experiments of a thousand other amateurs and professionals all over the world—that what we now know as short radio waves are easy to produce.

Unfortunately, however, all of the generators for very short waves, including Hertz's spark-gap and every device since produced, show themselves strictly limited in power production. A few watts output is possible enough. More than a few watts is not possible unless one is content to increase the wavelength.

Working with special vacuum tubes and with an oscillating circuit of his own design, Dr. Thomas has been able to produce radio waves as short as 2.4

(Continued on page 74)

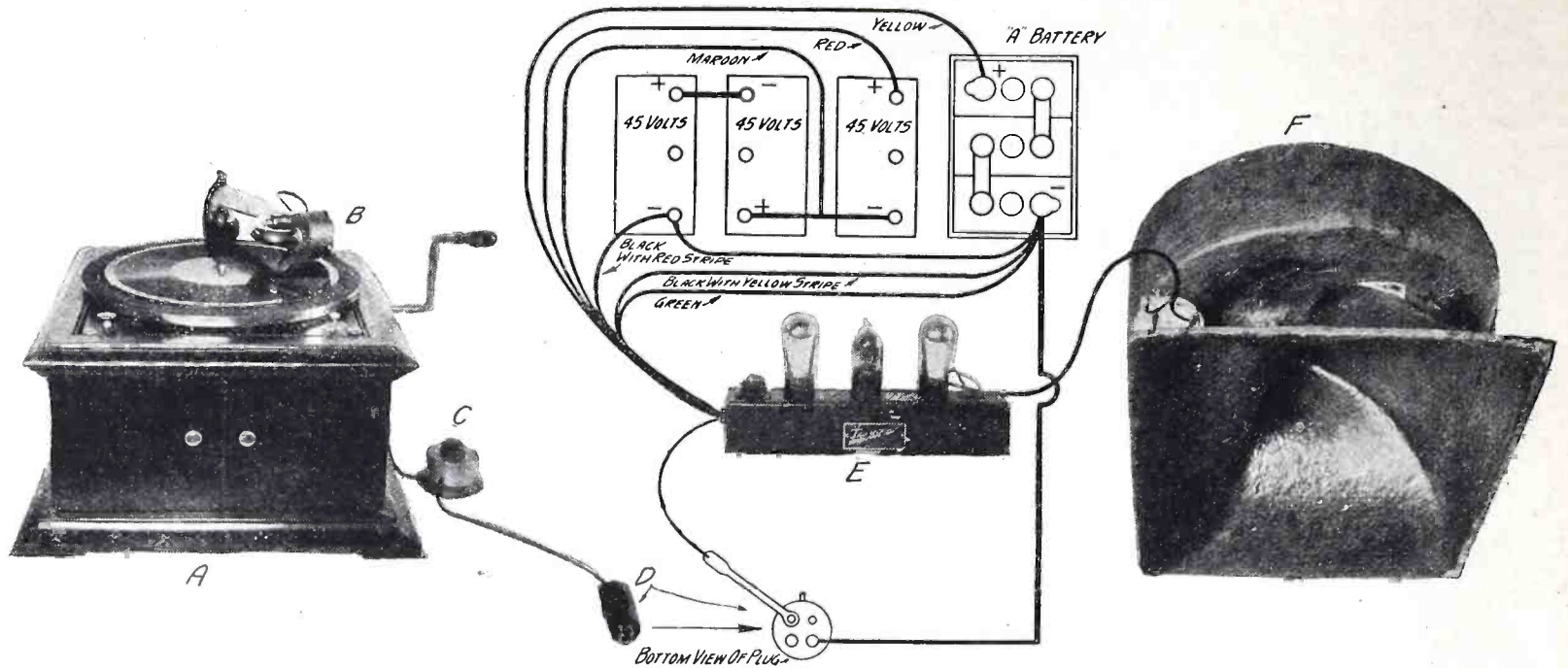

HOW THE NEW UNITS ARE CONNECTED TO A STANDARD PHONOGRAPH

FIGURE 1: The various instruments and parts shown in this pictorial diagram are designated by letters that reappear in the list of parts given below. This arrangement gives remarkably clear and realistic reproduction from a phonograph record.

HERE IS A LIST OF INSTRUMENTS AND ACCESSORIES THAT YOU WILL REQUIRE FOR THE ABOVE UNIT—

- | | | |
|---|--|------------------------|
| A—Any old phonograph; | three stages of low-frequency coupling, No. 304; | 1 6-volt "A" battery; |
| B, C and D—Warford reproducer, comprising pick-up, control unit and plug; | F—Donle cabinet reproducer; | 1 UX-201-a type valve; |
| E—Truphonic power amplifier, comprising | 3 45-volt "B" batteries; | 1 Donle High Mu valve; |
| | | 1 UX-112 type valve. |

How to Add the New Radio Amplification Units to Your Phonograph

The new "electrical pick-up" that gives reproduction to talking-machine records in better quality and greater volume than has ever before been possible.

If you already have a radio receiver and a phonograph (any type with a turn-table in running order will serve), all the new apparatus you need for hooking them up together is the newly invented electrical pick-up device that costs from \$10 to \$20; if you *don't* own a receiver, the same effects may be attained through a reproducer and amplifier—which will cost altogether from \$40 up to \$125. Demonstrations have shown that this invention gives better reproduction than has ever before been attainable.

By LAURENCE M. COCKADAY

HAVE you an old talking machine about the house? Or perhaps it's at your camp or summer cottage.

If you have one, there's a surprise and a real treat in store for you.

If by chance you haven't, you can pick one up for a song, both literally and figuratively speaking. For it is estimated that there are more than 14,000,000 old-type talking machines in the United States, most of them at the present time dumb, idle and scorned, with very little quick cash value. The simplest form of machine will do; all it really needs to have left is a smoothly running turn-table.

The old talking machine passed out of the picture for two reasons:

First, because radio flashed in with its novelty, its range of entertainment

and improved quality of reproduction.

Second, because the principles of radio were later applied to the talking machine itself.

The new-style machine is now very justly climbing in popularity, for the reason that the same principles of vacuum-valve amplification of sound frequencies employed in radio have been applied to the talking machine itself and have so improved its reproduction that it sounds as good as a first-class radio receiver. This is exemplified, for example, in the Victor Orthophonic and Brunswick Panatrope.

Another advance is shown in the advent of the large "exponential" horn-type reproducer. (See page 22 of this issue of POPULAR RADIO.) This type of loudspeaker successfully handles greatly

increased volume and brings out the low notes as the old talking machine never could. And still another improvement is in the records themselves. They, too, have gained by the application of radio principles, being made by an electrical amplification process.

And now it has become a simple matter for you to adopt these great improvements, apply them very easily to that old talking machine and convert it into an ultra-modern device that will produce music in marvelous tones, with a volume subject to control and ranging from the faint whisper of a violin to the rich swell of a great organ.

All this you can do with that old cast-aside talking machine, with the expenditure of a very little money, no mechanical skill, and almost no time. You

may do this somewhat progressively, if you wish to convince yourself of the unique functions and marked advances represented by each mechanical part.

The complete assembly may be divided into three parts, or divisions:

1. The electrical pick-up unit;
2. The power amplifier;
3. The new type of exponential horn.

In Figure 1 is shown a complete hook-up of these three new devices in connection with an old-style talking machine. (Other hook-ups are shown in Figures 4, 5 and 6.)

This combination produces a reproduction from the new electric records (such, for example, as the Victor, Columbia, Brunswick or Okeh types) that is an absolute revelation in tone quality—and perfection of lifelike reproduction.

At A in this diagram is shown the old-style talking machine, while at B is the electrical pick-up unit fastened onto the tone arm in place of the old-style mechanical sound box.

The volume control, C, and a plug, D, are part of the equipment furnished with the electrical pick-up device as a single unit; they are connected by a long, flexible cord that carries the current generated in the pick-up device, B, to the plug, D, and to the amplifier, E.

The diagram shown in Figure 3 also shows the proper connection from the plug to the amplifier, E, and to the three "B" batteries and the one storage battery required.

The new type of loudspeaker, F, may be obtained in a beautifully finished cabinet, but in the diagram in Figure 2 only the reproducer itself is shown in its crude, unfinished form, that you may get a better idea of its design. The cord is

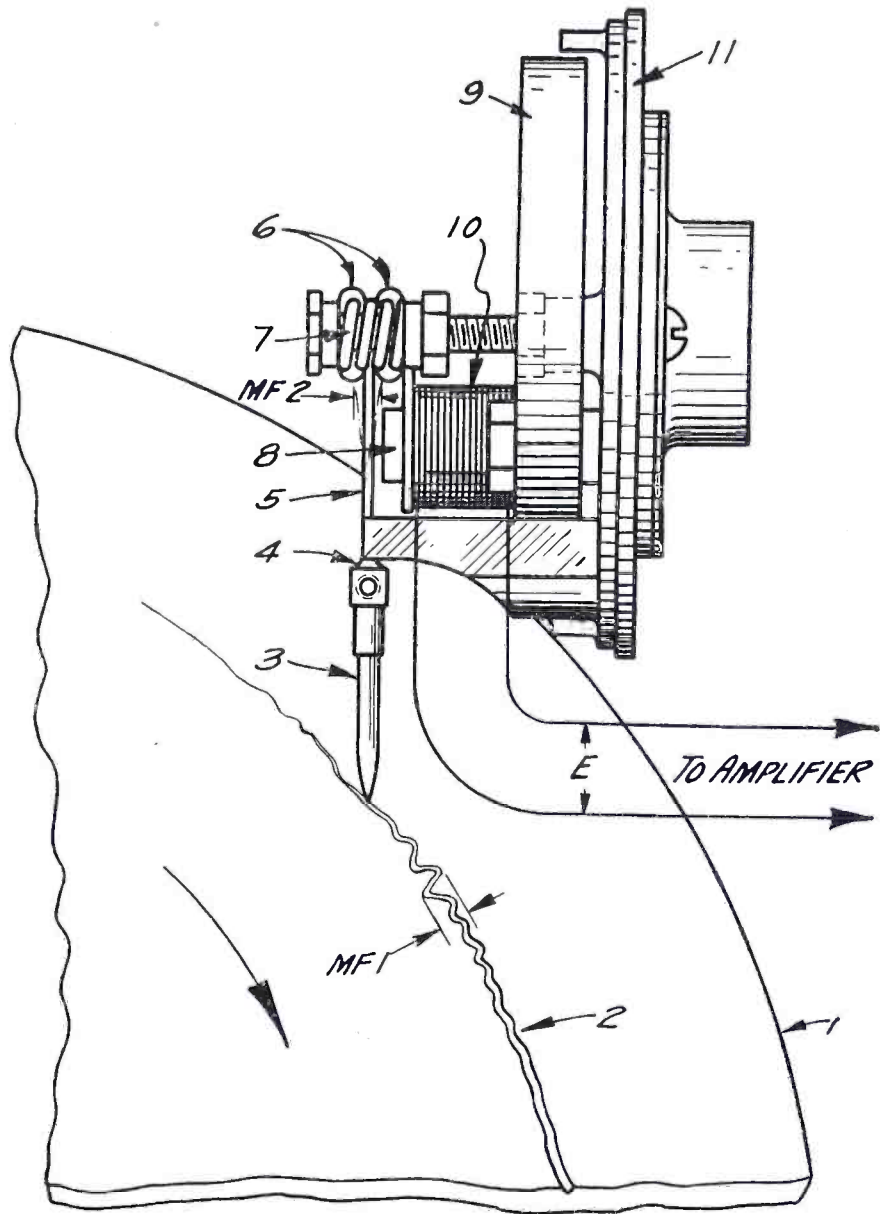

HOW THE ELECTRICAL PICK-UP WORKS

FIGURE 2: The needle, 3, to which is attached the vibrating armature, 5, follows the vibrations imprinted in the record. The vibration of the armature generates a current of electricity in the magnet, 10, which furnishes a voltage, E, corresponding exactly to the vibration, 2, on the record, 1. This voltage, E, is then introduced in a standard low-frequency amplifier such as used in the better radio sets and is reproduced with a high quality reproducer of the cone or horn type.

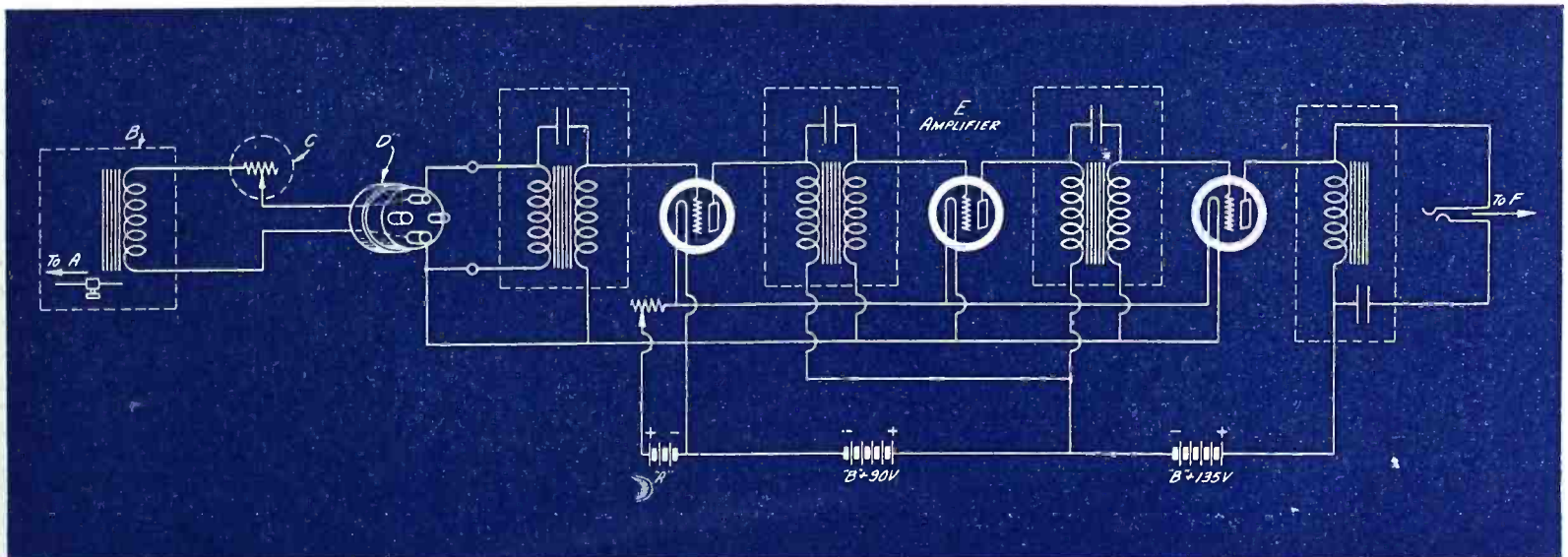

HOW THE AMPLIFIER IS CONNECTED TO THE ELECTRICAL PICK-UP

FIGURE 3: This drawing shows the theoretical diagram of a "pick-up" connected to the Tru-Phonic amplifier, E, shown in Figure 1. The volume control, C, is shown in series, although in most devices it is connected in shunt across the first amplifying transformer. It will be noted that the amplifier circuit is exactly the same as that used in radio receivers, and it is this arrangement that accomplishes the astonishing results that may be attained.

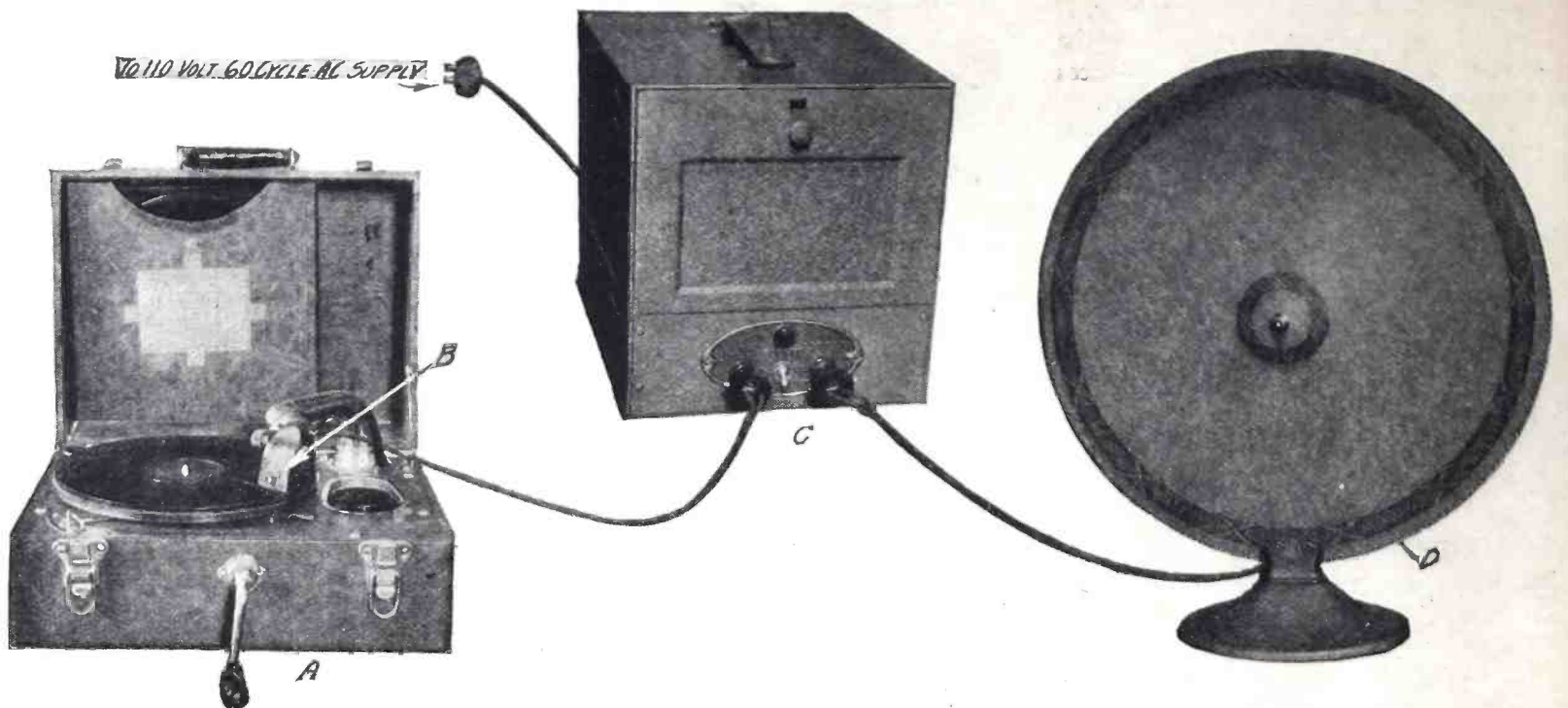

ANOTHER MATCHED COMBINATION OF UNITS THAT WORKS WITHOUT THE USE OF BATTERIES

FIGURE 4: Here is shown, at A, a portable phonograph with an electrical "pick-up," B, attached to a complete two-stage amplifier and power-pack, C. A high quality cone reproducer, D, is plugged into the power-pack amplifier. A plug is furnished with the power-pack amplifier that connects directly to the 110-volt, 60-cycle AC lighting lines.

HERE IS A LIST OF INSTRUMENTS AND ACCESSORIES THAT YOU WILL REQUIRE FOR THE ABOVE UNIT—

- A—Any old phonograph;
- B—Pacent Phonovox electrical pick-up;
- C—Special Pacent two-stage Powerformer, using UX-199 type valve in the first stage and a UX-210 type valve in the last stage;
- D—Pacent 18-inch standard cone-type reproducer.

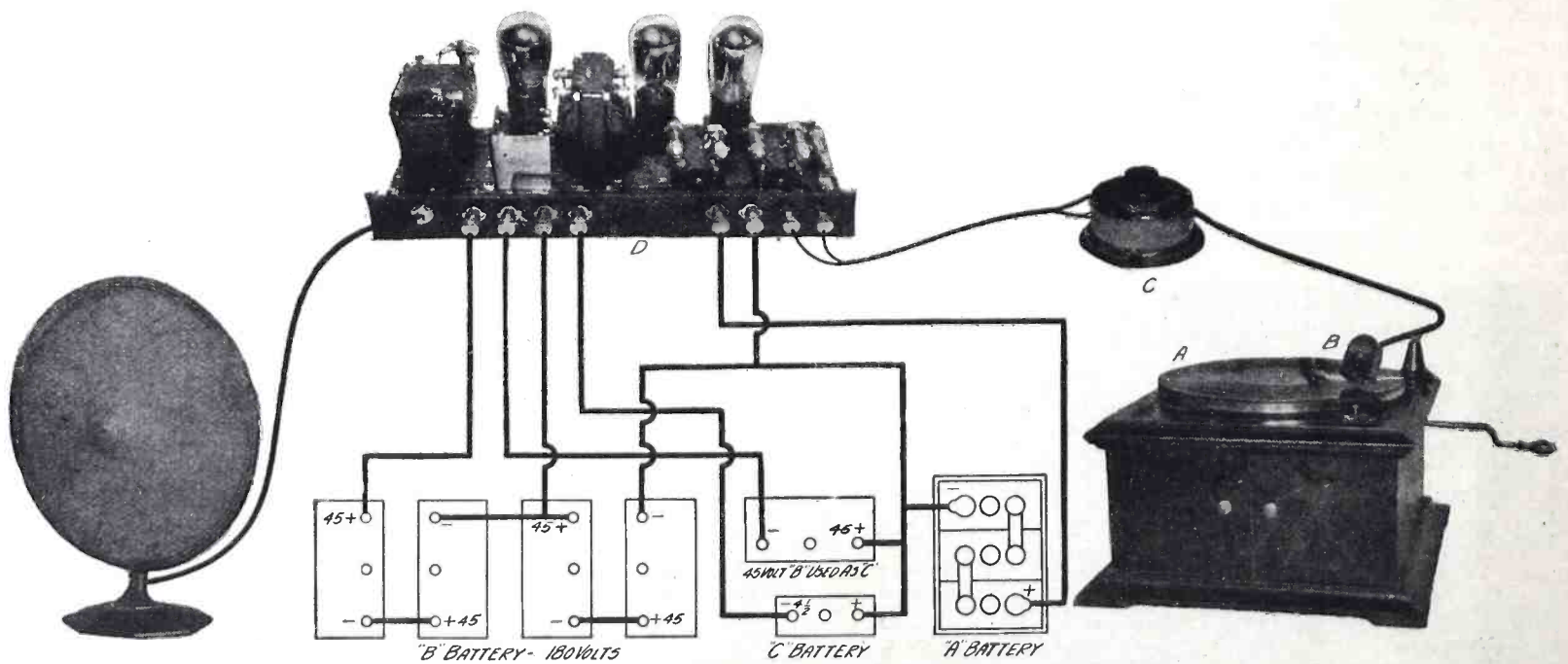

A MATCHED COMBINATION THAT USES RESISTANCE, COUPLING AND TRANSFORMER COUPLING

FIGURE 5: With this combination, that works on batteries and utilizes two standard UX-201-a valves in the first and second stages and a UX-171 type valve in the last stage, really fine results may be obtained from any phonograph. The construction of the amplifier, D, is fully described elsewhere in this issue. The list of parts for this combination is given below.

HERE IS A LIST OF INSTRUMENTS AND ACCESSORIES THAT YOU WILL REQUIRE FOR THE ABOVE UNIT—

- A—Any old phonograph may be used here;
- B—Bosch electrical pick-up;
- C—Bosch volume control;
- D—Quality amplifier (described on page 25 of this issue of POPULAR RADIO); 1 18-inch Western Electric cone reproducer, type 540-AW.

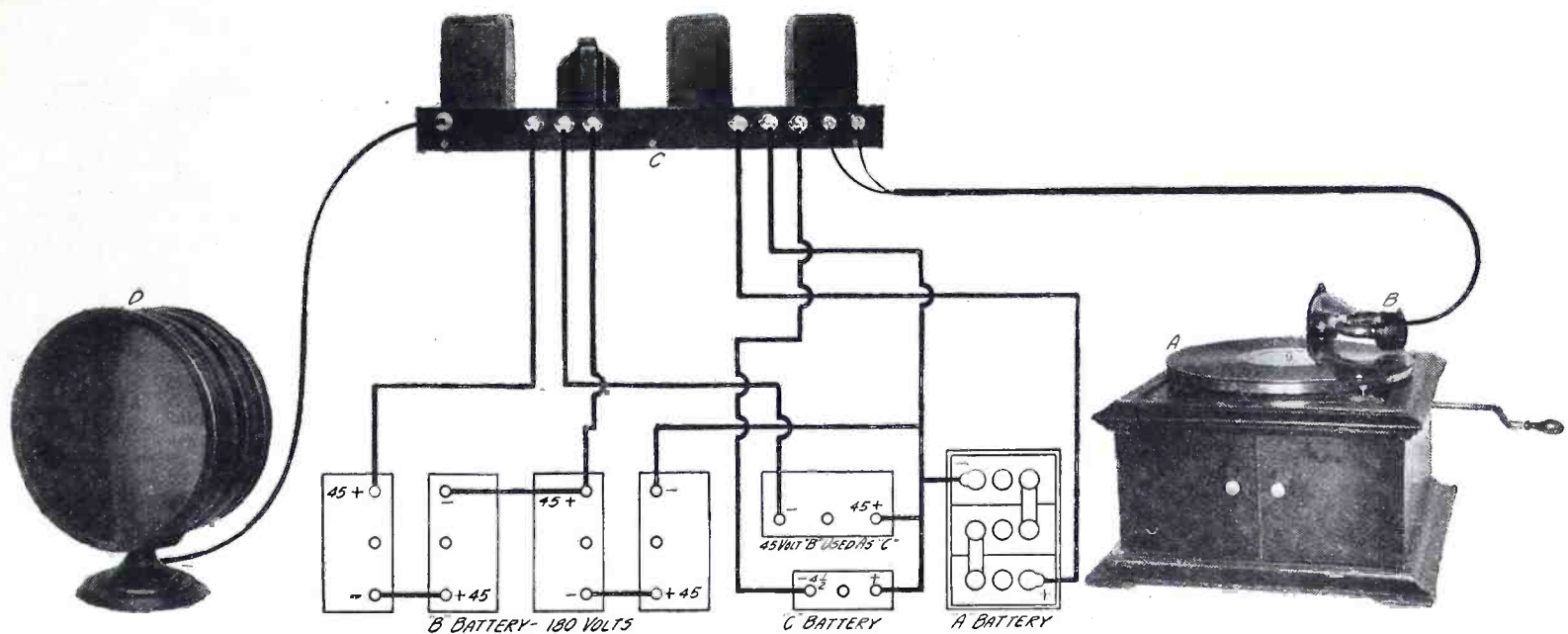

ANOTHER MATCHED COMBINATION THAT EMPLOYS DOUBLE-IMPEDANCE COUPLING AND TRANSFORMER COUPLING

FIGURE 6: This combination, which uses the parts listed below, gives exceptionally fine quality and brings out both the high and low notes. The amplifier, C, uses two UX-201-a type valves and a UX-171 type valve in the last stage of amplification.

HERE IS A LIST OF THE APPARATUS AND ACCESSORIES THAT YOU WILL REQUIRE FOR THE ABOVE UNIT—

- A—Any phonograph;
- B—Alden electrical pick-up equipped with volume control;
- C—High quality amplifier, described in the June, 1927, issue of POPULAR RADIO;
- D—Temple reproducer.

attached from the reproducer unit to the output terminals of the amplifier, E.

This particular combination of apparatus is due to the research work of Mr. H. P. Donle, the well-known radio and vacuum-valve expert, who has been working on this problem for a number of years.

The exact electrical connections for the pick-up device and the amplifier itself is shown in Figure 1. A study of this system will reveal the fact that any electrical impulses generated by the pick-up unit, B, travel along the wires to the control unit, C, by which the volume may be raised or lowered, to the plug, D, and from there on a standard three-stage Truphonic-coupled amplifier is employed. From this same point it will be noticed that exactly the same methods are used in this case to improve the phonograph as have been developed so successfully during the last year to make radio reproduction so faithful.

It will be of interest to study the method used in the pick-up device to convert the mechanical vibrations as obtained from the record into an electrical impulse that can be amplified by radio methods and finally reproduced by a radio loudspeaker.

Figure 2 is a sketch of the electrical pick-up unit that must be used to accomplish this purpose.

A cut-away section of a record is shown at (1) with the recording impulses designated at (2). The needle, 3, travels in this winding path and thus is supplied with a motive force,

MF1, which is transmitted through a bearing, 4, to a vibrating magnetic reed, 5. As the needle, 3, vibrates, the reed, 5, is also activated and vibrates in accordance with the amplitude of the motive force, MF2. This reed is dampened by two special rubber dampeners, 6, and held by a spring tension device, 7. Adjacent to the reed, 5, is a magnetic pole piece, 8, upon which is wound a coil of wire, 10. The magnet, 9, is fastened to the pole piece, 8, and the whole unit is mounted upon the framework, 11.

As the reed, 5, vibrates, it varies the gap between the reed and the pole piece, 8, thus changing the magnetic flux flowing through the magnet, 9, and generating an electrical impulse, E, in the coil, 10. This electrical impulse, E,

varies in strength or amplitude in exact accordance with the curves in the record and the force, MF1, applied to the needle, 3, and in turn to the reed, 5. The electrical impulse, as stated before, is then applied to the amplifier, E (Figure 1), through the variable-resistance control, C, and the plug, D.

Any kind of old-style talking machine that has a workable turn-table and a tone arm may be used with exactly the same results, as the only items that affect the tone quality and volume are the type of record used, the pick-up device, the amplifier and the reproducer.

The complete device may be used, too, with any good radio set and reproducer by merely placing the plug, D, in the detector socket of such a set. But in

(Continued on page 72)

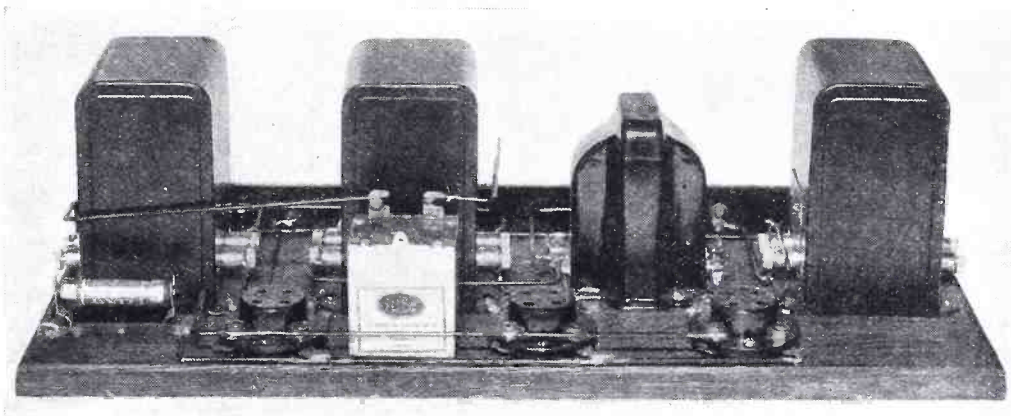

A CLOSE-UP OF THE AMPLIFIER SHOWN IN FIGURE 6

FIGURE 7: This unit, which is simple to build, uses two double-impedance coupling units, a high-quality transformer and an output filter. (The constructional data of this device was given complete in the June issue of POPULAR RADIO.)

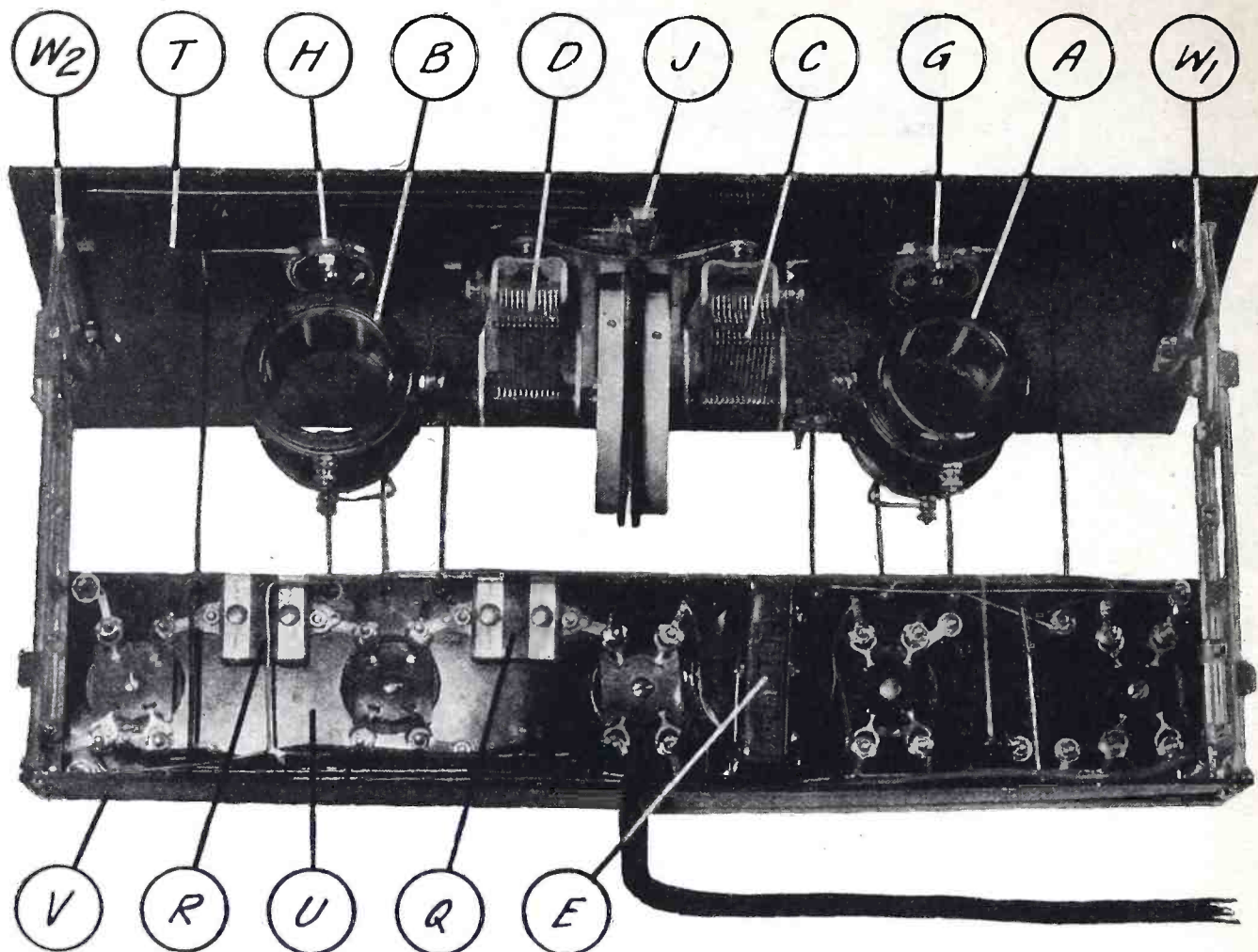

VIEW OF THE SET FROM BELOW

FIGURE 1: Here is shown the general arrangement of the apparatus mounted on the strip and on the front panel. The mounting of the instruments is greatly facilitated by the sectional assembly.

HOW TO ASSEMBLE THE New Unitune Receiver

This is the third of a series of articles on the assembly and operation of popular kits of parts that may be obtained for building really good radio receivers; they differ from the "How-to-Build" articles, in that the sets described have been designed outside of POPULAR RADIO EXPERIMENTAL LABORATORY by commercial engineers. The sets that are selected for description have been carefully tested in the POPULAR RADIO ELECTRICAL TESTING LABORATORY and will be chosen for their outstanding features and all-around efficiency.

By JOSEPH CALCATERRA

COST OF PARTS: *Not more than \$54.51*

HERE ARE THE PARTS THAT ARE USED IN THE NEW UNITUNE RECEIVER—

- A, B, C and D—Bruno high-frequency Unitune assembly unit consisting of an antenna coil, coupling coil and two variable condensers, .00035 mfd.;
- E—Bruno low-frequency transformer, type D;
- F1, F2, F3, F4 and F5—Pacent subpanel mounting sockets;
- G and H—Carter midget rheostats, 20 ohms, type No. M-20;
- I—Amperite No. 3A (for 112 or 171 type

- tube in last stage use Amperite No. 1);
- J—Bruno light switch;
- K—Electrad grid condenser with grid-leak clips, .00025 mfd., type GS;
- L—Durham metallized resistor, 2 megohms;
- M—Durham metallized resistor, .1 megohm;
- N—Durham metallized resistor, 1 megohm;
- O—Durham metallized resistor, 1 megohm;
- P—Durham metallized resistor, .5 megohm;
- Q and R—Electrad fixed condensers, .006 mfd., type P;

- S1, S2, S3 and S4—Eby engraved binding posts marked "ANT," "GND," "SPEAKER —" and "SPEAKER +," respectively;
- T—Westinghouse Micarta front panel, 7 by 18 by 1/8 inch;
- U—Westinghouse Micarta subpanel, 7 by 17 by 3/32 inch;
- V—Westinghouse Micarta back strip, 1 1/2 by 17 by 3/32 inch;
- W—Bruno adjustable brackets.

SO intent have some radio engineers been to get the ultimate efficiency out of a receiving circuit that they have lost sight of the average radio listener who looks upon a radio receiver merely

as a means of furnishing him with good reception at a minimum of cost and with a minimum expenditure of effort.

Just a short time ago, reports of the motor speed tests conducted on Major

Seagrave's "mystery racer" filled the columns of the daily papers and Sunday supplements. In these tests a speed of 207 miles an hour was attained by the racer, breaking all previous speed records

for a land-going vehicle. While these tests were interesting, few orders were received for this type of car. Most of us are content to jog along at the comfortable ordinary speeds prescribed by law.

No one questions that many laboratory and high-grade commercial radio receivers will do wonders in the way of distance reception through a heavy barrage of local interference. This type of reception, however, requires a considerable outlay of both time and money in the building of a receiver. Like the 80 and 90 mile-an-hour cars of commercial manufacture, such efficiency can only be produced at considerable expense.

The designers of the Unitune receiver were not primarily interested in producing a receiver exclusively for stunt reception. Rather, they worked to design a set having the following features:

1. Selectivity capable of tuning in local stations without interference;
2. Low cost of construction;
3. Good tone quality;
4. Suitable volume control without loss of quality;
5. Adaptability to all antenna sizes;
6. Simplified construction.
7. Ease in tuning.

The circuit itself is of the simplest possible type. It belong to the class of circuits which may always be depended upon to work when the last connection is made and the vacuum valves, batteries, reproducer, and antenna and ground leads are connected to the proper terminals. It requires no coaxing, no delicate adjustments, no hairline tuning.

The circuit calls for five vacuum valves. It consists of one stage of tuned high-frequency amplification; a tuned detector stage without regeneration to preserve best tone quality; a stage of transformer-coupled, low-frequency amplification and two stages of resistance-coupled, low-frequency amplification.

The circuit is designed for operation with UX-201-a type valves throughout. For greater sensitivity, UX-200-a type detector valve may be used. If that type of valve is employed, the grid return from the detector stage should be connected with the negative filament terminal of the detector socket instead of with the positive filament terminal. Figure 4 gives the wiring diagram of the receiver.

A UX-112 type valve may be used to advantage in the last low-frequency stage. In that case it is desirable to use a 9-volt "C" battery in the grid return lead of the last stage.

A voltage of 22½ to 45 volts should be used in the plate circuit of the detector. The "B+ Amp" terminal should be connected with the 135-volt terminal of the "B" battery. A lower voltage will not give good results with resistance-coupled amplification.

Two rheostat controls are employed. The rheostat G (see Figure 1) serves to adjust the high-frequency vacuum valve filament for sensitivity and volume.

The rheostat H is used to adjust the detector valve for most efficient operation.

An automatic filament control is em-

ployed for adjusting the filaments of the three low-frequency valves. A No. 3 type amperite should be used when all three valves are of the UX-201-a type. Three of these tubes require ¾-ampere at 5 volts. If a UX-112 or UX-171 type valve is used in the last stage, a No. 1 amperite, designed to pass one ampere at 5 volts should be used to take care of the extra quarter ampere.

A light-switch, combining the functions of battery switch and pilot light, is used to make and break the "A" battery circuit.

The Unitune tuner which is used as the basis of this circuit combines in a single, easily mounted assembly, two variable condensers and two tuned-high-frequency transformers. The whole assembly, together with the drum controls and panel plate, can be mounted on the front panel with two mounting screws. This unit simplifies the construction of the receiver and its operation.

The drum controls are arranged so that they can be moved by simply pressing on them together, or separately.

How to Assemble the Receiver

The construction of the receiver has been simplified by an ingenious method which permits the parts on the panel to be mounted and wired as one unit, and the parts on the subpanel to be mounted and wired as a separate unit.

Anchor studs are provided on the subpanel; the subpanel wiring is connected to these studs. Later the front panel and subpanel are mounted together and the wiring completed by running con-

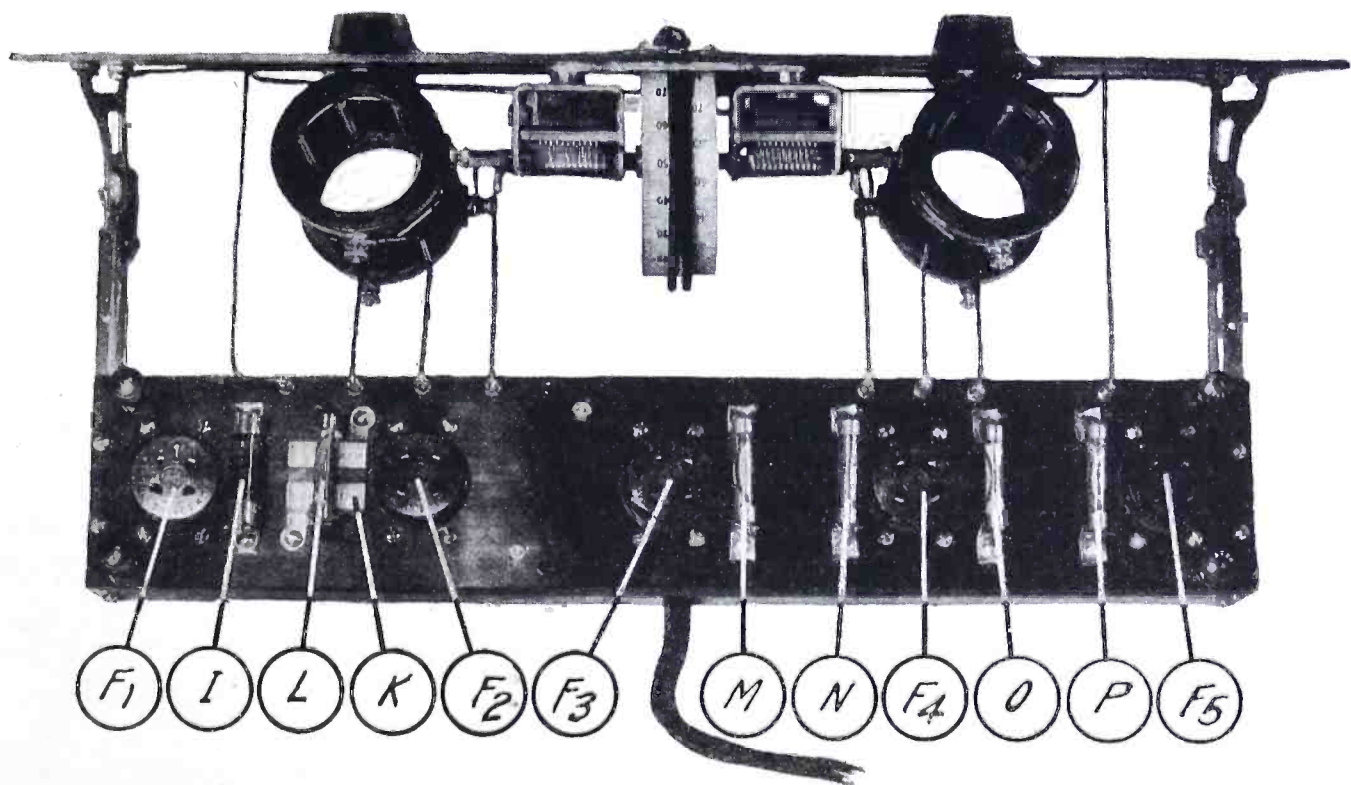

THE TOP VIEW OF THE RECEIVER

FIGURE 2: This photograph gives the reversed picture of the set as that shown in Figure 1. An examination of these two illustrations will show that all the wiring is done on the bottom side of the mounting strip, U.

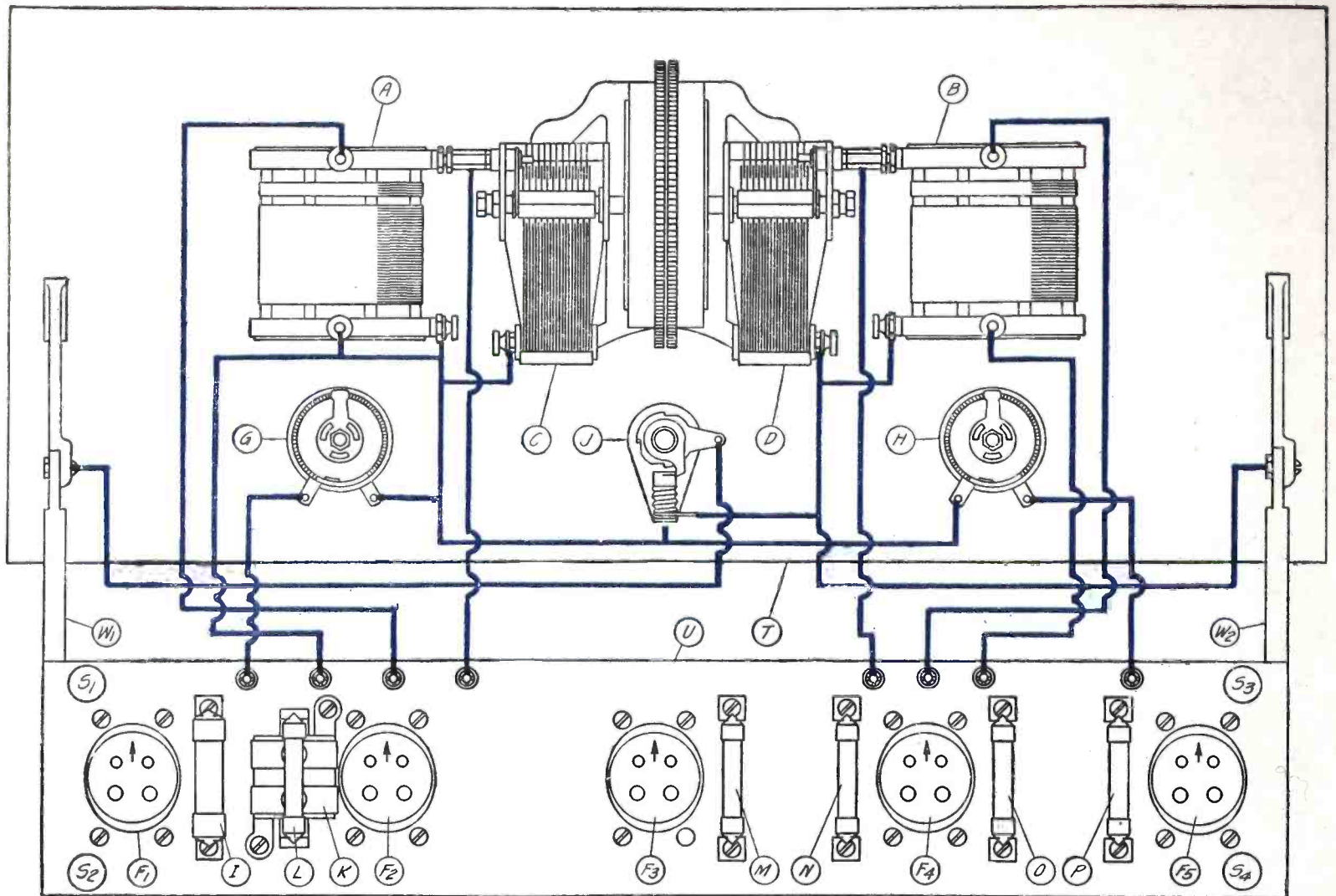

PART I OF THE PICTURE WIRING DIAGRAM

FIGURE 3: Here is shown the wiring of the instruments on the panel, T, as the set is viewed from above. The wiring itself is shown in colored lines, while the instruments are outlined in black. The rest of the wiring is shown in Figure 4.

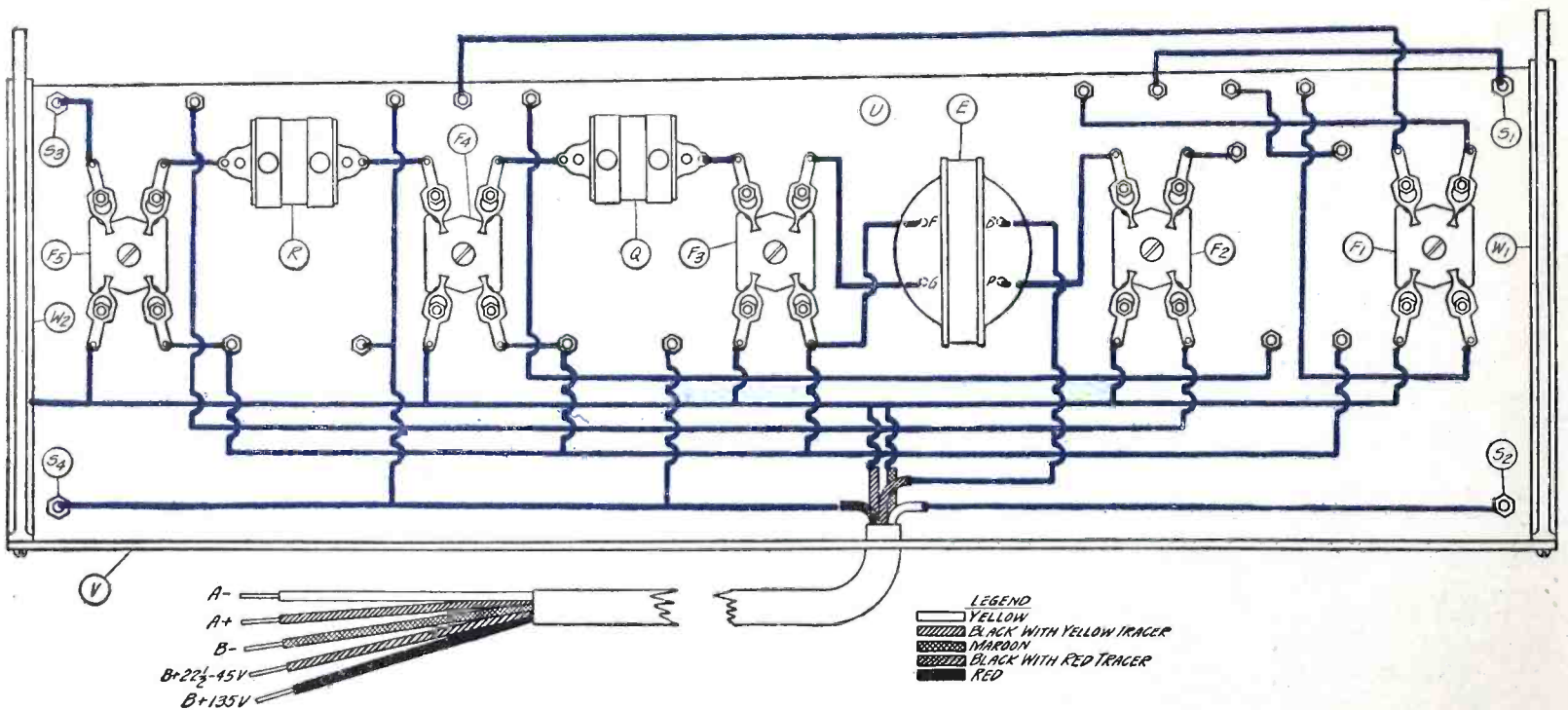

PART II OF THE PICTURE WIRING DIAGRAM

FIGURE 4: This drawing shows the wiring done on the underneath side of the mounting strip subpanel, U. The heavy colored lines show the connections that are made on the underneath side of this panel to the instruments mounted on it and to the connection cable. The instruments are outlined in black lines. The proper connections to the batteries from the cable itself are also indicated.

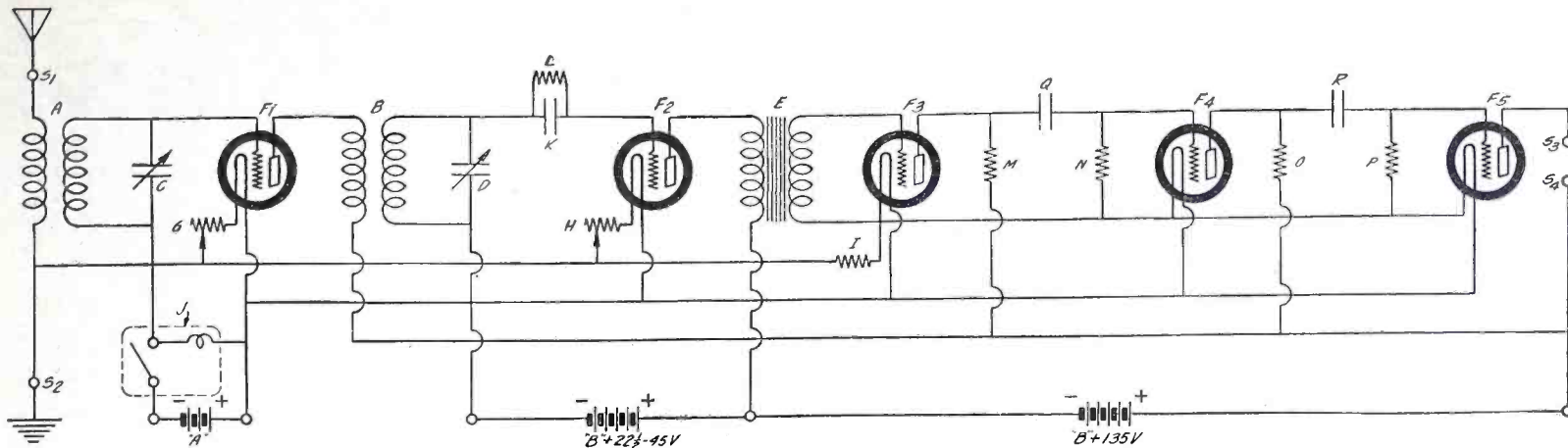

THE THEORETICAL DIAGRAM OF THE ELECTRICAL CIRCUIT

FIGURE 5: Here is given the proper hook-up for the various parts that go into the electrical circuit. One stage of high-frequency amplification with a vacuum-valve detector, one stage of transformer coupling and two stages of resistance-coupled amplification are used.

nections between the anchor studs mentioned and the terminals on the front panel.

The mounting of the parts on the panel and subpanel is a simple procedure and no detailed explanation of this part of the job is necessary. Merely mount the parts in the positions shown in Figures 1 and 2. There are no critical positions for the parts.

In wiring the parts, first connect all the "G" and "P" terminals of the sockets, transformers, condensers and coils as shown in the wiring diagram in Figure 4. Make the connections as short as possible, running them in straight lines from point to point so as to avoid parallel wires.

You can then proceed to wire up all the other terminals, covering the wires with spaghetti wherever necessary when they cross each other or come in close proximity to metal parts.

After the two units are completely wired, assemble the panel and subpanel units and connect the remaining terminals.

The metal brackets can be used as connecting pieces. One of the brackets is used to make the connection between the positive "A" battery lead and the light terminal of the battery-switch. The other bracket is utilized to make the connection between switch and ground terminals.

The terminals of the battery cable are connected directly with the leads on the set so that the only binding posts necessary are the ground; antenna and the two reproducer terminals.

At the battery end, the wires should be tagged with markers to avoid any possibility of mistakes in connecting up the set. If a "C" battery is used for the last stage, the positive terminal of the "C" battery should be connected with the negative "A" battery terminal. The wire of the cable which would ordinarily be connected for the negative "B" lead can be used for the negative "C" lead instead. In that case, the negative terminal of the "B" battery and the positive terminal of the "A" battery should be connected together at the batteries rather than at the set.

Before connecting up your batteries, check over the wiring to be sure that no errors have been made. When you are sure everything is all right, connect your batteries and make a final check by testing across the filament terminals of the sockets to see whether you have the proper filament voltage across the terminals. Be sure that the battery switch and rheostats are turned "on" when you make the test.

After all these preliminary tests have been made you can insert your valves, connect up antenna, ground and reproducer and tune in.

The knurled edges of the two tuning controls project through the panel and are spaced only a small fraction of an inch apart. This spacing is sufficient so that the two drums may be turned separately, or by the simple expedient of pressing the knurled edges together between the thumb and first finger the two controls will turn as one. To tune in the first station the two controls should be tuned individually. It may be found that there is a difference of a few degrees between the two settings. This difference should continue approximately the same throughout the waveband, and after the difference has once been determined by tuning in one station then the controls can thereafter be turned together as a single control. This applies particularly in the case of reception from local stations. In tuning in distant stations a slight readjustment of the individual controls will probably have to be made to bring the circuits into exact resonance.

All volume control should be done with the right-hand rheostat which controls the filament voltage of the high-frequency valve. Never use the tuning controls to adjust for volume.

The detector rheostat should be adjusted for maximum signal strength and then turned back as far as possible without sacrificing either the volume or quality.

The list of parts given on page 18 includes the exact instruments used in the unit from which these specifications were made up. The experienced amateur, however, will be able to pick out other reliable makes of instruments which have been approved by POPULAR RADIO which may be used with good results. But we recommend that the novice follow the list, as the diagrams in this article will tell him exactly where to bore the holes and exactly where to place the connections. If instruments other than the ones listed are used, the only change that will be necessary will be the use of different spacings for the holes that are drilled in the sub-base for mounting the instruments. To any reader who has difficulty in obtaining any of the parts which are necessary in making up these model receivers and power units, POPULAR RADIO SERVICE BUREAU, 627 West 43rd Street, New York City, will gladly assist in seeing that his requirements are promptly supplied.

The New "Exponential Horn"

What this recent and significant product of the radio experimental laboratory is—and the important part that it seems destined to play in the development of the radio art.

By DAVID LAY



Westinghouse

ONE OF THE NEW EXPONENTIAL HORNS AND ONE OF THE MEN WHO PUT THE EXPONENTS INTO IT

Mr. C. R. Hanna is one of the two Westinghouse engineers who developed, back in 1924, the theory of the exponential horn; he and Dr. Slepian have since perfected the folded horn, shown above. The mouth of this horn is approximately four feet square. On the table in front of Mr. Hanna is one of the loudspeaker units used with these new Westinghouse horns.

A NEW device is beginning to make a noise in radio. It is the so-called "exponential horn."

This horn is a new sound outlet for loudspeakers—and one which promises both to alter and to improve our present methods of discharging into the air the music and speech received by radio devices.

On the afternoon of May 12, 1927, a group of newspaper men and invited guests stood on one side of a valley near Pittsburgh, Pennsylvania. They listened to speech and music thrown across at them from the other side of the valley, where stood the research

laboratory of the Westinghouse Electric & Manufacturing Company. Motorists who chanced to be following the road along the valley's bottom, an occasional gardener digging up what he hoped would prove to be his beds of summer vegetables, housewives in their near-by kitchens; all were astonished to hear what seemed like celestial music rolling down out of the air around them. Although some of the listeners were more than a mile away from the quite ordinary-looking horn set up at the Westinghouse laboratory, both speech and music were audible clearly and loudly.

The occasion was a demonstration of

a new form of the exponential horn developed by two Westinghouse engineers, Mr. Clinton R. Hanna and Dr. Joseph Slepian. These are the same experts who presented before the American Institute of Electrical Engineers in 1924 the mathematical theory upon which the present practical developments are largely based.

Although probably the most spectacular of the recent applications of the exponential principle of horn design, the demonstration arranged by the Westinghouse engineers on the Pittsburgh hillside stands by no means alone. The exponential principle has been applied

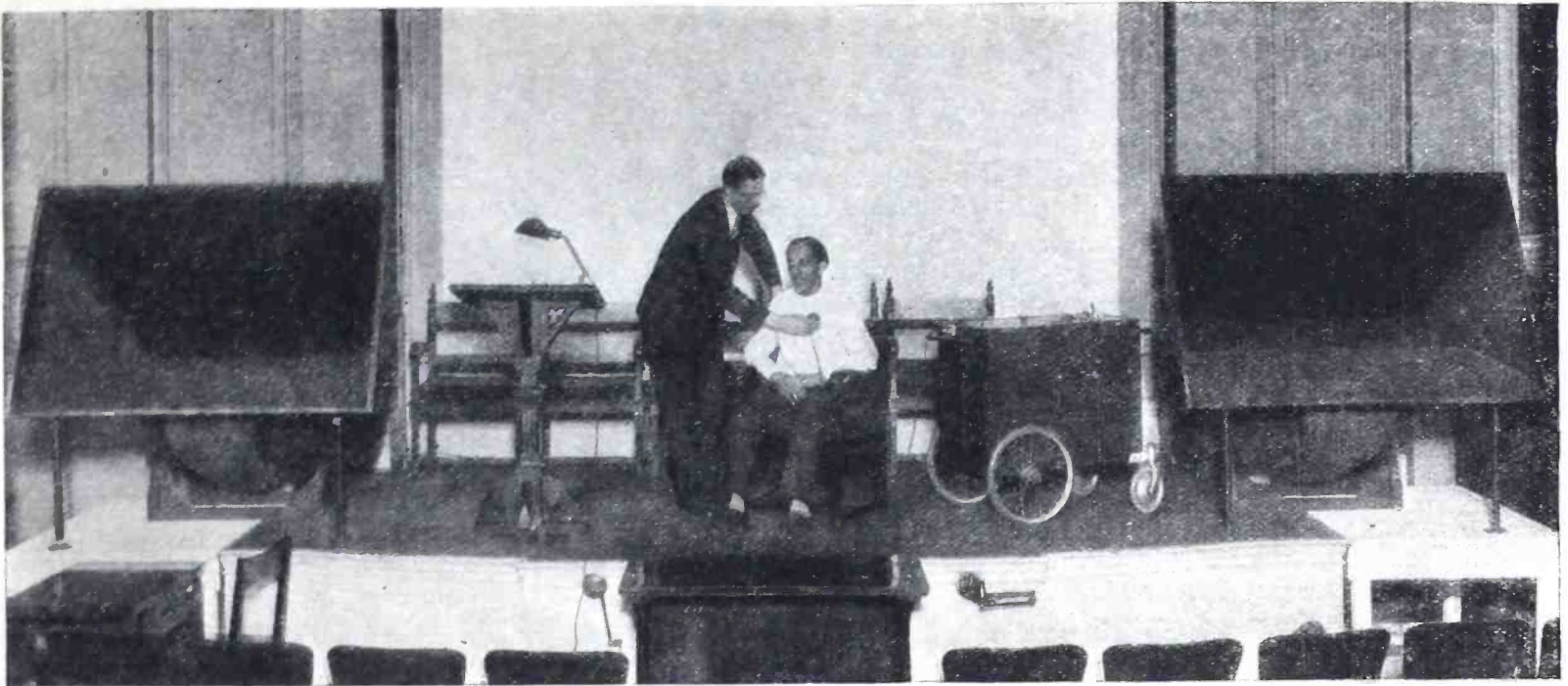

Bell Laboratories

TWO EXPONENTIAL HORNS REPORT A BEATING HEART

These two horns, both of an exponential design, were used by Mr. H. F. Hopkins to demonstrate the electrical stethoscope before the Kings County Medical Society, in Brooklyn, New York. Both horns are folded, so that greater length can be obtained without occupying too much space, but the exponential principle of increasing cross-section is carefully maintained. With these horns even the lowest rumbles in the sounds of the human heart can be made audible to a large audience.

importantly in recent horn designs by the engineers of the Bell Telephone Laboratories, including the designs for the horn of the Orthophonic Victrola and for the great horns used with the Vitaphone. It has been applied to the horn developed by Mr. H. P. Donle and illustrated on page 15 of this issue. Numerous other horns, intended for radio loudspeakers, for public-address systems and for other purposes, have been designed or are in development.

It seems unquestionable that something new has come, at last, into the field of the loudspeaking telephone.

It would be foolish to try to predict the detailed development of this new exponential principle. Prophets are not lacking to say that "the day of the cone loudspeaker is over"; that the old, familiar horn, once all but universal, will sweep the field once more.

This may prove to be true. But there are other possibilities, one of them being that the new exponential horns will be found to have their chief utility where reproduction must be loud, leaving to the present-day cone loudspeakers the varieties of reproduction in which loudness is not so essential.

Only time will tell the truth of such forecasts. This one fact, however, seems to be sure: whatever horns are designed from now on for acoustic purposes are apt to be based, in whole or in part, upon the exponential principles now in such rapid development. It may be safely said, I believe, that the invention of these principles will retain for the horn type of reproducing device a

necessary and honorable field in radio and in the phonograph arts, even though this field turns out not to include absolutely all of the industry.

The word "exponential" does not refer to the width of the horn, to its length, to its acoustic properties, or even to such matters as the details of its shape. It refers merely to the mathematical theory, a part of the standard physical theory of sound waves, according to which the new horns are designed.

In mathematical notation an "exponent" is a figure which indicates powers of numbers or roots of numbers.

For example, if you wish to set down mathematically the square of x or the square of ten, you write the x or the 10 followed by a small superscript figure 2. This figure is the "exponent." If the cube is to be indicated instead of the square, the exponent is the figure 3; similarly the exponent 4 indicates the fourth power of the number, which is the same as the square of the square, and so on. Readers of POPULAR RADIO are already familiar with the method of indicating very large numbers by powers of ten. The figure 10, for example, with an exponent of 6 indicates the sixth power of ten, which is the same as the cube of the square of ten, or, in ordinary notation, the same as one million.

If roots are to be expressed instead of powers, the exponent is negative. For example, an exponent of -2 indicates the square root; an exponent of -3 indicates the cube root, and so on.

Modern mathematics make great use

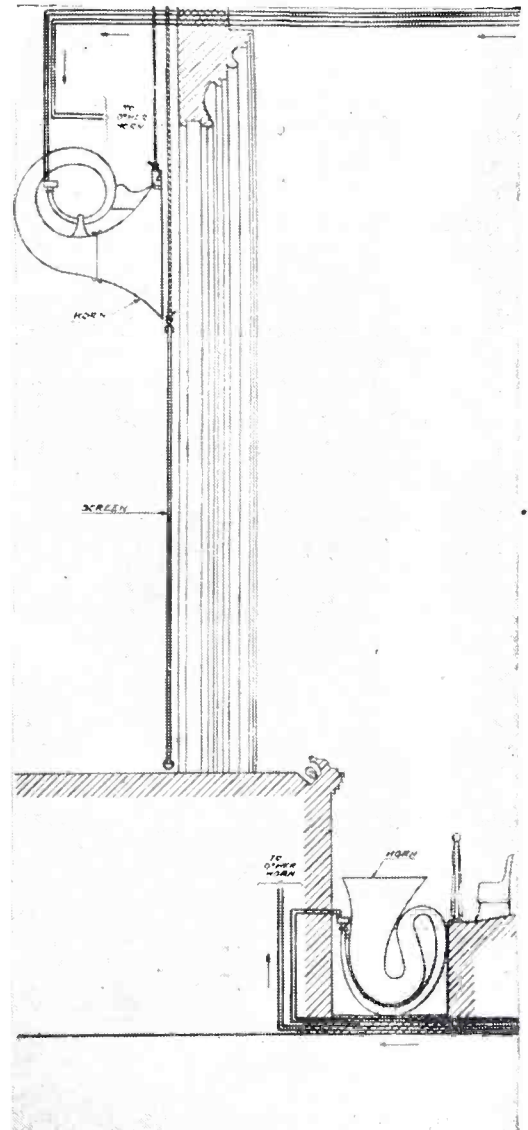

AN INSTALLATION IN A THEATER

When the exponential horns of a public address system are installed in a theater, one or more horns are placed in the orchestra pit and another set is hung behind the curtain, at the top of the stage.

of this device of exponents, both in ordinary algebra and in the more advanced varieties of mathematical calculation. The science of mathematical physics has found it convenient also to make use of exponential symbols and of equations in which powers or roots of quantities, all indicated by exponents, are contained. These are called "exponential equations." So universally are they employed nowadays in the theories of electricity, of sound, of light, and of other branches of physics, that modern physics has been called an "exponential science."

This makes clear the reasons why the new horns are called exponential horns. These horns are designed and constructed according to theories of sound, which theories are most conveniently expressed in the form of exponential equations. Instead of making models or diagrams illustrating the shape of horn desired, the modern acoustic designer may write down a mathematical equation, expressed in exponential terms and indicating exactly how the horn is to be built.

For the ordinary student of radio it is unnecessary to pursue these more complicated details of horn theory. In the case of the type of exponential horn used in the recent Westinghouse demonstrations, as well as the types now under active development in other laboratories, the essential characteristic of the horn can be expressed more simply.

It is that the cross-section of the horn doubles at equal intervals along its length. For example, if the cross-section of the horn at a distance of one foot in front of the diaphragm is one square inch, the cross-section at a distance of two feet will be two square inches, at a distance of three feet four square inches, at a distance of five feet sixteen square inches, and so on.

The exponential theory does not require, however, that the horn should enlarge as slowly as this. Instead of doubling the cross-section for each foot of length, it is possible to double it for each six inches of length or even for each three inches of length. In the case of the last-named horn, if the horn is one square inch in cross-section at a distance of three inches in front of the diaphragm, it will be two square inches in cross-section at a six inch distance, eight square inches at a foot distance, 128 square inches at two feet distance, and so on.

The amount by which the horn increases in cross-section for each unit of length is what is called its expansion ratio. This may be varied, making long, narrow horns or short, wide horns, all of them still retaining the essential exponential principle; the principle by which the cross-section of the horn increases

by the factor 2 for each equal increment of length.

To prove why it is that a horn corresponding to this principle has properties of such great value for the discharge of sound would involve a long mathematical discussion of little interest except to specialists. By analogy with the proverbial pudding, the proof of the horn is in the hearing. It has been agreed by every one who hears the new exponential horns that this test is passed with flying sounds, if not with flying

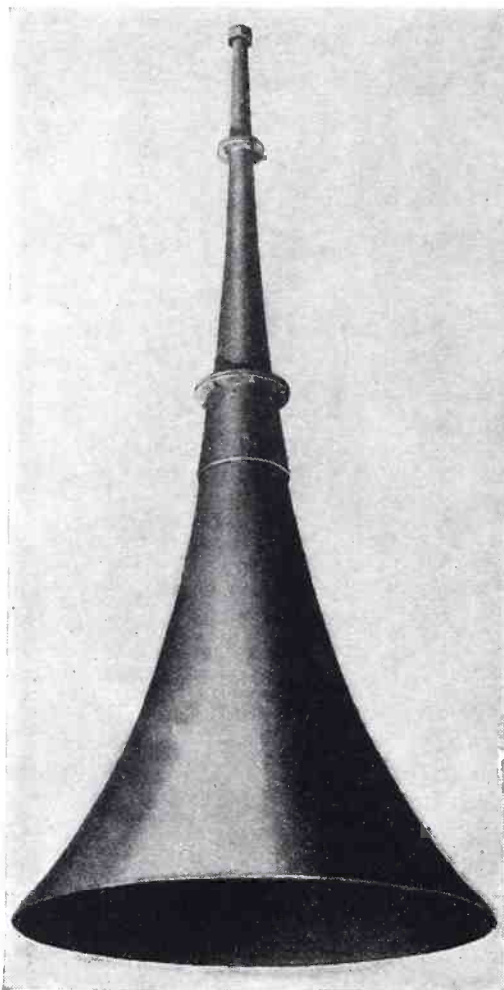

Bell Laboratories

A STRAIGHT MODEL OF EXPONENTIAL HORN

This unfolded exponential horn (made in three sections) shows the regular expansion of the horn in diameter, as required by the exponential principle. This type of horn has proved successful in public address systems for out-of-door use.

colors. There can be no doubt that horns which correspond to this exponential principle of design are much more satisfactory sound radiators than are horns which fail to meet this mathematical test.

Although the fact is well known to experts, it is not so well known, perhaps, to the radio beginner, that the horn of a loudspeaker adds nothing to the initial intensity of the sound. All of the sound which is to come out of any kind of horn must be present in the vibration of the diaphragm at the small end of the horn. However, if this diaphragm is allowed to vibrate freely in the air,

without any kind of horn in front of it, it discharges relatively little sound. The reason is that the diaphragm does not adequately "couple" with the air; which means that the area of the diaphragm is so small that the amount of air set into vibration by it is minute. The sound wave which proceeds outward from this center of disturbance is a relatively feeble one.

The advantage of the cone loudspeaker over a simple vibrating diaphragm, like the diaphragm of a telephone, is that the cone possesses a much larger vibrating surface. Accordingly, it sets into vibration enormously greater masses of air. This produces and discharges a far more intense wave of sound.

The advantage of any variety of horn, whether the new exponential one or the older more arbitrary varieties, comes from a similar ability to set more air into vibration in correspondence with the vibration of the diaphragm. This diaphragm, at the inner end of the cone of air contained inside the horn, sets this entire cone of air into vibrations like those of the diaphragm itself. In effect, the radiating surface from which sound waves are emitted becomes, not the relatively small surface of the diaphragm itself, but the entire front surface of the cone of air contained within the horn.

The advantage of the exponential horn, as may be shown mathematically from its detailed theory, is that it permits this preliminary communication of the sound to the internal cone of air and thence to the general air outside to take place with the minimum of interference and resistance. In technical terminology, the exponential horn "loads" the diaphragm more completely and with less distortion than can be accomplished with other existing kinds of horns.

In comparison with the cone loudspeaker the exponential horn probably will find its greatest advantage in an increase of loudness.

Ignoring electrical characteristics and confining attention to acoustic ones, there are three essential characteristics of a loudspeaker. One of them is the loudness; that is, the sound intensity which the loudspeaker emits for a certain electrical input (or a certain amplitude of vibration) of the diaphragm. The second is the amount of distortion which is produced, which means the degree (if any) to which the apparatus changes the acoustic characteristics of the sound vibrations emitted by the diaphragm. Third is what is called the "cut-off." This means the points of low frequency and of high frequency

(Continued on page 76)

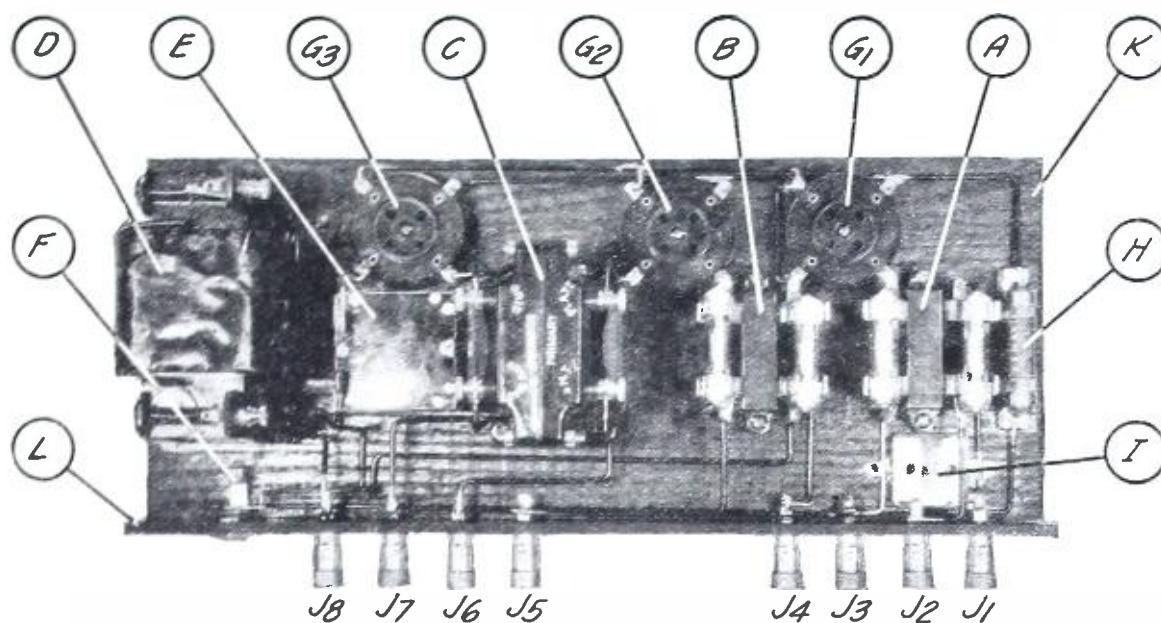

A VIEW OF THE NEW AMPLIFIER AS SEEN FROM ABOVE

FIGURE 1: This illustration shows the general arrangement of the various instruments that are used in this unit. They are all mounted on a baseboard and are designated by letters that correspond with the list of parts and with the text of the article.

A New Amplifier for Your Old Set

NUMBER 4. *How to build a low-frequency amplifier that utilizes two resistance-coupling units and one high-grade transformer-coupled unit*

This series of constructional articles describes in detail the modern methods of amplification at low frequencies for obtaining quality reproduction. The amplifier units are small, compact and easy to build and they may be inserted either in an old receiver or in a new one to obtain undistorted amplification.

By THE TECHNICAL STAFF

COST OF PARTS: *Not more than \$32.00*

HERE ARE THE PARTS THAT WERE USED IN THE LABORATORY MODEL OF THIS UNIT—

A and B—Amsco resistance-coupler units;
 C—Ferranti low-frequency transformer, type AF3;
 D—Amer Choke, No. 854;
 E—Tobe paper condenser, 4 mfd.;
 F—Any approved single-circuit jack (the Carter jack is illustrated in the diagrams that accompany this article);

G1, G2 and G3—Any approved cushion sockets (Amsco sockets illustrated);
 H—Any approved automatic filament control for 1 ampere (Amperite control illustrated);
 I—Any approved mica fixed condenser, .0005 mfd. (Aerovox fixed condenser illustrated);

J1, J2, J3, J4, J5, J6, J7 and J8—Any approved binding posts (X-L binding posts are illustrated in the accompanying diagrams);
 K—Hardwood baseboard, 6 by 14 by 1/2-inch;
 L—Bakelite binding-post strip, 1 1/2 by 14 by 3/16-inch.

HERE is a new amplification unit that is of value both to the owner of an old type of radio receiver and to the owner of a recent type. But its special appeal is to the former—for the simple reason that it enables him to “modernize” his old set with the aid of new apparatus.

This new amplifier embodies a new combination of *both* resistance and transformer coupling—with remarkably good results.

The amplifier may be installed in place of the old-fashioned unit in an old receiver. It will give him an enormous volume with exceptionally true-to-life quality and will bring out the drum and bass notes in a particularly realistic and impressive manner.

The model described was designed especially for this use by the staff of POPULAR RADIO EXPERIMENTAL LABORATORY; the results obtained were excellent.

The schematic wiring diagram is shown in Figure 3.

How to Construct the Unit

To build the amplifier, cut the baseboard, K, to the proper size, 6 by 14 and 1/2-inch. Then prepare the binding-post strip, L, as shown in Figure 2. The eight binding posts, J1, J2, J3, J4, J5, J6, J7 and J8, as well as the jack, F, should be attached to the strip.

The first two binding posts, J1 and J2, are for the input connections to the receiver with which the amplifier is to be

used; binding posts J3 and J4 are for the “A” battery; J5 is for the second stage “C” battery negative; J6 is for the “B” battery plus (+) for the second valve; J7 is for the “C” battery negative for the third stage and J8 is for the high voltage “B” battery positive for the first and third valves.

Notice that the “B” battery negative should be connected to the “B” battery positive of the detector “B” battery used with the receiver. These battery connections are all shown in Figure 4.

To proceed with the construction of the unit, the instruments may be fastened down in their relative positions by means of wood screws driven into the baseboard, K. The proper layout is given in Figure 2, which may also be

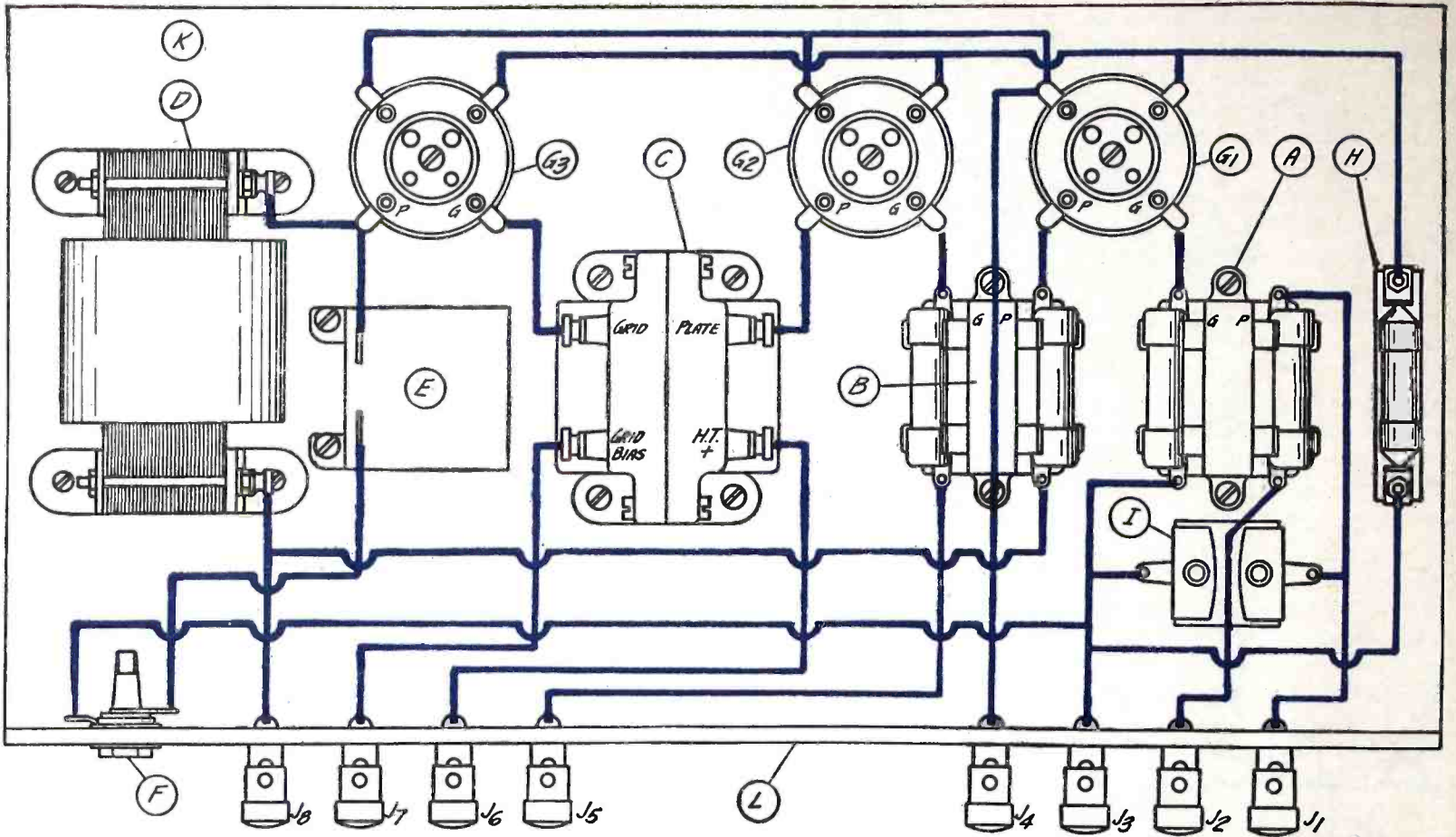

THE PICTURE WIRING DIAGRAM

FIGURE 2: This drawing shows exactly how to hook up the various instruments in their respective electrical places in the circuit. The heavy blue lines indicate the wiring, while the black lines indicate the outline of the instruments themselves.

The list of parts given on page 25 includes the exact instruments used in the laboratory model of this receiver. The experienced amateur, however, will be able to pick out other reliable makes of instruments which have been approved by POPULAR RADIO and which may be used with good results. But we recommend that the novice follow the list, as the diagrams in this article will tell him exactly where to bore the holes and exactly where to place the connections. If instruments other than the ones listed are used, the only change that will be necessary will be the use of different spacings for the holes that are drilled in the sub-base for mounting the instrument. To any reader who has difficulty in obtaining any of the parts which are necessary in making up these model receivers, POPULAR RADIO SERVICE BUREAU, 627 West 43rd Street, New York City, will gladly assist in seeing that his requirements are promptly supplied.

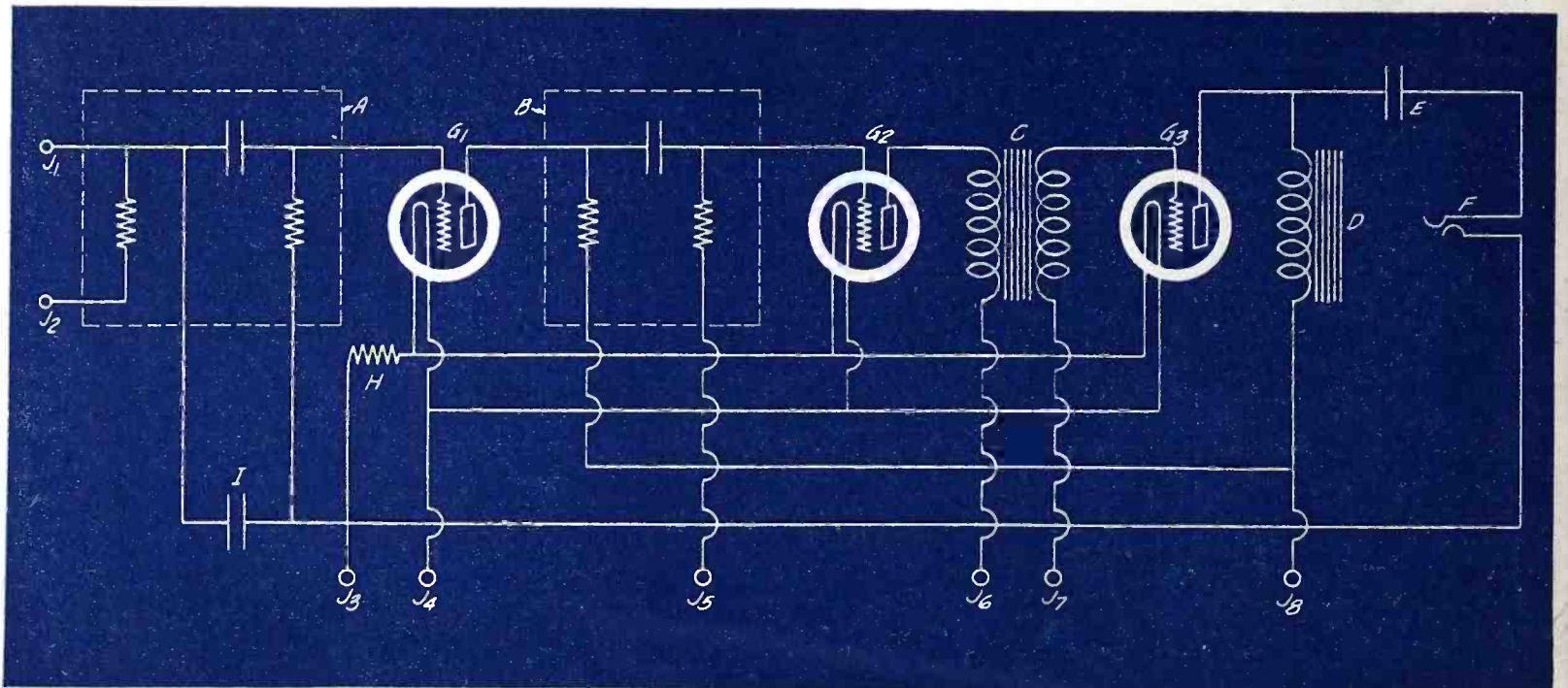

THE THEORETICAL CIRCUIT EMPLOYED

FIGURE 3: Here is shown the schematic diagram of the amplifier. The units indicated by dotted lines, A and B, are complete resistance-coupler units that couple the two tubes, G1 and G2. These are followed by a high quality transformer, C, and a power tube, G3. The output circuit contains a filter that improves quality, at the same time protecting the loud-speaker from heavy DC currents.

used as a picture wiring diagram so that no mistakes are made in wiring.

The wiring scheme in Figure 2 carries out the electrical hook-up shown in Figure 3. When the wiring is completed, the unit is ready to be installed and the batteries may be connected exactly as shown in Figure 4.

In the first two valve sockets, G1 and G2, insert two UX-201-a type valves and in the last valve socket insert a UX-171 type valve.

Notice that the last stage is equipped with an output unit that keeps the high voltage direct current from the windings of the loudspeaker while allowing the signal to pass through it.

When the valves have been placed in their respective sockets, and the amplifier input connections are made to the detector output connections of the receiver, the unit is ready for use. It should be used with a reproducer that is capable of giving high quality reproduction. The reproducer is plugged in by means of a phone plug into the jack, F.

The receiver that this unit is used with should be tuned in the usual manner and should give much better results than with the old amplifier that was first used with it.

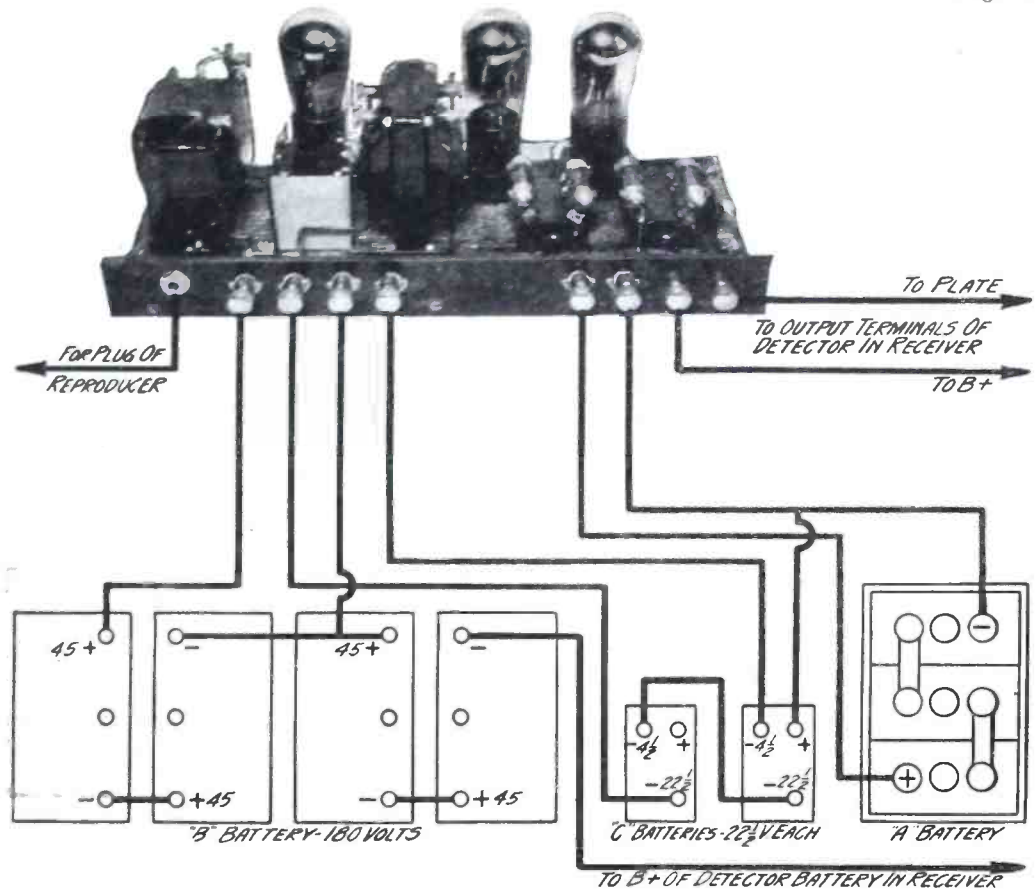

HOW TO HOOK UP THE AMPLIFIER

FIGURE 4: The proper connections to the amplifier from the batteries are given in this composite diagram. The connections to the detector tube and the reproducer are also indicated by the arrow-tipped lines in the upper right-hand and left-hand corners.



Harris & Ewing

A MINIATURE RADIO SET TO CLAMP ON YOUR TELEPHONE STAND

The ordinary telephone receiver may be used for picking up broadcast programs by means of this little attachment that has been invented by Mr. George F. Mitchell, of Washington, D. C. The visible receiving equipment is a wooden slab that encloses the crystal or tube detector and the wires for making connections to the telephone and to the "ground"; the telephone wires serve as the antenna. This miniature set interlocks with the regular telephone stand; two pins are used for making electrical connections between the radio unit and the cords that extend to the telephone receiver. The device does not interfere with the telephone service.

The NEW 1928 MODELS

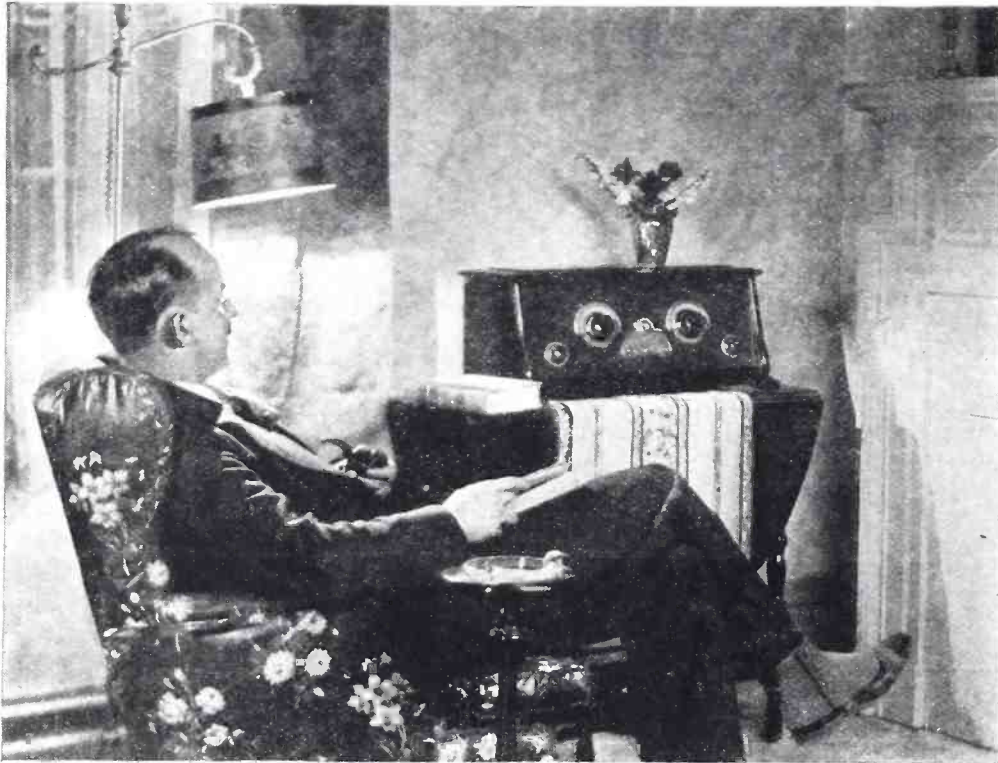

The New Marti Receiver

FEATURES: Uses six AC valves; includes a device that eliminates necessity for an antenna except for distant stations; retails for under \$250, with entire power-pack equipment as well as the valves.

THIS is the time of the year—in July and August—when the far-sighted radio fan begins to look over the new 1928 models of receiving sets. For this is the time of year that the coming season's models are making their appearance.

A review of the advance models of the latest receivers that have been tested by the POPULAR RADIO LABORATORY reveal two outstanding facts:

First, that while the fan will not have submitted for his selection the wide assortment of factory-built sets that in the hurly-burly days of broadcasting literally glutted the bewildered market, all of the models are designed on sounder scientific principles and are better constructed than before, and consequently represent sounder values;

Second, that a sufficient variety of models are available to meet the needs of both the fat and the thin purse, and of the city as well as the country dweller.

The advance information on a representative group of the new models, incorporated in this article, was obtained direct from the engineers and factories by the Technical Staff of POPULAR RADIO, and the brief summaries of the outstanding characteristics of each receiver here listed represent the unbiased opinions of the POPULAR RADIO LABORATORY.

For convenience to the reader, each

receiver is here described specially in detail.

* *

The New Marti Electric Power Radio

Description: This is a six-valve receiver which includes two stages of tuned high-frequency amplification, a vacuum valve detector and three stages of resistance-coupled, low-frequency amplification. The vacuum tubes are supplied with the receiver and are of the McCullough AC type with their cathodes heated by means of alternating current. The transformer used to step down the AC voltage to that required for heating the cathodes is built into the receiver, as is the "B" power-pack which converts the alternating lighting current into high voltage, direct current for the plate supply. A UX-216-b type valve is used as the rectifier. The receiver is tuned by means of two illuminated controls on the front of the cabinet. One of these tunes the input circuit, while the second control tunes the second and third tuned circuits together.

This receiver is available in either the table-mounting model shown in the illustration, with the power-pack equipment built in, or in a desk console model. The latter also contains a built-in reproducer of the orthophonic type. Both models are done in two-tone walnut. The receiver operates with an outdoor antenna

The advance information was obtained directly from these new receivers; it was diced tests conducted in the

By the TECHNICAL STAFF

of from 50 to 100 feet in length, depending on the proximity to the local broadcasting stations. Good local reception is made possible without an antenna, by means of a device that is built into the receiver and which causes the AC supply lines to function as an antenna as well as a current carrier.

Outstanding features: It is of compact size for a receiver which includes the entire power-pack equipment; no batteries are used, and no antenna is required except for distant reception.

Maker: Marti Electric Radio Co.

* *

The New Fada Special

Description: This is a 6-valve neutrodyne receiver of the table mounting type and is designed to be used either with batteries or power-packs that draw their supply from the house-lighting lines. Either an indoor or outdoor antenna may be used.

The receiver makes use of UX-201-a type valves in all but the last low-frequency amplifier stage, where a power valve of the 171 type is recommended. There are three stages of high-frequency amplification, two of which are tuned and one untuned. The two tuned stages are controlled by a single knob on the front of the receiver; a second control knob tunes the "input" or antenna circuit. The third control on the receiver front serves a dual purpose as the volume control and "off" and "on" switch. The coils and wiring of the high-frequency circuits are shielded to prevent stray pick-up and to reduce interstage coupling.

The high-frequency amplifier is especially designed to provide uniform sensitivity throughout the entire waveband from 200 to 600 meters. The tuned stages provide maximum sensitivity over only a part of this waveband, but at the point where their sensitivity starts to drop the sensitivity of the untuned stage increases, thus maintaining an even and high degree of amplification on all wavelengths.

The low-frequency amplifier consists

IN RADIO RECEIVERS

incorporated in this article the engineers who developed supplemented by unpreju-
POPULAR RADIO LABORATORY

of POPULAR RADIO

of two transformer-coupled stages. The tonal quality of this amplifier is such as to warrant the use only of a high-grade reproducer such as the Fada cone-type speaker.

The receiver is housed in an attractive mahogany cabinet that is finished in velvet brown duo-tone mahogany.

Outstanding features: All the coils are shielded. Uniform sensitivity is attainable throughout the waveband. The plate current consumption is low.

Maker: F. A. D. Andrea, Inc.

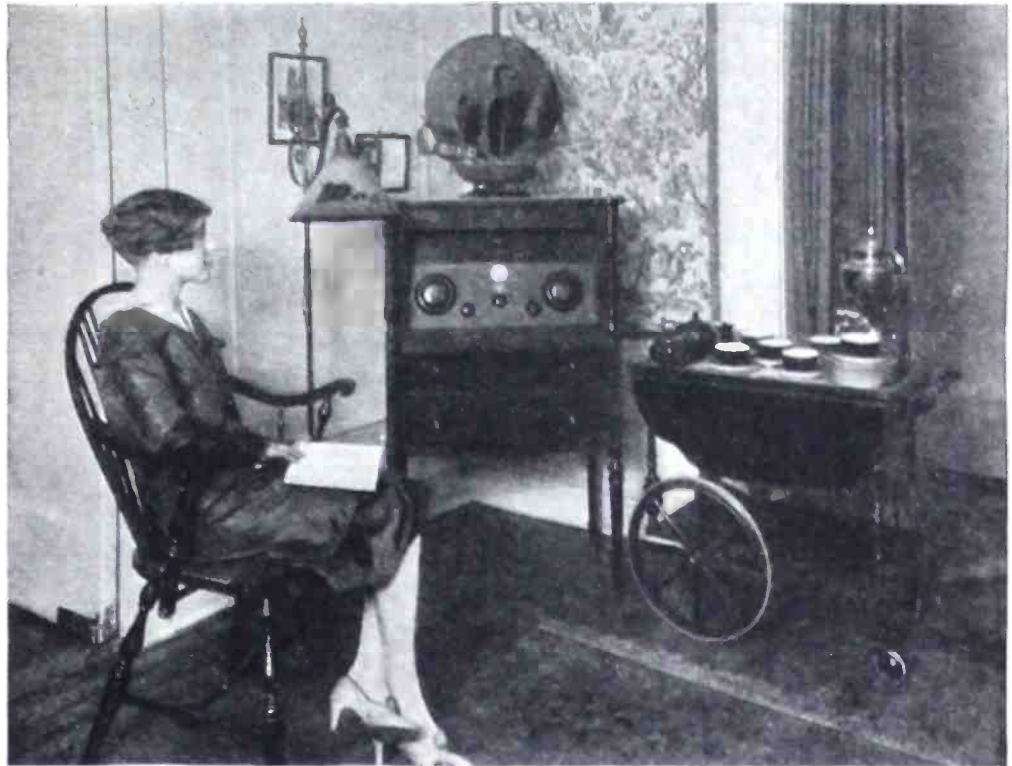

The New Nassau Receiver

FEATURES: Operates entirely on the house-current electric lines; uses six standard valves, with 210 power valve in the last stage; retails for about \$300, including a built-in power supply unit (but not including the valves).

The New Nassau Power Radio—Type D L P

Description: This is a console type receiver which obtains all its operating power from the AC lighting lines. In the lower part of the console cabinet is a totally shielded "ABC" power-pack that converts the 110 volt, 60 cycle current to direct current, which is applied to the receiver at the various voltages required for filament, plate and grid circuits. The rectifier unit makes use of a UX-216-b type rectifier valve. The receiver uses five of the UX-199 type valves and one of the UX-210 type. This latter valve, used in the last stage of low-frequency amplification, provides

an abundance of volume without overloading or distortion. The circuit consists of two stages of tuned-high-frequency amplification, a vacuum valve detector and three stages of "Tru-phonic"-coupled, low-frequency amplification. Two of the tuning condensers are mechanically coupled together and are tuned simultaneously by means of one tuning control. The condenser in the first stage is separately tuned. The three smaller knobs shown on the front panel in the accompanying illustration are for controlling volume, sensitivity

and filament current. The meter shown on the panel is used to adjust the filament current to the proper operating point, regardless of the AC line voltage, providing the latter is somewhere between 95 volts and 125 volts. Just above the control panel is a dash light with an adjustable shade which lights up the controls and permits of easy tuning even in a darkened room. This light also serves as a pilot light, as it only lights when the receiver is turned "on." The console which houses this receiver is of satin-finished walnut. The receiver is equipped with an extension cord and plug for connecting to the house lighting lines.

Outstanding features: No batteries are required; the power-pack is safe and fool-proof, as the case cannot be opened without first disconnecting it from the AC. It has great volume and gives reproduction of exceptional quality.

Maker: Nassau Radio Co.

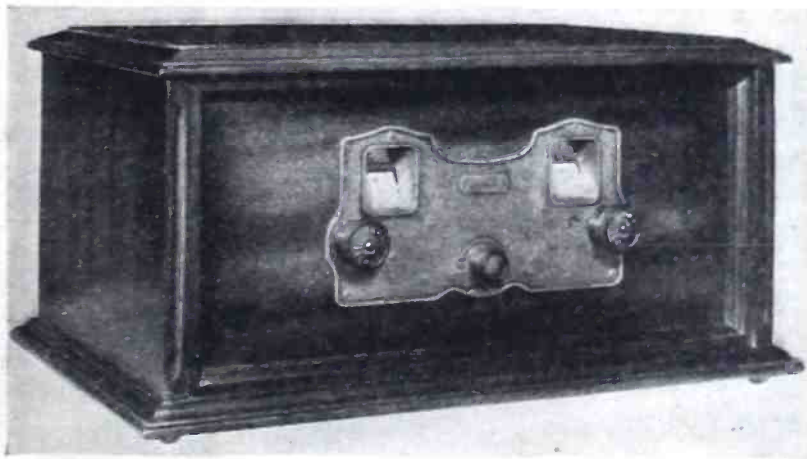

The New Fada Receiver

FEATURES: Is liberally shielded and includes other details found usually only in the higher priced sets; low plate current consumption and uniform sensitivity are attainable throughout the waveband; retails for less than \$100, without equipment.

The New Ferguson Model "Fourteen"

Description: This is a ten-valve receiver which employs six stages of high-frequency amplification, a vacuum valve detector and three stages of low-frequency amplification. The high-frequency amplifier consists of three untuned stages and three tuned stages. The low-frequency amplifier consists of one

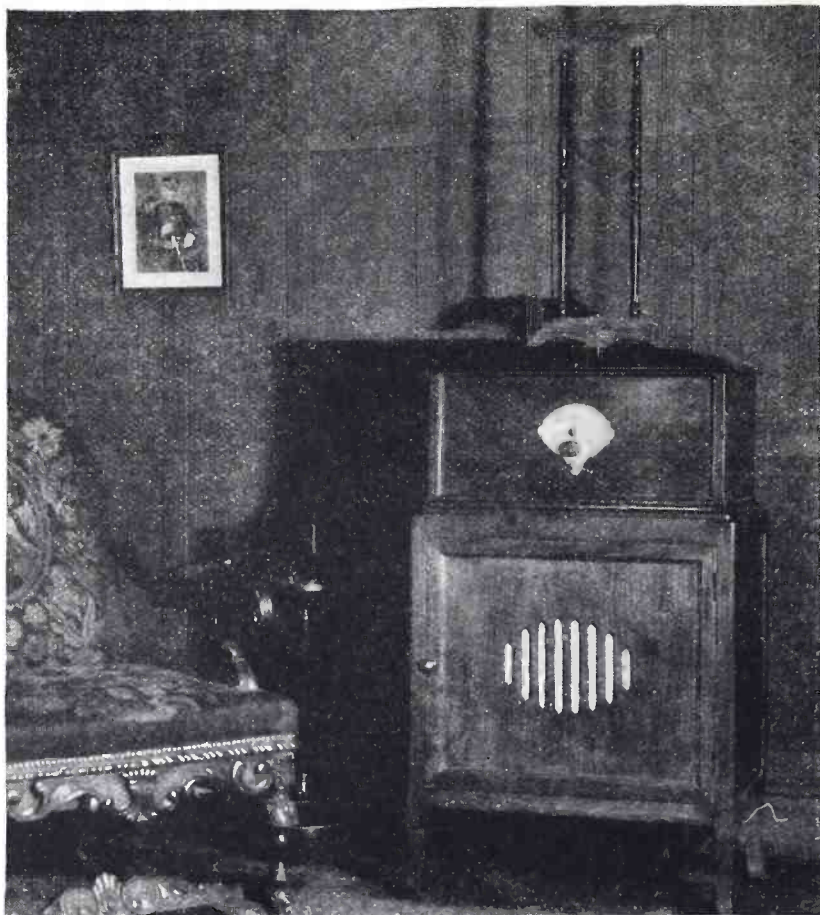

The New Ferguson Receiver

FEATURES: Has ten valves, with six stages of high-frequency amplification and only one tuning control. Retail for \$235, including the loop antenna.

transformer-coupled stage, followed by two stages of "Truphonic" coupling. Tuning is accomplished by means of a single control which is calibrated directly in wavelength. The receiver is designed primarily for use with a loop antenna, but it can also be used with an outdoor or indoor antenna. The "A" power supply is obtained from a storage battery and the "B" supply may be obtained from standard dry-cell "B" batteries or, preferably, from the Ferguson Hi-Power "B" power-pack. This power-pack delivers sufficient voltage to permit the use of a UX-171 type power valve in the last low-frequency amplifier stage. It also provides four different voltages, as required in the operation of this receiver.

The receiver is furnished in a walnut cabinet of the table-mounting type. A table to match, with a built-in reproducer and compartments for all equipment, as shown in the illustration, may also be obtained from the manufacturer, as extra equipment.

Outstanding features: It has six stages of high-frequency amplification, is entirely self-contained when used with table to match, and it eliminates the need for an antenna. It is extremely sensitive, has excellent selectivity and fine tone quality.

Maker: J. B. Ferguson, Inc.

The New Standardyne, Model S-27

Description: This is a 6-valve receiver that is tuned by means of a single control. Two other controls are also provided on the front of the receiver, to permit variation of volume and sensitivity to meet the requirements of the operator. The receiver consists of three stages of high-frequency amplification, two of which are tuned, a detector and two stages of transformer-coupled, low-frequency amplification. The single con-

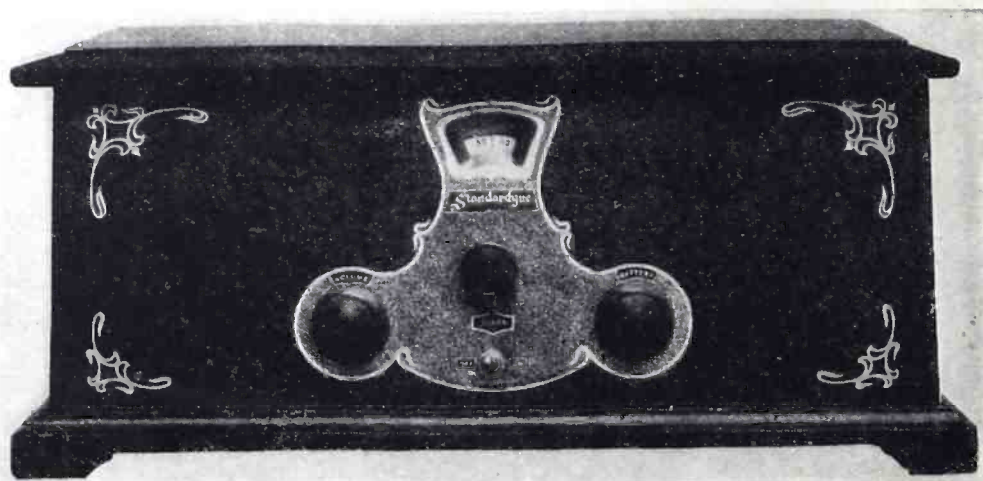

The New Standardyne Receiver

FEATURES: Includes several features usually found only in the expensive sets—not the least of which is a single-control tuning feature and three stages of high-frequency amplification. Retail for about \$50.

trol tuning feature is obtained through mechanical coupling between the tuned circuits.

A power valve of either the UX-112 or the UX-171 types is recommended for use in the last low-frequency stage, and UX-201-a type valves in the other five sockets. The receiver is not furnished with power supply equipment, but is intended for use with either batteries or external power-packs, depending on the requirements and wishes of the user. An antenna of approximately 75 feet in length is recommended.

The table mounting model of this receiver is inclosed in a willow cabinet. The receiver may also be obtained in a console cabinet of mahogany veneer.

Outstanding features: The cost of the receiver is low. Tuning is done with a single control. The size of the antenna has no effect on the tuning.

Maker: Standard Radio Co.

* *

The New Stewart-Warner Model 710 Matched Unit Receiver

Description: This receiver is inclosed in a console of attractive design, as shown in the illustration; it is of walnut and is finished with rubbed lacquer. The two large front doors swing open to disclose the receiver control panel and beneath this the grill behind which the built-in reproducer is located. In the lower compartment, space is also provided for all batteries or for power-packs, if they are used in place of batteries.

The receiver is a six-valve model which includes three individually shielded stages of tuned high-frequency amplification, a vacuum valve detector and two stages of transformer-coupled, low-frequency amplification. The valves recommended by the manufacturer are the Stewart-Warner 501-ax type throughout.

A power valve, however, may be used in the last low-frequency stage with improved results. Tuning is accomplished by means of a main control knob which tunes all but the "input" circuit. This circuit is individually tuned by means of an auxiliary control knob. The only other control is that for "volume." With the batteries or power-packs in place and connected up the receiver is entirely self-contained except for the antenna and ground connections. The antenna recommended is an outdoor wire about 75 feet long, if there are nearby broadcasting stations which might tend to cause interference, or 90 to 100 feet in length if the location is not too near local stations.

Outstanding features: The receiver is self-contained; it may be used either with batteries or with power-packs. It has an individually-tuned "input" or antenna circuit which permits the receiver to be exactly adapted to the antenna used. It is easy to operate.

Maker: Stewart-Warner Speedometer Corporation.



The New Day-Fan MG-Six

Description: This is a six-valve receiver that employs three stages of high-

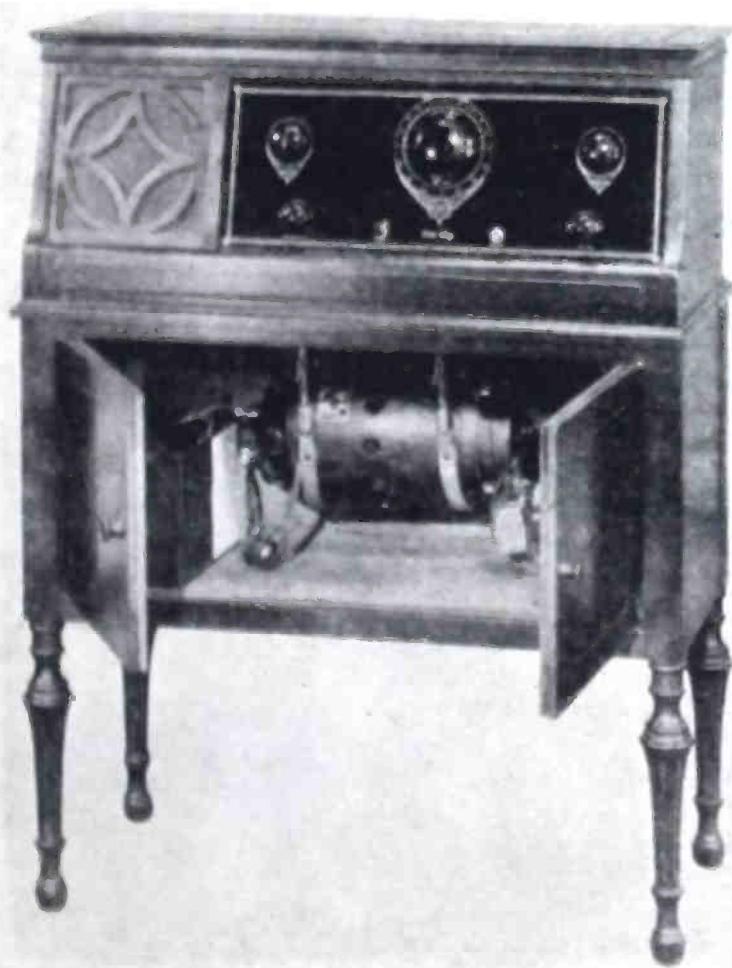

The New Day-Fan Receiver

FEATURES: This is perhaps the first radio receiver to use a small generator to supply all required operating voltages; otherwise it employs standard equipment; is self-contained except for antenna and ground connections. Retail for \$200, less valves.

The New Stewart-Warner Receiver

FEATURES: A six valve receiver with a built-in reproducer, all housed in a cabinet modeled after the style of the new types of talking machines; may be used either with batteries or power-packs.

frequency amplification, one of which is untuned, a vacuum valve detector and two stages of low-frequency amplification. It employs standard valves of the UX-201-a type, except in the last stage, where a power valve of either the UX-112 or the UX-171 type is used. The tuning arrangement is such that all circuits may be tuned simultaneously by the large central tuning knob, or the three tuned circuits may be individually tuned by independent adjustment of the knobs on either side of the main tuning control knob. There are also auxiliary adjustment knobs for controlling selectivity and volume to fit the requirements of the user.

The receiver and cone-type reproducer are inclosed in a single cabinet of hand-rubbed walnut. A screened grill conceals the reproducer. The base of the receiver consists of a radio table with an ample equipment compartment. This is finished to match the receiver cabinet.

One unusual feature of this set is the fact that all operating voltages are supplied by a motor-generator which is cradled in a spring suspension in the

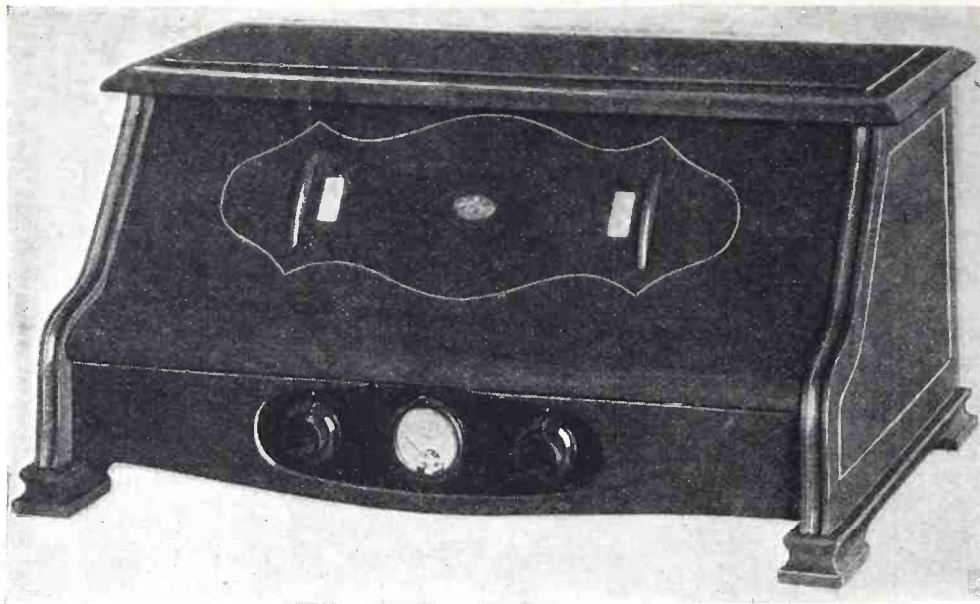

The New Wright-DeCoster Receiver

FEATURES: A seven-valve set that operates on dry cells; dry-cell "A" and "B" batteries may be used exclusively, or any combination of dry cells, storage battery or power-pack may be employed. Retails for about \$150.

equipment compartment itself. This unit operates from the 110 volt, 60 cycle house-lighting lines and generates direct current of suitable voltage. This direct current is filtered and is adapted to the various requirements of the receiver by means of resistances so as to supply the "A," "B" and "C" voltages.

Outstanding features: No batteries are required; it is self-contained except for antenna and ground connections. It is of neat design, has good tone quality and excellent selectivity.

Maker: Day-Fan Electric Co.

* *

The New Wright-DeCoster, Model VII

Description: There is still a tremendous demand for receivers which can be operated entirely from dry cell batteries; over half of our farms are without electricity, and many of these have no local facilities for charging storage batteries. There are also countless homes in cities and suburbs that are still without electrical supply. A good receiver that can draw all its operating power from dry cells is, therefore, in demand.

The Wright-DeCoster receiver fills this demand. It operates with maximum efficiency when a set of six standard 1½-volt dry cells are used for lighting the valve filaments and a set of three standard 45-volt "B" blocks for the plate supply. Equally good results are obtained with a four-volt storage battery for the filament supply.

The receiver uses six of the UX-199 type valves and one UX-120 type. There are three stages of tuned, high-frequency amplification, a vacuum valve detector and three stages of "truphonic"

low-frequency amplification. The receiver is intended for use with an outdoor antenna of 80 feet or more in length. Tuning is accomplished with two drum-type controls, one of which tunes the three high-frequency stages together and the other the antenna input circuit individually. There are two power controls. One of these varies the volume and sensitivity to suit the taste of the listener and the other varies the filament voltage. The proper setting of this latter control is indicated by the voltmeter which is mounted on the front of the receiver.

The cabinet is of the table mounting type and is finished in satin-duco, walnut. A table with a compartment for all batteries is obtainable as extra equipment from this manufacturer and also an excellent reproducer of the pedestal type.

Outstanding Features: This receiver is especially designed for use in homes where electric light lines are not available for charging a storage battery or for operating "A" or "B" power packs. It is equipped with voltmeter to insure proper adjustment of filament voltage, with a resulting long life of the vacuum valves.

Maker: Wright-DeCoster, Inc.

* *

The New Steinite, Model AC-1

Description: The AC-1 receiver is a high-boy console model which draws all its operating current from the AC house-lighting lines. The receiver proper makes use of four 199 type valves in the two stages of high-frequency amplification, detector and first low-frequency ampli-

fier stages. A 301-a or a 112 type valve is used in the second low-frequency stage. The filament supply current and the high-voltage plate supply are obtained through a power supply unit which is incorporated in the cabinet. The necessary grid biasing voltages are also obtained from this source.

There are two tuning controls, one to tune the "input" and the other to tune the two high-frequency circuits. In addition to these two controls, the front panel also carries two operating controls, one to vary the volume of reproduction and the other to adapt the receiver to the AC line voltage existing in any particular location. This latter adjustment permits the use of any line voltage between 100 and 125 volts. There is no guesswork in this adjustment, as it is only necessary to turn this control knob until the meter on the control panel reads 3 volts, which is the proper filament operating voltage.

The reproducer is also built into the high-boy console, making the receiver completely self-contained, except for the antenna. The console is of Philippine mahogany in an antique shaded finish and is equipped with front doors which completely conceal and protect the instrument when not in use. The set is equipped with an extension cord and plug for connection to the house-lighting lines.

Outstanding features: The receiver is low-priced. No batteries are required. All operating voltage is obtained from the 100-120 volt, 60 cycle, house supply lines. It contains a built-in reproducer.

Maker: Steinite Laboratories.

* *



The New Steinite Receiver

FEATURES: Includes the power supply unit and the reproducer in the same cabinet as the receiver itself; operates completely on AC house current. Retails for about \$150, which includes everything except the valves and the antenna wire.

The New Kolster, Model 6-H

Description: This six-valve receiver is inclosed in a walnut veneer console, together with a power speaker and a "B" power-pack. The source of filament power supply is optional with the purchaser. A storage "A" battery may be used, or an "A" power-pack may be purchased from this same manufacturer, as extra equipment. There is room in the console to accommodate whatever supply unit is selected, thus making the receiver self-contained except for the antenna and ground wires.

The receiver employs six 201-a valves in three stages of tuned high-frequency amplification, a detector and two stages of transformer-coupled, low-frequency amplification. All tuning is accomplished by means of a single control on the front of the receiver. The antenna should preferably be of the outdoor type and should not exceed 50 feet in length if the receiver is used in the immediate vicinity of broadcasting stations. If used in a more isolated location, the antenna may be around 75 feet in length.

Outstanding features: The receiver includes a built-in power reproducer. It is designed to use either a storage "A" battery or an "A" power-pack. A "B" power-pack is included in the receiver.

Maker: Federal-Brandes, Inc.

* * *

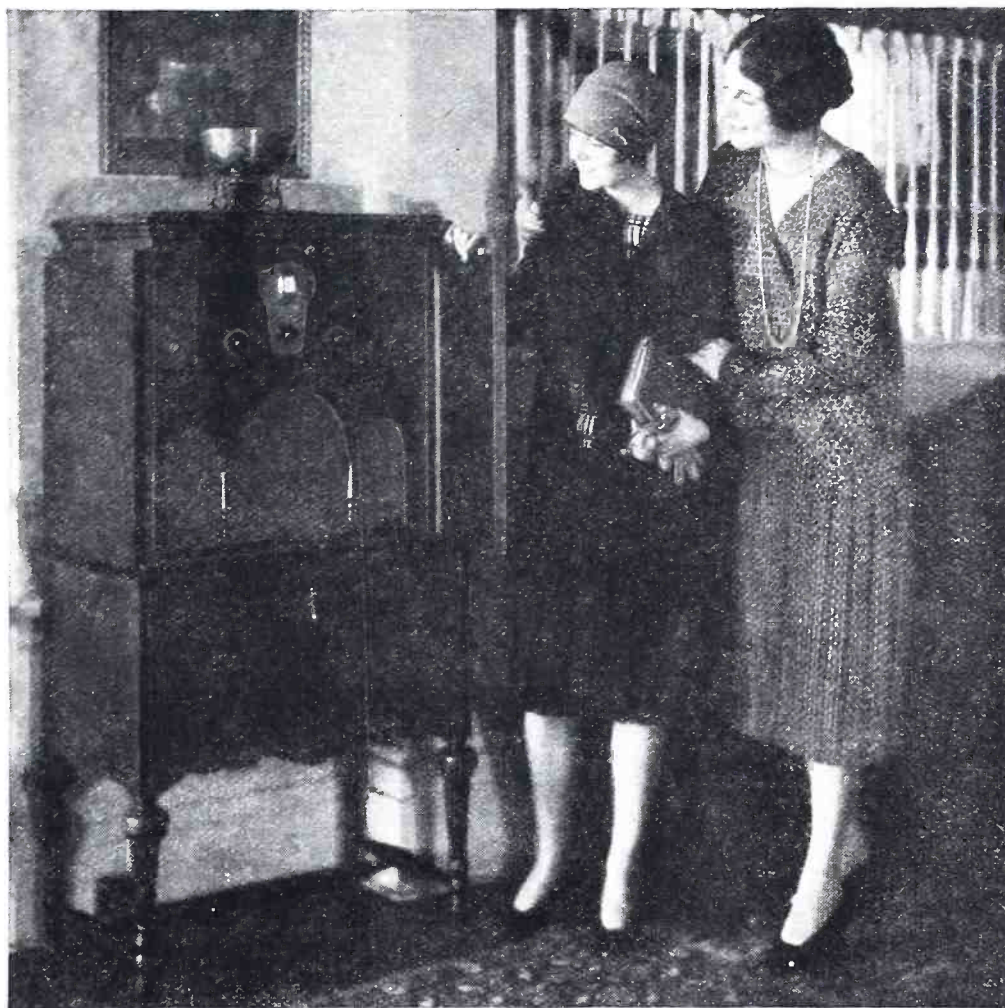

The New Kolster Receiver

FEATURES: Contains a built-in "B" power-pack and power amplifier; also a built-in reproducer. An "A" power-pack may be obtained as extra equipment to make the receiver entirely AC operated. Single-control tuning is employed and the tuning scale is calibrated in wavelengths. Retail for about \$250, not including valves or "A" power supply.

The New Herbert "Lectro" Model 120

Description: This receiver is made in a table-mounting model and is housed in an attractive walnut cabinet that is finished in a two-tone effect. Tuning is accomplished by means of three pointer-knobs which move over calibrated scales on the front of the receiver. The only other adjustment is a smaller knob

which controls the intensity of the signals, and thus serves both as a volume and a sensitivity control.

The receiver is electrically operated from the 110 volt, 60 cycle AC house lines, through the medium of a built-in "ABC" power-pack device which furnishes all voltages required by the receiver. The power-pack portion of the receiver is adjusted before it leaves the

factory to provide the correct voltages for best operation of the receiver. No adjustments need be made by the user other than that of the "intensity" control knob mentioned above. This latter adjustment is not critical.

The receiver uses a QRS 85 milliamperere rectifier valve in the power-pack, and four valves of the UX-199 type and one of the UX-112 type in the receiving circuit. The circuit consists of two stages of tuned high-frequency amplification, detector, and two stages of transformer-coupled, low-frequency amplification. It is intended for use with an outdoor antenna from 75 to 150 feet in length, including the lead-in. In congested locations, where there are nearby high-power broadcasting stations, the shorter length is to be preferred. An indoor antenna may also be used with good results.

Outstanding features: It uses no batteries, and no ground connection is required. It has a low first cost, a low operating cost, and is easy to install. The entire "ABC" power equipment is included with the receiver in a table mounting cabinet of normal proportions.

Maker: Harold Herbert, Inc.

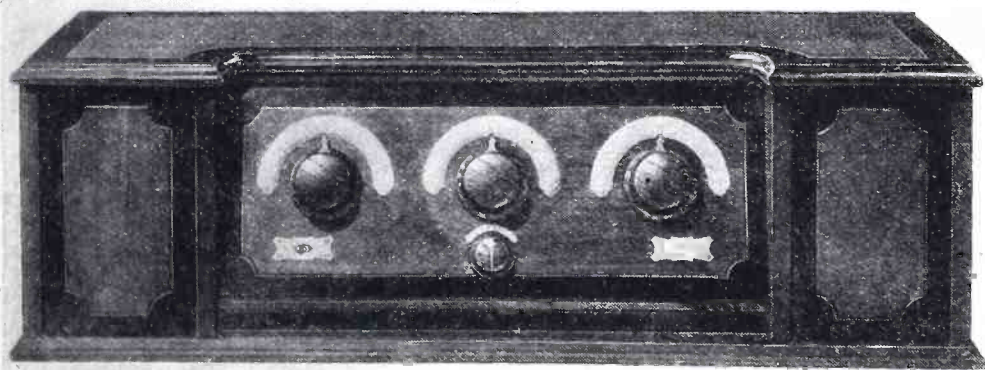

The New Herbert "Lectro"

FEATURES: A built-in power-pack is included in this receiver and supplies all operating current from the AC house lines. It may be mounted on any convenient table and requires no additional space for equipment. It retails for \$120, not including the valves or reproducer.



Henry Miller

A Unique Receiver for a Swimmer

A "stunt" in radio transmission and reception was recently demonstrated in Germany when a deep-sea diver, carrying a miniature transmitter beneath the water, broadcast radio signals to an airplane, which in turn rebroadcast them to Otto Kemmerick (shown above), who was swimming about in this unusual rubber suit that was equipped with a small receiving set and headphones.



A Cord That Permits Moving the Reproducer About

Name of instrument: Extension cord for a reproducer.

Description: This is a combination device which consists of a 50-foot reproducer cord, a plug and a connector block. The cord is made up of two flexible wires contained in a single cotton covering, and with the four ends termi-

What's New in Radio

Conducted by

THE TECHNICAL STAFF

Inventors, experimenters, manufacturers and readers generally are invited to keep the Technical Staff of POPULAR RADIO informed of all new apparatus that is of their own creation or that comes to their attention; if the apparatus passes the tests of the POPULAR RADIO LABORATORY it will be duly recorded in this Department for the information and benefit of all.

nating in phone tips. The tips at one end of the double cord are inserted in the plug and the plug is pushed into the output jack of the receiver. The tips at the other end of the cord are inserted in the pair of holes in one end of the small connector block and the phone tips on the end of the cord that is attached to the reproducer are inserted in the holes at the other end of this block. The reproducer can then be placed any distance from the receiver, up to 50 feet.

These cords are also obtainable in 20, 30 and 40-foot lengths.

Usage: To be connected between reproducer and receiver to permit the former to be placed in another room or at some point distant from the receiver.

Outstanding features: It permits the reproducer to be placed in any part of the house, or outdoors if desired, without the necessity of moving the receiver. It is neatly made.

Maker: Frank W. Morse Co.

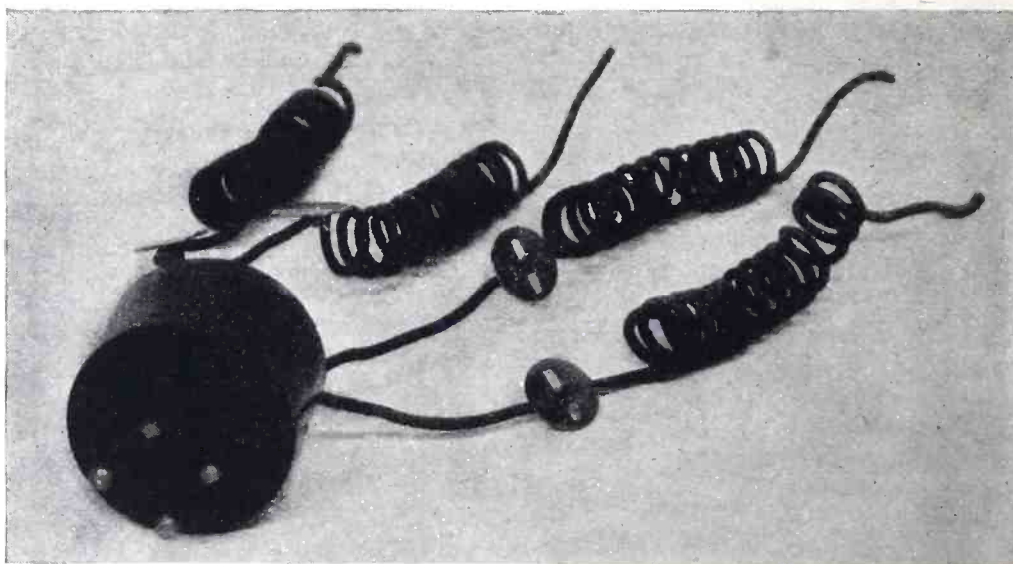

You Can Now Add a Power Valve to Your Receiver Without Any Change in Wiring

Name of instrument: Adapter for power valves.

Description: This adapter consists of a bakelite shell with four brass prongs on the bottom, similar to the base of a vacuum valve. Inside of the shell is a bakelite disc with four holes and spring contacts to accommodate the prongs of a standard UX-type valve base. There are also four flexible wire leads coming from the interior of the adapter. A power valve, such as the UX-171 type or the UX-112 type, may be plugged into the adapter, and the adapter then plugged into the socket of the last low-frequency amplifier stage of the receiver. The four

wires coming from the adapter are then connected to the positive and negative terminals of the additional "B" and "C" batteries required for the operation of the power valve. These four wires are clearly marked, so there can be no mistake in connecting them up.

Usage: To provide a simple means for using a power valve in the last low-frequency stage of a receiver which was not originally designed to accommodate this type of valve.

Outstanding features: It provides for power operation without necessitating new wiring.

Maker: Carter Radio Co.

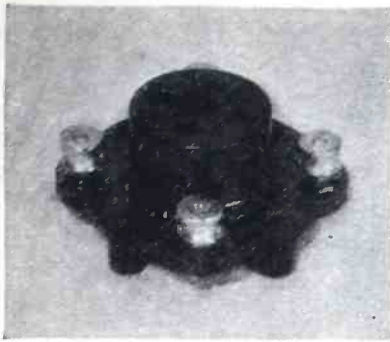

A Socket That Helps to Stop Microphonic Noises

Name of instrument: "Shock-proof" valve socket.

Description: This socket consists of a flat composition base set up on four legs of the same material. The button part of the socket, into which the valve is plugged, is suspended from this base by means of four metal springs, so that when the valve is placed in the socket it will be supported flexibly by these springs. Each one of the springs is stamped and bent in such a way that it serves also as the spring contact against the valve prong and as the soldering lug to which the wiring connections are made. This one-piece construction precludes the possibility of poor connections within the socket. In addition to soldering lugs, the socket is equipped with binding-post terminals, for use where it is desired to make unsoldered connections.

Usage: As the mounting for vacuum valves in a receiver. It is particularly useful for mounting the valves which are likely to cause microphonic trouble, such as the detector valve and the valve in the last high-frequency stage.

Outstanding features: It makes positive contact with good spring action. Stops are provided to prevent the floating portion of socket from being pulled up too far or pushed down too far when inserting or removing valves.

Maker: Pilot Electric Mfg. Co.

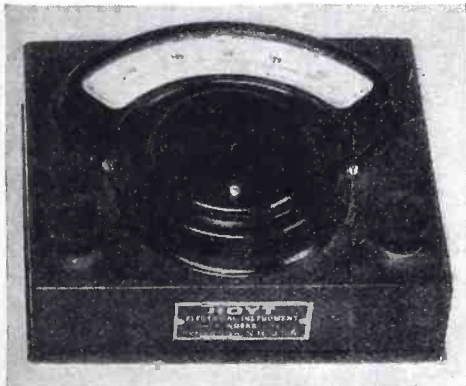

An Accurate Meter for "B" Voltages

Name of instrument: Model No. 515 high-resistance voltmeter, Style No. 3.

Description: This voltmeter is of the portable type and is enclosed in a wooden case with a metal and glass top plate and is equipped with a large scale with a range of 0-300 volts. The meter uses the D'Arsonval type of moving-coil movement and has a resistance of 1,000 ohms per volt.

Usage: For measuring the voltage output

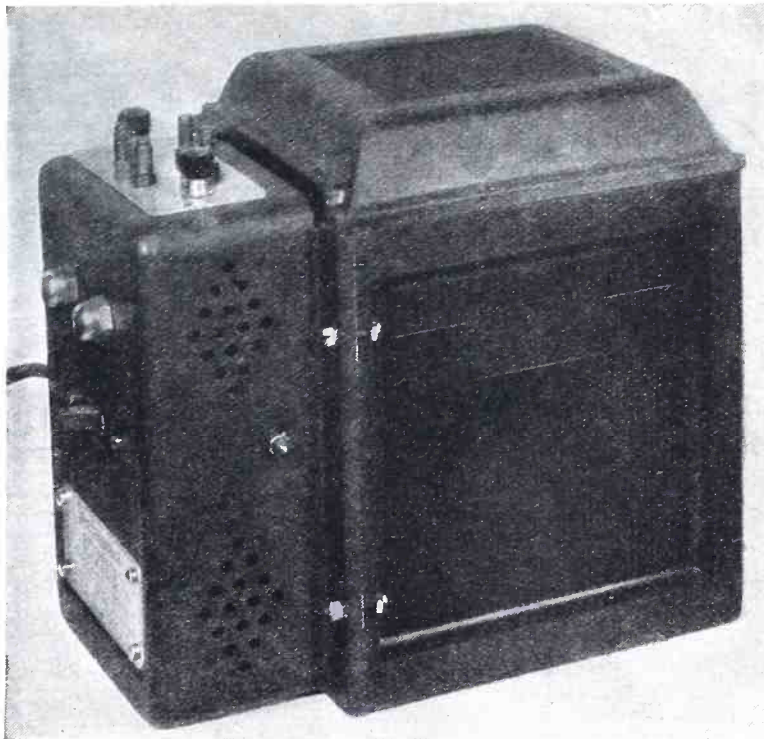

An "A" Battery With a Unique Trickle Charger

Name of instrument: "A" Autopower.

Description: This unit consists of a small storage battery and trickle charger combined in one unit. The battery is enclosed in a rubber case with a cover and the trickle charger is enclosed in metal and is attached to one end of the battery. On the trickle charger is a switch by means of which the receiver is turned "on" and "off." When the switch is thrown to the "on" side, the charger is disconnected from the line and the battery is connected to the receiver. When thrown to the "off" side, the action is reversed. The trickle charger used is unique, in that it contains no liquids, nor does it use a rectifier valve of any kind. Rectification is obtained through the use of an entirely new type of "solid" rectifier which requires absolutely no attention. The unit is equipped with an extension cord and

plug for connection to the house-lighting lines. There are several models of this unit for supplying either 4 or 6 volts and for use where the lighting line voltage is 110 volts at frequencies of 25 or 60 cycles.

Usage: To supply the power for lighting the filaments of standard 3 or 5-volt vacuum valves.

Outstanding features: It is positive in operation. An ample source of current is always available. It requires no attention, except occasional addition of water to the storage battery. It will operate any receiver regardless of the number of valves used. The charging rate may be varied from 1/10 ampere to 1/2 ampere by a simple adjustment provided on the outside of the rectifier unit.

Maker: Westinghouse Union Battery Company.

of "B" power-packs or other high-resistance DC circuits.

Outstanding features: It will accurately measure voltages in high-resistance

circuits where the average voltmeter would be inaccurate. It is mounted in a case of convenient size and shape.

Maker: Hoyt Electrical Instrument Works.

A Self-Contained Storage "A" Battery and Charger

Name of instrument: "A" power unit.

Description: A 6-volt storage battery and a trickle charger are enclosed in a single hard-rubber case. The trickle charger is of the electrolytic type, which supplies a sufficiently high current to keep the battery constantly charged. The instrument is provided with an indicator switch by means of which the trickle charger may be turned "on" and "off" at will. The operating cost of this unit is approximately the same as that of a 15-watt lamp—about one-sixth of a cent per hour.

Usage: To provide a constant supply for the filaments of any receiver.

Outstanding features: The battery and charger are combined in a single unit.

It is provided with an "on-off" switch. The charging rate is adequate to keep battery fully charged.

Maker: The Cooper Corporation.

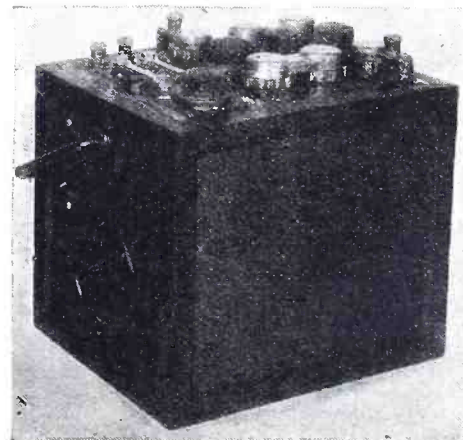

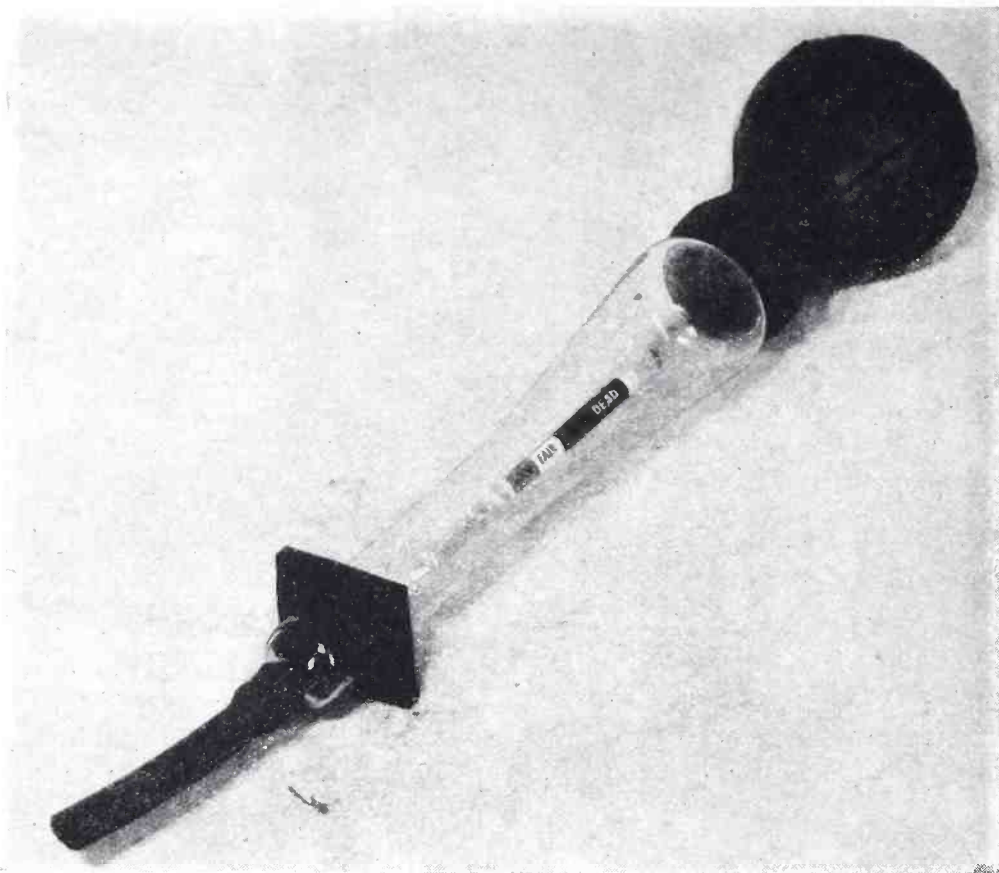

An Accurate Battery Tester

Name of instrument: Hydrometer.
Description: The shape of the barrel used in the construction of this instrument offers many advantages. The barrel is of heavy glass and is rather large in diameter near the bulb. The diameter gradually tapers toward the lower end, where it terminates in a nipple, over which a short length of rubber is slipped. A square rubber collar is fitted over the barrel to prevent the instrument from rolling. The rubber bulb is of heavy, springy rubber which provides strong suction. The float is designed in such a way

as to cause it to stand upright when floating. The float scale is calibrated and is also marked into four colored sections to facilitate quick reading.

Usage: To test the specific gravity of the electrolyte in a storage battery, thus determining the state of charge of the battery.

Outstanding features: It is accurate, well protected against breakage and easy to read. The float will not stick to barrel.

Maker: Scranton Glass Instrument Co., Inc.

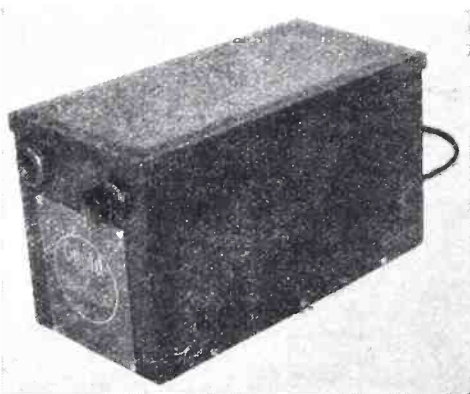

An Adjustable Voltage Supply Unit to Fit Your Receiver

Name of instrument: "B" Unipower.
Description: This "B" power-pack makes use of a full-wave, gaseous type rectifier valve and supplies ample "B" power for the operation of any receiver that does not require more than 135 volts. Terminals are provided to supply three different "B" voltages to the receiver. There is a knob on the front of the device by means of which the detector "B" voltage can be regulated as required. Also an adjustment

is provided to regulate the over-all "B" voltage output of the unit to fit the requirements of any particular receiver. The entire unit is inclosed in a neat metal case. As a safety measure a trigger switch is incorporated in the case so that the unit cannot operate when the cover is taken off the case. This prevents the user from touching any of the "live" parts of the unit while it is in operation. The "B" Unipower is designed primarily for use with the Gould "A" Unipower, and when so used it is turned "on" and "off" automatically with the receiver.

Usage: To supply all "B" voltages to a receiver which requires not more than 135 volts for the operation of a power valve, with a total current drain not exceeding 40 milliamperes. It can be used where the lighting-line supply is alternating current, rated at 110 volts, 50-60 cycles.

Outstanding features: It is completely inclosed and easy to operate. The output voltage is variable to fit the requirements of the receiver with which the unit is used. Special variable control is provided for the detector voltage.

Maker: Gould Storage Battery Co.

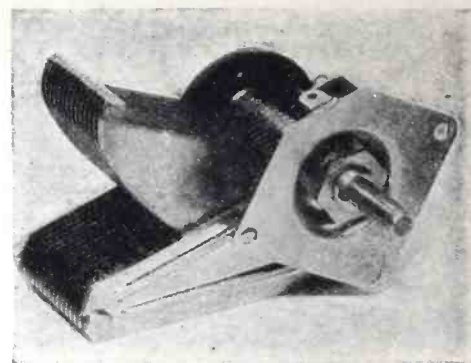

A Compact Tuning Unit

Name of instrument: Variable condenser.
Description: This straight-line-frequency condenser is sturdily made of brass plates with heavy-ribbed, metal end-plates. Insulation is provided by bakelite discs on which the bearings for the rotor are mounted. The stator plates are rigidly supported at three points. The rotor plates are crimped into a slotted shaft and the tips soldered into a slotted bar to maintain exact spacing. The condenser is designed for either single-hole mounting or for mounting by means of three screws through the panel, as desired.
Usage: For tuning the coils or transformers in a high-frequency circuit, or for any other purposes where a small variable capacity is required.
Outstanding features: It is compact size and rigid in construction. The plates are evenly spaced.
Maker: Benjamin Electric Mfg. Co.

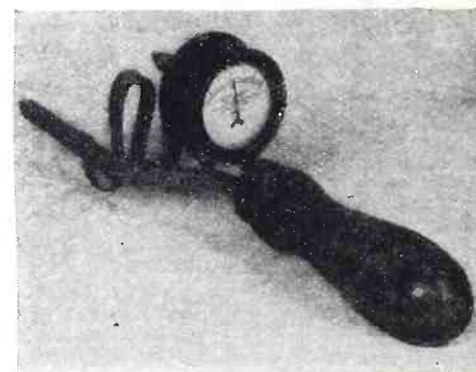

A Simple and Clean Storage Battery Tester

Name of instrument: Storage battery voltage tester.
Description: This instrument consists of a wooden handle from which protrude two pointed, metal prongs. These prongs are connected together by means of a long zigzag strip of metal that acts as a current shunt, and a voltmeter is mounted with its terminals connected to the two prongs. When the pointed prongs are dug into the terminals of a cell of a storage battery, the metal strip is shunted directly across the cell, thus placing the cell under a heavy load. At the same time the voltmeter shows the voltage of the cell.
Usage: For testing the state of charge and general condition of the individual cells of a storage "A" battery.
Outstanding features: It is substantial construction and easy to use. It does not require the opening of the battery or the handling of the acid electrolyte of the battery.
Maker: Battery Equipment and Supply Co.



Increased Selectivity for Superheterodyne Receivers

Name of instrument: Band-pass filter.

Description: This unit consists of a composition tube with flanged ends, upon which are wound two coils, each consisting of a large number of turns. The two ends of each coil-winding are brought out to soldering lug terminals. This filter is tuned by means of fixed condensers shunted across each of the windings. It may be tuned to frequencies anywhere between 20 and 80 kilocycles by using shunt capacities of the proper size.

Usage: When so tuned, this unit may be used as the filter transformer in the first or last stage of a superheterodyne intermediate-frequency amplifier, and will permit only the frequencies in a band 10 kilocycles wide to be amplified.

Outstanding features: When used in a long-wave amplifier, it will provide good selectivity without cutting sidebands, which would spoil the tonal qualities of reproduction. It can be used to advantage in most superheterodyne receivers in place of the present tuned (filter) transformer.

Maker: Samson Electric Co.

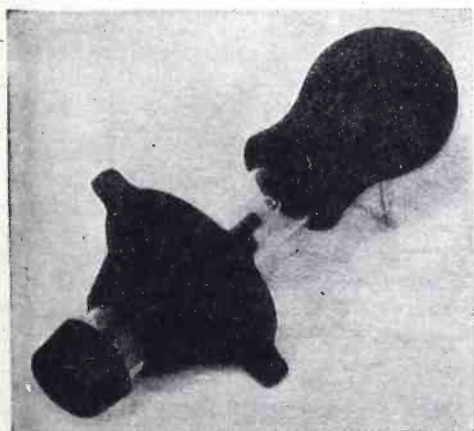

A Battery Tester That Fits in the Battery Vent Hole

Name of instrument: Hydrometer.

Description: The barrel and float in this

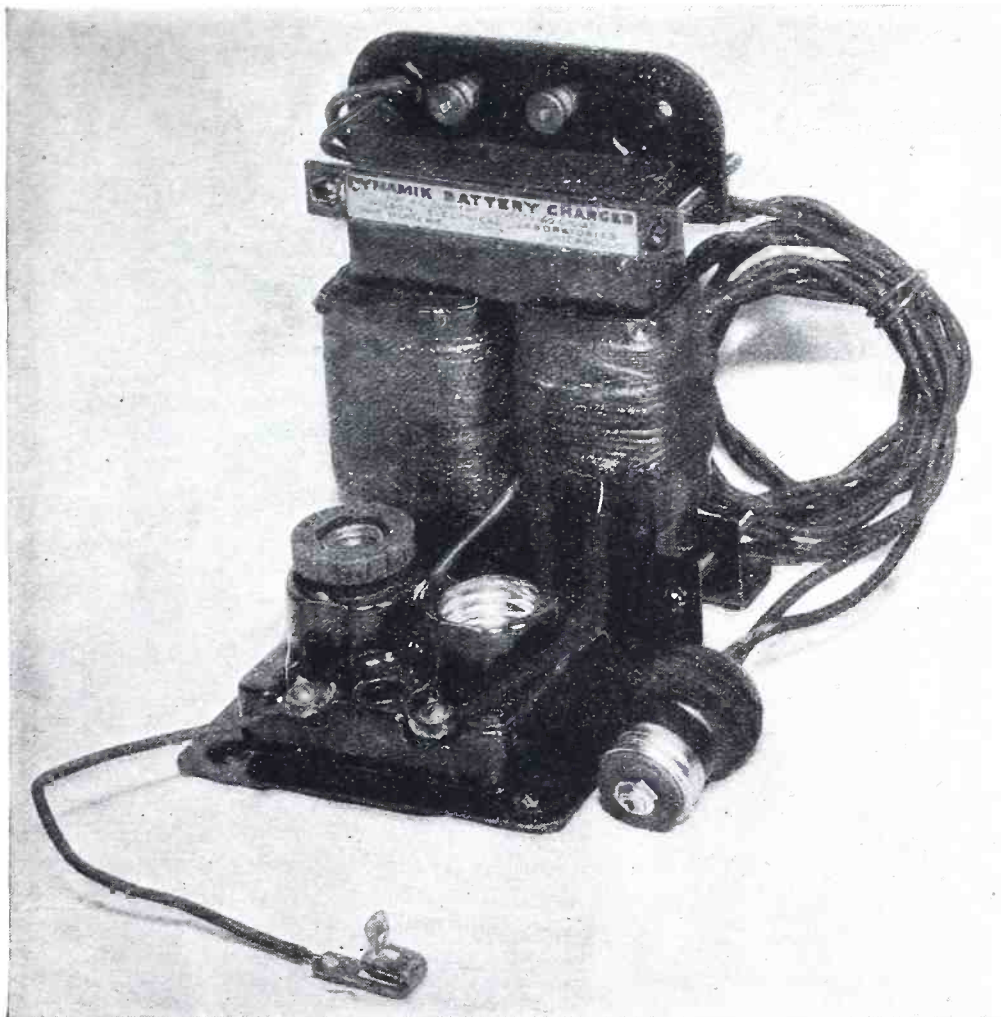

An Inexpensive Charger for Your Battery

Name of instrument: Banner (Dynamik) "A" battery charger, Model 750.*

Description: This unit consists of a Dynamik transformer mounted on a metal base, with a double porcelain receptacle with screw sockets for a rectifier valve of the 2½-ampere Tungar type and for a protective fuse. At the top of the transformer a terminal board is provided with binding posts for connection to the storage battery and with an extension cord and plug for connection to the lighting lines. As a matter of economy, this unit consists only of the essentials and is not enclosed in a metal case. The primary and secondary windings of the transformer are entirely separate and the battery may therefore be charged

without disconnecting it from the receiver.

This make of charger is also obtainable in three other forms. One is similar to the Model 750, but is enclosed in a metal case, and another, Model 600, is a trickle charger with a charging rate of .6 ampere; the Model 650 is a 2½-ampere charger which may be used to charge 6 or 12-volt batteries or may be used to charge storage "B" batteries.

Usage: For charging storage batteries from the 110-volt, 60-cycle, house-lighting lines.

Outstanding features: It is quiet and satisfactory in operation and operates at a low cost. It is amply protected against short circuit. Types 750 and 600 do not require that the battery be disconnected from the receiver.

Maker: Banner Radio Laboratories.

*The name of this line of products has recently been changed from Dynamik to Banner.

hydrometer are similar to those in standard hydrometers except that they are shorter. Instead of a long rubber tube to dip into the battery solution, the lower end of the glass barrel dips directly into the electrolyte. There is a large rubber collar around the barrel which serves as a stopper for the vent hole of the battery cell. This device is intended to be left in position in the vent hole of the cell at all times. When it is desired to test the battery, it is necessary to compress the bulb, release, and then take the reading in the usual way. In addition to showing the state of charge of the battery, this instrument shows when additional water is needed in the cells, because

when the electrolyte level drops too low the end of the hydrometer will not be immersed and therefore a reading cannot be taken. The large rubber collar is of graduated diameter, so as to fit snugly in a vent hole of any size.

Usage: For testing the state of charge and the electrolyte level of a storage battery.

Outstanding features: It provides a reliable check on the condition of the battery and indicates when the battery needs water. It need never be removed from the battery vent holes except to permit addition of water to cells.

Maker: Scranton Glass Instrument Co., Inc.

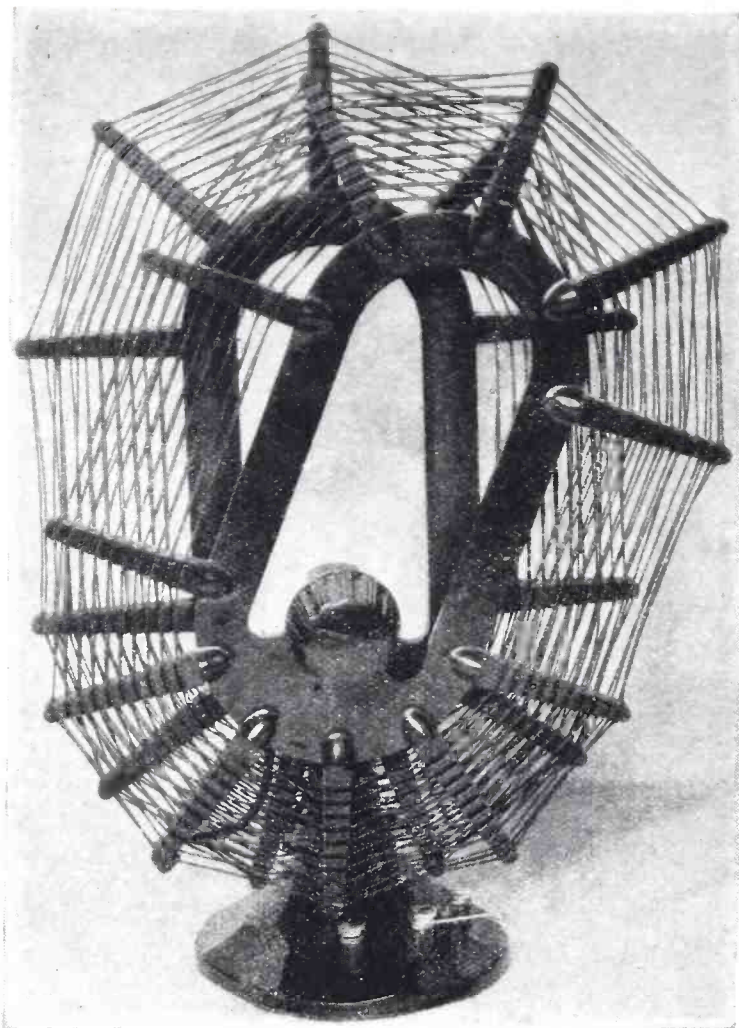

A Loop Antenna That You Can Tune

Name of instrument: "Tun-A-Loop."

Description: This loop antenna consists of two separate loop windings, so arranged that the position of one can be varied in its relation with the other, in this way varying the inductance of the entire unit. The two windings, in other words, act like a variometer. The frames upon which the wire is wound are of bakelite. The windings are of the spider-web type and are of silk-covered phosphor-bronze wire. The positions of the sections are varied by means of a knob on one of them. Three terminals are

provided so that the loop may be used in circuits which require a center-tapped loop. There is a calibrated scale on the loop base for use in noting the settings of the loop.

Usage: As a coil antenna for use with any radio receiver that is capable of operation with a loop antenna.

Outstanding features: The inductance of the loop may be varied to match the loop tuning condenser used. Also, it may be varied until its inductance is such that the settings of the loop tuning condenser will approximately correspond, for a given wavelength, with those of the other tuned circuits in the receiver. Good efficiency. Carefully made.

Maker: English-Whitman Products, Inc.

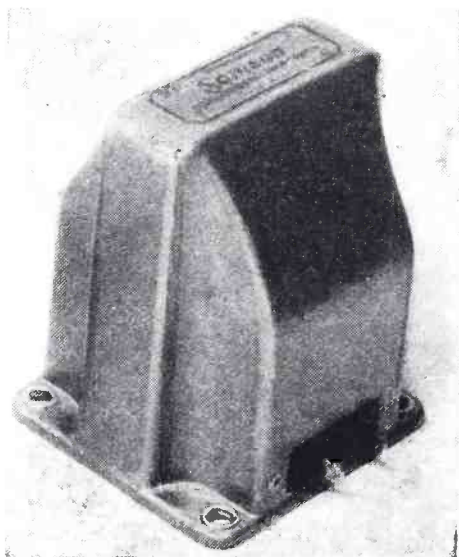

This Transformer Provides Excellent Tone Quality

Name of instrument: Low-frequency amplifying transformer.

Description: The windings of this "symphonic" transformer are of the helical type and are mounted on a core of special high-permeability iron. The windings are large and the electrical design of the instrument is such as to provide uniform amplification characteristics at all frequencies throughout the musical range. The instrument is assembled in a metal case of neat appearance which measures 3 3/8 by 2 1/2 by 2 7/8 inches over all. The terminals are placed close to the bottom of the case, two on the front side and two at the rear. A flange is provided at the bottom of the four corners; this is punched and eyeletted to accommodate the four mounting

screws. The turns ratio is approximately 3 to 1.

Usage: As a device to provide coupling between the vacuum valves in a low-frequency amplifier.

Outstanding features: Provides very uniform amplification at all audible frequencies, with the result that reproduction, when used with a high-quality reproducer, includes the extremely low as well as the very high musical tones. New type iron core. High primary impedance. Low distributed-capacity windings.

Maker: Samson Electric Co.



An "A" Power Unit That Keeps Itself Fully Charged

Name of instrument: "A" power supply unit with a master control-switch.

Description: This unit, which is known as the Exide "Radio Power Unit, Model 3A," consists of a storage battery and trickle charger, both inclosed in a ventilated metal case. The charger is a standard type that makes use of a tungar rectifier valve. The unit has three adjustments to provide different charging rates. The battery is a standard 6-volt storage battery of comparatively small size. The unit is also obtainable in a 4-volt size for use with receivers that employ UX-199 type valves. The master control-switch is a separate unit and controls the "A" and the "B" supplies of a receiver in a single operation; that is, when the switch is thrown "on," the "A" unit is disconnected from the lighting lines and is connected to the receiver. The "B" power-pack, if one is used, is at the same time connected to the lighting lines. Thus the entire voltage supply for the receiver is controlled by this switch.

Usage: As a constant and dependable filament-current supply source. Will supply sufficient "A" current for any receiver regardless of the number of vacuum valves employed.

Outstanding features: The battery in the unit is automatically kept fully charged at all times. The unit requires absolutely no attention, except the addition of distilled water in the battery cells about once every six months. The operating cost of this unit when used in conjunction with a 5-valve receiver that is in use 2 1/2 hours per day is approximately 2 cents per day. Compact in size.

Maker: The Electric Storage Battery Co.

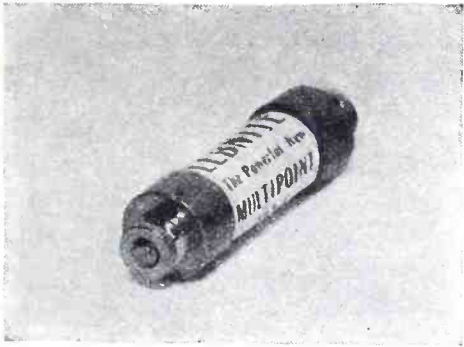

A Detector That Requires No Adjustment

Name of instrument: Lebnite Multipoint fixed detector.

Description: This crystal detector is of the cartridge type. Its adjustment is fixed before it leaves the factory and no further adjustment is required on the part of the user. The crystal used is one that does not burn out when subjected to heavy voltage impulses; it should therefore have a long life.

Usage: As a detector in reflex circuits or any other circuits which are designed for the use of a crystal detector.

Outstanding features: It is easily installed in receiver and requires no special mounting. The adjustment remains fixed. The detector will not burn out.

Maker: Palmer & Palmer.

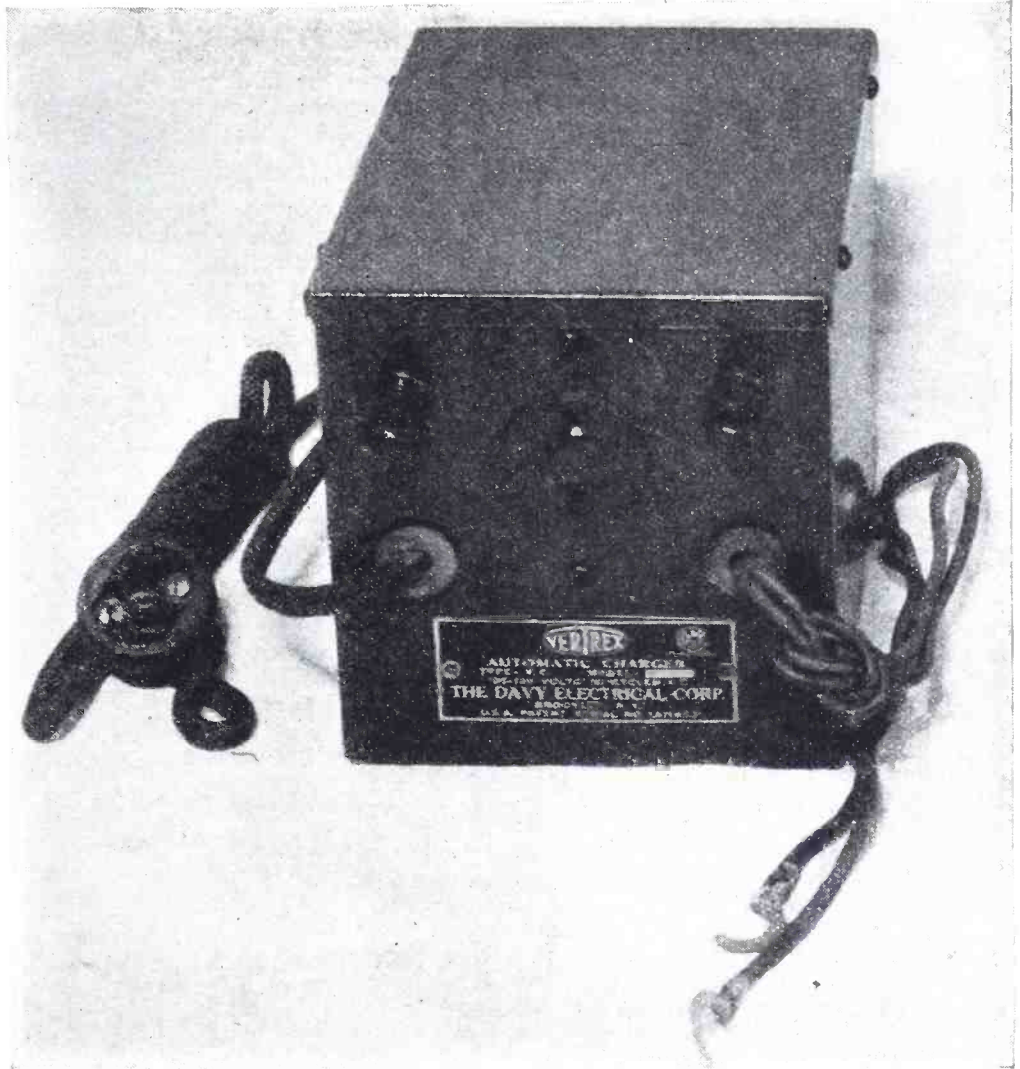

A Trickle Charger That Requires No Attention

Name of instrument: Vertrex automatic charger.

Description: This charger is enclosed in a metal case with dimensions of 4¾ by 7 by 5 inches. This case contains the necessary transformer, a relay switch and the special Vertrex rectifier. This rectifier does not employ liquids, vibrators or vacuum valves of any kind. It requires no attention. It also has the added advantage that it rectifies both halves of the wave. The charging rate varies automatically with the state of charge of the storage battery. If the battery is practically discharged, the charging rate is in excess of 1 ampere. As the battery becomes normally charged, this rate drops accordingly. A receptacle is provided in the case into which the plug of a "B" power-pack may be inserted.

Thereafter the control of the "B" power-pack and the trickle charger become automatic, in that when the receiver switch is turned "on" the charger is disconnected from the AC lines, the battery is connected to the receiver and the "B" power-pack is connected to the AC lines. When the receiver is turned "off," the action is reversed and the storage battery is put on "charge."

Usage: When used in conjunction with any standard 6-volt storage battery, it will keep the battery charged at all times. This unit operates from the 110-volt, 60-cycle lighting lines.

Outstanding features: It requires no upkeep expense or attention; it makes entire operation of the "A" and "B" voltages automatic.

Maker: Davy Electrical Corp.

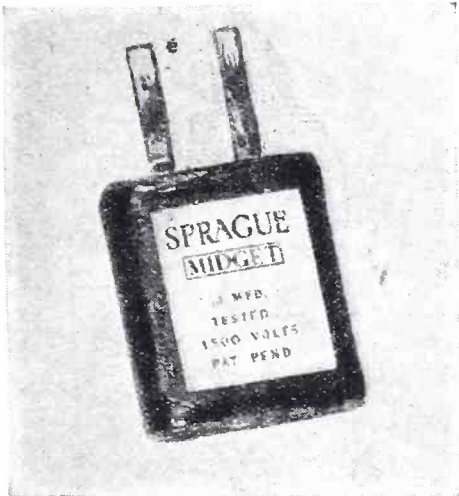

A Small Condenser That Is Easy to Install

Name of instrument: Midget fixed condenser.

Description: This miniature fixed condenser is manufactured on the same principle as high-voltage filter condensers. It is of paper and foil construction thoroughly impregnated. The soldering lugs are assembled into the body of the condenser and are of flexible material, and therefore easily bent to any position desired. These lugs are tinned to facilitate soldering.

Usage: Wherever a capacity between .00007 mfd. and .1 mfd. is required in a circuit.

Outstanding features: It is small size and is designed for use where the working voltage is anywhere up to 1,000 volts. It is easily installed. The capacity is accurately rated.

Maker: Sprague Specialties Co.

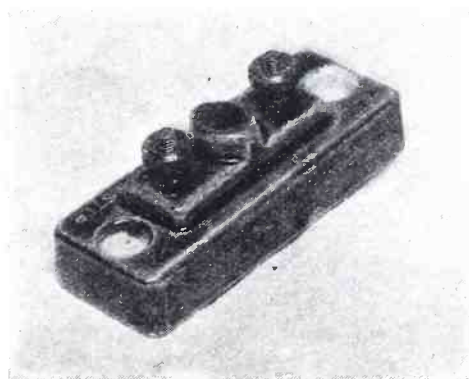

A Compact Lightning Arrester

Name of instrument: Weatherproof lightning arrester.

Description: This arrester consists of a molded porcelain case in which the protective element is carefully concealed. Terminals are provided in the form of binding posts on the top of the porcelain base and screw holes are provided for mounting screws. The over-all dimensions of this unit are 3 by 1¼ inches.

Usage: For installation in the antenna ground circuit to provide a path to the ground for lightning or extremely heavy static charges, thus protecting the receiver.

Outstanding features: It is approved by the National Board of Fire Underwriters, for use in either indoors or outdoors. It is fully protected from the weather, and is extremely small.

Maker: Kirkman Engineering Corporation.

What's New in Loudspeakers



The New Stevens Conoidal Speaker, Model A

Description: This cone is of a moisture-proof fabric construction and is constructed in a single piece, without seams. It is of the semi-free-edge type, and the cone is crimped to give a more flexible action. The rim is of wood and is finished in mahogany. The unit is furnished both with an easel base (in the illustration the speaker is shown mounted on this base) and a silk hanging cord. The owner therefore has the choice of hanging the reproducer on the wall or using it with the base. The cone is 17½ inches in diameter.

Outstanding features: Strongly made, to hang on the wall or to stand on the table; neat in appearance, and provides good reproduction.

Maker: Stevens & Co.



The New Timmons Cone

Description: This is a large-sized cone reproducer; the entire unit stands approximately three feet high and is equipped with an extra heavy metal base for greater stability. The cone is of parchment paper and is decorated with a well-executed ship scene. This method of decoration is a marked advance over the somber finish of most of the other large cones that are on the market. The driving rod is attached to the cone in an eccentric position, about half-way be-

tween the bottom and the center of the cone; this arrangement has the advantage that the long radius from the driving rod connection to the top of the cone permits the extremely low bass notes to be reproduced more freely, without cutting off the high notes, with the result that the reproduction curve is more uniform throughout the entire musical range.

Outstanding features: Great volume, good looking and marked with an even amplification curve.

Maker: Timmons Radio Corp.

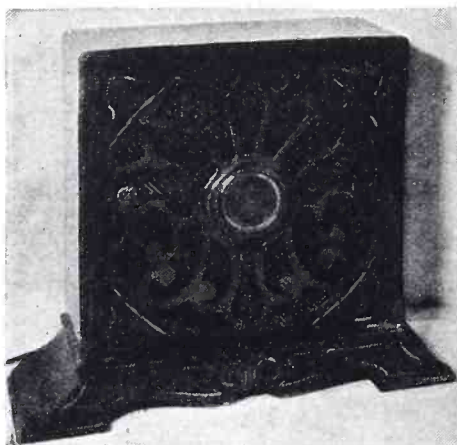

Spartan Disc Speaker, Model 100

Description: This reproducer has been designed to please the eye as well as the ear. The cabinet which encloses the disc is finished in walnut and has attractive lines. The front grill is finished to match and is backed up with silk. The cone is entirely concealed from view and from dust, and is of the floating type.

Outstanding features: Fully enclosed, neat appearance, and has good volume and tone quality.

Maker: Spartan Electric Corp.

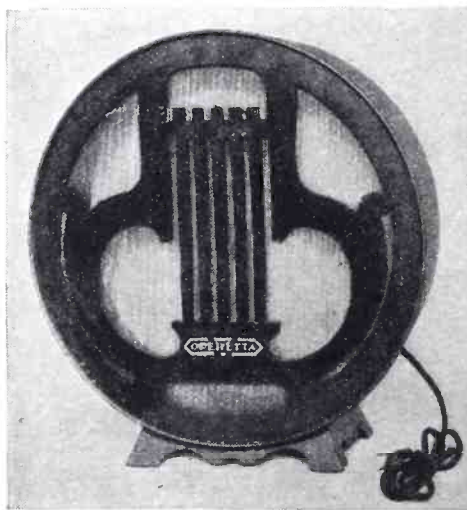

The New Operetta "Drum" Loudspeaker

Description: As the name implies, the case of this reproducer is drum-shaped and consists of an aluminum shell with a decorative wooden front grill backed with loosely woven gold cloth. The case is mounted on a heavy metal base and finished in bronze. The parchment cone is of the free-edge type.

Outstanding features: Compact and pleasing tone quality.

Maker: Victor Radio Corp.



The New Spartan Junior Disc, Model 400

Description: This reproducer is unusual in that the disc, or cone, is of pith-wood composition instead of the usual parchment paper. The frame and stand are finished in mahogany. The rough surface of the disc is finished in a mottled effect, which lends attractiveness to the entire unit. This reproducer is unusually low-priced.

Outstanding features: Low in price, attractive in appearance, and has good volume—especially on low notes.

Maker: Spartan Electric Corp.



The New Brandes Cabinet Cone No. 1100

Description: This reproducer consists of an elliptical parchment cone enclosed in a neat cabinet that is finished in Adam-Brown, duo-tone mahogany. This cabinet not only serves as a housing for the delicate cone and operating mechanism, but also contains a tone chamber that tends to provide well-rounded tone quality. There is an adjustment on the unit to provide maximum sensitivity and clarity of reproduction.

Outstanding features: Small in size, with large volume and clear reproduction.

Maker: Federal-Brandes, Inc.

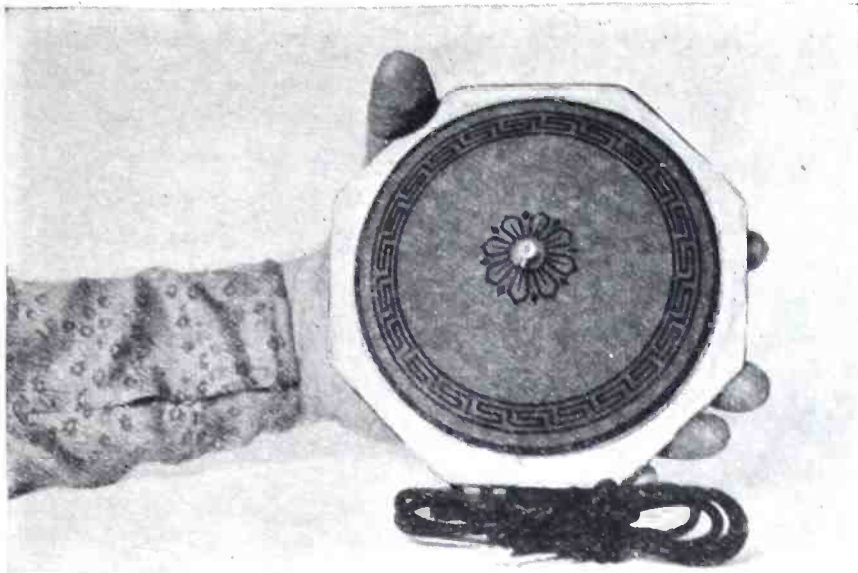

The Na-Ald Midget Cone Reproducer

Description: This is an unusual cone reproducer, chiefly in the matter of size. It is designed to fill a unique purpose and is not just a "trick." Its tiny volume is in proportion to its size; it is intended for use at times when great volume of reproduction is not desirable—such, for instance, as late at night when the family have gone to bed and the DX fan wants to listen in without waking the household. Another practical scheme is to use several of these units in different

rooms. Their cost is low and a number of them may be installed for the price of one standard-sized reproducer. A specially made small unit is attached to a rod that drives the miniature paper cone. The edge of the cone is bound with felt and rests against the composition sounding board. The small composition base is finished to match the octagonal sounding board. It is a standard cone in all respects but size.

Maker: Alden Mfg. Co.

also as a sound chamber to lend depth to the quality of reproduction. The front of the case is a wood grill backed with silk.
Outstanding features: Great volume. Clarity. Good-looking.
Maker: Amplion Corporation of America.



The New Wirt Cone Speaker

Description: This reproducer is of the free-edge cone type. It is enclosed in a metal case with a metal grill front, backed with silk. Provision is made at the back of the instrument for adjustment by means of a small knob to regulate the quality of reproduction. The entire instrument is finished in a pleasing bronze.

Outstanding features: Entirely enclosed in a metal case. Suitable for use with any set.

Maker: Wirt Co.

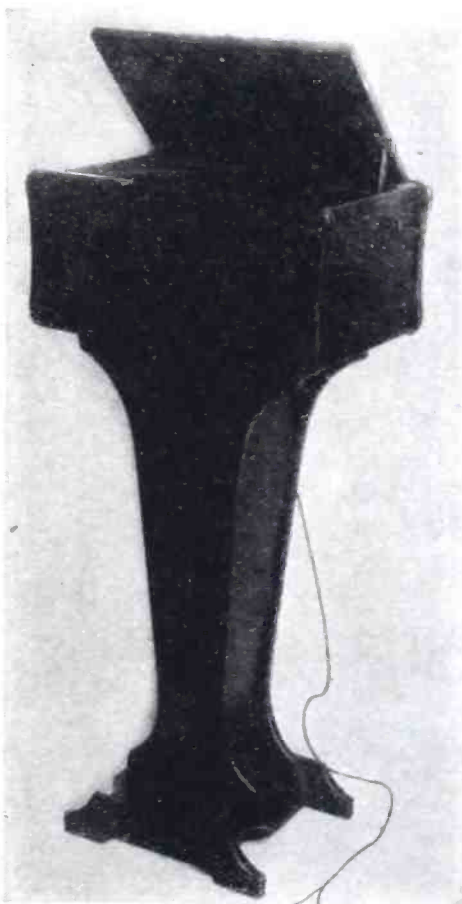

The New Wright-DeCoster, Model 101

Description: A unique note has been struck in the design of this reproducer, as is evident from the illustration. The long, tapering pedestal is actually a housing for a horn of special composition. The tip of this horn is near the bottom of the pedestal where the

reproducer unit is attached. The large end of the horn opens into the box-shaped portion at the top of the stand. The hinged top cover serves as a sounding board and is adjustable to any desired angle. The principle of this adjustable feature is similar to that of the adjustable top on a concert grand piano. The reproducer stands on the floor and measures 35 inches in height, with the sounding board closed. The case is of black walnut, finished in a dark brown.

Outstanding features: Contains an exponential horn. Excellent quality of reproduction. Attractive in design. Equipped with a volume control.

Maker: Wright-DeCoster, Inc.

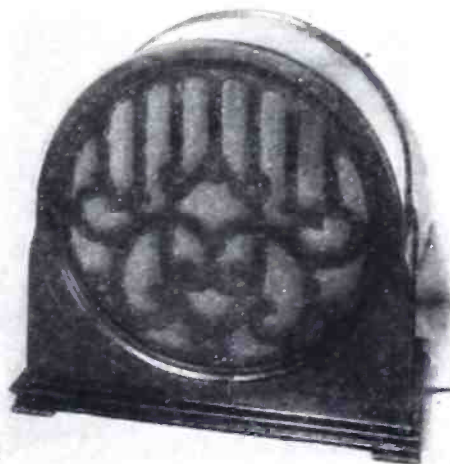

The New Amplion Cone, Model AC-12

Description: This cone reproducer is enclosed in a mahogany case, which serves as a decorative housing and



The New Baldwin "99"

Description: This model is enclosed in a metal container with an open metal grill at the front, lined with self-colored silk. The entire construction is finished in bronze. The reproducing assembly consists of a Baldwin balanced armature unit and a horn of special composition and design. The horn is unusual in form, and demonstrates excellent operating characteristics.

Outstanding features: Beautiful reproduction. Contains an efficient unit. Handles large volume without distortion.

Maker: Nathaniel Baldwin, Inc.

THE LATEST RADIO

VALVES

What they are, what they can do, how they rate and what they contribute to the progress of radio art.

Such rapid strides have been made—and are still being made—in the development of the vacuum tube that a new field is being opened to the experimenter and a new and better era of broadcast reception is promised to the fan. So important does POPULAR RADIO regard these new types of valves to the radio art that it has made a careful survey of the entire field and selected, tested and recorded the special features of the tubes of outstanding merit for the benefit of its readers of all classes.

By THE TECHNICAL STAFF

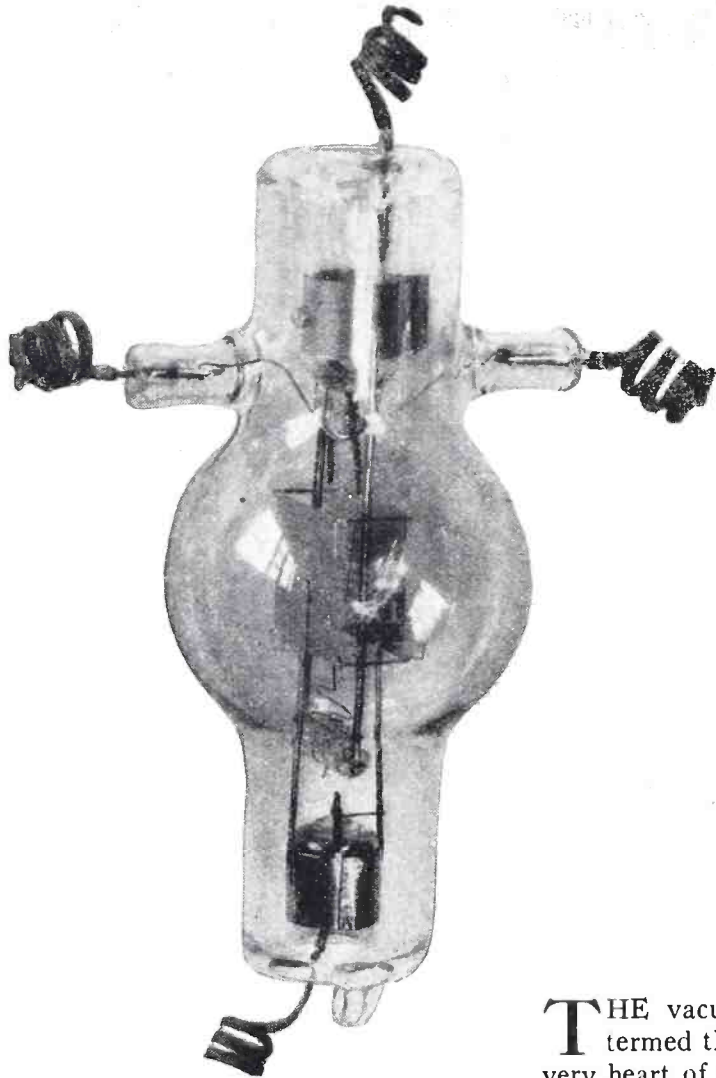

A High-Power Transmitting Valve for Short Waves

Name of valve: Type "H" transmitting valve.

Description: This vacuum valve was especially designed for the needs of amateur transmission fans, particularly in transmitters that work on wavelengths below 100 meters. It is unusual in shape and its greatest merit for short-wave transmission lies in the fact that the four external leads are widely separated instead of being bunched at the base, as has been the practice in ordinary valve construction. The valve is shaped like a cross. The filament leads are brought out of the ends of the cross arms, while the plate and grid leads come out at opposite ends of the long section of the valve. This arrangement provides not only superior insulation, but also reduces internal capacity. The valve has no base; instead, the wire terminals may be connected directly to their proper points in the circuit.

Valve rating:

Filament voltage—10 (AC).
 Filament current—2.35 amperes.
 Plate voltage—500 to 2,000.
 Plate current—50 to 100 milliamperes.
 Maximum input—150 watts.

Usage: As an all-purpose transmitting valve.

Outstanding features: Provides good results on any voltage input between 500 and 2,000 volts. Extremely low internal capacity, an especially advantageous feature for transmission at wavelengths below 20 meters. No socket or base required.

Maker: DeForest Radio Co.

THE vacuum tube (more properly termed the "vacuum valve") is the very heart of the radio receiving set.

At no period in the entire history of radio have so many or such significant developments been made in these vacuum valves as during the past few months, or has such a variety of types of valves been placed at the disposal of radio experimenters and broadcast listeners as will be available at or about the time that this issue of POPULAR RADIO is published.

The vacuum valves used for radio reception contain, in general, three common elements:

- (1) The plate;
- (2) The grid;
- (3) The filament.

The main variation between the different kinds of valves lies in the size and shape of the plate, in the mechanical dimensions of the grid and its spacing between the plate and the filament, and in the kind of filament material that is used to emit the stream of electrons

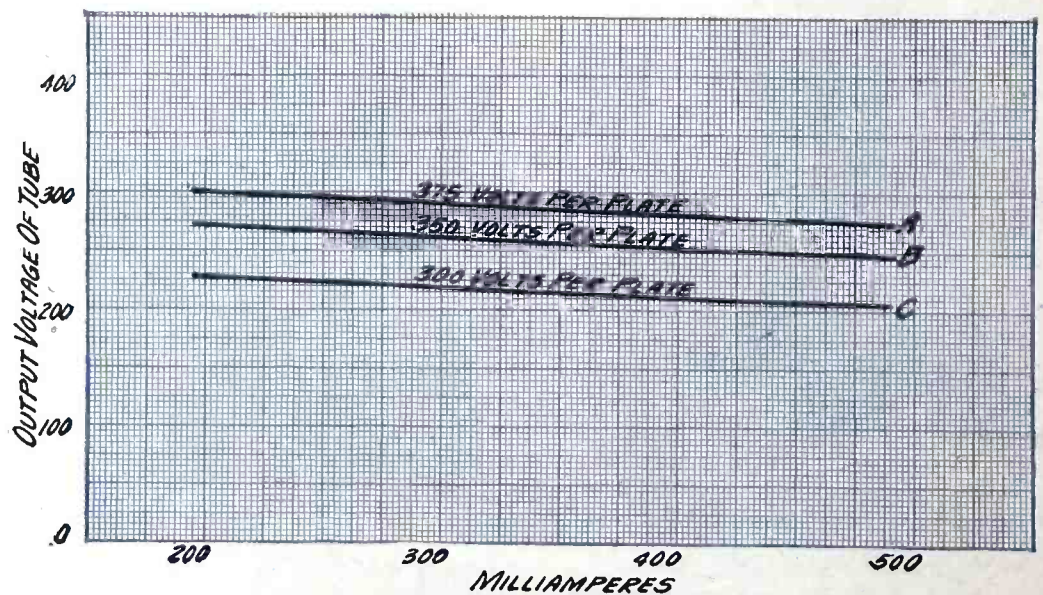

THE VOLTAGE REGULATION OF THE Q. R. S. FULL-WAVE RECTIFIER VALVE

CHART 1: These curves show the DC voltages of rectifier output obtainable at various current drains and at three different AC input voltages per anode (plate).

that does the work of amplification or detection.

In the descriptions of valves that follow, the proper voltages to be applied to the filament are given, as well as the correct filament currents; the standard plate voltages are also recorded, along with the proper grid-biasing voltages.

There are three other characteristics of an electrical nature which are essential to the engineer in picking out the type of valve that he wants to use for a specific purpose.

The first of these is the amplification factor, known as μ .

This factor is obtained by electrical measurement. It is the rate of change of plate current with grid voltage variation divided by the rate of change of plate current with plate voltage variation.

All that the layman need know about this factor is that it should be as high as possible, along with as low a plate impedance as is possible for general use.

The second electrical characteristic—the *plate impedance*—refers to the plate-circuit, AC resistance. It is the reciprocal of the rate of change of plate current with plate voltage variation for a complete AC cycle. The rate of

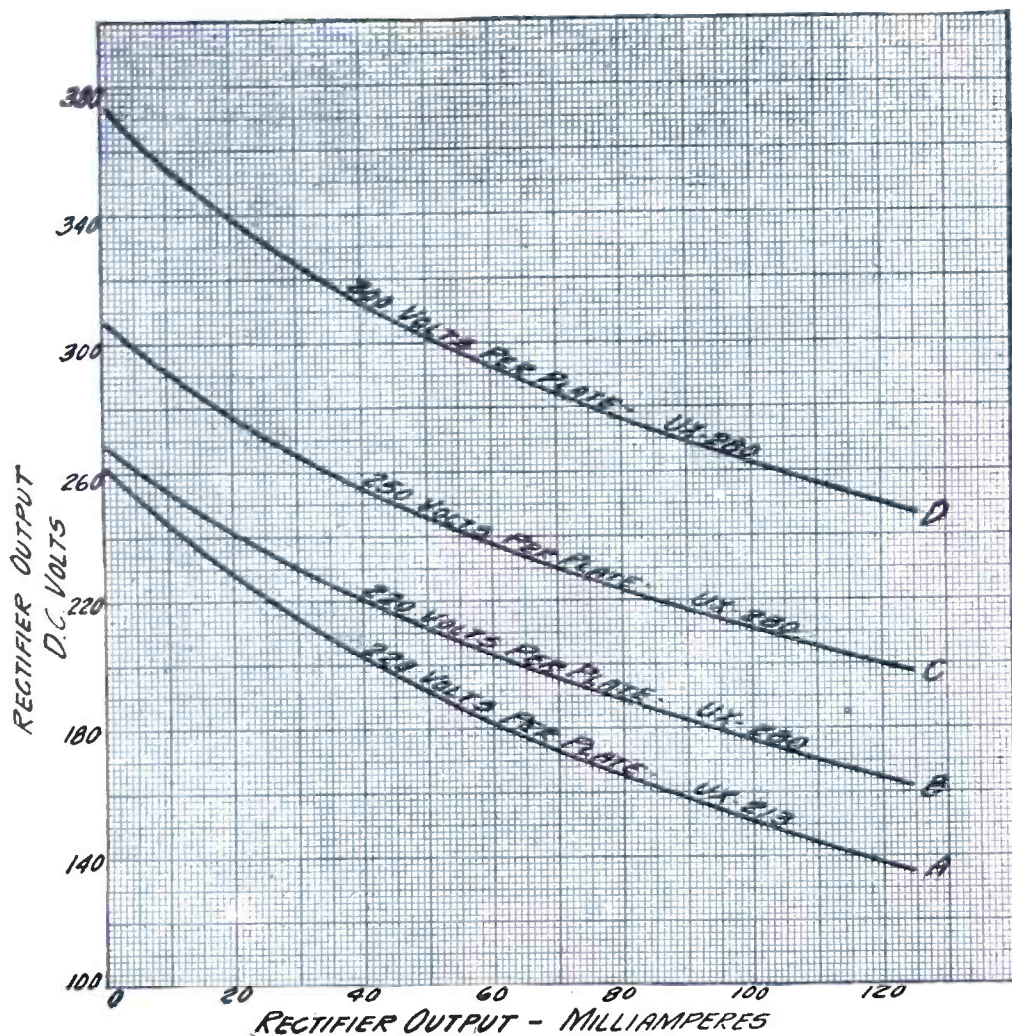

THE OPERATING CHARACTERISTICS OF THE UX-280 RECTIFIER VALVE

CHART 2: Curves B, C and D show the DC output voltage of the UX-280 valve at various current drains. A comparison of curves A and B shows the superiority of the UX-280 over the UX-213 when used with the same AC input voltage.

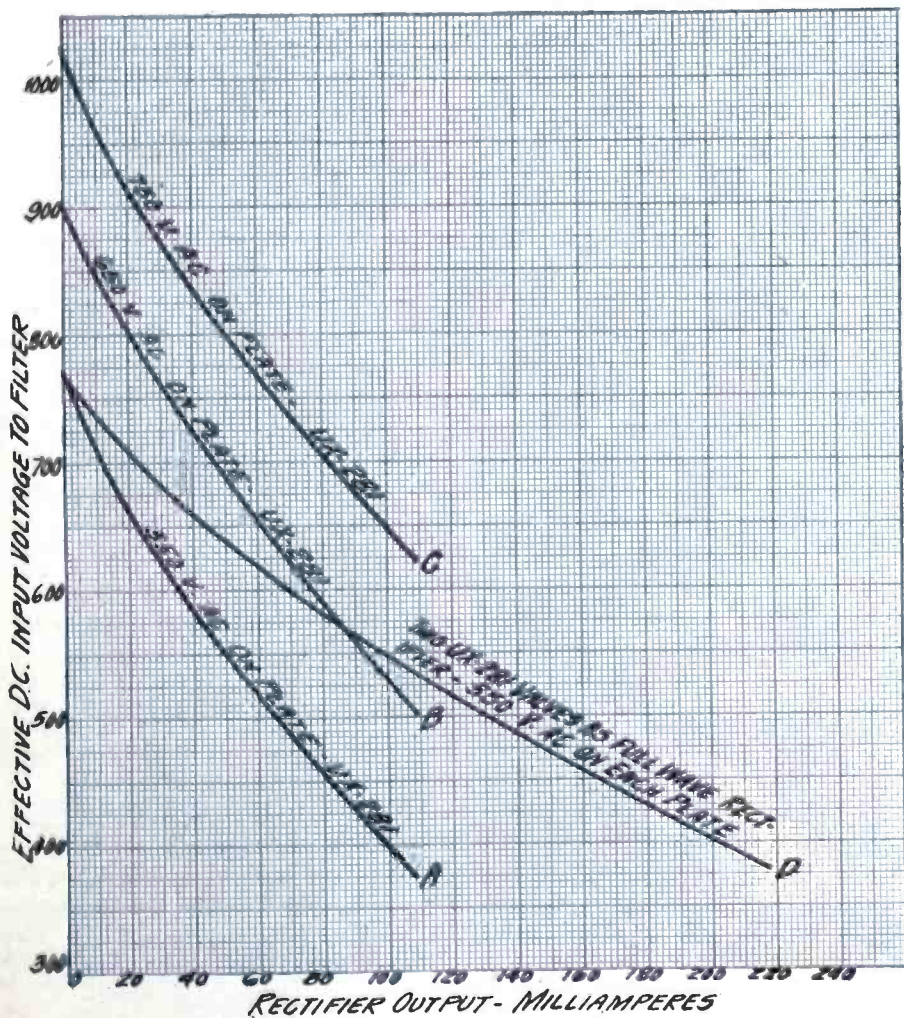

THE OPERATING CHARACTERISTICS OF THE UX-281 HALF-WAVE RECTIFIER VALVE

CHART 3: Curves A, B and C show the DC output with three different input voltage values. Curve D shows the output characteristics of two valves used for full-wave rectification.

change varies during the AC cycle.

In a valve that is used for power amplification, the plate impedance should be as low as possible. For voltage amplification, however, the plate impedance may run to rather high values without loss of efficiency.

The third electrical characteristic that is necessary in determining good valves from poor ones is the *mutual conductance*, which may be termed a "figure of merit"; this depends very largely upon the emission characteristics of the filament. Good valves have the higher values of mutual conductance. The mutual conductance is the rate of change of plate current with grid voltage variation for a complete AC cycle. The rate of change varies during the AC cycle.

The detailed information about these new tubes, as presented to the experimenter by the POPULAR RADIO LABORATORY in the following pages, should enable him to determine which of the new valves listed will give him the greatest improvement in his present set.

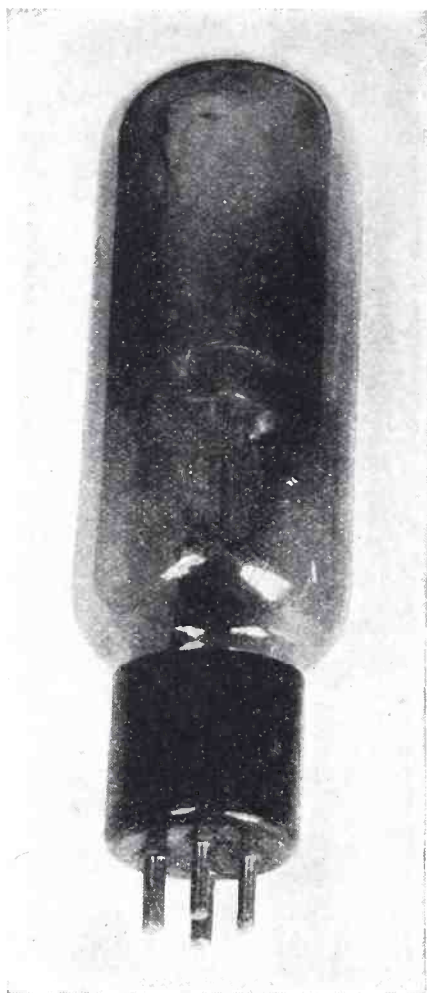

(See CHART 1)

The New Q. R. S. 400-Milliamper, Full-Wave Rectifier Valve

Name of valve: Q. R. S. gaseous rectifier.

Description: In its outward physical dimensions this valve is similar to the standard 50-watt transmitting valve. It is cylindrical in shape and measures 7 inches in overall length by 2 inches in diameter. It is equipped with a standard UX type base and may be used with any standard socket. There are four terminals, as in the case of a standard vacuum valve; two of these are for connection to the high-voltage output of the supply transformer; the other two are connected to a low-voltage winding on the transformer which provides the ionization current required in the operation of this valve. A suitable transformer for use with this valve consists of a primary winding and three secondary windings. The center-tapped high-voltage secondary winding should provide 375 volts each side of the center-tap at .3 ampere; the ionizer winding should furnish 4 volts at 5 amperes; and the center-tapped filament winding should supply 5 volts at .5 ampere, for the filament of a power amplifier valve. Chart 1 shows the output curves of the rectifier at various loads.

Outstanding features: Furnishes full-wave rectification for "ABC" supply. Well constructed. Will meet the voltage demands of any receiver, including all filament currents and up to 180 volts for the plate power for a power amplifier valve. Will deliver up to 400 milliamperes without overloading.

Maker: Q. R. S. Music Company.

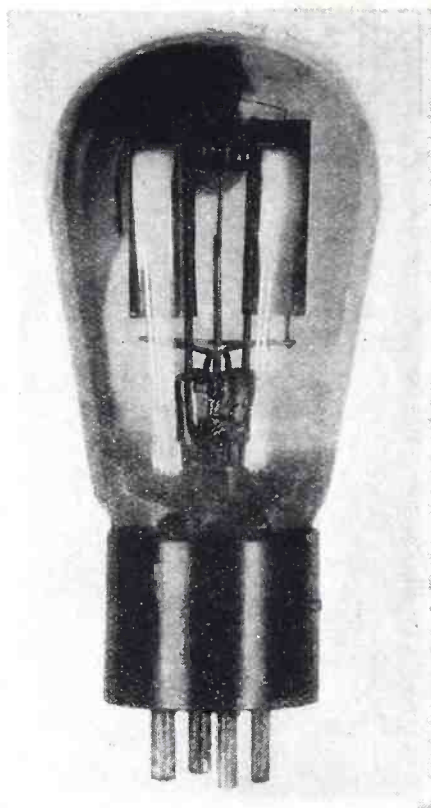

(See CHART 2)

Another New High-Power Valve for Full-Wave Rectification

Name of valve: Radiotron UX-280.

Description: This is a full-wave rectifier valve with characteristics similar to those of the UX-213, but it is intended particularly for use in "B" power-packs which must supply voltages and currents in excess of those obtainable with the UX-213 type rectifier valve. The UX-280 uses a ribbon-type, oxide-coated filament of rugged proportions, and is inclosed in a bulb of clear glass. It is equipped with a standard UX type of base.

This new rectifier valve may be substituted for the UX-213 type valve in existing "B" power-packs with a resulting large increase in voltage at a given current drain, as shown in curves A and B, Chart 2. Curves C and D of this figure show the output characteristics of this rectifier when used with higher AC input voltages up to the maximum of 600 volts (300 volts to each anode).

Valve rating:

Filament voltage—5, AC.
Filament current—2 amperes.
Plate voltage (AC)—300 to each plate (maximum).
Direct-current output—125 milliamperes (maximum).

Usage: As a full-wave rectifier in "B" power-packs which are required to provide a direct-current output not exceeding 125 milliamperes.

Outstanding features: Interchangeable with present UX-213 type rectifier valve. Can be used to provide much higher maximum current and maximum voltages than the UX-213 type. Requires smaller filter capacity than some of the other rectifier valves. Filament supply may be obtained from the filament winding of the power transformer that is also used to supply the high voltage.

Maker: Radio Corporation of America.

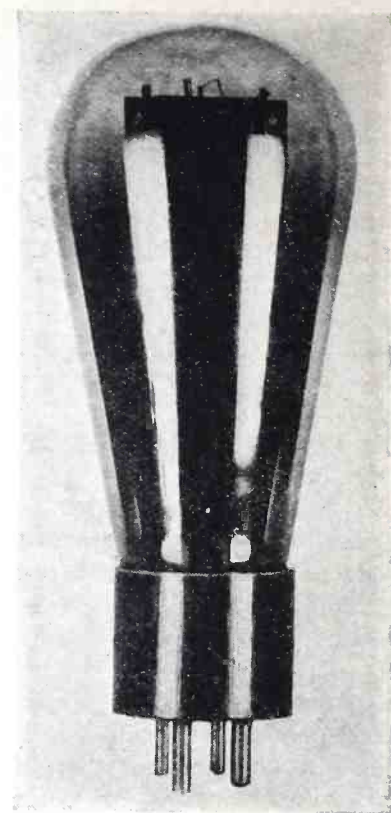

(See CHART 3)

A New Higher-Powered Rectifier Valve

Name of valve: Radiotron UX-281.

Description: This is a heavy-duty, half-wave rectifier that is similar in external appearance to the UX-216-b type valve. The new valve is capable of considerably greater output than is the 216-b, however. The UX-281 type valve is capable of supplying up to 110 milliamperes and is used with input voltages of from 550 to 750 as compared with the 65 milliamperes current output and the input voltage limit of 550 for the UX-216-b rectifier valve. In existing "B" power-packs which make use of a UX-216-b rectifier the new valve may be used without any alterations whatsoever, and with higher voltage output at a given current drain.

Two of the UX-281 type valves may be used as a full-wave rectifier to provide an output current up to 220 milliamperes, with increased voltage at any given current load. In Chart 3, A, B and C show the output of the UX-281 type valve with various input voltages. D represents the output of two of these valves when used for full-wave rectification.

Valve rating:

Filament voltage—7.5, AC.
Filament current—1.25 amperes.
Plate voltage (AC)—750 (maximum).
Direct current output—110 milliamperes (maximum).

Usage: As a half-wave rectifier in "B" power-packs where an output current up to 110 milliamperes or voltages up to 600 may be required. Where current requirements are greater than 110 milliamperes, two of these valves will supply double the current of one, when connected in a circuit for full-wave rectification.

Outstanding features: Rugged construction. Interchangeable with the present UX-216-b rectifier. Permits use of AC input voltages up to 750, with correspondingly high output voltages.

Maker: Radio Corporation of America.

A Powerful Full-Wave Rectifier Valve

Name of valve: Donle DR-IV.

Description: This valve is of the high-voltage, full-wave rectifier type. It is somewhat similar in characteristics to the standard 216-b type of rectifier, but has the advantage that it rectifies both halves of the cycle instead of only one. The construction of the valve is extremely simple. In appearance it is much like that of the 216-b, but its plate is split into two halves to provide the double rectifying feature.

Usage: As a rectifier in a "B" power-pack that is required to furnish sufficient plate voltage for the operation of a UX-210 type of power amplifier valve.

Outstanding features: High voltage with full-wave rectification, a combination obtainable heretofore only with two rectifiers of the UX-216-b type of valve.

Maker: Donle-Bristol Co.

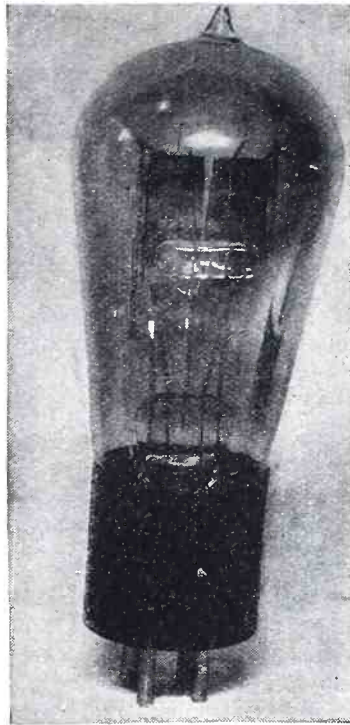

Filament current—.25 ampere.
 Plate voltage—45 to 135.
 Negative grid bias—1½ to 6 volts.
Valve characteristics (with plate voltage of 90 and negative grid bias of 4.5 volts), as determined in POPULAR RADIO TESTING LABORATORY:
 Plate resistance—8,500 ohms.
 Amplification factor—8.5.
 Mutual conductance—990 micromhos.
 Plate current—3.5 milliamperes.

Usage: May be used for any purpose for which a standard 201-a valve may be used, but is particularly recommended for use in high-frequency or low-frequency amplifiers.

Outstanding features: Superior amplifier characteristics. Clear glass bulb. Operates at full efficiency when there is considerably less than 5 volts on the filament.

Maker: Zetka Laboratories, Inc.

without overloading, and will therefore produce great volume without distortion.

Maker: Consolidated Electric Lamp Co.

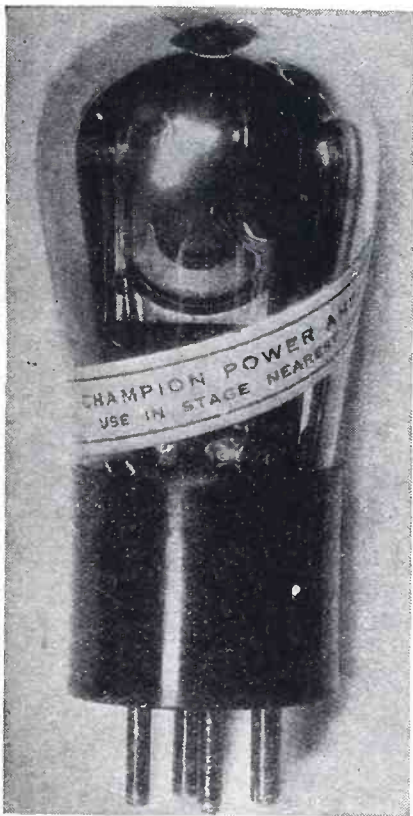

A Medium-Power Valve for the Last Stage

Name of valve: Champion, X-171.

Description: This power amplifier valve has the characteristics of the UX-171 type of valve.

Valve rating:

Filament voltage—5.
 Filament current—.5 ampere.
 Plate voltage—90 to 180.
 Negative grid bias—Up to 40.5 volts.

Valve characteristics (with plate voltage of 180 and negative grid bias of 40.5 volts), as determined in POPULAR RADIO TESTING LABORATORY:

Plate resistance—2,980 ohms.
 Amplification factor—3.3.
 Plate current—11 milliamperes.

Usage: As a power amplifier where plate voltages up to 180 are available.

Outstanding features: When used in the last low-frequency stage of a receiver, it will withstand a high signal input

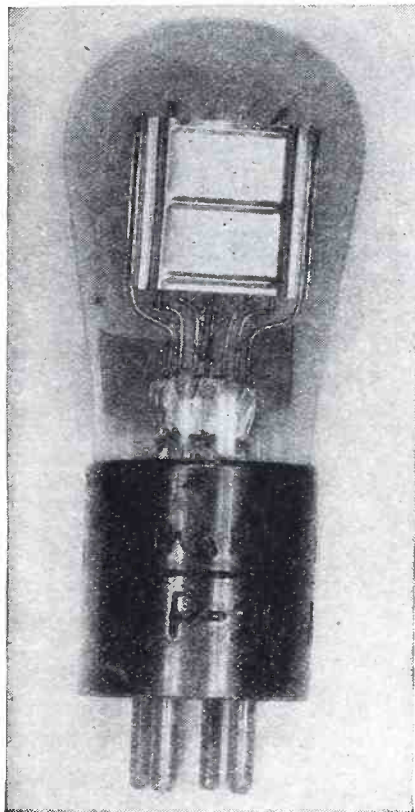

An Unusually Efficient Amplifier Valve

Name of valve: ZP-201-a.

Description: This valve is a standard 201-a type in size and shape. Its characteristics, when used as a low-frequency or high-frequency amplifier, are somewhat superior to those of the average 201-a valve, and when substituted for the standard 201-a type of valves in the amplifier stages of a receiver this superiority is quite noticeable. It is inclosed in a bulb of clear glass and is made under the special Zetka process of evacuation and conditioning.

Valve rating:

Filament voltage—5.

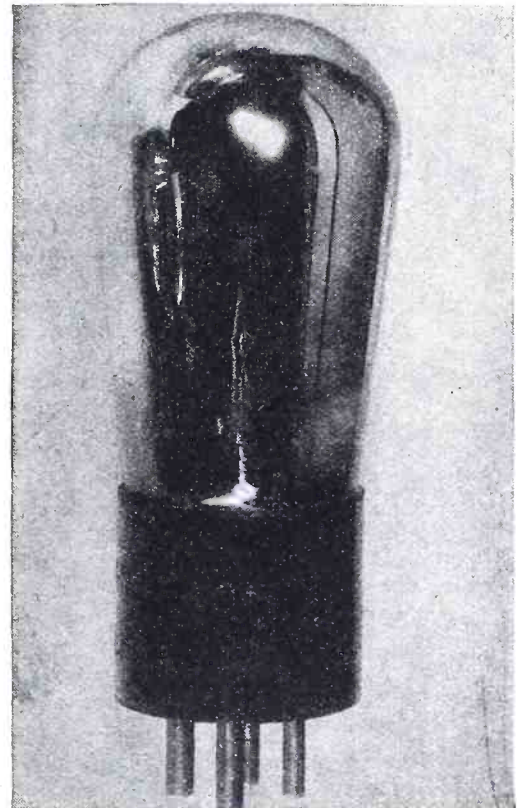

A Valve That Gives High Amplification

Name of valve: Magnatron, DC-240.

Description: This valve is especially suited for use in resistance-coupled, low-frequency amplifiers, on account of its high amplification factor. When so used, the amplification obtained is far superior to that obtained with the same amplifier using the UX-201-a type of valves. This valve is standard in size, shape and base.

Valve rating:

Filament voltage—5.
 Filament current—.25 ampere.
 Plate voltage—90 to 180.
 Negative grid bias—1.5 to 4.5 volts.
 Plate coupling resistance—250,000 ohms.
 Amplification factor—30.

Usage: As an amplifier where resistance coupling is used, or as a detector.

Outstanding features: When used in resistance-coupled amplifiers this valve provides amplification per stage approximately equal to that obtained with transformer-coupled amplifiers that employ the UX-201-a type of valves.

Maker: Connewey Electric Laboratories.



A Useful Rectifier Valve That Contains No Filament

Name of valve: "Speed" gaseous rectifier.
Description: This valve has the standard shape and size of its type, and is equipped with a standard UX-type base. The bulb is made of clear glass. It does not use a filament.

Valve rating:
Input voltage (AC)—300 (maximum).
DC output current—85 milliamperes (maximum).

Usage: As a full-wave rectifier in any standard "B" power-pack that requires a gaseous rectifier valve.

Outstanding features: Full-wave rectification. No filament to burn out.

Maker: Cable Supply Co., Inc.



A New Vacuum Valve with an AC Filament

Name of valve: VanHorne AC valve.
Description: This valve operates with "raw" alternating current applied to its filament. It contains the usual three elements, but uses an oxide-coated filament that is shorter, thicker and of lower resistance than the usual filament in 5-volt DC valves. This

filament draws a heavy current at 1 volt, which is its proper operating voltage. The alternating current for the filament is obtained from the house-lighting lines through the use of a step-down transformer.

Valve rating:
Filament voltage—1.
Filament current—2.0 amperes.
Plate voltage—90 to 157.5.
Negative grid bias—Up to 9 volts.

Valve characteristics (with plate voltage of 90 and negative grid bias of 4.5 volts), as determined in POPULAR RADIO TESTING LABORATORY:
Plate resistance—10,580 ohms.
Amplification factor—9.9.
Mutual conductance—1,000 micromhos.
Plate current—3.4 milliamperes.

Usage: In either high-frequency or low-frequency amplifiers. When used in standard receivers, in place of the UX-201-a type of valves, some changes in the wiring of the receiver are required.

Outstanding features: Eliminates the need for a storage battery. Operates efficiently and practically without hum.

Maker: VanHorne Co.

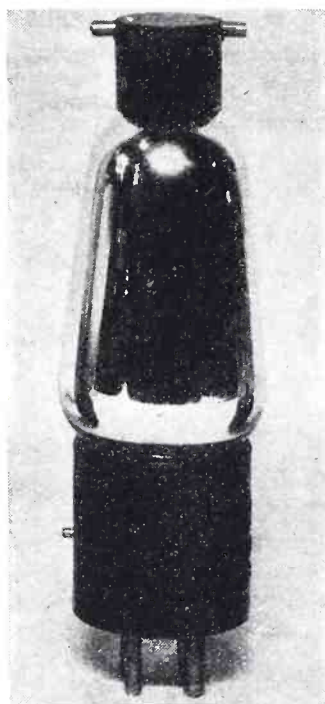

The Pioneer Among the AC-Operated Valves

Name of valve: McCullough AC valve, type 401.

Description: This AC valve does not require the use of an "A" battery, but draws its "A" current from the AC house-lighting lines through a small step-down transformer. The alternating current is applied to an element in the valve called the "heater." This heater is placed sufficiently close to the cathode of the valve to cause the required electron emission from the latter element, but without causing any disturbing influence such as would result from the application of alternating current directly to the cathode. A standard base is used on the 401 valve, although only three of its terminals are used. The AC supply for the "heater" is applied at two terminals which are mounted on a composition cap at the top of the valve. The AC leads are kept well away from the valve circuit terminals, thus avoiding hum.

Valve rating:

Heater voltage—3 (AC).
Heater current—1 ampere.
Plate voltage—150 (maximum).
Negative grid bias—0 to 9 volts.

Valve characteristics (with plate voltage of 90 and negative grid bias of 4.5 volts), as determined in POPULAR RADIO TESTING LABORATORY:
Plate resistance—10,600 ohms.
Amplification factor—8.5.
Mutual conductance—800 micromhos.
Plate current—2.62 milliamperes.

Usage: Suitable for any usage to which standard 201-a type valves can be applied.

Outstanding features: Good characteristics. No storage battery required for filament heating. Sturdily built. Long life.

Maker: McCullough Sales Co.



A Powerful New Half-Wave Rectifier Valve

Name of valve: DR Rectifier.

Description: In size and general external appearance this valve is similar to the standard UX-216-b type of rectifier, except that the DR valve is equipped with a standard isolantite base. It is a half-wave rectifier and is intended particularly for use in a transmitting circuit that employs the DeForest type D transmitting valve. It can also be used in a "B" power-pack to supply direct current for a receiver which includes a power-amplifier valve in the last low-frequency stage.

Valve rating:
Filament voltage—7.5.
Filament current—2.0 amperes.
Plate voltage (AC)—550 (maximum).
Direct-current output—75 milliamperes (maximum).

Usage: As a rectifier for any purpose where the current drain does not exceed 75 milliamperes and the input voltage does not exceed 550.

Outstanding features: When used with suitable filter circuit will supply sufficient plate current for any receiver, including those using power amplifiers. Isolantite base.

Maker: DeForest Radio Co.

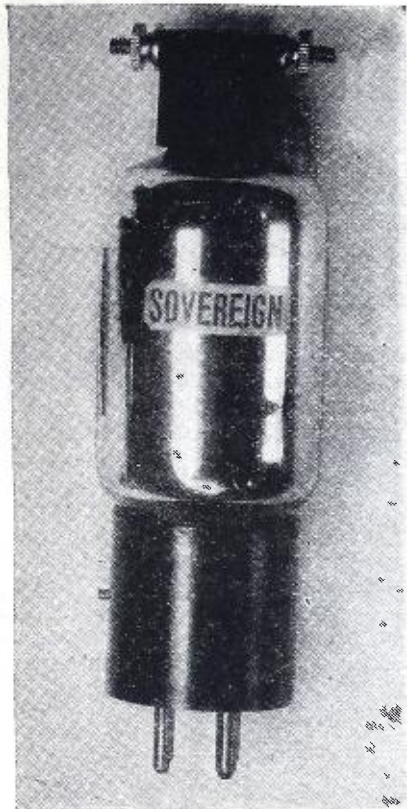

A Valve That Needs No "A" Batteries

Name of valve: Sovereign AC Tube.

Description: This valve does not require a storage battery, a dry battery, a rectifier or a filter for its filament supply. It is operated from the AC lines, through a small step-down transformer. A receiver equipped with these valves, and used in conjunction with a standard "B" power-pack, will not require the use of any batteries at all.

The valve is equipped with a standard base and can therefore be used in any standard UV- or UX-type sockets. Its main difference in appearance from that of the standard UX-201-a type of valve lies in the composition cap at the top of the valve. This cap is equipped with binding-post terminals for the heater element. The heater has as its sole purpose the heating of the cathode. Thus, instead of requiring the cathode to function both as a heater and as an emitter of electrons, as is the case in all standard valves, these functions are served by two separate elements in this AC valve. The heater element is placed close enough to the cathode to provide it with the necessary heat to cause suitable electron emission without introducing the hum that would probably result if raw alternating current were applied directly to the cathode. In its operating characteristics the Sovereign AC valve is almost identical with the standard UX-201-a type of valve.

Valve rating:

Heater voltage—3 (AC).
Heater current—1.1 amperes.
Plate voltage—22.5 to 160.
Negative grid bias—0 to 6 volts.

Valve characteristics (with a plate voltage of 90 and a negative grid bias of 4.5 volts), as determined in POPULAR RADIO TESTING LABORATORY:
Plate resistance—12,500 ohms.
Amplification factor—8.5.
Mutual conductance—680 micromhos.
Plate current—3.7 milliamperes.

Usage: As a detector, high-frequency or low-frequency amplifier in any receiver that is properly wired for the use of this valve. These valves can be used in place of UX-201-a type of valves in standard receivers through a modification of the filament wiring of the circuit.

Outstanding features: Eliminates the necessity for storage batteries or "A" power-packs. Requires only the use of a small and inexpensive step-down transformer to provide the low-voltage alternating current for the heater supply. Good construction and operating characteristics.

Maker: Sovereign Electric & Mfg. Co.



A Detector Valve That Improves Quality of Reproduction

Name of valve: Quality detector valve, type 150-d.

Description: This detector has the same filament requirements as the UX-201-a or UX-200-a type valves, and is therefore interchangeable with them. It is made expressly for use as a detector where the best tone quality is desired. It will not provide as great volume on weak signals as will detectors of the UX-200-a type, and is therefore recommended particularly for use in the reception of local programs. It is equipped with a standard UX-type base. For best results with this valve, it is important that the proper grid-leak value be used.

Valve rating:

Filament voltage—5.
Filament current—.25 ampere.
Plate voltage—20 to 80.
Grid condenser—.00015 to .00025 mfd.
Grid-leak—.5 to 2 megohms.

Usage: As the detector for use in any receiver that is equipped for the use of a 5-volt valve for this purpose, in cases where maximum tone quality is more desired than great sensitivity and volume.

Outstanding features: Extremely quiet in operation. Not easily overloaded. Interchangeable with any 5-volt, 1/4-ampere valve.

Maker: Magnavox Co.

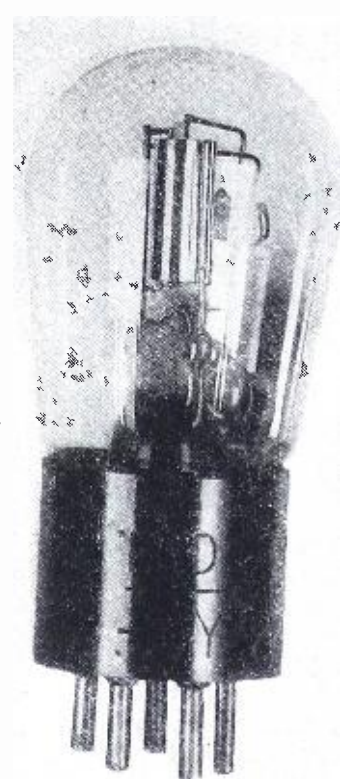

The New 5-Prong RCA "AC" Valve

Name of valve: Radiotron UY-227.

Description: Alternating current, drawn direct from the house-lighting lines through a small step-down transformer, is used to supply the heater element of this new valve. The heater element is independent of the other elements of the valve, but is placed in close proximity to the emitter element (the cathode, which corresponds to the filament in a standard valve). The alternating current is therefore confined to the heater and has no effect on the other elements, such as might cause an AC hum. This valve is inclosed in a bulb of clear glass, similar in shape to the UX-201-a type valve. The base is of the new "UY" design, with five contact prongs. It requires a special socket. The characteristics of this valve, both as a detector and as an amplifier, are much like those of a standard UX-201-a type valve. The UY-227 type valve is therefore useful as a detector, high-frequency amplifier or low-frequency amplifier.

Valve rating:

Heater voltage—2.5 (AC).
Heater current—1.75 amperes.
Plate voltage—45 to 180.
Negative grid bias—0 to 13.5 volts.

Valve characteristics (with plate voltage of 90 and negative grid bias of 4.5 volts).
Plate resistance—11,300 ohms.
Amplification factor—7.9.
Mutual conductance—730 micromhos.
Plate current—3 milliamperes.

Usage: As an all-purpose valve for detection, low-frequency amplification or high-frequency amplification.

Outstanding features: Requires no storage battery or "A" power-pack for its filament supply. Introduces no AC hum into reception, even when used as a detector. May be used as a detector in a receiver that is designed for the use of Radiotrons UX-226 as amplifiers. Similar in characteristics to the UX-201-a type.

Maker: Radio Corporation of America.



A Detector Valve of Increased Sensitivity

Name of valve: Champion, UX-200-a.

Description: This is a detector valve of the standard UX-200-a type. The base is of the UX type and the bulb is of clear glass.

Valve rating:

Filament voltage—5.
Filament current—.25 ampere.
Plate voltage—45.
Grid-leak—.5 to 2.0 megohms.
Grid condenser—.00025 mfd.

Usage: As the detector in any circuit or receiver that uses a detector valve with a 5-volt, .25-ampere filament.

Outstanding features: Extremely sensitive to weak signals.

Maker: Consolidated Electric Lamp Co.

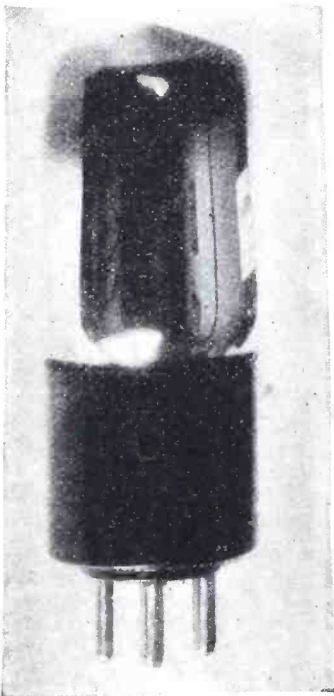

A Sturdy Vacuum Valve for Standard Use

Name of valve: Universal 201-a type.

Description: This is a general-purpose valve of the UX-201-a type, but it has the general appearance of all Magnavox valves. It is equipped with a standard UX-type base. It is designed for low internal capacity.

Valve rating:

Filament voltage—5.
Filament current—.25 ampere.
Plate voltage—45 to 135.
Negative grid bias—0 to 9 volts.

Valve characteristics (with a plate voltage of 90 and a negative grid bias of 4.5 volts), as determined in POPULAR RADIO TESTING LABORATORY:

Plate resistance—9,400 ohms.
Amplification factor—7.9.
Mutual conductance—840 micromhos.
Plate current—3.5 milliamperes.

Usage: As an all-purpose valve for use in circuits where a standard UX-201-a type valve can be employed.

Outstanding features: Low internal capacity.

Maker: Magnavox Co.

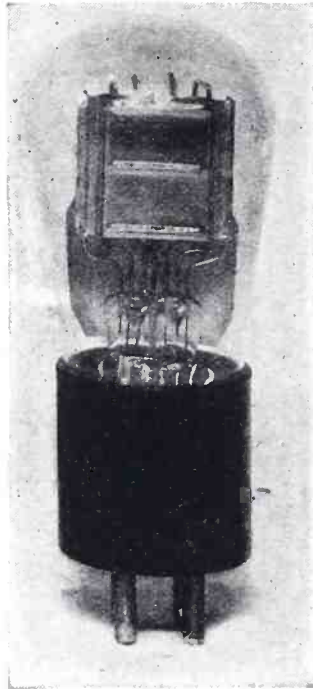

A New Low-Current Valve

Name of valve: ZP-100.

Description: This is a new vacuum valve for which the radio fan has long waited. Its characteristics, when used as a detector tube or as a high-frequency amplifier or a low-frequency amplifier, are similar to those of the standard UX-201-a type valve, yet the filament-current consumption is only slightly higher than that of a UX-199 type valve. This means that a "B" power-pack can be readily used to supply the "A," "B" and "C" voltages for a multi-valve receiver in which these new valves are used, with their filaments connected in series. Also, these valves may be used in many of the standard receivers, in place of the UX-199 type valves, to be operated from dry cells. Or in receivers which use the UX-201-a type valves the new Zetka valves can be substituted with a resulting decrease in filament-current consumption of 60 per cent. One of the drawbacks to ordinary 5-volt, low-current consumption valves in the past has been that of short life. These ZP-100 valves are absolutely guaranteed to give satisfaction to the consumer, and this guarantee applies to their life as well as to their characteristics. The valve is similar to the UX-201-a type valve in size, shape and base. It differs from this type, however, in that the bulb is of clear glass and, while in operation, the filament burns with a

dull red glow that can hardly be seen. The high efficiency of this valve, in spite of the low filament-current consumption, is a result of the method and materials used in coating the filament, plus the Zetka process of evacuation and of conditioning.

Valve rating:

Filament voltage—5.
Filament current—0.1 ampere.
Plate voltage—22½ to 135.
Negative grid bias—0 to 4.5 volts.

Valve characteristics (with plate voltage of 90 and negative grid bias of 3 volts), as determined in POPULAR RADIO TESTING LABORATORY:

Plate impedance—13,000 ohms.
Amplification factor—9.6.
Mutual conductance—740 micromhos.
Plate current—2.3 milliamperes.

Usage: As detector, high-frequency amplifier and low-frequency amplifier.

Outstanding features: Good operating characteristics. Low filament current. Excellent for use with filaments in series, to operate from the output of a suitable "B" power-pack.

Maker: Zetka Laboratories.

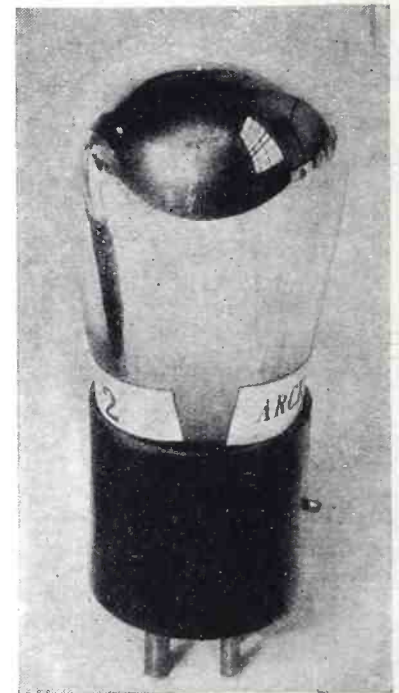

An Excellent Medium-Power Valve

Name of valve: Archatron, type 112.

Description: This valve is a typical UX-112 type in appearance and base. In its manufacture a special evacuation process is used which provides unusually high exhaustion.

Valve rating:

Filament voltage—5.
Filament current—.25 ampere.
Plate voltage—90 to 157.5.
Negative grid bias—4.5 to 10.5 volts.

Valve characteristics (with a plate voltage of 157.5 and a negative grid bias of 10.5 volts), as determined in POPULAR RADIO TESTING LABORATORY:

Plate resistance—3,900 ohms.
Amplification factor—5.7.
Mutual conductance—1,490 micromhos.

Usage: As an amplifier for use in the last low-frequency stage.

Outstanding features: Provides greater volume than does the UX-201-a type of valve, without overloading, when used in the last low-frequency stage.

Maker: Ken-Rad Corp.

The New RCA "AC" Valve

Name of valve: Radiotron UX-226.

Description: This valve has practically the same operating characteristics as the UX-201-a type valve, but its outstanding advantage lies in the fact that its filament is heated by means of alternating current, rather than from direct-current supply. The alternating current for the filament supply is obtained from the AC lighting line through the use of a small step-down transformer to change the voltage to 1½ volts. It is not interchangeable with the UX-201-a type valves in a receiver unless rather extensive alterations are made in the wiring of the receiver. In a receiver especially designed and constructed for the use of these valves as amplifiers the results obtained will be comparable with those obtained from any standard receiver which uses an equal number of UX-201-a type valves.

Valve rating:

Filament voltage—1.5 (AC).

Filament current—1.05 amperes.

Plate voltage—90 to 180.

Negative grid bias—6 to 13.5 volts.

Valve characteristics (with plate voltage of 90 and negative grid bias of 6 volts):

Plate resistance—9,400 ohms.

Amplification factor—8.3.

Mutual conductance—880 micromhos.

Plate current—3.7 milliamperes.

Usage: As either low-frequency or high-



frequency amplifiers. *Not to be used as detector.*

Outstanding features: The filament operates on raw alternating current. Characteristics similar to those of standard UX-201-a type valves. Eliminates the necessity for a storage battery or "A" power-packs.

Maker: Radio Corporation of America.

10.5 volts), as determined in POPULAR RADIO TESTING LABORATORY:

Plate resistance—3,700 ohms.

Amplification factor—7.4.

Mutual conductance—1,930 micromhos.

Plate current—12 milliamperes.

Usage: As an amplifier in the last low-frequency stage.

Outstanding features: Non-microphonic. Gives good volume without distortion.

Maker: Televocal Corp.

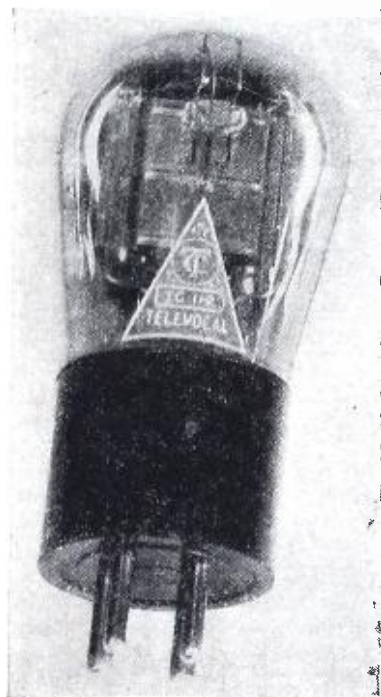

A New Non-Microphonic Power Valve

Name of valve: TC-112.

Description: This valve has the same size and appearance as the standard UX-112 type valve. Its characteristics also resemble the standard UX-112 type valve. It makes use of a special supporting plate for the valve elements to prevent short-circuiting of elements and to reduce microphonic effect.

Valve rating:

Filament voltage—5.

Filament current—.5 ampere.

Plate voltage—90 to 157.5.

Negative grid bias—4.5 to 10.5 volts.

Valve characteristics (with a plate voltage of 157.5 and a negative grid bias of



A Detector Valve That Will "Pep Up" Your Reception

Name of valve: Super-Sensitive Detector, 200-a type.

Description: This valve is intended especially for use as a detector to provide

greater sensitivity than is obtainable when the UX-201-a type of valve is used. It is slightly smaller in size than standard 5-volt valves and is of the distinctive Magnavox shape. The base is the standard UX type.

Valve rating:

Filament voltage—5.

Filament current—.25 ampere.

Plate voltage—45.

Grid condenser—.00025 mfd.

Grid-leak—2 to 5 megohms.

Usage: As the detector in any receiver that is equipped for the use of a 5-volt valve for this purpose.

Outstanding features: Greater sensitivity than the UX-201-a type valve when used as a detector. Comparatively quiet in operation. Interchangeable with UX-201-a type of detectors. Gives increased volume.

Maker: Magnavox Co.



A General-Purpose Valve

Name of valve: DL-2.

Description: This is a standard type of vacuum valve. It is equipped with standard UX-type isolantite base. It is intended for use as a detector or as a high-frequency or low-frequency amplifier. The use of a cushioned socket is recommended for mounting this tube.

Valve rating:

Filament voltage—5.

Filament current—.25 ampere.

Plate voltage—16.5 to 157.5.

Negative grid bias—0 to 9 volts.

Valve characteristics (with a plate voltage of 90 and a negative grid bias of 4½ volts):

Plate resistance—8,000 ohms.

Amplification factor—6.3.

Mutual conductance—780 micromhos.

Plate current—4.7 milliamperes.

Usage: As a detector, high-frequency amplifier or low-frequency amplifier.

Outstanding features: Particularly suitable for use in oscillating circuits in either the detector stage or high-frequency stage, because of smooth control of oscillation.

Maker: DeForest Radio Co.

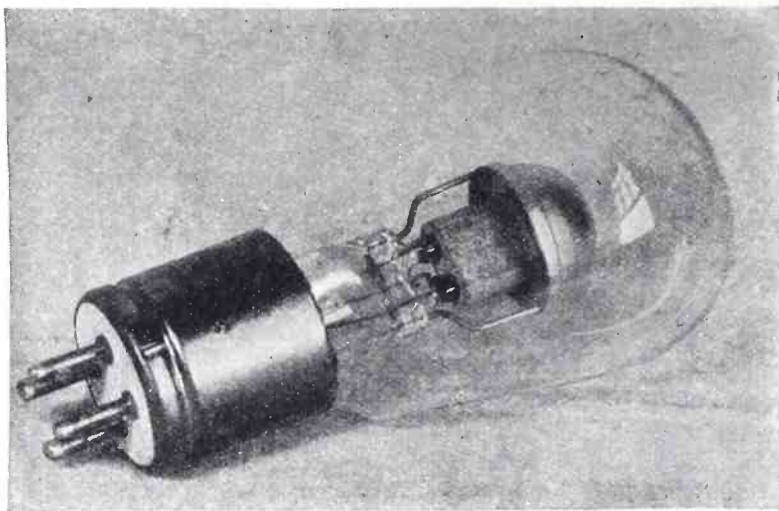

The New Raytheon Model BA, 350 Milliamperc Rectifier Valve

Description: This is a full-wave rectifier valve of the gaseous type; it is similar to the Raytheon BH rectifier valve in appearance, but slightly larger and of somewhat heavier construction. It is equipped with a standard UX-type base, which permits its use in any standard valve socket. While it has the usual four contact prongs, only three are used, as this valve has no filament or "heater" of any kind. The high-voltage alternating current which is applied to this valve to be rectified is obtained through a step-

up transformer with a center-tapped secondary capable of supplying 320 volts, each side of center-tap; and a smaller winding capable of supplying 5 volts at .5 ampere for the filament supply of a power valve.

Outstanding features: Furnishes full-wave rectification for "ABC" power packs. With a proper transformer and filter, this valve will deliver a maximum current of 350 milliamperes at approximately 200 volts. Well designed and well made.

Maker: Raytheon Manufacturing Co.



A Detector Valve That Is Highly Sensitive

Name of valve: SX-00-a.

Description: In physical appearance this valve is identical with the standard UX-201-a type, and it is equipped with a standard UX-type base. The internal construction differs from the UX-201-a type, however, and instead of being evacuated as highly as possible this valve has a certain gas content which is one of the reasons for its great sensitivity as a detector.

Valve rating:

- Filament voltage—5.
- Filament current—.25 ampere.
- Plate voltage—45.
- Grid-leak—2 megohms.

Grid condenser—.00025 mfd.

Usage: As a detector in any circuit or receiver which permits the use of a 5-volt, .25-ampere valve.

Outstanding features: A super-sensitive detector. Non-critical as to filament and plate voltages.

Maker: Sylvania Products Co.



A Dry-Cell Type of Valve

Name of valve: DL-3.

Description: The DL-3 is a dry-cell valve that corresponds in its operating characteristics to the standard UX-199 type of valve. It is provided with a standard UX-type isolantite base and measures 3½ inches in overall height. The base is equipped with a pin, so that this valve may be

used in either the old or new types of sockets. It may also be mounted in either a horizontal or vertical position.

Valve rating:

- Filament voltage—3.
- Filament current—.065 ampere.
- Plate voltage—16.5 to 90.
- Negative grid bias—0 to 4.5 volts.

Valve characteristics (with a plate voltage of 90 and a negative grid bias of 4.5 volts), as determined in POPULAR RADIO TESTING LABORATORY:

- Plate resistance—21,000 ohms.
- Amplification factor—8.0.
- Mutual conductance—380 micromhos.
- Plate current—1.8 milliamperes.

Usage: As a detector, high-frequency amplifier or low-frequency amplifier.

Outstanding features: May be mounted in any position. Less microphonic than the average dry-cell valve. May be mounted in any standard socket.

Maker: DeForest Radio Co.



A Standard Valve With a High Amplification Factor

Name of valve: SX-201-a.

Description: Isolantite is used throughout as an insulator in this valve. Not only is the UX-type base made of this material, but also it is used to support the filament and to reinforce the grid and plate structure within the valve. In shape and size this valve corresponds with the standard UX-201-a type, and its characteristics are such as to make it interchangeable with the standard valves in a receiver.

Valve rating:

- Filament voltage—5.
- Filament current—.25 ampere.
- Plate voltage—22.5 to 150.
- Negative grid bias—0 to 9 volts.

Valve characteristics (with a plate voltage of 90 and a negative grid bias of 4.5 volts), as determined in POPULAR RADIO TESTING LABORATORY:

- Plate resistance—15,000 ohms.
- Amplification factor—10.1.
- Mutual conductance—670 micromhos.
- Plate current—1.8 milliamperes.

Usage: As a detector, high-frequency amplifier or low-frequency amplifier.

Outstanding features: Low plate-current consumption. Rigid spacing of the internal elements.

Maker: Supertron Mfg. Co., Inc.



An Efficient Rectifier of the Gaseous Type

Name of valve: Corona valve, Z-80.
Description: This full-wave rectifier valve involves several new ideas in the method of localizing the useful gases that are used in the rectifying process. It is similar in size and appearance to the Raytheon valve and is interchangeable with any of the standard gaseous rectifiers now commonly used in "B" power-packs.

Valve rating:
 150 volts at 100 milliamperes.
 250 volts at 90 milliamperes (maximum).

Usage: As a rectifier for use in "B" power-packs which require output voltages up to approximately 250 and currents up to 90 milliamperes.

Outstanding features: Full-wave rectification. No filament. High-voltage output at normal current drain.

Maker: Schickerling Products Corp.

Plate voltage—22.5 to 135.
 Negative grid bias—0 to 4.5 volts.
Valve characteristics (with a plate voltage of 90 and a negative grid bias of 4.5 volts), as determined in POPULAR RADIO TESTING LABORATORY:
 Plate resistance—13,700 ohms.
 Amplification factor—9.7.
 Mutual conductance—1,372 micromhos.
 Plate current—2 milliamperes.

Usage: For any purpose for which a standard valve can be used.

Outstanding features: Standard all-purpose characteristics.

Maker: Tectron Radio Corp.

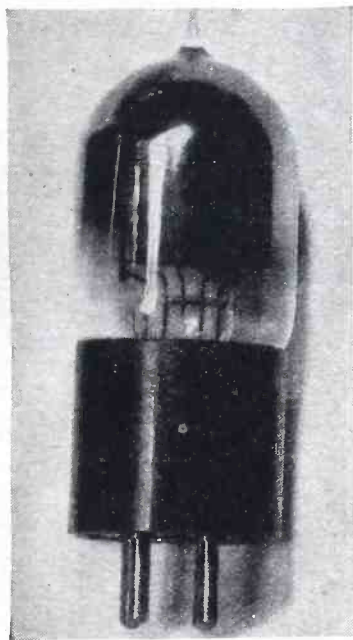

A Valve for Truphonic Amplifiers

Name of valve: DA-4 (Truphonic).

Description: This valve is somewhat smaller than the standard 201-a type, but is equipped with a standard UX-type base. It is a high-mu valve and it employs a 5-volt, 1/4-ampere filament.

Valve rating:
 Filament voltage—5.
 Filament current—.25 ampere.
 Plate voltage—90.
 Negative grid bias—0.

Valve characteristics (with plate voltage of 90 and no negative grid bias), as determined in the POPULAR RADIO TESTING LABORATORY:
 Plate resistance—32,300 ohms.
 Amplification factor—19.
 Mutual conductance—590 micromhos.
 Plate current—1.4 milliamperes.

Usage: Especially designed for use in the first and second stages of a "Truphonic" amplifier.

Outstanding features: High voltage amplification. Superior to the 201-a type valve when used in "Truphonic" amplifiers.

Maker: Donle-Bristol Corp.



A Tube for Standard Usage

Name of valve: Roy, type 201-a.
Description: This is a standard UX-201-a type of valve, with a UX-type base.

Valve rating:
 Filament voltage—5.
 Filament current—.25 ampere.



A Power Valve That Will Improve Reception

Name of valve: SX-171.
Description: This is a standard UX-171 type of valve with a UX-type base.

Valve rating:
 Filament voltage—5.
 Filament current—5 ampere.
 Plate voltage—90 to 180.
 Negative grid bias—0 to 40.5 volts.

Valve characteristics (with a plate voltage of 180 and a negative grid bias of 40.5 volts), as determined in POPULAR RADIO TESTING LABORATORY:
 Plate resistance—2,040 ohms.
 Amplification factor—2.77.
 Mutual conductance—1,372 micromhos.
 Plate current—20 milliamperes.

Usage: As an amplifier in the last low-frequency stage to avoid the distortion that results from overloading.

Outstanding features: Provides large volume without distortion from overloading. Contains a special reinforced support for the internal elements.

Maker: Schickerling Products Corp.

A Valve That Does the Work of Three

The next issue of POPULAR RADIO will contain an article by Manfred von Ardenne, the distinguished German radio expert who has just visited this country, telling of his experiments with Dr. Loewe on the new "multiplex" valves that can be made to serve the purpose of an entire amplifier.



Kadel & Herbert

A NEW KINK FOR Keeping Your Log-Book

Practical pointers that will help the broadcast listener to tune in on the station he wants—when he wants it.

By W. PENN LUKENS

DURING the past year or two an effort has been made to substitute the term frequency for wavelength, for use in identifying the places occupied by the various broadcasting stations. The effort has not been entirely successful. Apparently the term kilocycles frequency is a bit too technical for the lay mind.

The use of frequencies has undeniable advantages, and many call books and newspaper programs still list the frequency of each station as well as its wavelength. And the average fan is often forced to recognize that frequency has a meaning, for he may find that stations are fairly evenly allocated on the dial of his straight-line-frequency condenser, or that they are badly bunched on the lower portion of a straight-line-wavelength dial.

Recent acquisition of a superheterodyne receiver of remarkable range and selectivity, but with three-dial tuning,

has forced the writer to log dial readings in some accurate and convenient form. Several tries at the usual methods of recording stations soon forced the conclusion that logging would have to be primarily by frequencies, in order to give even distribution of the stations; yet it was also desirable to keep sight of wavelengths. Therefore the chart (reproduced in part at the right) was developed and has proven ideal for every requirement. It is illustrated as applied to the particular three-dial superheterodyne, but may be equally well applied to any type of set with any number of dials.

The chart or log table may be made on ordinary cross-section paper, on which the divisions are marked off ten to the inch. Such paper may be obtained at most stationery stores.

Lines are drawn vertically, in ink, to give a number of columns. The first

column shows kilocycles, and for the broadcast range should be from 1500 kilocycles down to 500 kilocycles. Each division of the cross-section paper represents five kilocycles.

The second column shows the wavelength in meters corresponding to the given frequency in kilocycles; the two columns together form what is known as a "conversion table." It is easy to find wavelength, roughly, by dividing 300,000 by the frequency in kilocycles. Thus for a frequency of 1000 the wavelength will be $300,000 \div 1000 = 300$ meters. For a frequency of 1500 the wavelength will be $300,000 \div 1500 = 200$ meters.

Of course the figure of 300,000 is only approximate. When making the chart it saves trouble and gives greater accuracy to take a call book which gives both wavelength and frequency—copying on the chart the wavelength in

meters in its proper kilocycle place. Thus 1000 kilocycles is actually 299.8 meters, 1200 kilocycles is 249.9 meters, 620 kilocycles is 483.6 meters, etc.

It is possible to go through a call book and write down on the chart the location, call letters, wavelength and frequency of every station, but to do so would partly defeat the purpose of the chart. The best method is to go through the call book and note down the data for each of the stations that one usually gets. Thus in Chicago there will be a list of from 75 to 100 stations normally received, such as WOC, WLW, KDKA, WJZ, KMOX, and WSM.

This listing may all be done at one time, saving time and promoting neatness. As these usual stations are actually tuned on the set, one need only to mark down the dial readings. When the operator tunes a station which is not pre-listed in this way, he must refer to the call book for its wavelength and frequency, in order to set it down in its proper place on the log chart.

It will be found that usually the stations are assigned a place every ten kilocycles. As the chart has a ruled space every five kilocycles, it is thus possible to list two stations for each frequency. But as there may be from two to twenty stations that have a given frequency, a second set of columns is added to the right of the dial readings, for listing the call letters and location of stations having duplicate frequencies, and hence duplicate dial readings. It is thus possible to list four or even six stations having the same frequency.

As the chart lists more and more stations, it becomes easy to forecast the exact dial readings which will bring in a desired but as yet unlisted station. The chart reads in an even sequence of decreasing frequencies and in a progressive sequence of increasing wavelengths. The dial readings will read in a similar sequence, as it is evenly spaced if the condensers are of the straight-line-frequency type, and similar to the meters reading if they are of the straight-line wavelength type.

From this log chart it is easy to see the relationship between kilocycles and meters, showing why some condensers crowd the stations at the lower end; it is easy to see, also, why some sets seem less selective on the long wavelengths, for WOW, Omaha, and KYW, Chicago, (Continued on page 76)

THE "LOG CHART"

This record may be most easily kept on cross-section paper that may be obtained in any stationery store; the vertical and horizontal rules in tint (which are not shown in the accompanying illustration) help to keep the alignments.

KILO-CYCLES	WAVE LENGTH	LOCATION OF STATION	CALL	1ST DIAL	2 ^D DIAL	3 ^D DIAL	CALL	LOCATION OF STATION
1350	225.4	CHICAGO	WBBM	10	28	36	WIBO	CHICAGO
1300								
1250	238	CHICAGO	WHT	17½	32	40		
	241.8	CHICAGO	WNAAE	23½	35	43		
	245.8	BALTIMORE	WBAL	26	36½	44½		
1200	250	CHICAGO	WMBB	28	38	45½		
800	374.8	HOTSPRINGS	WTHS	93½	84	95	KVOO	BRISTOW, OKLA.
	379.5	SCHENECTADY	WGY	95	85	97	WHAZ	TROY, N.Y.
	384.4	WINNIPEG	CRY	97	86	98½	WMBF	MIAMI BEACH
	389.4	CLEVELAND	WTAM	99½	88	100½		
	394.5	SAN ANTONIO	WDAI	101	89½	102		
750	399.8	LOUISVILLE	WHAS	104	92	104½	WHT	CHICAGO
	405.2	LOS ANGELES	KHJ	105½	93½	106	WOR	NEWARK
				108	96	108	WCRN	CHICAGO
	416.4	MINNEAPOLIS	WCCO	110½	98	110		
	422.3	CINCINNATI	WLW	113½	100	113		
700	428.3	SAN FRANCISCO	KPO	115½	101	115		
	434.5	ARLINGTON	NAA	117	102	116	WSD	ATLANTA
	440.9	JEFFERSON CITY	WOS					
	447.5	CHICAGO	WQJ	124½	107½	123	WMAQ	CHICAGO
	454.3	NEW YORK	WJZ	128	110½	126		
650	461.3	SHENANDOAH	KMA	130½	112	128½	WCAE	PITTSBURGH
	467	LOS ANGELES	KFI	133½	114	131		
	468.5	WASHINGTON	WRC	135	115	132		
	475.9	FORT WORTH	KBAP	137½	117	139½	WFAA	DALLAS
	483.6	DAVENPORT	WOC	141½	119½	137½	WSUI	IOWA CITY
	491.5	PORTLAND	KGW	146	122	141½	WFEL	CHICAGO
600	491.5	NEW YORK	WEAF					
	499.7	MEMPHIS	WMC					
	508.2	FORT WORTH	KFQB	153½	125½	150	WOO	PHILADELPHIA
	516.9	DETROIT	WCA	161	131½	156	WJR	DETROIT
	526	OMAHA	WOW	168	135½	163	WHO	DES MOINES
	535.4	CHICAGO	KYW	177	140	171	WHA	MADISON
550	545.1	ST. LOUIS	KSD	189	146½	179		

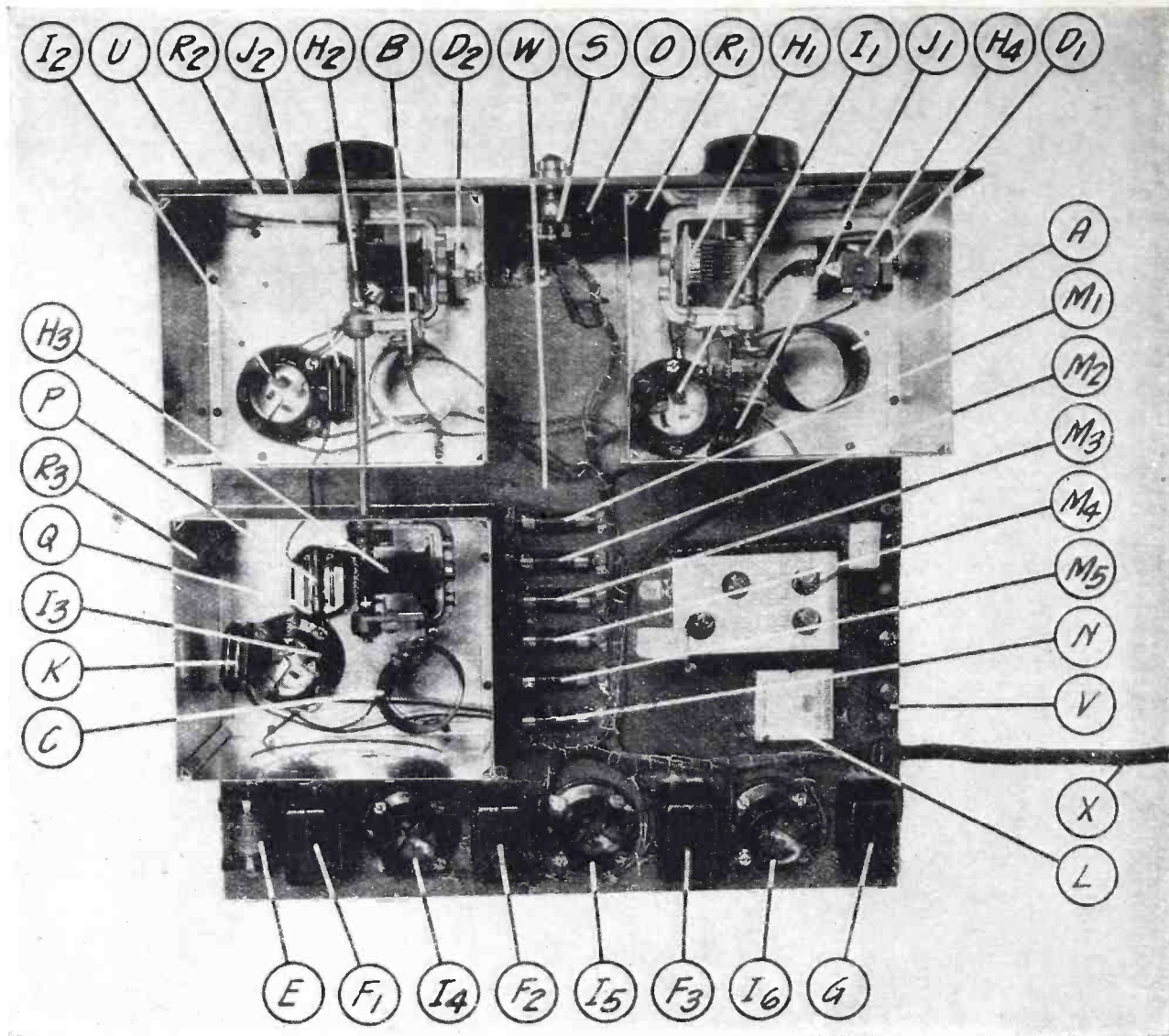

A VIEW OF THE RECEIVER FROM ABOVE

FIGURE 1: In this picture the tops of the shield "cans" are removed to show the layout of the instruments. The first high-frequency stage is shown at the upper right-hand corner; to the left is the second high-frequency stage, and below it is the detector stage. Note the cabled wiring.

HOW TO BUILD *The* Capacidyne Receiver

By HERBERT SNEAD

COST OF PARTS: Not more than \$79.00

HERE IS A LIST OF PARTS NECESSARY FOR THE CONSTRUCTION OF THIS RECEIVER—

A—Hammarlund autocoil;
B and C—Hammarlund coils, type RF-17;
D1 and D2—Samson R. F. choke, No. 125;
E—Samson R. F. choke, No. 85;
F1, F2 and F3—Na-ald truphonic couplers, No. 301;
G—Na-ald truphonic output, No. 300;
H1, H2 and H3—Hammarlund midline condensers, .00035 mfd.;
H4 and H5—Hammarlund balancing condensers;
I1, I2, I3, I4, I5 and I6—Na-ald sockets, type 400;

J1 and J2—Sangamo fixed condensers, .006 mfd.;
K—Sangamo fixed condenser, .001 mfd.;
L—Sangamo fixed condenser, series "A," 1 mfd.;
M1, M2, M3, M4 and M5—Amperites, No. 1A;
N—Amperite, No. 112;
O—Carter Hi Ohm variable resistance, 0 to 500,000 ohms;
P—Sangamo fixed condenser, .00025 mfd., equipped with grid-leak mounts;
Q—Polygrid fixed resistor, 3 megohms;

R1, R2 and R3—Hammarlund stage shields;
S—Carter "Imp" pilot switch;
T1, T2, T3 and T4—Eby binding posts, marked "Ant.," "Gnd.," "Speaker +" and "Speaker -," respectively;
U—Composition panel, 7 by 18 by 3/16 inch;
V—Composition binding-post strip, 3/4 by 5 3/4 by 1/8 inch;
W—Baseboard, 17 by 17 by 1/2 inch;
X—Battery cable, 6 leads.
Bus wire, spaghetti, etc.

THE golfer gets his big thrill from a perfect drive, flying far and straight down the fairway. The fisherman gets his from the struggles of the game fish, securely hooked. The radio constructor's moment occurs when the

first strains of music issue from his loudspeaker after his painstaking construction of a new circuit.

The Capacidyne offers a field of experiment in a new direction in high-frequency amplification. Capacitative

coupling with tuned-impedance amplification is the keynote of this new receiver. Truphonic amplification is incorporated in the low-frequency stages with excellent reproduction, both in quality and volume, as a feature.

The list of parts given on page 54 includes the exact instruments used in the laboratory model of this receiver. The experienced amateur, however, will be able to pick out other reliable makes of instruments which have been approved by POPULAR RADIO and which may be used with good results. But we recommend that the novice follow the list, as the diagrams in this article will tell him exactly where to place the connections. If instruments other than the ones listed are used, the only change that will be necessary will be the use of different spacings for the holes that are drilled in the sub-base. To any reader who has difficulty in obtaining any of the parts which are necessary in making up these model receivers, POPULAR RADIO SERVICE BUREAU, 627 West 43rd Street, New York City, will gladly assist in seeing that his requirements are promptly supplied.

It has been truly said that radio has made more "prevaricators" than golfing and fishing combined. With this statement in mind, claims bordering on the improbable have purposely been avoided in presenting this receiver. Every circuit has its advantages and its drawbacks. Suffice it to say that here is presented a circuit which offers sufficient selectivity for practical use without loss of quality due to cutting off sidebands, which provides sufficient voltage amplification for good volume and distance getting ability, which gives (within the scope of a moderate amount of money and a reasonably simple type of equipment) excellent reproduction—and which is simple to build and especially easy to operate.

The input amplifier comprises two

stages of high-frequency amplification. To prevent coupling through the "B" battery or "B" power-pack, if one is used, high-frequency chokes are placed in the "B" supply leads.

As the present-day popularity of stage shields is well founded in scientific principles, complete stage shields or "cans" for the two high-frequency amplifier valves and for the detector valve are incorporated. To simplify tuning, the second high-frequency stage condenser and the detector stage condenser are operated by a common shaft. Neutralization or other balancing means has usually meant a compromise between sensitivity and freedom from oscillation. For this reason a so-called automatic means of balancing has been avoided, and a control of sensitivity, serving

simultaneously as a volume control, has been included in the form of a variable high resistance in the plate circuit of the high-frequency valves.

Maximum selectivity in antenna tuning is acquired by automatic variation of primary coupling. Some regeneration is introduced into the antenna circuit and into the second high-frequency circuit by means of the small balancing condenser connected according to the "Rice" method.

Detector regeneration has purposely been avoided, and the loss of sensitivity resulting from its omission is amply compensated for by the avoidance of the distortion and instability that it introduces.

Filament control is automatic; it is considered superfluous to furnish manual

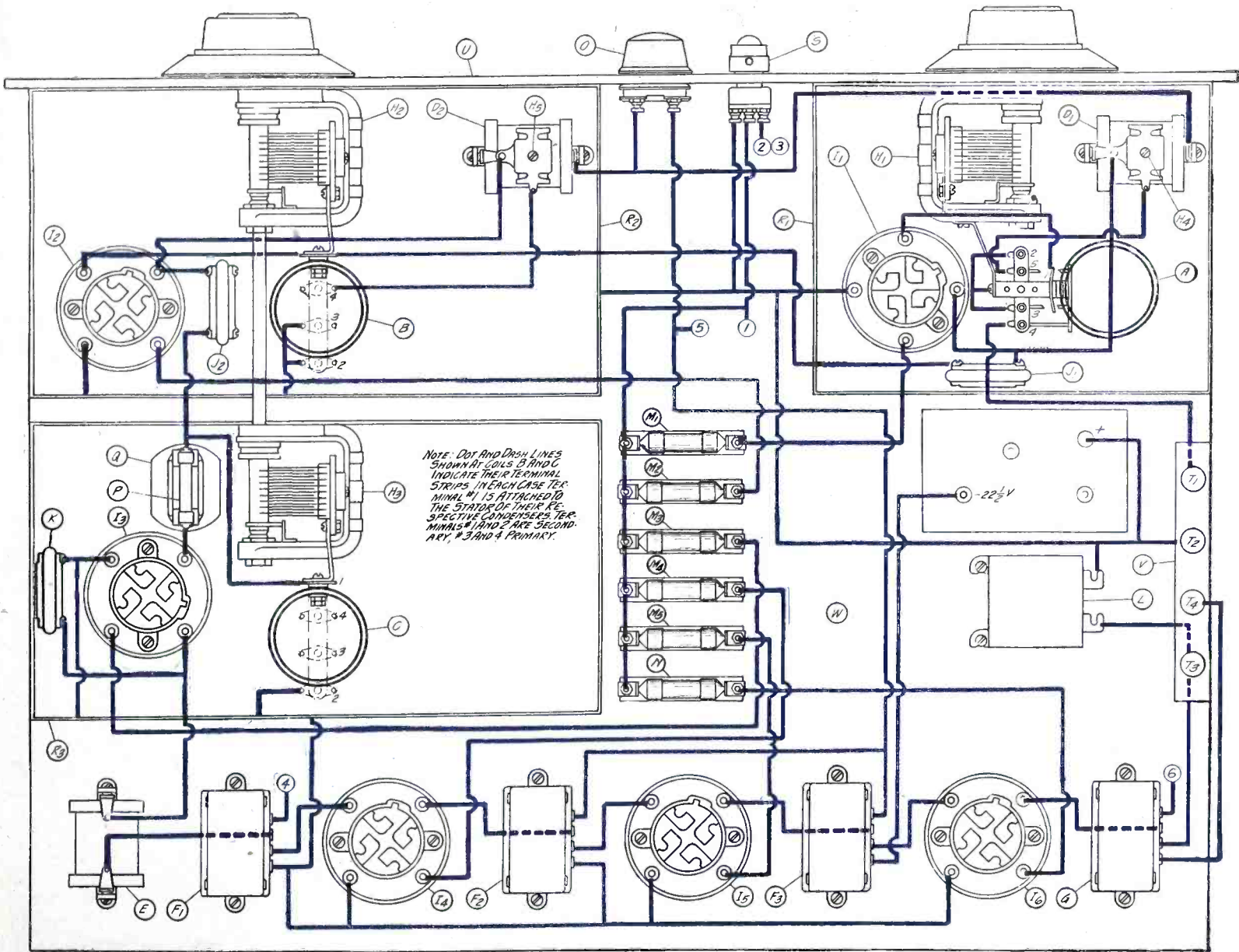

THE PICTURE-WIRING DIAGRAM

FIGURE 2: The proper positions of the instruments are indicated by the outline figures in black. The blue lines indicate the complete wiring scheme. The blue numbers correspond with the numbered battery leads of Figure 6, and show the proper cable connections to be made to the "A" and "B" batteries.

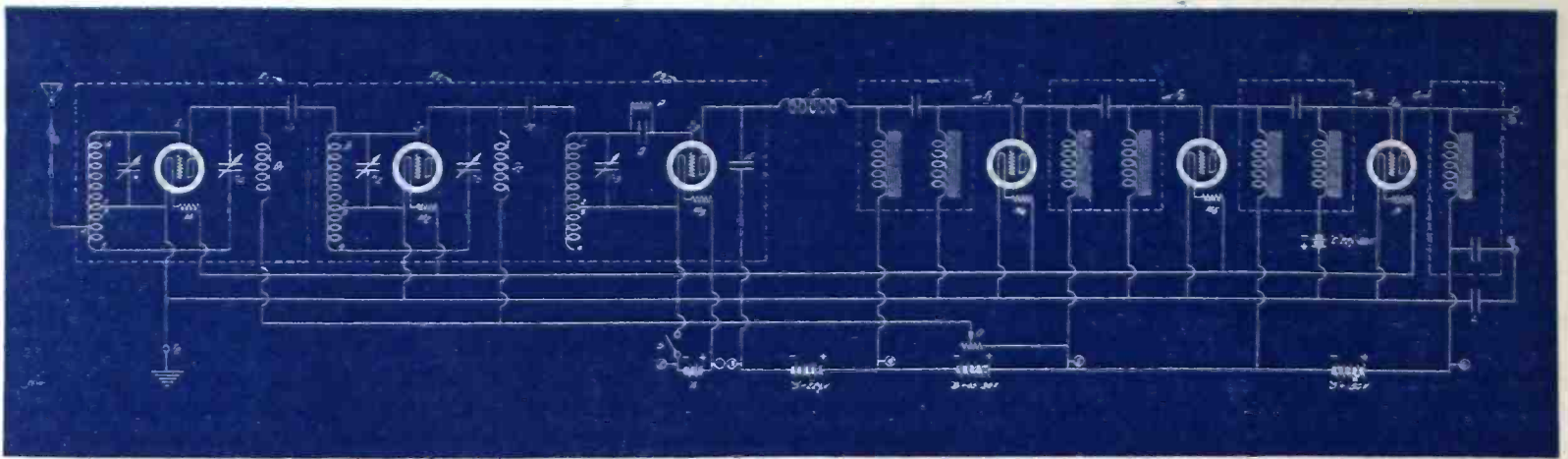

THE SCHEMATIC WIRING DIAGRAM

FIGURE 3: A certain amount of regeneration is obtained in the two high-frequency stages, shown at the left of the diagram. The regeneration is controlled by means of the balancing condensers, H4 and H5.

filament control for any of the valves in a circuit of this type which is essentially non-regenerative.

The low-frequency amplifier carries out the same general coupling scheme used in the high-frequency end.

The Donle magnetically coupled impedances (Truphonic) for both plate and grid, with capacitive stage coupling, are employed. Though such an amplifier requires three vacuum valves to be in excess, as to volume, to a two-stage transformer-coupled amplifier, the quality of reproduction delivered is well worth the extra valve. To permit the

use of the new semi-power output valves, carrying moderately high plate voltages, and to prevent this direct current from burning out the speaker windings, an output device is also incorporated. The foregoing briefly describes the general characteristics of the receiver.

How to Construct the Set

Of course we must commence with parts list, wiring diagrams and drawings. The parts given in the list at the head of this article are, in the author's opinion, the best to use for the specific purpose intended. Substitution of other makes

of high-grade parts is not to be discouraged, however, provided the constructor knows the essentials of receiver design.

Figure 4 shows the drilling layout of the panel used on the set herein illustrated. The binding post drilling layout is also shown in Figure 4. Inasmuch as this description is that of one experimenter telling how to duplicate his own favorite set, and not directions for assembling a kit produced by manufacturers, a small deviation from panel and baseboard sizes, and also in the arrangement of parts, is quite in order.

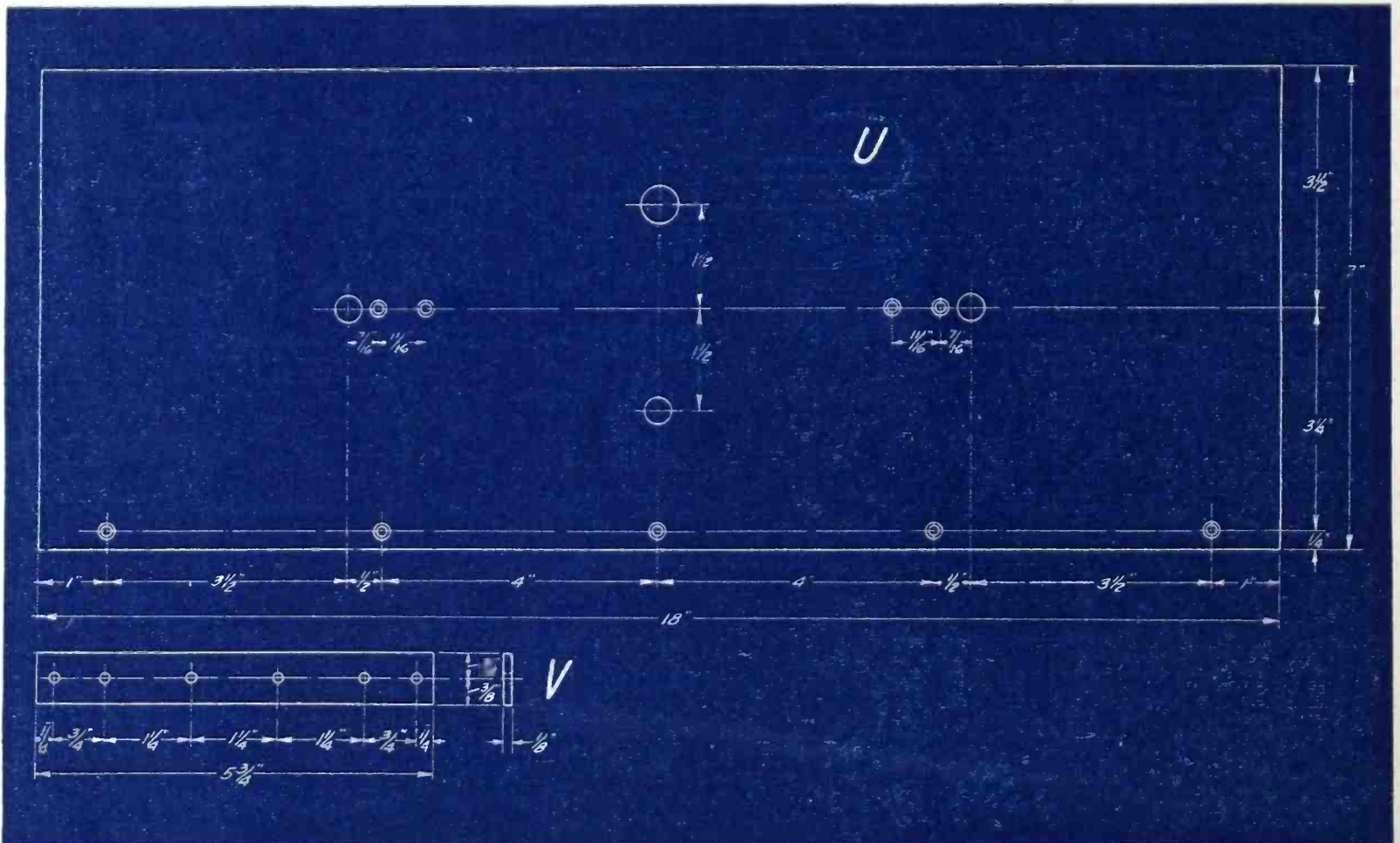

THE PANEL LAYOUT OF THE CAPACIDYNE

FIGURE 4: The exact drilling specifications of the front panel are indicated at U. In the lower left-hand corner, at V, is the drilling layout for the binding-post strip.

The schematic wiring diagram is shown in Figure 3 and the picture diagram in Figure 2. These need no particular explanation.

Having collected all of the necessary materials and parts, actual construction may be commenced. The first step is to drill the panel. The easiest method of drilling is to draw a template full size on heavy drafting paper and then cut out the template so that the edge of the paper corresponds to the edge of the panel. Then clamp the completed paper template to the panel and punch and drill right through the paper.

The layout drawing of the baseboard, giving exact locations and dimensions of the various parts, is purposely omitted, as there are no precautions that need be observed except the general one of so locating all equipment that all high-frequency leads are kept as short and direct as possible. Each shield contains within it all of the equipment pertaining thereto, including the fixed condenser that couples it to the following stage.

By placing the detector stage directly behind the second high-frequency stage, the two tuning condensers may be operated by means of a common shaft. The shaft is of 1/4-inch brass rod. The condensers lend themselves extremely well to this purpose, as their shafts may be removed by loosening the small set screws in the rotor sleeve, and the brass rod, of proper length, may be inserted. All of the equipment is to be screwed to the baseboard by means of round-head, brass wood-screws, and the panel may also be fastened in this manner.

A mounting to support the auto-couple coil is supplied with it by the manufacturer, which permits the turning of the condenser to change the coupling between the primary and the secondary. The primary is a split

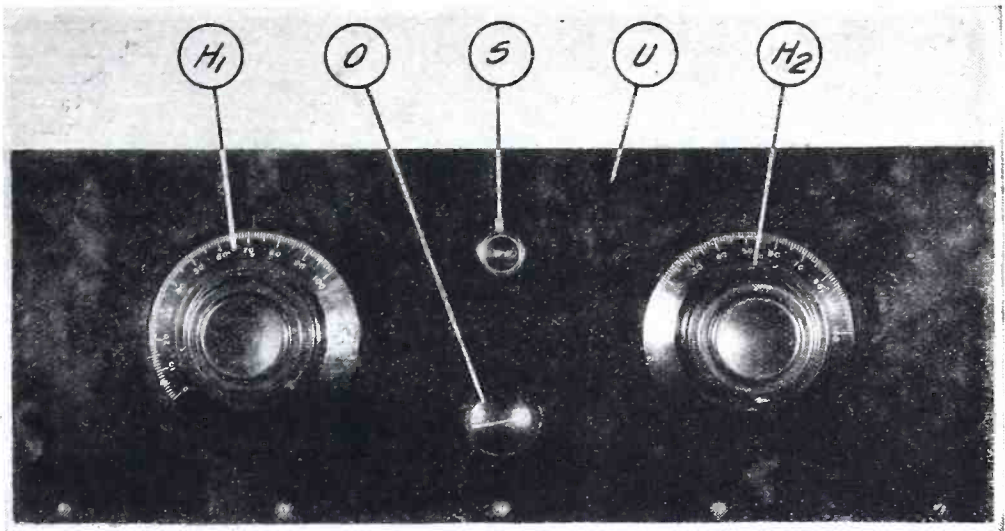

A FRONT VIEW OF THE CAPACIDYNE PANEL

FIGURE 5: The two large dials are the tuning controls; between them, at O, is the volume control knob. At S is the combination battery switch and pilot light.

winding, the mid-tap serving as the antenna connection, the inside end-tap serving for ground and the other tap serving for the feed-back connection. The other coils are not supplied with mounting brackets. These, however, can readily be made out of 1/2-inch brass strip or 1-inch by 1-inch brass angles, 1/2-inch wide, obtainable in any hardware store.

The primary winding of the detector coil is not used and is left unconnected. The primary of the second high-frequency coil is utilized for regeneration. The tap provided for neutralization is cut off close to the coil. The entire coil is fastened to the condenser stator connection by means of the bracket mentioned above.

In mounting instruments inside of the shields, make sure that none of their terminals are in contact with the shields.

How to Wire the Set

Wiring should be done in a strictly

speaking "electrical" manner. It should follow the diagram given in Figure 2. Flexible, insulated wire should be used, and all leads, except grid and plate leads, should be cabled and tied together with string. Wiring is facilitated if only the front and base of the shields are screwed fast, the sides, rear and top being fastened after the wiring is completed. Holes must, of course, be drilled through the shields for the passage of the connecting wires.

It will be noted that no jack is provided for the reproducer. Binding posts are preferred by the author. It is also desirable to incorporate a battery cable into the set wiring, as this makes short circuiting of the batteries less probable.

How to Operate the Receiver

The builder should experiment with plate and biasing voltages for the high-frequency and detector valves. It will usually be found that with 4 1/2 volts negative bias on the grid, 90 volts "B" battery potential will usually give best results for the high-frequency valves. If a UX-200-a detector valve is used 22 1/2 volts will be sufficient. With a UX-201-a detector valve and 4 1/2 volts bias, 45 volts will operate well.

The station settings correspond closely on the two dials, so that the user can take one in each hand and rotate them slowly to find the wanted stations. Volume is adjusted by means of the variable resistance.

It will be found that, contrary to usual practise, the antenna dial is the sharp setting dial, and the other dial is fairly broad. Of course, they tune absolutely independent of each other, the settings of one having practically no influence upon the settings of the other.

The writer has had exceptionally good success with this receiver and believes it will be of more than general interest to the experimenter as well as the fan.

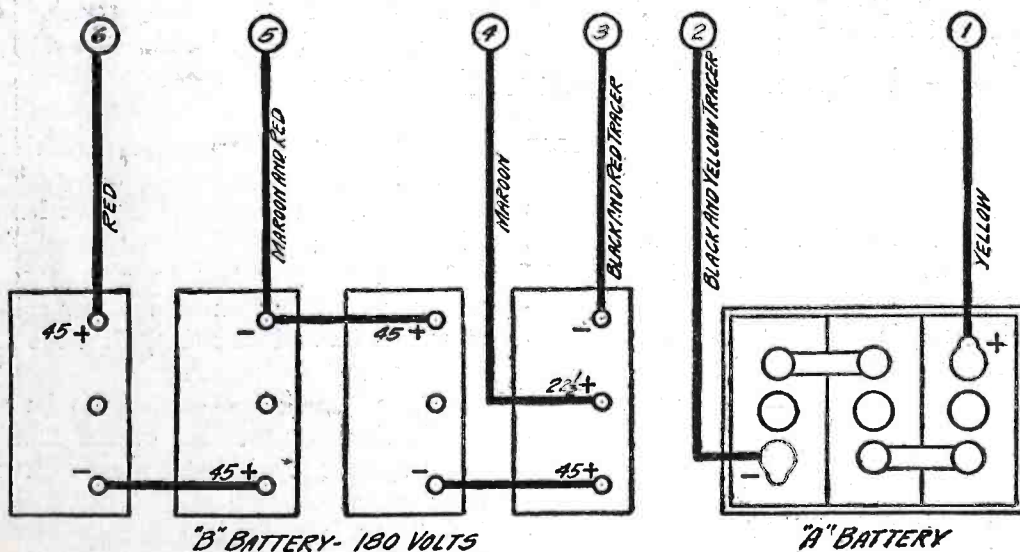

THE BATTERY HOOK-UP FOR THE RECEIVER

FIGURE 6: The numbered leads correspond with the BLUE numbers in Figure 2. Binding posts are not used for the battery leads; the leads shown above should be connected directly with the wiring of the receiver. The "C" battery is housed within the receiver.

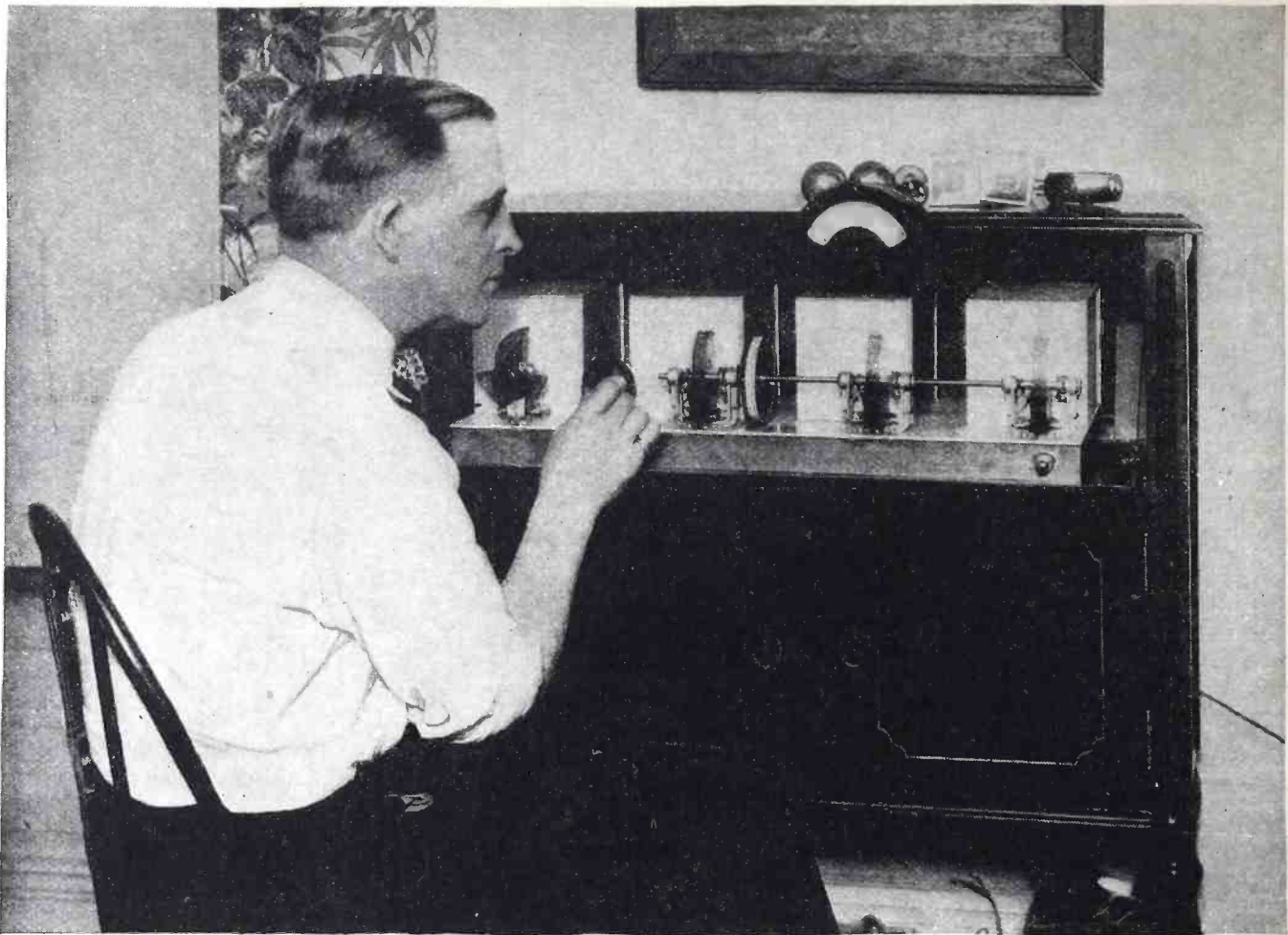

From a photograph made for POPULAR RADIO

AN EXPERIMENTAL MODEL OF THE NEW LC-28

When the preliminary development work on the new receiver had been completed, the constructional details were worked out progressively in the POPULAR RADIO LABORATORY, until simplicity in construction and wiring with highest efficiency in operation were finally achieved.

THE COMING OF THE NEW

LC-28 RECEIVER

With this issue, POPULAR RADIO makes this preliminary announcement of its latest and best contribution to the radio art—the remarkable new LC-28 receiver. Next month's issue—for September—will contain detailed information concerning the specific design of this receiver. And in the October number will appear the full constructional details.

ONCE more is POPULAR RADIO making a real and substantial contribution to the radio art.

The POPULAR RADIO LABORATORY—which contributed the popular Cockaday Four-Circuit Tuner in May, 1923, the Improved Four-Circuit Tuner in January, 1924, the Four-Circuit Tuner with Resistance-Coupled Amplifier in October, 1924, the LC-26 in December, 1925, and the LC-27 Receiver last year—has been engaged for many months in the development of a receiver that has been declared by unbiased experts to represent a definite advance in the field of radio reception.

It will be designated as the LC-28.

Ever since the introduction of the

LC-27, the Technical Staff of POPULAR RADIO have been making tests and proving certain new principles and theories in radio reception. These new theories are incorporated in the LC-28 circuit.

Next month's issue—for September—will contain detailed information concerning the specific design that has been finally adopted. And in the October issue will appear the complete constructional details.

The new LC-28 receiver marks an advance over the LC-27 receiver in several important respects. For instance:

When the LC-27 receiver was developed, the "Fourteen Points" of design were listed as follows:

1. The quality of reproduction had to

be as high as radio science permitted;

2. The cabinet had to be designed to harmonize with the representative home of good taste;

3. The receiver had to give a consistently good performance with a minimum of care and attention, after the set was once installed;

4. The tuning control had to be so simple that any member of the family could operate it without special instruction;

5. The selectivity had to be adequate to eliminate interference from stations on adjoining wavelengths;

6. The set had to operate on any type of outdoor antenna, a loop antenna or on no antenna at all;

7. The set had to operate on house current or batteries, as desired;
8. The parts had to be shielded adequately;
9. The power amplifier and output filter had to supply ample volume without distortion;
10. The construction had to provide for the use of nationally known valves and parts that are easily obtainable in any locality;
11. The set had to be non-regenerative in order to prevent radiation;
12. The receiver had to be of simple construction, with the minimum of adjustments, controls and balances;
13. The set had to have a sensitivity adequate to provide good reception of distant programs;
14. The set had to be fool-proof in construction.

In the development of the LC-28 receiver these fourteen points were carefully considered, not only because each point had to be covered, but covered in a manner that took into consideration the relative worth of each one of these features.

Point 1, for instance—the quality of reproduction had to be as near perfect as possible;

Points 2 and 3 are as important in the LC-28 as in the LC-27;

Point 4 was considered so essential in the new model that a special new drum dial has been incorporated that sim-

plifies and beautifies the receiver more than any other single item;

Point 5; the selectivity of the LC-28 has been increased without injuring the quality of reproduction;

Points 6 and 7 have been given the same importance in the LC-28 as in the LC-27;

Point 8; a unique design of shielding has been developed for the LC-28 that is adequate for increased amplification;

Points 9, 10, 11 and 12 are likewise important features; more especially so is No. 12. It is believed that the LC-28 is the simplest set to build that has ever been described in a radio publication.

Point 13; the sensitivity has been stepped up manifold without sacrificing the qualities called for in Point 12;

Point 14; the set is "fool-proof" not only in construction, but in installation and operation.

The Technical Staff of POPULAR RADIO believes that radio sets in the future will be built into *two units* or compartments; one of them will be the high-frequency end (including the detector); this may be called the "high-frequency pack."

The high-frequency pack of the LC-28 consists of three stages of tuned high-frequency amplification and a vacuum-valve detector. This is complete in a single shielded unit.

A second unit (including the low-frequency end) consists of two or three stages of low-frequency amplification;

this might be called the "low-frequency pack."

The kind of currents flowing in either of these units should be shielded from the currents flowing in the other and the two packs should be specifically *designed for their distinctive functions*.

A graphic layout of a complete unit set up is shown in Figure 1. This includes a phonograph pick-up which may be switched "on" in place of the high-frequency pack when it is desired to use the low-frequency pack and reproducer for the production of recorded programs.

The constructional article that will appear in October, therefore, will be concerned only with the "high-frequency pack," although the proper methods for using it with various types of manufactured low-frequency amplifiers will be shown, as well as how to build the various types and how to connect them properly in the circuit.

At the beginning of this article is shown one of the early laboratory models of the receiver; it was designed to be used with any type of outdoor antenna, with a loop antenna, or without any antenna at all.

The September issue will contain further advance information that will be of interest and value to the experimenter and to the engineer alike—as well as to everyone who is interested in the betterment of broadcast reception.

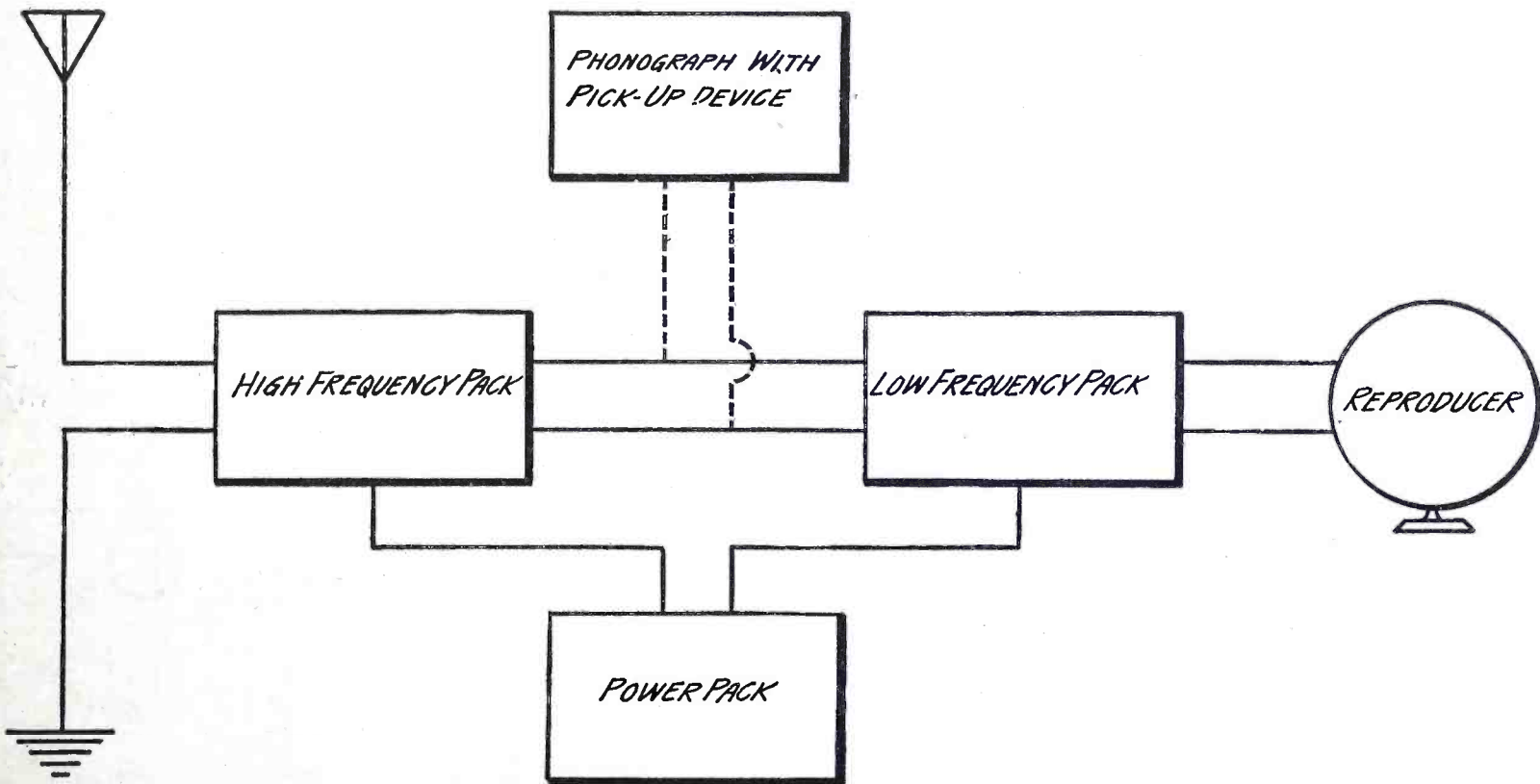

THE FUNDAMENTAL SCHEME FOR THE NEW LC-28

FIGURE 1: This schematic layout shows the general electrical design of the new LC-28. It comprises a broadcast pick-up (high-frequency pack with amplifier and detector stages), an electrical pick-up for phonograph programs, a low-frequency amplifier, a source of power ("ABC" power-pack) and a reproducer.

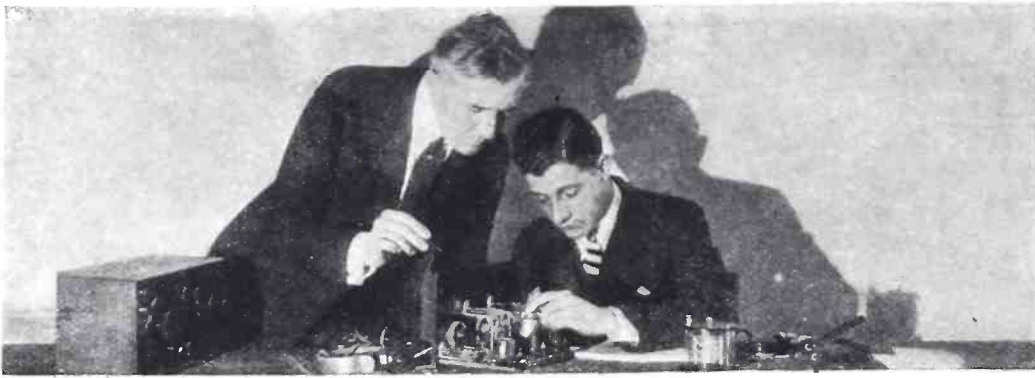

WITH THE EXPERIMENTERS

CONDUCTED BY S. GORDON TAYLOR

A Handy Set-Up for Testing Out New Circuits

I have been experimenting with various hook-ups for several years, and it has always been a matter of trouble or expense to provide each new detector circuit with an amplifier. Either I had to rebuild the old amplifier into the new circuit, or else I had to buy new parts for the amplifier in the new circuit.

I finally hit upon a scheme which permitted me to use one standard receiver so arranged that I could try out new detector circuits with the old amplifier without the necessity for dismantling the old detector circuit. And in testing the new detector circuits I could compare them with the old by an instantaneous change-over arrangement of switches.

The set-up I used is shown in Figure 1. My standard receiver, consisting of a Haynes tuner and a two-stage amplifier, is shown at the right. At the left is the new detector circuit with which I am experimenting at the present time. It

is a short-wave tuner capable of bringing in the stations that broadcast on the wavelengths around and below 100 meters.

A study of the circuit will show that when the three switches, A, B and C, are thrown to the left, the antenna, the amplifier and the "A" battery are connected to the new detector. When thrown to the right, the new detector circuit is cut out entirely and the standard detector hook-up is placed in circuit.

This particular combination of detector tuning units is an excellent one because it permits the receiver to cover the entire amateur and broadcast wavebands from 40 meters up to 550 meters. When it is desired to tune in stations below 200 meters the short-wave tuner is brought into play. To go back up to the regular broadcasting waveband requires only an instant to throw the switches, thus putting the standard tuner into operation.

—JAMES H. KNAPP, *Philmont, N. Y.*

How I Even Up the Wear on My "B" Batteries

THE tapping of the usual "B" battery block for the detector plate voltage and for the high-frequency amplifier plate voltages represents one of the greatest economic wastes in present-day radio. When a section of a "B" battery is given extra work to do (as in the case of an intermediate voltage tap), that section wears out first, spoiling the battery as a unit. And even so, it is seldom that the precise plate voltage required for best results can be obtained from the fixed taps of a "B" battery.

A simple and economical solution of the necessary plate voltages is to employ a variable resistor, with sufficient resistance range, connected in the lead going to the positive terminal of the entire "B" battery. One variable resistor should be employed for the detector valve and another for the high-frequency amplifier valves and additional individual resistors for any other required voltages, such as for the first low-frequency valve. A suitable resistor, shunted by a .01 microfarad condenser, so as to bypass the high-frequency currents around the variable resistance, should be incorporated in the circuit.

This arrangement permits of operating the detector valve and the high-frequency valves at their most critical point as regards plate potential. Meanwhile, the drain for intermediate plate voltages is placed on the entire "B" battery ensuring a longer useful life and also the absence of such noises as might arise through run-down and therefore defective cells. The efficiency of the receiver will be greatly increased.

—CHAS. GOLENPAUL

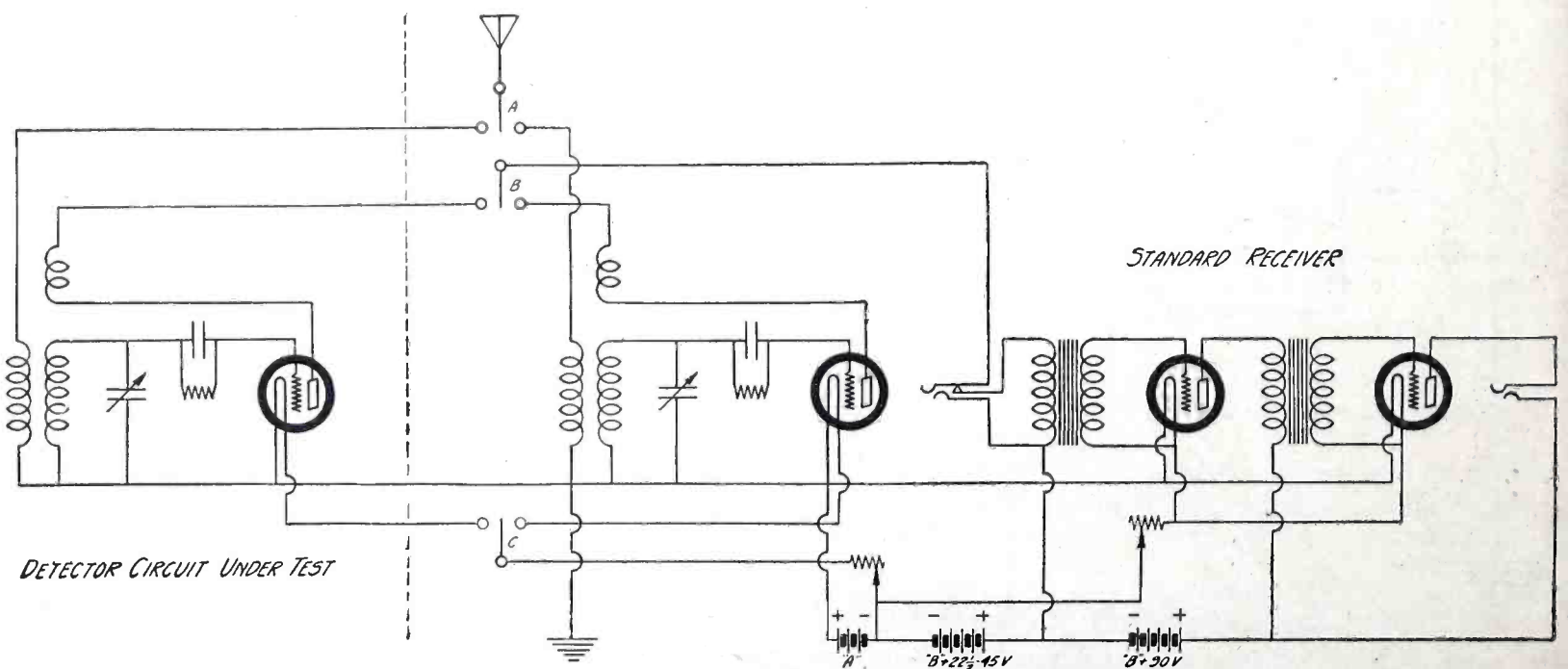

A SIMPLE RECEIVER AND TEST SET-UP

FIGURE 1: A simple three-valve receiver arranged with switches to facilitate trying out different detector circuits without dismantling the set.

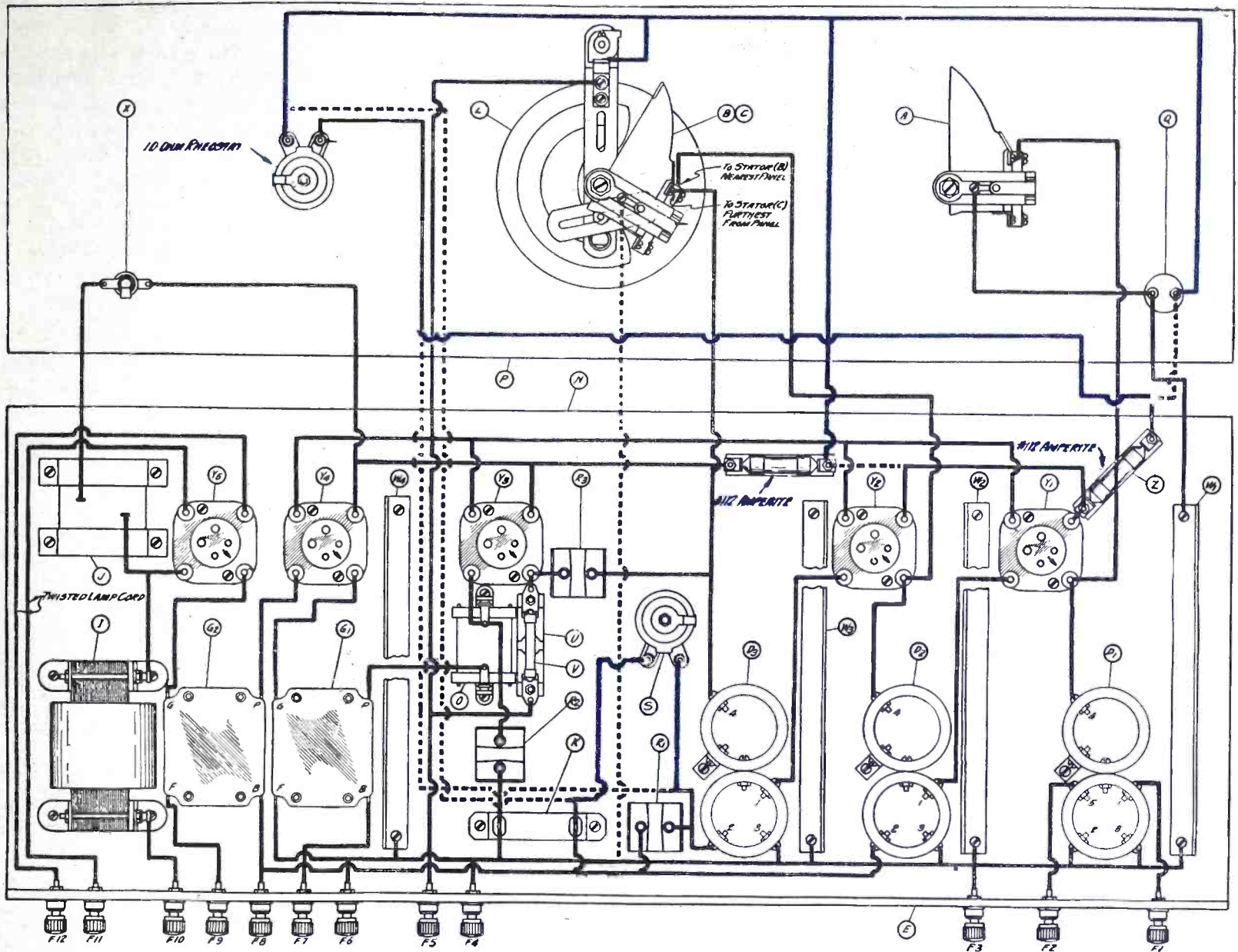

AN IMPROVED VOLUME CONTROL FOR THE LC-27 RECEIVER

FIGURE 2: This is the revised wiring diagram; the wires to be removed are indicated by the dotted lines; the BLUE lines indicate the new connections. A 10-ohm rheostat is installed on the panel in place of the old variable resistance, which is remounted on the baseboard; another amperite is also installed as shown. This scheme also provides automatic control of the pilot light.

Hints on the LC-27 Receiver

Improving the Volume Control

UNDER certain local conditions it has been found that the volume control incorporated in the LC-27 receiver is not always capable of cutting down the volume sufficiently. This is especially true where it is necessary to keep reproduction toned down to little more than a whisper.

An excellent volume control may be

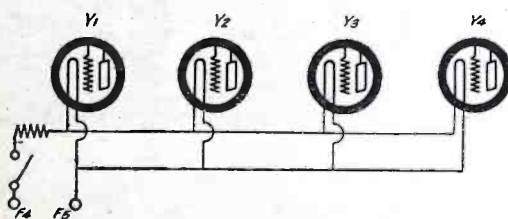

THE OLD FILAMENT CONTROL ARRANGEMENT

FIGURE 3: The first four valves of the LC-27, with their filaments regulated by a single amperite. The scheme of revision is shown in Figures 2 and 4.

obtained by the use of a filament rheostat to control the filament voltage of the two high-frequency amplifier valves. With this control the volume can be smoothly varied from zero to maximum.

Figure 3 shows the schematic diagram of the present arrangement of the two high-frequency valves, detector and first low-frequency valves. The filament of these four vacuum valves are connected in parallel and controlled by a No. 1 automatic filament control.

Figures 2 and 4 show the filament connections with the proposed volume control installed. The 10,000 ohm resistance, which is the present volume control, should be removed from the panel and remounted on the baseboard in the rear of the receiver, adjacent to coil D-3 and the fixed condenser R-1. A 1½-inch brass angle with a ⅜-inch hole for the shaft will serve very nicely as a mounting for this variable resistance. Once this unit has been adjusted

for best operation it may be left alone.

The 10-ohm rheostat should be mounted on the panel in the place formerly occupied by the 10,000 ohm resistance. Connect one side of this rheostat to the receiver side of the battery switch and the other side to a No. 112 amperite, which in turn is to be connected to the negative filament of the two high-frequency valves.

(Continued on page 71)

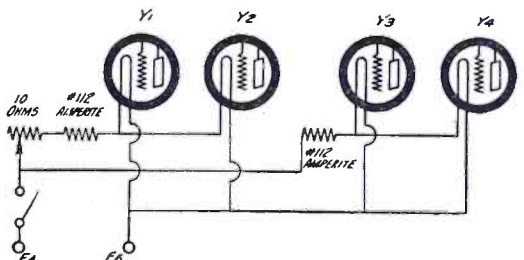

THE FILAMENT CONTROL REVISED TO CONTROL VOLUME

FIGURE 4: In this revised circuit, the 10-ohm rheostat regulates the filament current to the two high-frequency amplifier valves and thus controls the volume.



IN THE WORLD'S LABORATORIES

CONDUCTED BY DR. E. E. FREE

How the New Television Works

THE American Telephone and Telegraph Company's new process of television, developed largely by Dr. Herbert E. Ives and Dr. Frank Gray, of the Bell Telephone Laboratories, was mentioned in the preceding issue of POPULAR RADIO and has been so much discussed in newspapers and other publications printed more rapidly than this Department can be that there is no necessity to describe it in detail.* The scene to be transmitted is split up automatically, into a large number of separate units, each corresponding to a small section of the scene, like the cut-up blocks of a picture puzzle. These are then sent, in succession, over the wire or over the radio link, are put back together into the proper arrangement side by side, and the scene is thus reconstructed. The novelties of the new process are chiefly in the means perfected for doing this with the extreme rapidity which is necessary.

There are three important devices by which this speed is attained. The first is the method of viewing the object to be transmitted. Instead of illuminating the face of the sitter with a very intense light, as has been previously the custom of television experimenters, Dr. Frank Gray devised a plan of moving back and forth over the face of the sitter a small spot of intense light. Thus only one

tiny unit of the face is illuminated at once. The amount of light reflected from this illuminated spot, more light or less depending upon the whiteness or blackness of that spot, constitutes the signal to be transmuted into electricity and sent over the wire or by radio. The motion of the light spot is controlled by a rotating disk, slotted spirally, so that the light ray describes a repeated back-and-forth path.

The second important innovation is the huge type of photoelectric cell used to transmute the reflected light into an electric signal. This is the personal invention of Dr. Ives, who was also in general charge of the project. These

cells are glass cylinders about three inches in diameter and some fifteen inches long. Three such cells are used to receive light from the illuminated spot on the sitter's face and to transmute this in the usual manner into electricity.† Because of the great light-collecting power of these giant photoelectric cells the illuminated spot on the sitter's face may be small and may be passed over quickly, thus permitting the transmission of a picture with much detail without preventing high speed.

The third essential novelty of the new process is the ingenious means of exact synchronization between the transmitting apparatus and the receiver. Transmission is controlled by the moving spot of light, which is regulated, in turn, by the rotation of the slotted disk through which the light ray shines. At the receiving end, the electric signal sent over the wire and corresponding in strength with the whiteness of the point then being illuminated by the moving light spot, is transmuted back into light by a neon lamp in a manner not essentially new. The electric glow in the neon gas varies in intensity in strict correspondence with the strength of the arriving electric signal.

† On the properties of photoelectric cells, see: "Radio's Newest Instrument, the Photoelectric Cell," POPULAR RADIO for November, 1925, pages 397-404.

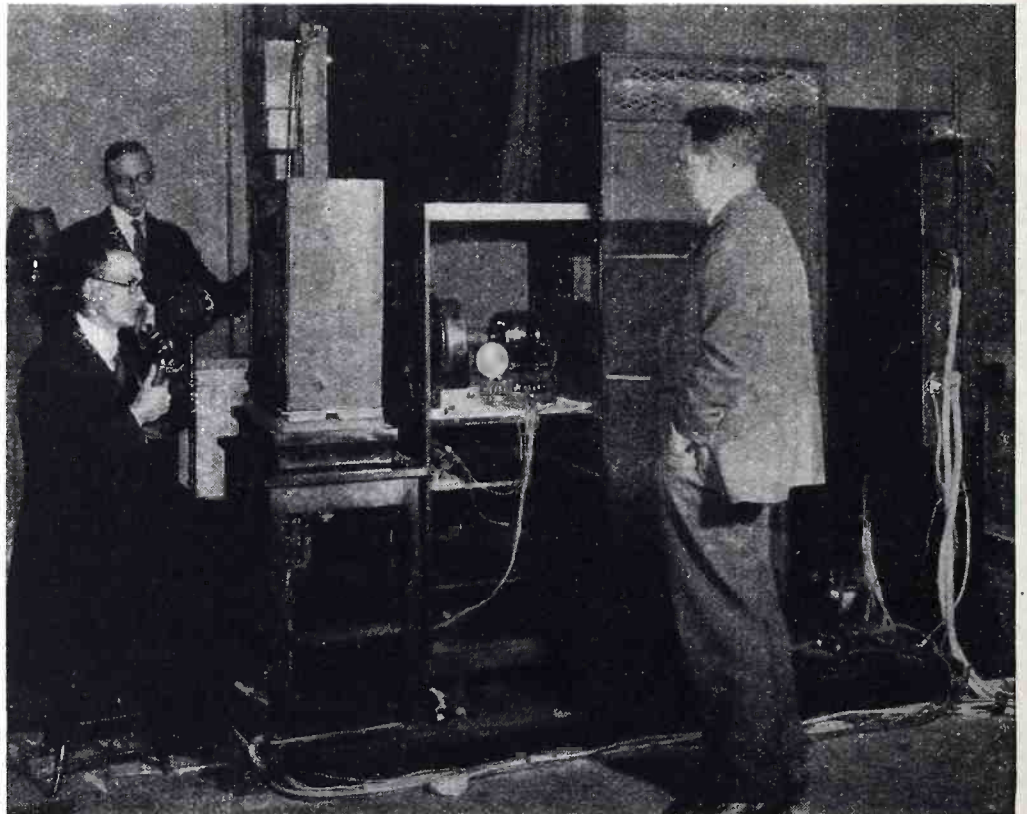

Bell Telephone Laboratories

THE NEW "ELECTRIC EYE" OF THE TELEPHONE

Mr. R. C. Mathes, of the Bell Telephone Laboratories, seated at the left holding the telephone instrument, is in position to be seen by television; the moving spot of light comes from an arc lamp in the box at the extreme right and is directed back and forth across his face by the revolving disk in the open box at the center. On the top and two sides of the smaller box which Mr. Mathes faces are three of the large photoelectric cells which transmute the light signal into an electric signal, for transmission by wire or by radio.

*The process was demonstrated, on April 7, 1927, at the Bell Telephone Laboratories, in New York City, to representatives of the press and to invited guests. Mr. Herbert Hoover, at the Washington end of a telephone wire, talked with Mr. Walter S. Gifford, president of the American Telephone & Telegraph Company, in New York, and was simultaneously visible to Mr. Gifford and to the New York audience. Thereafter, similar television transmission was demonstrated from the experimental radio station of the telephone company at Whippany, New Jersey. Technical details of the process are described in a pamphlet entitled, "Television, an Achievement in Electrical Communication," distributed to the guests on the occasion of this demonstration. Other technical details were discussed by Dr. Herbert E. Ives and Dr. Frank B. Jewett before the meeting of the National Academy of Sciences, in Washington, during the week of April 25, 1927. Popular descriptions of the process have been published in many newspapers and magazines; for example, in the *American Review of Reviews* (New York City) for May, 1927, pages 516-518.

To make this glow of the neon lamp reproduce the exact scene visible at the transmitter, the neon lamp must not be seen as a whole, but must be viewed one small unit at a time, each such unit corresponding to the point of the sitter's face illuminated at the corresponding instant by the moving light spot. To arrange this, the telephone engineers use a "viewing disk," slotted in precisely the same manner as is the disk which moves the light ray of the transmitter. This viewing disk allows the eye of the viewer at the receiver to see the neon lamp from point to point in succession, just as the moving light spot "sees" the face of the sitter.

Exact synchronism of these two disks is obviously a prime necessity. In the operation demonstrated between Washington and New York, the face of Mr. Hoover was divided by the moving light spot into 2,500 separate units. The entire face was covered by this light spot eighteen times a second, making 45,000 separate impulses which had to be sent and received each second. A defect of synchronism by more than one-half of the width of one position of the light spot would ruin the transmission. Accordingly the two disks, one in Washington and the other in New York, had to operate at the same speed with a variation of less than one ninety-thousandth of a second. This was done by using two sets of synchronous motors, driven by a master oscillator at one end of the line. Two control channels were used, one for coarse adjustment, the other for fine adjustment and to prevent "hunting."

The appearance of the image at the receiving end is lifelike, although not absolutely perfect. It is a glowing image, as though painted in fire, the light being that emitted by the neon lamp. Since eighteen complete images of the face or other scene are received every second, the illusion of motion is quite as perfect as in the motion picture, possibly more so. In radio transmission, it occasionally happens that two images appear side by side, one being a "ghost" of the other. This is ascribed by the engineers in charge to double transmission of the radio wave; one path direct and the other by reflection from the Heaviside Layer.

Experimental work directed toward perfection and application of television is actively under way in the Bell Telephone Laboratories. It is expected that the process, already the most successful demonstrated by anyone, will be still further improved.

POPULAR RADIO hopes to present in later issues descriptions of some of the technical details of the present process and of its improvements.

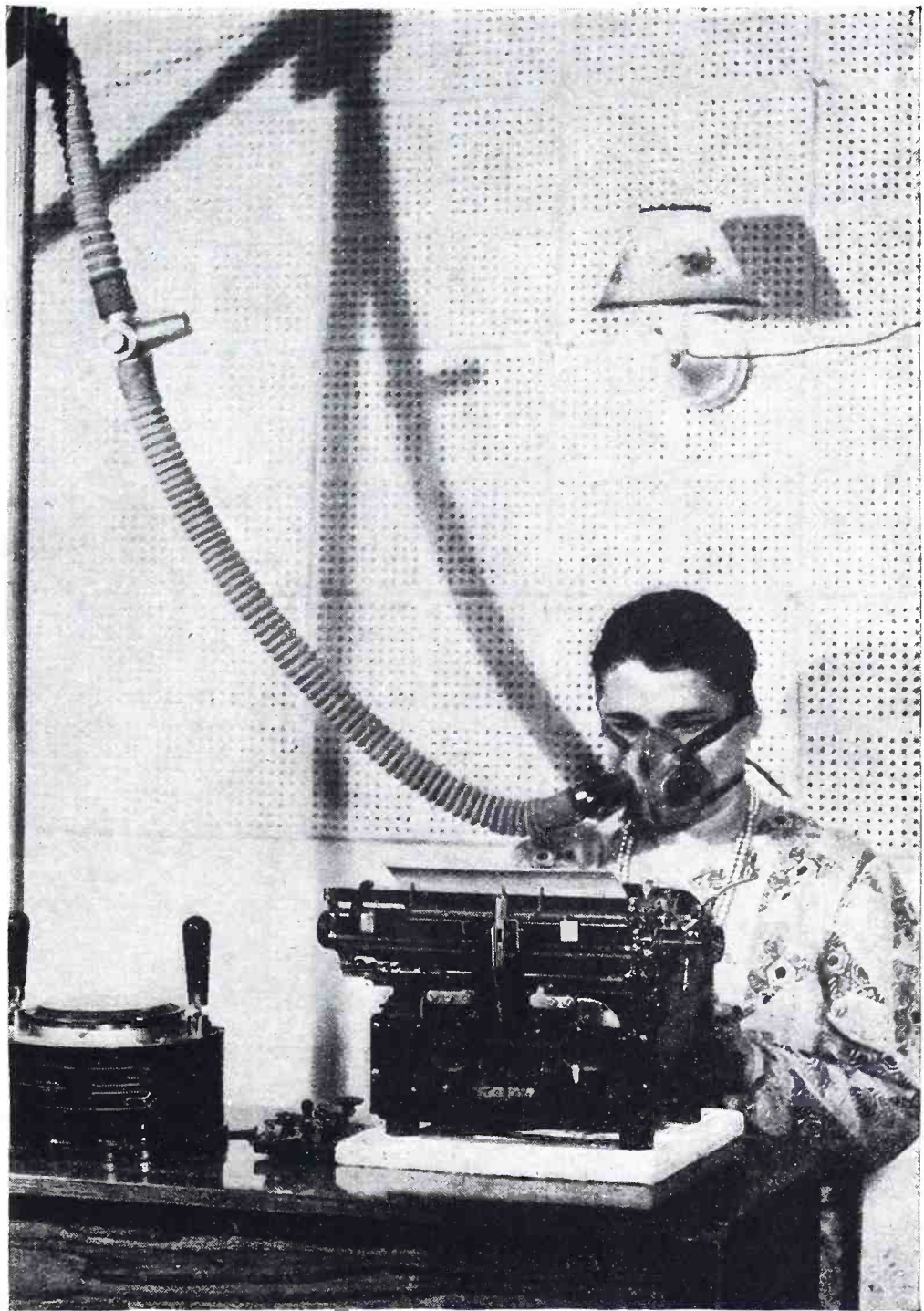

Underwood

TESTING NOISE WITH A GAS MASK

In experiments now being conducted by Professor Donald A. Laird, of Colgate University, on the psychological effects of noise, typists will wear gas masks, so that gases discharged in the breath can be analyzed. This will permit measurement of the energy consumed by the body in performing a given amount of mental or physical work. Professor Laird hopes to discover how noise affects nervous or physical energy. (The background is of Acousti-Celotex, a material which absorbs sound and helps to prevent reverberation.)

Which Noises Annoy?

By analogy with the familiar definition of dirt, noise has been called "sound out of place."

Radio is accused, we fear all too rightly, of causing some of these displaced sounds; for example, the sidewalk loudspeaker. On the other hand, noise is one of the continual difficulties in broadcasting studios and in radio laboratories. No radio engineer can afford to forget the large amount of investigation which is now being done, both by physicists and engineers, in connection with noise problems.

At the very basis of these matters lie some problems of psychology which are still unsolved. It is not known what varieties of noise cause the greatest disturbance and distress to human beings. It is not known whether a noisy workroom increases or decreases the output of work or the expenditure of energy on the part of the worker. It is not known whether noise is tiring to persons who have become accustomed to it, or merely to those who have been used to quiet. These uncertainties offer opportunities for psychological experimenta-

(Continued on page 78)



Here is POPULAR RADIO's selection of the "star" broadcast features that are scheduled as regular weekly events for the month beginning July 16—program numbers of outstanding merit that are selected on the basis of intrinsic worth, as well as upon their importance as determined by the large audiences reached by powerful single stations and by the chain stations that now cover the country. Every radio fan has—or should have—a receiver good enough to tune in on most of the features that are listed.

(THE PROGRAMS GIVEN HERE ARE SCHEDULED ACCORDING TO EASTERN STANDARD TIME; FOR BROADCAST LISTENERS LIVING IN LOCALITIES THAT USE DAYLIGHT SAVING TIME, THE TIMES OF PERFORMANCE ARE AN HOUR LATER THAN EASTERN STANDARD TIME.)

Mondays

ROXY AND HIS GANG; 7.30 P. M.; *110-piece symphony orchestra, with soloists*; WJZ, WBZ, WBZA, KDKA, KYW, WRC, WSB, WHAS, WSM.



The big musical jamboree of the week. Roxy and His Gang is the most ambitious broadcasting project yet attempted and it merits the attention of several million listeners. This program is made up of performances of individual artists, a huge chorus and a 110-piece symphony.

HIRE'S HARVESTERS; 8.30 P. M.; *instrumentalists and orchestra*; WJZ, WBZ, WBZA, KDKA, KYW, WBAL, WJR, WHAS, WSB, WSM, WMC.

The makers of a national beverage flood the country with snappy, good music. (Old listeners should note that Hire's Harvesters have changed from the red to the blue chain.)

BARRERE LITTLE SYMPHONY; 9.00 P. M.; *ensemble; classical selections only*; WABC.



George Barrere, the director of this ensemble, is one of the greatest musicians appearing regularly on the air; he is the first flutist of the New York Symphony. He performs the seemingly impossible in playing the flute and conducting the orchestra at the same time. This organization is a real favorite with the musical enthusiasts of New York.

WBAL STAFF CONCERT; 9.00 P. M.; *chamber music*; WBAL.

WBAL gathers its student talent for a little concert of good chamber music. WBAL, by the way, never disappoints its chamber music listeners.

WBAL DANCE ORCHESTRA; 10.00 P. M.; *dance music*; WBAL.

WBAL has for some time been known as a merchandiser of good dance music for late evening use.

LIDO VENICE DANCE ORCHESTRA; 10.10 P. M.; *jazz music*; WEEL.

A great dance orchestra with a great following. All of the dancing youngsters of New England swear by the Lido Venice's snappy, tuneful one-steps.

CORONADA ORCHESTRA; 1.00 A. M.; *dance music*; KMOX.

Those who dance late and strenuously will do well to try the Coronada Orchestra.

Tuesdays

DINNER CONCERT; 6.30 P. M.; *classical and semi-classical music*; WGY.

WGY's dinner concerts are always an aid to digestion and appetite. This music is relayed from the dining-room of Hotel Ten Eycke, Albany's finest hostelry.

WBAL DINNER MUSIC; 6.30 P. M.; *chamber music*; WBAL.
More good dinner music from WBAL's Staff Ensemble.

GEORGE OLSEN'S STROMBERG-CARLSON ORCHESTRA; 8.00 P. M.; *dance music*; WJZ, WBZ, KDKA, KYW.



George Olsen with a lot of musical stunts and some serious syncopation, if any syncopation can be called "serious." Mr. Olsen is perhaps one of the most ingenious orchestrators performing in the jazz industry, and his Tuesday night concerts are always an inspiration to those who are entertained by such music.

EDISON ENSEMBLE; 8.00 P. M.; *classic and popular music*; WRNY.

The great New York Edison Company, with a good-will program, has been a favorite with the New York public for the last year.

GREAT MOMENTS IN HISTORY; 8.30 P. M.; *historical events re-enacted*; WEAJ, WFI, WRC, WTAM, WWJ, WOC.

The invention of a Columbia University professor, with a bit of music thrown in for good measure. If you don't know your onions in history, here's your chance.

GRAND OPERA PROGRAM; 9.00 P. M.; *soloists and instrumentalists*; WJZ, KDKA, KYW.

This is the National Broadcasting Company's own program of heavy music, participated in by soloists and instrumentalists of standing. The material used in this program is usually made up of excerpts from the most popular operas. Naturally, the time limit does not permit the broadcasting of a complete opera.

EVEREADY HOUR; 9.00 P. M.; *varied program*; WEAJ, WEEL, WFI, WCAE, WGR, WWJ, WOC, KSD, WJAR, WCCO, WTAM, WGN, WSAI, WRC, WGY, WHAS, WSM, WSB, WMC, WTAG.



The summer music offered by the Eveready Hour is invariably made up of the Eveready Orchestra and a few soloists. The best offerings of this organization is put forth during the cooler months. Virginia Rea is the soprano of this group of artists.

EDUCATIONAL PROGRAM; 9.00 P. M.; *lectures*; WLWL.

WLWL becomes the big red schoolhouse of the air, with all sorts of professors talking about all sorts of things which should interest normal human beings.

MIXED QUARTET; 9.00 P. M.; *popular ballads*; WBAL.

An old-fashioned quartet with old-fashioned ideas about ballads.

SAM 'N' HENRY; 9.00 P. M.; *negro comedy*; WGN.

Nigger talk and songs by two masters of negro psychology.

WBAL DANCE ORCHESTRA; 10.00 P. M.; *popular selections*; WBAL.

The WBAL dance orchestra fills the time that used to be filled by the Baltimore Municipal Band.

VITROHM RESISTORS

—in power supply units

SILVER-MARSHALL

652 RESERVOIR B SUPPLY

Uses Vitrohm Resistor 507-64

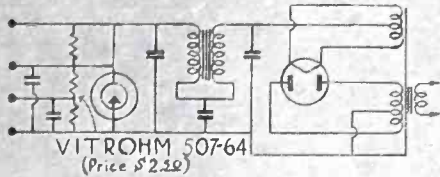

RAYTHEON A-B-C

350 m.a. CURRENT SUPPLY UNIT

Uses Vitrohm Resistor 507-62' and Vitrohm Rheostat 507-63

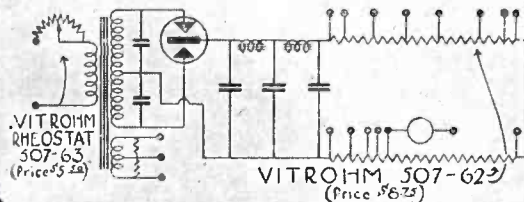

QRS A-B-C

400 m.a. CURRENT SUPPLY UNIT

Uses Vitrohm Resistor 507-62' and Vitrohm Rheostat 507-63

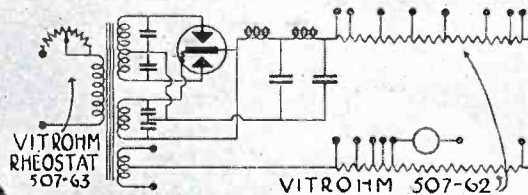

Vitrohms are "pre-aged" wire wound on porcelain tubes and protected by fused-on vitreous enamel for the permanent protection of resistance wire and terminals.

Per square inch of surface, Vitrohms have greater watt dissipation than any other resistor.

Send 15c for "How To Use Resistance in Radio." It contains many circuits of interest to all experimenters. Bulletin 507 describing Vitrohms for radio is sent without charge upon request.

* Approved by the Raytheon and QRS Laboratories.

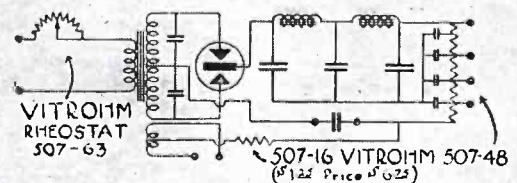

QRS and RAYTHEON

85 m.a. CURRENT SUPPLY UNIT

Uses Vitrohm Resistors 507-16' and 507-48'

Ward Leonard Electric Company

37-41 South Street

Mount Vernon, N. Y.

COCA COLA GIRL; 10.00 P. M.; *orchestra and continuity*; WEA, WEEL, WGR, WFI, WRC, WCAE, WWS, KSD, WHAS, WSM, WMC, WMAQ.

Miss Coca Cola steps out of the billboard into the studio of WEA, accompanied by a special orchestra and continuity about trips to the circus, the seashore and other places where people get hot and drink Coca Cola. There is a persistent rumor that the young lady who takes the part of the Coca Cola Girl is not nearly as beautiful as the original. However, she sings well, and perhaps the girl on the billboard can't do that.

DON AMAIZO; 10.00 P. M.; *violinist*; WJZ, KDKA, KYW, WCCO.



A cooking-oil manufacturer's idea of romance, with Godfrey Ludlow playing a romantic violin. While the continuity of this program is far from being anything to get excited about, the violin playing is well worth listening to.

FRANK CARROLL ORCHESTRA; 10.30 P. M.; *dance music*; WGBS, WIP.

The Arrow Head Inn Orchestra has been supplanted by Frank Carroll's Jazz Makers.

Wednesdays

DINNER CONCERT; 6.45 P. M.; *chamber music*; WSM.

WSM opens its Wednesday evening program with a half-hour of good dinner music. Those who like the old-fashioned Southern airs, played by Southern musicians, will do well to tune to this particular feature.

RADIO NATURE LEAGUE; 7.30 P. M.; *nature talks*; WBZ.



Thornton Burgess, and other close followers of capricious nature, lecture to the multitude about birds, bees, snakes and all the other children and denizens of the forest and fields.

KATZ AND HIS KITTENS; 8.00 P. M.; *dance orchestra*; WQJ.

Harry Katz and his playful kittens with a half-hour of rousing dance music.

STEINDAL STRING QUARTET; 8.30 P. M.; *semi-classical music*; KMOX.

Another one of the prides of St. Louis radiating some of the "Spirit of St. Louis" in the form of classical music.

REMINGTON TYPEWRITER BAND; 8.30 P. M.; *typical band selections*; WGY.



Edwin L. Daniels directing the smart band of the Remington Typewriter Company from the shell band-stand at Iliion.

IPANA TROUBADOURS; 9.00 P. M.; *dance music*; WEA, WEEL, WGR, WRC, WCAE, WWJ, WLIB, KSD, WCCO, WDAF, WGY.



Of all the jazz orchestras to appear on the broadcast chains, none has been quite so popular as the Ipana Troubadours.

MAXWELL HOUR; 9.00 P. M.; *orchestra and soloists*; WJZ, WBZ, KDKA, KYW, WHAS, WSB, WMC, WSM.

The brilliant strains of the special Old Colonel march written by Nathaniel Schilkret, the director of the Maxwell orchestra, is always the signal for the beginning of an hour of especially fine music. Perhaps no other single feature is followed more closely or keenly by the music lovers of airdom.

DAVID LAWRENCE; 10.00 P. M.; *"Our Government," lecture*; WEA, WGR, WRC, KSD, WGY, WMAQ, WEEL, WTAG.

David Lawrence knows a lot about the United States Government that about 100,000,000 other people don't know, and he knows how to tell it.

ENSEMBLE; 10.00 P. M.; *classics*; WABC.

If you see anything having to do with the classics mentioned on the program of WABC, always tune to it, and bet your bottom dollar on its quality.

RCA RADIOTRONS; 10.00 P. M.; *songs and comedy*; WJZ, WBZ, KDKA, WEBH.

The Radio Corporation of America tries to do right by broadcasting what is always a highly novel and entertaining period of song and comedy, participated in by artists of no small fame.

SUNSET INSTRUMENTAL QUARTET; 10.00 P. M.; *popular numbers*; KFI.

More California propaganda, supplied by a "native son" orchestra.

NATIONAL LIGHT OPERA COMPANY; 10.10 P. M.; *tabloid versions of well-known light operas*; WEA, WLIT, WRC, WCAE, WGY, WGR, KSD.

Carefully edited vest-pocket editions of light operas supplied by the National Broadcasting Company.

HOGAN'S DANCE ORCHESTRA; 11.00 P. M.; *dance program*; WOR. To say that this orchestra is one of a comparatively large number of good dance orchestras in New York is saying about all that could be said without risk of exaggeration.

BAMBOO GARDEN ORCHESTRA; 11.00 P. M.; *dance music*; WTAM. Cleveland's idea of a rip-snorting jazz band, playing all of the modern rip-snorting pieces.

Thursdays

WBAL DINNER MUSIC; 6.30 P. M.; *classical and semi-classical selections*; WBAL.

WBAL supplies a little music for the sunset with great success.

COWARD COMFORT HOUR; 7.30 P. M.; *solos and orchestra*; WEA. Just an hour of good old-fashioned music.

CONCERT ENSEMBLE; 7.35 P. M.; *chamber music*; WGN.

Chicago broadcasting gets out of its element and supplies a little very stimulating chamber music. This probably sounds very strange to the listeners in the Capitol of Air Jazz.

CADILLAC-LA SALLE SYMPHONY; 8.00 P. M.; *small symphony orchestra*; WEA, WEEL, WSAR, WTAG, WTIC, WGR, WSAI, WCSH, WCAE, WTAM, WWS, WFI, KSD, WGY, WHAS, WSM, WSB, WMC, WMAQ.

General Motors spends big dough on a small symphony, with results highly pleasing to the dial twisters. In listening to this small symphony, one is reminded of the very entertaining program supplied by Henry Hadley's little symphony when it was playing on the Willys-Overland program.

WBAL ENSEMBLE; 9.00 P. M.; *chamber music*; WBAL.

Once again WBAL throws a precious mite into the broadcasting plate.

CLICQUOT CLUB ESKIMOS; 9.00 P. M.; *banjo ensemble*; WEA, WEEL, WCCO, WGN, WCAE, WGY, WJAR, WTAG, KSD, WOC, WGR, WFI, WWJ.



Zip! Bang! Smash! Who can say that the Eskimo banjo ensemble is not one of the most stirring features on the air? They are as effervescent as the beverage they advertise.

FULLER ORCHESTRA; 9.30 P. M.; *popular music*; WGHP.

It is very difficult to pick a good jazz orchestra from all the good, bad and indifferent jazz bands playing in Chicago. The editor of POPULAR RADIO is assured that this is a particularly good jazz orchestra.

GOODRICH SILVER MASKED TENOR AND ORCHESTRA; 10.00 P. M.; *popular music*; WEA, WEEL, WCCO, WGN, WCAE, WJAR, WTAG, KSD, WOC, WGR, WFI, WWJ, WSAI, WCSH, WADC, WHAS, WSB, WSM, WMC.

The Silver Masked Tenor returns to the air, with Joseph Knecht directing the famous Goodrich Orchestra. Joseph Knecht used to direct a small ensemble that played dinner music at the Waldorf-Astoria dining-room. His musical education was received in Austria-Hungary and he is one of those solid European directors whose musical experiences would fill a book.

HOTEL BOSSERT ORCHESTRA; 11.00 P. M.; *popular dance orchestra*; WEA, WGY.

The good ship "Bossert" once again sails forth from the marine roof of Hotel Bossert in Brooklyn. This used to be a very good program, and rumor has it that it is still better.

KFI DRAMA HOUR; 11.00 P. M.; *varied program*; KFI.

Heavy drama supplied by a station that goes in for very little of that sort of thing. This particular period used to be filled by KFI Music Box Hour.

Fridays

HOTEL BREYTON HALL ORCHESTRA; 6.30 P. M.; *chamber music*; WOR.

The editor of this column never listens to anything else at 6.30 P. M. on Friday evening.

DINNER ORCHESTRA; 6.30 P. M.; *popular selections*; WBAL.

WBAL again steals in with a little dinner concert, carefully chosen and well played.

KING EDWARD HOTEL ORCHESTRA; 6.35 P. M.; *chamber music*; CNRT Hotel.

The western New Yorkers will do well to sample this morsel of Canadian musical luxury.

SUBANTENNA

UNDERGROUND ANTENNA SYSTEM

**Be Sure to Tune In
KYW**
(536 Meters)
every Wednesday Evening
7:30 to 8:00 P. M. Central
Daylight Saving Time. The
SUBANTENNA CRU-
SADERS and their accom-
panists will entertain you.

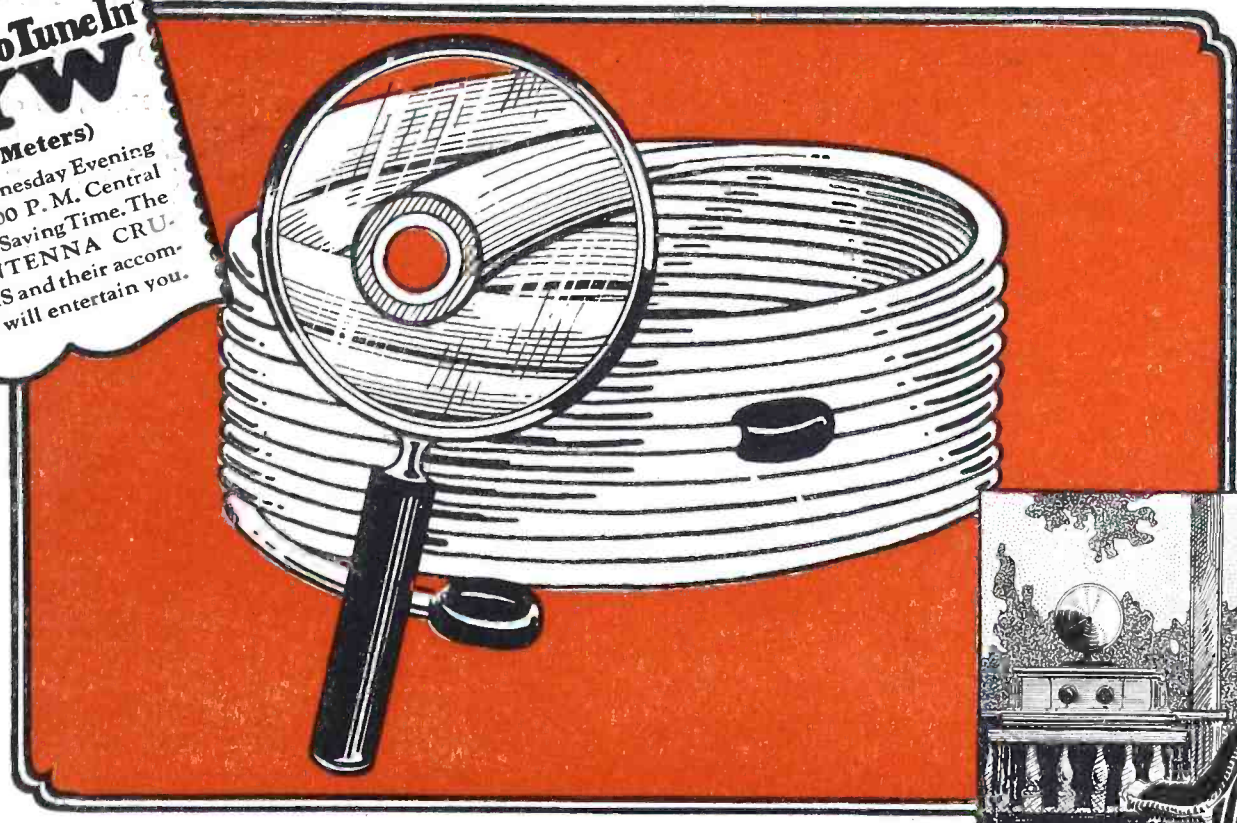

Gets Distant Stations Clear and Loud— Summer and Winter—Right thru Static

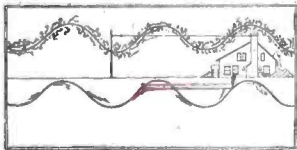

NOW—you can get "distance" in summertime. Loud, clean, clear distance, sweet and true in tone—almost like local. The marvelous new device illustrated above makes this possible. STATIC is no longer a nuisance.

Engineers have long known that the ratio of static strength to signal strength IN THE AIR, favored Static, but that in the GROUND, the ratio of static strength to signal strength favored the music you wish to hear. They knew that if some device could be perfected whereby broadcast waves could be taken out of the GROUND instead of from the air, that all-year-round distant reception would become a reality. SUBANTENNA is the answer. It completely does away with the old style up-in-the-air aerial; it picks up clear, filtered waves from the ground—it delivers a strong signal: waves so powerful that the tiny amount of weak ground static they may contain is drowned out. The performance of SUBANTENNA is nothing short of marvelous. It will amaze you—just as it has amazed laboratories and thousands of critical fans.

User Says "Static Is No More"
"I have received the Subantenna. My grandson installed it. STATIC IS NO MORE. Am well satisfied. I can tune in stations I never could coax out of the air even though I had a long aerial."—A. E. F., Kans.

User Says "Greater Distance"

"To show you that I received a program from Station PWX in Havana, Cuba, I enclose herewith a verification card from that station. On January 28th, I received a program on my set broadcasted from Buenos Aires, South America at 10:15 in the evening. Many other long-distance stations have been heard on my set after installing the Subantenna. I never could receive such distance on my outside antenna."—W. C. F., Chicago, Ill.

User Says "Gets More Stations"

"I get plenty of stations with my Subantenna, on the loud speaker that I have never been able to reach with my outside aerial. It absolutely cuts down interference to the minimum, cuts static out too—not just partly out—but all out."—H. S. M., N. Car.

User Says "Cuts Out Interference"

"Have had Subantenna some months and it beats any antenna I have ever had by forty miles. Have a five tube set and get New York City, Atlantic City, Atlanta, New Orleans, Fort Worth, Denver perfectly clear, and next to an elevated train with much interference. Cuts it all out."—C. H. Y., Chicago.

User Says "More Volume"

"We have been receiving stations that formerly did not register on the outside antenna. A marked increase in volume on Stations over 800 Kilocycles has been noted."—Capt. F. W. F., Md.

Eliminates Lightning Risk

Not only does SUBANTENNA make possible loud, clear DX in summer—not only does this remarkable invention better the selectivity of any set—but it also completely eliminates the Lightning hazard. With SUBANTENNA one can go right on listening-in dur-

ing the most severe electrical storm without noise, fear of attracting lightning or damaging the set.

FREE TRIAL

Make This Convincing Test

Install SUBANTENNA. Leave your old aerial up. Select a bad night when DX is almost impossible with the ordinary aerial. Make a comparison station for station, connecting first your aerial, then SUBANTENNA. If, from stations that are just a mess of jumbled noise with the old aerial, you don't get reception that rivals local in sweetness and clarity the instant you switch to SUBANTENNA, this test won't cost you even a single penny. Obtain a SUBANTENNA from your dealer or send coupon at once for scientific explanation of SUBANTENNA and for particulars of GUARANTEE and FREE TRIAL OFFER. Send COUPON NOW!

CLIP AND MAIL AT ONCE

CLOVERLEAF MFG. CO.,
2715-K Canal Street, Chicago, Illinois

Tell me all about SUBANTENNA, your unequalled, unconditional guarantee and your FREE TRIAL OFFER.

Name

Address

CLOVERLEAF MANUFACTURING CO.
2715 - K CANAL STREET CHICAGO, ILLINOIS

HAPPINESS BOYS; 7.30 P. M.; *songs and jokes*; WEAf.



Yes, they are still here—those two oldtimers—the Happiness Boys: Billy Jones and Ernie Hare. "How do you do, everybody, how do you do!"



HOTEL WHITEHALL TRIO; 7.45 P. M.; *string trio playing classics and semi-classics*; WABC.

Isn't it strange how good three string instruments can be made to sound when they are played by men who know how to play them?

CHELSEA CONCERT ORCHESTRA; 8.00 P. M.; *chamber music*; WPG.
A great Atlantic City boardwalk hotel permits listeners of the United States to sample its dinner music.

ROYAL HOUR; 8.30 P. M.; *orchestra and soloists*; WJZ, WBZ, KDKA, KYW.

The Royal Typewriter Company out for customers with a half-hour of music that has set up new standards.

PHILCO HOUR; 9.00 P. M.; *vocal and orchestral*; WJZ, WBZ, WBZA, KDKA, KYW.

Another radio manufacturer trying to pay its debt to broadcasting.

LA FRANCE ORCHESTRA; 9.30 P. M.; *popular orchestral music*; WEAf, WGR, WLIT, WOC, WCAE, WTAM, WWJ, KSD, WDAF, WMAQ.



Anne Byrne still at it with her very, very, very popular orchestra.

MOONLIGHT SEXTET; 10.00 P. M.; *vocal and instrumental music*; WJZ, WBZ.

The Moonlight Sextet is just another way of saying the Armchair Hour. Keith McLeod still performs on the Vibraphone just as if he was quite sure that his audience liked it.

DANCE ORCHESTRA; 11.00 P. M.; *dance music*; KDKA.

Real good dance music emerging from the smoke of Pittsburgh.

Saturdays

JACQUES RENARD'S ORCHESTRA; 6.45 P. M.; *dance music*; WEEI.
One of two particularly good dance orchestras broadcasting from the Bean City.

STRING ENSEMBLE; 7.40 P. M.; *classical music*; WGBS.
WGBS's own string ensemble with a comforting hour of classical music.

HOTEL TRAYMORE CONCERT; 9.00 P. M.; WPG.
An Atlantic City hotel supplying the public with a lot of good concert music.

BENJAMIN FRANKLIN ORCHESTRA; 10.05 P. M.; *chamber music*; WIP.

Benjamin Franklin Orchestra has been one of the favorites of the editor of this column for a long time and he can recommend it with a feeling that he cannot be taken as an easy musical customer.

ARCADIA DANCE ORCHESTRA; 12.00 M.; *dance music*; KMOX.
KMOX stirs the midnight air with a big dance band.

COLORADO ORCHESTRA; 12.30 A. M.; *dance music*; KOA.
This orchestra is the pride of Denver and of KOA.

Sundays

KFI MIDNIGHT FROLIC; 3.00 A. M.; *musical jamboree*; KFI.
KFI breaks loose with an after-theatre show of pretentious proportions. This air entertainment takes the form of an air vaudeville show with many actual vaudeville entertainers involved.

CROSLY RADIO FEATURE (alternate weeks); 5.30 P. M.; *Moscow Art Orchestra*; WEAf, WEEI, WJAR, WTAG, WGN, WFI, WRC, WSSH, WCAE, WTAM, WWJ, WSAI, KSD, WDAF, WHAS, WSM, WSB, WMC, WGY.
The Crosley Radio Hour with the Moscow Art Orchestra calls for applauding with elevated hands and shouts of "Bravo."

PARK V. HOGAN ORGAN RECITAL; 7.00 P. M.; *organ and vocal*; WJZ, WBAL.
The old WJZ stand-by, with Park Hogan, the official Estey organ concert master, at the console.

THE CAPITOL GRAND ORCHESTRA (and Major Bowes' family); 7.20 P. M.; *symphonic music and soloists*; WEAf, WEEI, KSD, WRC, WWJ, WJAR, WCAE, WTAG, WHAS, WSB, WSM, WMC.



The big Sunday feature, with 100-piece symphony and all kinds of vocal and instrumental talent turned loose. Major Bowes is Master of Ceremonies. Among Major Bowes' outstanding artists is Wee Willy Robyn, often called the "little man with the big voice."

DELLA ROBBIA CONCERT; 7.45 P. M.; *chamber music and solos*; WOR.
Here is a restful hour of music well fitted to a Sunday afternoon mood.

COOK'S TOURS; 8.30 P. M.; *travelogue with music*; WJZ.
Here's an opportunity to learn something about the other half of the world and how it likes its music.

AMBASSADOR CONCERT; 9.10 P. M.; *chamber music*; WPG.
WPG must have a hard time trying to find room for all the Atlantic City hotel orchestras on its program.

ATWATER KENT HOUR; 9.15 P. M.; *star soloists*; WEAf, WEEI, WFI, WCCO, WTAM, WGN, WCAE, WGR, WOC, WTAG, WWJ, KSD, WRC, WSAI, WGY, WHAS, WSP, WMC.



Although the Atwater Kent Hour is not as good in the summer time as in the winter time, it is good enough in the summer time to listen to regularly. The conductor is Niccolai Berezowski.

WABC HOUR OF DANCE MUSIC; 11.00 P. M.; *popular dance music*; WABC.
WABC deals in nothing but high-grade dance music.

Schedules of Dinner-Hour and Dance Programs of Special Note

★ Programs of Dinner-Hour Music
(Eastern Standard Time)

FEATURE	STATION	TIME
Palmer House Victorians	WEBH	7:15 P. M.; <i>daily except Sundays.</i>
Hotel Andrew Jackson Concert	WSM	7:15 P. M.; <i>Tuesdays; 6:45 P. M.; Wednesdays and Thursdays.</i>
Neopolitans	WTAM	6:00 P. M.; <i>Wednesdays and Thursdays.</i>
Emerson Gill's Orchestra	WTAM	6:00 P. M.; <i>Fridays.</i>
Bem's Little Symphony	KGO	9:00 P. M.; <i>daily except Saturdays.</i>
Katz and His Kittens	WQJ	8:00 P. M.; <i>daily except Sundays and Mondays.</i>
Hotel Tuller Concert	WGHP	7:00 P. M.; <i>daily except Sundays.</i>
WBAL Dinner Concert	WBAL	6:30 P. M.; <i>Tuesdays, Thursdays and Fridays.</i>
Joe Rine's Orchestra	WEEI	6:05 P. M.; <i>Mondays, Wednesdays and Thursdays.</i>
Jack Renard's Orchestra	WEEI	6:45 P. M.; <i>Saturdays.</i>
Mack's Collegians	KFI	9:30 P. M.; <i>Saturdays.</i>
Ray Fisher's Orchestra	KFI	10:00 P. M.; <i>Wednesdays.</i>
Concerts from Atlantic City Hotels	WPG	7:25 P. M.; <i>daily except Sundays.</i>
Special Dinner Programs	WBZ	7:00 P. M.; <i>daily.</i>
KDKA Little Symphony	KDKA	6:00 P. M.; <i>Tuesdays, Thursdays</i>
Coronado Orchestra	KMOX	7:00 P. M.; <i>Sundays.</i>
Drake Concert	WLIB	8:00 P. M.; <i>Tuesdays, Thursdays and Saturdays.</i>
Drake Concert	WGN	7:35 P. M.; <i>daily except Sundays.</i>
Colorado Orchestra	KOA	12:30 P. M.; <i>Saturdays.</i>

★ Programs of Dance Music
(Eastern Standard Time)

FEATURE	STATION	TIME
Packard Six Orchestra	KFI	1:00 A. M.; <i>Monday mornings.</i>
Coronado Orchestra	KMOX	1:00 A. M.; <i>Mondays, Tuesdays, Wednesdays, Fridays, Saturdays.</i>
Frank Carroll Orchestra	WGBS, WIP	10:30 P. M.; <i>Tuesdays and Saturdays.</i>
McDonald Recording Orchestra	WGBS, WIP	10:30 P. M.; <i>Thursdays.</i>
Van Horn Dance Hour	WPG	10:30 P. M.; <i>Fridays.</i>
Casino Dance Orchestra	WPG	11:30 P. M.; <i>Saturdays and Mondays.</i>
Silver Slipper Orchestra	WPG	11:30 P. M.; <i>Tuesdays.</i>
Golden Pheasant Orchestra	WTAM	10:15 P. M.; <i>Sundays.</i>
Emerson Gill Orchestra	WTAM	10:00 P. M.; <i>Mondays and Wednesdays.</i>
Far East Orchestra	WTAM	11:00 P. M.; <i>Thursdays.</i>
Bamboo Garden Orchestra	WTAM	11:30 P. M.; <i>Wednesdays and Fridays.</i>
Simovar Orchestra	WENR	1:00 A. M.; <i>Thursday, Friday and Saturday mornings.</i>
Midshipmen Orchestra	KGO	12:30 P. M.; <i>Thursdays.</i>
Katz and His Kittens	WQJ	10:00 P. M.; <i>Saturdays, Tuesdays, Wednesdays, Thursdays and Fridays.</i>
WBAL Dance Orchestra	WBAL	10:00 P. M.; <i>Mondays, Tuesdays, Thursdays and Fridays.</i>
Renard's Orchestra	WEEI	10:05 P. M.; <i>Mondays; 6:45 P. M.; Saturdays.</i>
Joe Rine's Orchestra	WEEI	10:05 P. M.; <i>Wednesdays.</i>
Nighthawks	WBBM	1:00 A. M.; <i>Mondays; 12:00 P. M.; Tuesdays and Thursdays.</i>

POPULAR RADIO Urges Its Readers to Apply Radio Amplification to Phonograph Records

Amazing results now possible, in quality and volume, with standard audio-frequency equipment. POPULAR RADIO to feature long series of articles beginning with this Issue.

IN this advertisement, POPULAR RADIO sets a precedent; for never before has a radio magazine attempted to "sell" its readers on new radio developments in space outside editorial bounds. This unique method of making editorial announcements was chosen only after it was decided that the publication, if it was to be of maximum service to its readers, should tell them of this new development in the most direct and convincing manner. In urging its readers to construct radio amplifiers for their phonographs, POPULAR RADIO feels that it is dispensing advice that will be deeply appreciated by lovers of good music and by those radio fans who are looking for new fields to conquer.

Any old phonograph may be used if the spring motor is operative. This, with an electrical pick-up, used in place of the old tone chamber, and a modern audio-frequency amplifier and loudspeaker will afford reproduction of almost unbelievable quality and volume. This is especially true with the new electrical cut phonograph records, although old records give amazing results. Such reproduction is rich, mellow, sonorous and perfectly *scratchless*. It marks the Renaissance of the phonograph; music from the plaintive whisper of a violin to the full crescendo of the New

York Symphony Orchestra, with a fidelity of tone never before dreamed possible by acoustic engineers. Once more the phonograph becomes a potential source of entertainment through the employment of radio equipment. Now, if a storm is brewing or the music on the air does not fit the mood, there is left a way to round the evening out with entertainment of a high order. Radio has found its running mate.

In suggesting the use of this new principle, the Engineering staff of POPULAR RADIO cannot too strongly recommend the use of the most modern amplifying apparatus of either the transformer, resistance or impedance-coupled types. The results with amplifiers built two or three years back are bound to be disappointing. Radio has entirely outgrown the reproduction of yesterday and the discriminating fan will not be satisfied with anything but *today's* results; results easily available to every reader of this publication by the use of standard radio devices.

This new development in the art, although an astounding engineering achievement, has not become generally known to the alert radio fan, and so confident is POPULAR RADIO that he will be anxious to know of it that it has taken this unusual means of informing him.

POPULAR RADIO
627 West 43rd Street
New York, N. Y.

[[POPULAR RADIO will be glad to send a list of approved phonograph pick-up units to those who are interested]]

Schedules of Dinner-Hour and Dance Programs of Special Note

★ Programs of Dance Music (Eastern Standard Time)

FEATURE	STATION	TIME
Brown Palace Orchestra	KOA	8:30 P. M.; <i>daily except Thursdays.</i>
Benjamin Franklin Orchestra	WIP	6:10 P. M.; <i>Thursdays</i> ; 10:05 P. M.; <i>Saturdays.</i>
McDonald's Orchestra	WIP	6:10 P. M.; <i>Mondays and Fridays.</i>
Bretton Hall String Quartet	WOR	6:30 P. M.; <i>Fridays.</i>
Dinner Concert	WWJ	6:00 P. M.; <i>except Saturdays and Sundays.</i>
Jack Jacobs Orchestra	WOR	6:15 P. M.; <i>Mondays, Wednesdays, Thursdays and Saturdays.</i>
Twilight Musical	WAIU	7:00 P. M.; <i>Mondays, Tuesdays and Wednesdays.</i>

★ Programs of Dinner-Hour Music (Eastern Standard Time)

FEATURE	STATION	TIME
Vincent Carr Orchestra	WIP	10:05 P. M.; <i>Saturdays.</i>
Vanderbilt Dance Orchestra	WOR	11:35 P. M.; <i>Tuesdays.</i>
Cass Hogan's Orchestra	WOR	11:00 P. M.; <i>Wednesdays and Saturdays.</i>
Fletcher Henderson's Orchestra	WOR	11:00 P. M.; <i>Fridays.</i>
Kentucky Serenaders	KYW	11:30 P. M.; <i>Saturdays.</i>
Roger Kahn's Orchestra	WJZ	10:30 P. M.; <i>Tuesdays.</i>
Goodrich Zippers	WEAF	10:00 P. M.; <i>Thursdays.</i>
Lido Venice Orchestra	WEEI	10:10 P. M.; <i>Mondays.</i>

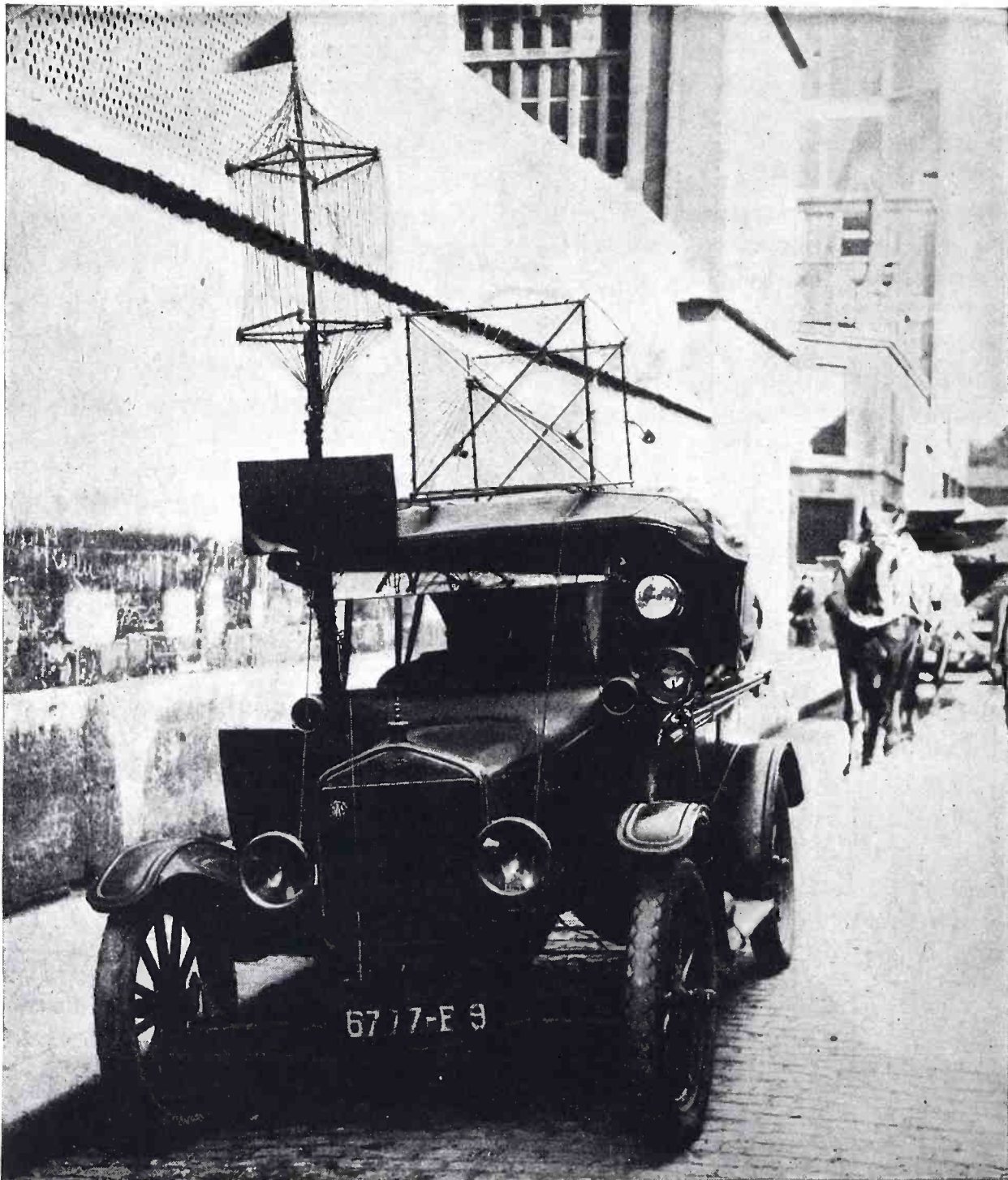

HE MAY HAVE MUSIC WHEREVER HE GOES

With antennas of his own making strung up on his car, this French radio merchant drives about the boulevards of Paris, on Sundays, giving a free radio concert, picked up from a broadcasting station, as he goes. It is not only a good way of spending the holiday, but affords him considerable advertisement, as his radio shop makes a specialty of ready-built cage antennas.

With the Experimenters

(Continued from page 61)

It would be possible to run the rheostat direct to the two high-frequency valves, but where the amperite is connected in series with the rheostat it acts as a safeguard to prevent overloading of the filament.

To control the filament current of the detector valve and the first low-frequency valve a No. 112 amperite, or any other approved 1/2-ampere automatic filament control, should be installed as shown in Figures 2 and 4.

Automatic Control of the Panel Light

IN the original arrangement the lamp of the illuminated tuning control of the LC-27 receiver was turned "on" and "off" by its individual switch.

By making the change as indicated in Figure 2, this lamp will be automatically turned "on" and "off" by the action of the battery switch on the receiver, and therefore serves as an actual "pilot light" to give visible indication when the set is "on" or "off."

The change required to accomplish this is simple. The lead from the frame of the dual condenser should be connected to the receiver side of the battery switch instead of the "A" negative (—) terminal in the rear of the receiver, as shown in the original diagram.

The lamp on the new-type Marco illuminated tuning control is entirely insulated from the metal frame. In this case one side of the lamp should be connected to the receiver side of the battery switch and the other connections may be followed out as shown in the original diagram.

In this arrangement there will be no further use for the individual switch of the pilot light, and it should therefore be left "on" at all times.

—CARL DORF

The First Transmission Without Antennas

FOR the first time on record two radio stations have communicated with each other over a distance of 900 miles without using transmitting antennas. On April 2nd, while Naval Research Laboratory station NKF, at Bellevue, near Washington, was communicating with the Naval Reserve station 4 XE, operated by Lieutenant-Commander W. J. Lee, USNR, at Winter Park, Fla., its aerial was disconnected. Only a slight decrease in the incoming signal strength was noted by Commander Lee at Winter Park, who then disconnected his own transmitting antenna. The two-way, break-in communication continued uninterrupted, although both stations were making use of only their helices as radiating systems.

AMERTRAN AMERTRAN AMERTRAN

Two New AmerTran Power Transformers for Use With New Tubes!

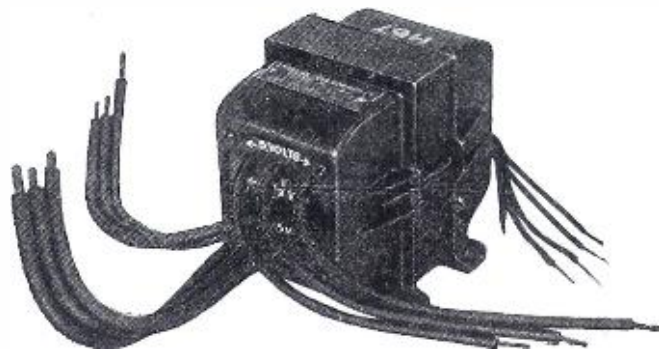

AmerTran Filament Heating Transformer
Type H-67, \$12.00 each

THIS transformer is intended for use with the new RCA UX-226 raw AC amplifier tubes and the new UY-227 detector tube. It also has a third filament winding capable of handling two UX-171 tubes. In connection with the new AC tubes, the type H-67 becomes the power source for the filament and is therefore a real "A" battery eliminator.

If you have a good plate supply system and a set with the new AC tubes and one or two UX-171 power tubes in the last state, the H-67 AmerTran is ideal, transforming the 50 or 60-cycle, 110-volt AC house light current down to the lower voltages for the correct operation of the new tubes.

AmerTran Power Transformer Type PF-281

This unit is designed for use with the new UX-281 rectifying tube, which can be operated at 550 volts plate up to a maximum of 750 volts plate and deliver 110 milliamperes DC as a half-wave rectifier. A 750-volt plate winding with a tap for 550 volts enables the transformer to be used either with a UX-281 or 216-B rectifying tube, where the output plate voltage is not required to be in excess of 450 volts.

In addition to the plate and filament windings for the rectifier and power tubes, the type PF-281 has filament heating windings (similar to the H-67) for the new AC tubes, and thereby incorporates in a single transformer unit the means for converting AC house current into filament and plate current and grid bias potential. When used with our type 709 and 854 Amer Chokes in the filter circuit, it is possible to construct a radio receiver which can be operated entirely from the house lighting circuit without an "A" eliminator, trickle charger or batteries.

Like all AmerTran power devices, this transformer has been generously designed to operate at a very low core density, reducing the hum from stray fields to a minimum. Utmost efficiency has been sought regardless of cost.

Write for further information, including booklet "Improving the Audio Amplifier".

American Transformer Co.

178 Emmet Street

Newark, N. J.

"Transformer Builders for Over 26 Years"

AMERTRAN AMERTRAN AMERTRAN

FREE Simplified BLUE PRINTS

You can have your choice of any one set of POPULAR RADIO Simplified Blueprints with your new or renewal subscription for POPULAR RADIO, accompanied by remittance of \$3.00. These Blueprints will make it possible for you to build a tested and approved set. You, as a reader of POPULAR RADIO, know the many entertaining, interesting and instructive articles that are published each month. We promise that throughout the coming months POPULAR RADIO will hold more and more of interest for Radio Fans.

Ease, Economy and Accuracy in Construction

Simplified Blueprints make it possible for anyone, without previous knowledge of radio, to construct a highly efficient radio receiver. These Blueprints consist of 3 diagrams as follows:

Panel Pattern

This Blueprint is the EXACT size of the actual set. So accurate that you need merely lay it on your panel and drill as indicated. No scaling or measuring to do, no danger of ruining the panel through faulty calculation.

Instrument Layout

Here again you have an actual size print of each instrument and binding post and its exact location both on the panel and within the cabinet.

Wiring Diagram

The unusual feature of this Blueprint is that it is an actual size picture diagram of the finished set. Each instrument and other parts appear in exact size and the wires are so clearly traced from one contact to another that you can connect all terminals accurately without even knowing how to read a hook-up diagram.

- Set No. 18—"The Improved Raytheon Power-Pack" (as described in the May, 1926, issue of POPULAR RADIO).
- Set No. 22—"The LC-27 Broadcast Receiver" (as described in the October, 1926, issue of POPULAR RADIO).
- Set No. 23—"The LC-Senior Power-Pack" (as described in the November, 1926, issue of POPULAR RADIO).
- Set No. 24—"The LC-Intermediate Power-Pack" (as described in the December, 1926, issue of POPULAR RADIO).
- Set No. 25—"The LC-Junior Power-Pack" (as described in the January, 1927, issue of POPULAR RADIO).

Use coupon below; indicate which set of Blueprints you want.

POPULAR RADIO
Dept. 49

627 West 43rd Street New York City

POPULAR RADIO, Dept. 49
627 West 43rd Street, New York City

Enclosed is my remittance of \$..... in full payment for subscription, with Blueprints as checked below, FREE.

- Set Number 18 Set Number 23
- Set Number 22 Set Number 24
- Set Number 25

Name.....
Street.....
City..... State.....

How to Add the New Radio Amplification Units to Your Phonograph

(Continued from page 17)



TWO MORE ELECTRICAL "PICK-UP" UNITS

FIGURE 8: Held in the right hand is the new Tectron magnetic pick-up device, while in the left hand is the small and compact Alden electrical pick-up unit that contains a volume control. (Matched combinations of apparatus that use these two units and the one shown in Figure 9 will appear in the August issue of POPULAR RADIO.)

the diagrams shown, the apparatus recommended by the designer has been used and has successfully produced the results described.

There are a variety of electrical pick-ups already on the market. There are several variations of the radio amplification which the skilled experimenter may adapt to meet his own views. There are complete kits ready for assembly by the inexperienced.

Anybody who has an old talking machine can make this conversion in less than fifteen minutes' time—and he will have a musical device that is ready to perform amazingly at a moment's notice, and repeat to his heart's content.

As an adjunct and companion to the radio set, it is ideal. It will furnish enough volume to replace an orchestra for dancing and will give music that is

hardly distinguishable from the real thing.

And when you take this new and interesting step, you may couple up first with the sound box in the old talking machine, then with any ordinary type of radio reproducer, and finally with one of the new exponential horns. Then play an old-type phonograph record and follow with one of the new-type electrically cut records. You'll be amazed.

Those of us who have been reluctant to put our old talking machines into the junk heap, hesitating, perhaps sentimentally, to charge off our investment; those of us who enjoy participating at least in the creation and building of something new and worth while; all those of us who are radio and music fans have a grand new field in which to surprise both ourselves and friends.



HOW ONE DEVICE IS USED ON A PHONOGRAPH

FIGURE 9: The new Crosley electrical pick-up unit rests on a special base that contains a volume control. A universal joint and an extension arm allow the pick-up unit to swing freely in the groove as the record rotates.

Your "B" Battery Eliminator
will give you better service with

Q · R · S

(Trade Mark Registered)

**Gaseous
Rectifier Tubes**

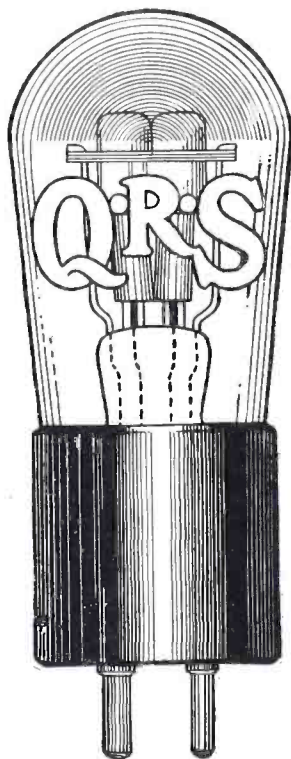

60 Milliamperes	-	\$4.50
85 Milliamperes	-	4.50
400 Milliamperes	-	7.00

Ask for Catalog of full line of Standard Tubes.

Guaranteed

The standing of the Q.R.S. Company, manufacturers of quality merchandise for over a quarter of a century, establishes your safety.

Orders placed by the leading Eliminator Manufacturers for this season's delivery, approximating Four Million Dollars' worth of Q.R.S. Rectifier Tubes, establishes the approval of Radio Engineers. Ask any good dealer.

THE Q · R · S COMPANY

MUSIC

Manufacturers

Executive Offices: 306 S. Wabash Ave., Chicago

Factories: Chicago—New York—San Francisco—Toronto, Canada—Sydney, Australia—Utrecht, Holland

Established 1900. References—Dun, Bradstreet, or any bank anywhere

Townsend "B" Socket Power "Best in World!"

Says A. W. GALE
of Gloversville, N. Y.

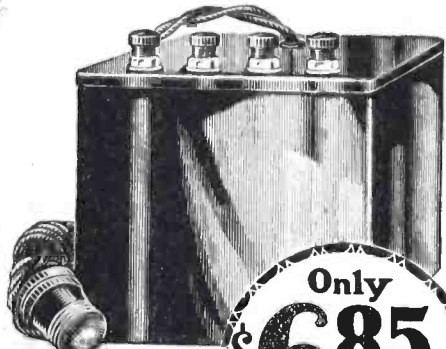

COMPLETE

Only
\$6.85
\$1.00 Down
Balance
COD

Below is a re-production of Mr. Gale's letter of May 8th, 1927.

48 W. Fulton St.,
Gloversville, N. Y.

"Received the Townsend all O. K. It is the best in the World and that is saying some. I have a Radiola 4 tube. Get more stations than ever before. Some of them are CFCF, CKNC, WGY, KDKA, WGZ, WIP, WWJ, KTHS, KOP, KOA, WHAS, WTAM and KSD—besides 4 in Chicago, all in the East and then some."

A. W. Gale.

Replaces "B" Batteries

The letter above speaks for itself—proves beyond doubt that the Townsend "B" Socket Power is the most remarkable value in Radio today. Sam E. Fry of 1415 Holmes St., Kansas City, Mo., writes: "Eliminator works fine. Showed it to a friend and he wants one also. I will say it sure beats batteries. I get stations I never got before on a 6 tube set." Charles Ellis, 88 Jones Ave., Columbus, Ohio, says, "Your Eliminator is working fine. Have had station WJAX and others over 1,000 miles distant. Picked up 22 different stations one evening and around 30 another time. My neighbor has a \$27.50 Eliminator and I don't see that it works any better than yours."

Delivers up to 100 volts on any set, on D. C. or A. C.—any cycle. Full tone, clarity and volume.

Tested and approved by America's leading Radio authorities—Radio News and Popular Radio Laboratories

ORDER TODAY!

Simply fill out the coupon and slip it into an envelope with only \$1.00 and mail at once. Your Townsend "B" Socket Power Unit will be sent promptly. Deposit only \$5.85 plus postage with the postman. Try out for 10 days—then if not delighted with improvement in reception, return it to us and purchase price will be refunded.

TOWNSEND LABORATORIES

713 Townsend St., Dept. 19, Chicago, Ill.

Attach Only \$1.00
to this Coupon!
SEND TODAY



TOWNSEND
LABORATORIES
713 Townsend St.
Dept. 19, Chicago, Ill.

Gentlemen: Attached find \$1.00. Kindly send at once Townsend "B" Socket Power Unit, C. O. D., for \$5.85, plus postage, on guaranteed 10-day free trial.

Name.....

Address.....

City..... State.....

The New Prospects of Transmitting Power by Radio

(Continued from page 13)

meters, or 240 centimeters, in wavelength and with a power output of 35 watts or a little more. These waves he demonstrated to the Society; showing the creation of sharply-marked nodes of current and voltage on the familiar Lecher wires, displaying the possibility of lighting lamps in the empty air by the energy pick-up of short straight-wire antennas, and so on.

A wavelength of 240 centimeters, while extremely short in comparison with even the shortest waves used in broadcasting, is still too long for the beam work which Dr. Thomas foresees. To make beams of radio waves as completely concentrated and parallel as the light-beam of a searchlight one must proceed just as the searchlight makers do. The waves

must be condensed and rendered parallel by a lens or by a curved mirror or both. The most convenient way to do this with radio waves would be by means of a metallic mirror, but that mirror must be at least as large, in diameter, as the length of one complete wave. For the 240-centimeter wave, therefore, a mirror necessary to make even a reasonably good parallel beam would have to be some eight feet across. The so-called "beam wireless," now in use by the Marconi interests between England and the Dominions, works on a somewhat different principle and does not produce the narrow beams or pencils of radio waves which Dr. Thomas has in mind.

A copper mirror eight feet in diameter is not out of the question. It would be

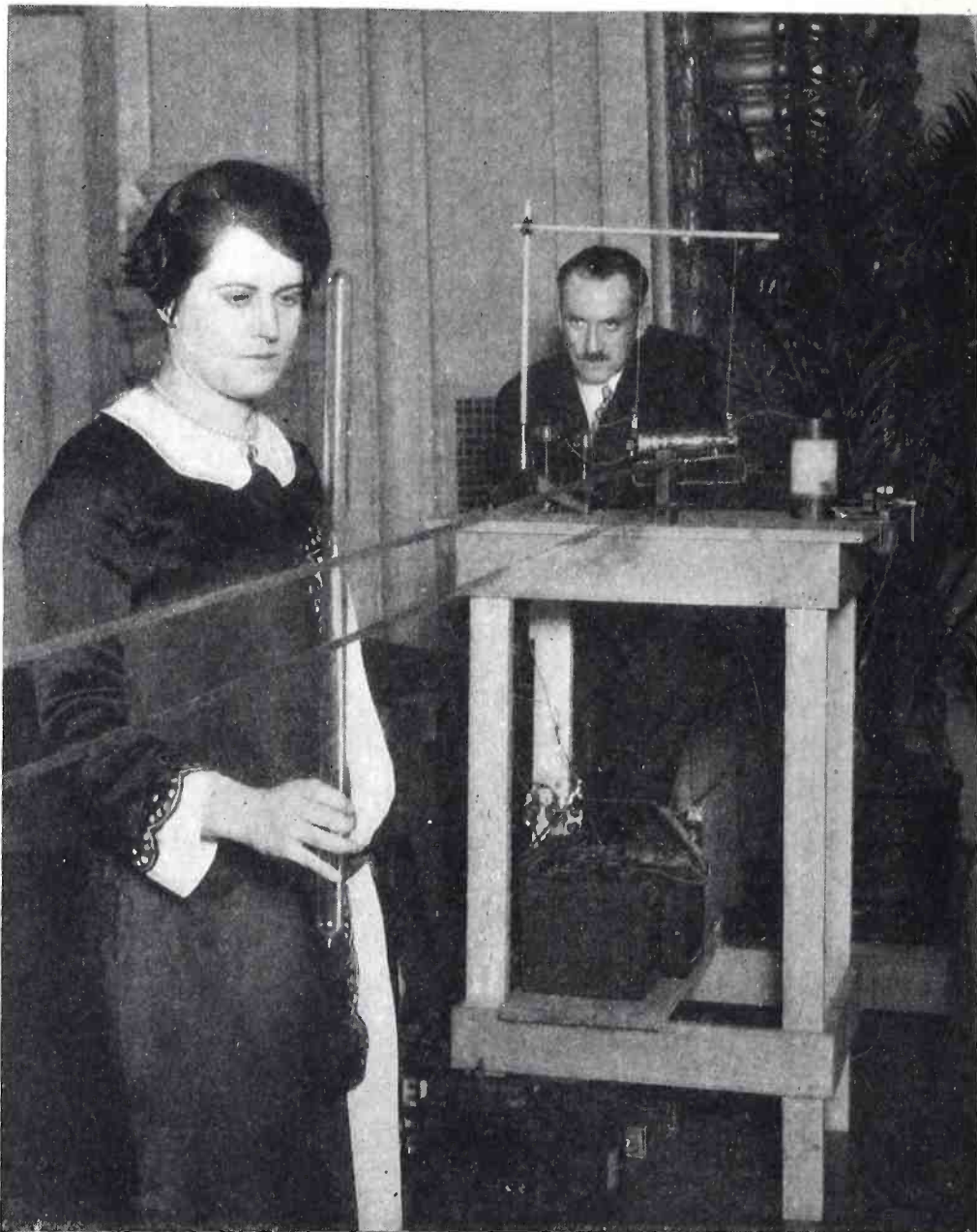

New York Electrical Society

Atoms Help to Demonstrate Power by Radio

In his New York City experimental talk on power by radio, Dr. Phillips Thomas indicated the very short wavelength employed by feeding the waves into a pair of horizontal aluminum ribbons, operating as Lecher wires. Nodes were then found by lamps or other indicators and the wavelength measured. In the background is Dr. Thomas, with the oscillator used to generate the waves; his assistant holds close to the ribbons a long glass vacuum tube containing a very little neon gas. When opposite points of high voltage along the Lecher ribbons, the neon atoms in this tube glowed brilliantly by induced electrification.

SANGAMO

MICA CONDENSERS

UNAFFECTED

by

MOISTURE



When the humidity hovers around 100, the components of your radio receiver are subjected to the equivalent of a water bath!

You can make certain, at least, that the fixed condensers in the circuit will not alter in capacity or efficiency under these conditions.

Use Sangamo Mica Condensers—they are permanently protected from all atmospheric action by a solid sheathing of pure bakelite!

SANGAMO .. ELECTRIC .. COMPANY
SPRINGFIELD, ILLINOIS

6336-3



See, Hear, The New



ELECTRIC SENIOR

(No Batteries)

ELKAY SENIOR

(Six Tubes)

ELKAY JUNIOR

(Six and Seven Tubes)

**JOBBER
 DEALERS**

Write for territorial rights

The Langbein-Kaufman Radio Co.
 Dept. P, 62 Franklin St., New Haven, Conn.

possible, therefore, to make parallel beams of these 240-centimeter waves, as Senatore Marconi did with slightly longer waves two or three years ago. But these would be neither narrow enough nor (with present transmitters) powerful enough for the spectacular results which Dr. Thomas believes possible. For these the wavelength must be shorter and the power larger. With the ten-centimeter waves which Dr. Thomas predicted as an illustration of radio beams, a four-inch copper mirror would be sufficient to produce a parallel beam quite of searchlight character. This, plus the increase of power output to the ten kilowatts which Dr. Thomas mentioned, is all that stands between us and the actuality of beams of radio power.

How difficult these actualities will be to realize no one can predict. The problem consists, as Dr. Thomas made clear, in devising new oscillating circuits which will operate at the enormous frequencies necessary—a wavelength of ten centimeters means a frequency of 3,000,000 kilocycles or three billion complete oscillations a second—and which will produce large power outputs at these enormous frequencies. No such oscillator is now known, but that should discourage no one. Only a few years ago a wavelength of one hundred meters was considered unreachable, except experimentally and with very low power. Today there is broadcasting as low as forty meters and three or four meters is quite easily attainable.

Assuming that it will be found possible to produce, in some manner, powerful wave discharges at frequencies in the neighborhood of the three-million-kilocycle mark, the production of the directed rays of radio waves will be quite simple. Their effect on the air must remain unknown until we have the beam to experiment with, but there is good theoretical reason to believe that they would ionize a fraction of the air atoms and make the path of the beam more or less conducting for ordinary electric currents, just as Dr. Thomas has assumed. His predictions stand as very reasonable possibilities—which is all that he implied that they were.

There is already material enough in the subject of radio power for some new Jules Verne to create another Captain Nemo and launch him on a romance about the world as it will be when Dr. Thomas' aerial radio beams actually do aid our contractors and bridge our rivers and cross our skies to feed the power antennas of our private houses. It would be far less wide a step from the present to that day than was the step which Jules Verne actually did take when he conceived Captain Nemo's wonderful submarine. Perhaps the beams of radio power will be attained no less quickly and no less completely.



Here's Work
 that's almost
Romance!

Learn RADIO for BIGGER PAY!



J. E. Smith
 President

Jobs paying \$50 and all the way up to \$200 a week are waiting for the Radio-trained man. Get into the new, growing Radio profession if you want to earn more money, have bigger opportunities for the future. I will train you at home in your spare time. Previous experience not needed—you learn quickly in a simple, clear, unforgettable way. Grade school education, or even less, is enough to start.

Earn \$15, \$20, \$30 Weekly Right Away "On the Side"

You learn it all by doing. So practical is the training you get that almost from the time you start you can put your new knowledge to use. Little Radio jobs, I'll show you how to do in your spare hours, can bring you as much as \$15, \$20, \$30 extra cash, weekly, after you get well started. This Radio training of mine is the one that's world-famous as the "Course That Pays for Itself." Many of my students put aside enough extra cash to start their own Radio business on graduation—all earned by this spare-time Radio work done while they are learning.

64-Page Book Sent FREE

Free—a 64-page book that tells you all about the bigger opportunities in Radio—the big money to be earned—how I'll prepare you thoroughly and completely in the quiet of your own home to enter any one of the twenty some odd lines of the Radio profession. Book tells all about my ways of helping you earn extra spare-time cash almost from the day you start with me. Gives all information about the six big outfits of Radio material I send you to experiment with: you can build more than 100 Radio circuits with these outfits, yet there's no extra charge for them. Everything—all services and material—included in one tuition fee (and you'll find it's surprisingly low, and can be paid in very small monthly amounts). Get the proof for yourself. Radio needs you—learn right now what it has to offer you. No obligation for the book—it's sent free—just mail the coupon today.

Address: J. E. SMITH, President

National Radio Institute
 Washington, D.C.



J. E. SMITH, President,
 National Radio Institute,
 Dept. H-86, Washington, D. C.

Dear Mr. Smith: Kindly send me your free 64-page book with all information about learning Radio for bigger pay. I understand this places me under no obligation.

Name.....
 Address.....
 Town..... State.....

LYNCH RESISTORS



The Complete Resistance Line

is a result of the focusing of the efforts of an organization, trained in the development and production of quality resistors, to the problem of supplying every resistance need of the manufacturer, engineer and radio fan.

This line includes every type of resistor required for receiving, transmitting and power supply work.

The stock sizes of Lynch Resistors have been carefully selected to meet the ordinary requirements of the average circuits. Special resistors of any desired sizes or characteristics can be had to order.

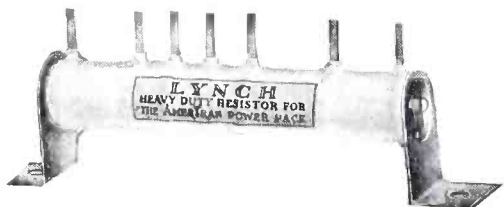

Tapped heavy duty type resistor for power amplifiers and battery eliminator circuits such as the Mayolian 171 and 210, the AmerTran and Silver Power Packs, and Thordarson 171 and 210. Price of AmerTran Tapped Resistor illustrated—\$8.50.



Metallized resistors give continuous, conductive, non-arcing, noiseless and permanent resistance. They are available in sizes ranging from .25 to 10 megohms at 50 cents each; .012 to .2 megohm at 75 cents each; and .0005 to .01 megohm at \$1.00 each.

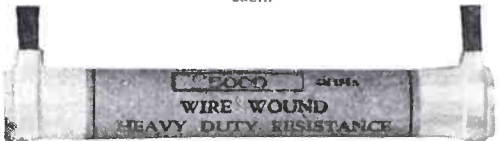

Type "P" heavy duty resistors, wire-wound on porcelain, are conservatively rated at 20 watts carrying capacity and are designed for power circuits where the use of high voltages make ordinary resistors impractical. The stock sizes range from 2,000 to 100,000 ohms at from \$1.25 to \$4.00 according to resistance values.

The Lynch Resistance Line also includes: Type "C" heavy duty metallized resistors; Filament Equalizers; Grid Suppressors; Type "G" heavy duty resistors, wire-wound on glass; the Resistance-coupled amplifier kit illustrated; Single and Double Leak-Proof mountings.

Folder giving complete specifications and prices sent on request.

ARTHUR H. LYNCH, INC.

General Motors Building

1775 Broadway, at 57th St., New York, N. Y.

The New "Exponential Horn"

(Continued from page 24)

below which and above which tones are not emitted.

For example, some loudspeakers will reproduce no tone below one hundred vibrations a second. These are said to have a low-frequency cut-off of one hundred cycles.

It is sometimes said that the advantage of a horn for a loudspeaker involves the question of resonance. This resonance really amounts to distortion. If the horn resonates to any specific frequency or group of frequencies, this means that the horn is exaggerating these particular frequencies, while producing a relative depression in the intensities of other frequencies. If the music or speech being discharged by the diaphragm itself is already distorted this additional distortion by resonance in the horn may actually improve the final result, provided, of course, that the exaggerations of the horn apply to those particular frequencies which the diaphragm is emitting in less than proper intensity. Even in this case, the procedure is a poor makeshift. It is better to discharge from the receiver and from the diaphragm exactly the frequencies desired and then to see to it that these frequencies come through the horn.

In freedom from distortion the exponential horns are quite satisfactory, but it is possible to avoid distortion with other types of loudspeaker also. The same is true of the matter of cut-off. The lowest frequency which a horn will

emit, which determines its low-frequency cut-off, is not fixed by the exponential principle, but merely by the length and width of the horn and by similar characteristics. Either an exponential horn or a cone loudspeaker or some non-exponential variety of horn can be designed to have a low and favorable cut-off, emitting frequencies down to fifty or sixty cycles or even lower.

It is the third factor, that of loudness, which brings the exponential horn its greatest victories. With a relatively small amount of energy emitted from the diaphragm itself, the cone of air, expanding as the horn enlarges in accordance with the exponential principle, transmits an exceptionally large fraction of this diaphragm energy to the outer air. If the exact dimensions of the horn provide the desirable low cut-off and if the details of design are adjusted to minimize distortion, it is possible to obtain great volume, which means loudness, without interfering with the absence of distortion which is so necessary for first-class musical reproduction.

To what extent, if any, the exponential horns are destined to replace the cone loudspeakers which now hold public favor, it is certain that the exponential principle will find important utility in all those varieties of radio reception where loudness is an essential; for example, where large audiences are being entertained or where music is to be provided for marching or for dancing.

A New Kink for Keeping Your Log-Book

(Continued from page 53)

are only ten kilocycles apart, even though their wavelengths are ten meters apart. At the same time WORD and KLZ are 60 kilocycles apart, though they also are only ten meters apart in wavelength. The ability of a receiver to separate two stations is a factor of kilocycle frequency difference instead of meters wavelength difference. Do not blame the set because it will not separate WOW and KYW, even though it does separate WWSW and WREO, and the wavelength difference is the same in each case.

One point which must be watched when making out the chart is probable inaccuracies in the call book data. Very few tabulations are entirely accurate; the errors often consist in giving the wrong kilocycle reading for a certain wavelength. This will throw the chart out of sequence, as kilocycles are the primary chart factor. Another type of error lies in showing an incorrect wavelength for a given station. If a

wrong kilocycle reading is given, it may show up as the listing is being done, for the wavelength reading will be out of sequence. If a wrong wavelength reading is given, the operator will find it out when he gets the dial readings for the station, for they will then be out of sequence.

It is best to put down only the stations on which you are *sure* the data is correct, if you are keeping the chart in ink. It may be better to keep the data in pencil, if it can be protected from smearing, for nowadays the stations are hopping from wavelength to wavelength, changing call letters, appearing and disappearing at a rate that makes it possible for any record to be quickly out of date.

This chart is, however, well worth the time which may be put on it, because it forms an accurate guide to tuning, because of its clear relationship between wavelength and frequency, and because of its neatness as a record of stations that have been received.

TWENTY OF THE WORLD'S GREATEST RADIO SCIENTISTS WROTE A SINGLE BOOK

AND POPULAR RADIO CALLED IT

"EVERYMAN'S GUIDE TO RADIO"

Contributed to by the world's leading radio scientists, without question, the most comprehensive, most interesting and absorbing, and the most complete radio book yet published in any country. It is impossible to give comparisons, because comparisons do not exist. One must read Marconi on the subject of "beam transmission"; the late Charles Steinmetz on "Waves"; Sir Oliver Lodge on Coils, or Ambrose Fleming on "Vacuum Tubes," before the significance of these writings of the masters of the art can be fully appreciated.

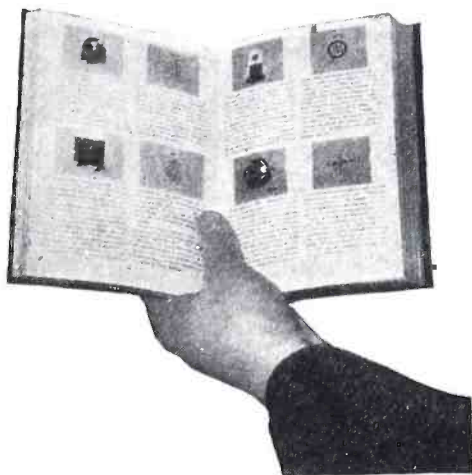

1300 Illustrations!
"Everyman's Guide to Radio" contains 1300 beautifully engraved illustrations in 1200 pages of text.

640 PAGES OF INSTRUCTIVE READING

For the "Broadcatcher" as Well as the Experienced Radio Enthusiast

This book of 640 pages, size 5 1/4" x 7 1/2", containing more than 1300 finely engraved illustrations, has been prepared by some of the greatest physicists and engineers of radio. "Everyman's Guide to Radio" stands as the first successful effort to meet the needs of all those who aspire to attainments in the science, whether they are "broadcatchers," skilled service men or students. This vast wealth of information represents studied compilation that has extended over two whole years and includes every phase of radio communication that can have any interest to those desiring meaty information.

QUICK ANSWER TO EVERY RADIO PROBLEM

Intelligent use of "Everyman's Guide to Radio" gives quick, understandable answers to practically every radio problem regardless of the technical accomplishment of the reader. Special emphasis has been laid on the illustrations contained in the "Guide." Hundreds of specially prepared drawings and photographs answer most radio problems at a mere glance. No effort or expense has been spared to make the "Guide" of maximum value to radio listeners. It is the fascinating story of radio in pictures and it is the most complete collection of instructive radio photographs ever published.

A BOOK YOU WILL BE PROUD TO OWN

It may be said without reserve, that "Everyman's Guide to Radio" is the most artistic and practical book ever published in the radio field. It contains over 640 pages printed on heavy calendered paper in legible type, making for the comfort and convenience of the reader. The covers are beautifully embossed and bound in Art Fabrikoid, better than leather, flexible, making the books conveniently portable.



Flexible!
These four books represent the latest practice in the art of book manufacture. Perfectly flexible, without damage to pages or binding.

CONDENSED TABLE OF CONTENTS

- Part 1*
 - The First Principles of Radio
 - The Electricity of Radio
 - The Easy Principles of Diagram Reading
 - How Waves Are Generated
 - Mechanics of Tuning
 - Detection and the Secret of Vacuum Tubes
- Part 2*
 - Audio Frequency Amplification
 - Radio Frequency Amplification
 - Variable Condensers
- Part 3*
 - Coils—How to Use Them
 - Improvement of Broadcast Reception
 - How to Make Radio Improvements
 - Learning the Language of Dots and Dashes
 - Batteries and Battery Chargers
 - Different Types of Radio Receivers
- Part 4*
 - Accessories and Radio
 - Wonders of Radio Transmission

POPULAR RADIO, 627 West 43rd St., New York



Convenient!
A lot of information in a small space. Just the right size for the pocket and light in weight.

EXAMINE THE VOLUME WITHOUT OBLIGATION TO BUY

So sure are the publishers of "Everyman's Guide to Radio" that this volume is just what everyone needs to complete his reference library and so sure are they that it is the most practical, complete and beautiful radio book yet published that they are willing to mail it to those interested for examination without obligation to buy. Just fill out the attached coupon and mail. The book will be mailed immediately. Upon arrival, you pay the postman \$4.00 plus postage. Examine the book for 5 days. If, after that time,

\$ 4⁰⁰

you are not convinced of the value to you, return in good condition and your money will be refunded, at once and in full, without question.

POPULAR RADIO, Inc.,
627 West 43rd Street,
New York, N. Y.

Gentlemen:

Send me "Everyman's Guide to Radio" in one volume. I agree to pay the postman \$4.00, plus postage. If, after carefully examining the book for a period of five days, I do not like it I will have the privilege of returning it to you and my money, in full, will be immediately returned.

Name.....

Address.....

City.....State.....

SM

UNIPAC for Power



The Silver-Marshall laboratories now offer a series of power packs absolutely without comparison. Type 660-210 Unipac, a push-pull amplifier using two UX-210 tubes, will deliver from 100 to 300 times more power than a 201-A tube, or from 4 to 17 times more power than average 210 power packs. Type 660-171 Unipac, with two 171 tubes will deliver equal or greater power than average 210 packs at far lower cost!

There is a Unipac for every need, from the most powerful receiving amplifier ever developed down to a lower power 171 power pack. There are models for phonograph amplification, turning any old phonograph in a new electric type actually superior to commercial models costing from five hundred to several thousand dollars. And every Unipac, operating entirely from the light socket, supplies receiver "B" voltage as well.

Predominant!

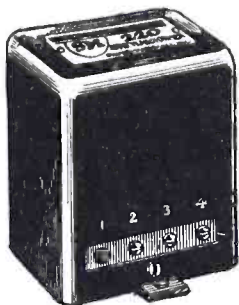

S-M 220 Audio Transformers are absolutely the finest audio amplifying devices that the market affords. That's why you'll find them selected for the season's most prominent designs—that's why you'll see them

in the studio amplifiers of such stations as WEBH, WCFL, WBBM, WCAE, WTAQ, KGDJ, WLBF and countless others. That's why you will eventually use 220's—for there's nothing finer. Price \$8.00 each.

The 220 Audio Transformer with a turn ratio of 3:1 has the highest primary impedance of any known transformer. This value—the criterion of low note amplification—is 19,000 ohms at 30 cycles and 626,000 ohms at 1,000 cycles, approximately.

SILVER-MARSHALL, Inc.
844 WEST JACKSON BLVD.
CHICAGO, U. S. A.

In the World's Laboratories

(Continued from page 63)

tion, some of which have been taken up recently by Professor Donald A. Laird, of the Department of Psychology of Colgate University.*

It is proposed to test the consumption of energy and the output of work by average workers under noisy conditions and under quiet ones. The results, when Professor Laird has completed and tested them, can scarcely fail to be of interest to the radio professions.

Radio Waves to Make New Chemistry Possible

ALTHOUGH some of the most spectacular features of the New York Electrical Society's program on "Power by Radio," presented by two Westinghouse engineers on April 20, 1927, were the short-wave demonstrations of Dr. Phillips Thomas, which Mr. Elway describes elsewhere in this issue of POPULAR RADIO, equally significant indications of future progress lay in the remarks of Dr. Harvey C. Rentschler, accompanying his demonstration of the high-frequency, high-vacuum furnace. The availability of this new physical and chemical tool is apt to make it possible, Dr. Rentschler believes, to explore a field of chemical reactions never before accessible to man.

The possibility of using high-frequency

* "Tests Show Effect of Noise on Nerves," by Emily C. Davis. *Science News-Letter* (Washington, D. C.), volume 11, pages 221, 227-228 (April 9, 1927).

electromagnetic waves, essentially similar to those used in radio, as carriers of heat energy and to attain high temperatures without contact with flames or with electric arcs, has already been discussed in POPULAR RADIO.* Oscillations generated by any variety of electric oscillator are run through a coil so placed that the electromagnetic field produced is absorbed more or less completely by some conducting object. Eddy currents produced in this object generate the heat. In Dr. Rentschler's arrangement of the apparatus either a mercury spark-gap feeding a transformer may be used as the source of energy, or a vacuum-tube oscillator may be employed. In either case the "radio power" thus generated is allowed to enter a vacuum, where it reacts with and heats the material on which the operation is to be carried out.

One practical accomplishment already realized is the production of thorium and uranium in solid metallic form, so that wires, rods or other objects may be made of these metals. As Dr. Rentschler demonstrated to the New York Electrical Society in a series of spectacular experiments, these remarkable metals have so great an affinity for the oxygen of the air, as well as for other gases, that it is virtually impossible to keep the metals from taking fire and burning up like tinder if they are heated in the air.

* "Melting Metals by Radio," by E. F. Northrup. *POPULAR RADIO* for May, 1924, pages 430-437.

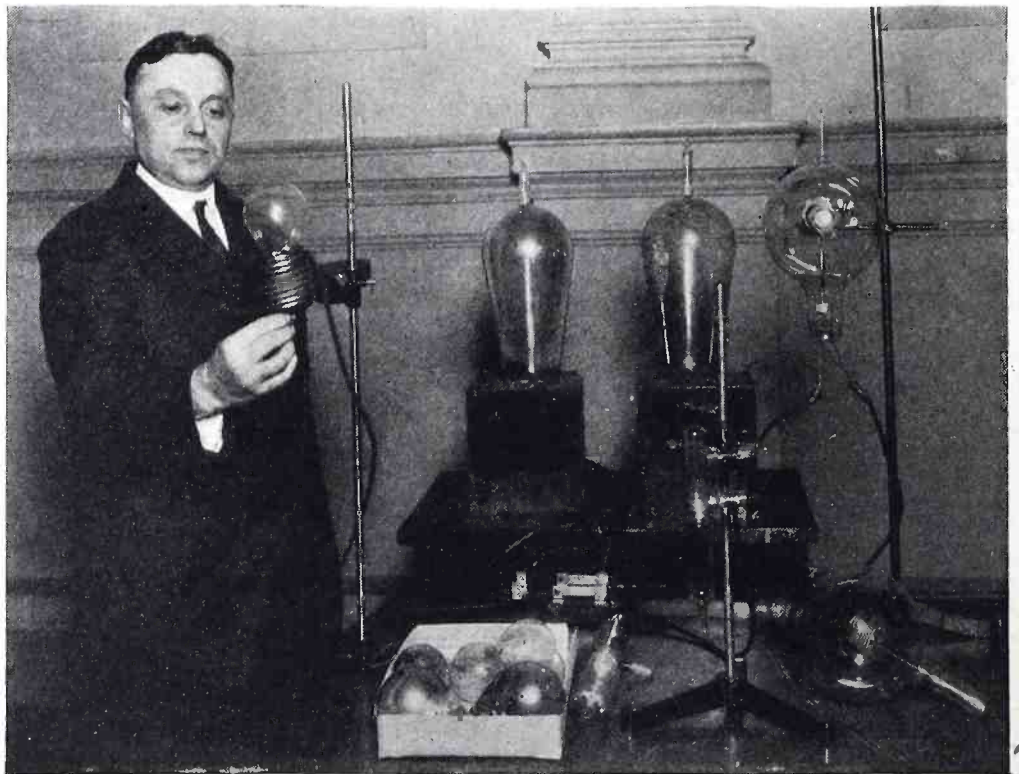

New York Electrical Society

A PROPHET OF CHEMISTRY BY RADIO HEAT

In demonstrating his high-frequency, high-vacuum furnace to the New York Electrical Society, Dr. Harvey C. Rentschler, Director of Research of the Westinghouse Lamp Company, predicted that new chemical reactions not possible in ordinary laboratories will be possible by the application of radio-generated heat inside a vacuum. A whole new field of chemical research is opened. Dr. Rentschler is holding a small vacuum bulb containing chemicals which will react when the radio power is turned on. In the background are the two mercury spark-gaps of the generator.

It is possible to prepare the metals by the reduction of their compounds with various chemicals. This yields powdered metal. Theoretically, this powder then can be fused into a solid lump, to be handled as other metals are. There is, however, the grave practical difficulty of inflammability. So soon as the powdered thorium or uranium is heated, even by the flame of a match or with an electric spark, it takes fire almost as though it were gunpowder. Many samples of uranium powder have thus gone off accidentally, Dr. Rentschler said, while attempts were being made to reduce the material to more solid and less inflammable forms.

This is the kind of problem for which the radio furnace is especially suitable. The inflammable metallic powder is packed into a crucible made of the difficultly fusible oxide of thorium called thoria. Crucible and powder are then placed inside the vacuum bulb of the radio furnace and subjected to the field generated by the oscillations in the coil of wire surrounding the crucible. The heat generated inside the metallic powder promptly melts this to a coherent metallic button. Since the melting takes place in a vacuum, with no oxygen present for the metal to combine with, no loss by burning occurs. The coherent metal, whether of thorium or uranium, possesses so much less surface in proportion to its mass that it does not burn in air, but remains reasonably unaffected. Wire, plates, rods and other forms have been made from both of the metals and are expected to find important uses.

There are many chemical possibilities, Dr. Rentschler went on to say, which have never been well explored because the reactions concerned require both heat and vacuum. Sometimes the vacuum is necessary because the presence of air, inescapable in ordinary laboratory operations, prevents or alters some feature of the reaction as it does in the heating of powdered thorium or uranium. In other instances the vacuum is necessary because some product of the reaction is to be set free in the form of vapor, which may be possible only at reduced pressure.

It is probable that most of the chemical reactions possible at ordinary pressures and in the open air have been examined, superficially at least, in the thousands of chemical laboratories now in operation all over the world. But that does not exhaust the possibilities of chemistry. Dr. Rentschler demonstrated to the Society several chemical reactions impossible under these ordinary conditions but which occur readily in the vacuum furnace. One of these was the production of pure metallic potassium, in the form of a vapor which condensed instantly to a brilliant mirror on the inside of the vacuum bulb in which the reacting materials had been placed.

RAYTHEON MANUFACTURING COMPANY

MAKERS OF RELIABLE RECTIFIERS

KENDALL SQUARE BUILDING

CAMBRIDGE, MASS.

March 31, 1927

Aerovox Wireless Corporation
70 Washington Street
Brooklyn, New York

Gentlemen:

Attention of Mr. S. I. Cole

From time to time our laboratory has made careful and constructive tests on the condensers manufactured by your company for use with our type "B" rectifier in B-Power Supply Units, for use with the "BH" rectifier and in B-Power Supply Units and in "A-B-C" Units using both the "BH" and "BA" 350 milliamperere rectifier.

The performance of these condensers has been entirely satisfactory when used in these circuits and the actual measured capacitance has not varied from the rated value more than three percent.

The non-inductive type of construction used in your condensers is highly recommended for these circuits as our tests show filter circuits using this non-inductive type of capacitance to have greater efficiency for a given number of microfarads used.

Manufacturers of high quality B-Power Units have realized that an adequate safety factor in condenser construction is essential for continuous satisfactory service and your efforts to develop a high quality condenser will undoubtedly react to the mutual benefit of those now interested in the socket power field.

From the results of our tests we are glad to recommend your condensers, to manufacturers interested in the development of quality B-Power Units.

Sincerely yours,
RAYTHEON MANUFACTURING COMPANY

By



D. E. Replogle
Sales Engineer



70 Washington Street Brooklyn, N. Y.

CABLE ADDRESS: RAYTHMANCO

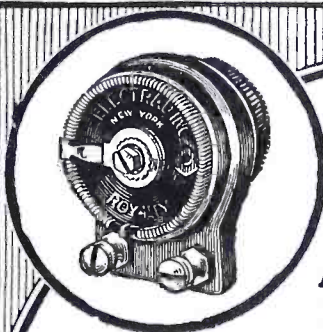

Exclusively Licensed by Technidyne Corporation under U. S. Patent 1593658.

Their Accuracy Endures

ROYALTY VARIABLE HIGH RESISTANCES

Wherever a high resistance is required insist on Electrad Royalty. These resistances control volume and tone with remarkable accuracy for the life of the set—indefinitely.

A range for every purpose—11 in all. Type E \$2.00. All other types \$1.50.

Write for free hook-up circular

At your dealers

175 Varick Street, Dept. 59
New York, N. Y.

ELECTRAD

Now you can build the kind of a radio you have always wanted



This BOOK TELLS HOW

No matter whether you want to improve a set you now have or build a new one—get this book first. Tells how to build the latest one, two and three dial receivers—5 to 7 tubes.

10¢ PREPAID

GEARHART-SCHLUETER, Fresno, Cal.

THE BIG WONDER

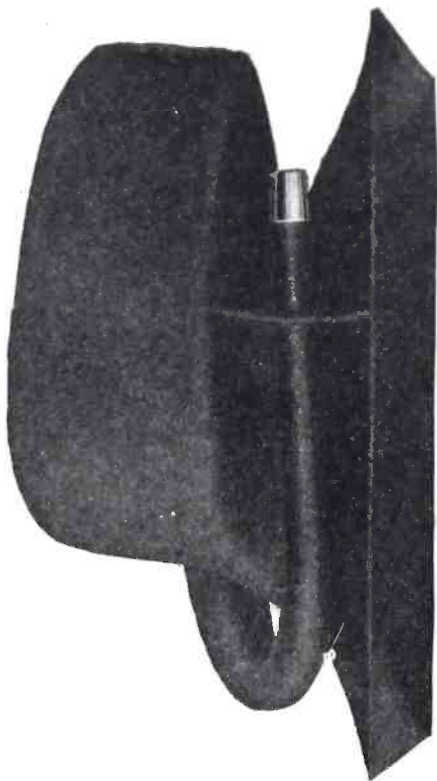

Type OB 1315
Air Column, 104 inches
Bell 18" x 24"; Depth 13"

The RACON Process assures uniformity; strength; maximum quality; minimum weight.

RACON

EXPONENTIAL

Sound Chambers

for

TRUE ORTHOPHONIC REPRODUCTION

(Mfd. under U. S. Pat. 1501032 and 1507711)

Every RACON Horn is acoustically correct in design and faithfulness of reproduction, regardless of SIZE. Every RACON Horn is made along lines conforming to the latest EXPONENTIAL theory of design.

THE LITTLE WONDER

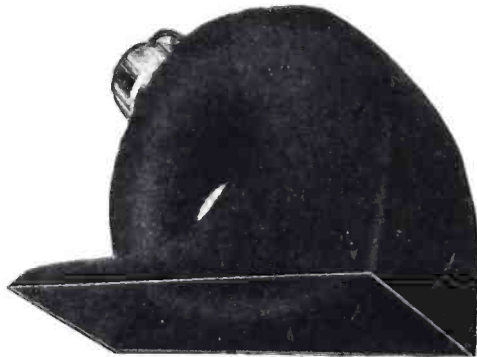

Type OB No. 317
Air Column, 60 inches
Bell 6" x 15"; Depth 10½"

For further details address

RACON ELECTRIC COMPANY, Inc.

18-24 Washington Pl., New York, N. Y.

Noises From Northern Lights

MANY observers in northern latitudes have reported from time to time that they not only could see the aurora borealis but could hear it, as the heavenly display is accompanied by clear hissing or crackling sounds, not merely in the earphones of a radio receiver but in the open air.

As the electric discharge which is believed to constitute the aurora is known to occur some one hundred or two hundred miles up in the air, this report of the noisiness of the display has seldom been taken seriously by the scientists. It seemed impossible that any noise which might be produced in the upper air could reach as far downward.

As has happened in so many other instances, it now turns out that the theoretical scientists were wrong and that the actual observers were right. A scientist of distinction, long experienced in auroral observations and whose word will be taken without question by his peers, has heard the sound of the aurora for himself. This fortunate observer is Professor Hans S. Jelstrup, of the Norwegian Geographical Survey, at Oslo. On the evening of October 15, 1926, while engaged in astronomical observations on a hilltop near Oslo, Professor Jelstrup and his assistant noticed a "faint whistling sound, distinctly undulatory, which seemed to follow exactly the vibrations of the aurora."*

It is still unthinkable that any sounds from the actual aurora should be carried through the air from the enormous heights at which these discharges occur. Furthermore, that hypothesis would be inconsistent with the observation of Professor Jelstrup that the sounds heard by him undulated in intensity in agreement with the variations of the aurora. The explanation which Professor Jelstrup suggests and which seems likely to be the true one, is that the electric discharges of the aurora cause induced electric charges on the eaves of houses, the branches of trees and other objects on the surface of the ground. A multitude of small sparks, escaping from these objects, can then be blamed for the hissing noises.

Recent newspaper dispatches from Switzerland announced that the fire department of a town in that country turned out one evening recently because of a glare of aurora in the sky which someone mistook for a fire. Now that the aurora has been proved to be noisy as well as brilliant, it is in order for some town to report that the aurora turned out the firemen by making them think that they heard the fire whistle.

* "The Aurora of October 15, 1926, in Norway and Sounds Associated With It," by Hans S. Jelstrup. *Nature* (London), volume 119, page 45 (January 8, 1927). There is a report of the same occurrence, presented by Professor Jelstrup to the French Academy of Sciences, through General Ferrie, in *Comptes Rendus de l'Académie des Sciences* (Paris), volume 189, pages 159-160 (January 17, 1927).

*The Coil's
the thing*

*that
makes*

Radio



NO RADIO UNIT IS ANY BETTER THAN ITS COIL



The performance of Battery Eliminators, Audio Transformers, Loud Speakers, and all other Radio Units is in exact ratio to the efficiency of their windings. **It's the Coil that does the work!**

Nearly all leaders in radio and radio parts use Dudlo Coils because they know their superiority.

DUDLO

Dudlo Manufacturing Corporation
FORT WAYNE, INDIANA

Are You Planning to Use the New Alternating Current Tubes?

Those who are planning to build new A. C. receivers or convert their old receivers by the use of A. C. tubes will do well to follow the activities of the POPULAR RADIO Laboratory. Our Laboratory experts are now planning and building full A. C. receivers of every type and this work will begin with this issue of POPULAR RADIO and will be described in full detail in the forthcoming issues. These new numbers of POPULAR RADIO will make radio history and those who are not subscribers will be wise to place a standing order with their news-dealer for a copy of POPULAR RADIO.

Of course, it is always better to subscribe at \$3.00 a year and be SURE of receiving your copy.

Subscription Dept.

POPULAR RADIO, Inc.

627 West 43rd Street, New York, N. Y.



This photograph shows the marvelous Bridge Tube Tester in use in POPULAR RADIO Laboratory. No other instrument known provides such accurate or convenient means for charting tube characteristics. Only tubes successfully passing this and other severe tests may be advertised in POPULAR RADIO.

How to Buy Vacuum Tubes with Safety

IT is obvious that no radio receiver can be better than its vacuum tubes, for it is in its vacuum tubes that the vital processes of detection and amplification take place. Here quality is gained or lost and sensitivity becomes a fact or a mere fancy.

If one could accurately visualize the delicate action taking place within the void spaces of this master device, one might have more respect for it and certainly more caution in making his future purchases, for vacuum tubes, unlike collar buttons or toothpicks, require at least an intelligent understanding of their great importance.

The POPULAR RADIO Laboratory, fully aware of its obligation to its readers in assisting them to purchase vacuum tubes wisely and with the absence of doubt as to performance, is using in its tube testing work, ap-

paratus of the most modern character. It is a matter of minutes for the POPULAR RADIO engineers to read the complete pedigree of a vacuum tube; its amplification constant, plate impedance, mutual conductance, space current and plate voltage are almost instantly discernable with the Special Bridge Tester. This highly specialized method of examination is applied to the products of all tube manufacturers, and only those successfully passing these tests may use the columns of POPULAR RADIO.

Such constant vigilance on the part of the Laboratory permits the reader to purchase vacuum tubes advertised in the columns of POPULAR RADIO with the comfortable feeling that the article is fully worth the price paid for it and that, used under the proper conditions, it will render satisfying service.

[[A list of approved vacuum tubes will be supplied to those sending a self-addressed envelope.]]

POPULAR RADIO, INC.

627 West 43rd Street

New York, N. Y.

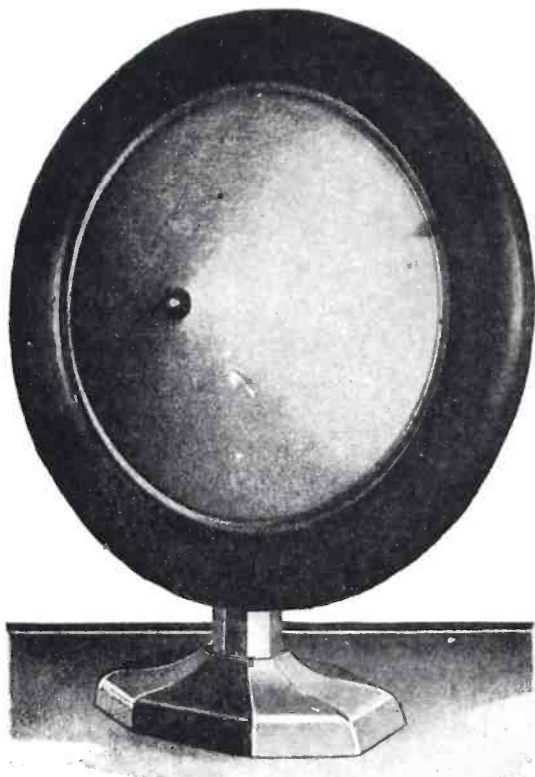

Model A. C. 20
Height, including base, 21 $\frac{1}{4}$ in.

Far ahead of today's accepted standards—the new Amplion Cone with M.A. 1 type unit

In quality of reproduction it sets a new high mark for others to strive for

THIS remarkable reproducer has an unusually wide musical range due to the striking developments embodied in the new Cone Unit.

One important feature of this unit is the felt-lined stylus protection bar which serves a double purpose. First, it protects the stylus itself against any possible injury. The felt lining, or stylus anchor, neutralizes the harmonics of the stylus itself.

This model employs a new principle in Cone construction—a 14" cone being mounted on an 18" sound board which extends toward the center in back of the cone to form a resonating chamber. The unit, cone and sound board are assembled on a rigid bronze bracket with a handsome bronze base.

The sound board is finished in dark walnut, which, with the gold-finished cone in the center, gives this instrument both graceful beauty and dignity.

Write to us for price list and literature illustrating and describing the new Amplion line.

THE AMPLION CORPORATION
OF AMERICA

280 Madison Ave., New York City

The Amplion Corporation
of Canada Ltd., Toronto

AMPLION

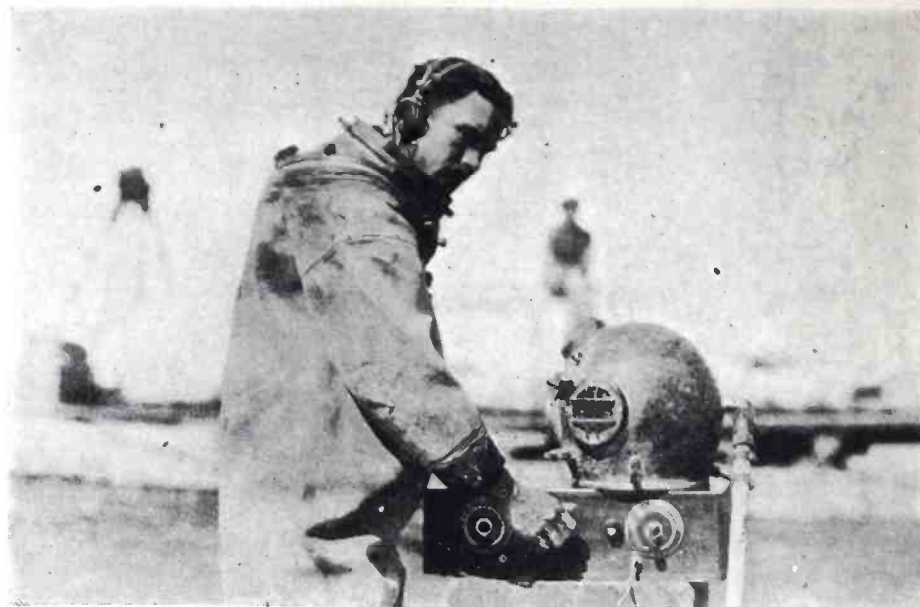

ONE OF THE WORLD'S MOST INDEFATIGABLE FANS
Not content with listening in at home, Harry L. Paige, a deep-sea diver of Corpus Christi, Texas, takes his radio receiver to work with him. He installs it on the float, attaches a fifty-foot extension cord to his headphones, tunes in—and descends beneath the waves of Corpus Christi Bay, bringing the ether waves down with him. He reports that he gets good reception.

BROADCAST LISTENER

*Comments on radio programs, methods and technique
—from the point of view of the average fan*

By RAYMOND FRANCIS YATES

Do Radio Fans Tune In on Lectures?

A CONTEMPORARY of ours recently raised the question, "Is radio educational?"

Whether it was his aim to instigate a controversy that he might stimulate interest in his writings or whether he was genuinely desirous of putting the question to a vote, is best known to himself. Be that as it may, the matter will bear some thought. We have, since the first wheeze of KDKA stimulated the fancy of the editor of the *Pittsburgh Post*, been strongly suspicious that radio pictured in the rôle of a college professor was a large and mushy piece of hokum.

That the average American broadcasting station offers some facilities for academic self-improvement cannot be denied, but does the broadcast listener want to take advantage of those facilities? That is just the point. He cares not a tinker's dam about them. No one understands this more than our broadcasters, and nothing proves it more conclusively than the evening programs of our studios. Mark the number of lectures. What is the ratio of educational lectures to music? It's small, and it is getting smaller. No studio manager is so dense that he cannot sense the waning interest in "educational programs"—meaning, in this case, lectures. People buy radios to be entertained, and the average listener jumps a station with a

lecturer as quickly as he would drop a hot soldering copper.

Forcing an educational program of this type is suicidal to a broadcasting station. A ten-minute check-up on radio circulation will prove that; WJZ tried it, WEAJ tried it. Although their material was excellent, bearing the stamp of Columbia and New York Universities, both the programs were flops and the stations, although by no means deserving it, lost listeners during these periods.

The public simply does not want to be educated by college professors. If it did, all our studios would be moved to the lecture rooms of our universities and sedate professors of English and rhetoric would replace the present crop of smart announcers.

The public made radio what it is today and many moons are going to pass before it changes it.

* *

Mr. Vorhees Shows the Way

THERE has come to the air recently over WJZ's wave a brand of popular music that is ravenously captivating both in orchestration and rendition. This delicious stuff is put out by "Don Vorhees and his Earl Carroll Vanities Orchestra," as the announcer says it.

Vorhees has got the knack of making the most banal trash enormously acceptable. His formula seems to be that of washing the face of the old stuff in such a delightfully entertaining way that it

eludes identification and leaves the listener with the impression that he has listened to an entirely new creation, or, if not a new creation, at least one almost wholly transformed. Not once have we heard Mr. Vorhees' orchestra play a conventional bar, and the marvelous ingenuity he displays in making his selections is refreshing. For several months we have made it a point to be in his audience at 7.30 each Saturday night and not once has he lugged out one of the battered numbers that have descended to the level of radio habits.

Where Vorhees put his hand on this stuff we do not know, but the fact remains that, unlike so many other of our popular musical freshies, he always appears with unusual numbers dressed up in a new and enjoyable way.

* *

A Novel Stunt

ALTHOUGH it bore the tag of a successful manufacturer of automatic hot-heaters from the hinterlands of Pennsylvania, the recent effort of WJZ to familiarize the "radioatti" with the musical monkey-shine of the Broadway shows was certainly a brilliant attempt to escape the conventional air practice. It was an imaginative and rather ingeniously managed tour of the New York playhouses and the best music of each was broadcast.

Once more somebody did some thinking beyond "Songs of Yesterday" and the big idea of an hour of negro spirituals with white talent from the First Baptist Church.

* *

What Ether Waves Do to Save Good Voices

THE radio did very badly with Marion Talley's voice during a recent Victor Hour. Either that or Miss Marion did very badly with her own voice. At times it sounded frightfully nasal and at other times it possessed all of the delicate qualities of music from a "sweet potato."

Of course, we should like to believe that the young lady's voice does not microphone well—an entirely reasonable theory. In singing one familiar song she reminded us, by contrast alone, of the beautiful way in which Caroline Andrews of the Capitol sings it.

It is known that the microphone treats some voices very badly and flatters others. The radio should not be taken as the final criterion in judging a singer's voice. But with the growing popularity of broadcast entertainment the "radio voice" is becoming almost as important as the "auditorium voice." And it does seem that the broadcasts wherein our *prima donnas* make a very bad score greatly outnumber those in which they justify their high and mighty position in the "highbrow" realms of music.

\$75 A WEEK BUILDING RADIO SETS

—in your spare time

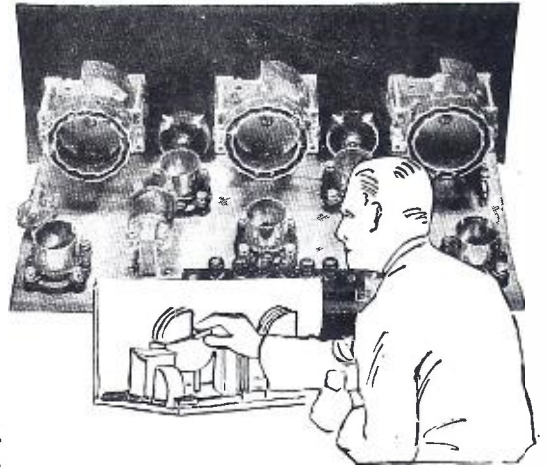

JOIN the Radio Association of America. Learn how to build and repair radio sets. The Association will train you—start you out in business if you wish. Be the radio "doctor" of your community. \$3 an hour upwards easily made. Radio offers you a big money-making opportunity right now.

Earns \$500 in Spare Hours

"I have at last found myself," writes Lyle Follick, Lansing, Michigan. "I have already made over \$500 building radio sets after working hours." Werner Eichler, Rochester, N. Y., writes, "I have made over \$50 a week in my spare time."

Our members are starting radio stores, increasing their salaries, securing better positions, earning big money for the most enjoyable kind of spare-time work.

What a Membership Means

A membership in the Radio Association of America gives you the most up-to-date and thorough training in the Science of Radio. You're taught how to build and repair all

kinds of sets. You receive the privilege of buying parts at wholesale prices.

You're helped to make money.

Join the Association Now

If you're interested in Radio for either pleasure or profit, join the Association without delay, because we have a plan whereby your membership may not—need not—cost you a cent. Only a limited number of these memberships are acceptable. Write now for details. Write before it's too late.

This Association has prepared a beautiful book that gives figure-facts regarding the profit possibilities of the Radio Industry, the purpose of the Association, and the details of the Special Membership Plan.

Mail This Coupon

RADIO ASSOCIATION OF AMERICA

Dept. PR-8---4513 Ravenswood Ave., Chicago

Send me your book and details of your Special Membership Plan.

Name.....

Address.....

City.....State.....

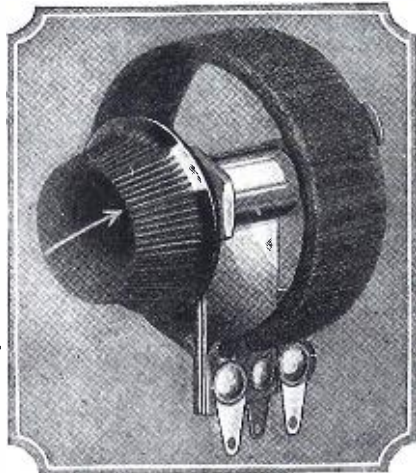

Heavy Duty Wire Wound Rheostats—Potentiometers

Designed especially for heavy current control. Impossible to break down under high temperatures. No fiber to warp or to burn out. All parts riveted or spot-welded together. Limiting factor is the fusion point of the Nichrome or Advance Wire used. These units dissipate over 50 watts at 482 degrees Fahrenheit. Diameter—2 inches, single hole mounting.

- 500 ohm Centralab Power Rheostat.....\$1.25
- 150 ohm Centralab Power Potentiometer..... 1.50

At your dealer's, or mailed direct.

Central Radio Laboratories
17 Keefe Avenue Milwaukee, Wis.



Write quick FOR HARRY ALTER'S New Wholesale RADIO BOOK

"Minute-Man" shipping service means quicker turnover for radio dealers — bigger business and more profits without increasing your capital investment.



Everything in RADIO at BED-ROCK PRICES made possible by cash buying and cash selling. If it is used in radio and is a reputable product, we have it. Send now for catalog.

Note: We sell radio retailers only

The Harry Alter Co.
1734 Michigan Avenue CHICAGO

FROST-RADIO

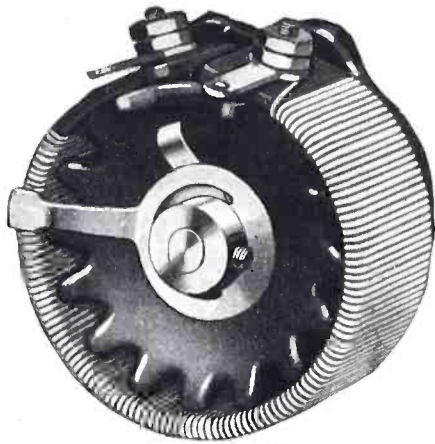

FROST-RADIO

De Luxe 400-ohm Resistance Unit Specified for Amertran Power Pack

THE new Frost-Radio De Luxe 400-ohm Resistance Unit, with windings on genuine Bakelite resistance strip, has been specified for the Amertran Power Pack. This unit gives wonderfully smooth control, and has less than half the resistance per turn of any other on the market. Air-cooled type, with Bakelite pointer knob. Order from your dealer today for your new Amertran Power Pack. Ask for No. 1824, 400-ohm Frost-Radio Resistance Unit.

List: \$1.25

HERBERT H. FROST, Inc.

Main Offices and Factory
ELKHART, IND.

Chicago	Washington, D. C.
New York	Pittsburgh
Boston	New Orleans
Philadelphia	St. Paul
Los Angeles	Buenos Aires

The Flood of Sentimental Songs

THE reminiscent program filled with the goofy sentimental songs of another day is, for the present at least, aces high with the program engineers who prescribe the broadcasting diet.

The epidemic of "old favorites" has been raging as it never raged before, and rarely does an evening pass that the wearied searcher for meaty entertainment is not called upon to share in the revival of ditties that, in days past, were A No. 1 ammunition for whiskey tenors in the maudlin stages of the old-fashioned Saturday night bat. These dolorous memories of the nineties might be immensely popular if used in homeopathic doses, but daily application is a bit too much to relish without objection. Heaven knows the average song is goofy enough without making any sustained effort to select the most sentimental ones! It's all very pretty and very sweet and very Bertha-M-Claylike to be implored by an announcer shedding onion tears to turn back the tattered, yellow pages of memory scented with withered roses—but, after all, it's banal stuff. It shows as few other things show what a powerful small amount of creative thought is being put into programs by those responsible for their acceptance.

Sentimental slush may have been sure fire once, but unless we're shooting wide of the mark, it compares very, very favorably with the popularity of bedtime stories at the present writing.

* *

Real Humor on the Air

WHILE the fact remains that the radio is sorely in need of something substantially and potently more humorous than the wise-cracking of studio sheiks, the situation has found some relief during the past few months by the constant appearance of such capable comedians as the Record Boys (WJZ) and Sam and Henry at WGN. We wish especially to commend the Record Boys, Sammy Stept, Frank Kamplain and Al Bernard, for they have, to our way of listening, succeeded with a brand of negro dialogue that is nothing short of outrageously funny. Since their first appearance we have been leaving the dinner table at the salad for fear of missing a single line of their chatter.

Dialogue well done may be worked up into a type of humor that is very acceptable on the radio, and we have yet to find better and more conspicuously entertaining masters of it than the Record Boys. One may laugh heartily at their puns without feeling ashamed for having permitted them to slip by one's guard.

We have yet to catch these fellows uttering a studied word or a line that is not deliciously spontaneous and delightfully humorous.

POPULAR RADIO DEALER AND JOBBER LISTS AVAILABLE TO MANUFACTURERS

The Service Bureau of POPULAR RADIO is able to place at the disposal of radio manufacturers a list of over 21,000 radio dealers, 3,926 radio manufacturers, 1,746 jobbers and 326 manufacturers' representatives. These addresses are immediately available for circularizing prospects for new Fall lines, and more detailed information and rates will be gladly supplied to those who wish to take advantage of what is without doubt one of the most carefully kept lists at present offered for use.

Address all inquiries to:

Service Bureau
POPULAR RADIO, Inc.
627 West 43rd Street
New York, N. Y.

CARTER

AS USUAL
is ready for the
latest developments
in the industry

The New
R. C. A.
Cunningham

and other

A. C. Operated Tubes

Rheostats, Potentiometers,
Adjustable Resistors (semi-
variable)

Ask your dealer

In Canada: Carter Radio Co., Ltd., Toronto

MEMBER
RMA

Carter Radio Co.
CHICAGO

A Plea for Fewer "Announcements"

WJZ, now the potential nucleus of a great national chain, has restored a practice which, to our mind, marks it as something in the way of a novice in the matter of presenting its program to the listener.

Instead of minimizing the work of its announcers, instead of making the announcer what he should be, a mere necessity, it attempts to glorify him and to make of him a positive luxury. Indeed, WJZ has originated the perfectly preposterous practice of having one announcer introduce the next, just as though announcers needed to be introduced. On one occasion the sanguine Mr. Cross announced the always audacious Mr. Sherris, and Mr. Sherris, graciously informing the audience that it was listening to WJZ, announced further that Mr. So-and-So would administrate next. And this all in the bare space of a minute or less!

Some day, perhaps, WJZ will learn that the great American radio audience, leaving out the frantic old maids, the high-school mush-note writers and the lady whose husband does not understand her, wants entertainment on the hoof and that it is not especially interested in anything that announcers have to offer aside from good articulation and perhaps just enough sense to know when the time has come to stop talking.

* *

A Unique Stunt

In their effort to transcend what have become the commonplaces of the air, a few of our broadcasters are resorting to devices that, appraised by their intrinsic value as producers of entertainment, make the commonplaces ripe with divertissement.

One of the most annoying of these new practices is that of asking the listeners to imagine they are this or that or that they are here or there.

If you are not asked to imagine that you are in an airplane or attending the coronation of Henry the VIII, you are called upon to listen to impossible stories that go to make up the continuity of the weekly program of some catsup manufacturer.

The exploits of Don Amaizo are cited as a good 12-pound example. In this program the millions of listeners in the second largest chain are presented with instalments of a romantic piece of claptrap that would not hold the attention of a nitwit. Not only the substance but the method of reading those episodes of the dashing Don Amazio remind us, for all the world, of the first time that we were exposed to the "Wizard of Oz" through the condescension of our school teacher in the third grade.

If our broadcasters must resort to the

imaginative assistance of the listeners, let them do it on rare occasions and let them do it more adroitly. Only once during the past six months have we managed to tap a program wherein we were asked to "imagine" and where, contrary to what we had been educated to expect, the "attention value" ran away up to 78 degrees. The pick-up came from the Long Island studios of the Famous Players-Lasky Corporation. The audience was supposed to be eavesdropping on the making of a new Richard Dix picture. While the whole thing was a gross piece of advertising, it was so cleverly done that had Mr. Lasky come to the microphone at the end of the performance and asked us to subscribe to his stock he would have found us in a mood to forgive him. The whole atmosphere of the great Long Island Studios was available.

And Graham MacNamee did an exceptional piece of descriptive announcing.

* *

The Stupefying Hand of the Censor

EITHER a certain station is becoming stupidly chauvinistic or it timidly blue pencils anything that might not conform with the $\frac{3}{8}$ -inch moral gauge of the Methodist fathers.

When a certain politician of New York attempted a sensible, accurate eulogy of George Washington from that studio, a puritan censorship descended upon him and prevented him from saying anything that would destroy in the smallest extent the national hokum that has been piled sky-high around our first President. Washington has long since ceased to be a man. He's a legend—an impossible, pure-minded simp who never took a drink, never told a lie and never did a thing that would make of him anything more virile or strong than a sex-complexed weakling.

Yet XYZ believes that this is the picture that its audience wants. In defense of its position it offers up the excuse that it has a diversified audience "whose prejudices it must respect." Naturally, it ignores those of its listeners who want to appraise Washington as a man and not as an angelic dunce. Imagine, if you will, such a man suffering the mental and physical torture of Valley Forge or any of the great campaigns engineered by the Commander-in-Chief of the American Forces! The whole thing becomes preposterous.

If this idiotic blue-penciling of history is the index of the rigorous puritan censorship that might be expected to follow it, we can rest assured that radio, one of the finest scientific flowers of the human intelligence, is doomed to the hands of the bigots. What radio has to fear most is coming to pass, and that is its use as a medium for propaganda.

RADIO

PARTS—ACCESSORIES AND SETS

Distributors Since 1919

WE MERCHANDISE THE FOLLOWING
LINES:

All-American Radio Corp.
Allen-Bradley Co.
American Hard Rubber Co.
Amsco Products, Inc.
Balkite (Fansteel Prod. Co., Inc.)
Barkeley Elec. Mfg. Co.
Benjamin Electric Co.
Birnbach Radio Co.
Brach Manufacturing Co., L. S.
Carter Radio Company.
Central Radio Lab. (Centralab).
Crosley Radio Corp.
Daven Radio Corporation.
Deutschmann Company, Tobe.
Dubilier Condenser Corp.
Durham Co.
Eby Manufacturing Co., H. H.
Electrad, Inc.
Fahnestock Electric Co.
Fleron & Son, Inc., M. M.
Frost, Inc., Herbert H.
Gilbert Company, A. C.
Herald Electric Company.
Interstate Electric Co.
Jefferson Electric Mfg. Co.
Jewell Elec. Instrument Co.
Karas Electric Company.
Majestic (Grigsby-Grunow-Hinds Co.)
Martin Copeland Company.
Mueller Electric Mfg. Co.
National Carbon Company, Inc.
National Company, Inc.
Perrine Quality Products Corp.
Radio Engr. Laboratories (REL).
Radio Corp. of America.
Radiall Company (Amperites).
Remler (Gray & Danielson Mfg. Co.)
Samson Electric Company.
Signal Electric Mfg. Co.
Silver-Marshall, Inc.
Steinite Laboratories.
Sterling Manufacturing Co.
Thordarson Elec. Mfg. Co.
Weston Electrical Instr. Corp.
Yaxley Manufacturing Company.
And many others.

DEALERS: Send for Our 1927-1928 Large
400 Page Profusely Illustrated Catalog

F. D. Pitts Company
219-A Columbus Avenue
BOSTON, MASS., U. S. A.

Complete A. C. Operation a Practical Reality

For the past several seasons the trend has been toward complete battery elimination. Many satisfactory plate supply units operating from A. C. have been developed, but filament operation from an A. C. source has presented more of a problem due to the larger currents required and increased expense in the rectifier and filter circuit.

The newly announced A. C. tubes offer an excellent solution to this problem.



TYPE 440-A

TYPE 440-A LOW VOLTAGE TRANSFORMER

The Type 440-A Transformer supplies voltages for all popular A. C. tubes and sufficient current for all ordinary receiver requirements. The following voltages and currents are available: Pri. 115 V (for lines 105-125) 60 cycles.

Sec. 2 volts.....	8 amperes
3.5 volts.....	2 amperes
5 volts.....	2.5 amperes
7.5 volts.....	2 amperes
Price.....	\$10.00

TYPE 438 SOCKET

The new type UY-227 or CX-327 detector tube has a separate heating element and requires a socket designed to take the new five prong base.

Type 438 Socket.....\$0.50

TYPE 439 RESISTANCE

The new A. C. tubes require a resistance with center-tap across the filament. The Type 439 resistance is adaptable to any type of socket.

Type 439 Center Tap Resistance.....\$0.60

TYPE 410 RHEOSTATS

The new A.C. tubes require low resistance rheostats capable of carrying ample current.

Resistance	Current	Price
.5 ohm	3.5 ampere	\$1.25
1.5 ohm	2.0 ampere	1.25



TYPE 438



TYPE 439



TYPE 410

Write for diagram showing how to adapt the filament wiring of the popular type of receiver to A. C. operation by use of General Radio parts especially designed for this purpose.

Your local dealer should have the necessary parts in stock.

If he is unable to supply you with all the items required, we shall be glad to send them to you prepaid upon receipt of list price.

GENERAL RADIO CO., Cambridge, Mass.

A New Broadcaster That Knows How

WHEN WABC picked up its traps and moved from the quiet of Richmond Hill, Long Island, to a spiffy new studio within the range of a taxi's klaxon from Carnegie Hall, we inclined toward the opinion that here was "just another broadcaster" coming to town, with nothing more laudable up its sleeve than the prospect of soliciting the attention of concert singers and temporarily embarrassed instrumentalists who had previously balked at a subway excursion to the fringes of Brooklyn.

Subsequent developments have forced us to revise this opinion, and we are now willing to admit that WABC is one of a precious few studios that form the nucleus of polite broadcasting in these United States.

And WABC has something more substantial in its fibre than a thin veneer of good manners. The majority of its program features are tasty and polite and the work of its announcers is always well within the confines of decency and propriety.

WABC, among other things, has been careful to recognize the limits of broadcasting, as the following statement from its publicity department shows:

"It is a well-known fact, which no doubt all broadcast listeners have discovered from their own experience, that large orchestras playing in large halls cannot be broadcast well at the present time. Problems of balance and volume, problems resulting from too much resonance, echoes and other extraneous noises make the broadcasting of large groups of instruments or singers exceedingly difficult. Results so far have been only mediocre, and it is therefore the belief of the Atlantic Broadcasting Corporation that for the present, at least until further progress is made in the art, that best results in the broadcasting of a large orchestra such as the New York Philharmonic can be secured by setting up ideal conditions in the studio and then utilizing a sufficient number of the master musicians of the orchestra to gain the necessary variety and color without bringing into the problem the so-far unsolved difficulties of excess volume. An excess volume is needless, causes blasting, and to the ear of the broadcast listener is far from pleasing."

Those who share the peculiar spell of the radio must agree that this is not the mere ravings of a publicity man; it is an engineering fact.

The feat of perfect transmission from such sources involves more than the planting of a microphone on a window-sill; and while we have listened to a few perfect examples of it, they come about as often as snow in June. If broadcasting ever descends to its soupiest reaches, it happens when an inexperienced broadcaster sallies forth to pick an outside event with a fifteen-dollar speech amplifier and a bundle of bell wire. Some of the best studios in the business have an extremely bad score,

Nassau Power Radio

The Ultimate
in radio
Reproduction

Your house current
operates it

NO } BATTERIES
CHARGERS
LIQUIDS
HUM



Distributors write for
territory

NASSAU RADIO Co.
60-A Court Street
Brooklyn, New York

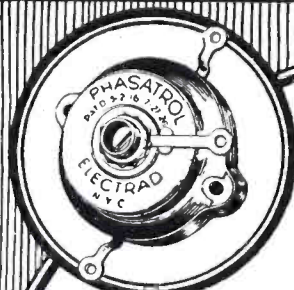

Licensed by Rider
Radio Corporation.
Pats. Pend. Pat-
ented 5-2-'16. Pat-
ented 7-27-'26.

To Stop R. F. Oscillations: "Phasatrols"

A true balancing device for
Radio frequency amplifiers

Radio fans everywhere are preparing for perfect Summer reception. They are equipping their receivers with Phasatrols, the marvelous new Electrad invention which puts an end to squeals caused by radio frequency oscillation.

Booklet showing how to install Phasatrol free upon request. Send for your favorite circuit with Phasatrols.

Price - - \$2.75

At your dealers, or write
Dept. 58, 175 Varick Street
New York, N. Y.

ELECTRAD

and yet, in the face of it, the thirty-five-dollar-a-week engineers of the washing-machine stations will tackle an outside job at the drop of the hat. All of which goes to show that broadcasting is still, except in precious few cases, in the hands of irresponsible youngsters.

* *

Good Manners in the Studio

SOME of our broadcasters are just beginning to realize that it is the little details just as much as the major gestures that go to make up the program that is in good taste.

Just as a miscue on the part of an actor or actress may destroy a dramatic performance, so might a sneeze or a carelessly spoken word in the studio tend to destroy a first-rate radio recital. It is indeed reassuring to find many of our Grade A studios insisting more and more upon proper conduct and the avoidance of those annoying little distractions that so quickly mar the texture of a program.

Mr. Frank McEnivy has sent on to us the code of studio conduct for performers as it is posted in KOA. That it has been thoughtfully worked out is evident:

Programs start on the minute.

Coughing, sneezing, clearing the throat, scraping the feet and other disturbances in the studios are annoying to listeners. The microphone is so sensitive that the slightest commotion may be transmitted to the unseen audience. Therefore, when the announcer calls, "Quiet, everybody!" kindly comply.

Do not begin singing or playing until the announcer gives the signal.

Unless you have memorized your music, be prepared with an extra copy, as you do not stand near the piano when singing.

Do not be perturbed if the announcer motions for you to move nearer the microphone or withdraw while singing.

Very loud singing or playing is objectionable, as it detracts from successful broadcasting, often producing a shattered effect. The best choral effects are obtained when each person sings in a subdued manner.

To pianists: Too much loud pedal spoils the rendition. The top of the piano should be left down, as the best broadcasting is accomplished when the instrument is closed.

Although KOA has been alert in this matter of "studio manners," it has overlooked many offensive things that happen daily in some of our best regulated studio families. How annoying it is to have a performer carry on random conversation with the announcer within range of the microphone and how utterly maddening it is to have an exceedingly presumptuous performer address the listener. Not that we are a snooty listener or that we are so strait-laced that we cannot tolerate informality, but we do object to informality on the air when we know there is nothing back of it but a desire on the part of the performer to "crash" his audience.

The VIII Commandments

—for hot weather radio reception

I. Don't try for distance records in midsummer; tune in on nearby stations if you want enjoyable reception.

II. Don't expect perfect reception every night; summer is the time of thunderstorms.

III. Use a longer antenna, more tubes, higher plate voltage, a more sensitive antenna and tune more carefully if you want louder signals.

IV. Don't force your set to give overloud signals; a moderate amount of volume will cause less distortion and is more desirable in every way.

V. Use a smaller antenna or a wave-trap to get rid of a nearby station that drowns out all other reception.

VI. Tune in on the high-power stations for the best summertime reception.

VII. Tune your set carefully; many fans complain that their set is worthless when their operation is actually at fault.

VIII. Read POPULAR RADIO; it will help you to operate your set to the best advantage and keep you up to date in radio.

* *

One of a Listener's Privileges

RECENTLY an irate *pater-familias*, accompanied by his lawyer, invaded the sanctum of the Radio Supervisor of the Second District, to demand that one of the well-known New York stations be shut off the air because it had allowed a song to be rendered from its studio that was, in his opinion at least, unsuited for youthful ears.

"If you didn't want to have your children listen to it, why didn't you tune it out?" inquired the Supervisor.

"The kids wouldn't let me," replied the nettled parent.

"Well," responded the Supervisor, "I don't see how you can expect the Department of Commerce to tune it off in your home. Besides, the song you refer to has been sung on every vaudeville and music hall stage in all of the big cities and at private concerts in residences, many times. We haven't the power to act as censors of the air to the extent of shutting off anyone who happens to offend you. But that is your privilege. Don't hesitate to exercise it."

—RADIO GUIDE

* *

A Useless Loudspeaker

MR. NEWLYRICH (*proudly exhibiting latest purchase*): My dear, here's a little present for you—a French loudspeaker; isn't it a beauty?

MRS. NEWLYRICH: Whatever made you go and buy that thing, James, when you know that I can't understand a word of French?

—Wireless Magazine



Acme ANTENNA

—with
**Seven Strands
of enameled
Copper Wire**

Best outdoor antenna you can buy. Seven strands of enameled copper wire. Presents maximum surface for reception, resists corrosion; this greatly improves the signal. Outside diameters equal to sizes 14 and 16. (We also offer solid and stranded bare, and stranded tinned antenna.)

Loop Antenna Wire

Sixty strands of No. 38 bare copper wire for flexibility, 5 strands of No. 36 phosphor bronze to prevent stretching. Green or brown silk covering; best loop wire possible to make.

Battery Cable

A rayon-covered cable of 5, 6, 7, 8 or 9 vari-colored Flexible Celatsite wires for connecting batteries or eliminator to set. Plainly tabbed; easy to connect. Gives set an orderly appearance.



Acme Celatsite Wire

Tinned copper bus bar hook-up wire with non-inflammable Celatsite insulation, in 9 beautiful colors. Strips easily, solders readily, won't crack at bends. Sizes 14, 16, 18, 19; 30 inch lengths.



Flexible Celatsite for sub-panel wiring

A cable of fine, tinned copper wires with non-inflammable Celatsite insulation. Ideal for sub-panel or point-to-point wiring. Strips easily, solders readily. Nine beautiful colors; sold only in 25 ft. coils, in cartons colored to match contents.



Spaghetti Tubing

Oil, moisture, acid proof; highly dielectric — used by leading engineers. Nine colors, for wire sizes 12 to 18; 30 inch lengths. (We also make tinned bus bar, round and square, in 2 and 2½ ft. lengths.)

Send for folder
THE ACME WIRE CO., Dept. P
New Haven, Conn.



ACME WIRE

MAKES BETTER RADIO

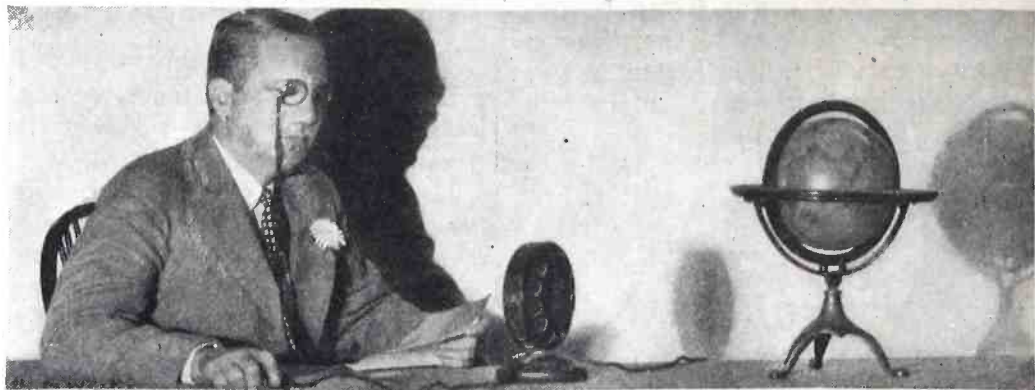

BROADCASTS

An Amateur Message That Met Itself Coming Back

AMATEUR radio has accomplished the hitherto impossible; it has actually performed a stunt in "less than no time." While operating an amateur receiver and transmitter one night, E. Granbacks, an operator of station 6CTX of Richmond, California, got in touch with an amateur station in Belgium with the call eb4WW. The Belgian gave Granbacks a message going to Hawaii, the time in Belgium being 4.45 A. M. Shortly after this Granbacks succeeded in hooking up with the desired amateur station in Hawaii, whose call was oh6AXW, and gave him the message. This occurred at 9.30 P. M., of the day before, in Hawaiian time. Thus a message actually traveled 7,500 miles and yet arrived at its destination seven and a half hours before it was filed in Belgium!

* *

The "Radio Rights" of Poets

POETS are beginning to realize that radio is opening up new avenues of revenue. In Sweden a bill has been recently introduced that provides the same protection to poets whose works are read in public—including radio broadcasting—that is accorded to dramatists, composers and others. The new bill aims to establish a system of royalty payments to poets whose work is read before the microphone.

* *

A Chance to Learn Radio Free

AN opportunity to learn about radio is one of the advantages offered to amateurs this summer by the U. S. Army. The chance to qualify as commercial operators, licensed by the Department of Commerce, is one of the practical features of the course, which will be conducted in connection with this year's Citizens' Military Training Camp at Fort Monmouth, N. J., a Signal Corps post. In addition to the regular Signal Corps course of instruction in the use of military radio, a special evening course has been authorized by General McRae for the Fort Monmouth camp.

This course will offer instruction in advanced methods of commercial radio practice and at the conclusion of the camp those students who have qualified will be eligible to take the Department of Commerce examinations.

At the evening courses the students will be instructed by army radio experts, and arrangements have been made for the youths to conduct experimental work in the Signal Corps laboratories at the post.

* *

A "Musical Counsel" Enters the Realm of Radio

IN view of the emphasis which POPULAR RADIO has always laid upon the use of radio for instruction purposes in our schools and colleges, particular interest is attached to the recent announcement that Walter Damrosch, the eminent musician who recently retired as conductor of the New York Symphony Orchestra, has accepted the post of "Musical Counsel" for the National Broadcasting Company. In this newly created position Mr. Damrosch will officiate and advise in all matters relating to the higher musical activities and possibilities of the radio; he already has under way a gigantic plan for promoting fine music through the medium of radio broadcasting, a plan that provides for a series of concerts supplemented by talks which will reach the majority of the 25,000,000 students in American schools and colleges.

* *

A New Interference Rule

It has been approximated roughly that the carrier wave of a 100-watt station may create interference over a distance of 100 miles, a 500-watt station over 500 miles, a 1,000-watt station over 1,000 miles, and a 5,000-watt station over 5,000 miles. Therefore, the deduction is that 5,000-watt stations should not be assigned to the same wavelength excepting when located on the Atlantic and Pacific coasts of the country. By the same process of reasoning, every station above 5,000 watts should be assigned an exclusive wavelength.

Ask us for a list of the latest models of receivers for which Hammarlund Products are officially specified

For Better Radio
Hammarlund
PRECISION
PRODUCTS

Write for illustrated literature describing the world-famous Hammarlund Roberts "Hi-Q" Receiver.

28 Leading Radio Engineers Specify
Hammarlund Products In Their Newest Receivers
HAMMARLUND MANUFACTURING COMPANY
424-438 W. 33rd Street, New York

Televocal QUALITY TUBES

"Televocal" Typifies Highest Quality in Tubes — Manufactured by Technical Experts

IN ALL TYPES

If Televocal Tubes do not maintain the highest characteristics and specifications, after exhaustive and scientific laboratory tests, they do not leave our factory.

Dealers, Order Through Your Jobbers.

With our factory constantly operating, we can assure prompt deliveries right through the season.



Televocal Corp'n
Televocal Bldg. 588 12th Street,
WEST NEW YORK, N.J.



Trade Mark Reg'd U. S. Pat. Office

B - BLOCK

No. 660



Specified for the SILVER-MARSHALL UNIPAC

In value—in performance this new TOBE B BLOCK, 660, lives up to the reputation to which its name entitles it. Chosen by McMurdo Silver for his new UNIPAC, it plays its part in the fine results obtained from this carefully engineered power amplifier.

Price, \$12.00

TOBE Condensers and B Blocks are found in all the leading radio units. Send for Pamphlet L-8.

Tobe Deutschmann Co.

Engineers and Manufacturers of
Technical Apparatus
CAMBRIDGE, MASS.

MAGNAPHON

Electrical Record Reproducer



Price \$12.50

Will make the old type phonograph or any of the small portables perform like the new Electrical Reproducing Machines costing from \$350 to \$1,000.

When static blankets the air—

When listening to a Radio Program is torture—

Buy a MAGNAPHON, place it on your old type phonograph or portable machine and broadcast your own music through the Radio Set.

The richness and tone range of the reproduction will prove really amazing.

The deep bass notes, the drum beats, the very high notes, will all issue forth with a life-like mellowness and brilliance.

EASILY INSTALLED

No adjustments—No removal of old sound box or fishing for correct angle is necessary. Just place the MAGNAPHON alongside the tone arm and insert the plug into the detector socket.

FROM YOUR DEALER OR US

If your dealer cannot supply you and will not get it for you, we will ship you direct on receipt of money order for \$12.50.

TECTRON RADIO CORPORATION
1270 Broadway New York

Australia Listens In on Denver

BROADCASTING stations in many cities of Australia and New Zealand recently declared a local "silent night" while receiving sets tuned in on an all-Australian program broadcast from station KOA, in Denver, Col. The program had previously been arranged by short wave communication between Sidney and Denver, and included such novelties as ballads of the Bushmen and New Zealand jazz. A seven hours' difference in time made it necessary for Denver to start broadcasting at 12.55 A. M. in order that Australia might listen in before dinner.

* *

A "National Radio Audition"

A NATIONAL radio audition for the purpose of uncovering the best undiscovered voices in America is announced by the Atwater Kent Foundation. According to the present plan, every community in the country is to be given an opportunity to elect by popular vote the best voices among men and women; these entries will compete in state and sectional auditions to be broadcast by radio. After the weeding out in the sectional audition, five men and five women will be brought to New York for the finals. Substantial prizes are to be offered for both the state and national winners, and it is hoped that the experiment will uncover a great deal of real talent that would not have been discovered otherwise.

* *

Radio Helps the Flood Victims

INSTALLATION of a radio set at base headquarters of the American Red Cross in Memphis, Tenn., was one of the first moves made by the relief forces in caring for 350,000 refugees from the Mississippi flood area; this set hooked up with thirty stations in concentration camps throughout the seven flooded states and on boats operating for the Red Cross. The flood covered the largest area of any disaster in Red Cross history, and inasmuch as the usual means of communication had been disrupted by the rampant waters, radio played an heroic rôle. The station at Memphis was installed by the Navy Department, which dispatched an officer with ten sets to that city early in May; other important emergency stations were located at Helena, Pine Bluff and Eudora, Ark., and Vicksburg, Miss. The radio hook-up was used to direct relief boats, to maintain communication between relief centers and to order supplies in emergencies. In some instances workers in camps cut off from supplies by the water actually "radioed" grocery lists to headquarters, greatly speeding up the process of procuring supplies.



Approved Power Supply Parts

An enthusiastic market demands sets powered from the light socket. Dongan, producing parts exclusively, offers to the set manufacturer power supply transformers and chokes designed for all electrically operated sets. Dongan Power Supply Parts represent the latest development in design and refinement in construction.

Receiver manufacturers can rely on Dongan as a source of supply on Power Supply Parts for all approved types, mounted or unmounted. Send your specifications to our engineering department. Samples available now.

Power Supply Transformers



used with 350-400 m.a. tubes. This transformer is constructed in a handsome, durable metal case.

\$15 List

Power Supply Chokes

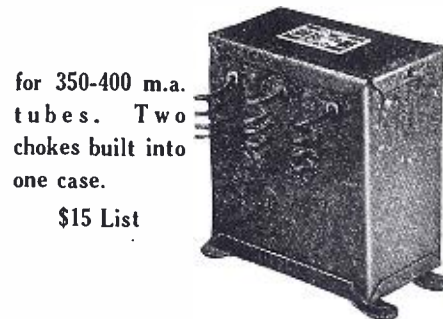

for 350-400 m.a. tubes. Two chokes built into one case.

\$15 List

FANS—Rebuild that old set. In the long run it will be an economy, and you'll have assurance of full-powered reception all the time—at a very low cost.

If your dealer cannot supply you, immediate delivery will be made upon receipt of check or money order. Specify type of rectifier you intend to use.

DONGAN ELECTRIC MFG. CO.
2991-3001 Franklin St., Detroit, Michigan

TRANSFORMERS of MERIT for FIFTEEN YEARS

First in the Field Specializing in Cockaday Kits

S. HAMMER RADIO CO.

303 ATKINS AVE., BROOKLYN, N. Y.

Build your BALSA-WOOD Speaker from the DURA-BALSA KIT

Complete Parts with Instructions
Price with Unit **\$14⁰⁰** | Price without Unit **\$8⁰⁰**

NEW AMERTRAN POWER PACK

NEW A B C POWER PACK

NEW BATTERYLESS A C TUBE RECEIVER

COCKADAY L C-27 BROADCAST RECEIVER

The Above Kits Can Also Be Obtained Completely Wired to Specifications.

Write for our interesting special circular which we have prepared on the LC-27 Receiver and above Kits.

DEALERS: WRITE FOR SPECIAL DISCOUNTS

The Famous Aero Short Wave Kit Now Improved!

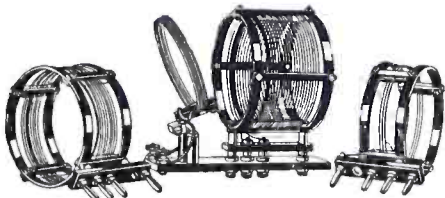

AERO LOW WAVE TUNER KIT

Code No. L.W.T. 125.....Price \$12.50

Always the prime favorite of all experts and amateurs insistent upon the very best in short wave of reception, the AERO Low Wave Tuner Kit for this season has been made even better than ever!

The Kit illustrated above is completely interchangeable. It includes 3 coils and base mounting, covering U. S. bands 20, 40 and 80 meters. You can increase or decrease the range of this short wave by securing the AERO Interchangeable Coils described below. All coils fit the same base and use the same condensers and the complete equipment covers a gapless range of 13 to 725 meters.

New AERO Interchangeable Coils

INT. No. 0.....Price \$4.00
Range 13 to 29.4 meters.

INT. No. 4.....Price \$4.00
Range 125 to 250 meters.

INT. No. 5.....Price \$4.00
Normal range 235 to 550 meters. However, by using .0001 Sangamo fixed across the rotor and stator of the .00014 variable condenser, the maximum wave band of this coil is increased to 725 meters.

Plan for D. X. Records Now!

Order any of these coils direct from us if your dealer doesn't happen to have them. Be sure to specify code numbers when ordering.

AERO PRODUCTS, INC.
Dept. 104 1772 Wilson Ave.
CHICAGO, ILLINOIS

Mormon Pictures Jesus as a User of Radio

THAT radio was understood and used by Jesus Christ and his missionaries, "as well as by Lucifer in his efforts to thwart the work of the Lord," is the extraordinary view expressed by Elder B. F. Grant, reported as a spokesman for the Mormon Church, in a recent talk broadcast from station KSL. The transmission of the human voice across the Atlantic Ocean daily by radio telephony is accomplished by the ingenuity of man, but "the science originated with God," according to the elder's statement. "The power to transmit speech without wires has always been known to God," Elder Grant added.

* *

A Chess Game by Radio

WHAT is thought to be the first chess game ever played by radio in the Dominion of Canada was recently staged between the chess club of Dartmouth, Nova Scotia, and the club of St. Johns, Newfoundland, through the cooperation of amateur station IDD, operated by Major W. C. Borrett, of the former city, and station 8AR, owned and operated by Loyal Reid, of St. Johns.

The game was reported to be a success, and it is expected that the two amateur stations will be called upon to arrange another match.

* *

Holland Is Ready to Ring Us Up

THE Dutch telephone service is said to be getting ready to start trials of radio telephone communication with the United States by way of the New York-London circuit. The connection will be effected by land wires to Amsterdam, sea cable from Amsterdam to London, and the present radio telephone system from thence across the Atlantic.

* *

Plans for an Endowed "University of the Air"

WHEN Merlin H. Aylesworth, President of the National Broadcasting Company, recently told the Boston Chamber of Commerce that "broadcasting has thrown the door wide open to those who would raise the level of national culture by greater educational opportunities and to the millions who yearn for some of the advantages of higher education," he voiced an opinion that has been reiterated in POPULAR RADIO on many occasions during the past five years. That a practical plan will develop from this dream, is indicated by the announcement that "the task is now before the leading educators of our country to formulate a program of general education that would be in effect a national 'university of the air.'"

YOUR RADIO PROBLEMS SOLVED

POPULAR RADIO maintains for the benefit of its readers a Technical Service Bureau and Laboratory, which will, without charge, answer by personal letter any question or problem submitted by a subscriber.

In writing please confine your questions to one general subject, writing on one side of the paper only, and enclose a self-addressed and stamped envelope.

It is possible that your individual problem has been covered in an issue of POPULAR RADIO, and so as an aid to you we endeavor to keep a supply of back numbers in stock. The condensed index below gives a few of the subjects that have appeared recently; look this list over and if the information you want is covered, we will be pleased to supply back numbers at 35c. a copy.

May, 1926

- How to Draw Up Your Own "Tuning Graphs."
- How to Build the Improved Raytheon Power-pack.
- How to Build an Antenna Mast for \$15.00.
- Fifteen Ways to Reduce Static.
- Do Your Coils Broadcast?

June, 1926

- How to Build the New Home Receiver.
- How to Put Up a Good Outdoor Antenna.
- How to Get the Most Out of Your Ready-made Receiver.
- Audio-frequency Amplification. How to Get it Without Distortion.
- Four New Combinations of Units for Assembling the Raytheon Power-pack.

July, 1926

- How to Get the Best Reception in Summer.
- The Best Crystal Set for \$13.00.
- How to Build the Newest Portable "Town and Country" Receiver.
- Four New Combinations of Units for Assembling the Raytheon Power-pack.
- How to Get the Most Out of Your S-C Receiver.

August, 1926

- A New Method of Using Harmonics for Determining Frequencies.
- POPULAR RADIO Circuits.
- How to Build the Improved Browning-Drake Receiver.
- How to Pick Out a Loudspeaker.
- How to Get the Most Out of Your "Town and Country" Receiver.
- Three Vacuum Tubes in One.

September, 1926

- Foretelling Radio Reception from the Weather Map.
- How to Build an Impedance-coupled Amplifier.
- A Radiant Crystal Pilot.
- POPULAR RADIO Circuits.
- How to Simplify Your Set with Automatic Filament Controls.
- Inside Information on New Radio Receivers.
- How to Wire Your House for Radio.

October, 1926

- How to Build the New LC-27 Receiver.
- The Radio Road Hog.
- POPULAR RADIO Circuits.
- Sets That Earn Incomes.
- Inside Information on New Radio Receivers.
- Why Signals Fade.

November, 1926

- How to Build the LC-Senior Power-pack.
- Waves and Wavelengths.
- POPULAR RADIO Circuits.
- How to Select Your Radio Parts.
- How to Patent Your Radio Inventions.
- How to Solder.

December, 1926

- Uncle Sam's New Short-Wave Net.
- How Circuit Resistance Affects Selectivity.
- POPULAR RADIO Circuits.
- How to Build the LC-Intermediate Power-pack.
- Inside Information on New Radio Receivers.

January, 1927

- How to Build the New KH-27 Receiver.
- To Start and Stop Your Set Automatically.
- POPULAR RADIO Circuits.
- The Quack Doctors of Radio.
- How to Build the LC-Junior Power-pack.

February, 1927

- The Coming of the "RADIO UNIVERSITY."
- How to Get Quality Amplification.
- How to Build and Use a Portable Test-Board.
- How to Assemble the All-Amaz Senior Three-tube Reflex Receiver.
- What's New in Radio.

March, 1927

- How to Build the Univolve Receiver.
- POPULAR RADIO Circuits.
- How to Increase the Range of Ammeters and Voltmeters.
- How to Build Your Own 36-Inch Cone Loudspeaker.
- What's New in Radio.

POPULAR RADIO

Dept. 48

627 W. 43d St., New York

SET BUILDERS

Write us before you build

BEFORE you build, get our prices on the parts you are planning to use.

We handle only brand new apparatus—standard makes that are fully guaranteed. **QUANTITY** sale of **QUALITY** parts explains our low prices. Compare with others and see why thousands of fans look to us as radio headquarters.

All the latest kits, accessories and parts—a million dollar radio stock to choose from.

CHICAGO SALVAGE STOCK STORE

Dept. PR 509 S. STATE STREET
CHICAGO, ILL.

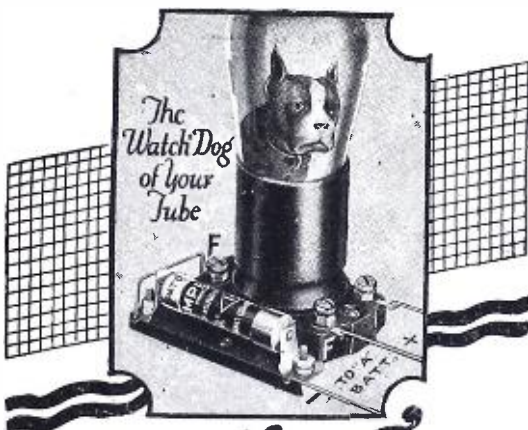

Getting FULL Tube Value

PERFORMANCE and life is what you pay for in a tube. Amperite alone insures getting both. Controls filament current automatically. Simplifies wiring. Eliminates hand rheostats. Identify by the name. Accept nothing else.

FREE—The Radial Book. Gives season's most popular Hook-Ups, and invaluable Construction Data. Send for it today to Dept. PR-8.

Radial Co., 50 Franklin St., New York



Price \$1.10
mounted (U.S.A.)

Sold Everywhere

AMPERITE

REG. U.S. PAT. OFF.
The "SELF-ADJUSTING" Rheostat

Transoceanic Calls Heard

POPULAR RADIO has just received a card from W. B. Jennings (NU-10N), 26 Tapley Street, Lynn, Mass, thanking us for forwarding to him some calls heard (QSL) cards from station EF-8EZ in France.

POPULAR RADIO is doing this same service for all other American amateurs. Arrangements have also been completed for forwarding American QSL cards to their proper destinations in foreign countries. This delivery is made through local agents in those countries who have or can obtain the present address of foreign amateurs. American amateurs are invited to send their cards to foreign amateurs through this office, which will not only assure safe delivery through the special agencies which are thus provided, but which will publish a monthly list in a "Transoceanic Calls Heard" department.

Address your cards to the foreign amateurs by call numbers and enclose them in envelope to—

The Calls Heard Editor,
POPULAR RADIO,
627 West 43rd Street, New York.

THE following stations were received and logged at the amateur station of A. Cremailh (EF-8JZ), at 15, Rue de Vitre, Rennes, France, using a receiver with detector and one stage of low frequency:

- NU-4RY—Feb. 20, 1927; signal strength R7; good rectified AC note on 37 meters; no fading;
- NU-1KF—Feb. 20, 1927; signal strength R6; very fine DC note on 37 meters; no fading;
- NU-3GW—March 6, 1927; signal strength R7-8; fine note on 36 meters; no fading;
- NU-8DEI—March 6, 1927; signal strength R7; rectified AC note on 37 meters; no fading;
- NU-1AAO—March 6, 1927; signal strength R9; rectified AC note on 36 meters; no fading;
- NU-1MV—March 6, 1927; signal strength R6-7; rectified AC note on 37 meters; no fading;
- NU-2CDR—Feb. 20, 1927; signal strength R6; good rectified AC note on 36 meters; no fading;
- NU-3BTQ—March 6, 1927; signal strength R6-7; good rectified AC note on 37 meters; no fading;
- NU-4XE—March 6, 1927; signal strength R9; splendid DC note on 39 meters;
- NU-2OR—March 6, 1927; signal strength R6; DC note on 40 meters; no fading;
- NU-2RS—March 6, 1927; signal strength R6; DC note on 40 meters; no fading;
- NU-1ID—March 6, 1927; signal strength R7-8; good DC note on 36 meters;
- NU-3BUV—March 6, 1927; signal strength R6; 37 meters;
- NU-1BKP—Feb. 27, 1927; signal strength R6-7; rectified AC note on 36 meters;
- NU-2BXU—March 8, 1927; signal strength R6; 41 meters; no fading;
- NU-2AVW—Feb. 27, 1927; signal strength R6; good rectified AC note on 37 meters; no fading;
- NU-1AIR—Feb. 27, 1927; signal strength R7; AC note on 36 meters; no fading;
- NU-8AVD—Feb. 27, 1927; signal strength R8; very good rectified AC note on 36 meters; no fading;
- NU-1AJX—Feb. 27, 1927; signal strength R7-8; good rectified AC note on 37 meters;
- NU-3HG—March 3, 1927; signal strength R6; good rectified AC note on 37 meters;
- NU-1RD—Feb. 13, 1927; signal strength R6-7; rectified AC note on 37 meters;
- NU-8BRC—Feb. 13, 1927; signal strength

ASK... ANY... RADIO... ENGINEER



The "Mountie" isn't lonely any more

WHEN the supply ship steams south from the last outpost of civilization in September, not to return until the following July, loneliness will never again beset the lives of the Royal Canadian Mounted Police who patrol that vast, wild area.

Radio is now brightening the long winter nights with music, special programs, messages and greetings from their "home folks."

And in the receiving sets of the "Mounties" is the best equipment obtainable. The batteries they use *must* be dependable. They *must* serve until new supplies are brought in a year later.

Ask any Radio Engineer

BURGESS BATTERY COMPANY
GENERAL SALES OFFICE: CHICAGO

Canadian Factories and Offices:
Niagara Falls and Winnipeg



BURGESS RADIO BATTERIES

NATIONAL TONE FILTER



A Power-Tube Output Unit—as recommended for use by R.C.A. and other makers of power tubes and by loud-speaker manufacturers universally. Contains choke and large capacity condenser. Instantly connected to any Radio set without tools, 'phone cord being provided with each Tone Filter for this purpose. Protects speaker and improves tone.

Price complete with 5-foot cord \$7.00
Price without cord \$6.50

A NEW NATIONAL B-POWER SUPPLY

A newly designed B-Eliminator, with special features not hitherto offered to the public, will be announced in the near future. The unit is small, light, simple and easy to set up. The price will be attractive.

The new NATIONAL B-POWER SUPPLY is manufactured under license association with Radio Corp. of America, General Electric Co., Westinghouse Electric & Manufacturing Co. and the American Telephone & Telegraph Co.

BE SURE YOU GET THE GENUINE
NATIONAL
RADIO PRODUCTS
NATIONAL CO., INC., W.A. READY, Pres.
MALDEN MASS.

- R7-8; very good DC note on 37 meters;
- NU-20X—Feb. 13, 1927; signal strength R6; rectified AC note on 37 meters;
- NU-2EAS—Feb. 13, 1927; signal strength R6; AC note on 37 meters;
- NU-2NZ—Feb. 13, 1927; signal strength R7-8; rectified AC note on 38 meters.
- NU-9CFM—Feb. 13, 1927; signal strength R5-6; fine DC note on 36 meters;
- NU-1AXA—Feb. 13, 1927; signal strength R7; very good rectified AC note;
- NU-2VK—Feb. 13, 1927; signal strength R6-7; rectified AC note on 37 meters;
- NU-7AA—Feb. 13, 1927; signal strength R6; very good rectified AC note;
- NU-3QW—Feb. 13, 1927; signal strength R6; rectified AC note on 36 meters; no fading;
- NU-2CYH—Feb. 13, 1927; signal strength R6-7; good DC note on 37 meters;
- NU-4OB—Feb. 19, 1927; signal strength R6; AC note on 37 meters;
- NU-3AUV—Feb. 19, 1927; signal strength R7; excellent DC note on 37 meters;
- NU-4AK—Feb. 19, 1927; signal strength R7; rectified AC note on 37 meters;
- NU-1BDH—Feb. 20, 1927; signal strength R4; rectified AC note on 43 meters;
- NU-1BFX—Feb. 19, 1927; signal strength R7; rectified AC note on 37 meters;
- NU-2CCD—Feb. 20, 1927; signal strength R6; rectified AC note on 40 meters;
- NU-11N—Feb. 20, 1927; signal strength R6-7; good DC note on 37 meters;
- NU-6TK—Feb. 20, 1927; signal strength R7; rectified AC note on 36 meters;
- NU-2TP—Feb. 20, 1927; signal strength R6-7; rectified AC note on 36 meters;
- NU-3AFW—Feb. 20, 1927; signal strength R7; rectified AC note on 37 meters;
- NU-1LC—Feb. 20, 1927; signal strength R7; rectified AC note on 37 meters;
- NU-3TI—Feb. 20, 1927; signal strength R6; rectified AC note on 37 meters;
- NU-8CYI—Feb. 20, 1927; signal strength R6; rectified AC note on 36 meters.

THE following stations were received and logged at the amateur station of R. Simon (EF-8IX), at 44, Rue Eugene Pelleton, Choisy-le-Roi (Seine), France, using a Schnell receiver with a detector and one stage of low frequency:

- NU-2AOL—March 23, 1927; signal strength R6; rectified AC note on 20 meters; some fading;
- NU-8NT—March 25, 1927; signal strength R5; DC note on 19.75 meters; slight fading;
- NU-1ABZ—March 23, 1927; signal strength R4-7; rectified AC note on 21 meters; some fading;
- NU-1RY—March 23, 1927; signal strength R7; DC note on 21 meters; slight fading;
- NU-1ALR—March 5, 1927; signal strength R4; rectified AC note on 37 meters;
- NU-3AUV—February 23, 1927; signal strength R7; fine DC note on 38.8 meters; no fading;
- NU-4OB—March 5, 1927; signal strength R5; rectified AC note on 38 meters; some interference;
- NU-8BAJ—March 13, 1927; signal strength R3-2; DC note on 39 meters;
- NU-5JF—Feb. 18, 1927; signal strength R4; rectified AC note on 37 meters;
- NU-8ACZ—March 14, 1927; signal strength R6; rectified AC note on 37 meters; some interference;
- NU-3SJ—Dec. 1926; signal strength R3; rectified AC note on 40.5 meters; much interference; bad fading;
- NU-1CJC—Feb. 6, 1927; signal strength R7-9; fine rectified AC note on 37.6 meters; bad interference;
- NU-8DEI—March 6, 1927; signal strength R7; DC note on 39 meters; no fading.

FREE

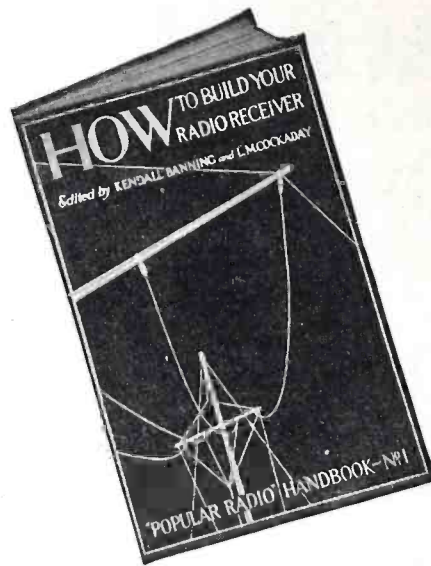

WITH POPULAR RADIO

Aside from the feature of economy, there is the thrill and satisfaction that comes from building your own receiving set.

Thousands of sets have never been constructed because of the atmosphere of mystery that has enveloped the whole subject of radio. Kendall Banning, Editor, and Laurence M. Cockaday, Technical Editor of POPULAR RADIO, through their close contact with the great radio public, sensed this and compiled a book that will convince the veriest beginner that technical training is not essential. If you have a little time to devote to a most fascinating pastime, send for a copy of "How to Build Your Radio Receiver."

Free Advisory Service

POPULAR RADIO is full of helpful suggestions as well as instructive and entertaining articles on radio and allied scientific phenomena. This information is supplemented by an advisory service that is free to all subscribers. Any problem you encounter that is not answered in the book or magazine will be answered by personal letter if you will submit it to the Technical Service Bureau.

A Valuable Combination

For the next thirty days we will give you a copy of "How to Build Your Radio Receiver," FREE and enroll you for all privileges of the Technical Service Bureau at no further expense, on receipt of your remittance of \$3.00 in payment for a 12 months' subscription for POPULAR RADIO. (As an alternative offer, if you wish the combination with POPULAR RADIO for 7 months only—send but \$2.00). In any event, you run absolutely no risk, as we will refund in full if you are not more than satisfied with your purchase.

CONTENTS

In "How to Build Your Radio Receiver" you will find complete constructional diagrams, specifications, photographs and instructions for building the following sets. Each has been selected as representative of its circuit because in laboratory tests it proved the best for distance, selectivity, tone volume, simplicity of construction, ease in tuning, reliability and all-around satisfaction.

- A \$5 CRYSTAL SET
- THE HAYNES SINGLE TUBE RECEIVER
- A TWO-STAGE AUDIO-FREQUENCY AMPLIFIER
- THE COCKADAY 4-CIRCUIT TUNER
- A 5-TUBE TUNED RADIO-FREQUENCY RECEIVER
- THE "IMPROVED" COCKADAY 4-CIRCUIT TUNER
- THE REGENERATIVE SUPER-HETERODYNE RECEIVER

POPULAR RADIO
627 West 43d Street, N. Y. C.

Offer expires August 30, 1927

POPULAR RADIO, Dept. 45A,
627 West 43d St., New York City

Enclosed remittance of \$3.00 is payment in full for a 12 months' subscription for POPULAR RADIO and copy of "How to Build Your Radio Receiver" FREE.

Name.....
Address.....
City..... State.....

Check here and remit \$2.00 if you prefer POPULAR RADIO for 7 months only in combination with "How to Build Your Radio Receiver."

THE following stations were received and logged at the amateur station of J. M. Sacazes (F-8SM) at 18 Bard Natabair, Toulouse, France, using a low-loss tuner with one stage of low-frequency amplification:

- U-2TP—Feb. 22, 1927; signal strength R7; no static; slight fading; bad interference;
- U-1BHM—Feb. 22, 1927; signal strength R5; no interference; no fading;
- NU-1BF—Feb. 27, 1927; signal strength R5; no atmospherics; bad interference; no fading;
- NU-2ARY—March 1, 1927; signal strength R6; no static or interference; no fading;
- NU-1ACH—March 1, 1927; signal strength R7; no static or interference; no fading;
- NU-2BXU—Feb. 26, 1927; signal strength R6; no interference or static; no fading;
- NU-3AFW—March 4, 1927; signal strength R7; no interference or static; no fading;
- NU-3CKJ—March 12, 1927; signal strength R6; no interference or static; no fading;
- NU-3AHL—Feb. 11, 1927; signal strength R8; good note; no fading;
- NU-2APD—Feb. 12, 1927; signal strength R7-8; unsteady note; slight interference; no static;
- NU-2CZR—March 12, 1927; signal strength R7; no interference; no fading;
- NU-1AEN—March 3, 1927; signal strength R6-7; no static; bad interference;
- NU-1AZA—March 6, 1927; signal strength R7; no interference or static; no fading;
- NU-8AX—March 6, 1927; signal strength R6-7; bad atmospherics; no interference; no fading;
- NU-111—April 4, 1927; signal strength R8; no atmospherics; no fading.

THE following stations were received and logged at the amateur station of L. Berger (F-8OEO) at Villa Babiole, Cambo, Basses Pyrenees, France, with a cage antenna and counterpoise and one stage of low-frequency amplification:

- NU-3GX—March 23, 1927; signal strength R3-4; rectified AC note on 41 meters; bad static; slight fading;
- NU-2CUQ—March 24, 1927; signal strength R6-7; good DC note on 37 meters; some interference; no fading;
- NU-4OY—March 31, 1927; signal strength R6-7; rectified AC note on 37 meters; no interference; bad static;
- NU-1CPB—March 31, 1927; signal strength R7-8; rectified AC note on 37 meters; much static and interference; slight fading;
- NU-8DJP—March 24, 1927; signal strength R7; fine DC note on 40 meters; bad interference; no fading.

THE following stations were received and logged at the amateur station of Albert Zedelis (NU-1ALS), at 43 Banks St., Montello, Mass., using a low-loss receiver with one stage of low-frequency amplification:

- EF-8ACY—March 13, 1927; signal strength R5; AC note;
- EF-8TIS—March 12, 1927; signal strength R4; calling 1AL; rectified AC note;
- EF-8GI—March 4, 1927; signal strength R6; rectified AC note;
- EF-8PJJ—March 13, 1927; signal strength R3; DC note;
- EF-8DDH—March 8, 1927; signal strength R5; rectified AC note.

THE DONLE—DR4 FULL WAVE RECTIFIER TUBE— THE LATEST ADDITION TO OUR LINE OF TUBES—IS NOW AVAILABLE.

INQUIRIES CONCERNING ITS ESPECIAL DESIRABILITY FOR B ELIMINATORS, POWER PACKS, ETC., ARE INVITED.

THE DONLE-BRISTOL CORPORATION

56 CAMBRIDGE STREET
MERIDEN—CONNECTICUT—U. S. A.

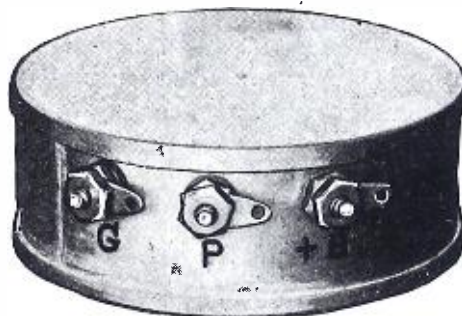

Shielded Tuned Radio Transformer, No. 30

SICKLES Diamond-Weave Coils

The new Sickles Shielded Tuned Radio Transformer prevents both outside and local interference. It is remarkably compact, sharp-tuning, sturdy.

Sickles Diamond-Weave Coils have established an enviable reputation for low distributed capacity, low dielectric losses, and large range of frequency with small variable capacity.

The ideal coil for the Na-Ald Localized Control Tuning Unit and the Na-Ald Truphonic Assembly.

There are Sickles Diamond-Weave Coils for all leading circuits.

THE F. W. SICKLES CO.
134 UNION STREET
SPRINGFIELD :: MASS.

No.	Coil Prices
30	Shielded Transformer \$2.00 each
24	Browning-Drake 7.50 set
18A	Roberts Circuit 8.00 set
25	Aristocrat Circuit 8.00 set



Best by YOUR test—
a confident challenge!

For All
Power Work

12 Watts
These units do not deteriorate or change in resistance value

EL MENCO
HY-WATT
TRADE MARK

HEAVY DUTY RESISTORS

For best results with Raytheon and other power circuits you must have permanently accurate resistors capable of carrying heavy loads without change or deterioration. "HY-WATT" Heavy Duty Resistors dissipate up to 12 watts.

100—500—1000—2000—5000 ohms	\$1.25
10,000—25,000—50,000 ohms	\$1.50
100,000 ohms	\$2.00

Write for full details and literature on El Menco Gridleaks and Resistors

Electro-Motive Engineering Corp.
127 West 17th St. New York, N. Y.



Bradleyunit-A PERFECT FIXED RESISTOR

CIRCUITS for B-eliminators, radio receivers, and other radio units usually require the use of one or more reliable fixed resistance units. In fact, fixed resistors are being used more extensively than ever, and the demand for high-grade units is growing, daily.

Bradleyunit-A is a solid molded fixed resistor, calibrated with great accuracy and fitted with silver-plated terminal caps which can be soldered without affecting the calibration of the unit. Bradleyunits are made in 20 different ratings for every purpose.



Ask your dealer for Bradleyunits, not "resistance units." They are sold in the distinctive Allen-Bradley checkered carton.

Mail this coupon to

ALLEN-BRADLEY CO.
276 Greenfield Ave., Milwaukee, Wis.

Please send me data on Bradleyunits and your folder on B-eliminator hook-ups.

Name.....

Address.....



The BEGINNER IN RADIO

CONDUCTED BY ARMSTRONG PERRY

Aerials for Uncrowded Locations

MILLIONS of radio fans live in villages or in open country where there is no need to limit themselves to the single-wire antenna, running from the garage to the house or from pole to pole on the roof. This is a type of antenna that is typical of more thickly populated places.

The amount of energy picked up by an antenna depends partly on the amount of surface exposed to the radio waves and partly on the height of the wire above the ground. It is possible to use too much wire, but it can hardly be placed too high under ordinary conditions. There is nothing to be gained by using so much wire that the fundamental wavelength or frequency of the antenna is greater than that of the stations to be received, but distance and volume can be gained by using as large and as long an antenna as can be used without overbalancing the receiver. If

the big antenna brings in too much interference, it can be cut down until some of the stations are shut out.

The illustrations show some successful antennas used in localities where there is plenty of room.

Automatic Filament Control

HAVE you ever wished that you could eliminate one more knob? You can by using an automatic filament control. It may make the vacuum valve last longer, too.

The filament of a vacuum valve is made of tungsten, about one-thousandth of an inch in diameter—almost as thin as the butter on a lunch-counter sandwich.

Tungsten in some forms is as brittle as the egg-shell found in the soft-boiled. This filament, even though made by a process that renders the metal ductile and surprisingly strong for its size, is injured easily.

Trying to make the filament blaze

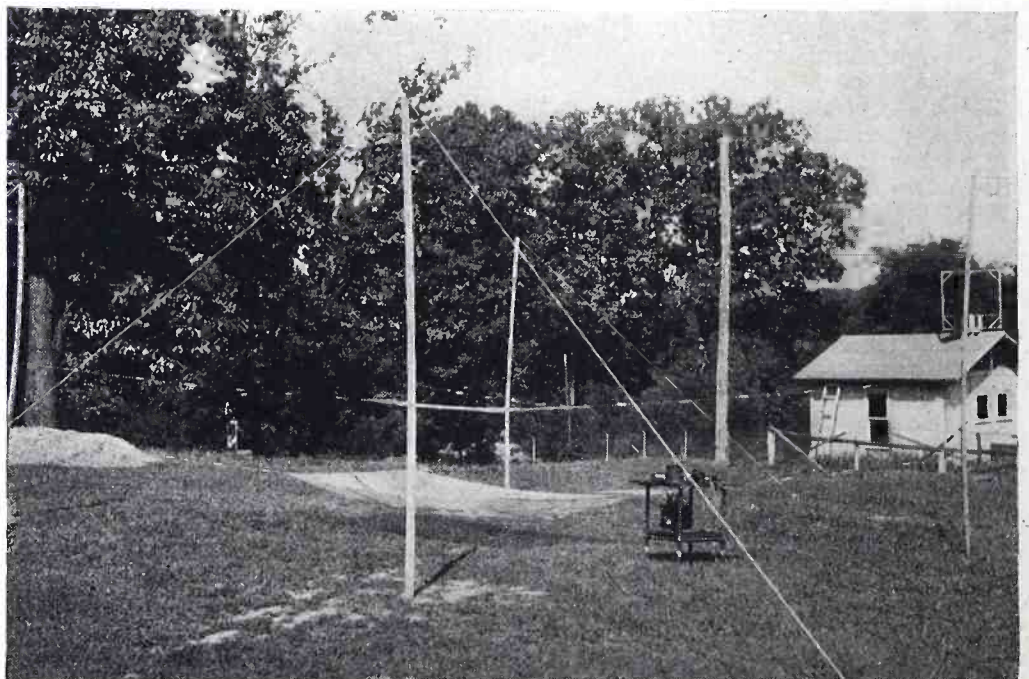

U. S. Bureau of Standards

AN ANTENNA MADE FROM A WIRE FENCE

The condenser antenna in the foreground consists of two horizontal sections of wire fencing, stretched parallel to each other about a yard apart. A large outdoor loop antenna may be seen on the house in the background.

like the Gay White Way tends to vaporize the metal, because of the heat. Operating it on too low a temperature may injure it also, by increasing its brittleness. There is a temperature that is exactly correct, but even an expert finds it difficult, if not impossible, to adjust the current accurately without the help of sensitive meters that no beginner is likely to own.

There are automatic filament controls which, it is claimed, will adjust and maintain the current at exactly the correct value. There is a control for each type of valve. The device consists of a filament of metallic alloy sealed in a glass bulb filled with inert gas.

The resistance that this filament offers to a current of electricity is comparatively small when it is cold, but it increases rapidly as the metal is heated. A given length of filament of a given diameter will pass a certain amount of current, no more and no less.

For example, the control designed for the UX-201-a type valve will pass ¼ ampere when connected to a 6-volt battery. If the voltage is increased slightly, the filament of the control instantly becomes hotter and the resistance increases, so that no more cur-

Use your radio set to electrify your Phonograph



A Revelation in Phonograph Reproduction

THE PACENT PHONOVOX, connected to your radio set and phonograph, represents the highest attainment yet reached in magnetic phonograph pick-up devices, at a cost of less than half that of other similar devices.

The fidelity of its reproduction, the full

rounded tones and the wide range of audible frequencies covered, will prove a revelation—even to the musical critic. There is no loss or fading out of the high violin and piccolo notes, so noticeable with ordinary phonograph reproduction. And the zooming of the bass viols are sharp, clear, distinct—the acid test of reproduction.

Your local dealer carries the Phonovox. If he hasn't it in stock, write us and we will see that you are promptly supplied, and will mail you interesting literature

PACENT PHONOVOX

—the Electric Phonograph Reproducer—

PACENT RADIO CORP.
156 West 16th St., New York

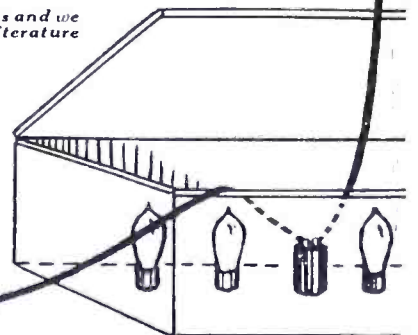

Price Complete \$12.50

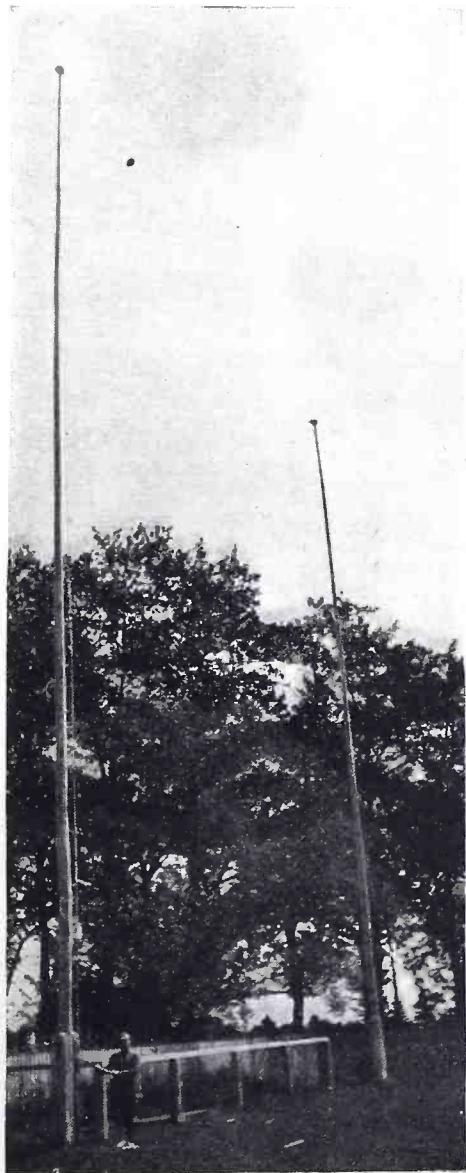

HIGH ANTENNAS MAKE FOR DISTANCE RECEPTION

These tall antenna masts are pivoted at their bases between heavy posts, so that they may be lowered easily for repairs.

"8 hour" SERVICE on any Kit or Parts

The most complete stock of QUALITY KITS and PARTS in the CENTRAL WEST enables us to offer this unheard of service. Only GENUINE parts specified by designers are used—NO SUBSTITUTIONS—All quality Parts and Kits are stocked—even those not listed below. Any item advertised in this issue obtainable here at quoted prices. WESTERN READERS are now assured of quicker service. Send your orders for quality merchandise and pleasing, rapid service.

Bruno Unitune Receiver	\$54.51
Silver-Marshall Unipac	62.00
R. G. S. Receiver	69.70
Low Frequency Amplifier	31.65
Browning-Drake Power Pack	100.15
New Browning Drake	85.45
Pre-Selector Kit	33.20
Hanmarlund-Roberts Hi-Q	63.05
Varion Power Pack	55.00
Silver Shielded Six	95.00
S-C II Receiver	60.35
L-C 27 Receiver	85.20
L-C 27 Senior Power Pack	65.00
L-C 27 Intermediate Power Pack	47.50
B-T Power Six	78.13
New Remler Infradyne	112.35
Karas Equamatic	89.24
New Samson (Cotton) Super	135.00
Clough Super	80.85
Chicago Daily News Receiver	46.30
Centralab Tone Amplifier	16.00
CeCo Tubes (as advertised)	1.75 up
S-M 652 Reservoir "B" (Less Tubes)	34.50

Send only \$5.00 with your order and we will ship within 8 hours any kit or part on the market—you pay balance upon delivery, plus small mailing charges. All Delivery Charges PREPAID on any kit, anywhere in the U. S., IF certified check or money order for full amount accompanies order. Prices on complete wiring of kits gladly given. SEND IN YOUR ORDER—we Guarantee real service and merchandise.

Austin-White
RADIO
125-7 SO. MARKET ST., CHICAGO, ILL.



World's Largest Radio Parts Producer Makes a Part for Every Radio Purpose

Complete manufacture in our own plant eliminates "outside" profits and creates world's greatest radio values.

LATEST PILOT PARTS

Shock Proof Socket
Illuminated Pilot-lite Dial
Pilot Art Dial
Centraline Condenser
Resistograd
(For B Eliminators, Etc.)
Pilotran Audio Transformer

PILOT PARTS ON SALE AT LEADING RADIO DEALERS, KRESGE & KRESS STORES



Model "N" Vario-Denser

Pep up Your Set!

Easier tuning—correct tube oscillation—more volume and clearness with an X-L VARIO DENSER in your circuit.

Specified and endorsed by foremost radio authorities in all leading circuits.

MODEL "N"—Capacity range 1.8 to 20 micro-micro farads. Micrometer adjustment assures correct oscillation control in all tuned radio frequency circuits, Neutrodyne, Roberts 2-tube, Browning-Drake, Silver's Knockout, Interflex circuit, Quadraformer, World's Record Super-9, B. T. Power-6, R. B. Lab. Circuit, etc. Price, \$1.00.

MODEL "G"—For Cockaday, Oliver Lodge N, Loftin-White, Nankin Ultra-5 circuits, filter and intermediate frequency tuning in super-heterodyne and positive grid bias in all sets. Capacity range, Model G-1 .00002 to .0001 Mfd. Model G-5 .0001 to .0005 Mfd. Model G-10 .0003 to .001 Mfd. Price each with grid leak clips \$1.50.



X-L Push Post Panel

X-L PUSH POST—Push it down with your thumb, insert wire, remove pressure, wire is firmly held. Vibrations will not loosen, releases instantly. A push post that excels in appearance, action, service and convenience. Price 15c.

PUSH POST PANEL—7 push posts mounted on black insulating panel with permanent white markings. Soldering lugs, raising bushings, screws for mounting, etc. in box complete. Price \$1.50.

FREE wiring diagrams showing use of X-L units in the new LOFTIN-WHITE constant coupled radio frequency circuit, and in other popular hook-ups. Send for yours today.



X-L Push Post

XL Radio Laboratories

2422 Lincoln Ave., Chicago, Ill.

YOU MAY NOW HAVE THE REALISM OF RADIO FROM YOUR OLD PHONOGRAPH BY USING THE NEW RECORDS AND STANDARD RADIO AMPLIFYING EQUIPMENT

SEE THIS AND FORTHCOMING ISSUES OF POPULAR RADIO

rent can pass than before. If the voltage is decreased, the temperature of the metal falls, the resistance is decreased and more current is allowed to pass.

The use of these automatic filament controls eliminates hand-operated rheostats and reduces the number of knobs on the receiver. It gives the operator one less thing to think about.

A portable set may be made smaller, lighter and easier to operate if these little automatic controls, about the size of grid-leaks, are substituted for rheostats. The beginner who likes to fiddle with a rheostat knob, however, may feel quite sure at times that if he could turn on a little more or a little less juice he could get that station whose call letters are coming in just too faintly to be understood.

A Beginner's Odd Experience

ALEXANDER MACKECHNIE, of Calvin, North Dakota, was experimenting with his one-valve receiver. It had a variocoupler, but one of his hook-ups employed the primary coil only; after trying it with fair results, he joined the leads from the two ends of the secondary coil. The hook-up is shown in the diagram on this page.

Immediately the stations began to come in louder.

It is difficult to explain why the joining of the two ends of the secondary coil should improve reception so much as he says it did. Leaving the secondary coil out of the consideration, his circuit resembles the single-circuit De

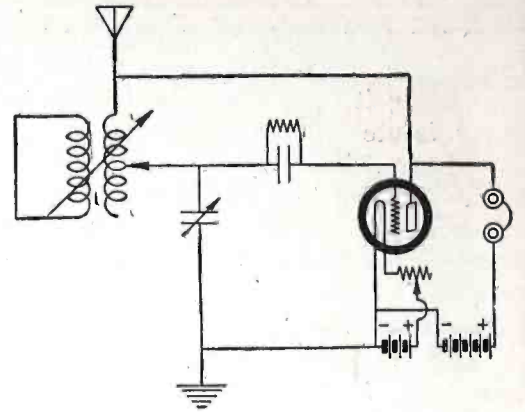

A BEGINNER'S HOOK-UP

At the left is shown the variocoupler with the secondary winding shorted. The closed secondary circuit probably acts as an absorption circuit.

Forest ultra-audion hook-up, except that the grid is connected to the end of the coil farthest from the antenna and the plate to the end nearest the antenna. These two connections are reversed in the usual ultra-audion diagram.

The secondary coil, with the ends joined, can absorb some energy from the primary coil, and the amount can be varied by turning the rotor and thus varying the coupling. It is unlike the wavetraps, or interference eliminator, because there is no condenser in its circuit and it is not conductively connected to the antenna.

It would seem that its effect on reception must be similar to that of "body capacity," which often is noticeable, especially in unshielded sets, when the hand is placed on a tuning knob. Sometimes a hand placed near a certain spot on a receiving set will more than double the volume of a signal that is being received.

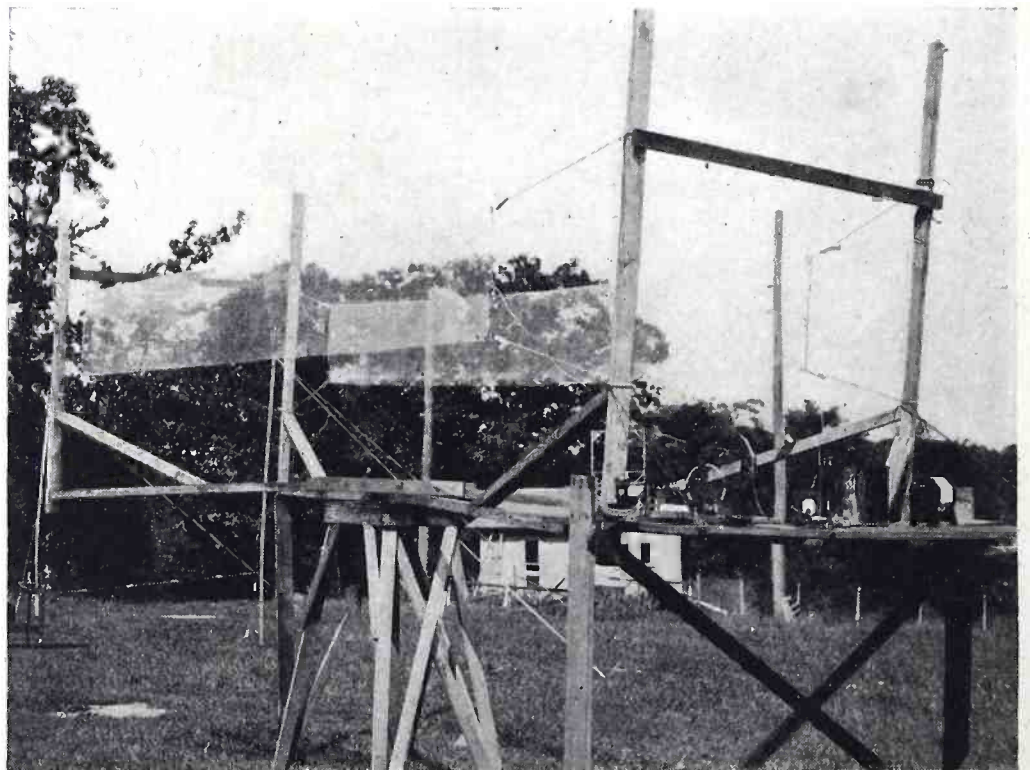

U. S. Bureau of Standards

ANOTHER TYPE OF FENCE-WIRE ANTENNA

Here is another condenser antenna made out of fencing wire; it was used in experimental work by the United States Bureau of Standards. It was found to be more efficient than the one shown on page 78.



Universal
CLAROSTAT
Universal range
Carrying capacity
20 watts.
List \$2.25

CLAROSTAT

To an even greater extent than in past seasons, CLAROSTAT, the greatest variable resistor, will be identified with the leaders—in receivers, in B eliminators, in power amplifiers and in A, B, C units.

POWER CLAROSTAT
Universal range
Carrying capacity
40 watts.
List \$3.50



Write for complete information
American Mechanical Labs., Inc.

285 N. 6th Street Brooklyn, N. Y.

Astounding!

"The only word that describes the reproduction of the 'ENSCO' 3 foot Cone or Roll type Speaker." The statement of one of the foremost Acoustic Engineers.

KIT GENUINE KIT
\$10 "ENSCO" \$10

Why has "ENSCO" been endorsed by all leading magazines and the foremost newspapers? Because—it is the most highly developed big cone assembly now offered to the public; it reproduces all frequencies and greatly reduces static. The "ENSCO" unit is the only direct-drive unit for large cone speakers.

Manufactured under U. S. Patent No. 1630119; "ENSCO" Cushion Drive Patent No. 1163854; Cone Diaphragm Patent No. 1003655 and other patents pending.

Assemble the "ENSCO" speaker in less than an hour. It works on any set with any power. No filters or chokes necessary, 90 to 250 volts without protection or 500 volts with transformer.

Six different types to choose from. Cones beautifully decorated and marked for assembly. Wall, pedestal or console; all fully described in illustrated instruction book.

Sold under absolute (money back) guarantee.

Engineers Service Co.

25 Church St. - - - - - New York City
73 Cornhill - - - - - Boston
28 E. Jackson Blvd. - - - - - Chicago

Ask your dealer or mail order to nearest office. Send money order, check or cash, or we will ship C. O. D. We pay shipping charges.

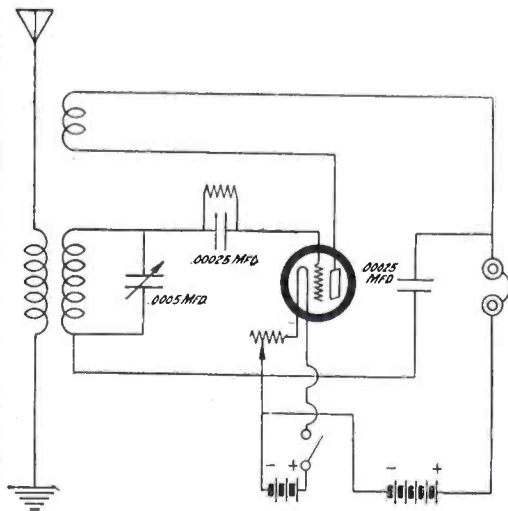

A CIRCUIT THAT GOT CUBA
Here is a simple one-tube, three-circuit tuned set that is capable of receiving at great distances.

A One-Tube Distance Getter

OSCAR BIRDSALL, who lives in Michigan, sends us the above hook-up which he has used with good success.

With this regenerative receiver and one stage of audio-frequency amplification, Oscar says he brought in Cuban and Mexican stations during the international tests.

A good three-circuit tuner, a variable condenser of .0005 mfd. capacity, and a 20-ohm rheostat are needed, he says, together with the other pieces of apparatus shown on the diagram.

What hook-ups get the longest distances for you? Write to us about them.

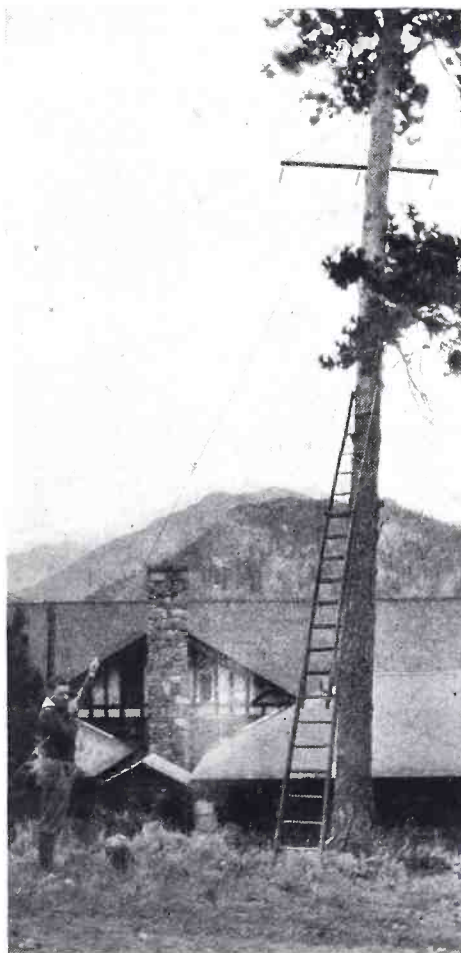

Fleet Photo Service

A TALL-TIMBER ANTENNA

In the summer camp, where there are plenty of tall trees and no neighbors to object, the antenna should be made high and long; this will enable you to tune in the distant city broadcasting.



Automatic Power Control

When you turn the switch on your set, the Automatic Power Control switches on the B eliminator and cuts out the trickle charger; and the reverse takes place when you turn off the set. Easily attached—perfectly reliable.

No. 444—Series Type Automatic Power Control—Now furnished in the new construction, exclusively Yaxley, to take care of sets having a current draw from four 199 type of tubes up to eleven 201 type of tubes, keeping the voltage drop below 2/10 volts... \$5.00

No. 445—Multiple Type Automatic Power Control—for all tube sets\$6.00

Cable Connector Plug

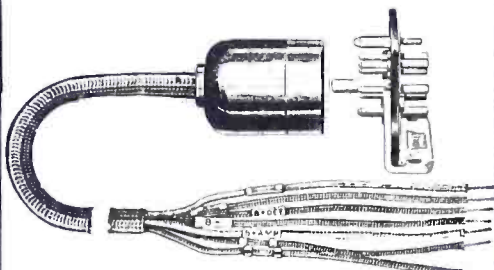

Simplifies battery wiring, eliminates old-fashioned unsightly mass of wires, and is a positive guarantee of an instant and correct battery connection. Bakelite construction, neat and handsome in appearance. Metal cable markers and colored chart (RMA standard color code) on the connector plate simplifies installation on any set. Phosphor bronze double contact springs are mounted in Bakelite and cannot work loose. Connector plate has brass contact pins, tinned for soldering, mounts on reversible bracket adaptable for sub-panel mounting. Extra fine quality, seven-strand (RMA standard colors) five foot cable. Six extra markers packed with each plug. No. 660—Cable Connector Plug, complete \$3.50

At your dealer's. If he cannot supply you, send his name with your order to

YAXLEY MFG. CO.
Dept. P 9 So. Clinton St.
CHICAGO

Announcing



-When the gong rings for the big fight.....

When the famous director lifts his baton...

When Babe Ruth steps to the plate and the score is tied.....

NEW PRICE
SUPER MUSICONE
\$12.75

"You're there with a Crosley!"



\$65

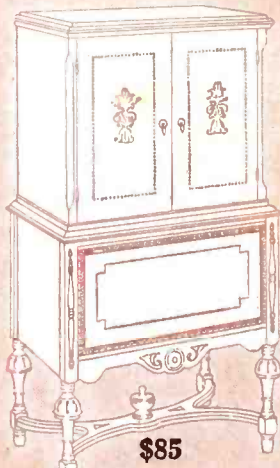

\$85



\$35

The "BANDBOX"
6 tube receiver
BATTERY TYPE

\$55.

AC TYPE
\$65

Approved Crosley Consoles

These three handsome cabinets, especially designed to receive the shielded chassis of the "Bandbox" and other Crosley receivers, have been approved by Powel Crosley, Jr., as mechanically and acoustically ideal for the installation of Crosley Radios.

H. T. ROBERTS CO.
914 S. Michigan Ave., Chicago, Ill.
Sales Agent for Approved Console Factories
SHOWERS BROTHERS COMPANY
The Wolf Manufacturing Industries

the ~~CROSLEY~~ "Bandbox"

and other new radio reception equipment
for the complete enjoyment of the 1927-28 radio season



Recent court decisions now greatly clarify radio patent situation.

Ever since Crosley entered the radio field their methods and developments have created a leading place for Crosley radio receivers. And now—completely available to Crosley—and amplifying Crosley supremacy in fullest measure, are the enormous resources, discoveries and ideas, embodied in patents of the Radio Corporation of America, The Westinghouse Co., The General Electric Co., The American Telephone and Telegraph Co., The Hazeltine Corp. and The Latour Corp.—under which Crosley is now licensed to manufacture.

No wonder the new Crosley receivers are in the forefront, their amazing efficiency acknowledged and demanded by that section of the radio trade which insists on the latest and best at all times.

THE "BANDBOX"

It is a new 6 tube set of astonishing sensitiveness. Many exceptional features commend the "Bandbox." The metal outside case, 'tho keeping out strong local signals effectually enough, did not fully satisfy Crosley ideals of fine radio reception. Signals must



be kept in order *inside the set*. Coils and condensers are like families living in a row of houses with no fences between. The children run around the yards; they meet, mix it up, quarrel and squabble. No harmony.

Magnetic and electric fields are the offspring of coils and condensers. With no fence between, they, too, run around the house, mix it up, quarrel and squabble. Howls and squeals result.



So, to keep each "family" or field of individual coils and condensers separated, metal fences are erected (copper fences for the coils) and the individual parts of the Bandbox are shielded as only found in the highest priced sets.

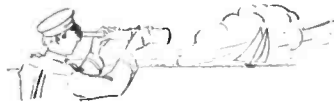

For fans who love to go cruising for faint, far-away signals the "Acuminators" intensify weak signals like powerful lens revealing distant scenes.

The "Bandbox" employs completely balanced or neutralized radio frequency stages, instead of the common form of lossy method of preventing oscillation. In presenting this important feature Crosley is exclusive in the field of moderate price radio.



Volume for dancing

Volume control is another big "Bandbox" feature. Signals from powerful local stations can be cut from room filling volume to a whisper.

Each "Bandbox" is fitted with a brown cable containing colored rubber covered leads for power and other connections.

The frosted brown crystalline finish harmonizes with the finest furniture and matches the frames of Musicones and the casing of the power converter. The bronze escutcheon creates an artistic control panel.

Withal, in the beautiful appearance and modest size of the "Bandbox" is the utmost in adaptability to requirements of interior arrangement or decoration. The outside case is easily and quickly removed for installation in console cabinets.



Soft and low thru volume control

AC AND BATTERY OPERATION

The "Bandbox" is built both for battery and AC operation. The new R.C.A.—AC tubes make the operation of the set directly from house current both practical and efficient.

In the AC set the radio stages and the first audio stage use the new R.C.A.—AC—UX-226 tubes. Filaments in these tubes are heated with raw AC current at proper voltage.

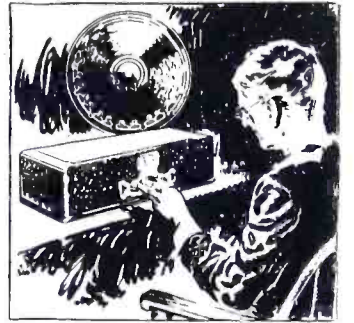
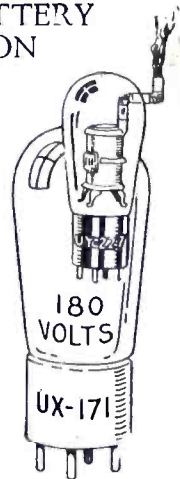

A Master Station Selector, with illuminated dial for shadowy corners, enables tuning for ordinary reception with a single tuning knob.

The UY-227, with indirectly heated emitter, is used with the detector. Power tube UX-171 at 180 volts plate.

There is no AC hum. The new R.C.A. Radiotrons do the work. The power supply converter is a marvel of radio engineering ingenuity. Half the size of an ordinary "A" storage battery, it supplies A, B and C current direct from lamp socket to tubes.

PRICE OF POWER CONVERTER \$60

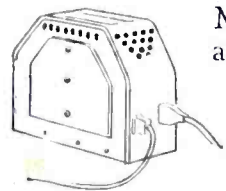

Models for 25 and 60 cycles. Snap switch shuts down set and power converter completely.

Write Dept. 16 for Descriptive Literature.

CROSLEY RADIO

Crosley Radio is licensed only for Radio Amateur, Experimental and Broadcast Reception. R. C. A. Radiotrons or Cunningham equivalents are supplied at standard prices with each Crosley Receiver. Prices slightly higher west of Rocky Mountains.

THE CROSLEY RADIO CORPORATION

Cincinnati, Ohio



Powel Crosley, Jr., Pres.



TILT-TABLE MUSICONE \$27.50

Although Musicones improve the reception of any radio set they are perfect affinities in finish, beauty and reproductive effectiveness for Crosley Radios. A new model built in the form of a Colonial Tilt-table and finished in brown mahogany stands 3 feet high.

12-inch Ultra Musicone \$9.75

16-inch Super Musicone \$12.75



Registered Trade Mark, symbolic of the sturdy dependability of Gold Seal Radio Tubes

POWER PLUS!

All the advantages of the newer type tubes *plus* the rugged dependability and quality performance that are *built into* Gold Seal Radio Tubes. Nation-wide acceptance of these superior products is striking evidence that the Gold Seal standards of finest materials and workmanship are appreciated by discriminating owners. Put Gold Seals in your set and enjoy the improvement they make.

If not yet obtainable from your local dealer, write us for illustrated descriptive circulars.

GOLD SEAL ELECTRICAL CO.
INCORPORATED
250 PARK AVE. NEW YORK

**Gold Seal
Radio Tubes**

All Standard Types

All Standard Types



Type GSX-213
Rectifier tube, designed to accomplish full wave rectification of alternating current (a. c.) to direct current (d. c.)
List price \$5.00



Type GSX-216B
For use in battery eliminators to rectify alternating current - advantageous in supplying the higher current required by power tube equipped sets. List price \$7.50



Type GSX-201a and Gs-201a
The popular general purpose type, for amplifier or detector. Long life and high efficiency.
List price \$1.75



Type GSX-171
High power tubes for use in last stage of audio amplification give increased volume. List price \$4.50