

Popular Radio

25¢

• APRIL • 1927 • *

— For the Fan —
Star Program Features of the Month

— For the Experimenter —
How to Build the New Browning-Drake

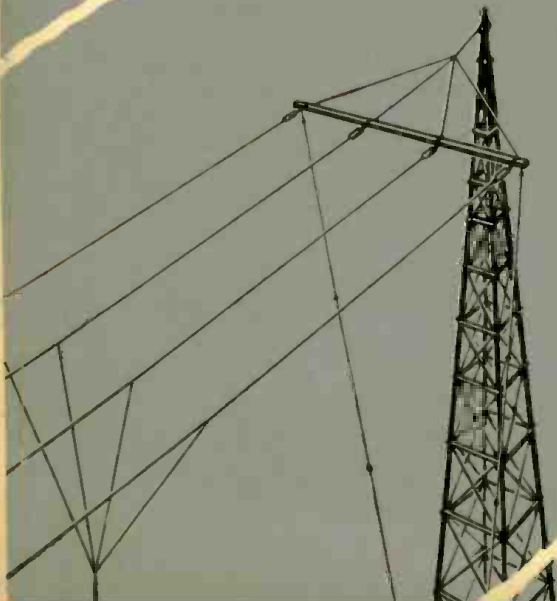

A REAL ABUSE TEST

So many people run their batteries up too high that, having made good Radiotrons for careful users, RCA set about to make Radiotrons that would stand abuse.

A year ago, an RCA Radiotron could stand about twenty hours of running under too heavy a current. Now it will outlive a hundred hours of such abuse.

Many very minute changes brought about through laboratory study have effected this improvement.

If you have children who are apt to turn up the rheostats carelessly, of course it is hard on the tubes. No tubes can be proof against ruin, but if you are using RCA Radiotrons, you know at least that they'll stand more than ordinary tubes.

Look for that RCA mark! You'll find it on Radiotrons for every purpose.



RADIO CORPORATION
OF AMERICA
New York Chicago
San Francisco



The stations are there get them!

You're not getting the most out of that storage battery set of yours. The set has a bigger distance reach... all it needs is a different tube in the detector socket. Put in the RCA super-detector—Radiotron UX-200-A. You'll get more stations—get the far-away ones more regularly and more easily! It's a small change, but it brings big results.

Bring your storage battery set up-to-date with
a power RADIOTRON UX-171 or UX-112
a detector RADIOTRON UX-200-A
and RADIOTRONS UX-201-A for all-round quality.

Bring your dry battery set up-to-date with
a power RADIOTRON UX-120
and RADIOTRONS UX-199 for all-round quality.

RCA Radiotron

MADE BY THE MAKERS OF THE RADYOLA

NEW!

Eveready Layerbilt "B" Battery No. 486, the Heavy-Duty battery that should be specified for all loud-speaker sets.



The Layerbilt patented construction revealed. Each layer is an electrical cell, making automatic contact with its neighbors, and filling all available space inside the battery case.

DIFFERENT!

For greatest economy all loud speaker sets require the new Eveready Layerbilt "B" Batteries

IT WILL pay you, in convenience and reliability as well as in dollars and cents saved, to use this remarkable battery.

The reason for the Eveready Layerbilt's surprising performance lies in its exclusive, patented construction. No other battery is like it. It is built in flat layers of current-producing elements, making practically a solid block. The layers make connection with each other automatically, and occupy all available space inside the battery case. Layer-building packs more active materials in a given area, and makes those materials produce more electricity.

Every loud-speaker set should use Heavy-Duty batteries, for they alone offer economy on modern receivers. When you buy new "B" batteries, be sure to get the Heavy-Duty size, and remember that the Eveready Layerbilt has proved to be the longest lasting, most economical of all Heavy-Duty batteries.

Our laboratories are continually testing batteries, and in all our tests we have yet to find a battery that is equal to the new improved and radically different Eveready Layerbilt "B" Battery No. 486. The development and perfecting of this remarkable

battery is an outstanding battery-building achievement. It is the result of many years' experience plus the facilities and resources of the pioneer manufacturers of all dry cell batteries.

NATIONAL CARBON CO., INC.
New York San Francisco
Unit of Union Carbide and Carbon Corporation

Tuesday night is Eveready Hour Night—9 P. M., Eastern Standard Time, through the following stations:

- | | |
|------------------|--------------------|
| WEAF—New York | WTAM—Cleveland |
| WJAR—Providence | WWJ—Detroit |
| WEEI—Boston | WGN—Chicago |
| WTAG—Worcester | WOC—Dayton |
| WFL—Philadelphia | wcco { Minneapolis |
| WGR—Buffalo | { St. Paul |
| WCAE—Pittsburgh | KSD—St. Louis |
| WSAI—Cincinnati | WRC—Washington |
| WHAS—Louisville | WSM—Nashville |
| WSB—Atlanta | WMC—Memphis |
| | wgy—Schenectady |

Popular Radio

EDITED by KENDALL BANNING



FOUNDED 1911

VOLUME XI

April, 1927

NUMBER 4

CONTENTS

(Cover design by Frank B. Masters)

Carrying Music on a Ray of Light FRONTISPIECE.....PAGE 326	Popular Radio Circuits INSTALLMENT No. 9: The "De Luxe Cle-Ra-Tone" Receiver The Silver "Shielded Six" Receiver <i>The Technical Staff</i>PAGE 346
The Three Blankets Around the Earth The newest scientific discoveries concerning the three concentric layers of gas around the earth that make radio, like life itself, possible By <i>E. E. Free, Ph.D.</i>PAGE 327	Uncle Sam's Wavemeter By <i>Andrew R. Boone</i>PAGE 348
How to Build the New Standard Browning-Drake Receiver Complete details of the latest and best Browning-Drake Receiver written exclusively for the readers of POPULAR RADIO by the inventors— <i>Glenn H. Browning and Dr. Frederick H. Drake</i>PAGE 331	How to Build the New SC-II Receiver All the newest ideas in receiver design—metal chassis, complete shielding, high-quality amplification—are features of this new set By <i>McMurdo Silver and Laurence M. Cockaday</i> ...PAGE 350
The New "Drama of the Ear" By <i>Charles D. Isaacson</i>PAGE 336	Practical Hints for Starting Your Radio Laboratory Five interesting and worthwhile experiments that show the amateur how to use a single meter for making measurements that involve resistance, current and voltage By <i>Paul L. Rittenhouse</i>PAGE 354
Resistance-Coupled Amplifiers— How to Make Them Work with Power-packs By <i>William T. Taber</i>PAGE 339	Your Laboratory Tools How to select, install and operate a small lathe in your experimental laboratory By <i>Lowell Madden, Jr.</i>PAGE 356
How to Get Quality Amplification NUMBER 2: How to build a low-frequency amplifier using the Triphonic coupling units <i>The Technical Staff</i>PAGE 341	What's New in Radio <i>The Technical Staff</i>PAGE 358
Helps for Cutting Down Man-Made Interference By <i>Laurence M. Cockaday</i>PAGE 343	"Buzzing" with Bussey in Brazil By <i>Ralph E. Thomas (2-UK)</i> ...PAGE 367
DEPARTMENTS	
In the World's Laboratories..... <i>E. E. Free</i>368	Star Program Features of the Month.....370
With the Experimenters..... <i>Richard Lord</i>380	Listening In..... <i>David Lay</i>38+
Broadcasts..... <i>Charles L. Reese, Jr.</i>406	Broadcast Listener..... <i>Raymond Francis Yates</i> ..+10

VOLUME XI

APRIL, 1927

NUMBER 4

Published monthly by Popular Radio, Inc., 627 West 43rd St., New York, N. Y.; telephone number, Chickering 1906; Douglas H. Cooke, President and Treasurer; Kendall Banning, Vice-President; Laurence M. Cockaday, Secretary; Joseph T. Cooney, Asst. Treasurer. Price, 25 cents a copy; subscription, \$3.00 a year in the U. S., Canada and all countries within the domestic postal zone; elsewhere, \$3.50 a year, payable in advance. The International News Company, Ltd., No. 5 Bream's Bldg., London, E. C. 4, sole distributors in England. Entered as second-class matter April 7, 1922, at the Post Office at New York, N. Y., under the act of March 3, 1879. Copyright, 1927, and title registered as a trade-mark by Popular Radio, Inc. Copyright in Great Britain by Popular Radio, Inc., 6 Henrietta St., Covent Garden, W. C., London, England. For advertising rates, address Popular Radio, Inc., 627 West 43rd St., New York, or 225 North Michigan Ave., Chicago. Printed in U. S. A.

LAURENCE M. COCKADAY, Technical Editor
CHARLES L. REESE, JR., Managing Editor

E. E. FREE, Ph.D., Contributing Editor
JOHN V. L. HOGAN, Contributing Editor

BUILD

The New

BROWNING-DRAKE

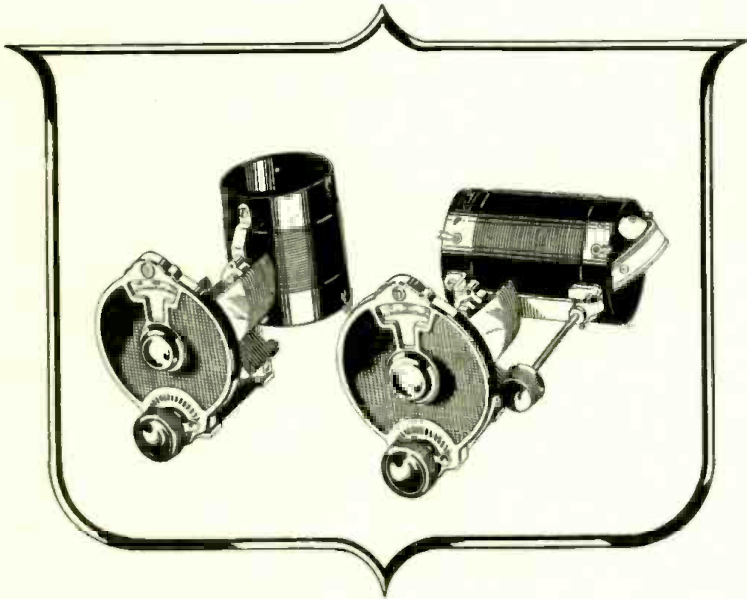

Official Kit Set

THE new Browning-Drake Assembly is now presented to the fans of this country, and with it the Browning-Drake Corporation announces the new Kit, designed for use in this new receiver. With its greatly increased selectivity and pleasing appearance, this Browning-Drake will hereafter be designated "Official."

Complete Browning-Drake factory-built receivers are now standard on the market. The well-known model 5-R has earned an unusual reputation for consistent performance and negligible dealer service. Your dealer will be glad to demonstrate this receiver.

DEALERS: There should be at least one distributor in your territory handling complete receivers, as well as all the parts for the Official Kit Assembly. We will be glad to forward the name of our nearest jobber.

BROWNING-DRAKE CORPORATION
BRIGHTON :: MASS.

BROWNING-DRAKE RADIO

A PAGE WITH THE EDITOR

ON page 370 of this issue starts the first of the expanded list of star broadcast program features of the month—features of outstanding merit during the coming month, beginning March 20th.

* *

THE purpose of this list is self-evident; to give our readers authoritative information about the programs just ahead—and to give that information specifically and by names that may be identified.

* *

THE present policy of the newspapers in omitting the identifying names of these standard features in their daily program lists (apparently inspired by the purpose of the business office to force paid advertising) has made the newspaper programs practically valueless to the radio fan.

* *

WHEN a newspaper, in its effort to avoid "free advertising," goes to the extreme of listing the New York Symphony orchestra (that appears on the Balkite Hour) merely as a "salon orchestra," it appears to be about time for some publication to serve the interests of the fans by giving them the advance information they want.

* *

SO POPULAR RADIO is stepping right up to meet this need.

* *

THIS present installment is merely the foundation of what will be gradually expanded into a regular and valuable feature of the magazine; advance information is not always easy to get.

* *

ALL of the program features included on this star list are worth tuning in on; they are really features of outstanding merit in their respective lines.

* *

AND each month new features will be added—and occasionally some will be taken off.

* *

THE Editor invites our readers to send him their opinions—especially their ideas for making this "honor list" bigger and better and more useful.

* *

HERE is a letter from a reader of POPULAR RADIO that tells its own story; it comes from M. J. Isler of Hoboken, N. J. As his experience checks up with the Editor's own (he also has an LC-27 in his home), Mr. Isler comments are here given *verbatim*:

"HERE is my frank opinion of my LC-27 receiver; I shall be glad to have you broadcast it through your periodical so that my fellow fans may realize what their good money can buy for radio entertainment in place of some of the junk most fans seem to get.

* *

"FORTY-EIGHT hours after I got a good look at the LC-27 at the Radio Show in New York last September and had obtained an advance copy at your booth, my receiver was completed—power-pack and all—(I had been using the Amertran 'B' power and audio transformers for months with the LC-26).

* *

"NEEDLESS to say the outfit has been functioning day after day ever since.

* *

"MY apparatus is identical to the parts used in the description by Mr. Cockaday except that I use a storage 'A' battery and trickle charger for my filament supply.

* *

"DURING my many pleasant evenings spent listening to real honest to goodness music. I recalled my many radio tours of the shopping districts and came to the following conclusion:

* *

"IT is a real pity that only a small percentage of the radio fans throughout the country avail themselves of the opportunity to obtain something really worth while for their home pleasures. I look at it somewhat like this:

* *

"HERE comes Mr. So-and-So, who creates this or that circuit and then goes on to explain how to synchronize this thing and how to vary the other thing, how to balance the next thing and after leaving the reader to guess where to throw his parts on the baseboard and panel, he seems to say, "There it is, the best circuit ever put out, go to it!" And a few thousand fools go right to it and then wonder why the completed dishpan producer doesn't act as outlined! But then it's too late; the money is gone and he's got to commence all over again.

* *

"LAURENCE COCKADAY is a real friend of the radio fan. Does he fill the air with a lot of ridiculous claims? Does he give you a few hundred complicated calculations to endure in order to make a set really work? He does not. He thoroughly covers every detail of construction, creates a circuit that will work as well for me as it will for himself—if

one can but read English and handle a soldering iron.

* *

"I've built all of Mr. Cockaday's creations in the broadcast receiver line and the result is always a set to be proud of; they function exactly as outlined and claimed by him in every respect.

* *

"THE results obtained with his LC-27 are truly remarkable; I defy anyone, anywhere, at this time to name a single receiver which will equal or excel the reproduction obtained with the LC-27. I've heard them all, from the crystal set up—and the LC-27 stands supreme.

* *

"HE just tells you very concisely how to place the apparatus, how to wire it and how to operate it.

* *

"I've built a dozen of these LC-27 receivers for my friends, and no one can tell one from the other when listening to a program; some are operating as far west as Los Angeles and as far south as Miami, with equally unsurpassable results. If you don't believe it, drop in and hear mine!"

* *

FROM an ardent English radio experimenter comes this friendly slap on the back:

"I think POPULAR RADIO gives the most useful, practical, interesting and bang-up-to-date information—and I don't mind who knows it!"

DEREK SHANNON, F. R. S. A.
(G5CG and G5PX)

* *

HOW to reduce interference with a device known as the "Pre-Selector"—another development of the POPULAR RADIO LABORATORY—furnishes the basis of an important contribution to the next issue of this magazine,

* *

This unit, which may be used with any receiver, is designed to overcome the general interference that is usually suffered in districts where several broadcasting stations are in simultaneous operation. It is connected between the receiver and the antenna, and it provides a degree of selectivity heretofore obtainable only with the finest superheterodyne sets.

Kendall Banning

Editor, POPULAR RADIO.

*“We’ve cut down our come-backs
with Faradon equipped sets”*

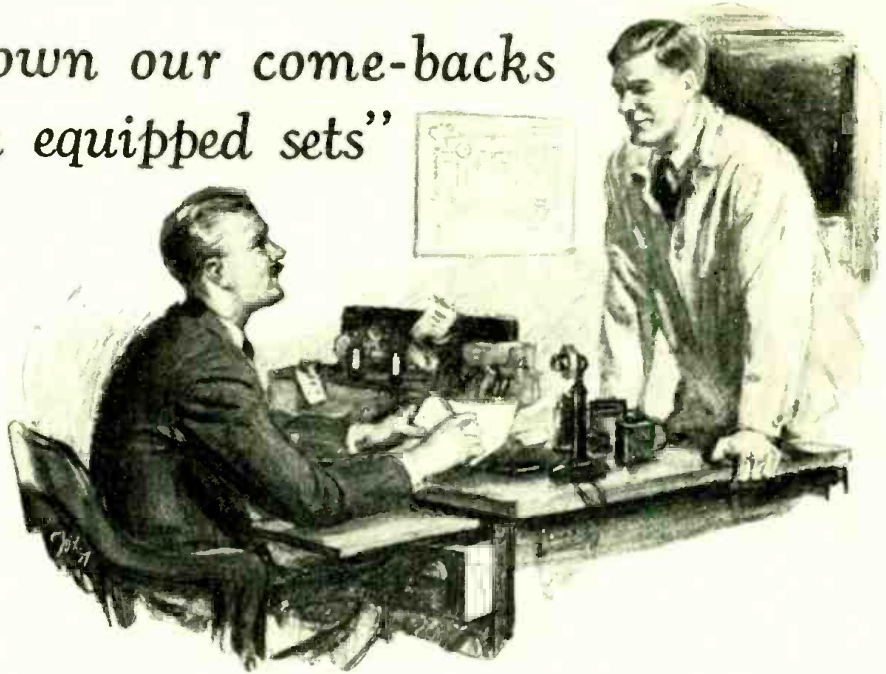

MANUFACTURERS who equip their sets with Faradon Capacitors free themselves from the complaints and returns caused by condensers of lesser durability.

The sheer dependability of Faradons can be best realized by the fact that they have been generally adopted for Automatic Railway Signals, and for Direction Finders at sea—two assignments where condensers must stand up.

For twenty years Faradon experts have combined skill and highest quality materials to make capacitors for each particular need. Faradon engineers are always ready to co-operate with manufacturers having under consideration special equipment which cannot be taken care of by the more than 200 standard Faradon Capacitors ready for prompt delivery.

**WIRELESS SPECIALTY
APPARATUS COMPANY**
Jamaica Plain : Boston, Mass., U. S. A.

Established 1907

Faradon

Electrostatic condensers for all purposes

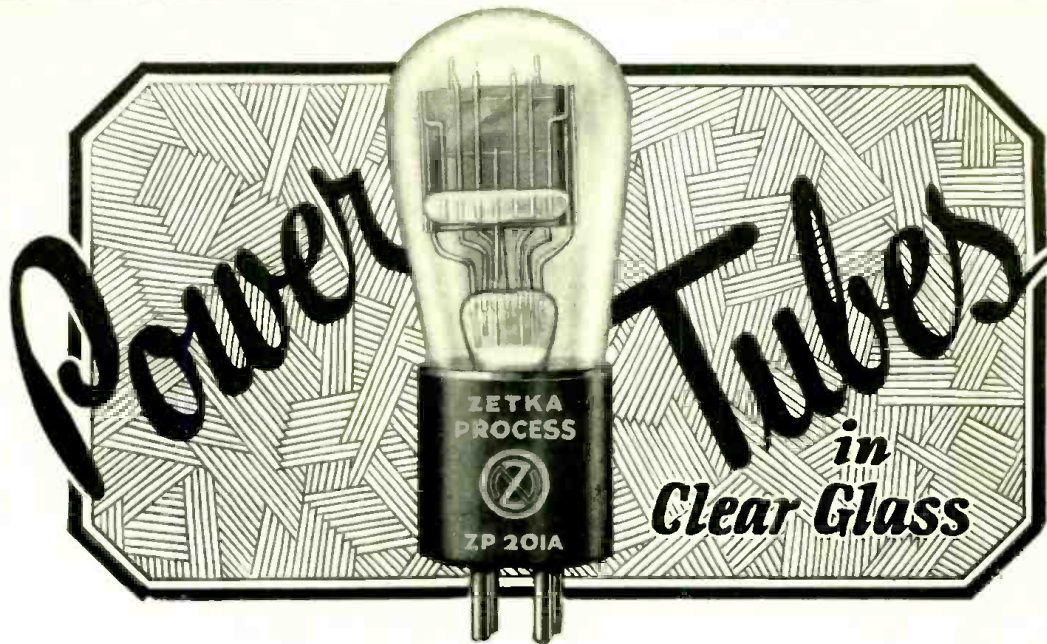

LOOK FOR THE
BLUE and ORANGE
BOX

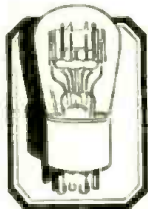

Z171
A specially designed superior power amplifier. Plate voltage up to 180 volts.

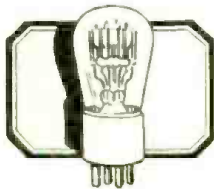

Z112
Another exceptional power tube for voltages up to 135 volts. Designed for superior power performance.

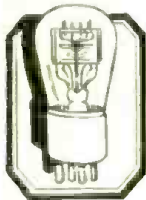

Z200A
A super-sensitive 1/4 amp. oxide filament detector. Absolutely quiet, extremely sensitive, longer lived.

Announcing the New ZETKA PROCESS ZP 201A POWER TUBE

Zetka Laboratories announce the creation of one of the most remarkable contributions to radio...an oxide coated, quarter ampere *clear glass* ZP 201A power tube.

This new tube assures almost unbelievable volume, with perfect preservation of natural tone. No bellow or blast. Full, round, accurate recreation. The ZP 201A was especially designed for use in all stages served by the regular 201A type tube, giving the unique result of "a power tube in every stage"...a long-life power tube costing you but \$2.50 instead of \$4.50.

Clear glass Zetka Process Tubes, made in all standard types, require no rejuvenation—are "new" tubes, during their entire life. See your nearest Zetka dealer about the new ZP 201A, then hear what a world of difference it really makes...how it brings your old set right up to date, and perfection! Clear glass identifies them.

Your set deserves this finer equipment. Prices no higher

ZETKA

The Clear Glass Tube

ZETKA LABORATORIES, INC.
73 WINTHROP STREET
NEWARK, N. J.



Bachrach

The Excellent Balance Between Technical and Popular Articles in POPULAR RADIO

"POPULAR RADIO is a very welcome visitor to our office each month. You certainly are to be congratulated on the excellent balance maintained between technical and news material, as well as on the selection of topics to be covered. A reader of POPULAR RADIO is given, in an interesting way, the most important developments in radio science as well as entertaining articles on various related subjects."

Laurence Marshall

GENERAL MANAGER RAYTHEON MFG. CO.

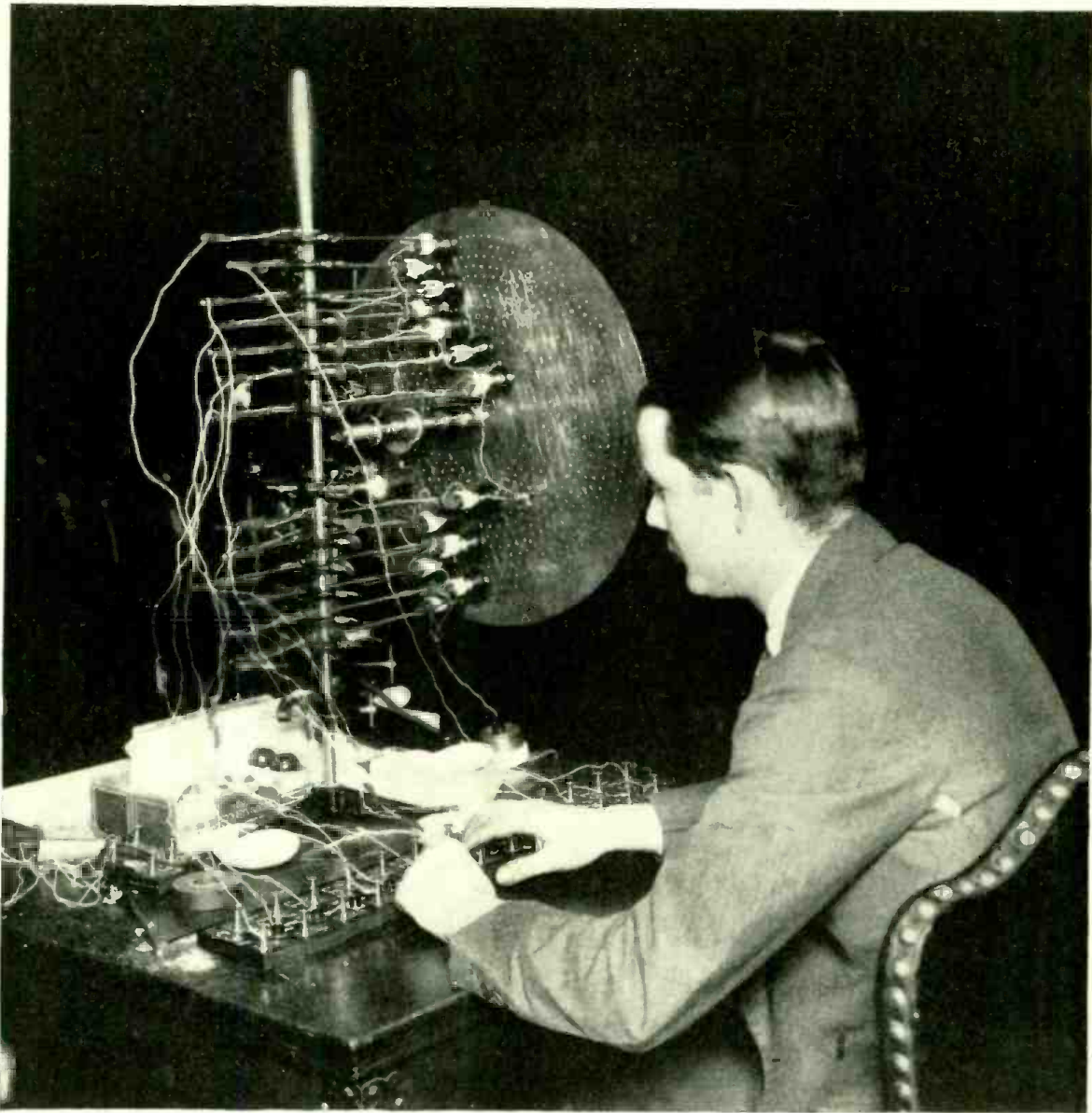

New York Electrical Society

Carrying Music On a Ray of Light

The New York Electrical Society, well known in the Metropolis for the interest of its programs of popular science, listened recently to the newest scientific and musical novelty, the "photoelectric organ," demonstrated by Dr. E. E. Free and Dr. Norman Hilberry. Light rays, shining through the holes in the rotating disc, produced interrupted pulses of light like the pulses of air in an organ pipe. Dr. Hilberry is shown above operating the switches which light the lamps; one lamp and one series of holes corresponding to each musical tone. The light ray, with its musical message, crossed the platform of the Society, was received on a photoelectric cell and converted by radio amplifiers into the audible music. Chords and other tonal combinations were played. When anyone stepped in the path of the light way, the music instantly ceased.

Popular Radio



VOLUME XI

April, 1927

NUMBER 4

The Three Blankets Around the Earth

Radio, like life itself, is possible only by the aid of the air. It is not the *lower* air which we breathe that is effective in radio, but the *upper* air—fifty to one hundred miles above the ground. There are three layers of this upper air and, curiously enough, it is the middle layer, not the outermost one, which is the coldest. This article tells of some of the newest scientific discoveries concerning these three concentric layers of gas around the earth.

By E. E. FREE, Ph.D.

IF you take an orange and wrap around it as tightly and smoothly as you can a sheet of ordinary linen writing paper, that will serve with reasonable exactness as a model of our earth and its air.

The sheet of paper will not be quite thick enough to represent all of the atmosphere, for there are traces of gas that venture up, we imagine, to heights of several hundred miles above the ground. But one thickness of writing paper will represent, if the earth itself is the three-inch orange, the thickness of the only part of the atmosphere which is now known to have any great importance to man. The outer surface of this paper wrapping will correspond, in its distance from the actual rind of the fruit, to the distance of the famous Heaviside Layer above the ground.

It is no longer necessary to remind the radio public how important this Heaviside Layer is for the science and art which interest us. Long-distance radio is made possible by the Heaviside Layer. Were it not for the conducting path which this Layer provides, thus causing the waves to curve around the earth instead of going off in straight lines through space, the trans-Atlantic radio telephone would be an impossibility. Even broadcasting over the land would probably reach only a few hundred miles,

instead of the thousands of miles which now constitute the nightly records. Other supposed manifestations of the Heaviside Layer, such as fading and the "skip-distance" effect, are not quite so popular amongst the fans, but no one will deny, even in his darkest moments when some much-desired station has just faded out, that the benefits which we owe to that radio-carrying layer far up in the air are far greater than the ills it sends us.

The numerous investigations of the path of radio waves in the upper air which have been carried out in recent years, notably by Drs. Breit and Tuve of the Carnegie Institution of Washington, have given us reasonably accurate estimates of the height of the Heaviside region above the ground. It seems to lie at elevations between 30 miles and 50 miles; higher at night than in the daytime and with some variation from season to season. This refers, of course, to the lower surface of the layer. Above that level there exists an unknown thickness of atmosphere which possesses the significant property of being a good conductor of electricity and thus of passing our radio waves easily from one side of the earth to another, or, indeed, entirely around the terrestrial ball and back again.

To return to our orange with the paper

wrapped around it, the outer surface of this sheet of paper corresponds to the under surface of the Heaviside Layer. Add a second wrapping of thicker paper, like blotting paper and that will correspond reasonably well to the thickness of the Heaviside Layer itself, the layer that carries our radio waves. It would be more correct to procure, were it possible, some kind of blotting paper composed of the most delicate and flimsy fiber, for the gases of the air at the height of the Heaviside region are almost as thin and tenuous as are the remnants of gas left inside the vacuum tube of a radio set.

Exactly how tenuous these gases are we do not know, for the electric and radio-carrying properties of this roof of the earth's atmosphere are far better known than almost anything else about it. It is impossible, unfortunately, to go up and visit it. The highest flights of airplanes and balloons have reached only about seven miles above the ground. Smaller balloons, carrying recording instruments but no human observer, have attained heights up to 24 miles. The man-made object which has been highest into the air in the history of the earth so far is probably some one of the shells fired at Paris during the World War from the great guns which the Germans mounted seventy-odd miles away. These

shells are believed to have risen to heights of nearly thirty miles above the ground—but unfortunately they brought back no messages of what they encountered.

Our actual knowledge of the atmosphere ceases, therefore, at less than one half of the height which has been fixed upon by radio tests as the lowest position occupied by the lower surface of that Heaviside region which most interests the radio engineer. Nor is there much hope that this lack in our direct knowledge will soon be repaired. It is true enough that Professor Goddard's rocket, many times described in *POPULAR RADIO*, would be quite competent to rise to fifty miles above the ground, or even to three or four hundred miles, and to bring back samples of the upper atmosphere. But the rocket has not been built, although it is undeniable that some one ought to provide funds so that it can be. At present, when we wish to know what exists in that upper air which is so important to all modern theories of the movement of radio waves, we must fall back upon such indirect evidence as we can procure in other ways.

The earth is frequently said to possess a "blanket" of air which keeps us tender humans warm against the cold of outer space. The metaphor is a good one, but the bed is better covered than that. Instead of one blanket wrapped around us we have three, one outside the other. And it now begins to seem probable that of these three protective layers the outermost one, not even dreamed of as existing until a few years ago, is probably the best of them all.

The layers of air immediately next the ground are subject—as who can forget?—to the continual excitement which we call weather.

Cold waves and hot waves come to plague us. The spasms and convulsions of storms arrive to vary the succession of chills and fevers. It is by no means a restful ocean of air at the bottom of which we are condemned to dwell. The small instrument-laden balloons which meteorologists can send up far higher than human aeronauts dare venture, tell us, however, that this restlessness does not last all the way up through our air. At a crucial height of about seven miles the small balloons enter the second of

the earth's blankets, the one which meteorologists call the "stratosphere" or the "isothermal layer."

The word isothermal refers to the curious and unexpected fact that this middle one of our three blankets is of very nearly the same temperature throughout, a temperature of about 80 degrees or 90 degrees below zero, Fahrenheit. That the air grows colder as one goes up the slopes of high mountains is well known. The same observation is made by aeronauts in balloons. There are very few places on earth, if any, in which one can be colder than in an airplane or a balloon four or five miles above the ground.

But at the bottom of the middle air blanket this fall of temperature ceases. At eight miles, at ten miles, even at the twenty-four miles which is the greatest height from which any balloon-lifted instruments have come back to us, the temperature remains still at that eighty or ninety degrees below zero which it had reached at a height of seven miles or so when the balloon entered the second blanket. The outer cold of space, after one has left the earth's atmosphere

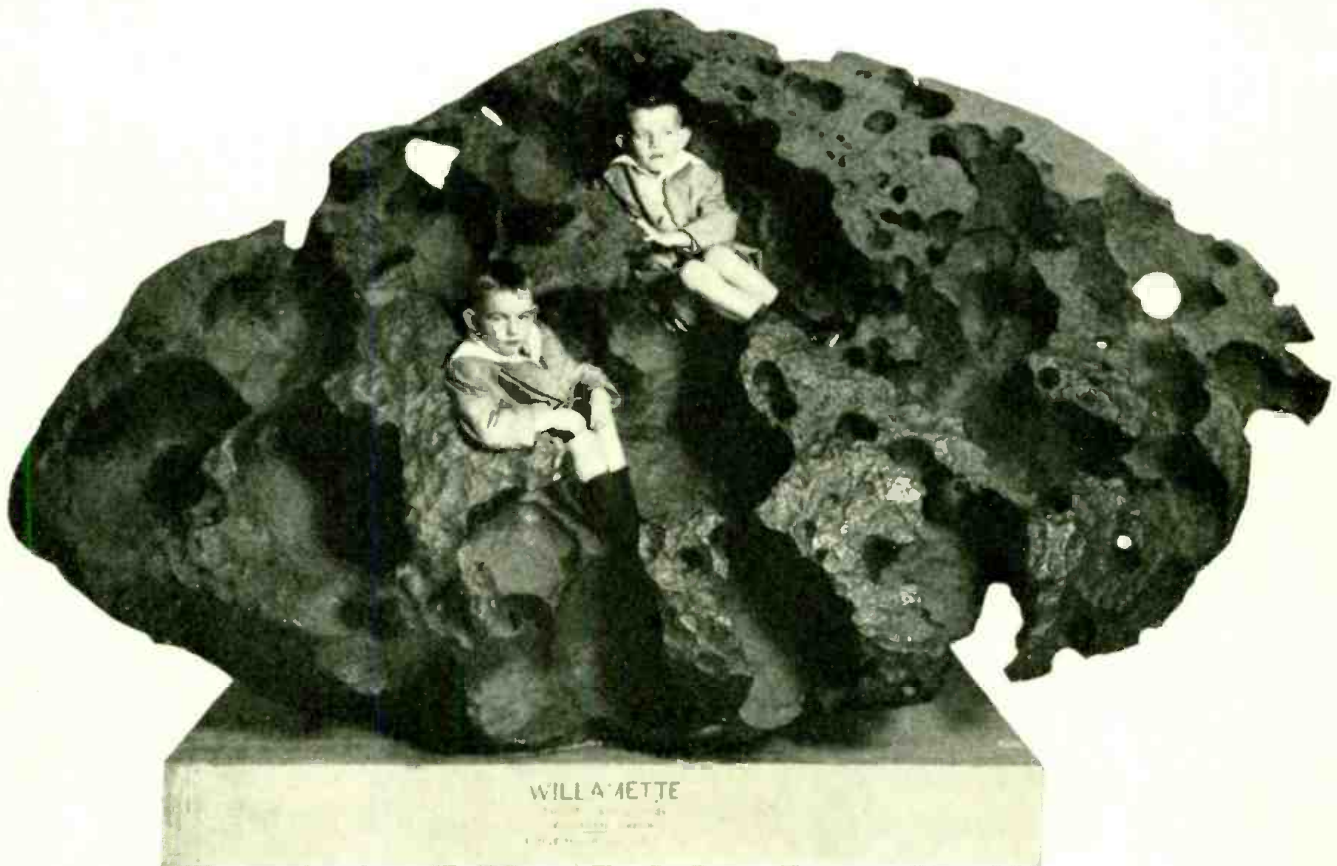

Brown Brothers

One Space Visitor That Penetrated Our Blankets

Nearly all of the meteors that hit the earth's air blanket from outer space are so small that they burn up instantly, making merely a streak of light in the sky. An occasional one is larger, survives the fiery experience forced on it by the air blanket and reaches the ground. This makes what scientists call a meteorite—a meteor that hits the earth. This meteorite was found near Willamette, Oregon, and is now in the Museum of Natural History, New York City.

altogether behind, is believed to approach what is called the absolute zero, a temperature which has been very nearly reached in our physical laboratories and which is calculated as approximately 460 degrees below zero, Fahrenheit. Why is the air of the earth's second blanket kept so warm? Cold as it is—for ninety degrees below zero is by no means a pleasant warmth according to human standards—this middle blanket is far warmer than the enormous degree of frost which we have always believed exists not so many hundreds of miles outside it.

The explanation is to be found, the meteorologists believe, in the properties of the third blanket; the one which wraps the earth on its very outside and which serves, most efficiently indeed, to repel the outer cold of space.

It is this third blanket, too, which acts as the Heaviside Layer, for there is good reason to believe that it begins at just about that same level of fifty miles above the ground which is indicated by the radio tests as the probable under surface of the Heaviside region.

Since this third and outermost blanket of air has never been reached by any kind of balloon, airplane or other man-made contrivance, not even by the shells from the big German gun, we must depend for what we know of it on indirect information. We actually do depend, in fact, on watching the bullets which comets are continually firing at the earth and which this outermost blanket of our air does us the enormous service of stopping. These bullets are the meteors, those flashing streaks of fire in the sky which we call "shooting stars."

These meteors hit the earth's atmosphere at the rate of many thousands each day. Most of them are small, probably not averaging larger than the size of a grain of sand. But they move at enormous speeds, often as great as twenty or thirty miles a second. They are believed to be the debris of comets, scattered in enormous numbers through the space which the earth must traverse each year in its journey around the sun. Some are iron; others are of stone. If one of them hit a man it would go through him, or through a dozen men, like the bullet from a superlatively powerful machine gun. It is probable that if our air blankets failed for a single year to protect us against this continual bombardment there would not be a man, woman, child or animal; perhaps not even a plant; left alive on earth.

But our outermost blanket of air not only saves us from these celestial missiles by stopping them and burning them up, it also provides us as it does so with a great many facts about its own nature. For many years scientists have been ob-

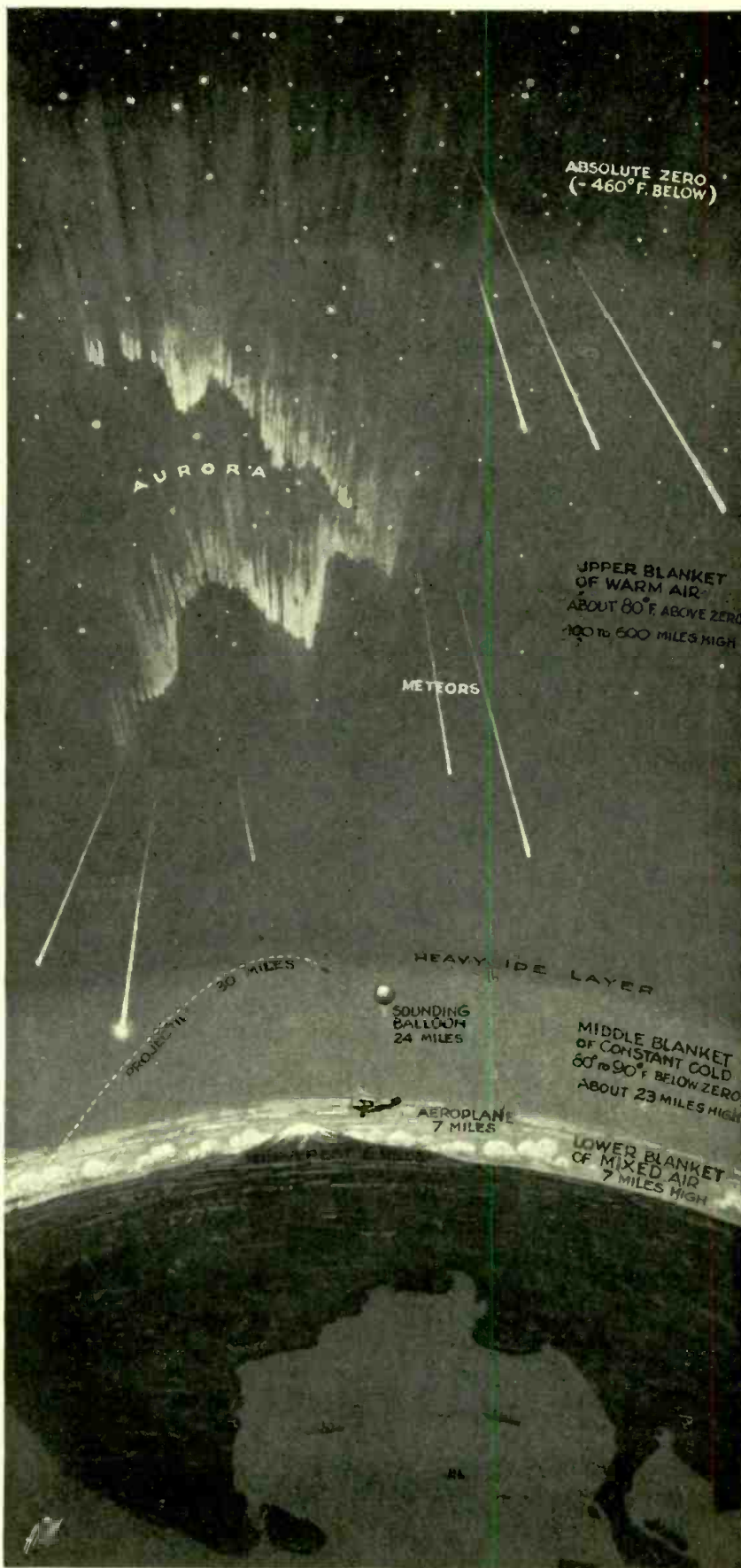

From a drawing by Arthur Merrick for POPULAR RADIO

What Happens Over Our Heads

In the uppermost blanket of warm air occur the auroras and most of the visible tracks of meteors. The other blankets are also shown.

servicing the shooting stars. That is how it was discovered, for example, that these spectacular visitors are related to the comets and are probably composed of cometary debris.

Beginning some years ago, two English scientists, Professor F. A. Lindemann and Mr. G. M. B. Dobson, have carried this study much farther.

They photographed the light streaks made by meteors, using two cameras at some distance from each other. Thus they determined the heights at which each meteor first appeared and the heights at which each one disappeared. They calculated the sizes of the solid projectiles which burnt up to produce the streaks of light. They estimated the brightness of each streak, and from this the amount of energy which was set free by the combustion of the metallic projectile. They won not only a vast increase of our knowledge of the meteoric projectiles themselves, but also some substantial nuggets of fact about the air which the meteors enter and which sets them on fire by its friction.

The most startling fact about this outermost of our air blankets is the fact that it is not cold. Indeed, it is far warmer than the middle blanket and may even be as warm as the inmost air which we ourselves breathe. The calculations seem to prove conclusively that the upper levels of the air are always warm. In his latest pronouncement Professor Lindemann favors a temperature of about 80 degrees above zero, Fahrenheit; that of a warm summer day on the earth's surface.*

This is a remarkable circumstance, but consideration of the probable com-

* "Meteors and the Constitution of the Upper Air," by F. A. Lindemann. *Nature* (London), volume 118, pages 195-198 (August 7, 1926). A recent lecture by Mr. G. M. B. Dobson, published under the title, "The Uppermost Regions of the Earth's Atmosphere," Oxford Press, England, 22 pages, 1926, embodies the same information.



U. S. Signal Corps

Recorders for the Heavens

Lieut. John A. Macready, noted aviator and holder of records for altitude, is shown with some of the recording and indicating instruments that airplanes carry on flights to the highest points which they can reach; still, well below the level of the Heaviside Layer, as shown on page 329.

position of the upper air renders it less surprising.

The uppermost levels of the atmosphere probably contain some oxygen. This oxygen is exposed to the intense light of the sun, containing a larger percentage of the very active ultraviolet rays than sunlight contains after it has been filtered through the three superposed blankets of our air and has reached the earth. These ultraviolet rays convert much of the oxygen into its

modified form which we call ozone. There is sure to be a relatively large percentage of this ozone in the uppermost layers of the air.

Ozone has a remarkable ability of absorbing sunlight and of holding on to it. It is probable, Professor Lindemann and Mr. Dobson believe, that the ozone absorbs enough sunlight to keep the upper layers of air warm. That is one reason why the middle blanket of our atmosphere is less cold than the absolute zero of outer space. It has a still warmer layer of air above it.

Such chemical changes in the uppermost layers of air as the production of ozone from oxygen would have the greatest importance for our theories of radio if we but knew what other gases are present in that outermost blanket, together with the oxygen. It is this outermost blanket we must remember, which constitutes the Heaviside Layer. Presumably the high electric conductivity of that layer is due to atomic changes of the nature of ionization, resulting in electrified atoms; changes of exactly the same kind as those experienced by the atoms of oxygen on their way to become molecules of ozone. It is very probable that the same ultraviolet rays which produce the ozone and thus permit that outer air to keep us warm, are effective, also, in producing the ionized atoms which keep our radio waves on the move.

All these matters we could calculate, probably with considerable accuracy, if we knew exactly what kinds of atoms are there and how many of each. Fortunately, there is an excellent chance that we will be able to find out. There is another well-known phenomenon which occurs in these same uppermost levels of the air. This is the Aurora or "Northern Lights."

For many years a distinguished Nor-

(Continued on page 397)



Photographs by Mr. W. B. Housman

Three Remarkable Photographs Made by the Light of the Aurora

On October 15, 1926, there occurred over the north of England and of Norway one of the most remarkable aurora displays ever seen. The streamers and curtains of electric fire were photographed by Mr. W. B. Housman, at Cumberland, England, who kindly permits POPULAR RADIO to present the three views reproduced above. On the left is a view of the west end of the auroral arch at about 10 P. M. In the center is the same region about three hours later. The narrow lines of light in the sky are made by the motion of the stars, the plate being exposed for some time in order to record the faint light of the aurora. At the right is the central portion of the auroral arch at about 1.30 P. M.

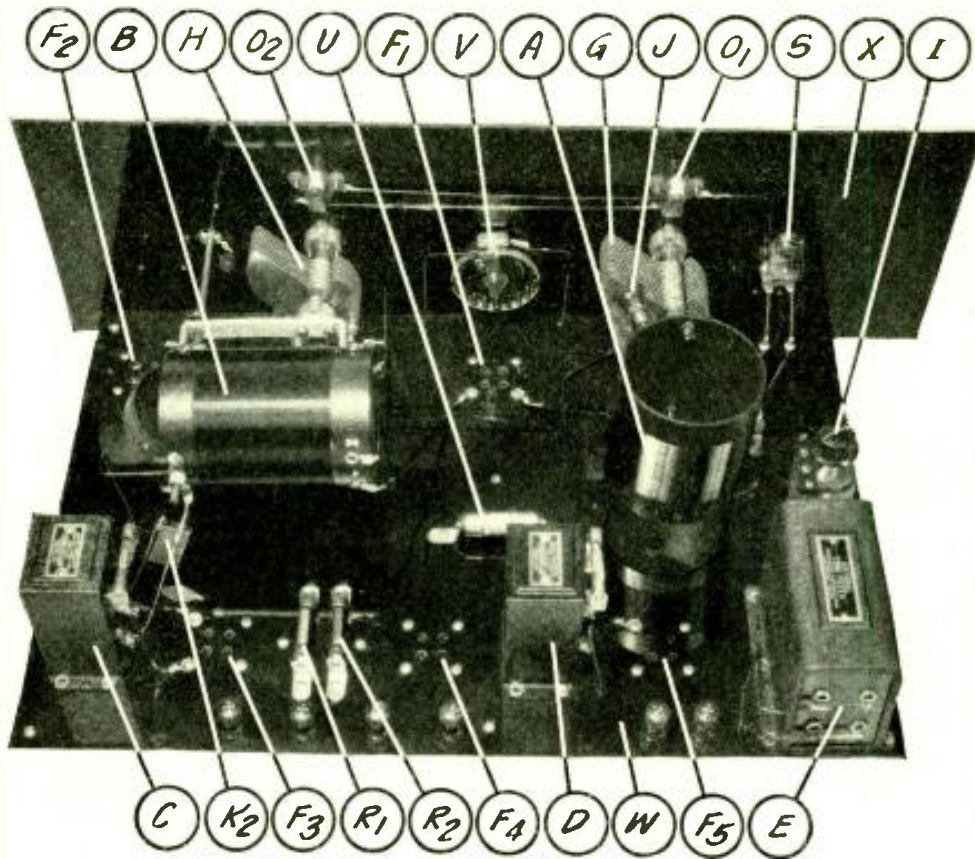

A REAR VIEW OF THE COMPLETED RECEIVER

FIGURE 1: This picture shows how the instruments are mounted on the panel and on the top side of the bakelite baseboard. Notice that the binding posts are mounted along the rear edge of the baseboard; the sockets are riveted directly to the base.

HOW TO BUILD THE NEW STANDARD

Browning-Drake Receiver

Complete details of the design and construction of the latest and best Browning-Drake Receiver—best both in all-around efficiency and in tone quality—are given here for the first time in this article written exclusively for the readers of POPULAR RADIO by the inventors—

GLENN H. BROWNING and DR. FREDERICK H. DRAKE

COST OF PARTS: *Not more than \$87.00*

HERE ARE THE PARTS THAT ARE USED IN THE NEW BROWNING-DRAKE RECEIVER—

- | | | |
|--|--|---|
| <p>A and G—Coil and condenser, comprising the new Browning-Drake antenna tuning unit;*
 B and H—Coil and condenser, comprising the new Browning-Drake high-frequency tuning unit for input detector;*
 C—National Impedaformer, first stage, equipped with Lynch resistor;
 D—National Impedaformer, third stage, equipped with Lynch resistor;
 E—National tone filter;
 F1, F2, F3, F4 and F5—Tube sockets (these are part of the equipment of the subpanel);
 I—Precise midget variable condenser, .0001 mfd.;
 J—Browning-Drake balancing device;
 K1, K2 and K3—Any approved fixed condensers, .001 mfd. (Tiny Tobe fixed condensers are here illustrated);</p> | <p>L—Any approved fixed condenser, .00907 mfd. (Tiny Tobe fixed condenser is here illustrated);
 M—Any approved by-pass condenser, 1 mfd. (Tobe by-pass condenser is here illustrated);
 N1, N2, N3, N4, N5, N6, N7 and N8—Any approved binding posts, marked respectively, <i>Ant.</i>, <i>Gnd.</i>, <i>A-</i>, <i>A+</i>, <i>B+ Det.</i>, <i>B+ Amp.</i>, <i>C-</i>, <i>C+</i> (Eby binding posts are here illustrated);
 O1 and O2—Pilot lamps attached to tuning dials, Y1 and Y2;*
 P—Tobe special type condenser, .1 mfd.;
 Q—Any approved resistor, 8 megohms (Electrad resistor is here illustrated);
 R1—Any approved resistor, .1 megohm (Electrad resistor is here illustrated);
 R2—Any approved resistor, .25 megohm (Electrad resistor is here illustrated);</p> | <p>S—Yaxley filament switch, equipped with Browning-Drake knob;
 T—Browning-Drake resistor, 33 ohms;
 U—Any approved automatic filament control for 1¼ amperes (Brachstat control is here illustrated);
 V—Any approved 30-ohm rheostat (Yaxley rheostat is here illustrated);
 W—Browning-Drake sub-panel, drilled and engraved and equipped with sockets, resistor clips and soldering lugs;†
 X—Browning-Drake front panel, drilled and engraved;‡
 Y1 and Y2—National illuminated vernier dials.*
 1 set of POPULAR RADIO blueprints.</p> |
|--|--|---|

*These parts are contained in the Browning-Drake kit.
 †These parts are contained in the Browning-Drake foundation unit.

The list of parts given on page 331 includes the exact instruments used in the unit from which these specifications were made up. The experienced amateur, however, will be able to pick out other reliable makes of instruments which have been approved by POPULAR RADIO which may be used with good results. But we recommend that the novice follow the list, as the diagrams in this article will tell him exactly where to bore the holes and exactly where to place the connections. If instruments other than the ones listed are used, the only change that will be necessary will be the use of different spacings for the holes that are drilled in the sub-base for mounting the instruments. To any reader who has difficulty in obtaining any of the parts which are necessary in making up these model receivers and power units, POPULAR RADIO SERVICE BUREAU, 627 West 43rd Street, New York City, will gladly assist in seeing that his requirements are promptly supplied.

THE past three years have brought forth no real fundamental changes in radio circuits. But they have brought forth improvements in the circuits and in the apparatus used, both from the standpoint of electrical efficiency and mechanical design.

The tendencies in radio today are toward:

1. Simplicity of control.
2. Better reproduction.
3. Operation of the receiver from the electric-light circuits.

Of course, the receiver must have other essentials; it must have, for example, selectivity sufficient to cope with the present broadcast situation and to allow the reception of distant signals when such are available.

The set described in this article may be operated with batteries or from the electric-light socket. It has two major controls; it is selective and sensitive; and it incorporates a low-frequency amplifier with excellent tone quality.

This circuit is built around an efficient tuned-high-frequency transformer developed at Crust Laboratories, Harvard University, by the authors. This high-frequency amplifier design has been brought up to date in every detail. A few minor improvements, which are the result of constant work on the set, have also been incorporated. One of these is an improved balancing system which has the advantage of being more nearly constant over a band of wavelengths from 200 to 500 meters. The selectivity of the circuit has been much improved, so that tuning, in the face of the present crowding of stations, may be accomplished to better advantage.

One stage of tuned-high-frequency amplification is used in conjunction with a regenerative detector unit.

The condensers and coils have been improved from an electrical standpoint and also from a mechanical standpoint. The coils are wound on a 3-inch form with enameled wire, spaced one-half a

diameter, which reduces the total high-frequency resistance to a minimum value as determined by Mr. Richardson, working on the problem at the Massachusetts Institute of Technology.

A combination low-frequency amplifier, consisting of one stage of impedance-coupled amplification, one stage of resistance-coupled amplification and a final stage of resistance-coupled amplification with an impedance leak, was chosen as a result of long experiment. This type of low-frequency amplifier not only preserves all of the qualities of resistance and impedance amplification, but it seems to be more stable in its operation when used with "B" power-packs, and it is therefore better suited to the AC-operated receiver.

The apparatus has been laid out so as to incur the least possible interaction troubles. Ample space has been left between the two tuning units for the high-frequency amplifier valve, and this arrangement allows for the shortest con-

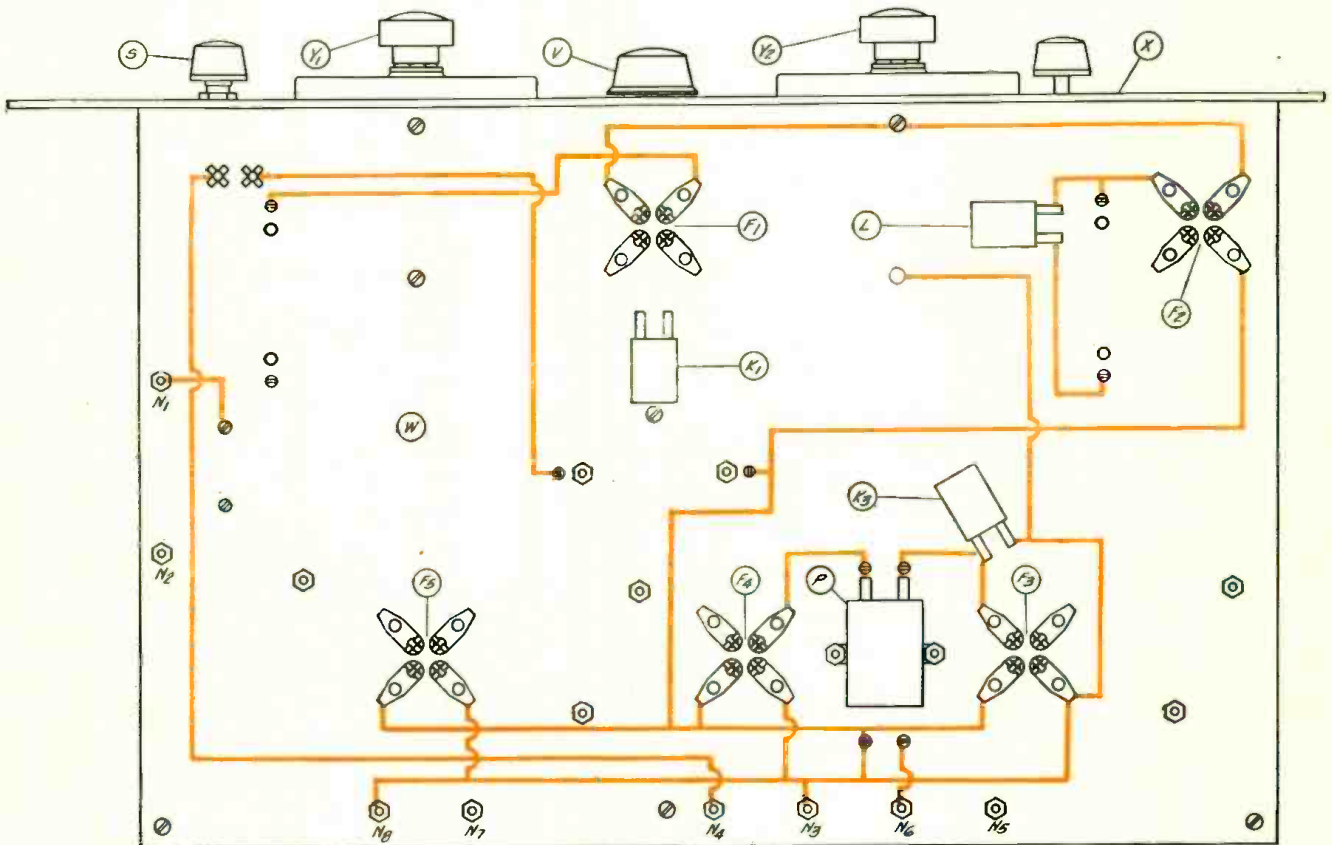

A NEW IDEA OF A PICTURE WIRING DIAGRAM
 FIGURE 2: This new method of showing a picture wiring diagram will eliminate any confusion between wiring and instruments. The instruments are outlined here in black; the wiring is in red. This drawing shows the wiring underneath the sub-panel of the new Browning-Drake receiver.

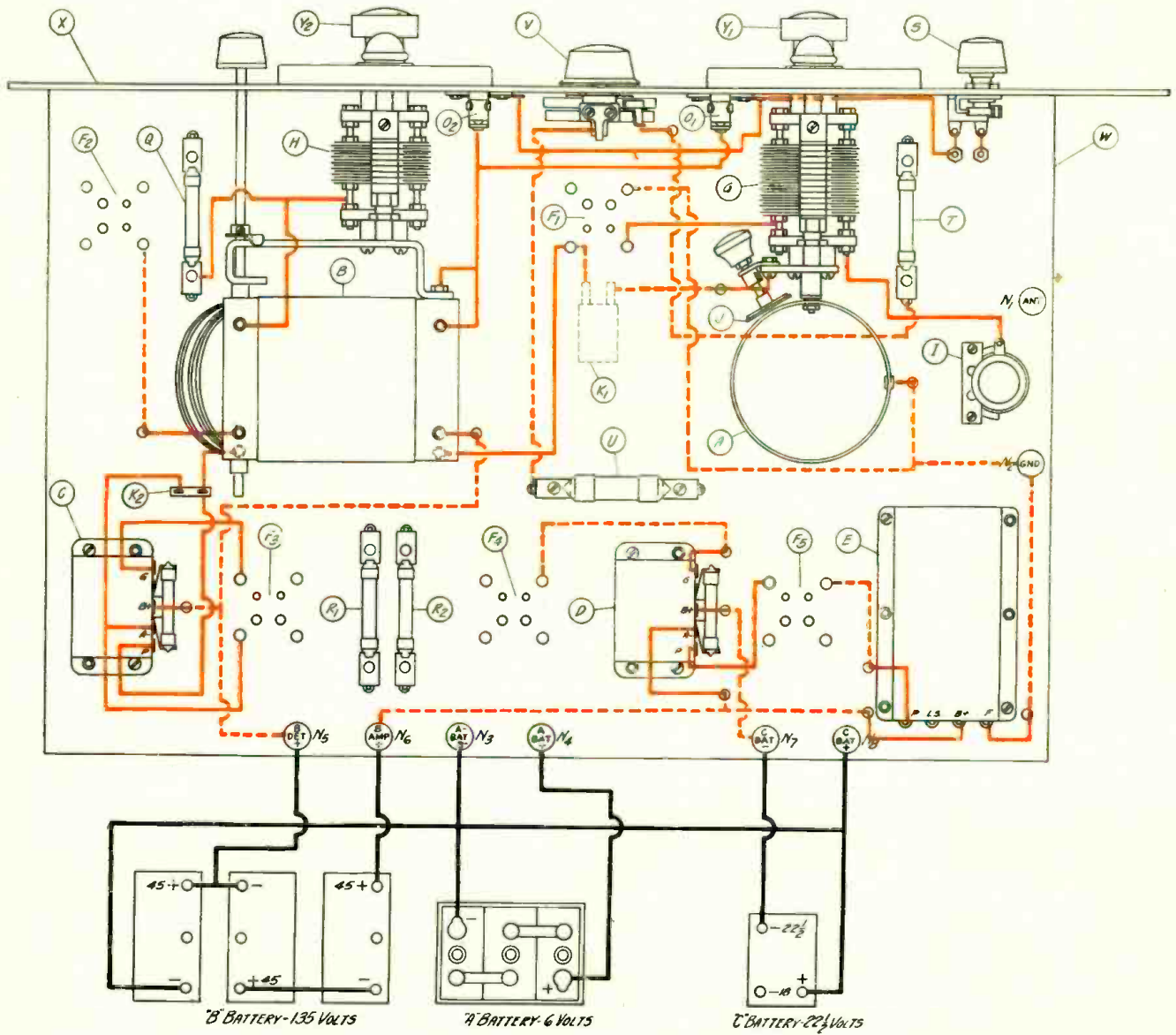

THE WIRING ON THE TOP SIDE OF THE SUB-PANEL.
 FIGURE 3: The instruments drawn in solid black lines are fastened on top of the base; the condenser shown in dotted black lines is under the base. The wiring done on the top of the sub-panel is shown in solid red; the wiring that leads below the panel is in dotted red. The battery connections are also shown.

nections for the high-frequency circuits. The detector is placed at the right of the condenser that tunes the transformer, and the low-frequency amplifier placed towards the rear to reduce similar coupling troubles.

Care has been taken not to place any of the apparatus too close to the coils, as this tends to increase their resistances and to make the tuning broader.

The tuning is accomplished by means of two new-type illuminated dials. In addition to these two dials, a filament switch, a 30-ohm rheostat for controlling volume and another knob, which rotates the tickler coil, are located on the front panel.

The circuit diagram of this Browning-Drake receiver is shown in Figure 6.

How to Construct the Set

As the front panel, X, and the sub-panel, W, may be obtained already drilled, little constructional data is necessary if the photographic illustrations and schematic diagrams are followed.

Mount all of the instruments on the sub-base, W, as indicated in Figures 1, 2, 3, 4, 5 and 7.

In wiring up, it might be well, however, to enumerate the most important connections that should be kept well away from the other connections—

1. The connections from the antenna binding post, N1, to the midjet condenser, I, and the connection from this condenser to the stator plates of the first tuning condenser, G.

2. Connections between the coils,

A and B, and the condensers, G and H (these carry more high-frequency currents than any other leads in the set).

3. The connection between the stator plates of the first condenser, G, and the grid of valve, F1.

4. The connection between the plate of the high-frequency valve, F1, and the primary of the high-frequency transformer, B.

5. The connection between the stator plates of the second tuning condenser, H, grid-leak, Q, and condenser, L.

6. The connection between the grid-leak, Q, and the condenser, L, and the grid terminal of the detector valve, F2.

It will be noted that the specifications for the third low-frequency stage of amplification called for an impedance in re-

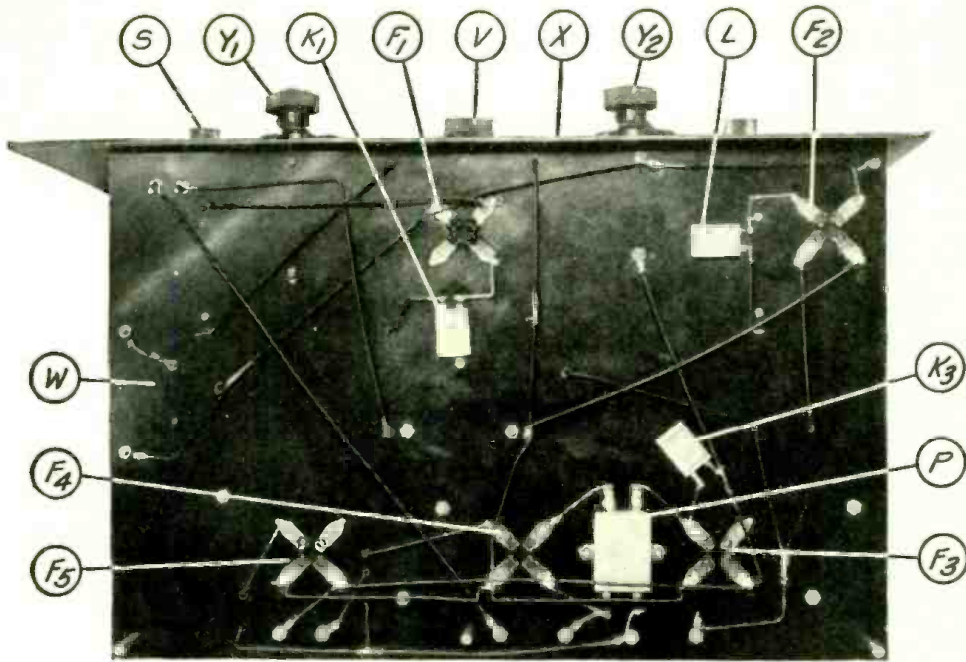

A VIEW OF THE SET FROM BELOW

FIGURE 4: This view shows the bottom of the baseboard and the condensers and socket prongs that are mounted on the under side.

versed position. The Impedaformer unit, D, was designed to accomplish this purpose.

In all the wiring work, it is advisable to make all high-potential connections first, that is, the connections to the grid and the plate terminals of the vacuum valves.

The new receiver is intended primarily for operation with regular 5-volt vacuum tubes except in the high-frequency amplifier, where a UX-199 type valve should always be used. This vacuum valve was chosen for the high-frequency amplifier on account of its small plate-to-grid capacity and the ease with which it is balanced. A resistance, T, of 33 ohms is placed in series with this tube's filament; this reduces the 5 volts, applied to all the other tubes, to 3 volts for this special high-frequency tube.

A 30-ohm rheostat, V, which is variable, is used solely as a volume control and may be turned completely on when maximum signal strength is required.

For the detector, a UX-200-a type vacuum valve has been chosen on account of its high sensitivity. The grid return on this valve is run to the negative side of the filament, as shown in Figure 6.

If the constructor desires to use a UX-201-a type valve as a detector, the grid return should run to the positive filament instead.

For the first two stages of low-frequency amplification High-Mu valves of the Daven, Zetka, Truphonic or Ceco types may be used, or if such great amplification is not necessary, regular

UX-201-a type valves are satisfactory. The former sometimes have slight tendencies to ripple, or cause what is commonly known as "motor boating" in such an amplifier. This is an unstable oscillation occurring when used with some "B" power-packs. This trouble may be

remedied in a number of cases by using one High-Mu tube and one regular UX-201-a type valve.

In the last stage of low-frequency amplification, it is essential to have some type of power valve, if the builder desires to deliver a large amount of un-

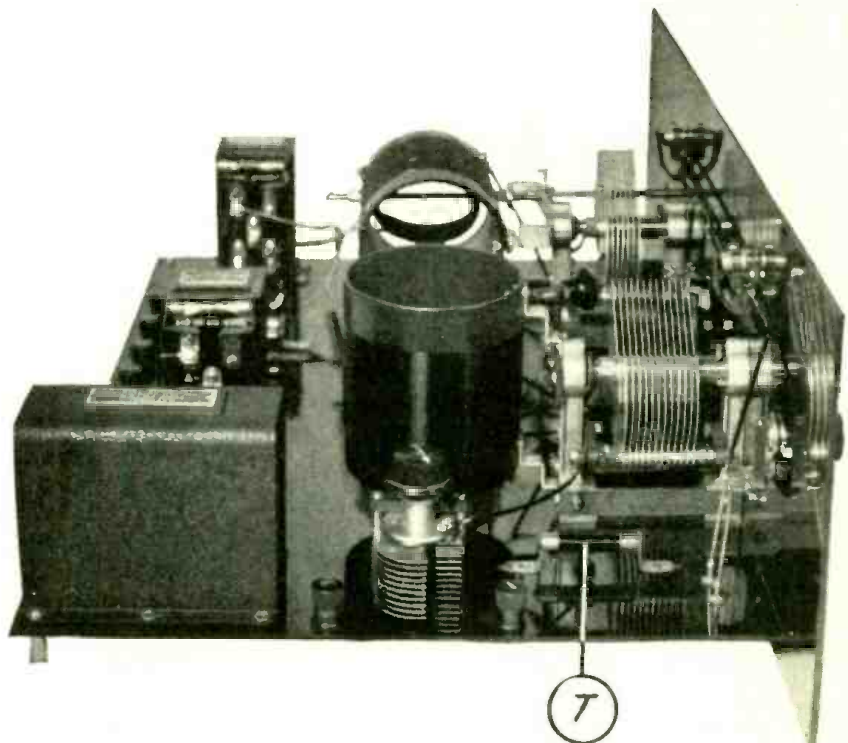

HOW THE SET LOOKS FROM THE LEFT

FIGURE 5: The general method of mounting the output filter, the condensers and coils and the small, midget, variable condenser for the antenna circuit is shown here.

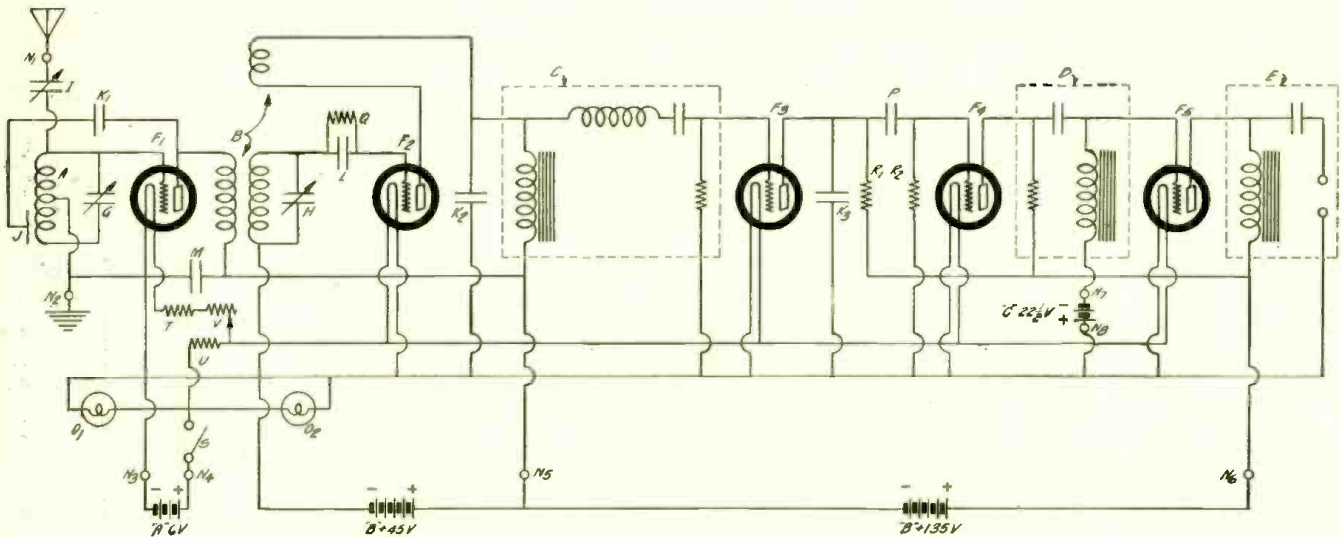

THE SCHEMATIC CIRCUIT DIAGRAM

FIGURE 6: One stage of high-frequency amplification balanced by a simple neutralizing scheme is used together with a regenerative vacuum-tube detector, one stage of impedance-coupled amplification, one stage of resistance-coupled amplification and a final stage of resistance-coupled amplification with an impedance leak and an output filter.

distorted volume to the reproducer. The last valve is really the only place in the set where power is an important factor. Valves of the UX-171 type have a plate impedance which more nearly matches that of good cone reproducers than that of other type tubes.

An output system, E, consisting of a low-frequency choke coil combined with a fixed condenser of about 4 mfd., keeps the DC power from flowing through the windings of the reproducer but allows it to feed the plate circuit of the last valve, F5.

This is desirable, in most cases, as it improves the tone quality at the same time that it protects the reproducer.

How to Operate the Receiver

When the set has been constructed according to the diagrams and photographic illustrations it is ready for installation.

Connect the set up, as shown in Figures 2 and 3, to the batteries, to the antenna, to the ground, and to the reproducer.

When the battery switch is turned "on" and all the tubes are in place, a slight "plop" should be heard upon touching the finger to the grid terminal of the high-frequency transformer, B, when the rotor coil is turned all the way up. This is a test for oscillation in the secondary of the high-frequency transformer. With the tickler coil set in this position, station whistles should be heard upon rotating dial Y2, if any broadcasting station is operating.

To balance the high-frequency tube, which is the one in socket F1, a station should first be tuned in. Then the rheostat, V, should be turned completely "off" and, if the station is a loud, local one, it will still be heard.

The balancing condenser, J, should then be adjusted until a *minimum* signal is obtained; the first tube, F1, will then be properly neutralized. When the balancing condenser, J, is set correctly, a change of the setting of the first dial, Y1, should not change the pitch of the whistle obtained in the detector circuit that operates on tube F2. Of course, the intensity of the whistle will be affected by the setting of the first con-

(Continued on page 389)

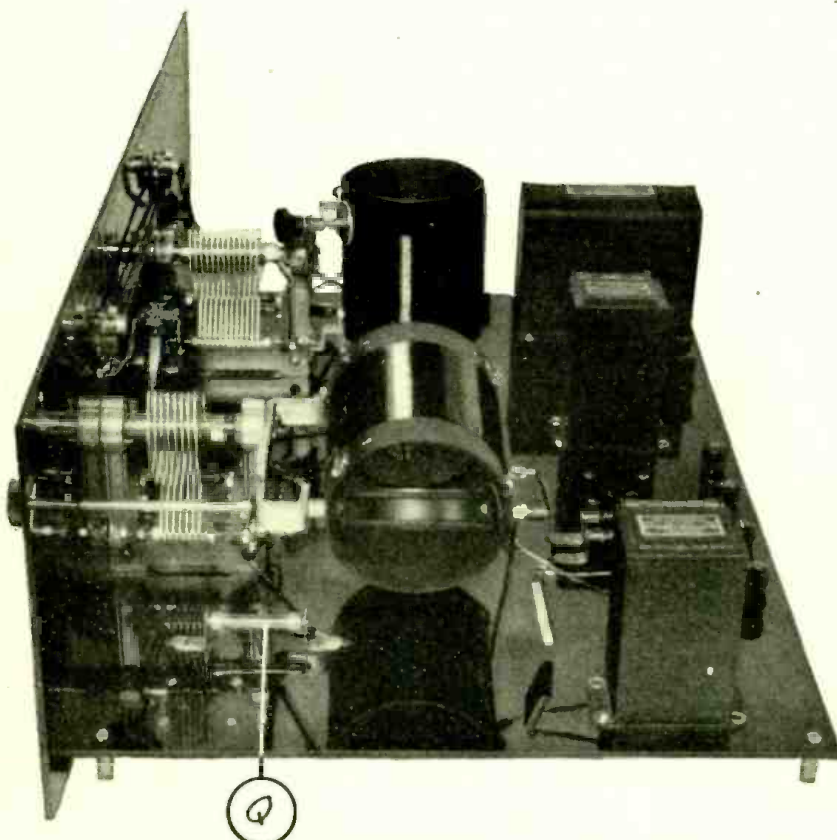

A VIEW OF THE SET FROM THE RIGHT

FIGURE 7: This additional view of the receiver shows again the simplicity and neatness of its design.



General Electric Co.

The New "Drama of the Ear"

Some of the ingenious methods devised by the producers of plays broadcast from studios, to simulate the sounds that build pictures in the minds of the listeners

By CHARLES D. ISAACSON

TO the producer of "legitimate" plays, stage noises are merely incidental. But to the producer of plays that are broadcast from the studio, stage noises are the very essence of its action and the breath of its life.

The technique of the radio drama is becoming more and more complex and interesting in its possibilities.

With the advent of the drama in broadcasting, the query arose "how can this ever be successful? One cannot see the players, hence the most important aid for understanding the action is gone."

Not long before the advent of broadcasting the theatrical producers were convinced that motion pictures could never satisfy an audience, because the "most important aid for understanding the action was gone"—the sounds. But

it was discovered that sounds can be seen as it is being discovered that seeing is possible through hearing. Of course, the motion picture has wisely preferred not to stand only on its own feet—a procedure not yet within the scope of broadcasting. It is for that reason that I am not sure that the radio theatre, at least before we have television, will ever succeed to the eminence of the screen play.

Motion pictures employ music to aid the action. The missing voices are simulated, if not materially improved through the emotion, action and speech, that is suggested by the harmonies of music and the supplementary "stage noises." In radio plays we have not so fine a substitute for the missing element of "seeing." Fortunately, however, it is possible to "see things" through other

mediums than the eyes or the ecstasy induced by alcohol or drugs—such, for example, as the imagination and related ideas.

The purpose of the radio player is to give impetus to the "seeing" areas of imagination, memory and comparative suggestiveness.

This seemingly theoretical pronouncement can be easily explained; the sounds of knives, forks, plates, suggest, through the memory sense, the idea of eating. The radio impresario may quickly paint a dining room scene without the aid of canvas, if there are heard the dishes, the rattle of knives and forks, the chairs drawn to the table and the stirring of food.

If he punches a pillow during the relation of certain ideas in the conversation, a bed, a couch or a comfortable

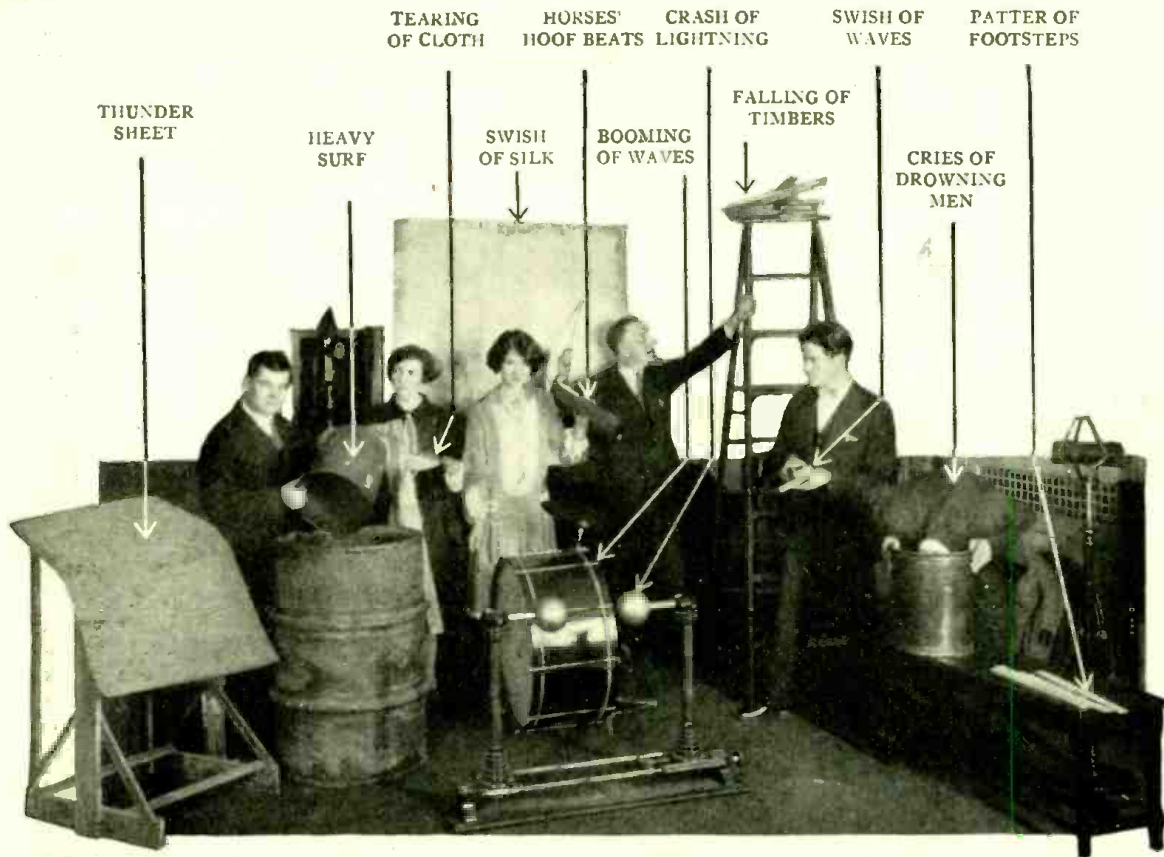

General Electric Co.

chair are pictured, according to the context of the lines in the play.

A fog horn tells of a dismal ocean scene, a rooster portrays the barnyard, a typewriter the business office.

So in the plays which are being broadcast the producers try to supply just enough sounds to stimulate the imagination and memory of the listeners.

This account of stage noises will not touch upon such commonplace sounds as the crashing of glass, the opening and closing of doors, the blowing of whistles, the ringing of the telephone, the galloping of horses, and the crashing of thunder, but upon the more subtle sounds.

During the broadcasting of my recent play, "Suppose It Should Happen," which was written with a radio presentation exclusively in mind, there is a tense situation. A husband and wife are awakened in the middle of the night to find in the elimination of every device of modern science that they are cut off from the world. They go to the telephone and it won't work. (The receiver arm of the telephone is heard to go frantically up and down.) The bell to the servants does not respond—but the listener can hear the push-button pressed. The electric light switch is useless, but the click of the switch with the helpless comment of the players are put upon the microphone. When the husband in a vain search for help goes down the steps, one can hear the tapping of the feet in the

loose slippers gradually dimming away in the distance—a sound effected by a sensitive board and a floor mike. To get the effect of his voice yelling from the hall below, the actor muffles his cries by covering his mouth with his hand. It becomes necessary to find a way in the dark; matches were struck and finally candles were lighted and are blown out when daylight comes.

All these effects are real, and are created right up at the microphone. (Technical readers know that a whisper at the microphone may be a scream on the loudspeaker.)

What the producers of radio dramas seek to do is to give close-up effects similar to those used on the screen. So they enlarge the ordinary sounds, just as the movie director enlarges his scenes. The movie makes you feel more intensely the emotion by intensifying it by artificial means; that is what the radio producers are endeavoring to do with sounds.

When, for instance, a character looks at the clock and the question of the time is important, the clock is brought right up to the microphone. When a sob is the note which defines the action, that sob is the close-up. So is a cough or a laugh. Once a producer wanted the comedy of getting the chewing food across to the radio audience, so he had a noisy eater chew celery at the microphone. In a tense moment, when a character has nothing to say—only his

anger, his fright, his utter bewilderment are to be expressed—his emotion is "pantomimed" by transmitting his hard, slow, staccato breathing as a close-up.

A letter should never be opened without the sound of its unfolding being heard. A newspaper should not be read without the rustling of paper.

Alice Brady, who starred in a radio play, assumed the rôle of a girl of long ago; she was supposed to wear a big hoop skirt costume of the period. Her dress was broadcast by the rubbing and swishing of a large piece of silk. Generally costumes are described or at least suggested by some phrase or sentence.

In the play "Suppose It Should Happen" (mentioned before) the husband and wife, frustrated by the absence of auto, train and street cars, resort to horseback to reach the city. It was all a dream, and to make the transition, the producers conveyed the sounds of the horses' hoofs getting slower and slower and finally timed exactly to the puff, puff, puff of a percolator which had been heated and brought up right close to the microphone!

Inasmuch as the Edison company's radio plays are based on scientific and particularly upon electrical subjects, the producers have naturally turned to sounds associated with that field. They have cleaned rooms with a vacuum cleaner, and used an electric curling iron; once when they were representing

a woman heating a curling iron over a candle, they had one of the characters say "Be careful, the wax smoke has blackened that," and rubbed the iron with a paper to accentuate the scene. They never suggest an automobile before the microphone merely with a horn—the listener hears the motor going and the self-starter working. A sewing machine gives the effect of the motor while the car is at rest. They have even broadcast the sounds of bread toasting, corn popping, water boiling, eggs opened, and food being stirred on the stove. So also is the washing machine heard working.

Once the producers released a flock of pigeons in the studio to get a certain effect; at another time they had a dog and cat embroiled in a real, not a staged fight!

A real life play termed "It Can Be Done" which was broadcast, re-enacted the tragedy of Sol Rothchild, nearly killed in an automobile accident and then condemned by the doctors to life-long paralysis. The presentation was slightly gruesome, but the automobile accident was a classic of the microphone. One heard the crash, the breaking of glass, the crunching of metal, the overturning of the machines, the screaming

of the crowds, the ambulance, and finally the operating room.

How was that all done? At the right moment, two pieces of metal were struck and then a plate of glass was hit and a little noise maker was slowly turned and the mob was set loose. The "mob" was four people, who, properly timed, gave the effect of many more. (And, speaking of crowds, a few people properly placed before the microphone are infinitely better than a real mob; in singing, also, it is better to have a dozen voices than a whole chorus set without regard to the microphone.)

In connection with the Sol Rothchild drama (with the principal actor carried to the studio on a stretcher to play his story in person) an ambulance bell was used; the operating room was suggested by the sound of instruments and the tearing of the bandages.

When "The Phantom Ship," a sailing vessel of many years ago, was broadcast as a play, one heard the conversation at the wharfs. The anchor was drawn up, the ship set sail, she rode the waves, encountered a storm, weathered it, came to calm, met a pirate ship, conquered and sailed back to port. The creak of the hull was simulated by a man moving back and forth in a creaky swivel

chair. The window shades were rattled to represent the sails in the wind. A board was run over sandpaper to represent the swish of the waves. The ropes souged and went up over pulleys; chains rattled; the captain and mate roared their orders. And when calm succeeded, the crew sang their chanteys.

One could list many novelty ideas in broadcasting sounds. In an indoor football game, for example, the audience listened to the sounds made by the players by placing the microphone in their midst during the scrimmages. The sounds of a circus—of the animals, the birds and the freaks—have been broadcast; so have the sounds of riveting, of sawing, of hammering, been broadcast from the top of an unfinished building in New York. Once some real atmosphere was created to put across a ghost story, by having it told actually to a group of youngsters who didn't know the microphone was open. And a scratching right on the microphone cage once gave the effect of a man trying to escape from a cell.

The dramatist of the future will make his plays with a definite conception of the limitations and opportunities of the microphone, and with an ability to translate "soundings" into "seeings."



International Newsreel

A NEW APPLICATION OF ETHER WAVES

Headphones that bring radio entertainment to the patient while he or she is undergoing an operation performed under spinal anæsthesia or local anæsthetics are the latest addition to the up-to-date operating room. Surgeons have found that music reduces the psychic shock of the operation and diverts the patient's mind. At St. Marks Hospital in New York City (where the above picture was taken) headphones were recently successfully used to minimize the shock to the patient.

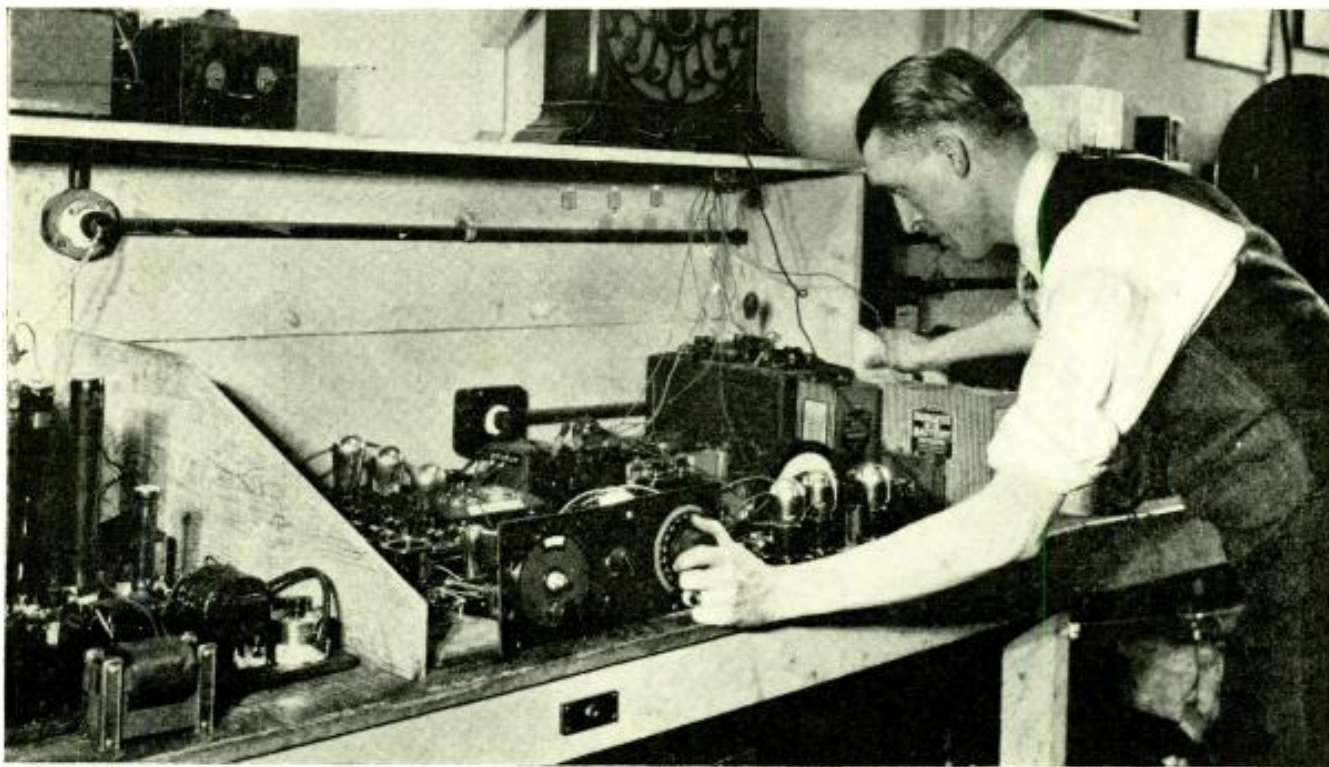

From a photograph made for POPULAR RADIO

TESTING RESISTANCE-COUPLED AMPLIFIERS IN THE LABORATORY

When resistance or impedance-coupled amplifiers are used in connection with certain types of "B" power-packs the parasitic oscillation at low frequencies known as "motor-boating" occurs and spoils the reproduction.

Resistance-coupled Amplifiers

How to Make Them Work With Power-packs

Squeals, "motor-boating" and "blocking" often spoil reproduction when this type of amplifier is used with a "B" power-pack; this article tells what causes this trouble—and how to get rid of it.

By WILLIAM T. TABER

EVER since "B" eliminators came into general use trouble has been experienced when they have been used in connection with resistance-coupled sets. This has been due to no inherent fault in the amplifiers or the power-packs but in the characteristics that arise when the two are coupled together.

A properly designed resistance-coupled amplifier will amplify the whole frequency band (as used in broadcasting). But it will also amplify the low-frequency hum from the AC power line so that a superimposed audio-frequency component, caused by regeneration due to the filter and the potential-dividing resistor network, may result.

In order to find out at exactly what frequency the trouble started, the writer, and his associate, Mr. J. G. Uzmann made many oscillograph pictures showing the electrical wave before

entering the amplifier and after leaving the several stages. The slightest distortion would be shown clearly in these photographs.

In working on this problem Mr. Uzmann and his engineering associates first segregated the four main symptoms of trouble; these may be described as follows:

1. The generation of a low-pitched fluttering sound;
2. The production of a high-pitched "squeal";
3. A slow "clucking" noise;
4. Complete blocking of the audio-frequency amplifier.

In general, all of the "B" power-packs now on the market, when used with resistance-coupled amplifiers, give these types of trouble.

This is due to the following causes:

1. Low-frequency regeneration, caused

by the "B" potential-dividing resistor network;

2. Relatively poor action from the filter circuits because of insufficient capacity or inductance or both in the filter network;

3. High-resistance filters;

4. Variable AC line voltages, or power surges;

5. Poor voltage control of rectified currents;

6. Occasional failure or irregular operation of the rectifier device;

7. Unstable variable resistances for "B" voltage adjustment;

8. Amplification of the unfiltered "ripple."

It has been found that these difficulties may be eliminated simply by changing a few resistance values in the low-frequency amplifier.

Resistance-coupled, low-frequency am-

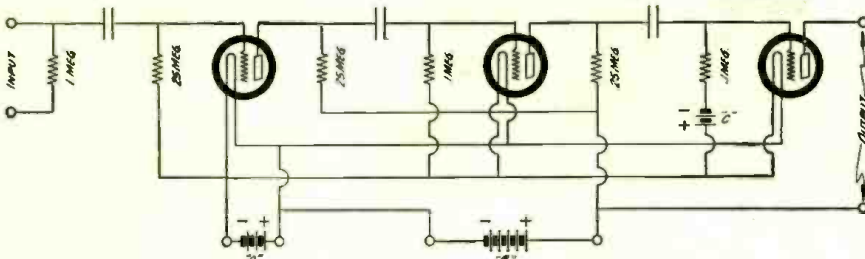

FIGURE 1: This diagram shows, schematically, the hook-up for a standard resistance-coupled amplifier.

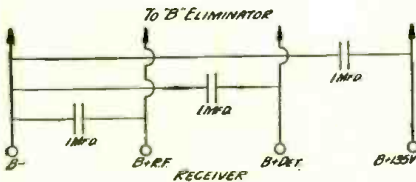

FIGURE 2: The addition of by-pass condensers across the various plate supplies to the intermediate stages will often eliminate regenerative troubles.

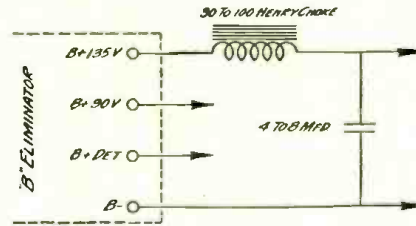

FIGURE 3: A choke coil in the high-voltage lead shunted by a large fixed condenser is sometimes sufficient.

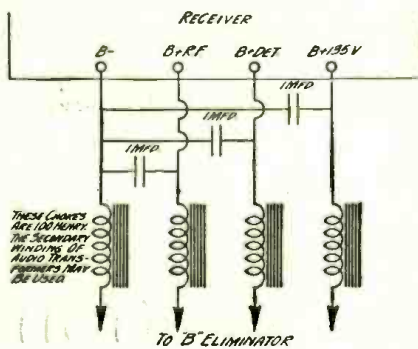

FIGURE 4: A combination of the schemes shown in Figures 2 and 3 may clear up the trouble if both fail separately.

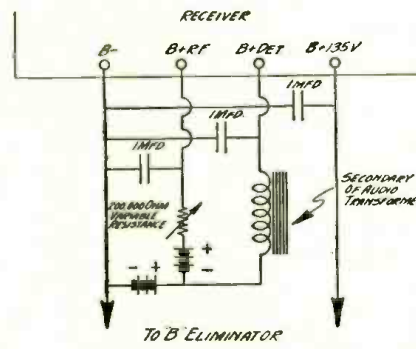

FIGURE 5: The variable resistance may be adjusted until the unwanted frequency beat stops.

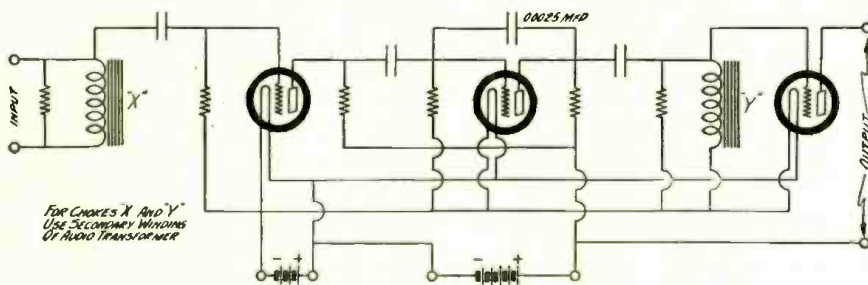

FIGURE 6: The use of two chokes, X and Y, with a .00025 mfd. condenser, as shown, often succeeds.

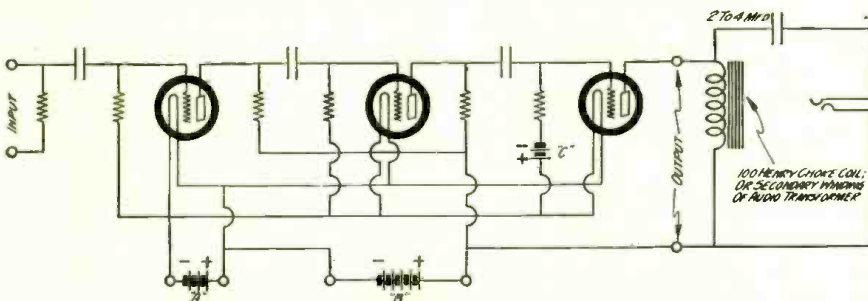

FIGURE 7: An output filter and proper "C" bias may eliminate trouble.

plifiers have heretofore used the following values for the coupling resistances:

- The first-stage, plate resistor— $1/10$ meg;
- The first-stage, grid resistor—1 meg;
- Second-stage, plate resistor— $1/10$ meg;
- Second-stage, grid resistor— $1/2$ meg;
- Third-stage, plate resistor— $1/10$ meg;
- Third-stage, grid resistor— $1/4$ meg;

These values have become accepted as standard; and you will most likely find that the ones in your resistance-coupled low-frequency amplifier correspond with them in resistance values.

Figure 1 shows the substitutions which should be made when the amplifier is to be used with a "B" power-pack.

- Change the first-stage, plate resistor from $1/10$ meg. to $1/2$ or 1 meg.;
- Change the first-stage, grid resistor from 1 meg. to $1/4$ meg.;
- Change the second-stage, plate resistor from $1/10$ meg. to $1/4$ meg.;
- Change the second-stage, grid resistor from $1/2$ meg. to $1/10$ meg.;
- Change the third-stage, plate resistor from $1/10$ meg. to $1/4$ meg.;
- Change the third-stage, grid resistor from $1/4$ meg. to $1/10$ meg.

Sometimes a high- μ tube may still show a slight tendency to produce the familiar symptoms even after these changes have been made but generally the first stage only is affected.

If you have this experience, either change the tube positions or replace the first high- μ tube with a UX-201-a type tube. The remaining recommendations are not ordinarily necessary unless the "B" power-pack filter is improperly designed.

Figure 2 shows the addition of a number of 1 mfd. condensers. These are placed so that the "B" power-terminal connections at the receiver will be by-passed. Always ground the "B" minus (—) terminal.

Sometimes it is necessary to improve the characteristics of the filter. This can be readily accomplished by increasing the values of the condensers or chokes, as shown in Figure 3.

Figure 4 shows a sketch of an audio amplifier with several recommendations for better operation. Sometimes all three of these must be used before complete elimination of the trouble is experienced. They are:

1. Use .25 or .1 megohm grid-leaks for the third and possibly the second stage;
2. Shunt the audio-transformer secondary winding across the plate resistors of any stage; the first stage is usually best.

(Continued on page 393)

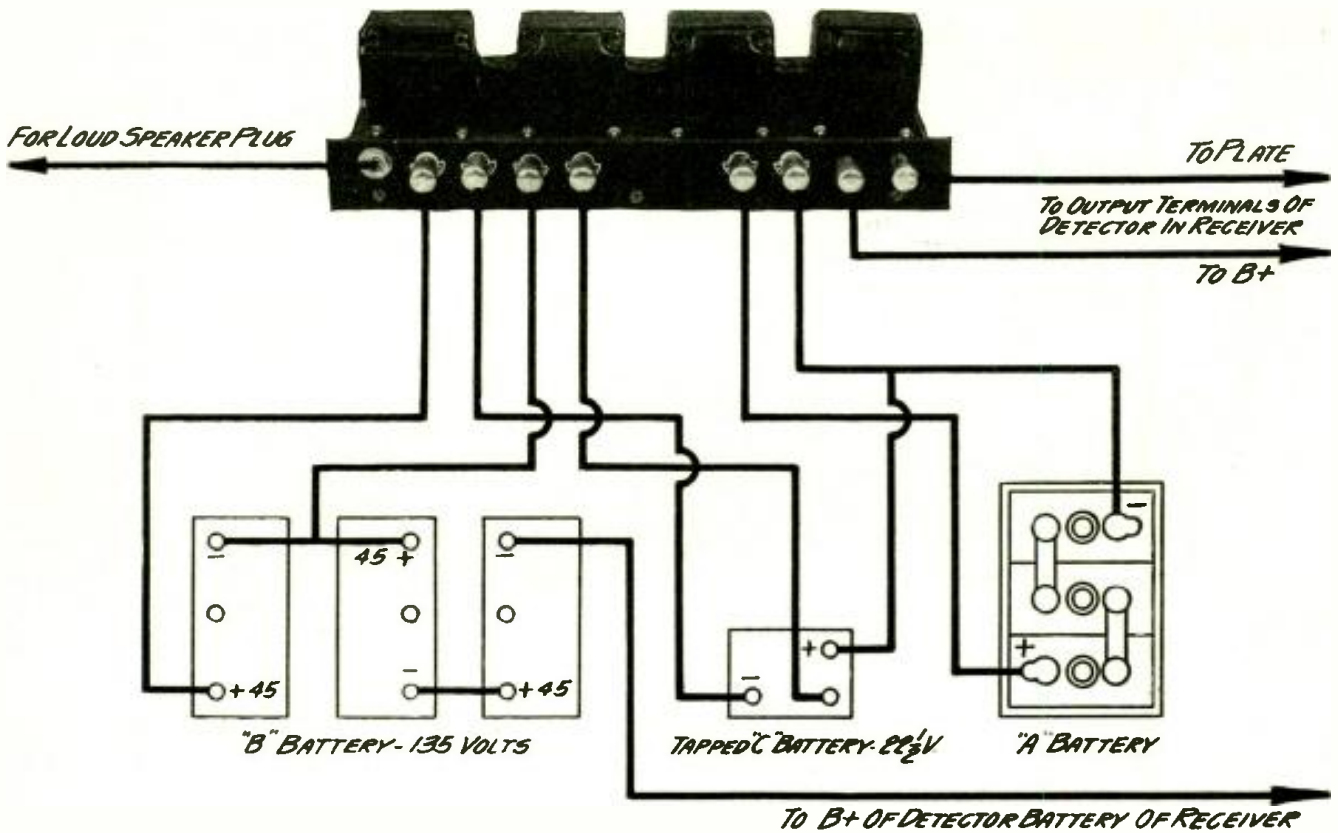

HOW TO HOOK UP THE AMPLIFIER

FIGURE 1: The proper connections for the batteries and for the input and the output of the Truphonic system are shown here; notice that the negative end of the "B" batteries is connected to the detector tap on the receiver.

How to Get Quality Amplification

NUMBER 2: How to Build a Low-Frequency Amplifier Using the Truphonic Coupling Units

This new series of constructional articles describes in detail the modern methods of amplification at low frequencies for obtaining quality reproduction. The amplifier units are small, compact and easy to build and they may be inserted either in an old receiver or in a new one to obtain undistorted amplification.

By THE TECHNICAL STAFF

COST OF PARTS: Not more than \$29.00

HERE ARE THE PARTS THAT WERE USED IN THE LABORATORY MODEL OF THIS UNIT—

- A, B and C—Na-ald Truphonic low-frequency couplers, No. 301;
- D—Na-ald output filter unit (choke and condenser), No. 300;
- E—Any approved automatic filament control for 1 ampere (Brachstat control illustrated);
- F1, F2 and F3—Any approved UX type vibrationless sockets (Benjamin sockets illustrated);
- G—Tobe output condenser, 4 mfd., working voltage 250 volts DC;
- H—Any approved small single-circuit jack (Carter jack illustrated);
- I1, I2, I3, I4, I5, I6, I7 and I8—Any approved binding posts (X-L binding posts illustrated);
- J—Hardwood baseboard, 6 by 12 by 1/2 inch;
- K—Composition binding-post strip, 1 1/2 by 12 by 3/16 inch.

HERE is a new amplifier embodying a new idea in inter-stage coupling unit design, that gives exceptionally true and natural reproduction. It is easy to assemble and consists of three stages of Truphonic-coupled amplification with an output filter for keeping the DC potential of the power tube from the windings

of the reproducer, thus protecting them from possible injury.

This amplifier may be incorporated in place of the old-fashioned amplifier unit in an old receiver to bring the quality of reproduction up-to-date, or it may be used with a new model that the experimenter proposes to build in his home.

The model described was designed especially for this purpose by the staff of POPULAR RADIO EXPERIMENTAL LABORATORY and the tests show that it is exceptionally good.

The schematic wiring diagram for the unit is shown in Figure 2.

(Continued on page 394)

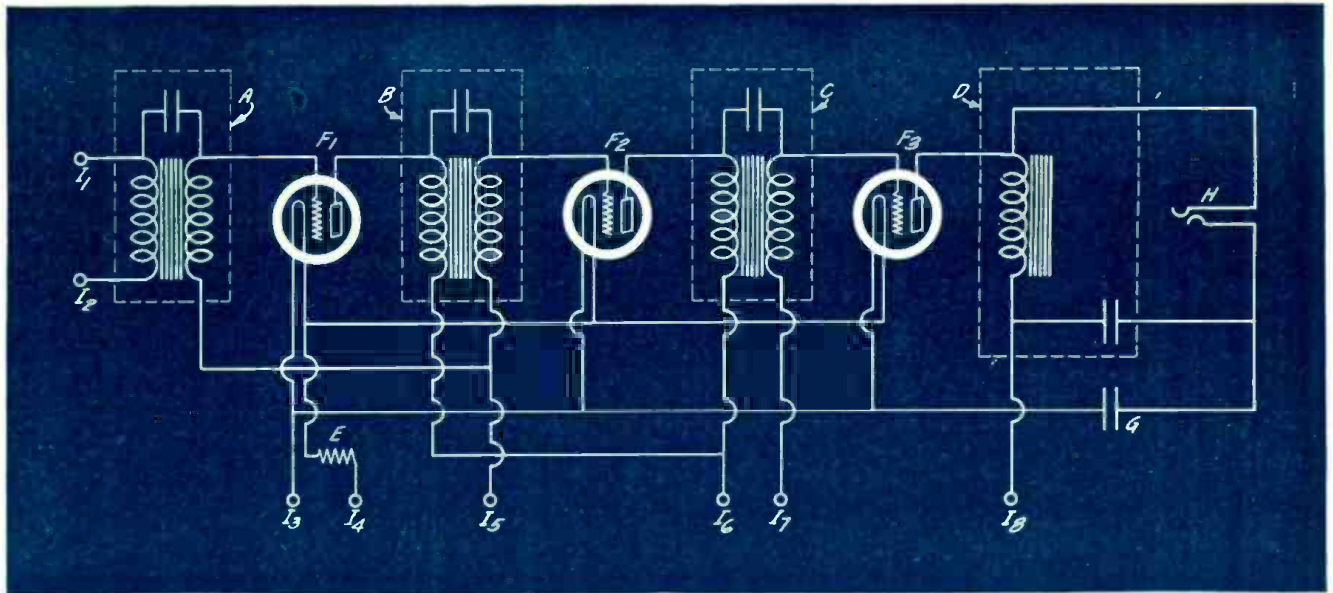

THE SCHEMATIC WIRING DIAGRAM

FIGURE 2: The exact scheme of connections of the three TruPhonic coupling units, A, B and C, and the output filter device, D, are given in this diagram. A second by-pass condenser, G, has been added to forestall the possibility of coupling in the output stage.

The list of parts given on page 341 includes the exact instruments used in the laboratory model of this receiver. The experienced amateur, however, will be able to pick out other reliable makes of instruments which have been approved by POPULAR RADIO and which may be used with good results. But we recommend that the novice follow the list, as the diagrams in this article will tell him exactly where to bore the holes and exactly where to place the connections. If instruments other than the ones listed are used, the only change that will be necessary will be the use of different spacings for the holes that are drilled in the sub-base for mounting the instruments. To any reader who has difficulty in obtaining any of the parts which are necessary in making up these model receivers, POPULAR RADIO SERVICE BUREAU, 627 West 43rd Street, New York City, will gladly assist in seeing that his requirements are promptly supplied.

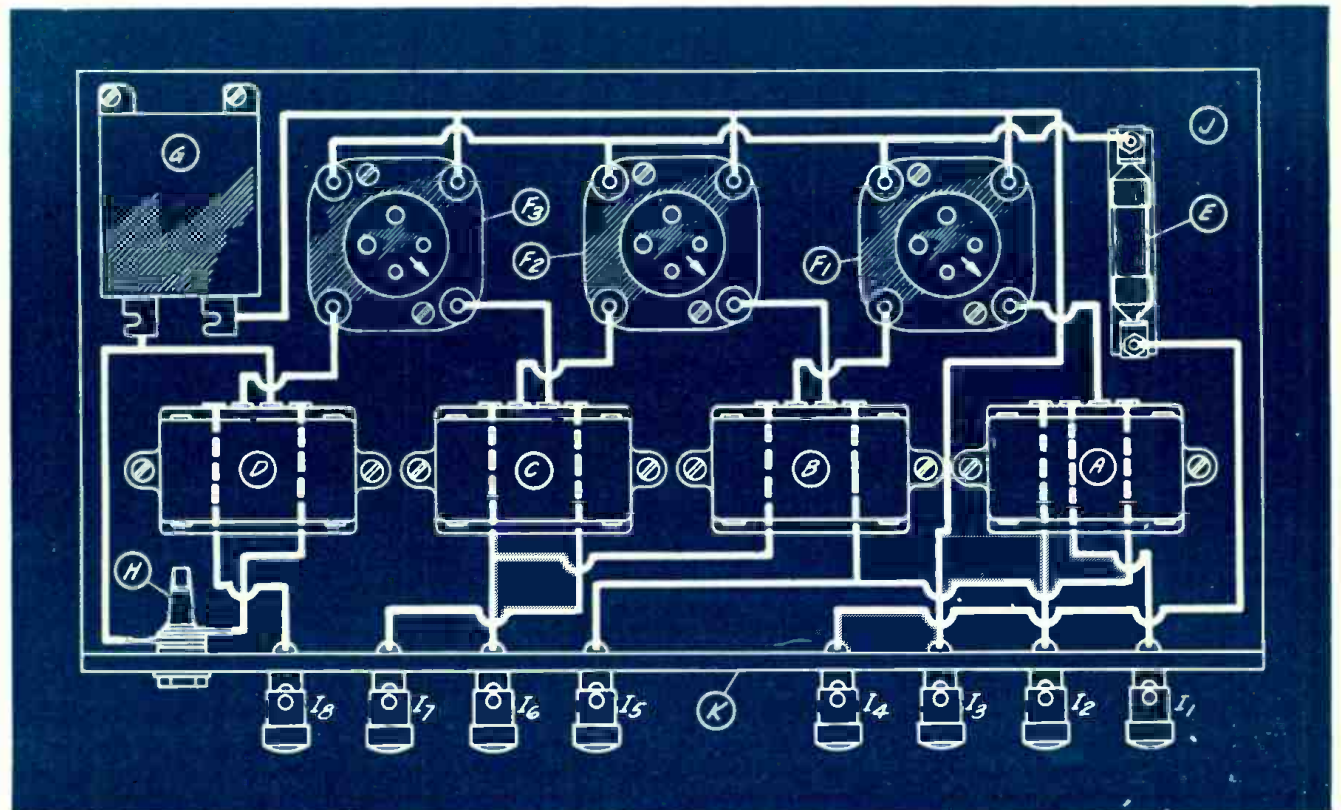

THE PICTURE WIRING DIAGRAM

FIGURE 3: This drawing, which will help the builder to lay out the instruments in their correct, relative positions, also gives in heavy white lines the exact electrical connections to every part used in the receiver.

HELPS FOR CUTTING DOWN MAN-MADE

Interference

Don't blame all radio interference on static and station interference; much of it may be due to machinery in your own home. This article tells how to trace down this troublesome type of interference and reduce it.

By LAURENCE M. COCKADAY

TO the man in the street there is only one kind of radio interference—static.

All of the troublesome noises that interfere with his radio reception he groups under this convenient name. And he takes them with a grumble like the weather—bothersome but unescapable.

But the expert knows that these noises may come from a great many different sources; he knows that much of the so-called "static" may be traced down and eliminated. So, for convenience, he divides the various kinds of radio interference into five general classes:

1. Static proper;
2. Interference between stations on adjoining wavelengths;
3. Interference from radiating receivers;
4. Code interference from badly-tuned spark transmitters;
5. Inductive interference from electrical machinery.

The first of these five divisions, static proper, is due to electrical disturbances in the atmosphere and is somewhat tied up with weather conditions. This trouble is rapidly being reduced by the increased power of modern broadcasting stations, which is placing the signals on a basis of greater strength than the static. This particular form of static is less of a troublesome feature than it used to be.

The second source, interference between stations may be—and will be—reduced by greater selectivity in modern receiver design and by a better zoning and allocation of transmitting stations.

The third interfering factor, the use of radiating receivers, is being brought more and more under a voluntary ban by the broadcast listeners themselves; this type of interference is perceptibly lessening.

Code interference from broadly tuned spark transmitters (the fourth class) is also gradually being done away with, as both the commercial and Navy code transmitters are gradually being converted into continuous-wave, vacuum-valve apparatus that is capable of being

tuned as sharply as the broadcasting apparatus itself.

The fifth kind of interference, however (inductive interference from electrical machinery), is causing more and more trouble as the antennas used for reception become smaller and smaller and sets become more sensitive. The more sensitive a receiver is, the more inductive interference it will pick up; and although this kind of interference is reduced by the use of modern shielding in the receiver, this does not, in itself, serve as a final remedy.

Under this latter type of interference may be classed interference from motors, elevators, oil burners, refrigerators, washing machines, high-frequency vibrators, violet-ray machines, rotary converters and dynamos in sub-stations, trolley cars, small DC and AC universal motors, electric signs, power transmission lines and many other electrical devices and appliances used in commerce or in the home.

The man-made static from these devices is generated at the point of contact of rotary switches—at the vibrators of high-frequency apparatus, at dirty commutators of motors or generators and through the leaks in power transformers or in transmission lines.

The small or large sparks set up by these leakage currents or contact arcs generate exactly the same kind of radio waves as set up by the old-fashioned spark transmitters. However, the electrical surges generated by these sparks, travel along the power lines, to which the apparatus is connected, and are thus easily picked up by receivers located near them.

This effect is more especially true in receivers that operate without batteries from associated power lines. The waves are usually picked up by the antennas of receivers from the power lines and produce crackling sounds, buzzes, hums and other raucous noises too numerous to mention.

The best way to cut out this trouble is to stop it at its source, to catch it before it gets into the power lines. This, fortunately, is really easy to do.



From a photograph made for POPULAR RADIO

HOW TO REDUCE INTERFERENCE FROM YOUR ELECTRIC MOTOR

FIGURE 1: A simple way to cut down trouble from this source is to insert a filter between the motor and the power lines. Filters like the one shown above are now made expressly for this purpose; they may be easily connected in circuit by any fan.

The power companies are always willing to cooperate with the radio users in checking up leaks in their lines and repairing them.

But the job in the home has been given little consideration, although it is easy to remedy. To stop the disturbances from motors and generators, an examination of the commutators should first be made. They should be cleaned with fine sandpaper and the brushes should be adjusted so that sparking will be reduced to a minimum. The same holds true for switches and other electrical contacting devices of this nature. This will not be a positive cure but it will reduce the trouble.

A further step, that will positively eliminate the trouble, is to interpose iron-core chokes of the proper inductance and of large enough wiring to pass the load-current. These should be connected as close to the apparatus as possible and should be designed to allow the free passage of the direct or alternating current for running the motor or other device. But these chokes should stop the high-frequency disturbances, generated at the contactor on the device, from passing back to the power lines. These

5 Sources of Interference



1: Old-type X-Ray apparatus used by doctors and dentists may broadcast interference to receiving sets within two city blocks.

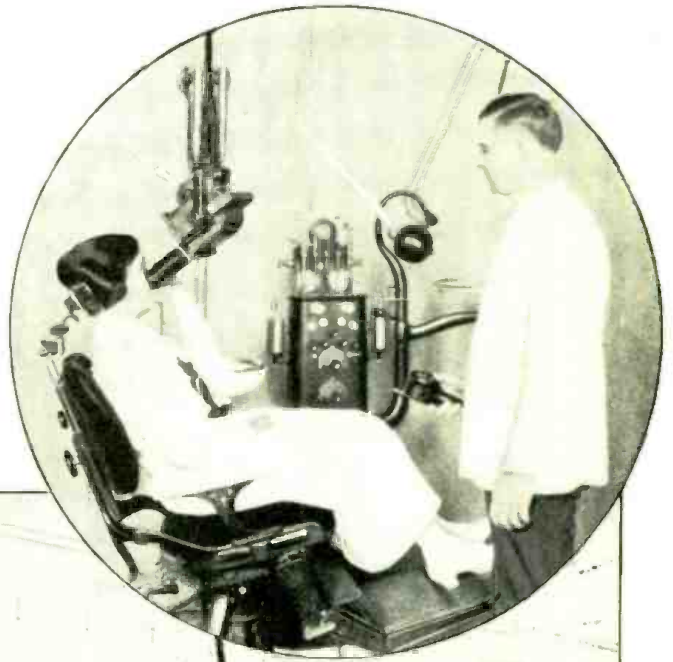

2: Dirty commutators on electric motors are a common source of interference.

Brown Broa.

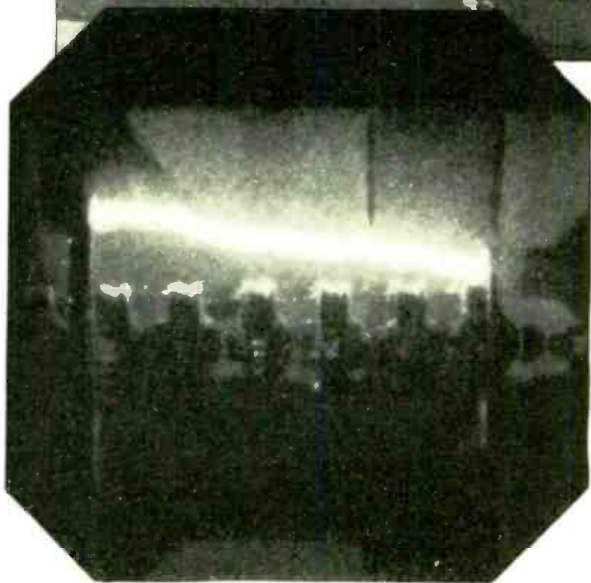
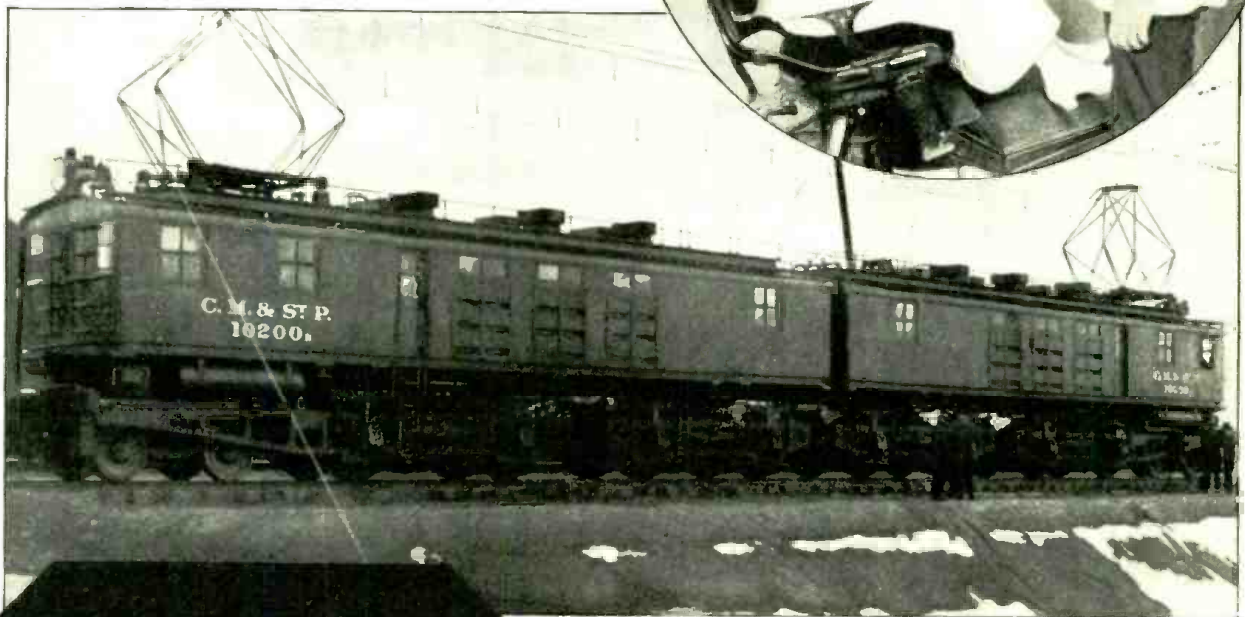

4: The high-tension apparatus used in testing laboratories may act as a transmitter of interference to receivers.

3: Sparks jumping from the trolleys of nearby electric trains will cause noises in your loud-speaker.

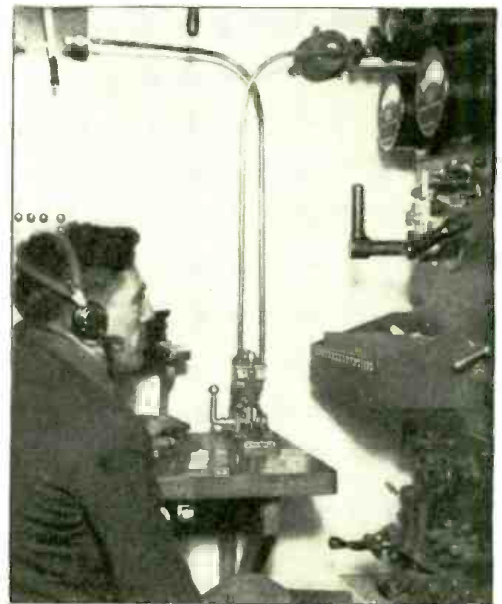

5: The old-time spark transmitters used on ships will cause widespread interference.

Keystone View Co.

high-frequency disturbances should then be by-passed to the ground. This may be done easily through the use of fixed condensers of reasonably large size which will interpose between the chokes and the brushes or contactors of the motor, or other device.

Two condensers may be placed in series across the brushes and the center point may be connected to a good ground. A further precaution on a sparking commutator is the use of a resistance in series with the condensers to reduce the pitting effect of the intensified sparks at the commutator.

Here is an outline of a simple piece of apparatus that will cure almost any case of man-made interference of this kind. If the interference is exceptionally bad, the chokes and condensers must necessarily be larger than for the average case; the only absolute necessity is a wire large enough to carry the current used by the device which is causing the trouble.

Usually an iron core of a square inch

in cross section, wound with 100 turns of insulated wire of the proper size, will be suitable for the electrical appliances used in the home. A layer of empire cloth should be wrapped around the core before winding and a closed core should be used in all cases. The best range of condensers is from 1 to 4 mfd. each and the resistances in series with them will usually be from 2 to 4 ohms.

This device is known as a filter and should be connected into the line between the motor and the source of power.

In applying a device of this kind to electrical machinery of any description, the important point to remember is that all leads between the filter and the actual point of the disturbance (as in a violet-ray tube), must be shielded and the shield must be grounded.

In apparatus that employs very high frequencies, such as the X-ray equipment used by doctors and dentists, this shielding is not always so easy; as a rule a metal cabinet is employed and the

X-ray valve itself is covered with lead, except at the window.

Any work around high-frequency or high-voltage machinery should be carefully done and only after consulting with some one who understands it thoroughly.

With large electrical machinery, such as electrical motor generators in substations, exactly the same tactics may be employed; but this work is usually carried on, as a matter of protection, by the public utility companies themselves.

The hum picked up from the AC lines is usually greatly reduced through suitable grounding. In the case of amplifiers or "B" power-packs, grounding of the cases of the instruments will help.

Simple and inexpensive devices, such as that pictured in Figure 1, are now obtainable at any radio store, for taking care of "man-made" interference from appliances which operate on powers up to and including $\frac{1}{4}$ HP. These appliances may be easily connected in circuit, and when used will reduce such interference for the set user.

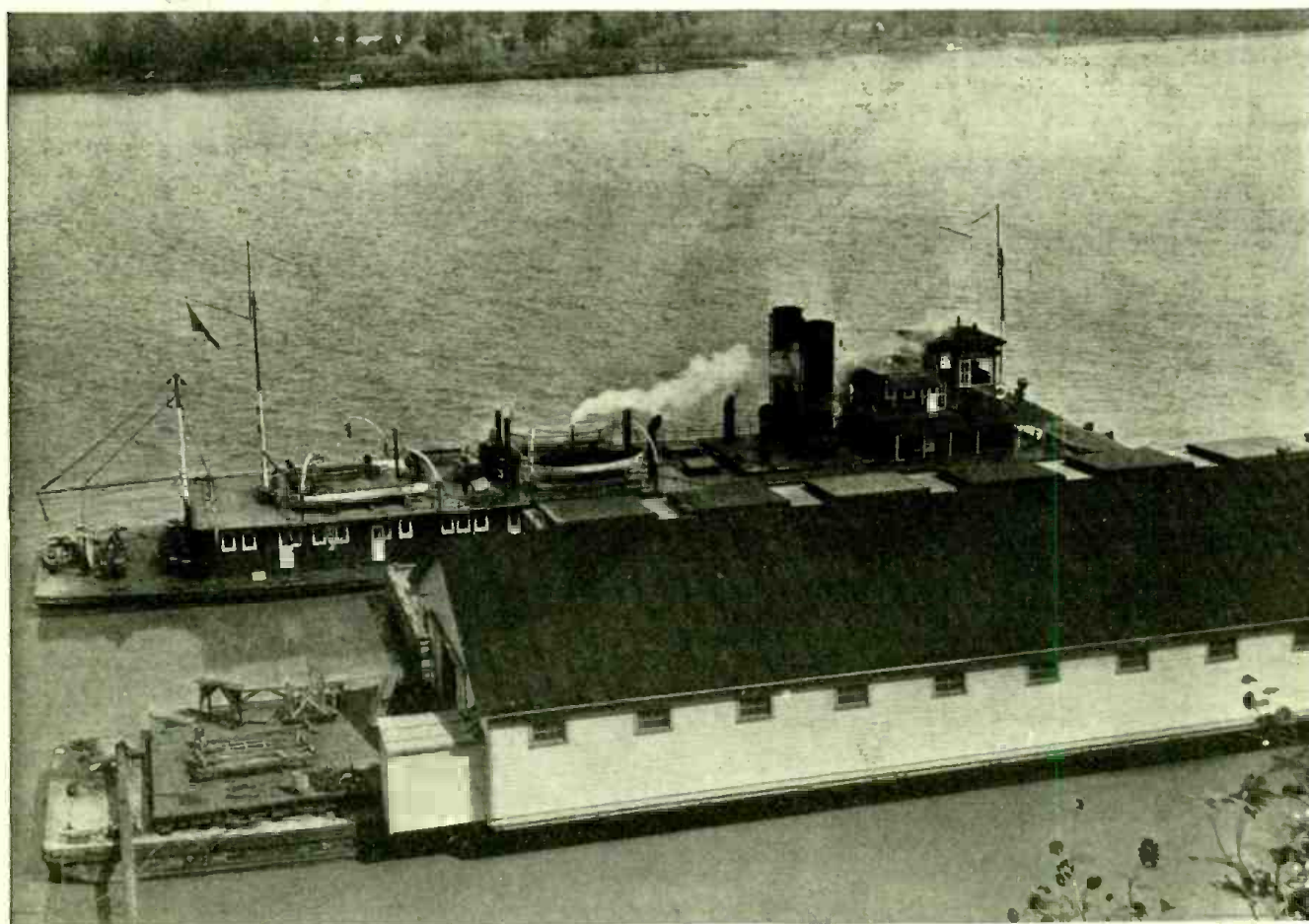

A. Richardson

HOW RADIO HELPS UNCLE SAM'S INLAND FLEET

Uncle Sam's fleet of barges was almost driven off the Mississippi River by railway competition—until radio appeared on the scene. Now the radio system on the government fleet, including a central 5-KW station at Memphis (WPI), Tenn., a 2-KW station on each towboat and a 1-KW station on each express boat (one of which is shown above), makes it possible for shippers to keep in touch with the progress of their goods down the river, to forecast the exact time when they will arrive and to provide the labor at the docks without wastage.

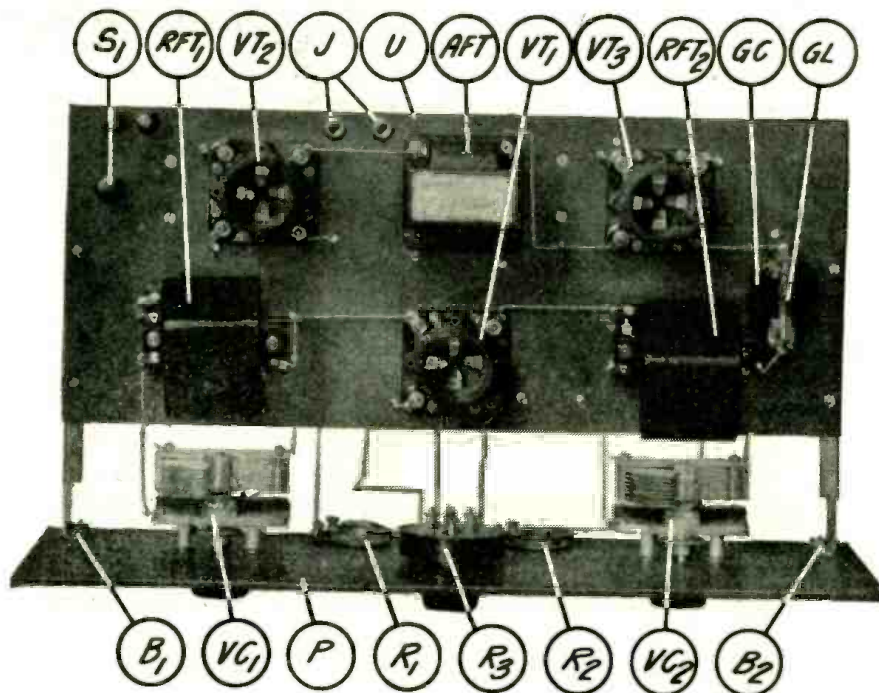

The "De Luxe Cle-Ra-Tone" Receiver

This receiver, while it employs only three vacuum valves, has remarkable possibilities. It employs a single-stage, high-frequency amplifier of excellent selectivity, a vacuum valve detector and one stage of high-grade, transformer-coupled, low-frequency amplification. The set may be readily combined with a complete power amplifier such as the Patent power amplifier without any changes in the circuit.

Popular Radio Circuits

INSTALLMENT NO. 9

THE PARTS THAT ARE RECOMMENDED FOR USE IN THIS RECEIVER ARE—

- | | | |
|---|---|--|
| RFT1 and RFT2—Benjamin tuned-high-frequency transformers, No. 8621; | B1 and B2—Benjamin shelf-supporting brackets, No. 8629; | P—Composition panel, 7 by 18 by 3/16 inch; |
| AFT—Rauland-Lyric low-frequency transformer, type R-500; | GC—Sangamo fixed condenser, .00025 mfd., with grid-leak mounting clips; | U—Composition sub-panel, 7 by 17 by 3/16 inch; |
| VC1 and VC2—Benjamin variable condensers, .00035 mfd., No. 8661; | GL—Daven grid resistor, 2 meg.; | Jones Cablelug battery connector; |
| VT1, VT2 and VT3—Benjamin sockets, No. 8645, or No. 9040; | C1—Sangamo fixed condenser, .00025 mfd.; | 2 Apex satin-silver CCW vernier dials; |
| R1—Carter midget rheostat, 10 ohms; | C2—Dubilier by-pass condenser, .5 mfd., type 656; | 2 Eby "Ensign" engraved binding posts, marked "Ant" and "Gnd"; |
| R2—Carter midget rheostat, 25 ohms; | C3—Sangamo fixed condenser, .002 mfd.; | Cabinet for 7 by 18-inch panel, depth, 10 inches. |
| R3—Centralab Radiohm, 200,000 ohms; | J—Two Carter 1mp tip jacks; | COST OF PARTS: \$45.00. |
| | S1 and S2—Benjamin switches, No. 8640; | |

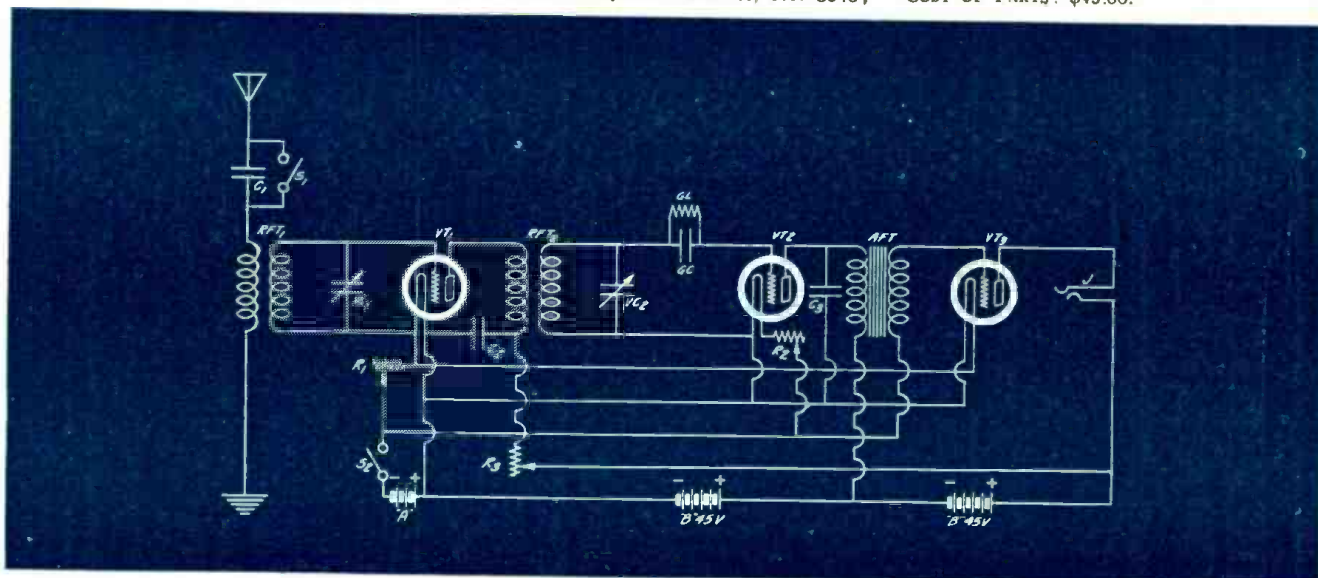

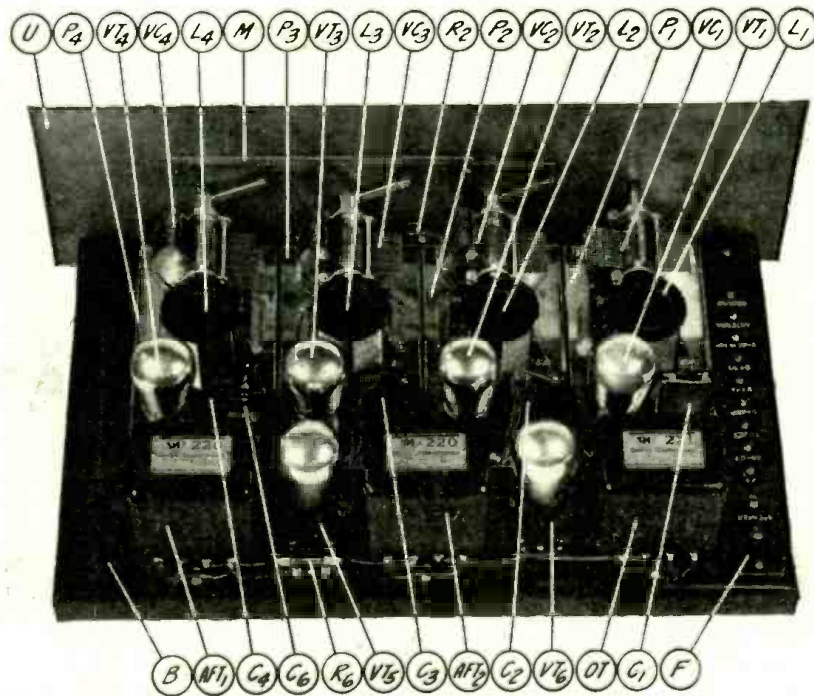

The Silver "Shielded Six" Receiver

This six-tube receiver incorporates balancing coils in its high-frequency amplifier; they are designed to reverse the feedback to the succeeding grid circuits of the tubes for stabilization. With three stages of high-frequency amplification, one detector and two stages of high-grade, transformer-coupled, low-frequency amplification, distance reception should be obtained with exceptional volume and clarity, especially when the output is coupled with a cone-type reproducer. A UX-171 type of tube is recommended for the last stage of amplification.

THE PARTS THAT ARE RECOMMENDED FOR USE IN THIS RECEIVER ARE—

- | | | |
|--|---|---|
| <p>L1—Silver-Marshall antenna-coupling coil, type 116A;
 L2, L3 and L4—Silver-Marshall high-frequency coils, type 115A;
 VT1, VT2, VT3, VT4, VT5 and VT6—Silver-Marshall sockets, type 511;
 S1—Yaxley "Midget" antenna switch;
 S2—Yaxley battery switch, No. 10;
 C1, C2, C3, C4 and C5—Polymet by-pass condensers, 1 mfd.;
 P1, P2, P3 and P4—Silver-Marshall shields, type 631;
 VC1 and VC4—Silver-Marshall variable condensers, type 316B;</p> | <p>VC2 and VC3—Silver-Marshall variable condensers, type 316A;
 R1—Carter fixed resistor, .5 ohm, No. H-1/2;
 R2—Carter "Hi-Pot" volume control, 25,000 ohms;
 R3—Polymet fixed resistor, .25 meg.;
 R4, R5 and R6—Carter fixed resistors, No. H-200, 200 ohms;
 AFT1 and AFT2—Silver-Marshall low-frequency transformers, type 220;
 OT—Silver-Marshall output transformer, type 221;
 J—Carter tip jacks (two), No. 10;</p> | <p>RFC—Silver-Marshall high-frequency choke coil, type 275;
 C6—Polymet mica condenser, .002 mfd.;
 M—Silver-Marshall triple-shaft-link motion, type 632;
 U—Crowe metal panel, drilled and engraved;
 B—Metal chassis, drilled;
 F—Composition binding-post strip, with terminals;
 2 Kurz-Kasch 100 four-inch dials, No. 567;
 1 Polymet resistor mounting;
 4 Silver-Marshall coil sockets, type 515.
 COST OF PARTS: \$95.00.</p> |
|--|---|---|

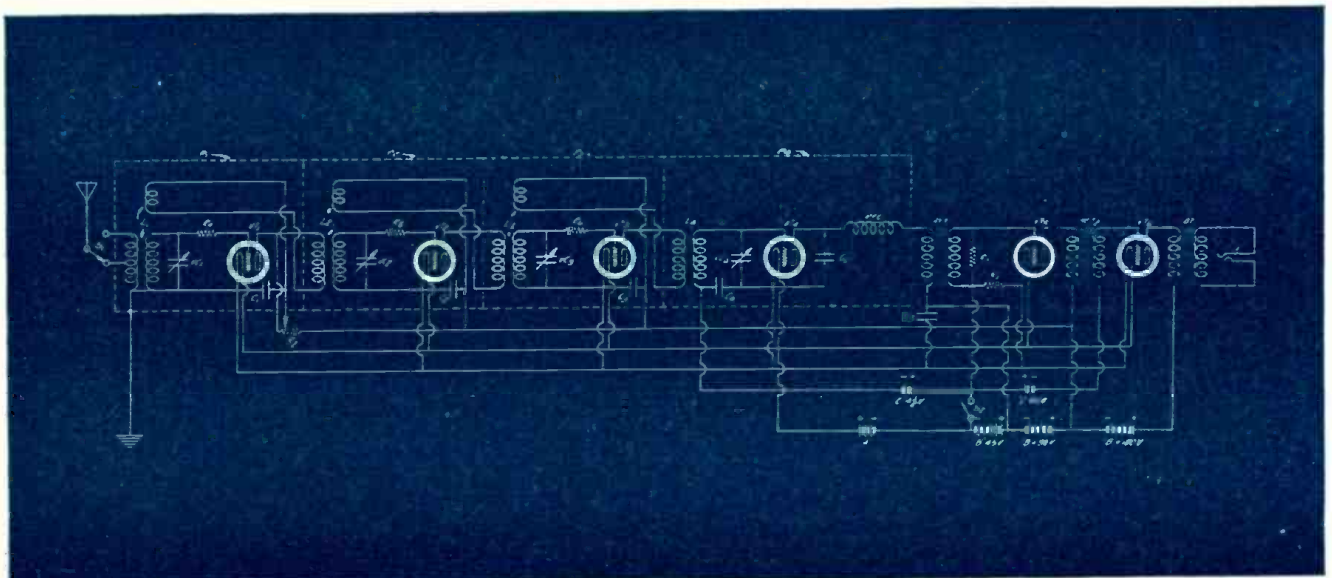

Q Do you want to check up on your wavelength? Read what station 6XBM is doing to reduce interference by helping every broadcaster and amateur transmitter to keep on the proper wavelengths

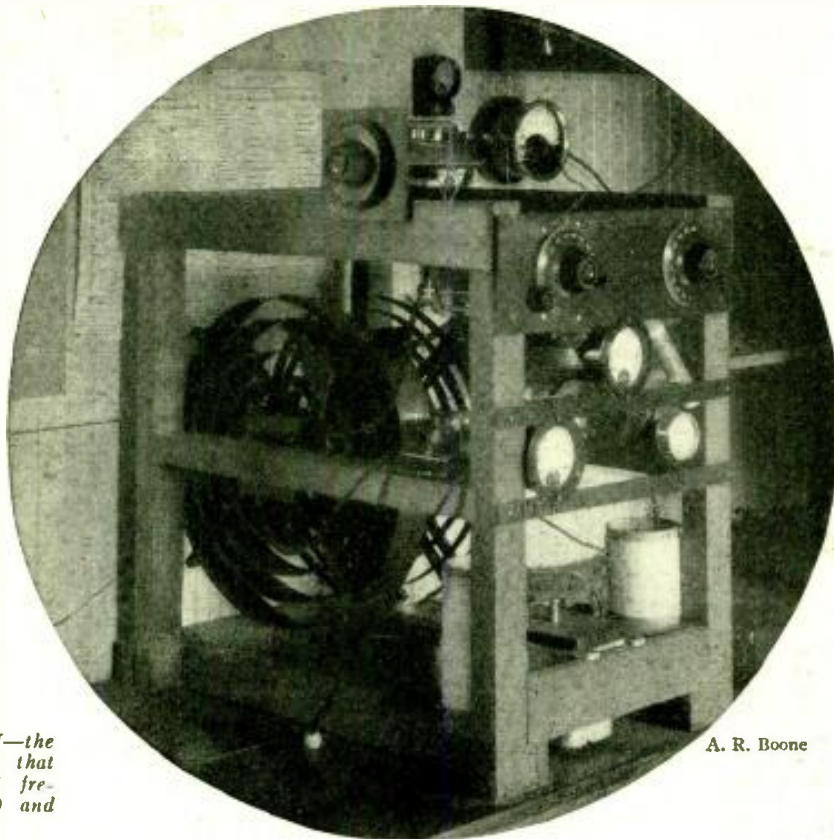

The "heart" of 6XBM—the vacuum-tube oscillator that generates the standard frequencies between 1,500 and 6,000 kilocycles.

A. R. Boone

Uncle Sam's Wavemeter

By ANDREW R. BOONE

HOUSED in a small wooden building in the rear of a high-voltage laboratory at Stanford University, California, is the station by which the wavemeters of half America may be calibrated—the Pacific Coast Standard Frequency Station, 6XBM.

Day after day this station transmits signals on frequencies ranging from the short-wave amateur bands to the high commercial wavelengths; from these signals the wavemeters that help to keep stations on their proper frequencies may be kept accurate by "hams" and engineers alike.*

Although these standard frequencies are transmitted mainly for the benefit of transmitting stations, listeners may also use them to calibrate their receivers. By merely noting the points on the dials on which each standard frequency comes

in, each listener may draw up an accurate chart that is invaluable in tuning in DX.

Extreme care is employed by 6XBM to keep the signals that are broadcast accurate to the last degree. Two transmitting sets on a master-oscillator power-amplifier system are used, one for lower frequencies (125 KC to 1500 KC, or 200 to 2,400 meters) and one for frequencies from 1,500 to 6,000 kilocycles. In the former, the master-oscillator is a UV-203, 50-watt tube and the power amplifier a UV-204, 250-watt tube; for higher frequencies a UV-204, 250-watt tube in a Hartley circuit is employed.

In operation the low-frequency set is tuned to an exact frequency. The master-oscillator inductor and the condensers are adjusted to produce approximately the desired frequency, the power output being kept low. With the capacity of the coupling condenser reduced, the antenna circuit is tuned to resonance with the master-oscillator frequency by adjusting for maximum antenna current

and minimum plate current. Then, to secure maximum output, the capacity of the coupling condenser is increased and the plate tap of the antenna inductor is adjusted to bring the plate current to approximately normal value. Final adjustments are made by turning the master-oscillator to the exact frequency desired and tuning the antenna circuit to it. The final tuning of the master-oscillator is accomplished by use of the small variable condenser shunted across two of the primary tuned-circuit condensers.

In transmitting with the high-frequency set the antenna circuit is not tuned exactly to resonance. In tuning for a given frequency, the antenna circuit coupling is loosened and the antenna condenser set so the antenna is detuned. Adjustments are made to produce approximately the desired frequency with the plate current at a low value, with the maximum antenna current which will allow stable operation without exceeding the safe value of the plate current. Final adjustments are made by means of

* Station WWV at Washington, D. C., sends out standard frequency signals for the benefit of eastern transmitters. The schedules which these two stations maintain may be obtained in bulletin form from the Bureau of Standards at Washington, D. C.

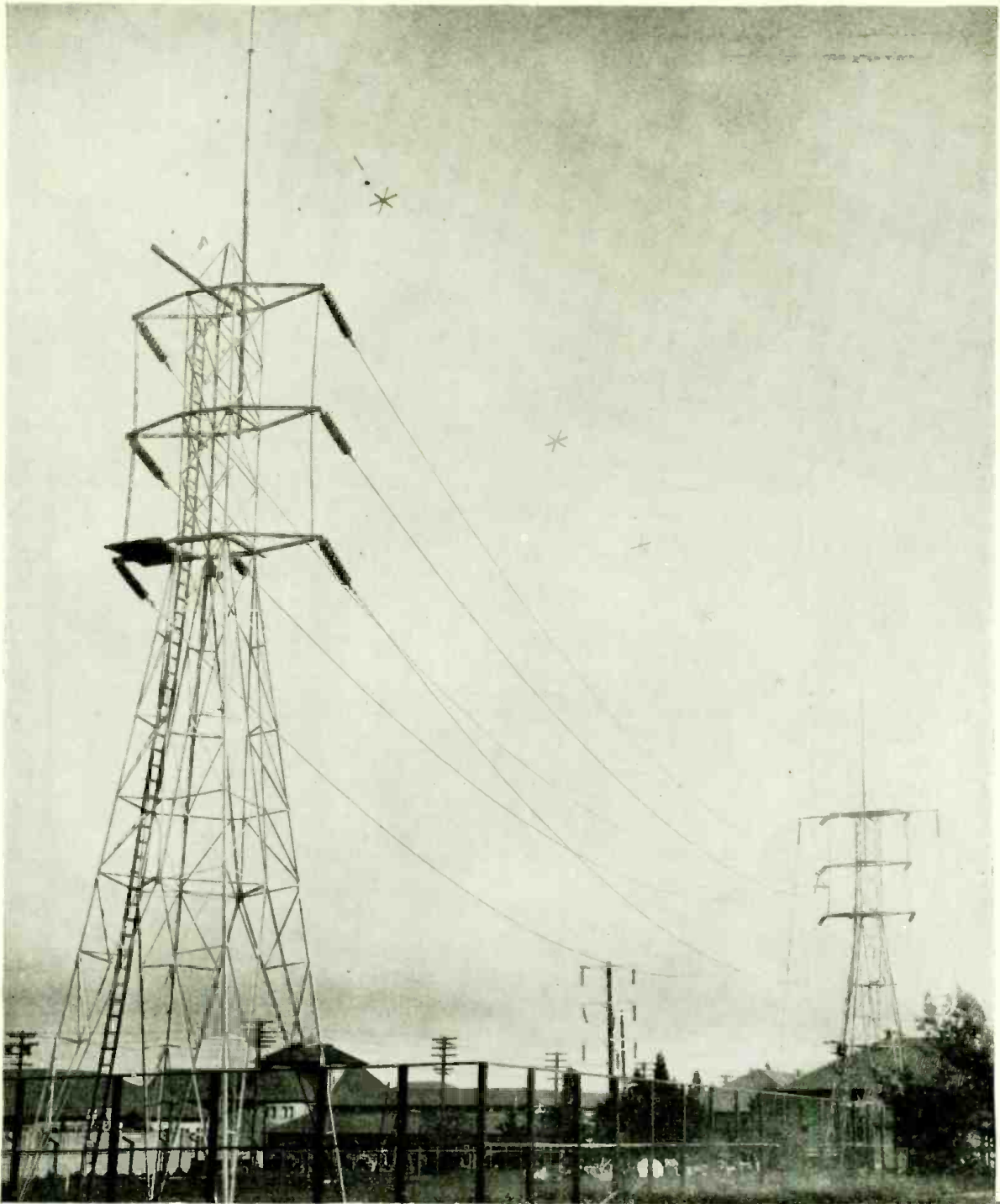

A. R. Boone

THE UNUSUAL ANTENNA SYSTEM OF 6XBM

These two towers, originally built for high-voltage power lines, are surmounted by wooden poles between which the transmitting antenna of the station is stretched. The antenna is 150 feet long and is built of six cables in the form of a hexagonal cage; the six-pointed forms that are used to insulate the cables from each other are made of porcelain rods.

a tuned primary-circuit condenser and a small variable condenser.

The two antennas form an interesting part of the equipment. They are approximately 85 feet above the ground, stretched between two wooden poles atop towers built originally for the high-voltage power lines. With the longer of the antennas, made of six cables 150 feet

long and arranged in a hexagonal cage, frequencies from 125 to 1,000 kilocycles can be transmitted; by means of the shorter, similarly built but only 25 feet long, it is possible to send all frequencies from 1,200 to 6,000. Porcelain rods insulate the antennas.

Two counterpoises extend from the building, one 220 feet long and consist-

ing of four cables spaced four feet apart. This is used for lower frequencies. The shorter, or six wires spaced six feet apart and 60 feet long, is used alone for high frequencies, or in combination with the longer counterpoise for frequencies between 125 and 1,350 kilocycles. The longer counterpoise is four feet above the ground, the shorter ten.

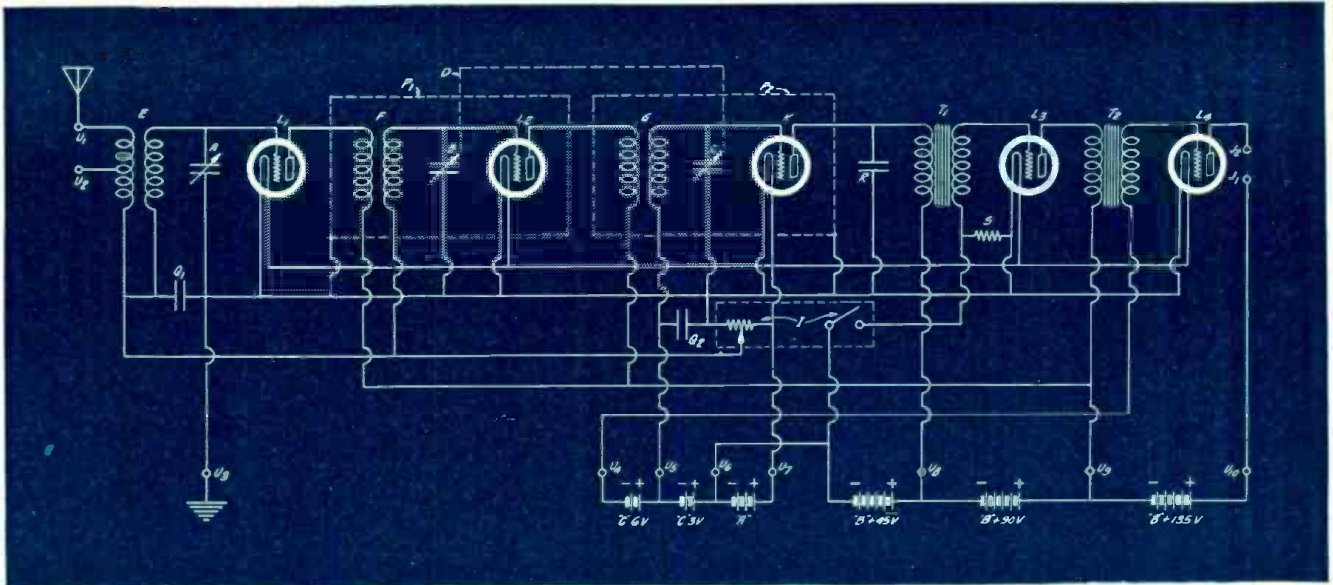

THE SCHEMATIC WIRING DIAGRAM OF THE SC-II RECEIVER

FIGURE 1: The electrical circuit used is simplicity itself. The two condensers, B and C, are connected together by a link motion, shown at D. Both the second high-frequency stage and the detector stage are in shielded cans. The detector circuit uses plate rectification with a C bias.

HOW TO BUILD

The New SC-II Receiver

All the newest ideas in receiver design—metal chassis, complete shielding, high-quality amplification—are features of this new “big brother” of the popular S-C Receiver. And it’s just as easy to build.

By McMURDO SILVER and LAURENCE M. COCKADAY

COST OF PARTS: *Not more than \$62.00*

THE PARTS THAT WERE USED IN THE LABORATORY MODEL OF THIS RECEIVER ARE—

- | | | |
|---|--|---|
| A—S-M variable condenser, type 316-A, .00035 mfd.; | K—Benjamin cushion socket; | R—Any approved mica fixed condenser, .002 mfd. (Polymet condenser illustrated); |
| B and C—S-M variable condensers, type 316B, .00035 mfd.; | L1, L2, L3 and L4—S-M UX-type sockets; | S—Carter resistor, .5 ohm, type H-½; |
| D—S-M link-motion unit, No. 637; | M1 and M2—National vernier dials, type B, clockwise rotation; | T1 and T2—S-M low-frequency transformers, No. 220; |
| E—S-M antenna coupling coil, No. 116-A; | N—Van Doorn decorated metal panel for the SC-II receiver; | U1, U2, U3, U4, U5, U6, U7, U8, U9 and U10—Any approved binding posts (Eby binding posts illustrated). Posts should be marked <i>Ant.</i> , <i>Ant.</i> , <i>Gnd.</i> , <i>A Bat.</i> +, <i>A Bat.</i> —, <i>C Bat.</i> +, <i>C Bat.</i> —, <i>45 Volts</i> +, <i>90 Volts</i> +, <i>135 Volts</i> +; |
| F and G—Interstage high-frequency coupling coils, No. 118-A; | O—Van Doorn stamped metal chassis for the SC-II receiver, including nuts, screws and insulators; | 1 set of POPULAR RADIO blueprints. |
| H1, H2 and H3—S-M coil sockets, No. 515; | P1 and P2—S-M aluminum stage shields, No. 631; | |
| I—Carter potentiometer switch, type M-200-S; | Q1 and Q2—Any approved by-pass condenser, 1 mfd. (Polymet condensers illustrated); | |
| J1 and J2—Any approved tip jacks (Carter No. 10 tip jacks illustrated); | | |

THE popularity of the original S-C receiver, the constructional details of which were published just a year ago in POPULAR RADIO, has convinced the authors that there is a large interest in low-priced receivers, incorporating the newest ideas in radio design and construction, among the radio fans who are experimenters and who enjoy building their own sets. It was with this idea in mind that the design work on the SC-II receiver was carried out by the authors.

Complete shielding was used in this new model, with high-efficiency coils of the spaced-winding type. The circuit employed is the standard two stages of tuned-high-frequency amplification with a vacuum-valve detector and two stages of low-frequency amplification using transformer-coupled units especially designed to bring out the low notes faithfully, as well as the higher ranges, and a power tube in the last stage to insure a really good quality of reproduction.

It was further decided to use, as embodied in the better and later designs of high-priced receivers, a metal chassis and sub-panel. The receiver has also been laid out so that the “bunched” or “cabled” idea of wiring could be easily done at home by the constructor.

The latest idea of shielding the detector and second stage to prevent coil pick-up has been incorporated in the design.

The tuning of the second stage of

high-frequency amplification and the detector is done by means of a single-control, mechanical coupling device for the two condensers.

Both the metal panel and the metal chassis have been stamped with the proper holes, so that the instruments may be immediately bolted to them, using these holes.

The tuning is done by means of two selector dials of the variable-vernier type, located on the front panel, with a combination switch and volume-control knob located between them.

The control for tuning is exceptionally simple and the whole system provides adequate selectivity and sensitivity, even in these days of crowding of the broadcast frequencies.

The proper by-passing arrangements have been incorporated in the design and the circuits so arranged as to produce high efficiency in both the high-frequency and the low-frequency stages of amplification.

The circuit diagram for the receiver is shown in Figure 1.

How to Construct the Receiver

Figure 4 shows a plan view of the sub-panel, O, and a side view of the front panel, N, attached to it.

In this drawing, all of the instruments that are mounted on top of the sub-panel are shown in heavy black lines, while the instruments mounted below the sub-panel are outlined in dotted lines. The actual wiring is shown in red. This makes it easy to follow the drawing in wiring up the set.

As mentioned before, the holes for mounting the instruments are already stamped into the chassis sub-panel, O, and the instruments may be attached directly thereto, following the layout, as

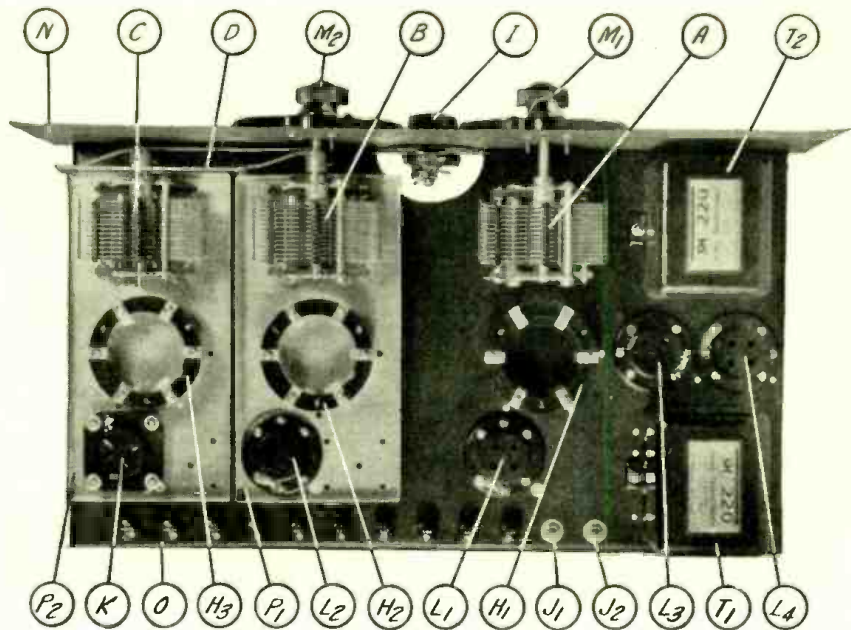

A VIEW OF THE SET FROM ABOVE

FIGURE 2: In this picture the shields have been removed from the second stage of the high-frequency amplifier and the detector stage, to show the arrangement of the parts. The coil sockets are in place, but the coils have been left out of the sockets.

shown in this diagram and in the accompanying photographic illustrations.

The construction is so simple and the pictures and drawings so complete, that no extensive description is necessary and a few remarks will cover this phase of the constructional work.

The first job is to mount the two shield bases, P1 and P2, and to mount the valve sockets, K and L2, at the same time as the coil bases, H2 and H3, and the two condensers, B and C. Note that the coil bases are mounted on metal collars so that they stand clear of the shield.

Next, attach the link-motion unit to the two condensers, B and C. Then mount the two transformers, T1 and T2, and the condenser, A, with the remaining coil socket, H1, and the remaining vacuum-valve sockets, L1, L3 and L4.

The unit may then be turned over bottom-side-up and the two by-pass condensers, Q1 and Q2, the small fixed condenser, R, and the resistance, S, fastened securely. All of the instruments may be attached in their correct positions by means of the bolts and screws furnished with the metal chassis. The two dials, M1 and M2, should be attached to the panel and the two top studs on each dial inserted through the panel and tightened with nuts. The panel should then be slipped in place and fastened by means of two screws to the two holes drilled for this purpose in the metal chassis. The bottom bolt of these dials is not to be fastened until the panel, N, is attached to the metal chassis, O, when they both may be tightened up with two nuts in back of the bottom side of the chassis.

Fasten the potentiometer switch, I, to the panel, N, and the flap of the chassis, X. Be careful to insulate this switch from the chassis by means of the insulating washers that are supplied with the panel.

Next, the dials may be tightened to the shaft of the condensers by means of the set screws with the condensers fully meshed when the dial readings register "0," which is the same point as "200" on the scale. An arrow points to this position.

When the binding posts, U1 to U10,

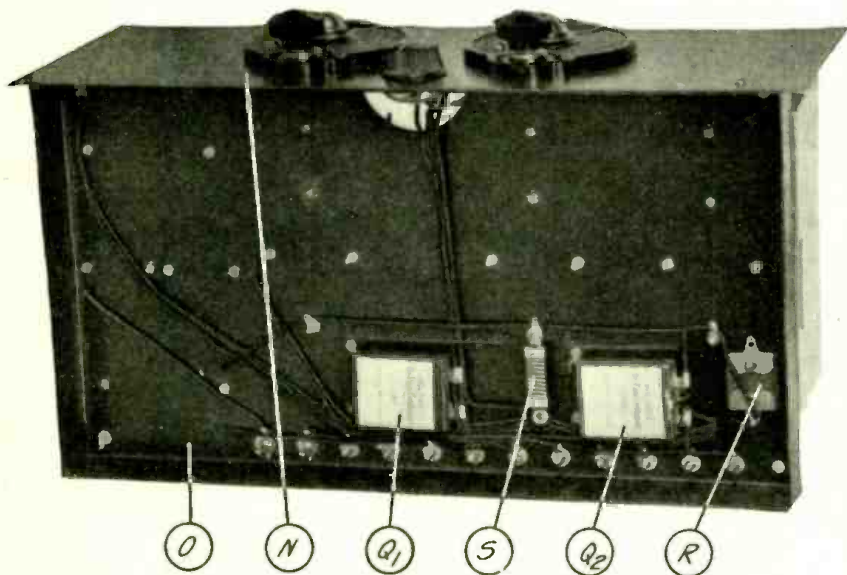

HOW THE RECEIVER LOOKS FROM BELOW

FIGURE 3: This view shows the metal chassis with the condensers and resistances that are mounted on the bottom side of the sub-panel.

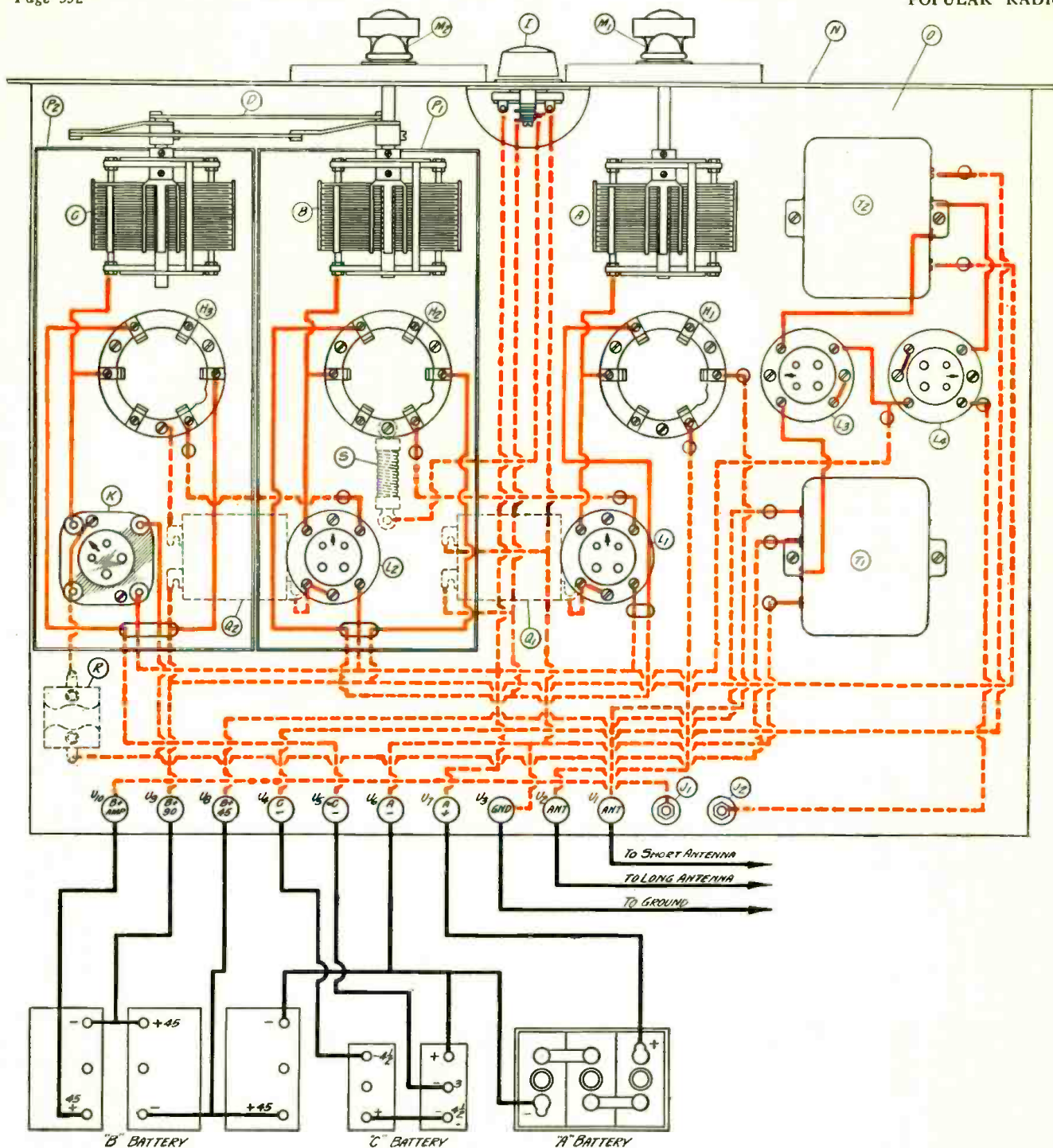

THE PICTURE WIRING DIAGRAM

FIGURE 4: This drawing shows the relative layout of the instruments and the construction of the set; the instruments are shown in black, with all of the wiring in red. The solid red lines indicate the wiring that is done on top of the metal chassis; the dotted lines indicate the wire that runs underneath the sub-panel. The battery connections and the connections to the antenna and ground are also shown.

inclusive, and the two tip jacks, J1 and J2, have been attached, the constructional work is complete. Notice that all of the binding posts and the tip jacks should be insulated from the metal sub-panel, O, by means of the small washers that are packed with the sub-panel itself. In Figure 4 the arrangement of the binding posts is clearly shown and the

proper markings for the posts are given. The set is now ready to be wired.

How to Wire the Receiver

This is really a very simple job, as all the wiring may be done with flexible wire. There are no precautions to be observed, except that the low-potential wiring should be pulled through the 3/8-inch holes found at the rear of each

high-frequency stage assembly of the set.

The leads connecting the plate of the high-frequency vacuum-valve to the primaries of the next high-frequency transformer are, as will be seen from the bottom view, shown in Figure 3, carried through the metal chassis, O, and then along it to a point 1/2 inch below the chassis in order to keep the capacity

from plate to filament as low as possible.

The plate lead from the detector valve, K, to the primary of the first low-frequency transformer, T1, runs from the condenser, R, one end of which is fastened to the shield by a mounting screw, along the chassis away from the other wiring and then up through the hole to the transformer, T1. It will be noticed that this wire is held in place by three lugs that are in turn held by the mounting screws, thus keeping it in a definite position and away from the balance of the wiring. This is all shown in Figure 3.

The wire used in hooking up the set may be either the Kellogg insulated hook-up wire, Corwin or Belden rubber-covered wire or flexible Celatsite.

When the wiring is finally completed, after following the details shown in Figure 4 and the accompanying photographic illustration, the schematic circuit, as shown in Figure 1, will be complete and the set is ready for installation.

How to Install the Set

Place the receiver in its cabinet and insert the vacuum valves in their proper places.

Insert UX-201-a type tubes in valve sockets K, L1, L2 and L3. Then insert a UX-112 or a UX-171 type valve in the last stage socket. Next, insert coil E in socket H1 and coils F and G in coil sockets H2 and H3. Be sure that these coils are placed in the correct sockets, or trouble may be experienced.

Next, connect up the batteries as indicated in Figure 4. Three blocks of 45-volt "B" batteries, two blocks of 4½-volt "C" batteries and a 6-volt storage battery are necessary with the UX-112. With a UX-171 type valve higher "C"

voltage is required. The ground wire should be connected to binding post U3 and, if a short antenna is used, it should be connected to binding post U1. If, on the other hand, a long antenna is to be used, it should be connected directly to binding post U2.

Next, insert the reproducer cord tips in the two tip-jacks, J1 and J2. Then place the top section of the shields, P1 and P2, in their proper places and the set is ready for operation.

How to Tune the Receiver

All tuning is accomplished by means of dials M1 and M2. As stated before, dial M1 tunes the antenna stage and dial M2 tunes the second stage of high-frequency amplification and the detector input circuit. The dial settings for these two controls is approximately the same throughout the entire range.

To start the receiver in operation, turn the potentiometer switch, I, in a clockwise direction over to the right until the vacuum valves light up to their correct brilliancy. The control, I, may then be used as a volume control while tuning in the two dials, M1 and M2, until a station is brought in to a maximum strength, when the control, I, may be turned back to give the proper volume.

The tone quality of the receiver in actual tests was exceptionally pleasing. And the authors feel sure that the receiver will give worthwhile results for the amount of money spent on it.

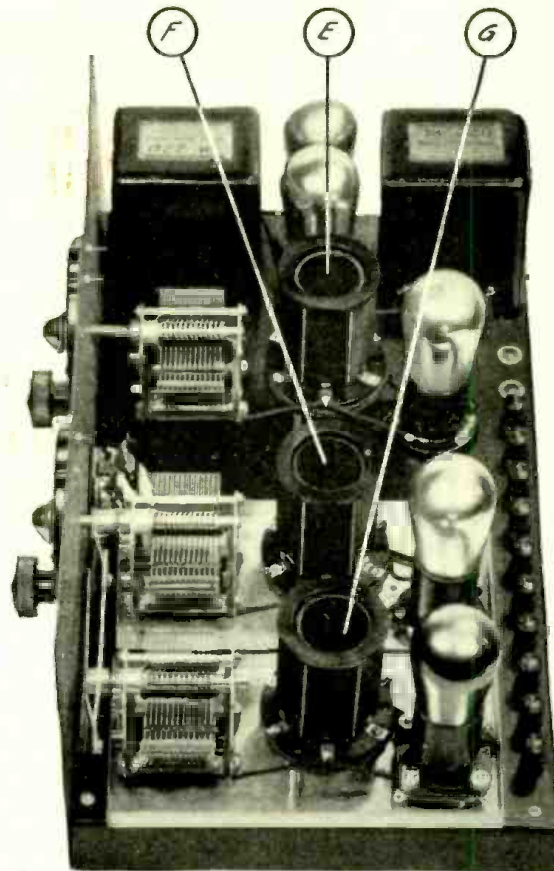

A RIGHT END VIEW OF THE RECEIVER
 FIGURE 5: This picture shows how all of the instruments on top of the chassis are mounted. Notice that the binding posts and the two loudspeaker tip-jacks are mounted in a row along the back with insulating bushings.

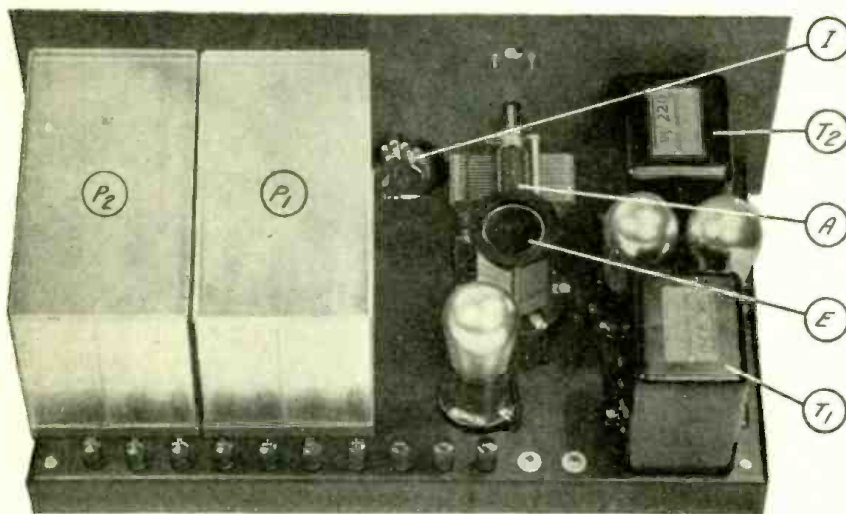

A REAR VIEW OF THE SET
 FIGURE 6: In this picture the cans are in place and the tubes are in their respective sockets. The two low-frequency transformers and their respective tubes are at the extreme right.

Five interesting and worth-while experiments that show the amateur how to use a single meter for making measurements that involve resistance, current and voltage.



HERE IS A LABORATORY THAT ANY FAN CAN DUPLICATE
 With only the instruments shown above—a pair of headphones, a simple receiving set and just one meter—the author made all of the experiments that are described in this article.

PRACTICAL HINTS FOR STARTING

Your Radio Laboratory

How to Make Your Voltmeter Do the Work of Several Instruments

By PAUL L. RITTENHOUSE

A REAL experimental laboratory is the goal of nearly any dyed-in-the-wool radio fan who is interested in more than just listening in. But there is one stumbling block that nearly every prospective experimenter runs into—the expense of laboratory instruments.

But there is a way to get around this obstacle by making one instrument serve the place of many.

With the aid of a little ingenuity, an inexpensive voltmeter, costing only eight or ten dollars, may be used to perform many experiments involving measurements of current, resistance and voltage.

A few of these experiments which are of general interest, are described in this article; the fan may easily discover other applications.

First of all, however, he should have some knowledge of the principles involved.

Practically every small voltmeter is energized by a comparatively small flow of current (usually 5 to 25 milliamperes, or thousandths of an ampere) and has a fairly high resistance added to the resistance of the actuating coil, for this purpose. Direct-current voltmeters usually have from 50 to 150 ohms resistance for each volt on the scale.

It is necessary first to find out just what the ohmic resistance of the meter is. The manufacturer usually has a record of the resistance noted with the serial number on the name-plate, or it will be measured at small expense by any electrical laboratory.

Let us suppose that we have a Weston type 280 voltmeter and that the resistance on the 30-volt scale is given as 1673 ohms, or 55.77 ohms per volt. Applying Ohm's law,

$$\frac{\text{Volts}}{\text{Ohms}} = \text{Amperes}$$

we find that

$$\frac{30 \text{ volts}}{1673 \text{ ohms}} = .018 \text{ amperes}$$

RESISTANCE (X) TO BE MEASURED

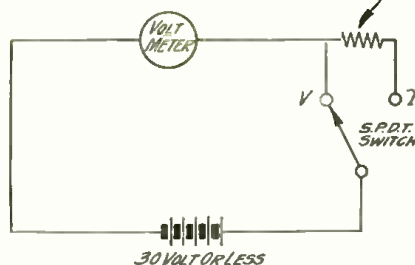

FIGURE 1: This simple diagram shows how the unknown resistance should be connected to determine its exact value.

or 18 milliamperes (discarding a negligible fraction) As the deflection of the needle is directly proportional to the flow of current, we know that if we add a resistance of 1673 ohms into a direct-current circuit with the meter and a battery with 30 volts, the resistance will become 3346 ohms and the current flow will be reduced to .009 amperes or half, with a reading of 15 volts. On this basis a formula can be made, to use in measuring any unknown resistance (within certain limits, as explained later), as follows:

$$X = \frac{(V-\gamma)R}{\gamma} \text{ where}$$

X is the unknown resistance;
 V is the reading with the meter only in circuit;

γ is the reading with the meter and the unknown resistance in circuit;

R is the resistance of the meter.

EXPERIMENT No. 1: Testing the Resistance of Headphones.

Let us try out this principle in practice starting on two pairs of headphones to compare their respective resistances. We know that a steady flow of current, through the coils of wire in the phones, will not meet the same resistance as an alternating flow, or even the pulsating

current from our "B" battery, as rapidly changed in ampere value through the action of the last low-frequency amplifying tube in our radio set. But the difference in direct-current (DC) resistance between our two pairs of phones will be approximately proportionate to the difference between their resistances as used in the set.

So we make the circuit connections shown in Figure 1.

For telephones A we find:

$R = 1673$ ohms (known voltmeter resistance).

$V = 20.5$ (reading on 30-volt scale, without unknown resistance in circuit).

$\gamma = 10.0$ (reading on 30-volt scale, with unknown resistance in circuit).

$$\text{Resistance } X = \frac{(20.5-10) 1673}{10} = \frac{17566.5}{10} = 1757 \text{ Ohm}$$

For telephones B we find, following the same procedure:

$V = 20.5$

$\gamma = 8.5$

$X = 2362$ ohms

So we know pretty well why telephones B cost \$10.00 while telephones A cost only \$4.75.

EXPERIMENT No. 2: Determining Antenna Leakage.

One evening we find that when listening to a local station the audibility seems low, so we determine to find whether there is leakage from the antenna to ground, which seems possible because it is raining in torrents. Connecting the antenna and ground wires in place of the telephones in the above circuit, we find that the resistance is 58,000 ohms. A little later the rain stops and we find that the antenna-to-ground resistance has increased to 113,000 ohms. So we measure again the following evening when the antenna insulators are dry; this time we find that we cannot even get a deflection.

We naturally want to know what this wet-weather leakage means in DX work so we take a variable resistance that we have in our second set, marked for maximum of 250,000 ohms, and move the sliding contact until we get the same deflection as when the wet antenna was connected in our circuit, with the ground. This gives us the same resistance as antenna-ground resistance. To find out what this much leakage means in DX work, we connect the resistance across the antenna and ground binding posts in our tube set, with a distant station tuned in, and find that the volume is greatly decreased.

This wet-weather leakage from antenna to ground must go, so the next good Saturday afternoon we do some climbing and put two good porcelain insulators at each end of our antenna,

and one to a guy wire connected just where the lead-in wire comes to the top of the window, to keep it away from the bricks. And the trouble is cured.

EXPERIMENT No. 3: Testing the Efficiency of Crystal Types as Detectors.

Next we become impatient one evening when we realize that the light contact of the crystal detector catwhisker gets out of adjustment all the time. We have read somewhere that a carborundum detector is used with a heavy contact that does not have to be changed, so we buy a carborundum detector. Then we decide to measure the resistances of both the old crystal and the carborundum. Connecting the crystal detector in the test circuit with the battery current flowing from crystal to catwhisker, the resistance figures 284 ohms. With the detector connections interchanged in the test circuit, however, the resistance measures only 84 ohms. We know that a crystal detector is a valve that, in effect, allows current to flow only in one direction, from catwhisker to crystal, but that in reality there is only a difference in resistances in the two directions, this difference giving the detector action.

Having gotten this far, we test the carborundum detector and find that the resistances in both directions are, respectively, 1395 ohms and 742 ohms. When we substitute the carborundum detector in our crystal set, it seems that the secondary circuit tunes much sharper; but the volume is cut down on the weaker stations. But being interested to find out what this is all about, we go to the library and dig out an article by a research man in the Carborundum

Company, which points out that the higher resistance of the carborundum detector is a disadvantage that does not offset the advantages of sharper tuning and a firm, permanent contact, but that, by the use of a stabilizing circuit, shown in Figure 2, with the carborundum detector, with a flashlight cell, fixed condenser and a tapped resistance, we can get the advantages and overcome the disadvantage of the high relative resistance.

EXPERIMENT No. 4: Determining the value of a "C" Battery in a Set.

The next experiment is to determine the value of a "C" battery in our tube set, as we have heard a good deal about the economy of a "negative biasing voltage." If we happen to have, for instance, a Weston type 280 meter, there is a binding post marked "1 volt." Using Ohm's law we figure that, at 55.77 ohms per volt reading, there are 5.577 ohms in the one-tenth voltmeter circuit, and dividing this into .1 volt, we get .018 amperes, or 18 milliamperes flow of current with full reading, which is the same figure that we got from dividing through for the 30-volt scale. Dividing 30 into 18 milliamperes, we find that each volt reading on the 30-volt scale will represent .0006 (6/10th milliampere). Connecting the .1-volt-meter circuit into our "B" battery circuit, we find that our meter reads 14 volts on the 30-volt scale, which, multiplied by .6 gives 8.4 milliamperes flow for the three UX-199 type tubes without "C" battery bias on the grid.

Connecting a 4½-volt "C" battery into the grid return circuits of all three
(Continued on page 390)

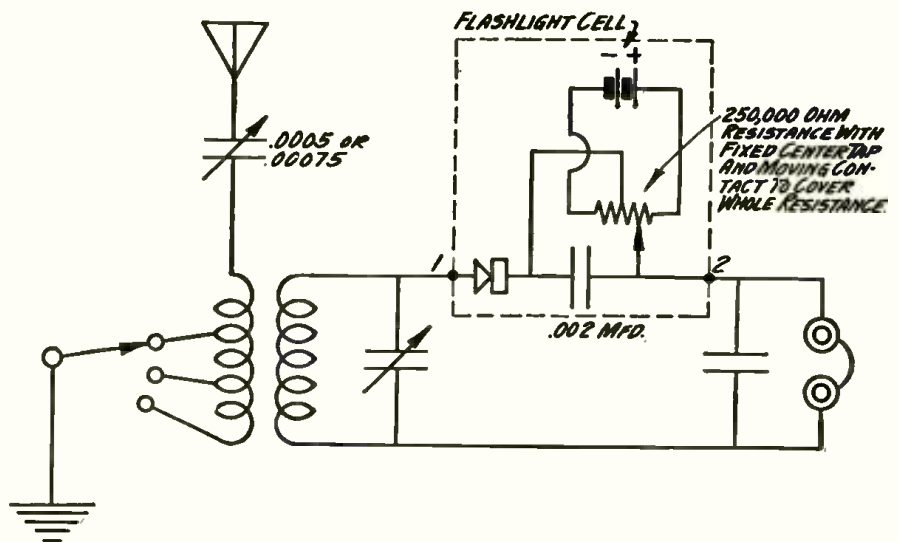

A SIMPLE CIRCUIT THAT EMPLOYS THE CARBORUNDUM STABILIZING UNIT

FIGURE 2: In his measurement of crystal resistances, in Experiment No. 3, the author found that carborundum offers a relatively high resistance that cuts down volume on the weaker stations. This disadvantage, however, may be overcome by the use of the stabilizing circuit shown above within the dotted line.

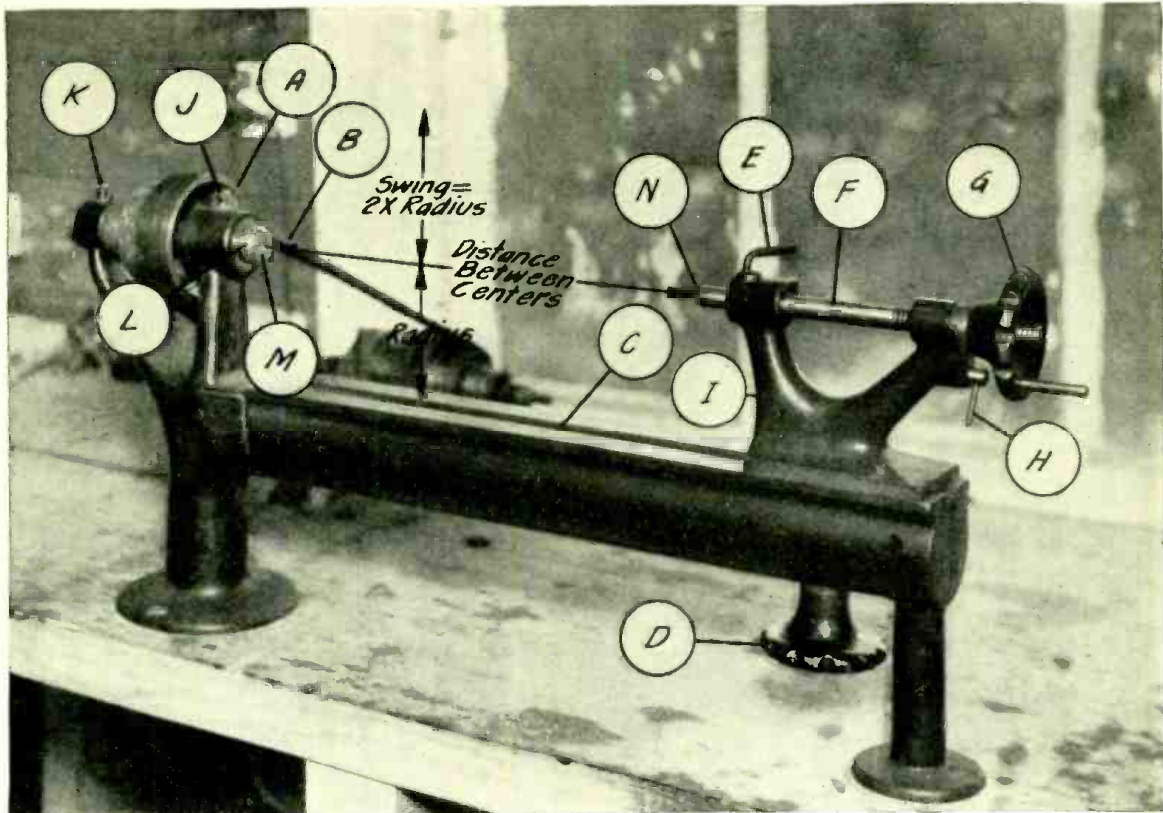

From a photograph made for POPULAR RADIO

THE LATHE STRIPPED OF ACCESSORIES

FIGURE 1: This picture gives a good idea of the lathe proper. The letters indicate the following parts: A is the cone pulley; B, the live spindle; C, the milled bed; D, the clamping nut for tail-stock; E, the lock screw for tail-stock spindle; F, the tail-stock spindle; G, the hand feed screw for tail-stock spindle; H, the screw feed release for tail-stock spindle; I, the tail-stock main casting; J and K, the live spindle oil cups; L, the threads on live spindle; M, the live center, and N, the dead center.

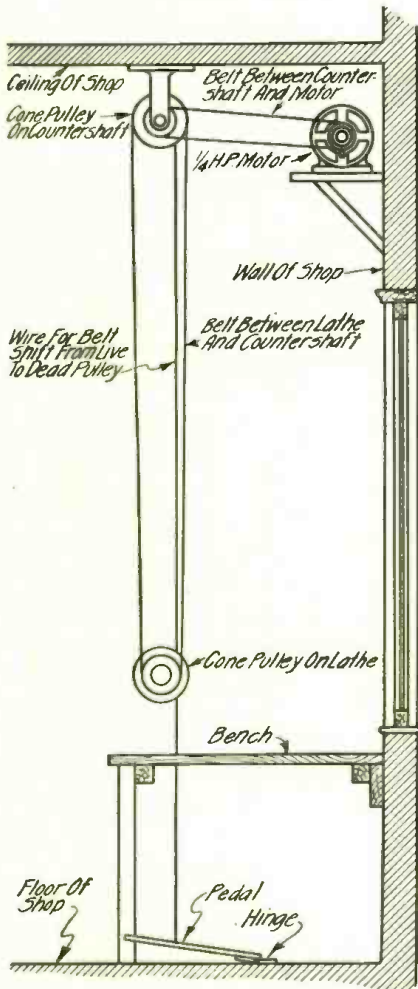

YOUR Laboratory Tools

ARTICLE No. 1

How to select, install and operate a small lathe in your experimental laboratory.

By LOWELL MADDEN, JR.

A SMALL bench lathe not only greatly increases the range of work that may be handled in the radio experimenter's shop, but it makes the owner less dependent on hand tools for the accomplishment of jobs that should really be done by the use of power. The lathe is the master tool and with it the mechanic may work faster, surer and more accurately.

While the ingenious application of hand tools will make the radio experi-

menter more or less independent of a lathe, he wastes a great deal of time in rigging up makeshifts that, no matter how carefully employed, mark his work as coming from the hands of a novice. In a jiffy, a lathe may be set up for grinding, polishing, sawing, screw cutting, metal turning, wood turning, buffing, spinning, knurling, fret sawing, coil winding or drilling. In each one of these operations, the mechanic is able to exercise greater control over his work and, by placing the burden of power entirely upon an electric motor, his capacity is multiplied manifold. It is true that a small hand drill may be used for winding small coils, drilling panels and polishing small bits of metal, but how much more

HOW TO SET UP THE LATHE

FIGURE 2: This will give the amateur millwright and lathe operator an idea of the best way to set up his equipment. Note that the lathe is not shown, but merely the position of the cone pulley.

quickly and accurately these jobs may be done on a lathe!

In purchasing a lathe, the experimenter should not only be guided by his actual needs but by certain mechanical features that mark the good tool. There are but two dimensions on a lathe that determine its size and capacity for work. One of these is what is called the "swing" of the lathe. This determines the size of a piece of work that may be revolved between its centers. Of course, the matter of weight enters into the question. One could not expect to revolve a hundred-pound piece of steel between the centers of a small tool, such as the one we have under consideration.

The distance between the centers (centers are indicated at MN, Figure 1) of the lathe and the lathe bed is called the "radius" and this multiplied by 2 gives the swing. The other measurement, that fixes the size of the lathe, is the distance between centers; that is, the distance between the live and dead centers when the tail stock of the lathe occupies the position at the extreme end of the bed, as illustrated in Figure 1.

The particular lathe under consideration is a Goodell-Pratt No. 125, which has a maximum distance between centers of 12 inches and a swing of 7 inches. This particular lathe was taken as a good example of a radio experimenter's tool, not only because of its size and good mechanical features, but because it may be equipped with a large variety of attachments that greatly increase its range of work. Save for two centers, the tee rest, slotted face plate, a table rest, saw arbor, tail feed handle and a drill chuck with a No. 1 Morse tapered shank, all other attachments, such as fret saws, scroll chucks, slide rests and circular saws, must be purchased separately. However, when all of these devices are available, the experimenter has at his disposal what practically amounts to a small machine shop.

One important feature to look for in the purchase of a lathe is cone bearings on the live spindle. This is the spindle marked "B" in the diagram (Figure 1). In Figure 4, the live spindle has been removed to show the conical shape of the bearings. A and B are the coned or tapered portions; A is a slight taper while B is an abrupt one. The cone collar B is screwed on to the live spindle and by adjusting this, the wear on the bearings may be taken up from time to time. Although the bearings may wear, they are always kept in perfect center and free of play by this ingenious arrangement.

The second important feature which determines the quality of a tool is the milled bed. Since the tail-stock of the lathe rides upon the bed, the ac-

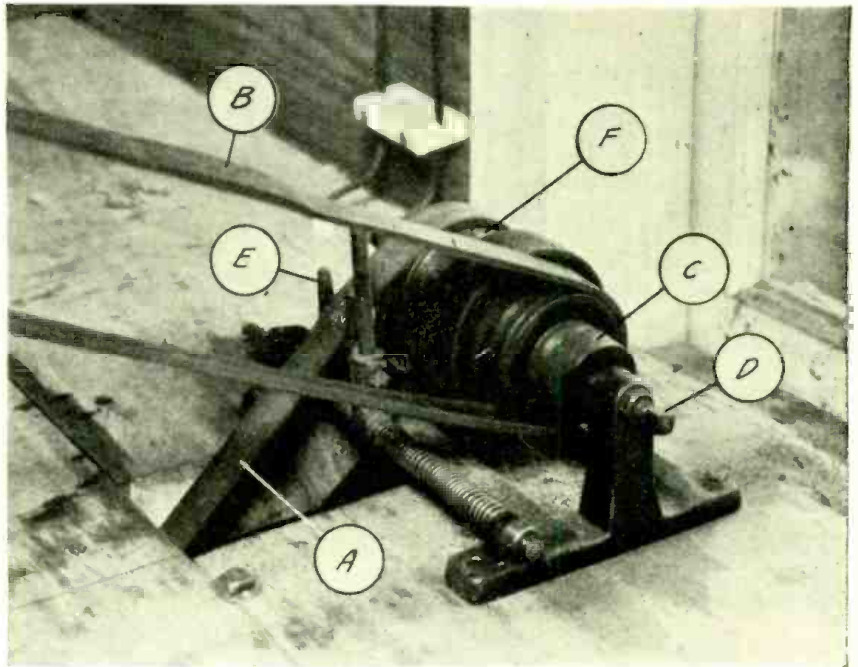

From a photograph made for POPULAR RADIO

THE POWER PLANT OF THE LATHE

FIGURE 3: This illustrates one way of installing a small countershaft of the lathe described. The power motor (1/4 hp) is inverted under the bench and connects with the countershaft by means of a belt. A. Belt B connects the cone pulley of the lathe with the cone pulley of the countershaft; F marks the power pulley while D marks the bearing adjustment. E refers to the forked belt shift.

curacy of any work turned out will depend largely upon the uniform surface of this part. The experimenter should also be careful to see that the tool is

equipped with plenty of oil and grease cups so that it may be oiled plentifully. Oil is cheaper than lathes and unless a
(Continued on page 392)

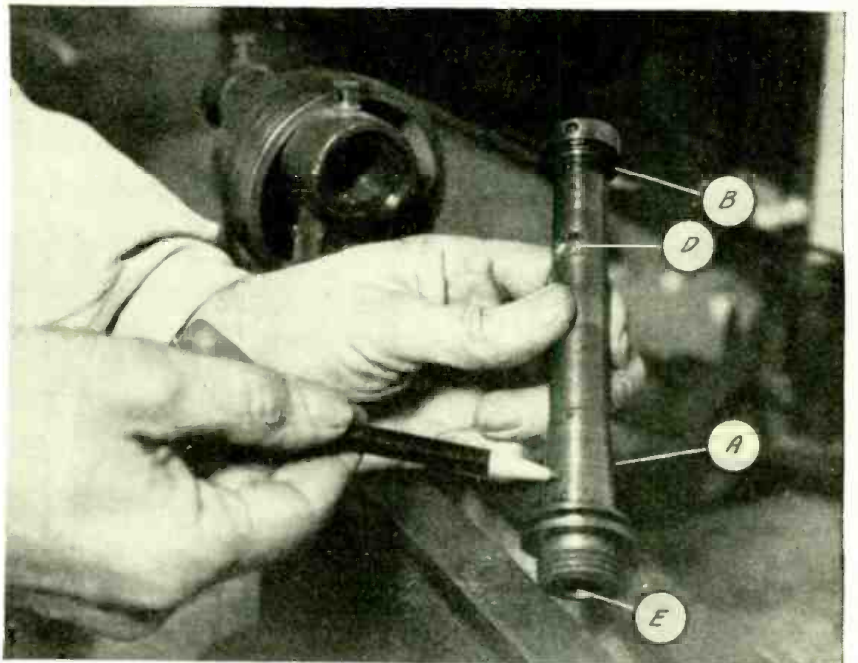

From a photograph made for POPULAR RADIO

WHAT THE LIVE SPINDLE LOOKS LIKE

FIGURE 4. By removing the live spindle from the lathe, the mechanic will easily learn how to keep the bearings in adjustment. A points to the long taper; B, to the conical-shaped collar which is screwed to the end of the live spindle. By adjusting the latter, wear in the bearings may be taken up. D shows the flat for the set screw which holds the cone pulley in place and E points to the hole in the spindle.

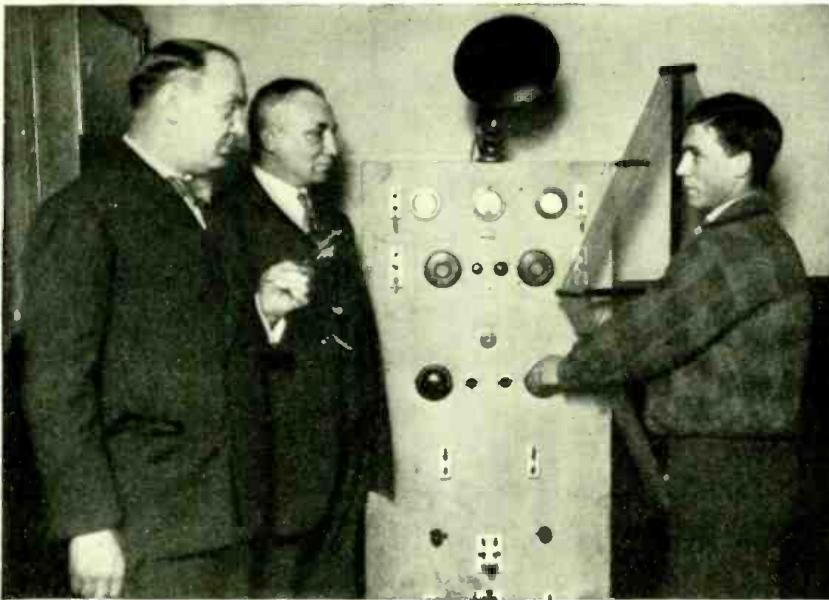

Herbert

Pocket Radio Sets to Help Police Catch Crooks

Here is the radio transmitter that has been designed to keep the police of Passaic, N. J., in touch with headquarters as they patrol their beats; the officers will pick up its transmissions on small, portable receivers. Michael Rusch (at right) is the creator of this system.

What's New in Radio

Conducted by
THE TECHNICAL STAFF

Inventors, experimenters, manufacturers and readers generally are invited to keep the Technical Staff of POPULAR RADIO informed of all new apparatus that is of their own creation or that comes to their attention; if the apparatus passes the tests of the POPULAR RADIO LABORATORY it will be duly recorded in this Department for the information and benefit of all.

Outstanding features: The "Truphonic" method of coupling is something comparatively new, but still old enough to have proven that it has decided merit. This type of coupling combines many of the advantages of the various other types of coupling systems. The quality of reproduction obtained with the use of this system of low-frequency amplification is excellent. The units are unusually compact and are simple to install and connect up. Three stages of such amplification are used.

Maker: Alden Manufacturing Co.



A Device to Insure Quiet Tube Operation

Name of instrument: Vacuum valve vibration repressor.

Description: This cap is molded of heavy, soft rubber with slits in the side to permit slipping it down over the top of a vacuum valve. The spring action of the rubber causes the cap to hug the valve snugly; this improves the repressor action.

Usage: To eliminate microphonic howls in a radio receiver.

Outstanding features: The springy action of the rubber causes the cap to conform exactly to the shape of the valve. Good appearance. Heavy weight. Stops howling in a low-frequency amplifier.

Maker: Spartan Electric Corp.



For Antenna Connections Where Soldering Is Impractical

Name of instrument: Aerial connector.

Description: This device consists of a nickel-plated, brass strip, which is provided with screw clamps at each end. In connecting a lead-in wire to the antenna, the lead-in wire is fastened into one end of this device and the antenna is clamped into the other end. This makes a solid physical joint as well as a good electrical connection between the antenna and the lead-in wire.

Usage: To attach the lead-in wire to the antenna wire.

Outstanding features: Simple in construction. Strong clamps. Good electrical conductor. Easy to install.

Maker: Heinemann Electric Co.



This Audio Coupler Enables You to Get Good Volume With Fine Tone

Name of instrument: "Truphonic" low-frequency coupler.

Description: This instrument is entirely inclosed in a metal case and is equipped with flexible leads by means of which the unit may be connected into the circuit of the low-frequency amplifier. These leads are clearly labelled to prevent confusion. Mounting feet are provided for attaching the unit to the baseboard or sub-panel of the receiver. The unit consists of two coils on a single core and a fixed capacity, shunted across the high potential ends of the coils.

Usage: To provide coupling between the vacuum valve circuits of a low-frequency amplifier.

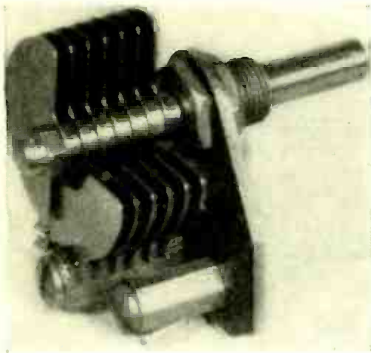

An Efficient Midget Variable Condenser

Name of instrument: Midget variable condenser.

Description: This condenser is well made, with its stator plates firmly crimped into a square metal post and insulated from the rotor plates and condenser frame by means of a small strip of insulating material on which the stator support is mounted. The rotor shaft has a single bearing, which is adequate for such a small condenser. The instrument is equipped for single-hole mounting and is provided with both screw connectors and soldering lugs.

Usage: As a balancing condenser for use in conjunction with two or more variable condensers in a gang to operate from a single control or for any other purpose where a small variable capacity is required.

Outstanding features: Extremely solid construction. Constant capacity. Strong bearing. Grounded rotor plates. Well insulated stator plates. Low minimum capacity.

Maker: Allen D. Cardwell Manufacturing Corporation.



High-Frequency Amplifiers May Be Easily Balanced With This Device

Name of instrument: Balancing unit for high-frequency amplifiers.

Description: This device consists of a variable high resistance and a fixed condenser which are enclosed within a composition case. A screw head is provided at the top so that the resistance may be adjusted by the use of a screw driver. The unit is designed so that it may be used for single-hole panel mounting or for base mounting. It is equipped with soldering lugs for making external connections.

Usage: In the plate circuit of high-frequency amplifier valves to reduce oscillation and stabilize the amplifier.

Outstanding features: Well constructed. Compact in size. Neat in appearance. Makes stabilization of high-frequency amplifiers a simple matter.

Maker: Electrad, Inc.



A Power Plant for a "B" Power-Pack

Name of instrument: Power transformer.

Description: This power transformer is designed to operate from the 110-volt, 60-cycle lighting lines. The secondary windings are all center-tapped and provide 300 volts for the plate supply and filament supply voltages of 5½ and 7½. The unit is completely inclosed in a pressed-metal case with a black crackle finish and is equipped with a composition terminal panel.

Usage: As the power transformer in any "B" power-pack which uses a gaseous or a filament type rectifier valve to provide the high voltage required for the plate supply of a receiver and also

the filament voltages required for the operation of the filament type rectifier tube; and for the UX-171, the UX-112, or the UX-210 type power valves used in the last low-frequency amplifier stage of the receiver.

Outstanding features: Compact size. Provides all necessary voltages for use in a standard "B" power-pack, including the filament voltages for the rectifier and power amplifier tubes. Well made. Efficient.

Maker: National Company, Inc.

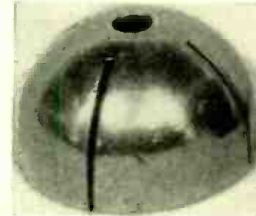

This Device Will Stop Microphonic Howls in Your Set

Name of instrument: Vacuum valve vibration repressor.

Description: This is a polished metal cap designed to fit over the top of vacuum valves. Four felt pads are glued to the inside to eliminate rattling which might occur if this cap fitted loosely on the tube. There are four slits which divide the cap into four segments and permit the segments to be adjusted to the exact circumference.

Usage: To be placed on vacuum valves to eliminate the microphonic howl which frequently occurs if the reproducer is placed too close to the receiver. Especially useful with UX-200-a type detector valves.

Outstanding features: Neat in appearance. Simple in construction. Nothing to break or wear out. Stops howling in a low-frequency amplifier.

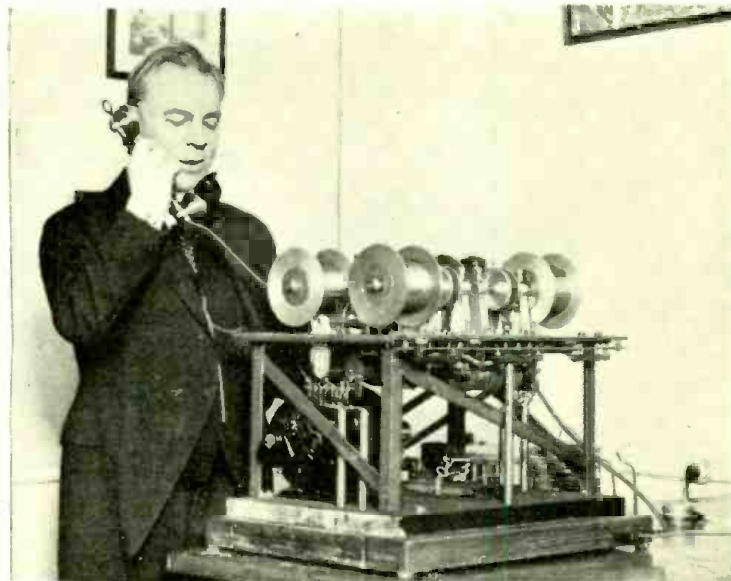

International News reel

A Machine to Record Broadcast Programs

Radio programs may be literally "put on the wire" by means of this device which records sounds permanently on a threadlike wire; the sounds may be reproduced with the aid of a radio amplifier and an ordinary loudspeaker.



A Die-Cast Variable Condenser of Unique Design

Name of instrument: Variable condenser.

Description: This condenser is out of the ordinary in that it does not make use of piled-up plates as does the usual variable condenser. The stator and slider (corresponding with the rotor in the ordinary condenser) are each cast in a single block. Each of these units consist of a casting which is made up of a series of concentric and alternate rings and grooves. The size of the two blocks is such that the rings of the slider mesh into the grooves of the stator and vice versa. The extent to which the two units are meshed governs the capacity of the condenser. The movement of the slider is a direction parallel with the control shaft. The entire condenser is completely inclosed in a metal case. The change from minimum to maximum capacity entails a 360-degree movement of the shaft.

Usage: As a variable tuning unit in a radio receiver or wherever a variable capacity unit is required.

Outstanding features: Great strength. Permanent characteristics. Good insulation. Extremely low DC resistance. Full 360-degree movement.

Maker: Furnell Mfg. Corp.



A Complete "A" and "B" Power-Pack in a Single Metal Case

Name of instrument: "A" and "B" Socket Power.

Description: The brown crystalline-finished metal case which incloses this unit measures 12 $\frac{3}{4}$ inches by 13 $\frac{3}{8}$ inches by 7 $\frac{1}{8}$ inches. The unit consists of a small 6-volt storage battery with an electrolytic trickle charger, for the "A" supply and an electrolytic

rectifier, filter and the necessary output resistances for the high-voltage, plate-supply of a receiver. The "Socket Power" will operate any receiver which uses eight vacuum valves or less. It will supply a maximum plate voltage of from 135 to 150 volts, depending on the current required by the receiver. The maximum practical plate current the device will supply is 50 milliamperes. The charging rate of the trickle charger may be regulated to meet requirements. The unit is supplied with an extension cord and plug, which in operation is plugged into any socket on a 110-volt, 60-cycle line. A switch is provided on the front of the case, by means of which the unit is turned "on and off." When turned "on" the "A" battery is connected to the receiver and the "B" supply section is connected to the AC line. When turned "off" the "B" supply is disconnected from the line, the "A" supply is disconnected from the receiver and is connected to the trickle charger. The "A" battery is therefore constantly on charge while the receiver is *not* in operation.

Usage: To supply the "A" and "B" voltages for the operation of a radio receiver.

Outstanding features: "A" and "B" supply devices complete in a single unit which is small enough in size to fit into the battery cabinet of a radio table or console. The "A" charging is automatic. Will operate any standard receiver, including those that use a UX-171 or a UX-112 type power tube in the last low-frequency amplifier stage. The entire unit requires no attention on the part of the owner except the occasional addition of distilled water to the solution in the battery and rectifier jars.

Maker: Philadelphia Storage Battery Co.



An Amplifier That Will Give Excellent Tone Quality From Any Receiver

Name of instrument: Low-frequency amplifier.

Description: This instrument, known as the Sonatron Amplifier, is a high-grade, three-stage, resistance-coupled, low-frequency amplifier. All of the parts except the vacuum valves are inclosed in a composition base. Terminals for connections to the batteries are provided along one edge of the base and provision is made for inserting the valves directly into the top of this base. A switch is also provided for turning the amplifier "off and on." Mounting holes at either end of this amplifier unit furnish means for fastening it down, if it is to be permanently included in a receiver. The three valves provided

with the amplifier unit are especially matched. The first one is a "high-mu" tube with an amplification constant of 32. The second valve has an amplification constant of 20, and the third an amplification constant of 6. This set of tubes supplies high amplification with excellent tone quality. For purposes of identification the vacuum valves are colored red, white and blue respectively.

Usage: As a high-quality, low-frequency amplifier that can be readily connected immediately after the detector in any receiver, to provide loud-speaker reception of pleasing quality. It may be used to convert a single-valve receiver, or a crystal receiver, into one which will provide good reception on a cone-type reproducer, or it may be used in place of the amplifier in a receiver which is not giving a good quality of reproduction. In any case only one connection in the receiver need be changed to accommodate it, and in the case of a single-tube or crystal receiver, no wiring changes are needed.

Outstanding features: Compact. Easily installed. Fine quality of reproduction. Low current consumption.

Maker: Sonatron Tube Co.

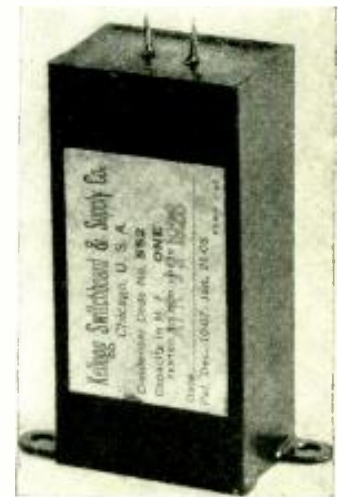

An Accurate High Capacity For Use as a By-pass Condenser

Name of instrument: Fixed by-pass condenser.

Description: The condenser is made of special tinfoil and paraffin paper and is assembled in such a manner as to insure accuracy of capacity rating. The assembly is sealed into a metal can with two soldering-lug terminals brought out through the sealing compound at one end. Mounting lugs are provided at the other end for mounting the condenser in an upright position by means of screws or bolts. The condensers are made in various capacities from .2 mfd. up to 4 mfd. and are given a breakdown test of from 400 to 750 volts, DC.

Usage: As a by-pass condenser where the condenser is not subjected to voltages in excess of 200 volts.

Outstanding features: Rigid assembly and permanent capacity.

Maker: Kellogg Switchboard and Supply Co.

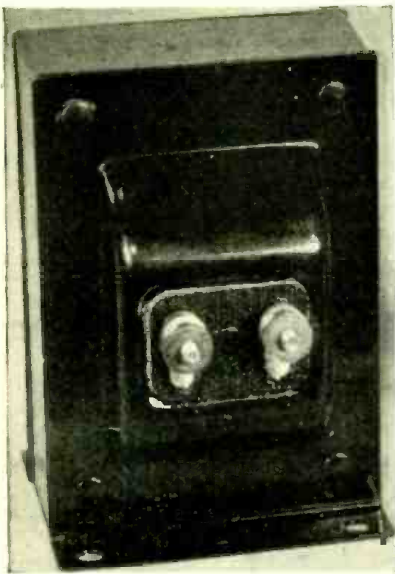

A Transformer to Provide Truthful Tone Quality

Name of instrument: Low-frequency transformer.

Description: This instrument is of generous proportions; this is one of the reasons for the fine quality of reproduction obtained from receivers in which this transformer is used. The instrument is entirely enclosed in a metal case except for the two small insulating panels on which the terminals are mounted. A flanged base is provided with holes to accommodate screws used in mounting the transformer in the receiver.

Usage: As a coupling device in a low-frequency amplifier.

Outstanding features: Strong construction. Terminals conveniently located. Entirely enclosed in metal case. Fine reproducing qualities.

Maker: Dongan Electric Mfg. Co.

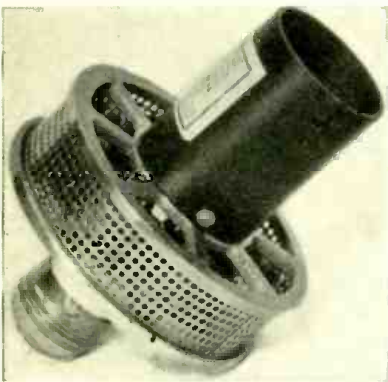

An Instrument That Puts New Life Into Old Vacuum Valves

Name of instrument: Tube reviver.

Description: This is a simply made device, which may be screwed into any alternating-current lamp socket. It consists of a suitable resistance inclosed in a ventilated case to prevent undue heating. On one side of this case is mounted the plug which screws into

a lamp socket and on the other side is a receptacle into which any vacuum valve of the UX-201-a type may be inserted for rejuvenation. Means are provided for supplying two different voltages to the filament of the valve, as is required in any satisfactory rejuvenation process.

Usage: UX-201-a type valves which have decreased filament emission due to old age or the use of excessive voltage on the filaments may be brought back to normal in a few minutes through the use of this device.

Outstanding features: Simple and sturdy in construction. Easy to use. Effective in action.

Maker: International Resistance Co.

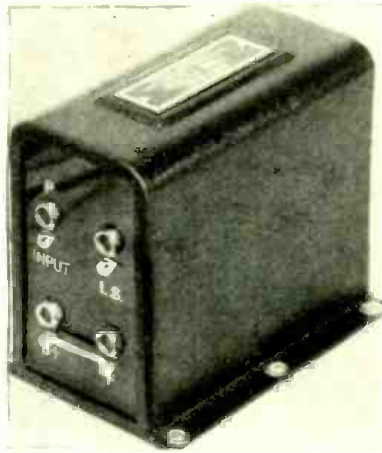

A Device That Protects the Reproducer Unit by Filtering Out the High DC Current

Name of instrument: Tone filter.

Description: This unit is enclosed in a neat metal case with a composition insert at one end which carries the four terminals of the instrument. The unit consists of an inductance and a bypass condenser so connected that when this device is connected between the receiver output and the reproducer the direct current passes through the inductance while the alternating current (which is the only useful part of the plate current so far as the reproducer is concerned) passes through the reproducer winding and actuates the reproducing mechanism. The terminals on this tone filter consist of four "phone tip" jacks, and a connecting cord provided with phone tip terminals is supplied with the instrument.

Usage: As a filter to keep the high current required in the plate circuits of power valves out of the windings of the reproducer. This not only protects the reproducer from excessively high current flow, but improves the quality of reproduction because of the elimination of the constant DC strain which would otherwise be present in the windings of the reproducer.

Outstanding features: Easily connected between reproducer and receiver. Provides ample protection for the reproducer where the DC current flow in the plate circuit of the power amplifier valve is not in excess of 35 milliamperes. Neat in appearance. Compact in size.

Maker: National Company, Inc.



A Variable Condenser That Saves Space Behind the Panel

Name of instrument: Variable condenser.

Description: This variable condenser is a precision instrument of highly efficient design. The spacing between plates is extremely small, with the result that the entire device projects only about one inch behind the panel. Isolantite is used as the insulating material. As a result, the dielectric losses are kept to a minimum. The tuning characteristics of this condenser are of the straight-line-frequency type; all plates are rigidly secured in position and a positive contact with the rotor section is constantly maintained.

Usage: As a tuning device in a radio circuit or for any use that requires a highly efficient variable capacity unit.

Outstanding features: Compact size. High efficiency. High-quality design and construction which mean the indefinite maintenance of high efficiency.

Maker: Pacent Electric Co., Inc.

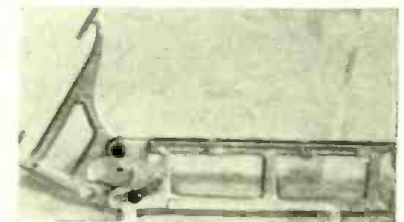

A Solid Foundation for Mounting Panels and Sub-panels

Name of instrument: Mounting bracket.

Description: This bracket is so designed that two of them furnish a solid foundation for a home-constructed receiver. The device is provided with the necessary screw holes for mounting the brackets on the base of the cabinet, if so desired, and for mounting the sub-panel, the main panel and the binding post panel on the bracket. The bracket is adjustable so that it will support the front panel of the receiver at any desired angle.

Usage: As a foundation for the assembly of any receiver. Two of these brackets are used in the average receiver, one at either end. The front panel, the sub-panel and the terminal strip may all be mounted directly on the brackets.

Outstanding features: Provides a rigid framework for the receiver assembly. Adjustable to permit mounting the front panel at any desired angle.

Maker: Bruno Radio Corp.



A Handy Extension Cord for Reproducers

Name of instrument: Cuno "Reel" loud-speaker extension cord, Model No. 687.

Description: This device consists of a 25-foot extension cord for use when it is desired to place a reproducer at some distance from the receiver. Its special value lies in the fact that the unused portion of the extension cord remains on a reel, which is inclosed in a metal case that is intended to be screwed on to the outside of the receiver cabinet. This reel makes use of a spring arrangement, which permits the extension cord to be pulled out to any length desired. But, when the extension is no longer required, it is only necessary to press a button on the case of the instrument and the extension cord will be wound on the reel by the spring arrangement mentioned above and with no effort on the part of the user. This device is equipped with a second cord to be connected

to the receiver where the reproducer would ordinarily be connected.

Usage: To permit the use of a reproducer at a point distant from the receiver.

Outstanding features: This unit automatically reels in any slack in the extension wire and therefore eliminates the loose, straggly appearance of the ordinary extension cord. Can be reeled up out of the way by simply pressing a button on the case.

Maker: Cuno Engineering Corp.



This Kit Simplifies Antenna Installation

Name of instrument: Antenna kit.

Description: This kit consists of a 100-foot coil of 7-strand, hard-drawn, copper wire, 50 feet of insulated lead-in wire, a lightning arrester, two glass insulators, one window lead-in strip, one ground clamp, three porcelain wall insulators, two porcelain lead-in bushings and the necessary screw eyes, staples, etc. All of this material is high grade.

Usage: Complete equipment for the installation of an outdoor antenna.

Outstanding features: High-grade material throughout. Most complete. Provides all the items needed for erecting an outdoor antenna.

Maker: M. M. Fleron & Son, Inc.



An "All Purpose" Variable Resistor

Name of instrument: Resistograd.

Description: This is a non-inductive resistance, the value of which may be varied approximately from zero to 30,000,000 ohms by means of the knob provided with the instrument. A special compound is hermetically sealed into the holding compartment. The resistance of this compound is varied according to the degree of contact obtained by turning the shaft.

Usage: As a variable grid-leak or for other purposes where a variable high-resistance unit is required.

Outstanding features: Neat appearance. Hermetically sealed with resistance material. Single-hole mounting. Equipped with control knob.

Maker: Pilot Electric Mfg. Co.

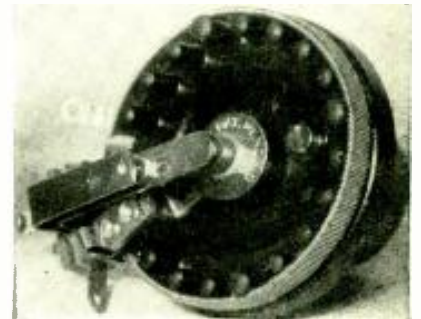

A Rheostat That Eliminates the Battery Switch

Name of instrument: Combination rheostat and battery switch.

Description: This rheostat may be obtained in various resistances to meet individual requirements. The wire-wound resistance element is carefully made with a large number of small turns which provide an extremely gradual variation of resistance. The resistance unit is clamped around a series of posts on the composition base of the instrument and is practically air-supported. This provision allows good radiation of any heat developed. The battery-switch feature is so arranged that when the rheostat is turned to the "off" position, the "A" battery circuit is broken and all the vacuum valves in the receiver are turned off, regardless of whether they all work through this rheostat or not.

Usage: In any radio receiver, for the control of the filament current to one or more vacuum tubes, and at the same time to serve as a battery switch for all of the vacuum valves.

Outstanding features: Air-cooled. Practically a vernier control of resistance. Single-hole mounting. Eliminates necessity for a separate battery switch.

Maker: Yaxley Manufacturing Company.

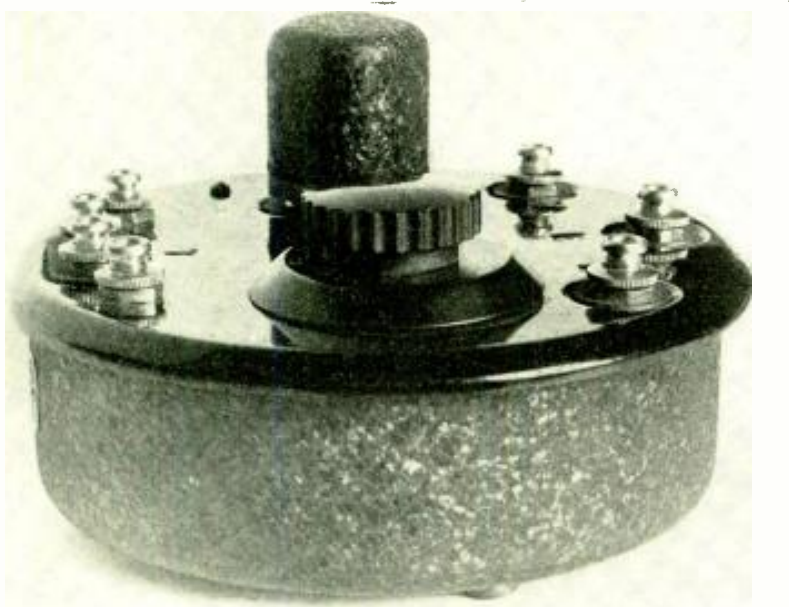

A "Shielded" Crystal Receiver

A metal panel and container completely inclose this new and popular German crystal set; even the crystal detector is hidden under a metal cap. Tuning is effected by means of a small variometer which is connected in series with a fixed antenna coil.

A Seven-tube Single-Control Receiver with Built-in Loop and Speaker

Name of instrument: The Rauland "Sovereign" Receiver.

Usage: For reception of broadcast programs.

Outstanding features: Single-control tuning. Equipped with reproducer and directional loop antenna, both of which are concealed within the cabinet. Space provided for batteries or power-packs within the cabinet. Requires no external equipment or wires. High selectivity. Luxurious appearance.

Description: The Rauland "Sovereign"* receiver consists of the standard Rauland seven-tube chassis mounted in a high-boy console.

The "Sovereign" model receiver is a beautiful piece of furniture. This cabinet is of the Spanish Renaissance period and is finished in brown, crackle parchment; the underlying field is of gold, but so little of this shows through the crackle finish that the composite tone is a decided brown.

A good idea of the design of the cabinet may be obtained from the accompanying illustration. It is five feet in height, 40 inches wide and 19 inches deep; the six-leg base is of solid walnut and is also finished in brown, but is highlighted in bronze.

Access to the compartments for installing the batteries, or the power-supply unit, as well as to the receiver, for installing the vacuum valves, is gained through a hinged portion of the rear wall of the cabinet.

The reproducer and loop are located in the upper half of the cabinet. The former is placed directly behind a grill which is in the exact center of this upper section. Just below this grill is a knob by means of which the loop may be turned to take full advantage of its directional properties.

In the center of the lower section of

*The name "Sovereign" applies to this console cabinet rather than to the receiver chassis because the same chassis is used in two other models: the "Lorraine" which is also a high-boy console model, but lower in price; and the "Forte" which is a table-mounting model of the treasure-chest type, and is lower in price than the other two models.

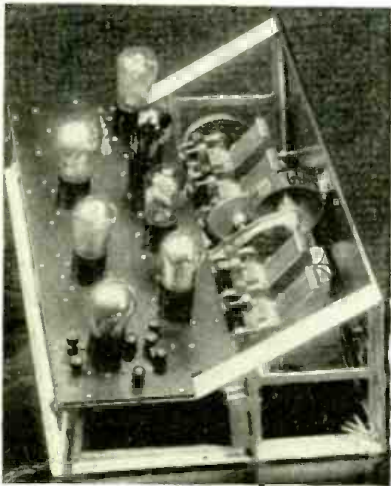

An inside view of the receiver chassis showing the method of ganging the four tuning condensers.



From a photograph made for POPULAR RADIO

A SELF-CONTAINED SINGLE-CONTROL RECEIVER

The loudspeaker is concealed in the upper part of the cabinet behind a grilled opening; the loop antenna is also installed inside of the console and is controlled by a knob on the panel.

the cabinet is the control panel of the receiver unit. This panel is of metal and carries two adjustment knobs, the "on-off" switch, and a small window behind which the calibrated tuning scale is visible. This scale is calibrated in both degrees and in wavelengths and is illuminated from within by a pilot light which lights automatically when the receiver battery switch is turned "on." The control and operation of the receiver is extremely simple. The wavelength tuning is accomplished entirely by means of the larger of the two adjustment knobs without any auxiliary controls or adjustments of any kind.

The other adjustment knob is the volume control; this permits the volume to be cut down to just the proper degree for most pleasing reproduction.

The use of the directional control knob is not required in the case of reception from local broadcasting stations, but it does help materially in the reception of weak signals from more distant stations. When an outdoor or indoor antenna is used in conjunction with a ground connection, this directional control knob is not used.

The "on-off" switch not only turns the "A" battery current on and off, but it also operates a relay inside of the cabinet. This relay switch in turn controls the current supply from the house-lighting lines to the "A" battery trickle charger and to the "B" power-pack if one of these units is used in place of "B" batteries.

For readers interested in semi-technicalities it may be noted that the receiver consists of three stages of tuned high-frequency amplification, a vacuum

valve detector and three stages of low-frequency amplification. Transformer coupling is used in the input to the first low-frequency stage and the input coupling to the second and third stages is done by means of impedance coupling.

The three variable condensers that tune the three high-frequency stages, and the variable condenser that tunes the antenna circuit, are all coupled together to operate from the single tuning control. In order to make possible the simultaneous tuning of four circuits, it is essential that the coils and tuning condensers be carefully matched; when the receiver leaves the factory it is exactly in adjustment and requires no further adjustment of any kind on the part of the ultimate purchaser of the receiver.

Each of the coils used in the high-frequency amplifier is individually shielded to prevent external pick-up and to eliminate interaction and feedback between stages. The precautions taken in this direction have been ample to provide the operator of the receiver an absolute control over oscillation, by means of the volume control.

The receiver is assembled on a heavy frame; a composition sub-panel is provided for mounting the parts which require a high degree of insulation. The front panel is spot-welded to the metal frame for greater security. The result of this strong construction is that the assembly is rigid—an essential feature where permanency of alignment is an important factor.

In tests on this receiver maximum results were obtained with the use of



From a photograph made for POPULAR RADIO

A New Radio "Time-Clock"

This novel device for turning your set "on" or "off" automatically may also be set to give a time signal in the loudspeaker to remind the listener of an appointment or a feature program. The device may also be adapted to turn a phonograph "on" or "off" or to regulate an oil-burning furnace. It was developed by Ushichiro Tokumi, a Japanese radio engineer.

an outdoor antenna of from 60 to 100 feet in length, including the lead-in wire. Good results, however, may be obtained with an antenna strung around the picture moulding of the room in which the receiver is located. For those who prefer to eliminate the antenna entirely, or in locations where interference between stations is particularly bad, the loop antenna solves the problem. This arrangement will provide plenty of "pick-up" on all local reception and many out of town stations.

A striking example of the selectivity of the set was found in the experience of the author while using one of these receivers in his hotel room during a visit to Chicago. It happened that there was a thousand-watt broadcasting station on the roof of the hotel which was in operation most of the afternoon and half of the evening. The antenna of this station was directly overhead and probably not more than 150 feet above the receiver. In spite of these conditions, and while this station was in operation, no difficulty was encountered in tuning in any of the other stations in and around Chicago, without interference from the station overhead.

The manufacturer of this receiver also manufactures the "Constant-B

Battery Eliminator," a unit well adapted for use with this receiver in place of the usual "B" batteries. This unit supplies the four "B" voltages required in the operation of the receiver, and operates from the alternating current, house-lighting lines. A switch is provided by means of which the maximum voltage to the receiver may be limited to approximately 135 volts where the UX-112 type power valve is used. Or, if it is desired to use a UX-171 type power valve, the switch may be thrown to the "high" side and the eliminator unit will then supply a maximum of around 180 volts.

If an AC light line is not available, the receiver will, of course, work just as satisfactorily with "B" batteries. When batteries are used, the UX-112 type power valve will be found best for use in the last low-frequency stage—at least from the standpoint of battery economy.

A storage "A" battery and trickle charger is recommended for the filament supply source.

The "C" battery should be of the small dry-cell type.

The tone quality of this receiver is decidedly good and a high degree of undistorted volume can be obtained on local and semi-distant stations.

Maker: All-American Radio Corporation.

A New Loudspeaker Extension Cord

Name of instrument: Extension cord for reproducers.

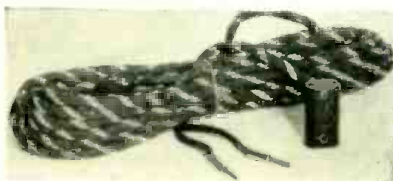

Description: This is a two-conductor cord with a woven cover; it is equipped with a double-spring connector, by means of which the extension cord is connected to the cord on the reproducer. The ends of this cord terminate in standard phone tips. In order to connect the extension cord into the reproducer circuit it is only necessary to insert one pair of these tips into the spring connector, which is

provided with the cord, and the tips of the reproducer cord into the other end of this connection. The free end of the extension cord is then connected to the receiver.

Usage: In connection with any reproducer when it is desired to place it at some distance from the receiver.

Outstanding features: Well made. Easy to install. Neat appearance.

Maker: Birnbach Radio Co.



An Interchangeable Coil for All-Wave Receivers

Name of instrument: Interchangeable toroid coil and base.

Description: These coils and mountings are an extremely workmanlike product of a European manufacturer. The coils are of silk-covered wire, wound in toroid form with no dielectric material whatsoever inside of the winding. The toroid is mounted on a composition center which is made in two parts so that when the parts are fastened together the coil is firmly clamped in place. An extension of this composition center-clamp also serves as the terminal plug. The four terminals make firm contact with corresponding terminals in the coil socket which is mounted in the receiver in much the same manner as a vacuum-valve socket, and has four binding posts for making connections to the other parts of the set. The coils are inserted in these sockets in the same manner that a vacuum tube is inserted in its socket. The coils are made in two sizes; the smaller covers a waveband of from 150 to 600 meters with a .0005 mfd. variable condenser. The larger coils cover the waveband from 600 to 2,100 meters with a similar tuning condenser. It is the work of a moment to change the receiver over from one with a maximum of 600 meters to one with a maximum of 2,100 meters.

Usage: A receiver which is equipped with these coils and coil sockets becomes a highly efficient receiver with a wavelength range from 150 to 2,100 meters.

Outstanding features: Substantial air-core windings. Extremely neat in workmanship and appearance. Highly efficient. Change over from one waveband to another is only a matter of seconds.

Maker: A. B. Stern and Stern, Stockholm, Sweden.

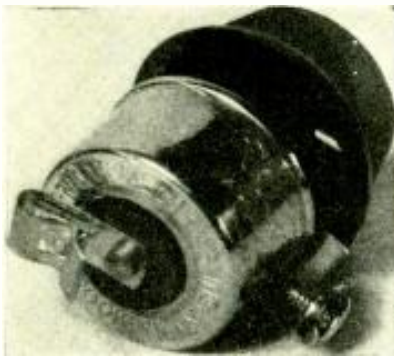

A Variable High Resistance That Carries High Currents

Name of instrument: Clarostat.
Description: This unit provides a resistance, continuously variable from zero to 5,000,000 ohms. This great range is accomplished by four complete turns of the knob which is attached to the unit. Except for the composition knob, the unit is completely inclosed in a drawn metal case with an insulated bushing for one of the terminals. The knob operates a plunger arrangement which varies the pressure on the resistive material contained in the unit, and in so doing varies the resistance of the instrument. One complete turn of the knob varies the resistance only from 0 to 500 ohms, thus giving accurate adjustment for any resistance within this range. A second revolution varies it from 500 to approximately 6,000 ohms, thus giving a sufficiently close adjustment anywhere within this range. The third and fourth revolutions of the knob provide a gradual increase of resistance from 6,000 ohms up to maximum.

Usage: As the voltage regulators in a "B" power-pack, as a volume control in the plate circuit of a receiver, or for any purpose which requires a variable resistance of this type.

Outstanding features: Smooth adjustment. Stable operation. Carries up to 20 watts of current. Single-hole panel mounting. Good mechanical design.

Maker: American Mechanical Laboratories, Inc.



A Long-Wave Transformer That Will Reduce Oscillation

Name of instrument: Long-wave, air-core transformer.

Description: This air-core transformer is compact and completely inclosed in an insulated case. The design of the

coils is such that there is no necessity for shielding the receiver in which these transformers are used and the units may be placed close together without dangerous interaction between stages. Each transformer is equipped with four binding-post terminals at the top of the case, and these terminals are arranged in an order that makes all leads as short as possible. The transformers are supplied in sets of four and the individual units are numbered from one to four to indicate their position in the receiver circuit.

Usage: As the coupling units in the intermediate-frequency amplifier of a superheterodyne receiver.

Outstanding features: Compact size. Convenient arrangement of connection terminals. Eliminate oscillation in the intermediate amplifier. Reduce "repeat points." Efficient coupling units for intermediate frequency amplifiers.

Maker: Lincoln Quality Products Co.



A Power-Pack Filter Condenser That Will Stand Up Under 400 Volts

Name of instrument: "B" block condenser unit.

Description: This condenser block includes five different condensers of capacities ranging from 1 mfd. up to 8 mfd. It is especially designed for use in "B" power-packs where the working voltage is not higher than 400 volts. This includes all power-packs which use either the gaseous or the filament type of rectifier valves. The capacities are correct for the standard "B" power-pack circuits. One side of each of the condensers is connected to a common terminal on the terminal panel. The other side of each condenser is brought out to an individual terminal. The complete unit is inclosed in a metal case.

Usage: To provide the high capacities required in the filter circuit of a "B" power-pack.

Outstanding features: Provides a desirable range of capacity values. Neat in appearance. Capacity values of the component condensers clearly marked on the terminal panel. The voltage rating allows a good factor of safety when used in the ordinary power-pack.

Maker: National Company, Inc.



A New Receiver of Remarkable Selectivity

Name of instrument: Elkay "Senior Six" Receiver.

Usage: For the reception of radio broadcasting.

Outstanding features: Remarkable selectivity. Excellent tone quality utilizing Truphonic low-frequency amplification. Complete shielding. Designed to use any make of vacuum valves. Neat appearance. Easy to tune.

Description: The outstanding features of the Elkay receiver are its great selectivity and sensitivity. Both of these characteristics are decidedly advantageous in view of the large number of broadcasting stations "on the air."

In making tests on this receiver, it was put into operation in a location where considerable trouble has been encountered due to the opening up of a new high-power station. When this station is in operation it has been found practically impossible, with the average receiver, to tune in any other stations within 20 meters of the operating wavelength of this new local station, without hearing the local program in the background.

Under these conditions it was a considerable surprise to find that the Elkay receiver was able to tune in, without any interference, stations within ten meters of this local station, as well as one station only six meters away. And this was accomplished while using an antenna slightly over 100 feet in length—long enough to make the tuning of the average receiver hopelessly broad.

If this receiver made use of four, or even of three, stages of tuned-high-frequency amplification this performance would not have been so remarkable; but it contains only two stages of high-frequency amplification. Moreover, apparently no sacrifice of volume, of sensitivity or tone quality

(Continued on page 396)



Herbert

A BUTTERFLY-PANELLED RECEIVING SET

Glass backed with real butterflies and pressed flowers and Chinese silk forms the panel of this four-tube single-control regenerative receiver. Both the set and the panel were made and designed by Wei Yoh Wu, a Chinese electrical engineer, in his laboratory at Astoria, New York.

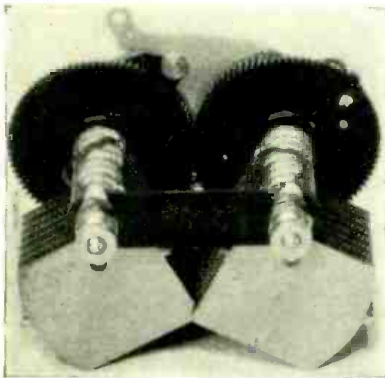

This Variable Condenser Eliminates Hand Capacity

Name of instrument: Variable condenser.

Description: The construction of this instrument is unique in that instead of having one set of movable plates that intermesh with a set of stationary plates, both sets of plates are movable. The plates are rectangular in shape and, as a result, the condenser measures only 3 1/2 inches across when the plates are entirely unmeshed. The plates are operated by a single shaft which is geared to the plates through gears of insulating material. In addition to providing mechanical coupling, these gears insulate the shaft from the plates so that the shaft is electrically isolated from the "live" parts of the circuit and hand-capacity effect is therefore eliminated. Mechanical means are provided to make a straight-line-frequency tuning characteristic in the circuit in which this instrument is employed.

Usage: As a tuning element in any high-frequency circuit, or for any other use where a variable capacity unit is required.

Outstanding features: Eliminates body capacity. Provides straight-line-frequency tuning. Occupies little space

behind the panel. Provides positive contacts through the use of pig-tail connections to moving plate sections. Eliminates the necessity for vernier dial in many cases, as a full 360 degree movement of the dial is used to vary the capacity of this unit from minimum to maximum.

Maker: Gray and Danielson Mfg. Co. (Remler Radio Mfg. Co.)



This Unit Simplifies the Construction of Power-Packs

Name of instrument: Power compact.

Description: This unit combines a power transformer, buffer condensers and filter chokes, all inclosed in a single metal case. Terminals are provided for connecting this unit to the other parts needed to make up a power-pack capable of supplying all necessary "B" voltages to a receiver, including the high voltage required by a UX-171 type power amplifier valve. The unit is designed for use with a ratheon rectifier valve. It is equipped with an extension cord and

plug for plugging into the AC light socket.

Usage: Combines the power transformer, buffer condensers and chokes in a single compact unit, for use in a power-pack to supply "B" and "C" voltages to a receiver which makes use of a UX-171 type power valve in the last low-frequency stage. The unit is also equipped to supply the filament voltage for the operation of the power valve.

Outstanding features: Compact size. Solid construction. Simplifies construction and wiring of a power-pack. Provides filament voltage for a half-ampere power tube.

Maker: Thordarson Electric Mfg. Co.



A Compact Receiver in a "Drawer" Cabinet

Name of instrument: Magnavox Radio Receiver, Model T.

Usage: For radio broadcast reception.

Outstanding features: Absolute single-control tuning. Unusually compact. Neat appearance. Good tone quality. Novel external design. Excellent selectivity and good distance reception. Equipped with battery cable and plug.

Description: One of the most striking features of this new set lies in its novel design. Instead of mounting the set in a cabinet which opens at the top, this receiver has been assembled in a wooden drawer which slides in and out of the cabinet.

This cabinet is of mahogany, finished in a quiet, two-tone effect of dark brown, with the front of the receiver drawer finished to match.

Another feature of the receiver is the simplicity of panel design. On it are mounted three knobs: A large one in the center which accomplishes all of the tuning of the receiver; a smaller knob to the right which provides a control for sensitivity and volume; and a third knob to the left to turn the receiver "on" and "off."

Just above the large wavelength tuning control is a window behind which a calibrated scale revolves; this shows the wavelength to which the receiver is tuned. The fact that this scale is calibrated in wavelengths simplifies the tuning of the receiver to a surprising degree.

The circuit employs five vacuum valves (tubes) and consists of two stages of tuned, high-frequency (radio-frequency) amplification, detector and two stages of transformer-coupled, low-frequency (audio-frequency) amplification. The coupled antenna circuit and the two stages of high-frequency amplification are tuned by variable condensers with their rotor plates mounted on a common control shaft. This shaft is operated by the large tuning control

(Continued on page 398)

“Buzzing” with Bussey in Brazil

By RALPH E. THOMAS (2-UK)



From the “River of Doubt” to New Jersey

Ralph Thomas, a radio amateur of New Brunswick, N. J., is one of the fortunate few to pick up code signals from the Dyott expedition in South America; the shaded portion of the above map shows the location of the explorers.



Nearly any “ham” would give his best 50-watter to pick up the magic letters “GMD,” the call letters of the George Miller Dyott expedition now exploring the wilderness of Brazil. The expedition is trying to proceed across the central plateau of Brazil and the Parecis Hills to explore the headwaters of the Rio Roosevelt, better known as the “River of Doubt.” Station GMD, operated by Eugene Bussey of Yonkers, New York, and transmitting on wavelengths between 20 and 80 meters, has kept the expedition almost constantly in touch with civilization; the expedition also carries a small portable set, 2-GYA, which relays messages through GMD from the more inaccessible regions.

SLOWLY the dials of the short-wave tuner swung around as I tuned in for long distance at Amateur Station 2-UK. Signals were coming in from all parts of the globe. Some of the signals were strong, clear and steady; others were faint, fading and scarcely readable.

But one fact was certain—this was a good night for “DX” reception.

Finally the dials ceased turning, for as the set was brought into resonance I heard the signals of British 2-NM calling “test U. S. A.”

A twist of the throw-over switch and my transmitter was ready for action; within a few minutes communication was established and a friendly chat ensued. In the same manner Portugal 1-AE, Mexican 5-B and several others were worked. All reported my signals “fine business.”

Feeling well satisfied with results so far, I turned to the lower end of the band and logged several Brazilian stations. One after another, Brazilian 1-AW, 1-IB, 1-AK and 5-AB were tuned in. But who was that faint, steady signal that was barely audible through the “Qrm” and occasional crashes of static, calling “cq, de GMD, GMD, GMD.”

Once more my transmitter was brought into play and my signals flashed out into space, calling “GMD, GMD, de 2-UK, 2-UK.”

There was a moment of suspense as I switched back to my receiver. Would GMD hear my signals and reply?

Sure enough, the faint signals this time could be heard calling 2-UK; communication had been established.

“This is G. M. Dyott Expedition, in the wilderness of Brazil,” said Bussey, the radio operator. “I am certainly glad to connect, as you are the first station to answer me for a long time. I have a long message for the *New York Times*; will you relay it for me?”

The interference at this point became so great that I was compelled to ask him to raise his wave. This he did, and after more or less difficulty all the traffic was cleared and the conversation took a general trend, and we chatted for several minutes. The message was as follows:

G. M. Dyott Expedition,
Brazil, Oct. 18, 1926.

New York Times,
New York:

Expedition now encamped on the banks of the Sepotuba, preparing for canoe transportation up river. Limited facilities neces-

sitate decrease in baggage and personnel. Perkins returning.

(Signed) G. M. Dyott.

“I am using a portable set with less than twenty watts input,” continued Bussey. “Your signals are clear, steady and very strong. What is the nature of your set and what power are you using?”

I gave him the information. My transmitter consists of a 50-watt tube in the Hartley circuit. The high voltage is supplied by an Acme 600-watt power transformer which transforms the 110-volt, 60-cycle house current to 1500 volts, which in turn is rectified by Rectigon tubes working on each half of the cycle. The inductances are sections of a Radio Corporation helix; the condensers are Dubilier. The radiating system consists of a vertical antenna 30 feet long and a horizontal counterpoise of about the same length, twelve feet from the ground. This is worked on the fundamental wavelength of thirty-seven and one-half meters, and is what is known as a current feed system. The receiver is a home-made affair built along low-loss lines and uses one step of audio frequency.

(Continued on page 391)



IN THE WORLD'S LABORATORIES

CONDUCTED BY DR. E. E. FREE

Messages by "Invisible Light"

THE famous "black light," better called invisible light, continues to play an important rôle in the day's news. As was mentioned recently in this department, Mr. J. L. Baird, now to the fore in England as an inventor of television apparatus, has used the invisible rays of infra-red, not only to operate his television machine but also to carry messages across the lecture platform. More recently, Dr. Donald C. Stockbarger, of the Massachusetts Institute of Technology, attracted much attention by delivering a lecture in Boston on the use of the invisible rays of ultraviolet light in producing various physical effects and, once more, in transmitting telegraphic and other messages across the lecture platform.

Although there is nothing scientifically new in these experiments (both the infra-red rays and the ultraviolet rays having been demonstrated by the famous English physicist, John Tyndall, more than a generation ago), the recent recrudescence of public attention to these matters is another sign of the lively interest in science which radio has done so much to foster.

The term "black light" is a misnomer. Anything which is "black" is something which absorbs the radiation which falls on it, so that no radiant energy (at least within the visible range) is reflected from it. What Mr. Baird and Dr. Stockbarger really use is *invisible light*. As explained many times in POPULAR RADIO, the spectrum of radiant energy begins at the long-wave end with the waves of radio and extends continuously to the shortest waves which constitute

the gamma rays of radium and the cosmic rays newly investigated by Dr. Werner Kolhoerster and Professor R. A. Millikan. A very short portion of this range of wavelengths constitutes what we call light, which means merely the wavelengths visible to the human eye. Exactly similar to these light waves but slightly longer than them are the infra-red waves. These are invisible. At the other end of the visible spectrum lie the equally invisible ultraviolet rays which are slightly shorter than those of visible light. Either of these varieties of invisible light may be used as beams to carry messages, as has been demonstrated many times by General Ferrié, Dr. Coblentz and others.

That either of the invisible rays will ever serve as an important rival to radio in the business of carrying messages through the ether is unlikely. For one thing, it is quite difficult to procure intense beams of either infra-red rays or of ultraviolet rays. The infra-red rays are emitted by any hot body, for example, by the heated wires of the modern household electric radiators. The ultraviolet rays are emitted by electric arcs, especially by the mercury arc used in the Cooper-Hewitt lamp. The usual practical source of ultraviolet is this Cooper-Hewitt arc contained in a quartz tube instead of a glass tube. Quartz is used because it is transparent to the ultraviolet rays whereas glass is opaque.

There is a difficulty, however, due to the fact that both the electric radiator (serving as a source of infra-red radiation) and the mercury arc which emits ultraviolet, also emit large amounts of ordinary visible light. To procure invisible beams of either form of rays it is necessary to filter out the visible light in some fashion. Up to the present this has proved quite difficult to do, as nearly all of the kinds of glass and other substances which transmit the invisible rays also transmit at least a portion of the visible ones. On the other hand, if the filtering substance is made sufficiently thick to hold back all of the visible radiation it also diminishes substantially the intensity of the invisible rays which it is desired to transmit.

What is needed in the present-day technique of using invisible radiation is what the radio engineer would call a band-pass filter, some device which will transmit, undiminished, the energy contained in frequencies corresponding to the wavelengths of the infra-red or of the ultraviolet, while absorbing and retaining the wavelengths on either side of this range.

The analogy with radio goes even deeper. Just as the band-pass filters now developed for either radio frequencies or

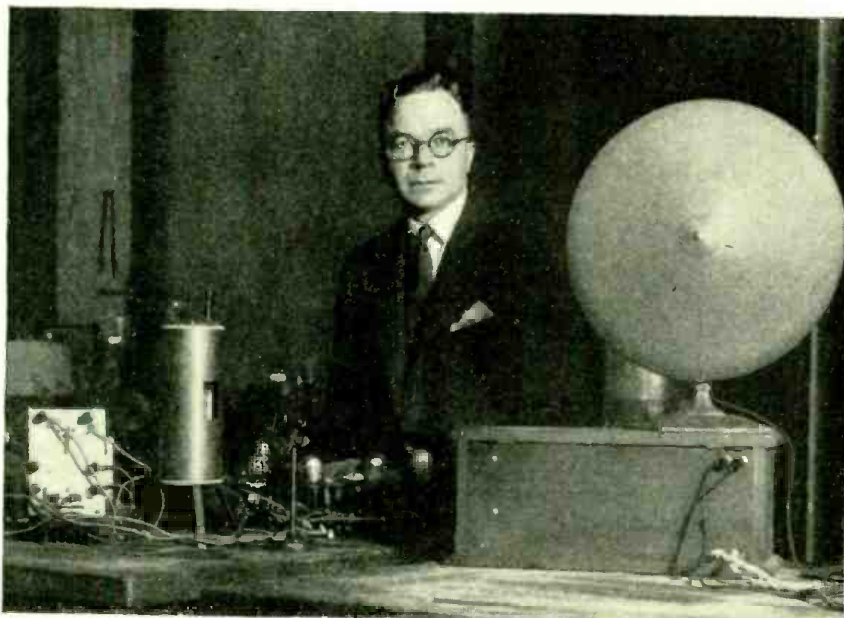

Underwood & Underwood

THE RAYS OF "BLACK LIGHT" PERFORM FOR HIM

Dr. Donald C. Stockbarger, of the Massachusetts Institute of Technology, recently demonstrated some of the remarkable properties of the rays of "black light," more properly called "invisible light." These rays are ether waves just a little longer or shorter than light rays.

audio frequencies procure their absorption by means of internal resonant circuits, so the atoms and electrons of substances operate, it is imagined, in resonance with the impinging rays, so that these rays are absorbed or transmitted just as the atomic resonances may determine.

Unfortunately, we still know much less about the theory of these atomic and electronic resonances than we do about the theory of band-pass filters. Perhaps when we understand these matters better we will be able to make more powerful beams of the invisible radiation, entirely free from visible light and, therefore, completely invisible.

Speedy Photoelectric Cells

A RECENT paper by Dr. F. E. Null, of the department of physics of the University of Illinois, begins with a sentence which is worth quoting. "The problem of photoelectric emission," Dr. Null writes, "is one of the most fundamental in physics but our knowledge of the subject is limited to a few simple laws."* The importance and behavior of the fundamental instrument of photoelectric emission, the photoelectric cell, was described in POPULAR RADIO some time ago by the Editor of this Department. Essentially it is a device by which an entering light ray falls upon a plate of sensitive metal and causes the emission from this metal of a stream of electrons. These electrons are precisely similar to those emitted by the filament of the

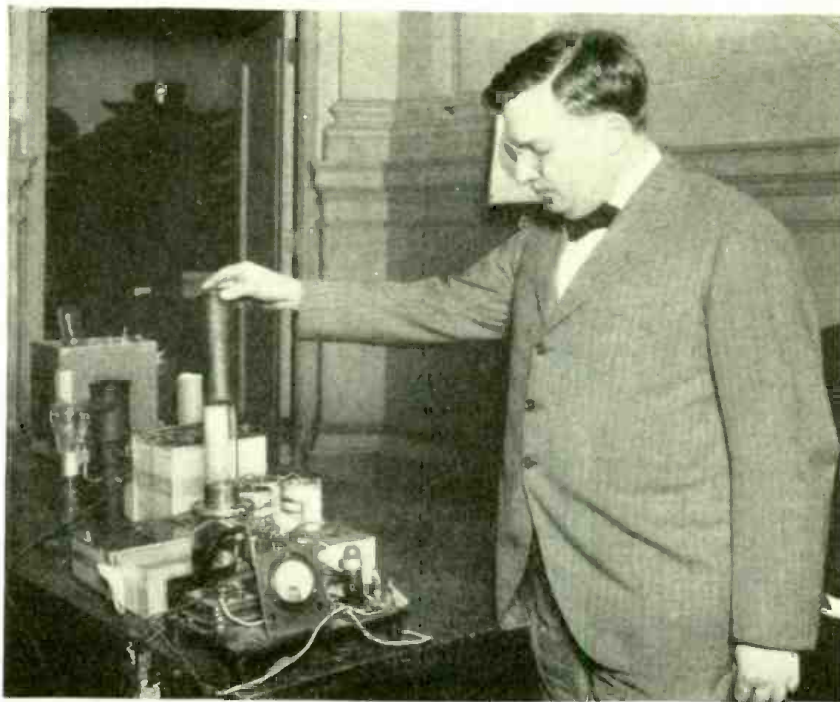

New York Electrical Society

PHOTOELECTRICITY AND RADIO MAKE A NOVEL BURGLAR ALARM

The upright glass tube touched by the experimenter's hand is a photoelectric cell. When the shadow of an intruder falls on this cell the electric signal produced by the shadow is magnified by a radio amplifier and rings a bell.

usual radio vacuum tube, the latter device being one in which the emission of the electrons is due to the heating of the filament rather than to light supplied from outside.

Photoelectric cells have been much

used in various light-detecting and light-measuring devices as well as in practical inventions for turning street lights on or off, for operating burglar alarms and many others. As Dr. Null implies, our knowledge of the true inwardness of photoelectric emission is now one of the most distressing low points in scientific information. Readers of this Department are already familiar with the present uncertainty concerning the nature of radiation; some facts indicating that light and other forms of radiation (including radio) are composed of waves, while other facts indicate that these radiations are composed of the tiny particles which have been christened quanta.

Many experimenters have suspected that a more searching study of photoelectric emission might resolve this controversy. Dr. Null agrees. By means of ingenious arrangements of his electric circuits he has been able to study the action of very short pulses of light affecting photoelectric cells. There is theoretical possibility that if the pulse of entering light is short enough; so that it includes only a limited number of waves or, if the other theory is preferred, a limited number of quanta; the action of the photoelectric cell might yield facts distinguishing definitely between the two theories.

Dr. Null's results have not yet reached
(Continued on page 400)

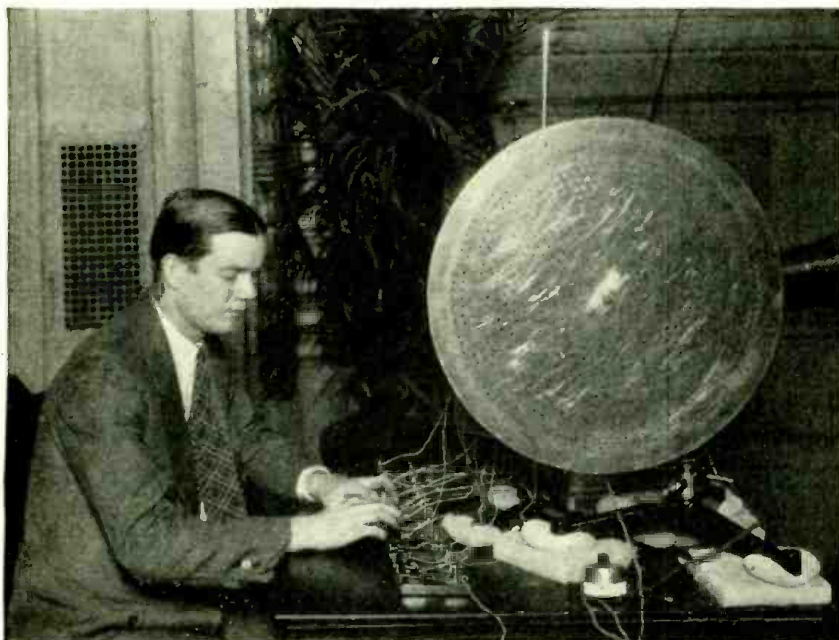

New York Electrical Society

HOW RADIO DEVICES ARE USED TO AID THE PHOTOELECTRIC ORGAN

This new device plays tunes from light rays. Beams of light from small lamps pass through the holes in the rotating disk to fall on a photoelectric cell twenty-five feet away. This produces an electric current which a loudspeaker converts into a tone.



Here is POPULAR RADIO's selection of the "star" broadcast features for the month beginning March 20—program numbers of outstanding merit that are selected on the basis of intrinsic worth, as well as upon their importance as determined by the large audiences reached by powerful single stations and by the chain stations that now cover the country. Every radio fan has—or should have—a receiver good enough to tune in on most of the features that are listed.

(Eastern Standard Time)

March 20

BEDFORD Y.M.C.A. MEN'S CONFERENCE; 4.00 P. M.; *Dr. S. Parkes Cadman*; WFAF, WEEI, WCSH, WTAG, WCAE, WSAI.

CROSLY RADIO FEATURE; 5.30 P. M.; *varied program*; WFAF, WEEI, WJAR, WTAG, WGN, WFI, WRC, WCSH, WCAE, WTAM, WWJ, WSAI, KSD, WDAF, WHAS, WSM, WSB, WMC, WGY.

THE CAPITOL GRAND ORCHESTRA (and Major Bowes' family); 7.20 P. M.; *symphonic music and soloists*; WFAF, WEEI, KSD, WRC, WWJ, WJAR, WCAE, WTAG.



The first part of this program, which includes the selections played by the full orchestra of seventy pieces, is broadcast direct from the stage of the Capitol Theatre, N. Y.; the latter part, that includes the soloists and small ensemble, is broadcast from the studio beneath the stage. The musical director is "Dr." Billy Axt—who has been playing solos, composing music and supervising the musical programs since "Roxie" first had charge of the Capitol in 1922. Dr. Billy's degree was obtained in Germany.

COOK'S TOURS; 8.30 P. M.; *talk and music*; WJZ.

A unique entertainment made up of a travelogue, delivered by a lecturer who has visited the spot described; interspersed with the folk and national music of the country and provinces treated.

ATWATER KENT HOUR; 9.15 P. M.; *star soloists*; WFAF, WJAR, WEEI, WFI, WCCO, WTAM, WGN, WCAE, WGR, WOC, WTAG, WWJ, KSD, WRC, WSAI, WGY, WHAS, WSM, WSB, WMC.



This feature—which comprises the foremost soloists of the operatic and concert stage—is broadcast every Sunday evening over a chain that now includes twenty stations, thus establishing it as perhaps the most widely known as well as the most costly radio program in the world. The solo artist on this program is Giovanni Martinelli, the grand opera star.

March 21

ROXY AND HIS GANG; 7.00 P. M.; *orchestra, with soloists*; WJZ, WBZ, WBZA, KDKA, KYW, WRC, WSB, WHAS, WSM.

RECORD BOYS; 8.00 P. M.; *songs and humor*; WJZ, WBZ.

The "boys" are Al Bernard, Sammy Sept and Frank Kamplain; their best works are negro specialties; their most famous song is the "Sermon on Da Letter S," which is becoming a radio classic.

HIRE'S HARVESTERS; 8.30 P. M.; *instrumentalists*; WFAF, WEEI, WGR, WLIT, WRC, WCAE, WTAM, KSD, WCCO, WSAI.

WILLYS-OVERLAND SYMPHONY; 8.30 P. M.; *symphonic music and soloists*; WJZ.

An ensemble of eighteen musicians, picked from the members of the New York Philharmonic Orchestra and directed by Henry Hadley. A distinguished guest artist is featured each week.

A. AND P. GYPSIES; 9.00 P. M.; *classical and semi-classical music*; WFAF, WEEI, WJAR, WDAF, WRC, WCSH, WTAM, WLIT, WWJ, WCAE, WSAI.



The featured soloist of this group is John Barnes Wells, tenor, widely known as a concert singer and composer and as "America's foremost composer of encore songs"; some of them are to be had on gramophone records. He graduated from Syracuse University in 1901; when he is not filling engagements, he teaches at Princeton.

RUDE LIGHT OPERA; 9.30 P. M.; *orchestra and soloists*; WJZ, KDKA, WBZ.

Here is a newcomer among the radio entertainers. The programs are confined to light and comic operas. The company numbers fourteen. The conductor is Walter G. Henschen; the soloists are Gladys Rice and Frank Munn.

LIDO VENICE DANCE ORCHESTRA; 10.00 P. M.; *jazz music*; WEEI.

B. A. ROLFE'S DANCE ORCHESTRA; 11.00 P. M.; *jazz numbers*; WFAF.

Broadcast direct from the Palais d'Or Restaurant of New York

March 22

DINNER CONCERT; 6.30 P. M.; WGY.

Those residing in New England and upper New York State who cannot receive well from New York City studios during the early part of the evening, will find in the dinner music of the Hotel Ten Eyck at Albany a type of chamber music that is exceptionally well executed. The orchestra numbers seven pieces.

EDISON ENSEMBLE; 8.00 P. M.; *classic and popular music*; WRNY.

A series of "Twenty-one Adventurous Nights" in the realm of music; the programs are all arranged by Charles D. Isaacson.

THE VIKINGS; 8.00 P. M.; *instrumental trio and guest soloists*; WFAF, WEEI, WJAR, WTAG, WGR, WFI, WCSH, WCAE, WTAM, WWJ, KSD, WSAI, WCCO, WOC, WGY.

This group specializes in Norwegian music—including folk music and classical compositions of the Norwegian composers.

CHAMPION SPARKERS; 8.30 P. M.; *popular music*; WJZ, KDKA, KYW, WBZ.

A spirited ensemble of eleven men, under the direction of Walter G. Henschen, with two soloists.

JOLLY BUCKEYE BAKERS; 8.30 P. M.; *vocal quartet and instrumentalists*; WFAF, WFI, KSD, WSAI, WCCO, WTAM, WTAG, WLIT, WWJ, WRC.

GRAND OPERA PROGRAM; 9.00 P. M.; *instrumentalists and soloists*; WJZ, KDKA, KYW.

This ensemble is directed by Cesare Sodero.

EVEREADY HOUR; 9.00 P. M.; *varied program*; WFAF, WEEI, WFI, WCAE, WGR, WWJ, WOC, KSD, WJAR, WCCO, WTAM, WGN, WSAI, WTAG, WRC, WGY.

BRIDGE INSTRUCTION; 10.00 P. M.; WFAF, WEEI, WCSH, WTAG, WJAR, WGR, WCAE, WTAM, WFI, WWJ, WSAI, WGN, WOC, WCCO, KSD, WRC, WGY.



Expert instruction in bridge, as played by experts. The hands to be played are given out beforehand by mail upon request; the plays are all announced by Graham MacNamee.

DON AMAIZO; 10.00 P. M.; *violinist*; WJZ, KDKA, KYW.

ARROWHEAD INN ORCHESTRA; 10.30 P. M.; *dance music*; WGBS, WIP.

GEORGE OLSEN'S ORCHESTRA; 10.45 P. M.; *dance music*; WJZ.

Broadcast direct from the Hotel Pennsylvania grill-room in New York—with Olsen himself announcing the numbers.

SAM 'N' HENRY; 11.00 P. M.; *negro comedy*; WGN.

Sam 'n' Henry are two comedians who use negro dialect; and, although they appear for only ten minutes, every minute is made lively by clean, wholesome humor.



Trade Mark Reg. U. S. Pat. Office



Actual Size

TOBE TINYTOBES

are small, accurate, fixed condensers in capacities of from .00007 Mfd. to .02 Mfd. They will stand any voltage at present employed in a Radio receiving set or power amplifier up to 1,000 volts continuous D. C., and have been tested up to 2,300 volts A. C. before breaking down. The phase angle averages .0005—an unusually low figure. They are light, compact, and easily attached anywhere in a set.

PRICES

	Each
.00007 to .0005 Mfd.	35c
.001 to .002 Mfd.	40c
.005 to .006 Mfd.	45c
.01 Mfd.	55c
.02 Mfd.	60c

Matched TINYTOBES for Samson Super Band-Pass Filter, \$1.40 per pair.



The TOBE 600 Line AmerTran Power Pack Type

A rugged, heavy-duty, high-voltage condenser, for use with the AmerTran or other power packs employing the 216-B and 210 Tubes. Will not break down in service. Equipped with TOBE Safety Terminals.

NEW PRICES

.5 Mfd.	\$2.00
1.0 Mfd.	2.50
2.0 Mfd.	3.50
4.0 Mfd.	6.00



TOBE BY-PASS CONDENSERS

Specified for the new OFFICIAL BROWNING-DRAKE KIT SET, the R-B Lab Circuit, and many others.

RADIO INTERFERENCE FILTER No. 1



THIS new and effective filter unit is designed for the reduction of annoying Radio-Interference, caused by household motors of the D.C. or universal types, on oil burners, refrigerators, elevators and dumb waiters, washing machines, etc. It may also be applied to vibrator motors, etc., and will, in most cases, reduce the interference to a point where it is no longer noticeable. It is designed to be attached directly to the offending appliance, *not* to the Radio set. Strongly cased in a grounded metal container, with lugs for attachment to floor or base plate, provided with 5 flexible leads, for immediate attachment, and with wiring-diagram directly on label. Once installed, requires no attention or adjustments. Designed by Sewall Cabot, noted Radio engineer, and carrying the TOBE trade-mark.

Write us for descriptive pamphlet L-2 on TOBE INTERFERENCE FILTER No. 1. The list price is \$15.00, and if your dealer is not already supplied, will gladly fill your order direct on receipt of your check or money order.



The TOBE 400 Line

Specially cased condensers for 400-volts D. C. operating voltage. For use with Raytheon BH and similar high-voltage rectifying tubes in B-Eliminators. Use short-path type condensers and equipped with unique TOBE safety terminals at base of can.

PRICES

1 Mfd.	\$2.00
2 Mfd.	2.75
4 Mfd.	4.50



B BLOCKS for Thordarson Power Compact

The first condenser B BLOCK, specifically designed for use with the Thordarson Power Compact Type R-171, is the TOBE B BLOCK Type R-171. The terminals are arranged so that they come close to those on the Thordarson Power Compact, for minimum time and length of wiring. Short-path, non-inductive condensers are used for increased efficiency. The price is \$12.

Thordarson makes a 210 unit, also, and there is the TOBE B BLOCK Type R-210 to go with it. Price, \$13.



VERITAS Hi-Current Resistor

A special and unexcelled resistor, capable of radiating 4 to 5 watts continuously without change or deterioration. Made to be soldered directly into the circuits without the use of clips, although of standard length, so that standard mounts may be used if desired.

PRICES

	Each
2,000, 3,000, 5,000, 7,500 and 10,000 ohms	\$1.10
50,000 ohms90
.1 meg.80
1/2, 1/4 and 1 meg.75

Tobe Deutschmann Co., Cambridge, Mass.

Engineers, Manufacturers and Importers of Technical Apparatus

March 23

IODENT'S NO. 1 AND NO. 2; 8.30 P. M.; *the Mitchel Brothers, banjo and piano;* WJZ, WBZ, KDKA, KYW.

DAVIS SAXOPHONE OCTETTE; 8.30 P. M.; *popular and classic music;* WEA, WEEI, WJAR, WTAG, WLIT, WRC, WCAE, WTAM, WSAI.

Under the leadership of Clyde Doerr, this group has been increased from a quintette to an octette; its programs are augmented by guest artists.

IPANA TROUBADOURS; 9.00 P. M.; *dance music;* WEA, WEEI, WGR, WRC, WCAE, WWJ, WSAI, WLIB, KSD, WCCO, WDAF, WGY.

One of the best of the dance-music ensembles, under the direction of Sam Lanin.

MAXWELL HOUR; 9.00 P. M.; *orchestra and soloists;* WJZ, WBZ, KDKA, KYW, WHAS, WSB, WMC, WSM.

An excellent group of artists who play not only the compositions of the great masters but some of the best of the lighter music as well. Their programs appeal especially to those who like really good music. Nathaniel Shilkret is the conductor.

SMITH BROTHERS; 10.00 P. M.; *humorous songs;* WEA, WTAG, WGR, WRC, WCAE, WWJ, WSAI, KSD, WOC, WCCO, WDAF.

The youthful "Scrappy" Lamberts and Billy Hillpat make up the popular music team listed as the Smith Brothers—"Trade" and "Mark"—of cough-drop fame. Both these young men lead the musical activities at Rutgers College, Brunswick, N. J., and it was not until they discovered that banjoing was more remunerative than engineering that they accepted the offer to broadcast professionally.



March 24

CLICQUOT CLUB ESKIMOS; 9.00 P. M.; *banjo ensemble;* WEA, WEEI, WCCO, WGN, WCAE, WGY, WJAR, WTAG, KSD, WOC, WGR, WFI, WWJ, WTAM, WSAI.

Every fan is familiar with the invigorating special music that invariably introduces this feature. Harry Resor is the "Chief Eskimo." As one listener aptly expresses it, "These programs make it feel thirsty!"

RCA RADIOTRONS; 9.00 P. M.; *songs and comedy;* WJZ, WBZ, KDKA, KYW.

A saxophone violin, piano—and a vocal quartet and a comedian.

GOODRICH ZIPPERS; 10.00 P. M.; *popular music;* WEA, WEEI, WCCO, WGN, WCAE, WJAR, WTAG, KSD, WOC, WGR, WFI, WWJ, WSAI, WCSH, WADC.

An ensemble of light musicians led by Henry Burr.

March 25

HAPPINESS BOYS; 8.00 P. M.; *songs and jokes;* WEA.

The old vaudeville team of Billy Jones and Ernest Hare has become one of the institutions of the air, despite the fact that it appears only at one station. This team has appeared before the mike not less than 287 times. They compose most of their own songs, but they get their jokes largely from Judge.



ROYAL HOUR; 8.30 P. M.; *orchestra and soloists;* WJZ, WBZ, KDKA, KYW.

Hawaiian music has been the particular hobby of this group—which means, of course, that it caters to a specialized popular taste. Joe Green is the leader and Charles Harrison, tenor, and Miss Helen Clark, contralto, the soloists.

LA FRANCE ORCHESTRA; 9.30 P. M.; *popular orchestral music;* WEA, WEEI, WGR, WLIT, WOC, WCAE, WTAM, WWJ, KSD, WDAF.

Miss Anna C. Byrne, conductor, is said to be the only woman leader of a regularly established broadcast ensemble. This group is of outstanding merit—not only in the quality of its playing, but in the selection and grouping of instruments that insure quality in transmission.

March 26

BALKITE HOUR; 9.00 P. M.; *New York Symphony Orchestra;* WEA, WEEI, WGR, WFI, WRC, WCAE, WSAI, WWJ, WTAM, WGN, KSD, WCCO, WDAF, WOC, WGY.

"OUR GOVERNMENT"; 10.00 P. M.; *talk by David Lawrence;* WEA, WTAG, WGR, WFI, WRC, WCSH, WGY.

March 27

BEDFORD Y.M.C.A. MEN'S CONFERENCE; 4.00 P. M.; *Dr. S. Purkes Cadman;* WEA, WEEI, WCSH, WTAG, WCAE, WSAI.

CROSLY RADIO FEATURE; 5.30 P. M.; *varied program;* WEA, WEEI, WJAR, WTAG, WGN, WFI, WRC, WCSH, WCAE, WTAM, WWJ, WSAI, KSD, WDAF, WHAS, WSM, WSB, WMC, WGY.

THE CAPITOL GRAND ORCHESTRA (and Major Bowes' family); 7.20 P. M.; *symphonic music and soloists;* WEA, WEEI, KSD, WRC, WWJ, WJAR, WCAE, WTAG.

COOK'S TOURS; 8.30 P. M.; *travelogue with music;* WJZ.

ATWATER KENT HOUR; 9.15 P. M.; *star soloists;* WEA, WJAR, WEEI, WFI, WCCO, WTAM, WGN, WCAE, WGR, WOC, WTAG, WWJ, KSD, WRC, WSAI, WGY, WHAS, WSB, WMC.



The soloist on this occasion will be Claudia Muzio, soprano—formerly one of the stars of the Metropolitan grand opera galaxy and now of the Chicago opera. While the fees paid for radio appearances are kept secret, it is estimated that they average \$1,000 each on the Atwater Kent series.

COLLIER HOUR; 9.30 P. M.; *variety program;* WJZ, KYW, WBZ, KDKA.

This feature is a recent addition to the Sunday night programs, is full of surprises of all sorts—music, interviews with famous authors, discussions of world politics, recitations, the reading of stories, and the philosophical comments of Collier's famous "Uncle Henry" go to make up this absorbing hour. It embraces adventure, romance, science, politics, music and the great range of thoughts that pass through the minds of the editors of a national magazine.

March 28

ROXY AND HIS GANG; 7.00 P. M.; *110-piece symphony orchestra, with soloists;* WJZ, WBZ, WBZA, KDKA, KYW, WRC, WSB, WHAS, WSM.

"Roxy," and the members of the old Capitol Theatre gang, have come back to the air. A new 110-piece symphony under the direction of Erno Rapee, and the famous French leader, H. Maurice Jacquet, will be heard together with a studio symphony of 60 pieces and solos from such old favorites as Frank Moulton, Margery Harcum, Gladys Rice, "Wee Willie" Robeyn, Gamby, Douglas Stanbury, Daddy Jim Coombs, and Florence Mulholland. Added to these will be heard regularly a mixed chorus of one hundred voices and selections played on the "largest theatre organ in the world." The program, which fills one and one half hours of broadcasting time, is the most ambitious musical event on the air today.

RECORD BOYS; 8.00 P. M.; *songs and humor;* WJZ, WBZ.

HIRE'S HARVESTERS; 8.00 P. M.; *instrumentalists;* WEA, WEEI, WGR, WLIT, WRC, WCAE, WTAM, KSD, WCCO, WSAI.

This clever group has been broadcasting popular music for over a year—yet their music-making always seems fresh and crisp; well worth listening to.

WILLYS-OVERLAND SYMPHONY; 8.30 P. M.; *symphonic music and soloists;* WJZ.

A. AND P. GYPSIES; 9.00 P. M.; *classical and semi-classical music;* WEA, WEEI, WJAR, WDAF, WRC, WCSH, WTAM, WLIT, WWJ, WCAE, WSAI.

WBAL ENSEMBLE; 9.00 P. M.; *chamber music;* WBAL.

In this delightful ensemble Michael Weiner plays the violin, LeRoy Evans is the pianist and Samuel Stone is the cellist. They confine their playing largely to the light classics.

RUDE LIGHT OPERA; 9.30 P. M.; *orchestra and soloists;* WJZ, KDKA, WBZ.

LIDO VENICE DANCE ORCHESTRA; 10.00 P. M.; *jazz music;* WEEI.

B. A. ROLFE'S DANCE ORCHESTRA; 11.00 P. M.; *jazz numbers;* WEA.

March 29

DINNER CONCERT; 6.30 P. M.; *classical and semi-classical music;* WGY.

EDISON ENSEMBLE; 8.00 P. M.; *classic and popular music;* WRNY.

THE VIKINGS; 8.00 P. M.; *instrumental trio and guest soloists;* WEA, WEEI, WJAR, WTAG, WGR, WSI, WCSH, WCAE, WTAM, WWJ, KSD, WSAI, WCCO, WGY.

CHAMPION SPARKERS; 8.30 P. M.; *popular music;* WJZ, KDKA, KYW, WBZ.

JOLLY BUCKEYE BAKERS; 8.30 P. M.; *vocal quartet and instrumentalists;* WEA, WFI, KSD, WSAI, WCCO, WTAM, WTAG, WLIB, WWJ, WRC.

GRAND OPERA PROGRAM; 9.00 P. M.; *soloists and instrumentalists;* WJZ, KDKA, KYW.

EVEREADY HOUR; 9.00 P. M.; *varied program;* WEA, WEEI, WFI, WCAE, WGR, WWJ, WOC, KSD, WJAR, WCCO, WTAM, WGN, WSAI, WTAG, WRC, WGY.

EDUCATIONAL PROGRAM; 9.00 P. M.; *lectures;* WLWL.

In this educational feature members of the faculty of the College of the City of New York appear before the microphone; their lectures are confined to the popular discussion of the world's economic and social problems.



From a "TWEET"
to a "ZOOM!"

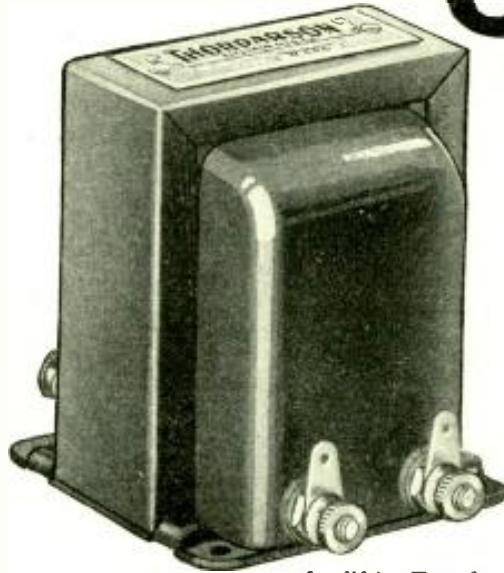

Amplifying Transformer
Type R-200



Thordarson Amplification Reproduces Every Note

NO NOTE of any instrument — not even the faintest harmonic — can escape Thordarson Amplification.

Leading Radio set manufacturers know this secret of musical reproduction. That is why you find more Thordarson transformers in quality receivers than all competitive transformers combined.

Whether you are buying a complete receiver, or whether you are building your own — if you enjoy music — be sure your transformers are Thordarson's.

THORDARSON

RADIO TRANSFORMERS

Supreme in Musical Performance!

THORDARSON ELECTRIC MANUFACTURING CO.
Transformer Specialists Since 1895
WORLD'S OLDEST AND LARGEST EXCLUSIVE TRANSFORMER MAKERS
Huron and Kingsbury Streets — Chicago, Ill. U.S.A.



**THORDARSON
POWER
COMPACT**

Stop overloading your last audio tube. A power amplifier and "B" eliminator built with the Thordarson Power Compact will give

full reproduction to the deeper tones that the ordinary amplifying tubes cannot handle.

POWER COMPACT R-171. Contains a power supply transformer, 2 filter chokes, 2 buffer condensers, a five volt filament supply. For Raytheon BH rectifier and UX 171 power tube. \$15.00.

POWER COMPACT R-210. Similar to type R-171 but designed for UX 216-B rectifier and UX 210 power tube. \$20.00.

Send for this free booklet
"Power From the Light Circuit"

Thordarson Electric Manufacturing Co. Huron and Kingsbury Sts., Chicago, Ill.		8551 A
Gentlemen: Without obligation on my part, please send me a copy of your free booklet, "Power From the Light Circuit."		
Name _____		
Street _____		
City _____		State _____

BRIDGE INSTRUCTION; 10.00 P. M.; WEA, WEEL, WCSH, WTAG, WJAR, WGR, WCAE, WTAM, WFI, WWJ, WSAI, WGN, WOC, WCCO, KSD, WRC, WGY.

DON AMAIZO; 10.00 P. M.; violinist; WJZ, KDKA, KYW.

ARROWHEAD INN ORCHESTRA; 10.30 P. M.; dance music; WGBS, WIP.

GEORGE OLSEN'S ORCHESTRA; 10.45 P. M.; dance music; WJZ.

SAM 'N' HENRY; 11.00 P. M.; negro comedy; WGN.

March 30

IODENT'S No. 1 AND No. 2; 8.30 P. M.; *The Mitchel Brothers, banjo and piano*; WJZ, WBZ, KDKA, KYW.

DAVIS SAXOPHONE OCTETTE; 8.30 P. M.; *popular and classic music*; WEA, WEEL, WJAR, WTAG, WLIT, WRC, WCAE, WTAM, WSAI.

IPANA TROUBADOURS; 9.00 P. M.; *dance music*; WEA, WEEL, WGR, WRC, WCAE, WWJ, WSAI, WLIB, KSD, WCCO, WDAF, WGY.

MAXWELL HOUR; 9.00 P. M.; *orchestra and soloists*; WJZ, WBZ, KDKA, KYW, WHAS, WSB, WMC, WSM.

SMITH BROTHERS; 10.00 P. M.; *humorous songs*; WEA, WTAG, WGR, WRC, WCAE, WWJ, WSAI, KSD, WOC, WCCO, WDAF.

March 31

DELLA ROBBIA CONCERT; 7.45 P. M.; *chamber music and solos*; WOR.

This concert (which lasts for thirty minutes) comes from the Della Robbia Room of the Hotel Vanderbilt in New York. At each concert two vocal soloists are featured, usually a soprano or coloratura or a baritone or tenor. This is always a safe port of entertainment in a radio storm.

CLICQUOT CLUB ESKIMOS; 9.00 P. M.; *banjo ensemble*; WEA, WEEL, WCCO, WGN, WCAE, WGY, WJAR, WTAG, KSD, WOC, WGR, WFI, WWJ, WTAM, WSAI.

RCA RADIOTRONS; 9.00 P. M.; *songs and comedy*; WJZ, WBZ, KDKA, KYW.

WBAL ENSEMBLE; 9.00 P. M.; *chamber music*; WBAL.

GOODRICH ZIPPERS; 10.00 P. M.; *popular music*; WEA, WEEL, WCCO, WGN, WCAE, WJAR, WTAG, KSD, WOC, WGR, WFI, WWJ, WSAI, WCSH, WADC.

MUSIC BOX HOUR; 1.00 A. M.; *varied program*; KFI.

This unique feature, under the direction of Gene Johnstone and participated in by the Jim, Jack and Gene Trio and a group of soloists, has grown in favor until it is now established as a regular weekly feature of this studio.

April 1

HAPPINESS BOYS; 7.30 P. M.; *songs and jokes*; WEA.

ROYAL HOUR; 8.30 P. M.; *orchestra and soloists*; WJZ, WBZ, KDKA, KYW.

BRUNSWICK-BALKE HOUR; 9.00 P. M.; *varied program*; WJZ, WBZ, KDKA, KYW, WHAS, WMC, WSB.

In this hour of classical music, the Brunswick-Balke-Collender Co. presents to the radio public the various stars that it has under contract for the production of records. The program compares favorably with the past programs of the Victor Talking Machine Co.

RADIO PLAY; 9.00 P. M.; *popular dramas*; WGY.

The WGY Players command the attention of one of the largest radio audiences in the United States. Practically all of the dramas and comedies broadcast have at some time or other been a Broadway hit. The plays usually last one and a half hours. Edward Smith is the dramatic director.

LA FRANCE ORCHESTRA; 9.30 P. M.; *popular orchestral music*; WEA, WEEL, WGR, WLIT, WOC, WCAE, WTAM, WWJ, KSD, WDAF.

ARMCHAIR HOUR; 10.00 P. M.; *vocal and instrumental music*; WJZ, WBZ.



This feature, in which Marley Sherris, Milton Cross, Keith McLeod, Walter Preston and Godfrey Ludlow participate, has grown to be an easy-to-listen-to institution of this studio. There is quartet singing, violin solos by Ludlow and vibraphone solos by McLeod. The music is usually of the strongly sentimental type. Sherris' portrait is at the left.

April 2

BALKITE HOUR; 9.00 P. M.; *New York Symphony Orchestra*; WEA, WEEL, WGR, WFI, WRC, WCAE, WSAI, WWJ, WTAM, WGN, KSD, WCCO, WDAF, WOC, WGY.

COLUMBIA PHONOGRAPH PROGRAM; 9.00 P. M.; *varied program*; WJZ, WGY, WBZ, KDKA.

"OUR GOVERNMENT"; 10.00 P. M.; *talk by David Lawrence*; WEA, WTAG, WGR, WFI, WRC, WCSH, WGY.

BENJAMIN FRANKLIN ORCHESTRA; 10.05 P. M.; *dance music*; WIP.
ARCADIA DANCE ORCHESTRA; 12.00 MIDNIGHT; *dance music*; KMOX.
COLORADO ORCHESTRA; 12.15 A. M.; *dance music*; KOA.

April 3

BEDFORD Y.M.C.A. MEN'S CONFERENCE; 4.00 P. M.; *Dr. S. Parkes Cadman*; WEA, WEEL, WCSH, WTAG, WCAE, WSAI.

CROSLY RADIO FEATURE; 5.30 P. M.; *varied program*; WEA, WEEL, WJAR, WTAG, WGN, WFI, WRC, WCSH, WCAE, WTAM, WWJ, WSAI, KSD, WDAF, WHAS, WSM, WSB, WMC, WGY.

THE CAPITOL GRAND ORCHESTRA (and Major Bowes' family); 7.20 P. M.; *symphonic music and soloists*; WEA, WEEL, KSD, WRC, WWJ, WJAR, WCAE, WTAG.



Yasha Bunchak, cellist of the Capitol Studio group, has been called the "Heifetz of the cello" by the musical critics of New York. He plays a \$30,000 cello which was given to him by General Limoff of the old Russian army. Yasha plays several solos during the Capitol Hour.

COOK'S TOURS; 8.30 P. M.; *talk with music*; WJZ.

ATWATER KENT HOUR; 9.15 P. M.; *star soloists*; WEA, WJAR, WEEL, WFI, WCCO, WTAM, WGN, WCAE, WGR, WOC, WTAG, WWJ, KSD, WRC, WSAI, WGY, WHAS, WSB, WMC.



The guest artist on this concert is Beniamino Gigli, a star tenor of the Metropolitan forces.

April 4

ROXY AND HIS GANG; 7.00 P. M.; *110-piece symphony orchestra, with soloists*; WJZ, WBZ, WBZA, KDKA, KYW, WRC, WSB, WHAS, WSM.

RECORD BOYS; 8.00 P. M.; *songs and humor*; WJZ, WBZ.

HIRE'S HARVESTERS; 8.00 P. M.; *instrumentalists*; WEA, WEEL, WGR, WLIT, WRC, WCAE, WTAM, KSD, WCCO, WSAI.

WILLYS-OVERLAND SYMPHONY; 8.30 P. M.; *symphonic music and soloists*; WJZ.

A. AND P. GYPSIES; 9.00 P. M.; *classical and semi-classical music*; WEA, WEEL, WJAR, WDAF, WRC, WCSH, WTAM, WLIT, WWJ, WCAE, WSAI.

WBAL ENSEMBLE; 9.00 P. M.; *chamber music*; WBAL.

RUDE LIGHT OPERA; 9.30 P. M.; *orchestra and soloists*; WJZ, KDKA, WBZ.

LIDO VENICE DANCE ORCHESTRA; 10.00 P. M.; *jazz music*; WEEL.

JACQUES RENARD ORCHESTRA; 10.05 P. M.; *dance music*; WEEL.
Jacques Renard has what is considered by the connoisseurs of jazz one of the best popular music orchestras in the vicinity of Boston.

B. A. ROLFE'S DANCE ORCHESTRA; 11.00 P. M.; *jazz numbers*; WEA.

April 5

DINNER CONCERT; 6.30 P. M.; *semi-classical and popular music*; WGY.

EDISON ENSEMBLE; 8.00 P. M.; *chamber music*; WRNY.

THE VIKINGS; 8.00 P. M.; *instrumental trio and guest soloists*; WEA, WEEL, WJAR, WTAG, WGR, WSI, WCSH, WCAE, WTAM, WWJ, KSD, WSAI, WCCO, WGY.

CHAMPION SPARKERS; 8.30 P. M.; *popular music*; WJZ, KDKA, KYW, WBZ.

JOLLY BUCKEYE BAKERS; 8.30 P. M.; *vocal quartet and instrumentalists*; WEA, WFI, KSD, WSAI, WCCO, WTAM, WTAG, WLIB, WWJ, WRC.

GRAND OPERA PROGRAM; 9.00 P. M.; *soloists and instrumentalists*; WJZ, KDKA, KYW.

EVEREADY HOUR; 9.00 P. M.; *varied program*; WEA, WEEL, WFI, WCAE, WGR, WWJ, WOC, KSD, WJAR, WCCO, WTAM, WGN, WSAI, WTAG, WRC, WGY.

WBAL JUBILEE SINGERS; 9.00 P. M.; WBAL.

EDUCATIONAL PROGRAM; 9.15 P. M.; *lectures*; WLWL.

BRIDGE INSTRUCTION; 10.00 P. M.; WEA, WEEL, WCSH, WTAG, WJAR, WGR, WCAE, WTAM, WFI, WWJ, WSAI, WGN, WOC, WCCO, KSD, WRC, WGY.

DON AMAIZO; 10.00 P. M.; *violinist*; WJZ, KDKA, KYW.

MUNICIPAL BAND; 10.00 P. M.; *band concert*; WBAL.

The Municipal Band of Baltimore under the direction of Nelsen C. Kratz is conceded to be one of the best city bands in the United States. The pick-up from the auditorium in which the band plays is exceptionally good and those who like band music on the radio will find in this feature something way and beyond the average band transmission.



RAYTHEON has proved its claims

EIGHTEEN months ago—a new invention! Now look at Raytheon!

Half of all the B-Power units in use today—hundreds of thousands of them—are Raytheon-equipped. Leading radio manufacturers, assured of fuss-proof reliable rectification, immediately went into the production of B-Power units in earnest. Tremendous sales have resulted.

The long life of the Raytheon tube has been proved by actual performance—time tested. Every tube is guaranteed for a year of normal service. No attention is required. Because of the reserve power which it delivers on sudden overloads, a Raytheon-equipped unit definitely improves the quality of performance by any set. The Raytheon policy of selling only to those manufacturers whose units were approved by Raytheon engineers has maintained the quality of Raytheon-equipped units.

Raytheon, the heart of reliable B-Power, has proved its claims. This Spring replace B-batteries with a Raytheon-equipped reliable B-Power unit—constant top-notch power—no depreciation when not in use.

RAYTHEON MANUFACTURING COMPANY
Cambridge, Massachusetts



These Better Radio Power Units are Raytheon-approved and Raytheon-equipped

- ACME B-POWER SUPPLY
- ALL-AMERICAN CONSTANT-B
- BOSCH NOBILITY
- BREMER-TULLY B-POWER UNIT
- BURNS B-BATTERY ELIMINATOR
- CORNELL VOLIAGE SUPPLY
- CROSLY A, B & C POWER
- ELECTRON CURRENT B SUPPLY
- ERLA HUM-FREE B ELIMINATOR
- GENERAL RADIO PLATE SUPPLY
- KINGSTON B-BATTERY ELIMINATOR
- MAJESTIC "B" CURRENT SUPPLY
- MAYOLIAN "B" SUPPLY
- MODERN "B" POWER
- NATIONAL POWER SUPPLY
- SPARTON RADIO B-POWER
- STERLING "B" POWER
- VALLEY B-POWER UNIT
- WEBSTER B-POWER UNITS
- ZENITH A, B & C POWER

ACME FLEXIBLE CELATSITE

Flexible, stranded wire for point-to-point and sub-panel wiring. Non-inflammable "spaghetti" covering. In black, yellow, green, red and brown; a color for each circuit. Put up in 25-foot coils.



The Original Celatsite

—a tinned, copper bus bar wire with non-inflammable "spaghetti" covering, for hook-ups. 5 colors; 30-inch lengths.

Celatsite Battery Cable

—a silk-covered cable of vari-colored Flexible Celatsite wires, for connecting batteries to set.

Prevents "blowing" of tubes; gives your set an orderly appearance.



We also offer the highest grade of "spaghetti" tubing for Nos. 10 to 18 wires. 5 colors; 30-inch lengths.

Stranded Enameled Antenna

Best outdoor antenna you can buy. 7 strands of enameled copper wire; maximum surface for reception. Prevents corrosion and consequent weak signals.

Send for folder

THE ACME WIRE CO., DEPT. P
NEW HAVEN, CONN.



For plugs, jacks, clips, condenser and transformer parts—

brass is the logical metal

Used for these screw-machine products, BRASS gives the right electrical conductivity and the mechanical accuracy essential to proper operation of radio sets and parts.

To the manufacturer BRASS means economy in quantity production.

COPPER & BRASS
RESEARCH ASSOCIATION
25 Broadway, New York



CORBETT CONSOLE for LC-27 Receivers

- Model S-20 Cabinet only..... \$27.50
- Model S-25 Table only..... 32.50
- Model S-20-25 Combination..... 60.00

Made of high quality, figured walnut plywood. Takes 8" x 26" panel, 25 degree slope. Drop front, and piano hinged top. Baseboard included with each cabinet.

The model S-25 table has 16" x 31" figured walnut top, and is very desirable for use with any table cabinet.

WALNUT INFRADYNE CABINETS.. \$26.00
for 7" x 30" panel and 10" x 34" baseboard.

WALNUT HAMMARLUND-ROBERTS HI-Q CABINETS..... \$17.50
for 7" x 21" panel, 12" deep. Chest type, given beautiful high-light finish.

Write for folder showing complete line of consoles, tables and cabinets, and dealers' prices.

CORBETT CABINET MFG. COMPANY
St. Marys, Pa.

ARROWHEAD ORCHESTRA; 10.30 P. M.; *dance music*; WGBS, WIP.
 GEORGE OLSEN'S ORCHESTRA; 10.40 P. M.; *dance music*; WJZ.
 SAM 'N' HENRY; 11.00 P. M.; *negro comedy*; WGN.

April 6

IODENT'S NO. 1 AND NO. 2; 8.30 P. M.; *The Mitchel Brothers, banjo and piano*; WJZ, WBZ, KDKA, KYW.

DAVIS SAXOPHONE OCTETTE; 8.30 P. M.; *popular and classic music*; WEA, WEEL, WJAR, WTAG, WLIT, WRC, WCAE, WTAM, WSAI.

The Davis Saxophone Octette is perhaps the only musical organization in the United States that involves only saxophones in different keys. Although the saxophone has never been admitted to the circle of formal music, this octette offers up a particularly entertaining branch of popular selections.

IPANA TROUBADOURS; 9.00 P. M.; *dance music*; WEA, WEEL, WGR, WRC, WCAE, WWJ, WSAI, WLIB, KSD, WCCO, WDAF, WGY.

MAXWELL HOUR; 9.00 P. M.; *orchestra and soloists*; WJZ, WBZ, KDKA, KYW, WHAS, WSB, WMC, WSM.

ARABIAN NIGHTS ENTERTAINMENT; 9.45 P. M.; *varied program*; WGN.

Here is an extravaganza of the air that offers many unusual things in the way of musical entertainment. As this studio does not arrange the actual details of this entertainment until a day or two before its presentation, little may be said beyond a general endorsement of past performances.

SMITH BROTHERS; 10.00 P. M.; *humorous songs*; WEA, WTAG, WGR, WRC, WCAE, WWJ, WSAI, KSD, WOC, WCCO, WDAF.

STEINDEL STRING QUARTETTE; 7.30 P. M.; *classical music*; KMOX.

April 7

CLICQUOT CLUB ESKIMOS; 9.00 P. M.; *banjo ensemble*; WEA, WEEL, WCCO, WGN, WCAE, WGY, WJAR, WTAG, KSD, WOC, WGR, WFI, WWJ, WTAM, WSAI.

RCA RADIATORS; 9.00 P. M.; *songs and comedy*; WJZ, WBZ, KDKA, KYW.

WBAL ENSEMBLE; 9.00 P. M.; *chamber music*; WBAL.

GOODRICH ZIPPERS; 10.00 P. M.; *popular music*; WEA, WEEL, WCCO, WGN, WCAE, WJAR, WTAG, KSD, WOC, WGR, WFI, WWJ, WSAI, WCSH, WADC.

This program has become famous for its variety. It features both instrumental and vocal soloists, quartets, duets, recitations and ensembles. The talent is exceptionally good.

MUSIC BOX HOUR; 1.00 A. M.; *varied program*; KFI.

Anything in the way of musical entertainment may be expected from the KFI Music Box program; it is a variety feature with plenty of surprises each week.

MIDNIGHT FROLIC; 3.00 A. M.; *varied program*; KFI.

This is one of the best variety hours on the air and is especially recommended for those who retire late on Saturday night. The talent is drawn from a "Big Time" vaudeville concert and involves monologues, comedy sketches, singing and instrumental numbers.

April 8

KING EDWARD HOTEL ORCHESTRA; 6.30 P. M.; *dance music*; CNRT.
 The King Edward Hotel dance orchestra is said to be the best organization of its kind in all of Canada. The King Edward is Toronto's smartest hotel.

HAPPINESS BOYS; 7.30 P. M.; *songs and jokes*; WEA.

ROYAL HOUR; 8.30 P. M.; *orchestra and soloists*; WJZ, WBZ, KDKA, KYW.

BRUNSWICK-BALKE HOUR; 9.00 P. M.; *varied program*; WJZ, WBZ, KDKA, KYW, WHAS, WMC, WSB.

RADIO PLAY; 9.00 P. M.; *drama*; WGY.

LA FRANCE ORCHESTRA; 9.30 P. M.; *popular orchestral music*; WEA, WEEL, WGR, WLIT, WOC, WCAE, WTAM, WWJ, KSD, WDAF.

April 9

JACQUES RENARD ORCHESTRA; 6.45 P. M.; *dance music*; WEEL.

BALKITE HOUR; 9.00 P. M.; *New York Symphony Orchestra*; WEA, WEEL, WGR, WFI, WRC, WCAE, WSAI, WWJ, WTAM, WGN, KSD, WCCO, WDAF, WOC, WGY.

HOTEL CHELSEA ENSEMBLE; 9.30 P. M.; *chamber music*; WPG.

The Chelsea Ensemble supplies the music for the guests of one of Atlantic City's smartest hotels and it provides for the listeners of WPG one of the choicest half hours of chamber concerts now broadcast from any station.

"OUR GOVERNMENT"; 10.00 P. M.; *talk by David Lawrence*; WEA, WTAG, WGR, WFI, WRC, WCSH, WGY.

BENJAMIN FRANKLIN ORCHESTRA; 10.05 P. M.; *dance music*; WIP.

ARCADIA DANCE ORCHESTRA; 12.00 P. M.; *dance music*; KMOX.

COLORADO ORCHESTRA; 12.15 A. M.; *dance music*; KOA.

April 10

BEDFORD Y.M.C.A. MEN'S CONFERENCE; 4.00 P. M.; *Dr. S. Parkes Cadman*; WEA, WEEL, WCSH, WTAG, WCAE, WSAI.

CROSBY RADIO FEATURE; 5.30 P. M.; *varied program*; WEA, WEEL, WJAR, WTAG, WGN, WFI, WRC, WCSH, WCAE, WTAM, WWJ, WSAI, KSD, WDAF, WHAS, WSM, WSB, WMC, WGY.

THE CAPITOL GRAND ORCHESTRA (and Major Bowes' family); 7.20 P. M.; *symphonic music and soloists*; WEA, WEEL, KSD, WRC, WWJ, WJAR, WCAE, WTAG.



The Capitol Symphony Orchestra—regarded by some as the best orchestra in New York—is directed by David Mendosa, who is said to be the youngest director of a large symphony in the world. He once played first violin with the Russian and later with the New York Symphony orchestra; he also conducts the studio ensemble.

COOK'S TOURS; 8.30 P. M.; *talk and music*; WJZ.

ATWATER KENT HOUR; 9.15 P. M.; *star soloists*; WEA, WJAR, WEEL, WFI, WCCO, WTAM, WGN, WCAE, WGR, WOC, WTAG, WWJ, KSD, WRC, WSAI, WGY, WHAS, WSB, WMC.

The guest artists are Kathryn Meisle and Leonora Cortez.

COLLIER HOUR; 9.30 P. M.; *varied program*; WJZ, WBZ, KYW, KDKA.

April 11

ROXY AND HIS GANG; 7.00 P. M.; *110-piece symphony orchestra, with soloists*; WJZ, WBZ, WBZA, KDKA, KYW, WRC, WSB, WHAS, WSM.

MALE QUARTET; 7.30 P. M.; *standard songs*; WBAL.

This quartet mixes two rich tenor voices with a basso and a baritone. John Wilbourn and Edward Jendrek are the tenors, while Conner Turner is the baritone and Walter Linthicum is the basso. They confine their activities to the standard old selections, but occasionally sing an unusual number.

RECORD BOYS; 8.00 P. M.; *songs and humor*; WJZ, WBZ.



Here are the "boys"—Al Bernard, Sammy Stept and Frank Kamplain.

HIRE'S HARVESTERS; 8.00 P. M.; *instrumentalists*; WEA, WEEL, WGR, WLIT, WRC, WCAE, WTAM, KSD, WCCO, WSAI.

WILLYS-OVERLAND SYMPHONY; 8.30 P. M.; *symphonic music and soloists*; WJZ.

A. AND P. GYPSIES; 9.00 P. M.; *classical and semi-classical music*; WEA, WEEL, WJAR, WDAF, WRC, WCSH, WTAM, WLIT, WWJ, WCAE, WSAI.

RUDE LIGHT OPERA; 9.30 P. M.; *orchestra and soloists*; WJZ, KDKA, WBZ.

LIDO VENICE DANCE ORCHESTRA; 10.00 P. M.; *jazz music*; WEEL.

B. A. ROLFE'S DANCE ORCHESTRA; 11.00 P. M.; *jazz numbers*; WEA.

April 12

DINNER CONCERT; 6.30 P. M.; *classical and popular music*; WGY.

EDISON ENSEMBLE; 8.00 P. M.; *classic and popular music*; WRNY.

THE VIKINGS; 8.00 P. M.; *instrumental trio and guest soloists*; WEA, WEEL, WJAR, WTAG, WGR, WSI, WCSH, WCAE, WTAM, WWJ, KSD, WSAI, WCCO, WGY.

CHAMPION SPARKERS; 8.30 P. M.; *popular music*; WJZ, KDKA, KYW, WBZ.

JOLLY BUCKEYE BAKERS; 8.30 P. M.; *vocal quartet and instrumentalists*; WEA, WFI, KSD, WSAI, WCCO, WTAM, WTAG, WLIB, WWJ, WRC.

GRAND OPERA PROGRAM; 9.00 P. M.; *soloists and instrumentalists*; WJZ, KDKA, KYW.

EVEREADY HOUR; 9.00 P. M.; *varied program*; WEA, WEEL, WFI, WCAE, WGR, WWJ, WOC, KSD, WJAR, WCCO, WTAM, WGN, WSAI, WTAG, WRC, WGY.

ARABIAN NIGHTS ENTERTAINMENT; 9.45 P. M.; *varied program*; WGN.

BRIDGE INSTRUCTION; 10.00 P. M.; WEA, WEEL, WCSH, WTAG, WJAR, WGR, WCAE, WTAM, WFI, WWJ, WSAI, WGN, WOC, WCCO, KSD, WRC, WGY.

The WEA bridge instruction period has become a training school for every aspirant to perfection in bridge. This half hour is conducted with the expert assistance of really famous bridge players who, having suggested four hands, tell the listeners how to play them according to the modern practices used in the game.

DON AMAIZO; 10.00 P. M.; *violinist*; WJZ, KDKA, KYW.

SAM 'N' HENRY; 11.00 P. M.; *negro comedy*; WGN.



This post —
trickle charge
to a 6-volt
battery . . .
Also charges
2- or 4-volt
batteries . . .

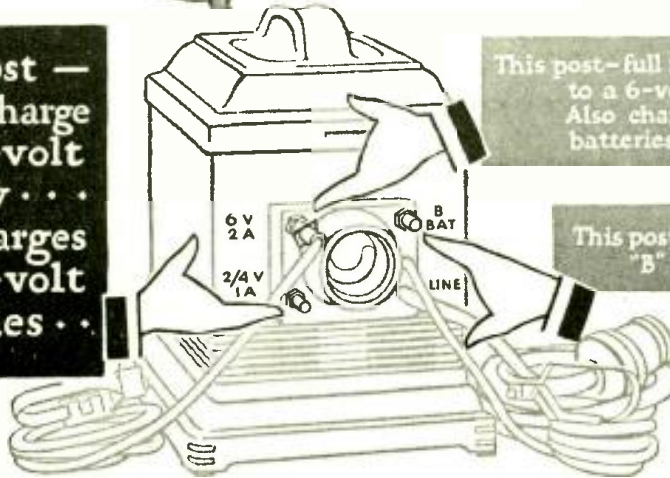

This post—full rate charge
to a 6-volt battery
Also charges auto
batteries

This post—charges all
"B" batteries

Trickle charge or full charge — both from the same Tungar

Here's a versatile little charger that can do a lot of different jobs.

It is a two-ampere Tungar that will trickle charge a 6-volt "A" battery—or give it a full rate charge.

It can also charge 2 or 4 volt "A" batteries, all "B" batteries—and automobile batteries, too.

It can easily be installed permanently—so that you need only throw a switch to charge your batteries. It is the time tested easy to use charger.

East of the Rockies
2 ampere Tungar - - \$18
5 ampere Tungar - - \$28
Trickle Charger - - \$12

Merchandise Department
General Electric Company
Bridgeport, Connecticut

 **Tungar**
REG. U.S. PAT. OFF.
BATTERY CHARGER

*Tungar—a registered trademark—is found only
on the genuine. Look for it on the name plate.*

GENERAL ELECTRIC

ARROWHEAD INN ORCHESTRA; 10.30 P. M.; *dance music*; WGBS, WIP.

GEORGE OLSEN'S ORCHESTRA; 10.45 P. M.; *dance music*; WJZ.



George Olsen's Pennsylvania Grill Orchestra takes the place of the Vincent Lopez Orchestra that used to play from this place. Olsen does his own announcing and both he and his orchestra is a great favorite with the WJZ audience.

April 13

IODENT'S NO. 1 AND NO. 2; 8.30 P. M.; *The Mitchel Brothers, banjo and piano*; WJZ, WBZ, KDKA, KYW.

DAVIS SAXOPHONE OCTETTE; 8.30 P. M.; *popular and classic music*; WEA, WEEL, WJAR, WTAG, WLIT, WRC, WCAE, WTAM, WSAI.

IPANA TROUBADOURS; 9.00 P. M.; *dance music*; WEA, WEEL, WGR, WRC, WCAE, WWJ, WSAI, WLIB, KSD, WCCO, WDAF, WGY.

MAXWELL HOUR; 9.00 P. M.; *orchestra and soloists*; WJZ, WBZ, KDKA, KYW, WHAS, WSB, WMC, WSM.

The weekly concert of a very few radio orchestras is anticipated more keenly than that of the Maxwell House group, under the able direction of Nathaniel Shilkret. Mr. Shilkret has in the past used splendid judgment in selecting his music and his programs are invariably mature and well rounded out.

SMITH BROTHERS; 10.00 P. M.; *humorous songs*; WEA, WTAG, WGR, WRC, WCAE, WWJ, WSAI, KSD, WOC, WCCO, WDAF.

JADE ROOM DANCE ORCHESTRA; 11.00 P. M.; *dance music*; WTAM. The Jade Room Dance orchestra offered by WTAM at 11.00 P. M. on Wednesdays is one of a precious few really good jazz bands in the State of Ohio.

April 14

CHATEAU SOURIER CONCERT; 7.45 P. M.; *chamber music*; CNRM. MUSIC BOX HOUR; 8.00 P. M.; *varied program*; KFI.

CLICQUOT CLUB ESKIMOS; 9.00 P. M.; *banjo ensemble*; WEA, WEEL, WCCO, WGN, WCAE, WGY, WJAR, WTAG, KSD, WOC, WGR, WFI, WWJ, WTAM, WSAI.

RCA RADIATRONS; 9.00 P. M.; *songs and comedy*; WJZ, WBZ, KDKA, KYW.

GOODRICH ZIPPERS; 10.00 P. M.; *popular music*; WEA, WEEL, WCCO, WGN, WCAE, WJAR, WTAG, KSD, WOC, WGR, WFI, WWJ, WSAI, WCSH, WADC.

April 15

HAPPINESS BOYS; 7.30 P. M.; *songs and jokes*; WEA.

MARKEL'S SOCIETY ORCHESTRA; 8.00 P. M.; *dance music*; WJZ, WBZ, KDKA, KYW.

ROYAL HOUR; 8.30 P. M.; *orchestra and soloists*; WJZ, WBZ, KDKA, KYW.

LA FRANCE ORCHESTRA; 9.30 P. M.; *popular orchestral music*; WEA, WEEL, WGR, WLIT, WOC, WCAE, WTAM, WWJ, KSD, WDAF.

RADIO PLAY; 9.00 P. M.; *drama*; WGY.

DANCE ORCHESTRA; 11.00 P. M.; *dance music*; KDKA.

April 16

JACQUES RENARD ORCHESTRA; 6.45 P. M.; *dance music*; WEEL.

BALKITE HOUR; 9.00 P. M.; *New York Symphony Orchestra*; WEA, WEEL, WGR, WFI, WRC, WCAE, WSAI, WWJ, WTAM, WGN, KSD, WCCO, WDAF, WOC, WGY.

COLUMBIA PHONOGRAPH PROGRAM; 9.00 P. M.; *varied program*; WJZ, WGY, WBZ, KDKA.

"OUR GOVERNMENT"; 10.00 P. M.; *talk by David Lawrence*; WEA, WTAG, WGR, WFI, WRC, WCSH, WGY.

BENJAMIN FRANKLIN ORCHESTRA; 10.05 P. M.; *dance music*; WIP.

COLORADO ORCHESTRA; 12.15 P. M.; *dance music*; KOA.

April 17

BEDFORD Y.M.C.A. MEN'S CONFERENCE; 4.00 P. M.; *Dr. S. Parkes Cadman*; WEA, WEEL, WCSH, WTAG, WCAE, WSAI.

CROSLY RADIO FEATURE; 5.30 P. M.; *varied program*; WEA, WEEL, WJAR, WTAG, WGN, WFI, WRC, WCSH, WCAE, WTAM, WWJ, WSAI, KSD, WDAF, WHAS, WSM, WSB, WMC, WGY.

THE CAPITOL GRAND ORCHESTRA (and Major Bowes' family); 7.20 P. M.; *symphonic music and soloists*; WEA, WEEL, KSD, WRC, WWJ, WJAR, WCAE, WTAG.

COOK'S TOURS; 8.30 P. M.; *travelogue with music*; WJZ.

ATWATER KENT HOUR; 9.15 P. M.; *star soloists*; WEA, WJAR, WEEL, WFI, WCCO, WTAM, WGN, WCAE, WGR, WOC, WTAG, WWJ, KSD, WRC, WSAI, WGY, WHAS, WSB, WMC.

The soloists are Richard Bonelli and Jeanette Vreeland—for this occasion only.

COLLIER HOUR; 9.30 P. M.; *varied program*; WJZ, WBZ, KYW, KDKA.

BAMBO GARDENS DANCE ORCHESTRA; 10.15 P. M.; WTAM.

This ensemble, under the direction of Emerson Gill, is a Cleveland organization recruited from the best popular music players in the "Sixth City." They have "appeared" regularly through WTAM for some time.

April 18

ROXY AND HIS GANG; 7.00 P. M.; *110-piece symphony orchestra, with soloists*; WJZ, WBZ, WBZA, KDKA, KYW, WRC, WSB, WHAS, WSM.

CONGRESS HOTEL DINNER CONCERT; 7.30 P. M.; *chamber music*; KYW.

RECORD BOYS; 8.00 P. M.; *songs and humor*; WJZ, WBZ.

HIRE'S HARVESTERS; 8.00 P. M.; *instrumentalists*; WEA, WEEL, WGR, WLIT, WRC, WCAE, WTAM, KSD, WCCO, WSAI.

WILLYS-OVERLAND SYMPHONY; 8.30 P. M.; *symphonic music and soloists*; WJZ.



This little symphony is under the personal direction of Henry Hadley, composer and orchestra leader. In assembling this group, Mr. Hadley did all of his recruiting from the ranks of the New York Symphony. With each concert there is presented a guest soloist.

A. AND P. GYPSIES; 9.00 P. M.; *classical and semi-classical music*; WEA, WEEL, WJAR, WDAF, WRC, WCSH, WTAM, WLIT, WWJ, WCAE, WSAI.

WBAL ENSEMBLE; 9.00 P. M.; *chamber music*; WBAL.

RUDE LIGHT OPERA; 9.30 P. M.; *orchestra and soloists*; WJZ, KDKA, WBZ.

LIDO VENICE DANCE ORCHESTRA; 10.00 P. M.; *jazz music*; WEEL.

B. A. ROLFE'S DANCE ORCHESTRA; 11.00 P. M.; *jazz numbers*; WEA.



B. A. Rolfe is perhaps the most accomplished cornetist in the United States, certainly the most accomplished on the air. His cornet solos (one of which he usually plays during his concert) are especially interesting, since he is able to reach and carry melody in the super-treble—a most difficult accomplishment. Previous to his entrance into the realm of popular music, Rolfe directed a formal orchestra, and his jazz orchestration always betrays his training in classical music.

April 19

HOTEL TEN EYCK DINNER CONCERT; 6.30 P. M.; *chamber music*; WGY.

EDISON ENSEMBLE; 8.00 P. M.; *classic and popular music*; WRNY.

THE VIKINGS; 8.00 P. M.; *instrumental trio and guest soloists*; WEA, WEEL, WJAR, WTAG, WGR, WSI, WCSH, WCAE, WTAM, WWJ, KSD, WSAI, WCCO, WGY.

CHAMPION SPARKERS; 8.30 P. M.; *popular music*; WJZ, KDKA, KYW, WBZ.

JOLLY BUCKEYE BAKERS; 8.30 P. M.; *vocal quartet and instrumentalists*; WEA, WFI, KSD, WSAI, WCCO, WTAM, WTAG, WLIT, WWJ, WRC.

GRAND OPERA PROGRAM; 9.00 P. M.; *soloists and instrumentalists*; WJZ, KDKA, KYW.

EVEREADY HOUR; 9.00 P. M.; *varied program*; WEA, WEEL, WFI, WCAE, WGR, WWJ, WOC, KSD, WJAR, WCCO, WTAM, WGN, WSAI, WTAG, WRC, WGY.

EDUCATIONAL PROGRAM; 9.15 P. M.; *lectures*; WLWL.

BRIDGE INSTRUCTION; 10.00 P. M.; WEA, WEEL, WCSH, WTAG, WJAR, WGR, WCAE, WTAM, WFI, WWJ, WSAI, WGN, WOC, WCCO, KSD, WRC, WGY.

DON AMAIZO; 10.00 P. M.; *violinist*; WJZ, KDKA, KYW.

ARROWHEAD INN ORCHESTRA; 10.30 P. M.; *dance music*; WGBS, WIP.

GEORGE OLSEN'S ORCHESTRA; 10.45 P. M.; *dance music*; WJZ.

SAM 'N' HENRY; 11.00 P. M.; *negro comedy*; WGN.

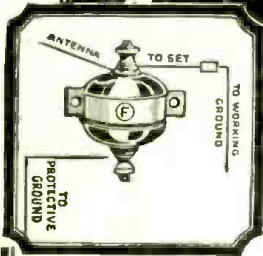
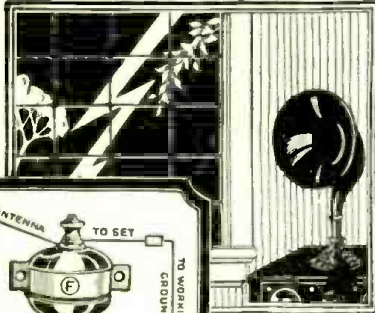

No. 248
E-5841
Underwriter's
App.

"Little Joe"

Lightning Arrester

Especially designed for Radio Work. Made of porcelain, small, neat, rugged and serviceable. Can be suspended on antenna or fastened to wall.

Ask Your Dealer

M'fd by CIRCLE F MFG. CO.

Trenton, New Jersey

HAMMARLUND Precision PRODUCTS

Are Officially Used in Seventeen of the
Newest Circuits

If you can't guess the reason
for Hammarlund popularity,
ask any radio engineer.

These 1927 Leaders Use HAMMARLUND PRODUCTS

Loftin — White; Hammarlund-
Roberts "Hi-Q";
Haynes "DX₂ Multi-valve"; La-
cault "LR4";
Cockaday "LC27"; Browning's
Drake;
Sargent "Infradyne"; Morrison
"Varion";
Pacent "Ultimax"; St. James
Super;
Victoreen Super; Harkness
"KH-27";
Henry - Lyford; Carborundum
Super;
Popular Science Monthly "Pow-
erful"; "World's Record" Su-
per;
Haynes-Cockaday "Uni-valve"

We shall be pleased to re-
fer to the proper author-
ities any inquiries regard-
ing the above circuits.

HAMMARLUND MFG. CO.
424-438 W. 33rd Street, New York City

For Better Radio
Hammarlund
PRECISION
PRODUCTS

An Explanation of AmerTran DeLuxe Efficiency

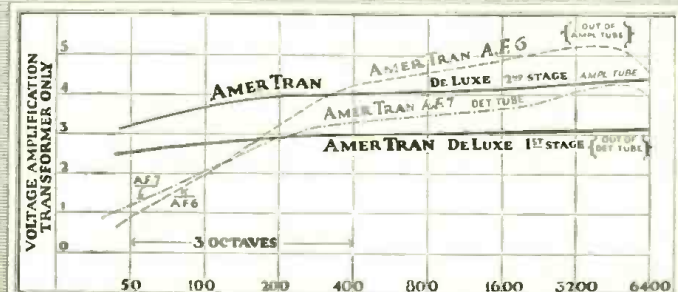

Frequency scaled in Octaves



The above curves are plotted from measurements made in accordance with the latest tentative rules of the N. E. M. A. These curves have been proven conservative, and accurately represent the AmerTran DeLuxe Audio transformer.

For one and one-half years the AmerTran DeLuxe has been used with great success by all those seeking improved audio amplification. The secret of its excellence centers chiefly in the special alloy core material which provides the high inductance needed for the normal amplification of the fundamental base tones. This makes possible an improved coil structure for maintaining the higher frequencies with no appreciable "peak" or "droop" until beyond the useful range.

There is a remarkable absence of the muffling of sibilant sounds and "background"—often noticeable with transformers having "drooping" characteristics.

The AmerTran DeLuxe is well made and designed to give long, dependable service. Metal cased and embedded in a solid compound, it is not affected by climatic changes.

The better reception obtained by installing correctly a pair of AmerTrans is final proof of their high efficiency rating.

THE AMERICAN TRANSFORMER CO.

178 EMMET STREET

NEWARK, N. J.

Transformer Builders for Over 26 Years

Write for free booklet, entitled "Improving the Audio Amplifier," together with other technical data.

The AmerTran DeLuxe, made in two types, for first and second stages, \$10.00 Each.

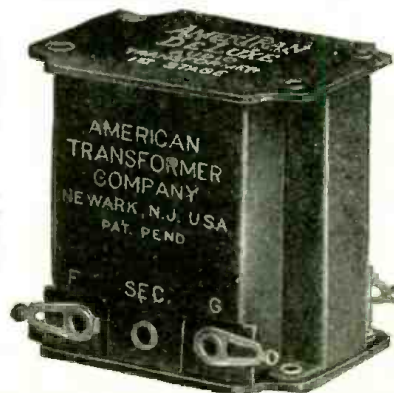

Other AmerTran Products:

AmerTran Power Transformer, Type PFS2, \$18.00 Each

AmerChoke, Type 854, \$6.00 Each

AmerTran Audio Transformers, Type Af7 and Af6, \$5.00 Each



Learn to Earn \$50 to \$250 a Week

Free Book "RICH REWARDS IN RADIO" Tells How.

If you're earning a penny less than \$50 a week, clip coupon below for FREE RADIO BOOK! Thousands of chances, good positions everywhere in this growing brand-new, big pay profession. Free Book gives all the facts. Radio needs trained men! Learn to be a Radio Expert, and draw down big pay for this easy, fascinating work.



I'll Train You Quickly At Home To Be A Radio Expert

Stay home and hold your job—I'll bring your training to you. You learn quickly and easily in your spare time without leaving home. Our years of experience in the big field of Radio means that we can train you as we have thousands of others. I supply you free of extra cost with all needed apparatus and receiving sets for practical work while learning, so you can master Radio quickly, easily, at home.

Big Demand For Trained Men In Radio

Hundreds of N. R. I. trained men are today holding down good, big jobs in the Radio field. Thousands of openings now await the trained man in this new profession. FREE EMPLOYMENT SERVICE WHEN YOU GRADUATE. Many other big features. Don't go along at \$25 or \$35 or \$45 a week when as a Radio Expert you can be pulling down real money for the same six days. Get the Facts—CLIP COUPON NOW.

Age or Lack of Experience No Drawback

You don't need high school training to learn by my methods—common schooling is enough. Lack of experience or education need not hold you back. My training is thorough and complete, but at the same time it's practical, simple, and clear. Young and old alike have won success in Radio through my help. Send coupon below for FREE Book—"Rich Rewards in Radio." Read for yourself.

WRITE NOW. Coupon will bring book and full details of big special offer of receiving sets and practice sets given with course. J. E. SMITH, President National Radio Institute Dept. D-86 Washington, D. C.

SPECIAL BOOK AND OUTFIT COUPON

National Radio Institute, Dept. D86, Washington, D. C.
Dear Mr. Smith: Please rush me free Radio book and details of outfit offer. No obligation.

Name.....
Address.....
Town.....State.....

You get receiving sets and practice instruments with course.

- FIVE BIG OUTFITS**
- (1) Modern Single Control Thousand Mile Vacuum Tube Set.
 - (2) Simple receiving equipment for practice work.
 - (3) Advanced receiving equipment for practice work.
 - (4) World-famous National Radio Institute.
 - (5) Practice set and buzzer outfit.



WITH THE EXPERIMENTERS

CONDUCTED BY RICHARD LORD

How to Make the Coils for the KH-27 Receiver

FOR experimenters who may want to build for themselves the coils for the KH-27 receiver, described in the January, 1927, issue of POPULAR RADIO, this additional information on the coils is provided.

These high-frequency transformers are of remarkable efficiency and through their use the losses in the high-frequency circuits of this receiver have been reduced to a minimum.

It is pretty generally admitted that a solenoid coil with a slight spacing between turns is at least as efficient as any other form and much more efficient than many of the trick forms of coil windings. The ideal coil would be a solenoid in which the turns are supported in air; that is, a coil with no composition tubing or with no foreign material of any kind in contact with the winding. Such a coil is practically impossible, however, as the turns must have some sort of support; and, if the winding is spaced, the support must be complete and rigid in order to maintain the original spacing between the turns.

The coils used in the KH-27 receiver are about as nearly free from dielectric material as any coils could be and still be rigid enough to insure the permanency of the characteristics and values of the coils.

These coils are machine wound on a semi-flexible film of cellulose material and each individual turn is cemented to this film. The result is that there is practically no dielectric between turns, and so little on the inside of the turns (the tubular film) that the losses from this source are so small as to be hardly measurable.

The main coil in the high-frequency transformers has two narrow clamping strips running its entire length, at right angles to the winding, to securely attach the terminal strip to the winding. Inside of the main coil, and approximately 1/8-inch smaller than the main coil in diameter, are the primary and balancing coils which are required in this particular circuit. These smaller coils are

equally spaced all around from the larger coil; and this spacing is made permanent by cementing a small spacer between each of these coils and the larger one. The clamping strip which runs through the larger coil serves as the other spacer; thus a rigid two-point suspension is obtained.

The two smaller coils are placed near the filament end of the larger secondary winding and the leads from these coils to the terminal mounting strip are therefore short and kept well distant from the grid end of the large coil. The grid terminal is provided right at the grid end of the coil, so this lead is also extremely short.

On the whole the construction of these transformers is decidedly simple and the entire volume of the dielectric used probably does not exceed that of the wire alone—which is certainly small when compared with the volume of the composition tubes generally used as the support for coils.

To further reduce losses, there are no large masses of metal used in the construction of the units. The terminals are in the form of soldering lugs and are attached to the terminal strip by means of eyelets. There are no bolts or nuts and therefore nothing to work loose. All connections from the windings to the terminals are securely soldered; and the connections from the terminals to the other apparatus, when the coils are mounted in a receiver, must be soldered also. Thus good connections are insured.

The exact specifications of these transformers are as follows:

The coil windings may be purchased from the Hammerlund Mfg. Co. The winding is manufactured in 20-inch lengths and should be ordered by the inch. For the three transformers used in the KH-27 receiver the windings required are:

- 6 1/2 inches of the 2-inch coil, wound with No. 24 green, silk-covered wire, spaced 40 turns to the inch;
- 2 inches of the 1 7/8-inch coil, wound with No. 26 green, silk-covered wire, spaced approximately 50 turns to the inch.

Three transformers are required;

these are indicated as T1, T2 and T3 in the constructional article in the January issue. The 2-inch coil winding is used for the three secondary coils; each of these consists of 80 turns. The 1 7/8-inch winding is used to make the primary and balancing coils.

The windings specified above are each in one piece, and the individual coils needed to make the transformers must be cut off these windings. In cutting the coils, allow two turns more than actually needed for each of the coils. These surplus turns allow free ends for connection to the terminal strip.

The transformer specifications are as follows:

T1—Secondary coil, 80 turns; primary coil, 15 turns with tap taken off at the 8th turn; balancing coil, 8 turns.

T2—Secondary coil, 80 turns; primary coil, 15 turns; balancing coil 11 turns.

T3—Secondary coil, 80 turns; primary coil, 15 turns; balancing coil, none.

The primary coils are placed inside of the secondaries, at the end next to the

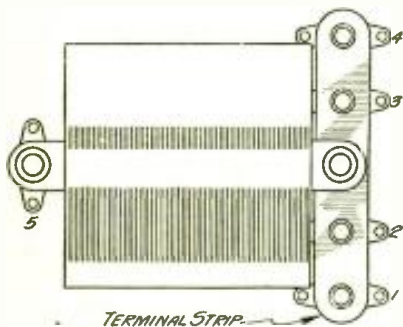

TERMINAL STRIP
TOP VIEW OF COIL

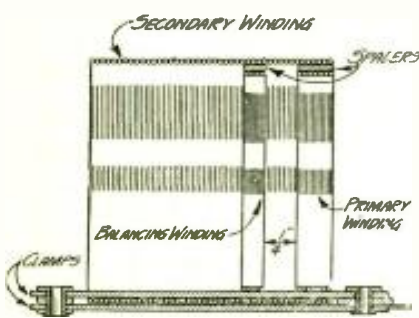

TRANSVERSE SECTION

HOW THE COILS FOR THE KH-27 RECEIVER ARE MADE

FIGURE 1: These two drawings, giving a top view and a transverse section of one of the radio-frequency transformers used in the KH-27 receiver, show clearly the general manner in which these coils are constructed. The top drawing shows the soldering lugs attached to the terminal strip by means of eyelets; the bottom drawing gives a clear idea of how the secondary winding is held between two thin strips of bakelite clamped together at the ends, and also how the primary and balancing windings are supported by small spacers cemented to the inside of the secondary.

Plate Voltage Aplenty for Big or Little Sets

Type 405

PLATE
SUPPLY



Price
with Type B H
(Raytheon)
LAMO LIFE RECTIFYING TUBE
\$ 46

The Type 405 Plate Supply delivers ample plate power to permit its use with multi-tube sets where there is a heavy current drain as well as with receivers having small current demands. The Type 405 Unit operates on 110-volt (60 cycle) A. C. and provides voltages of 45, 90, 130, and 200.

Voltages are readily adapted to plate requirements of all standard tubes in popular use by means of fixed resistances. These resistances are tightly sealed from dust and moisture, thus eliminating bothersome and noisy tendencies of variable resistance voltage controls.

The Unit is contained in a metal case with attractive black crystalline finish and has a conveniently located A. C. switch.

GENERAL RADIO

PARTS AND ACCESSORIES

The General Radio Company has endeavored to make it possible for the experimenter to obtain its products with minimum of effort. A careful selection of distributors and dealers has been made. They are best suited to serve you. If, however, you are unable to obtain our products in your particular locality, they will be delivered to you, postpaid, direct from the factory upon receipt of list price.

General Radio Co. Cambridge, Mass.

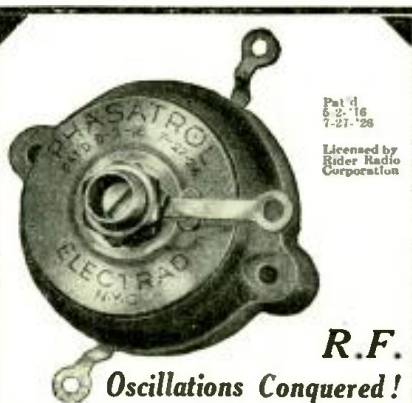

Pat'd
6-2-16
7-27-'28

Licensed by
Rider Radio
Corporation

R.F.

Oscillations Conquered!

“Phasatrol”

A true balancing device for radio frequency amplifiers.

If your set squeals or oscillates you need PHASATROLS.

If you are building a new set, and want the last word in electrical efficiency—equip it with PHASATROLS.

PHASATROL is the latest development in the field of radio frequency amplification. As a balancing device, it is far superior to any other methods heretofore in use for suppressing oscillations in the radio frequency amplifier circuit. It is being used and endorsed by leading radio authorities.

At your dealers or write direct. Write for Hook-up Circular.

Price, \$2.75



175 Varick St., Dept. 22, New York, N. Y.

ELECTRAD

Stop Those Howls

Simply insert the new CeCo Type “H” Special Hard Detector—

You'll see the difference at once



Type “H”
SPECIAL
HARD
DETECTOR
non-microphonic

The Tube
of
Longer
Life

Price
\$2.50

A Type
for Every
Radio Need

Makes a Good Receiver Better
Write for Complete Data Sheet
C. E. MFG. CO. Inc. . . . PROVIDENCE . R. I.

ASK... ANY... RADIO... ENGINEER

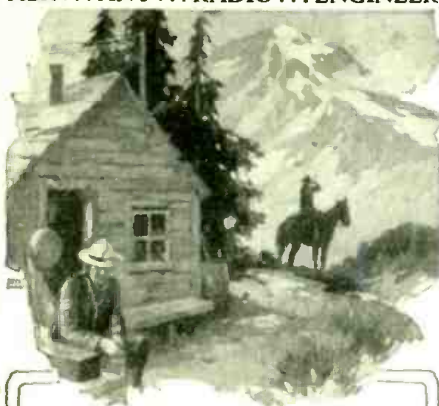

The "Mountie" isn't lonely any more

WHEN the supply ship steams south from the last outpost of civilization in September, not to return until the following July, loneliness will never again beset the lives of the Royal Canadian Mounted Police who patrol that vast, wild area.

Radio is now brightening the long winter nights with music, special programs, messages and greetings from their "home folks."

And in the receiving sets of the "Mounties" is the best equipment obtainable. The batteries they use *must* be dependable. They *must* serve until new supplies are brought in a year later.

Ask any Radio Engineer

BURGESS BATTERY COMPANY
 GENERAL SALES OFFICE: CHICAGO
 Canadian Factories and Offices:
 Niagara Falls and Winnipeg



BURGESS

RADIO BATTERIES

terminal strips and with the outer edge of the primary coil even with the edge of the secondary. The balancing coils are placed inside of the secondaries and spaced 1/4-inch from the inner ends of the primary coils.

The physical arrangement of the assembled transformers is as shown in Figure 1. The connections to the terminals are as follows:

- T1—Terminal 1, inner end* of primary; terminal 2, tap on primary; terminal 3, outer end of primary; inner end of balancing coil and outer end of secondary; terminal 4, outer end of balancing coil; terminal 5, inner end of secondary.
- T2—Terminals 1, 4 and 5 to be connected, as in the case of T1; terminal 3, outer end of secondary and inner end of balancing coil.
- T3—Terminal 1, inner end of primary; terminal 2, outer end of primary; terminal 3, outer end of secondary; terminal 4, not used; terminal 5, inner end of secondary.

—S. GORDON TAYLOR

* Inner end refers to end of coil away from the large terminal strip.

Helpful Hints for Building and Operating the LC-27 Receiver

FIRST of all, in building the LC-27 receiver, be sure that the spacing of the instruments is exactly as shown in the POPULAR RADIO diagram. If the shields are placed incorrectly so that they are closer to the coils than the specifications call for, it will cause your receiver to oscillate excessively.

If the experimenter desires, the pilot light may be controlled along with the five valves, from the battery switch. This is done by connecting the lead from the frame of the dual condenser to the receiver side of the battery switch instead of to the "A" minus connection in the rear of the receiver.

If you want to use the UX-171 type power valve in the last stage of this receiver and to control this valve from the battery switch, you may do so by mounting a half-ampere filament control in front of this socket*. Then connect one side of this filament control to the negative post of this socket and the other side to the receiver side of the battery switch. The "A" positive lead should be bridged over from the fourth socket.

The following suggestions will help those who require extreme selectivity.

If you have not already done so, connect your antenna to binding post No. 2 or, if you are using a power-pack with this set you can dispense with your outside aerial by connecting the ground lead to binding post No. 1. For further selectivity, try a .00015 mfd. fixed condenser in series with your antenna.

* See POPULAR RADIO for March, page 248.

FREE Simplified BLUE PRINTS

You can have your choice of any one set of POPULAR RADIO Simplified Blueprints with your new or renewal subscription for POPULAR RADIO, accompanied by remittance of \$3.00. These Blueprints will make it possible for you to build a tested and approved set. You, as a reader of POPULAR RADIO, know the many entertaining, interesting and instructive articles that are published each month. We promise that throughout the coming months POPULAR RADIO will hold more and more of interest for Radio Fans.

Ease, Economy and Accuracy in Construction

Simplified Blueprints make it possible for anyone, without previous knowledge of radio, to construct a highly efficient radio receiver. These Blueprints consist of 3 diagrams as follows:

Panel Pattern

This Blueprint is the EXACT size of the actual set. So accurate that you need merely lay it on your panel and drill as indicated. No scaling or measuring to do, no danger of ruining the panel through faulty calculation.

Instrument Layout

Here again you have an actual size print of each instrument and binding post and its exact location both on the panel and within the cabinet.

Wiring Diagram

The unusual feature of this Blueprint is that it is an actual size picture diagram of the finished set. Each instrument and other parts appear in exact size and the wires are so clearly traced from one contact to another that you can connect all terminals accurately without even knowing how to read a hook-up diagram.

- Set No. 18—"The Improved Raytheon Power-Pack" (as described in the May, 1926, issue of POPULAR RADIO).
- Set No. 19—"The New Home Receiver" (three tubes, two stages of radio-frequency amplification with crystal detector, as described in June, 1926, issue of POPULAR RADIO).
- Set No. 21—"The Improved Browning-Drake Receiver" (as described in the August, 1926, issue of POPULAR RADIO).
- Set No. 22—"The LC-27 Broadcast Receiver" (as described in the October, 1926, issue of POPULAR RADIO).
- Set No. 23—"The LC-Senior Power-Pack" (as described in the November, 1926, issue of POPULAR RADIO).
- Set No. 24—"The LC-Intermediate Power-Pack" (as described in the December, 1926, issue of POPULAR RADIO).
- Set No. 25—"The LC-Junior Power-Pack" (as described in the January, 1927, issue of POPULAR RADIO).

Use coupon below; indicate which set of Blueprints you want.

POPULAR RADIO

Dept. 49

627 West 43rd Street New York City

POPULAR RADIO, Dept. 49

627 West 43rd Street, New York City

Enclosed is my remittance of \$..... in full payment for subscription, with Blueprints as checked below, FREE.

- Set Number 18
- Set Number 19
- Set Number 21
- Set Number 22
- Set Number 23
- Set Number 24
- Set Number 25

Name.....

Street.....

City..... State.....

A rushing or hissing noise may be due to a noisy UX-200-a type valve. If possible, request your dealer to replace it with a better one, or if your input is great enough, try a UX-201-a type valve as a detector.

A good stunt to try to get rid of this objectionable noise is to connect a .0005 mfd. fixed condenser in parallel with fixed condenser R2. This increases the capacity of this condenser and by-passes some of the extraneous noises.

A high-pitched, whistling sound may be caused by a defective tube in the high-frequency stages or your first low-frequency stage.

The setting of your antenna dial for a given wavelength, should approximate half that of the wavelength dial, as the former has only 50 divisions as compared with the 100 divisions of the latter. The design of the condenser plates may make the tuning of the wavelength dial appear broad; actually this type of condenser (known as midline) provides good spacing between stations.

The "C" battery connection, as shown in the October issue, should be reversed; that is, the "C" minus lead should go to binding post No. 9 and the "C" positive lead to the negative post of the "A" battery.

The volume control that is mounted on the panel of your receiver is a regulator for the plate voltage of your second high-frequency stage. If it is not operating correctly, check over the sliding contact to make sure that the arm is making contact for the full length of the resistance.

If, when this receiver is used with either the Senior, Intermediate or Junior power-pack, reception is marred by a noticeable AC hum, it may be that the line frequency is less than sixty cycles.

To successfully operate the power-packs your line supply should be 110 to 120 volts AC, 50 to 60 cycle.

In some sections of this country the line frequency is in the neighborhood of 25 to 40 cycles. This is true of Buffalo, N. Y., and in some states in the west and also in certain sections of Canada. If your line supply is not of the prescribed frequency it will be necessary to employ a specially wound transformer in your power-pack.

Your power-pack should be kept at least two feet away from the receiver.

A hum may sometimes be caused by an electric light carrying alternating current too near the receiver. A hum may also be caused by AC lighting or power lines running near the antenna.

Be sure that the condensers in the power-pack are in the same relative positions as shown in the POPULAR RADIO diagram. If they are placed too near or against the chokes they decrease the effectiveness of the chokes and cause an objectionable hum.

—CARL DORF



STOP

STOP!

Use a
**Belden
Fused Radio
Battery Cord**

**Don't
Burn Out Tubes
Discharge Batteries
Incur Fire Hazard**



MAKE a neat job of wiring the batteries to your set by using this handy battery cord and get the tremendous advantage of fuse protection for your batteries and tubes. Fuses in the A and B battery circuits of the Belden Fused Radio Battery Cord prevent burned out tubes and damage to batteries due to short circuits.

Crossed wires can neither start fires, ruin batteries, nor burn out tubes if you use a Belden Fused Radio Battery Cord. Fuses are not interchangeable with each other or automobile fuses. You cannot get fuses of incorrect rating in the clips.

Every set needs the protection provided by the Belden Fused Radio Battery Cord. Don't risk operating your set without it. It is cheap insurance.

Fuses are enclosed in a neat bakelite two-piece cover.

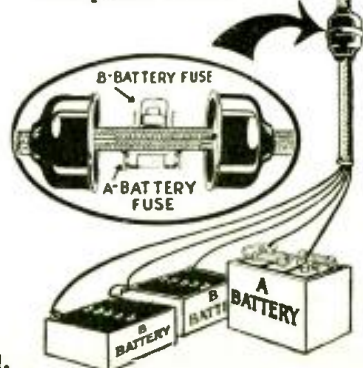

Ask your dealer to show you a Belden Fused Radio Battery Cord and explain the protection it provides. Get one today!

Belden Manufacturing Co.
2316A So. Western Ave., Chicago, Ill.



Bradleyohm-E

PERFECT VARIABLE RESISTOR

THIS oversize variable resistor is used as standard equipment for accurate plate voltage adjustment in B-eliminators made by the leading manufacturers of the country. The scientifically treated discs provide stepless, noiseless plate voltage control, and the setting will be maintained indefinitely.

Bradleyohm-E is made in several ranges and capacities to suit any radio circuit.

Send for Free Folder giving 7 B-eliminator hook-ups

Mail the coupon below for folder describing 7 hook-ups for B-eliminators using well-known kits and parts.

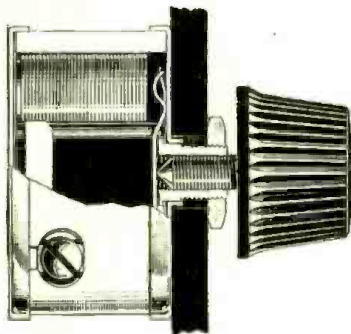

Ask your dealer to include Bradleyohm-E and Bradleyunit-A for variable and fixed resistance units when you build your B-eliminator.

Mail this coupon to

ALLEN-BRADLEY CO.
276 Greenfield Ave., Milwaukee, Wis.

Please send me your folder giving 7 B-eliminator hook-ups, and also data on all Allen-Bradley radio devices.

Name

Address



LISTENING IN

PRACTICAL pointers from experimenters and broadcast listeners. What helpful hints can YOU offer to your fellow fan? Readers are invited to address their letters to the Editor of this Department.

CONDUCTED BY DAVID LAY

How I Built My "Old Reliable" Four-tube Set

THIS receiver, as I have arranged it, has given me the utmost satisfaction insofar as clarity, distance and volume are concerned. Tuning is very sharp, in fact knifelike. The volume is tremendous and the distance obtained is all that can be expected.

A few evenings ago I tuned in on this set, San Diego, Calif., three stations in Texas, two in Kansas, one in Nebraska, one in Colorado, one in Louisiana, one in Mississippi, three in New York City, the St. Paul-Minneapolis station, one in Missouri, one in Tennessee, one in Alabama, one in Washington, D. C. and one in Atlantic City; and all of these were received on the loudspeaker! All musical notes were reproduced with life-like fidelity.

The circuit (see Figure 1) consists of a regenerative detector with a stage of radio-frequency amplification ahead of it and two stages of transformer-coupled audio after the detector.

The first tube is neutralized; in this way the tendency for this tube to oscillate is eliminated. The detector tube, as shown, has its filament connections wired for the standard UX-201-a type of tube. In order to use the new UX-200-a detector it will be necessary to

connect point "1" to point "3" instead of to point "2" as at present shown.

The parts that I used in constructing this receiver are:

- L1—General Radio 267D antenna coupler;
 - L2—Uncle Sam 3-circuit Tuner;
 - VC1 and VC2—Karas variable condensers, .0005 mfd.;
 - VC3—Variable baby .000045 condenser;
 - VT1, VT2, VT3 and VT4—Benjamin cushion type UX sockets;
 - C1—Sangamo fixed condenser, .0001 mfd.;
 - C2—Sangamo fixed condenser, .006 mfd.;
 - C3—Sangamo fixed condenser, .002 mfd.;
 - C4, C5 and C6—Tobe fixed condensers, 4 mfd.;
 - C7—Sangamo fixed condenser, .001 mfd.;
 - AFT1 and AFT2—General Radio audio transformers, old type (small), ratio 3 to 1 and 2 to 1, respectively;
 - AFC1—Thordarson output choke, 85 MH;
 - AFC2 and AFC3—Sampson audio-frequency chokes 3½ henries;
 - RFC1 and RFC2—Sampson radio-frequency chokes, 85 MH;
 - R1 and R2—Yaxley rheostats, 20 ohms;
 - R4—Amperite No. 1-A, with mounting;
 - R5—Amperite No. 112, with mounting;
 - GL—Lynch metallized 2-meg. grid-leak;
 - GC—Sangamo fixed condensers, .00025 mfd., with clips;
 - S—Yaxley filament switch and pilot light;
 - J—Small Yaxley Imp jacks, for cord tips;
 - Panel, 7 by 24 inches;
 - Sub-panel, 8 by 22 inches;
 - 2 Benjamin adjustable brackets;
 - 2 Marco vernier dials, large;
 - 3 Marco dials, rheostat size;
 - 1 Yaxley 4-point inductance switch;
- MARVIN C. WILLIAMS, Dept. of Mechanics Air Corps Technical School, Chanute Field, Ill.

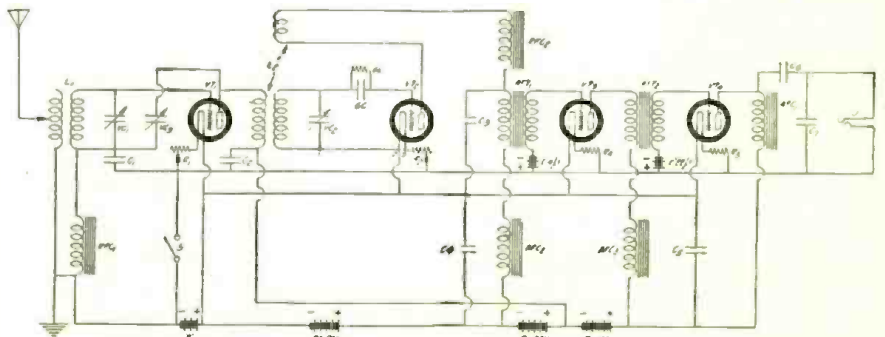

THE SCHEMATIC DIAGRAM OF THE RECEIVER

FIGURE 1: The circuit consists of one stage of high-frequency amplification, a regenerative detector and two stages of transformer-coupled, low-frequency amplification.

SHORT CIRCUITING WIRE

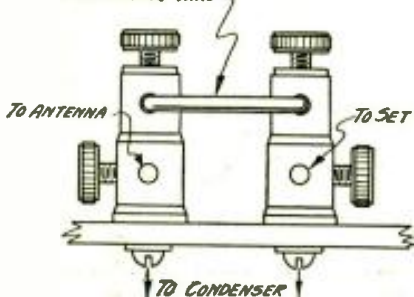

HOW TO GET LOW WAVES

FIGURE 2: You can tune down to lower wavelengths by inserting a variable condenser in the antenna circuit. A short-circuiting wire between the binding posts may be used to cut out the condenser when it is not desired by the fan.

Tuning Down to 200 Meters

If you are still operating the receiver that you purchased two or three years ago you may be missing the programs that are put on by stations that use wavelengths below three hundred meters. You can get in on these low wavelengths by inserting a 21-plate variable condenser in the antenna circuit.

I did this without involving any extra switches or troublesome movable parts.

As there was no room for the condenser inside the cabinet, I secured a piece of panel, size 4 by 5 inches, to a baseboard, size 4 by 4 inches, and mounted the condenser on the panel, leaving room for two double set-screw type binding posts underneath. I connected the two terminals of the condenser to the two binding posts, the aerial to the inside hole of one and the aerial post of the set to the inside hole of the other binding post. When you do not wish to use the condenser you may short-circuit it by placing a short piece of bus bar in the two outside holes.

—JOHN C. HEBERGER, Rochester, N. Y.

An Efficient Home-made Radio Lug

INSTEAD of soldering an ordinary lug to the end of a stranded wire I twisted the loose strands of the wire together and bent them to form a hook. To reinforce the stiffness of the hook which served as a lug, I put a drop of solder on it and put the hook in a flame which caused the solder to flow between the strands. While the solder was still soft I then flattened the hook, with pliers, to make a better contact surface.

This lug cost nothing and is no harder



A SIMPLE HOME-MADE LUG

FIGURE 3: A little solder is allowed to run through the strands of wire to make the lug more permanent

Audiophone Mfg. Corp. Henry Hyman & Co. C.M. Kramer Co.
 Acme Electric Mfg. Co. Harbison & Gathright King Elec. Mfg.
 All American Radio Co. Halloch & Watson Radio Kodel Radio Corp.
 American Apparatus Co. Holmes Jordan Radio Co. Kokomo Electric
 Aurad Company Inc. Lombardi Radio M
 Baklach Co., Co. Lane Mfg. Co.
 Brady Electric Lang Mfg. Co.
 Blood & Claus Langford Radio Co.
 Boston Radio Mf Martin, Glenn L.
 L. S. Brack Mfg Mayolian Radio
 Columbia Univer Macky Co.
 Consolidated Ba Modern Elec. Co.
 Cooper Corp. National Co. Inc
 Cunningham, Inc Peerless Radio Co.
 Chamberlain Ele Reichmann Co.
 Curtis Elec. Co Rollaway Motor Co.
 Davey Electric Rasla Elec. Co.
 Dynamic Radio O Superb Electric
 Dongan Electric Silver Marshall
 Electric Power C Storad Mfg. Co.
 Elec. Service Ex Sterling Mfg. Co.
 Englert Mfg. Co. Shore Elec. Mfg.
 Elec. Heat Contr Thordarson Elec.
 Electrical Resea U-Flex Mfg. Co.
 Edwards Battery Velvetone Radio
 Ferbend Electric Wedel Co.
 Fleming Bell Mfg. Co. Webster Co.
 Ford Radio & Mica Corp. Wagge Co.
 Gary's Battery Jewell Electric Inst. J. Andrew White
 Gossard Radio & Wire Co. Jordan Carisch Wright DeCoster
 General Radio Co. Jefferson Electric Mf Wolke Elec. Co.
 Golden Leutz Corp. C. E. Jacobs Zenith Radio Co.

from A to Z

almost UNANIMOUS!

An overwhelming majority of the country's leading manufacturers, technicians and engineers recommend and use CLAROSTAT wherever a variable resistance is specified. CLAROSTAT is time tested and tried—for ability to cover the entire range (from practically zero to 5,000,000 ohms)—for current carrying capacity (20 watts without packing, arcing or crackling noises) and for precision and dependability.

American Mechanical Labs., Inc., Brooklyn, N. Y.

CLAROSTAT

\$75 A WEEK BUILDING RADIO SETS
 In Your Spare Time

Join the Radio Association of America. Learn how to build and repair sets. The Association will train you—start you out in business, if you wish. Be the radio "doctor" of your community. \$3 an hour upwards easily made.

Earns \$500 in Spare Hours

"I have at last found myself," writes Lyle Follick, Lansing, Mich. "I have already made over \$500." Werner Eichler, Rochester, N. Y., writes: "—have made over \$50 a week in my spare time." Our members are starting radio stores, increasing their salaries, securing better positions, passing radio operator examinations, earning big money in spare time.

FREE Five-Tube Receiving Set If You Enroll Now.

New members receive one of the finest receiving sets made absolutely free. Coast-to-coast range. Most approved type. Unparalleled selectivity. To receive this wonderful set, you must act at once.

Join Association Now!

Are you interested in Radio for pleasure or profit? Join now because we have a special plan whereby your membership need not cost you a cent. Only limited number of these memberships acceptable. Write now for details—before it is too late.

----- Mail This Coupon -----

RADIO ASSOCIATION OF AMERICA,
 Dept. PR-4—4513 Ravenwood Ave., Chicago
 Send me details of your Special Radio Association Membership Plan.

Name.....
 Address.....
 City..... State.....

Beware of Lightning



One swift flash—and your set is gone. Safeguard your set and home as the National Board of Fire Underwriters say they must be protected.

WIRT LIGHTNING ARRESTER

Meets all requirements. It's the approved air-gap type, heavily insulated with Bakelite. A "petticoat" of Bakelite provides added protection in wet weather. The extra heavy terminals—far enough apart to prevent leakage—are designed for aerial connection without cutting wire. Metal parts are brass. Easily, quickly installed. Don't wait. \$1.25 at all dealers.

WIRT COMPANY

5243 Greene Street Philadelphia, Pa.



Don't let this happen to your set.

BRACH Storm King LIGHTNING ARRESTER



Over 2,000,000 Radios are Now Protected by Brach Arresters

Price Only **\$1**

Like all Brach Arresters the Storm King is backed by our

\$100 INSURANCE GUARANTY

Electrify your Radio with the Wonderful

BRACH

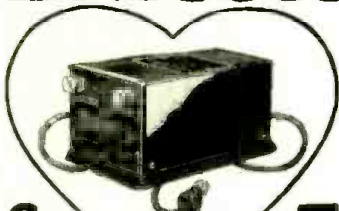

CONTROLIT
THE HEART OF THE POWER PLANT

Over 75,000 used within First Four Months

L.S. BRACH MFG. CO.

MEMBER **RMA**
NEWARK, N. J. TORONTO, CAN.

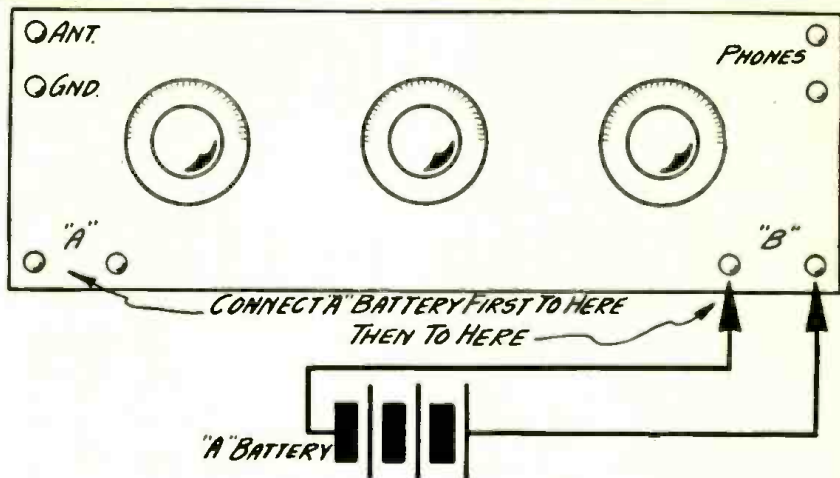

A SIMPLE BATTERY CONNECTION TEST

FIGURE 4: To make sure that the wiring in your set is correctly done, before you wire it up to the batteries, insert the tubes in their sockets and touch the tips of the "A" battery leads to the "A" terminals of the set. The tubes should light. Then touch the leads to the "B" terminals of the set. If the tubes light now, there is a short circuit.

to make than it is to solder a manufactured lug to a wire.

—FRANK HARAZIM, New York City

A Simple Battery Connection Test for Your Set

ONE of the most aggravating things that a listener can do to his receiving set is to burn out the tubes by accidentally connecting the "B" battery across the filament. This danger can be overcome by utilizing the simple test shown in Figure 4.

When the set is ready to hook-up to the batteries, put the tubes in their sockets and connect the "A" battery (the filament battery) to the "A" battery binding posts. If the connections are all correctly made, the tubes will light. Then, disconnect the "A" battery from the "A" battery binding posts and connect it to the "B" battery binding posts on the set.

Now, the tubes should not light. If they do light, it shows that they would have been burned out if the set had been connected up in the regular manner without a preliminary test, and that a wrong connection must be corrected.

—CHARLES F. FELSTEAD (6CU), Los Angeles, Cal.

How I Get Clearer Reception

I HAVE found that a one-microfarad condenser, connected across the "B" battery, as shown at C1 in Figure 5, often makes a considerable improvement in the strength and quality of the music received on a set. The reason for this is the fact that the condenser bypasses the radio-frequency current so that it does not have to pass through the "B" battery. If the "B" battery is rather old, its voltage is likely to fluctuate because of the uneven chemical action within the cells; this will cause frying and crackling noises in the set.

It is an advantage sometimes to connect an additional condenser of about .1 mfd., C2, across the portion of the "B" battery that is used for the detector.

—CHARLES F. FELSTEAD (6CU), Los Angeles, Cal.

How I Made My Own Grid-Leak

I HAVE found that I can make a grid-leak by taking a small strip of cardboard that has been dipped in India ink and then clamping each end, through the

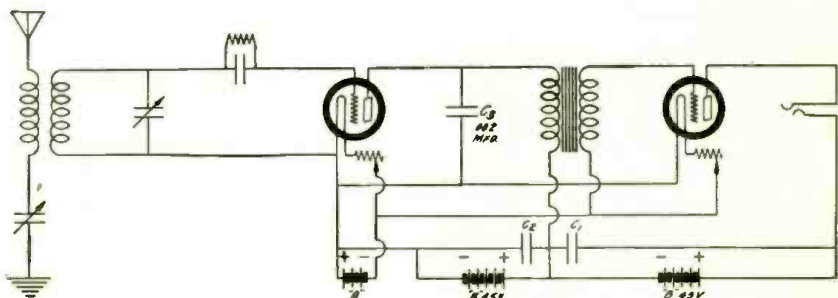

HOW RECEPTION MAY BE IMPROVED

FIGURE 5: A one-microfarad condenser connected across the "B" battery, as shown at C1, may considerably improve the quality and strength of reception. A .1-microfarad condenser connected across the detector part of the "B" battery sometimes also improves reception.

Every Radio Problem Answered In "Everyman's Guide To Radio"

**CONTAINS THE
WORLD'S KNOWLEDGE OF
RADIO**

Contributed to by the world's leading radio scientists; without question, the most comprehensive, most interesting and absorbing, and the most complete radio book yet published in any country. It is impossible to give compari-

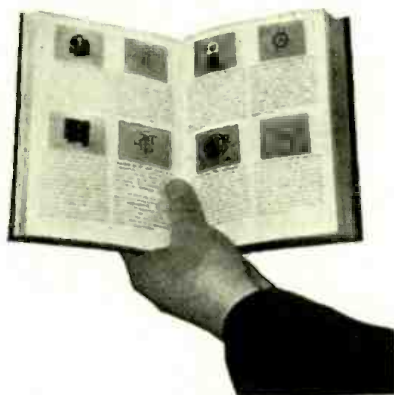

675 Illustrations!
"Everyman's Guide to Radio" contains
675 beautifully engraved illustrations in
640 pages of text.

**640 PAGES OF
INSTRUCTIVE READING**

Size 5 1/4"x7 1/2", containing more than 675 finely engraved illustrations and prepared by some of the greatest physicists and engineers of radio. "Everyman's Guide to Radio" stands as the first successful effort to meet the needs of all those who aspire to attainments in the science, whether they are "broadcasters," skilled service men or students. This vast wealth of information represents studied compilation that has extended over two whole years and includes every phase of radio communication.

**QUICK ANSWER TO
EVERY RADIO PROBLEM**

Intelligent use of "Everyman's Guide to Radio" gives quick, understandable answers to practically every radio problem. Special emphasis has been laid on the illustrations contained in the "Guide." Hundreds of specially prepared drawings and photographs answer most radio problems at a mere glance. No effort or expense has been spared to make the "Guide" of maximum value to radio listeners. It is the fascinating story of radio in pictures.

sons because comparisons do not exist. One must read Marconi on the subject of "beamed transmission"; the late Charles Steinmetz on "Waves"; Sir Oliver Lodge on "Coils," or Ambrose Fleming on "Vacuum Tubes," before the significance of these writings of the masters of the art can be fully appreciated.

**PHOTOGRAPHS
AND SPECIFICATIONS**

This information is invaluable to the radio constructor and set builder. It permits him to choose his parts intelligently and with a full knowledge of the particular use for which they are made. Never before has any organization taken upon itself the responsibility of bringing together within one volume the complete details of radio apparatus.

**A BOOK YOU WILL
BE PROUD TO OWN**

It may be said without reserve, that "Everyman's Guide to Radio" is the most artistic and practical book ever published in the radio field. The volume contains 640 pages printed on heavy calendered paper in legible type, making for the comfort and convenience of the reader. The covers are beautifully embossed and bound in Art Fabrikoid, better than leather, flexible, making the book conveniently portable.

CONDENSED TABLE OF CONTENTS

4 Volumes in 1

- Volume 1.*
The First Principles of Radio
The Electricity of Radio
The Easy Principles of Diagram Reading
How Waves Are Generated
Mechanics Tuning
Detection and the Secret of Vacuum Tubes
- Volume 2.*
Audio Frequency Amplification
Radio Frequency Amplification
Variable Condensers
Coils—How to Use Them
Improvement of Broadcast Reception
- Volume 3.*
How to Make Radio Improvements
Learning the Length of Dots and Dashes
Batteries and Battery Chargers
Different Types of Radio Receivers
- Volume 4.*
Accessories and Radio
Wonders of Radio Transmission

POPULAR RADIO, 627 West 43rd Street, NEW YORK

**EXAMINE THE VOLUME
WITHOUT OBLIGATION TO BUY**

So sure are the publishers of "Everyman's Guide to Radio" that these four volumes-in-one are just what everyone needs to complete his reference library and so sure are they that they are the most practical, complete and beautiful set of radio books yet published that they are willing to mail them to those interested for examination without obligation to buy. Just fill out the attached coupon and mail. The book will be mailed immediately. Upon arrival, you pay the postman \$4.00 plus postage. Examine the book for 5 days. If, after that time, you are not convinced of the value to you return in good condition and your money will be refunded at once and in full, without question.

\$ 4⁰⁰

POPULAR RADIO, Inc.,
627 West 43rd Street,
New York, N. Y.
Gentlemen:

Send me "Everyman's Guide to Radio." in one volume. I agree to pay the postman \$4.00, plus postage. If, after carefully examining the book for a period of five days, I do not like it, I will have the privilege of returning it to you and my money, in full, will be immediately returned.

Name.....

Address.....

City.....

State.....

(5)

Deal with New York's Largest Radio Store

LC-27 \$85.20

HAMMARLUND-ROBERTS \$85.00

SILVER SHIELDED SIX \$95.00

IMPROVED BROWNING-DRAKE \$65.00

SARGENT INFRADYNE \$113.10

SENIOR POWER PACK \$65.20

INTERMEDIATE POWER PACK \$47.50

JUNIOR POWER PACK \$38.90

UNIVALVE RECEIVER \$39.95

HENRY-LYFORD and other popular circuits

Write for Dealers' Prices

City Radio Stores

110 West 42nd Street New York
Downtown Store :: 79 Cortlandt Street

"World's Finest 3-Ft. Cone or Roll-Type" Loud-Speaker

"ENSCO" KIT ONLY \$10

Assemble in Less Than an Hour

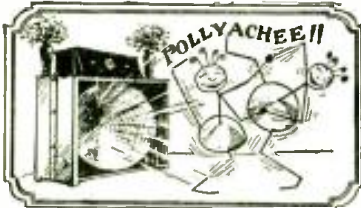

Complete parts furnished in kit form. We guarantee this speaker the equal of any manufactured cone speaker considering price.

With this **THREE FOOT CONE SPEAKER** you hear all the tones. It brings out the true depth and beauty of orchestral and instrumental music. Can be operated softly for living room music or full volume for dancing, and without trace of distortion.

Kit includes famous "ENSCO" cone unit, the only direct drive, distortionless unit for large cones; Alhambra Fonotex for big cone, with brass apex, two Blue Prints showing cabinet, stand, or roll-type construction. All necessary instructions for assembling.

Buy this wonderful speaker under our absolute guarantee. *Your money back* if you are not convinced that it is the finest reproducing medium. It works on any set, with ordinary Tubes or with Power Output.

ORDER COUPON—SEND NO MONEY

Write your name plainly as indicated below; then mail and complete kit will be forwarded to you. Just pay postman \$10.00 upon delivery.

Name.....

Address.....

ENGINEERS' SERVICE CO.
25 CHURCH ST. Desk Z NEW YORK CITY

India ink, with two small-sized nuts and bolts. By cutting the cardboard thinner and thinner I can get just the right thickness to give the proper resistance.

This simple resistance often comes in handy when I am experimenting with a new receiver.

—JOHN WESLEY, Morristown, N. J.

* * *

How to Get Into Tight Corners When Soldering Connections

I HAD nearly finished my new set when I found that I had just one more wire to solder. And my soldering iron was of such a size that it was impossible for me to get at the joint to apply the heat.

By taking an extra length of bus bar and wrapping it tightly around the point of the iron, I added a length sufficient to reach into the parts to be soldered. This extra piece, about an inch long, made it easy to get at the work.

Not only did this small piece of metal carry enough heat for the soldering but, as it had already been tinned, the soldering was simplified. The larger the wire that is used, the more heat it will carry and the better will be the work of soldering.

In doing soldering, it is better and neater to place under the joint a piece of heavy paper. This will pick up all of the odd pieces of solder falling down into the apparatus and may readily be removed without leaving any more debris.

—ARTHUR NUVOL, Lakewood, O.

* * *

How to Connect the Loud-speaker Properly

It is very important to have your loud-speaker connected properly to your set, for if the current flows through it in the wrong direction, the permanent magnet will be gradually demagnetized. To check this point, turn up the tubes to normal brilliancy, tune in a station, and move the adjusting knob or lever on the speaker until the speaker rattles slightly. Then reverse the cord tips. If the rattling increases, or if the music stops or becomes faint, it indicates that the current is now flowing through in the right direction, pulling the diaphragm closer to the poles of the magnet. The cord tips should be left connected this way, and the adjustment changed until the speaker is working properly. If however, when you reversed the cord tips, the slight rattle clears up more or less, this indicates the wrong connection, as the current is now opposing the permanent magnet, and pushing the diaphragm farther away from the magnets. The cord tips should be connected again as at first.

This method cannot, of course, be used on speakers not provided with an adjustment. Also, a few do not need to be connected in any special way.

—HOMER E. HOGUE, Venice, Cal.



Getting FULL Tube Value

PERFORMANCE and life is what you pay for in a tube. Amperite alone insures getting both. Controls filament current automatically. Simplifies wiring. Eliminates hand rheostats. Identify by the name. Accept nothing else.

FREE—The Radiall Book. Gives season's most popular Hook-Ups, and invaluable Construction Data. Send for it today to Dept. PR-4.

Radiall Co., 50 Franklin St., New York



Price \$1.10 Each mounted (U.S.A.)

Sold Everywhere

AMPERITE

REG. U.S. PAT. OFF.

The "SELF-ADJUSTING" Rheostat



Radio Convenience Outlets

Spring is the time to install Radio Convenience Outlets.

They enable you to get greater joy from your radio by eliminating all unsightly wires from the room. The Radio Convenience Outlet shown above is for battery connections—batteries can be placed in basement, closet, nearby bookcase or any out-of-the-way place, and wires led to radio set in a neat, attractive way.

Take your loud speaker to the porch this Summer by using the No. 135 Radio Convenience Outlet. You can also have radio reception in as many rooms as you wish without removing the set from original location.

No. 137—For Battery Connections \$2.50
No. 135—For Loud Speaker 1.00
No. 136—For Aerial and Ground 1.00

You'll like the Yaxley 444 Automatic Power Control for switching your B eliminator and trickle charger from your set. It sells for \$5.00.

At your dealer's. If he cannot supply you, send his name with your order to

Yaxley Mfg. Co.
Dept. P. 9 So. Clinton St.
Chicago, Ill.

YAXLEY

AMPHOTOGRAPHIC PRODUCTS

F. D. Pitts Company

INCORPORATED

219A Columbus Ave.
Boston, Mass., U. S. A.

Merchandising Radio Since 1919

DEALERS—send for large and profusely illustrated catalog on the products of scores of nationally advertised radio manufacturers.

Wholesale Exclusively

*"Pioneers in the
Distribution of Radio"*

Approved

By

Popular Radio

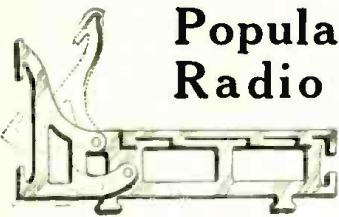

The "BRUNO" Adjustable Bracket

(45 to 90 degrees)

Such approval is awarded only to those products that stand up under the searching tests of POPULAR RADIO'S Electrical Testing Laboratories.

Adjustable brackets, \$1.25 a pair
Non Adjustable, 1.00 a pair

By mail or from your dealer

Booklet of instructions, circuits and blueprints, 25 cents by mail

BRUNO RADIO CORPORATION
40 Paynter Ave., Long Island City, New York

How to Build the New Standard Browning-Drake Receiver

(Continued from page 335)

denser, but the pitch should not vary when a proper neutralization has been accomplished.

How to Tune the Receiver

First, rotate the tickler which is controlled by the small knob to the right of dial Y2, to maximum position.

Next set the second dial, Y2, until a whistle is heard. This is the carrier wave of the transmitting station beating with the oscillations the set is producing and will be heard if a station is transmitting.

Turn back the rotor coil so that the whistle disappears and, at the same time, turn the left-hand dial, Y1 (the first condenser), until the signals are loudest. Readjust the two tuning condensers, Y1 and Y2, and the tickler coil until satisfactory volume is obtained. It will be found that the rheostat, V, makes an excellent volume control for tuning it down, regulating the signals received, without detuning the set.

The receiver is very selective—much more so than any Browning-Drake previously described; it is, therefore, necessary to tune the circuits to exact resonance in order to obtain the best quality.

Always regulate the volume by the rheostat, V, and the tickler coil—never by setting the dials Y1 and Y2 off resonance.

In case the builder is located in a nest of local broadcast stations, a metal panel and metal cabinet will stop any pick-up from the local stations on the coils and wires of the set so that outside stations should be easily tuned in while locals are operating. Ordinarily, this is not necessary.

Do not expect to get reception of distant stations up to 2,000 or 3,000 miles with the receiver every night—static and other interference will not permit it on any set, regardless of design. However, the receiver described, if carefully built and operated, will perform exceptionally well.

Many experimenters ask what type of antenna to use. The answer, as the authors see it, is to use a vertical antenna—that is, one as high as possible of from 50 to 70 feet in length. It will be found that the receiver performs well on a much shorter one, such as 10 to 20 feet of wire in the same room with the receiver. It should, however, be placed as high above the set as possible. Good insulation on the antenna system is important.

The ground connection should be made to a water pipe by means of a ground clamp. Radiators are sometimes suitable, especially if the heating system is hot water.

Rejuvenate your set with

FERRANTI

Make your set meet the 1927 demands of quality reception! Make it reproduce all the notes, bass and treble alike, with real volume, by installing Ferranti Transformers.

No matter how good your set may be now, Ferranti Transformers will make it better. They will give it new tone quality—the best you can have in radio—and improved volume. Because every note and tone will be faithfully rendered your set will please even the most captious of critics.

If you're already engaged in building a receiver, make sure that your transformers are by Ferranti. At slight added expense they will give it the best in tone and volume—and those are the two qualities most prized today!

— HIGHSPOTS —

High amplification ratio with flat curve. Ferranti brings out the fundamental frequency of low tones—none are heard merely by inference from higher harmonics.

Every transformer tested ten times—all short circuited turns eliminated.

Tested to 1,000 volts between primary and secondary and between primary and secondary and ground. Therefore, specially suited for use with power tubes requiring high plate voltages.

Primary shunted with built-in condensers of correct capacity.

Built by an established manufacturing company with forty years' experience in the winding of coils of fine wire for electrical instruments and meters.

For the best results—two Ferranti Audio Frequency Transformers, type A. F. 3—ratio 3½ to 1—\$12.00 each.

FERRANTI, Inc.

130 West 42nd Street, New York, N.Y.
Ferranti, Ltd., Ferranti Electric, Ltd.,
Hollinwood, 26 Noble Street, Toronto,
England. Canada.



Chosen by EXPERTS

GLENN H. BROWNING, Laurence M. Cockaday, Gerald M. Best and many other eminent radio designers use the Lynch Metallized Resistor in their experimental circuits and receivers. These men know radio; they have laboratory and testing equipment with which quickly to make accurate comparisons. There could be no better proof of the true merit of the Lynch Metallized Resistor than the endorsement of these experts.

Comprising a concentrated metallized deposit one-thousandth of an inch thick upon a rigid core, sealed forever within a glass tube, the Lynch Metallized Resistor gives conductive, non-arcing resistance that remains silent, accurate!

Dealers—Write us!

ARTHUR H. LYNCH, Inc.
Fisk Bldg., Broadway & 57th Street
New York, N.Y.

MEMBER RMA

Precision in Manufacture

The utmost care, the best of materials, the most skilled craftsmen make each Lynch Metallized Resistor the precision-built, yet rugged little instrument that it is.

Frequent rigid inspections, and sufficient aging before final test make possible our guarantee—**Absolutely Noiseless Permanently Accurate Dependable!**

Our warranted accuracy is 10% but through precision in manufacture, Lynch Metallized Resistors average within 5% in actual production.

Arthur H. Lynch

Because the fixed resistor is small in size, do not underestimate its vital importance.

FIXED RESISTOR
Arthur H. Lynch
NEW YORK, N.Y.
IMEG

PRICES:—

.25 to 10 Megohms	.50		
above .01 to .24 "	.75	Single Mounting	.35
.001 to .01 "	\$1.00	Double "	.50

Lynch Metallized Resistors cost no more than the ordinary kind. If your dealer cannot supply you it will be well worth your while to wait for the mail—we ship post-paid, at once.

LYNCH METALLIZED FIXED RESISTORS

Practical Hints for Starting Your Radio Laboratory

(Continued from page 355)

tubes, we find that the "B" battery flow is reduced to 4.9 milliamperes, while the flow is 6.3 milliamperes when we use the 3-volt tap on the "C" battery. This shows that with the full 4½-volt "C" battery bias our "B" battery will last something like 70 per cent longer. If our meter has no fractional-volt post connection (usually used for reading amperes, in connection with external shunts) it is quite possible that we can save the cost of a milliammeter by sending our 30-volt (or any similar value) meter to the manufacturer to have a binding post added, connecting directly to the rotor coil in the meter.

If this turns out to be impractical, it is still possible to use our 30-volt meter in circuit with our "B" battery and get an accurate enough milliamperage value, for our purpose, because the direct-current resistance of a tube is so much higher (something about 20,000 ohms) than the resistance of the 30-volt circuit of our meter, that the error is not prohibitive. Subtracting 20 percent from the reading when using the 30-volt scale of the meter, will just about compensate for the error, for all practical purposes.

EXPERIMENT No. 5: Checking the Energy Taken from an Antenna.

We have read somewhere that the energy taken from an antenna, fairly near a broadcasting station, is of the order of .0001 amperes, or 100 microamperes, so we decide to see what we can do toward checking this on our set, as our antenna is just one-third of a mile from a station using 1000 watts. Knowing that our 30-volt meter has about the same resistance as our cheaper headphones, and that the coil in the meter is wound with fine wire somewhat on the same principle as the coils in the telephones, we decide that if the meter is substituted for the telephones in our crystal set, we will get a good approximate idea of the energy delivered to our phones from the antenna, through the vario-coupler and crystal.

Having heard as far as Pittsburgh (from Chicago) on good nights in winter, with our crystal set, we feel confident that it will show up well. Making our connections of the meter to the phone binding posts, with the "positive" post of the meter to the crystal side of the detector, we find that the 30-volt scale reads a shade under 1 volt. It is not possible to read the number of tenths of a volt accurately, as the scale has scale lines only for volts and half volts, but it looks like nine tenths of a volt, so we multiply that into the figure of .6 milliamperage and get $.9 \times .0006 = .00054$ ampere, which is about half a milliamperage, or 540 microamperes.

demand AEROVOX

FILTER CONDENSER BLOCKS

For Working Voltages of 200, 300, 400, 600 and 1000 Volts D. C.

Flexible leads for connections eliminate all possibilities of leakage from soldering.

AEROVOX WIRELESS CORPORATION
6572 Washington Street
Brooklyn, N.Y.

WORLD Radio Units Save You 50%

"A" Current From Your Light Socket



World "A" POWER UNIT

Automatically provides even, unvarying "A" current from the moment you throw on your set switch. Finer reception, uninterrupted by "fade-outs" and "screches." Absolutely noiseless. Assures full tone quality from your set and wider D X range. A marvelous improvement—at less than half the cost of any similar equipment. Shipped complete, subject to inspection, on receipt of price—or C. O. D. if you wish.

25 Amp. Unit for sets of 4 tubes or less—\$12.75
60 Amp. Unit for sets of 5 tubes or more—\$15.75
5% discount if cash in full is sent with order.

\$12.75 Complete



Clearest Truest "B" Power with World Radio Storage

"B" Batteries 12 Cell 24 Volt

Sturdy construction. **SOLID RUBBER CASE** protection. Recharged for almost nothing. Endorsed and listed as standard by Radio News Lab., Pop. Radio Lab., Pop. Sci. Inst. Standards, Lefax, Inc. and other famous institutions. Just state minimum wanted, and we will ship same day order is received by express, C. O. D., subject to examination. 5% discount for cash with order.

Extra Offer: 4 Batteries in series (96 volts) \$10.50.

WORLD BATTERY COMPANY
1219 S. Wabash Ave., Dept. 77, Chicago, Ill.
Set your radio dial at 288.3 meters for the World Storage Battery Station W S B C.
Variety—New Talent—Always Interesting.

How to use Resistance in Radio!



Send
for this new booklet!

Ward Leonard Electric Company announces a booklet of interest to radio dealers, experimenters, and engineers.

Resistance assumes major importance in radio as higher voltages and currents are employed in power supply units.

"How to Use Resistance in Radio" tells the proper use of resistance and outlines many of the new A.C. and D.C. power circuits. It will be sent postpaid for 15c.

Ward Leonard Electric Company
Mount Vernon New York

Resistor Specialists for More Than 35 Years
7135-3

FREE

NEW 1927 Radio Catalog

BEFORE you build or buy a radio be sure to consult our new 100 page catalog — sent to you free. All the latest kits, accessories and parts — a million dollar radio stock to choose from.

WE SAVE YOU MONEY

We handle only brand new apparatus — standard makes that are fully guaranteed. QUANTITY sale of QUALITY parts explains our low prices. Compare with others and see why thousands of fans look to us as radio headquarters. Write for your copy of this new catalog today.

Chicago Salvage Stock Store

Dept. PR, 509 S. State Street, Chicago, U. S. A.

Measuring with other stations tuned in fairly broadly, we get the following energy readings:

Station Rating in Watts	Distance in Miles	Energy in Micro-amperes
3500	1¼	600
1000	½	450
1500	4	60
500	2	30
3500	15	30

Having found that our new crystal set, with a vario-coupler, with both the antenna and the detector circuits tuned to resonance gives much better volume and sensitivity than our old crystal set with a variometer connected directly to antenna and ground and to the detector, we measure the energy on the old set with the same stations tuned in, and find that the two nearest stations register only about half as compared with the new set, and that the deflections on the other stations are too small to read.

There are many, many measurements that we can make, along these lines. It becomes obvious that readings of fractional ampere flow of current will be subject to appreciable error if we have only a scale of 5 to 50 volts. Also, we can not read differences with our eye, on the scale, when testing resistance, where the scale difference between V and γ is less than 1 volt, but we can readily seal the moving arm of a high-resistance potentiometer with the included resistance about 20 to 30 times the known resistance of the meter coil, and then use the total of these two resistances as our R figure; and this enables us to make fairly accurate tests of unknown resistances up through still another range of higher values of resistance, by using more battery voltage in the higher test range.

"Buzzing" with Bussey in Brazil

(Continued from page 367)

After describing our sets and exchanging some personal conversation, Bussey complained of lack of sleep, so we made arrangements to get in touch again on the following night at midnight and then signed off.

At the time of this communication the G. M. Dyott Expedition was encamped at Palmital, so named because of the lone palm which stands there; it was to this palm that his antenna was fastened.

Bussey deserves considerable credit for his excellent work—all the more so because the results he obtained were obtained under severe handicap and with limited facilities. His operating was certainly of the best and his form excellent; without these, it would have been impossible to have copied his signals through the interference and atmospheric noises which are so often present on the lower wavelengths.



Made of "ALCOA ALUMINUM"

MEETING the highest radio standards—shipped to you in the most convenient knocked-down form for easy assembly. These Box Shields are made of heavy Aluminum (.080"-No. 12 B. & S.) and are supplied 5"x9"x6", which will cover most requirements. If the size does not meet your exact needs, change it—Aluminum is easy to work.

Manufacturers can obtain these shields made to their exact specifications or they can secure the necessary corner-post moulding and sheet to manufacture under their own supervision.

Those who use Aluminum have ample proof of its advantages. Insist on "Alcoa Aluminum," ask your dealer or write us.

"ALCOA ALUMINUM" Box Shields

Consist of: Top, Bottom, Sides
4 Extruded Corner Posts
8 Aluminum Screws



"ALCOA ALUMINUM" is furnished to manufacturers in the following forms:

Sheet: for shields, chassis, variable condensers, cabinets.
Panels finished in walnut and mahogany.
Die and Sand Castings.
Screw Machine Products.
Foil for fixed condensers.
High Purity Rods for rectifiers.
Stamping, rod, wire, rivets.

ALUMINUM IN EVERY
COMMERCIAL FORM

ALUMINUM COMPANY of AMERICA
2321 Oliver Bldg., Pittsburgh, Pa.



What Built the Reputation of

Mayolian

B SUPPLY

?

The "B" Without a Buzz



Type 612
Delivers 40 Mils at 180 volts
All voltages are adjustable
Complete with Raytheon Tube \$42.50

PIONEERING in battery elimination, Mayolian was probably the first manufacturer to adopt the now far-famed Raytheon tube as the heart of its B Supply Units, and to earn the approval of Raytheon. From that day to this, each Mayolian has been rigidly held to the standards of the Raytheon and Mayolian laboratories. Years of exhaustive research, extreme precision in manufacture, skilled supervision—all these have contributed to the pre-eminent position of Mayolian.

Today, no matter what make or type of receiver you have, there is a Mayolian to give it a continuous, uniform, noiseless "B" supply—direct from the nearest light socket, at half the cost of burning a 25-watt lamp.

The Heavy Duty Types of Mayolian employ the new Raytheon B H tube

The nearest dealer will gladly demonstrate in your own home.

Write us.

MAYOLIAN
RADIO CORPORATION
1668 Webster Ave., New York, N.Y.

Pioneers in Battery Elimination



*The Power of Niagara—
The Quiet of an Arctic Night*

Your Laboratory Tools

(Continued from page 357)

tool is well equipped for oiling, trouble will eventually result from worn parts.

In Figure 3 is shown the countershaft which is manufactured especially for this lathe. When the countershaft is mentioned, the experimenter immediately brings up the question, "Why is it not possible to belt the lathe directly to the driving motor?" First off, the question of variable speed is involved—different jobs on the lathe require different spindle speeds and this cannot be accomplished without cone pulleys. Putting a resistance in series with a motor might come as another suggestion. This would be impractical because it would reduce the power delivered to the work on the lathe. When a resistance is introduced into the circuit with an electric motor, the ratio of the power to the speed drops instantly.

In Figure 2 there is shown a suggested arrangement of the motor, the countershaft, the bench and lathe. This is the ideal arrangement.

Due to local difficulties, this arrangement was not followed out in the installation of the lathe photographed. The countershaft was placed on the bench back of the lathe with the motor inverted under the bench. Of course, a hole had to be cut through the bench to accommodate the driving belt. Due to the particular construction of this countershaft, the high speed or large pulley cannot be used with this arrangement because the shifting fork on the power belt will not permit it.

The countershaft under discussion is provided with a total of five pulleys; three of these are cast in one piece to form the cone while the other two are independent. One is an idler pulley upon which the belt of the motor runs while the lathe is stopped.

By the pedal arrangement shown in Figure 2, the lathe operator may push the driving belt A (Figure 3) over to the power pulley of the countershaft F. This countershaft is provided with small cone bearings the wear of which may be taken up by adjusting the screw D in Figure 3.

A word about the belt shifting arrangement. A piece of one-inch wood stock about eighteen inches long is provided with a hinge and fastened to the floor, as shown in Figure 2. This is connected to the countershaft belt shift by a piece of picture wire.

Remember that the large pulley on the shaft must be opposite the small pulley on the lathe. Otherwise variable speed would be impossible because the ratio of the diameter of one of the pulleys to the one opposite would always be the same.

In the next article the writer will analyze the parts of the lathe more carefully and show the experimenter how he may proceed with small turning jobs.

YOUR RADIO PROBLEMS SOLVED

POPULAR RADIO maintains for the benefit of its readers a Technical Service Bureau and Laboratory, which will, without charge, answer by personal letter any question or problem submitted by a subscriber. This service is, however, also available to readers other than subscribers, at the very nominal rate of \$1.00 the inquiry.

In writing please confine your questions to one general subject, writing on one side of the paper only, and enclose a self-addressed and stamped envelope.

It is possible that your individual problem has been covered in an issue of POPULAR RADIO, and so as an aid to you we endeavor to keep a supply of back numbers in stock. The condensed index below gives a few of the subjects that have appeared recently; look this list over and if the information you want is covered, we will be pleased to supply back numbers at 35c. a copy.

May, 1926

- How to Draw Up Your Own "Tuning Graphs."
- How to Build the Improved Raytheon Power-pack.
- How to Build an Antenna Mast for \$15.00.
- Fifteen Ways to Reduce Static.
- Do Your Coils Broadcast?

June, 1926

- How to Build the New Home Receiver.
- How to Put Up a Good Outdoor Antenna.
- How to Get the Most Out of Your Ready-made Receiver.
- Audio-frequency Amplification. How to Get it Without Distortion.
- Four New Combinations of Units for Assembling the Raytheon Power-pack.

July, 1926

- How to Get the Best Reception in Summer.
- The Best Crystal Set for \$13.00.
- How to Build the Newest Portable "Town and Country" Receiver.
- Four New Combinations of Units for Assembling the Raytheon Power-pack.
- How to Get the Most Out of Your S-C Receiver.

August, 1926

- A New Method of Using Harmonics for Determining Frequencies.
- POPULAR RADIO Circuits.
- How to Build the Improved Browning-Drake Receiver.
- How to Pick Out a Loudspeaker.
- How to Get the Most Out of Your "Town and Country" Receiver.
- Three Vacuum Tubes in One.

September, 1926

- Foretelling Radio Reception from the Weather Map.
- How to Build an Impedance-coupled Amplifier.
- A Radiant Crystal Pilot.
- POPULAR RADIO Circuits.
- How to Simplify Your Set with Automatic Filament Controls.
- Inside Information on New Radio Receivers.
- How to Wire Your House for Radio.

October, 1926

- How to Build the New LC-27 Receiver.
- The Radio Road Hog.
- POPULAR RADIO Circuits.
- Sets That Earn Incomes.
- Inside Information on New Radio Receivers.
- Why Signals Fade.

November, 1926

- How to Build the LC-Senior Power-pack.
- Waves and Wavelengths.
- POPULAR RADIO Circuits.
- How to Select Your Radio Parts.
- How to Patent Your Radio Inventions.
- How to Solder.

December, 1926

- Uncle Sam's New Short-Wave Net.
- How Circuit Resistance Affects Selectivity.
- POPULAR RADIO Circuits.
- How to Build the LC-Intermediate Power-pack.
- Inside Information on New Radio Receivers.

January, 1927

- How to Build the New KH-27 Receiver.
- To Start and Stop Your Set Automatically.
- POPULAR RADIO Circuits.
- The Quack Doctors of Radio.
- How to Build the LC-Junior Power-pack.

February, 1927

- The Coming of the "RADIO UNIVERSITY."
- How to Get Quality Amplification.
- How to Build and Use a Portable Test-Board.
- How to Assemble the All-Amx Senior Three-tube Reflex Receiver.
- What's New in Radio.

March, 1927

- How to Build the Univalve Receiver.
- POPULAR RADIO Circuits.
- How to Increase the Range of Ammeters and Voltmeters.
- How to Build Your Own 36-Inch Cone Loudspeaker.
- What's New in Radio.

POPULAR RADIO

Dept. 48

627 W. 43d St., New York

Resistance-coupled Amplifiers

(Continued from page 340)

3. Shunt a similar winding across the ordinary grid resistance; this is usually done in the last stage.

In rare cases it may be necessary to place choke coils in one or more "B" plus (+) leads. Experiment alone will determine this. The diagram shown in Figure 5 gives some suggestions for trials.

In other rare cases, particularly with six-tube and super-heterodyne receivers, the use of partial "B" battery operation gives best results. Figure 6 shows this method with a complete wiring diagram.

Of course, as has been shown many times before, it is always preferable to completely eliminate the "B" voltage from the loudspeaker. The method shown in Figure 7 is a most excellent one, which at the same time produces better quality, eliminates demagnetization of the unit and prevents burnt windings. This method embraces the use of a high inductance choke and a large fixed condenser in the loudspeaker circuit.

Simply changing the resistors, as shown, will, in ninety-nine cases out of a hundred, give perfect results with "B" power-packs.

* *

The Curse of Fame

I have been written about so often. It is becoming monotonous.

There was the news item stating that radio owners were the most contented home lovers on earth.

I was one of the radio owners.

There was the feature story referring to the great number of listeners to a certain radio program.

I was one of the listeners.

There was the statistical review giving the number of radio fans (estimated) in the United States.

I was one of the fans.

One radio magazine announced that it had more subscribers than any other publication.

I was one of the subscribers.

There was the article announcing that a certain midwestern broadcasting station put on a program that was heard by millions and millions.

I was one of the millions and millions.

I have been written about so often. It is becoming monotonous.

—FRANK ROMANO

* *

In a German Laundry the operators have jazz programs by wireless while they work. Perhaps this is to help them in putting the syncopated edge on the collars.

—WIRELESS MAGAZINE

Vee Dee

Metal Panel and Sub-Panel

FOR THE

S. C. II Receiver

(SILVER COCKADAY)

Price of complete unit— including all necessary screws, nuts, bolts and bushings, individually packed in convenient container \$5.00

If Your Dealer cannot supply you, order direct



Approved and adopted for the S. C. II Receiver

VEE DEE METAL PANELS for Nationally Famed Kits—Drilled and Decorated

L. M. Cockaday L.C. 27, \$3.70
Browning-Drake Improved, \$3.05
Hammerlund-Roberts Hi-Q, \$2.70
Karas Equamatic, \$3.50
Infradyne-Rentler Type, \$3.75
Bremer-Tilly Power Six, \$3.05
Citizens Super, \$3.25

Ask Your Dealer or order direct

Approved and Adopted

by the engineers who designed the popular and efficient S. C. II Receiver. The panel is accurately drilled, beautifully finished and artistically decorated. The sub-panel is designed for easy mounting and wiring—is rigid in construction and precisely in position for all outlets and inputs.

Stock Panels

We carry stock metal panels in all standard sizes, beautifully finished and decorated. Easy to drill. Prices, \$2.15 to \$3.55.

For Sets and Kits

Vee Dee Metal Panels, Sub-panels and Shielding are being adopted as standard equipment by America's foremost set and kit manufacturers.

We invite correspondence from manufacturers who want special designs worked out. Write for details.

The Van Doorn Company

160 North La Salle Street Chicago, Illinois

Factory, Quincy, Illinois

NATIONAL TUNING UNITS

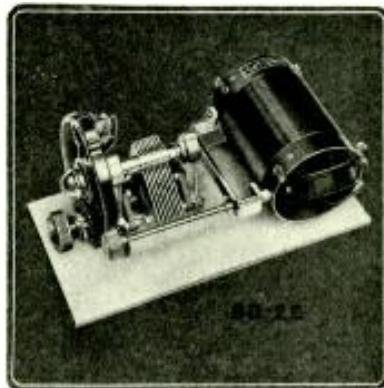

NATIONAL Tuning Units comprise the famous BROWNING-DRAKE Coils and R. F. Transformers with their Slot-wound primaries, the new NATIONAL EQUITUNE Condensers with their light and rigid Girder Frames, and the NATIONAL ILLUMINATED Velvet-Vernier Dials.

DESIGNED AND OFFICIALLY APPROVED By GLENN H. BROWNING

NATIONAL Tuning Units are standard for good Radio sets. So are NATIONAL Impedance Transformers for quality audio, NATIONAL Tone-Filters for power tube output connection.



NATIONAL Co. makes heavy-duty B-Supply Units and 6-stage Power Amplifiers. Write National Company, Inc., W. A. READY, President, Cambridge, Mass., for Bulletin 116-L-4.



ENGINEERING and MASS PRODUCTION

Those two features are important to you, the manufacturers of sets and eliminators.

Dongan's reputation for being a step ahead in transformer design, and a large factory devoted entirely to the production of parts, has placed Dongan transformers and chokes as standard equipment in many leading sets and battery-eliminators.

As a source of supply you will find the utmost in cooperation in the Dongan organization.

This is NEW Dongan Transformers and Chokes for use with Raytheon BA 350 MA and Q. R. S. 300 MA Rectifying Tubes Write for complete details

DONGAN ELECTRIC MANUFACTURING COMPANY 2983-3001 Franklyn St. Detroit, Mich.

TRANSFORMERS of MERIT for FIFTEEN YEARS



Use Power tubes for good quality at full volume

Simply adapt to your set with

Connectorals

(Reg. U. S. Pat. Off.)

The use of a Power Tube in the last audio will very greatly improve your tone quality. No change in set wiring is necessary when Connectorals are used.

For UX 171 and UX 112 Tubes, Na-Ald 112 Connectorals are recommended for maximum volume with storage battery sets. These tubes will deliver without distortion several times the volume of the regular 201A. Price \$1.50.

For UX 120 Tubes in UV 201A sockets, the Na-Ald No. 120 Connectoral should be used. To convert a storage battery set to dry batteries with ample loud speaker volume, use a UX 120 tube in the last audio stage with the 120 Connectoral and UX 199 tubes with 419X Adapters in the other sockets. Price \$1.25.

For the UX 120 Tube in UV 199 sockets, ample loud speaker volume without distortion is obtainable from any set equipped for UV 199 tubes by means of the UX 120 or equivalent tube, with the Na-Ald No. 920 Connectoral. The tube is raised slightly, but provides for its use in most sets with limited headroom. Price \$1.25.

For UX 120 tubes in the UV 199 sockets of the Radiola Superheterodyne Semi-Portable and Radiola Super VIII. These excellent Superheterodynes will deliver ample volume for loud speaker operation when equipped with the UX 120 used with the Na-Ald No. 420 Connectoral. Price \$1.25.

ALDEN MANUFACTURING CO.
Dept. 321-C Springfield, Mass.



Model AC15

The Amplion Grand
List Price \$135

This remarkable instrument utilizes an entirely new principle in radio reproduction—a combination of soundboard, air-column and cone. This results in a marvelous depth of note-resonance and a fine natural tone.

Every Amplion Grand sold is a laboratory model, personally tested and approved by Amplion's Chief Engineer.

The handsome walnut cabinet 34" x 33" x 18½" is sturdily built—its rich finish will grace the most beautifully appointed room.

Other Amplion Models from \$12 to \$50

THE AMPLION CORPORATION OF AMERICA
Suite X 280 Madison Ave., New York City
The Amplion Corporation of Canada Ltd., Toronto, Ont.



How to Get Quality Amplification

(Continued from page 341)

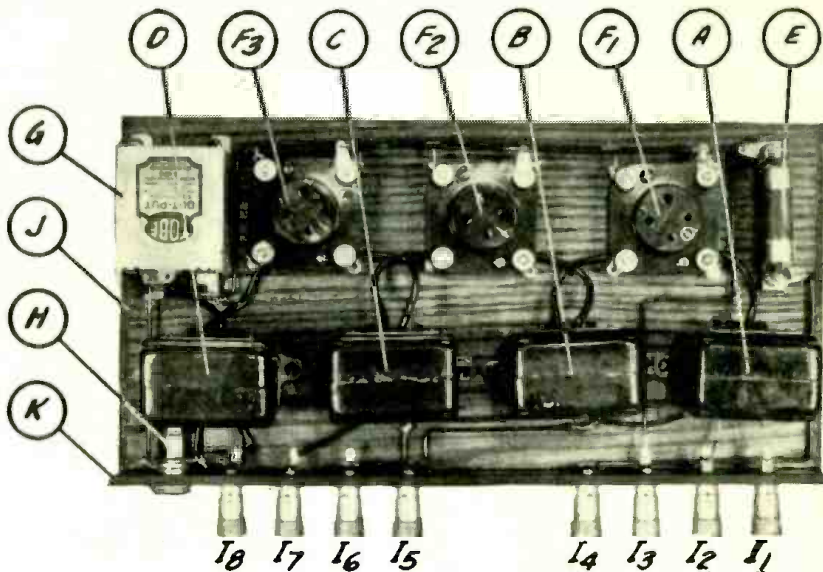

THE AMPLIFIER AS SEEN FROM ABOVE

FIGURE 4: This picture shows how the completed unit should look. The instruments are all fastened down to the baseboard by means of short, brass wood screws.

How to Construct the Unit

To build the amplifier, cut the baseboard, J, to the proper size, 6 by 12 by ½ inch. Then prepare the binding-post strip, K, as shown in Figures 3 and 4. This should run the entire length of the baseboard.

Next, attach the eight binding posts, I1, I2, I3, I4, I5, I6, I7 and I8, as shown in Figure 3, and attach the jack, H, as shown in the same diagram.

The first two binding posts, I1 and I2, are for the input connections to the receiver with which the amplifier is to be used; binding posts I3 and I4 are for the negative and positive terminals of the "A" battery; binding posts I5 and I7 are for the "C" (—) minus battery terminals. The positive "C" battery terminal is connected to the negative terminal of the "A" battery; binding posts, I6 and I8, are for the "B" (+) battery connections for the intermediate tubes and for the last tube.

The negative "B" battery terminal should be connected to the "B" (+) plus terminal of the detector battery, as shown in Figure 1. After the binding-post strip, K, has been attached to the baseboard, J, by means of three screws inserted through the holes in the strip and into the edge of the baseboard, the other instruments may be mounted on the baseboard (see Figures 3 and 4).

The instruments may be fastened down in their correct relative positions by means of wood screws driven into the baseboard, J.

The wiring should be done exactly as shown in Figure 3; this carries out the wiring scheme given in the schematic drawing in Figure 2. When the wiring is completed, the unit is ready to be installed.

In Figure 1 is shown the method of connecting to the detector and to the batteries that are to be used with the amplifier. Insert two Truphonic Hi-Mu valves in sockets, F1 and F2, and insert a UX-112 type power valve or a UX-171 type power valve in the last socket, F3.

The amount of "C" battery used will depend upon the type of tube used in this last socket.

When the valves have been placed in their respective sockets, the amplifier is ready for use. It should be used with a reproducer that is capable of producing high quality signals. The reproducer is plugged in by means of a phone plug into the jack, H.

The receiver, that this unit is used with, should be tuned in the usual manner and the quality of reproduction will be found to be excellent even when the volume is raised to the full undistorted output of the power valve.

Here Is One Solution to Power Troubles

Watch the next issue of POPULAR RADIO for the complete constructional details of an improved totally shielded power unit for use with a gaseous rectifier-type valve that gives higher output "B" voltages with an increased number of voltage combinations. It will also supply the "A," "B" and "C" voltages for the last valve in the receiver.

Write For Hampton-Wright's Radio Economy Catalog

A Great Radio Store Is At Your Command

The new spring catalog is now ready for you with a complete list of fine radio sets and parts. Set builders and fans will find this great book a pleasure and help in their radio activities.

Write today for this free catalog and have the satisfaction of doing business with Hampton-Wright.

Specify Catalog A-8

Hampton-Wright
P. O. Box 181
Indianapolis, Ind.

See that screw

A SCREW DRIVER
ADJUSTS AN X-L
IN CROWDED
PLACES



**X-L
VARIO
DENSER**

Little Things Can Make
a Big Difference
as for instance

X-L PRODUCTS

Endorsed by Authorities and specified in all leading hook-ups.

Model "N" A slight turn obtains correct tube oscillation on all tuned radio frequency circuits. Neutrodyne, Roberts two tube, Browning-Drake, McMurdo Silver's Knockout, etc., capacity range 1/2 to 20-micro-microfarads. Price \$1.00.

Model "G" with grid clips obtains the proper grid capacity on Cockaday circuits, filter and intermediate frequency tuning in heterodyne and positive grid bias in all sets. Capacity range:

Model G-1—.00002 to .0001 MFD
Model G-5—.0001 to .0005 MFD
Model G-10—.0003 to .001 MFD
Price \$1.50

X-L PUSH POST

Push it down with your thumb. Inset wire, remove pressure and wire is firmly held. Releases instantly. Price 15c.

Push Post Panel permanently marked in white on black insulating panel. In box including soldering lugs, raising bushings and screws for mounting, etc. Price \$1.50.

FREE Wiring Diagrams showing use in most popular circuits sent on request. Write today.



X-L Radio Laboratories 2422 Lincoln Ave. CHICAGO, ILL.

Norden-Hauck Super-10

AROUND THE WORLD WITH THE U. S. NAVY



Panel size, 36"x8"x1/4"

Super 10-tube Standard Admiralty Model

Weight: 55 lbs.

A SUPER-10 has been installed on board the "U. S. S. Wright," now sailing for Asiatic waters with the U. S. Aircraft Squadrons. This receiver will also be used for entertaining civilian representatives at various ports of call.

A New and Advanced Model Highest Class' Receiver in the World

THE NORDEN-HAUCK SUPER-10 is an entirely new and advanced design of Receiver, representing what we believe to be the finest expression of Modern Radio Research Engineering. It is the product of years of experience devoted exclusively to the attainment of an ideal Broadcast Receiver—regardless of cost.

Results obtained in every respect will upset all your previous ideas of good radio reception. The unusually large number of unsolicited testimonials constantly being received from users—concerns and individuals of international repute—indicates the absolute superiority of the NORDEN-HAUCK SUPER-10.

You, too, may enjoy the advantages of this wonderful receiver at a surprisingly moderate cost. Here are only a few of the host of features that place the NORDEN-HAUCK SUPER-10 far in advance of competition.

- 10 tubes employed to give perfect reproduction with unlimited range and volume power.
- Super selectivity on all wave lengths.
- Built to Navy Standards.
- Wide wave length range without change of coils, 200-550 meters full.
(Adaptable 35 meters to 3600 meters if desired.)
- Use Loop or Antenna.

- Simple to operate, having only two major tuning controls.
- No Harmonics. Signals are received only at one Point.
- Special Power Audio Amplifier, operating any loudspeaker and eliminates necessity of external amplifier.
- Can be operated directly from house current with socket power devices.
- Thoroughly shielded at all necessary points.

Complete Price List for Socket Power Operation

1 NORDEN-HAUCK SUPER-10, completely constructed and laboratory tested	\$307.00
*1 Heavy-Duty 200 V. "B" Eliminator and Tube, 50/60 cycle A/C 110 V.	42.50
1 Automatic "A" Power Supply, complete	29.50
10 Tested Tubes, including Power Tube	22.50
1 Western Electric Cone Speaker, 540AW or Farrand Sr., and Plug	32.60
1 Set Antenna Equipment, complete	5.00
2 "C" Batteries	2.00

TOTAL COST OF ALL ITEMS—NOTHING ELSE REQUIRED.....\$441.10
* 25/30 cycle A/C current, \$47.50.

PROMPT EXPRESS SHIPMENTS NOW BEING MADE

Upon Request complete literature attractively illustrated, will be gladly mailed without charge, or full size constructional blue prints, showing all electrical and mechanical data, will be promptly mailed postpaid upon receipt of \$2.00.

TEAR OFF AND MAIL TODAY

NORDEN-HAUCK, Inc.
Philadelphia, U. S. A.

Gentlemen:—

Please send me without cost or obligation on my part, attractive illustrated literature describing the new Norden-Hauck Super-10.

I enclose \$2.00 for which please send me, postpaid, complete full size constructional drawings and all data for building the Super-10.

Name _____

Address _____

Write, Telegraph or Cable Direct to
NORDEN-HAUCK
Incorporated
ENGINEERS
MARINE BUILDING
Philadelphia, U. S. A.

CARTER

NEW

Heavy Duty
Resistance Units



Half Size

All resistances
1/4 to 1000 Ohms

For vacuum-tube filament circuits to reduce 6 volts to 5 volts without the use of a variable resistance, also for use with U.V.199 tubes. There are many other uses for these resistances, which are set forth in our illustrated booklet. Mailed free on request.

Any dealer can supply

In Canada: Carter Radio Co., Limited, Toronto

CARTER RADIO CO.
CHICAGO



Are You Building The New Browning-Drake Receiver

as described in this issue of

POPULAR RADIO

We have complete parts for this quality circuit, as used in the laboratory model—

\$ 85.45

PARTS FOR NEW

S-C-11

RECEIVER

\$ 61.25

We have specialized in hard to obtain quality parts for several years. Our mail order service department is equipped to supply you within 24 hours of receipt of your order.

Dealers Don't Buy

until you have our catalog. If you haven't already received it, send for a copy to-day.

HEINS & BOLET

Wholesale and Retail

44 PARK PLACE NEW YORK

What's New in Radio

(Continued from page 365)

has been made in order to obtain this high degree of selectivity.

The "Super-Selector" makes use of six vacuum valves in all. The first two are used in the two stages of tuned-high-frequency amplification. The third valve, which may be of either the UX-200-a type valve or the 201-a type, functions as a detector. The last three valves are used in a three-stage "TruPhonic" low-frequency amplifier. This is one of the newer types of low-frequency coupling which provides really excellent tone quality with ample volume.

The coils and condensers in the three tuned circuits are completely shielded; this accounts in part for the selectivity of the receiver and tends to eliminate local disturbances such as noise from power lines and other sources.

Each of the vacuum valves is equipped with a fixed, filament-control resistance of the cartridge type, with the exception of the first two, which operate through a single, fixed resistance. All of these resistances are removable, however, and may be replaced with resistances of different values if so desired. This makes it possible to use any valve combination desired. For instance, if a UX-201-a type tube is to be used in the last low-frequency stage, a 1/4-ampere resistance is used. If a UX-112 type or a UX-171 type power valve is to be used it is a simple matter to plug in a 1/2-ampere resistance instead. When the receiver leaves the factory it is provided with suitable resistances for the use of UX-201-a type tubes in all but the last stage. Thus the receiver may be kept up to date by taking advantage of any new types of tubes that may be brought out.

Provision is made in the receiver for separate "B" and "C" battery connections for the last low-frequency stage. This permits the owner to choose the type of vacuum valve to be used in this stage. The use of a power valve is recommended, because the volume of reproduction obtained with the volume control turned up full is more than sufficient to overload a UX-201-a type tube. If a "B" power-pack is used in place of "B" batteries, and it is capable of delivering around 180 volts for the plate of the power tube, the UX-171 type valve is to be preferred. If 135 volts of "B" battery are used then the UX-112 type valve is a more practical valve to use because of its lower current consumption, and because of a correspondingly longer life for the batteries.

The battery requirements, at least so far as the "B" batteries are concerned, are a little out of the ordinary in that four different voltages are recommended, namely, 22 1/2, 67 1/2, 90 and the high voltage for the power valve (135 to 180 volts). If batteries are used, this requirement presents no difficulties. But "B" power-packs have terminals for only three voltages. The writer has found, however, that the 67 1/2-volt lead from this receiver may be connected to the same terminal of the power-pack as is the 90 volt wire. At least this works out satisfactorily where the power-pack used is one

which makes provision for varying the voltage for the detector and intermediate voltage requirements of the receiver.

The filament-current requirements of the receiver are taken care of by a 6-volt storage battery, or any standard type of "A" power-pack, or a combination storage battery and trickle charger. In other words, any device may be used providing it is capable of delivering 1 1/4 amperes for the operation of the filaments of the receiver.

The "C" battery requirements depend on the type of vacuum valve used in the last stage. The instructions packed with power tubes give complete information on this point. In any event, the dry-cell type of batteries are recommended for this use. They are small in size and have extremely long life when used for this purpose. Some "B" power-packs, however are designed to provide the "C" voltage as well as the "B" voltages.

An outdoor antenna about 100 feet in length, including the lead-in, is suitable for use with this set. Where the utmost selectivity is required, however, an antenna about 75 feet in length, over all, should provide best results especially in a locality where there are numerous broadcasting stations. In suburban locations where there is no possibility of strong interference between stations, an antenna up to 150 feet in length will give best results.

The Elkay receiver is inclosed in an attractive mahogany cabinet of the table-mounting type which measures 25 inches long, 14 inches wide and 11 inches high. The front of the cabinet, or panel is also of mahogany and slopes back.

In the center of the front panel is a large and artistic, antique silver escutcheon plate through which the tuning controls projected in the form of three thin discs. These have knurled edges to afford a good finger grip. On the sides of two of these discs are smaller and wider drums which are calibrated, and which move with the larger drums to indicate the relative setting of these two tuning controls.

The three tuning discs are placed flat up against each other and at right angles to the panel so that just a sector projects through the opening in the escutcheon plate. The center disc is about an eighth of an inch larger in diameter than the other two so that its circumference will project slightly beyond the others and therefore make it possible to adjust this control without interfering with the adjustment of the other two. It is possible to tune the receiver with one hand by means of a clutch arrangement in which all three discs are turned by simply revolving the center disc.

In addition to the three controls for individual circuits, there are two other knobs on the panel. One is the battery switch by means of which the receiver is turned "off and on," and the other is a control which gives the operator full control over the volume of reproduction.

Maker: Langbein-Kaufman Radio Co.

How to Reduce Interference

By the use of a device known as a "Pre-Selector" (to be described in POPULAR RADIO for next month), the selectivity of ANY receiver may be improved. Ask your newsdealer to lay aside your copy.

Flux a factor in Satisfactory Reception

THE importance of the proper flux for radio soldering, has become so significant, that manufacturers of better radio sets have, after extensive laboratory tests, adopted Kester Rosin Core Solder—alert set builders, too, use nothing but Kester Radio Solder, the handy size package of Kester Rosin Core Solder.

Pure rosin, as in Kester Radio Solder, is absolutely non-corrosive and is the only safe flux for radio. Being a hard, dense substance, rosin will not attract and collect dust (carbon particles) which forms a path for leakages. Chloride fluxes in either paste, liquid or compound form are highly corrosive. They absorb moisture from the air, and when heat is applied, a spattering, fuming and spreading action is caused. The areas over which flux is thus spread attract and collect dust (carbon particles) which forms an excellent path for leakages and soon impairs the receptive quality of any set.

Insist upon knowing that the set you buy has been soldered with Kester Rosin Core Solder and be equally sure that you use only Kester Radio Solder on the set you hook up yourself.



A free sample—write for it now

KESTER Radio SOLDER

The safe solder and flux for radio

CHICAGO SOLDER COMPANY

4221 Wrightwood Avenue
Chicago, U. S. A.

SANGAMO

MICA CONDENSERS

IN *intermediate*



SIZES

IMPROVE
TONE
RANGE
and
VOLUME

IT is accuracy, not luck, that makes one receiver more selective or sensitive than another that is almost its twin. Condenser accuracy is especially important and the cost of accurate condensers is small—the effect immense.

Capacities in microfarads and prices

0.00004	0.001	} 50c.
0.00005	0.0012	
0.00006	0.0015	} 60c.
0.00007	0.00175	
0.00008	0.002	} 70c.
0.0001	0.0025	
0.00012	0.003	} 85c.
0.00015	0.0035	
0.000175	0.004	} 95c.
0.0002	0.005	
0.00025	0.006	} \$1.00
0.0003	0.007	
0.00035	0.0075	} 1.15
0.0004	0.008	
0.0005	0.01	} 1.20
0.0006	0.012	
0.0007	0.015	} 1.25
0.0008		

With Resistor clips. 10c. extra.

Sangamo Electrical Company

Springfield, Illinois

6332-I

RADIO DIVISION, 50 Church Street, New York

The Three Blankets Around the Earth

(Continued from page 330)

Norwegian scientist, Professor Carl Stormer, has observed and photographed these beautiful streamers and curtains which seem to flash up from the magnetic pole of the earth on winter nights. He has observed some of them at heights as great as nearly five hundred miles above the ground. The average height is about sixty to seventy miles, well within that mysterious outer blanket of warm air which is also the Heaviside Layer. Undoubtedly the Aurora is caused by streams of electrified particles, probably free electrons, reaching the earth from the sun and traveling downward along the lines of magnetic force centering at the magnetic pole.

Undoubtedly, also, these solar particles produce the glow of the Aurora by hitting against atoms of the earth's upper air. Dr. Lars Vegard, a distinguished Norwegian physicist often quoted in POPULAR RADIO, has devoted much investigation to the problem of what atoms it is that are giving out this Auroral light. He believes that he has located at least one of the atomic sources in solid particles of frozen nitrogen. Another scientist, Professor J. C. McLennan of the University of Toronto, doubts Professor Vegard's conclusions. He proposes other atomic candidates as responsible for the Aurora; a mixture of atoms of helium with atoms of oxygen.

When this uncertainty has been resolved; when we know, as undoubtedly the Aurora will one day tell us, just what atoms we are dealing with in those outermost lightest and fluffiest layers of the earth's third blanket; we will be able to go far toward determining just what kinds of electric changes in the air atoms are responsible for the remarkable properties of the Heaviside Layer; properties so useful to our present-day radio.

715 Broadcast Stations

TODAY there are 715 broadcasting stations in the United States—a gain of 177 broadcasters over a year ago. This includes twenty-two portable transmitters. Disregarding these transient stations, the State of New York leads with 61 fixed stations, Illinois stands second with 60. When portable sets are taken into consideration, Illinois is first by about eight stations. The list by states shows that California is third with 52 stations; Pennsylvania fourth, with 44, next, Ohio with 34. The next twelve states follow in order: Texas, 32; Washington and Michigan, 27 each; Iowa, 25; Missouri and New Jersey, 24 each; Wisconsin, 20; Massachusetts 19; Nebraska, 17; Indiana, Minnesota and Florida, 16 each. Nevada remains the only state without a single station, as it stood last year.



Lowest Priced QUALITY "B" Eliminator

Outstanding quality confirmed by lasting good performance on over 50,000 sets. The following interesting endorsements are but a few out of thousands—but actually your best means of verifying our claim of "singular value" in the good Ferbend "B" Eliminator.

FROM MELROSE, MASS.

If radio fans only knew the wonderful kick that can be obtained from your Eliminator, they wouldn't waste any more money on "B" Batteries.—C. S. Merrill.

RICHMOND, VA.

Your Eliminator has got it all over any that I ever used and I tried several different makes costing much more.—Wm. H. Bryant.

DULUTH, MINN.

I have used your Eliminator for over a year and it is one of the best investments I ever made.—L. W. Peters.

NILES, OHIO

The Eliminator I purchased from you a year ago has given results that could not be surpassed regardless of price. I have logged KF1, KGC, KFON, CZE, and 6 KW.—F. J. McGuirk.

Original cost less than half of any equipment of similar quality; lowest maintenance cost.

\$12.50

Model III, for all sets using 90 Volts.

Model IV, for extremely large sets and sets using power tubes; delivers up to 180 Volts, 50-60 Cycle, A. C.—\$17.50.

MONEY BACK GUARANTEE

Equal to Any not only in operation, but in workmanship, quality, durability and appearance. Sooner or later you will change to "B" Socket Power. Why pay more?

Approved and passed by the rigid laboratory tests of Radio News and Popular Radio.

See your Dealer—or Send Direct Shipment made direct on receipt of price, or C. O. D. if preferred. Use for 10 days to convince yourself—if unsatisfactory write us within that time and purchase price will be refunded. Send Coupon TODAY.

FERBEND ELECTRIC COMPANY
419 W. Superior Street Chicago, Illinois

FERBEND "B" ELIMINATOR

FERBEND ELECTRIC CO.
419 W. Superior St., Chicago, Ill.

- () Send \$12.50 model.
- () Send \$17.50 model.
- () Send at once. Payment enclosed.
- () Send C. O. D. () Send Literature.

Name.....

Address.....

City..... State.....

22½ v. **\$2.65**



"HAWLEY" NEW TYPE

45 volts \$5.25, 90 volts \$10.00, 112½ volts \$12.50, 135 volts \$14.75, 157½ volts \$16.80, 180 volts \$19.20. Includes chemical. Nothing to purchase extra. Special sizes to order. Easily recharged upon any current including 32 volt systems. Any special detector voltage easily had. Operates any 1 to 10 tube set. Tested and approved by leading authorities, such as Popular Radio Laboratories, etc. Over 4 years sold on a non-red-tape 30 day trial offer with complete refund if not thoroughly satisfied. Further guaranteed 2 years. Knock-down kits at still greater savings. Complete "Hawley" "B" Battery charger \$2.75. Order direct—same day shipments, shipped C.O.D.—simply pay expressman cost on delivery or write for my free literature, testimonials, etc.

B. HAWLEY SMITH
315 Washington Ave., Danbury, Conn.



Announcing
the first of a series of new models
of

TIMBRETONE
REG. U.S. PAT. OFF.

Combined with the utility of a smoking stand is a loud speaker. Carry it about and have it where you want it—on the porch or alongside of your easy chair.

Sales offices

SANFORD BROS.

CHICAGO 30 W. Walton Pl.
CHATTANOOGA 615 Broad Street
SEATTLE Am. Bank Bldg.
SAN FRANCISCO 311 Mianna Street

Factory: **TIMBRETONE MFG. CO.**
Hoosick Falls, N. Y.

What's New in Radio

(Continued from page 366)

and the three tuned circuits are therefore adjusted simultaneously by the operation of this control.

In order that these three circuits may be tuned by a single control it is essential that the values of the circuits be carefully matched. This requires careful attention; and it has apparently been worked out with a high degree of success. The calibration of the wavelength indicator scale appears to be carefully adjusted also, as the maximum variation found was less than two per cent and the average variation less than one per cent.

The receiver is designed to use either standard vacuum valves, or the valves manufactured by the Magnavox Company. The recommended tube equipment consists of three of the standard UX-201-a type valves (or three of the Magnavox type A valves) for the two high-frequency amplifier stages and for the first low-frequency stage. For the detector a UX-200-a type valve is recommended, and for the second low-frequency stage a power tube of the UX-112 or the UX-171 types should be used. The UX-201-a type valves may be used throughout if desired, but the sensitivity and volume of the receiver will suffer in consequence of this change.

As the manufacturer of this receiver especially recommends the use of the UX-171 type power tube it is advisable to equip the receiver with a "B" power-pack by means of which the high voltage for the plate supply can be obtained from the house lighting lines. The current drain of this power valve is comparatively large and would be hard on "B" batteries. If batteries are used, however, they should be of the heavy-duty type. A "B" power-pack capable of supplying about 180 volts at 25 to 30 milliamperes will give excellent results with this receiver. Taps should be provided for the 45-volt and the 90-volt supplies.

To light the filaments of the five tubes either a six-volt storage "A" battery or an "A" power-pack capable of supplying approximately 6 volts at 1½ amperes may be used.

The grid-biasing voltage for the power valve may be obtained either from a dry-cell battery or from the "B" power-pack if the latter is one of the type which supplies this "C" voltage as well as the "B" voltage. If dry-cells are used, one of the smallest size "B" batteries is quite suitable. The biasing voltage required will vary from 26 to 40 volts, depending on the amount of "B" voltage used.

The installation of the receiver is simple, as it is equipped with a battery cable, the individual wires of which are plainly marked for the proper terminals. The end of the cable that goes to the receiver terminates in a plug arrangement; this eliminates the necessity for binding-post terminals at the receiver.

An outdoor antenna about 75 feet long, including the lead-in, will produce good results with this receiver. In locations close to broadcasting stations, however, this length may be cut down to 50 feet or so; or a small fixed condenser of about .00025 mfd. may be connected in series with the lead from a longer antenna to give the same effect, so far as increased selectivity is concerned.

During the tests of this receiver it was found possible to tune in one station after another by simply starting with the dial setting for 200 meters and then slowly turning the control knob. Even using a 100-foot antenna, with a small fixed condenser in series, it was found possible to tune in many out-of-town stations without interference from the numerous and powerful local stations. A number of Chicago stations were brought in during the early evening, with excellent volume and a good quality of reproduction.

Maker: The Magnavox Company.



A Space-saving Jack

Name of instrument: Jack.

Description: This jack is carefully made and is provided with ample insulation between terminals. The connecting terminals are all at the panel end of the instrument and the spring contacts extend only ¾ of an inch back from the panel. The jack is designed to mount by means of a single hole drilled through the panel. The connection terminals are in the form of soldering lugs, and are widely separated to avoid the necessity for running connection wires close together.

Usage: As a convenient means for connecting headphones or a reproducer into a circuit.

Outstanding features: Its extremely small size makes this jack invaluable in any receiver where space is limited. Workmanship and materials are first class. Connection terminals are easy to get at.

Maker: Carter Radio Co.

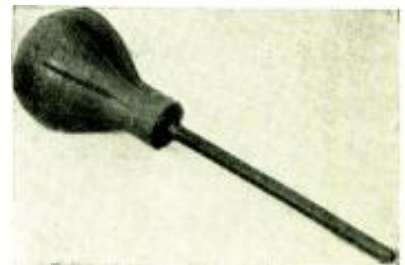

It's Easy to Add Water to Your Battery With This Simple Device

Name of instrument: Battery filler.

Description: This instrument consists of a moulded hard rubber tube six inches in length, to one end of which is attached a soft rubber bulb. The bulb holds approximately ½ pint of water.

Usage: For adding distilled water to the electrolyte in storage batteries.

Outstanding features: A strong, well-made device. The long, slender nozzle permits water to be added to batteries without spilling and without the necessity of removing the battery from the cabinet.

Maker: Joseph Esserman Mfg. Co.

It's Easy For Anybody To Build With *SIMPLIFIED BLUEPRINTS*

LAURENCE M. COCKADAY has personally supervised the preparation of *Simplified Blueprints* of twelve of POPULAR RADIO'S most popular circuits. Each set consists of three *Actual Size* Blueprints; first, a Panel Pattern; second, an Instrument Layout; and third, a Picture Wiring Diagram all simplified in the fullest sense of the word because

The Panel Pattern can be laid on the panel and all holes drilled as indicated. No scaling to do and so accurate there is no danger of ruining the panel through faulty calculation.

The Instrument Layout placed on the sub-base permits you to indicate by pinpricks the exact location of every screw.

The Picture Wiring Diagram gives every instrument in exact size and position with every wire clearly indicated from one contact to the other. With no knowledge of radio symbols you can assemble every part and complete your wiring with no chance of error.

Priced at \$1.00 per Set

Set No. 11—"5-Tube Tuned Radio-Frequency Receiver with Simplified Control" (as described in August, 1925, issue of POPULAR RADIO).

Set No. 12—"8-Tube Superheterodyne with Single Control" (eight tubes, two straightline variable condensers, as described in October, 1925, issue of POPULAR RADIO).

Set No. 14—"The LC-26 Broadcast Receiver" (as described in December, 1925, issue of POPULAR RADIO).

Set No. 15—"The Orthophase Receiver" (a circuit development using a new principle in radio-frequency amplification, making a receiver with great sensitivity, combined with sharp tuning and ease of operation, as described in February, 1926, issue of POPULAR RADIO).

Set No. 16—"The S-C All Wave Receiver" (equipped with inter-changeable coils so that it has practically an unlimited wavelength range, covering all wavelengths from 50 to 550 meters, as described in March, 1926, issue of POPULAR RADIO).

Set No. 18—"The Improved Raytheon Power-Pack" (as described in the May, 1926, issue of POPULAR RADIO).

Set No. 19—"The New Home Receiver" (three tubes, two stages of radio-frequency amplification with crystal detector, as described in June, 1926, issue of POPULAR RADIO).

Set No. 21—"The Improved Browning-Drake Receiver" (as described in the August, 1926, issue of POPULAR RADIO).

Set No. 22—"The LC-27 Broadcast Receiver" (as described in the October, 1926, issue of POPULAR RADIO).

Set No. 23—"The LC-Senior Power-Pack" (as described in the November, 1926, issue of POPULAR RADIO).

Set No. 24—"The LC-Intermediate Power-Pack" (as described in the December, 1926, issue of POPULAR RADIO).

Set No. 25—"The LC-Junior Power-Pack" (as described in the January, 1927, issue of POPULAR RADIO).

Full constructional and parts details for these Receiving Sets will be found in the issue of POPULAR RADIO indicated. Back issues of POPULAR RADIO will be furnished at the rate of 35c a copy

Popular Radio

627 West 43d Street

Dept. 44

New York City

POPULAR RADIO, Inc., Dept. 44
627 West 43d St., New York City

Date.....

Enclosed is my remittance of \$....., for which kindly send me Blueprint Set (s) consisting of Panel Pattern, Instrument Layout and Wiring Diagram as checked below:

<input type="checkbox"/> Set Number 11	<input type="checkbox"/> Set Number 16	<input type="checkbox"/> Set Number 22
<input type="checkbox"/> Set Number 12	<input type="checkbox"/> Set Number 18	<input type="checkbox"/> Set Number 23
<input type="checkbox"/> Set Number 14	<input type="checkbox"/> Set Number 19	<input type="checkbox"/> Set Number 24
<input type="checkbox"/> Set Number 15	<input type="checkbox"/> Set Number 21	<input type="checkbox"/> Set Number 25

Name.....

Address.....

City..... State.....

DEALERS

Write for terms
on these
fast selling
Blueprints.

A NEW FREE SERVICE
To SET BUILDERS

POPULAR RADIO
 Laboratory tested sets are easier to build if you use our **FREE PICTURE WIRING DIAGRAMS** with our

SIMPLIFIED FULL SIZE BLUEPRINTS

A radio set constructed from one of our kits is not only easier for the experimenter to build but its appearance both inside and out, makes it more valuable to you.

Every Stamford Shop Kit includes a set of full size simplified Blueprints. An instrument layout shows every part in exact size and position. A picture-wiring diagram shows where and how to connect each wire. By following the wiring plan of the designer your set cannot fail to perform more efficiently.

Our Kits contain everything needed to complete the set, down to the last piece of bus bar and screw. Every panel is machine-drilled and artistically decorated.

Check opposite the sets you are interested in for complete data and prices of kits and parts.

Write for Prices on
Browning-Drake
New Receiver
 as described in this issue

Diamond-of-the-Air
5-TUBE KIT—
 Complete Parts \$37.50
 Licensed under Armstrong
 Patent No. 1,113,149

Just Tear this Advt. out

Let Us Quote You on—

Gentlemen: Without obligation, send me full information and prices on sets which I have marked X.

Univalve Receiver as specified

Cockaday's LC-27

Improved Browning-Drake

S.C. Single control. All Wave

Hammarlund-Roberts HQ

PORTABLE TEST BOARD

QUALITY AMPLIFIER

SHORT EQUIPMENT

I enclose \$1.00 for Simplified Blueprints

RADIO SHOP OF STAMFORD
 20 Worth St. Stamford, Conn.

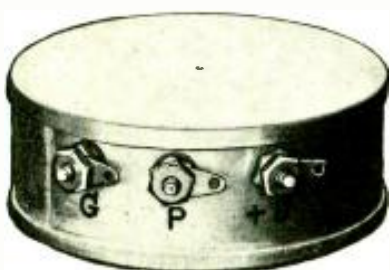

Shielded Tuned Radio Transformer, No. 30

SICKLES
Diamond-Weave Coils

The new Sickles Shielded Tuned Radio Transformer prevents both outside and local interference. It is remarkably compact, sharp-tuning, sturdy.

Sickles Diamond-Weave Coils have established an enviable reputation for low distributed capacity, low dielectric losses, and large range of frequency with small variable capacity.

The ideal coil for the Na-Aid Localized Control Tuning Unit and the Na-Aid Truphonic Assembly.

There are Sickles Diamond-Weave Coils for all leading circuits.

THE F. W. SICKLES CO.
 134 UNION STREET
 SPRINGFIELD :: MASS.

No.	Coil Prices	
30	Shielded Transformer	\$2.00 each
24	Browning-Drake	7.50 set
18A	Roberts Circuit	8.00 set
25	Aristocrat Circuit	8.00 set

In the World's Laboratories

(Continued from page 369)

this degree of speed. He has demonstrated, however, that the quantity of electricity emitted from the sensitive photoelectric metal is proportional, even for the shortest light-flashes which he has obtained, to the lengths of these flashes. Additional experiments are proposed, using still shorter flashes obtained by the passage of pencils of light through a shutter mechanism which will interrupt the light at a rapid rate, separating it into a succession of very short flashes.

A similar principle, although employing much less rapid interruption, was used recently by Dr. Norman Hilberry, Mr. C. A. Johnson and Dr. Ann Hepburn, of New York University, in constructing a new musical instrument, christened the photoelectric organ, which the Editor of this Department had the honor to demonstrate before a recent meeting of the New York Electrical Society. In this apparatus a beam of light from a small lamp was interrupted at audio frequency by passing it through a series of holes bored in a rotating metal disk. The light-beam, carrying this musical frequency, then fell upon a sensitive photoelectric cell, the electrical impulses so produced being amplified in the usual fashion and transmuted into sound by a conventional loudspeaker system.

**Ballistic Characteristics of the Photoelectric Cell." by F. E. Null. *Journal of the Optical Society of America* (Menasha, Wisc.), volume 14, pages 73-85 (January, 1927).

Radio Power From the Ocean?

THE distinguished French engineer, M. Georges Claude, well known as a pioneer in the investigations of gas compression which have led to the production of oxygen, hydrogen, neon and still rarer gases from atmospheric air, startled the scientific world a few months ago by announcing his conviction that large amounts of useful power might be obtained from the water of the sea.*

M. Claude begins his argument from the admitted fact that the water at the bottom of the deep ocean is always cold in all parts of the world, seldom rising more than a few degrees above the freezing point. On the contrary, the surface waters of the oceans in tropical regions are usually warm. This condition is maintained, oceanographers know, by means of a slow circulation of polar water southward along the bottoms of

the oceans and of tropical water northward along the ocean surfaces.

M. Claude proposes that the hot surface water of the tropical ocean should be exchanged with the cold water in the greater depths; or, what is the same thing, that the cold water should be brought up to the surface to serve as the cooling agent for great vacuum condensers in which steam produced from the hotter surface water, also in vacuum, could be condensed.

This process is merely one variety of heat engine, quite analogous to the familiar steam engine. In the theory of such heat engines heat may be treated, as all engineers know, as though it were a substance. The heat contained in the surface waters of the ocean would be transferred, by some combination of mechanisms, to the cold water of the deep ocean. During this transfer the engineers could arrange to take toll of the heat, procuring a fraction of it in the form of electric power or other useful energy.

The theory is unquestionable. There seems little doubt that an apparatus could be constructed actually to obtain useful power in this way. The only fly in the ointment is the bulk and cost of the machinery. The reputation of M. Claude among engineers is so high that his proposals have attracted enormous attention all over the world. While none of his critics are willing to say definitely that the procedure is impossible, it must be admitted that the sum total of engineering comment is adverse rather than favorable. It is admitted by the best friends of the proposal that the condensers, boilers and other machines necessary would run to enormous mag-



Underwood

POWER FROM THE SEA

M. Georges Claude, distinguished French inventor, proposes to get power from the tropical oceans. This might be practicable if power transmission by radio were already a possibility.

**"On the Utilization of the Thermal Energy of the Sea." (in French) by Georges Claude and Paul Boucherot. *Comptes Rendus de la Académie des Sciences* (Paris), volume 184, pages 929-933 (spoken November 15, 1926; printed as of November 22, 1926). See also: "On the Utilization of the Energy of Natural Hot Waters" (in French), by P. Villard. *The same*, volume 184, pages 1001 (November 29, 1926); "On the Utilization of the Thermal Energy of the Sea" (in French). *The same*, volume 184, pages 1005-1006 (November 29, 1926). The first paper of MM. Claude and Boucherot was reprinted in *La Nature* (Paris), number 2748, pages 357-359 (December 4, 1926).

HOW TO MIX WITH THE BEST PEOPLE

You, too, can move in the best circles!

THIS is the story of Angela Apple and how she became the toast of the town (*name on request*) overnight. It seems a travelling salesman came to their house one night—no that isn't the story. We'll rub it out and start all over! Angela was worried no end. She suffered from chill-blains, stuttering, fallen arches, plain face and an Inferiority Complex—1927 sport touring.

None of the gay young bloods would

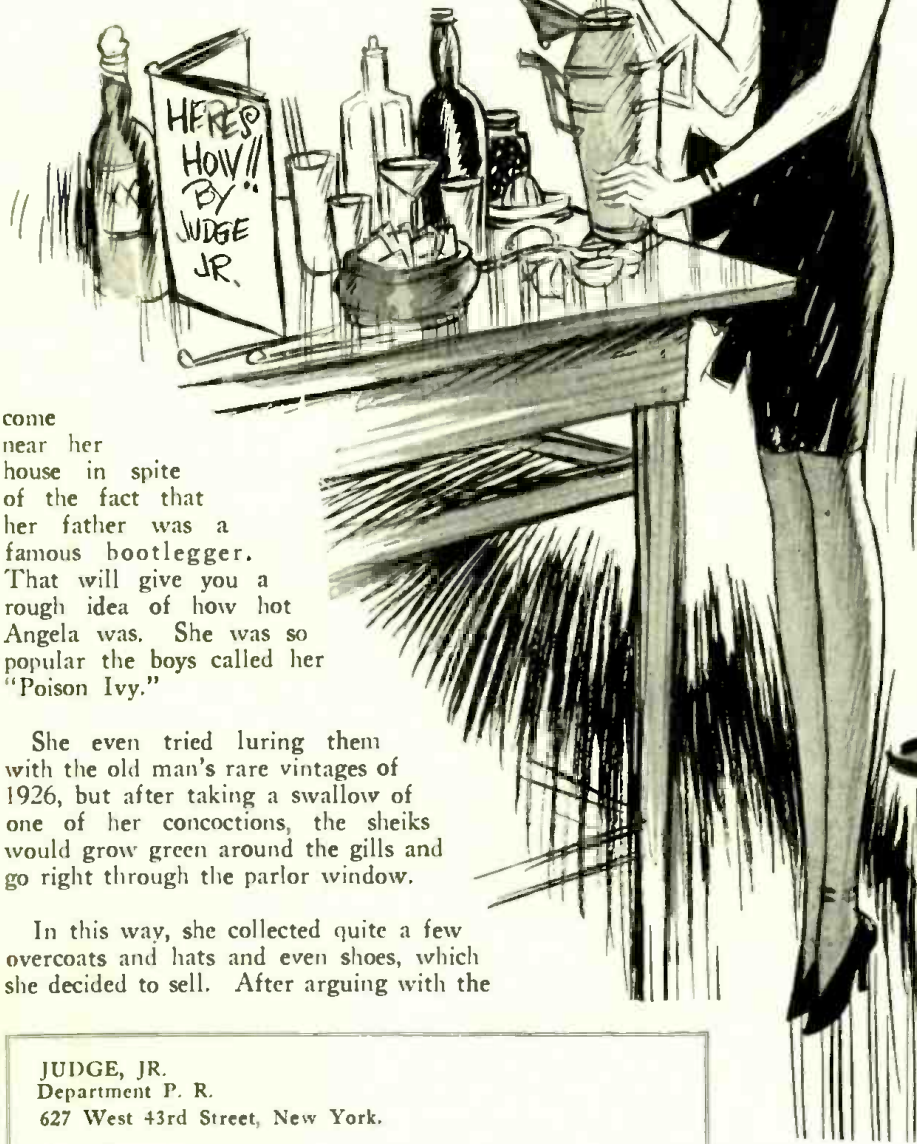

come near her house in spite of the fact that her father was a famous bootlegger. That will give you a rough idea of how hot Angela was. She was so popular the boys called her "Poison Ivy."

She even tried luring them with the old man's rare vintages of 1926, but after taking a swallow of one of her concoctions, the sheiks would grow green around the gills and go right through the parlor window.

In this way, she collected quite a few overcoats and hats and even shoes, which she decided to sell. After arguing with the

big-hearted old clothes man one entire morning she took the dollar and went downtown, and as she passed a bookstore window she glanced in and what do you think she saw! You guessed it! A copy of "Here's How!" by Judge, Jr!

Well, to get down to the coupon, she went right in and bought it and **THAT NIGHT** she 'phoned all the boys to come over because her father was giving away bottles of gin. And did the boys come? Well, you can bet your sweet life they did, Gentle Readers!

Angela mixed them some snifters from "Here's How!" and about five o'clock in the morning the old man called down



and wanted to know if the gang was ever going home!

And every night now Angela's house is crowded with young sheiks from all over the state and she's the envy of every girl in town!

JUDGE, JR.
Department P. R.
627 West 43rd Street, New York.

DEAR JUNIOR:

I want to be popular, too, and mix with the best people. Here's a dollar for my copy of "Here's How!"

.....
.....

FREE PARTS for the new "Town & Country" Receiver

If you want to build your own set, here is your opportunity. For each of the parts you need for this New "Town & Country" Receiver. Call on all your radio friends, and on anyone who has a set and tell them of the many special features of POPULAR RADIO.

These liberal offers will make it possible for you to secure an order from every one you call upon. For each subscription with remittance you send us you will receive credits as per the following scale:

POPULAR RADIO		
4 Months for \$1.00 counts 16 credits		
6	1.50	25
8	2.00	33
12	3.00	50
24	5.00	75

Send us the full amount collected with names and addresses of subscribers and tell us the parts your credits entitle you to and we will send them to you. If the subscriptions you secure do not give you enough credits for the parts you want, we will allow you to purchase credits at the rate of 3 cents each. Example: With (7) seven 1-year subscriptions (350 credits) and 36 cents additional in cash you may have a Silver-Marshall antenna coil, No. 110 A, a Silver-Marshall type No. 340, midgeet variable condenser, 3 Electrad by-pass condensers and an Anaco potentiometer for which you need 362 credits.

If the parts you want are not listed in this advertisement, we are prepared to supply them. Let us know what you want and we will tell you how many credits you will need.

On page 399 are described POPULAR RADIO's Simplified Blueprints. You can have any set of prints you want for only 40 credits. You may also secure a copy of "How to Build Your Radio Receiver" described on page 413 for 60 credits.

CREDITS Needed for Parts Required for the new "TOWN & COUNTRY" RECEIVER

(Described and illustrated in the July, 1926, issue of POPULAR RADIO.)

Quantity	Item	Credits
1	Silver-Marshall antenna coil, No. 110-A, equipped with coil socket No. 515.	140
1	Silver-Marshall oscillator coil, No. 111-A, equipped with coil socket No. 515.	140
1	Silver-Marshall type No. 340 midgeet variable condenser, .00025 mfd. equipped with knob.	60
2	Silver-Marshall No. 210 long wave radio-frequency transformers for use with No. 199 type vacuum tubes or 240	480
1	Silver-Marshall No. 211 long wave radio-frequency transformer for use with No. 199 type vacuum tube and equipped with calibrated fixed shunt condensers.	240
2	Samson Uniform frequency variable condensers, No. 67, .00035 mfd. @ 350	700
2	Dubilier Fixed Condensers, .00025 mfd. with grid leak clips, 640 G @ 20	40
1	Dubilier Fixed Condenser, .002 mfd.	16
3	Electrad by-pass condensers (in cans) 5 mfd. @ 34	102
1	General Radio audio-frequency transformer No. 285, 1-6 ratio	240
1	General Radio audio frequency transformer, No. 285, 1-2 ratio	210
3	General Radio Miniature Jacks, No. 274-J with three miniature plugs, No. 274-P @ 12	36
1	Yaxley Jack No. 2-A	24
1	Yaxley Jack No. 1	20
1	Yaxley Battery Switch No. 10	20
1	Anaco 20 ohm rheostat with knob	50
1	Anaco potentiometer, 400 ohms with knob	60
2	Daven Grid Leak Resistors, 2 meg-ohms @ 20	40
7	Benjamin UX type sockets No. 9040 @ 30	210
1	Precise Condenser Shunt Extension Bushing Connector No. 744	24
1	Jewell "A" and "B" battery voltmeter, pattern No. 145-B panel mounting and equipped with push button	360
2	Walbert "Univernier" Dials 4 in. in diameter, scale reading left to right @ 50	100
1	Eveready No. 703, 4 1/2 volt flashlight battery	16
	Hardwood Baseboard, 8 1/2 by 19 inches	20
	Composition binding post strip	10
	Composition Mounting Block for loop plugs	6
	Composition Mounting Block for multi-plug socket	6
	Composition Panel, 7 by 20 inches	72
	2 Brass Brackets	8
	7 Eby Binding Posts	42
	Soldering Lugs and Screws	10
	Total	3532

Write for List of Free Parts for Other Popular Radio Receivers

POPULAR RADIO
Department 41B
627 West 43d St. New York City

nitude. How these could be placed safely on any kind of floating powerhouse does not appear. Furthermore, the transmission of the power produced to regions where power is in demand would be enormously troublesome.

Here is where radio might enter the matter. If radio transmission of power ever becomes practicable (which at present seems more than doubtful) a more favorable face might be placed on M. Claude's proposal. From the viewpoint of present radio engineering, however, the thing most needed is not a great source of power produced in units of enormous magnitude and equally enormous output, but of some new and cheap way of obtaining power in small units.

In spite of the great development in recent years of apparatus by which radio receivers may be operated from the usual power lines, it must be admitted that the essential problems of power for radio are still unsolved.

The Sun, but Not Weather, Affects Radio

ONE of the most interesting papers presented before the recent meeting of the Institute of Radio Engineers, in New York City, was that of Mr. Greenleaf W. Pickard, on the correlation of radio reception with certain terrestrial disturbances.*

*"The Correlation of Radio Reception with Solar Activity and Terrestrial Magnetism," by Greenleaf W. Pickard. For publication in the *Proceedings of the Institute of Radio Engineers* (New York), cited from advance proof released at the meeting of the Institute, New York City, January 10, 1927.

It is well-known to the radio public that Mr. Pickard has been engaged for several years on the measurement of the strength of radio waves coming from various transmitters and received in his laboratory at Newton Centre, Massachusetts. The work reported at the New York meeting included the reception records made in this way on the transmissions of Station WBBM, at Chicago.

Mr. Pickard was unable to identify any exact relation between the weather at Newton Centre or at Chicago and the variations of radio reception. It was possible, however, to correlate the conditions of radio propagation quite definitely with the existence of solar disturbances, as exemplified by magnetic storms, Auroras, and similar occurrences. In discussing Mr. Pickard's paper, Dr. M. I. Pupin, of Columbia University, agreed with this diagnosis of solar effects on radio, an agreement which Dr. Pupin had already expressed a few weeks before in his presidential address to the American Association for the Advancement of Science, already noted in this Department.

One of Mr. Pickard's evidences for the conclusion that factors which cause good or bad reception are not controlled by local weather is the fact that these radio conditions seem never to be local.

"I have found," Mr. Pickard said, "that a bad night for reception in Newton Centre is in general a bad night anywhere in the United States. And I have also found that European reception of distant broadcast stations agrees re-



Underwood

A GROUP OF RADIO'S "ARISTOCRACY OF BRAINS"

Dr. Ralph Bohn (in front of the desk) is receiving the Liebman Memorial Prize of the Institute of Radio Engineers from Mr. Donald McNicol, former President of the Institute. Dr. Bohn himself is the new president. At Mr. McNicol's left is Mr. John V. N. Hogan, Contributing Editor of POPULAR RADIO. Next to him is Mr. R. H. Mariott. Behind Dr. Bohn are Professor Michael I. Pupin, of Columbia University; Mr. L. E. Whittemore and Mr. E. F. W. Alexanderson, well-known inventor and radio engineer of the General Electric Company.

markably well with my measurements of WBBM."

The solar effects on radio conditions; whether these effects be due to ether waves, to electrons, or (as Dr. Pupin suggested) to the positively-charged nuclei of atoms which we call alpha particles; are evidently worldwide, which is something that cannot be said of weather.

Another of Mr. Pickard's paragraphs deserved to be nailed up as a motto in the laboratory of every scientist.

"The secrets of this universe," he said, "yield rather to observation than to pure speculation. When we have a sufficiency of the right kind of data we can form suitable explanations; until then we are groping in the dark."

Definitely as this statement applies to the present more or less useless theorizing about the relations between radio and weather, no fault can be found with the many experimenters who are examining weather facts and endeavoring to obtain the kind of observations which Mr. Pickard suggests. It is worth while to call to the attention of these experimenters a booklet written by Professor Eugene Van Cleef, of Ohio State University, and issued by the Taylor Instrument Companies of Rochester, New York.†

†"The Weather for Radio Listeners, Broadcasters and Others," by Eugene Van Cleef. Published by the Taylor Instrument Companies, Rochester, New York, October, 1926, 34 pages. Some of Professor Van Cleef's ideas are outlined in his article "How a Low Barometer Affects Radio," *Radio Broadcast* (Garden City, N. Y.), volume 10, pages 152-153 (December, 1926).

The Electron Inspires a Song

SIR RICHARD PAGET, the distinguished English physicist, whose sense of humor was evidenced some time ago by his success in producing artificial speech by manipulating his two hands clasped together, recently amused the members of the Physical Society of London with a song, three verses of which follow:*

There was a jolly electron—alternately bound and free—
Who toiled and spun from morn to night, no Snark so lithe as he;
And this the burden of his song for ever used to be—
"I care for nobody, no, not I, since nobody cares for me.

Though Crookes at first suspected my presence on this earth,
'Twas J. J. Thomson found me—in spite of my tiny girth.
He measured first the "e by m" of my electric worth;
I love J. J. in a filial way, for he it was gave me birth!

So whether I rest as static charge, or rove in the ether free,
Or whether I settle in nuclear state, perched up on a proton's knee,
Or whether I spin my quantum yarns, in a spectroscopic key,
I'll love the "Physicals" all the time, since all of 'em dote on me.

*"The Jolly Electron," by R. A. S. Paget. *Nature* (London), volume 118, page 885 (December 18, 1926).

First in the Field
Specializing in
Cockaday Kits

S. HAMMER RADIO CO., 303 Atkins Ave. Brooklyn, New York

Cockaday Sets Now Made Easier to Build by Our New "Ready-to-Wire" Plan
50% of Your Time, Work and Worry SAVED!

All you need do is to connect bus-bar according to diagram, solder and your set is finished. These Kits are sent to you completely mounted, and assembled on a Veneered Mahogany baseboard and genuine bakelite panel, drilled and engraved. Genuine parts used as listed below; exactly as used in Mr. Cockaday's Laboratory Model. COMPARE OUR OFFER!

LC-27 BROADCAST RECEIVER SENIOR AND INTERMEDIATE POWER PACKS

1 Hammarlund mid-line dual condenser, .000275 mfd.	\$ 7.50
1 Hammarlund mid-line single condenser, .000275 mfd.	4 65
1 Precision Duo-Octoform coil set comprising one antenna coupler and two inter-stage couplers	10.00
1 Amertran De Luxe first-stage transformer	10.00
1 Amertran De Luxe second-stage transformer	10.00
1 Amerchoke #854	6.00
1 Dubilier or Tobe 4 mfd. Filter condenser	5.50
1 Dubilier filter condenser, 1 mfd.	.60
1 Mar-Co illuminated control scale 0 to 100	3.50
2 Mar-Co small controls, scale 0 to 50 and 50 to 0.	1.50
1 Carter Battery Switch	.65

1 Samsun radio-frequency choke coil #85.	\$1.50
3 Aerovox mica fixed condensers, .00025 mfd.	1 85
1 Durham or Davern Resistor 4 meg.	.50
1 Lynch Grid Leak Mounting	.35
1 Carter Gem Jack	.25
1 Carter variable resistance, 0-10,000 ohms.	2.00
12 Eby blinding posts	1 80
1 Benjaalis UX Sockets	3 75
1 Amperite No. 1	1 50
Mechanical Kit, consisting of aluminum shields, binding post strip, decorated panel and Talt brackets	12 50

READY-TO-WIRE KIT PRICE **\$85²⁰**

LC-27 SENIOR POWER PACK KIT \$65²⁰

LC-27 INTERMEDIATE POWER PACK KIT \$47⁵⁰

SILVER SHIELDED SIX KITS *In Stock Now!*

HAMMARLUND-ROBERTS HI-Q KITS

Authorized Headquarters for the

NEW! KENNETH HARKNESS KH-27 RECEIVER BROWNING-DRAKE RECEIVER

The Above Kits Can Also Be Obtained Completely Wired to Specifications

Write for our interesting special circular which we have prepared on the LC-27 Receiver and above Kits

DEALERS: WRITE FOR SPECIAL DISCOUNTS

The POPULAR RADIO Atlas and Log

will give you a list of all the NEW Broadcasting Stations with wavelengths and other necessary information

A Complete Atlas and Station Log
The "POPULAR RADIO International Radio Atlas and Log" will supply you with full information regarding broadcasting stations of the United States and Canada.

This most useful and practical Atlas consists of 16 pages, size 12" x 15", printed on good paper, from clear type in two colors and contains a complete series of double page maps, including—The World—The United States—Canada—North and South America, showing location of principal broadcasting, leading commercial and governmental radio stations.

SPECIAL FREE OFFER

You may have a copy of the "POPULAR RADIO International Radio Atlas and Log" free, with POPULAR RADIO for (8) eight months

For Only \$2.00

Pin \$2.00 in bills to the coupon below. If you are a subscriber to POPULAR RADIO your subscription will be extended eight months.

Date.....

POPULAR RADIO, Dept. 42A,
627 West 43rd St., New York City.

Enclosed is my remittance of \$2.00 for which you are to enter my subscription (extend my subscription) for (8) eight months for POPULAR RADIO and send FREE a copy of the "POPULAR RADIO International Radio Atlas and Log."

Name

Address

City..... State.....

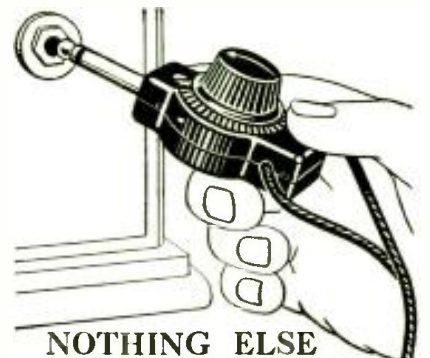

NOTHING ELSE LIKE IT!

HERE is a simple radio control—the Centralab Modu-Plug—that is unique even in a field where phenomenal developments are common.

Provides smooth, noiseless control of tone and volume direct at the plug with the set operating at full efficiency. Without adjusting tuning dials or other controls, you can regulate volume from a whisper to maximum simply by turning the little knob on this plug. "Reduces static interference—clarifies tone." Replaces the ordinary loud-speaker plug.

\$2.50 at your dealer's, or mailed direct on receipt of price.

CENTRAL RADIO LABORATORIES
17 Keefe Ave., Milwaukee, Wisconsin
Manufacturers of variable resistances for all radio circuits





The Senior Six
ELKAY
With Truphonic Audio

Renders in true color all the tones of the scale from bass to treble. Brings in the voice in natural, human quality. Complete shielding for quiet tone background. Centralized control, but with fine adjustment for selectivity.

POPULAR RADIO has tested and approved the Senior Six Elkay, and editorially has fully described this receiver.

NOW READY: New Junior Six ELKAY; an improved T. R. F. receiver designed thruout on Elkay standards, but at a price of \$80.

Jobbers, Dealers: Write for Elkay franchise.

The Langbein-Kaufman Radio Co.
Dept. P, 62 Franklin St., New Haven, Conn.

Ether Waves as Old as the Dinosaurs

A FEW months ago in this department were described the investigations of Professor Harlow Shapley, of Harvard University, leading to the conclusion that some of the faint spiral nebulae visible in photographs made through great telescopes lie at such enormous distances from the earth that the light rays which they send us need over ten million years to make the journey.*

Now comes Major Edwin P. Hubble, the well-known astronomer of Mount Wilson Observatory, with a still more astonishing estimate. He has located some star-groups, also of the spiral nebula type, which are at a distance, he estimates, of about 140,000,000 light years, fourteen times as far away as Professor Shapley's group. The universe does not long remain, any more, of one determined size. Scarcely is the ink dry on the report of one widening discovery than another comes along to make our knowledge of space still wider.

It is interesting to consider the age of the ether waves which come to us from those very distant islands in space, with which rays Dr. Hubble took the photographs to make his estimate. One hundred and forty million years ago there was no creature at all like man

on earth; there were not even apes. The earth was in the possession of great reptiles of the dinosaur type, although the best days of this remarkable group of beasts were already passing. There existed some tiny cat-like and weasel-like creatures, scurrying about beneath the feet of the bulky reptiles. These were our ancestors. In the time that has passed since Dr. Hubble's light rays left the atoms that produced them and started out toward the earth, there has been time for the entire evolution of mankind, from a weasel to us.

Static in Panama

ADDITIONAL determinations of the directions with which atmospheric disturbances arrive at the radio stations at Panama are reported in a recent note by Dr. L. W. Austin, of the United States Bureau of Standards.* Dr. Austin's conclusions are that during the dry season, roughly between January and April, most of the atmospherics come from the high Andes Mountains in South America. In midsummer, on the other hand, there is a great deal of disturbance from the lower-altitude regions of Central America and Mexico, also much local disturbance from the immediate neighborhood of the stations.

*"Direction Determination of Atmosphere Disturbances on the Isthmus of Panama," by L. W. Austin. *Journal of the Washington Academy of Sciences* (Baltimore, Md.), volume 16, pages 457-460 (October 18, 1926).

*"Ether Waves Ten Million Years Old," POPULAR RADIO for October, 1926, pages 592, 594-595.

Build the
"Town and Country"
Portable Receiver
with
Simplified
Blue Prints

The "Town and Country" Portable Receiver, developed by the POPULAR RADIO LABORATORY and described in the July, 1926, issue, marks a decided advance in portable receiver design. While not a "vest pocket" receiver, the new "Town and Country" is small enough to be taken along on a motor boat or train trip. Efficiency has not been sacrificed for the sake of compactness.

The receiver uses six UX-199 tubes and one UX-120 power tube. Operating on a loop, tone quality is guaranteed by the use of a fundamentally correct circuit, high-class transformers and cone-type speaker.

The "Town and Country" Portable Receiver is mounted in a special mahogany cabinet with a drop front and is equipped with a carrying handle. All equipment, including the folding loop, cone loud-speaker, batteries and connecting cable, is installed in a suitcase. Connections from the equipment to the set are made by means of jacks and plugs.

By using POPULAR RADIO Blue Prints in building your "Town and Country" receiver, you can save time, eliminate the possibility of error, and make your set exactly like the laboratory model.

If your local dealer cannot supply you with Blue Prints of this set, they will be sent postpaid upon receipt of \$1.00 per set.

POPULAR RADIO
Service Bureau 44-D
627 W. 43rd St., New York City

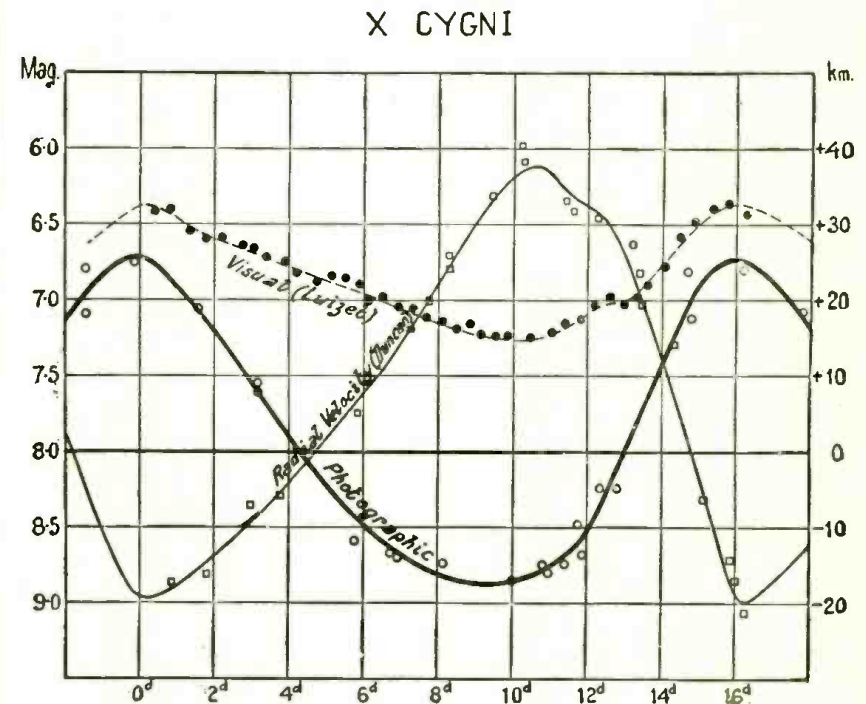

CURVES WHICH FIX THE AGE OF LIGHT RAYS

These curves indicate the variations of the star named X Cygni, one of the variable stars of the Cepheid class, which stars astronomers use to determine the remoteness of nebulae like those which Major Edwin P. Hubble has found to be sending us light rays over one hundred and forty million years old. The "period" of such a variable star is given by the time between each two successive high points of the curves marked "visual" and "photographic." This period corresponds to the true brightness of the star.

Wanted: Facts About Sparks

ALTHOUGH the kind of electricity conventionally called "frictional electricity" was the first kind to be discovered and remained for centuries the only kind which men knew about at all, there are still many facts concerning this kind of electricity of which we remain profoundly ignorant.

For example, there is no certain information about which way the electrons jump when one substance is rubbed on another.

If you stroke the back of a cat with a rubber rod (assuming the cat to permit such a familiarity) it may be that the electrons will jump from the cat to the rod, so that the latter becomes negatively electrified and the cat positively. On the other hand, there appear to be occasions—or kitties—which produce the transfer in the reverse direction; yielding a positive rod and a negative cat. No one knows just what conditions of cat, rubber, air or something else cause the direction of the electron jumps to be reversed in this erratic fashion.

That these matters furnish excellent opportunities for amateur experimenters to work advantage to science without great expense for apparatus is suggested by some interesting observations recently published by Mr. P. E. Shaw, of the University College, Nottingham, England.* Avoiding the somewhat complicated conditions introduced when one of the experimenters is a cat, Mr. Shaw confines his present communication to the electrifications produced when two substances of the same kind—in this case, two hard rubber rods—are rubbed or struck together. Even in this instance the results are by no means simple. The direction of the electrification depends, Mr. Shaw finds, upon the condition of the surfaces of the two rods and upon many other circumstances which would be likely to be considered negligible by experimenters not in the secret.

In past centuries many of the greatest advances of science have resulted from the researches of amateurs, working with little equipment and animated merely by the desire to find out the truth and to have fun while doing so. The complexity and expense of great modern laboratories now deter many amateurs from attempting scientific work. What would be the use, they think, of competing with such rich, powerful and well-staffed institutions? Their timidity is not to the advantage of science. A multitude of researches might be undertaken with optimism and with no more equipment than the furniture of a kitchen; with, for example, a piece of discarded hard-rubber radio panel and the family cat.

*"The Electrical Charges from Like Solids," by P. E. Shaw. *Nature* (London), volume 118, pages 659-660 (November 6, 1926).

FREE PARTS

for the

"LC-27 Broadcast Receiver"

If you want to build your own set, here is your opportunity to secure FREE all the parts you need for the LC-27 Broadcast Receiver. Call on all your radio friends, and on anyone who has a set and tell them of the many special features of POPULAR RADIO.

These liberal offers will make it possible for you to secure an order from every one you call upon. For each subscription with remittance you send us you will receive credits as per the following scale:

POPULAR RADIO

4 Months for \$1.00 counts 16 credits

6	"	"	1.50	"	25	"
8	"	"	2.00	"	33	"
12	"	"	3.00	"	50	"
24	"	"	5.00	"	75	"

Send us the full amount collected with names and addresses of subscribers and tell us the parts your credits entitle you to and we will send them to you. If the subscriptions you secure do not give you enough credits for the parts you want, we will allow you to purchase credits at the rate of 3 cents each. Example: With (7) seven 1-year subscriptions (350 credits) and \$1.50 additional in cash you may have an AmerTran De Luxe first-stage radio-frequency transformer, for which you need 400 credits.

If the parts you want are not listed in the advertisement, we are prepared to supply them. Let us know what you want and we will tell you how many credits you will need.

On page 399 are described POPULAR RADIO'S Simplified Blueprints. You can have any set of prints you want for only 40 credits. You may also secure a copy of "How to Build Your Radio Receiver" described on page 413 for 60 credits.

CREDITS Needed for Parts Required for the LC-27 BROADCAST RECEIVER

(Described and illustrated in the October, 1926, Issue of POPULAR RADIO.)

Quantity	Item	Credits
1	—Hammarlund mid-line dual condenser, .000275 mfd.	300
1	—Hammarlund mid-line single condenser, .000275 mfd.	186
1	—Precision Duo-Octaform coil set, one antenna coupler and two inter-stage couplers.	420
1	—AmerTran De Luxe first-stage transformer.	400
1	—AmerTran De Luxe second-stage transformer.	400
1	—Amerchoke No. 854.	240
1	—Dubilier No. 902 filter condenser, .4 mfd.	220
1	—Dubilier No. 907 Filter Condenser, .4 mfd.	24
1	—Mar-Co illuminated control, scale 0 to 100.	140
2	—Mar-Co small controls for LC-27.	60
1	—Carter battery switch.	26
1	—Samson radio-frequency choke coil No. 85.	60
3	—Averovex mica fixed condensers, .00025 mfd.	42
1	—Durham resistor, 4 megohms.	20
1	—Lynch grid leak mounting.	14
1	—Carter Gem Jack.	10
1	—Carter resistance, 0-10,000 ohms.	80
10	—Eby binding posts.	60
5	—Benjamin UX sockets.	150
1	—Amperite.	44
	Mechanical Kit consisting of aluminum shields, binding post strip, decorated panel and Tait brackets.	500
	Total	3408

Write for List of Free Parts for Other Popular Radio Receivers

POPULAR RADIO

Department 41A

627 WEST 43d STREET

NEW YORK CITY

Build Your LC-27 Receiver

with the aid of

Popular Radio SIMPLIFIED Blue Prints

Easy, Quick and Accurate

POPULAR RADIO believes that this new circuit, which is the outstanding contribution of Laurence M. Cockaday to the experimental set-builder for this year, constitutes not only one of the most important advances that has so far been made in the radio art, but that it is distinguished by a tonal quality—particularly in the lower registers—that is unsurpassed.

This receiver embraces the 14 points of an ideal radio receiver to meet the demands of the average man's requirements.

1. A quality of reproduction that is as nearly perfect as possible;
2. A cabinet designed to blend harmoniously with the finest surroundings;
3. Consistently good performance with a minimum of care and attention, once the set is installed;
4. A tuning control so simple that any one may operate the set without special instruction;
5. A selectivity adequate to eliminate interference from stations on adjoining wavelengths;
6. An ability to operate on any type of outdoor antenna or with no antenna at all;
7. A capacity to operate on house current or batteries, as desired;
8. Adequate shielding of parts;
9. A power amplifier and output filter to supply ample volume without distortion;
10. A construction that provides for the use of nationally known tubes and parts that are easily obtainable in any locality;
11. A non-regenerative circuit;
12. A simple construction with a minimum of adjustments;
13. A sensitivity adequate to provide good reception of distant programs;
14. A fool-proof construction.

By using POPULAR RADIO Simplified Blueprints in building your LC-27 Receiver, you can save time, eliminate the possibility of error, and make your set exactly like the laboratory model (see page 399).

If your local dealer cannot supply you with Blueprints of the LC-27 Receiver, they will be sent post-paid upon receipt of \$1.00.

A full description of this Receiver, with detailed directions for building, was published in the October, 1926, issue of POPULAR RADIO. Send 35 cents for a copy.

We also have Blueprints of The LC-Senior Power-Pack, The LC-Intermediate Power-Pack and The LC-Junior Power-Pack which were designed to operate The LC-27 Receiver.

POPULAR RADIO

Service Bureau 44-B

627 West 43rd Street

New York City



The obverse of the medal; the original is two-and-one-half inches in diameter.

The Popular Radio Medal for Conspicuous Service

TO every radio amateur, to every amateur experimenter and broadcast listener, who is instrumental in alleviating human suffering or saving human life, directly through the medium of radio, recognition will hereafter be extended in the form of a medal that shall be known as "The Popular Radio Medal for Conspicuous Service." This medal is unique within the realms of radio, in that it shall be awarded not for scientific achievement or invention, but for service to humanity.

To insure a fair and unbiased consideration of all claims, a Committee of Awards has been appointed that includes five distinguished citizens of international fame. To assist this Committee of Awards, an Advisory Committee has been appointed that numbers among its members some of the most eminent citizens of the United States, including representatives of many of our most distinguished institutions.

The conditions under which the medal will be awarded are here specified:

1. The medal shall be known as the Popular Radio Medal for Conspicuous Service.
2. The medal shall be awarded, without discrimination as to sex, age, race, nationality, color or creed, to those radio amateurs, radio experimenters, broadcast listeners and other non-professionals through whose prompt and efficient action radio is utilized to perform an essential part in the alleviation of human suffering or in the saving of human life within the territorial confines of the United States and its possessions, or in the waters thereof.
3. The medal shall be awarded by a Committee of Awards that shall not exceed five in number. No member of this Committee shall be an employee, officer or stockholder of POPULAR RADIO, INC., nor shall any such employee, officer or stockholder have a vote in the deliberations of the Committee.
4. An Advisory Committee, which shall co-operate with the Committee of Awards and which shall be particularly charged with the responsibility of making recommendations for awards of this medal, shall be made up of men and women who, because of their interest in the public welfare or because of their connection with institutions that are consecrated to public service, are in positions to bring to the attention of the Committee of Awards the exploits of candidates who are within their own special fields of activity.
5. The medal will be awarded for services rendered since Armistice Day, November 11, 1918.
6. Recommendations for awards may be submitted to the Committee of Awards at any time and by any person. Every recommendation must contain the full name and address of the candidate, together with a detailed account of the accomplishment on which the proposed award is based, and must be accompanied by corroboratory evidence from persons who have first-hand knowledge of the circumstances and whose statements may be verified to the satisfaction of the Committee of Awards.

FREE PARTS for the new Univalve Receiver

If you want to build your own set, here is your opportunity to secure FREE all the parts you need for this "Univalve Receiver." Call on all your radio friends, and on anyone who has a set and tell them of the many special features of POPULAR RADIO.

These liberal offers will make it possible for you to secure an order from every one you call upon. For each subscription with remittance you send us you will receive credits as per the following scale:

POPULAR RADIO

4 Months for \$1.00 counts 16 credits
6 " " " 1.50 " 25 "
8 " " " 2.00 " 33 "
12 " " " 3.00 " 50 "
24 " " " 5.00 " 75 "

Send us the full amount collected with names and addresses of subscribers and tell us the parts your credits entitle you to and we will send them to you. If the subscriptions you secure do not give you enough credits for the parts you want, we will allow you to purchase credits at the rate of 3 cents each. Example: With (7) seven 1-year subscriptions (350 credits) and 90 cents additional in cash you may have 2 Cardwell Taper Plate Variable Condensers, equipped with 2 Cornell Etched Vernier Dials for which you need 380 credits.

If the parts you want are not listed in this advertisement, we are prepared to supply them. Let us know what you want and we will tell you how many credits you will need.

On page 399 are described POPULAR RADIO'S Simplified Blueprints. You can have any set of prints you want for only 40 credits. You may also secure a copy of "How to Build Your Radio Receiver" described on page 413 for 60 credits.

CREDITS Needed for Parts Required for the new "UNIVALVE RECEIVER"

(Described and illustrated in POPULAR RADIO.)

Quantity	Item	Credits
2	Hammerlund Autocouplers	280
2	Cardwell Taper Plate Variable Condensers, type 160 E, 00035 mfd. Equipped with 2 Cornell Etched Vernier Dials	380
1	Karas Harmonik Low-Frequency Transformer	120
1	Thordarson Low-Frequency Transformer, 2-1 Ratio	280
1	Any Approved Battery Switch (Carter Switch Illustrated)	26
1	Any Approved Automatic Filament Control, .25 amp. (Amperite Illustrated)	44
1	Any Approved Mica Fixed Condenser with Grid-leak Clips, 00025 mfd. (Electrad Condenser Illustrated)	16
1	Any Approved Mica Fixed Condenser, 0001 mfd. (Electrad Condenser Illustrated)	12
1	Any Approved Mica Fixed Condenser, 0005 mfd. (Electrad Condenser Illustrated)	12
1	Any Approved Grid-Leak, 4 megohms (Polymer Grid-leak Illustrated)	10
1	Any Approved Small Single-Circuit Jack (Electrad Jack Illustrated)	16
1	Bakelite Front Panel, 7 x 15 x 3-16 inch	100
1	Hardwood Sub-base, 7 x 14 x 1/2 inch	20
1	Bakelite Binding-post Strip, 1 x 9 x 3-16 inch	12
7	Any Approved Binding Posts, marked Ant. Grnd., A Minus, A Plus, B Minus, B Amp. Plus, B Amp. Plus, respectively (Eby Binding Posts Illustrated)	42
2	Small Brass Brackets	4
1	Benjamin Vibrationless Socket	30
Total		1598

Write for List of Free Parts for Other Popular Radio Receivers

POPULAR RADIO
Department 41
627 West 43d St. New York City



The reverse; the name of each recipient will be engraved in the space provided.

- The medal will be awarded to as many individuals as qualify for it and at such times as the Committee of Awards may authorize.
- All considerations not specified herein shall be left to the discretion of the Committee of Awards.

All communications to the Committee of Awards may be addressed to—

The Secretary of the Committee of Awards, POPULAR RADIO Medal for Conspicuous Service, 627 West 43rd Street, New York.

The Committee of Awards

- HIRAM PERCY MAXIM, *President of the American Radio Relay League.*
 E. F. W. ALEXANDERSON, *Chief Consulting Engineer of the Radio Corporation of America.*
 MAJOR GENERAL CHARLES MCK. SALTZMAN, *Chief Signal Officer of the Army.*
 REAR ADMIRAL W. A. MOFFETT, *Chief of the Bureau of Aeronautics, U. S. Navy.*
 DR. JOHN H. FINLEY, *publicist and journalist.*
 Secretary: Dr. E. E. Free, 627 West 43rd Street, New York.

Advisory Committee

- SENATOR JAMES W. WADSWORTH, JR., *of New York.*
 HON. JOHN BARTON PAYNE, *Chairman, American Red Cross.*
 ADOLPH LEWISOHN, *publicist.*
 JUDGE BEN S. LINDSAY, *of the Juvenile and Family Court, Denver, Col.*
 DR. J. MCKEEN CATTELL, *Past President, American Association for the Advancement of Science.*
 DR. J. H. DELLINGER, *Past President, Institute of Radio Engineers.*
 FARLEY OSGOOD, *Past President, American Institute of Electrical Engineers.*
 C. E. GRUNSKY, *Past President, American Society of Civil Engineers.*
 DR. DAYTON C. MILLER, *President, The American Physical Society.*
 W. L. ABBOTT, *President, The American Society of Mechanical Engineers.*
 W. J. HOLLAND, *President, Carnegie Hero Fund Commission.*
 GEORGE K. BURGESS, *Director, Bureau of Standards.*
 COLIN H. LIVINGSTONE, *Past President, Boy Scouts of America.*
 DANIEL C. BEARD, *Chairman, National Court of Honor, Boy Scouts of America.*
 MISS SARAH LOUISE ARNOLD, *President, Girl Scouts.*
 DR. W. D. HAGGARD, *President, American Medical Association.*
 K. A. BICKEL, *President, United Press Association.*
 KENT COOPER, *General Manager, The Associated Press.*
 H. P. DAVIS, *Vice-President, Westinghouse Electric & Manufacturing Company.*
 DR. VERNON KELLOGG, *General Secretary, National Research Council.*
 JESSE LYNCH WILLIAMS, *Past President, Authors' League of America.*
 PROFESSOR GEORGE B. PEGRAM, *Dean of the Faculty of Applied Science, Columbia University.*
 PROFESSOR H. H. SHELDON, *Professor of Physics, New York University.*
 WM. HAWLEY ATWELL, *Grand Exalted Ruler, Order of Elks.*
 PROFESSOR EDWIN B. WILSON, *Harvard University, National Academy of Science.*
 W. E. HARKNESS, *Vice-President, American Telephone & Telegraph Company.*
 WILLIAM L. SAUNDERS, *President, United Engineering Societies.*
 COL. J. R. MCQUIGG, *Past Commander, The American Legion.*
 JOHN R. MOSS, *President, Kiwanis International.*
 W. D. TERRELL, *Chief Supervisor of Radio, Department of Commerce, Washington, D. C.*

Greatest Receiver Ever Developed

In the latest issue of the *Citizens Radio Call Book*, there is a descriptive article regarding the *New Camfield Super-Selective Nine Receiver*. This circuit is considered by experts as the greatest receiver ever developed. An outstanding achievement is the simultaneous increasing of both selectivity and sensitivity to a point heretofore considered impossible.

CAMFIELD'S Super-Selective Nine

The *Super-Selective Nine* offers to set builders unusual opportunities, for here is a circuit that will meet every requirement for the very best in radio reception. Another feature that will appeal to the radio public is the turning of a switch on the panel, which converts this set from a 5-tube, two-control receiver for local stations, to a nine-tube super-selective and super-sensitive circuit, capable of tuning through powerful local stations and receiving distant ones on a ten kilocycle separation of frequency.

Write today for book on this wonder circuit and have the facts before you. Use the handy coupon below. Send 25c. today—now.

Camfield Radio Mfg. Co.
357-364 E. Ohio Street,
Chicago, Ill.



Mail Coupon Now

Camfield Radio Mfg. Co.
357-364 E. Ohio St., Chicago, Ill.
Enclosed find 25 cents for booklet, "Camfield's Super-Selective 9."

Name.....
Address.....

Send for Latest RADIO CATALOG and GUIDE

Free 1927 Radio Guide

The big 164-page Barawik Guide book is used by hundreds of thousands of radio enthusiasts. It's the handiest and most reliable radio reference guide, and a big money-saver. Keep up to date by utilizing Barawik service.

164 Pages of Bargains

It gives 164 pages replete with reliable information about the newest and most advanced ideas in radio development, describes and illustrates the latest improvements. It will keep you posted on what's up to date. It will help you to build a better set, improve your old one and make it up to date or buy a complete new modern one. Every radio set owner, amateur, beginner and fan should have a copy.

Lowest Prices on Parts

It will pay you to get our prices for complete parts for the popular circuits featured in *POPULAR RADIO* and other magazines. Whenever a new circuit appears for which you want complete parts, write or wire us and they'll be on their way to you quickly. We know what parts to send you. Simply give name of circuit and we'll take care of the rest. We guarantee you a big saving on every order.



Send for Free Copy Now!

Get our new radio catalog today before you spend another cent on radio. Just mail the coupon and free copy will be sent you. Also please include name of a friend interested in radio.

BARAWIK CO.

Dept. 64
Chicago, U. S. A.

Mail This Coupon Now! For Free Copy

Name.....
Address.....
Fax.....
Address.....



BROADCASTS

CONDUCTED BY CHARLES L. REESE, JR.

Re-broadcasting U. S. Programs

AMERICAN broadcast programs will be picked up and re-broadcast in England—if the plans of British radio engineers are carried out. Every Tuesday British broadcasting engineers will test the reception from the United States and whenever it is sufficiently good they will inform the London Station 2L.O. The London program will then be switched off and an American program will be relayed to all listeners, even to those who own only crystal sets.

* *

The First Suicide for Love of a Broadcast Artist

WHAT is probably the first case of suicide due to unrequited love for a broadcast artist occurred in Vienna on February 6, when a fifty-two-year-old radio fan, a cook, turned on the gas in her room because of her failure either to see or to receive letters from an ethereal musician whose broadcast music had enthralled her.

* *

Radio Is Now a Billion-Dollar Industry

THE manufacture of radio parts has developed into a billion-dollar industry within six years, sales for the period from 1920 to 1926 totaling \$1,492,000,000, Frank A. Arnold of the National Broadcasting Company, recently stated.

Annual sales mounted from \$2,000,000 in 1920 to \$500,000,000 in 1926, Mr. Arnold said, and so far only 6,000,000 of the 27,000,000 homes in the United States have been supplied with radio receiving sets. Of the 950 broadcasting stations in the world 673 are operated within the United States.

As indicating the immensity of the industry, Mr. Arnold declared there was a potential audience of 30,000,000 in the United States within reach of a single human voice. Directly and indirectly the industry gives employment to 300,000 persons, working for 3,500 manufacturers, jobbers and distributors. Last year \$20,000,000 was spent on advertising by radio in this country

through 400 stations accepting paid advertising, and twelve New York City newspapers carried 3,500,000 lines of radio advertising.

* *

A Novel Invitation to Tune In

HERE is a novel form of announcement of a broadcast program feature; it came to the editor of POPULAR RADIO in the shape of a *fac-simile* reproduction of a long-hand note:

Mrs. Clayton Darius Lee requests the honor of your company at the radio, Fridays in February at two-forty, and asks you to "Tune In," on "WJZ" R. S. V. P. (after the talks) Mrs. C. D. Lee, 790 Broad Street, Newark, New Jersey.

* *

A Radio-Equipped Expedition to Persia

WHEN the Forbes-Leith Expedition to Persia penetrates the wilds of the country, it will depend upon radio for maintaining its contact with civilization. The fortunate young radio amateur selected for this important task is a friend of the POPULAR RADIO family—Charles E. Warren, Jr., of New York. He reports that the portable transmitter selected is built to operate on 20, 34, and 44 meters; the power rating is normally 250 watts. A UV-204-a tube is used with a DC plate supply of 2000 volts. The circuit is the Hartley. A Grebe receiver, type Cr. 13, will be carried. The expedition is already on its way.

* *

A "Vest Pocket" Set

AN approach to the long-heralded "vest-pocket radio receiver" is made in the miniature portable set recently patented by Henry Csanyi of New York. His invention (Patent No. 1,617,236) is described as "a unitary and hand-portable radio receiving set, comprising a telephone receiver with its coil and diaphragm, a tuning coil disposed adjacent the receiver coil, a fixed crystal detector, including a crystal and a detector contact cooperating therewith and arranged at the axis of the tuning coil."

Changes in the List of Broadcasting Stations in the U. S.

During the month of February, 1927, the following changes were reported in the list of broadcasting stations:

STATIONS ADDED

WMBL	Lakeland, Florida	410.0
WFLA	Boca Raton, Florida	448.0
KFGQ	Boone, Iowa	300.0
KGEX	Muscataine, Iowa	258.0
KGZ	Kalispell, Montana	352.0
KGFF	Alva, Oklahoma	206.4
WMBO	Auburn, New York	238.0
WMBN	Memphis, Tennessee	245.0
WEBE	Cambridge, Ohio	234.0
WJPW	Ashtabula, Ohio	239.9
KROX	Seattle, Washington	265.3
WLBW	Boston, Massachusetts	480.0
KGEO	Grand Island, Nebraska	271.0
KGFG	Oklahoma City, Oklahoma	384.0
WMBQ	Brooklyn, New York	210.0
WMBU	Pittsburgh, Pennsylvania	236.1
KSCJ	Sioux City, Iowa	444.0
WMBR	Tampa, Florida	250.0
WMBW	Youngstown, Ohio	279.0
KGFM	La Crescenta, California	210.0
WMBX	Columbus, Mississippi	265.3
KGFI	Fort Stockton, Texas	220.4
WNBK	Endicott, New York	265.4
KOLO	Durango, Colorado	355.1
WMBY	Bloomington, Illinois	231.1
KGJ	Los Angeles, California	210.0
KGA	Spokane, Washington	340.7
WNBA	Forest Park, Illinois	238.0
WFIW	Hopkinsville, Kentucky	356.9
WNBK	LeRoy, New York	354.0
KGFM	Yuba City, California	460.0
KGFK	Hallock, Minnesota	225.0
WNBK	Knoxville, Tennessee	325.0
WNBK	Peru, Illinois	357.0
KWBS	Portland, Oregon	200.0
WNBK	Bloomington, Illinois	486.0
KLIT	Portland, Oregon	380.0
KGFL	Trinidad, Colorado	225.0
WALK	Bethayres, Pennsylvania	285.0
KELW	Burbank, California	536.0

STATIONS DELETED

WLBW	Canastota, New York
WGBR	Marshfield, Wisconsin
KXRO	Seattle, Washington
KGDI	Seattle, Washington
KFYO	Texas, Texas
WWPR	Detroit, Michigan
KFOO	Salt Lake City, Utah

CHANGES IN CALL LETTERS

WLBW	Philadelphia, Pa.	change to	WPSW
WMBX	Columbus, Miss.	change to	WCOC
WGBB	Clearwater, Fla.	change to	WFHH
WSWS	Batavia, Ill.	change to	WTAS
KFQP	Iowa City, Iowa	change to	KGFB
KGDZ	Decorah, Iowa	change to	KWLC
KOMO	Seattle, Wash.	change to	KGFA

CHANGES IN WAVELENGTHS

WCSH	Portland, Me., 256.3	change to	499.7
WOK	Homewood, Ill., 217.3	change to	410.0
KGCN	Concordia, Kan., 210	change to	235.0
WMPC	Lapeer, Mich., 222	change to	202.0
WFHH	Clearwater, Fla., 265.3	change to	355.4
KDYL	Salt Lake City, Utah, 245.8	change to	246.8
KGCG	Newark, Ark., 239.9	change to	224.2
WBBK	Brooklyn, N. Y., 249.9	change to	267.7
WKBO	Jersey City, N. J., 220.4	change to	472.2
WGBU	Fulford, Fla., 277.6	change to	384.4
WCRW	Chicago, Ill., 416.4	change to	410.7

* These call letters have been assigned to another Seattle station.

* *

Federal Radio Commission Nominated

JUST as this issue of POPULAR RADIO goes to press, President Coolidge sent to the Senate the nominations of the five members of the Federal Radio Commission provided for by the new law. The nominees were as follows:

William H. G. Bullard, Rear Admiral, U. S. N., retired, of Media, Pa.; for a term of six years.

Orestes H. Caldwell of Bronxville, N. Y., editor of *Radio Retailing*; five years.

Eugene O. Sykes of Jackson, Miss., former Justice of the Supreme Court of Mississippi; for four years.

Henry A. Bellows of Minneapolis, director of Washburn-Crosby radio station; for three years.

John F. Dillon of San Francisco, supervising radio operator; for a term of two years.

Trans-Oceanic Calls Heard

POPULAR RADIO has now completed arrangements for forwarding to transmitting amateurs in England, France, Germany, Austria, Ireland and Italy all calls heard (QSL) cards that may be addressed to them by American amateurs care of this magazine. These cards will be delivered through local agents in those countries, who have or can obtain knowledge of the present address of the foreign amateurs. Plans have also been completed by this magazine for forwarding to transmitting amateurs in this country in turn all QSL cards that may be addressed to them by amateurs from those countries. American amateurs are invited to send their cards to foreign amateurs through this office, which will not only assure safe delivery through the special agencies which are thus provided, but which will publish a monthly list in a "Trans-Oceanic Calls Heard" department.

Address your cards to the foreign amateurs by call numbers and enclose them in envelopes to—

The Calls Heard Editor,
POPULAR RADIO

627 West 43d Street, New York

THE following stations were received and logged at the amateur station of W. M. Smith (U-3GP) at 1729 Irving Street, Washington, D. C., on a special type of receiver employing two stages of audio:

- F-8BRN—Jan. 24, 1927; signal strength R3; calling CQ;
- F-8JRK—Jan. 24, 1927; signal strength R4; calling CQ;
- P-1AE—Jan. 25, 1927; signal strength R5;
- B-8O—Feb. 1, 1927; signal strength R5; heard calling CQ and, later, working U-8EU;
- Y-2YT—Jan. 30, 1927; signal strength R6; calling CQ;
- EF-8OLO—Jan. 5, 1927; signal strength R5; calling CQ;
- EF-8YOR—Jan. 5, 1927; signal strength R4; calling CQ and later working NU-5BY;
- EB-71—Feb. 7, 1927; signal strength R5; calling CQ;
- EK-4UAH—Jan. 4, 1927; signal strength R5.

THE following stations were received and logged at the amateur station of S. Williamson (G-2ACI) at 22, Hurst Grove, Bedford, England, on an O-v-1 Reinartz receiver:

- U-3CMZ—Aug. 17, 1926; signal strength R4; calling CQ on 38 meters; AC note; atmospheric R2;
- U-9BPB—Aug. 18, 1926; signal strength R4; calling U-2BS on 38 meters; AC note; no fading;
- U-3LD—Aug. 18, 1926; signal strength R4 to R5; calling CQ on 38.25 meters; DC note; noticeable atmospheric; slow fading;
- U-4LK—Aug. 18, 1926; signal strength R3; AC note on 38.7 meters; atmospheric R6;
- U-3CJN—Aug. 17, 1926; signal strength R2; calling CQ on 40 meters; DC note; no fading;
- U-4RR—Aug. 11, 1926; signal strength R3; calling CQ on 38 meters; DC note; no fading.

THE following stations were received and logged at the receiving station of J. Thomas (R-274) at 3 Avenue des

Chalets, Paris (XVI^{me}), France, on an O-v-1 Reinartz receiver with a single-wire antenna 8 meters long and no ground:

- U-9BLF—Sept. 28, 1926; signal strength R5 to R6; good, steady wave; much interference from American stations;
- U-9CET—Sept. 30, 1926; signal strength R6 to R7; good, steady, rectified AC note; much interference from American stations;
- U-5LE—Sept. 28, 1926; signal strength R3; rectified AC note; interference from U. S.;
- U-5MAJ—Oct. 2, 1926; signal strength R3 to R4; DC note; much interference from U. S. station;
- U-3AFW—Oct. 2, 1926; signal strength R7; good, steady, rectified AC note; much interference from U. S.;
- U-4AAH—Oct. 2, 1926; signal strength R6; DC note; much interference from U. S.;
- U-9BEQ—Sept. 30, 1926; signal strength R3; DC note; much U. S. interference;
- U-7EK—Sept. 30, 1926; signal strength R5 to R6; rectified AC note; very bad fading; much interference from U. S. stations;
- U-7WU—Sept. 30, 1926; signal strength R5; rectified AC note, almost DC; bad fading; much U. S. interference.

* *

Do You Know That—

At the first of the year there were 668 licensed broadcasting stations in the United States, operating on the 89 available wave bands?

Since November, 1920, 1,538 broadcasting stations have been licensed by the United States Government; of this number over 60 percent have been discontinued.

No one broadcasting station can, at the present time, render regular dependable, day and night service all the year round to an audience more than 100 miles from its antenna.

There is an average of five listeners to each radio receiver, according to a recent estimate made by radio engineers.

A recent questionnaire sent to broadcast listeners indicated that 51 percent of set owners also owned their own homes, 46 percent owned their own pleasure cars; 50 percent owned pianos and 74 percent owned phonographs.

Estimates of the radio audience in the United States range from 16,000,000 to 25,000,000 people.

There are more receiving sets owned and operated in the United States in January, 1927, than there were a year ago; a recent survey shows that a year ago there were eight cities which have over 200,000 receivers, as follows:

New York	628,000
Boston	345,000
Chicago	354,000
Detroit	266,000
Philadelphia	247,000
Cincinnati	216,000
Pittsburgh	214,000
Cleveland	206,000

New

Sterling

Raytheon Tube

"B" Eliminator

for \$28⁰⁰

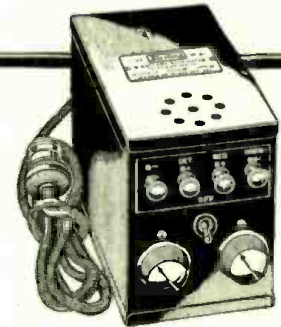

Model
RT-81

THIS low-priced "B" Eliminator is ideal for all five-tube sets including Radiolas 25 and 28.

It embodies the Sterling perfected adjustment for high, intermediate and detector voltages. It adds tone quality to your reception.

No larger than a single dry "B" Battery, it delivers three times the voltage.

And it gives sure, silent, steady power. Easily installed too. Complete with long-lived B. H. Raytheon Tube—\$28.00.

Sterling

"B" ELIMINATORS

Ask your Dealer for Sterling RT-81
or send for complete description.

THE STERLING MFG. CO.
2831 Prospect Ave. Cleveland, O.

Raytheon
LONG LIFE RECTIFYING TUBE

**Before Deciding
Where to Buy
Your Kit
CONSIDER**

THAT, the Precision Coil Company has specialized in Popular Radio kits for the past three years.

THAT, we have sold thousands of kits to satisfied fans all over the world.

THAT, all parts are exactly as used in the Popular Radio Laboratory model.

THAT, we guarantee all kits fully for workmanship and materials.

**ORDER YOUR KIT FROM THE
PRECISION COIL CO., AND BE
SURE OF SATISFACTION**

KITS IN STOCK

- Univalve Receiver, complete with tube \$47.45
- Sir Oliver Ldgc N Circuit, complete with tubes \$49.25
- The K. H.-27 \$86.00
- The LC-27 \$85.20
- LC Senior Power Pack \$65.00

And others.

Write us today enclosing check or money order. Kits built complete for small additional fee, if desired

PRECISION COIL CO., Inc.
209 CENTRE ST., NEW YORK CITY



R. G. Moffett

A LOUDSPEAKER IN EVERY ROOM

By merely applying at the office, every guest of the George Washington Hotel of Jacksonville, Florida, may obtain a loudspeaker to plug into the socket provided for that purpose in his room. A Western Electric 4-B superheterodyne receiver is employed for reception. The installation cost \$10,000.

BROADCAST LISTENER

*Comments on radio programs, methods and technique
—from the point of view of the average fan*

By **RAYMOND FRANCIS YATES**

**Is the Microphone Showing
Up the Opera Stars?**

If the radio does one thing, it puts in their proper places the vocal stars and near stars who, largely through the scheming and alacrity of a publicity man, have buncombed this land into believing that they are artists of the first water and that their warbling has that charm that comes only from the throat of the genius. Put Mary Smith and Sadie Jones on the air with Marion Talley or Frances Alda and you will convince yourself that access to stardom is either a matter of publicity, spondules or influence with the powers that are able to make big singers out of little ones.

During our experience with the radio we have heard literally hundreds of young sopranos who (provided they are fairly presentable) could match any of Talley's performances so far as radio performances are concerned, and who could, given a beautiful gown, a concert hall and a manager in a frock coat, put on a show that would draw admissions from the snootiest critics. After all is said and done, all a concert singer needs is a voice that will get by with a solo in any Fifth Avenue church and a concert hall affording the proper environment. Any good publicity man, furnished with enough money, can perform the miracles that make first-class stars from this kind of material.

Take the glittering concert hall and the sparkling gowns away from the majority of our metropolitan stars and place them beside a young lady with something a trifle better than the voice of the average radio soprano and you will, unless you are familiar with the idiosyncrasies of each voice, be unable to distinguish one from the other. During a recent recital over the radio by Frances Alda, this very thing was proven; Alda, to our way of thinking, took her position among thousands of musical nobodies who had appeared before the very same microphone. Even her repertoire was chosen a bit amateurishly, and, all in all, she gave a demonstration that was forty kilometers from justifying her position in the world of music. And there are others.

* *

**The Nuisance of the Religious
Propagandists**

ALL of our half-baked and shoddy theologians, it would seem to one who watches the radio closely, are unloading much loose-talk into the microphones of the country nowadays. If they do not have access to a broadcaster supported by their own cult for propaganda purposes, they sally forth to convince the proprietor of otherwise respectable studios that, aside from the house of God, itself, the radio is the greatest soul-saving device ever created

**YOUR OWN
BUSINESS
Without Capital**

Right now, there is an opportunity in your locality to profitably devote your spare time or all your time to a pleasant, easy and profitable business—one that does not require any training or capital.

The publishers of POPULAR RADIO offer you an opportunity to become their local representative to take care of expiring subscriptions and new subscriptions for POPULAR RADIO and one other popular magazine that they publish.

SALARY AND COMMISSION

All material will be furnished you free of charge and you will be paid an attractive commission and salary.

Mail coupon for full particulars.

POPULAR RADIO, Dept. 46,
627 W. 43rd St., New York City.

Send me full particulars regarding your salary and commission offer to local representatives.

Name.....

Address.....

Has the Popular Radio Laboratory Put the "Silent Test" to the Receiver You Purchased?



*You May Buy With Confidence When the
Popular Radio Laboratory Says: "APPROVED"*

BUYING a radio receiver solely on the strength of its appeal to your ear is like purchasing a clock simply because you like its tick. It may be a badly designed clock with a weak spring, a fluctuating escapement and it may be an inaccurate keeper of time. The same applies to your radio receiver. It may sound well; it may look well, but, like Pandora's chest, it may be filled with hundreds of little imps of bad engineering who will murder your "B" batteries, interfere with your selectivity, poison your vacuum tubes and finally exhaust your temper and your pocket-book. It is not difficult to find a radio that will please your ear and match your purse, but that is only two

of many things you must insist upon — that you must know — to make your purchase safe. How would the set of your choice perform on Popular Radio's "Silent Test"?; how would it answer the doubts of Popular Radio's engineering department when they forced it to "speak" through the medium of milliammeters, millivoltmeters, audibility meters and thermo-couples instead of a loudspeaker? Perhaps it would tell a shocking story of the many engineering crimes committed by its designers. It might be that this "third degree" would bring about a confession telling why you used four sets of "B" batteries last year when two sets should have been plenty or perhaps, it would throw light on the mysterious way in which the rectifier valves in your "B" eliminator "burn out."

How can you buy with confidence? Certainly not merely by listening. You can't hear losses in a high-frequency coil nor can you see the grid bias on the power tube. These things *must be measured* and many of them should be known before you purchase a receiver. But you probably could not do these things yourself even if you owned the proper oscillators and measuring instruments. The dealer would not permit you to turn his shop into a testing laboratory.

So confident has the radio trade become in the severity, honesty and engineering sense displayed in the laboratory vacuum tests that manufacturers have, in innumerable instances, brought their newly designed receivers in for examination before launching into production. This has been a gratifying indorsement of Popular Radio's Laboratory.

In purchasing a receiver advertised in or tested by Popular Radio, you can rest assured that its performance has been carefully checked up by the engineers of the Popular Radio Electrical Testing Laboratory and that a thorough record of its technical pedigree has been put on file. This great amount of work (about one week is required to properly test a receiver) is done that you may buy with confidence; with the comfortable feeling that your interests have been protected.

As you probably know, Popular Radio does not accept receiver advertising at random. It is guided by the readings of sensitive meters and by its own conscience. Remember that the popularity of a receiver is not always an index to engineering perfection, but a set advertised in Popular Radio may always be taken to mean that it represents, what is considered to be the best engineering practice of the day at the price offered.



The laboratory has spared no one in its tests and there is on the market today receiving sets that could not, under any cir-

cumstances, be advertised in the pages of the magazine. A publication must keep the faith of its readers regardless of costs.

A list of tested and approved receivers may be had by addressing a stamped and self-addressed envelope to the Service Department, Popular Radio, 627 West 43d Street, New York City.

and that their message—always charged with the divine stuff, of course—will give a studio prestige among the Christian brotherhood.

Few broadcasters, if any, apparently have the courage to refuse these agents of the Kingdom; and daily the air is made heavy with their vapid rantings.

On Sunday the radio sets of the land become mere instruments for salvation; and, regardless of the geographical location of one's domicile, there is practically nothing to listen to but the lessons of the fathers. Whether it is fear or faith that causes our studio managers to place their facilities at the disposal of the churchy brethren is not a question to be answered by this Department, but the fact remains that on Sunday radio is solely in the hands of God's self-appointed engineering staff. The listener is a target for the howlers of cults bearing all shades of theological coloring, from the clowning Billy Sunday's to the highly dignified and reverend gentlemen who are entrusted with the souls of the more successful Babbity.

During a holiday visit to Buffalo where the magic bunk of the doctors of evangelism is practiced as assiduously as any place in the United States, we had occasion to observe the dedication of still another microphone to holy purposes and to collection plates heavy with the hard-earned lucre of the yokels. This radio tabernacle with its clowning disciple is but one of an already large and still growing number of such institutions. It renders futile the efforts of many Buffalo broadcasters who attempt to use the air while the ballyboosing brethren are throwing out their challenges to the heathen. The owners of this new ether bunk mill are as insolent as they are inconsiderate; they well represent that brazen clique of mountebanks who see in the radio a device to keep the evangelical industry in a thriving condition.

* *

The Position of the "Radio Critics"

This commentary is becoming increasingly difficult to prepare; we have arrived at a point in our critical career where we find few things to shoot at that have not, at some previous date, been shot at before. For over five years now, we have been wadding up these critical pellets to heave at the studio managers, and we have, we now feel, become practically exhausted of any ideas that are worth exposing to the intense minds of our readers. We have squirted ink at the announcers; we have accused the studio managers of incompetency; we have waged, in our own crude way, unmitigated warfare against the soprano epidemic; we have aimed many a ripe tomato at the parlor baritones, and, Godknows, our supply of

bad eggs has been spent upon the wind-jammers who daily and nightly caress our microphone with sweet nothingness. And of what avail has all of this shouting been?

Radio is still pretty much in its overalls; it still awaits those tempering touches that will make of it something akin to an art rather than a raw entertainment with no more pattern and certainly with no more contemplation than is exercised by a child using building blocks.

If radio has failed to do one thing, it has failed to take fullest advantage of the criticism it has received from the press. Our studio managers, it seems, have come to look upon radio critics as egotistic blackguards, fully unaware of the problems that beset the makers of programs, and are motivated by nothing more lofty or inspiring than the desire to gush steam and vitriol. The radio critic, to hear the novitiates of the studios, is a mere nuisance who airs nothing but private opinions for no reason at all, and who has not the slightest knowledge of the deeper problems of the art. This viewpoint of the studio managers is, unfortunately, true in many cases, due, it would appear, to the poor choice of talent made by the editors of the country. On the other hand, a surprisingly large number of the better papers have engaged sober, sincere and capable men for this work. But whether it is confusion or pure incompetence, our studio impresarios regard all critics who attempt to write something more sincere and pointed than dishwater, as meddling imbeciles trying to display something they do not have.

At least twenty-five percent of the radio criticism printed has been sound and honest; but our studio managers go on stubbornly making the errors and overlooking the opportunities for improvement that are so clearly pointed out. They cannot read anything more important into this criticism than so much *blah-blah*.

It is evident that our impresarios of the radio must learn to be less dogmatic and more tolerant of the radio critic who is really trying to point out some of the obvious weaknesses of broadcasting.

* *

Hello, Roxy!

Now that Roxy has returned to the air with the original members of the old gang and a 110-piece symphony orchestra to boot, the best efforts of many of our great studio directors bid fair to be very badly outdone. Roxy's standards are not only high but his showmanship has always worried his competitors, whether in the theater or on the air. The radio fans appear to be in for an enlivening period of broadcast entertainment.

FREE

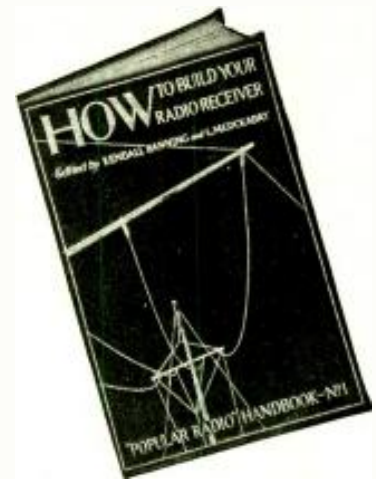

WITH POPULAR RADIO

Aside from the feature of economy, there is the thrill and satisfaction that comes from building your own receiving set.

Thousands of sets have never been constructed because of the atmosphere of mystery that has enveloped the whole subject of radio. Kendall Banning, Editor, and Laurence M. Cockaday, Technical Editor of POPULAR RADIO, through their close contact with the great radio public, sensed this and compiled a book that will convince the veriest beginner that technical training is not essential. If you have a little time to devote to a most fascinating pastime, send for a copy of "How to Build Your Radio Receiver."

Free Advisory Service

POPULAR RADIO is full of helpful suggestions as well as instructive and entertaining articles on radio and allied scientific phenomena. This information is supplemented by an advisory service that is free to all subscribers. Any problem you encounter that is not answered in the book or magazine will be answered by personal letter if you will submit it to the Technical Service Bureau.

A Valuable Combination

For the next thirty days we will give you a copy of "How to Build Your Radio Receiver," FREE and enroll you for all privileges of the Technical Service Bureau at no further expense, on receipt of your remittance of \$3.00 in payment for a 12 months' subscription for POPULAR RADIO. (As an alternative offer, if you wish the combination with POPULAR RADIO for 7 months only—send but \$2.00). In any event, you run absolutely no risk, as we will refund in full if you are not more than satisfied with your purchase.

CONTENTS

In "How to Build Your Radio Receiver" you will find complete constructional diagrams, specifications, photographs and instructions for building the following sets. Each has been selected as representative of its circuit because in laboratory tests it proved the best for distance, selectivity, tone volume, simplicity of construction, ease in tuning, reliability and all-around satisfaction.

A \$5 CRYSTAL SET
THE HAYNES SINGLE TUBE RECEIVER
A TWO-STAGE AUDIO-FREQUENCY
AMPLIFIER
THE COCKADAY 4-CIRCUIT TUNER
A 5-TUBE TUNED RADIO-FREQUENCY
RECEIVER
THE "IMPROVED" COCKADAY 4-CIR-
CUIT TUNER
THE REGENERATIVE SUPER-HETERO-
DYNE RECEIVER

POPULAR RADIO

627 West 43d Street, N. Y. C.

Offer expires April 30th, 1927

POPULAR RADIO, Dept. 45A,
627 West 43d St., New York City

Enclosed remittance of \$3.00 is payment in full for a 12 months' subscription for POPULAR RADIO and copy of "How to Build Your Radio Receiver" FREE.

Name.....

Address.....

City.....State.....

Check here and remit \$2.00 if you prefer POPULAR RADIO for 7 months only in combination with "How to Build Your Radio Receiver."

Through this man's invention the Musicone revolutionizes the loud speaker field

Powel Crosley Jr



Prices slightly higher west of the Rocky Mountains

Crosley Radios \$29. to \$98.

NOW!
The Genuine
CROSLLEY MUSICONE
\$ 9.75
16 inch size . . \$14.75

C. A. Peterson, only 24 years old, is responsible for the amazing tone, the surprising volume and the startling fidelity of reproduction of the Crosley Musicone.

Nearly three years ago a shy and reticent young man walked into the office of Powel Crosley, Jr., with an idea for a radio loud speaker under his arm. When he unwrapped the newspaper around it, Mr. Crosley instantly saw its great possibilities.

Mr. Crosley offered him the equipment of his laboratories, the assistance of his engineers and the resources of his company.

In a short time Peterson produced a marvelous actuating mechanism so designed as to vibrate freely without choking regardless of the heavy electrical impulses applied to it. It revolutionized the loud speaker field.

Within a few weeks after its announcement the Musicone captured the loud speaker market and has dominated it ever since. Horns with their ugly appearance and their harshness of reproduction which so discredited radio in early days were promptly obsolete.

The Musicone has been imitated in appearance but the patented actuating unit has never been equalled. Incidentally, Mr. Peterson's royalties on this instrument have been over \$90,000.

Attached to a good radio the Musicone delivers pure, true tones, without distortion regardless of how suddenly the crashes of orchestra or high shrill notes come through it.

As an ornament its rich bronze frame and the quiet tones of its ornamental cone are an addition to the decorations of any room. Made in two sizes and at two prices without any difference in quality.

The 12-inch Ultra Musicone for small rooms, apartments, etc. \$ 9.75

The 16-inch size Super Musicone for large rooms or porch use. \$14.75

**CROSLLEY
MUSICONES**

The Crosley Radio Corporation

Powel Crosley, Jr., Pres.
Cincinnati, O.

Write Dept. 16 for Descriptive Literature

*Long prophesied
Often attempted
Makeshifts frequently employed
Here at last!*

CROSLEY Radio Energy

*with only a
switch to snap*

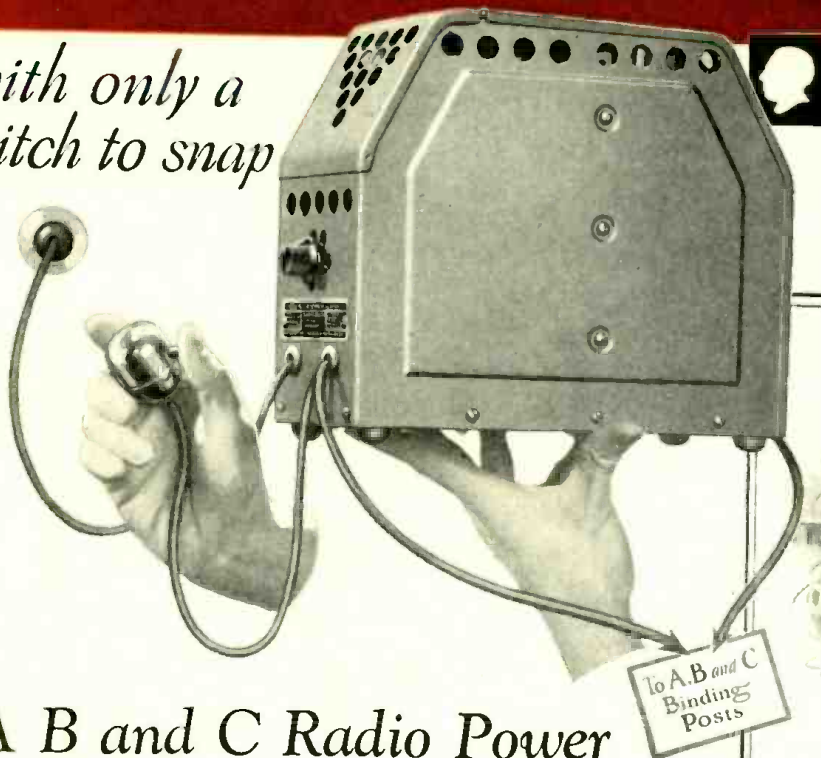

A B and C Radio Power

from house current outlet direct into the radio with no more attention or thought than you bestow on a vacuum cleaner or your electric iron. This wonder box weighs only 13 lbs., stands 9 inches high and is 4 inches wide, and is about half the size of an ordinary A storage battery. It is a mechanical device transforming ordinary 110 volt, 60 cycle house power into smooth, quiet radio energy for the new Crosley radios without slightest interfering hum and with the certainty of an electric motor. **PRICE \$50.**

Crosley radios designed for use with this marvelous power supply are the AC-7, a 6-tube table model at \$70, and the AC-7-C, a 6-tube console at \$95. See these wonderful sets at any Crosley dealers, or write Dept. 16 for descriptive literature.

Crosley sets are licensed under Armstrong U. S. Patent No. 1,113,149, or under patent applications of Radio Frequency Laboratories, Inc., and other patents issued and pending. Prices slightly higher west of the Rocky Mountains.

The CROSLEY RADIO CORPORATION
Powel Crosley, Jr., Pres. Cincinnati, O.

- No more batteries to fuss with.
- No more batteries or battery charger to water.
- No failure of the power plant just as you sit down to a fine program.
- No batteries to recharge.
- No batteries to renew.
- No apologies to make to callers because "the batteries must be getting low."
- No upsetting the house to have the radio serviced.
- NO MORE** annoyances from the vital power supply end of the radio. A snap of the switch is the only demand your radio makes upon you from NOW ON.

SM

Selected for the S-C II



Buy Now and Save Money

Now is the time to buy the S-M products listed below, for on April 1st prices will increase (due to the fact that these items contain from one and a half to two times as much material as competitive products, priced far higher in most cases).

	Price now	Price April 1st
220 Audio Transformer	\$6.00	\$8.00
221 Output Transformer	6.00	8.00
329 Power Transformer	6.00	9.00
330 Power Transformer	6.00	9.00
331 Unichoke	6.00	8.00
275 R. F. Choke	.60	.90
276 R. F. Choke	.60	1.00
D and E coils	3.25	5.00

* March 1st the 221 output transformer will be available with tip jacks and cord, known as No. 222, at \$8.00.

The S-C II is a remarkable receiver, for it incorporates the latest developments of shielding and all-metal construction found in the finest factory receivers, plus a degree of sensitivity and a quality of reproduction to be found in few other sets at anywhere near the cost.

You can build the S-C II in a few hours' time, using standard parts available at any good dealers, and have a receiver comparing favorably with factory-built receivers priced far higher.

Or, if you want a more sensitive, more powerful set than the S-C II, the famous Silver Shielded Six comes as a kit for \$95.00—"unquestionably the finest kit ever offered," is the opinion of thousands of users.

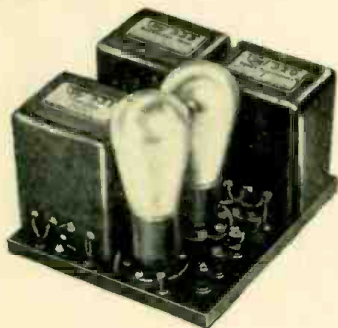

652 Reservoir B

A new S-M "B" eliminator kit is available, guaranteed to operate any receiver of from one to ten tubes absolutely without "motor-boating," "putting," or "humming" noises common to some "B" eliminators.

Most important, the output voltage of the 652 kit, using a CX-313 rectifier and CX-374 glow tube, is wonderfully constant. The 90-volt tap will not vary over 3 volts with current drains between zero and 45 M.A. The 180-volt tap will furnish ample reserve power for the largest power tube, and the 45-volt tap will not vary over 4% at normal detector current drains!

The 652 kit contains all necessary parts, including steel chassis and hardware, ready to assemble in an hour's time, using only a screw driver, pinchers and soldering iron. Price, less CX-313 and CX-374 tubes, \$34.50.

Silver-Marshall, Inc.

844 W. Jackson Blvd.,

Chicago, U.S.A.