

Popular Radio

★ FEBRUARY • 1927

25¢

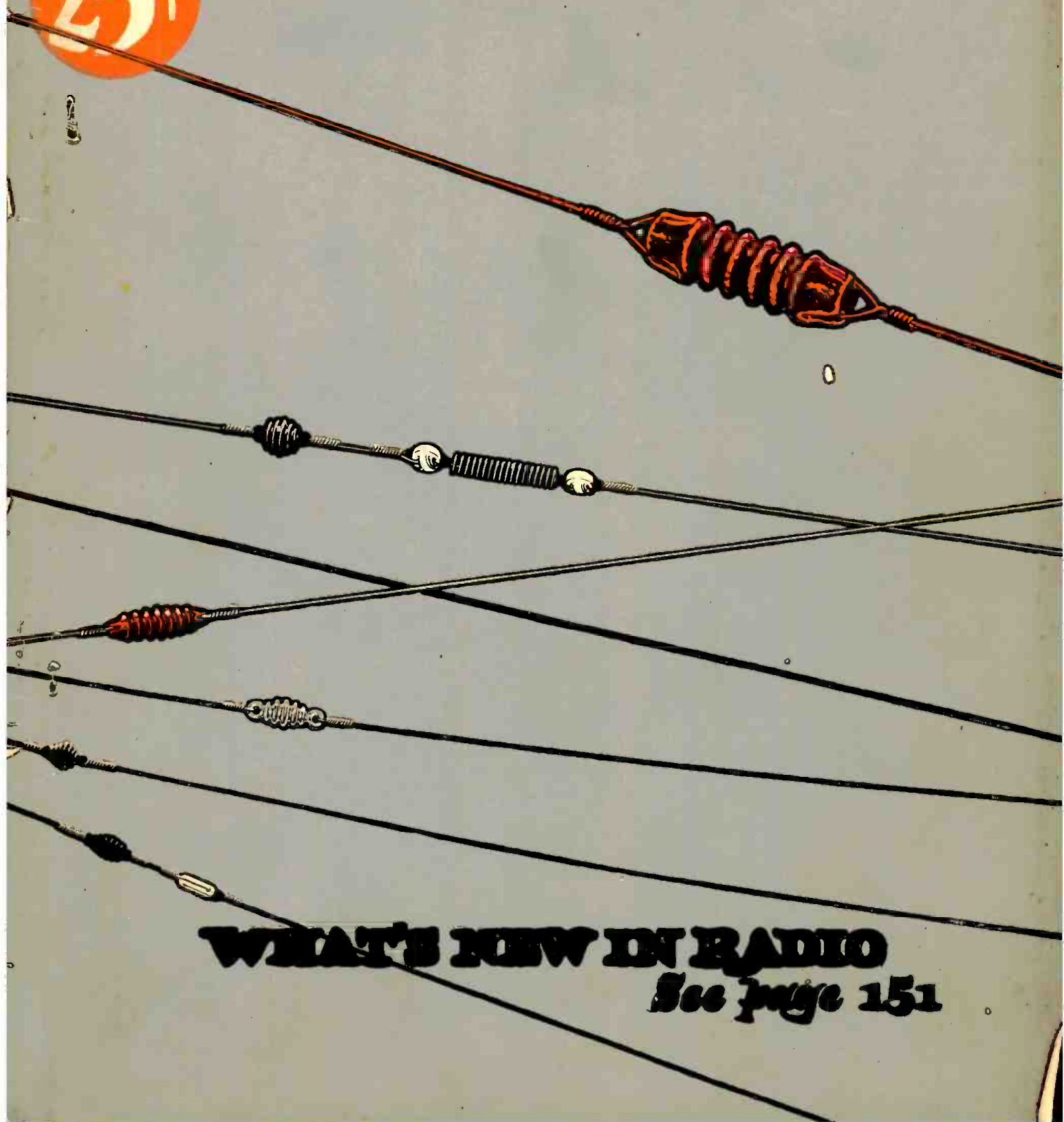

WHAT'S NEW IN RADIO

See page 151

SEEING
M O R E
THAN THE
MICROSCOPE

Electrons, which are very important in radio, are too small for any microscope to make visible. Yet our eyes can watch their paths—study their habits.

In the laboratories where Radiotrons are studied there are instruments which make all these things possible—and more. Knowing how many electrons leap across from the filament to the plate of a vacuum tube is in its way as abstruse a study as the measurement of distant stars by astronomers. Yet this abstruse research has a definite application in the RCA Radiotron in your radio set. That is why the laboratories back of RCA spend millions in scientific research that is far too much like "pure science" for an ordinary manufacturer.

Radiotrons are improved and new ones are developed, to make radio better. Because this research shows in results, Radiotron users keep five great factories busy!

Watch your tubes, always, for the RCA mark. You will find it on Radiotrons for every purpose.



clear up the tone

Do you get a blast when you turn the volume up a bit? Do you get sweet, clear tone at low volume, but noise when it's louder? The trouble's probably right in one tube—the tube in the last audio stage. The Radiotron laboratories discovered that no ordinary tube can let big volume through clearly. Change one tube to an RCA power Radiotron. *Then* turn up the volume and it comes through *clear!*

*Bring your storage battery set up-to-date with
a power RADIOTRON UX-171 or UX-112
a detector RADIOTRON UX-200-A
and RADIOTRONS UX-201-A for all-round quality.*

*Bring your dry battery set up-to-date with
a power RADIOTRON UX-120
and RADIOTRONS UX-199 for all-round quality*

RADIO CORPORATION OF AMERICA - NEW YORK - CHICAGO - SAN FRANCISCO

RCA Radiotron

MADE BY THE MAKERS OF THE RADIOLA



The Layerbilt patented construction revealed. Each layer is an electrical cell, making automatic contact with its neighbors, and filling all available space inside the battery case.

Eveready Layerbilt "B" Battery No. 486, the Heavy-Duty battery that should be specified for all loud-speaker sets.

This is the Heavy-Duty Battery in which the new Layerbilt construction provides greater economy

THERE'S an important discovery in radio economy awaiting all users of loud-speaker sets who have been buying the smaller Light-Duty "B" batteries instead of the large Heavy-Duty size required by such sets. Because the Light-Duties cost somewhat less to buy they seem like an economy, but the surprising fact is that the Eveready Layerbilt No. 486 lasts more than twice as long though it does not cost anywhere near twice as much. It is, therefore, much more economical—we believe it to be the most economical "B" battery ever built. Certainly it has proved this by laboratory tests and the service it has given to radio listeners in their own homes during the past eighteen months.

Eveready Layerbilt's remarkable life

is due to its unique construction. All other dry cell "B" batteries are assembled of cylindrical cells, with much waste space between them, and many soldered connections bridging the gaps.

Several years ago we struck boldly out, away from this tradition, seeking a better method. We wanted to avoid waste space, minimize soldering, and get more current and longer life from a given quantity of active materials. The Eveready Layerbilt is the result.

This patented, exclusive battery is built in layers of flat current-producing elements, making automatic connection with each other. Every available inch inside the battery is occupied usefully. You get more battery for your money, and that battery is more efficient.

Remember this about "B" batteries: All loud-speaker sets require Heavy-Duty batteries, and the Eveready Layerbilt has proved time and again to be the longest lasting and most economical Heavy-Duty "B" battery.

Manufactured and guaranteed by
NATIONAL CARBON CO., INC.
 New York San Francisco
 Canadian National Carbon Co., Limited
 Toronto, Ontario

Tuesday night is Eveready Hour Night—
 9 P. M., Eastern Standard Time, through
 the following stations:

WEAF—New York
 WJAR—Providence
 WEEI—Boston
 WTAG—Worcester
 WFI—Philadelphia
 WGR—Buffalo
 WCAE—Pittsburgh
 WSAI—Cincinnati

WTAM—Cleveland
 WWJ—Detroit
 WGN—Chicago
 WOC—Davenport
 WCCO—Minneapolis
 St. Paul
 KSD—St. Louis
 WRC—Washington

Popular Radio

EDITED by KENDALL BANNING



FOUNDED 1911

VOLUME XI

February, 1927

NUMBER 2

CONTENTS

(Cover design by Frank B. Masters)

The Coming of the "Radio University"

By Bruce Bliven PAGE 127

How to Get Quality Amplification

NUMBER 1: How to build a combination transformer and impedance-coupled audio-frequency amplifier

By Laurence M. Cockaday PAGE 131

A Station that Weighs 5½ Pounds

An extraordinary transmitter made by the Marines at a cost of only \$22.00

By Andrew R. Boone PAGE 133

Popular Radio Circuits

INSTALLMENT No. 8:

The Karas "Equamatic" Receiver
The Norden-Hauck "Super-10" Receiver

The Technical Staff PAGE 134

Three Prize-Winning Ideas for Improving Broadcast Programs

The Winners of the POPULAR RADIO Contest PAGE 136

1. "Stagger the Broadcast Programs"
By William Andrew Mackay
2. "Each Station Should Identify Itself by a Specialized Program," By Charles D. Isaacson
3. "Prevent by Law the Interference of Broadcast Stations," By Harold Moore

How to Build and Use a Portable Test-Board

"Trouble-shooting," as well as the testing of tubes and checking the operating conditions of a receiver, are made easy by the use of this simple test unit

By Albert G. Craig PAGE 137

Is Radio Broadcasting Killing the Wild Savageries of Jazz?

By Earl Reeves PAGE 139

The Fight Against Distortion

The ingenious tricks employed by radio engineers to deliver good broadcasting to your home

By Raymond F. Guy PAGE 141

Radio à la Carte

Four remarkable contributions to the radio art by an amateur who "never took a lesson in his life"

By Arthur L. Lippmann PAGE 145

How to Assemble the All-Amax Senior Three-tube Reflex Receiver

The first article in a series on the assembly and operation of popular kits of parts

By Morris M. Silver PAGE 147

What's New in Radio

The Technical Staff PAGE 151

DEPARTMENTS

The Yes and No Man	158
What Readers Ask	David Lay 176
With the Experimenters	Richard Lord 184
In the World's Laboratories	E. E. Free 188
Broadcast Listener	Raymond Francis Yates . . 198
Broadcasts	Charles L. Reese, Jr. 202

VOLUME XI

FEBRUARY, 1927

NUMBER 2

Published monthly by Popular Radio, Inc., 627 West 43rd St., New York, N. Y., telephone number, Chickering 1906; Douglas H. Cooke, President and Treasurer; Kendall Banning, Vice-President; Laurence M. Cockaday, Secretary; Joseph T. Cooney, Asst. Treasurer. Price 25 cents a copy; subscription \$3.00 a year in the U. S., Canada and all countries within the domestic postal zone; elsewhere \$3.50 a year, payable in advance. The International News Company, Ltd., No. 5 Bream's Bldg., London, E. C. 4, sole distributors in England. Entered as second class matter April 7, 1922, at the Post Office at New York, N. Y., under the act of March 3, 1879. Copyright, 1927, and title registered as a trade-mark by Popular Radio, Inc. Copyright in Great Britain by Popular Radio, Inc., 6 Henrietta St., Covent Garden, W. C., London, England. For advertising rates address Popular Radio, Inc., 627 West 43rd St., New York, or 225 North Michigan Ave., Chicago. Printed in U. S. A.

LAURENCE M. COCKADAY, Technical Editor
CHARLES L. REESE, Jr., Managing Editor

E. E. FREE, Ph.D., Contributing Editor
JOHN V. L. HOGAN, Contributing Editor

from Franklin to Faradon

Compare Franklin's crude Leyden Jar with the compact, efficient Faradon Capacitor of modern radio.



Model WS By-Pass Unit

Made in
1/2 MFD
1 MFD
and 2 MFD
Units

The Wireless Specialty Apparatus Company, established in 1907, manufacturers of Faradon, specializes in electrostatic condensers for all purposes.

For Dependability
insist upon Faradon equipment for your radio set and battery eliminator.

Wireless Specialty Apparatus Company

Jamaica Plain, Boston, Mass., U. S. A.



Made in
U. S. A.

Price \$10.50

Model WS-3750 "Universal" Filter Capacitor Block

Other models in blocks or individual units with any desired capacities and voltage ratings.

Faradon By-Pass and Filter Capacitors



A PAGE WITH THE EDITOR



From a photograph made for POPULAR RADIO

How POPULAR RADIO Helps Its Readers and the Manufacturers of Radio Receivers and Radio Parts—

by maintaining a well-equipped electrical-testing laboratory and a staff of engineers whose duty it is to test every piece of radio apparatus as soon as it is placed on the market by the manufacturers, and to place this data at the disposal of POPULAR RADIO readers. A report on every set or part tested by the POPULAR RADIO LABORATORY telling the class of apparatus, giving the usages and outstanding features and describing the apparatus tested, appears monthly in the enlarged department, "What's New In Radio." This department is being used more and more by the readers of POPULAR RADIO as a "buyer's guide" and by the retail and jobber trade as a catalogue of the better apparatus to stock and to supply to their consumers.

ON page 136 are given the prize winners of the contest for the best answer to the questions "How Can Radio Broadcast Programs Be Improved," which was announced in the September number of this magazine.

THE task of selecting the prize winners was no easy one.

AFTER all of the letters had been considered, a preliminary selection of 16 was made. These 16 letters (which received the highest marks of the judges) were then re-submitted and reduced to 6. And from these surviving 6 the final selections were made.

ONE of the noteworthy features of the contest was the number of suggestions of "staggering" radio programs of a group of stations so that at any hour the listener could select a feature that interested him most. This was the suggestion that won the first prize for Mr. W. A. Mackay. Among others who presented particularly able arguments for this form of organization of programs were Edward T. Vaile, I. E. Morrison, W. P. Miller, Vernon May, Charles Cohen and K. M. MacIvain.

SEVERAL contestants proposed that each broadcasting station specialize in some one form of program—jazz, grand opera, lectures, sports, topical songs, religious services, symphonic music or whatever the facilities of the station permit.

AMONG other suggestions were many of an original and unusual nature, most of which reflected a serious study of the subject.

FOR instance, George D. Keller, who evidently has a lottery complex, suggests that the stations mail to their lists of fans a letter like this:

"WE assume that you are grateful to the artists who, at no expense to you, make our programs possible. You have shown us by your letters that you appreciate the efforts put forth by this station to entertain you. In order to stimulate your response and to broaden your field of cooperation we will mail to you upon request a postal card addressed to this station. Each card contains five coin receptacles and under the flap of each receptacle is a number. Once every month we will conduct a drawing at this station and valuable

prizes will be awarded to the holders of the lucky numbers. Put a dime into one of the coin receptacles in order to qualify in these contests; the more dimes you put into the card, the better chance you will have of drawing the lucky number. There is a questionnaire printed on each card and your answer to the questions contained thereon will determine the class of programs that we will broadcast in the future. Your cooperation will assist us in paying for the services of talented musicians and in paying the royalties required for the privilege of broadcasting copyrighted music."

"GET rid of the beginner, the has-beens and the never-will-be's who are now cluttering up air programs" is the gist of several letters.

FOR every station to devote each day of the week to a specialized program—devoting Sunday to church services, Monday to lectures, Tuesday to dramas, Wednesday to popular songs, Thursday to jazz, Friday to classical music and Saturday to a *pot pourri*—is the novel suggestion of Henry F. Behre of San Francisco.

AND a very large percentage of the contestants suggested that religious services be reduced, and confined on Sundays to the morning hours only.

ALTOGETHER, the contest was illuminative and instructive, and the many ideas that were set forth were automatically brought to the attention of those who are in positions to act upon them.

IN the coming issue of POPULAR RADIO—for March—will appear two constructional articles of unusual interest to the experimenter.

ONE article will give the complete constructional details of a loudspeaker that can be built at home at a cost of about \$15.00.

AND the other article will tell how to build a single-tube receiver that will cost about \$25.00, and that will operate a loudspeaker—by means of a new type of valve that may be made to do the work that it ordinarily takes four or five tubes to do.

Kendall Banning
Editor, POPULAR RADIO

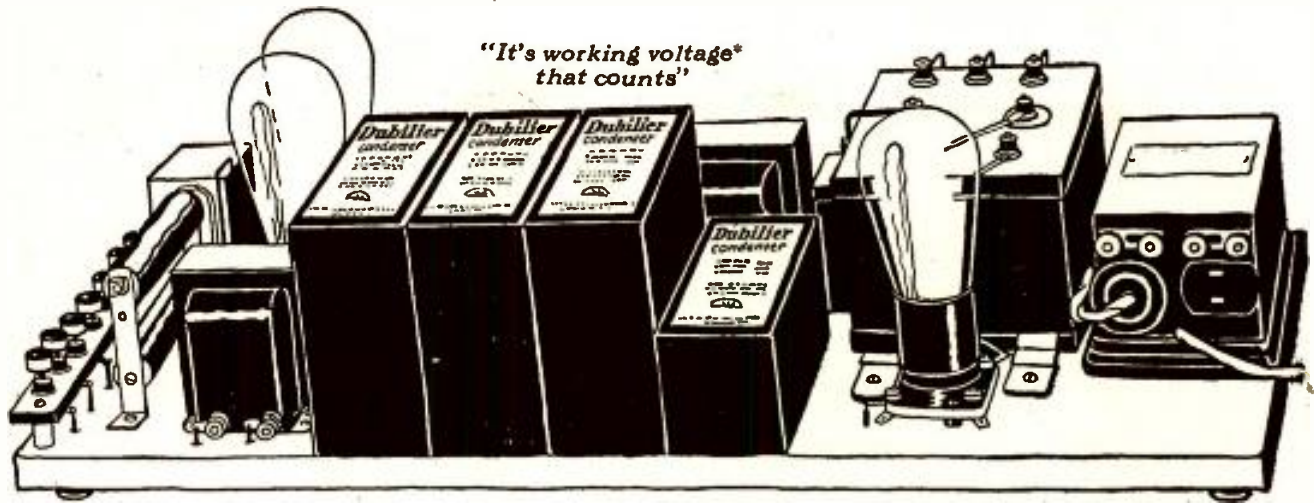

Power amplification has amazed the world

The amazing results obtained with power amplifiers is the radio sensation of the year. Perfect tone quality and the capacity to handle the full-volume of a brass band without distortion, has made power amplification the "last word" in radio.

You, too, can enjoy all these advantages even with your old set, and at a minimum cost, by building a power amplifier with Dubilier Condensers.

Dubilier Condenser Type 903, illustrated, is designed to withstand the high voltage surges which often occur in the filter circuits of power amplifiers. In fact all Dubilier Condensers are built with this high margin of safety, and with an indicated *working voltage** that insures a long life in continuous operation.

Send 10c. for our booklet "Seventeen Ways to Improve Your Set." It gives the most recent information on power amplifiers, filters and battery eliminators.

**Working voltage means more than "test voltage." It is the voltage at which a condenser may be safely used in continuous operation.*



Dubilier

CONDENSER CORPORATION

4377 BRONX BLVD., NEW YORK, N. Y.



\$12.50

COMPLETE
Nothing else to buy. Replaces "B" Batteries. Operates direct from Electric Light Socket on 110-120 volt A. C. Lighting Circuit. Delivers up to 100 volts.

\$17.50
New High Voltage Model
Complete: Delivers up to 180 Volts

Not only the most reasonable

but proved by 40,000 users to be also the most convenient, unfailing and satisfactory "B" Eliminator

New High Voltage Model

for extremely large sets, or sets using power tubes, now perfected. Delivers up to 180 volts. One control adjusts voltages on all taps.

Equal to any "B" Eliminator regardless of price—not only in operation, but in workmanship, quality, durability and appearance

Money Back Guarantee

Stop paying out money for costly, unreliable battery service and repairs. Permanent excellence can be built into economical "B" service. 40,000 users of the good Ferbend "B" Eliminator agree. That is why during the slack summer season we worked at full capacity to meet orders. That is why hundreds of unsolicited testimonials prove beyond the shadow of a doubt its splendid, enduring performance.

Ask Your Dealer—or Send Direct

Shipment made direct on receipt of price, or C. O. D. if preferred. Use for 10 days to convince yourself—if unsatisfactory write us within that time and purchase price will be refunded. Use Coupon NOW.

FERBEND ELECTRIC COMPANY
419 W. Superior St., Chicago, Ill.



They Want YOU to Know

Montreal, Canada
I am pleased to advise that the Ferbend "B" Eliminator purchased from you is a wonder and is giving results far beyond my expectations. The tone and volume would satisfy the most critical. James Stroud, Electrical Engineer.

Yonkers, Ohio
Your Eliminator is the best buy I have made in a long time. It has already more than paid for itself in saving on "B" batteries. R. L. Welsh.

Springville, N.Y.
Having had perfect results with the seven Eliminators recently purchased you may send me six more by express at once. Leonard J. Cooper.

Burbank, Calif.
I am more than pleased with your Eliminator. I am getting several Eastern stations through about 15 locals using the Eliminator. Jean Bernard.

St. Petersburg, Fla.
I used your Eliminator all last winter, and it was as good, if not better than several I tried of much higher price. I am more than satisfied. Geo M. Pratt.

Trenton, N. J.
I have used your Eliminator for several months and unhesitatingly recommend it. It has added 25 per cent to the volume of my set and always has full volume. J. M. Starker.

New Orleans, La.
The "B" Eliminator which I purchased from you some three or four months ago has given entire satisfaction and I am well pleased with its performance. C. J. Murphy.

Wilmington, N. C.
I am well pleased with the Eliminator I purchased some time ago. It is all you claim and more. It brings in signals louder and clearer than any set of dry batteries I ever used. T. E. Lyon.

Amsterdam, N. Y.
I have compared your Eliminator with other makes and it cannot be beat. My reception has easily increased 60 per cent. It gives me much better results than I was ever able to get with dry batteries. William Davis.

Wheeling, W. Va.
The Eliminator purchased some time ago is giving remarkable results. William A. Raper, Jr.

Des Moines, Ia.
Your Eliminator is fine. Rev. F. A. Case.

Louisville, Ky.
Your Eliminator is all you claim it to be. Am very much pleased with it. Alonzo G. Smith.

Oil City, Pa.
Your Eliminator has given me good service for over a year. George May.

St. Louis, Mo.
After giving your "B" Eliminator a thorough trial wish to state that I am thoroughly satisfied. It's performance is perfect—absolutely no hum whatever. Frank Kolar.

Mattapan, Mass.
I have used your Eliminator for six months and am satisfied with it in every way. It has increased the volume of my 6-tube Neutrodyne fully 60 per cent and there is absolutely no hum from the 60-cycle line. John W. Pursell, Jr.

Second Successful Year

FERBEND "B" ELIMINATOR

Approved and passed by the rigid Laboratory Tests of the two foremost Radio Laboratories in America
—Radio News and Popular Radio

FERBEND ELECTRIC CO.
419 W. Superior St., Chicago, Ill.
 Send \$12.50 model. Send \$17.50 model.
 Send at once. Payment enclosed.
 Send C. O. D. Send literature.
Name
Address
City..... State.....



**POPULAR RADIO Is an Authoritative Source
of Information**

"I have always found POPULAR RADIO to be an interesting and thoroughly reliable source of information in which the broadcast listener may find the newest and most important developments in radio described in a non-technical manner, as well as technical articles for the more advanced fan."

Frank H. Dana

**PRESIDENT, BROADCAST LISTENERS
ASSOCIATION OF AMERICA**

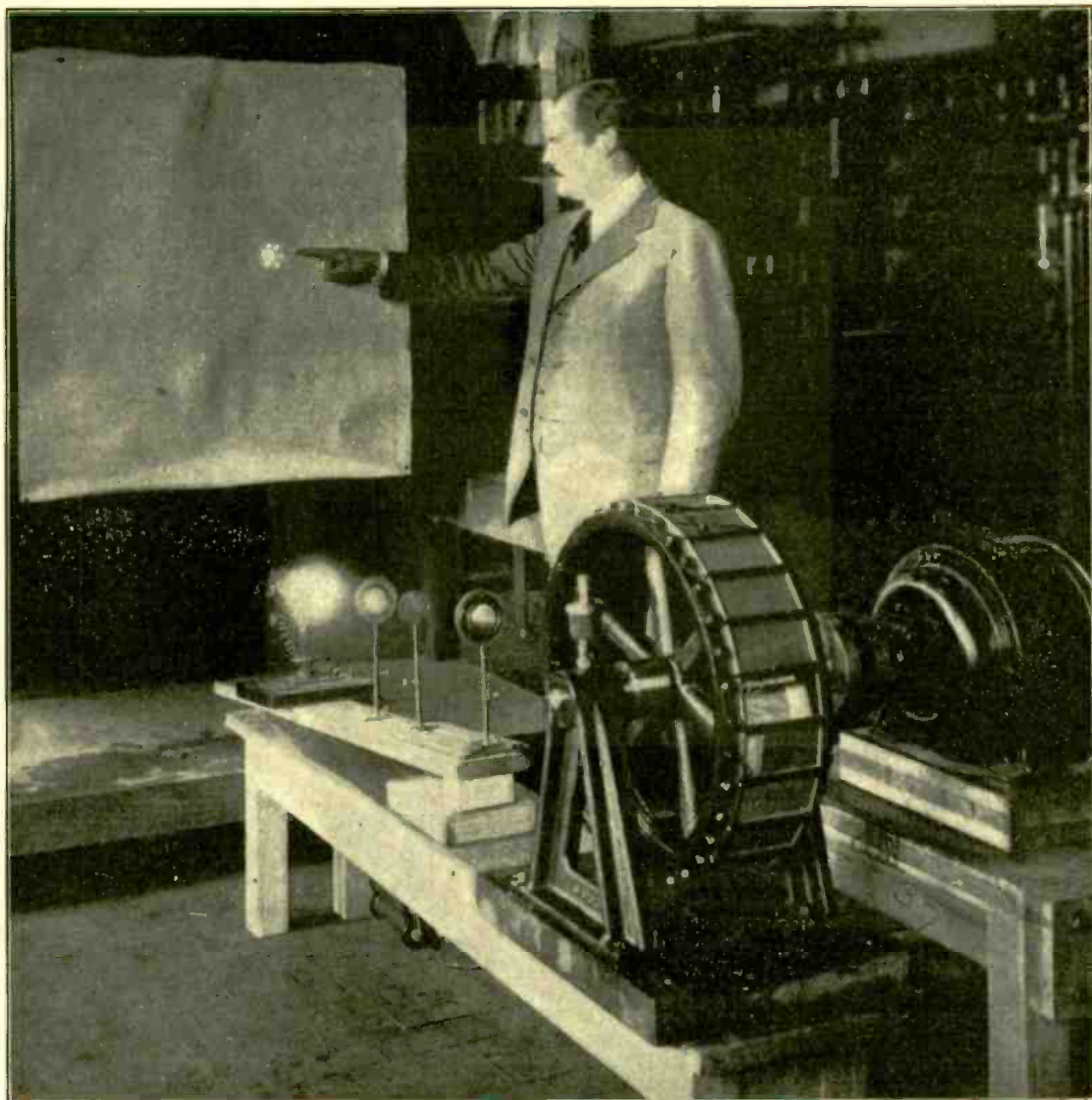

A "Blackboard" Demonstration that May Some Day be Visible in the Classrooms of All the World

The eminent engineer Mr. E. F. W. Alexanderson has just announced that the work on his new device for projecting pictures by radio has "already proved that the expectation of television is not unreasonable and may be accomplished with means that are in our possession at the present day." Previous television devices have been demonstrated by C. F. Jenkins, Edouard Belin and J. L. Baird. When this dream of the scientists is eventually realized, it will open up extraordinary possibilities in educational work—not only to schools and colleges but to the public generally. Mr. Alexanderson's projector (shown above) is composed of seven light sources which are converged onto a revolving drum which carries twenty-four mirrors. By means of this device, a "still picture" may be transmitted by radio in two minutes; to transmit moving pictures by radio, this speed must be increased about 600 times.

To attain this speed is the problem that is yet to be solved by the inventors.

Popular Radio



VOLUME XI

February, 1927

NUMBER 2

THE COMING OF THE "RADIO UNIVERSITY"

Broadcasting is beginning to break down the artificial barriers which have surrounded that "education" which has long been reduced to courses framed by our colleges and dispensed only to our youth. How some of our universities and schools are now seeking to take advantage of the larger opportunities that radio offers is told in this article (the first of a series) by—

BRUCE BLIVEN

RADIO broadcasting began as a toy. Then it mushroomed suddenly into a gigantic amusement enterprise, which has grown so rapidly that nobody can keep pace with it. The next and most important step is still ahead. Radio will become an integral part of our whole civilization. It will bring about changes in every way comparable to those which followed the invention of printing in the fifteenth century.

In particular, radio is destined to have tremendously significant effects upon education.

It is somewhat surprising to me that despite all the talk and writing about radio in the past three or four years, so little attention has been paid to this aspect of its future usefulness. To be sure, we have had plenty of cocksure prophecies that it would "take the place of the classroom," or "do away with textbooks," prophecies so absurdly impossible of fulfillment that they hardly need to be refuted. What we have not had is any really serious study of radio as an educational force. Just what is it good for? What is it doing today? What may we reasonably expect in the not too distant future, basing our prediction on a study of the facts and

sternly resisting the tendency to romanticize? These are the questions which I shall seek to answer in this article.

They are already important questions. Radio, even now, is one of the greatest media in existence for the dissemination of ideas. It is of course the speediest mechanism ever devised; and before very long as many people will be accessible by way of the ether as can now be reached by newspapers. (While the number of newspapers printed is still far larger than the number of receiving sets, there is great duplication of circulation among readers, one person buying several papers a day; and though a newspaper can be read by only one person at a time, when the loudspeaker is going most of the members of the family perforce have to hear what the radio has to say.)

The day is not far distant, then, when broadcasting will be the biggest single means of arguing to, or enlightening, the people. It is already one of the two most effective, the motion picture being the other. People had been talking and listening for many thousands of years before they learned to read and write, and most of us handle these new tools rather awkwardly even yet. Something

we can see or hear is much more effective than something which we must translate from arbitrary symbols on paper into sounds and then words. It can readily be demonstrated that people will absorb ideas over the radio when they are "too tired to read"; and that they will get ideas out of the air which are too difficult for them to get in other ways.

In a sense, of course, the whole development of the radio has been educational. The amateur builder who puts together his own set—the DX hound who studies geography by way of the dials—the licensed amateur operator who talks at 3 A. M. with a man half a world away; all these are in the most real sense pushing back their mental horizons, getting that new and broader view of the world they live in, which is one of the chief ends of education. Even the casual listener who tunes in and out haphazardly on football games, dance music, speeches, symphony concerts and advertising talks picks up a great deal more information than he realizes; and while much of it is of little or no use, a good percentage is valuable.

With these aspects of the subject, however, it is not at present my purpose

to deal. I wish to report on the more formal use of broadcasting as a definite part of a systematic educational effort, both for children and adults. When we turn to this phase of the matter we find that radio is already being used, and very seriously, for the dissemination of information. Indeed, I doubt whether anyone, even among those who are engaged in the business, realizes to what an extent this is true, unless he has looked into it carefully as the writer has just done.

Already the number of people who are getting useful information from the radio regularly week by week is at least four times as large as the total enrollment in all the colleges and universities of the country—and this despite the fact that the number of college students has itself doubled in the past ten years.

One of the most important educa-

tional developments is, in fact, the broadcasting of college lectures. All over the country, leading institutions are giving extension courses over the air, as a by-product, so to speak, of their regular work. New York University, Columbia, Union College, Syracuse University, the State Universities of Michigan, Minnesota, Iowa, Nebraska, the University of Pittsburgh, the Kansas State Agricultural College, the Michigan State College, are but a few of fully fifty institutions of higher learning which are regularly using the radio. Numerous other institutions cooperate with broadcasting stations on occasion. For example, the University Extension Division of the Massachusetts State Department of Education broadcasts, through station WBZ, the Westinghouse Company at Springfield, Mass., a series of courses in which members of the

faculty at Harvard, Yale, Amherst, Massachusetts Institute of Technology and other institutions appear before the microphone. The Edison station at Boston, WEEL, has a course in which no fewer than thirty college presidents speak over the air. These include the heads

of Wellesley, Smith, Bowdoin, Radcliffe, Clark, Mt. Holyoke; Williams, Amherst, Brown, Wesleyan and the Massachusetts Institute of Technology.

I have before me letters from almost a score of the leading radio stations of the country, narrating their experience in broadcasting educational material, and from them I am able to draw the typical picture of educational broadcasting as it exists today. The lectures are usually given by college professors in some nearby institution. They are given in the late afternoon or early evening, and a typical course is eight or ten lectures on one subject, each fifteen to thirty minutes in length.

It is now the general custom to invite listeners to write in and get a syllabus or other printed material, for which they usually pay a small fee, not more than \$1 each. This has a double purpose: it does in fact help the listener to follow the course, and it also lets the broadcaster know how many people are seriously interested in each subject offered. In some cases written work is asked for and sent in by the students; but this is exceptional. Also unusual, but rapidly becoming less so, is the broadcasting of instructions for laboratory work of various sorts, including experiments in physics, chemistry, etc.

Generally speaking, the colleges have

RADIO CORRESPONDENCE COURSES
Application for Credit Enrollment

Name

Mailing address

Permanent address

Age.....Date of application

Present occupation

Elementary grades: where and when

High school: where and when

Graduate f.....

Colleges and universities attended with dates of attendance and degrees received

Do you want graduate or undergraduate credit for this course?

Have you ever been enrolled as a correspondence student with us?

Courses desired (department, course number and title)

State definitely what work you have done in the general subjects in which above courses fall:

Amount enclosed (draft or postal order)

Shall we send your texts C. O. D.?

Do you wish to enroll unclassified?

Remarks:

A University That Gives Credits for Radio Courses

The University of Iowa has for two years offered "Radio Correspondence Courses" of twelve lectures each. The enrollment fee is \$2.00, supplemented by written assignments, required reading and examinations. Satisfactory completion of these courses gives the student a credit of two semester hours on the University work. The courses are broadcast from station WSUI at Iowa City.



not yet reached the point where they are willing to give formal credit toward a degree to those who have obtained their instruction *via* the ether waves. In a number of instances they grant a certificate or diploma to those who can pass examinations satisfactorily or by other written work show that they have faithfully absorbed the material offered them but as a rule these diplomas do not mean very much. However, the College of Applied Science of the University of Iowa gives the same formal credit to those who complete "air courses" which is received by other extension students whose study is done by mail. One hundred radio listeners have already been granted such credit, after completing courses to the satisfaction of the instructors. The University reports that of those who enroll for radio instruction a larger percentage complete their work than is true of correspondence students.

What subjects are being given at present by radio? While nearly everything in the ordinary college curriculum has been tried in one place or another, the most popular courses fall into three main divisions. First come general cultural subjects—languages, literature, social science, history, philosophy, current events. The field of women's interests is the next great division: household arts, cooking, home decoration, dress, the care of children. Finally come courses of a semi-technical nature for men, particularly in agricultural subjects: the care of crops, animal husbandry, or even, for city and suburban listeners, how to plant and tend a garden.

Courses in foreign languages, especially in French and Spanish, are among the most popular, despite the fact that these subjects are among the least suitable for radio presentation, as listening to the student's efforts and correcting his errors of pronunciation and grammar is such an important part of language teaching. New York University, which has been a pioneer in this field and has broadcast a complete "Air College," first through WJZ and more recently through WOR, reports that philosophy seems to have been the subject of widest general interest. Other courses of wide appeal are geology, psychology, English and social science. WCCO, the Washburn Crosby station at Minneapolis, finds its best items, aside from technical courses for farmers, are political science, language and literature. WGN, the Chicago Tribune station, broadcasts, among other things, piano lessons, English and Spanish. Approximately 1,000 students enroll for each course. Westinghouse station WBZ, Springfield, Mass., finds in common with others that critical courses in artistic, musical and literary subjects—



The Largest Classroom in the World

Up to the time that radio broadcasting became established the sound of the instructor's voice was confined within four walls and limited to students within prescribed ages. Today his voice may reach millions—of all ages and conditions. What effect will this modern range have upon our conception of the term "education?" (The above picture shows Prof. F. L. Bishop of the University of Pittsburgh broadcasting a series of science lectures from KDKA.)

music appreciation, dramatic criticism, short story writing, and the like, are well received. A number of stations broadcast book reviews regularly, and find this one of their most important features. Columbia University, which has experimented widely with courses in many subjects, broadcasting through WEA, is at present emphasizing rather practical courses for women: child health, interior decoration, cooking and domestic science in general. The lectures on health which are broadcast from numerous stations at the present time should properly be called educational, using the term in its broader sense. So too should the lectures on current events by such men as H. V.

Kaltenborn of New York City, which, while not given under the auspices of any educational institution, do serve a most useful function in enlightening the listeners as to what is going on in the world.

Broadcasting by colleges, while it is perhaps the best known educational aspect of radio, is in reality but a small part of the total activity in that field. Another great enterprise at present is that of the United States Government. While several governmental departments or bureaus are using the air to some extent, the most complete and serious effort is that of the Department of Agriculture, addressed to farmers. The Department made a brief experi-

ment in broadcasting in the spring of 1926; and it was so successful that at present a very ambitious program is under way. Government experts have prepared an elaborate series of courses, and these are mailed out in mimeographed form to the radio stations, where announcers read them over the air. They are offered exclusively to one radio station in each district, so that there is no overlapping except, perhaps, for receivers with exceptionally long range. While a station is not required to take all of the courses offered by the Department, it is of course understood that any material requested will be broadcast. Once a series is started, there is no danger of its being dropped before its completion, for the listeners would undoubtedly make an effective protest if such a thing were tried.

Among the features which the Department of Agriculture is offering is a daily talk by "Aunt Sammy," who gives informal but decidedly informative talks to women on dress, food and similar domestic topics. She answers questions, suggests menus, and provides quantities of household hints of every description.

There is also the "United States Radio Farm School," which gives information

to the farmer. (In fact, such a multiplicity of advice to the farmer is on the air nowadays that any agriculturist who owns a radio set has small excuse for not doing his job in expert style!) The Radio Farm School is offering twenty-four courses, of eight lessons each, in livestock, poultry culture and dairy farming. These are accompanied by printed lesson sheets, and bulletins on specific subjects.

Five days a week there is a "Noon Farm Flash" of fifteen minutes. This is a dialogue, supposed to be a telephone conversation between a farmer and a county agent. In these, current farm problems are brought up and advice given regarding them.

"Letters to Dad" is another lively series. A farmer's son, away at agricultural school, supposedly writes home telling his father of the new ideas in scientific agriculture which he is acquiring. There are also courses in agricultural economics, and "The Autobiographies of Infamous Bugs and Insects" are given so that the farmer may know how to fight these pests which in the United States alone destroy, every year, crops representing the labor of one million men.

An effort is made to have farmers

enroll as regular students in the Radio Farm School, and those who complete the course satisfactorily are given formal certificates to that effect. Up to September 15, more than 500,000 requests for enrollment cards had been received by the Department.

Thus far I have discussed only the use of the radio in educating adults. I need hardly say that it has enormous potentialities also as an adjunct to the regular public and private schools. These potentialities are only just beginning to be explored, but the success already achieved shows what lies ahead.

In several cities, notably in Atlanta, Ga., the radio is being used regularly as a means of instruction. Every school is fitted with a good receiving set and loud speaker, and on a carefully worked out schedule, instruction in various subjects is broadcast from a central station. The arguments used in favor of this work in the schools of Berkeley, Calif., apply as well to Atlanta and all other communities. They are:

(1) All the students have the advantage of instruction by the one best teacher in the city in each subject.

(2) The other teachers also have the opportunity to hear the work done by

(Continued on page 168)



One of the Stations that Are Owned and Operated by Colleges

The Rensselaer Polytechnic Institute of Troy, New York, is one of the scores of educational institutions that owns and operates broadcast stations, not only for the purpose of extending its educational scope but incidentally for the instruction of its students in scientific and mechanical equipment of the plant and in the experimental laboratory.

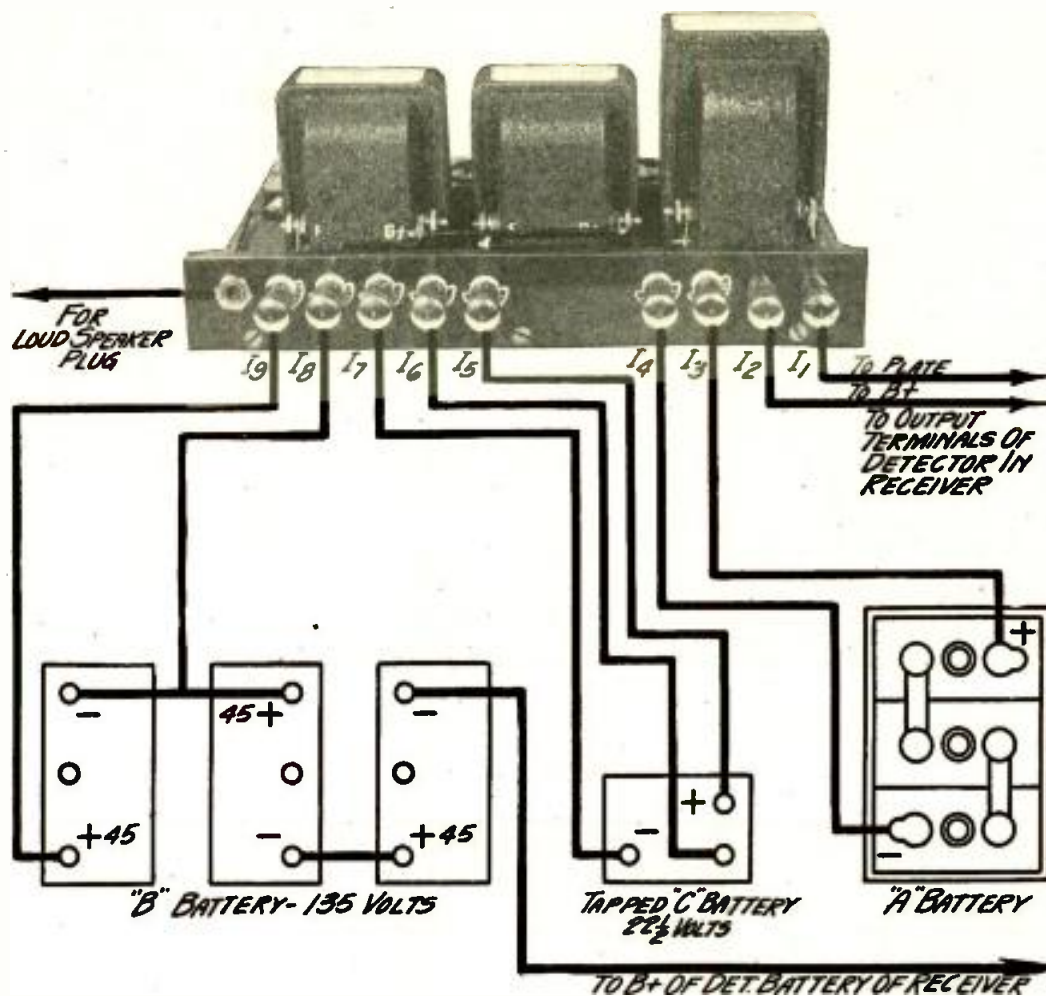

HOW TO CONNECT UP THE AMPLIFIER

FIGURE 1: This picture hook-up shows how the audio-frequency amplifier that is described in this article is connected to the batteries, the loudspeaker and the receiving set.

HOW TO GET QUALITY

AMPLIFICATION

NUMBER 1: *How to Build a Combination Transformer and Impedance-Coupled Audio-frequency Amplifier*

The first of a new series of constructional articles that will describe in detail the modern methods of amplification at low frequencies for obtaining quality reproduction. These amplifier units are small, compact and easy to build, so that they may be inserted either in an old receiver or in a new one in order to obtain undistorted low-frequency amplification.

By LAURENCE M. COCKADAY

COST OF PARTS: *Not more than \$29.00*

HERE ARE THE PARTS THAT WERE USED IN THE LABORATORY MODEL OF THIS UNIT—

- A—Rauland-Lyric audio transformer;
- B—Rauland-Trio, type R-300;
- C—Rauland-Trio, type R-310;
- D1, D2 and D3—any approved vacuum-tube socket (Remler type 50 sockets illustrated);

- E1 and E2—any approved automatic filament control, 1/2-ampere size (Elkay controls illustrated);
- F—baseboard, 6 by 10 by 1/2-inch;
- G—bakelite binding-post strip, 1 1/2 by 10 by 1/4-inch;

- H—any approved open-circuit jack (Carter short jack, No. 1 illustrated);
- I1, I2, I3, I4, I5, I6, I7, I8 and I9—any approved binding post (X-L binding posts illustrated);
- Connection wires, screws, etc.

HERE is an audio-frequency amplifier that is designed to give great volume with clear quality as well as good high and low-note reproduction when used with a good loudspeaker. Compact and easily put together, it consists of a single stage of high-quality

transformer-coupled amplification with two stages of impedance-coupled amplification.

This amplifier may be incorporated in place of the unit used in an old style receiver to bring the quality "up to date," or it may be used in connection

with a new model that the home set-builder is experimenting with. It was designed especially for this purpose by the engineering staff of POPULAR RADIO LABORATORY and it has been found to give exceptionally good results when

(Continued on page 174)

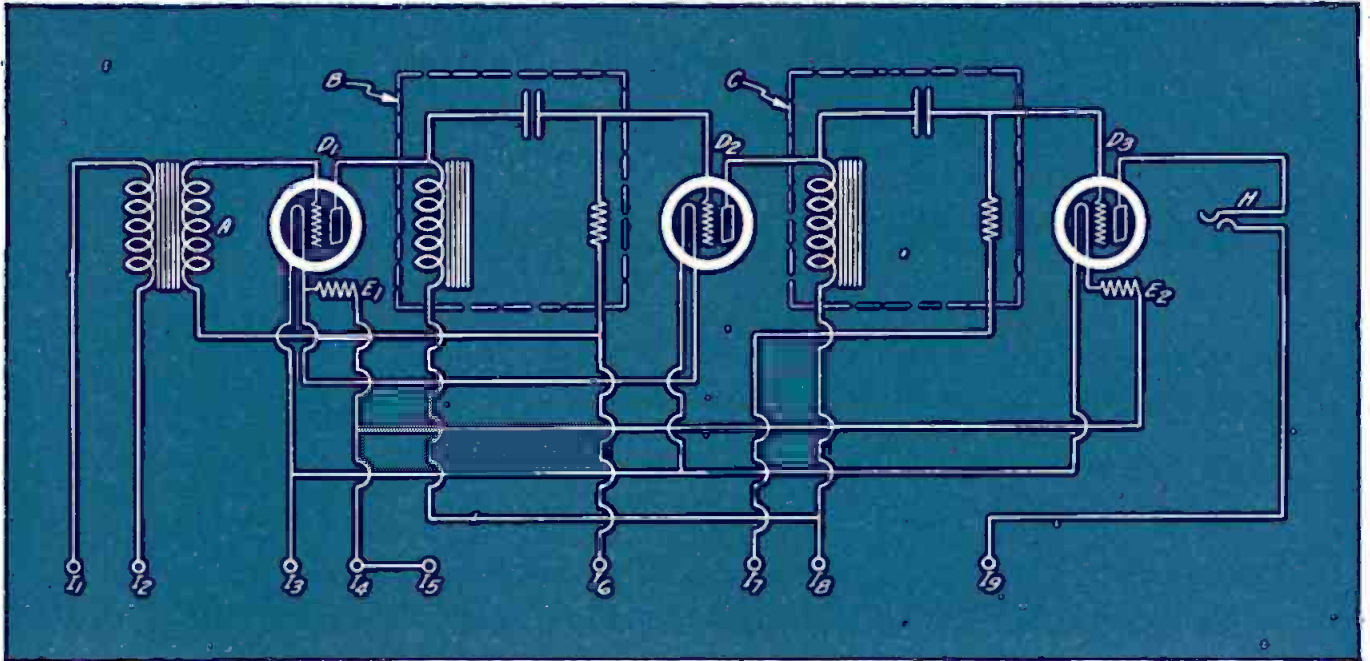

THE SCHEMATIC WIRING DIAGRAM

FIGURE 2: This drawing gives the electrical circuit for the new amplifier; it comprises one stage of high quality transformer amplification and two stages of special impedance-coupled low-frequency amplification.

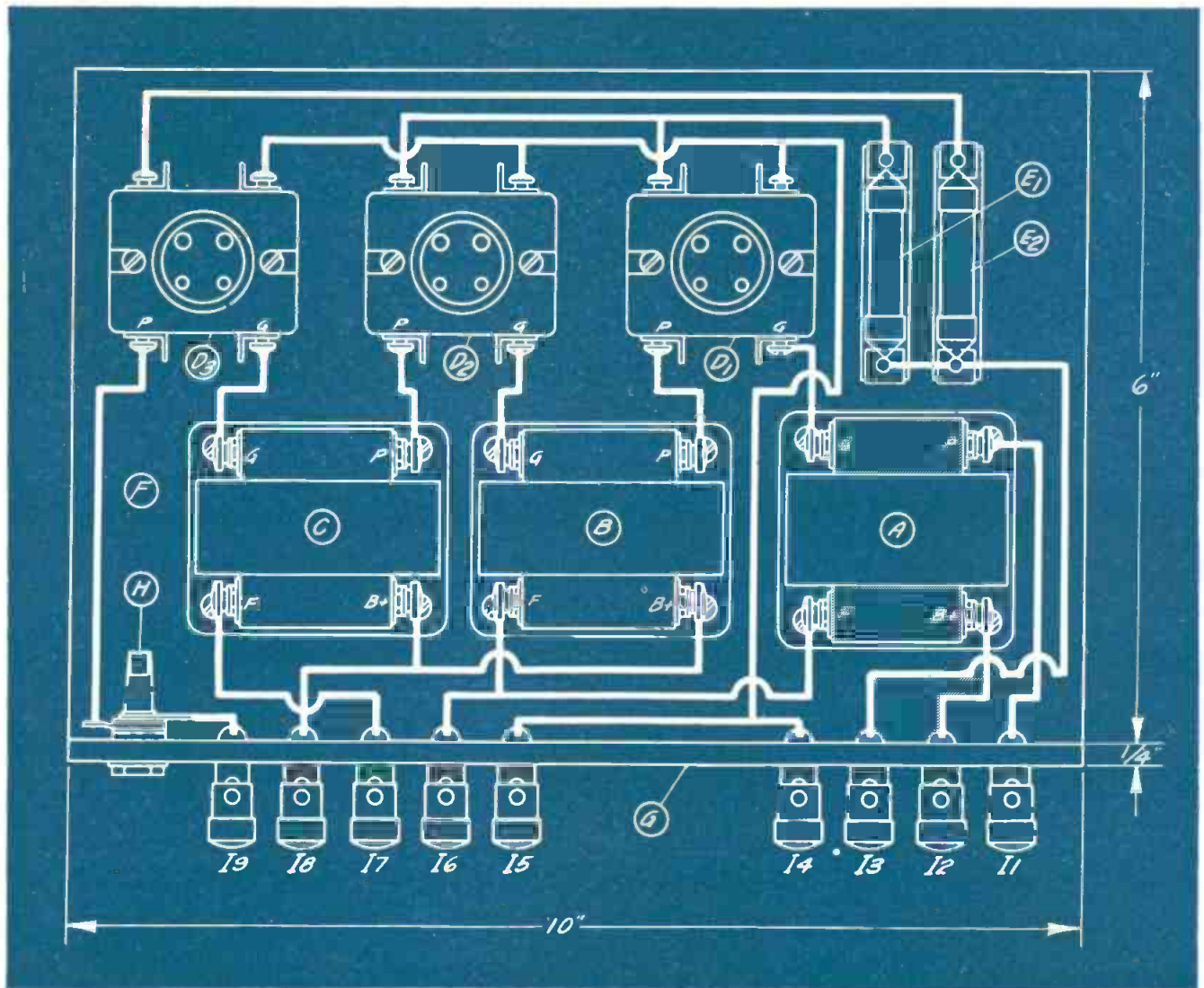

THE PICTURE WIRING DIAGRAM

FIGURE 3: This drawing shows the arrangement of the units on the baseboard and the manner in which they are connected; the wiring is shown in heavy white lines. All of the parts are marked with designating letters that correspond with the letters given in the list of parts and in the accompanying text.

A Station that Weighs 5½ Pounds

An extraordinary transmitter made by the Marines at a cost of only \$22.00

By ANDREW R. BOONE

"DIT, dit, dit . . . dah . . . dah . . . dit . . ."

A Marine aviator, 5,000 feet above the Pacific, works his transmitting key.

One hundred and fifty miles away a second aviator listens.

Through the night comes the message: "dit, dit, dit . . . dah . . . dah . . . dit . . ."

One of the smallest practical radio transmitting sets in the world, constructed by Capt. Francis E. Pierce and other marine officers and enlisted men, is in operation.

This latest contribution to radio communication consists of a set built from parts culled from the navy's scrap heap at North Island and put together by skilled hands; \$22.00 is the cost of the transmitter, and that came from the pockets of officers and enlisted men.

This little transmitter weighs only five and one-half pounds. It measures about the size of a typewriter, but it weighs far less. It is 9 inches wide, 9½ inches deep and 10 inches from front to rear.

With a sending radius of about 300 miles, the new transmitter, in the opinion of officers who built it, will revolutionize radio code transmission and reception to and from airplanes. It will take the place of sets few of which weigh less than 125 pounds. The set—including transmitter, receiver, antenna, batteries and dash control—weighs exactly seventeen and one-quarter pounds!

On fifty flights made by Capt. Pierce and other Marine officers at San Diego, the set worked "perfectly" forty-seven times: three times reception failed; but the failures are attributed to factors outside the set itself.

Two "fine points" are found in the set which make for its excellence: a high-frequency oscillator controlled by a one-inch-square quartz crystal, ground for a frequency of 3000-4000 kilocycles. With this crystal, a steady, high-frequency oscillation can be maintained. This is in contra-distinction to the former experi-

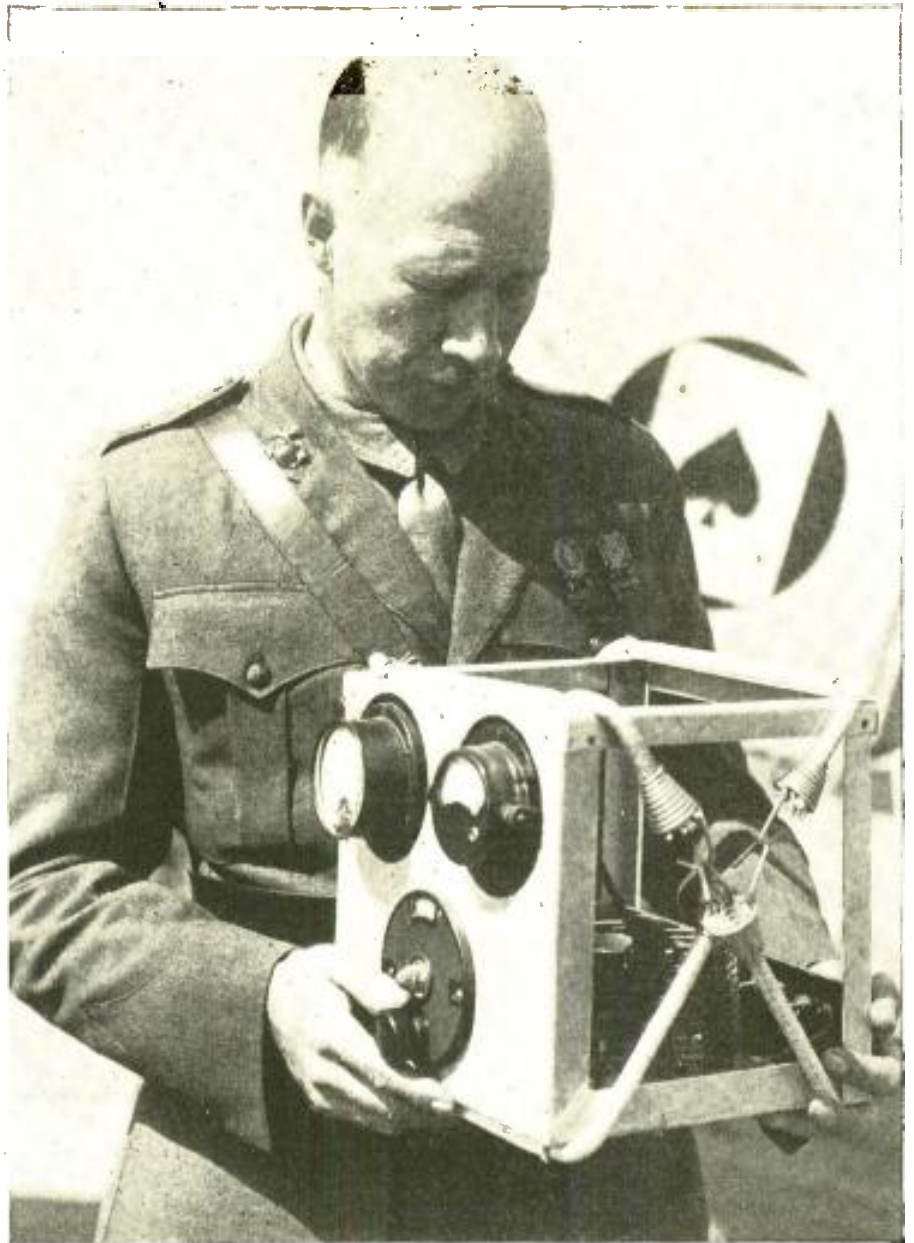

Andrew R. Boone

Radio's Latest Contribution to Military Aeronautics

This tiny but very practical little transmitting station has a sending radius of 300 miles; it was built by Capt. Francis E. Pierce of the Marine Corps from "the navy's scrap heap." With batteries, antenna, receiver and full equipment, it weighs 17¼ pounds.

ence of aviators, who have generally had unsatisfactory results with a swinging antenna.

The transmitter is constructed of aluminum sheet material and angles; the front panel measures 9 by 10 inches and the base 9 by 9½ inches. On the front panel is mounted the milliammeter for measuring the total current in the tuned-plate, "tank" circuit. The tiny base-panel contains the clips for the crystal, the grid-biasing resistance, the plate-blocking condenser, a socket for the 50-watt tube, the grid and plate chokes, the inductance for the plate circuit and the keying relay. The transmitter in action is swung by a shock-absorber cord that is suspended just beneath the aviator's cockpit.

Already the set serves for communication between Marine planes at San Diego and between planes and a radio-truck station, which also operates the 5½-pound transmitter. Two antennas serve the ground end of the station, one long and one short, for high and low frequencies. Each ground antenna extends from a pole 15 feet high to the truck chassis.

Power comes to the plane set from a wind-driven generator, mounted on the fuselage. The ground set derives its energy supply from storage batteries which are charged by a generator connected to a tiny gasoline motor.

The new transmitter is easily installed and dismantled, and it is effective over an area 600 miles in diameter.

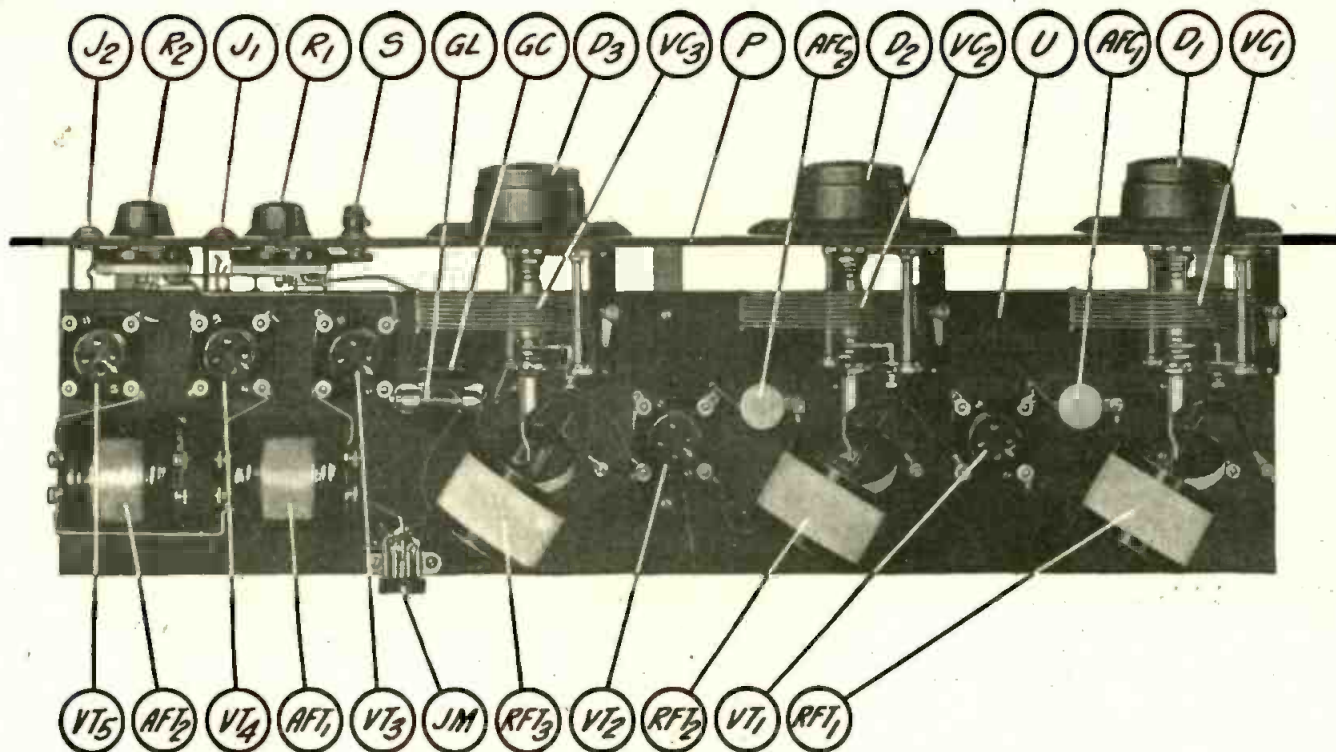

The Karas "Equamatic" Receiver

It is well known that the tendency to oscillate on the lower wavelengths is due to too much coupling between the primary and secondary coils of the radio-frequency stages. In the "Equamatic," the primary rotates in the secondary, and in such a manner that the circuit is kept just below the state of oscillation at all wavelengths. The efficiency of this receiver is thus kept at a maximum.

Popular Radio Circuits

INSTALLMENT NO. 7

THE PARTS THAT ARE RECOMMENDED FOR USE IN THIS RECEIVER ARE—

RFT1, RFT2 and RFT3—Karas Equamatic RF transformers;
 AFT1 and AFT2—Karas Harmonik audio transformers;
 VC1, VC2 and VC3—Karas Orthometric special extended shaft condensers, .00037 mfd.;
 AFC1 and AFC2—Karas Equamatic retard coils;
 VT1, VT2, VT3, VT4 and VT5—Ben-

jamin UX-type tube sockets;
 R1—Yaxley rheostat, with dial, 10 ohms;
 R2—Yaxley rheostat, with dial, 20 ohms;
 R3 and R4—Amperites, No. 1A, with mountings;
 J1—Yaxley interstage jack, No. 4;
 J2—Yaxley open-circuit jack, No. 1;
 S—Yaxley filament switch;
 GL—Amsco grid gate, 2 meg.;
 GC—Sangamo grid condenser with grid-

leak clips, .00025 mfd. capacity;
 D1, D2 and D3—Karas micrometric vernier dials;
 P—composition panel, 7 by 28 inches, drilled and engraved;
 U—composition sub-panel, 6 by 27 inches, drilled;
 JM—Jones multiplug with mounting, type BM;
 3 Karas equamatic sub-panel brackets.

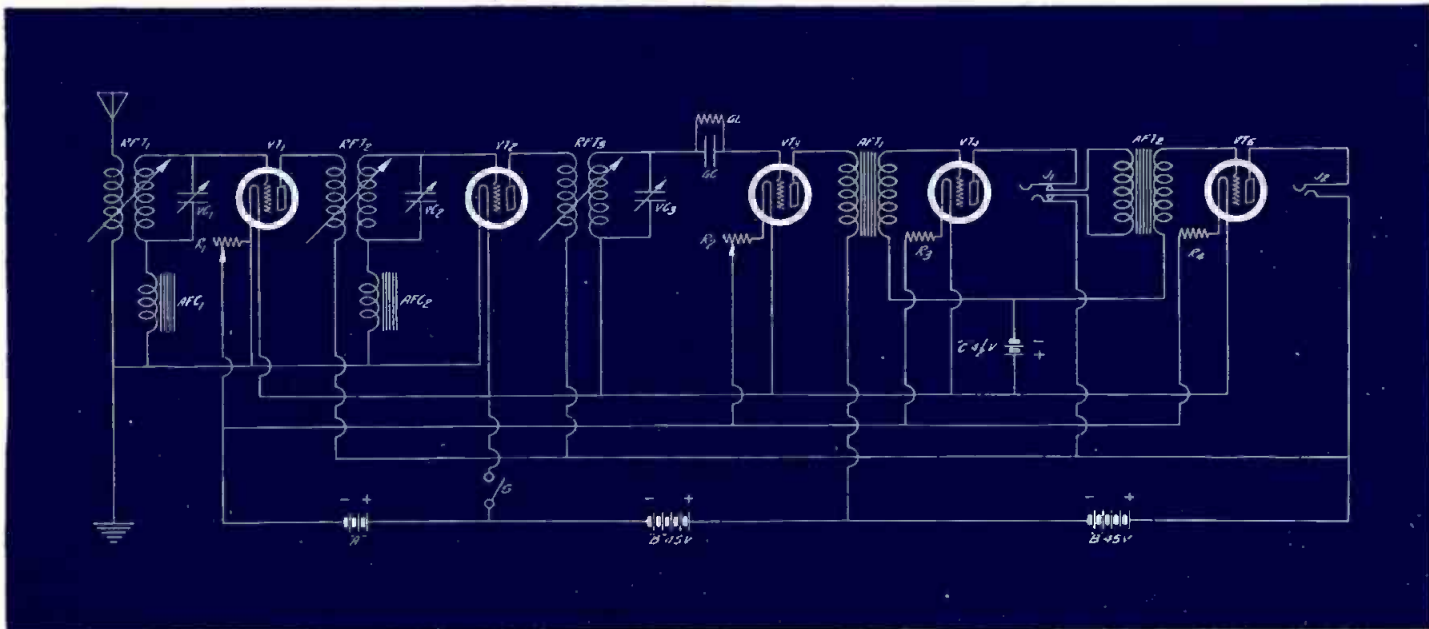

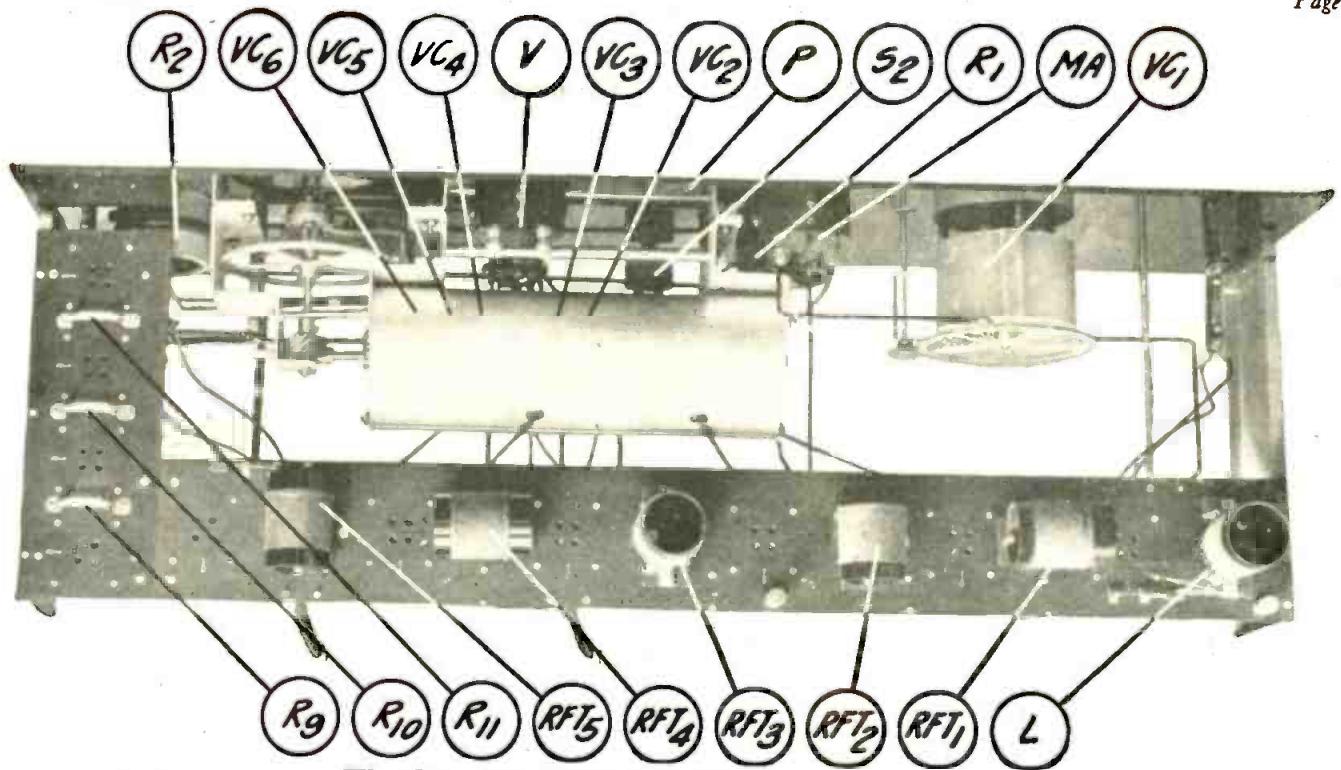

The Norden-Hauck "Super-10" Receiver

This set is a remarkable, straight radio-frequency receiver containing five stages of tuned radio-frequency amplification, a detector, one stage of transformer-coupled and three of impedance-coupled audio. The distance obtainable with such a radio-frequency amplifier should be sufficient to satisfy the most ambitious of set builders. Six tuned circuits are incorporated in the set but only two tuning controls are used. All tubes are of the UX-201-a type except the detector, which is a UX-200 type tube and the last audio-frequency tube.

THE PARTS THAT ARE RECOMMENDED FOR USE IN THIS RECEIVER ARE—

- | | | |
|--|---|--|
| <p>L, RFT1, RFT2, RFT3, RFT4 and RFT5—Norden-Hauck radio-frequency transformers, type A;</p> <p>AFT—Norden-Hauck audio-frequency transformer, ratio 6 to 1;</p> <p>AFC1, AFC2 and AFC3—Norden-Hauck impedance-coupled units;</p> <p>VC1—Norden-Hauck variable condenser, shielded;</p> <p>VC2, VC3, VC4, VC5 and VC6—Norden-Hauck variable gang condenser, shielded;</p> <p>C1—fixed mica condenser, .00025 mfd.;</p> <p>C2, C3, C4 and C5—by-pass condensers, .5 mfd.;</p> <p>C6—fixed mica by-pass condenser, .005 mfd.;</p> | <p>C7—fixed grid condenser, .00025 mfd.;</p> <p>C8, C9 and C10—fixed mica blocking condensers, .5 mfd.;</p> <p>R1 and R2—General Radio rheostats, type 214-a, 2 ohms;</p> <p>R3, R4, R5, R6 and R7—Norden-Hauck type S-10 grid resistors, 750 ohms;</p> <p>R8—metalized grid resistor, .2 meg.;</p> <p>R9, R10 and R11—metalized grid resistors, 30,000 ohms;</p> <p>VT1, VT2, VT3, VT4, VT5, VT6, VT7, VT8, VT9 and VT10—tube sockets, integral with base panels;</p> <p>S1—Norden-Hauck selector switch;</p> <p>S2—Cutler Hammer filament switch, type C-H No. 8008;</p> <p>J1—Norden-Hauck single-circuit filament</p> | <p>control jack;</p> <p>J2—Norden-Hauck open-circuit jack;</p> <p>MA—Weston milliammeter, type 301, scale zero to 50;</p> <p>V—Weston voltmeter, type 301, double scale zero to 7.5 to 150;</p> <p>P—bakelite panel, 36 by 9 by ¼-inch, drilled and engraved;</p> <p>6 grid leak clips and spacers;</p> <p>Gearing for gang condenser;</p> <p>Brackets, posts for base panels;</p> <p>2 General Radio vernier knobs, type 239;</p> <p>Weston meter switch, for type 301 volt meter;</p> <p>Cabinet, 36 by 9 by 10¼ inches;</p> <p>Bus-bar, lugs, nuts, screws, etc.;</p> <p>2 General Radio knobs, type 137-D.</p> |
|--|---|--|

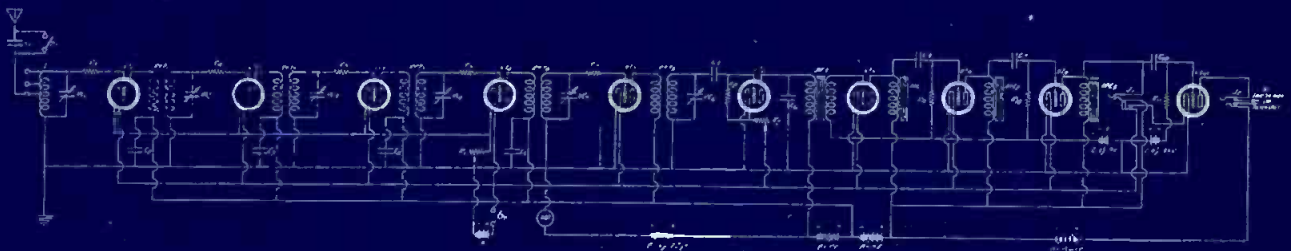

THREE PRIZE-WINNING IDEAS FOR

Improving Broadcast Programs

1. "Stagger the Broadcast Programs."
2. "Each Station Should Identify Itself by a Specialized Program."
3. "Prevent by Law the Interference of Broadcast Stations."

Those, in the opinions of the judges, are the best answers received, in the prize letter contest conducted by POPULAR RADIO to the question: "How Can Radio Broadcast Programs Be Improved?"

AFTER several weeks of careful deliberation, the judges of the contest (announced in the September, 1926 issue of this magazine) have awarded the prizes to the following contestants:

FIRST PRIZE (\$50.00) to William Andrew Mackay, Coytesville, N. J.

SECOND PRIZE (\$20.00) to Charles D. Isaacson, care of Station WRNY, Roosevelt Hotel, New York.

THIRD PRIZE (\$10.00) to Harold

Moore, 116 North Wadlington Street, Marion, Indiana.

In addition to the above, prizes of \$5.00 each have been awarded to the following contestants:

H. P. Angus, Box 247, Forest Park Station, Springfield, Mass.

H. G. Cisin, 312 Webster Avenue, Brooklyn, N. Y.

F. P. Pursell, 601 Prospect Avenue, Scranton, Pa.

W. P. Miller, 1161 Fifth Street, San Diego, California.

I. E. Morrison, 1772 Wilson Avenue, Chicago, Illinois.

E. W. Vaill, 33 Seneca Place, Upper Montclair, N. J.

The selection of the prize winners was no easy matter. Every one of the hundreds of suggestions was carefully con-

sidered, and the choice was finally narrowed down to sixteen of outstanding merit.

These surviving sixteen letters were re-submitted to every one of the judges who graded each letter on a percentage basis. The six letters that received the highest rating were again re-submitted for final selection—with the result announced above.

Many of the letters entered in the contest embodied good ideas; some of them were so original that reference will be made to them elsewhere in this magazine. The letters that won the three first prizes are printed in full herewith.

"Stagger the Broadcast Programs"

(Winner of the first prize of \$50.00)

By WILLIAM ANDREW MACKAY

THE trouble with broadcasting is simple to analyze; there is too much of one thing at a time.

The early hour of the evening is the lecture hour; the later hours are dance hours. All stations are alike.

What malign fate is it that persuades every single station in our city, or in any city, to put on exactly the same kind of program at exactly the same minute each night?

Yes it is so easy to do something about it. All that the stations need to do is to stagger the programs; one kind of program at one hour, another kind at another hour. Never the same kind of program at the same hour for any two near-by stations at the same time.

There are six stations that my wife and I can hear conveniently on our radio set. There are also six hours in the usual radio evening, from 6:00 P.M. until midnight. If I owned those six stations what I would do with their programs is represented on the accompanying "program diagram."

Let station Number One fill up its evening with an hour-by-hour program which has now become (alas!) virtually the standard thing for all stations.

Between 6:00 and 7:00 we will have an orchestra playing classic selections, tempered, perhaps by a trace of the "popular"; this is now what appears as "dinner music" on so many stations' programs.

For the next hour, 7:00 to 8:00, we will allow the professors to talk, just as they do now. Preferably there should be four or five of them during the hour, for there are few speakers who cannot exhaust practically everything really interesting that they know in fifteen minutes or less.

(Continued on page 180)



From a photograph made for POPULAR RADIO

The First Prize Winner—William A. Mackay, 2AQB

Old timers in radio will identify Mr. Mackay by his call letters which have become widely known to amateurs during the past few years. This picture was made in station 2AQB in Coytesville, N. J., owned and operated by Mr. Mackay.

“Trouble-shooting,” as well as the testing of tubes and checking the operating conditions of a receiver, are made easy by the use of this simple test unit



From a photograph made for POPULAR RADIO

THE AUTHOR TESTS A RECEIVER WITH THE NEW DEVICE

FIGURE 1: This instrument, which may be assembled at home at a cost for parts of not more than \$22.00 makes it possible for the set-owner to locate and repair trouble in his receiver without guess work.

HOW TO BUILD AND USE

A PORTABLE TEST-BOARD

By ALBERT G. CRAIG

HERE ARE THE PARTS THAT WERE USED IN THE LABORATORY MODEL OF THIS UNIT—

C—connection plug (UX-201-a tube base);
V—any approved voltmeter, range zero to 8 volts (Weston, model 301 illustrated);
MA—any approved milliamperes, range zero to 25 milliamperes (Weston

model 301 illustrated);
VT—any approved UX-type socket (Benjamin Cle-ra-tone socket illustrated);
S1 and S2—Muter double-pole, double-throw knife switches, stock No. 2020;
S3—Muter single-pole, double-throw knife

switch, Stock No. 2010;
T—composition panel, 7 by 14 inches;
U1 and U2—hardwood supports for panel, 2 by 7 by ½-inch;
4 binding posts, any approved type (Eby binding posts illustrated).

HERE is a portable test unit that has been especially designed to fit the needs of the experimenter who wants a handy test board that may be used to check the operating conditions of a receiver, to determine the characteristics of vacuum tubes and for general trouble-shooting.

The unit is simple to build and simple to operate.

The test board consists mainly of a connection plug for insertion in any of the tube sockets in the set, a socket on the test board in which the tube which

is replaced by the connection plug may be inserted for test and a four-wire cable connecting these two. A filament voltmeter with a reversing switch and a plate milliammeter are connected in the circuit on the test board.

The two principal connections on the board may be changed at will by switches. The first of these is for determining the operating conditions of tubes as used in the radio set and for locating trouble. The second may be used to determine the operating characteristics of the vacuum tube itself.

How to Use the Test Board to Examine the Operating Conditions of Tubes in the Receiver

Remove one tube from the radio set under test and place it in the socket, VT, of the test board. Next, insert the connection plug, C, in the empty socket of the radio set.

Then, set the voltmeter reversing switch, S1, so that the filament voltmeter reads in the right direction. Set the other double-pole, double-throw switch, S2, so that the plate and grid wires of the connection plug go direct

to the socket, VT, of the test board.

The tube on the test board is now operating under the same direct current voltage and plate condition as when it is used normally in the radio set. The filament voltage and the plate current of the tube under test should now be observed and should approximate the tube manufacturer's specifications.

The specifications for all standard types of tubes are given in the table on page 146.

It may be noted that the specifications in this table are made up for zero resistance in the plate circuit of the tube, while the tube in the radio set will ordinarily be operated with some piece of apparatus in the plate circuit, which may have considerable resistance, such as an audio-frequency transformer or a plate-coupling resistor. Therefore, the "B" voltage supplied may have to be considerably higher than the table rating to produce normal plate current.

How to Use the Test Board for Tube Testing

The voltmeter reversing switch, S1, need not be changed in order to test the tube. The other switch, S2, should be thrown over in the opposite direction. The links should be left across the "C"

battery and "B" battery binding posts.

The filament wires run direct from the connection plug to the filament of the tube on the test board as before. The grid wire from the socket, VT, on the test board may now be connected through switch S3 to either side of the filament of the tube thus changing the grid-bias by the same amount as the reading of the filament voltmeter, V. The plate wire runs from the connection plug to the plate of the tube on the test board as before.

There will normally be some piece of apparatus in the plate circuit of the tube now and it is advisable to keep the resistance of this instrument as low as possible for tube testing.

One suggestion would be to make the test in a radio-frequency socket as the DC resistance of the radio-frequency transformer is usually low. Another suggestion would be to make the test in a socket that has a jack in the plate circuit of the tube and to insert a short-circuited plug in this jack.

For a given plate voltage, the plate current may now be taken as a measure of the plate resistance of the tube under test; and, if the plate current is normal, the change in plate current by reversing switch S3 (changing the grid-bias)

may be taken as a measure of the amplification factor of the tube under test.

A few observations on the behavior of good, standard tubes under these tests will aid noticeably in judging other tubes.

The "C" battery binding posts, 1 and 2, are to be used for inserting the proper "C" battery when testing tubes that require a grid bias as large as $22\frac{1}{2}$ or 45 volts. The "B" battery binding posts, 3 and 4, are not for the purpose of inserting additional "B" battery voltage, but it was intended that the link might be removed and a flexible lead run from binding post 3 to any desired voltage tap of the receiver "B" battery. Binding post 4 is then left unconnected.

An example of the use of this flexible lead in measuring tube characteristics may be given. Switch S3 was set on the negative filament connection. Binding post 3 was connected to the $67\frac{1}{2}$ -volt "B" battery tap and the reading of plate current meter MA, was 4 milliamperes. Binding post 3 was next connected to $112\frac{1}{2}$ -volt tap of the "B" battery and the reading of MA was 10.1 milliamperes. The change in plate current per volt of "B" battery change

(Continued on page 164)

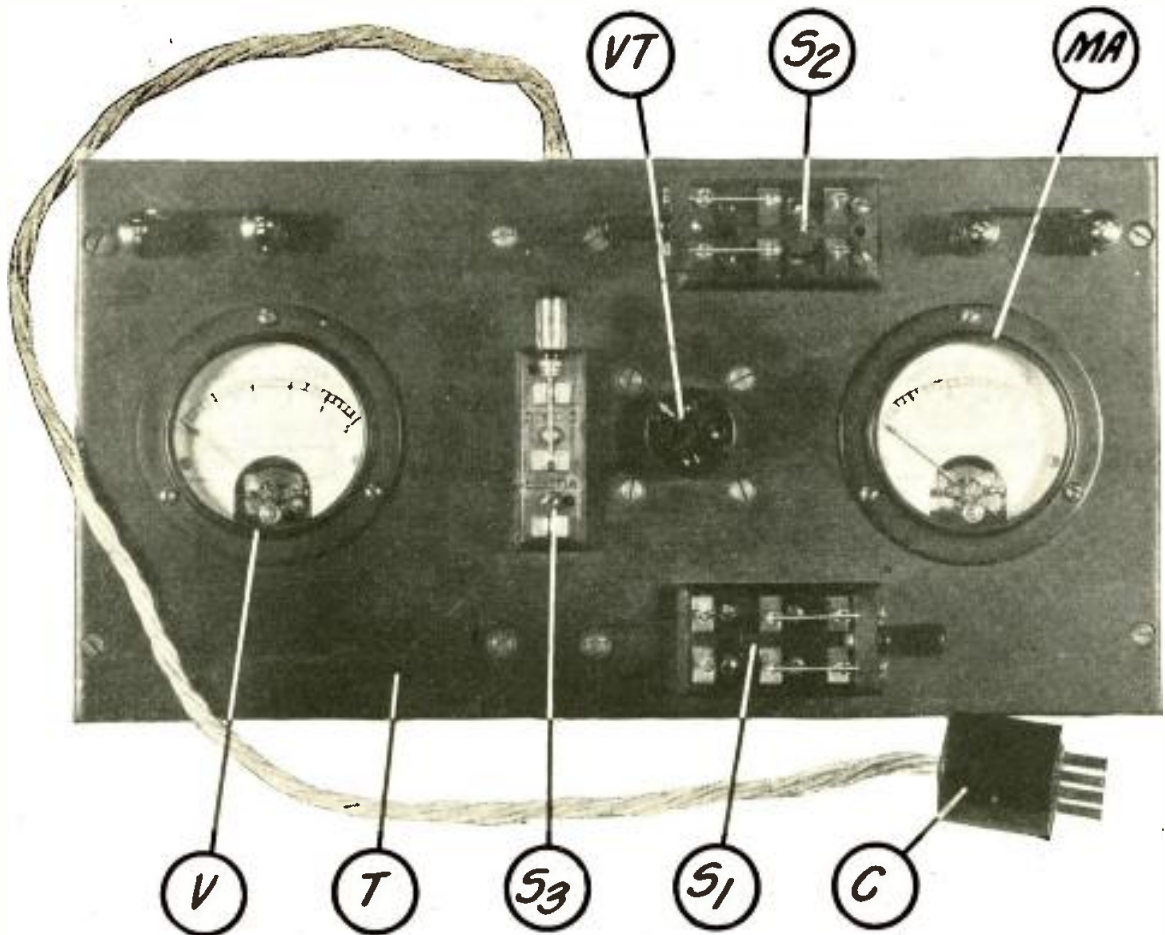

HOW THE TEST BOARD LOOKS FROM ABOVE

FIGURE 2: Two meters are mounted directly on the panel with three switches, tube sockets and the binding posts in easily accessible positions. The extension cord is fastened to the terminals beneath the test board and they extend to the connection plug made out of the base of a burnt-out vacuum tube.

Is Radio Broadcasting Killing the Wild Savageries of JAZZ?

By EARL REEVES



GENTLEMEN of superior intellects lately have had a habit of referring to the rest of us as "jazz hounds." Moreover, they study the job-lot of us through thick-lensed spectacles and refer to this era as "The Jazz Age."

They are not tossing us bouquets: it's brickbats they are throwing.

They go on and say we have low musical tastes; and that radio not only proves it but has contributed to our cultural downfall.

The only trouble with these wise fellows is that they are all wrong. They have not studied the available evidence.

The evidence decidedly is in our favor. We have discovered with some amazement that we *like* good music—and that jazz does not wear well.

As regards the blare-blare of jazz and the sticky-sweet fluff-stuff that is produced along Tin Pan Alley we are somewhat like the boy who went to the country to visit his grandmother. He was continually getting into the sugar, so she took him to the pantry, showed him the sugar-barrel and invited him to eat all of its contents if he wished. When she asked him later whether he had

eaten it all he said he had eaten "all of it that was good."

When we had a jazz hunger—while the craze was at its height—radio crashed through and gave us a chance to have all the jazz we wanted.

And we've had about as much of it as was good.

But I must not fall into the error of which the learned professors are guilty; I must not generalize without citing the evidence.

Mr. Charles B. Popenoe comes very near being an authority. He built the first permanent broadcasting station and was director of broadcasting for the Radio Corporation of America.

"Less than ten percent of our public want jazz," he told me. "We therefore decided to keep it off the air until very late at night."

Mr. Popenoe explained that his statement was not a guess, but was based on a careful study. He added:

"The telephone people, while operating WEAf, discovered that less than five percent of that station's audience wanted jazz."

This survey amazed the officials who

made it, Mr. C. F. McClelland (now general manager of the National Broadcasting Co.) admits.

"More important than the percentage itself," he said, "is the great change in taste which it shows over a period of two or three years."

Here also I found another striking bit of evidence. Picture the managers of this great station making a first timid experiment at putting grand opera on the air. A station which was a quarter of a million dollar a year experiment, testing out on the millions of us who cannot indulge in luxury, the music usually sung for the "diamond horseshoe" of the

Metropolitan Opera House. The men who are hid from us, far behind the microphone, building programs, smiled at each other over their first tiny "grand opera troupe." Sometimes they referred to the singers as "the long haired gang"; or would say, perhaps, "Bring on the high-brows." They thought it rather a presumption that they should be meddling with grand opera: they were rather sheepish about it: what in the world would we think of them?

The millions of listeners have changed the views of station managers regarding this troupe. It is nothing to be apologetic about: it is a very important and popular group of singers. Grand opera by radio has become so important, in fact, that expert musicians are employed regularly now to "cut" operas from their full stage size score to a length suitable for entertainment in our living rooms.

Cutting grand opera to radio studio proportions is a brand new profession. To me, that is a very striking fact.

In a sense, the two stations mentioned are endowed institutions. They are maintained by the biggest unit in the radio world as a service to set purchasers and as indirect advertising.

The advertiser who walks up to the radio broadcast counter and lays down hard cash for time on the air in order to win friends for his product must have a very hard-boiled measure of what we like. Or he should have. To mention two prominent "radio advertisers."

The Silvertown Orchestra began entertaining us with dance music only and worked from that to the briefing of musical comedies:

The National Carbon Company started its "goodwill advertising campaign" with the jazziest of "blues" and with minstrel shows, and later paid out many thousands to give us musical comedy and light opera—believing that giving us such musical diet pays.

In a sense, the story thus far concerns the metropolitan districts, although these big stations reach across the country, directly or in tie-ups.

But what of stations actually located in the west?

Louis J. Johnen gave me a report on station WLW (the Crosley station in Cincinnati).

"Most of our programs," he said, "are what may be termed popularly classical; that is, they consist of the more or less familiar classics.

"As far as abstruse music is concerned I can assure you that it is little to the taste of the radio audience."

"On the other hand," Johnen said, "Jazz, though it has its few devotees, is not so popular as is commonly supposed."

Station WLS, owned by the Sears-

Roebuck Agricultural Foundation, reaches still farther into the territory where men are men.

Although previously convinced that the farmers of the country preferred "popular" music, WLS several months ago tried out a symphony orchestra series with amazingly favorable response. On opening night the "Blue Danube Waltz" alone brought in fifty letters.

This station still experiments, tabulating mail, cross indexing it, and "measuring" its public; and I have what might

What Radio Is Doing to Sales of Jazz

"THROUGH the medium of broadcasting the life or sale of popular sheet music has been considerably hampered. Every music publisher in the business will acknowledge that the sales of popular sheet music have fallen off considerably—and that radio is sorely to blame."

Paul A. Specht

DIRECTOR OF SPECHT'S ORCHESTRA

be called an "ad interim" report, as follows:

"Our evidence indicates that a radio station, if it is going to be of the greatest service to the persons who pay for its operation, must run throughout the week at least 60 percent popular and 40 percent classical or semi-classical. But by popular music I do not mean entirely wild and screeching jazz continuously, but some jazz and in addition music that always is known to the general public."

I get somewhat similar signs from the station operated by the State College of Washington—which carries the case to the Pacific coast.

And I think the learned critics who refer to the millions of us as "jazz hounds" and deplore our musical taste accordingly, will have to admit that all this is a far cry from what they would have expected the figures to show.

There is one man well-known to you—Mr. A. Atwater Kent—who is very certain that radio is killing jazz and lifting our musical tastes to higher levels. When he wanted to remind us pleasantly that he builds radio sets he decided to give us the most famous opera singers.

"Our decision came about as the result of exhaustive inquiries," he explained.

"After our concerts had begun we received thousands of letters of appreciation. We addressed a questionnaire to a list of approximately six thousand of

these commentators. The responses were most interesting and enlightening. Replies were received from 48 states and 569 cities and towns, covering both rural and metropolitan centers.

"Ninety-two percent expressed the view that there was not too much classical music. A slight majority, 56 percent, indicated the belief that there is too much jazz music broadcast."

Like President Coolidge, Mr. A. Atwater Kent was born in rock-ribbed Vermont; moreover, he built his business in conservative Philadelphia. Yet this double-dyed Yankee bet several hundred thousand dollars that he knew what we wanted—and that it was *not* jazz!

In Tin Pan Alley, whence comes jazz, radio is viewed with mixed feelings.

Managers of song factories who once tried to get a new song on the air to help advertise it are much more apt today to say: "For Heaven's sake, don't let 'em broadcast it."

To be sure, in rainy England splashing holiday crowds still trudge homeward chanting a promising that it ain't goin' to rain no mo', and the author of that bellowing refrain was made famous here at home by radio; nevertheless, the number of song-writers who have been "made" by radio is a very small percentage of the number who have been "unmade."

"The big hits are harder to find today," the manager of one of the leading music publishing houses said mournfully. "In the beginning we thought it was good advertising to broadcast a song. But we have found that the sentimental songs of the sort that have been big hits in the past can be killed by too constant radio repetition."

"Of course jazz and sentiment are still the best sellers—" this from a retailer—"but they are relatively less popular, sales have decreased; while the good old tried and familiar songs are selling better. These songs bear repetition: they never grow old. Radio has made them more popular."

One of the editors of a music magazine rounded out this picture of the tastes of all-of-us for me.

"I know of many composers who have quit writing songs because the jangles they are capable of writing no longer will go down with the public," he said. "Men who could collect fifteen or twenty thousand dollars a year royalties a few years ago had to 'accept' positions as shoe clerks, soda dispensers, or collar salesmen."

From all of which I conclude that if radio is not killing jazz dead, it is at least reducing the popularity of the lighter-weight products of Tin Pan Alley—and proving to us that we like better music.

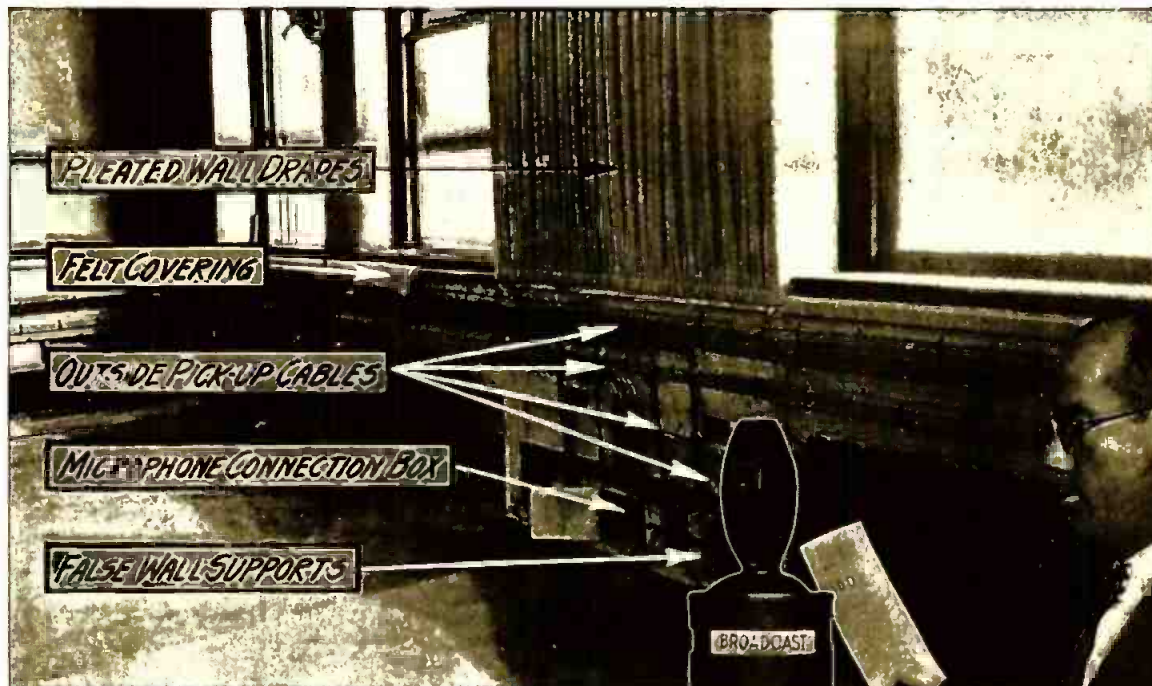

THE SKELETON OF A MODERN STUDIO

The walls must be designed and constructed with the greatest care to prevent the least distortion in tone quality from entering the microphone. Here are shown the mass of wires, the drapery and the other elements that go into the making of the room from which the broadcasting is done.

The Fight Against DISTORTION

The ingenious tricks employed by radio engineers to deliver good broadcasting to your home

By RAYMOND F. GUY

THE fundamental problem and purpose of broadcasting is the transmission of vibrations of sound and of electricity. The broadcaster picks up sound vibrations, converts them into electrical ones and finally transmits them, in so far as possible, in exactly the same proportions as when they were first produced.

The sound vibrations range from approximately 30 to 15,000 per second; beyond these limits the average person cannot hear and the transmitting stations so far have been unable to transmit because of apparatus limitations. It has been found that a frequency band of from 50 to 7000 cycles is ample for obtaining excellent transmission; and that is approximately the band that is covered by the better grade of stations.

These vibrations of sound, during speech or music, change very rapidly in frequency and in amplitude. In the case of symphony orchestras, such as, for instance, the New York Philharmonic, the amplitude at one part of a selection may be 10,000 times as great as at another part.

Practically all single sources of sound have one fundamental frequency and several harmonics or overtones. It is these overtones which distinguish various sources of sound from each other, which make a violin sound like a violin and a flute like a flute.

A number of these wave shapes are shown in Figure 3 to illustrate this point. The difference in the number of harmonics and in their shapes is what distinguishes them from each other.

It is obvious that to obtain correct transmission the harmonics must be transmitted faithfully in their right proportion; and it is here that the difficulty arises. Needless to say, the transmission will be most natural and pleasing when there are no extraneous noises caused by obstreperous wire lines, noisy pick-up devices or by generator hums.

The first requirement is that the sound emitted at the source, whatever it may be, must reach the microphone in its original state. If the microphone is too far distant and if the hall or studio is not well designed acoustically, the original sound will be heard plus several echoes from the walls and ceiling and even from large objects of furniture.

It is interesting to note that the reason



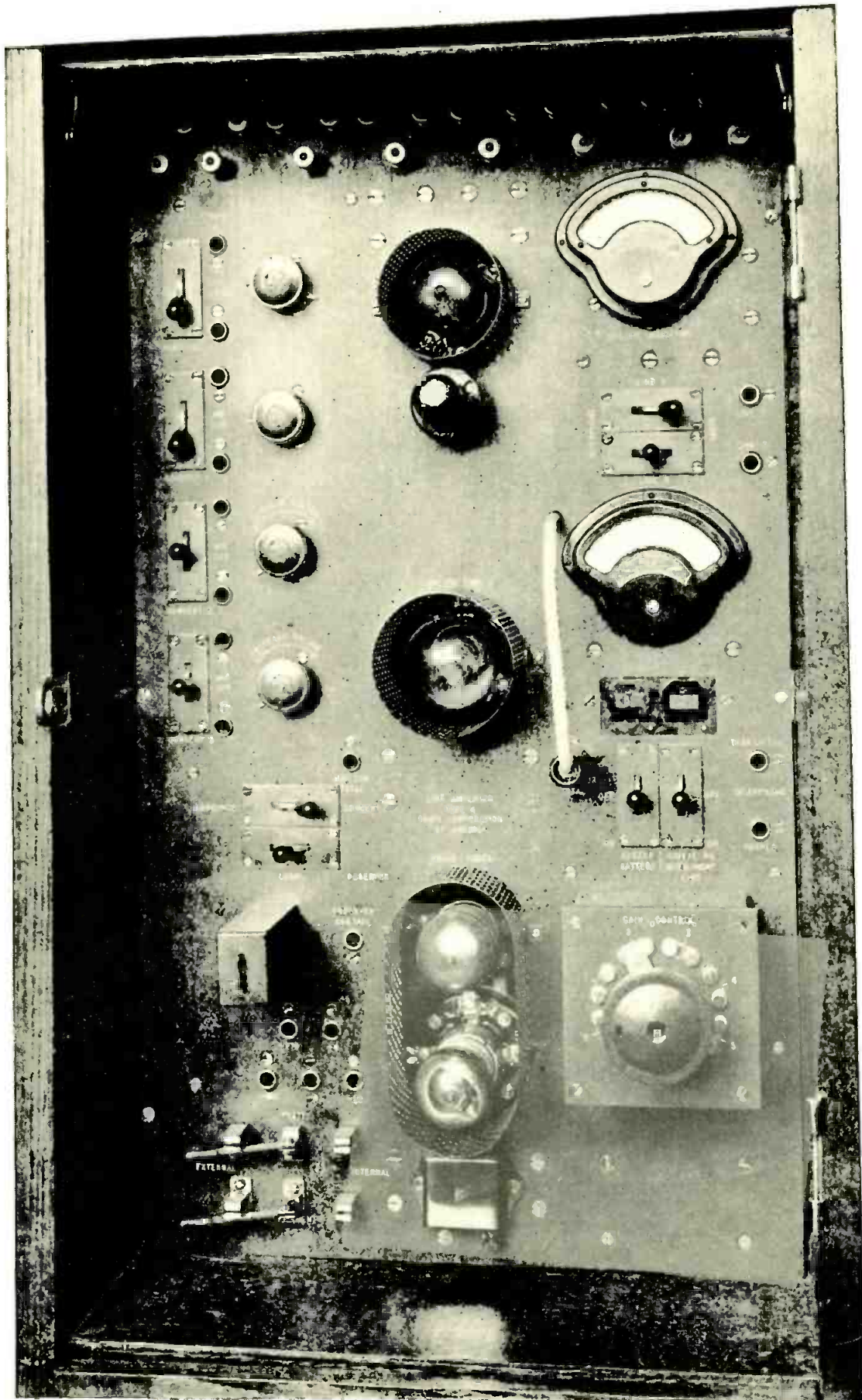

The Elaborate Control Board in the Broadcasting Station
Where the Modulation Work Is Done

FIGURE 1: The type of control board that is used to pick up programs. Means are provided for the operator to listen in while the currents are passing over the land wires to the station, so that he may check up on the reproduction and adjust the amplifier circuits to values that will make the reproduction as lifelike as possible. The legends printed on the panel fully explain what all of the instruments are for.

any sound such as the music from an orchestra in a large hall sounds "distant" is because there are echoes accompanying the original sound. Who has not heard an out-of-studio broadcast from an auditorium, for instance, such as the Republican Convention Hall in Cleveland, without picturing the size of the hall from the sound of the organ? Subconsciously one times the echo. This is in itself confusing, but, in addition, there is often a certain frequency at which a room is resonant, resulting in a "ringing." Anyone may verify this by whistling up and down the scale in some small room or enclosure and noting the predominance of certain pitches which will usually be quite pronounced.

Another possible factor is the reflection of sounds from the walls, floors or ceilings, which causes high and low sound pressure areas or nodes, which are known as "standing waves." These may be easily observed, if one has a strong single-frequency sound source in a comparatively bare room, by walking slowly toward or away from the source of sound. The nodes will be evidenced by the fact that the sound will be much more intense at various places than at others closer to the sound source. They

usually occur at regularly spaced intervals.

To cure or to minimize these sources of distortion, the microphone is placed as close to the sound source as is consistent with good musical balance and freedom from overloading. This is a very simple remedy; and it is usually sufficient because the ratio of original sound to the echoes, as the microphone is moved closer, is much improved.

The surest method, however, is to treat the walls, floor and ceiling with acoustical absorbents such as a thick carpet on the floor and monks cloth or felt on the walls and ceiling. The best sound absorbents are open windows and close behind come audiences. Human beings absorb sound in more ways than one.

Monks cloth is not sufficient alone to dampen the walls unless it is used in excessive quantities. This is because low frequencies pass through it quite readily whereas frequencies of the order of 3000 cycles are fairly effectively absorbed.

It is reported that the studio walls of one New York station were originally carefully modeled of layers of thick felt, air and specially painted, sound transparent muslin at considerable

expense, only to have the whole business spoiled by well-meaning but unknowing workmen who gave the muslin a coat of shellac, thus rendering the surface hard and making it a good sound reflector.

In some cases it would help to move the broadcasting from one part of a hall to another where the walls are irregular instead of flat, as the irregular walls would not reflect as much sound in any one direction. This method is not practicable and is rarely, if ever, used.

The next step the vibrations take is a change from sound to electricity in the "microphone."

There are three types of microphones in use in which the sound causes a change in resistance, in inductance or in capacity. These are known respectively as carbon, electrodynamic and condenser (or electrostatic) transmitters. The carbon and condenser types, and some forms of the electrodynamic transmitters, employ metallic diaphragms which, unless they are carefully dampened and stretched so that their resonance period is very high, cause an unnatural predominance of certain frequencies that result in distortion.

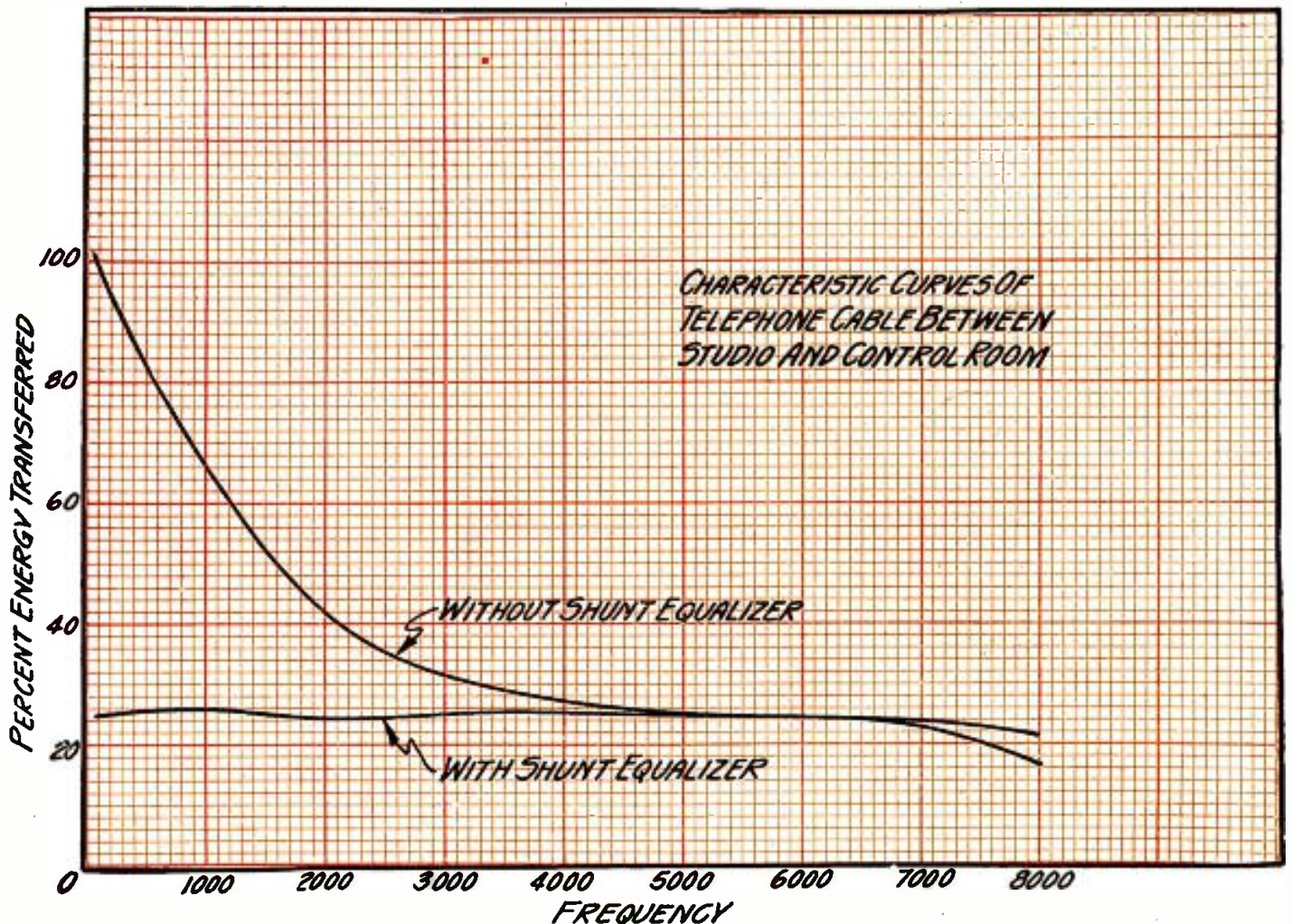

HOW A POOR TELEPHONE LINE MAY BE IMPROVED BY LOADING
 FIGURE 2: These curves show how a telephone line with an uneven transmission characteristic may be improved so that it will pass all frequencies with more uniformity.

Condenser and carbon microphones have their diaphragms stretched to a natural period of approximately 6000 cycles.

Electrodynamic microphones often have low resonant periods, that is, below 50 cycles. These devices are often very sensitive to mechanical shock so that elaborate shock-proofing, and in some types, "doctoring" is required because of a frequency response characteristic which varies inversely as the frequency. Because of these difficulties and their low voltage output they are little used.

The most commonly used type of transmitter is the double-button carbon device which contains a light duralumin diaphragm .002 of an inch thick, which is so stretched and dampened that its frequency response curve is flat from about 100 to 6000 cycles. On each side of this diaphragm is a gold-plated area against which the carbon rests. The carbon is held in place by means of a felt ring separated .003 of an inch from the diaphragm; and, as the smallest carbon globules are about .005 of an inch in diameter, they stay in place.

As the sound waves strike the diaphragm they compress the carbon in one button and loosen it in the other, thereby changing its resistance. This is a pushpull device which minimizes distortion.

The most serious drawback to carbon devices is "blasting." When too violent impulses strike the diaphragm they cause it momentarily to leave the carbon, breaking the circuit and causing

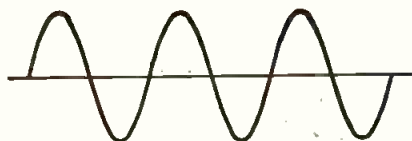

TUNING FORK WITH NO UPPER HARMONICS

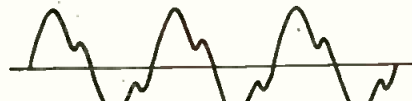

TUNING FORK WITH ONE HARMONIC



PIPE ORGAN



WAVESHAPE OF A VIOLIN - SIX HARMONICS

HOW HARMONICS AFFECT WAVE FORMS

FIGURE 3: This series of four curves shows how harmonics change the character of the sound without altering its pitch. In this case, the tuning fork, the pipe organ and the violin curves are shown with their accompanying harmonics.

an annoying raspy sound. All carbon microphones have this disadvantage but it may be prevented by careful handling. Another disadvantage is the hiss produced by the carbon itself when current is passed through it.

However, because of its simplicity, its ruggedness and its comparatively high output, the carbon microphone is used in practically all broadcast studios.

Another type of microphone which is used to a much more limited extent is the condenser type, which is similar to the carbon device with the exception that it has no carbon buttons.

A special backplate, in this type, forms one plate of a variable condenser, while the diaphragm is the other plate. The capacity and thus the voltage across its terminals when it is charged, is varied by sound waves which move the diaphragm. This device and its associated circuit, which is shown in Figure 4, may be made so that it will be sensibly flat in characteristic over an extremely wide range.

The great disadvantage of the condenser transmitter is that it has a very low output and very high impedance so that it must have extremely careful shielding and insulation. Imperfect insulation between the back plate and ground will result in current leakage and will cause an irritating popping noise. If the device is imperfectly shielded it will pick up any stray fields within a wide area.

We are accustomed to two megohm grid-leaks in our receivers but the insulation between the plates of this device must be practically infinite. One noisy transmitter was found to have a resistance, between terminals, of 500 megohms.

Noisy microphones have to be care-
(Continued on page 162)



A MODERN BATTERY OF MICROPHONES

This is a popular type of microphone unit; this particular installation was used at the broadcasting of the inauguration of President Coolidge. Six double-button microphones were employed to obtain a high quality pick-up.

Radio à la Carte

(Inventions marked* are ready)

Four remarkable contributions to the radio art by an amateur who "never took a lesson in his life"

By ARTHUR L. LIPPMANN

The Degenerative Cougher* With Push-pulmonary Amplification.

Frequent theatre-goers have become so accustomed to hear coughing in the theatre that the absence of these agreeable sounds has marred many an otherwise pleasant evening spent listening in to the radio at home.

My new Degenerative Cougher uses one bronchial tube and can be connected to your set in a moment.

At suitable intervals during the broadcasting of a play or concert, it will emit raucous hawkings through your loudspeaker. These sound so life-like that it will be hard for you to realize that you are sitting comfortably at home instead of in row H on the aisle.

The set employs a croop aerial and has been referred to as the "one-lung larynx" circuit; and it faithfully reproduces all varieties of cough from simple asthma to chronic bronchitis.

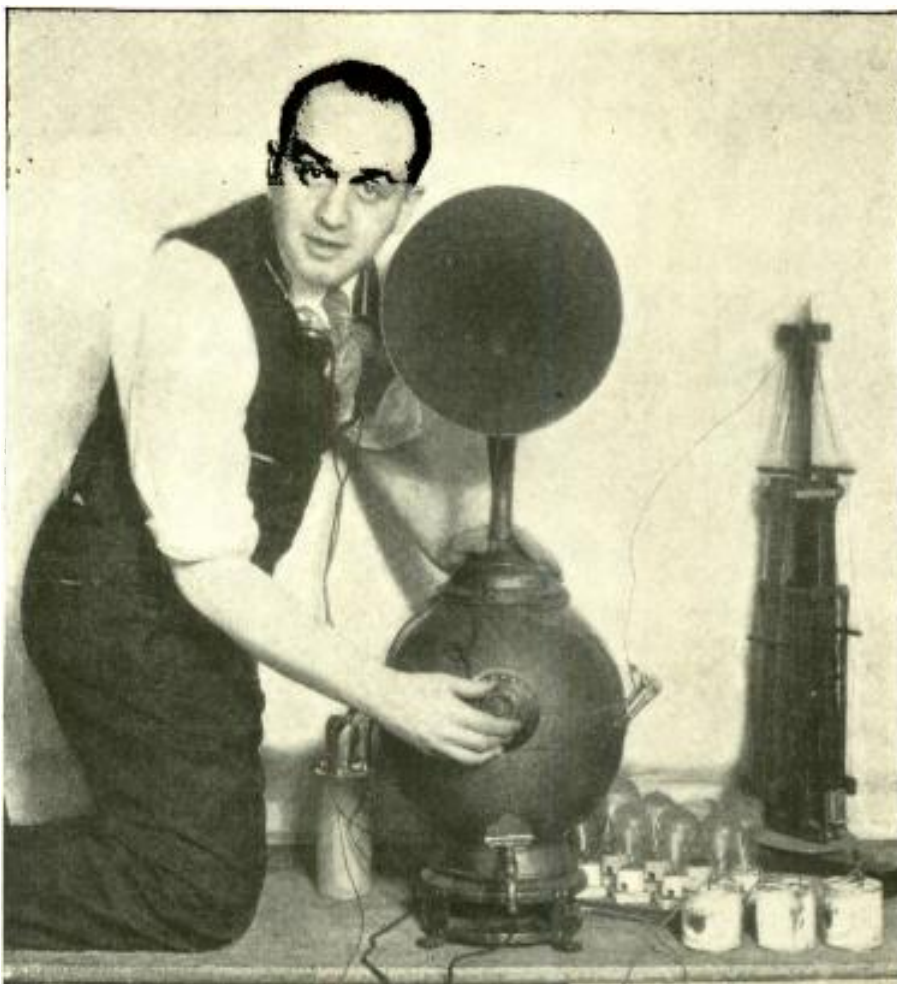

From a photograph made for POPULAR RADIO

THE OPERATION OF THIS SET MAY BE SUMMARIZED AS "AWFULLY SIMPLE, SIMPLY AWFUL"

"There is no need of expensive equipment in assembling these sets" claims the author, "In fact, I ~~urned~~ *urned* this particular set myself. A thermos vacuum bottle, a few milk condensers, an old grid iron—and the trick is done."

The Titillating Titterdyne*

Because the humor of wise-cracking radio announcers usually falls so flat, I early discerned the necessity for an appliance such as a chuckler coil that would generate laughter, no matter how banal the comedy of the announcer.

Simple but ingenious, this attachment automatically ejects graduated quantities of laughing gas from a small vial in the primary circuit as needed. For example:

- Let X = Bum Joke
- G = Laughing Gas
- ∴ X + G = Series of Mild Chuckles
- ∴ XG = A Perfect Scream

The Dynamic Discriminator* Employing a Series of Three Educated Grid Leaks

Statistics in Illinois for 1924-25 revealed the astonishing fact that 66 2/3 percent of the insane radio listeners had become mad through hearing such selections as "The Road to Mandalay" and "At Dawning" sung five or six times during the course of one evening.

The Dynamic Discriminator's Educated Grid Leaks will prevent this condition. Each is filled with two ounces of TNT, and functions as follows:

Educated Grid Leak No. 1 (Ph. D. Harvard): Automatically explodes after the fourth singing of "Macushla" on any one evening.

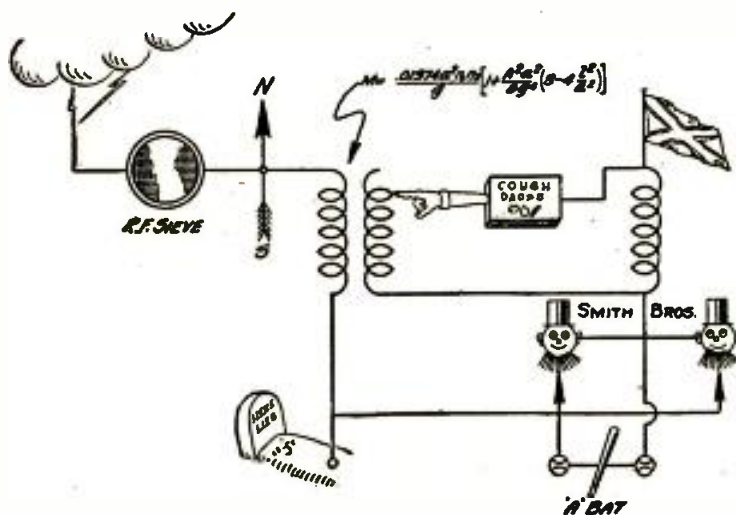

THE FINAL LAY-OUT OF THE DEGENERATE COUGHER

FIGURE 1: The author layed out this hook-up all by himself "Some of the connections," he explains, "are remote but wealthy."

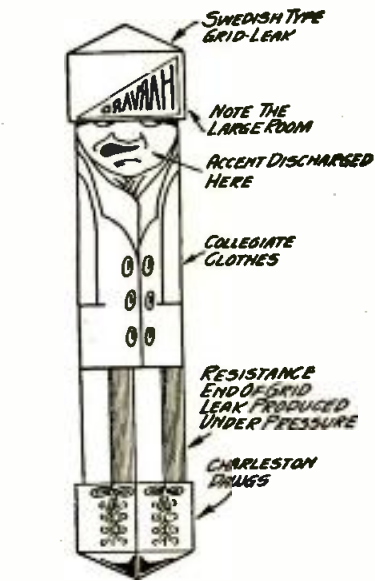

ENLARGED SEVERAL TIMES IN FACT, VERY OFTEN

AN EDUCATED GRIDLEAK (SOMEWHAT EXAGGERATED)

FIGURE 2: The peculiar functions of this apparatus limits its use exclusively to the Dynamic Discriminator Receiver.

Educated Grid-leak No. 2 (B. A., M. A. Dartmouth): Blows up your set at the first bar of "Humoresque" or "Kashmiri Song." Model B goes off as soon as announcer says, "You will now hear 'The Road to Mandalay', sung by"

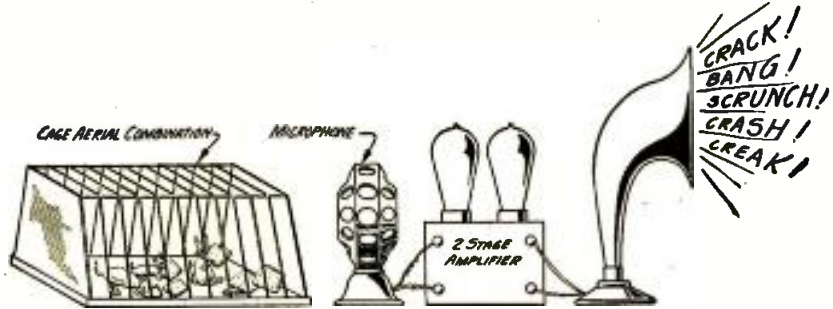

A UNIQUE STATIC DEVICE

FIGURE 3: Good, old-fashioned static from contented, healthy mice—that is the secret of the Static Influx circuit shown above.

Educated Grid Leak No. 3 (Unusually brilliant; educated at Leipsic and Heidelberg): Trained to wreck your set upon the third rendition from any station in one evening of "The Shooting of Dan McGrew" or "Gunga Din." Model B explodes as soon as any "old time fiddlers" are announced.

thing is lacking—there is a void. Do you know what you're missing?

Static!

In the Static Influx Receiver, concealed in a little tin cage before the second audio stage, I have placed a trained mouse and a box of ordinary soda crackers. When you tune in, the crackers are automatically shoved into the mouse apartment.

"Crackle! Crackle! Crunch!" comes the noise from the mouse cage through the audio amplifiers and into your loud-speaker, assuring you of Grade A, dependable static whenever you need it to perfect the program.

Two spare mice and a dozen soda crackers are essential with each Static Influx.

The Static Influx*

Radio without static is like corned beef without cabbage. Staticless radio sounds unnatural and artificial. Several years of radio listening has educated us to expect a little static to leaven the program. Some cold, clear nights the music doesn't soothe, doesn't entertain. Some-

GENERAL						DETECTION						AMPLIFICATION								
TUBE	USE	BASE	MAXIMUM OVERALL DIAMETER	MAXIMUM OVERALL HEIGHT	A* BATTERY VOLTAGE (SUPPLY)	FILAMENT TERMINAL VOLTAGE	FILAMENT CURRENT (AMPERES)	DETECTORS AND AMPLIFIERS						AMPLIFIER "B" BATTERY VOLTAGE	AMPLIFIER "C" BATTERY VOLTAGE	AMPLIFIER # PLATE CURRENT (MILLIAMPERES)	OUTPUT RESISTANCE (OHMS)	MUTUAL CONDUCTANCE (MICROMMhos)	VOLTAGE AMPLIFICATION FACTOR	MAXIMUM UNDISTORTED OUTPUT (WATTS)
								DETECTOR GRID RETURN LEAD TO	GRID LEAK (MEGOMHS)	GRID CONDENSER (MFD)	DETECTOR "B" BATTERY VOLTAGE	DETECTOR PLATE CURRENT (MILLIAMPERES)	AMPLIFIER "B" BATTERY VOLTAGE							
UX-201-B	Detector Amplifier	Large Standard UX Base	1 1/16"	4 1/16"	6 Storage	50	.25	+F	2 to 9	.00025	45	15	135	9	2.5	11,000	725	8	55	
UX-199	Detector Amplifier	UX 199 Base	1 1/16"	3 3/8"	Dry Cell 4 1/2 Storage 4	30	.06	+F	2 to 9	.00025	45	1	90	4 1/2	2.5	16,500	380	6.25	7	
UX-199	Detector Amplifier	Small Standard UX Base	1 1/16"	4 1/8"	Dry Cell 4 1/2 Storage 4	30	.06	+F	2 to 9	.00025	45	1	90	4 1/2	2.5	16,500	380	6.25	7	
W0-11	Detector Amplifier	W0 11 Base	1 1/16"	4 1/8"	Dry Cell 1 1/2 Storage 2	11	.25	+F	3 to 5	.00025	22 1/2 to 45	15	90	4 1/2	2.5	15,000	400	6	7	
WX-12	Detector Amplifier	Large Standard UX Base	1 1/16"	4 1/16"	Dry Cell 1 1/2 Storage 2	11	.25	+F	3 to 5	.00025	22 1/2 to 45	15	90	4 1/2	2.5	15,000	400	6	7	
DETECTORS																				
UX-200	Detector Only	Large Standard UX Base	1 1/16"	4 1/16"	6 Storage	50	1.0	-F	1/2 to 2	.00025	16 1/2 to 22 1/2	1	—	—	—	—	—	—	—	
UX-200-A	Detector Only	Large Standard UX Base	1 1/16"	4 1/16"	6 Storage	50	.25	-F	2 to 3	.00025	45	15	—	—	—	—	—	—	—	
POWER AMPLIFIERS																				
UX-120	Power Amplifier Last Audio Stage Only	Small Standard UX Base	1 1/16"	4 1/8"	Dry Cell 4 1/2 Storage 4	30	.125	—	—	—	—	—	135	22 1/2	6.5	6,600	500	3.3	110	
UX-112	Power Amplifier	Large Standard UX Base	1 1/16"	4 1/16"	6 Storage	50	.5	—	—	—	—	—	157 1/2 135 90	10 1/2 9 6	8 6 2.5	4800 5500 8800	1670 1435 890	8.0 7.9 4.0	195 120 40	
UX-171	Power Amplifier Last Audio Stage Only	Large Standard UX Base	1 1/16"	4 1/16"	6 Storage	50	.5	—	—	—	—	—	180 135 90	40 27 16	20 16 10	2000 2200 2500	1500 1350 1200	3.0 3.0 3.0	700 330 130	
UX-210	Power Amplifier Oscillator	Large Standard UX Base	2 1/16"	5 1/8"	Transformer 8 Storage 8	6.0 6.0 6.0	1.1 1.1 1.1	—	—	—	—	—	425 350 250 157 135 90	35 27 18 10 1/2 9 4 1/2	22 18 12 6 4.5 3	5000 5100 4800 7650 6800 9700	1550 1500 1350 1050 940 775	7.7 7.6 7.5 7.5 7.5 7.5	1940 825 500 100 65 18	
RECTIFIERS																				
MODEL	USE	BASE	MAXIMUM OVERALL DIAMETER	MAXIMUM OVERALL HEIGHT	PURPOSE	Filament Terminal Voltage: 50 Volts Filament Current: 2.0 Amperes Max. AC Input Voltage per plate: 220 Volts (RMS) Δ Max. Rectified Current (both plates): 65 Milliamperes														
UX-213	Full Wave Rectifier	Large Standard UX Base	2 1/16"	5 1/8"	For use in rectifying systems particularly designed for this Tube	Filament Terminal Voltage: 7.5 Volts Filament Current: 1.25 Amperes Max. AC Input Voltage: 550 Volts (RMS) Δ Max. Rectified Current: 65 Milliamperes														
UX-216-B	Half Wave Rectifier	Large Standard UX Base	2 1/16"	5 1/8"	For use in rectifying systems particularly designed for this Tube	Filament Terminal Voltage: 7.5 Volts Filament Current: 1.25 Amperes Max. AC Input Voltage: 550 Volts (RMS) Δ Max. Rectified Current: 65 Milliamperes														

* Loudspeaker coupling recommended at this plate potential due to large plate current. Δ indicates "B" and "C" battery voltages. R M S indicates "Root Mean Square" as indicated on an AC voltmeter. ΔΔ Connection to shell of base for third terminal which is the lead to mid point of filament.

A TABLE THAT TELLS YOU WHAT TUBES TO USE

All of the standard types of vacuum tubes are given above with their filament, grid and plate characteristics as to standard applied voltages. The table also tells the use of the tubes and gives other ratings that should be helpful to the experimenter.

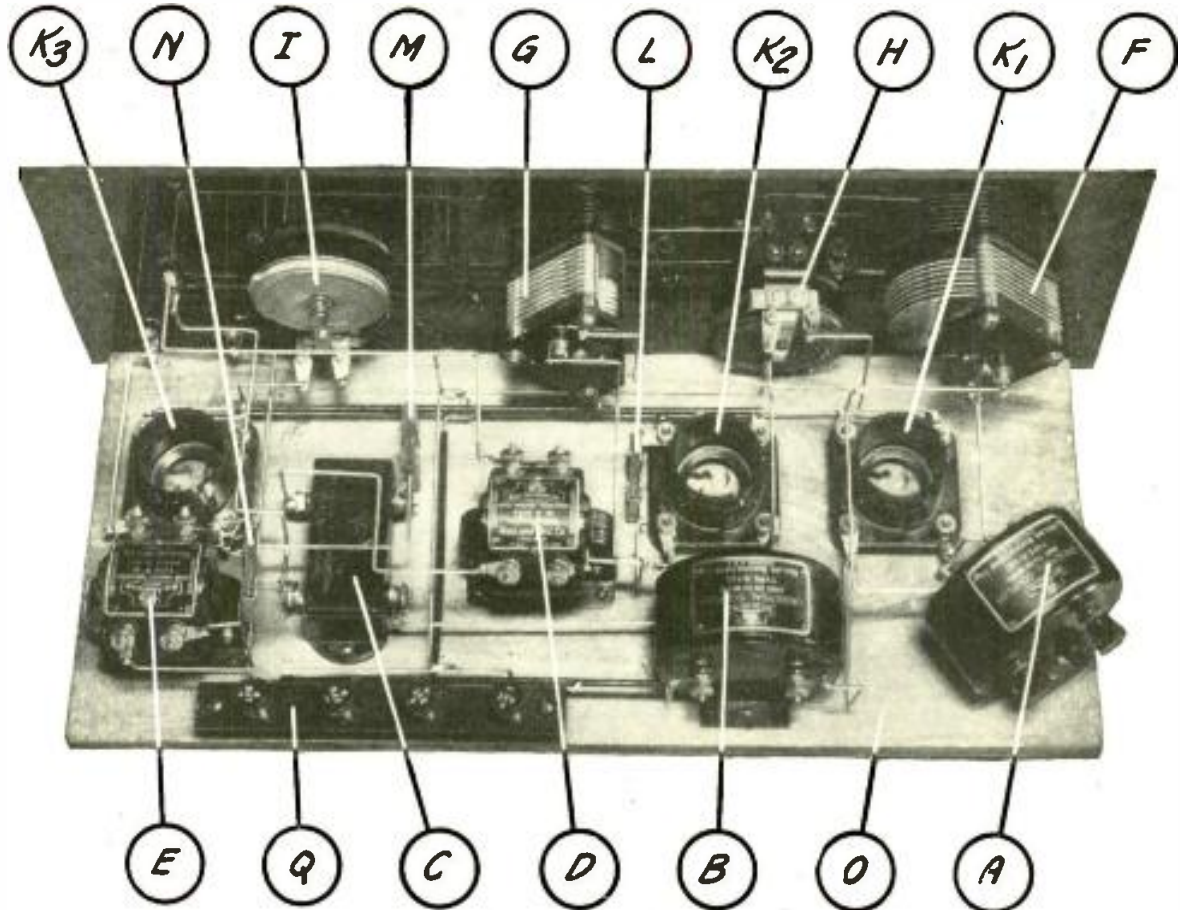

HOW THE RECEIVER LOOKS FROM THE REAR

FIGURE 1: This picture shows the general arrangement of all the parts mounted on the baseboard and on the back of the main panel. Notice the neat arrangement of the units and the easy wiring scheme.

HOW TO ASSEMBLE THE

All-Amax Senior Three-tube Reflex Receiver

This is the first of the series of articles on the assembly and operation of popular kits of parts that may be obtained for building really good radio receivers. These articles will differ from the regular "How-to-Build" articles in that the set described has been designed outside of POPULAR RADIO LABORATORY by commercial engineers. The sets that will be picked for description, however, will have been carefully tested in the POPULAR RADIO LABORATORY and have been chosen for their outstanding features and all-around efficiency.

By MORRIS M. SILVER

COST OF PARTS: *Not more than \$44.00*

HERE ARE THE PARTS THAT ARE CONTAINED IN THE KIT—

- | | | |
|--|---|--|
| <p>A and B—All-American Universal coupler, type R-140;</p> <p>C—All-American radio-frequency transformer;</p> <p>D and E—All-American audio-frequency transformer, type R-21;</p> <p>F and G—Bremer-Tully bakelite end plate variable condenser, .0003 mfd.</p> <p>H—Carter rheostat, 6 ohms;</p> <p>I—Carter rheostat, 30 ohms;</p> | <p>J—Grewol or Rasla fixed crystal detector;</p> <p>K1, K2 and K3—All-American 201-a type sockets;</p> <p>L—Dubilier type 601 mica condenser, .00025 mfd.;</p> <p>M—Dubilier type 601 mica condenser, .0001 mfd.;</p> <p>N—Dubilier type 601 mica condenser, .0005 mfd.;</p> <p>O—baseboard, 6 7/8 inches by 17 inches;</p> | <p>P—composition panel, 7 inches by 18 inches;</p> <p>Q—composition binding-post strip, 3/4-inch by 6 inches;</p> <p>R—binding-post strip supports consisting of 1/4-inch brass tubing each 5/8-inch long;</p> <p>S—standard cabinet for 7 inch by 18 inch panel;</p> <p>6 binding posts, wood screws, bus bar, etc.</p> |
|--|---|--|

THE theory of operation of an ordinary receiver is so generally understood by the amateur builder that there is no necessity for describing it here. The theory of the reflex principle is not so

thoroughly understood, however, and the home-builder is advised to study it before he starts out to construct this receiver.

The first tube and its accompanying

equipment, in the All-Amax Senior receiver serves as one stage of straight, radio-frequency amplification, with its input tuned by the variable condenser, F. The output of this stage is, of

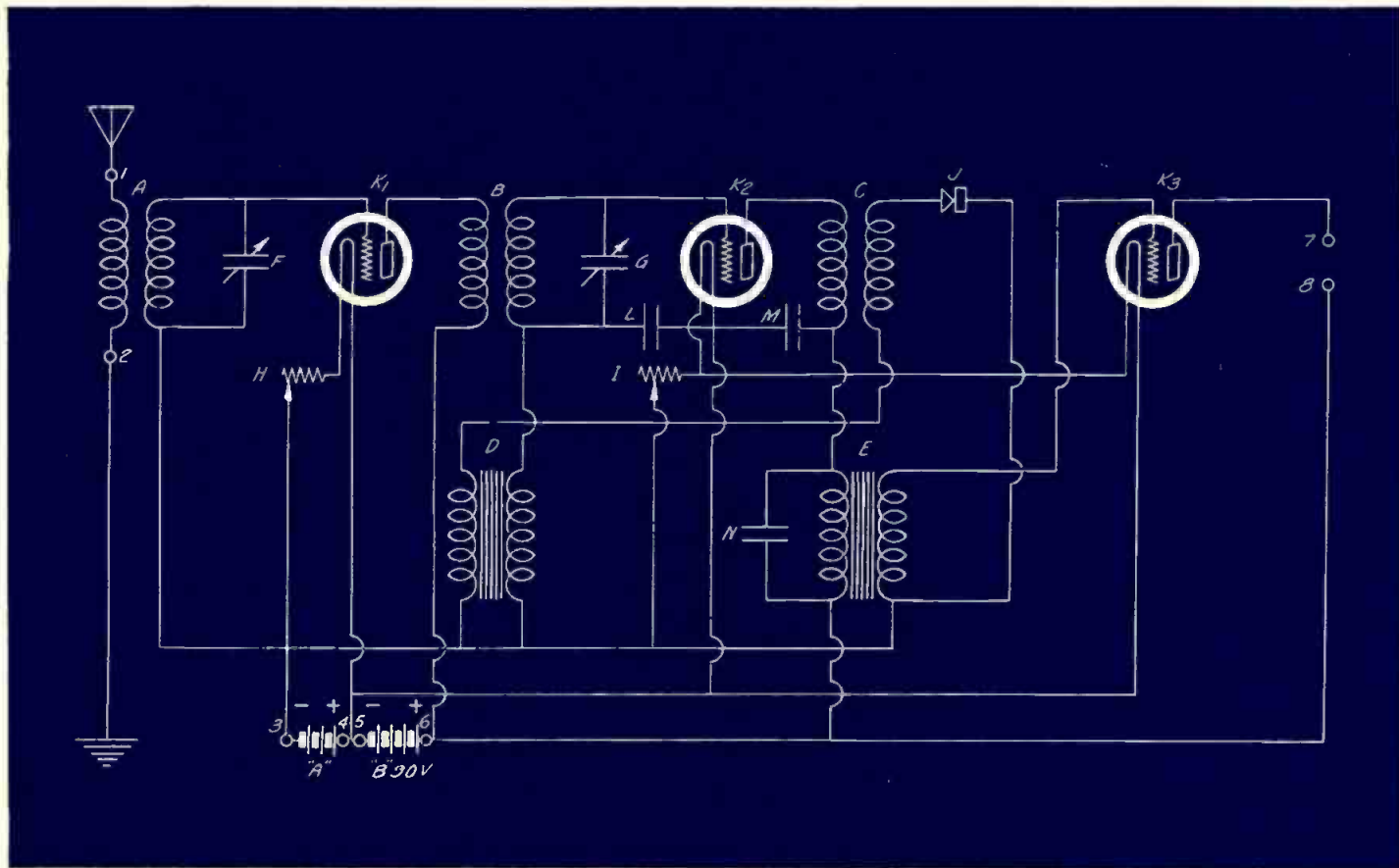

THE SCHEMATIC WIRING DIAGRAM

FIGURE 2: This drawing shows, in schematic form, the circuit used in this simple receiver. An "A" battery voltage of 6-volts and a "B" battery voltage of 90-volts is sufficient for ordinary operation of this receiver.

The list of parts given on page 147 includes the exact instruments used in the kit from which these specifications were made up. The experienced amateur, however, will be able to pick out other reliable makes of instruments which have been approved by POPULAR RADIO and which may be used with good results. But we recommend that the novice follow the list, as the diagrams in this article will tell him exactly where to bore the holes and exactly where to place the connections. If instruments other than the ones listed are used, the only change that will be necessary will be the use of different spacings for the holes that are drilled in the sub-base for mounting the instruments. To any reader who has difficulty in obtaining any of the parts which are necessary in making up these model receivers, POPULAR RADIO SERVICE BUREAU, 627 West 43rd Street, New York City, will gladly assist in seeing that his requirements are promptly supplied.

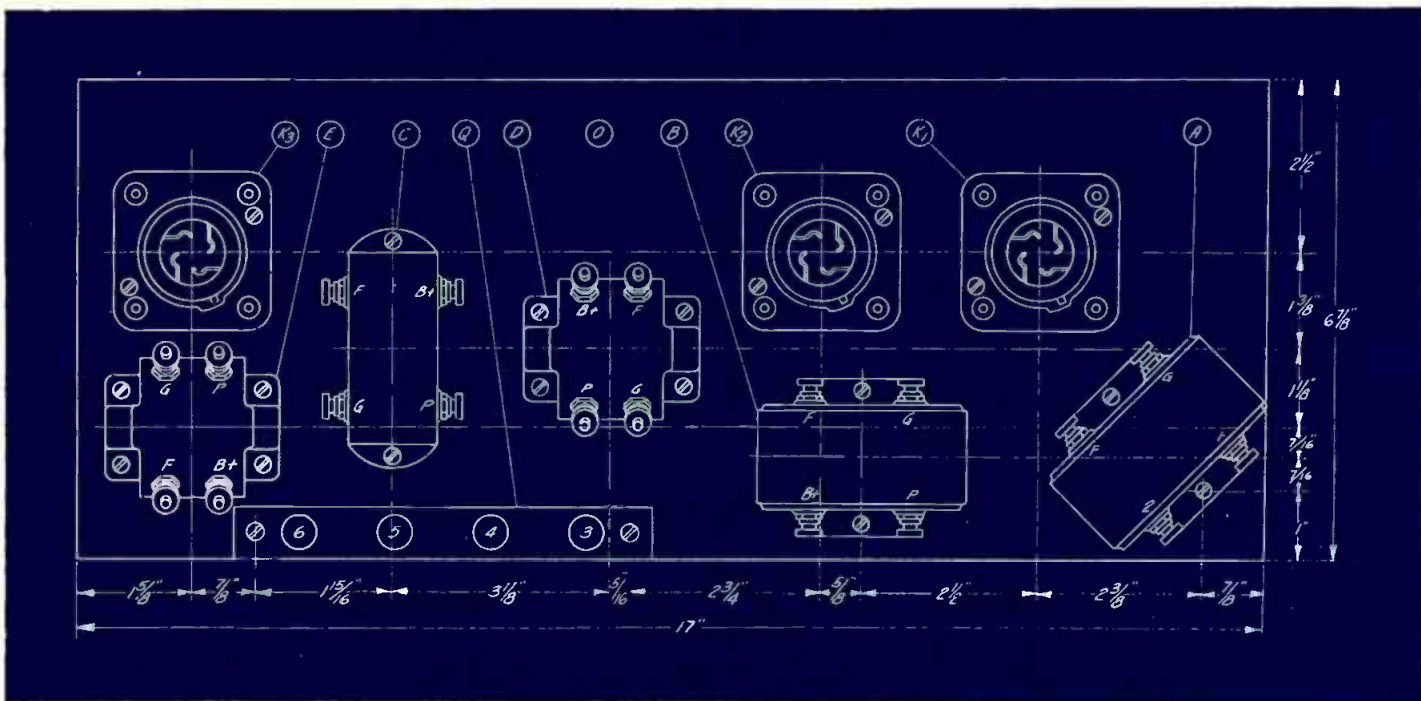

THE WORKING DRAWING FOR CONSTRUCTION

FIGURE 3: All of the parts should be mounted on the baseboard in the exact positions shown here; these positions are determined from center to center for all of the instruments.

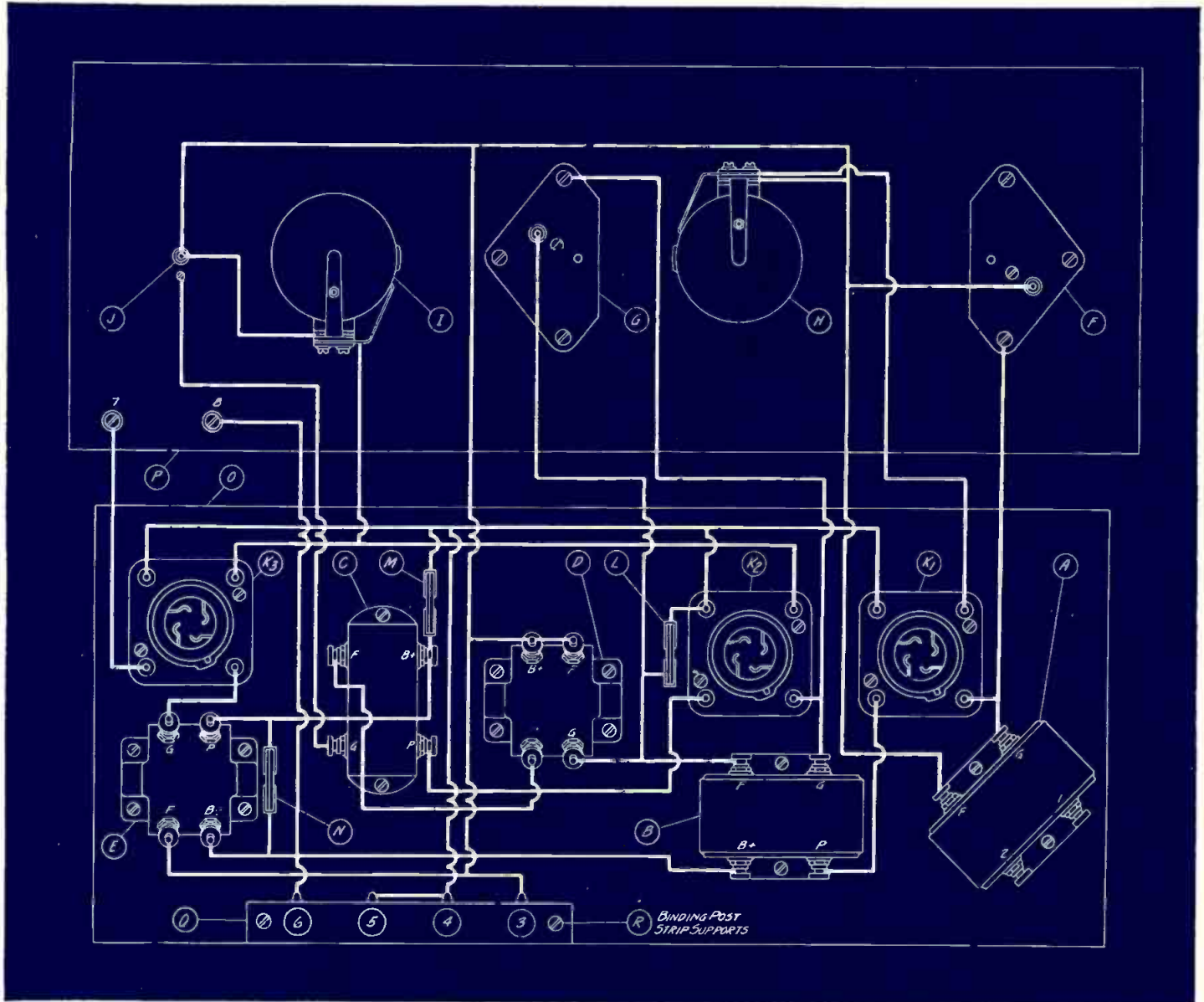

THE PICTURE WIRING DIAGRAM

FIGURE 4: *The instruments in this diagram are drawn in about their relative positions.*

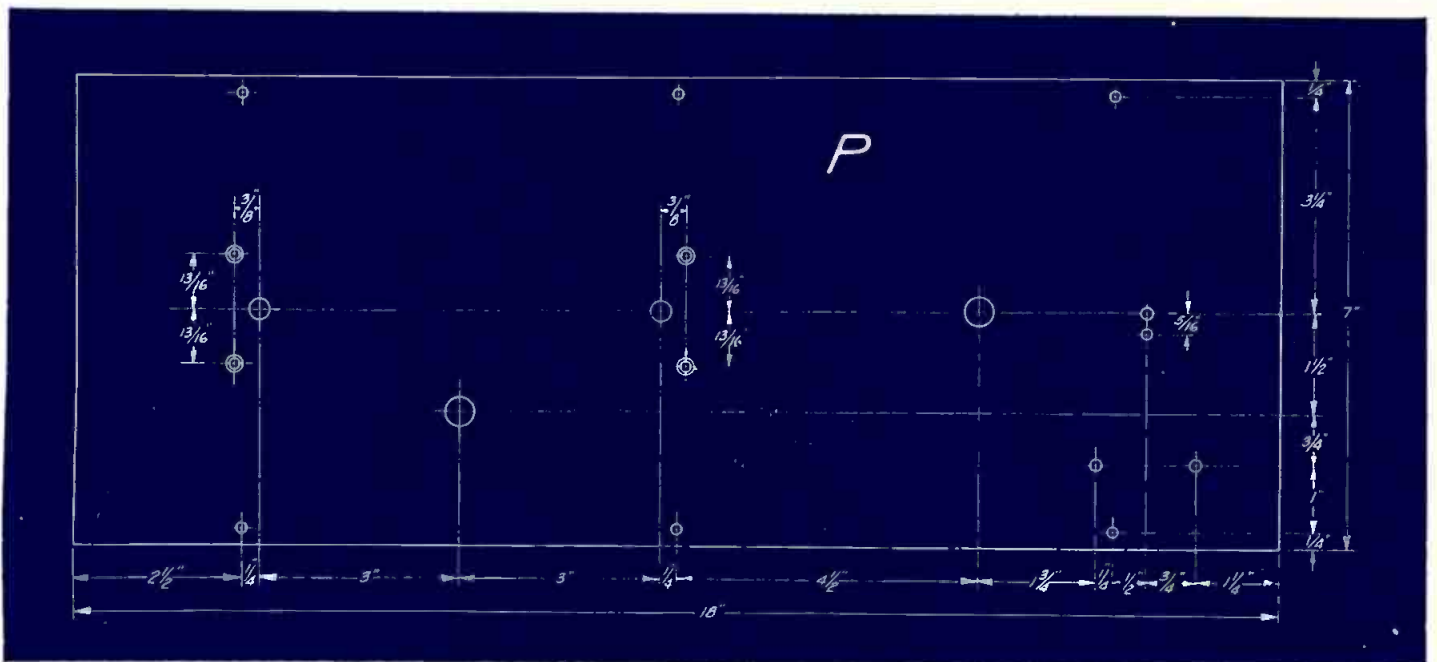

HOW TO DRILL THE PANEL

FIGURE 5: *This drawing gives the exact drilling plan of the panel used in the receiver kit.*

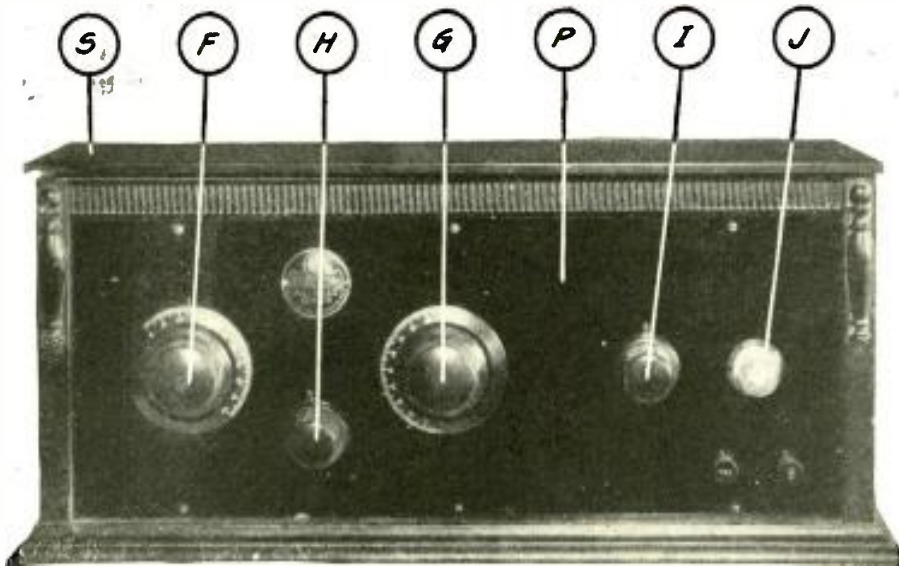

A FRONT VIEW OF THE RECEIVER

FIGURE 6: The controls are marked with designating letters that will enable the operator to easily pick out the proper knobs and controls as outlined in the text.

course, present in the primary of the coupler, B, and from here is transferred, by electro-magnetic induction to the secondary of this coupler. The secondary winding is in the grid circuit of the second tube, and is tuned by the variable condenser, G.

A study of this portion of the circuit shows that one of the windings of the audio transformer, D, is also in this circuit, between the grid coil of B and the filament circuit. However, another path for the radio-frequency current, from grid coil to filament, is provided by the fixed condenser, L. This is the path taken by the radio-frequency output of the first tube by virtue of the fact that radio-frequency currents can pass through a small fixed condenser without hindrance, while they will not pass readily through the windings of an audio transformer. In considering the radio-frequency portion of this circuit, therefore, the winding of the audio-frequency transformer, D, may be disregarded.

The same condition exists in the output circuit of the second tube which includes the tube plate, the primary of the untuned transformer, C, and the fixed condenser, M. The energy in this circuit is transferred by electro-magnetic induction, as before, to the secondary of coupler C, in the circuit with which is the crystal detector, J, and the primary of the audio transformer, D. The crystal detector has a rectifying action on the incoming signal energy and converts it from a radio-frequency current to one of audio frequency, and this audio-frequency current is transferred to the secondary of transformer D.

Here the action is exactly the reverse of the action described above. The audio-frequency current cannot pass

through the condenser, L, because of the low capacity of the latter and therefore must pass through the secondary of the transformer, B, in order to operate the grid of the tube. Thus this second tube is made to serve as an audio amplifier tube this time. Its audio-frequency output cannot pass through condenser, M, and is therefore forced to pass through the primary of the audio-

frequency transformer, E. Here the usual transfer of energy, from primary to secondary is made and the signal passes on to the last tube for further amplification and then to the loud-speaker where it is reproduced as an audible sound.

It is important in a reflex circuit to provide adequate means for separating the radio-frequency current from the lower or audio-frequency current. The fixed by-pass condensers, L and M, are vital factors in accomplishing this, and their capacity is often critical.

The complete circuit, as shown in Figure 2, makes use of a tuned antenna circuit, one stage of tuned-radio-frequency amplification, one stage of untuned-radio-frequency amplification, a crystal detector, and two stages of transformer-coupled, audio-frequency amplification.

With the theory of the receiver thus outlined the construction of the set becomes more understandable and logical.

The kit as sold, has all the instruments mounted on both the panel and baseboard and the necessity, for those who have the kit, to mount the instruments is eliminated. For those who may have an unassembled kit of parts, it is necessary only to follow the details
(Continued on page 166)

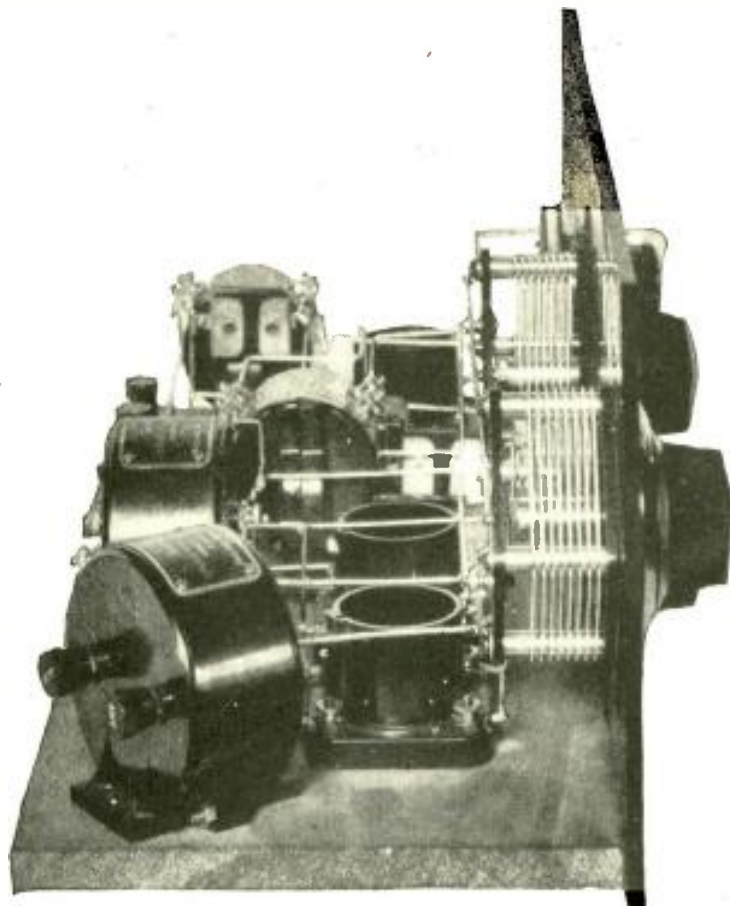

A VIEW OF THE RECEIVER FROM THE LEFT

FIGURE 7: A side view of the coils, condensers and tube sockets and their method of assembly on the wood baseboard and the panel may be seen in this illustration.

What's New in Radio

Conducted by
THE TECHNICAL STAFF

Inventors, experimenters, manufacturers and readers generally are invited to keep the Technical Staff of POPULAR RADIO informed of all new apparatus that is of their own creation or that comes to their attention; if the apparatus passes the tests of the POPULAR RADIO LABORATORY it will be duly recorded in this Department for the information and benefit of all.



A Unit for a Home-made Loudspeaker

Name of instrument: Loudspeaker unit.

Description: This is a new floating armature type of reproducer motor for

actuating a horn that may be built at home, or for use in combination with a phonograph horn. It contains a new diaphragm of specially drawn aluminum and is very efficient at both high and low frequencies.

Usage: As an actuating device in a home-built loudspeaker or phonograph.

Outstanding features: High efficiency. Reproduces high and low notes with equal fidelity of tone quality. Rugged construction of unit.

Maker: Bert E. Brown.

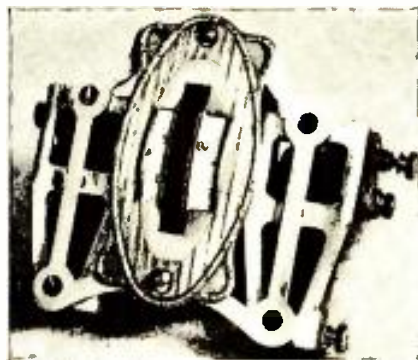

This Device Allows Two Circuits to be Tuned Individually or Together as a Single Unit

Name of instrument: Dual tuning condenser with a special control.

Description: This unit consists of two well-made and efficient straight-line-fre-

quency variable condensers, sturdily mounted on a metal frame and equipped with individual, calibrated drum-scalcs. The unit is so designed that these twin drums project through a rectangular hole cut in the panel of the receiver and covered by a bronze escutcheon plate, which is provided with the instrument. The drums project through the panel, side by side, and on their inner edges have knurled flanges which provide the necessary finger grip for use in tuning. These drums may be rotated individually using both hands or they may be rotated together by allowing one finger to grip both flanges. Thus, the two circuits, to which this instrument is connected may be controlled as a single circuit or, individual adjustments may be made.

Usage: As the capacity tuned element in a receiver having two tuned circuits.

Outstanding features: Sturdy construction. High efficiency. Neat appearance. Simple to install and operate.

Maker: Bruno Radio Corp.



A TWENTY-FIVE HORSEPOWER LOUDSPEAKER

This huge horn reproducer is an experimental unit built by the Marconi Company to determine how much current a loudspeaker can be constructed to carry. This model will use as much as 20,000 watts, the equivalent of about 25 horsepower.



A New Rectifier Tube for Trickle Chargers

Name of instrument: Rectifier valve for trickle chargers.

Description: This is a new tube of the Tungar family and is especially designed as a half-wave rectifier for use in trickle chargers; it delivers a charging current to the battery of one ampere or less. A trickle charger equipped with this rectifier requires absolutely no attention on the part of the owner.

Usage: In trickle chargers specially designed to accommodate this tube.

Outstanding features: Positive operation. Foolproof. Requires no attention.

Maker: General Electric Co.



Herbert

AN IDEA FOR A HAND-PAINTED LOUDSPEAKER

This decorated reproducer is of the eccentric cone type; the driving pin is located near the bottom of the speaker, instead of at the center, to give the speaker a wider frequency range.



A Safeguard Against Short Circuits in the Battery Connections

Name of instrument: Fused battery connection cable.

Description: This is a standard, seven-wire, coated, battery cable with terminals at one end to connect to the batteries and corresponding terminals at the other end to connect to the receiver. The special advantage of this cable lies in the fact that it is equipped with a small bakelite container which holds fuses in the "A" and "B" battery circuits. Thus, if either of these circuits are short-circuited or improperly connected, the fuses will blow out, thus eliminating any possibility of damage to the tubes or batteries.

Usage: As a connecting cable between the batteries and a radio receiver.

Outstanding features: Well made. Neat appearance. Provided with fuses to protect batteries and tubes from accidental short circuits or burn outs.

Maker: Belden Mfg. Co.

operation in the last stage of audio-frequency amplification.

Outstanding features: Capable of handling higher power. May be installed in an old set without rearranging the wiring. Easy to install. Gives improved operation.

Maker: Q.R.S. Music Co.

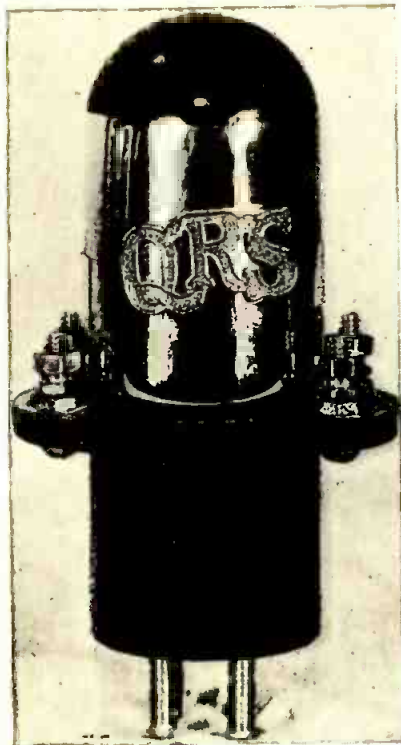

A Power Tube That Will Improve an Old Receiver

Name of instrument: Power tube and adapter.

Description: This new tube, which is capable of handling large powers, is designed especially for the last stage of amplification. It is equipped with four extra binding posts for connecting externally, to the wiring of the set, additional "B" and "C" batteries to get the utmost in volume and quality from the receiver the tube is used with.

Usage: In connection with a receiver for adapting the receiver to power tube



A Dial That Will Improve the Appearance of Your Panel

Name of instrument: Tuning control.

Description: This control is entirely contained in a neat circular bakelite molding and is equipped with a window through which the numbers and dial settings revolve under a hair line, for accurate adjustment. It is designed to be placed on the front of the panel and is attached by means of a set screw that fastens to the shaft of the tuning instrument with which it is to be used.

Usage: As a tuning control in any radio-frequency circuit.

Outstanding features: Neat, mechanical design. Smooth operation. Clear vision, when mounted on a panel.

Maker: Samson Electric Co.

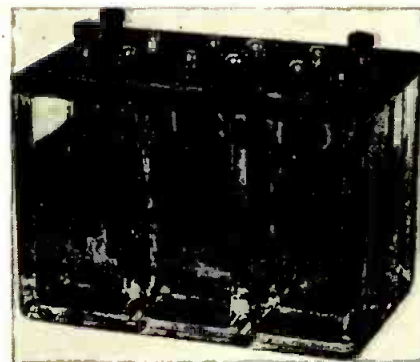

A Unit That Eliminates Rectifier Tubes and Gives Increased Voltages

Name of instrument: Rectifier cell.

Description: This new six-cell rectifier may be connected to any of the standard "B" power-packs as a rectifying element. The voltage drop across the cell is less than in ordinary rectifying tubes and this cell will raise the voltage of a "B" power-pack considerably. It is designed to be used as a full-wave rectifier. The elements are mounted rigidly in an insulated case, the top portion of which is of molded insulating material; the bottom jar portion is of glass. It is equipped with four binding posts and makes a rigid, strong, unspillable cell. The liquid used is non-corroding and needs replacing with distilled water only two or three times a year.

Usage: In connection with a "B" power-pack as a rectifier.

Outstanding features: High efficiency. Neat appearance. Compact. Not mussy. Easily installed.

Maker: Auto Vacuum Products Co.

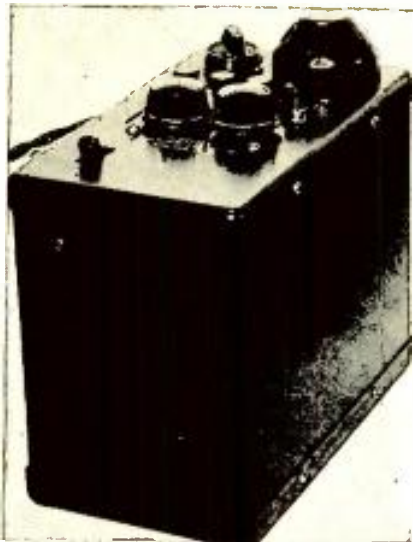

A "B" Power-pack to Supply Variable Voltages

Name of instrument: "B" battery eliminator.

Description: This unit, which is completely enclosed in a black metallic case, will furnish all the necessary plate voltages to any standard receiver. It is equipped with terminals to provide three different voltages to the receiver and has a sufficiently high voltage to operate either a UX-112 or UX-171 type power tube at maximum efficiency. The device is equipped with an extension cord and plug to plug into any 110-volt, 60-cycle, alternating current lighting line.

Usage: To supply all plate voltages to radio receivers.

Outstanding features: Quiet operation. Substantial construction. Has variable controls which can be adjusted to provide the exact required voltages to any receiver. It is equipped with an "on" and "off" switch and also with a rheostat to vary the alternating current input as desired.

Maker: Kokomo Electric Co.



Herbert

A COMPACT SUPERHETERODYNE WITH A NOVEL INDICATOR SCALE

The strange panel design of this seven-tube set built by Mr. Wei Yoh Wu, is due to the indicator system; each knob actuates a bell which moves the indicating arrow up and down the length of the scale.

for this use that are mounted on the extension base of the tube itself.

Usage: In connection with an old-type receiver for using power amplification.

Outstanding features: Rugged construction. Efficient operation. Long life. Brings an old set up to date.

Maker: Van Horne Co.

radio-frequency amplification. *Outstanding features:* Equipped with the new standard base. Especially satisfactory characteristics for radio-frequency work. Long life.

Maker: Cleartron Vacuum Tube Co.



An Attachment that Brings An Old Receiver Up to Date

Name of instrument: Combination power tube and adapter.

Description: This new power tube is equipped with the standard base and also with two sets of binding posts that may be used for connecting additional "B" and "C" batteries to an old receiver that did not use a power tube. The tube may simply be placed in the last stage socket and the additional "B" and "C" voltages directly attached to the binding posts intended



A Tube with Better Characteristics for Radio-Frequency Work

Name of instrument: Vacuum tube.

Description: This tube in appearance is similar to a standard vacuum tube equipped with the UX type prongs. The interior construction and the evacuated process used, make the tube exceptionally satisfactory for use in a radio-frequency amplifier. The tubes run uniform in inter-element capacity which makes them very stable in operation in balanced circuits.

Usage: In a receiving set as a vacuum-tube amplifier and more especially for



A Cable and Plug That Helps to Prevent Shorts

Name of instrument: Battery cable.

Description: This cable connector consists of seven leads that may be used for the "A," "B" and "C" batteries. These wires terminate in a connection plug that is suitably insulated and fits a socket that may be connected to the receiving set itself in place of binding posts.

Usage: For a receiving set installation between the batteries and the set.

Outstanding features: Neat in appearance. Easy to install.

Maker: Yaxley Mfg. Co.



A Coil to Increase the Radio-Frequency Amplification in an Old Set

Name of instrument: Radio-frequency coupling coil.

Description: This unit consists of a primary and secondary winding wound by the exclusive Benjamin process that gives a self-supporting coil of extremely low distributed capacity and high inductance. The bakelite mounting strip is provided with eyelets so that it may be screwed down to a base-board. This strip also carries the terminals that are connected to the other parts of the circuit.

Usage: In a radio-frequency amplifier as an interstage coupling.

Outstanding features: Low resistance. Low distributed capacity. High inductance. Easy to install in a receiver.

Maker: Benjamin Electric Mfg. Co.



A Device that Improves Quality of Reproduction and Protects the Loudspeaker

Name of instrument: Loudspeaker filter.

Description: This new unit comprises a high inductance choke coil in combination with a large capacity condenser that is incorporated in a shielded metal can and that should be connected in the plate circuit of the power tube in all modern receivers. The high inductance choke coil has a high enough inductance at low frequencies to obtain the full output of the power tube and the condenser is so

connected that the direct current cannot flow through the loudspeaker. When this device is used only the voice or musical current that actually produces the sounds in the loudspeaker is fed through the loudspeaker windings, thus preventing burnt windings when large power tubes or high voltages are used.

Usage: In connection with a modern receiver as a DC output filter.

Outstanding features: Produces better quality on the low notes. Takes DC load off the loudspeaker. Protects the operator from serious shock when inserting the loudspeaker into the jack.

Maker: General Radio Co.

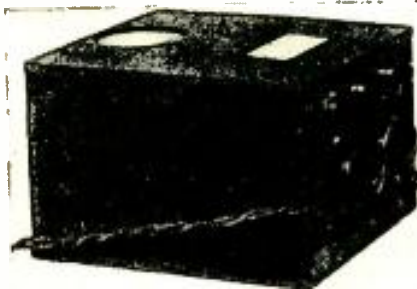

A Power-pack that Eliminates Battery Problems

Name of instrument: "B" power-pack.

Description: This unit, which is encased in a crystalline metal cabinet, may be used to furnish "B" power to a radio receiver. It is equipped with fixed-voltage terminals of various orders that make it suitable for use with any receiver and it contains two variable taps for detector or amplifier voltages that may be critical in a receiver. It is also equipped with an extension cable that connects directly to the 110-volt, 60-cycle, alternating current lighting mains. It will operate with either the standard, type B, Raytheon tube or with the newer BH type Raytheon tube, where more power is required. It will furnish enough voltage to operate a power tube in connection with any receiver.

Usage: As a "B" power supply in connection with radio receivers employing vacuum tubes.

Outstanding features: Compact. Sturdy construction. Continuous and silent operation. Furnishes high voltage for power tubes.

Maker: All-American Radio Corp.

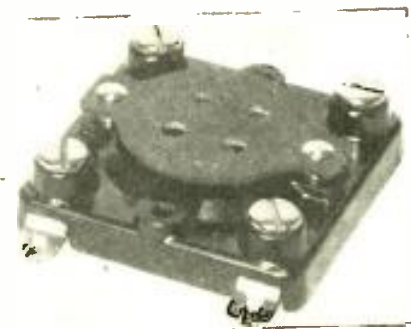

A Positive Contact Socket

Name of instrument: Vacuum-tube socket.

Description: This socket is of molded bakelite and is equipped with contact springs which assure a positive sliding

contact on the prongs of any standard vacuum tube. Each of these spring contacts and the lug, by means of which the external connections to the socket are made, are stamped out of a single piece of metal; this eliminates any possibility of a poor connection between the contacts and the socket terminals. The soldering terminals are of special construction, which doubly insure good connections.

Usage: May be used as a holder for any of the standard vacuum tubes in any part of any radio circuit.

Outstanding features: Substantial construction. Firm spring contacts and the elimination of faulty connections from the tube prongs to the external circuit.

Maker: H. H. Eby Mfg. Co.



A Handy Unit for Testing Apparatus

Name of instrument: Circuit testing outfit.

Description: This unit, which consists of two insulated handles equipped with electrodes and suitable connection wire is well insulated. It contains a series glow lamp which is mounted in a socket that may be connected to any AC or DC lighting line for testing open and closed circuits.

Usage: For laboratory testing of wiring or for testing instruments used in radio

Outstanding features: A compact portable unit for testing. Well insulated. Easily set-up. Neat in appearance.

Maker: Universal Test Equipment Co.



A DC Charger for Radio Fans Who Have Direct Current Lighting in Their Homes

Name of instrument: DC charger.

Description: This unit, which is mounted on a substantial metal frame contains resistance elements and a suitable meter for charging storage "A" batteries direct from the DC lighting mains. It is well insulated both from an electrical and a thermal standpoint. It is equipped with suitable terminals for connecting to the "A" battery and an extension cord for connecting to the 110-volt, DC lighting line.

Usage: In connecting with an "A" battery for DC charging.

Outstanding features: Invaluable to set owners where direct current is obtainable. Compact. Easily installed. Safe in operation.

Maker: Ward-Leonard Electric Co.

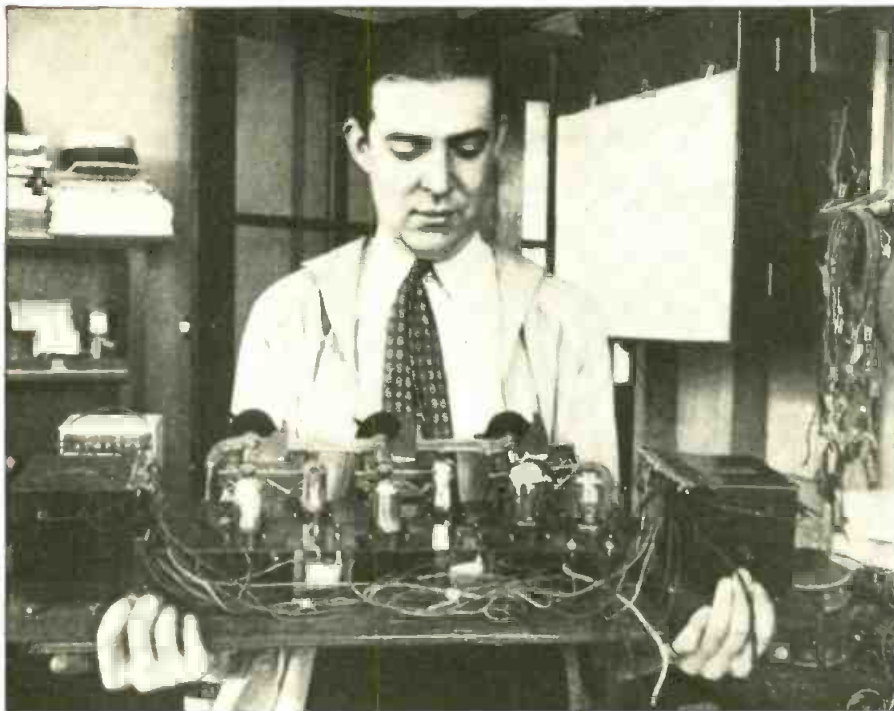

Herbert

A HOME-MADE POWER-OPERATED RECEIVER

Not many fans would care to undertake the construction of a set as intricate as this five-tube, power-operated set built by Harold Herbert appears to be. The first four tubes are of the UX-199 type; the last tube on the right is a type BH Raytheon and is part of the power unit.



A Battery-and-Charger that Eliminates Old Time Battery Problems

Name of instrument: Combination trickle charger and storage "A" battery.

Description: This unit comprises three separate cells of the conventional high quality storage battery mounted in a heavy glass container. It also comprises an electrolytic rectifier or charger that keeps the battery in fully charged condition at all times and without any care from the operator. It is equipped with a heavily insulated extension cord for connection to the lighting socket. Outside of occasionally filling with distilled water no other attention is required.

Usage: For supplying "A" current to vacuum tubes.

Outstanding features: Rugged construction. Needs extremely little care. Satisfactory operation.

Maker: Vesta Battery Corp.



A Unit That Will Increase Volume in Your Set

Name of instrument: Audio-frequency amplifying transformer.

Description: A large size transformer carefully mounted in a shielded metal case containing a primary winding of exceptionally high inductances, so that the low tones are amplified with all their full volume and rotundity. The distributed capacity of the transformer is kept low so that the high tones are not minimized and the quality of reproduction is kept even over a wide band of frequencies. It is equipped with a suitable bypass condenser that is mounted inside the case; the terminals are well insulated and substantially mounted in accessible positions for connecting to the battery and tube circuits.

Usage: In connection with a low-frequency amplifier as an interstage

coupling device.
Outstanding features: Good reproduction of low tones and high tones. High amplification over a wide band of frequencies. Excellent workmanship. Neat appearance.

Maker: Ferranti Limited.



An Extremely Compact Raytheon Power-Pack

Name of instrument: Raytheon power-pack.

Description: This unit, which employs a step-up transformer, choke system, and filter condensers with regulating resistances for both the detector and intermediate voltages for amplifiers, is constructed in such a way that it takes up a very small space. It is furnished with a long extension cord for connection to the lighting plug. The unit will

furnish an extremely high voltage for the power tube with variable voltages for the other tubes in the circuit as needed.

Usage: In combination with a receiving set for supplying suitable "B" power for all tubes.

Outstanding features: Compact design. High voltages obtained. Easy regulation. Efficient operation with receiver.

Maker: Silver-Marshall, Inc.



A Seven-tube Receiver that Costs Only One-Fourth of a Cent an Hour to Operate

Name of instrument: Argus Electric Radio Receiver.

Usage: For radio broadcast reception.

Outstanding features: Uses no batteries; draws all operating current from the alternating current lines. Costs less to operate than a single 25-watt lamp. Requires no more technical knowledge to operate than does an electric toaster or any other household device. Absolutely quiet in operation; no hum. Excellent tone quality and volume. Fine appearance.

Description: This seven-tube receiver employs three stages of radio-frequency amplification, detector, and three stages of audio-frequency amplification. Tuning is accomplished by means of two controls which operate calibrated, rotating scales that are located behind small windows in the panel.

In addition to the two tuning controls, three other knobs and a milliammeter arc located on the panel. One of these knobs is used to regulate the current supplied to the receiver and its proper adjustment is indicated by the reading of the meter. That is, the knob is turned in a clockwise direction until the pointer on the meter reaches a red mark on the scale. The knob is then left in this position while the receiver is in operation. This knob also serves as a switch to turn the receiver "on" and "off." Another knob, located just above the left-hand tuning scale, is the volume control. The variation obtained with this control is so gradual, that the volume may be regulated to any desired degree from zero to maximum. The last control regulates the sensitivity of the receiver; it is conveniently located just above the right-hand tuning scale. When tuning the receiver for reception from local stations this control may be set at a point which provides suitable sensitivity and may be left at that point permanently. If it is desired to tune in distant stations, however, this control is advanced to a point which provides the maximum degree of sensitivity.

The receiver is housed in two styles; the table-mounting style of cabinet and the high-boy console cabinet containing a built-in loudspeaker. Both cabinets are made in a beautiful burl walnut panelled effect, and are decidedly attractive in appearance.

To install the receiver it is only necessary to plug the extension cord, on the receiver, into the nearest electric lamp socket or wall outlet. The plug is left thus connected permanently as the connection is automatically broken when the receiver is turned "off" by means of the control knob on the panel of the receiver. Wires running to the antenna and to the ground are connected up in the usual manner.

If the receiver is to be used solely for local and semi-distant reception, there is no necessity, in many cases, for an antenna. A special binding post is provided inside of the receiver which may be connected to the binding post in the receiver to which an antenna would ordinarily be connected.

If an outdoor antenna is to be used, its size will be largely governed by local reception conditions. A suitable antenna will be from 50 to 150 feet in length, overall. If the receiver is located close to one or more broadcasting stations, a short antenna will be found best. Where there is no possibility of local interference, a long antenna may be used. In the latter case the installation will have the advantage of somewhat greater volume, in the reception of programs from distant stations, than would be the case were a smaller antenna used. An indoor antenna may be used with gratifying results where for one reason or another it is not desired to have an antenna wire outside.

The tube requirements of this receiver are rather unique, in that a combination of small and large tubes is used. Tubes of the UX-199 type are used for the three stages of high-frequency (radio-frequency) amplification, the detector, and one stage of low-frequency (audio-frequency) amplification. In the second low-frequency

stage a standard UX-201-a type tube is used and in the last low-frequency stage a power tube of the UX-171 type is used.

For those readers who are interested in more technical details of this receiver it will be of interest to know that two of the high-frequency amplifier stages are tuned while the third is untuned. The antenna circuit input to the first stage is tuned by means of a variable condenser which is operated by one of the two tuning controls on the panel. The other tuning control operates two condensers which simultaneously tune the input to the second and third high-frequency stage. A small variable balancing capacity is included inside of the receiver for the purpose of synchronizing these two tuned circuits. This balancing capacity need be adjusted only once.

The low-frequency amplifier consists of one stage of the transformer-coupled type, followed by two stages of the impedance coupled type. This combination provides excellent quality and plenty of volume.

The filament current for the five UX-199 type tubes is supplied from the DC output of the electrolytic rectifier and filter. These filaments are connected in series and draw a total of approximately 60 milliamperes. The filaments of the two larger tubes are operated on alternating current, stepped down by a small transformer. The DC plate supply is obtained from the same source as the current for lighting the UX-199 type tube filaments.

The rectifier is a "bridge" arrangement of four highly efficient electrolytic cells and the output is passed through a filter of unusual quality. As a result of the quality of these two units, and careful design in the receiver itself, the set is remarkably quiet in operation.

The sensitivity of the receiver is good, as is to be expected from a receiver which makes use of three stages of radio-frequency amplification of good design.

Maker: Argus Radio Corporation.



A Receiver That Uses One of the Home-builders' Most Popular Circuits

Name of instrument: Browning - Drake Model 5-R Receiver.

Usage: For the reception of broadcasting.

Outstanding features: Good appearance.

High selectivity and sensitivity. Ample volume with fine quality of reproduction. Popular price.

Description: The Browning-Drake receiver has only comparatively recently been available in the form of a manufactured receiver. Heretofore if a radio

enthusiast desired to obtain a receiver employing this circuit it was necessary to build the receiver himself or to have it made to order.

In spite of this condition the Browning-Drake circuit became surprisingly popular and as a result of this popularity the receiver was placed on the market as a standard, commercial, broadcast receiver.

(Continued on page 173)

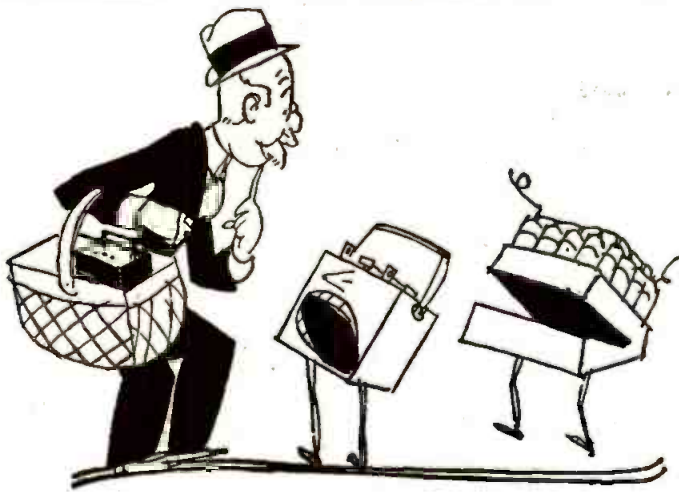

What's power for "A" is power for "B"

—provided, of course, that you use a Rectigon. That's the one best way to keep both "A" and "B" batteries in topnotch form. There's no starving of batteries when you have this home charger to keep them full of pep. And, man alive, the unsuspected power your set shows then! Remember, too, that the bulb used for "B" battery charging is enclosed, like all other parts, in metal, free from harm. And keep in mind that your Rectigon will charge your automobile batteries.

so all batteries are kept lively with

No noise as it charges—not a bit of fuss. Not even a murmur that would disturb the mildest slumber.



No acids, no chemicals—no moving parts—nothing to spill or burn. No muss, no worry. You'll have no spoiled rugs, no ruined clothing.



Saves its cost in short order—Count the dollars spent in a few trips to the service station and you'll hotfoot it for a Rectigon, for the good it does your pocketbook as well as your batteries.



Snaps on in an instant—Just plug into the light socket, snap on the terminals. Saves service station bother. Spares interruptions caused by absent batteries.



Perfect safety for your set—If you tune in while you're charging there'll be no harm either to set or batteries. Nor will batteries be discharged if anything happens to the current while your Rectigon's attached.



No Storage Battery Radio
is Complete
Without a Rectigon

The Westinghouse Rectigon Battery Charger

©, 1927, W. E. & M. Co.



THE RECTIGON is a superb Westinghouse product. Things you *can't* see, like extra heavy insulation, things you *can* see, like the durably enameled case—all are of highest quality. Westinghouse also manufactures a complete line of radio instruments, and Micarta panels and tubes.

WESTINGHOUSE ELECTRIC & MANUFACTURING CO.

Tune in on KDKA KYW - WBZ KFKX

What Built
the Reputation
of

Mayolian
"B" SUPPLY

The "B" Without a Buzz

?



Type 612
Delivers 40 Mills at 180 volts
All voltages are adjustable
Complete with Raytheon Tube \$42.50

PIONEERING in battery elimination, Mayolian was probably the first manufacturer to adopt the now far-famed Raytheon tube as the heart of its B Supply Units, and to earn the approval of Raytheon. From that day to this, each Mayolian has been rigidly held to the standards of the Raytheon and Mayolian laboratories. Years of exhaustive research, extreme precision in manufacture, skilled supervision—all these have contributed to the pre-eminent position of Mayolian.

Today, no matter what make or type of receiver you have, there is a Mayolian to give it a continuous, uniform, noiseless "B" Supply—direct from the nearest light socket, at half the cost of burning a 25-watt lamp.

The Heavy Duty Types of Mayolian employ the new Raytheon B II tube

The nearest dealer will gladly demonstrate in your own home.
Write us.

MAYOLIAN
RADIO CORPORATION
1668 Webster Ave., New York, N.Y.

Pioneers in Battery Elimination



The Power of Niagara—
The Quiet of an Arctic Night

The YES and NO MAN

JUST ME.—*Harry Richman* has been "appearing" at WFBH. *** Yes, he's the same old Harry and still operates that night club at 257 West 57th Street, New York. *** He is also in George White's new edition of the "Scandals."

MARKO.—Were *Mary Garden* and *Will Rogers* paid for their part in the inaugural program of the National Broadcasting Co? *** Were they paid? You can bet your life they were paid!

BRIGHT EYES.—*Soman*, the WRNY violinist, was at one time a member of the Boston Symphony Orchestra under *Dr. Muck*. *** No, *Belle Baker* is not to be a regular member of the Eveready staff; there are few regulars on this staff, most of the work being done by guest artists. *** The WGBS minstrels are broadcast alternate Sunday nights. *** Yes, they are mighty good.

SINCERE.—*Mr. Wad* (WBAL) teaches the piano at the Peabody Conservatory of Music in Baltimore. *** Are we crazy about the *Royal Heroine*? *** Yes, she sings well, but we have many other things in life to go crazy over. *** Sifting the ashes for instance.

SANE BUG.—"Trade" is *Scrappy Lambert* and "Mark" is *Billy Hillpat* in the Smith Brothers period at WEA. *** They both come from Rutgers College, where they used to lead the musical activities. *** No, we had not heard that old *Mark Smith* died in a coughing spasm.

C. D. L.—*Charles D. Isaacson*, studio director of WRNY, was formerly musical critic of the old New York "Mail." *** *Broughton Hall* writes all of the continuity for WBAL and a very good job he does with most of it. *** Do we think there should be a school for announcers? Yes, there ought to be hundreds of schools for announcers!

DOUBLE S.—Who is the funniest man on the air? *** There's literally thousands of funny men on the air—but very few of them know it. *** Seriously, we don't know who could be called the funniest man that has been on the air; certainly not *Will Rogers*.

BO-PEEP.—The *Silver-Masked Tenor* is not and never has been a member of the Metropolitan Opera Co. *** Yes, *Broken-shire* wrote a song, but it fluttered and died, strange as it may seem. *** *Ralph Wentworth* lives in New Jersey.

FOUR-SQUARE.—Yes, *Sigurd Nilssen* of the Vikings used to be with the Capitol Gang; he is a graduate of Whiteman Conservatory of Music and sang in his debut at Monte Carlo. *** *Granlund* (NTG of WHN) wrote a book of poetry once; we don't know who published it. *** Let's see now, it seems as though *Doris Kenyon* collaborated with him.

HARRY B. B.—*Milton Cross* (WJZ) has never written any songs as far as we know. *** *Edward Husing* of the same

staff has written some popular stuff. *** Was *Keith McLeod* ever associated with WIIN? *** My, no!



JILL WITHOUT JACK.—*Jack Coleman* is the tenor of the WSBF Grand Opera Company. *** Sure, here's his photo. *** While we're searching through the files, below is *Allen McQuhae's* photo. *** Sure send on the two gallons of cider; now who's going to supply the doughnuts?



CHARLES B.—*Hollywood McCosker* is still associated with WOR; he broadcasts very little. *** However, *Joe Barnett* of that studio aspires to become an opera singer and all of his time outside the studio is spent studying; if his vocal cords show this ambition with him, he shall some day become a great singer.

CURIOUS II.—You're right; *Frances Alla* is the wife of *Gatti-Casazza*, manager of the Metropolitan Opera Co. *** What makes you think *McNamee* was half "lit" when he announced for the Army-Navy game? *** We cannot testify as to that, Dear Sir; keep in mind, however, that it was a cold day and "plenty of feeling and no pain" makes one more or less unconscious of the elements.

ALICE - BLUE - GOWN.—*Astrid Fielde* (WJZ) hails from North Dakota, where her father settled after arriving from the Scandinavian Peninsula. *** She was a childhood friend of *Edward Grieg*. *** Do we sing tenor or bass? We sing terrible.

JAKE.—You lose your hat; *Godfrey Ludlow* doesn't come from Austria but from Australia. *** *Lucrezia Bori* is Spanish and received much of her musical eddycation in Italy. *** *Madge Tucker* announces for the WJZ women's hour; she comes to WJZ from the staff of WRC. *** Yes, *Milton Cross* was actually in *Mary Garden's* apartment when he announced for her in the inaugural National Broadcasting program. *** You bet your sweet potatoes *Mary Garden* was paid to broadcast.



HERE'S WORK THAT IS ALMOST ROMANCE!

Now Owns a Radio Store

"The Radio business is rushing just now. Building many Super Heterodynes, also doing installation and repairing. To your course I owe all my success in the Radio profession." A. J. Ommodt, Bowman, N. Dak.

Controls First Car by Radio

"I operate the portable broadcasting station in rear car, driving front car by Radio control. Will operate this car from New York to Frisco—13 months trip. Then we take the car around the world—a three years' tour. I owe it all to you." Leo Paul, New York City.

You Can Do What These Men Did!

I Will Train You at Home to Fill a Big Pay Radio Job

Get into the great new Big-pay Industry—Radio. If you're earning a penny less than \$50 a week, clip coupon now. Send for AMAZING FREE BOOK, "Rich Rewards in Radio." Why go along at \$25 or \$35 or \$45 a week, when you could earn \$50 to \$250 in the same six days, as a Radio Expert? Hundreds of N. R. I. trained men are doing it—why can't you? I'll train you just as I trained them—just as I trained the men whose letters you see on this page. I'll teach you quickly at home in your spare time to be a Radio Expert, and draw down big money for the easiest and most fascinating work in the world.

\$50 to \$250 a Week as a RADIO EXPERT

It's the trained man, the Radio Expert, who gets the big jobs of this profession—paying \$75, \$100, \$200 a week and up. Free book gives all the facts. Every day N.R.I. trained men are taking good places in the Radio field—men like you—men like those whose stories I show you here. You can prepare just as they did by new practical methods, learn right at home in your spare time. Lack of experience no drawback—common schooling all you need. Our tested clear methods make it easy for you. We guarantee to train you successfully. Big Free Book contains all the proof.

Clip Coupon Now for FREE BOOK

Most amazing book on Radio ever written—full of facts and pictures—tells all about the great Radio field, how we prepare you and help you start. You can do what others have done—GET THIS BOOK. Send coupon today—no obligation.

J. E. Smith, Pres. NATIONAL RADIO INSTITUTE Dept. B-86 Washington, D. C.



Originators of Radio Home-Study Training

These Instruments Given FREE of Extra Cost

All instruments shown here and others sent to all my students free of extra cost under short time special offer. Clip coupon now—find out all about this big unequalled offer while you still have time to take advantage of it. This training is intensely practical—these instruments help you do the practical work.

My Radio Training is the "Famous Course That Pays for Itself"

Make more money quick when you take up this practical course.

I show you how to increase your earnings almost from the start of your course through practical pointers I give you.

Howard B. Luce of Friedens, Pa., made \$320 in 7 weeks during his spare time. D. H. Sutt of Newport, Ark., writes "While taking the course I earned in spare time work approximately \$900." Earl Wright of Omaha reports making \$400 in a short time while taking his course—working at Radio in his spare time only! Sylvester Senso, 207 Elm St., Kaukana, Wis., made \$500. These records not unusual—these men are a few of hundreds.

And when you graduate, my big Free Employment Department helps you get the job. You get just the same preparation and assistance toward success we gave C. C. Gielow, Chief Operator of the Great Lakes Radio Telegraph Co., E. W. Novy, Chief Operator of Station WRNY, Erie Chambers, Radio Engineer for Stewart-Warner, J. E. Fetzer, Chief Engineer of Station WEMC. The National Radio Institute, established 1914, today offers you the same opportunity these men had under a bond that guarantees you full satisfaction or money refunded. It's your big chance to get into the great Radio field—mail coupon TODAY for my big Free Book and proof!

\$70 in one Day for T. M. Wilcox

"I am in business for myself and recently made \$70 in one day. I was an electrician of rich experience and was occupying a splendid position as telephone superintendent when I enrolled with your course believing it would open up greater opportunities—have not been disappointed. Estimate that Radio will be worth tens of thousands of dollars to me in the next few years." T. M. Wilcox, Belle Island, Newfoundland.

Kimball With WMAQ Chicago

"Accepted a position with the Chicago Daily News Station WMAQ. My income practically doubled, thanks to your fine course. I handle all consultation also do operating." Keith Kimball, Station WMAQ, Chicago, Ill.

Promoted to Big Job

"Just been made Sales Manager of this Radio firm—received a very good increase in pay. Up to present have been getting salary which in 3 months enabled me to purchase a new car." R. Jones Bay City Mich.

Read the true stories printed in this border of men who got out of the rut



Chief Engineer Station WEMC

"Please communicate with my two junior operators here who want to increase their knowledge of Radio. Being a graduate of your course I know they could do nothing better for themselves than study it for it is the way to success in this profession." John E. Fetzer, Chief Engineer, Station WEMC, Berrien Springs, Michigan.



Photo shows Graduate E. F. Spadoni in his own Radio store at Chicago, Ill. "Your course gets the credit," says Spadoni.



MAIL THIS NOW!

J. E. Smith, President NATIONAL RADIO INSTITUTE Dept. B-86, Washington, D. C.

Dear Mr. Smith: Without obligating me in anyway, send me your free book "Rich Rewards in Radio" and all information about your practical, home-study Radio course.

Name..... Age.....
Street Address.....
Town..... State.....

SEND THIS COUPON



Easy! Just connect Jefferson Tube Charger to the two "A" battery terminals for 10 minutes, once a month, as per directions for large or small tubes.

Keep tubes full of 'pep' (without removing them from set)

TUBES weaken with use, cut down the sensitivity and power of your set, and consume more current. To enjoy top-notch programs every night, keep your tubes always like new.

Once a month, for ten minutes attach a Jefferson Tube Charger to your set. The improved reception—plus longer life of tubes and batteries—are worth many times the small price of \$5. Also rejuvenates run-down or paralyzed tubes. Guaranteed, patented and made ONLY by Jefferson. Get one today—from your dealer.

JEFFERSON ELECTRIC MFG. CO.
Largest manufacturers of small transformers
508 So. Green St. Chicago, Ill.

Patented Jefferson No. 275 Tube Charger

ACME ENAMELED ANTENNA

Best outdoor antenna you can buy. 7 strands of enameled copper wire; maximum surface for reception. Prevents corrosion and consequent weak signals.

The Original Celatsite
—a tinned, copper bus bar wire with non-inflammable "spaghetti" covering, for hook-ups. 5 colors; 30-inch lengths. We also offer the highest grade of "spaghetti" tubing for Nos. 10 to 18 wires. 5 colors; 30-inch lengths.

Flexible Celatsite
Flexible, stranded wire for point-to-point and sub-panel wiring. Non-inflammable "spaghetti" covering. In black, yellow, green, red and brown; a color for each circuit. Put up in 25-foot coils.

Celatsite Battery Cable
—a silk-covered cable of varicolored Flexible Celatsite wires, for connecting batteries to set. Prevents "blowing" of tubes; gives your set an orderly appearance.

Send for folder
THE ACME WIRE CO., DEPT. P
NEW HAVEN, CONN.

ACME WIRE MAKES BETTER RADIO

DESIGNED to OUTLAST World Storage 'A' Battery



Two-Year Guarantee Bond in Writing **NEW LOW PRICES**

Famous the world over for reliable, enduring performance. Solid Rubber Case lasting protection against acid or leakage. Approved and Listed as Standard by Leading Authorities including Radio News Laboratories, Popular Sci. Inst. Standards, Pop. Radio Laboratories, Radio Broadcast Laboratories, Radio in the Home and Lefax, Inc.

Send No Money
Just state number wanted and we will ship same day order is received, by express C.O.D. Pay expressman after examining batteries. 5% discount for cash with order. Remember, you save 59% on World Batteries—so send your order today.

WORLD BATTERY COMPANY
Dept. 3
1219 S. Wabash Ave. Chicago, Ill.

- Solid Rubber Case Radio Batteries
- 6-Volt, 100-Ampere \$10.00
- 6-Volt, 120-Ampere \$12.00
- 6-Volt, 140-Ampere \$13.00
- Solid Rubber Case Auto Batteries
- 6-Volt, 11-Plate \$10.00
- 6-Volt, 13-Plate \$12.00
- 12-Volt, 7-Plate \$14.50

Get your radio dealer 100.3 meters for the World Storage Battery Station WDB. Variety—see to list—always interesting. Jerry Sullivan, Dir. and Associates, "CAL-LAW-50"

HARMONY.—The Gloria Trumpeters are Katherine Williams, Louise Curer, Cora Roberts and Mabel Coapman. *** You see, they're all ladies. *** Westell Garden is the new tenor with the Capitol Gang; he's a son of Westell the London publisher. *** Lucrezia Bori is a native of Valencia; she made her debut in "Carmen" at the Constanzi. *** The WEAFF Opera Co. is made up of Frances Sebel, soprano, Devora Nadworney, contralto, G. di Benedetto, tenor, Carl Rollins, baritone, and Nino Ruisi, basso. *** My, but you're inquisitive; you must do a lot of talking over the back fence!

MAY BEE.—Scottie Miller was the WEAFF impersonator of Harry Sander. "Roamin' in the Gloamin'" has been Harry Laundered over the air many times and we're getting in a murderous mood about it; at the best these Scotch dialect songs are much like bagpipe music, and bagpipe music—well, you have to have a very constructive, practical mind to regard it as music at all. *** We can never get over the notion that bagpipers are playing with a mouth full of beans and molasses and that some of the beans and molasses have in some way or other got down into the vitals of the instrument.

GRANDPAW.—Gambi and Douglas Stanbury are going with Roxy's new gang; we don't believe that they are married yet. *** If they are it's a deep purple secret.

SCANDAL-MONGER.—Does Milton Cross get paid for his singing with the various advertisers at WJZ? *** No, he does not get paid for this work; he sings in a Brooklyn church on Sunday.

MAURICE B. H.—Florence Mulholland is not appearing on the air just now; she is singing in the choir of the Brick Church at 5th Ave. and 37th St., New York. *** Tommy Dowd is still assistant to Major Bowes, and you will always find him working behind the scene during the Sunday night concert.



AMBROSE CHANNEL.—Teddy Baehr did the announcing for the World Series from WSBF.

D.S.R.—Paul Ash is a WGN artist who has a wide-awake publicity man. *** Fame in jazz nowadays amounts to 40 percent radio appearance and 58 percent good publicity; good playing supplies the delinquency. *** But Paul Ash can play.

DANNY.—Lambdin Kay is still at the old post. *** Yes, he's a newspaper man and he's married; his perfect Southern drawl makes him very popular here in the North.

CARL Q.—The National Broadcasting Co. will soon be located at 701 Fifth Avenue., in what will be known as the "National Broadcasting Building."

Attach this marvelous amplifier

\$25
ready to
attach

to your set
in less than
5 minutes



and get
the biggest thrill out of
radio you have ever had

Any radio set—no matter what type, make, or age—can instantly be transformed to give you such rich and clear and natural reproduction of music and speech that you will be absolutely astounded. You cannot duplicate Truphonic amplification, *no matter how much you can afford to pay.* At the low price of \$25, the Truphonic brings a thrilling new enjoyment of radio within the reach of all.

Truphonic Amplification is not surpassed—at any price

If you want this new thrill in radio, do this:

Get the Truphonic amplifier at your radio dealer's. Place it alongside, or behind your set. Make one simple connection to your set. (A clip goes over one prong of the detector tube—done in 10 seconds). Connect the battery cable. Take the regular standard audio tubes from your set. Insert them in the Truphonic, along with an extra tube (either 201A or power tube). Plug loudspeaker into Truphonic. That is all. The rest is a song of praise from you, and from all of your friends who hear it.

The Truphonic employs an audio coupling system that we have found to be definitely superior to transformers, resistance coupling, or impedance. Three stages of this advanced coupling give much greater distortionless volume than is possible by any other method.

A Power tube can be used, and in fact is recommended for the very best results, owing to the fact that for great volume a power tube has

a much greater undistorted output capacity than a 201A.

We recommend using a UX171 tube. (The wiring to extra B and C batteries is provided for in the Truphonic cable). This combination gives exceptional volume, with an unapproached faithfulness. But in any case, whether you use a power tube or not, the Truphonic will vastly improve upon your present reproduction.

(Truphonic Amplification is also to be had in single coupler units described on the next page.)

Don't let another night go by without getting all that radio can give in beautiful reproduction. Attach a Truphonic to that set of yours and expect the biggest radio thrill you have ever had.

If your dealer has not yet stocked the Truphonic Amplifier, we will send you one direct C. O. D. on a 5-day money back trial. Be sure to mention your dealer's name and address.

ALDEN MFG. CO., Dept. 319-C, Springfield, Mass.



TRUPHONIC

POWER AMPLIFIER





A few points on Truphonic superiority

We make the statement without reservation—that Truphonic amplification not to be confused with impedance is the most perfect audio coupling so far developed. We further state that using the same tubes in a comparison with any other method of coupling, whether transformer, resistance, or impedance, Truphonic affords the most perfect reproduction obtainable in radio—regardless of the price you pay.

These are strong statements—but they hold out to you the promise of the greatest radio enjoyment you have ever had.

This is good news indeed for radio fans and set-builders, as well as for set manufacturers, for today radio value is measured by radio reproduction.

Convincing proof

Here are just a few examples of Truphonic superiority:

With 201-A tubes throughout Truphonic is better than any other method in quality and volume.

With Hi-Mu tubes in the first 2 stages, the volume simply steps up, maintaining the same quality. In fact 2 stages of Truphonic with Hi-Mu tubes at 90 volts will give you greater amplification and quality than two transformers using one 201-A and one 171 Power Tube at 180 volts.

With 199 tubes results are noticeably better with Truphonic and you can go so far as to use four stages of Truphonic with a 120 in the last stage. This of course could not be done satisfactorily with transformers or resistance.

With 199 tubes in the first two stages and a 210 power tube in the last stage results are obtained which could not be duplicated with other coupling methods.

We give this data to show how universal Truphonic is in its use with various tube combinations, giving in every case results superior to all other coupling methods.

Low in price

Every set-maker, whether amateur or commercial, owes it to himself to get full information on Truphonic amplification.

The individual Truphonic Coupler is No. 301 and is priced at \$5.00. If your dealer cannot supply, write direct.

The quick attachable Truphonic Amplifier (fully described elsewhere in this issue) consists of 3 stages of Truphonic coupling and the Output Unit.

The Output Unit No. 300, which has the same exterior appearance as the Truphonic Coupler, is designed to protect your speaker from demagnetization and burning out. RCA recommends the use of an output unit with all power tubes. Price \$5.00.

ALDEN MANUFACTURING CO.
Dept. 319-C, SPRINGFIELD, MASS.

The Fight Against Distortion

(Continued from page 144)

fully cleaned and dried in a dessicator before assembly. However, the usual cause of trouble in these devices is a dent in the diaphragm which is caused by someone sticking a fingernail on the diaphragm, and which reaches to the back plate causing a short-circuit.

The third type of microphone employed is the electrodynamic type which is used chiefly by the British Broadcasting Company. It consists of a moving coil of thin, light wire which is supported in a strong magnetic field. It is suspended in a rubber cradle which is in turn fastened to a large wooden frame which may be wheeled about.

In passing from the microphone the vibrations, which are now in electrical form, go to an amplifier, in the case of out-of-studio work, a portable one, in which they are strengthened perhaps thousands of times. Figure 1 shows a new model of line amplifier which was recently developed for the Radio Corporation stations and which gives an amplification of several thousand times in fine steps with a noiseless control.

Wire lines are necessary in passing from the outside-of-studio point to the control room. These are either overhead or underground cables. The wires in cables have a certain amount of resistance which is of no great importance and a certain amount of capacity which is very important because the higher the frequency or number of vibrations becomes, the more the vibrating electrical energy passes from one to the other instead of going on to the radio control room. Assuming the energy at 100 cycles to be 100 percent the energy at 10,000 cycles may be as small as 4 or 5 percent.

In other words, 95 percent of the energy which we want transmitted uniformly is lost at the high extreme and very little at the low.

Figure 2 shows the curve of a typical cable. The great distortion present is obvious. Longer or shorter cables cause distortion in proportion although open wire on poles is not nearly as bad, as the wires are separated by a foot or more, thus lowering the total capacity.

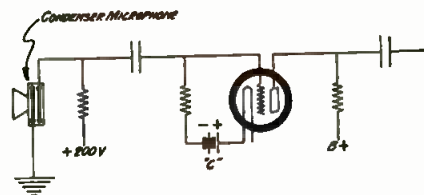

A MICROPHONE AMPLIFIER COMBINATION

FIGURE 4: The use of a condenser microphone with resistance-coupled amplification is shown here diagrammatically.

Plain electrical resistance decreases the energy but the vibrations retain their exact proportions, so that it is merely necessary to add uniform amplification to bring it up to its original strength.

Various means of correction for capacity losses are employed. Capacity in a circuit causes the current to lead the voltage and inductance causes the current to lag behind the voltage.

Advantage is taken of this fact in placing loading coils in certain telephone cables. These coils give uniform transmission over a fairly wide range, depending on how closely spaced they are. If they could be perfectly distributed such as by placing a minute loading coil in each infinitesimal length of cable, the line would not distort. In practice, they are about 1500 feet apart and give good transmission up to perhaps 2000 cycles. This method is not good enough for a broadcasting circuit, however, and so it is not used.

The method most commonly employed is to shunt down the amplitude of the low frequencies, by means of a network, to the level of the higher ones and to amplify up to the desired level with a flat amplifier. Another method is to construct an amplifier which amplifies the high frequencies as much more than the low as necessary to give uniform output for line plus amplifier. The last two methods require individual adjustment for each line and the latter is especially difficult to adjust exactly.

The vibrations have now arrived in good shape in the control room of the station and from here we will assume they reach the air without further loss.

How to Build Your Own Cone Loudspeaker

In the March issue of POPULAR RADIO, will appear a constructional article on a 36-inch cone loudspeaker that may be built in less than an hour on the kitchen table for not more than \$15.00. Every fan knows that the 36-inch cone-type reproducer brings out the low notes with exceptionally life-like reproduction; here is a chance for you to build a good one in your spare time.

**Windsor Wall or Table
Type Cone Speaker
Amazes Radio World**



Model 210
(Pat. Applied For)

The latest model Windsor Cone Loudspeaker has astonished the world of radio. In convenience, quality of reception, and extremely low price, it far surpasses anything yet offered. The cone is 22 inches in diameter and is supported by an easel back. It can be hung up on the wall, as in the picture above, or stood upon any flat surface as shown in the picture below. It contains the famous Windsor loudspeaker unit noted for its extreme clarity and fidelity of reproduction.



Model 210
22-inch Cone
Loudspeaker
with easel back

\$15⁰⁰

(West of
Rockies \$18)
(Pat. Applied For)

Model 302 (Shown below)
With Moulded Composition Horn Loudspeaker and 18-inch Cone Loudspeaker.



(Pat. Applied For)

In this Windsor Console is combined both the Windsor Moulded Composition Horn Loudspeaker and the 18-inch Windsor Cone Loudspeaker. The top is 30 in. x 17 in. and stands 29 in. high. Plenty of battery and equipment space is provided by large shelf in rear. Price, finished in Mahogany or Walnut **\$48⁰⁰**
(West of Rockies, \$55)

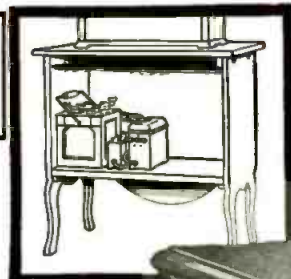

Rear view at left shows large compartment with ample space for batteries, battery charger, or battery eliminator, which are entirely concealed from view. Back is open for ventilation of batteries.

At right is shown the Cone Loudspeaker, with its panel, which is quickly and easily removable, allowing instant access to all batteries, battery charger, battery eliminator or other equipment and wiring.



(Pat. Applied For)

Model 200—with 22-inch Cone Loudspeaker

This Windsor Cone Loudspeaker Console is equipped with a 22-inch Windsor Cone Loudspeaker. Its top is 30" x 17" and is 29" high. The battery shelf provides ample space for batteries, charger, battery eliminator and other equipment. Beautifully finished in either Mahogany or Walnut.

Model 200

\$29

Console
with Cone
Loudspeaker
Ready for
Set and
Batteries
(West of
Rockies, \$35)

**This is the Fastest Selling Line of
Loudspeakers and Loudspeaker
Consoles in the Radio World Today**

The quality of radio reception made possible by Windsor Cone and Horn Loudspeakers and Loudspeaker Consoles so far surpasses anything heard heretofore that it amazes and delights every radio enthusiast. The Windsor Line is so complete that everyone can find in it a loudspeaker, loudspeaker table, or loudspeaker console exactly to fit their particular needs.



Model 100
with Moulded Composition
Horn Loudspeaker or 16-
inch Cone Loudspeaker
(Pat. Nov. 18, 1924)

Above is shown a beautiful Windsor Loudspeaker Console, finished in either Walnut or Mahogany, which provides ample space on top for any radio set. The battery shelf beneath will accommodate all necessary equipment. Equipped with either Moulded Composition Horn or 16-inch Cone Loudspeaker. Size: 38 in. x 18 in., and 29 in. high. Price **\$40⁰⁰**
(West of Rockies, \$42.50)

To the right is shown the newest Windsor Loudspeaker Console. It is equipped with a 22-inch Cone Loudspeaker and cabinet suitable for 7-inch radio panels up to 26 inches in length. Battery shelf provides ample space for all equipment. Beautifully finished in either Walnut or Mahogany. Price (without receiving set) **\$44⁰⁰**
(West of Rockies, \$52.00)

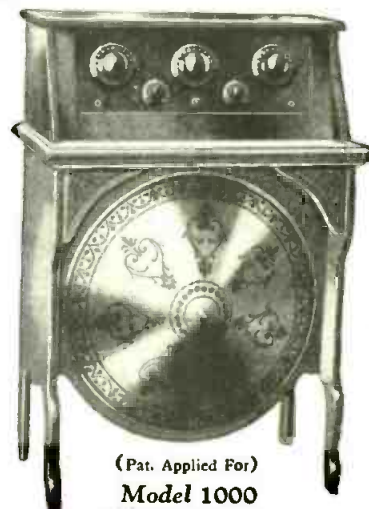

(Pat. Applied For)

Model 1000
with 22-inch Cone
Loudspeaker

Note to Dealers: Write or wire today for details of the highly profitable Windsor line.

Electrical Department

WINDSOR FURNITURE COMPANY

1414 Carroll Avenue • CHICAGO, ILLINOIS
Los Angeles Branch—917 Maple Avenue



Build this professional set —and know you have the best

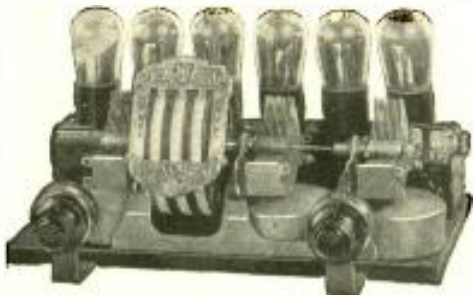

The professional set shown above, for all its compactness, is a giant in performance. And there are two very definite reasons why this set which may be built for less than \$40 will out perform sets costing actually 5 times as much!

TRUPHONIC Amplification

The audio end is the now famous Truphonic amplification (fully described on another page).

Three stages of the superior Truphonic amplification and an output unit to protect your speaker are housed in a steel catacomb. The gang socket panel which neatly covers the catacomb provides for 6 tubes—3 for audio, and 3 for the tuning end of the set. No holes to drill, no apparatus to mount. Can be used in a hundred different circuits. Price 6 tube—\$25. 7 tube—\$27.



Localized Control Tuning Unit

With the Localized Control Tuning Unit all three condensers can be tuned together or separately by the fingers of one hand, giving single dial simplicity with multiple dial efficiency.



When used with shielded coils and the Truphonic Catacomb Assembly you have a set that is ultra professional in efficiency. Rotors grounded to chassis, coil shields grounded to chassis, no grid leads longer than 2 inches, most advanced amplification, output unit—a thoroughly engineered set that you wouldn't trade for a commercial set at 5 times the cost.

Localized Control Tuning Units (including handsome panel plate) are provided in several models. Double (.000375) \$8. Double (.0005) \$10. Triple (.000375) \$10. Quadruple (.000375) \$15. Double with Tickler Control (.000375) \$10.

If your dealer hasn't the Truphonic Catacomb Assembly and Localized Control Tuning Unit, send to us. Be sure to mention your dealer's name and address.

ALDEN MANUFACTURING CO.
Dept. 319-C Springfield, Mass.

How to Build and Use a Portable Test Board

(Continued from page 138)

may be calculated to be .135 milliamperere.

With binding post 3 connected to the 67½-volt "B" battery tap, a 5-volt grid-bias change made by reversing switch S3 was found to change the plate current reading from 4 to 8.7 milliamperes or a change of .94 milliamperere per change in grid-bias.

Dividing the rate of change of plate current produced by changing the grid-voltage by the rate of change of plate current, produced by changing the plate voltage or .94 by .135, shows an amplification factor of 7.

The DC plate resistance for zero bias may be obtained by dividing the plate voltage by the plate current in amperes or 112½ by .0101—this gives 11,000 ohms. The alternating current plate resistance may be assumed to be .8 of the DC plate resistance for the UX-201-a type tube or 8,900 ohms.

The mutual conductance is equal to the amplification factor divided by the AC plate resistance times one million, when expressed in micromhos, or 790.

How to Construct the Test Board

The schematic diagram, shown in Figure 3, and the top view of the unit shown in Figure 2, will enable any one to locate the component parts of the test board in a convenient position and to wire the board without more detailed information. The exact location of parts is not at all critical and the design may be changed to suit the builder.

The test board illustrated was made up on a standard, 7 by 14-inch panel with two hardwood supports, 2 inches high, at the ends.

The connection plug was made of the base of an old UX-201-a type tube, the glass being broken out and the cement in the base removed with a knife after heating slightly with the soldering iron. The four wires of the cable were passed down through the prongs of the plug and soldered flush with the ends.

The binding posts on the switches were all removed and long 6/32 brass machine screws were connected in their place and passed down through the panel for convenience in wiring.

A One-tube Set That Will Operate a Loudspeaker

This remarkable receiver—which will be described in full in the March 1927 issue of POPULAR RADIO—employs only one tube yet it will give as great loudspeaker volume and as good reproduction as most four and five-tube sets.

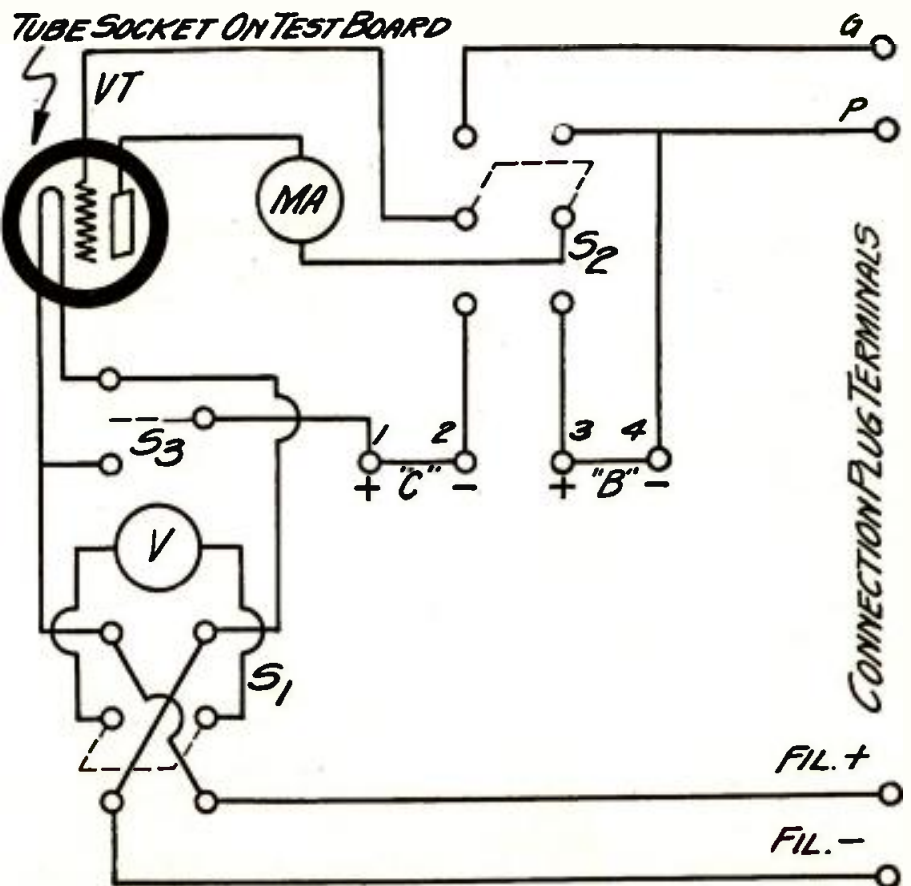

HOW TO WIRE THE TEST BOARD

FIGURE 3: The electrical connections are shown to the vacuum tube switches and the voltmeter and the milliammeter. The four terminals at the right end, in the lamp socket base, are used as a connection plug.

30 DAYS FREE IN YOUR HOME

Tested and approved by all of Radio's Highest Authorities



Send Coupon for Amazing Special Offer!

USER-AGENTS! GET OUR

Greatly Reduced Wholesale Prices!

BIG DISCOUNTS to User-Agents who will allow friends to listen to their Miracos.

BEAUTIFUL · BIG · POWERFUL

MIRACO

Retail LIST Price **49.75** GET SPECIAL OFFER **One year GUARANTEE**

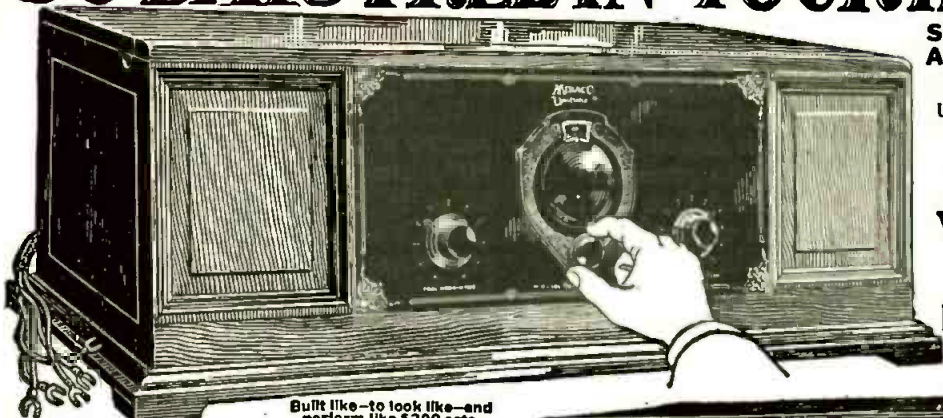

Built like—to look like—and perform like \$200 sets

Real Single Dial Control!

Magnificent Big Powerful Miraco "Unitune" Get Special Offer Amazing Low Price!

The celebrated Miraco Ultra—U.S. Navy type circuit, has also been adapted to Single Dial Tuning—without sacrifice of selectivity, volume, clearness, power, tone, or distance getting qualities! In the magnificent big Miraco Unitune—above shown, you turn one vernier knob for stations everywhere. Beautiful hand-rubbed, piano hinged, solid walnut cabinet, 28 in. long, 15 in. deep, 10 in. high. Sloping Bakelite panel is walnut finished to match. Also offered on 30 days free trial!

Coast to Coast and Foreign Reception Certified



by Miraco users

Enormous sales of the celebrated Miraco big fine Receivers (resulting from delighted users so highly endorsing them to friends) again enable us to add costs of costly new features, latest refinements and up-to-the-minute improvements such as you might expect to find only on much higher priced sets. Miraco's this year are still better—more beautiful—more selective—more powerful for less money than ever before.

USER-AGENTS WANTED . . . WRITE!

Reports from users everywhere leave little for us to add. These are only a few of the many in our files and which we receive daily. Send coupon for plenty of additional proof and testimony of nearby users.

Miraco Separates Stations That More Expensive Sets Can't

Logged stations from coast to coast the second evening we had Miraco and got some difficult stations because of so many broadcasting stations coming in under the same number. We can separate them where some of the best receiving sets in the neighborhood cannot. We are well pleased with the set and heartily recommend it. W. J. PETERSON, Seibert, Colorado.

N. Y. Heard Europe

I received six foreign stations during test week: 2LO, OEH, OAX, Lima, Peru, Hamburg, Germany; PTT, Paris, France; SCR, Brussels, Belgium. The Miraco is some set! Local and distant stations come in so loud that you have to shut it down. Had Porto Rico on the loud speaker last week so you could hear it through the whole house. GUS EHRMAN, FULTON, New York.

Beats \$200 to \$300 Sets in Demonstration

Miraco is the best performer in this town. I have demonstrated against \$200 and \$300 sets and beat them for distance and quietness.

OREN W. FAWCETT, Saybrook, Illinois.

Experts Say It Can't Be Beat

I am very well pleased with my Miraco. Fact is, it was such a surprise that I haven't gotten over it yet. I have operated sets all over the world for the last seven years. I think that I ought to have some idea of what a broadcast receiver should be. I am sure that you have a set that can't be beat. I logged fifty-six stations first night. A. W. BRYANT, Terre Haute, Ind.

Out Performs Costlier Sets

Like the Miraco very much. The first night I received KFI (Los Angeles), WPG, WHN, CFCF. This is covering from coast to coast; received 47 stations that night, and the next night I received 27 stations. That is more than a lot of sets are doing that cost from 50 to 100 per cent more than mine. It is all you claimed it is and a little more. C. A. MOORE, Van Dyke, Mich.

Alaska Hears Chicago

I am living up here in Alaska one thousand miles from Seattle and it takes a good receiver to pick up any radio in this district, especially near Juneau, our Capital City, which seems to be bothered with electrical currents and static, but the Miraco picked up stations as far as Chicago. I've heard Omaha several times. LESLIE F. PARKER, Gustavus, Alaska.

Finds It Superior to High Priced Set

Miraco is working fine. Have compared it with the (names expensive set) and find it superior in performance. The most pleasing feature of this machine is the counter-balancer. I haven't seen another set with this remarkable feature, and it makes an impression on those who hear and see. WILLIAM KRUMMEL, Mapleton, Iowa.



27 in. Long Solid Walnut Cabinet

Big Powerful New MIRACO

TRADE MARK REGISTERED

ULTRA-SELECTIVE LONG DISTANCE RECEIVERS—EASY ON CURRENT

Tremendously increased sales of the beautiful big Miraco's—due to user-agents finding them unbeatable among the fine, high-grade sets (even at several times the price!) for razor-edge selectivity combined with extreme long distance reception, clear natural tone, powerful loud speaker volume and economical operation—enable us to GREATLY REDUCE the wholesale prices. Latest, up-to-the-minute models—Sets and accessories! Get the big new discounts and Amazing Special Offer! Send postal or the coupon today—Now!

Compare with Any 6 to 8 Tube Sets—

Unless 30 Days' Trial proves your Miraco the most selective, the clearest toned and most powerful distance-getter among sets using up to 8 tubes—don't buy it! Enjoy a powerful big Miraco in your home—at our risk—and be thoroughly convinced. Your verdict final—absolutely no strings to our offer. Satisfaction unconditionally guaranteed.

Operate from Light Socket or Batteries

Miracos are specially adapted and unsurpassed for economical operation with A- and B-light socket power supply units—or with batteries. Power tubes and more than 90 volts of "B" Current may be used, although the power built right into a Miraco makes unnecessary the use of other than regular tubes and 90 volts.

Factory Prices Save You 1/2! Send Coupon

Save or make a lot of money on sets and accessories by dealing direct with a big, old, reliable manufacturer (7th successful year). Greatly reduced wholesale prices—get User-Agent's Special Offer on Demonstrating Set (no contract to sign, no red-tape). Our offer will AMAZE you. Send Coupon now!



RELIABILITY!

The Midwest organization was one of the very first to engage in the manufacture of radio sets. We consider them to be both morally and financially responsible. They have a reputation for fair and equable dealings. THE PROVIDENT SAVINGS BANK & TRUST CO.

7th Anniversary Special!

FREE! 30 DAY TRIAL!

Only \$19.95 net—an unheard-of price for a high-grade, fully guaranteed 5-tube radio! It's the new \$30 (retail list) Miraco Compact—14" wide, finished in brown mahogany. Can't be equalled anywhere near the price in quality of construction, selectivity, distance-getting power, tone, ease and economy of operation—let 30 days' trial prove this! Complete with high-grade accessories—nothing else to buy—only \$49.85 net. Act quick—supply limited. Get Special Offer!

5 TUBE GUARANTEED RADIO

Another bargain, direct from factory. Coast to Coast range. Powerful, selective; clear, sweet tone.

All the Proof you want is waiting for You!

Coupon or postal brings reports from hosts of users in your vicinity and elsewhere proving that Miraco sets at rock-bottom money-saving factory prices, outperform sets costing up to four times as much. You can also buy speakers, tubes, batteries, etc., at big savings from us! Get our proposition before spending money elsewhere.

MIDWEST RADIO CORPORATION
Pioneer Builders of Sets

479-W Miraco Building
Without obligation, send free literature, testimony of users, AMAZING SPECIAL OFFER and full particulars of your big money-saving factory-price proposition on Guaranteed Miraco sets and all radio supplies.

NAME _____
ADDRESS _____

\$19.95

This Coupon is NOT an Order





Note this important point



SILENCER SOCKET

There is a difference in radio sockets. Any engineer or radio fan of long standing who has had years of experience with Na-ald sockets, and with other sockets, will tell you that—very emphatically.

And now to crown the achievements of the pioneer socket designer and manufacturer comes the nation-wide acceptance of the Na-ald Silencer Socket.

Note how the same continuous strip of phosphor bronze which holds the prongs of the tube in triple-locked, firm embrace and provides connection with the binding posts, gives also the silencing and cushioning effect which renders the tube free from all disturbing microphonic noises more effectively than does any other socket.

Be sure to get nothing less than the Na-ald Silencer Socket No. 481 XS for the set you build. Owing to great production facilities this socket can be priced at 50c.

Two other Na-ald sockets are the 481 X—similar to the 481 XS but minus the silencing feature—at 35c, and the 400, the heavy duty De Luxe Socket for the high voltage power tubes, priced at 75c.



481 XS Silencer Socket

Na-ald Sockets are at all good dealers. If out of stock, write to us, mentioning dealer's name and address.

ALDEN MANUFACTURING CO.
Dept. 319-C SPRINGFIELD, MASS.

Potter Condensers

Build the best—

- Socket Power Devices
- A and B Supply Devices
- Power Amplifiers
- Impedance Amplifiers

And are best—

- For Filter Uses
- Rectifiers
- By Pass
- Blocking D.C.

American made of best of materials to full capacity. All sizes and types.

POTTER MFG. CO.
North Chicago, Ill.

Potter
BY PASS AND FILTER
Condensers

How to Assemble the All-Amaz Senior Three-tube Reflex Receiver

(Continued from page 150)

of Figures 4 and 5 in mounting the instruments.

It is advisable to wire the assembled panel and baseboard separately up to the point where it is necessary to connect some part on the panel with another on the baseboard; then the panel may be mounted on the baseboard and the wiring job completed.

Wherever filament wires cross close together it is best to insulate them with spaghetti or covered bus bar. All wiring of the grid and plate circuits should be isolated as much as possible.

It is good practice to solder wherever possible. The writer has formed a habit of using soldering lugs in place of bending the ends of wires into a loop, to be held down by a nut or terminal. The best joints are made by bending the end of the wire to be soldered in an L shape so that this end and the other wire are parallel. The parallel faces thus present a large surface for soldering.

A six volt storage "A" battery is used to supply the filament current. Three 201-a tubes require a total current of slightly less than 3/4-ampere per hour. A storage battery with a capacity rating

of 100 ampere-hours will therefore operate the filaments well over 100 hours on a single charge.

The high-voltage plate supply for the receiver may be obtained from dry-cell "B" batteries, or from storage "B" batteries; in either case the voltage required is 90. At this voltage the current consumption from the "B" batteries is approximately 11 milliamperes per hour. This means that two "large" size 45-volt blocks of dry-cell "B" battery will provide about 300 hours of service.

The use of a power supply unit in place of the "B" batteries is practicable with this receiver. This is a unit which draws its energy from the alternating current electric light lines and should be one which is provided with terminals to supply 90 volts. There are a number of these units on the market and instructions for building several types have been given in POPULAR RADIO.*

Figure 9 shows how to connect the batteries to this receiver. If a power supply unit is used its negative terminal and the 90-volt terminal are connected

*See POPULAR RADIO for November, 1925, May, 1926, June, 1926, July, 1926, November, 1926 and December, 1926.

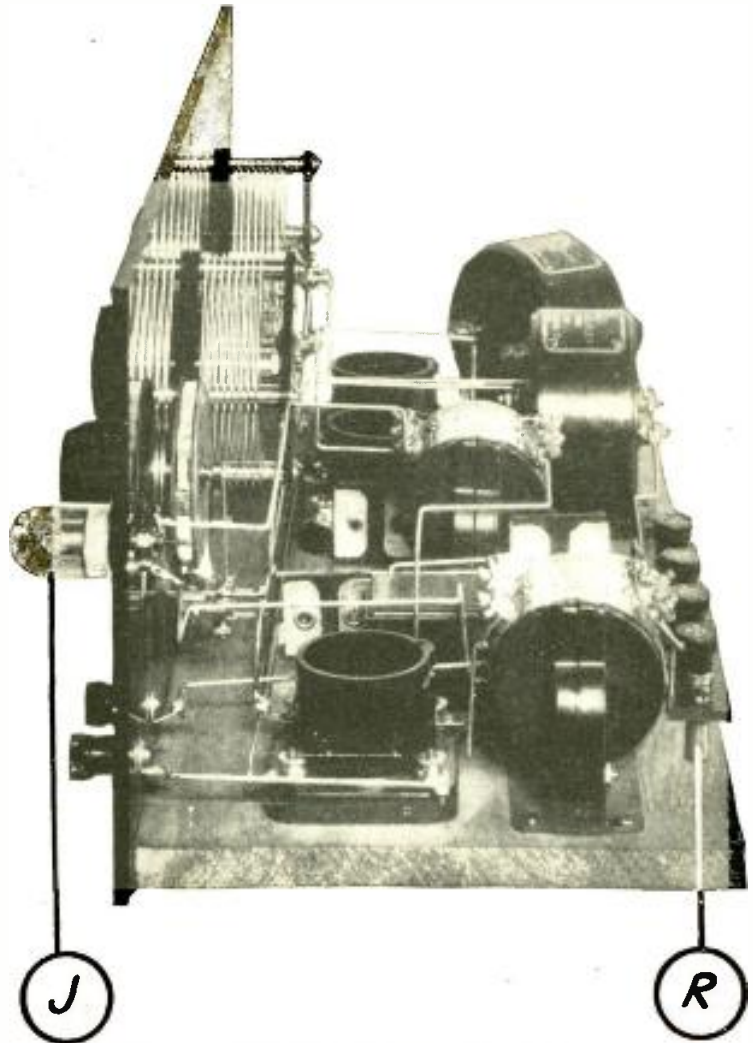

A VIEW OF THE RECEIVER FROM THE RIGHT
FIGURE 8: Another side view showing the right end of the receiver with the detector mounted on the panel and the binding-post strip and audio transformers mounted on the baseboard.

A NEW Amplifier Unit

that provides for Extremely Faithful Reproduction

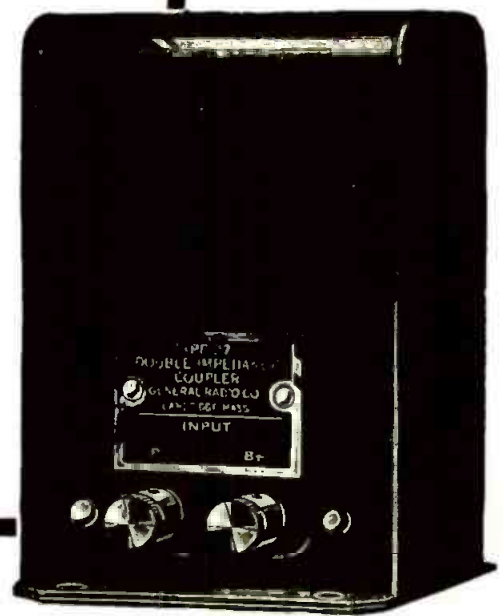
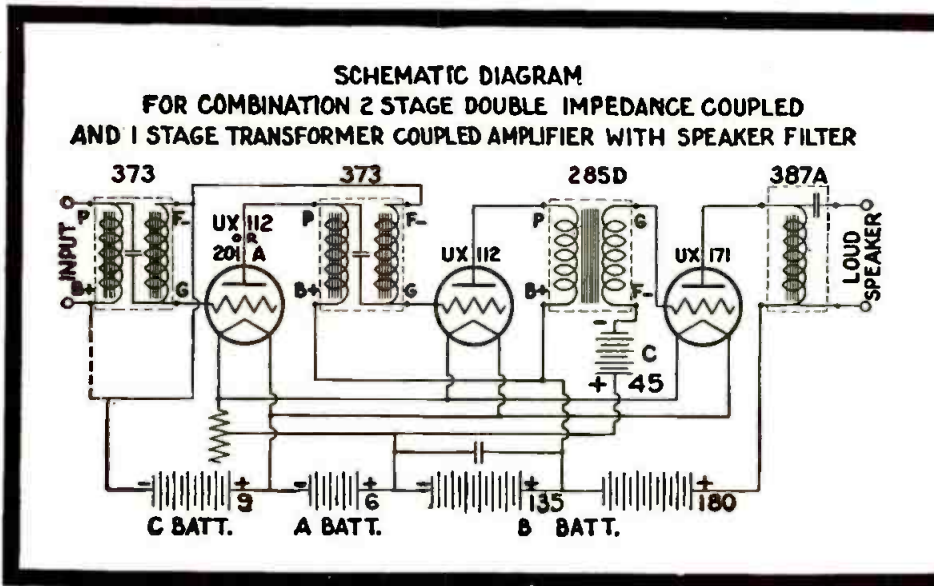

**Type 373
Double Impedance Coupler**

While the use of double impedances is not new in principle the General Radio Type 373 Double Impedance Coupler is unique in design and performance. To facilitate installation the complete unit, consisting of two impedances and a fixed condenser, is contained within a metal shell. It is connected in precisely the same manner in an audio amplifier circuit as a transformer.

**Announcing a NEW
Single Hole Mounting
Rheostat**

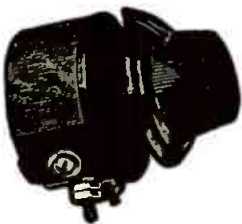

The Type 410 rheostats are similar in general appearance and construction to the well known Type 301 rheostat, except that they have the single hole mounting feature, and a flanged knob, with engraved pointer of moulded Bakelite.

Furnished with resistances of 6, 12, and 25 ohms.
Type 410 Rheostat..... \$1.25

The extent of its range of even amplification is from appreciably below 100 cycles to over 10,000 cycles, with a gradual downward deviation of slightly less than 7% between 100 and 400 cycles. This deviation in an otherwise perfect amplification curve is so slight as to be practically negligible, because the ear of the average individual cannot detect a variation of intensity of much less than 25%.

The amplification curve, in fact, compares favorably with that generally obtained with resistance coupled systems which have the disadvantage of large sacrifices of plate voltages.

The General Radio Double Impedance Couplers have the further advantage that when connected as shown in the above diagram, with one transformer coupled stage, they may be used with a properly designed Plate Supply Unit.

Type 373 Double Impedance Coupler.....	\$6.50
The following parts are used in the General Radio Laboratory Amplifier:	
2—Type 373 Double Impedance Couplers.....	\$13.00
1—Type 285-D Audio Transformer.....	6.00
1—Type 387-A Speaker Filter.....	6.00
3—Type 349 UX or CX Sockets.....	1.50
1—Type 410 or 301 Rheostat 6 ohms.....	1.25
Complete cost of amplifier parts.....	\$27.75

If your dealer is unable to supply you with any of the above items, we shall be glad to send them to you prepaid upon receipt of list price.

GENERAL RADIO

Parts and Accessories

GENERAL RADIO COMPANY

CAMBRIDGE, MASS.



A good name
NA-AID
 in radio

Use Power tubes for good quality at full volume

Simply adapt to your set with
Connectoralds

Reg. U. S. Pat. Office





The use of a Power Tube in the last audio will very greatly improve your tone quality. No change in set wiring is necessary when Connectoralds are used.

For UX 171 and UX 112 Tubes, Na-Aid 112 Connectoralds are recommended for maximum volume with storage battery sets. These tubes will deliver without distortion several times the volume of the regular 201A. Price \$1.50.

For UX 120 Tubes in UV 201A sockets, the Na-Aid No. 120 Connectorald should be used. To convert a storage battery set to dry batteries with ample loud speaker volume, use a UX 120 tube in the last audio stage with the 120 Connectorald and UX 199 tubes with 419X Adapters in the other sockets. Price \$1.25.

For the UX 120 Tube in UV 199 sockets, ample loud speaker volume without distortion is obtainable from any set equipped for UX 199 tubes by means of the UX 120 or equivalent tube, with the Na-Aid No. 920 Connectorald. The tube is raised slightly, but provides for its use in most sets with limited headroom. Price \$1.25.

For UX 120 tubes in the UV 199 sockets of the Radiola Superheterodyne Semi-Portable and Radiola Super VIII. These excellent Superheterodynes will deliver ample volume for loud speaker operation when equipped with the UX 120 used with the Na-Aid No. 420 Connectorald. Price \$1.25.

ALDEN MANUFACTURING CO.
 Dept. 319-C Springfield, Mass.

POPULAR RADIO
5 MONTHS FOR \$1.00

To double our list of subscribers, we will for a limited time accept \$1.00 as payment in full for a five months' subscription for POPULAR RADIO. This offer is open to new subscribers only. Tell your friends about it. They will appreciate this money saving opportunity to secure POPULAR RADIO promptly and regularly each month.

The convenient coupon gives other attractive offers good for either new or renewal subscriptions.

POPULAR RADIO
 627 West 43rd Street
 New York City

Date.....1927.

POPULAR RADIO, Dept. 27,
 627 West 43rd Street,
 New York City.

Enclosed is remittance of \$....., payment in full for subscription order for POPULAR RADIO as checked below.

5 months for \$1.00 (new subscribers only)

7 months and "How to Build Your Radio Receiver" for \$2.00.

12 months and "How to Build Your Radio Receiver" for \$3.00.

12 months and Set of "Simplified Blueprints" (see page 200) for \$3.00.

24 months for \$5.00.

Name.....

Address.....

City.....State.....

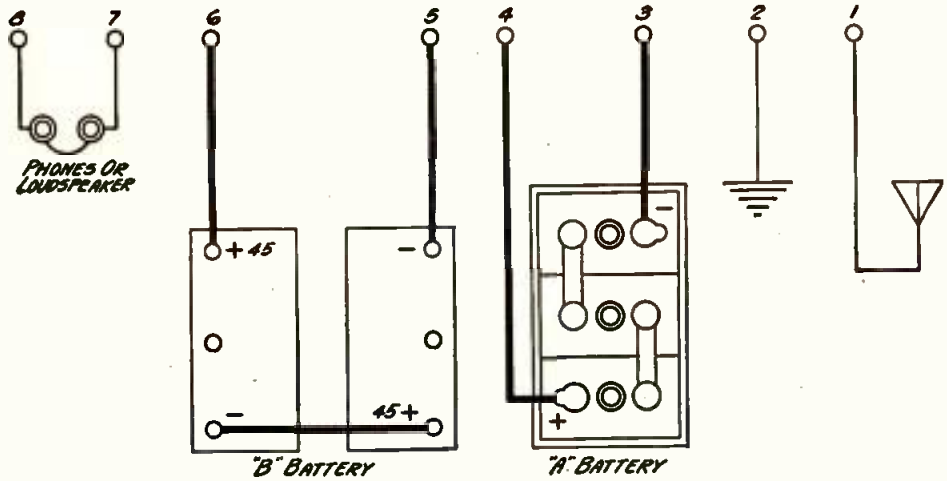

HOW THE BATTERIES SHOULD BE HOOKED UP

FIGURE 9: The antenna and ground are connected to posts Nos. 1 and 2; the "A" battery is connected to posts 3 and 4 with the positive terminal to post 4. The 90-volts of "B" battery are connected to posts 5 and 6 with the positive terminal to post 6 and the phones or loudspeaker are connected to posts 7 and 8.

to similar terminals on the receiver, in place of the "B" batteries.

Installing the Receiver

An antenna of from 50 to 125 feet in length is recommended, depending on location. In areas where broadcast stations are numerous the short aerial will provide better selectivity while in more isolated sections a longer antenna, up to 125 feet will provide better volume.

Operation of the Receiver

Before tuning in for stations adjust the crystal detector until the greatest "rush" is heard. Turn the rheostats about half way and rotate the two tuning dials simultaneously, starting

from zero. When a station is heard, adjust the dials for maximum volume and readjust the crystal. At this point it is advisable to also adjust the position of the coupling transformer, A, to eliminate interstage coupling.

With the first rheostat, H, turned off and the earphones connected to the set, adjust the coupling by turning the coupler on the baseboard until the least music is heard in the phones. To facilitate this adjustment it is advisable to employ flexible wire for the connections to this coupler. After the proper position has been found bus wire may be substituted for the temporary, flexible wires, because no further adjustment is required.

The Coming of the Radio University

(Continued from page 130)

this exceptionally able and fit person.

(3) In classes which involve activity by the children—penmanship, for instance—the teacher who is present in the classroom has an opportunity to observe and correct her pupils at her leisure while the burden of the lesson is being carried by someone else.

It might also be mentioned that lessons thus broadcast are followed by many persons in addition to those in the classroom. It is not at all uncommon for parents, or others who are in no way connected with the schools, to write in and ask whether they may not submit papers for correction, in these radio courses.

In New York City, station WJZ has broadcast recitations by model classes for the benefit of the school children. A particularly good group of children is put through a demonstration before the microphone in arithmetic, English or geography while thousands of others listen in.

A subject which is so important that it well deserves a whole article—or for that matter, a book—to itself, is the

educational influence of the radio as regards music. While no statistics are available, it is probable that by this means the number of person-hours, so to speak, of listening to good music has increased not less than 1000 percent in the United States—and by "good music" I mean the best works of the best composers. Today the chances are strong that any child brought up in one of the 5,000,000 homes which are equipped with radio receivers will hear a vast quantity of fine music, well played. Not only does he hear this music, but because of the explanations made by the announcers he knows who are the composers, and something of the theory which lies behind the various compositions.

Indeed, in some cases he may go much further than this. The New York Edison Company broadcasts through station WRNY a series of fine weekly concerts, offering exceptional music played by fine musicians. It mails out to radio listeners a booklet containing the programs for the whole series, and elaborate, carefully written program notes. Anyone

KEEP RADIO UPKEEP DOWN



1. A simple combination switch that controls both "A" charging and radio reception.

2. Indicator that proves the charge.

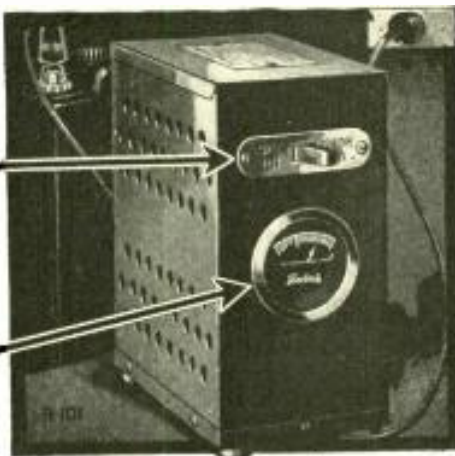

Unusual features of this trickle charger

THE Sterling Trickle Charger, in addition to being automatic, reliable and absolutely noiseless, has exclusive features you cannot afford to overlook.

The R-102 Trickle Charger is equipped with an automatic control unit, the master key to the operation of eliminator, battery charging and the set—automatic control

complete! This means getting the most enjoyment out of your radio with the least attention to your storage "A" Battery.

Made in 2 Models:

R-101, with Combination Switch . . . \$14.00
R-102, with Automatic Control . . . \$17.50

Send for booklet "G" giving complete information on all necessary caretakers and inspectors of radio

THE STERLING MANUFACTURING CO.
2835 Prospect Ave. Cleveland, Ohio.

Sterling TRICKLE CHARGER



Adapters for all tube and socket combinations

Na-Ald Adapters are indispensable to the set owner and set builder who wants a simple and instantaneous means of adapting any particular type of tube to the particular type of socket that is used in his set. For instance, if your set is now equipped with standard 201A sockets, and you want to use the small UV 199 type tube, simply insert the Na-Ald Adapter No. 429 into the 201A socket and insert the 199 tube into the adapter.



No. 419X

The various types of Na-Ald Adapters are given below. Specify them for best results.

For adapting small UX 199 and UX 120 tubes to UV 201A sockets, use Na-Ald Adapter No. 419X. Price 35c.



No. 421X

To bring up to date and decidedly improve the Radiola III and IIIA and similar sets employing WD II Tubes, use Na-Ald No. 421X. Price 75c.



No. 429

For adapting UV 199 tubes to standard 201A sockets use the Na-Ald No. 429 Adapter. Price 75c.

To adapt all UX tubes and UV 201A tubes to UV 199 sockets use Na-Ald Adapter No. 999. Price \$1.00.

Na-Ald Adapters are sold by all good radio stores and carry the Na-Ald unconditional guarantee.



No. 999

ALDEN MANUFACTURING CO.
Dept. 319-C SPRINGFIELD, MASS.

YOUR OWN BUSINESS Without Capital

Right now, there is an opportunity in your locality to profitably devote your spare time or all your time to a pleasant, easy and profitable business—one that does not require any training or capital.

The publishers of POPULAR RADIO offer you an opportunity to become their local representative to take care of expiring subscriptions and new subscriptions for POPULAR RADIO and two other popular magazines that they publish.

SALARY AND COMMISSION

All material will be furnished you free of charge and you will be paid an attractive commission and salary.

Mail coupon for full particulars.

POPULAR RADIO, Dept. 26,
627 W. 43rd St., New York City.

Send me full particulars regarding your salary and commission offer to local representatives.

Name.....

Address.....

who will take the trouble may lay the groundwork for a surprisingly extensive knowledge of good music by following these concerts with the aid of the explanatory material. Sir Walford Davies, Chairman of the National Council of Music of Great Britain, said recently that "Ten minutes' vigorous, clear transmission of great music daily would change the musical taste of the country in ten or fifteen years." His statement is by no means unreasonable.

One of the most striking demonstrations of the power of radio in musical education is now in progress in the state of Connecticut through a cooperation between the State Board of Education and station WTIC, the Travelers' Insurance Company of Hartford. For the first time, a special course in Music Appreciation is now being given by radio for the children of the entire state, and is apparently successful. Fully 100,000 children heard the first lecture-recital in the series and the number is growing. Separate lessons are broadcast for children of all ages, from the primary grades up through high school. Competent speakers explain the significance of various types of music, of which the listeners then hear examples played by a good orchestra, or sung by special vocalists whose abilities and reputation are such that ordinarily it would be impossible to engage them for classroom work. Among the subjects treated in the course, which this year embraces twenty lessons, are folk music, the music of the great composers, music for special occasions such as Christmas, elementary music forms, rhythmical and harmonic studies, and the evolution of musical instruments.



THE ROSTRUM OF THE NEW "RADIO COLLEGE"

In a single course of instruction by radio the University of Minnesota has enrolled 2,300 students, scattered in 26 states. These courses are supplemented by outside reading. Above, Prof. A. E. Jenks is shown broadcasting a lecture on anthropology from station WCCO.

What could be more striking than the thought of one or two hundred thousand students, in every town in Connecticut, and even in other nearby states, in schools of every type from vast temples in large cities down to the little school-house at the crossroads, all listening at once to a lesson given over the radio!

And music, of course, is only one of many subjects which are appropriate for such treatment. Think, for example, of the new impetus which could be given to the study of geography if Lieut. Commander Byrd, on returning from his successful flight over the North Pole, could have described his experiences to the school children of Connecticut—or for that matter, of the whole United States. Why should not courses in government have the benefit of addresses by members of the President's Cabinet? Or students of history hear Pershing explain the American strategy in France?

Perhaps the most striking of all the experiments in education *via* radio is that which the government of Haiti is at present attempting. Most of the Haitians live in mountainous, inaccessible country; they are very poor; and nine out of every ten are unable to read or write. At the same time there are many things which the government wants to tell them. They are particularly in need of instruction in personal hygiene, sanitation, and in important facts about agriculture, by means of which nearly all of them earn their living. I am advised by Mr. W. W. Cumberland, in charge of this work for the Haitian government, that receiving sets equipped with loudspeakers are being installed in all the villages large enough to make it worth while. Thereafter the government from its own broadcasting station, HHK, will tell the Haitians what they need to know. Not only will useful information of the sort mentioned above be given, but new laws and regulations will be announced and explained, and news of miscellaneous government activities be broadcast. In fact, the radio will serve the Haitians as the daily press does in other countries where the percentage of literacy is higher.

A similar development is being worked out in Mexico, where the Calles government is confronted by the same problem of a large illiterate population which can be reached in no other way. Incidentally, one wonders what these ignorant and superstitious villagers will make of the wonderful box which speaks with the voice of a man! Will they not be tempted to incorporate into their religious ceremonies worship of the receiving set as a new and highly effective variety of black magic?

I could go on almost indefinitely describing the educational uses of the radio, but space forbids. I can only mention, for example, the new interdominion broadcasting scheme of the British through which every part of the

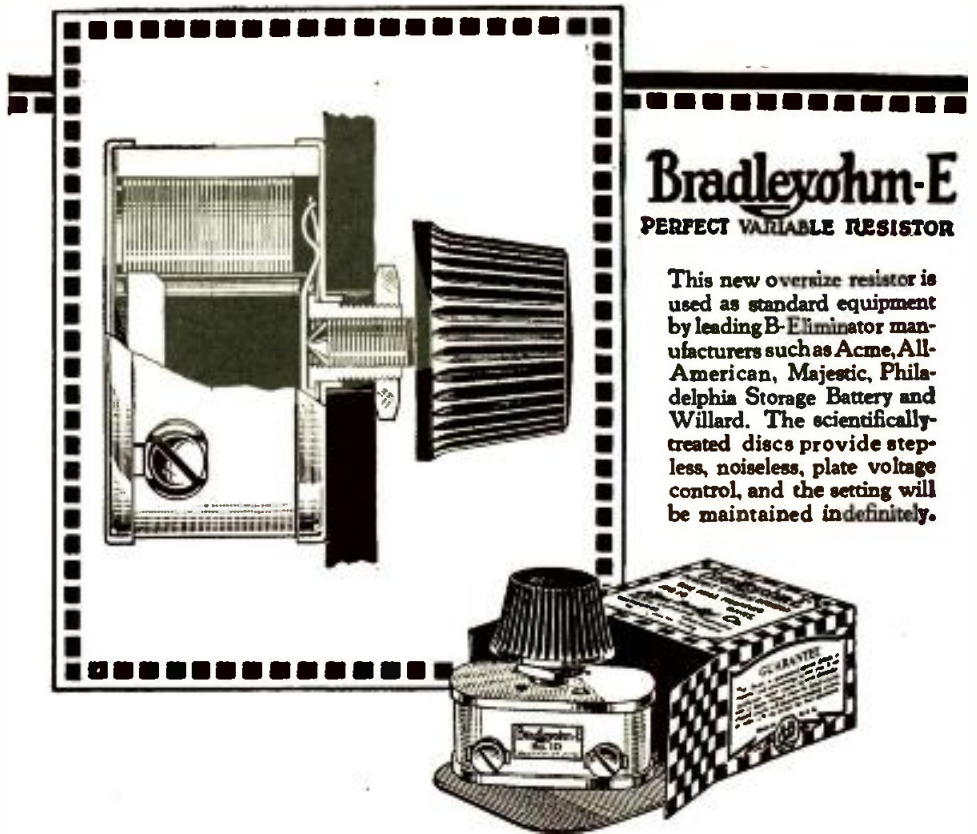

Bradleyohm-E

PERFECT VARIABLE RESISTOR

This new oversize resistor is used as standard equipment by leading B-Eliminator manufacturers such as Acme, All-American, Majestic, Philadelphia Storage Battery and Willard. The scientifically-treated discs provide stepless, noiseless, plate voltage control, and the setting will be maintained indefinitely.

Use Allen-Bradley Resistors for B-Eliminator Hook-Ups

A LLEN-BRADLEY research engineers have developed a series of variable and fixed resistors especially suited for B-Eliminator hookups. The success of their efforts is indicated by the fact that Allen-Bradley resistors, both variable and fixed, are used by more than fifteen B-Eliminator manufacturers, including European as well as the largest American manufacturers.

Bradleyunit-A

PERFECT FIXED RESISTOR

Another triumph of the Allen-Bradley Research Laboratory is Bradleyunit-A, a perfect fixed resistor that contains no glass, requires no hermetic sealing, and can be soldered into place without the use of clip mountings. Bradleyunit-A is not affected by temperature or moisture.

The silent, smooth control of plate voltage so essential in B-Eliminator service is obtained with Bradleyohm-E. For fixed step adjustment of voltage, Bradleyunit-A is recommended.

Do not experiment with make-shift resistors when these Allen-Bradley units have been pronounced the ideal units for B-Eliminator service.

Ask your dealer for them, today!



ALLEN-BRADLEY COMPANY,
276 Greenfield Avenue,
Milwaukee, Wisconsin

Please send me your literature on Allen-Bradley radio devices and B-Eliminator hookups.

Name

Address

Chosen by EXPERTS

GLENN H. BROWNING, Laurence M. Cockaday, Gerald M. Best and many other eminent radio designers use the Lynch Metallized Resistor in their experimental circuits and receivers. These men know radio; they have laboratory and testing equipment with which quickly to make accurate comparisons. There could be no better proof of the true merit of the Lynch Metallized Resistor than the endorsement of these experts.

Comprising a concentrated metallized deposit one-thousandth of an inch thick upon a rigid core, sealed forever within a glass tube, the Lynch Metallized Resistor gives conductive, non-arcing resistance that remains silent, accurate!

Dealers—Write us!

ARTHUR H. LYNCH, Inc.
Fisk Bldg., Broadway & 57th Street
New York, N.Y.

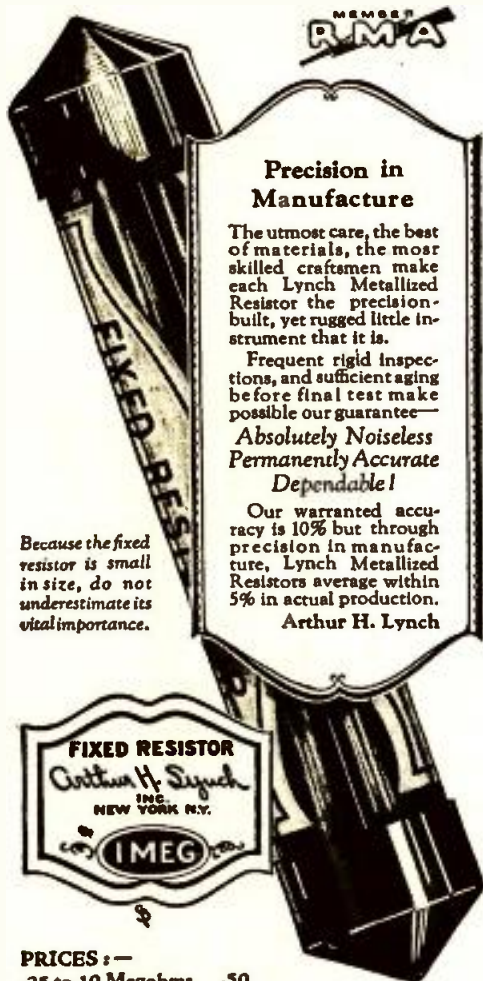

Because the fixed resistor is small in size, do not underestimate its vital importance.

Precision in Manufacture

The utmost care, the best of materials, the most skilled craftsmen make each Lynch Metallized Resistor the precision-built, yet rugged little instrument that it is.

Frequent rigid inspections, and sufficient aging before final test make possible our guarantee—

**Absolutely Noiseless
Permanently Accurate
Dependable!**

Our warranted accuracy is 10% but through precision in manufacture, Lynch Metallized Resistors average within 5% in actual production.

Arthur H. Lynch



PRICES:—

.25 to 10 Megohms	.50	Single Mounting	.35
above .01 to .24 "	.75	Double "	.50
.001 to .01 "	\$1.00		

Lynch Metallized Resistors cost no more than the ordinary kind. If your dealer cannot supply you it will be well worth your while to wait for the mail—we ship post-paid, at once.

LYNCH METALLIZED FIXED RESISTORS

Empire will be linked up. Speeches delivered in London or at any of seven other points will be rebroadcast in every dominion simultaneously, and special "Round the Empire" programs will be given in which India, Australia, South Africa, etc., will take part in turn with characteristic native music and with addresses by representatives. These programs will reach 400,000,000 inhabitants of the Empire and 100,000,000 other persons—assuming that they all have receiving sets, and in a few more years that assumption will by no means be fantastic.

I should perhaps sound a note of warning, lest what I have written should give to some of my readers an exaggerated idea of what is possible. Up to the present, it is true, education by radio has not been used to give a thorough and advanced knowledge of any subject. The aim is to give the listeners what they want; and by experimentation it is found that they prefer short lectures, not many on any one subject, and a rather light and popular style of treatment. Thus far, radio education for adults, has been in character and content about equal to Chautauqua lectures or the average speech before the average Woman's Club. Such material is not a substitute for hard, solitary study. It is certainly not a substitute for classroom work, since 90 percent of the useful things a pupil learns he gets from his fellow students—and they have no connection with the formal subject of instruction. Teaching by radio bears little relation to that most difficult of all tasks, stimulating the individual to think for himself.

On the other hand, some of these objections are due to the newness of the whole idea, and may be remedied with time. Experts in pedagogy have as yet paid no attention to the art of radio teaching. No technique has been worked out; no special textbooks have been written to accompany lectures over the air. No attempt has been made, for example, to link the showing of an educational motion picture film with broadcasting of an accompanying address. There is reason to believe that when these questions are studied great progress will ensue.

Most important of all, the radio is destined to break down the artificial barriers which at present surround "education" and make it a thing only for the young, to be laid aside forever as soon as maturity has been reached. Most of the experiments I have been describing are intended to reach adults; this is as it should be. For after all, education is a part of growth, and when growth stops, decay begins.

When we try to envisage the future in these new terms, a fascinating prospect unrolls itself. I shall not attempt to discuss it here, however, since it deserves and indeed demands separate treatment in another article.



World Radio Storage "B" Battery
12 Cell—24 Volt

Proved value. Thousands of users find reception almost magical. Clear, true power—instantly and unendingly. Wise economy. Sturdy construction—Solid Rubber Case protection. Recharged for almost nothing. Endorsed and listed as standard by famous Radio institutions including Pop. Radio Laboratories, Pop. Sci. Inst. Standards, Radio News Lab., Lefax. Inc., and other Radio authorities. What more need be said? *Extra Offer: 4 Batteries in series (96 volts) \$10.50.*

Send No Money Just state number wanted and we will ship same day order is received, by express C. O. D. Pay expressman after examining batteries. 5% discount for cash with order. Remember—you save 50% on World Batteries, so send order to-day.

WORLD BATTERY COMPANY
1219 So. Wabash Ave. Dept. 77 Chicago, Ill.
Makers of the Famous World Radio "A" Storage Battery
Prices: 6-volt, 100 Amp. \$10.00; 120 Amp. \$12.00; 140 Amp. \$13.00.
All equipped with Solid Rubber Case.
Set your radio dials at 288.8 meters for the World Storage Battery Station WBSO. Variety—New Talent—Always Interesting.
JERRY SULLIVAN—Director and Announcer—"Chi-CAW-go!"



Radio Convenience Outlets

Know greater radio enjoyment. Install a Yaxley Radio Convenience Outlet for loud speaker and phone connection in every room. Consists of wall plate and wall socket jack with screw terminals. Fits any standard switch box. Easily wired. Wiring diagrams in each package.

No. 135 As described above..... Each \$1.00
No. 137 With Plug, for battery connections..... " 2.50
No. 136 For aerial and ground... " 1.00

Automatic Power Control

Takes care of your Bel eliminator or trickle charger or both. Turn the set on—the trickle charger is off, the Bel eliminator is on, and the reverse when the set is turned off.

No. 444 Series Type for sets having tubes with a current draw equal to or greater than 6 U. V.-190 types of tubes..... Each \$5.00

Also makers of Famous Air-Cooled Rheostat, Jacks, Jack-Switches, Cable Connector Plugs, etc.

At your dealer's. If he cannot supply you send his name with your order to
YAXLEY MFG. CO.
Dept. P, 9 So. Clinton Street
Chicago, Ill.

What's New in Radio

(Continued from page 156)

The receiver employs five tubes and consists of one stage of tuned high-frequency (radio-frequency) amplification, a regenerative detector and three stages of resistance-coupled low-frequency (audio-frequency) amplification. The tube employed in the high-frequency amplifier is a UX-199 type tube. The other four tubes may be the UX-201-a type, or they may be UX-199 type tubes if the use of a storage battery is impractical for any reason. It is advisable to use a power tube in the last low-frequency stage. Where UX-199 type tubes are used in the first four sockets a UX-120 type power tube may be used in the last stage. Either a UX-171 or a UX-112 tube may be used for the power stage if UX-201-a type tubes are used in the second, third and fourth sockets. In any event, the UX-199 type tube must be used in the high-frequency amplifier stage.

In spite of the fact that this receiver includes only one stage of high-frequency amplification, and contains only two tuned circuits, the sensitivity and the selectivity of the receiver are really remarkable.

The operation of the receiver is simple. There are two tuning controls but the adjustment of one of these controls is not critical. As a result the adjustment of this latter control, in tuning in a given station, need only be approximate, while the exact tuning is accomplished by means of a second control. This is true in reception from local and semi-distant stations. In reception of weak signals from distant stations both of the controls require accurate adjustment.

There is a volume control included on the panel of the receiver which provides a gradual control of volume, from maximum down to practically zero. In addition there are two knobs by means of which the filament current from the "A" battery is controlled. These two knobs require only an initial adjustment.

A filament switch is also provided on the panel to turn the receiver "on" and "off." The last two items on the panel are the jacks; one for plugging in a reproducer unit and the other for use with headphones.

The pleasing appearance of the receiver is obtained through the use of a cabinet finished in two-tone mahogany. The front panel and the control knobs are of polished black bakelite; all engraving is done in gold.

The battery requirements of the receiver will depend upon the type of tubes used. The normal tube equipment, where a storage "A" battery is used, consists of a single UX-199 type tube, three UX-201-a type tube and a UX-112 type power tube. With this tube equipment a 6-volt storage battery is used for the filament supply; for the plate supply a "B" battery potential of 135 volts is sufficient for normal use.

If extreme volume is desired, however, the "B" battery potential may be increased to 180 volts. The "C" battery consists of two of the small 4.5-volt "C" battery blocks.

The receiver will operate with almost any kind of antenna. If an indoor antenna is used it should be about 40 feet in length, while an outdoor antenna should be from 50 to 100 feet in length.

Maker: Browning-Drake Corporation.

\$75 A WEEK BUILDING RADIO SETS

— in your spare time

JOIN the Radio Association of America. Learn how to build and repair radio sets. The Association will train you—start you out in business if you wish. Be the radio "doctor" of your community. \$3 an hour upwards easily made. Radio offers you a big money-making opportunity right now.

Earns \$500 in Spare Hours

"I have at last found myself," writes Lyle Follick, Lansing, Michigan, "I have already made over \$500 building radio sets after working hours." Werner Eichler, Rochester, N. Y., writes, "I have made over \$50 a week in my spare time."

Our members are starting radio stores, increasing their salaries, securing better positions, passing radio operator examinations, earning big money for the most enjoyable kind of spare-time work.

What a Membership Means

A membership in the Radio Association of America gives you the most up-to-date and thorough training in the Science of Radio.

You're taught how to build and repair all kinds of sets. You're given the train-

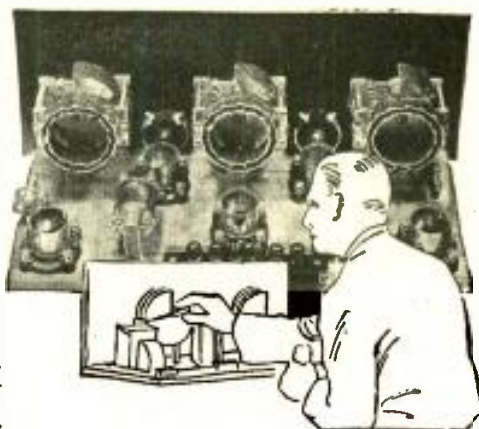

ing you need in preparing for a Licensed Radio Operator's examination. You receive the privilege of buying parts at wholesale prices.

You're helped to make money.

Join the Association Now

If you're interested in Radio for either pleasure or profit, join the Association without delay, because we have a plan whereby your membership may not—need not—cost you a cent. Only a limited number of these memberships are acceptable. Write now for details. Write before it's too late.

This Association has prepared a beautiful book that gives figure-facts regarding the profit possibilities of the Radio Industry, the purpose of the Association, and the details of the Special Membership Plan.

Mail This Coupon

RADIO ASSOCIATION OF AMERICA
Dept. PR-2---4513 Ravenswood Ave., Chicago

Send me your book and details of your Special Membership Plan.

Name.....

Address.....

City..... State.....

Yale GROUND HOG INCREASES POWER AND DISTANCE on your RADIO

Marvelous newly invented ground gives greatly improved reception. Increases power and distance, users say. Thousands getting results like D. S. Friedman, Radio Engineer of Burlington, Iowa, who writes, "Am very much pleased with way your Ground Hog operates. Am now able to tune in any good stations with little trouble from static." Everyone pleased and delighted. Users report, "Leaks stopped," "Static reduced," "end to jangling even in midsummer," "Results never dreamed of." Absolute satisfaction guaranteed or money back at once.

Efficiency Always Insured

Only ground on market that has power to draw and hold moisture thus assuring maximum efficiency at all times. Holds moisture indefinitely. Highly sensitive to radio energy. Proven valuable aid to clear, powerful distance reception.

SEND NO MONEY

Every radio owner needs a Yale Ground Hog. To introduce, we offer to those who act at once, regular \$5.00 size for only \$2.00. Send name today and pay postman \$2.00 plus 17c postage on delivery, or send only \$2.00 with order and save postage.

Highest Approval



Tested and approved by Popular Radio Laboratory and other high scientific radio authorities. You can order direct today with absolute confidence of value and satisfaction.

FREE—Complete description of Ground Hog, proof of user satisfaction and full details of amazing special offer free on request—Send name today.

Yale Specialty Supply Co.

131 W. 5th St., Kansas City, Mo.



Announcing

the first of a series of new models of

TIMBREONE

REG. U.S. PAT. OFF.

Combined with the utility of a smoking stand is a loud speaker. Carry it about and have it where you want it—on the porch or along side of your easy chair.

Sales offices

SANFORD BROS.

CHICAGO 30 W. Walton Pl.
CHATTANOOGA 615 Broad Street
SEATTLE Am. Bank Bldg.
SAN FRANCISCO 311 Minna St.

Factory: TIMBREONE MFG. CO.
Hoosick Falls, N. Y.



Shielded Tuned Radio Transformer, No. 30

SICKLES Diamond-Weave Coils

The new Sickles Shielded Tuned Radio Transformer prevents both outside and local interference. It is remarkably compact, sharp-tuning, sturdy.

Sickles Diamond-Weave Coils have established an enviable reputation for low distributed capacity, low dielectric losses, and large range of frequency with small variable capacity.

The ideal coil for the Na-Aid Localized Control Tuning Unit and the Na-Aid Truphonic Assembly.

There are Sickles Diamond-Weave Coils for all leading circuits.

THE F. W. SICKLES CO.
134 UNION STREET
SPRINGFIELD :: MASS.

No.	Coil Prices
30	Shielded Transformer \$2.00 each
24	Browning Drake 7.50 set
18A	Roberts Circuit 8.00 set
25	Aristocrat Circuit 8.00 set

How to Get Quality Amplification

(Continued from page 131)

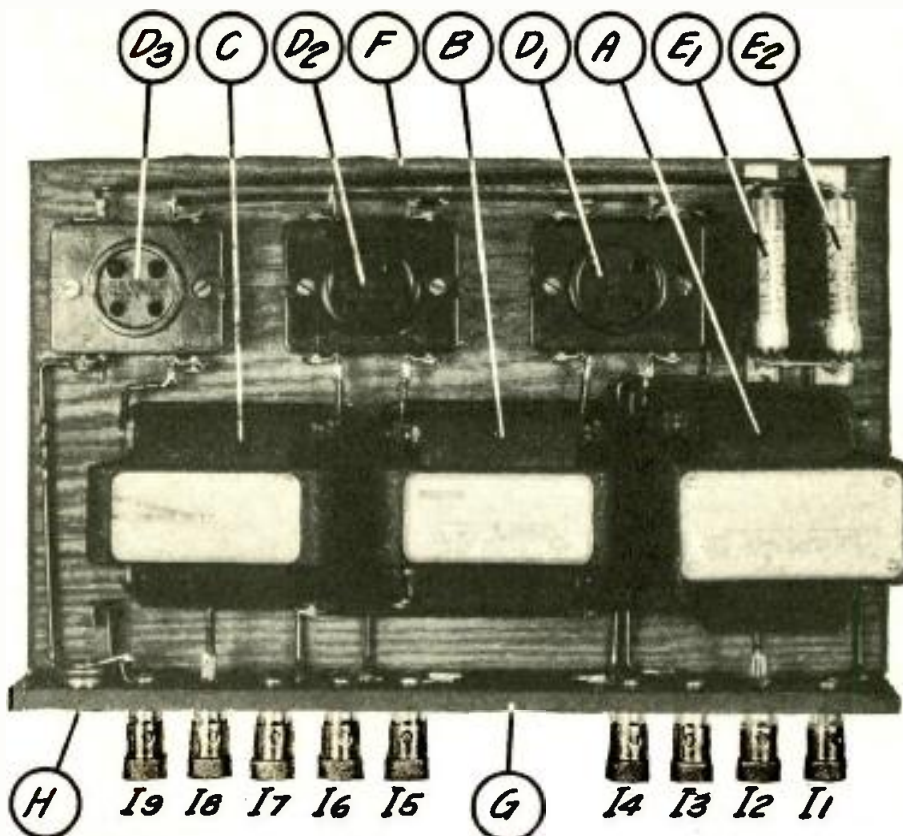

HOW THE AMPLIFIER LOOKS FROM ABOVE

FIGURE 4: This picture shows the arrangement of the parts and the general appearance of the amplifier when completed.

tested with a number of receiving sets.

The schematic wiring diagram for this unit is shown in Figure 1.

How to Construct the Unit

To construct the unit, cut the baseboard, F, to the proper size, as shown in Figure 3. Then, prepare the binding-post strip, G, and attach the nine binding posts, I1, I2, I3, I4, I5, I6, I7, I8 and I9, as shown in Figure 4 and the jack, H.

Now, fasten the binding-post strip, G, by means of three screws to one of the long sides of the baseboard, F, and you are ready to mount the instruments on the baseboard.

Mount the three amplifying units, A, B and C in their proper positions and fasten them down to the baseboard with short, strong, round-head wood screws.

Next, fasten down the three sockets, D1, D2 and D3 using two thin, flat-head, wood screws to each instrument. Then, mount the two automatic fila-

ment control mountings and insert the two controls, E1 and E2.

The wiring should be done exactly as shown in Figure 3; this carries out the wiring scheme given in Figure 2. When the wiring is completed, the instrument is ready to be installed.

In Figure 1 is shown the manner of connecting to the detector and to the batteries that are to be used with the amplifier.

Insert two UX-201-a type tubes in the first two sockets, D1 and D2, and insert a UX-171 type tube in the last socket, D3.

The amplifier is now ready for use and a loudspeaker that is capable of reproducing high-quality signals should be inserted, by means of a plug, in the jack, H.

The receiver that this unit is used with should be tuned in the usual manner and the quality of reproduction will be found to be excellent even when the enormous volume that the unit is capable of producing is used.



Reception Not Deception

Volume, not noise.

Tone, not blare.

Clear, mellow, perfect reception of every sound from a whisper to a full orchestra.

That's what radio enthusiasts everywhere are enjoying with the new Dulce-Tone, the perfected radio-talking-machine-speaker.

Dulce-Tone, for \$10, and your phonograph make the finest loud speaker money can buy. Try it and see. Your money back if you're not completely satisfied. At your dealers, or send the coupon.

THE GENERAL INDUSTRIES CO.

Formerly named The General Phonograph Mfg. Co.

601 Taylor St., Elyria, Ohio

Enclosed is \$10 for my Dulce-Tone. If I'm not satisfied after 10 days' trial, I'll return it and get my money back.

Name.....
Street.....
City..... State.....

The list of parts given on page 131 includes the exact instruments used in the unit from which these specifications were made up. The experienced amateur, however, will be able to pick out other reliable makes of instruments which have been approved by POPULAR RADIO which may be used with good results. But we recommend that the novice follow the list, as the diagrams in this article will tell him exactly where to bore the holes and exactly where to place the connections. If instruments other than the ones listed are used, the only change that will be necessary will be the use of different spacings for mounting the instruments. To any reader who has difficulty in obtaining any of the parts which are necessary in making up these model amplifiers, POPULAR RADIO SERVICE BUREAU, 627 West 43rd Street, New York City, will gladly assist in seeing that his requirements are promptly supplied.



Trade Mark Reg. U. S. Pat. Office

RADIO INTERFERENCE FILTER No. 1



Actual Size

TINYTOBES

A new TOBE product making the TOBE line complete, from the smallest to the largest fixed condensers required in Radio.

TINYTOBES are specified in the Lincoln Superhet., Victoreen, Sampson T. C., and many other leading circuits.

It would be hard to find a more efficient, compact and generally advantageous small fixed condenser than the TINYTOBE.

PRICES

	Each
.0001 Mfd.00025 Mfd.	35c
.0005 Mfd.	35c
.001 Mfd. and .002 Mfd.	40c
.005 and .006 Mfd.	45c
.01 Mfd.	55c
.02 Mfd.	60c

No condensers of this kind are genuine unless they bear the trade-mark name TINYTOBE. Accept no substitutes.



The TOBE 600 Line

High-voltage condensers for AmerIran and similar high-voltage packs. Big, husky 1000-volt D. C. continuous-operating voltage condensers—made to stand the gaff. Equipped with TOBE safety terminals.

PRICES

5 Mfd.	\$1.75
1.0 Mfd.	2.50
2.0 Mfd.	4.00
4.0 Mfd.	7.00



TOBE Filter Condensers

The standard for general radio use. For all operating voltages up to 300 volts D. C. Used by Philco, National Company, General Radio Company, King Radio, and many other leading manufacturers.



THIS new and effective filter unit is designed for the reduction of annoying Radio-Interference, caused by household motors of the D.C. or universal types, on oil burners, refrigerators, elevators and dumb waiters, washing machines, etc. It may also be applied to vibrator motors, etc., and will, in most cases, reduce the interference to a point where it is no longer noticeable. It is designed to be attached directly to the offending appliance, *not* to the Radio set. Strongly cased in a grounded metal container, with lugs for attachment to floor or base plate, provided with 5 flexible leads, for immediate attachment, and with wiring-diagram directly on label. Once installed, requires no attention or adjustments. Designed by Sewall Cabot, noted Radio engineer, and carrying the TOBE trademark.

Write us for descriptive pamphlet L-2 on TOBE INTERFERENCE FILTER No. 1. The list price is \$15.00, and if your dealer is not already supplied, we will gladly fill your order direct on receipt of your check or money order.



The TOBE 400 Line

Specially cased condensers for 400-volt D. C. operating voltage. For use with Raytheon BH and similar high-voltage rectifying tubes in B-Eliminators. Use short-path type-condensers and equipped with unique TOBE safety terminals at base of can

PRICES

1 Mfd.	\$2.00
2 Mfd.	2.75
4 Mfd.	4.50



TOBE Output Filter Condenser

This 4 mfd. TOBE Condenser—working voltage 250—has been specially designed for construction of power tube output filters, now so generally required between the power tube plate of a Radio set and the speaker—for protection of speaker windings. Price \$3.50.



The TOBE Veritas HI-Current Resistor

A special and unexcelled resistor, capable of radiating 4 to 5 watts continuously without change or deterioration. Made to be soldered directly into the circuits without the use of clips, although of standard length, so that standard mounts may be used if desired.

Prices	Each
2,000, 3,000, 5,000, 7,500, and 10,000 ohms.	\$1.10
50,000 ohms.90
.1 meg.80
1/2, 1/4 and 1 meg.75

Tobe Deutschmann Co., Cambridge, Mass.

Engineers, Manufacturers and Importers of Technical Apparatus

The Old Way

each time you turned your set on or off you had to operate

3 Switches



NOW—

you operate everything with **ONE** switch—the SET SWITCH



BRACH

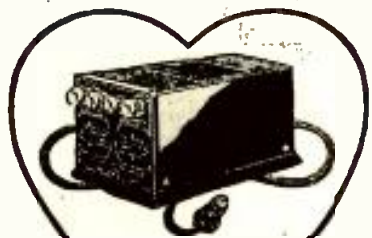

CONTROLIT DOES IT

—AUTOMATICALLY

Manufactured by the Makers of the Famous **BRACH** LIGHTNING ARRESTERS

L.S. BRACH Mfg. Co. NEWARK, N. J. TORONTO, CAN.



WHAT READERS ASK

CONDUCTED BY DAVID LAY

In justice to our regular subscribers a nominal fee of \$1.00 per question is charged to non-subscribers to cover the cost of this service, and this sum must be inclosed with the letter of inquiry. Subscribers' inquiries should be limited to one question or one subject.

What Is the Proper Size Tuning Condenser for a Short-wave Receiver?

QUESTION: I am planning the construction of a receiver to cover the short-wave bands between 30 and 200 meters, but I do not seem to be able to find any really authentic information as to the proper size for the tuning condensers to be used in such a circuit. The circuit that I have selected is the shunt-feed Hartley circuit and I am planning to use plug-in coils that I expect to make myself. I realize that if I use a very small tuning capacity I shall have to make quite a few coils to cover this waveband; but I am willing to do this. What I want is an arrangement which will enable me to spread the stations well out over the dial instead of having them all crowded in together as they are on most short-wave receivers that I have heard in operation.

—FRED STEWART

ANSWER: In the shunt-feed Hartley circuit there is only one tuning condenser; the other condenser is used to control regeneration and may be a standard 250 micro-microfarad (.00025 mfd.) receiving condenser. It is immaterial whether this latter condenser is straight-line-capacity, straight-line-wavelength or straight-line-frequency; the selection of the tuning condenser, however, is most important.

In the writer's short-wave receiver, the

tuning condenser has a maximum capacity of approximately 40 micro-microfarads (.00004 mfd.). This size was selected, after extensive tests, as the most practical size for the purpose. Using this condenser, seven coils in all are required to cover the waveband you mention. The wavelength range of each coil slightly overlaps the wavelength range of the next smaller and the next larger coils so that the band from 27.7 meters to 225 meters is completely covered.

Even with such a low-capacity tuning condenser as this there is some crowding at the lowest wavelengths; but if a high ratio vernier dial is used with this condenser there is no overcrowding and the tuning becomes quite simple.

The tuning condenser should have an approximate straight-line-frequency characteristic.

How to Build a Four-Tube LC-26 Receiver

QUESTION: I want to build an LC-26 receiver, but I prefer to use only four tubes instead of five. To accomplish this I am planning to use only two stages of audio-frequency amplification, with two Amertran transformers instead of one stage of transformer and two stages of resistance coupling. Is this plan practical, and can you give me the necessary hook-up?

—HOLMES STANLEY

ANSWER: Yes, this is an entirely practical plan. The added transformer should be the "second stage" type if you wish to

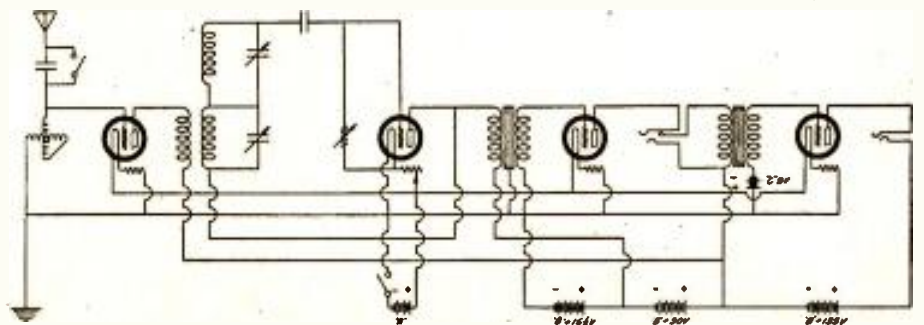

THE SCHEMATIC WIRING DIAGRAM FOR THE FOUR-TUBE LC-26 RECEIVER

FIGURE 1: The last two stages of audio-frequency amplification, which were resistance-coupled in the original receiver, are here replaced with one stage of transformer-coupled audio-frequency amplification. This plan will eliminate one tube without impairing the fine tone quality which is obtainable with the LC-26 receiver.

RECEPTION AT ONE POINT *only* ON THE DIAL

At
ONE POINT
only

Think of It!

There is no reappearance
of stations with the New

MADISON-MOORE ONE • SPOT TRANSFORMER

With this new, improved instrument you log the desired station at ONE particular point on the dial and always bring in that same station at that identical point—not in a half dozen or more places. The intermediate frequency of the MADISON-MOORE *One • Spot* Transformer is of such high value that reappearance of any station in the entire broadcast range is eliminated.

In addition to this fixed *One • Spot* reception, you get Positive Selectivity, Higher Quality and Greater Distance. Yet, the price of this latest model is less than for the former one!

To know the joy of exact selectivity without duplication, and to get a world of Radio Satisfaction, install MADISON-MOORE *One • Spot* TRANSFORMERS.

If your dealer can't supply you, write us.

MADISON-MOORE RADIO CORPORATION

2524 D Federal Boulevard

Denver, Colorado, U. S. A.

MADISON~MOORE

The Finest RADIO APPARATUS in the World!

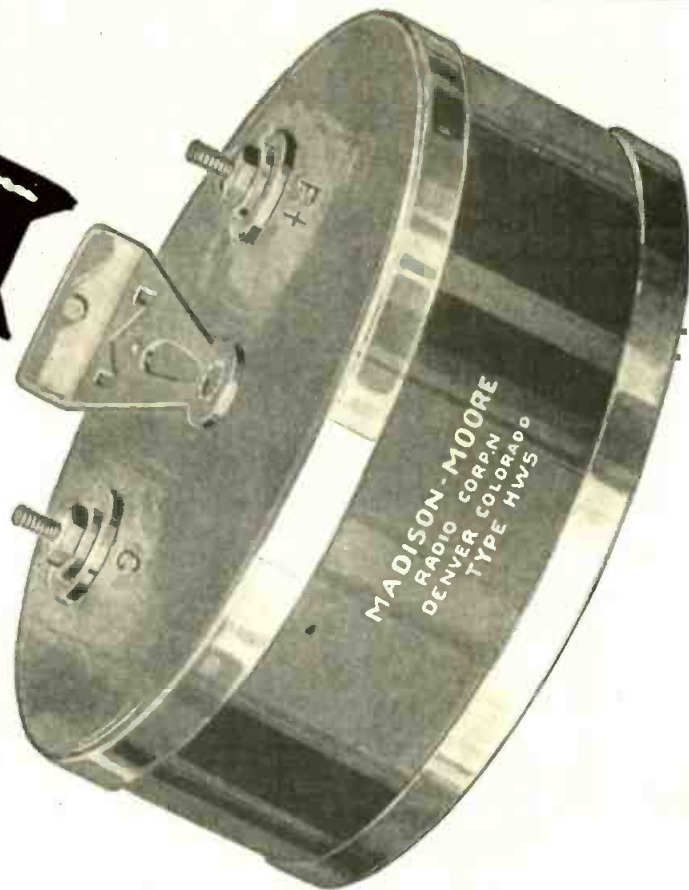

Bring the Musical Quality of your Radio up to 1927

THE chief difference between your present set and one of the latest design is—tone quality. This you can quickly remedy without rewiring or changing the circuit. Merely replace the old audio transformers with Jefferson Concertones and enjoy the most life-like, modern-day reproduction of programs!

These large new Jefferson Concertones evenly and faithfully amplify all voices and all instruments. Their musical range is complete. They do not lose, distort or "blast" any audible notes from the lowest (30 cycles) to the highest (10,000 cycles). Ideal for safe, continuous use with high-voltage power tubes. Unaffected by humid climates. Fully shielded in handsome green enameled metal cases.

JEFFERSON ELECTRIC MFG. CO.
Largest manufacturers of small transformers
508 So. Green St., Chicago, Ill.

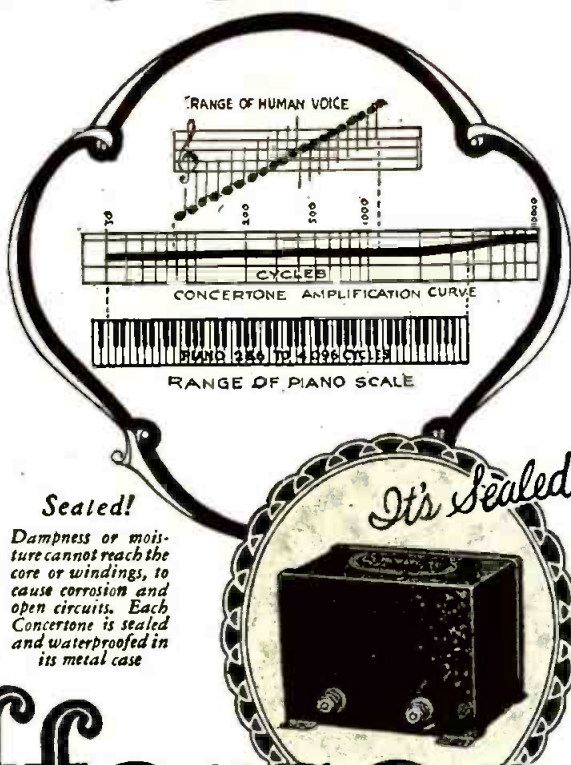

Sealed!

Dampness or moisture cannot reach the core or windings, to cause corrosion and open circuits. Each Concertone is sealed and waterproofed in its metal case

Jefferson Concertone Transformers

obtain the same fine tone quality as the original LC-26 receiver. The diagram for the connections is shown in Figure 1. You will notice that all connections up to and including the input to the third tube remain the same as in the original diagram. The output of the third tube goes to the new audio-frequency transformer, and also to a headphone jack. The plate voltage on the third tube is reduced to 90 volts.

The plate voltage on the last tube will depend upon the type of tube used. A power tube is strongly recommended and this may be of either the UX-112 or the UX-171 type. If the plate voltage is supplied from dry-cell "B" batteries, the use of the 112 tube with a plate voltage 135, as shown in the diagram, is recommended. The "C" battery voltage required on the last tube will then be approximately 9 volts.

How to Eliminate Excessive Whistling in the Superheterodyne

QUESTION: I am using a superheterodyne receiver and although tone quality and DX reception are wonderful, I find some difficulty in tuning in distant stations because of numerous whistles which are constantly present at many points on the dial. These are not regenerative whistles caused by my own receiver because I get them when the intermediate amplifier is not oscillating. During the daytime I have much less trouble from this source, and after midnight the number of whistles gradually diminishes. The receiver is a straight seven-tube super and employs a loop antenna. Can you suggest the cause and remedy for my trouble?

—DANIEL CUMMINS

ANSWER: Your trouble lies in the fact that your loop circuit tunes too broadly. As a result several signals are present in your first tube circuit at the same time as the signal that you are trying to tune in. These frequencies or beats between some of these frequencies, and the fundamental or harmonic frequencies of your oscillator, combine to give you heterodyne beats of audible frequency.

The first step toward the elimination of

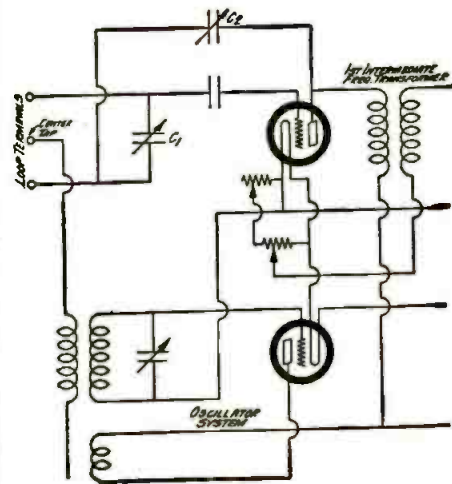

ADDING REGENERATION TO THE SUPERHETERODYNE

FIGURE 2: To sharpen the tuning and increase the sensitivity of a standard superheterodyne receiver it is necessary to take a third lead off the loop and add the variable condenser shown at C2. The above drawing gives all the wiring changes.

Send for Latest RADIO CATALOG and GUIDE

New 1927 Radio Guide Free

The new Barawik Guide, the big 164-page book that hundreds of thousands of radio enthusiasts turn to when they want the latest and best in radio. It's the handiest and most reliable radio reference guide, and a big money-saver besides. Keep up to date by utilizing Barawik service. It will help you to solve many a radio problem and save you tremendous sums on the very things you need and use most.

Brimful of the best approved standard radio sets, parts, and kits, at savings that will appeal to the thrifty. Profusely illustrated with reliable, guaranteed goods at a real saving.

164 Pages of Bargains

It gives 164 pages replete with reliable information about the newest and most advanced ideas in radio development, describes and illustrates the latest improvements. It will keep you posted on what's up to date. It will help you to build a better set or buy a complete new modern one. Every radio set owner, amateur, beginner and fan should have a copy.

Get Our Prices on Parts

It will pay you to get our prices for complete parts for the popular circuits featured in POPULAR RADIO and other magazines. Whenever a new circuit appears for which you want complete parts, write or wire us and they'll be on their way to you quickly. We know what parts to send you. Simply give name of circuit and we'll take care of the rest. We guarantee you a big saving on every order.

Send the Coupon for Free copy Today—NOW!

Get our new radio catalog today before you spend another cent on radio. Just mail the coupon and free copy will be sent you. Also please include name of a friend interested in radio to whom we can send free copy.



BARAWIK CO.

540-545 Monroe St.
Chicago, U.S. A.

Mail This Coupon Now! For Free Copy

Name.....
Address.....
City.....
State.....
Zip.....

S O S Hydrometer

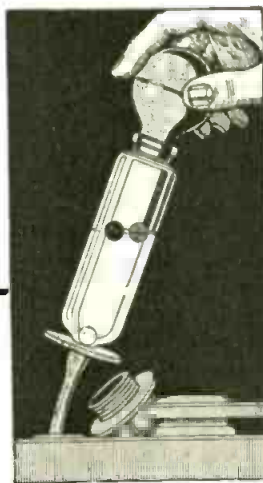

Simple
Durable
Accurate

75c
Complete

Test your battery without withdrawing the Hydrometer. Balls make reading simple and easy.

Swim all three, charged fully
Sinks the white, charge still right
Sinks the green, charge is lean
Sinks the red, charge is dead

Accurate—durable—no float to read or break. Over six million patented Chaslyn Balls used by leading Battery Manufacturers as standard equipment in Glass-Cased Batteries and Power Units.

Ask your dealer. If he can't supply send seventy-five cents to:

THE CHASLYN COMPANY
4609 Ravenswood Avenue Chicago

this fault is to check over the circuit of your first tube to make sure that there are no poor connections that might provide high resistance and therefore broad tuning. If you cannot eliminate your trouble in this way, we suggest that you alter this circuit as shown in Figure 2. To make this change you will notice that a third connection is required on the loop; this is made by scraping the insulation off the winding of the loop, at a point approximately at the middle of the winding, and connecting the third lead to this point.

The small variable condenser, marked C2 in the diagram, is a nidget condenser with a maximum capacity somewhere around 50 micro-microfarads (.00005 mfd.). The purpose of this little condenser is to permit the control of oscillation in the circuit of the first tube. The other instruments shown in the diagram represent the ordinary parts used in a standard super-heterodyne input circuit, and are presumably those that you now have in your receiver.

After your circuit has been changed in accordance with the diagram, tune in any convenient station in the usual manner. It is best to set condenser C2 with its plates unmeshed at first. After the station has been tuned in, turn the knob of C2 until just before the point where the tube breaks into oscillation. This control is then left at that position, and it will require practically no further attention.

This scheme will not only make your input circuit more selective, and thus stop the trouble you have had with heterodyne whistles, but it will also increase the sensitivity of your receiver.

How to Use the 200-a Detector Tube in the LC-26 Receiver

QUESTION: I have substituted a UX-200-a type detector tube for the old 200 type used in my LC-26 receiver, after adding a 20-ohm rheostat, as specified on page 470 of the September, 1926 issue of POPULAR RADIO. The result of this change has been to almost treble the volume of incoming signals, and to greatly increase the sensitiveness of the receiver. On the other hand I find difficulty in controlling oscillation unless the rheostats are adjusted for maximum resistance; and in that case a peculiar fluttering sound starts which ruins reception. I might add that I am using a Raytheon power-pack for the plate supply.

—ANDREW LLOYD

ANSWER: The trouble you mention will sometimes occur when a UX-200-a type detector tube is used in an LC-26 receiver which draws its plate voltage from a Raytheon power-pack, but only when the filament of the UX-200-a type tube is lighted at lower than normal brilliancy.

The solution of the problem is to decrease the plate voltage on the plate of the UX-200-a type tube, and to operate the filament at approximately normal voltage, that is, five volts. The proper plate voltage in this case will be found to be somewhere around 15 volts, and is obtained by turning the knob of the detector plate voltage control as far out as it will go and still make contact inside of the Bradleyohm which is used for this purpose. This point is best found by turning the knob all the way out, and then slowly turning it in again until there is just a perceptible increase in the strength of the signal which is tuned in. If turned in too far the signal will become loud and rough.

NATIONAL POWER AMPLIFIER



AT TACHES easily to your present set, rests in a console beneath it, banishes B-batteries—once adjusted requires no more attention—omits *nothing* for fidelity of audio amplification at natural volume.

The modern broadcast station puts its beautiful programs on the air through a faultlessly designed amplifier. The NATIONAL Power Amplifier attached to your present Radio set, passes on the program to you unchanged, lifelike and real. Don't blame the broadcast station for poor reception until the NATIONAL Power Amplifier has squarely placed the blame on it. For with this fine new instrument the quality is limited only to that of the station you are listening to.

Price, completely assembled and tested (without tubes)—\$89.00.

Raytheon BH Tube extra—\$6.00

Sold also in kit form with full instructions for assembly in an evening.

Price of kit (with Raytheon BH Tube, but without audio tubes)—\$84.00.

NATIONAL products are built to engineering standards of excellence. Anyone who has ever built a set using NATIONAL BROWNING-DRAKE Coils and Transformers knows what that means. Send for Bulletin 116-PR.



National Co. Inc., Engineers and Manufacturers—W. A. Ready, Pres., Cambridge, Mass.

Makers of NATIONAL BROWNING-DRAKE Coils and Transformers, Impedance Transformers, Condensers, Power Transformers, etc. for Radio.

See the World FREE!



Taste Romance and Adventure In the Far Lands of the Earth

How often you've longed to see for yourself the awe of Egypt's pyramids—the beauties of the gorgeous Mediterranean sunset—the squalor of China's ancient cities!

Spend a few years, or the rest of your life, tasting high adventure on the seven seas and in all the world's great ports—roving the earth's highways and byways! You can do it FREE—all your expenses paid—and earn a good salary besides!

Only one profession will carry you around the world at will, travelling like a gentleman, but that's the most interesting and pleasant work: there is—Radio Operating! Easily and quickly learned, there's no other profession like it for the man who wants the experiences and pleasures of world-travel. Radio operators are needed—all sea-going ships like the one shown here must carry from one to half a dozen or more.



Take a Look Beyond the Skyline—Without a Penny's Expense

Radio operators aboard ocean liners live luxuriously—they rank as officers of the ship. Meals, a private cabin, all other living needs are furnished free, and besides the operator draws a good salary. You can learn quickly and easily at home in your spare time to be a Radio operator through our practical training methods. Take a look at the FREE BOOK which tells how—mail coupon below.

This U. S. Government-recognized school has been training successful operators since 1914. Our graduates are all over the world. We maintain an Employment Department to put you on your own ship. The world-famous NATROMETER, our own patented invention, obtainable only by students of this Institute, is recognized as the best and easiest way to learn the Radio code. A few short months with the aid of the famous Natrometer and our quick home training, and you too can be a fully qualified Radio operator, sitting in your cabin like the one shown above, bound out for Liverpool or Nagasaki!

Read the Free Book that tells all about this fascinating profession and our practical Government-recognized methods of training you for it. Send coupon TODAY—no obligation. Special tuition offer now on for limited time includes world-famous Natrometer free of extra cost with your course. Act at once.

NATIONAL RADIO INSTITUTE WASHINGTON, D. C.

SPECIAL OFFER COUPON

National Radio Institute, Dept. BB-86, Washington, D. C.

Gentlemen: Without obligating me in any way send me your free book and information about your special limited Natrometer offer.



World-Famous Natrometer

Name

Address

Three Prize-Winning Ideas for Improving Programs

(Continued from page 136)



Charles D. Isaacson

Winner of the Second Prize

From 8:00 to 9:00 the singers will be allowed to sing.

For the next hour, 9:00 to 10:00, those who tune in on Station Number One will hear the jokesters of radio; whatever "Boys" or "Twins" or Toms or Dicks or Harrys which the resources of the station can command.

From 10:00 to 11:00 comes the hour that I would assign to the musical or choral group sent by advertisers or by their own urges to be heard.

Finally, as the evening wanes, we have the inevitable and repose-inviting jazz.

Station Number One, then, merely retains its present, well-standardized program. What do we specify for the other six stations? As will be clear from the diagram, these have exactly the same sequence of types of program material, but displaced one hour.

Station Number Two repeats the program of Station Number One, one hour later. Station Number Three is still another hour behind, and so on.

I do not mean, of course, that these succeeding stations repeat the same actual programs! The sameness is merely in the type of material presented. All of the stations will present, for example, one hour each evening of talks. Each station will



Harold Moore

Winner of the Third Prize

have a different set of talkers. And the talk hour will come from each station at a different hour of the evening.

The advantages of this scheme will be apparent if you run your eye along one of the horizontal lines of the program diagram.

Take, for example, the seven-to-eight o'clock section, when supper is over and a little radio is called for. Station Number One, it is true, is presenting the talk which now is virtually inevitable at this hour from all stations. But there are five other stations. One station has an orchestra, one has some singers, a third has ensemble music of some sort and a fourth is in the hands of humorists. There is even one that has jazz.

Whatever your taste, while you are waiting for your supper to digest, you can find something from one station or another, to suit what you wish.

The same will be true during the next hour and the next. There is always variety; always something to please each of the larger groups of moods or tastes to which we human animals are subject. There is even provision for the individual who wants to hear the same kind of thing all evening. The jazz party merely has to tune in a different station on each

Hour	Station One	Station Two	Station Three	Station Four	Station Five	Station Six
6 to 7	Orchestra	Jazz	Ensemble music	Humor	Songs	Talks
7 to 8	Talks	Orchestra	Jazz	Ensemble music	Humor	Songs
8 to 9	Songs	Talks	Orchestra	Jazz	Ensemble music	Humor
9 to 10	Humor	Songs	Talks	Orchestra	Jazz	Ensemble Music
10 to 11	Ensemble music	Humor	Songs	Talks	Orchestra	Jazz
11 to 12	Jazz	Ensemble music	Humor	Songs	Talks	Orchestra

THE "PROGRAM DIAGRAM"

This chart shows how the broadcast programs of a group of stations (in this case, six of them) might be so co-ordinated that the listener could select the type of program feature that he prefers at any one time.

hourly change. Persons who desire to listen for a whole evening to the professors—if any such individual still survives—can do likewise and have their aches for learning eased.

The essence of the plan is, of course, the idea of staggering the periods devoted to one or another class of program, so that the different stations in one city or region would always have different types of material on the air. Every listener whose tastes are at all catholic would find something to suit.

It does not matter whether there are six stations in such a plan or sixteen; it does not matter whether the allotments of hours and types of programs are the same for each evening or whether they rotate; it does not matter how long the periods are; whether one hour or a half hour or even shorter.

What *does* matter is the idea.

It would protect us from the eternal sameness of turning dials one point after another to bring in nothing but repetitions of jazz and then jazz and then more jazz.

“Each Station Should Identify Itself by a Specialized Program”

By CHARLES D. ISAACSON
Program Director Station WRNY

(Winner of the second prize of \$20.00)

Just as persons, playhouses and publications have learned that it is better to stand for something definite, rather than to try to encompass everything, so it would seem radio broadcast stations might follow suit.

Magazines, even of national character, adopt a character and classification. Even newspapers are not just newspapers. Persons are specialists. Playhouses are known by type.

Radio broadcast stations, eager to please everybody and lose no one, madly endeavor to cover everything.

The station which stands for a more specialized program will do much for itself, the listeners, and a general clearing up of the situation.

This applies not only to music but to dramatics, and educational material. It is better for listeners to know when they want something—dancing, concert music, playlets, inspiration—and that there is one sure place to find it and eventually to expect to be able to tune in to the opera station, the jazz palace station, the vaudeville station; and so on.

If the vaudeville houses can run 365 days a year, and “Abie’s Irish Rose” for five years, why not radio stations with constantly altering variations of a definite policy?

Temporarily, it helps to know the set time any given impresario is serving fish, flesh or fowl—the chowder, chocolate pudding and corn-beef-and-cabbage days. The most successful features are appearing now at stated moments. Therefore, if the time has not yet arrived for stations to be replicas of the “Ladies’ Home Journal,” “Musical Courier,” Metropolitan Opera House, Keith’s vaudeville houses, and so on, at least let there be some kind of unity to any given evening.

Jumping from hot jazz to hymns is dropping the curtain on one audience and preparing for the next. Why not set the stage for an evening and allow one atmosphere to remain, with all the multiple variations which are possible?

Further, why not weave a thread, somewhat connecting the different features? The announcer, backed by the ingenious program director can keep a “plot” going, however thin or vague.



Inside Aerial and Loop Wire



Belden Aerial Wire



Lead-In and Ground Wire



Belden 20-Ft. Radio Extension Cord

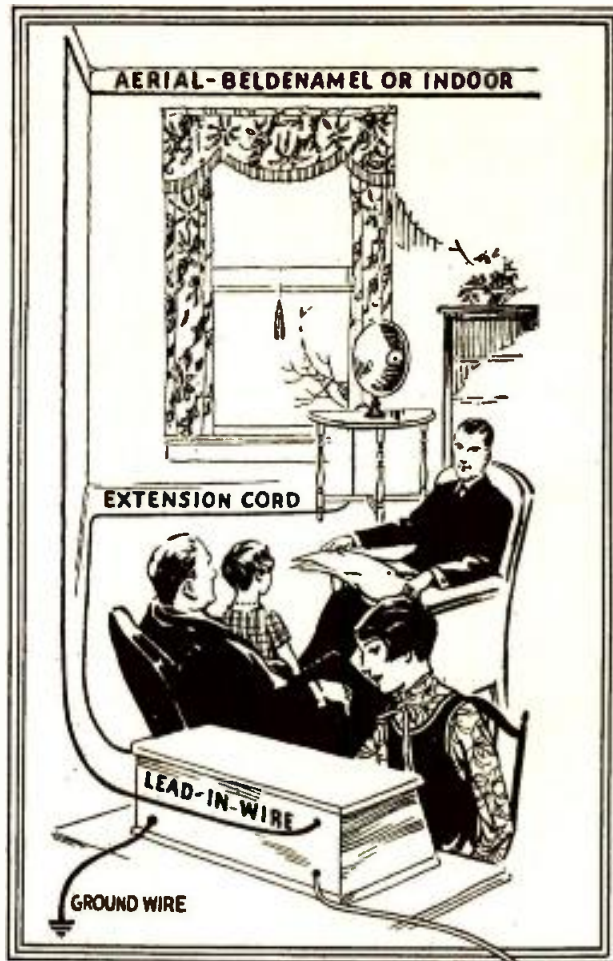

Belden Accessories that Improve Your Set

FOR an outdoor aerial, use a Belden Enamel Aerial. It cannot corrode or deteriorate. For indoor aerials, use the Belden Indoor Aerial Wire. And do not forget Belden Lead-In and Ground Wire to finish the job. All of these items are included, if you wish, in the new Belden Superadio Antenna Kit.

The Belden 20-foot Loudspeaker Extension Cord brings the loudspeaker where you want it. For safety to tubes and batteries, and protection against fire, use a Belden Fused Radio Battery Cord.

Ask your nearest dealer to explain how Belden Radio Accessories help you get better results from your set.

The Belden Fused Battery Cord provides:

- 1—An A-battery fuse.
- 2—A B-battery fuse.
- 3—A polished bakelite cover for the battery fuses.
- 4—A compact connecting cable that dispenses with loose wires.
- 5—A color-code on each wire for identifying each circuit.
- 6—A time saver, because the cord is quickly connected and easily concealed.

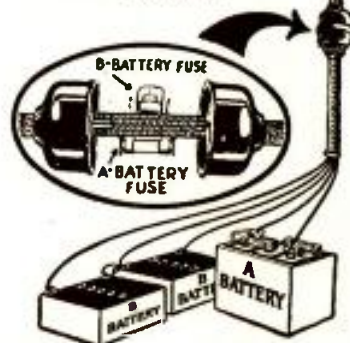

BELDEN MANUFACTURING COMPANY
2316A South Western Avenue Chicago, Illinois

THOUSANDS OF RADIO SET OWNERS need these improvements



THE U. S. Navy, the Signal Corps and 69 makers of leading standard sets use the variable resistance controls made by Central Radio Laboratories. These improved controls should be used on your set if you want the last word in quality for fine reception. Yet, owing to our huge output the cost is no more than for many inferior devices.

Modernize Your Old Set with Centralab Modu-Plug

Tone volume is, as you know, the one big improvement in this year's best sets. You can enjoy this improvement with your present receiver for only \$2.50. Modu-Plug is especially for that purpose. It provides full tone volume control from a whisper to maximum, simply by adjusting the small knob on the plug. Matches the speaker impedance to the set. Attaches instantly without tools.

Standard type Modu-Plug replaces present speaker plug. Cord type fits sets not equipped with jacks. Either type, at dealer's, or mail direct **\$2.50**

Centralab Radiohm

With "A" Battery Switch

Here is the variable resistance, guaranteed always smooth, noiseless and permanent in adjustment. Tapered to control oscillation and volume, it also has a positive, quick acting "A" battery switch. One knob replaces two. Turning knob to right lights tubes, then increases volume. To left decreases volume, then cuts off batteries. Resistance is 0 to 500,000 ohms. You cannot imagine the great improvement until you try it. Adapted to all circuits.

At dealer's, or mail direct. **\$2.30**

Centralab RheostatS

Where your old design rheostat overloads, heats-up and quickly becomes noisy on new style tubes using increased current. Centralab Ribbon-type Rheostats will operate smoothly and permanently quiet. Insulated



metal discs hold rigid a smooth flat resistance surface instead of wires, insuring even regulation and no dead spots. Every set using this rheostat is improved. 2 resistances for 5 to 10 tubes, at dealer's, or mail direct, **\$1.25**

SEND NO MONEY—If your dealer isn't supplied, order direct from us. Send no money. Simply pay postman on delivery, plus few cents postage. In-stall and test for 10 days. Then if you are not more than pleased and delighted with the wonderful results, return the goods to us and your money will be refunded. **10 DAYS'**

FREE TRIAL!
CENTRAL RADIO LABORATORIES
17 Keefe Avenue Milwaukee, Wis.

Centralab

Which brings us down to individual features. It is never necessary for even the last lonely soprano to give a disjointed fifteen minutes. It is pure laziness on her part and the station officials when her act has no rhyme or reason. Let her assume some character, let her few moments take on a color, atmosphere, idea. It's remarkable how a little intelligent juggling makes what is otherwise utterly stupid into an interesting and stimulating diversion. But it will take time and money.

A broadcast station with a small stock company of clever people in their specialty of varied specialties, rehearsed in a constant series of timely, interesting divers-tissements, would be the sensation on the air. But it would take some money, lots of ingenuity and brains.

"Prevent by Law the Interference of Broadcast Stations"

BY HAROLD MOORE

(Winner of the third prize of \$10.00)

BEFORE offering any suggestions looking to the improvement in radio broadcasting it will be necessary to discover who is getting the most out of radio and what are the benefits derived. This will further necessitate the analysis of radio programs as to their use and the class of listeners patronizing them.

Radio programs naturally fall into three grand groups:

1. The program of entertainment
2. The program of education
3. The program of business

Programs of entertainment no doubt command the largest number of listeners.

Programs of education have a small but earnest group of listeners.

Programs of business probably have the smallest total of listeners; but within this group we find one class of patrons who are deriving great practical benefits from radio. I have reference to the rural class, or specifically the farmer. Radio has been a great invention for the farmer. It has become an indispensable factor in his social and economic life; in fact, it has become a part of his everyday life, and he is depending more and more on the radio to govern his day's activities.

As this nation is an agricultural nation, depending to a great extent upon the rural element for its prosperity, and standing among the great countries of the world we can readily see that any factor promoting the interests of the farmer effects the nation as a whole, and each and every individual therein.

Therefore, what improvements can be made in radio broadcasting that will maintain this practical and beneficial feature to the third group and at the same time please the hordes of listeners in the first and second groups?

The most important improvement in radio broadcasting would be for Congress to pass a law classifying the stations and regulating the distribution of wavelengths. The public recognizes and appreciates the wonderful service given by the big stations, and these Goliaths of the air should be given permanent wavelengths, and preference in other regulations. I know of no one thing that is more annoying and detrimental to the service than to have some lesser station move up into the territory of the more important stations. A single powerful local may blot out many stations for some listeners and a few for the perfectly equipped expert. We of the midwest have to contend with a dozen powerful stations and scores of less potent but equally persistent broadcasters. Taken as a whole, the broadcasting situation is



FREE

NEW 1927 Radio Catalog

BEFORE you build or buy a radio be sure to consult our new 100 page catalog—sent to you free. All the latest kits, accessories, and parts—a million dollar radio stock to choose from.

We Save You Money

We handle only brand new apparatus—standard makes that are fully guaranteed. QUANTITY sale of QUALITY parts explains our low prices. Compare with others and see why thousands of fans look to us as radio headquarters. Write for your copy of this new catalog today.

Chicago Salvage Stock Store
Dept. PR, 509 S. State Street, Chicago, U. S. A.

FREE SIMPLIFIED BLUE PRINTS

You know how helpful, interesting and practical POPULAR RADIO is. You fully appreciate that at \$3.00 a year it is a real bargain. Consequently you should find it easy to convince one, two or more of your friends, who are not now subscribers, of the unusual value when any one of these twelve sets of Simplified Blueprints (described on Page 200) is offered free with their twelve months' subscription for POPULAR RADIO at the regular price of \$3.00. In addition to the Blueprints given to your friends we will allow you one set free for each new subscription you send us with a \$3.00 remittance. Five new subscriptions and remittance of \$15.00 would entitle you to five sets free.

Only one set of Blueprints free with a renewal subscription whether your own or a friend's.

POPULAR RADIO, INC., Dept. 23
627 West 43d Street, New York City

Enclosed is my remittance of \$.....covering annual subscriptions for POPULAR RADIO (names on sheet attached). Send me set(s) checked below.

- | | |
|-------------------------------------|-------------------------------------|
| <input type="checkbox"/> Set No. 4 | <input type="checkbox"/> Set No. 19 |
| <input type="checkbox"/> Set No. 6 | <input type="checkbox"/> Set No. 21 |
| <input type="checkbox"/> Set No. 14 | <input type="checkbox"/> Set No. 22 |
| <input type="checkbox"/> Set No. 16 | <input type="checkbox"/> Set No. 23 |
| <input type="checkbox"/> Set No. 17 | <input type="checkbox"/> Set No. 24 |
| <input type="checkbox"/> Set No. 18 | <input type="checkbox"/> Set No. 25 |

(See page 200 for description of Sets)

Name.....

Address.....

Foreign postage 50c extra. No extra for Canada.

satisfactory—but exasperating. The air lanes are overburdened and traffic regulations inefficient. A corps of air cops will have to be formed, men who will everlastingly listen in and have the authority to pull in to the curb broadcasters who are "broad" pirates who sail the air without license, and other disturbers too numerous to mention.

I believe this would be a great improvement in broadcasting and would favorably impress all groups of listeners. And the thought in this paper is a "law" governing and regulating the broadcasting stations in order that practical benefits that are now being realized may be maintained and assured, with the resultant benefit to all. This law could be hurried along by the concerted action of the broadcasting stations and the popular appeal of the radio fans to their congressman. I would like to see a radio magazine sponsor this kind of movement.

It Is Reported That—

THE radio industry now ranks 33rd on the list of large industries in the United States, taking its place with the shipbuilding, leather and chemical industries.

THE sales of radio apparatus in the United States are now twice as large as the sales of kodak and sporting goods; twice as large as carpet and rug sales, and one third as large as all furniture sales.

IN 1925 the sales of radio batteries, both dry and storage, in this country amounted to \$45,000,000—a sum equal to the sales of batteries for all other purposes except automobiles.

IN the same year \$50,000,000 was spent for vacuum tubes for radio sets and an almost equal amount for loudspeakers and similar accessories.

THE number of radio manufacturers in the United States is estimated at not less than 3,000, and perhaps as high as 5,000.

IT is estimated that nearly half a million people are employed directly or indirectly in the radio industry in the United States.

THERE are approximately 25,000 radio dealers in the United States and nearly 1,000 jobbers; 5,000 of these dealers handle radio apparatus exclusively.

IT is estimated that there are at least 350,000 radio sets in present use by farmers alone.

ABOUT fifteen colleges and universities in the United States are now giving lectures and extension courses by radio; four or five of them enroll their radio students and issue certificates upon completion of the courses.

THE average price of the present day radio set is estimated at \$80; this estimate is based on a listing of all the sets now on the market.

THE weight of the average receiving set is 13 pounds.

THE average sale per radio customer (based upon information recently obtained from a group of five representative retail stores), amounted to \$95. This compares with \$51.88 in 1924 and \$16.22 in 1923.

First in the Field
Specializing in
Cockaday Kits

S. HAMMER RADIO CO., 303 Atkins Ave. Brooklyn, New York

Cockaday Sets Now Made Easier to Build by Our New "Ready-to-Wire" Plan
50% of Your Time, Work and Worry SAVED!

All you need do is to connect bus-bar according to diagram, solder and your set is finished. These Kits are sent to you completely mounted, and assembled on a Veneered Mahogany baseboard and genuine bakelite panel, drilled and engraved. Genuine parts used as listed below; exactly as used in Mr. Cockaday's Laboratory Model. COMPARE OUR OFFER!

LC-27 BROADCAST RECEIVER

SENIOR AND INTERMEDIATE POWER PACKS

1 Hammarlund mid-line dual condenser, .000275 mfd. \$ 7.50	1 Samson radio-frequency choke coil #85... \$1.50
1 Hammarlund mid-line single condenser, .000275 mfd. 4.65	3 Aerovox, mica fixed condensers, .00025 mfd. 1.05
1 Precision Duo-Octoform coil set comprising one antenna coupler and two inter-stage couplers. 10.50	1 Durham or Daven Resistor 4 meg. .50
1 Amertran De Luxe first stage transformer. 10.00	1 Lynch Grid Leak Mounting. .35
1 Amertran De Luxe second-stage transformer. 10.00	1 Carter Gem Jack. .25
1 Amerchoke # 854. 6.00	1 Carter variable resistance, 0-10,000 ohms. 2.00
1 Dubiller or Tobe 4 mfd. Filter condenser. 5.50	12 Eby binding posts. 1.80
1 Dubiller filter condenser, .1 mfd. .60	5 Benjamin UX Sockets. 3.75
1 Mar-Co Illuminated control, scale 0 to 100 3.50	1 Amperte No. 1. 1.10
2 Mar-Co small controls scale 0 to 50 and 50 to 0. 1.50	Mechanical Kit consisting of aluminum shields, binding post strip, decorated panel and Talt. brackets. 12.50
1 Carter Battery Switch. .65	

READY-TO-WIRE KIT PRICE **\$85²⁰**

LC-27 SENIOR POWER PACK KIT \$65²⁰

LC-27 INTERMEDIATE POWER PACK KIT \$47⁵⁰

SILVER SHIELDED SIX KITS *In Stock Now!*

HAMMARLUND-ROBERTS HI-Q KITS

Authorized Headquarters for the NEW! KENNETH HARKNESS KH-27 Receiver

The Above Kits Can Also be Obtained
Completely Wired to Specifications

Write for our interesting special circular which we have prepared
on the LC-27 Receiver and above Kits.

Authorized service station for the LC-27.

DEALERS: WRITE FOR SPECIAL DISCOUNTS

Bradley-Amplifier

Resistance-Coupled
PERFECT AUDIO AMPLIFIER



Provides audio amplification with minimum distortion. Bradley unit molded resistors used in the Bradley Amplifier do not vary with age and are not affected by atmospheric conditions. Can be used to replace transformer amplifiers in standard radio sets with decided increase in tone quality.

Allen-Bradley Co.

Electric Controlling Apparatus

276 Greenfield Avenue Milwaukee, Wis.

Bradley Leak

THE PERFECT GRID LEAK



Provides a noiseless range of grid leak resistance from 1/4 to 10 megohms. Assures most effective grid leak resistance value for all tubes. Small grid condenser (0.00025) is separate. Metal parts nickel plated. One hole mounting.

Allen-Bradley Co.

Electric Controlling Apparatus

276 Greenfield Avenue Milwaukee, Wis.



No. 3527 Unit

Increase the Volume of Your Present Set

It is easy now to get much greater undistorted power from your present radio receiver whether it has 2 tubes or 8 tubes. At the same time and at little additional expense you eliminate the need of B-batteries.

No. 3527 Unit Full Wave Rectifier

for use with

one UX 213 tube and power amplifier UX No. 171 tube. This unit includes one No. 2505 transformer and two No. 514 chokes. Full Power and B-battery Eliminator. No. 3527—\$15.00 List

No. 3516 Full Wave Rectifier

for use with

one Raytheon BH tube and one UX No. 171 tube. This unit includes one No. 2593 transformer and two No. 514 chokes built into substantial metal case. Exceptional power for all purposes. Eliminates B-batteries. No. 3516—\$13.00 List

Fans—Send check or money order to factory if your dealer cannot supply you. Deliveries are prompt. Manufacturers—As exclusive parts manufacturers Dongan offers the receiver and battery eliminator manufacturer a reliable source of supply. Our engineering department will co-operate with you in effecting the proper designs of the latest types for your requirements. Ask for a representative or send your specifications.

DONGAN ELECTRIC
MANUFACTURING COMPANY
2983-3001 Franklyn St. Detroit, Mich.

What Really Comes Through Your Transformer?



We know what you want to get out of your set. Everyone wants it. It is clear, pure-toned reception—and you don't want to miss a note from the muffled base of the kettledrum or the profound booming of the bass-viol to the shrill "sky-high" tones of the fife and piccolo.

So much depends on your circuit, so much on your speaker—but even more on your transformers. To render sweet music and to get the full range of orchestral or instrumental performance, the transformer must faithfully reproduce all frequencies.

The FERRANTI transformer meets every condition of good audio reception

By installing Ferrantis you can modernize your old set or perfect your new one. With its amplification curve an almost straight line, Ferranti will give you an uncensored message from the sending station.

Ask your dealer for Ferranti Transformers. If he does not carry them, write us and we shall tell you where you can get them. No better transformer is available at any price.

HIGHSPOTS

- High amplification ratio with flat curve.
- Ferranti brings out the fundamental frequency of low tones—none are heard merely by inference from higher harmonics.
- Every transformer tested ten times—all short-circuit turns eliminated.
- Windings have high impedance.
- Built by an established manufacturing company with forty years' experience in the winding of coils of fine wire for electrical instruments and meters.
- Primary shunted with built-in condenser of correct capacity.
- Tested to 2000 volts between primary and secondary and between primary and secondary and ground.

FERRANTI, Inc.
130 West 42nd Street
New York, N. Y.



WITH THE EXPERIMENTERS

CONDUCTED BY RICHARD LORD

How Power Tubes Improve Reception

POWER tubes are power handlers, not power producers as many think.

Of itself, a power tube will not produce more volume than a non-power tube. The value of a power tube lies in the fact that its design permits it to handle greater volume without distortion.

Most receiving sets are capable of delivering more volume to the last audio tube than can be handled without distortion by the usual types of amplifying tubes. This is where the power tube is needed—in the last audio stage—where it can receive the volume developed in the earlier stages of the set and pass it on, amplified but undistorted, to the loudspeaker.

The electrical characteristics of power tubes are quite different from those of the customary amplifying tubes. Power tubes consume more "B" battery current and they require greater "C" battery voltage.

The wrong "C" voltage robs the power tube of its ability to handle greater volume without distortion. In addition, if the "C" voltage is too low, the "B" current consumed by the tube is multiplied many fold, which rapidly

exhausts the "B" battery. Merely substituting a power tube for some other tube in the last audio stage of a receiver will not bring about any noticeable improvement in reception. Provision must be made to allow placing the correct "C" voltage on the grid of the power tube.

The newest power tubes are the CX-371 and UX-171. These tubes can be operated on "B" battery voltages of 90, 135 or 180 volts. For ordinary home use, 135 volts of "B" battery will supply ample for the CX-371 and UX-171 power tubes.

With these tubes, when the "B" battery voltage is 135 volts, the "C" battery voltage should be 27 volts. A new 22½-volt "C" battery has been introduced by one of the battery manufacturers, and, when connected in series with a 4½-volt "C" battery, the combination will deliver the 27 volts required by these power tubes operating at 135 volts of "B" battery.

—N. W. AYER

Two Useful Tables for the Coil Winder

HERE are two tables that the amateur will find many uses for.

TABLE I

Turns Per Inch of Magnet Wire on Coils					
size B & S gauge	enameled	single- cotton- covered	double- cotton- covered	single- silk- covered	double- silk- covered
20	29	25	23	27	26
21	32	28	26	31	29
22	36	31	28	34	32
23	41	34	31	38	36
24	43	37	33	42	39
25	51	41	36	47	43
26	56	43	39	52	46
27	64	49	42	57	52
28	71	54	45	63	56
29	79	58	48	70	63
30	88	64	56	77	67
31	100	69	57	85	72
32	112	75	60	93	78
33	134	81	64	102	84
34	140	87	66	112	91
35	156	94	73	120	97
36	173	101	78	130	104
37	201	108	84	141	110
38	225	115	89	151	117
39	256	122	95	163	123
40	288	130	102	179	129

The first table may be used to determine how much wire will be necessary to wind coils of various sizes and kinds of magnet wire and to aid in calculations of inductance and resistance.

The second table will give the number of inches of wire around a core of a given diameter and also the circumference of the core's diameter. It may be used in the calculation of resistance and inductance as well.

TABLE II

Number of Inches of Wire Around a Core of a Given Diameter		
diameter in decimals	diameter in fractions	circumference
.25	1/4	.785400
.50	1/2	1.57080
.75	3/4	2.356200
1.0	1	3.1416
1.50	1 1/2	4.71240
2.0	2	6.2832
2.5	2 1/2	7.85400
3.0	3	9.4248
3.5	3 1/2	10.99560
4.0	4	12.5664
4.5	4 1/2	14.13720
5.0	5	15.7080
5.5	5 1/2	17.27880
6.0	6	18.8496
6.5	6 1/2	20.42040
7.0	7	21.9912
7.5	7 1/2	23.56200
8.0	8	25.1328
8.5	8 1/2	26.70360
9.0	9	28.2744
9.5	9 1/2	29.84520
10.0	10	31.4160
10.5	10 1/2	32.98680
11.0	11	34.5576
11.5	11 1/2	36.12840
12.0	12	37.6992

—FREDERICK J. RUMFORD

A Smooth Control for Regeneration

In my article on regeneration, "The Radio Road Hog," which appeared in the October issue of POPULAR RADIO, I did not have space to describe one other efficient and recent type of regeneration control.

The circuit diagram for this method of control is shown in Figure 1.

In this illustration, L is the secondary and L1 is the fixed tickler. The plate connection from the detector tube is direct to the following transformer; this is similar to the arrangement of the wiring for a non-regenerative set.

An additional connection from the

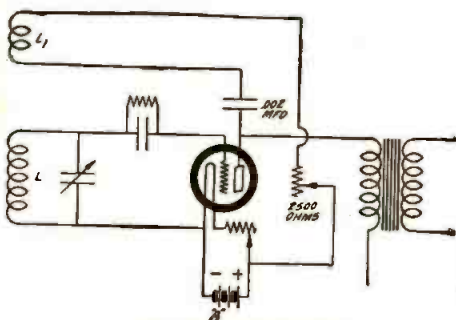

A SMOOTH CONTROL

FIGURE 1: This diagram shows an additional method, suggested by Mr. Roberts which will give a smooth control of regeneration in the receiver.

And Now Announcing!

CARBORUNDUM GRID LEAKS AND COUPLING RESISTORS

Reg. U.S. Pat. Off.

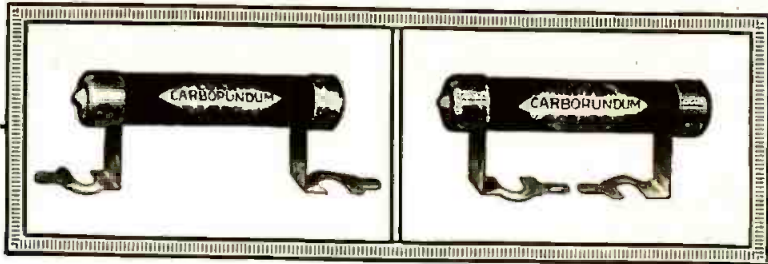

ABSOLUTELY noiseless—

Do not disintegrate with use or time—

No metallic film but instead a solid rod of dense unbreakable Carborundum—one of the greatest of all electrical resisting materials.

Made in all standard values and tested under actual operating conditions.

Grid Leaks or Resistors from your dealer or direct, 35c. each

Send for the new Carborundum Hook-Up Book D-5

THE CARBORUNDUM COMPANY, NIAGARA FALLS, N. Y.

Sales Offices and Warehouses in

New York • Chicago • Boston • Philadelphia • Cleveland • Cincinnati • Detroit
Pittsburgh • Milwaukee • Grand Rapids
The Carborundum Co., Ltd., Manchester, Eng.

Bradleystat

PERFECT FILAMENT CONTROL



Provides complete noiseless filament control for all radio tubes without change of connections. Metal parts are nickel plated. One hole mounting. Self contained switch opens battery circuit when desired.

Allen-Bradley Co.

Electric Controlling Apparatus

276 Greenfield Avenue Milwaukee, Wis.

Bradleyometer

THE PERFECT POTENTIOMETER

Uses graphite disc resistors which are noiseless and not affected by atmospheric conditions. Metal parts are nickel plated. One hole mounting. Finish and knob match Bradleystat. Made in 200 and 400 ohm ratings.

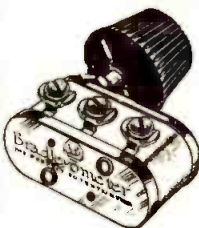

Allen-Bradley Co.

Electric Controlling Apparatus

276 Greenfield Avenue Milwaukee, Wis.



AC 12 - - - \$30

Amplion Cone superiority lies in its clear reproduction of speech

—this is the supreme test of radio reproducers, especially the Cone Type.

The Amplion Cone is enclosed in a handsome mahogany cabinet, 14" x 14" x 9"

No matter what set you may use, the Amplion Cone will help it to give you its best performance.

Amplion reproducers range from \$12 to \$50

Have your dealer give you a demonstration or write for illustrated Amplion booklet which describes all models.

THE AMPLION CORPORATION OF AMERICA
Suite X, 280 Madison Avenue
New York City

The Amplion Corporation of Canada Ltd.

AMPLION

Two Times Two!

"Built Better" —this always has been, and is the policy of AEROVOX.

One year ago the demand for high grade Fixed Mica Condensers, Filter Condensers, Power Supply Condenser Blocks, and Lavite Resistances forced us to double our floor space and equipment.

Today, even though we are now operating on a 24 hour schedule, we are *again* compelled to double our facilities. With our present plant in full swing—without costing our customers one single production day—we are moving to new quarters at 60-72 Washington St., Brooklyn, N. Y.

"Two times two"—this is our growth for the year just passing. Does the "Built Better" policy pay? AEROVOX thinks so. More than 200 radio manufacturers and thousands of you fans evidently think so, too.

Wherefore, we thank you!



plate of the detector is made through and to the tickler, with a .002 mfd. fixed condenser in series, to keep the "B" (+) plus out of the tickler circuit. The other terminal of the tickler is connected through a variable high resistance to the "A" (+) plus line, between the "A" battery and the rheostat.

While it is not always possible to install this method in a standard set, due to the fact that the condenser and the resistance are in the tickler circuit, thus reducing the efficiency of the tickler to some extent, it may be recommended for a tickler that is hard to control through excessive regeneration on the low waves, and it furnishes a very smooth and positive control of regeneration.

In building a coil for the arrangement, it is generally necessary to add a few turns to the specified number on the tickler windings, in order to balance the added resistance in the circuit of the condenser and the variable resistor.

—J. E. ROBERTS

Modifications of the Browning-Drake Circuit

MANY questions have come to our attention concerning the numerous Browning-Drake receivers which have been described in various magazines.

All these receivers have the same radio-frequency amplifier and simply differ in the layout of the apparatus and in the type of audio-frequency amplifier used. To state that one particular set is better than another is saying that the type of audio amplifier that is employed in any one of the sets is preferred by the designer. Experimenters know that the various types of audio amplifiers—resistance, impedance, transformer, and combinations of the above—all have their good and bad points.

The success or failure of a particular receiver usually lies in the radio-frequency part of the circuit and not as a rule in the audio-frequency end. Therefore, the home constructor should be extremely careful, in building any of the various Browning-Drake sets, to have the wires from the plate of the radio-frequency tube kept well separated from all other wires. This same statement applies to the connections to and from the balancing circuits and to and from the grids of the radio-frequency and detector tubes.

How to Build a One-Tube Receiver for \$25.00

In the March issue of POPULAR RADIO, will appear the first constructional article on the Univalve Receiver—which contains but two tuning dials and a switch on the panel and employs a new type of tube that accomplishes reception equal to that of most ordinary four or five-tube sets.

Build this set; it will be a marvel to your friends and acquaintances.

BROADCAST LISTENERS

The POPULAR RADIO ATLAS and LOG will give you a list of all the NEW Broadcasting Stations with wavelengths and other necessary information

A Complete Atlas and Station Log The "POPULAR RADIO International Radio Atlas and Log" will supply you with full information regarding broadcasting stations of the United States and Canada.

This most useful and practical Atlas consists of 16 pages, size 12" x 16", printed on good paper, from clear type in two colors and contains a complete series of double page maps, including—The World—The United States—Canada—North and South America, showing location of principal broadcasting, leading commercial and governmental radio stations.

SPECIAL FREE OFFER

You may have a copy of the "POPULAR RADIO International Radio Atlas and Log" free, with POPULAR RADIO for (3) eight months.

For Only \$2.00

Pin \$2.00 in bills to the coupon below. If you are a subscriber to POPULAR RADIO your subscription will be extended eight months.

Date.....

POPULAR RADIO, Dept. 22A
627 West 43rd St., New York City.

Enclosed is my remittance of \$2.00 for which you are to enter my subscription (extend my subscription) for (3) eight months for POPULAR RADIO and send FREE a copy of the "POPULAR RADIO International Radio Atlas and Log"

Name.....

Address.....

City..... State.....



Double Enjoyment Volume with Perfect Tone

Why sacrifice the excellent reproducing qualities of a set by the use of an inferior speaker. Proper design and construction has produced in the BURNS Speaker a most satisfying instrument. It is possible to reproduce with amazing exactness every note of music and inflection of the voice that the set is capable of picking up. A trial will convince.

At Your Dealer's or Write Direct

American Electric
COMPANY

STATE AND 64TH STREETS
CHICAGO, U. S. A.

Ask about BURNS B-Eliminator

The 2 ampere Tungar will Trickle Charge, too!

Trickle charge a 6 volt battery from one post. Give it a full charge from another. The 2 ampere Tungar charges ALL radio "A" and "B" storage batteries—and auto batteries also. It's a simple matter of connection. Just look at this diagram.

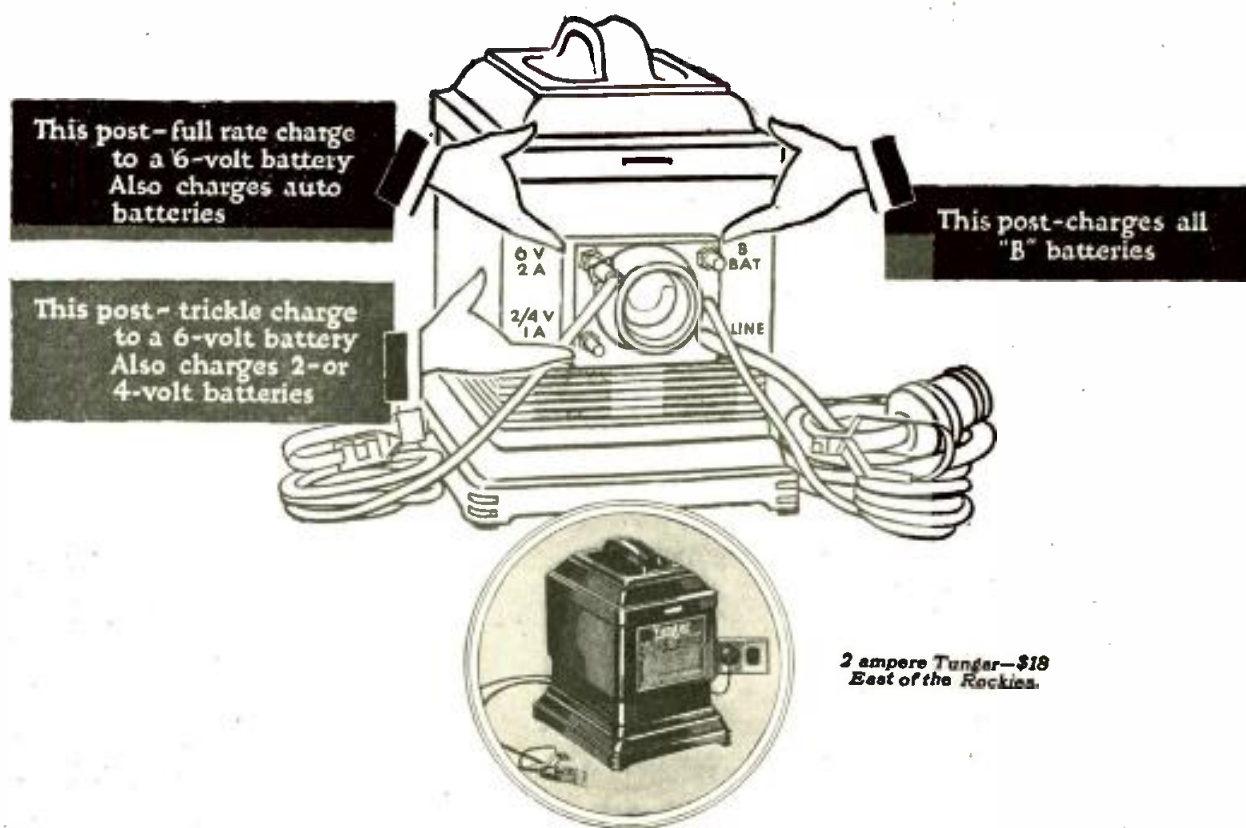

 **Tungar**
 REG. U.S. PAT. OFF.
BATTERY CHARGER

Merchandise Department
 General Electric Company
 Bridgeport, Connecticut

Tungar—a registered trademark—is found only on the genuine. Look for it on the name plate.

GENERAL ELECTRIC



Have you changed it Lately?

FEW people realize what a remarkable improvement they can secure in tone quality by occasionally changing the Resistors in their sets.

Remember that the characteristics of tubes and batteries constantly change. Even when you replace old tubes with new ones there is always a variance.

Changing values within your set require Resistors of proportionately different values if you are to have the harmony and unison of all elements which affects perfect reception.

Most internal Receiver noises are NOT from faulty tubes, "B" batteries or loose connectors, but are purely the result of unstable grid Resistors.

Wise radio owners keep several extra Durham Resistors, of various ranges from 1 to 5 megohms, on hand and occasionally change them to meet varying conditions. Try it yourself and note the immediate improvement in tone quality.

(500 Ohms to 10 Megohms)

DURHAM METALLIZED RESISTORS

INTERNATIONAL RESISTANCE COMPANY

Dept. A, 1936 Market St. PHILADELPHIA, PA.



IN THE WORLD'S LABORATORIES

CONDUCTED BY DR. E. E. FREE

Another Proof that All Ether Waves Are Alike

ANOTHER step in proof of the similarity of all kinds of ether waves, from the longest waves of radio to the shortest waves of Dr. Millikan's cosmic rays, has been taken by Dr. A. Dauvillier, of the Laboratory for Physical Research on X-rays, in Paris. It will be remembered that one of the gaps long existing in the series of ether waves was closed some time ago when the late Dr. E. F. Nichols and Dr. J. D. Tear proved that the shortest radio waves could be measured on the same apparatus upon which were detected the longest of the waves of heat. Similarly, these longest heat waves were detected by typical radio

apparatus, thus completing the proof that long heat waves and the very short radio waves are identical.*

On the other side of the waves of visible light, being shorter than these visible waves whereas the heat waves are longer than them, there has long been another portion of the ether-wave series which, while not containing an actual gap, has been insufficiently explored. This is the region between the longest of the X-rays and the shortest of the rays of ultraviolet light. Few physicists have doubted, as a matter of theory, that ultraviolet light and X-rays were connected by a region of uniform

*"The Shortest Radio Waves Ever Produced by Man," by Ernest F. Nichols. POPULAR RADIO, Volume 4, Pages 22-29 (July, 1923):



Delano, Paris

HE MEASURES X RAYS LIKE OTHER ETHER WAVES

In addition to examining the X rays with spectrographic apparatus, Dr. A. Dauvillier, of Paris, has also measured their intensity with a photoelectric cell, similar to the cells used for light rays. This supplies another proof that all ether waves, including radio waves, belong to one continuous series.

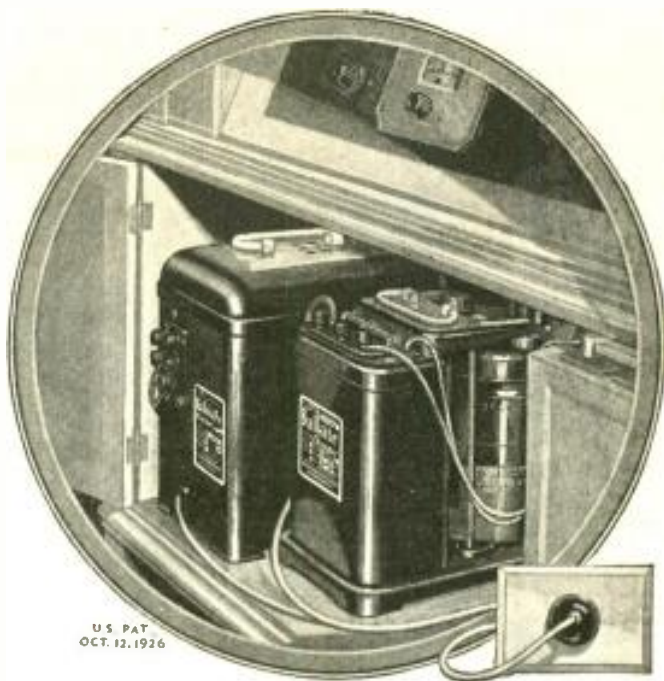

Make your radio set a light socket receiver now with Balkite "B" and the new Balkite Trickle and High-Rate Charger



Balkite Trickle Charger \$10

For those who require a charger of limited capacity only. Can be left on continuous or trickle charge thus automatically keeping the battery at full power. Charging rate about .5 ampere. Over 300,000 in use. Price \$10. (West of Rockies \$10.50. In Canada \$15.)



Balkite Combination

Once connected to your "A" battery, supplies automatic power to both "A" and "B" circuits. Controlled by the filament switch on your set. Entirely automatic in operation. Serves any set now using either 4 or 6-volt "A" batteries and requiring not more than 30 milliamperes at 135 volts of "B" current—practically all sets of up to 8 tubes. Price \$59.50. (In Canada \$83.)

All Balkite Radio Power Units operate from 110-120 volts AC current with models for both 60 and 50 cycles. The new Balkite Charger is also made in a special model for 25-40 cycles.

Now, with the best portion of the radio season before you, make your radio set a light socket receiver by adding Balkite "B" and the new Balkite Charger.

Balkite "B"—the proved "B" power supply—eliminates "B" batteries entirely and supplies "B" current from the light socket. The new Balkite "B"-W serves any set of 5 tubes or less requiring 67 to 90 volts; Balkite "B"-X sets of up to 135 volts and 8 tubes [illustrated]; Balkite "B"-Y any standard set. Most owners of even small sets will buy Balkite "B"-X for its reserve power.

The new Balkite Charger with both high and low charging rates combines the advantages of both trickle and rapid charging. At the low rate, on

trickle charge, it automatically keeps your "A" battery fully charged, and in effect converts it into a light socket "A" power supply. Its high rate provides an ample reserve of power for the largest sets.

Both Balkite "B" and the Balkite Charger are entirely noiseless in operation. Both are permanent pieces of equipment, with no bulbs and nothing to wear out or replace. Other than a slight consumption of household current, their first cost is the last.

Add these two Balkite Units to your receiver now. Then you too will know the pleasure of owning a radio set always ready to operate at peak power. Ask your dealer. *Fansteel Products Company, Inc., North Chicago, Illinois.*

Balkite Charger \$19.50. (West of Rockies \$20. In Canada \$27.50.) Balkite "B"-W \$27.50. "B"-X \$42. "B"-Y \$69. (In Canada "B"-W \$39. "B"-X \$59.50. "B"-Y \$96.)

[Walter Damrosch and the New York Symphony on the air
Every other Saturday night a symphony concert. On alternate Saturdays
one of Mr. Damrosch's famous piano recitals. Over stations: WEAf,
WEEL, WGR, WFI, WCAE, WSAI, WTAM, WWJ, WGN, WCCO,
KSD, WDAF, WOC, WCAP. Balkite Hour 9 P. M. Eastern Time.]

FANSTEEL
Balkite
Radio Power Units

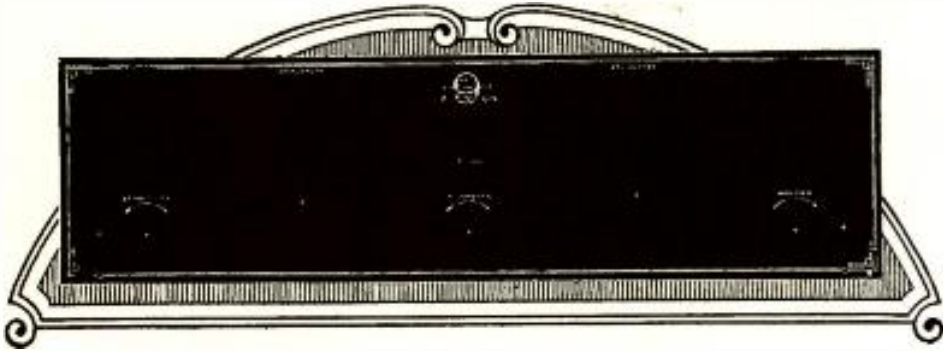

Formica Kit Panels

From one end of the country to the other, home set builders are producing handsome radio sets by the use of Veri Chromed Formica panels for the leading kits.

These panels include the Karas Equamatic, Bremer Tully Power Six, H. F. L. Nin-in-Line, Superheterodyne with sub panel, Victoreen single dial and two dial. There is also an Infradyne 7x28" and 7x30", Aerodyne, St. James 8 Tube, Bremer Tully Counterphase, Browning Drake National, Madison Moore Superheterodyne, Camfield Duoformer, two styles of Best's Superheterodyne. They are sold by the leading jobbers and dealers.

Special panels cut to size and Formica Tubing are also available for amateurs.

The FORMICA INSULATION COMPANY

4641 SPRING GROVE AVENUE

CINCINNATI, OHIO

Hear the FORMICA
Orchestra Tuesday
9 to 10
over WLW

FORMICA

Formica has a
Complete Service on
Insulating Material
for Radio Manu-
facturers

Sheet Copper for Shielding

Shielding

Prevents aerial radiation and feedback.

Insulates against interference from adjoining circuits.

Improves efficiency, selectivity and tone quality.

USE SHEET COPPER
because it combines low resistance with easy working qualities.

COPPER & BRASS
RESEARCH ASSOCIATION
25 Broadway — New York

CARTER

"HI-OHM" Volume Control

(Full Size) (PAT. PEND.)



SIX TYPES
10,000 to
500,000
Ohms
\$2.00

Complete
with Knob

Banish fear from your set. Carter parts are your insurance that your set will perform and give satisfaction. Each part is an original design for a specific purpose. The better set designers designate Carter Parts. They stake their reputations on Carter results.

Any dealer can show you why.

In Canada: Carter Radio Co., Limited, Toronto

CARTER RADIO CO.
CHICAGO

gradation, the shortest light rays being virtually indistinguishable from the longest X-rays. The contribution of Dr. Dauvillier is that he has succeeded in covering this somewhat doubtful region of ether waves by a continuous spectrographic methods which are employed with ordinary light waves.†

It is found, as was expected, that the longest X-rays respond to these spectrographic methods in exactly the same manner as do the shortest ultraviolet rays. Again, we have proof that all of the ether waves are alike. This leaves in the whole series of ether waves only the relatively narrow gap between the gamma rays of radium, which were the shortest waves known until recent years, and the new cosmic rays of Millikan, which are a little shorter. No physicist is much concerned by this gap, as everyone feels sure that the rays which occupy it will be of exactly the same character as the gamma rays and the cosmic rays.

Whatever be the exact physical nature of the thing which we call radiation, including radio waves, light and all the rest, this thing is evidently the same throughout the entire ether-wave series. The cosmic rays of Millikan, the visible rays of light, the new rays in the ultraviolet-X-ray region investigated by Dr. Dauvillier; all are of the same fundamental nature.

†"The discovery of the Characteristic Series O and N of low frequency. A Spectrographic Junction between the X-rays and the Extreme Ultraviolet" (in French). *Comptes Rendus de l'Académie des Sciences* (Paris), volume 183, pages 656-658 (October 18, 1926). Dr. Dauvillier also published an equivalent note in English in *Nature* (London), volume 118, page 551 (October 16, 1926).

A Radio Glow Phenomenon That is Worth Studying

An interesting line of experimentation which may have, it appears, important possibilities of radio development is mentioned in a brief note signed "B. A. R." in a recent issue of *Amateur Wireless*.* According to this note, if a quartz crystal, similar to those now in common use as control oscillators in radio transmission circuits, be cut into the shape of a rod and placed in a tube containing low-pressure neon gas, this quartz rod will glow when set into oscillation by means of electric energy. The glow results, doubtless, from the electrification of the neon gas in the same manner as in the ordinary neon lamps.

When the frequency of the electric energy supplied to the quartz crystal is the same as the fundamental frequency of oscillation of the crystal itself the whole crystal glows uniformly, B. A. R. reports, with the neon glow. But when the frequency applied to the quartz crystal corresponds with one of the harmonics of that crystal, the neon glow then takes on a banded appearance, the crystal being illuminated in bands which encircle it like painted stripes.

*"Luminous Crystals," by B. A. R. *Amateur Wireless* (London), volume 9, page 735 (November 20, 1926).



The New 6-Tube



With Donle Truphonic Audio Amplification

which delivers pure tone in any volume over the entire tonal scale, and the patented Elkay Synauto R. F., which smooths out the tuning over the whole dial from 200 to 580 meters ... is a receiver that will be modern for years to come.

Completely shielded. Neat Uni-Control—the flexibility of 3 dials at your finger tips. In brown antique, Duco-finished mahogany, \$125. (Exclusive franchise to the Trade).

The Langbein-Kaufman Radio Co.
Dept. P.

62 Franklin Street New Haven, Conn.

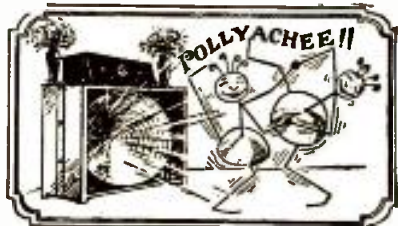

With the "Ensko 3 ft. Cone Kit" you can make your own Cone Speaker in less than an hour—You can then enjoy all of the True Tones of Music without distortion.

Complete parts furnished in kit form. We guarantee this speaker the equal of any manufactured cone speaker at any price. With this THREE FOOT CONE SPEAKER you hear all the tones. It brings out the true depth and beauty of orchestral and instrumental music. Can be operated softly for living room music or full volume for dancing, and without trace of distortion. Kit includes famous "ENSCO" cone unit, the only direct drive, distortionless unit for large cones; Alhambra Fonotex for big cone, with brass apex, two Sepia Prints showing cabinet or simple stand construction. All necessary instructions.

Buy this wonderful speaker under our absolute guarantee. Your money back if you are not convinced that it is the finest reproducing medium obtainable at any price. It works on any set, with ordinary Tubes or with Power Output.

ORDER COUPON—SEND NO MONEY

Write your name plainly as indicated below, then mail and complete kit will be forwarded to you. Just pay postman \$10.00 upon delivery.

Name.....

Address.....

ENGINEERS' SERVICE CO.
25 CHURCH ST. Desk Z NEW YORK CITY

The New British Radio Beam Service

On October 25, 1926, the British Post Office Department, jointly with the Marconi Company, began commercial service from England to Canada over the beam-system radio link, stations for which have been under erection for months. A week's test prior to that date had shown the system capable of handling an average of 600 letters per minute, this speed being maintained simultaneously in both directions. On October 26, the day after the announcement of the successful tests of the system, Senator Marconi delivered the James Forrest Lecture of the Institution of Civil Engineers in London, taking for a part of his subject the recent accomplishments and probable future of this new low-power system of long-distance radio. Few recent radio advances have attracted more public attention than the installation thus emphasized and described.

The beam-system consists, as has been described often in POPULAR RADIO, of a transmitting antenna which sends off the major part of the emitted energy in a given direction, instead of scattering that energy broadcast through space. The transmitting antennas have been worked out during several years of tests conducted by the Marconi Company, under the direction of Senator Marconi himself and of Dr. Franklin. Essentially they are great wire screens or curtains, usually constructed of a series of hanging wires. There are two of these curtains, one behind the other. The forward curtain (in the direction in which the radio beam is to be sent) is energized by the transmitting oscillator. The other curtain serves as a "reflector" for the energy, in almost exactly the same way as was demonstrated by Dr. Heinrich Hertz, the discoverer of radio waves, nearly forty years ago.

The wavelength used in the present beam links is approximately one hundred meters. Twenty kilowatts has been found to be sufficient power for the service between England and the Canadian installation, near Montreal. Additional transmitting and receiving stations are being built, faced in the proper directions for beam communication between England and the other dominions of the British Empire. Unfortunately, the beam system cannot yet be applied to the longer wavelengths, the necessary dimensions of the transmitting and reflecting curtains being impracticably large.

The development now needed is some discovery which will permit the sending of directed beams of the relatively long waves from curtains and reflector which are smaller in size than the wavelength of the frequency to be used. No system that promises to accomplish this purpose is visible at the present time.

ASK... ANY... RADIO... ENGINEER



With the "Trouble-Shooters" of the North Atlantic

ICE-BERGS—towering, ponderous, deadly mountains of ice drift southward from the ice fields of the Arctic into the traffic lane of trans-Atlantic steamers.

Locating and destroying them is the perilous and never-ending duty of the United States Coast Guard Cutters.

Shell fire and high explosives, however, often fail to blow the bergs from the sea, and warnings are then broadcast by radio to every ship whose course lies through the danger zone.

Smooth power, unfailing dependability over long periods and under all conditions of service are qualities demanded in the radio batteries used in this dangerous naval service.

The fact that Burgess Batteries meet those requirements recommends them to you for your own receiving set.

Ask Any Radio Engineer

BURGESS BATTERY COMPANY

GENERAL SALES OFFICE: CHICAGO

Canadian Factories and Offices:
Niagara Falls and Winnipeg



BURGESS RADIO BATTERIES

SANGAMO

Mica Condensers in intermediate sizes



IMPROVE
TONE
RANGE
AND
VOLUME

IT is accuracy, not luck, that makes one receiver sweeter and more powerful than another that is almost its twin. Especially condenser accuracy, for the closer you come to absolute accuracy at these critical parts, the more wonderful your receiver will be. The cost of accurate condensers is small—the effect is immense.

Now you can get Sangamo Mica Condensers in capacities in between the usual stock sizes so you can build with greater accuracy than ever before. They are guaranteed to be accurate, and they always stay accurate, being solidly molded in bakelite. Neither heat, cold, moisture, pressure nor acid fumes will affect their capacity, because bakelite seals the delicate parts against all outside influences.

Capacities in microfarads and prices

0.00004	0.001	} 50c.
0.00005	0.0012	
0.00006	0.0015	
0.00007	0.00175	
0.00008	0.002	
0.0001	0.0025	} 60c.
0.00012	0.003	
0.00015	0.0035	
0.000175	0.004	
0.0002		
0.00025	0.005	70c.
0.0003	0.006	85c.
0.00035	0.007	90c.
0.0004	0.0075	95c.
0.0005	0.008	\$1.00
0.0006	0.01	1.15
0.0007	0.012	1.20
0.0008	0.015	1.25

With Resistor clips. 10c. extra.

Also Sangamo By-Pass Condensers

1/10 mfd. 80c.	1/2 mfd. 90c.
1/4 mfd. 80c.	1 mfd. \$1.25

Sangamo Electrical Company

6332-1

Springfield, Illinois

RADIO DIVISION, 50 Church Street, New York

SALES OFFICES—PRINCIPAL CITIES

For Canada—Sangamo Electric Co. of Canada, Ltd., Toronto.

For Europe—British Sangamo Co., Ponders End, Middlesex, Eng.

For Far East—Ashida Engineering Co., Osaka, Japan

Electricity in the Upper Air

STUDENTS of atmospheric electricity, which now ought to include all students of radio, will be interested in a recent French study made by measurements in balloons and extending to altitudes as great as 20,000 meters (over 12 miles).* On the average, the intensity of the electric forces in the atmosphere was found to decrease up to an elevation of about five miles. Below about two miles the change of the electric field was approximately 10.4 volts per meter. At four miles this had decreased to 2.3 volts per meter. At still higher elevations the electrification again increased, so that fields as great as 40 volts per meter were found at elevations of five to six miles above the ground.

*"Records of the Electrical Field of the Atmosphere Up to 20,000 Meters" (in French), by P. Idroac. *Comptes Rendus de l'Académie des Sciences* (Paris), session of June 28, 1926.

A Novel Neon Oscillator

A NOVEL combination of a neon lamp and a selenium cell, for operation as an audio-frequency oscillator, is described in a recent note by Mr. T. Thorne Baker, the well-known English physicist.* The light of the neon lamp is produced, as is now well known, by the excitation of the atoms of neon gas inside the globe. Under proper conditions of operation a direct-current supply to this lamp produces a glow which seems to the eye to be continuous. In

*"A Remarkable Selenium Cell," by T. Thorne Baker. *Amateur Wireless* (London), volume 9, page 634 (November 6, 1926).

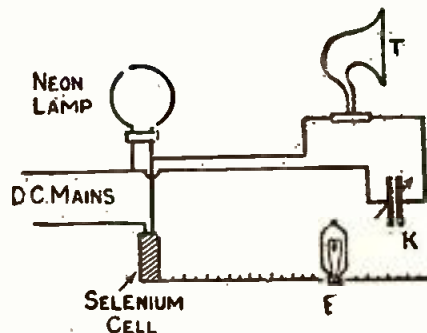

From *Amateur Wireless*

This diagram shows an experimental hook-up in which a selenium cell is used to control the frequency of a neon-lamp oscillator.

reality, however, this neon glow is intermittent.

The pulses of light from the neon lamp correspond, of course, to electric pulses in the circuit with which the lamp is connected. These may be used to produce a low-frequency current, either for direct supply to a loudspeaker or for amplification in the usual way. The frequency of the pulsations of the neon lamp is altered by the resistance in its current-supply circuit. Mr. Baker's device makes use of a selenium cell to provide this alteration in the resistance. The selenium cell being inserted in this current-supply circuit and the rays of an ordinary electric lamp being allowed to fall on the cell, the alteration of the intensity of this light, conveniently arranged for by moving the lamp backward and forward, produces a corresponding change in resistance of the selenium and thence in the frequency at which the lamp oscillates.

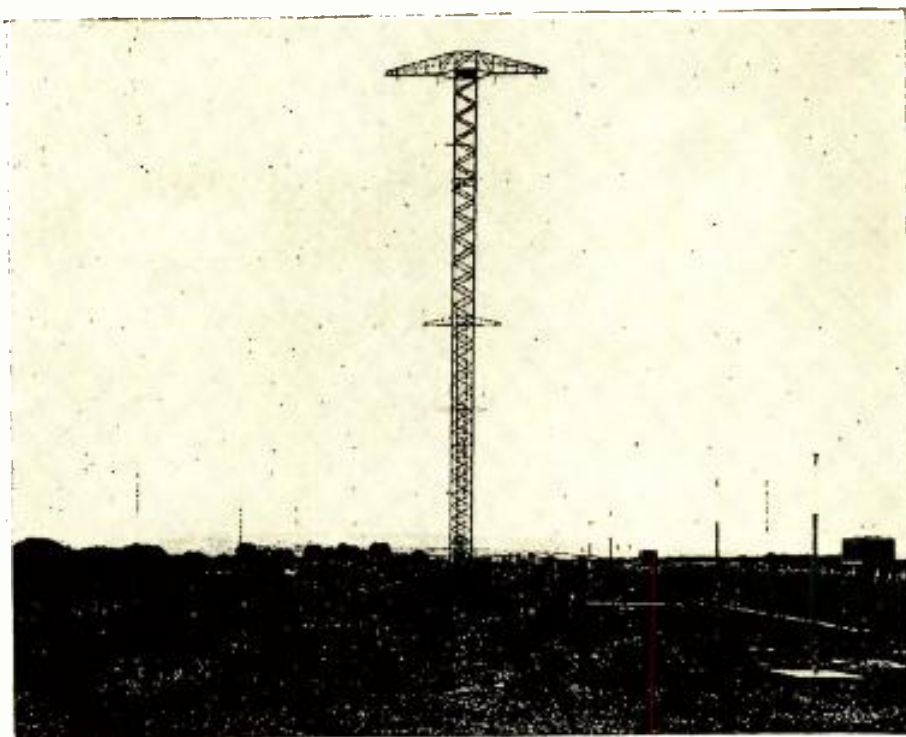

Underwood & Underwood

WIRE CURTAINS THAT DIRECT THE RADIO BEAM

This row of tall steel masts, erected at Bodmin, England, support the curtains of hanging wires which send the radio beams to Canada. The lower ends of the vertical wires may be seen at either side of the picture. Attached to them are the weighted levers which hold the wires vertical and at proper tension. The upper ends of the wires hang from horizontal cables attached to the arms of the masts.

Power from the Light Circuit



Type R-171
\$15.00

Type R-210
\$20.00

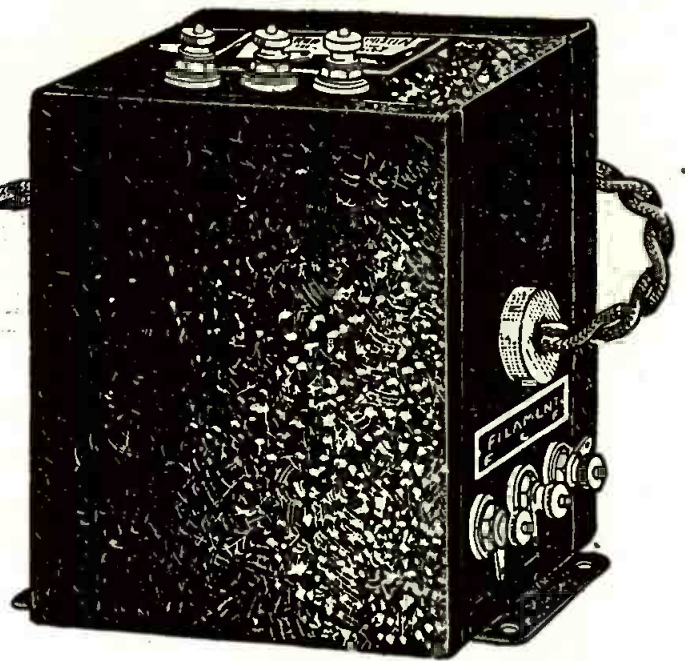

The Complete Foundation Unit for Home Constructed Power Amplifiers

HERE is what you have been waiting for — a silent and efficient power amplifier and B eliminator that will equal anything on the market — one that you can build yourself in less than an hour.

The Thordarson Power Compact is the complete foundation unit for power amplification. It contains: (1) a power supply transformer, (2) two filter choke coils of 30 henries, and (3) a power tube filament supply, tapped at the exact electrical center (an exclusive Thordarson feature), all in one compound filled case.

Two types of Power Compact are available: R-171 is designed for use with power tube UX-171 and Raytheon BH rectifier. Type R-210 is designed for use with power tube UX-210 and UX 216-B rectifier. Each type of compact supplies the proper values of current for maximum efficiency operation of its corresponding power tube.

Packed with each compact is a complete set of instructions which can easily be followed, even by the man with no radio experience.

Remember that when you buy a Thordarson product it is guaranteed and backed by over thirty years' manufacturing of reliable transformers.

For Sale at Good Dealers Everywhere
or Direct from Factory

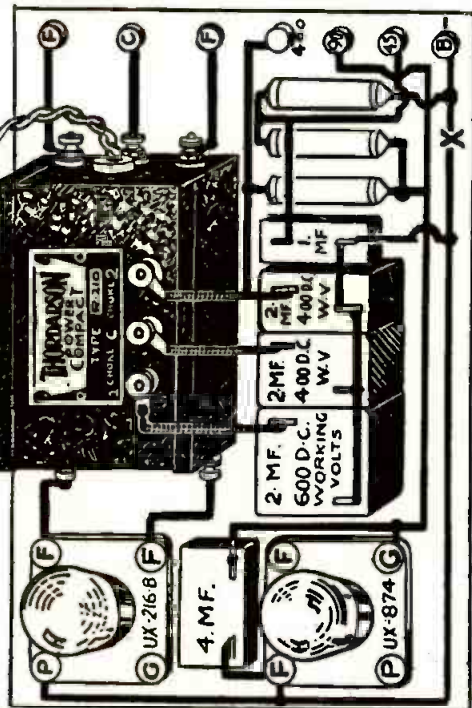

B-ELIMINATOR AND SUPPLY FOR UX-210 POWER AMPLIFIER -

This Booklet is Yours for the Asking:

POWER FROM THE LIGHT CIRCUIT

THORDARSON ELECTRIC MFG. CO.
500 W. Huron St., Chicago, Ill.
Gentlemen:

I would greatly appreciate receiving a copy of your new booklet "Power from the Light Circuit."

Name.....

Address.....

City..... State.....

THORDARSON POWER COMPACT

THORDARSON ELECTRIC MANUFACTURING CO.
Transformer specialists since 1895
WORLD'S OLDEST AND LARGEST EXCLUSIVE TRANSFORMER MAKERS
Chicago, U.S.A.

CeCo Tubes Recommended by Hammarlund-Roberts Inc. for the Hi-Q Receiver



Write for data sheet of the Complete CeCo Line
C. E. MFG. CO., Inc.
 Providence, R. I.
 Largest Plant in the World Making
 Radio Tubes Exclusively

Is This a Clue to Useful Atomic Power?

AN important experiment on the relation between energy and matter—an experiment which may prove, in fact, to be the beginning of the long-expected conquest of atomic power—was carried out recently in Berlin by two German physical chemists, Dr. Fritz Paneth and Dr. Kurt Peters.* As yet, the experiment is the promise of atomic power rather than the actuality. Nevertheless, it is agreed by scientists that if this experiment is confirmed by repetitions which are now being made by Dr. Paneth at Cornell University it will constitute a significant probability that the supply of useful power in the world will ultimately be increased from atomic sources.

The experiment itself was simple. Dr. Paneth and Dr. Peters pumped a certain amount of very pure hydrogen gas into a glass container in which was a quantity of finely divided palladium. Palladium is one of the metals of the platinum group. When precipitated from its solutions in ways well-known to chemists, the palladium is obtained, not in its ordinary metallic form, but in the form of a very finely divided black powder. It has long been known that this powdered palladium is able to absorb and retain volumes of gases vastly greater than its own volume. Hydrogen is absorbed with especial readiness. It has been imagined that the gas so absorbed is probably condensed in the form of thin, but almost solid films on the surfaces of the tiny particles of the palladium powder.

In the experiment of Dr. Paneth and Dr. Peters all that they did was to leave the hydrogen gas in contact with the metallic palladium for a time. On then pumping out the hydrogen once more and testing it with a spectroscope, the German scientists discovered the presence in the gas of a small amount of helium. This had not been there previously.

All of the probable sources of error having been watched for or corrected, Dr. Paneth and Dr. Peters concluded that what happened was a transformation of some of the atoms of hydrogen into atoms of helium. This transformation was induced, they assume, by mere contact with the metallic palladium, this being an example of the phenomenon of catalysis, the well-known ability of certain finely-divided metallic powders and other substances to bring about chemical or physical changes in which the powdered catalyst itself takes no part.

The importance of this particular atomic transmutation for the matter of atomic power lies in the fact that this transformation of hydrogen into helium

*"On the Transformation of Hydrogen into Helium" (In German), by Fritz Paneth and Kurt Peters. *Die Naturwissenschaften* (Berlin), volume 14, pages 956-962 (October 22, 1926).

F. D. Pitts Company

INCORPORATED

219A Columbus Ave.

Boston, Mass., U. S. A.

**Merchandising
 Radio
 Since 1919**

DEALERS — send for large and profusely illustrated catalog on the products of scores of nationally advertised radio manufacturers.

Wholesale Exclusively

**"Pioneers in the
 Distribution of Radio"**

Wonderful Volume with Clearness AMPL-TONE



\$3.00

Phonograph makers have spent years perfecting the acoustic properties of their phonographs. Use an AMPL-TONE Unit and make a real Loud Speaker in an instant or use it in your horn and get better results.

After all, speakers are as good as their unit. We make a real unit at a real price. Money gladly returned if you are not entirely satisfied.

We make units for other manufacturers.

The UNION FABRIC CO.
 DERBY, CONN.

Makers of the Excellent French AMPL-TONE Headset

Please send me an AMPL-TONE Unit for which I enclose \$3.00.

Name.....

Address.....

State.....

SPECIAL

KH-27 \$86.00

LC-27 \$85.20

**HAMMARLUND-ROBERTS
 \$85.00**

**SILVER SHIELDED SIX
 \$95.00**

**Improved Browning Drake
 \$65.00**

**SARGENT INFRADYNE
 \$113.10**

**SENIOR POWER PACK
 \$65.20**

**Intermediate Power Pack
 \$47.50**

**JUNIOR POWER PACK
 \$38.90**

HENRY LYFORD and other popular circuits
 Send Money Order for Immediate Delivery

**City
 Radio Stores**

110 West 42nd Street, New York
 Downtown Store :: 79 Cortlandt Street



for His New "KH-27" Receiver

Kenneth Harkness Uses HAMMARLUND Condensers & Coils

The interesting Harkness receiver described in POPULAR RADIO employs one of the fifteen outstanding circuits of the season, for which Hammarlund Precision Products are officially specified by the designers.

Could there be more convincing testimony to the excellence of Hammarlund design and workmanship?

In addition to supreme efficiency Hammarlund Condensers and Coils have distinctive refinements which commend them to the careful set builder who takes pride in his handiwork. Any radio engineer will tell you that Hammarlund Products typify the best the radio world affords.

To insure permanent satisfaction with your "KH-27" Receiver, build it with the Hammarlund parts Mr Harkness uses.

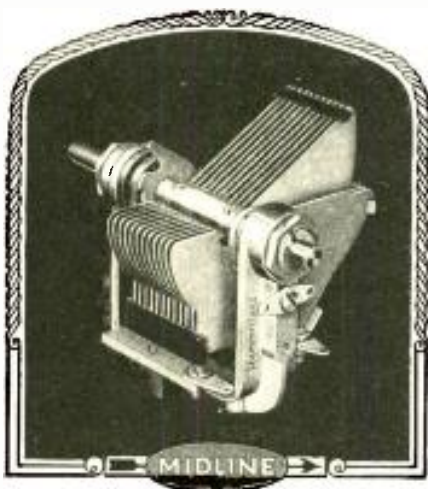

Hammarlund Products Are Also Officially Specified For These New Circuits:

Cockaday "LC-27"; Lacault "LR-4"; Sargent "Infradyne"; Henry-Lyford; Browning-Drake; Pacent "Ultimax"; Victoreen Super; Loftin & White; Carborundum Super; Morison "Varion"; Haynes "DX-2 Multivolt"; Popular Science Monthly "Powerful"; Hammarlund-Roberts "Hi-Q"; St. James Super.

We shall be pleased to refer to the proper authorities your inquiries about any of these receivers.

HAMMARLUND MFG. CO. 424-438 W. 33rd Street, New York City

For Better Radio Hammarlund PRECISION PRODUCTS

is precisely the one previously selected by physicists as the transformation most likely to occur easily and to set free some energy. Indeed, it is now assumed by most of the investigators of the physics of the stars that this transformation of hydrogen into helium is probably occurring in the interior of these celestial bodies, including our own sun, and probably constitutes the source of energy for these great heavenly power-houses.

The energy does not come, as in the case of radium, from any explosion of the atoms of hydrogen, but rather from the condensation of these atoms into heavier atoms. One helium atom weighs a little less than four atoms of hydrogen. It is assumed, therefore, that four hydrogen atoms combine to produce one helium atom and that in so combining they lose a tiny fraction (about three-fourths of one percent) of their combined weight. It is this weight (scientifically called "mass") which is supposed to be converted into energy. Modern physical theories, including, notably, the Einstein theory of relativity, indicate that conversion of matter into energy in this fashion would produce quantities of power which are enormous according to usual human standards. For example, if the mass of one teaspoonful of water could be converted entirely into energy, the mass itself disappearing, the quantity of power thus made available would be approximately 100,000,000 horsepower-hours, or enough to operate New York City's largest electric power-house for nearly five days.

In the actual experiment carried out by Dr. Paneth and Dr. Peters this possible development of power was not detected. The percentage of the hydrogen transformed into helium was minute. The evolution of power, if it occurred, was undoubtedly too small to be measured by ordinary procedures. Nevertheless, if the hydrogen-helium transformation occurred at all it must have been accompanied, physicists believe, by the freeing of energy. The mere repetition of the Paneth-Peters experiment will run no power-houses but it may represent the first yielding of the wall of ignorance which has kept us from finding and using the supposed enormous source of useful energy inside the atom.

Since the extension of radio in all its multitudinous possibilities is bound up so intimately with the production, distribution and use of power, any scientific advance which alters the basis of the world's power supply is sure to prove of the greatest effect on radio conditions. Imagine, for example, a vacuum-valve driven by its own atomic power and in which the decomposition of a millionth of one percent of the mass of the filament would operate the tube for a human lifetime.

ALUMINUM IS A NECESSITY IN RADIO

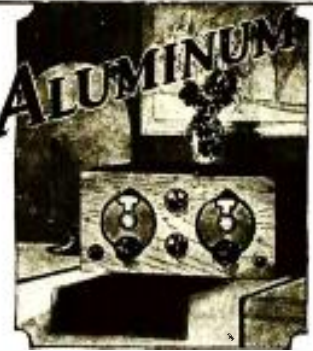

The R. B. Lab. 2-tube receiver, housed in Aluminum, is an example of advanced design. The Aluminum Panel combines shielding with beauty.



ODAY the crowding of the air makes shielding essential. Radio has turned to Aluminum for shielding because its properties permit the effective elimination of many of the hazards to perfect reproduction. By using Aluminum for top, base, size and center interstage shield, the designer of the R. B. Lab. 2-tube Receiver has created an effective combination. The 3/32" sheet Aluminum Panel is a photographic reproduction of a rare piece of walnut. Hammarlund-Roberts, Silver-Marshall, L. C. 27 and Varion A. C. specify Aluminum for shielding. Alcoa Wing type Aluminum shields prevent interstage interference effectively and economically. Can-type Shields made of Aluminum are fully effective—individually protecting the various stages. Alcoa Aluminum is effective due to its high durability and low electrical resistance. Used for cabinets and Panels Alcoa Aluminum is light, easily worked and is valuable in the most beautiful wood effects.

Here are some of the Applications:

Alcoa Shields. Box Shields. Cabinets. Panels. Variable Condensers. High-Purity Rods. Foil for Fixed Condensers. Die-Castings. Screw Machine Products.

ALUMINUM COMPANY of AMERICA PITTSBURGH, PA.



ALUMINUM COMPANY OF AMERICA Room 2321 Oliver Building, Pittsburgh, Pa.

Gentlemen:

Please send me a complimentary copy of the booklet checked on this coupon.

Name.....
Street.....
City.....
Circuit I now use.....
Circuit I will built next.....

Check the square for one, or both, of the booklets.

Booklet "Aluminum Radio Shields" A treatise by Cockaday and Free on Radio Shielding.
 Booklet "Aluminum for Radio" Describes the general application of Aluminum to radio.

A Shortage of Trained Radio Men!

Never has there been such a demand for qualified radio men—service men, salesmen, technicians, broadcast and commercial radio operators. The Radio Institute of America has been called upon for trained men by radio organizations located in all parts of the country. Yet we cannot supply the New York City demand alone.

You can't get better radio training than that offered by the Radio Institute of America. These courses planned and supervised by RCA secure you your 1st Class Commercial Radio Operator's License. And an immediate position awaits every graduate.

Moreover you can study at home in spare time.

This coupon will bring you complete information.

-- TEAR OUT --

B

Radio Institute of America
322-A Broadway, New York City

Please send me full information about your Home Study Course of radio instruction.

I am interested in the complete course, including code instruction, which qualifies for the U. S. Gov't Commercial or Amateur Radio License.

I am interested in the technical course for radio dealers, jobbers and salesmen.

Name.....

Address.....

RADIO INSTITUTE OF AMERICA

Formerly Marconi Institute
Established in 1909

322-A Broadway, New York City

A Low-frequency Standard for Future Centuries

At the meeting on November 24, 1926 of the New York Electrical Society, a Society which has the distinction of being the oldest electrical society in the United States, Dr. Edward R. Berry, consulting engineer of the Lynn, Mass. works of the General Electric Company, presented a lecture on his recently developed material, clear fused quartz, in which lecture he pointed out the well-known, but commonly forgotten fact that during the long period of scientific investigation of sound the world of science has never possessed any absolutely permanent standard of sound frequencies. Tones are commonly identified, Dr. Berry recalled, by comparison with a standard tuning fork, the frequency of which has been determined, in its turn, by comparison with previous tuning forks. The ordinary tuning fork, made of metal, is by no means a constant thing. In the course of years the internal crystallization of the metal will change and its pitch, which means its frequency, will change also.

Dr. Berry recalled the story that the higher pitch now used by European musicians had come about through the gradual change of the standard tuning forks used. When music first began to be standardized, so the story goes, the tuning forks were slightly lower in

pitch, for each note of the piano, than they are today. These forks were carried around in musicians' pockets and otherwise subjected to wear. This removed a trifle of the metal. The forks rose in pitch. The result is that European orchestras are now pitched higher than they were two hundred years ago.

Although there is no question of this last fact, the story which Dr. Berry quoted, was admitted to be probably apocryphal. Nevertheless, it is unquestionable that we would have difficulties in preserving for future generations the exact pitch of present day music. No metallic tuning fork could be expected to last even so long as a century without some change of pitch.

Dr. Berry described to the Society a new form of tuning fork made of his clear fused quartz, which fork will maintain indefinitely, he asserted, the pitch to which it is tuned. Also, this fused-quartz tuning fork is affected only slightly by temperature, which is not the case with metal forks. On a warm day, for example, a standard metal tuning fork will be pitched appreciably lower than on a cold day.

Quartz plates, cut from natural crystals of this mineral, are now in common use in radio apparatus for maintaining constant standards of radio frequency. Dr. Berry's proposal implies that the same mineral in its clear fused form is likely to constitute the basic unchanging standard of audio-frequency also.



New York Electrical Society

AN AUDIO-FREQUENCY STANDARD FOR A THOUSAND YEARS

Dr. Edward R. Berry, of the Lynn Works of the General Electric Company, is holding a tuning fork made of clear fused quartz, a material which is immune to the gradual changes of pitch suffered by metal forks. Enduring standards of radio-frequency are also provided by quartz, in the form of plates cut from crystals.

Still the undisputed leader

Rauland-Lyric AUDIO TRANSFORMER

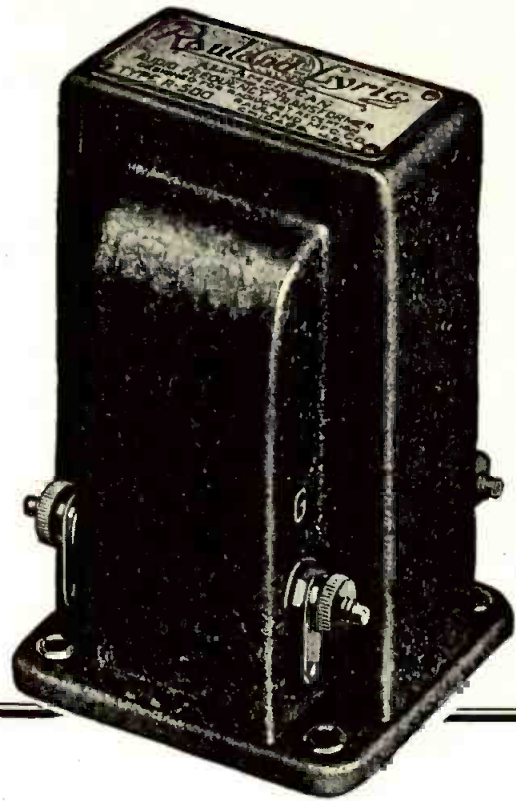

If you love music, and want your radio set to reproduce tones *faultlessly*, there is one audio transformer you can absolutely depend on—the famous Rauland-Lyric.

Voices and instruments alike are amplified with amazing realness by the Rauland-Lyric; with faithful amplification of those "overtones" essential to full, natural reproduction. The amplification curve of the Rauland-Lyric illustrates its outstanding superiority in tone purity.

The Rauland-Lyric is the undisputed leader in its field. It is invariably chosen by set builders who want the utmost in perfect tone quality.

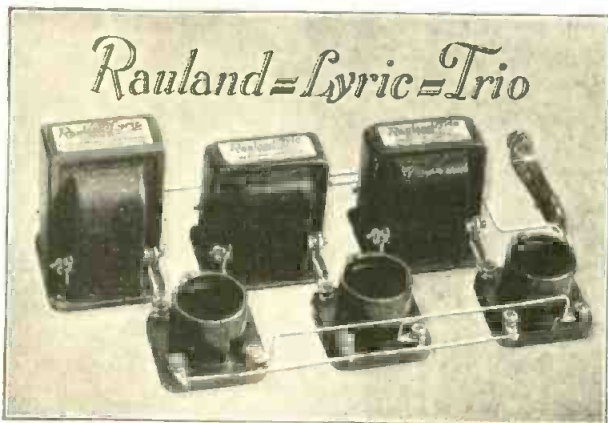

Write for "Modern Audio Amplification",
a free book, describing this fine unit.

A new high mark in three-stage audio amplifiers

Your receiver's tone quality depends in large measure on correct audio amplification. The famous Rauland-Lyric Transformer may now be combined with two Rauland-Trios (impedance units) to form the Rauland-Lyric-Trio—the highest known perfection in three-stage audio amplification. Rauland-Trio is a compact, well-made unit—containing in one shell—inductance, resistance, and capacity in correctly balanced relation.

New 1927 Radio Key Book

You'll enjoy reading it—48 pages of interesting, up-to-the-minute facts about radio, simply told. Also full construction details of all leading types of circuits. Send 10 cents (coin or stamps) to cover postage and mailing cost.



ALL-AMERICAN RADIO CORPORATION

4207 Belmont Avenue, Chicago, Illinois

POLYMET CONDENSERS

Stand the Gaff!



Condensers are the watchdogs—guardians of the receiver or power unit you construct. Assure success by choosing only condensers that stand the gaff!

Extensive research and latest, most modern equipment and skill enable Polymet to build condensers of exceptionally high voltage breakdown test. Only the finest materials are employed. An improved process renders them non-inductive with high dielectric resistance for long life and durability.

Raytheon Circuit Condensers

Approved by the Raytheon Company with high rating
Type F-1000—14 Mfd.
Tapped at 1, 1.2, 2, 8, \$9.50
Type F-1001—.1-C-1
Mfd. (illustrated) \$2.00



High Voltage Condensers
The right size for every use
.1 to 5 Mfds.
60c. to \$4.50

Fixed Mica Condensers

With or without Grid Leak Mounting clips—individually tested for 1000 volt breakdown test. Plates and lugs in one piece. Capacities guaranteed. All sizes. 25c. to \$1.00.

Write for complete details and illustrated descriptions of all Polymet Products. Sent free on request.

POLYMET MANUFACTURING CORP.
599-C Broadway, New York, N. Y.

"World's Largest Manufacturers of Radio Essentials."



POLYMET PRODUCTS

BROADCAST LISTENER

Comments on radio programs, methods and technique
—from the point of view of the average fan

By RAYMOND FRANCIS YATES

The Gold Star Feature of Last Month

BUT a few weeks back the Breyer Ice Cream Co., one of WJZ's regular and honored customers, exposed a variety show bearing the date of 1890. This was perhaps the most ingeniously managed piece of radio scenario and continuity writing that we have listened to since Paul Stacey of the Eveready Hour microphoned Bill Brown's Lincoln story. There was an unmistakable atmosphere created and that was the atmosphere of the 19th Century variety show—brown derbys, mutton-legged trousers, and horse-hair watch-fobs.

The particular hit that caught our fancy happened to be the lion tamers' act and when this old grouchy admits being entertained by a lion tamers' act on the radio you can bet your pet detector tube, that said lion tamers' act was a wow.

It is no simple matter to create an illusion or atmosphere through the agency of a microphone and when one does hear a good example of it, it's time to get out the gold star and paste it in front of the right name.

* *

One of the Advantages of a Small Ensemble

THE fidelity of transmitted music seems (although we have not consulted our Engineering Department on this point) to be in ratio with the number of instruments or the number of soloists who supply the music.

Much of the music produced by our big symphonies and ensemble is lost in the mechanism of radio, due to the inherent weakness of the microphone and its associated devices. For that reason, a well managed trio (and the Sitig Trio of WOR is well managed) offers just about as delightful music as one has the right to expect in these days of radio. Just about every note played manages to squeeze through and that, Kind and Noble Sir, is saying a phonograph full when you get the old slide rules out to show how much of the sound of a symphony gets through as compared with that portion that goes irretrievably to the bow-wows.

* *

What Are Your Ten Favorite Features?

A READER has asked us to name the ten best regular events on the air.

He seems to forget that what is relish for one man is the equivalent of pestilence and mental suffering for another.

We can imagine nothing more incongruous than a half-stewed flapper at a ribald Saturday night party being thrown into a fit of ecstasy over Walter Damrosch's concerts. Yet, we think them magnificent. The proper appreciation of broadcast features, depends on who you are, where you are and what you happen to be doing.

Our personal list of favorites varies almost from week to week. Right today it includes:

Walter Damrosch
The Eskimos
Henry Hadley's Willys-Overland Hour
The Happiness Boys
The Capitol Theatre Family
The Eveready Hour (not always)
The Atwater Kent Hour (not always)
The Silvertown Cord Orchestra
B. A. Rolfe's Orchestra
The A and P Gypsies

This list, naturally, does not include many excellent features. There is the Ipana Troubadours for instance, and Ben Bernie, Lopez, Cook's Tours, Breyer's Hour and Hohner's Harmony Hour to mention but a few of the more satisfying weekly events that sometimes reach high peaks of excellence.

* *

A Plea for the Use of English in the Studio

TO HEAR some of our quixotic young heroes of the microphone toss off the high-sounding names of foreign composers in French, German and Spanish, one wonders why the mother-tongue cannot in some way be adapted to this use.

This may be a strange, even a crude suggestion, but somehow we cannot overcome the notion that English pronunciation of all foreign names should be practiced in our radio studios and that all members of the radio *intelligentsia* who desire to display their erudition in matters musical should do so in only the presence of their friends and relatives.

For over five years now, we have suffered while our studio boys have been struggling to master those delicate foreign names that so readily and effectually mark the scholar and the wit. At times this ordeal was enough to rupture the patience of a saint, so hot and yet so hopeless did the campaign for perfection become.

Those who are suffering from the Vanity Fair complex quite forget that it is perfectly proper to pronounce foreign words and proper names in English. It is not necessary to call Wagner, "Vog-

ANYONE CAN BUILD A SET WITH SIMPLIFIED BLUEPRINTS



AURENCE M. COCKADAY has personally supervised the preparation of *Simplified Blueprints* of seven of POPULAR RADIO's most popular circuits. Each set consists of three separate *Actual Size* Blueprints; first a Panel Pattern; second, an Instrument Layout; and third, a Picture Wiring Diagram all simplified in the fullest sense of the word because

The Panel Pattern can be laid on the panel and all holes drilled as indicated. No scaling to do and so accurate there is no danger of ruining the panel through faulty calculation.

The Instrument Layout placed on the sub-base permits you to indicate by pinpricks the exact location of every screw.

The Picture Wiring Diagram gives every instrument in exact size and position with every wire clearly indicated from one contact to the other. With no knowledge of radio symbols you can assemble every part and complete your wiring with no chance of error.

Priced at \$1.00 per Set

Set No. 18—"The Improved Raytheon Power-Pack" (as described in the May, 1926, issue of POPULAR RADIO).

Set No. 19—"The New Home Receiver" (three tubes, two stages of radio-frequency-amplification with crystal detector, as described in June, 1926 issue of POPULAR RADIO.)

Set No. 21—"The Improved Browning-Drake Receiver" (as described in the August, 1926, issue of POPULAR RADIO).

Set No. 22—"The LC-27 Broadcast Receiver"

(as described in the October, 1926, issue of POPULAR RADIO.)

Set. No. 23—"The LC-Senior Power-Pack" (as described in the November, 1926, issue of POPULAR RADIO.)

Set No. 24—"The LC-Intermediate Power-Pack" (as described in the December, 1926 issue of POPULAR RADIO.)

Set No. 25.—"The LC-Junior Power Pack" (as described in the January, 1927 issue of POPULAR RADIO.)

Full constructional and parts details for these Receiving Sets will be found in the issue of POPULAR RADIO indicated. Back issues of POPULAR RADIO will be furnished at the rate of 35c a copy

Popular Radio

627 West 43d Street

Dept. 24

New York City

POPULAR RADIO, Inc., Dept. 24
627 West 43d St., New York City

Date.....

Enclosed is my remittance of \$....., for which kindly send me Blueprint Set (s) consisting of Panel Pattern, Instrument Layout and Wiring Diagram as checked below:

- | | |
|--|--|
| <input type="checkbox"/> Set Number 18 | <input type="checkbox"/> Set Number 22 |
| <input type="checkbox"/> Set Number 19 | <input type="checkbox"/> Set Number 23 |
| <input type="checkbox"/> Set Number 21 | <input type="checkbox"/> Set Number 24 |
| <input type="checkbox"/> Set Number 25 | |

Name.....

Address.....

City..... State.....

DEALERS

Write for terms
on these
fast selling
Blueprints.

CLAROSTAT

plays a leading role in



every circuit
every B eliminator . . .

IN almost every circuit sponsored by POPULAR RADIO . . . in over 80 nationally known B eliminators, CLAROSTAT, *the greatest variable resistor*, is functioning daily—silently, smoothly and powerfully.

This universal recognition is easily explained by the fact that CLAROSTAT alone covers the entire range, from practically zero to 5,000,000 ohms; has a current carrying capacity of 20 watts without the slightest trace of packing, arcing or crackling noises; acts as the perfect voltage control in B eliminators and as oscillation control in T.R.F. sets.



Invaluable to Fans! "The GATEWAY TO BETTER RADIO"—32 pages covers everything . . . reception, transmission, amplification, and battery elimination.
Send 25c in stamps or coin to

Dept. P. R.
AMERICAN MECHANICAL LABS.
INC.
285 N. 6th St. Brooklyn, N. Y.

ner" or Chopin, "Showpan" to be correct. Find the German or the Frenchman who bothers to find the proper pronunciation of English words. They promptly give them their own pronunciation and right it is that they should. But here, our scholars and near-scholars consider it a badge of social distinction to be able to roll off a few foreign names no matter how badly they do it. To this class of pretenders, it is nothing short of musical sabotage to sing an opera in English. That is an unforgivable sin.

What we need in our broadcasting is more and better English and less high school French, German, Spanish and Italian.

* *

A Word About Giving the Names of Composers

AFTER five years of listening to the radio, we stop to wonder how many times we have been informed by gracious and accommodating announcers that Mendelssohn wrote a spring song, Cadman wrote "At Dawning," Chopin wrote an Etude and that Victor Herbert was the composer of "Kiss Me Again." This does not complete the list, but we dare say that our personal score in this radio game of "Who Wrote The Song" runs way, way up into the millions.

All of which makes us ask, is it necessary to name the composer for each selection, unless, of course that selection has a common name like "Sonata" or "Humoresque" or "Meditation."

True, there are many selections that bear the name of "Humoresque," in such a case it is necessary to mention the name of the composer. But who, in these loud days of the radio, needs to be informed that Verdi was the father of "Il Trovatore" or that Charlie Cadman must shoulder the guilt for "At Dawning."

This protest is part of our campaign for better and more simple announcing, announcing without frills or flapdoodle. We want back the good old days when announcements were courteous but short and to the point Mr. So-and-So who gave birth to a popular ditty or dirge is really of small concern to us unless the gentleman was or is a master of his art. And the chances are if he was or is a master of his art we should have heard of him previously.

* *

Too Much Music in One Place

IN its ingratiating bow to the public, The National Broadcasting Company put on what was, without doubt, the most ostentatious program ever released into our great American atmosphere. It was big, it was noisy and it did just exactly what its far-seeing sponsors wanted it to do; it set the tongues of the yokels wagging and it nursed forth a volume of publicity that made a big record.

FREE

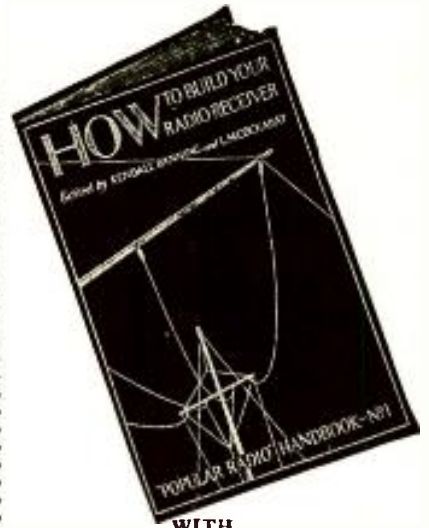

WITH
POPULAR RADIO

Aside from the feature of economy, there is the thrill and satisfaction that comes from building your own receiving set.

Thousands of sets have never been constructed because of the atmosphere of mystery that has enveloped the whole subject of radio. Kendall Banning, Editor, and Laurence M. Cockaday, Technical Editor of POPULAR RADIO through their close contact with the great radio public sensed this and compiled a book that will convince the veriest beginner that technical training is not essential. If you have a little time to devote to a most fascinating pastime, send for a copy of "How to Build Your Radio Receiver."

Free Advisory Service

POPULAR RADIO is full of helpful suggestions as well as instructive and entertaining articles on radio and allied scientific phenomena. This information is supplemented by an advisory service that is free to all subscribers. Any problem you encounter that is not answered in the book or magazine will be answered by personal letter if you will submit it to the Technical Service Bureau.

A Valuable Combination

For the next thirty days we will give you a copy of "How to Build Your Radio Receiver" FREE and enroll you for all privileges of the Technical Service Bureau at no further expense, on receipt of your remittance of \$3.00 in payment for a 12 months' subscription for POPULAR RADIO. (As an alternative offer, if you wish the combination with POPULAR RADIO for 7 months only—send but \$2.00). In any event, you run absolutely no risk as we will refund in full if you are not more than satisfied with your purchase.

CONTENTS

In "How to Build Your Radio Receiver" you will find complete constructional diagrams, specifications, photographs and instructions for building the following sets. Each has been selected as representative of its circuit because in laboratory tests it proved the best for distance, selectivity, tone volume, simplicity of construction, ease in tuning, reliability and all-around satisfaction.

- A \$5 CRYSTAL SET
- THE HAYNES SINGLE TUBE RECEIVER
- A TWO-STAGE AUDIO-FREQUENCY AMPLIFIER
- THE COCKADAY 4-CIRCUIT TUNER
- A 5-TUBE TUNED RADIO-FREQUENCY RECEIVER
- THE "IMPROVED" COCKADAY 4-CIRCUIT TUNER
- THE REGENERATIVE SUPER-HETERODYNE RECEIVER

POPULAR RADIO

627 West 43d Street, N. Y. C.

Offer expires Feb. 28th, 1927

POPULAR RADIO, Dept. 25A,
627 West 43d St., New York City

Enclosed remittance of \$3.00 is payment in full for a 12 months' subscription for POPULAR RADIO and copy of "How to Build Your Radio Receiver" FREE.

NAME.....
Address.....
City.....State.....

Check here and remit \$2.00 if you prefer POPULAR RADIO for 7 months only in combination with "How to Build Your Radio Receiver."

That there were moments when this program ascended close to Radio Heaven no one will deny.

On the other hand, the honest critic and the sincere connoisseur of broadcasting must admit that it at times did considerable floundering about and that, to even the most casual listeners, it presented something of the spectacle of a big, overgrown musical circus, that was being run off without much attention to details and certainly with no respect for the tenants of better broadcasting. It was one of those programs that could have been put on by any smart young studio shiek providing he was handed \$50,000 and told to go on the open entertainment market and spread himself. Such a fellow pounces naturally on big names and big publicity.

Mary Garden was heavy artillery for the front page, but she was the musical equivalent of last years derby when she sang. It requires only money and certainly no talent to hire Will Rogers.

We have no desire and no motive to minimize this colossal program; it was an enormous event. But its price tag stuck out on it like the trade mark on a can of beans. It was made up of the kind of talent that gets publicity in this land of ours, and as a publicity producer it was far more valuable than as an agency for entertainment.

It is conceivable that a man gifted in musical matters as they appeal to the taste of the masses, could have assembled a program that would have cost less than a third of \$50,000 and that, although not such an abundant producer of front page stories, would have been much more enjoyable.

Of course we are not so stupid as to think that this mammoth performance did not do a deal of good for broadcasting. It did, by its sheer weight of publicity value. In this it merely followed the prescribed way that we have of doing things here in America. Like George Bernard Shaw, everybody considers the "cart and the horn" before they weigh intrinsic value. Big money, big names and ten cents worth of judgments are the essentials.

We had still another fault to find with this gala event. The young man who did the planning failed to consider the effect on the microphone of the Oratorical Society recital together with the Philharmonic. Never before has the microphone been called upon to swallow such an appalling complication of sound frequencies. As a matter of honest fact, the microphone did not swallow all of them due, it seemed, to a bad case of nausea. At this point the program simply overstepped itself technically as well as otherwise, and while this high-priced noise-making might have made a heavy impression on the country at large, it caused mutterings at the listening posts of those who really know good transmission when they hear it.



The Most Desirable Tuning Device Ever Designed For Set Builders!

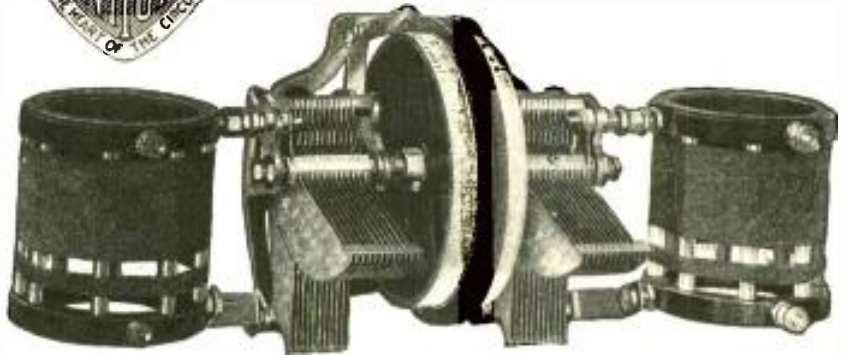

THE "BRUNO" R. F. UNITUNE Mounts Panel with only two screws

The basic "BRUNO" UNITUNE is constructed on an aluminum frame upon which are mounted two .0005 mfd. straight line frequency condensers which operate independently of each other through the medium of a pair of moulded bakelite drums whose knurled edges and graduated scales project through the front of the panel and a magnificent bronze plate. *These drums work alone or together.* No other condensers necessary. This UNIT may be purchased in all capacities, completely assembled for \$11.00.

ALL OTHER "UNITUNES" assembled with one or more Quartzite Coils for all popular circuits range in price from \$12.00 to \$21.00.

Send 25 cents for booklet of Instructions and blueprints.

Buy "Unitunes" At Your Dealer or from us

BRUNO RADIO CORPORATION

Long Island City

New York

POPULAR RADIO SETS ARE EASIER TO BUILD IF YOU USE SIMPLIFIED BLUEPRINTS

Every Radio Shop Kit includes a set of full-size Blueprints. An instrument layout shows every part in exact size and position. A picture-wiring diagram shows where and how to connect each wire. By following the wiring plan of the designer your set will perform more efficiently.

A Radio Shop Kit contains everything you need to complete the set, down to the last piece of buss bar and screw. Every panel is machine-drilled and artistically decorated.

A radio set constructed from one of our kits is not only easier for the experimenter to build but its appearance both inside and out, makes it more valuable to you.

Check the coupon below for complete data on any receivers in which you are interested and for our prices of complete kits and parts.

Cockaday's LC-27 Custom Built
Write for Prices on Various Models

DIAMOND-OF-THE-AIR
5-TUBE KIT—Complete Parts \$37.50
Licensed under Armstrong Patent No. 1,118,149

The RADIO SHOP of **STAMFORD**
20 Worth St., Stamford, Conn.
SERVICE FOR SET BUILDERS

Coupon

The Radio Shop of Stamford, 20 Worth St., Stamford, Conn. Gentlemen: Without obligation, send me full information and your prices on the sets below which I have marked X.

I enclose \$1.00 for Blueprints of the

Cockaday's LC-27 Receiver.

Improved Browning-Drake

S-C, Single Control, All Wave

Hammarlund-Roberts HI-Q

PORTABLE TEST BOARD

QUALITY AMPLIFIER

SHORT WAVE EQUIPMENT

Name.....

Address.....

City.....State.....

HAND BOOK FREE WITH Popular Radio

Kendall Banning, Editor, and Laurence M. Cockaday, Technical Editor of POPULAR RADIO, have compiled a book that will prove to anyone that he can build a set which will give distance, selectivity and tone volume, and at the same time a very definite basic knowledge of radio.

BUILD YOUR OWN SET AND SAVE MONEY

In "How to Build Your Radio Receiver," you will find complete specifications, constructional diagrams, photographs and instructions for building all of the following sets:

- A \$5 Crystal Set
- The Haynes Single-Tube Receiver
- A Two-Stage Audio-frequency Amplifier
- The Cockaday 4-Circuit Tuner
- A 5-Tube Tuned Radio-frequency Receiver
- The "Improved" Cockaday 4-Circuit Tuner
- The Regenerative Super-Heterodyne Receiver

ADVISORY SERVICE ALSO FREE

POPULAR RADIO maintains a big modern laboratory with a trained staff of investigators under the personal supervision of Mr. Cockaday. This Laboratory is always available through our Technical Service Bureau to answer, free to subscribers, by personal letter any problems you encounter which are not answered in either the "Handbook" or the magazine.

SPECIAL BOOK OFFER

You can secure a copy of "How to Build Your Radio Receiver" FREE, and have all the privileges of the Technical Service Bureau without additional expense, if you will send a remittance of \$3.00 in full payment of 12 months' subscription for POPULAR RADIO. (Or as an alternative, you may have the book and privileges of the Technical Service Bureau with POPULAR RADIO for 7 months only—for \$2.00. A two dollar bill will do.)

Remember you take no chance—we will refund your money in full if you are not more than satisfied.

POPULAR RADIO

Department 25

627 West 43rd Street, New York

22½ v. **\$2.65**U
N
A
C
I
DE
V
E
R
L
A
S
T
I
N
G**“HAWLEY” NEW TYPE**

45 volts \$5.25, 90 volts \$10.00, 112½ volts \$12.50, 135 volts \$14.75, 157½ volts \$16.80, 180 volts \$19.20. Includes chemical. Nothing to purchase extra. Special sizes to order. Easily recharged upon any current including 32 volt systems. Any special detector voltage easily had. Operates any 1 to 10 tube set. Tested and approved by leading authorities, such as Popular Radio Laboratories, etc. Over 4 years sold on a non-red-tape 30 day trial offer with complete refund if not thoroughly satisfied. Further guaranteed 2 years. Knock-down kits at still greater savings. Complete “Hawley” “B” Battery charger \$2.75. Order direct—same day shipments, shipped C.O.D.—simply pay expressman cost on delivery or write for my free literature, testimonials, etc.

B. HAWLEY SMITH

315 Washington Ave., Danbury, Conn.

Write For
Hampton-Wright's
Radio
Economy Catalog

**Every Radio Fan
and Set Builder
Needs This Book**

Hampton-Wright's organization has assembled thousands of radio parts and sets for your entertainment and help. Thousands of users all over the country are finding this equipment and prompt service a real aid to better radio. Write now for your free copy listing only efficient articles.

Speci:y Catalog A-8

Hampton-Wright
P. O. Box 181
Indianapolis, Ind.

**BROADCASTS**

CONDUCTED BY CHARLES L. REESE, JR.

Interference With Broadcasting Recognized as Illegal

WHAT is believed to be the first arrest for interference with radio broadcasting was recently made in Chatanooga, Tennessee where Martin T. Walters, a university student was brought before Federal Judge Hicks charged with broadcasting without a license, operating out of his wavelength and using false call signals. This is the first recognition by the courts that interference with broadcasting may be regarded as detrimental to the general public welfare and to the rights of the broadcaster in particular.

nouncing, it is doubtful if many fans would welcome any such assumption of authority by the state, involving, as it is claimed, an encroachment upon the rights of free speech.

A New Transmitter Tube For “Hams”

A TUBE of a new type, that may soon be available for amateur use, has just been made for the Navy. The tube is of a special high-frequency type for use in connection with a piezo-electric control. Durability is another outstanding characteristic of the tube; several are reported to have survived experiments for over 1,200 hours.

The Effect of Radio Programs on Concert Attendance

THE often predicted “fall of the concert halls” before the competition of radio broadcasting at last threatens to become an actuality in England where the management of Queen's Hall, London's famous musical center, have announced that they cannot hope to draw large enough audiences to meet expenses as long as radio offers concerts for practically nothing, and that they expect to turn the hall into a movie theatre. One bright feature of the situation is that if the general ruin of the concert business follows the failure of Queen's Hall, the concert artists must turn to radio for their livelihood and in this way greatly improve the general level of broadcast music.

The First “Radio Fraternity”

RADIO has been given its first “collegiate” touch by Norman, Oklahoma amateurs who recently formed what is believed to be the first Greek-letter radio fraternity—Alpha Sigma Delta.

Another Government Seeks to Monopolize Radio

THE recent decision of the broadcasting companies of Japan to consolidate and continue operation as one company is said to be the first step towards a radio monopoly in that country which will be directed and controlled by the government.

Two More Countries Plan to License Radio Receivers

THE widespread plan of paying the costs of broadcasting by a license fee on all receiving sets—which has been sporadically suggested in this country—has gained two more advocates in Hong Kong and Peru. In Hong Kong a governmental bill has been introduced that stipulates a yearly fee of \$2.50; Peruvian listeners will be required to pay \$5.00 semi-annually and the set will be confiscated if the fee is not paid. The United States thus remains practically the only important nation in which listeners must depend upon advertisers to supply them with radio entertainment.

A Protest Against a State Censorship of Radio

THE right of a broadcasting station to transmit its own account of news events through its own announcers was hotly contested recently in New York when the State Athletic Commission was reported to have attempted to dictate to station WMSG which men should be assigned to cover the boxing bouts held in Madison Square Garden and also the salary to be paid for the announcing. Although this move is said to have been made to better the quality of the an-

Question: What is This?

ANSWER: It is a B-Power Unit—a necessity for best radio reception with up-to-date tubes and speakers.



Q. What does it do?

A. It replaces "B" Batteries, and supplies B-current from the light socket at voltages that are known—and for which the tubes were designed.

Q. Where are the Knobs?

A. Why bother with knobs? None are necessary with the B-T method, consequently you do not have to guess at the voltage delivered by the sound of the set. Tuning a set is enough—you don't have to tune this eliminator also.

Q. Can't I measure voltages from ordinary eliminators?

A. Not by any ordinary means.

Q. Why should I buy the B-T—there are others cheaper.

A. Also higher—but not better. Your set can't deliver better quality than the current you put into it. When you get a larger set or use power tubes cheap eliminators may fail to deliver sufficient or break down under higher voltages. For every element in our construction there is a cheaper substitute. This unit is engineered and manufactured with the same thoroughness that has made every previous B-T Product an outstanding success. This is your best, in fact, your only assurance. There is less economy in cheap battery substitutes than anything we know of. In this unit you are buying insurance as well as economy and convenience.

Q. Do you build receivers?

A. Yes, the Counterphase.



HERE IS THE "EIGHT" CLOSED

Q. Where are the Dials?

A. There are no dials. Stations are read directly in wavelengths.

Q. But How are the Stations Logged?

A. We do that—using an exclusive patented method. Each set is individually calibrated before shipment.

Q. How Do You Tune?

A. Open the door and turn one knob, which tunes five stages at once.

Q. What is the Rejector?

A. A tuned stage without tube employing a principle never before successfully applied to a radio set. It is exclusively B-T and gives the selectivity which distinguishes the Counterphase from all other single-control sets.

Q. Does "BETTER TUNING" explain the COUNTERPHASE?

A. Yes, fully.

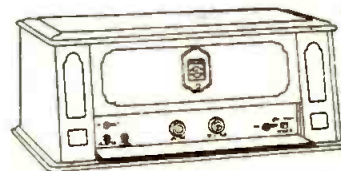

HERE IS THE "EIGHT" OPEN

Send today for your copy of "Better Tuning"
sent to any address for 10c.

BREMER-TULLY MFG. CO., 520 So. Canal St. Chicago, Illinois



No. 248
E-5841
Underwriter's
APP.

"Little Joe" Lightning Arrester

Especially designed for Radio Work. Made of porcelain, small, neat, rugged and serviceable. Can be suspended on antenna or fastened to wall.

Ask Your Dealer

M'f'd by CIRCLE F MFG. CO.
Trenton, New Jersey

Used in the Kenneth Harkness-27 6-Tube Hook-up



Used in POPULAR RADIO
IMPROVED

Browning-Drake Hookup

Indorsed by leading radio authorities

Model "N" A slight turn obtains correct tube oscillation on all tuned radio frequency circuits. Neutrodyne. Roberts two tube Browning-Drake, McMurdo Silver's Knockout, etc., capacity range $\frac{1}{4}$ to 20-micro-micro farads. Price \$1.00.

Model "G" with grid clips obtains the proper grid capacity on Cockaday circuits, filter and intermediate frequency tuning in heterodyne and positive grid bias in all sets. Capacity range:

Model G-1—.0002 to .0001 MFD
Model G-5—.0001 to .0005 MFD
Model G-10—.0003 to .001 MFD
Price \$1.50

X-L PUSH POST

Push it down with your thumb, insert wire, remove pressure and wire is firmly held. Releases instantly. Price 15c.

Push Post Panel permanently marked in white on black insulating panel. In box including soldering lugs, raising bushings and screws for mounting, etc. Price, \$1.50



X-L Radio Laboratories 2422 Lincoln Ave.
CHICAGO, ILL.

Trans-Oceanic Calls Heard

POPULAR RADIO has now completed arrangements for forwarding to transmitting amateurs in England, France, Germany, Austria, Ireland and Italy all calls heard (QSL) cards that may be addressed to them by American amateurs care of this magazine. These cards will be delivered through local agents in those countries, who have or can obtain knowledge of the present address of the foreign amateurs. Plans have also been completed by this magazine for forwarding to transmitting amateurs in this country in turn all QSL cards that may be addressed to them by amateurs from those countries. American amateurs are invited to send their cards to foreign amateurs through this office, which will not only assure safe delivery through the special agencies which are thus provided, but which will publish a monthly list in a "Trans-oceanic Calls Heard" department.

Address your cards to the foreign amateurs by call numbers and enclose them in envelopes to—

The Calls Heard Editor,
POPULAR RADIO
627 West 43d Street, New York

THE following stations were received and logged at the amateur receiving station of J. Thomas (R-274) at 3 Avenue des Chalets, Paris 16me, France on an 0-v-1 Reinartz receiver using a single-wire antenna eight meters long and no ground.

U-3JO—Nov. 20, 1926; signal strength R6; steady, rectified AC note, 600 cycles, almost pure DC; no fading.

U-3AY—Nov. 20, 1926; signal strength R5; steady AC note; easily read; no fading.

U-3BMS—Nov. 20, 1926; signal strength R4 to R5; good, steady DC note; no fading.

U-8AMU—Nov. 20, 1926; signal strength R4; good, steady, rectified AC note; no fading.

U-1CJH—Nov. 20, 1926; signal strength R5; good, steady, rectified AC note; no fading.

THE following stations were received and logged at the amateur receiving station of Charles Pavy (R-244) at 10 Rue de la Republique, Arras, Pas de Calais, France on an 0-v-1 Bourne receiver using two cage antennas, nine meters long and fourteen meters high with a cage lead-in and a water-pipe ground.

U-2AOS—Nov. 15, 1926; signal strength R4; calling CQ; rectified AC note; no fading; interference R5.

U-5EV—Nov. 18, 1926; signal strength R5; calling CQ; rectified AC note; no fading.

U-3BWT—Nov. 16, 1926; signal strength R5; calling CQ; rectified AC note; no fading.

THE following stations were received and logged at the amateur station of C. S. Bradley (G-2AUX), 10 Montemotte Road, London, N. 8, England, on a Hartley receiver with a detector and one stage of audio using a single-wire antenna 30 feet high and 40 feet long.

U-2CFT—Nov. 7, 1926; signal strength R3; calling A-7CW on 38 meters; very good DC note; no fading.

U-8CT—Nov. 7, 1926; signal strength R5; calling CQ on 35 meters; very rough AC note; no fading.

RADIO PROBLEMS SOLVED

POPULAR RADIO maintains for the benefit of its readers a Technical Service Bureau and Laboratory, under the personal supervision of Laurence M. Cockaday which will, without charge, answer by personal letter any question, problem or request for information submitted by a subscriber. This service is, however, also available to readers, other than subscribers, at the very nominal rate of \$1.00 the inquiry.

In writing please confine your questions to one general subject, writing on one side of the paper only, and enclose a self-addressed and stamped envelope.

It is possible that your individual problem has been covered in an issue of POPULAR RADIO, and so as an aid to you we endeavor to keep a supply of back numbers in stock. The condensed index below gives a few of the subjects that have appeared recently, look this list over and if the information you want is covered, we will be pleased to supply back numbers at 35c. a copy.

February, 1926

- How to Reduce Distortion in Amplification.
- Some Stunt Sets.
- Important Kinks in Wiring.
- How to Cut Down Your "B" Battery Bill.
- Hints for Amateurs.

March, 1926

- Why and How the Milliammeter Increases the Efficiency of Your Set.
- What "Inductance" Really Is.
- List of Broadcast Stations in the U. S.
- How to Build the S-C Receiver for Short and Long Waves.

April, 1926

- How to Get an Operator's "Ticket."
- What a "Straight-line Frequency" Condenser Really Is.
- How to Build a Power-pack Amplifier.
- The New "Crystal Pilot."
- How to Build and Operate a Low-Power Transmitter.
- The POPULAR RADIO Medal for Conspicuous Service.

May, 1926

- How to Draw Up Your Own "Tuning Graphs."
- How to Build the Improved Raytheon Power-pack.
- How to Build an Antenna Mast for \$15.00.
- Fifteen Ways to Reduce Static.
- Do Your Coils Broadcast?

June, 1926

- How to Build the New Home Receiver.
- How to Put Up a Good Outdoor Antenna.
- How to Get the Most Out of Your Ready-made Receiver.
- Audio-frequency Amplification. How to Get it Without Distortion.
- Four New Combinations of Units for Assembling the Raytheon Power-pack.

July, 1926

- How to Get the Best Reception in Summer.
- The Best Crystal Set for \$13.00.
- How to Build the Newest Portable "Town and Country" Receiver.
- Four New Combinations of Units for Assembling the Raytheon Power-pack.
- How to Get the Most Out of Your S-C Receiver.

August, 1926

- A New Method of Using Harmonics for Determining Frequencies.
- POPULAR RADIO Circuits.
- How to Build the Improved Browning-Drake Receiver.
- How to Pick Out a Loudspeaker.
- How to Get the Most Out of Your "Town and Country" Receiver.
- Three Vacuum Tubes in One.

September, 1926

- Forecasting Radio Reception from the Weather Map.
- How to Build an Impedance-coupled Amplifier.
- A Radiant Crystal Pilot.
- POPULAR RADIO Circuits.
- How to Simplify Your Set with Automatic Filament Controls.
- Inside Information on New Radio Receivers.
- How to Wire Your House for Radio.

October, 1926

- How to Build the New LC-27 Receiver
- The Radio Road Hog
- POPULAR RADIO Circuits
- Sets That Earn Incomes.
- Inside Information on New Radio Receivers.
- Why Signals Fade.

November, 1926

- How to Build the LC-Sentor Power-Pack.
- Waves and Wavelengths.
- POPULAR RADIO Circuits.
- How to Select Your Radio Parts.
- How to Patent Your Radio Inventions.
- How to Solder.

December, 1926

- Uncle Sam's New Short-Wave Net.
- How Circuit Resistance Affects Selectivity.
- POPULAR RADIO Circuits.
- How to Build the LC-Intermediate Power Pack.
- Inside Information on New Radio Receivers.

January, 1927

- How to Build the New KH-27 Receiver.
- To Start and Stop Your Set Automatically.
- POPULAR RADIO Circuits.
- The Quack Doctors of Radio.
- How to Build the LC Junior Power-pack.

POPULAR RADIO
Department 28
627 W. 43d St., New York

U-9DNG—Nov. 7, 1926; signal strength R3; calling Z-3AJ on 39 meters; very good AC note; no fading.

U-2AJM—Nov. 7, 1926; signal strength R4; calling U-8GM on 38 meters; good AC note; no fading.

U-3CKJ—Nov. 7, 1926; signal strength R3; calling A-2RG on 39 meters; low-pitched AC note; no fading.

U-1CEZ—Nov. 7, 1926; signal strength R7; calling CQ on 40 meters; very good AC note; no fading.

U-4AK—Nov. 7, 1926; signal strength R3; calling F-8FJ on 38 meters; good DC note; no fading.

U-1ADS—Nov. 7, 1926; signal strength R7; calling I-ACD on 39 meters; very good AC note; no fading; heard later calling I-1AU; slight fading; signal strength still R7.

U-2CJE—Nov. 7, 1926; signal strength R5; calling C-4DW on 39 meters; good, steady AC note; no fading.

U-1GA—Nov. 7, 1926; signal strength R4; calling CQ on 39 meters; good DC note; no fading.

U-2AXY—Nov. 7, 1926; signal strength R3; calling CQ on 40 meters; very good DC note; no fading.

U-2AMJ—Nov. 7, 1926; signal strength R4; calling I-1AM on 38 meters; good, steady AC note; no fading.

U-1VZ—Nov. 7, 1926; signal strength R5; calling K-4YAB on 39 meters; very good AC note; no fading.

U-2NZ—Nov. 7, 1926; signal strength R6; calling CQ on 39 meters; rough AC note; no fading.

U-8BTH—Nov. 7, 1926; signal strength R4; calling K-4YAB on 38 meters; rough AC note; slight, regular fading.

U-9ELL—Nov. 7, 1926; signal strength R4; calling M-A9 on 40 meters; very good AC note; no fading.

The following stations were received and logged at the amateur receiving station of J. Thomas (R-274), 3 Avenue des Chalets, Paris (16), France, on an 0-v-1 Reinartz receiver using a water-pipe antenna and no ground.

U-1BJK—Oct. 30, 1926; signal strength R3; calling F-8FR; good tone; no fading.

U-3JO—Oct. 31, 1926; signal strength R4; calling G-5PZ; steady almost pure AC note; no fading.

U-3BQJ—Oct. 31, 1926; signal strength R3; calling F-8SSW; good, steady DC note; no fading.

U-2CJB—Nov. 13, 1926; signal strength R3 to R4; noticeable fading.

U-1AOF—Nov. 13, 1926; signal strength R4; calling F-8LX; good steady DC note; no fading.

U-2BAD—Oct. 30, 1926; signal strength R3; calling CQ; good, steady, rectified AC note; no fading.

U-8DON—Oct. 30, 1926; signal strength R3 to R5; calling F-8CL; good steady DC note; decided fading.

The following stations were received and logged at the amateur receiving station of Robert Larcher (R-010), 17 Rue Fessart, Boulogne - Billancourt (Seine), France on a receiver using a vacuum-tube detector and one stage of audio on a 4-meter indoor antenna.

U-8CCS—Oct. 31, 1926; signal strength R4; calling U-8BTB on 37 meters; steady AC note; no fading.

U-2ALM—Oct. 31, 1926; signal strength R4; calling CQ on 38 meters; very steady, pure DC note; slight fading.

U-4AAH—Oct. 31, 1926; signal strength R5; calling CQ on 37 meters; steady, musical AC note; slight fading.

A New Set for Real Fans

Sir Oliver Lodge's famous "N" circuit

ENGLAND'S MOST POPULAR RADIO RECEIVER — MORE SELECTIVE THAN A SUPERHET — USES THE NEW CLEARTRON MULTI-VALVE (3 TUBES IN ONE)



batteries, loud speaker, etc. and tune in. Five minutes from the time you get your LC-27 you can enjoy its matchless quality.

Every LC-27 we build is carefully tested and fully guaranteed. An LC-27 Receiver must function exactly like the original model or it cannot leave our factory.

ONLY \$10 EXTRA

It costs only \$10 more to buy the LC-27 tested, built complete, and enclosed in the cabinet of your choice. There are three cabinet models from which you can choose. Prices, built complete, are as follows:

- With Corbett cabinet, S-20, pictured above, \$122.70.
- With open front Corbett Cabinet, S-15, \$113.20.
- With Blandin Cabinet, R-20, \$114.70.

Write us today. We still have a few on hand. Enclose check or money order.

THE NEW K. H.-27

1 K. H.-27 Kit of Essential Parts	\$49.50
3 Hammarlund 17-plate condensers (Mid-line or S.L.F.)	14.25
1 Yaxley Rheostat, 10 ohms	1.35
1 Yaxley Fixed Resistance, 2 ohms	.15
1 Yaxley Battery Switch, Midget type	.50
1 Yaxley Pilot Light Bracket	.50
1 Yaxley Open Circuit Jack, Junior type	.45
1 Yaxley Antenna Switch, Double circuit, Junior type	.85
1 Micamold Grid condenser, .00025 M.F. with C.L. mounting	.45
1 Micamold fixed condenser, .001 M.F.	.40
2 Micamold fixed condensers, .002 M.F.	.80
1 Micamold grid leak mounting	.30
1 Micamold grid leak, 2 or 3 megohms	.45
2 Dubilier 1 MFD Condensers	2.50
2 X-L Variodensers, Type G 1 (.001 Max.)	3.00
4 Amperites (3 Type 1A and 1 Type 112)	4.40
2 Aristocrat Vernier Port Dials	4.00
11 Eby Binding Posts, engraved	1.65
1 6 Volt Lamp for Pilot Light	.50
Total Cost, including diagram	\$86.00

THE LC SENIOR POWER PACK

Described in November, 1926, POPULAR RADIO

1—Brach Control	\$ 6.00
1—AmerTran transformer, PF-52	18.00
1—Benjamin UX-Socket	75
1—AmerChokes, No. 854	12.00
1—Eby binding posts	1.05
1—Precision paper filter condenser, No. 26, 2 mfd.	5.50
1—Precision paper filter condenser, No. 24, 2 mfd.	3.00
1—Precision paper filter condenser, No. 44, 4 mfd.	5.50
1—AmerTran resistor, No. 400	7.50
1—Centralab resistance, 5 watts, 2,000 ohms	2.00
1—Bakelite binding post strip, 3 1/2" x 1 1/2" x 1/4"	1.50
1—Brass mounting strip, 1 7/8" x 1/2" x 1/16"	.80
1—Hardwood baseboard, 8 1/2" x 1 1/2" x 1/4"	.60
1—Set POPULAR RADIO Blueprints	1.00
Total Cost	\$85.20

Wired complete \$7 extra

PRECISION COIL CO., INC.
209 Centre St., New York City

ESSENTIAL KIT

A new model of economy. Four tube volume with 2 tubes, including a UX 112 Power tube. Single dial control. Complete descriptive diagram and data for building with each kit. Order yours today.

1 Set of Precision "N" Coils	\$6.00
1 Prec. Var. Condenser type "N", .00025 Mfd. Cap.	4.25
2 X-L Variodensers, type G-10	3.00
1 7 x 14 x 3/16 drilled panel	3.50
1 7 x 13 1/4 baseboard	.75

Including diagrams.....\$17.50

PARTS YOU WILL NEED BUT MAY HAVE

1 Cleartron Multi-valve	\$6.50
1 Electrad Royalty Resistance, 500,000 ohms	1.50
1 Electrad Fil. Switch	.40
1 Electrad Double Mtg. with .01 fixed Cond.	1.75
1 Electrad Resistor .1 meg.	.60
1 Electrad Resistor .5 meg.	.60
1 Amperite 6 volt 1/2 amp.	1.10
1 Amperite 6 volt 1/2 amp.	1.10
1 Electrad gridleak 3 meg.	.60
2 Samson transformers	10.00
1 Silver Marshall Dial	2.50
8 Fahnestock clips	.20
2 Patent Sockets @ 65c	1.30
1 Electrad .00025 grid cond. with mtg.	.40

Including diagrams, etc.....\$28.55

COCKADAY'S LC-27 BUILT COMPLETE

NOW you can buy the new LC-27 Receiver built complete exactly as Mr. Cockaday's own laboratory model. All you have to do is connect the set with

batteries, loud speaker, etc. and tune in. Five minutes from the time you get your LC-27 you can enjoy its matchless quality.

Every LC-27 we build is carefully tested and fully guaranteed. An LC-27 Receiver must function exactly like the original model or it cannot leave our factory.

ONLY \$10 EXTRA

It costs only \$10 more to buy the LC-27 tested, built complete, and enclosed in the cabinet of your choice. There are three cabinet models from which you can choose. Prices, built complete, are as follows:

- With Corbett cabinet, S-20, pictured above, \$122.70.
- With open front Corbett Cabinet, S-15, \$113.20.
- With Blandin Cabinet, R-20, \$114.70.

Write us today. We still have a few on hand. Enclose check or money order.

THE NEW K. H.-27

1 K. H.-27 Kit of Essential Parts	\$49.50
3 Hammarlund 17-plate condensers (Mid-line or S.L.F.)	14.25
1 Yaxley Rheostat, 10 ohms	1.35
1 Yaxley Fixed Resistance, 2 ohms	.15
1 Yaxley Battery Switch, Midget type	.50
1 Yaxley Pilot Light Bracket	.50
1 Yaxley Open Circuit Jack, Junior type	.45
1 Yaxley Antenna Switch, Double circuit, Junior type	.85
1 Micamold Grid condenser, .00025 M.F. with C.L. mounting	.45
1 Micamold fixed condenser, .001 M.F.	.40
2 Micamold fixed condensers, .002 M.F.	.80
1 Micamold grid leak mounting	.30
1 Micamold grid leak, 2 or 3 megohms	.45
2 Dubilier 1 MFD Condensers	2.50
2 X-L Variodensers, Type G 1 (.001 Max.)	3.00
4 Amperites (3 Type 1A and 1 Type 112)	4.40
2 Aristocrat Vernier Port Dials	4.00
11 Eby Binding Posts, engraved	1.65
1 6 Volt Lamp for Pilot Light	.50
Total Cost, including diagram	\$86.00

THE LC SENIOR POWER PACK

Described in November, 1926, POPULAR RADIO

1—Brach Control	\$ 6.00
1—AmerTran transformer, PF-52	18.00
1—Benjamin UX-Socket	75
1—AmerChokes, No. 854	12.00
1—Eby binding posts	1.05
1—Precision paper filter condenser, No. 26, 2 mfd.	5.50
1—Precision paper filter condenser, No. 24, 2 mfd.	3.00
1—Precision paper filter condenser, No. 44, 4 mfd.	5.50
1—AmerTran resistor, No. 400	7.50
1—Centralab resistance, 5 watts, 2,000 ohms	2.00
1—Bakelite binding post strip, 3 1/2" x 1 1/2" x 1/4"	1.50
1—Brass mounting strip, 1 7/8" x 1/2" x 1/16"	.80
1—Hardwood baseboard, 8 1/2" x 1 1/2" x 1/4"	.60
1—Set POPULAR RADIO Blueprints	1.00
Total Cost	\$85.20

Wired complete \$7 extra

PRECISION COIL CO., INC.
209 Centre St., New York City

THE PRECISION RADIO FREQUENCY CHOKE COIL

Can be used wherever this type of coil is necessary. Very compact, being one inch in diameter and one and one-half inches long. Can be mounted on a sub-panel or a baseboard. Bracket for baseboard mounting provided with each coil. Has a very low distributed capacity, due to the slotted form of winding. List price \$1.00.



HIGH VOLTAGE FILTER CONDENSERS

Made in the following capacities particularly for use where high voltage condensers are necessary:

- *No. 46—4 mfd. DC working voltage 600. Price \$9.00
- *No. 26—2 mfd. DC working voltage 600. Price \$5.50.
- *No. 44—4 mfd. DC working voltage 400. Price \$5.50
- *No. 24—2 mfd. DC. working voltage 400. Price \$3.00.

*Specified for the Senior Power-Pack.



THE ORIGINAL COCKADAY COIL

The only coil ever specified by Laurence M. Cockaday, inventor of the famous Cockaday Four Circuit Tuner for use in his set. The best hard rubber tubing and double silk covered copper wire insures a coil of unusual quality, resulting in increased volume and greater selectivity. Dielectric and leakage losses are extremely low. Price, \$5.50.



The Watch Dog of your Tube



FREE
Write today for "The Radiall Book" with Hook-Ups and construction data to Dept. PR2.

Perfect Tube Performance demands AMPERITE

REG. U.S. PAT. OFF.

The "SELF-ADJUSTING" Rheostat

Amperite alone can give you full value from your tubes. Guarantees perfect filament current control under every condition—automatically. Don't accept substitutes claimed just as good. Insist on Amperite. It is the only automatic, variable filament resistance—and nothing else will do. Eliminates hand rheostats. Simplifies wiring. Price \$1.10 mounted (in U. S. A.). Sold everywhere.

RADIALL COMPANY
52 Franklin St.
New York



U-8BN—Oct. 31, 1926; signal strength R3 to R4; calling CQ on 37 meters; steady AC note; slight fading.

U-4IW—Oct. 31, 1926; signal strength R4; calling CQ on 38 meters; very steady pure DC note; slight fading; much interference.

U-2TP—Oct. 31, 1926; signal strength R5; heard answering CQ-DX from F-8JF; rough AC note, very steady; no fading.

U-9BAZ—Oct. 31, 1926; signal strength R4 to R5; calling CQ on 38 meters; rough, double AC note; slight fading.

U-3LW—Oct. 31, 1926; signal strength R5 to R7; calling K-4YAC on 37 meters; clear, steady AC note; decided fading.

U-1AKM—Oct. 31, 1926; signal strength R5; calling G-6YD on 38 meters; steady AC note; no fading.

U-8CEO—Oct. 31, 1926; signal strength R6; calling CQ on 40 meters; steady AC note; no fading.

U-3NR—Oct. 31, 1926; signal strength R5; signing off on 39 meters; steady, clear AC note; slight fading.

U-9ARA—Oct. 31, 1926; signal strength R3; calling CQ on 37 meters; clear, steady AC note; slight fading; much interference.

U-2CFT—Oct. 31, 1926; signal strength R6; calling G-2KZ on 37 meters; very steady AC note; slight fading; much interference.

U-1CMX—Oct. 31, 1926; signal strength R6; calling CQ-DX on 37 meters; clear, steady AC note; no fading.

U-1XV—Oct. 30, 1926; signal strength R5; in communication with I-1MA; steady pure DC note; slight fading.

Megaphoning Programs from Airplanes

A NOVEL medium of publicity has been opened by the completion of a radio experiment by Harry F. Paar, operator of commercial broadcast station K-WCR in Cedar Rapids, Iowa.

Mr. Paar mounted a specially constructed receiver on a Waco airplane and equipped it with a Magnavox tele-megaphone, secured to the side of the ship. Programs are picked up from various points while the plane is in flight and are megaphoned through the loudspeaker. Clarity of tone from the ship show little change as the elevation of the ship ranges from 400 to 1600 feet. By use of a portable superheterodyne receiver and the telemegaphone it is planned to have the ship circle over outlying towns and megaphone programs put on the air by station K-WCR.

* *

Cuba and Mexico Sign a Radio Treaty

An international radio system has been provided for in a treaty which has been recently signed by the representatives of the governments of Cuba and Mexico by which the radio systems of the two countries are to be connected. The treaty provides for three classes of service; official service, messages in connection with the operation of the system, and public messages. The official messages are to be carried free, and all of the profits of the international service are to be divided equally between the two countries.

Build Your LC-27 Receiver

by the aid of

Popular Radio SIMPLIFIED Blue Prints

Easy, Quick and Accurate

POPULAR RADIO believes that this new circuit; which is the outstanding contribution of Laurence M. Cockaday to the experimental set-builder for this year, constitutes not only one of the most important advances that has so far been made in the radio art, but that it is distinguished by a tonal quality—particularly in the lower registers—that is unsurpassed.

This receiver embraces the 14 points of an ideal radio receiver to meet the demands of the average man's requirements.

1. A quality of reproduction that is as nearly perfect as possible;
2. A cabinet designed to blend harmoniously with the finest surroundings;
3. Consistently good performance with a minimum of care and attention, once the set is installed;
4. A tuning control so simple that any one may operate the set without special instruction;
5. A selectivity adequate to eliminate interference from stations on adjoining wavelengths;
6. An ability to operate on any type of outdoor antenna or with no antenna at all;
7. A capacity to operate on house current or batteries, as desired;
8. Adequate shielding of parts;
9. A power amplifier and output filter to supply ample volume without distortion;
10. A construction that provides for the use of nationally known tubes and parts that are easily obtainable in any locality;
11. A non-regenerative circuit;
12. A simple construction with a minimum of adjustments;
13. A sensitivity adequate to provide good reception of distant programs;
14. A fool-proof construction.

By using POPULAR RADIO Simplified Blueprints in building your LC-27 Receiver, you can save time, eliminate the possibility of error, and make your set exactly like the laboratory model (see page 199).

If your local dealer cannot supply you with Blueprints of the LC-27 Receiver, they will be sent post-paid upon receipt of \$1.00.

A full description of this Receiver, with detailed directions for building, was published in the October 1926, issue of POPULAR RADIO. Send 35 cents for a copy.

POPULAR RADIO
Service Bureau 24-B

627 West 43rd St., New York City

How to use Resistance in Radio!



Send for this new booklet!

Ward Leonard Electric Company announces a booklet of interest to radio dealers, experimenters, and engineers.

Resistance assumes major importance in radio as higher voltages and currents are employed in power supply units.

"How to use Resistance in Radio" tells the proper use of resistance and outlines many of the new A. C. and D. C. power circuits. It will be sent postpaid for 15c.

Ward Leonard Electric Company
Mount Vernon New York
Resistor Specialists for More Than 35 Years

7135-3

Build The Outstanding Circuit of the Year

HENRY- LYFORD

Receiver

With the Deliberately Unbalanced Circuit

This new unbalanced feature gives a tremendous increase in sensitivity without losing selectivity. Were a manufacturer to build this set, with labor, overhead and selling costs which of necessity must be added to material it would easily come within the \$300 class.

A Simple Circuit—Easy to Build

Simple instructions are furnished with each complete set of parts and all you need is a screw driver, soldering iron and a pair of pliers.

COMPLETE LIST OF STANDARD PARTS

Carefully packed and fully guaranteed

\$69.50

Every Dealer
Should have our New
CATALOG

This catalog is published by our Kit Service Department, for customers who desire complete parts for all popular circuits.

SENT ON REQUEST

Make requests to Service Dept.

HEINS & BOLET
Wholesale and Retail

44 Park Place New York

Before
You
Build
a Set
Get
this
Catalog
of



I. C. A. PANELS & PARTS FANS!

Your set can be made to look and to operate as well as a "factory" set if you build it with I.C.A. Insulation materials. We carry in stock panels for over 70 popular circuits, in hi-gloss Insuline or Bakelite, drilled and decorated by the beautiful Etch-O-Gravure Method, all ready to set up. Or we can furnish you with blanks in Insuline or Bakelite, black and wood finishes, all standard sizes.

I. C. A. PANELS for "Popular Radio" Circuits

Improved Browning-Drake—5 tube; Silver-Cockaday—4-tube; LC-27—5-tube; Daven Bass Note—6-tube; Orthophase—5-tube; Samson T.C. Circuit—4-tube; Reflex Receiver—5-tube; McLaughlin Super-Het—8-tube; Amortran B Supply and Amplifier.

We also furnish Sub-Panels for the above and all other popular circuits.

I.C.A. INSULATION PRODUCTS include, Tubing; Spaghettil Tubing; Rods; Sub-Panel Mounting Brackets; Sockets; Socket Shells; Blinding Post Panels; Vernier Dials; Pointer Knobs; Grid Leak Holders; Knife Switches; Three-Stage Resistance Coupled Amplifier; Aerial Insulators, etc.

Don't take substitutes for the genuine I.C.A. Products. If your dealer can't supply you write us direct, Dept. P-8.

INSULATING CO. OF AMERICA, Inc.
59 Warren St. New York City

Changes in the List of Broadcasting Stations in the U. S.

These corrections and additions to the list which was published in the March, 1926, issue of POPULAR RADIO (together with the changes which have been published in succeeding months) make the list correct as of January, 1, 1927. Further changes will be published each month in this magazine.

STATIONS ADDED

KFOX	Seattle, Washington	210.0
KGCU	Mandan, North Dakota	285.0
KGDO	Dallas, Texas	285.0
KGDP	Pueblo, Colorado	280.7
KGDR	San Antonio, Texas	240.0
KGEA	Seattle, Washington	345.0
KVI	Tacoma, Washington	242.5
KVOS	Seattle, Washington	333.1
KXL	Portland, Oregon	400.0
WABF	Pringleboro, Pennsylvania	410.7
WBKN	Brooklyn, New York	231.1
WBMC	Woodside, New York	293.9
WDWM	Newark, New Jersey	280.2
WEKD	Philadelphia, Pennsylvania	249.9
WJBJ	Chicago Heights, Illinois	419.3
WKBU	New Castle, Pennsylvania	238.0
WLBG	Petersburg, Virginia	332.3
WLBH	Farmingdale, New York	230.0
WLCI	Ithaca, New York	266.0
WLIB	East Wenona, Illinois	296.9
WMBS	Harrisburgh, Pennsylvania	360.0
WMHA	New York, New York	230.0
WMVM	Newark, New Jersey	475.9
WPAB	Norfolk, Virginia	319.0
WPEP	Waukegan, Illinois	212.6
WRRS	Racine, Wisconsin	360.0
WSYR	Syracuse, New York	352.7
WWPR	Detroit, Michigan	300.0
WWVA	Wheeling, West Virginia	348.6
WRSC	Chelsea, Massachusetts	270.1
WLBA	Philadelphia, Pennsylvania	236.1
KYA	San Francisco, California	399.8
WBET	Boston, Massachusetts	384.4
KGDZ	Decorah, Iowa	431.0
WTRL	Midland Park, New Jersey	280.2
KGDY	Oldham, South Dakota	210.0
WLBH	Portable	225.4
WLBQ	Ashland, Ohio	220.4
WLBQ	Atwood, Illinois	230.6
WLBK	Cleveland, Ohio	300.0
WLBQ	Galesburg, Illinois	243.0
WCOM	Manchester, New York	282.0
WLBK	Belvedere, Illinois	335.0
WMPC	Lapeer, Michigan	222.0
WOKT	Rochester, New York	340.0
WBSO	Wellesley Hills, Massachusetts	242.0
KFCR	Santa Barbara, California	413.0
KGDY	Shreveport, Louisiana	291.1

STATIONS DELETED

KFJC	Junction City, Kansas	218.8
WABQ	Haverford, Pennsylvania	260.7
WEBZ	Savannah, Georgia	263.0
WHBG	Harrisburg, Pennsylvania	230.6
WJBX	Osterville, Massachusetts	280.0
WIBH	New Bedford, Massachusetts	209.7
KFUU	Oakland, California	220.4

CHANGES IN WAVELENGTHS

KFDY	Brookings, S. D., 305.9	change to	299.8
KPFW	Oakland, Cal., 315.6	change to	325.8
KRLD	Dallas, Tex., 357.1	change to	353.0
KSBA	Shreveport, La., 312.6	change to	260.7
KWTC	Santa Ana, Cal., 260.7	change to	263.0
WCBR	Providence, R. I., 209.7	change to	234.2
WCWS	Bridgeport, Conn., 209.7	change to	232.4
WEDC	Chicago, Ill., 422.3	change to	249.9
WFCI	Pawtucket, R. I., 229	change to	258.5
WKBM	Newburgh, N. Y., 215.7	change to	285.5
WKBO	Jersey City, N. J., 309.1	change to	303.9
WSAR	Fall River, Mass., 254.1	change to	322.0
WKBO	Jersey City, N. J., 309.1	change to	303.9
WJAR	Providence, R. I., 305.9	change to	483.6
WIBW	Portable, 220.9	change to	215.7
KRLD	Dallas, Texas, 353	change to	357.1

CHANGES IN LOCATIONS

KSBA	Kennonwood, La., change to	Shreveport, La.
WCWS	Providence, R. I., change to	Bridgeport, Conn.

New Radio Beacons Protect Shipping

With twelve new radio beacon stations added within a single year, bringing the total number up to 28, the Coastal and Great Lakes shipping of the United States is now said to be better protected than that of any other country.

These radio beacons, which are under the direction of the Government Light-house Service, will supply bearings to thousands of ships this year.

Vee Dee

ART



Metal Panels

for Kits and Sets



For Nationally Famed Kits— Drilled and Decorated

L. M. Cockaday LC-27, \$3.70

Browning-Drake Improved, \$3.05

Hammarlund-Roberts Hi-Q, \$2.70

Silver-Cockaday, Panel and Chassis

\$4.60

Karas Equamatic, \$3.50

Infradyne-Remler Type, \$3.75

Bremer-Tully Power Six, \$3.05

Citizens Super Panel and Chassis,

\$6.60

Write for Discounts

Receivers equipped with Vee Dee metal art panels will yield the utmost in efficiency, accuracy, durability, beauty and economy.

Vee Dee Metal Panels are finished in beautiful wood grains, bronze duotones and high lighted novelty effects. Precisely drilled to the thousandth part of an inch. Every special panel includes vulcanized fibre bushing for best insulation.

Vee Dee Metal Panels are being adopted as standard equipment by prominent manufacturers of kits and sets.



STOCK METAL PANELS

In all standard sizes. Easy to drill. Retail prices range from \$2.15 to \$3.55. Beautifully finished and artistically decorated.

Manufacturers—Jobbers

Save money and improve your sets by adopting Vee Dee Metal Art Panels. We co-operate in working out new panel designs. Lowest prices—liberal terms. Write to

THE VAN DOORN COMPANY
160 North La Salle Street Chicago, Ill.
Factories, Quincy, Ill.

30 Days Free Trial

Just Out -
1927
Model

Yes Sir!
You can put a new 1927 Westingale Radio in your home and use it to your heart's content on 30 Days' Trial. Listen to music, concerts, news, sports, market reports from stations all over the country. Compare it with old style 3 or 4 dial sets costing more, then if not convinced that Westingale gives you the greatest Radio satisfaction and the best value for your money, you don't have to keep it.

NOW! Westingale offers the last word in Radio. Either 1 or 2-Dial Control — easiest to tune and years ahead in powerful reception and tone. Newest period type cabinets, two-tone walnut finish. The front panel embossed in dull gold with artistic Spanish Galleon design. Unbeatable for performance, appearance or price.

2-Dial, 5 tubes \$47⁰⁰

1-Dial, 5 tubes \$57⁰⁰

Where else can you get so much for the money on 30 days trial? Why pay more? Why take chances? Why not have the NEWEST Radio when you can try them at our risk. Before you buy get our Free Catalog and 30 Day Trial Offer.

AGENTS

Make Big Profits — Buy at Cost

We want to appoint agent or dealer and place one Westingale Demonstrating set in each locality. Get demonstrator at big discount in price and on 30 days' trial, and make \$50 to \$100 a week as our representative. Our Free Book tells how.

Your Own Radio -- FREE

Our FREE Catalog also explains a plan whereby you can put a Westingale Radio in your home on 30 Days' Trial—demonstrate it to your neighbors and friends and get your own set without cost. Write for catalog, discounts and complete details today.

Westingale Electric Co., Dept. 144, 1751 Belmont Ave., Chicago, Ill.

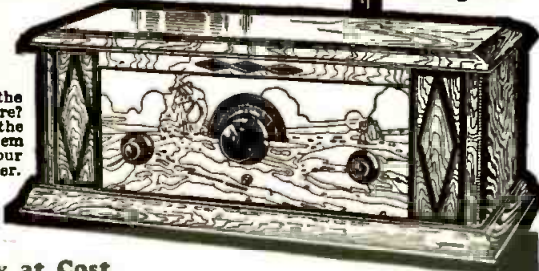

New ONE
Dial Radio

\$57⁰⁰

Retail Price

Big Discounts
to Agents

Outstanding Program Features of the Month

JANUARY 20th TO FEBRUARY 15th
DURING the coming month, January 20th to February 15th, the following regular and special program features are scheduled. This list, which will be augmented monthly as advance information is received, will be published in each issue of the magazine; all broadcast stations are invited to report coming program features of outstanding interest or importance. Reports should reach the Editor of POPULAR RADIO on or before the 23rd of the month preceding.

JANUARY
(Eastern Standard Time)

- 20th; *Royal Typewriter Orchestra*, WGY; 9:00 P.M. (Also broadcast from WRC, WBZ and WJZ).
- 20th; *Clicquot Club Eskimos*, WEA; 9:00 P.M. (Also broadcast from WEEL, WCCO, WGN, WCAE, WJAR, WTAG, KSD, WOC, WGR, WFI and WWJ).
- 20th; *Goodrich Zippers*, WEA; 10:00 P.M. (Also broadcast from WEEL, WCCO, WGN, WGR, WCAE, WJAR, WTAG, KSD, WOC, WSI, WWJ, WSAI and WADC).
- 21st; *Happiness Boys*, WEA; 8:00 P.M.
- 21st; *Breyer Hour*, WJZ and WRC; 9:00 P.M.
- 21st; *La France Orchestra*, WEA; 9:30 P.M. (Also broadcast from WEEL, WGR, WLIT, WOC, WCAE, WTAM, WDAF, WWJ and KSD).
- 22nd; *New York Symphony Orchestra with Walter Damrosch*, WEA; 9:15 P.M. (Also broadcast from WEEL, WGR, WFI, WCAE, WWJ, WSAI, WTAM, WGN, KSD, WCCO and WDAF).
- 23rd; *Capitol Theatre Grand Orchestra*, WEA; 7:20 P.M. (Also broadcast from KSD, WRC, WWJ, WSAI, WCAE and WTAG).
- 23rd; *Atwater Kent Hour*, WEA; 9:15 P.M. (Also broadcast from WSAI, WEEL, WFI, WCCO, WTAM, WGN, WCAE, WGR, WOC, WTAG, WWJ and KSD).
- 23rd; *Godfrey Ludlow*, WJZ; 9:30 P.M. (Also from WGY).
- 23rd; *Maxwell House Coffee Hour*, WJZ; 10:15 P.M. (Also broadcast from WBZ, WRC, WGY and KDKA).
- 24th; *Willys-Overland Hour*, WJZ; 8:30 P.M.
- 24th; *A & P Gypsies*, WEA; 9:00 P.M. (Also broadcast from WEEL, WJAR, WDAF, WRC, WCAE, WTAM, WLIT and WWJ).
- 24th; *Fireside Boys*, WJZ; 9:50 P.M.
- 24th; *B. A. Rolfe's Palais D'Or Orchestra*, WEA; 11:00 P.M.
- 25th; *Classical music, small ensemble*, WRNY; 8:00 P.M.
- 25th; *Vikings*, WEA; 8:00 P.M. (Also broadcast from WEEL, WJAR, WTAG, WGR, WFI, WCAE, WTAM, WWJ, KSD, WSAI, WCCO and WOC).
- 25th; *Jolly Buckeye Bakers*, WEA; 8:30 P.M. (Also broadcast from WFI, KSD, WSAI, WCCO, WTAM, WWJ, WTAG and WLIB).
- 25th; *Eveready Hour*, WEA; 9:00 P.M. (Also broadcast from WEEL, WFI, WCAE, WGR, WWJ, WOC, KSD, WJAR, WCCO, WTAM, WGN, WSAI and WTAG).
- 25th; *Champion Spark Pluggers*, WJZ; 8:00 P.M. (Also broadcast from WGY and WRC).
- 25th; *Keystoners*, WJZ; 9:00 P.M. (Also broadcast from WRC and WGY).
- 25th; *Auction Bridge Instructions*, WEA; 10:00 P.M. (Also broadcast from WEEL, WCAE, WTAM, WTAG, WJAR, WGR, WCAE, WTAM, WFI, WWJ, WSAI, WGN, WOC, WCCO, and KSD).
- 25th; *Cook's Tours*, WJZ; 10:00 P.M. (Also broadcast from WRC and WGY).
- 25th; *George Olsen's Orchestra*, WJZ; 10:45 P.M.
- 26th; *Eastman Theatre Orchestra*, WJZ; 6:30 P.M. (Also from WHAM).
- 26th; *Davis Saxophone Octette*, WEA; 8:30 P.M. (Also broadcast from WEEL, WJAR, WLIT, WRC, WTAG and WCAE).
- 26th; *Sixty White Minutes*, WJZ; 9:00 P.M. (Also broadcast from WBZ, KDKA and KYW).
- 26th; *Ipana Troubadours*, WEA; 9:00 P.M. (Also broadcast from WEEL, WGR, WRC, WCAE, WWJ, WLIT, KSD and WCCO).
- 26th; *Smith Brothers*, WEA; 10:00 P.M. (Also broadcast from WTAG, WGR, WRC, WCAE, WWJ, WSAI, KSD, WOC, WCCO, and WDAF).
- 27th; *Royal Typewriter Orchestra*, WGY; 9:00 P.M. (Also broadcast from WRC, WBZ and WJZ).
- 27th; *Clicquot Club Eskimos*, WEA; 9:00 P.M. (Also broadcast from WCCO, WGN, WCAE, WJAR, WTAG, KSD, WOC, WGR, WFI and WWJ).
- 27th; *Goodrich Zippers*, WEA; 10:00 P.M. (Also broadcast from WEEL, WCCO, WGN, WCAE, WJAR, WTAG, KSD, WOC, WGR, WSI, WWJ, WSAI and WADC).
- 28th; *Happiness Boys*, WEA; 8:00 P.M.
- 28th; *Hohner Harmony Four*, WEA; 8:30 P.M. (Also broadcast from WEEL, WLIT, WGR, WRC, WCAE, WLIT, WTAM and WWJ).
- 28th; *Breyer Hour*, WJZ and WRC; 9:00 P.M.
- 28th; *La France Orchestra*, WEA; 9:30 P.M. (Also broadcast from WEEL, WGR, WLIT, WOC, WCAE, WTAM, WDAF, WWJ and KSD).
- 29th; *New York Symphony Orchestra with Walter Damrosch*, WEA; 9:15 P.M. (Also broadcast from WEEL, WGR, WFI, WCAE, WWJ, WSAI, WTAM, WGN, KSD, WCCO and WDAF).



New Vitalitone Ship Model Cone Speaker

Not a picture, but a real model of a ship sculptured by a foremost artist—and finished in antique polychrome—powered with the wonderful Vitalitone Unit and Cone—We are the pioneer manufacturers of cone speakers—and know what you want—Here it is.

“SUPREME QUALITY AND BEAUTY”

And only \$12.50 F.O.B. N. Y.

Your dealer or direct.

Vitalitone Radio Corporation

88 University Place, N. Y., U. S. A.

Build a 3 ft. Cone Speaker as fine as any you can buy

**-SAVE
4/5
Retail
Price**



A 3 ft. Cone Speaker, which you can build in one evening at home, with PENN Cone Speaker Unit will give as fine TONE QUALITY as a factory-built speaker costing 5 times as much.

"Received material and have completed speaker. Sure is fine. Thank you," writes R. Hanson, Joliet, Ill.

"Never have heard its equal." "Have built 6 and they are simply wonderful."

"Really enjoyed reception for the first time," are other comments.

Complete, detailed, easy-to-follow instructions will let you get same satisfactory results. It takes just as long to build a 3 ft. speaker using a less satisfactory unit as it does to build one using the

Penn Cone Speaker Unit

which costs very little more. A marvel of design and construction; adjustable to the audio output of set with which speaker is used; so sensitive it works with any set that will operate a loud speaker. Magnet, pole pieces and armature are plated to prevent rust, preserve magnetism; shortest, strongest drive rod on any unit; full 16 oz. horse-shoe magnet; will take all volume the tubes will pass. Unit only, \$9.50. Complete parts—including 2 sheets Alhambra FONOTEX, Back Rings, Unit Mountings, Ambroid Cement and Unit—only \$14.15.

Ask your dealer for the genuine PENN Cone Speaker Unit and complete parts. If he cannot or will not supply you, we will ship on receipt of price. Pamphlet, "How to Build a 3 ft. Cone Speaker" sent for 10c, coin or stamp. Write today.

PENN RADIO SALES COMPANY

104 FIFTH AVE. Suite 2196 NEW YORK CITY
Exclusive Selling Agents for G. R. PENN MFG. CO., N. Y. C.

DEALERS: Your customers are reading and acting on it. You can sell these demanded items. Write us for full information.

Build Your Improved Browning-Drake

with
**Popular Radio
SIMPLIFIED
Blue Prints**

Easy, Quick and Accurate

The Improved Browning-Drake Broadcast Receiver, designed by Arthur H. Lynch, former Editor of Radio Broadcast and built and approved in the POPULAR RADIO LABORATORY.

Here is a receiver which combines all the advantages of a circuit that has long been recognized as standard with new ideas and improvements which have been made in receiver construction since the circuit was first designed.

High efficiency that emphasizes fine tone quality is the outstanding characteristic of this new model.

By using POPULAR RADIO Blue Prints in building your Improved Browning-Drake Broadcast Receiver, you can save time, eliminate the possibility of error, and make your set exactly like the laboratory model (see page 104).

If your local dealer cannot supply you with Blue Prints of the Improved Browning-Drake, they will be sent postpaid upon receipt of \$1.00 per set.

A full description of this set, with detailed directions for building, was published in the August, 1926, issue of POPULAR RADIO. Send 35c for copy.

POPULAR RADIO

Service Bureau 24-C

627 W. 43rd St., New York City

- 30th; Capitol Theatre Grand Orchestra, WEAFF; 7:20 P.M. (Also broadcast from KSD, WRC, WWJ, WSAI, WCAE and WTAG).
- 30th; Atwater Kent Hour, WEAFF; 9:15 P.M. (Also broadcast from WSAI, WEEI, WFI, WCCO, WTAM, WGN, WFI, WCAE, WGR, WOC, WTAG, WWJ, and KSD).
- 30th; Godfrey Ludlow (violinist) WJZ; 9:30 P.M. (Also from WGY).
- 30th; Maxwell House Coffee Hour, WJZ; 10:15 P.M. (Also broadcast from WBZ, WRC, WGY and KDKA).
- 31st; Willys-Overland Hour, WJZ; 8:30 P.M.
- 31st; A & P Gypsies, WEAFF; 9:00 P.M. (Also broadcast from WEEI, WJAR, WDAF, WRC, WCSH, WCAE, WTAM, WLIT and WWJ).
- 31st; Fireside Boys, WJZ; 9:50 P.M.
- 31st; B. A. Rolfe's Palais D'Or Orchestra, WEAFF; 11:00 P.M.

FEBRUARY

- 1st; Classical music, small ensemble, WRNY; 8:00 P.M.
- 1st; Champion Spark Pluggers, WJZ; 8:00 P.M. (Also broadcast from WGY and WRC).
- 1st; Vikings, WEAFF; 8:00 P.M. (Also broadcast from WEEI, WJAR, WTAG, WGR, WFI, WCSH, WCAE, WTAM, WWJ, KSD, WSAE, WCCO and WOC).
- 1st; Jolly Buckeye Bakers, WEAFF; 8:30 P.M. (Also broadcast from WFI, KSD, WSAI, WCCO, WTAM, WWJ, WTAG and WLIB).
- 1st; Eveready Hour, WEAFF; 9:00 P.M. (Also broadcast from WEEI, WFI, WCAE, WGR, WWJ, WOC, KSD, WJAR, WCCO, WTAM, WGN, WSAI and WTAG).
- 1st; Keystone, WJZ; 9:00 P.M. (Also broadcast from WRC and WGY).
- 1st; Auction Bridge Instructions, WEAFF; 10:00 P.M. (Also broadcast from WEEI, WCSH, WTAG, WJAR, WGR, WCAE, WTAM, WFI, WWJ, WSAI, WGN, WOC, WCCO and KSD).
- 1st; Cook's Tours, WJZ; 10:00 P.M. (Also broadcast from WRC and WGY).
- 1st; George Olsen's Orchestra, WJZ; 10:45 P.M.
- 2nd; Eastman Theatre Orchestra, WJZ; 6:30 P.M. (Also from WHAM).
- 2nd; Davis Saxophone Octette, WEAFF; 8:30 P.M. (Also broadcast from WEEI, WJAR, WLIT, WRC, WTAG and WCAE).
- 2nd; Sixty White Minutes, WJZ; 9:00 P.M. (Also broadcast from WBZ, KDKA and KYW).
- 2nd; Ipana Troubadours, WEAFF; 9:00 P.M. (Also broadcast from WEEI, WGR, WRC, WCAE, WWJ, WLIT, KSD and WCCO).
- 2nd; Smith Brothers, WEAFF; 10:00 P.M. (Also broadcast from WTAG, WGR, WRC, WCAE, WWJ, WSAI, KSD, WOC, WCCO and WDAF).
- 3rd; Royal Typewriter Orchestra, WGY; 9:00 P.M. (Also broadcast from WRC, WBZ and WJZ).
- 3rd; Chicquot Club Eskimos, WEAFF; 9:00 P.M. (Also broadcast from WEEI, WCCO, WGN, WCAE, WJAR, WTAG, KSD, WOC, WGR, WFI and WWJ).
- 3rd; Goodrich Zippers, WEAFF; 10:00 P.M. (Also broadcast from WEEI, WCCO, WGN, WCAE, WJAR, WTAG, KSD, WOC, WGR, WSAI, WWJ, WSI and WADC).
- 4th; Happiness Boys, WEAFF; 8:00 P.M.
- 4th; Breyer Hour, WJZ and WRC; 9:00 P.M.
- 4th; La France Orchestra, WEAFF; 9:30 P.M. (Also broadcast from WEEI, WGR, WLIT, WOC, WCAE, WTAM, WDAF, WWJ and KSD).
- 5th; New York Symphony Orchestra with Walter Damrosch, WEAFF; 9:15 P.M. (Also broadcast from WEEI, WGR, WFI, WCAE, WWJ, WSAI, WTAM, WGN, KSD, WCCO and WDAF).
- 6th; Capitol Theatre Grand Orchestra, WEAFF; 7:20 P.M. (Also broadcast from KSD, WRC, WWJ, WSAI, WCAE, WTAG).
- 6th; Atwater Kent Hour, WEAFF; 9:15 P.M. (Also broadcast from WSAI, WEEI, WFI, WCCO, WTAM, WGN, WFI, WCAE, WGR, WOC, WTAG, WWJ and KSD).
- 6th; Godfrey Ludlow (violinist), WJZ; 9:30 P.M. (Also from WGY).
- 6th; Maxwell House Coffee Hour, WJZ; 10:15 P.M. (Also broadcast from WBZ, WRC, WGY and KDKA).
- 7th; Willys-Overland Hour, WJZ; 8:30 P.M.
- 7th; A & P Gypsies, WEAFF; 9:00 P.M. (Also broadcast from WEEI, WJAR, WDAF, WRC, WCSH, WCAE, WTAM, WLIT and WWJ).
- 7th; Fireside Boys, WJZ; 9:50 P.M.
- 7th; B. A. Rolfe's Palais D'Or Orchestra, WEAFF; 11:00 P.M.
- 8th; Classical music, small ensemble, WRNY; 8:00 P.M.
- 8th; Champion Spark Pluggers, WJZ; 8:00 P.M. (Also broadcast from WGY and WRC).
- 8th; Vikings, WEAFF; 8:00 P.M. (Also broadcast from WEEI, WJAR, WTAG, WGR, WFI, WCSH, WCAE, WTAM, WWJ, KSD, WSAI, WCCO and WOC).
- 8th; Jolly Buckeye Bakers, WEAFF; 8:30 P.M. (Also broadcast from WFI, KSD, WSAI, WCCO, WTAM, WWJ, WTAG and WLIT).
- 8th; Eveready Hour, WEAFF; 9:00 P.M. (Also broadcast from WEEI, WFI, WCAE, WGR, WWJ, WOC, KSD, WJAR, WCCO, WTAM, WGN, WSAI and WTAG).
- 8th; Keystone, WJZ; 9:00 P.M. (Also broadcast from WRC and WGY).
- 8th; Auction Bridge Instructions, WEAFF; 10:00 P.M. (Also broadcast from WEEI, WCSH, WTAG, WJAR, WGR, WCAE, WTAM).

For fine Cone Speakers that you Build or Buy



ALHAMBRA FONOTEX, developed especially for cone speakers, is used by nearly all the leading makers of fine cone speakers because it produces tone quality far superior to less expensive substitutes. Alhambra FONOTEX is not paper but a distinctive product. It has almost no grain, therefore it has no resonance point of its own but resonates uniformly at all frequencies. Practically impervious to atmospheric changes.

Whether you buy a cone speaker or build your own, be sure that the cone is made of Alhambra FONOTEX.

At dealers in 38" x 38" sheets for 3 foot cones. Price 75c. If your dealer will not get Alhambra FONOTEX for you we will ship f.o.b. New York. Add \$1 for special packing to the cost of the number of sheets you want.

The SEYMOUR Co.,
Desk 111
325 West 16th Street
New York City

ALHAMBRA FONOTEX

FOR CONE TYPE LOUD SPEAKERS

To Manufacturers:

If you are not using it, we can demonstrate that Alhambra FONOTEX will improve the tone of your cone speaker.

DEALERS—Radio constructors from all parts of the country send to us for Alhambra FONOTEX because their dealers do not carry it. Don't lose any more sales; stock Alhambra FONOTEX.

JOBBER—Write us if we are not adequately represented in your territory. We have an interesting proposition.

Flux a factor in Satisfactory Reception

THE importance of the proper flux for radio soldering, has become so significant, that manufacturers of better radio sets have, after extensive laboratory tests, adopted Kester Rosin Core Solder—alert set builders, too, use nothing but Kester Radio Solder, the handy size package of Kester Rosin Core Solder.

Pure rosin, as in Kester Radio Solder, is absolutely non-corrosive and is the only safe flux for radio. Being a hard, dense substance, rosin will not attract and collect dust (carbon particles) which forms a path for leakages. Chloride fluxes in either paste, liquid or compound form are highly corrosive. They absorb moisture from the air, and when heat is applied, a spattering, fuming and spreading action is caused. The areas over which flux is thus spread attract and collect dust (carbon particles) which forms an excellent path for leakages and soon impairs the receptive quality of any set.

Insist upon knowing that the set you buy has been soldered with Kester Rosin Core Solder and be equally sure that you use only Kester Radio Solder on the set you hook up yourself.



A free sample—write for it now

KESTER Radio SOLDER

The safe solder and flux for radio

CHICAGO SOLDER COMPANY
4201 Wrightwood Ave.
Chicago, U. S. A.



Now is The Time you need a Ducon!

When there's sleet and snow and howling winds—that's the time when antenna troubles come. Many is the good program that has been missed while the B.C.L. was trying to make up his mind to tackle the broken antenna on his icy roof.

And that is why every set owner should have a little Ducon handy. Plugged into any light socket it makes an aerial out of all your house wiring without risk. What is more, it gives greater selectivity in crowded areas—gives better results than most outdoor aerials do. And it puts an end forever to the annoyance of a broken aerial.

Good dealers sell the Dubilier Ducon on five days' trial for \$1.50. Buy one now and have it handy when you need it—you will probably never want to go back to the old aerial again.

Send 10c in stamps or coin for our new 32 page booklet "Seventeen Ways to Improve Your Set." It will tell you things that only experts know about the use of fixed condensers.

Dubilier

CONDENSER AND RADIO CORPORATION

4377 Bronx Blvd., New York, N. Y.

- WFI, WWJ, WSAI, WGN, WOC, WCCO and KSD).
- 8th; *Cook's Tours*, WJZ; 10:00 P.M. (Also broadcast from WRC and WGY).
- 8th; *George Olsen's Orchestra*, WJZ; 10:45 P.M.
- 9th; *Eastman Theatre Orchestra*, WJZ; 6:30 P.M. (Also from WHAM).
- 9th; *Davis Saxophone Octette*, WEA; 8:30 P.M. (Also broadcast from WEEL, WJAR, WLIT, WRC, WTAG, WCAE).
- 9th; *Sixty White Minutes*, WJZ; 9:00 P.M. (Also from WBZ, KDKA and KYW).
- 9th; *Ipana Troubadours*, WEA; 9:00 P.M. (Also broadcast from WEEL, WGR, WRC, WCAE, WWJ, WLIB, KSD and WCCO).
- 9th; *Smith Brothers*, WEA; 10:00 P.M. (Also broadcast from WTAG, WGR, WRC, WCAE, WWJ, WSAI, KSD, WOC, WCCO and WDAF).
- 10th; *Royal Typewriter Orchestra*, WGY; 9:00 P.M. (Also broadcast from WRC, WBZ and WJZ).
- 10th; *Citiquot Club Eskimos*, WEA; 9:00 P.M. (Also broadcast from WEEL, WCCO, WGN, WCAE, WJAR, WTAG, KSD, WOC, WGR, WFI and WWJ).
- 10th; *Goodrich Zippers*, WEA; 10:00 P.M. (Also broadcast from WEEL, WCCO, WGN, WCAE, WJAR, WTAG, KSD, WOC, WGR, WSI, WWJ, WSAI and WADC).
- 11th; *Happiness Boys*, WEA; 8:00 P.M.
- 11th; *Hohner Harmony Four*, WEA; 8:30 P.M. (Also broadcast from WEEL, WLIT, WGR, WRC, WCAE, WLIB, WTAM and WWJ).
- 11th; *Breyer Hour* (orchestra and vocal), WJZ and WRC; 9:00 P.M.
- 11th; *La France Orchestra*, WEA; 9:30 P.M. (Also broadcast from WEEL, WGR, WLIT, WOC, WCAE, WTAM, WDAF, WWJ and KSD).
- 12th; *New York Symphony Orchestra with Walter Damrosch*, WEA; 9:15 P.M. (Also broadcast from WEEL, WGR, WFI, WCAE, WWJ, WSAI, WTAM, WGN, KSD, WCCO and WDAF).
- 13th; *Capitol Theatre Grand Orchestra*, WEA; 7:20 P.M. (Also broadcast from KSD, WRC, WWJ, WSAI, WCAE and WTAG).
- 13th; *Atwater Kent Hour*, WEA; 9:15 P.M. (Also broadcast from WSAI, WEEL, WFI, WCCO, WTAM, WGN, WFI, WCAE, WGR, WOC, WTAG, WWJ and KSD).
- 13th; *Godfrey Ludlow* (violinist), WJZ; 9:30 P.M. (Also from WGY).
- 13th; *Mazwell House Coffee Hour*, WJZ; 10:15 P.M. (Also broadcast from WBZ, WRC, WGY and KDKA).
- 14th; *Willys-Oerland Hour*, WJZ; 8:30 P.M.
- 14th; *A & P Gypsies*, WEA; 9:00 P.M. (Also broadcast from WEEL, WJAR, WDAF, WRC, WCSH, WCAE, WTAM, WLIT and WWJ).
- 14th; *Fireside Boys* (vocal), WJZ; 9:50 P.M.
- 14th; *B. A. Rolfe's Palais D'Or Orchestra*, WEA; 11:00 P.M.
- 15th; *Classical music, small ensemble*, WRNY; 8:00 P.M. WJZ; 9:50 P.M.
- 15th; *Champion Spark Pluggers Orchestra*, WJZ; 8:00 P.M. (Also broadcast from WGY and WRC).
- 15th; *Vikings*, WEA; 8:00 P.M. (Also broadcast from WEEL, WJAR, WTAG, WGR, WFI, WCSH, WCAE, WTAM, WWJ, KSD, WSAI, WCCO and WOC).
- 15th; *Jolly Buckeye Bakers*, WEA; 8:30 P.M. (Also broadcast from WFI, KSD, WSAI, WCCO, WTAM, WWJ, WTAG and WLIB).
- 15th; *Eveready Hour*, WEA; 9:00 P.M. (Also broadcast from WEEL, WFI, WCAE, WGR, WWJ, WOC, KSD, WJAR, WCCO, WTAM, WGN, WSAI and WTAG).
- 15th; *Keystoners*, WJZ; 9:00 P.M. (Also broadcast from WRC and WGY).
- 15th; *Auction Bridge Instructions*, WEA; 10:00 P.M. (Also broadcast from WEEL, WCSH, WTAG, WJAR, WGR, WCAE, WTAM, WFI, WWJ, WSAI, WGN, WOC, WCCO and KSD).
- 15th; *Cook's Tours*, WJZ; 10:00 P.M. (Also broadcast from WRC and WGY).
- 15th; *George Olsen's Orchestra*, WJZ; 10:45 P.M.
- 16th; *Eastman Theatre Orchestra*, WJZ; 6:30 P.M. (Also from WHAM).
- 16th; *Davis Saxophone Octette*, WEA; 8:30 P.M. (Also broadcast from WEEL, WJAR, WLIT, WRC, WTAG and WCAE).
- 16th; *Sixty White Minutes* (orchestra), WJZ; 9:00 P.M. (Also broadcast from WBZ, KDKA and KYW).
- 16th; *Ipana Troubadours*, WEA; 9:00 P.M. (Also broadcast from WEEL, WGR, WRC, WCAE, WWJ, WLIB, KSD and WCCO).
- 16th; *Smith Brothers* (vocal and instrumental), WEA; 10:00 P.M. (Also broadcast from WTAG, WGR, WRC, WCAE, WWJ, WSAI, KSD, WOC, WCCO and WDAF).

Antennas Now a Part of Motorboat Equipment

ANTENNA wires strung from the mast to the hull are no longer necessary in the latest type of motorboat which is being provided by the manufacturers with built-in loop antennas that are embedded in the hull when the boat is built.

To Speed Radio Patents

UNDER the supervision of Secretary Hoover, the Radio Division of the U. S. Patent Office has made some rapid strides in cleaning up its unfinished business. Although this Division is the largest in the Patent Office, and has been transferred to the Department of Commerce for only a year, it is but five and one-half months behind its work.

When Secretary Hoover took over the Radio Division of the U. S. Patent Office, no radical changes in administration were made. Instead, a committee of experts was instructed to study the situation and report to the Secretary. The results of the work of this Committee have just been received.

Among some of its recommendations are increased salaries for the technical and scientific employees, with an additional force to handle the clerical work; modern equipment for the office, as well as the construction of a new building; an amendment in statutes governing Patent Office practice, largely covering appeals, making the Patent Office decisions final except as they may be reviewed by a U. S. District Court.

"Diseases" Caused by Radio

NEW diseases with names derived from the radio are progressing fast and unchecked. At first the doctors told us that radio fans suffered from "radio-ears," when it was necessary to wear headphones to tune in distance. Next came "disto-mania," which is self-explanatory, followed by "audio-toxication" and "nocturnal radiophasia."

Of course, these diseases are perfectly harmless unless they become chronic, although they are infectious. The latest ones are "microphobia," which is a word meant to describe the disease-like fear experienced by first-timers, and some old-timers too, when they first appear before the microphone of a broadcasting station.

The newest disease is "microphonitis," which is defined as "a chronic infection which so expands the ego that one is never content except when talking through the 'mike.'"

Starving Trappers Saved by Radio

WHEN the *Bay Eskimo*, supply ship of the Hudson's Bay Company, was crushed in the ice of Hudson's Straits last July, and the relief ship sent to save the men on board failed to reach her, radio was finally turned to as a last resort and proved to be the means of saving the trappers' lives. An appeal for help was broadcast by the company through station WBZ and another hunting post, hundreds of miles away, picked up the call and rushed food by dog sled over the icy wastes to the ship in time to save the marooned men.

Radio Tells the Time

KEEPING America on time is the latest duty of the radio broadcasters, now that the Western Union and the telephone companies refuse to answer questions about the time. The man without a receiver may be out of luck, but the radio listener will continue to set his watch by the time signals from Arlington or whenever a broadcaster signs on or off.

* *

\$1,000,000 for a Broadcast Station

SOME idea of the tremendous value of a modern broadcasting station may be obtained from the price paid for station WEAJ which was recently sold to the Radio Corporation of America for one million dollars. A large part of the value of a station of this kind, of course, lies in the good will of its listeners and the fact that it is known from one end of the country to the other.

* *

Radio Telephones on German Express Trains

A REGULAR "wired wireless" telephone system by means of which telephone calls may be made between any telephone in Berlin and Hamburg and express trains running between these cities, has been opened to the public after months of experiment. Rates are no higher than for ordinary long distance calls and the transmission is said to be extraordinarily clear. Both the transmitting and receiving antennas are located along the roofs of the Pullman cars; the impulses then travel to telephone wires running along the tracks.



E. B. Harvey, Los Angeles

PARK CONCERTS VIA LOUDSPEAKERS

To Los Angeles belongs the credit for first carrying into effect the plan of broadcasting (from station KNX) concerts to its public parks, through the medium of receiving sets and loudspeaker installations such as is pictured above. The nine installations cost the city a total of \$22,675; but the average cost for one band concert in one park used to be \$200; now the music of one band is broadcast to the other eight parks.

New Full-Wave Gas Rectifier Tubes

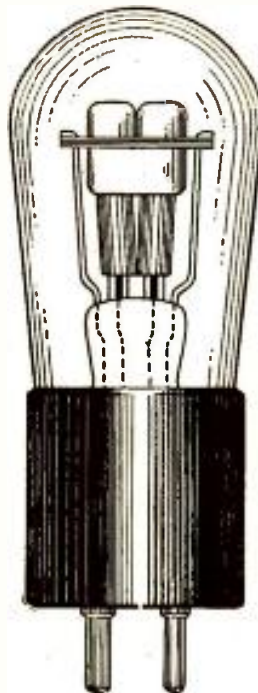

- 60 Milliamps - - - - - \$6.00
- 85 Milliamps - - - - - \$6.00

Guaranteed. Made under our own patent applications. We do not use the old short path principle.

We also have some news regarding an A, B and C Eliminator without batteries or charger, if you are interested.

Write for dealers' or manufacturers' discounts; or better, order samples for comparison tests.

R. G. Dun or Bradstreets will tell you our guarantee is good.

The Q·R·S Music Company
306 S. Wabash Ave., Chicago



MODEL "C" CHEST

Cabinets in stock—have piano hinge and are 10" deep—grooved front top rail being removable. Illustration shows gold line wood panel to match.

Sizes	Walnut Only	Panel to Match
7x18-10	\$15.00	\$1.26
7x21-10	17.00	1.47
7x24-10	19.00	1.68
*7x26-10	21.00	1.82
7x30-10	23.00	2.10
*7x28-11	23.00	1.96

*For Madison-Moore Receiver.
*For Victoreen Receiver.

Walnut Infradyne Cabinet
\$30⁰⁰

LC-27 Cabinets

Mahogany or Walnut with Baseboard
\$18⁰⁰

The LC-27 cabinets have 25° slope and take 8" x 26" panel. They are full 10" deep back of the panel.

WRITE FOR folder showing complete LC-27 Line and other Radio Furniture.

CORBETT CABINET MFG. COMPANY
St. Marys - - Pennsylvania

Simplified Blue Prints

of the

"Town and Country"

Portable Receiver

The "Town and Country" Portable Receiver, developed by the POPULAR RADIO LABORATORY and described in the July, 1926 issue, marks a decided advance in portable receiver design. While not a "vest pocket" receiver, the new "Town and Country" is small enough to be taken along on a motor boat or train trip. Efficiency has not been sacrificed for the sake of compactness.

The receiver uses six UX-199 tubes and one UX-120 power tube. Operating on a loop, tone quality is guaranteed by the use of a fundamentally correct circuit, high-class transformers and cone-type speaker.

The "Town and Country" Portable Receiver is mounted in a special mahogany cabinet with a drop front and is equipped with a carrying handle. All equipment, including the folding loop, cone loudspeaker, batteries and connecting cable, is installed in a suitcase. Connections from the equipment to the set are made by means of jacks and plugs.

By using POPULAR RADIO Blue Prints in building your "Town and Country" receiver, you can save time, eliminate the possibility of error, and make your set exactly like the laboratory models (see page 199).

If your local dealer cannot supply you with Blue Prints of this set, they will be sent postpaid upon receipt of \$1.00 per set.

POPULAR RADIO

Service Bureau 24-D

627 W. 43rd St., New York City

A Loudspeaker That Is Heard in Two Cities

RADIO shops with their outside loudspeakers have a serious rival now as a purveyor of free music to the people of Camden, N. J., for a monster loudspeaker has been installed there on top of a high building and may be heard all over the city. Such a tremendous amount of amplification is used that the music from the speaker has often been heard in Philadelphia across the river; and on one occasion, traffic was stopped on the new Delaware River Bridge by crowds of people looking for the source of the broadcast.

Let Your Dress Be Your Antenna

FEMININE fans who like to carry their radio with them in the shape of small portable sets will welcome the suggestion made by Felicia Sorel, a dancer, who declares that the gilt tape used for indoor aerials makes an ideal trimming for dresses and a handy loop antenna at the same time.

Have You Ever Heard—

THE canary birds sing in the lobby of the Hotel Commodore during the dinner music broadcast from that hotel through station WJZ?

The tick of the metronome between the selections and announcements from station PWX in Cuba?

The traffic policeman's whistle on the corner of 34th Street and Fifth during the dinner hour concert at the Waldorf-Astoria broadcast through station WEAf?

The lazy southern drawl of the WSB announcer?

The "tweet-tweet-tweet" of the Arlington time signals, rebroadcast through station KDKA?

The "toodle-oo" of the staccatone between the selections at station WRNY?

Greece Limits Listening Range for Fans

IT'S no news when a government restricts transmitters to a certain wavelength range but it is unusual for a nation to forbid listeners, as Greece has recently done, to listen in on certain wavelengths. The use of all privately owned receiving sets that are capable of picking up messages transmitted on a wavelength of 2,000 meters or more has been prohibited; owners of such apparatus must have their sets adjusted by the government to receive only the lower wavelengths before they may be used again. Although no explanation has been proffered, it is suspected that the Greek Government plans to use the higher wavelengths for official business and wants to be sure that no one, in Greece at least, will be able to listen in.

British Fans Hear U. S. Programs Nightly

BRITISH air-planes, according to recent reports from London, are flooded every night now in the early morning hours by programs broadcast by American stations. As soon as darkness has fallen over the full width of the Atlantic, at about 1.30 A.M. Greenwich time, listeners find that they can pick up an astonishing number of American stations that were entirely inaudible during the tests last winter. One fan is reported to have picked up WJZ on a simple three-tube set comprising only a detector and two stages of audio-frequency amplification with such strength that it could be heard on a loudspeaker all over a fair-sized room with good volume.



Herbert



A TALKING BOOK FOR YOUR LIBRARY

The innocent looking volume on the the right is actually a loudspeaker; a metal rod from the speaker unit actuates the pages of the book which reproduce the sound in much the same manner as a cone speaker. The left view shows how the covers of the book have been rigidly mounted on a base; the leaves conceal the speaker unit. Milton Gabler designed and built this curious speaker.



SM

“Installment Building”



Again Silver-Marshall comes to the front with a radically new idea to add to your radio enjoyment.

It's called “Installment Building”, for it lets you select the finest of radio receivers, the S-M Shielded Six, build it step by step as your inclination and pocket-book allows, and enjoy its remarkable

performance from the very minute of your first purchase.

Think what this means! You can build the Shielded Six with its tone quality guaranteed to be the most satisfying you've ever heard, its three stages of individually shielded equalized tuned R. F. amplification—with an initial investment of less than \$27.00!

Then, step by step, discarding nothing, buying nothing you do not always use, you can add to it until the last tube is in place, and you have a receiver the equal of two to five hundred dollar factory built sets of the latest design!

Ask your dealer for details of the S-M “Installment Building Plan”.

A, B, C Power Supply

Have you seen the new Radio Mechanics A, B, C eliminator? You can build this thoroughly practical, tried and proven power supply for your present receiver. It will eliminate all batteries, and will furnish ample A, B and C power for 201A and power tubes. Write for details.

Silver-Marshall, Inc.

844 W. Jackson Blvd., Chicago, U. S. A.



The excellence of the S-M power units is attested to by the fact that they have been selected in well over half the A, B, C power supplies that have been designed by such prominent authorities as L. M. Cockaday, G. M. Best, M. B. Sleeper and Radio News Laboratories.

220 Audio Transformer	\$6.00
221 Output Transformer	6.00
329 Power Transformer	6.00
330 Power Transformer	6.00
331 Unichoke	6.00
332 Condenser Bank	10.00

A New and Advanced Model

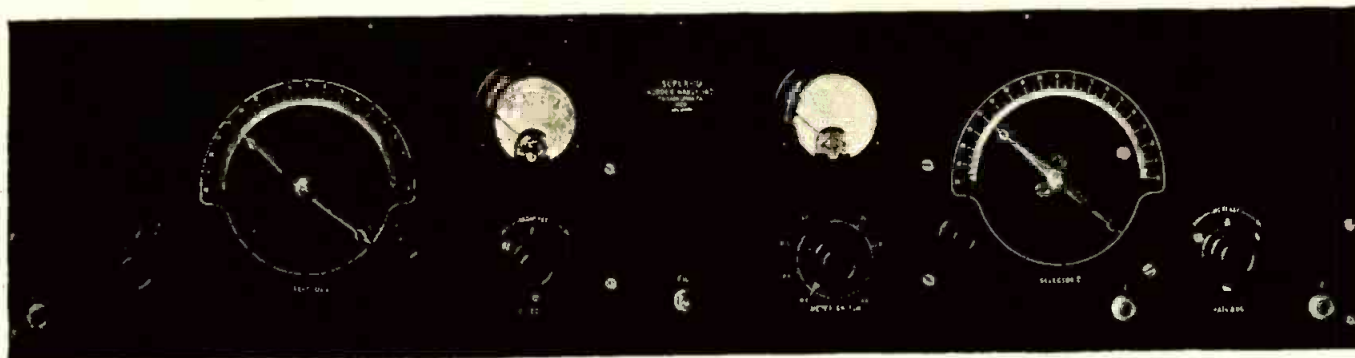

Panel Size: 36" x 9" x 1/4"

Standard Admiralty Model

Weight: 55 lbs.

NORDEN-HAUCK Super-10

THE NORDEN-HAUCK SUPER-10 is an entirely new and advanced design of Receiver, representing what we believe to be the finest expression of Modern Radio Research Engineering. It is the product of years of experience devoted exclusively to the attainment of an ideal Broadcast Receiver—regardless of cost.

Results obtained in every respect will upset all your previous ideas of good radio reception. The unusually large number of unsolicited testimonials constantly being received from users—concerns and individuals—of international repute—indicates the absolute superiority of the NORDEN-HAUCK SUPER-10.

You, too, may enjoy the advantages of this wonderful receiver at a suprisingly moderate cost. Here are only a few of the host of features that place the NORDEN-HAUCK SUPER-10 far in advance of competition:

- 10 tubes employed to give perfect reproduction with unlimited range and volume power.
- Super selectivity on all wave lengths.
- Built to Navy Standards.
- Wide wave length range without change of coils, 200-550 meters full. (Adaptable 35 meters to 3600 meters if desired.)
- Use Loop or Antenna.
- Simple to operate, having only two major tuning controls.
- No Harmonics. Signals are received only at one Point.
- Special Power Audio Amplifier, operating any loudspeaker and eliminates necessity of external amplifier.

Write, Telegraph or Cable Direct to

NORDEN-HAUCK, Inc.

ENGINEERS

MARINE BUILDING

Cables: "Norhauck"

PHILADELPHIA, U. S. A.

TEAR OFF AND MAIL TODAY

NORDEN-HAUCK, Inc.
Philadelphia, Pa.

Gentlemen:—

- Please send me without cost or obligation on my part, attractive illustrated literature describing the new Norden-Hauck Super-10.
- I enclose \$2.00 for which please send me, postpaid, complete full size constructional drawings and all data for building the Super-10.

NAME

ADDRESS

The NORDEN-HAUCK SUPER-10 is available completely constructed and laboratory tested, or we shall be glad to supply the complete engineering data, construction blue prints, etc., for those desiring to build their own receiver.

UPON REQUEST complete literature, attractively illustrated, will be gladly mailed without charge, or full size constructional blue prints, showing all electrical and mechanical data, will be promptly mailed postpaid upon receipt of \$2.00.

CROSLLEY 1927 RADIOS

Each set giving the utmost in radio enjoyment at its price. All prices slightly higher West of the Rocky Mountains. All prices are without accessories.



The 5-50—\$50

Enthusiastic owners report amazing performance—a drum delivering stations loud, clear and sharp; each an almost imperceptible turn of the drum apart. Write station letters on drum, return to them at will. Single drum station selector. Acuminators, power tube adaptability and all metal chassis that shields the units from each other. Beautifully finished. Mahogany cabinet, rose gold trimmings.



The 5-75 Console—\$75

This set includes ideas for radio reception perfection not found in any other radio. Marvelous exclusive Crosley "Crescendon" and "Acuminators" increase volume on distant stations and bring in programs entirely missed and passed by on ordinary one-dial control radios. Console model stands 40 inches high. The Crosley Musicone is skillfully built into the cabinet in a manner which is both an artistic and an acoustical triumph. Ample space for batteries and accessories.



"6 Tube RFL-90" Console, \$90

Introducing the double drum station selector! Crosley's winning non-oscillating perfectly balanced tuned radio set. Includes Musicone skillfully built into exquisite console mahogany cabinet of two-tone finish to match finest surroundings. Room for batteries and all accessories; 40 inches high; 30 1/2 inches wide.



The Crosley Musicone

The secret of the popularity of this highest selling loud speaker on the market lies in its actuating unit. This and NOT the cone shape is the reason for its perfect reproduction of all audible sound. BEWARE of imitations. There is only one genuine Musicone. It is built solely by Crosley under mass production methods which makes its unmatchable value possible.



CROSLLEY

BETTER... COSTS LESS

RADIO



"—as long as I can pick up 27 programs in 30 minutes beside our 3 locals interference won't bother me

I sat down the other night with this Crosley set. One control. Beginning at one end of the broadcasting wave band, I tuned in 27 stations, loud and clear, just like the Cincinnati stations, three of which were going full blast. I listened to each program; identified it; didn't hear any others in the background, and passed on to the next—all with one finger. It was between 7:00 and 7:30 P. M. Central Standard Time.

The air was certainly full. Some of the stations were less than a dial marking apart. It is amazing how the jiggers they call "acuminators" helped on such fine separation.

Even using a hundred foot aerial the local stations were easy to go through. One of them only a few blocks away from my home. Some radio, I call it! \$50.00 seems too little. I'd like to see some two hundred dollar sets do as well!

Write Dept. 16 for Catalog
THE CROSLLEY RADIO CORPORATION
 Powel Crosley, Jr., Pres.
 CINCINNATI, OHIO

Crosley sets are licensed under Armstrong U. S. Patent No. 1,113,149, or under patent applications of Radio Frequency Laboratories, Inc., and other patents issued and pending.

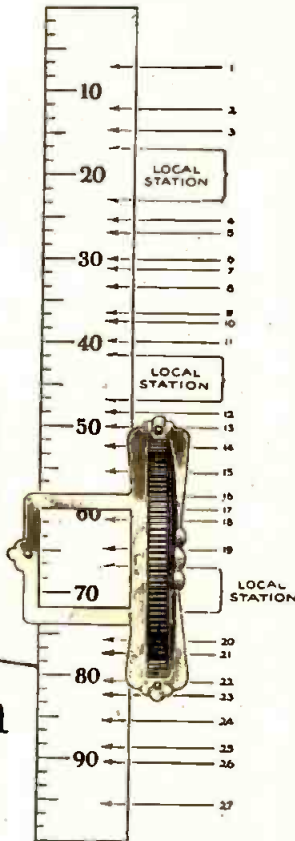

The above scale reading shows how stations picked up by Mr. X—appeared on the Crosley graphic drum station selector.

Name on request.

Single Drum Control

\$50.

Prices slightly higher West of the Rocky Mountains.



Crosley 1927 Features

Many exclusive—others found only in highest priced radios.
THE "CRESCENDON"
 When, on ordinary radios, ears must strain to catch a station miles away a turn of the Crescendon on Crosley radios instantly swells reception to room filling volume. An exclusive Crosley feature.

ALL-METAL SHIELDED CHASSIS
 This truly great radio achievement, found in several Crosley sets, furnishes a substantial frame for mounting elements, produces excellent alignment of condensers, shields the units from each other, prevents interference, improves the stability of the circuit, increases selectivity and saves costs by standard-

izing this phase of manufacture.
THE SINGLE - DRUM STATION SELECTOR
 Nothing in radio equals the joy or the convenience of single drum control. Crosley single drum control enables you to find the stations sought without log book or "tuning."
"THE ACUMINATORS"
 Crosley Acuminators permit tuning in—loud and clear—weak stations

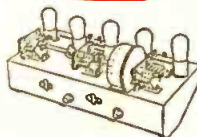

passed over and entirely missed by ordinary single dial radios. In tuning high powered and local stations they are not used. They are an exclusive Crosley feature.

POWER TUBES

Power tube adaptability marks the Crosley "5-50," "5-75" and "RFL" sets. This feature typifies Crosley provision for best radio reception at moderate cost.





New and Improved
**FRESHMAN
MASTERPIECE**

*This Beautiful Console
with built-in Cone Speaker*

is the most perfectly toned radio ever produced.

Its construction with the large cone speaker immediately below Freshman's new QUALITY receiver is so co-ordinated that it results in a tone unexcelled in any radio set.

This handsome genuine mahogany console is an article of furniture you will be proud to have in your home.

Can be Electrified

if you install the new Freshman "ABC" Power Supply.

CHAS. FRESHMAN CO., INC.
Freshman Bldg., - New York
2626 W. Washington Blvd., Chicago

\$79⁵⁰

Slightly higher
Denver and
West.



Write for 48-page book illustrating
all Freshman Products. It's free.



The World's Greatest Radio