

Popular Radio

with which is combined The Wireless Age

JANUARY · 1926

25¢

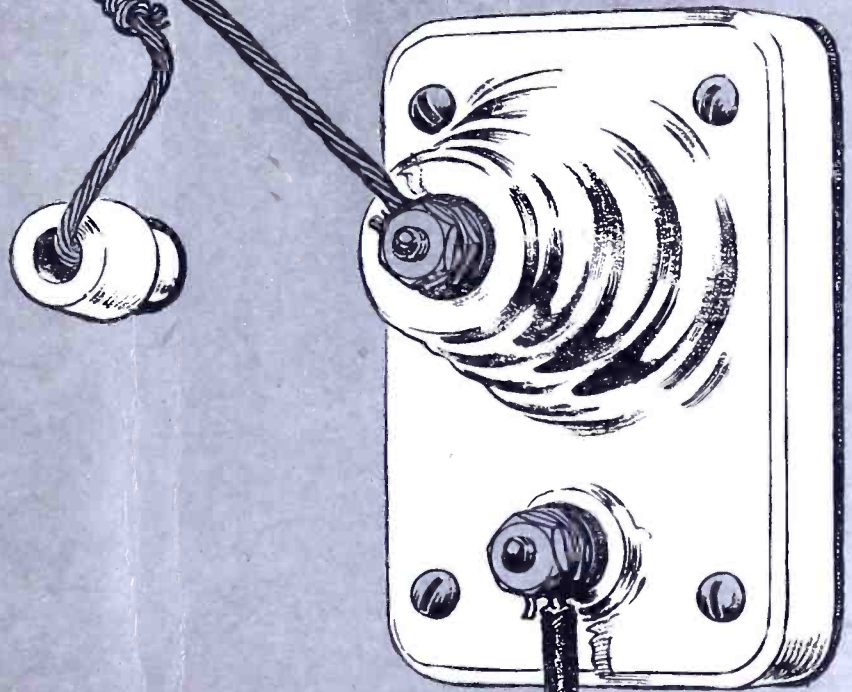

**How to Get the Most Out of
Your LC-26 Receiver**

give your radio set more power with one new Radiotron



Radiotron UX-112

DRIVE a car uphill beyond its power—and the motor knocks. Drive a radio set beyond its power—and the last tube chokes. But change one single tube in the set—and you have the power you need for *greater volume and finer tone.*

The new RCA power tubes add about fifty per cent greater efficiency to any radio set. They cost but \$2.50, and need only an inexpensive adapter and a little extra current. Change the tube of the last audio stage to a new power tube, as any dealer will show you—and in ten minutes you have a new set.

RADIOTRON UX-112

The new storage battery power Radiotron UX-112 may be used in sets that use Radiotron UV-201-A.

Radiotron UX-112—\$6.50

RADIOTRON UX-120

The new dry battery power Radiotron UX-120 may be used in sets that use Radiotron UV-199.

Radiotron UX-120—\$2.50

You would not use any but a Mazda lamp in your lighting circuit. Why use any but an RCA Radiotron in your radio set? They are made by the same skilled workers, backed by the same research laboratories. But the Radiotron is far more delicate to make.



Radiotron
UX-120

RADIO CORPORATION OF AMERICA
NEW YORK . CHICAGO . SAN FRANCISCO

RCA Radiotron

MADE BY THE MAKERS OF RADIOLAS

Brandes

EXPERTS IN RADIO ACOUSTICS SINCE 1908



The Brandes Cone—a truly decorative bit of furniture that conceals a remarkable speaker.



The Type H a horn of graceful lines and antique green and black finish. Great in volume—true in tone. Adjustable.

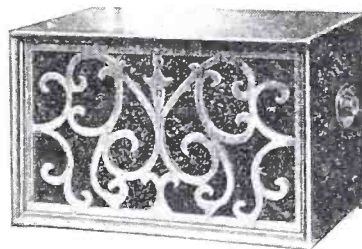

The Brandes Cabinet of mahogany, finished in walnut brown. The same unit, quality of tone and even greater volume than the Type H Speaker.



The Adjustable Table-Talker. Gooseneck horn. Finished in brown—felt-padded base. Adjustable. A most satisfactory buy.

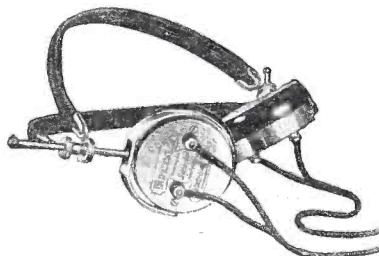

The Superior Matched Tone Headset is now, as always, ideal to tune in with—to listen undisturbed and undisturbing.



The Audio Transformer—amplifies at an unusually high ratio—1 to 5. Two steps of amplification may be used without transformer distortion.

Send for an interesting booklet describing Acoustics by Brandes.

Brandes Products Corp.
200 Mt. Pleasant Ave.
Newark, N. J.

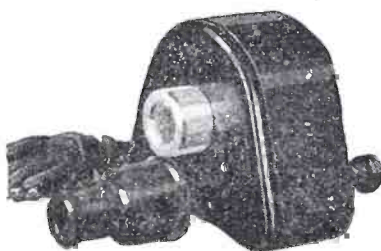

The Phonograph Attachment—a splendid speaker with any good phonograph. Same unit as type H horn. Adjustable and furnished with a connection to fit all phonographs.

The new Brandes Speakers—perfected now after many busy years of experiment—give new clarified mellowness to the low tones, new rounded sweetness to the high.

Be sure your set is in its best voice—always—with acoustics by Brandes.

© Copyrighted by Brandes Products Corp., 1926

All apparatus advertised in this magazine has been tested and approved by POPULAR RADIO LABORATORY

POPULAR RADIO

WITH WHICH IS COMBINED "THE WIRELESS AGE"

EDITED by KENDALL BANNING



FOUNDED 1911

CONTENTS for JANUARY, 1926

| VOLUME IX | (Cover design by Frank B. Masters) | NUMBER 1 |
|---|---|----------|
| The Modern Tower of Babel..... | FRONTISPIECE | |
| The New Wave-Transmission Phonograph..... | Henry C. Harrison..... | Page 3 |
| How to Get the Most Out of Your LC-26 Receiver..... | L. M. Cockaday and S. G. Taylor..... | 10 |
| Will Radio Kill the Small Newspapers?..... | Paul Dupuy..... | 22 |
| The Atom..... | William Bragg..... | 24 |
| Article No. 4: The Nature of Crystals | | |
| Some New and Useful Facts About Coils..... | D. R. Clemons..... | 30 |
| When Your Set Won't Work..... | Edgar H. Felix..... | 40 |
| A Measurement Chart..... | Raoul J. Hoffman..... | 45 |
| No. 13: For Use When Selecting a Rheostat for a Multi-Tube Circuit | | |
| Straight-Line-Frequency Condensers..... | Herbert J. Harries..... | 48 |
| Simple "How-to-Build" Articles for Beginners..... | Laurence M. Cockaday... | 56 |
| No. 14: How to Build a One-Tube Regenerative Receiver for Use With the New UX-199 Tube | | |
| Handy Tools for Radio Fans..... | The Technical Staff..... | 60 |
| No 9: The Hand Drill | | |
| DEPARTMENTS | | |
| In the World's Laboratories..... | E. E. Free..... | 61 |
| What's New in Radio Apparatus..... | The Technical Staff..... | 69 |
| The Broadcast Listener..... | Raymond Francis Yates.. | 74 |
| In the Experimenter's Laboratory..... | Laurence M. Cockaday... | 80 |
| Some Methods for Determining the Distributed Capacity of Coils..... | | 80 |
| How to Simplify Connections..... | | 83 |
| A Milliammeter as an Aid in Preserving Batteries..... | | 83 |
| Making the Tuned Radio-Frequency Receiver More Selective..... | | 83 |
| The Old Reliable Single-Layer Solenoid Coil..... | | 83 |
| Pure DC Power Supply for a Five-Watt Transmitter..... | | 84 |
| Balancing the Single Control Superheterodyne..... | | 87 |
| Broadcasts..... | J. Andrew White..... | 89 |
| With the Inventors..... | William G. H. Finch..... | 96 |
| Listening In..... | Lloyd Jacquet..... | 100 |

VOLUME IX

JANUARY, 1926

NUMBER 1

Published monthly by Popular Radio, Inc., 627 West 43rd St., New York, N. Y., telephone number, Chickering 1906; Douglas H. Cooke, President and Treasurer; Kendall Banning, Vice-President; Laurence M. Cockaday, Secretary; Joseph T. Cooney, Asst. Treasurer. Price 25 cents a copy; subscription \$3.00 a year in the U. S., Canada and all countries within the domestic postal zone; elsewhere \$3.50 a year, payable in advance. The International News Company, Ltd., No. 5 Bream's Bldg., London, E. C. 4, sole distributors in England. Entered as second class matter April 7, 1922, at the Post Office at New York, N. Y., under the act of March 3, 1879. Copyright, 1926, and title registered as a trade-mark by Popular Radio, Inc. Copyright in Great Britain by Popular Radio, Inc., 6 Henrietta St., Covent Garden, W. C., London, England.

Printed in U. S. A.

LAURENCE M. COCKADAY, *Technical Editor*

E. E. FREE, Ph.D., *Contributing Editor*

JOHN V. L. HOGAN, *Contributing Editor*

For advertising rates address

E. R. CROWE & COMPANY, INC.

New York: 25 Vanderbilt Avenue

Chicago: 225 North Michigan Avenue

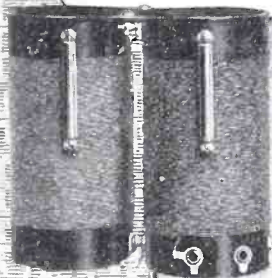
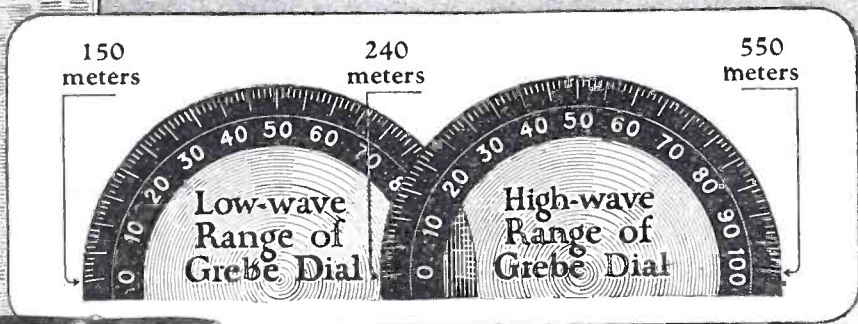

Grebe Synchronizer with
No. 10 1/2 inch. dia.
and
Low-Wave Extension
Circuit

Can Your Set Receive All Stations?

OVER 100 stations are broadcasting on less than 240 meters. How many are beyond the reach of your set? The Synchronphase can get them all.

Grebe Low-Wave Extension Circuits make possible a range of from 550 down to 150 meters. This is accomplished by an automatic switch which enables one dial to cover two wave ranges. The first, from 550 to 240 meters, corresponds to the practical tuning range of the usual set. The second overlaps this and extends down to 150 meters. To change from one range to the other is simplicity itself. Simply move the center dial past the 100 mark for the high range and beyond the zero mark for the low range.

The Synchronphase is thus well-equipped to take care of future station assignments as well as all present ones.

Ask your dealer to demonstrate this and other Grebe advances in radio development

A. H. Grebe & Co., Inc., 109 West 57th St., New York
Factory: Richmond Hill, N. Y.
Western Branch: 443 So. San Pedro Street, Los Angeles, Cal.

The GREBE SYNCHROPHASE

TRADE MARK REG. U.S. PAT. OFF.

This company owns and operates stations WAHG and WBOQ; also low-wave rebroadcasting stations, mobile WGMU, and marine WRMU.



"The Gods cannot help one who loses opportunities."

—Mencius

The wise man will provide against the future by securing a Synchronphase.

Doctor *Wheeler*



All Grebe apparatus is covered by patents granted and pending.

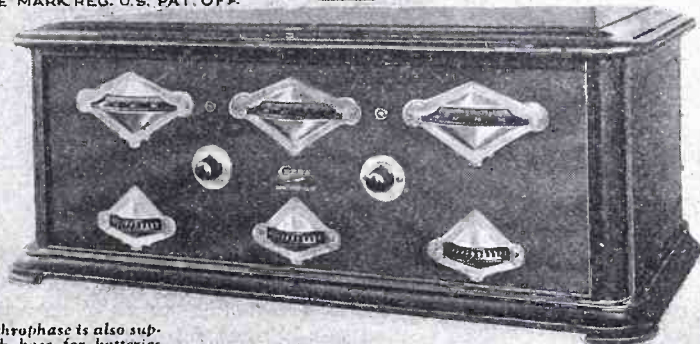

The Synchronphase is also supplied with base for batteries and in a deluxe Console Model.

All apparatus advertised in this magazine has been tested and approved by POPULAR RADIO LABORATORY

PAGES WITH THE EDITOR

PERHAPS some day a scheme will be devised for checking up on the actual number of readers of *each copy* of POPULAR RADIO.

ORDINARILY a magazine publisher assumes that there is an average of five readers to every copy. The circulation of POPULAR RADIO among radio clubs, electrical laboratories, business offices, schools and colleges would indicate that this average is at least maintained and probably exceeded. And reports like the following tend to confirm this impression:

"A COUSIN of mine in America," writes C. R. Boydell of Manchester, England, "posts POPULAR RADIO to me, and when I've read it I pass it around to all of my radio friends, who look forward to it as they look forward to their meals."

THE Editor would like to get reports from readers about the numbers of readers each copy

of POPULAR RADIO probably has—based on their personal observations.

ON page 449 of POPULAR RADIO for November (in "Practical Pointers about Transformers" by Frederick E. Nimmcke) the author gives formula No. 11 as follows:

$$S = H + a \text{ inches.}$$

The author writes that the formula *should* have appeared thus:

$$S = H + 2 \times a \text{ inches.}$$

ON page 98 of this number of POPULAR RADIO Mr. Lloyd Jacquet makes his first appearance as the conductor of the department "Listening In."

THIS department will be made up entirely of communications from broadcast listeners and experimenters who have discovered useful and helpful bits of information that they are willing to share with the Other Fellow.

(Continued on page 6)

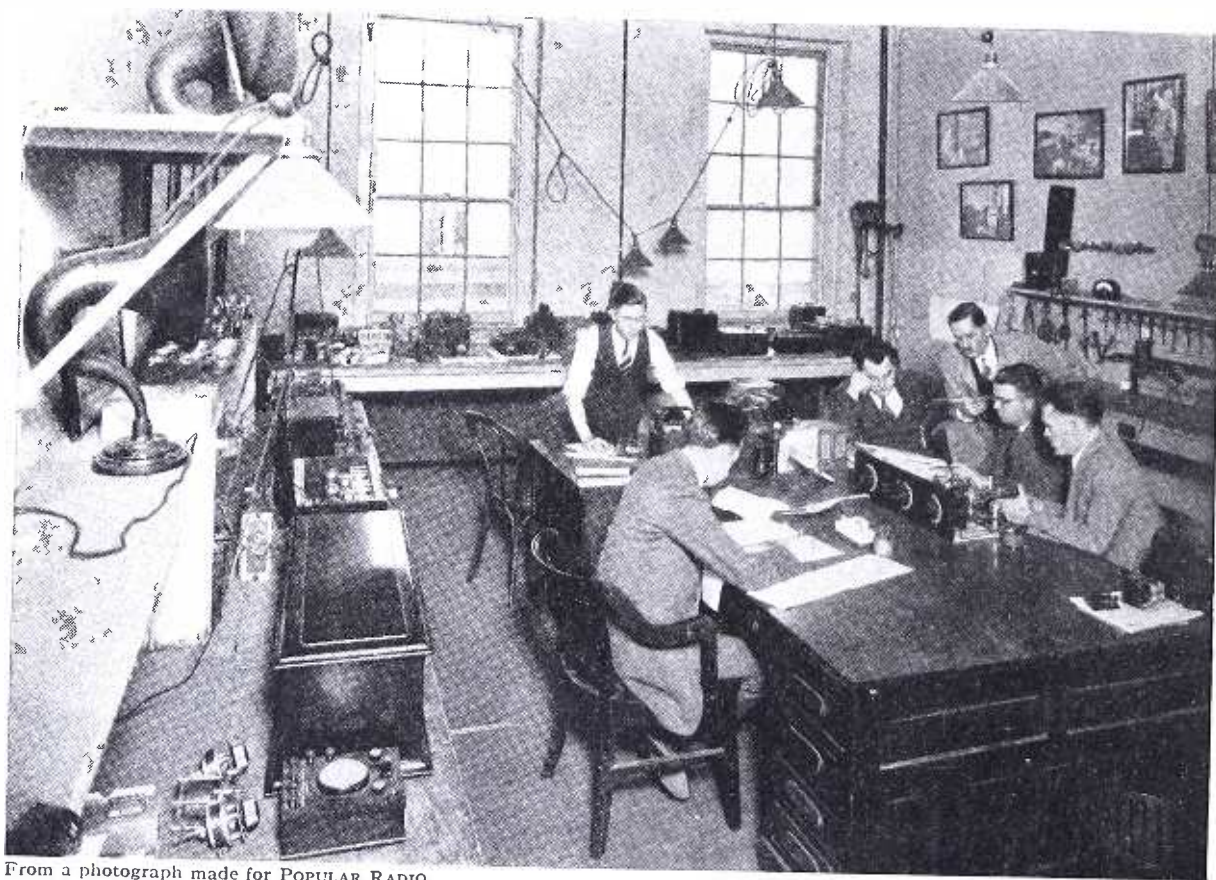

From a photograph made for POPULAR RADIO

WHERE POPULAR RADIO'S EXPERIMENTAL WORK IS DONE

In the POPULAR RADIO LABORATORY in New York is conducted a large part of the experimental and development work on which the articles in this magazine are based. Here, also, are tested all of the radio apparatus that is submitted for approval. This laboratory is supplemented by laboratories maintained by individual members of the Technical Staff.

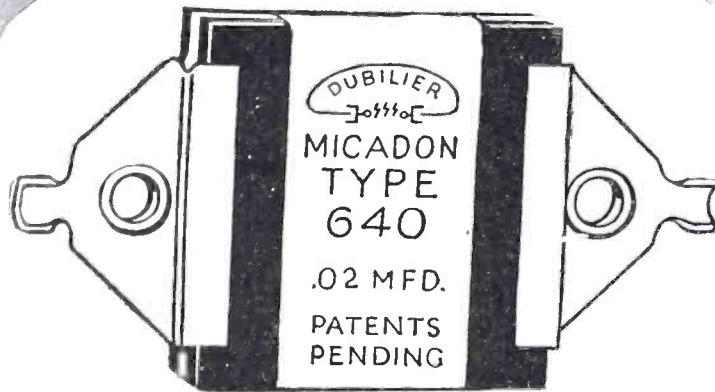

MICADONS

Found in famous radio sets

In radio sets that have earned fame and a reputation for quality, you will find Micadons—the foremost fixed condensers of radio.

Over 25 million in use

More than 25 million Micadons are today giving satisfactory service—they are found in 90% of all the radio sets in use.

The reason is

Dubilier *knows how* to make efficient fixed condensers and their methods are fully protected by basic patents. Micadons are the result of twenty years' intensive, scientific research.

Dubilier
CONDENSER AND RADIO CORPORATION

PAGES WITH THE EDITOR
(Continued from page 4)

ALL readers are invited to send in the successful results of their experiments to Mr. Jacquet. Make the letters short and to the point—and enclose diagrams or photographs if they add interest or value to the text.

NEXT month POPULAR RADIO will present its readers with another "how-to-build" article on which its creator, Mr. R. J. Griffith, in collaboration with the staff of the POPULAR RADIO LABORATORY has been long engaged. It has been termed the Orthophase Receiver.

THE distinguishing features of the Orthophase Receiver during the period of its development, extending over a period of several months, have been summarized thus:

1. Extremely good selectivity.
2. High sensitivity.
3. Good tone quality.
4. Simplicity of construction.

DURING the experimental work the set in the POPULAR RADIO LABORATORY in New York consistently picked up Pacific Coast stations on a 15-foot antenna.

FROM the Technical Editor comes this brief description of the new features of the Orthophase Receiver:

"THE set comprises one stage of push-pull radio-frequency amplification and one stage of reflexed audio-frequency amplification, the tubes in this reflexed stage being in parallel. The reflexed radio-frequency current (which in most reflex sets is wasted) is built up and its phase reversed, after which it is applied to the grids of the push-pull stage, in phase with the incoming oscillations from the antenna, thereby aiding or reinforcing the incoming signal. In the present set one stage of transformer-coupled audio-frequency amplification and one stage of resistance-coupled audio-frequency is added."

THE Fourth National Radio Conference that was convened in Washington, D. C. by the Secretary of Commerce on November 9 has now passed into history. It was a notable gathering of representatives of the radio amateurs, of the broadcast listeners, of the broadcast stations, of the radio manufacturers and dealers, and of authors and composers whose literary and musical writings are now brought by radio before millions of people where before they were brought before only thousands.

THE full significance of the gathering will not appear until the nine committees which were appointed to tackle the many problems that beset radio begin to function.

POPULAR RADIO took an active part in the conference, not only through its accredited representative, Mr. Laurence M. Cockaday, the Technical Editor, but also through some of its staff writers and contributors. Mr. Cockaday

was appointed to Committee No. 4 on "Operating Regulations." Mr. Wm. G. H. Finch (who conducts our department "With the Inventors") and Mr. John V. L. Hogan, Contributing Editor, were both appointed to Committee No. 1 on "Allocation of Frequency or Wavelength Bands." And six more of POPULAR RADIO's contributors were honored by appointments.

A REPORT of the activities of the conference and of the committees will appear in the next issue of this magazine.

"YOUR pleased readers have complimented you on nearly everything in connection with the contents of your magazine from your probity of purpose to the accuracy and lucidity of your articles and instructions upon things radio," writes Mr. P. W. A. Fitzsimmons, president of the Michigan Mutual Liability Co., "but I have never seen a compliment paid to the designer of your front outside cover illustrations.

"Permit me to step into the breach and most enthusiastically do this, because never before have I seen such simple outlines of correspondingly simple devices become so artistic as under the treatment which your artist accords them. The illustrations are distinctive, artistic and well serve the purpose of prompt identification of the various excellent issues of POPULAR RADIO. Long may you prosper, and may you have no 'interference!'"

THOSE radio fans who have progressed in their experimental work to the point that they have become interested in transmitting as well as receiving will find in next month's issue of POPULAR RADIO an article of very particular value entitled "How to Build and Operate a Low-wave Transmitter."

AMONG the virtues of this particular transmitting set are the following:

- It is simple of construction.
- It has a dependable daylight range of 500 miles.
- It may be built at a cost for parts of only about \$25.00, exclusive of accessories.

LIKE all of the "how-to-build" articles that appear in this magazine, the set was constructed in the POPULAR RADIO LABORATORY and tests and experiments were conducted upon it under varied conditions until the desired results were attained. And not until then was the "how-to-build" description of it written.

Kendall Banning
Editor, POPULAR RADIO

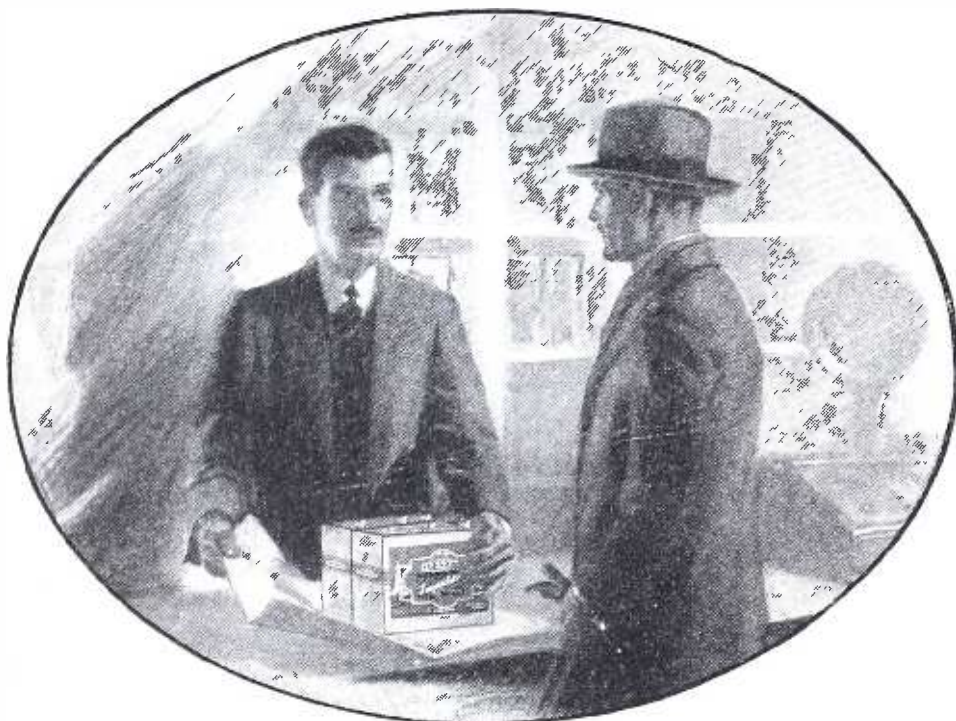

“These Eveready Batteries are the correct size for your set. With average use they will last you a year or longer”

“You have been one of the many who use ‘B’ batteries that are too small in capacity for their receivers. That makes you buy ‘B’ batteries twice as often as necessary. Fit the right size Evereadys to your set and add a ‘C’ battery,* if you haven’t one, and you’ll get maximum service at minimum cost.”

The life of your Eveready “B” Battery depends on its capacity in relation to your set and how much you listen in. We know, through investigation, that the average year-round use of a set is two hours a day. Taking that average we have proved over and over on

*NOTE: In addition to the increased life which an Eveready “C” Battery gives to your “B” batteries, it will add a quality of reception unobtainable without it.

sets of one to three tubes the No. 772 Eveready “B” Battery used with a “C” battery will last a year or longer. On sets of four and five tubes, the larger heavy duty Eveready batteries used with a “C” battery will last eight months or more.

The secret of “B” battery satisfaction and economy is—

With sets of from 1 to 3 tubes use Eveready No. 772.

With sets of 4 or more tubes use either of the heavy duty batteries, No. 770 or the even longer-lived Eveready Layerbilt No. 486.

We have prepared a new booklet, “Choosing and Using the Right Radio Batteries,” which we will be glad to send you upon request. This booklet also tells about the proper battery equipment for use with the new power tubes.

Manufactured and guaranteed by
NATIONAL CARBON CO., Inc.
 New York San Francisco
 Canadian National Carbon Co.,
 Limited, Toronto, Ontario



LEFT—Eveready Layerbilt “B” Battery No. 486. 45 volts, for maximum economy on four, five or more tubes.

RIGHT—Eveready DryCell Radio “A” Battery, 1 1/2 volts. The battery built especially for dry cell tubes.



EVEREADY

Radio Batteries

—they last longer

EVEREADY HOUR
 EVERY TUESDAY AT 9 P. M.
 —Eastern Standard Time

For real radio enjoyment, tune in the “Eveready Group.” Broadcast through stations—

- | | |
|------------------|------------------|
| WEAF—New York | WCAE—Pittsburgh |
| WJAR—Providence | WSAI—Cincinnati |
| WEEI—Boston | WWJ—Detroit |
| WTAG—Worcester | WOC—Davenport |
| WFI—Philadelphia | WCCO—Minneapolis |
| WGR—Buffalo | WCCO—St. Paul |
| | KSD—St. Louis |

All apparatus advertised in this magazine has been tested and approved by POPULAR RADIO LABORATORY

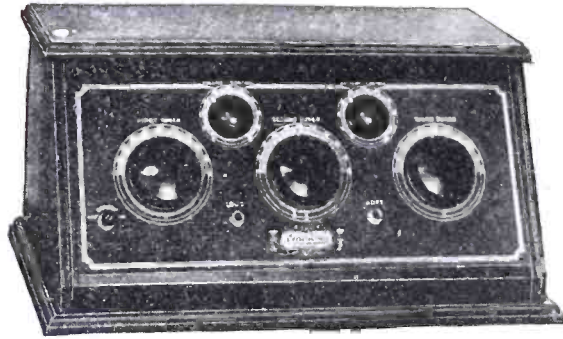

Clearartone Five Tube Model 100

**A Gift
out of the
Ordinary**

NOT "how many can we make," but "how well can we make them," is the dominating thought where Clearartone sets are built. Each set is treated as an individual creation rather than one of many.

What wonder then that Clearartone sets reproduce with unusual clarity of tone. That they possess remarkable selectivity, range and volume. That they are encased in cabinets of exquisite design.

Everybody prefers the individual, distinctive, hand-wrought gift. For this reason the Clearartone Five Tube Set will bring more pleasure on Christmas morning than could any ordinary set.

LAST MINUTE SHOPPERS:

If your dealer does not carry Clearartone, wire us for immediate delivery.

Price, \$85.00 with Radiotron Tubes. Tubes include either five UX 201A, or four UX 199 and one UX 120 power tube. Use with either dry cell or storage batteries.

We also sell seven-tube loop sets, complete. Nothing additional to buy.

THE CLEARARTONE RADIO COMPANY
2427 Gilbert Avenue, Cincinnati, O.

CLEARARTONE *Complete*
RADIO SETS

All apparatus advertised in this magazine has been tested and approved by POPULAR RADIO LABORATORY



A Unique Combination of Technical
Information and Human Interest

"THERE is no magazine like POPULAR RADIO for a happy balance between the technical news of progress in radio that one must read, and good 'human interest' features that one may enjoy."

John C. Sleeper

PRESIDENT, SLEEPER RADIO CORPORATION.

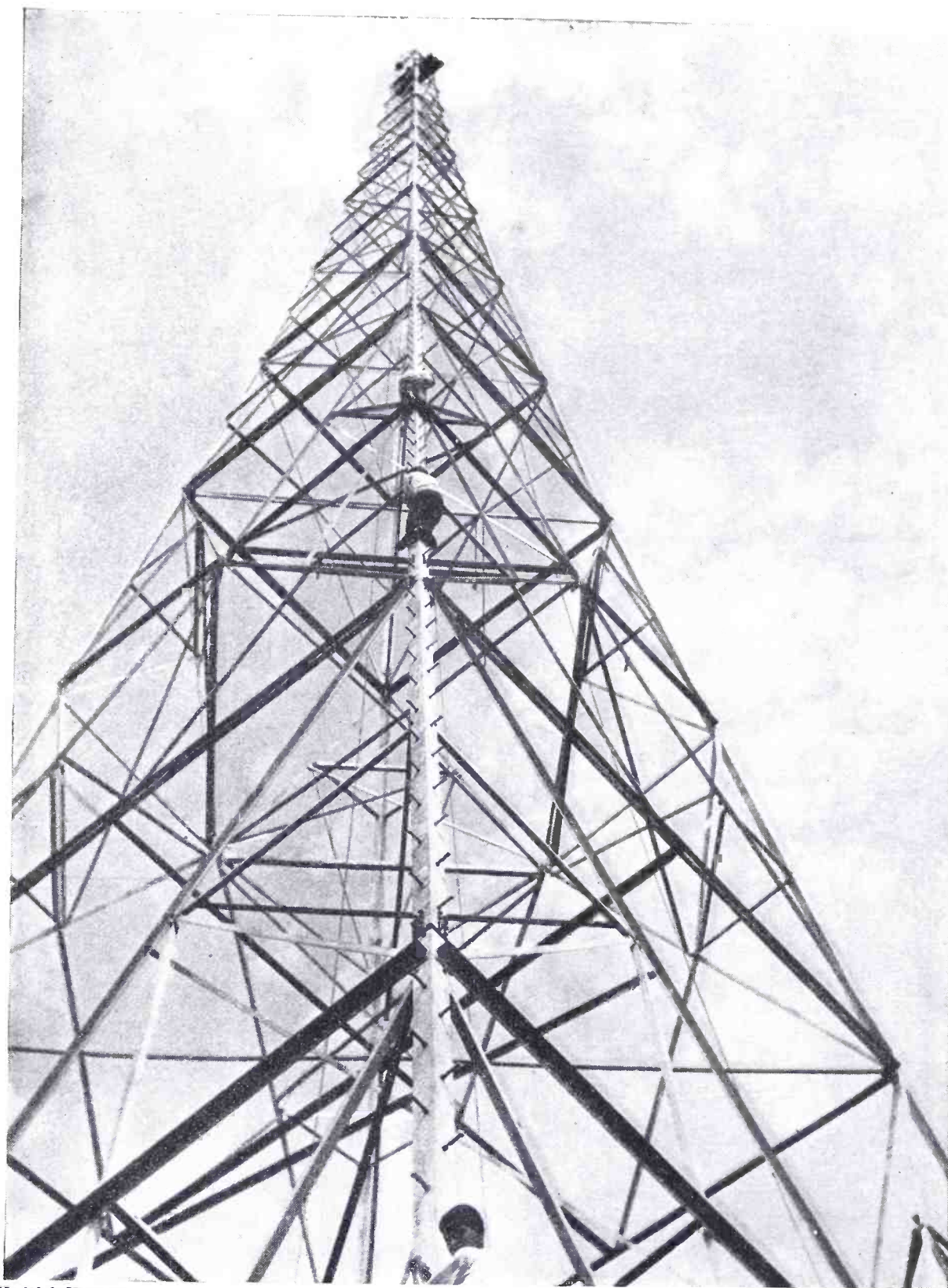

Kadel & Herbert

The Modern Tower of Babel

"I will lead them in paths that they have not known; I will make darkness light before them, and crooked things straight."

—ISAIAH, 42:16.



Popular Radio

WITH WHICH IS COMBINED "THE WIRELESS AGE"

VOLUME IX

JANUARY, 1926

NUMBER 1



The New Wave-Transmission Phonograph

ONE of the most important advances made in the science of sound is the creation of the new talking machine that involves the use of mechanical apparatus and principles developed by radio engineers. This article, which has been prepared exclusively for POPULAR RADIO, reveals for the first time the scientific details of this invention.

By HENRY C. HARRISON

DEVELOPMENT of a new mechanical phonograph by electrical engineers working in Bell Telephone Laboratories is a natural result of their recent applications of electrical theory to mechanical problems.

Since the inception of the telephone, the development work on it has passed through a number of stages. In the pioneer days, the method was necessarily that of guess-and-trial, guided by good judgment and such theory as was then available.

In the field of telephony these many experiments led to satisfactory conversation over only moderate but constantly increasing distances, even as great as between New York and Denver. During these years, however, the theory of electrical transmission was being developed gradually by various mathematical physicists. A little more than ten years ago it reached such a stage that the mathematical method of design replaced the pioneer method of trial so far as elec-

trical circuits were concerned. It then became possible to design telephone lines of any length so that they would have pre-computed qualities.

In recent years these theoretical methods of designing electrical lines have been made the basis of theoretical methods of designing the vibrating parts of such mechanical systems as telephone receivers and transmitters.

Still more recently, these methods of design have been applied to the phonograph.

It was recognition of the fact that a phonograph is a mechanical system for transmitting wave energy that led to the application of electrical wave-transmission theory to it. With this method of design, it has been a fairly simple matter to calculate just what requirements each part of the phonograph must meet, and with these requirements known, it has been a matter of comparatively few experiments to obtain nearly perfect reproduction.

The quality of reproduction given by the new phonograph, as compared with that of previous construction, is more readily demonstrated to the ear than described in words. Some idea of the improvement, however, may be formed from the fact that a talking machine that embodies this new principle reproduces five and one-half octaves, whereas the older type reproduces about three octaves, and the phonograph of twenty years ago something of the order of one octave. Listening to the machine, one hears the low-frequency tones as well as the high ones. Its reproduction of these low frequencies gives naturalness to speech and music, makes it comfortable to the ear and carries over the full power

of the rhythm. At the other end of the scale the machine's reproduction of high frequencies gives clarity and detail. They move the "master's voice" from a position hidden behind the horn right out into the room. They make all the instruments in an orchestra stand out individually, each with its own peculiar quality of tone.

On the new phonograph, not only is the full range of frequencies reproduced but it is reproduced without perceptible peaks or valleys; that is, without the regions of exaggerated loudness or weakness in different parts of the frequency range. An example of a peak is what one hears when one speaks with his head in a barrel; an example of a valley is

The Newly Discovered Facts About Sound

The fundamental thing about radio is the handling of wave energy, of vibrations. Two kinds of waves are involved. From the loudspeakers and telephones come the mechanical waves of sound. In the electrical parts of radio instruments, as well as in the ether, the waves are electromagnetic ones. Many of the principles are the same. In this article Mr. Harrison describes the application of wave-energy principles to the acoustic problem of designing a high-quality phonograph. This involves "mechanical impedance," "mechanical transformers," other novel concepts which will interest every radio engineer. The research constitutes, POPULAR RADIO believes, one of the greatest recent advances in the science of sound. Facts uncovered by the telephone engineers were put at the disposal of the talking machine interests, whose researches have put them in position where the new technique could be appreciated and applied. Thus radio, often accused of having damaged the phonograph industry, actually contributes one of the greatest advances which that industry has ever made.

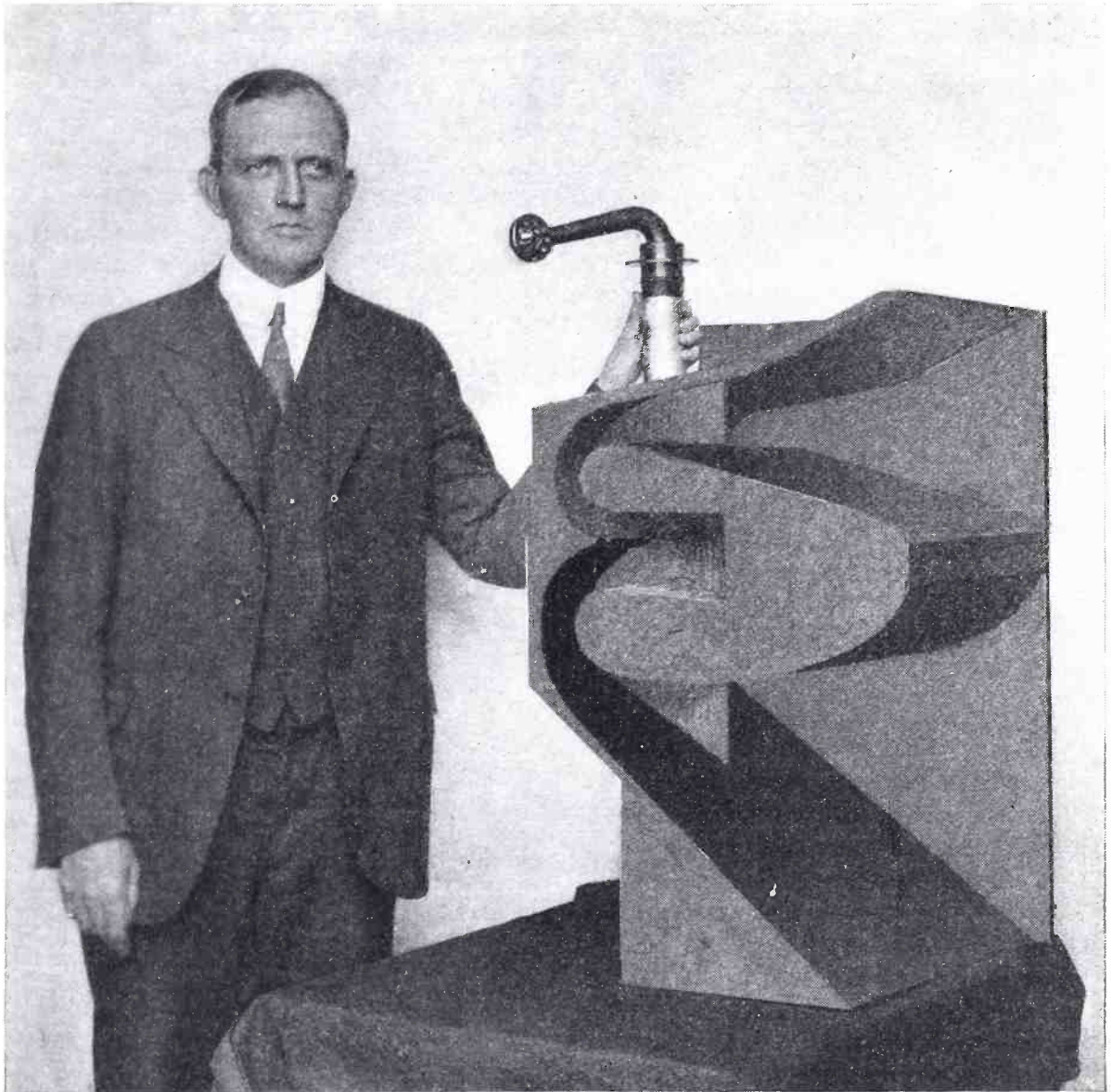

From a photograph made for POPULAR RADIO by the Bell Laboratories

THE INVENTOR OF THE APPARATUS

Mr. Henry C. Harrison with the acoustic system of the new orthophonic talking machine. Note how the internal partitions fold the horn so that a greater length can be contained in the case of the instrument.

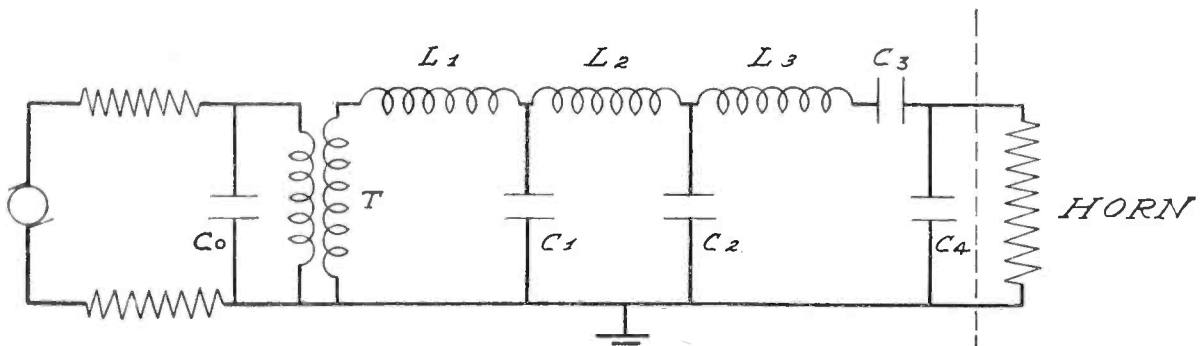

THIS CIRCUIT IS THE ELECTRICAL ANALOGUE OF THE NEW ACOUSTIC SYSTEM

FIGURE 1: The alternator represents the input from the record; L_1 is the mass of the needle arm; L_2 that of the spider, and L_3 that of the diaphragm. T is a transformer corresponding to the needle-arm leverage; C_0 the elasticity of the needlepoint, C_1 that of the needle arm, C_2 that of the spider arms, C_3 that of the diaphragm edge and C_4 that of the air chamber.

THE CONSTRUCTION OF THE SOUND REPRODUCER

FIGURE 2: A section of the sound reproducer, showing the needle and needle-arm, the spider, and the aluminum-alloy diaphragm, the latter being indicated by the bent line. The tube at the right is the inner end of the horn.

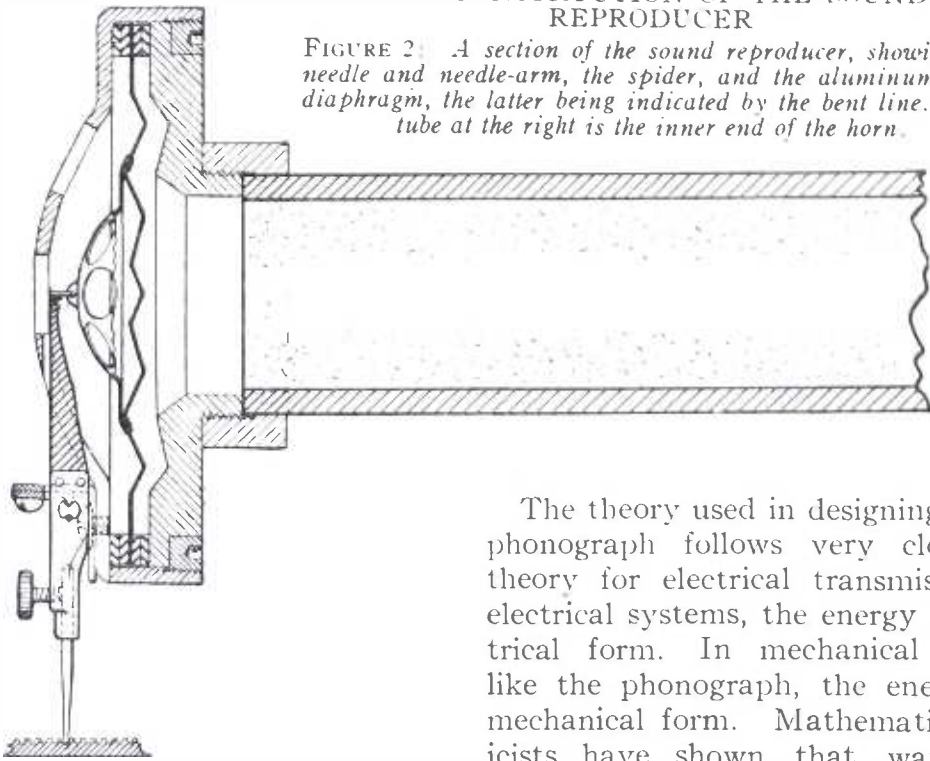

what one hears in the voice of a person with a bad cold.

In scientific language, these changes in quality are expressed as changes in the distribution of sound intensity with frequency. From this viewpoint, speech and music are made up of simple flute-like tones of various pitches and various intensities. For example, the different vowels of speech are distinguished from each other, not by their fundamental frequency, but solely by the distribution of intensity among their overtones. Because elements of speech have this character, one may speak into a barrel of just the right size and find that when he speaks one vowel a different one is heard. A phonograph with the same peak will make the same change.

Similarly, a phonograph with "valleys" which rob the reproduction of the frequency range belonging to the resonant cavities of the head which are choked up during a cold makes a singer or speaker sound as though he had a bad cold. The phonographs of twenty years ago abounded in these peaks and valleys. The new phonograph is practically free from these defects.

The theory used in designing the new phonograph follows very closely the theory for electrical transmission. In electrical systems, the energy is in electrical form. In mechanical systems, like the phonograph, the energy is in mechanical form. Mathematical physicists have shown that wave-energy formulas worked out in one field apply to the other field with simply a change in nomenclature. The corresponding terms in the two fields are as follows:

| <i>Mechanical</i> | <i>Electrical</i> |
|---|------------------------|
| Displacement (total movement) | Charge |
| Velocity of displacement | Current |
| Force | Potential (voltage) |
| Mass | Inductance |
| Elasticity | Reciprocal of capacity |
| Mechanical resistance (frictional loss) | Resistance |

In designing high quality wave transmission systems, either electrical or mechanical, the important matter is matching impedance throughout the system.

This means that each part of the system then offers to the wave energy a path of equal ease of flow, so that its flow through the system proceeds without any reflection. Thus there are no resonance peaks. Even structures which are apparently so different as needle arms, diaphragms and horns can be substantially matched in mechanical impedance to the wave energy.

In addition to preventing internal reflection and consequent peaks, matching

impedance gives a phonograph a substantially uniform mechanical resistance. Hence the power taken from the record groove is proportional to the transverse velocity of the groove squared. And since this full energy is transmitted out into the air, the result is faithful reproduction. The older phonographs are not matched in impedance. They neither take correct amounts of power from the record nor transmit this power to the air without reflection and resonance peaks. In addition to giving faithful reproduction, the matching of impedance reduces the wear on the records because the resonance points, with associated high pressure of the needle point against the record groove, are eliminated.

As the first step in designing a matched impedance phonograph, the diagram of mechanical impedances is needed.

Figures 1 and 2 are sketches of an acoustic phonograph and of its mechanical impedance diagram.

In Figure 1, the same symbols are used for mass, elasticity, and mechanical resistance as are commonly used in electrical impedance diagrams for inductance, capacity, and electrical resistance.* These quantities are corresponding ones as respects the storage or dissipation of energy; hence they have corresponding effects on the transmission of wave energy. The system is shown with its shunt branches working into substantially free space. Actually, the branches work into air, but because of their small size compared with the wave-

*In this diagram certain second-order effects are omitted for the sake of clearness. The complete diagram and a full description of the technical features will appear in a paper to be presented at the Midwinter Convention of the American Institute of Electrical Engineers.

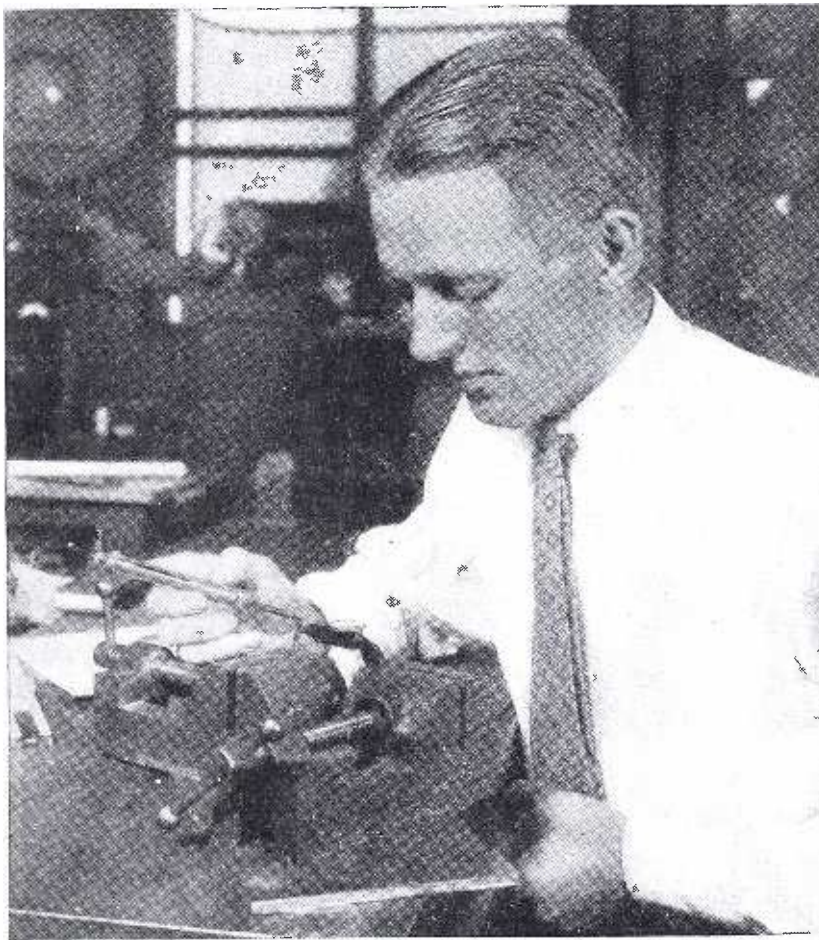

MEASURING THE ELASTICITY OF THE NEEDLE-ARM

Mr. Arthur Bates is making one of the fundamental measurements upon which the phonograph design depends. In mechanical wave systems elasticity is the equivalent of the reciprocal of capacity in electrical systems.



PIONEERS IN THE APPLICATION OF MATHEMATICS TO THE PHONOGRAPH

Mr. Harrison (at the left) is holding the sound reproducer which he is explaining to Mr. Joseph P. Maxfield, who developed the electrical methods by which high quality records are made for use with the new machine. In the foreground lies one of the aluminum-alloy diaphragms.

lengths in air of speech frequencies, the air acts like free space. In a mechanical system free space is analogous to an infinite capacity, or "ground," in an electrical system.

The shunt branches of the line are ones through which vibration velocity, that is, the mechanical current, flows from the main line to space. The series elements in the line are ones through which all of the line mechanical current must pass. The symbol used for a mechanical transformer is the one usually used in electrical circuits and indicates merely a change in displacement velocities at this point.

The term "mechanical current" is used as meaning the root mean square of vibration velocity in centimeters per second. The term "alternating force" is used as meaning the root mean square of forces, in dynes, tending to set up or vary mechanical currents. By the "mass of a part" is meant the mass in grams which, located at the point at which the part ties into the mechanical line, would

have the same kinetic energy as the part. Similarly, by the "elasticity" of a part is meant the elasticity in dynes per centimeter which, located at the point of attachment, would store the same potential energy as the part.

It is evident from these diagrams that the first three sections of this network constitute a transmission system of the low-pass filter type and hence will have a high frequency cut-off. The series elasticity, due to the diaphragm edge, does not belong in a low-pass filter and interferes with the transmission of the lower voice frequencies unless very small.

The principles and formulas that govern transmission networks such as this one are worked out for analogous electrical lines by J. A. Fleming, A. E. Kennelly, and George A. Campbell. Building upon the foundation these scientists have laid, the telephone engineers were able to treat the design of an acoustic phonograph as an engineering problem. Certain results were desired, certain limitations had to be met as to

materials and dimensions, and certain other factors might be varied practically at will. Calculations were made for the various parts, and these were checked by measurements of the characteristics of the parts as vibrating elements. Here an entirely new technique was developed, as for instance the direct measurement

of mechanical impedances over a range of frequencies.

Thus it was possible for the mechanical impedances of the different parts of the system to be carefully matched, just as should be done to the electrical wave-energy circuits used in telephony or in the parts of radio apparatus.



From a photograph made for POPULAR RADIO by Victor Talking Machine Co.

THE COMPLETED MACHINE

In the small diagram at the right is shown the arrangement of the gradually widening passages through which the sound waves travel. Note the great length (70 inches) of the new horn, as compared with the older and more familiar types. Above, Reinald Werrenrath, the grand opera singer, is seen listening to a record of his own voice on one of the first machines to be completed.

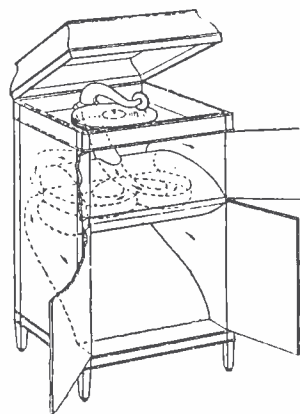

IN POPULAR RADIO for next month—February—will appear the complete, detailed specifications for building one of the latest and most efficient sets that have been developed—the Orthophase Receiver.

HOW TO GET THE MOST

By S. GORDON TAYLOR and L. M. COCKADAY

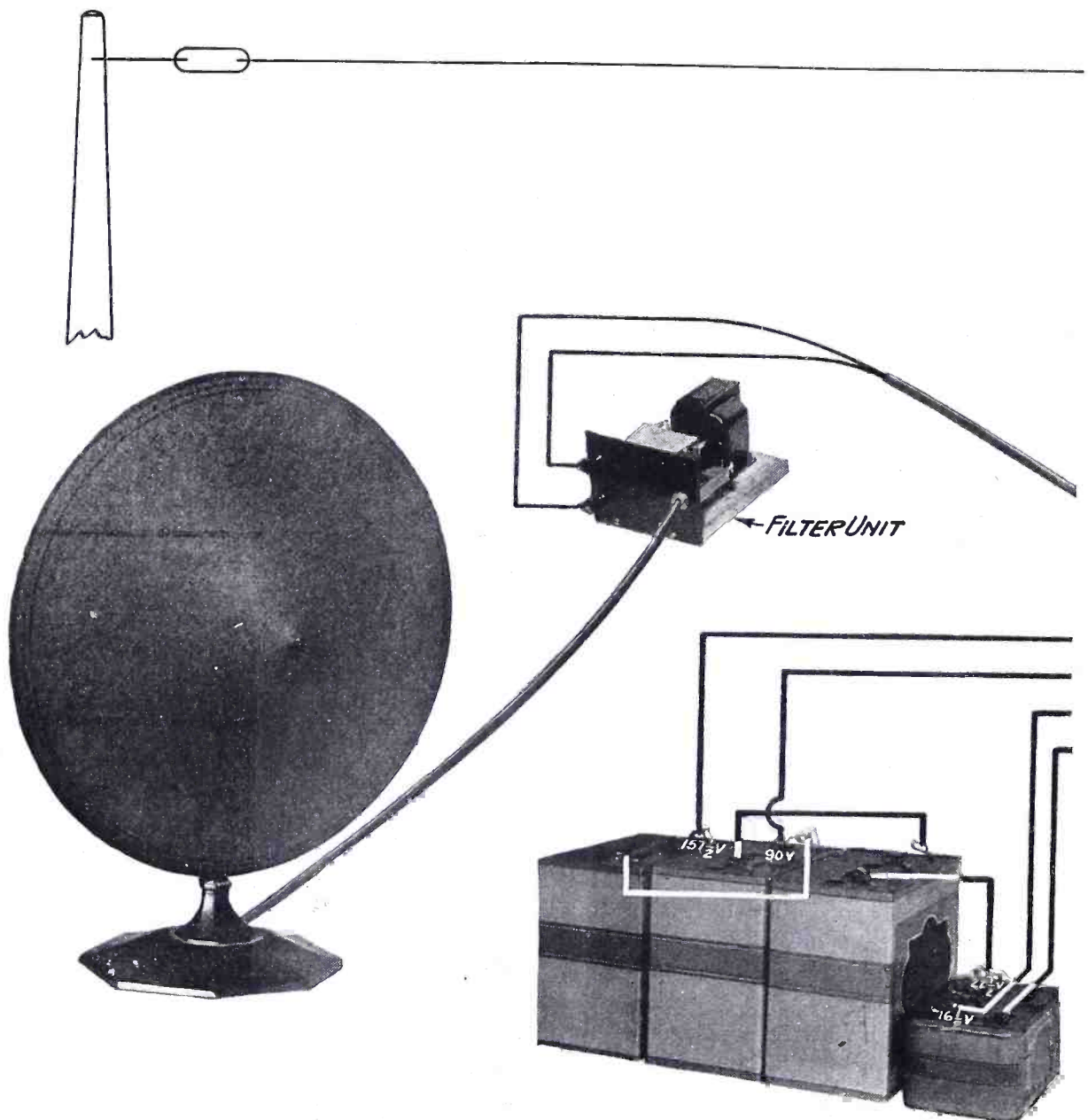

SO great has been the interest shown on the part of readers of POPULAR RADIO, and so keen has been the competition among radio fans and experimenters to be one of the first to build one of the new LC-26 receivers and to get it in operation, that this article—which takes the place of the “How to Get the Most Out of Your Ready-made Receiver” article that would ordinarily appear in this issue—follows by popular demand.

To test the capacities of this receiver the authors have taken it to a number of cities in the East and experimented with actual receiving conditions for the purpose of telling experimenters who have built this set exactly what to do when they install and operate it.

First of all, let us start with a general description of the receiver.

It uses a simple antenna circuit that is easily resonated over the whole band of

OUT OF YOUR LC-26 SET

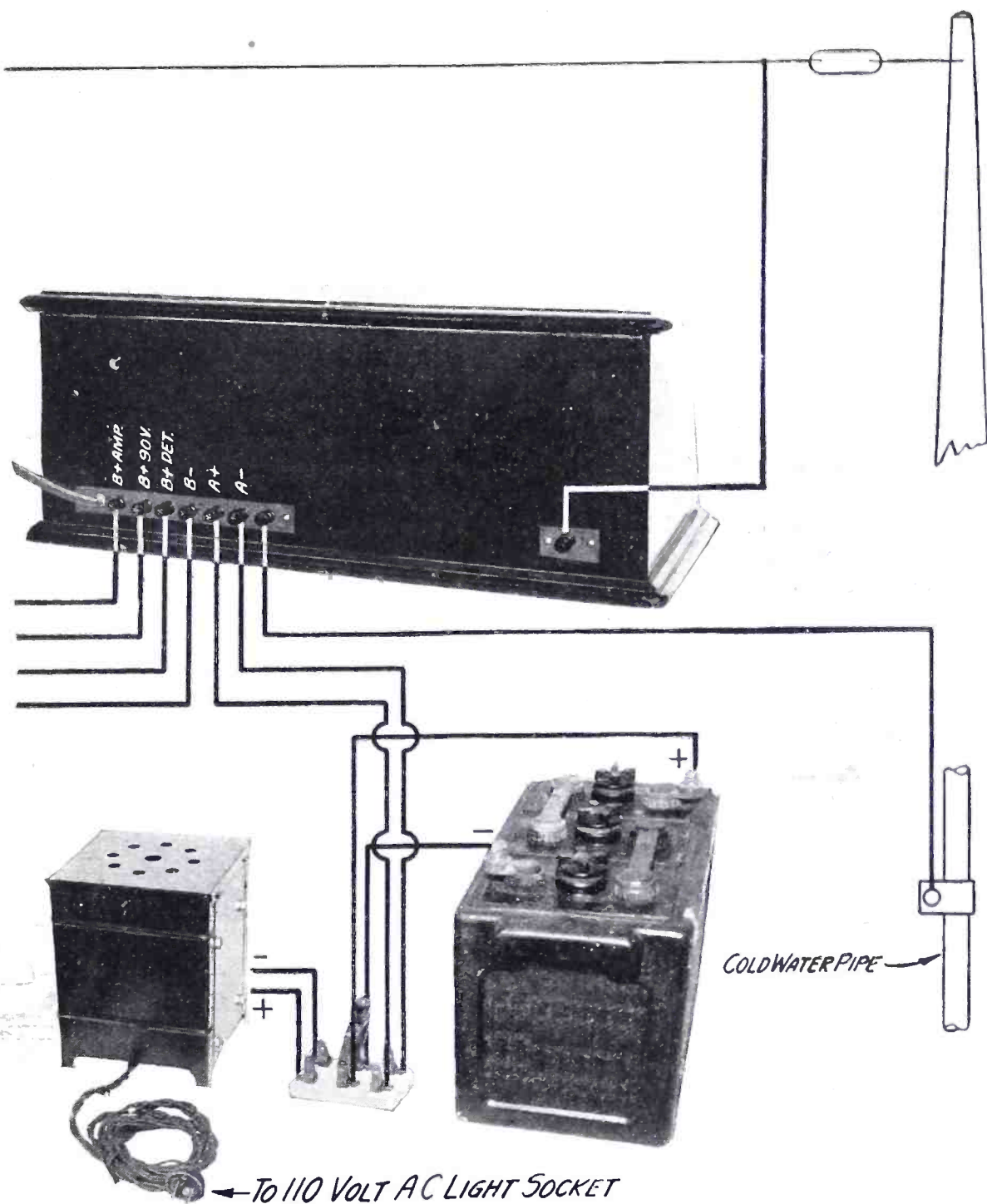

CHECK UP YOUR INSTALLATION WITH THIS DIAGRAM

FIGURE 1: Pictured here are shown the rear view of the LC-26 Receiver, the cone loud-speaker, the filter unit, the three large "B" batteries, the small "B" battery, the charger, the charging switch and the storage battery. The connections between these units are shown in heavy lines to the exact binding posts and terminals that they should run to including the antenno and ground connections. If you use this simple diagram when installing your set you will find that it will give you perfect satisfaction.

broadcast wavelengths. This circuit is similar to that used in the old variometer-tuned sets. What was a disadvantage in the old sets is, however, a great advantage in this receiver. The tuning of this particular circuit is extremely broad. This leaves the sharply-tuned trap circuit, which is the input to the detector, to do the actual sharp selecting that is necessary to tune out local stations and bring in the distant ones. Therefore, the receiver may be considered as essentially a single-control device (in the case of local reception) as the input tuning accomplished by the variometer has very little effect. It may be used as a sort of volume control. For distance, however, it helps considerably. The receiver cannot radiate on account of the use of the stage of non-oscillating radio-frequency amplification used ahead of the detector. Both circuits are controlled by the stabilizer (or intermediate circuit) which is coupled closely to the plate circuit of the

radio-frequency tube and coupled looser to the detector circuit, thus allowing regeneration in the detector but preventing oscillation in the radio-frequency stage. This is a much more simple method than the usual compensating condenser or neutralizing scheme, as it is almost impossible to properly neutralize a single stage radio-frequency amplifier throughout the whole wavelength band when used with a regenerative detector.

The audio-frequency amplification has been the subject of much experiment and has been chosen for its straight-line-frequency amplification and particularly at the low frequencies, so that the drum and bass viol tones are brought out with startling clarity.

If the receiver is installed and operated as described in this article it will bring to the experimental listeners a new thrill from broadcasting that comes from reception of this broadcasting as it is really being transmitted.

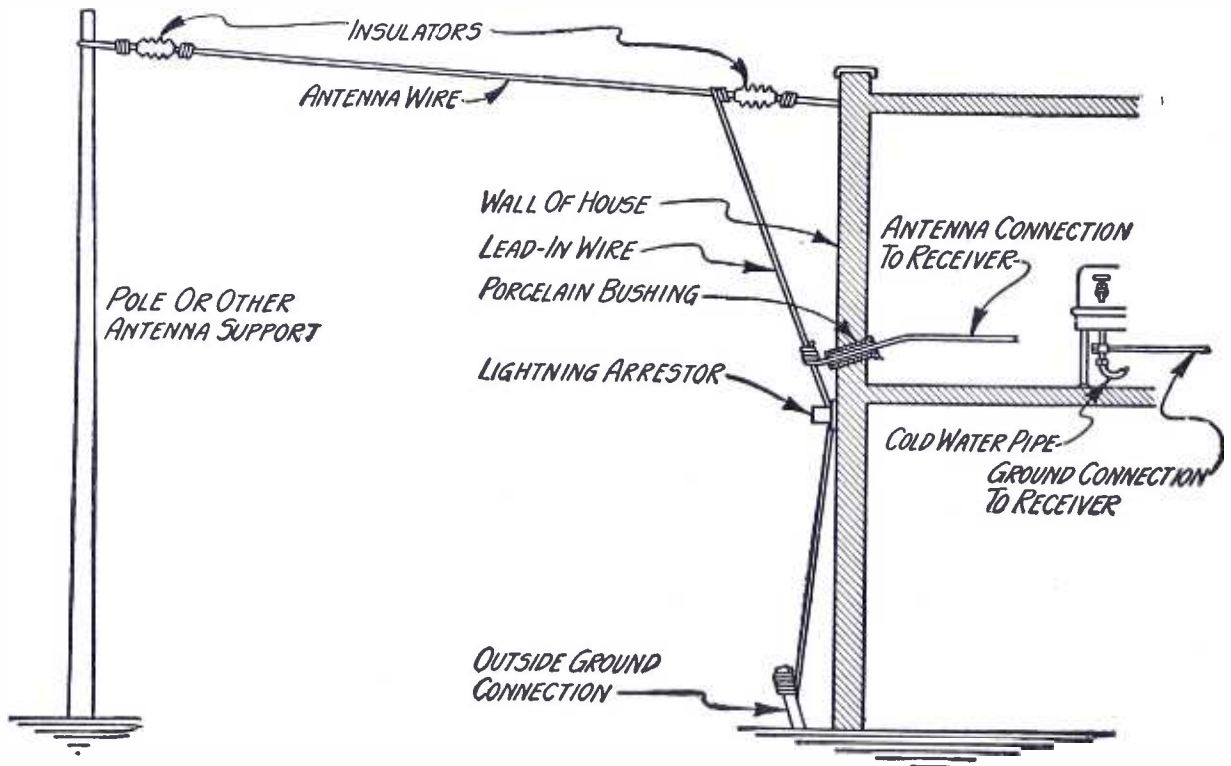

AN EXCELLENT ANTENNA ARRANGEMENT

FIGURE 2: The design of the antenna is necessarily governed, in most cases, by the roof or yard space available. However, many of the ideas suggested by this illustration may be used to advantage in any antenna installation. The best length for the antenna will depend in each case on the interference conditions.

TO "A" BATTERY CONNECTIONS OF RECEIVER

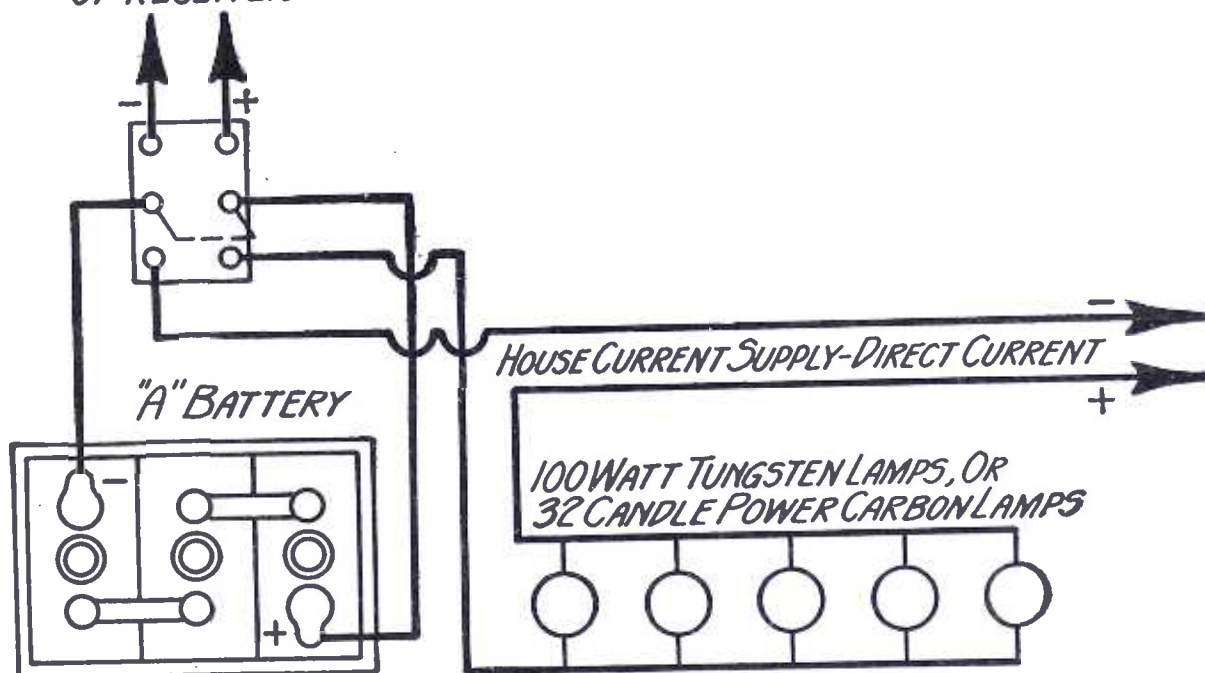

CONNECTIONS FOR CHARGING "A" BATTERY FROM DC HOUSE SUPPLY
 FIGURE 3: The type of battery charger used depends on the kind of house supply current. If it is alternating current, a regular AC charger is used. If the house supply is direct current, however, a simple arrangement of electric lamps is used as shown here. If preferred a DC battery charging resistance may be used instead of the lamps.

The Theory of Operation

The antenna circuit of the LC-26 receiver is tuned to resonance with the incoming signal from a broadcasting station by means of the variometer A. (See diagram, pages 496-7 of the December issue of POPULAR RADIO.) The fixed condenser G simply serves to adapt the receiver to the size of antenna used. This method of tuning the antenna circuit is probably the most efficient known because of the preponderance of inductance obtained in the circuit in this way.

It will be noted that the variometer is also in the grid or input circuit of the radio-frequency amplifier tube. Thus the variometer serves not only to tune the antenna but only as an auto-transformer to transfer the antenna energy to the radio-frequency amplifier, the voltage drop across the variometer being impressed across the grid-filament circuit of the tube.

For a small amount of energy impressed upon the grid of a vacuum tube a comparatively large amount of energy may be made to flow in the plate circuit of the tube, due to the amplifying action of the tube. This additional energy is not generated in the tube itself but is drawn from the high-voltage "B" battery which is connected in the plate circuit of the tube. In other words, the energy in the output circuit of the tube is drawn from the "B" battery but the amount drawn is regulated by the throttle action of the grid circuit of the tube.

The energy in the plate circuit of the radio-frequency amplifier tube Q1 flows through the

coil B which is in series with the plate and "B" battery. Coil C is closely coupled to this coil B, so closely that it absorbs much of the energy from the plate circuit of the first tube, thus preventing oscillation in the radio-frequency amplifier. Coil C with its tuning condenser E therefore serves as an absorption circuit or stabilizer. The fact that the first tube cannot oscillate prevents the receiver from radiating energy into the antenna system, a condition which would cause annoyance to neighboring receivers.

The energy absorbed by the stabilizer circuit is not lost, however, as this circuit is in series with the coil D and its tuning condenser F. Both of these coils are in the grid circuit of the detector tube Q2; therefore the energy absorbed from coil B is usefully transferred to the input of the second tube. In this circuit there is again a preponderance of inductance, consisting of the inductance of coil C plus that of coil B. The use of so much inductance is made possible by the fact that the two tuning condensers E and F are connected in series; therefore their total capacity is only half that of either one alone. Inasmuch as the frequency or wavelength of the circuit is governed by the product of the capacity and inductance, it naturally follows that the use of such small capacity calls for the use of large inductance. The stabilizer is tuned to a lower wavelength than the total grid circuit. This use of a double condenser is not therefore the same as that of tuning two stages of radio simultaneously. In this case it is a regeneration control. The energy input

to the detector tube is not only amplified by this tube, but it is rectified. Up to this point in the circuit all the energy has been in the form of alternating current of high frequency. The output of the detector tube, however, consists of pulsating direct current which really amounts to direct current with an alternating current component. Both kinds of current are therefore present in the plate circuit of this tube.

The audio-frequency component of this energy is lead through the primary of the audio-frequency amplifying transformer J, but the radio-frequency current passes with difficulty through the high inductance such as that of this primary winding. Moreover, this radio-frequency component serves no useful purpose in the audio-frequency amplifier. It could be used to advantage, however, if fed back to the input side of the detector tube because then it would be amplified again by the amplifier action of the tube. This is exactly what is done. A wire is connected from the plate of the detector tube back to the coil C in the detector input circuit. This produces the regenerative action and results in the detector tube practically serving the purpose of two tubes, one use being a radio-frequency amplifier and the other use a detector.

Regeneration can only be obtained up to certain limits, of course. Carried beyond certain limits, the detector tube would break into oscillation, thus distorting the signals. In most regenerative receivers this is the practical limit to which regeneration may be carried. In the LC-26 receiver, however, it can be carried far beyond this point because oscillation will stop when the radio-frequency circuit is tuned to resonance with the input circuit to the detector tube, as is the case when both circuits are tuned to a broadcasting station's wavelength, and signals will be heard clearly and undistorted.

This explains why this receiver with its five tubes gives the results of a six-tube receiver, without any of the trouble usually encountered in neutralizing such a receiver.

For ordinary reception it is not necessary to have the detector oscillating. For long distance work, however, an oscillating condition of the detector tube makes the tuning of the receiver extremely simple, because it is merely necessary to turn the large tuning dial until a carrier wave whistle is heard, then adjust the variometer knob until, when it reaches resonance with the detector circuit, oscillation will suddenly stop and the distant station will be heard. The amount of regenerative action desired can be obtained by adjustment of the detector rheostat, P. The pulsating direct-current output of the detector is audible if a pair of headphones is connected in the circuit. From this point on in the circuit another type of amplification is used. The purpose of the radio-frequency amplifier was to build up the alternating current (radio-frequency) energy, thus increasing the sensitivity of the receiver. The purpose of the audio-frequency amplification used after the detector is to build up volume so as to make possible the use of a loudspeaker.

The energy flowing through the primary of the audio transformer J sets up a corresponding

flow in the secondary winding of this transformer by the process of electromagnetic induction. The use of inductive coupling, as furnished by the transformer, is necessary here to isolate the grid of the audio-amplifier tube from the high voltage of the "B" battery in the detector plate circuit. By means of the secondary winding the energy is impressed on the grid of the tube Q3 and the amplified energy is taken out at the plate of this tube. The use of one stage of transformer-coupled, audio-frequency amplification produces high amplification (through the voltage step-up action of the transformer) of excellent quality.

The LC-26 receiver makes use of resistance coupling in the second and third audio-frequency amplifier stages. This type of coupling does not produce such great amplification per stage, but the reproduction is flawless over the whole range of audible frequencies. In addition to this, the current consumption from the "B" batteries is much lower with resistance-coupled amplification than with "unbiased" transformer-coupled amplification.

There is no particular point in providing variable adjustment of filament heating voltage for any of the tubes except the detector. For this reason the automatic filament control resistances O1, O2, O3 and O4 are used with the other tubes, and a rheostat is provided on the panel only for control of detector filament current.

The Antenna and the Ground

The antenna requirements of the LC-26 receiver are not at all critical and for that reason satisfactory results may be obtained with the use of almost any kind of a wire strung up wherever it is convenient.

As an example of just how great the sensitivity of this set is, plenty of volume is obtained from all the New York City and nearby stations when operating the receiver in the suburbs of the city approximately twelve miles from the nearest station, without using any antenna at all, by simply connecting the ground lead to the antenna binding post on the receiver, with the ground binding post left disconnected.

It is, however, in general use advisable to employ some sort of an antenna. As a matter of fact, where an outdoor and also an indoor antenna can conveniently be erected, it is worthwhile to put up both. This is suggested because during the summertime, when the static is troublesome, the indoor antenna can be used, thus eliminating much of this form of interference. During the cooler months when there is better reception weather, the outdoor antenna may be used. (Incidentally, this suggestion applies not only to this receiver but to all receivers which are sufficiently sensitive to operate satisfactorily on an indoor antenna.)

The outdoor antenna has the advantage of greater "pick-up" and is therefore to be preferred when it is desired to tune in distant stations. An outdoor antenna consisting of a single copper wire somewhere between 60 and 100 feet, is amply large for this receiver. Little is to be gained by making the antenna longer than 100 feet, but it is not advisable to have it less than 60 feet or thereabouts because of the decreased "pick-up." These lengths include

the entire length of the wire, from the antenna binding post on the receiver to the end most distant from the receiver.

It is impossible to give exact instructions for erecting an outdoor antenna because practically every installation has its own peculiar conditions and requirements. However, in Figure 2 is illustrated an ideal antenna. Some of the ideas suggested in this illustration may be used in all installations. The matter of insulation of the antenna and "lead in," for instance, may be used in almost every case. Some general suggestions for this may be offered: For instance, it is not advisable to have the antenna wire close to trees or buildings, but especially trees. A distance of ten feet should be the minimum spacing from the latter obstacles. If necessary to use a tree to support the further end of the wire, be sure that the insulator is placed at least ten feet from the foliage. In such a case precautions must be taken to prevent the wire from being broken by the swaying of the tree in the wind. This is most easily accomplished by running the wire through a pulley fastened to the tree and suspending a weight on the free end of the wire, making ample allowance for the free play of the wire.

The kind of wire used is not particularly important so long as the wire is copper. It may be plain wire not smaller than No. 14. Or it may be the regular seven-strand aerial wire. Make the antenna proper and the lead-in all one piece if this is possible. If this cannot be done solder the joint where they come together, thus insuring a good electrical connection.

The height of the antenna is important only up to a certain point. It is, of course, well to make it as high as conditions will permit. Put it as high as you can, but try to get it higher than surrounding objects if that is possible. If the antenna is erected on the roof of an apartment house which is already occupied by a number of other antennas, try to put it above and at a right angle to the others and see that it is clear of the pent houses and vent pipes. If it is necessary to erect poles on the roof, don't be satisfied to tie the poles to vent pipes; drill a hole part way through a heavy wood block, set the block on the roof (it need not be fastened down), erect the pole with its base resting in the hole in the block and then guy the pole with at least three wires. The other ends of the guy wires may be secured to bolts in the walls, or to the bases of other vent pipes. Gal-

vanized iron guy wire of about No. 12 size is good for this use because of its strength.

A good ground connection is also important. If the house is provided with a cold water supply, the ground wire may be fastened to the water pipe nearest the receiver by means of a ground clamp. Hot water pipes will also serve in a pinch, but do not ground the receiver to a gas pipe; this is against the rules of both the gas companies and of the Board of Fire Underwriters, and in addition is usually a poor ground because of the insulating gaskets frequently installed in the pipe line where it enters the house.

The Batteries

A 6-volt storage "A" battery is required for lighting the filaments of the vacuum tubes and for the high voltage plate supply a set of "B" batteries of 157½ volts is used.

The "A" battery should be one of not less than 100-ampere-hour capacity and should, of course, be one designed for radio use. When the receiver is in operation the current drain on this battery is approximately 2¼ amperes-per-hour and a fully charged 100-ampere-hour battery will operate the receiver for about forty hours without recharging. Batteries with greater capacity will, of course, operate the receiver a longer time on a single charge.

A hydrometer should be used to measure the state of charge of the battery. This instrument measures the specific gravity of the electrolyte in the battery and is equipped with a scale which reads from 1,150 for a discharged battery to 1,300 when the battery is fully charged. The battery should never be allowed to run down to such an extent that the reading falls below 1,185. Many make a practice of recharging the battery when the reading falls to 1,200, and this is a good practice.

The "B" battery consumption of the LC-26 receiver is lower than that of most five-tube receivers, in spite of the fact that the voltage used is somewhat higher than usual. In ordinary use the dry-cell type of "B" batteries is therefore entirely practicable. Using the full voltage specified above and with the receiver operating an average of two hours a day, a set of the ordinary large size "B" batteries will have a life of between five and six months.

Using the "heavy duty" type of batteries the life will be increased to approximately ten months under the same conditions. The life

| | | | |
|--------------------------------|----------|----------|----------|
| Hours of use daily | 2 | 3 | 4 |
| Large size batteries | 166 days | 105 days | 72 days |
| Heavy duty batteries | 297 days | 190 days | 134 days |

THE LIFE OF THE BATTERIES

This table shows the approximate life of a set of "B" batteries with the LC-26 receiver. It will be noted that the "heavy duty" type of batteries give almost double the service of the usual "large" (five pound) type, although the cost of them is only about 50 percent greater. The above figures are based on the use of the total voltage specified (namely, 157½ volts), but takes into consideration the normal drop in voltage as the batteries wear down. When the batteries drop from 45 volts each to 34 volts they are worn out and should be replaced.

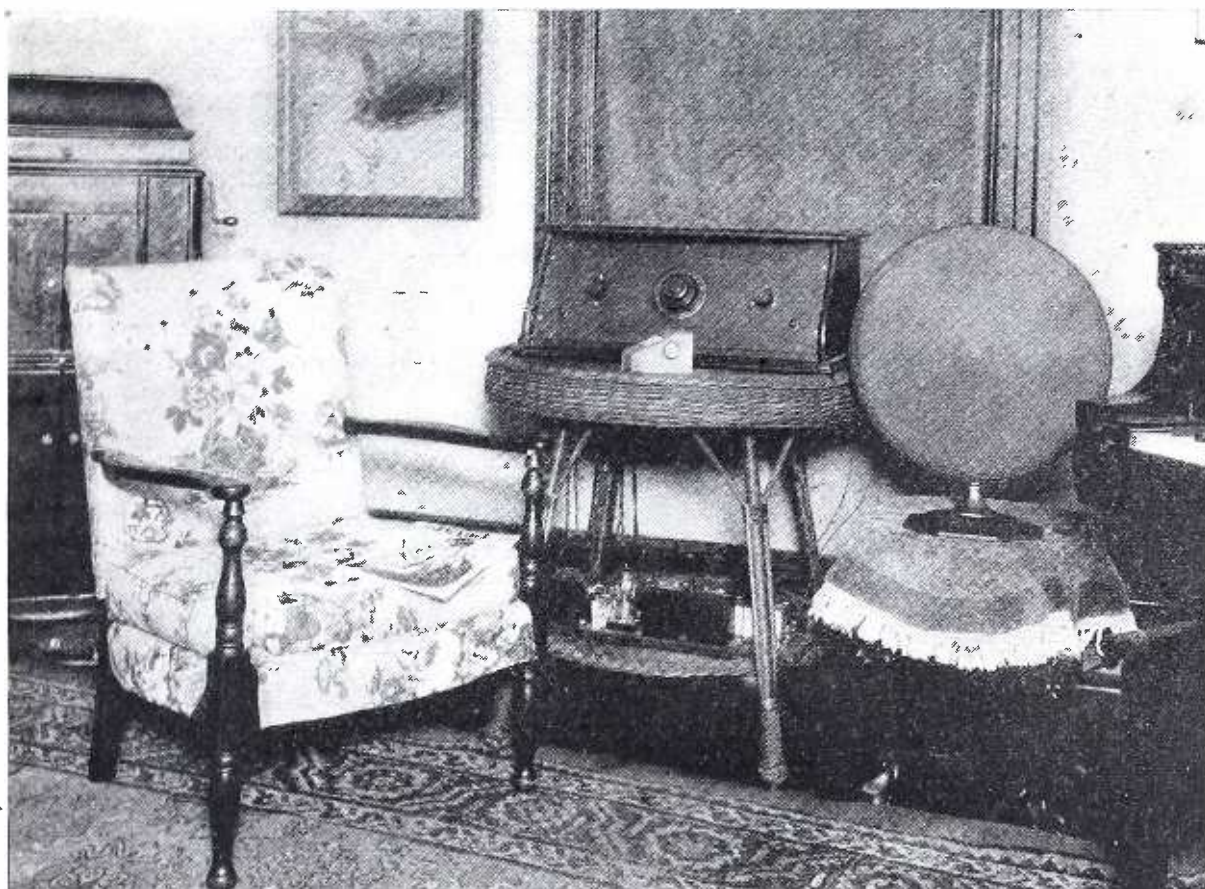

From a photograph made for POPULAR RADIO

THE LC-26 INSTALLED WITH THE RAYTHEON PLATE-SUPPLY UNIT

FIGURE 5: *This picture shows the receiver working without "B" batteries. The Raytheon unit as described in the November issue of POPULAR RADIO may be seen on the shelf of the table with the cone loudspeaker at the right.*

of these two types of batteries under various conditions are shown in the table on page 16. The use of the "heavy duty" type of batteries is recommended where dry-cell batteries are used because their increased life is greater than their increase in cost over the usual "large" size batteries; they are therefore cheaper in the end.

If the receiver is to be used on an average of more than two hours a day the use of storage "B" batteries is recommended. The first cost of such battery equipment is considerably higher than that of dry cells, of course, but the first cost is about the only cost for perhaps several years, as the cost of recharging the batteries is so small as to be insignificant.

In place of "B" batteries the Raytheon Plate Supply Unit (described in the November issue) may be used with results equal to those obtained with either the dry-cell or storage "B" batteries. This unit has several advantages. There is nothing to wear out and require replacement, as in the case of dry-cell "B" batteries, and recharging is not required as in the case of storage "B" batteries. In addition, this unit takes up less room than do batteries of either type and the first cost is no greater than that of the storage type of "B" batteries.

In using the Raytheon unit with this receiver, the total output voltage of the unit is applied

to both the radio and audio-frequency amplifier tubes of the receiver. The connections are shown in Figure 1. Using such high voltage on the radio-frequency amplifier tubes would not prove satisfactory with most receivers because of the tendency of this portion of the circuit to oscillate. In the case of the LC-26 receiver, however, the radio-frequency stage will not oscillate, regardless of the voltage applied. The detector "B" + post on the receiver is connected to the post on the Raytheon Unit bearing the same designation. The knob of the variable resistance in the Raytheon Unit is then adjusted to a position where signal strength is greatest. This will provide the detector tube with the proper plate voltage. The position of the knob will be almost all the way out.

An "A" battery charger to operate from the electric-house lighting line will be needed unless the owner wishes to go to the trouble of taking his storage battery to a service station to be charged. Some manufacturers are placing units on the market which consist of a storage "A" battery and charger combined to operate from the alternating current house line and which operate automatically so that no attention is required other than the occasional addition of distilled water to make up for evaporation. There are also several types of alternating current chargers on the market. When the charger

and battery are separate, a five-ampere charger is recommended, and the particular type selected will depend on the purchaser's judgment. The three main considerations in the case of a charger to operate on AC are constancy of operation, noiselessness and necessity for replacement of parts. The first two points may be determined by requesting a demonstration before purchasing. In general the type of chargers using a rectifier tube are to be preferred as they require no adjustment, are fool-proof and most nearly noiseless.

When storage "B" batteries are used, some means must be provided for charging them.

"A" battery chargers may be obtained which will also charge the "B" batteries, or attachments may be purchased to use in conjunction with "A" battery chargers when it is desired to charge the "B" batteries. Then, of course, separate "B" battery chargers are on the market and at comparatively low cost.

In Figure 1 will be found a convenient method for connecting up the "A" battery charger in such a way that it is only necessary to throw the switches to put the battery on charge.

When the house-lighting supply is direct current, only a charging resistance is needed. This may be a bank of five 100-watt lamps connected in parallel as shown in Figure 3.

The Tubes to Use

The UV-200 or C-300 tube has been found best for the detector tube in this receiver. The extreme sensitiveness of this receiver is due largely to the employment of regeneration in

the defector circuit and this circuit has been designed with the UV-200 type of tube in mind. Other tubes will not provide the same sensitiveness, nor as good tone quality.

For the radio-frequency amplifier a UV-201-a type of tube is used, as also in the first and second stages of audio-frequency amplification. That is, the first, third and fourth sockets from the left-hand end of the receiver, the detector socket being the second.

In the last socket, which is in the third stage of audio-frequency amplification a power tube is used because the usual types of tubes such as the UV-201-a cannot handle the great volume in this stage. The set is designed to use a Radio Corporation UX-112 power tube in the last stage with a No. 112 amperite to control the filament current. A UV-201-a tube can be used but will not produce the maximum in tone quality or volume but if it is used an amperite cartridge of suitable resistance must be used with it. Builders of this receiver who happen to have a Western Electric VT-2 or 216-A tube on hand can use it in this last stage. In that case a No. 1 amperite should be used.

The use of UV-199, WD-12 or any other of the dry cell tubes in this circuit is not advised.

The Operation of the Receiver

The connections to antenna, ground and batteries are clearly shown in Figure 1.

Before making these connections, place the five vacuum tubes in their respective sockets. Starting with the first socket at the left, the tubes to be used are: UV-201-a, UV-200, UV-201-a, UV-201-a and UX-112. Now connect the



From a photograph made for POPULAR RADIO

AN ALL-NIGHT SESSION IN CALIBRATING THE RECEIVER

FIGURE 6: The authors are here shown obtaining the data on an LC-26 installation at Mr. Taylor's home laboratory, for the purpose of making up the tuning chart shown in Figure 4.



From a photograph made for POPULAR RADIO

AN LC-26 INSTALLATION WITH DRY CELL "B" BATTERIES AND A STORAGE "A" BATTERY

FIGURE 7: *An ideal installation of the receiver, with the batteries placed in a radio cabinet. The wire shown running from the upper right-hand corner of the set along up the wall is an extension cord to the cone loudspeaker which is placed on the other side of the room.*

"A" battery with its negative side to binding post No. 3 and its positive side to binding post No. 4. To be sure that the filament circuits are all intact, turn the battery switch on the front of the receiver to the "on" position. All but the second tube should light up. Next turn the small right-hand knob half way on, in a clockwise direction. This should light the detector-tube filament.

If all of the tubes light up properly, remove all but the first and connect the "B" batteries as shown in Figure 1. The four tubes should be removed first to avoid the possibility of burning them out in case anything goes wrong in the wiring which might permit the "B" battery voltage to be applied to the filaments. In such a case the single tube left in the set would light up very bright. If everything is right up to this point, connect the antenna and ground to the receiver, replace the other four tubes, and insert the loudspeaker plug in the jack S.

Signals from a broadcasting station can now be tuned in. The tuning dial should be set for the station desired, the proper setting being obtained from the tuning chart in Figure 4.

Next rotate the small left-hand knob until the station is heard with maximum volume. The switch R1 should be turned to the left for an outdoor antenna and to the right for the indoor antenna. As explained before, the purpose of this switch is to adapt the antenna circuit constants to the antenna in use.

Now that a station is tuned in, try different settings of the detector rheostat (the small right-hand knob on the panel front). One point will be found at which signals have the desired strength and clarity. This is the proper setting. The point of maximum reception, however, will not be the same on nearby stations, as on distant stations, the latter requiring that the rheostat knob be turned further in a clockwise direction. Do not tune in stations with more volume than is enjoyable.

After tuning in several local stations, and becoming somewhat familiar with the operation of the receiver, try a more distant station. Set the large dial for the station you wish to tune in, then slowly rotate the left-hand knob until the station is picked up. When the station is heard, adjust the tuning dial and the two

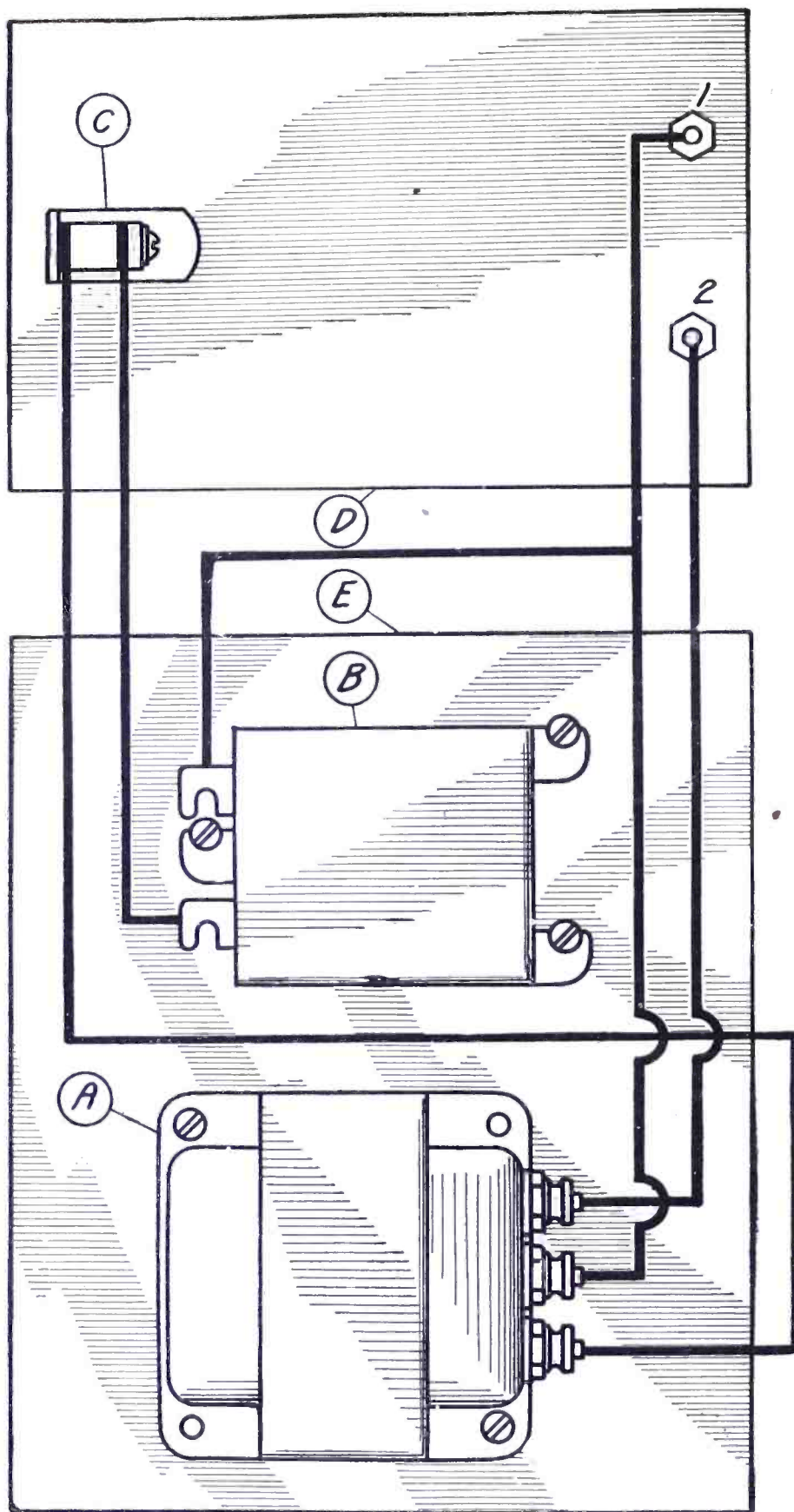

A REVISED DIAGRAM OF THE SHUNT-PLATE FEED UNIT

FIGURE 8: This is used to keep the direct current of the plate supply out of the loudspeaker, allowing only the alternating current of audible frequencies to pass through the loudspeaker.

small knobs until suitable volume is obtained. Now the proper adjustment for the grid-leak I may be made.

With the distant signals tuned in rotate the knob of I until the signals are at the maximum. It is best to move this knob a little at a time, and to remove your hand from the receiver while the effect of the change is being noted, otherwise the presence of the hand on the grid-leak may have a slight detuning effect. The proper setting of the grid-leak will usually be found to be with the knob screwed a little to the right of the point where a clicking or rattling sound is heard as the knob is rotated. Once the proper setting of this instrument has been found it may be left indefinitely at that setting.

The last stunt to be tried is to change the three UV-201-a tubes around until the best position for each is found. One of the three may be found to function better than the other two as a radio-frequency amplifier tube (in the left-hand socket). Leave the tubes in the sockets in which the combination is found to be best.

It is extremely easy to tune in distant stations if the heterodyne beat method is used. This is accomplished by turning the rheostat knob far enough in a clockwise direction to cause a hissing sound in the loudspeaker, indicating that the detector circuit is in an oscillating condition. The tuning dial is then rotated until the whistle of a carrier wave is heard. Leaving the tuning dial set at this point the left-hand small knob may be rotated until the whistle suddenly stops and at this point the speech of music from the station will be heard, somewhat distorted. The distortion can be cleared up by turning the rheostat knob back (anti-clockwise). The tuning dial and the two small knobs should then be slightly readjusted to bring the station up to maximum volume. When looking for distant low-wave stations, keep the left-hand small knob turned with the arrow in a horizontal position and pointing to the left. For high-wave stations the left-hand small knob may be turned further in a clockwise direction. With a few minutes practice one can become proficient in this method of tuning.

When this method of tuning is used with the loudspeaker connected to the set the whistle of the carrier waves will, of course, be audible to listeners who may be in the room with it.

Do not be afraid of using this method as the receiver cannot radiate. So far as interference with neighboring receivers is concerned, there need be no worry; even when using the heterodyne method of tuning the first tube does not oscillate, therefore the whistles are confined to the detector circuit and do not get to the antenna where they might cause trouble to the neighbors who have receivers.

To turn off the receiver it is only necessary to throw the switch R2 to the off position. This breaks the "A" battery circuit and automatically turns off the "B" batteries. If the "Raytheon Plate Supply Unit" is used instead of "B" batteries, it will also be necessary to withdraw the plug in the line which supplies the house-lighting current to the Raytheon unit.

Installation and Equipment

For the assistance of those who are contemplating the installation of an LC-26 receiver, brief descriptions of the installations in the homes of three of the members of the POPULAR RADIO organization are given below, with illustrations.

In all three cases the cone-type of loudspeaker is used. In one of the illustrations the loudspeaker does not show, as it is suspended in a doorway between two rooms with the object of keeping it as far from walls and other obstacles as possible, thus eliminating a certain amount of harshness which is present when any loudspeaker is so placed that emitted sounds of large volume strike a flat, unbroken surface such as that of a bare wall, at close range.

In two of the illustrations it will be noted that the receivers are placed close to the window where the antenna lead-in wire is brought into the house. This aids the general efficiency of the antenna. The ground leads in each case are kept as short as practicable also.

The diagrams given of these three installations will show some differences in the current supply for the receivers. In the photo and diagram, Figure 5, for instance, the high-voltage plate supply is obtained from the Raytheon Plate Supply Unit, which may be seen on the shelf under the table. A constructional description of this unit was given in the November issue. The filament supply in this case is obtained from a six-volt storage battery. In Figure 7 the plate supply is from regular dry-cell type of "B" batteries. The filaments are supplied by a combination storage "A" battery and charger (Gould Uni-Power).

In Figure 6 storage "B" batteries are used to provide the plate supply. A glimpse of these may be had on the shelf under the table. The filaments are supplied by a six-volt storage battery installed with a charger and switching arrangement so that in order to charge the battery it is only necessary to throw the switch to the "charge" side.

In the case of Figure 8 there is one piece of equipment used which does not show in the picture but is found helpful in producing the utmost in tone quality; it is a shunt-plate unit connected between the loudspeaker and the set, the purpose of which is to keep the direct current from the batteries out of the loudspeaker windings, where it serves no useful purpose, but to permit the full modulated current of the signals to pass through the windings. In addition to improving the tone, this device prevents any demagnetizing effect the direct-current flow might have on the magnets of the loudspeaker. This unit is somewhat similar to that described on page 556 of the December issue. Slight changes in the connections as shown there were made in adapting it to the LC-26 receiver, however. The diagram of the filter, as used with the LC-26 receiver, is shown below in Figure 8.

We are glad to give definite assurance that this receiver cannot, under any condition, radiate energy into the antenna circuit. It is truly a "golden rule" receiver.



"RADIO MAY METROPOLITANIZE THE RURAL DISTRICTS"

That radio is destined to have a marked effect upon two widely different types of newspapers—the large metropolitan dailies on one hand and the small town newspapers on the other—is the conclusion of the author of this article. He is the publisher of LE PETIT PARISIEN, and one of the best-known journalists of France.

Will Radio Kill the Small Newspapers?

By SENATOR PAUL DUPUY

A LARGE group of newspaper owners, publishers and editors have decided that radio is a serious menace to the newspaper world.

Similar antagonism has been caused by former innovations. When the first phonographs appeared, theatrical people forecast the death of opera and concerts. They were wrong; the phonographs helped musical productions. The first movies were denounced as an agent that would destroy the legitimate drama. Yet today the stage thrives as never before and the prosperity of the cinema is proverbial.

Now it is radio's turn to receive the attention of the gloom dispensers. Just as labor has objected to each new mechanical device, so the stage, the screen, the press are wailing over the "ruin" to be visited upon them by radio. Yet theater managers

who have had the nerve to broadcast plays or parts of plays report that the broadcasts increased the box office receipts. And certainly there have been no reports of bankruptcy or of loss of circulation from those newspapers that have erected broadcasting stations even though they put upon the air some of the same news that later appears in their columns.

There is one possibility that may be regarded as a danger. By the use of radio we may eventually metropolitanize the rural districts and smaller towns. Their interests may become identical with the interests of the big communities. This possibly will menace the life of the country newspaper.

It may be that the rural resident will, eventually, prefer to read the suburban edition of the big daily, as he will there

get a wider scope of information about the events of which he heard by radio the night before.

But even this may prove less a matter of regret than we should at first think. After all, the individual is rapidly sinking into unimportance, and the community or the state is becoming the unit of human thought. As the world shrinks, as it is made smaller by rapid means of communication, by ships, trains, airplanes, telephones, telegraph and radio, the nation may also gradually become secondary and the world will be one great unit, recognized as such not only by the statesmen

and the diplomats but also by the man in the street.

In that day the little local paper will be of such slight interest that it will die a natural death, unmourned even by its owner. Radio will have been more directly responsible for this change than any one other element of our complex civilization. It is one possibility of the effect of radio on the publisher. The time may be coming when, because of radio, the big metropolitan dailies will have a greater rural influence and, as a corollary, some of the small local papers will be gradually killed off.

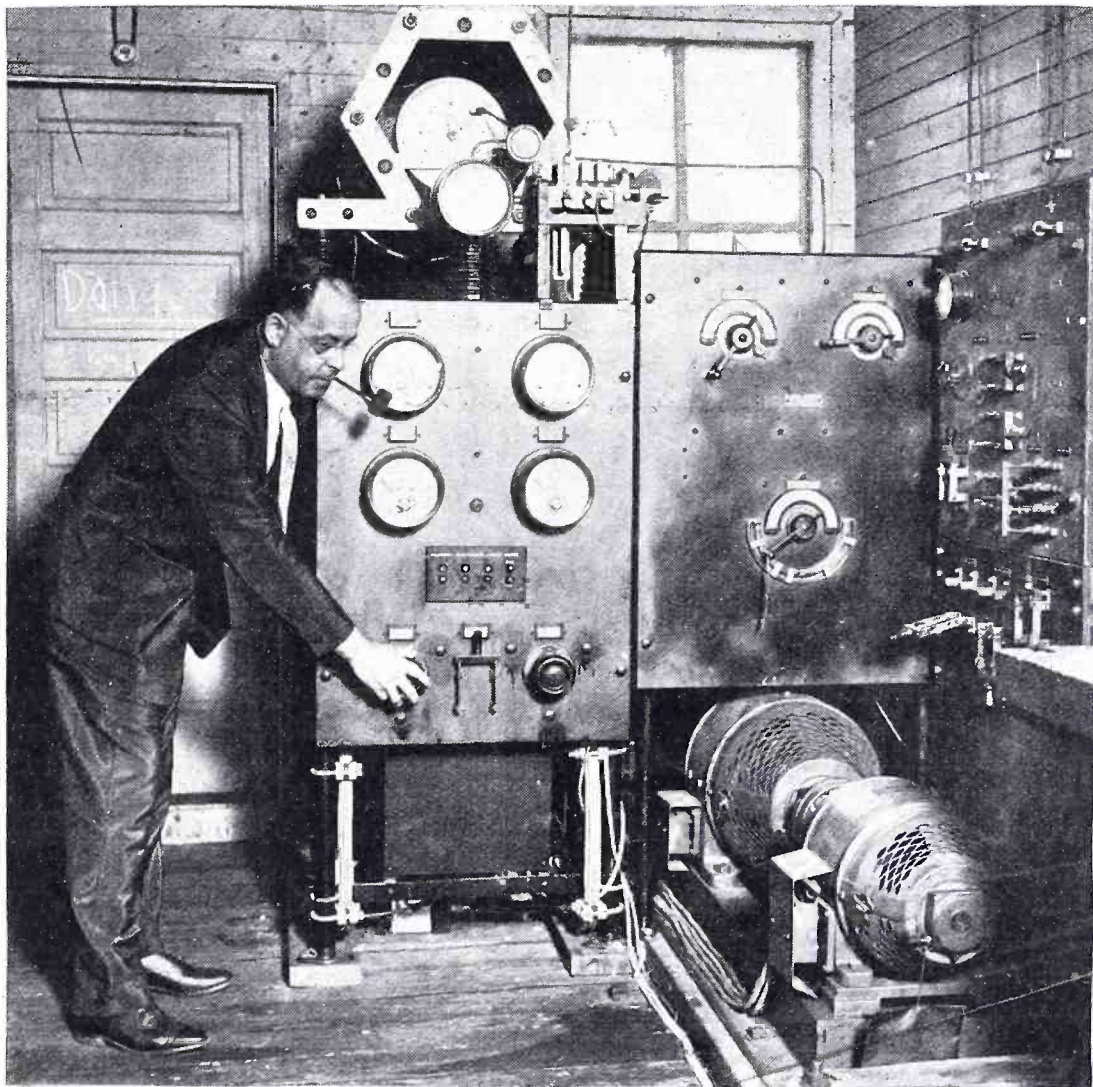

Pacific & Atlantic

THE NEW UNDER-WATER TRANSMITTER

To enable the crews of submarines to converse with each other while their vessels are submerged, the Navy Department has developed this special apparatus.

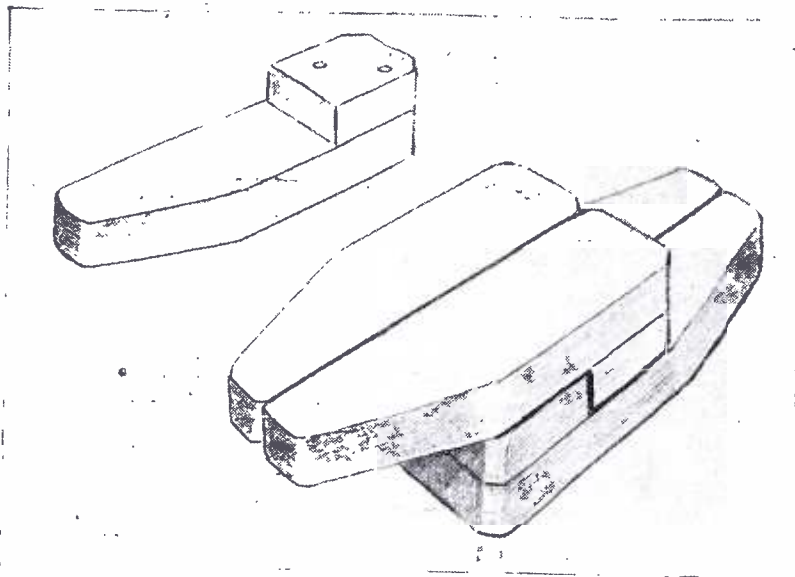

HOW NATURE ARRANGES MOLECULES

FIGURE 1: *This wooden model illustrates the common pattern in which molecules are arranged. Each atom resembles a wooden shoe; four shoes closely packed form a unit of structure that is repeated again and again.*

The ATOM

ARTICLE NO. 4

The Nature of Crystals

Tremendous power is believed to lie within the minute and constantly moving particles of matter known as atoms. The entire universe, the scientists tell us, is made up of only ninety different kinds of atoms. One of these—the thorium atom—furnishes the activating power for modern vacuum-tube filaments as used in modern radio transmission and reception; this is one instance in which the energy that lies within the atom has been harnessed. To extract the energy from atoms and to make it of service to civilization is one of the most important problems that now comes before the experimenters in science.

By SIR WILLIAM BRAGG, K.B.E., D.Sc., F.R.S., M.R.I.

WE have seen that when the effects of heat motion sufficiently overpower the forces of mutual attraction between the molecules, the latter may have an independent existence and form a gas; and, further, that when the forces have gained somewhat the upper hand the molecules may cling together and still retain a considerable freedom of motion; the substance is then a liquid.

We have now to consider a final stage in which the molecules are so locked together that no molecule can move

from its position. It is, let us say, tied to the next molecule at more than one point, so that the whole structure is rigid or solid; fastened together as the various parts of a bridge are riveted together in a firm whole.

The persistent tendency to form a crystal is very mysterious. Given time enough, Nature will always succeed in arranging the molecules according to a pattern, and, in general, a very simple pattern (Figure 1). The molecules may lie for a time in a higgledy-piggledy way, tied together so strongly that the sub-

stance behaves more or less like a solid; this is the case in glass. But the molecules are always trying to creep into their places in a regular scheme, and often succeed in time.

Is every solid body a crystal therefore?

The answer to the question is that it tries to be, and is in general far more successful than usually appears. Some things are obviously crystalline, such as quartz or, as it is sometimes called, rock crystal. *Krustallos* is the Greek for both quartz and ice. Other substances are less obviously of crystal form. Such are the metals which usually show no regularity of outer form, but do so under certain circumstances; in all cases, the crystalline structure can be proved by the use of X-rays. And again, there are many cases where X-rays alone can show the crystalline structure which otherwise would be overlooked, as, for example, in a film of paraffin wax melted on to a plate.

One or two experimental illustrations of the process of crystallization may be given. An old and well-known example is shown in Figure 2. The sodium acetate which is dissolved in the liquid is very ready to crystallize; all the molecules are ready to set to partners and are only waiting for someone to begin. A little encouragement is given by dropping in a minute crystal of the substance, which sets an example to the rest, and the crystals are seen to grow quickly until the whole mass is really solid. Or, again, we spread a very saturated solution of a substance on a glass sheet in the lantern; the heat dries off the liquid and the crystals grow quickly under our eyes. This substance crystallizes easily and quickly, and for that reason gives us a convenient and ready illustration. Other things take long to form; the diamond, for example, takes so long or requires such special arrangements that the mode of its growth is very imperfectly understood.

A crystal is a regular arrangement of the units of pattern; just as an orchard

may contain a regular arrangement of trees. The plan of an orchard may, of course, be drawn on a piece of paper, while the plan of a crystal could only be fully set out in space of three dimensions, but the analogy is sufficient. Our object is to find out the plan. When we stand in a regular planted orchard or hop-field, we see rows of trees and alleys between them running away from us in many directions. In a crystal there are lines of the pattern units running away in all directions from any one of them; and, further, many planes can be drawn through any one of these lines, each of which will be studded with the units in regular fashion.

Now, if we were told that in a certain orchard there were alleys 12 feet wide that ran in a north and south direction, and other alleys of other widths that ran in other directions, we should have enough knowledge to enable us to make a plan of the orchard showing the positions of the trees. In the same way, if we could find the distances between a few different sets of planes of the crystal, we could map out the positions in space of the units that lie on these planes.

This is exactly what the X-rays enable us to do; they give us the

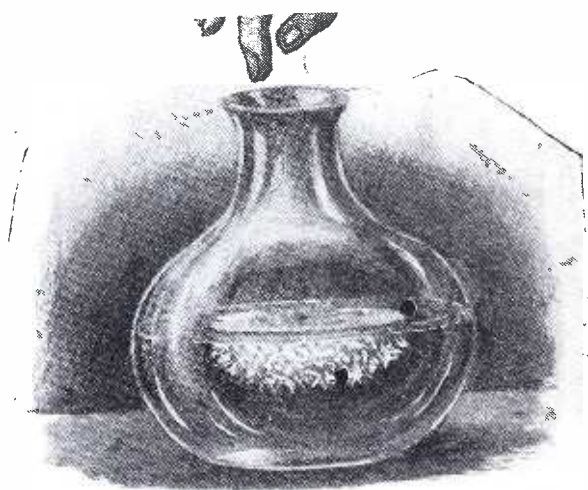

A SIMPLE ILLUSTRATION OF
CRYSTALLIZATION

FIGURE 2: *The sodium acetate in the decanter is more than ready to crystallize. But the process does not begin until a minute fragment of the crystal itself is dropped into the solution.*

distances between the various sets of planes. The mode in which the measurement is made is somewhat difficult to understand without some knowledge of the physics of wave motions; but perhaps the model shown in Figures 3a and 3b will be of some assistance. The model consists, in the first place, of a table on which spots are painted at regular distances; they represent the arrangement of the pattern units in the crystal. Stencils made of thin sheet lead are cut to represent waves. On the left of the picture the waves are supposed to be rolling in on the crystal, and the stencils are, of course, arranged to be in step with each other. The successive sheets which can be drawn through the pattern units in the crystal act like reflectors, each sheet reflecting a very feeble wave,

while the great bulk of the wave flows on and meets successive sheets. The model is intended to show some of these reflected waves passing together out of the crystal on the right. It may be seen from the model that these bundles of reflected waves may or may not be in step with each other as in Figures 3a and 3b respectively. In the former case, there is a comparatively strong reflected wave formed by the combination of the weak reflected waves, of which there may be hundreds of thousands. In the latter the waves are out of step; and there is practically no wave motion as the result. It all depends on the relative adjustment of three factors—the length of the wave, the distance between the successive sheets, and the inclination of the direction of the advancing waves

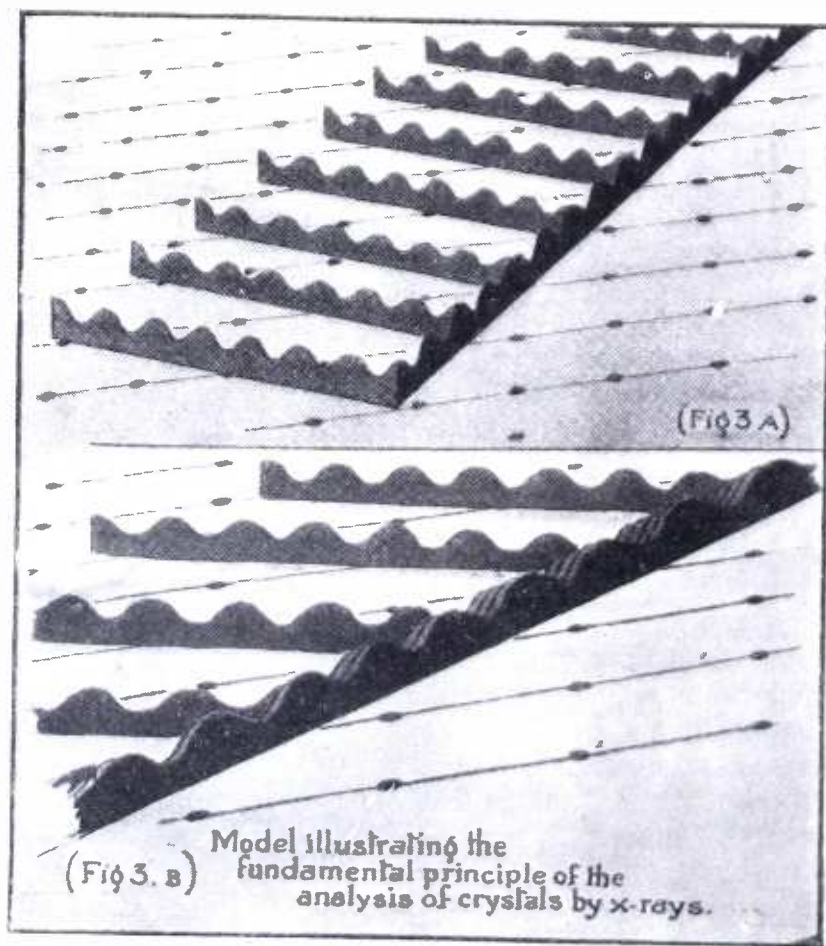

HOW CRYSTALS ARE ANALYZED BY X-RAYS

FIGURES 3A AND 3B: By means of these two models the fundamental principles of this phenomenon are illustrated as explained on pages 25 and 26.

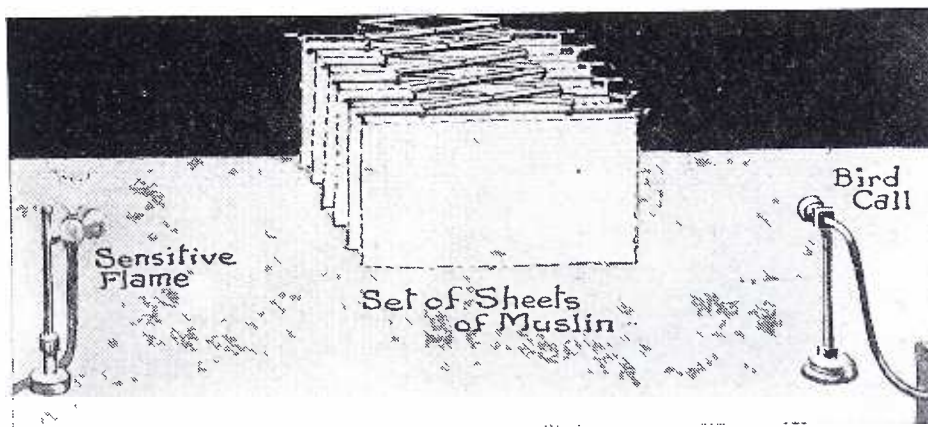

HOW SOUND IS REFLECTED

FIGURE 4: Lord Rayleigh's experiment, to demonstrate the phenomenon of the reflection of sound, by means of a set of sheets of muslin; an illustration of the reflection of x-rays by a crystal.

to the planes of the sheet. In practice, what happens is that the crystal is slowly turned round while bathed in a beam of X-rays; at certain angles the reflections flash out. From the magnitude of the angles the distances between the sheets are calculated.

Many years ago the late Lord Rayleigh showed an analogous experiment of acoustics. A high-pitched whistle (Figure 4) emitted sound-waves one or two inches long. A set of muslin sheets was held by a "lazy-tongs" arrangement so that their distances apart could be varied; the sound went through all the sheets, losing a little of its intensity by reflection at each of them. The combined reflections acted upon a sensitive flame, making it flare as shown; but only if the distances between the sheets were properly adjusted.

The experiment of the X-ray and the crystal is the fundamental experiment of the new investigations into the structure of matter. It shows how the pattern units are spaced in the crystal.

The diamond is perhaps the most interesting of all the crystals in the world. It is remarkable for the beauty and simplicity of its structure, and important because it is the simplest of the forms in which the atoms of carbon join themselves together. The basis of structure of organic substances can be

found within it. It is the hardest mineral that we know, and its brilliance makes it one of the most prized of all jewels. It is already possible to explain many of the properties of the diamond from a consideration of the way in which Nature has designed it. Every carbon atom has four neighbors placed round it in a perfectly symmetrical manner. This is in perfect agreement with the long-established chemical fact that the carbon atom tends always to link itself with four other atoms and no more. For example, methane is a gas in which the molecule consists of a carbon atom linked to four hydrogen atoms. This is the marsh gas which is generated in marshy ground, and sometimes burns with a feeble light, the so-called will-of-the-wisp.

It is odd that the simple form in which carbon atoms group themselves should make so brilliant a gem, and that a form nearly as simple should be so opposite in character as graphite or black lead. A single crystal of graphite is almost unobtainable and the X-ray methods are somewhat hampered in their application to the determination of its structure.

It is impossible to reduce it to powder in a mortar. It becomes simply a mass of fine flakes which slide over one another with the utmost ease. For the same reason, it is easy to slip on a

black-leaded hearthstone, because some of the flakes cling to the hearthstone and some to the soles of one's shoes and the flakes slide readily over one another. Graphite therefore makes one of the best of lubricants.

The diamond and graphite structures are the only two which are composed of carbon alone. Structures of carbon and hydrogen, or carbon, oxygen and hydrogen, or the same with a flavoring of other atoms, are very numerous and form a most important part of the substances found in nature. Indeed, their study constitutes the bulk of the subject of organic chemistry. They are found as the main constituents of living organisms, whence their name; we meet them continually in industrial work, as in the dye industry, the leather industry, the cotton industry, the manufacture of explosives, and in many other places, so that their study is of the highest importance.

If we dissect the diamond structure, we arrive at combinations of carbon atoms which we find are the basis of all these organic compounds. We take

the graphite sheet which we have formed by splitting the diamond in parallel planes; it is a hexagonal network. We now cut through certain bonds and divide the whole up into separate hexagons. Each carbon atom is now joined to two others; it has two idle bonds. To one of these we attach in each case a hydrogen atom, and we have now the famous benzene ring.

Benzene was discovered by Faraday in 1825; a few drops of his original liquid are preserved in the library of the Royal Institution. He did not know its form, only that six carbon and six hydrogen atoms went to the making of it. It was Kekulé who first guessed that the carbon atoms formed a closed chain.

The benzene ring is found in half of the sum-total of organic substances, and because some of the first to be studied were the essences of the lemons, oranges, and the like, the whole class of substances founded on the benzene ring has been called the "aromatic."

The placing of the hydrogen atoms

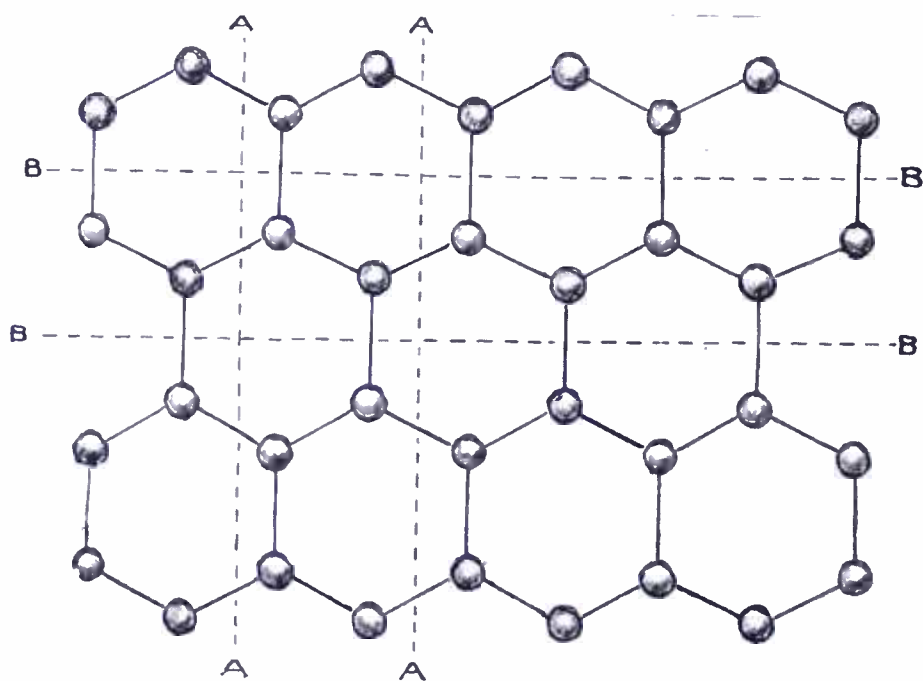

THE HEXAGONAL FRAMEWORK OF THE DIAMOND

FIGURE 5: *The graphite sheet that shows the division into the two kinds of chain molecules, AA and BB.*

round the benzene ring has quite removed the strong attachment to other rings which it had when it formed part of the graphite sheet. Benzene is a liquid at ordinary temperature. All sorts of additions and substitutions can be made to the ring, and every new substance made in this way has its own special properties.

The graphite sheet may be cut up in other ways: along the lines *a a* in Figure 5, or, again, along the lines *b b*. The chain may be of infinite length. Both these chains occur in Nature; they are the basis of the so-called chain compounds. They have been investigated in the Royal Institution. Dr. Müller and Dr. Shearer have found it possible to measure the length of the chain to a high degree of accuracy. Take for instance, the latter chain; every carbon has vacancies for two attachments except the end carbons, which have three. Let one of them be satisfied with three hydrogens, and let the other end carry a special group formed of two oxygens and one hydrogen. Then we have a series of substances called the "fatty acids," all known to chemists and named by them. Thus we have palmitic, myristic, lauric acid, and others. When the chain is short, the substance is liquid at ordinary temperature. But the longer chains belong to solid substances, and the longer the chain the higher the melting point.

When a little of one of the solid members of the series is melted and poured on to a piece of glass or mica, layers of molecules are formed on which all the molecules are perpendicular to the glass; and the layers lie above one another, hundreds in succession, like a series of carpets, each hair of which represents

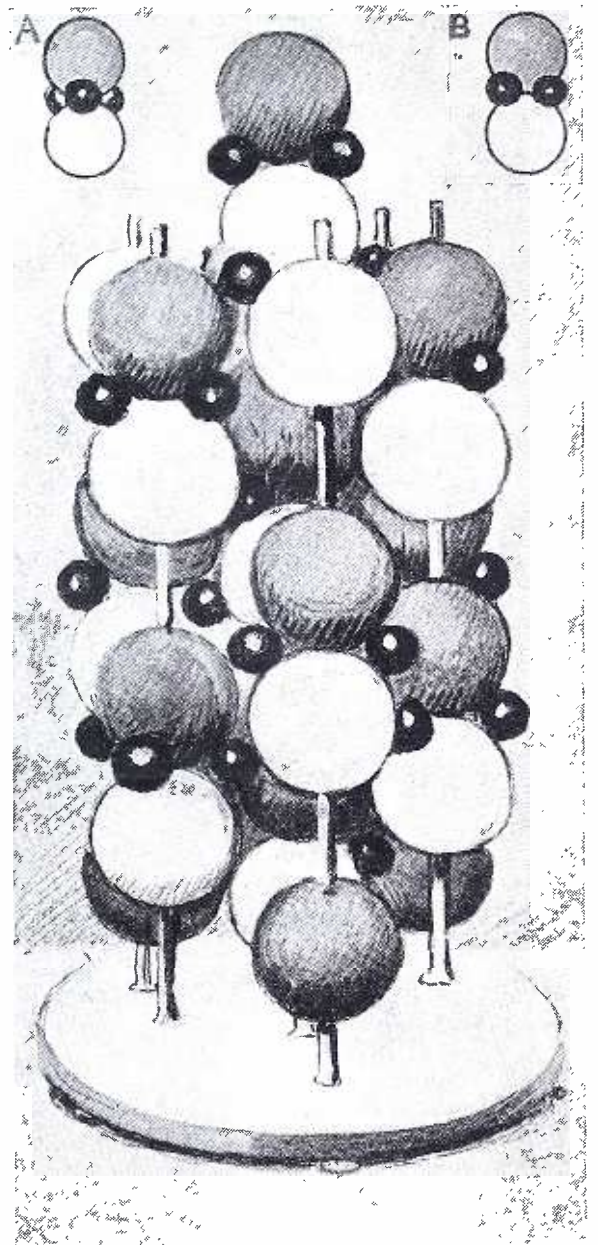

THE RUBY MOLECULE

FIGURE 6: This model contains two atoms of aluminum and three of oxygen. A shows one side of a molecule and B the other side.

a molecule. It is the arrangement in layers which makes it possible to measure the lengths of the molecules by means of X-rays.

Important Kinks in Wiring

What wires to "bunch"; what wires to isolate; what wires to use spaghetti covering on—these are some of the useful bits of information in an article by Louis W. Hatry—in POPULAR RADIO for February.



From a photograph made for POPULAR RADIO

A PRACTICAL INVESTIGATOR OF COILS AND THEIR FUNCTIONS

The author of this article, who is an instructor in radio, is an Associate Member of the American Institute of Electrical Engineers and of the Institute of Radio Engineers. His studies of coils have helped materially in the work of radio experimenters.

SOME NEW AND USEFUL FACTS ABOUT

COILS

Many fallacies exist in the minds of experimenters about the "low-loss" feature of coils or inductances. Many of the so-called "low-loss" coils that are now popular in the radio field have lower efficiency than some of the older types. Just what constitutes a "low-loss" coil and how the characteristics of coils have been carefully studied is told in this article.

By D. R. CLEMONS

DISTRIBUTED capacity of inductance coils may be defined as the inherent constant C_o which satisfies the equation for frequency,

$$f = \frac{1}{2\pi\sqrt{LC_o}}$$

for the coil free and oscillating at its fundamental, and for the coil operating in a tuned circuit, C_o satisfies the equation

$$f = \frac{1}{2\pi\sqrt{L(C+C_o)}}$$

in which C represents condenser capacity lumped in farads, L the pure self induction and C_o the distributed capacity of the coil, units being in farads and henrys.

As both the self induction and distributed capacity of coils follow directly the geometrical dimensions of the coil, in obtaining a maximum self induction with a given length of wire, a large capacity may result. Inherent coil capacity, which is undesirable, involves the

coil dimensions and the inductive capacity of the dielectric through which the electric field acts, hence with a given self induction the variable is the constant K , of the medium surrounding the coil. The most satisfactory formulas for evaluating coil capacity seem to have been given by Mr. G. Breit, and for cylindrical windings of bare wire in air, with the coil free and ungrounded, C_o yields well to the formula

$$C_o = 0.06952 K l \text{ m-mfds.}$$

where l is the coil perimeter and K the inductivity of the dielectric. The constant K is usually doubtful, as dielectrics about coils are largely influenced by compound materials such as insulation, tubing, and possibly varnishes.

Interesting discussions have arisen due to divergent opinions as to the exact effect of foreign dielectrics such as varnishes which tend to increase undesirable capacity inherent to the coil. One prominent writer believes that "due to the higher constant of insulating papers, the addition of papers between layers (of multi-layer coils) will increase the distributed capacity directly as the inductive constant of the paper."

From the literature dealing with losses in inductor coils it seems that with capacity a certain fault in coils, any addition whatever of varnish or insulation which tends to increase capacity magnifies the defect directly as the constant of such added material. As a result of snap judgment one visualizes enormous increase of capacity and this has led to an over-estimation of its magnitude. While application of varnishes does increase the coil capacity, it is impossible in any coil for this increase to be directly as the inductive constant of the varnish used, and in most cases is entirely removed from the constant. In fifteen coils successively treated with various high class varnishes, every one showed an actual decrease of effective resistance. This was due to the better insulating properties of varnish than for raw cotton and silk insulation *exposed to atmospheric changes of humidity*. To show the actual improvement of the various coils, Table I is given. Not one showed an increase of resistance after having been treated.

It will be shown that capacity increases directly as the inductive constant only when the coil's electric field is entirely

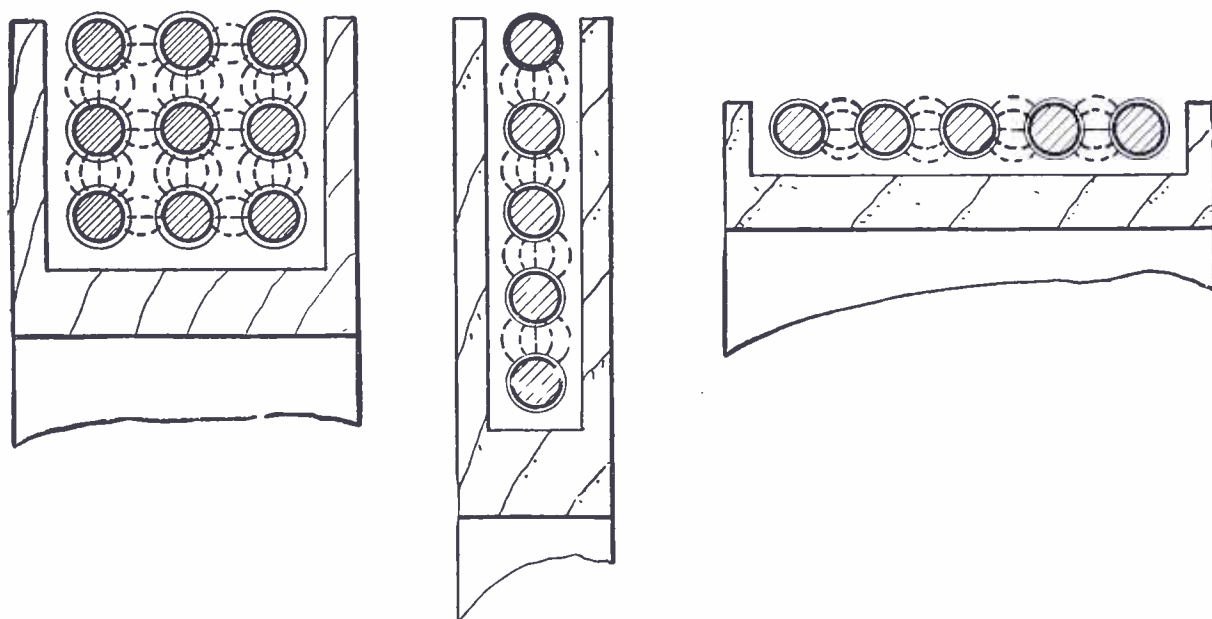

THE ELECTROSTATIC FIELDS AROUND COILS

FIGURE 1: At the left is shown a multi-layer coil with its accompanying electrostatic field; notice that it covers a greater area than the fields in either the spiral winding (in the center), or the solenoid winding (at the right). The wires are shown as in cross-section.

occupied by the added dielectric material which condition is never possible in fact; also, other factors which indirectly determine capacity increases include, or depend upon the coil shape, nature of wire insulation, penetrability and inductivity of the varnish or compound and so on.

Characteristic electric fields are shown for the solenoid, spiral and compact windings, which embrace practically all types of winding now in use, sketches being given in Figure 1. While greatest flux density is found between adjacent turns for the spiral and cylindrical windings, the density per unit area is much greater in the compact windings due to the components of the many turns in traverse layers acting through small distances. By observing the induction effects between two circular areas one may form a mental picture of the action in the entire field as applied to coils of any shape.

In Figure 2, two wire cross-sections represent two areas on adjacent turns of a winding, the wires having cotton insulation of normal thickness, the remaining medium being air. Now, the potential difference acting through space between the sections permits an atomic orientation or orbitary shifting of the tiny electrical components within atoms occupying space and the dielectric about the two surfaces, which motion is equivalent to a movement of electrical energy and is large or small according to the inductivity of the medium considered. The potential of one section acting toward the potential of the second section

at very high frequencies causes such action in the medium, and we may consider it a sudden and highly transient movement of electrical energy through the medium. We may think of the intensity of this movement as closely resembling the quotient of the strain divided by the stress as in mechanics. While displacement is present, energy is stored in the medium, and as displaced units can act through but a short distance they have a velocity and distance, which gives the equivalent of current for a short interval of time; so for high radio frequencies the period of the potentials appearing on the wire sections becomes more nearly equal to the free displacement period of the entire atomic system of the dielectric, at which frequencies the energy stored during transient periods is considerable.

To represent this action in space where it becomes necessary to observe the equi-potential lines along which induction is taking place, familiar lines of electric force may be obtained. Both the gradient distribution and apparent lines may be observed by laying two smooth metal discs on an ebonite plate; a potential of several thousand volts is applied to the electrodes and fine mica dust is sifted over the space occupied by the electrical fields. The dust particles arrange themselves as the solid lines shown in Figure 3. We find that such electric lines of force represent only lines along which induction and displacement act, that they arise and return perpendicularly from potential surfaces, and that

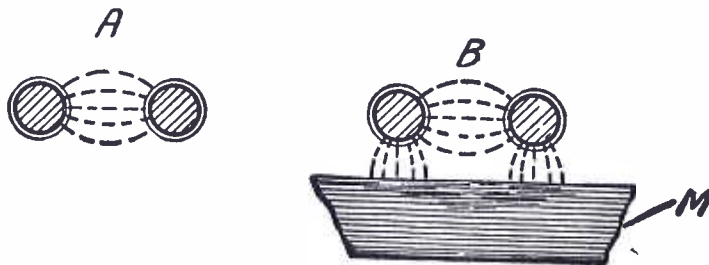

THE ELECTROSTATIC FIELD BETWEEN TWO TURNS OF WIRE

FIGURE 2: At A is shown the distribution of the electrostatic field between two turns of wire in air and at B is shown the field of two turns of wire wound on an insulating tube. Notice that in this case the electrostatic field is included through part of the insulating material thus slightly increasing the capacity between the two turns of wire.

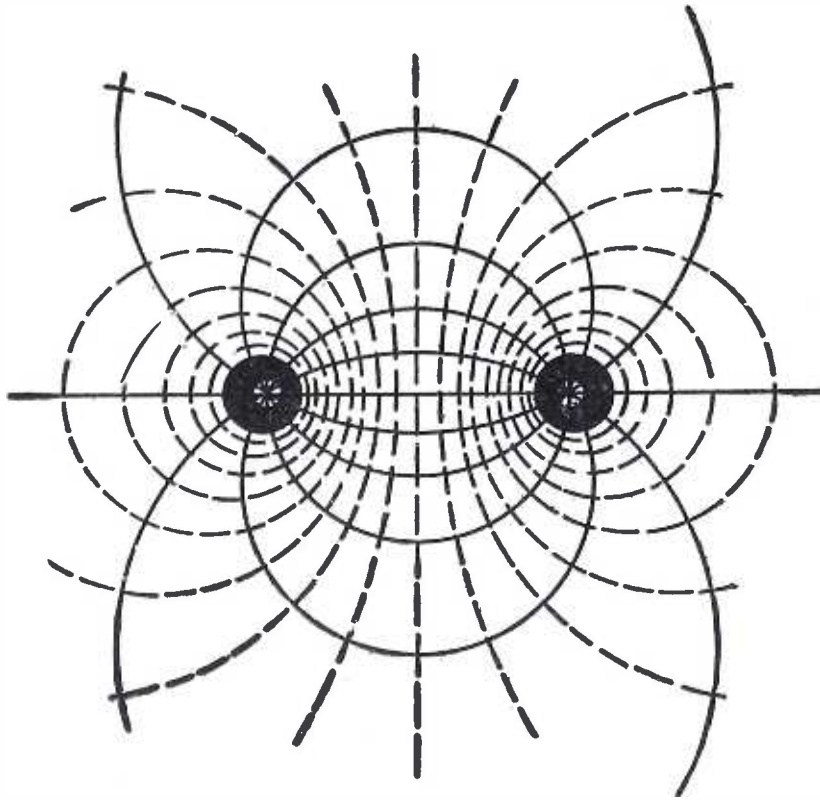

A THEORETICAL FIELD OF FORCE BETWEEN TWO TURNS OF WIRE)

FIGURE 3: *Two black dots represent the two wires in cross-section and the dotted lines are the equi-potential lines. The solid lines show the apparent lines of force that have been given roughly for different types of coils in Figure 1.*

a number of them from one electrified surface is related to more than one other surface, or between numbers of other surfaces acting in the same medium in the case of inductance coils. Where a large number of turns are acting in a small volume of space the distribution of potential causes displacement quite uniform near each surface, but in acting through the dielectric, the entire displaced action is formed by the component of the many points acting as in Figure 4. Methods for calculation of component fields represented by such lines were given by Maxwell and others.

Referring to Figure 6D (assuming a uniform dielectric everywhere about the wire surfaces) the capacity is increased according to the constant of the medium, and the flux in the medium at any region is the voltage gradient of that segment divided by the flux resistance or elasticity of the medium in that segment, which latter value is the reciprocal of the permittance in the dielectric segment con-

sidered. And were the two wires without insulation other than air, we have a uniform flux distribution in space as considered from the current axis at any instant; hence under these conditions the coil capacity yields well to formula calculations of distributed capacity for the air insulated coil in free space.

Now; let us suppose that these two wires are sections wound on a fiber tube, M, or are near to some medium of higher permittance than air as shown in Figure 2B.

We find that, due to the higher permittance of the medium at M, a high gradient and approximately equal displacement is also present in M in addition to that through the air or between the two wires, assuming that both wires are separated from the tubing M and from each other only by their cotton insulation. Obviously, then, we have in addition to the flux actually between turns, another growth of flux through the medium M, and the capacity is ac-

cordingly increased by the presence of this new sub-material. Though induction acts through a much greater distance in the medium M than for the space directly between the wires, it occurs through a medium of considerable permittivity, and if this is sufficiently high the voltage division permits considerable flux to be developed.

To demonstrate the reappearance of flux in greater density even though acting through such greater distances, the following experiments were made:

Two hardwood cubes 1.25 inch on a side were covered with lead foil glued to their surfaces; the blocks were secured by screws to a bakelite strip, their separation being about 0.1 inch between parallel surfaces. Short terminals of

very fine wire connected with the blocks are shown in Figure 5A. Now, one familiar with condensers considers the surfaces or area actually between the two plates, since the edge effect is negligible as compared with flux density in the dielectrics of high inductivity generally used. Between electrified bodies having plane surfaces, displacement may act through a medium not actually between the parallel surfaces forming the electrodes. This "edge effect" between plates as computed by Maxwell is demonstrated at Figure 7. The two blocks suspended in air gave 26.1 m-mfds. capacity. The blocks were lowered to touch the surface of a quantity of olive oil and then raised to prevent cohesion and capillarity, the oil being shown in Figure 5A, for

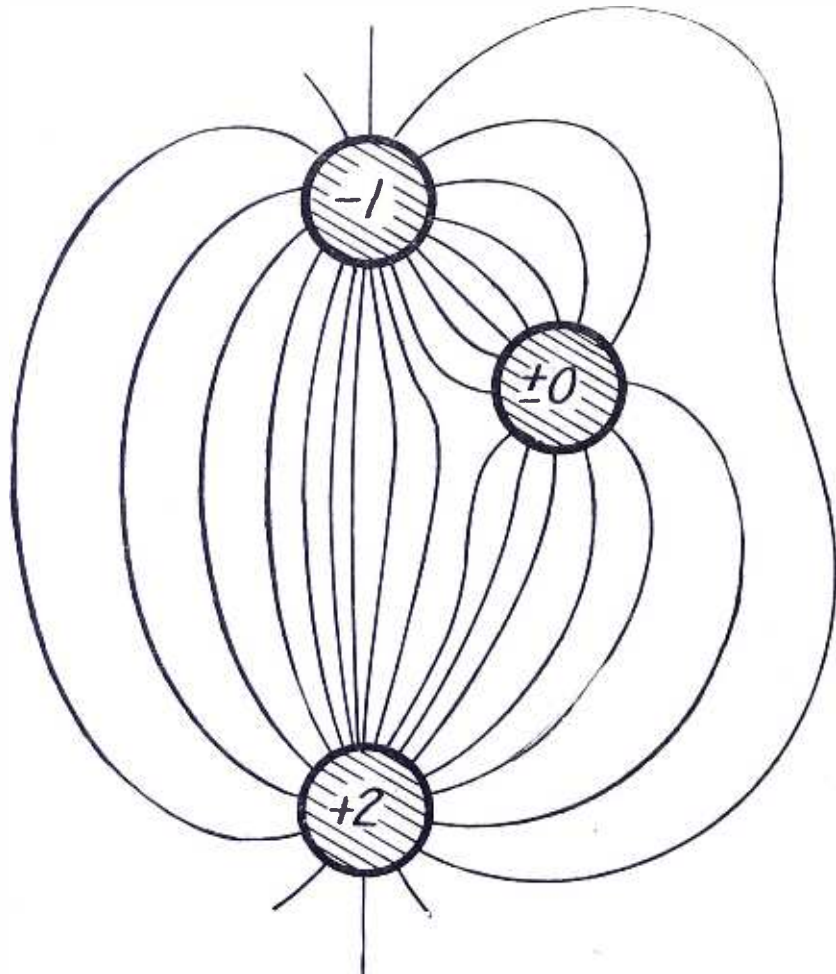

THE DISPLACEMENT OF ELECTRIC LINES OF FORCE IN CROWDED COILS
 FIGURE 4: *This drawing shows diagrammatically how the electric fields between adjacent turns in multi-layer coils may be crowded and distorted. Although the spacing at the surface of the wire is usually fairly uniform, the spacing in the less dense part of the field is usually non-uniform.*

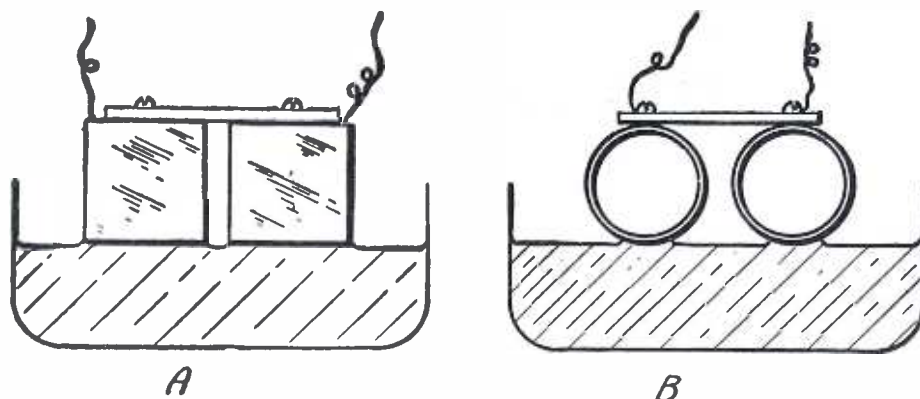

HOW THE TESTS WERE MADE

FIGURE 5: These drawings show how two square fiber blocks and two cylinders covered with foil were used in tests in a tank containing oil to determine the effect of change in capacity when the blocks and cylinders were suspended in air or when they touch the surface of the oil which had a higher dielectric constant than air itself.

which position the capacity became 36.8 m-mfds. The increase of 40 percent is due to the effects previously explained and shown in Figure 2B. To represent the effect for round wires, two fiber cylinders 1.25 inch diameter and 1 inch long were covered by a cylinder of foil and adjacent surfaces were separated 0.06 inch as shown in Figure 5B. In air the capacity between these cylinders was 1.70 m-mfds., and when lowered to oil, the surfaces barely touching the surface as shown, the capacity increased 53 percent to 2.61 m-mfds. Obviously the potential redistributes itself in acting through this new medium. At this time the cubes were entirely submerged in the oil which extended a depth of 0.5 inch on all sides of the blocks. The capacity increased from 26.1 for the blocks in air to 66.5 m-mfds., giving an increase of 2.55, which compares well with the inductivity of the oil, which was 3.08. This illustrates experimentally that the presence of new dielectrics about wires

should increase the distributed capacity of the system. The increase is slight and never becomes according to the constant of the material unless the entire electric field acts in the new medium. The blocks did not show an increase according to the constant K for this reason, but submerged to a greater depth in a greater volume of oil, the constant was approximately the same as the ratio of the capacities for the two positions. Figure 2B is equivalent to wire wound on insulating material.

To show the actual increase of capacity due to forms and tubing requires exacting methods. The tubing must be removed without any disturbance whatever of the coil dimensions. To draw a tube from a coil without changing dimensions of the coil, hence its self inductance, is almost impossible; hence, simply to measure the fundamentals of a coil with and without the tubing does not indicate whether it is capacitive, inductive, or a change of both constants. When meas-

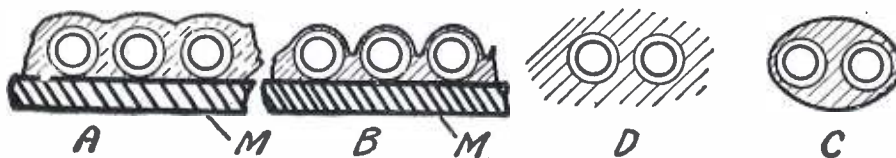

HOW TESTS WERE MADE ON COILS WITH WIRE COVERED WITH AN INSULATING VARNISH OR FILLER

FIGURE 6: At the left are shown wires wound on an insulating cylinder and then varnished or dipped in an insulating compound. Notice that the compound makes a body that covers up the wires in greater or less degree.

ured in terms of wavelength only, the effects of tubing on coil capacity are reported much too large and lead to an over-estimation of this effect.

To show exactly the increase to expect from the addition of tubing the following experiments were performed:

A flint glass cylinder 0.08 inch thick and having a slight taper was obtained and wound with No. 26 double-cotton-covered wire into a coil 18.5 cms. long and 7.0 cms. mean diameter; several thin strips of paper were pasted along the outer surface forming spirals to securely hold the winding shape constant during the experiment. The coil was carefully measured and found to be of 824.8 mhys. pure inductance and of 2.889 m-mfds. distributed capacity. Then the glass tube was carefully removed and the coil, now a mere shell, was measured and found to have 824.8 mhys. pure inductance as before but a smaller capacity of 2.580 m-mfds. When the tube was again inserted both con-

stants were found to be again their first value, showing that while the inductance remained constant the tubing increased the capacity only 11.8 percent although the glass had a very high constant of 6.85. By sealing one end of the tube it was then filled with oil, giving in effect an oil core inside the winding, for which the capacity increased 2.68 times becoming 7.76 m-mfds.

Next, the tube was filled with distilled water. The capacity became 23.92 m-mfds., the inductance in both cases remaining the same (the constant of distilled water is about 80). The coil was then removed from the tube and dipped in hot paraffin which was absorbed by the insulation and enclosed the wires somewhat as shown in Figure 5 at A, its depth being about 0.6 inch. The capacity increased to 4.39 m-mfds., showing a tendency to increase according to the constant when the material occupies the space subject to maximum flux density along the winding.

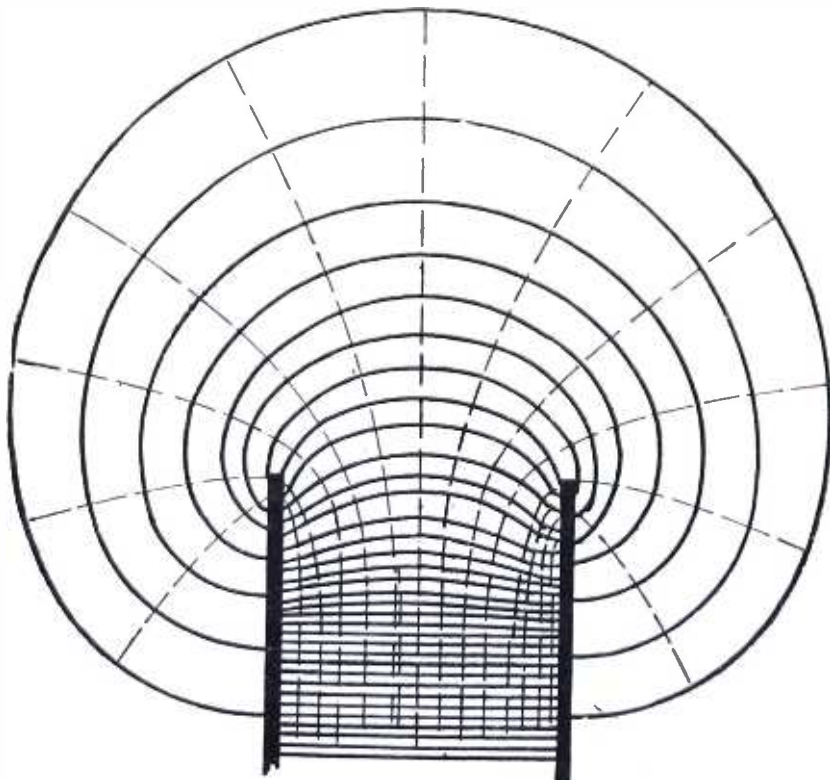

THE FIELD AT THE EDGE OF CONDENSER PLATES

FIGURE 7: *The curve of the equi-potential lines and the stressed lines at the ends of two parallel condenser plates. Notice how the field is bent around the edges of the plates.*

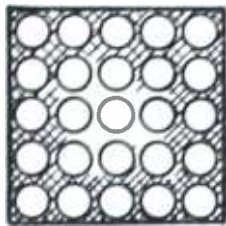

FIGURE 8: This drawing shows how a multi-layer coil impregnated with liquid varnish really has only the outer portion covered. The varnish seldom penetrates through the insulation except by long immersion.

Owing to the difficulties encountered in removing bakelite tubing from the finished winding without altering the self induction of the coil, another method of measuring the effect of bakelite material was resorted to. We have elsewhere referred to the similarity of constants and field distribution about solenoids and spirals of small winding depth, and we find by observation one plane surface of a perfectly flat spiral is equivalent to the inner cylindrical surface of the solenoid; therefore, by laying a perfectly flat spiral upon a sheet of material we have the equivalent of a tube having the same thickness as the sheet, and the effect on the capacity is identical. In this way there is no change of self induction or of initial capacity while handling the coil. A flat spiral 17.4 cms. diameter wound with 41 turns of No. 22 double-cotton-covered wire having 220.2 mhys. inductance and 3.10 m-mfds. capacity for the free coil was first placed on a sheet of laminated bakelite material 10 inches square and 0.187 inch thick, the copper being separated from the material by its cotton insulation only. The capacity increased from 3.10 m-mfds. to 4.60 m-mfds., which is 1.48 times the free coil capacity; then, when lain on a similar grade of material twice as thick or 0.376 inch, the capacity became 5.6 m-mfds., which is 1.81 times its free value. Though this increase is considerable, it is not proportional to the constant of this very satisfactory material having inductivities of 2.6 to 3.07, depending on the grade.

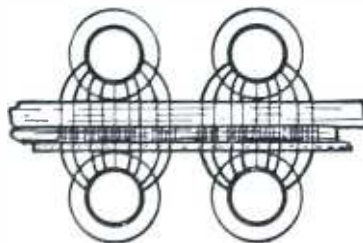

FIGURE 9. This diagram shows the action of a few layers of paper on the electrostatic fields between layer turns of wire.

To show the increase of capacity for a dielectric of greater volume and which is everywhere closely related to one surface of the coil, the spiral was next lowered with one surface resting on oil having a constant of 2.11; then the capacity, due to the action being illustrated in Figure 2B, was increased from 3.1 m-mfds. to 6.70 m-mfds., which is about as before, 1.821 times the free coil capacity. To provide a dielectric of high permittance distilled water was again used and the coil lowered to the surface gave 79.4 m-mfds. capacity which increased from the normal 3.1 m-mfd. Although the constant of distilled water is about 80 the increase is but 25.5 times the free coil capacity. The inductance was not altered by the presence of the water. Obviously, then, the addition of tubing will only slightly increase coil capacity; the increase will not be directly as the constant of the tube or form but is governed somewhat by it, also the thickness and nature of the material together with considerations of the insulation depth on the wire.

Insulating varnishes may be applied to solenoids and spirals without increasing their resistance at normal frequencies, nor does varnish or impregnations appreciably increase the capacity of the coil if it is applied thinly. Referring to Figure 6 at B we find that wires wound over the tube have a slight increase due to the tubing being inserted or remaining in the electric field; then since varnish seldom does more than penetrate the fibers of cotton and silk, and probably merely fills the cavities within the wind-

ing, a great quantity of material is not added by a light application of varnish though it occupies a position of greatest density about the wire. Hence the mere substitution of one dielectric for another does not cause a great increase of capacity.

For example:

A solenoid of 23 double-cotton-covered wire had a capacity of 7.245 m-mfd., and after having applied three heavy coats of Redmanol, a phenol product, the capacity increased to 8.275, which is but 14 percent above normal for this extra heavy application of this varnish, and though its constant is about 2.62 when properly dried under heat and pressure.

Although cotton and silk have each an inductivity of about 4.86 when it resembles a solid dielectric, it is not an important detail where the insulation about wires consists of cotton or silk as these are usually a complex non-solid nature due to the complex position of the fibers making up the dielectric; therefore, cotton insulation absorbing varnish becomes practically a compound solid dielectric. For solenoids and spirals, since varnish ordinarily occupies but a small part of the entire electric field the capacity increase in them is small and is certainly far from any direct relation to the constant of the varnish material, but with a given coil the increase will largely depend on the absorbing properties of the wire insulation together with *the amount of varnish applied* and its inductivity when dried.

In Figure 6A, where A represents a greater quantity of varnish than at B, the capacity at A should be larger than at B which is small, since at A the flux acts through a greater volume of dielectric material than at B where a large part of the field is through air only. To demonstrate this: two No. 22 double-cotton-covered wires having a length equal to one complete turn on the coil described were lain parallel and twisted together; their capacity was 22.80 m-mfd.; then the

wire was submerged in olive oil as in Figure 5D for which the capacity became 69.0 m-mfd. for the oil dielectric; then, by drawing up the wires cohesion of the oil gave a distribution of oil as at Figure 5C, which is about the shape that applied and dried varnish would have assumed, then the lumped capacity was but 57.0 m-mfd. Therefore, a light application of varnish would resemble B and C in Figure 5 for which the capacity increased 2.25 times, while for complete submersion the increase is obviously 3.02, which was found to be the constant of the oil used. Such wetting of the winding gives the equivalent effect of an applied varnish on the coil. We have shown the coil capacity should increase according to the constant K only when the electric field is entirely contained within the added dielectric, but this is never the case for coils used in radio circuits and of the solenoid and spiral class, but since the field of the compact windings of square cross-section is largely contained within its winding surfaces, the field of the latter type does act almost entirely through impregnation material applied to coils of the *compact* type, and the increase is approximately as the constant. To illustrate this: 3 coils of equal wire-lengths were designed for best shapes in spiral, cylindrical and compact types of winding. By submerging each coil below the surface of oil of known constant we have the equivalent effect of the electric field acting within a large dielectric about the entire coil, while, by withdrawing them, the oil wetting the insulation and adhering between turns is at once equivalent to an application of varnish, which method applied to the three coils described gave the following results:

| Coil | Co Dry in Air, m-mfd. | Saturated, m-mfd. | Submerged, m-mfd. | Increase per cent. |
|---------------|-----------------------------|----------------------|----------------------|-----------------------|
| Solenoid..... | 3.566 | 4.18 | 4.44 | 17.3 |
| Spiral..... | 2.520 | 2.972 | 4.04 | 18.0 |
| Compact..... | 4.190 | 7.547 | 8.684 | 80.0 |

For the first two the gain is but 17 and 18 percent of the free capacity, but for the compact winding the saturated ca-

TABLE I

| Coil | Wire insulation | As they lay | Resistance without varnish | Coated with thin layer of varnish | Final resistance | Decrease percent. |
|------|------------------|-------------|----------------------------|-----------------------------------|------------------|-----------------------------|
| 15 | 23 double cotton | 1000 | 27.70 | Silk | 23.65 | -14.5 |
| 16 | 23 | 1000 | 27.2 | Paralac | 25.21 | -7.6 |
| 17 | 23 | 1000 | 27.40 | Celulose | 25.10 | -8.4 |
| 18 | 23 | 1000 | 27.62 | Paraff | 24.62 | -10.8 |
| 19 | 23 | 1000 | 9.22 | Resin | 8.5 | 5.0 |
| 11 | 30 | 500 | 68.00 | Silk | 63.50 | 6.7 3 layer banked |
| 7 | 23 | 500 | 28.10 | Paralac | 24.30 | 13.5 2 layer banked |
| 8 | 23 | 500 | 4.50 | Celulose | 4.2 | 5.2 |
| 9 | 26 enamel | 200 | 28.40 | Silk | 6.80 | 5.20 |
| 10 | 22 double silk | 200 | 67.40 | Bakelite | 58.4 | 13.3 section 4 layer banked |
| 14 | 24 enamel | 200 | 10.74 | Silk | 10.4 | |

capacity is 1.8 times the free capacity, while complete submersion increased the capacity 2.07 times, showing that the compact winding gives a capacity increase nearly as the inductive constant with perfect saturation or impregnation. The oil in this case had a constant of 2.11. Air pockets and impenetration prevented a direct increase, therefore, a coil of the honeycomb type of 100 turns was submerged. This permitted penetration to all parts of the coil and the increase was from 11.27 to 23.61 m.mfd. which is approximately as the constant 2.11 of the dielectric.

Thin varnishes applied to coils fail to entirely penetrate compact windings, therefore it is improbable that increases in this type is greater than 70 percent above the free coil capacity. One coil being wound up of square cross-section and supposedly well impregnated with liquid bakelite was found to have but the outer portion impregnated as shown in Figure 8 which would be the case for most varnishes applied with a common brush or by simple submersion.

The addition of thin paper insulation in multi layer coils will not increase the capacity directly, or even approximately, as the constant of the paper. Referring to Figure 9 we have several thicknesses of paper between two successive layers. While the paper is located in position of greatest flux density it does not even approximately occupy the entire electric field which in a large number of turns, is a component of many potentials acting. Though it has a higher centimeter gra-

dent than for air between two turns, it does not occupy such a relative position with respect to the traverse layers or to the entire field acting in the region of the winding. Since the paper is probably less than 0.003 inch thick in most cases, any refraction of flux in it is negligible and the density is not appreciably increased, moreover, traverse layers being further separated tends to reduce the flux and capacity of the winding for a given wire-length. The potentials in a thin segment of a compound dielectric are divided according to the thickness and inductivity of the medium. A potential E acting between two such wires, and through the cotton insulation of thickness d_1 , and constant k_1 , develops a potential E_1 through the paper of thickness d_2 and constant k_2 according to the formula,

$$E_1 = \frac{E}{\left(1 + \frac{d_1 k_2}{d_2 k_1}\right)}$$

Obviously the comparative thinness of the paper cannot permit a great potential to operate through it except at a small segment where the wires rest on the paper hence the total increase of flux and capacity is slight and is certainly not directly as the inductivity of the paper would indicate.

Apart from the effects of capacity, the effective resistance of inductance coils also involves leakage and other dielectric losses. It is certain that any varnish will improve the insulating properties of raw cotton and silk exposed to moisture as we have shown in Table I.



From a photograph made for POPULAR RADIO

When Your Set Won't Work

Where to Look for Trouble and How to Fix It

By EDGAR H. FELIX, M.I.R.E.

WHEN your first automobile gave trouble, it made some kind of a snort, squeak, wheeze, or dying gasp which gave you a clue to the cause of trouble.

But a radio set just simply stops working.

The powers that operate it are invisible; they do not cause response to our sense of smell, taste or pressure. They respond only to our sense of hearing. These forces are so elusive that a detective cannot trace them. They slip out of the wrong door at the least opportunity, and if you do not treat them exactly as you should they will not serve you.

It is for this reason that radio receiving troubles are so hard to analyze. The only apparent way to find the cause

of trouble is to try every connection, every control, every adjustment, one at a time, until you finally hit upon the part out of order or the incorrect adjustment.

There is, however, a sensible, logical, and direct process of analyzing faults in a radio set. In this article I will give you an idea of what to do if your set suddenly stops working.

There are only three general symptoms of trouble which can be detected by the human senses. These three symptoms all appeal to the sense of sound. First, you can easily tell if you are not receiving any signals at all; second, you know when you get an unusually weak signal—much weaker than you are accustomed to hearing from a given station; and, third, you

can readily distinguish noisy reception.

Although these three distinctions do not seem to be of particular help, they do enable you to at once eliminate a good many possible causes of trouble and to concentrate upon those which are most likely to be the cause.

What to Do When You Hear No Signal At All

The first of these symptoms of trouble—when you hear no signal at all—is perhaps the least exasperating. There is no question that something is wrong when you do not hear anything. Consequently you set to work to solve the mystery.

If you have been receiving signals nicely, and then suddenly they stop without any apparent cause, look first to the adjustment of your detector.

If you use a crystal detector, monkey with the adjustment until you have found a sensitive spot. In this lies the cause of most of the troubles in crystal detector receiving.

An excellent aid to adjusting a crystal detector is the use of a high-pitched buzzer. Connect with one side of your detector the terminal of the buzzer where the make and break of the connection is made. You can easily identify which buzzer terminal this is by the little spark at the set screw making the contact with the movable arm of the buzzer. This contact is connected directly with one of the two terminals of the buzzer.

When the buzzer is thus connected and operating it will set up magnetic waves in the secondary circuit of your receiver which will enable you to adjust your detector. At various detector adjustments the buzzer sound in the head telephones varies in strength. Leave the detector adjustment alone when you find a good loud point—you are then ready to receive.

When a vacuum tube detector gives no signal at all it is usually a sign that something serious has happened. Vacuum tube detector troubles, however, are not difficult to locate.

Where to Hunt for Vacuum Tube Trouble

The first thing to do is to examine your filaments. Do they light properly and to full brilliancy? If they light at all, the filaments are not burned out. If they do not light when a battery of proper voltage is applied to them, they are burned out. For this there is usually no remedy except to buy new tubes.

But this is not the only possible cause of vacuum tube trouble. The filament may be burning properly; the spring contacts to the prongs of the tube, on inspection, may show that a good contact is being made with each prong, yet you may not hear a sound. Sometimes the new thoriated filament tubes lose their vitality without the filament burning out. If this is the case try out the tube in a tube rejuvenator to restore the thorium to active condition.

Look to your "B" battery, which provides the high voltage for the plate circuit. Are its connections complete? Do you get a loud click in the phones when you disconnect the telephones from the plate circuit? If you do not there is something wrong with the plate circuit. Trace it from beginning to end, from the plate as far as the filament. Try your phone connections. Sometimes one of the cords pulls off the head piece or loudspeaker connections. Sometimes the plug does not make a good contact with the jack.

With some sets there is a variometer in the plate circuit. This variometer makes it a regenerative receiver. Occasionally the connection to the rotor becomes broken from continued use. Examine the leads carefully.

How to Test the Plate Circuit

Touch one of the plate battery binding posts with your wet finger. If your plate circuit is complete, your filaments lit, your "B" battery at full strength and the wiring correct, you should hear a click when you touch the "B" battery binding post with a wet finger. There

is something wrong in the plate circuit itself if you do not hear a click under these conditions. It may be with the telephones or the loudspeaker.

How to Check Up Your Antenna

The cause of trouble may lie in the antenna system. A loose antenna connection sometimes makes it possible to hear faint signals, but when your lightning switch grounds the antenna, the chances are that not a sound can be heard in your telephone receivers. Look over the antenna system, trace it through the tuning inductances to the ground connection; trace the secondary circuits of the receiver from the grid connections on the tube bases to the filaments, making sure there are no loose connections with switches, binding posts or movable tuning elements such as variometers and variable condensers.

If your set ever worked at all, a search of the kind I have indicated will locate the cause of trouble.

What to Do When Your Signals Are Unusually Faint

A different kind of trouble may be the cause when you hear only weak signals. Every station comes in evenly and smoothly, but it is only half or one-quarter as loud as usual. This usually happens when you are trying to demonstrate your radio set to friends.

With a crystal receiver the first thing to do is to get a better adjustment of the crystal. If a number of careful attempts of adjustment produce no improvement, look elsewhere for trouble.

With a larger set using radio frequency amplification and a vacuum tube detector there are various possible causes. First, be sure the filaments light to normal brilliancy. It may be that the filament storage battery has run down and needs charging. In that case you do not get proper filament brilliancy.

Another possible cause is a run down "B" battery. Large capacity batteries last from six to twelve months. Some

of the small sizes last anywhere from one day to three months. You never know what to expect of a small battery. If the "B" battery has run down, you do not get a sharp click when the telephones or loudspeaker or the "B" battery are suddenly disconnected from the plate circuit. Be sure the filaments are lighted when you make your test.

With a home-made vacuum tube set, where the binding posts for the storage battery and the "B" battery are not marked with plus and minus signs, you may make the error of reversing the battery connections. If you have done this, reverse them again so that they are as they should be. The positive terminal of the "B" battery should connect with the plates of the tubes either directly or through the phones and tickler coil.

Another possible cause of trouble is too great a degree of filament brilliancy on the soft detector tube or too high plate voltage or a grid-leak of too high resistance. As you gradually increase the filament brilliancy beyond normal, the first effect is a rapidly increasing hiss. A still greater increase causes a louder hiss until you hear a click and signals stop altogether. Your tube is now what is termed in technical parlance "paralyzed." Under this condition you may sometimes see a faint blue glow around the filament and near the plate. Oftentimes a strong signal from a nearby station tips the balance and causes tube paralysis if the grid-leak is not properly adjusted.

Too much plate voltage also causes the same trouble. Reduce the plate voltage to normal, and decrease the resistance of the grid-leak.

When using a regenerative receiver there is another possible cause for signals dying out. If too much inductance is used in the plate circuit the tube starts oscillating which destroys the tone of all voice and spark signals. A readjustment of plate inductance is necessary to remedy this.

Weak signals are often received when

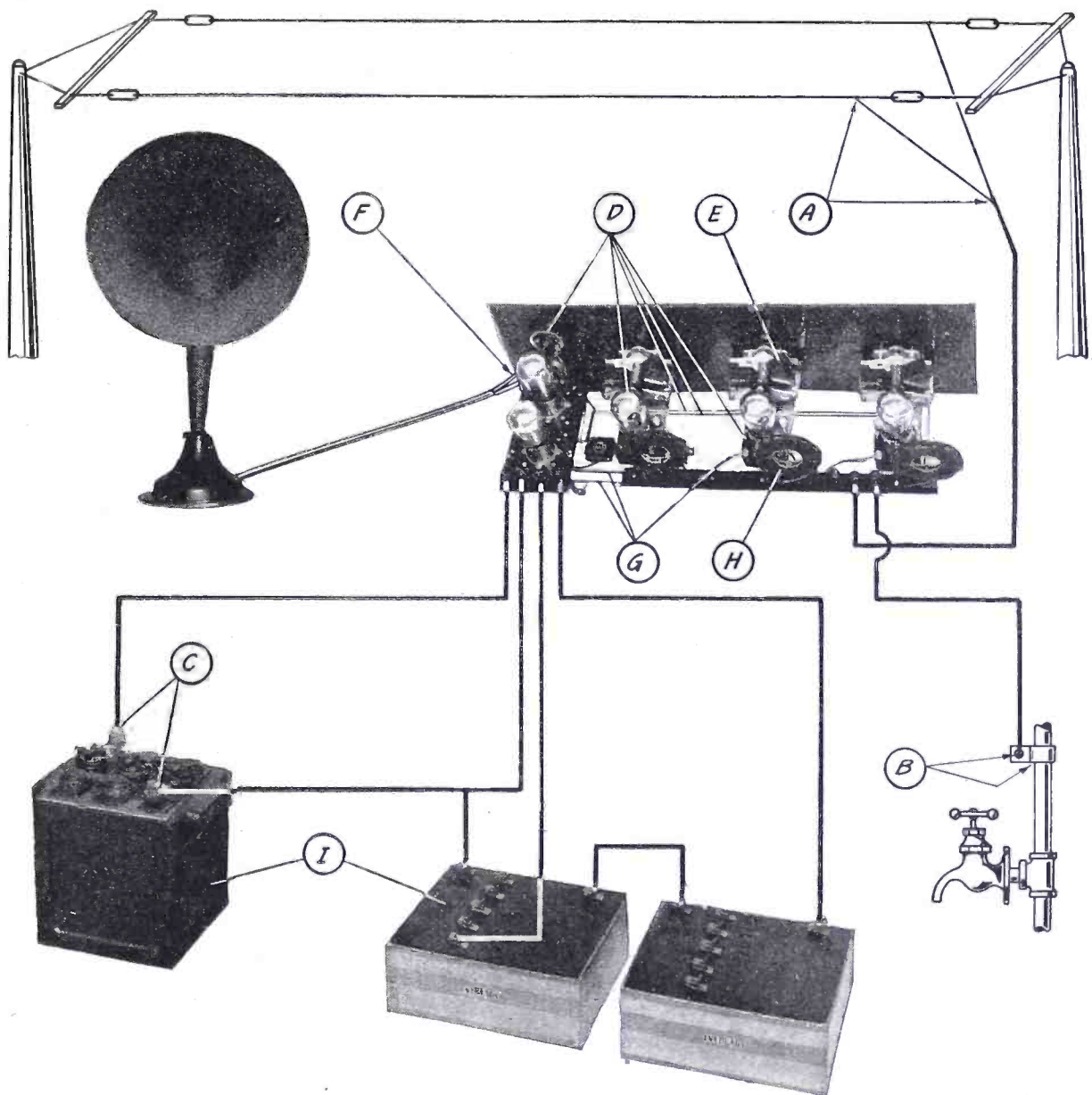

When Your Receiver Won't Work—

- A—See that your lead-in and antenna wires are securely and electrically connected;
- B—See that your ground connection has perfect contact with the water pipe, radiator, or other grounding means;
- C—See that your "A" battery wires are connected to a clean surface of the lead terminals; the *negative* terminal must go to the *negative* binding post of the set;
- D—See if the filaments are lighted. If they are not—
1. See if your socket prongs make contact; if they do not, bend them up higher;
 2. See if your "A" battery connections are poor;
 3. See if the filament wiring in the set is unsoldered or broken;
 4. See if a tube is bad; test it out in another socket to find out if only prongs need bending up;
 5. See if the rheostat winding is making a complete connection with its terminals.
- E—See that your condenser plates are spaced equally and do not touch each other;
- F—Change the phone tips of your loudspeaker terminals, to give best reception;
- G—See that all the soldered connections of the grid and plate circuits are all right. If you are not sure that the connection is complete, test it by placing a pair of headphones across the connection with a "C" battery in series with the headphones; if there is a *loud* click the connection is perfect. (This test applies to all connections.)
- H—Test the primaries and secondaries of the coils by the headphone-battery method;
- I—Test your "B" batteries, which should measure at least 80 percent of original voltage. Your "A" battery should show no less than 1175 on the hydrometer before recharging.

the antenna is disconnected, either by a break in the lead-in or by leaving the switch in the grounded position through an oversight. Trace the entire antenna system through your set. See that good connections are made with the tuning elements. If there is a variometer used, examine the connections. See that the ground lead is unbroken and makes good contact with your ground connection.

Go up on the roof and see if the antenna wire or the lead-in "grounds" at any point. Trace the secondary circuit of your set. You often get weak signals although there is a break in the grid connection to the secondary inductance.

If your trace of antenna and secondary circuits has shown them to be in good working order, the trouble must lie in the tube circuits. Do not overlook the test for phone sensitiveness and condition of "B" battery already mentioned. Your diagnosis, if thoroughly done, is bound to reveal the cause of trouble.

How to Check Noisy and Irregular Reception

The final class of troubles accompany noisy reception. You may for a moment get a good loud signal and then suddenly it dies down; later it comes back in full strength. This is the easiest kind of trouble to locate. But you can only locate this if you keep your temperature below 104 and refrain from getting excited.

When great variation of signal strength attends reception there is a loose connection somewhere. Slowly operate each control of your set, one at a time. If there is a break in the variometer leads or the connections to the switches, you may readily find it by this process. If the trouble lies in a loose connection, sit perfectly still in front of the set for a moment without moving your head or hands and see if any variation in signal strength takes place. If it does not, continue in your search for

broken connection. Shake the wire which leads to the telephone head piece or loudspeaker. If that produces a series of clicks and wheezes you may find the copper wire has come loose from the cord tip.

Sometimes the trouble is not with your set at all. It may be that there are variations in the strength of the incoming signal, due either to transmitter troubles or to an absorptive receiver in your immediate vicinity. This is not difficult to diagnose. All you have to do is to tune to some other station, whether spark or telephone, it makes no difference. If a loose connection is the cause of your trouble it will affect all stations alike instead of only one particular station.

If varying the controls and trying the head receivers does not locate the trouble, trace each circuit, beginning with the plate circuit. See that the connections at the base of the tube are good. Trace all the battery connections and the plate circuits. Then trace the secondary circuits from the grid through the inductances to the filaments. Finally trace the antenna circuit from one end through the tuning elements to the ground.

A steady reception of noise, which does not vary no matter what tuning adjustment is used, is sometimes caused by a low "B" battery used with a reflex receiver. It is often possible to get additional service from such "B" batteries by using them on non-reflexed tubes. With heavy current drain sets extra large "B" batteries give the most economical service in cost per hour of use. Another cause of noise may be vibrating tubes caused by building vibration, typewriters or nearby machinery.

There are other causes of trouble but these which I mention constitute the 99 percent of them all. The remedy in each case is simple and obvious once the cause is located.

Once you have successfully discovered a trouble, the next time it occurs you can locate it in an instant.

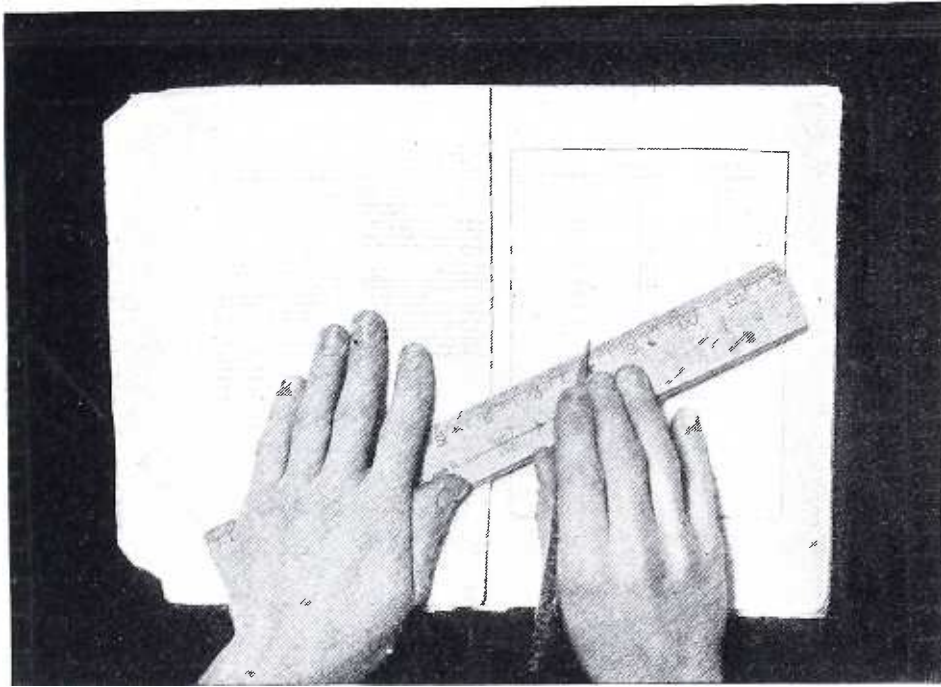

From a photograph made for POPULAR RADIO

HOW TO SCALE OFF THE ANSWER TO YOUR RHEOSTAT PROBLEM
First determine the positions on the charts where the known specifications are located; then connect these points with a ruler which will fall upon the reading you seek.

A MEASUREMENT CHART

FOR USE WHEN SELECTING A RHEOSTAT FOR A
 MULTI-TUBE CIRCUIT

Article No. 13

By RAOUL HOFFMAN, A.M.E.

TO control more than one tube by a single rheostat simplifies not only the building of a radio set, but reduces the contacts in the filament circuit; and thus adds to the efficiency of a radio receiver.

Difficulty is often encountered in the selection of the proper rheostat.

Applying Ohm's law to the filament circuit, we have

$$\text{Amperes} = \frac{\text{Voltage}}{\text{Resistance}} \dots \dots \dots 1$$

where the resistance is equal to the sum of the resistance of the rheostat and the resulting resistance of the parallel-connected tubes.

By connecting tubes in parallel,* the resulting resistance will be inversely proportional to the number of tubes used; therefore equation (1) will be

$$n \times \text{Amperes} = \frac{\text{Voltage}}{R + \frac{R_T}{n}} \dots \dots \dots 2$$

or

$$\text{Amperes} = \frac{\text{Voltage}}{n R + R_T} \dots \dots \dots 3$$

wherein n denotes the number of tubes, R the resistance of the rheostat, R_T the resistance of a single tube.

* See January, 1925 issue of POPULAR RADIO, page 58.

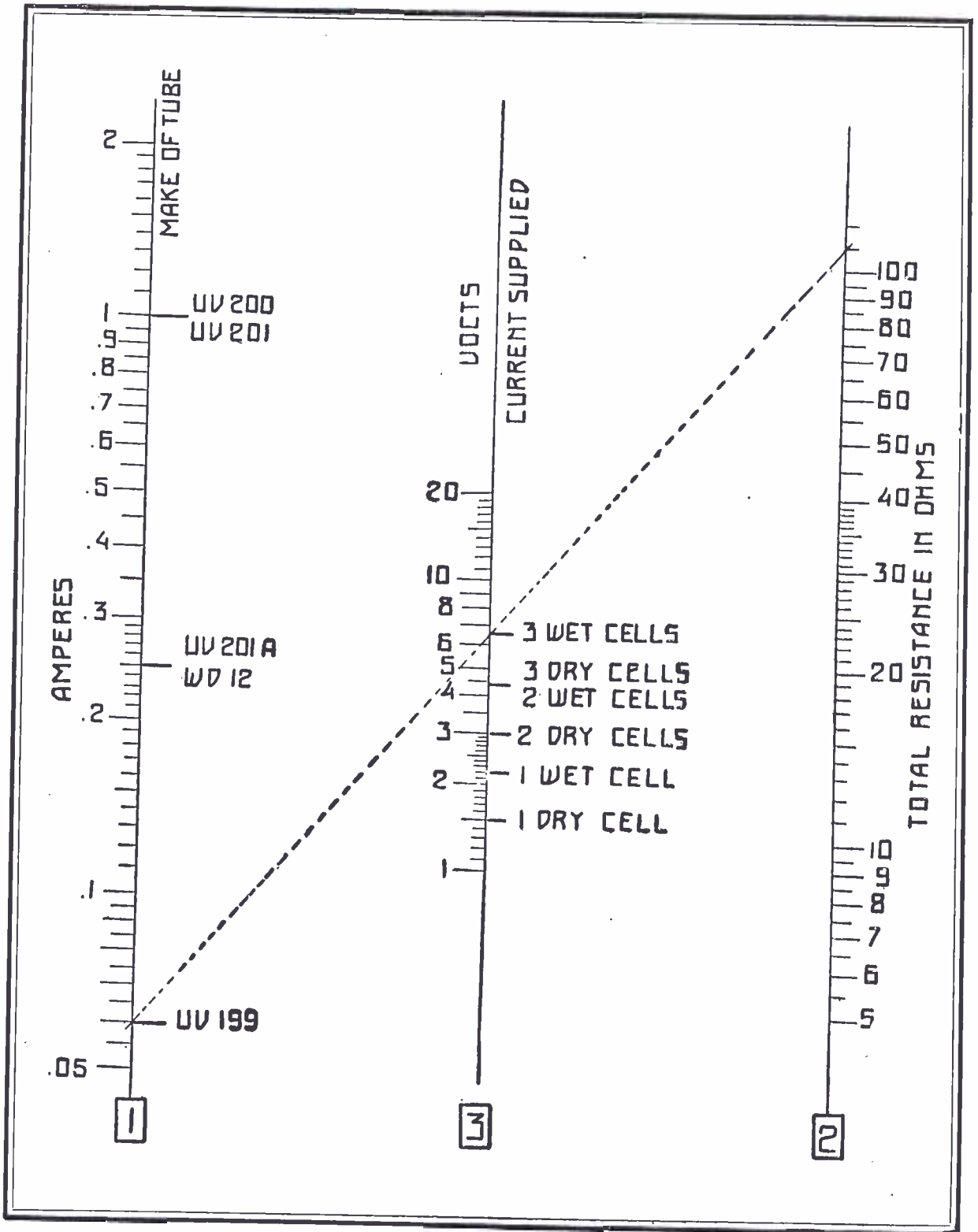

MAKE YOUR CALCULATIONS ON THIS TABLE

FIGURE 1: The text of this article tells you just how to figure out the proper resistance for the rheostat to employ in radio receiving circuits with various "A" battery voltages.

To evaluate equation No. 3 we find first, with the aid of equation No. 1, the total resistance required, then subtract the resistance of a single tube and

divide the remainder by the number of tubes to be used, then add 2 to 3 ohms for control of the filament, to get the correct rheostat.

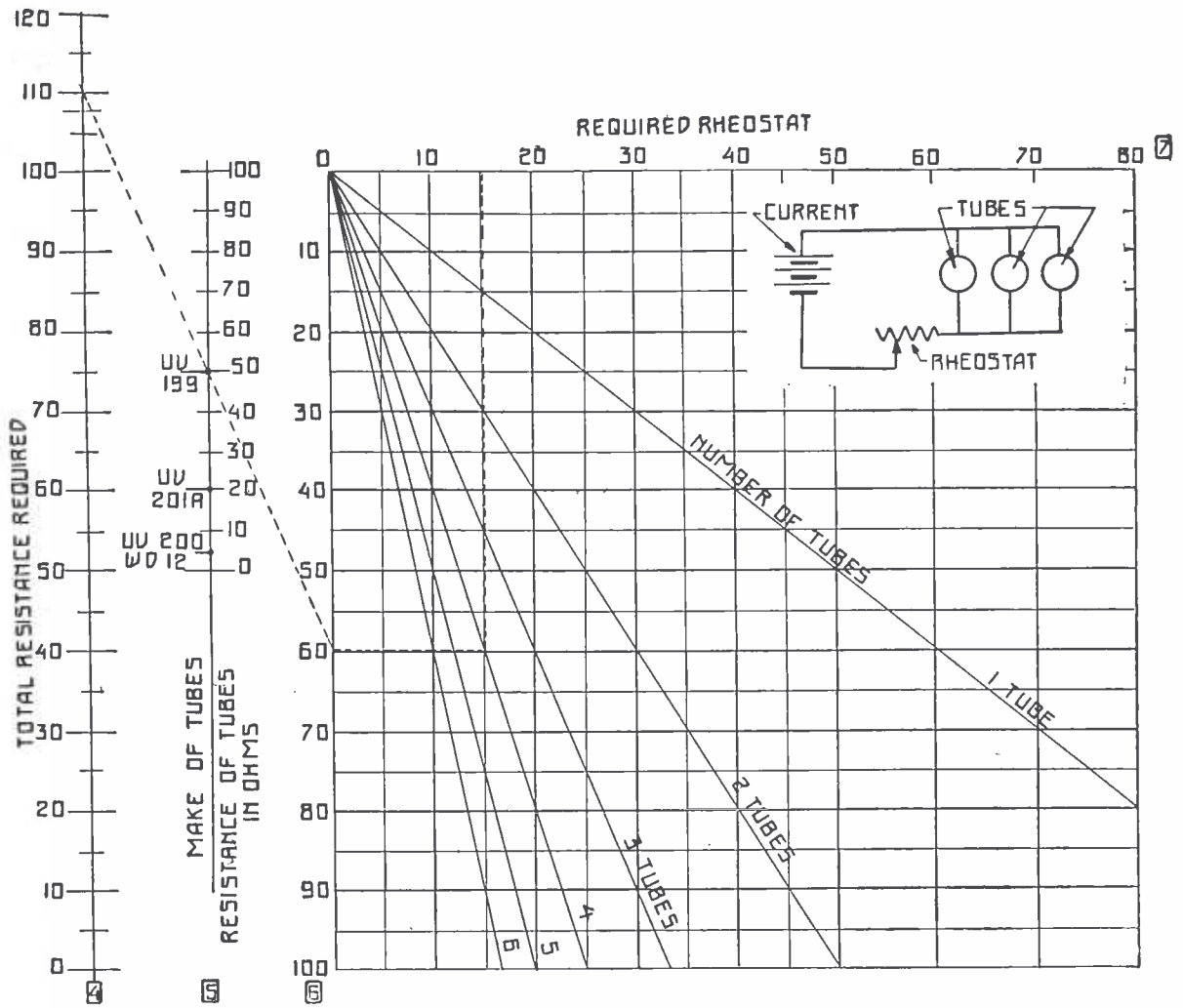

THE SUPPLEMENTARY CHART

FIGURE 2: This chart used in conjunction with that in Figure 1, indicates the proper resistances to use for a number of tubes. The text explains in detail just how these charts are used.

For ready calculations, the chart in Figure 1 will eliminate mathematical operations as follows:

We have a three-cell storage battery (6.6 volts) and want to know the rheostat required for controlling four UV-199 tubes connected in parallel.

Connect UV-199 on scale No. 1 with "3 wet-cells" on scale No. 3. You will find on scale No. 2 the resulting resistance of 110 ohms.

Then draw a straight line through 110 on scale No. 4 in Figure 2 and UV-199 on scale No. 5 intersecting 60 on scale No. 6; following horizontally to "4 tubes," then vertically to the scale No. 7, you will find the required rheostat is of 15 ohms, and adding 3 ohms for control, you will have a rheostat of 18 ohms to suit conditions.

To obtain best results the "characteristics" of the tubes should be the same.

Another Hoffman Measurement Chart—

for the simple calculation of inductance of toroid coils—will appear in a near issue of POPULAR RADIO. Keep these charts for reference in your experiment work.

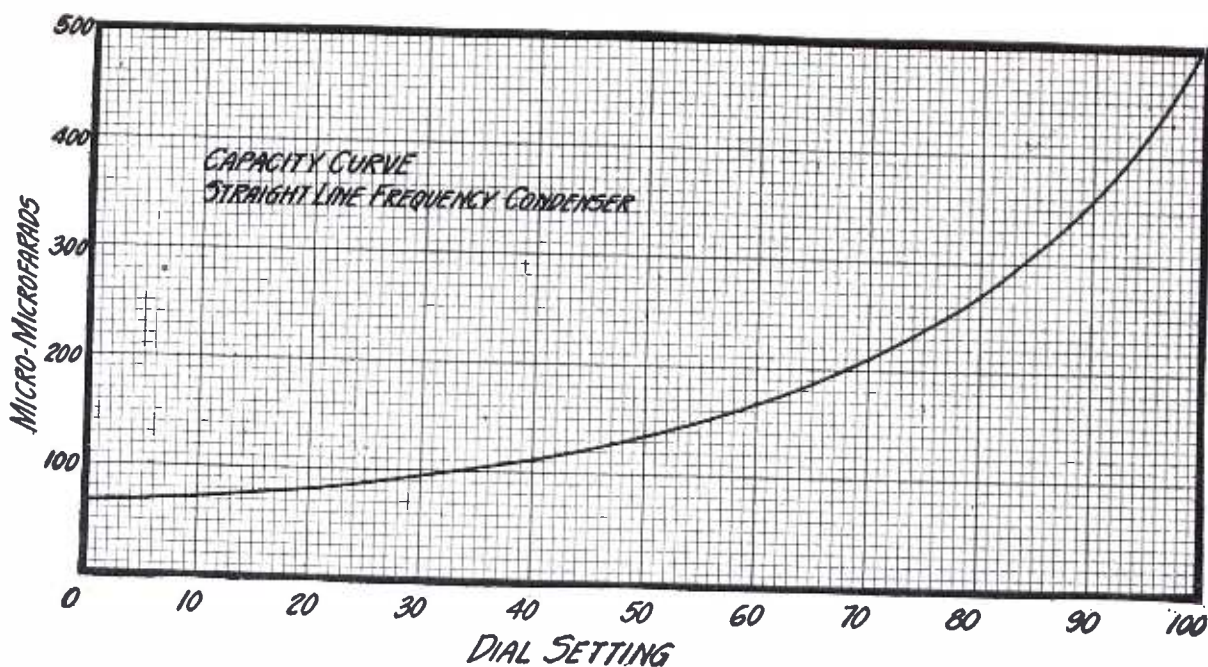

IDEAL CAPACITY CURVE FOR THE NEW SLF CONDENSER

FIGURE 1: This diagram shows the necessary variation of capacity of a straight line-frequency condenser with the setting of the tuning dial. Notice that at the lower settings the rate of increase is slow but at the higher settings the rate of increase increases greatly.

THE PART THAT YOUR CONDENSER PLAYS IN

TUNING

What is the difference between "straight line capacity," "straight line wavelength" and "straight line-frequency" condensers? Just how do they affect tuning? What system gives the best tuning facilities? The answers are in this article.

By HERBERT J. HARRIES

WHEN KDKA was the only broadcasting station working on a regular schedule, and tuned-radio-frequency circuits were not as popular as they are today, a condenser was a condenser and it made little difference whether the plates were square or circular or what shape they were so long as the capacity was variable.

In 1925, A.D., however, with nearly six hundred broadcasting stations sharing the relatively few frequency bands at the disposal of the Department of Commerce, the situation is decidedly different. Between the Atlantic and the Pacific there probably is not a single "BCL" (broadcast-listener) who has not done

considerable "cussing" at one time or another, mentally or orally, because he found that his receiver tuned so broadly on the higher frequencies (lower wavelengths) that separating the multitude of stations concentrated on the first 30 or 40 divisions of his dials was an impossibility.

Everyone knows that this situation exists, but no one seems to have made a careful analysis as to *why* it exists.

Why must we be content with broad tuning on the higher frequencies when the same coil and condenser tune "sharp as a needle" on 550 to 650 kilocycles? Is it not possible to build a condenser which will have more nearly uniform tuning characteristics?

And the dials most commonly used have the 180-degree tuning range calibrated uniformly from 0 to 100. Is it not possible to shape the condenser plates so that one frequency band of 10 kilocycles will correspond to one degree on the dials? In other words, if WCAE transmitting on 650 kilocycles tunes in at 90, why can we not make the condensers so that KSD on 550 kilocycles will tune in at 100, WHT on 750 kilocycles at 80, WWJ on 850 kilocycles at 70 and so on?

Is it possible to do these things?

Let us consider first the matter of broad tuning at the higher frequencies.

Obviously a circuit which tunes sharply at one dial setting is not going to tune broadly at another unless its resistance has been materially increased. Apparently then, as we reduce the capacity of the condenser we increase the resistance of the resonant circuit.

Suppose we consider it from another point of view. When the capacity is

maximum, the full area of the rotor plates is in close relation to an equal area of the stator plates with nothing between them but some thin sheets of the best dielectric known—air. The dielectric losses are extremely low, and the 550 kilocycle current has presented to it a path of very low resistance.

As we reduce the capacity, however, we reduce the area of the rotor plates that is close to the stator plates and likewise reduce the area of the dielectric path through the air. Finally, as we continue to reduce the capacity we reach a point where the path through the air constitutes a relatively small portion of the dielectric circuit. Consequently, most of the current is forced to flow through the solid dielectric used to support the plates and the dielectric losses become exceedingly high. The resistance at 0 dial setting may be as high as 10 to 20 times the resistance at full capacity.

This increase in resistance does not take

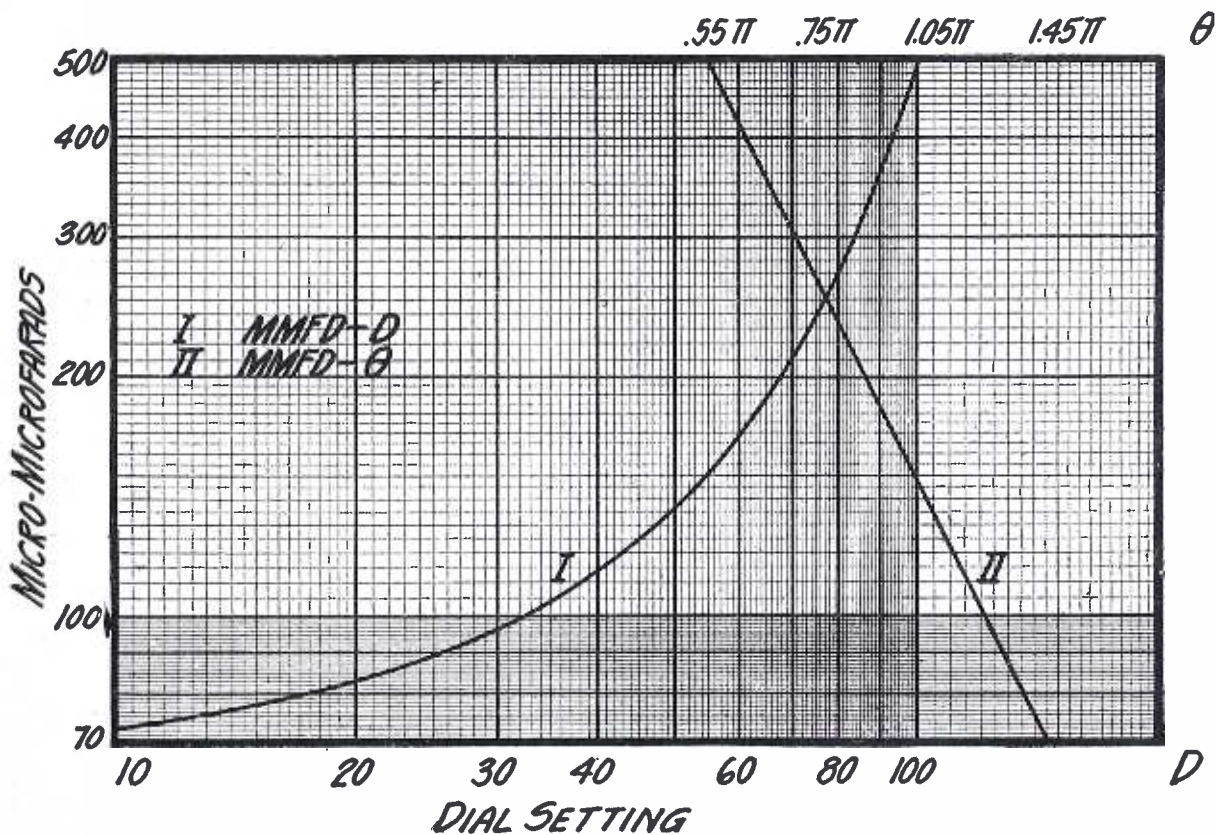

THIS CURVE SHOWS CAPACITY AGAINST DIAL SETTING

FIGURE 2: The values are here plotted on logarithmic co-ordinates. If a simple relation were to exist between the dial setting and the capacity, curve I would be a straight line. This is a proof that the curve is not a simple hyperbolic.

place at a uniform rate by any means. Down as low as 40 on the dial it may be scarcely perceptible, but somewhere between 20 and 40, depending upon the shape of the plates and the excellence of the condenser, it begins to rise quite rapidly. It is interesting to note that of two condensers of present day design and equal excellence of construction, the one with circular plates will show the lower resistance at say 20 or 10 on the dial.

To maintain sharp tuning then, as the capacity of the condenser is reduced, it seems apparent that we need only to provide a low resistance path for the current at the lower dial settings. That would not be so difficult if we could manage to mount the plates on air.

Now let us drop that consideration until later on and give some thought to the question of using 100 percent of our dials and having the stations spaced uniformly around them. The data given in Table I will be of assistance. Assuming that our tuned circuit contains a low-loss inductance of 168 microhenries and a variable condenser of 500 micro-microfarads capacity, the actual tuning capacity needed at each 100 kilocycle step between 550 and 1,550 kilocycles has been calculated from the formula

$$C = \frac{159200^2}{f^2 L}$$

where C = capacity in micro-microfarads, f = frequency in kilocycles, and L = inductance in microhenries. A condenser with a maximum capacity of 500 mmfd.

was chosen for no particular reason except that the writer is a firm believer in keeping the coil resistance down to a reasonable figure, and that does not, in general, permit the use of coils of 300 to 400 millihenries inductance.

The table gives the numerical values of the capacity needed at each tenth division on the dial to space the stations uniformly around it. Perhaps we can visualize these capacity requirements a little more easily by plotting them against the dial settings on rectangular co-ordinates, as is done in Figure 1. It is a hyperbolic curve, as the formula from which we calculated the values for C told us it would be, but it is not a simple hyperbolic curve. We can prove this easily by plotting the same values on logarithmic co-ordinates, as is done in Figure 2. If a simple relation existed between C and the dial setting D , curve I would be a straight line. The fact that we get a curve shows that no such simple relation exists. This will be considered further later on.

To digress for a moment, let us see what results we would get by using either one of the two types of condensers most commonly used at present, the circular plate (straight-line-capacity) type and the square-law (straight-line-wavelength) type.

First, for each type, we must plot a capacity-dial setting curve as in Figure 3 where I, the straight line, is the curve of the circular plate condenser and II is the curve of the square-law condenser.

Then by plotting the capacities in Table

TABLE I

| Frequency kilocycles | Inductance mh. | Capacity mmfd. | Dial setting |
|----------------------|----------------|----------------|--------------|
| 550 | 168 | 500 | 100 |
| 650 | 168 | 358 | 90 |
| 750 | 168 | 269 | 80 |
| 850 | 168 | 209 | 70 |
| 950 | 168 | 168 | 60 |
| 1050 | 168 | 137 | 50 |
| 1150 | 168 | 114 | 40 |
| 1250 | 168 | 97 | 30 |
| 1350 | 168 | 83 | 20 |
| 1450 | 168 | 72 | 10 |
| 1550 | 168 | 63 | 0 |

TABLE II

| Frequency kc. | Capacity mmfd. | θ | (D) |
|---------------|----------------|-----------|---------|
| 550 | 500 | 0.55π | (100) |
| 650 | 358 | 0.65π | (90) |
| 750 | 269 | 0.75π | (80) |
| 850 | 209 | 0.85π | (70) |
| 950 | 168 | 0.95π | (60) |
| 1050 | 137 | 1.05π | (50) |
| 1150 | 114 | 1.15π | (40) |
| 1250 | 97 | 1.25π | (30) |
| 1350 | 83 | 1.35π | (20) |
| 1450 | 72 | 1.45π | (10) |
| 1550 | 63 | 1.55π | (0) |

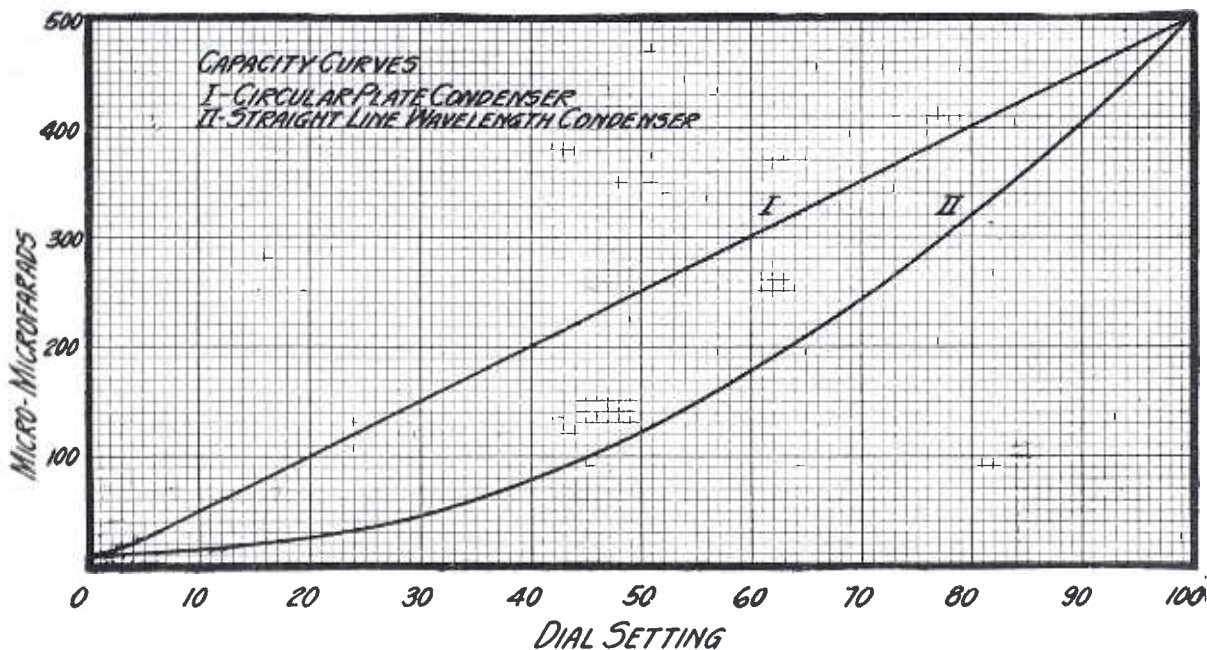

THE CAPACITY CURVE FOR TWO TYPES OF CONDENSERS

FIGURE 3: Curve I shows the capacity variation of a straight line-capacity condenser and curve II shows the capacity variation of a straight line-wavelength condenser.

I against the corresponding dial settings from Figure 3 we can determine where the different stations will come in on the dial. This is done in Figure 4, where curve I is that of the circular plate condenser and curve II is that of the square-law condenser. Curve III is added to show what we would get if the frequency bands were uniformly distributed over the 100 divisions on the dial.

An analysis of Figure 4 is quite illuminating. It shows us that, contrary to the generally accepted belief, the circular plate condenser is to be preferred for this particular combination of capacity and inductance. Only the lower 13 divisions on its dial are unused in covering the broadcasting frequency range whereas the lower 35 divisions of the square-law condenser are of no service.

We could extend the usefulness of the latter by doubling the inductance and halving the maximum capacity, that is, by using a 250 mmfd. condenser instead of one with 500 mmfd. maximum capacity. But in doing so we would just about double the resistance of the coil. Also, the resistance of the 250 mmfd. condenser below about .30 on the dial

would be so great that the tuning would be broad. The net gain would probably be negative, assuming that a low-loss inductance was used and the 500 mmfd. condenser would probably prove more satisfactory, so far as selectivity and sensitivity were concerned, even though the dial range would be 13 percent smaller.

Let us make one more comparison before we drop the circular plate and square-law condensers from the discussion. If we could straighten the circular edges of the dials out and lay them side by side we would get a very clear picture of the relative amount of crowding we would experience with each condenser. This has been done, theoretically, in Figure 5 where the 100 divisions are represented as lying in a straight line. The number of 10 kilocycle frequency bands included within each ten divisions is clearly shown, and the desirability of the condenser which has the characteristics pictured in Figure 5-C is very apparent.

Having satisfied ourselves that our theoretical condenser will be much more satisfactory than circular plate and square-law condensers, we now have be-

fore us the problem of shaping the plates so as to provide those characteristics.

Figure 1 gives us a picture of the condenser we propose to design. The maximum capacity will be 500 mmfd. and down to 70 or 60 on the dial it must decrease rapidly. As a matter of fact, the formula tells us it must decrease in inverse proportion to the square of the frequency corresponding to each dial setting, as given in Table I.

Now we have another point to consider. It has been customary heretofore

to design condensers with as low minimum capacity as could possibly be obtained with the exercise of the utmost ingenuity. Careful designers have turned out condensers in which the minimum capacity was less than two percent of the maximum. A fair figure for the lowest possible minimum of our condenser would be about 10 mmfd. But Table I shows that our capacity at 0 dial setting is 63 mmfd. Where on the dial can we put those 53 mmfd. we are "long"?

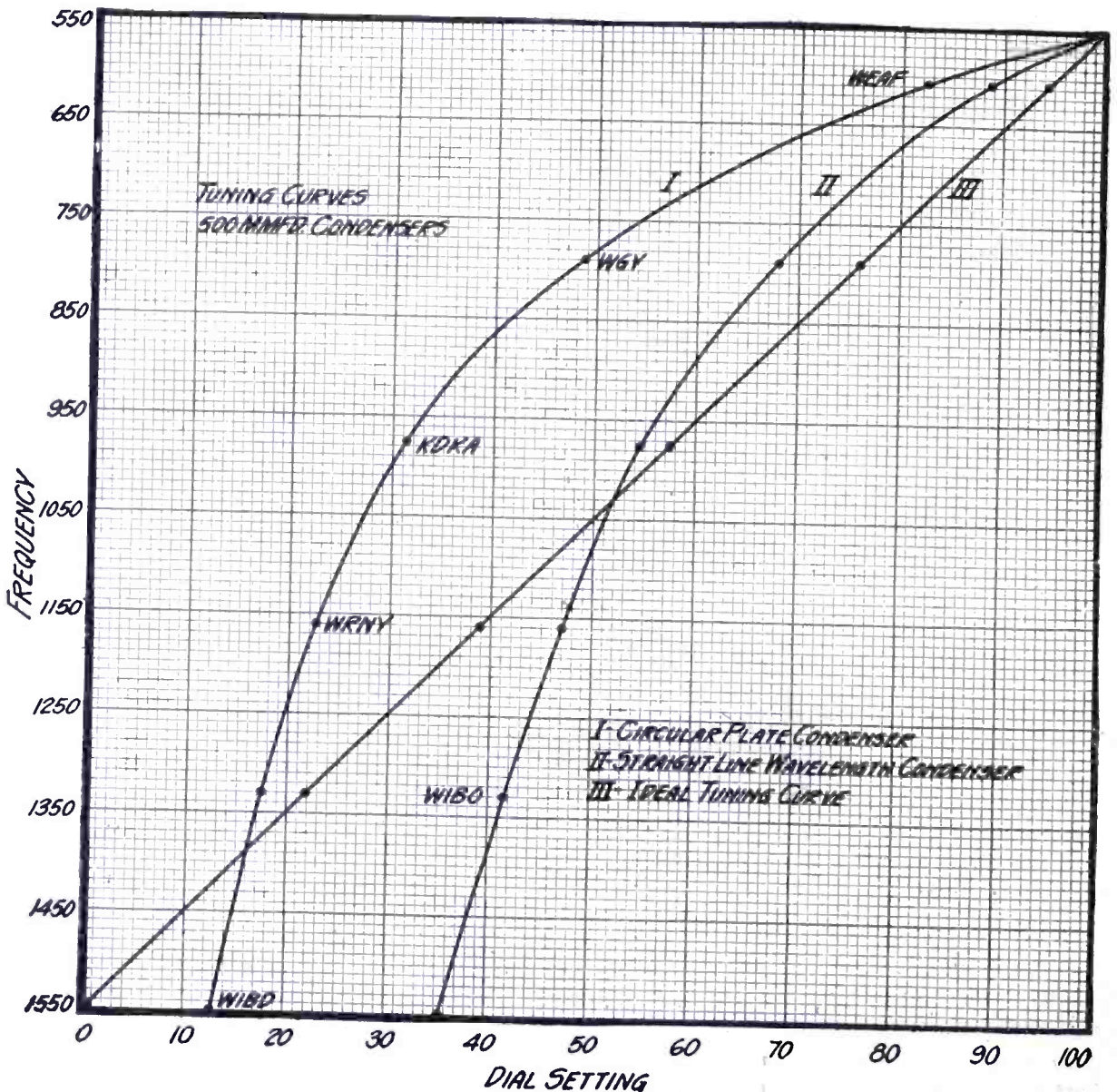

A TUNING CURVE FOR THREE CONDENSERS

FIGURE 4: Curve I is the frequency against dial-setting curve for the straight line-capacity condenser. For this combination of capacity and inductance, the straight line-capacity condenser is to be preferred to the straight line-wavelength condenser as there are only thirteen unused divisions on the dial setting as against thirty-five divisions in the case of the latter.

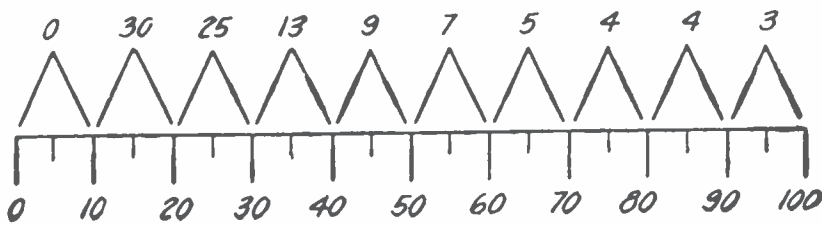

FIGURE 5A: This drawing shows the number of ten kilocycle bands included in each ten degrees on the dial for curve I in Figure 4.

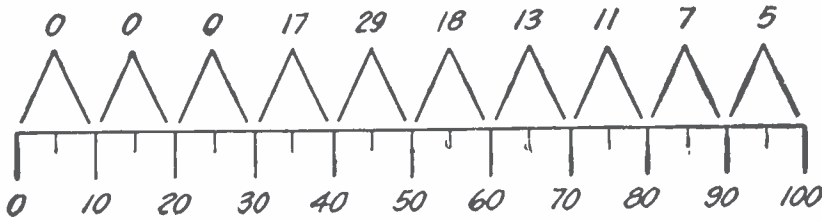
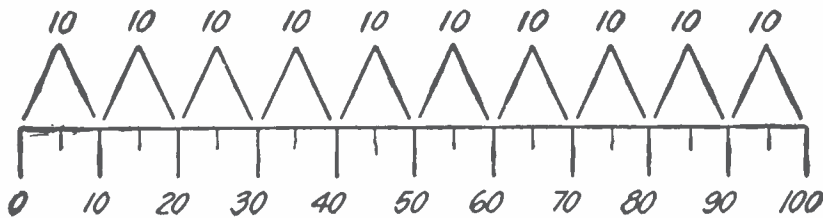

FIGURE 5B: In this diagram is shown the number of ten kilocycle bands included in each ten divisions for curve II in Figure 4.



IDEAL TUNING DISTRIBUTION

FIGURE 5C: Notice that the frequencies are evenly distributed over the entire dial setting, so that every ten division covers a frequency range of 100 kilocycles. This is true of the curve III which is shown in Figure 4, for a straight line-frequency condenser.

Why put them on the dial at all? Just because it has been customary for the range of a condenser to be from the maximum to the lowest possible minimum is not a good reason for continuing the custom. And since we do not need those 53 mmfd. as variable capacity for tuning why not leave them in the condenser as a fixed capacity. This may sound like rank heresy to those who have exerted every effort to get a low minimum, but to the writer it sounds logical.

And somewhere back there we needed a low resistance path at low dial settings so the current would not be forced through the solid dielectric. Here is where we get it. We just take those 53 mmfd., spread them out over some circular brass or aluminum plates, provide some thin sheets of perfectly good air and there we are!

Now let us take a look at Figure 6-a which shows us the approximate shape our rotor plates will assume. What form the stator plates take is immaterial so long as we can provide convenient mounting means.

We have decided that a part of each rotor plate will be a circle. Consequently, no matter what the dial setting, the projection of the circle upon the stator plates, shown shaded in Figure 6-b, will be invariable and great enough to provide our 53 mmfd. All we have left to do now is to determine the exact shape of the rotor plates which will give us the capacity curve in Figure 1. The approximate shape is shown dotted in Figure 6-a and Figure 6-b.

Determining the equation of the boundary curve would not be difficult if a simple relation existed between any value

of capacity and the corresponding dial setting. But we proved by curve I in Figure 2 that no simple relation exists.

We can consider this in another way. Our formula

$$C = \frac{159200^2}{f^2 L}$$

can also be written

$$C = \frac{a_1}{f^2}$$

where $a_1 = 159200^2/L$. Also, since we wish to distribute the frequency bands uniformly over the dial, we should be able to write

$$f = a_2 D$$

where a_2 is some constant. Then we could substitute $a_2 D$ for f in the preceding formula and get

$$C = \frac{a_1}{a_2^2 D^2} = \frac{a}{D^2} \quad (a = a_1 / a_2^2)$$

But this is not true because the preceding equation is not true.

Suppose we check the latter against Table I. When $D = 100$, $C = 500$, then

$$500 = \frac{a}{100^2} \text{ and } a = 5 \times 10^6$$

Using other values of D we get

| | |
|-----------------|-------------|
| when $D = 70$, | $C = 1020$ |
| $D = 40$, | $C = 3125$ |
| $D = 10$, | $C = 50000$ |

which do not check at all with the values we have listed in Table I.

This discrepancy is due to the fact, as we stated before, that no simple relation exists between C and the corresponding setting D . But the boundary curve is a hyperbolic spiral, from our original formula, so the formula

$$C = \frac{a}{D^2}$$

would be true if D were properly expressed. If, instead of D , we use another designation, θ , for the dial setting and in addition have the dial read backwards for purposes of calculation, we can give values to θ for which the formula will be true. We therefore prepare Table

II and use it instead of Table I.

We now find that whereas our previous formula

$$f = a_2 D$$

was true for only one value of D and not for any other, the corresponding formula

$$f = k_2 \theta$$

is true for all values of θ listed in Table II. Substituting this expression for f we now have

$$C = \frac{k}{\theta^2}$$

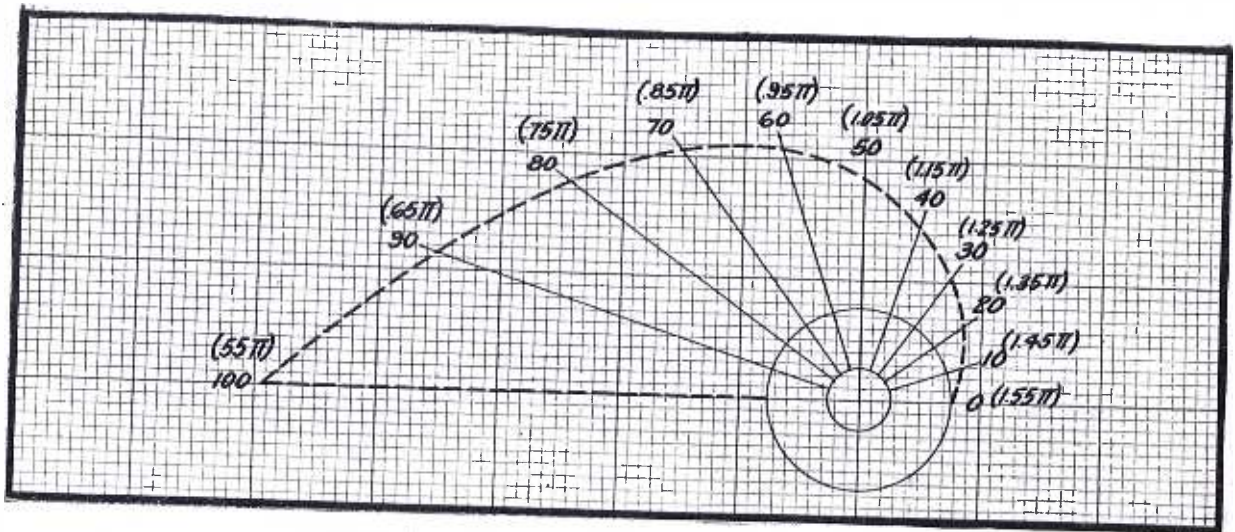

THE SHAPE OF THE ROTOR SECTION

FIGURE 6A: The correct curve for the rotor plate shape for a straight line-frequency variable condenser that will give the variation of capacity as shown in Figure 1 and that will give the tuning characteristics shown in curve III in Figure 4.

and we find that this is true for any value of θ given in the table, for when values of C are plotted on logarithmic co-ordinates against the corresponding values of θ we get the straight line marked curve II in Figure 2.

If we had not decided that part of each rotor plate would be a circle, the outline of the plate could now be expressed

$$R_1 = \sqrt{\frac{fk}{\theta^2}}$$

But we have to take the circle into consideration, as well as the semi-circle cut-out of the stator plates to accommodate the shaft, so our final formula becomes

$$R_1 = \sqrt{\frac{fk}{\theta^2} - R_2^2 + R_3^2}$$

where R_1 = the radius of the hyperbolic section, R_2 = the radius of the circular section, and R_3 = the radius of the semi-circle cut out of the stator plates.

We can now replace our specially-calibrated, backward-reading dial by a standard one reading 0 to 100 and if our coil is of the proper inductance we will find the stations between 550 and 1,550 kilocycles uniformly distributed over 100 percent of our dial, as shown by curve III, Figure 4 and in Figure 5-c. Also, we have taken advantage of a fact incident to the design of inverse-square-law condensers, whereby they must be designed with some pre-determined minimum capacity, by making that minimum more than six times its customary value and using it to provide a low resistance path for the current at low dial settings.

In the foregoing we have not taken into consideration the capacity of the coil. This, of course, would affect the radius of the circular portion of the plate and would have to be considered in determining suitable dimensions. Also, it will be apparent to the thoughtful reader that a condenser of this type must be used with a definite coil if absolutely straight-line characteristics are to be maintained. The writer has not determined to exactly what extent a certain percentage variation in inductance would affect the straight-

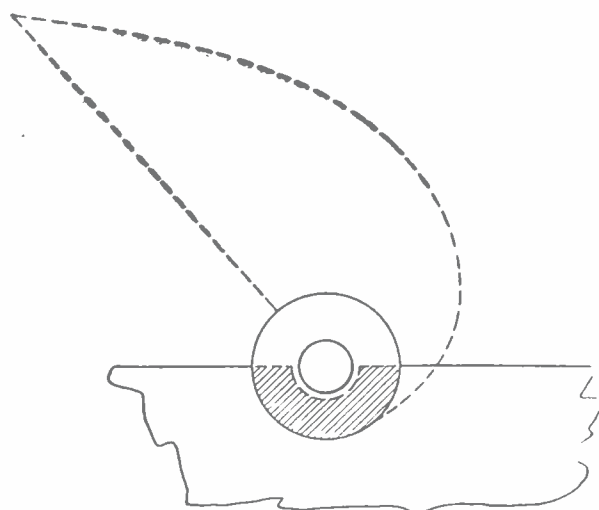

ANOTHER DRAWING OF THE ROTOR SECTION

FIGURE 6B: *The projection of the circular part of the rotor plates upon the stator plates. This area will be invariable, as the condenser is rotated and should be great enough to provide the 53 mmfd. shunt capacity that should be spread out over the whole dial setting.*

line tuning characteristic but it would be inappreciable, in all probability, over a range of plus or minus ten percent.

In conclusion, it should be noted that a square-law condenser should be designed to cover a pre-determined wavelength range, and an inverse-square-law condenser should be designed to cover a pre-determined frequency range, which corresponds in each case to the broadcast range. If this is not done, the broadcast range, in which probably 95 percent or more of the users of this class of apparatus are interested, will be concentrated on 60 to 85 percent of the dial and the remainder will be useless. Keeping this in mind, it is obvious that if we design the condenser so as to get the lowest minimum possible, in line with present practice, the tuning range of the condenser will be much greater than is needed. To get the full benefit of the 100 divisions on our dials we must provide a pre-determined minimum *which is greatly in excess of present practice!* This is no real disadvantage for the high minimum provides a low resistance path for the current at low dial settings and thus reduces the resistance of the tuned circuit by a very considerable amount.

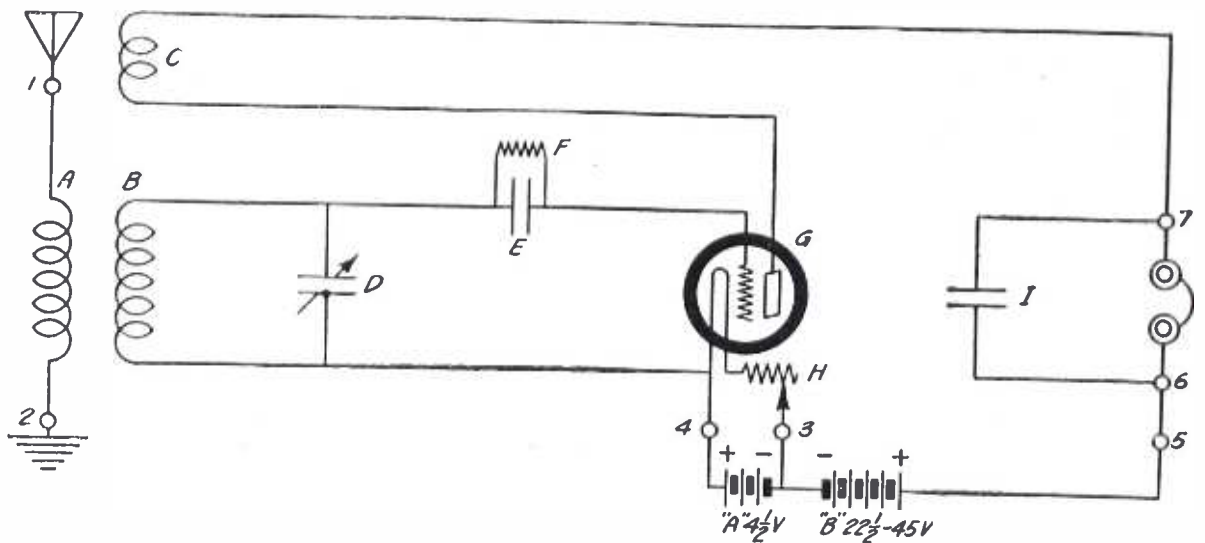

THE THEORETICAL CIRCUIT DIAGRAM
 FIGURE 1: This drawing shows the general circuit connections for the various instruments that go to make up the receiver.

Simple "How-to-Build" Articles for Beginners No. 14

*How to build a one-tube regenerative receiver for use with
 the new UX-199 tube*

By LAURENCE M. COCKADAY

COST OF PARTS: *Not more than \$19.00*

APPROXIMATE RANGE: *1,000 miles*

HERE ARE THE ITEMS FROM WHICH THE LABORATORY MODEL WAS BUILT—

A, B and C—primary, secondary and tickler coils of Aero coil three-circuit tuner;
 D—Continental Separator (variable condenser), .0005 mfd.;
 E—Sangamo fixed condenser, .00025 mfd.;
 F—Electrad grid-leak, 3 megohms;
 G—Pacnet socket No. 82 for UX-199 tube;

H—Carter "Imp" rheostat, 25 ohms;
 I—Sangamo mica fixed condenser, .002 mfd.;
 J—composition panel, 7 by 12 inches;
 K—hardwood baseboard, 7 by 10 inches;
 Seven Eby binding posts;
 Two large Century dials.

THE latest addition to the series of simple sets for the beginner is more than just an ordinary dry-cell set. It was especially designed to be used with the new UX-199 for quality reception combined with selectivity and long distance-getting ability. This receiver will be found to be an easily operated set and will enable the beginner to tune out the local stations and bring in the distant ones on headphones. It uses finely designed and manufactured apparatus throughout and may be considered the

nucleus of a receiver that may be added to from time to time to make a really fine loudspeaker set. It operates directly from three dry-cell batteries for the "A" battery and one 22½-volt or 45-volt "B" battery.

The set is regenerative and the coupler used gives a nice control of the regeneration. The secondary coupling to the antenna is controlled by a semi-variable coil A shown in Figure 4.

The tickler coil is controlled by the dial C which is attached to the coil C as shown

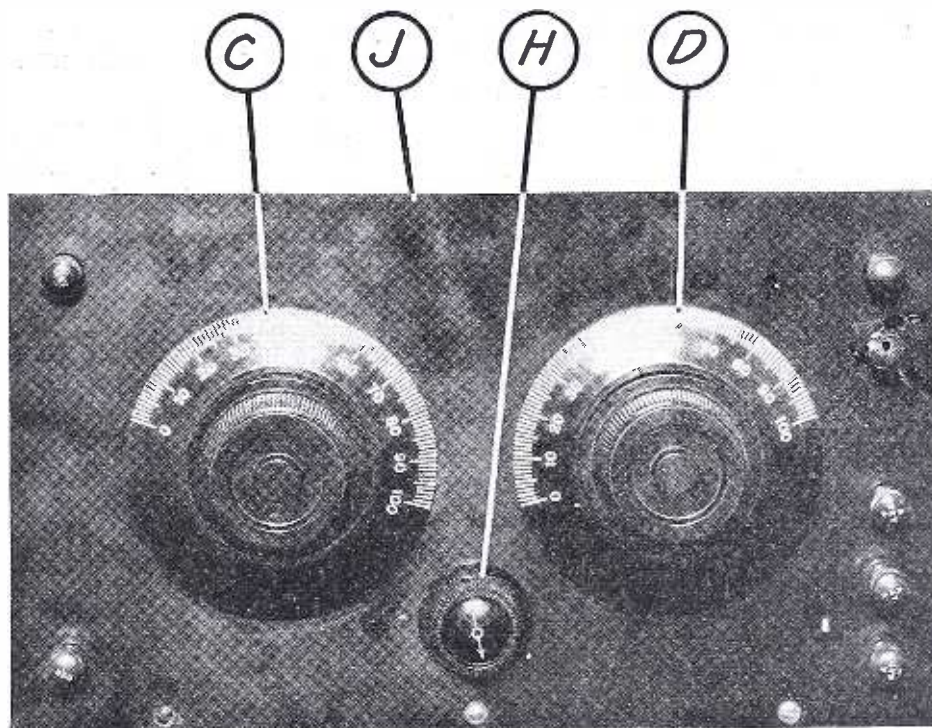

VIEW OF THE PANEL FROM THE FRONT

FIGURE 2: This picture gives the general arrangement of the front panel with the two large dials, the small rheostat dial and the seven binding posts mounted in the correct positions.

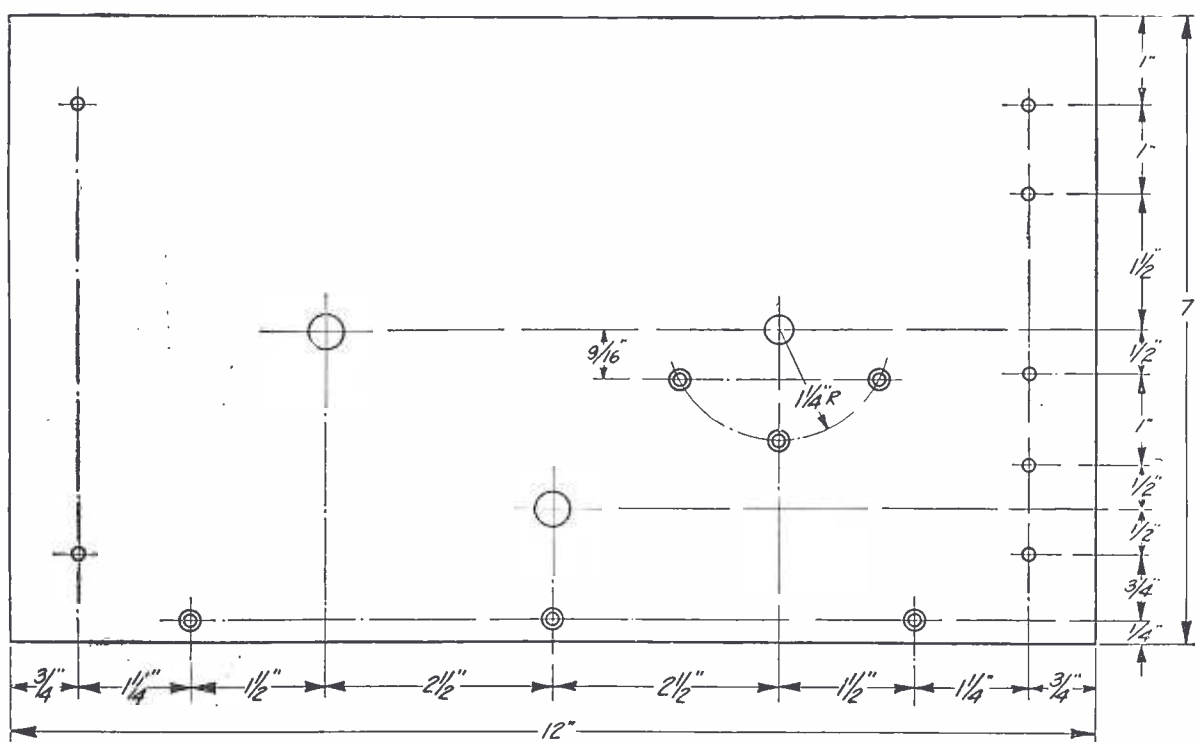

THE DRILLING PLAN FOR THE PANEL

FIGURE 3: In this drawing are shown the exact locations for the holes that are to be drilled in the panel for mounting the instruments and the binding posts. The holes outlined with a double circle should be countersunk.

in Figure 2, which is the front view of the set.

The unit that is described here was built and carefully tested in the POPULAR RADIO LABORATORY. The construction of the set is simple and the completed receiver, as stated before, is easy to operate.

Take this issue of the magazine to a radio store and ask the dealer to give you exactly the same parts as those that are included in the list at the beginning of this article.

Then take the parts home and drill the panel J (as shown in Figure 3) which gives the size of the panel and the correct

spacing for all of the holes that are used to mount the instruments and the binding posts.

Then, mount the instruments in their correct positions on the panel and base-board as shown in Figures 4 and 5. When this is done, wire up the instruments with standard, round bus wire, as indicated in Figures 1 and 5.

When you have finished wiring up connect the antenna, ground and batteries (see Figure 1) to the binding posts and then you are ready to listen in.

To tune the receiver all that is necessary is to revolve the dial D, with the

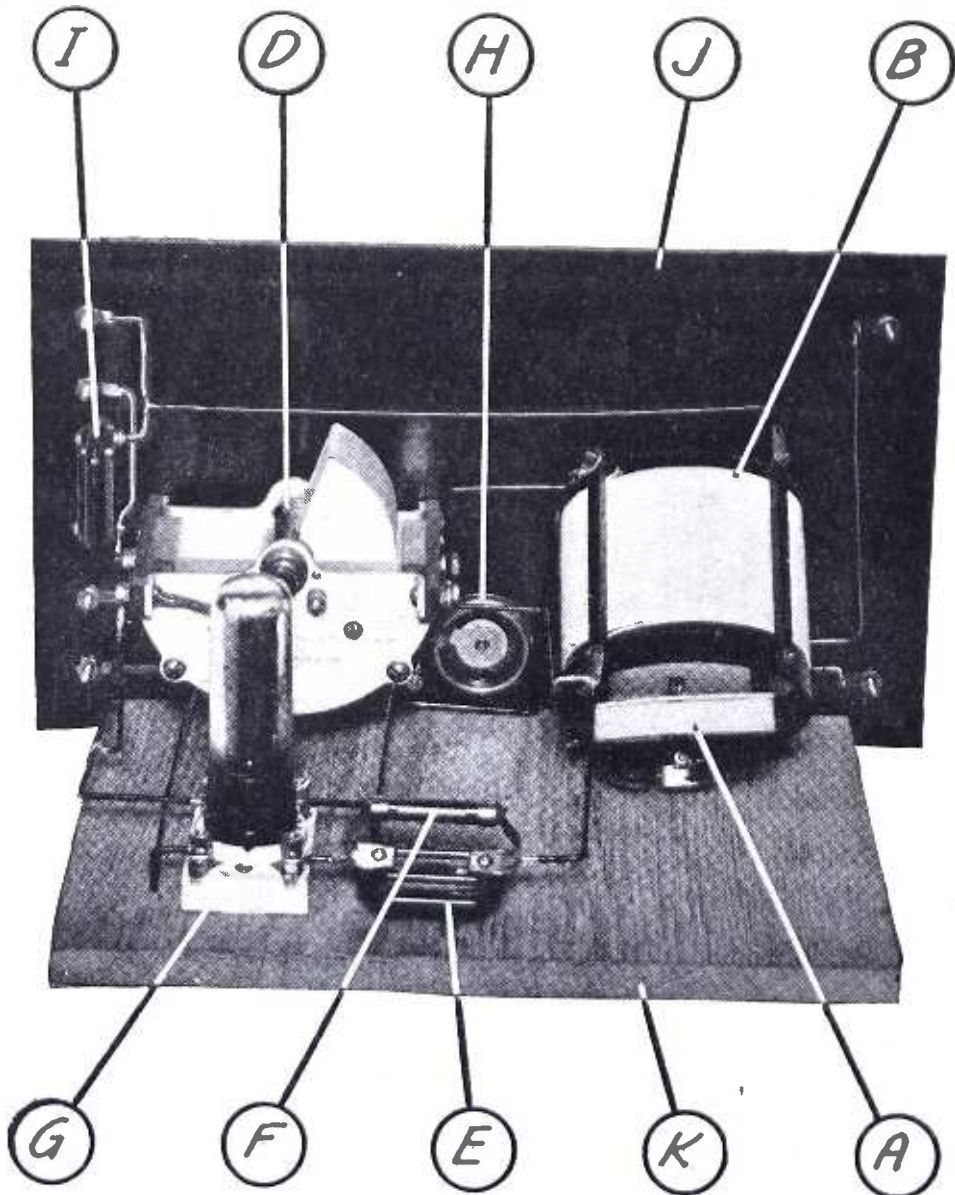

VIEW OF THE SET FROM THE REAR

FIGURE 4: Here are shown the various instruments mounted on the back of the panel and on the sub-base with the connecting wires in place.

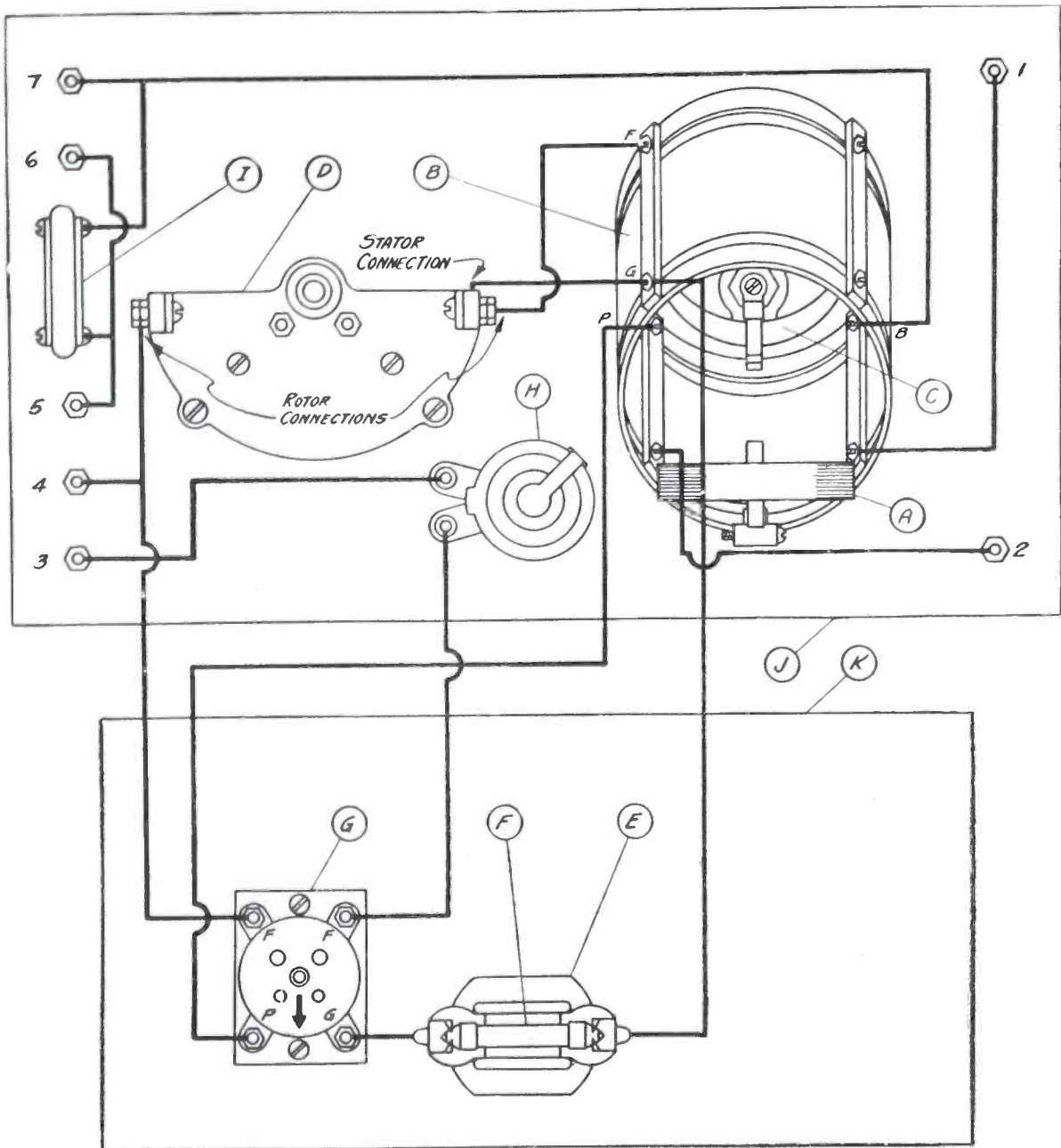

THE PICTURE WIRING DIAGRAM

FIGURE 5: In this diagram the exact way to run the wires is shown. The upper rectangle represents the panel and on it are shown the instruments which are drawn in about their relative positions. The lower rectangle represents the baseboard and on it are shown the socket and the grid-leak and condenser.

dial C set at a rather low value and the small knob H turned so that the filament of the vacuum-tube lights with the correct brilliancy.

When a signal is tuned in, the dial C may be adjusted so that the signal comes in loudest and clearest. Some other small adjustments may then be made by the small dial H and the dial D for final settings.

The correct type of antenna to use with this receiver is a single wire of about 100 to 150 feet in length.

If the set is built correctly as shown in the pictures and diagrams, the operator, after he becomes familiar with the tuning, will find that he will get exceptionally good reception on the headphones from stations up to an average distance of about 1,000 miles.

Handy Tools for Radio Fans: No. 9

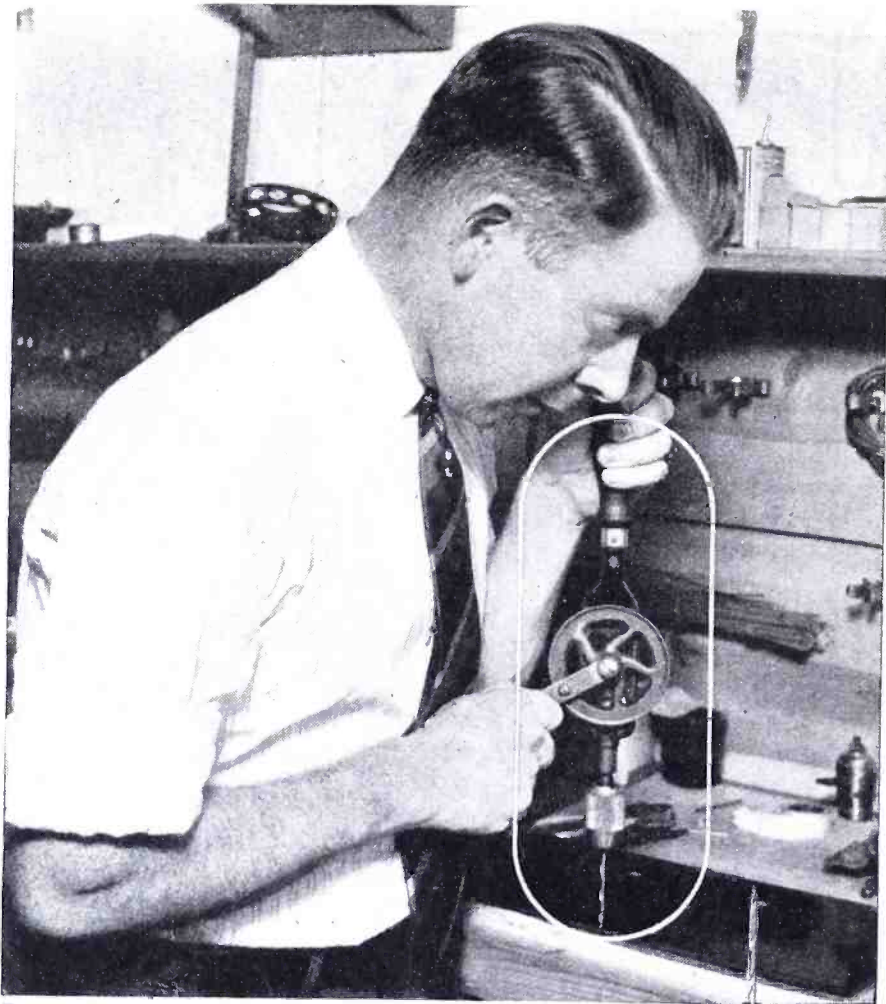

From a photograph made for POPULAR RADIO

THE HAND DRILL

A useful tool for preparing panels

THE radio experimenter who likes to build his own set will find a drill of this type nearly indispensable when he comes to the point of drilling the panel to mount his instruments.

The drill is composed of a long handle frame to which is attached a large and small beveled gear. A crank is attached to the large gear while the smaller is fastened to a shaft that carries a chuck. The chuck is adjustable to fit a large number of different sized drills.

The preceding suggestions in this series were SIDE-CUTTING PLIERS, SCREW-DRIVERS, THE HYDROMETER, THE BATTERY-TESTING VOLTMETER, THE FILE, THE JACKKNIFE, THE ELECTRIC SOLDERING IRON and THE SOCKET WRENCH.



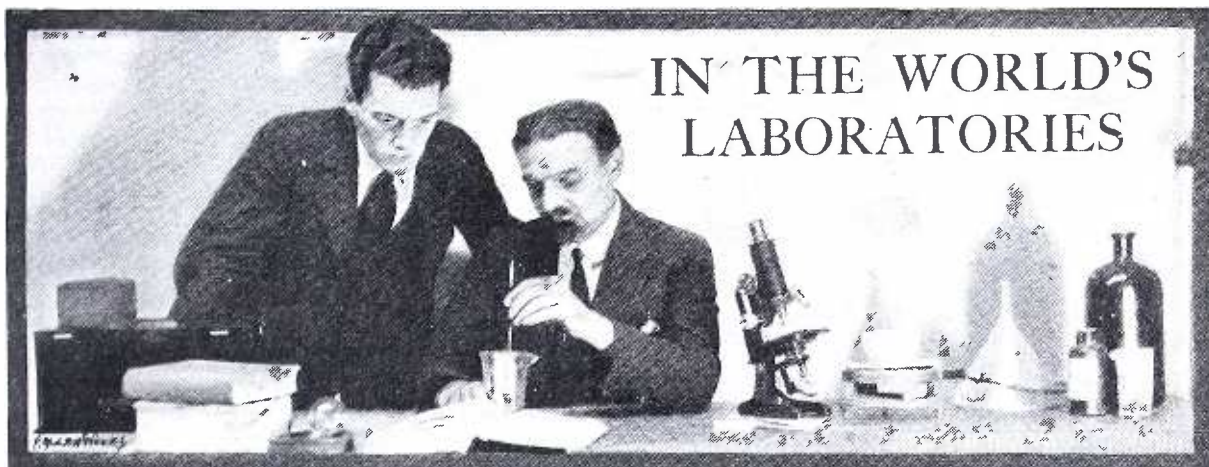

IN THE WORLD'S LABORATORIES

CONDUCTED BY DR. E. E. FREE

Sun Spots May Bother Radio

THE sun is growing spotted again. During the past fall as many as fifteen spots were sometimes visible at one time and some of these spots were more than twenty thousand miles in diameter. Such spots are believed to be evidences of great storms on the sun. They are invariably accompanied by vast magnetic disturbances, which disturbances frequently reach the earth and manifest themselves by alterations in the direction of the magnetic compass, by strong stray currents in telegraph lines and the like.

The spottedness of the sun is known to vary according to a more or less regular cycle with a period of approximately eleven years. The minimum of this sun-spot cycle was passed in 1923 and the number and activity of the spots are now increasing. A recent newspaper interview with Dr. J. A. Fleming, of the Department of Terrestrial Magnetism of the Carnegie Institution of Washington,* warns the public to expect magnetic disturbances whenever the number of sun spots is great. It is probable that the effects of the sun spots on the earth include, also, a share in the creation of static, so we may perhaps expect more static this year than last. Possibly there will be a maximum of static, coinciding with the maximum of sun-spot activity which is due in 1929.

Super-power and Fading

LAST summer's tests of super-power broadcasting, culminating in the alternative transmissions from WGY on fifty kilowatts and on ordinary power, have definitely established two conclusions. First, super-power does not cure fading; many observers reporting that the fading was quite as noticeable on the high power as on the low. Second, the degree of interference on the high power was not noticeably greater than on

* Released through Science Service, Washington, D. C., October 20, 1925.

the low, except, of course, in the immediate vicinity of the station.*

These conclusions seem to have surprised many of the listeners, although there is no reason for such surprise. Both results are quite in accord with the best present-day theories of radio wave propagation. Fading is believed to be due to atmospheric phenomena, mainly the existence and movement of areas of different ionization in the upper air. Such effects ought to apply equally to a wave of any power, so long as its wavelength is unaltered. Similarly with interference, the intensity of any wave falls off so rapidly with increasing distance from the transmitter that a "blanketing" effect from a super-power station would not be expected to extend more than a very few miles from the antenna. On the other hand, the distance range at which a station is audible above the static level ought to be approximately proportional to the power used, and this seems to have been the case with last summer's tests. The continued tests made since then and which are still in progress will lead, doubtless, to still more exact information.

Up and Down Movement of the Heaviside Layer

THAT the famous Heaviside Layer, instead of being a part of the atmosphere lying at a reasonably constant height above the earth's surface, is really located at an extremely variable height, much higher at night than in the daytime and much higher in winter than in summer, is the interesting conclusion derived from the recent high-frequency transmission tests conducted co-operatively by the Radio Division of the Naval Research Laboratory, at Bellevue, D. C., and the American Radio Relay League. Prelimi-

* The results of the tests are reported in a statement from the United States Bureau of Standards, published in the *New York Times* for September 13, 1925, and in the *General Electric Review* (Schenectady, N. Y.), vol. 28, page 720 (October, 1925). Some additional data released by the engineers of WGY were published in the *Radio Section* of the *New York Herald-Tribune* for October 4, 1925.

nary results, together with a tentative theory of high-frequency wave propagation, are reported by Dr. A. Hoyt Taylor and Dr. E. O. Hulburt, of the Naval laboratory.*

Newspaper accounts, released by Secretary Wilbur, of the Navy, on August 19, 1925, and printed in full in the *New York Times* of August 20, 1925, as well as in other newspapers, referred to the experiments as proving the existence of a "radio roof" around the world. Of course, the experiments prove nothing of the sort. In so far as a "radio roof" exists it is merely another name for the well-known Heaviside Layer. The experiments are, however, of very real importance and, presumably, Dr. Taylor and Dr. Hulburt were not responsible for the newspaper accounts.

By "high-frequency" waves Dr. Taylor and Dr. Hulburt mean the short-wavelength waves, below 100 meters, which are now coming rapidly into use. The tests involved waves from longer than this 100-meter limit down to some as short as 18 meters. The theory developed is essentially an extension of the ionization hypotheses elaborated recently by Appleton, Nichols and Schelleng, Alexanderson and others.† The new contributions of the present paper are essentially two. First is the evidence for the upward and downward movement of the Heaviside Layer from time to time. Second, there is evidence and an explanation concerning the interesting phenomenon of "skipped distance" with these shorter waves.

Radio experts no longer regard the Heaviside Layer as any mirror-like thing which actually reflects the radio waves. It is merely a layer

* "Wave Propagation at High Frequencies," by A. Hoyt Taylor and E. O. Hulburt. *QST* (Hartford, Conn.), vol. 9, number 10, pages 12-21 (October, 1925). The substance of the paper was read before the International Convention of the American Radio Relay League, at Chicago, last summer. A brief abstract of the theoretical results, by Dr. Taylor and Dr. Hulburt, appeared in *Science* (Lancaster, Pa.), vol. 62, pages 183-184 (August 21, 1925).

† For a general account of these theories see "How the Air Affects Radio," *POPULAR RADIO*, vol. 8, pages 199-206 (September, 1925).

of the air, well up in the atmosphere, in which layer the number of ionized air atoms is unusually high. These ions, you remember, are merely atoms of oxygen or nitrogen or other gases which have lost one electron each, so that the atom comes to possess a positive electric charge. At the same time the lost electrons are set free, so that the space in the Heaviside region contains a relatively large number of loose negative electrons as well as a relatively large number of positive ions. These ions and electrons bend the radio waves, so that a wave ascending from a transmitting station into the upper atmosphere tends to be bent downward when it enters the Heaviside region. If it is bent sufficiently it may even return to the surface of the earth.

It is this bending, Dr. Taylor and Dr. Hulburt believe, which accounts for the phenomenon of "skipped distance," the frequently-repeated observation that short radio waves are perceptible close to the transmitter and also far away, but not in an intermediate zone. The waves perceived far away are reflected waves, returned to the earth's surface from the Heaviside Layer. In certain instances it is possible, they think, for a back-and-forth reflection between the earth and the Heaviside Layer to be repeated several times, so that the transmitting station will be surrounded by successive circular zones of reception and of silence.

These phenomena were already known, more or less clearly, with the longer waves commonly used in broadcasting. By testing them with shorter waves it has been possible to formulate mathematical relations between the width of the "skipped distance" band, the wavelength and the height and properties of the supposed ionized zone in the Heaviside region. Tests made on different short wavelengths showed differences in the width and position of the "skipped distance" band. These results varied, also, with the hour of the day and with the season. Hence the possibility of reaching conclusions as to the different heights of the ionized region at different times.

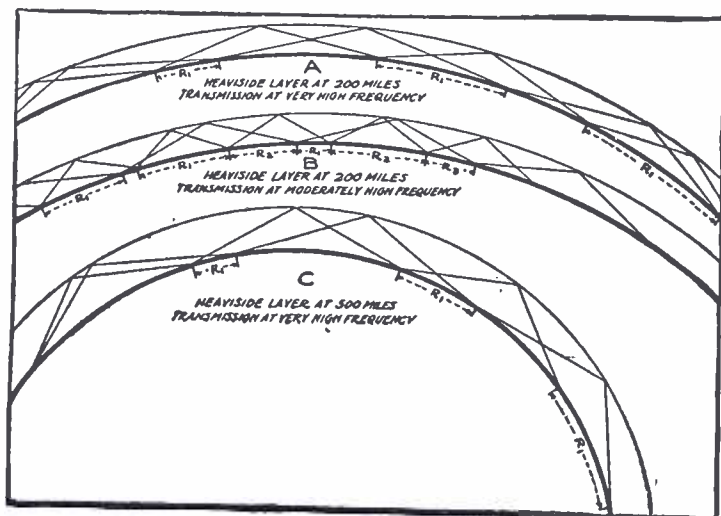

Reproduced from *QST*

REPEATED REFLECTIONS FROM THE HEAVISIDE LAYER

Rays of radio waves from a short-wavelength transmitter may be reflected back and forth between the Heaviside Layer and the ground, thus producing successive bands of interference and non-interference. These bands vary with the average height of the Heaviside region.

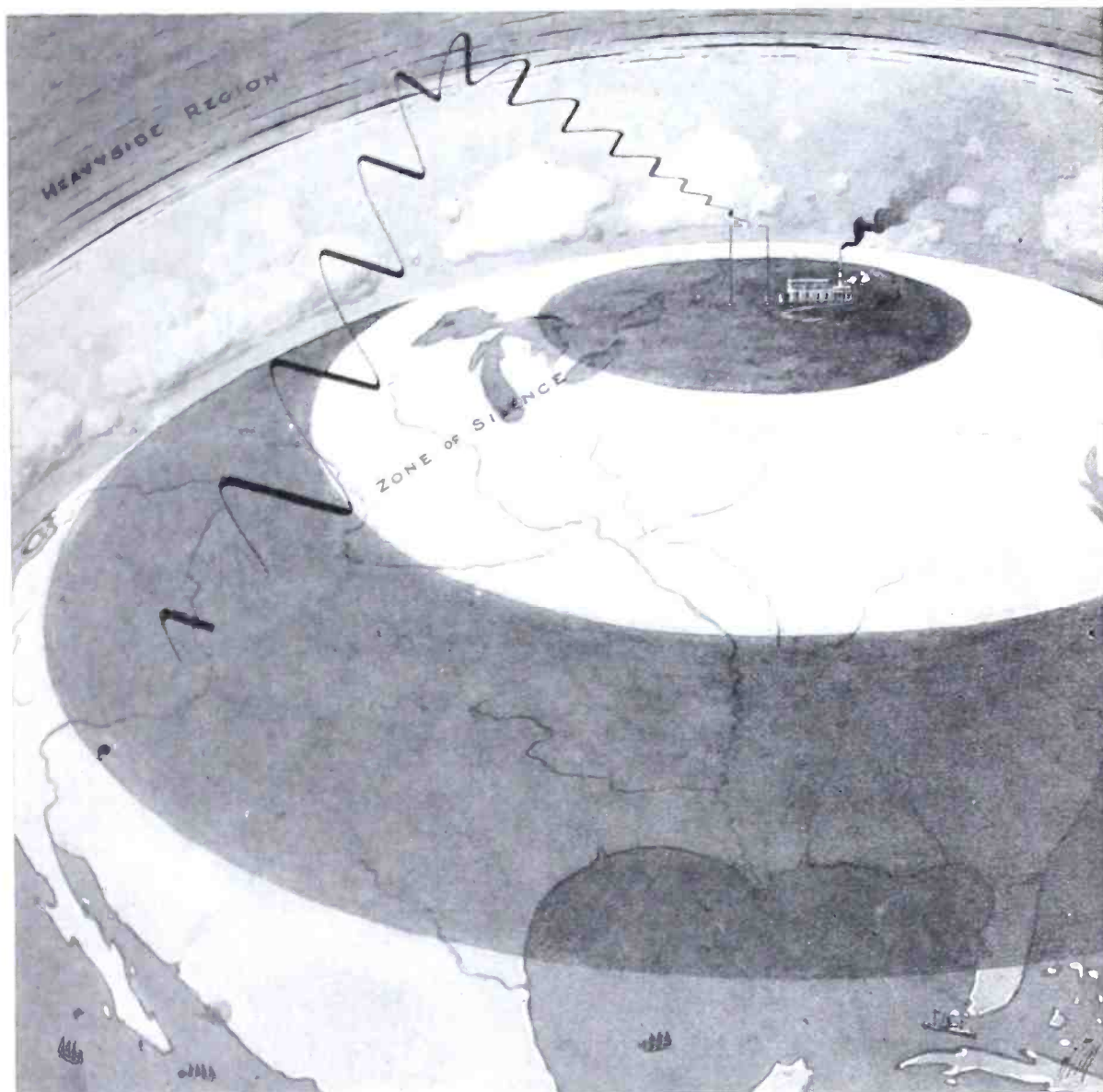

From a drawing for POPULAR RADIO by Arthur Merrick

HOW THE HEAVYSIDE LAYER CAN CAUSE ZONES OF SILENCE

Close to the transmitter there is a zone in which the signal is heard by the direct path. At a little greater distance these direct waves are so absorbed as to be inaudible in ordinary receivers. At a still greater distance a wave reflected from the Heaviside Layer is picked up. The transmission may be received clearly in this outer zone, shown by shading on the map, although no signal is detected in the intermediate zone of silence.

This height varies, Dr. Taylor and Dr. Hülbert believe, between limits which may be as wide as 500 miles and 100 miles above the earth's surface. Sunlight increases ionization in the lower air, thus lowering the position of the Heaviside region. This is why the Layer is lower in the daytime than at night.

If information concerning the propagation of radio waves in the upper and lower levels of the atmosphere continues to accumulate for a few months more as rapidly as it has during the past year we will be in position soon to write a complete theory of radio transmission for all wavelengths, all hours and all seasons; a theory which will take account of all our present mysteries of fading, dead spots and the like. And in this in-

vestigation the short waves below 100 meters are proving, as predicted long ago by POPULAR RADIO to be the most effective tool which radio science has yet obtained.

Using Two Antennas for Directional Reception

THERE can be little doubt that one of the features of the perfect system of radio reception—if we ever obtain such a system—will be the possibility of directional reception; a receiver which will receive with full strength the waves arriving from one direction while not

receiving waves from any other direction. There would be two advantages in this. One is the easy elimination of interference from other transmitting stations of nearly the same wavelength. The other and more important advantage is the substantial elimination of static. As was pointed out by Professor E. M. Terry over a year ago,* most of the static comes from certain limited points of the compass. If a receiver can be directed to avoid these static sources the reception will be substantially clearer.

That certain types of antennas possess directional properties has been known since the very beginnings of radio. It has long been known, too, that a system of two antennas, connected to the same receiving circuit, may be made to take on a high degree of directional sensitivity. But practical application has lagged. Professor Terry used two antennas in his directional static work just quoted. Also, Mr. H. T. Friis of the Bell Telephone Laboratories, reported recently

* "Tracing Static to Its Lair," by Earle M. Terry, POPULAR RADIO, vol. 6, pages 342-349 (October, 1924).

an ingenious system of attaching two loop antennas to a movable frame, so that the plane containing the two loops could be rotated to obtain a directional effect.† But the most extensive experiments on the two-antenna system—also called the "spaced antenna" or "spaced aerial" system—that have come to light are those conducted by the Marconi Company, in England, under the direction of the well-known radio engineer Mr. C. S. Franklin. With interruptions, these experiments have been in progress since 1913. Certain features of the results, and especially a method of recording and evaluating them, are described in a recent article by Mr. E. Green.‡

A simple vertical antenna of the usual type has almost no directional properties; waves from all directions are received almost equally well. An ordinary closed loop antenna has a certain degree of directional response. Its sensitivity is substantially higher for waves coming from either of the two opposite directions in the plane of the loop than for waves at right angles to these. A combination of a vertical antenna and a loop can be so arranged that the system as a whole has unidirectional properties; that is, it receives best from one of the directions in the plane of the loop and almost not at all from the opposite direction. It was such a combination which was used by Professor Terry.

Instead of this combination of a vertical antenna and a loop, two loops may be used. The distance between these loops may be varied, being adjusted to a known fraction of the wavelength being received, usually one-sixth. The relative pick-up of the two loops may be varied, by altering the sizes of the loops or otherwise. The position of the plane of the two loops may be varied by revolving them around a common center, as was done by Mr. Friis. The individual planes of the two loops may be altered by rotating them individually, as is done for the single receiving loop of the radio compass. Finally, the phase-angle of the received waves from the two antennas may be altered by a phase-changer, thus making the two waves any desired degree out of phase with each other.

It is obvious that these manifold possibilities of varying the relation of the two antennas to each other put into the hands of the radio engineer a large number of different reception conditions. Many of these have been worked out in the English experiments. Some have been found quite useful in practice; especially, it appears, a combination of two loops each of which can be rotated independently about its own vertical axis.

For any such system it is possible to construct what is called a polar diagram, which is a chart showing just how the reception characteristics of the antenna system vary with direction. Some of these diagrams are reproduced herewith. They may be thought of as constructed by drawing outward in each direction from the

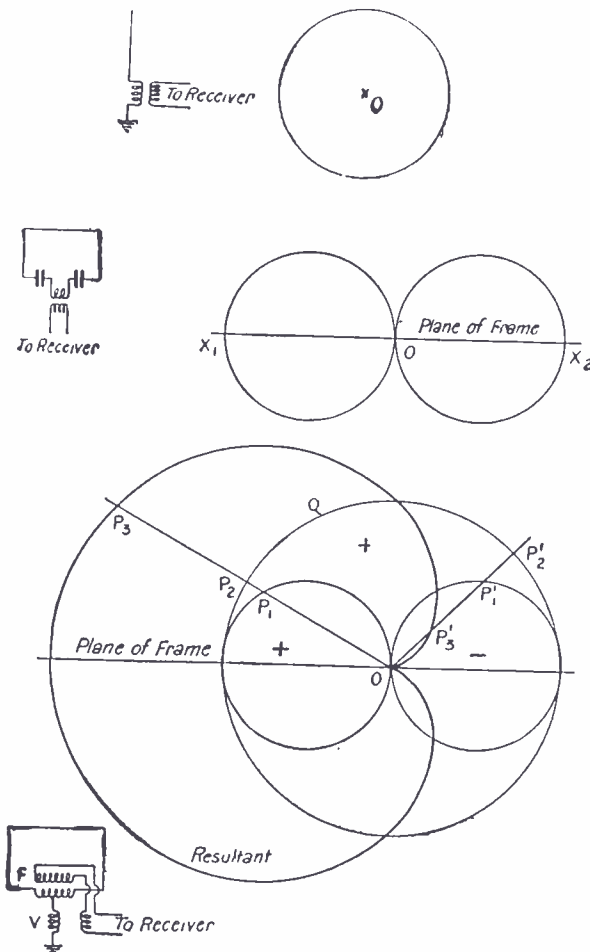

Reproduced from *Experimental Wireless*

POLAR DIAGRAMS FOR RECEIVING ANTENNAS

The top diagram shows that a vertical wire receives equally well from all directions. The middle diagram shows the two-direction reception of a loop. The bottom diagram shows the combined reception of a loop and a wire, the heart-shaped curve indicating the combination of the other two.

† "New Antenna System Reduces Static," this Department of POPULAR RADIO, September, 1925, pages 280-281.

‡ "The Polar Curves of Reception for Spaced Aerial Systems," by E. Green. *Experimental Wireless and The Wireless Engineer* (London), vol. 2, pages 828-837 (October, 1925.).

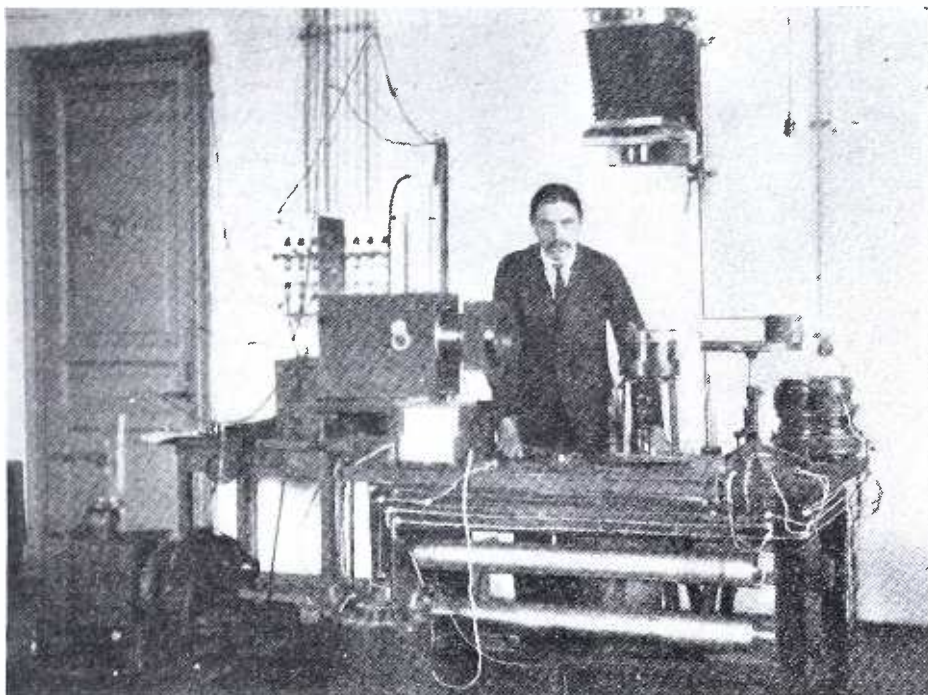

From a photograph made especially for POPULAR RADIO

MEASURING THE SHORTEST ETHER WAVES FROM RADIUM

With this apparatus, Professor Skobeltzyn, of Leningrad, has measured the effective wavelength of ether waves so short that over one hundred trillions of them are necessary to equal the length of one ordinary radio wave. The rays are used to set free electrons in the chamber just at Professor Skobeltzyn's left and the paths of these electrons in a magnetic field are photographed.

point of reception, a line the length of which is proportional to the intensity of reception in that direction. The polar curves reproduced are then constructed by connecting the outer ends of these directed lines. While the use of these polar diagrams is by no means new in radio engineering, the present paper of Mr. Green is the most comprehensive account which has appeared so far on the use and construction of such diagrams for two-antenna reception systems.

Measuring the Shortest Ether Waves

THE shortest ether waves so far detected by any method are the so-called gamma rays given off by radium and other radioactive materials. These rays are still shorter than the waves of the X rays, although the two ranges overlap somewhat; the shortest X rays produced from X-ray tubes being shorter than some of the longer gamma rays from radium. The shortest gamma rays are, however, substantially shorter than any other known form of radiation. They are believed to have a wavelength of only one five-hundred-billionth of a meter.

These waves are less than one hundred-thousandth of the wavelength of the shortest waves of visible light. As compared with radio waves the discrepancy is still greater. In the length of one ordinary broadcasting wave 300 meters long, there would be approximately 150,000 billions of these shortest gamma-ray waves. Imagine yourself walking from New York to

San Francisco. You would have to take some seven million steps. Now imagine an ant walking the same distance. He would take many more steps. But if one of the ant's steps corresponded to one of the shortest ether waves and if he had to walk the length of one ordinary broadcasting wave, his journey would last not merely from New York to San Francisco but fifty times around the earth. So tremendous is the difference between our familiar radio waves and these shortest ether waves which scientists get from radium.

The gamma rays are far too short to be measured by any of the methods used for measuring the wavelengths of radio waves or of light. They are too short, even, to be measured by the crystal methods used to measure X rays. The gamma rays must be studied by indirect methods. One of the most successful of these methods has been described recently by Professor D. Skobeltzyn of the Department of Physics at the Polytechnic Institute of Leningrad, Russia.* As several investigators have done before him, Professor Skobeltzyn makes use of the fact that when the gamma rays strike against matter they sometimes set free electrons, just as light rays do in the photoelectric cell.

The speed of these freed electrons depends, it is believed, on the wavelength of the gamma rays which called them forth. Accordingly, Professor Skobeltzyn exposes these freed electrons to a magnetic field and measures the degree

* "The Effective Wavelength of Gamma Rays," by D. Skobeltzyn. *Nature* (London), vol. 116, pages 206-207 (August 8, 1925).

to which this field bends their paths. From this he deduces their speeds, and thence the wavelength of the gamma rays which freed them. By this method he reaches the wavelength of one five-hundred-billionth of a meter already mentioned, a value which accords quite well with estimates of the wavelength of these shortest waves made by other experimenters using different methods.

Hydrogen Atoms Operate Useful Accessory

A SCIENTIFIC device which deserves more attention from radio experimenters than it has yet received is the "ballast resistor," an instrument which serves to hold an electric current approximately constant in spite of a considerable variation of the impressed voltage. Suppose, for example, that you wish to charge a storage battery at a constant rate from a power main the voltage of which is quite variable. A ballast resistor will help you to do it. Suppose that you wish to operate an electric lamp at constant intensity in spite of some up or down variations of

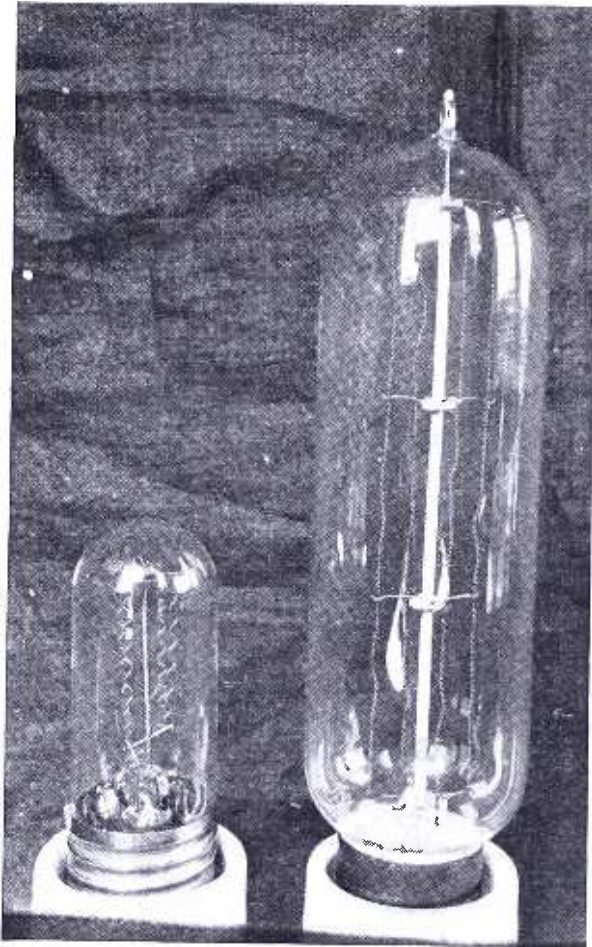

General Electric

TWO BALLAST RESISTORS

Both consist of iron wire in an atmosphere of hydrogen. In one the iron filament is coiled, in the other it is merely crinkled. It dare not be drawn tight because of its expansion and contraction with temperature.

the voltage. Here, too, a ballast resistor will help. The device operates, in fact, like an electric governor, keeping the current in a circuit constant much as an engine governor keeps the flywheel at a constant speed even though the steam pressure may vary.

The ballast resistor consists of an iron wire in an atmosphere of hydrogen. Its peculiar properties depend on the relations of the iron and the hydrogen, respectively, to the temperature of the wire. As current passes through the wire the wire becomes hotter, just as any conductor will do. This change of temperature changes the electric resistance of the wire, which is also something that happens with the majority of conductors. In the case of iron wire, it happens that a rise of temperature increases the resistance (at ordinary temperature ranges) so that relatively less current will flow. All this is quite usual. Wires of most metals behave in the same way. The peculiarities come in with the hydrogen.

A hot wire in an atmosphere of any gas loses heat to the gas. Gas atoms hit against the wire, acquire some additional energy from it and move away. This cools the wire. The rate of this cooling depends on the nature of the gas atoms, on the gas pressure and on the difference of temperature between the wire and the gas. In the ballast resistor the hydrogen atoms behave in this same way. When current is passing the iron wire is hot. The hydrogen atoms cool it, removing the heat produced continually by the electric current.

Now suppose that the voltage applied to the iron wire increases. Momentarily more current will flow. This will make the wire a little hotter. Two things then happen. First, the resistance of the wire increases, since it has become a little hotter. At the same time, the amount of heat lost from the wire to the hydrogen atoms increases, thus slightly cooling the wire. By a proper choice of the size and length of the iron wire and of the pressure of hydrogen in the tube, it is possible so to adjust these two changes that the increase in the resistance of the wire just compensates for the increase in the voltage, thus passing the same current as before.

Ballast resistors must be designed, of course, for the particular current and voltage-range on which they are desired to operate. Mr. H. A. Jones, of the Research Laboratory of the General Electric Company, has computed recently the necessary formulas and tables. Experimenters desiring to make use of the device will find full and practical information in Mr. Jones' paper.*

An Electrolytic Theory of Crystal Detectors

THE action of the familiar crystal detector is still a good deal of a mystery. What happens is that the alternating current in the radio-frequency part of a receiver passes the crystal in one direction, but not in the other. The crystal acts as a one-way valve for the

* "The Ballast Resistor in Practice," by H. A. Jones, *General Electric Review* (Schenectady, N. Y.), vol. 28, pages 329-335 (May, 1925), and "The Theory and Design of Ballast Resistors," same author and publication, pages 650-659 (September, 1925).

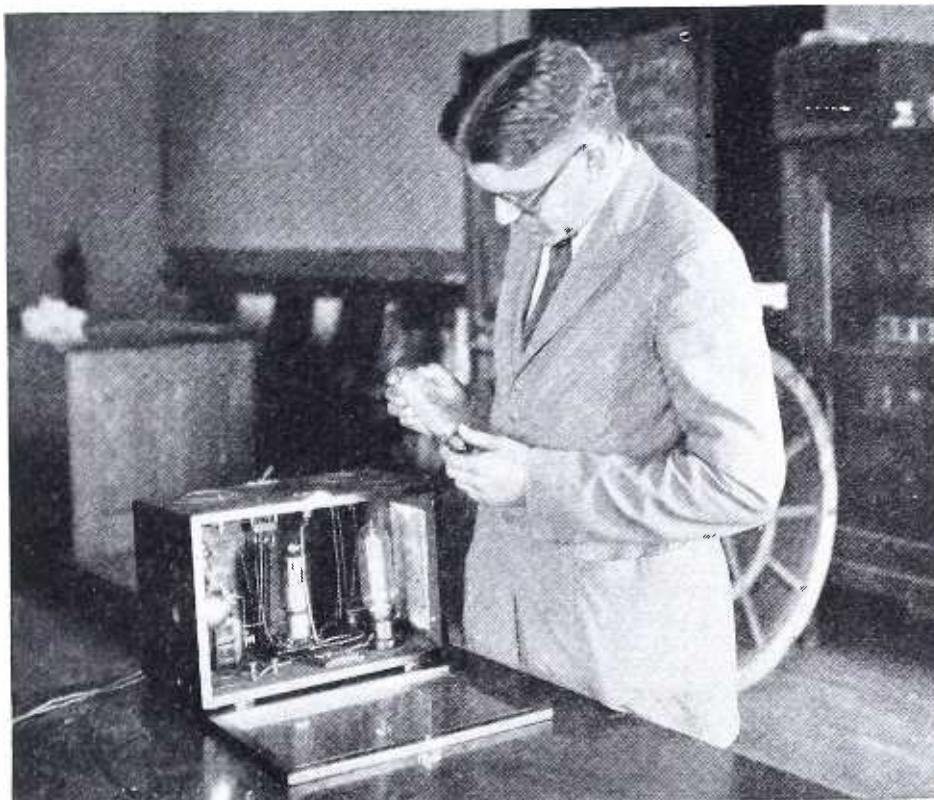

General Electric

THE CONSTANT-CURRENT BALLAST RESISTOR

Mr. H. A. Jones is holding one of the ballast resistor tubes in his hand. Another is inserted in the set-up on the table. One of these resistor tubes will hold the current through it at an approximately constant value in spite of considerable variations of the impressed voltage.

electrons. Everyone knows this. What no one knows is why the crystal acts this way. Why can electrons pass from cat-whisker to crystal (or the reverse) but not in the opposite direction?

There have been many theories for this rectifying action of the crystal. Some of them have been noted in this department. The latest—and in many ways the most plausible—has been proposed recently by Mr. Alfred Clive James of East London College, London, England.*

It is an electrolytic theory, which means that it involves the same general kind of electrochemical action which happens when you charge a storage battery or when you pass an electric current through acidified water. When you thus "electrolyze" the water the water is broken up. Oxygen atoms appear at one of the electric terminals; hydrogen atoms appear at the other terminal. Now a crystal consists, for example, of lead sulphide, which is galena. It contains lead atoms and sulphur atoms. What happens, Mr. James thinks, is that the current passing through the crystal drives the lead atoms and the sulphur atoms apart from each other, more or less. In a similar way, the current in the water drives apart the atoms of hydrogen and of oxygen.

The lead atoms accumulate, he believes, at the point where the cat-whisker touches the crystal. These atoms accumulate very quickly, just as the bubbles of the gases appear instantaneously when the current is turned through water. They may be accumulated, in fact, by a single, one-direction pulse of the current. During this one pulse more and more lead atoms continue to accumulate in contact with the others. The spot of metallic lead thus formed at the crystal surface makes an easy path for the electrons into or out of the crystal.

Suppose, now, that the direction of the current changes. The lead atoms would then tend to go in the other direction. But a lot of lead atoms have become attached already to the cat-whisker. These must be removed. In a sense, they must be "dissolved" again in the main mass of the crystal, just as a part of the material on the active plates of a storage battery is dissolved while the battery is being discharged. This removal of the lead atoms absorbs some of the energy of that pulse of the current. At the same time, some sulphur atoms are left at the point of contact. These are non-conducting. No current gets through.

When the current reverses once more the lead atoms again accumulate in contact with the cat-whisker, the current passes, and the cycle begins all over again.

This theory involves the assumption that the metal atoms in a crystal of galena are able to move around, more or less freely, through

*"The Rectification of Alternating Currents by Crystals," by Alfred Clive James. *The Philosophical Magazine* (London), Series 6, vol. 49, Pages 681-695 (April, 1925).

the meshes of a fixed network of sulphur atoms. We do not know enough about the inside structure of galena crystals to say definitely whether or not this is true, but there seems to be no important evidence against it. Also, it provides, for the first time, a possible mechanism to explain the mysterious occurrence of sensitive and insensitive spots on the same crystal surface.

In crystals of argentite, which is sulphide of silver instead of sulphite of lead, the movable atoms are those of silver. These silver atoms accumulate and dissolve at the contact point, just as the lead atoms do in galena. The sulphur atoms are fixed, as before. Other crystals, such as carborundum, are thought of as acting in the same general way, some electrolytic change inside the crystal being responsible for the rectifying action.

So far, all this has little practical importance. But if it does prove that Mr. James has put his finger on the vital clue to crystal rectification we will doubtless be able soon to improve the utilization of crystals in practical radio. Even now, it is notorious that crystal detection is more nearly distortionless than any other procedure which we know how to use. Perhaps a knowledge of how the atoms act inside crystals will yet bring the crystal back to an honored place in radio.

One-way Propagation of Radio Waves

ONE of the puzzles of radio has long been the apparent fact that transmission may be possible in an east-to-west direction (or vice versa) when it is not possible in the opposite direction between

the same two stations. This has seemed very surprising. Radio waves are supposed to pass through the ether. If at the same instant and with the same power, a station in England can reach one in the United States but cannot hear the precisely similar signal moving in the opposite direction, it looks as though the ether were a one-way street, a supposition which the physicists have never been willing to entertain. Yet many instances of such apparent one-way transmission have been observed in the past five or six years.

Captain T. L. Eckersley, of the British Marconi Company, now comes to the rescue with a suggestion of two ways in which such a difference between wave propagation in opposite directions might be produced.* Both ways depend on the assumption that there may exist in the atmosphere more or less separate clouds of "slabs" of ionized air, an assumption already made, years ago, by Dr. Reginald A. Fessenden.†

If these "slabs" of ions are in motion, either vertically or in a direction parallel to the latitude, there will be reactions on the passing radio waves, which reactions are unidirectional and may oppose either the east-to-west wave or the west-to-east one, while at the same time favoring the propagation in the reverse direction. Captain Eckersley analyzes briefly the mathematical and physical conditions necessary for such a one-way barrier to the waves.

* "Non-Reversible Transmission," by T. L. Eckersley. *Nature* (London), vol. 116, pages 466-467 (September 26, 1925).

† "Wireless Telegraphy," by Reginald A. Fessenden. *The Electrical Review* (London), vol. 58, pages 744-746 (May 11, 1906) and pages 788-789 (May 18, 1906). See Dr. Fessenden's article, "How Ether Waves Really Move," *POPULAR RADIO*, vol. 4, pages 337-346 (November, 1923).



General Electric

HE FINDS SOMETHING INTERESTING IN MATTER

One of the features of the meeting of the American Chemical Society, at Los Angeles, last summer, was an address by Dr. Willis R. Whitney, of the General Electric Company on "Matter—Is There Anything in It?" By a series of ingenious and spectacular demonstrations Dr. Whitney showed the chemists some of the remarkable properties of the tiny electrons and protons which make up the atoms of matter and which are so important in radio.

WHAT'S NEW IN RADIO APPARATUS



THIS department is conducted by POPULAR RADIO LABORATORY for the purpose of keeping the radio experimenter and the broadcast listener informed concerning the newest inventions and the approved developments in radio equipment. Only such apparatus as has been tested and endorsed by the Laboratory is noted in these columns.



A neat binding post that is easy to operate.

A SPRING BINDING POST

Name of instrument: Binding post.

Description: A small, neat binding post that contains a spring top, which when pushed in opens the hole in the side to which the wire may be inserted. Upon releasing the pressure of the spring by taking the finger off the binding post a firm solid connection is made. Equipped with circular name plates that designate what the binding post is to be used for. Neatly made and nickel plated.

Usage: In combination with a home-built receiving set for making connections to the batteries and the antenna and ground.

Outstanding features: Ease of operation. Good contact. Neat appearance.

(Further details furnished on request.)

A TUBE REJUVENATOR

Name of instrument: Tube rejuvenator.

Description: This piece of apparatus is contained in a metal cabinet with a black crystalline finish. The apparatus is

equipped with a long extension cord for fastening to the 110-volt 60-cycle lighting lines. It will reactivate both the small and large thoriated filament tubes of the 199 or 201-a type. It is equipped with a lever which changes connections in the interior for producing the high current for flashing the filament, the medium current for maximum reactivation of the filament and the normal current for lighting the filament during test. When this lever is moved to the extreme left a reading on the meter is obtained that gives an indication of the filament emission, so that the operator may determine just when his tube is fully reactivated.

Usage: As an accessory for radio set owners in getting their tubes in good condition.

Outstanding features: Compactness. Efficiency. Ease of operation. Equipped with a meter.

(Further details furnished on request.)

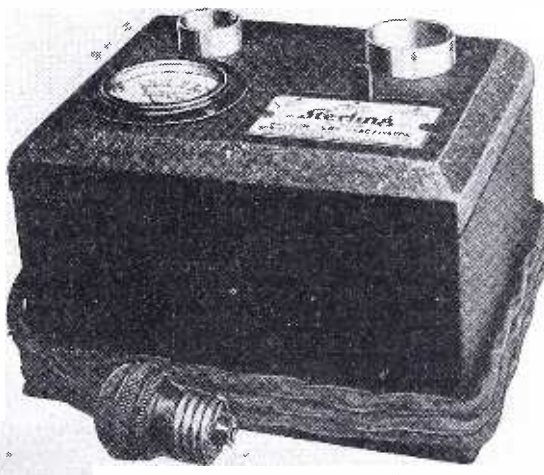

A compact device for making new tubes out of old ones; it operates simply and efficiently.

A TRANSFORMER FOR THE NEW RAYTHEON TUBE

Name of instrument: Step-up transformer.

Description: This transformer consists of a primary winding for operation on 110 volts 60 cycles alternating current with a split secondary winding which is statically shielded from the primary by means of a copper shield brought out to a separate binding post. This secondary supplies the high voltage alternating current to each side of the full-wave rectifying tube, with which the transformer is designed to be used. The instrument is mounted in a black enamel case with an extension cord running to the lighting socket. The case is so designed that a free circulation of air is obtained.

Usage: As a transformer for supplying the necessary energy to the Raytheon Plate Supply Unit.

Outstanding features: Neat in appearance. Sturdy in construction. Easy to install. (Further details furnished on request.)

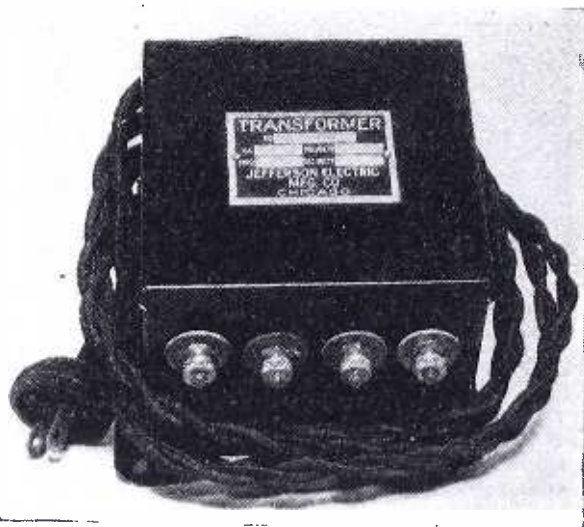

A well-made plate-supply transformer.

A NEW RHEOSTAT

Name of instrument: Rheostat.

Description: A novel means of supporting the rheostat winding is used in this device; it is bent around a series of insulated plugs made in one piece with the bakelite base of the instrument. This gives the resistance element a large radiation of heat and prevents burning out the coil or damaging the insulation upon which the resistance wire is wound. A novel means of variable contact is made in which the flexible contactor runs around the outside of the element. The instrument is equipped with soldering lugs.

Usage: In any receiver for controlling the filament current of vacuum tubes.

Outstanding features: Accurate workmanship. Good contact. High radiation of heat. Smooth action. Neat appearance.

(Further details furnished on request.)

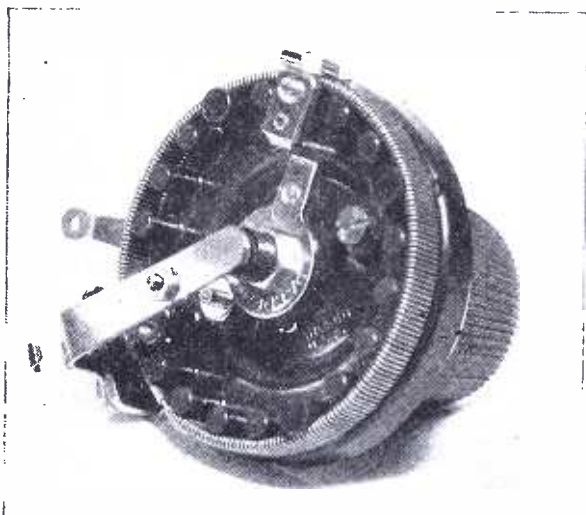

This rheostat will not get hot.

A TWIN VARIABLE CONDENSER

Name of instrument: Double variable condenser.

Description: This unit is unique in design by reason of the employment of two sets of rotor plates on a single shaft and two insulated sets of stators. It may be used for tuning two stages of radio-frequency amplification simultaneously by means of a single knob or for other uses where a tandem condenser is found. The workmanship of this unit is of the same high standard as other instruments by the same maker.

Usage: In any radio-frequency circuit for tuning.

Outstanding features: High efficiency. Compactness. Dual operation. Easy to mount on panel.

(Further details furnished on request.)

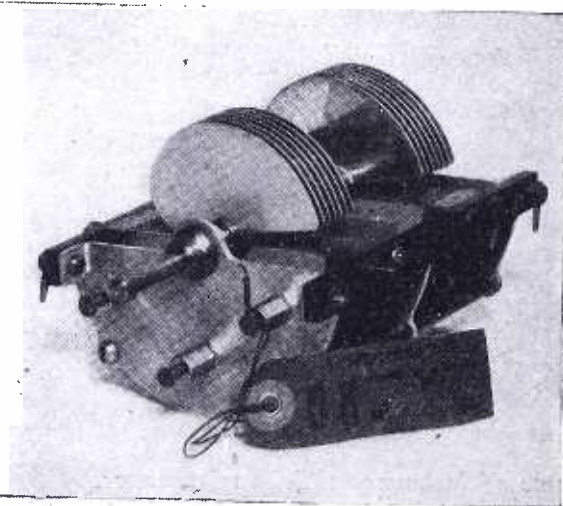

Single-control may be accomplished with this condenser.

A UNIVERSAL TUBE SOCKET



A socket for all standard tubes.

Name of instrument: Vacuum-tube socket.

Description: This new socket is available for use with all of the new UX type of tubes, new WD type of tubes and for the older UV-201-a types. It is fitted with a new special contact that is one piece throughout and including the soldering lug. A metal support is fastened with two screws to the top of the socket for holding some of the tubes in rigid upright position.

Usage: In a radio receiver for mounting vacuum tubes.

Outstanding features: Compactness. Fits all standard types of tubes except the old 199. Neat in appearance. Low capacity. Good contact.

(Further details furnished on request.)

A WELL INSULATED CONNECTOR

Name of instrument: Connection block.

Description: This device consists of a cylinder of glass supported by two metal clamps—one at each end. Two other metal terminals are provided—insulated from each other and from the end clamps by means of the glass cylinder. These contain Fahnestock clips as well as soldering lugs to which the lead wires may be directly connected.

Usage: In the experimental laboratory as terminals for batteries or generators.

Outstanding features: Good insulation. Compactness. Ease of installation and attachment.

(Further details furnished on request.)

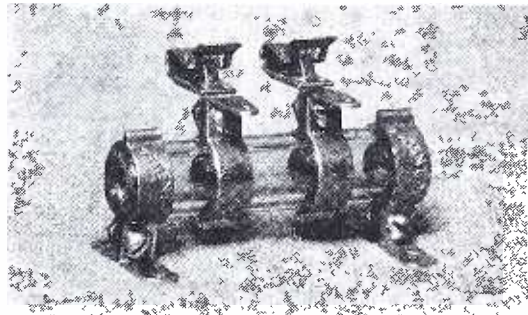

A small connection block in which the terminals are well insulated from each other and from everything else by means of a glass tube.

A NOVEL ANTENNA TERMINAL

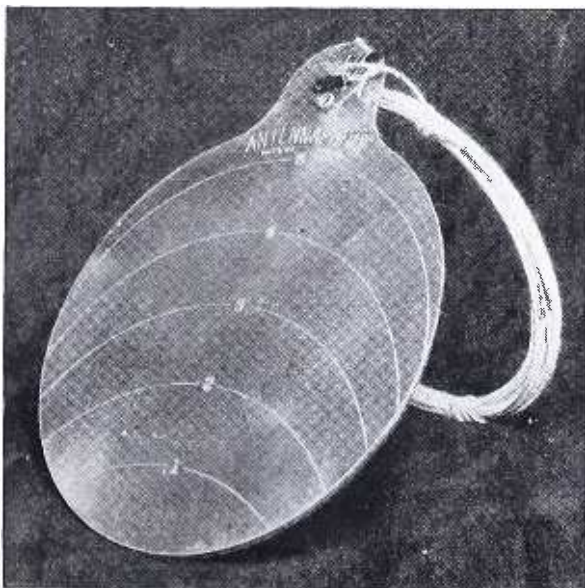

A novel device to connect the telephone wires to the set as an antenna.

Name of instrument: Antenna connection.

Description: This device is a small disc of metal of about the same diameter as the bottom of a telephone stand. It is equipped with a Fahnestock binding post and a length of wire which may be attached to the antenna post on the receiving set. By merely placing the telephone desk stand on it, the felt bottom of the telephone stand acts as an insulator and as the dielectric of a small condenser of which the metal plate is one terminal and the desk stand is the other terminal. In this way, the radio signals that are collected by the telephone wires may be transferred to the receiving set. The signal strength obtained with an attachment of this kind is somewhat dependent upon the local telephone circuit, but a sensitive set should give results in nearly all cases.

Usage: In connection with a telephone line and a radio receiving set as a pick-up device.

Outstanding features: Simplicity. Compactness. Easily installed.

(Further details furnished on request.)

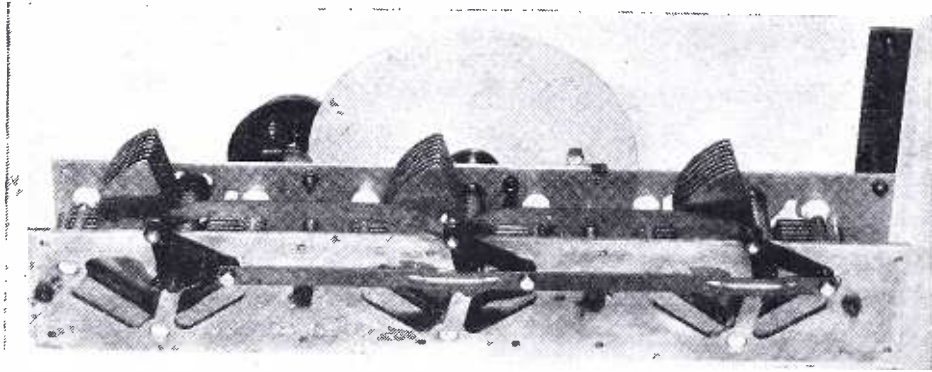

Three condensers harnessed together to give you single-control with a dial calibrated in wavelength.

A UNIT CONTROL TRIPLE CONDENSER

Name of instrument: Triple Condenser Unit.

Description: In this novel unit three condensers are mounted and controlled by a single knob which acts through friction through the large solenoid disc. The disc is set on the rotor shaft of the middle condenser and a novel cam arrangement turns the two outside rotor units of the condensers. The dial is calibrated in wavelength and when the unit is used with the proper coils any

wavelength may be tuned in by simply turning the single knob so that the reading appears at the indicator.

Usage: In a receiving set for tuning a two-stage radio-frequency amplifier with a single knob.

Outstanding features: Single control. Uniform capacity settings. Efficiency. Direct wavelength calibration. Fine workmanship.

(Further details furnished on request.)

A STORAGE BATTERY THAT CHARGES ITSELF

Name of instrument: Storage battery with self-contained trickle charger.

Description: This "A" supply unit is made in two sizes for either 4 or 6 volts operation and contains either two or three cells respectively. It also contains a trickle charger that keeps the cells always in operating condition. It is equipped with binding posts for connection to the set and a switch that is used for connecting the batteries through either the charger or to the receiver. A plug is furnished for connecting to the socket of the ordinary alternating current lighting lines. By this arrangement a small switch may be thrown to either one of two positions which provide the set with filament current, or charge the batteries. In this way, the battery is being continuously charged at all times at a very slow rate except when it is furnishing power to the receiving set.

Usage: In connection with a receiving set for supplying filament current.

Outstanding features: Automatic in operation. Reliable. Keeps batteries always in good condition. Relieves the set owner from worries about keeping battery charged. Neat in appearance.

(Further details furnished on request.)

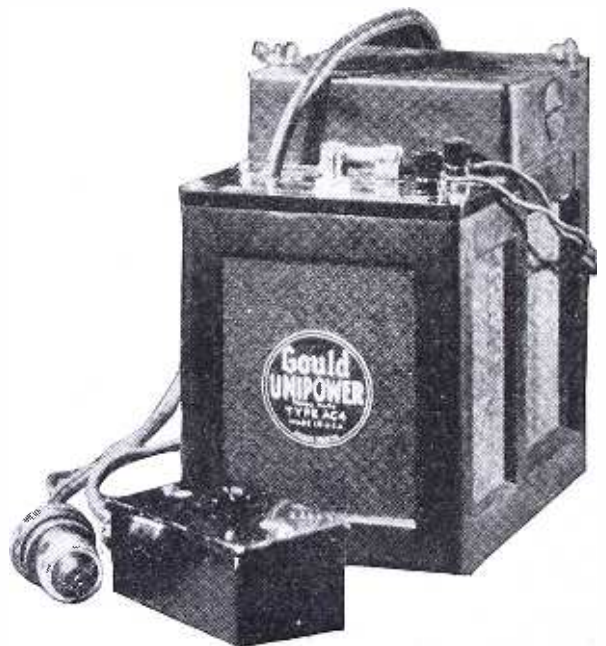

Simply throw a switch to connect this battery to your receiving set; then throw it back again and it becomes fully charged while not in use.

Apparatus Approved by Popular Radio

This list of apparatus approved by the POPULAR RADIO LABORATORY will be continued as a part of the WHAT'S NEW IN RADIO APPARATUS department until all instruments, parts and complete sets have been included. The listing is alphabetical by manufacturer's name and the installment in this issue includes the letters U through Z.

AUDIO-FREQUENCY AMPLIFIERS

Veby complete 3-stage resistance-coupled amplifier; Veby Radio Co.

AUDIO-FREQUENCY TRANSFORMERS

*"United" audio-frequency transformer; United Mfg. & Distributing Co.
Audio-frequency transformer; Louis E. Werts*

BATTERIES

*RB "B" battery; Universal Battery Co.
U. S. L. radio "A" and "B" batteries; U. S. Light & Heat Corp.
Waterbury "A" battery; Waterbury Battery Co.
Westinghouse crystal case "A," "B" and "C" batteries; Westinghouse Union Battery Co.
"Willard" radio batteries; Willard Storage Battery Co.
Radio "B" battery; Winchester Repeating Arms Co.
"Wizard" "A" and "B" batteries; Wizard Battery Co.
"World" storage "A" and "B" batteries; World Battery Co.*

BATTERY CHARGERS AND RECTIFIERS

"Valley" battery charger; Valley Electric Co.

BINDING POSTS

Lettered binding posts; Walnart Electric Mfg. Co.

CRYSTAL DETECTORS

*"Cummings" union crystal; Union Radio Elec. Stores, Inc.
"Yellowtip" crystal detector; Wholesale Radio Equip. Co.*

DIALS

*Micrometer dial; U. S. Tool Co., Inc.
Knobs and dials; Walbert Mfg. Co.
Dial; Walnart Electric Mfg. Co.
"Workrite" E-Z-Tune dial; Workrite Mfg. Co.
Knobs and Dials; Yaxley Mfg. Co.*

FIXED CONDENSERS

*Fixed condenser; Walnart Electric Mfg. Co.
Fixed condenser; Yaxley Mfg. Co.*

GRID-LEAKS AND RESISTANCES

*Variable grid resistances; Walnart Electric Mfg. Co.
Royalty variable grid-leak; Wireless Products Corp.
Royalty resistance units; Wireless Products Corp.
Resistance unit; Yaxley Mfg. Co.*

HEADPHONES

*"Ampl-tone" phones; Union Fabric Co.
"Warren" phones; Warren Radio Phone Mfg. Co.
"Workrite" concert headset; Workrite Mfg. Co.*

JACKS

*Union tip jack; Union Radio Corp.
Jacks; Yaxley Mfg. Co.*

KITS

*U-ni-dial kit; Unidial Radio Co.
Super-heterodyne kit; Victoreen Radio, Inc.*

LOOPS

Variable radio loop antenna; Werner Radio Mfg. Co.

LOUDSPEAKERS

*Black Beauty reproducer; United Radio Corp.
"Utah" phono-speaker; Utah Radio Products Co.*

*"Van-Le" reproducer; Van-Le Corporation
Professional reproducer; Voluma Products, Inc.
"Moon" loudspeaker; Wilson Utensil Co.
"Windsor" loudspeaker; Windsor Furniture Co.*

MISCELLANEOUS ACCESSORIES

*Dial adjusters; Union Radio Corp.
Valley clip; Valley Electric Co.
Solder flux and rosin core solder; Valley Forge Chemical Co.
Var Flex tubing; Var Flex Corp.
Var Flex wire core; Var Flex Corp.
"Cross Country" circuit (parts and instructions); Vesco Radio Co.
"Penetrol" (auxiliary unit); Walbert Mfg. Co.
Panelites; Walbert Mfg. Co.
Adjuster; Walnart Electric Mfg. Co.
"Workrite" concentrator; Workrite Mfg. Co.*

PANELS

Hard rubber panels; United States Rubber Co.

PHONE PLUGS

*G. W. 5-circuit plug; G. E. Walker Co., Inc.
Plug; Yaxley Mfg. Co.*

PHONOGRAPH ATTACHMENTS

Ampl-tone loudspeaker unit; Union Fabric Co.

POTENTIOMETERS

*Potentiometer; United Scientific Laboratory, Inc.
Potentiometer; Yaxley Mfg. Co.*

RADIO CABINETS

*De Luxe radio cabinets; Utility Cabinet Co.
Radio cabinet; Whaling Wood Products Co.*

RADIO-FREQUENCY TRANSFORMERS

*"United" radio-frequency transformer; United Mfg. & Distributing Co.
"Victory" 4-circuit transformer; Victory Radio Co.
"Werner" radio-frequency transformer; Werner Radio Mfg. Co.*

RECEIVING SETS

*"Unidyne" receiver; United Mfg. & Distributing Co.
U-S-L Broadcast receptor; U-S-L Radio, Inc.
"Radiodyne" receiver; Western Coil & Electrical Co.
"Elf" crystal receiver; Westwyre Co.
Zenith receivers; Zenith Radio Corp.*

RHEOSTATS

*Rheostat; United Scientific Laboratory, Inc.
"Unity" vernier rheostat; Unity Mfg. Co.
Rheostat; Wilcox Laboratories.
"Workrite" vernier rheostat; Workrite Mfg. Co.
Rheostat; Yaxley Mfg. Co.*

SOCKETS AND ADAPTERS

*V. T. Socket; Union Radio Corp.
Walbert safety rim socket; Walbert Mfg. Co.
Walnart sockets (bakelite insulation); Walnart Electric Mfg. Co.*

SWITCHES

*Filament lock switch; Walbert Mfg. Co.
Switch; Walnart Electric Mfg. Co.
Midget battery switch; Yaxley Mfg. Co.
No. 210 Pilot light switch; Yaxley Mfg. Co.*

TESTING INSTRUMENTS

Weston panel voltmeter; Weston Electrical Instrument Corp.



Louisville Courier-Journal

DUPLICATING THE WORLD'S SERIES BY RADIO

Replaying the innings of world's series baseball games on a field in Louisville, Kentucky, while the games were actually going on in Pittsburg or in Washington was the feat that radio made possible. Two Louisville teams took the part of the big leaguers and duplicated every play within a few minutes after it was made. The players all wore headphones. These were wired to their feet and a connection made through metal discs set in many parts of the field. The broadcast report was picked up by receivers and transmitted to the players who re-enacted what they heard.

The BROADCAST LISTENER

*Comments on radio programs, methods and technique
—from the point of view of the average fan*

By RAYMOND FRANCIS YATES

Some Grade-A Broadcasting at Last

THE big-meter waves have washed up a few A-number-one radio-acts since the appearance of our smashing review in the November issue. As a matter of fact, it begins to look as though we might have to take back what we said about the small difference between the summer and winter season. Here we have heard Josef Hoffmann, Olga Samaroff, May Peterson and Louise Homer and Toscha Siedle all within the space of a single month! That's a pretty heavy brand of entertainment after you've grown accustomed to a musical diet consisting chiefly of nothing but homeopathic doses of twenty-nine-cent phonograph records. It's getting so that you cannot tell what radio will do next. One day it is walking down Sixth avenue in a crash suit smoking Cincos and the next day it is swanking down Fifth

avenue with a full cutaway, a topper and a fifty-cent straight. You say it with razzberries one day and with a great big bunch of orchids the next.

There is just one little fault that we have found with the Atwater-Kent programs. Not that we wish to put on the elegant air of the snooty connoisseur, for we are perhaps one of the worst listeners that ever fell into applauding with the rest of the pretenders at Carnegie Hall.

It seems to us that these air concerts would be immensely improved with a more brilliant accompaniment for the singing artists. In the concert hall, with its dazzling chandeliers, its smartly dressed women and its gayly decorated walls, there is created an atmosphere that makes the piano sufficient, but that same piano is a pretty drab background in a radio recital. This admission may show us up as being one of the rawest radio critics in the business, but just the same we feel that Mr. Atwater-Kent would

be giving his concerts a full twelve-pound sound by adding a small symphony orchestra. A concert in Carnegie Hall and a concert in the home of J. Whoasis Smith, 567 Plimpton avenue, the Bronx, U. S. A., are two totally different things. In Carnegie Hall it is not difficult to make May Peterson sound like a \$3,000-a-night voice with the piano as the only support, but when you lift that voice out of the Hall and place it in the average American home you haven't very much left. It's just like taking the purple spot off the stage mystic.

There is no good reason to say that Mr. McNamee is doing a fine bit of announcing in connection with the Atwater-Kent programs, because he isn't. If Mr. McNamee is not flattering the star he is flattering or patronizing his audience, and if he isn't doing that he is tossing out a literary garden of American Beauties. Still Mr. McNamee is the star announcer of WEA, and was rushed right from the World's Series to the opening concert of the Atwater-Kent programs. It does seem a bit incongruous that a man should perform so efficiently at baseball, at the ringside, at political conventions, at football and at big league recitals. Either Mr. McNamee is a very keen and widely learned gentleman or he is of just ordinary sophistication and is being badly over-worked.

If we had the handling of the Atwater-Kent programs we should engage an announcer with the training and background of—of—

Just fancy that, we can't think of a soul! Well, we'd save Mr. McNamee for the next World's Series, anyway.

* * *

A Hot Shot from Chicago

Just when we are beginning to take seriously the many, many thousands of flattering letters received, along comes a Chicago reader with a mad on.

"Dear Sir:

"Don't take this salutation seriously.

"Beyond a doubt you are of the type that would kick the crutches from under a cripple in a traffic jam. I have been reading with growing disgust and finally with pity your puny efforts at mirth under the section 'The Broadcast Listener.'

"Now for a dose of your own literary effort. Perhaps I can set your warped intellect right regarding broadcasting in the Chicago district. I refer especially to your paragraph 'The Chicago Listeners Strike.' In the first place Chicago is still in the republic and neglecting the 18th Amendment the Constitution is holding sway. A petition from thousands of broad-

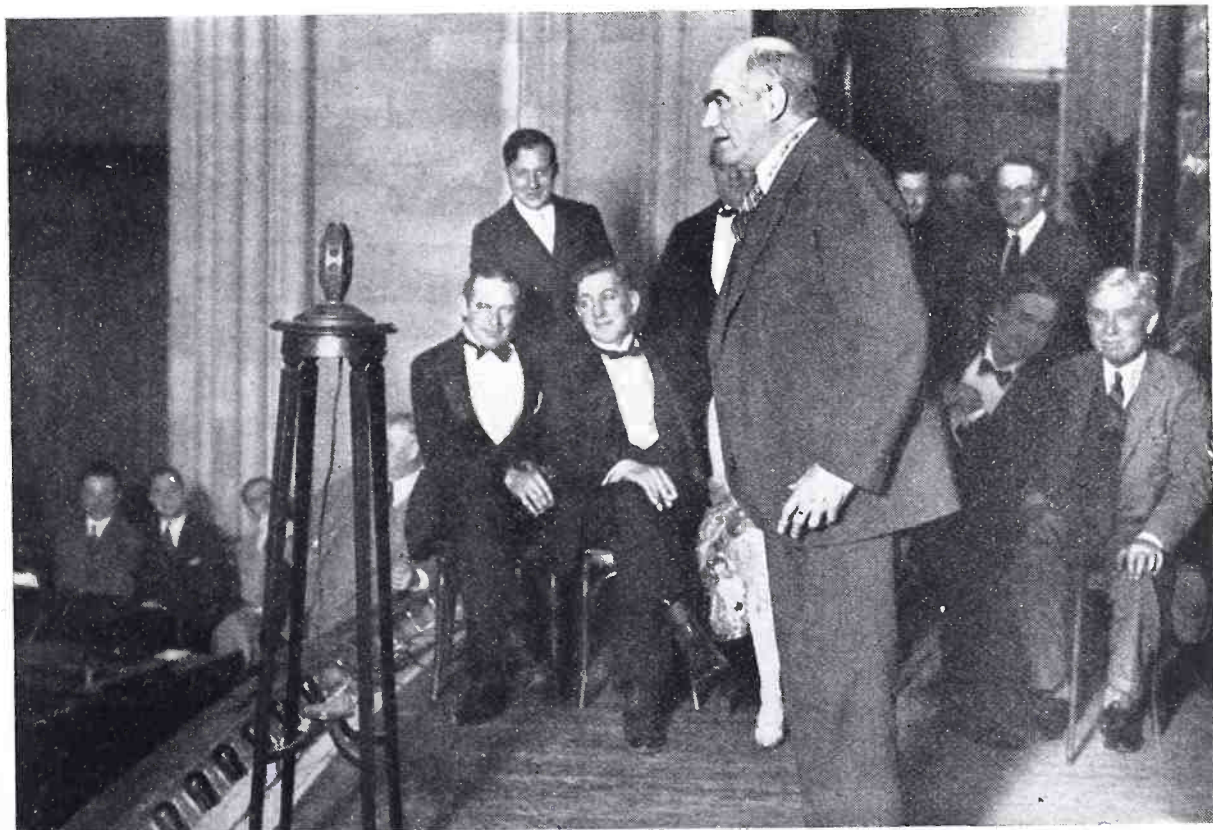

Kadel & Herbert

THEATRICAL STARS ENTERTAIN HOSPITAL PATIENTS BY RADIO

A program which was designed for the special benefit of hospital patients, and furnished by many famous stars of the theater, was broadcast recently from the Friars Club in New York. Burr MacIntosh, actor, author and lecturer, is here shown before the microphone in the famous club's quarters.

cast fans has forced the Chicago broadcasting stations to close one night a week. We've a right to our opinion here as well as you in the Empire State. In addition, the Mayor's Radio Commission requested all local stations to close on Monday evening. Many broadcasters took advantage of this by reason of the fact that their stations were located outside the corporation limits. After a good deal of effort, the Radio Broadcast Listener's Association, of which I am *not* a member, succeeded in closing all these stations with one exception. This station is negligible, because it is on too high a frequency and cannot be heard well on the ordinary receiver.

"We'll admit that broadcasting is not yet on the hoity-toity plane you are planning on putting it. There are as many people who like dance music and popular songs as there are those who enjoy highbrow music. I am of the opinion that there is room for every type of music and program. But were we to accept your recommendation, we would degenerate to your type of spineless jellyfish, wanting only one thing and to hell with the others. I have listened to Art Linnick go from one station to another, singing the same song six days a week for one whole summer. Certainly we are entitled to hear the Hotel Nicollet orchestra at Minneapolis or the Hotel Alexandria orchestra at Los Angeles one night a week. As far as I'm concerned they could close every Chicago station seven nights a week and I'd never miss 'em. But there are thousands who would. We are entitled to one night a week to hear what the other fellow is doing. You might reply, 'Get a good set.' Thank you, I have one, but the most selective in the shadow of WIBO, WQJ, WBBM and WEBB would have a

sweet time cutting off the dozens of wavelengths on which some energy is being radiated. Thirty-two local broadcasting stations are capable of blanketing the entire broadcast spectrum.

"Believe me sincere,

"H. M. D."

We did feel a little mean and small after reading H. M. D.'s letter, but we walked right out and tossed off a Coca-Cola and came back feeling fine. Part of the next three days we spent trying to think up a funny answer for H. M. D.'s calling us a kicker of crutches from under cripples in traffic jams, but for the life of us we could not think of a thing that had the right kind of a ring to it. We might have told him, however, that we once stood for fifteen minutes on a nickel that a poor old lady had dropped in the post office. There's really no telling what we might do in a traffic jam.

When we came to the part of Mr. H. M. D.'s letter wherein he accuses us of trying to lift broadcasting to a hoity-toity plane we just lost control of ourself and guffawed so that you could hear it all over the place. That is, perhaps, the funniest statement that has ever been made in this department. We had thought up until this time that "our puny efforts at mirth" was one of the most substantial barrels of solid hoke mined in the western hemisphere. Another letter like that and we shall go right up to Carnegie Hall and write a cruel and devastating *critique* on Mr. Walter Damrosch's conducting.

Mr. H. M. D. says "I am of the opinion that there is room for every type of music and program." That either proves that Mr. H. M. D.

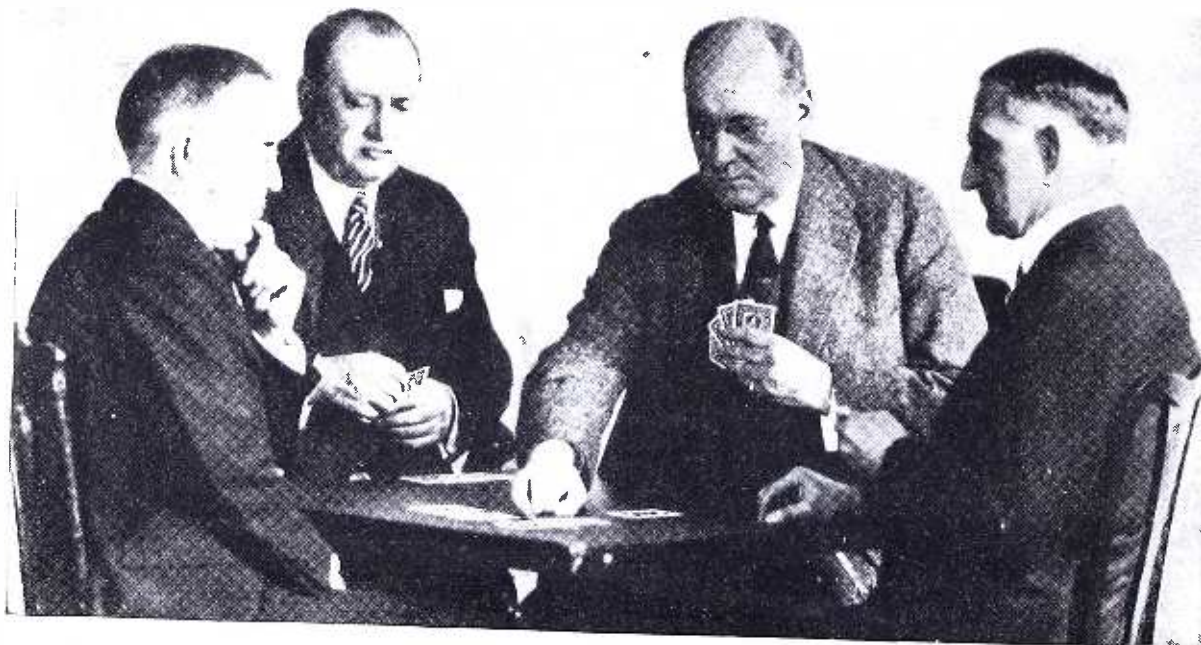

BROADCAST-LISTENERS SIT IN ON A BRIDGE GAME WITH EXPERTS
Radio fans recently had a chance to learn the fine points of auction bridge from some of the best-known authorities when games played by E. V. Shepard, W. C. Whitehead, Milton C. Work, and Sidney S. Lenz were broadcast play by play.



Kadel & Herbert

POLITICAL CAMPAIGNERS DISCARD THE "STUMP" FOR THE "MIKE"

Instead of addressing the handful of listeners who can come within range of his voice, the politician of today addresses hundreds of thousands at a time by radio. The political contests of tomorrow will be largely contests for access to broadcasting stations. Here is a peep at the broadcast debate between Governor Smith of New York and Representative Ogden Mills on the eve of Election Day at Buffalo.

is a member of the Kiwanis Club or that he has really given serious thought to this business of broadcasting. It invariably happens that a man doing heavy thinking on the subject of programs eventually comes to the conclusion that America is a racial vegetable stew and that, consequently, its broadcasting must be built upon the principle of a crazy-quilt or a Beloochistan rug.

If you meet us on the street some day muttering strangely and incoherently, you will know that we succumbed to the mental strain of trying to devise a hoity-toity program that will please cosmopolitan America.

Seriously, we shall try to be more tolerant, as Mr. H. M. D. wishes. You know the voice with the smile wins, and we really should have more Kewpie dolls smiling at us from the mantelpiece.

* * *

The Demands of the Society of Authors and Composers

UP until a few months ago we had worked up quite a bit of sympathy for the Society of Authors, Composers and Publishers, but subsequent action of the Society in attempting to extort what would amount to a fee of from \$100.00 to \$200.00 a day from each broadcaster in the United States, has left us a bit cold and prejudiced. The demands are exorbitant and ridiculous, and they show that the officers of the organization have a very poor head for "figgers." At the rate mentioned, there is not

one broadcaster in the country that will be able to meet these demands and, except in isolated cases where broadcasters desire to use special programs, the Society's income from radio will be small enough to carry around in the change pocket of any overcoat.

If the Society would ask a reasonable charge of say \$10.00 a day for each broadcaster using its copyright music, its income would be increased by some hundred thousand dollars a year, which would be just so much gravy. Instead of being satisfied with this the Society is setting to the task of gathering in millions from an industry that has been bankrupt since the very day it was born.

* * *

An Atlantic City Fan Breaks Loose

"Dear Sir:

"When one does a good thing it is natural that one likes to know that others appreciate it. Consequently, I am doing something very unusual for me—taking the time and trouble in a very lazy life to congratulate you on your strong editorials. I refer especially to 'Studio Sheiks' and 'Some Pretty Bad Stations.'

"In your next editorial, please comment on these lady-like announcers who try to put such pathos in their voices. It is plainly evident that they are listening to themselves. I refer especially to Clarence Bowden of WOO and Major Bowes of the Capitol. Major Bowes

certainly does 'love his little family'—my God! "You must listen to Clarence tell about the composers of the organ compositions he plays. It is certainly amusing to listen to these fellows with their broad A's and their totally affected pronunciations of various sorts and styles.

"And while I'm all het up and mad, I want to damn this word *ensemble*, which seems to have just been discovered. Orchestra and band are good old-fashioned words and they are exact in their meaning.

"The writer of 'The Broadcast Listener' certainly has courage.

"C. S. D."

(Will Mr. H. M. D. please note?)

* * *

How to Run a Broadcasting Studio

If anybody should ever ask us to manage a broadcasting studio we should immediately post a set of rules and regulations, which, if followed out, would make it the best station in this great big world of ours. After you stop to carefully weigh this boast, it really isn't saying a lot. If you set out to make a better Woolworth Building or a better radio magazine than POPULAR RADIO (advt.) you'd have a pretty hard job on your hands, but the formula



Kadel & Herbert

A FLYING BROADCAST STUDIO

The cabin of the giant Sikorsky airship was converted into a studio when Maxine Brown broadcast her part of the program from a spot a thousand feet or so above the earth. The program was sent out on a 40-meter wave, was picked up at WGBS and rebroadcast on the station's regular wavelength.

for the world's best broadcasting station should be just about as easy as an improvement in circus lemonade.

Rule No. 1. Announcers must refrain from giving even a hint concerning their identification.

Rule No. 2. Any announcer caught using the broad A or making other effort to sound ritzy, will arrange his own appointment with the cashier.

Rule No. 3. Announcers must not use the phrase "and now at this time." Now usually means "at this time." (WJZ-WJY staff please note.)

Rule No. 4. One soprano will be permitted to sing two selections from this studio every third Friday.

Rule No. 5. The equipment of this station is not available to the clergy unless they can relieve their voices of every trace of sanctimonious moaning in the lower register.

Rule No. 6. NO HAND CLAPPING IN THIS STUDIO.

Rule No. 7. All boys under twenty years of age who play Hohner harmonicas are referred to the program manager of WENF and WJZ.

Rule No. 8. No artist (especially female) will be permitted to tell the audience that he or she was "thrilled" or that it was a "perfectly wonderful experience."

Rule No. 9. If Major Bowes broadcasts from this studio, will he please refrain from calling his troupe his "happy little family." That is obvious applesauce.

Rule No. 10. Song pluggers will please apply to Mr. N. T. Granlund, seventh floor (third office to the right), Loew's State Theater Building, Broadway and Forty-fifth street, New York City, U. S. A.

Of course, we could go on writing these rules until the cows came home. What we really wanted to do was to show you that we are a big, bright-eyed boy, conscious of and alert to all of the sad little mistakes that our large-minded impresarios are making. The chances are that we might be wrong, too, but if we are as wrong as our impresarios, we will, on Thursday morning, March 25, rain or shine, take a nose dive from the top of the Columbus statue at the Fifty-ninth street entrance to Central Park.

* * *

Dramatic Reading and Other Whatsis

MRS. GLORIA WATKINS JONES, patron of the arts, and wife of the wealthy local cigar manufacturer was one of the first to discover radio as a means of lifting the literary tastes of the masses above the level of the confession magazines and the illustrated tabloids. Mrs. Jones is a big, indignant person when it comes to the subject of appreciating the greater things in literature and she recounts, with not a little feeling, the slovenly tendencies of the modern

reader who could easily be lead to believe that Oscar Wilde was a great ball pitcher of the 90's, that Newton invented the Fig-Newton or that Captain Dingle is the world's greatest writer of sea stories.

Now Mrs. Jones can practice her sophistication at her bridge parties with no objection on the part of this department but when some supposedly intelligent studio manager knowingly presents her with twenty minutes and one thousand watts of power something should be done about it. Permit any Mrs. Jones to heave in the throes of a recitation, wherein there is much tragedy and loads and loads of subtle literary perfection, and you commit one of the worst and most disgusting broadcasting crimes that can be committed in this or any other country. Here is one vote against dramatic reading on the air.

* * *

Negro Spirituals

A LOT of broadcast singers have lately gone in for the moaning of negro spirituals, and it's getting so that you cannot turn to the radio without hearing the white man's version of the colored man's prayer. There is nothing more easily overdone (that may not be strictly true, but let's assume that it is) than the sanctimonious wailing of darky hymns, and we must request that our studio managers consult this department before engaging any more quartettes all filled up with spirituals. By the time the second or third hymn is reached that gloomy, Alice-is-dead-in-the-next-room atmosphere is created, and you feel like going right out to the corner drug store where they wrap it up to look like laundry.

* * *

Some Extraordinary Announcements

EITHER Mr. Phillips Carlin (one of the WEAJ boys) is a very subtle humorist and a thirty-third-degree announcer or we are just plainly and hopelessly dull. Perhaps you have had better luck with Mr. Carlin, but it has been our experience to completely fumble the meaning of nine of every ten announcements that this gentleman makes. It is more than barely possible that his reflections are a bit too esoteric for us but we are inclined to doubt this, for it was only the other day that our Research Department handed us a report on Carlin which seemed to indicate that his general registration record was low.

We copied a few of his announcements recently just for the purpose of examining them at our leisure, but so far all efforts at translation have failed. Our Psychology Department offers a prize of two full United Cigar Store coupons to any reader discovering a meaning, **however vague**, in the following Carlin announcements:

EXHIBIT NO. 1

"You are sitting all alone. The cat is asleep in front of the fireplace and it is six o'clock in the morning. You hear a gay whistle and you run out to see who it is and it happens to be the ice man. 'Lonesome.'"

EXHIBIT NO. 2

"Some say it was the joke you heard in your cradle, others the rattle. 'Pal of My Cradle Days.'"

EXHIBIT NO. 3

"A pile of logs and stone. The boys find this a very hard number. A pile of logs and stone indicate a home."

One could not truthfully say that Mr. Carlin is verbose, for it is evident that he has some definite thought in mind. He does not seem to be able to concoct a combination of words to convey that thought. It may be—and we just happened to think of this—that his thought is so weak that all of the words in the dictionary would not help it.

* * *

The Roxy Formula

ALL of our studio managers must have taken to their various cellars for the purpose of muttering to themselves on the day after Roxy's return to the air. A special messenger, dust-covered and breathless, has just placed a communication from 195 Broadway on our desk which states that all WEAJ mail records were broken on Saturday, October 31, 1925, the day after Roxy's broadcast. We also have it on mighty good authority that all Eastern stations were broadcasting only to the immediate families of their performers on the night Roxy made his return to WEAJ.

It has always puzzled us how Roxy's formula has so successfully kept all of our great studio managers baffled. Roxy is perhaps the easiest man in the world to follow because his methods are so simple. Of course, simplicity is a hard thing to fathom after all, and it would not be fair to be too harsh with the studio boys for their having permitted Roxy's very simple tricks to elude them.

If you've got any ear for music at all (we are quite sure that *you* have an ear for music, but we sometimes have our doubts about all the rest of the listeners in America) you know that Roxy does not go to the booking offices of the Sterling Vaudeville Circuit to find his musical talent. Trick No. 1 is to get good performers. Trick No. 2 (and this *is simple*) is that of maintaining variety by permitting his artists to sing or play but one or two numbers at a time.

Now that Roxy is exposed, we shall expect all of our great studio managers to follow him. Not that we would for a single moment underrate these hard-thinking fellows, but anyone wishing to place a little five to one bet on the outcome will please communicate with our third secretary, 627 West 43d street, New York, N. Y.

G On page 98 of this issue a new department is inaugurated under the direction of Mr. Lloyd Jacquet.



IN THE EXPERIMENTER'S LABORATORY

CONDUCTED BY LAURENCE M. COCKADAY

Some Methods for Determining the Distributed Capacity of Coils

BEFORE going into the methods of determining the distributed capacity of coils it may be well to briefly outline the advantages to be derived from decreasing this capacity.

This capacity arises from the existence of a series of nearly parallel wires in a coil. Any two adjacent wires are roughly analogous to two small plates of a condenser. No coil is, therefore, a pure inductance, but it may be considered a pure inductance with the summation of all the inter-turn capacities as a shunt capacity. Most of this capacity is between two adjacent turns because the capacity from one turn to the second from it decreases at a rate proportional to the distance between them raised to a power greater than unity. That is, the capacity does not decrease directly as the distance between the conductors is increased, as is the case in a condenser of the usual type where the stray field is negligible, but at a greater rate.

The main objection to this capacity lies in the fact that this series of small condensers is usually of a high-loss type. This is due to the fact that the wire insulation and some of the supporting material are in the electrostatic field and cause dielectric and resistance losses. Both of these decrease with increase in frequency, but when it is remembered that the power dissipation in a condenser increases directly with increase in frequency, the other factors remaining constant, it is evident they are still important. Other factors remaining constant (i.e., frequency, capacity and power factor) the power loss is proportional to the square of the voltage, so this should be kept low. This can be best accomplished by using a straight solenoid type of winding. In a coil of this type it is evident that if there is a potential difference of X across the coil, the potential difference (voltage) between two successive turns is $\frac{X}{N}$ where N is the number of turns.

The distributed capacity can be decreased by slightly spacing the turns. The losses can be minimized by improving the dielectric in

the field, minimizing the amount of it and decreasing conduction (decrease resistance) between turns. Spacing the turns decreases the latter considerably.

Variable condensers have been improved to the point where they have only one percent, or less, the resistance of the average coil. Working on coils is, therefore, well worth while.

To measure the distributed capacity of coils a variable standard of capacity and a wave-meter are necessary. For rough work a variable condenser of the General Radio type No. 247 can be used. This should have a calibration curve.*

For the man who dislikes mathematics the graphical method of determining distributed capacity is best although this is less accurate than the other systems to be given.

$$\lambda = 1.885 \sqrt{L(C + C_0)} \quad (1)$$

Where λ is wavelength in meters

L the pure inductance of the circuit in microhenries

C the value of the shunt capacity used in micro-microfarads and

C_0 the distributed capacity of the coil in micro-microfarads.

Squaring both sides

$$\lambda^2 = 3.553 L(C + C_0) \quad (2)$$

As L is constant the relation between λ^2 and C is linear and the plot will be a straight line as shown in Figure 1. The slope of this line ($\frac{Y}{X}$ in Figure 1) is equal to 3.553 times L where L is the inductance of the coil. The distance from the origin (the point marked O) to the point where the linear curve crosses the abscissa (Z in this case) determines the distributed capacity. This follows from the fact that when λ^2 is made equal to O in equation (2) $C = -C_0$.

The value of the inductance can be determined from this curve by dividing the slope of the curve by 3.553 or

$$L = \frac{Y}{3.553 X} \quad (3)$$

*See article by the author on page 386 of the October, 1925, issue of POPULAR RADIO.

For X, or the value of capacity to be used choose some convenient value. In Figure 1 X is 100 or the difference between 280 and 180 mmfds. (micro-microfarads). The corresponding value of Y, which is the increase of λ^2 between these capacity values, is in this case 102,500 or substituting in (3)

$$L = \frac{103,000}{3.56 \times 100} = \frac{1030}{3.56} = 289 \text{ micro-henries} \quad (4)$$

The value of L is in micro-henries since this was the unit used in equation (1). In this case it should be noted that only three significant figures were used. Actually with a small chart of this size only the first two figures should be used in the computations since because of the size of the chart and the accuracy in measurement only the first two will be reliable.

If in equation (1) C is very large as compared with C_0 , the latter can be neglected for approximate determinations of L or λ . If, for example, C is about 1,000 mmfd. (.001 mfd.) and the measurement of L is made for an average coil designed for broadcasting frequencies the error introduced by neglecting C_0 is only of the order of 2 percent, assuming the determination of λ is accurate. If this is then used to determine C_0 , which is what we are primarily interested in, the value gotten will

be accurate within a fraction of a mmfd. which is ample. If then another determination of λ is made (i.e., the resonant wavelength of the parallel resonant circuit composed of the capacity C and the coil to be measured) at a low setting of C, C_0 then becomes a large percentage of the total shunt capacity to L. Knowing the approximate value of L and the value of C these can be substituted in (2) and the value of C_0 determined.

The following procedure should be used to get C_0 . Connect the coil, the distributed capacity of which is wanted, across the variable standard of capacity. Set this condenser at a high setting, giving a high value of capacity C. This should be about 1,000 mmfd. The wavelength of this circuit should then be determined with a wavemeter.* A "set up" of this type is shown in Figure 2. The oscillator is shown at O, and C is the variable standard capacity. The coil is shown at L for which C_0 is wanted (it is placed on a small box shown in the foreground to shorten the leads to C) and W is the standard wavemeter. In this case the wavemeter had no resonance indicator in the circuit. The condenser C was set to a

*See "An Oscillating Wavemeter," by S. Gordon Taylor, page 267, September, 1925, issue of POPULAR RADIO.

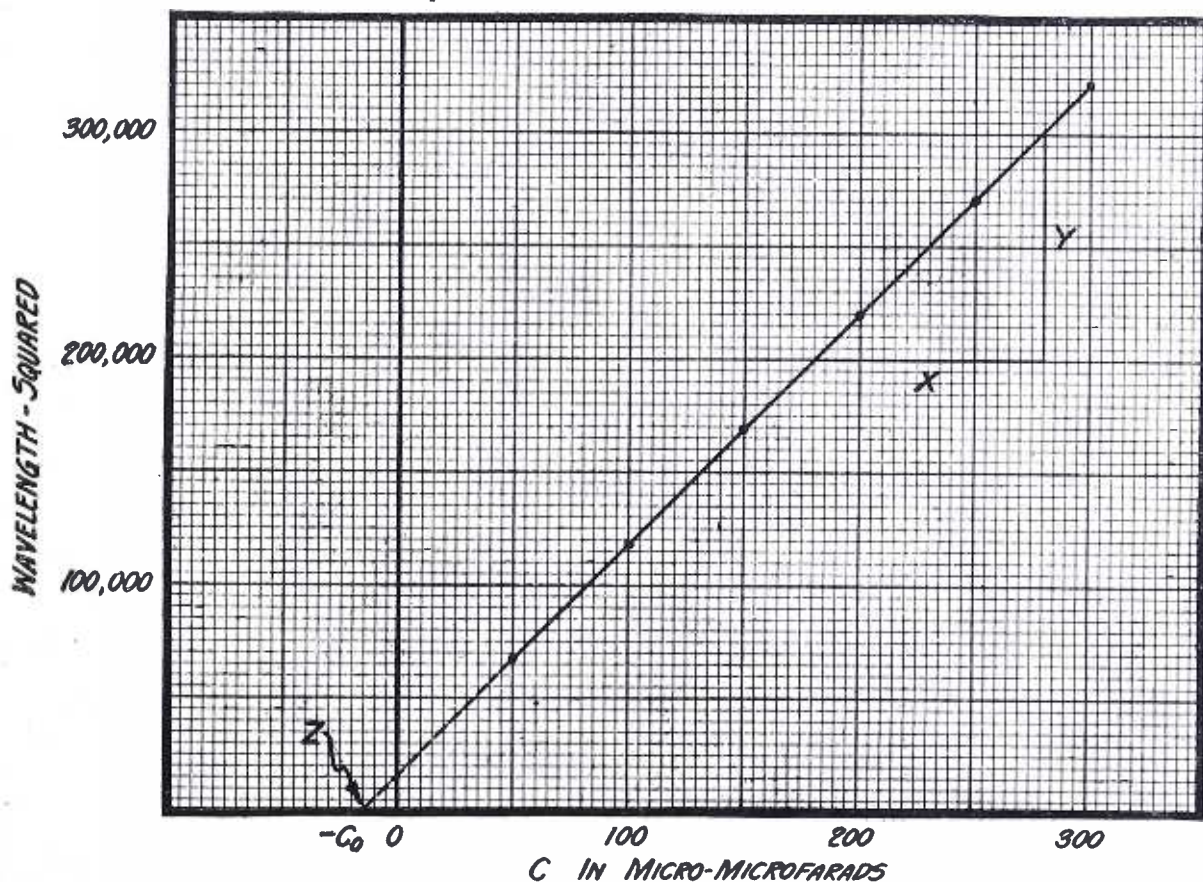

THE GRAPHICAL METHOD OF DETERMINING DISTRIBUTED CAPACITY

FIGURE 1: Several wavelength measurements of a coil and condenser circuit are made and the wavelength-squared plotted against the capacity at each point. It is shown that the distance OZ represents the distributed capacity of the coil used.

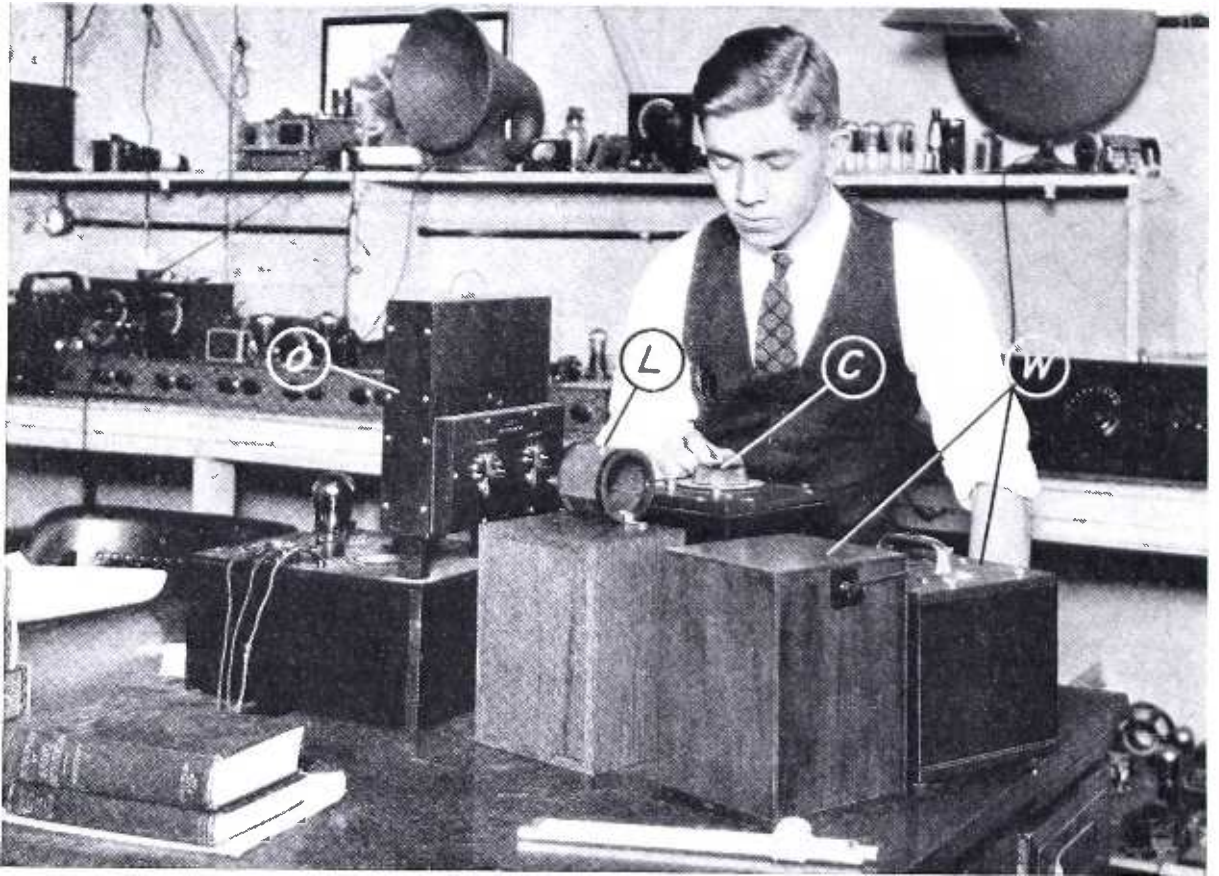

From a photograph made for POPULAR RADIO

THE LABORATORY MEASUREMENT OF DISTRIBUTED CAPACITY

FIGURE 2: The coil of which distributed capacity is to be measured is lettered *L* and its tuning condenser is called *C*. The oscillator *O* supplies the radio-frequency current to the tuned circuit *LC* and a wavemeter *W* shows the wavelength of the radio-frequency current. Results of these measurements are plotted as the curve of Figure 1.

high value. Then *O* was tuned until there was a sharp deflection in the plate current meter. The coupling between *O* and the circuit *LC* was decreased until the deflection was very sharp indicating the latter was in resonance with *O*. The standard wavemeter was then tuned until there was again a sharp deflection in the plate meter of *O*. The wavelength reading of *W* then gave the wavelength to which *LC* was tuned. Then C_0 was neglected and the readings of *C*, and λ , were substituted in (5) giving *L* within 1 or 2 percent depending on the relative values of *C* and C_0 as gotten by subsequent calculations. The subscript 1 is used to indicate values of *C* and λ for the first or high wavelength setting and the subscript 2 for the second values of *C* and λ taken at a low wavelength.

$$L = \frac{\lambda_1^2}{3.553 C_1} \quad (5)$$

where *L* is in micro-henries and *C* in micro-microfarads.

Condenser *C* is then set at a low value (50 mmfd. or less if *C* is accurately calibrated) which is called C_2 . The wavelength reading of this setting is called λ_2 . These values are

substituted in (6) which gives the distributed capacity C_0 in micro-microfarads.

$$C_0 = \frac{\lambda_2^2 - 3.553 L C_2}{3.553 L} \quad (6)$$

If λ can be measured accurately and a more precise value of C_0 is wanted *L* should be gotten by substituting C_1 , gotten by direct reading, and C_0 , from (6) in equation (2) and solving for *L*. This more precise value of *L* can then be substituted in (6). In the computations given more significant figures have been used than the theory of precision would warrant, but this has been done to provide an equation which is more valuable for accurate determinations. An equation can easily be worked out which will give C_0 directly in one operation but this involves involution, or the extraction of roots, and is therefore somewhat more involved.

If the experimenter is interested only in the value of C_0 the so-called "harmonic" method of determining it can be used. In this system integral multiples of some given frequency are used. These can most easily be obtained by using some harmonic, say the second, of the oscillator. The value of the resonant fre-

quency will vary inversely as the square root of the capacity since the inductance is constant. Hence the value of C plus C_0 (the total capacity in shunt to the theoretically pure inductance L .) will be one-quarter of that used for the fundamental when the second harmonic (or double the frequency) is used. Or mathematically

$$(C_f + C_0) = 4 (C_{2f} + C_0) \quad (7)$$

where C_f is the value of the variable standard at the fundamental, C_{2f} is the setting of the standard for resonance at the second harmonic frequency and C_0 is the distributed capacity as before. Solving for C_0 we get

$$C_0 = \frac{C_f - 4 C_{2f}}{3} \quad (8)$$

where C_0 is given in the same units that are used for C_f and C_{2f} .

Since the resonance point for the second harmonic is somewhat difficult to determine, particularly with a low-power oscillator, the oscillator frequency can be doubled by adjustment and the values of C_f and C_{2f} determined. This increases the possibility of error but makes computations simpler and is accurate enough for all ordinary work.

To facilitate this and numerous other measurements the experimenter's wavemeter should have both a wavelength and frequency calibration chart. The latter can be made by taking enough values of λ from the present curve and obtaining their frequency equivalents to plot a new curve. The relation is expressed in (9) where f is expressed in k.c. (kilo-cycles)

$$f_{\text{k.c.}} = \frac{300,000}{\lambda} \quad (9)$$

—HUGH S. KNOWLES

How to Simplify Connections

A HANDY and useful accessory has recently been placed on the market by a number of manufacturers; it consists of a battery cable which usually comprises five leads of different colors bound into a single cable. The colored leads make it easy to tell which should be used for the "A" battery positive and negative wires and the "B" battery positive and negative wires.

The use of such cable will go a long way to eliminate mistakes in connecting up as well as making a much neater job in hooking up to the battery.

The antenna wire should never be connected in the same cable as the battery wires, however, as this would make too high a capacity between the antenna and ground parts of the circuit with a corresponding loss in signal strength

A Milliammeter as an Aid in Preserving Batteries

IF the experimenter will connect a milliammeter in series with his "B" batteries he will be able to tell just what plate current his set is drawing and by the use of "C" batteries he can reduce the total current necessary to operate the receiver to a low value that will permit of great saving in the life of the "B" battery.

Every experimenter should own a milliammeter for direct current with a scale reading of zero to 25 milliamperes that will take care of nearly all types of receiver.

Making the Tuned-radio-frequency Receiver More Selective

IN some locations close to broadcasting stations, the ordinary tuned-radio-frequency set that employs two stages of radio-frequency amplification, vacuum-tube detector and two stages of audio-frequency amplification sometimes will not give tuning sharp enough, with the ordinary 100 to 150 foot outdoor antenna, to enable the user to choose between the local stations or to receive distance while the local stations are on the air. To eliminate this trouble it is suggested that the antenna be cut down to about 50 feet in length. This will enable much sharper tuning and although it may cut down the volume of signals from the distant stations somewhat, it will enable them to be received without interference from the locals.

The Old Reliable Single-layer Solenoid Coil

RECENT investigations have proven the single-layer coils to be the best type that has yet been developed. The considerations of length over diameter should be very carefully gone into.

To get the maximum inductances in a single-layer coil the limits should be kept somewhere about an equal value for the length and diameter.

Coils in other shapes than cylindrical all will need a longer length of wire for a given inductance and therefore the ratio of inductance to resistance will be smaller with a corresponding reduction in the overall efficiency of the coils.

The distributed capacity can be considerably lowered by spacing the turns slightly on the tube upon which the coil is to be wound.

Sizes of wire should lie between No. 18 and No. 30 inclusive, to hold the resistance at radio-frequencies used in broadcasting and other short-wave work, down to a low value. There is not much difference between any of these sizes.

The coils may be wound with either double silk covered copper wire or with copper wire with one layer of cotton and one layer of silk.

Pure DC Power Supply for a Five-watt Transmitter

Too many amateur transmitting stations in operation today have an alternating current note that produces considerable interference. It is true that many of these have rectifiers and filters in the power supply circuit, but still the signals transmitted carry the unmistakable hum of an AC modulation. Probably not more than ten or fifteen percent of the amateur stations have a really pure, steady DC output, in spite of the fact that the great majority of owners have gone to the trouble and expense of equipping their stations with rectifiers and filters. In many of these cases the rectifier is not functioning properly, although, of course, there are numerous cases where the filter does not have sufficient inductance, or capacity.

Many amateurs blame their trouble on the use of short waves, claiming that it is impossible to obtain a good DC note on short wavelengths. Others are laboring under the impression that a pure DC note is so sharp in tuning that slight swinging or unsteadiness makes it unreadable.

The tone quality of the note is not in itself important, but when the air is full of static there is no question but that the high "birdie" note of DC gets out at distances that cannot be approached by AC or poor DC notes.

In tests made at one of POPULAR RADIO's experimental stations it has been proved conclusively that a pure DC note is easily obtainable; that it can be made steady so that its sharp tuning qualities are not a drawback, and that it is more easily read through static or other interference. Following is the equipment used for supplying the pure DC to the transmitter, using the 110-volt AC house lighting line as the source of power.

The power-supply equipment to be described is for use with a transmitter using a single 5 or 7½-watt tube. When larger tubes are used the only change required is to provide suitable equipment to supply the higher voltage required and to increase the number of rectifier jars. The reader may easily make these adaptations himself.

Parts for Power Supply Unit for Five-watt Transmitter

- 1 Dongan type O1, 200-watt power transformer, voltage output 550 each side of center tap;
- 1 Dongan type D7, 80-watt filament supply transformer, voltage output 8, with center tap;
- 1 Acme 30 henry choke, 0.15 ampere current carrying capacity;
- 2 National Condenser Co.'s paper condensers, 2 mfd. capacity, tested for 1,000 volts;
- 1 Chemical rectifier (See below for constructional data);
- 1 Double pole, single throw snap switch, 110-volt;
- 1 Allen-Bradley Radiostat (For use with VT-2, UV-202 or C-302 tubes; not needed with the new UX-210 tube).

The Rectifier

In making up a rectifier for use with an amateur transmitting set the usual practice is to use a miscellaneous collection of jelly glasses for the jars, and strip lead and aluminum for the metallic elements. There is no question but that such a combination will work—probably as well as any other materials—but at best such a rectifier is an unsightly mess. A rectifier which is much more pleasing in appearance and which does not become crusted all over with crystallized solution can be made as easily, and with little more expense. It is such a rectifier that is to be described here.

The parts needed are:

- 24 half pint "salt mouth" bottles, and cork stoppers to fit. See Figure 3 for dimensions;
- 9 feet of aluminum rod, 5/16 inch in diameter;
- 9 feet of lead rod, 5/16 inch in diameter;
- 2 feet of glass tubing, ¼ inch in diameter;
- 48 round head brass 6-32 machine screws, ½ inch long;
- 1 package "20 Mule Team" borax;
- 1 can lye;
- 6 quarts distilled water.

Before starting with a description of the constructional details, a word of warning should be given regarding the metals used. It is essential that both the lead and the aluminum be chemically pure. It is wise to purchase the metal rods from a chemical supply house, because they usually carry only the purest of metals. It is also necessary to exercise the utmost care in cleaning the metals and in absolute cleanliness. Use distilled water, which can be purchased from the druggist, or from a storage battery service station.

The first operation in the construction of the rectifier is to cut the lead and aluminum rods into 4½-inch lengths, making twenty-four lengths of each. Two holes should be drilled in each of these lengths, one down from the top which should be threaded to accommodate the 6-32 screws, and the other at right angles to the first but not threaded as it is used only to slip the connecting wires through. See Figure 3 for the necessary dimensions and the position of the holes.

Set the metal elements aside for the time being. Then prepare the cork stoppers as shown in Figure 3. Three holes are drilled in each, the outer holes for the metal rods and the center hole for a one-inch piece of the glass tubing. This latter serves as a vent pipe and also permits the addition of distilled water from time to time to make up for evaporation. To cut the glass tubing into 1-inch lengths a three-cornered file is used. File a small niche in the glass at every inch and then break the tubing at these points with the fingers. It will be found that the break will be clean cut and square.

The solution may now be prepared, or, it may be advisable to prepare the solution before the work described above is done, because the solution *must settle for about twenty-four hours before it can be poured into the rectifier*

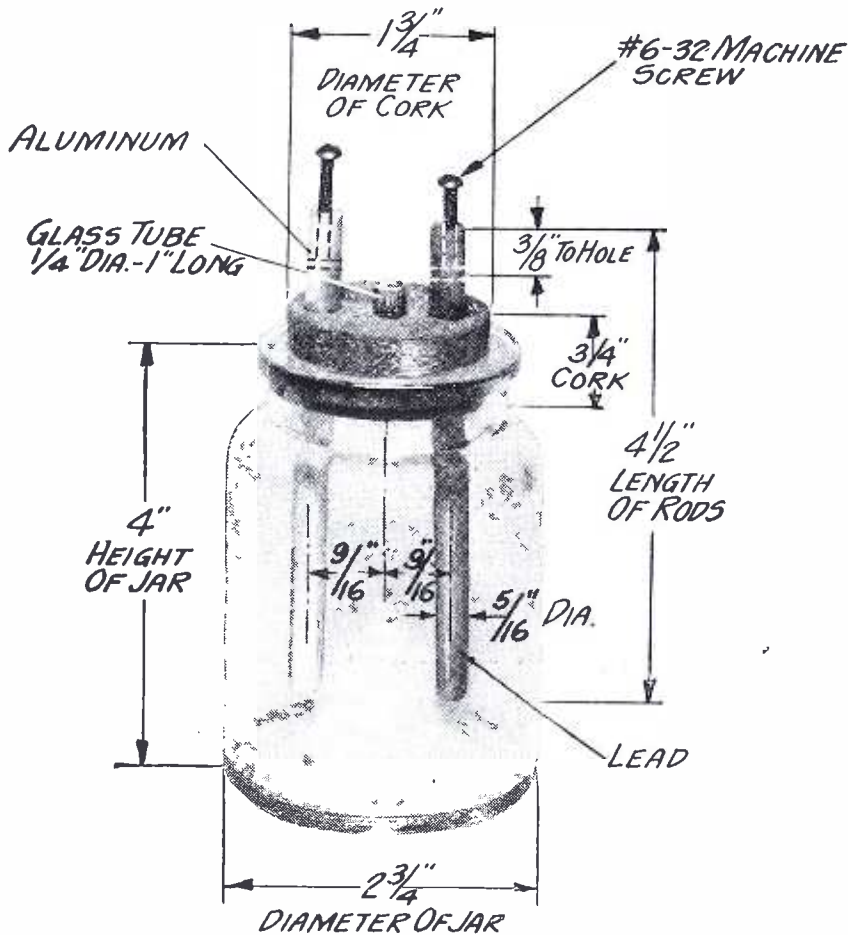

THE FINISHED RECTIFIER JAR

FIGURE 3: All the necessary dimensions are given here for the assembly of a rectifier jar. Complete constructional data are given in the accompanying text.

jars. The vessel used for mixing the solution may be an earthenware crock or an enamel pot. In making the solution for the model rectifier constructed in the laboratory two glass bottles, each of a gallon capacity, were used. These are convenient because the bottles can be picked up bodily and shaken, thus mixing the solution thoroughly, and can be corked up while the solution is settling, thus keeping the dust out.

The solution used is made up of six quarts of distilled water and the entire package of borax. If the water is heated in a clean vessel before adding the borax it will be found that the borax will dissolve more rapidly. However, it is not necessary to heat the water. Mix the solution thoroughly until all of the borax has dissolved (if the water is hot) or until no more will dissolve. Then set the solution aside for twenty-four hours, during which time the excess borax will settle to the bottom, or crystallize on the bottom and sides of the vessel. It is only the clear liquid that is used in the rectifier, so in dipping or pouring the solution from the vessel try not to disturb the settleings. Do not become impatient and use the solution in less than twenty-four hours, because this will result in a creeping crystal formation in the

rectifier jars which is decidedly messy and unattractive in appearance.

Now comes the cleaning process. The jars and corks should be washed in warm water with soap, then thoroughly rinsed in clean cold water. Then they may be set aside.

The cleaning of the metal elements is perhaps the most important job of all. In an earthenware, china, glass or enamel vessel, mix one-quarter of a can of lye in about two quarts of boiling water. Do not use a metal pot for this purpose and do not use enamelware if the enamel is chipped. Also be very careful not to get any of the lye solution on the clothes or hands, as it will eat almost anything it comes in contact with. Treat it with as much respect as you would a powerful acid. Do not use it indoors if this can be avoided, as there are some fumes from the mixture which are unpleasant to breathe and will tarnish silver and other metals which may be in the

Clean the metal elements one at a time, finishing all the aluminum pieces before starting with the lead. Hook a wire through the hole in one end of an aluminum element and lay it in the lye solution until it froths violently. Then remove it and rinse in cold running water. Rinse it thoroughly, and lay it out on a clean

piece of cloth or paper. It is important not to let the cleaned aluminum come in contact with the hands or anything which will permit it to collect grease or dirt. When the aluminum has been cleaned with lye it should be a light silver color, almost white. If it is not, it is an indication that the aluminum is not pure and is unfit for use in a rectifier.

Next clean the lead elements in the same way, using the same solution. The lead will not froth as did the aluminum. There will be no visible indication of the cleaning process on the lead. Simply let each piece rest in the solution for about twenty seconds; then remove, wash and lay out on paper as with the aluminum. Do not let the lead come in contact with the aluminum, however.

Everything is now ready for assembly of the jars. To insert the elements in the corks, wrap a piece of clean paper around the lower end of the element to protect it from the fingers and force the top end through one of the holes in the cork. An aluminum element goes in one outside hole and a lead element in the other. The glass tube is placed in the middle hole, as explained above. When the two elements and glass tube have been placed in the cork the whole cork is inserted in the neck of one of the bottles, which has been filled almost to the neck with the borax solution. The jar is then completed and should look as shown in Figure 3. The lower ends of the metal elements should be at least $\frac{1}{2}$ -inch from the bottom of the bottles.

When the twenty-four rectifier jars have been completed thus far, they must be formed. This is most conveniently accomplished by simply connecting them up in the circuit in which they are to be used, as shown in Figure 4.

When the alternating current input to the transformer is turned on with the rectifier connected across the transformer secondary, there will be a momentary rush of current through the rectifier circuit. This current will be reduced to practically zero within a few seconds, however; an indication that the rectifier is starting to form.

It is well to leave the rectifier connected in this way for a few hours, as an aid to the forming process. Then it may be connected up to the transmitter. The forming process will continue in the ordinary operation of the transmitter thereafter.

It may be found that one or perhaps more of the rectifier jars does not function as it should. One test for this is to measure the voltage drop across each jar with an ordinary DC voltmeter. Measure one cell at a time. If any of them show no voltage they are defective and should be removed from the circuit. It will be found that the voltage across some jars may be only half that across others, but these may be left in the circuit. Any that are lower than half the voltage of the highest should be removed. These may either be made over with new solution and new aluminum electrodes, or they may be left out entirely, as eighteen or twenty jars are sufficient where the transformer voltage rating is between 500 and 600 on each side of the center tap.

The above description covers a rectifier suitable for an input of 600 volts to each half of the rectifier. For use with a transformer having an output of 1,000 to 1,200 volts each side of the center tap a minimum of thirty-six rectifier jars should be used, eighteen in each half. In any case it is well to make up a few extra jars so that defective ones may be weeded out

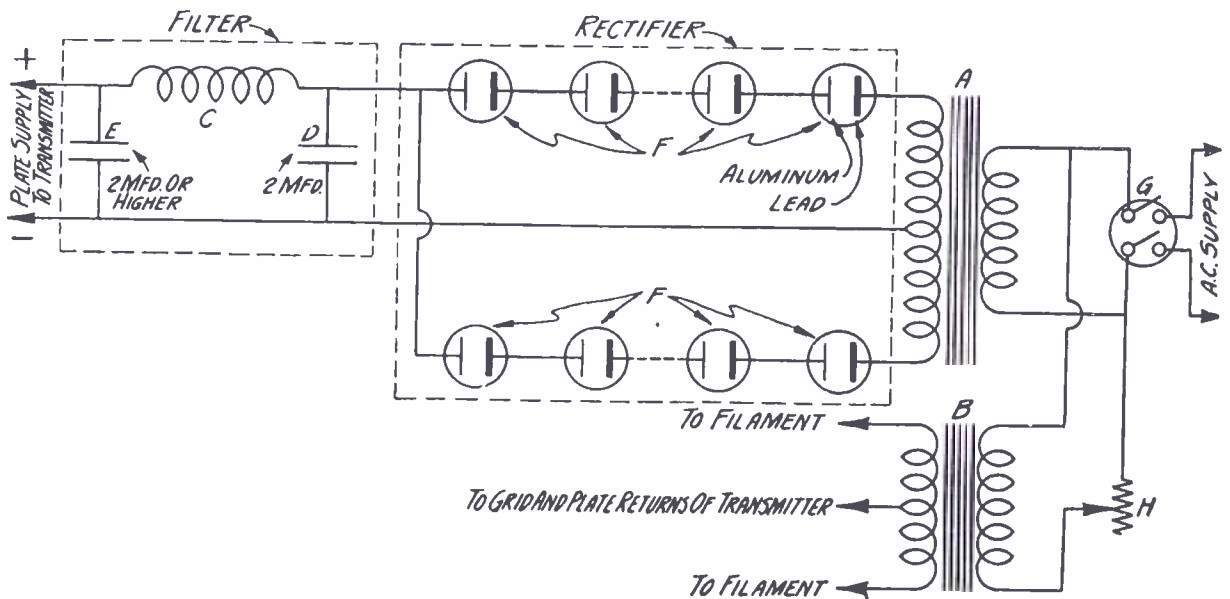

THE DIAGRAM OF THE POWER SUPPLY UNITS

FIGURE 4: The transformers, rectifier and filter are required to furnish a pure DC input to the transmitter, where the alternating current house lighting lines are used as the source of power. In "forming" the rectifier jars this circuit may be used without connecting the filter output terminals to the transmitter, or "forming" may be accomplished with the output connected to the transmitter. In the rectifier portion of the diagram only eight jars are shown. This, of course, is not the number actually used.



Balancing the Single control Superheterodyne

Some means of controlling the filament are necessary with one end of the filament. This is accomplished by the effect of throwing the filament center off center. The filament voltage should be

adjusted to the proper value. This is done by turning the filament control knob. The filament voltage should be adjusted to the proper value.

Then attach a small dial to the shaft of the rear condenser.

Next set the small vernier condenser so that its rotor plates are about one-third meshed.

Now tune in a broadcasting station the same way as with any two-control superheterodyne. It will be noted that when the loop is tuned to the incoming signal it will be possible to hear the station at two different settings of the oscillator condenser (rear). The lower of these two points is the one that should be used.

When the station has been tuned in with maximum signal strength, tighten the set screws in the connecting collar and the receiver will be ready for operation with the single control.

It is advisable to balance the condensers on a low-wave station. A good check may then be obtained by tuning in another station at the other end of the scale. If this is found possible (it will probably be necessary to adjust the vernier condenser slightly) the receiver is properly balanced.

If, however, it is found that stations at the other end of the waveband cannot be tuned in properly, even with the use of the vernier condenser, try rebalancing the condensers with a medium wave station, say around 380 meters. The leeway allowed in the capacity of the vernier condenser should be sufficient then to permit tuning in high or low wave stations.

When it is necessary to use the vernier condenser to tune in a station with maximum volume the main tuning dial should be readjusted

after each movement of the vernier condenser.

As in the case of all condensers, zero setting is obtained in those of the straight-line-frequency type when the plates are unmeshed. With the condensers specified for use in this superheterodyne receiver, however, capacity should be increased by turning the rotor in a clockwise direction, as shown in Figure 1. Never turn the rotor in an anti-clockwise direction from the zero point when using these particular condensers because then it will be found that the low-wave stations all fall within a very small band on the dial scale. If operated properly, that is, in a clockwise direction, it will be found that the low-wave stations spread out over a goodly portion of the dial scale. This is simply another way of saying that the straight-line-frequency effect is obtained only when capacity is increased by turning the rotors in a clockwise direction.

It is also essential in balancing the condensers that both be turned somewhat clockwise from the zero point. Unless the rotors are both meshed on the same side of the condensers, the capacity of one condenser will be increased while that of the other is decreased, after the two have been coupled together to be operated by the single dial. In that case, of course, the condensers will not be balanced on any wavelength except the one on which the balancing process was carried out.

—S. GORDON TAYLOR



Kadel & Herbert

"WITH MUSIC BY THE HOTEL SAVOY ORCHESTRA"

By the simple but ingenious idea of installing a receiving set on his coffee stand, this humble restaurateur furnishes his guests with the same music as is enjoyed by the patrons of London's swaggar hostelry.

BROADCASTS

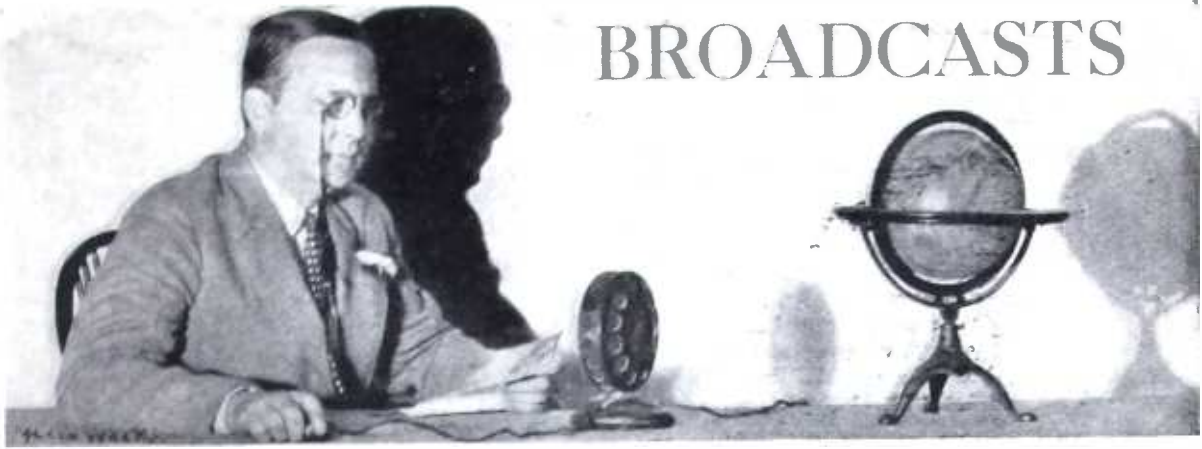

CONDUCTED BY J. ANDREW WHITE

In this department the Dean of Broadcasters whose voice is known to millions of broadcast listeners—records items of interest and value to all radio fans everywhere.

Will Wavebands Supplant Street Bands?

It appears that the thrill that comes once in a lifetime to the small boy is to become even more rare in occurrence, with the possibility in sight that the brass bands which have since time immemorial headed street parades are to disappear from the leading position of these processions. Such a fell blow at tradition landed in Chicago recently, it is reported, when KYW transmitted band music so successfully to the open air parade which opened the 1925 National Radio Exposition that the marchers completed their procession along Michigan Avenue to the home grounds without the aid of the customary marching musicians. The parade carried with it a number of radio receivers and powerful amplifiers which supplied the full volume of brass so clearly that another pioneering achievement in a new field for radio was voted a complete success.

* * *

A Princely Tribute to a Radioman

IN the reports of the rousing welcome which was extended to the Prince of Wales when he arrived home after his 25,000 mile voyage to South Africa and South America, considerable space was devoted to the manner in which the heir to the British throne recognized personal services of the officers and others in the official party and the distribution of numerous gifts and souvenirs. Yet that which was probably the most considerate act of all received scarcely any notice. It was the speeding up of the battle cruiser *Repulse* so that she would arrive at Spithead earlier than originally intended, in order that a young radio operator on board the vessel would be enabled to attend the funeral of his father, who died at London several days before the returning voyagers were

due home. The operator was the son of Fred Bramley, Secretary General of the Council of the Trade Union Congress.

“Rag Chewing”—by Radio

THE ability to carry on a successful half-hour's conversation appears to be the sole requirement for membership in the novel organization known as the “Rag Chewer's Club,” but when it is added that this must be accomplished by radio and the friendly confab over the ether waves directed to and maintained with one who is already a qualified member, then it is understood why those who have accomplished the feat compose an honorary group of the membership of the American Radio Relay League. The unique fraternity of amateur radio men has already enrolled several thousand enthusiasts in the few months of its existence, and the roster shows that there are friendly conversationalists of the requisite ability in every state in the Union, in every province in Canada, and that six countries in Europe and Asia are represented.

Heat, Light and Power via the Ether?

CONCURRENT with the announcement of the amateur half-hour air talkers organizing themselves, comes word from London that science is scheduled so to improve things that the very foundation of this particular organization is threatened. That is, if we are to take seriously the prediction of Professor A. M. Low, who is quoted in the daily press as saying: “The demand for speed and yet more speed will shorten business conversations to a matter of seconds or fractions of seconds. A few rapid facial expressions and some thought waves will serve the purpose of the present day thirty-minute conversation.”

Professor Low predicts a lot of other things, including the transmission of power by radio, because radio waves and light waves are the same; it is only a question of the length of the wave. It is confidently to be expected therefore that some day scientists will shorten the radio wave to the length of light waves, and then we will have radio light. And since heat is also a type of wavelength, he sees nothing improbable in science converting the heat at the Equator into radio waves and broadcasting them to the poles, where, of course, the process would be reversed with reconversion into heat waves. He concludes that this power "will be free like water."

All of which was current and snappy conversation when I entered the radio field more than fifteen years ago—that is, all except the part which predicts the furnishing of power free. That is new, so the item stands.

How Broadcasting Settles the Labor Problem in Venezuela

A STORY worthy of an O. Henry setting is contained somewhere within the dispatch from Venezuela, that the Government has temporarily banned radio receiving sets because they keep people there from working. It appears that Venezuela has a large number of listeners, considering its population, and many of them give up their afternoons to enjoyment of broadcasting instead of going back to work after lunch. An official ban was put on afternoon programs, therefore, several months ago, but operators on ships entering Venezuelan harbors and in private broadcasting stations in the oil belt, over whom the Government had no control, continued to send out daytime programs and to cope with the situation the Government was forced to the expedient of barring the importation of receiving sets. This has resulted in a marked increase of popularity of the owners of sets which reached the interior before

the ban went into effect, and even the smallest Venezuelan villages, it is said, have community listening-in parties.

The Effect of Radio on Home Life

IN a conference on modern parenthood held under the auspices of the Child Study Association of America at New York, radio was held to be an unmixed blessing to family life, though the automobile and the motion picture were thought to be disturbers of hearthside unity. This viewpoint was presented by Dr. John M. Cooper, associate professor of sociology at the Catholic University, Washington, D. C., whose subject was the effect of machine made recreation on family life. The topic followed a lengthy discussion of whether religion tended to unite or separate family groups into factions because of the serious problem presented to many conscientious parents, who, themselves subscribing to no given faith, yet felt that their children should receive religious training.

Bangkok Takes to the Air

BANGKOK is now broadcasting. The first important program in Siam, it is reported, was arranged by the Signal Corps of the army, with the assistance of the cavalry band, the musical selections and some news items provided by the local newspaper being received at five installations located at Hua Hin, Ayudhuz, Korat and at two of the official palaces. Satisfactory reception continued throughout the three hours scheduled for the program.

A "Minister of Communications"

CUBA may be establishing a precedent that the United States may follow in unifying its communication activities under one head. The Cuban Director of Telegraphs appears to be



Kadel & Herbert

FIFTY-FIVE WORDS A MINUTE WINS THE CONTEST FOR CODE RECEPTION
Fifty-five words a minute were received and recorded without an error by Joseph Chaplin in winning a contest in which speed and accuracy were the two essentials. The winner is the smiling operator seated third from the left.



Fotograms

THE FIRST RADIOPHONE BOOTH ON AN OCEAN LINER .

Telephone booths from which the passengers can ring up and converse with shore stations or other ships within a few hundred miles radius, have been installed for the first time on the ocean liner Berlin. The phone is connected directly with the ship's radio room where all the transmitting and receiving apparatus is located.

the administrative head of radio activities, in the new order which has created a department to handle matters pertaining to radio, telegraphy, posts, railway, ship and air lines. The Government of Cuba, a member of the international convention, controls eight commercial stations and all radio except broadcasting, which being operated for entertainment and not for gain, is permitted to be carried on in private hands. Thirty-six broadcasting stations are in operation; among the larger is that owned by the telephone company, PWX. Another is operated by the tobacco monopoly. - Only ten of the broadcasters operate with one kilowatt or more power incidentally, although Cuban call letters are familiar to American fans all over the country.

* * *

Cash Prizes for Radio Fans

A PRIZE of fifty dollars has been awarded to

a Canadian amateur as the first recognition of a suggested improvement in the reception of pictures by radio. G. J. Shadick, of Regina, Saskatchewan, was the radio enthusiast to win the first award, his recommendation being to use a blank sheet of paper on the recording or receiving cylinder of the radio apparatus, around which he proposed to wrap a sheet of ordinary carbon paper, the movements of a metal stylus over this sheet of carbon paper reproducing the writing or drawing transmitted from the sending set. The plan is an obvious improvement on the pen and ink method now in use. Two additional awards are to be made public later by C. Francis Jenkins, the Washington inventor, who has announced that prizes aggregating \$175.00 every two months will be presented to fans who offer practical suggestions which can be adopted for improving the Jenkins method of transmitting pictures by radio.

Fanatical Censors Now Seek to Ban "Indecent" Music

ALMOST any radio fan will agree that there is a lot of "crazy" music on the air these nights, but few would undertake to say that any of it is "indecent." The problem of determining that very difficult difference, however, came up recently in the capitol city of our fair land, when from a musty file of police regulations some one dug up an order forbidding "indecent music" and put it up to the Washington guardians of law and order to enforce the official "don't"—if they can agree on what it prohibits. The difficulty seems to rest with deciding whether swaying intonations are to be blamed for men forgetting home and babies, temporarily, or whether the important thing is that the tom-tommy sort of Oriental music should be confined to its point of origin, somewhere in the deserts, where, as one of the policewomen said, "the desert natives have self-respect enough to dance by themselves." At last reports the authorities were wide apart in defining a standard.

Will Radio "Standardize" Our Speech?

BROADCASTING is suggested as one means of standardizing speech by none other than Poet Laureate Bridges, in a tract of the Society for Pure English. That seems to be a good thought, so far as it goes, for radio may well be called a monitor of enunciation. But pronunciation—that is quite another thing.

Standardization there looks impossible. We all have individualisms of pronunciation, and that seems to be a good thing. After all, whether we agree or disagree with the way the other fellow says it, what does it matter? Houston in Texas and the street of the same name in New York sound entirely different when spoken by natives of the two cities, and Greenwich and Haverhill and Los Angeles are others it is immediately apparent it would be hard to get together on. Personally, it is rather a pleasant shock to me to hear someone on the air who happens to live in another part of the country pronounce a name a little differently from the way I do. I figure that he is right, and so am I, for that matter; we both understand each other, anyhow, and, after all, that is all that matters.

* * *

96 Hours of Continuous Listening In

ENTHUSIASTIC fans have made all manner of boastful claims as to the number of continuous listening hours they have put in at a radio receiver, but the most ardent dial manipulator will certainly have to sing low in the face of the claim of Mike Newman, veteran showman, who recently drove from Los Angeles in the interests of a movie film and announced on his arrival that there was no such thing as "silent hour" on the trip across country with a radio receiver mounted back of the driver's head going practically all the ninety-six hours and fifteen minutes running time required to travel 3,370 miles of the journey.



G. Crowther, England

A SHORT-WAVE TRANSMITTER THAT HAS COVERED OVER 5,400 MILES
Communication in daytime with a Rio-de-Janeiro amateur, M. Fresin, is the accomplishment of this English amateur, Herbert Hiley (G.21.H.) of Keighly, Yorkshire, England. The transmission was made with a Hartley loose-coupled circuit on a wavelength of 42 meters with 15 watts on the aerial.

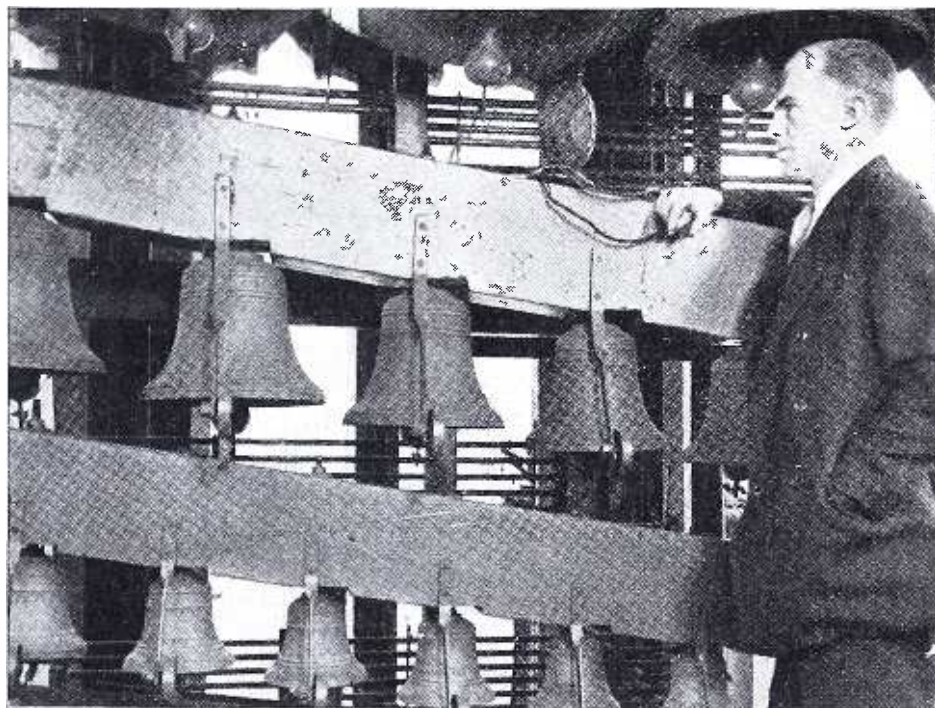

Kadel & Herbert

CHIMES THAT PEAL ACROSS A CONTINENT

By the simple expedient of bringing the microphone into the belfry of the Park Avenue Baptist Church in New York, the music of the famous carillon presented by John D. Rockefeller is now broadcast as a regular feature from Station WJZ.

Only One State Without a Station

NEVADA is the only state in the Union which now has no broadcasting station. Wyoming was out, but the licensing of the new station, KFBU, at Laramie, brings the state of large plains back to the fold.

* * *

The World Buys American Radio Apparatus

TWENTY-NINE countries of the world are now importing American radio equipment, and the estimated total for the year has been set at \$8,334,000, a new record. In the first eight months of 1925, the orders ran nearly three million dollars more than for the same period last year, with the indications pointing to Japan becoming our largest customer, with Canada and Great Britain respectively second and third.

* * *

An Amateur Radio Net to Cover the Country

AN amateur radio network covering practically the entire nation is being prepared by the Signal Corps with a view to securing the aid of some 3,000 amateurs for the establishment of additional communication channels which could be used in national emergencies and for the communication of the national guard and the reserve and civil units of the army. Those who

would like to enroll in this new auxiliary service are invited to get in touch with the Corps Signal Officer of their own area, Corps headquarters being located in Boston, New York, Baltimore, Atlanta, Columbus, Chicago, Omaha, San Antonio and Presidio, Cal.

* * *

16 Percent of American Homes Have Radio

ONE of the latest estimates of the extent of radio is that there are approximately sixteen receiving sets to every one hundred American homes, compared with fifty-two automobiles and thirty-six talking machines. Figuring on that basis the conclusion is reached that seven years more will be required for the number of radio sets to pass the number of phonographs.

* * *

All Wavelength Limitations Are Off—in Esthonia

ALL wavelength limitations in broadcasting have been removed in Esthonia, a matter which will be of some interest to designers of radio receiving equipment who have been handicapped in building sets for foreign markets which, as in the case of Esthonia, have up to now so restricted the operable band of wavelengths that the ordinary type of broadcast receiver could not be used.

Hotel Has Radio Rental Service

A RADIO service for guests has been started at one of New York's leading hotels. A six-tube portable receiver is placed in one's room on a reasonable renting basis. The sets are kept in the electrician's office and may be rented by notifying him.

* * *

Radio As a Dramatic Plot

RADIO plays a leading role in a rollicking German comedy entitled "Rundfunk." This is the first German theatrical production in which radio furnishes the principal motif. The story is that of a merry widow and an irascible widower, and also of the widower's daughter and an opera star, who are brought together through the girl's hearing the artist sing over the radio. The manner in which the audience followed the radio jargon and slang demonstrated how universal radio already has become in Germany.

* * *

The World's Radio Headquarters Without a Station

It seems strange that the radio headquarters for the world at large should have no local broadcasting station of its own, but that has been the case with Berne, Switzerland, up to recently, when a public subscription was started to raise 200,000 francs to provide for the station proposed by the Radio Club of Berne. This particular Swiss city, it may be explained for the benefit of newcomers into radio, has long been the headquarters of the International Telegraph Convention, where international

regulations are made and call letters assigned to the various subscribing nations.

* * *

Radio on Gondolas

It is reported from Venice that radio amateurs there have hit on a particularly bright idea to attract tourists to their particular crafts. Many of them, fortunate possessors of gondolas, have fitted them up with receiving sets, and go floating along the canals of a moonlit night. The effect is surprisingly romantic when turning a corner in a silently gliding gondola to hear from the next canal, wafted on the night air, some dreamy love melody from the Vienna or Italian Station.

* * *

They Take to Radio Instead of Drink

THE British workman of today prefers radio to whisky, according to Captain Charles Nicholson of the Salvation Army. "Drunkenness has been reduced by one-half during the last few years," the Captain reports, "and many public drinking houses are often empty on Sunday evenings."

* * *

Yugoslavia's First Steps in Broadcasting

YUGOSLAVIA is to have a broadcasting station, secured from Germany on reparations account. It is to be erected near Zagreb, but as there are at present only 145 receivers in the homes nearby, the radio station will be used for a time at least solely for the State. It is hoped that later it will be released for general use.

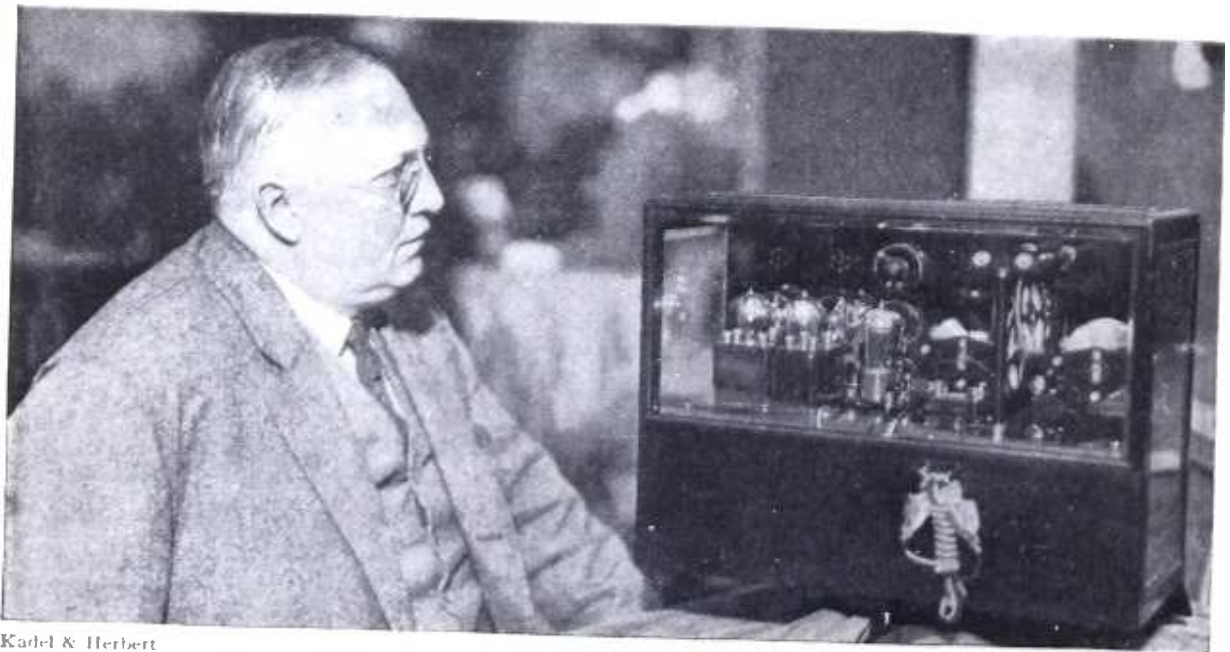

Kadel & Herbert

A GLASS-INCLOSED RECEIVER

The noted doctor and X-ray specialist, Dr. F. L. Satterlee, demonstrates a set using his circuit that is claimed to work without an antenna. The theory of operation is based upon a tuned-ground system.

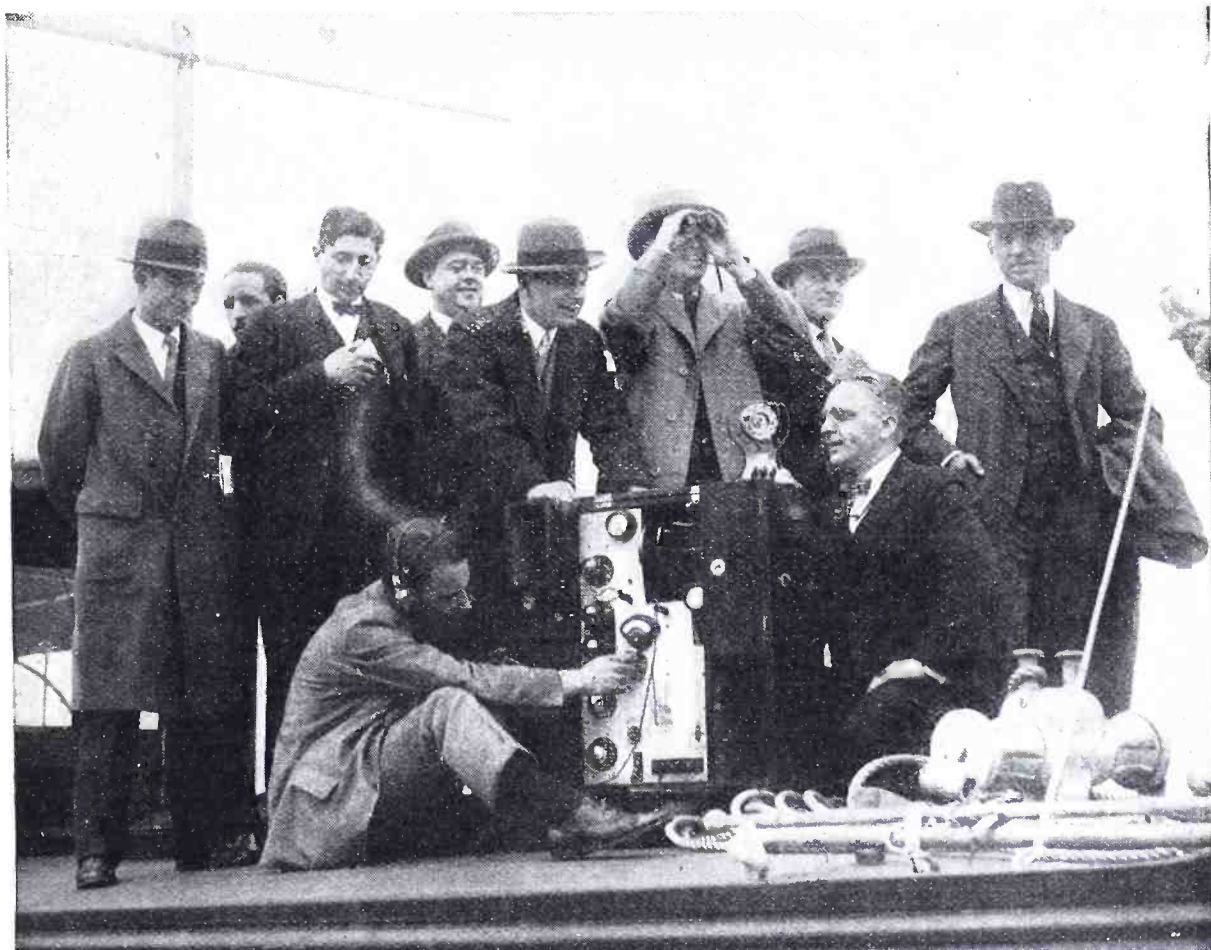

International

BROADCASTING "SIDE-LINE" REPORTS OF BOAT RACES

One of the features of this summer's regattas was the running account of the progress of the boat races, made by "radio reporters." This picture shows J. Andrew White talking into the microphone on the yacht "Elco," broadcasting through WJZ.

Long Distance Reception on Crystal Sets

LISTENING to programs broadcast from London through the long winter nights is the engaging prospect held out for owners of simple crystal sets, according to announcements made by the Radio Corporation that all arrangements have been completed for an exchange of British and American programs, at least several times a week and perhaps nightly. The music and speech will come from the new station at Daventry, seventy-five miles from London, be picked up at Belfast, Me., and retransmitted through the new WJZ station at New Brunswick, N. J., which is to be one hundred times as powerful as the present WJZ.

* * *

Californian Schools Use Broadcasting Regularly

EXPERIMENTS that have been carried on over a period of eight months at Oakland, California, have convinced the local educational

authorities that radio broadcasting is of definite value in classroom instruction. Dr. Virgil E. Dickson, head of the department for "research and guidance" in the Oakland public schools, who is carrying on this experiment finds that the subjects best suited to broadcasting are penmanship and drawing; in drawing, particularly, radio has stimulated greater originality on the part of the pupil than has instruction that is given by the teacher in person. Entirely new fields of possibility have been opened by the experiments, and a new era of educational methods may result.

* * *

The Patron Saint of Radio Fans

THE automobilists have already chosen their patron saint, who is St. Christopher. But the radio enthusiasts have not yet designated theirs. The new French publication, "La T. S. F. pour Tous," is organizing a referendum among its readers in order to learn their opinion on this subject. The first results seem to be in favor of Joan of Arc.



WITH THE INVENTORS

CONDUCTED BY WILLIAM G. H. FINCH

This department will keep you in touch with the latest inventions of interest on which patent rights have been granted, and which are significant contributions to radio art.

A Novel Cone Loudspeaker

DR. HANS SCHARF of Berlin was granted patent No. 1,540,229 for a cone-shaped loudspeaker.

In loudspeakers that employ the usual type of telephone receiver in combination with a horn, one drawback lies in the fact that not the entire surface of the diaphragm is exposed to the air. Furthermore, during its movement the diaphragm produces objectionable noises because it is rigidly held around its periphery.

In this invention these drawbacks are avoided by holding the diaphragm around its periphery in a manner that the diaphragm contacts only with some soft material, preferably rubber, and the whole surface of the diaphragm is exposed to the air.

The diaphragm disclosed in this invention moves practically freely in the air and substan-

tially parallel with its normal position. This should result in improving the quality and quantity of the reproduced sound.

The soft material, *i.e.*, rubber used for holding the diaphragm, is preferably stretched over the whole surface of the diaphragm or it may be solidly connected therewith around its periphery. Due to this provision the vibration of the diaphragm will be materially damped.

In Figures 1 and 2 these features will be noted; also that the diaphragm is cone-shaped of metal; it is entirely covered with a piece of rubber cloth. This is a feature that is not found in domestic cone-type speakers.

A New Radio Receiving System

THE Commissioner of Patents recently allowed 56 claims to Oscar C. Roos of Boston, in letters patent No. 1,545,697 covering a very novel electrical acoustic method of reducing interference and static disturbances in radio phone receivers which possesses considerable merit.

The invention relates to broadcast receiving systems and more especially to such systems whereby the effect on the signal-indicating device of electrical vibrations created in the system by abrupt or impulsive electrical forces (such, for example, as "static disturbances" or electrical vibrations created in the system by interfering signal waves), is eliminated or reduced to a minimum so that the signal-interference ratio is a maximum.

Mr. Roos has discovered that the irregular non-musical noises or non-harmonious vibrations produced by a signal-indicating device, such as a telephone receiver when the receiving system is acted upon by abrupt or impulsive electrical forces, may be converted into spatialized periodic vibrations.

In carrying out the invention, he provides means for converting the electrical vibrations developed in the receiving system by abrupt or impulsive electrical forces. The electrical vibrations developed therein by the electromagnetic waves, the energy of which is to be received into

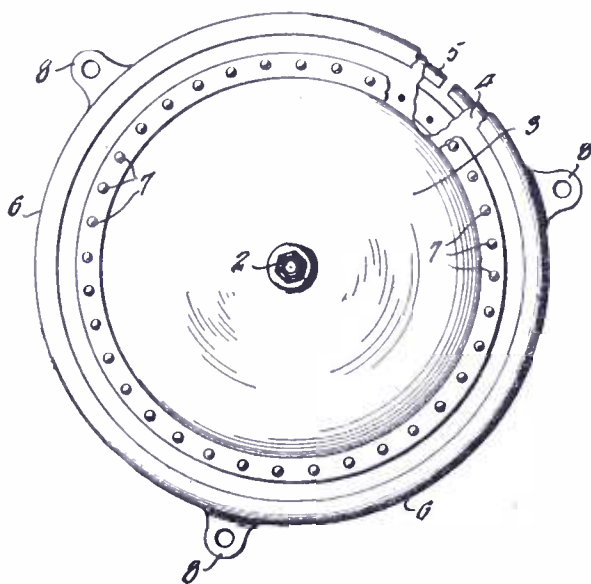

FIGURE 1: Top view of Scharf loudspeaker in which a few details of construction are shown.

dephased specialized non-electrical vibrations, such, for example, as sonorous vibrations produced in an air column, and an apparatus so associated with such means that the amplitude therein of the non-electrical vibrations resulting from the waves, the energy of which is to be received is large compared to the amplitude therein of the non-electrical vibrations resulting from the abrupt or impulsive electrical forces, and a signal-indicating device associated with said apparatus. The non-electrical vibrations which pass into the apparatus may be converted into electrical vibrations by any suitable means, and in such case a signal-indicating device is operatively connected with such means.

The invention comprises means for converting the irregular complex noises produced by a signal-indicating device (such as a telephone receiver) when the receiving system is acted upon by abrupt or impulsive electrical forces into well defined steady acoustic vibrations of any convenient pitch. This means consists, for example, of a resonant air chamber so designed that when the confined body of air therein is shocked into vibration at its own period, an acoustic vibration different in pitch from that of the signal will be produced, the pitch of which signal is under complete control of the operator by means of the heterodyne. The complex sound, consisting of the acoustic vibration produced by the signal waves and the non-musical noise produced by the electrical disturbance, which is introduced into the air chamber, will produce a resultant complex vibration which is the sum of its components, but which, when of audible pitch, is different in sound from either.

The invention also comprises a means for spatializing the two sound waves that make up the resultant acoustic vibration, such means being, for example, a resonant air-chamber of such dimensions that the two sets of vibrations will produce stationary sound waves. These, being of different frequencies, will be dephased. Means are provided for picking up the stationary

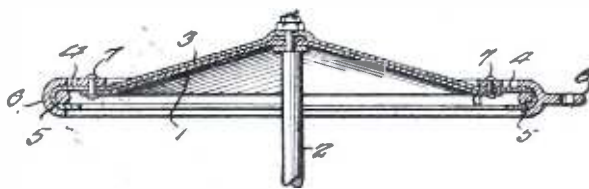

FIGURE 2: Cross section view of the new Scharf cone-type of loudspeaker.

sound waves produced by the signal waves at a point where the amplitude thereof is large compared to the amplitude of the stationary sound wave formed by the electrical disturbance; for example, at a pressure loop of the former and a pressure node of the latter.

Having separated two sets of sound waves and picked up a portion of the energy of the stationary sound wave formed by the signal vibrations, use may be made of it for producing the signal or one may employ apparatus such as a radio transmitter for reconverting such sound waves into electrical vibrations, and transmit the latter to a radio broadcast receiver. By transmission through several stationary-wave separating devices in succession, further separation of the signal and interference vibrations may be affected.

It is also contemplated to use a sound reflection or refraction device whereby the sonorous vibrations produced by the signal waves after separation from the sonorous vibrations produced by the electrical disturbances may be concentrated on the apparatus which reconverts them into electrical vibrations.

It will be obvious that the principle underlying the invention may be embodied in a great variety of apparatus and that various circuit arrangements may be employed in connection therewith for converting the energy of electromagnetic waves into sonorous vibrations at one end of the apparatus and for converting sonorous vibrations into readable signals at the other; and

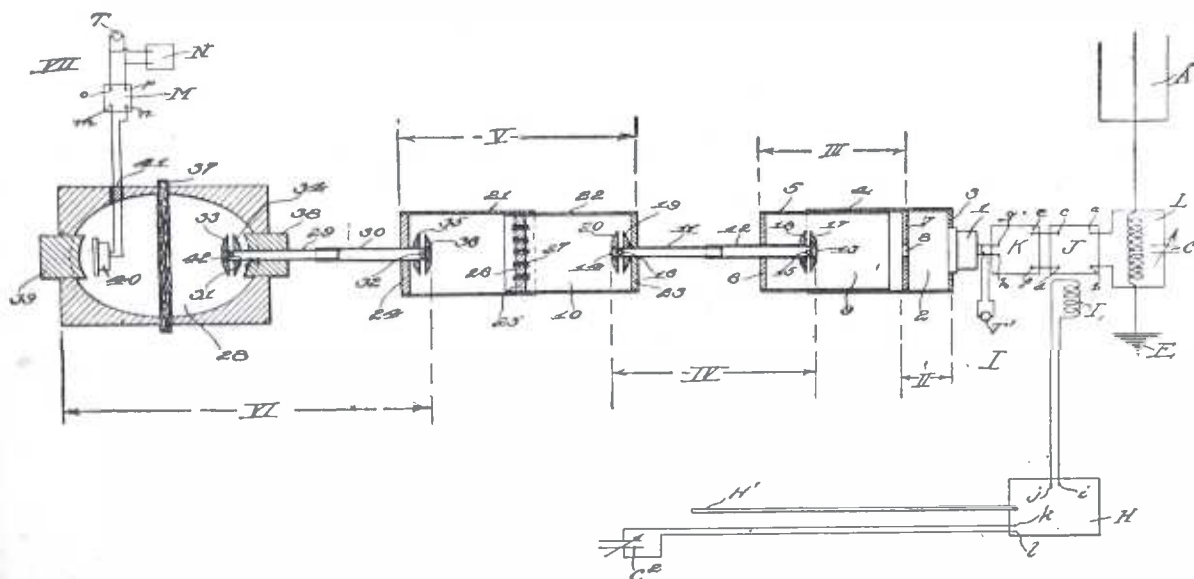

FIGURE 3: A schematic diagram of the Roos radio receiving system. It is a very novel electrical acoustic means for reducing interference and static disturbances and possesses considerable merit.

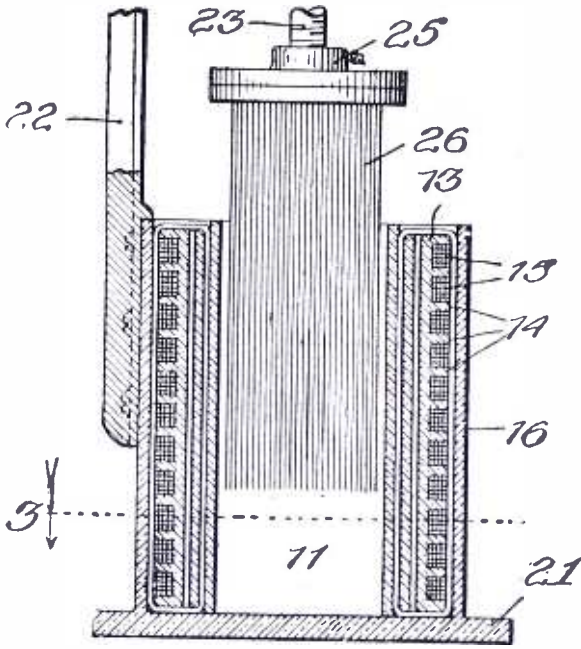

FIGURE 4: This shows a cross section view of the Sandell radio frequency transformer; the movable feature of the iron core may be seen in the above diagram.

therefore, it will be understood that the several embodiments of the invention described are illustrative merely and not restrictive.

A Radio Frequency Transformer

A NEW design in radio frequency transformers is shown in patent No. 1,541,398, issued to Henry K. Sandell of Chicago, Ill. It is particularly adapted to be used for radio frequency amplification in radio receiving sets.

A feature of this invention is the design (see Figures 4, 5 and 6) the construction of which provides a radio frequency transformer in which the iron core is movable and the de-saturation time of the iron is varied. By properly choosing the values this time may be brought into step or resonance with the natural period of inductance of the secondary coil.

The primary is aperiodic and the secondary is periodic or resonant for the present broadcasting frequency band. In other words, varying the iron in the core varies the frequency of the secondary coil so that by this means the resonance of the circuit in which the secondary coil is placed may be tuned. When this occurs the strength of current that flows in this coil is greatly increased. The relation between the soft iron core and the secondary is very sensitive to small changes in either, while relatively large changes in the primary are permissible without materially altering the operation of the transformer.

If desired short pieces of the soft iron wire may be embedded in a non-magnetic substance to form the movable core and by properly proportioning this the wires 12 (Figure 6) may be omitted altogether from the final design or assembly.

A New Crystal Detector

FERDINAND SCHNEIDER was recently granted U. S. Patent No. 1,549,926 for a new crystal detector.

His invention relates to that class of receiving devices for damped or undamped electric waves, on which a gap between electrodes is bridged over by means of a preferably spherical member of wave-reactive material, i.e., a crystalline substance which is responsive or sensitive to electric waves; for example, silicon, molybdenum glance, pyrites, carborundum or the like, said wave reactive member being subjected to pressure.

He has found that members composed of such wave-reactive material have not a uniform sensitiveness throughout, and therefore make these members movable along the electrode gap, preferably by means of rotation around their centers; this insures that the most sensitive points of the wave-reactive member or members can be brought in contact with the electrodes.

Another feature of the invention is that the

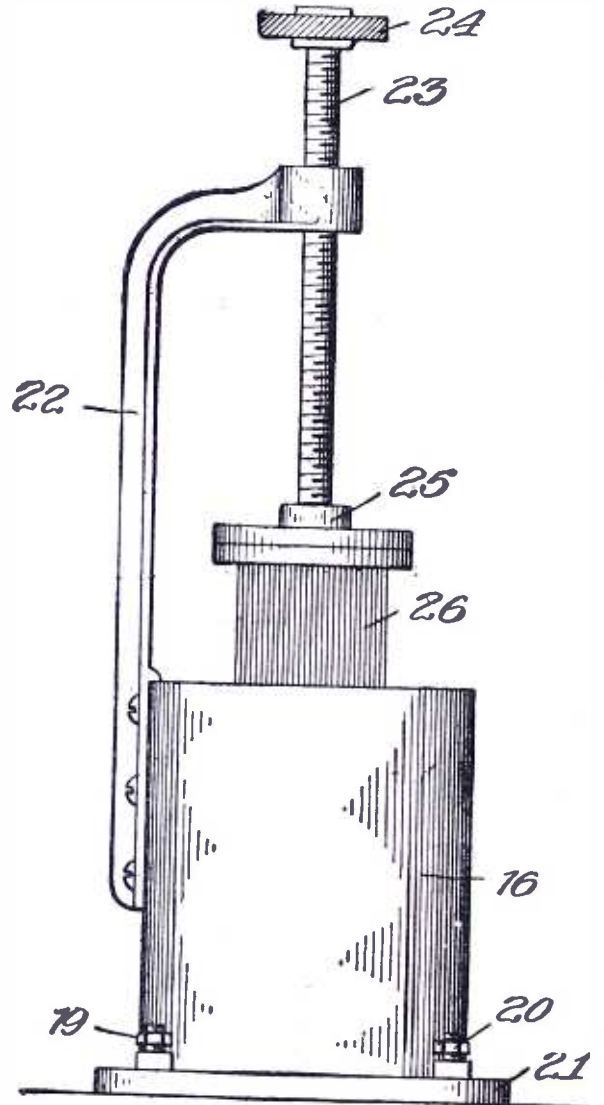

FIGURE 5: Is another view of the Sandell transformer, completely assembled; in this diagram can be noted an important detail—the means for adjusting the iron core.

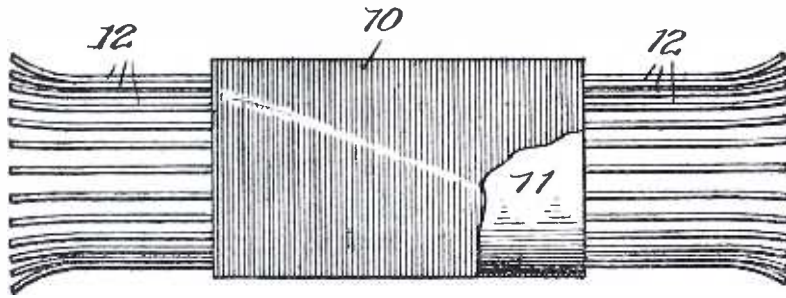

FIGURE 6: This shows the iron core assembly.

pressure exerted on the wave-reactive member or members is made adjustable so that the effect may be increased. By roughening the edges of the electrodes in contact with the wave-reactive member, or by bending electrodes of sheet metal, the inventor increases the number of points of contact and finally forms the wave-reactive member or members from the most wave-sensitive parts of the reactive substance, which he ascertained by previous experiment. By this means the specific resistance is considerably reduced, so that weak-current relays connected up can be used without the hitherto necessary intensifiers or extra sources of current, because speeches or sounds are received with a more powerful clear tone.

A New Vacuum Tube Socket

IN patent No. 1,547,729 issued to William T. Booth of Brooklyn, N. Y., is disclosed a new and improved form of tube socket structure to be used in vacuum tube sets and telegraphy and telephony.

An object is to provide an improved socket structure so that a socket in use with one form of set and adapted to be used with one type of tube, cannot be used with any other type of tube while in that particular use.

Another object is to so construct the socket structure that the new element added which constitutes the invention, may be readily adapted to or removed from the socket structure.

In the ordinary vacuum tube socket the tube fits by means of a bayonet and lock-joint into the socket, the terminal plugs at its lower end slightly contacting with a plurality of terminal springs. In the ordinary tube these terminal plugs on the base of the tube are definitely positioned angularly with respect to the bayonet pin also on the base, and similarly the terminal springs on the socket are definitely positioned angularly with respect to the bayonet lock so that when the tube is in position definite terminal springs will contact with definite ter-

minal plugs on the tube. In order to adapt a socket for use only with one type of tube, this invention comprises the provision of a plate of insulating material which is interposed in a plane between the terminal springs and the plane of the base of the tube when in position in the socket. This plate is provided with suitable apertures which are definitely placed angularly with respect to the bayonet slot of the particular socket to which it is adapted, so that the terminal plugs only of the tube which is to be used with this socket will properly fit the aperture in the above-mentioned insulating plate and thereby pass therethrough to make contact with the terminal springs.

A New Inductance Coil and Tuning Methods

FRANCIS DE WILLY of Los Angeles, Cal., was recently issued Letters patent No. 1,549,247 for improvement in "Inductance Coil and Tuning Methods." One of the objects of the invention is to provide a transformer for an electrical circuit or radio apparatus which is exceptionally efficient in operation in comparison with the present type of transformers.

Other objects of the invention, as set forth in the patent, are to provide a transformer operating to prevent re-radiation of energy from the receiving apparatus; operative to absorb or take up a maximum signal strength; operative to reduce the outside magnetic field around the transformer and thus eliminate undesired coupling with other units of the receiving system; and operative to provide a coupling for a radio apparatus tending to stabilize the action of the apparatus and to increase the range and signal strength.

Another object is to provide a simple form of detecting circuit for a wireless receiving set, operative to efficiently amplify signals received while providing a sharp tune and stable apparatus which may be constructed at a low cost.

A Cardinal's Impression of Radio

"BY common consent, radio is a force of immeasurable potency. It will unquestionably affect the history of humanity as electricity and steam and the printing press have affected it. We may say, in a certain sense, that radio surpasses these and other agencies, for it is able to influence millions of people scattered over the earth profoundly, instantaneously. It is one of the greatest powers that man has ever had in his hand."

—CARDINAL HAYES



LISTENING IN

PRACTICAL pointers from experimenters and broadcast listeners. What helpful hints can YOU offer to your fellow fan? Readers are invited to address their letters to the editor of this Department.

CONDUCTED BY LLOYD JACQUET

How to Avoid an Uneven Battery Drain

I NOTICE that when my "B" batteries have reached the point of recharge, it is usually the first 45-volt battery that is discharged first.

A little curiosity enabled me to find out why this was. By studying the diagram of con-

or so. But a mistake is made when 45 volts are fed the detector tube, for the drain increases one hundred percent.

If you want to make the first "B" battery last as long as your other batteries, reduce the extra drain on it as much as you can by using minimum voltage of the detector tube, consistent with good results.

It might, in fact, be a good idea to change

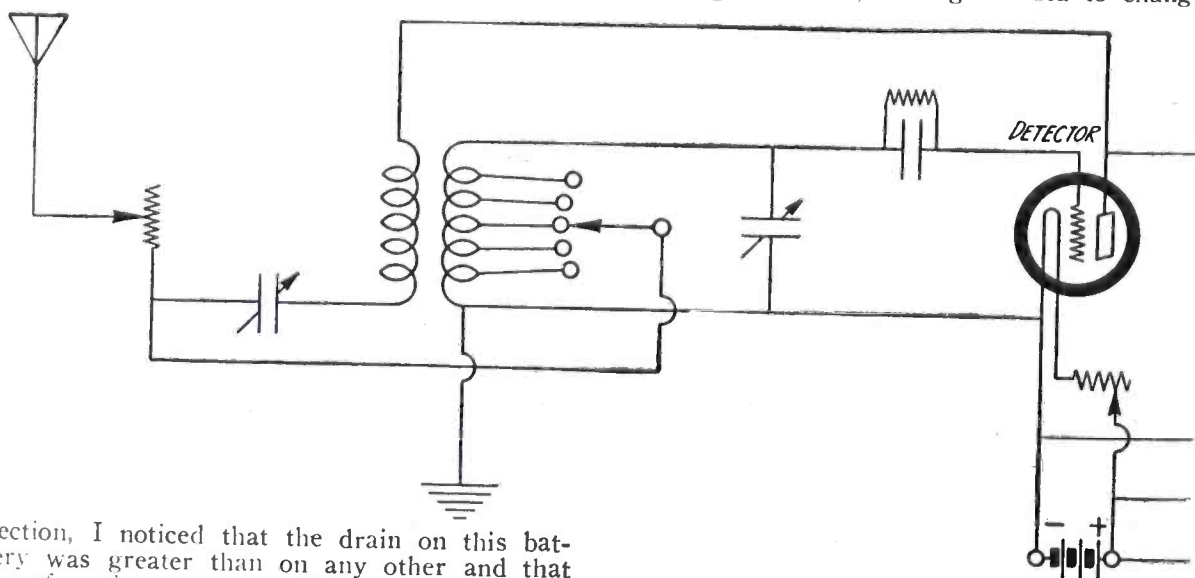

nection, I noticed that the drain on this battery was greater than on any other and that therefore its energy would be used up in a smaller unit of time, as compared with the other batteries.

Indeed, I can see that besides supplying energy for the detector tube, through the tapping of the first $22\frac{1}{2}$ volts, and being connected in the plate circuits of the amplifying tubes, this battery is being overloaded this much more. If the voltage is only $22\frac{1}{2}$ perhaps the current drain is low, of the order of $\frac{1}{2}$ milliamper

THESE $22\frac{1}{2}$ VOLTS ARE SUPPLIED BY A HALF OF THE FIRST 45 VOLT BATTERY ALREADY SUPPLYING 90 VOLTS TO THE AMPLIFIERS.

the position of the first and second sets of batteries occasionally.

—ED DOWNING, *Brooklyn, N. Y.*

* * *

Short Waves On a Crystal Set

THERE are many short-wave broadcasting stations now operating which have programs just as interesting as the longer-wave stations. In fact, some of these short-wave programs are repetitions of the original broadcasts.

Most broadcast receivers are so designed that they will not tune below 250 meters. For those who are curious yet who do not feel as though they want to invest much money in the reception of short-wavelengths, the crystal set offers great possibilities.

A crystal receiver can be built with odds and ends about the house. Get a variable condenser, a discarded coil, and a crystal detector. The circuit can be completed by means of a few small fixed condensers. The hook-up is simplicity itself. One of them was given in POPULAR RADIO for May, 1922.

Wind only 30 to 40 turns of wire on the coil. Use your present antenna if you so desire, although a shorter one would be better. Then, some evening when it is getting late, turn off your regular set for the crystal outfit and listen in. With the big stations using super-power, crystal reception is a possible thing within fifty to one hundred miles of the station.

—HARRY BRANDE, *San Francisco, Cal.*

* * *

What I Found About Grid-leaks

RECENTLY I had occasion to try out a friend's grid-leak for him, while he was building his own set, a one-tube affair. I noticed how much better his grid-leak operated than my own. I procured a new one, but it didn't function as well as that of my friend.

I bought one dozen of them, assorted in sizes. I tried every one of them, but with little difference in efficiency than the original one in my set. I found three or four of them, however, that really made a big difference in my receiver.

It has been my experience that grid-leaks are not always uniform, either in resistance reading, or in performance. Unless an excellent make is used, you can never be sure of the resistance value. This, however, has little to do actually with the actual performance of the unit.

Have a variety of grid-leaks on hand and experiment to find the best one. Not any old grid-leak will do. It is sometimes necessary to go through a bunch of them to get a few good ones. Buy only the best you can afford.

—C. STEVENS, *Trenton, N. J.*

* * *

Fieldless Coils

I HAVE already seen diagrams and articles referring to the use of the new types of coils, known as the "toroid," "doughnut," and other similar names, in which the constructor was shown to place these coils at right angles to each other.

In the old days of cardboard coils, inefficient condensers and leaky transformers, such precautions were imperative. But since these coils are supposed to be built to do away with the very nuisance that the writer of the article warns against, it isn't necessary to locate these coils at right angles to each other.

Such construction proves bulky and difficult in many cases, and nothing is achieved by it. It is of far more importance to remove from any winding the metallic masses of transformers, condensers and other units, which would create a real loss if placed too prominently in the electromagnetic field of a coil.

—JOHN L. SAWYER, *Kansas City, Mo.*

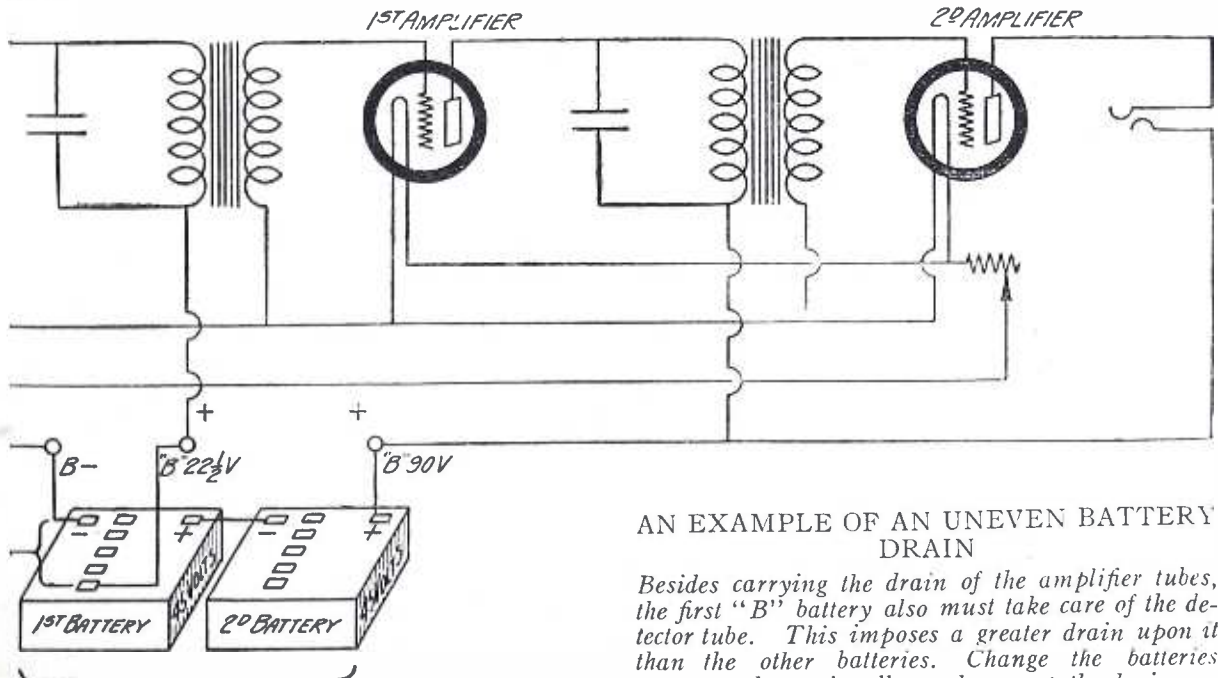

AN EXAMPLE OF AN UNEVEN BATTERY DRAIN

Besides carrying the drain of the amplifier tubes, the first "B" battery also must take care of the detector tube. This imposes a greater drain upon it than the other batteries. Change the batteries around occasionally, and even up the drain.

THIS AMOUNT (90 VOLTS) IS SUPPLIED BY TWO 45 VOLT BATTERIES TO THE AMPLIFIERS.

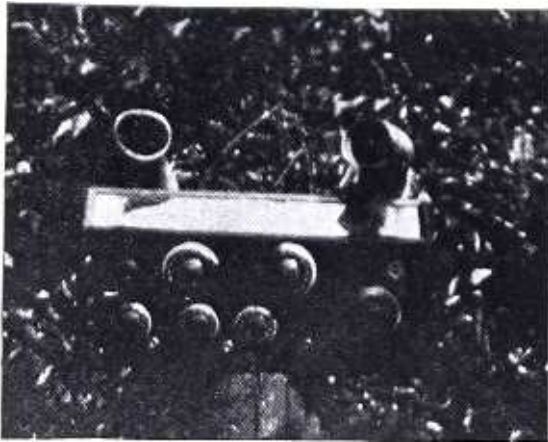

COW HORNS AS LOUDSPEAKERS

These cow horns, fifteen inches in length, make up the loudspeaking part of this radio set. Even if they do look like periscopes, they add an odd tone to any radio installation.

* * *

A Novel Home-made Horn from the Farm

ALTHOUGH nearly every possibility for the design of radio loudspeakers has been thought of, here is a new idea that has many merits beside originality.

The cow horn, because of its very substance, is clear-toned, and solid. The making of a good loudspeaker unit for radio use out of a pair of cow horns is simplicity itself.

First secure a pair of horns; this will not be difficult if you live on a farm. Cut the tips of the horns off with a hack saw and at a point where the opening thus provided will fit into the hole of a telephone earpiece. By means

of sealing wax or cement, the horns are fastened to the earpieces.

If the horns are big, like the ones shown in the illustration, the effect when the set is turned on will be most pleasing.

To add a touch of artistry, the interiors of the horns may be gilded, and a decorative rim placed on each. The horns work very well on this five-tube set.

—LOUIS YASSEN, *Chicago, Ill.*

* * *

How to Handle Glass in Your Set

GLASS is being used to a large extent by experimenters who build radio sets. Because glass is such a good insulating material, it probably would be even more extensively used were it not for the fact that it is hard to work.

How to drill glass has already been told in POPULAR RADIO, but many set builders have had the experience of cracking a finished glass panel in the assembly of instruments.

Glass will not stand as much strain as other materials used in radio work, such as hard rubber, bakelite, fiber and others. But if the strain is eliminated or relieved there is less danger of breakage. One way to relieve this strain is by using care (when two or more mounting screws or nuts are located on a piece of apparatus) that one screw is not brought down tight first, and the others pulled up afterward.

When two or more screws or nuts are required for mounting a piece of radio apparatus, tighten up slightly on each screw or nut consecutively until all are brought up tight. This hint is good not only when working glass, but is advisable in any case where it is necessary to eliminate the possibility of strain or breakage.

—W. A. FRICKE, *Chicago, Ill.*

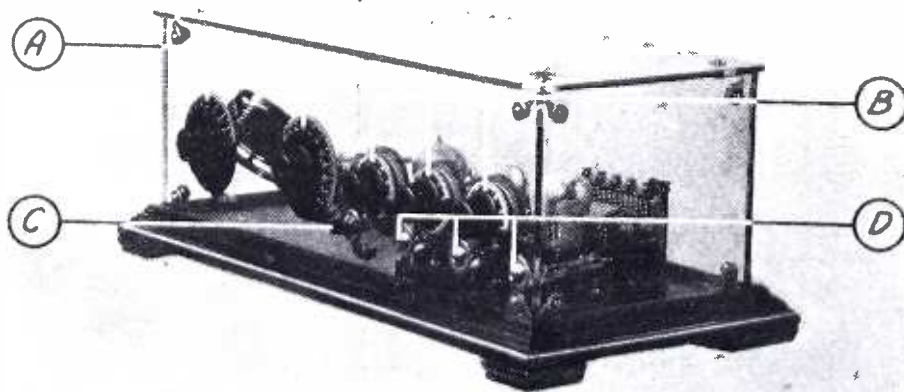

A HOME-MADE SET ENCLOSED IN A GLASS CASE

Glass is particularly attractive when it serves to enclose the components of a radio set. Here is the work of a Chicago firm, who can drill glass and prepare the holes, with bushings for mounting the instrument without breakage.



60
 "Your Dials Bother Me
 Like the Devil"

That's what an enthusiastic Micro-Dial listener wrote us after his first night's experience. And his bother was STATIONS.

Stations he had never heard before—or even heard of! Stations that came in so fast that he hadn't room for them all in the gaps he had left in his log book! Stations that kept coming long after his bedtime hour had passed!

Read the simple story of what Micro-

Dials did for this broadcast listener, as he told it to us, over his own signature.

Write for our folder, "Your Dials Bother Me Like The Devil." We will send it postpaid to any address.

Better still, get the folder from your Jewett Dealer. Read it on the spot and take your Micro-Dials home. You can install them yourself without drilling or sawing, and using no tool but a screwdriver.

JEWETT RADIO & PHONOGRAPH COMPANY
 8000 TELEGRAPH ROAD PONTIAC MICHIGAN

Factories: Allegan, Michigan — Pontiac, Michigan

In Canada

Jewett Radio Phonograph, Ltd.
 Waterbury, Ontario

Quality Broadcasting in March
 Jewett Products—Station WJW

Export Sales Office

110 Broad Street, New York, N. Y.

The Jewett
Micro-Dial

© 1932 Jewett Radio and Phonograph Co.

All apparatus advertised in this magazine has been tested and approved by POPULAR RADIO LABORATORY

What a Definite Policy Proved

It is the policy of the Daven Radio Corporation to manufacture precision products which permit of no deviation. Daven Resistors and Grid-Leaks are guaranteed within 10% of rated value — Sleeper says we do better.

Daven

M. B. SLEEPER, Inc.
TECHNICAL PUBLISHER
52 VANDERBILT AVE
NEW YORK

Radio Engineering Magazine

Books of Technical Accuracy for Experimenters

July 14th,
1925.

Daven Radio Corp.,
158 Summitt Street,
Newark, N.J.

Dear Mr. Frasse:-

I gave myself a very pleasant surprise last evening. After reading Ghirardi's story about the method you employ in the manufacture of gridleaks, I thought just for fun that I would check up on you. Accordingly, I measured about fifteen Daven gridleaks of various sizes and found, much to my surprise, that every one that I tested was within 5% of the rated value.

It is very encouraging to think that, slowly, we are getting production on some parts, at least, to a point of perfection where it is possible to put the device in a circuit and know that it will do what the label says it should do.

Cordially,
M. B. Sleeper

M. B. Sleeper-MGM

* In March, 1925 issue of Radio Engineering



THE RESISTOR MANUAL is the handbook of Resistance Coupled Amplification. At dealers' 25c. By mail, postpaid 30c.

DAVEN PRODUCTS ARE SOLD ONLY BY GOOD DEALERS

----- "CLIP THIS COUPON" -----
 DAVEN RADIO CORPORATION,
 153 Summit Street, Newark, New Jersey
 Please send me the following on Resistance Coupled Amplification:
 Check one. Resistor Manual. 30c is enclosed. Complete catalog (free).
 Name

"The Sine of Merit"
DAVEN RADIO CORPORATION
Resistor Specialists

Newark

Reg. U. Pat. Off.

New Jersey

THE BIG LITTLE THINGS OF RADIO

All apparatus advertised in this magazine has been tested and approved by POPULAR RADIO LABORATORY

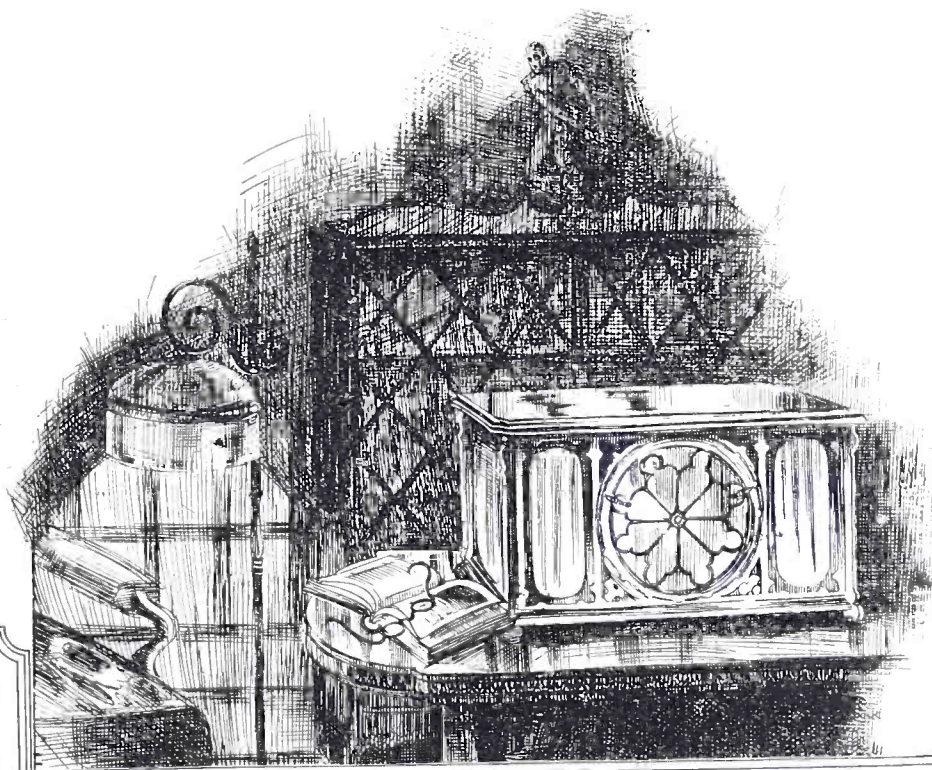

NO DIALS
 NO PANEL
 BUILT-IN
 LOUDSPEAKER

For the Well Appointed Home

PEOPLE of taste will instantly recognize in the ULTRADYNE, Model L-3, the long-awaited perfection in *radio-musical instruments*. This new receiver offers complete mastery of the air's riches; effortless operation—as simple as playing a phonograph; and a new artistic form that blends harmoniously with its environment.

\$135.00

West of the Rockies
 \$140.00

The ULTRADYNE, Model L-3, is a six-tube receiver employing the fundamental principles of the best circuits greatly refined and marvelously simplified. No dials—no panel; just two inconspicuous levers which constitute a station-selector. Volume adjustment, the only other control. Beauti-



fully duco finished, duo-toned panelled mahogany cabinet. To protect the public, Mr. Lacault's personal monogram seal (R.E.L.) is placed on the assembly lock bolts of all genuine ULTRADYNE Model L-3 Receivers. All Ultradyne Receivers are guaranteed so long as these seals remain unbroken.

Write for illustrated descriptive folder

ULTRADYNE
 MODEL L-3

PHENIX RADIO CORP., 116 E. 25th St., New York

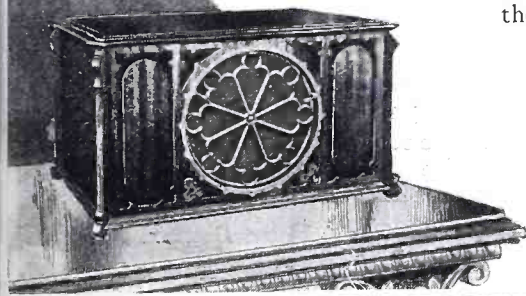

All apparatus advertised in this magazine has been tested and approved by POPULAR RADIO LABORATORY

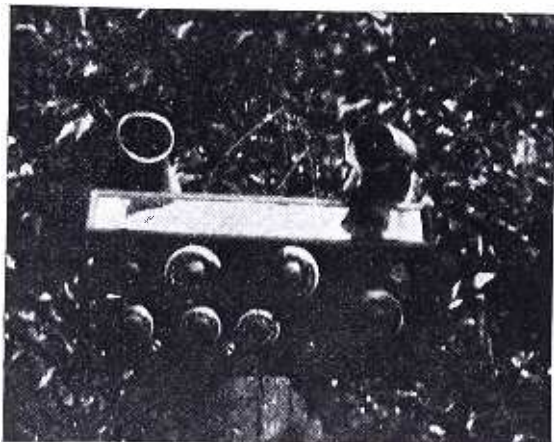

COW HORNS AS LOUDSPEAKERS

These cow horns, fifteen inches in length, make up the loudspeaking part of this radio set. Even if they do look like periscopes, they add an odd tone to any radio installation.

* * *

A Novel Home-made Horn from the Farm

ALTHOUGH nearly every possibility for the design of radio loudspeakers has been thought of, here is a new idea that has many merits beside originality.

The cow horn, because of its very substance, is clear-toned, and solid. The making of a good loudspeaker unit for radio use out of a pair of cow horns is simplicity itself.

First secure a pair of horns; this will not be difficult if you live on a farm. Cut the tips of the horns off with a hack saw and at a point where the opening thus provided will fit into the hole of a telephone earpiece. By means

of sealing wax or cement, the horns are fastened to the earpieces.

If the horns are big, like the ones shown in the illustration, the effect when the set is turned on will be most pleasing.

To add a touch of artistry, the interiors of the horns may be gilded, and a decorative rim placed on each. The horns work very well on this five-tube set.

—LOUIS YASSEN, *Chicago, Ill.*

* * *

How to Handle Glass in Your Set

GLASS is being used to a large extent by experimenters who build radio sets. Because glass is such a good insulating material, it probably would be even more extensively used were it not for the fact that it is hard to work.

How to drill glass has already been told in POPULAR RADIO, but many set builders have had the experience of cracking a finished glass panel in the assembly of instruments.

Glass will not stand as much strain as other materials used in radio work, such as hard rubber, bakelite, fiber and others. But if the strain is eliminated or relieved there is less danger of breakage. One way to relieve this strain is by using care (when two or more mounting screws or nuts are located on a piece of apparatus) that one screw is not brought down tight first, and the others pulled up afterward.

When two or more screws or nuts are required for mounting a piece of radio apparatus, tighten up slightly on each screw or nut consecutively until all are brought up tight. This hint is good not only when working glass, but is advisable in any case where it is necessary to eliminate the possibility of strain or breakage.

—W. A. FRICKE, *Chicago, Ill.*

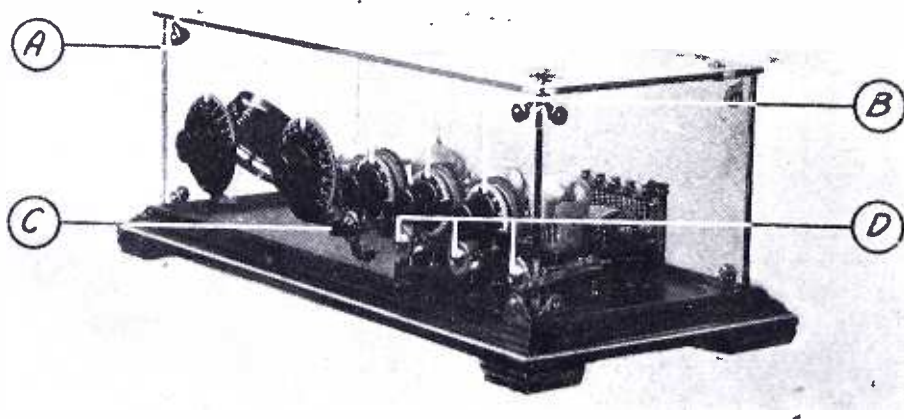

A HOME-MADE SET ENCLOSED IN A GLASS CASE

Glass is particularly attractive when it serves to enclose the components of a radio set. Here is the work of a Chicago firm, who can drill glass and prepare the holes, with bushings for mounting the instrument without breakage.

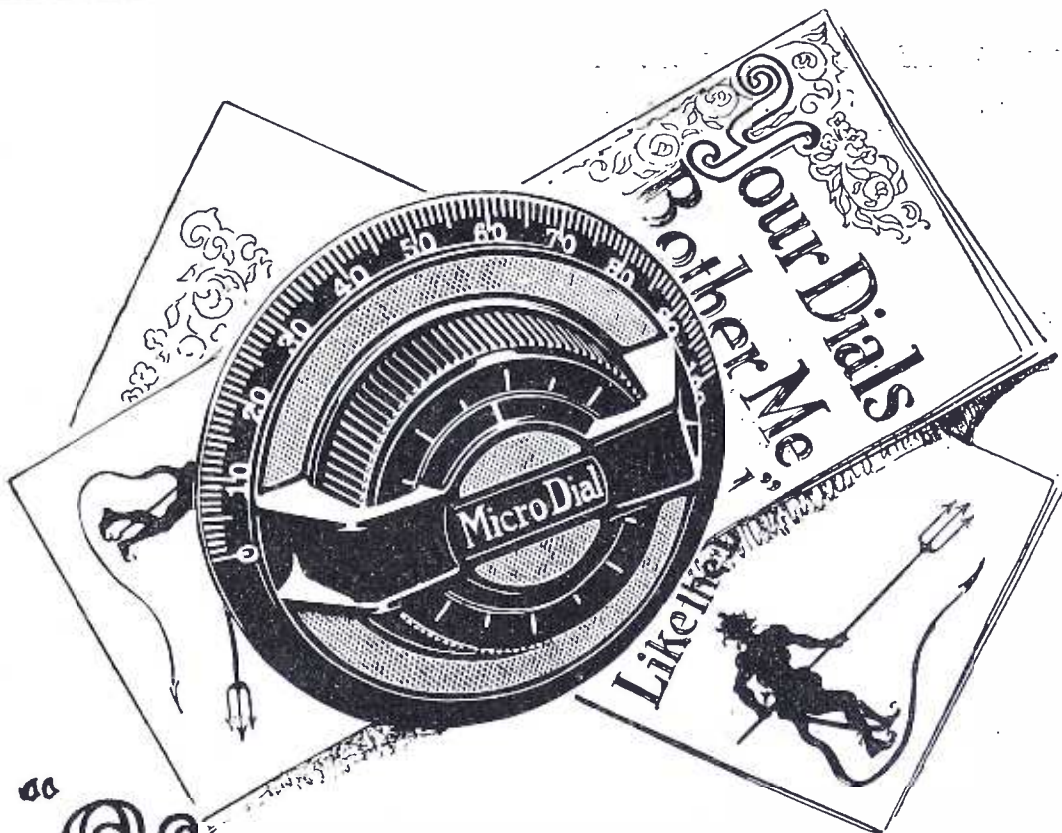

"Your Dials Bother Me Like the Devil"

That's what an enthusiastic Micro-Dial user wrote us after his first night's experience. And his bother was STATIONS.

Stations he had never heard before—or even heard of! Stations that came in so fast that he hadn't room for them all in the gaps he had left in his log book! Stations that kept coming long after his bedtime hour had passed!

Read the simple story of what Micro-

Dials did for this broadcast listener, as he told it to us, over his own signature.

Write for our folder, "Your Dials Bother Me Like The Devil." We will send it postpaid to any address.

Better still, get the folder from your Jewett Dealer. Read it on the spot and take your Micro-Dials home. You can install them yourself without drilling or sawing, and using no tool but a screwdriver.

JEWETT RADIO & PHONOGRAPH COMPANY
5668 TELEGRAPH ROAD PONTIAC, MICHIGAN

Factories: Allegan, Michigan — Pontiac, Michigan

In Canada
Jewett Radio-Phonographs, Ltd.
Walkerville, Ontario

"Quality Broadcasting to Match
Quality Products—Station WJR"

Export Sales Office:
116 Broad Street, New York City

The Jewett Micro-Dial

© 1925 Jewett Radio and Phonograph Co.

All apparatus advertised in this magazine has been tested and approved by POPULAR RADIO LABORATORY

Faradon

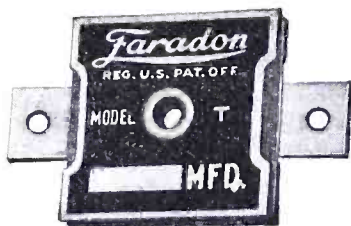

NOW **Faradon** FOR

SET BUILDERS

FARADON MICA CONDENSERS, since the advent of radio broadcasting, have been used extensively by the great broadcasting stations throughout the country, and are now available for receiving sets, in the Model T.

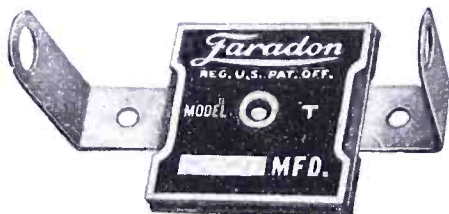

The Model T brings distinctive appearance to the set and permanently improves reception. For superior results use Model T's. Your dealer now has them or can get them for you. For quality at low cost.

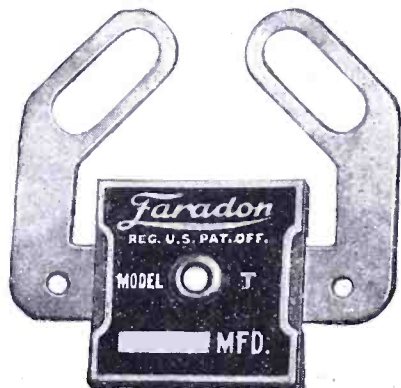

"Fit out with Faradon"

Wireless Specialty Apparatus Co.

JAMAICA PLAIN, BOSTON, MASS., U. S. A.

ELECTROSTATIC CONDENSERS for all PURPOSES

Faradon

F
A
R
A
D
O
N

F
A
R
A
D
O
N

Wonderful Volume with Clearness—AMPL-TONE



Phonograph makers have spent years perfecting the acoustic properties of their phonographs. Use an AMPL-TONE Unit and make a real Loud Speaker in an instant or use it in your horn and get better results. After all, speakers are as good as their unit. We make a real unit at a real price. Money gladly returned if you are not entirely satisfied.

WE SELL UNITS TO MFRS.

Late at night when the family has retired, don't disturb them. Use AMPL-TONE HEADSETS. They produce the best results and are unsurpassed as a distance getter. Price \$5.00.



You can buy direct from us also
The UNION FABRIC CO. DERBY, CONN.

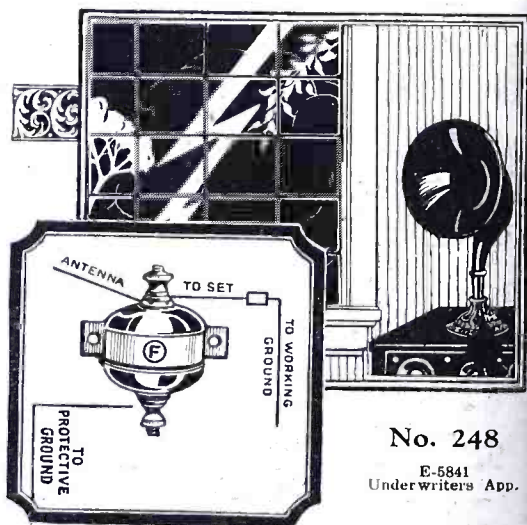

No. 248

E-5841
Underwriters' App.

"Little Joe" Lightning Arrester

Especially designed for Radio Work. Made of Porcelain, small, neat, rugged and serviceable. Can be suspended on antenna or fastened to wall.

Ask Your Dealer

M'd by **CIRCLE F MFG. CO.**
Trenton, New Jersey

Continuous, unfailing "A" Power

—in a single compact unit . . . that automatically replenishes itself

THE new Gould Unipower asks for a place in your set on this basis—that it will contribute more than anything else to the convenience, perfection and economy of operating your set—that it will give you the most that your money can buy—that it will banish "A" battery failure, the most frequent cause of poor radio reception.

Here are the facts about Unipower.

Unipower is a single compact "A" power unit that fits *inside* most radio cabinets. It takes the place of dry "A" batteries or of separate storage battery and charging units. It is *not* a battery eliminator and should not be confused with any other radio power device.

Unipower is quickly and easily installed. Just connect two wires to your set, plug in on your light current, and the job's done! Unipower is equipped with an exclusive Balkite charger of special design. Unipower will last you for years, and there are no tubes, bulbs, lamps or working parts that require frequent replacement.

A unique feature of Unipower is the single master control switch that governs the operation of your entire set. When the switch is ON, Unipower feeds your set rich, quiet power with neither hum nor noise. When the switch is OFF, Unipower *automatically* replenishes itself on a low trickle charge and with a minimum consumption of current—a few cents a month.

The first cost of Unipower is moderate—and the first cost is the last. When you also consider that Unipower banishes dry "A" battery renewals, or the bother of charging a storage battery, and increases the life of your tubes, you see how economical Unipower really is. You'll find that it pays for itself over and over again.

Decide to see the new Unipower today. The nearest radio dealer has it. Ask him for a demonstration. The Gould Storage Battery Co., Inc., 250 Park Avenue, New York.

FREE! Write for interesting booklet, "Unipower, a triumph in radio power"

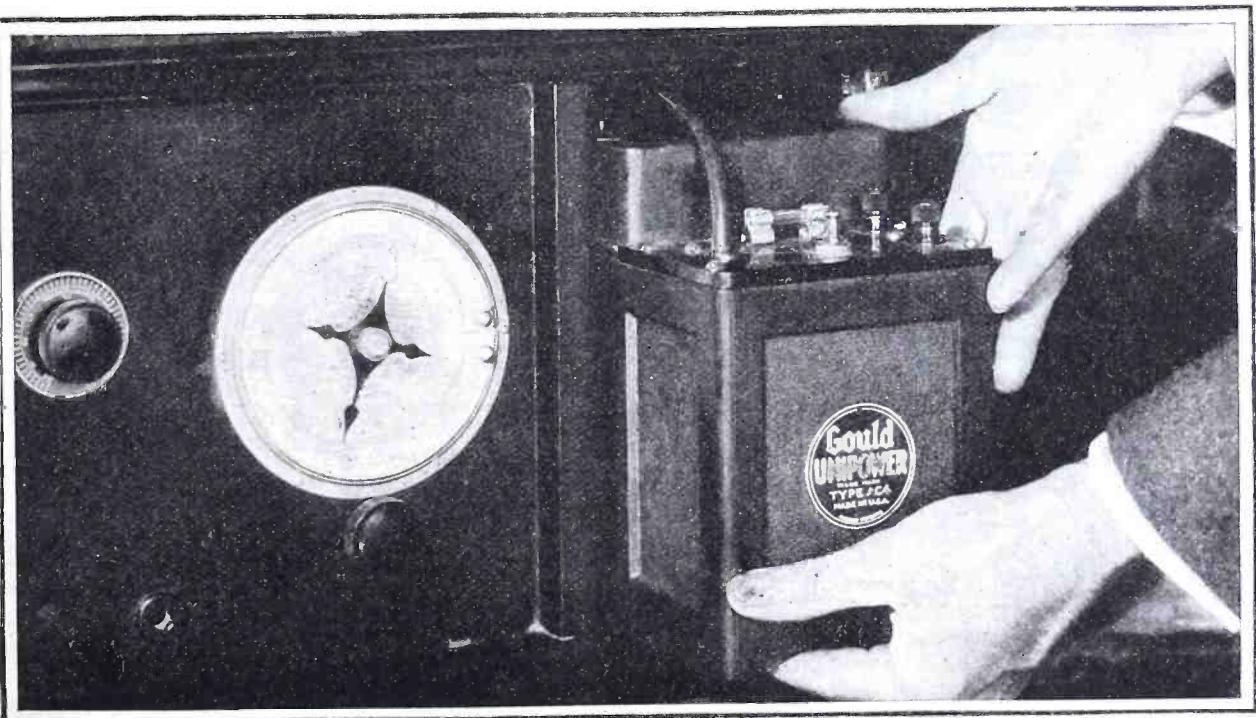

Unipower operates from alternating current, 110-125 V-60 cycle. It is supplied in two types. The 4 Volt type is for sets using UV-199 tubes or equivalent and retails for \$35.00. The 6 Volt type is for sets using UV-201-A tubes or equivalent and retails for \$40.00. West of the Rockies, prices are slightly higher. (Special models, 25-60 cycle, are available.)

Unipower

TRADE MARK

On when it's off ~ Off when it's on

Unipower fits comfortably inside most set cabinets. It is quickly and easily installed. Connect two wires to your set, plug in on your house current and you have continuous, unfailing "A" power of the highest quality and refinement instantly at your command.

All apparatus advertised in this magazine has been tested and approved by POPULAR RADIO LABORATORY

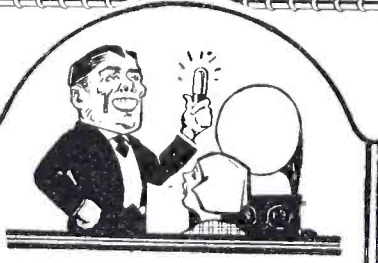

**now we'll
have clear
music**



MAGNATRONS in your set will give sweet purity of tone—clear and complete rendition of all the wealth of overtones. Music and speech come from the loudspeaker of the Magnatron equipped set with rich fidelity and generous volume, recreating in your home the actual performance itself, whether it be ten or a thousand miles away.

Magnatrons are the product of the oldest exclusive makers of vacuum tubes. That, in a large measure, explains their excellence. There's a Magnatron for every purpose. The DC-201A, the DC-199 [large or small base], the DC-120 [for super volume], and the Rex [for B Eliminators]. All list for only \$2.50 each.

Write for your **FREE** copy of "POT POURRI"—a snappy review of mirth and music to Department P. R.

CONNEWAY ELECTRIC LABS.
Magnatron Building
Hoboken, N. J.

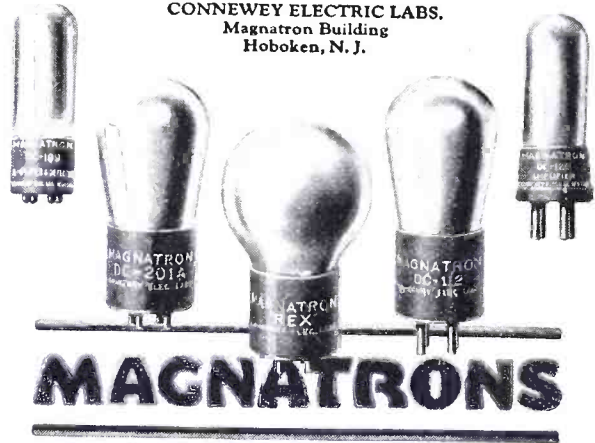

MAGNATRONS

Complete factory stock for Pacific Coast carried at Pacific Radio Labs., 256 So. Los Angeles St., Los Angeles, Cal.

JOYCE BROS. Wonder cell!

**Replaces
Dry Cells**



Cuts radio operating costs in half
Allows constant, steady power. New patented storage cell. Smaller than dry cells. More powerful. Many times as long-lived. Can be recharged from house lighting current. The most welcome radio accessory of all times.



Ask your dealer for Wonder Cells. If he is without them for the moment write direct to us and we will see that you are supplied. Send for **FREE** circular.

THE HELIOS BATTERY CO.
71 Chestnut St., Boston, Mass.



Where you see these signs
⊥ in circuits—use ⊓

Potter BY-PASS Condensers

- They prevent "B" voltage fluctuation
- Allow undistorted amplification
- Make possible full bass tones at all frequencies
- Improve reception with "B" Supply Units
- Essential for building the new Autoformer Amplifier

As easily attached as the "B" battery
Made in 1/10, 1/4, 1/2, 1, 2, 3 and 4 Microfarad sizes

At your Dealer's
POTTER MANUFACTURING COMPANY
North Chicago, Illinois



Radio Parts *that work!*

THE keen, crisp winter nights are here! It is the open season for "long distance"—and more exciting, this year, with super-power on the air.

New thrills await you if your set is adjusted for highest receiving efficiency, and you are especially fortunate if Allen-Bradley Radio Devices are used for delicate tuning in the vital parts of your circuit. With the Magic of Graphite Discs at your command, you have new fields to conquer—new DX records to make.

Allen-Bradley Radio Devices have stood the test of time and service, and the popular demand for them continues unabated. Have you noticed that the best known writers in radio publications invariably recommend Allen-Bradley Radio Devices? *They always work!*

Send for "The Magic of Graphite Discs"

USE THE COUPON

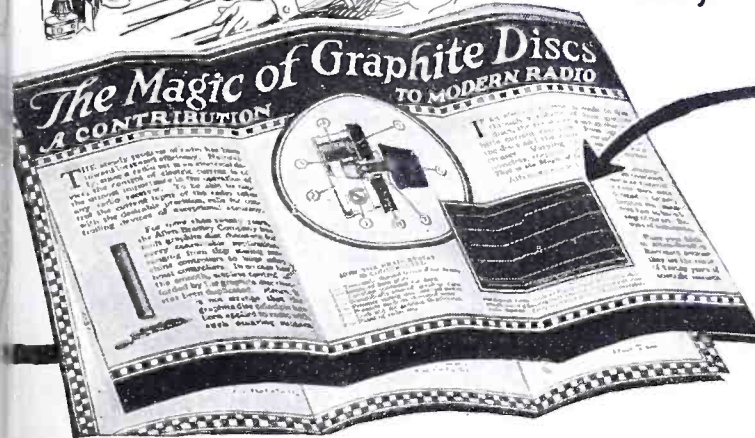

ALLEN-BRADLEY CO.,
276 Greenfield Ave., Milwaukee, Wis.

Please send me new illustrated circular—"The Magic of Graphite Discs."

Name

Address

.....

All apparatus advertised in this magazine has been tested and approved by POPULAR RADIO LABORATORY



Sensation of Season
B-Eliminators

Using New RAYTHEON Tubes
with



Operating a radio set is now a source of keen delight to every member of the family. Consistent performance every night is assured with the new B-Eliminators using the remarkable new Tubes and Dongan Transformers and Chokes. And any one can build this B-Eliminator at small cost.

Indorsed by leading radio engineers and well-known magazine editors, every radio lover can now possess the simplicity and 100 per cent. reception possible with the new Raytheon Tube B-Eliminators.

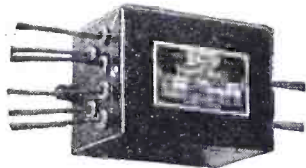

Transformers

| | | | |
|----------|-----------|--------------------------------|--|
| Type No. | | | |
| 509 | Full wave | For RAYTHEON Tubes | |
| 537 | Full wave | For R.C.A. U X 213 Tubes | |
| 537 | Full wave | For Cunningham C X 313 Tubes | |
| 538 | Half wave | For R.C.A. U X 216-B Tubes | |
| 538 | Half wave | For Cunningham C X 316-B Tubes | |

List \$7.00

Chokes

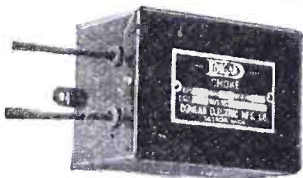

| | |
|----------|---------------|
| Type No. | |
| 514 |20 henry |
| 506 |30 henry |
| 539 |50 henry |

List \$5.00

Full instructions and description mailed on request. Ask your dealer or send check or money order to factory. Sold under guarantee.

For Set Manufacturers

Dongan is the standard maker of transformers and chokes for the leading manufacturers of B-Eliminators. Engineering data and quotations furnished on request.

More than 42 of the country's leading sets use Dongan Audio Transformers. Any type you require. Your requirements can be handled promptly in our big plant. Prices on request

DONGAN ELECTRIC MANUFACTURING CO.
2983-3001 Franklin St. Detroit, Mich.



GENUINE BAKELITE

Radio Panels

We cut, drill and engrave for you Radio Panels of genuine Bakelite. *Send rough sketch for estimate.* A properly drilled and engraved panel ready for mounting is half the job of construction. Plain panels shipped C. O. D. same day order is received. Write for New Catalog on Radio Panels, Tubes and Rods—all of genuine Bakelite.

STARRETT MFG. CO.
522 S. GREEN ST., CHICAGO

CARTER
New "IMP" Rheostat

All Resistances



(Pat. Pend.)

\$1.00. Half Size.

(Complete with Knob)

Smallest rheostat made, yet most efficient. A Carter designed contact arm that assures positive, even contact. No jerking or noises. One hole mounting. Potentiometer same size.

MEMBER **RMA** Any dealer can supply

In Canada—Carter Radio Co., Limited, Toronto



What I would do if I wanted more money—By J. Matheson Bell

First of all I'd make up my mind definitely that I was going to do it.

I don't believe any man living can get any more money worth while without firmly believing that he can. Determination will conquer failure anytime, anywhere.

I'll work harder on my present job to make the boss feel that he owes me more.

But I won't stop there.

I'll put my spare time to work.

I'll quit losing money by making my things pay.

I wouldn't give up my present job if I'd make more money by working longer hours.

And something that could be sold anywhere, either in my home or some one else's home.

It would be something would have to be a little out of the ordinary because it would have to be of special interest in the evening.

It would be the time of day when the man and his wife are at home so I'd find something that would be of interest to both of them.

I feel sure that such an article would have to be something for the home, something they would both use and enjoy.

So far so good, but what will that something be.

Piano? No, but come to think of it I can't play one myself so that's out.

Automobile—

Sounds better, guess I could learn to drive, but seems to me that everybody now has one. At any rate the auto ends good—let's see if there is anything better.

Gramophone—

Can't sound near so good as the auto.

Vacuum Sweeper—



How Can I Make More?

True—I don't know anything about radio, but I have lots of friends who have learned something about it, so I think I could. What sounds good to me is, that I can demonstrate in the home in the evening, the very time of the day for me, and that's just when all the music is being broadcasted.

I'll have competition. I expect it. I'll have to know just what my demonstration will do that the other fellow's won't, so lets see what would make the biggest appeal.



Thinks Hard!

They may be satisfied with music from nearby stations, but they'll ask me for distance, so I must be able to get "by" our powerful nearby station. The radio I want must be selective so I can tune out our nearby station if I desire.

I can picture myself in some prospect's home with a radio that will do that, but I wonder if that is enough—maybe my competitor will be there also—maybe he can do all those things as well as I can.

Then where am I?

I've got it—I'll tell you what my radio must do—I want one that my prospect can do all the tuning, so that he will get the thrill of bringing in the music from a distance clear and loud and with a tone that will please.

Not so much interest to the man and I don't see just how I'd show up dust at night.

Radio— Why, the Sam Hill didn't I think of that before, but let's see if it will do—let's see what its good points are as well as its bad ones.

After all he is the one who is going to operate it, so why wouldn't it be better and best if all he had to do was sell himself. I'll admit I'm not much of a salesman, so if I find a radio that will sell itself then I'll not only whip competition but I'll do it easily.

Best of all, I'll make that extra money I want.

Who knows, I may be so successful at it that I can give up my present job and give it all my time—Geethat sounds too good to be true, but other men have done it so why can't I—I can and I will.

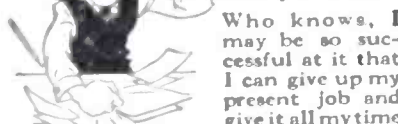

Gets An Idea—

But what radio can I sell that will do what I want and yet sell at a reasonable price—I don't want one so high that my people can't buy—but it must be a good one.

Then when I do sell it, they will want me to fix anything that goes wrong so somebody must teach me how to service radio—that's something I can't afford to overlook.

Where is such a radio?

Where is a manufacturer who will teach me how to sell and how to demonstrate—where I can learn this business, both selling and servicing radio—there must be someone.

There is—Ozarka Incorporated of Chicago—the sign of the long distance goose—they have a 64-page book "The Ozarka Plan" which they will send me if I tell them about myself and mention the name of my county. Where is my pen and some paper? I'm going to make more money and I'm going to start right now by writing for this book.

I am greatly interested in the FREE Book, Ozarka Plan No. 100, telling how I can establish myself in the radio business and increase my present income.

Writes to Mr. Bell a 64-page book "The Ozarka Plan" which they will send me if I tell them about myself and mention the name of my county. Where is my pen and some paper? I'm going to make more money and I'm going to start right now by writing for this book.

Use This Coupon!

J. Matheson Bell, Pres., OZARKA, Inc., 124 Austin Avenue C, Chicago, Illinois

I am greatly interested in the FREE Book, Ozarka Plan No. 100, telling how I can establish myself in the radio business and increase my present income.

OZARKA



INCORPORATED

124 Austin Avenue C Chicago, Illinois

124 Austin Avenue C Chicago, Illinois

Name..... Address..... City..... County..... State.....

All apparatus advertised in this magazine has been tested and approved by POPULAR RADIO LABORATORY

Separates Those Crowded Stations

No matter how crowded the low wave stations—perfect separation is easily effected with the Tune-rite dial's convenient motion; low wave stations as easy to tune in, as clear and as perfect in tone, as high wave stations.

So scientifically thought out that it's really a revelation in tuning. Gives your present set every advantage of the straight line frequency receiver, but without the necessity and expense of rewiring. Gradually changing ratios from 24 to 1 at low wave lengths to 2 2/3 to 1 at high wave lengths does the trick. Instantly attached to any set.

Convert your set to straight line frequency. Send for instructions.

RADIALL COMPANY

Dept. T. P. R.-1, 50 Franklin St., New York

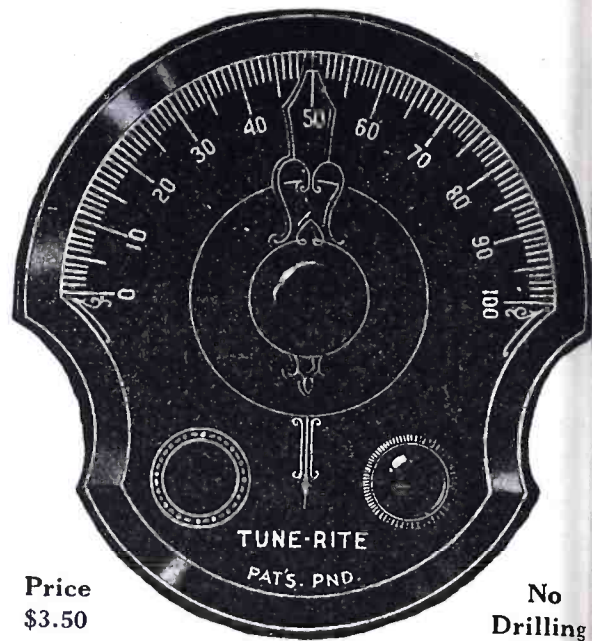

Price \$3.50

No Drilling

TUNE-RITE

The Straight Line Frequency Dial

Made by the makers of Amperite, the "Self-Adjusting" Rheostat

Make your own coils with the Franklin Coil Winder

Low loss self support-ing

Same device winds both spider web or solenoid coils in different sizes. Coils easily removed in perfect shape. All metal brass and aluminum. Approved by Popular Radio.

For sale only by
FRANKLIN COIL WINDER
81 Irving Place New York City

You can wind Coils for all Circuits

PATENTED OCT. 13 1925

Price 4.00 dollars

Hoyt "Super"-Control Meter

For instant attachment to the Radiola Superheterodynes No. 25 and No. 28. A precision type moving coil volt-meter, with bronze rim, rubbed mahogany case and cloth-covered base, complete with cord. The scale of the meter is marked in red at 3 volts.

With this meter users of these sets will always secure the exact filament voltage for clearest reception and longest life of the tubes.

Price \$8.50

BURTON-ROGERS CO.
26 Brighton Ave. Boston, Mass.
National Distributors

All apparatus advertised in this magazine has been tested and approved by POPULAR RADIO LABORATORY

McLaughlin—LC-26—Hammarlund-Roberts

All Approved By the Fan!

Here are the circuits that the radio fans of the country have taken for their own. Each of them represents the best in simplicity, efficiency, and most of all—results.

A MONTH ago L. M. Cockaday gave the experimenter the LC-26. The basis of this new single-control set is the famous Four-Circuit Tuner! This means much to the man who must have the utmost efficiency from the fewest number of tubes.

Cockaday LC-26

| | |
|--|---------|
| 1 General Radio Type 269 Variometer with knob | \$5.30 |
| 1 General Radio Rheostat Type 214A, 7 Ohms | 2.25 |
| 1 Precision Octoform Coil Set | 5.50 |
| 1 Amsco Double Condenser No. 1814 | 6.25 |
| 1 Micamold Condenser .00015 mfd. | .35 |
| 1 Micamold Condenser .00025 mfd. | .35 |
| 2 Daven Resisto-Couplers with .1 mfd. condensers | 3.00 |
| 1 Amertran DeLuxe 1st Stage Transformer | 10.00 |
| 1 Bradley Leak 1/4 to 10 Megs. | 1.85 |
| 3 Bradley units 1/4 meg | 2.25 |
| 1 Bradley unit 1/2 meg | .75 |
| 3 Amperites 1A | 3.30 |
| 1 Amperite No. 112 | 1.10 |
| 5 Benjamin Standard Sockets | 5.00 |
| 1 Carter Single Circuit Jack | .70 |
| 2 Carter No. 2 Jack Switches | 2.00 |
| 8 Eby Binding Posts | 1.20 |
| 1 Fynur Vernier Dial | 3.50 |
| 1 Drilled and Engraved Panel | 7.50 |
| 1 Cabinet, Mahogany or Walnut Finish | 14.50 |
| 1 Hardwood Baseboard | .50 |
| 4 Small Brass Brackets | .20 |
| 2 Large Brass Brackets | .15 |
| 1 Antenna Connection Block 1 x 2 Inches | .15 |
| 1 Battery Connection Block 1 x 9 Inches | .25 |
| | \$77.90 |
| Blueprints for LC-26 | \$1.00 |

FOR the multi-tube set fan the McLaughlin Receiver with its single control is offered. It is one of the year's favorites.

McLaughlin One-Control Receiver

| | | |
|--|----------|--------|
| 2 Precise No. 750 Syncrodensers | 4.50 ea. | \$9.00 |
| 1 Precise No. 744 Connector | | .60 |
| 1 Marco 4 in. Vernier Dial | | 2.50 |
| 1 Hammarlund Midget Condenser | | 1.80 |
| 2 Carter "Imp." Jacks with plugs for loop wires | .50 ea. | 1.00 |
| 1 Benjamin 8-Gang Socket Shelf | | 11.00 |
| 1 Drilled Bakelite Panel 10 in. x 14 1/2 in. x 1 1/8 in. | | 4.35 |
| 1 Pr. Precise Aluminum Brackets | | 2.00 |
| 1 Weston Voltmeter 0 to 7 volts | | 8.00 |
| 1 Weston Milliammeter 0 to 25 M.A. | | 8.00 |
| 1 Benjamin Battery Switch | | .35 |
| 1 N. Y. Coil Condenser .006 mfd. | | .75 |
| 2 Dubilier 1 mfd. Condensers 1.25 ea. | | 2.50 |
| 1 Dubilier No. 640G .00025 mfd. | | .55 |
| 1 Daven 2 megohm Grid-Leak | | .50 |
| 1 Precision Inducto Coupler No. 260 | | 1.85 |
| 1 Precise No. 1900 Filterformer | | 4.50 |
| 1 Precise No. 1700 Super-Multi-former | | 20.00 |
| 1 Gen. Radio Rheostat, Type 214-A, 2 ohm, 2 1/2 amp | | 2.25 |
| 1 Gen. Radio Potentiometer, Type 214-A, 400 ohm | | 3.00 |
| 1 Precise Audio-Freq. Transformer No. 480, 2 1/2-1 ratio | | 7.50 |
| 1 Precise Audio-Freq. Transformer No. 480, 5-1 ratio | | 7.50 |
| 1 Carter Double Circuit Jack | | 1.00 |
| 1 Carter Single Circuit Jack | | .70 |
| 18 in. Stranded Wire for Oscillator Circuit | | .10 |
| 1 N. Y. Coil Condenser .00025 mfd. | | .35 |
| 28 ft. Celatsite Wire | | 1.40 |
| Bus-bar, Screws and Lugs | | .75 |

| | |
|------------------------------------|----------------|
| 1 Mahogany Finished Cabinet | \$9.60 |
| 1 D.T.W. Loop | 25.00 |
| 8 Truc-Blue Tubes | 3.50 ea. 28.00 |
| Total | \$166.40 |
| Blueprints for McLaughlin Receiver | \$1.00 |

THE thousands who have followed experimentally the development of the Roberts Circuit know the possibilities of this set. Here it is in a kit which is easy to build and containing parts of a grade which insure success.

Hammarlund-Roberts

| | |
|---|---------|
| 1 Special Foundation Unit (Drilled and Engraved Panel and Sub-panel, Metal Brackets and Wire) | \$9.40 |
| 2 Rauland Lyric Transformers | 18.00 |
| 1 Hammarlund Midget Condenser | 1.80 |
| 2 Hammarlund .0005 S. L. F. Condensers | 10.00 |
| 1 Set Hammarlund-Roberts Coils | 6.00 |
| 2 Naald Super DeLuxe 4 in. Dials | 1.50 |
| 5 Naald DeLuxe Sockets | 3.75 |
| 1 Naald K3843 1 1/4 in. Dial | .25 |
| 4 Amperites 1A | 4.40 |
| 5 Prs. Union Phone Tip Jacks | 1.25 |
| 1 Carter 25 Ohm Imp. Rheostat | 1.00 |
| 1 Carter Imp. Battery Switch | .65 |
| 1 Carter Single Circuit Jack, No. 101 | .70 |
| 1 Dubilier Type 640G .00025 Condenser | .50 |
| 1 Dubilier Type 640 .002 Condenser | .45 |
| 1 Dubilier Type 640 .006 Condenser | .80 |
| 1 Durham Resistor | .40 |
| | \$60.85 |

Hammarlund-Roberts Cabinet especially designed for the Hammarlund-Roberts Receiver. Finished in mahogany. Artistically decorated—well-built. A pleasing addition to the furniture in your home. Price \$10.

As Used!

The exact parts for the **RAYTHEON PLATE SUPPLY UNIT**... \$41.10

Mail orders filled promptly

WHOLESALE RETAIL



15 East 40th Street, New York City

Our service to Dealers and fans consists not alone in shipping material. It is our aim to have new material first, to ship you promptly and, most of all, to send you the exact parts called for by you. Substitutions are costly—when the set won't work.

A postcard will bring the list of parts and full information on these or any other circuits in which you are interested. If you are an experimenter and find special apparatus hard to get, utilize our connections with most of the radio manufacturers in this country and abroad.

On to Success in RADIO!



Mr. R. L. Duncan
Director of the
Radio Institute
of America

RADIO is a profession well worth following. The work is interesting—fascinating. The pay is high. The demand for new men—skilled men—is strong.

You can embark, right now, on a successful career in radio. With a few months study under the expert instruction of the Radio Institute of America you can pass your U. S. Government Commercial or Amateur Radio License Examination and be ready for your first real radio job.

Study in spare time

There's no need to give up your present work. Study at home in spare time. If you really want to make a success in radio, fill in and mail the coupon to the Radio Institute of America for information on the finest theoretical and practical radio courses offered today.

RADIO INSTITUTE OF AMERICA

Formerly Marconi Institute
Established in 1909

322-A Broadway New York City

Radio Institute of America
322-A Broadway, New York City
Please send me full information about your Home Study Course of radio instruction.
I am interested in the complete course, including code instruction, which qualifies for the U.S. Gov't. Commercial or Amateur Radio License.

Name.....

Address.....

The KODEL MICROPHONE Loud Speaker



Two Models
\$15

\$20

THE loud speaker that has the whole country talking. An exact replica of the microphone used in broadcasting. Tremendous volume - - rich clear tone - - Handsomely finished in Roman Gold. At any radio dealer.

Write for descriptive literature

THE KODEL RADIO CORP.
504 E. Pearl St. Cincinnati, O.
Owners of Broadcasting Station W K R C

Steinite ^{LOW} ^{LOSS} Interference Eliminator

No Radio Set Complete Without It

Now you can select stations at will, cut out interference and undesired stations—tune in loud and clear. **Wonderful results with any tube or crystal set** using any kind of aerial except loop antenna. Partially absorbs static.



\$1 Amazing Results,
Better Reception
Guaranteed or We
Refund Your Dol-
lar. Send Order
Today.
Post-
paid

Select Stations At Will

Try this Interference Eliminator on your set—no tools—nothing to add—attached in 2 minutes to aerial. Doesn't disturb present log. Directions easy to follow. Two big banks testify to our reliability. Order today—dollar bill will do—we take the risk—money back if you say so.

STEINITE LABORATORIES

301 Radio Building, ATCHISON, KANSAS

Write for complete Steinite Radio literature—it's FREE. Most beautiful and least expensive radio sets in America.

All apparatus advertised in this magazine has been tested and approved by POPULAR RADIO LABORATORY

Balkite

Radio Power Units

the ideal power supply for any radio set

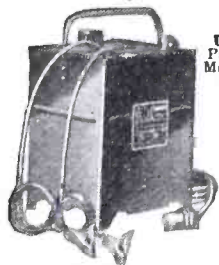

U. S. Patent
May 27, 1924

Balkite Battery Charger

Entirely noiseless. Can be used while the set is in operation. Charging rate 2.5 amperes. Operates from 110-120 AC 60 cycle current. Special model for 50 cycles. Also for 25-40 cycles with 1.5 ampere charging rate.

Price \$19.50
West of Rockies, \$20
In Canada, \$27.50



U. S. Patent
May 27, 1924

Balkite Trickle Charger

Can be connected to the usual 6-volt battery and left on permanent (or trickle) charge. Automatically charges the "A" battery and supplies "A" current from the light socket.

With smaller batteries can be used as an intermittent charger, or trickle charger if a resistance is used.

Charging rate .4 to .5 amperes. Size 5 1/2 x 2 3/4 x 5 inches. Operates from 110-120 AC 60 cycle current. Special model for 50 cycles. Price \$10

West of Rockies, \$10.50
In Canada, \$15

Balkite Radio Power Units are the ideal power supply for any radio set. They simplify and improve radio reception. They reduce the amount of attention you must give your set. With their use your current supply is always exactly what is required for each circuit.

The popular Balkite Battery Charger is entirely noiseless and can be used while the set is in operation.

The Balkite Trickle Charger converts your "A" battery into a permanent "A" power unit that supplies full "A" current at all times from the light socket.

Balkite "B" eliminates "B" batteries entirely and supplies plate current from the light socket. Balkite "B" for sets of 6 tubes or less. Balkite "B" II for sets of 6 tubes or more.

An ideal installation is a Trickle Charger and "A" battery, and Balkite "B." This enables you to operate your set entirely from the light socket.

Noiseless—No bulbs—Permanent

All Balkite Radio Power Units are entirely noiseless in operation. They have no moving parts, no bulbs, and nothing to adjust, break or get out of order. Each is a permanent piece of equipment with nothing to wear out or replace. They require no other attention than the infrequent addition of water. They require no changes or additions to your set.

Manufactured by
FANSTEEL PRODUCTS COMPANY, Inc.
North Chicago, Illinois

FANSTEEL

Balkite

Radio Power Units



U. S. Patent
May 27, 1924

Balkite "B"

Eliminates "B" batteries. Supplies plate current from the light socket. Operates with either storage battery or dry cell tubes. Keeps "B" circuit always operating at maximum efficiency. Requires no attention other than adding water twice a year.

Designed for sets of 6 tubes or less. Occupies about same space as 45 volt dry "B" battery. Operates from 110-120 AC 60 cycle current. Special model for 50 cycles.

Price \$35
In Canada, \$49.50



U. S. Patent
May 27, 1924

Balkite "B" II

Same as the new Balkite "B" but will fit any set including those of 8 tubes or more. Operates from 110-120 AC 60 cycle current. Special model for 50 cycles.

Price \$55
In Canada, \$75

The Gould Unipower is equipped with a special Balkite Radio Power Unit

BALKITE BATTERY CHARGER · BALKITE TRICKLE CHARGER · BALKITE "B" · BALKITE "B" II

ALL BALKITE RADIO POWER UNITS ARE TESTED AND LISTED AS STANDARD BY THE UNDERWRITERS' LABORATORIES

All apparatus advertised in this magazine has been tested and approved by POPULAR RADIO LABORATORY

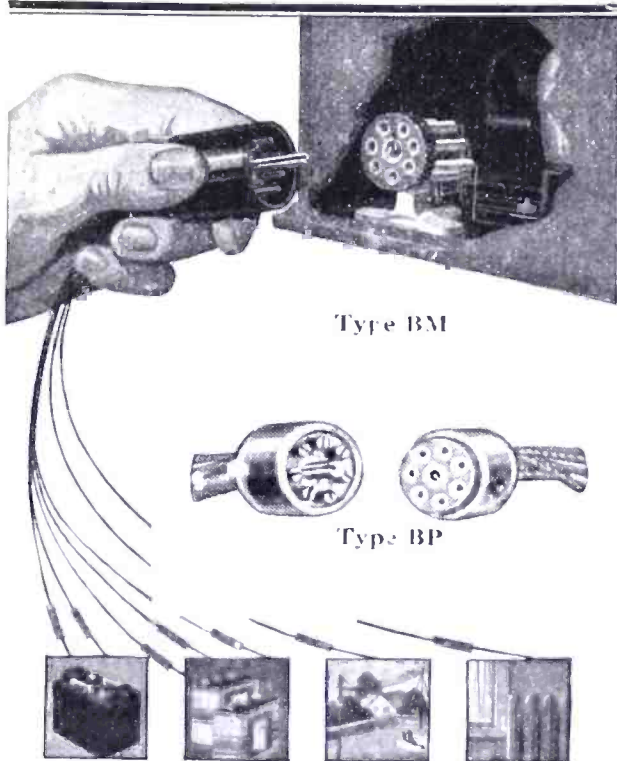

Type BM

Type BP

Jones MULTI-PLUG

THE STANDARD SET CONNECTOR

YOU wouldn't have an auto without a self starter. **THEN** why a radio set without a Multi-Plug?

BUY BUILD EQUIP YOUR RADIO with a MULTI-PLUG

Affording a plug and socket connection between the radio set and all outside connections, Jones Multi-Plug is as essential to the radio as a cord and socket to the electric iron.

Type BM—For Set Building—\$4.50.
Type BP—Adaptable to any set—\$5.00.

HOWARD B. JONES, CHICAGO, ILL.
618 S. Canal Street

Premier B Battery Cabinet

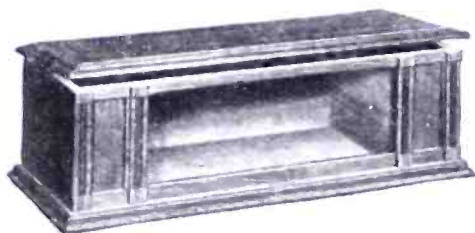

Our Premier B Battery Cabinet is a beautiful piece of furniture. The B battery compartment will take any type B battery. The space of each B battery compartment is 4 1/2" wide, 8 1/2" high and 10" deep.

| No. | For Panel | Deep | Genuine Walnut |
|--------|-----------|------|----------------|
| 718-10 | 7 x 18 | 10" | \$18.50 |
| 721-10 | 7 x 21 | 10" | 19.00 |
| 724-10 | 7 x 24 | 10" | 19.50 |
| 726-10 | 7 x 26 | 10" | 20.00 |
| 728-10 | 7 x 28 | 10" | 21.00 |
| 730-10 | 7 x 30 | 10" | 22.00 |

F.O.B. Waukesha, Wis.

The tops of these cabinets are figured walnut, the ends and B battery panels are select walnut, all 5 ply veneer. The bases are built up of massive molding. Nickel plated piano hinges and lid holders. The material and finish in these cabinets will equal the best furniture obtainable.

WE MAKE 9 STYLES OF CABINETS FOR 14 SIZES OF PANELS. Send for our 1925-26 line of cabinets at "Factory to User" prices.

Utility Cabinet Company

Phone 721

Waukesha, Wisconsin

NOW! Build a Real Set!

T.R.F. KIT
\$12.00

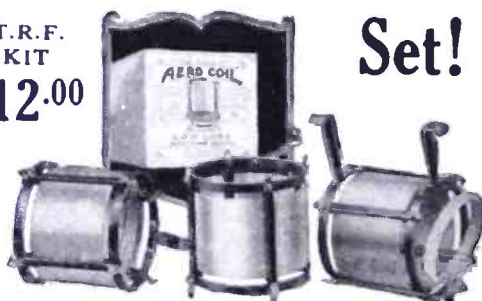

AERO COILS

Build a 5 Tube T. R. F. Receiver using the new Aero-Dyne Circuit and the new matched Aero Coils!

You will have a receiver, which because of the lower high frequency resistance and distributed capacity of its R. F. Transformers, will cut right through strong local interference.

It is the patented construction of Aero Coils—their 95% air dielectric and their dopeless airspaced windings which make them capable of a degree of selectivity and of volume and tone far exceeding the commercial standard.

For any set there is a kit of Aero Coils. Buy them at your dealers. Full instructions are in every package. Write for the free Aero Booklet.

| | | |
|------------|------------------------|---------|
| No. CT80 | —3 Circuit Tuner | \$ 8.00 |
| No. RFR110 | —R.F. Regenerative Kit | \$11.00 |
| No. WT40 | —Wave Trap Unit | \$ 4.00 |
| No. OS55 | —Oscillator | \$ 5.50 |
| No. AX45 | —Antennae Coupler | \$ 4.50 |

AERO PRODUCTS, Inc.
217 No. Desplaines St. Chicago

All apparatus advertised in this magazine has been tested and approved by POPULAR RADIO LABORATORY

SUPREMACY

IN every industry there is some one product that by sheer merit and outstanding quality and performance is accepted as the standard by which other products may be judged.

In the Radio Industry it is the Mu-Rad Transcontinental Receiver.

Only One Dial to Tune

Write Dept. F. 5 for Literature

MU-RAD RADIO CORPORATION

Factory Sales Offices
Asbury Park, N. J. Newark, N. J.



The - ONE DIAL CONTROL -
MU-RAD
Transcontinental Receiver

WORLDWIDE
25

All apparatus advertised in this magazine has been tested and approved by POPULAR RADIO LABORATORY

There's economy and satisfaction in these Valley Radio units

You will find both economy and satisfaction in the use of the Valley B-Eliminator and the Valley Battery Charger.

Economy in the B-Eliminator because it stops forever the expense of buying new B batteries. . .

Economy in the charger because it recharges your own storage battery at home overnight at one-tenth the cost of service station charging. . .

And satisfaction in both because, by using them, you need never miss a program on account of low or worn-out batteries.

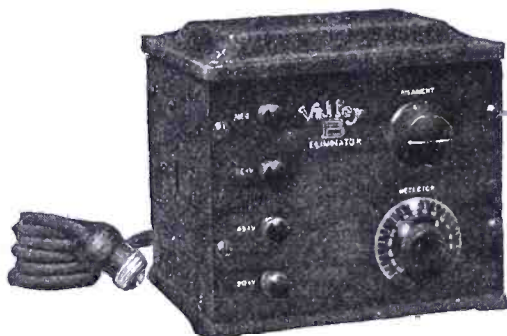

THE VALLEY B-ELIMINATOR operates from any ordinary light socket and provides a steady, noiseless flow of B current at a constant voltage all the time. For receiving sets of from one to eight tubes. Costs less at the start than wet B batteries. Costs less in the long run than dry cells. Much more satisfactory than both.

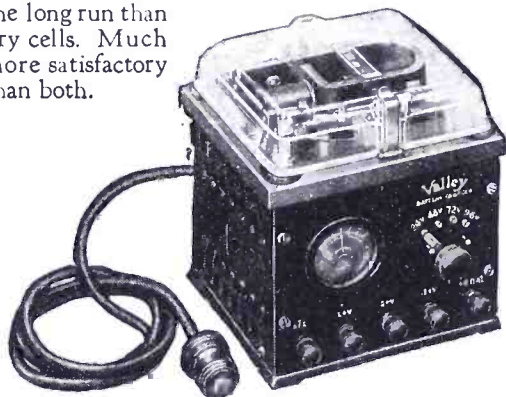

THE VALLEY BATTERY CHARGER is the only charger needed for all radio storage batteries. Its correct 6-ampere charging rate makes overnight charging a possibility.

Most radio dealers handle the Valley B-Eliminator and Valley Charger. Any of them will be glad to show you these units and explain their advantages.

Radio Division

VALLEY ELECTRIC CO. ST. LOUIS, U. S. A.

Branches in Principal Cities

Valley Electric

Get This Big Western Radio Catalog

NEW
1925-1926
EDITION

DEALERS, send for our big live catalog. Contains nationally advertised high quality sets, kits and parts. Use your letterhead.



Western Radio MFG CO.
134 W. Lake St. Chicago, Ill.

ACME COILS

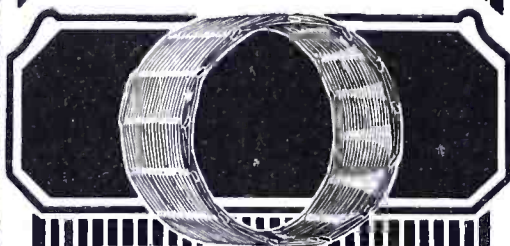

SUPER-SOLENOID.

EFFICIENT RADIO COILS
Require

A Specialized Organization for Economical Production

We make Coils only. Our entire resources are devoted to Radio Coils.

For that reason we are able to render Radio Set Manufacturers an unequalled coil service.

Regardless of your own facilities you will undoubtedly find this service profitable to you. Ask us for estimates and samples.

ACME PRODUCTS CO

107 W. Canton St.

Boston, Mass.

Do You Want to Read the Truth About Variable Condensers?



Type 334 SLW
Variable Condenser

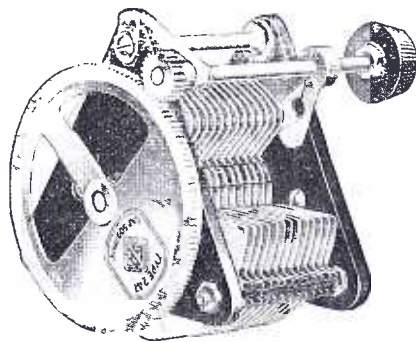

Type 247-H SLW
Geared Variable Condenser

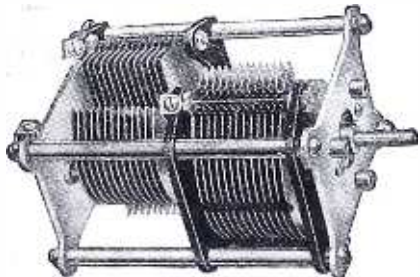

Type 374 S.L.F.
Variable Condenser

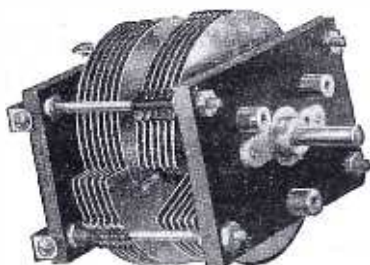

Type 248
Tandem Condenser

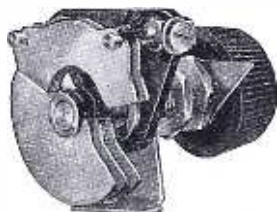

Type 368
Micro Condenser

The question of what type of condenser to use is still uncertain in the minds of many set builders.

In order that the amateur may have reliable information to guide him in the selection of the proper condenser for his specific needs we have prepared a booklet which contains a complete discussion of all types of variable condensers. This booklet does not go into deep technical detail on the subject but it covers in a complete, yet comprehensive manner everything pertaining to "low-loss" condensers, laboratory condensers, straight line wavelength vs. straight line frequency condensers—in fact nothing is omitted that is of vital concern to everyone who is interested in radio construction and operation.

This booklet is not a prejudiced discussion of the merits of one particular type of condenser, because the General Radio Company manufactures many types of condensers, each designed to meet its own respective requirements.

If you want Gospel and not gossip on the subject of variable condensers write for our 20 page FREE illustrated booklet, "The Truth About Variable Condensers."

Address Dept. P.

GENERAL RADIO COMPANY
Cambridge 39, Mass.

GENERAL RADIO

"Behind the Panels of Better Built Sets"

All apparatus advertised in this magazine has been tested and approved by POPULAR RADIO LABORATORY

The New Transformer

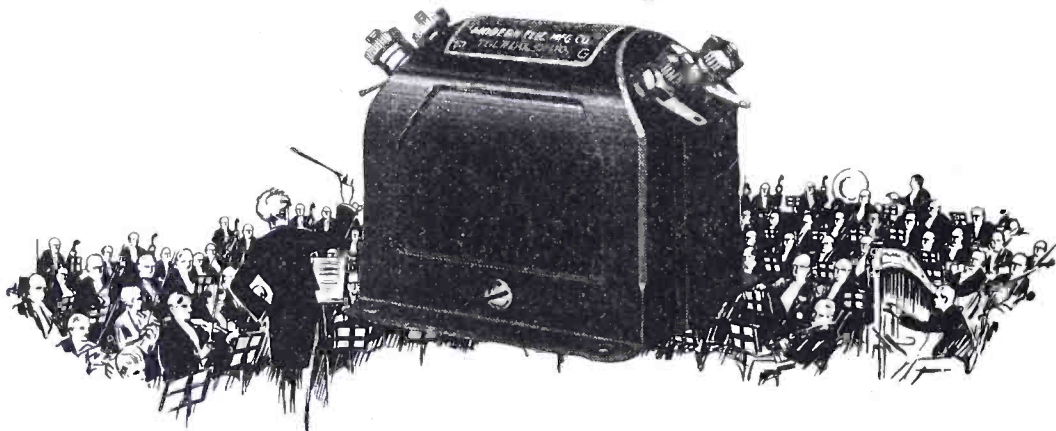

MODERN-SYMPHONY

Covers the Entire Range of Musical Frequencies

The new Modern-Symphony Transformer has been especially designed to reproduce and amplify the range of sound frequencies of any great orchestra. It will bring to you with equal faithfulness the basso profundo or the high treble.

The new Modern-Symphony Transformer will delight you. Besides, it is built by a manufacturer of Standard Equipment.

MODERN ELECTRIC MANUFACTURING CO., Toledo, Ohio

ANNOUNCING

A COMPLETE NEW LINE OF

ADJUSTABLE CONSOLES, TABLES AND ENCLOSURES

Many new designs and Patent Pending features. A standardized size. Panels are adjustable to length, depth, width, location, tilted or upright.

All in one enclosure, with deep panel beveling, beautiful woodcraft decorative effects, built-in loops, inside antenna and other new features.

Large production at factory-to-you prices.

Watch for them! (Next issue.) Wait for them!

Better still, write for literature.

Factory and Sales Department

Detroit Woodcraft Corp.

The Original The Adjustable
2262-4 Hendrie St. Detroit, Mich.

Makes any radio look like a A R-A-D-I-O

TONE

Full, sweet, mellow and natural, without the slightest indication of distortion, is another achievement that is making the APEX SUPER FIVE the most popular of all receiving sets.

VOLUME

That supplies dance music or entertainment without any loss, is a feature for which the APEX SUPER FIVE is world famed.

DISTANCE

Lends added enjoyment to radio with an indescribable fascination of tuning-in far away stations, which is always possible with the APEX SUPER FIVE.

Ask your dealer for a demonstration. Your eyes and your ears will tell you that APEX stands at the high point of perfection in both performance and appearance.

\$80 without accessories.

SUPER 5

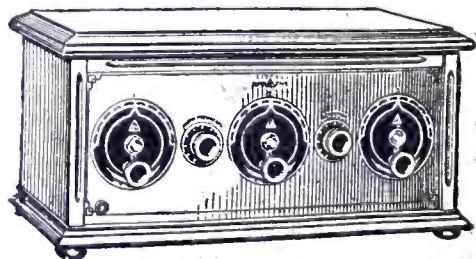

APEX ELECTRIC MANUFACTURING CO.
1410 W. 59th St. Dept. 102 CHICAGO

All apparatus advertised in this magazine has been tested and approved by POPULAR RADIO LABORATORY

Product of over 30 years' Experience



The Favorite Voice of Radio in All Tongues



TO hear an Amplion in comparison with any or all other loud speakers is to appreciate at once why Amplions are the largest selling radio reproducers throughout the world—favorites of music lovers in all lands.

The actual originators and oldest makers of loud speakers, Alfred Graham & Co., London, England, evolved The Amplion. Its superbly life-like

reproduction and supreme clarity on all notes give eloquent testimony to Graham's more than thirty years' experience in sound reproduction.

Bring out the full musical quality of your set with an Amplion loud speaker or console unit. The prices are \$12 to \$42.50. All Amplions are completely equipped with cord and panel plugs. Write for the "Amplion Pedigree" and dealer's address.

THE AMPLION CORPORATION OF AMERICA

Executive Offices: Suite X, 280 Madison Ave., New York City

Canadian Distributors: Burndept of Canada, Ltd., Toronto

Associated Companies and Agents: Alfred Graham & Co., London, England, Patentees; Amplion Corporation of Canada, Limited, Toronto; Compagnie Francaise Amplion, Paris, France; Compagnie Continentale Amplion, Brussels, Belgium; Amalgamated Wireless (Australasia), Ltd., Sydney and Melbourne; British General Electric Company, Ltd., Johannesburg and Branches; Indian States and Eastern Agency, Bombay and Calcutta; C. J. Christie E. Hijo, Buenos Ayres; David Wallace & Co., Valparaiso; Mestre & Blatge, Rio de Janeiro; F. W. Hammond & Company, London and Tokio.

AMPLION

Charges A or B Batteries 3 Times as Fast

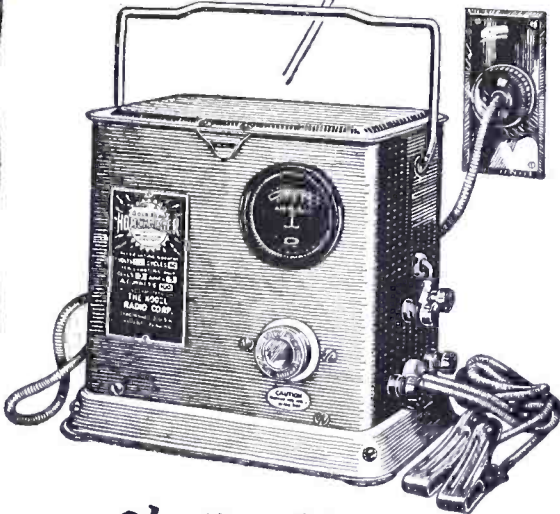

The New 5 Ampere GOLD SEAL HOMCHARGER

NOW you don't have to wait for days while your batteries charge. The new 5-ampere GOLD SEAL HOMCHARGER charges A or B batteries three times as fast as old-fashioned 2-ampere chargers - - It fully charges the average radio battery **OVERNIGHT!**

There are no bulbs to break, no acids to spill, no extras to buy - - - It is trouble-proof, shock-proof, fire-proof. Any radio dealer can show you the new 5-ampere GOLD SEAL HOMCHARGER.

Write for **FREE** booklet "The Secret of Distance and Volume in Radio" - 16 pages of helpful radio information.

\$19.50

Manufactured Only By
The Kodak Radio Corporation
Owners of Broadcasting Station WKRC
504 EAST PEARL ST. CINCINNATI, O.

Also manufacturers of KODEL RADIO Receivers and the famous KODEL MICROPHONE LOUD SPEAKER.

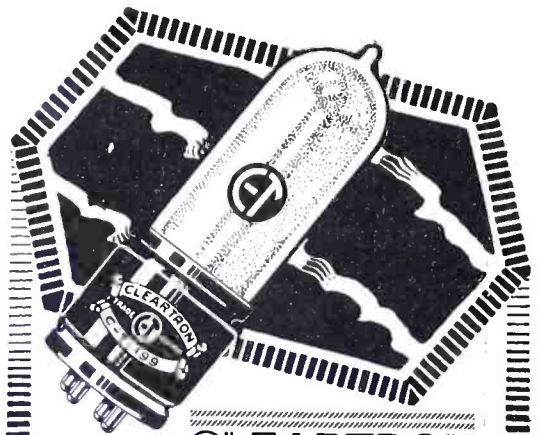

STANDARD
TYPES
\$2.50

CLEARTRON

GUARANTEED  RADIO TUBES

Being unequalled for their long life and easy drain on batteries, Cleartrons are the most economical tubes you can buy. Use them for better tone and more volume. Perfect service or instant replacement guaranteed.

At all Reliable Dealers

Write for Free six page tube folder
C-T 101A. A Hi-Mu Tube. Price \$3.00.

CLEARTRON VACUUM TUBE CO.
28 West 44th St. New York City
Factories: West New York, N. J. Birmingham, Eng.

FOR BETTER RECEPTION

ANOTHER **RADIO TRIUMPH**



PUR-A-TONE AUDIO COUPLER

For Improved Resistance
Attains Maximum Results



Pur-A-Tone Audio Coupling supersedes transformer coupling. Fewer parts required. Construction simplified. More compact.

Pur-A-Tone is standardized, interchangeable for all stages and withstands high voltages.

BRACH-STAT Automatic Filament Controls eliminate the need of hand rheostats on all amplified circuits. Give longer life to your radio tubes.

L. S. BRACH MFG. CO.
Newark, N. J.

Be a RADIO EXPERT

They Earn \$50. to \$250. a week in Radio—most fascinating work on earth



Learn Quickly And Easily At Home This Practical Way ~ ~ ~ ~

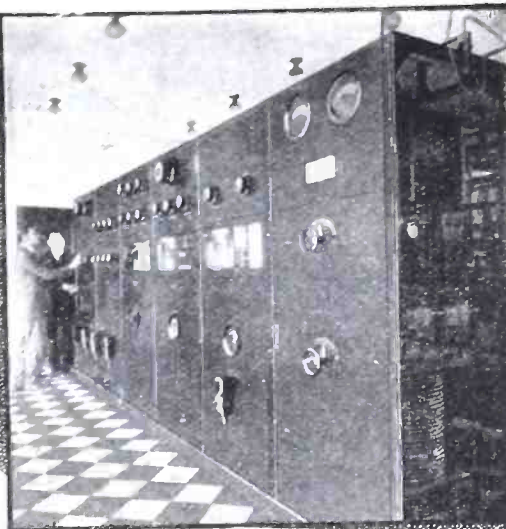

Train At Home For A Big-Pay RADIO JOB

Radio today is urgently in need of trained men—Radio Experts. Astonishing opportunities—thousands of them—have been opened up by enormous strides of the Radio industry. That's why it's easy to make big money in Radio—\$50 to \$250 a week. Here's a field that is teeming with opportunities and room for expansion—a brand-new, wide awake, and uncrowded industry. If you're earning a penny less than \$50 a week clip coupon now for Free Book and proof.

Instruments Given With Course

Receiving sets, from simplest kind to thousand mile receiver included without extra charge in your course. Other apparatus given to help you learn. An UNEQUALLED OFFER. Many other big features for limited time only.

Your Satisfaction Guaranteed

Master Radio Engineers will show how to qualify quickly and easily at home, for Radio's fine jobs. We guarantee to train you successfully. You don't risk a penny, for we will gladly return every cent paid in tuition if upon completion of course you aren't absolutely satisfied. Back of this guarantee stands all the resources of National Radio Institute, U.S. Government recognized and the oldest and largest Radio home-study school in the world.

Famous Course That "Pays For Itself"

Spare time earnings are easiest in Radio—receiving sets everywhere nowadays. In every neighborhood there are scores of jobs you can turn your hand to in an hour or so after supper. Right at the start of your course we give you practical money-making lessons which teach you how to do this work, then how to get it—so by our practical plan you can make your course pay its own way while you're studying.

Get This Book

"Rich Rewards in Radio"—most amazing book concerning Radio ever written, will be sent to you promptly when you send the coupon. ACT NOW.



You Can Do What Others Have Done

Why go along at \$15 or \$25 or \$35 a week, when the roughly-trained Radio Experts earn a hundred or more in the same six days? What this training has done for hundreds of others, it can do for you. Send coupon at once.

Radio Needs Trained Men

Age or Lack of Experience No Drawback

You don't need experience before taking this course, and common schooling is enough. Our tested, practical methods make learning clear and easy—the most natural thing on earth.

Get All the Facts At Once

Astonishing facts on the marvelous new industry of golden rewards—Radio—the fastest-moving, live-wire line. Free Book puts all the facts before you, No obligation. Send coupon for it now.

NATIONAL RADIO INSTITUTE
Dept. AT8 Washington, D. C.

N.R.I. TRAINED MEN ARE SUCCEEDING BIG



Operates WMAQ
"Accorded a position with Chicago Daily News—station WMAQ. My income practically doubled, thanks to your fine course." Keith Kimball, Chicago, Ill.



Gets Big Job
"Just been made Sales Manager of this Radio concern—a big raise in pay. Regret I did not take course sooner." R. E. Jones, Bay City, Mich.

"Your course so completely covers a Radio it is worth \$40 a week more to anyone in the electrical line since graduation have averaged \$50 to \$80 a week more." Preston Fowler, Gordon, Neb.

"My charges for consultation now \$2.50 per hour. The course is worth to me at least \$50, 000." R. V. B'klyn, N.Y.



"Your course worth \$2500 a year to me—Radio a gold mine. All my success due to your splendid course." A. R. Herke, Winnipeg, Canada.

MAIL THIS COUPON

National Radio Institute,
Dept. AT8, Washington, D.C.

Without obligating me in any way, send your Free Book, "Rich Rewards in Radio"—also full information on your practical, home-study Radio course.

Name

Address

Town State

LARGEST RADIO SCHOOL IN THE WORLD

ORIGINATORS OF RADIO HOME-STUDY TRAINING

All apparatus advertised in this magazine has been tested and approved by POPULAR RADIO LABORATORY

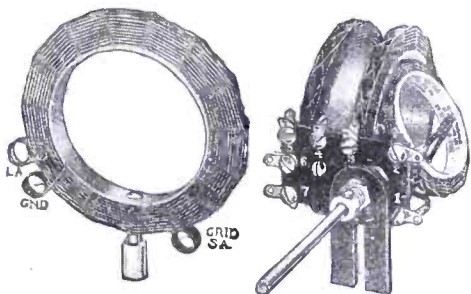

Sickles Coil Set No. 24 for Browning-Drake Circuit. Price \$7.50.

SICKLES

DIAMOND-WEAVE COILS

(Trade Mark registered Aug. 4, 1925)

For Browning-Drake, Roberts, Craig, and Hoyt Circuits

(Patented Aug. 21, 1923)

Compactness of form, rigidity of construction, and the supremely efficient Diamond-Weave method of winding are well-known characteristics of Sickles Coils.

These refinements of design and construction result in low distributed capacity, low dielectric losses and large range of frequency with small variable capacity.

There are Sickles Diamond-Weave Coils for all leading circuits.

Send for descriptive catalog

The F. W. Sickles Co.

134 Union Street

SPRINGFIELD, MASS.

COIL PRICES

| | |
|-------------------------|-------------|
| No. 18A Roberts Circuit | \$ 8.00 set |
| No. 24 Browning-Drake | 7.50 set |
| No. 20 Craig Circuit | 4.50 set |
| No. 19 Acme Reflex | 4.50 set |
| No. 8 Knockout Reflex | 4.00 set |
| No. 21 Hoyt Circuit | 10.00 set |

FREE

Radio Stamps

168 beautiful copper etched American, Canadian, and European stamps (8 different colors), each with the call letters of a station, FREE with Ideal 48-page Radio Stamp Album and Log. As you hear new stations, just put proper stamps in your album. An interesting game—a fascinating hobby. Makes your radio a real pleasure. Album and stamps become a permanent and interesting record of stations you receive. You and your children will enjoy it. You will be proud to show this to your friends. Also contains complete list of stations both alphabetically and by call letters. Hundreds of hours of pleasure for a few cents. Worth many times small cost. Complete album, 8"x11", heavy board, two colored covers, \$1 plus postage.

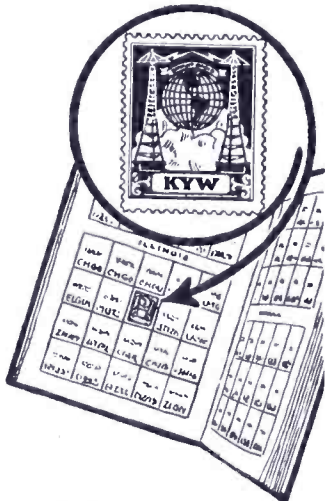

Send No Money

Just pay postman after album and FREE stamps arrive. We prepay postage if you prefer to pay with order. MONEY REFUNDED if not DELIGHTED. Enjoy this album. Send order today—NOW. Postal will do. IDEAL CO., Dept. 6931, 366 Wrigley Bldg., Chicago

TREGO The World's Lowest Priced 5-Tube Tuned Radio Frequency Set

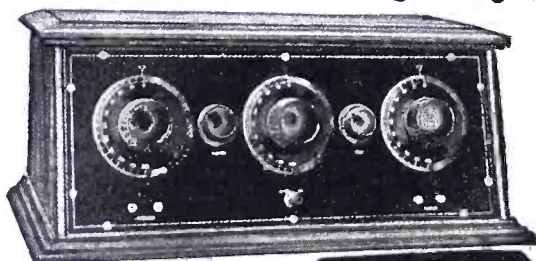

Coast to Coast Range

HERE'S the set that sells and satisfies! It's the TREGO 5-Tube Tuned Radio Frequency Set—highest quality at a price within the reach of all.

Retails at only \$45.00. Gives you Big Profits. Sells 10 to 1 over higher priced sets. Millions want it! Storage or dry-cell operation. Backed by our Iron-Clad Guarantee. Sold only through dealers.

Send for Monthly Catalog and exclusive dealer plan. This TREGO TRF5 is only one of the hundreds of profitable quick-selling items listed—just off the press. Get your copy now—cash in on the fall and winter radio demand.

TREGO RADIO MFG. COMPANY
Manufacturers and Wholesale Distributors
1431 Chestnut St., Kansas City, Mo.

List Price
\$45.00

All apparatus advertised in this magazine has been tested and approved by POPULAR RADIO LABORATORY

RADIO 'RITHMETIC

QUESTION:

What's the Difference Between
Good and Poor Radio Reception?

ANSWER:

A RECTIGON!



NO storage-battery radio is complete without a **RECTIGON.**



TO recharge one or two-cell radio "A" batteries with a Rectigon, merely adjust "snap" terminals as shown above. Takes but a moment.



TO recharge three or six-cell radio "A" or automobile batteries merely adjust "snap" terminals as shown above. Very simple.

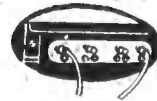

TO recharge eleven to forty-eight cell "B" batteries merely adjust "snap" terminals as shown here. (An instruction sheet packed with every Rectigon.)

THERE'S no muss or fuss with a Rectigon. No acids, no chemicals, no moving parts and no noise.

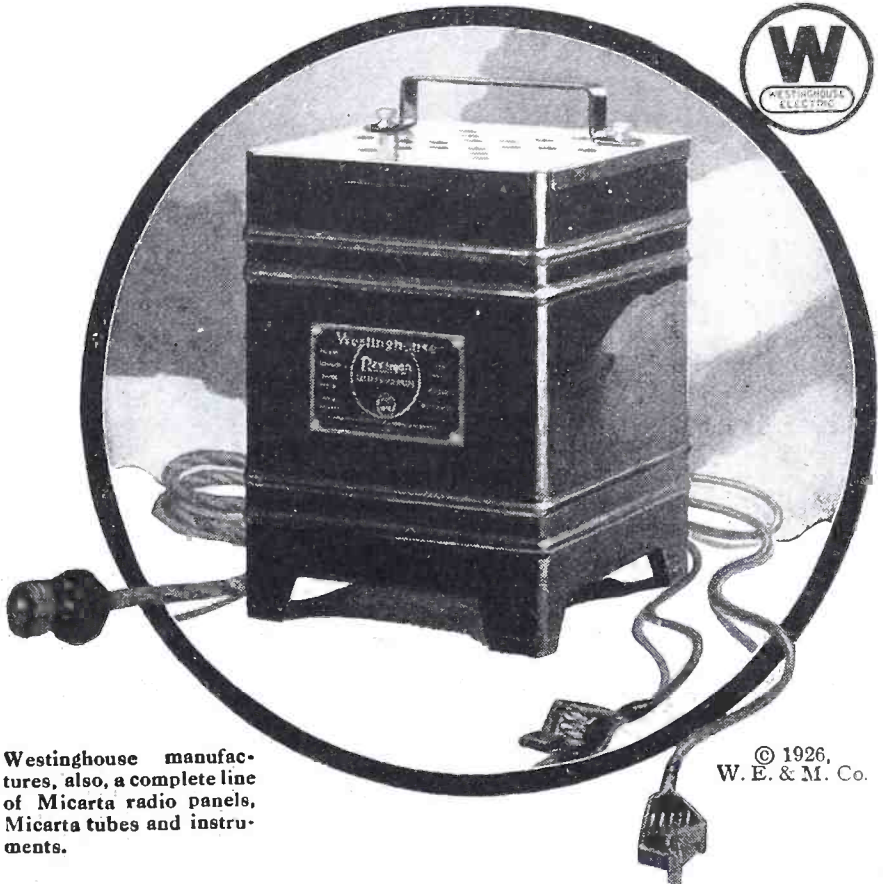

Westinghouse manufactures, also, a complete line of Micarta radio panels, Micarta tubes and instruments.

© 1926, W. E. & M. Co.

THE Rectigon offers a real solution to the oft-repeated question, "What's the matter with my set?" Ask any owner of a Westinghouse Rectigon. There are radio fans by the thousands to tell you there's no better, surer way to keep your batteries full of pep *than with a Rectigon.*

WESTINGHOUSE ELECTRIC & MANUFACTURING CO.
SOUTH BEND, INDIANA

The Westinghouse Rectigon Battery Charger

All apparatus advertised in this magazine has been tested and approved by POPULAR RADIO LABORATORY

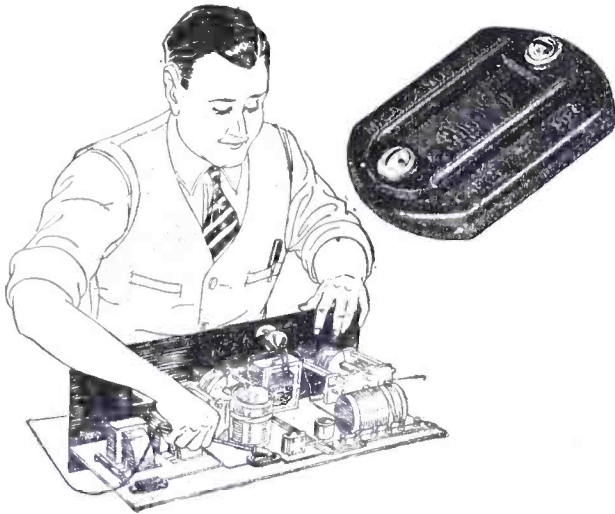

Keeping dad's radio going

Many a son is the family radio expert, but few have as fine an opportunity to keep posted as the man who wrote the letter printed below. He is a radio mechanic with one of the biggest electrical supply firms in Washington, D. C.—and just about everything new in radio parts comes to him for a practical test.

He writes us:

"My father lives in the mountains of Pennsylvania and, of course, has a radio receiver to keep in touch with the business world.

"For some time he has had trouble tuning in stations, so when I went up to make him a visit I took along one of your .00025 mfd. Sangamo fixed condensers with grid leak terminals.

"I tested the set and found that the grid condenser had changed its capacity, due to dampness, as it had been kept near an open window. I installed the .00025 mfd. Sangamo fixed condenser and the set changed completely; tuning became easier, and quality of reception was improved 100 per cent."

"Yours very truly,
(Signed) E. L. Maschmeyer"



SANGAMO
By-Pass Condensers now available.
1 mfd. \$1.25
1/2 mfd. .90

Sangamo Electric Company
Springfield, Illinois

RADIO DIVISION, 50 Church Street, New York

SALES OFFICES—PRINCIPAL CITIES

For Canada—Sangamo Electric Co. of Canada, Ltd., Toronto.
For Europe—British Sangamo Co., Ponders End, Middlesex, Eng.
For Far East—Ashida Engineering Co., Osaka, Japan

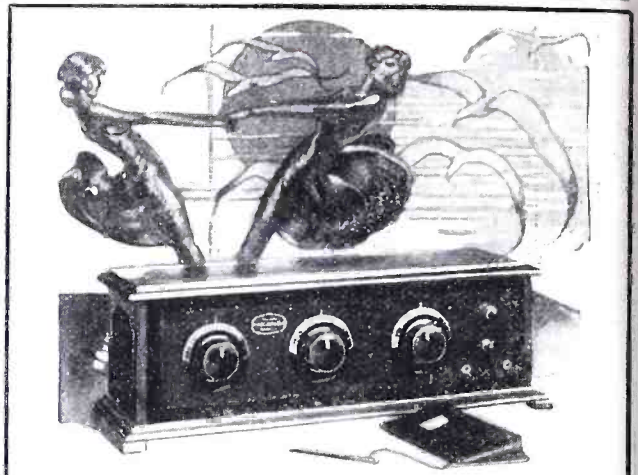

A GUARANTEE OF GOOD RADIO

Thousands of Arborphone owners know they are certain of excellent reception to-night and every night. For Arborphone Receivers are built upon thoroughly proved principles—of the newest, improved parts and materials.

\$55⁰⁰

Tuning is highly selective and simple. Distance—you can satisfy all reasonable demands.

Cabinet work is in excellent taste.

From any standpoint you will be proud of your Arborphone, appearance and performance. Ask your dealer to demonstrate or write to factory for beautiful catalog.

\$60.00 in Rocky Mt. and Pacific Coast States

MACHINE SPECIALTY CO.
Ann Arbor Michigan

ARBORPHONE

12-Cell—24 Volt Storage 'B' Battery
Positively given free with each purchase of a WORLD "A" Storage Battery. You must send this ad. with your order. WORLD Batteries are famous for their guaranteed quality and service. Backed by years of successful manufacture and thousands of satisfied users. Equipped with Solid Rubber Case, an insurance against acid and leakage. You save 50 per cent and get a

2-Year Guarantee Bond in Writing
WORLD Battery owners "tell their friends." That's our best proof of performance. Send your order in today.

Solid Rubber Case Radio Batteries
6-Volt, 100-Amperes . . . \$11.25
6-Volt, 120-Amperes . . . 13.25
6-Volt, 140-Amperes . . . 14.00

Solid Rubber Case Auto Batteries
6-Volt, 11-Plate . . . \$11.25
6-Volt, 13-Plate . . . 13.25
12-Volt, 7-Plate . . . 16.00

SEND NO MONEY Just state battery wanted and received, by Express C. O. D. subject to your examination on arrival. **FREE "B" Battery** in cash in full with order. Buy now and get a guaranteed battery at 50 per cent saving to you.

WORLD BATTERY COMPANY
1219 So. Wabash Ave., Dept. 3 CHICAGO, ILL.

World For AUTO and RADIO STORAGE BATTERIES

Approved and Listed as Standard by Leading Authorities including Radio News Laboratories; Popular Science Institute of Standards; Popular Radio Laboratories; Radio Broadcast Laboratories; Radio in the Home, and Lefax, Inc.

DKKA - WEAF - WGN - WJS - KHJ - RGO - KFAF - WJY - KOP

All apparatus advertised in this magazine has been tested and approved by POPULAR RADIO LABORATORY

Make Your Radio Gift A Gift of Practical Service

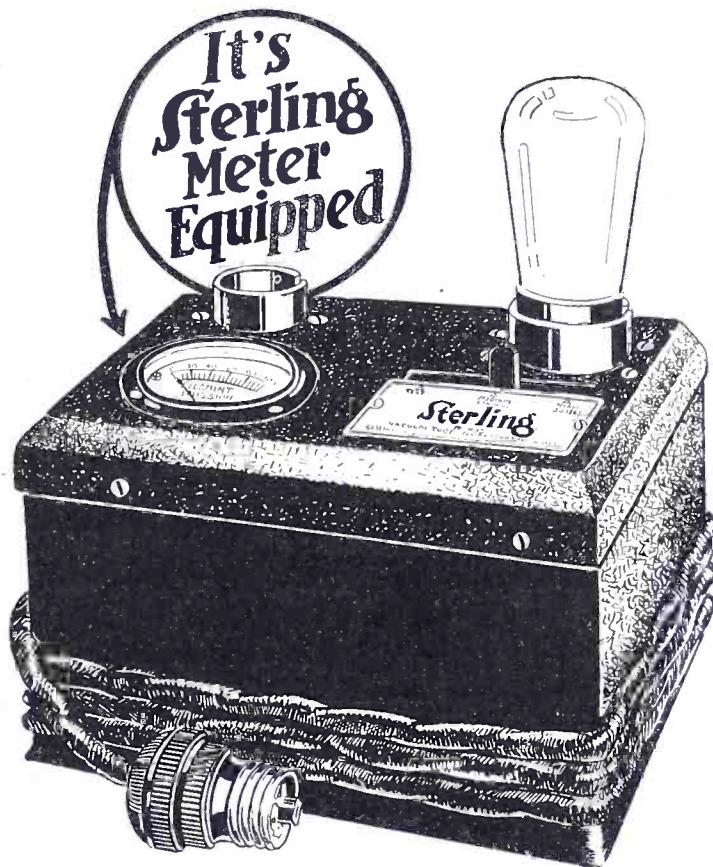

Other STERLING "Gifts of Service"

Home Tube Testers
for small tubes \$10.00
for large tubes 8.50

Battery Chargers
\$16.00 to \$25.00

Pocket and Panel Meters
\$1.00 to \$6.00

What could be more appropriate—

than the gift which insures renewed and continuous vitality to radio tubes—for without good tubes the best broadcasting is poorly received.

What gift could be more practical than a tube reactivator which shows when to renew tube life and shows how good each and every tube is after treatment.

Make your radio Christmas gift a Sterling *metered* tube reactivator a gift that friends and family will appreciate most—because it prolongs the joy of radio throughout the year.

Ask your dealer for the tube reactivator that renews your tubes and tests them too—that's the

Sterling

TUBE REACTIVATOR

Price:

\$12.50
(50-60 cycle)

\$14.00
(25-40 cycle)

Mention cycle
when ordering

THE STERLING MFG. COMPANY

2831-53 Prospect Ave., Dept. G., Cleveland, Ohio
(World's largest manufacturer of small meters)

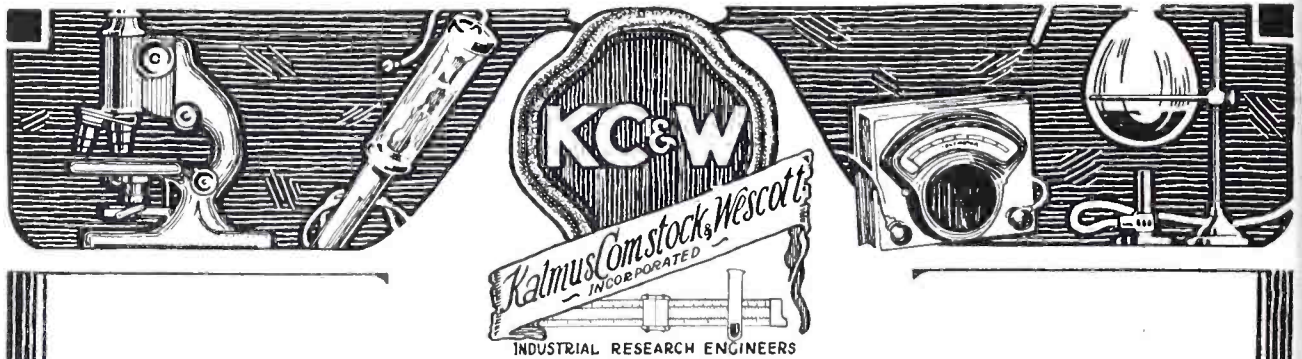

“RESEARCH IS THE KEY TO THE FUTURE OF RADIO”—
says R. E. Renaud in “Popular Radio”

Radio manufacturers, radio investors and the buying public are beginning to realize the tremendous importance of research work based on science and method.

Large manufacturers maintaining research departments of their own find our services of great value for the solution of problems which arise from time to time outside the more specialized field of their own research departments.

Smaller manufacturers may now have their necessary research work done without the financial burden of maintaining research departments of their own.

A descriptive booklet will be furnished on request.

KALMUS, COMSTOCK & WESCOTT Inc.
 CHAMBER OF COMMERCE BLDG. *Industrial Research Engineers.* BOSTON, MASSACHUSETTS

Oh boy
KESTER
Rosin Core
Radio SOLDER
Sure is Safe and Simple
APPROVED BY RADIO ENGINEERS
A GENUINE SOLDER
CHICAGO SOLDER COMPANY
 4221 Wrightwood Av., Chicago, U.S.A.
Originators and World's Largest Manufacturers of Self Fluxing Solder
YOUR DEALER CAN SUPPLY YOU

**ELKAY 5-TUBE
 SUPER-SELECTOR**

Compares favorably in appearance, selectivity, volume, distance and tone quality with sets at twice its price. Has one stage R. F., detector, one stage of transformer coupled amplification and two resistance coupled amplifiers. Only two dials. A radio frequency choke permits same smooth operation on low or high wave lengths. Control over selectivity a distinct departure—an ELKAY invention.

\$80

Also made with 4 tubes at \$70. Blue prints, \$1.00. See the ELKAY at your dealer's. (Dealers, write for exclusive agency.)

THE LANGBEIN-KAUFMAN RADIO CO.
 511 Chapel St., Dept. P., New Haven, Conn.

An L&K Product

TUNERS ELKAY SETS, KITS

All apparatus advertised in this magazine has been tested and approved by POPULAR RADIO LABORATORY

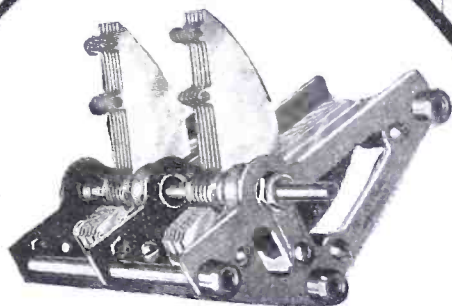

Made under Hogan Patent No. 1,014,002
Jan. 9, 1912

Reduces Interference

The most vexing problem you have to face with your radio set is INTERFERENCE.

U. S. Tool Engineers have perfected a Straight Line Frequency Condenser that distributes the stations uniformly over your dial and makes possible a degree of selectivity you never thought possible.

No more crowding—minimum interference when you use U. S. Tool Straight Line Frequency Condensers.

Write for Booklet

U. S. TOOL COMPANY
INC.
AMPERE, N. J.

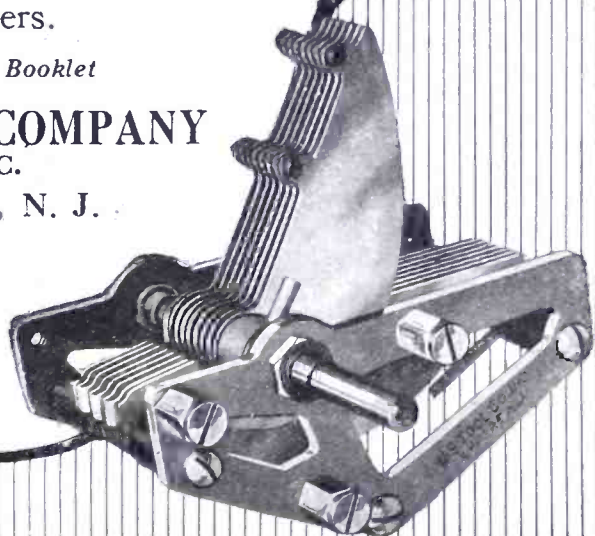

Ring in the New Year!

Listen to the clear tinkling bells on the frosty midnight air—at the stroke of 12.

WHY NOT USE THE "B" RECTIFIER?

Rhamstine*
"B"
Rectifier

Only
\$25.00

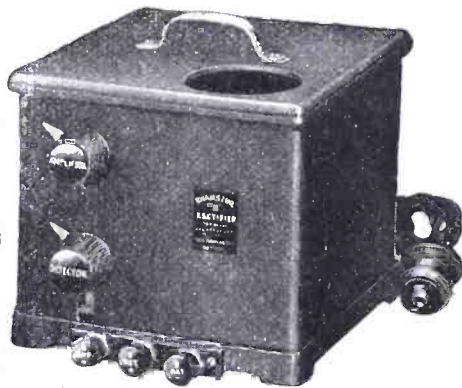

(tube not included)

A Rhamstine* "B" Rectifier eliminates "B" Battery troubles, converts alternating current (110 volts) into direct current, and assures a continuous flow of power through Radio receiving set at a constant voltage. The "B" Rectifier gives you better reception and reproduces the original sound in all its natural fullness. Its efficiency will amaze you. Endorsed by Radio Manufacturers and Dealers. Why not get one? Sold on assured satisfaction—you can depend upon Rhamstine* quality and performance. Send no money. Just check the coupon.

WHY BUY NEW TUBES?

A Rhamstine* Tube Booster will re-energize the filament and reproduce the clear tones, and give better volume and reception. A few minutes, once a month, will re-create the energy in the old tubes and make them just like new

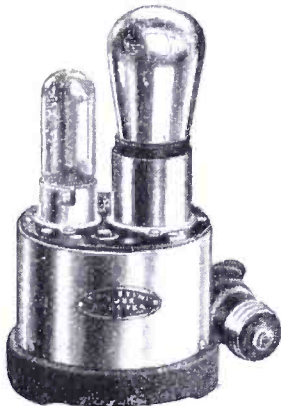

Rhamstine*
Tube Booster

Only \$6.00

Works on any A.C. 110-120 volts, 50-133 cycles—201A or 199 type tubes.

Mail the Coupon Today

J. THOS. RHAMSTINE* (1)
Woodbridge at Beaubien,
Detroit, Mich.
Please send me
 Rhamstine* Tube Booster at \$6
 Rhamstine* "B" Rectifier at \$25
by express C. O. D. subject to inspection. If I am not entirely satisfied with the "B" Rectifier I will return it to you in five days and receive a refund of the full purchase price.

Name.....

Address.....

City.....

J. THOS. RHAMSTINE*
Radio and Electrical Products
Woodbridge at Beaubien, Detroit, Mich.

Heath Straight Line Wavelength Condensers

Give better radio reception all around the Dial

Write for Booklet

Heath Radio and Elec. Mfg. Co.
206-210 First Street, Newark, N. J.

To-day
-in every
good set!

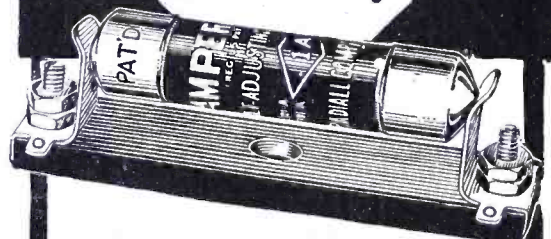

"I'm a MASTER OPERATOR"

AMPERITE never distinguishes between a novice and an experienced operator for the wonderful clarity and full, rich tones it makes possible. Just pull the switch and each individual tube does its utmost to outdo the other tubes. The "Self-Adjusting" rheostat that takes the guess out of tube control. Used in all popular construction sets. Price, \$1.10.

There is an AMPERITE for every tube

Write for free hook-ups

Radiall Company

Dept. P.R.-1 50 Franklin St., N. Y. City

AMPERITE
REG. U.S. PAT. OFF.

The "SELF-ADJUSTING" Rheostat

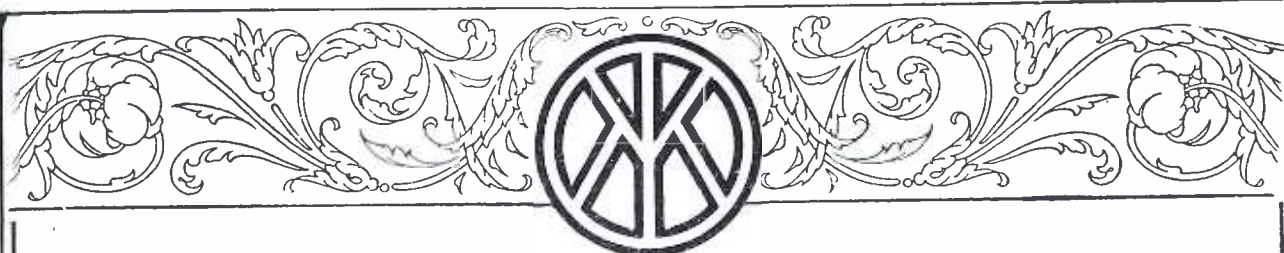

Kit containing complete parts, nothing else to buy. Simple to install. You can change over your present set in half an hour.



Group Control comes either with Center Master Control Dial or for sets with graduation on panel, a Master control pointer Knob is provided.

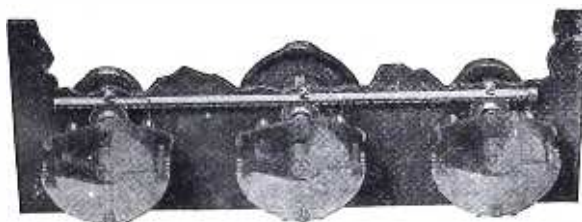

Rear View

KURZ-KASCH Aristocrat E-Z-TOON (EASY TUNE) Group Control

**For the set you have
For the set you build**

End complicated tuning by equipping your set with an Aristocrat E-Z-TOON Group Control.

One Master Vernier dial (or vernier pointer Knob) controls all tuning units, at the same time providing Vernier adjustment for each separate tuning unit.

Rotating the master dial locates the station, and by tuning the correcting vernier on each unit, perfect tuning can be obtained.

Simple to install, no extra parts to buy. No panel to drill. Can be installed in half an hour.

Complete with instructions, \$7.50. Ask your dealer. Write us for illustrated folder.

Manufactured by
THE KURZ - KASCH COMPANY
Largest Exclusive Moulders of Bakelite
Factory & Main Office Dayton, Ohio.

All apparatus advertised in this magazine has been tested and approved by POPULAR RADIO LABORATORY

TOBE

"A BETTER CONDENSER"

The Perfect Filter Condenser for "B" Eliminators

Tobe condensers were specified in "How to Build" articles on B battery supply units in the November issues of Radio News, Popular Radio, Radio Broadcast and Radio.

FIRST—Because of their uniformity (less than 5% variation from rated capacities).

SECOND—Because of their permanence (their rigid construction assures permanence of rated capacities through variation of temperature).

THIRD—Because of their high megohm resistance (indicating extreme low loss and high insulation).

FOURTH—Because of their capacity to withstand overload (can operate at voltages up to 700 D.C. without breakdown).

TOBE CONDENSERS are made in sizes from .00025 Mfd. to 4.0 Mfd.

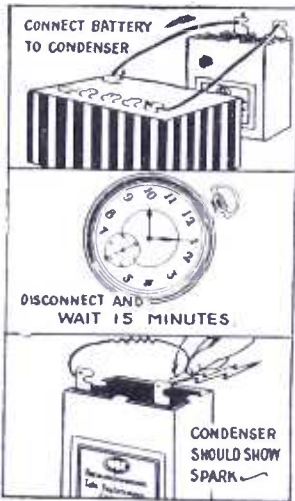

Compare Tobe Condensers with others by this simple test

Charge your condenser from your battery, then remove the connections from the condenser and wait fifteen minutes. Then discharge the condenser by shunting a wire from one terminal to the other. If a spark appears it is proof that the condenser is capable of holding its charge for quarter of an hour.

Any condenser which fails in this test is not suitable for by-pass or filter work. Insist on Tobe condensers for by-pass B battery or B eliminator use.

They are distinguishable by their silvered-aluminum cases and their easily identified cartons of new and distinctive design.

Tobe Deutschmann Co.

CORNHILL

BOSTON, MASS.

Technical Booklets Worth Reading

Cardwell Quality Radio Parts are standard. Write for Bulletins on any or all of the following. They give a liberal education on radio theory and practice:

- 51 Variable Condensers
- 52 Special Condenser Types
- 85 Straight-Line Condensers
- 55 Cordweave Coils (on press)
- 56 Transmitting Condensers
- 71 Equitrol Dials
- 36 Engineering Service
- 37 Audio Transformers
- 82 Professional Set Builders Plan
- 60 Dealer Electrotypes
- 72 Exclusive Dealer Agencies

PLEASE! Be sure to check ONLY bulletins in which you are interested.

ALLEN D. CARDWELL
Manufacturing Corporation
81 Prospect St. - - Brooklyn, N. Y.

FOR CLEAR, QUIET "B" POWER



RADIO Storage "B" Battery

12 Cells 24 Volts Lasts Indefinitely—Pays for Itself

Economy and performance unheard of before. Recharged at a negligible cost. Delivers unfailing power that is clear, pure and quiet. Approved and listed as Standard by leading Radio Authorities, including Pop. Radio Laboratories, Pop. Sci. Inst. Standards, Radio News Lab., Lefax, Inc., and other important institutions. Equipped with Solid Rubber Case, an insurance against acid and leakage. Extra heavy glass jars. Heavy rugged plates. Order yours today!

SEND NO MONEY wanted and we will ship day order is received. Extra offer: 4 batteries in series (96 volts), \$10.00. Pay expressman after examining batteries. 5 per cent discount for cash with order. Mail your order now!

WORLD BATTERY COMPANY
1219 So. Wabash Ave., Dept. 77 Chicago, Ill.
Makers of the Famous World Radio "A" Storage Battery
Prices: 6-volt, 100 Amp. \$11.25; 120 Amp. \$13.25; 140 Amp. \$14.00.
All equipped with Solid Rubber Case.

World STORAGE BATTERIES

Set your Radio Dials at 210 meters for the new 1000 watt World Storage Battery Station, WSBC, Chicago. Watch for announcements.

KDKA - WEA - WGN - WJS - KHJ - KGO - KFAF - WJY - KOP

TIMBRETONE

REG. U.S. PAT. OFF.

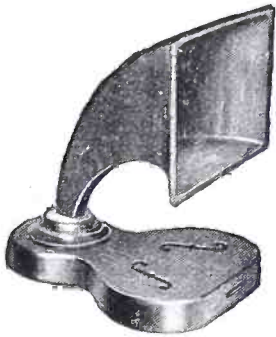

List \$20.00

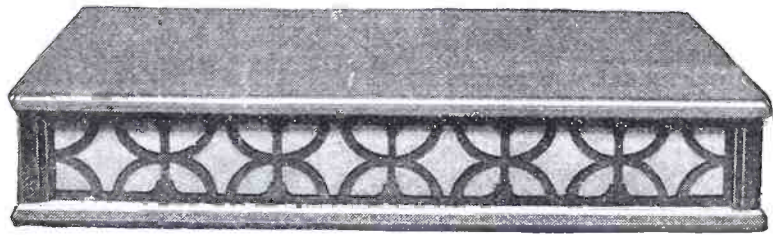

List \$30.00

Pronounced by experts to be the most wonderful toned Radio Speaker they have ever heard. An improved four pole unit with non-metallic diaphragm results in the hearer wanting to own one. It is a real musical instrument. Duco Mahogany finish—all wood.

For Sale By

SANFORD BROTHERS

Chicago, Ill.
30 W. Walton Place

Seattle, Wash.
Am. Bank Bldg.

Chattanooga, Tenn.
615 Broad St.

San Francisco, Cal.
311 Minna St.



FACTORY:

TIMBRETONE MFG. CO.
Hoosick Falls, N. Y.

All apparatus advertised in this magazine has been tested and approved by POPULAR RADIO LABORATORY



Radion Panels in black and Mahogany come cut in all standard sizes.

The double advantage of RADION

THERE are two important requirements for any set:

- (1) *Efficient reception and* (2) *Good appearance*

The selection of RADION goes far toward fulfilling both these requirements. RADION Panels possess superior insulating qualities not excelled in any other panel made. RADION has such a beautiful surface finish that it noticeably enhances the appearance of any set.

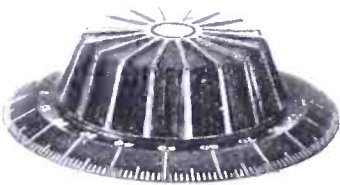

New No. 10 4-inch Radion Dial, built to conform to the fingers, helping you to get close tuning.

This double advantage of RADION is due to the fact that it is the *only insulation that was made to order for radio purposes exclusively.*

The high-resistant characteristics possessed by RADION Panels mark all RADION loss parts—Sockets, Dials, Insulators, Tubing, etc. Adopted by leading manufacturers and sold universally by radio dealers.

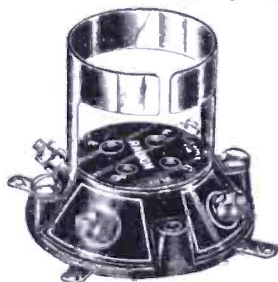

No. 2 Radion Socket for new UX tubes with collar adapter, for old type tubes. No. 4 same as No. 2, without collar adapter, for new UX tubes exclusively.

Send for booklet, "Building Your Own Set." Mailed for 10 cents.

Manufacturers—Our facilities and equipment for the manufacture of molded parts are second to none. Write us for prices on quantities.

AMERICAN HARD RUBBER COMPANY
(Dept. B 13) 11 Mercer St.
New York City

RADION

The Supreme Insulation

Made to Order for Radio Purposes Exclusively

Burns



*Clarity
Volume
Beauty*

PRICES
Three Finishes
\$22.50 \$25.00
\$30.00

FOR REAL ENJOYMENT

Use the BURNS Loud Speaker on your receiving set. Produces utmost in volume and clarity of tone. Reaches full range of musical scale—equal to hearing the original production.

At your dealers or direct

American Electric Company
State and 64th Streets, Chicago

TWO WONDERS of the NIGHT!

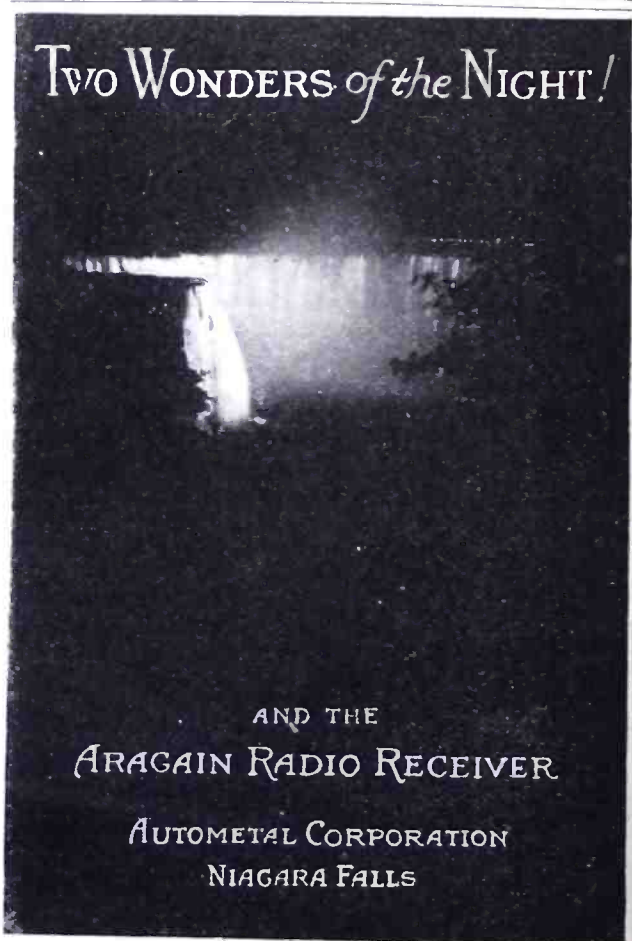

AND THE
ARAGAIN RADIO RECEIVER

AUTOMETAL CORPORATION
NIAGARA FALLS

All apparatus advertised in this magazine has been tested and approved by POPULAR RADIO LABORATORY



When a Finer Transformer Is Made It Will Bear This Name-Plate

Radio moves rapidly. Perhaps some time there may be seen a *better* transformer than what we now know as Rauland-Lyric. It may sell at \$9, or \$10, or \$15, or \$7. But the careful observer of the past year's developments will entertain not a moment's doubt of one thing: when the better transformer comes it will come beneath the famous Rauland-Lyric name-plate. Behind this as a pledge rests the entire organization and resources of the All-American Radio Corporation

Rauland-Lyric is easily obtainable from better-class dealers everywhere. The price is nine dollars. Descriptive circular with technical data may be had on request to All-American Radio Corporation, 4201 Belmont Avenue, Chicago

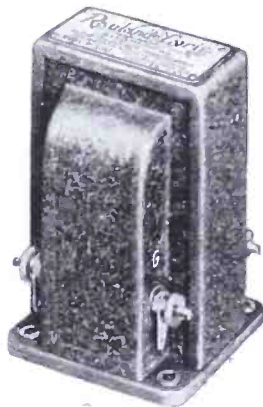

Rauland-Lyric tone quality is now available in a complete receiver: the new All-American Model R (a five-tube tuned-radio-frequency set) now being shown. If your preferred dealer does not display it, send to us for descriptive booklet

How to Get the Most Out of Your Set

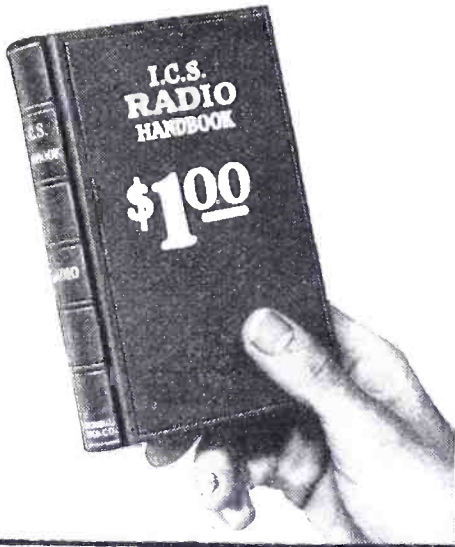

Learn the principles of radio from this remarkable book

514 PAGES

Compiled by **HARRY F. DART, E.E.**
Formerly with the Western Electric Co., and
U. S. Army Instructor of Radio
Technically edited by **F. H. DOANE**

STOP turning the dials blindly. Learn what happens when you turn them and why. Then you will get greater distance, greater volume, most enjoyable quality.



The I. C. S. Radio Handbook will help you to get more enjoyment out of radio. It clears up the mysterious — tells you just what you want to know. Written by nationally known radio authorities in language that you can understand. An absolute necessity for every radio fan. A wonderful bargain at \$1. Note this partial list of contents—

Electrical terms and circuits, antennas, batteries, generators and motors, electron (vacuum tubes), many receiving hook-ups, radio and audio frequency amplification, broadcast and commercial transmitters and receivers, super-regeneration, licenses, etc.

Send only \$1 with the coupon today and get this 514-page I. C. S. Radio Handbook.

Money Back if Not Satisfied

INTERNATIONAL CORRESPONDENCE SCHOOLS
Box 8250-G, Scranton, Penna.

I enclose \$1. Please send me—post-paid—the 514-page I. C. S. Radio Handbook. It is understood that if I am not entirely satisfied I may return this book within five days and you will refund my money.

Name

Address

Check here and enclose \$1.50 instead of \$1 if you wish the De Luze Leatheroid Edition.

LOMBARDI Straight Line Frequency Condensers

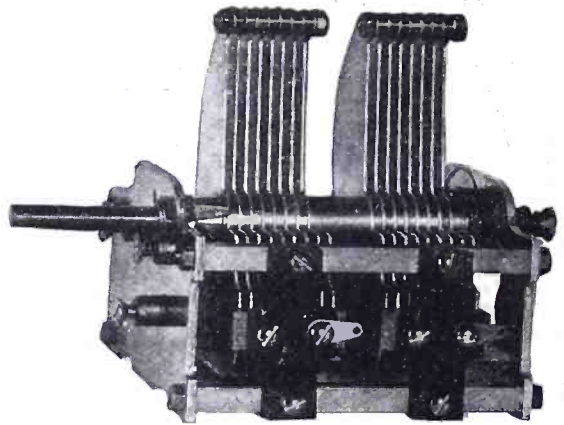

Are real precision instruments, fit for the highest grade of Radio Sets. Their substantial and careful design is immediately apparent to anyone who knows Radio. Patented ball and taper-bearing shaft and watch spring pig tail insure permanent accuracy. Made in both single and multiple units. Multiple units licensed under Hogan patents.

Manufacturers and home set builders write for full descriptive matter.

LOMBARDI RADIO MFG. CO.
67 Minerva St., Derby, Conn.

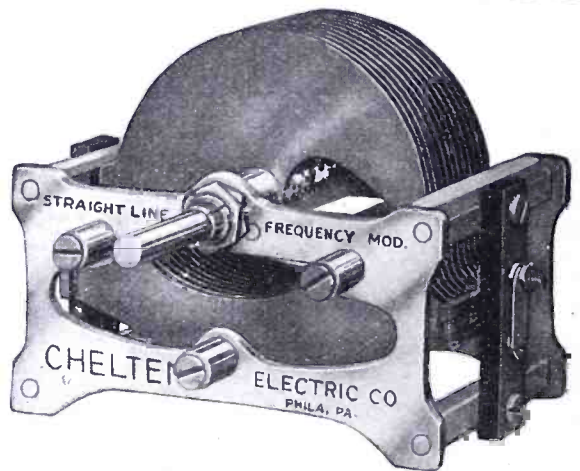

The Chelton Straight-Line Frequency Condenser (Modified)

A real Condenser scientifically designed from practical operating standpoint. Dependable in every way. Spreads low wave stations. Provides uniform separation over tuning range. Standard frame—soldered brass plates.

Send for our booklet, "Straight-Line Frequency Tuning," an authoritative study on this vital subject. It's free.

CHELTON ELECTRIC CO.
4859-65 Stenton Ave., Philadelphia

All apparatus advertised in this magazine has been tested and approved by POPULAR RADIO LABORATORY



Distance with Volume

THREE stages of perfectly matched audio enable you not only to hear, but to enjoy even the distant stations with loud speaker volume and absolute tone fidelity.

In the acid test of comparative performance, the Ferguson wins every time, because it is fundamentally correct in design and precision-built in its super-craftsmanship.

The graceful dignity of Ferguson cabinet work is the crowning touch that has won a permanent place for the Ferguson in so many of the better homes throughout the country.

Go to your Authorized Ferguson Dealer—hear the Ferguson in comparison with others and you will learn why it has been popularly acclaimed: "The Gold Standard of Radio Receivers."

J. B. FERGUSON, INC.
41 East 42nd Street • New York, N.Y.

Ferguson

J. B. INCORPORATED

The Gold Standard of Radio Receivers

Ferguson "Six"—Two tuning controls
(A six tube Tuned R. F. Receiver)
Cabinet Model \$180
Console Model \$290

Ferguson "Eight"—One tuning control
(A six tube Tuned R. F. Receiver)
Cabinet Model \$226
Console Model \$348
(Above prices are less accessories)

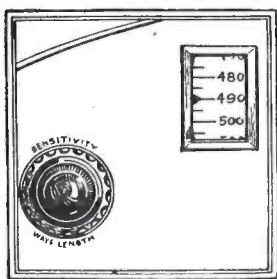
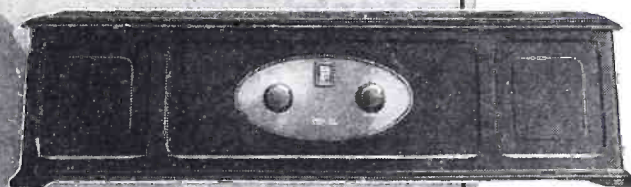

One Tuning Control—
***Calibrated in Meters!**

Simply choose your program, turn up its wavelength and in comes your station—right on the line!

The Wilson "B" Radiopower Unit

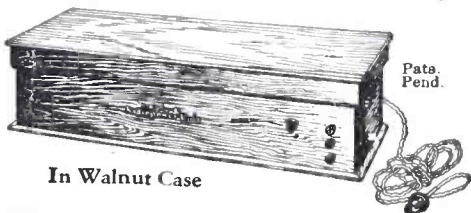

In Walnut Case

This new unit will enable you to get the most out of your receiver. Provides uniform "B" voltage at minimum cost. Operates from light socket. *Will not set up the slightest hum.* Hook it to your set and forget it except to switch it on and off. Nothing to adjust. Nothing to get out of order. No acid to spill. No expensive replacements. The most dependable, convenient and economical plate current supply. Price complete \$35.

Write for complete information

The Andrews Paddlewheel-Coil

Pata. Pend.

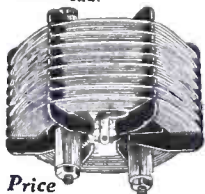

Price \$3.00

This coil can be used in any hookup requiring a high grade inductance. You will be pleased with results because of its negligible losses, minimum distributed capacity and exceptionally high ratio of inductance to resistance.

It greatly improves tone quality, making possible any desired volume without distortion. Used in such well-known receivers as the *Deresnadyne* and *Buckingham*. Ask your dealer for constructional blueprints of tested circuits employing this superior coil.

Our Technical Dept. will answer inquiries.

Duo-Spiral Folding Loop

Handsomely finished in silver and mahogany to harmonize with the finest home furnishings.

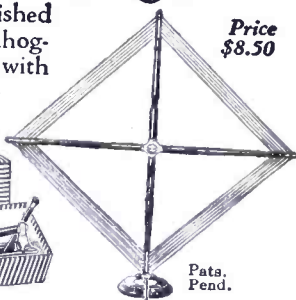
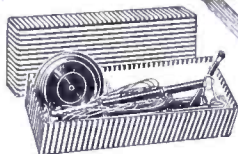

Price \$8.50

Pata. Pend.

Folds neatly and compactly. Has graduated silvered dial and insulated handle. Use a Duo-Spiral for selectivity and to reduce static. A special model for every circuit.

If your dealer cannot supply these standard products, write direct.

Radio Units Inc.

1301 First Avenue Maywood, Illinois
Perkins Elect. Ltd., Montreal, Toronto, Winnipeg

An Inside Aerial 1,000 Feet Long!

Effarsee ANTENNAE

REG. U. S. TRADE MARK PATENT PENDING

Gives Longer Range—More Volume—Greater Selectivity—Less Static!

The New EFFARSEE (Type IXL) gives you the equivalent of a thousand feet of copper wire. Increases volume tremendously, minimizes static, makes any set more selective.

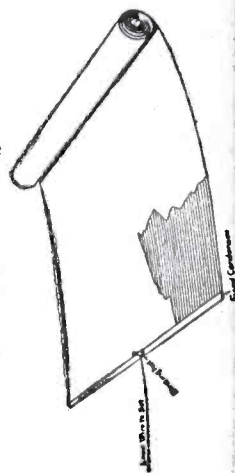

Equipped with Fixed Condensers Gives Greatly Improved Reception!

EFFARSEE is scientifically designed to give local and distance reception at its very best. Can be used inside or out—covered with parchment, it rolls up—can be hung on walls, in closets, hidden under rugs. Has coast to coast reception records. Write for booklet of testimonials and distance reports.

Type IXL (Large) . . . \$4.00

Type BXL (Small) . . . \$2.50

At any radio dealer or write direct.

THE FISHWICK RADIO CO.

137 Central Parkway

Cincinnati, O.

Radio Dealers WANTED!

If you are the type of dealer who hustles after business, who isn't content to wait for trade to come in but who takes sets out to demonstrate, can talk and sell quality merchandise, and knows Radio values, we have a big proposition for you.

Are you that dealer?

50% DISCOUNT TO DEALERS

We manufacture a complete line of high grade receivers and sell to dealers at 50% discount. We are authorized distributors for more than 225 Nationally advertised lines.



Write today for amazing offers new 112-page catalog and regular monthly catalogs quoting below-the-market prices on latest merchandise—all free. Everything in Radio for less. Just fill in coupon, pin to your letter head and mail today, NOW.

AMERICAN RADIO MFG. CO.
1416-18 McGee Street, Dept. P., Kansas City, Mo.

AMERICAN RADIO MFG. CO., 1416-18 McGee St., Dept. P, Kansas City, Mo.

Gentlemen: Mail me your new 112-page catalog. Also put me on list for regular monthly mailings.

Name.....

Address.....

City..... State.....



Separate All Stations Evenly

IT is not necessary to tear down and rebuild your present set in order to separate the stations evenly on the dials. By merely substituting *Rathbun Straight Line Frequency Converters* for your present dials—you will be able to secure real S. L. F. tuning.

Here is a variable vernier control that provides a ratio of 50 to 1 down where the stations are crowded—gradually and smoothly decreasing in uniform ratio over the full 360° of the dial. The stations are evenly separated around the entire circle. There are only two moving parts—a cam and a lever. The action is dependable and accurate—without a particle of backlash. Easier tuning and immeasurably better logging are obtainable from straight line capacity condensers with these new converters.

Remember that we build the Rathbun Single Hole Mounting Condenser with genuine Bakelite ends. This year's models are enclosed with transparent pyralin dustbands which preserve their high efficiency for life. They are small, light and rugged—always reasonably priced.

Ask your dealer for Rathbun Straight Line Frequency Converters
He has them in stock or will get them for you promptly

PRICE \$3.50

RATHBUN MANUFACTURING CO., INC.

JAMESTOWN, N. Y.



The Hammarlund Roberts Foundation Unit

Contains All
Special Parts

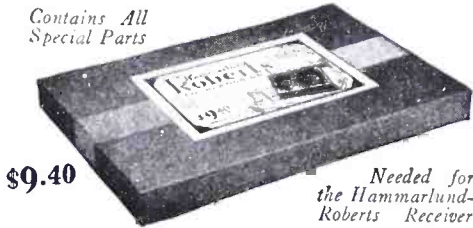

\$9.40

Needed for
the Hammarlund-
Roberts Receiver

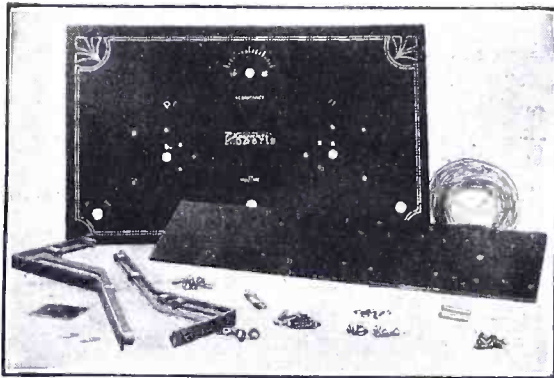

The interest in this new wonder circuit is nationwide and justly so. Here is a five-tube receiver with the sensitivity and selectivity of a super-heterodyne, representing the composite ideal of ten famous radio engineers.

You can easily build it yourself with the Hammarlund-Roberts Foundation Unit and the parts listed below.

- | | |
|--------------------------------|--|
| 2 Hammarlund S-L-F Condensers | 2 Rauland-Lyric Transformers |
| 1 Hammarlund Midget Condenser | 1 Carter Rheostat, Jack and Battery Switch |
| 1 set Hammarlund-Roberts Coils | 1 Durham Resistor |
| 5 Na-ald "Deluxe" Sockets | 4 Amperites |
| 2 Na-ald Dials | 3 Dubilier Condensers |
| | 5 Pairs Union Phone Tip Jacks |

Send 25 cents for illustrated booklet giving complete details on assembling, wiring and operating the Hammarlund-Roberts Receiver.

HAMMARLUND MFG. CO.
424-438 W. 33rd St., New York

For Better Radio
Hammarlund
PRECISION
PRODUCTS

HEADQUARTERS For LC-26 Parts

General Radio Parts
E.I.S. Apparatus
Dubilier Condensers
Weston Meters
Formica Panels
Premier Jacks
Cunningham Tubes
General Electric Tungars
Mahogany Cabinets
Special Engraving
Special Condensers, Coils,
Shielding, Etc.

No General Catalog Issued

Write for Quotation on any Radio Apparatus or Material Required.

NORDEN-HAUCK, Inc.

ENGINEERS

1617 Chestnut Street, Philadelphia, Pa.

G-K SPRING BINDING POSTS

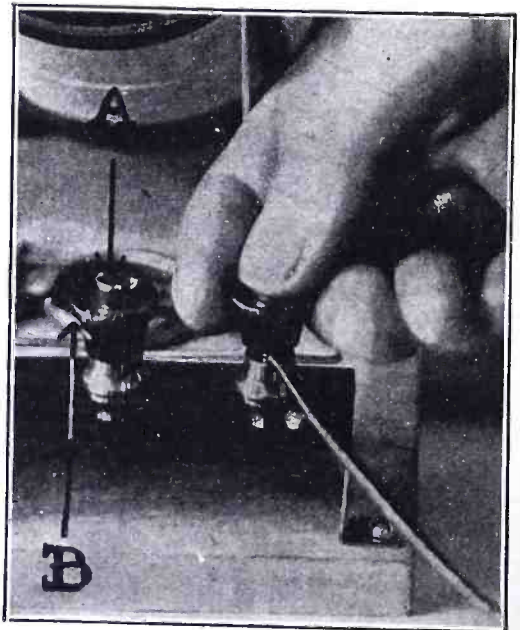

Built for the RADIO INDUSTRY. Choice of Leading Engineers. Genuine Bakelite Knob—Spring Contact and Release—Patented.

List 15c Each

Inquiries Solicited from the Trade

GANIO-KRAMER COMPANY, INC.

238-40 West 53rd Street

New York City

SYLVANIA tubes are made slowly, with infinite care. Step by step, under the critical eyes of a corps of inspectors, they pass from one skilled workman to another. And into each piece and part is put only the finest materials and the best workmanship that is within the reach of the radio industry. Then there is test after test to establish beyond any question of doubt that each tube is the exact counterpart of every other tube. Thus it is that you can try set after set of Sylvania's in your receiver and get from each the same unvarying degree of quality performance.

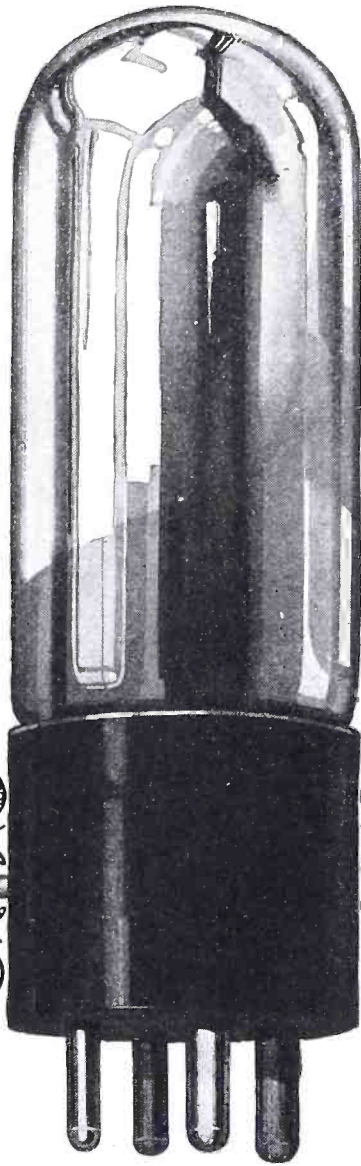

THERE are no better methods or processes known than those used in the making of Sylvania tubes. The guarantee of complete satisfaction, without reservation, to every user of Sylvania tubes is substantial proof of it. If you have not experienced Sylvania performance, if you have not discovered for yourself their greater volume, keener sensitivity, better tone, and longer life—you have an almost unbelievable radio performance before you.

To Radio Dealers: Behind each Sylvania tube stands a thoroughly responsible organization, well known and respected. It will be worth your while to write us regardless of any present connections. You are invited to investigate the Company's responsibility through any of the commercial agencies.

A size and type for every need, \$2.50



Sylvania

SYLVANIA PRODUCTS COMPANY
EMPORIUM . . . PENNSYLVANIA

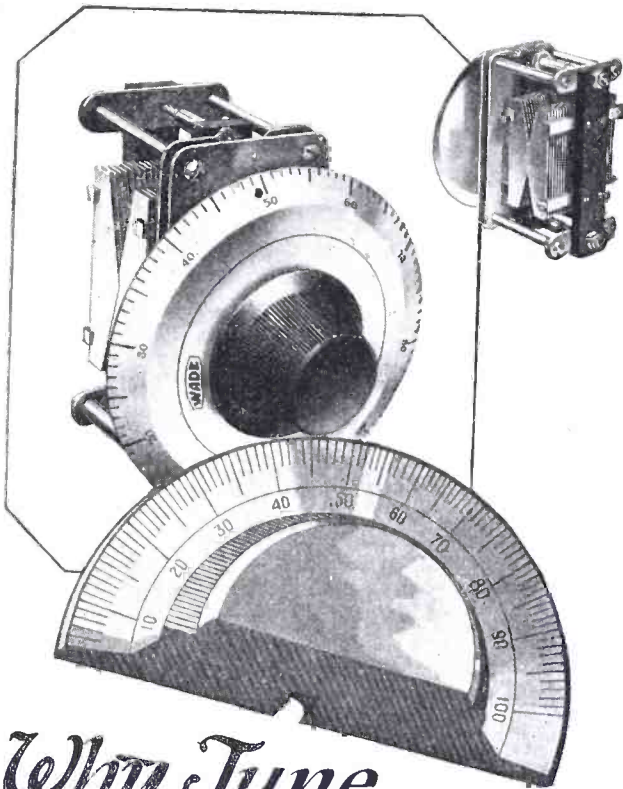

Why Tune With Only Half a Dial?

UNIQUE design of Wade Condensers spreads stations over the entire 360 degree dial. The Wade is a complete tuning unit built with specially designed vernier dial. This means twice as much space between stations for close tuning adjustment; even wider separation of stations than the rotor plate types of straight line frequency condensers using standard 180 degree dials. None of the annoyance of overlapping stations and jumbled reception. The Wade Condenser gives the lowest minimum capacity and wider tuning range. Covers the whole broadcast range and down below 200 meters.

Wade Tuning Unit Including Condenser and Dial

The Wade Tuning Unit consists of a Wade Condenser geared to a four-inch 360 degree vernier dial of 16 to 1 ratio. Finest possible control with no backlash. Prices below are for the complete unit.

| | |
|---------------------------|--------|
| Capacity .000125 mfd..... | \$6.00 |
| Capacity .00025 mfd..... | 6.25 |
| Capacity .00035 mfd..... | 6.35 |
| Capacity .0005 mfd..... | 6.50 |

THE VIKING TOOL AND MACHINE CO., INC.
Licensee
745-B 65th Street
Brooklyn, N. Y.



FREE HOOK-UPS AND BIG RADIO GUIDE

Many valuable pages of the latest, approved hook-ups and information are contained in the new big Barawik Radio Guide and Catalog. This valuable book is sent free to radio fans. Shows thousands of new standard radio parts, sets and kits at tremendous savings.

Set Builders Headquarters

We guarantee savings to you of 10 to 25%, and as high as 50%, so be sure to get this book before you spend another cent for anything in radio. We are the oldest mail-order institution specializing in radio supplies. It will pay you to do business with a house that knows the goods and assures you a square deal.

Send us your name and address—postal or letter—(also please include name of radio friend) and we'll send free copy at once.

RADIO
GUIDE

Here Are a Few Sample Bargains from the Barawik Catalog

| | |
|---|--------|
| Guaranteed 201A type Tubes..... | \$1.15 |
| Guaranteed 45-v. large B batteries..... | 2.55 |
| Complete parts for Reimler-Best 8-tube Super..... | 48.45 |
| Complete parts for B-T Counterphase..... | 63.50 |
| Complete parts for Silver Super Autodyne..... | 62.50 |
| Complete parts for Hazeltime Neutrodyne..... | 29.25 |
| Complete parts for Browning-Drake circuit..... | 32.25 |
| Complete parts for McLaughlin 8-tube Super..... | 82.50 |

Order direct from this ad or get a free copy of our complete catalog of everything in radio

THE BARAWIK COMPANY

103-104 S. Canal St.

Chicago, U. S. A.

FREE BLUEPRINTS



A Wild Radio Fan!

Is one who finds he cannot get selectivity and distance because he has used cheap transformers. To prove the selective and sensitive combinations obtainable with—

WERNER Radio Frequency TRANSFORMERS.

which cover the entire broadcasting wave range and have been used by the best radio Engineers for the past 2 years, we will furnish a full size Blue Print of a selective loop receiver **FREE** if you order from us direct.

Werner transformers are fully guaranteed and tested 'on actual broadcast reproduction; guaranteed damp and moisture proof and will give perfect reception in any climate.

WERNER LOOP ANTENNA

Used with any type of loop receiver. Adjustable to a fine degree of clearness, can be folded or extended without tools.

Price Postpaid \$14.00.

Send for free circuit diagram and descriptive literature. Book containing 9 up to date practical R. F. circuit diagrams and treatise on R. F. Amplification, postpaid, 25c.

Werner Products Approved by "Popular Radio."

WERNER RADIO MFG. CO.
204-206 NINTH STREET
BROOKLYN, N. Y.

**Audio
Freq.
\$6.**

**R. F.
\$4.**

**Ask
Your
Dealer.**

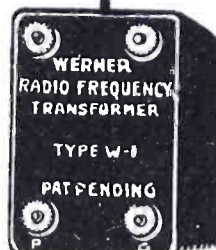

The Best Panel Is Also The Most Handsome

Because of its structural strength, fine insulating qualities and splendid finish Formica has been preferred as a panel material by the great majority of makers of quality radio sets.

Complete Formica Panels supplied with decorations by the Veri-Chrome process have an attractiveness that makes them great favorites with set buyers. In numerous instances where manufacturers making different models have used Veri-Chrome decoration on one panel and not on others, the Veri-Chromed panel has proved to be a large sales maker.

When you select your radio set ask to see one with a Formica panel decorated by Veri-Chrome—and form your own conclusions.

Complete panels decorated with Veri-Chrome are available for some of the better known kits. In some instances the Veri-Chromed panel is included in the kit package by the manufacturer.

Formica panels in standard sizes are sold in neat individual envelopes by leading parts dealers everywhere.

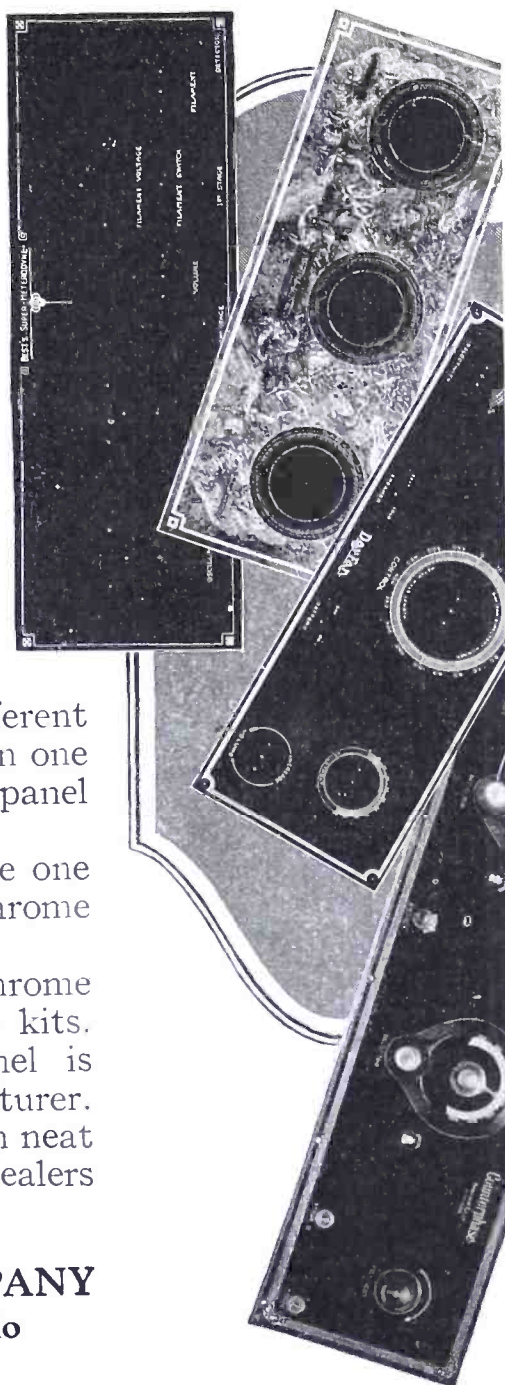

THE FORMICA INSULATION COMPANY
4641 Spring Grove Avenue, Cincinnati, Ohio

SALES OFFICES

New York, 50 Church Street
Chicago, 9 S. Clinton Street
Cleveland, 516 Caxton Bldg.
Rochester, 327 Cutler Bldg.
Toledo, 419 Ohio Bldg.
Minneapolis, 1026 Second Avenue
New Orleans, Whitney Central Bldg.
Pittsburg, 422 First Avenue

Philadelphia, 725 Bulletin Bldg.
Baltimore, 709 Title Bldg.
Havana, Cuba, 55 Calle Obispo
Boston, 6 Beacon Street
Denver, 1420 16th Street
St. Louis, 1362 Syndicate Trust Bldg.
Kansas City, 308 E. 17th Street

FORMICA

Made from Anhydrous Bakelite Resins
SHEETS TUBES RODS

All apparatus advertised in this magazine has been tested and approved by POPULAR RADIO LABORATORY



ACME WIRE RADIO PRODUCTS

Flexible Celatsite

Flexible stranded wire for "point to point" and sub-panel wiring—latest method of wiring sets. 5 colors; black, yellow, green, red and brown, one for each circuit. 25 ft. coils.

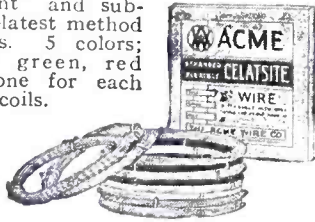

The Original Celatsite Wire

Celatsite is a tinned copper bus bar wire with a non-inflammable "spaghetti" insulation in five colors. Supplied in 30 inch lengths.



Flexible Varnished "Spaghetti"

A perfect insulation tube for all danger points in set wiring. Costs little more and is worth a lot more than the cheaper substitutes offered. Black, yellow, red, green, brown; for wires No. 10 to No. 18. 30 inch lengths.

Stranded Enameled Antenna



The best outdoor antenna you can put up. 7 strands of enameled copper wire; maximum surface for reception. Enameling prevents corrosion and consequent weak signals. 100, 150 or 200 ft. coils, boxed.

Loop Antenna Wire

You can make a good loop with Acme wire made of 65 strands of fine copper wire, green silk covered. Flexible; non-stretching, neat.

Celatsite Battery Cable

For connecting A and B Batteries (or current supply) to radio set. Silk braid covering 5 flexible Celatsite wires—5 feet long—a different color for each terminal. Prevents messy wiring and "blown" tubes. Adds greatly to the appearance of your set.



Send for folder
THE ACME WIRE CO., Dept. P
New Haven, Conn.

FIXED
RESISTORS

Micamold
REG

FIXED
CONDENSERS

"Made of Mica and Moulded in genuine Bakelite"

Capacity of Resistors and Condensers guaranteed within 5% and constant in value.

They are indestructible and moisture proof.

At all good Radio Stores.

MICAMOLD RADIO CORP.
FLUSHING AND PORTER AVES.
BROOKLYN, N. Y.

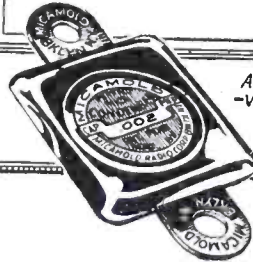

ACCURACY GUARANTEED
-VALUES REMAIN CONSTANT



ATTENTION DEALERS

Send for our 200 page catalog



The finest and largest exclusive
Radio Catalog in the
United States

Schneitter Radio Company

Dept. G.

St. Joseph, Missouri

All apparatus advertised in this magazine has been tested and approved by POPULAR RADIO LABORATORY

Easy to Build this 5 Tube Receiver

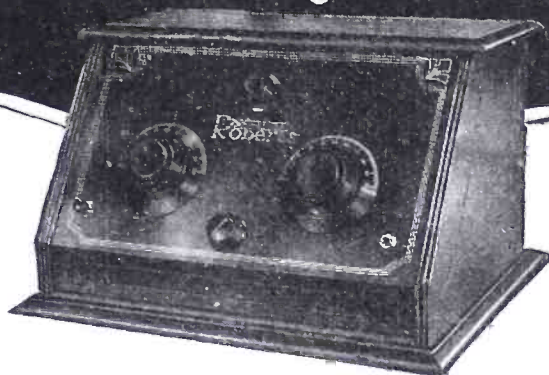

**Send for
This Book**

Gives you step-by-step directions for assembling, wiring and operating the Hammarlund-Roberts receiver. Fully illustrated.

25c.

**Associate
Manufacturers**

All-American Radio Corp.
Alden Mfg. Co.
Radiall Company (Amperites)
Carter Radio Co.
Union Radio Corp.
International Resistance Co., Inc. (Durham Resistors)
Westinghouse Micarta
Hammarlund Mfg. Co., Inc.

THE beautiful simplicity of the Hammarlund-Roberts is one of the many stirring features that have made this receiver the talk of the country.

The creative genius that conceived the idea of a masterly five-tube receiver, and the engineering skill that brought the idea to reality, kept always in mind the limited mechanical ability of the inexperienced builder. The result is a plan of assembly so complete, so detailed, that a man or boy, following the step-by-step directions in the instruction book, may construct the Hammarlund-Roberts in the course of an evening.

The masterpiece of ten leading engineers—equal in performance to a standard eight-tube set—backed by some of the best-known parts manufacturers in the radio field—this is the Hammarlund-Roberts. Today it is the one radio receiver talked about above all others.

Complete assembly, less cabinet, \$62.30

HAMMARLUND-ROBERTS, 1182-B Broadway, New York

Hammarlund Roberts

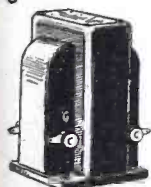

Ranland Lyric
ALL-AMERICAN
TRANSFORMER

Here are some of the famous parts used in the Hammarlund-Roberts



AMPERITE



**DURHAM
UNION**



Hammarlund



Carter



NA-ALO



All apparatus advertised in this magazine has been tested and approved by POPULAR RADIO LABORATORY

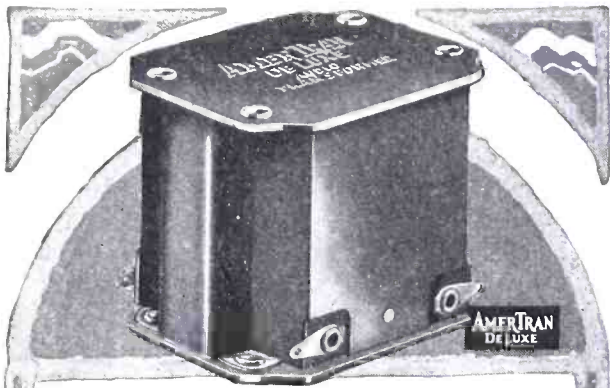

Volume with True Quality!

THE value of radio as an entertainer increases only with the realism and quality of reception. This requires good broadcasting—reception and amplification equal to, or better than, the broadcast range of audio frequencies—and a loud-speaker of uniform response over the same range. Heretofore one of the weak links in this chain has been the audio amplifier.

But it is now possible with AMERTRAN DeLuxe audio transformers to obtain faithful, strong reproduction over a range of frequencies down to the lowest pitched audible sound. This is nearly three octaves lower than that previously obtained. The deep boom of the drum, the thrum of the base viol, and the thunder of the pipe organ are reproduced with startling realism—and at no sacrifice of the highest notes within the audible range. Once tried, the AMERTRAN DeLuxe will be recognized as setting a new high standard of excellence in audio amplification.

AMERTRAN DeLuxe requires no special circuit other than the use of a large tube in the last stage to prevent overloading at the low frequencies bought out. It is made in two types.

Price, either type, \$10.00

AMERICAN TRANSFORMER COMPANY
178 Emmet Street, Newark, N. J.

"Transformer builders for over twenty-four years"
SOLD ONLY AT AUTHORIZED AMERTRAN DEALERS

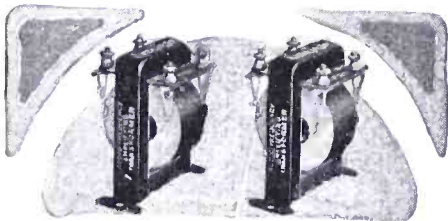

AMERTRAN Audio Transformers type AF6 (turn ratio 5) and AF7 (turn ratio 3½) have been substantially reduced in price. As before, they are today the leaders in their class. No changes have been made in the electrical characteristics since they were first sold. Either type now \$5.00.

We have prepared a booklet describing these and other AmerTran products, together with recommendations for their use. We shall be glad to send you a copy upon request.

Be sure to see other AmerTran ad on page 58

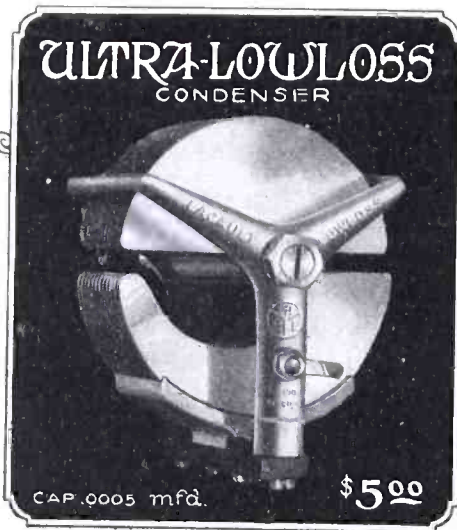

Quick, positive tuning

SPEED, ability to turn directly to any station, to tune in instantly and get your station on any wavelength and to eliminate crowding of stations at the lower end of the dial, is the outstanding feature of the Ultra-Lowloss Condenser.

With one station of known wavelength located on the dial, all others can be found instantly. Special design of Cutlass stator plates distributes stations evenly over the dial—each degree on a 100 degree dial represents approximately 3½ meters difference in wavelength.

In addition, losses common in other condensers are reduced in the Ultra-Lowloss to a minimum by use of only one small strip of insulation, by the small amount of high resistance metal in the field and frame, and by a special monoblock mounting of fixed and movable plates.

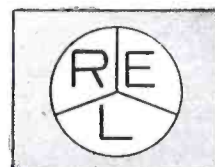
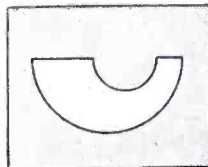

Designed by R. E. Lacault, E.E., originator of the famous Ultradyne receiver and Ultra-Vernier tuning controls. The Cutlass Stator Plate (illustrated above) is exclusively an Ultra-Lowloss feature. Mr. Lacault's personal monogram seal (R. E. L., also shown above) is your guarantee of satisfaction and Lacault design.

At your dealers; otherwise send purchase price and you will be supplied postpaid.

ULTRA-LOWLOSS CONDENSER

PHENIX RADIO CORPORATION
116 East 25th St. New York, N. Y.

→ AROUND THE WORLD →

2 LO London
365 m., 2FC Sydney
1100 m., RH Vienna
600 m., BAV Haeren
1100 m., DKP Kbely
1150 m., KOMAROV
1800 m., OXE Lyngby,
2400 m., BERLIN
430 m., PA5 Amsterdam
1050 m., EBX Cartagena
1200 m., ROME 470 m.,
LP, Königswusterhausen
680 m., WGY Schenectady
109 m., 3LO Melbourne
1720 m., KOA Denver
322.4 m., BUDAPEST
2000 m., SBR Brussels
270 m., WEAF New York,
491.5 m., HAMBURG
392 m., WMBF Miami Beach
384.4 m., CFAC Calgary
430 m., WGY Schenectady



40 m., 5MA Adelaide
850 m., CYX Mexico City
350 b., FL Eiffel Tower
2600 m., 2BD Aberdeen
495 m., PRG Prague
1000 m., PCGG The Hague
1070 m., 2FL Sydney
770 m., STOCKHOLM
440 m., HBI Geneva
1100 m., WGY Schenectady
1660 m., BRESLAU
415 m., KGO Oakland
361.2 m., CKAC Montreal
425 m., CHAC Halifax
400 m., PWX Havana
400 m., KDKA Pittsburgh
64 m., FRANKFORT
467 m., WOAZ San Antonio
394.5 m., NAA Arlington
2500 m., CHXC Ottawa
435 m., WOC Davenport
483.6.

Traveling around the World

A yacht equipped with a Universal Plio-6, traveling around the world, would hear broadcasting programs every night regardless of its location, because the Universal Plio-6 tunes all wave-lengths from 35 meters to 3600 meters. An American owner of this Golden-Leutz Receiver can listen for all European stations as it tunes to the different wave-lengths used by foreign broadcasters. In addition, for reception of American broadcasting stations from foreign countries this wonderful receiver, designed by Chas. R. Leutz, is already breaking distance records.

Cable, wire, write or phone for literature today

Manufactured by

GOLDEN-LEUTZ, INC.

(With which has been incorporated Experimenters Information Service and E.I. S., Inc.)

476 Broadway - - New York City

CABLES "EXPERINFO," NEW YORK

A RADIO CABINET OF BEAUTY AND ELEGANCE DIRECT TO YOU AT LOWEST COST

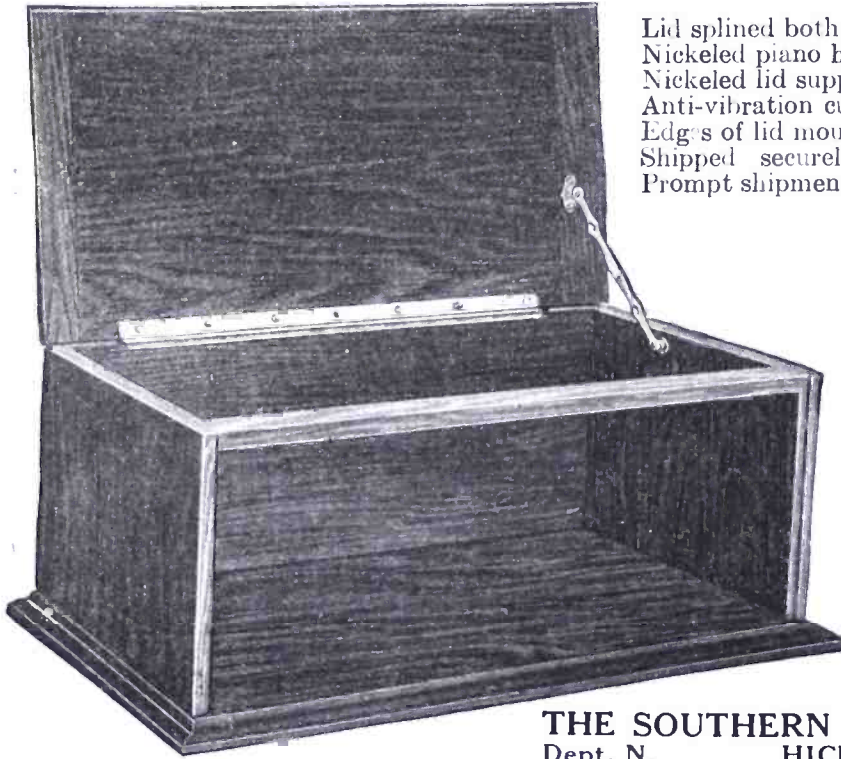

Lid splined both ends to prevent warping.
Nicked piano hinge—Full length.
Nicked lid support of artistic design.
Anti-vibration cushion feet (not visible in cut).
Edg's of lid moulded to match bottom.
Shipped securely packed in strong carton.
Prompt shipment. Big stock for holidays.

| | Hardwood, Rubbed Mahogany Finish | Solid Black American Walnut |
|----------------------------------|--|-----------------------------------|
| 7 x 18 x 7 1/2 or 10 in. deep | \$3.50 | \$5.00 |
| 7 x 21 x 7 1/2 or 10 in. deep | 3.75 | 5.25 |
| 7 x 24 x 7 1/2 or 10 in. deep | 4.00 | 5.50 |
| 7 x 26 x 7 1/2 or 10 in. deep | 4.75 | 6.25 |
| 7 x 28 x 7 1/2 or 10 in. deep | 5.50 | 7.00 |
| 7 x 30 x 7 1/2 or 10 in. deep | 6.00 | 8.00 |

Add 25c. for "E-Z" Fone plug.
CASH WITH ORDER or C. O. D.
if 1/2 of price is sent with order.
Prices F. O. B. Hickory, N. C.
Order express shipment, often
cheaper than mail and much safer
from damage.
FREE WITH EACH CABINET
a glued-up stock non-warping 1/2-
inch BASEBOARD.
Free Catalogue.

THE SOUTHERN TOY COMPANY, INC.
Dept. N. HICKORY, NORTH CAROLINA

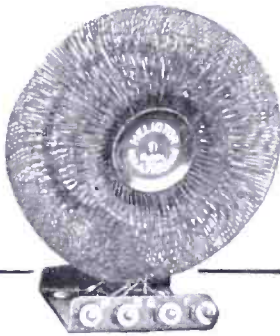

The
Heliotor

A True
Toroid

Have you noticed the increased use of toroidal coils in the finer sets? Here is an opportunity to have a real toroidal coil.

HELIOTOR center weave construction forms maximum induction section with small coil diameter and low interturn capacity. Resulting compactness of turns with improved position of toroidal primary gives greater power and selectivity. You can use HELIOTORS in all types of radio frequency sets. Sizes for .00025, .0003, .00035, and .0005 condensers. Range from 200-570 meters.

Our bulletin on "BETTER AMPLIFICATION" gives complete description of HELIOTORS with hookups and methods of installation. Yours for the asking. May we send you one?

GEO. A. FREEBURG CO.
165 Lovell St. Elgin, Illinois



MEMBER
RMA
**FAHNESTOCK
CONNECTORS**

Popular Wherever
Radio Is Used!

FAHNESTOCK Perfect Radio Connectors are used by Manufacturers of Standard Sets and Parts—and Makers of Wet Batteries and Dry Batteries. Their Sure Patented Grip is Recognized Universally by Enthusiastic Users.

ANTENNA CONNECTOR
Eliminates splicing and soldering of wires. Snap larger connector over antenna wire; insert lead-in wire into smaller clip and a perfect connection is the result. Made of the finest quality Phosphor Bronze.

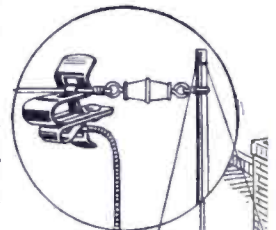

FAHNESTOCK
ELECT. CO.
L. I. CITY,
N. Y.



On Wings they ride the ether waves



Patented July 25, 1925; May 2, 1911

Patented July 25, 1925; May 2, 1911

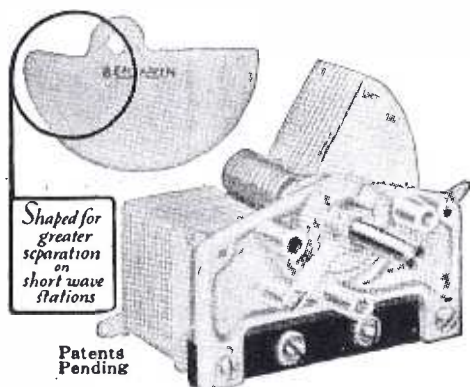

Benjamin Low Loss, Long Range Condensers

First of all a wonderful low loss condenser. The shape of the rotor blades eliminates bunching of stations on the lower side of the dial and makes tuning very easy. Unpolished silver plate finish. Friction disc on rotor shaft adjusts turning tension without loosening or throwing plates out of alignment. Made in three sizes: 13 plate for .00025 Mfd., 17 plate for .00035 Mfd., and 25 plate for .0005 Mfd. Drilling template furnished with each condenser.



Benjamin Tuned Radio Frequency Transformers

Even in what has been considered an excellent set, it is astounding what an improvement in tone, quality, volume and selectivity the introduction of these coils produces. Low Resistance. Low Distributed Capacity. Space wound, air core; double green silk insulation - the nearest approach to an all-air dielectric construction and the highest type of inductance possible.

BENJAMIN CLE-RA-TONE Shock Absorbing Radio Socket

Stops tube noises.

Assures clear reception.

Four delicately adjusted springs support the socket and absorb all jars and shocks.

The Cle-Ra-Tone Socket "floats" above its base.

Bakelite, used wherever possible, insures sturdiness, long life and high insulation.

Flexibility of springs is not affected by stiff bus wiring.

Handy lugs make soldering easy.

Benjamin Cle-Ra-Tone Sockets prevent the transmission of outside vibrations into microphonic disturbances.

"Push" Type Cle-Ra-Tone Socket

A socket made with the precision of a jeweled watch. It embodies all of the wonderful shock absorbing features and qualities of the regular Cle-Ra-Tone Socket.

The "Push" Type Socket is designed to accommodate the new standard UX "push" type base radio tube. It will also take tubes with the ordinary bases, excepting the UV-199.

Sold through Radio Jobbers and Dealers everywhere

Benjamin Electric Mfg. Co.

120-128 S. Sangamon Street, Chicago

247 W. 17th Street, New York

448 Bryant Street, San Francisco

Manufactured in Canada by the Benjamin Electric Mfg. Co. of Canada, Ltd., Toronto, Ontario

All apparatus advertised in this magazine has been tested and approved by POPULAR RADIO LABORATORY

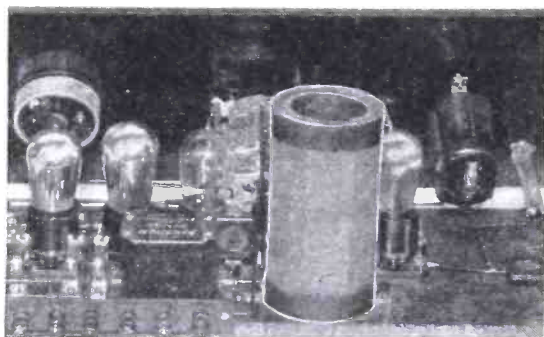

Used in the Cockaday LC-26

The Precision Octaform Coil shown above is the coil used in Mr. Cockaday's new LC-26 Receiver. Price \$5.50.

The Cockaday LC-26 Receiver Kit

For the convenience of those consumers and dealers who wish to buy the Cockaday LC-26 in complete kit form we offer the following parts exactly as used in Mr. Cockaday's laboratory model.

| | |
|--|----------------|
| 1 General Radio variometer, type 269, equipped with rheostat knob | \$5.30 |
| 1 General Radio rheostat, type 214-a, 7 ohms, equipped with rheostat knob | 2.25 |
| 1 Precision Octaform coil set | 5.50 |
| 1 Amsco special double unit condenser No. 1813 each section .0003 mfd. | 6.25 |
| 1 Micamold fixed condenser, .00015 mfd. | .35 |
| 1 Micamold fixed condenser, .00025 mfd. | .35 |
| 2 Daven resisto-couplers (new type which incorporates 1 mfd. condenser concealed in base). | 3.00 |
| 1 Amertran DeLuxe transformer, first stage | 10.00 |
| Bradley leak, 1/4 to 10 meg. | 1.85 |
| 3 Bradley units, 1/4 megohm | 2.25 |
| 1 Bradley unit, 1/2 megohm | .75 |
| 3 Amperites No. 1a | 3.30 |
| 1 Amperite No. 112 | 1.10 |
| 5 Benjamin standard "Cle-ra-tone" sockets | 5.00 |
| 1 Carter single-circuit jack, No. 101 | .70 |
| 2 Carter Jack switches, No. 2 | 2.00 |
| 8 Eby binding posts | 1.20 |
| 1 Fynur vernier control knob and dial | 3.50 |
| 1 Universal decorated panel, 8 x 22 inches | 7.50 |
| Blueprints | 1.00 |
| 4 Small brass brackets | |
| 1 Antenna connection block, 1 x 2 inches | |
| 1 Battery connection block, 1 x 9 inches | 1.75 |
| 2 Large brass brackets | |
| Screws and buss wire | |
| Solid Walnut Cabinet | 17.00 |
| Total | \$81.90 |

Parts for the Cockaday "B" Eliminator (Raytheon Plate Supply Unit)

This kit contains all the parts exactly as used by Mr. Cockaday in designing his laboratory model which was described in the November issue of POPULAR RADIO.

Dealers—Write for information on Coils and Kits.

Precision Coil Company, Inc.

209 Centre St. New York, N. Y.

22½ Volt
un-acid
everlasting
rechargeable
"B"

Storage
Battery

\$2.95

includes
chemical



45 volts \$5.25, 90 volts \$10.00, 112½ volts \$12.50, 135 volts \$14.75, 157½ volts \$16.80. Truly the biggest buy today. Easily charged on any current including 32 volt systems. Any special detector plate voltage had. Tested and approved by leading authorities such as POPULAR RADIO laboratories. Over 3 years sold on a non-red tape 30 day trial offer with complete refund if not thoroughly satisfied. Further guaranteed 2 years. Knock-down kits at greater savings. Complete "Hawley" "B" Battery charger \$2.75. Sample cell 35c. Order direct—send no money—simply pay the express-man cost on delivery. Or write for my free literature, testimonials and guarantee. Same day shipments.

B. HAWLEY SMITH, 315 Washington Ave., Danbury, Conn.

RADIO MANUAL FREE WITH POPULAR RADIO

Kendall Banning, Editor, and Laurence M. Cockaday, Technical Editor of POPULAR RADIO, have compiled a book that will prove to any one that he can build a set which will give distance, selectivity and tone volume, and at the same time a very definite basic knowledge of radio.

BUILD YOUR OWN SET AND SAVE MONEY

In "How to Build Your Radio Receiver," you will find complete specifications, constructional diagrams, photographs and instructions for building all of the following sets:

- A \$5 Crystal Set
- The Haynes Single-Tube Receiver
- A Two-Stage Audio-Frequency Amplifier
- The Cockaday 4-Circuit Tuner
- A 5-Tube Tuned Radio-Frequency Receiver
- The "Improved" Cockaday 4-Circuit Tuner
- The Regenerative Super-Heterodyne Receiver

ADVISORY SERVICE ALSO FREE

POPULAR RADIO maintains a big modern laboratory with a trained staff of investigators under the personal supervision of Mr. Cockaday. This Laboratory is always available through our Technical Service Bureau to answer, free of charge, by personal letter any problems you encounter which are not answered in either the "Handbook" or the magazine.

In POPULAR RADIO each month you will find the very latest news of the radio field as well as helpful suggestions and instructive and entertaining articles on radio and allied scientific phenomena.

SPECIAL BOOK OFFER

You can secure a copy of "How to Build Your Radio Receiver" FREE, and have all the privileges of the Technical Service Bureau without additional expense, if you will send a remittance of \$3.00 in full payment of 12 months' subscription for POPULAR RADIO. (Or as an alternative, you may have the book and privileges of the Technical Service Bureau with POPULAR RADIO for 7 months only—for \$2.00. A two dollar bill will do.)

Remember you take no chance—we will refund your money in full if you are not more than satisfied.

POPULAR RADIO

Dept. 15

627 West 43d Street New York City

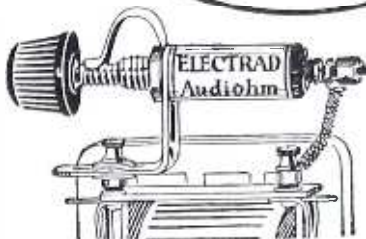

A Certified Check Against Distortion

As clear and mellow as chime sounds—Let the "Electrad" Audiohm banish that stuttering, sputtering reception forever.

If you want pure tones, clear and mellow, whether high, low or medium pitch, improve your set with the Audiohm. Insure reproduction that will equal in smoothness and richness the original tones of the artist.

Build or improve your set with "Electrad" Radio Essentials—Certified Grid Leaks. Variohms, Lamp Socket Antenna, Resistance Coupled Amplifier Kits, and many others. At your dealer's. If he can't supply, write.

"ELECTRAD" AUDIOHM—Price \$1.50. Eliminates distortion. Easily attached to secondary of first audio transformer. Once set it's permanent.

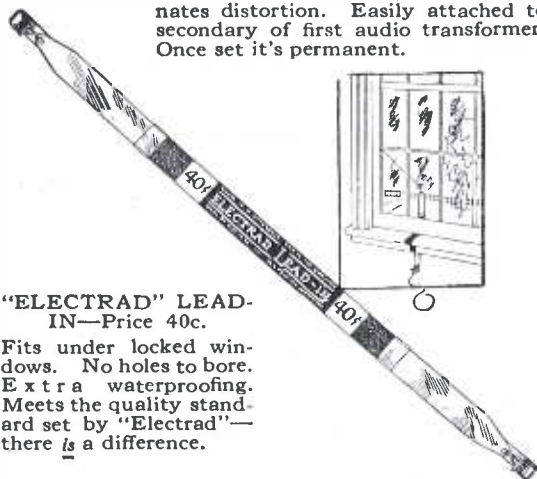

"ELECTRAD" LEAD-IN—Price 40c.

Fits under locked windows. No holes to bore. Extra waterproofing. Meets the quality standard set by "Electrad"—there is a difference.

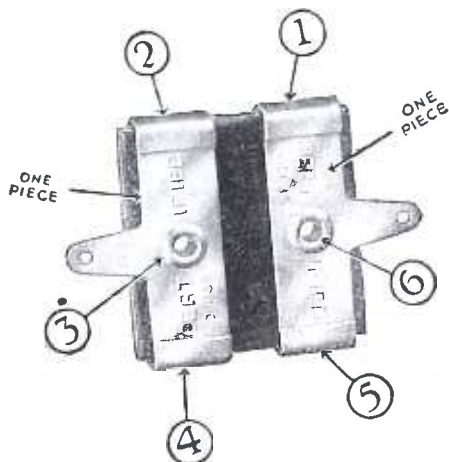

The Six Point Pressure Condenser

THE "Electrad" Certified Fixed Mica Condenser is a revelation in accuracy and design. Ingenious, rigid binding and firm riveting fastens parts securely at Six different points, insuring positive electrical contact. Impervious to temperature and climatic variations. Exerts even pressure upon the largest possible surface—can't work loose. Binding strap and soldering lug in one piece. Accuracy and quietness assured always. Value guaranteed to remain within 10% of calibration. Standard capacities, 3 types. Licensed under Pat. No. 1,181,623, May 2, 1916, and applications pending. Price 30c to 75c in sealed dust and moisture-proof packages.

ELECTRAD INC.

428 Broadway, New York City

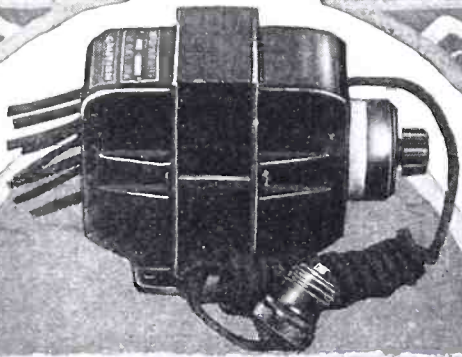

A Real Power Transformer

The modern home may now utilize its electric service for the operation of a Radio Receiver. Reception is greatly improved when efficient B and A eliminators are employed to use this steady power.

The AmerTran Power Transformer Type PF-45, 65 VA—60 cycles 110 volts primary, 450-8/4-8/4 secondary, is intended for use in converting the standard 110 volt, 60 cycle alternating house lighting current to a higher voltage for the plate and low voltages for filament supply. It can be depended upon to give good results when used in connection with the different tubes now available and is designed with the usual margin of safety. It is a real power transformer, in design, construction and usefulness.

The AmerTran Power Transformer Type PF-52 is another transformer of the AC Power Type similar to Type PF-45 except that it has a plate winding for 525 volts AC and a metal ground shield between the primary and secondary windings.

Price: TYPE PF-45 \$15.00 ~ TYPE PF-52 \$18.00

AMERICAN TRANSFORMER COMPANY
178 Emmet Street, Newark, N. J.

"Transformer builders for over twenty-four years"
SOLD ONLY AT AUTHORIZED AMERTRAN DEALERS.

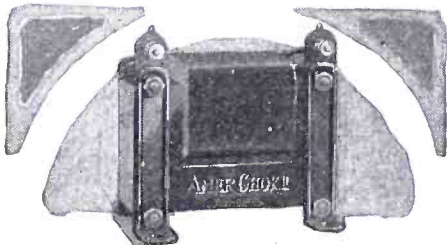

The AmerChoke Type 854 is a choke coil or impedance of general utility designed primarily for use in filter circuits. It has a current capacity up to 60 milliamps, and a no load inductance of approximately 100 henrys at 60 cycles.
Price \$6.00 each.

We have prepared a booklet describing these and other AmerTran products, together with recommendations for their use. We shall be glad to send you a copy upon request.

Be sure to see other AmerTran ad on page 52

Are You the Man?

to be first in your town to sell and demonstrate **POWEROLA**, the famous 5 tube, *no-battery electric light socket radio receiver* (not an attachment), universal for D. C. or A. C. (100-115 v., 40-60 cycle), now sold and demonstrated by **THE NEW YORK EDISON CO.**, public utility companies and radio, electric and music dealers everywhere. Absolutely dependable, fully guaranteed, powerful, practical, perfect in performance.

**Are You the Man
Who Sees Opportunities Ahead
for Real Money Making**

Write for literature, terms and prices at once.

POWEROLA RADIO CORP.
Dep't. P. R. 1845 Broadway, N.Y. City

**DON'T
WAIT!**



PEP UP THAT SET NOW WITH
X-L RADIO PRODUCTS

Just install them in your receiver and hear them speak for themselves

Endorsed by POPULAR RADIO LABORATORY and other leading radio authorities in all the latest circuits

Model "N" Vario Denser

Capacity range 1.8 to 20 micro-micro-farads, for balance in Roberts two tube, Browning-Drake, McMurdo Silver's Knockout, Neutrodyne and tuned radio frequency circuits.
Price \$1.00

Model "G" Vario Denser

For the Cockaday circuits, filter and intermediate frequency tuning in super-heterodyne and positive grid bias in all sets.

G-1- .00002 to .0001 MF.
G-5- .0001 to .0005 MF.
G-10- .0003 to .001 MF.

Price Each With Grid

Leak Clips, \$1.50

X-L Push Post

A binding post that really does excel in looks, action, service and convenience. Just push it down—insert wire—cannot jar loose from vibration. No screwing or danger of shearing off wires. Furnished attractively plated with soldering lug and necessary markings.

Price Each 15 Cents



X-L RADIO LABORATORIES
2422 Lincoln Ave. CHICAGO

This Transforms Your Radio

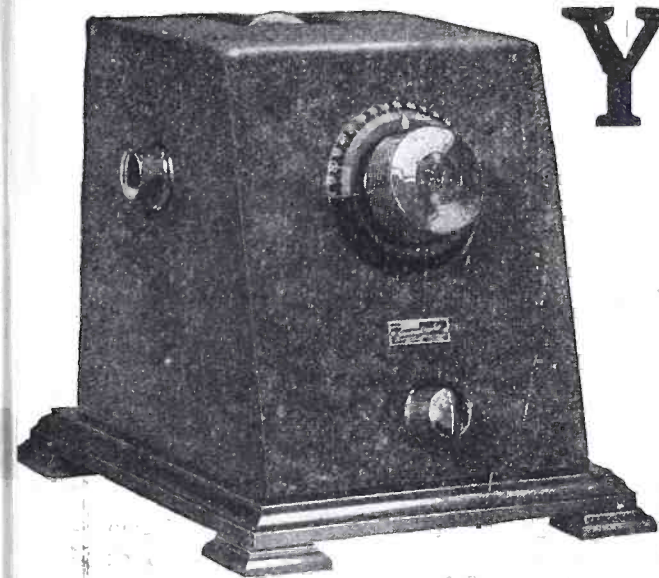

DOLLARS NOW CONFIRM IT

Signal strength multiplied 188 times in scientific test by the marvelous Penetrola was an astonishing announcement. Questions swamped us. But proof was positive. Orders, cash, rush requests followed. Never has there been such a radio sweep. The same features responsible for supreme Walbert Isofarad radio showed Penetrola able to improve any radio set beyond all known methods.

Station WCBF, for example at 29 on the Audibility Meter, was spoiling WCAL at 35. Then on comes Penetrola—WCAL now 2,000 and WCBF now zero! That's Penetrola selectivity, intensification, and volume—normally every time! It even makes

possible shorter aerials. It stabilizes any set; prevents radiation; keeps you far from oscillation. Nothing else can do it. Quickly, easily, any set can be transformed with Penetrola, amplifying ahead of detection, where weakest signals can be saved. The highest priced receiver alone might not approach your present set, plus Penetrola at \$35 complete in stunning black Crystalite case, for instant attachment, no wiring or changes needed. Penetrola kit with full instructions \$15. Fans everywhere have avoided delay by remitting cash direct to factory for prompt shipment. State whether you use aerial or loop and make of set—mention dealer's name.

Walbert Isofarad is the only complete receiver with Penetrola results built in. The Isofarad kit gives you most advanced radio with greatest economy. Send 25c for the Isofarad booklet, explaining how elusive radio principles are now applied practically by Walbert.

WALBERT MFG. CO., 947 Wrightwood Ave., Chicago

PENETROLA

All apparatus advertised in this magazine has been tested and approved by POPULAR RADIO LABORATORY

Adapto

RADIO CABINETS by DONEHUE

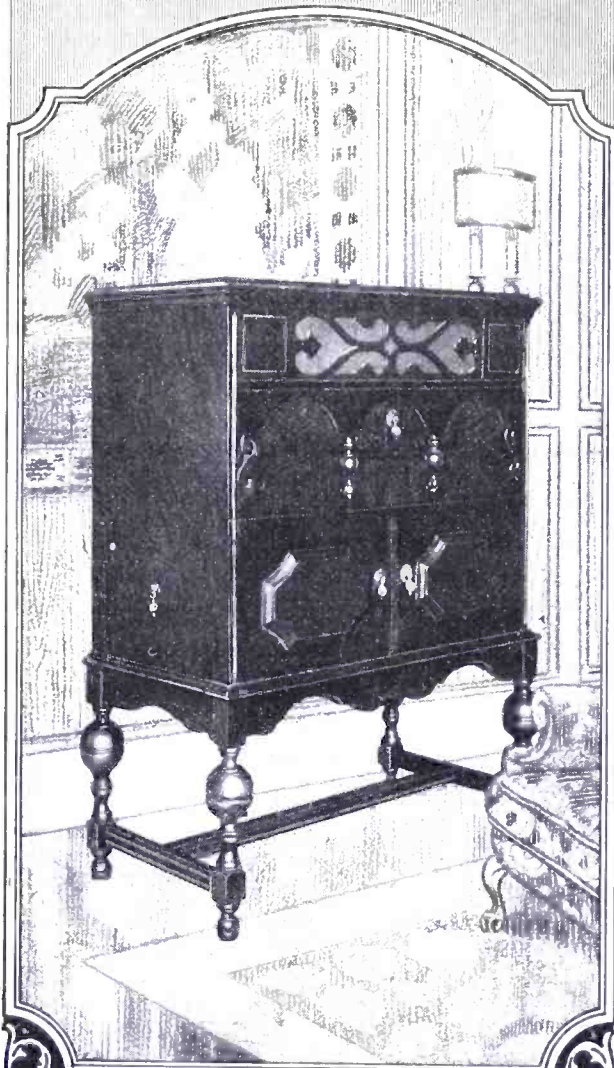

Obtainable in
Walnut and Mahogany

Transform your present radio set into a beautiful console model. Your panel assembly drops right into the ADAPTO Cabinet without changing a wire or disturbing a part. Storage battery drawer that permits refilling and recharging without lifting battery out or disturbing a wire. Loud speaker horn, built right into cabinet. Three models in mahogany or walnut. Write for illustrated folder.

L. P. DONEHUE CO.
PERTH AMBOY N. J.

MUTER

DEPENDABLE RADIO PRODUCTS



Lightning Arresters—
approved by Fire Under-
writers. Retail . . . **50c**

Complete Aerial Kits—every-
thing for complete installation with
instructions. Retail **\$3.50**

Resistance Amplifiers—
all assembled and
ready for use.
Retail . . . **\$8.00**



**Audio Frequency
Transformers**— tests
have proven the quality.
Retail **\$2.25**

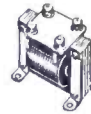

**Automatic Shock Proof Phone
Plugs**—a real value at
this price **50c**



Mfd. by **LESLIE F. MUTER CO.**
76th & Greenwood Ave., Chicago

Sold by
All Leading Radio Dealers

those*
who know
recommend
AEROVOX
Fixed
Condensers

*Tested and approved by M. I. T., Yale, Radio News, Popular Radio and Popular Science. Used by over 200 of America's leading set manufacturers.

Made in all capacities. Also manufacturers of Grid Leaks, Resistors, Resistofomers and Rheostats.

another reason why you should insist on them—

Chicago Office: 53 W. Jackson Boulevard
Cincinnati: 304 Palace Theatre Building

AEROVOX WIRELESS CORPORATION

491 Broome Street

New York City

All apparatus advertised in this magazine has been tested and approved by POPULAR RADIO LABORATORY



Powel Crosley, Jr., has always done the unexpected.

His announcement Dec. 26th is no exception to that rule.

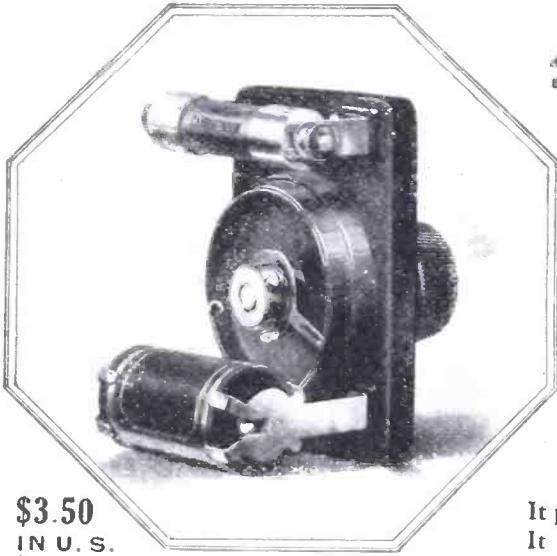

\$3.50
IN U. S.
(WITHOUT BATTERY)

The Carborundum Stabilizing Detector Unit gives a potentiometer controlled booster voltage to the Carborundum Fixed Detector.

A small sized flash-light battery is all it needs and of course it comes to you equipped with the genuine Carborundum Detector.

Send for Descriptive Circular Showing Hook-Ups. From your Dealer or Direct

MADE BY THE CARBORUNDUM COMPANY, NIAGARA FALLS, N. Y.

New York : Chicago : Boston : Philadelphia : Cleveland : Detroit : Cincinnati : Pittsburgh : Milwaukee : Grand Rapids

BANISHES DETECTOR TROUBLES

And Now—

The Carborundum Stabilizing Detector Unit

BUILT around the Carborundum Fixed Detector is this simple, highly efficient stabilizing device. By adjusting the detector resistance to match the circuit it absolutely controls self oscillation in the radio frequency tubes.

It permits operation at peak of regeneration.

It gives greater sensitivity—increased selectivity—clearer tones.

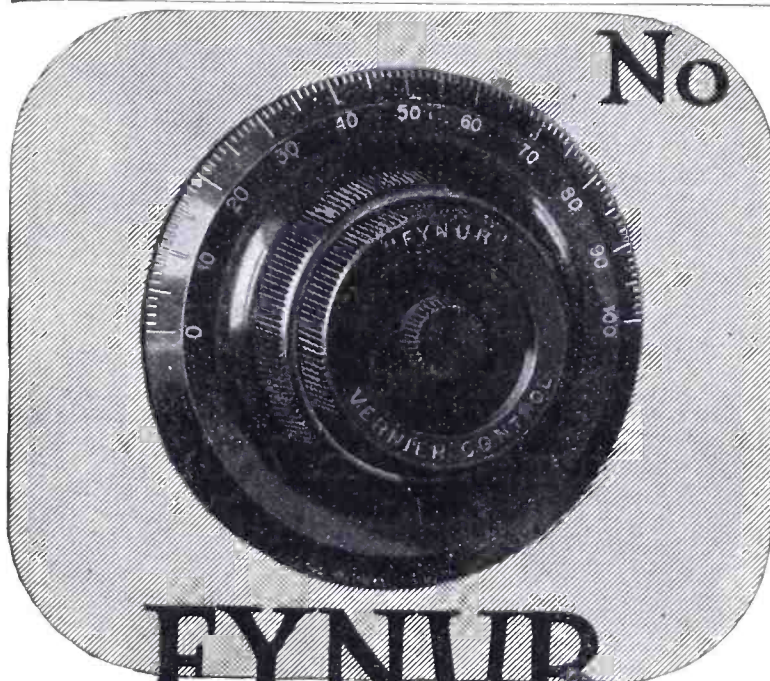

FYNUR
VERNIER
CONTROL

\$3.50

No Backlash
in this New Dial

Used in Cockaday's new
LC-26 RECEIVER

The Fynur dial operates by traction (not gears) so that no backlash or lost motion is possible. With Fynur dials you can get greater distance, and separate the low wavelength stations perfectly. Dual control. A quality dial for those who want the best—beautiful, mechanically perfect, and durable. So simple in construction that a child can take it apart and reassemble it. Manufactured by August Goertz & Co., Inc., 270-286 Morris Ave., Newark, N. J.

All apparatus advertised in this magazine has been tested and approved by POPULAR RADIO LABORATORY

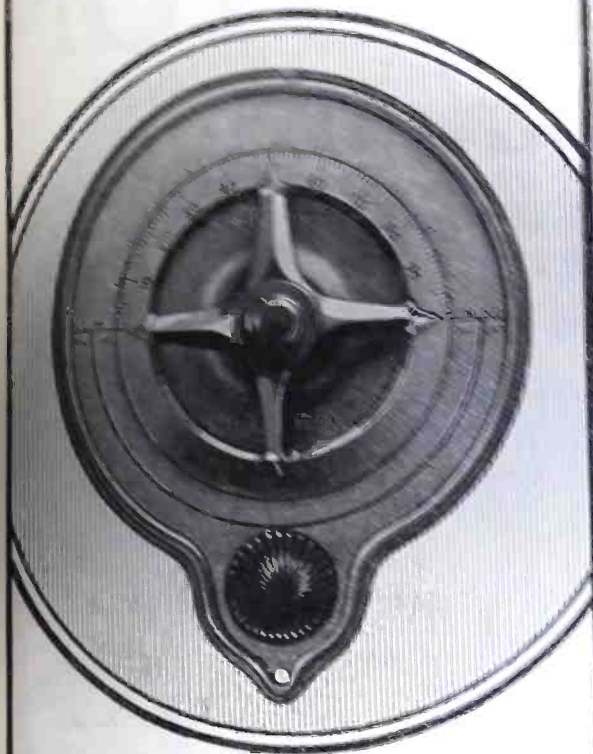

Pacent Engineering Achievements

DESIGNED and built by engineers in America's largest 100% radio laboratory and factory. You cannot buy better parts. They are backed by a name that is your guarantee of perfection both in workmanship and results.

The Pacent Microvern solves your tuning problem. It definitely holds the minutest variations, and logs your stations by name, wavelength and frequency.

Cat. No. 1208, Silvered, Price \$2.00
Cat. No. 1207, Gold Plated, Price \$2.50

The Pacent **TRUE S. L. F.** Condenser built from start to finish to chart a true straight line results in an even spacing of stations on the dial according to frequency.

Cat. No. 1209, Price \$1.50

Get them from your dealer or write

**PACENT MICROVERN—
A SUPER TUNING
DEVICE**



**PACENT TRUE
STRAIGHT-LINE
FREQUENCY CONDENSER**

Pacent Electric Company, Inc.,
91 Seventh Ave., New York

Washington
Birmingham
Detroit
Chicago

Jacksonville
San Francisco
Buffalo
Boston

Canadian Licensees
White Radio Lines

Pac
RADIO

Why WESTON Popularity?



Results! Continuous and long-life dependability! Assurance in use! Beauty of design!

These are the reasons for the great popularity of these two of the famous Weston Radio Line.

The Weston Instant-Change Radio Plug, the pioneer automatic device of its kind, gives fast, positive and most satisfactory contact between headset and loudspeaker.

The Weston Model 489 Radio Table Voltmeter supplies a portable instrument of great value in checking all voltage conditions of radio sets and has given thousands of radio enthusiasts more economical reception, longer tube life, better battery service, more resonance in tone, greater volume and distance.

To get the best from your receiving set use a reliable and dependable voltmeter. Write for the complete information contained in our new free edition of "Weston Radio Instruments."

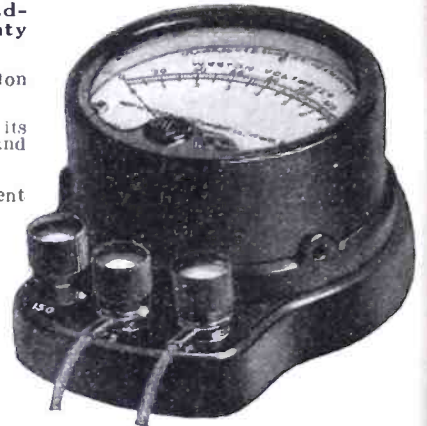

WESTON ELECTRICAL INSTRUMENT CORPORATION

115 Weston Avenue

Newark, N. J.

STANDARD THE WORLD OVER

WESTON

Pioneers since 1888

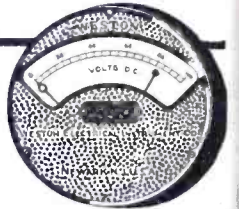

YOUR RADIO QUESTIONS ANSWERED

POPULAR RADIO, with which is combined *The Wireless Age*, maintains for the benefit of its readers a Technical Service Bureau and Laboratory, under the personal supervision of Laurence M. Cockaday which will, without charge, answer by personal letter any question, problem or request for information submitted by a subscriber. This service is, however, also available to readers, other than subscribers, at the very nominal rate of 50 cents the inquiry.

In writing please confine your questions to one general

subject, writing on one side of the paper only, and enclose a self-addressed and stamped envelope.

It is possible that your individual problem has been covered in an issue of POPULAR RADIO, and so as an aid to you we endeavor to keep a supply of back numbers in stock. The condensed index below gives a few of the subjects that have appeared recently, look this list over and if the information you want is covered, we will be pleased to supply back numbers at 35c. a copy.

March, 1925

- How to Build the Improved DX Regenerative Receiver.
- Factors that Govern the Capacity of Condensers.
- What "Induction" Means to Your Set.
- A Five Meter Vacuum-tube Transmitter and Receiver.

April, 1925

- Single Control Receivers.
- How to Improve Broadcast Reception, VI: Increasing the Selecting Power of Your Receiver.
- How to get the Most out of Your Ready-made Receiver.
- Quartz Crystal as a New Wavelength Standard.

May, 1925

- Factors That Affect Antenna Capacity.
- How to Wire Your Home to Have Radio in Every Room.
- Handy Tools for Radio Fans, The Hydro-meter.
- How to Build the "Portable Town and Country Receiver."

June, 1925

- New Development in Vacuum Tubes.
- How to Build a Five-tube A-C Receiver.
- How to Draw Up Your Own Tuning Chart.
- Watt's Law in a Nutshell.
- "What Set Shall I Buy?" First Installment.

July, 1925

- The Best 101 Hook-ups.
- "What Set Shall I Buy?" Second Installment.
- Broadcast Stations in the United States.
- What's New in Radio Apparatus.

August, 1925

- "Motion Pictures" by Ether Waves.
- A New Type of Hornless Loudspeaker.
- How to Build a 5-Tube Radio-Frequency Set with Simplified Control.
- Trouble Shooting.
- Hints for Amateurs.

September, 1925

- How the Air Affects Radio.
- When You Turn Your Dials.
- Useful Charts for Amateurs.

- Call Letters That Have a Past.
- Broadcasts.

October, 1925

- How Earth Magnetism Affects Radio Waves.
- How to Improve Broadcast Reception.
- What Makes a Low-loss Coil?
- How to Build the New 8-Tube Super-heterodyne with a Single Control.

November, 1925

- Radio's Newest Instrument—the Photo-electric Cell.
- How to Build the Raytheon Plate Supply Unit.
- New Methods of Calibrating Your Receiver.
- Practical Pointers About Transformers.
- Multi-layer Coils.

December, 1925

- How to Build The New LC-26 Receiver.
- How to Improve Broadcast Reception.
- What Every Radio Experimenter Should Know About Condensers.
- "Truthful Reproduction," How to Get It from Your Set.
- Radio that Runs on a Beam.

Popular Radio

627 West 43d Street

Dept. 18

New York City

All apparatus advertised in this magazine has been tested and approved by POPULAR RADIO LABORATORY

Baker Cabinets

QUALITY

THIS HANDSOME CABINET, MASSIVE AND ARTISTIC IN DESIGN, WILL GRACE WITH BEAUTY THE RICHEST SURROUNDINGS. BEAUTIFUL HAND RUBBED FINISH IN RICH ADAM BROWN.

EVERY PIECE OF FINEST QUALITY KILN-DRIED MAHOGANY.

The Raised Panel Ends and Graceful Ogee (beveled) edge Running Completely Around Cover together with the Beautiful Grain of Wood Contribute in Making Baker Cabinets Superior in Design and Finish.



There is no higher class workmanship or better material used in making the richest and best furniture than that embodied in Baker Cabinets. Our products are not to be classed with "Radio Boxes" but are exquisitely designed and beautifully finished Radio Furniture that will dignify any atmosphere.

There are generous rubber feet on base, heavy felt rests for cover and stay-joint to hold cover when open. All hardware is heavily nicked. Standard panels fit perfectly in rabbeted grooves (not slots). Space is provided for Dry Cell "A" and "B" batteries which may be placed behind instruments and wiring of set.

"BUILT WITH THE GRACE AND BEAUTY OF A YACHT"

BAKER CABINETS are carefully wrapped in wax paper to protect their beautiful finish and packed in heavy fibre cartons. Shipped Knocked-down, in but four pieces, they may be assembled in a few minutes. Screws are furnished and holes already drilled. No baseboard is required. The cabinet's base is used for mounting instruments. Sides and top may be removed quickly when changing hook-up or making repairs. Accuracy in panel sizes and perfect fit of all parts absolutely guaranteed.

PRICE LIST, TYPE A-65

Inside Depth Ten Inches Behind Panel
Cover, sides and base are built of mahogany one inch in thickness.

| | | |
|---------------|---------------|---------------|
| 7x12, \$10.50 | 7x14, \$12.50 | 7x18, \$14.50 |
| 7x21, \$16.50 | 7x24, \$18.50 | 7x26, \$19.50 |
| 7x28, \$20.50 | 7x30, \$21.50 | |

PRICE LIST, TYPE B-570

Inside Depth 8 Inches, Behind Panel
Built of mahogany which finishes one-half inch in thickness.

| | | |
|---------------|---------------|---------------|
| 7x12, \$8.75 | 7x14, \$9.50 | 7x18, \$10.50 |
| 7x21, \$11.50 | 7x24, \$12.50 | 7x26, \$13.50 |
| 7x28, \$14.00 | 7x30, \$15.00 | |

IF DEALER CANNOT SUPPLY, ORDER DIRECT BY MAIL AND WE WILL SHIP PROMPTLY, CHARGES PREPAID ANYWHERE IN THE UNITED STATES, UPON RECEIPT OF PRICE. SATISFACTION GUARANTEED.

BAKER YACHT BASIN, INC., Quincy Point, Mass.

Jobbers and Dealers Write for Trade Discounts to
QUINCY QUALITY PRODUCTS COMPANY, INC.
 DISTRIBUTORS
 Queens Village, L. I. New York

All apparatus advertised in this magazine has been tested and approved by POPULAR RADIO LABORATORY

Separate those crowded

This is the only Dial where no backlash can ever develop

Try them on your set

Read our guarantee

We also Guarantee:

This dial will absolutely tune in from 20 to 25% more stations than any other dial—Try Them!

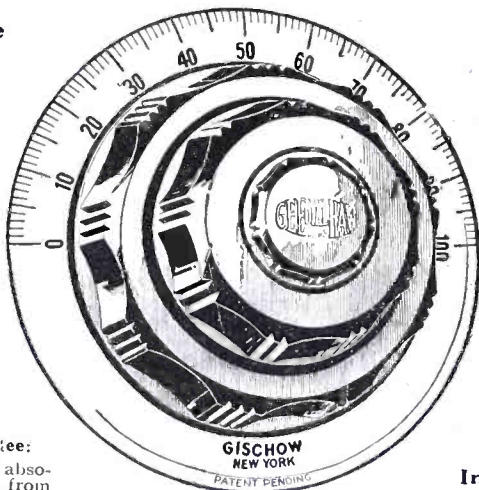

PROVEN BY TEST
SUPREME MASTER
FOR SHARP TUNING

low-wave stations by the smooth, hair-line tuning of the

GEE^{DIAL} HAW
Micrometer
Tuning DIAL

In price the cheapest for the work it does.

Ratio 100 to 1
No Backlash
and none can ever develop

OUR GUARANTEE

If the use of the GEE HAW DIAL does not materially improve the selectivity of any radio set on which it is installed, it may be returned to us (accompanied by bill of sale from dealer) and purchase price refunded without question or argument. Does any other manufacturer of dials dare duplicate this offer? Price \$3.00.

Knobs made of Bakelite, scales reading 0 to 100—Black or Silver finish, 100 to 0—Black or Silver, 200 to 1—360° Black.

OTTO R. GISCHOW CO. INC. 125 West 51st St
NEW YORK CITY

M. SIMONS & SONS CO., Export Div., 220 B'way, N. Y.

THE BANK FIAT WOUND LOOP

"Remarkable Efficiency Combined with Unusual Beauty"

Has your receiver the selectivity, volume, clarity and range that it should have?

The FIAT will fulfill and even surpass expectations in the attainment of greatly improved reception.

Contrary to a popular belief, the FIAT loop can be used on such sets as the Neutrodyne and Brown-Drake by a slight circuit change. The resulting reduction in static interference and improved tone quality are amazing.

A Browning-Drake set built for test and used with the FIAT has consistently brought in K.F.I. Los Angeles on the loud speaker at Chicago.

Diagrams showing the necessary circuit modifications will be sent on request.

In efficiency and appearance, the FIAT loop surpasses all others.

Furnished in genuine WALNUT or MAHOGANY, highly polished. Arranged to tune with .0005 M.F. condenser. Provided with center-tap.

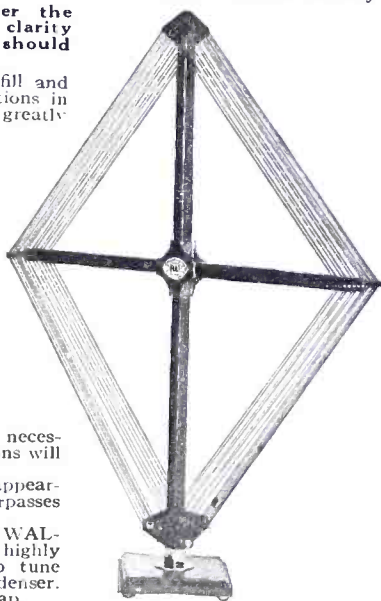

Patd. Oct. 27, 1925

PRICE \$12.50

RADIO APPLIANCE LABORATORY
Dept. "P" 4884-90 North Clark Street, Chicago, Ill.

GET YOUR SET OF SIMPLIFIED BLUE PRINTS FREE

You know how helpful, interesting and practical POPULAR RADIO is. You fully appreciate that at \$3.00 a year it is a real bargain. Consequently you should find it easy to convince one, two or more of your friends who are not now subscribers, of the unusual value when any one of these **eight** sets of Simplified Blueprints (described on page 84) is offered free with their twelve months' subscription for POPULAR RADIO at the regular price of \$3.00.

In addition to the Blueprints given to your friends we will allow you one set free for each new subscription you send us with a \$3.00 remittance. Five new subscriptions and remittance of \$15.00 would entitle you to five sets free.

Only one set of Blueprints free with a renewal subscription whether your own or a friend's.

POPULAR RADIO, INC., Dept. 13
627 West 43d Street, New York City

Enclosed is my remittance of \$ covering annual subscriptions for POPULAR RADIO (names on sheet attached). Send me set (s) checked below.

- | | |
|------------------------------------|-------------------------------------|
| <input type="checkbox"/> Set No. 4 | <input type="checkbox"/> Set No. 11 |
| <input type="checkbox"/> Set No. 6 | <input type="checkbox"/> Set No. 12 |
| <input type="checkbox"/> Set No. 7 | <input type="checkbox"/> Set No. 13 |
| <input type="checkbox"/> Set No. 9 | <input type="checkbox"/> Set No. 14 |

(See page 84 for description of Sets)

Name.....
Address.....

Foreign postage 50c. extra. No extra for Canada.

All apparatus advertised in this magazine has been tested and approved by POPULAR RADIO LABORATORY

Straight Frequency Line Tuning

Marks a new era in Radio progress—
Sweeping country like a tornado—
Fans welcome it with open arms—
Irresistible demand growing by leaps and bounds—

KARAS Started It— and KARAS Is Carrying On!!

When we sprung the Karas Orthometric Condenser on a restless, hungry radio public—we knew we had started something. But we scarcely expected to be snowed under with such a literal avalanche of orders. We inaugurated Straight Frequency Line Tuning at the psychological moment. Radio Fandom was waiting hungrily for something new. And here was something—not only new—but so perfectly simple—so thoroughly scientific—so downright sensible, that everyone wanted KARAS Orthometric Condensers at once. Our scheduled production was like a drop in the

bucket. Buyers pleaded—cajoled—even threatened. Our plans were doubled, trebled, quadrupled. But it all took time. KARAS Orthometric Condensers could not be thrown together. It took months to train gangs to build them with the absolute *precision* KARAS demands. So tens of thousands had to wait or buy other makes, hurriedly assembled to supply the demand we had created. NOW—after months of preparation we are able to produce enough KARAS Orthometric Condensers to take care of at least a fair share of the demand.

How KARAS Orthometric Condensers Simplify the Tuning of Any Radio Set

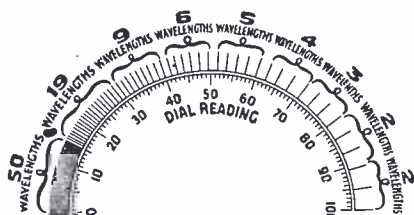

Ordinary Condenser Arrangement of Wavelengths
Ordinary straight capacity condensers crowd 70 of the 100 wavelengths into the first 30 points of the dial.

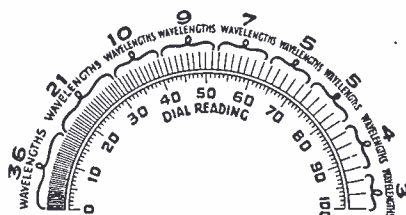

Straight Wavelength Condenser Arrangement
With straight-line-wavelength condensers 57 of the 100 wavelengths are crowded into the first 30 points on the dial.

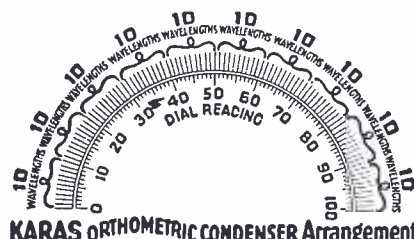

KARAS ORTHOMETRIC CONDENSER Arrangement of Wavelengths on Dial

Karas Orthometric Condensers insure absolutely equal dial separation of all wavelengths, 200 to 600 meters.

U. S. Gov't. separates all stations 10 kilocycles apart. Old type condensers—straight line capacity and straight line wavelength—crowded the low wavelength stations into the first few degrees on the dial. Difficulty in tuning—confused heterodyning interference—garbling of programs—these were the results. KARAS Orthometrics give low wavelength stations the same equal separation as high ones. It is the last word in making *real* selectivity possible.

Karas Orthometrics are both theoretically and mechanically perfect. Made entirely of brass—plates patent leveled and securely bridged to insure permanent alignment. Every joint soldered. Grounded frame and rotor. Adjustable cone bearings. Spring copper pigtail. In short, so beautiful a job that one engineer, on seeing the condenser for the first time, smilingly inquired, "How many jewels?"

If your dealer hasn't secured a stock of Karas Condensers

Order on this Coupon!

Note the long eccentric plates

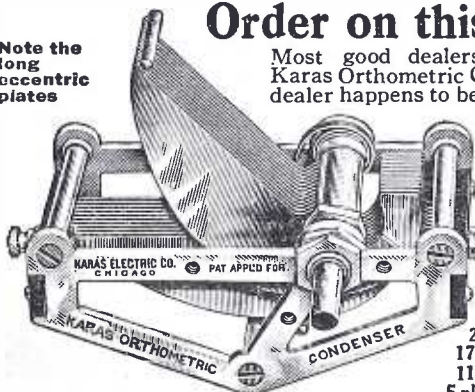

Most good dealers everywhere, sell Karas Orthometric Condensers. If your dealer happens to be one who hasn't secured them, we will supply you direct on our 30-day Money-Back Guarantee. Just fill in and mail this coupon at once. Send no money. Pay your postman on delivery.

Sizes and Prices—
23 plate, .0005 Mfd., \$7.00
17 plate, .00037 Mfd., 6.75
11 plate, .00025 Mfd., 6.50
5 plate, .0000972 Mfd., 6.50

KARAS ELECTRIC COMPANY

4037 North Rockwell Street, Chicago, Ill.

For more than 50 years makers of PRECISION Electrical Apparatus.

Karas Electric Co.,
4037 N. Rockwell St., Chicago

Please send me.....Karas Orthometric Condensers, size.....at \$.....each. I will pay the postman the list price, plus postage, on delivery. It is understood that I have the privilege of returning these condensers any time within 30 days if they do not prove entirely satisfactory, and you will refund my money at once.

Name.....

Address.....

Dealer's Name.....
If you send cash with order, we'll send package postpaid

All apparatus advertised in this magazine has been tested and approved by POPULAR RADIO LABORATORY

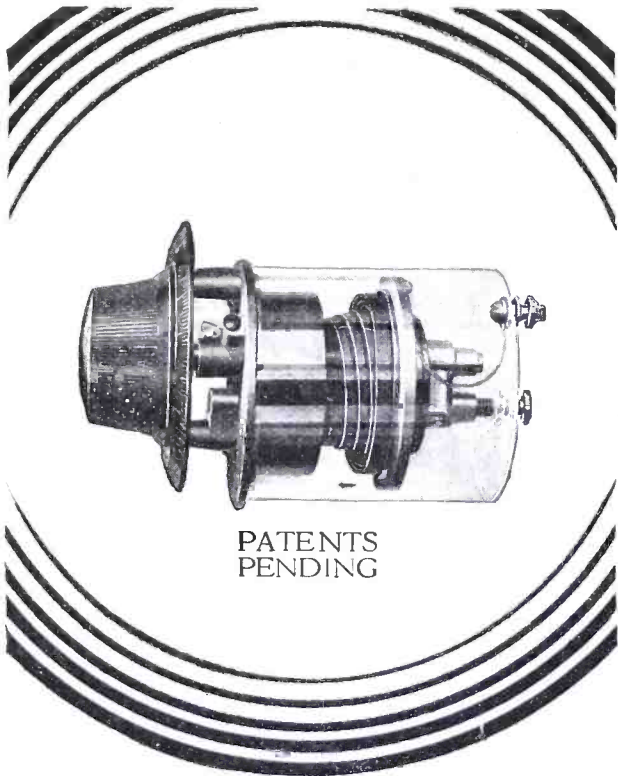

PATENTS
PENDING

The First radical improvement in radio SLF condensers

ATLAST! A new era in variable condensers. Professionals recognize in the new FURNELL Condenser—based on an entirely new and simplified principle—the most practical and efficient condenser ever designed for Straightline Frequency tuning.

It is the only condenser of its type on the market and experts agree that:

"It's the most important step forward that has yet been made in its field."

The FURNELL replaces open multiple plates with two shielded plates, each coiled in the form of an evolute. Assures clean-cut separation of stations, tone clarity and scientific precision heretofore impossible. Dust-proof, moisture-proof, damage-proof.

Each condenser complete with special 4 inch Bakelite 360° Dial and enclosed in transparent dust-proof case.

Exclusive Sales Franchises Available to Reputable Jobbers in Locations Still Open.

Write for Literature

Furnell Manufacturing Corp.
24F Scott St. Newark, N. J.

FURNELL

360° TAPER COIL
CONDENSERS

LEADER—Loud Speakers —Units

**Beauty
in
Tone**

The
LEADER
SENIOR
(as illus-
trated) 22
inches high,
13 3/4 inch
bell. List
Price

\$18.00

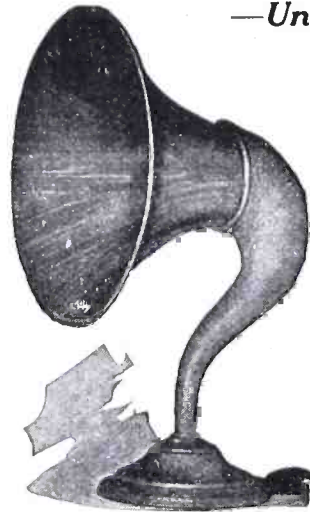

**Beauty
in
Appear-
ance**

The
LEADER
JUNIOR,
exactly the
same except
in size, 18
inches high,
12 inch bell.
List Price

\$14.00

LEADER Speakers combine a wide range of volume with clarity and faithful reproduction of tone. The heavy cast aluminum gooseneck eliminates all metallic and vibration distortion.

The bell is beautiful mahogany or walnut finish—the base and gooseneck in wine-gold.

THE LEADER UNIT

An adjustable horn unit for any horn. Console or phonograph — List Price, \$5.00.

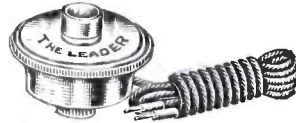

Sample horn sent to any reliable jobber on approval at our expense.

VICTOR RADIO CORPORATION

4319 N. Western Avenue, Chicago



-it's in the Tube

Your receiving set can be no better than its tubes. CECO Tubes give maximum results in clarity of tone, rich volume and long life.

Our charted tests (results confirmed by laboratories of national reputation) PROVE CECO TUBES SUPERIORITY — as detectors, as amplifiers.

Buy CeCo Tubes whether your set takes one tube or eight. Now ready! CeCo Tubes with new type Long PRONG BASES. Also, power amplifier tubes, E (Dry Cell Type), F (Storage Battery), for last stage of Audio Frequency. Ask your radio dealer.

C. E. Mfg. Co., Inc.
702 Eddy St., Providence, R. I.

CECO
TUBES



Most-Demonstrated Set of the Season

From radio as you have known it, to Thorola Islodolyn is as great a change as could happen, even in radio! Here is so much of an advance that it seems to put final highest development into view. Thorola Islodolyn now brings you radio safe from being surpassed.

Only the Thorola Islodolyn principle of *Isolated Power* makes it all possible. Based on the epochal discovery of Thorola Low-Loss Doughnut Coils, Islodolyn action literally isolates the radio impulses—keeps them from interfering with each other—from tangling up—from weakening themselves—*gives you closest tuning always.*

Sharpest selectivity is certain, wherever you are. Tone is unbelievably pure, since interference is defeated. Superabundant volume is available at extreme distances because power, instead of being wasted, neutralized, or damped, is put fully behind one chosen station only.

These amazing results, free from mysterious, unmanageable, disappointing old elements of radio reception, are the regular performance of Thorola Islodolyn receivers. Excellence is uniform in all Thorola sets, and throughout the range of reception. Your radio parties proceed as scheduled. Stations come in as logged. Words and music come in *as broadcast!*

It is the latest proof of Thorola eminence, first established by the matchless tonal accuracy of Thorola Loud Speakers. Now there is a complete receiver, Thorola Islodolyn, even further ahead. Go to the nearest Thorola store and listen to the most-demonstrated radio set.

REICHMANN COMPANY, CHICAGO

Illustrated: 5-tube Thorola Islodolyn in Burled Walnut with Circassian top \$100

New Model 51, Genuine Mahogany Cabinet \$85

Console Model .. \$225

5-Tube Thorola Islodolyn in smart Thorocco Finish \$85

| | |
|-------------------|---------------------|
| Thorola 4 Speaker | Thorola Jr. Speaker |
| \$25 | \$15 |

Islodolyn action is based on Thorola Low-Loss Doughnut Coils. They bring many Thorola advantages to other receivers

| | | | |
|------------------|------|----------|-----|
| Set of 3 Coils . | \$12 | Per Coil | \$4 |
|------------------|------|----------|-----|

Thorola Low-Loss Straight Line Frequency Condensers can also be bought separately \$5.50 and \$6

Thorola Golden Audio Reproducing Transformer \$4.50

Thorola Islodolyn

All apparatus advertised in this magazine has been tested and approved by POPULAR RADIO LABORATORY

Two Good "Signal" Loops

Take Your Choice

Table
Type
Complete
\$8.50

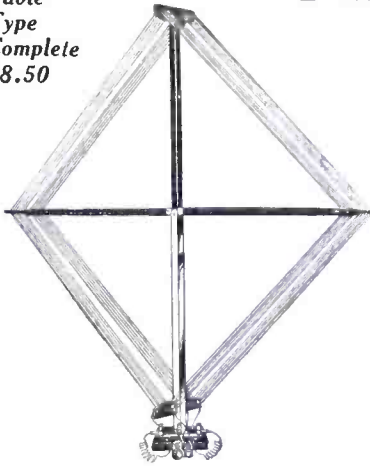

A bracket type that attaches right onto the end of your radio cabinet or a table type—you can't miss it on either one. When you buy a Signal Loop you're buying more than just good looks. You're buying an aerial backed by thirty years of experience in the manufacturing of electrical equipment.

Where quarters are close, remember the bracket type loop attaches right onto the end of your set and does away with that "extra piece of apparatus." It turns a complete 360° in the width of the standard cabinet.

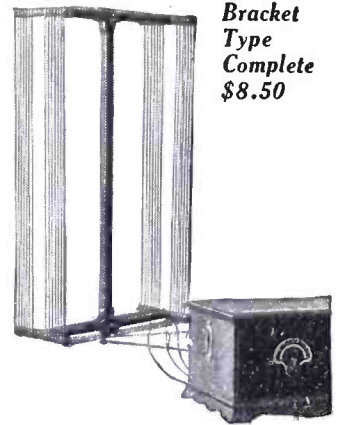

Bracket
Type
Complete
\$8.50

Both aeriels are beautifully constructed. The bracket type is of solid walnut. The table type is mahogany finished. All metal parts are heavily nickel plated. A third tap is provided for sets requiring it. Ask your favorite dealer to show you the Signal Loops—either type \$8.50. You will surely want one.

Jobbers and Dealers. If you are not fully acquainted with Signal Radio Products, we will be pleased to send you complete information. Write us at once for literature.

Signal Electric Manufacturing Co.

Dept. 10-A

Branches In All
Principal Cities

Menominee, Mich.

screw-machine products —brass

For plugs, jacks, clips, condenser and transformer parts, etc., BRASS assures economy in quantity production. It also gives the right electrical conductivity and the mechanical accuracy essential to proper operation of radio sets and parts.

COPPER & BRASS
RESEARCH ASSOCIATION
25 Broadway, New York

Price
\$4.00
Each

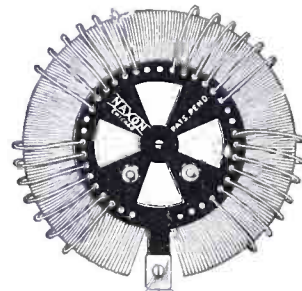

\$12.00
Set of
Three

NAXON

Toroidal Transformers

Seven Points of Superiority

1. Correctly distributed external primary.
2. Absence of usual secondary eddy-current losses.
3. Maximum magnetic coupling with minimum capacity coupling.
4. Sturdy construction without coil housings to absorb energy.
5. Spaced low-resistance windings.
6. Silver plated primary reduces skin losses.
7. Each turn a perfect toroid. No trick-style windings with losses at every angular bend.

RADIO FANS—If your dealer cannot supply you, get the facts—write us!

DEALERS—Practically all the jobbers recognize NAXON superiority and stock a supply. If your jobber cannot supply you now write us direct.

Naxon Electrical Laboratories
Inductance Research Division
4524-26 Cottage Grove Avenue, Chicago

The World Expected a Supreme Radio Set from **KELLOGG** *and here it is!*



WAVE-MASTER
Standard Model
\$125.00



WAVE-MASTER
Brown Walnut Console
with inbuilt horn
\$275.00

A Separate Circuit for Each 40 Meter Wavelength Band!

KELLOGG — for 28 years makers of precision telephone instruments — producers of quality parts since radio began — Kellogg has perfected a radio receiver worthy to bear the Kellogg name.

In the new **WAVE-MASTER** there are nine separate circuits—one for each 40 meter wavelength band. Each circuit gives that maximum efficiency heretofore found only in one short section of the dials of ordinary radio frequency sets. Each circuit brings within the range of the tuning dial a different group of stations.

Merely set the pointer to the wave zone in which you are interested and tune in with the one dial.

This dial actually has a tuning

range of 540 degrees — over three times the range of any other set.

All other radio frequency sets have variable capacity which must be tuned, usually with three different dials, to balance with their inductance coils.

The **WAVE-MASTER'S** inductance is not fixed but variable and is easily and quickly tuned, with the one dial, to balance the fixed capacities

Write for full description. Please mention your radio dealer's name.

Ask for Folder No. 6-A.

Kellogg Switchboard & Supply Company
1066 W. Adams St., Chicago, Ill.

Radio Dealers and Jobbers

The **WAVE-MASTER** franchise, backed by Kellogg resources and our powerful advertising campaign, is most valuable. Wire, or get into Chicago, quick, and see us.

KELLOGG **WAVE MASTER** SWITCHBOARD & SUPPLY CO.

All apparatus advertised in this magazine has been tested and approved by POPULAR RADIO LABORATORY



Patented Nov. 18, 1924

Windsor Loudspeaker Console

For EVERY Radio Set

A stunning piece of furniture that restores order in the room where you have your Radio! No more cluttered table-tops, nor litter of equipment under-foot.

No unsightly horn in evidence, either! This console has its own loudspeaker, in-built. It's out of sight, but with very apparent tonal superiorities. For it has the highest-developed type of unit. With horn built of special non-vibrating, extra-hard material. Produces clear, non-vibrant tone.

There's ample room for everything; space for A and B wet batteries—or battery eliminator—and for a charging outfit, too.

Finished in mahogany, or walnut color. Dainty design of parqueterie on two front panels. Top, 38 in. x 18 in.

Additional pattern No. 128 (Special for Radiola No. 125) in two-tone finish. Top, 21 in. x 31 in. Fitted with doors for access to control switches of combination eliminator-charger.

The price, forty dollars, is for the complete console and includes the loudspeaker horn and unit. Thousands of dealers are showing this artistic addition to home radio equipment.



Non-Vibrant Horn

The clearest tone producer on the market. Made of special composition which defeats vibration.

Rear View—Set Hooked Up



Price, \$40
West of Rocky Mts., \$42.50

Windsor Furniture Co.

1430 Carroll Ave.
Chicago, Ill.

"Take No Chances—Use Como" COMO DUPLEX

The World's Standard Push Pull Transformer



PRICE \$11.00 per pair
For maximum volume without distortion
What Prominent Writers on Radio Subjects say About Como.

Lewis B. Hagerman, Technical Editor, *Chicago Post*: "Actual Tests show this transformer to be far superior to any others of similar makes."

R. J. Robbins, *New York Sun*: "After consideration of several well-known makes of push pull transformers which are available 'COMO DUPLEX' was selected as most satisfactory."

C. White, *Radio World*: "'COMO DUPLEX' is infinitely superior—most other push pull transformers seem to be ordinary transformers with a center tap brought out as a makeshift."

E. P. Gordon, *Open Road*: "A system of audio-amplification which is becoming increasingly popular. Its use . . . will give surprising results in both quality and volume, and is thoroughly recommended by this department."

NEED WE SAY MORE?

COMO APPARATUS COMPANY

Manchester, New Hampshire
For Sale at Leading Dealers



"a new 5-Tube Set with all the power and none of the grief of the Supers"—so wrote Henry M. Neely, Editor of *Radio in the Home*, Philadelphia.

Get This Book

Write today for this big fascinating 32-page booklet which tells how you can build the truly amazing new QUADRAFORMER receiver. Based on a new radio principle, five tubes give remarkable results.

Enclose 10c and you'll have it by return mail

Gearhart-Schlueter Radio Corp'n

714 Voorman Avenue, Fresno, California

All apparatus advertised in this magazine has been tested and approved by POPULAR RADIO LABORATORY

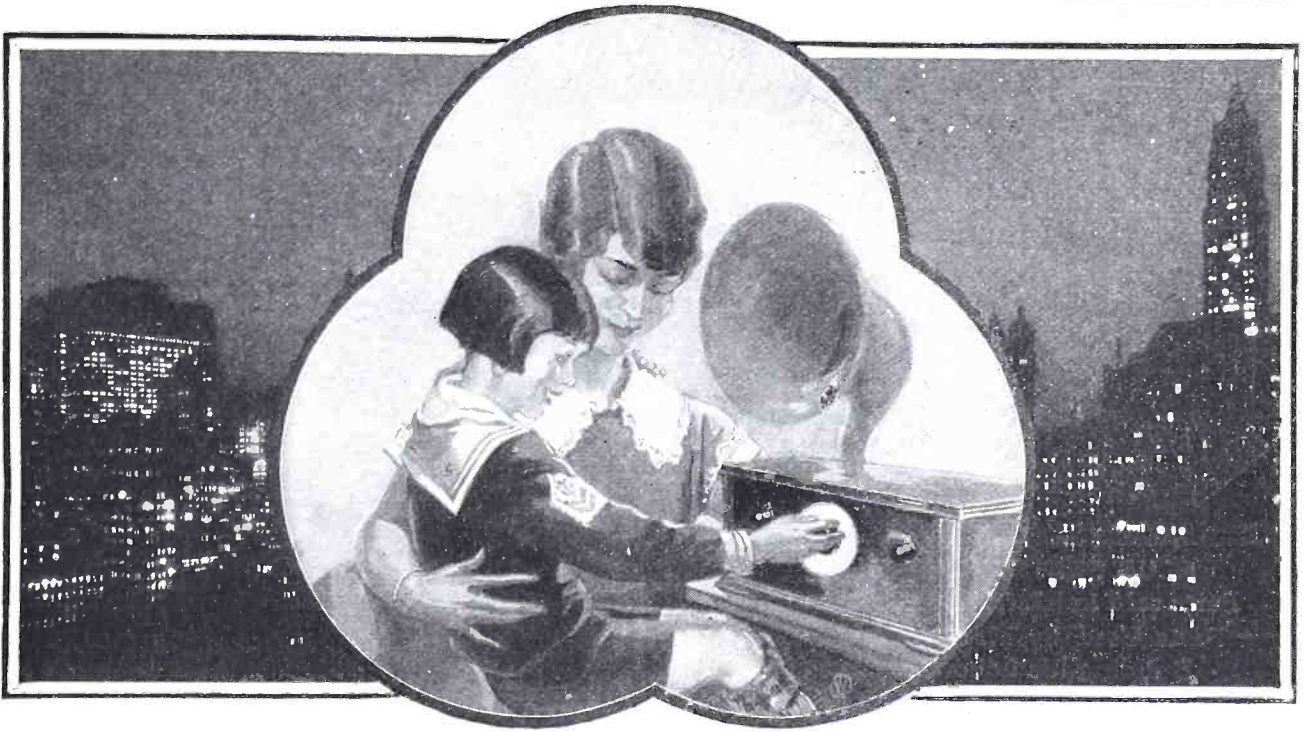

Enchanting Radio Nights for Everyone

Each night, when a myriad flashing lights make fairylands of the cities, a million folks tune in. Play-weary youngsters hear wonderful bedtime tales; light-footed boys and girls dance to the rhythmic music of fine orchestras, and their elders listen to great musicians and world-famous men. Winter nights no longer drag in Radio Homes.

Bakelite played no small role in bringing radio within reach of all. Makers of radio sets and parts quickly found that the use of Bakelite improved both performance and appearance. That its splendid in-

ulating properties made it ideal for tube bases and sockets, transformers, rheostats and many other parts and accessories. That its strength and permanently beautiful color and finish made it superior for panels, dials and knobs.

Make sure that the radio equipment you buy is Bakelite Insulated. 95% of the radio set and parts manufacturers use Bakelite.

Write for Booklet 28.

BAKELITE CORPORATION

247 Park Avenue, New York, N. Y.
Chicago Office: 636 West 22nd Street.

"The registered Trade Mark and Symbol shown below may be used only on products made from materials manufactured by Bakelite Corporation. Under the capital "B" is the numerical sign for infinity, or unlimited quantity. It symbolizes the infinite number of present and future uses of Bakelite Corporation's products."

BAKELITE

THE MATERIAL OF  A THOUSAND USES

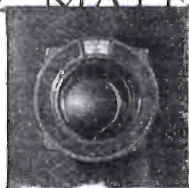

Bell Mfg. Co.
Vernier Dial.



Shaw Insul. Co.
Dial.



Polymet Mfg. Co.
E. Z. Stat.



Airgap Products Co.
Socket.



O. R. Gischow Co.
Gee Haw Dial.

All apparatus advertised in this magazine has been tested and approved by POPULAR RADIO LABORATORY

Standard Parts Mr. Laurence Cockaday's **L. C. 26** Broadcast Receiver

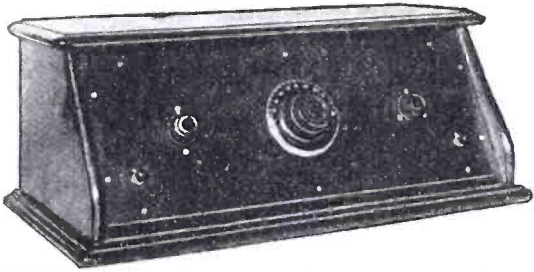

Improved four circuit tuner, single dial control, one stage of radio frequency amplification, cannot oscillate or radiate.

BLUE PRINTS FURNISHED

Parts sold in kit form or separately

Parts Used by Mr. Cockaday in Building his Laboratory Set

| | List Price |
|---|------------|
| 1 General Radio variometer, type 269, equipped with rheostat knob. | \$5.30 |
| 1 General Radio rheostat, type 214-a, 7 ohms, equipped with rheostat knob. | 2.25 |
| 1 Precision Octaform coil set. | 5.50 |
| 1 Amsco special double unit condenser No. 1814, each section .0003 mfd. | 6.25 |
| 1 Micamold fixed condenser, .00015 mfd. | .35 |
| 1 Micamold fixed condenser, .00025 mfd. | .35 |
| 2 Daven resisto-couplers (new type which incorporates .1 mfd. condenser in base). | 3.00 |
| 1 Amertran DeLuxe transformer, first stage. | 10.00 |
| Bradley leak 1/4 to 10 meg. | 1.85 |
| 3 Bradley units, 1/2 megohm. | 2.25 |
| 1 Bradley unit, 1/2 megohm. | .75 |
| 3 Amperites No. 1a. | 3.30 |
| 1 Amperite No. 112. | 1.10 |
| 5 Benjamin standard "Cle-ra-tone" sockets. | 5.00 |
| 1 Carter single circuit jack, No. 101. | .70 |
| 2 Carter Jack switches, No. 2. | 2.00 |
| 8 Eby binding posts. | 1.20 |
| 1 Fynur vernier control knob and dial. | 3.50 |
| 4 Small brass brackets | |
| 1 Antenna connection block 1 x 2 inches | .80 |
| 1 Battery connection block, 1 x 9 inches | |
| 2 large brass brackets | |

Complete Parts (including 1 Bakelite drilled and engraved Panel 8 x 22") **\$59.75**

We Also Carry Complete Parts For

HAMMARLUND ROBERTS-RECEIVER

Endorsed by Ten Leading Radio Engineers

Engineers of the leading manufacturers who make these parts endorse the operation of the Hammarlund-Roberts Receiver only when it is constructed with these specified units which the designers have found to coordinate most efficiently with one another.

Order from this list and we guarantee you prompt delivery.

| | | | |
|--------------|---|-----------|----------------|
| Unit No. 1. | 2 Rauland-Lyric Transformers | at \$9.00 | \$18.00 |
| Unit No. 3. | 2 Hammarlund .0005 mfd. Model "C" S. L. F. Condensers | at 5.00 | 10.00 |
| Unit No. 2. | 1 Hammarlund "Midget" Condenser 5 plate, 16 mmfd. | at 1.80 | 1.80 |
| Unit No. 4. | 1 Set Hammarlund-Roberts Coils | at 6.00 | 6.00 |
| Unit No. 5. | 2 Na-aid "Super DeLuxe" 4 in. Bakelite | at .75 | 1.50 |
| Unit No. 6. | 5 Na-aid "DeLuxe" Sockets | at .75 | 3.75 |
| Unit No. 7. | 1 Na-aid K3844-1 1/2 in. Dial | at .20 | .20 |
| Unit No. 10. | 1 Carter 25-ohm "Imp" Rheostat | at 1.00 | 1.00 |
| Unit No. 11. | 1 Carter Single Circuit No. 101 "Hold Tight" Jack | at .70 | .70 |
| Unit No. 12. | 1 Carter "Imp" Battery Switch | at .65 | .65 |
| Unit No. 16. | 1 Durham Metallized Resistor | at .40 | .40 |
| Unit No. 8. | 4 Amperites No. 1-A | at 1.10 | 4.40 |
| Unit No. 13. | 1 Dubilier Type 640-G .00025 mfd. Grid Condenser | at .50 | .50 |
| Unit No. 14. | 1 Dubilier Type 640 .002 mfd. Fixed Condenser | at .45 | .45 |
| Unit No. 15. | 1 Dubilier Type 640 .006 mfd. Fixed Condenser | at .80 | .80 |
| Unit No. 9. | 5 Pres. Union Phone Dip Jacks, per pair | at .25 | 1.25 |
| Unit No. 17. | 1 Hammarlund-Roberts Formulation Unit (contains engraved bakelite Westinghouse mica panel, drilled bakelite sub-panel, metal brackets and wire) | at 9.40 | 9.40 |
| | Complete Parts as specified | | \$60.80 |
| | Cabinet \$10 Extra | | |

Booklet "How to Build the Hammarlund-Roberts Receiver" with complete diagram and illustrations—Postpaid 25c

HEINS & BOLET
44 PARK PLACE, NEW YORK

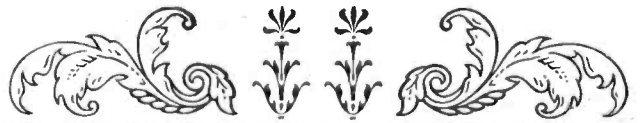

RAYTHEON

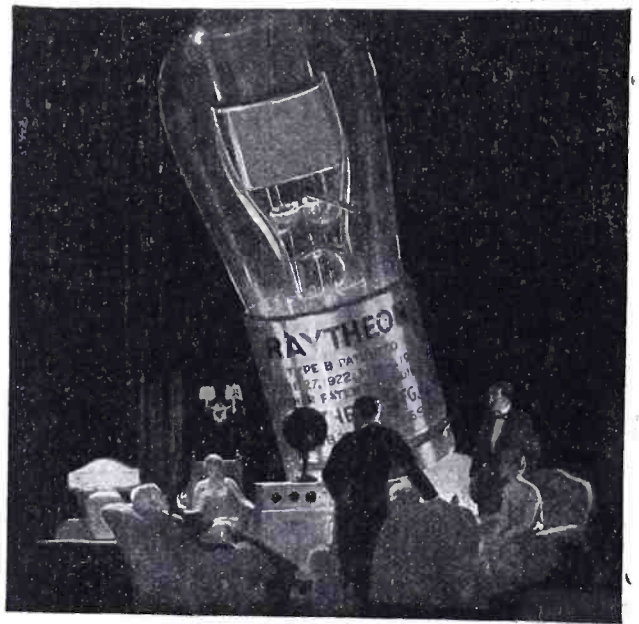

Progress comes not through a happy hit or miss process. In each link of the broadcast chain—from microphone to loud speaker—we realize the results of years of unremitting effort for something better. Today attention is focused on the elimination of the battery, that most unreliable and expensive source of electric power now in commercial use. That this should come about as a result of scientific research was to be expected. That it should make possible an added beauty of tonal reproduction gives further assurance of the permanency of the RAYTHEON rectifier in this field.

RAYTHEON, the result of five years of research and experiment, and the work goes on to maintain the standard already set. Ask your dealer to explain the meaning of Full Wave Rectification, No Filament, Reserve Power, and a sixty milliamper rectifier for six dollars.

RAYTHEON B-eliminators or specially designed parts for home-built units are made and sold by these and other well-known manufacturers:

Acme Apparatus Co.
All-American Radio Corp.
Dongan Electric Mfg. Co.
General Radio Co.
Jefferson Electric Mfg. Co.
Mayolian Radio Mfg. Co.
Thordarson Electric Mfg. Co.
Tobe Deutschmann Co.

RAYTHEON MANUFACTURING COMPANY
CAMBRIDGE, MASSACHUSETTS



“Just a slight turn of the dials and with all Chicago local stations broadcasting I get everywhere outside”

Now only

\$59.50 GET SPECIAL OFFER Retail

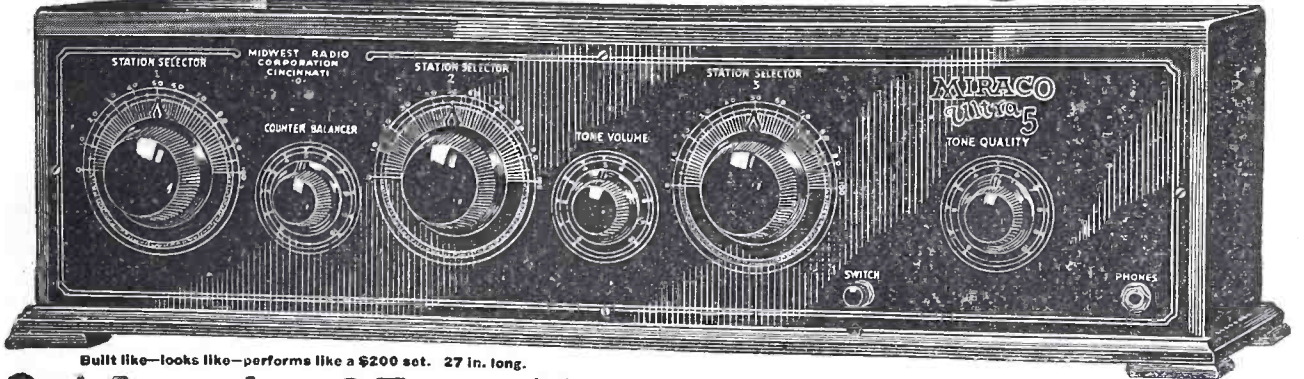

Built like—looks like—performs like a \$200 set. 27 in. long.

Get Amazing Offer

we make to Users who will demonstrate our set to friends.

MIRACO RADIO GETS 'EM COAST TO COAST

Notice!

er prices. So the Improved Ultra-5 for 1926 is even a better set—a more beautiful set—a more selective and more powerful set—incredible as this may sound!

COAST TO COAST RECEPTION VERIFIED BY USERS Report from users of the Powerful New Miraco Ultra-5 everywhere leave little for us to add. These are only a few of the thousands in our files and which we receive daily:

CALIFORNIA THE FIRST NIGHT Received KFI Los Angeles, Cal. and Mexico City the first night, before about twenty more on my Ultra-5. Ray K. Eaton, Okla.

CANADA TO THE GULF AND COAST TO COAST I sure do like the Miraco Ultra-5. I got from CKY, Winnipeg, Canada, to WMB, New Orleans, and from WGY, New York, to KFI, California, last night. Case, M. D., Searsville, Ill.

CUTS THROUGH THE LOCALS My set certainly cuts through the local. For a good well made set and good workmanship it can't be beat. I know if there is anything on the air, my Miraco Ultra-5 will bring it in. J. H. A., Chicago, Ill.

PRaises Its CLEAR TONE Received the Ultra-5. It is working fine and in fact is the clearest toned outfit I ever heard. I have gotten 50 or more stations including KFI, Los Angeles, Calif. W. A. C., Polwin, Kansas.

CALIFORNIA HEARS CINCINNATI THE FIRST EVENING I wish to thank you for your promptness in shipping me the perfect condition in which the Ultra-5 arrived. I have given your promises to be absolutely truthful. The tone, volume, and distance are excellent. The first evening, I enjoyed a concert from Cincinnati. E. E. S., San Francisco, Cal.

NEW YORK GETS 'EM COAST TO COAST I have one of your Miraco Ultra-5 radios and it's a working fine. I get all stations from coast to coast and would like to be one of your agents. Kendrick, E. E., Congers, N. Y.

OUTPERFORMS ALL OTHER SETS IN HIS LOCALITY There is not a radio in this neighborhood that can compare with the Miraco Ultra-5. J. H. C., Alden, Iowa.

COAST TO COAST THE FIRST NIGHT The first night I had the Miraco Ultra-5 I got Santa Catalina Island on the Pacific Coast, also New York and last night Chicago. W. O. K., Weston L. W., Hot Springs, S. D.

TENNESSEE HEARS CALIFORNIA Received my Ultra-5 O. K. Never saw a set packed so well. As to performance, it's just simply wonderful. No trouble for me to get Los Angeles, California, and without any interference. Wonderful tone and easily operated. W. F. T., Adamsville, Tenn.

AS GOOD AS IT LOOKS I received the Ultra-5 in fine shape. It is a beautiful piece of furniture and works just as good as it looks. Arthur E. A., Greenock, Pa.

YOU'LL WANT IT, TOO! The Miraco Ultra-5 you sent me is so satisfactory I would like the agent to let me have it. Torrance, Conn.

HAS EXCEPTIONALLY FINE TONE My Ultra-5 works fine. My friend liked it very much and said it certainly is a good set and has an exceptionally fine tone. I would like to sell your sets in my spare time. H. M. S., Stuttgart, Ark.

Enormous demand for the celebrated Miraco Ultra-5 (resulting from its many enthusiastic users) highly recommending it to their friends enabled us to add hosts of costly new features, latest refinements and up-to-the-minute improvements such as you might expect to find only on the newest sets sold at much higher prices.

TUNES OUT POWERFUL NEARBY STATION AND GETS DISTANCE We are sure having fine luck with the set. We act everywhere with all Chicago stations broadcasting.

WE act everywhere with all Chicago stations broadcasting. We act everywhere with all Chicago stations broadcasting. We act everywhere with all Chicago stations broadcasting.

WE act everywhere with all Chicago stations broadcasting. We act everywhere with all Chicago stations broadcasting.

WE act everywhere with all Chicago stations broadcasting. We act everywhere with all Chicago stations broadcasting.

WE act everywhere with all Chicago stations broadcasting. We act everywhere with all Chicago stations broadcasting.

WE act everywhere with all Chicago stations broadcasting. We act everywhere with all Chicago stations broadcasting.

WE act everywhere with all Chicago stations broadcasting. We act everywhere with all Chicago stations broadcasting.

WE act everywhere with all Chicago stations broadcasting. We act everywhere with all Chicago stations broadcasting.

WE act everywhere with all Chicago stations broadcasting. We act everywhere with all Chicago stations broadcasting.

WE act everywhere with all Chicago stations broadcasting. We act everywhere with all Chicago stations broadcasting.

WE act everywhere with all Chicago stations broadcasting. We act everywhere with all Chicago stations broadcasting.

we make to Users who will demonstrate our set to friends.

The Powerful New

MIRACO Ultra-5

Guaranteed by One of the Oldest Radio Builders

Tested and Approved by Radio's Highest Authorities

[ULTRA SELECTIVE FIVE TUBE SET IN MAHOGANY CABINET]

You can either save or make a lot of money by sending coupon today for our Amazing Special Offer. It will astonish you. Just say you'll let your friends listen to the powerful new Miraco Ultra-5 in your home and we ship it to you ON APPROVAL at the wholesale price—satisfaction unconditionally guaranteed.

Compare its construction with highest priced sets. Note the neat, sturdy, high-class construction. All wiring concealed under genuine Formica base panel (A). Wiring is flexible and prevents broken or noisy connections.

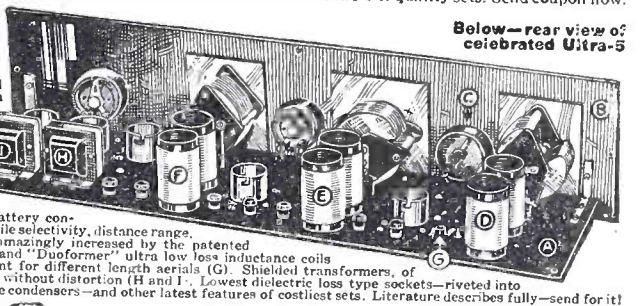

Below—rear view of celebrated Ultra-5

AGENTS! DEALERS! Write for the new Miraco proposition. Nation-wide use and popularity of Miraco sets coupled with their amazingly low prices make them wanted everywhere.

Other Miraco Long Distance Sets \$13.95 Retail. Remember you are dealing with a big, responsible corporation—one of the oldest and most successful in the industry.

All the Proof you want is waiting for You! Reports from hosts of users in every state prove Miraco sets—at rock-bottom factory prices—outperform sets costing up to three times as much.

Send coupon for Amazing Special Offer. MIDWEST RADIO CORPORATION, Pioneer Builders of Sets, Cincinnati, Ohio. 479-T East Eighth Street. Send free literature, AMAZING SPECIAL OFFER and all particulars regarding your big money-saving proposition on Guaranteed Miraco Sets and all radio supplies.

Better Tone!

—with dry cells and UX 120
than with storage batteries

Note: The UX 120 is a new three volt dry battery power tube. Used for audio frequency amplification, this tube will produce better quality and greater loud speaker volume than regular storage battery tubes.

Any set owner can easily install a UX 120 tube in his set in a few minutes by using the new Na-Ald Number 120 Connectorald. It is a simple, efficient means of introducing the necessary additional "B" and "C" voltage required for this tube into the plate and grid circuit *without rewiring the set*. As easy to use as an adapter.

Just slip the Connectorald onto the UX 120 tube and put the tube in the socket. Connect the batteries—and—well, that's all there is to it. Except to enjoy a quality and volume you would not have believed possible. No need to fuss with charging batteries. The simplicity, economy and freedom from attention characteristic of dry cells is now combined with the real volume and quality previously obtainable only with storage battery tubes.

The No. 120 Connectorald is suitable for all sockets—metal neck as well as insulated. For sale at radio, electrical and hardware stores. Price, \$1.25.



Na-Ald Adapters

Na-Ald Adapter 419-X

With this adapter the Na-Ald deluxe Socket will take the new UX 199 small base tube. Price, 419-X, 35 cents.

Na-Ald 420 Connectorald

No. 420, equipped with cables, enables owners of Radiola Super-Het to get the great increase in volume and clarity the new UX-120 tube develops. Price, 420, \$1.25.

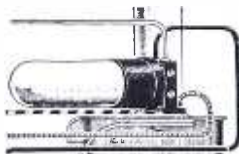

Na-Ald Adapter 421-X

No. 421-X makes possible the shift from WD-11 to UX tubes. Especially designed to enable owners of Radiola III, and III-A to enjoy the improved operation the new tubes provide. Price, 75c.

All Na-Ald products are for sale at radio, electrical and hardware stores, everywhere. Send for complete data on adapters for new tubes.

ALDEN MANUFACTURING COMPANY

Also Makers of the Famous Na-Ald Sockets and Dials
DEPT. C12 SPRINGFIELD, MASS.



Build Your LC-26

With the Aid of
Popular Radio Blue Prints

It is Easy
Quick and Accurate

The LC-26 is the ideal all-around receiver, combining unusually fine tone quality, selectivity and distance-getting ability, with simplicity of construction and operation. It operates on any antenna from 10 feet to 200 feet long, indoors or out.

In tests at Washington, D. C. the LC-26 brought in over 40 stations in one night, the farthest away being KGW, Portland, Oregon.

At Chicago, Ill. the LC-26 brought in KFI, Los Angeles, every night for a week, and over 60 other stations. WEAJ, New York, was heard clearly at eleven o'clock in the morning.

At New Haven, Conn. it brought in WMBF at Miami Beach, Florida, at 4:00 P.M., as well as New York stations for which New Haven is a dead spot.

All reception on the LC-26 is on the loudspeaker, as it has no phone connection.

By using POPULAR RADIO Blue Prints in building your LC-26, you can save time, eliminate the possibility of error, and make your set exactly like the laboratory models.

The *Panel Layout* is exact size. It can be used as a template for marking off the location of all screws and holes.

The *Instrument Layout* is also exact size and can be used as a template for locating all instruments, and screw holes.

The *Wiring Diagram* is approximately exact size and shows clearly the location of every wire and connection. It also carries a list of all parts used in building the laboratory set.

If your local dealer cannot supply you with Blue Prints of the LC-26, they will be sent postpaid on receipt of \$1.00 per set.

A full description of the LC-26, with detailed directions as to how to build it, was published in December POPULAR RADIO.

POPULAR RADIO

Service Bureau 14-A
627 West 43d Street
New York



Whether You Buy or Build Insist on EBY Cushion Sockets

The most important elements in any set are the *tubes*. There's no getting around that! And what else but the *sockets* are responsible for the life and efficiency of those tubes? Whether you build or buy see to it that the tubes in your set are mounted on EBY Cushion Sockets.

The design of this revolutionary socket provides a three-point wiping contact on each of the four tube prongs. Each spring clip acts as a shock-absorbing cushion for the tube and is securely riveted to the base eliminating all microphonic noises and protecting the tube against damage from vibration.

Furthermore, EBY Cushion Sockets, which are now ready for delivery, fit all standard tubes including the new UX.

Manufacturers, jobbers and dealers write for complete information

H. H. EBY MFG. COMPANY
4710 Stenton Ave., Philadelphia, Pa.
Makers of EBY Quality Binding Posts



Here is the socket that many of the foremost manufacturers and set builders depend on for 100% tube efficiency and protection. You can get them at most good dealers for

60c
each

All apparatus advertised in this magazine has been tested and approved by POPULAR RADIO LABORATORY

The Reason!

THE TUBE WITH A SENSIBLE GUARANTEE

QUALITY!
PERFORMANCE!
DEPENDABILITY!

are the factors which made Supertron the foremost Tube in America!!!

The Public buy and enjoy Supertrons because they are assured of satisfaction by a serial numbered guarantee on each tube for their protection—at their own price; the public demand price—two dollars.

The best dealers sell Supertrons because they give the most satisfaction; the best profit and a permanent good will.

The jobbers who practice their purposes sincerely carry Supertrons to serve their dealers better because Supertron facts are beyond dispute.

Backed by a rigid policy; substantial organization and clean merchandising.

ALL \$2.00 EACH
TYPES Canada \$2.75

DISTRIBUTORS

- C. E. Niehoff & Co. Chicago
- Fireside Radio Set Co. Chicago
- Yahr & Lange Milwaukee
- The Roycraft Co. Minneapolis
- Hippee-States Auto Sup. Des Moines
- Sorenson Lamp Co. Des Moines
- Orr Bros. Cedar Rapids
- Radio Dealers Sup. Co. San Francisco
- Franklin Electric Supply Co. Philadelphia
- Keystone Radio Dist. Co. Philadelphia
- Swanson Electric Co. Evansville
- M. H. Johnson Electric Co. Utica
- Hinsdill Electric Co. Troy
- Iroquois Sales Co. Buffalo
- Hamburg Bros. Pittsburgh
- Radio Stores, Inc. Denver
- Reynolds Radio Co. Denver
- Burr-Fowler Syracuse
- American Radio & Supply Co. Cincinnati
- Ed. J. Goetz Co. Cincinnati
- Elgin Radio Corp. Elgin
- Turner Lippee Co. Newark, N. J.
- Herbrick-Lawrence Nashville
- Banner Accessories Co. St. Louis
- Witte Hardware Co. St. Louis
- J. W. Jenkins Sons Music Co. Kansas City
- E. S. Cowie Electric Co. Kansas City
- Specialty Service. Brooklyn
- G. J. Seedman Brooklyn
- Hermann-Brownlow Springfield, Mo.
- Hillman's Inc. Augusta, Me.
- Alberta Radio Co. Alberta, Canada
- Imperial Radio Co. Sault Ste. Marie, Can.
- F. X. Guillevin Montreal, Can.

BRANCH OFFICES

- | | | |
|--------------|-------------|-------------|
| ATLANTA | MINNEAPOLIS | OMAHA, NEB. |
| DALLAS | KANSAS CITY | LOS ANGELES |
| PHILADELPHIA | DENVER | PORTLAND |
| PITTSBURGH | BUFFALO | TOLEDO |
| CHICAGO | BOSTON | ST. LOUIS |
| DETROIT | | |

SUPERTRON MFG. CO., Inc.
HOBOKEN, NEW JERSEY

Export Department 220 Broadway, N. Y. C.

QUAM

Condensers— with the Pyrex end plate are lowest loss and highest quality. Used as laboratory standard in all parts of the world. Outstanding features include:—

1 1/4" leakage paths on Pyrex end plate. 2 to 1 helical gears for sharp tuning. No backlash. Brass frame with brass plates soldered in place. Furnished straight-line wavelength and straight-line frequency. Quam condensers will improve your set. \$6 and up. With 360 degree bakelite dial, add \$1.

Quam audio transformers for better amplification—\$5.

QUAM RADIO CORPORATION
1925 S. Western Ave., Chicago, Ill.

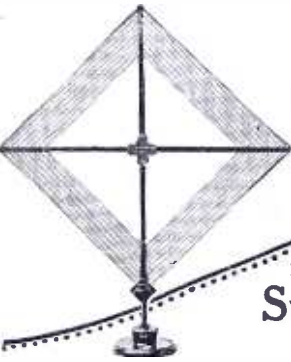

KORACH

Tuned Loop
Multiple Switch Board Tuner
Directional
Base Compass for Logging
Collapsible

For those who demand
Superior Results

Leads the march toward perfect radio reception under all conditions. Not merely a "loop" but an ingenious arrangement of mechanical skill designed for superior results. L. M. Cockaday, using this loop, reached out across the Atlantic to audibly hear many trans-continental Stations.

Selectivity Plus Distance

unheard of with common loop aerials. The Korach excels on all sets designed for loop reception. Priced at \$16.50 and for sale by all good dealers. Full particulars sent for 2c stamp and name of local dealer.

KORACH RADIO CO.
20 E. JACKSON BLVD. Dept. 10 CHICAGO, ILL.
Dealers and Jobbers: Write today for attractive proposition

THE KORACH JUNIOR
A modification of the "Senior" but possessing all its important features - - - \$12.50

All apparatus advertised in this magazine has been tested and approved by POPULAR RADIO LABORATORY



Tested Parts

All parts offered in our catalog including those combined in knock-down KITS have been carefully tested and approved by our graduate Radio Engineers. Satisfactory results are guaranteed.



Panels for Kits

A completely drilled and engraved panel is included with each of our kits. Makes set building easy and sure.

Just Out!

Our Latest 1926

FREE

RADIO CATALOG

BEFORE you build be sure to consult our latest 100 page radio catalog. A dependable guide for set-builders. Knock-down sets and kits for all the latest circuits. No finer or more complete assortment to be found anywhere. Latest designed parts. And the prices — *every one quoted means a big saving for you!*

Write for your **FREE** copy today!

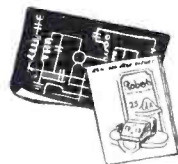

Blueprints

Complete BLUE-PRINTS and easy-to-understand IN-STRUCTION BOOK included with each of our KITS. No technical knowledge required to build your own set.

Save Money

Our enormous buying power permits us to pay spot cash and get rock-bottom prices. Be sure to see our catalog before you buy — save money. Write for your free copy today.

CHICAGO SALVAGE

509 South State Street

Dept. PR6

STOCK STORES

CHICAGO, U. S. A.

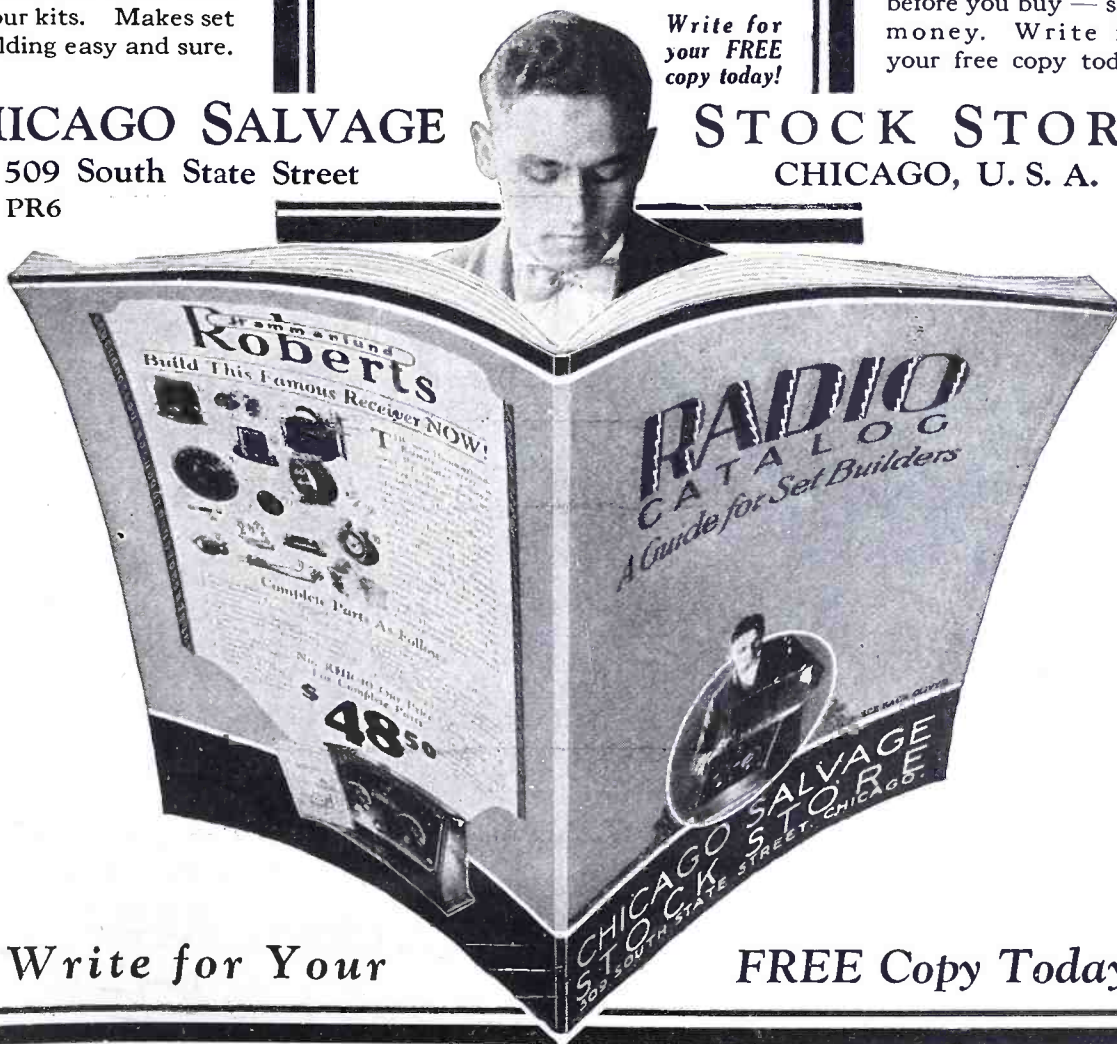

Write for Your

FREE Copy Today!

All apparatus advertised in this magazine has been tested and approved by POPULAR RADIO LABORATORY

Real Fine Tuning!

JUST consider the prestige of the Rasla name, the fame of John Clyde Davidson, Rasla chief engineer. Both are behind the Rasla Strate-Lyne. That's why the Strate-Lyne is a better condenser, a condenser that really separates stations.

The RASLA STRATE-LYNE is built to standards usually adhered to only for laboratory precision instruments. The plates are heavier than on any other condenser, the spacing and alignment is more accurate. Split bushings are provided at both ends. The plates are acid dipped, the end plates nickelled and highly polished. Transparent bakelite insures true low loss.

RASLA STRATE-LYNE

Straight Line Frequency Condenser

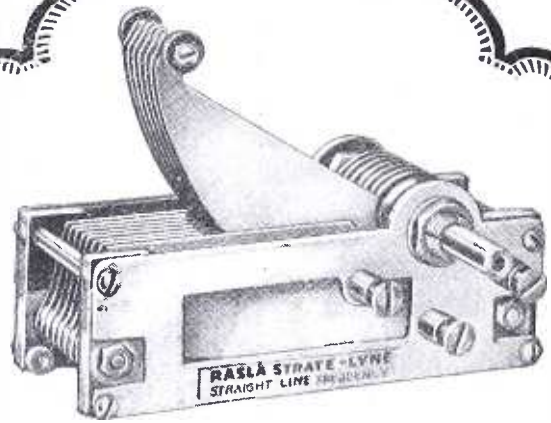

LIST PRICES

| | |
|---------------------|---------------------|
| .00025 . . . \$1.60 | .00035 . . . \$5.00 |
| .0003 . . . 4.75 | .0005 . . . 5.25 |

At your dealer's or direct if he can't supply you



The Rasla Fixed Detector is sensitive—and remains so. Best for reflex or any circuit. At your dealer's \$1.25.

FREE—Write for the complete Rasla hook-up

Davidson Radio Corp., 222 Fulton St., N.Y.

Fit for the home of a king—
built for the home of
moderate means.

A

\$60 Receiver for \$25

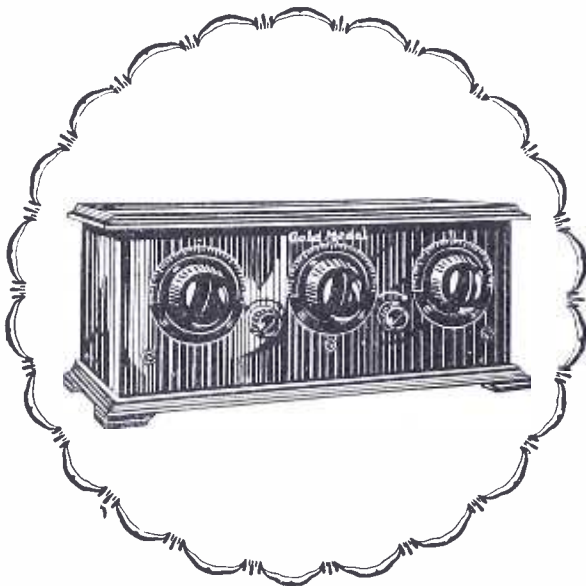

7" x 18" Solid Mahogany Cabinet

ONLY
\$25

The Gold Medal 5-tube tuned radio frequency receiver "that stormed the country!" Manufactured to sell at \$60, now \$25.

Distance, volume, and good tone quality. Guaranteed to operate or money refunded. Send \$25 by money-order or certified check and this fine receiver will be sent express prepaid. Tubes, batteries and speaker extra.

EUREKA OUTLET CORP.

1038 Longwood Ave.

New York City

The Book To Go By—When You Go To BUY!

The Biggest and most complete radio guide book published. Compiled by experts—96 pages crammed full of exceptional radio values and interesting data for radio enthusiasts. From first to last page, it's an illustrated review of the newest and finest in radio. Everything



Included: Sets, parts, equipment, apparatus, cabinets of every description: 1 tube sets to the finest, multi-tube outfits. Your radio library is not complete until you have this book. Write for your copy today—NOW. It's FREE! A postal brings it.

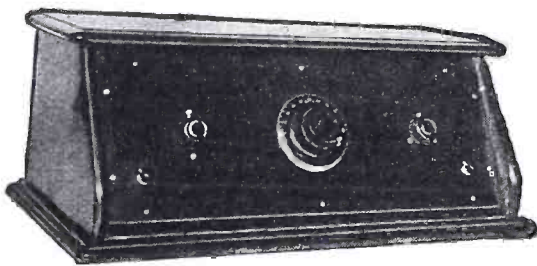

SPECIAL Christmas OFFER
Cockadays
FACTORY BUILT
LC-26 Receiver

Another COCKADAY winner and The House of WRS is now ready to serve Cockaday Fans by IMMEDIATE DELIVERY on all parts used in this circuit. Our customary iron-bound satisfaction guarantee is part of every sale!

FACTORY BUILT—WITH PARTS EXACTLY AS USED BY MR. COCKADAY

This set is a **FACTORY BUILT RECEIVER!** Built by the most capable, expert radio technicians. Every major part entering into its construction conforms exactly to Mr. Laurence Cockaday's laboratory model. The receiver is completely assembled—ready to use!

Your Guarantee

A COCKADAY CIRCUIT
SOLD BY THE
HOUSE OF WRS!

- 1 General Radio Variometer, type 269, equipped with rheostat knob
- 1 General Radio Rheostat, type 214-a, 7 ohms, equipped with rheostat knob
- 1 Precision Octaform coil set
- 1 Amesco special double unit condenser No. 1814, each section .0003 mfd.
- 1 Micamold fixed condenser, .00015 mfd.
- 1 Micamold fixed condenser, .00025 mfd.
- 2 Daven resisto-couplers (new type which incorporated 1 mfd. condenser concealed in base)
- 1 Amerfran DeLuxe transformer, first stage
- 1 Bradleyleak $\frac{1}{4}$ to 10 meg.
- 3 Bradleyunits $\frac{1}{4}$ megohm
- 1 Bradleyunit $\frac{1}{2}$ megohm
- 3 Amperites No. 1a
- 1 Amperite No. 112
- 5 Benjamin standard "Cle-ra-tone" sockets
- 1 Carter single-circuit jack, No. 101
- 2 Carter Jack switches, No. 2
- 8 Eby binding posts
- 1 Fynur vernier control knob and dial
- 1 Universal decorated panel, 8 x 22 inches

PRICE
7750

Every receiver is thoroughly inspected and subjected to a rigid test and must meet high standards before leaving the factory!

LC-26 KITS

Immediate Delivery

An entire page is devoted exclusively to this new circuit to flash across the radio horizon. You will find complete general and technical details about it. **WRITE FOR YOUR COPY NOW!**

Hammarlund
Roberts
RECEIVER

THE SEASON'S SENSATION! Originated and endorsed by 10 of the foremost radio engineers!

All Specified Parts In Stock
 Completely described in our catalog. Write for a copy now—it's the book to go by, when you go to buy!

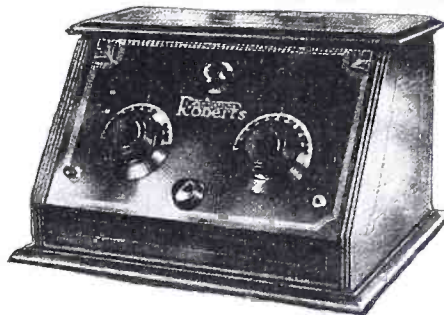

WE ARE HEADQUARTERS FOR ALL

Standard Kits
B-T Counterphase
New Silver Marshall
McLaughlin Single Control Superhet

Described in full detail in our catalog. A postal brings you your copy. Costs you nothing!

WHOLESALE RADIO SERVICE Co.
Dept. 1025 **6 Church St.,** **N. Y. C.**

First in the Field
Specializing in
Cockaday Kits

S. HAMMER RADIO CO., 303 Atkins Ave. Brooklyn, New York

Cockaday Sets Now Made Easier to Build by Our New "Ready-to-Wire" Plan
50% of Your Time, Work and Worry SAVED!

All you need do is to connect bus-bar according to diagram, solder and your set is finished. These Kits are sent to you completely mounted, and assembled on a Veneered Mahogany baseboard and genuine bakelite panel, drilled and engraved; in a solid Mahogany Cabinet. Genuine parts used as listed below; exactly as used in Mr. Cockaday's Laboratory Model. **COMPARE OUR OFFER!**

8 TUBE NEW SINGLE DIAL CONTROL SUPERHETERODYNE

- | | |
|--|--|
| 2 Precise No. 750 Syncrodensers .0005 \$9 00 | 1 N. Y. Coil fixed condenser .006. \$ 75 |
| 1 Precise No. 744 Coupler. 60 | 1 N. Y. Coil fixed condenser .00025 35 |
| 2 Precise Aluminum Brackets pr. 2 00 | 2 Dubilier L. Mfd. By-Pass condensers. 2 50 |
| 1 Precise No. 1900 Filterformer. 4 50 | 1 Dubilier No. 640 fixed condenser .00025 clips 45 |
| 1 Precise No. 1700 Super Multi-former. 20 00 | 1 Daven grid leak 2 meg. 50 |
| 2 Precise Audio Transformers No. 480—5 to 1 and 1 1/2 to 1.15 00 | 1 Precision Inducto coupler No. 260. 1 85 |
| 1 Marco 4 inch Vernier Dial. 2 50 | 1 Gen. Radio 2 Ohm Rheostat No. 214-A. 2 25 |
| 1 Hammarlund, Jr., Midget. 1 80 | 1 Gen. Radio 400 Ohm Pot. No. 214-A. 3 00 |
| 2 Carter Imp. Jacks. 1 00 | 1 Genuine Bakelite Panel Drilled and Engraved 10" x 14 1/2" x 3-16" 4 35 |
| 1 Carter Holdrite Do. Jack. 1 00 | Wire, screws, etc. 20 |
| 1 Carter Holdrite Single Jack. 70 | |
| 1 Benjamin No. 9050 8-gang socket shelf. 11 00 | |
| 1 Benjamin Battery Switch. 35 | |
| 1 Weston No. 301 Volt Meter. 8 00 | |
| 1 Weston No. 301 Milliammeter 8 00 | |

READY-TO-WIRE KIT, PRICE, \$101.⁶⁵
WIRED COMPLETE In Genuine Mahogany Cabinet \$115.⁰⁰
UNASSEMBLED KITS IN STOCK
D. T. W. LOOP IN STOCK

Cockaday's New LC-26 Receiver

- | | |
|---|--|
| 1 General Radio Variometer type 269 with rheostat knob \$5.30 | 3 Bradleyunits, 1/4 megohm... \$2.25 |
| 1 General Radio Rheostat type 214-a, 7 ohms, with rheostat knob. 2.25 | 1 Bradleyunit 1/2 megohm... 75 |
| 1 Precision Octaform coil set 5 50 | 3 Amperites No. 1a... 3 30 |
| 1 Amusco Double Unit Condenser No. 1814. 6.25 | 1 Amperite No. 112... 1.10 |
| 1 Micamold fixed Condenser .00015 mid. .35 | 5 Benjamin standard "Ciera-tone" sockets. 5 00 |
| 1 Micamold fixed Condenser .00025 mfd. .35 | 1 Carter single-circuit jack No. 101... 70 |
| 2 Daven resisto-couplers (new type). 3 00 | 2 Carter Jack switches No. 2... 2 00 |
| 1 Amertran DeLux transformer, first stage. 10 00 | 8 Eby binding posts. 1.20 |
| Bradley's leak 1/4 to 10 meg.† 1.85 | 1 Fynur vernier control knob and dial. 3.50 |
| | 1 Universal decorated panel, 8 x 22 inches. 7.50 |
| | 4 Small brass brackets. 2 |
| | 2 Bakelite Connection Blocks 1 x 2 plus 1 x 9. .31 |
| | 2 Large Brass Brackets. |

READY-TO-WIRE KIT, PRICE, \$62.⁰⁰
WIRED COMPLETE In Genuine Mahogany Specified Cabinet \$80.⁰⁰
UNASSEMBLED KITS IN STOCK

HAMMARLUND ROBERTS! KITS IN STOCK!

WRITE FOR BOOKLET about these Parts and Kits. Also for Free Radio Catalog

Transportation Prepaid. One-third must accompany all C. O. D. orders. Not insured unless insurance charges included

Cockaday "B" Eliminator

(Raytheon Plate Supply Unit)

A really dependable method for obtaining a "B" source of supply from the electric light wires in your home. Humless—long life (over 10,000 hours on tests). Parts for the Cockaday "B" Battery Eliminator may be obtained exactly as described in November POPULAR RADIO—Price \$42.05.

A Substitute for a Loop Aerial

Now you can build the McLaughlin 8-tube One Control Receiver without having to use a loop aerial. The Precision Antenna Coupler makes your outdoor aerial serve just as well. Price \$3.50.

ORDER FROM US TODAY

PRECISION COIL CO., Inc.

209 Centre Street

New York, N. Y.

BROADCAST LISTENERS

The POPULAR RADIO ATLAS and LOG will give you a list of all the NEW Broadcasting Stations with wavelengths and other necessary information

A Complete Atlas and Station Log

The "POPULAR RADIO International Radio Atlas and Log" will supply you with full information regarding broadcasting stations of the United States and Canada.

This most useful and practical Atlas consists of 16 pages, size 12" x 15", printed on good paper, from clear type in two colors and contains a complete series of double page maps, including—The World—The United States—Canada—North and South America, showing location of principal broadcasting, leading commercial and governmental radio stations.

SPECIAL FREE OFFER

You may have a copy of the "POPULAR RADIO International Radio Atlas and Log" free, with POPULAR RADIO for (8) eight months

For Only \$2.00

Pin \$2.00 in bills to the coupon below.

If you are a subscriber to either POPULAR RADIO or The Wireless Age, your subscription will be extended eight months.

POPULAR RADIO

627 West 43d Street

New York City

Date

POPULAR RADIO, Dept. 12A
627 West 43d St., New York City.

Enclosed is my remittance of \$2.00 for which you are to enter my subscription (extend my subscription) for (8) eight months for POPULAR RADIO and send FREE a copy of the "POPULAR RADIO International Radio Atlas and Log."

Name

Address

City State

All apparatus advertised in this magazine has been tested and approved by POPULAR RADIO LABORATORY

To our old friends of Popular Radio— a little “tip”!

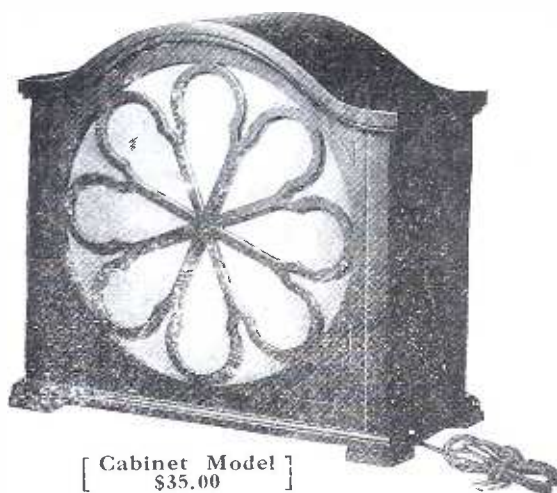

[Cabinet Model]
\$35.00

YOU have probably seen a dozen loud-speaker advertisements in the last month. Horns, cones, what not. You've read all sorts of claims. Now just between us—as old timers, here's a tip.

Frankly, it relates to Acme, but you don't care do you, as long as you get what you're looking for?

Well to make it quick. Acme has a new “double free-edge cone” loud speaker. We have no reputation as

slow pokes but it's taken us exactly 5 years, thousands on thousands of dollars and 256 experimental models to make it right—to give exact reproduction of the human voice and all musical instruments.

Perhaps we need scarcely tell you what you can expect from speakers hastily conceived and hastily manufactured. If it has taken us 5 years with all our experience specializing on “amplification without distortion” what must be the answer?

So hear the new Acme—we know you'll know.

Meanwhile, if you haven't already a copy, be sure to send for the new 10th Edition of “Amplification without Distortion.”

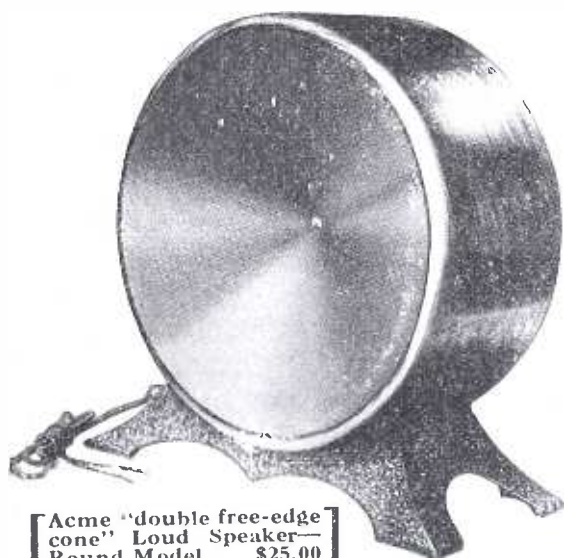

[Acme “double free-edge cone” Loud Speaker—Round Model, \$25.00]

Claude Cairns

CLAUDE F. CAIRNS
Pres.
Acme Apparatus Co.

Send for your copy

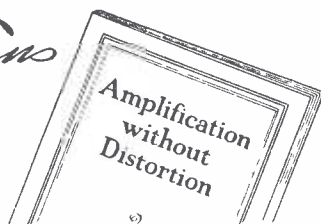

ACME

~for amplification

ACME APPARATUS COMPANY,
Dept. C7, Cambridge, Mass.

Enclosed find ten cents (stamps or coin) for my copy of the new 10th Edition of “Amplification without Distortion.”

Name

Street

City State

All apparatus advertised in this magazine has been tested and approved by POPULAR RADIO LABORATORY

For Quality **CORBETT'S CABINETS** For Quality

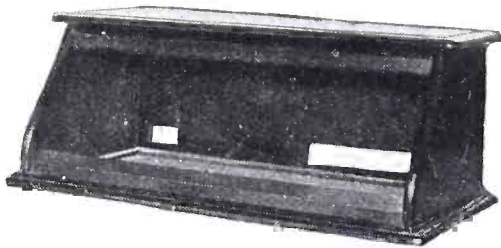

CABINET For LC-26 Receiver

Built exactly to specifications with piano hinge, lid stay, and splined mounting board.

List prices:

GENUINE AMERICAN WALNUT... \$17.00
 GENUINE MAHOGANY... 17.00
 MAHOGANY OR WALNUT FINISH. 14.50

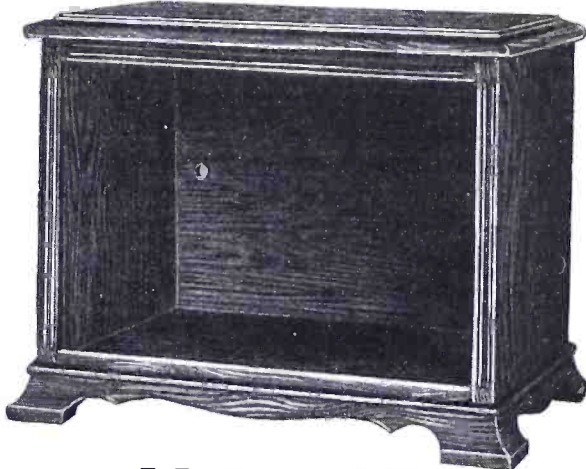

McLaughlin Super-Heterodyne

To specifications in October, 1925, issue with piano hinge and lid stay.

List prices:

GENUINE AMERICAN WALNUT. \$12.00
 GENUINE MAHOGANY..... 12.00
 MAHOGANY FINISH..... 9.60

Standard Cabinets in Stock (Specify model "T.")

Of the same design as the McLaughlin cabinet above except having rabbeted instead of grooved front. Piano hinge and lid stay.

| Size | Mahog- finish | Walnut any or Ma- hogany | Size | Mahog- finish | Walnut any or Ma- hogany | Size | Mahog- finish | Walnut any or Ma- hogany |
|--------|------------------|-----------------------------------|---------|------------------|-----------------------------------|---------|------------------|-----------------------------------|
| 7x18-8 | \$8.55 | \$9.50 | 7x28-8 | \$11.80 | \$14.70 | 7x21-10 | \$10.90 | \$13.25 |
| 7x21-8 | 9.30 | 11.50 | 7x40-8 | 12.75 | 15.55 | 7x24-10 | 11.70 | 14.65 |
| 7x24-8 | 10.10 | 12.60 | 8x30-8 | 13.70 | 17.10 | 7x26-10 | 12.65 | 15.80 |
| 7x26-8 | 10.70 | 13.35 | 7x18-10 | 10.20 | 11.65 | 7x-0-10 | 13.30 | 16.65 |

SPECIAL CABINETS TO ORDER

SHIPPING CHARGES PREPAID

CORBETT'S CABINETS have been preferred for several years by quality set builders and are unquestionably superior in design and finish. They are backed by our guarantee to please you. Carefully hand rubbed piano finish. Well packed for shipment.

WRITE FOR CATALOG showing attractive models for all sizes of radio cabinets, consoles and tables.

Jobbers and Dealers write for discounts.

CORBETT CABINET MFG. COMPANY
 St. Marys, Penna.

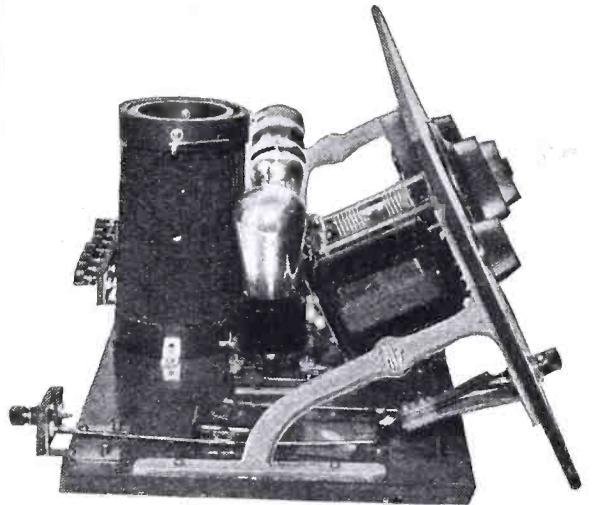

YOUR L. C. 26 Receiver will be easier to build and look better if you use these **Special Alloy Brackets**. Approved by Popular Radio Laboratory. Made especially for the New Popular Radio Standard Cabinet described in the December issue of Popular Radio. Sent postpaid anywhere in the world upon receipt of price. Your dealer will carry them if you ask him. Mail order houses carry them or order direct.

Price, \$2.00 per pair

Made to save you time and trouble

TAIT, 161st Street and Brook Ave.
 New York City

Simplified Blueprints

LAURENCE M. COCKADAY has personally supervised the preparation of *Simplified Blueprints* of eight of POPULAR RADIO's most popular circuits. Each set consists of three or more *Actual Size Blueprints*; first a Panel Pattern; second, an Instrument Layout; and third, a Picture Wiring Diagram all simplified in the fullest sense of the word.

Priced at \$1.00 per Set

Set No. 4—"Cockaday 4-Circuit Tuner with Resistance-Coupled Amplifier" (five tubes, distortionless, two dials, automatic vacuum tube control, as described in the October 1924 issue of POPULAR RADIO).

Set No. 6—"The Cockaday 8-Tube Super-heterodyne Reflex Receiver" (eight tubes, two tuning dials, loop, non-radiating, distortionless, as described in January 1925 issue of POPULAR RADIO).

Set No. 7—"The Craig 4-Tube Reflex Receiver with the New Sodian Detector" (four tubes, two tuning dials, short antenna, non-radiating as described in February 1925 issue of POPULAR RADIO).

Set No. 9—"Portable Town and Country Receiver" (six tubes, three stages of transformer coupled radio-frequency amplification, loop antenna, tuned by variable condenser as described in May 1925 issue of POPULAR RADIO).

Set No. 11—"5-Tube Tuned Radio-Frequency Receiver with Simplified Control" (as described in August 1925 issue of POPULAR RADIO).

Set No. 12—"8-Tube Super-heterodyne with Single Control" (as described in October 1925 issue of POPULAR RADIO).

Set No. 13—"Raytheon Plate Supply Unit" (a really dependable method for obtaining a "B" source of supply as described in November 1925 issue of POPULAR RADIO).

Set No. 14—"The LC-26 Broadcast Receiver" (as described in December 1925 issue of POPULAR RADIO).

Full constructional and parts details for these Receiving Sets will be found in the issue of POPULAR RADIO indicated. Back issues of POPULAR RADIO will be furnished at the rate of 35c a copy.

POPULAR RADIO

Department 14

627 West 43d Street, New York

All apparatus advertised in this magazine has been tested and approved by POPULAR RADIO LABORATORY

Here it is!

Amsco No. 1814—a siamese pair, each .00032 mfd. for the single control. L. C.-26 Receiver.

Described in the December issue of POPULAR RADIO.

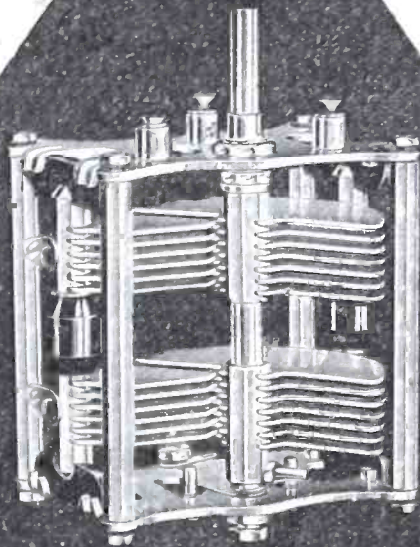

AMSCO 14 Plate Special

—for the single control radio receiver
designed by L. M. Cockaday.

This condenser is exactly right for the "L. C.-26" circuit—each unit being electrically paired for straight line capacity and mechanically matched for synchronization. It is practically zero loss—with a minimum capacity that admits of tuning in the low wave bands you can't afford to miss. You will find it free of body capacity effects—and absolutely noiseless during adjustment.

Ask your dealer for Amsco No. 1814 Special.

If you can't get it, write us, at Dept. D



AMSCO
PRODUCTS

Broome and Lafayette Streets
New York City

Write for interesting booklet
"The Heart of The Hook-up"

All apparatus advertised in this magazine has been tested and approved by POPULAR RADIO LABORATORY

McLaughlin
uses
PRECISE

PRECISE SYNCRODENSER
.0005 mfd \$4.50
.00035 mfd \$4.00
(with or without lug)

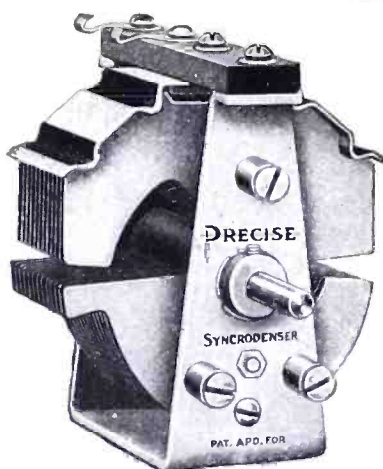

Do You Know?

THAT Precise Syncrodensers are the ORIGINAL and ONLY straight-line frequency condensers combining straight-line capacity at the higher end thus assuring uniform station separation.

DO YOU KNOW that Precise Syncrodensers will make your receiver easier to tune, due to the characteristics of design and construction.

Select Precise when building your receiver and be assured of maximum tuning efficiency regardless of what type of set you are constructing. They are rigid and compact and can be mounted either on panel or sub-panel requiring a minimum of space.

Ask your dealer to show you the PRECISE line, or write for literature.

PRECISE MFG. CORP. ROCHESTER, NEW YORK

Branch Offices:

126 Liberty St., New York City
205 West Harrison St., Chicago, Ill.
821 Market St., San Francisco, Cal.

454 Builders' Exchange, Minneapolis, Minn.
1127 Pine St., St. Louis, Mo.
701 A. O. U. W. Bldg., Little Rock, Ark.

Canadian Distributors:

PERKINS ELECTRIC, Ltd., Toronto, Montreal, Winnipeg



PRECISE
No. 285 Transformer.
Ratio $4\frac{1}{2}$ to 1.
Price, \$5.00



PRECISE
Comet Transformer.
Ratio $3\frac{1}{2}$ to 1.
Price, \$3.25



PRECISE No. 480
Supersize Audio
Transformers.
Ratios 5 to 1, $2\frac{1}{2}$ to 1.
Price, \$7.50 each



PRECISE
Filterformer.
Price, \$4.50

Every Precise Instrument Is a Laboratory Product

All apparatus advertised in this magazine has been tested and approved by POPULAR RADIO LABORATORY

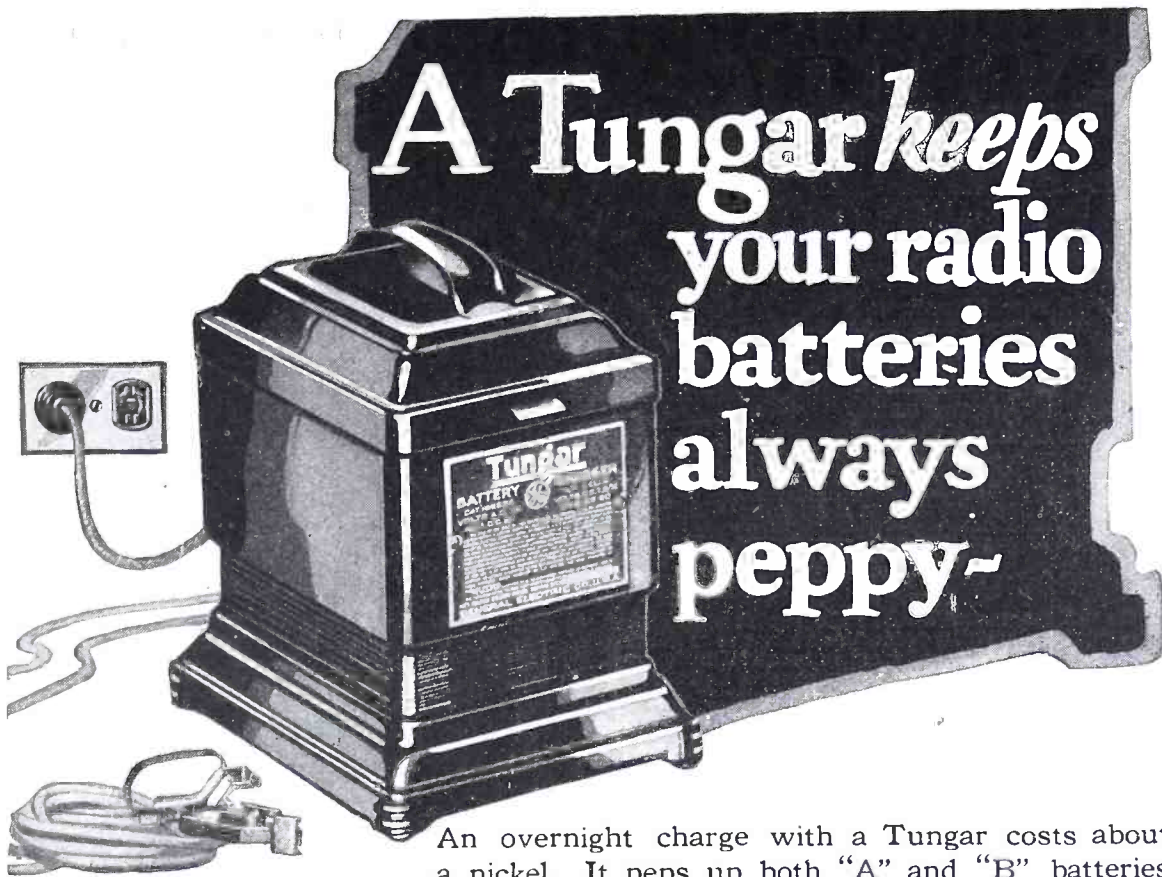

An overnight charge with a Tungar costs about a nickel. It peps up both "A" and "B" batteries and keeps your radio set at its full-toned best.

Tungar — the original bulb charger — is noiseless. It contains no substance which will spoil furnishings. Just clip it to your set and plug it into the house current. It can't blow out Radiotrons if the battery is left hooked to the set while charging.

Use a Tungar—the charger that needs no attention.



The Tungar is a G-E product, developed in the Research Laboratories of General Electric.

The new Tungar charges any make and size of storage battery: radio "A" and auto batteries, and "B" batteries as high as 96 volts in series.

East of Rockies

Two ampere size \$18.00
Five ampere size \$28.00

60 cycles . . . 110 volts

Tungar

REG. U.S. PAT. OFF.

BATTERY CHARGER

Tungar—a registered trademark—is found only on the genuine. Look for it on the name plate.

Merchandise Division

General Electric Company, Bridgeport, Conn.

GENERAL ELECTRIC

All apparatus advertised in this magazine has been tested and approved by POPULAR RADIO LABORATORY

Send for this RADIO BOOK FREE

1926 Catalog of RADIO BARGAINS

Save 1/3 to 1/2

The World's Largest Exclusive Radio Mail Order House Will Send You This Wonderful Book FREE



AMERICAN RADYNOLA

5 TUBE SET

\$29.50

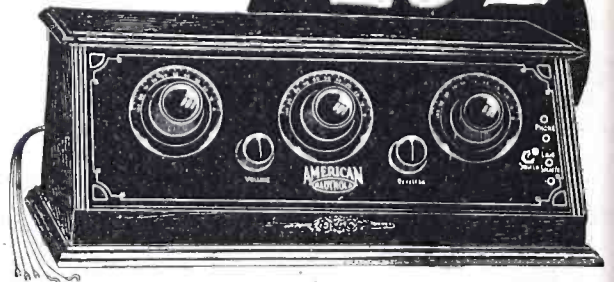

64 illustrated pages containing thousands of bargains in radio sets, semi-finished sets and radio kits of all styles, sizes and approved circuits. **5-tube sets as low as \$29.50.** Beautiful models of the very latest designs and types. Elaborate console models with loudspeakers built right in cabinets of genuine mahogany and walnut. **All sets guaranteed.** Coast to coast receiving range. Also contains everything in radio supplies, including batteries, chargers, loudspeakers, transformers, condensers, rheostats and any other parts you may want for improving your set or building a new one. Guaranteed saving to you of 1/3 to 1/2.

The Biggest 5-Tube Value on the Market

Positively the world's greatest 5-tube radio bargains. **Regular \$75.00 value.** Our large quantity production enables us to sell this set for **only \$29.50**, fully built and wired in beautiful mahogany cabinet of latest design with sloping Bakelite panel of Satin finish, handsomely etched and engraved as illustrated. Constructed of the finest low-loss condensers, coils and sockets. Bakelite baseboard panel and dials. **Price for set only. \$29.50**

This set with all accessories, including the famous American Bell loud speaker with adjustable unit, 2-45 volt "B" batteries, one guaranteed 100 Ampere Hour, storage "A" battery, cable for battery connection, 5-201A tubes, Aerial and ground equipment, and everything complete ready to set up and operate. **Nothing else to buy. Price \$59.75**

Transportation charges extra. Shipping weight 25 lbs.

Order Direct from This Page! Save About One-Half!

Order direct from this page. Save 1/2 to 1/2. Our guarantee protects you. Money cheerfully refunded if you are not satisfied. Write your order and prices plainly. Send post office money order or bank draft for full amount to insure safety. Refer to any bank or commercial agency regarding our reliability.

SEMI-FINISHED 5-TUBE RADIO FREQUENCY SET

\$18.75

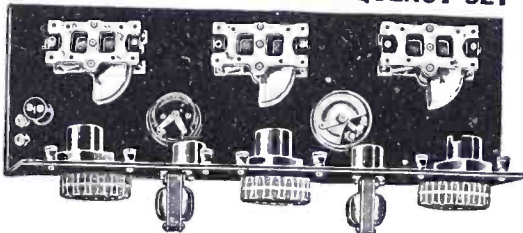

This special offer is astounding the radio world. **Coast to coast reception on loud speaker.** Low loss condensers and sockets. Highest quality transformers. Bakelite rheostats. All wiring concealed under Bakelite baseboard. 7x18 panel—fits into any standard 7x18 cabinet. Complete instructions for operating. **Guaranteed saving to you of \$50.00. Price of set all mounted, \$18.75.** Cabinet of same model as American Radynola pictured above \$5.65 extra.

You must have our catalog no matter what set or kit you want. Our line is complete and includes all popular sets, such as Superheterodyne, Neutrodyne, Ultradyne, Reinartz, Regenerative, Radio Frequency, Browning-Drake, Super-Heterodyne Reflex and all other latest circuits. Kits, sets and parts manufactured by all well known manufacturers such as Frost, Howard, Baldwin, Brandes, Western Electric, Columbia and others.

Our semi-finished sets come with all parts mounted on panel and baseboard ready for wiring. Do not fail to send for our catalog. Remember—we are the largest exclusive radio mail order dealers in the world and carry the best of everything in radio. We save you 1/2 to 1/2 on the following kits. Detailed descriptions appear in our catalog.

SEMI-FINISHED 8-TUBE SUPER-HETERODYNE

\$43.75

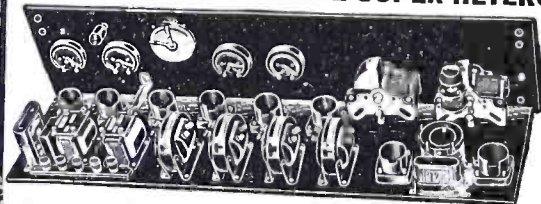

World's Famous 8-tube Superheterodyne. Fully mounted on panel and baseboard. Comes **completely assembled** ready to wire and operate. We have testimonials from thousands of builders of this set. Some have received foreign stations on loop aerial. Unsurpassed in volume and tone quality. Low-loss straight line frequency condensers, vernier dials, finest quality rheostats. Matched Columbia long waved transformers. Requires only three screws for attaching panel and baseboard and set is ready to operate. 7 x 30 panel. **Price of set only \$43.75.**

Requires following accessories to complete this set: 7x30 cabinet, 8-201A tubes for storage battery operation or No. 199 tubes for dry cell operation. 100 Ampere hour storage battery, 2-45V "B" batteries, loud speaker, center tapped loop aerial. All these items are listed in our catalog at a tremendous saving.

Complete Parts for Best 45 Kilocycle Super-Heterodyne Genuine Remler Parts

\$49.50

Catalog includes list of broadcasting stations, general radio information and facts about our free service division. Write for it today.

NEUTRODYNE
Genuine licensed Neutrodyne kit of parts, come fully assembled on the panel and baseboard with complete instructions. **Price, \$29.75**

COCKADAY
3-tube Cockaday kit of parts, fully assembled on panel and baseboard, ready to wire. **Price, \$15.85**

FOUR TUBE BROWNING DRAKE AND COCKADAY'S NEW LC 25 CIRCUIT PARTS ARE IN OUR CATALOG.

Complete Parts for Coc' a-day Resistance Coupled and 5-tube set at prices that will astound you. Also complete parts for AC Kit.

RANDOLPH RADIO CORPORATION

159 N. Union Ave. Dept. 225 Chicago, Illinois

All apparatus advertised in this magazine has been tested and approved by POPULAR RADIO LABORATORY



The New
McCULLOUGH
AC
RADIO TUBE

ANNOUNCEMENT

The New McCullough AC Tube is now being manufactured, for the McCullough Sales Co., by KELLOGG SWITCHBOARD & SUPPLY COMPANY, CHICAGO.

An assurance of standard of quality and uniformity—and of sufficient production to meet the tremendous nation-wide demand for this greatest-of-all advances in Radio development.

An ALTERNATING CURRENT Tube, operated by simply plugging into the AC lighting socket (through small step-down transformer). Developed to perfection—the fulfillment of radio's long felt and greatest requirement.

A Tube with greater electron emission and increased signal response. A Tube of more rugged construction and LONGER LIFE.

List Price \$6

RADIO SET MANUFACTURERS AND
 JOBBERS OF RADIO TUBES ARE
 URGED TO GET IN LINE WITH
 THIS IMPORTANT DEVELOPMENT

Tubes Ready for Prompt Delivery

*The Tube That
 Eliminates
 "A" Batteries
 from Radio*

McCULLOUGH SALES CO.

Distributors McCullough AC Tubes

PITTSBURGH, PA., 963 Liberty Avenue NEW YORK, 25 W. Broadway
 CHICAGO, 533 Wabash Avenue

All apparatus advertised in this magazine has been tested and approved by POPULAR RADIO LABORATORY



The Heart of the Bradley-Amplifier



TUCKED away within the polished bakelite base of the Bradley-Amplifier are six inconspicuous, solid molded resistance units known as Bradley-units.

The Bradleyunit is the heart of the Bradley-Amplifier because it alone can amplify the incoming tone frequencies without distortion. It replaces the ordinary bulky audio-frequency transformer and eliminates the most frequent cause of distortion in a radio receiver. The Bradleyunit cannot deteriorate or change with age.

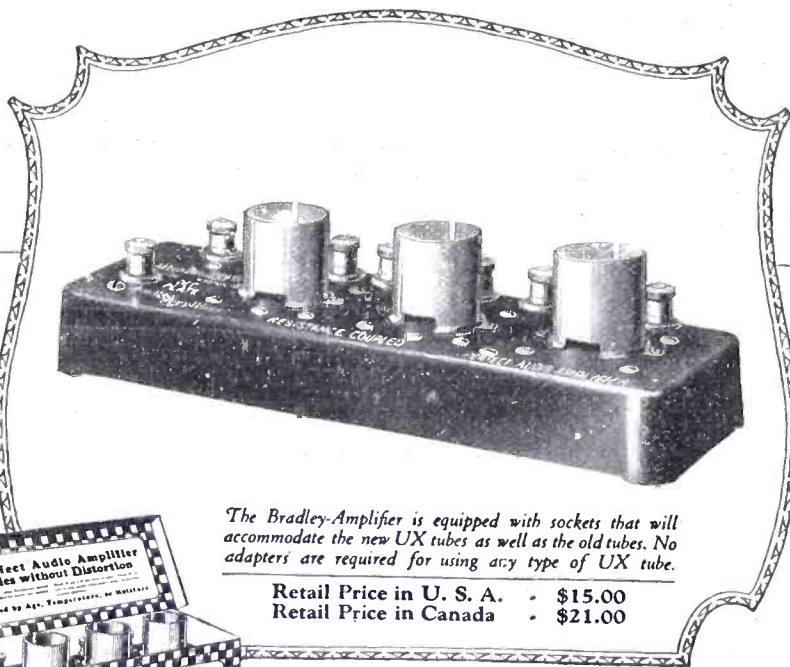

The Bradley-Amplifier is equipped with sockets that will accommodate the new UX tubes as well as the old tubes. No adapters are required for using any type of UX tube.

Retail Price in U. S. A. - \$15.00
Retail Price in Canada - \$21.00



Surprise Your Friends

With The Improved Tone Quality of Your Set

IT IS NOT ENOUGH that a good radio receiver is selective or is able to bring in distant stations. Quality of reproduction is now considered as important as selectivity and sensitivity.

Fortunately, the tone quality of your radio set can be quickly improved and perfected without disturbing the existing wiring of the set. All that is necessary is to replace your present audio-transformer amplifier with a Bradley-Amplifier. This compact unit employs no transformers and amplifies all tone frequencies with faithfulness and clarity, and without distortion.

It is a mark of distinction to have a radio receiver of fine tone quality and you will surprise your friends with the remarkable improvement in your set that follows the use of a Bradley-Amplifier. It is as easy to install as a B-Battery and usually can be installed within the receiver cabinet.

Be sure to try one, tonight.

Ask Your Nearest Radio Dealer for a

Bradley-Amplifier

Resistance-Coupled
PERFECT AUDIO AMPLIFIER

ALLEN-BRADLEY CO.
276 Greenfield Ave.
Milwaukee, Wisconsin

Please send me, by return mail, literature on the new Bradley-Amplifier.

Name.....

Address.....

.....

These wonderful new tubes

are **matched**—every one must pass an exacting test for uniformity as well as the supreme quality which has made Gold Seal Tubes famous.

Put a full set of these wonder tubes in your radio and enjoy a revelation in reception—clear, rich tones, full resonant volume, and thrilling distance.

They cost no more—yet the life of Gold Seal Tubes is two times that of ordinary tubes, by actual test.

Gold Seal Products Co.
250 Park Avenue, - New York City

[NOTE:
If not obtainable from
your local dealer, write
direct to us.]

GOLD SEAL
Radio Tubes

\$
2.50
everywhere



The new C-H Socket for the UX tubes. Same one-piece, double-grip, SILVER plated contacts used in the standard C-H Socket with the ORANGE shell. Heatproof Thermoplastic base. Genuine low-loss construction and attractive appearance.

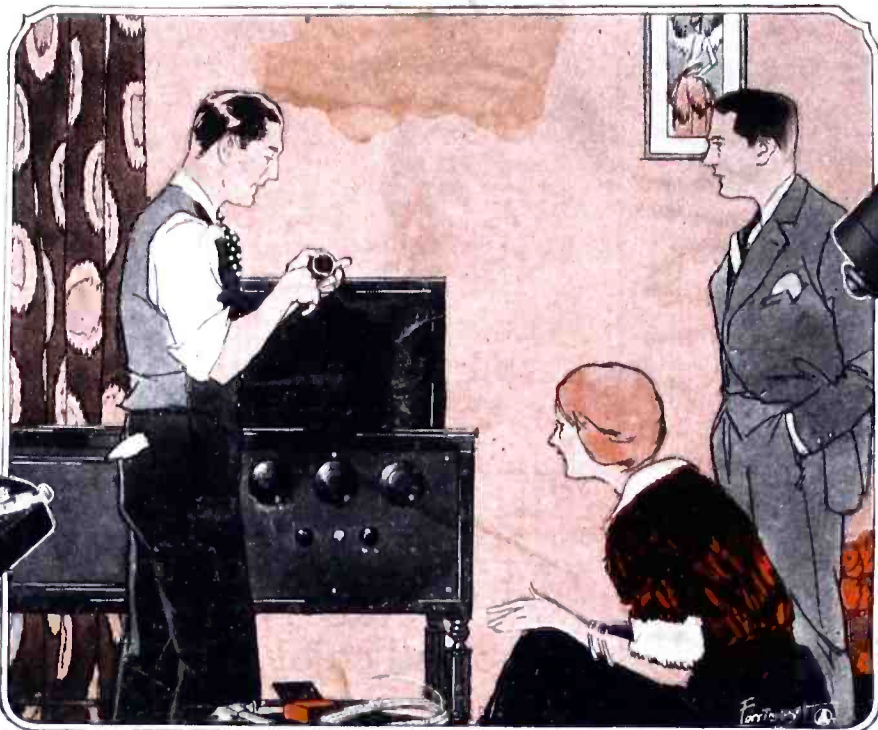

The original radio switch—with the long life mechanism, outlasts these. Easy to mount, only one hole needed, and adjustable to all panel thickness. Can also be used in new batteryless sets.

In Radio especially— “it’s the little things that count”

A list of some of the prominent radio manufacturers using C-H products

- Aeme Apparatus Co.
- American Bosch Magneto Co.
- Astral Radio Corp.
- Boissier Radio Corp.
- Chelsea Radio Co.
- Crosley Radio Corp.
- Dayton Fan & Motor Co.
- Dubilier Condenser & Radio Corp.
- Electrad, Inc.
- Freed-Eisemann Radio Corp.
- Garod Corporation
- Gillilan Bros., Inc.
- Howard Radio Co.
- Allen T. Hamscomb
- The Keyport Laboratories
- King Electric Mfg. Co.
- LeMor Radio, Inc.
- Magnus Electric & Radio Co.
- Malone-Lemmon Laboratories
- Wm. J. Murdock
- Newport Radio Co.
- The Radio Compak Co.
- R. B. Radio Co.
- Robbins Radio Co.
- Simplex Radio Co.
- R. E. Thompson Co., Inc.
- Workrite Mfg. Co.

WHEN your radio set goes wrong, just as you are comfortably settled before the fireplace expecting to spend a great evening, it is annoying.

And ten to one, it's only some little wire or part that in itself is insignificant. Really, though, there's no excuse for such things happening.

GOOD parts of good material and carefully built are insurance against such annoyances.

Cutler-Hammer radio products are GOOD parts. Both amateur builder and set manufacturer can attest that fact. They are designed by radio control experts, backed by 25 years' experience, built of the highest quality material and sold at a price you are glad to pay.

Whether you buy or build, insist on C-H radio parts, for it's these good little parts that count and assure constant, efficient service from your set.

THE CUTLER-HAMMER MFG. CO.

Member Radio Section, Associated Manufacturers of Electrical Supplies

Milwaukee, Wisconsin

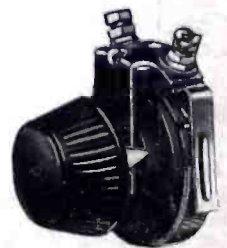

While C-H Rheostats are built to engineers' specifications, they are designed for the use of the novice. They are built as a unit and are not dismantled for mounting.

The closely wound, fine resistance wire is prevented from slipping or wearing out of true by a bronze spring. Thus smooth, quiet control is assured either advancing or decreasing the potential.

There is no jumping, no back lash; and no sticking.

Only one hole for mounting. Self-centering in oversize holes and adjustable to any panel thickness.

CUTLER-HAMMER

Radio Parts for Performance