

Popular Radio

with which is combined The Wireless Age

Edited by KENDALL BANNING

25¢

NOVEMBER ★
1925



How to Build the Raytheon
Plate Supply Unit



New principles in radio developed by RCA

The new Radiolas, embodying new principles of radio reception, are not only the product of RCA, but have behind them as well, the research facilities, the engineering and manufacturing skill of General Electric and Westinghouse. They meet, with new standards of achievement, *all five fundamentals* of good radio reception.

1. **Quality of tone**—New Radiotrons and new RCA Loudspeakers mean perfection of tone never before achieved.
2. **Volume of tone**—The new Radiotrons make possible tremendously greater volume of tone.
3. **Selectivity**—The Super-Heterodyne is known to be the most selective set on the market, and this selectivity has been carried to an even greater degree of exactness.
4. **Range**—Power amplification has brought *improved distance reception*.
5. **Simplicity**—The new uni-control system at last brings single control operation to complete, practical success. And some of the new Radiolas can be operated entirely on the house current without batteries—a final step in a series of achievements that put radio today many strides ahead.

Radiola 25 (pictured above with Loudspeaker Model 100), a six tube uni-control Super-Heterodyne, that uses the new power tube. It has space in the cabinet for dry batteries, but can be used with Loudspeaker 104 without batteries. With 6 Radiotrons but without loudspeaker . . . \$165



RCA-Radiola

MADE BY THE MAKERS OF RADIOTRONS



Radiola 28, eight-tube uni-control Super-Heterodyne, extremely selective. It gives great volume on dry batteries, or if used with the Model 104 Loudspeaker, all batteries can be replaced by 110 volt, 60 cycle A. C. lighting circuit. With 8 Radiotrons. \$260



Radiola 20, an entirely new five-tube, tuned radio frequency set, with regeneration Antenna type, with the new dry battery power Radiotron. Without accessories \$102.50
With 5 Radiotrons . . . \$115



Radiola Loudspeaker, Model 100, RCA Cone type, achieving new clarity and far wider tone range. Can be used with any radio receiver \$35

Be sure to see the new Radiolas and hear them demonstrated. Write today to the nearest RCA district office for the booklet that describes the entire line in detail.

RADIO CORPORATION OF AMERICA
New York Chicago
San Francisco

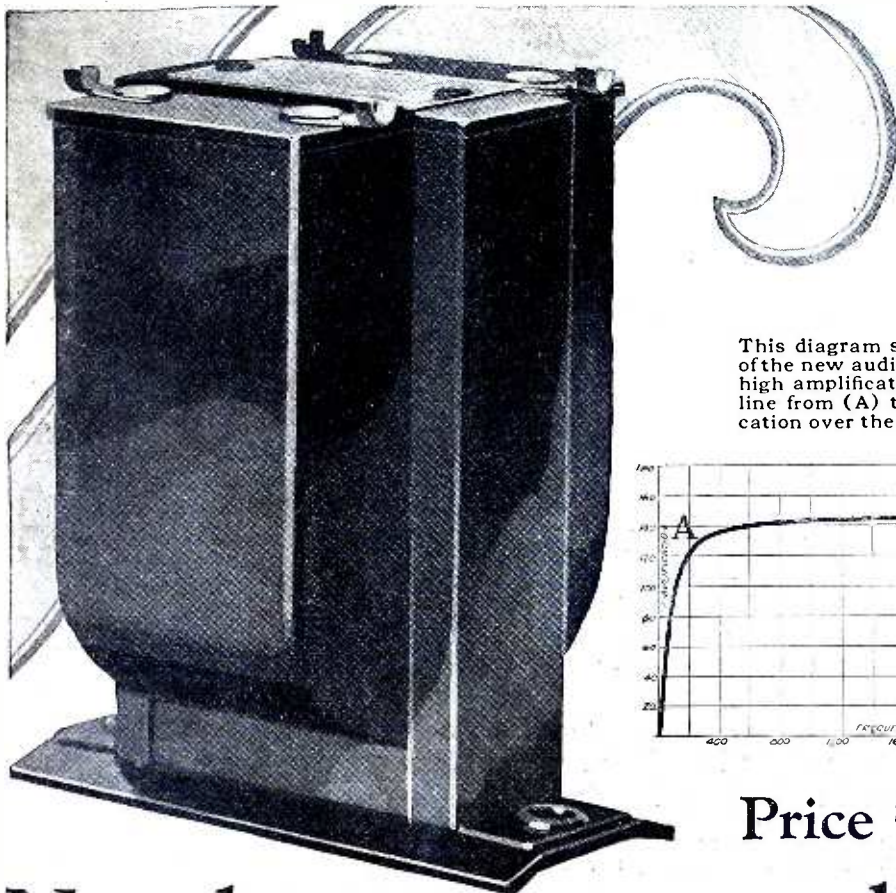

This diagram shows the amplification curve of the new audio transformer. (A) shows the high amplification of the low tones. Straight line from (A) to (B) shows uniform amplification over the whole range.

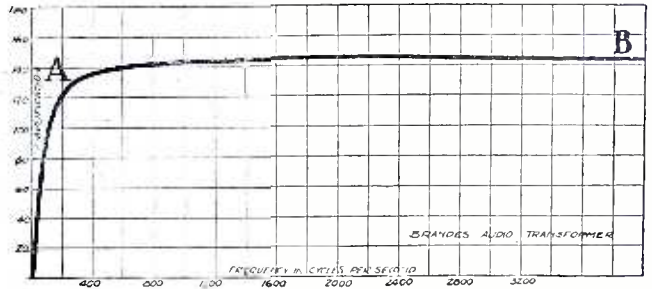

Price \$400

New low tones — new high tones with a Brandes Transformer

HERE'S a new audio transformer that "lets through" the deep and the high tones—that gives an *even* amplification over the whole range.

It amplifies at a high ratio of 1 to 5—without any transformer distortion. And its perfect amplification of the overtones gives mellowness and reality.

Address, 200 Mt. Pleasant Ave., Newark, N.J., for an interesting booklet describing Acoustics by Brandes.

Prices slightly more west of the Rockies and in Canada

The Type H—a horn of graceful lines and antique green and black finish. Great in volume—true in tone. Adjustable . . . \$18

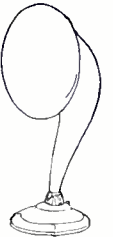

The Brandes Cabinet Speaker of mahogany, finished in walnutbrown. The same unit, quality of tone and even greater volume than the Type H \$30 (pictured below).



The Brandes Cone—a truly decorative bit of furniture that conceals a remarkable speaker \$38 (pictured above).

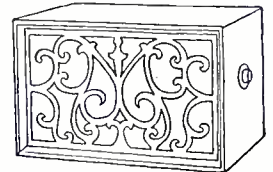

Brandes

EXPERTS IN RADIO ACOUSTICS SINCE 1908

All apparatus advertised in this magazine has been tested and approved by POPULAR RADIO LABORATORY

POPULAR RADIO

WITH WHICH IS COMBINED "THE WIRELESS AGE"

EDITED by KENDALL BANNING



FOUNDED 1911

CONTENTS for NOVEMBER, 1925

VOLUME VIII	(Cover design by Frank B. Masters)	NUMBER 5
Radio Apparatus Sorts Cigars by Color		FRONTISPIECE
Radio's Newest Instrument—the Photo-electric Cell	<i>E. E. Free</i>	Page 397
How to Build the Raytheon Plate Supply Unit	<i>Laurence M. Cockaday</i>	405
A Measurement Chart	<i>Raoul J. Hoffman</i>	415
No. 12: For Estimating the Inductance of a Single-layer Coil		
New Methods of Calibrating Your Receiver	<i>Morris S. Strock</i>	418
How to Get the Most Out of Your Ready-made Receiver	<i>S. Gordon Taylor</i>	427
No. 9: The Garod Neutrodyne Type V Receiver		
The Atom	<i>William Bragg</i>	438
Article No. 3: The Nature of Liquids		
Handy Tools for Radio Fans	<i>The Technical Staff</i>	443
No. 8: The Socket-Wrench		
Practical Pointers About Transformers	<i>F. E. Nimmcke</i>	444
Multi-layer Coils	<i>Oliver Lodge</i>	453
Simple "How-to-build" Articles for Beginners	<i>Laurence M. Cockaday</i>	456
No. 13: How to Build a Single-stage Impedance-coupled Amplifier		

DEPARTMENTS

In the World's Laboratories	<i>E. E. Free</i>	460
What Readers Ask	<i>Hugh S. Knowles</i>	468
The Broadcast Listener	<i>Raymond Francis Yates</i>	472
In the Experimenter's Laboratory	<i>Laurence M. Cockaday</i>	476
What's New in Radio Apparatus	<i>The Technical Staff</i>	486
With the Inventors	<i>William G. H. Finch</i>	488

VOLUME VIII

NOVEMBER, 1925

NUMBER 5

Published monthly by Popular Radio, Inc., 627 West 43rd St., New York, N. Y., telephone number, Chickering 1906; Douglas H. Cooke, President and Treasurer; Kendall Banning, Vice-President; Laurence M. Cockaday, Secretary; Joseph T. Cooney, Asst. Treasurer. Price 25 cents a copy; subscription \$3.00 a year in the U. S., Canada and all countries within the domestic postal zone; elsewhere \$3.50 a year, payable in advance. The International News Company, Ltd., No. 5 Bream's Bldg., London, E. C. 4, sole distributors in England. Entered as second class matter April 7, 1922, at the Post Office at New York, N. Y., under the act of March 3, 1879. Copyright, 1925, and title registered as a trade-mark by Popular Radio, Inc. Copyright in Great Britain by Popular Radio, Inc., 6 Henrietta St., Covent Garden, W. C., London, England.

Printed in U. S. A.

LAURENCE M. COCKADAY, *Technical Editor*
 E. E. FREE, Ph.D., *Contributing Editor* JOHN V. L. HOGAN, *Contributing Editor*

For advertising rates address

E. R. CROWE & COMPANY, INC.
 New York: 25 Vanderbilt Avenue Chicago: 225 North Michigan Avenue

ONE OF THE GREATEST OF RADIO DEVELOPMENTS

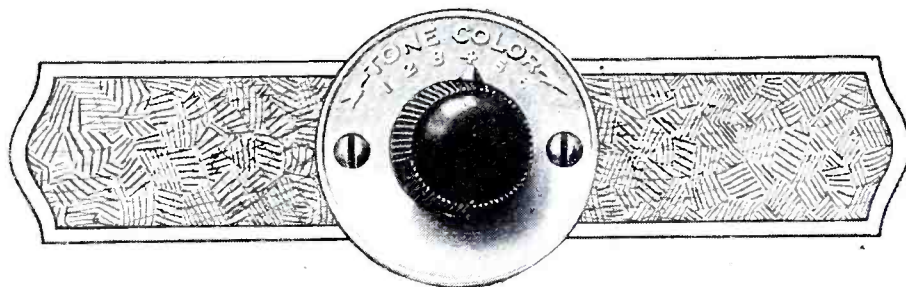

Grebe "Colortone"

THIS tone control is, perhaps, the greatest of recent Grebe inventions.

Grebe "Colortone" enables you to alter to your taste, the quality of speech or music from high, thin pitch to deep, round tones with all the variations between. The Synchronphase is independent of the loud speaker's influence.

With the "Colortone" a complete range of tone characteristics is thus available and the best qualities of any loud speaker are brought out.

The "Colortone" makes it possible to suppress considerably the high pitch frequencies caused by heterodyne interference of one station with another and also to reduce, to a great degree, disturbances due to static.

Ask your dealer to demonstrate this as well as the many other exclusive Grebe features; then compare

A. H. Grebe & Co., Inc., Steinway Hall, 109 West 57th St., N. Y.
 Factory: Van Wyck Boulevard, Richmond Hill, N. Y.
 Western Branch: 443 So. San Pedro Street, Los Angeles, Cal.

The

GREBE

SYNCHROPHASE

— TRADE MARK REG. U.S. PAT. OFF. —

This company owns and operates stations WAHG and WBOQ; also low-wave rebroadcasting stations, mobile WGMU and marine WRMU.



"It is only he who possesses absolute truth who can create."

— Confucius

The constant seeking for truth has created the "Colortone" and other Grebe advances in radio reception.

Doctor Hux

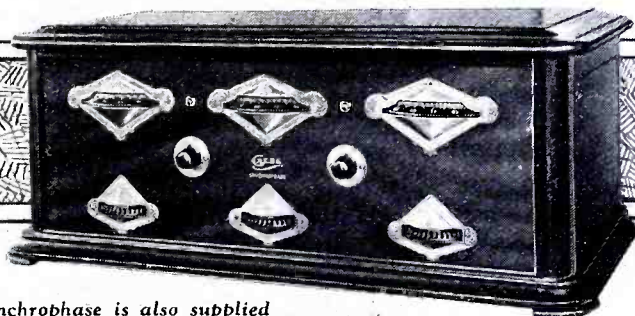

Synchronphase is also supplied with base for batteries and in a de luxe Console model.



All Grebe apparatus is covered by patents granted and pending.

All apparatus advertised in this magazine has been tested and approved by POPULAR RADIO LABORATORY

PAGES WITH THE EDITOR

"ONE of the most valuable services that POPULAR RADIO has rendered to the radio industry," a prominent scientist recently told the editor, "has been the stabilizing of the industry through the medium of the tests made of radio apparatus in POPULAR RADIO LABORATORY."

THIS observation checks up with similar comments that have reached us from many sources—from radio amateurs, from broadcast listeners, from dealers, from manufacturers.

POPULAR RADIO'S policy of submitting to rigid test every piece of radio apparatus that is submitted to the laboratory, and of rejecting every piece of radio apparatus that does not meet the required standards, and of refusing advertisements of all unsatisfactory apparatus, has not only proven invaluable to radio fans by guarding them against inferior products, but has been of inestimable value to the manufacturers themselves, who have in many cases been able to improve their products through the expert advice and constructive suggestions of our laboratory staff.

UP to August 1, 1925, over 1,500 pieces of radio apparatus have been tested and approved. Of this number many were not approved until certain changes were made in

them in accordance with recommendations of the laboratory. And many pieces of apparatus were rejected entirely.

No advertisement is accepted by POPULAR RADIO unless the product or the service advertised is approved by the laboratory, and no advertisement is accepted that contains extravagant or misleading claims.

To every manufacturer whose product is approved is issued a POPULAR RADIO CERTIFICATE OF APPROVAL shown on this page. The original of this certificate is 13½ inches wide by 12 inches high, beautifully printed on a Japan vellum.

So valuable do manufacturers consider this certificate that the originals are almost invariably framed and hung in prominent positions in the sales rooms or offices.

AND in most instances, also, duplicate copies of this certificate are furnished to the salesmen. Experience has shown that the "sales resistance" of prospective buyers is appreciably lessened upon presentation of this proof that the apparatus has met the standards set by POPULAR RADIO LABORATORY.

(Continued on page 6)

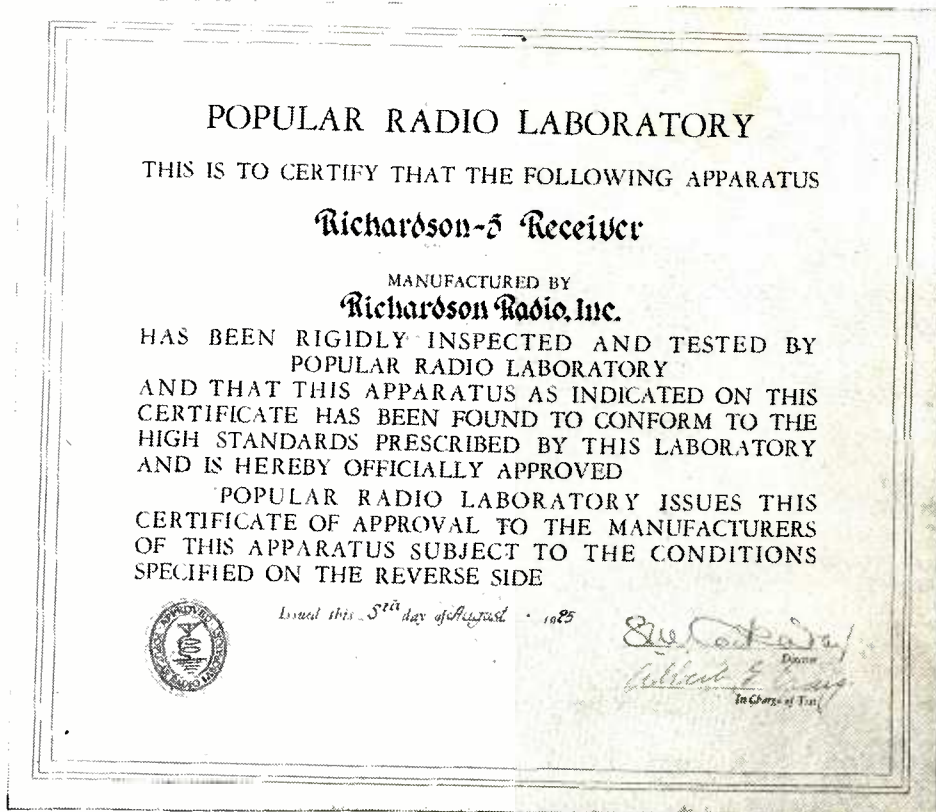

POPULAR RADIO'S CERTIFICATE OF APPROVAL

The original is printed on Japan vellum, and is 12 inches high by 13½ inches wide. The manufacturer is authorized to use on the product approved the small oval silver imprint that is shown affixed in the lower left corner.

Your set at its best *always* with a **Super-Ducon** —the "B" Battery Substitute

When guests come in, your set is ready. No run-down "B" batteries—no batteries being recharged. There's the Super-Ducon plugged into the light socket—ready to deliver a steady, silent flow of current.

It's the perfect substitute of "B" batteries—equipped with a specially designed RCA tube (Rectron UV-196) that has an average life of more than 1000 hours. It's a thoroughly efficient device—made and backed by Dubilier. And it *keeps* your set at its best!

Tested and listed by the National Board of Fire Underwriters

Dubilier

CONDENSER AND RADIO CORPORATION

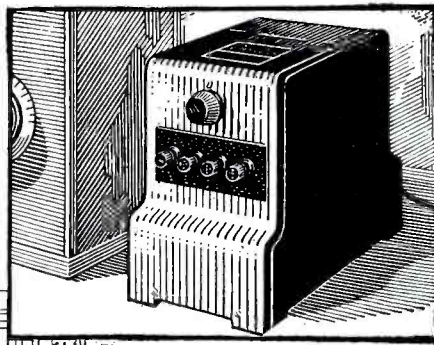

A.C. Type 800—
\$47.50

(60 cycles—110 volts)
Write for descriptive booklet
No. D-3

"The Super-Ducon—
and how to install it."

4377 Bronx Boulevard
New York City

PAGES WITH THE EDITOR
(Continued from page 4)

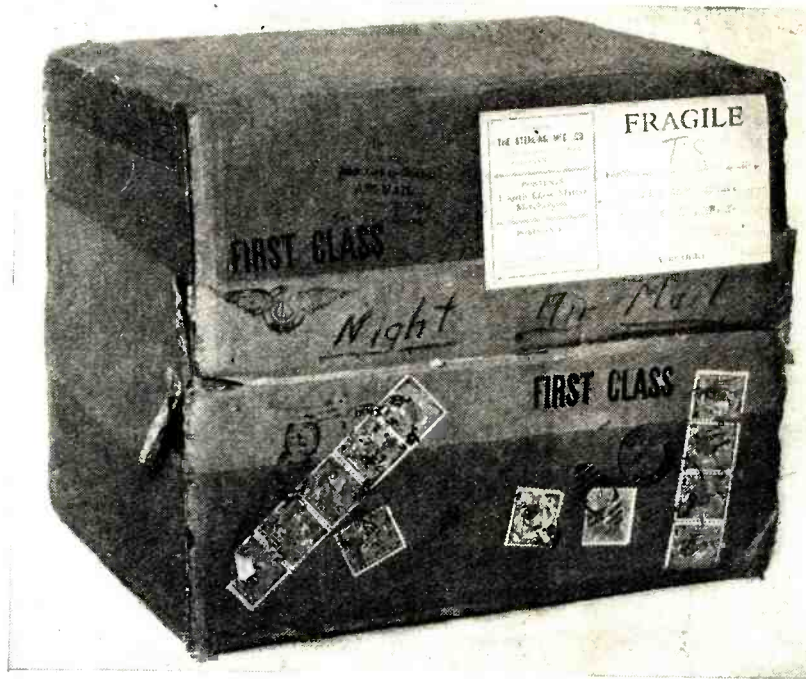

WHAT ONE MANUFACTURER THINKS OF POPULAR RADIO'S O.K.

The Sterling Manufacturing Company, manufacturers of a tube reactivator, sent in copy for an advertisement for the October issue of POPULAR RADIO. But as the reactivator had never been tested and approved by POPULAR RADIO LABORATORY, we could not accept the advertisement until a sample had been sent to us. As we were nearing the closing date for the magazine, we wired the Sterling Mfg. Co. to send us one of the instruments and they, realizing the importance of getting it on time in order to have their advertisement run in the magazine, sent it by first-class air mail from Cleveland to New York, at a cost of \$10.80 for postage.

POPULAR RADIO LABORATORY makes no charge for making these tests. It makes no charge for the Certificates of Approval.

AND it makes no distinction whatever between manufacturers who advertise in POPULAR RADIO and those who do not.

THE testing of any radio part places the manufacturer under no obligation whatever to advertise in POPULAR RADIO. Indeed, many hundreds of pieces of radio apparatus have been tested and approved which have never been advertised and may never be advertised in POPULAR RADIO.

FURTHERMORE, every manufacturer of radio apparatus that is approved by POPULAR RADIO LABORATORY is authorized to use the small silver "Seal of approval" in his advertising and to stamp it into the product itself, or to attach the seal to it in the form of a label.

So high are the standards that have been established by the laboratory, and so impartially have these tests been made, and so helpful have been the changes and improvements that have been suggested by the technical staff of the laboratory, that the POPULAR RADIO stamp of approval has been accepted generally as standard of merit.

AND it was this service—valuable alike to the buyer, seller and maker of radio apparatus—that the prominent scientist had in mind when he commented upon the important part that POPULAR RADIO has played in stabilizing the radio industry.

THE snapshot of Mr. John Hays Hammond, Jr., which appeared on page 218 of our September issue, proved to be in reality a portrait of one of Mr. Hammond's former assistants, taken during some of their experimental work in radio. To show that he harbors no ill will as the result of this photographic error, Mr. Hammond has not only sent the Editor an authentic portrait of himself but his opinion of POPULAR RADIO to boot. You will find them both on page 395 of this number.

IN the next number of POPULAR RADIO will appear a complete "How-to-Build" description of the latest and most important contribution of the POPULAR RADIO LABORATORY—the remarkable LC-26 radio receiver.

Kendall Banning
Editor, POPULAR RADIO

**EVEREADY HOUR
EVERY TUESDAY AT 9 P. M.**

Eastern Standard Time

For real radio enjoyment, tune in the "Eveready Group." Broadcast through stations—

WEAF	New York	WSAI	Cincinnati
WJAR	Providence	WWJ	Detroit
WEEI	Boston	WCCO	Minneapolis
WFI	Philadelphia	WOC	St. Paul
WGR	Buffalo	WOC	Davenport
WCAE	Pittsburgh	WCTS	Worcester



Eveready Columbia Ignitor "A" Battery, the proven dry cell for all radio dry cell tubes 1½ volts



*No. 766
22½-volt
Large
Horizontal
Price
\$2.00*



*No. 486
45-volt
Layerbilt
Extra-Large
Vertical
Price
\$5.50*

ALWAYS RELIABLE

EVEREADY Radio Batteries are always uniform and reliable! Evereadys perform the same, everywhere, for everybody, needing no skill, calling for no experimentation, wasting no time, saving you money. Trouble-proof, wonderful Evereadys. There is an Eveready dealer nearby.

Manufactured and guaranteed by
NATIONAL CARBON CO., INC.
 New York San Francisco
 Canadian National Carbon Co., Limited
 Toronto, Ontario

EVEREADY Radio Batteries

- they last longer

All apparatus advertised in this magazine has been tested and approved by POPULAR RADIO LABORATORY



Quality Detected—Service Amplified
by

Cunningham RADIO TUBES

Since 1915 Standard for All Sets

PEAK SATISFACTION
in detection, amplification and rugged long life are factors that have marked the radio tubes bearing the Cunningham name.

You want real music, true tone clarity and utmost sensitivity from your radio set. Cunningham Radio Tubes—gleaming and glowing in every socket—are the secret in your obtaining the utmost in broadcast reception.

Home Office,
182 Second Street
SAN FRANCISCO

E. J. Cunningham Inc.

CHICAGO
NEW YORK

All apparatus advertised in this magazine has been tested and approved by POPULAR RADIO LABORATORY



Wide World

The High Place Occupied by POPULAR RADIO in the Radio Profession

"I WISH to congratulate you on the work that POPULAR RADIO has been doing. You have balanced the subject matter of the magazine remarkably well, maintaining a very dignified and reliable scientific background, yet making it readable and of popular interest to the public. From personal experience I know the skill which this involves. I wish to congratulate you also for the high place that your magazine has taken in the estimation of the radio profession."

John Hayes Hammond

PRESIDENT, HAMMOND RADIO
RESEARCH LABORATORY

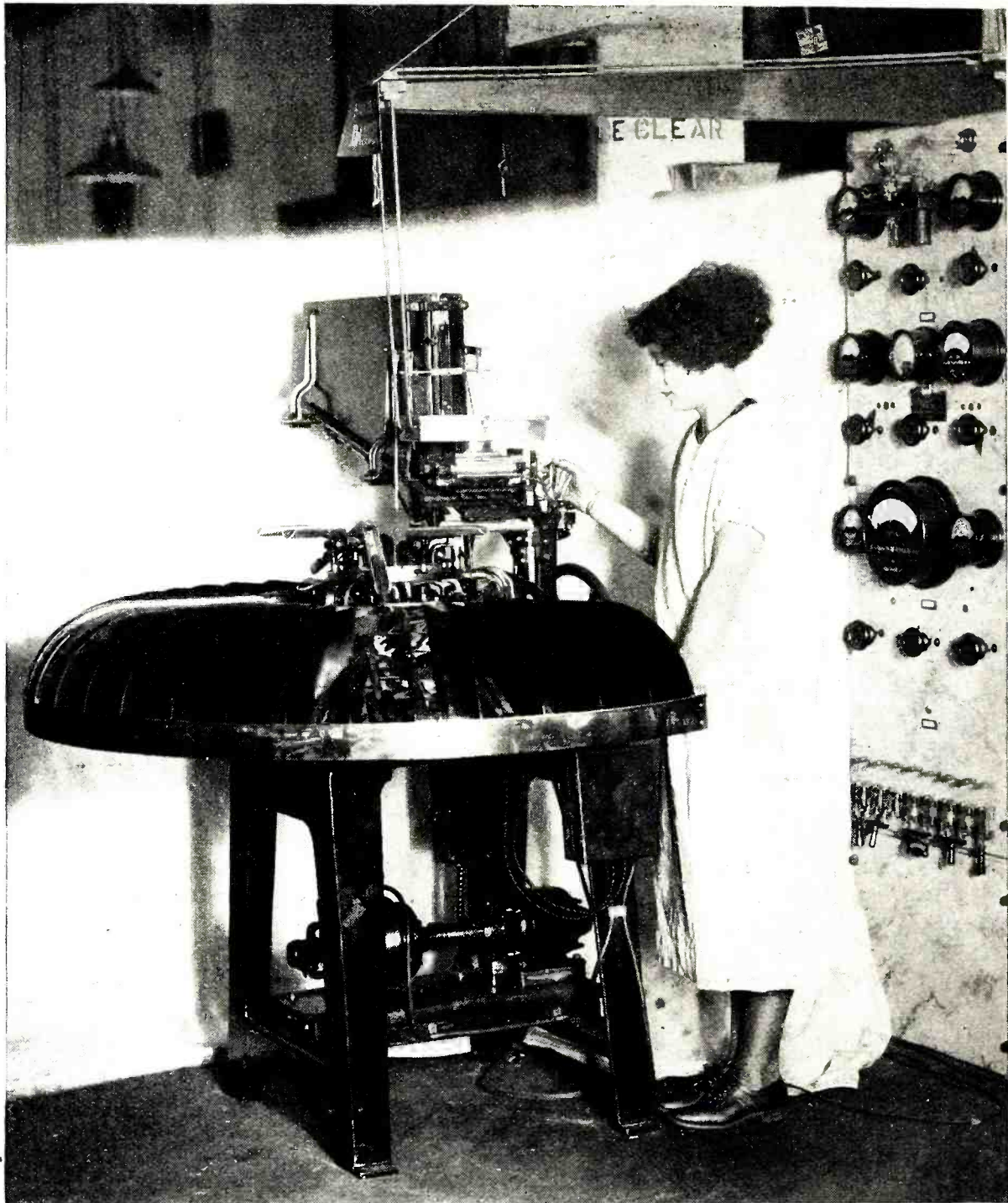

American Machine and Foundry Co.

Radio Apparatus Sorts Cigars by Color

THE remarkable photo-electric cells, now coming rapidly into use in radio, especially for the broadcasting and reception of pictures, have been made to do the work of the human eye in selecting the lighter, the darker and the redder varieties of cigars. A beam of light is reflected from the cigar into a photo-electric cell. This operates a relay which sorts the cigars into differently colored groups.

Popular Radio

WITH WHICH IS COMBINED "THE WIRELESS AGE"

VOLUME VIII

NOVEMBER, 1925

NUMBER 5



RADIO'S NEWEST INSTRUMENT—

The Photo-electric Cell

In all the marvelous development of radio, one new device is essential—the photo-electric cell. This article describes how photo-electric cells are built and how our familiar friends, the electrons, operate them, much as they do the ordinary vacuum tubes of radio.

By E. E. FREE

THE rise of modern radio began with the perfection of the vacuum tube—one of the most remarkable and useful instruments ever devised by science, and the first one, with the exception of a few laboratory devices, in which free electrons were put to work for a useful purpose. The entire radio industry would collapse overnight if those tiny electrons which fly off from the hot filaments of our vacuum tubes went on strike and refused to behave any longer in the manner which we have grown so confidently to expect.

Now another electron device is beginning to find uses in radio as well as in other industries. It, too, is a vacuum tube, although constructed and operated quite differently from the familiar detectors and amplifiers used in radio.

It is called a photo-electric cell.

What the photo-electric cell does is to convert a light beam into a stream of electrons. Or, to speak more exactly, the light beam which enters the cell starts off a stream of electrons, much as the heat of the filament of an ordinary radio vacuum tube starts the electrons to streaming from it and across to the plate. By means of photo-electric cells, arranged with various other devices and accessories, it is possible to convert a light signal into an electric signal, or even to convert into audible sounds a regular vibration which has been carried by the light beam.

Photo-electric cells are in use in nearly all of the modern systems of sending pictures by wire or by radio.

These cells serve to convert the alternations of the light which constitute the picture into electric alternations which

can be sent over the wire or superposed on an outgoing carrier wave. Similarly, photo-electric cells serve to translate the photographic record of the talking moving picture back into electric oscillations, which may then be converted once more into audible sound. Again, the photo-electric cell is one of the very few relay devices which has practically no lag and no inertia. Finally, it is being applied rapidly to the measurement of the intensity and quality of light.

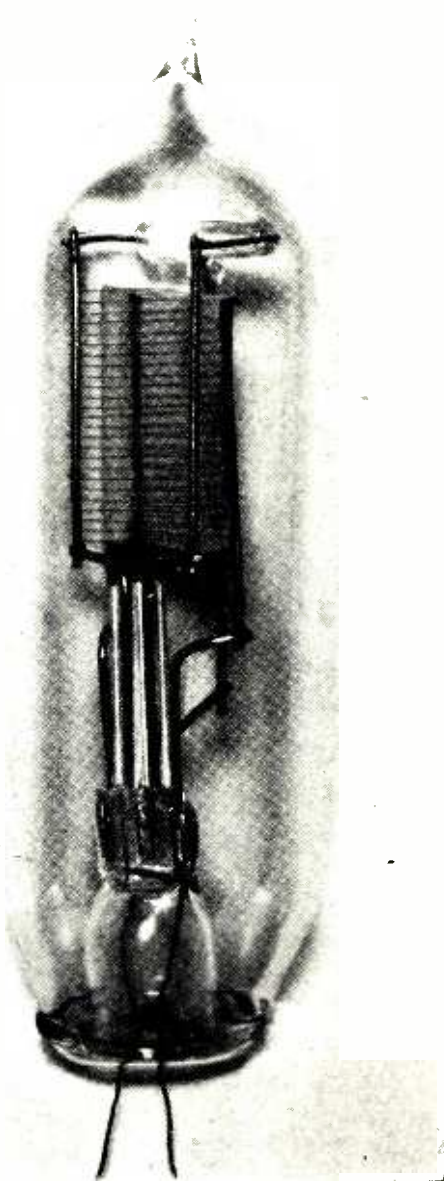

From a photograph made for POPULAR RADIO

INSIDE A PHOTO-ELECTRIC CELL

This blank, into which the alkali metal has not yet been introduced, indicates the assembly of the parts shown in illustrations on following pages.

The basic principle on which the photo-electric cell operates was discovered long ago by the German physicist, Hallwachs, and is simple. It is merely that certain metals have the property of giving off electrons when the surface of the metal is illuminated.

Under ordinary conditions, with the surface of the metal exposed to the air, this emission of electrons is imperceptible. The electrons are lost in the vast swarm of air atoms which surround the metal.

But if the metal is put in a vacuum and if a beam of light is then allowed to fall on it, the electrons are not stopped by the air atoms. They become quite perceptible. If some kind of a grid or plate or other collector is put in the vacuum with the illuminated metal plate, the electrons may be collected on this and will give a quite measurable "plate current," just as do the electrons which are driven off by heat from the filament of an ordinary vacuum tube. The electrons will continue to be given off and the current due to them will continue to flow so long as the beam of light continues to fall on the metal plate.

Just as a dynamo is a machine for converting mechanical motion into electricity and as a telephone is a device for converting electric vibrations into the vibrations of sound, so the photo-electric cell is an energy converter of another kind. It converts a part of the energy of light into electricity; that is, into free electrons. At present the best photo-electric cells make this conversion of light energy into electric energy only very inefficiently. Most of the energy of the light goes to waste. But even the dynamo is not a perfect converter of one kind of energy into another, and it was still less perfect in its early days when it had just been invented. It has been improved. Possibly the photo-electric cell will be improved no less.

If it can be, there are some interesting possibilities. One of them is the utilization of sunlight. It is sunlight which

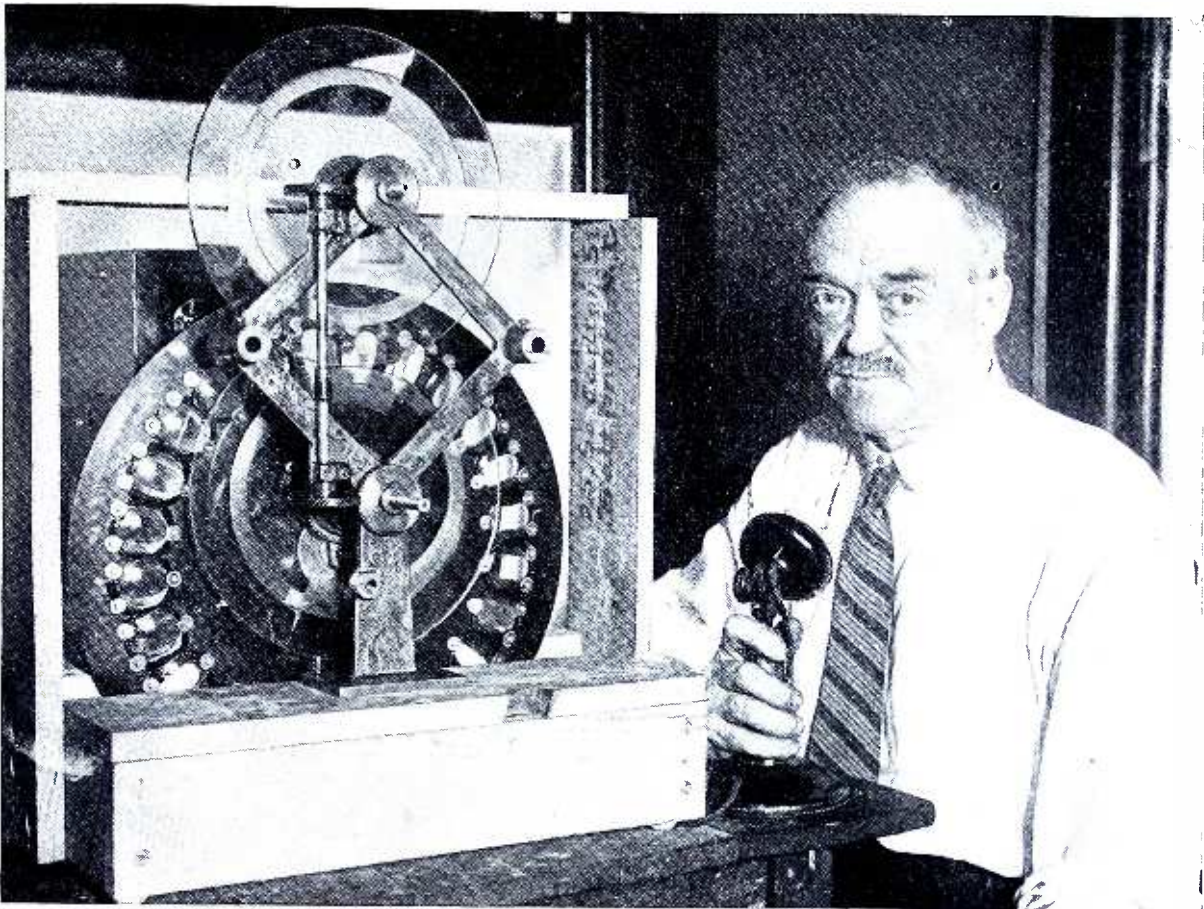

Henry Miller

PHOTO-ELECTRIC CELLS ARE USED TO BROADCAST MOVING PICTURES
This famous apparatus (already described in POPULAR RADIO), is employed by Mr. C. Francis Jenkins, of Washington, D. C., to send moving pictures by radio. Photo-electric cells are used at the transmitting end, in order to translate the variations of light and shade into electric vibrations which are then sent out as modulations on the radio wave.

keeps the world alive. Solar energy raises the water from the sea to make the rain, it provides the power that drives the winds, it gives living plants the energy which they need to produce sugar and starch and fodder and wood. The total amount of sunlight and solar heat which falls on the earth is equivalent in heat value to the burning of 100,000,000 tons of coal *each minute* for ever and ever.

If we could but catch and use a small fraction of this power—if we possessed, for example, a really efficient photo-electric cell, which would convert eighty or ninety percent of this solar energy into electricity—we would not need to worry any more about the exhaustion of the coal mines. Energy would be about the cheapest thing in the world.

Unfortunately, no such boon is in sight. Even with the most efficient and modern types of photo-electric cell a beam of full sunlight falling on the cell will free only enough electrons to produce a minute fraction of an ampere. The device is now, and probably will be for some time, a way of detecting light *signals* rather than a way of making practical use of the energy in the light.

This is so because the action of the photo-electric cell is essentially an atomic action and one in which only a small fraction of the atoms of the active metal are taking part at any one instant. Most of the modern photo-electric cells use, as the active metal, one of the so-called "alkali" metals, potassium, sodium, lithium, caesium or rubidium.

All of these metals have atoms pos-

sessing, we believe, the same significant characteristic. One of the electrons of each atom is relatively far away from the center of the atom and is attached relatively loosely to it. It is as though our solar system had a number of planets close in to the sun and firmly held to it, while one lonely planet was away off in space, far outside the others and likely to be detached rather easily from the rest of the group.

It is probably these outer, loosely bound electrons of the atoms in the plate of potassium which are detached by the

light rays and which are responsible for the photo-electric effect.

So much has been written lately about the nature of atoms and the relations of electrons to them that everyone interested in radio has a general idea of what they are like. Our potassium plate, for example, is not really smooth and solid, as it seems to be. It is really a rather open network of atoms, held near each other by their mutual electric and magnetic attractions. Around the central body or "nucleus" of each atom there revolve a number of electrons, behaving

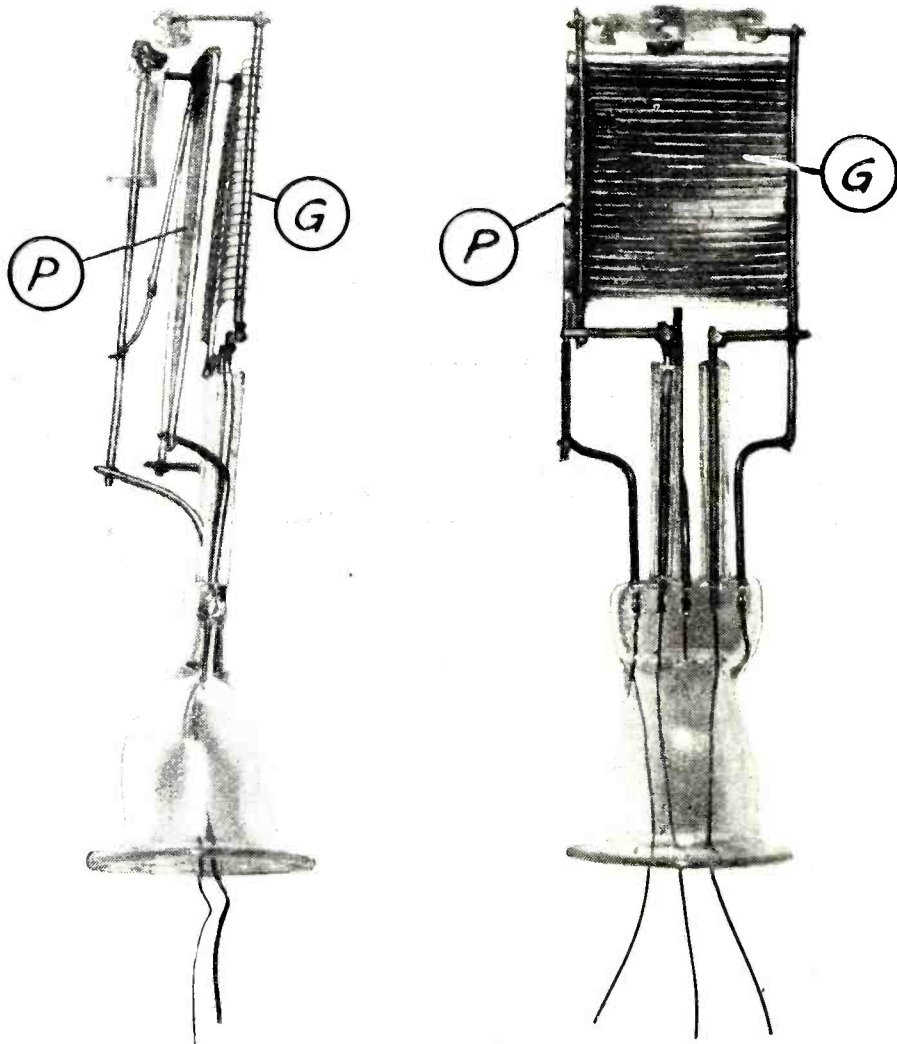

HOW A PHOTO-ELECTRIC CELL IS CONSTRUCTED

These pictures show a side view and a front view, respectively, of the type of photo-electric cell that is called the "phototron." This cell was developed by Mr. Samuel Wien in the laboratories of the Photion Corporation in New York City. P indicates the plate on which the coating of active alkali metal is to be placed. G is the wire grid, in front of the plate, which serves to collect the electrons. Two of the wires connect to the grid, the third one to the plate.

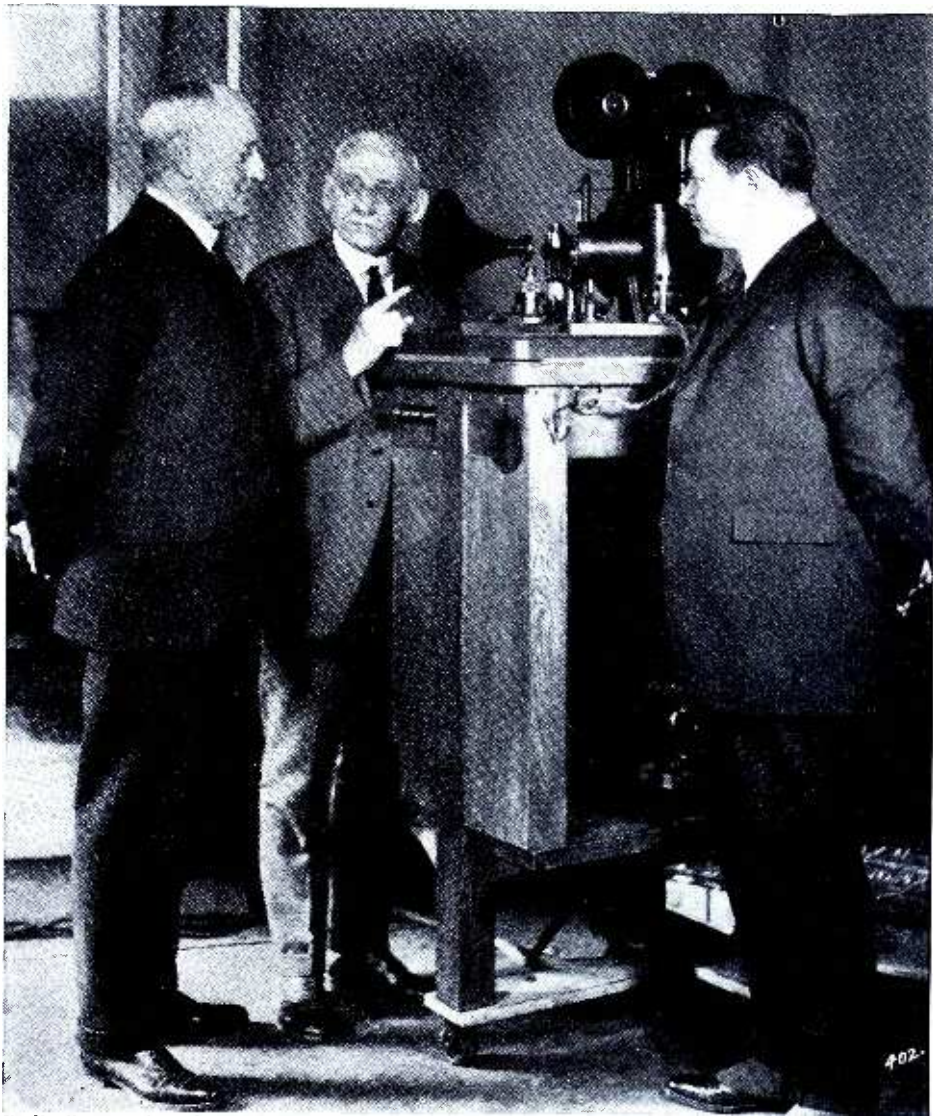

Radio Corporation of America

ANOTHER INVENTOR WHO USES PHOTO-ELECTRIC CELLS

In the center is Mr. C. A. Hoxie, of the General Electric Company, demonstrating his apparatus for making sound records on a motion picture film. General Harbord, of the Radio Corporation of America, is at the left, and Mr. Sarnoff at the right. Mr. Hoxie's invention makes use of a photo-electric cell to re-translate the photographic record into electric vibrations and thence into sound.

much as do the planets which surround our sun, except that the electron planets revolve in many different planes, not close to one plane as do the astronomic planets. In the atom of potassium there are nineteen of these planetary electrons.

The size of these atoms and electrons is, of course, astoundingly minute. In that famous classic, "Alice in Wonderland," the fortunate Alice chanced to find, you remember, some magic medicines which made her shrink or swell at will. Suppose we had some of the

shrinker and suppose we stood in front of the potassium plate of a photo-electric cell and used it. We would grow small enough to get inside the cell; then small enough to stand quite comfortably on one of the grid-like wires in front of the plate; small enough, finally, that we could begin to see the tiny atomic nuclei and the flying electrons surrounding them.

When we got to this point we would be so small that it would take about a billion of us, laid end to end, to make an inch. The entire population of the world

could come in with us into the photo-electric cell and still leave plenty of room for some new arrivals from Mars.

To put it another way, if you were as small as that and if you walked off across the potassium plate at a speed corresponding to a swift walk of an ordinary-sized man, it would take you nearly forty years, walking continuously day and night, to walk one inch.

Small as you would be, the electrons

driven off from the potassium by the light beam would be much smaller still. They would look like grains of dust. As you stood close to the surface of the metal one of these dust grains would get loose once in a while from the atom to which it had been attached and would whiz past you. This would happen very seldom indeed, in comparison with the number of atoms present. Even in a very strong light, only one electron out

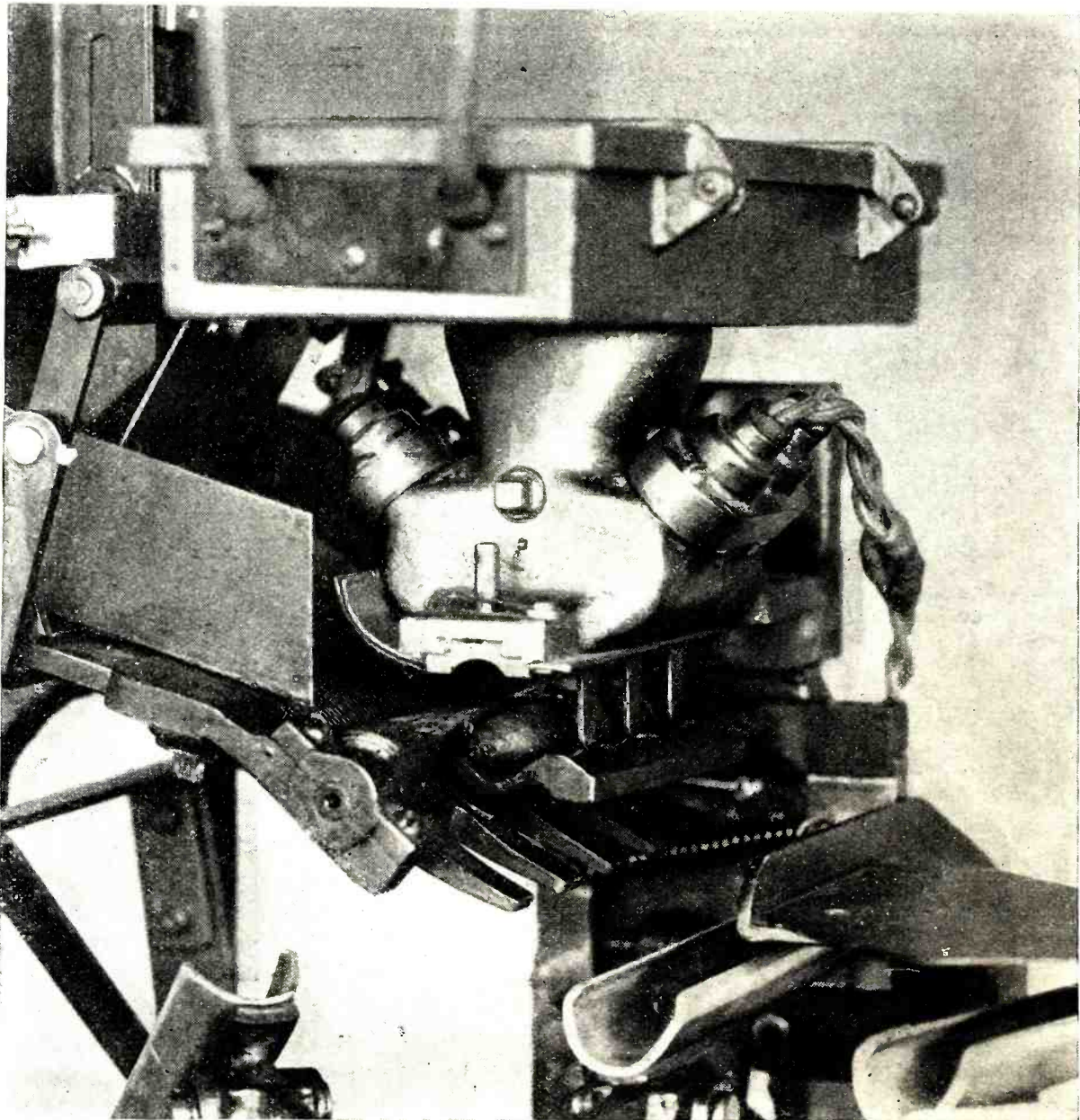

American Machine and Foundry Co.

THE PHOTO-ELECTRIC EYE OF THE CIGAR SORTING MACHINE

This is a part of the machine shown entire in the frontispiece of this issue. The cigar is seen resting in the little trough in the center. In the box above is a photo-electric cell which receives light reflection from the cigar. Different colors reflect different amounts and quantities of light, so that the cell can distinguish them automatically.

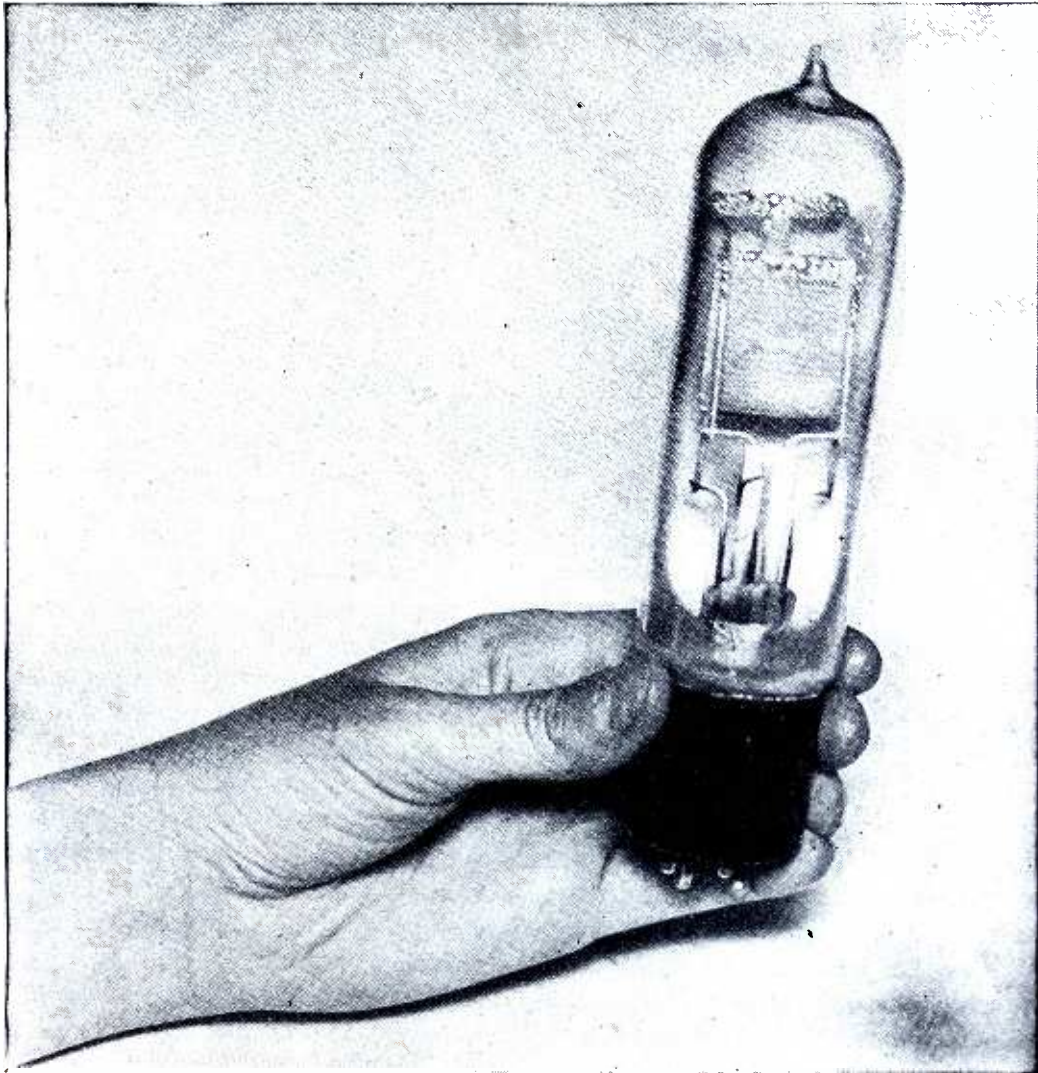

From a photograph made for POPULAR RADIO

A MODERN PHOTO-ELECTRIC CELL COMPLETE

This is the finished phototron, the internal parts of which have been shown in preceding illustrations. Note the droplets of congealed potassium clinging to the supports and to the upper edge of the plate. A thin coating of this metal covers the surface of the plate and forms the active material for the detection of any light ray entering from the front of the cell and passing through the wires of the grid. This cell is equipped with a standard radio base.

of many million atoms is detached each minute by the photo-electric action. The reason why the action is perceptible at all is simply that so many billions of billions of atoms are present in even the tiniest plate of potassium.

Why the light drives out an occasional electron in this way from the assemblage of potassium atoms is one of the things that the physicists still do not know. It is well known, of course, that atoms can lose electrons in a number of ways.

Suppose, for example, that a lot of atoms of potassium are flying around

freely in a heated space, forming a potassium gas. The atoms will hit against one another frequently, just as sand grains do in a dust storm. Some of these collisions of one atom with another will be quite forcible; even more forcible, in proportion to size, than the collision of two high-speed express trains. It has been proved that such collisions occasionally knock off the loosely-bound outer electron, leaving the potassium atom minus one electron. It then possesses one unbalanced unit of positive electric charge, a unit which was previ-

ously neutralized by the electron which has disappeared. This positively charged potassium atom is called an "ion."

Other things besides atomic collisions can make an atom lose an electron in this way. One of them is light. An intense beam of ordinary light or of ultraviolet light or of X rays, sent into a mass of gaseous potassium atoms will produce some ionization. It will knock out electrons from some of the atoms. Doubtless something of this same sort takes place at the surface of the solid potassium in the photo-electric cell. The light waves come along and hit against some of the tiny atoms in the plate or against the individual electrons of these atoms. A few of the electrons fly off and produce the photo-electric effect.

We do not yet know just what light rays are. To say that they are ether waves does not help us much, for we know very little about the properties of the ether or even whether there really is any ether. Accordingly, we can only guess, very dimly, at what kind of interaction takes place between the light ray which strikes the potassium plate and the electron which then escapes from that plate. Such guesses as there are have great interest for the physicist. They lie close, for example, to the present puzzles of the quantum theory of light and to certain aspects of the famous Einstein theory of relativity. But they are not, at present at least, of much practical assistance in radio or in the understanding of photo-electric cells.

For practical purposes what one needs to remember is this. When light hits against a plate of potassium or of certain other metals in a vacuum, electrons are given off from this plate. Within limits, the number of electrons thus given off per second is proportional to the intensity of the light. A grid, or some other device, opposite to the illuminated plate is kept at a high positive potential relative to the plate. The electrons immediately seek this grid. They may be returned to the plate through a galvanometer, which

measures their number. This is the photo-electric current of the cell. It is proportional to the intensity of the light.

One of the practical uses of photo-electric cells is to measure the intensity of light in this way. Starlight has been measured thus by the astronomers. Botanists have used the same device to measure the light needed by plants.

More frequently, however, photo-electric cells are used to detect interruptions or variations in a light beam. Suppose, for example, that a light ray from an electric lamp is falling on a photo-electric cell, and suppose that you cut off this light intermittently by placing your hand in and out of the beam. You could telegraph dots and dashes in this way; indeed the military signalling instrument called the heliograph is so operated.

If this dot-and-dash light beam falls on a photo-electric cell the cell will translate the dots and dashes into electric signals. Variations of intensity in the light beam, without entire interruption, are similarly recorded by variations in the current from the photo-electric cell. The resultant currents can be amplified to any desired strength. Thus the varying light-record of the talking moving picture is made to operate a loudspeaker. Thus a code message may be telegraphed along a light beam. Thus the light of a star will make its own record of the instant at which it passes the cross-wires of a telescope, to mark the standard time.

It is quite possible, even, that everything which we see is due to a photo-electric effect. Light which falls on our eye produces, we know, a change of some kind in the sensitive retina at the back of the eyeball. Many physiologists believe that this change is a photo-electric change; that some constituent of the retina loses electrons under the influence of light, just as does the potassium plate of the photo-electric cell.

The eye may be a living photo-electric cell. Turning the argument around, a photo-electric cell may serve, quite successfully, as a radio eye.

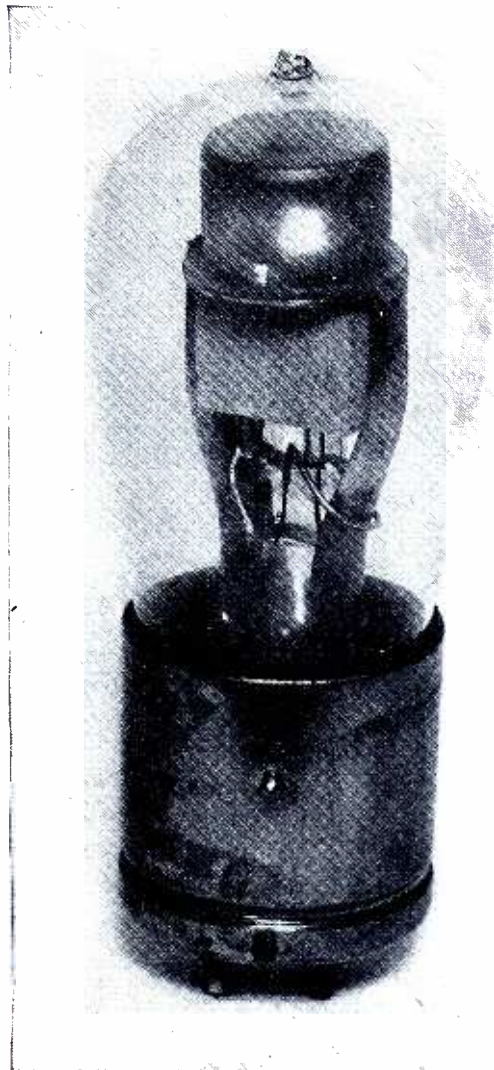

THE RECTIFIER TUBE

FIGURE 1: *The Raytheon tube which makes possible this new device is a filamentless tube of the famous "S" type. But it has been developed so that a single tube utilizes both halves of the alternating current for rectification.*

HOW TO BUILD THE Raytheon Plate Supply Unit

For years the radio world has been waiting for a really dependable method for obtaining a "B" source of supply from the electric light wires in our homes. This article describes the new unit that is the first to solve this problem.

By LAURENCE M. COCKADAY

COST OF PARTS: *Not more than \$45.00*

HERE ARE THE ITEMS YOU WILL NEED—

- | | |
|---|--|
| <p>A—Raytheon tube;</p> <p>B—Acme Apparatus Company transformer for Raytheon plate-supply unit, type No. B-4; (See note on page 414)</p> <p>C1 and C2—Acme Apparatus Company 30 henry choke coils for Raytheon plate-supply unit, type No. B-2; (See note on page 414)</p> <p>D1 and D2—Tobe shielded, high-voltage</p> | <p>paper condensers, 2 mfd.;</p> <p>D3 and D4—Tobe shielded, high-voltage paper condensers, 4 mfd.;</p> <p>D5—Tobe shielded, high-voltage paper condenser, 1 mfd.;</p> <p>D6 and D7—Tobe shielded, high-voltage paper condensers, .1 mfd.;</p> <p>E—Federal socket, type No. 16;</p> |
|---|--|

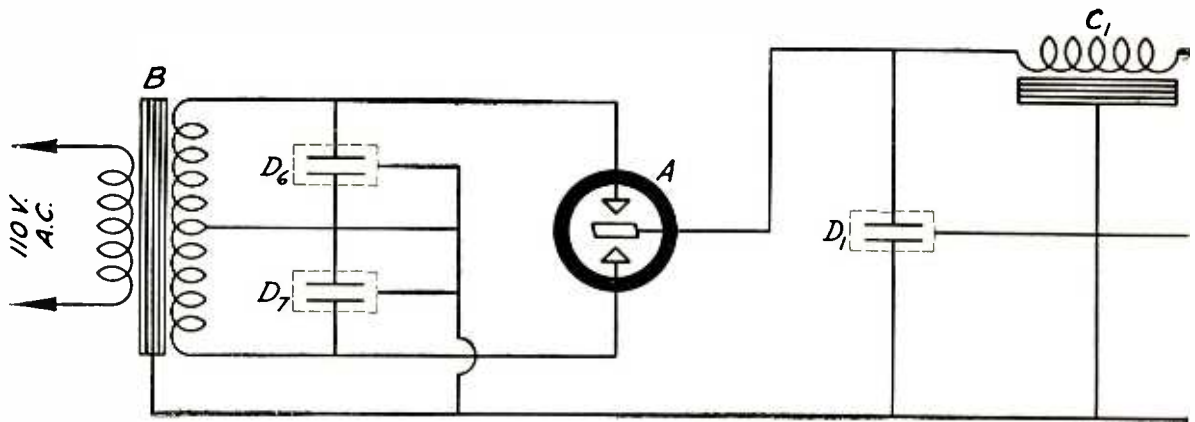

THE COMPLETE CIRCUIT DIAGRAM

FIGURE 2: The hook-up for the plate supply unit. All the symbols for the instruments bear designating letters, which are used consistently in the list of parts, text and illustrations.

- F—Benjamin cleat receptacle, type No. 9401;
- G—Bradleyohm No. 10, 100,000 ohms;
- H—Bradleyunit resistance, 7,500 ohms;
- I—Electrad resistance mounting;

- J—hardwood baseboard, 7 by 20 inches;
- K—composition binding post strip, 1 inch by 7 inches;
- L—small brass brackets (see Figure 9).

THE development of so-called “B” eliminators during the past two years has been rapid. During that time there has been a great amount of experimentation in an endeavor to obtain a really satisfactory method for employing the alternating current as an energy supply for the plate circuits of vacuum-tube receivers. During this time there have also been some hundreds of such allied schemes made public for accomplishing this end—some of them very successful and some of them not at all so.

Heretofore the two main drawbacks

to such a device have been:

First: the inability to filter out all hum;

Second: the short life of the rectifier tubes.

Of course, this second consideration applies only to plate-supply units that employ vacuum tubes as rectifiers.

It is well known that the UV-201-a tube when used as a rectifier may be easily overloaded when employed in connection with a set that employs five tubes or more. This is especially true when the receiver uses no “C” batteries

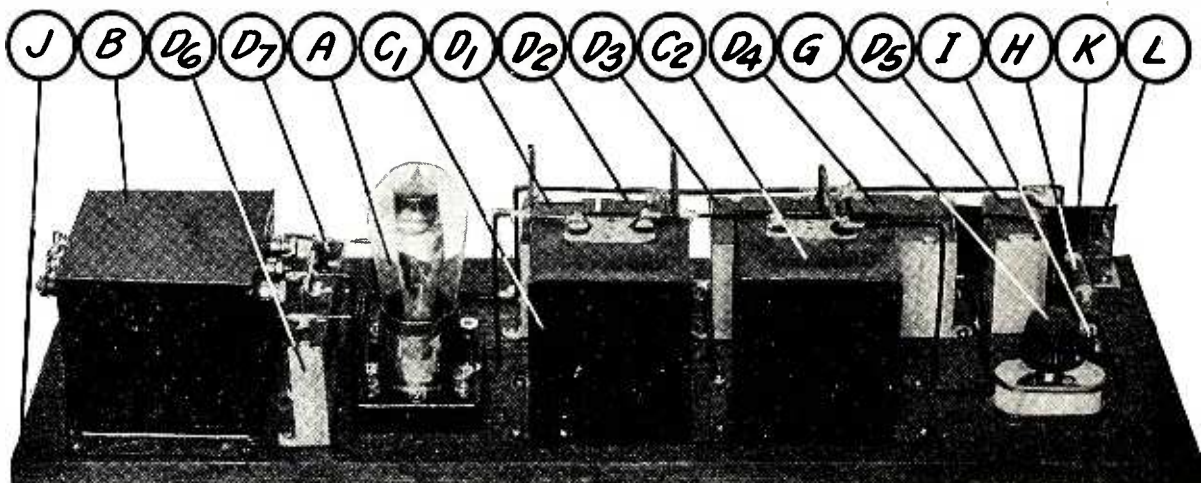

THE FRONT VIEW OF THE UNIT

FIGURE 3: This picture shows the general location of the transformer, the Raytheon tube, the choke coils and the variable resistance.

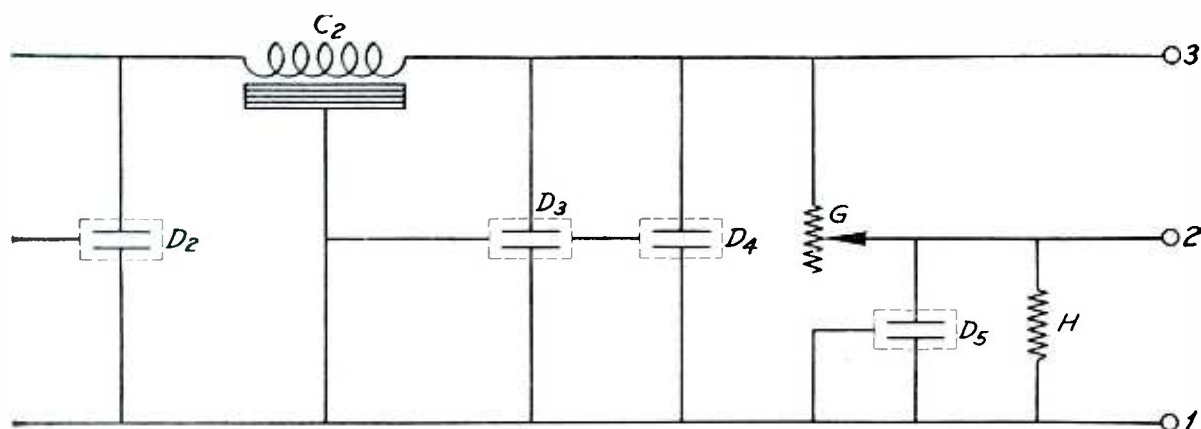

and thus places a heavy current drain on the plate-supply unit. This causes excessive filament emission from the rectifying tubes and reduces their life to a mere 250 to 300 hours. This is, of course, unsatisfactory.

There has been an insistent demand from the readers of POPULAR RADIO during the past year to have our Technical Staff tell them how to build a device of this sort, but we have withheld publication awaiting the development of this new device until it had reached the stage where the first cost would be the last cost and where the tube would be a permanent thing and where there would be no possibility of an alternating current hum in any receiver to which it might be attached.

This has finally been realized, and its application is due to the development

of a remarkable new filamentless, double-wave rectifier tube—the Raytheon.

This tube is pictured in Figure 1.

The tube is the final development of the famous "S" tube which has been for years popular among the amateurs as rectifiers in their transmitting sets. Mr. C. G. Smith, the inventor, has finally produced a tube which is about the size of the ordinary receiving tube, but which takes the place of two large rectifier tubes heretofore used. It really is two tubes in one but contains no filaments and operates by means of ionization. The tube has been given a conservative rating of 150 volts at 60 milliamperes, taken from the output of the unit which will be described. Even on full load the full peak of the wave of the alternating current is rectified instead of being cut off as is the case of

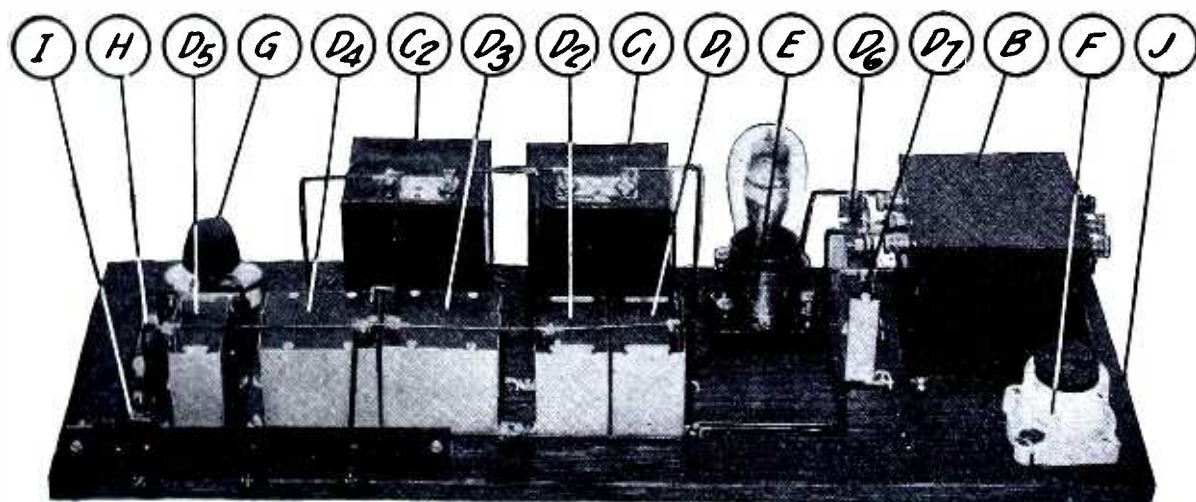

THE REAR VIEW OF THE DEVICE

FIGURE 4: This illustration shows the positions of the binding post strip, the fixed resistance, the condensers and the porcelain cleat receptacle for connection to the A.C. mains.

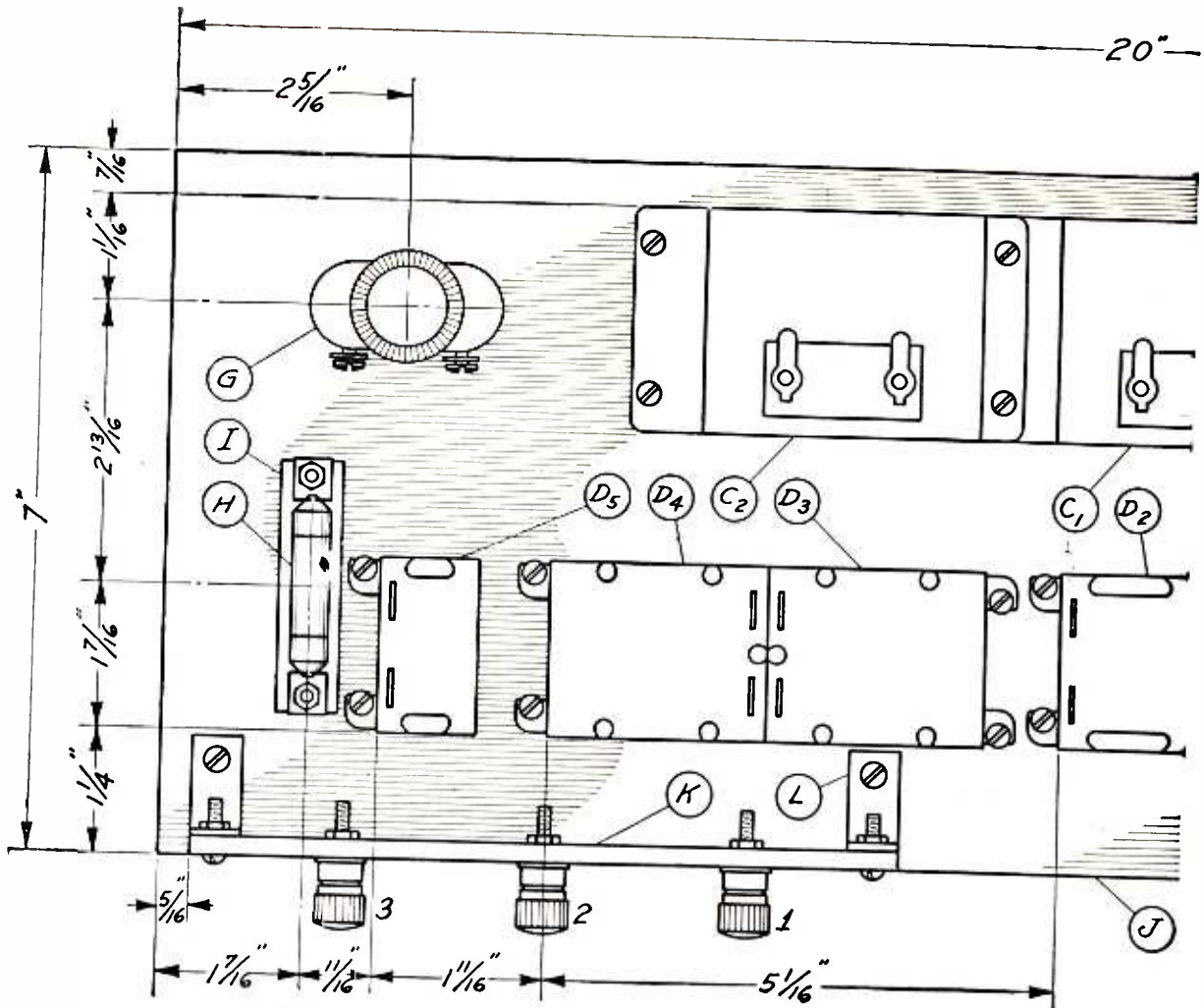

THE WORKING DRAWING FOR CONSTRUCTION

FIGURE 5: This drawing gives the correct dimensions and spacing for mounting all the component parts of the plate supply unit.

the filament tube in which the load may cause the limited emission to cut off the current.

The advantages of this tube for use in such a device are the following:

1. Full-wave rectification;
2. Filament-less operation;
3. Long life;*
4. High voltage output;
5. High current output;
6. Rugged construction;
7. Compactness;
8. Uniform results.

Since the development of the tube there has been a lapse of almost a year. During this time the design and functioning of numerous circuits have been under careful test and consideration.

* These tubes have been tested upwards of 10,000 hours at full load without any sign of deterioration.

The final design, which has proven to be the most satisfactory, is the one which will now be described.

By referring to Figure 2 it will be noticed that the tube A contains 2 anodes and a single cathode. The tube is so arranged that when used in a standard UV-201-a socket the anodes are connected to the filament terminals and the cathode to the plate terminal, the grid contact being left open. The input to this tube is supplied from a step-up transformer that operates on 110 volts (alternating current) and that employs a split-secondary winding for applying half potential on each side of the tube through its prospective anodes. Stable operation of the rectifier is facilitated by means of two "buffer" condensers of low capacity which are designated on the

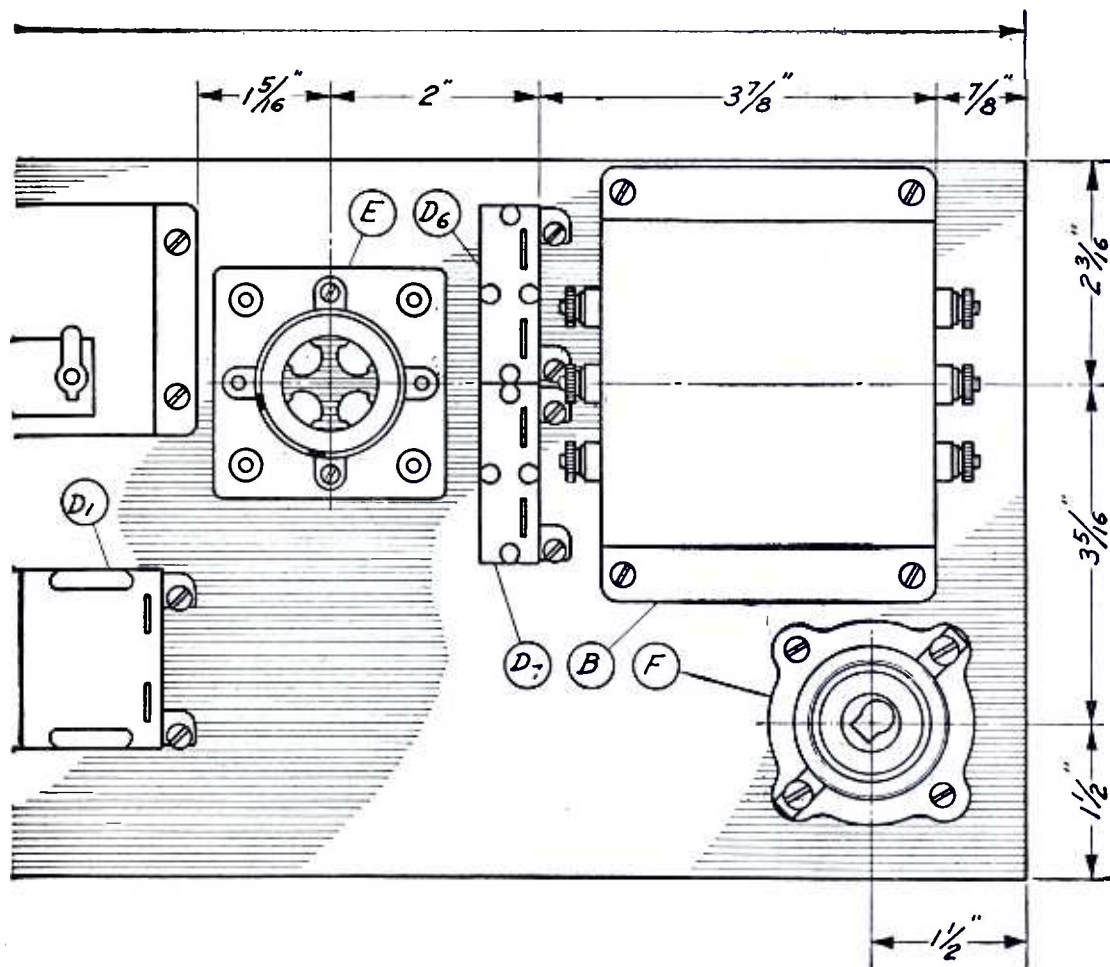

circuit diagram (Figure 2) as D6 and D7.

The rectified full-wave current is then applied across the terminals of the condenser D1 which voltage is then passed on through a large choke coil C1 and applied across the terminals of a second filter condenser, D2. The condensers act as voltage reservoirs and, as the choke resists variations in current, the voltage applied to D2 is very constant. The voltage across this condenser is then supplied through a second filter choke C2 and is stored up in the two larger condensers D3 and D4, which are connected in parallel and which act as the main reservoirs for the direct-current energy to be supplied to the tubes. The full voltage from the filter is then applied across terminals 1 and 3 which may be connected directly to the plate terminals of the amplifier tubes. Terminal 3 is about 90 to 105 volts positive and terminal 1 is negative. For reducing the voltage for use on the detector a suitable

high-resistance G is inserted in series with the high potential line and another fixed resistance H is used directly across the plate circuit of the detector tube which may be connected between terminals 1 and 2, where 2 would be positive. These two resistances act as a potentiometer. A bypass condenser, D5 of 1 microfarad is placed across these two terminals to allow audio and radio-frequency currents to pass in the plate circuit of the detector without diminution. The resistance of the fixed unit H is rather low so that the plate-current variation of the detector tube is only a small part of the current flowing through H. This eliminates any trouble from a change in the dynamic operation of the detector tube through varying currents flowing through the variable resistance G, which otherwise might vary the voltage drop across G over wide limits that would be dangerous to quality reproduction. The unit is absolutely stable in operation, is

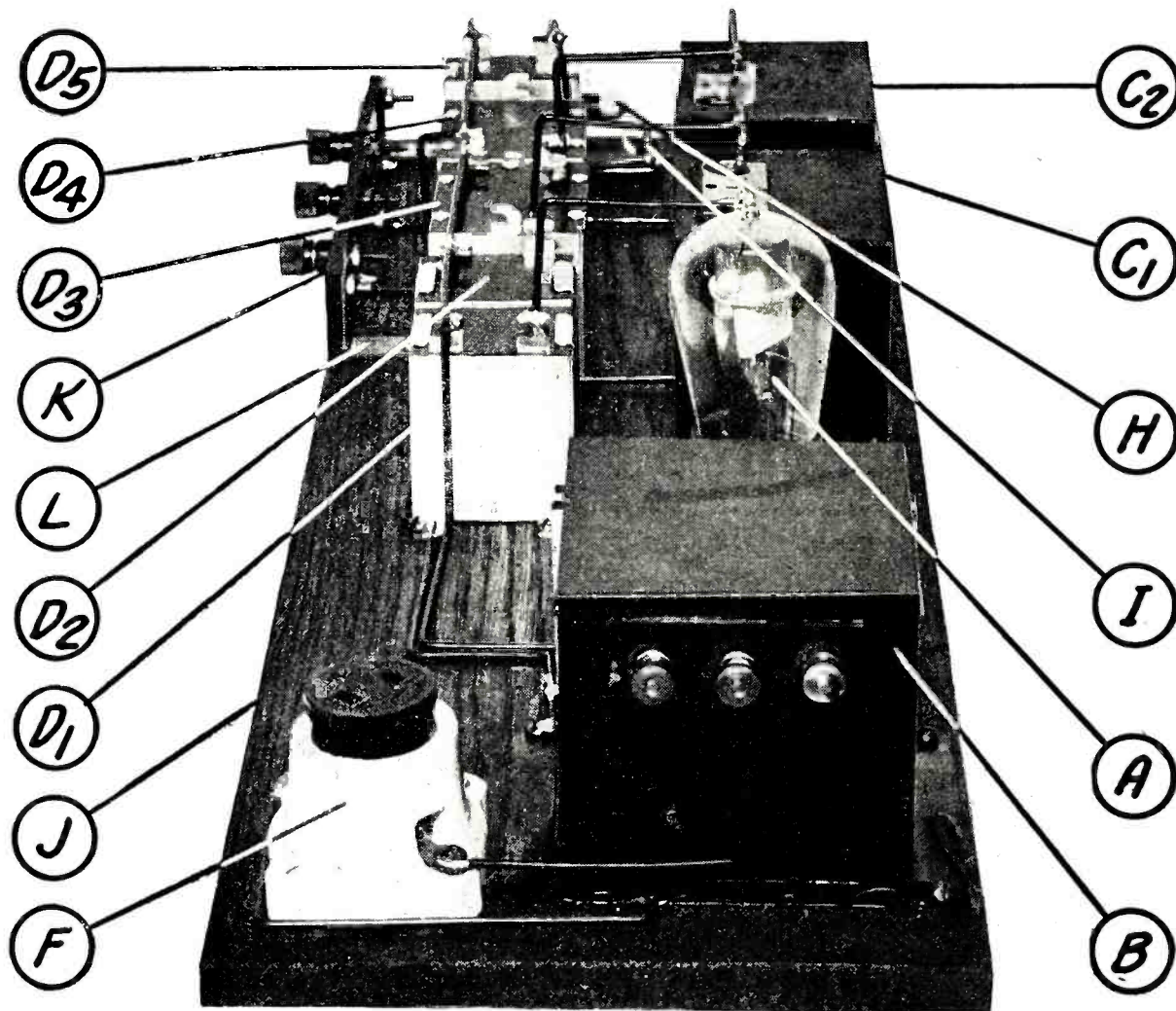

HOW THE UNIT LOOKS FROM THE LEFT

FIGURE 6: *In this picture of the input end of the unit the porcelain receptacle will be seen connected directly to the two left-hand input terminals of the transformer.*

permanent and will give perfect satisfaction to prospective builders who follow the details of construction that are given here.

Parts Used In Building the Unit

In all the diagrams in this article each part bears a designating letter; in this way, the prospective builder of a set may easily determine how to mount the instruments in the correct places and connect them properly in the electric circuit.

The same designating letters are used in the text and in the list of parts at the beginning of the article.

The list of parts there given includes the exact instruments used in the unit from which these specifications were made up. The experienced amateur, however, will be able to pick out other reliable makes of instruments which may be used with equally good results. But we recommend that the novice follow the list, as the diagrams in this article will tell him exactly where to bore the holes and exactly where

to place the connections in wiring up.

If instruments other than the ones listed are used, the only change that will be necessary will be the use of different spacings for the holes that are to be drilled in the panel for mounting the instruments.

How to Construct the Unit

After procuring all the instruments and materials for building the unit, the experimenter should prepare the baseboard J. This should be made of one-half inch oak and cut to the size of seven inches by twenty inches as shown in Figure 5. When this has been done the baseboard should be dried out thoroughly by placing in an oven or in a warm place for a few hours and fastened securely under heavy weights to prevent warping. Then it may be given a coat of shellac. When it has finally dried, the instruments should be mounted upon it.

First of all, mount the lighting socket F in its correct position by means of two wood screws as shown in Figures 4, 5, 6, 7 and 8. After this has been done fasten the transformer B in its proper position by means of four screws. Be sure that the output terminals are facing to-

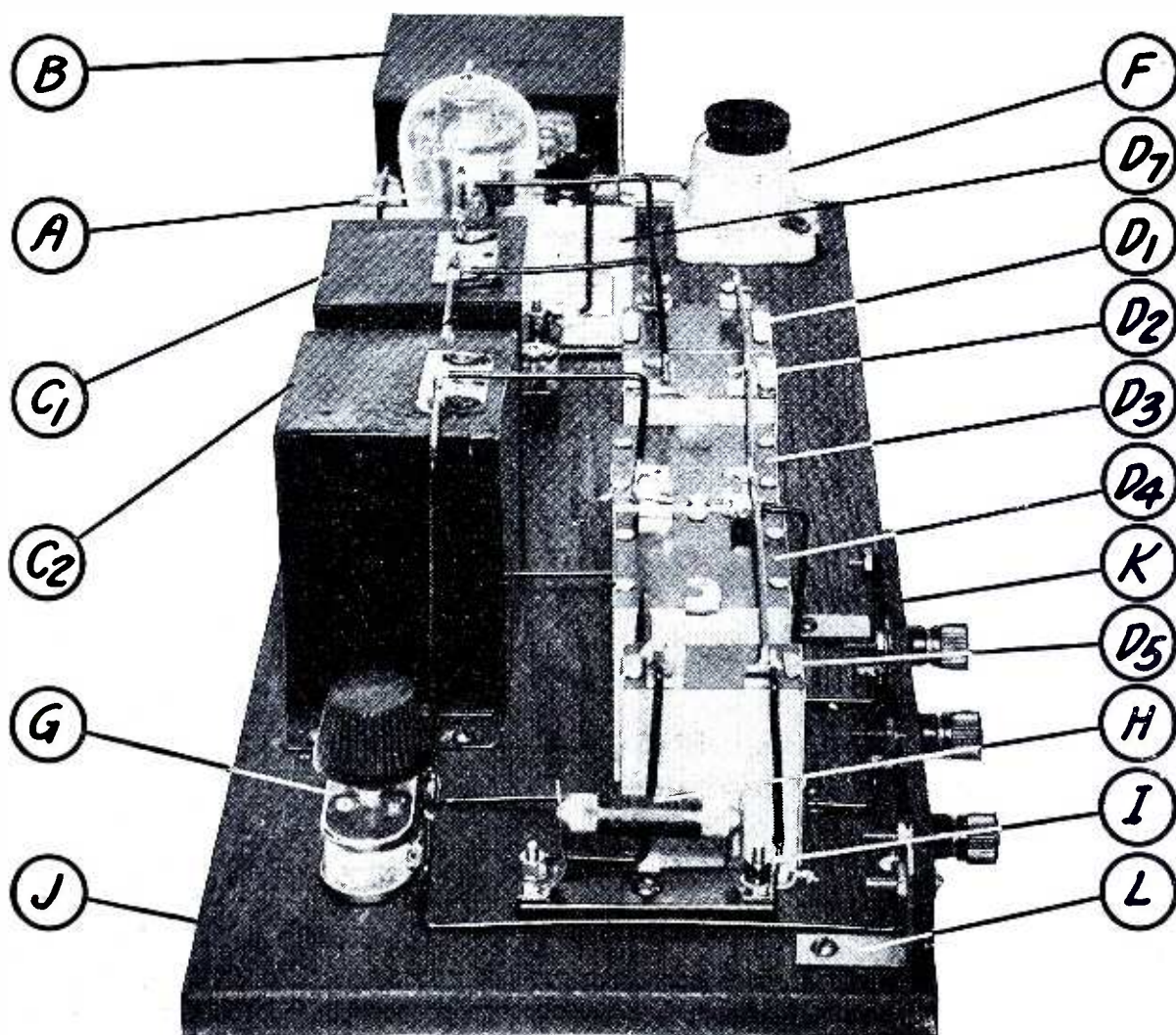

HOW THE UNIT LOOKS FROM THE RIGHT

FIGURE 7: This diagram shows the output end of the device with the binding post strip and the two resistances for obtaining a variable detector voltage.

wards the left as in the plan view, Figure 5.

Then mount the two condensers D6 and D7 in their respective positions by means of four wood screws as shown in Figures 3, 4 and 5.

The two chokes C1 and C2 may next be placed in their respective positions as shown in the three same Figures.

Notice that the two middle mounting-flaps of the chokes C1 and C2 are placed one over the other so that only two screws are used between the two chokes for mounting instead of four, making a total of six screws for mounting the two chokes. (See Figure 5.)

Now, fasten the Bradleyohm G in its position by screws inserted through the holes underneath the knob which extends right through the instrument.

The next job will be to mount the two condensers D1 and D2 into position as shown in Figure 5. They may be mounted with two screws to each instrument.

Next, do likewise with the two condensers, D3 and D4. The flaps for mounting these condensers may be bent into the correct position as shown. When this is done finish mounting

the condensers by placing D5 in its position and making fast by two more wood screws. Then place the resistance mounting I in place and attach to the sub-base with a screw in the same manner. Insert the fixed resistance H in its terminals.

Next, on the construction program will be the preparation of the binding-post strip K. This should be cut from hard rubber and drilled as shown in Figure 9. When it has been drilled, cut and bend the two brackets L as shown in Figure 9 and drill them for the screw holes that fasten to the strip and also to the sub-base. After they have been connected to the strip by means of two machine bolts and nuts the whole assembly may be tightened to the sub-base as shown in Figures 4, 5, 6 and 7 with two sturdy wood screws. The binding posts 1, 2 and 3 may then be attached and firmly tightened.

The last job will be to mount the socket E in its correct position as shown in Figure 5 with the socket slot pointing towards the left as denoted by the small black portion of the rim in the drawing. This is extremely important.

When this work is completed the unit is

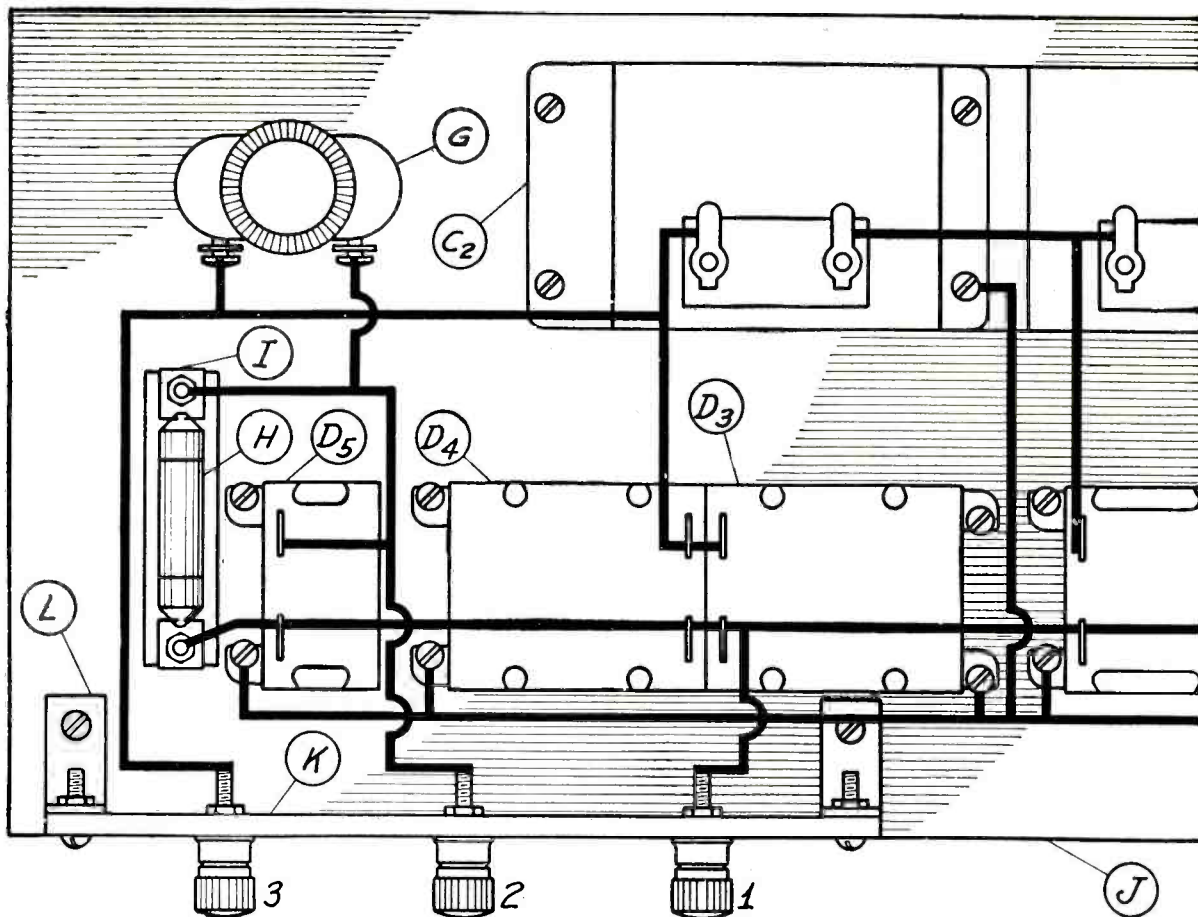

THE PICTURE WIRING DIAGRAM FOR CONNECTING UP THE INSTRUMENTS

FIGURE 8: All the instruments have been drawn in their approximate positions. The heavy black lines show the exact way to run the wires for connecting up the instruments.

ready to be wired up and connected in the circuit.

How to Wire the Unit

The mechanical and electrical design of this device have been worked out with extreme care through many months of experiment and test. The whole unit is self-shielding and it is due to this as well as the electrical design of the filter circuit that there is no hum produced in the receiving set to which it is attached.

It is recommended that all wiring be done with an insulated, solid, round bus-wire.*

In wiring up refer constantly to the picture wiring diagram in Figure 8. Notice that in this arrangement of parts the alternating current as applied to the socket F is isolated from the output as obtained from terminals 1, 2 and 3 on the connection block K. The alternating-current transformer B is also fully shielded from the output. Notice that the cases of the transformers and the chokes and all the condensers are connected together on the negative side of the direct-current voltage which is on the center tap of the transformer and the binding

* The type of bus wire used in all of the experimental set-ups and in the model which is being described was "Celatsite."

post No. 1. This provides full electrostatic shielding throughout.

Start wiring by making the two connections from the socket F to the two low-voltage terminals of the transformer B. These are the two binding posts that should ordinarily be used with the ordinary set that requires about 90 volts or so. Where 125 to 135 volts is necessary, the wire that goes to the center terminal may be disconnected and attached to the far terminal (looking at the baseboard as shown in Figure 8); this results in a larger voltage ratio in the transformer with a correspondingly higher plate voltage applied to the set.

Next, run two wires from the outside secondary terminals of the transformer B to the outside terminals of the condensers D6 and D7 and extend these two wires over to the two right-hand terminals of the socket E.*

Next, join the two adjacent (inside) terminals of the condensers D6 and D7 by a wire that also goes to the middle terminal of the secondary of the transformer B. Extend this same wire to

* Right-hand and left-hand and front and back as applied to wiring refer to the diagram in Figure 8. Front being the closest to the observer and back being the side of the instruments turned away from the observer.

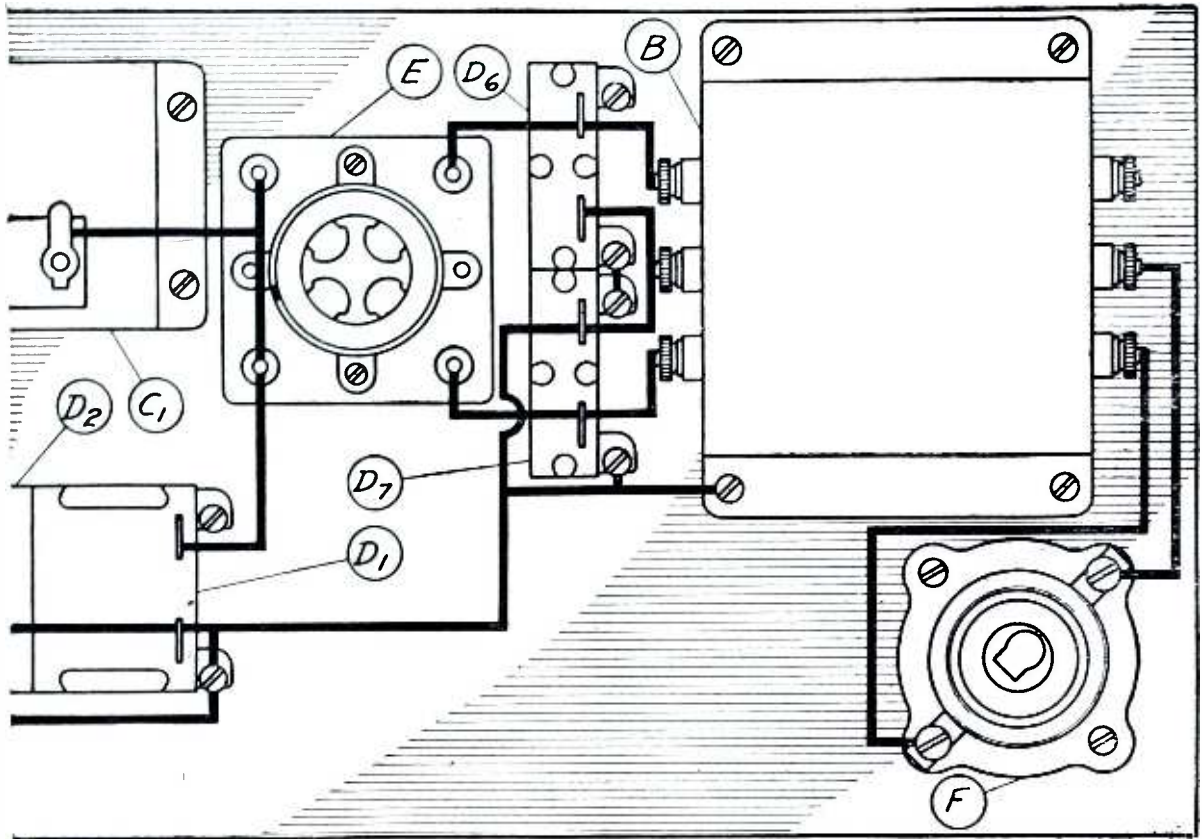

the screws that fasten to the metal cases of the transformer B and both of the condensers D6 and D7. Also run this wire over to the cases of the condensers D1, D2, D3, D4 and D5. An extension of this wire should run to the front terminals of D1, D2, D3, D4 and D5 and also to the binding post No. 1 and the front terminal of the resistance mounting I. (See Figure 8.) Another extension of this ground lead should go to the front middle screw that fastens the two chokes C1 and C2 to the baseboard.

In making connection to the cases it will be necessary to file the metal lugs bright and shiny and then fasten the mounting screws down tightly and make soldered connections to them.

The next job will be to connect the two left-hand terminals of the socket E together by a wire and run one extension to the back terminal of condenser D1 and another extension to the right-hand terminal of choke C1. Then join the left-hand terminal of choke C1 to the right-hand terminal of choke C2 by a wire and run an extension from here to the back terminal of condenser D2. The left-hand terminal of choke C2 may then be attached by a wire to the two back terminals of condensers D3 and D4 and an extension run from this wire over to the left-hand terminal of the variable resistance G and also to the high-voltage binding post No. 3.

Next, run a wire from the back terminal of the fixed resistance mounting I over to the right-hand terminal of the variable resistance G and then run an extension from this point to the back terminal of the condenser D5, running a wire from there on to the binding post No. 2. This completes the wiring of the unit. Be sure that you have done it exactly as shown in Figure 8.

Check over your connections a number of times to be sure that you have made no mistakes. If you make every connection exactly as shown you will have no trouble in getting the unit to work properly. In doing your wiring job remember that care and neatness will enable you to do an efficient job. Don't hurry, but take it easy.

All of the instruments are marked with designating letters so that you should not make any mistakes.

How to Install the Unit

After the wiring has been completed the unit is ready to be installed and placed in operation so that it may furnish the direct current necessary for operation of the receiver that it is to be used in conjunction with. Place the unit in the radio table or cabinet where you have previously kept the "B" batteries in a position as shown in the photograph on page 406 with the transformer, the chokes and the adjustable Bradleyohm pointing toward you. Be sure that it is at least one foot distant from the receiver.

Next obtain a double-conductor cord with an ordinary light socket plug and jack attached to each end.

It is advisable to obtain about 15 feet of standard lamp cord and two lamp socket plugs for this purpose. Attach one of the plugs to each end. Then screw the detachable part of one plug into the Benjamin socket F on the plate-supply unit, and screw the detachable part of the other end of the cord into an ordinary lamp socket. When both ends of the cord are plugged in a connection will be made direct from the lighting line to the unit which will follow standard electrical practice and insure you against any possibility of fire or short-circuit.

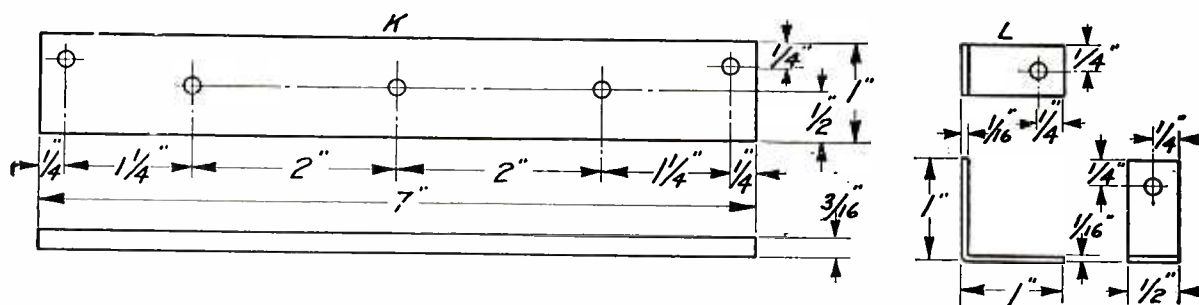

DETAILS OF THE CONNECTION BLOCK AND SMALL BRASS BRACKETS
 FIGURE 9: This drawing gives the necessary data for making the insulating strip on which the binding posts are mounted. It also gives the dimensions for making the brackets that are used to fasten the strips to the base.

Of course, the lighting socket fixture where you are taking off the juice should be turned off.

Next connect binding post No. 1 on the unit to the terminal of your radio receiving set that is marked "B" battery minus (-).

Then connect binding post No. 2 on the unit to your detector "B" battery plus (+) binding post on the receiver. Next connect binding post 3 on the unit to the amplifier "B" battery plus (+) binding post on the receiver. The unit is now ready to furnish a pure direct current (wholly unmodulated or without hum) to your receiver.*

Now turn on the rheostat and light your tubes to their correct brilliancy as you have in preceding times. Then turn on the switch at the light socket and your Raytheon plate-supply unit will start to function.

Next adjust the small knob on the variable resistor G until you get the correct plate voltage for the detector tube. It is best to set this at a rather high setting (turned out three-fourths of the way) and then tune in a station, after which the maximum signal strength and quality can be adjusted for with G. There are no further ad-

* Be sure that the filament circuit of your receiver is grounded somewhere in the hook-up.

justments to be made on the unit and it will give you steady satisfaction for years. In fact, it should last you permanently unless you break the glass bulb of the tube.

To turn off the Raytheon unit, all that is necessary is to switch off the current at the socket as you would ordinarily do with a floor lamp or an electrical toaster. There is no upkeep beyond the expense of the extremely small current drawn by the transformer B which is negligible.

If all the instructions that are given in this article are followed minutely, even a beginner can build this unit and obtain very fine and enjoyable results both on local and distant reception.

* The following manufacturers have been supplied with the design and also have placed on the market their own transformers and choke coils for use with the Raytheon plate-supply unit. All of these instruments have been built into the same type of unit in POPULAR RADIO LABORATORY as that described here, and they have all been approved for use in this circuit. This means that the experimenter may choose any of these makes according to his preference:

- General Radio Co.; transformer type No. 365 and chokes type No. 366;
- Jefferson Electric Co.; transformer type No. 355 and chokes type No. 356;
- Dongan Electric Co.; transformer type No. 509 and chokes type No. 514.

Cockaday's Newest—and Best—Receiver

ONE of the centers of attraction at recent national radio shows was the newly developed Cockaday receiver. Judging from the interest shown in a model of this new development (which incorporates the principle of the Four-circuit Tuner with unified control and incorporating radio-frequency amplification as well as distortionless resistance-coupled amplification), it will be the most popular home-made receiver of the year 1926.

In this receiver, the name and description of which will be published in the December issue of POPULAR RADIO, the designer, while retaining all of the fine characteristics of the old Four-circuit Tuner, has made use of some of the newest and most important developments that have been made during the last year for obtaining *better sensitivity, more selectivity and purer reproduction*. The receiver will operate on any antenna between 10 feet and 200 feet in length—and may be built by the experimenter at a cost for parts not in excess of \$60.00.



From a photograph made for POPULAR RADIO

HOW TO SCALE OFF THE ANSWER TO YOUR PROBLEM

With the position of the known specifications found on the chart on the opposite page, it is a simple matter to find the unknown specifications with no other help than that of a ruler and a good eye.

A MEASUREMENT CHART

FOR ESTIMATING THE INDUCTANCE OF A SINGLE-LAYER COIL

ARTICLE NO. 12

This article gives the amateur a quick method for determining the mechanical and electrical specifications of coils that are required for a certain band of wavelengths with specified sizes of condensers—thereby eliminating much loss of time in experimenting by the “cut-and-try” method.

By RAOUL J. HOFFMAN, A.M.E.

IN designing a radio circuit to cover a certain band of wavelengths using a condenser with a maximum and minimum capacity, the amount of inductance may be readily ascertained and thus the tapping of the coil may be eliminated.

In the following simplification of the well-known formula of Nagoaka,

$$L = \pi^2 d^2 n^2 / K \dots\dots\dots 1)$$

L denotes the inductance in microhenrys, d the diameter, n the number of turns to the inch, l the length of the coil and K the correction factor depending on the relation of l/d shown by the line A on the accompanying chart.

To simplify the formula we have replaced the curve A by the straight line B, which after evaluation will follow the equation.

$$K = .69 \sqrt{l/d} \dots\dots\dots 2)$$

and by transposing equation No. 2 into No. 1 and by substituting for the metric units, the British units in inches we will have, the inductance

$$L = .0033 \sqrt{l^3 n} \dots\dots\dots 3)$$

wherein l denotes the total length of the wire used and n the number of turns to the inch.

Looking at the chart we see that the

How to Make Resistance Measurements

The next article of this series will explain how to make resistance measurements to determine the proper rheostat to employ in your receiving set for the multiple control of tubes. The value of the multiple control idea lies in the fact that it reduces the number of variable contacts in a filament circuit. A measuring chart will accompany this article. Besides, there will be a graph that will give tube data that any fan should be glad to get.

line *B* is within 3 percent of the line *A*, when the diameter of the coil is not larger than ten times the length and not less than seven-tenths of the length, which is within the limits of practical design.

Drawing a line *C* parallel with line *B*, we will have a point *D* on line *A* which denotes the maximum possible inductance for the same length of wire, which will be reached when the diameter is two and a half times the length of the coil.

The alignment chart shown will be a substitute for equation No. 3, when you connect the number of turns on scale No. 1 with the total length of the wire on scale No. 2 and read the inductance

at the intersection on scale No. 3 in microhenrys.

To find the total length of wire on a coil, connect the total number of turns on scale No. 4 with the diameter of the coil on scale No. 5 and read, at the intersecting point on scale No. 6, the total length in inches or feet.

Example: To find the inductance of a coil 3 inches in diameter with 75 turns of No. 22 DSC wire closely wound, connect 75 on scale No. 4 with 3 on scale No. 5, and the length of 700 inches on scale No. 6; then connect No. 22 on scale No. 1 with 700 on scale No. 2 and you will find that the line intersects scale No. 3 at 345 microhenrys which is the inductance of the coil.

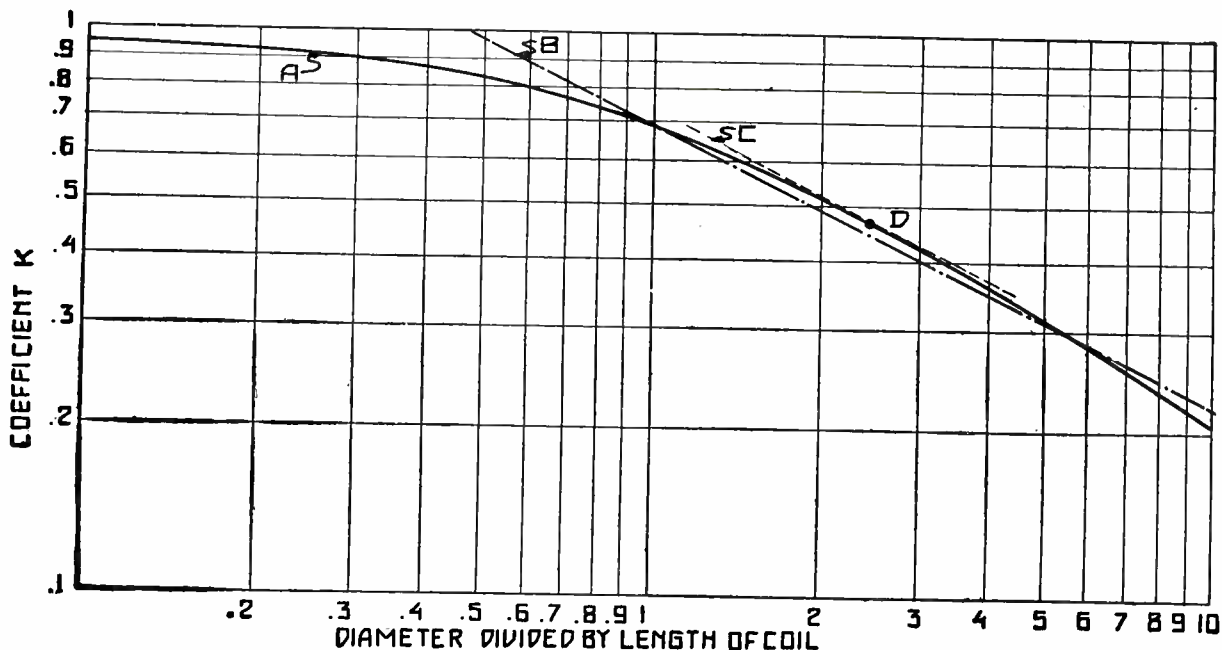

HOW THE MATHEMATICAL BASIS FOR THE MEASUREMENT CHART IS DETERMINED

This graph shows how the formula of Nagoaka was plotted and modified to find the lines B and C which are sufficiently accurate for the practical use of the measuring chart on the opposite page.

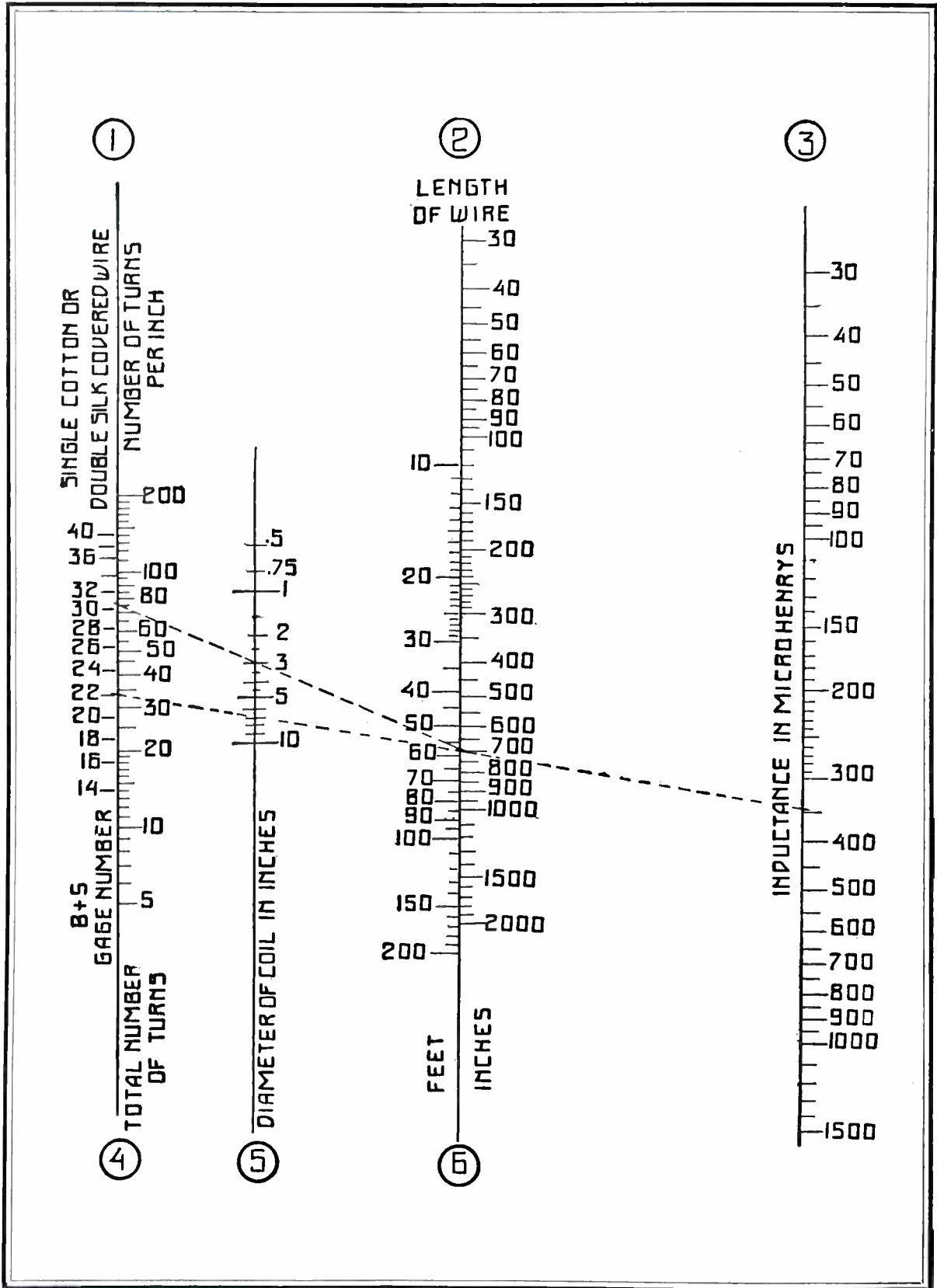

THIS IS THE CHART THAT CALCULATES FOR YOU

The text of this article tells you exactly how to determine the inductance of single-layer coils. This chart can be used for estimating inductances of practically all coils that are now in general use in radio receiving sets. It can only be used accurately, however, for solenoid types of inductance coils.

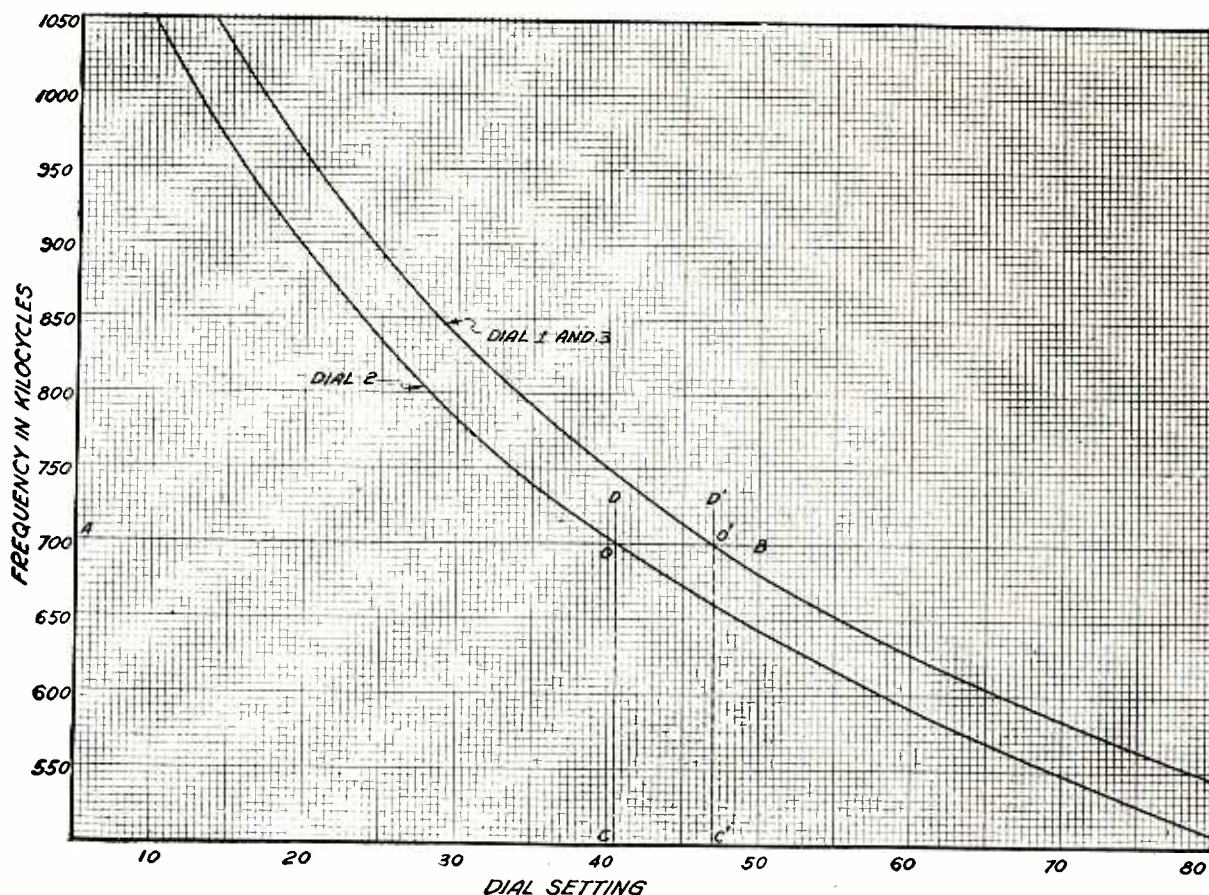

A SPECIMEN FREQUENCY TUNING CHART

FIGURE 1: This chart shows exactly how to set the dials of a standard neutrodyne receiver for any specific frequency within the broadcast range.

NEW METHODS OF Calibrating Your Receiver

This article describes a method for preparing charts for your receiver that will tell you exactly where to set the dials for any station, the wavelength or frequency of which you already know. One of these charts will give you a permanent record of the dial settings for all the stations that are listed in the call book.

By MORRIS S. STROCK

NO one can deny that a good deal of the fascination of radio comes from receiving the programs of distant stations.

The fad of spotting numerous stations merely for the purpose of hearing the announcer is not to be commended; nevertheless, it is true that, given two equally enjoyable programs, nearly everyone prefers to listen to the one that

comes from the greater distance, although it may not be received as well.

A tabular record of stations heard is often used to assist in resetting the dials of the receiving set to a particular broadcasting station. This method requires the locating of each individual station. Sometimes the dial settings that correspond to the frequency or wavelength of a new station can be estimated from the table, but this is usually unsatisfactory in the case of distant stations.

NOTE: This article has been approved for publication by the Bureau of Standards.

A second method of finding the dial settings that correspond to the frequencies of broadcasting stations, consists in locating a few stations that have a uniform separation over the broadcast frequency band and then in plotting curves from this data. The curves furnish a graphical method of obtaining the dial settings corresponding to a given frequency. Typical curves are shown in Figure 1. One curve is plotted for each frequency control dial on the receiving set. Curves plotted to wavelength instead of frequency have the form shown in Figure 2.

Although this method is pretty generally known, it is not widely used. This may be due to the fact that the plotting and reading of curves appears difficult to the non-technical man. It is also probable that the advantages of this method are not generally appreciated.

These advantages are:

- (1) The elimination of hunting for new stations;
- (2) The maintaining of a permanent calibration for the receiving set.

In explanation of the first point it may be stated that when curves are employed with sets that have a high degree of selectivity, one may often locate a distant station which normally would not be heard.

The importance of the second point is evident when one considers the recent changes in frequency assignments to broadcasting stations and the difficulty of relocating these stations on the receiver dials. With the aid of curves, the dial settings that correspond to a new frequency assignment can be immediately determined.

It is the purpose of this article to describe the method of obtaining and

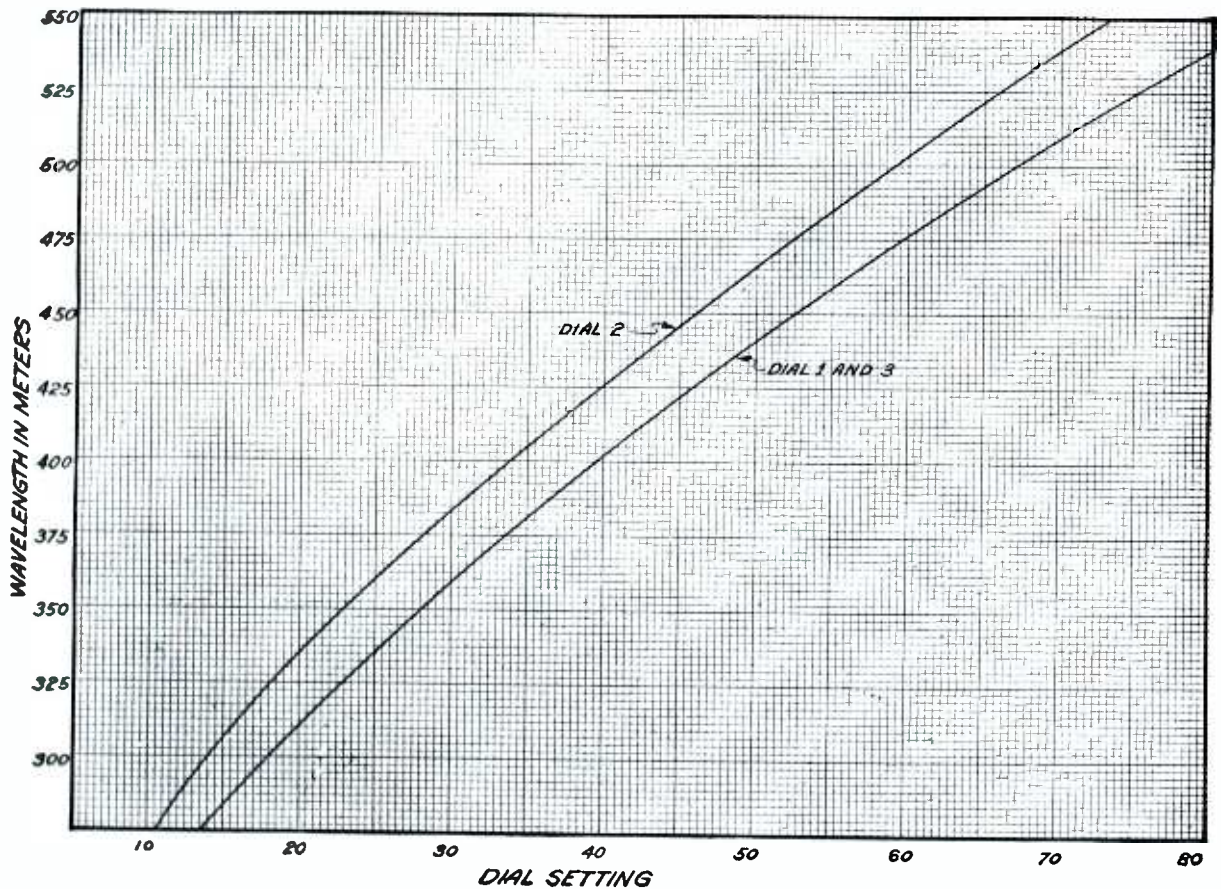

A CHART THAT INCORPORATES A TUNING RECORD IN WAVELENGTH
 FIGURE 2: This gives you at a glance the correct dial settings for any of the wavelengths that lie within the present broadcast waveband. The text of the article explains how to make these charts and how to use them.

using accurate calibration curves. In this, the use of certain stations which maintain a constant frequency close to their assigned values is suggested. These stations, which are known as "Standard Frequency Stations," are listed each month in the Department of Commerce *Radio Service Bulletin*.* The data given on page 422 (with the addition of a wavelength column) are taken from a recent issue of that publication.

These stations are measured regularly at the Bureau of Standards, and as shown in the table, have extremely small deviations. In all probability there are many other broadcasting stations that maintain frequencies close to the assigned values; the stations in this list are, however, of known reliability. If the broadcast listener is able to receive all of the Standard Frequency Stations they will enable him to obtain reliable curves which will assist in adding distant stations to the radio log.

As many stations deviate somewhat from their assigned frequencies, they will

not always be found on the receiver dials at the exact settings indicated by the curves. Since, however, the deviations may be in either direction, the calibration curves obtained from Standard Frequency Stations will follow what may be termed a mean path between the deviating stations and consequently, a minimum error will be introduced in obtaining the dial settings.

The importance of using Standard Frequency Stations for obtaining curves increases in direct ratio with the selectivity of the receiving set.

Sets that have a high degree of selectivity are generally also very sensitive, and in the eastern part of the country should permit reception of all Standard Frequency Stations. Sets of moderate sensitivity and selectivity may not be capable of picking up all of these stations. These sets will not permit of extremely close dial settings; their calibration curves will be slightly less accurate; consequently it is not so necessary to depend entirely upon the Standard Frequency Stations for obtaining these curves.

* Obtainable from the Superintendent of Documents, Government Printing Office, Washington, D. C., for 25 cents a year.

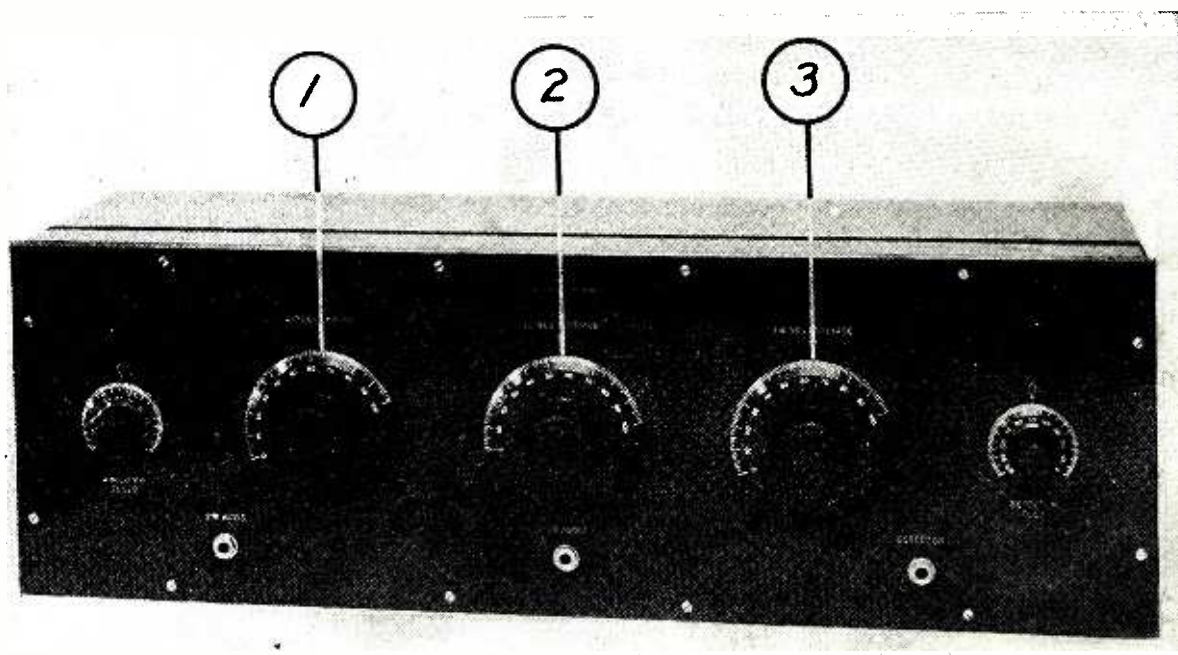

A STANDARD NEUTRODYNE

FIGURE 3: This is a receiver that was used in making up the chart shown in Figures 1 and 2. The dials marked 1, 2 and 3 correspond with the curves which are also marked with the same designating numbers so that the operator may know exactly at what settings they should be adjusted for various wavelengths or frequencies.

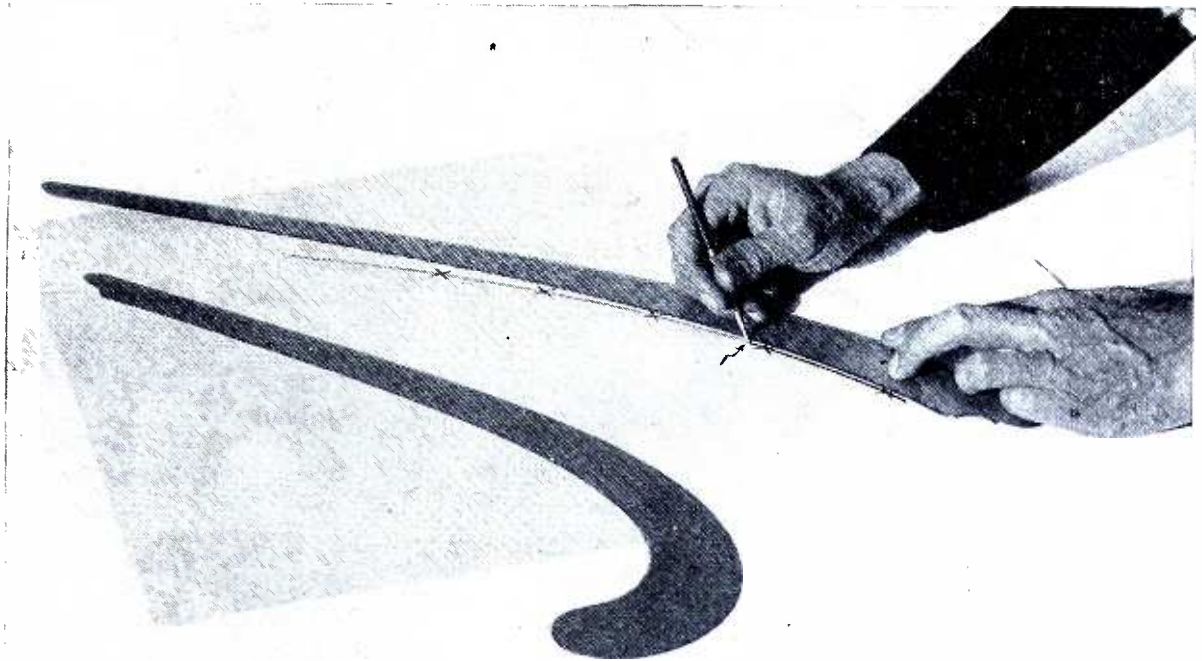

INKING IN THE CURVE

FIGURE 4: *This photograph shows how the various points that have been plotted on cross-section paper are connected with a smooth curve line which is guided by a set of French curves.*

Owing to the fact that frequency allocations to broadcasting stations are determined by a uniform separation of ten kilocycles, the use of kilocycles in plotting and reading curves offers the advantage of simplicity; but as broadcasting stations are generally listed in meters, it will be necessary to make conversions. These conversions are easily made and the small amount of time required to do this will be found worth while. To change meters to kilocycles or to change kilocycles to meters, divide either quantity into 300,000. In the former conversion, the resulting number of kilocycles which is nearest an even multiple of ten should be chosen.

Figure 1 shows three curves obtained from the Standard Frequency Stations by the use of a neutrodyne set, a picture of which is shown in Figure 3.

In this set it so happens that curves for dials 1 and 3 are practically identical.

Figure 2 shows curves for the same receiving set that uses wavelengths instead of frequencies. As the curves furnish a permanent calibration, attention should be given to all features of the receiving installation which might cause a

change in the dial settings for a particular frequency. In general it will be necessary to see that the receiving antenna and ground wire are permanently installed and even the question of approximately constant "B" battery voltage and filament currents should be given some attention unless it has been definitely ascertained that these factors will have no effect upon the calibration of the receiving set.

This is the method employed for obtaining and for using the curves in Figure 1, although using the dial settings for the neutrodyne set, is applicable to all types of receiving sets.

The dials of the receiving set were carefully adjusted to obtain a maximum signal from each Standard Frequency Station, giving data as shown on page 422

These observations represent the average of several trials. Care was taken to read the dials with the eye of the observer directly in front of the zero markings.

The plotting of curves from the data obtained from the receiving set requires care, as the dial settings for the various broadcasting stations are obtained from

these curves. A rather detailed description of this process is, therefore, required. The cross-section paper used for this purpose should be accurately divided into small squares, preferably not larger than about one millimeter. Paper with larger subdivisions than this may be used, but this will require a sheet of rather inconvenient size in order to obtain an accurate frequency or wavelength scale.

The vertical scale, representing frequencies of wavelengths, is chosen so that the smallest square or division represents not more than five kilocycles or two and one-half meters.

The horizontal scale, giving dial settings, should be so chosen that the slope of the curve will be approximately 45 degrees.

The curve shown in Figure 1 was plotted on cross-section paper divided into one-millimeter squares. On the vertical axis, one millimeter represents five kilocycles, and on the horizontal axis, two millimeters represent one division on the receiver dials.

The following explanation shows the method of plotting points on the curve sheets:

The frequency or wavelength of the broadcasting station is located on the vertical axis and the corresponding dial settings are located on the horizontal axis. A light horizontal line, AB (Figure 1), is drawn through the frequency point and vertical lines CD and

C'D' are drawn through the points on the horizontal axis representing the dial settings. These lines must be carefully located so as to determine accurately intersecting points O and O'. Other points are located in the same manner.

These points are to be joined with smooth even curves. For this purpose, celluloid curves of the type shown in Figure 4 are most satisfactory. In lieu of this, one may use a piece of rubber insulated copper wire of sufficient stiffness to remain in any desired shape. The wire is first straightened and then carefully bent to the required curvature, as the eye is a fair judge of the uniformity of curved lines, it is even possible to sketch in the curves determined by the plotted points in free-hand fashion. The inaccuracies involved by this process will be greatly reduced when the points are plotted to a larger scale than previously mentioned. The adoption of any of these methods does not warrant a lesser degree of care and accuracy in locating the required points.

The explanation given below assumes that the curves are drawn with the aid of curves forms and inked in with a draftsman's ruling pen. It will also be of assistance in obtaining reliable curves when some other method is employed.

The curve forms are so chosen that the edges approximate the curves determined by the points. In starting the

Station	Location	Assigned frequency (kilocycles)	Assigned wavelength (meters)	Period covered by measurements (months)	Number of times measured	Average percentage deviations from assigned frequencies noted in measurements
WEAF	New York, N. Y.	610	491.5	3	35	.0
WCAP	Washington, D. C.	640	468.5	18	81	.1
WRC	Washington, D. C.	640	468.5	15	61	.1
WSB	Atlanta, Ga.	700	428.3	18	70	.1
WGY	Schenectady, N. Y.	790	379.5	21	115	.1
WBZ	Springfield, Mass.	¹ 900	333.1	11	29	.1
KDKA	East Pittsburgh, Pa.	² 970	309.1	18	143	.1

THIS TABLE GIVES A LIST OF STANDARD FREQUENCY BROADCASTING STATIONS.

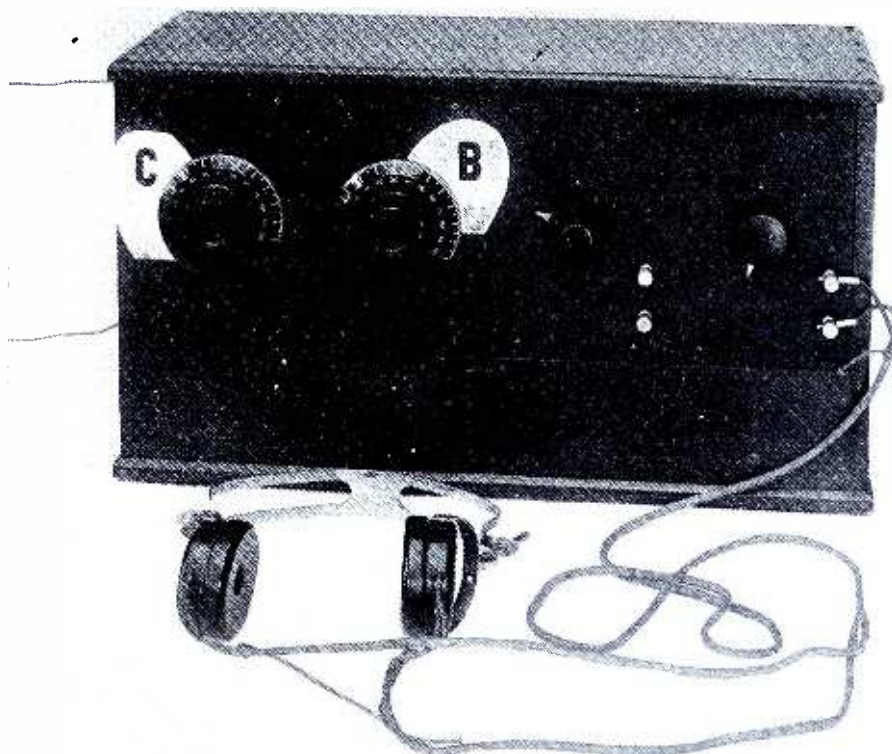

A REGENERATIVE RECEIVER

FIGURE 5: The chart shown in Figure 6 incorporates the dial settings for the wavelength control C and the regeneration control B. This is a more difficult type of receiver to chart, although it is readily accomplished if the details of the text are followed closely.

curve, the celluloid form is fitted to at least three points. The curve is then drawn only part way to the third point, and the celluloid form is readjusted so that it exactly coincides with a portion of the curve previously drawn and so that it includes at least two additional points.

This method is illustrated in Figure 4, in which the heavy line represents the inked portion of the curve, the double line represents the curve as previously drawn in pencil, and the arrow represents the point where the inked line is stopped preparatory to shifting the celluloid form before it *begins* to diverge from the pencilled curve.

The curves may be accurately extended beyond the limiting points determined by the Standard Frequency Stations provided a uniform rate of curvature is adhered to.

The use of the completed curves to determine the dial settings on the receiving set corresponding to the frequencies

of broadcasting stations is similar to the procedure used in plotting points for the curves. From a point on the vertical axis (Figure 1) representing a frequency of say, 650 kilocycles, a horizontal line is projected to the right until it intersects the curves. From these intersecting points vertical lines are projected downward, giving points of intersection with the horizontal axis, 49 and 55.5, which determine the dial settings for 650 kilocycles.

The data obtained in this manner should be recorded in a table giving the broadcasting station, the frequency, and the dial settings corresponding to that frequency.

When the dials of the receiving set are adjusted according to this data, it will in some cases be necessary to make only slight changes in the settings in order to obtain signals of maximum intensity. This condition will generally be caused by a slight deviation of the broadcasting station from its assigned

frequency. In the event of a station being assigned a new frequency, the new dial settings can be immediately determined from the curves.

Although these instructions are based upon curves for the neutrodyne set, the ideas there given apply to various kinds of receiving sets. Circuits that employ regeneration will usually show an appreciable change in the setting of the tuning dial for a particular broadcasting station when the dial controlling regeneration is readjusted; hence it is desirable to consider certain refinements in obtaining and using calibration curves for such sets.

Some objection may be raised as to the necessity of plotting curves for receiving sets which may be made to generate, as in the operation of such sets it is a simple matter to locate broadcasting stations by the whistles produced with the carrier waves. As this method results in interference to other receiving sets it is objectionable on that score. It is also true that if one has a dial setting obtained from a curve, he is more apt to wait for that particular station, provided it is reasonably certain that the dial setting is correct. In using calibration curves for receiving sets of the regenerative type, distant stations may usually be located without the production of disturbing whistles. This result is secured in the method described below.

Figure 5 shows a regenerative set having an untuned primary circuit with fixed coupling to the secondary. The range of broadcast frequencies is covered

by the condenser dial, C. The small knob directly below this dial is used to obtain a fine adjustment by friction with the edge of the dial. Dial B controls regeneration. The calibration curve obtained from this set is shown in the upper part of Figure 6. The lower curve shows the approximate variations in settings of dial B with settings of dial C giving maximum regeneration. This second curve represents a mean between the points as plotted, it being impractical to obtain these points accurately.

To obtain the points for these curves, dials B and C were carefully set to an approximate maximum signal from the broadcasting station. Dial B was then carefully readjusted until the best position was found for maximum regeneration *without oscillation*. This process required a slight readjustment of dial C. The settings of the two dials were then recorded together with the assigned frequency of the broadcasting station. Dial settings for other broadcasting stations were obtained in the same manner.

After the settings of dials C and B were determined for the Standard Frequency of other broadcasting stations, the points were plotted on cross-section paper in a manner similar to that described. The method of locating the points for the two additional curves was as follows:

The settings for dials C and B for a broadcasting station of 900 kilocycles were found to be 29 and 83 respectively. From the 900-kilocycle point on the

Station	Frequency in kilocycles	Wavelength in meters	Dial 1	Dial 2	Dial 3
WEAF	610	491.5	64.5	56.4	64
WRC	640	468.5	59.4	52	57.6
WCAP					
WSB	700	428.3	47.2	41	47.4
WGY	790	379.5	35	29.4	34.8
WBZ	900	333.1	24	19.3	24
KDKA	970	309.1	19.4	14.8	19.5

A SAMPLE TABLE THAT MUST BE PREPARED IN PREPARATION FOR THE CHARTS.

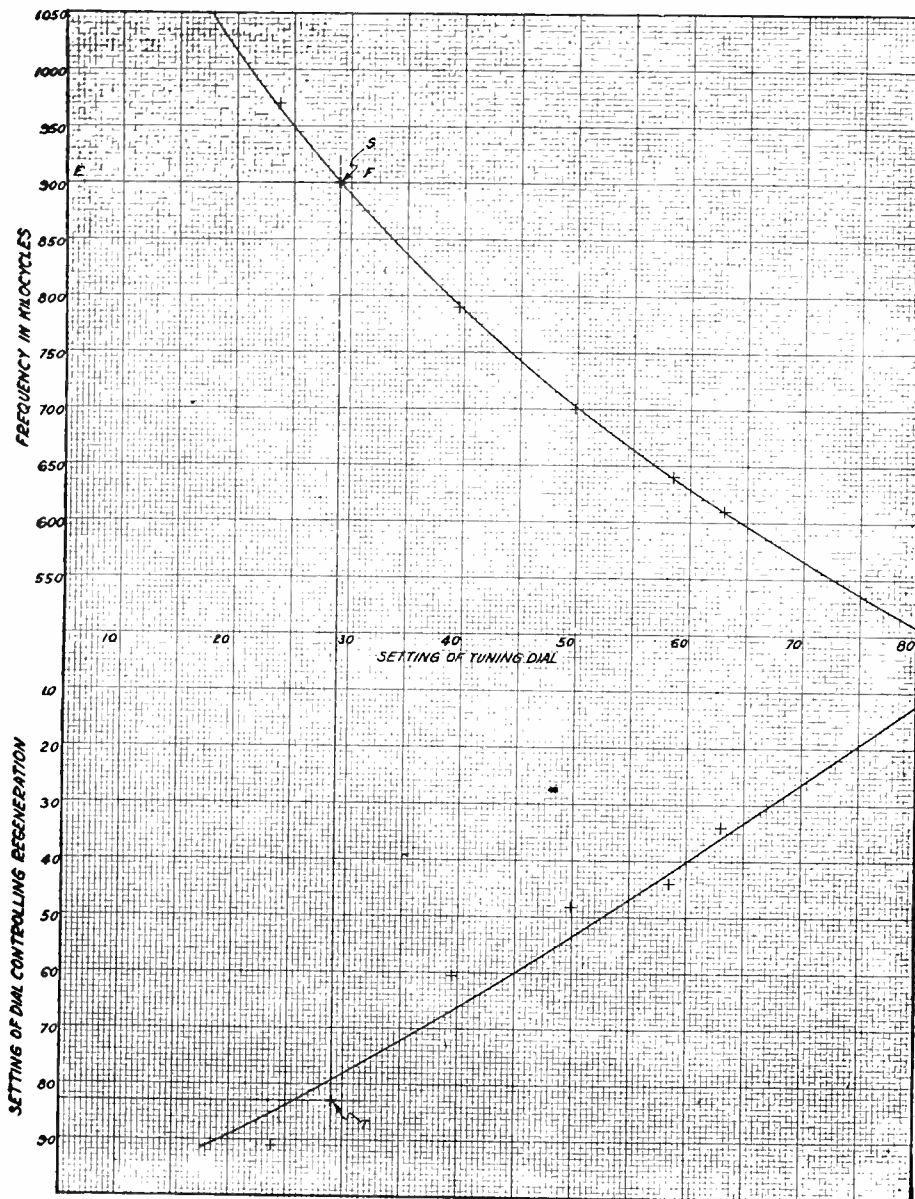

THE TUNING CHART FOR A REGENERATIVE RECEIVER

FIGURE 6: These two curves give the dial settings for the dials B and C of the regenerative receiver shown in Figure 5. The upper curve gives the setting of the dial B in frequency and the lower curve gives the corresponding setting of the dial C.

vertical axis (Figure 6) a horizontal line EF was drawn to the right and a vertical line was drawn up from a point on the horizontal axis corresponding to a dial setting of 29. This determined a point, S, for the upper curve. The vertical line was then extended downward below the horizontal axis. From a point on the lower vertical axis corresponding to a setting of 83 for dial B, a horizontal line was drawn to the right, giving an intersecting point, T.

When all the points were located in

this manner they were connected with smooth curves as already described.

The data from these curves should be recorded in a table that gives the broadcasting station, its assigned frequency, and the required dial settings.

Assume that it is required to obtain the dial settings for a station with a frequency of 650 kilocycles. From this point on the vertical axis, a line is projected to the right until it intersects the upper curve. From this intersecting point a line is projected down until it

intersects the lower curve. From this point a third line is projected to the left and the point of intersection with the vertical axis determines the approximate setting of the dial controlling regeneration.

In obtaining data for curves for a regenerative set which has a small (vernier) condenser connected across the terminals of the tuning condenser, it will be necessary to maintain a definite setting of this small condenser. This setting should preferably give one-half the capacity of this condenser. In the subsequent use of the set, the small condenser is turned to the same position, the proper settings of the other dials are obtained from the curves, and the small tuning condenser is used for the final tuning adjustment.

The data obtained from the curves of the type shown in Figure 6 will give airily reliable dial settings that corre-

spond to the frequencies of various broadcasting stations. As the lower curve is less accurate than the upper curve, the method of setting the dials of the receiving set will require most careful attention to the setting of the dial that controls the tuning; that is, dial C in the set shown in Figure 5. Having set the dials at the predetermined points, the detector filament rheostat is carefully adjusted until maximum regeneration, without oscillation, is obtained. A slight readjustment of the dial controlling regeneration may then be made.

A careful following out of these instructions for obtaining and using calibration curves for receiving sets should result in reception from an increased number of stations and, in the case of regenerative sets, there will be an almost total elimination of radiating interference.

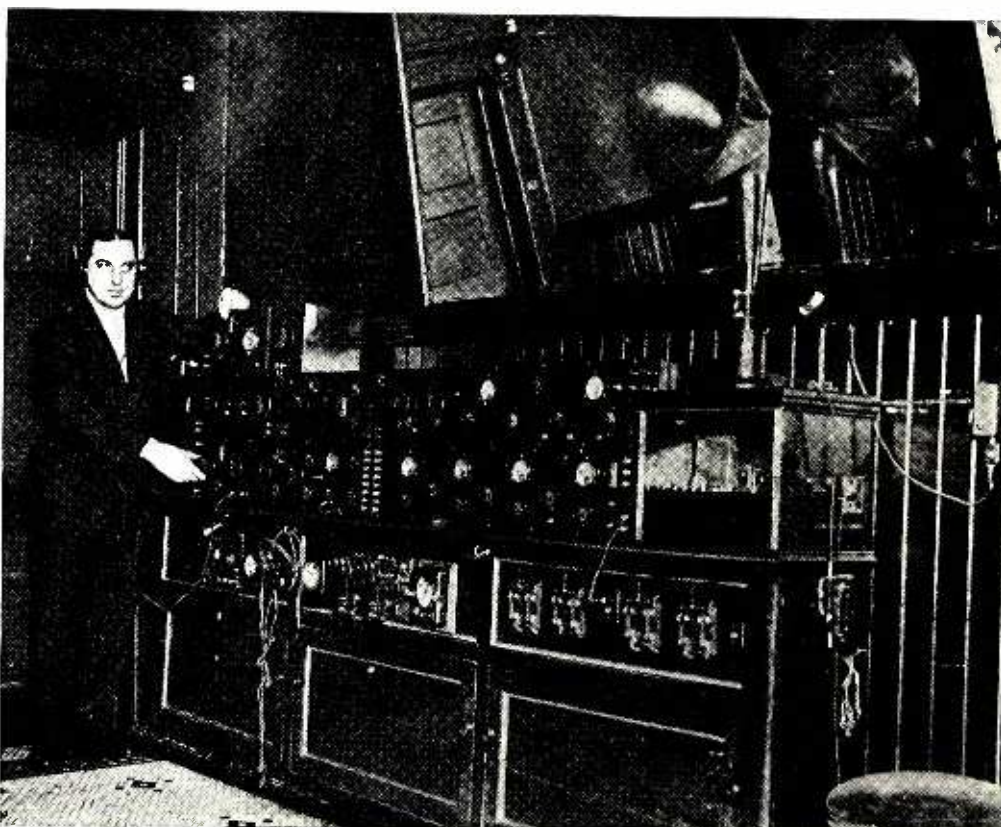

Kadel & Herbert

IS THIS THE "LARGEST RADIO RECEIVING SET IN THE WORLD?"

Anyway, it is one of the largest. It was built by Robert J. Sieglack of Sheepshead Bay, N. Y., at a cost for parts alone said to be over \$3,000. It is a special superheterodyne circuit and employs twenty-three tubes.

G The helpful information incorporated in the articles of this series is obtained by independent and unbiased experiments conducted by the staff of the POPULAR RADIO LABORATORY.

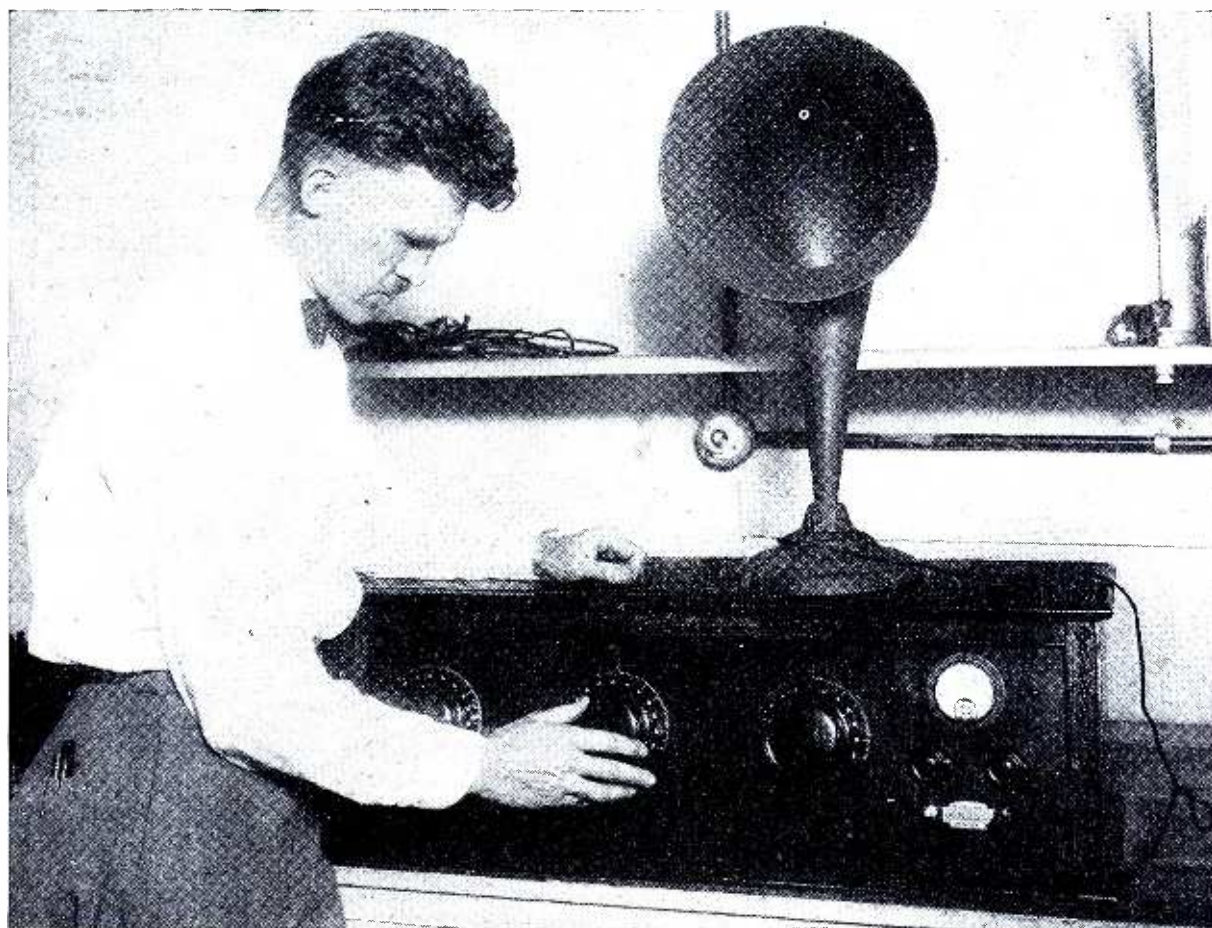

HOW TO GET THE MOST OUT OF YOUR READY-MADE RECEIVER

NO. 9: THE GAROD NEUTRODYNE TYPE V RECEIVER

This series of articles explains the theory, operation, equipment and care of standard receiving sets

This series does not indorse the product of any manufacturer or make comparisons between receivers. The sets already described include: No. 1, the Eagle Neutrodyne; No. 2, the Radiola Superheterodyne; No. 3, the Melco Supreme Receiver; No. 4, the Crosley Trirdyn; No. 5, the De Forest Reflex; No. 6, the Atwater Kent; No. 7, the Grebe Synchrophase Receiver; No. 8, the Freed-Eisemann Receiver.

By S. GORDON TAYLOR

EXPLANATION OF SYMBOLS IN FIGURE 1—

RFC1—Antenna coupling coil;
RFC2 and RFC3—Radio-frequency coupler coils;
VC1, VC2 and VC3—Variable condensers;
VT1, VT2, VT4 and VT5—UV-201-a or C-301-a vacuum tubes;
VT3—UV-200 or C-300 vacuum tube;

AFT1 and AFT2—Audio-frequency amplifying transformers;
R1 and R2—Blocking resistances;
R3—Smoothing resistance;
R4—Grid-leak resistance;
R5 and R6—Filament rheostats;
R7 and R8—Automatic filament controls;

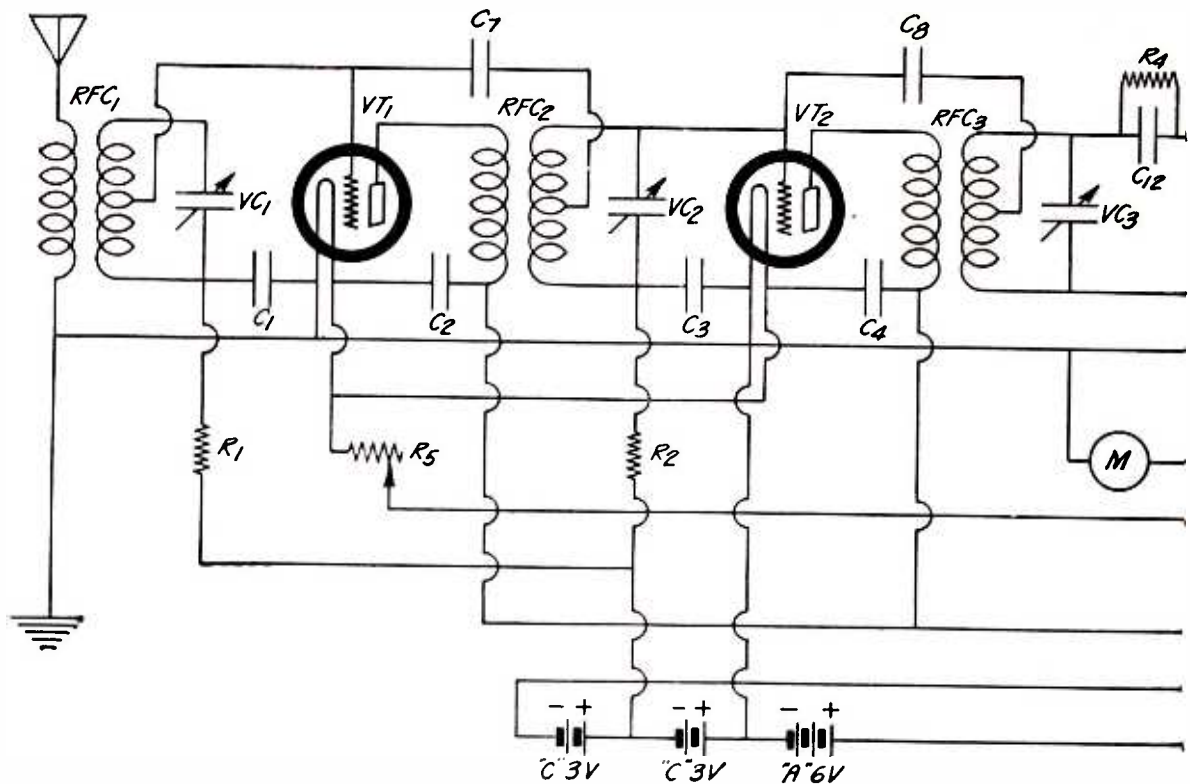

THE WIRING DIAGRAM OF THE GAROD NEUTRODYNE RECEIVER, TYPE V

FIGURE 1: The designating symbols used are explained in the list of parts and in the text.

C1 to C12—Fixed condensers;
 M—Double range voltmeter;
 M—Meter resistance coil;
 S1—Battery switch;
 S2—Voltmeter switch;
 J—Phone jack.

THIS five-tube receiver is of the tuned-radio-frequency amplification type, making use of the neutrodyne method of preventing oscillation in the radio-frequency amplifier stages. A description of the theory of operation of this type of receiver has already been given in this series of articles.*

Construction of the Receiver

The receiver is of ample size to permit plenty of spacing between parts, thus preventing to a large extent undesirable interaction between the various circuits. The panel is of wood, finished to match the cabinet; the tuning controls are likewise finished in a shade to match the

rest of the receiver. Ease of tuning is made possible by the use of large dials and the panel is sloping so that it is not necessary for the operator to crouch down before the receiver in order to tune it.

The parts of the tuning instruments which come in contact with the wood panel are at low potential. This is not important, however, inasmuch as well seasoned and finished wood is an excellent insulator, with little possibility of electrical leakage. The balance of the instruments are mounted on a wooden sub-base to which the panel is also attached. Thus the entire "works" may be readily removed from the cabinet if necessary, as shown in Figure 3.

The two radio-frequency-amplifier tube sockets are mounted directly on the sub-base but the detector and audio-frequency-amplifier sockets are placed on a rubber strip which in turn is mounted on two springs. Thus vibrations are absorbed by the cushioning

* Those who wish to familiarize themselves with the theory of operation are referred to the articles of this series which appeared in POPULAR RADIO for December 1924 and August 1925.

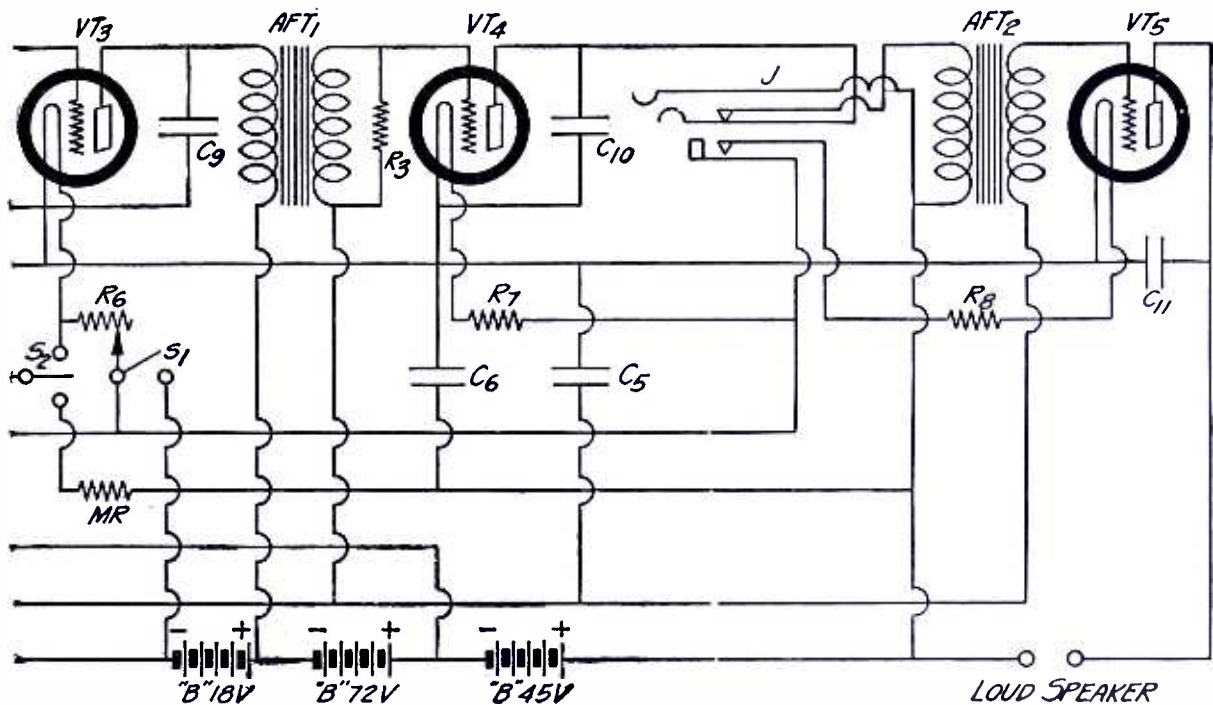

springs and microphonic tube noises, sometimes encountered when a radio receiver is jarred, are eliminated. Vibrations do not cause trouble in the case of the radio-frequency-amplifier tubes; therefore a cushioned mounting is not necessary so far as they are concerned.

The cabinet itself is of mahogany and presents a pleasing appearance. Access to the receiver for inserting vacuum tubes and connecting battery leads is gained by removing a panel at the rear of the cabinet.

How the Receiver Works

The first two vacuum tubes, from the left (looking from the front of the receiver) are the radio-frequency-amplifier tubes. It is the function of these two tubes and the accompanying equipment to amplify the incoming signals in the exact form in which they are received. This is in the form of an alternating current of high frequency—much too high to lend itself to audible reproduction. Before reproduction is possible, the signals must pass through what is called a detector. In this receiver an-

other vacuum tube is used as a detector and is placed near the panel on the right-hand side of the receiver. If headphones were connected in the output circuit of this detector tube the incoming signals would be distinctly heard, the headphones serving to transform the electrical energy, after it has been rectified by the detector tube, into sound energy.

Instead of connecting the headphones into the output circuit of this tube two more amplifier tubes are provided, the purpose of which is to amplify the rectified current from the detector thus making the use of a loudspeaker possible.† These two audio-frequency-amplifier tubes are those directly behind the detector (VT4 and VT5, Figure 3).

Tuning the receiver to the incoming signal is accomplished by means of three variable condensers, VC1, VC2 and VC3. These tune the input energy to the first three tubes. By tuning each of these three circuits to resonance with the incoming signal, that signal will be

† A more detailed explanation of the amplifier and detector action may be obtained from the previous articles of this series, in the December 1924 and the March, June, August and September 1925 issues.

passed along to the detector and the audio-frequency amplifiers (VT3, VT4 and VT5). If any one of the circuits is out of resonance the passage of the signal will be blocked. The method of tuning will be explained later.

Antenna and Ground

In localities where there are several local broadcasting stations it will be found that results are generally more satisfactory if a short antenna is used. This may be located out of doors and should be about 60 to 75 feet in length measured along the antenna from the receiver to the far end of the wire, and including both the antenna proper and the lead-in wire. Or it may be erected indoors, strung along the picture moulding or even along the baseboard. The indoor antenna may be anything over 40 feet in length, measured as above, and should preferably be strung continuously in one direction, rather than around two

or more sides of one room. It is sometimes possible, for instance, to run the wire from the receiver, across the room and then into a hall where a good straight stretch is available.

Short antennas such as the above will do much to reduce static interference which is sometimes bothersome in summer. It will also prevent nearby, powerful broadcasting stations from overlapping or interfering with broadcasting from more distant or weaker stations, which operate on nearly the same wavelength. An indoor antenna will prove entirely satisfactory for all local and moderately distant reception. The short outdoor antenna will, as a rule, provide reception from somewhat greater distances than the indoor type.

For reception from great distances a long outdoor antenna up to 150 feet in length is recommended. This should be strung as high above the ground as possible and should be kept well clear of

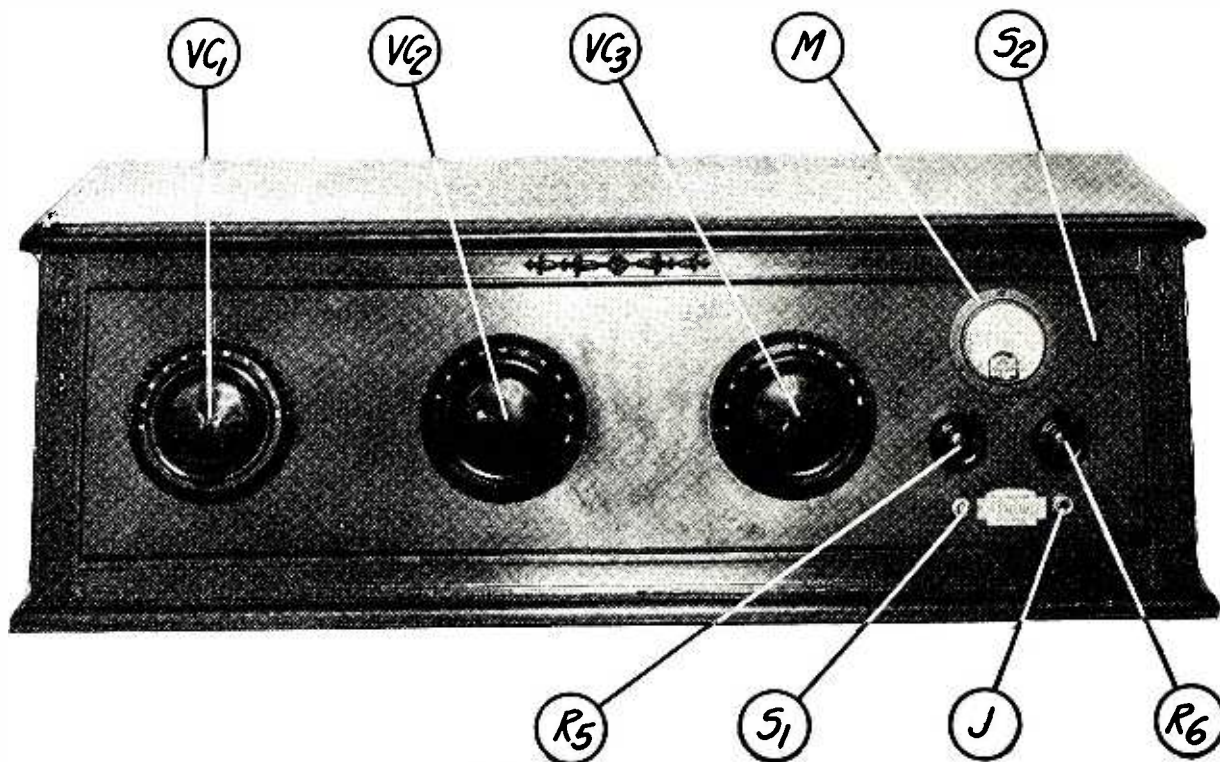

FRONT VIEW OF THE RECEIVER, SHOWING THE PANEL CONTROLS

FIGURE 2: *Tuning is accomplished by means of the three large dials. The meter at the right normally shows the voltage across the detector filament, which should be maintained at five or lower. This meter may also be used to obtain the voltage reading of the "A," "B" and "C" batteries, as explained in the text. The use of the two rheostat dials, R5 and R6, and of the filament switch S1 and phone jack J, are explained in the text.*

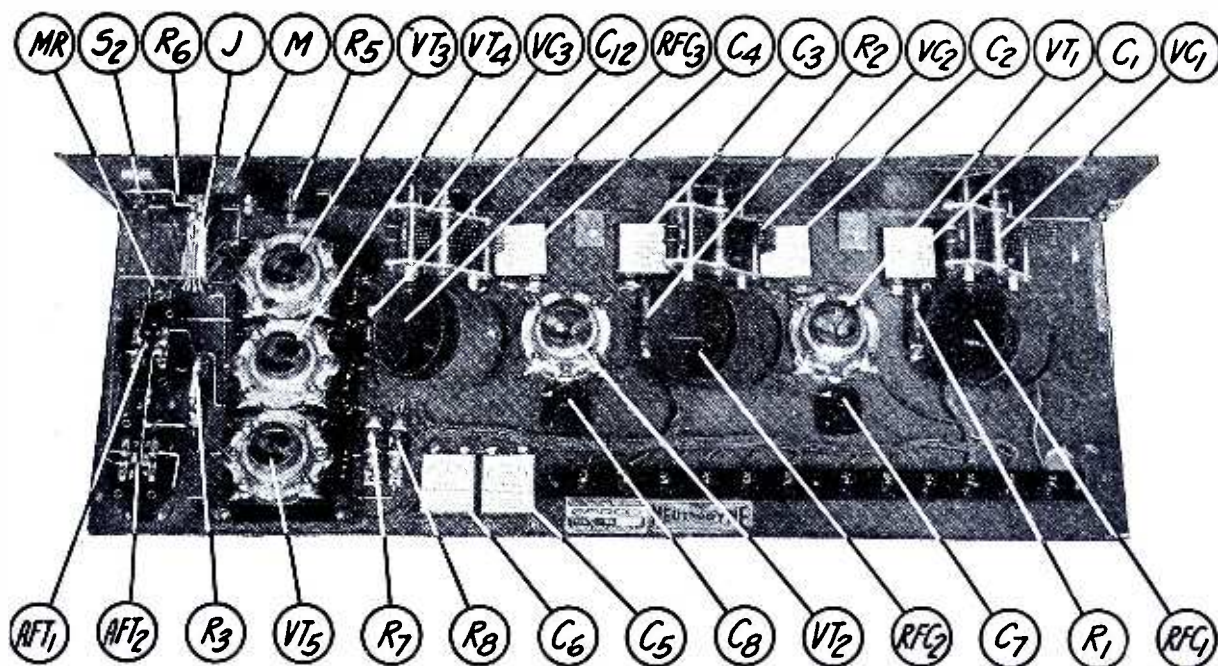

THE RECEIVER REMOVED FROM CABINET

FIGURE 3: A view of all the instruments is clearly shown here. The designating letters are the same as those used in Figure 1.

trees or other buildings. Trees especially have a tendency to absorb radio waves and it is therefore advisable to keep the antenna wire at least 10 feet from them and preferably 20 feet.

For the outdoor antenna, long or short, the use of ordinary bare, seven-strand copper antenna wire has proven entirely satisfactory. The insulators should be of high quality. If possible the wire should be purchased in a single length so that no joints are necessary. If it is necessary to make joints, however, they should be clean and well soldered. This applies to joints in the antenna proper and also where the lead-in wire is joined to the antenna. A fair substitute for soldered joints may be made by scraping the wire clean and joining the two ends together by twisting; then wrapping the joint in tinfoil and finally wrapping two layers of rubber tape around the tinfoil.

In the case of an indoor antenna, where it is to be strung along the walls, insulated wire should be used. This may be No. 14 stranded wire or single-conductor insulated wire of the same

size. In tacking it up care should be exercised to prevent the tacks from going through the insulation and making contact with the wire. This difficulty can be avoided by using the small insulated staples or double pointed tacks which straddle the wire.

Figure 4 suggests a good arrangement for the outdoor antenna. The method of placing the insulators is clearly shown; also a good way to bring the lead-in wire into the house. The method of connecting the lightning arrester is also given. It is a requirement of the Fire Underwriters that every outdoor antenna be equipped with an approved lightning arrester. In most cases the ground side of the arrester may be connected to the same ground connection as used for the receiver instead of using a separate outside ground connection as shown in Figure 4. In a few localities, however, the insurance companies require that the arrester be mounted and grounded outside of the house.

A good ground connection for the receiver is of much more importance than is usually believed. There are many

who believe that simply driving an iron pipe a foot or two into the ground provides a positive connection. Occasionally it does, but more often it does not.

The best all-around ground connection is one made to the cold water pipes, scraped clean at the point of contact. In some cases, however, there may be insulated sections in the pipe line, especially at the water meter, so it is always a good move to bridge a piece of wire across the meter, attaching the ends to the pipe on each side of the meter. For this purpose ground clamps may be used, after the pipe has been filed clean where the clamps are to be attached.

If there is no cold water pipe in the house a good connection can usually be made by suspending a coil of copper wire in a well, or burying a quantity of copper wire several feet underground at a point where the ground is moist. In any case it is advisable to keep the ground lead as short as possible by using the nearest

ground connection that proves satisfactory.

The Vacuum Tubes to Use

The amplifier tubes, VT1, VT2, VT4 and VT5, are UV-201-a's or C-301-a's. These are so-called "hard" tubes. Many makes of these tubes are now going on the market, some good and some not so good, therefore it is best to stick to standard makes in purchasing the tubes.

For VT3, which is the detector tube, a "soft" tube is used; this may be either the UV-200 or the C-300. In many of the present day receivers a UV-201-a or C-301-a tube is used as detector but the Garod receiver is designed for the use of the UV-200 type tube. The manufacturer has two reasons for the choice of this detector; experimental and development work on this receiver convinced him that the "soft" detector tube lent a mellowness

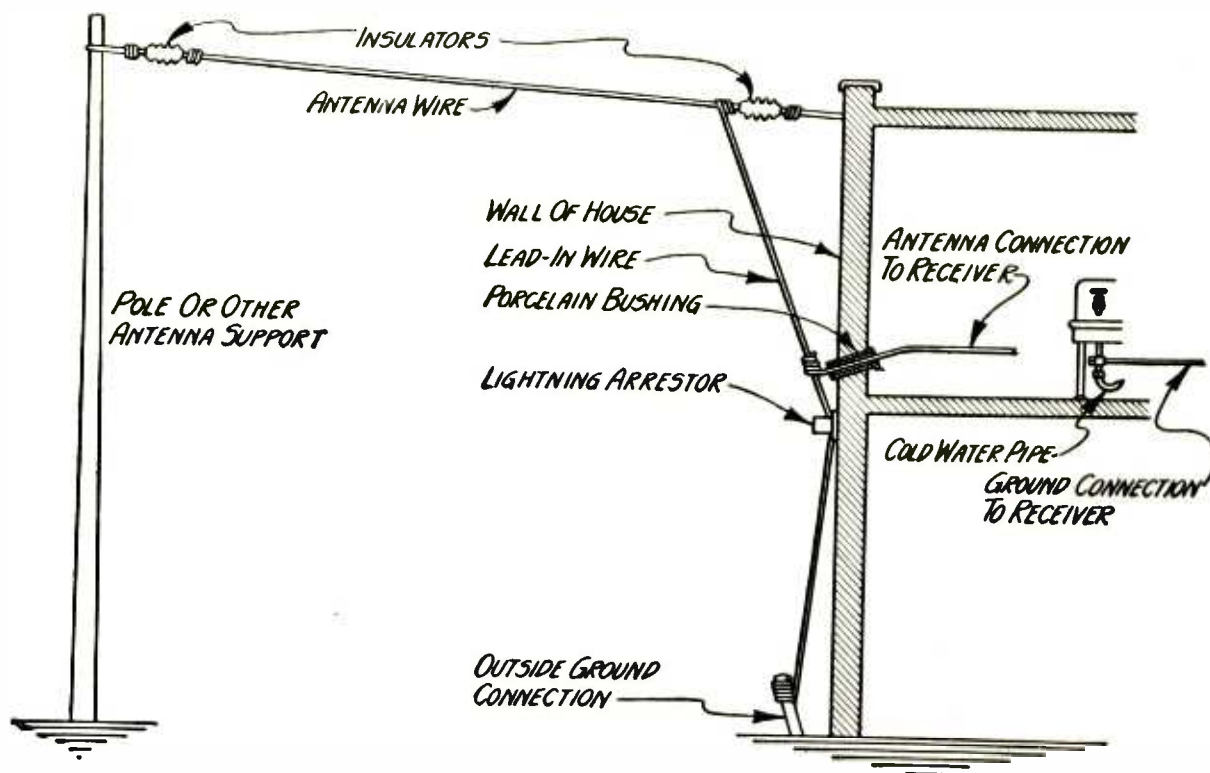

AN EXCELLENT ANTENNA ARRANGEMENT

FIGURE 4: The design of the antenna is necessarily governed, in most cases, by the roof or yard space available. However, many of the ideas suggested by this illustration may be used to advantage in any antenna installation. The best length for the antenna will depend in each case on the interference conditions.

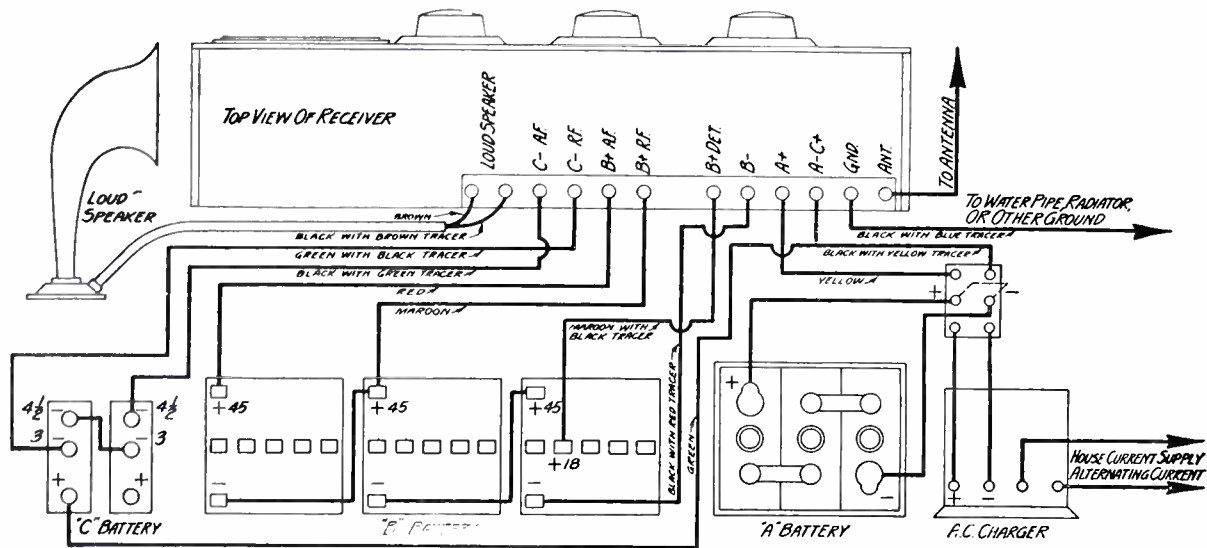

HOW TO CONNECT UP THE RECEIVER

FIGURE 5: Here all the external connections are shown; also a convenient battery charging arrangement. When the double-pole, double-throw switch is thrown up the storage battery is connected to the receiver. To charge the battery it is necessary merely to throw the switch down and the battery is thus connected to the charger. The charger plug is then inserted in the alternating current house lighting socket. When the house supply is direct current the charger connections used are those shown in Figure 6.

to the tone quality of the receiver which was not obtainable with the "hard" tube and secondly, he found the UV-201-a type of tube to be less sensitive to weak signals from distant stations.

There is no question but that the UV-200 works out very well in this receiver and its use is therefore recommended.

What Batteries to Use

Three types of batteries are used with the Garol receiver. First there is the 6-volt "A" battery to light the filaments of the vacuum tubes; then there is the high-voltage "B" battery to supply the necessary plate current, from which the power for the amplified signals is obtained. And finally, there is the low-voltage "C" battery which provides the proper "bias" to the grids of the audio-frequency amplifier tubes to produce the best tone quality in the amplifier and at the same time conserve the current of the more expensive "B" batteries.

The 6-volt "A" battery must be of the storage type. Any of the standard makes of radio storage "A" batteries

will serve this purpose and should have a capacity of not less than 100-ampere-hours.

The "B" batteries may be of either the dry-cell or storage type. Either will give satisfactory results. The table below shows the approximate life of dry-cell "B" batteries under different conditions of service.

The "C" battery is a small battery unit made up of three flashlight cells in a single block, having a total voltage of 4½-volts. For "C" battery voltage higher than 4½-volts two of these blocks may be connected in series, thus providing for potentials up to 9 volts. The current consumption from this battery is practically nil and for that reason there would be no advantage in using a storage battery here. The life of this battery should be a year at least, regardless of how much daily use the receiver is subjected to.

The storage "A" battery needs little attention. It will need an occasional charge and for this purpose a battery charger may be purchased in any radio store. This is a device which permits charging the battery from the lighting

circuit. It is first essential to determine whether the house supply is alternating or direct-current because the type of charger needed will depend on the kind of house supply current.

Another necessary accessory is a hydrometer, which is an instrument used to measure the state of charge of the storage "A" battery. It is an inexpensive glass instrument with a rubber bulb on one end by means of which some of the electrolyte (liquid solution) from the battery is drawn up into a chamber in which there is a calibrated float. It is from the point on the calibrated scale at the top of the solution that the reading is taken. A reading of 1,285 indicates a fully charged battery while a discharged battery will register approximately 1,150. When the reading drops to 1,185 the battery should be recharged at once as allowing further discharge is likely to injure it. A fully charged storage battery with a capacity of 100 ampere hours should operate this receiver for approximately 40 hours before recharging becomes necessary. The current drain of the receiver is about two amperes per hour and the life of a single charge should theoretically be 50 hours but as stated before, it is not advisable to run a battery down completely.

About once every month or two a little distilled water should be added to each of the three cells of the storage

battery, in order to keep the electrolyte level somewhat above the tops of the plates. The electrolyte consists of sulphuric acid and distilled water. The acid does not evaporate, however, and therefore does not need replacement as does the water. A word of caution should be given here against allowing any of the electrolyte to spill over onto the floor or clothing because the acid will leave its mark on anything it touches.

How to Operate the Receiver

For use in connecting up the receiver to batteries and antenna the Garod Company have available a connection cable containing a sufficient number of wires for all connections to the receiver. Each of these wires is of a different color so that the proper leads are easily distinguishable. The complete connections are shown in Figure 5 and in each case the color of the wire is noted. An "A" battery charger has been shown in the diagram, with a double-pole, double-throw switch for disconnecting the battery from the receiver and connecting it to the charger. With this arrangement it is never necessary to disconnect the leads from the "A" battery. To charge the battery the plug from the charger is inserted in a convenient alternating-current, house-lighting fixture and the switch is thrown to the side from which wires lead to the charger. When

TABLE OF ESTIMATED "B" BATTERY LIFE
WITH GAROD RECEIVER

<i>Receiver Used hours per day</i>	<i>2 hours</i>	<i>3 hours</i>	<i>4 hours</i>
Batteries 1 and 2	154 days	96 days	63 days
Battery 3	200 days	130 days	92 days
3 batteries inter- changed weekly	166 days	106 days	72 days

The above estimates are based on the battery voltages specified in this article, and assuming that the loudspeaker is used and volume is kept at maximum at all times while receiver is in operation. The current drain from the first 90 volts of "B" battery will be higher because it supplies both the radio and audio-frequency-amplifier tubes, while the other 45-volt battery supplies only the audio amplifier. To even up the wear on the batteries, therefore, it is well to interchange them once a month, putting the third where the first was before, the first where the second was before, and so on.

TO "A" BATTERY CONNECTIONS OF RECEIVER

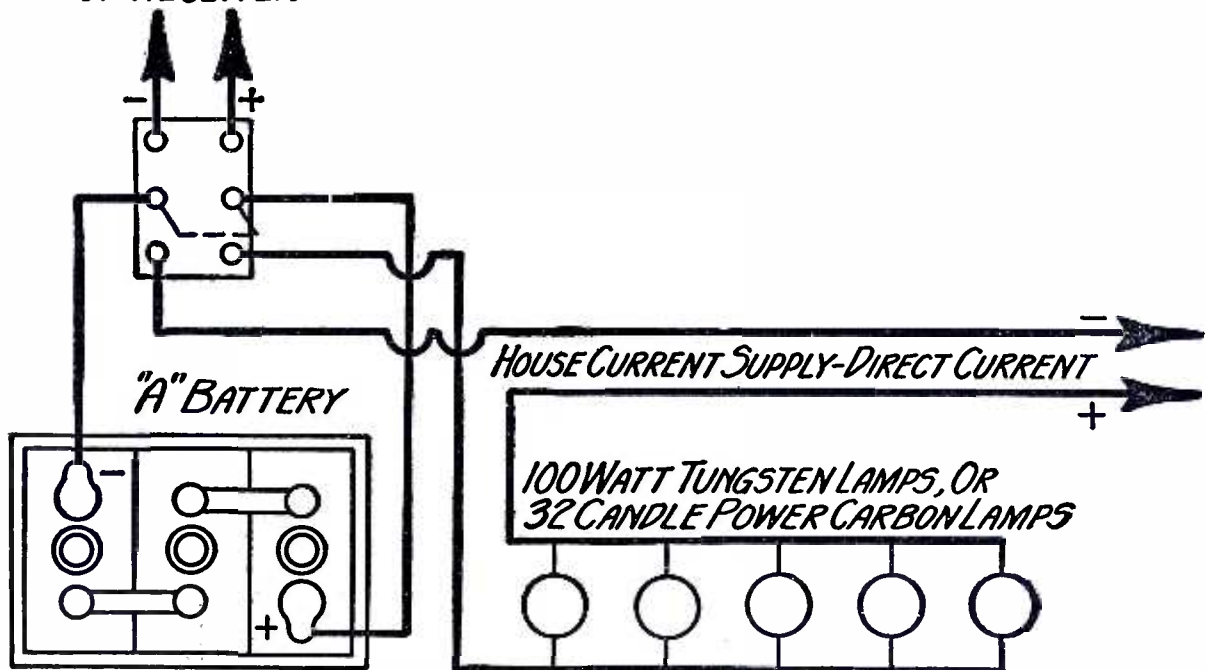

CONNECTIONS FOR CHARGING "A" BATTERY FROM D.C. HOUSE SUPPLY
 FIGURE 6: The type of battery charger used depends on the kind of house supply current. If it is alternating current, a regular A.C. charger is used. If the house supply is direct current, however, a simple arrangement of electric lamps is used as shown here. If preferred a D.C. battery charging resistance may be used instead of the lamps.

the charge is completed it is only necessary to pull the charger plug from the lighting socket and throw the switch to the side from which wires go to the receiver. This arrangement is not only convenient, but is absolutely fool-proof as it is impossible to have the battery connected to the charger and the receiver at the same time, a condition which would in all probability result in burned-out tubes.

It must be borne in mind that this arrangement applies only where the house supply is *alternating current*. For charging a battery from a *direct-current* house supply the charger may consist of simply a bank of five ordinary 100-watt lamps. Connections are shown in Figure 6.

Assuming that the five tubes have been placed in their sockets and the receiver is all connected as shown in Figure 5, it is ready to put into operation. The two knobs, volume and detector control should first be turned as

far as possible in a counter-clockwise direction. Then the battery switch knob is pulled out. The tubes in sockets VT4 and VT5 should now light up. Next turn the volume control in clockwise direction until the tubes in sockets VT1 and VT2 are lighted to the same brightness as the audio-frequency amplifier tubes. Then turn the detector control knob in clockwise direction until a faint hissing sound is heard in the loudspeaker, and turn it back again until the hissing has just stopped. This will be the most sensitive point of adjustment for the detector. The detector tube will light up much more brilliantly than the other four tubes.

As the detector control is adjusted it will be noticed that the hand of the meter will move. As a rule the hissing sound will start when this hand has reached about $4\frac{1}{2}$ -volts on the lower scale of the meter dial. The control should never be turned sufficiently far to bring the meter hand past 5-volts,

TUNING CHART OF GAROD NEUTRODYNE RECEIVER				
<i>Station</i>	<i>Wavelength</i>	<i>Dial No. 1</i>	<i>Dial No. 2</i>	<i>Dial No. 3</i>
KDKA	309	43	41	40
KYW	535	94	89	89
WAAM	263	28	27	28.5
WAHG	316	44	43	42
WCAE	461	77	73	73
WEAF	492	84	80	80
WEBJ	273	33	31.5	31
WEEI	476	81	77	77
WGCP	252	25	24	25
WGY	380	60	57	56
WHN	360	56	53	52
WLIT	395	64	60	60
WLW	422	69	65	65
WMCA	341	51	49	48
WNYC	526	91	86	87
WOKO	233	12	14	16
WOO	508	87	83	83
WOR	405	64	61	61
WOS	441	73	69	69
WPG	300	40	39	38
WRC	469	79	75	75
WRNY	259	27	26	27
WTAM	390	62	58	57

otherwise the tube will last only a short time.

At first when tuning in a broadcasting station it is advisable to use headphones, which should be plugged into the jack at the lower, right-hand corner of the panel. When this is done the light in VT5 goes out. This is due to the automatic filament control feature of this jack which cuts off the filament-supply current to this tube, inasmuch as only four tubes are used with the headphones.

The actual tuning of the receiver to bring in broadcast programs is accomplished by turning the three dials slowly and in unison. It is well to start with the three dials set at any number, say 40. If nothing is heard, turn them each to 42, then on to 44, and so on. In this way it will not be long before some broadcasting is heard. Each of the three dials is then adjusted separately to the point where the signals come in with sufficient volume. It may be that the three dials will not be set exactly alike, perhaps having a difference of one degree or so. This is especially true of the left-hand dial, the setting of which

varies slightly according to the length of the antenna.

With this first station tuned in, re-adjust the volume and detector knobs. The best setting is the lowest one that will produce sufficient volume and maximum clarity. If these knobs (one at a time) are turned all the way off (counter-clockwise) and then turned slowly clockwise, the volume of signals will increase steadily up to a certain point, after which there will be no increase in signal strength. This is the point at which to leave these controls set. If turned higher both tube and battery life are wasted.

The next move is to try various "B" battery voltages on the detector tube. In Figure 5 the connection is shown at 19½ volts. Move this to the 18-volt tap of the "B" battery, then try 16½, then go up to 21, etc. One tap will usually give better results than the others, and this is the tap to which the wire should be left connected. It is advisable to slightly readjust the detector control knob after each change in "B" battery voltage during these tests, to

keep it at the point of maximum results. This point varies some with variations of the "B" battery voltage.

If desired, more, or less, "B" battery voltage may be used on the audio-amplifier (although 90 volts should always be used on the radio frequency amplifier tubes). Tests have demonstrated, however, that 135 volts is best for ordinary conditions and it is recommended that this be the voltage used. This also applies to the "C" battery. In this case 3-volts has been found best for the radio-frequency amplifier and 6-volts for the audio-frequency amplifier. These are the voltages shown connected in Figure 5. So far as tone quality and volume are concerned $4\frac{1}{2}$ or even 3-volts of "C" battery on the audio-

frequency amplifier will give practically the same results as 6 volts, but the higher "C" battery voltage increases the life of the "B" batteries materially.

How to Chart the Receiver

As each new broadcasting station is tuned in an accurate record of the settings of the three dials should be kept. After twenty or thirty stations have been tuned in and recorded they may be transferred to another piece of paper and arranged in alphabetical order according to call letters. Thus when it is desired to tune in any particular station it is only necessary to consult this chart for the dial settings for this station and set the dials accordingly.



American Legion

OLD DOCTOR RADIO CHEERS UP OUR DISABLED SOLDIERS

In this ward of the Walter Reed General Hospital in Washington, D. C., the beds have been furnished with headsets that enable each patient to listen in as he desires. The radio equipment was furnished by the New York Sun-Roxy Radio Fund, in collaboration with the American Legion.

The ATOM

ARTICLE NO. 3

The Nature of Liquids

Scientists tell us that the entire universe is made up of only ninety different kinds of atoms. Tremendous power is believed to lie within these minute and constantly moving particles. To solve the age-old mysteries that lurk within them and to harness their energy has now become one of science's greatest problems.

By SIR WILLIAM BRAGG,
K.B.E., D.Sc., F.R.S., M.R.I.



THE "CRYOPHORUS" EXPERIMENT

FIGURE 1: *The two glass bulbs, together with the connecting tube, contain only water—with no air. When the lower bulb is emptied of water and immersed in liquid air, the water in the upper bulb freezes.*

THE difference between a gas and a liquid is that in the former the atoms and molecules move to and fro in an independent existence, whereas in the latter they are always in touch with one another, even though the touch is transient and they change partners continually.

Heat is required to make a liquid turn into a gas, because the molecules must be given greater energy to enable them to break away from one another; we see this when the wet street dries in the sunshine. Sometimes it may seem that there is no supply of heat when a liquid evaporates, but there must be a source somewhere, though it may be unnoticed.

For instance, the supply may come from the liquid itself, which becomes colder in consequence. The way in which this takes place is quite simple.

The molecules in the liquid are in motion, vibrating, turning, shifting their positions. At the surface there are always some that are for the moment more energetic or less lightly held than their fellows, and these may part company and be flung off into space. It is, on the whole, the more energetic that go, so that the average energy of the remainder is reduced. This is equivalent to saying that the temperature of the remainder is lowered.

Cooling by evaporation is a familiar effect. When our hands are wet, they feel cold because of the evaporation of the water. The surgeon may use an ether spray when he wants to cause a local freezing; nature cools our bodies by the same principle, but in a gentler fashion. In hot dry countries, drinking-water is cooled by putting it into a porous canvas bag, so placed that it is shaded from the sun but exposed to the wind, and the hotter the wind the better.

The experiment of the cryophorus (Figure 1) illustrates the point very well. The two bulbs and the connecting tube contain only water, no air. The water is brought to the upper bulb; the

THE ATOM

lower, which is empty, is immersed in liquid air. In a surprisingly short time the water is frozen solid. The explanation is that the water molecules which fling themselves from the surface of the water make their way in large numbers down the tube and so to the lower bulb. This would happen anyhow, whether there was or was not liquid air round the lower vessel; but if there were none they would come back again and return to the water carrying their superabundant energy with them. The liquid air cools the walls of the lower vessel, and they in turn cool the molecules that strike them, so that they stay there, and their energy is never restored to the water.

When a liquid boils in the open air, the molecules leave the surface at such a rate and with such energy that they push back the air *en masse*; in evaporation, the molecules leave one by one and must make their way as individuals through molecules of the air.

The forces that bind molecule to molecule in a liquid are very great indeed. In a drop of water that hangs from one's finger the molecules cling to one another like the bees in a swarm that hangs from a tree. But this gives

a very feeble idea of the magnitude of the forces that can be exerted. It is well known that a liquid strongly resists compression; it is not generally known that it strongly resists extension also.

Curiously enough, the effect of the water-hammer is met with in places where it has caused great commercial loss. When screws began to be turbine-driven, they were found to be eaten away and attacked by some powerful acid. The cause was at last traced to the formation of empty spaces in the water; they moved so fast that the water could not follow them. Especially did this happen near the tips of the blades. The drawing in Figure 2 is from a photograph taken in the Turbinia Works; the screw is turning in a tank, and the water flowing past it contains a series of cavities in the form of spirals. When these cavities collapse the shock is so severe, and if any part of the blade happens to form part of the cavity, the blow may tear away a portion of the metal.

Since every molecule in a liquid has some attraction for every other molecule, there is a general tendency to move s

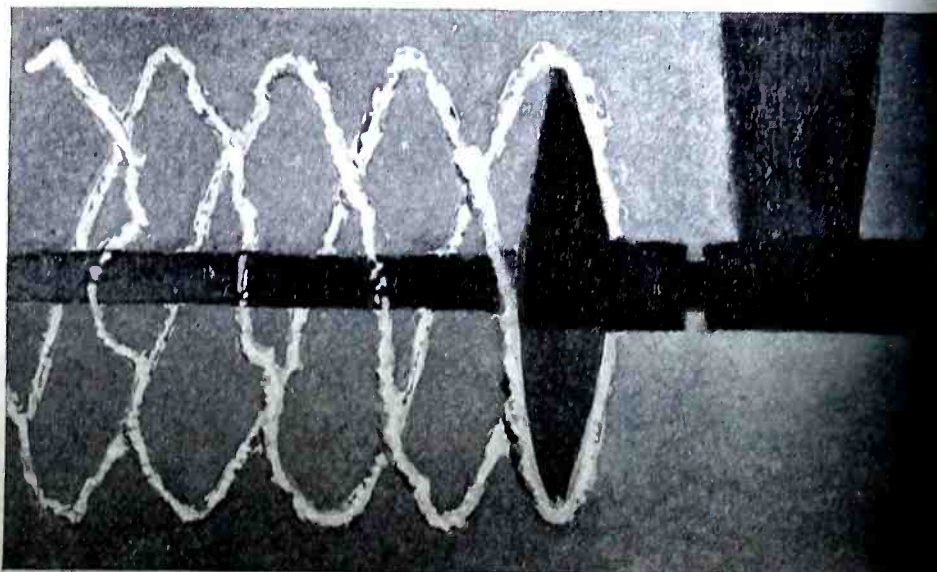

THE DESTRUCTIVE EFFECT OF A "WATERHAMMER" ON A SHIP'S SCREW
FIGURE 2: When the spiral cavities, formed in the water by the action of a revolving screw, collapse, the shock is so severe as to damage the metal that may come in contact with them.

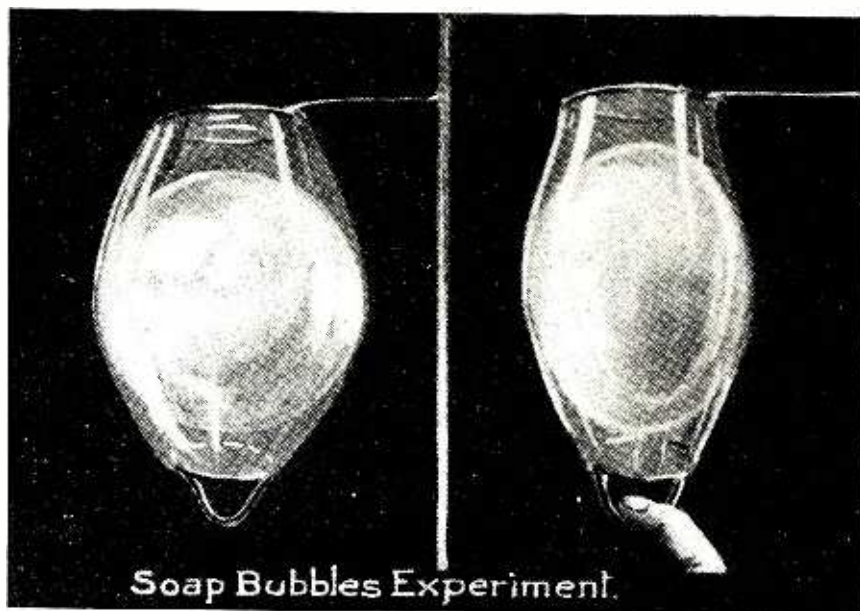

AN EXPERIMENT WITH SOAP BUBBLES

FIGURE 3: *Here is a soap bubble blown within another bubble. So long as the drop of water on the bottom of the inside bubble does not touch the outer bubble, the two will not coalesce, even though the outside bubble is distorted as shown.*

give each molecule as many neighbors as possible. Any separate portion of a liquid, therefore, tries to gather itself into a sphere. So raindrops try to become round, and so do drops of molten lead as they fall in a shot-tower. Mercury gathers itself into drops when it is spilled upon the table, and the smaller the drops the more nearly they approach to the spherical. The liquid behaves as if it had an outside layer which resisted being stretched; it has to have the

smallest possible amount of surface. This is very well seen in an experiment with the liquid toluidine. The dark-looking liquid, toluidine, does not mix with water, and its density is such that it floats conveniently in the middle of a vessel containing a layer of pure water riding on a layer of salt water. The liquid gathers itself together into a large drop, which takes a spherical form. If disturbed by a glass rod it wobbles heavily through a variety of remarkable shapes.

When a glass plate is forced to the bottom of the mercury in a dish, it does not rise again—in fact, it requires considerable force to release it. The reason is that the mercury will not make its way under the plate, because in doing so its atoms must be spread out, against their desire to herd together.

Very interesting cases arise when certain molecules are put into water—as, for example, when we make a soap solution.

In soap there are many molecules of a very peculiar form, which we shall be able to examine more closely when we come to consider the action of X rays.

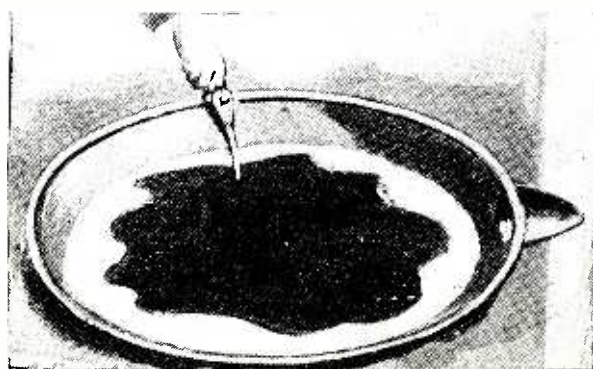

HOW OIL CLEARS THE WATER OF POWDER

FIGURE 4: *A few drops of oil dropped upon the surface of water covered with powder will instantly cause the powder to arrange itself outside of the rim of oil.*

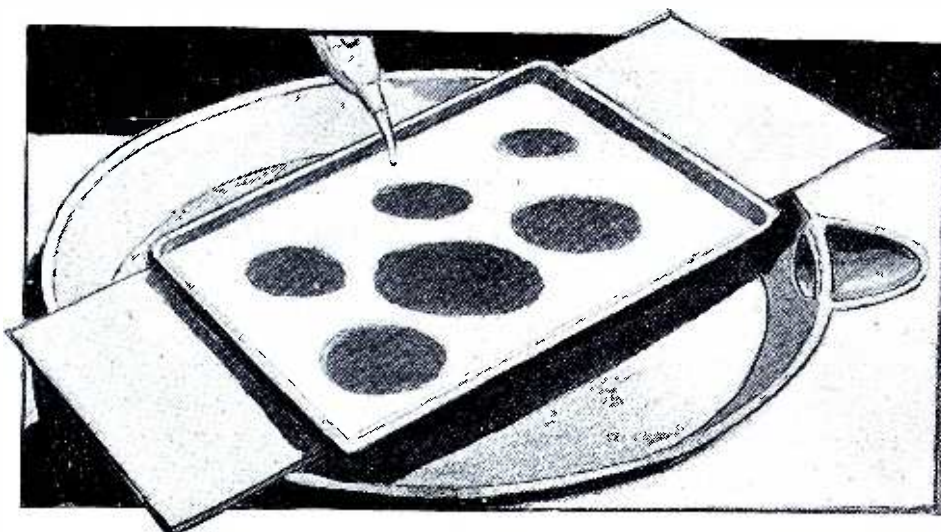

THE AREA OF A DROP OF OIL ON WATER

FIGURE 5: *When drops of oil are put upon water covered with powder, small circles are cleared; the sizes show how much of a layer one-molecule-thick can be covered by the oil that is put on.*

Their length is very long compared to their width. The central part is a zigzag chain of carbon atoms, and at each end there are what we may call finials, consisting of certain special atomic groups. One of the finials has a strong attraction for water, and the other has not. The consequence is that, whenever these molecules arrive at the surface of the soapy water in the course of their wanderings, they take up an arrangement in which that finial which has the attraction for water is directed inwards, and the other finial is on the outside.

However, the molecules have a certain attraction for each other which prompts them to line up side by side. The consequence is that a special film of these molecules forms all over the water, the molecules standing at right angles to the water surface in which they are rooted. It reminds one of a row of policemen linked arm in arm to hold back a crowd. Such a film resists rupture, and may exert remarkable powers of holding together its content of water and soap. We use this principle whenever we blow a soap-bubble; the thin wall of the bubble has a film both inside and out, and when we stretch the bubble, more of the molecules slip

out of the liquid and take their places in these films.

Some years ago Mr. C. V. Boys showed in a lecture-room a long series of beautiful experiments on soap-bubbles. In one of them, which is illustrated in Figure 3, he blew one soap-bubble inside another, and, withdrawing his pipe, allowed the second to rest gently within the first. He showed that at first it was necessary to extend the outer bubble by attaching a small weight at the bottom, in the manner shown in the figure. There is then a circle of contact between the two bubbles; the drop on the bottom of the inside bubble does not come into contact with the outer. If it did there would be a col-

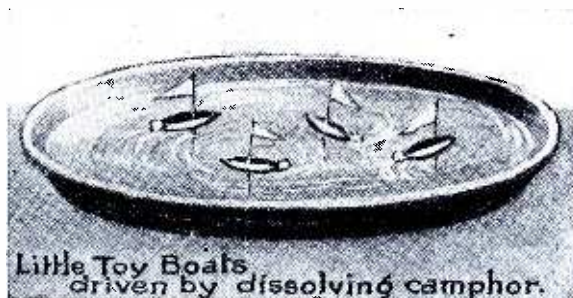

BOATS DRIVEN BY CAMPHOR

FIGURE 6: *A small lump of camphor fastened to the stern of a miniature boat propels it slowly through the water, due to the chemical action.*

“The Atom and the Nature of Things”

SIR WILLIAM BRAGG is a pastmaster in the art of expounding the mysteries and wonders of science to popular audiences, and his lectures at the Royal Institution in England fascinated his hearers, both young and old. He has written for POPULAR RADIO special abridgments of the six lectures, the first two of which—on “The Atoms of Which Things Are Made” and “The Nature of Gases”—were published in our issues of August and September respectively. The next article will treat of “The Nature of Crystals: the Diamond.”

lapse, because the two bubbles would actually join together and try to become one bubble. These things may be explained by referring to the peculiar arrangement of the long chain molecules. The outside is in each case a sheet of the finials which have so little attraction for water—and, indeed, for each other. Consequently, when two bubbles seem to touch, the outside sheet of one has no attraction for the outside sheet of the other and there is no desire to coalesce. One bubble can be pressed against the other without harm, or rest on the other, as in the illustration. But the drop of water would form a link. When it is carefully drained away, there is no longer any need to pull the outer bubble out of shape.

If we put a drop of oil on water, the long chain molecules of the oil at once arrange themselves side by side on the outside of the water, one end of the molecule rooted in the water and the other in the air. The action is extraordinarily prompt. If the surface of a sheet of water (Figure 4) is covered with

a powder, and a little oil is allowed to fall on it, the surface is cleared at once. When a very minute quantity is put on to the water a small circle is cleared, the size of which shows how much of a layer one-molecule-thick can be covered by the amount of oil put on (Figure 5). When camphor is dissolved in water, the solution spreads at once, and in so doing exerts a back pressure on the fragment of camphor. Hence the wriggings and twistings of the fragments of camphor thrown on water—a very old experiment. A little lump of camphor fastened to the stem of a miniature boat propels it slowly across the water; in the experiment illustrated in Figure 6 a small flotilla went through various evolutions.

An oil film seems to offer no opportunity to the wind to raise waves. The air blast in Figure 7 (a vacuum cleaner used as a blower) caused a series of ripples to run along the tank, which were stilled at once when a drop of oil was let fall. When the oil film had been blown away the ripples began again.

OIL QUIETS TROUBLED WATERS

FIGURE 7: *Anyone may test the trick long known to mariners, of dropping oil on waters that are disturbed by wind that, in the case of a miniature tank, may be applied as shown in this picture.*

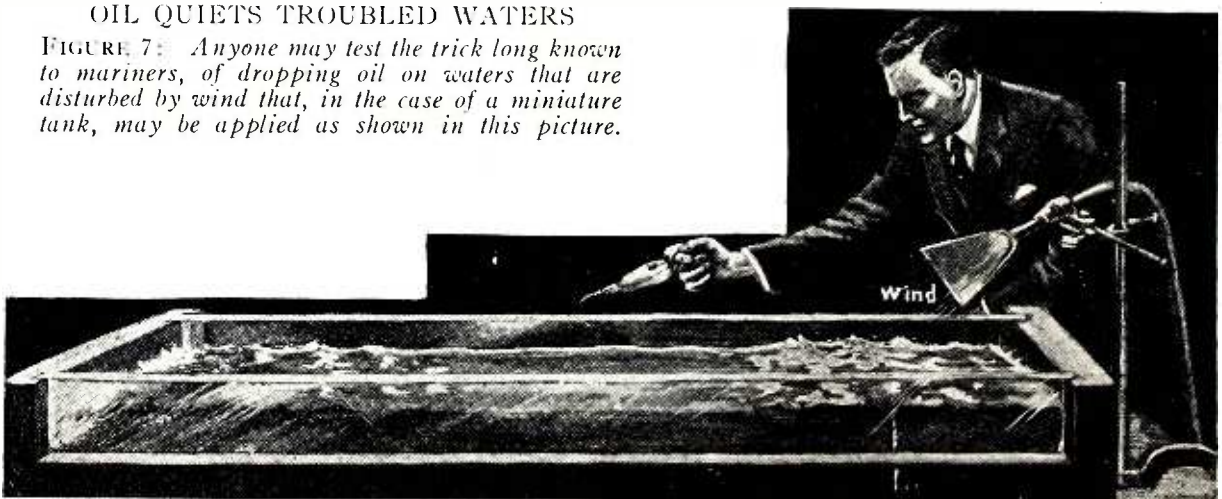

Handy Tools for Radio Fans: No. 8

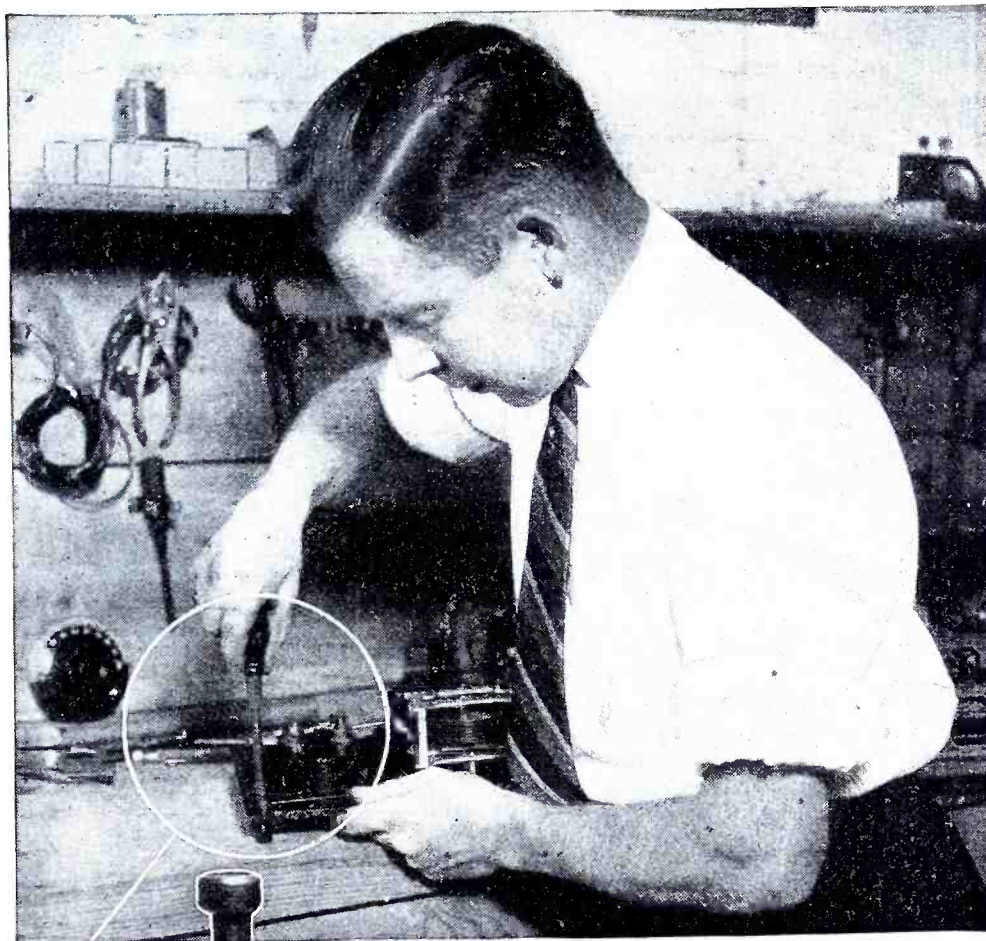

From a photograph made for POPULAR RADIO

THE SOCKET WRENCH

A useful device for tightening nuts

WHERE it is necessary to tighten bolts and nuts of various sizes in a radio set—especially where it is impossible to use an ordinary wrench—the socket type of wrench as shown in this picture is extremely handy.

The wrench is made up similar in appearance to a screw-driver. But it contains a socket for either hexagon or round nuts. This is a useful tool for the amateur experimenter and set builder to have on hand for keeping all the terminals in his set secure and tight to insure good connections. Many times the trouble in a receiving set is through faulty terminal contacts due to loose threads on the screws or bolts that make connections.

The preceding suggestions in this series were SIDE-CUTTING PLIERS, SCREW-DRIVERS, THE HYDROMETER, THE BATTERY-TESTING VOLTMETER, THE FILE, THE JACK KNIFE and THE ELECTRIC SOLDERING IRON.



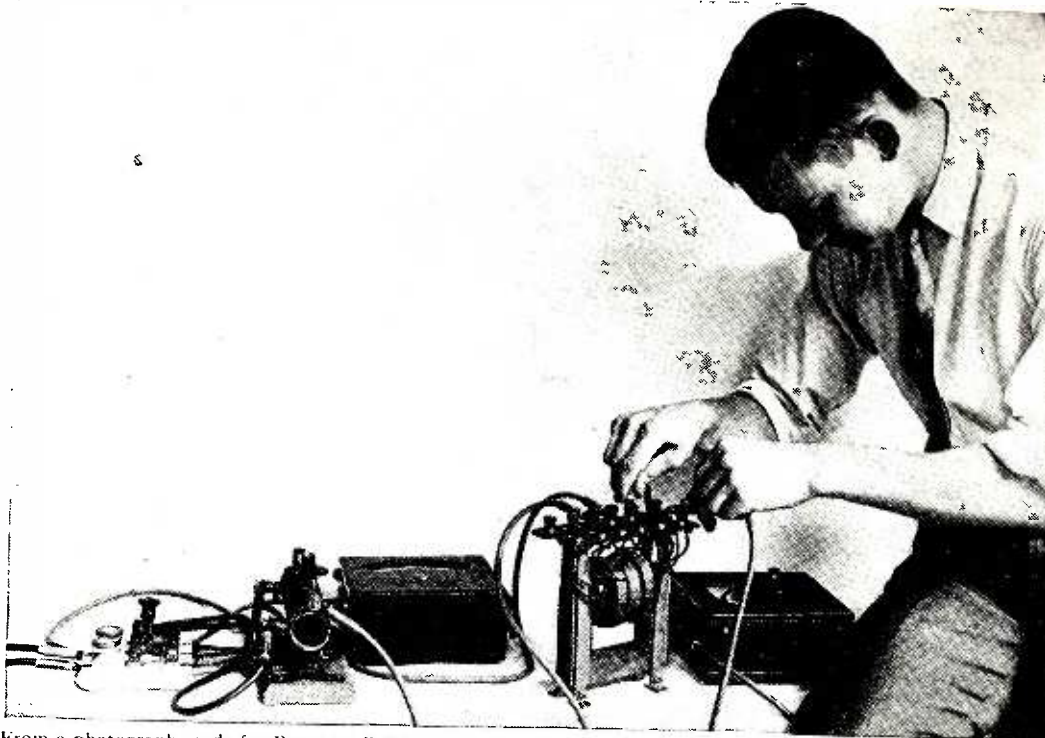

From a photograph made for POPULAR RADIO

TESTING THE FINISHED TRANSFORMER

The electrical characteristics may be checked up with a voltmeter and an ammeter before it is placed in actual service—as the author is here doing.

PRACTICAL POINTERS ABOUT TRANSFORMERS

What they are, how they work, and how they are designed and built—together with construction details for the radio experimenter.

By F. E. NIMMCKE, E.E.

THE day is fast approaching when the "A" and "B" batteries will no longer be used in connection with radio sets. Where the house current is available, there the required voltages to operate the set will be obtained by plugging into the light socket just as though it were an ordinary household appliance.

Direct current and alternating current are conveniently adapted to radio purposes because of the small amount used and the small maintenance cost of the necessary equipment. Several articles describing the construction of "A"

and "B" eliminators and storage battery charging devices using alternating current have appeared in print; in conjunction with these devices, transformers are used either to step up or step down the supply voltage. This flexibility of alternating current facilitates its use.

In the printed articles on the subject, the types of transformers used are usually of a specified make; they are not designed or constructed. Yet the radio enthusiast would get as much pleasure out of designing and constructing a transformer as he would in making a

set. The lack of knowledge as to what it does, how it is designed, and how it is constructed, is his greatest drawback.

In this article is given the necessary data to design and construct transformers for voltages and capacities that are ordinarily encountered in radio work. The mathematical complexities have been reduced to the simplest forms requiring only a good knowledge of arithmetic.

Before proceeding with the design of a transformer, it is well to give a brief theory of its operation:

A transformer is an alternating current device which converts electrical energy at one potential to energy at a higher or lower potential. It consists chiefly of three parts:

- (a) The iron core;
- (b) The primary winding;
- (c) The secondary winding.

The iron core is the magnetic link between the primary and secondary windings and forms a low resistance path for the magnetic lines of force. The primary winding receives energy from the supply line, while the secondary winding receives the induced energy and delivers it to the secondary external circuit.

The operation of the transformer depends upon the theory of mutual induction. When an alternating voltage is impressed upon the primary winding of a transformer, an alternating current flows. At no load (that is, with the secondary disconnected from its external circuit), one component of this current known as the "magnetizing component" sets up a magnetic field or flux about the primary winding. This flux, by virtue of self-inductance, sets up in the primary winding a counter voltage which is nearly equal to the impressed voltage. The difference between the impressed voltage and the counter voltage is known as the effective voltage, as it causes the primary current to flow.

This flux about the primary winding and through the iron core also cuts the turns on the secondary winding thereby inducing in it a voltage. In rotating

machinery, such as an alternating current generator, the conductors or turns cut a stationary flux, whereas in the transformer the flux cuts the stationary conductors producing the same result. When the secondary winding is connected to an external load, such as the filaments of vacuum tubes, a current will flow in the secondary winding. This current creates a flux opposite to the primary flux, as shown in Figure 1.

The secondary flux tends to decrease slightly the primary flux, and in so doing it reduces the counter voltage, thereby increasing the effective voltage and hence more current flows in the primary. This operation is automatic and depends upon the secondary load. The tendency of this action is to maintain the primary flux and the primary counter voltage practically constant.

The voltage induced in the secondary will depend upon the number of turns that are cut by the primary flux. That is to say, if the primary has 100 turns and the secondary 10 turns, then 100 volts impressed upon the primary would give a result of 10 volts at the secondary terminals. This is a "step-down" transformer and shows that the voltages of the primary and secondary are directly proportional to the number of turns in the windings. If this same transformer is used again, but this time the 10-turn winding is the primary and has

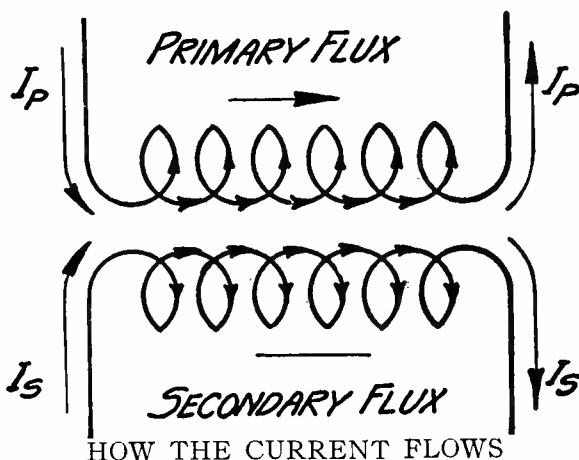

FIGURE 1: This drawing shows how the current in the primary sets up a current in the secondary of the same frequency, but of a voltage depending on the turns ratio.

impressed upon it 10 volts, then 100 volts would result at the terminals of the 100-turn or secondary winding. This is a "step-up" transformer. The ratio of the secondary voltage to the primary voltage is known as "the ratio of transformation" and may be expressed by r .

$r = \text{secondary voltage/primary voltage}$. (1) If r is greater than 1, it is a step-up transformer; and if r is less than 1, it is a step-down transformer. The primary side of a transformer is that side to which the voltage is applied; it may have a large or a small number of turns—this is irrelative to the term "primary." The secondary side is that side to which the output load is connected.

In general there are two classes of iron-core transformers:

- (1) The core type;
- (2) The shell type.

The chief distinction between these two types is the arrangement of the coils with respect to the core. In the core type the iron core is embedded in the coils and the external surface of the coils is exposed throughout, while in the shell type the coils are partly embedded in the iron core which forms a shell around them. The two types are shown in Figure 2.

The simpler of the two for amateur construction is the core type. As single

phase alternating current is commonly used in house lighting from which radio sets are operated, this article will deal with single phase core type transformers.

In design work the designer must use his judgment as to the application of theory to practice. Many design values are assumed and the calculated results must be adjusted to make the construction practical. The design procedure following is self-explanatory, and with a little judgment on the part of the designer, excellent results will be obtained.

Before the actual design is started, the requirements or specifications of the transformer must be known. These are:

- (1) The capacity or output of the transformer;
- (2) The frequency of the supply voltage;
- (3) The primary or supply voltage;
- (4) The desired secondary or output voltage.

To facilitate design calculations, the output is assumed to equal the input, since the losses in a transformer are very small.

The output of the transformer is calculated from the current that must be supplied by the secondary, and from the desired secondary voltage. It is the product of the voltage and current expressed in volt-amperes.

$$P = E \times I \quad (2)$$

where P is the output in volt-amperes,

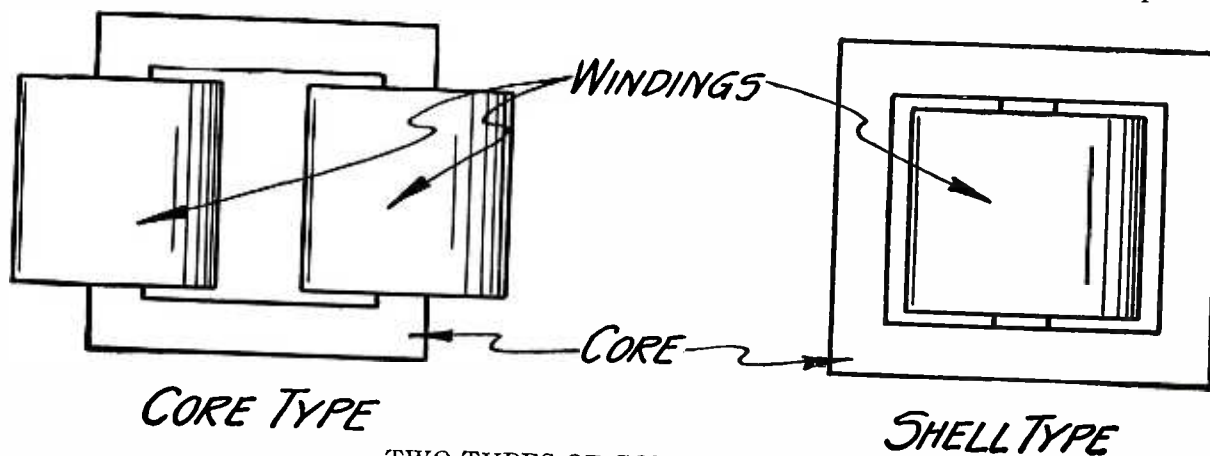

TWO TYPES OF CONSTRUCTION

FIGURE 2: At the left is shown the regular square core type of transformer with the primary and secondary coils wound on opposite legs. At the right is the shell type, in which two legs of the core surround the primary and secondary windings which are both wound one over the other on the middle leg.

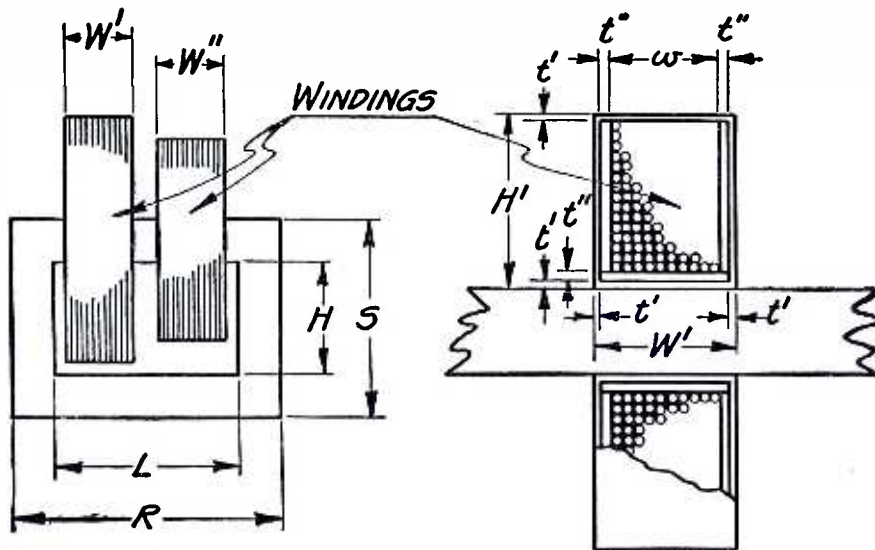

THE GENERAL DESIGN OF THE WINDINGS

FIGURE 3: These drawings give the general designations for the various dimensions of the coils to be figured, and the design for mounting the coils on the core.

E is the secondary voltage, and I is the output current. If the transformer is to light the filament of, say, 3 UV = 201-a tubes, then the required transformer capacity is as follows: Each tube draws 0.25 ampere at 5 volts, hence the total current is $3 \times 0.25 = 0.75$ ampere at 5 volts; therefore, the output is $5 \times 0.75 = 3.75$ volt-amperes. The input also is 3.75 volt-amperes. Assuming that the supply voltage is 110 at a frequency of 60 cycles, then the primary current is the input divided by the supply voltage, or $P/E - 3.75/110 = 0.034$ ampere. The values known thus far are: primary and secondary voltages, primary and secondary currents.

The next step is to determine the number of turns from the general formula

$$N = \frac{E \times 10^8}{4.44 B A F} \quad (3)$$

where N is the number of primary turns, E the primary voltage, B is the flux density or magnetic lines of force per square inch of core area, A is the net core area in square inches, F is the frequency of the supply voltage, 4.44 and 10^8 are constants. The constant 10^8 is expressed as 100,000,000. The primary voltage is known. The flux density, B, is assumed from values ranging from

50,000 to 80,000 lines per square inch of core area, a good average is 60,000 lines per square inch. The core cross-section for this type of transformer may be assumed from areas ranging from 0.5625 to 2.25 square inches. The net area, A, is obtained by multiplying the assumed area by 0.9 (for 0.014 inch iron) which makes allowances for oxide coating or other insulating material placed between the core punchings. It is convenient to use square cores which facilitate not only the construction but also the winding of the coils. For instance, a core area of 0.5625 sq. in. will mean a core 0.75 inch wide and 0.75 inch deep. In order not to have an excessive number of turns, the values of B and A should be large, yet within the above limits. Here again the designer must use his judgment.

To determine N, the known values and the assumed values are substituted in formula (3). The known values in the example are:

$$E = 110; F = 60.$$

The assumed values are:

$$B = 60,000; A = 1.56 \times 0.9 = 1.40$$

hence,

$$N = \frac{110 \times 100,000,000}{4.44 \times 60,000 \times 1.40 \times 60} = 491.5 \text{ turns}$$

Since a half turn is inconvenient, the number of primary turns are 492. The secondary turns are determined by multiplying the primary turns by the transformation ratio obtained from formula (1). In this example $r = 5/110 = 0.045$. Multiplying 492 by 0.045 there results 22.14 turns. Adjusting the primary turns to 500 and the secondary turns to 24, the ratio will be $24/500 = 0.048$. This ratio will give a secondary voltage of $110 \times 0.048 = 5.28$. This is satisfactory because it is better to have the voltage a little higher than too low.

The size of wire to be used is next determined. The current density which is the amperes per square inch of copper cross-section, may range, for this small type of transformer, from 1,200 to 2,500 amperes. The size of wire best suited for radio work ranges from No. 18 B.S. Gage to No. 28 B.S. Gage D.C.C. Either No. 22 or No. 24 B.S. Gage wire can be used for the filament current winding, depending upon the number of tubes, whereas No. 26 or No. 28 B. S. Gage wire can be used for the plate current and primary windings. Of course smaller wire could be used but the mechanical strength must also be considered. The size of wire for each winding can be determined by dividing the current in the winding by the copper

cross-sectional area in square inches of the wire. The formula is

$$D = \frac{I_w}{A_w} \text{ amperes} \quad (4)$$

where D is the current density, I_w the current in the winding, and A_w is the cross-sectional area of the wire. The value of D must lie within the limits stated. In the example, let the primary consist of 500 turns of No. 26 B.S. Gage D.C.C. wire and the secondary of No. 24 B.S. Gage D.C.C. wire, then the current densities are

$$D_p = \frac{0.034}{0.000201} = 169 \text{ amperes}$$

$$D_s = \frac{0.75}{0.000314} = 2,388 \text{ amperes}$$

The high secondary current density is permissible because of the comparatively few turns in the winding.

The last item to be determined is the size of the iron core punching. This punching should be of the "L" shape because of the ease with which the core can be assembled. The primary and secondary windings should be arranged according to layers and turns per layer. If the primary or secondary winding has a very large number of turns, it is best to split the total number

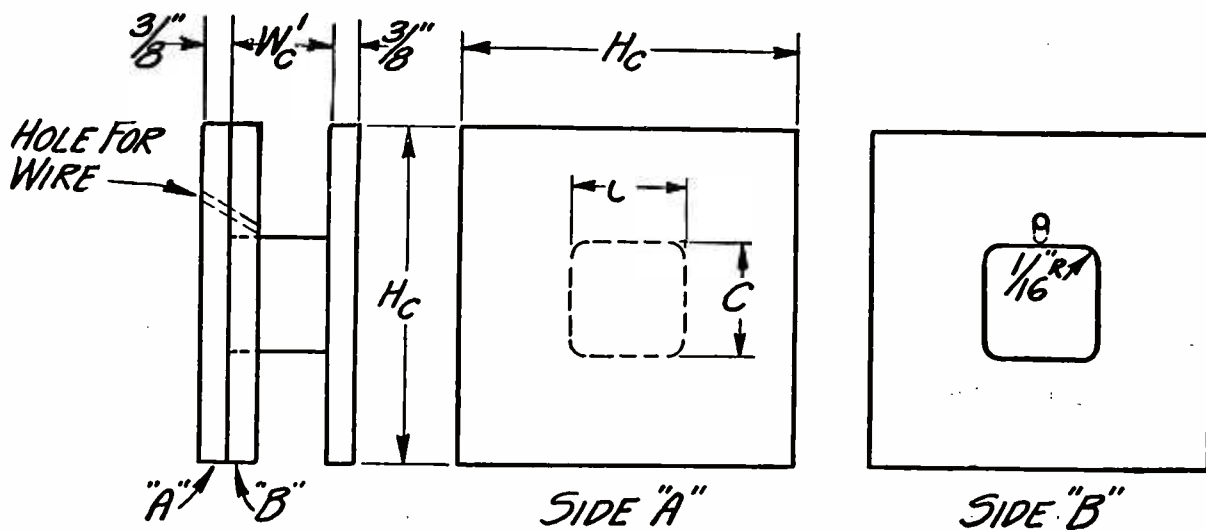

THE DIMENSIONS OF THE WINDING FORMS

FIGURE 4: By referring to the figures given here and the designations that are explained in the text, a proper size for the transformer-coil forms may be determined for any small experimental transformer.

of turns into two coils each having the same number. All coils are of the "pancake" type because they are easily wound, insulated and assembled. In the example, the primary winding of 500 turns may be arranged in 25 layers with 20 turns per layer; the secondary winding of 24 turns may be arranged in 4 layers with 6 turns per layer.

When the coils have been arranged, then allowances for insulation between turns, between coils, between coils and the core, between coil ends and the core, and for the clearances in construction work, must be made.

Referring to Figure 3, the procedure is easily followed. Let N represent the number of turns per layer, n the number of layers, and d the diameter of the wire in inches over the insulation, which is found in the B.S. Gage Wire Table, then the width, w , of the coil is

$$w = N \times d \text{ inches} \quad (5)$$

If t' is the thickness in inches of the linen tape, and t'' the thickness of the fiber insulation, then the total width, W' , is

$$W' = w + 2t' + 2t'' \text{ inches} \quad (6)$$

The value of t' varies from 0.005 to 0.008 inch, and that of t'' from 1/32 to 1/16 inch.

Letting the letters represent the same as above and 0.125 inch for construction clearance, then the height, H' , of the coil in inches is

$$H' = n \times d + 2t' + 2t'' + 0.125 \quad (7)$$

Applying the values of the preceding example to formulas (5), (6) and (7), there results

$$\begin{aligned} w &= 20 \times 0.024 = 0.48 \text{ inch} \\ W' &= 0.48 + 0.01 + 0.0625 = 0.5525 \text{ inch} \\ H' &= 25 \times 0.024 + 0.01 + 0.03125 + 0.125 \\ &= 0.76625 \text{ inch} \end{aligned}$$

Similarly the dimensions of the secondary coil are computed.

$$\begin{aligned} w &= 6 \times 0.028 = 0.168 \text{ inch} \\ W'' &= 0.168 + 0.01 + 0.0625 = 0.2405 \text{ inch} \\ H'' &= 4 \times 0.028 + 0.01 + 0.03125 + 0.125 \\ &= 0.27825 \text{ inch} \end{aligned}$$

Allowing 1/16 inch between coils and 1/8 inch on each end for clearance, then the length, L , of the core opening is the sum of the total widths of all the

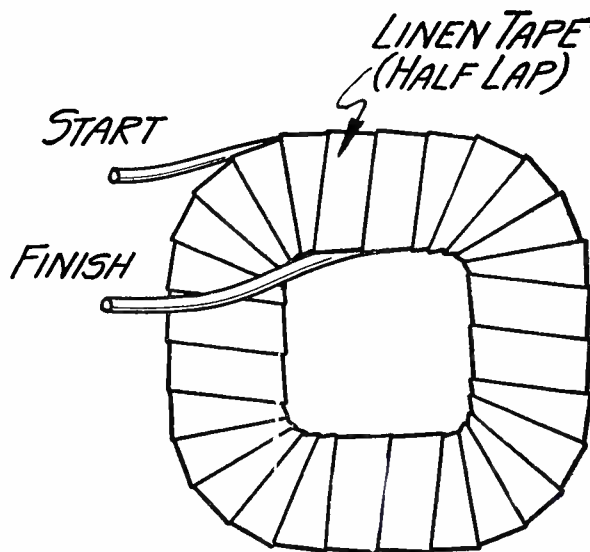

WRAPPING THE COIL

FIGURE 5: This diagram shows how the coil should be wrapped with tape when it is completed.

coils plus allowance between coils plus twice the clearance at each end, or

$$L = W' + W'' + 0.0625 + 2 \times 0.125 \text{ inches} \quad (8)$$

The width, H , of the core opening is the largest value of the height of the coils obtained by formula (7) plus 1/8 inch for clearance, thus

$$H = H' + 0.125 \text{ inches} \quad (9)$$

If a is the width of the core punching, then the length, R , of the long leg of the punching is the length L plus twice the core width, thus

$$R = L + 2 \times a \text{ inches} \quad (10)$$

The length, S , of the short leg of the punching is the width H plus the core width, thus

$$S = H + a \text{ inches} \quad (11)$$

The thickness of the core punching is 14 mils (0.014 inch) for frequencies from 50 to 100 cycles, and 20 to 40 mils (0.020 to 0.040 inch) for frequencies below 50 cycles. The number of core punchings required is determined by dividing the depth of the core by the thickness of the punching and multiplying the quotient by 2 since two punchings are required to form a closed core. The formula is

$$N_p = 2 \times a / t_p \quad (12)$$

where a is the core depth which in a

square core is equal to the width, and t_p is the thickness of the punching in inches. An addition of a few punchings should be made to the value obtained by formula (12).

Substituting the values of the example in formulas (8), (9), (10), (11) and (12), there results

$$L = 0.5525 + 0.2405 + 0.0625 + 0.25 = 1.1055 \text{ inch}$$

$$H = 0.76625 + 0.125 = 0.89125 \text{ inch}$$

$$R = 1.1055 + 2 \times 1.25 = 3.6055 \text{ inch (3}\frac{5}{8} \text{ inches)}$$

$$S = 0.89125 + 1.25 = 2.14125 \text{ inch (2 } \frac{9}{64} \text{ inches)}$$

$$N_p = 2 \times 1.25 / 0.014 = 179 \text{—call it 200 punchings.}$$

The width of the core in the above formulas is 1.25 inches.

The number of coils of a transformer depends upon its purpose. If it is to light the filaments of the tubes in the set, supply the "B" voltage, and also light the filaments of the rectifying tubes, then 3 or 4 coils are necessary. The output in this case is

$$P = P' + P'' + P''' \text{ volt amperes (13)}$$

where P' is the output of the filament coil for the set, P'' is the output of the "B" voltage coil, and P''' is the output of the filament coil for the rectifier. The input is determined by substituting the value of (13) in formula (2) and dividing by the supply or primary voltage.

The number of turns of the various coils is determined from the different voltage ratios using the primary or supply voltage as a common voltage to all coils.

The size of wire is determined from the current to be carried in each coil as illustrated by formula (4). The primary current will be equal to the total output divided by the primary voltage.

All the coils are placed on one leg of the core and the size of the punching is computed in a manner similar to that in the illustrative example.

This completes the necessary information for the construction of a transformer.

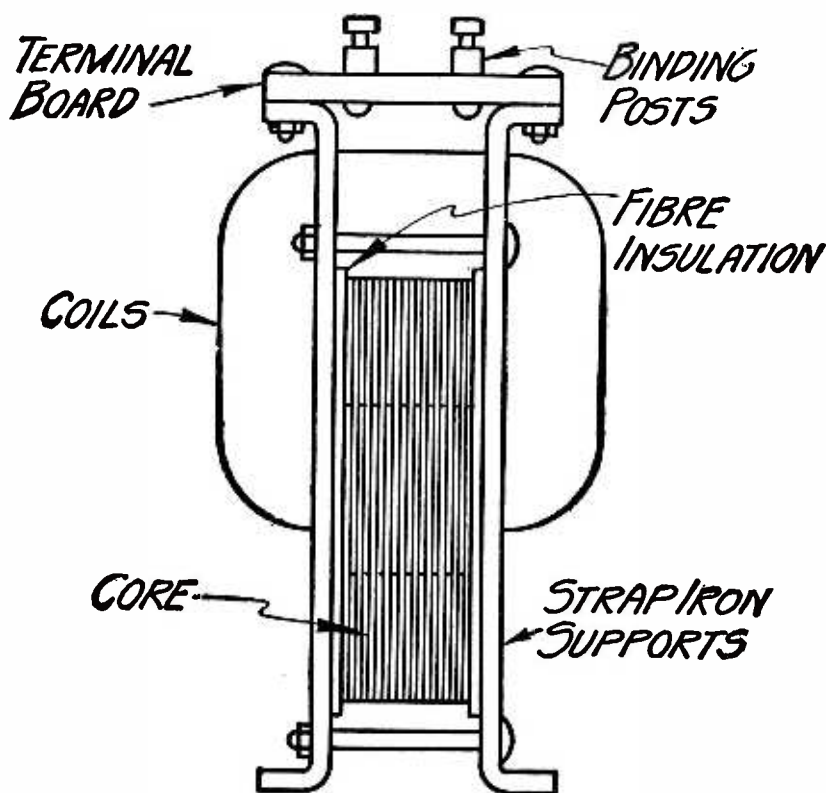

THE FINAL MOUNTING OF THE TRANSFORMER

FIGURE 6: This drawing shows how the coils are assembled on the core with the strap iron supports in place and the terminal board and binding posts attached in the proper positions.

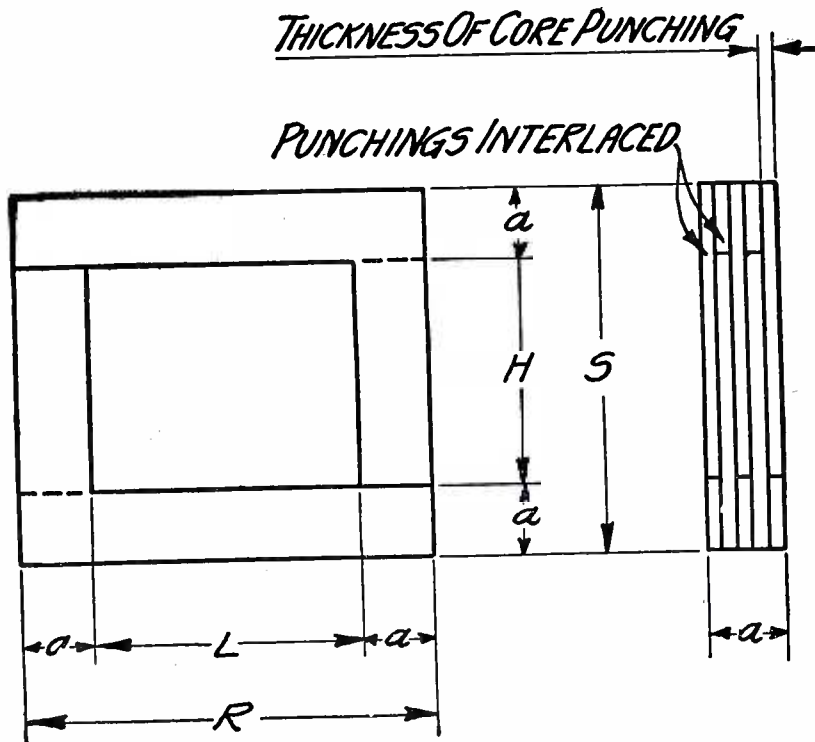

THE DIMENSIONS FOR THE CORE LAMINATIONS

FIGURE 7: How the core pieces of special iron are cut to size and assembled by interlacing with each other. The designations for the various dimensions are all explained in the article.

Before the construction of the transformer is started, the necessary material should be secured. The number of punchings, which should be silicon steel, has been determined by formula (12). The quantity of wire of the required size can be calculated from the formula

$$\text{Pounds of wire} = \frac{0.2618 \times d \times N}{F} \quad (14)$$

where d is the mean diameter of the coil in inches, N the total number of turns in the coil, and F the number of feet in one pound of wire (taken from the B.S. Gage Wire Tables). The amount of sheet fiber can be estimated by a rough calculation of the areas of coil ends, usually one square foot of 1/32 or 1/16 inch fiber will suffice. One roll of 3/4 inch linen tape will be enough to wrap all the coils. About 3 feet of 3/16 inch by 5/8 inch strap iron will do for the clamps to hold the core punchings together. The miscellaneous material consisting of machine screws and nuts, binding posts, and a terminal board, is usually found in every experimenter's shop.

The coils are wound on a constructed wooden form which serves for all coils. The sides of the form may be of soft wood while the core should be of hard wood. Referring to Figure 4, the dimensions of the form are determined as follows: The width of the core is equal to the width of the core punching plus 1/8 inch (1/16 inch on each side) for clearance. The corners of this core should be rounded as shown in the figure (about 1/16 inch radius).

$$C = a + 0.125 \text{ inches} \quad (15)$$

The two sides, one of which can be removed, thus permitting the wound coil to be taken from the form, are about 3/8 inch thick. The dimension, H_c , is equal to twice the largest value obtained by formula (7) plus the width of the wooden core plus 3/4 inch allowance. Thus

$$H_c = 2H + C + 0.75 \text{ inches} \quad (16)$$

The core and sides of the form are square. The width, W_c , is the largest width determined by formula (6). This width can be reduced to accommodate

different coil widths by using the adjustable side (B), Figure 4, which has a square hole thereby permitting it to be slipped over the wooden core. When the side (B) is used, it is fixed to side (A). The form may be mounted in a lathe or some other suitable winding device. A revolution counter should be attached to the winding device thereby assuring accurate count of the number of turns.

Before winding, the fiber ends and fiber core are adjusted in place on the form. These may be held temporarily by pieces of cord or wire which can be removed when the first layer of wire has been wound. The coil is started by inserting the end of the wire (leaving enough for connections) through a hole in one side of the form. The initial reading of the counter is noted. The wire is fed under slight tension to the form which revolves at a speed convenient for the winder. The layers should be carefully wound so as to produce a neat compact coil. A coat of shellac may be applied after each second or third layer, and when the required number of turns have been completed, as indicated by the final figures of the counter, the coil is given a thorough coat of shellac and permitted to dry. The coil is then removed from the form and taped half-lap with linen tape, as shown in Figure 5. The finished coil is shellaced and then baked. The terminals of "start" and "finish" on the coil should be indicated. This is important if two coils are to be connected in series to

increase the voltage; the direction of the turns in each coil must be the same.

The winding form is put together again with the fiber ends and core in place for the next coil. Each coil is taped, shellaced and baked. If it is desirable to wind a small coil, the side (B) is adapted as previously described.

The clamps that hold the core punchings together are made to serve as supports for the transformer and the terminal board. The clamps are made of strap iron and the dimensions are determined from the overall dimensions of the iron core and the top of the coils plus a clearance of about $\frac{1}{2}$ inch for the terminal board, Figure 6. Ordinary machine screws and nuts may be used as bolts to tighten the clamps.

When the finished coils are arranged in an order such as shown in Figure 3, the punchings are fed from both sides through the opening in the coils. This leg is first built up and then the closing leg is sandwiched in. The core punchings are interlaced as shown in Figure 7. The completed core is squared up by tapping the punchings with a block of wood. The clamps, insulated from the iron core by fiber strips, are put in place and tightened up. The terminal board with binding posts is then mounted on the clamp supports, and the coil ends are connected to the binding posts.

This completes the transformer. The various coil voltages should be checked with an A.C. voltmeter before any connections to the set are made.

What Every Radio Experimenter Should Know About Condensers

IN POPULAR RADIO for next month—December—will appear an article by Mr. Sylvan Harris that will give the reader some valuable but little known data about variable condensers, and particularly about the "low-loss" fallacies as applied to this type of instrument.



Kadel & Herbert

TUNING AN ANTENNA INDUCTANCE

Here is a large transmitting inductance as used in the experimental radio-telephone transmitter at the College of the City of New York. In order to tune the transmitter to a certain wavelength, the man in the picture cuts in or out turns of the coil until the antenna ammeter before him indicates the maximum amount of current flowing in the antenna circuit.

Multi-layer Coils

Article No. 14

Useful data about coil construction that insure maximum inductance and minimum resistance and capacity

By SIR OLIVER LODGE, F.R.S., D.Sc., LL.D.

IN a previous article about interference that is caused by damping, I explained how the addition of inductance to a radio circuit prolongs oscillations and how the frequency of such a circuit can be controlled by inductance coils in which the phenomenon of damping occurs.*

It is highly important that the capacity of these inductances be kept as low as possible. To overcome the effects of capacity, coils must be wound in a par-

* "Why Damping Causes Interference," by Sir Oliver Lodge. POPULAR RADIO, vol. VI, No. 5, pages 452-456 (November, 1924).

ticular manner and upon materials, if so wound, which will not tend to increase capacity.

Furthermore, wire of the proper dimensions and of a requisite number of turns must be used to reduce capacity in inductive circuits that would otherwise fail to tune sharply in a radio receiver.

Additional calculations for the proper wire that should be used and the dimensions of coils and the number of layers required on windings will be explained here for those who are experimenting

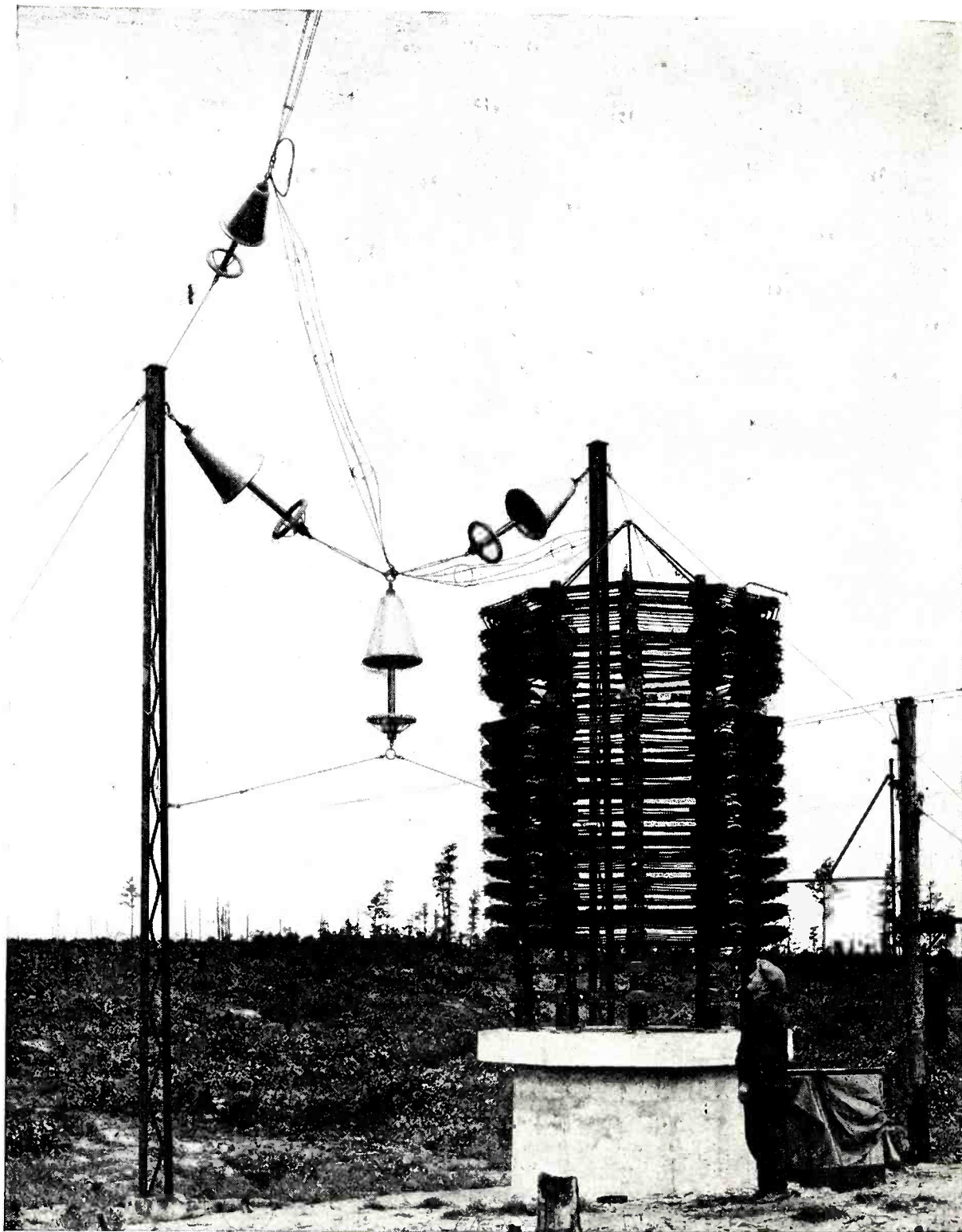

Radio Corp. of America

AN OUTDOOR TUNING INDUCTANCE OF A HIGH-POWERED
TRANSATLANTIC RADIO STATION

This massive coil is an antenna inductance at the Rocky Point radio central, located near New York. This type of inductance must be heavily insulated, as shown, and must stand clear of any neighboring objects that might lower its efficiency by drawing current from it by induction.

with the construction of inductance coils.

For coils to have the maximum value of inductance the channel for the wire should be three units square, the external diameter of the coil should be 14 units, and the internal diameter eight units. The particular "units" can be adjusted to suit the desired conditions. For instance, each "unit" might be chosen as a couple of millimeters.

Suppose the covered wire is $\frac{1}{x}$ th of such unit thick; then the number of turns in each layer of the above coil is $3x$, and there will be $3x$ layers. So the number of turns is $9x^2$. The mean diameter of the coil is 11 units, and the average length of each turn is therefore 11π or say 34 units; wherefore the total length of wire will be $34 \times 9x^2$. The inductance of a coil of this shape has already been shown, by general reasoning and calculation, to be $3nl$, being the maximum obtainable for that length of wire and therefore for that resistance and capacity. So we discover that the inductance comes out

$$L = 3nl = 8100x^4$$

of the same units of length approximately, taking 3×34 as 100. If the unit selected is, as above suggested, a couple of millimeters, and if the value of x is, say 10—both these things being arbitrary—the value of L , as thus calculated, is 1.62×10^7 millimeters, or 16.2 kilometers, or 1.62 millihenries.

The maximum deleterious or distributed capacitance of such a coil would be obtained, as above, by reckoning $\frac{rb}{T}$, which is $5.5 \times 3 \times x$ of the same unit; or, if the unit is a couple of millimeters and $n = 10$, as above, the capacitance is 330 millimeters, which is a third of a meter.* This is not too big, and is capable of reduction by basket-winding.

To reckon the resistance, we should have to know the thickness of the uncovered wire, and its conductivity; but resistance is a thing easily obtained by direct measurement, and is hardly worth pre-determination, as inductance is.

*This is approximately 37 micro-micro-farads. See appendix to Sir Oliver Lodge's article in POPULAR RADIO for September, 1923.

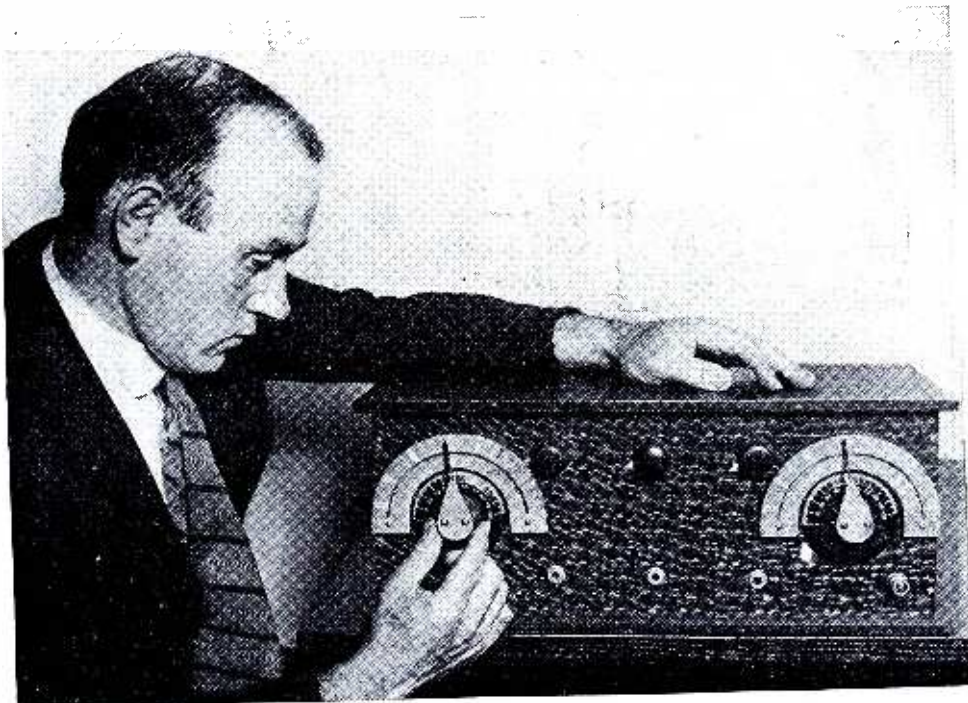

† Kadel & Herbert

A NOVEL MARKING SYSTEM FOR A RECEIVER

The picture illustrates how Mr. George Jacobson indicates, by paper markers, the dial location of each station. He notches the piece of sheet copper (shown fitted into a slot that covers the face of the calibrated dial). His indicator is attached directly to the dials.

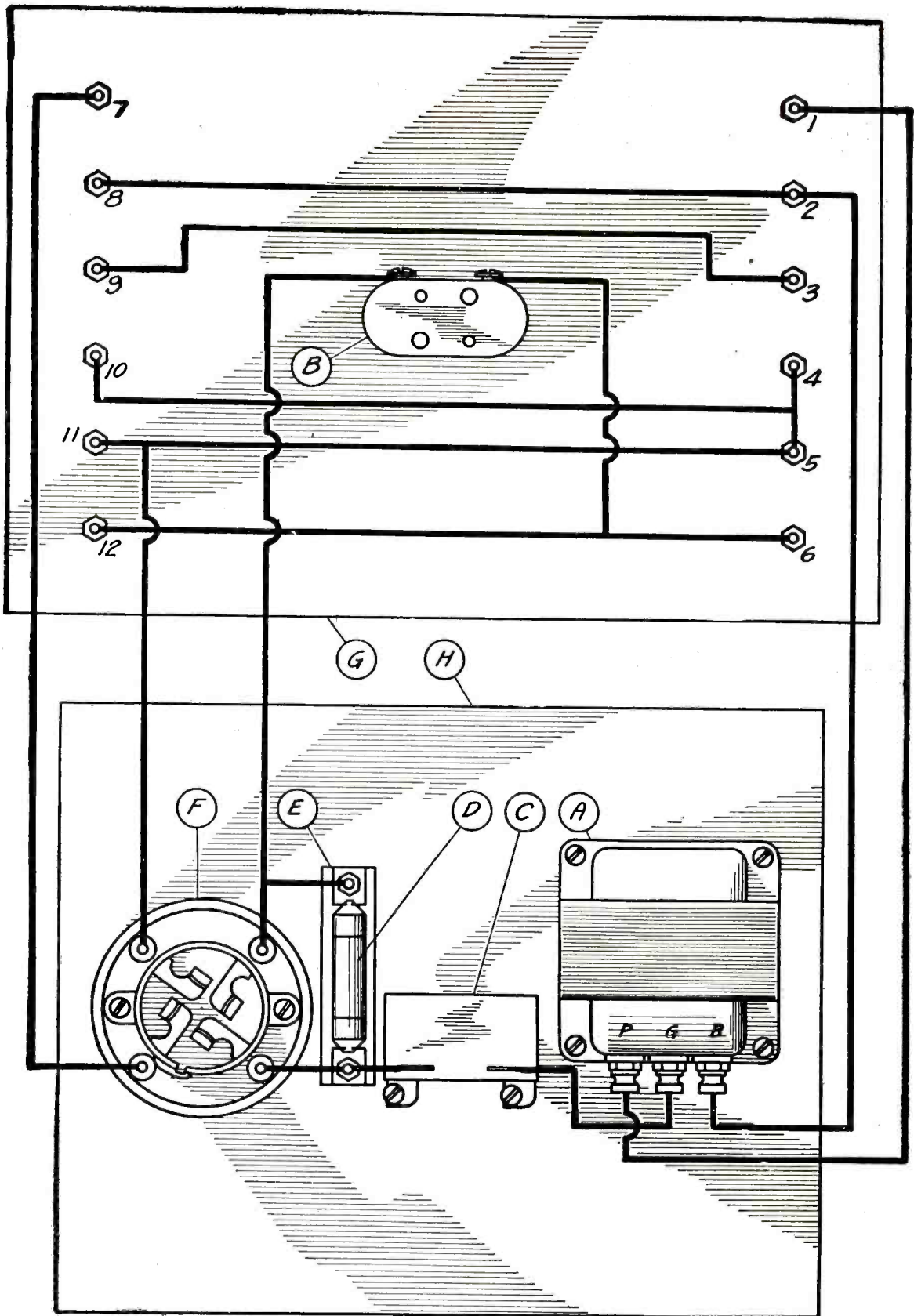

THE "PICTURE DIAGRAM" OF THE HOOK-UP

FIGURE 1: This illustration shows the exact manner in which the instruments are placed on the panel and baseboard and how the wires run in relation to them. The upper rectangle shows the back of the panel, and the lower one shows the baseboard. All the parts are lettered to correspond with the designations in the text and in the list of parts.

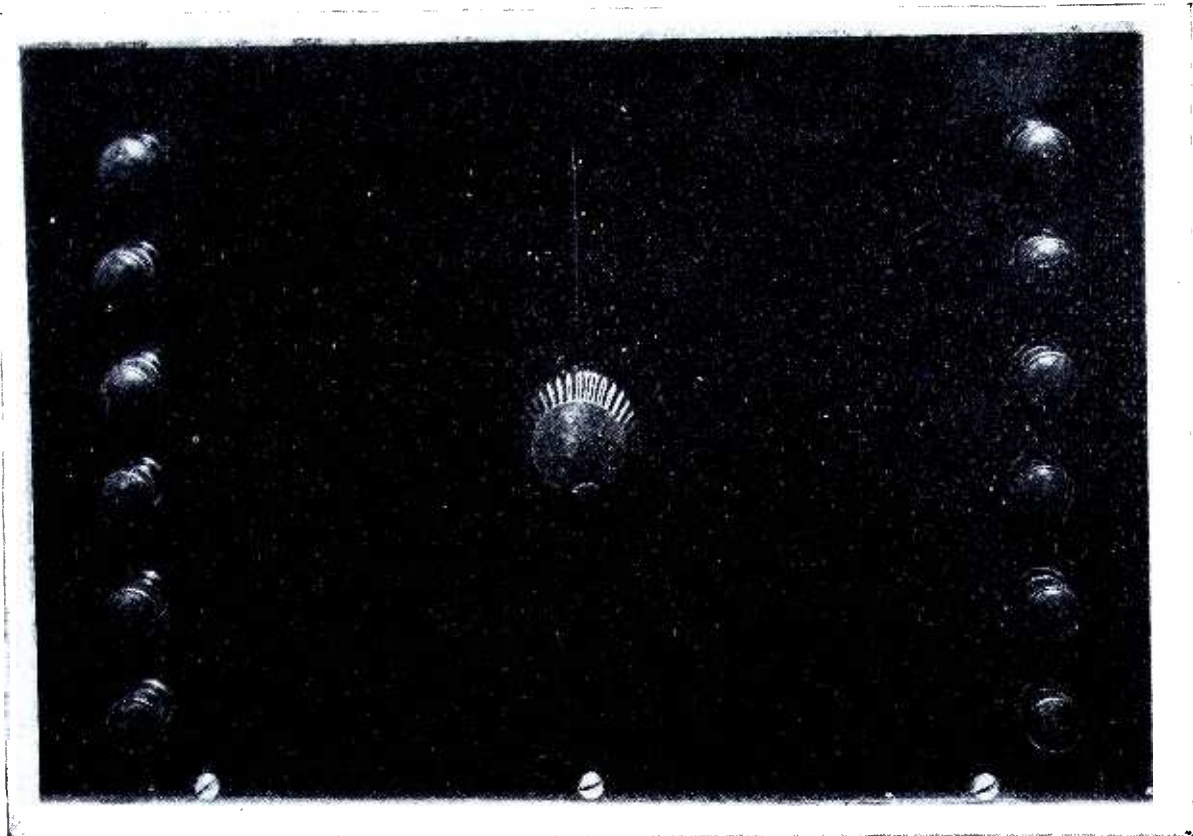

THE PANEL ARRANGEMENT

FIGURE 2: *This picture shows the front view of the panel with the rheostat mounting in the center and the binding posts in two rows, one at each end.*

Simple "How-to-Build" Articles for Beginners No. 13

*How to build a single-stage impedance-coupled amplifier
for use with a standard 6-volt tube*

By LAURENCE M. COCKADAY

COST OF PARTS: *Not more than \$13.50*

HERE ARE THE ITEMS YOU WILL NEED—

A—Thordarson autoformer;
B—Bradleystat;
C—Deutschmann bypass condenser, 1 mfd.;
D—Bradley unit resistor, 500,000 ohms;
E—Electrad resistance mounting;

F—Naald standard vacuum-tube socket;
G—composition panel, 7 inches high by 10 inches long;
H—hardwood baseboard, 7 inches by 8¾ inches; twelve binding posts.

THIS thirteenth unit of this series is a single-stage vacuum-tube audio-frequency amplifier that utilizes the principle of impedance-coupling.

This unit will be found efficient and useful for connecting to the preceding

detector or amplifier units that have been described in this series.*

This amplifier was built in the POPULAR RADIO LABORATORY for the express purpose of submitting to the amateur be-

*See POPULAR RADIO for September, 1925.

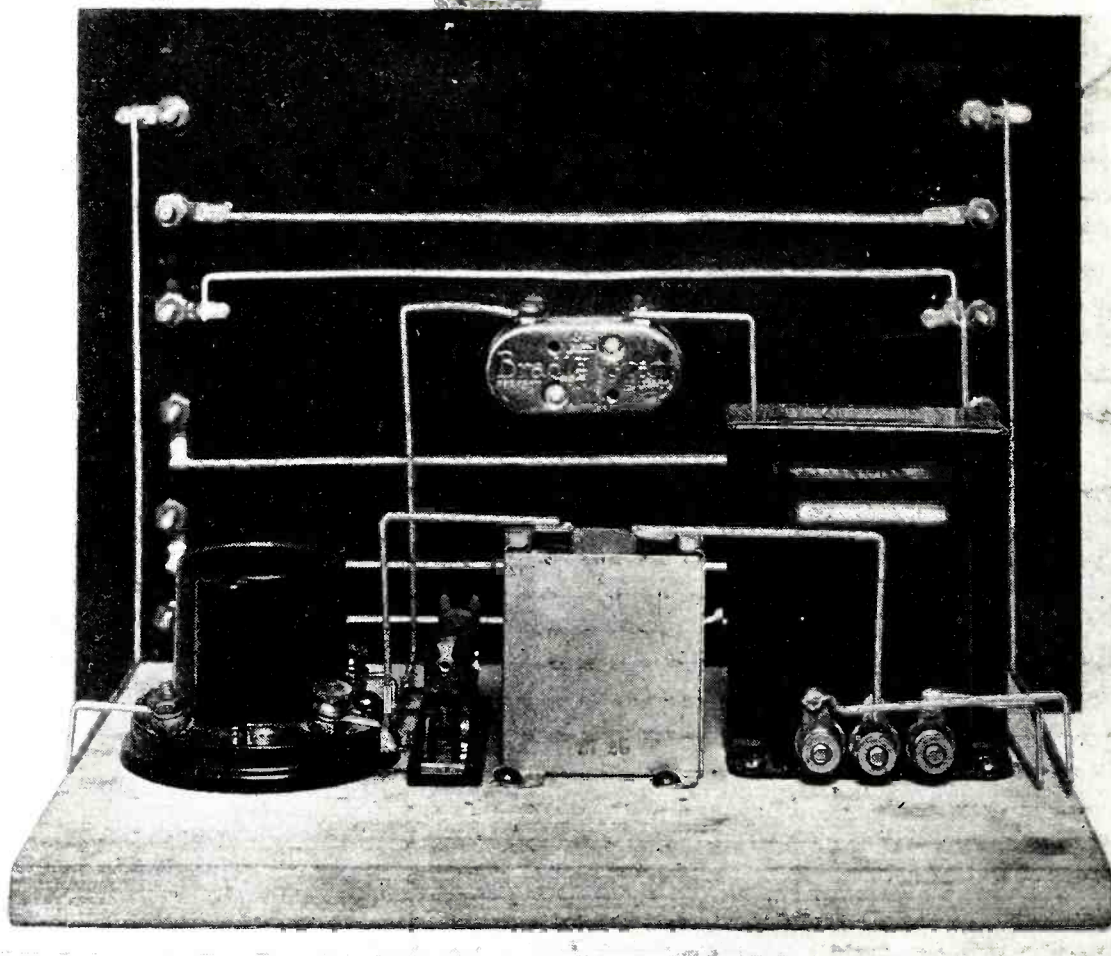

THE REAR VIEW OF THE AMPLIFIER

FIGURE 3: Study this view in connection with the picture diagram of the amplifier in Figure 1. The location and connecting points of each wire appear clearly and you can determine just how to bend the wires to get the shortest connection with the proper clearance.

ginner an impedance-coupled amplifier that will give him fine reproduction, and at the same time teach him something of the theory that is involved in impedance audio-frequency circuits.

After a decision has been reached by the prospective builder, take these pages to a radio dealer and ask him to supply you with the parts listed at the head of the article. When you have your parts ready for mounting, you may spread them out on a kitchen work-table and begin the construction of the unit.

Mount them on the panel and baseboard as shown in the picture diagram and the two other illustrations that accompany this article. These three illustrations show you exactly how to mount the instruments and also exactly where

to put the wires that connect them together in the electrical circuit.

Next, connect up the instruments in the electrical circuit as indicated specifically in the picture wiring diagram.

If you follow the directions shown there you cannot make a mistake, as the instruments are all marked with designating letters that reappear in the list of parts.

When you have finished wiring up, all you have to do is connect the telephones or loudspeaker, the batteries and the tuning unit, and you are ready to begin reception.

To connect this unit, be sure to do the following:

Place the tuning unit on the table and connect the antenna and ground:

Then, connect this amplifier alongside of it on the right-hand side by bridging across the binding posts 1, 2, 3, 4, 5 and 6 to those on the tuning unit. Binding posts 1 and 2 are the input terminals to the impedance. Binding posts 3 and 4 are the "B" battery connections, and binding posts 5 and 6 are the "A" battery terminals. Binding posts 3 and 5 are the positive terminals in each case.

Then connect the "A" battery across the terminals 11 and 12 with the positive terminal on binding post 11. Connect the "B" battery across binding posts 9 and 10 with the positive terminal on post 9. Connect the telephones or loud-speaker across posts 7 and 8.

If the tuning unit uses a "soft" detector the connection on this unit between 3 and 9 should be disconnected and the 22½-volt "B" battery tap applied to post 3. The amplifier voltage of 90

volts may then be applied across 9 and 10 as previously stated:

If this amplifier is to be used following another amplifier, however, it should be left as shown in the diagram without any change in the wiring.

Place a UV-201-a tube in the socket, F, and turn up the rheostat, B, and the unit is ready for operation.

You will find that you will obtain truthful reproduction if a good loud-speaker is used with this type of amplifier.

Do not turn up the rheostat which controls the filament current to the tube any higher than is necessary to produce sufficient volume. This will conserve the batteries and lengthen the useful life of the tube.

There are no further adjustments to be made in the operation of this simple amplifying unit.

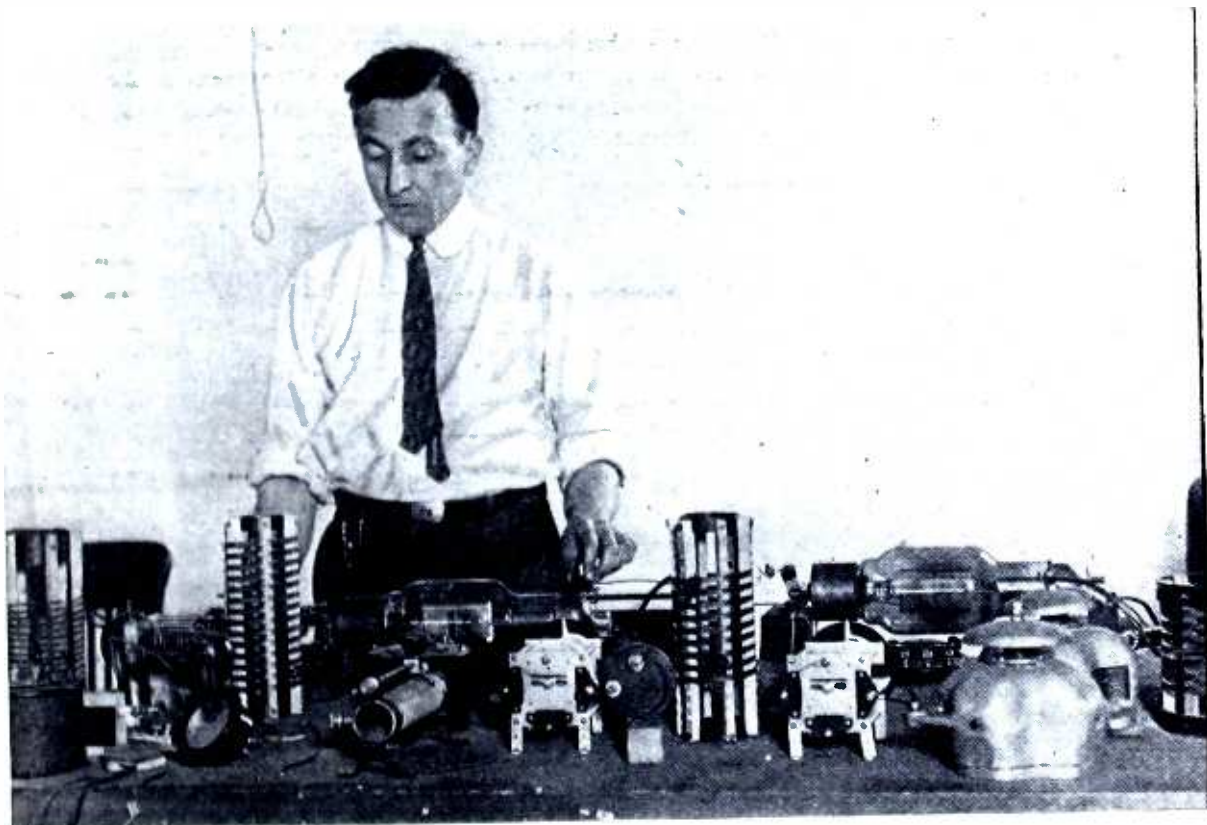

Henry Miller

A 17-METER TRANSMITTER

This experimental apparatus has been developed at the United States Naval Research Laboratory; it has been used in daylight communication with the MacMillan Arctic Expedition. Mr. R. S. Fisher, Associate Engineer of the Laboratory, is here shown making an adjustment on the transmitter at the U. S. Naval Research Laboratory at Bellevue, D. C.



IN THE WORLD'S LABORATORIES

CONDUCTED BY DR. E. E. FREE

A Liquid-filled Loudspeaker

A NOVEL idea in loudspeaker design comes from an amateur in France. He fills the inner part of the horn, where its diameter grows small toward the telephone attachment, with a liquid; for example, with water.* The small end of the horn is closed by a diaphragm which is connected to the moving part of the telephone unit. Through this diaphragm the sound waves enter the liquid. In front of the liquid is another diaphragm, to hold the liquid in place.

All sound waves coming from the telephone unit must pass through the mass of liquid before they can actuate the outer diaphragm and escape into the air. It is claimed that the liquid mass removes a great deal of "rattle," thus delivering a purer tone than is possible with ordinary horns.

Moisture Does Not Increase Coil Resistance

IN the course of some tests of different types of tuning coils carried out recently in the testing laboratories of the *Popular Science Monthly*, Mr. Thomas Vanacore obtained some rather surprising results concerning the effect of condensed moisture on the radio-frequency resistance of coils wound of number 22 insulated wire on three-inch composition tubing.† The coils were 44 turns each. One was wound with double-silk-covered wire, one with double-cotton-covered wire and one with enameled wire.

All three coils were first tested dry. They were then put for three hours in a closed box containing boiling water. Presumably the windings absorbed a considerable amount of moisture. A re-test showed no appreciable increases of resistance, even for frequencies as high as 1,500

*A note by M. Louis L'Hopitault in *Radio-Electricité* (Paris) vol. 6, page 176 (May 10, 1925).

† "Surprising Facts About Tuning Coils," by Thomas Vanacore. *Popular Science Monthly* (New York), vol. 107, number 2, pages 70 and 117 (August, 1925).

kilocycles (200 meters). The coil wound with cotton-covered wire was then dipped in water and tested again. So long as liquid water was present between the windings of the coil the resistance was nearly seven times higher than before, but so soon as the coil had dried a little its resistance returned to normal.

While these results require confirmation and extension—especially by the actual determination of the amount of moisture present in the windings at the moment of test—they establish a probability that the exposure of tuning coils to moist air is unlikely to cause enough absorption of moisture to alter appreciably the constants of the coils. This appears to be the case whether the insulating material be silk, cotton or enamel.

Why the Coated Filament Emits More Electrons

ONE of the prominent types of filament for radio vacuum tubes is the one consisting of tungsten wire coated with the oxides of barium or strontium. This coating greatly improves the electron emission and it was these coated filaments which first made possible the low-temperature filament used in the 199-type tubes and other dry-battery tubes.

A detailed study of the behavior of these coated filaments under various conditions has been made by Mr. Lewis R. Koller of the Edison Lamp Works of the General Electric Company.* He finds, among other things, that a very slight trace of oxygen in the tube decreases the electron emission enormously. Certain other gases cause increases. This means, Mr. Koller believes, that the unusually high emission of these coated filaments is not due to a film of the oxide, but to an actual film of metal—of metallic barium or strontium—into which the oxide originally added has become converted.

*"Electron Emission from Oxide Coated Filaments," by Lewis R. Koller, *Physical Review* (Corning, N. Y.), vol. 25, pages 671-676 (May, 1925).

This is believed to be true, also, of the thoriated filament, which is a filament the wire of which contains a trace of the metal thorium. This thorium comes to the surface of the filament. The layer of thorium atoms acts to increase the emission. Just why a layer of atoms of metallic thorium or barium or any other metal should behave in this way is still one of the mysteries of physical science. Doubtless it is related to the atomic structures of these metals.

Driving Sodium Atoms Through Glass

THE use of photoelectric cells for the conversion of light energy or of light-ray signals into electric energy or electric signals is growing in many fields of scientific and industrial work, including radio. Most of these photoelectric cells depend either on the element selenium or on one of the alkali metals, sodium, potassium, rubidium, caesium and lithium. Much interest attaches, therefore, to a process, recently perfected by Dr. Robert C. Burt, of the California Institute of Technology, by which sodium atoms can be driven through the glass walls of an ordinary electric lamp bulb, producing a coating of very pure metallic sodium on the inside walls of the bulb.*

The bulb is placed, tip down, in a bath of melted sodium nitrate, kept at a temperature of approximately 312 degrees, Centigrade (583 degrees, Fahrenheit). A current is passed through the filament of the bulb in the usual manner. An electrode dips into the melted

* "Sodium by Electrolysis Through Glass," by Robert C. Burt. *The Journal of the Optical Society of America* (Menasha, Wisconsin), vol. 11, pages 87-91 (July, 1925). We are indebted to Dr. Burt for some additional information.

sodium nitrate and a voltage of approximately 220 volts is maintained between this electrode and the mid-point of the filament in the bulb, the filament being negative. Under these conditions, when electrons escape from the heated filament (just as they do from the filament of a radio vacuum tube) they are drawn against the inside surface of the glass by the potential difference between the filament and the outside bath of fused sodium nitrate. It is as though the glass were the plate of a vacuum tube.

The glass of the bulb contains sodium and the atoms of this sodium (or some of them) are able to move around in the glass. When the electrons from the filament hit against these mobile sodium atoms they neutralize them and the atoms then come out on the surface of the glass and form a layer of metallic sodium. What happens, in the language of the physical chemist, is that sodium *ions* in the glass acquire one electron each and become free sodium *atoms*. Meanwhile, new sodium ions enter the outside surface of the glass, coming from the bath of sodium nitrate. The overall effect is, therefore, the driving of sodium atoms through the glass, to produce a metallic layer on the inside.

While this process is not at all difficult to carry out in any well-equipped radio laboratory there are some conditions and precautions which cannot be described in a brief note. Experimenters intending to make use of Dr. Burt's process should first consult his paper referred to, where they will find all necessary details.

Alexanderson's Theory of Twisting Waves

THAT a twisting of radio waves as they pass over the earth's surface may explain some of the mysteries of fading—and may be put to practical use in other directions—is the theory proposed



From a photograph made especially for POPULAR RADIO

HOW SODIUM ATOMS ENTER A LAMP BULB

The lamp bulb, inverted in a bath of molten sodium nitrate, is visible in the center, just in front of Dr. Burt. The base of the bulb is removed and a glass tube is sealed to its side, so that a wire can enter to make contact with the sodium coating which will be formed inside the glass.

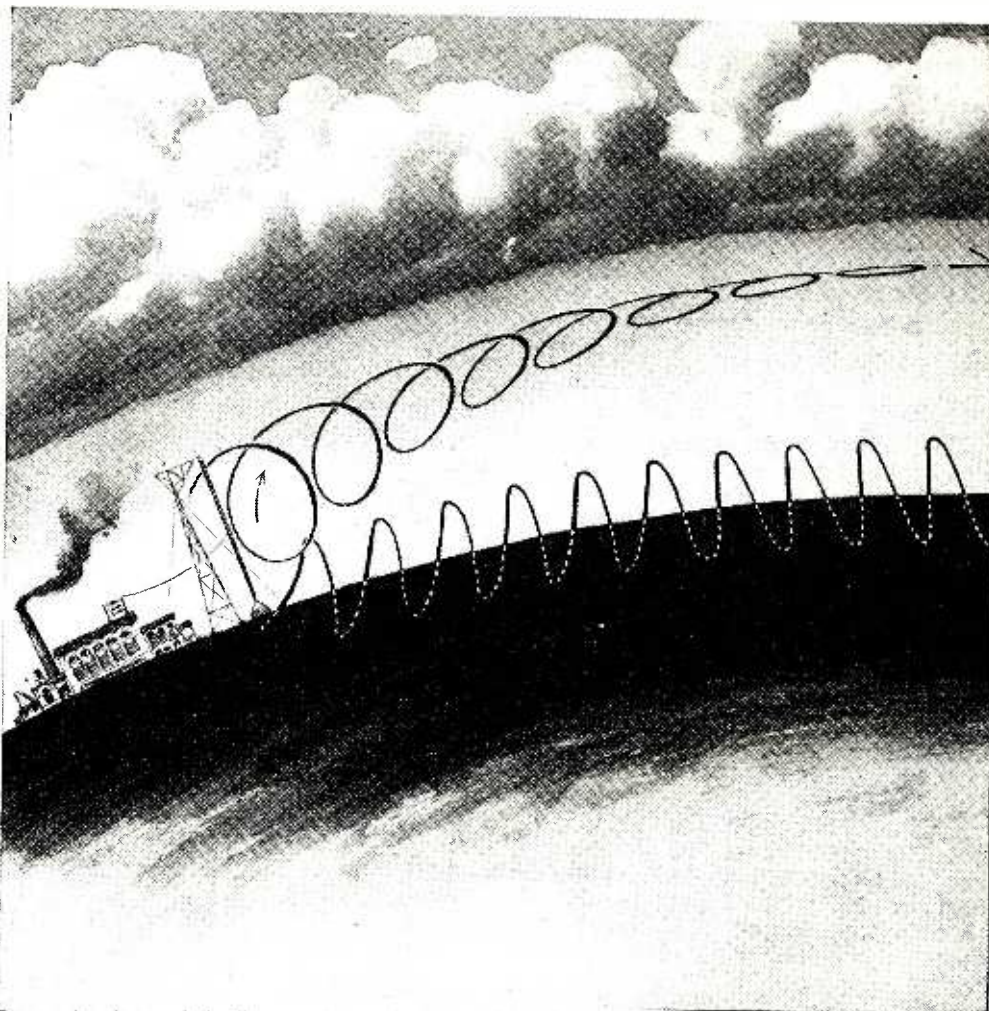

From a drawing made for POPULAR RADIO by Arthur Merrick

HOW THE EARTH'S MAGNETISM CAN TWIST A POLARIZED RAD-

Some antennas produce a polarized radio wave—which means a wave that vibrates only in one direction. In the drawing above, the wave starts with a vertical polarization. As it travels, the gradual twist has made the wave horizontally polarized; at the receiving station the wave is again vertically polarized, but it is now upside down.

recently by Mr. E. F. W. Alexanderson, Chief Consulting Engineer of the Radio Corporation of America, a theory now undergoing active discussion and examination in many of the radio laboratories of the world.*

The essential of this theory is the idea of polarized waves, an idea already quite familiar to students of the shorter electromagnetic waves which we call light. You must form a clear mental picture of what polarization is before the Alexanderson theory of twisting waves will mean much to you.

* Mr. Alexanderson announced the theory in newspaper statements released beginning July 19, 1925. An account, under Mr. Alexanderson's signature, was published in the Radio Magazine of the *New York Herald-Tribune* on July 26, 1925, page 3, and in the radio section of the *New York Telegram* on August 1, 1925, page 2, as well as in other newspapers throughout the United States. Later statements, based on subsequent interviews with Mr. Alexanderson, appeared as follows: by H. G. Silbersdorff in the radio section of the *New York Sun*, August 8, 1925, page 3, and in the radio magazine page of the *New York Evening World*, August 22, 1925; by R. K. Squire in the *New York World* (morning), August 16, 1925; by Everett M. Walker in the Radio Magazine of the *New York Herald-Tribune*, August 23, 1925, page 2.

Any ether wave may be thought of, you remember, as a vibration of the ether in a direction at right angles to the motion of the wave. A cork bobbing up and down on the surface of a pond of water, as water waves pass under it, is an exact model of what we believe happens in the ether. We are not sure that the ether has any "particles" in it, but it is convenient to think of it as though it had and to imagine these little ether-particles as moving up and down when an ether wave passes them. The upward swing of the particle is one phase of the wave; the following downward swing is the other phase.

But in ordinary ether waves not all of these swings of the ether particles are up-and-down. Some of them are right-and-left, some are at angles of forty-five degrees to the vertical, and so on. It is as though a lot of corks on water were set bobbing in all conceivable directions as a wave passed them, not merely up and down. This is difficult to imagine for water, but it is easy enough to see how there could be two such directions of motion for the bobbing cork; one of them up and down (as usual), the other hori-

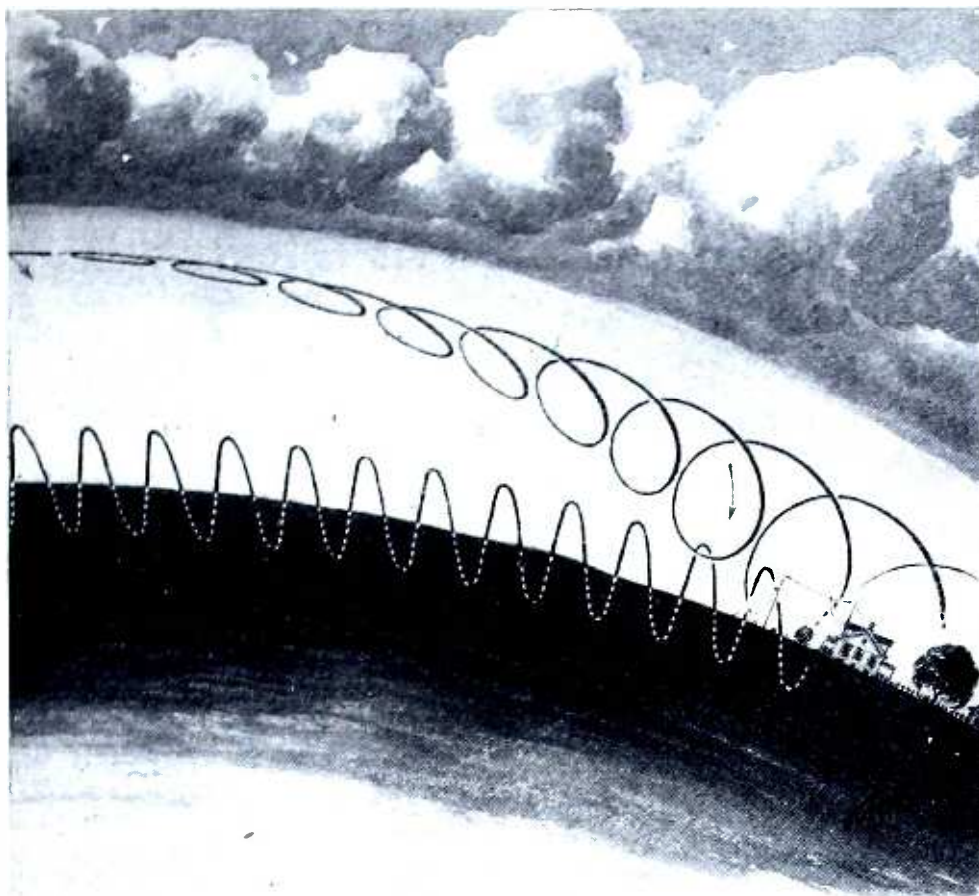

TO WAVE SO THAT INTERFERENCE AND FADING ARE PRODUCED

one direction. As such a wave passes through the earth's magnetic field the wave's plane polarization; its vibrations are up and down. When half the path has been completed vibrates back and forth parallel to the surface of the earth. The twist continues. At the Accordingly it is reverse to the ground wave, which has retained its original up-and-down fere and will produce fading or a "dead spot."

zontal, along the water surface. If the surface of the water were swung back and forth, from left to right, as it would be by rotating a pail or tub that held it, this would give the horizontal back and forth motion of the cork.

In the ether we can have these vertical and horizontal waves too. Ordinarily we have both of them and many other waves vibrating at different angles between horizontal and vertical. A beam of light contains, for example, some ether waves which are vibrating vertically, others which are vibrating horizontally, still others vibrating at every angle in between. So far as the direction of vibration is concerned, all ordinary light beams are composed of mixed waves.

It is possible, however, to sort out these mixed beams and to produce light in which all the vibrations are up-and-down, or all of them horizontal, or all of them in any other selected direction. This is called *polarized light*. It means merely that all the waves are vibrating in the same plane. A wave on a pond of water is a naturally polarized wave; its vibration is exclusively up and down. The ordinary wavy line which we

draw in diagrams to depict an ether wave is really a polarized wave. If we wanted to depict an unpolarized wave we would have to draw an infinite number of such wavy lines, all at different angles to the surface of the paper, thus showing that the vibration is really a mixed one, occurring in many directions at the same time.

Radio waves are subject to exactly these same conditions of polarization. Long ago, during the early experiments of Hertz, the possibility of generating a polarized radio wave was discovered. Such waves were produced and their properties were studied. These facts, however, have dropped out of use and out of the minds of radio men. Mr. Alexanderson has brought them back.

The degree of polarization of a radio wave depends, primarily, on the nature of the antenna which generates the wave.⁴ Some antenna systems produce mixed waves, vibrating in nearly all directions, like a beam of ordinary light. Other antennas produce horizontal waves, analogous to the motion of a water surface caused by rotating the pail back and forth. An antenna consisting of a horizontal loop of wire will pro-

duce such horizontally-polarized waves. The ordinary vertical antennas produce, in the main, waves which are vertically polarized, analogous to an ordinary up-and-down water wave. By using straight vertical rods for antennas, this vertical polarization of the wave can be made nearly perfect.

The next step is the possibility of altering the direction of polarization of the wave as the wave moves. Suppose, for example, that you generate a wave in which the vibrations are altogether up-and-down and that this wave starts out on its journey through space. The up-and-down character of the vibrations may change. A magnetic field, for example, will *rotate* the direction of polarization of the wave, so that the wave twists. Presently the direction of polarization will be horizontal, instead of vertical. It may even twist around altogether, so that the wave is exactly upside down. All these twists and rotations have been well known for years in the case of light waves. Mr. Alexanderson has discovered that they can exist, also, with radio waves.

If a radio wave starts out with an up-and-down polarization, as, for example, from a vertical-wire antenna, it is likely to maintain that position so long as the wave follows the ground. The partially-conducting ground or ocean acts as an anchor, so to speak, for the wave. It keeps the direction of vibration upright. But if the wave starts out horizontally it has no such anchor. It will usually twist around as it moves. Also, the vertically-polarized waves which travel high up in the atmosphere, so that they lack an anchorage to the ground, are similarly likely to twist as they move. This may help to explain, Mr. Alexanderson believes, the phenomena of fading, dead spots, and the like. It may be

possible, also, to make use of purposely polarized waves to attain long-distance transmission or for other purposes. The practical applications of these phenomena of wave polarization in radio may prove to be quite important. They remain to be worked out.

A New Generator for Ultra-short Radio Waves

THE famous experiments of Nichols and Tear, described over two years ago in POPULAR RADIO, resulted in the production of radio waves as short as .22 millimeter.* Heat waves nearly twice this length were produced by the same experimenters from a mercury arc lamp, thus linking the spectrum of light rays, heat rays and radio waves into a continuous whole.† A Russian physicist, Madam A. Glagolewa-Arkadiewa, has now succeeded in producing radio waves even shorter than those of Nichols and Tear. Her shortest are only .082 millimeter long. More important still, she has devised a new and promising method for the production of ultra-short radio waves of any wavelength.§

The new generator consists of iron filings. These are suspended in oil, which is kept

*See "The Shortest Radio Waves Ever Produced by Man," by Ernest Fox Nichols, POPULAR RADIO, vol. 4, pages 22-29 (July, 1923).

†See "Ultra-short Waves from a Mercury Arc Lamp," in August, 1925, POPULAR RADIO, page 175.

§"A New Source of Short Electromagnetic Waves of Ultra-Hertzian Frequency" (in German), by A. Glagolewa-Arkadiewa, *Zeitschrift für Physik* (Berlin), vol. 24, pages 153-165 (1924). We are indebted to Madam Glagolewa-Arkadiewa for additional information.

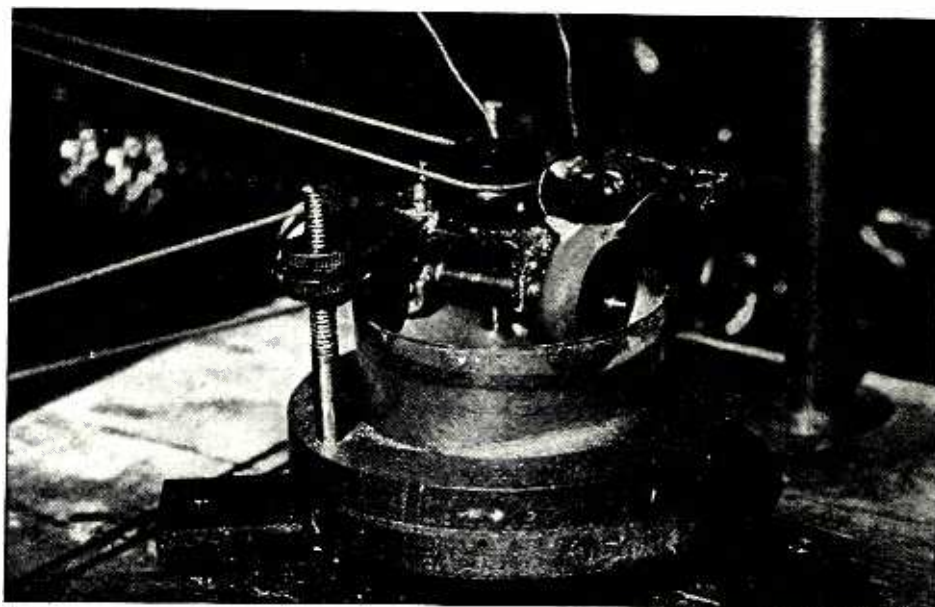

From a photograph made especially for POPULAR RADIO

THE IRON-FILING OSCILLATOR FOR SHORT WAVES

With this apparatus, Madam Glagolewa-Arkadiewa has been able to produce relatively intense beams of ultra-short radio waves, shorter than one ten-thousandth of a meter. The dish contains a mixture of iron filings and oil. This mixture is lifted on the rim of the small wheel and the discharge of an induction coil passes between the two terminals visible just above the wheel.



From a photograph made especially for POPULAR RADIO

STUDYING THE ULTRA-SHORT WAVES

The waves from the generator pass upward, through a hole in the inclined mirror, against the horizontal, disc-shaped mirror. On downward reflection from this, the waves are directed to the right by the inclined mirror. The two-plate mirror on the right is a part of the interferometer by which the waves are measured. Madam Glagolewa-Arkadiewa stands behind the apparatus.

stirred mechanically so that the filings will not settle. Into the mixture of oil and iron filings there dips a slowly rotating wheel, so that a layer of the oil-filings mixture is carried up on the edge of the wheel, like mud on a wagon tire. The two leads from an induction coil dip into this rim of filings on the wheel. The discharge occurs through the oil-filings mass, so that each tiny bit of iron becomes a miniature broadcasting station. The wavelength of the waves sent out depends, in the main, on the size of the bits of iron in the filings. These are the oscillators.

Madam Glagolewa-Arkadiewa measured the waves thus produced, using a thermocouple and an interferometer similar in principle to the instrument used by Nichols and Tear. She found it possible to get waves of almost any wavelength in the range of ultra-short waves, down to the limit already mentioned of .082 millimeter. The radiation is never "sharply tuned," so that all of it would be of the same wavelength. The wavelengths depend on the size of the particles of iron and these are never of exactly the same size. However, the method is said to produce a much more intense radiation than that of Nichols and Tear, which is understandable when one thinks of the many individual bits of iron that are radiating simultaneously.

Further work is being carried out with the method, which is believed to be susceptible of

considerable improvement; for example, by using small, uniform iron spheres instead of the angular filings. This ought to concentrate the radiation much more completely at a single wavelength. Another possibility which may be suggested is the use of a larger volume of the mixture of filings and oil, perhaps excited inductively by a nearby spark-gap connected to high-capacity condensers. It is to be hoped that experimenters everywhere will try out the new method and some of the extensions of it which seem possible.

New Resonance Indicator for Wavemeters

Most varieties of wavemeters depend on adjusting a local tuned circuit to resonance with the wave to be measured. The point of exact adjustment is marked by some form of resonance indicator. Usually this is some type of radio-frequency thermo-galvanometer.

The United States Bureau of Standards has recently improved on this method by substituting for the thermo-galvanometer a combination of a crystal detector and a sensitive milliammeter.*

* "An Improved Type of Wave Meter Resonance Indicator," by Morris S. Strock. United States Bureau of Standards, Scientific Paper Number 502 (vol. 20, pages 111-118), issued March 6, 1925. Obtainable from the Superintendent of Documents, Washington, D. C., for five cents, postpaid.

The hook-up provides a combination of capacitive and inductive coupling. The new indicator is said to be more sensitive than the thermogalvanometer and more uniform in its response at different parts of the wavelength scale. It can be attached to most of the types of resonance wavemeter now in use.

New Facts About Wave Propagation

CAPTAIN T. L. ECKERSLEY, the well-known research engineer of the Marconi Company and of the British Broadcasting Company, has made two recent contributions of considerable importance to the newer theories of radio wave movement through the atmosphere and around the earth.* In the first of these contributions he studies the peculiar musical noises often heard if a telephone is placed in series with a large antenna.† These noises usually start, Captain Eckersley reports, with a sharp click and a tone which is too high in frequency to be audible. The frequency rapidly decreases, so that a musical tone is heard. The pitch of this tone then falls rapidly to a constant value of the order of 300 to 1,000 cycles, at which pitch the tone dies away.

From calculations which are too mathematical for short summary Captain Eckersley concludes that these musical sounds must be due to an electric disturbance originating high up in the atmosphere, probably from some electric impulse from outside the earth. This disturbance gradually dies away. The limiting lowest pitch of

* For an account of these recent theories of wave propagation see "How the Air Affects Radio" in POPULAR RADIO for September, 1925, pages 199-206; also the article by Nichols and Schelleng on pages 309-316 of the October issue.

† "A Note on Musical Atmospheric Disturbances," by T. L. Eckersley. *The Philosophical Magazine*, vol. 49, page 1250 (June, 1925).

the tone heard in the receiver enables the calculation of some of the electrical characteristic of the layer of air in which these disturbances originate and die. These characteristics turn out to be much the same as those assumed, on other grounds, for the ionized layer of upper air contemplated by the recent wave-propagation theories.

The other recent contribution of Captain Eckersley is a calculation of the probable behavior of waves of different wavelength, propagated around the earth according to the recent theories of air ionization and wave motion.* On the usual assumptions as to the number of air ions and the like, Captain Eckersley finds that the waves longer than about 400 meters and the waves shorter than about 40 meters should suffer relatively little from absorption by the ionized air. Between these limits, in the region of 400-meter to 40-meter waves, the atmospheric absorption should be very high, a result which is striking agreement with modern experience in the daytime transmission of waves of long, short and intermediate wavelengths.

A Crystal Control for Broadcasting Stations

THE application of the properties of quartz crystals to the construction of precision wavemeters is already familiar to the majority of radio enthusiasts.† Another step has now been

* The calculations have not yet been published in detail. Captain Eckersley summarizes his results in a letter to *Nature* (London), vol. 115, pages 942-943 (June 20, 1925).

† See "The Quartz Crystal as a New Wavelength Standard," by Dr. Walter G. Cady, in POPULAR RADIO for April, 1925, pages 357-365; also the photograph of a quartz-crystal wavemeter reproduced and described in this Department in POPULAR RADIO for June, 1925, page 569.

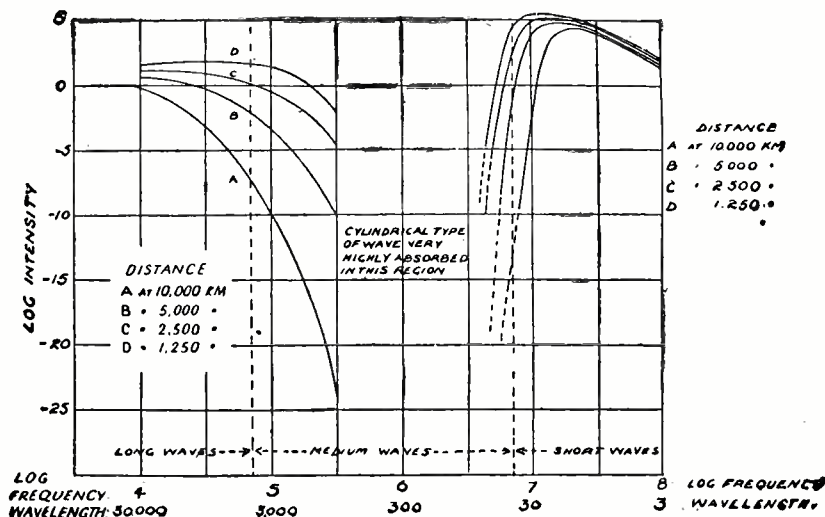

FIG. 1.

From *Nature*

ATMOSPHERIC ABSORPTION FOR DIFFERENT WAVELENGTHS

These curves, plotted from the calculations of Captain Eckersley, show how the absorption of the wave energy by the air is greatest for wavelengths close to the present broadcasting range. These curves are calculated, not observed, but agree fairly well with observed facts.

taken in the use of these remarkable crystals. They have been applied to the practical problem of maintaining the frequency of a broadcasting transmitter unchanged, so that the station may be accurately on the wavelength specified for it by the radio authorities of the United States Government. The new control method has been worked out by the engineers of KDKA, where it is now in use. It is to be extended, the Westinghouse Company reports, to WBZ, KYW and KFKX.*

It is a property of crystals of quartz, as well as of some other substances, that they contract or expand in size under the influence of electric forces. Conversely, an expansion or contraction of the crystal produces electric changes.

The use of such crystals for wavemeters depends upon the mechanical vibration of the crystal. Each crystal has, of course, a natural frequency at which it vibrates when hit or compressed, just as has a bell or one of the wooden strips of a xylophone. If a quartz crystal be placed in an oscillating circuit tuned to the natural frequency of the crystal, the mechanical vibration of the crystal will feed electric pulses of this same frequency back into the circuit. These can be made to reinforce and stabilize the oscillations of the circuit itself. If the circuit tends to vary in frequency the crystal will pull it back to its proper frequency.

This suggests a possible use of similar devices in reception. Many listeners desire sets which are tuned, automatically, to a certain limited number of stations. It is convenient, for example, to have four or five switches, one for each of the chief local stations. Anyone can then tune in a desired station merely by setting the tuning switch on the proper button. Such tuning arrangements are possible and are occasionally used but there is a disadvantage in that the same setting of condensers and coils does not always tune the set to exactly the same wavelength. Perhaps this can be accomplished with quartz crystals. It may be possible to get a set of these, each tuned to the frequency of one local station, and connect all of them in a receiving circuit so that each one, when thrown in by the switch, will hold the receiver rigidly on the desired wavelength. Here is an interesting problem for experimenters.

The Size of Light Particles

ONE form of the modern quantum theory holds that light is really composed of tiny particles, shot out from a luminous body like bullets from a gun.* It is usually assumed that these particles or "quanta" must be extremely tiny, only a few millionths of the size of an electron or even less. A contrary opinion has now been expressed, however, by Professor Gilbert N. Lewis, one of the foremost American chemists.†

*From a statement issued by the Westinghouse Electric and Manufacturing Company, for release September 5, 1925.

†See, for example, "New Theories of Ether Waves," POPULAR RADIO for August, 1925, page 168.

‡"The Theory of Reaction Rate," by Gilbert N. Lewis and David F. Smith. *Journal of the American Chemical Society* (Easton, Pa.), vol. 47, pages 1508-1520 (June, 1925).

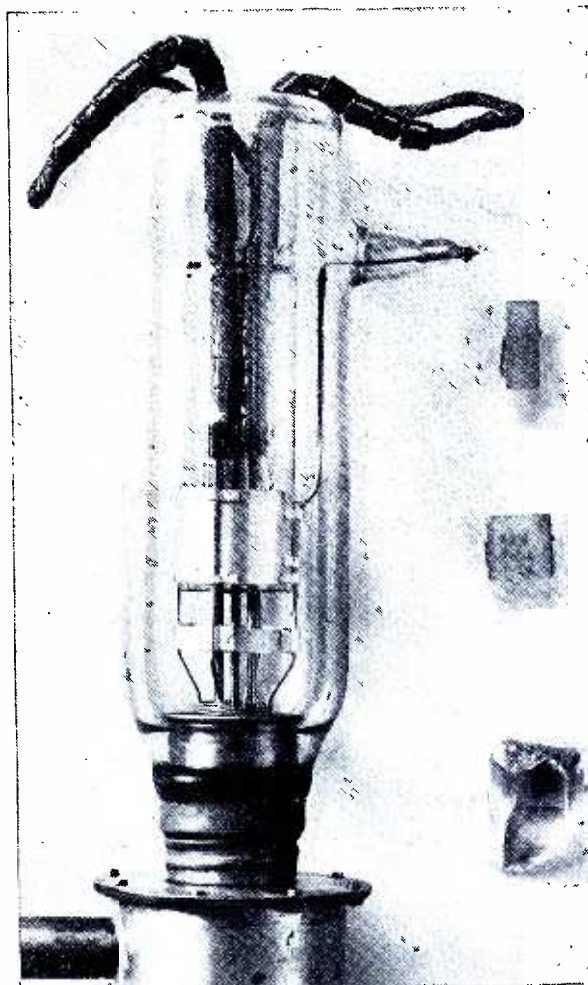

Westinghouse

REGULATING CRYSTALS

The one-kilowatt transmitting tube is contrasted with two plates of cut quartz, such as are used to regulate its frequency. The third crystal (below) is a fragment of natural quartz.

In an article dealing chiefly with theories of chemical reaction, Professor Lewis and his collaborator find it necessary to calculate the "radius" of a quantum, meaning by that the nearest distance which the flying quantum can usually approach to an atom of matter without being absorbed by the atom.

The value comes out as approximately 1.4×10^{-7} centimeter, which is not only much larger than an electron, but is actually larger than an atom. Calculations made long ago by Lord Rayleigh on the basis of the wave theory of light (which the quantum theory now aspires to supplant) had led to almost this same value for the "shadow" cast by a single atom. There are, of course, numerous hypotheses by which this large "shadow" can be reconciled with the data suggesting that the individual quantum must be very small. For example, the quanta may be attracted by the atoms when they fly near enough to them. But, evidently, neither the quantum theory nor the wave theory is yet perfect.

WHAT READERS ASK

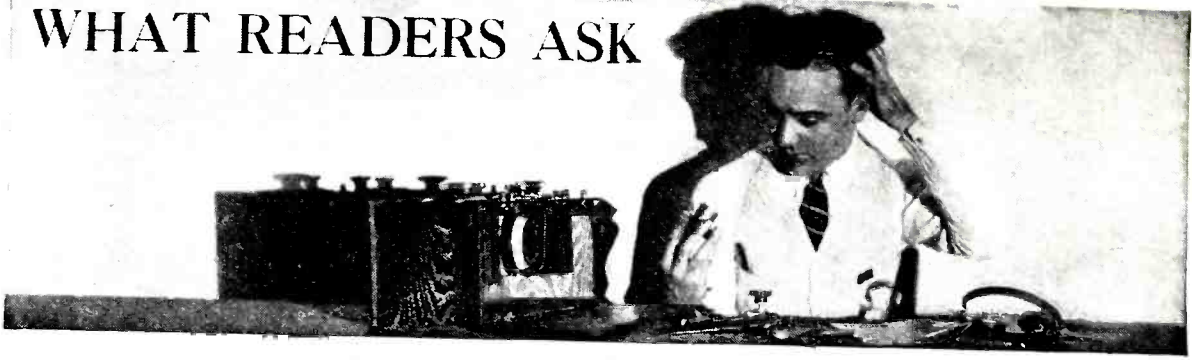

CONDUCTED BY HUGH S. KNOWLES

In justice to our regular subscribers a nominal fee of fifty cents per question is charged to non-subscribers to cover the cost of this service, and this sum must be included with the letter of inquiry. Subscribers' inquiries should be limited to one question or one subject.

The Four-tube Roberts Circuit

QUESTION: Please give me a diagram showing how to hook-up the four-tube Roberts receiver with a stage of push-pull amplification. I have all the coils, but would like to know the proper size for the other instruments to be used in the circuit. Also please furnish me with a list of parts.

ERNEST VAN BROOKS

ANSWER: Figure 1 shows the hook-up for

the Roberts circuit. It consists of one stage of radio-frequency amplification (neutralized), vacuum detector (regenerative), one stage of transformer-coupled amplification (reflexed), and one stage of push-pull audio-frequency amplification. The parts you will need for building this circuit are the following:

- L1, L2, L3, L4, L5 and L6—primary, secondary, compensating plate circuit, detector grid circuit and detector plate circuit coils respectively of the Roberts kit;
- VC1 and VC2—variable condensers, .0005 mfd;
- C1—neutradon condenser;
- C2—mica fixed condenser, .005 mfd.;
- C3—mica fixed condenser, .0025 mfd.;

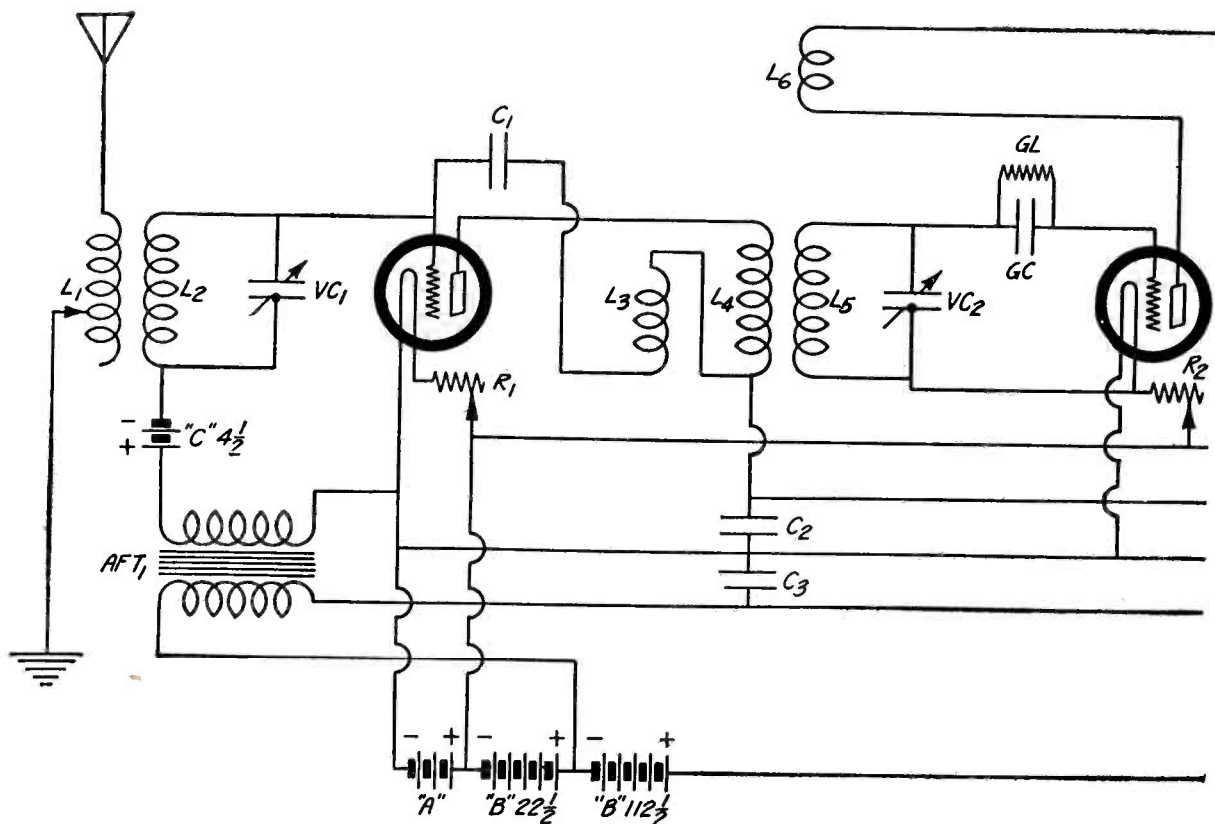

- GC—mica fixed condenser, .00025 mfd.;
- GL—variable grid-leak;
- R1, R2 and R3—filament rheostats, 20 ohms;
- J1—double-circuit jack;
- J2—single-circuit jack;
- AFT1—audio-frequency amplifying transformer;
- AFT2—input push-pull transformer;
- AFT3—output push-pull transformer.

There are two "C" batteries, one of three volts and the other of 4½ volts, used in the receiver. It is recommended that standard tubes of the UV-201-a type be used. The voltage of the "A" batteries will then be 6 and the voltage for the "B" batteries as shown 135 volts.

A "Hard" Detector for This Four-circuit Tuner

QUESTION: I have one of the five-tube, four-circuit tuners described in the October 1924 issue of POPULAR RADIO. I want to change to a UV-201-a detector. I have had considerable trouble securing good UV-200 tubes and would also like to reduce my filament consumption. Can this be done?
E. T. LOOCK

ANSWER: Although this change is not generally recommended it may be worth while in your case. The grid-leak should be connected to the positive "A" battery lead. These tubes show a marked tendency to oscillate with the normal grid bias secured with a negative leak return. With a positive return the tube is operated on a better portion of the grid-cur-

rent, grid-voltage curve giving better detection. You may find voltages as high as 22½ volts good on the detector particularly on loud signals. A 20-400 type Dublwundr should be used instead of the 6-400. If one of these is not obtainable use a separate 20 or 30-ohm rheostat on the first tube leaving the potentiometer circuit of the Dublwundr connected.

A "B" Battery Eliminator

QUESTION: Is it possible for me to make a really satisfactory "B" battery eliminator, one that will get rid of all the A.C. hum and not be too bulky?
THOMAS J. BOWAN

ANSWER: Yes; experiments in our laboratory have proven the possibility of this. High grade materials, the correct electrical constants and some neat wiring ability will enable anyone to make one of these convenient adjuncts to a radio set. Mr. Cockaday gives complete details in this issue of POPULAR RADIO.

Two Sets on One Antenna

QUESTION: Can two radio sets use the same aerial?
FRED PULEN

ANSWER: As a rule this is decidedly not satisfactory. In the case of two regenerative receivers the radiation from each receiving set tends to produce squeals and howls in the other. With some circuits used in a few sets it can be done.

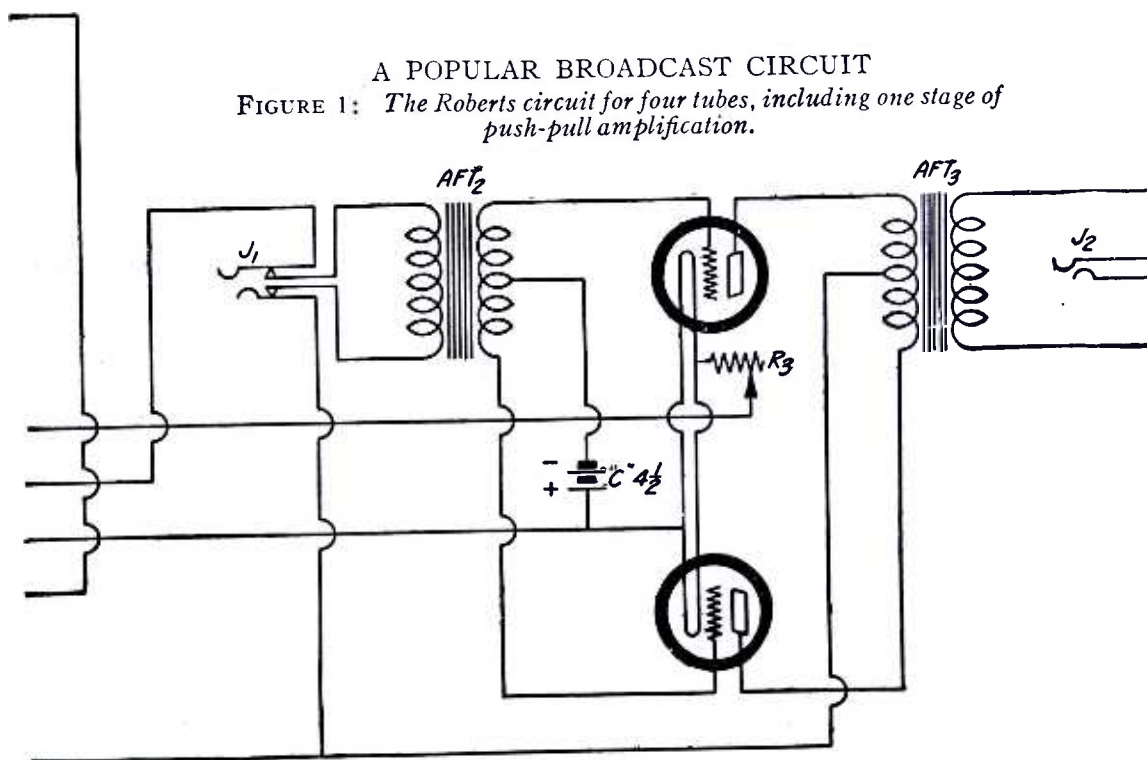

A POPULAR BROADCAST CIRCUIT
FIGURE 1: The Roberts circuit for four tubes, including one stage of push-pull amplification.

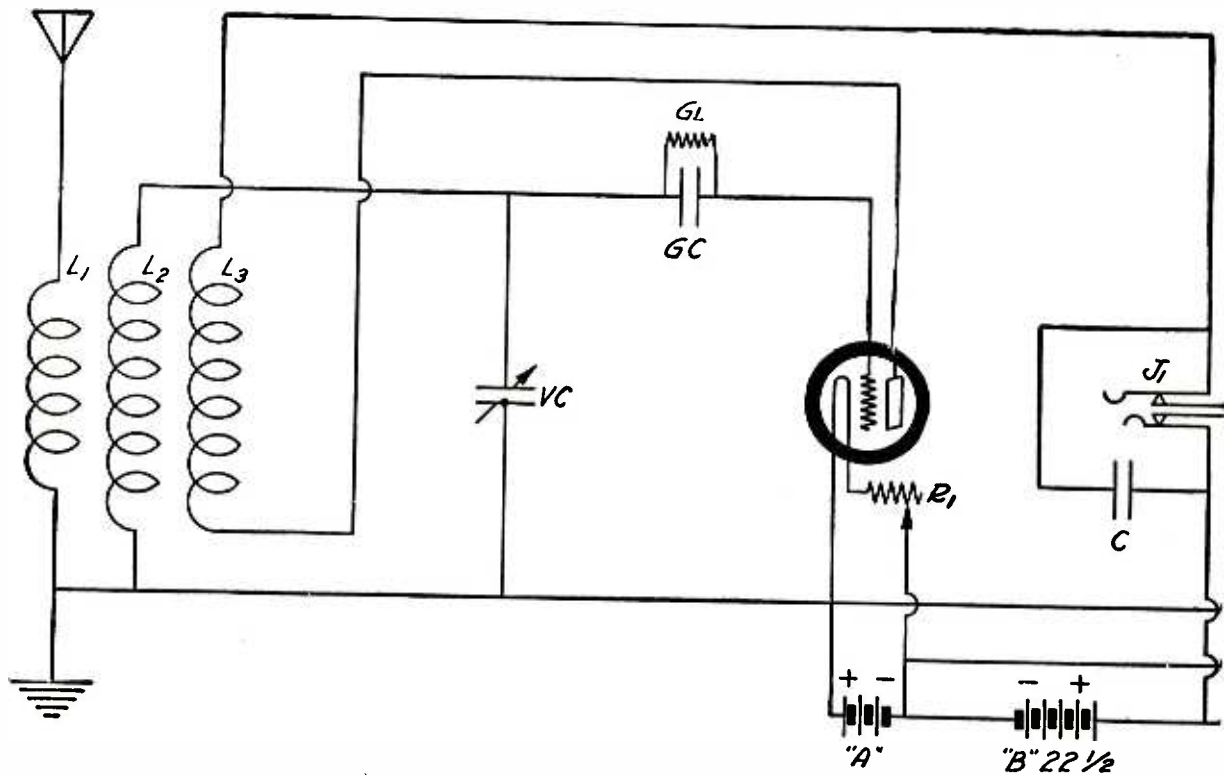

Hook-up for Three-circuit Coupler and Two Stages of Audio-frequency Amplification

QUESTION: Please give me a diagram containing the connections for a standard three-coil coupler tuned with a single variable condenser, with two stages of audio added to it so that it will operate a loudspeaker satisfactorily.

ROBERT SAUNDERS

ANSWER: You will find the circuit requested in Figure 2. This makes a satisfactory set with three tubes. The parts you will require for construction are the following:

L1, L2 and L3—primary, secondary and tickler coils of a standard three-coil coupler;

VC—variable condenser, .0005 mfd.;

C—mica fixed condenser, .0005 mfd.;

GC—mica fixed condenser, .00025 mfd.;

GL—variable grid-leak;

J1 and J2—double-circuit jacks;

J3—single-circuit jack;

AFT1 and AFT2—audio-frequency amplifying transformers;

R1—filament rheostat, 6 ohms;

R2 and R3—filament rheostats, 20 ohms.

It is recommended that you use a UV-200 or a C-300 tube for the first tube, which is the detector. For the second and third tubes, you may use any standard tube of the hard type.

If the set is to be employed for portable use—three C-299 or UV-199 tubes may be inserted, with a 4½-volt "A" battery instead of the usual 6-volt storage battery.

How to Make the Higher Waves Come in Stronger

QUESTION: I have a three-circuit regenerative receiver which gives wonderful results on the low wavelength stations, but even the local stations operating above 400 meters are weak. They can all be heard, so apparently the set is capable of tuning high enough, but those above 400 meters are decidedly lacking in volume. The coupler used consists of a primary and a secondary wound on a bakelite tube, with the tickler on a rotor inside of this tube. The secondary is tuned by a variable condenser, but the primary is not tuned. I use this receiver with an antenna 57 feet long. The selectivity and tone quality are so good that I would like to have your advice as to what can be done to correct the lack of volume on the higher waves.

STANLEY SCOFIELD

ANSWER: Undoubtedly your antenna is too short to give proper results with this receiver. The primary winding is semi-aperiodic and is not strictly untuned. True, you do not tune it in operating the receiver but the antenna circuit, including the primary coil, has a natural frequency to which it responds better than to other frequencies. As the primary coil and

A STANDARD CIRCUIT FOR LOUDSPEAKER RECEPTION

FIGURE 2: This diagram gives the correct hook-ups for two stages of audio-frequency amplification when used in connection with a standard three-circuit coupler.

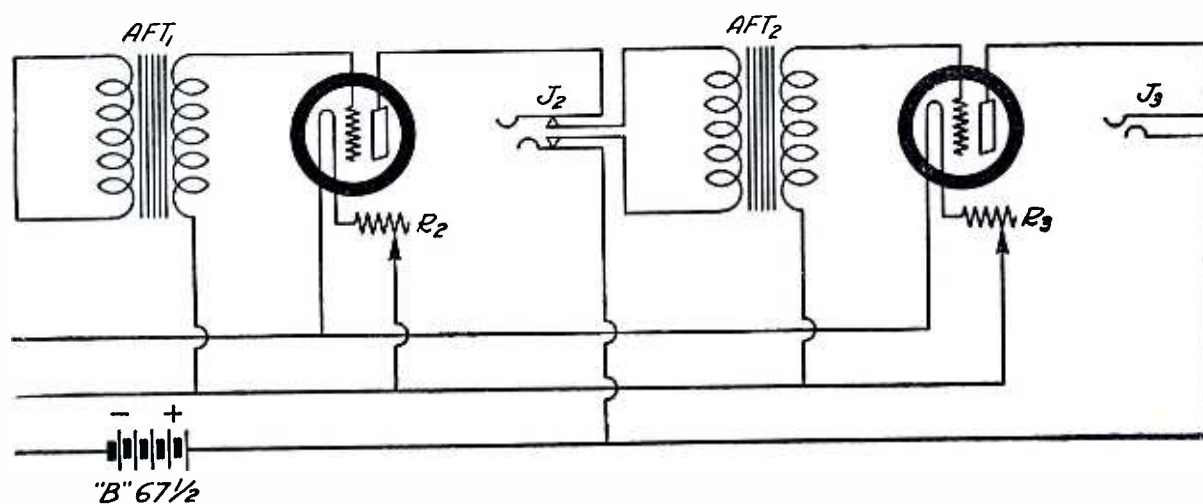

your antenna are both comparatively small, the natural frequency of the combination is such that it is broadly tuned to a low wavelength. As you go above this wavelength it follows that the signal strength will drop off. If you can increase the length of your antenna to 100 or 125 feet we would advise you to do so. If this is not convenient you can improve results by connecting a variometer between the antenna and the receiver. This will help you to tune the antenna circuit to any wavelength desired. Or a coil and condenser may be used in place of a variometer. In such a case, connect the coil between the antenna and the receiver, then connect the stator plates of the variable condenser to the antenna and the rotor plates to the ground. The coil may consist of 40 turns on a three-inch form, preferably tapped every ten turns. The variable condenser may be one of .0005 mfd. capacity.

Meters for Experimenters

QUESTION: I have reached the stage in the radio game where I am not satisfied to build a receiver and then sit back and listen; I like to fuss around, and I am gradually building up a small laboratory. By experimenting I hope to gain a better understanding of the principles employed in radio. What I particularly want right now is to purchase some meters for use in making various measurements of voltages and currents. I cannot afford to go into this too heavily,

but could afford two or three fairly good meters. Can you suggest two or three meters which would be most useful to me in my radio experiments?

I can't afford extremely costly instruments; for that reason I would like to have you tell me the most useful and most commonly used meters that a student should have.

HENRY BRADBURN

ANSWER: Your move is a wise one, as there is nothing of greater assistance to the experimentally inclined radio fan than suitable meters, not only in enabling him to keep his receiver battery equipment up to date, but also to enable him to study the electrical requirements of receivers, vacuum tubes and other apparatus. Our first choice of meters would be a voltmeter with a double range. Suitable ranges are 0 to 7 and 0 to 140 volts. This meter is used for measuring filament voltages, battery voltages and other equipment. Our second choice is a milliammeter with a range of 0 to 25 milliamperes. Such a meter is useful in measuring the "B" battery current consumption of a tube or a receiver. Few sets require over 25 milliamperes for the plate supply; therefore this range is adequate. Third choice falls to an ammeter with a range of 0 to 3 amperes. This is used in measuring the filament current consumption of a single tube, or of an entire receiver. By its use one can safeguard against turning rheostats too high and thus providing greater than the rated current to the filament with a resulting decreased life of the tube.



Fred Smith

BROADCASTING A GENUINE GYPSY DANCE

The enterprising "Radio Barcelona" station in Spain goes out into the highways and byways for its programs; note the microphone that is picking up the music of the gypsy dance during the "Verbena holiday" in the open square at Barcelona.

The BROADCAST LISTENER

*Comments on radio programs, methods and technique
—from the point of view of the average fan*

By RAYMOND FRANCIS YATES

A Chance to Earn \$20.00

SOMETIMES we think of throwing our better judgment (it may be bad judgment, but it is the best we have) to the winds and being like the East Side belle at Coney Island who just naturally and spontaneously labels everything "swell." It is easier, you know, to write a department reeking with whipped cream and toilet water than it is to sit down and prepare a long line of hoke which may or may not fall into that category of literary belly-aching called criticism. However, aside from our having suffered with a ripe-tomato throwing complex since the early age of five, we firmly believe that radio broadcasting can be vastly improved, which, after all, is not a strange or ridiculous hypothesis.

There is a charming trait in American people which causes them to overlook the shortcomings in many things, and the radio is no excep-

tion. We believe that said "charming trait" is a potential danger to the growth and artistic expansion of air entertainment in that our studio managers, in place of being constantly reminded of the extraordinarily punk job they are doing, are permitted to feel that they are the generalissimos of a new and highly efficient fountain of culture and entertainment. As a matter of fact, they are nothing of the sort. And this quivering old hand has not the courage to say that it can show them wherein they err. It is you, Dear Reader, with your superheterodyne and neutrodyne, who must tell our cocky studio directors where they get off. What's more, we have a dark plan to incite you to do that very thing.

We want you to outline for us what you believe to be a perfect radio program—the very kind of a program that you would like to hear. Save that the letters must be in this office within thirty days after the publication of

this issue of POPULAR RADIO, there is not another condition. If paper is scarce, write on both sides, we don't care.

A reward of twenty dollars will be paid to the writer of the most practical and well-balanced program. The writers of the three next best letters will receive an autographed copy of a book on broadcasting that we once wrote with Roxy.

Incidentally, if the program is real good we shall make a brave effort to have it broadcast here in New York. We have been challenged by the studio managers many, many times, and it is about time we delivered something more tangible and useful than a sarcastic spasm of very bad English.

* * *

The Chicago Listeners Strike

AMONG the very funny things that have happened in broadcasting during the last three years, the threatened strike of the long-distance fans in Chicago is perhaps the funniest. We wouldn't be a bit surprised if it was not a lot of newspaper noise, but then, of course, who would blame the listeners in Chicago for threatening not to listen to programs that are unworthy of Rahway, N. J.? However, it seems that it is not quality but quantity that is of greatest interest to those who are kicking up the fuss. From all indications a noisy group of long distance cranks who yap over their records like silly school kids, want all of the broadcasting stations in Chicago to close shop one night in each week while they paw over the ethereal wares of the country.

Things are coming to a pretty pass when a bunch of idiots set out to prevent the sensible people in Chicago from listening to their local stations. Yet, aided by the newspapers, they seem to be making out quite a case for themselves and we should not be a bit surprised to find them in the end victorious. After all it is the squawker who wins his point in the long run.

* * *

Studio Sheiks

FOR a long time (oh, it must be all of five months) we have been debating on the advisability of compiling and publishing a deep scarlet exposé involving two of every three radio announcers in these United States of America. At a special conference held in our great big luxuriously appointed Directors' Room at the POPULAR RADIO headquarters, it was recently decided to tell the public of this country a thing or two about its salad-eating heroes in the studios. The dirty nature of this exposé must be excused as part of our general campaign for more intelligent announcing and program administration.

How anybody with anything but a warped sense of esthetic values can relish and even revel in the literary flabdoodle so freely peddled by the average sleek-haired station ballyhooer is far more than our research department has been able to fathom. However, be that as it may, our present unpleasant task is to prove that our radio studios are in the majority of cases manned by a lot of skirt-crazy dullards with a strong leaning toward Stacomb and Sixth Avenue Russian cigarettes.

What our studios need more than anything else in the world (and we have a lot of things in this world, haven't we?) are men who have survived their flirtatious days; men who are not rendered mentally *hors de combat* by the mere appearance before the microphone of a sparingly dressed blond soprano or a goo-gooed-eyed brunette. We're a pretty wise old owl when it comes to sampling the atmosphere of any particular place and we know whereof we speak. If just about fifty percent of our studio sheiks were permitted to go back to the soda fountains from which they came or from which they should have come, the improvement in announcements would be immediate and big. We need men who have settled down; men engaged in the serious business of making a livelihood for their families; men with enough experience in life to make them want to create sympathetic understanding and



Kadel & Herbert

DELIVERING THE SOUNDS OF BROADCASTING TO MAIN STREET

What is claimed to be the largest radio microphone in the world is owned by station WOR, of Newark, N. J. It is an exact duplicate of the smaller "Mike," but inside of it there are six of the small type. It stands out of the window of the New York studio of the station, and on occasion it is used to pick up the noises of the Gay White Way for broadcasting.

not a mere "impression." Our sheiks are so bent on soliciting "mush notes" from high-school girls and nutty old women who ought to know better that they are oblivious to the niceties that go to make up proper and intelligent conversation. The average announcer leads a "microphone life" which is so far removed from his normal routine of living that he makes himself ridiculous every time he opens his mouth to the audience. When one side of a man's life is intended to reveal Oxford, Harvard or Dartmouth, and the other side requires only the simple rudiments of life so beautifully supplied by Public School No. 23, that man cannot help but expose the Public School No. 23 side every time he attempts to display the Oxford or Harvard side. That is as sure and as inevitable as the great big red nose on our face.

If you see us marching down Fifth Avenue some day with a big banner saying, "Kick the Sheiks out of the Radio Studios," you will know that we are terribly serious about this matter and that correct announcing is the passionate part of an old body that has very few other things to be passionate about.



Pacific & Atlantic

THE "WORLD'S CHAMPION RADIO FAN"

This is the title conferred on W. D. Johnson of Cambridge, Mass., by the American Radio Relay League at the close of its convention in Chicago on August 21. Mr. Johnson walked and rode a bicycle all the way from his home to the Windy City to attend the gathering.

Is "Studio" Correct?

ANYTHING that grows as fast as broadcasting has grown usually forgets to do a lot of things that it should have done. One of these things, and one that has worried this old busybody a great deal, is the term "studio." Doesn't a "broadcasting room" come a little closer to meeting the requirements of a theater than a "studio?" Can a place sheltering a public performance, even though the performance be invisible, be properly called a "studio?" If we are displaying an undue amount of ignorance in this matter we should like to be corrected by some of our more intelligent and enthusiastic readers.

* * *

Some Pretty Bad Stations

THE American public probably falls easier than any other public in the world; you can sell it orange juice made of rank organic acids, plays soaked in the very essence of obscenity, periodicals crammed with the hottest kind of bunk, newspapers slimy with scandal, prize fights as fixed as the Belt of Orion, baseball heavy with business conspiracy and movies so full of diabolical rot and suggestive situations that they transcend even the hoochie-coochie of the old-time circus. Is it any wonder that this same public has tolerated the measly effort of eight out of every ten of our broadcasting stations?

An impartial critic must admit that we have but thirty-five or possibly forty broadcasting stations that are actually trying to lift broadcasting to the plane of a decent source of American entertainment. Take out WJZ, WGY, WEA, KFI, WOR, WRAC, WGR, WLW and a few others of similar caliber and you have nothing left but a series of cheap hangouts for jobless small-time vaudeville performers, industrious song pushers, parlor boobs, hopeless pupils of honorless music teachers, nutty reformers, quack health doctors and Kiwanas Club lecturers.

* * *

The Poor Announcers Again

WE'RE getting along in years now and we really should take a more kindly attitude toward many things, especially announcers. But it is pretty hard to break bad habits and so we might just as well let the evil spirit take its course.

It often happens in broadcasting from restaurants, hotels and the like that the orchestra requires a little rest and that the announcer is called upon to fill in the interim with more or less illuminating remarks concerning this or that. A great deal of research on the subject has proven that the average announcer (and it seems that nearly all announcers, like ice men and waiters, are average or so close to average that you can't tell the difference) has a difficult time being illuminating about this or that. Give 99 out of every 100 announcers five minutes of their own in which to hold the attention of the radio audience and they will invariably commit oratorical hari-kari in the first 27 seconds. We have misplaced our notes on the matter, but we believe it is eleven times

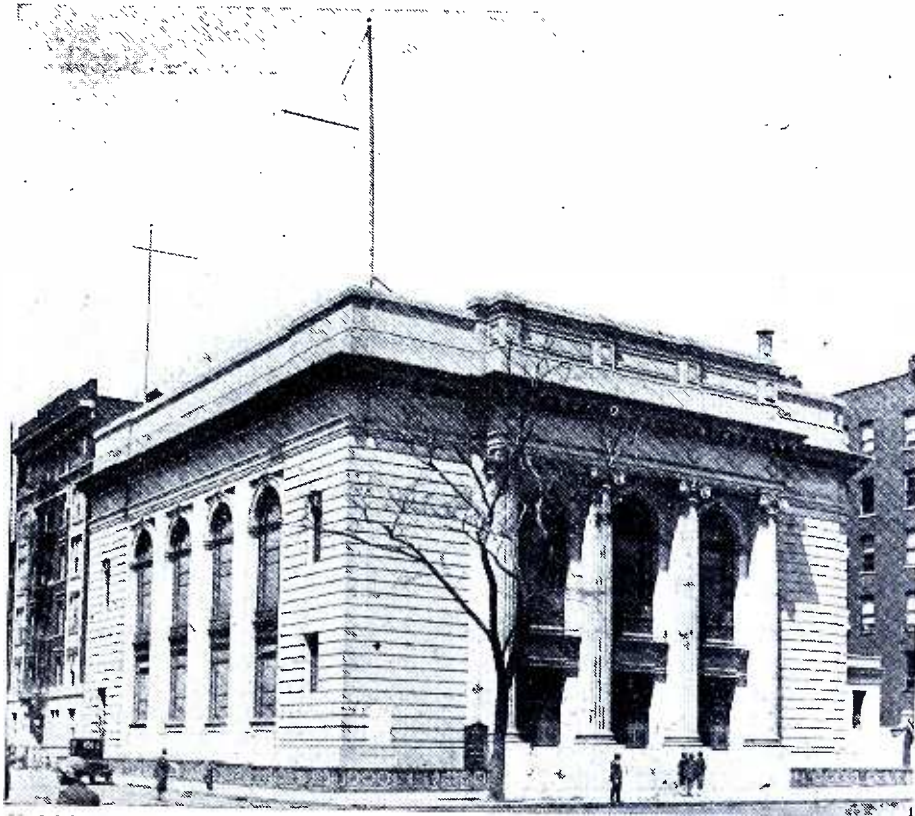

Kadel & Herbert

BROADCASTING SEVENTH-DAY ADVENTIST DOCTRINES

Another and more powerful transmitting station has been installed in the City Temple of New York (WSAP) for the purpose of spreading the propaganda of this sect.

that we have listened to a dramatic account of how Schubert jotted down the theme of a great masterpiece on the menu in a dimly lighted Bohemian *rendezvous*. Indeed the tragedies in the lives of all of the great masters are as familiar to us as the story of Little Red Riding Hood and Charlie Chaplin's latest *affaire de coeur*. Yet announcers have standardized on this sort of "fill-in" material, so what are you going to do about it? It's a pity that they cannot be a little more practical about using this valuable time now that the country knows what inspired Massenet's "Elegie" and how Bach won his musical spurs at the clavichord thousands and thousands of moons before Berlin and Cadman squeezed out of their musical souls such astounding hits as "Bebe" and "At Dawning." A few baseball scores, a few news items or a harmonica solo by one of the youngsters of Public School 57 would fill the bill beautifully as far as we are concerned and it would give the announcers the opportunity of saving their list of superlatives for general purposes. Let those who will dramatize the lives of musicians but we feel pretty sure that's no job for our studio men, big and learned as they are.

* * *

The Good Ship *Bossert*

If we should be crowded into a corner and pressed real hard for an expression of opinion as to the greatest broadcaster on the air we should almost admit that WEAF was that

broadcaster. If WJZ should tighten a few loose bolts, we might change our opinion. Anyway, to say that a certain station is best is not admitting a great deal for, after all, there are not more than a few centimeters separating the worst from the best. Be that as it may, WEAF does manage at times to work in little innovations that show that somebody is doing a little thinking in the interests of better programs.

While we have not gone completely wild over the idea, it is a bit novel and refreshing to have the announcer tell you that such and such a hotel orchestra is playing from an imaginary ship and to have that orchestra start off with the ringing of ship bells and the lively strains of "Over the Bounding Main." While we are a long way past the days when we could roll ourselves up in a blanket on the daybed and imagine that we were cuddled up in a big sleigh swaying over the snow-covered hillsides, we are not so old and crabby that we cannot adjust ourselves to the notion under discussion. What we crave is originality in broadcasting and we don't mind being asked to conjure up a childish illusion to help some poor overworked impresario believe that he has hit upon a big idea. We'd gladly imagine that we were a teddy bear and go snoozing under the sewing table for a bumble bee nest if it came right down to the matter of encouraging originality on the air. If you are "looking" about some evening for something light and good just try the good ship *Bossert*.

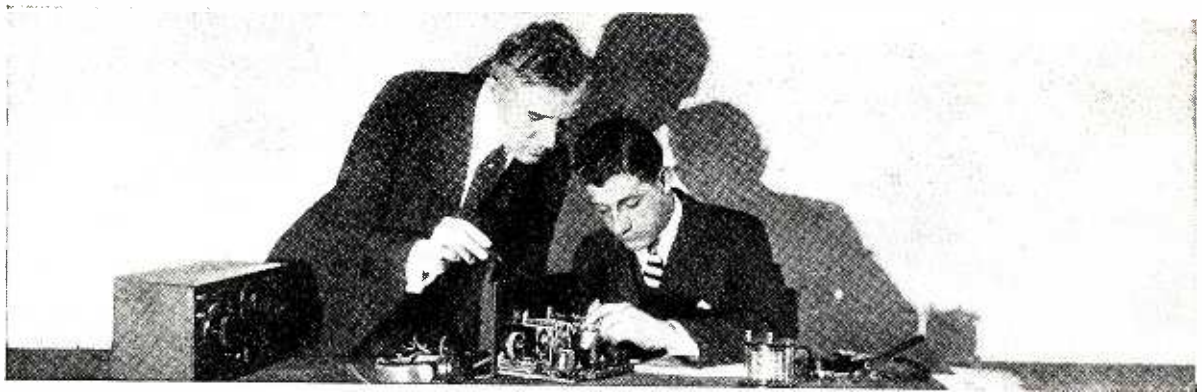

IN THE EXPERIMENTER'S LABORATORY

CONDUCTED BY LAURENCE M. COCKADAY

A Short-wave Receiver

LIST OF PARTS—

- L1—Antenna inductance coil; (see below for construction data);
- L2 and L3—Closed circuit inductance coil; (see below for construction data);
- L3—Choke coil; (see below for construction data);
- VC1—Cardwell variable condenser, .0001 mfd. capacity (7 plate);
- VC2—Cardwell variable condenser, .00025 mfd. capacity (11 plate);
- R1—Amsco rheostat, 30 ohms;
- R2—Daven grid-leak; best resistance should be determined in each individual case; a resistance of 4 megohms is usually correct);
- S1 and S2—Na-ald sockets No. 499 for UV-199 or C-299 tubes;
- J—Single circuit, filament control jack;
- AFT—Thordarson audio-frequency transformer, ratio $3\frac{1}{2}$ to 1;
- C1—Sangamo fixed condenser with clips for grid-leak mounting;
- J2, J3 and J4—General Radio coil mounting jacks, No. 274J;
- Miscellaneous—composition panels, 2 pieces 5 inches by $3\frac{1}{2}$ inches for mounting the variable condensers; 1 piece 26 inches by 1 inch to be cut up for binding post strips, coil mounting, etc.; 9 Eby binding posts; 12 inches of $\frac{1}{2}$ inch by $\frac{1}{16}$ inch strap brass; bus wire; baseboard 17 inches by $8\frac{1}{2}$ inches; 1 lb. No. 16 DCC copper wire; $\frac{1}{4}$ lb. No. 28 DSC wire; 9 General Radio coil mounting plugs No. 274P.

SHORT-WAVE reception—that is, on wavelengths under 100 meters—is in its infancy, so far as broadcasting is concerned. But there

is every indication that it is going to grow fast.

During the past winter several of the large

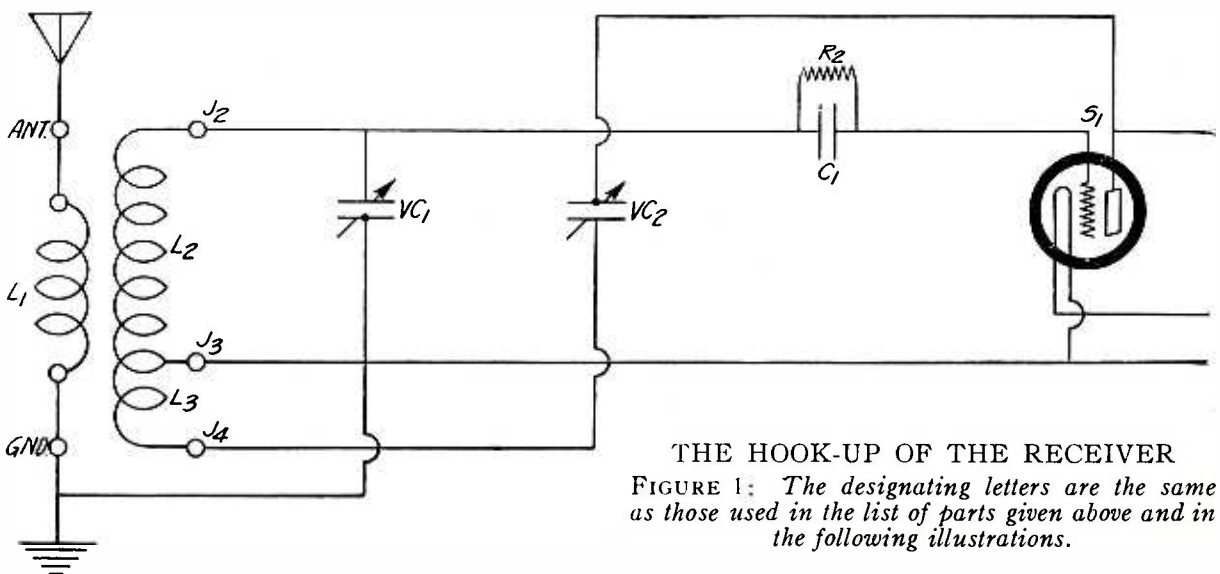

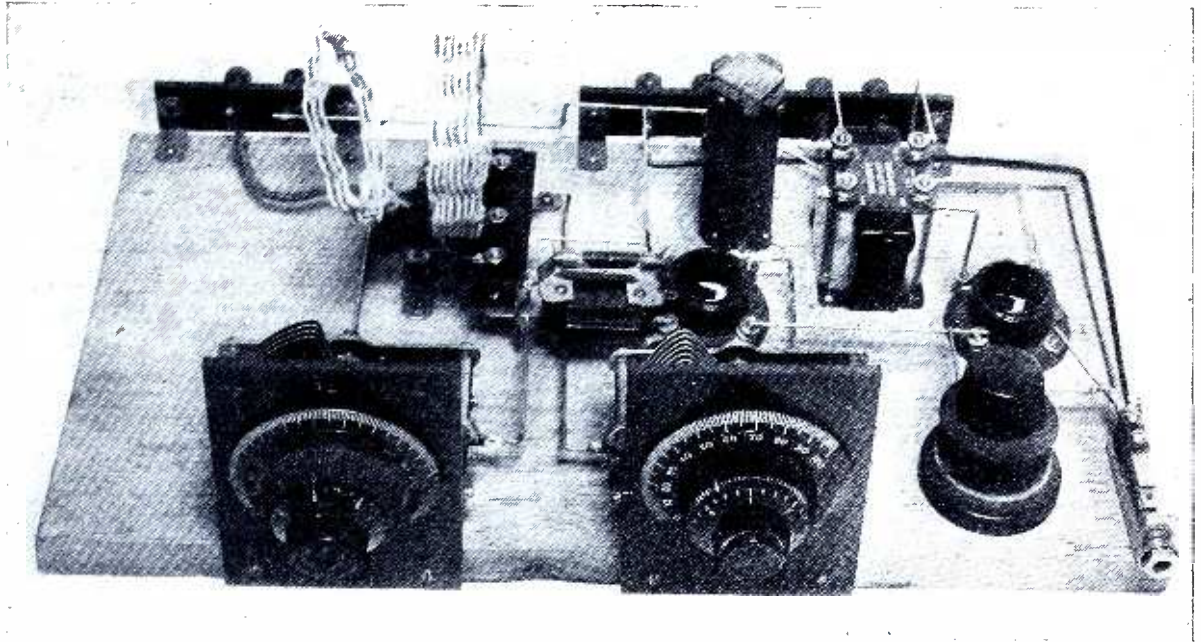

THE FRONT VIEW OF THE RECEIVER

FIGURE 2: *In this and in Figure 3 a clear idea of the layout of the various instruments may be obtained. The wavelength tuning is accomplished by means of the left-hand dial, while regeneration is controlled by the one at the right.*

broadcasting stations have been transmitting their programs simultaneously on their regular wavelengths and on short waves around 100 meters or lower. Current reports indicate that this fall there will be a network of broadcasting stations all the way across the continent, that will follow this practice.

Many radio fans, whether they be dyed-in-the-wool experimenters or simply broadcast fans, are playing with the idea of short-wave reception because the short waves have opened up a large and promising field for experiment, and also because broadcast reception on the short waves has some remarkable features. Surprising distances can be covered during the daytime on wavelengths around 50 meters and lower. Static interference is decidedly less than on the regular broadcast wavelengths and exceptional DX reception is possible. The simple receiver described here, using a detector and one stage of audio, frequently brings in

KDKA with sufficient volume to operate a loudspeaker during the summer months, even though it is in operation about 300 miles from Pittsburgh. This station operates on a wavelength of sixty odd meters. At times during the summer when static on KDKA's regular wavelength of 309 meters was so bad as to make reception unsatisfactory, they could be heard clearly on the short wavelength with no trouble from static. This is not always true, but it is certain that static is less troublesome on the short waves than on the regular broadcasting band.

When the new short-wave transmitter in California is put into operation in the fall there is every reason to believe that a simple two or three-tube short-wave receiver on the Atlantic coast will bring this station in with much more certainty than a multitube receiver operating on wavelengths greater than 300 meters. It is a proven fact that amateur continu-

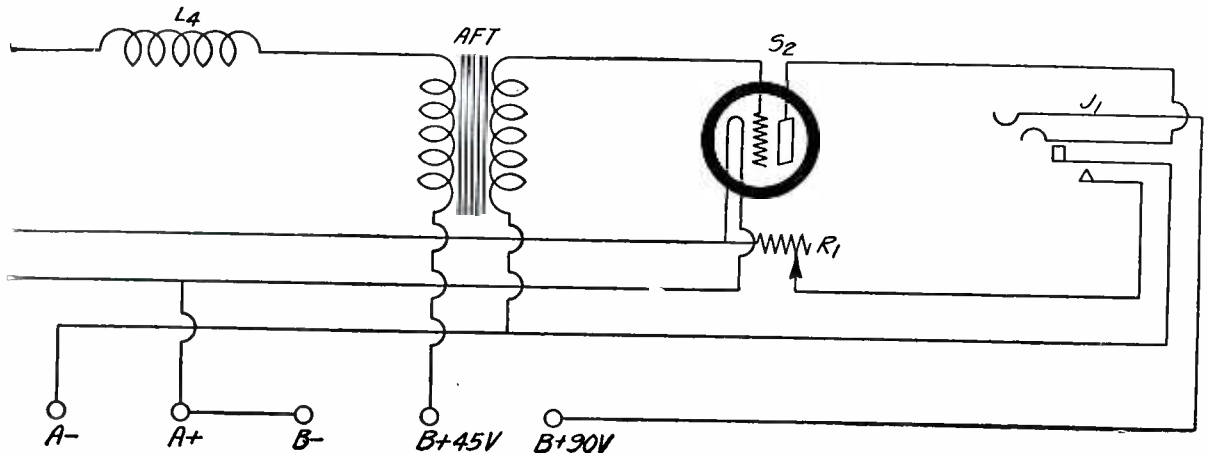

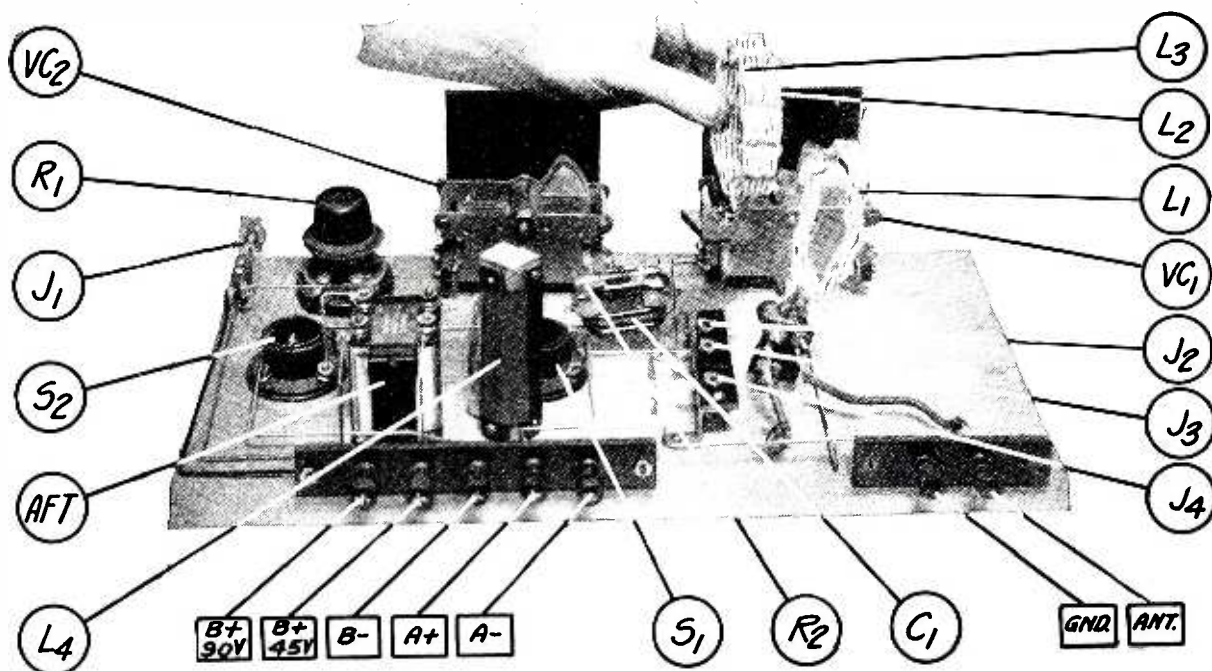

THE REAR VIEW OF THE SET

FIGURE 3: The symbols used correspond with those in Figure 1 and in the list of parts. The proper connections for the antenna, ground and batteries are shown. Note that the secondary coil is just being plugged into the receiver, by means of the plugs on the coil and jacks J2, J3 and J4.

ous wave transmitters operating on the short waves, and using only a fraction of the power used on broadcasting stations, have carried on reliable communication between California and New England at midday. The receivers used in these tests were no more elaborate than the one described here. Of course, both the transmitters and the receivers were highly efficient, but the main credit for this remarkable bit of

work belongs to the inherent qualities of the short waves as a medium for radio work.

The layout of the instruments on the base-board is clear from the illustrations, Figures 1, 2, 3 and 4. The coils may easily be made at home in the following manner:

The choke coil consists of 200 turns of the No. 28 DSC wire, wound on a tube 1¼ inches in diameter and 4 inches long. The choke coil shown in the illustration was wound on a form made up of four ½-inch strips of hard rubber, thus making a semi-air-core coil. Card-board tubing which has been given two coats of shellac will serve the purpose quite satisfactorily, however.

The coils for the antenna and closed circuits are of the air-core type, wound on a form as shown in Figure 4. It will be necessary to make three closed-circuit coils to cover the different wavebands up to 90 meters. Larger coils can be made to cover wavelengths above this range if desired.

For the antenna circuit two coils should be made. One should have five turns, for use in reception up to about 60 meters, the other should have 10 turns for waves higher than this. If the antenna used is a long one, however, the five-turn coil will be enough, and even with this small coil it may be necessary to use a .00025 fixed condenser in series with the antenna.

The winding form is made by laying out a circle 3 inches in diameter on a piece of 1-inch board, and then laying off 13 equidistant points on this circle. At each of these points drill a hole through the board for the pegs which are

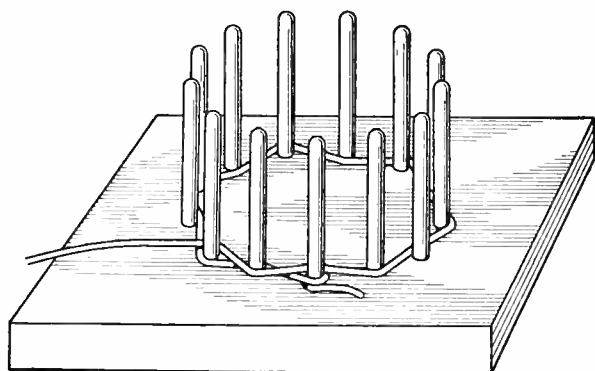

THE COIL WINDING FORM

FIGURE 4: This is the winding form for winding the air core coils; dimensions will be found in the text. The pegs may be metal tubing, wood dowels or any other fairly strong material; solid metal rod is probably the most satisfactory, however, as it does not burr or split at the ends as is sometimes the case with tubing or wood, when it is necessary to use a hammer to force the pegs in and out of their holes.

to be used for the coil form. These pegs may be made of 3/16-inch metal rod, or they may even be large sized nails, although the rough surface of the latter is liable to scrape the insulation off the wire. The holes should be slightly smaller than the pegs so that the pegs will be rigid when driven into place. After the pegs are in place (if the holes have been made sufficiently snug it will be necessary to hammer them in) the five-turn antenna coil may be wound as a starter.

The No. 16 DCC wire is first looped around one of the pegs. With the board flat on the table and this peg nearest the body, start the winding toward the left. With the wire coming around the outside of the first peg, run it inside of the next peg to the left, outside of the next, and so on. Because of the odd number of pegs it will be found that the second turn of wire passes on the inside of the peg at which the winding was started, outside of the second peg, and so on. After five complete turns have been wound on the form, slide the whole coil up a little on the pegs, after looping the end of the winding around the same peg that the beginning was looped around, and cut the wire with a couple of inches of free end.

Now remove this first peg by pushing a nail up through the hole in which the peg rests. Next run a piece of cord down through the hole (in the coil) left by the peg, and tie the

end of this cord tight so that the coil will retain its shape.

Next, remove another peg and run the cord up through the hole in the coil, remove the next peg and run the cord back down through this hole, and so on. Thus when all the pegs have been removed the coil will be held securely in shape by this lacing.

For greater security, especially in the case of larger coils, the lacing can be continued until it has gone around twice. After tying the end of the lacing cord, the first antenna coil is completed. Another coil of ten turns may then be wound in the same manner.

The tapped coils for the closed circuit are wound in the same general way. The first coil, to cover the wavelength band from 12 to 30 meters, consists of five turns, with a tap at the second turn. The winding is started as before and continues for one complete turn and around again to the peg before the one on which the winding was started. Here the tap is taken off, then the winding is continued two complete turns and on to the peg before the one at which the tap was taken. The lacing and removal of this coil is the same as described above. The two turns make up the plate inductance (L3-Figure 5) while the larger part is the grid inductance (L2).

The next larger coil is wound in the same manner and consists of nine turns, tapped at the third. The third coil consists of 18 turns,

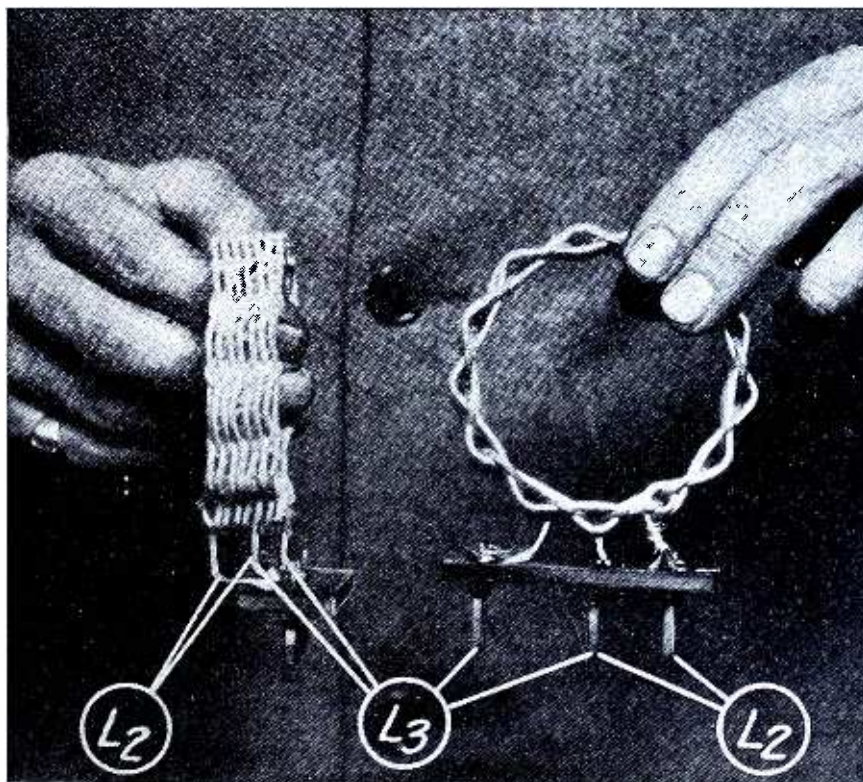

FRONT AND SIDE VIEW OF THE COILS

FIGURE 5: Two of the coils are shown here, all mounted and ready for use. Note that the three plugs are unevenly spaced; this is also true of the jacks into which the plugs slip. This is done to prevent plugging the coil into the receiver backwards.

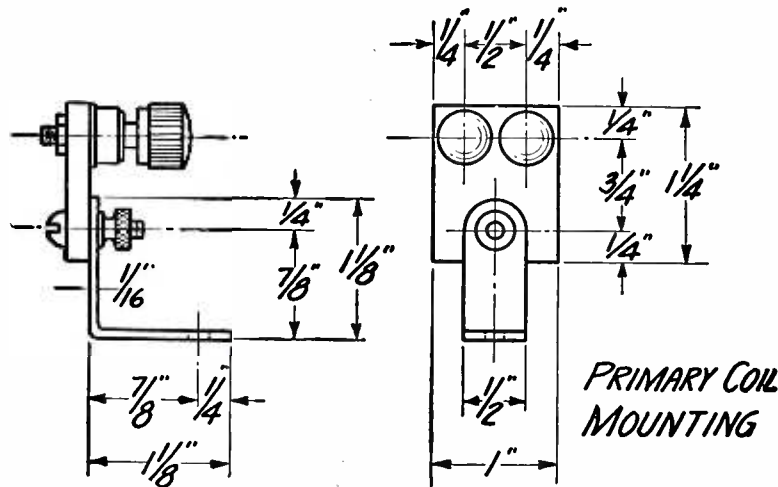
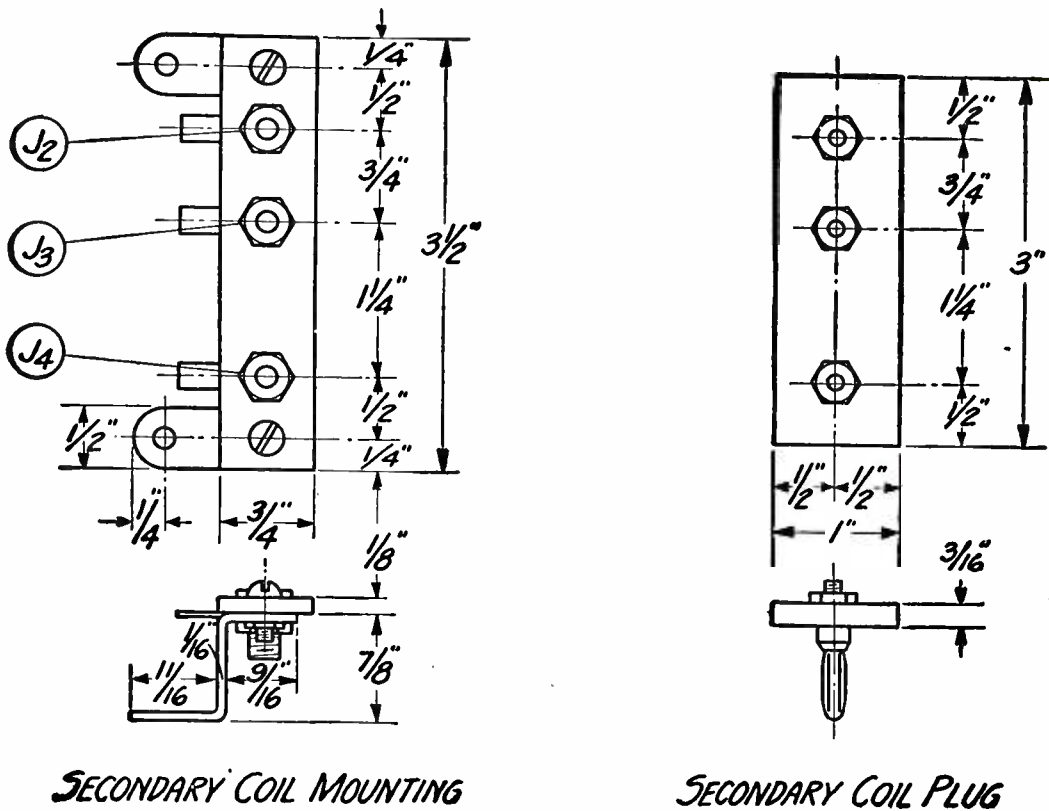

DETAILS OF THE MOUNTINGS FOR COILS

FIGURE 6: The primary and secondary coil mountings are secured to the baseboard of the receiver as shown in Figures 2 and 3. The bolt and nut in the middle of the primary mounting permit swinging the primary coil to and from the secondary coil, thus permitting just the proper degree of coupling between the two. The method of mounting the coils on the secondary coil plug is shown in Figure 5.

tapped at the sixth. By means of these three coils the entire band from 12 meters up to 90 meters may be covered. To go higher than this a coil of 36 turns, tapped at the twelfth turn is suggested. In each case the larger portion of the coil represents L2 in the hook-up, or the grid coil.

Tuning is so sharp on these low wavelengths that the use of a low capacity tuning condenser is essential. If a .00025 mfd. variable condenser is used for VC1, instead of the .0001 mfd. condenser specified it becomes diffi-

cult to find and tune in signals, as even when the dial is turned slowly stations are liable to be skipped over unnoticed.

The mounting of the coils is the next step in the preparation of the receiver. Due to the comparatively small wavelength range of each coil, it is first of all necessary to arrange for quick change of the closed circuit coil. Also, the antenna coil must be mounted in such a way as to permit swinging it to and from the closed circuit coil, to vary the coupling between the two.

For the closed circuit coils a fixed mounting is provided on the baseboard, provided with three small jacks. Then each of the closed circuit coils is mounted on a small composition strip by means of three of the General Radio coil plugs. The plugs are mounted on the strip as shown in Figure 6, and the three leads from the coil are soldered to the lugs provided with the plugs. With each of the coils provided with these plug contacts, changing coils becomes as simple an operation as inserting a phone plug in a jack.

The method for mounting the antenna inductance coils is also simple. There is, however, less occasion to change coils here so plugs and jacks are not necessary. Two binding posts serve as mountings. The two ends of the coil winding are sufficiently rigid to provide ample support when connected to these binding posts.

When operating the receiver, VC1 is the wavelength tuning control while regeneration is controlled by means of VC2. The adjustment of VC2 has practically no effect on VC1 and the receiver is surprisingly stable in operation. There is no body capacity noticeable in tuning with VC1 and the slight body capacity resulting when the hand is placed on the dial of VC2 is of little importance as this dial is not touched after a station has been brought in, all the fine tuning being done with VC1.

To put the receiver into operation the batteries, antenna and ground are connected.

If UV-199 or C-299 tubes are used (and they serve as well as the larger tubes for this receiver), either three dry-cells connected in series, or a storage battery may be used for the filament supply. A single-wire antenna, 50 feet in length, will serve as well as anything else for an antenna. If a larger antenna is used

the coupling between the antenna and closed circuit coils must be loosened. In other words the antenna coil should be swung away from the other until the two are almost at right angles.

When the rheostat is turned on slightly and the phone plug is inserted in the jack J1, the tubes should light and the receiver is in readiness for reception. Starting at zero, turn the dial of VC2 until a "plop" is heard as the receiver goes into oscillation. Leave this dial set just beyond this point and rotate the dial of VC1. If, in rotating VC1 another plop is heard it means that oscillation has stopped and VC2 must be turned a little higher. When the receiver is made to oscillate with VC1 set at 100 then oscillation should continue uninterrupted throughout the entire scale of VC1. If it does not do this, it is usually an indication that the fundamental frequency of the antenna circuit is the same as that to which the receiver is tuned when oscillation stopped. The remedy is to reduce the coupling by swinging L1 further from the closed circuit coil.

When the receiver is oscillating and VC1 is rotated slowly, a "birdie" whistle will be heard when VC1 passes over a signal. If the signal is code, VC2 should be turned back until oscillation stops and then up again just past the point where oscillation starts. This will be the point of maximum signal strength for code reception. Dial VC1 is then carefully adjusted for best results. If the signal is one from a broadcasting station then VC2 should be turned back until oscillation just stops and VC1 should be more carefully adjusted. Voice signals are best just below the point of oscillation as they are badly distorted if oscillation is permitted.

—S. GORDON TAYLOR

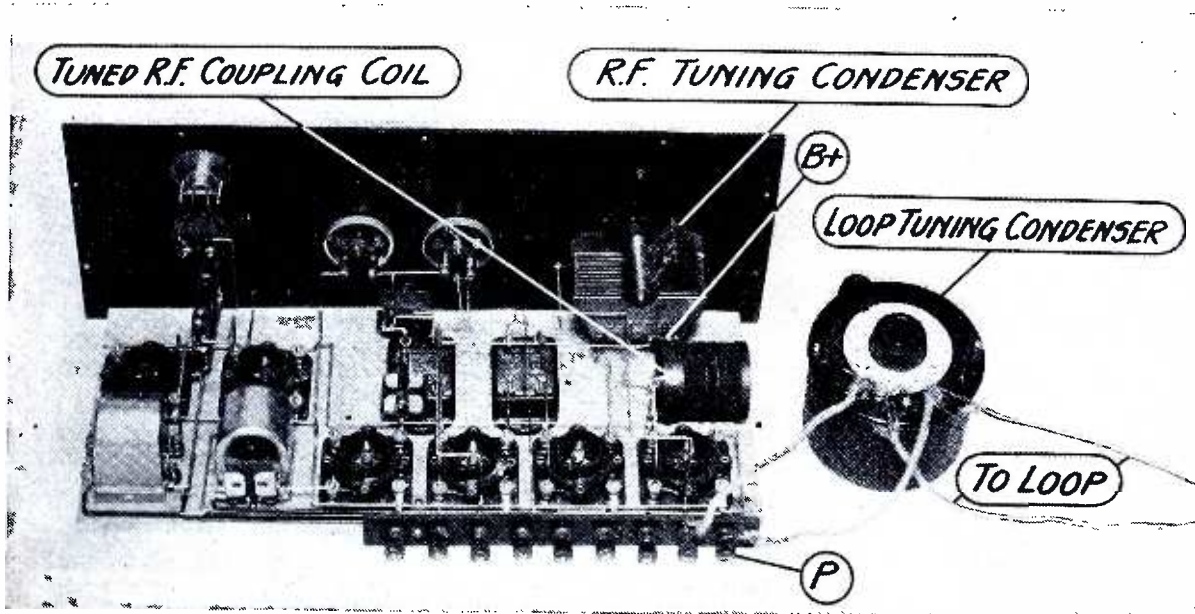

VIEW OF THE SET FROM THE REAR

FIGURE 7: Here is shown the location on the baseboard of the new radio frequency coupling unit. The method of connecting the loop tuning condenser is also illustrated.

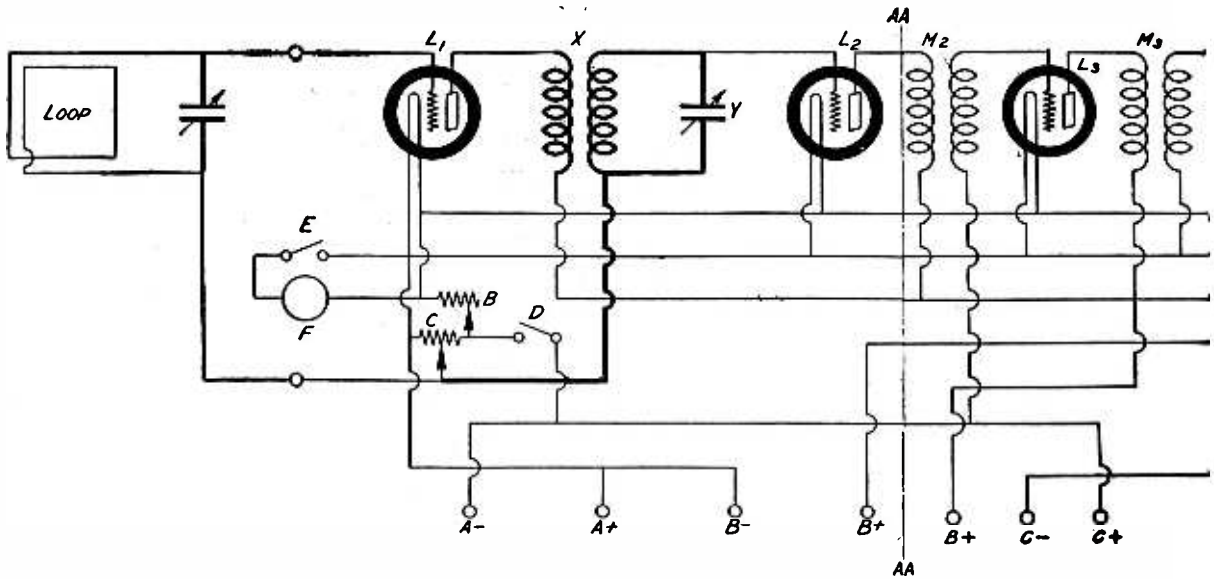

Alterations In the "Town and Country Receiver"

It has been found that under certain conditions the "Town and Country Receiver" (described in the May, 1925, issue of POPULAR RADIO) did not provide sufficient selectivity when used in the immediate vicinity of high-powered broadcasting stations.

To improve the receiver in this respect experimental work has been carried on in the POPULAR RADIO Laboratory with the result that the selectivity is now sufficient for use in any location. Used in the heart of New York City, within a few blocks of several powerful stations, no difficulty is now found in separating them absolutely so that any one station may be tuned in without any trace of interference from any of the others. In a night test in New York it was found possible to tune in KDKA at Pittsburgh (309) meters without any interference from WGBS or WAHG, local stations working on 316 meters. Cleveland and Philadelphia stations were tuned in on 390 and 395 meters respectively, while the local stations WOR and WJY were working on 405 meters.

In addition to increasing selectivity, the alterations made in the receiver increased the volume surprisingly. Operating the receiver in the suburbs of New York City, the city stations were entirely too loud for comfort on the loudspeaker. Ample loudspeaker volume was obtained with the plug in the first jack.

The alterations made were simple. The first radio-frequency transformer was replaced with a tuned-radio-frequency transformer and a variable condenser for tuning this transformer. Thus there are two tuned circuits. The input to the first tube is tuned by means of the variable condenser connected directly across the loop and the input to the second tube is tuned by means of the variable condenser shunted across the new tuned-radio-frequency transformer.

First of all, the variable condenser and the first radio-frequency transformer are removed from the receiver. This variable condenser may be used for tuning the loop. It will not be mounted in the receiver proper. The new variable condenser is now mounted on the panel in place of the one just removed, using the same shaft hole.

The new radio-frequency transformer is mounted at the end of the baseboard in a horizontal position between the variable condenser and socket No. 1 and with the connecting lugs pointing to the left looking from the rear of the receiver. (See Figure 7.) It should be laid with the primary connections uppermost. These are the two terminals which are connected to the small winding in the center of the transformer. The secondary terminals will then come at the bottom. The mounting is accomplished by drilling a hole through the rim of the form and between the two secondary terminals. Run a wood screw down through this hole into the baseboard. A washer about $\frac{1}{4}$ inch in thickness should be placed between the baseboard and the coil form. When mounted in this position the two terminals nearest the panel are: upper, B+; lower, F. The upper and lower rear terminals are Plate and Grid, respectively. The B+, Grid and Plate terminals are connected into the circuit the same as the corresponding terminals of the old transformer and in addition, the grid terminal also connects to the stator plates of the new variable condenser. The F terminal of the coil is connected differently, however, inasmuch as it goes to the wire running from the second loop binding post at the rear to the arm of the potentiometer. A connection from this wire goes to the rotor plates of the variable condenser.

The variable condenser which was removed from the receiver may be used to tune the loop. There is hardly enough space on the panel to

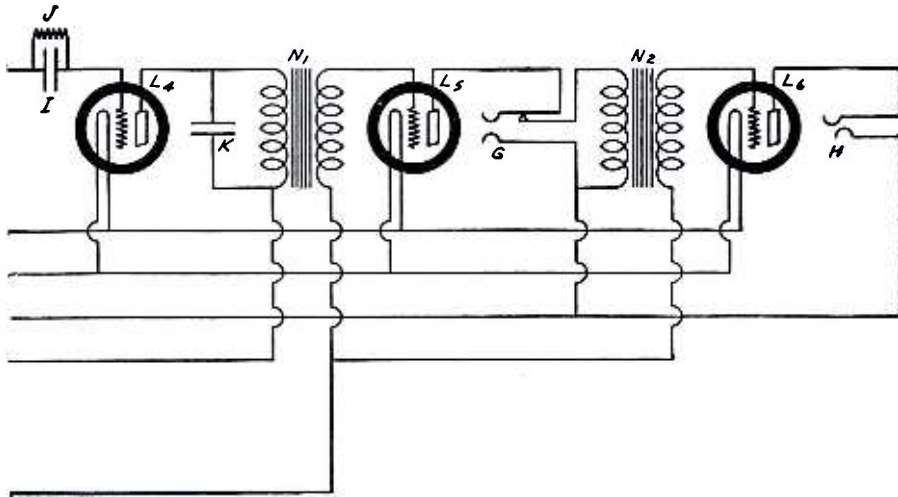

THE COMPLETE NEW CIRCUIT

FIGURE 8: This is the same diagram as in Figure 9, except that the new instruments and connections are shown in heavy lines. The new instruments used are: (X) Precision radio frequency coupling unit, and (Y) Bradleydenser, capacity .0005 mfd. The location and use of these instruments are explained in the text.

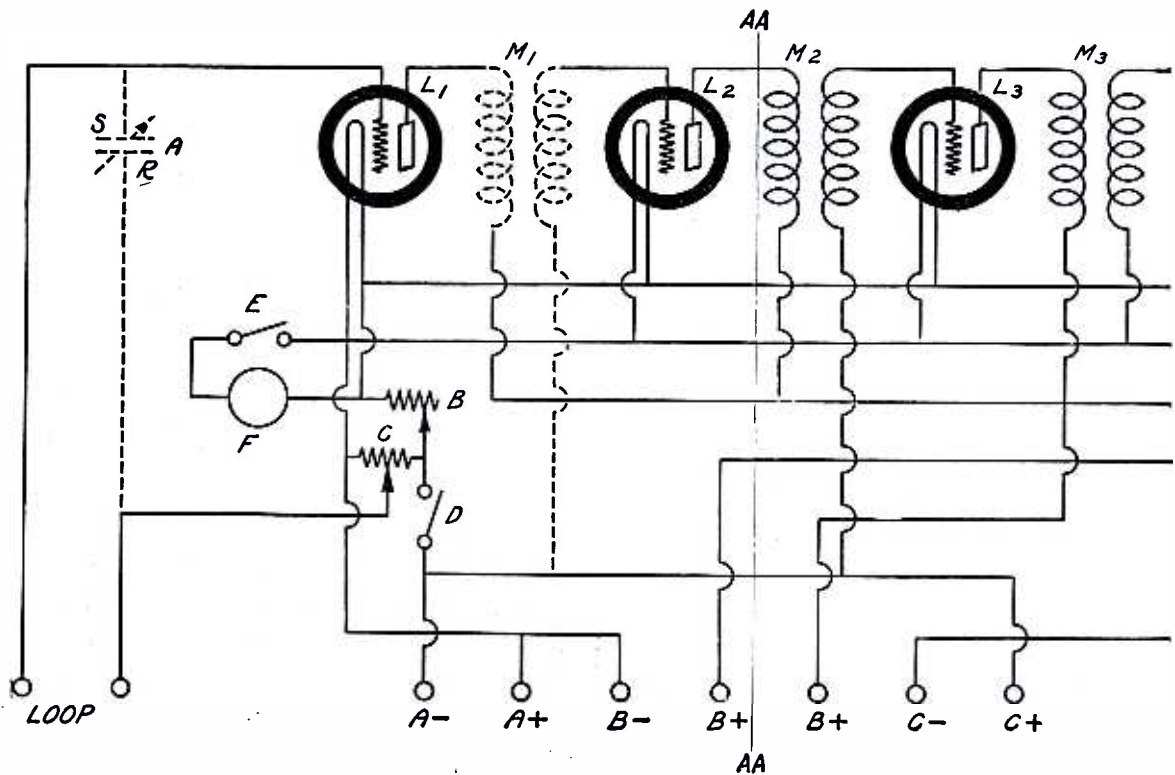

CHANGES IN THE HOOK-UP

FIGURE 9: This shows the first half of the hook-up as given in the descriptive article in the May 1925 issue of POPULAR RADIO, but with dotted lines to indicate the instruments and connections which are to be removed. These include the transformer M1 and the variable condenser A, as well as the connection from the transformer to the filament or "A" battery circuit. (The balance of the circuit beyond AA is not shown as it remains the same as in the May issue.)

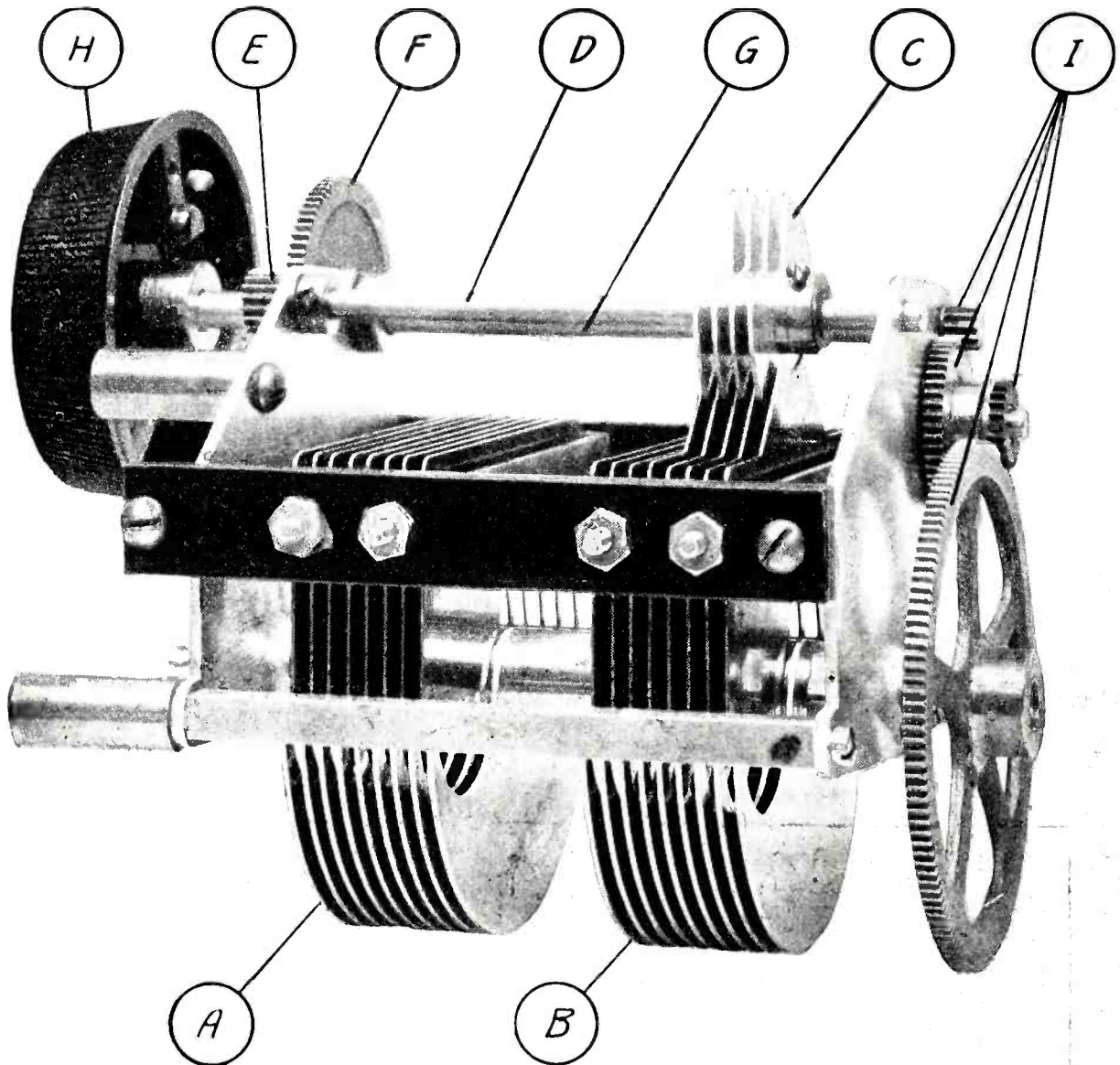

A NOVEL IDEA FOR TUNING TWO CIRCUITS SYNCHRONOUSLY

FIGURE 10: This picture shows two variable condensers controlled by a single knob. The capacity of condenser B pulsates quickly above and below the capacity of the condenser A. This is accomplished by means of the small "booster" condenser C.

mount this condenser, so it is set up next to the loop, outside of the receiver. In the laboratory a General Radio mounted type of condenser was used for tuning the loop, for the sake of convenience, but the original condenser can be used by mounting it on a small piece of panel material, with a small baseboard to support the panel. It is connected across the two "loop" terminals of the receiver, the two sides of the condenser also being connected to the loop. The connections are shown in Figure 8. The reason for using a different condenser in the receiver is that the original condenser had a capacity of only .00035 mfd., whereas a capacity of .0005 mfd. is required to cover the broadcasting waveband with the type of tuned-radio-frequency transformer used.

Operation of the receiver is the same as before in all respects except that there are two circuits to be tuned now instead of one. Both

of the dials can be "logged," however, because when a broadcasting station is once tuned in, it may always be brought in again at the same setting of the dials.

To tune in the first station, it is well to start with the dial set at 40 and then to slowly rotate the other dial (loop tuning condenser), keeping the potentiometer adjusted just below the point of oscillation. If no stations are heard, change the setting of the panel condenser dial to 35 and again rotate the loop tuning condenser dial. Repeat this process, if nothing is heard, setting the panel condenser on 30, and so on until a station is finally heard. Then readjust both condensers and potentiometer until the signals have maximum volume. The settings of the dials can then be recorded for use when it is again desired to tune in this particular station.

—S. G. TAYLOR

A New Idea in Single-control

It is a well-known fact, when using tandem condensers for controlling two radio-frequency stages with a single dial, that unless the two coils have exactly the same values of inductance the two circuits cannot be both placed in resonance.

I have been working for more than two years on single-control receivers with the usual type of gear condensers with success.

During 1924, however, I conceived the idea of a method of securing absolute resonance between associated circuits using one control knob. The method which I employ uses no separate vernier or other balancing devices. This method consists of turning one of the controls continuously, shifting the second control backward and forward automatically so as to "cross" the resonant position of the first control.

Referring to the picture (Figure 10) the small condenser marked C shown at the top of the second unit B is connected on the shaft E which is energized through the gear E

which gets its motion through the gear F of shaft G operated by Dial H. The two units A and B are operated simultaneously by the gear train I, which is also connected by the shaft G to the dial H.

It will also be seen that as the two condenser units A and B are being rotated slowly the small unit C is being rapidly changed so that the resonance point of the second unit crosses the resonance of the first unit and, therefore, a point can easily be found where the two units will always be in resonance even though the coils do vary somewhat.

The ratio between the control knob and the vernier shaft on the model shown in the photograph is approximately five to one and the ratio between the control knob and the main shaft is twenty-five to one, giving a ratio of 125 of the vernier capacity to $\frac{1}{2}$ revolution of the main shaft.

Owing to the fact that the vernier is of smaller capacity no trouble will be experienced in stopping the control knob at the exact resonant point for any stations.

—T. E. NEW



Kadel & Herbert

THE NEW 10-METER TRANSMITTER

This apparatus was developed by the Bureau of Standards for testing the short wavelengths that are now so popular.



THIS department is conducted by POPULAR RADIO LABORATORY for the purpose of keeping the radio experimenter and the broadcast listener informed concerning the newest inventions and the approved developments in radio equipment. Only such apparatus as has been tested and endorsed by the Laboratory is noted in these columns.

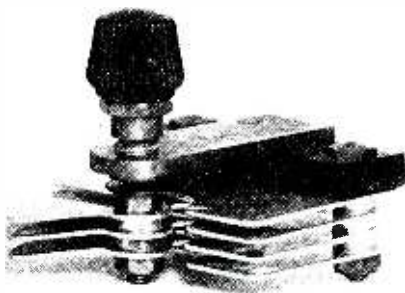

A seven-plate variable condenser.

A MIDGET VARIABLE CAPACITY

Name of instrument: Small variable condenser.

Description: The stator plates and also the rotor plates of this small variable condenser are mounted on a strip of hard rubber by means of two posts with suitable washers and nuts and with a shaft that is held by small brass arms and that contains a small knob at one end for revolving the plates. It is well constructed and an efficient piece of apparatus.

Usage: In a receiver in any place where a small variable capacity will be found useful.

Outstanding features: Compactness. Efficient. Easily adjustable. Neat in appearance.

Maker: Lombardi Radio Mfg. Co.

A NEW IMPEDANCE COUPLER

Name of instrument: Impedance-coupling coil.

Description: This instrument is really an audio transformer with part of the inductance to be connected in the plate

circuit of a vacuum tube and the whole included in the circuit in series with a large fixed condenser as an impedance coupler in a distortionless audio-frequency amplifier. The coils are wound on a very large core which eliminates the possibility of saturation. It is equipped with three binding post terminals, to which are attached soldering lugs. The whole case is fitted with a metallic shield which may be grounded.

Usage: In a radio receiver as a coupling device at audio frequencies.

Outstanding features: High primary inductance. Truthful reproduction. Neat appearance. Adequate iron core.

Maker: Thordarson Electric Mfg. Co.

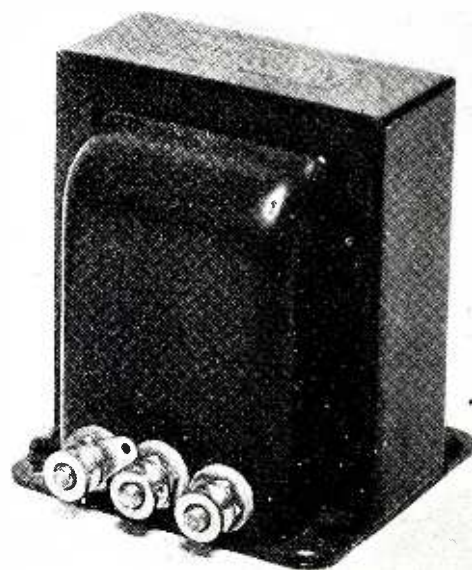

A highly efficient audio-frequency coupler.

A MODIFIED SOLENOID COIL

Name of instrument: Tuned-radio-frequency transformer.

Description: This coil is constructed in a manner that causes it to be self-supporting; it is practically a solenoid winding with a minimum of dielectric material in the electrostatic field between turns. It may be used wherever the ordinary tuned-radio-frequency coil has been used before and in a radio-frequency amplifier that is to be tuned with a variable condenser. It is equipped with soldering terminals for making connections to the other parts of the circuit.

Usage: In any receiver as an interstage-coupling device at radio frequencies.

Outstanding features: Low distributed capacity. Maximum inductance shape. High efficiency. Simple to connect in the circuit.

Maker: Benjamin Electric Mfg. Co.



A shielded inductance coil.

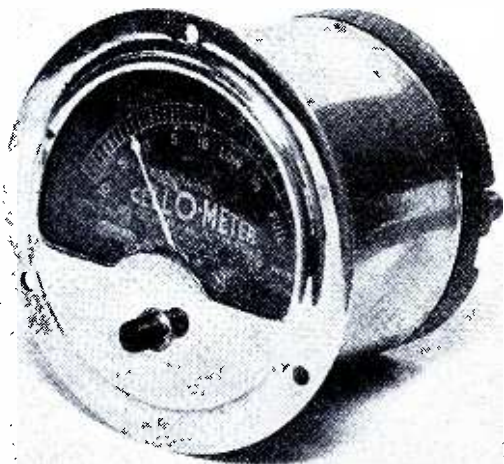

A new type of battery meter.

A NOVEL BATTERY TESTER

Name of instrument: Battery testing meter.

Description: This instrument, which may be used in connection with a storage battery, is termed the Cel-O-Meter. It contains two scales; the one at the left indicates the rate of charge or discharge of the storage battery; the scale at the right indicates the condition of the battery—showing whether it is fully charged, half charged or low. This determination is made by means of pressing a small button on the surface of the front panel. It is an accessory that will give the set owner an immediate indication of the condition of the storage battery.

Usage: In connection with a storage battery for determining its electrical condition.

Outstanding features: Compact. Quick reading. Sturdy in structure.

Maker: Cellokay Mfg. Corp.

A TUBE REACTIVATOR

Name of instrument: A tube rejuvenator.

Description: This device contains a current converter for applying a series of currents to the filament circuits of thoriated filament tubes for renewing the filament emission of tubes that have been damaged or that are partially worn out. It is suitable for use with either the standard 201-a type or 199 type that operates from a thorium emission principle. It is equipped with two sockets for the two types of tubes and two sets of push buttons for applying the current.

Usage: In connection with thoriated filament vacuum tubes for restoring them to active use.

Outstanding features: Compact. Neat in appearance. Efficient.

Maker: J. Thomas Rhamstine.



An instrument that renews vacuum tubes.



CONDUCTED BY WILLIAM G. H. FINCH

This department will keep you in touch with the latest inventions of interest on which patent rights have been granted, and which are significant contributions to radio art.

Reduction or Elimination of Static

A METHOD and apparatus for reducing or eliminating static and other electrical disturbances in radio telephonic and telegraphic reception, is proposed by David G. McCaa of Lancaster, Pa., in his patent No. 1,522,136. It is claimed that with this invention the effects of static, atmospherics, strays and other natural or artificial disturbances, including other radio signals, are reduced on radio or other receiving systems, whereby the desired signals are readily distinguishable or become intelligible, notwithstanding the simultaneous existence of strong disturbing effects.

The system is shown in Figures 1 and 2. The received electrical energies representing both the desired signal and the disturbing effect are divided between reactive paths, one of which is employed for effecting the translation of the desired signals, and with another of which is associated means for impressing thereon a part of the energy of the desired

signals which were previously amplified, to cause a change of reactance, which thereby withholds from the signal translating path the effect of the undesired oscillations to greater degree than the effects of the desired signal.

An Improved Vacuum Tube

In patent No. 1,529,626, recently issued to Ernest Y. Robinson, of Manchester, England, means are disclosed whereby the electrodes or metallic members of a vacuum tube may form also part of the usual glass envelope.

A Static Elimination System

JOSEPH SLIPAN, of Swissvale, Pa., was granted patent No. 1,513,286, covering a system for static elimination which is quite novel and worthy. It is shown that the desired result may be obtained by including, in the receiving antenna, a resistor having such value as to effectively damp the receiving system. Non-resonant means are then associated with the

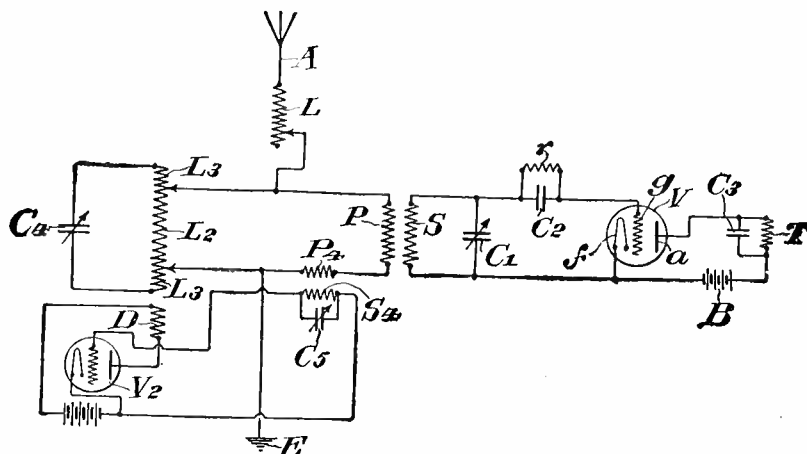

THE CIRCUIT DIAGRAM FOR THE McCAA ANTI-STATIC DEVICE

FIGURE 1: This diagram gives theoretically the circuit plan for the device whereby static or artificial disturbances are reduced and the desired signals made more readily distinguishable and intelligible.

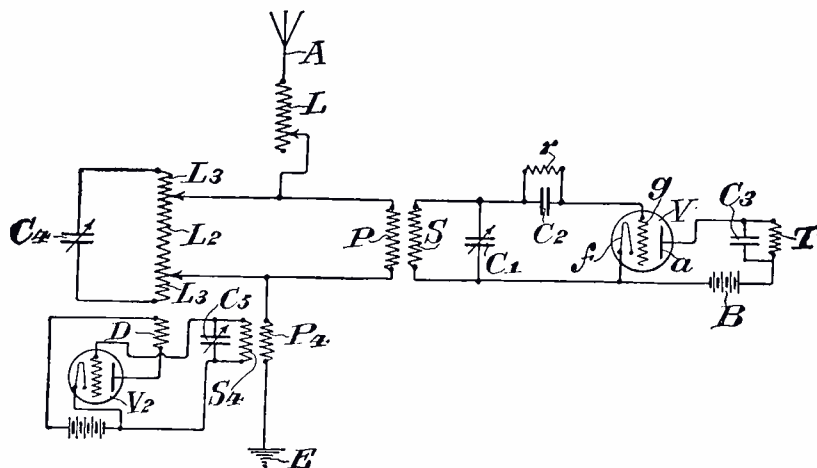

ANOTHER VARIATION OF THE McCAA SYSTEM

FIGURE 2: This schematic drawing shows another means for accomplishing static or interference reduction by means of a specialized circuit which decreases static but preserves the intensity of the signal itself.

resistor, whereby the voltage-drop therein may be substantially neutralized for currents of predetermined frequency only.

For Reducing Interference

J. WEINBERGER, of New York, in his patent No. 1,525,526, also discloses a radio receiving circuit that is designed to reduce interference from other stations. This is accomplished by the use of intermediate tuned circuits and also a phase shifter designated as 10 in Figure 3.

It is understood that a number of manufacturers made application for license to manufacture receivers embodying the inventions set forth in the Schloemilch & Von Bronk patent number 1,087,892. POPULAR RADIO is curious to know who were the successful applicants. It will be appreciated if these applicants will identify themselves by communicating with Wm. G. H. Finch, care of POPULAR RADIO AND WIRELESS AGE, 627 West 43d Street, New York.

Who Were Licensed Under Navy Owned Patents?

SOME time ago the Navy Department announced that it would license manufacturers under various patents owned by the Navy De-

A New Variable Resistance Grid-leak

GEORGE H. HUMM of Fairfield, Conn., has been issued Letters Patent number 1,541,817 for a variable resistance grid-leak to be especially applicable for use in vacuum tube receiving circuits. This invention relates to a vari-

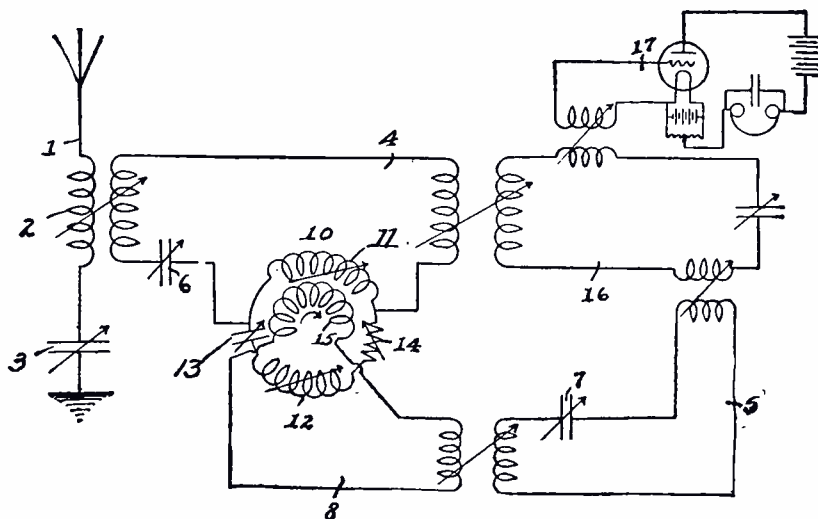

THE WEINBERGER ANTI-STATIC METHOD

FIGURE 3: A diagram for the intermediate tuned circuit system which incorporates a phase shifter for static signal reduction.

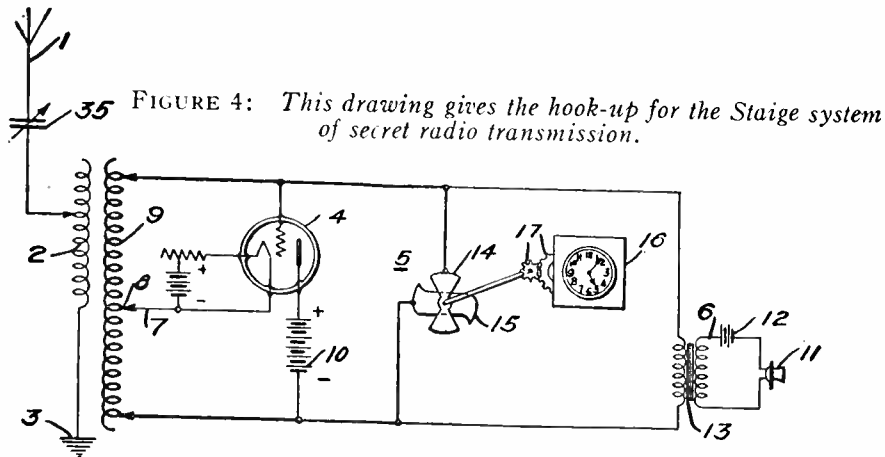

able resistance, especially for use with radio apparatus, and particularly a variable resistance grid-leak for shunting the condenser between the vacuum tube and antenna in series with the grid of the tube. As is well known, a high resistance leak is necessary across the grid condenser to relieve the grid of the surplus of electrons of such polarity as would, if allowed to accumulate, choke the tube and cause distorted signals.

It is an object of the present invention to provide a variable resistance which will provide a given maximum and minimum resistance, and in which a continuous range of varying resistances may be provided between these points, so that the variation of voltage across the grid condenser, occasioned by the power, distances or other varying factors of different broadcasting stations, may be accurately compensated for, permitting a higher resistance to be placed in the circuit during the reception of weak signals, so that a minimum of energy is lost and a reduced resistance during the reception of reduced signals, to prevent distortion.

Further objects are to provide a device of this character which will be of simple and durable construction, convenient to install and manipulate, and will not deteriorate through use or age.

Secret Radiophone System

A SYSTEM of secret and selective radio transmission and reception that is applicable both to radiotelephony and telegraphy is disclosed in patent No. 1,528,032 issued to Stephen A. Staige, of Pittsburgh, Pa. He proposes that the carrier wave frequency be caused to vary through a predetermined cycle within certain limits. In order that the receiving station may receive messages sent by a system of the character designated, it is necessary that the timing of the receiving station shall pass through the same cycle, *i.e.*, wavelength of variation in frequency.

The transmitting circuit is shown in Figure 4, which is tuned by the variable condenser 5, which is provided with various shaped plates

in order to produce any desired variation in the periodic change in frequency.

Figure 5 shows the receiving circuit in which 34 designates a variable condenser of similar construction and it will be noted that the variable tuning condensers in both circuits are geared to a clock motion. Any other suitable means may be employed to rotate said variable condenser so long as both are driven in synchronism.

The condensers may be rotated at any desired speed and an almost unlimited frequency or wavelength variation may be had.

It is evident that a transmitting station equipped with such a device would be intelligible at a receiving station only if said receiving station is equipped with a similar tuning device run at the same speed or in synchronism.

Other systems have been designed to accomplish the same purpose in which, however, no use is made of a moving device which must be kept in synchronism or speed at both the transmitter and receiver. Use is made of band filters in which certain frequencies are taken out at the transmitter and supplied at the receiver through local oscillators and filters.

It was thought some time ago that certain manufacturers possessing such systems would employ them to broadcast the highest grade of programs and only receivers supplied by them possessing the above features would be able to receive them, and by such methods they would be able to derive a direct revenue to support such programs.

A Variable Condenser

AN invention just patented by F. E. Stern and J. C. Randall of Hartford, Conn., patent number 1,537,561, relates to the type of condensers provided for radio communication sets that have a plurality of fixed plates and a plurality of plates interposed therewith and rotatively adjustable with relation thereto.

When the ordinary condensers of this character are in service and subject to the action of high frequency radio currents, the movement of a body toward or from the condenser changes the static conditions. For instance, after the condenser is adjusted to give the best

results the removal of the hand from the knob used to turn the movable plates will alter the capacity of the condenser sufficiently to throw the apparatus out of tune. Furthermore, it is essential that the circuit connection with the movable plates be sure and positive under all conditions of service and wear, and that the movable plates be capable of easy movement when desired but that they be restrained from accidental movement after having been adjusted.

The object of the invention is to provide a simple, cheap and efficient means which can be used as a guide for locating the condenser on the panel on which it is to be mounted and which means can subsequently be employed in such manner as to eliminate the objectionable influence of the movement of the body toward or from the condenser; also to provide a tensioning means for the movable plates which will ensure a good and efficient contact under all conditions of expansion, contraction and wear.

These objects are attained by forming an independent metallic disc with the necessary openings to permit it to be applied to the front of the panel to which the condenser is to be fastened; in this way it may be used as a templet for ensuring the exact drilling of the hole for the operating spindle and also the holes for the attachment screws through the panel. The disc is afterwards located on the front of the condenser between it and the back of the panel, and is grounded so as to neutralize the effect of the application of the hand to or the removal of the hand from the operating knob. Further, it forms the tensioning spring (that bears on the rear end of the spindle which carries the movable plates) in such manner that there is a line contact between the parts which keep bright and clean even under the wear of long and constant service.

Induction Coil Mounting

RICHARD C. ROSE of Osceola, Ark., was granted patent number 1,539,210. This invention has reference to inductance coil mountings especially designed for use in radio receiving systems. The primary object of the invention is to provide a device of this character wherein the mutual inductance between the primary and secondary circuits may be varied uniformly throughout the entire areas of the coil.

Another object of the invention is to provide a device of this character which may be used for either double or triple mounts for practically any conventional type of coils, and means are provided to permit of minute adjustment of the mutual inductive fields.

Another important object of the invention is to provide a coiled mounting constructed for the reception of coils of various sizes, thereby adapting the device for various usages.

Amplifying Apparatus

THIS invention discloses an electron discharge apparatus and circuits for amplifying and detecting high frequency signaling currents (radio telephony and telegraphy); it bears patent number 1,547,152, issued to Frank R. Elder of Schenectady, N. Y. One of the objects of the invention is to provide a circuit arrangement whereby the amount of amplification which may be obtained with a single device may be greatly increased.

It has been proposed in the past to employ a three-electrode electron discharge device for the simultaneous amplification of radio-frequency currents and audio-frequency currents. Another object of the invention is to provide a practical system whereby a four-electrode electron discharge device, particularly one of the negative resistance or pliodynatron type, may be employed for the simultaneous amplification of both radio and audio-frequency currents.

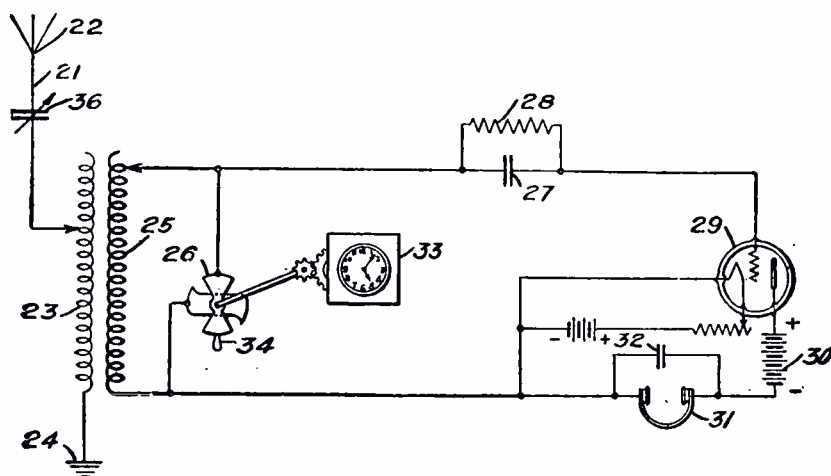

THE STAIGE SYSTEM FOR SECRET RECEPTION

FIGURE 5: The electrical connections for a receiver which embodies the patented system of reception of signals which have been transmitted by the method explained in Figure 4.

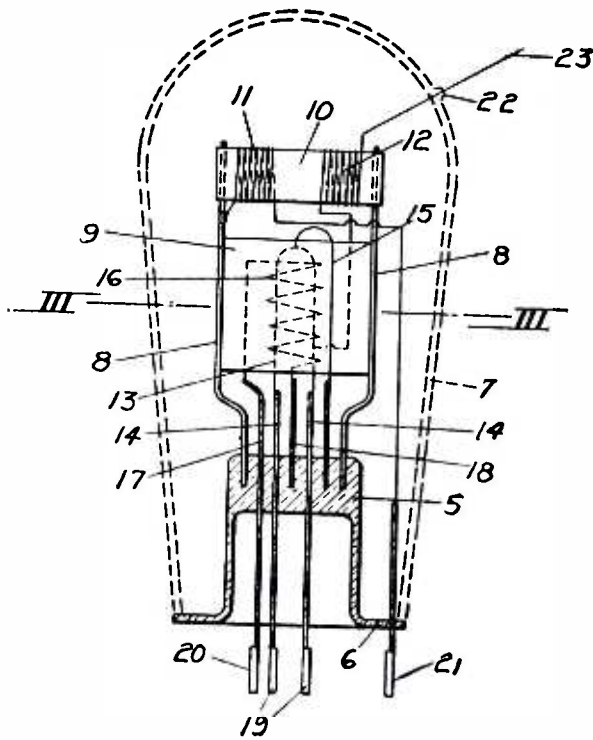

A COMBINATION TUBE AND RADIO FREQUENCY TRANSFORMER

FIGURE 6: This gives an idea how McCullough has modified the standard vacuum tube assembly to accommodate radio frequency transformers within the envelope of the tube. It shows clearly the structure which permits shortening the leads in the plate circuit.

A Unique Amplifying Apparatus

In letters patent No. 1,547,154 issued to Albert W. Hull of Schenectady, N. Y., there is disclosed an electron discharge apparatus and circuits for

amplifying and detecting high frequency signaling currents. Another feature of the invention is to provide a circuit arrangement whereby the amount of amplification which may be obtained with a single device may be greatly increased.

Similar results have been obtained in the past by reflexing *i.e.* using the same tube to perform two operations, that of radio and audio frequency amplification.

Mr. Hull obtains the above results in a new way. He does so by employing a pliodynatron or a tube with two grids, plate and filament.

A Combination Tube and Transformer

MR. FREDERICK S. McCULLOUGH, Wilkesburg, Pa., who is well known for his work with alternating current tubes, makes another contribution to the radio art. In patent No. 1,528,735, recently granted to him, he proposes to mount coils or radio frequency transformers within the envelope of the tube, thereby eliminating a number of external lead connections. This results in a material advantage in shortening of lead wires and in the consequent reduction of distortion due to the decreased impedance and capacity of such leads.

Furthermore, such construction enables apparatus involving the use of vacuum tubes to be very compact by reason of the saving of space gained by the elimination of such coils and lead wires.

In Figure 6 is shown the novel supporting means provided within the vacuum tube itself for mounting of coils or transformers within the tube, and an inspection of Figure 7 shows a wiring diagram illustrating a circuit employing this invention.

It is evident from both these drawings how such a construction eliminates long lead wires and results in the advantages as set forth in this patent.

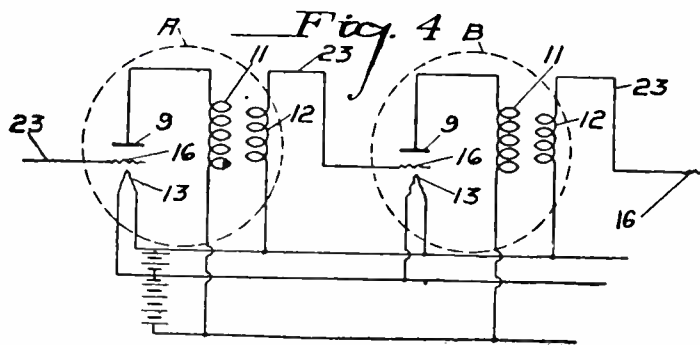

THE WIRING DIAGRAM OF THE CIRCUIT THAT EMPLOYS THE McCULLOUGH INVENTION

FIGURE 7: This diagram shows a standard radio frequency amplifier circuit in which the invention is employed. The wiring is considerably simplified by this arrangement.

New and Useful Data About Coils

Do you know that many "low-loss" coils really have lower efficiency than some of the older types? See POPULAR RADIO next month—for December.



Two Superspeakers Now— Both by JEWETT

With the new Jewett Superspeaker Console, a Radio reproducing instrument enters the realm of fine furniture.

Yet there is no sacrifice of brilliancy, volume or tone.

For the console is, in every essential, a Superspeaker. Its design is by the same staff of young Radio Wizards. Its concealed horn has the same proved Superspeaker air column. Its reproducing unit is the same exclusive, adjustable Jewett Vemco.

See how harmoniously this Console blends into any setting you choose—how notably it graces the most perfectly appointed living room. And rely on it always to give you Radio duplicated by but one other instrument we know—The Superspeaker itself.

Console cabinets are Jewett Built, of walnut or mahogany as you select. Top is inlaid with Arlington Ivory. Grille is pressed leather. Drape is silk in a neutral brown.

A highly perfected product by a builder world famous in the field of Quality Radio reproducers.

Your receiver deserves a Jewett reproducer.

JEWETT RADIO & PHONOGRAPH COMPANY

5668 Telegraph Road

Pontiac, Michigan

**Quality Broadcasting to Match
Quality Products—Station WJR**



"There is no substitute for the best"

© 1925 Jewett Radio & Phonograph Co.



All apparatus advertised in this magazine has been tested and approved by POPULAR RADIO LABORATORY

ONE DIAL CONTROL

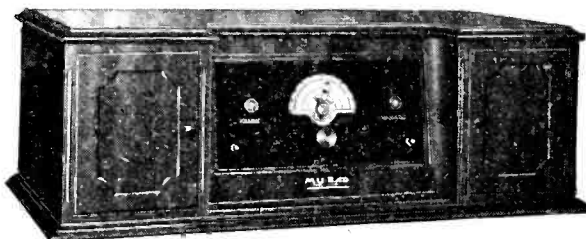

MODEL A—\$175

*Sockets Fit
All New Type
Tubes*

Radio's Remarkable Innovation

The MU-RAD

Transcontinental Receiver

With **ONE DIAL CONTROL**

YOU made this radio receiver. To answer a tremendous demand for simplicity without sacrificing efficiency Mu-Rad developed this New One Dial Receiver for you. This innovation in radio reception marks the most distinctive advance since the conception of radio. In addition to the one dial control, Mu-Rad embodies every principle necessary to good radio reception.

Just a slight turn of the one dial brings in local or distant stations. A station once logged always comes in at the same dial setting. It is so simple a child can operate it.

Write Dept. F-3 for Literature

MU-RAD RADIO CORPORATION

Factory:
Asbury Park, N. J.

General Sales Offices:
972 Broad St., Newark, N. J.

All apparatus advertised in this magazine has been tested and approved by POPULAR RADIO LABORATORY

ONE DIAL CONTROL



MODEL B—\$125

*Sockets Fit
All New Type
Tubes*

You'll Want To Own

The MU-RAD

Transcontinental Receiver

With ONE DIAL CONTROL

GO TO your nearest dealer—ask him to demonstrate this new Mu-Rad—The Transcontinental Receiver with One Dial Control. See how easy it is to operate that single dial and tune in scores of stations. Note its remarkable selectivity, its life-like reproduction, its tone, volume and beauty. Try tuning it yourself. It's so easy—a child can operate the Mu-Rad.

Radio experts say that this sensational receiver will probably not be improved upon for years to come.

Write Dept. F-3 for Literature

MU-RAD RADIO CORPORATION

Factory:
Asbury Park, N. J.

General Sales Offices:
972 Broad St., Newark, N. J.

All apparatus advertised in this magazine has been tested and approved by POPULAR RADIO LABORATORY



Unlike Some Music OZARKA Service Satisfies Every Owner—

IN radio, when one selection does not please, you simply tune it out and pick up another broadcasting station. If it is a question of unsatisfactory volume or tone in your instrument then it becomes an entirely different matter.

You have certain very definite ideas in mind as to what you want your radio to do. Will you allow us to make a few suggestions regarding a plan whereby you can settle the radio question?

Select the instruments which you think might answer. Have a demonstrating instrument

brought to your home. Let each salesman, in turn, make the necessary battery connections. Let him tell you how to operate it but do all the tuning yourself.

You'll buy the instrument then, based on your own operation. You'll size up each one for

- ease of tuning
- distance received
- volume
- tone
- selectivity
- price.

OZARKA

124 Austin Avenue C,
Chicago, Illinois



**YOU'LL KNOW
THE MAN BY
THIS BUTTON!**

All apparatus advertised in this magazine has been tested and approved by POPULAR RADIO LABORATORY



OZARKA Senior S-I

Complete With All Accessories
Including Hi-Power Speaker

\$125.00

West of Rockies, \$137.50

Canada, \$180.00

There still remains one very important question to settle—the matter of service. No matter what anyone tells you sometimes little things may go wrong. The best radio salesman often knows nothing of correcting radio troubles—satisfy yourself.

Our Ozarka representative in your community will gladly put an Ozarka in your home for such a test. More than this, you will find that he is a thoroughly trained mechanic on our instrument. He has gone through a complete course of study under Ozarka Engineers, the men who designed and perfected the Ozarka.

3187 such men today can correct any trouble which may occur on any Ozarka instrument—more men are being factory trained daily. You wouldn't buy an instrument blindly—then don't buy service the same way. Any radio instrument is only as satisfactory as the quality of service behind it.

Our Book No. 200 shows the full Ozarka line from \$75.00 to \$197.50, complete with all accessories.

A Few More Men Are Needed

In a great many counties we have the man we want. He is rapidly building up a permanent and profitable business of his own because he has an instrument that will more than meet all competition. More than this, he is trained to back up his sales with the kind of service that counts.

Many well established Ozarka representatives started by giving us only their spare time—their evenings. If your county is open you can do the same.

The investment in cash is very small. The investment in time necessary for study is considerable. It requires patience, but the results have enabled many men to get out of the salary and time clock class.

Any previous sales experience is helpful but not necessary. We can and will teach you how to sell.

Send Coupon for FREE Book!

The 84-page "Ozarka Plan" is entirely too expensive to be sent out on postal card requests. It will be sent FREE to any man who mails the coupon below and who is really anxious to improve his condition. Tell us about yourself, ask for Ozarka Plan No. 100 and don't fail to give the name of your county.

Ozarka Incorporated
124 Austin Ave. C,
Chicago, Illinois

Without obligation send book "Ozarka Instruments No. 200" and name of Ozarka Representative.

I am greatly interested in the FREE book "The Ozarka Plan" whereby I can sell your radio instruments.

INCORPORATED

124 Austin Avenue C,
Chicago, Illinois

Name.....

Address..... City.....

County..... State.....

All apparatus advertised in this magazine has been tested and approved by POPULAR RADIO LABORATORY

The United Achievement

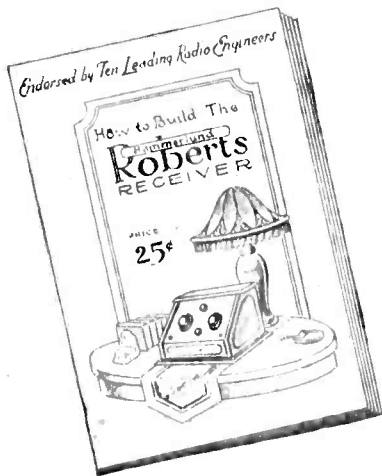

Write for "How to Build It" Book—Now!

Write for this most complete book, giving full details on assembling, wiring and operating the Hammarlund-Roberts Receiver. Fully illustrated.

25^c

Dominant Features

1. Sensitivity equal to a super-heterodyne.
2. Selectivity. No interference even in crowded areas.
3. Tone quality.
4. Non-radiating.
5. Simplified tuning, only two major controls.
6. Automatic filament control.

THE DIFFERENCE in this receiver is no mere superficial difference. It is a distinction that you, yourself, and thousands of others have made in discussing the "ideal receiver"—a difference that began with its very conception in the minds of the inventor and his collaborating engineers.

The Hammarlund-Roberts is a "composite receiver," incorporating the individual achievements of ten leading radio engineers.

Every unit in the Hammarlund-Roberts Receiver represents the highest attainment of a leading engineer. The transformers were selected by a transformer engineer, familiar with every reliable make. The condensers were similarly determined on by an engineer whose special study has been condenser characteristics, functions and construction. A man whose whole effort has been on resistance research and perfection selected the resistance units. Even the smallest, usually-neglected units, were made



All apparatus advertised in this magazine has been tested and approved by POPULAR RADIO LABORATORY

of Ten Radio Engineers

the object of scrutinizing study. Never before has so much extraordinary thought been given to every detail of a receiver.

This combination of harmonizing units in the most desirable circuit is a receiver that is truly the ultimate of five-tube reception, a composite of the higher ideals in radio.

And now—you can obtain this remarkable Hammarlund-Roberts Receiver for LESS than the price of any factory made five-tube receiver on the market of anywhere near equal quality. Anyone can build this new type receiver from the illustrated "step by step" instructions in the construction book described at the left.

Write for descriptive folder

Hammarlund Roberts

1182-B Broadway
New York City

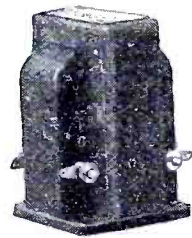
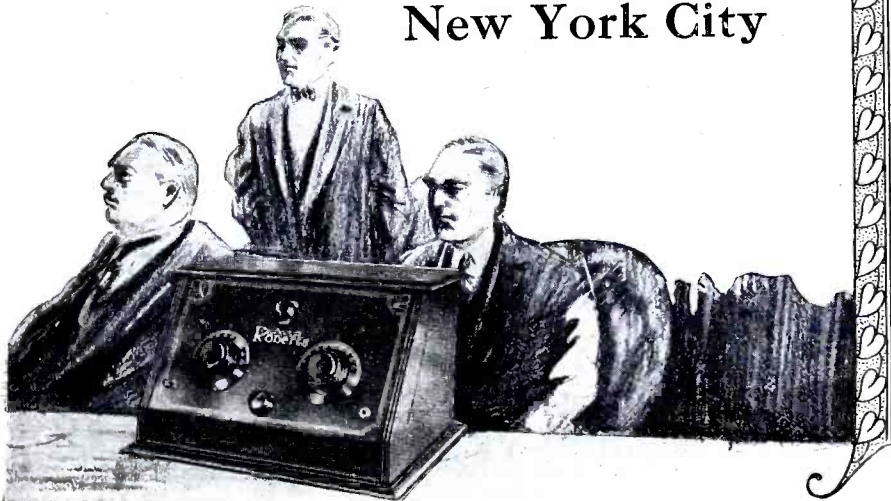

Rauland Lyric
ALL-AMERICAN
TRANSFORMER

Mf'd by the All-American Radio Corp.



AMPERITE

Mf'd by the Radiall Co.



UNION

Mf'd by the Union Radio Corp

Other Associate Manufacturers

beside those whose products are listed below

- Hammarlund Mfg. Co.
- Alden Manufacturing Co.
- Carter Radio Co.
- International Resistance Co.
- "Durham Resistors"
- Westinghouse Micarta

\$60⁸⁵

Price of entire
assembly
(cabinet extra)

All apparatus advertised in this magazine has been tested and approved by POPULAR RADIO LABORATORY



Beauty and Permanence

Radio Built for the Years to Come

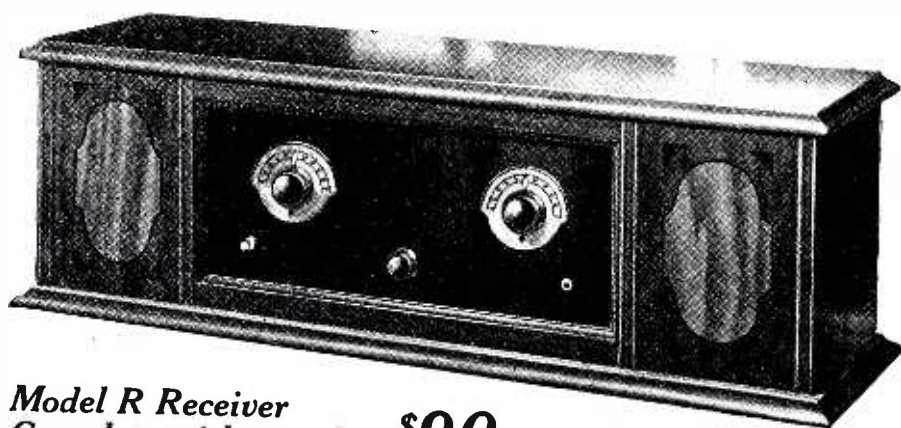

Model R Receiver
Complete without tubes \$90

The radio receiver here pictured is offered to the public by the ALL-AMERICAN RADIO CORPORATION, a pioneer in the manufacture of reliable radio apparatus, as an ideal example of the *solid value* which a thoroughly equipped and experienced organization can build into a product.

Forget for a moment the entire question of price. Think of any radio set you have ever admired or wished to own. Compare, first, its *construction*, with this brief outline (on opposite page) of the value which is built into the ALL-AMERICAN Model R.

Then, apply the final test—*compare the performance* with that of your former ideal of a radio receiver. After that—and not until then—remember the price at which it is offered, and simply ask yourself—“What can I get by paying more?”

All apparatus advertised in this magazine has been tested and approved by POPULAR RADIO LABORATORY

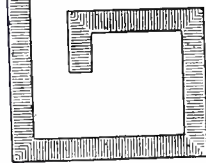
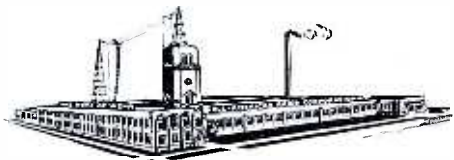
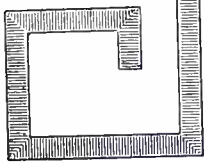

Built and wired complete in the new ALL-AMERICAN factory, the Model R embodies many notable improvements developed in the ALL-AMERICAN Laboratories. It is offered at a *moderate price*, but with the emphasis upon its superlative *quality*, deliberately inviting your frank investigation of this question —

What Can You Get by Paying More?

ALL-AMERICAN challenges comparison on the basis of the Six Vital Principles of Solid Value in Radio Receivers

1. Quality of tone

In the belief that tonal perfection is all-important, the ALL-AMERICAN Model R is equipped complete at the factory with *Rauland-Lyric* tone amplification. These laboratory-grade transformers, designed especially for lovers of artistic music, are recognized by highest authorities as the very finest on the American market.

2. Ease in Tuning

Two dials (360° type) control the ALL-AMERICAN Straight-Line-Frequency TUNING, reaching easily all wave channels, new and old, and eliminating all crowding of the low-wave stations. Touching the fingers to the dials does *not* affect the tuning.

3. Quietness

Practically all the various noises picked up directly from the air by ordinary coils have been eliminated in the ALL-AMERICAN Toroids. The unequaled quality of the *Rauland-Lyric* tone amplifier results in a remarkable quietness.

4. Selectivity

A test of the ALL-AMERICAN Model R will be a revelation to the experienced listener, in the sharpness of tuning which has been achieved solely through improved condenser and inductance design, without impairing tone quality in the slightest degree.

5. Sensitiveness to distant signals

The ALL-AMERICAN Tuned-Radio-Frequency system embodies the most advanced refinements of the present year. The result is a sensitiveness which challenges comparison with any other set made, irrespective of the number of tubes employed.

6. Appearance and serviceability

The ALL-AMERICAN Model R comes in a beautiful two-tone mahogany cabinet, with inlaid designs, which accords with the decorative scheme of the most fastidious home. Ample space is provided within it for all batteries, or for a "B" socket-power if preferred. The ALL-AMERICAN "steel chassis" construction rounds out a set that will be a source of uninterrupted enjoyment for years to come.

Have your dealer demonstrate the Model R for you

The leading wholesaler of radio apparatus in your community has probably been, for years, an ALL-AMERICAN Authorized Distributor. ALL-AMERICAN Guaranteed Radio Products are sold everywhere by responsible and reliable dealers

ALL-AMERICAN RADIO CORPORATION, 4211 Belmont Avenue, Chicago, Illinois
E. N. Rauland, President

MEMBER
ALL-AMERICAN
Pioneers in the Radio Industry

OWNING AND OPERATING STATION WENR—266 METERS

All apparatus advertised in this magazine has been tested and approved by POPULAR RADIO LABORATORY

The Walbert Univernier

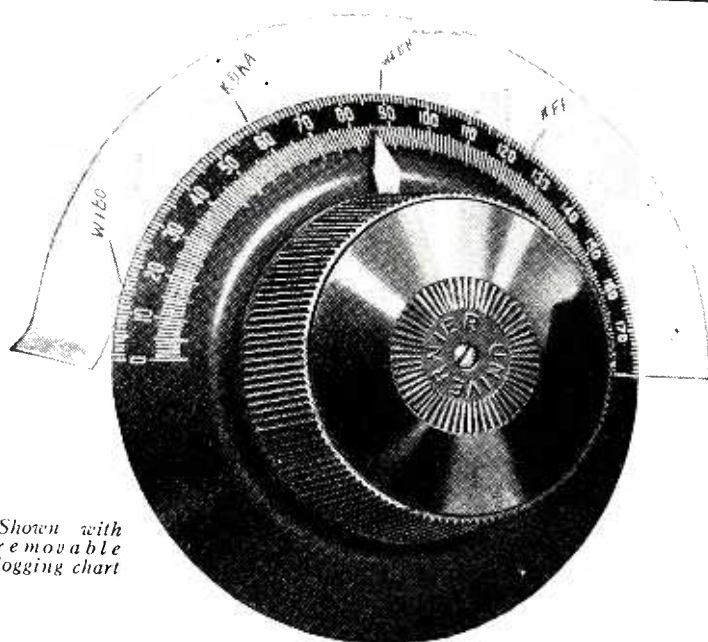

Shown with
removable
logging chart

Minute Hand Tuning

Remove the minute hand from a clock—how accurately could you tell time from the hour hand alone?

Not within four or five minutes either way.

Exactly the same thing holds true of the direct ratio radio dial. You cannot control hand palpitation within two or three meters of the wave-length desired. That is fatal to exact tuning.

The Walbert Univernier adds minute-hand accuracy to tuning. Its 12 to 1 ratio enables you to separate stations with split-hair fineness—to tune efficiently and to exclude interferences of all kinds. Univernier "slow-motion" first finds the station desired—then brings it in with crystalline clearness.

Logging with the Univernier becomes an exact science. An extremely practical removable logging chart is furnished with each Univernier—once the station is logged it remains permanently at your instant command.

Examine a Univernier. You will see why the original vernier dial still remains unapproachable.

Price \$1.50.

4-inch dial.

* * *

All genuine Bakelite.

* * *

No plating or paint to deteriorate.

* * *

Smooth firm action.

* * *

Positive anchorage — no friction.

* * *

No pressure on condenser bearing.

* * *

Large knob maintaining high ratio and comfortable control.

WALB

Manufacturing Company, 923

All apparatus advertised in this magazine has been tested and approved by POPULAR RADIO LABORATORY

The Walbert Univernier Condenser

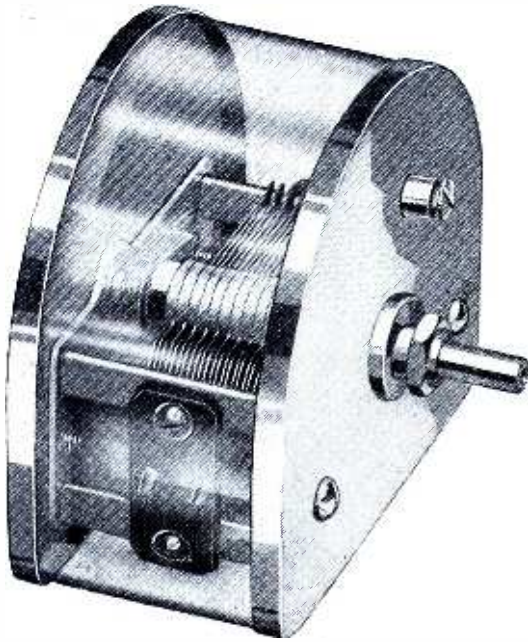

All Walbert Products protected by Pats. or Pats. Pend. U. S. and Foreign

No Dust Fluctuation

Dust-proof construction—Straight Line Frequency characteristics—life-time bearings—center hole mounting with auxiliary support. Both mechanically and electrically the Walbert Univernier Condenser is a finished product.

With spring brass plates a full inch shorter, the Univernier Condenser covers the important 90% of the broadcasting range with S.L.F. characteristics. Stations are spread evenly along the dial. No bunching at the low end. Inconstant alignment and static coupling effects of the longer plates are avoided.

Walbert dust-proof construction follows the example of the most expensive laboratory condensers. Dust on the plates changes the capacity and logging and often shorts the condenser. The Univernier Condenser is entirely enclosed just as the finest scientific condensers.

You will find the Univernier condenser a small-size precision instrument that sets a new standard in condenser design.

Maximum Capacity .00035 M. F.....	\$3.50
Maximum Capacity .0005 M. F.....	4.00
Minimum Capacity .0000105 M. F.	

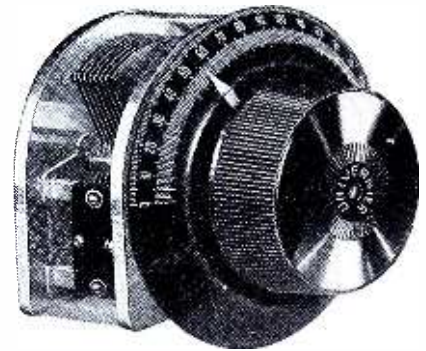

The combination of the Univernier dial and the Univernier condenser is the most perfect tuning unit ever made. The mounting of the combination is extremely simple. Parts are perfectly co-ordinated and operate smoothly without wear. With this combination you will achieve selectivity and tonal clarity usually associated only with high-priced receivers.

Combination Unit .00035 M. F.....	\$5.00
Combination Unit .0005 M. F.....	5.50

ERT



Wrightwood Avenue, Chicago

All apparatus advertised in this magazine has been tested and approved by POPULAR RADIO LABORATORY



Your Radio and MICARTA

YOUR radio will be built of the best only when a Micarta panel adds efficiency and beauty to careful building.

It is the easiest of materials to engrave and machine. Smooth holes may be drilled without the slightest sign of a chip. It is not affected by temperature changes, water or oil.

Micarta panels are now available in the soft, deep gloss of mahogany and walnut as well as in black. You will find them at your dealer's packed in the orange and black envelopes.

Westinghouse Electric & Manufacturing Company
East Pittsburgh Pennsylvania
Sales Offices in All Principal Cities of
the United States and Foreign Countries



W

MICARTA RADIO PANEL

REG. U.S. PAT. OFF.

Micarta is used by leading radio manufacturers because of its low power loss, high dielectric strength and pleasing appearance. Micarta radio panels can be drilled and machined with ease.

SEE DIRECTIONS ON OTHER SIDE
Westinghouse Electric & Manufacturing Co.
EAST PITTSBURGH, PA.

Westinghouse

284536 A

All apparatus advertised in this magazine has been tested and approved by POPULAR RADIO LABORATORY



RADIO 'RITHMETIC

"A" batteries + "B" batteries + RECTIGON = clear radio reception

HARK back to your old arithmetic and those busy boys "A" and "B". They were forever doing "a certain piece of work". They're still inseparable. Nowadays "A" and "B" storage batteries are busy with clear radio reception.

"A" still depends upon "B", and vice versa. Both need to be kept fully alive to do their best work. Both *can* be kept alive easily and dependably through the use of *one* [did you know that?] compact little device—

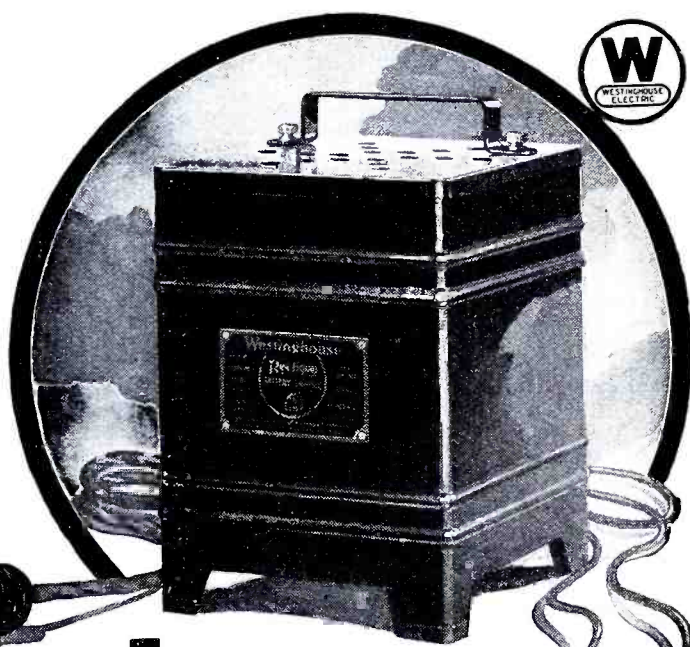

The Westinghouse Rectigon Battery Charger

© 1925 W. E. & M. Co.

To recharge 1- or 2-cell radio "A" batteries merely adjust "snap" terminals as shown here. Takes but a moment.

To recharge 3- or 6-cell radio "A" or automobile batteries merely adjust "snap" terminals as shown here. Simple as can be.

To recharge 11- to 48-cell "B" batteries merely adjust "snap" terminals as shown here. (An instruction sheet packed with every Rectigon).

Superiorities
 THERE'S no muss or fuss when you use the Rectigon. No acids or chemicals. No moving parts and no noise!
 It has high quality insulation throughout. Even the case is protected with Rectigon enamel, acid-resisting enamel. Guaranteed to completely satisfy.

No storage battery radio is complete without a RECTIGON

All apparatus advertised in this magazine has been tested and approved by POPULAR RADIO LABORATORY

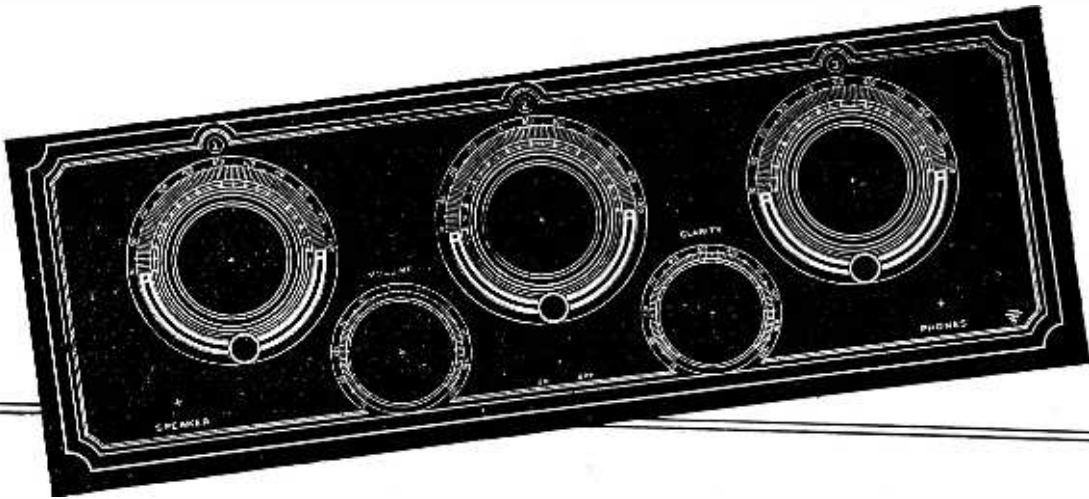

Exceptional Technical Resources Alone Make Formica Possible

VERI-CHROME PANELS

By the purchase of a controlling interest in the Veri-Chrome laboratories, the financial and production resources of the Formica Insulation Company have been placed behind this remarkable new process for decorating radio panels. Elaborate decorations can be produced much more rapidly and more economically than by engraving. Decorations designed by the leading American artists are offered. Tuning scales may be marked directly on the panel eliminating the standard dial and substituting pointers instead. The reduction in cost is large. Write for prices on complete panels finished in this way in quantity.

THE exceptionally fine finish, remarkable uniformity, and evenly maintained quality of Formica over many years are due to the first rate technical resources which the Formica Insulation Company has concentrated on its work.

The Formica laboratories have been leaders in developing the material, and the largest producing equipment in the country has given first rate service to manufacturing and trade users of radio panels and insulation.

Formica has not only the largest organization in the world devoted to this product, but it is an organization that concentrates all its attention on just one thing.

Formica panels for home set builders, in gloss black, dull black, walnut and mahogany are packed in neat craft paper envelopes and sold by leading dealers everywhere.

Insist on Formica and build your set for permanence.

THE FORMICA INSULATION COMPANY 4641 Spring Grove Avenue, Cincinnati, Ohio

- 1 Formica is used by nearly all the leading set makers—and has for years been used by more set makers than any other material.
- 2 Formica is unaffected by weather and time—it lasts forever.
- 3 Formica in appearance is the finest of all panel materials and always remains so.
- 4 Formica's electrical qualities of every kind far exceed any possible requirement.
- 5 Formica has high mechanical strength and will not break in use.
- 6 Formica will not sag from heat or cold flow under pressure. It retains its dimensions. Everything you fasten to it stays tight and precisely where you put it.
- 7 Formica panels are sold in neat craft paper envelopes which assure you that you are getting the genuine.
- 8 Formica is one of the most widely approved materials in radio.

SALES OFFICES

50 Church Street New York, N. Y.
9 South Clinton St. Chicago, Ill.
516 Caxton Bldg. Cleveland, Ohio
327 Cutler Bldg. Rochester, N. Y.
422 First Avenue Pittsburg, Pa.
6 Beacon Street Boston, Mass.
55 Calle Obispo Habana, Cuba

1026 Second Avenue Minneapolis, Minn.
725 Bulletin Bldg. Philadelphia, Pa.
708 Title Building Baltimore, Md.
585 Mission Street San Francisco, Cal.
419 Ohio Building Toledo, Ohio
309 Plymouth Bldg. New Haven, Conn.
Whitney Central Bldg. New Orleans, La.

FORMICA

Made from Anhydrous Bakelite Resins
SHEETS TUBES RODS

Hear the Formica Orchestra over WLW every Tuesday evening from 9 to 10 Central Standard Time.

All apparatus advertised in this magazine has been tested and approved by POPULAR RADIO LABORATORY

A New Conception of Radio

*A
New Kind of Receiver
No Dials - No Panel
Built-in Loudspeaker*

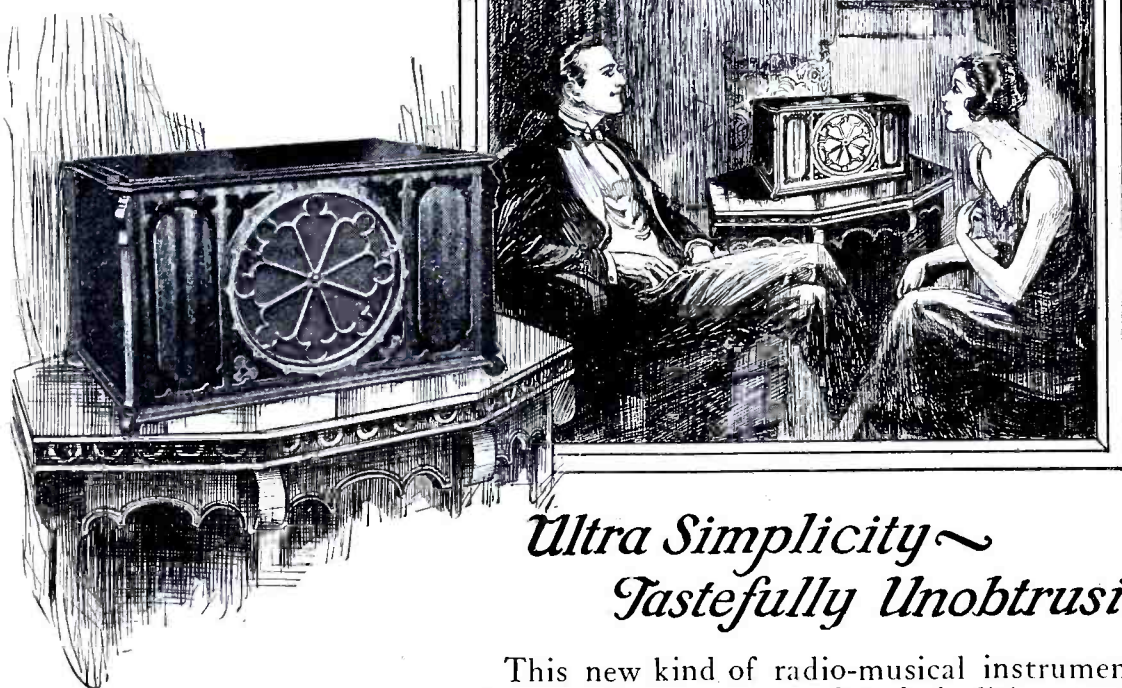

*Ultra Simplicity ~
Tastefully Unobtrusive*

\$135

Designed by R. E. Lacault, E. E., Chief Engineer of this Company, and formerly Radio Research Engineer with the French Signal Corps Research Laboratories.

To protect the public Mr. Lacault's personal monogram seal (R. E. L.) is placed on the assembly lock bolts of all genuine ULTRADYNE Model L-3 Receivers. All Receivers are guaranteed so long as these seals remain unbroken.



This new kind of radio-musical instrument marks the complete mastery of technicalities to the point where the whole range of radio's resources are literally at your instant command.

The Ultradyne, Model L-3, supplants the usual "laboratory machine." It is a new artistic table-piece that makes the entrance of radio into the well-appointed home *unobtrusive, inconspicuous*. It represents the triumph of art over mere mechanics.

The Ultradyne Model L-3 fulfills every thing that the critically-minded have demanded of radio. A six-tube receiver employing the fundamental principles of the best circuits, greatly refined and marvelously simplified. No dials—no panel: Just two inconspicuous levers which constitute a station-selector. Duco finished, two-toned mahogany cabinet.

Skepticism will vanish if you will let your local dealer demonstrate this new modern receiver.

Illustrated folder on request

Phenix Radio Corp., 116 E. 25 St., New York

ULTRADYNE
MODEL L-3

All apparatus advertised in this magazine has been tested and approved by POPULAR RADIO LABORATORY

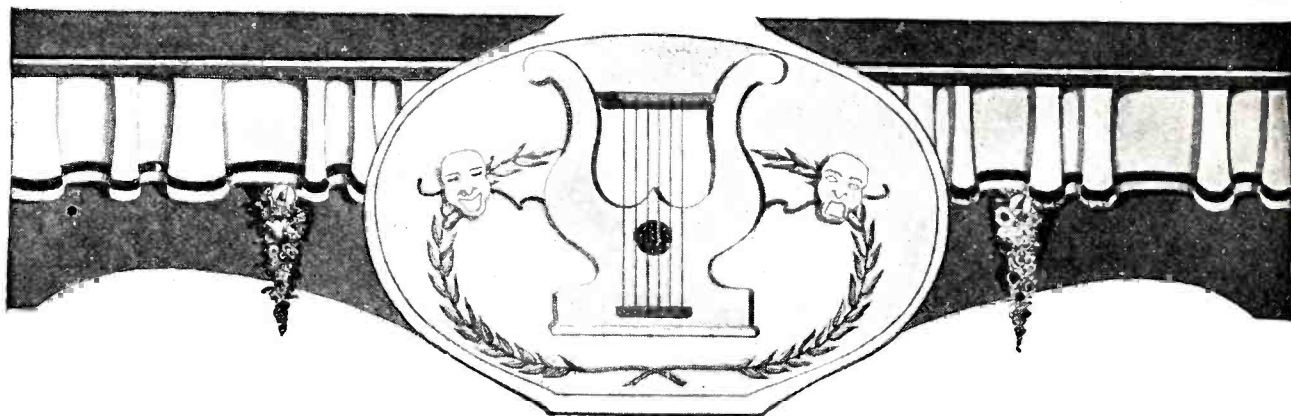

Fifty Years for Stability

Discriminating people must have assurance of unquestioned stability back of every piece of merchandise they purchase. This year, the fiftieth anniversary of the Holtzer-Cabot Electric Company, is an opportune time to bring before the radio public a medium priced loud speaker that is unsurpassed by any other at, or near its price. This loud speaker is on sale at dealers who are most jealous of their reputation. Insist upon hearing it.

National
Loud Speaker
\$12.⁰⁰
Adjustable
Control

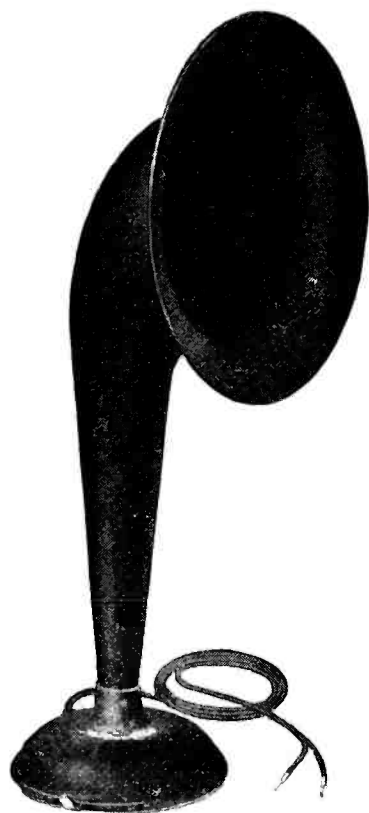

1875-1925
For Fifty Years
Manufacturers
of Quality
Electrical
Apparatus

The Holtzer-Cabot
Electric Co.
125 Amory Street
Boston, Mass.



All apparatus advertised in this magazine has been tested and approved by POPULAR RADIO LABORATORY

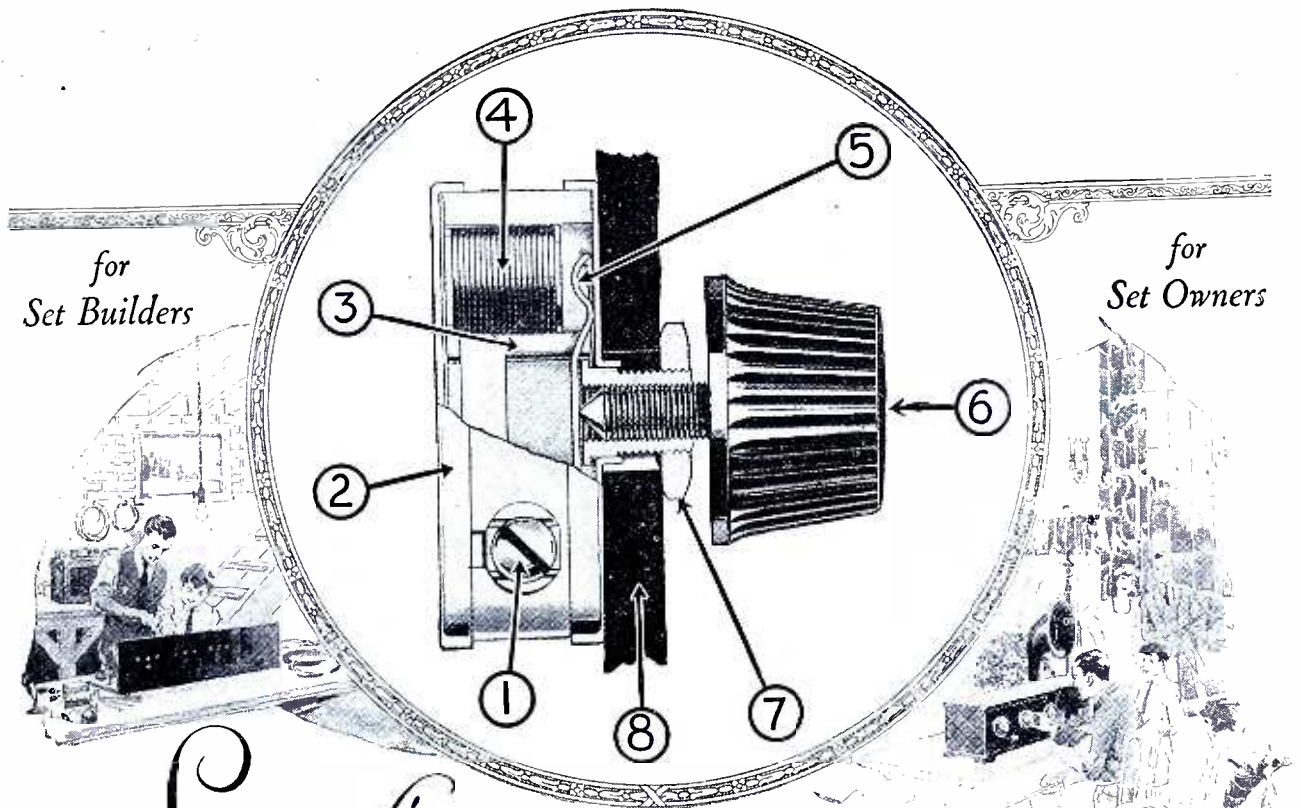

Superfine — in finish and performance

WHETHER you build your own radio receiver or buy a factory-built set, you will improve your set by installing Allen-Bradley Perfect Radio Devices. Not only are Allen-Bradley Radio Devices strikingly beautiful in finish and design, but their marvelously silent, selective control never fails to amaze and delight you. The eight salient, unrivaled Allen-Bradley features are:

- 1 Terminals are readily accessible. Designed for bus bar wire or terminal lugs.
- 2 Metal parts are heavily nickle-plated and buffed to a high polish.
- 3 Container is made of glazed porcelain that excludes moisture.
- 4 Specially-treated graphite discs give amazingly wide and noiseless control.
- 5 Internal switch opens battery circuit, if desired, by turning knob to the left.
- 6 Highly polished bakelite knob is removable if you prefer to match other dials.
- 7 One-hole mounting makes installation simple and easy on all sets.
- 8 Can be used with any panel thickness. Back panel extension is extremely small.



Bradleyohm—Perfect Adjustable Resistor

Bradleyleak—Perfect Grid Leak $\frac{1}{4}$ to 10 Megohms

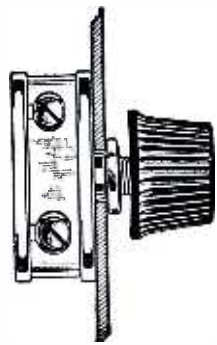

Bradleystat—Perfect Filament Control for All Tubes

Mail the Coupon for Latest Booklet

Allen-Bradley Co.
Electric Controlling Apparatus

276
Greenfield
Avenue



Milwaukee,
Wisconsin

Mfrs. of Graphite Disc Rheostats
for Over 20 Years.



Bradleyohm—Perfect Adjustable Resistor

ALLEN-BRADLEY CO.
276 Greenfield Ave., Milwaukee, Wis.

Please send me your latest literature on the complete Allen-Bradley line of Perfect Radio Devices.

Name

Address

All apparatus advertised in this magazine has been tested and approved by POPULAR RADIO LABORATORY

*Specified
by
McLaughlin*



WESTON
Radio Instruments

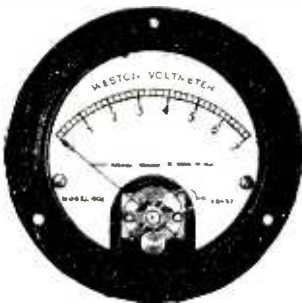

Weston
Model 301
7 Volts



Weston
Model 301
25 Milliamperes

WESTON Radio Instruments are specified as standard equipment on the new McLaughlin single control, radio set. These instruments permit close regulating of the filament voltage and plate current, thus insuring long life of tubes and batteries and the best operating conditions of the set.

Weston instruments are standard the world over and experienced operators know the value of equipping their sets with proven, dependable meters—they know that cheap and inferior instruments are unreliable and are the most expensive in the long run.

Are you profiting by their experience?

*Write for Radio Circular "J" describing
Weston Radio Instruments*

**WESTON ELECTRICAL INSTRUMENT
CORPORATION**

115 Weston Avenue, . . . Newark, N. J.

STANDARD THE WORLD OVER

WESTON

Pioneers since 1888



All apparatus advertised in this magazine has been tested and approved by POPULAR RADIO LABORATORY

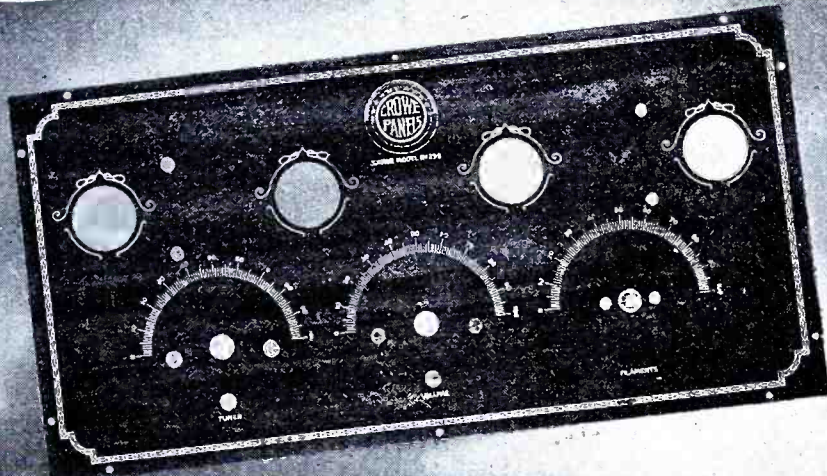

"THE PERFECT PANEL"

Crowe Etched Metal Panels

The introduction of Crowe metal panels marks a long step forward in better radio reception. Leading radio engineers and authoritative laboratory tests give them the highest rating as a paneling medium.

Crowe panels are made of brass and bronze—not dielectric or insulating materials. Crowe panels shield the set from disturbing interferences, while reducing losses and "body capacity" effects to a negligible minimum.

They will not break, split nor warp. In appearance, Crowe panels are masterpieces of metalcraft, produced in a wealth of beautiful finishes to harmonize with all the popular styles of cabinet work.

Makers of quality receiving sets have been quick to avail themselves of this superior paneling medium. Be sure the set you buy carries a Crowe metal panel.

*Write for latest list of makes equipped with Crowe panels,
and our instructive folder, "Why the Receiving Set I Buy
Should Be Panelled with a Crowe Metal Panel."*

CROWE NAME PLATE & MANUFACTURING CO.
1749 Grace Street, CHICAGO

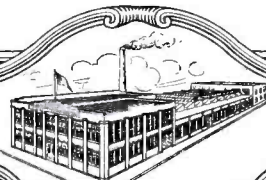

Producers of Name Plates and Etched

Products for Nearly a Quarter Century

All apparatus advertised in this magazine has been tested and approved by POPULAR RADIO LABORATORY

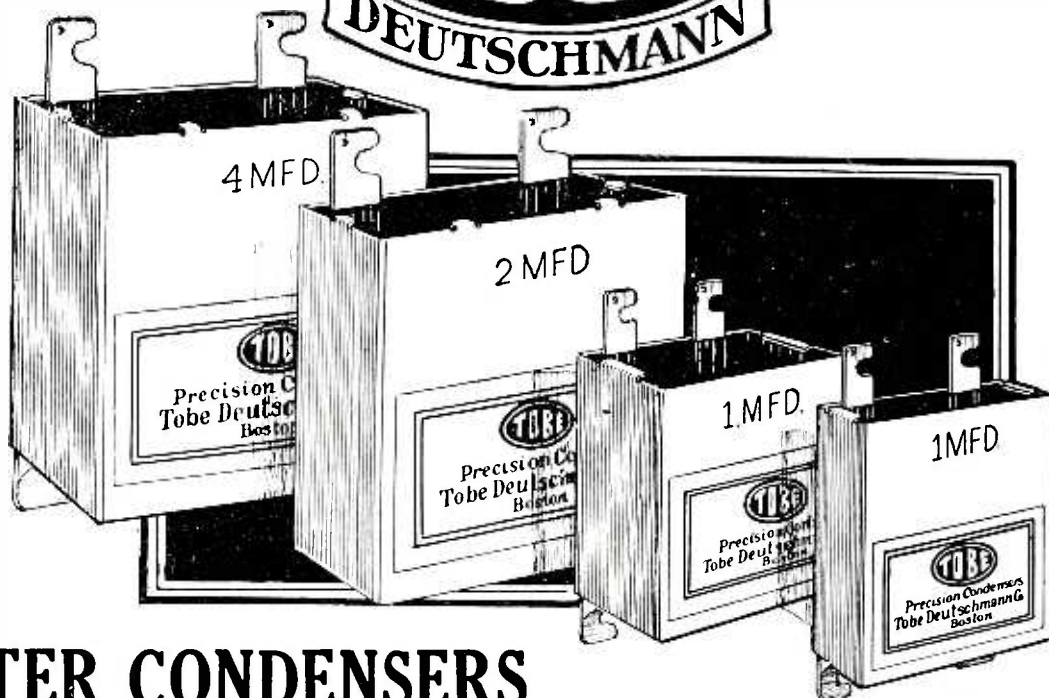

FILTER CONDENSERS

*recommended for the Raytheon
plate supply unit*

1 M. F. D.

Type 705
Price, 70 cents

1 M. F. D.

Type 708
Price, \$1.25

2 M. F. D.

Type 709
Price, \$1.75

4 M. F. D.

Type 711
Price, \$3.75

TOBE condensers are recommended for the "Raytheon Plate Supply Unit", the following types being used—2 Type 705, 1 Type 708, 2 Type 709, and 2 Type 711.

The Raytheon unit, or any B battery eliminator circuit, depends very largely for its operating efficiency upon the filter condensers used. TOBE condensers alone possess all of the following favorable characteristics:

Will operate at voltages up to 700 D.C. without breakdown or overheating.

High megohm resistance—indicating perfect insulation.

Capacities guaranteed to be within 5% of accuracy.

Extreme heat or cold has no effect on TOBE condensers.

Compact and handsome in appearance.

Current consumption practically nil.

TOBE condensers are better condensers—discernible by their silvered finish. Ask your dealer for them by name "TOBE".

Manufacturers, jobbers and dealers write for prices, circulars, and discounts, etc.

Tobe Deutschmann Company
CORNHILL, BOSTON, MASS.

All apparatus advertised in this magazine has been tested and approved by POPULAR RADIO LABORATORY

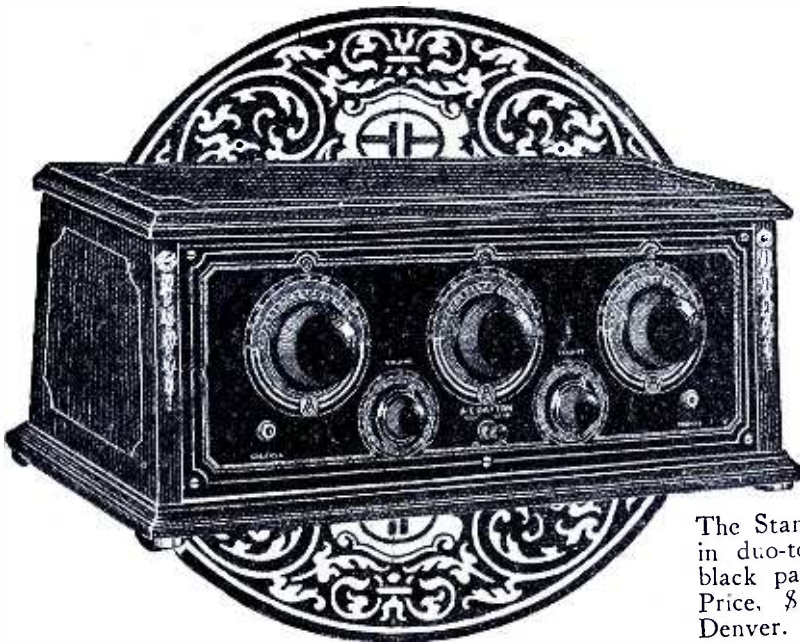

The Standard X1-10 Cabinet in duo-tone mahogany, with black panel etched in silver. Price, \$115—\$120 West of Denver.

Here's Common Sense for Radio Buyers!

YOU could spend half of your time listening to rival claims in radio, but—

Nowhere, no matter how much you pay or how little, will you get clearer, truer, sweeter, more dependable reception than the A-C DAYTON will give you!

With five tubes and its specially developed tuned radio frequency circuit, the A-C DAYTON is famous for its selective powers. Its range assures you any station your neighbor's good set gets—with probably much more volume and clarity than he can hope to obtain!

You can pay less for radio—and risk having your en-

joyment limited by lack of distance, interference and noises. You can pay more—if you want to spend the money. But because nothing has been left out of the A-C DAYTON which would make it better and nothing added to endanger its true reception, you cannot get a finer balance of clearness, range, volume, control—and price!

When you have grown tired of reading all that is written about radio and radio receivers, go to the nearest A-C DAYTON dealer and *hear* radio as it is! Trust your own ears—and let the receiver do the talking!

THE A-C ELECTRICAL MANUFACTURING CO.
DAYTON, OHIO

Makers of Electrical Devices for More than Twenty Years

A-C DAYTON

RADIO

for the man who believes his own ears

All apparatus advertised in this magazine has been tested and approved by POPULAR RADIO LABORATORY

Write us,

if necessary, and we will put you in touch with your nearest A-C DAYTON Dealer.

To unscramble
the stations

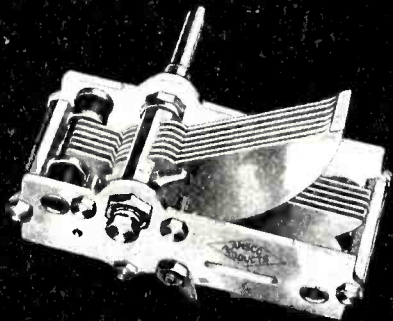

To get the
Finest Tuning

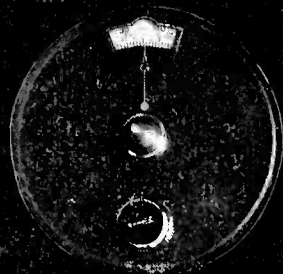

To
save your Tubes
and Batteries

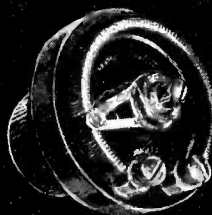

The new AMSCO ALLOCATING CONDENSER

(STRAIGHT LINE FREQUENCY)

SPREADS the stations evenly around the dial according to their frequency in kilo-cycles. Eliminates the crowding on low waves and simplifies tuning.

And unlike previous S. L. F. designs, its "half-a-heart" rotor plates save space in the cabinet. Three sizes—single or Siamese.

The new AMSCO VERNIER DIAL

AS easily installed as an ordinary dial—and as easily manipulated. *But*—each turn of the dial is translated to 1/13th the motion—giving finesse to your fingers. A precision instrument, without momentum or back-lash. There is no vernier like it for distance-getting. Low in price.

The new AMSCO RHEOSTATS AND POTENTIOMETERS

NOTHING saves tubes and batteries like correctly designed, electrically efficient resistance instruments in the radio circuit.

Stromberg-Carlson, Freed-Eismann, Priess Radio and other builders of the highest type receivers have selected AMSCO. It will pay to investigate. Ask your dealer or write to the makers:

AMSCO PRODUCTS, Inc. Dept. D
Broome and Lafayette Sts., N. Y. City
Makers of the Melco Supreme Radio Receiver

*This Catalogue
represents the
world's greatest
radio store*

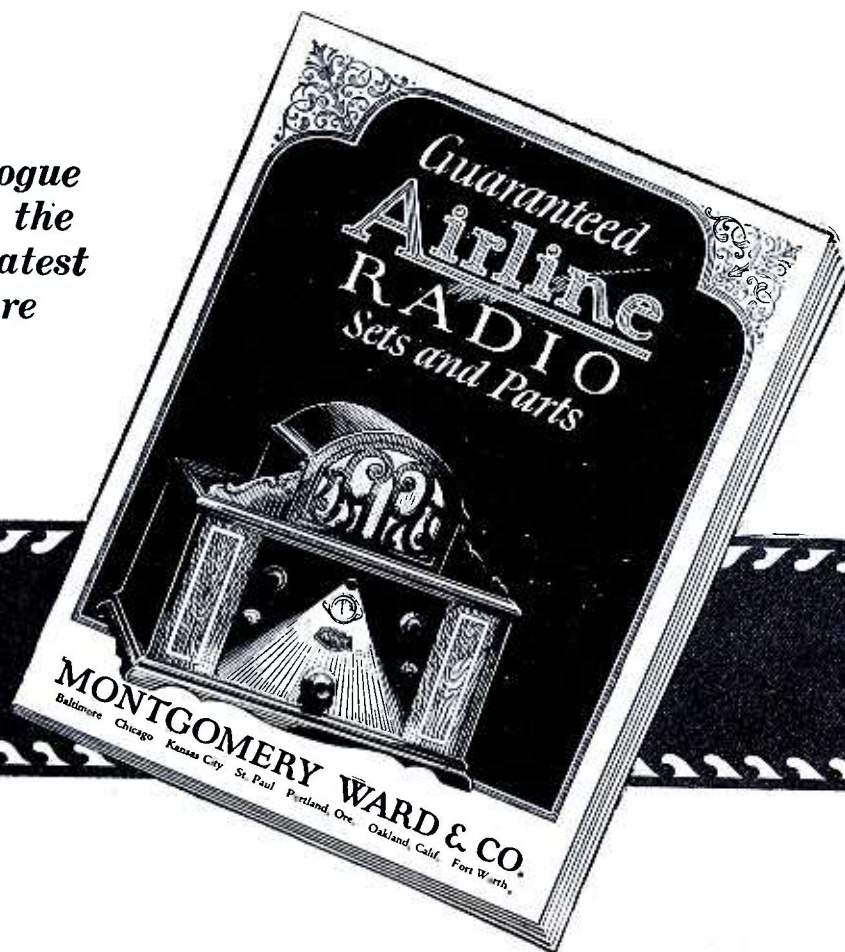

Ward's New Radio Catalogue Is Yours Free

Where you buy Radio is equally as important as the set you buy.

Send to Radio Headquarters for the most complete Catalogue of the season. See for yourself what is new in Radio and what has been actually tested and approved.

See for yourself what low prices can be made on Radio when it is sold without the usual "Radio profits."

A Complete Radio Manual

This new 52 page Radio Catalogue shows everything in parts, batteries, cabinets, contains a list of stations, a radio log for recording stations. It shows the best of the new

sets. One tube sets that give amazing results. Five tube sets with a single dial to turn. Think of tuning in one station after another by turning a single dial!

Every price quoted means a big saving to you. Everything offered is tested by our own Radio Experts; in fact, the best experts compiled this Catalogue for you. Write for this free 52 Page Book. It is yours Free.

Our 53 Year Old Policy

For 53 years we have sold only quality merchandise under a Golden Rule Policy. You can rely absolutely upon the quality of everything shown in this Radio Catalogue.

Write to the house nearest you for your free copy of Ward's new Radio Catalogue. Address Dept. 38-B

ESTABLISHED 1872
Montgomery Ward & Co.

The Oldest Mail Order House is Today the Most Progressive

Baltimore Chicago Kansas City St. Paul Portland, Ore. Oakland, Calif. Ft. Worth

All apparatus advertised in this magazine has been tested and approved by POPULAR RADIO LABORATORY

The New HAMMARLUND CONDENSER

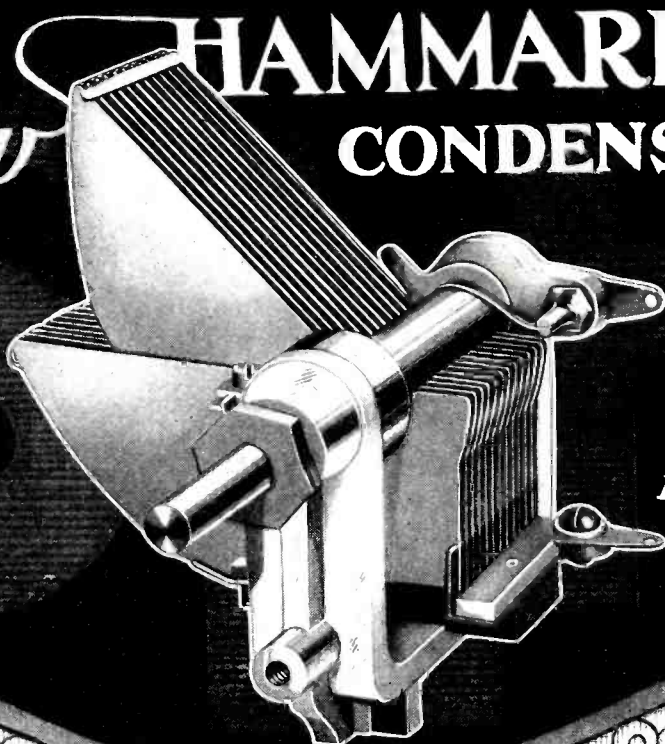

*Distributes
Stations
Equally*

A STRAIGHT-LINE FREQUENCY ACHIEVEMENT

RUGGED, compact, sublimely efficient, with all the refinements of 15 years' experience comes the latest Hammarlund achievement—the condenser that distributes stations equally over your dials and solves the problem of critical tuning.

You will recognize many distinctive "HAMMARLUND" features of world renown. Others are new—the perfections of advanced engineering and the natural progress of radio development

Soldered, non-corrosive brass plates, with sturdy tie-bars that insure permanent alignment; one small piece of Isolantite insulation placed outside of the electro-static field; warpless aluminum frame grounded to rotor; adjustable ball bearings at both ends of rotor shaft; bronze clock-spring pigtail; single hole mounting; a separate "hand-capacity" shield for use if needed. Made in all standard capacities; a quality product at a moderate price.

At the Better Dealers. Write for Descriptive Folder

HAMMARLUND MANUFACTURING COMPANY
424-438 West 33rd Street New York City

For Better Radio
Hammarlund
PRECISION
PRODUCTS

All apparatus advertised in this magazine has been tested and approved by POPULAR RADIO LABORATORY

The clear tone of The Amplion comes from 30 years' experience in creating loud speakers



Distinct voicing of commands at sea is vital! At left, one of the naval loud speakers produced by the Amplion organization and installed on over 12,000 ships of leading navies and shipping companies throughout the world.

ALL who hear the Amplion are won by its wonderful clearness and deep, full, life-like tone-qualities which have made it the world's largest-selling loud speaker.

The explanation is that The Amplion was evolved by the actual originators and oldest producers of loud speakers. * Long before radio attained general popularity, Graham loud speakers had been adopted—because of outstanding excellence—by the exacting British Admiralty and naval experts of other nations. The Amplion, introduced in 1920, was based on thirty years of successful experience.

Hear The Amplion in comparison with any or all other radio reproducers. Let your ears tell you why it is so widely known as "The world's finest loud speaker." Amplion Loud Speakers, \$12 up. Phonograph units in two sizes. Interesting literature and dealer's address on request.

THE AMPLION CORPORATION OF AMERICA

Executive Offices: Suite X, 280 Madison Ave., New York City

Canadian Distributors: Burndep of Canada, Ltd., Toronto

* Alfred Graham & Co., London, England, Patentees

AMPLION

The World's Standard Loud Speaker

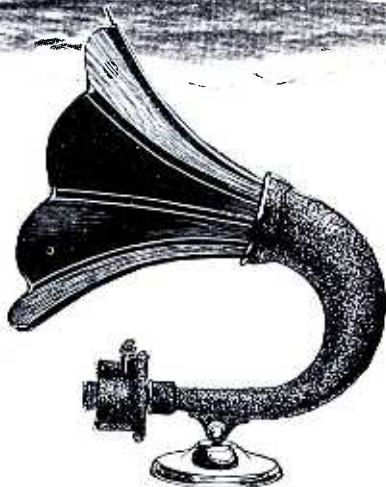

Clarity is also essential to full enjoyment of radio. Thirty years' experience in creating loud speakers, unrivaled for clearness of tone, evolved The Amplion. Ask to hear the improved new Amplion Dragon, AR-19, illustrated above.

The supremacy of The Amplion has won world-wide recognition and leadership in sales. Partial list of nations in which Amplions are ruling favorites among music-lovers:

- UNITED STATES
- DOMINION OF CANADA
- ENGLAND
- SCOTLAND WALES
- IRELAND
- NORWAY SWEDEN
- DENMARK
- HOLLAND BELGIUM
- FRANCE SPAIN
- SWITZERLAND
- ITALY JAPAN
- SOUTH AFRICA
- NEW ZEALAND
- AUSTRALIA



All apparatus advertised in this magazine has been tested and approved by POPULAR RADIO LABORATORY

Every Precise Instrument Is a Laboratory Product



McLaughlin
specifies!
Precise!

The New Precise Syncrodenser

DURING past seasons the words "PRECISE" and "QUALITY" have grown to be synonymous among radio set-builders seeking radio apparatus of scientific accuracy and precision. The new Precise Syncrodenser is an able assistant for increasing Precise Prestige. It permits the radio set-builder to obtain a scientific combination of straight line frequency and straight line capacity which results in the most ideal separation of stations on the dial range yet found in a condenser.

By use of the Syncrodenser the lower half of the dial from 0 to 50 has fewer stations, while the upper half contains many stations found between 0 and 50 on ordinary condensers, in addition to the high wave length stations. This

absence of crowded stations on the lower half of the dial permits finer tuning and tremendously increases the selectivity of any set. The Syncrodenser is strongly built and can be mounted on panel or sub-panel in any position. Prices, .0005 mfd. cap. \$4.50; .00035 mfd. cap. \$4.00.

Several new Precise Transformers have made the Precise Line the most complete line of transformers in the world. There is a ratio and price for every set-builder. The No. 480 Super-size Transformer bids fair to stand in a class by itself. For volume and range of tone it has no superior.

Ask your dealer to show you the complete Precise Line.



Comet Transformer
Price **\$3.25**



Branch Offices:

126 Liberty St., New York City
53 W. Jackson Blvd., Chicago, Ill.
821 Market St., San Francisco, Cal.

454 Builders Exchange, Minneapolis, Minn.
1127 Pine St., St. Louis, Mo.
701 A. O. U. W. Bldg., Little Rock, Ark.

Canadian Distributors:

PERKINS ELECTRIC, Ltd., Toronto, Montreal, Winnipeg



**No. 480 Super-size
Audio Transformer**
Price **\$7.50**

All apparatus advertised in this magazine has been tested and approved by POPULAR RADIO LABORATORY

KODEL RADIO

The Emblem of  Worth in Radio

The Best that Radio Offers



LOGODYNE
"BIG FIVE" **\$90⁰⁰**

Five tubes, self-balanced tuned radio frequency; sloping panel gold engraved; beautiful, massive, Adam brown mahogany cabinet; compartment for batteries; stations already logged for easy tuning.

If the LOGODYNE Big Five excelled only in performance it would not be a KODEL RADIO.

But combining as it does the ultimate in good performance, a tone as mellow and true as a rare old music instrument, a cabinet artistry worthy of the old masters the LOGODYNE Big Five expresses the perfection required of the entire KODEL RADIO line—the best that radio offers.

Free Send for the new edition of our free booklet "The Secret of Distance and Volume in Radio". Gives helpful interesting information on radio operation.

THE KODEL RADIO CORPORATION
504 East Pearl Street Cincinnati, Ohio



LOGODYNE "Big Five" Console Model—the Aristocrat of Radio; built-in loud speaker; compartment for batteries and charger **\$275**



LOGODYNE "Standard Five" Console Model—beautiful brown mahogany; built-in loud speaker; compartment for A and B batteries and charger..... **\$165**



LOGODYNE "Standard Five"—five tubes self-balanced tuned radio frequency; gold engraved panel and sub-panel; battery compartment; handsome brown mahogany cabinet..... **\$70**

KODEL "Gold Star" Models—Radio's greatest set values; Three Tube "Gold Star" Model. **\$30**

Two Tube "Gold Star" Model. **\$20**

One Tube "Gold Star" Model... **\$12**

"Gold Star" Crystal Set..... **\$ 6**

All apparatus advertised in this magazine has been tested and approved by POPULAR RADIO LABORATORY

NO-DIAL ^(Patented) 5 Tube Receiver

\$98⁰⁰ less accessories

Licensed under Blackmore Patents & Patents pending. Hogan Patent 1,014,002.

10% ADDITIONAL WEST OF
THE ROCKY MOUNTAINS

~ and Now a Receiver
Without Dials! Simple,
trouble-proof, beautiful~

New!



Listen! Sweetly, clear, an overture, the prelude to a concert in a distant city floats into the room and fills it. A touch of the finger brings it to you. No need to know about radio—no need to understand its myriad technical terms.

A wonderful instrument is the NO-DIAL, so simplified it is amazing! There are no dials to twist—none of the trying nervous tension that the adjustment of dials produces—just pure enjoyment. Be you ever so much of a novice, what you must do for yourself with other radio sets—THE NO-DIAL DOES FOR YOU.

THE SET FOR THE ENTIRE FAMILY

Scrap the log book—forget past radio disappointments. NO-DIAL is the griefless, worryless receiver you have been waiting for. The entire edge of the cover is a permanent, visible station record. Stations once found

and recorded always come in at that same point. It's that simple!

NO-DIAL is a new combination of tuned radio frequency and resistance coupling.

The cylindrical NO-DIAL case is of spun aluminum, absolutely shielding it from body capacity. Finished in beautiful brown mahogany crystalline, matching the higher priced loud speakers.

Tube for tube the NO-DIAL recognizes no superior and on test it has outperformed many higher priced sets.

GUARANTEED

The NO-DIAL is guaranteed against defects in workmanship and material.

Place your order now with your dealer if you expect to get delivery. The demand is exceeding all expectations. Accept no complicated substitute.

Literature sent on request

The Ohio Stamping & Engineering Company, Dayton, Ohio, U. S. A.

DEPARTMENT PR11

RAYTHEON

The new rectifier that perfects the B-battery eliminator

PURE, resonant, clear tone—reserve power—freedom from worries of all kinds—aren't these the things you have always looked for in a B-eliminator? The things you have never been able to realize?

Here, then, is a tube that makes all these possible—that has immeasurably long life, uniform quality, ample power to run a ten-tube set. The RAYTHEON Rectifier is the result of prolonged experimentation and scientific research. It is the last word in the perfection of the B-battery eliminator, developed by an organization that is in the forefront of the engineering field, and sponsored by radio editors and leading manufacturers.

Complete B-eliminators or parts, specially designed for use with RAYTHEON tubes, are manufactured and sold by:

Acme Apparatus Co., Cambridge, Mass.
 All-American Radio Corp., Chicago, Ill.
 Dongan Electric Mfg. Co., Detroit, Mich.
 General Radio Co., Cambridge, Mass.
 Jefferson Electric Mfg. Co., Chicago, Ill.
 Thordarson Electric Mfg. Co., Chicago, Ill.

You can buy these B-eliminators, parts, and RAYTHEON Rectifying Tubes at your dealer's. Price of tube, \$6. Look for the RAYTHEON name. It is the mark of quality and your assurance of satisfaction.

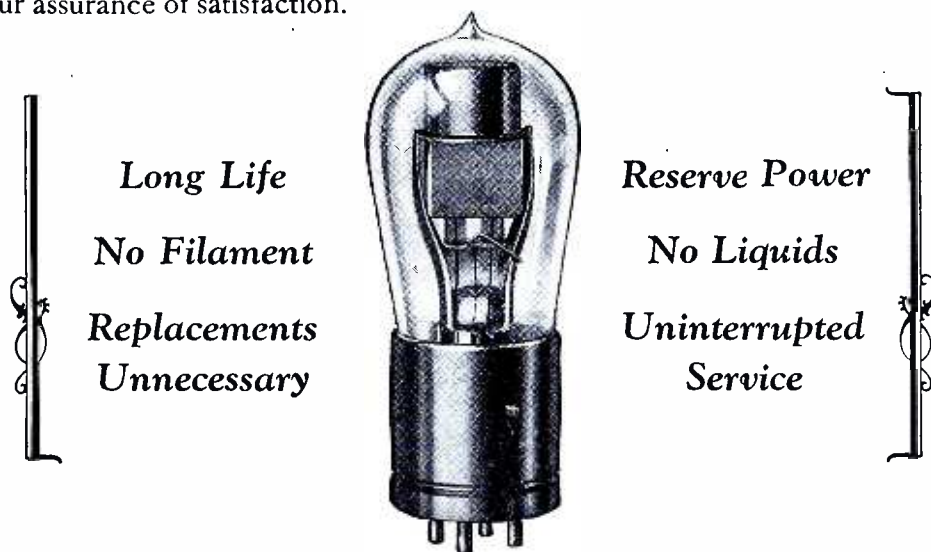

AMERICAN APPLIANCE COMPANY
 CAMBRIDGE, MASSACHUSETTS

*Organization Integrity—Honest Merchandising—Truthful Advertising
 Scientific Research—Sound Engineering—Basic Patents—Substantial Backing*

Ferguson

J. B. INCORPORATED

The Gold Standard of Radio Receivers



As the notes of Orpheus inspired the Argonauts in their quest of The Golden Fleece, so the surpassing tone fidelity of Ferguson, The Gold Standard of Radio Receivers, charms even the true music critic.

THE latest of the Ferguson six-tube Receivers—the Model "Eight"—wins every time with the true radio enthusiast, and with those who are not, too. You will revel in its ability to deliver "volume" —with tone quality—on even the distant stations. You will delight in its ingenious supercraftsmanship; its graceful, rugged dependability.

The lady of the house will welcome it into the library among her cherished heirlooms, for its value as a true musical instrument of dignity and charm. The single tuning control will fascinate her.

In a World of extravagant claims, the provable performance of a Ferguson is outstanding. Never built down to win on a price, each Receiver is a precision-built Standard Bearer of the Ferguson ideal.

Go to your nearest Authorized Ferguson Dealer and compare!

J. B. FERGUSON, INC.
41 East 42nd Street • New York, N. Y.

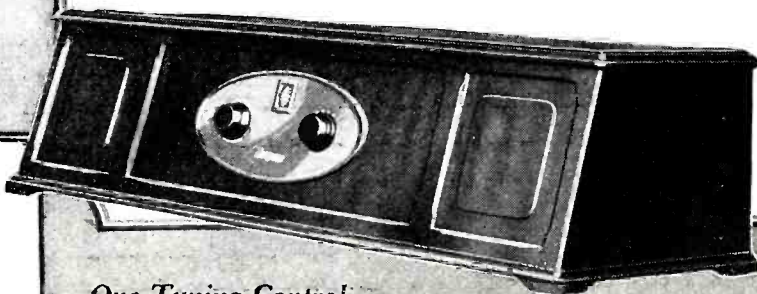

**One Tuning Control—
Calibrated in Meters!**

With the Ferguson Model "Eight" (a six-tube Receiver) simply choose your program, turn up its exact wavelength, and in comes your station.

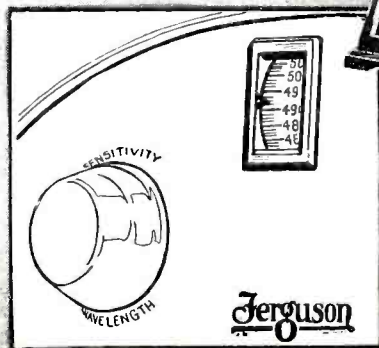

All apparatus advertised in this magazine has been tested and approved by POPULAR RADIO LABORATORY

ANNOUNCING

the New Type 334

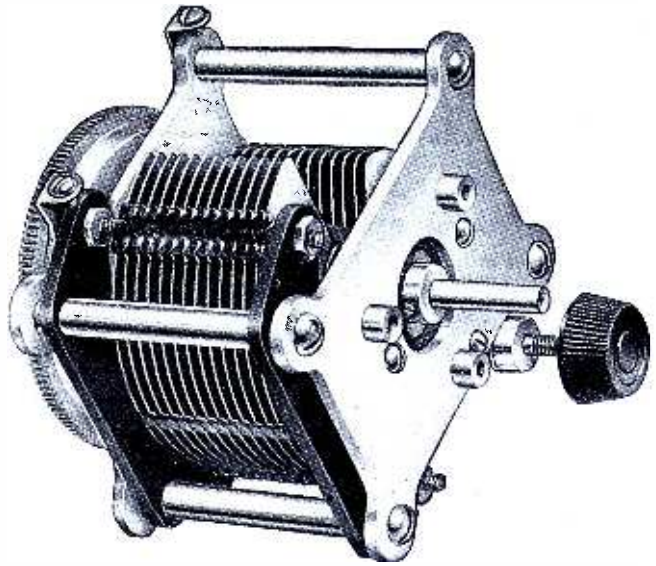

GENERAL RADIO

Straight Line WAVELENGTH CONDENSER

In certain instances of radio construction the shielding effect of a metal end plate condenser is particularly desirable.

To meet the popular demand for this type of condenser the new type 334 has been developed and is now available at popular prices in all standard capacities both with and without vernier.

In designing these condensers points that have been stressed particularly are ruggedness, permanence of calibration, and uniformity between individual condensers of the same capacity.

These are the factors so essential to the successful operation of modern radio sets.

Rotor and Stator units are similar to those used in the well-known type 247 condensers and good interplate conductivity is assured thru solder-sealed contacts.

All General Radio condensers are rigidly inspected before leaving the factory and are thoroughly guaranteed electrically and mechanically.

Models with Vernier Gear

Type	Capacity	Price
334-H	.0005 MF.	\$5.25
334-P	.00035 MF.	5.00
334-M	.00025 MF.	4.75

Models with Counter Weight

Type	Capacity	Price
334-F	.0005 MF.	\$4.25
334-N	.00035 MF.	4.00
334-K	.00025 MF.	3.75

*Ask to see them at your local dealers
or write for our New Catalog 922-P*

GENERAL RADIO CO., Cambridge, Mass.

"Behind the Panels of Better-Built Sets"

All apparatus advertised in this magazine has been tested and approved by POPULAR RADIO LABORATORY

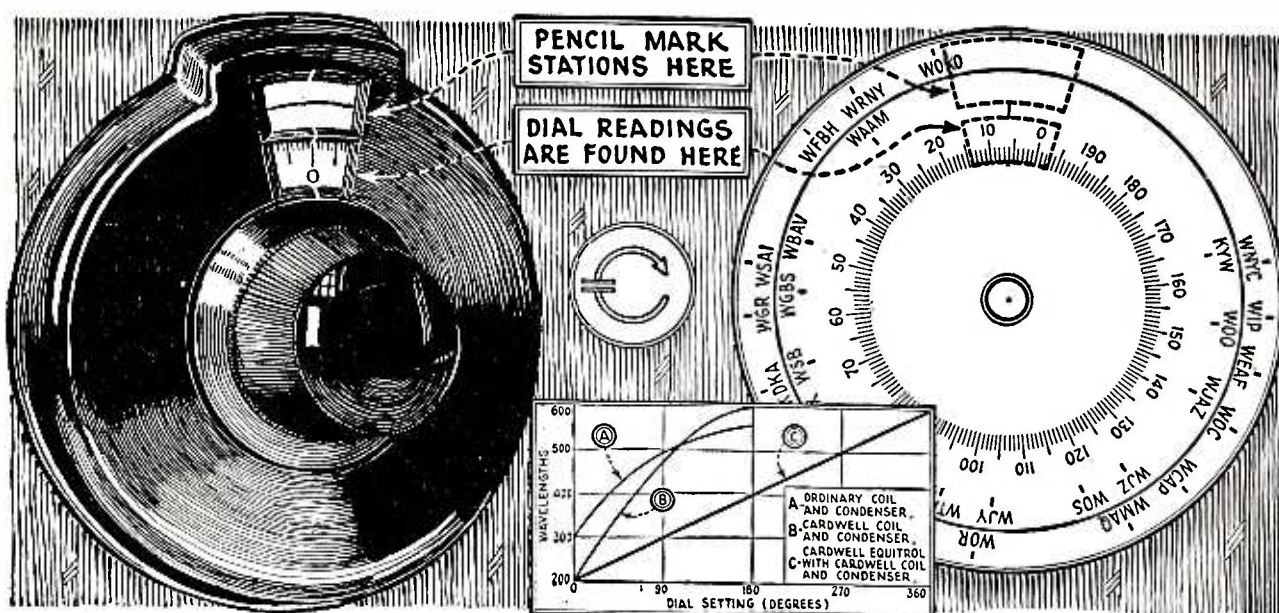

A NEW RADIO COMPASS

STRAIGHT-LINE tuning affords unusual convenience to the radio operator when the dial gives an equal separation of wave-lengths over its entire range. The Cardwell Equitrol dial is designed to afford not only equal spacing in wave-lengths but doubles the distribution on the dial by utilizing a 360 degree motion instead of the usual 180 degree. Thus it becomes a "compass" and the radio navigator can obtain his station "bearings" at any point without the usual crowding on the lower scale—less than with most so-called "S L F" condensers because it has a 360° dial action! It makes Cardwell type "C" condensers semi-SLF.

The Equitrol is a *variable* ratio vernier dial. It operates with the standard semi-circular plate condenser and converts it into a "straight-line for wave-length" unit by compensating the curve shown in the graph above marked "B." By using the Equitrol it is unnecessary to dismantle a set by putting in specially shaped condensers in order to secure "straight-line" convenience.

When used with efficient condensers and coils, such as Cardwell types, the maximum *dial visibility* is obtained. Note how much wider the range in wavelengths of curve "B" as compared with curve "A."

Equitrols will add to the attractiveness of your radio set. Pencil logging can be done with ease and neatness.

Write today for Bulletin No. 71. It tells all about the Equitrol. If you wish the name of a local dealer who stocks Equitrols we will be glad to refer you to him.

Equitrols are sold singly, price \$3.50, and in sets of three, price \$10.00. When purchasing be sure to return the Government postal enclosed with all Cardwell units. It insures satisfaction and brings you new data on circuits and parts of interest.

THE ALLEN D. CARDWELL MANUFACTURING CORPORATION
81 Prospect Street, Brooklyn, N. Y.

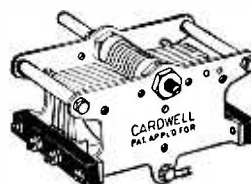

CARDWELL CONDENSERS

are made in two series. Series "B" have semi-circular rotor plates, (SLC). Series "C" have specially shaped rotor plates but the same size, overall, etc. They give semi-SLF calibration. Either type gives ample selectivity in terms of dial reading and are considered the best in design of all low-loss condensers because they are the pioneers. Note that there are over 150 varieties; vernier, transmitting, balancing, etc.

Series B			Series C		
Type	Cap*	Price	Type	Cap*	Price
154-B	150	\$4.00	168C†	130	\$4.00
141-B	250	4.25	170C†	250	4.25
153-B	300	4.50	192C†	300	4.25
152-B	350	4.75	171C†	340	4.50
123-B	500	5.00	173C†	500	5.00
137-B	1,000	6.00	175C†	1,000	7.75

* MMF. † Specify it for clockwise or counter-clockwise dials.

CARDWELL EQUITROLS*

* Trade Mark Registry Applied for

All apparatus advertised in this magazine has been tested and approved by POPULAR RADIO LABORATORY



\$25

West of Rockies,
\$26.50
In Canada, \$35

The SAAL Soft SPEAKER

brings the best out of your set

SAAL Jr.

The same in every respect as the Saal Soft Speaker except it measures 18½ instead of 21½ inches in height.

\$20

West of Rockies, \$21
In Canada, \$27.50



In the Saal Soft Speaker Unit the action of four pole pieces of a powerful magnet are concentrated on a carefully poised armature. This armature is connected to the diaphragm by a pin. This pin moves the diaphragm with a push and pull motion. There are no springs. The action is extremely precise, reproducing all consonants and overtones, yet the unit can't get out of order. This unit is used as standard by many leading manufacturers of fine radio receivers in built-in models.

YOU may have the best receiver ever built, but the quality of your entertainment is limited by the quality of your speaker. Bring the best out of your set by using the Saal Soft Speaker.

The Saal does not force you to choose between volume and tone quality. It combines volume with a velvet tone. It is not a fad. It is not a trumpet. It is a faithful reproducer of radio programs, properly constructed and shaped for the accurate reproduction of sound. It removes the objection to loud speakers. It has no blare, no blast, no metallic ring.

The Saal Soft Speaker is

made to last a life-time. The neck is of aluminum. The bell is of genuine Bakelite. There is no wood, no tin, no composition. It has nothing to warp, crack or deteriorate. The reproducing unit is all-metal and cannot be harmed or "blasted" by the loudest receiver. It maintains its tone with any volume. There is no adjustment knob to complicate tuning.

In appearance the Saal, with its black bell, black crackle throat and graceful lines is the aristocrat of horns. Also furnished with a brown bell and gold or silver stippled throat at \$5 extra. It is guaranteed to give you satisfaction. Hear it at your dealer's today.

SAAL *Soft* **SPEAKER**
VOLUME WITH TONE QUALITY

Manufactured and guaranteed by H. G. SAAL COMPANY, 1800 Montrose Ave., Chicago, Ill.

All apparatus advertised in this magazine has been tested and approved by POPULAR RADIO LABORATORY

The New Pfanstiehl

"OVERTONE" RECEIVER

"Single Dial Six"

Having six tubes and but one dial

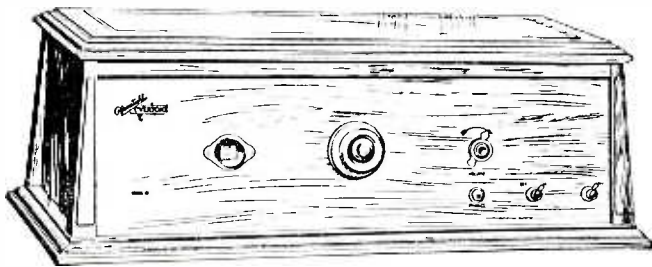

MODEL 10—Overtone Single-dial 6-Tube Receiving Set. Price \$155.00 (less accessories)

AFTER all the complicated radio receivers people have had to contend with, it is a pleasure to operate the new Pfanstiehl. There is nothing like it. You do not have to adjust or fix anything. A child can get as good results as a technician.

The Pfanstiehl Overtone receiver has the simplest radio frequency circuit we have ever seen. It dispenses with the adjusting and neutralizing devices found in other sets. They are not needed. No stray radio energy can "spill over" between circuits. Hence no devices are required to correct it.

You Tune with a Single Dial

It is so simple you can tune in the dark. You do not have to grope around adjusting dials. You turn at once to the wave length desired. The illuminated station finder is a great convenience. It facilitates the logging of stations. It also acts as a signal to show whether the power is on or off.

A Perfect "Overtone" Receiver

The matchless tone of the Pfanstiehl Overtone receiver is of course due to the overtones. They are perfectly reproduced because the pattern of vibrations which make them is kept intact—an exclusive Pfanstiehl accomplishment.

The radio panel is of wood, swept clean of all non-essentials. It is rich looking. The tuning dial is of wood. All exposed metal parts are gold plated. The soft amber glow of the station finder adds a brilliant touch to the panel assembly.

An Exclusive Dealer Franchise

The Pfanstiehl line is sold through exclusive dealers who are thus protected against unfair competition and price cutting. Whatever good-will the dealer builds up for Pfanstiehl is his own. He enjoys a liberal profit and is expected in return to push the line aggressively with the cooperation of the maker.

For further details, address

PFANSTIEHL RADIO COMPANY

11 South La Salle Street, Chicago, Illinois

Prices West of the Rockies Slightly Higher



Actual Wave Length GLOW'S
from Illuminated
Disc—No Scale
Necessary



MODEL 10C—A complete 6-Tube Single-dial Console Overtone Receiver with Overtone Speaker, Control Board, Battery Charger and Compartments for Battery built in. Price \$450.00 (less tubes and batteries).



MODEL 10S—Overtone Single-dial 6-Tube Receiving Set with demountable Console Stand, Overtone Speaker built in. Price \$200.00 (less tubes and batteries).



MODEL 8—A low priced 2-Dial 5-Tube Receiving Set, Pfanstiehl quality throughout. Price \$85.00 (less accessories)



MODEL 8C—Two-dial 5 Tube Receiving Set, demountable from console stand, permitting use on floor or table. Overtone Speaker built in. Price \$135.00 (less tubes and batteries).

All apparatus advertised in this magazine has been tested and approved by POPULAR RADIO LABORATORY



Distortion



Perfection

Where is the difference in radio transformers?

THE audio frequency transformers in your radio perform a most important duty. They aid in increasing the volume of sound . . . in building it up to the desired strength. BUT—

When sound is increased, the tendency is toward distortion. That's where the difference comes in transformers. Inefficient transformers will give distorted reception, just as a defective mirror will show a distorted image.

Whether you are building a set, or buying one, be sure about the transformers. No radio, remember, can be better than its transformers. A safe guide to follow is the Jefferson trade mark. You can depend on quality in performance when the name "Jefferson" is on the product.

Jefferson Transformers are made by transformer specialists—the world's largest manufacturers of small transformers. There is a very definite reason why leading radio engineers specify "Jefferson." You'll find it in the clear, sweet, life-like amplification which Jefferson Transformers give. Sold by the better dealers, used by leading set manufacturers.

JEFFERSON ELECTRIC MANUFACTURING CO.
501 South Green Street, Chicago, Ill.

Makers of Jefferson Radio, Bell Ringing and Toy Transformers; Jefferson Spark Coils for Automobile, Stationary and Marine Engines; Jefferson Oil Burner Ignition Transformers.

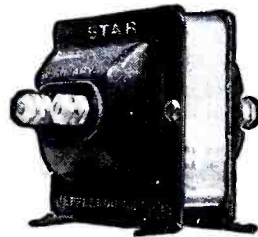

There is a Jefferson Transformer for every radio need.

JEFFERSON Tube Rejuvenator

Keep your radio tubes like new! Rejuvenate them regularly, AT HOME, just as you recharge your storage battery. Jefferson Home Rejuvenator doubles and trebles tube life, quickly pays for itself. Raises your set's efficiency to 100%, and keeps it there! Completely restores paralyzed or exhausted tubes. Takes large or small tubes—types 201-A, 301-A, UV-199, C-299, 5-VA. Don't be without this long-awaited radio necessity. \$7.50 at leading dealers.



JEFFERSON

RADIO TRANSFORMERS



All apparatus advertised in this magazine has been tested and approved by POPULAR RADIO LABORATORY

MEETING POPULAR DEMAND

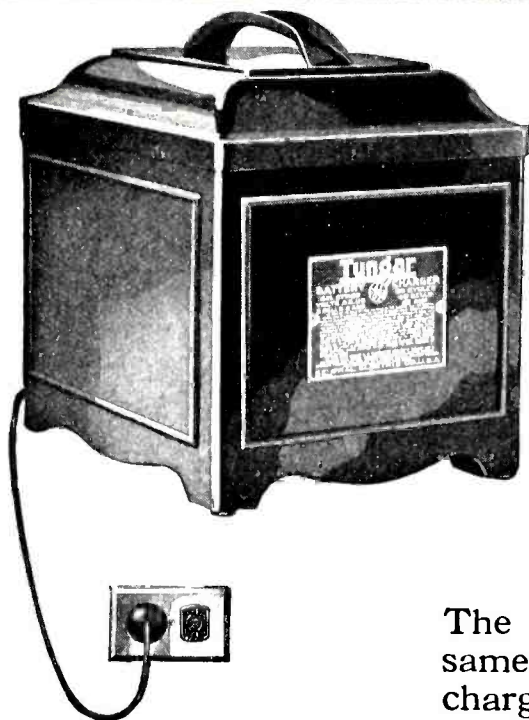

**5 ampere
Tungar
in a new
model!**

The new five ampere Tungar—at the same price as the old—means a quick charge of all kinds of storage batteries.

- It is more silent than ever.
- It cannot burn out Radiotrons.
- It cannot create radio interference.
- It charges any make and size of storage battery: radio "A" and auto batteries, and "B" batteries as high as 96 volts in series—all without attachments.



The Tungar is a G-E product developed in the great Research Laboratories of General Electric.

Five ampere Tungar
(East of the Rockies)
\$28.00

Two ampere Tungar
(East of the Rockies)
\$18.00

60 cycles—110 volts

Tungar
REG. U.S. PAT. OFF.
BATTERY CHARGER

TUNGAR—a registered trademark—is found only on the genuine. Look for it on the name plate.

Merchandise Division
General Electric Company, Bridgeport, Conn.

GENERAL ELECTRIC

All apparatus advertised in this magazine has been tested and approved by POPULAR RADIO LABORATORY

Better than ever!

The NEW IMPROVED

Mayolian "B" SUPPLY

"The 'B' Without a Buzz"

110 MILLIAMPERES CURRENT OUTPUT

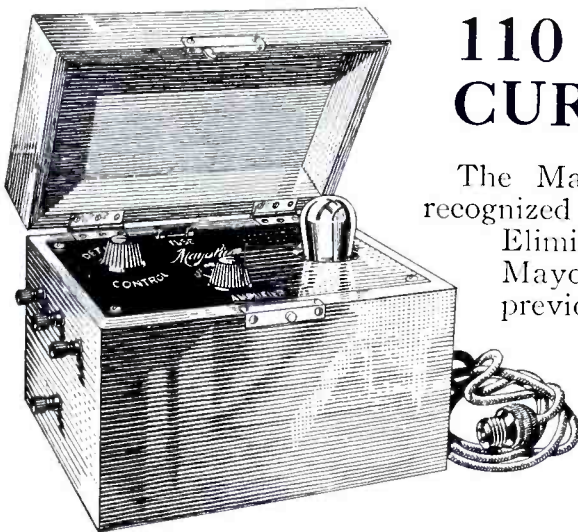

The Mayolian "B" Supply always has been recognized as the standard by which all "B" Eliminators are measured. Now—the new Mayolian is a vast improvement over our previous models. It will POSITIVELY operate ANY set, and materially improve reception.

At the New York Radio Show, and wherever the new Mayolian has been demonstrated, it has created a sensation. It has operated sets when other eliminators failed.

The new Mayolian is equipped with the famous Raytheon rectifying tube, the life and efficiency of which is practically unlimited. It consumes very little current, is stable and uniform in operation and actually is the "B" Supply without a hum.

The amplifier voltage is variable from 90 to 200 volts. The detector voltage from 0 to 65

volts, and is controlled by two simple knob adjustments; when these are adjusted to the set, the Mayolian requires no further attention.

The new Mayolian is encased in a compact and attractive cabinet, which harmonizes with the furnishings of any room.

Mayolian "B" Supply is backed by our established reputation, and is absolutely guaranteed.

Type 606—Alternating Current, 110 Volts, 60 Cycles. Price (including tube) \$47.50

Type 607—Direct Current, 110 Volts, Price, complete. \$25.00

If your dealer cannot supply you, send money order, and we will ship direct. Regular discounts to Jobbers and Dealers.

MAYOLIAN RADIO CORPORATION

1991 BROADWAY NEW YORK CITY

NEW YORK DISTRIBUTOR: 20th CENTURY RADIO CORP.
102 Flatbush Ave., Brooklyn, New York

All apparatus advertised in this magazine has been tested and approved by POPULAR RADIO LABORATORY

Put UNIPOWER in your radio set and put an end to the most frequent cause of poor radio reception

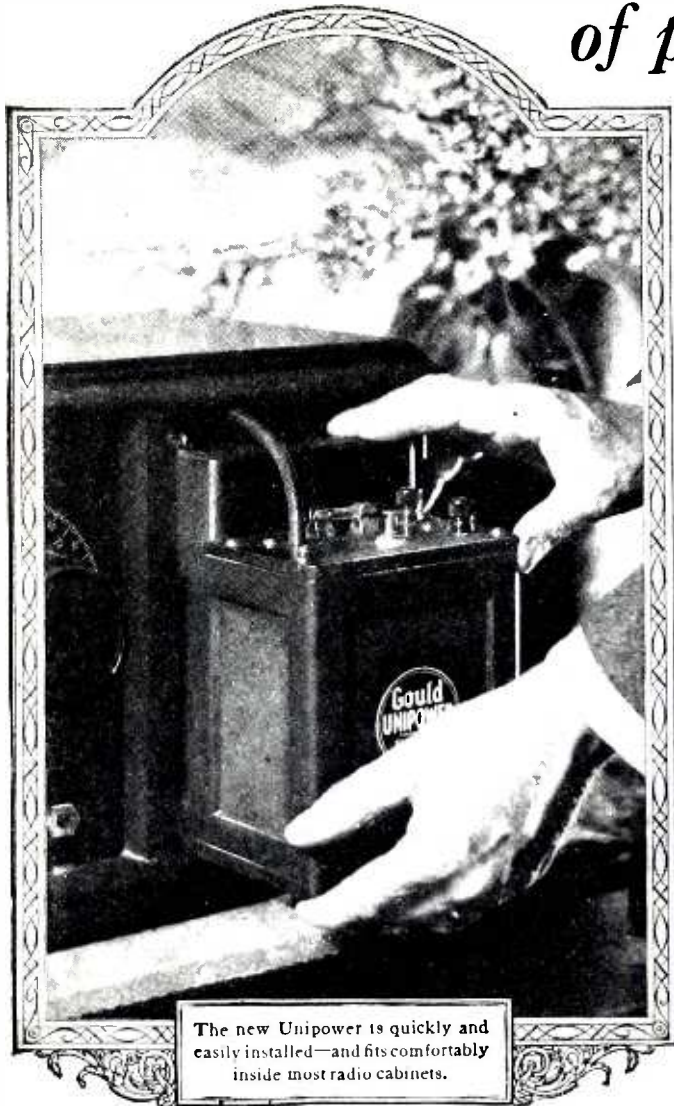

The new Unipower is quickly and easily installed—and fits comfortably inside most radio cabinets.

The first cost is the last!

Unipower's first cost is moderate—and the first cost is the last because Unipower has no tubes, bulbs, lamps or working parts that require frequent and expensive replacement. Unipower will last you for years. Compared with dry "A" battery operation, Unipower pays for itself over and over again.

The standard Unipower operates from alternating current, 110-125 volt—60 cycle. The 4 volt type is for sets using UV-199 tubes or equivalent, and retails for \$35.00. The 6 volt type is for sets using UV-201-A tubes or equivalent, and retails for \$40.00. West of the Rockies, prices are slightly higher. (Special models, 25-50 cycle are available.)

FREE!

Write for interesting booklet, "Unipower, a triumph in radio power"

NO longer is it necessary for you to put up with the inconvenience of operating your set on dry "A" batteries—or the bother of charging a storage battery every week or so! No longer need your "A" batteries fail when you want them most. And that today is the most frequent cause of poor radio reception.

You can now equip your set with Unipower and have the thrill of *continuous, unfailing* "A" power of the highest quality and always at full voltage.

Unipower is a compact, scientifically designed "A" power plant that automatically converts house lighting current into radio power. Unipower is *not* a battery eliminator and should not be confused with any other radio power device.

Unipower comes to you completely wired and assembled—all you have to do is connect two wires to your set and plug it in your house current! Unipower is equipped with an exclusive Balkite charger of special design.

A unique feature of Unipower is the master-control switch that governs the operation of your entire set. When the switch is *ON*, Unipower feeds your set rich, quiet power that gives ideal reception, with neither hum nor noise. When the switch is *OFF*, Unipower automatically replenishes itself on a low trickle charge and with a minimum consumption of current—a few cents a month.

Ask your radio dealer for a Unipower demonstration today. The Gould Storage Battery Co., Inc., 250 Park Ave., New York.

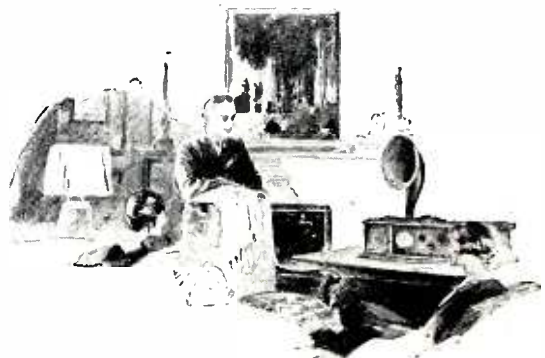

Unipower

Off when it's on ~ On when it's off

All apparatus advertised in this magazine has been tested and approved by POPULAR RADIO LABORATORY

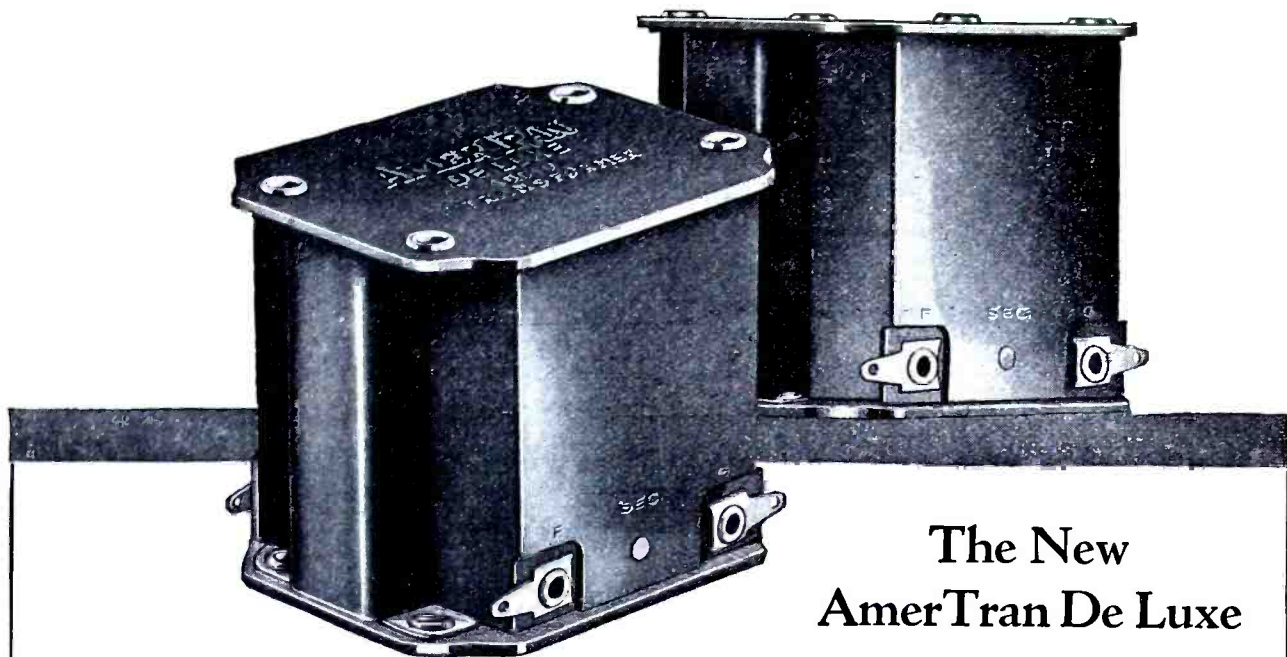

The New AmerTran De Luxe

The new De Luxe model AmerTran audio transformer possesses an unusually straight line frequency characteristic extending the range below the lowest note now being broadcast. While the AmerTran AF-6 and AF-7 have, for years, been considered the leaders in audio frequency amplification, this new De Luxe AmerTran shows a gain of about three octaves below that previously obtained.

The AmerTran De Luxe is a transformer of moderate size and weight, enclosed in a strong metal case with mounting holes at both top and bottom so that it may be inverted, affording simplified connections.

While the AmerTran De Luxe will improve any set, appreciation of its uniform amplifying qualities can best be realized when operated in conjunction with straight line frequency loudspeakers, such as the best cone and disc types and with a tube in the last stage capable of handling the output. It is for those who are satisfied only with

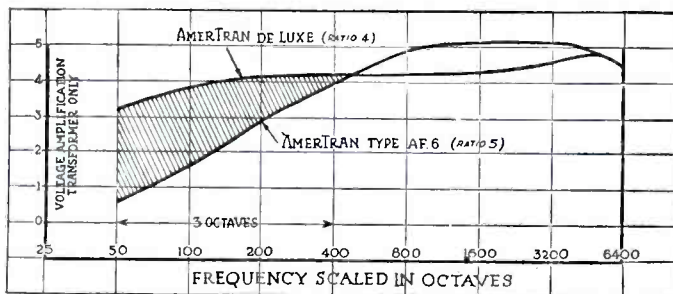

the utmost in quality that this transformer has been developed.

The AmerTran De Luxe is made in two types, one for the first stage and one for the second stage, and plainly marked

as such. The chief difference between these two types is that the first stage transformer has approximately 50% greater primary inductance than the second stage transformer, thus more nearly corresponding to the operating impedances of the tubes out of which they work. For this reason it is advisable to purchase and operate these transformers by the pair!

Price, either type, \$10.00 at any authorized AmerTran Dealer

AMERICAN TRANSFORMER COMPANY, 178 Emmet Street, Newark, N. J.
 "Transformer builders for over twenty-four years"

AmerTran Models AF-6 & AF-7 now reduced to \$5.

American Transformer Co., 178 Emmet St., Newark, N. J.
 Gentlemen: Enclosed find check (money order) for \$..... Please send me First Stage and Second Stage AmerTran De Luxe Audio Transformers at \$10.00 each.

Name.....
 Address.....
 Dealer's Name.....
 Address.....

PR

All apparatus advertised in this magazine has been tested and approved by POPULAR RADIO LABORATORY

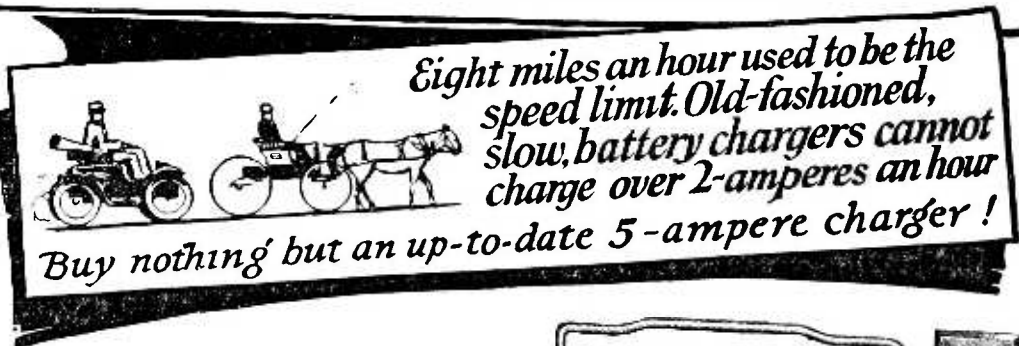

The New Improved
5 AMP. A & B
GOLD SEAL
HOMCHARGER
\$19.50



Over 500,000 already in use

Three Times as Fast!

Better Because:—

New micrometer adjustment, hinged lid, and carrying handle. No bulbs to buy or break.

Can be used anywhere—contains no acids or other harmful liquids to spill.

Approved by underwriters—trouble-proof, shock-proof and fireproof.

Beautiful cabinet in maroon and gold.

Free Write for new edition of our instructive booklet on radio operation "The Secret of Distance and Volume in Radio."

No more of the long, bothersome waits that were necessary when the slow, 2-ampere battery charger was the best that radio offered.

The New Improved 5-ampere GOLD SEAL HOMCHARGER charges your battery overnight—it charges three times as fast as the slow, obsolete chargers that were last year's best. **And it charges both A and B batteries without additional equipment.**

Don't let anybody sell you an obsolete slow 2-ampere charger. You need a full 5-ampere charging rate for real efficient service. To be *absolutely sure*, insist on the **GOLD SEAL HOMCHARGER.**

The Kodak Radio Corporation
 50 East Pearl Street Cincinnati, Ohio.



All apparatus advertised in this magazine has been tested and approved by POPULAR RADIO LABORATORY

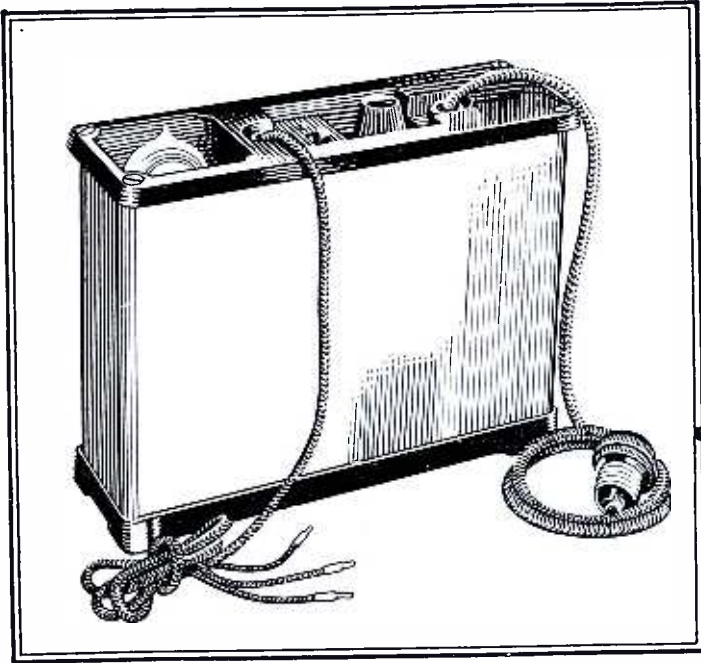

Illustration at left shows Acme "B" Eliminator. Made in two types. Type E-1 (110 Volts 60 cycle), \$50. Type E-2 (110 volts D. C.), \$20. For details see text below.

USES RAYTHEON TUBE

Parts for B-Eliminator as described in Mr. Cockaday's article.

B-230 Henry Choke \$5.00

B-3 Transformer - 7.00

No noise—no hum—no "B" Batteries

WE ARE proud to take this opportunity to make our announcement of the successful completion of our efforts to perfect an eliminator of "B" Batteries which has no hum, no noise, no distortion—the Acme "B" Eliminator.

The big job in finding a method of hooking up house electric current to replace "B" batteries in radio sets has not been to eliminate the hum. That was easy. The problem was to discover a way of overcoming the distortion set up by modulation of the plate current.

Now, after two years' experiment and research we have won out.

You can guess the result. NO "B" batteries to quit cold when you need them most. You get permanent reception, better reception and higher voltage that is constant. There is nothing to wear out. The first cost is the last—and the current consumed is trifling. A cent for every six hours.

Not only this, but the new Acme "B"-Eliminator has two voltages—100 and 150. It is highly effective on any set from 2 to 10 tubes. What is more, the detector voltage is 0 to 70.

The rectifier consists of an Acme Transformer and vacuum tube, with no filament to burn out.

This rectifier (Raytheon) tube handles both sides of the wave and will last indefinitely.

The filter current so successfully smooths out the rectifier pulses in current and voltage that a source of power is delivered of a better nature than batteries.

The full story of not only this new "B"-Eliminator and how to make one but the new MA-2 closed type transformer, the new Acme "double-edge cone" loud speaker and all other Acme receiving apparatus is contained in the ninth edition of "Amplification without Distortion," which is just coming off the presses.

Most of you, as old friends of Acme, are probably familiar with former editions, over 200,000 of which have been issued. The new one is more complete and interesting than ever. Send for your copy.

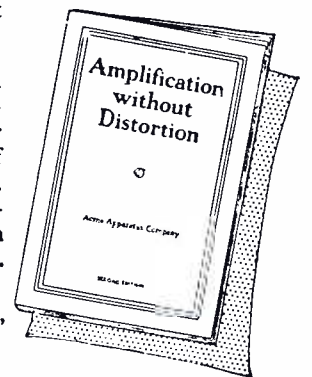

CLAUDE F. CAIRNS,
President Acme
Apparatus Co.

ACME

~ for amplification.

ACME APPARATUS COMPANY,
Dept. C6, Cambridge, Mass.

Enclosed find ten cents stamps or coin for my copy of the new 9th edition of "Amplification Without Distortion."

Name

Street

City State

All apparatus advertised in this magazine has been tested and approved by POPULAR RADIO LABORATORY

We Announce—

the appointment of the firm of Sanford Brothers, as the Sales Representative of the TIMBRETONE MFG. CO.

We believe this new plan will mean greater and better service to all and we suggest that you direct your inquiry to the nearest office:

Chicago, Ill.
39 W. Walton Place

Chattanooga, Tenn.
615 Broad St.

Seattle, Wash.
Am. Bank Bldg.

San Francisco, Cal.
311 Minna St.

FACTORY
HOOSICK FALLS, N. Y.

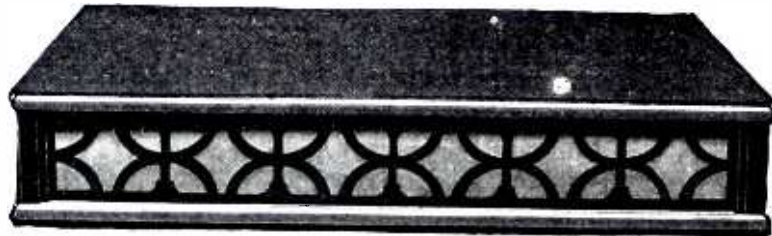

In the new **TIMBRETONE** we have succeeded in increasing the **TIMBRETONE** -vibration scale both higher and lower. This has been done by making several changes of our own in the unit—greatest of which is the **TIMBRETONE** non-metallic diaphragm.

The entire speaker is made of natural wood.
18 $\frac{3}{4}$ " long, 10 $\frac{1}{4}$ " wide, 4" high, 4 $\frac{1}{2}$ lbs. weight.

Price East of Rocky Mountains, \$30.00. West, \$35.00.

Special proposition to manufacturers of sets.

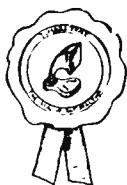

TIMBRETONE MFG. CO.
Hoosick Falls, N. Y.

When the Loos Brothers Sing from W.E.B.H.

Robert Loos sits at home and hears them as naturally as though they were singing in the same room.

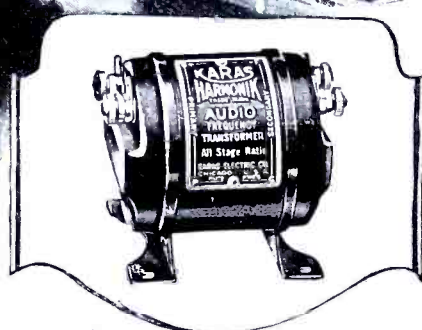
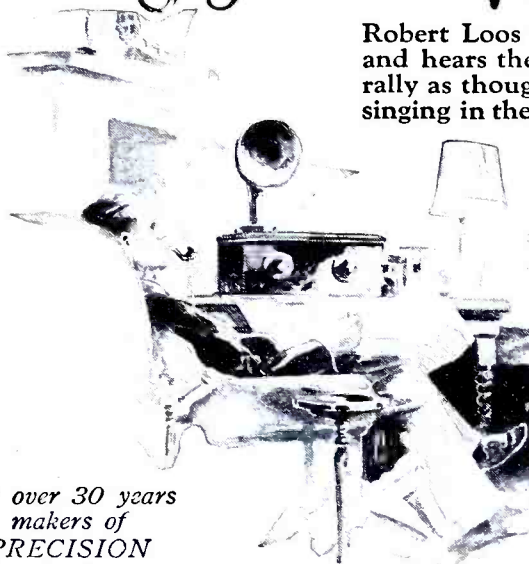

For over 30 years makers of **PRECISION** Electrical Apparatus.

Karas Harmonik Transformers Amplify Radiocast Music with Absolute Fidelity!

No sooner had Karas Harmonik Transformers been introduced than letters began to pour in from all over the country. Exacting set builders could not restrain their enthusiasm.

"Now I know radio as I never knew it before."

So Mr. E. M. Lubeck of Kokomo, Indiana, expressed himself. "Karas Harmoniks bring in every voice and every instrument as distinctly as one could get them in the room," wrote the Rev. Wm. Stellan of Columbus, Ohio. "I consider your transformer a real musical instrument. Like a good violin, it has fine tonal qualities at all pitches covering the musical scale." That was the comment of Mr. Walter Krause of 7807 Burnham Ave., Chicago.

These few reports—picked at random from scores of letters—tell you more convincingly than WE can tell you, the wonderful results YOU can obtain through installing Karas Harmonik Transformers in your set.

Here, for your enjoyment, is an audio transformer, scientifically designed to reproduce through your speaker all of the beauty of radiocast music—exactly as it is rendered in the studio.

High, low, and medium audio frequencies are amplified to an equal degree. Sonorous bass notes pour forth from the speaker in full strength and rich tone quality. The vital harmonics and rich overtones are brought out in their true beauty by this marvel of audio transformers.

Dear Sirs: I take great pleasure in praising your wonderful Karas Harmonik Transformers. I am using two of them in a three-tube Low-Loss set which I built. I have two brothers singing from Edgewater Beach, WEBH Station. Well, their singing comes in so natural and clear that at times we think they are right in the same room with us. They also tell me mine is the clearest set they have ever heard.
Robert Loos, 1640 N. Leavitt St., Chicago, Illinois

All last season, home set builders—the most discriminating class of radio enthusiasts—bought Karas Harmoniks and enjoyed a musical quality of radio reception that owners of factory-built sets knew nothing about.

If YOU want the utmost musical enjoyment that radio has to offer, get a pair of Karas Harmonik Transformers at once. It is

very simple to install them or, if you don't care to do it for yourself, any radio repair man will do it for you at small expense. Why not make up your mind right now to have the best music your set is capable of giving?

Most good radio dealers carry Karas Harmoniks. If your dealer is out of them, order direct of us. Send no money, just pay the postman \$7.00 each on delivery.

Karas Electric Co., 4059 N. Rockwell St., Chicago, Ill.

Please send me pairs of Karas Harmonik Audio Frequency Transformers. I will pay the postman \$7 apiece, plus postage, on delivery. It is understood that I am privileged to return the transformers any time within 30 days if they do not prove entirely satisfactory to me, and my money will be refunded at once.

Name

Address

If you send cash with order we'll send Transformers postpaid

All apparatus advertised in this magazine has been tested and approved by POPULAR RADIO LABORATORY

NOW!
for Tuned Radio Frequency
Matched AERO COILS!

T. R. F.
KIT
\$12.00



95%
Air Dielectric
Dopeless
Air-Spaced
Windings

NOW you can build a set and have all three tuning dials tune exactly the same—or, you can build a one control set using a gang condenser and know that it's going to work right. AERO Coils are matched!

But—the matched feature of Aero Coils is not their only exclusive feature.

Aero Coils are, by electrical measurement and by use tests, the most powerful, most selective and most sensitive inductances ever designed. They will enable your set to sharply cut through powerful locals and will bring in, with tremendous loud speaker volume, signals you have always had to listen to on head phones.

Build with Aero Coils. You are sure of their superiority because that which makes them so is patent-protected. The Tuned Radio Frequency Kit is \$12.00 complete with circuit diagrams and instructions. At your dealers—or direct, if your dealer hasn't them.

**Use AERO COILS
In Any Circuit**

[The only Air Dielectric Coils Having Variable Primaries in Antennae Circuits.]

- Three Circuit Tuner \$8.00
- Radio Frequency Regenerative Kit 11.00
- Wave Trap or Crystal Set Unit 4.00
- Oscillator Unit 5.50

Free booklet giving valuable information on radio frequency amplification sent on request. Write now for the "Aero Booklet"

AERO PRODUCTS, Inc.
1772 Wilson Avenue, Chicago

AERO COIL
LOW LOSS INDUCTANCES

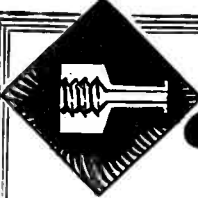

Lastite

CENTERED TERMINAL

If your object is to attain excellence in radio structure, the basic importance of the Lastite will interest you as much as it does us.

"With a bus wire soldered to it, the Lastite is its own lock nut."

There can be no structural element in radio more basically important than this feature of the Lastite.

Lastites hold the bus wires and, so, help while you arrange them.

The Lastite is easier to solder to than a lug, is easier to put on, is stronger and looks incomparably better than any other kind of terminal.

Being more than just a contact, the Lastite is the only radio terminal which can be advertised and recommended, on its merits, for the service it performs.

PATENTS APPLIED FOR

Write or telegraph for samples

William Stevens Co.,
27 Hammatt Road, Roslindale, Mass.

The Aalco Loop

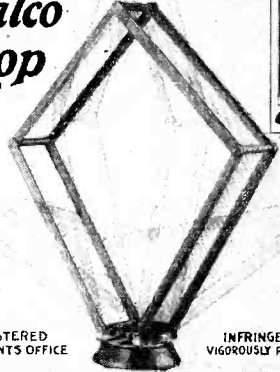

REGISTERED
U.S. PATENTS OFFICE

INFRINGEMENTS
VIGOROUSLY PROSECUTED

**Adjustable to any position
Wiring always taut
GUARANTEED FOR A LIFETIME**

THE AALCO — the lowest resistance loop made — assures maximum selectivity and range, and perfect dial matching made possible by variable inductance. Constructed of the highest grade materials in a new and masterly design. Length 24 in.—Normal Ht. 30 in.—Wavelength range 120-600 meters. LABORATORY TEST RESULTS UPON REQUEST.

Price \$15.00
AALCO RADIO LABS.
6336 Cottage Grove Ave., CHICAGO.

All apparatus advertised in this magazine has been tested and approved by POPULAR RADIO LABORATORY

5
TUBES
\$80



SUPER-SELECTOR

Resistance Coupled!

Combined resistance and transformer coupling; hence marvelous clarity of tone. Control of selectivity—a distinct departure, an ELKAY invention—of extreme importance to those close to B. C. centers.

Complete control of oscillation. R. F. device that permits the same smooth operation on the low wave lengths as on the high. Exceptionally handsome mahogany cabinet. A genuine triumph, based on the fundamental ELKAY circuit. Compares favorably in appearance, selectivity, volume, distance and tone with any set at any price.

Also built for 4 tubes at \$70. Write for folder. Amateur set builders, write for kit prices on ELKAY sets.

TO THE TRADE

We are assigning exclusive territory only. We guarantee to maintain prices during the winter of 1925-6. We refuse to deal with "gyp" or cut price houses. And, on top of all this, we offer you, in a handsome cabinet, a set that holds its own in selectivity, volume, distance and tone with any set at any price. If interested, write on your letterhead.

The Langbein-Kaufman Radio Company

Dept. P

511 Chapel St., New Haven, Conn.

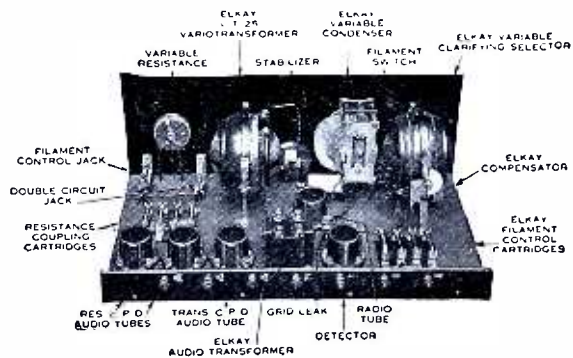

An LK Product



All apparatus advertised in this magazine has been tested and approved by POPULAR RADIO LABORATORY

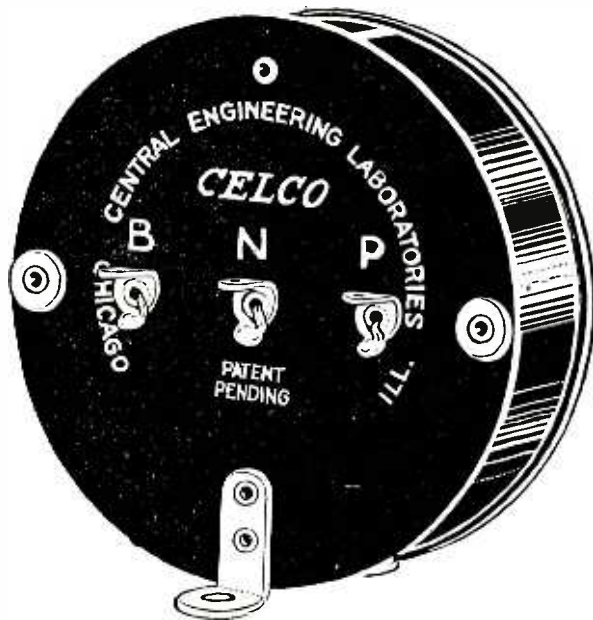

CELCO Indicating Battery Switch

There need be no more annoyance over tubes burning all night if a Celco Battery switch is in your set. The jeweled pilot light emits a soft golden glow that makes it as hard to forget to turn off as it is easy to turn on. Simple to install—only two holes to be drilled in panel, one for pilot light and one for switch.

Agent Representatives
wanted
Some Good Territory Still Open

CELCO

Double "D" Coil
Intermediate Frequency Transformers
THE HEART OF THE
SUPERHETERODYNE
Greater Volume, Super-
Selectivity, Quality Reception

Air Core type, Matched and Peaked Uniformly and Exactly. You will never know the real possibilities of the superheterodyne until you use these transformers. Get laboratory results in your every-day set. Secure maximum effectiveness in Pressley, Super-Autodyne, Tropadyne or the straight superheterodyne circuits.



CENTRAL ENGINEERING LABORATORIES
3345 No. Lincoln St. Chicago, Ill.



Sickles Coil Set No. 24 for Browning-Drake Circuit. Price \$7.50.

SICKLES

DIAMOND-WEAVE COILS

(Trade Mark registered Aug. 4, 1925)

*For Browning-Drake, Roberts, Craig,
and Hoyt Circuits*

(Patented Aug. 21, 1923)

Sickles Coils for the famous Browning-Drake Circuit are the latest Sickles achievement in efficient design for a particular use. They are priced at \$7.50 a set.

The New No. 18A Coils for any Roberts Circuit are absolutely standard equipment. They are priced at \$8.00 per set.

Coil Set No. 20, at \$4.50, is for use specifically with the New Reflex Receiver designed by Albert G. Craig using the Sodian detector.

Coils for the Hoyt Circuit at \$10.00 a set, for the Knock-out Reflex Circuit at \$4.00 a pair, and the Tuned Radio Frequency coils at \$2.00 each are other standard Sickles Coils. We manufacture also for manufacturers' special requirements.

Send for descriptive catalog

The F. W. Sickles Co.

134 Union Street
SPRINGFIELD, MASS.

An entirely new system of Radio Reception

Sickles Diamond-Weave Coils have been specified for use in the Hoyt System of Signal Augmentation, by the inventor, Francis R. Hoyt. We have a limited number of blue printed copies of Mr. Hoyt's original laboratory notes on this new system of radio reception, together with nine circuit sketches, which will be sent free to you upon receipt of this coupon and four cents for postage.

The F. W. Sickles Co.
Springfield, Mass.

Please send information of Hoyt System

Name

Address

Popular Radio

All apparatus advertised in this magazine has been tested and approved by POPULAR RADIO LABORATORY

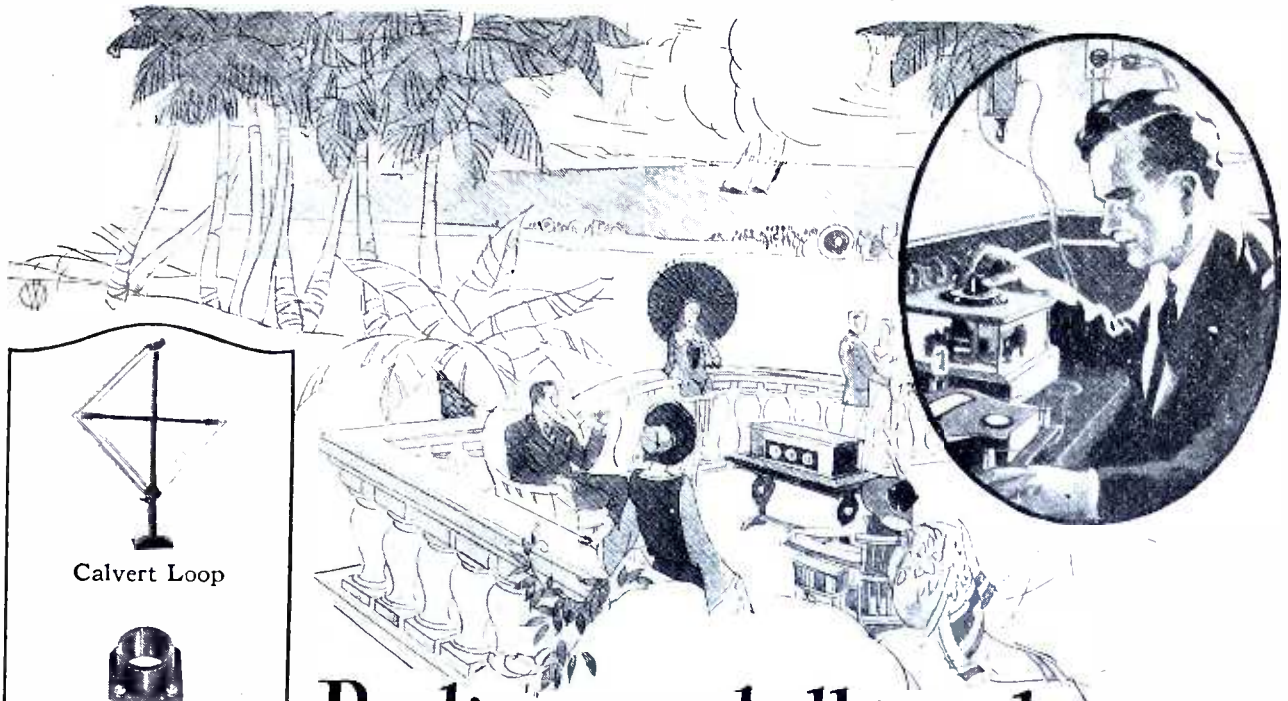

Calvert Loop



Bennington
Tube Socket



Mason Z & T Jr.
Detector



Saal
Soft Speaker



Patent Knob



Pathe Dial

Radio tested all insulations- and adopted Bakelite

In the laboratories of radio manufacturers, in actual use in all climates and under adverse conditions, Bakelite has proven its superiority for radio insulation.

The reason for this dominance of Bakelite in radio is easily understood. Its high insulation value, so essential to tonal quality, is unimpaired by time, temperature variations or by service.

Bakelite is generally used for exposed radio parts, dials, knobs, panels and accessories, because its color and high finish are permanent, undimmed by exposure or handling.

The use of Bakelite in the set you buy or build, will insure you against inferior reception through defective insulation. It will pay you to make sure that Bakelite is used in the radio set or parts that you buy.

Write for Booklet 28

BAKELITE CORPORATION

247 Park Avenue, New York, N. Y.
Chicago Office: 636 West 22d Street

Bakelite is an exclusive trade mark and can be used only on products made from materials manufactured by the Bakelite Corporation. It is the only material which may bear this famous mark of excellence.

BAKELITE



BAKELITE
is the registered trade mark for the phenol resin product manufactured under patents owned by the Bakelite Corporation.

THE MATERIAL OF A THOUSAND USES

All apparatus advertised in this magazine has been tested and approved by POPULAR RADIO LABORATORY



**EARN
\$50 to \$250
A WEEK**

Be a Radio Expert

Learn Quickly at Home

Get into the great new Big-Pay Industry—Radio. If you're earning a penny less than \$50 a week, *clip coupon now*. SEND FOR AMAZING FREE BOOK. Be a Radio Expert, and draw down big money for easiest and most fascinating work in the world. Positions everywhere. Every community needs its Radio Experts. Short hours. BIG PAY. *Free book gives all the facts*. GET IT NOW—CLIP COUPON. Master Radio Engineers will show you the way to qualify for the fine jobs waiting in Radio. You can do it quickly and easily at home.



Thousands of Jobs Now Waiting

Get a fine position like Fetzer did quick with N. R. I. training behind him. Fetzer (picture above) is a successful, high class man — Chief Operator WEMC, the "Radio Lighthouse." Thousands of openings await the trained man.

Get This FREE Book!

Send coupon now for FREE BOOK—"Rich Rewards in Radio." Read for yours of the unequalled opportunities to cash in big as a Radio EXPERT—a trained man in the World's Fastest Moving Industry.

You Get These

These receiving sets, from simplest kind to thousand mile receiver, given to you without cost



with your course. An UNEQUALLED OFFER. Write quick. Clip coupon now for Special Offer, including Receiving sets without extra charge.

National Radio Institute, Dept. 32 NB, Washington, D. C.

MAIL COUPON

National Radio Institute, Dept. 32NB, Washington, D. C. Without obligating me in any way please send me your free book, "Rich Rewards in Radio." Also complete information on your practical home-study Radio course, with all instruments and short time Special Offer.

NAME.....
ADDRESS.....
TOWN.....STATE.....

"Los Angeles to Boston on this indoor aerial!"

—the report of an Indiana user

Effarsee
ANTENNAE
REG. U. S. TRADE MARK
PATENT PENDING

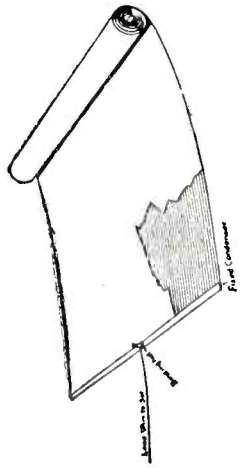

Enthusiastic users everywhere have added hundreds of miles to best distance records with this scientifically designed antenna.

*Greater Volume
Cuts Static
More Selectivity*

Equipped with special fixed condensers, large size contains 1,000 feet of copper wire, insulated from moisture, covered with parchment. Can be rolled up, or hung on the wall, in closets, or under rugs.

Write for distance reports of enthusiastic users

Type IXL (Large) . . . \$4.00
Type BXL (Small) . . . \$2.50
At any radio dealer or write direct.

THE FISHWICK RADIO CO.

137 Central Parkway

Cincinnati, O.

CARTER
"IMP" Pilot Switch

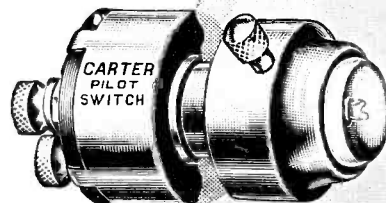

\$1.50

Complete with Lamp

Eliminates the chance of leaving your tubes burning and running your battery down. A quarter turn snap switch, positive in action, automatically indicated by red "pilot" light when tubes are burning. When switch is "off" light goes out. Simple to install. Single hole mounting. Battery consumption negligible. Operates on either 4½ or 6 volts. No set is complete without one—go to your dealer today.

MEMBER RMA In Canada—Carter Radio Co., Limited, Toronto



Just Hear It!

MODEL 24

Five tubes. Tuned Radio Frequency. Rich mahogany cabinet. 7 in. x 22 in., with a beautiful etched metal panel. Equipped with the famous line of Kelford parts, made by us in our own factory. Has a variable antennae tuning switch, assuring efficient reception, with either long or short antennae.

\$59⁵⁰



Electrola

COMPARE the Electrola for clarity and tone. Try it for volume. Test it for distance and selectivity. We challenge you to find any receiver, regardless of price, that will give you any better service, more pleasure and satisfaction, and that is a bigger value.

We urge such a comparison because the Electrola is NOT an assembled set. Every part entering into its construction, except the cabinet, is made by us in our own factory.



MODEL 18—\$80

Five tubes. Tuned Radio Frequency. Rich mahogany cabinet, 7 in. x 24 in. Great distance getter, and a beautiful piece of furniture.

We know what Electrola will do and has done for others, and are equally confident it will give you the same all-around radio satisfaction.

WRITE FOR FREE RADIO BOOKLET

It is yours for the asking, an interesting and descriptive booklet, explaining many things about radio you ought to know. Send for your copy to-day.

THE AMERICAN SPECIALTY Co., Bridgeport, Conn.

America's Pioneer Manufacturer of Radio Parts

All apparatus advertised in this magazine has been tested and approved by POPULAR RADIO LABORATORY

A RADIO CABINET OF BEAUTY AND ELEGANCE DIRECT TO YOU AT LOWEST COST

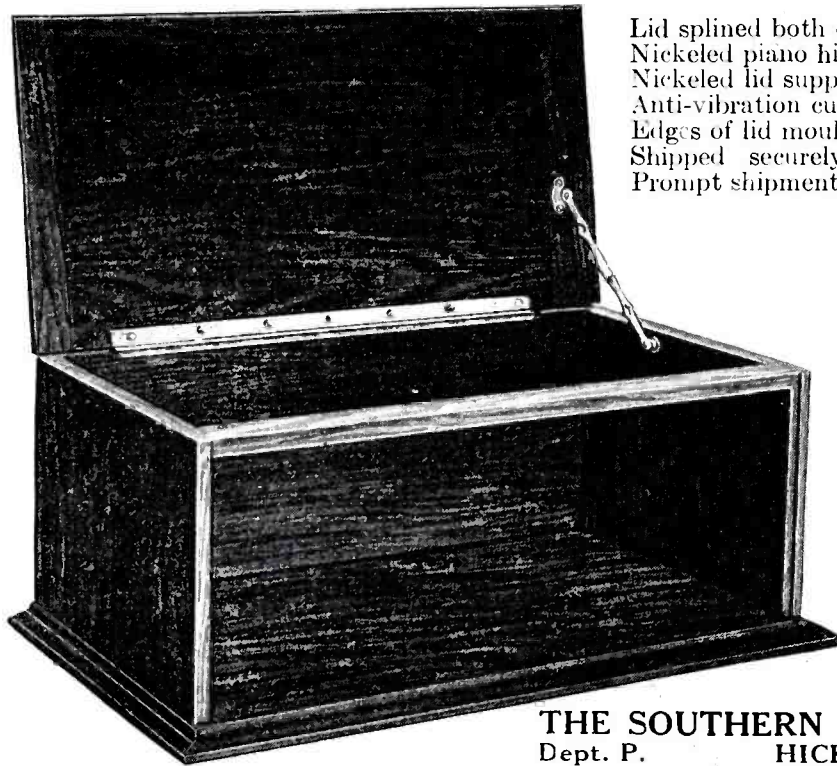

Lid splined both ends to prevent warping.
Nicked piano hinge.
Nicked lid support of artistic design.
Anti-vibration cushion feet (not visible in cut).
Edges of lid moulded to match bottom.
Shipped securely packed in strong carton.
Prompt shipment.

	Hardwood, Rubbed Mahogany Finish	Solid Black American Walnut
7 x 18 x 7 1/2 or 10 in. deep	\$3.50	\$5.00
7 x 24 x 7 1/2 or 10 in. deep	4.00	5.50
7 x 26 x 7 1/2 or 10 in. deep	4.75	6.25
7 x 28 x 7 1/2 or 10 in. deep	5.50	7.00
7 x 30 x 7 1/2 or 10 in. deep	6.00	8.00
7 x 21 x 10 in. deep	3.75	5.25

CASH WITH ORDER or C. O. D.
if 1/4 of price is sent with order.
Prices F. O. B. Hickory, N. C.
Order express shipment, often
cheaper than mail and much safer
from damage.

FREE WITH EACH CABINET
a glued-up stock non-warping 1/2-
inch BASEBOARD.

Free Catalogue.

THE SOUTHERN TOY COMPANY, INC.
Dept. P. HICKORY, NORTH CAROLINA

The New Universal

KELBRAKET

"Girders for Radio"

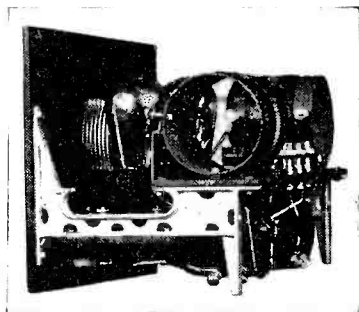

Appearance and accessibility built into a
two-tube reflex set with KELBRAKETS.

Clean-cut aluminum Kelbrakets, weighing
only 4 ounces, hold main and sub pane's
rigid and supplant the old "plank."

KELBRAKET No. 15 (per pair) ... \$1.50
KELBRAKET No. 7 (per pair) ... 2.00

Write for the "KELBRAKET BOOK"

KELLERADIO, INC.
821 Market Street San Francisco, Cal.

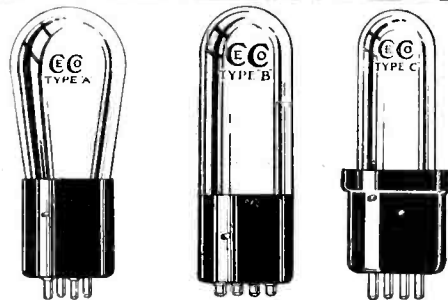

	"A"	"B"	"C"
Filament Volts	5.0	3.0	3.0
Filament Current	0.25	.06	.06
Plate Voltage	20 to 120	20 to 80	20 to 80

Made with Brass and Bakelite Bases

Make a Good Receiver BETTER—

Use CeCo Tubes as radio frequency ampli-
fiers, detectors, oscillators, or audio frequency
amplifiers. They have established a new
standard of time excellence.

Clear tone; increased volume, longer life!
You'll SEE the difference in YOUR receiver
whatever its type.

Every tube guaranteed

Write for new, Illustrated
Catalog showing test charts
of CeCo Tubes.

C. E. Manufacturing Co.
Providence, R. I.





A Movable Set of Wonderful Tone

Sold complete by a reliable manufacturer with tested tubes, batteries, loop and loud speaker

for \$200

Nothing extra to buy!

YOU need no outside aerial or ground wire with the Cleartone 91, seven tube loop set. It can be moved to the sick room or the front porch or taken to camp—for it is as movable as a phonograph.

The tone of the set is unusually fine. It is a real musical instrument. It

will give you loud speaker volume over great distances, and do everything you expect from a high quality radio.

It is also a splendid piece of furniture, handsome in every detail. It is the ideal set for the apartment house where an aerial cannot be erected, or for the farm where charging equipment is not available.

- Model 90 Complete with Detached Loud Speaker \$185
- Model 91 Complete with Built-in Loud Speaker 200
- Model 92 Console, Built-in Loud Speaker 275

Dealers: This set is out of the fierce competition on five tube sets. You can demonstrate it anywhere. All tested equipment installed by factory prevents service difficulties. It is going big. Write or wire for exclusive dealer plan.

THE CLEARTONE RADIO COMPANY

2427 GILBERT AVENUE

CINCINNATI, OHIO

ACCESSORIES FURNISHED WITH CLEARSTONE SETS
 7 Radiotron Tubes 2 45-Volt Ray-O-Vac "B" Batteries
 9 Ray-O-Vac Dry "A" Batteries 1 Clearstone Loop Antenna
 1 Clearstone Loud Speaker

CLEARSTONE *Complete* RADIO SETS

All apparatus advertised in this magazine has been tested and approved by POPULAR RADIO LABORATORY

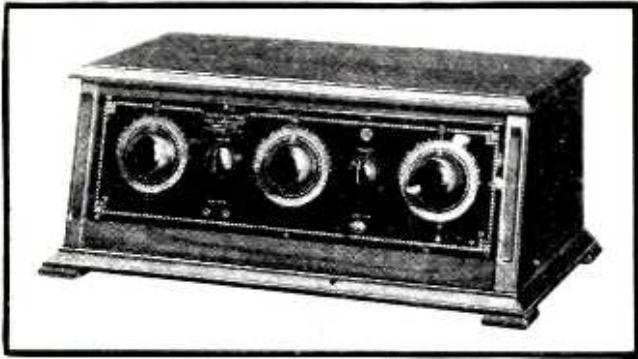

AINSWORTH *Invites Comparison*

There are a good many radio receivers on the market—many with distinctive features that are worthy of consideration when buying a set.

But with the many to choose from, it is often difficult to select the one that will give YOU the greatest satisfaction.

That is why we invite comparison of the AINSWORTH Torodyne with any other set. Let your dealer show you WHY it is selective; WHY its tones are so clear; WHY it brings in distant stations with so much volume; WHY its logging is accurate and consistent. And above all, insist on hearing it and then judge for yourself.

The use of Toroidal (doughnut type) transformers, with its other distinctive features, place the AINSWORTH Torodyne in a class of its own.

If your dealer cannot supply you with complete information regarding this set, write us for details. THE AINSWORTH RADIO COMPANY, 308 Main St., Cincinnati, Ohio.

Price \$100.00

AINSWORTH TORODYNE

Toroidal Receiver

Better Results with
Less Space — Using

DUPLEX

*Straight Line
Frequency*

CONDENSERS

Their specially shaped-out stators afford separation on all wave-lengths, increasing selectivity and eliminating interference. Their carefully planned design retains all low-loss advantages and keeps DUPLX S. I. F. Condensers as small as the previous models.

Learn the secret of DUPLX superior construction. Sample plate and literature sent on request.

DUPLX CONDENSER & RADIO CORP.
50 Flatbush Avenue Extension
Brooklyn, N. Y.

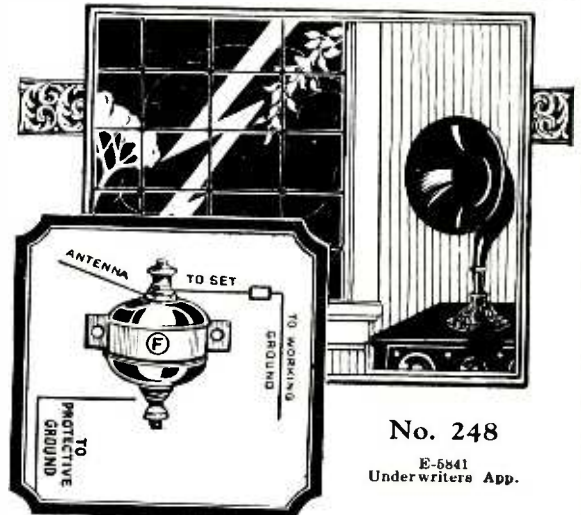

No. 248

E-5841
Underwriters App.

“Little Joe” Lightning Arrester

Especially designed for Radio Work. Made of Porcelain, small, neat, rugged and serviceable. Can be suspended on antenna or fastened to wall.

Ask Your Dealer

M'd by CIRCLE F MFG. CO.
Trenton, New Jersey

All apparatus advertised in this magazine has been tested and approved by POPULAR RADIO LABORATORY

This New Universal Tester Should Be a Part of Every Set Owner's Equipment

—a help to the set owner
—a profit-maker for the service man—

Tests Your Vacuum Tubes

Tests Your A and B Batteries

Tests Your Transformers and Sockets

Tests Wiring Circuits

THIS instrument is a veritable little radio mechanic in itself. If reception isn't satisfactory let it find out for you where the fault lies

You can determine the plate current and hence the amplifying value of tubes, without disturbing the set. Large or small tubes may be tested. It tests the condition of the batteries, finds weak sockets, wiring leaks, transformer troubles — practically anything the matter with your set — is quickly and accurately located.

This new Sterling "Universal" Tube Tester solves your radio problems. It insures the *best* reception possible from your set.

The
STERLING MFG. CO.
CLEVELAND, OHIO
Dept. G

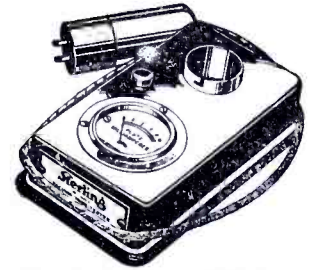

Sterling "Home" Tube Tester

for testing tubes to show whether they are fair, poor, or good amplifiers. Price \$8.50

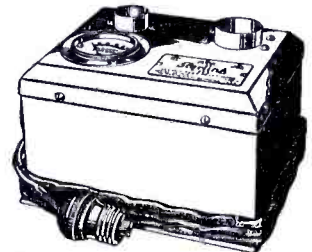

Sterling Tube Reactivator

It renews the filaments of UV-201, C-301A, UV-199 and C-299 types of tubes. It shows by the filament emission meter whether reactivation is necessary and how much better an amplifier the tube is after treatment. Price \$12.50

This instrument is featured by a plate and filament emission meter and a plate milliammeter to determine plate current and amplifying values of tubes. It is extremely compact, good looking and as easy to carry as a camera.

Price
\$18.00



Sterling
Universal
Tube Tester

All apparatus advertised in this magazine has been tested and approved by POPULAR RADIO LABORATORY

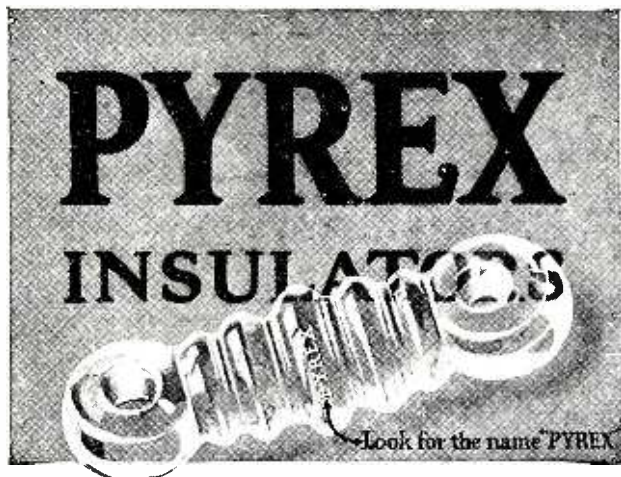

PYREX Insulators are used by the United States Government for the most exacting service. They must not be confused with ordinary glass insulators.

They thought he had bought a better set!

HE invited his friends to hear his radio. It sounded so much clearer; it brought in the distant stations so much louder that they thought he had bought a better set.

“No,” he said, “It’s the old set—but I’ve put in PYREX Antenna Insulators. Now I get every bit of energy that’s on the air. These insulators really insulate—they don’t let energy leak away. And they cost only 45c each.

Industrial and Equipment Division

CORNING GLASS WORKS, Corning, New York

World’s Largest Makers of Technical Glassware

Wonderful Volume with Clearness—AMPL-TONE



Phonograph makers have spent years perfecting the acoustic properties of their phonographs. Use an AMPL-TONE Unit and make a real Loud Speaker in an instant or use it in your horn and get better results. After all, speakers are as good as their unit. We make a real unit at a real price. Money gladly returned if you are not entirely satisfied.

WE SELL UNITS TO MFRS.

Late at night when the family has retired, don’t disturb them. Use AMPL-TONE HEADSETS. They produce the best results and are unsurpassed as a distance getter. Price \$5.00.



You can buy direct from us also
The UNION FABRIC CO. DERBY, CONN.

YOUR THREE BEST BETS



X - L RADIO PRODUCTS

Just install them in your receiver and leave them speak for themselves
Endorsed by LAURENCE M. COCKADAY and other leading radio authorities and publications

Model “N” Vario Denser

Capacity range 1.8 to 20 micro-micro-farads, for balance in Roberts two tube, Browning-Drake, McMurdo Silver’s Knockout, Neutrodyne and tuned radio frequency circuits.
Price \$1.00

Model “G” Vario Denser

Two capacity ranges, .00016 to .00055 and .0003 to .001 Microfarads, for the Cockaday circuits, filter and intermediate frequency tuning in super-heterodyne and positive grid bias in all sets with grid-leak clips.
Price \$1.50



X-L Push Post

A binding post that really does excel in looks, action, service and convenience. Just push it down—insert wire—cannot jar loose from vibration. No screwing or danger of shearing off wires. Furnished attractively plated with soldering lug and necessary markings.

Price Each 15 Cents

**X-L RADIO LABORATORIES
2422 Lincoln Ave. CHICAGO**

All apparatus advertised in this magazine has been tested and approved by POPULAR RADIO LABORATORY



SILENT POWER—

- Reception—Clear and “humless.”
- Voltage—Smooth and sustained.
- Tube—Long life. No filament to break or burn out.
- Control—Very simple—by means of switch in case.
- Once in operation, no further attention necessary.

If your dealer does not carry Epom, write the distributor nearest to you for the name of a reliable dealer who will demonstrate and supply you.

New York
New York
Newark
Newark
Philadelphia
Philadelphia
Boston
Boston
Hartford
Binghamton
Syracuse
Utica
Baltimore
Richmond

E. B. Latham & Company
Sibley-Pitman Elec. Corp.
Tri-City Elec. Company
E. M. Wilson & Son
Jones-Beach & Co.
F. H. Stewart Elec. Co.
Pettingell-Andrews Co.
Wetmore-Savage Elec. Sup.
So. New England Elec. Co.
Elliott Engineering Co.
Burr-Fowler Company
Steifvater Elec. Co.
Southern Electric Co.
Southern Electric Co.

Chicago
Kansas City
Cleveland
Cleveland
Columbus
Cincinnati
Pittsburgh
Indianapolis
Detroit
St. Louis
New Orleans
Atlanta
Birmingham
Dallas
Houston

Commonwealth Edison Co.
B-R Electric Company
Erner Electric Company
Republic Electric Co.
Erner & Hopkins Co.
Post-Glover Elec. Company
Union Electric Company
Indianapolis Elec. Sup. Co.
Electrical Specialties Co.
Wesco Supply Company
Wesco Supply Company
Carter Electric Co.
Matthews Electric Co.
Southwest G. E. Co.
Southwest G. E. Co.

EPOM

ELECTRICAL PRODUCTS OF MERIT

“B” BATTERY ELIMINATOR

EPOM CORPORATION 114 E. 47th St. N. Y. City

All apparatus advertised in this magazine has been tested and approved by POPULAR RADIO LABORATORY



TRIMM Entertainer is a quality speaker at an intermediate price. The large Trimm Unit may be adjusted to give desired tone and volume. Volconite horn stands 19½ inches high, has a bell 12 inches in diameter. The Entertainer is one of the biggest values in radio because it gives the satisfaction and performance of highest grade speaker at a truly reasonable price.

TRIMM	
Superior Reproducers	
HEADSETS	
Professional - -	\$5.50
Dependable - - -	4.40
PHONODAPTERS	
Giant Unit - -	\$10.00
Little Wonder -	4.50
SPEAKERS	
Home Speaker -	\$10.00
Entertainer - -	17.50
Cabinette - - -	17.50
Concert - - -	25.00
Cheilo - - -	30.00

TRIMM
RADIO MANUFACTURING
COMPANY
24 So. Clinton St.
CHICAGO
U.S.A.

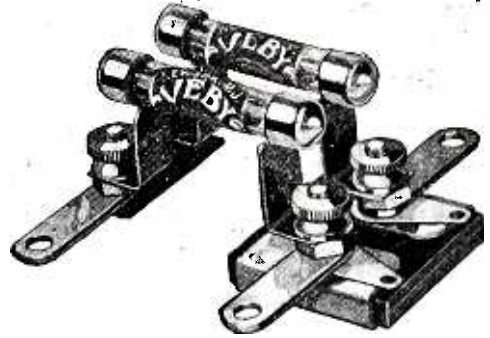

VEBY RESISTANCE COUPLER
Build Your Own
AMPLIFIER

With the VEBY Resistance Coupler it is an easy matter to build a **Resistance Coupled Amplifier**. It mounts directly on the sockets by means of connecting links. The Coupler as illustrated less the condenser..... **\$1.25**

VEBY AMPLIFIER TUBES especially made for Resistance Coupled Amplification. A. F. 20..... **\$3.00**

VEBY POWER TUBE for use in the last stage of the Amplifier. A. F. 6..... **\$4.50**

At good Dealers only, or write direct to the

VEBY RADIO COMPANY
"QUALITY RESISTORS"
47-51 MORRIS AVE., NEWARK, N. J.

Premier B Battery Cabinet

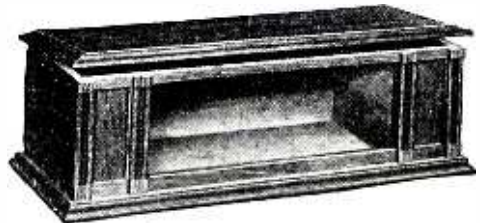

Our Premier B Battery Cabinet is a beautiful piece of furniture. The B battery compartment will take any type B battery. The space of each B battery compartment is 4½" wide, 8½" high and 10" deep.

No.	For Panel	Deep	Genuine Walnut
718-10	7 x 18	10"	\$18.50
721-10	7 x 21	10"	19.00
724-10	7 x 24	10"	19.50
726-10	7 x 26	10"	20.00
728-10	7 x 28	10"	21.00
730-10	7 x 30	10"	22.00

F.O.B. Waukesha, Wis.

The tops of these cabinets are figured walnut, the ends and B battery panels are select walnut, all 5 ply veneer. The bases are built up of massive molding. Nickel plated piano hinges and lid holders. The material and finish in these cabinets will equal the best furniture obtainable.

WE MAKE 9 STYLES OF CABINETS FOR 14 SIZES OF PANELS. Send for our 1925-26 line of cabinets at "Factory to User" prices.

Utility Cabinet Company

Phone 721 Waukesha, Wisconsin

All apparatus advertised in this magazine has been tested and approved by POPULAR RADIO LABORATORY

"Astoundingly Selective!"

"Delightfully clear tone with Amazing Volume"
"Tremendously Powerful"

"Gets 200 to 600 meter Stations coast to coast"
"A great big beautiful set"

"Simple to tune - easy to log"

Built like—
looks like—
performs like a \$200 set

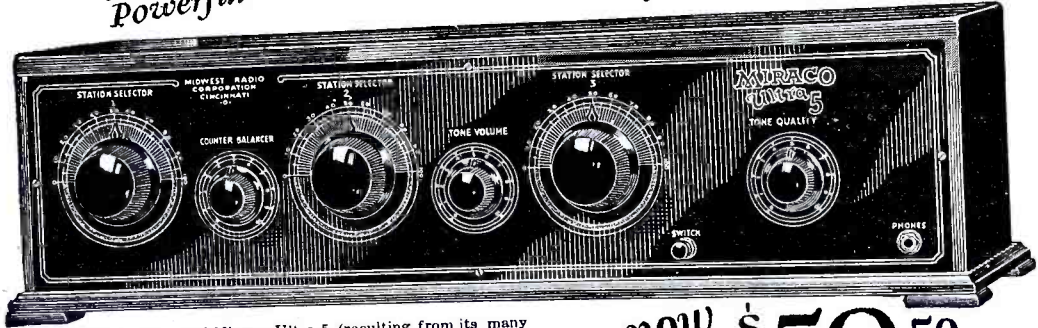

*NOTICE! Enormous demand for the celebrated Miraco Ultra-5 (resulting from its many enthusiastic users so highly recommending it to their friends) has enabled us to add hosts of costly new features, latest improvements and up-to-the-minute improvements such as you might expect to find only on the newest sets selling at much higher prices. So the Miraco Ultra-5 for 1926 is even a better set—more beautiful set—a more selective and more powerful set—incredible as this may sound!—for less money than ever before.

now only \$59⁵⁰ retail

SEND FOR SPECIAL OFFER!

MIRACO RADIO GETS 'EM COAST TO COAST

Reports from Ultra-5 users everywhere leave little for us to add. These are typical of the many in our files and which we receive daily.

PENNSYLVANIA HEARS CALIFORNIA VERY LOUD

I received the Ultra-5 Set, set it up as directions called for, and received Dallas, TEXAS first station. Will list a few of the stations received in two hours: KDKA, WJLA, WOR, WQAW, WOS, WTAM, WCAE, WLW, WOO, WJY, WJS, KFI, KSJ, WWJ, WHN, WHX. It is very easy for me to receive Los Angeles, California, loud enough to be heard in my room in the house. W. E. Uniontown, Penna.

CALIFORNIA GETS NEW YORK ON LOUDSPEAKER

I have got stations from coast to coast without any trouble at all on the Ultra-5. WTAM, Cleveland, Ohio, comes in on loudspeaker nearly as loud as the nearby stations do. I have brought in on loudspeaker with ample volume to hear all over the room stations WEA, N. Y., KDKA, Pittsburgh, Pa., WGY, N. Y., CHXN, Ottawa, WSAI, Cincinnati, WCCO, St. Paul, Minn., WLS, Chicago, S. S. Dorris, California.

NEW JERSEY HEARS CALIFORNIA ON LOUDSPEAKER

MIRACO Ultra-5 working fine. Have received Western coast. Had two stations in California on same night. Have had many other stations. Receive all other stations with loudspeaker. Nivison Van. Freehold, N. J.

MONTANA HEARS BOTH COASTS

Ultra-5 Set is O. K. Have got New York to Los Angeles, Winnipeg to Dallas, Texas. Have had some 60 odd stations in two weeks. W. H. Polson, Montana.

RADIO EXPERT SPEAKS FROM EXPERIENCE

As I sell almost all kinds of sets, I have operated all of them and will state that the Miraco Ultra-5 is as good if not better than any other set in the market today. Felix J. Pawtucket, Rhode Island.

PREFERS IT TO \$150 SETS

I received your Miraco Ultra-5 Radio Set and it surely is a peach. I have tried and heard radios up to the value of \$150.00, but I like yours the best. William L. Syracuse, N. Y.

ILLINOIS HEARS ALASKA

The night I received the Ultra-5 I tuned in New York City. The second day I tuned in KFI, Los Angeles, Calif., and KFJ, Juneau, Alaska. Can get anything in the United States. I will put it against any set I have ever heard. H. B. Ashkum, Illinois.

GOT CALIFORNIA BETTER THAN \$269 SET

Received the Miraco Ultra-5 the other day and it is a big surprise. Compared it with my friends' \$269.00 and could bring them in just as loud and clear on my Ultra-5. Really I brought in Los Angeles, California, on speaker louder than he did. Am more than pleased. Kyle New Albany, Miss.

The Powerful New **MIRACO Ultra-5**

[FIVE TUBE OUTFIT IN BEAUTIFUL MAHOAGANY CASE]

Let the testimony of its many users everywhere—as voluntarily reported to us in writing—convince you that a Miraco Ultra 5 actually is unsurpassed for selectivity, long distance range, clear tone, loud speaker volume and beauty—combined with economy and simplicity of operation—at several times the price. Send coupon for plenty of this proof and reports of users which leave no doubt that the Miraco Ultra 5 gets programs coast to coast.

Completely built, carefully tested and factory guaranteed by one of America's oldest and most successful makers of quality sets, the Miraco Ultra-5 illustrated above (latest improved model for 1926) in the opinion of radio experts is an astonishing bargain. Selectivity, long distance reception, clarity and volume have been amazingly increased—"B" battery consumption is minimized—oscillations are easily controlled on all wave-lengths, through use of latest radio inventions.

Among these are: "Duoformers" (ultra low-loss inductance coils); the "Counter-Balancer" (patented); flexible wiring which prevents broken or noisy connections; an adjustment for different lengths aerials; use of only two rheostats; a cut-out switch; concealed wiring under genuine Formica sub-panel; beautifully gold-etched genuine Formica front panel; large Bakelite knobs with "needle-point" indicators (for fine tuning)—and other features of costliest sets. Literature describes them fully. Send for it—and Special Offer!

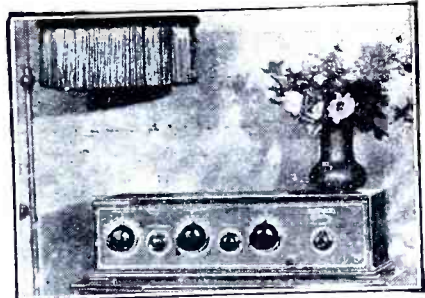

cealed wiring under genuine Formica sub-panel; beautifully gold-etched genuine Formica front panel; large Bakelite knobs with "needle-point" indicators (for fine tuning)—and other features of costliest sets. Literature describes them fully. Send for it—and Special Offer!

Other Miraco Long Distance Sets \$13⁵⁰ retail

Wonderfully improved new models in one-tube and three-tube Miraco Long Distance Sets also ready at lower prices. Powerful new Miraco R-3 at only \$27.35 (retail) operates loudspeaker on distant stations. New one-tube Model R is also a record breaker for distance

at \$13.75. All Miraco sets work on storage or dry batteries, are easily connected and operated. Unmatched value! Let testimony of users convince you.

Write for literature and Special Offer—use coupon.

All the Proof you want is waiting for You!

Reports from their hosts of users in every state prove Miraco sets—at rock-bottom factory prices—outperform sets costing three times as much. Send for latest literature, SPECIAL OFFER and plenty of additional testimony from users leaving no doubt that "Miraco Radio Gets 'em Coast to Coast."

SEND COUPON FOR SPECIAL OFFER!

Dealers! Jobbers! Agents!

Write for the new Miraco proposition. The wonderful tone, volume and distance-getting quality of Miraco Sets makes them easy to sell. Send coupon for proposition; good territory open.

Send coupon for free bulletins and special offer

MIDWEST RADIO CORPORATION
Pioneer Builders of Sets, 479 G E. Eighth St., Cincinnati, O.
Send free literature, SPECIAL OFFER and all particulars regarding Miraco Sets. () Agent () User () Dealer

NAME.....
ADDRESS.....

All apparatus advertised in this magazine has been tested and approved by POPULAR RADIO LABORATORY

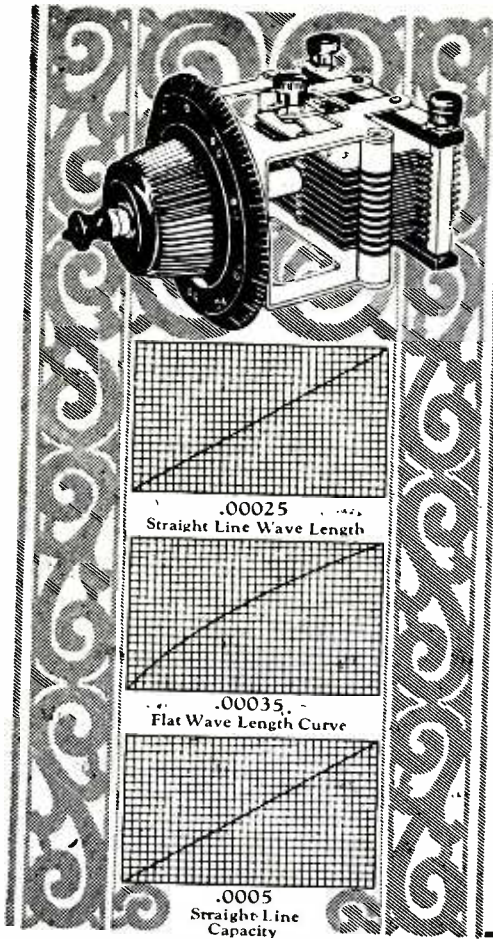

Consider what a Condenser is for! Your choice will be

The **BARRETT & PADEN** Micrometer Condenser

(for any Type of Set)

YOU USE a variable condenser to obtain certain capacity values in the tuning circuit. One measure of a condenser's efficiency is the precision with which it enables you to obtain the various wanted capacities.

The Barrett & Paden Micrometer Condenser will give you a wider variation of capacity values and far more accurate adjustment than any other condenser in the world, for the same reason that a mechanic's micrometer enables him to make infinitely closer measurements than he could with a rule.

Get These Results!

You will hear stations which have never had a place on your dials before; tuning will be easier and selectivity much better; signals will be louder because of the extremely low loss characteristic of this condenser.

Install Barrett & Paden Micrometer Control Variable Condensers in your set now. You will be amazed at the immediate tremendous difference they will make in your set's performance. At your dealers or direct.

.00025—straight line wave length
 .00035—flat wave length curve
 .0005 —straight line capacity

\$ 6.00 including dial

BARRETT & PADEN 1314 Sedgwick St., Chicago, Ill.

Prepared by Kirtland-Engel Adv. Co., Chicago

THE COMBINED RADIO RECORD and INSTRUCTION BOOK



The ideal medium for keeping a record of Stations heard, receiving conditions, programs reports, receipts etc.

Contains full instructions and hook-ups for building, installing and operating the most successful receiving sets.

Revised lists of Broadcasting Stations supplied to owners of book **FREE** of charge.

Price one dollar, at your dealers or sent prepaid.

A COMPLETE TROUBLE FINDING CHART, supplied with each book.

Flexible Fabrikoid binding, gold stamping, 160 pages, size 5 1-2" X 8 1-2", printed on Bond paper. Contains complete list of Broadcasting Stations of the World and double page map of United States.

Published by

LISTEN-IN PUBLISHING COMPANY
 110 Main Street, Cambridge, Mass.

FREE two unusual RADIO CATALOGS



FOR "FANS"

OUR new 64-page Radio Catalog including all the best and latest Kits, Parts and Accessories for broadcast receiving sets. Lowest prices in the country!

More than 1,000,000 fans and hams make our store their headquarters—get these books and find out why

FOR "HAMS"

NEW 32-page booklet of army and navy transmitting apparatus and miscellaneous specials for "hams" such as W. E. Choke Coils, Generators, Resistance Boxes, etc.

Write for either or both

509 South State Street



Dept. P R 6 Chicago Ill.

All apparatus advertised in this magazine has been tested and approved by POPULAR RADIO LABORATORY

UNIVERSAL PLIO-6

The Only Set That Tunes All Wave Lengths Within Distance Range

35 TO 3600 METERS

3AR Melbourne 480—WGY 109—2FL Sydney 770—WKAQ San Juan 360—2BL Sydney 350—PCFF Amsterdam 2000
 Karachi—Bombay—KOP—WGY 1660—6KW Tuinucu 340—Bankok—NSF Hilversum 1050—WLW—KDKA 64.
 KYW—5NO New Castle 400

WESTERN UNION TELEGRAM

1925 JUL 2 PM 3 17

Received at

CA229 TO COLLECT 4 EXTRA

O EASTTITTSBURGH PEIN 2 214P

C R R LEUTZ

476 BROADWAY NEWYORK NY

REPLYING YOUR WIRE GREATEST DISTANCE SHORTWAVE TRANSMISSION AT NIGHT WAS MAXIMUM OBTAINABLE ON THIS EARTH OR TWELVE THOUSAND MILES STOP THIS WAS NOT A FREAK BUT THE SIGNALS WERE USED TO REBROADCAST THE PROGRAM IN AUSTRALIA WITH EXCELLENT RESULTS AND WAS ACCOMPLISHED EVERY TIME WHEN ARRANGED STOP DAYLIGHT RANGE VARIES PARTICULARLY WITH FREQUENCY STOP HAVE PUT SIGNALS IN SOUTH AFRICA WHEN DAYLIGHT AT RECEIVING POINT C W HORN SUPT RADIO OPERATIONS WESTINGHOUSE.

TELEGRAM

LEASED WIRE: N. Y.—SCHENECTADY

134 HISSHOWELL

JUL 1 1925

PLEASE INFORM C R LEUTZ FEATURE WRITER AT 476 BROADWAY NEW YORK IN ANSWER TO HIS TELEGRAM TODAY THAT OUR SHORT WAVE STATIONS HAVE BEEN ON THE AIR SO SHORT A TIME THAT IT IS IMPOSSIBLE TO GIVE MUCH INFORMATION ON RETURNS STOP WE ARE USING 3B AND 100 METER STATION AND HAVE NIGHT TRANSMISSION ONLY STOP GREATEST DISTANCE THUS FAR ON EITHER WAVE IS LONDON ENGLAND WHERE WE ARE RECEIVED NIGHTLY STOP IPVIN N. REEVES OF LONDON REPORTS NIGHTLY RECEPTION STATING THAT HE CAME THROUGH EARLY MORNING DAYLIGHT WITHOUT ANY AFFECT ON SIGNAL.

W T HEENAM 4:55

WOC—CYL Mexico City 510—2FC Sydney 1100—KFI—PA5 Amsterdam 1050—Vienna—Colombo—WWJ—WCX Lakehurst 80—ICE Rome 470—5PY Plymouth 330—Voxhaus 430—CNRC Calgary 440—Madras—Stuttgart 437 BAV Brussels 1100—6FL Sheffield 303—WGY 38—PCGG Hague 1050—Otchiski—KGW—CFAC 430—CHXC Ottawa—EBX Cartagena—NAA 2500—PCMM Ymuiden 1050—SBR Brussels 262—KHJ—LOX Palermo 375—OXE Lyngby 2400—KOA—2SB Sydney—OKP Kbely 1150—2BE Belfast 435—KGO—YN Lyons 470—I Nice 360—FL Eiffel Tower 2600—PTT Paris 450—5XX Chelmsford 1600—LOZ Monte Grande 425—2LS Leeds 346—5MA Adelaide 850—2LO London 365—PWX Havana 400—RAS Vladivostok—WMBF—CJCM Mont Joli—LOR Buenos Aires 400—LP Berlin 2370—VIR Rangoon

- 3LO Melbourne 1720
- 6BM Bourne-mouth 385
- 5WA Cardiff 350
- PRG Prague 1800
- 2ZY Manchester 375
- HB2 Lausanne 850
- JJC Funabashi
- JSB Chemulpot
- 3FL Melbourne 400



- 6VL Liverpool 318
- HBI Geneva 1100
- KDKA 64
- POZ Berlin 2800
- 2EH Edinburgh 325
- 5IT Birmingham 475
- Munich 485
- Leipzig 452
- 2BD Aberdeen 495

THE NEW UNIVERSAL PLIO-6

Six tube, 2 Stages Non-Regenerative Tuned Radio Frequency Amplification, Detector and 3 Stages Distortionless Radio Amplification. Receiving range from 1,000 to 12,000 miles depending upon location, station transmitting, wave-length received and other variable factors

FULL DETAILS NOW AVAILABLE FROM MANUFACTURERS

GOLDEN-LEUTZ INC.

476 BROADWAY :: NEW YORK CITY

Manufactured under Hogan Patent 1,014,002 - Other Patents Pending

CABLES "EXPERINFO" NEW YORK

All apparatus advertised in this magazine has been tested and approved by POPULAR RADIO LABORATORY

Rhamstine* TUBE BOOSTER



Rhamstine*
Tube Booster
Only \$6.00

Your radio enjoyment depends largely on the tubes. If they do not function properly you can not get a full, clear tone. They can be made "just like new"—the Rhamstine* Tube Booster renews their youth with all that the word implies—pep, freshness, a true, full, round tone which carries the message as "clear as a bell."

Works on any alternating current 110-120 volts, 50-133 cycles. It matters not whether you use 201-A or 199 Type Tubes.

Send no money—check the coupon below—pay on delivery.

"B" RECTIFIER (Eliminates "B" Battery)

Rhamstine*
"B" Rectifier
Only \$25.00



The Rhamstine * "B" Rectifier is a quality product which furnishes an always dependable source of "B" power. It eliminates "B" Battery troubles such as chemical action, dead cells, recharging, and gives a continuous and uniform current, reproducing perfectly the original sound.

The cost is nominal compared to the pleasure and satisfaction derived from the service it performs.

Send no money—just check the coupon. The "B" Rectifier is shipped on 5-day approval. If not satisfied, your money will be refunded as cheerfully as the sale is made.

Mail the Coupon Today

J. THOS. RHAMSTINE * (11)
Woodbridge at Beaubien,
Detroit, Mich.
Please send me

- your Tube Booster at \$6
 - your "B" Rectifier at \$25
- by express C. O. D. subject to inspection. If I am not entirely satisfied with the "B" Rectifier I will return it to you in five days and receive a refund of the full purchase price.

Name.....
Address.....

J. THOS. RHAMSTINE*
Radio and Electrical Products
Woodbridge at Beaubien Detroit, Mich.

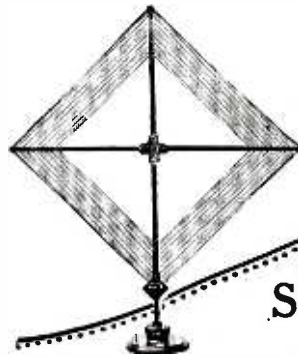

KORACH

Tuned Loop
Multiple Switch Board Tuner
Directional
Base Compass for Logging
Collapsible

For those who demand
Superior Results

Leads the march toward perfect radio reception under all conditions. Not merely a "loop" but an ingenious arrangement of mechanical skill designed for superior results. L. M. Cockaday, using this loop, reached out across the Atlantic to audibly hear many trans-continental Stations.

Selectivity Plus Distance

unheard of with common loop aerials. The Korach excels on all sets designed for loop reception. Priced at \$16.50 and for sale by all good dealers. Full particulars sent for 2c stamp and name of local dealer.

KORACH RADIO CO.
20 E. JACKSON BLVD. Dept. 10 CHICAGO, ILL.
Dealers and Jobbers: Write today for attractive proposition

THE KORACH JUNIOR

A modification of the "Senior" but possessing all its important features - - - \$12.50

AEROVOX

CONDENSERS

AEROVOX
for Accuracy



AEROVOX
for Quality



AEROVOX
for Results



Made in all capacities. Write for particulars of complete line including Restiformers, Rheostats and Grid Leaks.

Chicago Office: 53 W. Jackson Boulevard
AEROVOX WIRELESS CORPORATION
491 Broome Street New York City

All apparatus advertised in this magazine has been tested and approved by POPULAR RADIO LABORATORY

DISTON

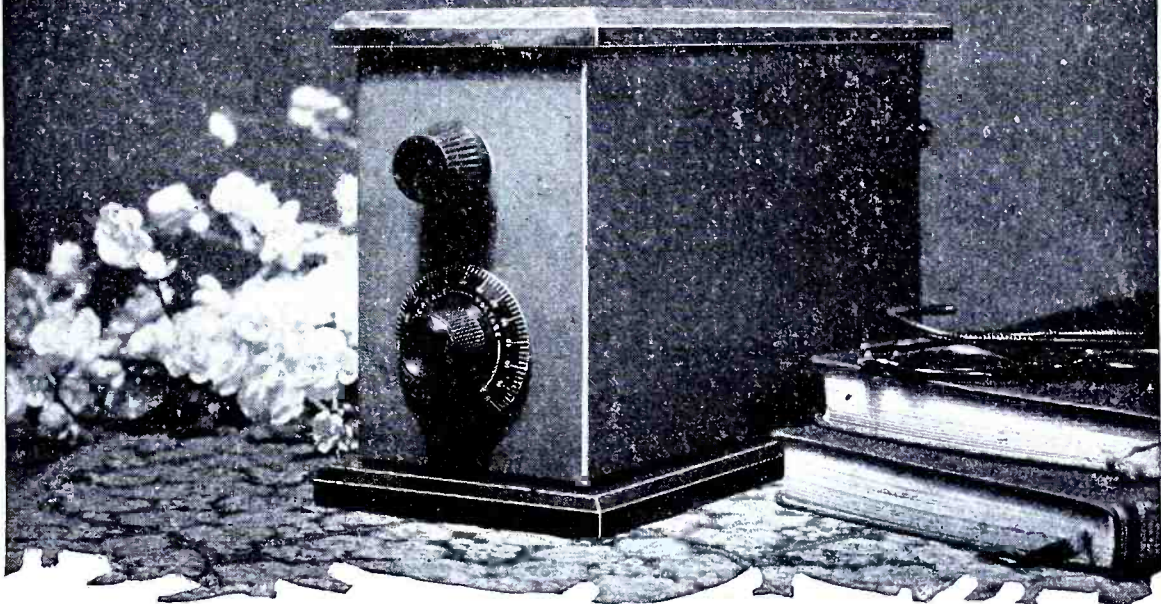

*Handsomely finished in velvet green Duco with solid walnut satin finish top and bottom.
Beautiful in appearance and perfect in performance.*

Amazing Clarity, Selectivity, Volume and Distance — from your receiver

DISTON is offered to you as a positive means for bettering reception with your present receiver. It removes the uncertainty of "B" Battery conditions and provides easy means for getting ultimate performance night after night, without apology—critical adjustment and tedious care, at less expense than "B" Battery operation. It uses ordinary alternating current from your light socket to provide the proper "B" current for your individual set, tubes and loud speaker. DISTON is free from current noises and hum. Ample provision for adjustment to every type of circuit—home and factory-built.*

You Can Know Without Obligation

You can confirm DISTON advantages in your own home. Write for full details giving set name and circuit. We will arrange for test either direct or through your dealer as you prefer.

DISTON KITS
for Set Builders
60, 50, 25 cycle
\$28.50—\$42.75

RADIO PRODUCTS, Inc.
Dept. PR Richmond, Ind.

DISTON—Ready
for Operation
60, 50, 25 cycle
\$40—\$60

**Owners of the older types of receivers will be pleased and gratified by the surprising increase in performance that DISTON makes possible.*

All apparatus advertised in this magazine has been tested and approved by POPULAR RADIO LABORATORY

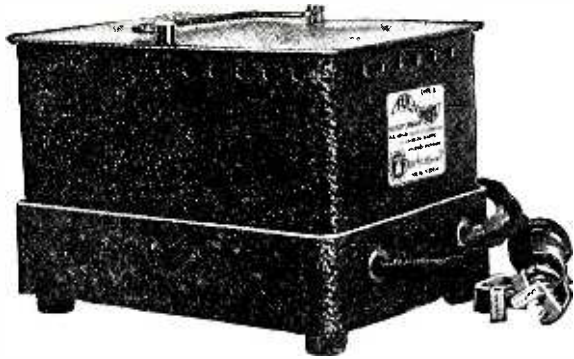

Charge Your Battery Overnight with the

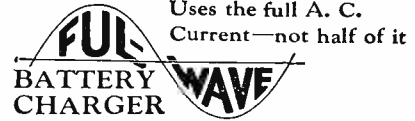

Uses the full A. C. Current—not half of it

Model "A"—for radio "A" and 6 volt automobile batteries. A.C. line, 40 to 60 cycle, 110-120 volts. Battery—6 volts 6-8 amperes. Comes complete with cords, plug and leaded clips. Price **\$18.00** East of the Rockies

Model "A-B"—for charging radio "A" and "B" batteries simultaneously. A.C. line, 40 to 60 cycle, 110-120 volts. Battery—"A," 6 volts 3-4 amperes; "B," 48 to 96 volts in series, 1/10 ampere, up. Price **\$22.00** East of the Rockies

Pays its cost in a short time by what it saves you

Ask your dealer to show it to you—or write for booklet.

Charges in almost half the time because it uses the full electric wave. Costs less to operate. Uses no acids, cannot spill or boil over, needs no expensive bulbs, operates quietly, needs no adjustment.

SIMPLE—STURDY—EFFICIENT.

Sealed at the factory and a guarantee is packed with each charger sold.

LIBERTY ELECTRIC CORP. of NEW YORK- 342 Madison Ave. New York

Be A RADIO EXPERT

STUDY at HOME

Radio, the wonder of all ages, has grown with gigantic strides. Radio experts are needed to keep pace with the growth. Thousands of good-paying positions are open to trained men. Be a radio expert—earn big money—travel—get into the limelight. There's romance, power and fortune ahead for men with vision now just as there was when Henry Ford got started on his auto. The ground-floor opportunity is here.

YOU EARN WHILE YOU LEARN

No matter what your present occupation is, I can qualify you in a few weeks time to write your own income ticket in the fascinating, fast-growing, big-money long-profit field of Radio! And not only am I able to give you a better, more complete knowledge of Radio itself, but I will show you how to apply your knowledge to turn it into big money quickly.

\$2,000 to \$10,000 a Year!

Millions of dollars a year are now being divided among radio men and so well trained as I propose to train you. You will command \$2,000 to \$10,000 a year salary or you can take it as profits from a real business all your own. I will show you.

Fascinating New Profession

I am not going to make you a mere radio mechanic. I will train you to handle the big problems of Radio as well, because that's where the big money lies. You will be qualified in every branch of radio.

Learn Quickly—At Home

Under my personal direction you will learn quickly at home—in spare time. Don't wait to think this over. Mail in the coupon at once—and when you have all the facts before you, then give serious thought to my offer and your future.

The Wonderful SUPERDON

A high powered advanced design broadcast receiver. Gets all stations within 3000 mile circle. Mail the coupon Now for full details of this wonderful instrument and how to get it FREE. Mail the coupon Now! Today!

IRWIN J. MENDELS Director, AMERICAN Radio Engineers Dept. 12, Hearst Square, Chicago

MAIL THIS COUPON

IRWIN J. MENDELS, AMERICAN Radio Engineers Dept. 12, Hearst Square, Chicago, U. S. A.

Send me your big catalog and full particulars of your complete course of training. Also tell me more about the A.R.E. Twin Superdon Long Distance Receiver and how I can get it FREE.

Name.....
Address.....
City..... State.....

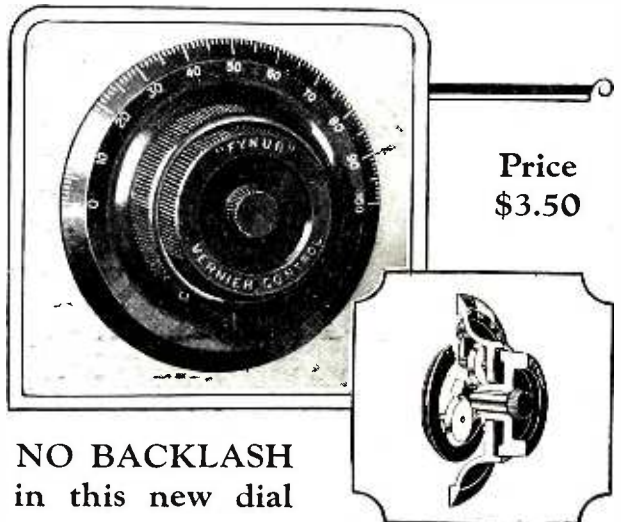

NO BACKLASH in this new dial

No backlash is possible in the new Fynur Vernier Control. There are no gears to mesh, so there can be no lost motion, and the movement is always smooth and free.

If you want the utmost accuracy in reception, and unless you have it you cannot expect the best results from your set, use Fynur dials.

If your dealer cannot supply you, write to us.

AUGUST GOERTZ & CO., INC. Newark, N. J. 270-286 Morris Ave.

FYNUR VERNIER CONTROL

All apparatus advertised in this magazine has been tested and approved by POPULAR RADIO LABORATORY



Radio evenings are complete If you have a Valleytone

Appearance

The Valleytone is mounted in a solid walnut cabinet, finished in two tones with inlaid gold stripes. It may also be procured in beautiful console models. Special Valley tables with built-in loud speaker may be obtained for the cabinet model.

Valleytone Console Model

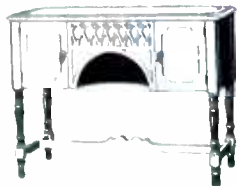

Valley table with built-in loud speaker

You can always count on a full evening's entertainment if you have a Valleytone Radio Receiving Set. . . . Music with your dinner . . . bedtime stories for the children . . . a play, an opera, or a concert . . . jazz, mammy songs, spirituals . . . the whole range of radio broadcasting can be yours.

With the Valleytone, you can choose your programs by the clock and hear them all the evening through. . . . For the Valleytone is selective. It will separate and bring in stations only four or five meters apart and will easily separate local and distant stations.

Valleytone selectivity gives a new meaning and puts a new pleasure in radio.

And with the balanced tone of the Valleytone when you hear a station you marvel that any reproducing mechanism can really achieve such faithfulness and such natural results. The superiority of the Valleytone can be demonstrated. The Valleytone thrives on comparison. Wherever it is judged by results and performance, it wins a new owner.

Any authorized dealer will be glad to demonstrate the Valleytone for you.

VALLEY ELECTRIC COMPANY, Radio Division, ST. LOUIS, U.S.A.

Branches in Principal Cities

Valleytone Receiving Sets

Valley Battery Chargers

Valley B-Eliminators

Valley Electric

All apparatus advertised in this magazine has been tested and approved by POPULAR RADIO LABORATORY



"I wish we had more men like him"

"I've given him two promotions in the last year and he's made good each time.

"I always feel safe in moving him up because I know that he's preparing himself to handle bigger work.

"The International Correspondence Schools keep me advised of the progress he is making and I've encouraged him to keep on. His spare-time studying certainly has made him a valuable man to this firm."

Why don't you study and get ready for promotion too? We'll be glad to help you if you will only make the start. And the way to do that is easy.

Choose the work you like best in the coupon below; then mark and mail it to the International Correspondence Schools today. This doesn't obligate you in the least, but it will bring you information that will help to start you on a successful career. This is your opportunity. Don't let it slip by.

Mail the Coupon for Free Booklet

INTERNATIONAL CORRESPONDENCE SCHOOLS Box 8253-F, Scranton, Penna.

Without cost or obligation, please tell me how I can qualify for the position or in the subject before which I have marked an X:

BUSINESS TRAINING COURSES

- | | |
|--|---|
| <input type="checkbox"/> Business Management | <input type="checkbox"/> Salesmanship |
| <input type="checkbox"/> Industrial Management | <input type="checkbox"/> Advertising |
| <input type="checkbox"/> Personnel Organization | <input type="checkbox"/> Better Letters |
| <input type="checkbox"/> Traffic Management | <input type="checkbox"/> Show Card Lettering |
| <input type="checkbox"/> Business Law | <input type="checkbox"/> Stenography and Typing |
| <input type="checkbox"/> Banking and Banking Law | <input type="checkbox"/> Business English |
| <input type="checkbox"/> Accountancy (Including C.P.A.) | <input type="checkbox"/> Civil Service |
| <input type="checkbox"/> Nicholson Cost Accounting | <input type="checkbox"/> Railway Mail Clerk |
| <input type="checkbox"/> Bookkeeping | <input type="checkbox"/> Common School Subjects |
| <input type="checkbox"/> Private Secretary | <input type="checkbox"/> High School Subjects |
| <input type="checkbox"/> Spanish <input type="checkbox"/> French | <input type="checkbox"/> Illustrating <input type="checkbox"/> Cartooning |

TECHNICAL AND INDUSTRIAL COURSES

- | | |
|---|--|
| <input type="checkbox"/> Electrical Engineering | <input type="checkbox"/> Architect |
| <input type="checkbox"/> Electric Lighting | <input type="checkbox"/> Architects' Blue Prints |
| <input type="checkbox"/> Mechanical Engineer | <input type="checkbox"/> Contractor and Builder |
| <input type="checkbox"/> Mechanical Draftsman | <input type="checkbox"/> Architectural Draftsman |
| <input type="checkbox"/> Machine Shop Practice | <input type="checkbox"/> Concrete Builder |
| <input type="checkbox"/> Railroad Positions | <input type="checkbox"/> Structural Engineer |
| <input type="checkbox"/> Gas Engine Operating | <input type="checkbox"/> Chemistry <input type="checkbox"/> Pharmacy |
| <input type="checkbox"/> Civil Engineer | <input type="checkbox"/> Automobile Work |
| <input type="checkbox"/> Surveying and Mapping | <input type="checkbox"/> Airplane Engines |
| <input type="checkbox"/> Metallurgy | <input type="checkbox"/> Navigation |
| <input type="checkbox"/> Steam Engineering | <input type="checkbox"/> Agriculture and Poultry |
| <input type="checkbox"/> Radio | <input type="checkbox"/> Mathematics |

Name.....
 Street.....
 Address..... 3-6-24
 City..... State.....
 Occupation.....

Persons residing in Canada should send this coupon to the International Correspondence Schools Canadian, Limited, Montreal, Canada.

Good Company

MAKE YOUR TUBES KEEP GOOD COMPANY

Bad tubes in your set spoil the good ones

REFORM your backsliding tubes with the

\$7.50 BURTON & ROGERS TUBE FLASHER BRINGS BACK BAD TUBES

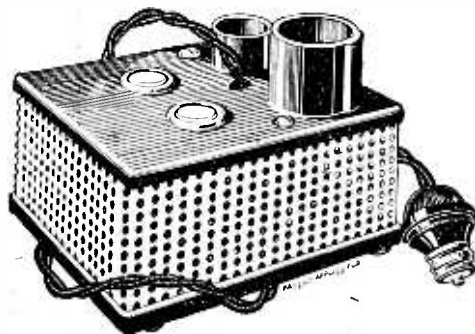

One model for D.C. or A.C., all cycles. Utmost simplicity of operation. For tubes with thoriated filaments. Results will exceed your expectations.

Send for our booklet "Save a Life"

BURTON & ROGERS MFG. CO.

755 Boylston Street, Boston, Mass.

You Save 50%

Approved!

Listed as Standard by Leading Authorities including Radio News Laboratories, Popular Science Institute of Standards, Popular Radio Laboratories, Radio Broadcast Laboratories, Radio in the Home and Le-fax, Inc.

World Radio "A" and Auto Batteries are famous for their guaranteed quality and service.

Backed by years of successful manufacture and thousands of satisfied users. Equipped with Solid Rubber Case an insurance against acid and leakage. You save 50 per cent.



Radio Station W S B C

Set your Radio Dials at 210 meters for the new 1000 watt World Storage Battery Sta. W S B C, Chicago, Ill. Watch for announcements.

2-Year Guarantee Bond in Writing

WORLD Battery owners tell their friends. That's our best proof of performance. Send your order in today

- | | |
|--|---------|
| Solid Rubber Case Radio Batteries | |
| 6-volt, 100 Amperes | \$11.25 |
| 6-volt, 120 Amperes | 13.25 |
| 6-volt, 140 Amperes | 14.00 |
| Solid Rubber Case Auto Batteries | |
| 6-volt, 11-plate | \$11.25 |
| 6-volt, 13-plate | 13.25 |
| 12-volt, 7-plate | 16.00 |

SEND NO MONEY

Just state battery wanted and we will ship day order is received, by Express, C. O. D., subject to your examination on arrival. Extra Offer: 5 per cent discount for cash in full with order. Buy now and get a guaranteed battery at 50 per cent saving to you.

WORLD BATTERY COMPANY
Dept. 3 1219 So. Wabash Ave., Chicago, Ill.

Build this phenomenal new radio in 45 minutes

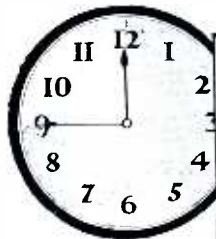

The revolutionary Erla Circloid-Five Factory-Bilt Kit—as you receive it.

Price \$49.50

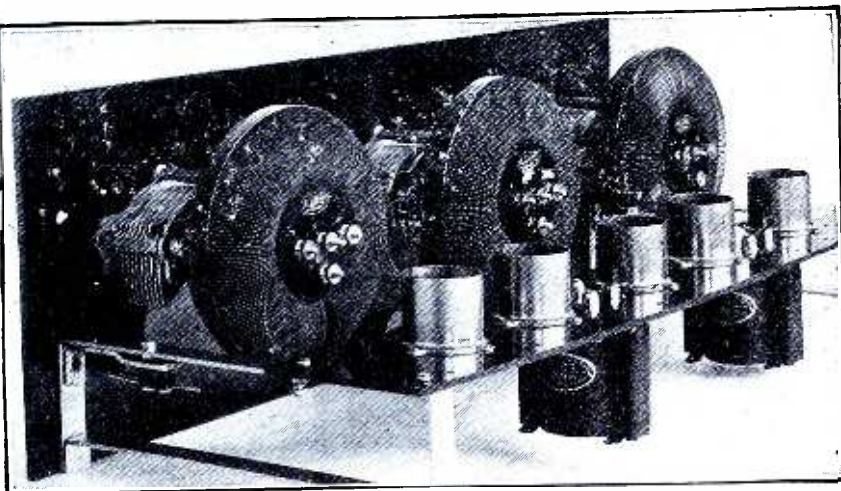

This new type kit is factory assembled. Ready cut, flexible, solderless leads make it ridiculously easy to wire. Amazing new inductance principle brings results hardly thought possible. Send for book, *Better Radio Reception*.

NOW anyone can build the finest of receivers in only a few minutes. No more wire bending or soldering. Merely attach a few ready cut, flexible eyeletted leads and the job is done. We guarantee that the finished set is unsurpassed even by the costliest factory-built receiver.

But most amazing is the new inductance principle incorporated in this last word in kits—called the Erla Circloid principle of amplification.

Four vital improvements result from this great discovery, which are not found in ordinary sets.

1. Greater Distance: Erla * Balloon *Circloids have no external field, consequently do not affect adjacent coils or wiring circuits. This enables concentration of proportionately higher amplification in each stage, with materially increased sensitivity and range.

2. More Volume: Increased radio frequency amplification made possible by Erla Balloon Circloids gives concert volume to distant signals inaudible with receivers of conventional type.

3. Increased Selectivity: Erla Balloon Circloids have no pick-up quality of their own. Hence only signals flowing in the antenna circuit are amplified. Static is greatly reduced for this reason.

4. Improved Tone Quality: The self-enclosed field of Erla Balloon Circloids eliminates stray feed-backs between coils and consequently does away with mashing of signals and distortion. Tone is crystal clear and perfectly lifelike.

Write for free information on kit—also book

See how 45 minutes of fun will give you the newest and most nearly perfected set known to radio science. Easy as A-B-C to finish. Examine it at any Erla dealer's, or send the coupon for full information, illustrations and diagrams *free*. Also ask for remarkable new book, "Better Radio Reception," describing the sensational new Circloid principle. Enclose 10c for mailing and postage on book.

ELECTRICAL RESEARCH LABORATORIES
2533 Cottage Grove Ave., Chicago

*Trade Mark Registered.

ELECTRICAL RESEARCH LABORATORIES,
2533 Cottage Grove Avenue,
Chicago, U. S. A., 11 B



Send me free information on kit. Enclose 11c. for postage for book "Better Radio Reception."

This sign identifies authorized Erla distributors. All are equipped to give complete radio service.

Name.....

Address.....

City..... State.....

Dealers *Exclusive franchises are available to high class dealers in localities still open. Write or wire immediately.*

All apparatus advertised in this magazine has been tested and approved by POPULAR RADIO LABORATORY

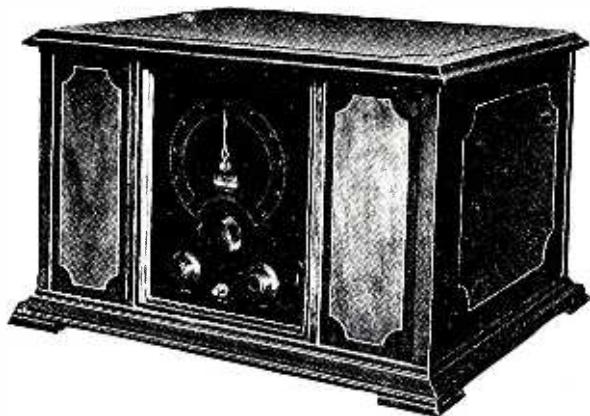

The LE MOR UNI-CONTROL Receiver With "Pretuned Radio Frequency"

List Price, \$145.00

over the broadcast range. **PRETUNING** thus assures perfect peak value operation of all stages with but a single dial. There are no vernier or subsequent adjustments. Besides this innovation the **UNI-CONTROL** has the advantages of equal frequency spacing, velvet slow-motion accuracy, and minimum current consumption. The five tubes are cushion mounted; the panel is antique bronze framed in an attractive walnut cabinet with ample battery space.

Built and Guaranteed by
LE MOR RADIO, Inc.
ASBURY PARK, N. J.

Write for Distributors Franchise



"—results are truly amazing."

THAT WONDERFUL BROWNING-DRAKE "FIVE"

Never has a radio set been received with such general approval as the Browning-Drake which "took New England by storm."

Embodying radio frequency, super-regeneration and resistance coupled amplification this set is nightly sweeping the country from coast-to-coast. Its fidelity of tone is truly remarkable. The Browning-Drake won its popularity on sheer merit.

YOU CAN NOW GET THIS SET FOR THE PRICE OF THE PARTS

THE SET, utilizing such parts as NATIONAL regenerative kit, BENJAMIN sockets, FEDERAL Jacks, AEOLUS rheostats, tested and certified grid leak and condensers, completely mounted and assembled on panel and baseboard (not wired). **\$57.50**

The set of no regrets

Picture wiring diagram, which makes wiring very simple, included. A few hours' work and the set is yours merely for the price of the parts.

Write for Free Circular

MAIL ORDER RADIO CO.

Box 123

Cambridge-A-Mass.

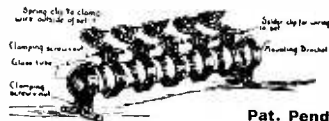

Something New

Hornig Glass Insulated Terminal Strips

Samples sent postpaid on receipt of following prices:

2 connections	\$.50	Each includes a glass tube, two mounting brackets and all necessary machine screws and nuts
3 connections	.65	
4 connections	.80	
5 connections	.95	
6 connections	1.10	
7 connections	1.25	
8 connections	1.40	

Write for Dealer and Jobber Discounts

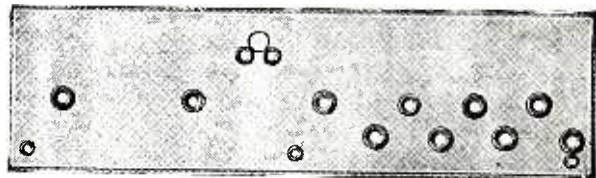

Hornig Glass Panels and Cabinets
(equipped with Safety Bushings Pat. App.)

Ask for our Bulletins

A. W. HORNIG

3921 Dickens Avenue, Chicago, Ill.
Tel. Spaulding 3156

Absolute Accuracy!

For the man who demands absolute accuracy in Radio apparatus, there is no substitute for "General Instrument".

Their products have become recognized by the competent radio technician as a nucleus around which can be built a radio receiver that will perform unflinchingly. Radio engineers use them as standards for comparison.

If you are a seasoned amateur, you know the meaning of "General Instrument". If you are a beginner just learning the mysteries of Radio and have the ability to become an expert, you will soon discover the open door to Radio Perfection is "General Instrument".

The inimitable Rheostat



TYPE 40

Without the organization of General Instrument back of it this rheostat could not be built. Therefore it cannot be imitated. Once you get it you have the real thing—but you must say "General Instrument".



STATOR

Concentric Straight Line Frequency Condenser

(Pyrex Insulated)

Not a tradename but an accurate description of General Instrument Type 80.



Patented

OBTAINABLE AT BETTER CLASS RADIO DEPARTMENTS

General Instrument Corporation
Manufacturers of Laboratory Equipment

423 Broome Street New York City

All apparatus advertised in this magazine has been tested and approved by POPULAR RADIO LABORATORY

Stations Don't "Bunch" On the Dials

ULTRA-LOWLOSS CONDENSERS

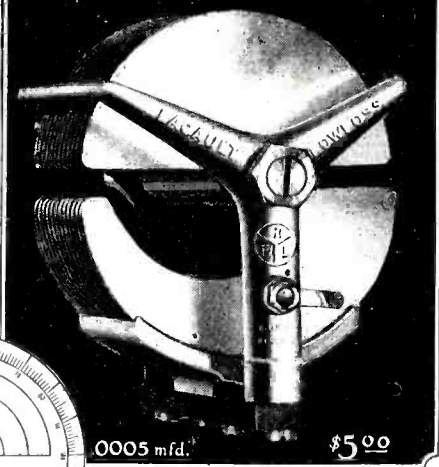

0005 mfd.

\$5.00

Patent Pending

Showing stations "bunched," using any ordinary condenser.

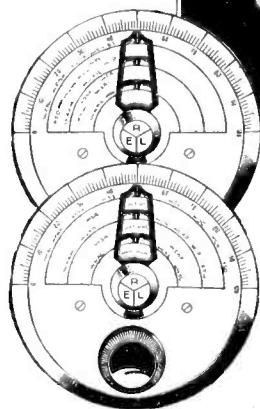

Tuning Simplified Now!

Same stations using Ultra-Low-loss Condensers "spread," simplifying tuning.

The day of tedious fumbling about for your stations is past—science has been brought into play. Now, with the Ultra-Lowloss Condenser you can instantly tune in on any station as easy as turning the hands of a clock to the hour.

With one station of known wavelength located on the dial, all others can be found instantly. Each degree on a 100 degree dial represents approximately $3\frac{1}{2}$ meters difference in wavelength.

This simplification of tuning is made possible by the new Cutless Stator Plates to be found only in the Ultra-Lowloss Condenser. This condenser was developed with one predominating purpose—to overcome losses common in other condensers. Designed by R. E. Lacault, originator of the famous Ultradyne Receivers and Ultra-Vernier Tuning Controls.



This seal on a radio product is your assurance of satisfaction and a guarantee of Lacault design.

ULTRA-LOWLOSS CONDENSER

PHENIX RADIO CORPORATION
116 East 25th St. New York



\$3.25
COD

RADIO Storage "B" Battery

12 Cells 24 Volts Lasts Indefinitely—Pays for Itself

Economy and performance unheard of before. Recharged at a negligible cost. Approved and listed as Standard by leading Radio Authorities, including Pop. Radio Laboratories, Pop. Sci. Inst. Standards, Radio News Lab., Letex, Inc., and other important institutions. Equipped with Solid Rubber Case, an insurance against acid and leakage. Extra heavy glass jars. Heavy, rugged plates. Order yours today!

SEND NO MONEY Just state number of batteries wanted and we will ship day order is received. Extra Offer: 4 batteries in series (96 volts), \$12.75. Pay expressman after examining batteries. 5 per cent discount for cash with order. Mail your order now!

WORLD BATTERY COMPANY
1219 So. Wabash Ave., Dept. 77 Chicago, Ill.
Makers of the famous World Radio "A" Storage Battery
Prices: 6-volt, 100 Amp. \$11.25; 120 Amp. \$15.25; 140 Amp. \$14.00
All equipped with Solid Rubber Case.

World STORAGE BATTERIES

Set your Radio Dials at 210 meters for the new 1000 watt World Storage Battery Station, WSHC, Chicago. Watch for announcements.

KDKA WFAF WGN WJS KHJ KGO KFAF WJY KOP

EVERYTHING IN RADIO AT BARGAIN PRICES

Barawik Saves You 10% + 50%

America's Greatest Radio Institution offers you the most remarkable bargains in the history of Radio. A complete selection of standard, high-grade, guaranteed radio sets, parts and kits at rock bottom prices. No matter what you want we have it at a big saving. Over 100,000 radio buyers have saved thousands of dollars buying from Barawik. This season our thrifty values will amaze you.

Get the Barawik Radio Guide Before You Spend Another Cent

Our free radio guide illustrates and describes these bargains—everything to make radio a greater pleasure and convenience. Be sure to get our catalog before you buy a single radio part. Also illustrates the latest hook-ups and gives valuable information that every radio fan or beginner will find helpful. Send for it now—by letter or postal

LATEST HOOK-UPS FREE

Here Are a Few Samples of Real Savings: Order Direct from This Ad

- McLaughlin One Control, 8-tube Super, as described in POPULAR RADIO, with Loop... \$126.45
- Cockaday 8-tube Superhetrodyne... 77.50
- Cockaday 5-tube 4 Circuit... 65.79
- 4-Tube Browning Drake... 44.95
- Remler Best Superhetrodyne parts... 48.45
- Model L2 Ultradyne Kit with all parts... 59.50
- 5-Tube Bremer Tully Nameless All Genuine Low-loss parts... 41.95

Parts all exactly as specified and of same brands or equal quality brands as in original specifications

THE BARAWIK COMPANY

102-104 S. Canal St., Chicago, Ill.

All apparatus advertised in this magazine has been tested and approved by POPULAR RADIO LABORATORY

Quality Sells Them - Not Price!

BRIGHTSON TRUE BLUE RADIO TUBES

WORD-OF-MOUTH endorsements have played an enormous part in making radio sales. The numerous technical radio terms combined with the plentiful claims for "marvelous, outstanding, wonderful achievements in radio" have left the radio purchaser in a daze amid a heap of radio literature. So he's gone to his neighbors and his friends and purchased radio equipment on their advice *because he knew the value of their word.*

When True Blue Tubes were first advertised as "The Finest Radio Tube in the World" no one could prove such a claim. It was necessary to have faith in the product.

Today an ever increasing army of True Blue users will testify to the truth in True Blue advertising. Ask your neighbor True Blue user — *he knows the value of our word.*

BRIGHTSON LABORATORIES, INC.
WALDORF-ASTORIA HOTEL
16 WEST 34TH ST., NEW YORK



The finest radio tube in the world



All apparatus advertised in this magazine has been tested and approved by POPULAR RADIO LABORATORY

Werrenrath
Seidel
Homer
Garrison
Case
Hempel
Austral
Ballester
Althouse
Middleton
Salmond
Powell
and others

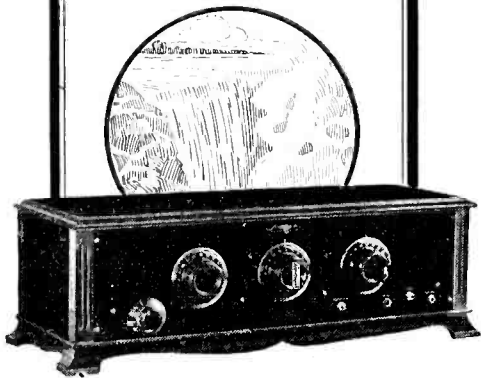

"Quality Commensurate with the Concert!"

THESE great artists will be heard by the radio audience of America on Sunday evenings during the coming season.

The concerts of these Masters deserve the best possible reception in your home. This may be obtained with exceptional clarity and tonal quality by using the

ARAGAIN CONCERT GRAND Radio Receiver

AUTOMETAL CORPORATION
311 Falls St., Niagara Falls, N. Y.

Price \$180 f. o. b. Niagara Falls

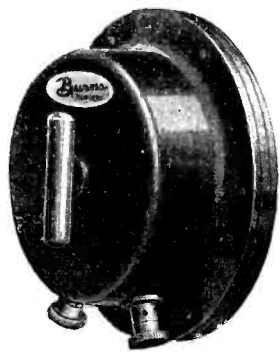

Burns SPEAKER WITH CONCERT UNIT

The Heart of the Speaker

Large size and scientific construction of the Concert Unit gives the remarkable tone values which, combined with the special amplifying properties of the BURNS horn, produce wonderful results.

BURNS horn is of distinctive design with pyralin flare in several handsome finishes.

Prices — \$22.50 — \$25.00 — \$30.00

Manufacturers

American Electric Company

State and 64th Streets
CHICAGO, U. S. A.



YAXLEY



The New YAXLEY Panel Light 50¢

At your dealer's. If he cannot supply you send his name with your order to

YAXLEY MFG. CO. Bulb Extra
Dept. P, 217 No. Desplaines St., Chicago

All apparatus advertised in this magazine has been tested and approved by POPULAR RADIO LABORATORY



**Give Your Tuner a
Man
Sized
Voice**



Now—you can enjoy loud speaker reproduction with your favorite tuner. Using the "Electrad" Resistance Coupled Amplifying Kit it's easy and economical to build an amplifier unit. And you will get a clarity and fidelity of tone unequalled by any other amplifying method.

"ELECTRAD" 3-STEP RESISTANCE COUPLED AMPLIFIER KIT No. 1-C—A Big \$6.75 value. Contains the necessary Resistor Couplers, Certified Mica Condensers, Condenser mounting, Certified Grid Leaks, and Resistors. Nothing else needed except sockets, rheostat and busbar.

"ELECTRAD" LAMP SOCKET ANTENNA
Price 75c

Plugs in on any light socket. Reduces interference. Passed by Underwriters. No outdoor aerial needed.

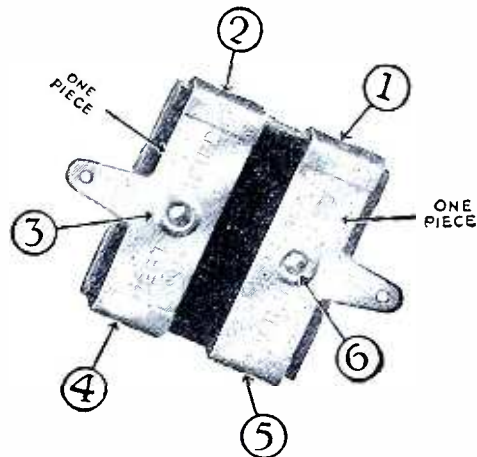

**The Six Point
Pressure Condenser**

THE "Electrad" Certified Fixed Mica Condenser is a revelation in accuracy and design. Ingenious, rigid binding and firm riveting fastens parts securely at Six different points insuring positive electrical contact. Impervious to temperature and climatic variations. Exerts even pressure upon the largest possible surface—can't work loose. Binding strap and soldering lug in one piece. Accuracy and quietness assured always. Value guaranteed to remain within 10% of calibration. Standard capacities, 3 types. Licensed under Pat. No. 1,181,623, May 2, 1916 and applications pending. Price 30c to 75c in sealed dust and moisture proof packages.

Always insist upon getting "Electrad" Radio Products—Audiohms, Lead-Ins, Lightning Arresters, Certified Grid Leaks and many others. At all good dealers.

ELECTRAD INC.

428 Broadway, New York City

There's economy and satisfaction in these Valley Radio units

You will find both economy and satisfaction in the use of the Valley B-Eliminator and the Valley Battery Charger.

Economy in the B-Eliminator because it stops forever the expense of buying new B batteries. . .

Economy in the charger because it recharges your own storage battery at home overnight at one-tenth the cost of service station charging. . .

And satisfaction in both because, by using them, you need never miss a program on account of low or worn-out batteries.



THE VALLEY B-ELIMINATOR operates from any ordinary light socket and provides a steady, noiseless flow of B current at a constant voltage all the time. For receiving sets of from one to eight tubes. Costs less at the start than wet B batteries. Costs less in the long run than dry cells. Much more satisfactory than both.

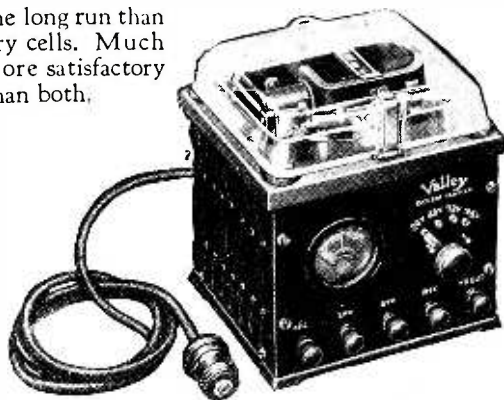

THE VALLEY BATTERY CHARGER is the only charger needed for all radio storage batteries. Its correct 6-ampere charging rate makes overnight charging a possibility.

Most radio dealers handle the Valley B-Eliminator and Valley Charger. Any of them will be glad to show you these units and explain their advantages.

Radio Division

VALLEY ELECTRIC CO. St. LOUIS, U. S. A.
Branches in Principal Cities

Valley Electric

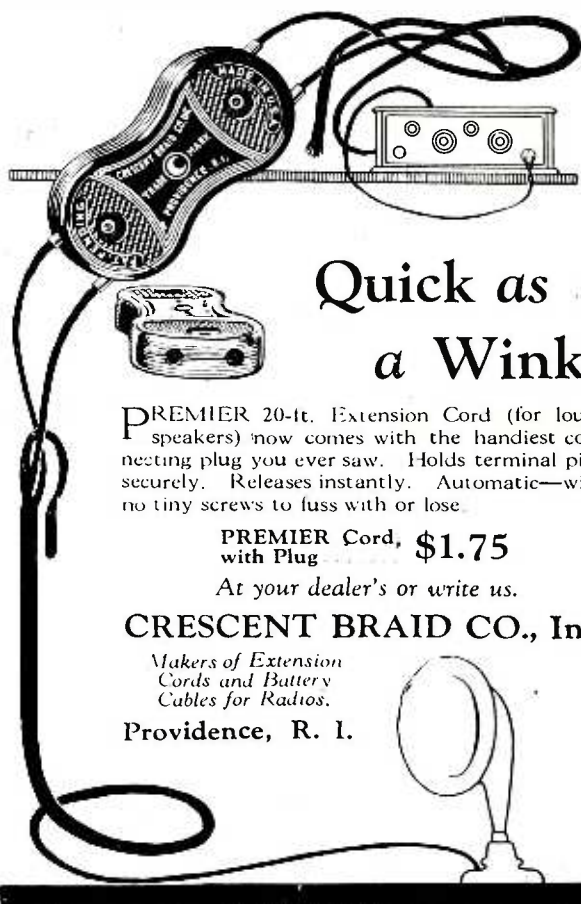

Quick as a Wink!

PREMIER 20-ft. Extension Cord (for loudspeakers) now comes with the handiest connecting plug you ever saw. Holds terminal pins securely. Releases instantly. Automatic—with no tiny screws to fuss with or lose.

PREMIER Cord, with Plug, \$1.75

At your dealer's or write us.

CRESCENT BRAID CO., Inc.

Makers of Extension Cords and Battery Cables for Radios.

Providence, R. I.



Where you see these signs
⊥ in circuits — use ⊥

Potter BY-PASS Condensers

- They prevent "B" voltage fluctuation
- Allow undistorted amplification
- Make possible full bass tones at all frequencies
- Improve reception with "B" Supply Units
- Essential for building the new Autoformer Amplifier

As easily attached as the "B" battery
Made in 1/10, 1/4, 1/2, 1, 2, 3 and 4 Microfarad sizes

At your Dealer's

POTTER MANUFACTURING COMPANY
North Chicago, Illinois



Vigilance

Constant vigilance is the price of uniformity and constant vigilance is maintained over Magnatrons. That is why Magnatrons are uniform, and uniformly good.

The Magnatron DC-201A, DC-199, and DC-199 (large base) now list for only \$2.50 each.

Connewey Electric Laboratories
Magnatron Bldg. Hoboken, N. J.

MAGNATRON REX
the new tube for B' battery eliminators



MAGNATRONS

All apparatus advertised in this magazine has been tested and approved by POPULAR RADIO LABORATORY

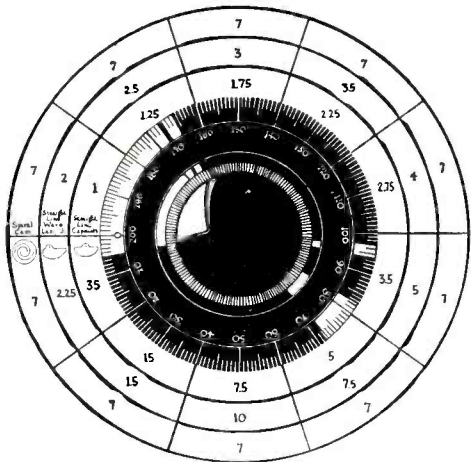

This Chart Tells the Success Story of the "Signal" Spiral Cam Condenser

The Signal Spiral Cam Condenser is the only condenser on the market equipped with this unique and highly efficient control. The distinct advantage of its construction is best illustrated by the chart reproduced above. Note the even distribution of stations over the complete 360° of the dial as compared to typical condensers of other types. It's all in the cam!

Other Important Features

The Signal Spiral Cam Condenser operates with velvety smoothness and with a complete elimination of back lash, permitting easy and accurate tuning. It is compact being no larger than the old semi-circular type. It is die cast throughout insuring absolute uniformity. It is designed for either single or three-hole mounting. Built in three sizes with unusually low minimum capacities in all sizes giving a high tuning ratio. One price for any capacity—.00035, .00025, .0005—\$4.00. See the Signal Spiral Cam Condenser at your dealers.

Signal Bracket Type Loop Aerial—attaches right onto your radio cabinet and solves the problem of using a loop for close quarters. Equipped with third tap. Send for detailed literature. See this loop at your dealers.

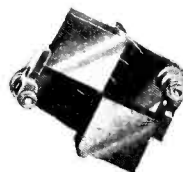

SIGNAL ELECTRIC MFG. CO.

Dept. 10-K Menominee, Mich.

Branches In All Principal Cities

TREGO The World's Lowest Priced 5-Tube Tuned Radio Frequency Set



Coast to Coast Range

HERE'S the set that sells and satisfies!

It's the TREGO 5-Tube Tuned Radio Frequency Set—highest quality at a price within the reach of all.

Retails at only \$45.00. Gives you Big Profits. Sells 10 to 1 over higher priced sets. Millions want it! Storage or dry-cell operation. Backed by our Iron-Clad Guarantee. Sold only through dealers.

Send for **Monthly Catalog** and exclusive dealer plan. This TREGO TRF5 is only one of the hundreds of profitable quick-selling items listed—just off the press. Get your copy now—cash in on the fall and winter radio demand.

TREGO RADIO MFG. COMPANY

Manufacturers and Wholesale Distributors

1431 Chestnut St., Kansas City, Mo.

List Price
\$45.00

BIG MONEY!

\$3,000 to \$10,000 a year

Want to make big, easy money? Learn how to install, operate, repair, construct and sell Radios. Write now for facts about the amazing opportunities for Radio experts, and our special offer of a FREE 1000-mile receiving set, and how you can quickly train at home by mail.

Be a Radio Expert

No previous experience necessary. Anyone with ordinary education can now learn Radio quickly under our simplified home-study plan. We need men right now to represent our Association. Be the Radio expert in your neighborhood. Get your share of the big profits. Hundreds about you want Radios and advice how to operate. You can earn enough money right from the start to pay for course. Nothing difficult about it. Low cost and easy terms.

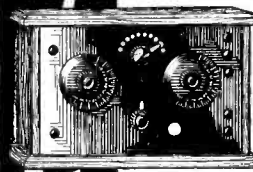

FREE
1,000-MILE
Receiving Set

Don't miss this big special offer to supply FREE all parts necessary to construct a high-grade 1000-mile receiving set. You can sell this set alone for practically the entire cost of the course. Send for the facts now. Find out all about this big-pay field. Address

Radio Association of America
4513 Ravenswood Ave., Dept. (511) Chicago, Ill.

Equip your set with Balkite Radio Power Units

They provide unfailing, uniform current for both circuits



U. S. Patent May 27, 1924

Balkite

Battery Charger

This popular battery charger is entirely noiseless and can be used while the radio set is in operation. Charging rate 2.5 amperes. Operates from 110-120 AC 60 cycle current. Special model for 50 cycles. Also for 25-40 cycles with 1.5 ampere charging rate.

Price \$19.50

West of Rockies, \$20
In Canada, \$27.50



U. S. Patent May 27, 1924

Balkite

Trickle Charger

Charges both 4 and 6 volt radio "A" batteries. Will furnish more current than is used for 6 dry cell or 2 storage battery tubes, if used only while the set is in operation. If allowed to "trickle" charge continuously will also furnish enough current for as many as 8 dry cell or storage battery tubes. Size 5 1/2 in. long, 2 3/4 in. wide, 5 in. high. Operates from 110-120 AC 60 cycle current. Special model for 50 cycles. Price \$10

West of Rockies, \$10.50
In Canada, \$15

Equip your set with Balkite Radio Power Units. They improve and simplify radio reception. With their use your current supply is unfailing and always exactly what is required for each circuit.

The Balkite Battery Charger is entirely noiseless and can be used while the set is in operation. The Balkite Trickle Charger is especially adapted to sets of small "A" current requirements. It enables owners of sets now using dry cells to make a most economical installation. Balkite "B" II eliminates "B" batteries and supplies plate current from the light socket. It fits any set. The new Balkite "B" at \$35 is especially designed to serve sets of 6 tubes and less.

Noiseless—No bulbs—Permanent

All Balkite Radio Power Units are entirely noiseless in operation. They have no moving parts, no bulbs, and nothing to adjust, break or get out of order. Each is a permanent piece of equipment with nothing to wear out or replace. They require no other attention than the infrequent addition of water. They require no changes or additions to your set.

Manufactured by

FANSTEEL PRODUCTS COMPANY, Inc.
North Chicago, Illinois

FANSTEEL Balkite Radio Power Units



U. S. Patent May 27, 1924

Balkite "B"

Eliminates "B" batteries. Supplies plate current from the light socket. Operates with either storage battery or dry cell tubes. Keeps "B" circuit always operating at maximum efficiency. Requires no attention other than adding water twice a year.

Will serve any set requiring not more than 20 milliamperes at 90 volts — practically all sets of 5 tubes or less, and most 6 tube sets. Occupies about same space as 45 volt dry "B" battery. Operates from 110-120 AC 60 cycle current. Special model for 50 cycles.

Price \$35

In Canada, \$49.50



U. S. Patent May 27, 1924

Balkite "B" II

Same as the new Balkite "B" but will fit any set including those of 8 tubes or more. Operates from 110-120 AC 60 cycle current. Special model for 50 cycles.

Price \$55

In Canada, \$75

The Gould Unipower is equipped with a special Balkite Radio Power Unit

BALKITE BATTERY CHARGER · BALKITE TRICKLE CHARGER · BALKITE "B" · BALKITE "B" II



All apparatus advertised in this magazine has been tested and approved by POPULAR RADIO LABORATORY



QUIET
FAST
SAFE

\$22.00
Complete with
2 bulbs, \$14.00
without bulbs
east of Rockies.

The New TWIN BULB HANDY CHARGER

WHEN YOUR "A" or "B" battery gets low it's a simple matter to recharge it with the new Twin Bulb HANDY CHARGER. Just hook it up at night, and in the morning you have a strong, fully recharged battery. The new Twin Bulb HANDY CHARGER cannot overcharge or discharge your battery. It is perfectly safe. The special ammeter shows the rate of charge. Yet it is fast and economical, too, because it uses *both* halves of the AC wave.

Take the uncertainty, disappointments and trouble out of your battery charging by getting the new Twin Bulb HANDY CHARGER. It is absolutely quiet and is the last word in battery chargers. Ask your dealer or write us for additional information.

INTERSTATE ELECTRIC Co.
4337 DUNCAN AVE.
ST. LOUIS ' ' U. S. A.

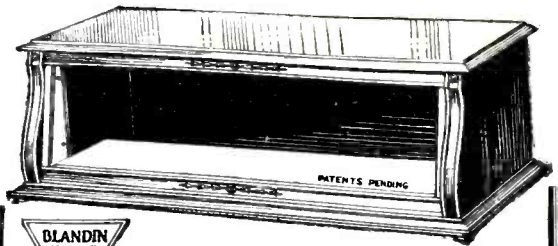

You'll Like This Duplex

One cabinet—

Any panel size, 7x26, 7x24, 7x21 or 7x18".
Depth 10". Room for all dry batteries.

Either straight or sloping panel—grooves,
no screws.

Solid mahogany. Latest lacquer hand-
rubbed finish. Entire lid raises. Full
length piano hinge. Folding lid supports.
Felt covered feet. Extra 1/2" mounting
board.

Write for Duplex and Console illustrated
price lists. Dealers, write your jobber.

The new Blandin Console is ready for
you.

Blandin
Radio Cabinets

Built by
BLANDIN
1500-16th St.
Racine, Wis.



The Red Stripe A Radio Guide Line

For your protection, throughout the center
of every Dilecto radio panel is a Red Stripe.
You can see it along the edge of every
panel.

If you buy or build a set Look for the Red
Stripe—and you'll be sure of the finest,
strongest radio panel that can be made.
Dilecto is a Phenolic condensation material.

THE CONTINENTAL FIBRE COMPANY
Factory: Newark, Delaware

Service on Dilecto, Conite, Contex and
Vulcanized Fibre from:

New York, 250 Park Ave. Chicago, Wrigley Bldg.
San Francisco, 75 Fremont St. Los Angeles, 307 S. Hill St.
Seattle, 1041 Sixth Ave., South
Pittsburgh, Farmers Bank Bldg.

Dilecto

Mohawk

Manufactured by Mohawk Corporation of Illinois
Independently Organized in 1924

Radios Kits Parts

You can now buy, in knock-down form, the famous one-dial Mohawk Radio, "five tubes, just one dial to tune." Or, if you prefer, you can obtain, separately, the splendid Mohawk parts used in this remarkable set.

If you buy a new radio, do not fail to hear the one-dial Mohawk with its super-selective three-in-line, *balanced* condenser. To test the Mohawk is to want one.

If you intend to *build* a set, by all means get a Mohawk kit. Or if you rebuild your present radio, *modernize* it—convert it into a one-dial set with the patented Mohawk condenser and other Mohawk parts.

For quality in all radio parts insist on Mohawk. Sold by leading dealers.

Manufacturers
MOHAWK CORPORATION OF ILLINOIS
Independently Organized in 1924
Chicago, Ill.

Sales Department
THE ZINKE COMPANY
1323 S. Michigan Ave.
Chicago, Ill.



Mohawk No. 143 Kit. Includes Mohawk Three-in-line *balanced* condenser; Mohawk Selectune Dial; three standard Mohawk radio-frequency transformers. With this kit you can convert any three-dial, five-tube tuned radio-frequency radio into a one-dial set. \$23.50.

Mohawk No. KU51 Kit, including all parts, with cabinet, ready for quick assembly. Price, \$75.

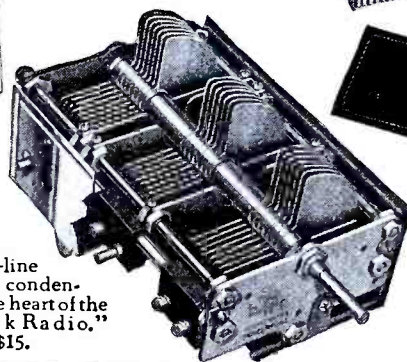
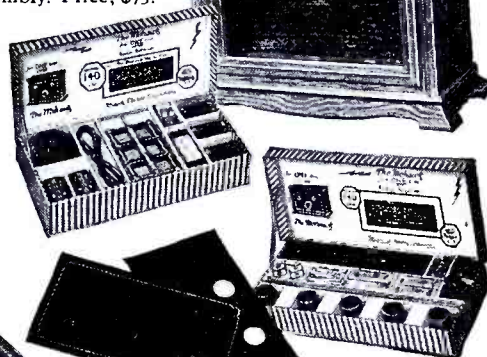
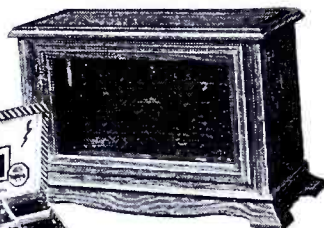

Mohawk Three-in-line *balanced* condenser—"the heart of the Mohawk Radio." \$15.



Mohawk Radio, "5 tubes, just one-dial to tune." [Accessories extra]. \$100.

All apparatus advertised in this magazine has been tested and approved by POPULAR RADIO LABORATORY

LOMBARDI

Straight-Line-Frequency Condenser

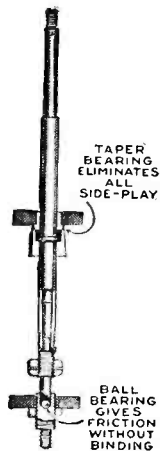

SHAFT CONSTRUCTION
Patented
May 13, 1924

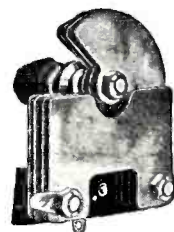
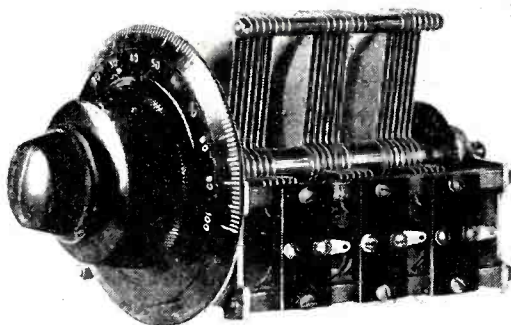

LOMBARDI JUNIOR

Midget Condenser for Balancing Stages of Multiple Controlled Radio Frequency, for Capacity Antenna Coupling and Tuned Tickler Regeneration

Lombardi Straight-Line-Frequency Condensers give sharp tuning and separation of low wave stations not possible with any other type. Made with highest mechanical and electrical precision. Absolute minimum of loss and variation from rated capacity. Patented adjustable ball and taper shaft bearings eliminate all play in rotor. Watch-spring pigtail makes positive contact. Made in single or multiple units. Multiple Condensers licensed under Hogan patents.

Recommended in August "Popular Radio" for use in Craig Tuned Radio Frequency Set

LOMBARDI RADIO MANUFACTURING COMPANY

67 MINERVA STREET, DERBY, CONN.

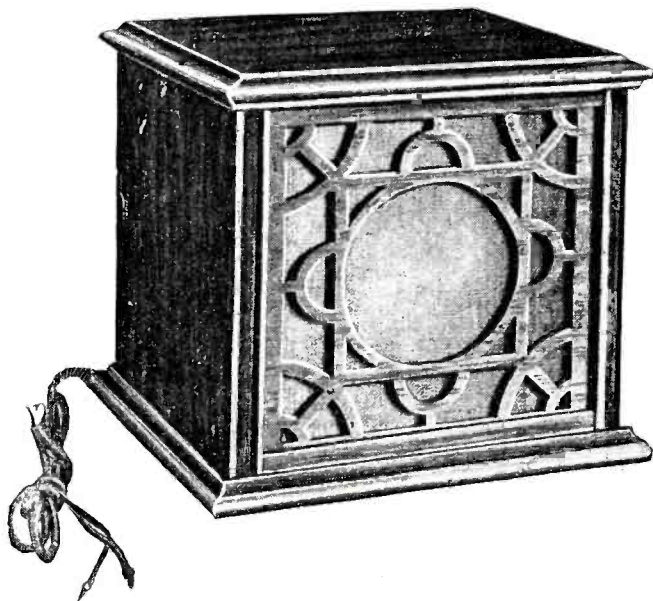

YOU HAVE BEEN WAITING for a really efficient medium sized Cabinet Loud Speaker at a reasonable price. But you want first an up-to-date reproducer of speech and music, and then a piece of nice furniture that will harmonize with the finish of your set.

THE IVEY LOUD SPEAKER IS ALL OF THAT.

SPECIFICATIONS

A powerful **high-pitched** telephone Unit that has just been perfected in the laboratory. A Horn developed by experts. A highly finished Cabinet of pleasing design, size 8 x 9½ x 8¼. Your choice of rich mahogany finish or solid walnut. Price \$15.00 F. O. B. Hickory. Cash with order. Shipped in a strong WOODEN BOX, with 5-foot cord all ready to use.
Dept. P, THE SOUTHERN TOY CO., Inc., Hickory, N. C.

WE SOLD 4000 SETS
Had 4000 Favorable Reports
Before We Felt Justified to Say



Quality Radio Apparatus

Now we invite you to go to your Apex Dealer who will be glad to make a personal demonstration for you in your home or in his store. A demonstration will prove to you that Apex Radio Receivers will give you everything you can possibly wish for in a radio receiver from the standpoint of selectivity, clarity, volume, distance, and attractiveness of design.

- The APEX Super Five, without accessories \$95
- The APEX De Luxe, without accessories \$135
- The APEX Baby Grand Console, without accessories \$225
- The APEX Utility Radio Table..... \$75
- The APEX Entertainer (Loud Speaker) \$22.50
- The APEX Console Entertainer..... \$27.50

Upon request we will gladly mail you descriptive Folder.

APEX ELECTRIC MFG. COMPANY
1410 West 59th St. Dept. 1102 CHICAGO

Prices West of Rockies slightly higher. Canadian Prices Approximately 40% Higher.

All apparatus advertised in this magazine has been tested and approved by POPULAR RADIO LABORATORY

“As efficient as Radion Panels”

The best recommendation for these Radion low-loss parts



THE very latest developments in radio are embodied in the complete line of Radion low-loss parts—*moulded of Radion, the insulation made to order for radio purposes exclusively.*

Leading set manufacturers and thousands of amateurs know by experience that Radion Panels are most effective in reducing surface leakage and leakage noises. This means lowest losses and greater efficiency, especially noticeable in super-sensitive circuits. All the Radion low-loss parts have the same high-resistant characteristics of Radion Panels.

You can now get Radion Sockets, Dials, the new Radion Loud Speaker Horn, Tubing, Binding Post Strips, Insulators, etc. Radion Panels in black and Mahoganite come cut in standard sizes for whatever set you wish to build.

Send for booklet, “Building Your Own Set”. Gives wiring diagrams, front and rear views, shows new set with slanting panel, lists of parts and directions for building popular circuits. Mailed for 10 cents.

AMERICAN HARD RUBBER COMPANY
Dept. B11, 11 Mercer St., New York City

NEW!

Practical types of low-loss Radion sockets for the new tubes and a collar adapter, if you like, for the old style bayonet type tube.



No. 2 Socket for new UX tubes with collar adapter for old type tubes. No. 3 same as No. 2 without binding posts.



No. 4 Socket for new UX tubes. No. 5 same as No. 4 without binding posts.

RADION

The Supreme Insulation

Made to order for radio purposes exclusively

AMERICAN HARD RUBBER COMPANY
Dept. B11, 11 Mercer St., New York City

Please send me your booklet, “Building Your Own Set,” for which I enclose 10 cents, in stamps.

Name

Address

All apparatus advertised in this magazine has been tested and approved by POPULAR RADIO LABORATORY

**HEADQUARTERS FOR
Specified Parts
McLAUGHLIN**

Single Dial Control
SUPERHETERODYNE

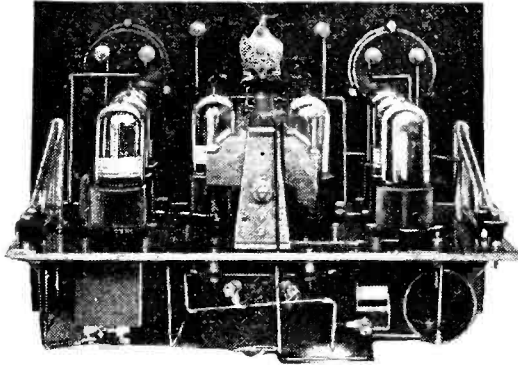

8 Tubes designed to fit your phonograph or an individual cabinet

We sell every standard part down to the last screw as specified by Mr. James L. McLaughlin in October Popular Radio.

BLUE PRINTS FURNISHED

Parts Specified
by Mr. McLAUGHLIN

	List Price	Total
2 Precise No. 750 syncrodensers, .0005 mfd.	\$4.50	\$9.00
1 Precise No. 744 coupler	.60	.60
2 Precise aluminum brackets (per pair)	2.00	2.00
1 Precise No. 1000 filtransformer	4.50	4.50
1 Precise No. 1700 super-multiformer	20.00	20.00
1 Precise audio-frequency transformer, No. 480—5 to 1	7.50	7.50
1 Precise audio-frequency transformer, No. 480—2 1/2 to 1	7.50	7.50
1 Marco 1-inch vernier dial, clockwise	2.50	2.50
1 Hammarlund, Jr. midget condenser	1.80	1.80
2 Carter imp. jacks (with plugs for loop wires)	.50	1.00
1 Carter double-circuit "holdtite" jack	1.00	1.00
1 Carter single-circuit "holdtite" jack	.70	.70
1 Benjamin No. 9050 8-gang socket-shelf	11.00	11.00
1 Benjamin battery switch	.35	.35
1 New York Coil mica fixed condenser, .006 mfd.	.75	.75
1 New York Coil mica fixed condenser, .00025 mfd.	.35	.35
2 Dubilier 1 mfd. by-pass condensers	1.25	2.50
1 Dubilier No. 640 mica fixed condenser, .00025 mfd. with grid-leak clips	.45	.45
1 Daven grid-leak, 2 megohms	.50	.50
1 Precision Inducto-coupler, No. 260	1.85	1.85
1 General Radio rheostat, type 214A, 2-ohm, 2 1/2 amp.	2.25	2.25
1 General Radio potentiometer, type 214A, 400-ohm	3.00	3.00
18" stranded wire for oscillator circuit	.10	.10
1 Bakelite panel, 10 inches by 14 1/2 inches by 3/16	4.35	4.35
Total Cost of Parts	\$85.45	
Ready to wire kit price		99.60

OPTIONAL

1 Weston No. 301 Voltmeter 0 to 7 volts	\$8.00
1 Weston No. 301 Milliammeter 0 to 25 milliamperes	8.00

Expressage Prepaid—1/3 Cash with C. O. D. Orders

FREE

New 1926 reference book (over 100 pages) containing illustrations and description of every standard well known part, sent free on request.

HEINS & BOLET

44 PARK PLACE, NEW YORK

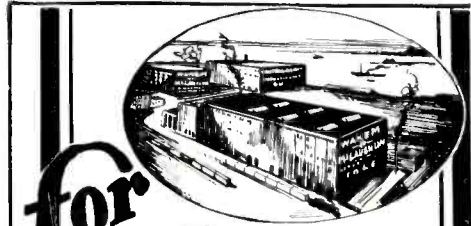

for radio dealers

—our big new catalog; fully illustrates the best in radio. Write on letterhead for copy — ask for B1005.

We Ship Fast

Wakem & McLaughlin, Inc.

225 E. ILLINOIS STREET CHICAGO, ILL.

If you want the best!

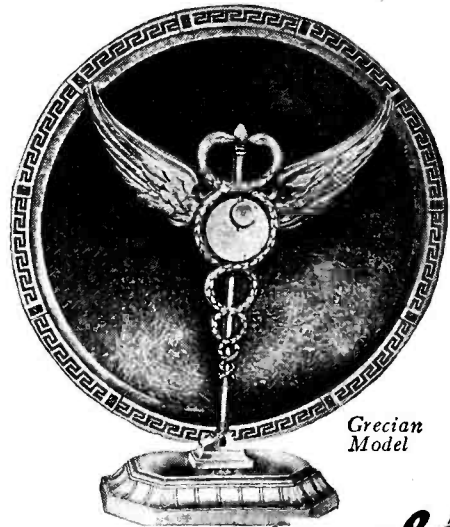

Grecian Model

Pathe Sets Operate From House Current

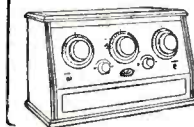

Pathé

CONE LOUD SPEAKER

Exquisite in tone
Exquisite in design
Exquisite in workmanship

Some territory for both jobbers and dealers still open. Write

PATHÉ PHONOGRAPH AND RADIO CORPORATION
Dept. 48 20 Grand Avenue, Brooklyn, N. Y.

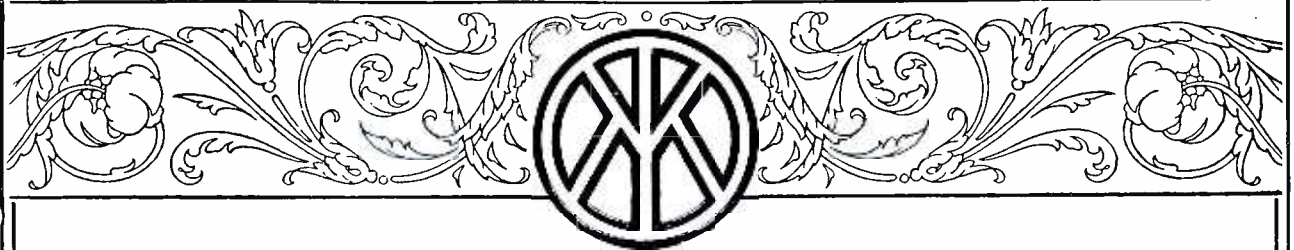

KURZ-KASCH

Aristocrat

Line

"Aligns rite—Holds tite"

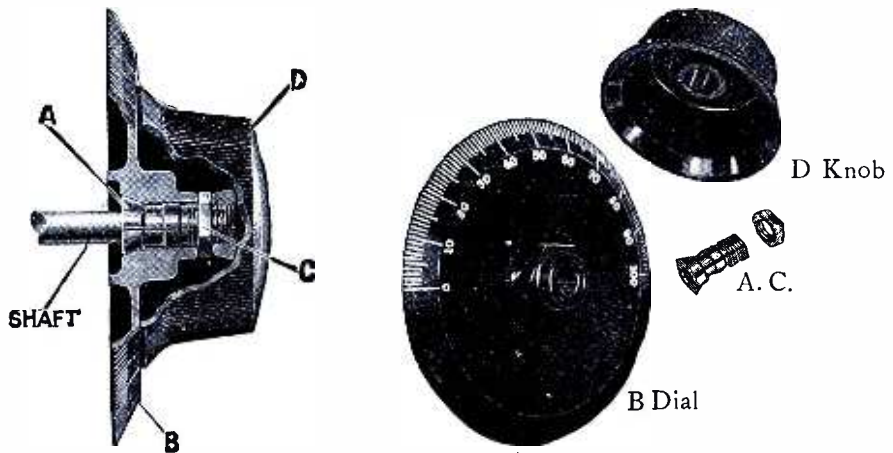

A—Split Bushing
C—Fastening nut for tightening bushing on shaft.

The Kurz-Kasch patent split bushing method of mounting at once became popular. Over two hundred Radio manufacturers and thousands of set owners, appreciating these products,

have purchased them in ever increasing quantities. The high quality and workmanship have earned for Kurz-Kasch products the position of leadership. They are the acknowledged best.

*Kurz-Kasch
bear this
Insist on*



*Products
Trade-mark
the genuine*

Write for illustrated literature on complete Kurz-Kasch line, Dials, Knobs, Sockets, Potentiometers, Rheostats, etc.

Manufactured by
THE KURZ-KASCH COMPANY
 Largest Exclusive Moulders of Bakelite
 Factory & Main Office Dayton, Ohio.

All apparatus advertised in this magazine has been tested and approved by POPULAR RADIO LABORATORY

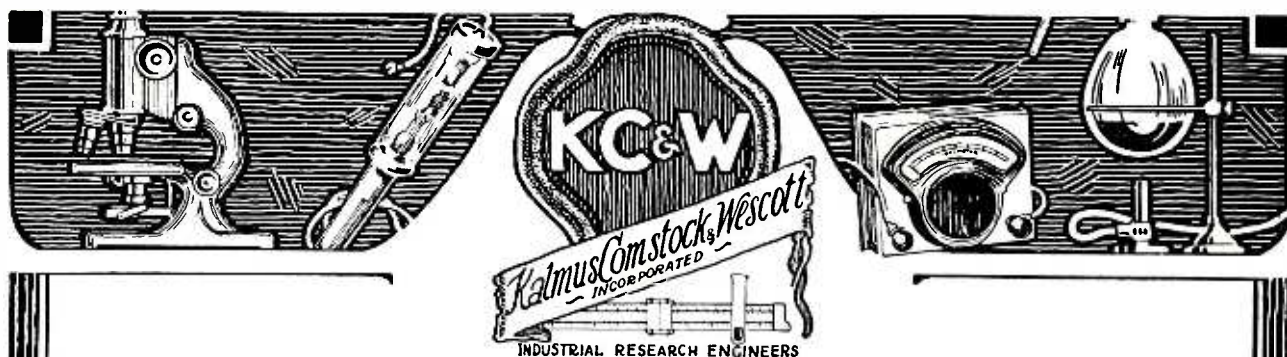

SCIENTIFIC RESEARCH FOR RADIO MANUFACTURERS UNDER THE DIRECTION OF—

Dr. Herbert T. Kalmus,
S. B. Mass. Inst. of Tech., 1904.
Ph. D. Univ. of Zurich, 1906.

Dr. Daniel F. Comstock,
S. B. Mass. Inst. of Tech., 1904.
Ph. D. Univ. of Basle, 1906.

Dr. Ernest W. Wescott,
S. B. Harvard, 1911.
S. M. Mass. Inst. of Tech., 1914.
Ph. D. 1916.

Dr. Emory L. Chaffee,
S. B. Mass. Inst. of Tech., 1907.
A. M. Harvard, 1908—Ph. D. 1911.

Dr. Leonard T. Troland,
S. B. Mass. Inst. of Tech., 1912.
A. M. Harvard, 1914—Ph. D. 1915.

Mr. Eastman A. Weaver,
S. B. Mass. Inst. of Tech., 1915.
S. M. Mass. Inst. of Tech., 1916.

A descriptive booklet of our organization,
facilities and service will be sent upon request.

KALMUS, COMSTOCK & WESCOTT Inc.

110/114 BROOKLINE AVE. Industrial Research Engineers. BOSTON, MASSACHUSETTS

For Quality **CORBETT'S** CABINETS For Quality

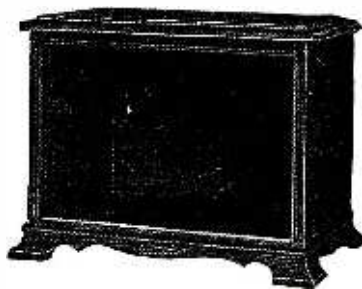

SINGLE CONTROL SUPER-HETERODYNE To Popular Radio specifications

(Above cabinet has grooved front, all others are rabbetted, otherwise the same)

Size	Mahog- any finish	Walnut or Ma- hogany	Size	Mahog- any finish	Walnut or Ma- hogany	Size	Mahog- any finish	Walnut or Ma- hogany
7x18-8	\$4.55	\$9.50	7x24-8	\$11.80	\$14.70	7x21-10	\$10.90	\$13.25
7x21-8	9.30	11.50	7x30-8	12.75	15.65	7x24-10	11.70	14.65
7x24-8	10.10	12.60	8x30-8	13.70	17.10	7x26-10	12.65	15.30
7x26-8	10.70	13.35	7x18-10	10.20	11.55	7x30-10	13.30	15.65
SINGLE CONTROL SUPER-HETERODYNE						9.60 12.00		
COCKADAY FOUR CIRCUIT or REFLEX SUPER-HET.						12.90 16.10		

SPECIAL CABINETS TO ORDER—

SHIPPING CHARGES PREPAID

"CORBETT'S CABINETS" have been preferred for several years by quality set builders, and are unquestionably superior in design and finish. Backed by our guarantee to please. Full length piano hinge and lid stay. Carefully hand rubbed piano finish. Accurately made of best kiln dried lumber and well packed for shipment.

MOUNTING BOARDS with 1" splined ends and varnished—18 to 26", 50c., 28 to 30", 60c. each.

SPECIAL CONSOLE for Single Control Super-Het in stock. Write for illustrated booklet.

LIBERAL DISCOUNTS to dealers.

CORBETT CABINET MFG. COMPANY
St. Marys, Penna.

with the \$100 Guarantee



Absolutely warranted to protect your set from lightning, with a guarantee to pay you \$100 or repair your set, should it be damaged through any fault of the

FIL-KO-ARRESTER.

Listed as standard under the re-examination service of National Board of Fire Underwriters.

If your dealer has none, send his name with remittance to Dept. FK-112L

DX Instrument Co.
Harrisburg, Pa.





Pat.
April
21, 1925

Other
U. S. and
Foreign
Patents
Pending

*Radio programs as clear
as a picture in focus*



DISTORTED reception is comparable to a blurred photograph; each prompts about the same amount of mental distress. Conversely, the absolute clarity of the programs brought to you by a set equipped with Accuratune dials is strongly reminiscent of the perfect photographs produced through the agency of a good lens. The Accuratune focuses beautifully and precisely, with all the high lights and shadings of the various programs preserved with infinite accuracy, and with even those stations now so closely grouped on the lower wave lengths easily and readily segregated.

The Accuratune can be quickly substituted for ordinary dials without alteration of your set.

MYDAR RADIO CO.
5 CAMPBELL STREET, NEWARK, N. J.

The Loud Speaker
Sensation...
\$15.00



Design Patented

The KODEL
MICROPHONE
LOUD SPEAKER

An exact replica of the transmitting microphone used in broadcasting stations.

The efficient KODEL SOUND UNIT, with an ingenious new snail-shell horn, mounted inside the microphone case, produces a remarkably clear, full-toned volume, with every note as rich and true as when it enters the transmitting microphone in the studio. Non-vibrating tone chamber absolutely eliminates distortion.

With Kodol, Jr. unit, \$15; with large Kodol unit, \$20; Radio dealers everywhere have them.

THE KODEL RADIO CORP.
504 E. Pearl St. Cincinnati, O.

Manufacturers of Kodol Radio Receivers and Accessories, and Homcharger Battery Chargers.



AP
COILS & COILS

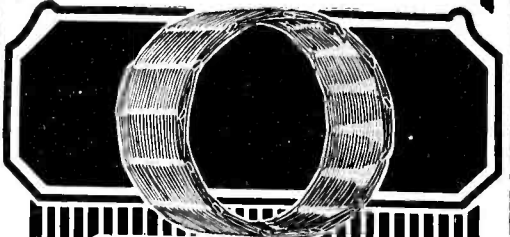

SUPER-SOLENOID.

EFFICIENT RADIO COILS
Require

A Specialized Organization for Economical Production

We make Coils only. Our entire resources are devoted to Radio Coils. For that reason we are able to render Radio Set Manufacturers an unequaled coil service.

Regardless of your own facilities you will undoubtedly find this service profitable to you. Ask us for estimates and samples.

ACME PRODUCTS CO

107 W. Canton St. Boston, Mass.

MUTER

**DEPENDABLE
RADIO PRODUCTS**



Lightning Arresters— approved by Fire Underwriters. Retail . . . **50c**

Complete Aerial Kits— everything for complete installation with instructions. Retail **\$3.50**

Resistance Amplifiers— all assembled and ready for use. Retail . . . **\$8.00**



Audio Frequency Transformers— tests have proven the quality. Retail **\$2.25**

Automatic Shock Proof Phone Plugs— a real value at this price **50c**



Sold by
All Leading Radio Dealers

Adapto

Radio Cabinets by Donehue

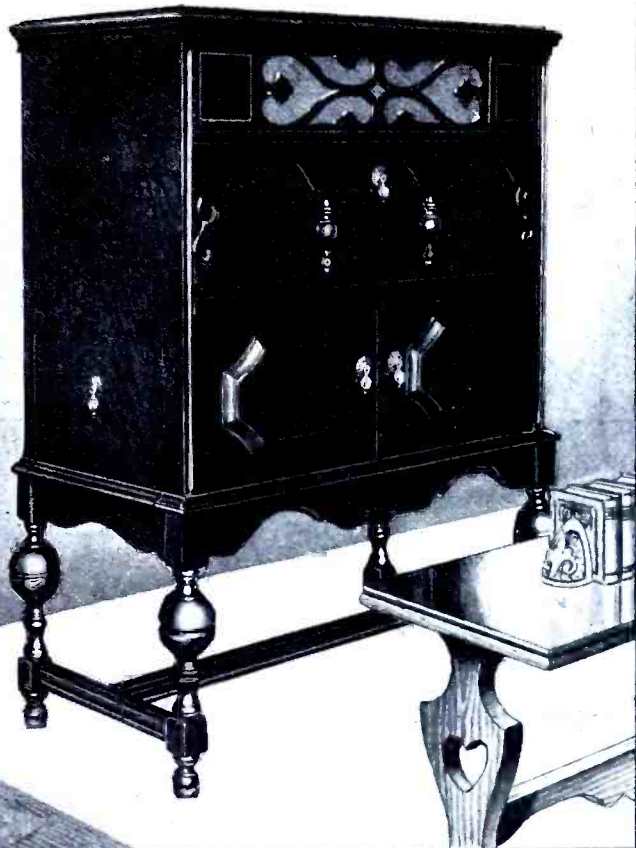

NEW convenience, new beauty for your radio. Transform your present receiver into the latest type art model without changing your panel assembly. Beautiful period consoles in either walnut or mahogany. Wired, ready for installation. Entire panel assembly drops into cabinet; sliding sections accommodate any size panel. Everything concealed. Storage battery, charger, distilled water, and charger switch contained in ventilated compartment sliding from the side; nothing to lift or; no wires disturbed. Built-in loud speaker horn (adaptable to any unit), with special resonance chamber. Handy drawer for tools, accessories and odds and ends.

Write for name of the nearest ADAPTO dealer and illustrated literature

L. R. DONEHUE CORP.

PERTH AMBOY, N. J.

First in the Field
Specializing in
Cockaday Kits

S. HAMMER RADIO CO., 303 Atkins Ave. Brooklyn, New York

Cockaday Sets Now Made Easier to Build by Our New "Ready-to-Wire" Plan
50% of Your Time, Work and Worry SAVED!

All you need do is to connect bus-bar according to diagram, solder and your set is finished.
These Kits are sent to you completely mounted, and assembled on a Veneered Mahogany baseboard and genuine bakelite panel, drilled and engraved; in a solid Mahogany Cabinet. Genuine parts used as listed below; exactly as specified by Mr. L. M. Cockaday. **COMPARE OUR OFFER!**

8 TUBE NEW SINGLE DIAL CONTROL SUPERHETERODYNE

2 Precise No. 750 Syn. condenser 0005 \$9.00	1 N. Y. Coil fixed condenser 0006 \$7.50
1 Precise No. 744 Coupler .60	1 N. Y. Coil fixed condenser 00025 35
2 Precise Aluminum Brackets pr. 2.00	2 Dubilier 1. Mid. By-Pass condensers 2.50
1 Precise No. 1900 Filter former 4.50	1 Dubilier No. 640 fixed con- denser 00025 clips 45
1 Precise No. 1700 Super Multi- former 20.00	1 Daven grid leak 2 meg. 50
2 Precise Audio Transformer No. 480 5 to 1 an 125, 601 15.00	1 Precision Inducto-coupler No. 260 1.85
1 Marco 4 inch Veneer Dia. 2.50	1 Gen. Radio 2 Ohm Rheostat No. 214-A 2.25
1 Hammerlund B. Midset 1.80	1 Gen. Radio 400 Ohm Pot. No. 214-A 3.00
2 Carter Imp. Tubes 1.00	1 Genuine Bakelite Panel Drilled and Engraved 16" x 14 1/2" x 3-16" 4.35
1 Carter Holding Do. Jack 1.00	Wires, screws, etc.
1 Carter Holding Single Jack .70	
1 Benjamin No. 9050 8 gang 55 Let Shell 11.00	
1 Benjamin Battery Switch .35	
1 Weston No. 301 Volt Meter 8.00	
1 Weston No. 301 Milliammeter 8.00	

READY-TO-WIRE KIT PRICE, . \$101.45
UNASSEMBLED KIT PRICE, Write Us
WIRED COMPLETE In Genuine Ma- hogany Cabinet . \$115.00
D. T. W. LOOP IN STOCK

These Complete KITS in STOCK

- Raytheon Plate Supply Unit.
- COCKADAY — 8 Tube Super-Hetero-
dyne Reflex Receiver.**
- COCKADAY — 5 Tube 4 circuit Tuner
with Resistance Coupled Amplifier.**
- COCKADAY — 5 Tube AC Receiver**
- HAMMERLUND ROBERTS RECEIVER.**
- BROWNING DRAKE RECEIVER**
- AND OTHER KITS**

Parts in all our kits exactly as specified.

**COCKADAY'S Authorized ANTENNA COUPLER for
the 8 Tube Super-Het for use with outdoor aerial \$2.00**

WRITE FOR CIRCULAR about these Parts and Kits. Also for Free Radio Catalog

Transportation Prepaid. One-third must accompany all C. O. D. orders. Not insured unless insurance charges included

You Must See Them!

Our New Line

IDEAL RADIO CONSOLES ARE BEAUTIES

and embody novel ideas in construction along with beauty of design, fine cabinet work and finish. Built especially for the set owner or builder who wishes to enclose his radio in a handsome piece of furniture.

Our regular line of Consoles will accommodate any set with panel 7 to 8 inches high and up to 32 inches long. Cabinets and Consoles for odd size sets built to order.

New catalog, ready for distribution soon, contains pictures and descriptions of our complete line. Write for it before buying a Console.

IDEAL RADIO CABINET CO.

(Not Inc.)

281 Vermont St.,

Blue Island, Ill.

"Take No Chances—Use Como" COMO DUPLEX

The World's Standard Push Pull
Transformer



PRICE \$12.50 per pair

For maximum volume without distortion

What Prominent Writers on Radio
Subjects say About Como.

Lewis B. Hagerman, Technical Editor, *Chicago Post*: "Actual Tests show this transformer to be far superior to any others of similar makes."

R. J. Robbins, *New York Sun*: "After consideration of several well-known makes of push pull transformers which are available 'COMO DUPLEX' was selected as most satisfactory."

C. White, *Radio World*: "'COMO DUPLEX' is infinitely superior—most other push pull transformers seem to be ordinary transformers with a center tap brought out as a makeshift."

E. P. Gordon, *Open Road*: "A system of audio-amplification which is becoming increasingly popular. Its use will give surprising results in both quality and volume; and is thoroughly recommended by this department."

NEED WE SAY MORE?

COMO APPARATUS COMPANY

Manchester, New Hampshire

For Sale at Leading Dealers

All apparatus advertised in this magazine has been tested and approved by POPULAR RADIO LABORATORY

Send for this RADIO RADIO BOOK FREE

1926 Catalog of RADIO BARGAINS Save 1/3 to 1/2

AMERICAN RADYNOLA 5 TUBE SET

\$29.50

The World's Largest Exclusive Radio Mail Order House Will Send You This Wonderful Book FREE

64 illustrated pages containing thousands of bargains in radio sets, semi-finished sets and radio kits of all styles, sizes and approved circuits. **5-tube sets as low as \$29.50.** Beautiful models of the very latest designs and types. Elaborate console models with loud speakers built of right in cabinets of genuine mahogany and walnut. **All sets guaranteed.** Coast to coast receiving range. Also contains everything in radio supplies, including batteries, chargers, loud speakers, transformers, condensers, rheostats and any other parts you may want for improving your set or building a new one. Guaranteed saving to you of 1/3 to 1/2.

The Biggest 5-Tube Value on the Market

Positively the world's greatest 5-tube radio bargains. **Regular \$75.00 value.** Our large quantity production enables us to sell this set for **only \$29.50**, fully built and wired in beautiful mahogany cabinet of latest design with sloping Bakelite panel of Satin finish, handsomely etched and engraved as illustrated. Constructed of the finest low-loss condensers, coils and sockets. Bakelite **\$29.50** baseboard panel and dials. **Price for set only.** Transportation charges extra, shipping weight 25 lbs.

This set with all accessories, including the famous American Bell loud speaker with adjustable unit, 2-45 volt "B" batteries, one guaranteed 100 Ampere Hour, storage "A" battery, cable for battery connection, 5-201A tubes, Aerial and ground equipment, and everything complete ready to set up and operate. Nothing else to buy. **Price \$59.75** Transportation charges extra. Shipping weight 100 lbs.



Order Direct from This Page! Save About One-Half!

Order direct from this page. Save 1/3 to 1/2. Our guarantee protects you. Money cheerfully refunded if you are not satisfied. Write your order and prices plainly. Send post office money order or bank draft for full amount to insure safety. Refer to any bank or commercial agency regarding our reliability.

SEMI-FINISHED 5-TUBE RADIO FREQUENCY SET

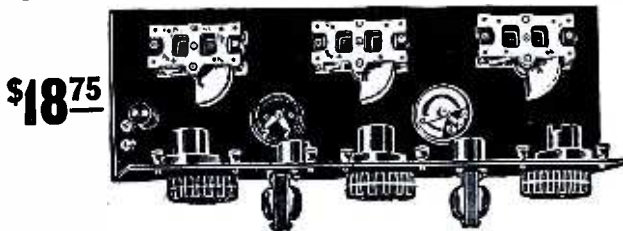

This special offer is astounding the radio world. **Coast to coast reception on loud speaker.** Low loss condensers and sockets. Highest quality transformers. Bakelite rheostats. All wiring concealed under Bakelite baseboard. 7x18 panel—fits into any standard 7x18 cabinet. Complete instructions for operating. **Guaranteed saving to you of \$50.00. Price of set all mounted, \$18.75.** Cabinet of same model as American Radynola pictured above \$5.65 extra.

You must have our catalog no matter what set or kit you want. Our line is complete and includes all popular sets, such as Superheterodyne, Neutrodyne, Ultradyne, Reinartz, Regenerative, Radio Frequency, Browning-Drake, Super-Heterodyne Reflex and all other latest circuits. Kits, sets and parts manufactured by all well known manufacturers such as Frost, Howard, Baldwin, Brandes, Western Electric, Columbia and others.

Our semi-finished sets come with all parts mounted on panel and baseboard ready for wiring. Do not fail to send for our catalog. Remember—we are the largest exclusive radio mail order dealers in the world and carry the best of everything in radio. We save you 1/2 to 1/3 on the following kits. Detailed descriptions appear in our catalog.

SEMI-FINISHED 8-TUBE SUPER-HETERODYNE



World's Famous 8-tube superheterodyne. Fully mounted on panel and baseboard. Comes **completely assembled** ready to wire and operate. We have testimonials from thousands of builders of this set. Some have received foreign stations on loop aerial. Unsurpassed in volume and tone quality. Low-loss straight line frequency condensers, vernier dials, finest quality rheostats. Matched Columbia long waved transformers. Requires only three screws for attaching panel and baseboard and set is ready to operate. 7 x 30 panel. **Price of set only \$43.75.**

Complete Parts for Best 45 Kilocycle Super-Heterodyne Genuine Remler Parts \$49.50

Requires following accessories to complete this set: 7x30 cabinet, 8-201A tubes for storage battery operation or No. 199 tubes for dry cell operation. 100 Ampere hour storage battery, 2-45V "B" batteries, loud speaker, center tapped loop aerial. All these items are listed in our catalog at a tremendous saving.

Catalog includes list of broadcasting stations, general radio information and facts about our free service division. Write for it today.

NEUTRODYNE
Genuine licensed Neutrodyne kit of parts, come fully assembled on the panel and baseboard with complete instructions, **\$29.75** ready to wire. Price.

COCKADAY
3-tube Cockaday kit of parts, fully assembled on panel and baseboard, ready to wire **\$15.85** Price.

FOUR TUBE BROWNING
DRAKE and also PRESSLEY and REMLER SUPER-HETERODYNE **At Bargain Prices.**

Genuine Parts for Cockaday Resistance Coupled and 5-tube set at prices that will astound you. Also complete parts for AC Kit.

RANDOLPH RADIO CORPORATION
159 N. Union Ave. Dept. 95 Chicago, Illinois

All apparatus advertised in this magazine has been tested and approved by POPULAR RADIO LABORATORY

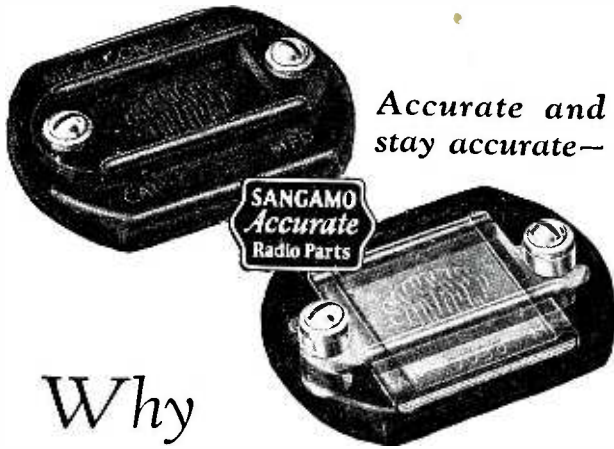

Accurate and stay accurate—

SANGAMO
Accurate
Radio Parts

Why Sangamo Condensers have sealed edges

EVERYBODY who is up to date on radio knows that "Sangamo Mica Condensers are solidly molded in bakelite." Front, back, and sides—all enclosed in one solid jacket of smooth brown bakelite. Why such a radical change from the usual method of manufacturing fixed condensers? Simply this. Exposed edges permit moisture to creep in.

It has been proved in official testing laboratories that a condenser, though accurate when made, may increase its equivalent series resistance twenty times over in a few weeks, because it is injured by moisture, absorbed through the edges, from humidity or salt air. Then it no longer acts as a condenser, but as a resistance unit, causing distortion noises that are often mistaken for static.

The edges of the Sangamo are sealed tight permanently. A doubting Thomas boiled one for 50 hours in water, dried it off and then tested the capacity. There was no change! You do not have to look for water to plunge your condensers into. Moisture is in the air all the time—causing condenser trouble that spoils fine reception.

Now Ready Sangamo By-Pass Condensers

1 Mfd. . . . \$1.25
1/2 Mfd.90

Insist upon Sangamo mica condensers and keep the moisture out! Accuracy guaranteed within 10 per cent of marked capacity. They ARE accurate—and STAY accurate.

Dealers have them or can quickly procure them.

Sangamo Electric Company
Springfield, Illinois

1421-1
RADIO DIVISION, 50 Church Street, New York

SALES OFFICES—PRINCIPAL CITIES

For Canada—Sangamo Electric Co. of Canada, Ltd., Toronto.
For Europe—British Sangamo Co., Ponders End, Middlesex, Eng.
For Far East—Ashida Engineering Co., Osaka, Japan

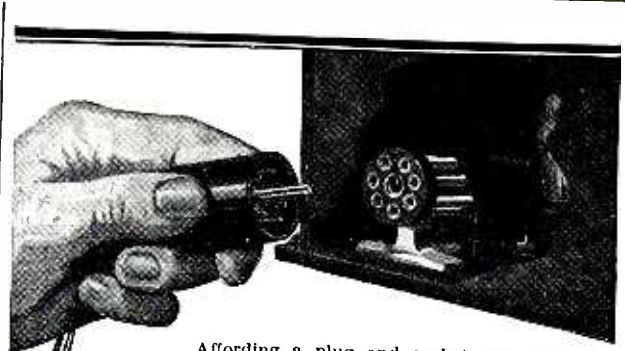

Affording a plug and socket connection between the radio set and all outside connections, Jones Multi-Plug is as essential to the radio as a cord and socket to the electric iron. For safety and convenience leading set manufacturers have adopted this item as standard equipment. You too, need a Multi-Plug for the set you are building or the set you now have. See your dealer or write direct for descriptive folder C.

TYPE BM For set Building \$4.50
TYPE BP Adaptable to any Set \$5.00
HOWARD B. JONES CHICAGO, ILL.
618 S. Canal St.

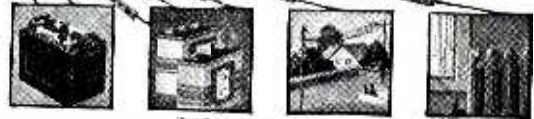

Jones
MULTI-PLUG
THE STANDARD SET CONNECTOR

McLAUGHLIN

ONE CONTROL

Build this marvelous new single control 8-tube radio receiver described in October Popular Radio. Simple in construction. Anyone can build it. Receiving range up to 3,500 miles. Draws only 10 milliamperes plate current insuring longer life for "B" batteries. Ready-built this set would cost over \$200 complete. Send your money-order for parts to-day and build it yourself. Parts complete without cabinet, \$101.35.

U-NI-DIAL RADIO CO.
35 Greenwood Ave.,
East Orange, N. J.

RECEIVER

All apparatus advertised in this magazine has been tested and approved by POPULAR RADIO LABORATORY

Single Dial Tuning

Yet Greater Selectivity



Kellogg
Symphony
Reproducer
\$25.00

*"NOW
I Get What
I Want
When I Want It"*



Standard Model
5-Tube Wave Master
in beautifully finished
cabinet of solid, genuine
Mahogany. Price
\$125.00

KELLOGG Found the Way!

HERE, at last, is a radio set that is REALLY easy to tune. Just one tuning dial—but what a magic dial it is! For it actually has a range of 540 degrees—over three times more station finding range than the ordinary dial. A dial that gives lots of room for a wide separation of stations. Makes it so easy to tune in the one you want and to completely blot out the others.

In fact, this remarkable new Kellogg receiver is exactly the set busy men and women everywhere have been asking for. A set that brings in what you want when you want it—without fussing, without "hushing" the rest of the family, without any need of knowing what is going on inside the handsome cabinet. Simply superb in the musical quality of WAVE MASTER reception.

This masterpiece of receiving sets is the product of a manufacturing company that would naturally be expected to design a great set. For 28 years, the Kellogg Switchboard & Supply Company has been making precision electrical instruments—telephones, switchboards. Ever since the beginning of radio we have been making radio parts of the highest quality. But not until now have we been able to perfect a radio receiver that we felt was worthy to carry the Kellogg name.

The Kellogg WAVE MASTER has little in common with other five-tube sets. It operates on a new, better and more efficient principle. By using a new system of amplification and detection, we have solved the difficult problem of single dial tuning.

We have done it without any sacrifice of selectivity; instead, we have INCREASED selectivity as greatly as we have increased simplicity. Would you know more about the WAVE MASTER? Write for complete technical description. Ask for Folder No. 6-K.

Radio Dealers and Jobbers!

We are now closing sales franchises in open territory, which is fast being taken up. The WAVE MASTER franchise, backed by Kellogg resources and our powerful advertising campaign is most valuable. Wire us if interested—or get into Chicago quickly and see us regarding this money-making proposition.

Kellogg Switchboard & Supply Co., 1066 W. Adams St., Chicago



The Wave Master Console Model

A beautiful genuine mahogany model with inbuilt horn,
\$235.00

Also made in a handsome Console Model. Price
\$275.00

KELLOGG WAVE MASTER

SWITCHBOARD & SUPPLY CO.

All apparatus advertised in this magazine has been tested and approved by POPULAR RADIO LABORATORY

ALL SPECIFIED PARTS FOR McLAUGHLIN ONE CONTROL RECEIVER

<p>2 Precise No. 750 Syncrocondensers. Each \$4.50 \$9.00 1 Precise No. 744 Connector.60 1 Marco 4" Vernier Dial (clockwise). 2.50 1 Hammarlund, Jr. Midget Condenser. 1.80 2 Carter "Imp" Jacks with plugs for loop wires. Each.50 1.00 1 Benjamin No. 9050 8 gang socket shelf. 11.00 1 Drilled Bakelite Panel 10" x 14½" x 3/16". 4.35 1 pair Precise Aluminum Brackets. 2.00 1 Weston No. 301 Voltmeter 0 to 7 volts. 8.00 1 Weston No. 301 Milliammeter 0 to 25 milli- amperes. 8.00 1 Benjamin Battery Switch.35 1 New York Coil mica fixed Condenser .006 mfd.75 2 Dubilier 1 mfd. by-pass Condensers. Each \$1.25 2.50 1 Dubilier No. 640 mica fixed Condenser .00025 mfd. with grid leak clips.45 1 Daven 2 megohm grid leak.50 1 Precision Inducto Coupler No. 260. 1.85 1 Precise No. 1900 Filtoformer. 4.50</p>	<p>1 Precise No. 1700 Super-Multiformer. \$20.00 1 General Radio Rheostat type 214A 2 ohm. 2½ amperes. 2.25 1 General Radio Potentiometer type 214A 400 ohm 3.00 1 Precise Audio Frequency Transformer No. 480 5 to 1 ratio. 7.50 1 Precise Audio Frequency Transformer No. 480 2½ to 1 ratio. 7.50 1 Carter double circuit "Holdtite" Jack. 1.00 1 Carter single circuit "Holdtite" Jack.70 18" stranded wire for oscillator circuit.10 1 N. Y. Coil mica fixed Condenser .00025mfd.35 28' Celatsite Wire. 1.40 Bus bar, screws, lugs.75 1 Mahogany finished cabinet. 9.60</p> <p style="text-align: right;">Total. \$113.30</p> <p>1 D T W Loop. \$25.00 8 True Blue Tubes at \$3.50. 28.00</p>
--	--

Ask for any Parts you can't get

WHOLESALE RETAIL

MORISON

Electrical Supply Co. Inc.

We Carry All Standard Radio Receivers. Also Complete Line of Parts Representing Reputable Manufacturers

Establish connections with Morison NOW. C O D Mail Orders Filled promptly

WRITE TODAY!

15 East 40th Street, New York City

22½ Volt un-acid everlasting rechargeable "B" Storage Battery
\$2.95
 including chemical

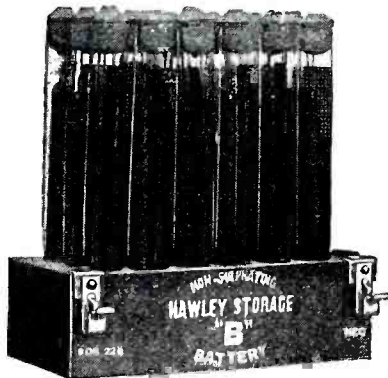

Does not lose charge standing idle. SPECIAL—2 22½ (45 volts) \$5.25; 90 volts \$10.00. Any special detector or amplifying voltage easily had. Very easily charged. Nearly 3 years sold on a non-red tape 30 day trial offer with complete refund if not thoroughly satisfied. Further guaranteed 2 years. Knock-down kits at still greater savings. Complete ready to run "B" battery charger \$2.75. Sample cell 35c. Order direct—send no money—simply pay expressman when delivered, or write for my free literature, testimonials, and guarantee. My large 36-page radio goods catalogue 10c. Same day shipments.

**B. F. SMITH, 31 Washington Ave.,
Danbury, Conn.**

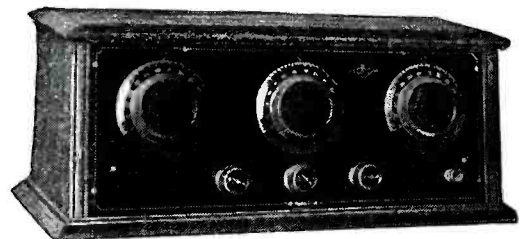

Radio that Entertains!
1926 Simplex SR 8
\$65

No tinkering! No fussing! Nothing but pure enjoyment in this newest refinement of the renowned Simplex five-tube radio frequency circuit. New tone modulator gives you brass band volume or a lullaby murmur at a finger touch. Exceptionally selective. Noted for distance. Easy to tune.

Simplex SR 5 (Five Tubes) \$57

Look for the Simplex nameplate on the receiver you buy. Our name is widely copied. Be sure you get the original Simplex, made in Philadelphia.

See Simplex at your dealer's or write direct

SIMPLEX RADIO COMPANY

Main and Rector Sts.

Phila., Pa.

All apparatus advertised in this magazine has been tested and approved by POPULAR RADIO LABORATORY



Sylvania

*A Tube that promises
much and delivers more*

CONSERVATIVELY there is no better tube made than the Sylvania—that is our promise to you, our guarantee.

Aside from this honest assurance, you have the good opinion of thousands of users who know that Sylvania tubes do deliver more satisfying service: better tone, greater sensitivity, more volume, longer life.

Built into Sylvania tubes is almost an unbelievable degree of accuracy, painstaking skill, sterling quality. Nothing is left undone that will make them the more worthy of your enthusiastic approval. And the fact that they cost no more than many ordinary tubes is a very definite reason why you should insist on getting them.

BEHIND each Sylvania tube stands a thoroughly responsible organization, well known and well respected for many years throughout the electrical world. Its guarantee of complete satisfaction, both to the customer and to the trade, means something and will be upheld under any and all conditions.



To Radio Dealers

The rapidly widening circle of Sylvania enthusiasts is making our dealer franchise more and more valuable. Regardless of your present connections write or wire for full particulars now.

*S 01-A, S 99 Large Base,
S 99 Small Base*

SYLVANIA PRODUCTS CO.

EMPORIUM, PA.

THE TUBE WITH A SENSIBLE GUARANTEE



Made with Precision!

Right from the start at our factory each SUPERTRON is produced with PRECISION as the dominating factor.

The material, each process, the triple test, and the final inspection, are all guided by the most exacting PRECISION. The unit of PRECISION called SUPERTRON is serial numbered and wrapped in a certificate bearing a corresponding number.

Thus giving you a means of identification to assure full satisfaction

Precision Made for Your Satisfaction
Serial Numbered for Your Protection

DISTRIBUTORS

- | | |
|------------------------------|------------------------|
| C. E. Niehoff & Co. | Chicago |
| Fireside Radio Set Co. | Chicago |
| Yahr & Lange | Millwaukee |
| L. W. Cleveland Co. | Portland, Me. |
| The Roycraft Co. | Minneapolis |
| Hippee-States Auto Sup. | Des Moines |
| Sorenson Lamp Co. | Des Moines |
| Orr Bros. | Cedar Rapids |
| Radio Dealers Sup. Co. | San Francisco |
| Western Light & Fix. Co. | Los Angeles |
| Franklin Electric Supply Co. | Philadelphia |
| Keystone Radio Dist. Co. | Philadelphia |
| Allentown Radio Dist. Co. | Allentown |
| Goodlin Auto Sup. Co. | South Bend |
| Swanson Electric Co. | Evansville |
| M. H. Johnson Electric Co. | Utica |
| Hinsdill Electric Co. | Troy |
| American Phonograph Co. | Albany |
| Rosen Talking Machine Co. | Boston |
| Balt. Hub Wheel & Mfg. Co. | Baltimore |
| Cycle Auto Supply Co. | Buffalo |
| H. D. Taylor Co. | Buffalo |
| Iroquois Sales Co. | Buffalo |
| Hamburg Bros. | Pittsburgh |
| Radio Stores Inc. | Denver |
| Reynolds Radio Co. | Denver |
| Burr-Fowler | Syracuse |
| American Radio & Supply Co. | Cincinnati |
| Elgin Radio Corp. | Elgin |
| Alberta Radio Co. | Alberta, Canada |
| Imperial Radio Co. | Sault Ste. Marie, Can. |
| F. X. Gullezzin | Montreal, Can. |

Branch Offices

- | | |
|---------------|----------------------------|
| ATLANTA | Georgia Savings Bank Bldg. |
| DALLAS | 2006 1/2 Commerce St. |
| PHILADELPHIA | 353 No. 4th St. |
| INDIANAPOLIS | 19 Arcade |
| CHICAGO | 21 E. Van Buren St. |
| PITTSBURGH | 1406 Keenan Bldg. |
| DETROIT | 714 Lafayette Bldg. |
| MINNEAPOLIS | 229 So. 4th St. |
| KANSAS CITY | 410 E. 14th St. |
| DENVER | 1641 Stout St. |
| SAN FRANCISCO | Rialto Bldg. |
| BUFFALO | 293 South Elmwood |
| BOSTON | 99 Bedford St. |
| OMAHA, NEB. | 625 Securities Bldg. |
| LOS ANGELES | 3208 Glendale Blvd. |

SUPERTRON MFG. CO., Inc.
HOBOKEN, NEW JERSEY
Export Department 220 Broadway, N. Y. C.

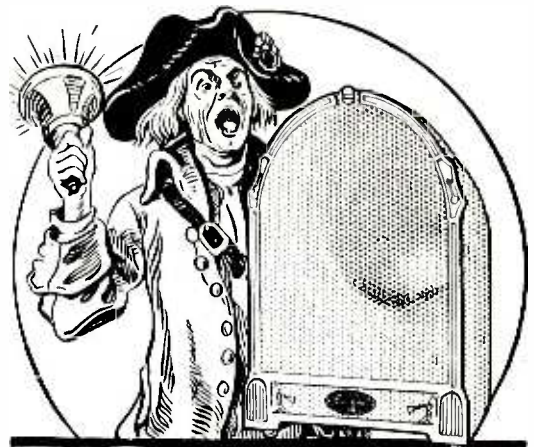

The TOWN CRIER
Radio's Most Beautiful Speaker

You will be delighted with the gorgeous colors . . . the handsome, stippled finish, and the novel design of the Town Crier—the Speaker with the voice that thrills.

Ask your dealer to show you a Town Crier Speaker. Write today for beautifully illustrated circular describing the Golden Polychrome and Green Polychrome models.

List Price \$17.50

West of the Rockies \$18.50

GALE RADIO LABS.

2512 Irving Park Blvd.

CHICAGO



Tone Clarity
Beyond Expectation

Just pull the switch and note the clarity and richness of tone any Amperite-equipped set gives you. Amperite is the automatic rheostat which does away with hand rheostats and filament meters. No guessing. No uncertainty as to correct tube current. Tubes last longer. Makes any novice a master operator. Insist upon Amperite when you buy or build. Price \$1.10.

Write for free hook-ups

RADIALL COMPANY

Dept. P. R.-14, 50 Franklin St., N. Y. City



You, Too, Can Wave the Magic Wand!

Benjamin Super Radio Parts have taken all uncertainty and chance out of radio reception. With seeming magic they bring amazing volume and tonal perfection, without disturbances, distortions or radio losses, with increase in selectivity and ease in tuning.

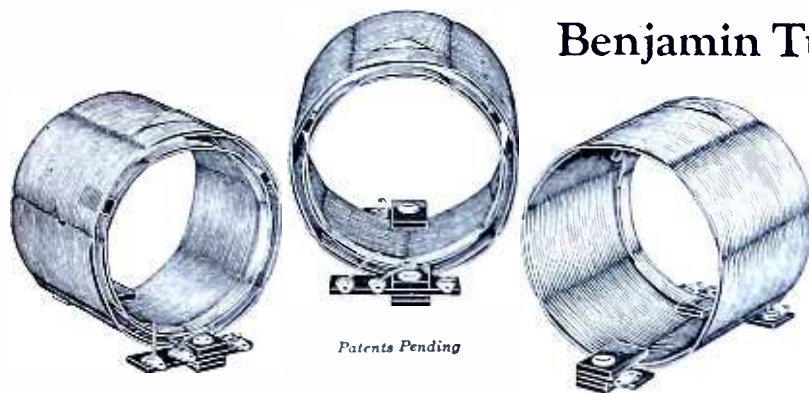

Benjamin Tuned Radio Frequency Transformers

Even in what has been considered an excellent set, it is astonishing what an improvement in tone, quality, volume and selectivity the introduction of these coils produces. Low Resistance. Low Distributed Capacity. Uniform, both in inductance and distributed capacity. Space wound, air core;

double green silk insulation—the nearest approach to an all-air dielectric construction and the highest type of inductance possible. Coils are coupled so as to reduce capacity coupling to a minimum.

Benjamin Cle-Ra-Tone Gang Sockets

A step toward greater simplicity in the construction of Radio Receiving Sets. Spring Suspended, Shock-Absorbing Cle-Ra-Tone Sockets, mounted on a single Bakelite base, with ample room for other equipment. They add greatly to compactness of the set and preserve the advantages found with individual Cle-Ra-Tone Socket. This 8-Tube Gang Socket is particularly adaptable for the McLaughlin circuit described in Popular Radio for October. Easily installed in standard phonograph cabinet. Made in other sizes to fit into any type of circuit.

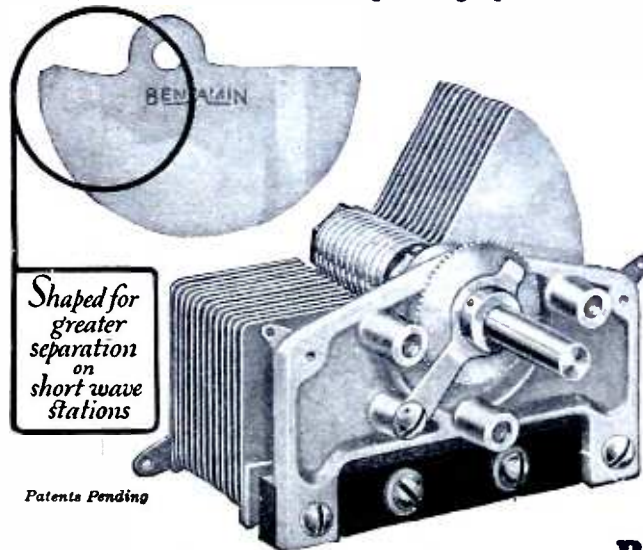

Benjamin Low Loss, Long Range Condensers

First of all a wonderful low loss condenser. The shape of the rotor blades spreads the broadcast range on the lower wave lengths, eliminating bunching of stations on the lower side of the dial and makes tuning very easy. A beautiful instrument, in unpolished silver plate finish. Friction disc on rotor shaft adjusts turning tension without loosening or throwing plates out of alignment. Made in three sizes: 13 plate for .00025 Mfd., 17 plate for .00035 Mfd., and 25 plate for .0005 Mfd. Drilling template furnished with each condenser.

Shaped for greater separation on short wave stations

Patents Pending

Benjamin Electric Mfg. Co.

247 W. 17th St.
New York

120-128 S. Sangamon St.
Chicago

448 Bryant St.
San Francisco

Manufactured in Canada by the Benjamin Electric Mfg. Co. of Canada, Limited, Toronto, Ontario

All apparatus advertised in this magazine has been tested and approved by POPULAR RADIO LABORATORY

THE DOUBLETOROID COIL



Patented March 31, 1925
Price \$2.75

The magnetic path is shorter.
It is the most compact.
Write for booklet in which Professor J. H. Morecroft gives his opinion of these coils.

“Doubletoroids” can be mounted at any angle or spaced at any distance.

“Doubletoroids” make more selective sets possible, since they do not form miniature loop aerials.

“Doubletoroids” hold static and other disturbances to a minimum since no current from an external source can influence them.

Outstanding Features of the “Doubletoroids”

Both primary and secondary are true toroids.

Patented June 16, 1925



It's Variable

The Nonoise Gridleak improves reception because it can be adjusted for every station. Fits standard brackets. Absolutely noiseless. At all dealers and in the better sets.

NONOISE GRIDLEAK

RADIO FOUNDATION, INC.
25 West Broadway
New York

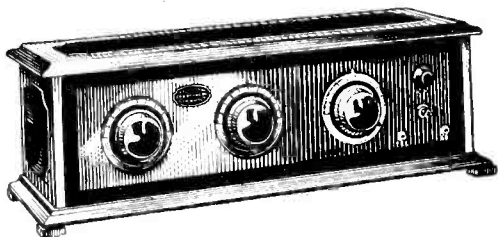

ARBORPHONE

Perfected Reception
in this 1926 Model

You will be proud of your Arborphone for the vast reaches of radio are yours. Whether you are an adventurous rover or just demand a purity of reception from your favorite stations, Arborphone will satisfy you.

Beauty — good taste — Arborphone possesses both virtues. Fashioned in a design of simplicity the cabinet instantly commands admiration for its maker's artistry. A most interesting radio message, in which Arborphone is described will be given you upon request.

DEALERS

In every community will be an Arborphone dealer. Priced at \$55 Arborphone is one of Radio's choice opportunities. Fully guaranteed by a thoroughly reliable organization.

MACHINE SPECIALTY CO.

ANN ARBOR, MICHIGAN
“All You Could Ask of a Radio”

\$55

(Add \$5 West of the Rocky Mountains)

Count the ways
you can use

CHELTEN

The Original

Midget Condenser

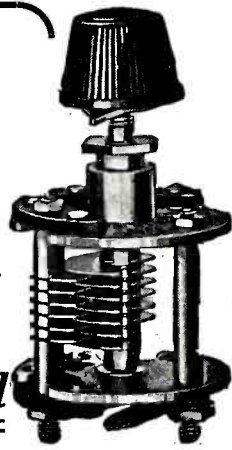

Patent Pending

Bridge meas. max. cap. .000045 Mfd. Frequency meas. max. cap. **\$1.50** .000027 Mfd. . . .

1—As a neutralizer. 2—As a vernier. 3—For capacity antenna coupling. 4—For capacity regeneration control. 5—For adding regeneration to superheterodyne loops. 6—As a stabilizer. 7—For tuning long wave transformers in superheterodynes. Works wonders—but get the original Chelten. Ask your dealer or write direct.

Straight-Line Frequency

Get the truth about it. Write for free booklet describing the new Chelten Straight-Line Frequency Condenser (Modified).

CHELTEN ELECTRIC COMPANY
4859-65 Stenton Avenue, Philadelphia

The Sensation of the Season

MODEL 5-F-5

New and Improved **FRESHMAN MASTERPIECE**



A five tube tuned radio frequency receiver, encased in as fine a heavy genuine mahogany cabinet as ever graced any radio set.

\$60.

Every part embodied is newly constructed resulting in greater efficiency and finer tone quality. The illustration shows our new straight line wave length, low loss condenser and vernier device, permitting the reception of stations over a wave length from 190 to 550 meters.

For Sale By Authorized Freshman Dealers Only

Chas. Freshman Co. Inc.
Radio Receivers and Parts
FRESHMAN BUILDING
240-248 WEST 40TH ST. - NEW YORK, N.Y.
CHICAGO OFFICE — 2626 W. WASHN' BOULEVARD

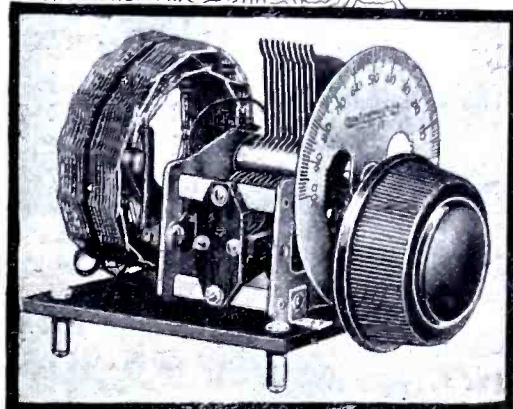

Vernier feature assures greater selectivity and sharper tuning.

All apparatus advertised in this magazine has been tested and approved by POPULAR RADIO LABORATORY

Now you can UNDERSTAND RADIO!

Know all about it—build and repair sets—explain the vacuum tube—operate a transmitter—be a radio expert!



514 PAGES
100,000 SOLD

Compiled by **HARRY F. HART**
E.E.

Formerly with the Western Electric Co., and U. S. Army Instructor of Radio.
Technically Edited by **F. H. DOANE**

More than 100,000 radio fans rely on this I. C. S. Radio Handbook to take the mystery out of radio. A wonderful value at \$1. Hundreds of illustrations and diagrams explain everything so you can get the most out of whatever receiver you build or buy.

It contains: Electrical terms and circuits, antennas, batteries, generators and motors, electron (vacuum) tubes, most receiving hook-ups, radio and audio frequency amplification, broadcast and commercial transmitters and receivers, wave meters, super-regeneration, codes, license rules. Many other features.

A practical book. Written by experienced radio engineers in language that you can understand. Something useful on every page of its 514 pages. A book that will save you many times its small cost.

Just mail the coupon with a dollar bill and your name and address, and we will send you this 514-page I. C. S. Radio Handbook by return mail. Note the other good books listed below and the low prices.

INTERNATIONAL CORRESPONDENCE SCHOOLS
Box 8252-F, Scranton, Penna.

I enclose \$....., for which send me, post-paid, the Handbooks marked X, at \$1 each. It is understood that if I am not entirely satisfied I may return them within five days and you will refund my money.

RADIO HANDBOOK, \$1

- Automobile Handbook - - - - - \$1
- Electrical Handbook - - - - - \$1
- Chemistry Handbook - - - - - \$1
- Pharmacy Handbook - - - - - \$1
- Traffic Handbook - - - - - \$1
- Building Trades Handbook - - - - - \$1
- Machine Shop Handbook - - - - - \$1
- Salesman's Handbook - - - - - \$1
- Advertising Handbook - - - - - \$1
- Bookkeeper's Handbook - - - - - \$1
- Civil Engineer's Handbook - - - - - \$1
- Steam Engineer's Handbook - - - - - \$1

Name.....

Address.....

Enclose \$1.50 for each book if you want the Leatheroid binding. All of the above books can be had in this binding except the Traffic Handbook and the Building Trades Handbook.

Build On FIBROC

The panel is the foundation of every receiving set. Upon the panel depends the efficiency, the satisfactory operation and the appearance of the set you build.

Start your set right at the foundation, as the better manufacturers do, by using

FIBROC (BAKELITE) PANELS

By so doing you'll have a better looking set, a more efficient set—one that will withstand hard usage and be free from distortion. You'll find FIBROC-BAKELITE Panels easy to handle and moderate in cost.

Your dealer has or can get FIBROC-BAKELITE Panels

Fibroc-Bakelite Feature

High dielectric strength assuring lowest dielectric losses. Great tensile strength. Will not warp, crack, chip, feather or cold flow. Easily worked. Readily engraved. In black, high polish or mat finish; mahogany, circassian walnut or natural finish. Standard sizes each packed in individual envelope.

FIBROC INSULATION CO.
257 Lincoln Ave.
Valparaiso, Ind.

For Winding Coils Use Fibroc-Bakelite Tubes

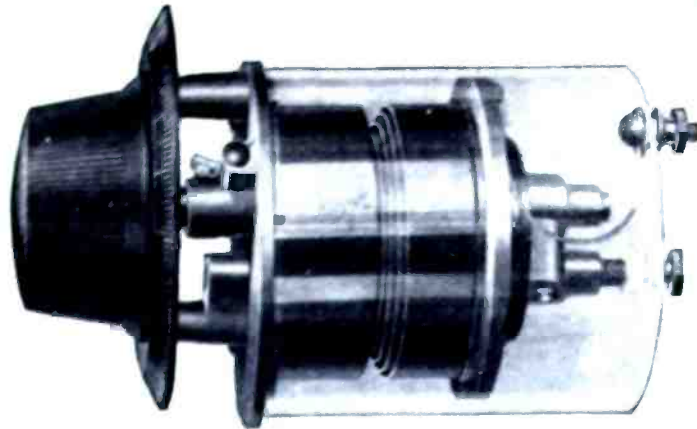

PATENTS
PENDING

The Most Talked-Of Condenser In Radio Today

At the recent Radio Shows in New York—wherever it has been shown or demonstrated—the Furnell Paper Coil Condenser aroused a veritable furor of interest.

The enthusiastic endorsement of the Furnell by men of highest experience in radio mechanics, has been one of the most gratifying tributes to this new and radical condenser achievement.

Mechanically and electrically, professional claim that the Furnell Condenser offers in the simplest, most practical form, the correct solution of the straight-line frequency problem.

By the use of the Furnell Condenser, the crowding of low wave stations is entirely done away with. Regardless of wavelength, all stations are tuned in with remarkable ease and clarity, over a complete revolution of the dial.

Only two plates are used in the Furnell. Each plate is in the form of an evolute coil, like an un-wound clock spring. The rotor coil is tapered, and made to mesh and align perfectly with the

stator coil, through a sliding motion, on a spiral worm rotor shaft.

The unique method of meshing the rotor and stator coils, affords a wonderful smoothness of operation and a precision in tuning impossible with the old type of condenser, while it eliminates all necessity for a vernier.

Each Furnell Condenser is furnished complete with a fine quality 360 degree dial, affording a full rotation and a complete and equal separation of stations over the entire dial.

And to insure its permanent accuracy and precision, under all working conditions, the Furnell Condenser is entirely enclosed in an attractive, strong, transparent Pyralin case. This shield insure absolute protection against dust, moisture and damage.

No matter what type or model you build, buy, or sell, you can't know its best performance until you use this wonderfully improved type of condenser. In three capacities, single and multiple

Write for literature

Furnell Condensers will not be ready for sales distribution until December. We invite your interest in awaiting this new and radical condenser achievement.

A nation-wide organization of exclusive Sales Distributors is now being established. Write or wire for plans and particulars.

The FURNELL MANUFACTURING CORPORATION
889F BROAD STREET, NEWARK, N. J.

FURNELL
360° TAPER COIL
CONDENSERS

Approved, Endorsed, Recommended!

THE CARBORUNDUM DETECTOR

Eminent radio engineers, radio authorities and writers have given unstinted praise to the Carborundum Detector for reflex and crystal sets:

The Carborundum Detector has earned their compliments because.

It is the one detector made with a Carborundum specially developed for radio purposes.

This detector is fixed permanent—No cat's whisker nuisance.

It sharpens the tuning, increases volume and selectivity, brings in true, clear tones.

It is highly sensitive yet rugged. It won't burn out.

The Carborundum Detector is guaranteed.

THE CARBORUNDUM COMPANY
NIAGARA FALLS, N. Y.



\$1.50
IN U.S.A.
From Dealers or Direct

Sensational Approval!

When has any single radio product been accorded, in two short months, the enthusiastic reception given the MAR-CO dial?

Already, five prominent set makers have adopted it as standard equipment: McLaughlin has approved it for his Single-control Super, where supreme accuracy is imperative; and five other noted circuit designers have specified it for their newest sets.

Go to your dealer, to-day, and examine this dial. Turn it once, and you'll see how far ahead it is of any previous type of dial.

Martin-Copeland Company
Providence, Rhode Island

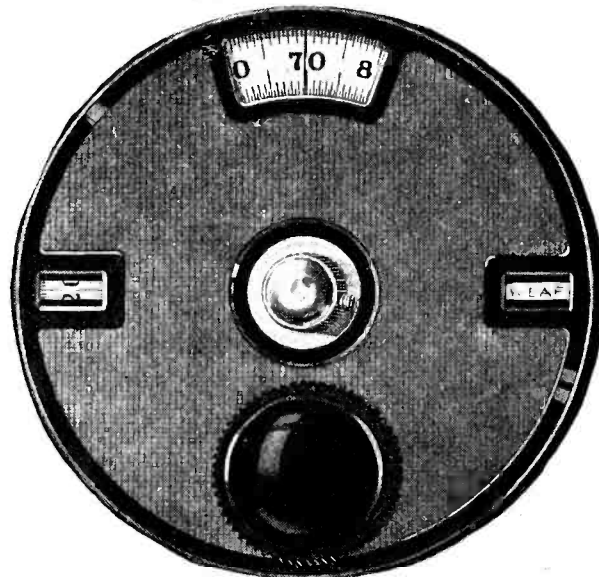

Nickel Plated \$2.50 Gold Plated \$3.00
Clockwise or Counter Clockwise Action

MAR-CO
RADIO PRODUCTS

Vernier Dial

All apparatus advertised in this magazine has been tested and approved by POPULAR RADIO LABORATORY

ANNOUNCING *New Models of* U.S. TOOL CONDENSERS

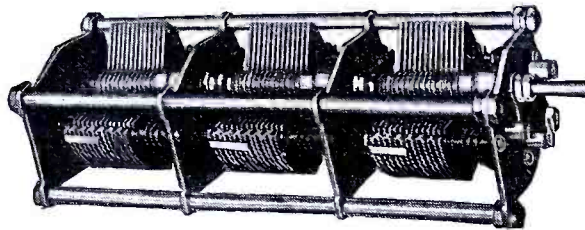

Made
Under
Hogan
Patents
Jan. 9, 1912
Pat. No.
1,014,002

MULTIPLE Condensers *For Single Control Receivers*

Single Dial Receivers are the Latest Improvement in Radio. You can build a very efficient set using the New U. S. Multiple Condensers.

Model 8

An efficient condenser made with new and patented one-piece stator, guaranteed to give sharp tuning at the lower broadcasting wave lengths.

Capacity, Max. .00025, Min. .0000076. \$2.70
Max. .00030, Min. .000008 . . 2.85
Max. .00035, Min. .0000086. . 2.95
Max. .00050, Min. .000011 . . 3.75

Model 9

Same as Model 8, but with Vernier and Kurz-Kasch Dial.

Capacity, Max. .00025, Min. .0000076. \$3.75
Max. .00030, Min. .000008 . . 3.85
Max. .00035, Min. .0000086. . 4.10
Max. .00050, Min. .000011 . . 4.75

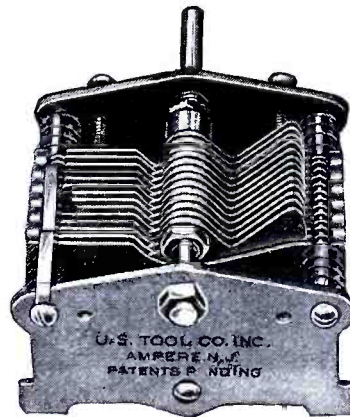
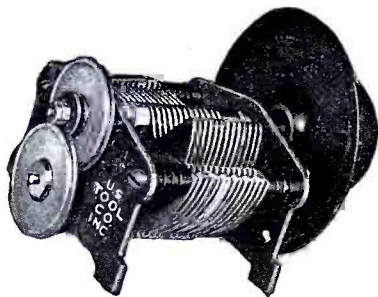

U. S. Tool Products are accepted as the Standard of Quality and Performance.

WRITE FOR LITERATURE

SEE THESE NEW MODELS AT YOUR DEALER'S

U.S. TOOL CO., INC. AMPERE, N.J.

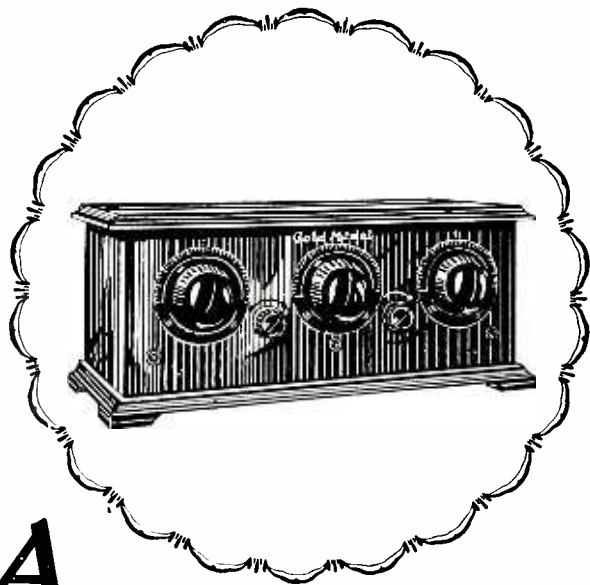

A \$60 Receiver for \$25

The Gold Medal 5-tube tuned radio frequency receiver "that stormed the country!" Manufactured to sell at \$60, now \$25.

Distance, volume, and good tone quality. Guaranteed to operate or money refunded. Send \$25 by money-order or certified check and this fine receiver will be sent express prepaid. Tubes, batteries and speaker extra.

Dealers Supplied

EUREKA OUTLET CORP.
1038 Longwood Ave., New York City

**ONLY
\$25**

The Wilson "B" Radiopower Unit

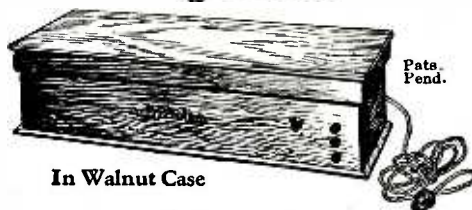

In Walnut Case

This new unit makes it possible to use a light socket for "B" voltage, *without any troublesome hum from alternating current.*

Supplies the constant voltage necessary for perfect reception. No acid to spill. No moving parts. Requires no attention. Semi-automatic in operation. The least expensive type of unit because of low first cost, minimum current consumption and long life. *In handsome walnut case. Price \$35.*

The Andrews Paddlewheel-Coil



Price
\$3.00

For best results in home-built sets it is safer to use equipment employed in the best commercial receivers. Here is a superior coil used in such high grade receivers as the *Deresnadyne* and *Buckingham*. It can be used in any hook-up requiring a high type inductance.

Has exceptionally high ratio of inductance to resistance with minimum distributed capacity. Improves tone. Increases range, volume and selectivity. Blue prints of tested hook-ups employing this coil are available.

Our Technical Dept. will answer inquiries.

Duo-Spiral Folding Loop

Handsomely finished in silver and mahogany to harmonize with the finest home furnishings.

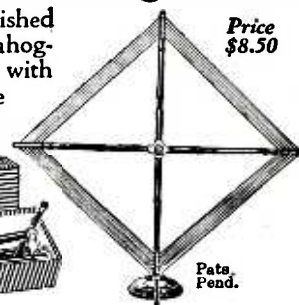

Price
\$8.50

Easily portable. Has insulated handle and graduated dial. Reduces static and other interference. A special model for every circuit.

See these standard units at your dealers or write for complete information.

Radio Units Inc.

1301 FIRST AVE., MAYWOOD, ILL.
Perkins Elect. Ltd., Montreal, Toronto, Winnipeg

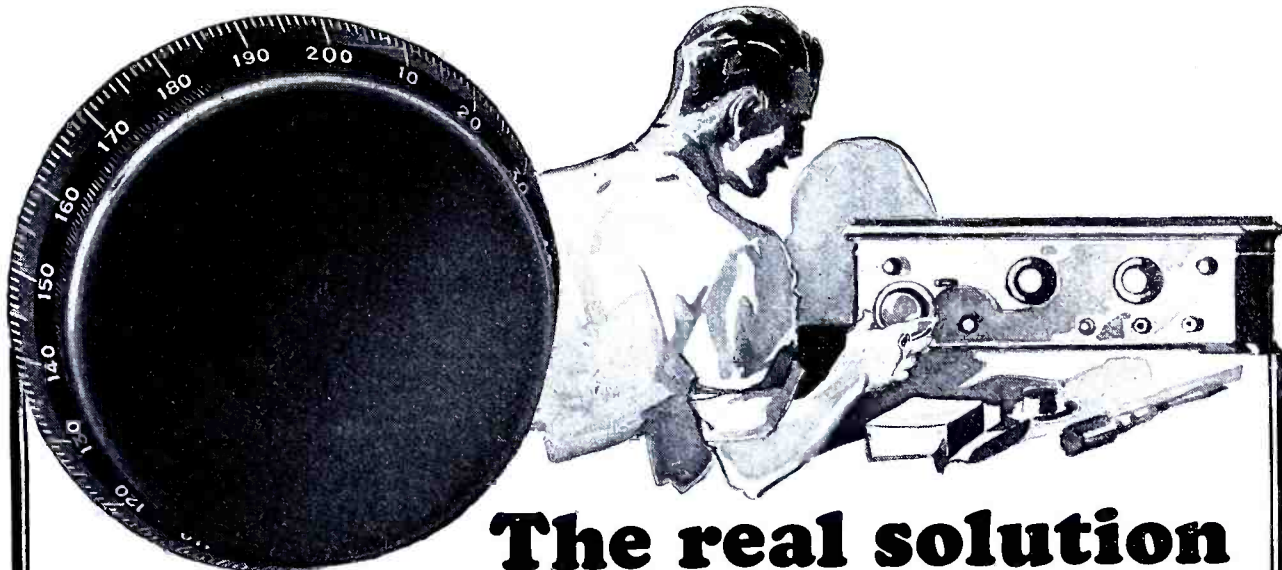

The real solution to the tuning problem!

MAKE your radio a 1926 model. Replace your present Dials with Rathbun Straight Line Frequency Converters which spread all stations within the range of your receiver uniformly around the whole circle of 360°. All stations are a uniform distance apart on these new Converters which is the ideal tuning condition.

Why be satisfied with Dials or Condensers which are limited to 180° or only half the dial? Why stop at 180° when there are 360° in the circle? No gears with their back lash, no friction with its slippage in Rathbun Straight Line Frequency Converters—only two moving parts, a

variable cam and a lever. Easily and quickly installed on any set—it is not necessary to cut Condenser shafts or drill panels.

The Rathbun Straight Line Frequency Converter is one of the few really new things in Radio during the past three years.

Don't forget that we build the Rathbun Single Hole Mounting Condenser with genuine Bakelite ends. This year's models are all enclosed with transparent pyralin dust bands which preserve their high efficiency for life. Small, light, rugged, handsome and none lower loss or higher in efficiency. Reasonably priced.

Ask your dealer for Rathbun Straight Line Frequency Converters. If he has not yet stocked them, he will quickly obtain them

PRICE \$3.50

Rathbun Manufacturing Co., Inc.
Jamestown, N. Y.

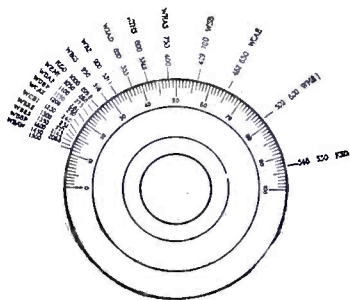

Stations indicated in kilocycles and wave lengths showing crowding with an ordinary capacity condenser

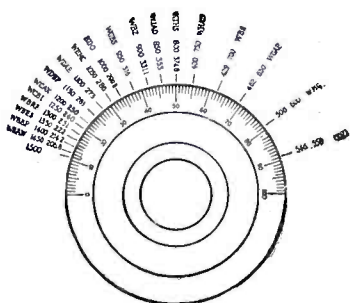

Stations partially separated and tuning slightly improved with a Straight Line Wave Length Condenser

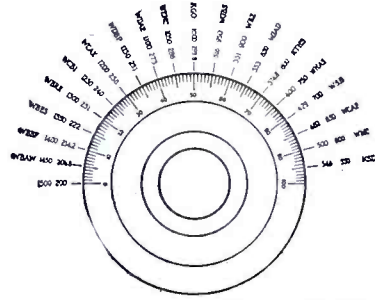

Practically even separation over half the dial with a Straight Line Frequency Condenser

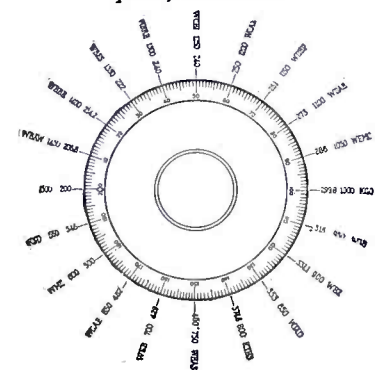

Complete and equal separation of stations over the entire dial with the Rathbun Straight Line Frequency Converter



D. T. W. LOOP

ELECTRICALLY SUPREME: Large size—27 inch sides—gives great pick-up. Genuine Litz with spacing permanently assured. Very low R.F. resistance. Unique system of taps with jumpers to divide loop without dead ends, adapt it to center tap and loop regenerative sets and allows tuning at low wave lengths without change of condenser. Graduated circular plate at base gives compass settings.

MECHANICALLY SUPREME: Constructed of beautifully finished hardwood, structurally rigid with minimum weight. Folds instantly for storage or transportation. When open all looseness in wires is immediately taken up—appearance always perfect.

MADE TO LABORATORY STANDARDS FOR A LIFETIME OF EFFICIENT USE.

Selected by McLaughlin in October Popular Radio for his Single-Control Superheterodyne.

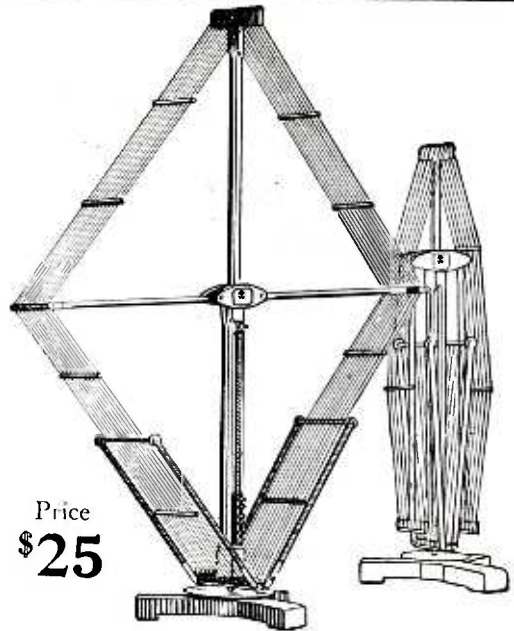

Price
\$25

• TOBE • DEUTSCHMANN • CO. •
• CORNHILL • BOSTON • MASS. •

DisXron Tubes

are noted for their "Pep." They will make that set of yours shout with joy! The tone is brilliant and clear. They "eat up" DX, too!

All standard types. Every tube tipless, mounted on a base of pure BAKELITE and GUARANTEED to give absolute satisfaction.

Order from your dealer, or direct by mail, C. O. D. or prepaid by Money Order. All types, \$1.75 each. WE PAY POSTAGE.

(Dealers: Write Now!)

JUSTRITE SALES CO.

Dept. 200

230 Market St. Newark, N. J.

BUILD WITH

SIMPLIFIED BLUEPRINTS

LAURENCE M. COCKADAY has personally supervised the preparation of *Simplified Blueprints* of seven of POPULAR RADIO's most popular circuits. Each Receiver set consists of at least three separate *Actual Size* Blueprints; first, a Panel Pattern; second, an Instrument Layout; and third, a Picture Wiring Diagram all simplified in the fullest sense of the word.

Set No. 4—"Cockaday Four-Circuit Tuner with Resistance-Coupled Amplifier" (five tubes distortionless, two dials, automatic vacuum tube control, as described in the October, 1924, issue of POPULAR RADIO).

Set No. 6—"The Cockaday 8-Tube Superheterodyne Reflex Receiver" (eight tubes, two tuning dials, loop, non-radiating, distortionless, as described in January, 1925, issue of POPULAR RADIO).

Set No. 7—"The Cray 4-Tube Reflex Receiver with the New Sodium Detector" (four tubes, two tuning dials, short antenna, non-radiating as described in February, 1925, issue of POPULAR RADIO).

Set No. 9—"Portable Town and Country Receiver" (six tubes, three stages of transformer, coupled, radio-frequency amplification, loop antenna, tuned by variable condenser as described in May, 1925, issue of POPULAR RADIO).

Set No. 11—"5-Tube Tuned Radio-Frequency Receiver with Simplified Control" (as described in August, 1925, issue of POPULAR RADIO).

Set No. 12—"8-Tube Superheterodyne with Single Control" (as described in October, 1925, issue of POPULAR RADIO).

Set No. 13—"Ratheon Plate Supply Unit" (as described in November, 1925, issue of POPULAR RADIO).

\$1.00 PER SET OF THREE PRINTS

POPULAR RADIO, Inc., Dept. 114,
627 West 43d St., New York City

Date.....

Enclosed is my remittance of \$..... for which kindly send me Blueprint Set (s) consisting of Panel Pattern, Instrument Layout and Wiring Diagram as checked below:

Set Number 4 Set Number 9
 Set Number 6 Set Number 11
 Set Number 7 Set Number 12
 Set Number 13

Name.....
 Address.....
 City..... State.....

All apparatus advertised in this magazine has been tested and approved by POPULAR RADIO LABORATORY



Everyone Interested in RADIO Should Write for this FREE Radio Book



Write for Your **FREE** copy **10-day**

90 PAGES OF RADIO VALUES

The finest and most complete radio value book published is yours free. A post card brings you your copy—send for it Now—TODAY! When you buy from WRS, you save the jobbers' and retailers' double profit! In addition, it is "chockful" of interesting data every fan wants to know: Trouble Shooting Chart, Revised and Complete List of Broadcasting Stations, Log Chart, etc. **ALL MERCHANDISE GUARANTEED.** You MUST be satisfied or your money will be refunded. 24 hours service—orders shipped on same day received!

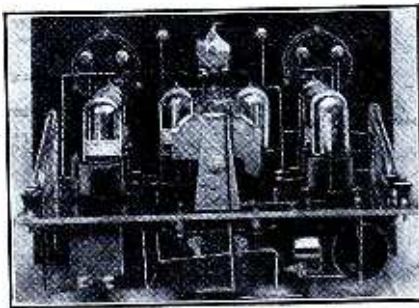

McLAUGHLIN SINGLE CONTROL SUPERHETERODYNE WRITE FOR SPECIAL PRICE

8 Tubes Free

GUARANTEE: All parts exactly as specified by Mr. McLaughlin.

D. T. W.

German Imported Loop



- 2 Precise No. 750 Syncrodensers, .0005 mfd
- 1 Precise No. 744 Coupler
- 2 Precise Aluminum Brackets
- 1 Precise No. 1900 filterformer
- 1 Precise No. 1700 super-multiformer
- 1 Precise Audio Frequency Transformer
- 1 Precise AF Transformer No. 480 2 1/2 to 1
- 1 Marco 4 in. vernier dial Clockwise
- 2 Carter Imp jacks, Loopwire Plus
- 1 Hammarlund Jr. Midget Cond.
- 1 Carter double-circuit hold-tite jack
- 1 Carter Single
- 1 Benjamin No. 9050 8 gang socket
- 1 Benjamin battery switch
- 1 Weston No. 301 Voltmeter, 0 to 7 volts scale
- 1 Weston No. 301 milliammeter, 0 to 25 milliamperes scale
- 1 N. Y. Coil Mica Fixed Cond., .006
- 2 Dubilier 1. mfd bypass cond., .00025
- 1 No. 640 mica fixed condenser .00025 mfd. with grid leak clips
- 1 Daven Grid Leak, 2 megohms
- 1 Precision Inducto-Couple, No. 260
- 1 General Radio Rheostat, type 214A, 2-ohm, 2 1/2 Amp.
- 1 General Radio Potentiometer, type 214A, 400-ohm
- 1 Bakelite panel, black or mahogany, 10 in. x 14 1/2 in. x 3-16 in., drilled, engraved
- 1 Set Popular Radio Blueprints
- 40 Ft. Tinned Bus Bar Wire
- 1 Book, complete, detailed instructions for building this remarkable set
- Stranded Wireloop for coupling oscillator to circuit
- 1 "C" Battery
- 1 Box consisting of drilled and engraved panels, sub-panels, brackets, screws, nuts, lugs, wire, etc.

WRS PRICES ARE LOWER SERVICE IS BETTER VALUES ARE HIGHER

FREE

POSTAGE FREE with all orders over \$5.00

YOUR SATISFACTION INSURANCE

Our MONEY-BACK Guarantee is your absolute insurance of thorough satisfaction. Your money is still YOUR MONEY until you are thoroughly satisfied. Money refunded without question or quibble.

Browning Drake FOUR TUBE RECEIVER

- One Panel—7x24 in. Drilled and Engraved
 - One baseboard—8 1/2 x 23 1/2 in.
 - One National tuning unit B-D 1 (This contains one .0005 mf. National DX condenser with 4-inch Velvet Vernier dial and one antenna coil mounted as a unit.)
 - One National unit B-D 2 (This contains one .0005 mf. National DX condenser with 4-inch Velvet Vernier dial and one National Regenerator, also mounted as a unit.)
 - One Rathbun 3-plate vernier condenser for balancing
 - Four standard Benjamin tube sockets
 - One General Radio 6-1 audio Transformer Type 285A
 - One SERCO Audio Transformer 3 1/2 to 1 ratio
 - Two SERCO Rheostats, New Type of 30 ohms resistance
 - One 25 ohm fixed resistance
 - One Hoyt 2-inch voltmeter with a scale reading of 0 to 60 volts
 - One .0001 mf fixed condenser
 - One .001 mf
 - One .00025 mf fixed grid condenser
 - One Electrad variometer for variable grid leak
 - One BMS double circuit jack
 - One BMS single open circuit filament control jack
 - One filament switch
 - One 1. mf. by-pass condenser
 - Nine binding posts
 - Twenty feet of wire for connecting parts
 - One Box of assorted screws, nuts, etc.
 - One Box of instructions and blue prints
 - One Binding post strip
 - Two Brass Brackets
- KIT PRICE \$44.95**

WE SPECIALIZE

In EVERY circuit approved by the technical engineers of RADIO BROADCAST. Cockaday and other leading radio authorities. Cockaday Super, Cockaday DX, Ultradyne, Superdyne, Pressley Reflex, Reflex, etc.

Raytheon Plate Supply Unit. Complete Parts in Stock. Write for Special Price.

Complete Parts for the NEW

Hammarlund Roberts RECEIVER ENDORSED BY TEN LEADING ENGINEERS

The ONE non-radiating receiver with the sensitivity of the superheterodyne. Razor blade selectivity even in crowded areas. Tuning reduced to the simplicity of two major controls. Automatic filament control, superb tone plus the entire elimination of distortion.

- The parts listed below are exactly as specified by the originators of this circuit
- 2 Rauland Lyric Transformers
 - 1 Hammarlund Midget Condenser
 - 2 Hammarlund .0005 mfd. Straight-Line frequency Condensers
 - 1 Set Hammarlund Roberts Coil
 - 2 Alden "Super DeLuxe" Sockets
 - 5 Alden DeLuxe Sockets
 - 1 Alden K-3843 1 1/2-inch Dial
 - 4 Amperites No. 1-A
 - 5 Prs. Union Phone tip jacks
 - 1 Carter 25 ohm "Imp" Rheostat
 - 1 Carter Single circuit No. 101 "Hold-tite" Jack
 - 1 Carter "Imp" Battery Switch
 - 1 Dubilier Type 640-G .00025 mfd. Grid Condenser
 - 1 Dubilier Type 640 .002 mfd. Fixed Condenser.
 - 1 Dubilier Type 640 .006 mfd. Condenser
 - 1 Durham Resistor
 - 1 Hammarlund-Roberts Foundation Unit
- COMPLETE, \$60.85.** This Cabinet FREE, Fine mahogany finish, fancily grooved cabinet with sloping panel front, exactly as specified by circuit builders

WRITE FOR SPECIAL PRICE



FREE

A copy of our radio Guide Book and Catalog should be in every fan's library. It's chockful of interesting data and hundreds of exceptional radio values. A postal brings it. Be sure to

DO IT NOW

WHOLESALE RADIO SERVICE CO.

Manufacturers and Wholesale Distributors of Radio Apparatus
Be sure to address DEPT. PR 11

6 CHURCH STREET

NEW YORK CITY

All apparatus advertised in this magazine has been tested and approved by POPULAR RADIO LABORATORY

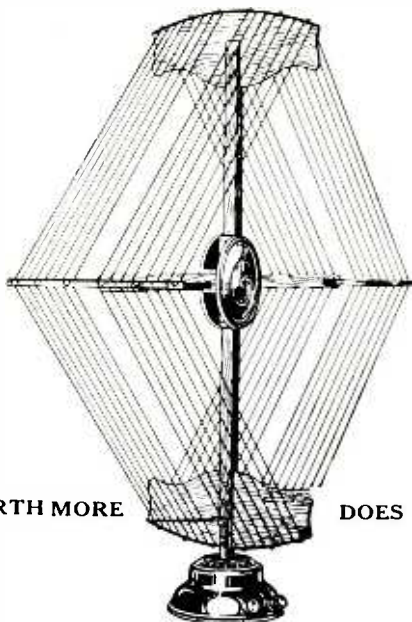

WORTH MORE DOES MORE

The Berling Loop

TO WIN
MORE FRIENDS

A highly efficient loop for the modern
Superheterodynes and Tuned
Radio Frequency Receivers

The Berling Loop incorporates
the following features:

1. High ratio of inductance to resistance
2. Low distributed capacity
3. Maximum practical inductance
4. Extremely low radio-frequency resistance
5. Easily adjustable to rotating vertical plane.
6. Perfect electrical contact and connections
7. Collapsible
8. Height, over all, 26 inches

Price \$12.50

NOTE: If your Dealer cannot supply you,
we will ship direct on receipt of order and
name of your local Dealer.

BERLING MAGNETO CO., INC.
BUFFALO, N. Y., U. S. A.

Na-Ald Sockets and the new standard tube bases

*Adapters for old sockets—
and a brand new socket too*

RADIO fans can now use any of the new tubes in the famous Na-Ald De Luxe Socket. This is the socket that has two points of contact with each tube terminal. It is the socket with the *side-scraping* contacts that may be easily cleaned by simply rotating tube three or four times without removing it from the socket. It is also the socket proved by laboratory tests to be most efficient in low losses and low capacity.



Adapter 419-X

The Na-Ald De Luxe Socket will take the new tubes UX-201A, UX-12 and UX-112 without an adapter. By the use of this adapter No. 419-X it will take the new small base tubes, Nos. UX-199 and UX-120. 419-X sells for 35c.

Other Na-Ald adapters and the new socket

The Super-Het No. 420-X adapter, equipped with cables for connections, enables the owners of Radiola Super-Het, to get the great increase in volume and clarity the new UX-120 tube develops. Price of 420-X Adapter, \$1.25.

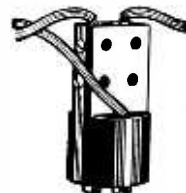

Adapter 420-X

There is a new adapter for use in making the shift from WD-11 to UX tubes. It is especially designed to enable the users of Radiolas II, III and III-A to enjoy the improved operation the new tubes provide. Price, 421-X, 75c.



Adapter 421-X

The 481-X Na-Ald Socket is a brand new socket that will take any of the UX series of tubes without an adapter. Price 35c.; No. 481-XS cushion mount 50c.

You can obtain Na-Ald adapters, sockets or dials at radio, electrical and hardware stores everywhere.



New Socket 481-X

Write for catalogue and free information, "What to Build," giving tested, selected circuits.

ALDEN MANUFACTURING COMPANY

Also Makers of the Famous Na-Ald Dials

Dept. C-11

Springfield, Mass.

Alden Processed
NA-ALD
Sockets and Dials

All apparatus advertised in this magazine has been tested and approved by POPULAR RADIO LABORATORY

BOSCH RADIO



The Bosch Radio Receiver, unapproached in tonal quality, volume, selectivity, simplicity of operation and beauty of design, is a product of an organization excelling in the manufacture of precision electrical equipment. The Bosch radio receiver and the Ambotone—the Bosch

wood conoid reproducer—combines to give a new standard of quality in radio reproduction. The Bosch radio dealer near you will demonstrate the Bosch radio triumph. The Bosch Receiver \$145.00 . . . The Ambotone Reproducer \$27.50 . . . The Junior Ambotone \$14.50.

AMERICAN BOSCH MAGNETO CORPORATION
 SPRINGFIELD, MASSACHUSETTS

All apparatus advertised in this magazine has been tested and approved by POPULAR RADIO LABORATORY

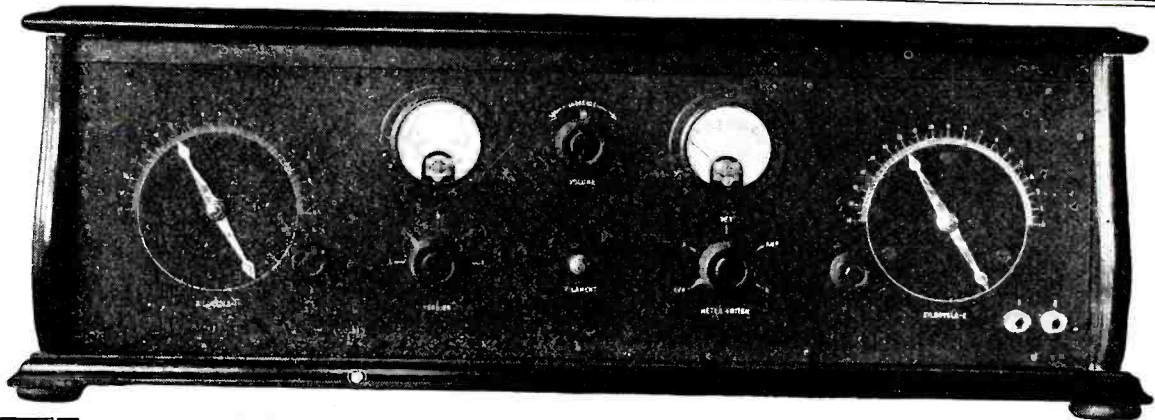

The Best in the World

No Batteries

are required even to operate the most powerful 10-tube receiver. We have experimented with many types of "Eliminators" and now recommend without qualification the

Model A Power Unit

One Customer Telegraphs:

"Receiver assembled, performing like a thoroughbred."

The Amateur or Experimenter with his ultra-modern high-powered receiver is years ahead of Commercial Radio.

It is significant that unsolicited testimonials are constantly being received from even the far corners of the earth, where Norden-Hauck Engineers have furnished the finest radio apparatus known to the art today.

Quotations gladly furnished on radio parts and apparatus having non-infringing uses.

Write for Literature

NORDEN-HAUCK, INC.

Engineers

1617 Chestnut Street, Philadelphia, Penna.

ANNOUNCING
THE New Type B
NATIONAL Velvet Vernier DIAL
the dial with the variable ratio

This Dial will please you because of its intrinsic beauty—ease of mounting (fits any condenser)—its velvety smoothness—no back lash—and because it is the only dial that enables you to *pick your own ratio*. These are exclusive features possessed by the new National. *Write for Bulletin 107 P. R.*

NATIONAL CO., Inc.
W. A. READY, President
110 Brookline St., CAMBRIDGE, MASS.

BLUEPRINTS—FREE

You can have your choice of any one of seven POPULAR RADIO Simplified Blueprints with your new or renewal subscription for POPULAR RADIO, accompanied by remittance of \$3.00.

You, as a reader of POPULAR RADIO, know the many entertaining, interesting and instructive articles that are published each month. Every issue some new item is sure to attract your attention.

Ease, Economy and Accuracy in Construction
Simplified Blueprints were prepared under the personal supervision of Laurence M. Cockaday. They make it possible for anyone, without previous knowledge of radio, to construct a highly efficient radio receiver. Each set of Receiver Blueprints consists of at least 3 prints as follows:

Panel Pattern
This Blueprint is the EXACT size of the actual set. So accurate that you need merely lay it on your panel, and drill as indicated. You can readily appreciate the convenience of this Blueprint. No sealing or measuring to do, no danger of ruining the panel through faulty calculation.

Instrument Layout
Here again you have an actual size print of each instrument and binding post and its exact location both on the panel and within the cabinet. Even the cabinet structure is clearly shown.

Wiring Diagram
The unusual feature of this Blueprint is that it is an actual size picture diagram of the finished set. Each instrument and other parts appear in exact size and the wires are so clearly traced from one contact to another that you can connect all terminals accurately without even knowing how to read a hook-up diagram. Blueprints described in detail on page 110.

POPULAR RADIO, 627 West 43d St., New York

POPULAR RADIO, Dept. 119,
627 West 43rd Street, New York City.
Enclosed is my remittance of \$3.00, in full payment for subscription, with Blueprints as checked below, FREE.

- | | |
|--|--|
| <input type="checkbox"/> Set Number 4 | <input type="checkbox"/> Set Number 9 |
| <input type="checkbox"/> Set Number 6 | <input type="checkbox"/> Set Number 11 |
| <input type="checkbox"/> Set Number 7 | <input type="checkbox"/> Set Number 12 |
| <input type="checkbox"/> Set Number 13 | |

Name.....
Address.....
City.....State.....

All apparatus advertised in this magazine has been tested and approved by POPULAR RADIO LABORATORY



From Start to Finish— TRUE Straight Line FREQUENCY

*Spaces all stations equally.
Special Brass Plates.
Rigid construction.
Negligible losses.*

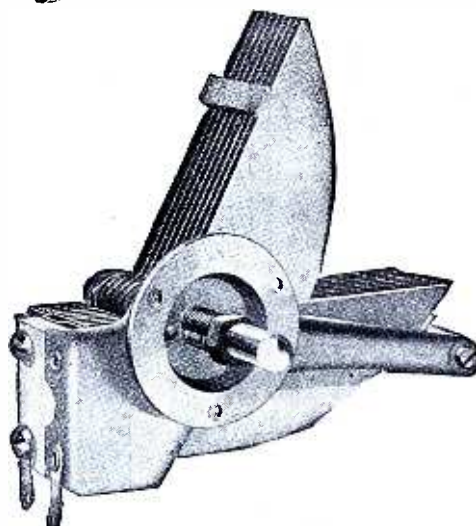

*Properly placed Isolantite
gives perfect insulation.
Practical adjustable one hole
mounting.*

Pacents TRUE Straight Line Frequency Condenser

THE shape of the plates alone does not guarantee straight line frequency spacing. Best results follow when the entire condenser from start to finish is built with one objective—*True* straight line frequency.

Every single part of the Pacents *True* Straight Line Frequency Condenser was especially designed and constructed for real S-L-F operation.

Nothing has been improvised from old parts or frames. Everything is new—from start to finish.

When you buy a Pacents S-L-F Condenser, you are purchasing a product that is the result of 18 months' engineering research and experiment. You can therefore be absolutely sure of perfect straight line frequency operation with wide, accurate spacing of stations.

*17 plates .00035 Mfd. Max., Cat. No. 250B, Price \$3.50
23 plates .0005 Mfd. Max., Cat. No. 250C, Price \$4.50*



Use a Pacents Microvern for Sharp Tuning

Here is the latest Pacents achievement in vernier dials that makes sharp tuning easy. It is a new departure both in appearance and mechanical features. The practical 5 to 1 ratio permits the most delicate adjustments to be made in quick time, not the slightest backlash. It is absolutely noiseless in operation and is easily mounted on any condenser.

Silver or gold finish, Cat. Nos. 150S, 150G, Price \$2.00

Our interesting new booklet, giving full details mailed on request.

PACENTS ELECTRIC COMPANY, Inc.
91 Seventh Avenue, New York City

Washington
Minneapolis
Boston
San Francisco
Chicago
Birmingham

Pacents

RADIO ESSENTIALS

Philadelphia
St. Louis
Buffalo
Jacksonville
Detroit
Pittsburgh

Canadian Licensee: White Radio, Limited, Hamilton, Ont.

DON'T IMPROVISE — PACENTIZE

All apparatus advertised in this magazine has been tested and approved by POPULAR RADIO LABORATORY



Patented Nov. 18, 1924

Windsor Loudspeaker Console

For EVERY Radio Set

A stunning piece of furniture that restores order in the room where you have your Radio! No more cluttered table-tops, nor litter of equipment under-foot.

No unsightly horn in evidence, either! This console has its own loudspeaker, in-built. It's out of sight, but with very apparent tonal superiorities. For it has the highest-developed type of unit. With horn built of special non-vibrating, extra-hard, ceramic material. Produces clear non-vibrant tone.

There's ample room for everything; space for *largest* A and B wet batteries—or battery eliminator—required for any home set; and for a big charging outfit, too.

Finished in mahogany, or walnut color. Dainty design of parqueterie on two front panels. Top, 38 in. x 18 in. Substantially built; the product of a 40-year old furniture maker.

The price, forty dollars, is for the *complete* console and includes the loudspeaker horn and unit. Thousands of dealers are showing this artistic addition to home radio equipment.

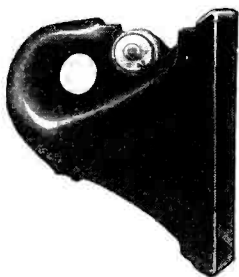

Non-Vibrant Ceramic Horn

The clearest tone producer on the market. Made of special composition which defeats vibration.

Rear View—Set Hooked Up



Price, \$40
West of Rocky Mts., \$42.50

Windsor Furniture Co.

1430 Carroll Ave.
Chicago, Ill.



ACME WIRE RADIO PRODUCTS

The Original Celatsite Wire



Celatsite is a tinned copper bus bar wire with a non-inflammable "spaghetti" insulation in five colors. Supplied in 30 inch lengths.

Flexible Varnished "Spaghetti"

A perfect insulation tube for all danger points in set wiring. Costs little more and is worth a lot more than the cheaper substitutes offered. Black, yellow, red, green, brown; for wires No. 10 to No. 18. 30 inch lengths.

Celatsite Battery Cable

For connecting A and B Batteries (or current supply) to radio set. Silk braid covering 5 flexible Celatsite wires—5 feet long—a different color for each terminal. Prevents messy wiring and "blown" tubes. Adds greatly to the appearance of your set.



Enameled Antenna Stranded

The best outdoor antenna you can put up. 7 strands of enameled copper wire; maximum surface for reception. Enameling prevents corrosion and consequent weak signals. 100, 150 or 200 ft. coils, boxed.



Loop Antenna Wire

You can make a good loop with Acme wire made of 65 strands of fine copper wire, green silk covered. Flexible; non-stretching, neat.

The New Celatsite

Flexible stranded wire for "point to point" and sub-panel wiring—latest method of wiring sets. 5 colors; black, yellow, green, red and brown, one for each circuit.



Send for folder
THE ACME WIRE CO.
Dept. P. New Haven, Conn.

Also makers of fine enameled wire and coil-windings for Audio Transformers, Battery Chargers, "B" Battery Eliminators

THE DAVEN LEAK AND CONDENSER



EQUALS



SOLVES A DUAL PROBLEM

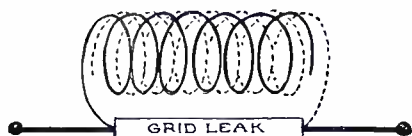

Diagram of the Leak and Condenser. There are two coils of wire, each forming one of the "plates" of a tiny condenser.



Assembly of the Leak and Condenser.



The cross section above shows construction and assembly of the Leak and Condenser.

A pair of wires, coated with a special insulating material are wound in parallel, in a single layer, upon the Bakelite bobbin. To distinguish these in the illustration, one is shown dark, and the other light. The dark wire is connected to cap "A" in the illustration, and the light wire to the cap "B." Each wire therefore has one open end and one end connected to a terminal, thus forming two plates of a condenser.

The method of winding insures that the spacing between them can vary only the smallest fraction of a percent. This gives extreme uniformity. This is a great stride forward, as grid condensers in the past have been known to vary in capacity as much as 300 percent.

And now, the Grid Leak. One of permanent and constant value is absolutely essential. Daven's reputation for manufacturing precision Grid Leaks needs no comment here.

The Leak is suspended in the centre of the Bakelite cylinder on which the condenser is wound. The ends of the leak are connected to the caps which are also the terminals of the condenser.

Manufacturers are invited to send for a sample.

The Sine of Merit

DAVEN RADIO CORPORATION

Resistor Specialists

Newark Reg. U. S. Pat. Off. New Jersey

Daven engineers have produced an innovation so simple and effective that you will wonder it was not thought of before.

Leading engineers and radio manufacturers have asked us repeatedly if we could not improve the old-fashioned combination grid leak and grid condenser which is (1) unattractive and cumbersome, (2) often inaccurate.

The Daven Leak and Condenser Contains No Mica

Grid condensers (particularly those of the mica type) often lack uniformity in capacity, especially in lower values; are susceptible to injury during soldering operations, and change capacity frequently after installation.

The Daven Leak and Condenser contains no mica and delivers all the efficiency the name Daven implies. It is a great step forward, both electrically and mechanically.

Manufacturers you will instantly recognize the convenience and practicability of this new device. *Set Builders*—the Leak and Condenser will make your set more attractive and save you time and trouble. *Jobbers and Dealers*—here is something new. Show it to those of your customers who know radio. The Leak and Condenser is precision-built, like all other Daven products, moisture proof and rugged. It takes up less space, is better looking. Made with five different values of grid leaks: 2, 3, 4, 5 and 7 megohms. The condenser is known as type "D" and is correct for all makes of detector tubes. Price \$1.00, including clips.

CLIP THIS COUPON.....

DAVEN RADIO CORPORATION D-11-25
158-160 Summit Street, Newark, New Jersey.

Please send me the following

Check Leak and Condenser Bulletin
Here: Resistor Manual. 30c is enclosed.
 Complete Catalog (free).

Name

Address

.....



Get the handbook of Resistance Coupled Amplification. At Dealer's 25c. By mail 30c.

THE BIG LITTLE THINGS OF RADIO

All apparatus advertised in this magazine has been tested and approved by POPULAR RADIO LABORATORY

No More Crowding!

HERE is a real straight line frequency condenser at last—a condenser that really eliminates crowding, that really spaces stations evenly over the dials. It is the creation of Rasla, a name made famous by fine parts.

The RASLA STRATE-LYNE is built to standards usually adhered to only for laboratory precision instruments. The plates are heavier than on any other condenser, the spacing and alignment is more accurate. Split bushings are provided at both ends. The plates are acid dipped, the end plates nickelled and highly polished. Transparent bakelite insures true low loss.



The Rasla Fixed Detector is sensitive—and remains so. Best for reflex or any circuit. At your dealer's \$1.25.

FREE—Write for the complete Rasla hook-up:

Davidson Radio Corp., 222 Fulton St., N.Y.

RASLA STRATE-LYNE

Straight Line Frequency

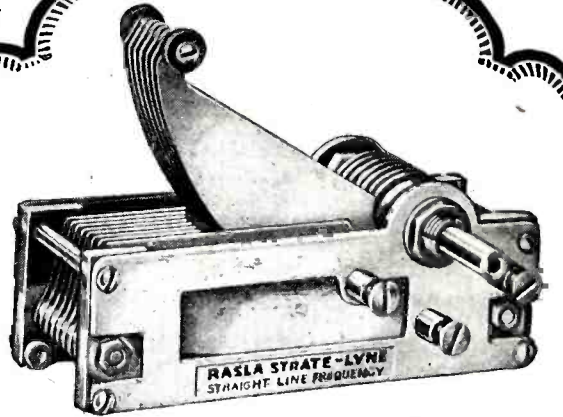

LIST PRICES

.00025 . . . \$4.00	.00035 . . . \$5.00
.0003 . . . 4.75	.0005 . . . 5.25

At your dealer's or direct if he can't supply you

A Big Step Ahead

AMPLIFIER AND DETECTOR



TUBES

4 Points of Superiority

50% Longer Life

Higher Mutual Conductance

Uniformity Interchangeable in any Stage

Non-Microphonic

In performance they lead in brilliancy, clearness and wider range of tone differentiation.

At your dealer's - - \$2.50 per tube

If your dealer cannot supply you send us name and \$2.50 for each tube wanted, plus P.P.

Tube "R" Rectifier Tube - - - -	\$3.00
Tube "P" Semipower Tube - - - -	\$5.00
Tube "X" Double Duty Rectifier Tube -	\$5.00

ABERDEEN SPECIALTY CO., INC.

Main Sales Office
Suite 411 1001 Chestnut Street Philadelphia

Statement of the ownership, management, circulation, etc., required by the act of Congress of August 24, 1912, of "Popular Radio," published monthly, at New York, N. Y., for October 1, 1925, State of New York, County of New York.

Before me, a Notary Public in and for the State and county aforesaid, personally appeared Douglas H. Cooke, who, having been duly sworn according to law, deposes and says that he is the Business Manager of "Popular Radio," and that the following is, to the best of his knowledge and belief, a true statement of the ownership, management, etc., of the aforesaid publication for the date shown in the above caption, required by the Act of August 24, 1912, embodied in section 411, Postal Laws and Regulations, to wit: 1. That the names and addresses of the publisher, editor, managing editor, and business managers are: Publisher, Popular Radio, Inc., 627 West 43d Street, New York City; Editor, Kendall Banning, 627 West 43d Street, New York City; Managing Editor, None; Business Manager, Douglas H. Cooke, 627 West 43d Street, New York City. 2. That the owner is: Laurence M. Cockaday, 627 West 43d Street, New York City; Kendall Banning, 627 West 43d Street, New York City; Popular Radio, Inc., whose stockholders are: New Fiction Publishing Corporation, 627 West 43d Street, New York City, whose stockholders are: Douglas H. Cooke, 627 West 43d Street, New York City; Vernal W. Bates, 46 George Street, New Haven, Conn.; Willy Blair, 4607 Ross Avenue, Dallas, Texas; Harold B. Emerson, 9 East 40th Street, New York City; Estate of William Green, 627 West 43d Street, New York City; *Harris Corporation, 34 Pine Street, New York City; Le Roy Sargent, St. Petersburg, Fla.; Abel I. Smith, 120 Broadway, New York City; Louis H. Strouse, Samuel Falk and Frank C. Fisher, Trustees in bankruptcy of Metropolitan Finance Corporation, 9 East 40th Street, New York City. *Harris Corporation with the following as Trustees in dissolution of Harvey Fisk & Sons (1921) now dissolved; John Donovan, 30 Church Street, New York City; Harvey Fisk, 34 Pine Street, New York City; Joseph M. Shellabarger, 30 Church Street, New York City. 3. That the known bondholders, mortgagees, and other security holders owning or holding 1 per cent. or more of total amount of bonds, mortgages, or other securities are: None. 4. That the two paragraphs next above, giving the names of the owners, stockholders, and security holders, if any, contain not only the list of stockholders and security holders as they appear upon the books of the company but also, in cases where the stockholder or security holder appears upon the books of the company as trustee or in any other fiduciary relation, the name of the person or corporation for whom such trustee is acting, is given; also that the said two paragraphs contain statements embracing affiant's full knowledge and belief as to the circumstances and conditions under which stockholders and security holders who do not appear upon the books of the company as trustees, hold stock and securities in a capacity other than that of a bona fide owner; and this affiant has no reason to believe that any other person, association, or corporation has any interest direct or indirect in the said stock, bonds or other securities than as so stated by him. Douglas H. Cooke, Business Manager. Sworn to and subscribed before me this 19th day of September, 1925. Joseph T. Cooney, Notary Public, New York County. (My commission expires March 30, 1926.)

All apparatus advertised in this magazine has been tested and approved by POPULAR RADIO LABORATORY

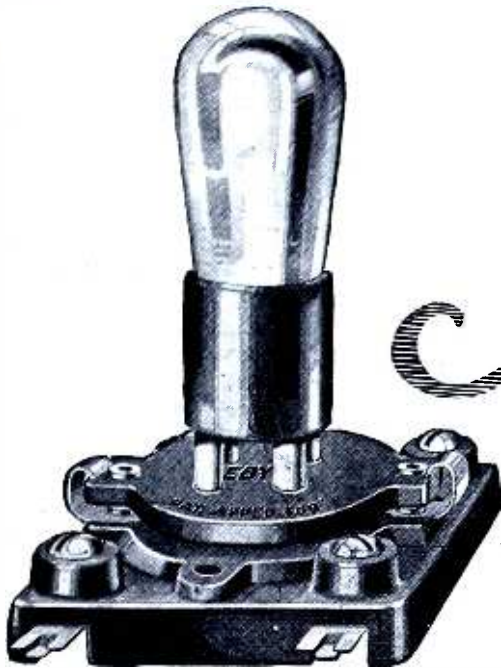

Cut shows tube prongs entering guide plate. Tube rests on plate when fully inserted.

New!

EBY CUSHION SOCKETS

Positive Contact on a Shock-Absorbing Base

Tube floats on resilient action of genuine phosphor bronze springs.

Prong holes in guide plate make it impossible to get tube in wrong.

Screws keep all contacts tight and eliminate losses and noises.

Mechanical spring grip of soldering lugs insures a perfect connection.

Contacts riveted to inserts—no bolts or nuts to come loose.

Genuine Bakelite base for lowest losses.

Contacts float tube on springs and eliminate microphonic noises.

Upper surface holds contact as tube is forced in.

Three clawed spring contact entirely encloses tube prongs.

Lower surface holds contact as tube is pulled out.

Contact spring floats tube free of all jolts and vibrations.

Three clawed spring makes perfect contact at all times regardless of variations in tube prongs.

The ingenious design of the new EBY Socket instantly appeals to engineers and to set-builders.

The illustrations show how each of the four tube prongs is firmly gripped its entire length by the three-jawed Phosphor Bronze spring clips. The novel design of these contact jaws is a radical departure from the old style one-point contact type.

Each spring clip is securely riveted to the Bakelite base, thus assuring a good electrical joint and permitting the tube to "float" when in service. This shock-absorbing feature not only eliminates microphonic noises, but is a guarantee against tube damage.

The "stripping" action of the springs further aids in maintaining a positive, wiping contact at all times, regardless of the size of prong or the amount of solder on the prong tip.

Old style sockets will not give the advantages of interchangeability and other features of the new U X Tubes. The Eby-Cushion Socket is built especially for them.

The list price of this socket is 75c. A letter will bring complete information to manufacturers, jobbers, dealers or set-builders.

H. H. EBY MFG. CO.
 4710 Stenton Ave.,
 Philadelphia, Pa.

Another EBY Quality Product

All apparatus advertised in this magazine has been tested and approved by POPULAR RADIO LABORATORY

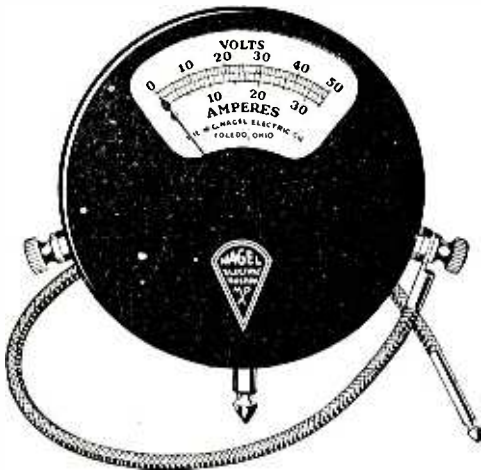

If you own a "Super-Het" or are operating your set with dry cells, you need this Nagel Voltammeter, a combination instrument for testing both A and B batteries.

60 Ohms per Volt!

High resistance means longer life for batteries

60 Ohms per volt is high resistance. Nagel Voltmeters and Voltammeters are built to this standard, enabling the user to test his batteries by intermittent touch or continuous contact without danger of shortening their life by draining them. Nagel instruments are accurate under any condition and are used by experimenters because of their dependability. If your dealer cannot supply you, write The W. G. Nagel Electric Company, 513 Hamilton Street, Toledo, Ohio.

NAGEL

Manufacturers of
**DRY CELL TESTERS · AMMETERS
 HIGH-RESISTANCE VOLTMETERS
 and VOLTAMMETERS · BAKELITE
 HOT MOULDED INSULATIONS**



The Remo Trumpet

(Concert Type)

Acknowledges No Superior!

Perfect reproduction with volume, without distortion. The secret of beautiful tone lies in this loud-speaker. You must hear it to be convinced. Your dealer will arrange this. Send us his name.

Price \$25.00

The Remola Concert Cabinet

The same tone quality as the Remo Trumpet, but even sweeter. A mahogany cabinet of just the right size.

Price \$25.00

**The Remo Corp.
 Meriden, Conn.**



Actual Size

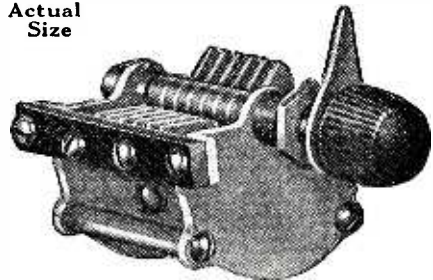

CONTINENTAL

LOW LOSS

JUNIOR CONDENSER

—a miniature low loss condenser of advanced design and precision workmanship which makes a perfect vernier with none of the faults of friction attachments and geared devices.

This little marvel will make long distance stations come sailing through local broadcast with increased volume and amazing clarity.

Now \$1.25

If your dealer can't supply you, write to us direct
GARDINER & HEPBURN, INC.
 611 Widener Building, Philadelphia, Pa.



THE SATURN CONNECTOR

Brings Radio to Every Room—

The Saturn Plug Is the Best Plug on the Market

Place your loud speaker in any room regardless of the location of your receiver. Hook up a Saturn Connector between them—it's done in a flash. The result—enjoyment of radio reception *where you want it*. Think of the convenience! Music with your meals, music in your bedroom, music in the sickroom, music anywhere.

No assembling—just plug in the wires from your receiver at one end and from your loud speaker at the other end. A side snap releases the tips. No levers to pull or buttons to press. No loss of tone or volume—the Saturn Connector grips the wires with bulldog tenacity and releases them with ease.

You'll want to have this modern radio convenience, also the wonderful Saturn Plug which gives the quickest and surest connection of any plug on the market.

At your dealers or Send 80c Today for the Saturn Connector and Plug. Money Refunded if You Are Not Satisfied.

The SATURN MFG. and SALES CO., Inc.

48 Beekman St.,

New York City

Jobbers and Distributors: Write for attractive proposition

Buy Them
as a
Combination
Only
80c.

or 40c. for
either the
plug or
connector

*Needed wherever
THERE'S
A RADIO*

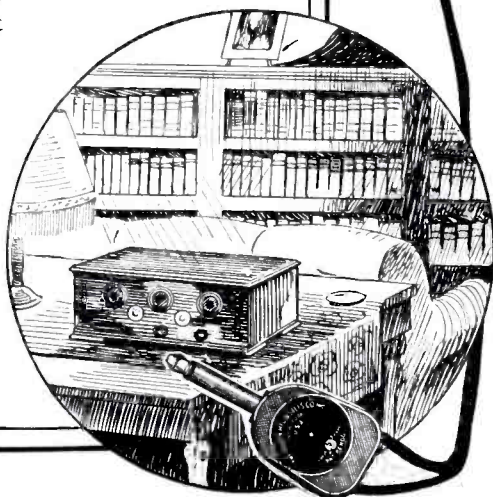

Bare Necessities

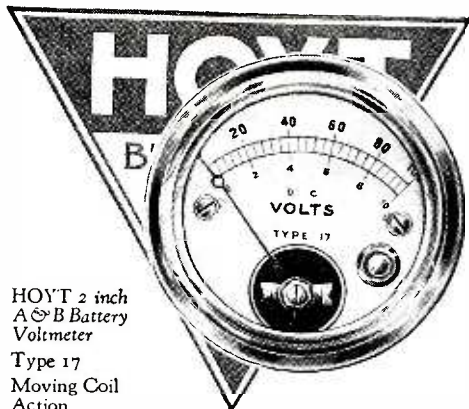

HOYT 2 inch
A & B Battery
Voltmeter
Type 17
Moving Coil
Action

Your car will run without an ammeter, oil gauge or speedometer. But would you care to run it in that way? At any moment electric current might fail, bearings burn out, gasoline give out, all without warning.

When you run a radio set without the positive knowledge of its condition and operation, that can be given only by the use of meters, you are taking just the same kind of a chance. You may damage your set and its accessories irreparably without a moment's warning.

The first automobiles were sold without full equipment — because the public had not been educated to demand it.

Radio sets have been similarly sold. But as the public becomes more educated it is demanding meters.

**KEEP AHEAD OF THE TIMES
AND TROUBLE IN YOUR
RADIO WITH HOYT METERS.**

Our book "HOYT METERS FOR RADIO" shows the complete HOYT line of Radio Meters; Send for it.

Burton-Rogers Company

26 Brighton Ave. :: :: Boston, Mass.

National Distributors

Get This Big Western Radio Catalog

NEW
1925-1926
EDITION

Dealers, send for our big live catalog. Contains nationally advertised high quality sets, kits and parts. Use your letterhead



Western Radio MFG Co.
134 W. Lake St. Chicago, Ill.

"HOW TO BUILD YOUR RADIO RECEIVER" FREE with POPULAR RADIO

Kendall Banning, Editor, and Laurence M. Cockaday, Technical Editor of POPULAR RADIO, have compiled a book that will prove to any one that he can build a set which will give distance, selectivity and tone volume, and at the same time a very definite basic knowledge of radio.

Build Your Own Set and Save Money

In "How to Build Your Radio Receiver," you will find complete specifications, constructional diagrams, photographs and instructions for building all of the following sets:

- A \$5 Crystal Set
- The Haynes Single Tube Receiver
- A Two-Stage Audio-frequency Amplifier
- The Cockaday 4-Circuit Tuner
- A 5-Tube Tuned Radio-frequency Receiver
- The "Improved" Cockaday 4-Circuit Tuner
- The Regenerative Super-Heterodyne Receiver

30 DAY OFFER

You can secure a copy of "How to Build Your Radio Receiver" FREE, and have all the privileges of the Technical Service Bureau without additional expense, if you will send a remittance of \$3.00 in full payment of 12 months' subscription for POPULAR RADIO. (Or as an alternative, you may have the book and privileges of the Technical Service Bureau with POPULAR RADIO for 7 months only—for \$2.00. A two dollar bill will do.)

POPULAR RADIO, Dept. 115
627 West 43d St., New York City, N. Y.

Enclosed remittance of \$3.00 is payment in full for a 12 months' subscription for POPULAR RADIO, with advisory service and copy of "How to Build Your Radio Receiver" FREE.

Name.....

Address.....

City.....State.....

Check here if you want the \$2.00 offer of POPULAR RADIO with "How to Build Your Radio Receiver" and Technical Service Bureau privileges for 7 months only.

B ELIMINATORS

Assured Success with
New Type Tubes and



Transformers



Designed especially for operation with the new Filament and Non-Filament Tubes, Dongan Transformers and Chokes are most essential parts of the remarkable new B-Eliminators. These new Eliminators are thoroughly indorsed by Cockaday and other authorities.

Names famous in the industry are found on these new type tubes. Likewise Dongan—long a leader in the production of quality transformers—shares in this achievement.

Chokes



ORDER BY NUMBER

Prices and Specifications

No. 509	Full wave	For Raytheon Tubes
No. 537	Full wave U X 213	For R.C.A. Tubes
No. 537	Half wave C X 313	For Cunningham Tubes
No. 538	Half wave U X 316B	For R.C.A. Tubes
No. 538	Half wave C X 216	For Cunningham Tubes

List \$7.00

CHOKES

No. 514	20 henry
No. 506	30 henry
No. 539	50 henry

List \$5.00

Other Special Transformers and Chokes for both A and B Eliminator Requirements

Build your B-Eliminator with Dongan Transformers and Chokes. See your dealer or send check or money order Now. Shipments made same day order received.

DEALERS

Get your share of this business.
Full details upon request.

MANUFACTURERS

We can serve you on any quantity.
Prices on request.

Dongan Electric Manufacturing Co.

2983 Franklin Street, Detroit Mich.

Transformers of Merit for 15 Years



Trumpets

Timbre of brass and thunder of trombone! Out over mountain and prairie, through storm and sunshine, it is carried on the waves of the air from the steel towers of the broadcast station. And in your home it rings out clear and strong — held fast to all the purity of the original by the marvelous power of Rauland-Lyric.

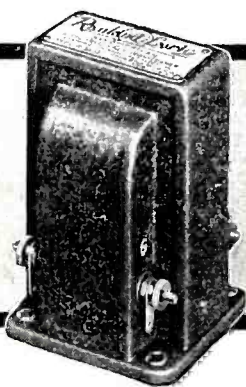

Rauland-Lyric is a laboratory-grade audio transformer designed especially for music lovers. The price is nine dollars. Descriptive circular with amplification curve will be mailed on request. All-American Radio Corporation, 4201 Belmont Ave., Chicago.

Rauland-Lyric
AN
ALL-AMERICAN
TRADE MARK
TRANSFORMER
The Choice of Noted Music Critics

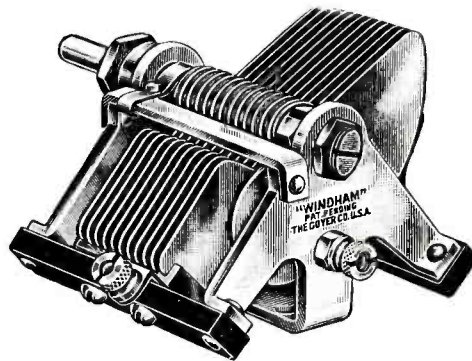

Small, Rigid, Durable

The New "Windham"

Station Separating CONDENSER

A NEW { STANDARD OF EXCELLENCE
MEASURE OF WORKMANSHIP
DEGREE OF SATISFACTION

For Those Who Are Seeking Better Things in Radio

Let us tell you more about this superior condenser that sells at a price within the reach of all

Desirable territory may be had, if you write today

THE GOYER COMPANY

Willmantic, Conn., U. S. A.



SOLD under a positive guarantee—you take no chances when you buy EMPIRE-TRONS—no finer tube made! Retail in U. S. A. at \$2.50. If your dealer cannot supply, write us.

EMPIRE SPEAKERS

Beautiful in design; scientifically constructed; acoustically correct. Made in all popular models and crystalline finishes. Retail at \$13.50 up. We supply fibre horns to manufacturers of Loud Speakers at special prices. Inquiries solicited.

EMPIRE LOUD SPEAKER UNITS Phono-Speakers

Equal to any Unit on the market.
Retail—\$6.50.

Write for Illustrated Folder "P"

Empire dealers are the leaders in every field
Distributors Wanted—Write for prices

Amer. International Trading Co.

24-26 Stone St., New York

Cable Address "Stanmarks"



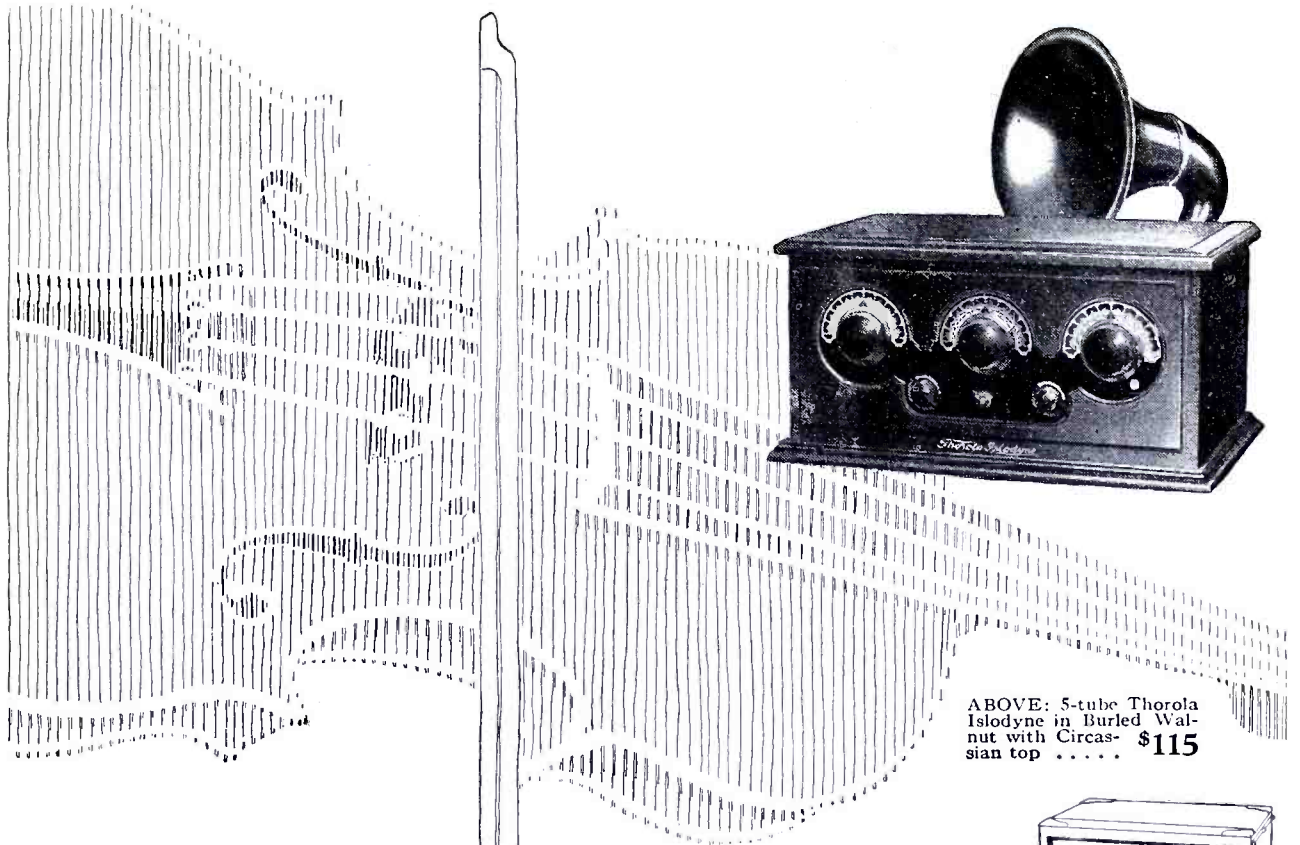

ABOVE: 5-tube Thorola Islodyne in Burled Walnut with Circasian top \$115

The Name of Music

Because it so clearly meant *Music* and natural speech, Thorola from the very first was a great name in radio. The loud speakers which established Thorola now lead by an increased margin, with their new technical refinements such as the self-harmonizer; with their new burnished Bakelite horns, the largest forms of this material ever produced; and with still finer beauty, exemplified by the identifying golden throat-band.

Only when it became possible to produce a complete radio receiver of similar artistic perfection, was the 5-tube Thorola Islodyne sponsored. It is the only radio set with Thorola Low-Loss Doughnut Coils. They *isolate* power,

concentrating upon one chosen set of signals only—the crux of selectivity. Full power applied without interference yields the strength that alone pierces distance and rolls up volume. Gone are “pick-up,” intercoupling, excess “feedback”—but Thorola Islodyne owners do not even know the unstable, temperamental old elements of radio.

For them there is Thorola tone which reflects their high taste; range worthy of pride; uniformity of results that forestalls embarrassment! Have a demonstration—at your dealer’s—and in your home every night.

REICHMANN CO., CHICAGO

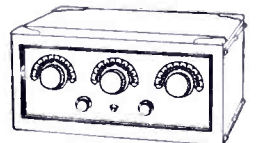

5-Tube Thorola Islodyne in smart Thorocco Finish \$85

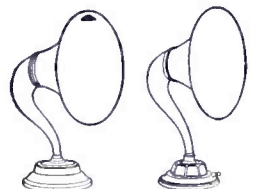

Thorola 4 Speaker \$25

Thorola Jr. Speaker \$15

Islodyne action is based on Thorola Low-Loss Doughnut Coils. They bring many Thorola advantages to other receivers



Set of 3 Coils . . . \$12

Per Coil \$4

Thorola Low-Loss Straight Line Frequency Condensers can also be bought separately \$5.50 and \$6

Thorola Golden Audio Reproducing Transformer \$4.50

Thorola

I S L O D Y N E

All apparatus advertised in this magazine has been tested and approved by POPULAR RADIO LABORATORY

Morrison

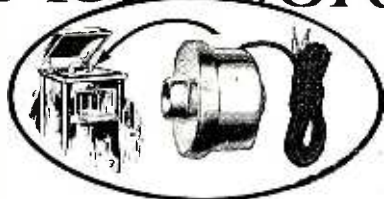

Loud Speaker

Mocking Bird Unit

Patented

Price \$7.50

All fans remember the pioneer of adjustable units—Morrison Model C. For 3 years this unit was a standard of comparison. In trend with radio's great growth Morrison now offers the Mocking Bird Unit, the peer of all units.

You cannot equal the tone reproduction of the Mocking Bird Unit attached to the tone arm of your phonograph. Adjustment of volume to suit your taste requires only a slight turn of the little dial on the back of the unit. Radio assumes new delights—purity of tone and remarkable volume are marvelous.

If your dealer cannot supply you send check or money order to factory or we will ship C. O. D.

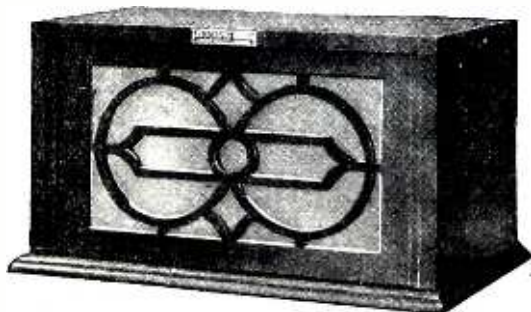

The Mocking Bird Cabinet

The handsome Mocking Bird Cabinet at \$30 list is a real musical masterpiece. Morrison Mocking Bird Units and Cabinets at most good dealers.

Set Mfg's

Attractive quantity prices on Units to build into your Sets.

Dealers

Morrison has always been a merchandising leader. New schedule of discounts ready—write or wire.

Morrison Laboratories Inc.
345 E. Jefferson Ave., Detroit, Mich.

Oh boy
KESTER
Resin Core
Radio SOLDER

Sure is Safe and Simple
APPROVED BY RADIO ENGINEERS
A GENUINE SOLDER
CHICAGO SOLDER COMPANY
4221 Wrightwood Av., Chicago, U.S.A.

Originators and World's Largest Mfrs. of Self-Fluxing Solder.
OUR DEALER CAN SUPPLY YOU!

ASK COCKADAY

POPULAR RADIO maintains for the benefit of its readers a Technical Service Bureau and Laboratory, under the personal supervision of Laurence M. Cockaday which will, without charge, answer by personal letter any question, problem or request for information submitted by a subscriber. This service is, however, also available to readers, other than subscribers, at the very nominal rate of 50 cents the inquiry.

It is possible that your individual problem has been covered in an issue of POPULAR RADIO, and so as an aid to you we endeavor to keep a supply of back numbers in stock. The condensed index below gives a few of the subjects that have appeared recently, look this list over and if the information you want is covered, we will be pleased to supply back numbers at 35c. a copy.

August, 1925

- “Motion Pictures” by Ether Waves.
- A New Type of Hornless Loudspeaker.
- How to Build a 5-Tube Radio-Frequency Set with Simplified Control.
- Trouble Shooting.
- Hints for Amateurs.

September, 1925

- How the Air Affects Radio.
- When You Turn Your Dials.
- Useful Charts for Amateurs.
- Call Letters That Have a Past.
- Broadcasts

October, 1925

- How Earth Magnetism Affects Radio Waves.
- How to Improve Broadcast Reception.
- What Makes a Low-loss Coil?
- How to Build the New 8-Tube Superheterodyne with a Single Control.

POPULAR RADIO

Department 118

627 West 43d Street - - New York

All apparatus advertised in this magazine has been tested and approved by POPULAR RADIO LABORATORY



The Mark of quality whether you buy or build!



Manufacturers know by careful testing what fans have learned from experience

A list of some of the prominent radio manufacturers using C-H products

- Acme Apparatus Co.
- American Bosch Magneto Co.
- Astral Radio Corp.
- Boissier Radio Corp.
- Chelsea Radio Co.
- Crosley Radio Corp.
- Dayton Fan & Motor Co.
- Dubilier Condenser & Radio Corp.
- Electrad, Inc.
- Freed-Eisemann Radio Corp.
- Garod Corporation
- Gillfillan Bros., Inc.
- Howard Radio Co.
- Allen T. Hamscomb
- The Keyport Laboratories
- King Electric Mfg. Co.
- LeMor Radio, Inc.
- Magnus Electric & Radio Co.
- Malone-Lemmon Laboratories
- Wm. J. Murdock
- Newport Radio Co.
- The Radio Compak Co.
- R. B. Radio Co.
- Robbins Radio Co.
- Simplex Radio Co.
- R. E. Thompson Co., Inc.
- Workrite Mfg. Co.

YOUR new radio set can have C-H quality whether you buy or build. Today, reliable dealers everywhere carry C-H radio parts because fans have learned by experience to demand this trademark that insures proper design—highest quality at lowest cost.

But most of these dealers also sell radio sets and accessories that incorporate this same high C-H quality. Radio manufacturers have learned by careful testing what fans already know from experience—the economy of good parts.

Whether you buy or build—the C-H trade-mark on the parts of your radio set is a guarantee of satisfaction.

THE CUTLER-HAMMER MFG. CO.

Member Radio Section, Associated Manufacturers of Electrical Supplies

Milwaukee, Wisconsin



The New C-H UX Socket
for the new UX tubes. Same C-H one piece, silver plated, double grip contacts as in standard socket. Heat proof Thermoplas body — terminals cannot loosen under heat of soldering iron.



The Perfected C-H Rheostat
Designed to radio engineers' specifications. Revolving drum type with one hole mounting. All spring tensions adjusted at factory and undisturbed by mounting. Instrument cannot turn on panel. Very small size — less than 3/4-inch back of panel and narrower than standard socket. Operation smooth and quiet. 6 ohms, 15 ohms, and 30 ohms — perfect control for all tubes and their combinations.

CUTLER-HAMMER

Radio Parts for Performance

All apparatus advertised in this magazine has been tested and approved by POPULAR RADIO LABORATORY

ORDER NOW—AND SAVE

Regular Prices in Effect—November 10th

Now before the Fall Season begins you may subscribe for your favorite magazines at greatly reduced rates,

POPULAR RADIO Two annual subscriptions \$5.00 Additional one year gift subscriptions only \$2.50		
*Judge *Popular Radio \$8.00 Reg. For \$5.50	*Cosmopolitan *Good Housekeeping Popular Radio \$9.00 Reg. For \$7.50	Film Fun *Judge *Popular Radio \$10.00 Reg. For \$7.25
Pictorial Review Modern Priscilla Popular Radio \$6.50 Reg. For \$5.10	McCall's Popular Radio \$4.00 Reg. For \$3.50	*Judge *Film Fun *Wit of the World \$10.00 Reg. For \$7.00
Today's Housewife McCall's Popular Radio \$4.50 Reg. For \$3.75	*American Magazine *Woman's Home Companion Popular Radio \$7.00 Reg. For \$5.75	Success Popular Radio \$5.50 Reg. For \$4.00

* Combinations starred (*) must go to one address.

Now before the publishing business is in the full swing of the annual Fall rush, is the time to send in your subscriptions and save money on your magazine purchases for the entire year.

This page represents an opportunity for you to secure your entire season's reading at a substantial cash saving over regular rates. The special combinations above and the representative list at the side should cover all the magazines you are accustomed to read. But if any of your favorites are missing, let us quote prices. You will find our rates as low or lower than you can get anywhere else.

SEND MAGAZINES AS HOLIDAY GIFTS

As most of these combinations can be sent to different addresses, you will find that your friends and neighbors will be glad to have you forward their order with your own that they may take advantage of these very low prices.

If your subscriptions for any of these magazines have not yet expired, your present order will be entered as an extension.

So fill out the coupon below and mail it promptly. These prices will be advanced to regular rates on and after November 10th, 1925.

POPULAR RADIO

627 West 43d Street, New York City, N. Y.

Date.....192 .

POPULAR RADIO, Dept. 112,
 627 West 43d Street,
 New York City, N. Y.
 Enclosed remittance of \$..... is payment in full for the
 magazines ordered on the attached list.

Name.....

Street and Number.....

City..... State.....

(If not a NEW subscription, please mark R after
 the name of the magazine, to indicate RENEWAL.)

Prices for Canada and foreign countries will be quoted on request.

MAKE any selection you wish from the following list, to be sent to different addresses if desired. Remit only the amount shown in the right-hand column, if more than one magazine is ordered. All quotations cover twelve issues to the year unless otherwise specified. POPULAR RADIO may be added to any combination of right-hand figures at \$2.50 for each yearly subscription.

American Magazine.....	reg. \$2.50	for \$2.50
Atlantic Monthly.....	4.00	4.00
Baseball Magazine.....	2.00	1.75
Century Magazine.....	5.00	4.00
Christian Herald (52 issues)...	2.00	1.50
Collier's Weekly (52 issues)...	2.00	1.75
Cosmopolitan Magazine (Hearst's International)....	3.00	2.50
Delineator.....	2.00	1.50
Designer.....	1.50	1.10
Etude (Music Magazine).....	2.00	1.60
Field and Stream.....	2.50	2.25
Film Fun.....	2.00	1.75
Forbes Magazine (24 issues)...	5.00	4.50
Golden Book.....	3.00	2.75
Good Housekeeping.....	3.00	3.00
Harper's Bazar.....	4.00	4.00
Harper's Magazine.....	4.00	3.50
House and Garden.....	3.50	3.25
House Beautiful.....	3.00	2.75
Judge (52 issues).....	5.00	4.25
*Ladies' Home Journal.....	1.00	1.00
McCall's Magazine.....	1.00	1.00
Modern Priscilla.....	2.00	1.75
Outlook (52 issues).....	5.00	5.00
People's Home Journal.....	1.00	.80
Pictorial Review.....	1.50	1.50
Popular Radio.....	3.00	2.50
Popular Science Monthly.....	2.50	2.50
Q. S. T.....	2.00	1.85
Radio.....	2.50	2.00
Radio Broadcast.....	4.00	3.50
Radio Digest (52 issues).....	5.00	4.50
Radio News.....	2.50	2.25
Radio World (52 issues).....	6.00	5.00
Review of Reviews.....	4.00	2.75
*Saturday Evening Post.....	2.00	2.00
Science and Invention.....	2.50	2.25
Screenland.....	3.00	2.00
Snappy Stories (24 issues)....	4.50	4.00
Success.....	2.50	1.75
Sunset Magazine.....	2.50	1.90
Theatre Magazine.....	4.00	3.75
Today's Housewife.....	.50	.50
Vogue (24 issues).....	5.00	4.50
Wit of the World.....	3.00	2.50
Woman's Home Companion.....	1.50	1.50
World's Work.....	4.00	3.50

For Boys and Girls

American Boy.....	reg. \$2.00	for \$2.00
American Girl.....	1.50	1.40
Boys' Life.....	2.00	1.75
Boys' World (52 issues).....	.60	.60
Child Life.....	3.00	2.50
Every Child's Magazine.....	1.50	1.25
Every Girl's (10 issues).....	1.00	.95
Everyland (10 issues).....	1.50	1.40
Girls' Companion (52 issues)...	.60	.60
John Martin's Book.....	4.00	3.50
Junior Home Magazine.....	2.50	2.10
Kindergarten-Primary (5 issues)	.75	.70
Little Folks.....	2.00	1.60
St. Nicholas.....	4.00	3.50
Young People's Weekly (52 issues).....	.85	.85
Youth's Companion (52 issues) "	2.00	2.00

*These magazines do not club but may be added to any combination at the price shown.

All apparatus advertised in this magazine has been tested and approved by POPULAR RADIO LABORATORY

A REAL RADIO SET

for \$27.27

Built Around

THE HEATH CONDENSER

Designed by Citizen's Radio Call Book Laboratory

NOW you can build a super-efficient radio set at an extremely low cost.

The well known performance of the Heath Condenser caused the Citizens Radio Call Book Laboratory to design a radio set featuring this remarkable Condenser. There are two points of vital interest about the **HEATH CONDENSER**—

1. Permanent Flat Plates—stamped under huge presses to absolute flatness and tempered to prevent warping.
2. A micrometer geared vernier that reduces ordinary adjustments to hair breadth distinction.

To each purchaser of a Heath .0025 Variable Condenser we are giving a complete set of plans, and instructions on how to build this high quality, low cost radio set. See your dealer and get yours today, or if your dealer cannot supply you, order direct, giving your dealer's name.

HEATH RADIO AND ELECTRIC MFG. CO.

206-210 First St.

Newark, N. J.

Manufacturers of

HEATH CONDENSERS

HEATH SOCKETS

HEATH DIALS

HEATH RESISTANCE COUPLED AMPLIFIERS

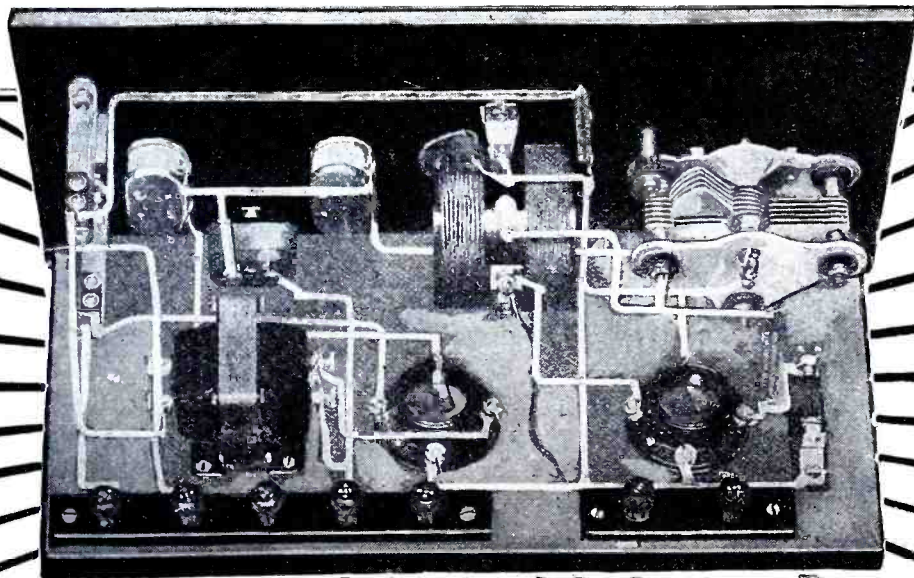

All apparatus advertised in this magazine has been tested and approved by POPULAR RADIO LABORATORY

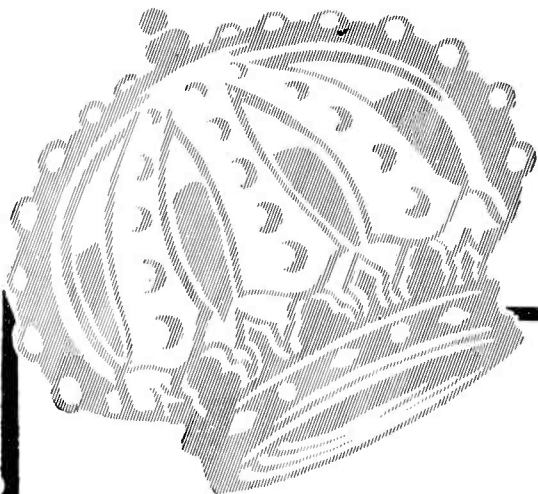

KING

IN RADIO

TONE, full and clear—lifelike reproduction—beauty which blends with the other furnishings and at the same time holds its distinctiveness—selectivity which enables you to tune out troublesome local stations—freedom from noise and distortions, easy operation, reliability — these are some of the outstanding features of "King In Radio" Receivers.

They are made in the two circuits proven best both by the judgment of engineers and public demand—

King-Hinners Neutrodyne Receivers
King Five Broadcast Receivers

Both are offered in console, built-in reproducer and plain table type models in two-tone American walnut or two-tone dark mahogany.

Prices from \$75 to \$250.00

Ask your dealer to demonstrate "King In Radio." Compare it with any other receiver for tone and beauty. It is the only way you can appreciate it.

KING QUALITY PRODUCTS, Inc.
BUFFALO, N. Y.

Jobbers and Dealers:

"King In Radio" products are backed by an extensive national advertising campaign.

The "King In Radio" sales franchise is most liberal. Write for full information.

KING
NEUTRODYNE
HINNERS

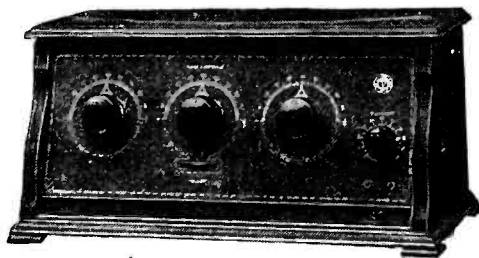

King Five
Broadcast Receiver
Model 30

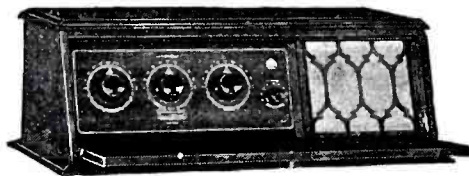

King Five
Broadcast Receiver
Model 30S



King-Hinners
Neutrodyne
Model 25C



All apparatus advertised in this magazine has been tested and approved by POPULAR RADIO LABORATORY

Before You Buy Condensers—

No condenser is better than its bearings. Before you buy examine a B-T Condenser. Note how easily and quick the bearings can be adjusted for wear without disturbing the plate alignment, or changing capacity. See the die cast construction of rotor and stator and consider the lower resistance due to this type construction.

Reflect on the care in design and construction evident in this condenser and you are sure to buy a B-T.

Three types: Straight Line Wave Length—
Straight Line Frequency and Tandem.

Write for Literature.

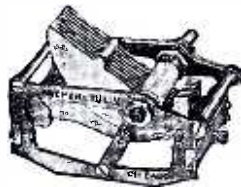

The Newest and Best in Radio

The newest and best in circuits and apparatus is shown in "Better Tuning".

Whether you own a set or not, whether you are going to build or buy, you are sure to find this booklet the biggest dime's worth in radio.

Postpaid on receipt of ten cents.

BREMER - TULLY MFG. CO.

532 S. Canal Street

Chicago, Illinois

All apparatus advertised in this magazine has been tested and approved by POPULAR RADIO LABORATORY

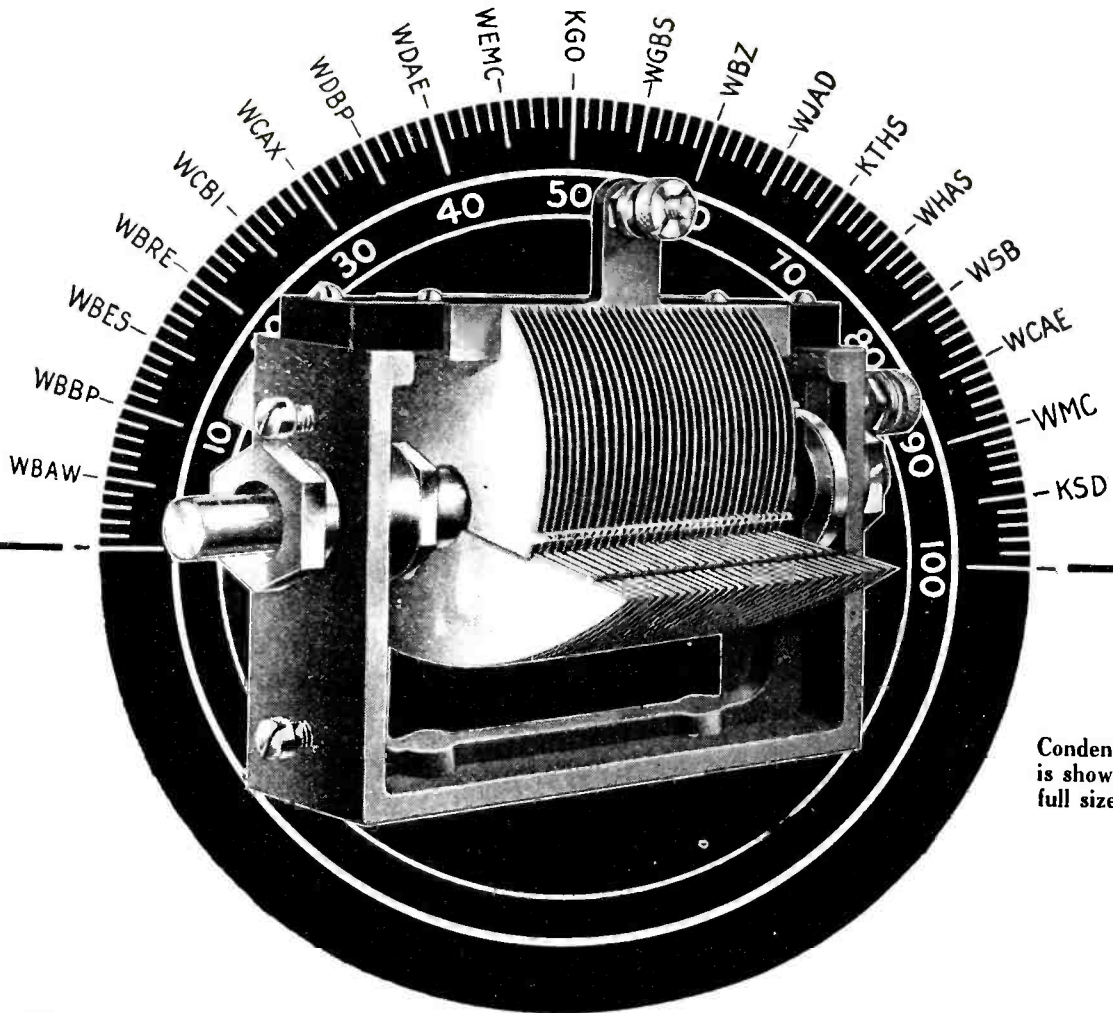

Condenser is shown full size

Smallest Uniform Frequency Condenser—Easily fits into present sets

Full size illustration above shows these condensers are but 2 1/4" with plates fully extended—half to a third the size of others. Increase the selectivity of your receiving set and do away with crowding of station readings—85 out of 100 usually come below 100 on dial—by using Samson Uniform Frequency Condensers.

Samson Uniform Frequency Condensers

the precision of a fine instrument to 1/10,000 inch tolerance, silver plated all over for high surface conductivity and—in addition—have gold plated rotor and stator plates to prevent oxidization. This grounded rotor type instrument has a minimum capacity of 12 mmf., and losses lower than most laboratory standards.

Samson Uniform Frequency Condensers are built with 500 mmf., \$7.00 350 mmf., \$6.75 250 mmf., \$6.50

SAMSON ELECTRIC COMPANY

Manufacturers Since 1882

Sales Representatives in Thirty Leading American Cities

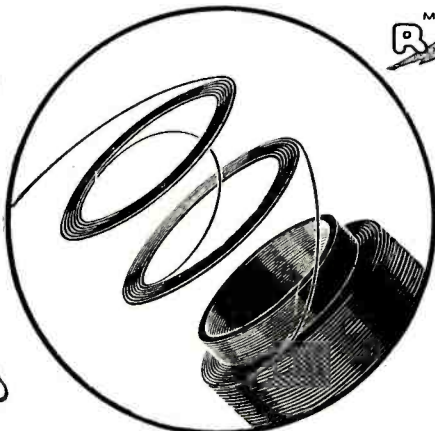
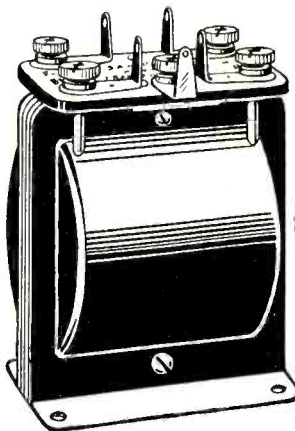

The winding trail to true amplification taken by many electrical engineers, radio engineers, college professors, and employees of public service corporations who know is the helical winding found only in

Samson HW-A1 AUDIO FREQUENCY Transformer

This winding brings out the rich low tones other transformers stifle because of its minimized distributed capacity and leakage effects with consequent increased efficiency and high uniform amplification over entire audible range. Two ratios, 6:1 and 3:1.....\$5.00

All apparatus advertised in this magazine has been tested and approved by POPULAR RADIO LABORATORY



INDUCTO COUPLER

Price \$1.85

James L. McLaughlin, the authority on superheterodyne design recognized the superiority of Precision Coils when he recommended the Inducto Coupler for use in his One Control Superheterodyne. The Inducto Coupler is for use where a split winding coil is desired.

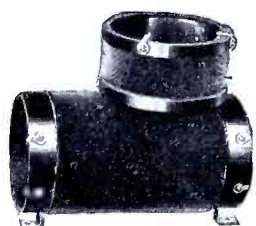

COCKADAY COIL

Price \$5.50

Because the success of his 4-circuit tuner so largely depended on the efficiency of the coil, Cockaday in specifying the Precision Cockaday Coil, paid a great compliment to the marked accuracy and efficiency of Precision Coils.



R-F COUPLERS

Price \$2.50 each

This highly efficient coil is one of the finest radio frequency coils on the market. The hard rubber core is octagonal in shape, with the sides concave, permitting the wire to touch at only eight points. This gives a coil that is 90% air core and yet having the rigidity of one wound on a solid surface cylinder.

For the Critical Part—
A Precision Coil

The New COCKADAY "B" Battery Eliminator Kit

Raytheon Plate Supply Unit

PRECISION Kits for building the marvelous new Cockaday AC "B" plate supply unit are ready to be shipped the day order is received. No hum. Steady, constant supply of current. Indefinite life.

Made of the finest standard quality parts exactly as in Mr. Cockaday's laboratory model:

1 Raytheon Tube	\$6.00
1 Acme Transformer	7.00
2 Acme 30 henry Choke Coils	10.00
2 Tobe shielded, high voltage paper Condensers 2 mfd.	3.50
2 Tobe shielded, high voltage paper Condensers, 4 mfd.	7.50
1 Tobe shielded, high voltage paper Condenser, 1 mfd.	1.25
2 Tobe shielded, high voltage paper Condensers, .1 mfd.	1.40
1 Federal Socket, type 16	1.00
1 Benjamin Cleat Receptacle, type 940135
1 Bradleyohm No. 10—100,000 ohms.	2.00
1 Bradley Unit Resistance—7,500 ohms75
1 Electrad Resistance Mounting35
1 Hardwood baseboard, 7 x 20 inches	.50
1 Composition binding post strip, 1 x 7 inches25
1 Pair small brass brackets20
Total	\$42.05

Precision Kits are absolutely guaranteed. Complete Popular Radio constructional blueprint is included in each kit.

Send money order today for above amount or we will ship the kit C.O.D. upon receipt of your order. Postpaid anywhere in the U.S.A.

Dealers write for information about the complete Precision Line.

PRECISION COIL Co., INC.
209 Centre Street, New York, N. Y.

Marvelous Tone Quality

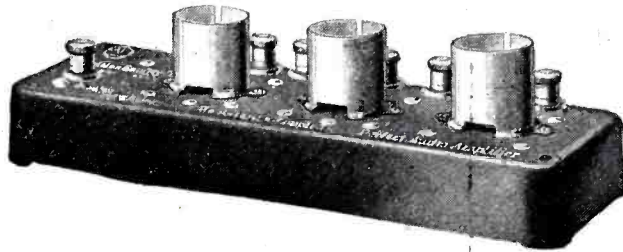

Enjoy Amplification Without Distortion by Installing a Bradley-Amplifier

RADIO EXPERTS all agree that the resistance coupled amplifier gives the most faithful reproduction of all tones received from the broadcasting station. In the Bradley-Amplifier there are no transformers to choke out the high or low frequencies so essential for perfect reproduction of all instruments.

With the Bradley-Amplifier a violin sounds like a violin and a flute sounds like a flute. The perfectly-balanced Bradleyunit resistors, neatly concealed in the base, transfer the music from tube to tube with perfect clarity. They do not age or deteriorate. They need no adjustment.

The Bradley-Amplifier is so extremely compact that it can be tucked within any radio set. It is all ready to connect—no technical knowledge is required. It is just as easy to install as a B-battery. Try one, tonight, and enjoy amplification without distortion.

Note the carefully-concealed wiring, Bradleyunits, and condensers. Nothing exposed except tube sockets, which will accommodate the new UX tubes.

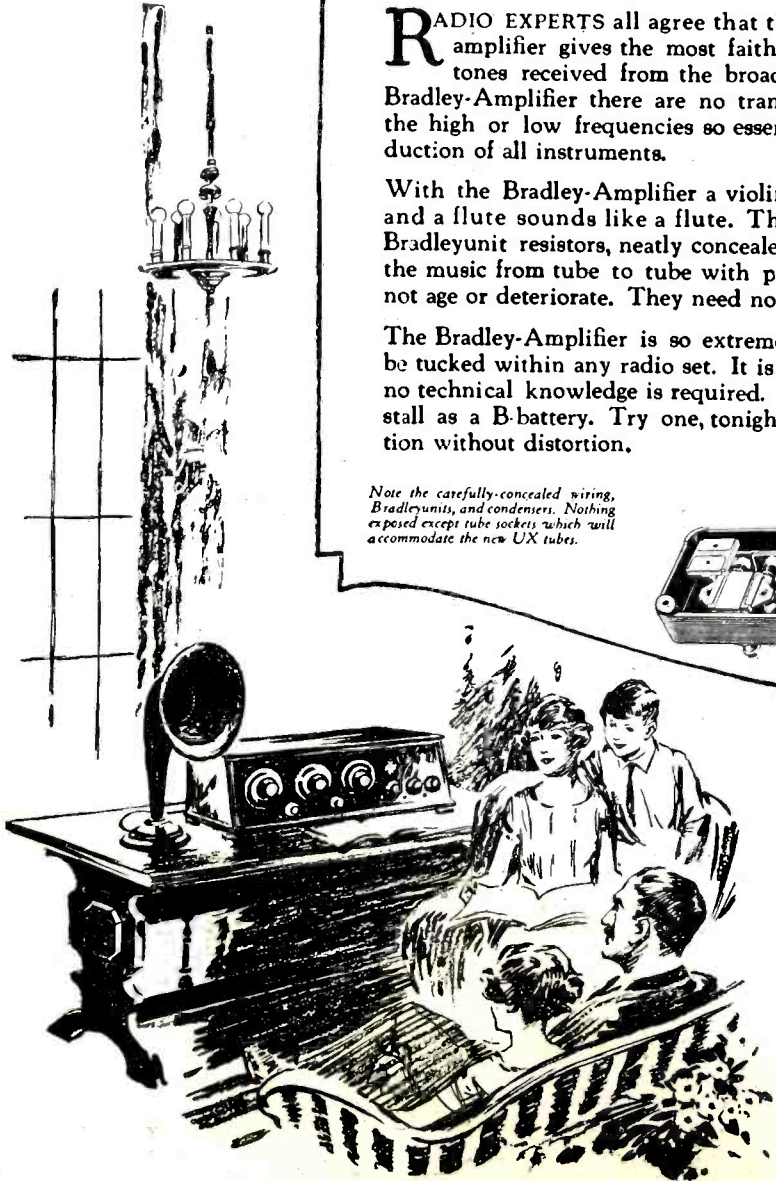
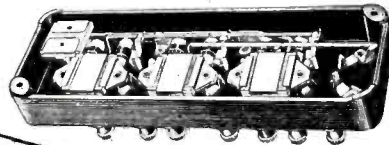

Use the

Bradley Amplifier

PERFECT AUDIO AMPLIFIER

Manufactured by

Allen-Bradley Co.

Electric Controlling Apparatus

276 Greenfield Avenue

Milwaukee Wisconsin

A Real Long Range Crosley Receiving Set, \$9.75

Do not assume from its very interesting price that this very unusual Crosley set is a toy. Its impressive performance alone entitles it to serious consideration.

Heretofore, the \$10 radio was designed only for local reception. Now the Crosley Pup extends the entertainment radius to 1500 miles under ordinary conditions. Place it beside some costly multiple-tube set and operate the dials. Both tune through local stations sharply. Both get the same programs with equal ease and clarity. Both let you tap the infinite enjoyment coming through the air. There is only one difference—the Pup operates with head phones instead of a loud speaker.

The Pup is the newest Crosley set with a price that reflects the volume-production economies of the world's largest builder of radios. It is substantially constructed and permanent in every regard. Its design is an improvement of the famous Crosley one tube set with which Leonard Weeks of Minot, N. D., heard the MacMillan Polar Expedition while the rest of America listened in vain. Almost overnight the Pup has become the most popular Crosley set ever offered. It is being bought for youngsters whose curious fingers cannot resist the lure of dials and switches; for the cook, the maid, the old folks back home, and for shut-ins. Traveling men are selecting it because of its easy portability, and radio enthusiasts to have inexpensive check on their larger sets. Hear it once—and you will own one too!

In addition to the Pup, there is a Crosley for every price and preference. Operating 1, 2 and 3 tubes, these are encased in handsome Crosley-built cabinets and range in price up to the Super-Trirdyn Special which retails for \$60. Each will deliver the superlative performance that has made the word "Crosley" a hall mark of radio perfection in millions of homes throughout the world.

THE CROSLLEY RADIO CORPORATION CINCINNATI, OHIO

Owning and operating W L W, first remote control super-power broadcasting station



**Crosley 3 Tube
52 S. D.**

Mahogany finished cabinet, sloping panel. Holds all batteries... \$32.50



**Crosley Super-Trirdyn
Regular**

More compact than the Special Model—but exactly the same superb performance... \$45.00



**Crosley Super-Trirdyn
Special**

Matchless performance and exquisite beauty combined. Solid mahogany cabinet with popular sloping panel... \$60.00

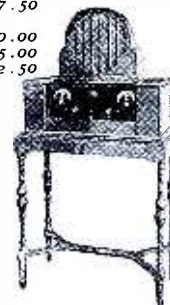

Crosley De Luxe Combination

Musicone De Luxe \$27.50
Super - Trirdyn
Special..... 60.00
Console Table..... 25.00
Complete..... 112.50



**Crosley 2 Tube
51 S. D.**

A true long range set, easy to tune and handsome in appearance... \$23.50

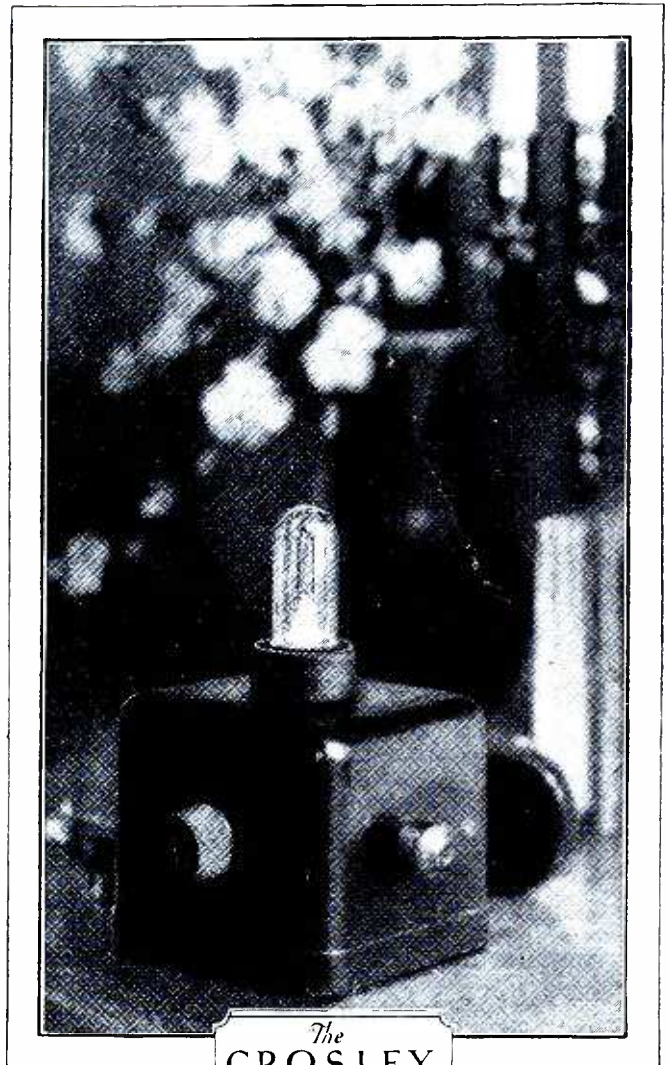

The
CROSLLEY
Pup - \$9.75

Crosley manufactures receiving sets which are licensed under Armstrong U. S. patent No. 1,113,149 and priced from \$9.75 to \$60.00 without accessories. None of the prices include batteries, tubes, headphones, etc. Add 10% to all prices west of the Rocky Mountains.

CROSLLEY · RADIO

B E T T E R · C O S T S L E S S

PRESS OF WILLIAM GREEN, NEW YORK

OPERADIO

The Original Self-Contained Radio

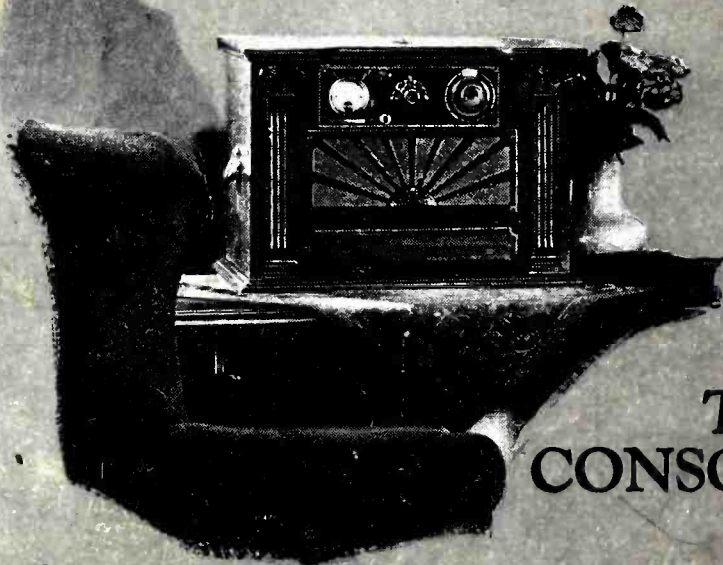

The CONSOLETTA

Operadio Convenience in a Cabinet of Classic Beauty

The tremendous popularity of the Operadio—which has increased radio enjoyment by making it available anywhere—has led to this beautiful six tube cabinet set for home and apartment use.

The set in its compact mahogany case may be easily carried to any

room of the house. It is entirely self-contained; no outside wires or connections being used. The special loop supplied with the set may be used either concealed within the cabinet or exposed, plugged into the top when extremely directional effects are desired. Write for further information.

THE OPERADIO CORPORATION, 8 South Dearborn St., Chicago, Ill.
Built by the manufacturers of the famous Operadio Portable.

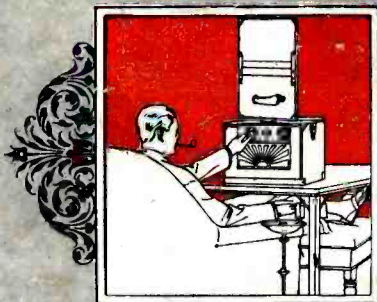

The Operadio Portable may be used anywhere indoors or out, upstairs or down.



It is a complete, self-contained set, and may be closed and carried anywhere.



For those who desire a furniture model, the Tudor Cabinet is available to house the set.