

Popular Radio

Edited by KENDALL BANNING

★ DECEMBER
1924

25¢



In this Issue —

**How to Build a Non-radiating
7-Tube Super-heterodyne Receiver**

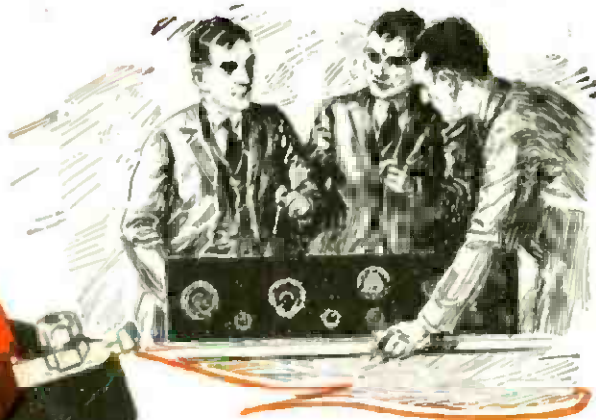
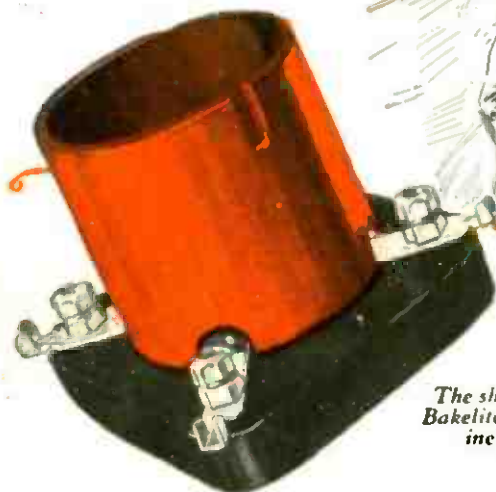

The shell is ORANGE Bakelite—the base genuine Thermoplas

The More You Know About Radio the Better You Will Like This Socket

If ever a device were designed to increase the efficiency of all receiving sets, it was this new socket by the Master Builder. Radio Engineers praise it—new set builders marvel at its ease of installation and the clear, loud reception obtained that bespeaks the absence of losses—many old-timers have even rewired their sets to establish new distance records and enjoy clearer reception with this better socket.

You'll like its construction, embodying a minimum of both insulation and metal—capacity absolutely minimized *without sacrifice of mechanical strength*. And its base of ebony Thermoplas in beautiful color contrast with the thin shell of orange Bakelite adds greatly to the appearance of any set as the construction does to its efficiency.

You'll like its contacts (the source of losses and noise in most sockets); they are radically new in design, formed of phosphor bronze and *silver* plated—because the contact resistance of silver does not increase as it stands exposed to air. Then, too, electrical losses are minimized by providing maximum spacing between terminals, both in insulation and in the air.

You will like the way the tube is inserted and removed without turning—which prevents twisting the bulb from its base. You will like its appearance—its small size—its neatness. You will like its silvered posts with slotted nuts that are fastened *well* with either screw driver or wrench. You will like the way these terminals are arranged for soldering—extra long so that they may be bent down where under-wiring is desired—and provided with ears to hold the wire in place for soldering. And best of all you will like the price, 90¢. *This socket that meets the specifications of the most exacting radio engineer costs no more than most of those on the market today!* If your dealer has not yet been stocked, you can be supplied direct from factory at regular price plus 10¢ for packing and postage.

THE CUTLER-HAMMER MFG. CO.

Member Radio Section, Associated Manufacturers of Electrical Supplies
Works: MILWAUKEE and NEW YORK

"Built By The Master Builder"



These Exclusive Features Assure Better Reception

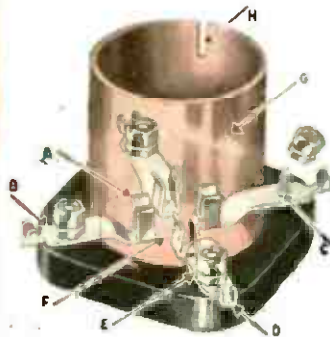

A
Perfect contact. Both sides of tube prong cleaned when inserted—no contact or wear on soldered end.

B
All metal parts *silver* plated—perfect contact for the life of the set. Silver may tarnish but its contact resistance does not change.

C
One piece contact construction. The binding post is NOT a part of the circuit—the wire to the socket always touches the contact strip which carries the current direct to the tube prong—no joints to cause losses.

D
Convenient terminals for soldering—full length to allow bending down for under-wiring. Ears hold wire in place for soldering.

E
Extra handy binding posts—tight connections with either wrench or screw-driver. Lock washers hold terminals rigid.

F
Wide spacing of current-carrying parts both in air and insulation—true low-loss construction.

G
A minimum of both metal and insulation for low capacity. Shell of thin Bakelite—the base of genuine Thermoplas.

H
The tube is held in place by merely a vertical motion—no twisting to separate bulb from base.

The attractive orange shell helps identify this better socket, but the famous C-H trade mark both on the socket and on the orange and blue box is your genuine protection.



RADIO SOCKET

Table-Talker



What greater gift?

Fun for the holidays—for all the year. Fun for the fellow who gets the gift—and for the family. Give it all— give a Table-Talker.

You're sure of its tone. Sure that it will always be loud yet pleasant, because its horn is matched to the unit. It reproduces every word, every note with vivid clarity—it makes the joys of radio real!

\$10
It needs no extra batteries

Brandes

Superior Matched Tone Headset \$6
\$7 in Canada

Table-Talker \$10.
50¢ extra west of the Rockies
In Canada \$12.50

The name to know in Radio

Copyrighted by C.Brandes, Inc. 1924

Navy Type Matched Tone Headset \$8
\$9 in Canada

POPULAR RADIO

EDITED by KENDALL BANNING



CONTENTS for DECEMBER, 1924

(Cover design by Frank B. Masters)

VOLUME VI

NUMBER 6

The New Voice of Destiny	FRONTISPIECE
A Sailor Gets the Toothache	Aaron H. Ulm
Broadcasts from Atoms	E. E. Free
The Men Who Made Radio	554
First Instalment	
How to Get the Greatest Value from Your Storage "A" Battery	Arthur L. Kaser
Useful Tips for the Radio Listener	Y. Z. Muts
How the Army Teaches the Code	Paul McGinnis
How to Get the Most Out of Your Ready-made Receiver	S. Gordon Taylor
Simple "How-to-Build" Articles for Beginners ..	Laurence M. Cockaday
No. 4: How to Build a Single-tube, Reinartz-circuit Receiver	
How to Build a Non-radiating 7-tube Super- heterodyne Receiver	Paul Edwards
The "Black Light" Radio	S. R. Winters
A Tube Set That Requires No Batteries	Marshall D. Beuick
How to Use a House Bell Wire as an Antenna ..	William L. Crosby
How to Select Your Audio-frequency Trans- former	Jesse L. Marsten

DEPARTMENTS

"Trouble Shooting"	S. Gordon Taylor
What Readers Ask	Laurence M. Cockaday
In the World's Laboratories	E. E. Free
What's New in Radio Apparatus	Technical Editor
Listening In	Kendall Banning
Hints for Amateurs	Albert G. Craig
Broadcasts	David Lay

VOLUME VI

DECEMBER, 1924

NUMBER 6

Published monthly by Popular Radio, Inc., 627 West 43rd St., New York, N. Y., telephone number Chickering 1906; E. R. Crowe, President; Kendall Banning, Vice-President; H. C. Bodman, Secretary; Douglas H. Cooke, Treasurer; Joseph T. Cooney, Asst. Treasurer. Price 25 cents a copy; subscription \$3.00 a year in the U. S., Canada and all countries within the domestic postal zone; elsewhere \$3.50 a year, payable in advance. The International News Company, Ltd., No. 5 Bream's Bldg., London, E. C. 4, sole distributors in England. Entered as second class matter April 7, 1922, at the Post Office at New York, N. Y., under the act of March 3, 1879. Copyright, 1924, and title registered as a trade-mark by Popular Radio, Inc. Copyright in Great Britain by Popular Radio, Inc., 6 Henrietta St., Covent Garden, W. C., London, England.

Printed in U. S. A.

LAURENCE M. COCKADAY, Technical Editor

E. E. FREE, Ph.D., Contributing Editor

JOHN V. L. HOGAN, Contributing Editor

For advertising rates address

E. R. CROWE & COMPANY, INC.

New York: 25 Vanderbilt Avenue

Chicago: 225 North Michigan Avenue

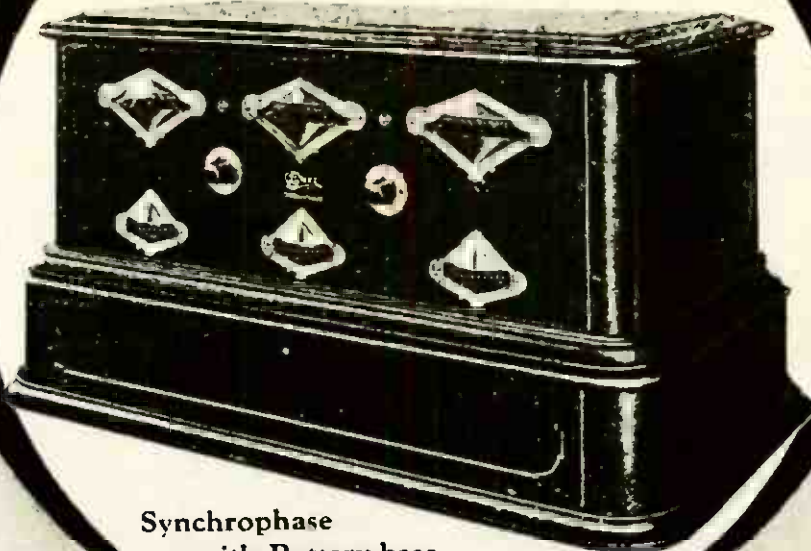

Synchrophase
with Battery-base

GREBE SYNCHROPHASE

TRADE MARK



"Of what use is cleverness
of speech?"
—Confucius

Words, even though select-
ed and phrased with the
greatest deliberation, can-
not do full justice to the
Grebe Synchrophase—and
its performance.

Doctor Wfu



TRADE MARK
REG. U.S. PAT. OFF.

IN THIS outstanding triumph of fif-
teen years of radio development,
a new type of fieldless "Binocular"
coil transformer—unaffected by
local interference—is used for tun-
ing the detector and two stages of
Balanced tuned radio frequency.

The settings for the various broad-
cast stations are equally spaced over
the dials. The S-L-F (straight line
frequency) condensers accomplish
this.

Write for literature

A. H. GREBE & COMPANY, INC.

Van Wyck Blvd., Richmond Hill, N.Y.

Western Branch: 443 So. San Pedro St., Los Angeles, Cal.

All Grebe apparatus is covered
by patents granted and pending.

PAGES WITH THE EDITOR

A FEW days before this present number of POPULAR RADIO went to press, the Editor took a visitor (a man whose acquaintance with radio was largely limited to the raucous-voiced receiving sets that are occasionally found above the entrances of radio shops) into the POPULAR RADIO LABORATORY.

* * *

HIS ears were greeted by a burst of song that not only filled the laboratory with volume, but volume so pure, so clear, and so completely free of any suggestion of the mechanical, that the visitor stood spellbound. He could not believe for a moment that he was not in the actual presence of a great singer.

* * *

"We are just testing out the new eight-tube superheterodyne reflex receiver," explained Mr. Cockaday. "We've been experimenting with it for six months."

* * *

THE test proved a revelation to the visitor—who for the first time in his life had heard a receiver that made him want to own one.

* * *

THAT is the set that will be described in detail with full working plans, in the next number of POPULAR RADIO—for January. The few

who have heard this remarkable instrument have declared that it approaches nearer to perfection than any receiver that has yet been developed, regardless of cost.

* * *

YET the total cost of parts needed for building it (exclusive of batteries, loudspeaker and tubes) is not more than \$90.00.

* * *

THE Editor believes that this new Cockaday receiver will meet instant acclaim throughout the radio world, and that it will establish itself as the most valuable contribution to the radio world that has yet been made.

* * *

"IN the course of a month I skim through several radio magazines, but POPULAR RADIO is the only one I read. It is a sort of Radio Bible. It can be trusted just as blindly as the Bible without knowing all the whys, but only knowing that it represents proved facts."

—REV. GEORGE F. HILL, *Elisabeth City, N. C.*

* * *

No sooner had POPULAR RADIO come out with its article, "Will We Have a Radio Censorship," in November, than a radio censorship storm broke in New York City. And the storm was of special significance because it gave the
(Continued on page 6)



From a photograph made for POPULAR RADIO

A POPULAR RADIO READER JOINS AN EXPLORING EXPEDITION

Do you remember the call for volunteers, issued by POPULAR RADIO a few months ago—a call for a radio operator to sail with a group of scientists, writers, explorers and motion-picture men on a four years' cruise around the world? As a result of that call, Mr. John M. Clayton of Ossining, New York, was finally selected from the hundreds of applicants. Mr. Clayton is an old-time amateur (his call letters were 5BV when he lived in Arkansas before the war, and 5AF-5ZL after the war) who has been actively identified with the American Radio Relay League, the Radio Club of America, the Institute of Radio Engineers and other groups of dyed-in-the-wool radio amateurs. The expedition is scheduled to start from New York some time this coming spring, under the direction of Mr. Barry Buchanan.



For a Merry Christmas—for a merry time every day and for many years to come—give your loved ones a Thompson Radio Receiving Set, a Thompson Speaker, or both.

THOMPSON RADIO

Thompson Radio Receiving Sets and Thompson Radio Speakers deliver the highest quality of simplified and economical radio entertainment. Both nearby and distant radio programs cannot be more faithfully reproduced than with a Thompson Radio Receiving Set. One of the many reasons for the advanced development and perfection in Thompson Radio

products is an organization composed of radio engineers who have been making radio apparatus exclusively ever since "radio" was called "wireless."

The 5-tube GRANDETTE is \$125. The 5-tube PARLOR GRAND, (shown in large picture below) is \$145. The 6-tube CONCERT GRAND, is \$180. Prices are without tubes or batteries. The Thompson Speaker, with conical diaphragm and other special features, is now \$28.

If your dealer does not handle Thompson Radio products, write direct to us for attractive literature and name of dealer near you.

R. E. THOMPSON MANUFACTURING CO.

Manufacturers of Radio Apparatus for the U. S. Army and Navy and many foreign governments



30 CHURCH ST.
NEW YORK, N. Y.
FACTORY:
JERSEY CITY, N. J.

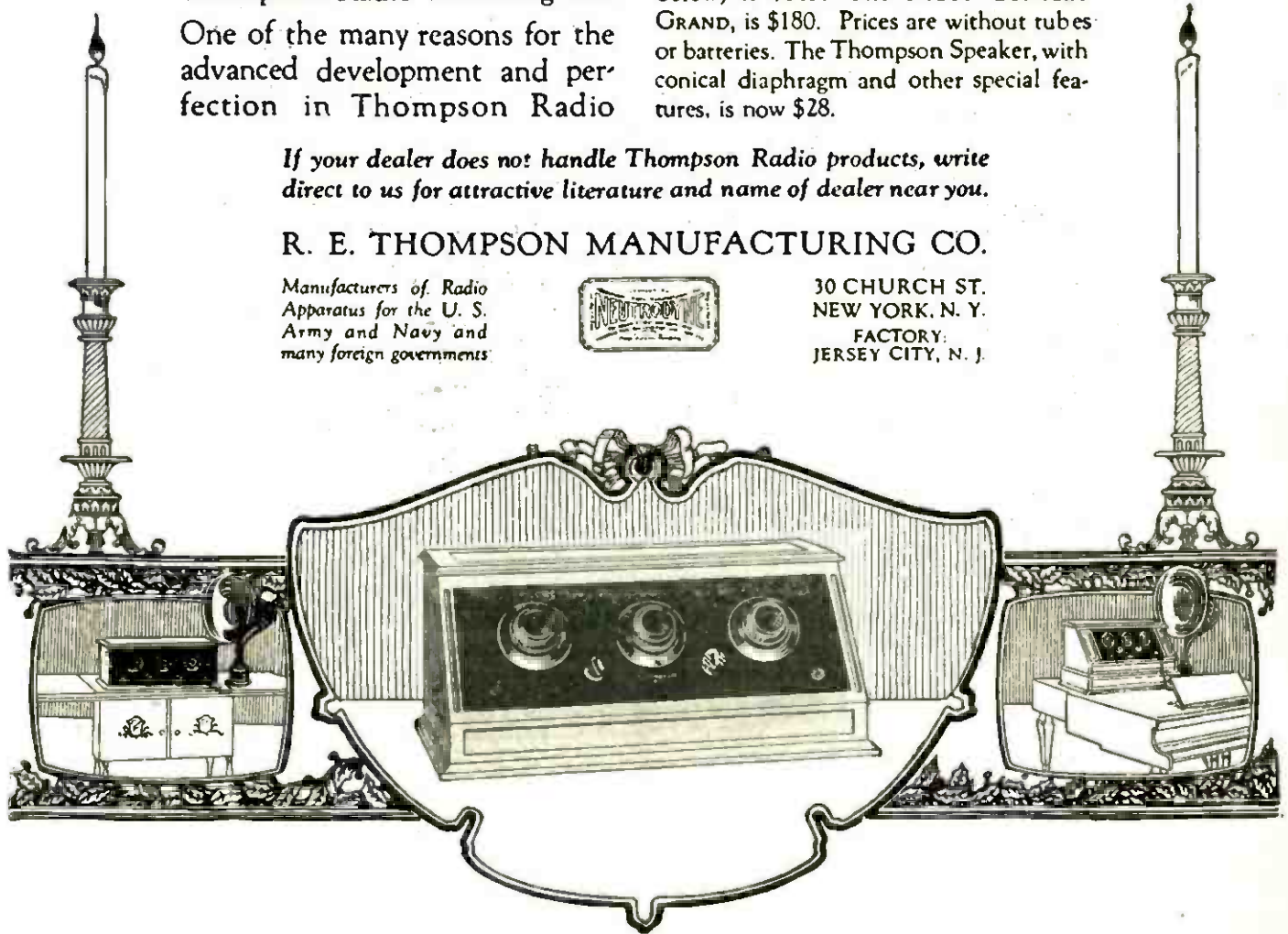

All apparatus advertised in this magazine has been tested and approved by POPULAR RADIO LABORATORY

PAGES WITH THE EDITOR
(Continued from page 4)

radio fans a taste of what may be expected when the government—more particularly the city government—runs a broadcasting station.

BROADCASTING station WNYC was recently opened in New York as a "municipal station," meaning that it is owned and operated by the city government. And the city government at the present time means Mayor Hylan and the Tammany organization.

THE purpose of station WNYC as announced by the Mayor, was, to "keep the people informed about the city's business"—a proper and laudable aim. And in line with this policy, the Mayor broadcast a long statement about the city's rapid transit problems.

It was there that the trouble started.

THE Mayor has ideas about the subject that are not shared by many New Yorkers, and his plans are interwoven with local politics; consequently his remarks were regarded as political propaganda and a vigorous effort was made to broadcast the other side of the case from the same station by the doughty Major General John F. O'Ryan.

BUT the Mayor decreed that the General could not use the municipal station for any such purpose—unless the General submitted his remarks to the Mayor beforehand and had them censored to suit the Mayor's ideas!

It is in precisely this way that a city-controlled station which may be manipulated to serve the political whims of the party in control, is looming as a menace. For the power that can control the broadcasting stations controls a medium of communication that is growing in influence and importance.

POPULAR RADIO does not believe that a censorship of this kind serves the interests either of radio or of the public at large. It does not believe that any group of politicians or reformers or censors or religious cranks or other propagandists should seize radio or any other medium of communication to serve their special and selfish purposes.

AT the present time dangers to radio from this source are in all probability slight. But they are dangers to be watched by all who have the interests of radio at heart, and who still believe that the rights of free speech as guaranteed by the Constitution should be guarded and preserved.

MONTH by month the Cockaday four-circuit tuner is gaining in popularity not only in the United States but throughout the world. "In France," reports Mr. Frederic Delano, POPULAR RADIO's Paris representative, "the four-circuit tuner is now holding the center of the stage."

AND here is a tribute from a four-circuit fan who has built over two dozen of these sets: "I was one of the first to attempt to build the four-circuit tuner of which your radio engineer, Laurence M. Cockaday, is the designer," he writes, "and have yet to see any set that is better. I have built some twenty-five Cockaday sets since then and have never had anyone dissatisfied with his set. It is a set well worth recommending to anyone."

—WILLIAM R. WIPPER,
Maspeth, Long Island, N. Y.

ONE of the Editor's favorite authors is Old Ed Howe of Atchison, Kansas—despite the fact that he is temperamentally indisposed toward radio and other new-fangled notions.

"THE radio greatly encourages our disposition, already too pronounced, to lie," he writes. "In country papers such items as this are distinguishing features:

"George Bartlett last night caught Hong Kong on his radio set and heard every word distinctly."

WHICH reminds the Editor of the somewhat differently phrased comment of Mr. H. C. Bulla of Chester, South Carolina, who observes:

"In a recent issue of your magazine I noticed some comment by Mr. John Keiran of 32 Allegne Street, Roxbury, Massachusetts, who challenges anyone to beat his record with a two-tube set. This item reminds me of one I once read in a poultry magazine, in which a man challenged anyone to beat his egg-record. He claimed to have fed a certain kind of laying mash, and one hen laid eggs so fast they were linked together like strands of beads."

PROBABLY both of these reports are exaggerated.

"I WISH to commend POPULAR RADIO for its stand in keeping advertisers out of the articles in the magazine."

—SAMUEL MELNICK

THIS copy of POPULAR RADIO that you are holding in your hand contains 276 pages. And that is just 204 pages bigger than the first copy of the magazine that made its appearance in May, 1922.

THAT represents a growth of 261 percent in thirty-one months.

AS one reader has observed: "POPULAR RADIO has grown its first teeth—and used 'em!"

Kendall Banning
Editor, POPULAR RADIO

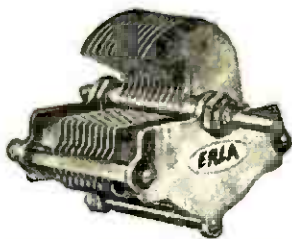

Exclusive features give Erla Miniloss Condensers high efficiency. Dielectric and resistance losses absolutely minimized. Compensating plate form. 5 to 41 plates. priced \$3.50 to \$5.50 each.

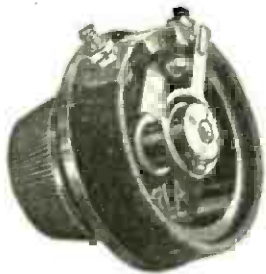

Uncanny smoothness and sensitiveness bespeak the advanced design of Erla Precision Rheostats. Single hole mounting eliminates need for disassembly. 6, 25, or 40 ohm. Price, \$1.10 each.

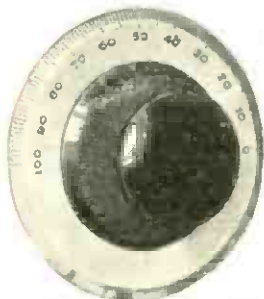

Built for permanent true running; with Bakelite knob shaped for sensitive touch; and highly artistic calibration, Erla dials better any panel. Three sizes for 1/8 shaft. Price, 50c to \$1.25.

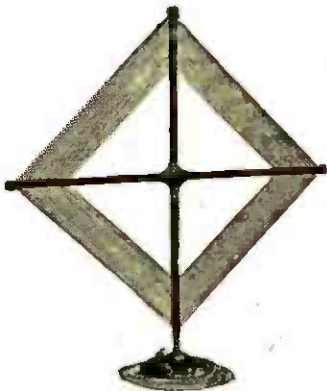

Adding to receiver efficiency is the advanced Erla Loop. Rigidly erected—compactly folded—easy in rotation—beautifully finished. Standard and De Luxe models, \$7.50 and \$10 respectively.



CIR-KIT builds new Supereflex— Greatest of Erla Circuits

Erla led the radio amateur out of the wilderness of circuits. Erla initially introduced exclusive circuit ideas which made radio history, particularly because those ideas have uninterruptedly kept Erla circuits in advance of contemporary radio.

Remarkably significant is the fact that so many thousands of seasoned experimenters, once attracted to Erla circuits, consistently adhere to Erla. So there is a note of finality when Erla now announces the new Erla Supereflex Circuits. They represent highest development of the inherently superior Erla principles, acknowledged responsible for the most powerful circuits ever built, tube for tube.

Bringing these latest and finest circuits within the reach of everyone is the Erla CIR-KIT, effecting not only extreme economy, but also greatest ease of construction. Only

screwdriver and pliers are needed to transform any Erla CIR-KIT quickly and skillfully into the most efficient of radio receivers.

CIR-KIT provides you with everything, including specially designed Erla Synchronizing Transformers, Erla Certified Capacity Condensers, Erla Cushion Sockets, and finally Erla famous Solderless Connectors, banishing all solder difficulties. Each unit and connection is unerringly located through full-size blue-prints; drilled, lettered panel; and stenciled baseboard.

With Erla CIR-KIT you yourself can confidently and proudly put into finished form the highest achievement of Erla radio engineers—Erla Supereflex Circuits. CIR-KIT receivers of one to five tubes are available, in loop and antenna types. See the Erla dealer, or write direct, mentioning your dealer.

ELECTRICAL RESEARCH LABORATORIES
Department R, 2500 Cottage Grove Avenue, CHICAGO

ERLA

Circuits of Certainty

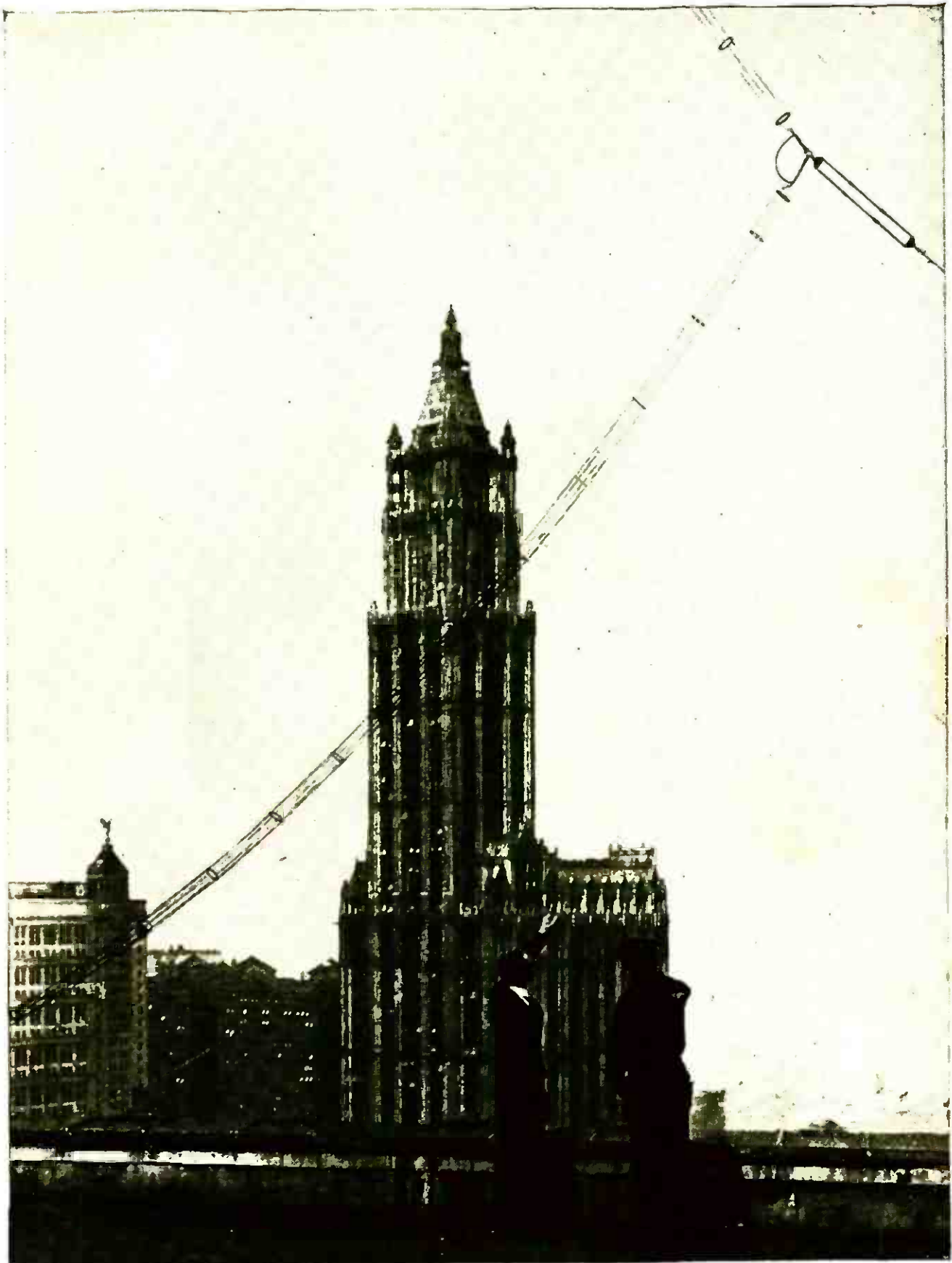

International

The New Voice of Destiny

"Radio has passed from the field of an adventure to that of a public utility. Nor among the utilities is there one whose activities may yet come more closely to the life of each and every one of our citizens, nor which holds out greater possibilities of future influence, nor which is of more potential public concern. It must now be considered as a great agency of public service."

—HERBERT HOOVER

Popular Radio

VOLUME VI

DECEMBER, 1924

NUMBER 6



A Sailor Gets a Toothache

How Uncle Sam is throwing a radio net over the waters that surround our country for the protection of men and women who become stricken on ships that do not carry doctors

By AARON HARDY ULM

"Request consultation as to advisability of extraction of infected tooth. *Maranzes.*"

THIS message in international code ticked in at the New York station of the Independent Wireless Telegraph Company at 9 P.M., January 29, last.

A seaman on the steamship *Casey*, a freighter, somewhere on the Atlantic Ocean, had a toothache. The ship's master, Captain Maranzes, had a pair of forceps and evidently was ready if not anxious to use them, but, being a cautious man, he wanted professional direction.

The radio message that he broadcast and which was picked up at New York was telephoned to Marine Hospital No. 70 of the U. S. Public Health Service.

Good medical and dental opinion now frowns on the hasty pulling of teeth even by energetic captains of vessels far from doctors of medicine and dentistry.

Because they do or in this case did, the tooth-aching sailor who was on the *Casey* still has a full set of teeth—and

for the same reason, probably, he now lives.

A few moments after his message of inquiry was picked up at New York, Captain Maranzes received the following reply:

"Request information as to location and number of teeth, condition of gum, if there are any cavities in teeth and general symptoms of patient. *Sprague.*"

The signer of this message was E. K. Sprague, Medical Officer in charge of Marine Hospital No. 70. It was midnight, however, before further details reached the hospital. They were set forth in the following message:

"One side of jaw badly swollen. Four to five teeth affected. No cavities in teeth. Has been in serious condition and has had fever and partial collapse. Incision was made in jaw and pus discharging. Is now somewhat better. If discharge continues, shall I extract teeth? *Maranzes.*"

Just as the Marine Hospital doctors had suspected, this message disclosed the

fact that the sailor was suffering from more than mere toothache and that he needed remedies other than could be applied with forceps.

They immediately radioed the following advice to the captain:

"Do not extract teeth. Apply continuous hot compresses to cheek. Give five grains aspirin every four hours. Give patient a dose of salts immediately. Wash out mouth every hour with alkaline antiseptic. If no alkaline antiseptic use a teaspoonful of salt to a glass of warm water. Take temperature and pulse every

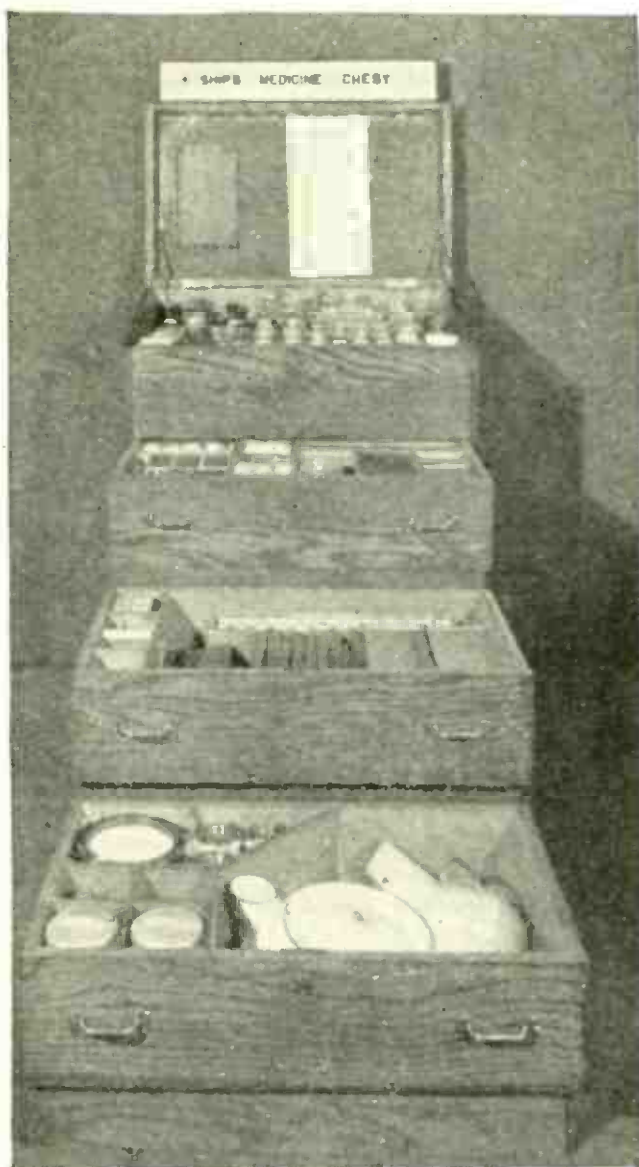

THE SAILOR'S FIRST AID KIT

Legislation is now being pressed to make it compulsory for every ship to carry this standardized medicine chest. As it contains the drugs and medical instruments that are specified in the instructions given by radio, it is a big advantage to the "radio doctor" in treating his patient.

four hours. Keep us informed of condition."

On the succeeding day the patient developed quite serious symptoms as shown by the following message received at the hospital at 7 P.M.:

"Patient shows signs of tetanus, lockjaw. Blood discharge very light color. Very violent at times. One-quarter grain of morphine no effect."

The captain evidently still was thinking of his forceps—for who wouldn't like to pull somebody else's aching teeth?

But he was restrained by the following message from New York:

"Continue treatment previously recommended. Have patience."

He did, and thus on the following evening he was able to radio as follows:

"Patient greatly improved. Thanks for services rendered."

In pre-radio times that sailor's toothache probably would have been disastrous to him. He would have been left to suffer in the fo'cas'le without attention, or a ship's officer, with no medical training, would have yanked out a lot of his teeth and carved his jaw with little regard for prophylaxis. In either case, tetanus or blood poisoning very probably would have developed and done deadly work.

The case is about as dramatic as any that have become of record since, some two and a half years ago, the ether was made, *via* radio, an all but instantaneous connecting link between ships and their crews and passengers anywhere and the world's store of medical knowledge.

The reports of these cases—there now are numerous ones—leaves highly dramatic elements to the imagination; brevity, as with all utterances of seamen, mark them for its peculiar own.

While no limit is put on the length of messages any ship's officer may radio in making requests for medical advice, these appeals and subsequent reports, if

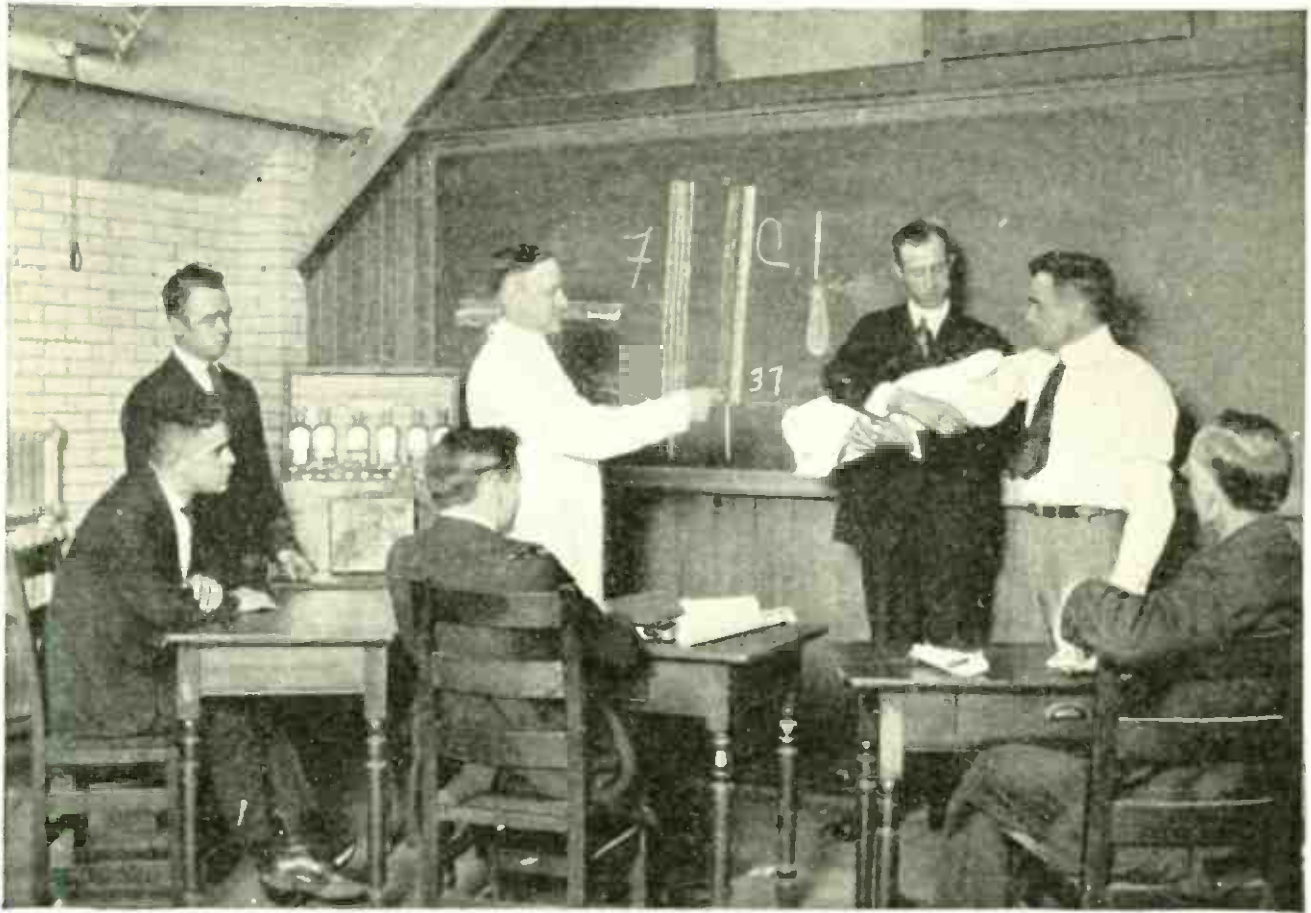

Seaman's Church Institute

SHIP'S OFFICERS ARE TAUGHT FIRST AID

In the absence of a ship's doctor, a ship's officer must have a working knowledge of first aid—and the law on this subject is being strictly enforced. Here is a first aid class for officers at the Seamen's Church Institute in New York.

any, invariably are made in the briefest possible and most prosaic terms.

There is no reciting of history, a practice so dear to the average patient; and even the doctors make use of none of the lingo common to the consulting room, the hospital and the medical book.

Radio medicine, now becoming an international practice, necessarily is a simple science, or, rather, must express itself in simple terms.

This new extension of the healing art, though first begun on a modest scale only a few years ago, has now become international. It has modified and may subdue one of the ancient horrors of the sea, that of coming down with serious illness far from land and medicines and doctors.

One easily can imagine, for instance, the feeling of fear which swept a certain vessel, when recently, while on the way from a Central American to a

North Atlantic port, one of the crew was found in his bunk stupored by high fever and with skin deeply yellow.

The first thought was of the danger of the entire crew coming down with yellow fever with no physician aboard to provide remedies, with, if the ship reached port, a long period of quarantining and fumigation and notoriety ahead. A description of the case was sent by radio to New York and medical advice was asked.

"The man probably has nothing more serious than yellow jaundice," the doctors agreed.

They radioed back a few simple directions for handling the case and asked to be kept advised. Next day he was reported on the way to recovery.

The doctors got together on this case, as they do on most of those which the radio brings to them from the sea. For it takes wise diagnosing and astute pre-

scribing to handle all cases properly.

Most of the cases that arise in the North Atlantic go to the U. S. Public Health Service Marine Hospital No. 70, down by the water front, in New York City. Advice also is supplied by Marine Hospital No. 21 on Staten Island, and by marine hospitals at Key West, Florida; New Orleans, La.; San Francisco, California, and, for the Great Lakes, Cleveland, Ohio; and by Public Health Service stations wherever located, as at San Juan, Porto Rico; the Virgin Islands, Hawaii and the Philippines.

The messages usually are received at stations of the Radio Corporation of America, most of them from the North Atlantic coming through WNY on top of the Bush Terminal Building in New York City.

Stations of the Independent Wireless Telegraph Company also accept these messages, transmit them to Public Health Service hospitals or stations and re-transmit the replies.

All of the service is rendered without

charge of any kind to anyone. Vessels of any nationality may make use of it. Recently two foreign radio companies, the Bergen in Norway, and the Goteborg in Sweden, agreed to likewise receive and take care of all requests for medical advice coming to them from the sea. These companies can take care of these requests when made in any one of six languages, Norwegian, Danish, Swedish, German, English or French.

Moreover, those steamship companies whose vessels are accompanied by doctors are now putting their resources into the great radio medical pool by means of which sailors anywhere will be able always to procure quick medical advice and, frequently in emergencies, more direct aid.

Recently a freighter was ploughing through the Atlantic when an explosion occurred in the engine room and blew away the chin of an assistant engineer. As in the case of practically all freighters, there was no physician aboard. A message calling for medical help was broadcast. It was picked up by the

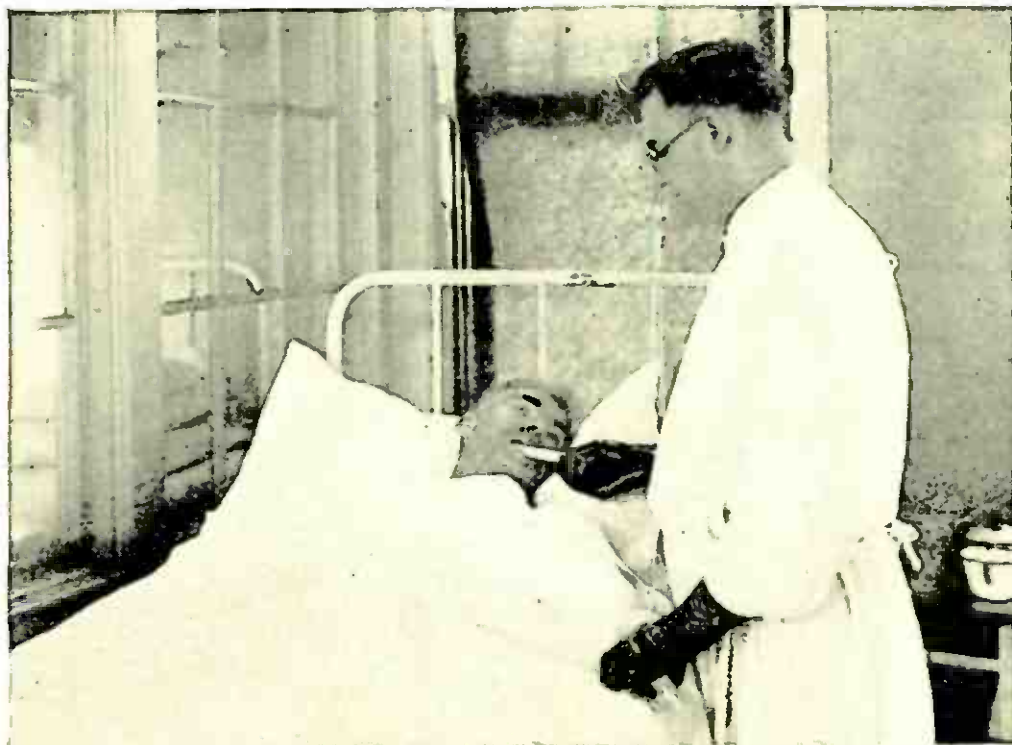

From a photograph made for POPULAR RADIO

HE OWES HIS LIFE TO RADIO

This sailor-patient at the U. S. Marine Hospital No. 21 at Stapleton, New York, was treated at sea by an unskilled ship's officer on advice asked and given by radio. Before this radio service was inaugurated many men who were stricken ill died.

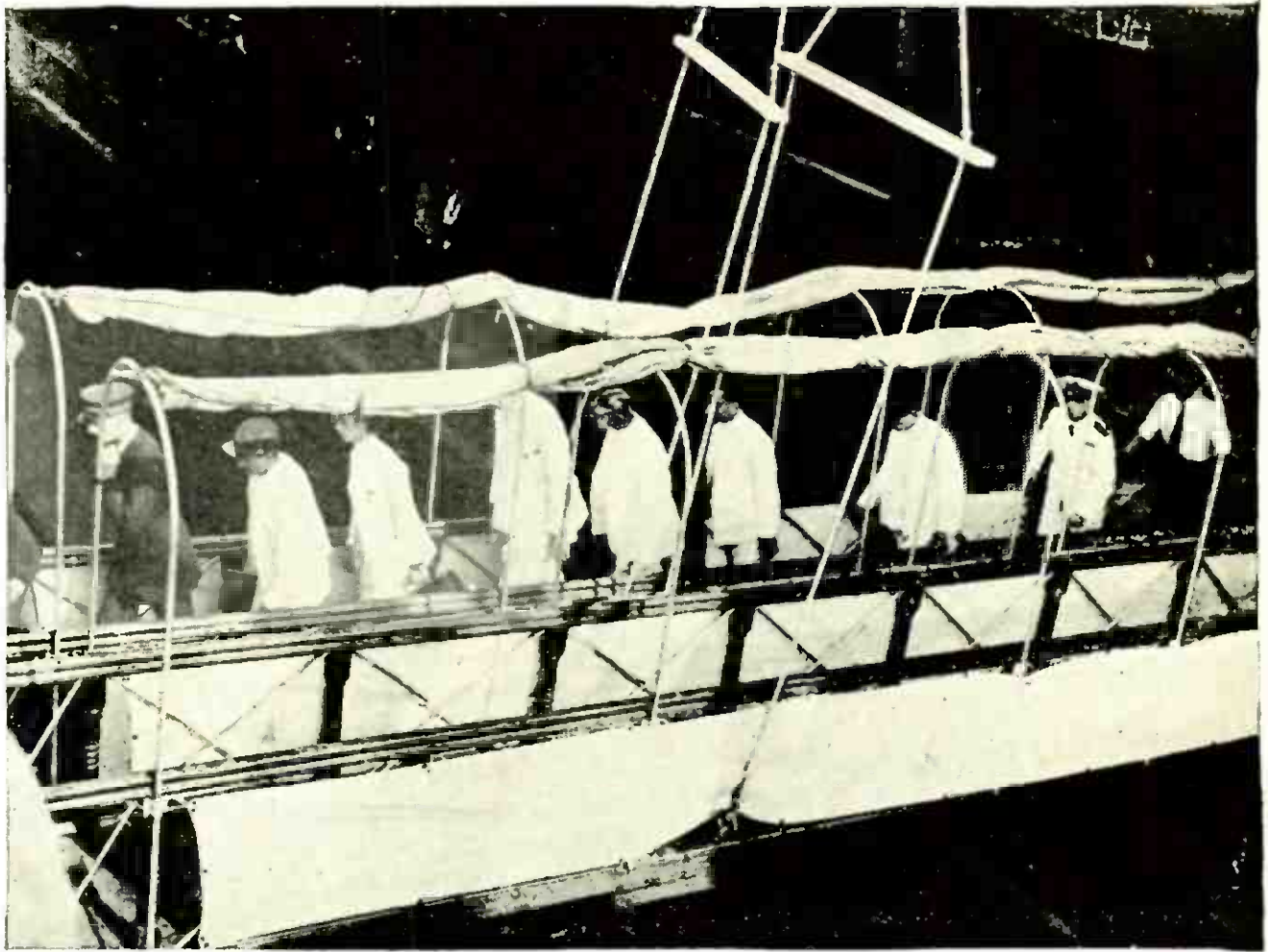

Underwood & Underwood

RADIO SUMMONED THESE DOCTORS TO THE *ARABIC*

Almost the first men to climb the gang plank of the storm-stricken ship when she reached New York with many casualties, were ambulance surgeons who were notified by radio to be prepared to take care of the storm's victims. And they did.

Berengaria, the big liner, which was not far away. The passenger vessel shifted its course in order to meet the freighter, from which it took the injured engineer, who thus was brought immediately under the direct attention of a physician. The *Berengaria* then radioed the marine hospital on Staten Island that it had an emergency case aboard. So when the passenger ship arrived at Quarantine an ambulance awaited it. The injured man was hurried to the hospital and at this writing is recovering.

All the big liners carry doctors and well equipped hospital rooms. The law requires physicians to be only on ships which handle immigrants, which most of those carrying transatlantic passengers of any kind do. Coastwise passenger ships are not required to carry physicians and few of them do so. The United

Fruit Company passenger steamers to Central and South America carry doctors, and the company has given orders that an appeal for medical aid from anywhere reaching one of its ships shall be attended to. These radio appeals for medical help always have precedent over everything except S. O. S. or distress calls.

Ninety percent or more of vessels at sea carry no doctors. The law requires licensed officers to know how to render first aid. Only since the practice of providing medical advice by radio came into existence has this law been enforced. Officers who apply for licenses are now examined by Public Health Service physicians, from whom they also may procure training.

While the laws require vessels to carry medicines, there is no specification as to

what kind they always must have on board. Those who inaugurated the radio method are now urging the amendment of the law so as to require each vessel to carry a standardized medicine chest. If this were done physicians prescribing at long distance always would know what medicines and instruments are available on shipboard.

The leader in this as in radio medical service for seamen is the Seamen's Church Institute of New York, notably Capt. Robert Huntington, director of the Institute's navigation school. It was through the radio facilities of the school that the first medical aid was provided regularly by wireless for seamen. Experiments there were so successful that the other and larger agencies which now carry it on took over the work.

These agencies are so far-reaching that a sailor stricken with acute indigestion on a ship even five thousand miles from shore frequently can get medical aid quicker than a person on land ordinarily can get. And often it is better help than one on land would get, for the reason that the attention of any number of physicians can be procured almost at once for the sailor.

There are, of course, shortcomings in this method of handling cases of disease or accident. The doctors must make a diagnosis usually on slight and superficial information. Treatment must be applied by laymen. Frequently the needed medicines or instruments are not on shipboard.

Thus treatment prescribed generally is of the kind that is good for almost anything and will do no harm regardless of the cause of the complaint.

Evidently treatment by radio is highly successful. Of all the cases on record which could be examined in only one was death reported. And in that one the patient—the captain of a vessel—evidently was dying before resort was made to the radio for help.

These cases include many troubles, some of them apparently serious.

A woman passenger aboard the steamship *Rosalind* is stricken with appendicitis with the vessel twenty-four hours from Halifax, its destination. The captain radios for word as to what to do, probably with a vision of himself performing an abdominal operation. But the vision was unjustified.

"Apply ice to the right side of abdomen," the doctors, after quick consultation, advise. "Rest in bed. Do not give cathartic."

The patient evidently reached port and recovered.

When these messages reach the marine hospitals the doctors on duty always get together and jointly make diagnosis and prescribe.

Frequently, they can only radio back for more information.

This happened recently in a case that, if all the facts were known, might sound in the full telling like a Joseph Conrad short story.

"Patient losing blood rapidly," said the message. "Please give information regarding making him comfortable." That was all.

The doctors radioed back:

"Please advise from what part of body the blood is coming and the cause of the bleeding."

"Patient has broken scalp," came the reply. "His head is split open." Belaying pin, probably.

"Sew small pieces of gauze into wound," the ship's officer was advised. "Apply gauze dressing to wound with pressure. Keep man in bed."

All of this happened, with the vessel somewhere far out in the Atlantic and the doctors at a hospital in the lower section of New York, between 1.30 and 2.10 A.M., of the morning of May 1, this year!

"Man on board," wirelessly the master of the ship *Aquita* recently, "severe tonsillitis. Can not swallow even water. No nourishment for five days."

"Put ice to throat," he was told. "Give water and milk through tube in

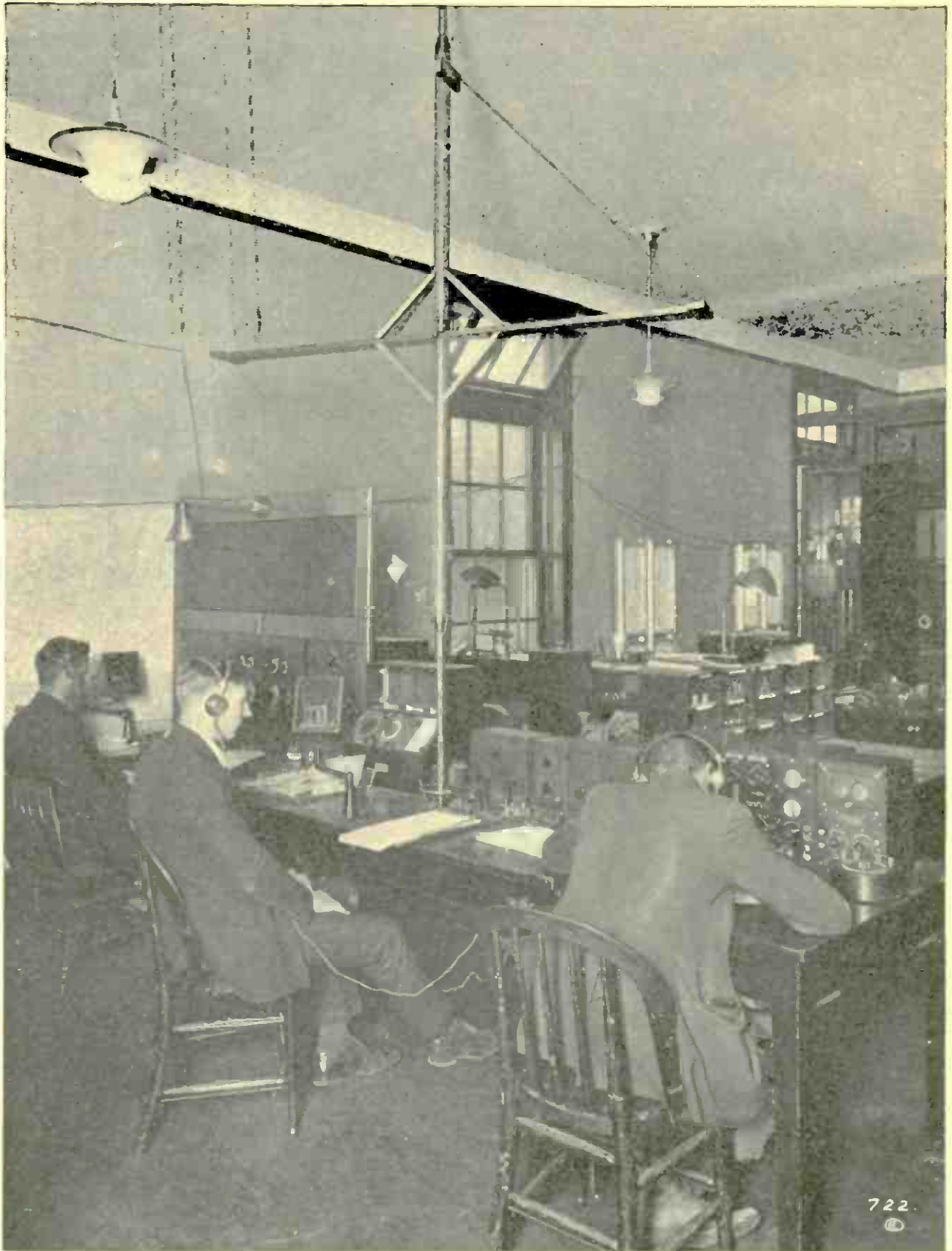

Radio Corporation of America

WHERE CALLS FOR MEDICAL ADVICE ARE RECEIVED

Into this radio room of station WIM at Chatham, Massachusetts, come many of the messages that ask for medical advice for ships at sea. No charge of any kind is made for this service.



Radio Corporation of America

A TYPICAL RADIO ROOM ON A STEAM TRAWLER

Ships of this class carry no doctor; consequently the radioman on such a ship is frequently the only link between the expert advice of doctors on shore and the sick member of the crew.

nose or in throat past obstruction; also aspirin 5 grains every three hours."

Apparently the man was saved; nothing more was heard from him.

Sherlock Holmes' science of deduction often comes in handily.

A vessel was a few days out of Norfolk. A member of the crew doubled up with stomach cramps; the captain radioed for advice.

As the trouble might have been due to any one of several causes only simple remedies were prescribed.

Then came a message stating that six other members of the crew were similarly stricken.

"Did all eat at the same mess?" the ship was asked.

They did. Then it was a relatively simple matter; the trouble was ptomaines caused by something they had eaten. They were saved, and the guilty article of food was discovered and what was left of it tossed into the sea.

A man ashore at Bermuda "cele-

brated." He boarded the ship "in bad shape."

Next day the captain radioed that the man was blind. He was told to use atropine and belladonna solutions. He had none of either drug, but he did have boric acid and castor oil, which he did use.

When he later reported, the captain stated that the man's general condition was better but that the blindness continued. He was arranging to transfer him to a passenger vessel.

Rarely are they advised to use the knife, and then in only simple cases.

On one ship there was a man with an infected finger. The captain reported that he had lanced it without relief and that the infection was spreading.

"You probably didn't cut deep enough," he was told, and was advised to slice it to the bone, with details as to cauterization and after treatment.

The following is a typical case of full use being made of the radio to save

life and reduce suffering from illness by persons on doctorless ships:

July 27, 1923; 4.30 P.M. From the SS *Benjamin Brewster*, via station WNY, Radio Corporation of America.

"Thirty miles south Nantucket light. Seaman sick 5 A.M., July 26, in ship hospital, 6 A.M., gave dose salts, 7.30 A.M., 5 grains quinine. Fever 103, no vomiting. Bowels moving good, slight pain in chest. At noon fever 104, pulse very rapid, 98 per minute, gave quinine. At 2 P.M. fever 103.4. No chill. Please advise treatment."

Reply as sent immediately:

"Keep patient in well ventilated room. Give fluids, water, lemonade, soda bicarbonate in glass water. More information requested. Has patient a cough, character of expectoration, number of respirations per minute. Recommend patient be put ashore and in hospital as soon as possible. Treatment given is satisfactory."

At 6.15 P.M. the ship's captain radioed:

"En route to Europe. Cannot put patient ashore. Temperature 103.5, expectoration white, no cough, respirations O.K."

Immediate reply:

"Continue treatment recommended this afternoon and report condition tomorrow."

At 1 P.M. the following day the captain wirelessly as follows:

"Patient better this morning; 12, midnight, fever 99; chills at 7 A.M., fever 103; 10 A.M., fever 102. No cough. No sore throat. Very slight pain in chest. Expectations white but very dry. Respirations normal. No difficulty in breathing. Body extremely hot but no perspiration. Given plenty of air but kept well wrapped up. Continuing treatment indicated in yesterday's message. Gave oatmeal. No difficulty in taking nourishment."

To which an hour later the doctors radioed the following reply:

"Give 20 grains quinine immediately and repeat in four hours. Give glass of liquids every two hours, weak lemonade with a little sugar or plain water. Give sponge bath with cool water if temperature rises above 103. Keep bowels open well with

moderate doses of salts. Continue soda bicarbonate as ordered. You are handling case very well. Keep us informed if patient does not improve or if he becomes worse, giving symptoms in full."

At 4.30 P.M. on the following day the captain radioed as follows:

"Patient given sponge bath yesterday, fever dropped almost instantly. Fever 100-101. No more pain in chest. No cough. No sore throat. Kidneys act well. Bowel O.K. Patient very hungry. Keeping him on liquid diet. Continuing soda bicarbonate as ordered and giving him quinine occasionally."

The doctors at the marine hospital replied:

"Report and treatment satisfactory. Stop bicarbonate."

Four days later the captain advised:

"Patient all O.K. yesterday. No symptoms of any kind. Many thanks."

In this case the captain spared no words and, in carrying out orders, no pains. Hence the patient received as good medical attention and fared as well as would have been the case had he been in the hospital.

But all ship captains are not such apt go-betweens. One, for example, was told to give his patient a tepid sponge.

"What is a tepid sponge?" he inquired through the tir.

"A lukewarm bath," he was told. Since then the word "tepid" has been omitted from the lexicon of radio medicine. "Lukewarm" has taken its place.

How many lives are saved and how much suffering eliminated by this use of the wireless?

Nobody knows. Usually no final reports are made. Intimate details generally are retained by that "ol' devil" the sea, as the veteran sailor in "Anna Christie" calls the ocean, which he hates, fears—and loves. But one of the "ol' devil's" worst terrors, that of suffering and dying because of the vast reaches often between those on its bosom and medical succor, has been torn from it by radio.

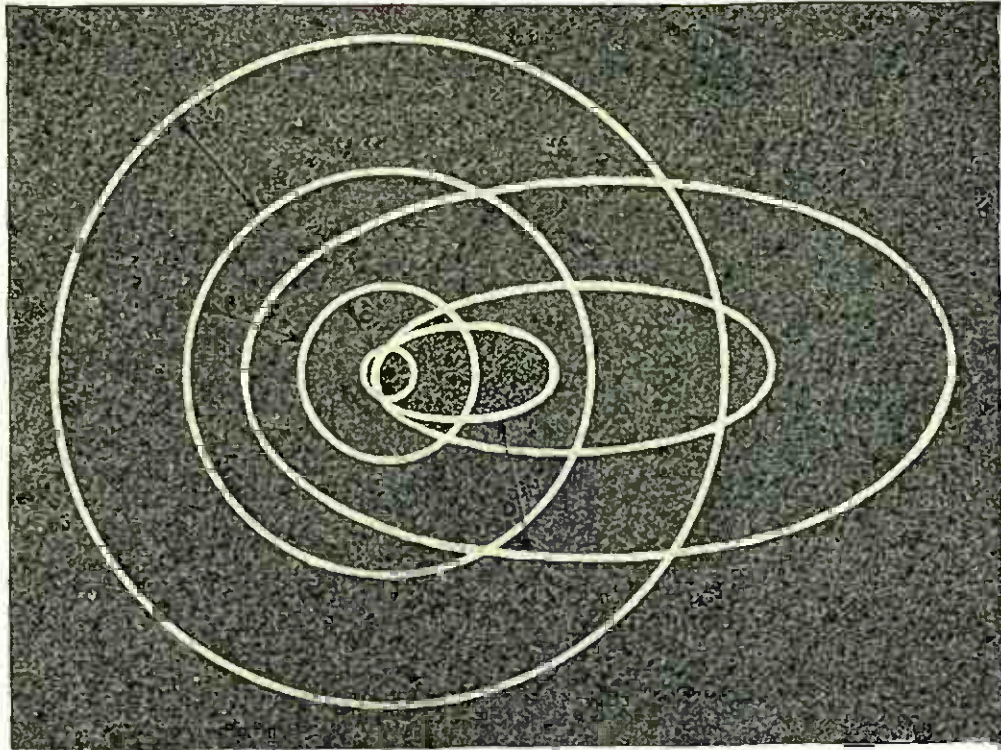

WHY THE HYDROGEN FLAME GIVES LIGHT

This diagram shows a few of the many possible electron orbits in an atom of hydrogen gas. There is only one electron in this atom and, accordingly, only one of these orbits is occupied at a time. Whenever the electron jumps from one orbit to another one (as indicated by the arrows A, B, C and D), a pulse of light is sent out. These light-pulses form the "broadcasts from atoms."

Broadcasts from Atoms

How Bohr's Theory of atomic structure explains the production of light waves from the atoms of matter

By E. E. FREE, Ph.D.

THE universe contains, so far as we know, only two things: electricity and ether waves.

From the center of our earth outward to the most distant of the stars the probing finger of science has discovered nothing else. In every natural phenomenon, from the collision of two vast suns to the life history of an earth-worm, everything is explainable as electricity or ether waves or the interactions of the two.

Light is a form of ether waves. What we call heat is either an ether wave or a form of agitation in matter; and matter, as everybody knows nowadays, is really a form of electricity. Sound, too, is a vibration in matter and is therefore

electrical. Magnetism and gravitation remain imperfectly understood, but these also, there is every reason to believe, are caused by some variety of ether waves that we have failed, as yet, to catch and analyze.

And every material thing; the earth, the bodies of men and women, the eyes we see with and the ears we hear with, the copper wires that we build into our radio sets and the glass that houses our vacuum tubes, the sun and the moon and all the unnumbered millions of the stars; all these are composed of electricity, of the two fundamental kinds of electric particles that scientists call the *proton* and the *electron*.

To readers who have followed the

articles on atomic science in recent issues of POPULAR RADIO, this last statement will carry no surprise.* The simplest kind of matter, they will remember, is the atom of hydrogen gas. This atom contains only two particles; one electron and one proton. The electron is a particle of negative electricity; the proton is a particle of positive electricity. The electron revolves around the proton as our earth revolves around the sun.

The other kinds of atoms, making up the list of eighty-six chemical elements that have been discovered, are composed of these same protons and electrons; varying numbers of them up to nearly five hundred being put together in rapidly moving systems all constructed on essentially the solar system model, a central "sun" around which revolve a number of tiny "planets."

That is the modern picture of what atoms are like.

These atomic systems are almost in-

* "New Theories of How the Atom Is Put Together," by Sir Joseph J. Thomson, September, 1923, pages 179-186; "700,000,000,000,000,000,000 Electrons for a Cent," by E. E. Free, January, 1924, pages 41-48; "Bohr's New Theory of Atoms," by E. E. Free, April, 1924, pages 319-327; "Do Electrons Play or Loaf," by Robert A. Millikan, August, 1924, pages 109-116.

conceivably tiny. More than 2,000,000,000,000,000 of even the largest atoms could crowd together comfortably enough on the surface of a pinhead.

The printed letters on this page are composed essentially of atoms of the chemical element, carbon. Each carbon atom contains one central "sun" and six electrons revolving around this as "planets." Yet so tiny is the entire assemblage that the little black dot that indicates a period at the end of this sentence contains more than 30,000 times as many carbon atoms as there are people in the world.

Of course this is far too small for us to see. The smallest dust speck visible under the most powerful microscope ever devised contains many billions of atoms.

How, then, can we be sure that the atom really does contain these particles of electricity spinning around a central "sun" that is also electrical?

We know by means of ether waves.

The universe does not consist, remember, of atoms only. It contains, in addition, a great assemblage of ether waves; the waves of light pulsing back and forth

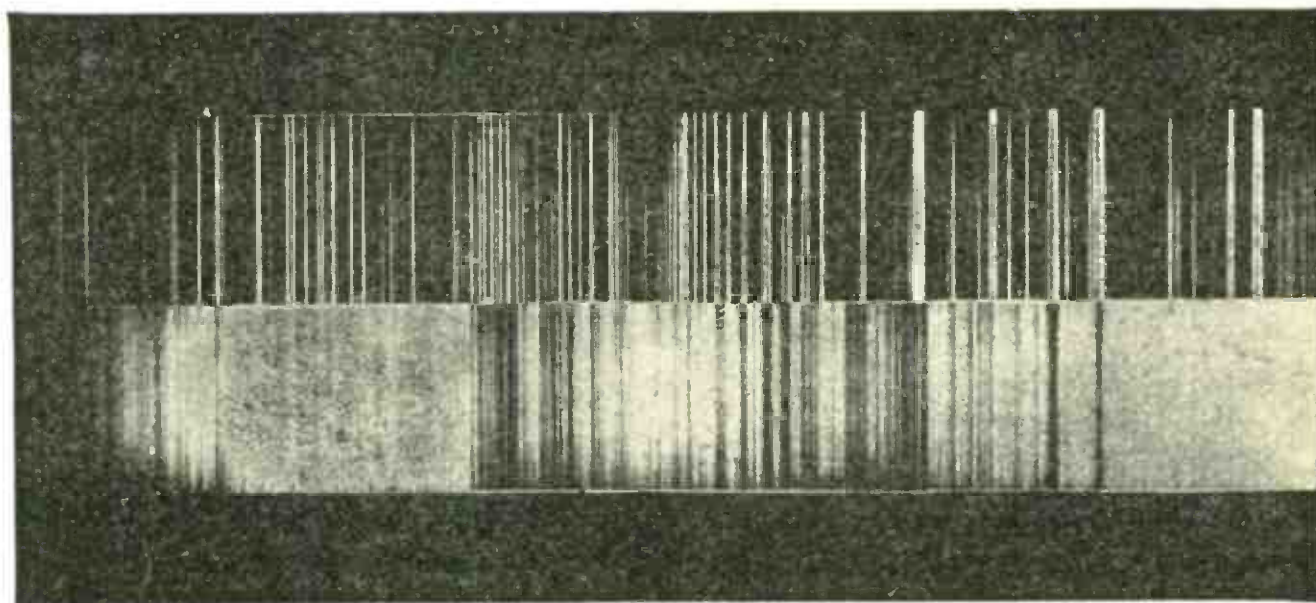

Brown Bros.

WHAT A LIGHT SPECTRUM LOOKS LIKE

This picture shows two photographs of spectra, which are the sets of bright lines and bands visible in a spectroscope whenever the light that comes from a group of excited atoms is analyzed by that instrument. Each one of these separate lines corresponds to an electron jump from one definite orbit to another one in each of the atoms that are emitting the light.

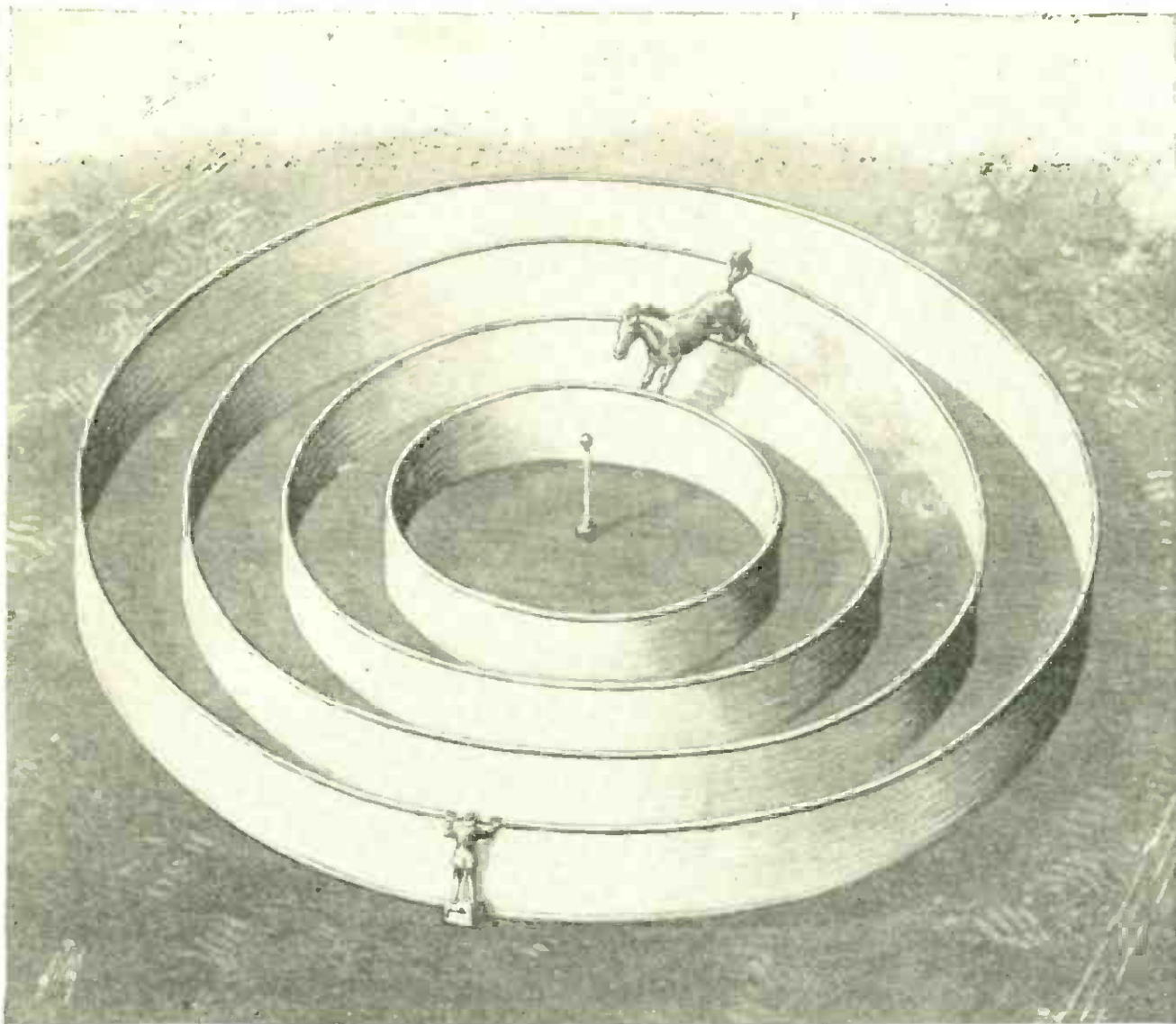

From a drawing made for POPULAR RADIO by Arthur Merrick

HOW WE "SEE" A BROADCASTING ATOM

The man at the outer fence can see the horse only when the horse is jumping over a fence. Just so, in a hydrogen atom, we can "see" the electron only when it jumps from one orbit to another.

• between the stars, the waves of heat coming to us from the sun, the waves of electric energy that we are now using so amazingly in radio.

These ether waves begin and end on atoms. If you light a match what happens is, that the billions of atoms in the flame send out ether waves of light. These ether waves enter your eyes and strike against the other atoms that compose the organ that you see with, your retina. The act of seeing is a kind of broadcasting. The atoms in the burning match broadcast an ether wave. This wave is picked up by the "receiver" atoms in your eye.

The same thing happens when you see

a star. Atoms in that star, off many billions of miles in space, are hot or are excited by electricity. They broadcast ether waves in the form of light. These waves travel the vast distance through space and strike, finally, against the receiving instrument of your eye. Starlight is the broadcast news from other worlds.

The most important thing about all this is the process by which these ether waves are sent out and received. This process represents the *relation* between the two fundamental things in the universe; the atoms (which are electricity) and the ether waves. How do atoms broadcast ether waves? How do other

atoms receive them? These are possibly the deepest secrets of the universe and they are secrets which modern science has made substantial progress in deciphering.

This began with the science of spectroscopy.

The spectroscope is an instrument that makes an artificial rainbow. Ordinary white light, such as the light of the sun, is passed through an arrangement of glass prisms and lenses. It comes out split up into its seven primary colors just like the colors of the rainbow.

These colors differ, of course, in the wavelengths of the ether waves that compose them. The shortest light waves are on the blue end of the rainbow strip or spectrum; the longest waves are on the red end of the strip. The atomic broadcasting stations that send out the light waves use a number of separate wavelengths, just as radio broadcasters do.

And curiously enough, it was found that each kind of atom, like each terrestrial broadcasting station, has its fixed wavelength or wavelengths. A white light, such as sunlight, contains practically all the wavelengths, but that is merely because it is coming from a vast number of atoms and assemblages of atoms of many different kinds.

If the United States contained a billion or two separate radio stations and if they all were sending at the same time, each on its own separate wavelength but if all these wavelengths were separated from each other by very tiny intervals, that would be a fair picture of what is happening when any body like the sun is sending out white light.

But, if you take one kind of atom by itself and let it send out light, the result is very different. Suppose, for example, that you have a glass tube filled with hydrogen gas and that you send a powerful electric current through this tube so that the hydrogen atoms are disturbed and begin to broadcast. You will not get white light as you do from the glow-

ing sun. On the contrary, the light waves sent out by the hydrogen atoms will comprise only a few distinct wavelengths. In a spectroscope they appear as lines of color at certain fixed positions along the rainbow strip of the spectrum. Other parts of the spectrum are dark.

This is what scientists call the spectrum of hydrogen. It contains ten very bright lines and a number of fainter ones.

In broadcasting language this means that the transmitter of the hydrogen atom broadcasts light at ten or more perfectly definite wavelengths; just as WGY, for example, broadcasts its programs nowadays at two separate wavelengths and sometimes at three.

And these ten (or more) wavelengths of the hydrogen atom are perfectly characteristic of that atom. Every hydrogen atom that sends out ether waves at all sends out one or more of these specific wavelengths. If you find the lines of these wavelengths in an unknown spectrum you know that this spectrum is coming from hydrogen atoms just as surely as when you pick up a station on a radio wave of 492 meters you know that you are hearing from WEAF.

More surely, in fact, for the different kinds of atoms maintain their wavelengths much more exactly than the man-made broadcasters do and, with a very few exceptions, no two kinds of atoms ever broadcast light on exactly the same wave.

This gives you the clue to what is called spectrum analysis. The astronomer examines, for example, the light rays coming from a distant star. He photographs the spectrum of this light. In it he finds certain definite lines. This means that certain definite wavelengths are present in the light. He compares these with the wavelengths known to be sent out by various kinds of atoms. Thus he determines what atoms exist off there in the star halfway across the universe. This is how we know that

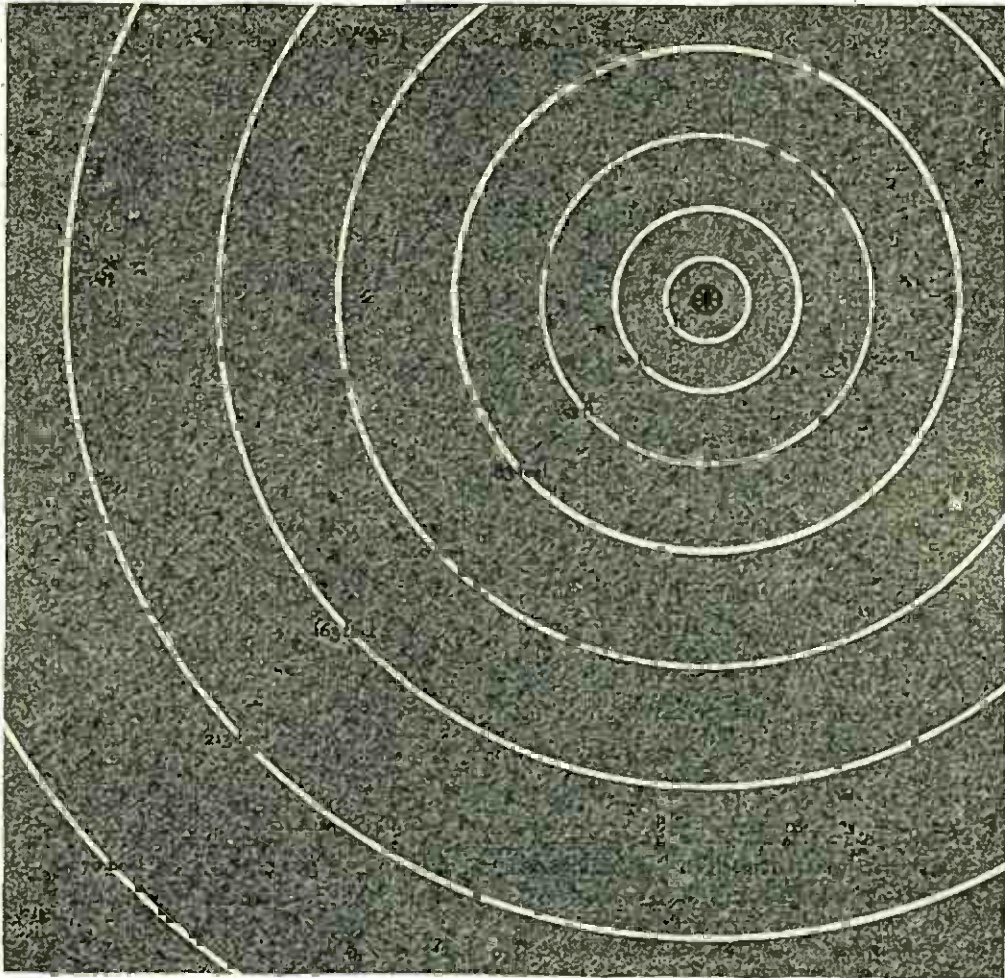

THE RELATIVE DIAMETERS OF THE ORBITS IN A HYDROGEN ATOM
If the inmost electron orbit of a hydrogen atom is regarded as being the size of the forty-inch wagon wheel at the center of this diagram, then the next eight orbits outside this have the diameters shown here in feet and drawn to scale.

the atoms in the stars are the same as the atoms that we find here on earth.

But this leaves untouched the problem of *why* the atoms broadcast their light messages in this definite way. What kind of oscillators and modulators or other apparatus do the atoms possess that make them able to send out ether waves with such exactness as to wavelength? This is the problem that Professor Niels Bohr has clarified so greatly in the past ten years as a part of his remarkable work on atoms.*

Professor Bohr starts from the idea of atomic structure already explained; the idea that all atoms consist of electron planets revolving around a central particle, also electrical, which acts as the atomic sun. It is convenient to con-

sider the simplest known atom, that of hydrogen. This consists, you remember, of one electron planet revolving around a single positive particle, a proton.

In the actual hydrogen atom the orbit of the single electron is very small. It measures only about four-billionths of an inch in diameter. We can think better in larger sizes, so let us imagine that we can magnify a hydrogen atom by about ten billion times so that it is forty inches in diameter, about the size of an ordinary wagon wheel.

On this scale the proton at the center will be still so small that it will be entirely invisible. Even the electron planet, which is nearly two thousand times larger than the proton, will be only about one four-thousandth of an inch in diameter, too small to be visible except with the help of a good microscope.

* See the article already referred to in *POPULAR RADIO* for April, 1924, pages 319-327.

These two particles make up the atom. All the rest of it is empty space.

This represents, furthermore, the normal, inactive atom. It is not sending out any ether waves. So long as the electron stays in this normal orbit, the size of a wagon wheel, it does not broadcast any light. To see how it does broadcast light, according to the theories of Professor Bohr, we must consider the other possible orbits that it may occupy.

In the solar system of which our earth and our sun are parts there exist, as everybody knows, eight separate orbits each occupied by a planet. Our earth is the third from the center, both Mercury and Venus being closer to the sun than we are and moving in orbits smaller than the earth's.

The atom of hydrogen possesses also a number of possible orbits for its electron planet. But there is only one electron in the atom. So what happens is that this same electron may occupy at different times different ones of the possible orbits.

It is when the electron moves from one of these orbits to another one that there occurs, Professor Bohr believes, the transmission of the ether wave that we call light. It is then that the atom becomes a broadcaster.

In the wagon-wheel model that I have

described the forty-inch orbit is the smallest and inmost one. It is here that the electron stays when the atoms are cold and not otherwise disturbed. But suppose that some outside force, as, for example, another fast-moving electron comes along and knocks the planetary electron out of this inmost orbit?

If this happens there is another orbit that the electron can occupy at a certain distance outside the smallest orbit. This second orbit would be, on the wagon-wheel scale, 160 inches in diameter, or a little more than thirteen feet. Still outside of this is a third possible orbit thirty feet in diameter; beyond this is a fourth orbit about fifty-three feet in diameter, a fifth orbit about eighty-three feet in diameter, and so on at least as far as an orbit that is 490 feet in diameter and possibly to still larger ones.

When an electron is knocked out of an atom it must occupy one of these larger orbits or else it must go off altogether. For reasons that we need not discuss here, Professor Bohr believes that the electron cannot occupy any position in the atom except in one or the other of these specified orbits.

So much for the electron as it goes out. Now let us consider its return.

The attraction between the electron

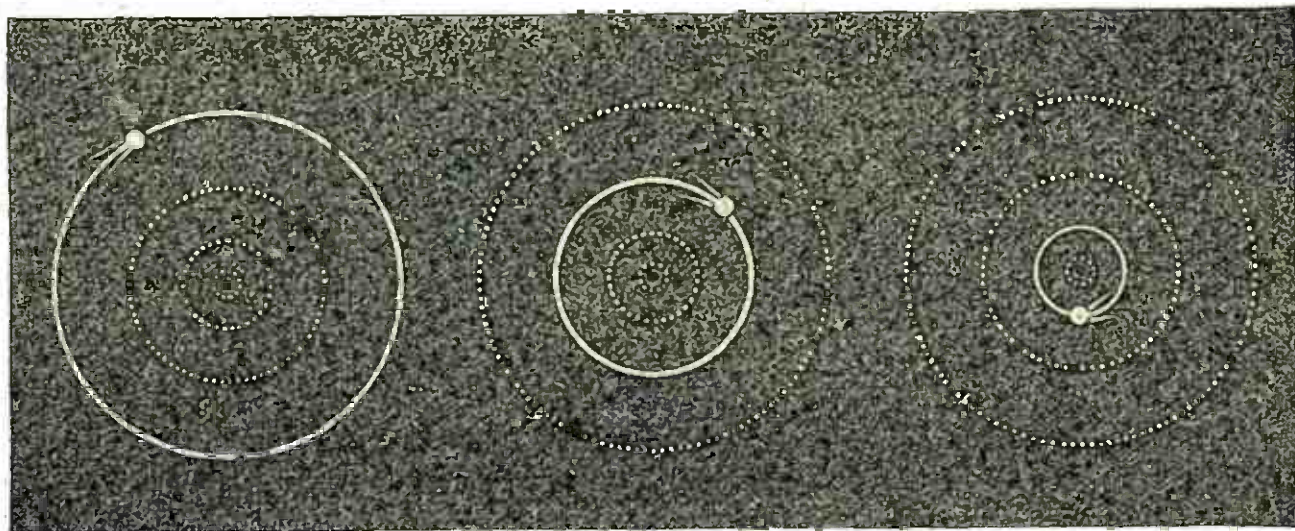

THREE SUCCESSIVE STAGES OF A RETURNING ELECTRON

In the diagram at the left the electron occupies the third orbit from the center. This position is unstable and the electron jumps to the second orbit, as illustrated in the center diagram. This position, too, is transient. The electron jumps finally to the inmost orbit, as illustrated at the right. For each jump a pulse of light is sent out.

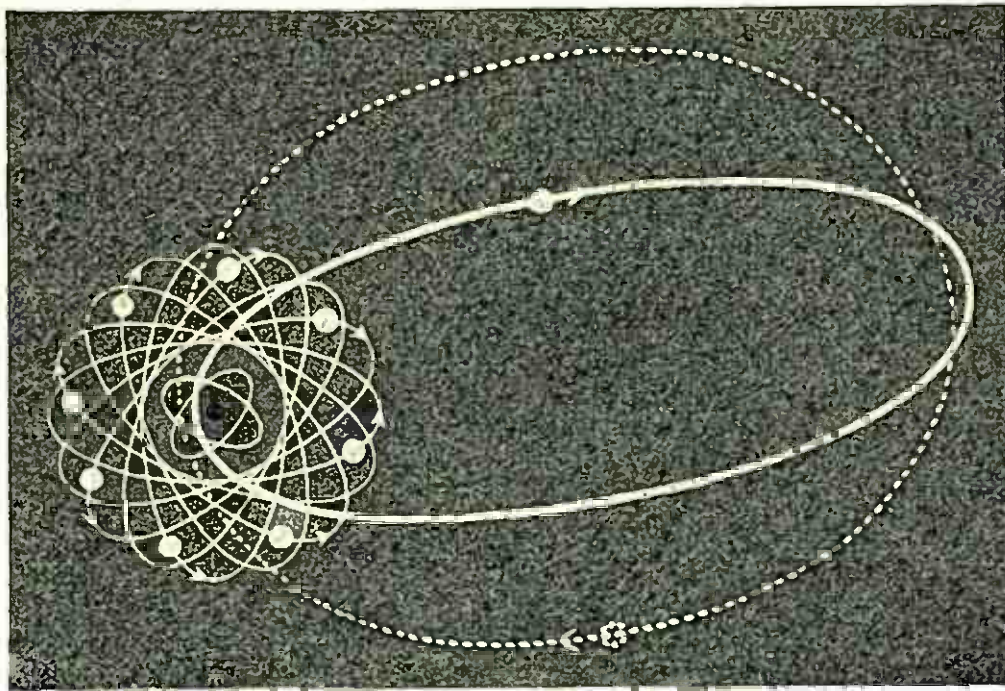

HOW A MORE COMPLICATED ATOM RADIATES LIGHT

This diagram represents an atom of sodium. The electrons that occupy the closely interlaced orbits near the center of the atom do not ordinarily jump about or send out light. But the outer electron, occupying the long orbit shown by the heavy white line, may occupy many other orbits—as, for example, the one shown by the dotted line. When this outer electron jumps about from one of these orbits to another the characteristic light spectrum of sodium is sent out.

and the central proton of the atom makes the electron want to come back, just as our earth would be attracted back toward the sun if some force accidentally displaced it from its present orbit.

And as the electron comes back, it does so by jumps. It occupies, in turn, the succession of orbits that I have described. Suppose that it has reached the fourth orbit, the one that is fifty-three feet in diameter on the wagon-wheel model. Its next move is to cross over by a sudden jump to the next orbit inside, that is, to the one that is thirty feet in diameter. As it does so something very amazing happens. The electron (or *something* in the atom) sends out a pulse of light.

This is the essential idea of Professor Bohr's theory of atoms and ether waves; the theory that is now accepted by practically all the scientists working in this field. The idea may be stated thus:

☐ *Light is sent out by atoms only when one or more of the atomic electrons moves from one possible orbit*

inside the atom to another orbit closer to the center of the atom.

The wavelength of the light that is sent out depends upon which orbit the electron has left and which one it goes to. In the hydrogen atom, for example, a jump from the fourth orbit to the third one sends out a single one of the possible wavelengths. This makes one of the lines in the spectrum of hydrogen. The other lines are made by other jumps; one, for example, by a jump from the third orbit to the second, another by a jump from the fourth to the second (for under certain conditions the electron may skip an orbit), and so on.

In less simple spectra the conditions may be extremely complicated and difficult to understand. But in all of them that have been studied the general idea here described has been found to hold. All spectral lines—all the ether wave broadcasts that atoms send out—are believed to be due to sudden jumps of this kind made by electrons or groups of electrons inside the atomic structure.

It is by taking the observed lines of

spectra as measured in the laboratory and working backward from them to the atomic orbits and electron jumps that might have caused them that Professor Bohr and his associates have been able to establish most of the conclusions about atoms that we have already described.

The atomic transmitter, then, is the electron. The thing that determines the wavelength transmitted is the particular jump that the electron makes. Only when the electron jumps is there any radiation of light. So long as it stays in a single orbit it radiates nothing.

Let me quote an analogy that I have used elsewhere to make this clear.*

Imagine a series of race tracks one inside the other like the concentric grooves of that once familiar game called "Pigs in Clover." Imagine these tracks separated by high board fences. Now put a race horse in the outermost track and instruct him to run around it until, when he happens to feel like it, he is to jump the inside fence into the next track, run around it for a while and then jump the next fence, and so on until he reaches the innermost track of all.

If, then, you watch this procedure from the field outside the outermost fence, you will not see the horse at all so long as he is running in a single track. The fences hide him. But whenever he jumps a fence from one track into the next you will see him for an instant as he goes over.

So with the hydrogen atom. You see the electron only as it jumps from one orbit to another one, for it is only then that the electron radiates light.

The next step that atomic science must take is the discovery of what really happens when one of these electron jumps occurs. We know nothing about this at all. We do not even know that the

electron "jumps" in the ordinary sense of that word. What happens, so far as we can judge, is that an electron disappears from one orbit and simultaneously an electron appears in another orbit.

Perhaps it is not the same electron at all. Perhaps an electron is destroyed in the first orbit and a second electron created out of ether or ether waves or something in the second orbit. We do not know what electrons are. It is entirely conceivable that they may be merely a form of ether waves or that both they and ether waves may be different forms of the same thing. These things are still mysterious.

And they lie close, we may be sure, to that greatest of all scientific problems, the problem of what constitutes that ultimate reality of Nature which appears to us now as matter, again as electricity, another time as waves in the ether and perhaps—who knows?—as what we are accustomed to describe as mind.

Like the fable of the blind men who attempted to describe the elephant, although each had felt a different part of him, all these apparent facts of nature may be equally imperfect descriptions each of one aspect of the whole.

Doubtless, science will attain, some day, a more complete description of these things. And nothing is likely to contribute more largely to this end than the investigation of those much longer ether waves that originate, we do not yet know how, from masses of moving electrons in wires, and that we call the waves of radio.

* "Bohr's Model of the Atom," by E. E. Free. *Industrial and Engineering Chemistry*, vol. 16, pages 192-193 (February, 1924).

HOW TO BUILD AN 8-TUBE SUPERHETERODYNE-REFLEX RECEIVER

In the next number of POPULAR RADIO—for January—will appear an exclusive "how-to-build" description of the most advanced and efficient radio receiving set that has yet been developed—the latest and the most important product of the POPULAR RADIO LABORATORY. Copies may be obtained at the newsstands on December 20th.



The MEN WHO

1st Installment

THE FIRST MAN TO CREATE AND DETECT RADIO WAVES

When JEAN BAPTISTE BIOT, a French physicist, read that Galvani had observed a frog's legs twitching in the vicinity of an electric spark prior to 1790, he was prompted to make experiments of his own. So in 1819 he produced electric sparks from a static machine and detected their effects at a distance of more than 30 feet, also by the convulsions of a frog's legs. Biot offered no explanation of this phenomenon—but he was actually creating and detecting radio waves.

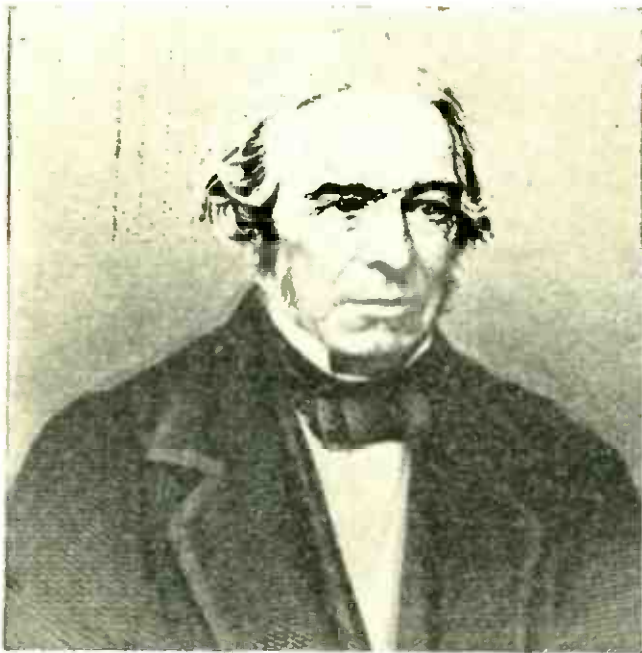

THE FIRST MAN TO DEMONSTRATE ELECTROMAGNETIC INDUCTION

MICHAEL FARADAY, who started his career as a "laboratory boy," was the pupil of the great chemist Sir Humphrey Davy of the Royal Institution of London. As early as 1831 he contributed to electrical science the basic idea of electromagnetic induction—which is of tremendous importance in transformers, magnetic relays and many other devices. He maintained that the medium through which magnetic lines of force traveled was the same medium through which light and heat traveled. And he was right.



THE GRANDFATHER OF HIGH-FREQUENCY OSCILLATIONS

The stage lost a talented disciple but science acquired a genius when JOSEPH HENRY, a school-teacher of Albany, N. Y., gave up his ambition to become an actor and turned to "natural philosophy." In 1832 he first produced high-frequency electric oscillations—not accidentally, but with the knowledge of what he was doing. Later, with a one-inch spark, he magnetized a needle wrapped in a coil of insulated wire located two floors below the spark source, and proved that electromagnetic energy could be transmitted through the air.

MADE RADIO

THE FIRST SCIENTIST TO DEDUCE THE THEORY OF ELECTRIC WAVES

WILLIAM CLERK MAXWELL, the noted Scotch physicist who was both a theorist and an experimenter, deduced in 1867 the probable existence of the electric waves that are now employed in radio. But he was unable to prove his conclusions by actual experiment. He did, however, develop the electromagnetic theory of light, and he showed that light, heat and electric waves all travel at the same speed, but that they differ in wavelength.



Courtesy Columbia University Library

THE FIRST OF THE "BRASS POUNDERS"

SAMUEL F. B. MORSE was one of America's best known painters—although he is popularly known as the inventor of the electromagnetic telegraph. As a matter of fact, he merely put upon a practical commercial basis the discovery of Joseph Henry. In 1842 he sent telegraphic signals across the Chesapeake Canal at Washington, D. C., with a circuit containing six pairs of plates in the form of a galvanic battery, a key and 100 feet of insulated wire, one end of which was connected to a plate immersed in the canal; on the opposite shore was a galvanometer and a length of wire connected to the water. He gave his name to the Morse code, known to all radio amateurs.



THE DISCOVERER OF INTERFERENCE OF ELECTRIC WAVES IN WIRES

At the time of the Franco-Prussian War in 1870, a German scientist, WILHELM VON BEZOLD, devised a crude laboratory experiment to produce electromagnetic waves in wires and showed that these waves display the phenomenon of interference, already well known with the waves of light. This gave important confirmation to the ideas of Maxwell, but the waves of von Bezold could not be detected in free space, so the confirmation was not complete.



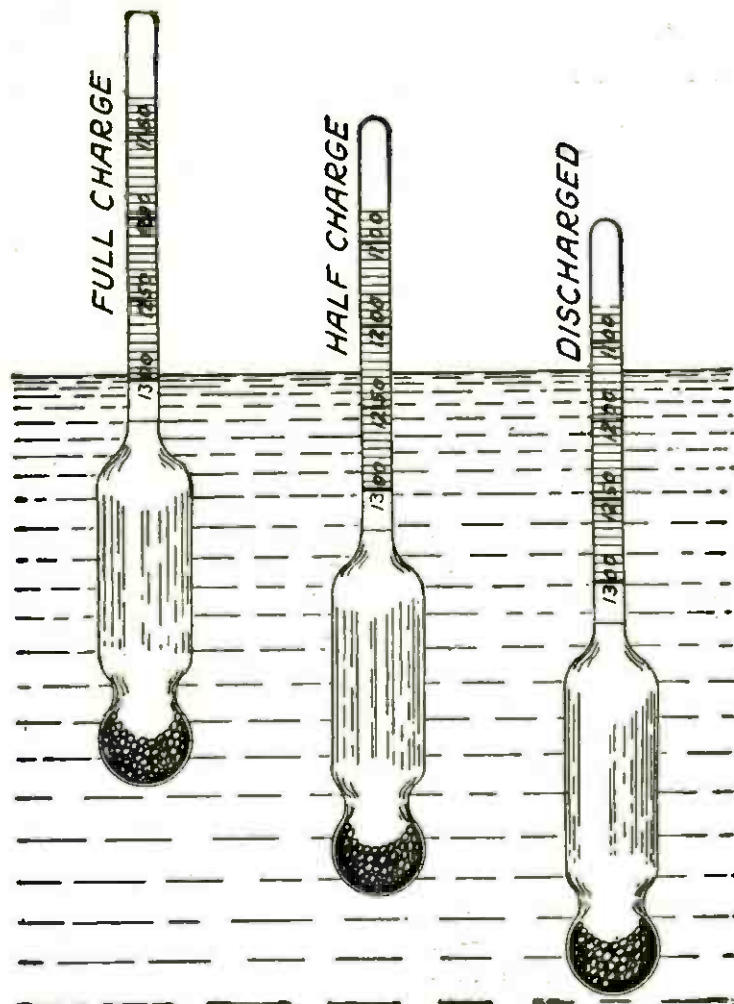

WHAT THE HYDROMETER READINGS MEAN

FIGURE 1: When the hydrometer sinks down so that the level of the top of the solution is near 1,100, as shown at the right, the battery is practically discharged and should be recharged at once until the hydrometer floats up to nearly 1,300, as shown at the left.

HOW TO GET THE GREATEST VALUE FROM Your Storage "A" Battery

When the filament battery runs down the blood supply to the tubes is not sufficient to sustain life in the radio set. If dry cells are used the discharged ones should be replaced with new ones. If a storage "A" battery is employed it should be recharged when the filament refuses to light at its normal brilliancy. All this is taken as a matter of fact by a great many radio set owners, with no thought of the "why and wherefore." The following article is for the benefit of those who would like to get some inside information on the construction and chemical operation of the storage battery

By A. L. KASER

THE lead-plate storage battery, sometimes referred to as an accumulator, is made up of electrodes that contain active elements of lead peroxide and sponge lead as the positive and negative materials respectively, immersed in a dilute solution of sulphuric acid.

When fully charged and in good condition, the positive plates have a dark reddish-brown or chocolate color, while the negative plates are gray or slate colored. The plates may be readily distinguished by their color and also by the character of the active material

on them. The lead peroxide is hard, like soapstone, while the negative material is soft and can be readily cut into with the finger-nail. The negative material is pure lead which has been reduced to a sponge-like form.

On discharge, the electrolyte (the solution) combines with the active materials of the electrodes and, on charge, the active materials are reduced to their original condition. The chemicals extracted from the electrolyte are released and returned to the electrolyte. It follows then, that the density of the electrolyte is greater at the end of charge than at the end of discharge, and also that the active material on the plates expands as discharge proceeds.

The unit of capacity of any storage battery is the *ampere-hour*. This is generally based on an eight-hour rate of discharge.

Thus a 100 ampere-hour battery will give a continuous discharge of $12\frac{1}{2}$ amperes for eight hours. Theoretically it should give a discharge of 25 amperes continuously for four hours, or 50 amperes for two hours. As a matter of fact, however, the ampere-hour capacity *decreases* with an *increase* of discharge rate.

The capacity of a cell is proportional to the exposed area of the plates to which the electrolyte has access, and depends on the quantity of active material on these plates.

The capacity of batteries depends, therefore, on the size and number of plates in parallel, their character, the rate of discharge and also the temperature. Taking the eight-hour rate of discharge and temperature of 60 degrees F. as standard, the capacities which obtain in American practice are from

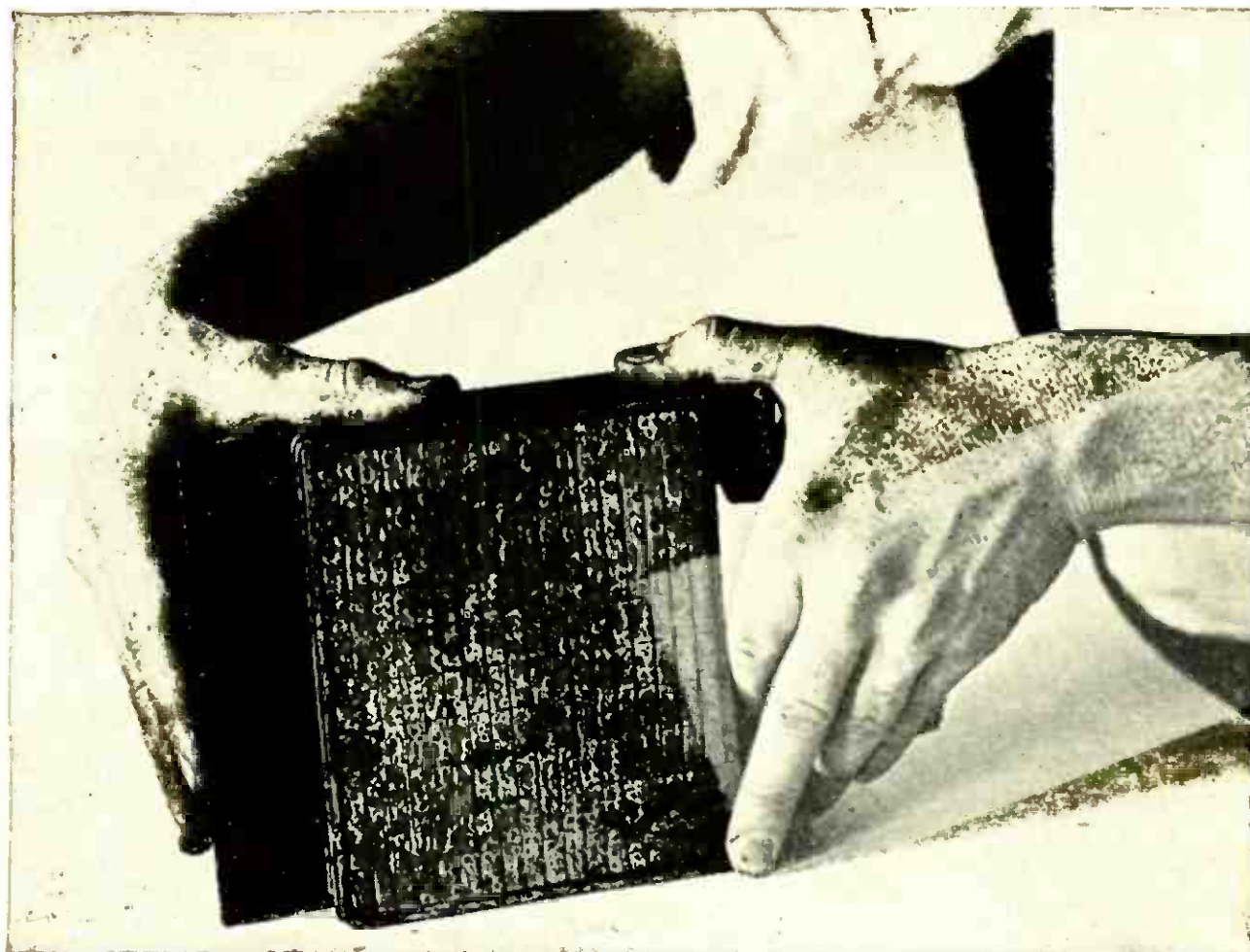

INSERTING THE SEPARATORS BETWEEN THE PLATES

FIGURE 2: A thin sheet of wood or perforated rubber is used as insulation between each positive and negative plate to prevent them from making contact with each other and thus cause an internal short-circuit.

40 to 60 ampere-hours a square foot of positive plate surface (equals number of positive plates in parallel multiplied by the length by the breadth and by 2). If the capacity under the above conditions is taken at the eight-hour rate as normal, the table below shows the decrease in capacity with increase in discharge rate for average American plates:

	<i>Percent of capacity at 8-hour rate</i>
8-hour.....	100 percent
6-hour.....	96 "
4-hour.....	88 "
2-hour.....	70 "
1-hour.....	48 "

The voltage of any storage cell depends only on the character of the electrodes, the electrolyte density, and the condition of the cell, and is *independent* of the size of the cell. The voltage of the lead sulphuric-acid cell, while on charge is from 2 to 2.5 volts, while on discharge it varies from 2.0 down to 1.7 volts. High battery voltages are obtained by joining the required number of cells *in series*. Thus for 100-volt circuits, approximately 50 cells in series are required.

The density of the electrolyte is measured with an instrument called a hydrometer (Figure 1), which is immersed in the liquid and floats with a greater or less amount projecting above the

surface of the liquid according to the density or dilution of the liquid. It has a scale on the upwardly projecting portion, on which the degree of density may be read. Where cells are so small that the hydrometer cannot be immersed in the electrolyte, it is customary to use a combination syringe and hydrometer which draws up into itself some of the liquid from the cell.

In addition to an effect on the voltage and electrolyte density, the temperature also influences the capacity and efficiency. The capacity of a cell, at discharge rates of eight hours or less, increases with the temperature. If the capacity at 60 degrees F. is taken as normal, the increase of capacity will be about one percent for discharges at four-hour rate, and at the two-hour rate the increase is about two percent, for each degree increase in temperature.

The electrolytic action seldom penetrates to a depth greater than 1/16 of an inch at ordinary discharge rates, so that where the thickness of the active material, measured from the surface of the electrolyte to the conducting plate, exceeds this amount, the portion in excess of this thickness is practically useless.

In order to obtain any desired capacity, the proper number of plates are

Hints for Keeping Up Your Battery

- 1: *Keep the battery charged.*
 - 2: *Never lay tools on top of a battery or they may cause a complete discharge by short-circuiting it.*
 - 3: *Add nothing except distilled water.*
 - 4: *Acid should never be added unless some has been spilled from the cells accidentally.*
 - 5: *Boiled water is not distilled water.*
 - 6: *A discharged battery will freeze easily while a fully charged one will not freeze in this climate.*
 - 7: *To find the positive and negative poles of a battery when no marks are visible fill a glass vessel half full of salt and cover with water. Run a wire from each terminal of the battery and hold them about one inch apart in the solution. Bubbles will rise from the negative wire. Also, there is usually more greenish corrosion around the positive terminal than the negative.*
 - 8: *Never light a match and look in the vent caps. The hydrogen gas in the battery is liable to explode and cause serious injury to the eyes.*
 - 9: *Keep the battery charged and don't let it get "thirsty."*
-

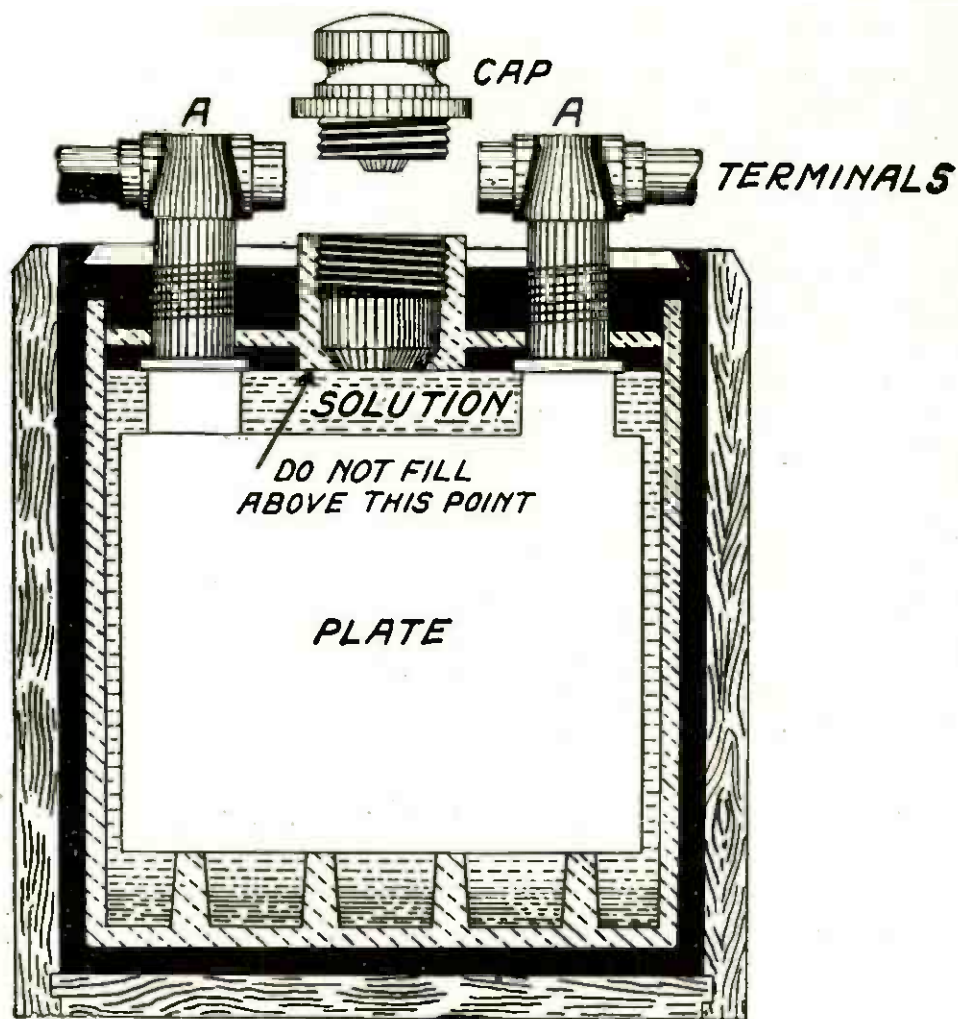

HOW THE STORAGE BATTERY IS PUT TOGETHER

FIGURE 3: Inside the outer wooden case is the rubber jar that contains the plates and solution. The black area is the pitch composition that is run in between the case and the jars. Note the ridges in the bottom of the jar that support the plates and provide room below them for the sediment to collect without causing a short-circuit.

assembled in a cell, all the plates in one cell being necessarily in parallel, the positives being joined together in one group and the negatives in another group, interleaved with the positives. Customarily, the number of negative plates exceeds the number of positive plates in each cell by one, so that the extreme end plates of each cell are negative plates. The plates of similar character in a cell are joined together by so-called burning the plate terminals to a common bus-bar, which is also lead. The burning is in reality a lead-welding process, in which the heat of an oxy-hydrogen blow-pipe is used to melt the parts together. This is the universal method of joining up the lead work in battery installations.

The plates are assembled in containing cells usually made of hard rubber. The cells are, in most cases, provided with upwardly projecting ribs and on these ribs the plates are supported. As the alternate electrodes are at opposite potentials they must not come in contact with each other, otherwise an internal short-circuit will result which will discharge the cell and injure the plates. In order to prevent this, some spacing arrangement or method of separation is necessary. The separators are made of specially treated pieces of wood or rubber. The illustration in Figure 2 shows one of these spacers as well as the method of inserting it between the plates.

The troubles to which batteries are

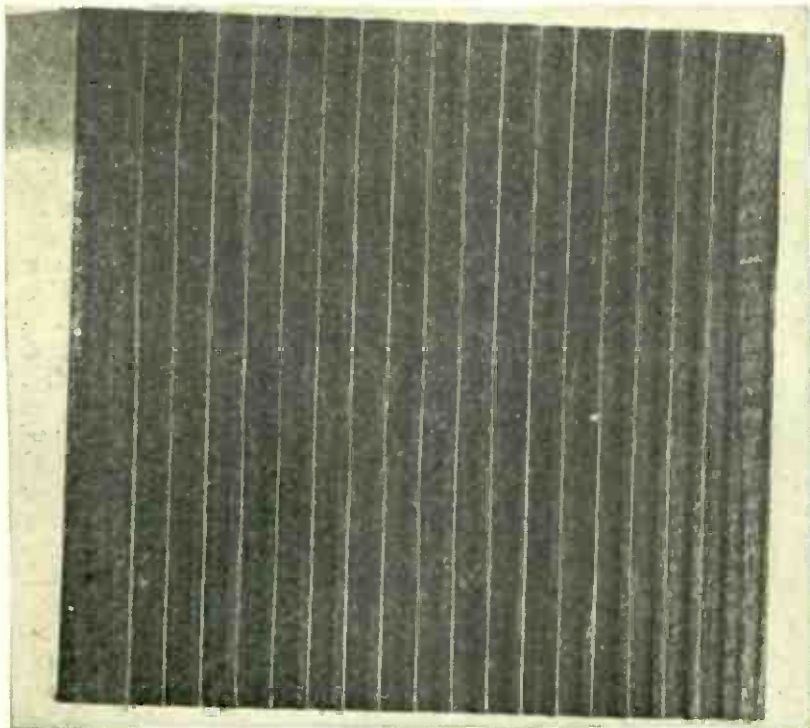

THE WOODEN SEPARATOR

FIGURE 4: *Specially treated cedar wood is cut into thin sheets, flat on one side and grooved on the other. They are always placed with the grooved side toward the positive plate.*

most commonly subject are:

- First*; loss of capacity;
- Second*; loss of voltage;
- Third*; corrosion of electrodes;
- Fourth*; distortion and fracture;
- Fifth*; shedding of acting material.

Nearly all these except the third are directly traceable to over-discharge, although overcharge and impurities in the electrolyte are important factors.

As has been shown on discharge, that

portion of the active material which enters into the chemical combination with the electrolyte is reduced to lead sulphate. As this sulphate is mixed with the uncombined active material, the whole mass retains its conductivity to a large extent and does not expand to a harmful degree if provision is made for a reasonable amount of expansion in the plate. If discharge be prolonged, however, beyond the proper point, it

THIS PLATE WAS SPOILED BY STANDING DISCHARGED TOO LONG
 FIGURE 5: *When the storage battery is discharged beyond a gravity reading of 1.100, or is left for a considerable length of time in a discharged condition, lead sulphate forms on the surface of the plate and closes up the pores. This greatly reduces the electrical capacity of the battery.*



TOO HIGH CHARGING CURRENT RUINED THIS PLATE

FIGURE 6: *After years of service, the positive plates gradually go to pieces. This plate gave out long before its time because of excessively high charging rates and prolonged over-charging. The large amount of gas produced under these conditions loosens the active material and it drops out.*

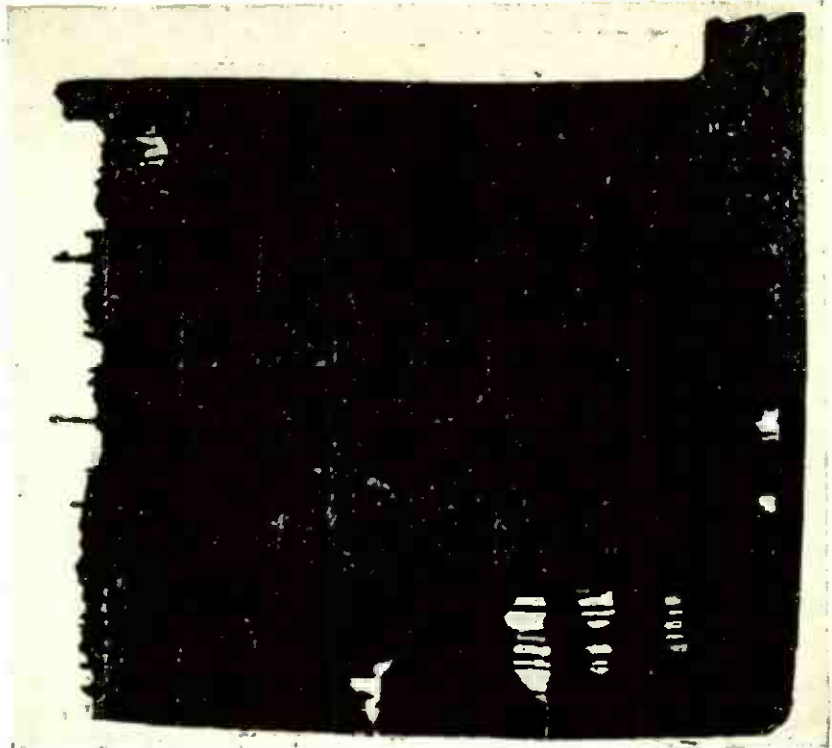

produces an over sulphation which manifests itself in a variety of ways. The lead sulphate deposits in white crystals on the surface of the plates. Its excessive increase in volume closes up the pores in the plates, thus reducing the true active surface. The expansion either causes the active material to loosen and fall from the supporting grid, or with certain types of plates, it will distort the electrode, and in some cases fracture it. The distortion usually takes the form of a warped surface and is known as "buckling."

Over-discharge may be caused by the prolonging of the current from the battery on discharge; by internal discharge, produced by impurities in the electrolyte,

and by accidental short-circuiting of the plates, which last frequently occurs inside the cell. Internal short-circuiting may be caused by buckled plates which are so far distorted as to crack the wood separators and come in contact with each other, but it is most likely to be caused by active material deposits which accumulate in the bottom of the cell. When this sediment has reached such a thickness that it touches two electrodes of opposite polarity it will short-circuit the plates to a greater or lesser degree and cause over-discharge with the attendant troubles above named.

A little care will greatly prolong the life of a storage battery. A few random hints (see page 558) may not come amiss.

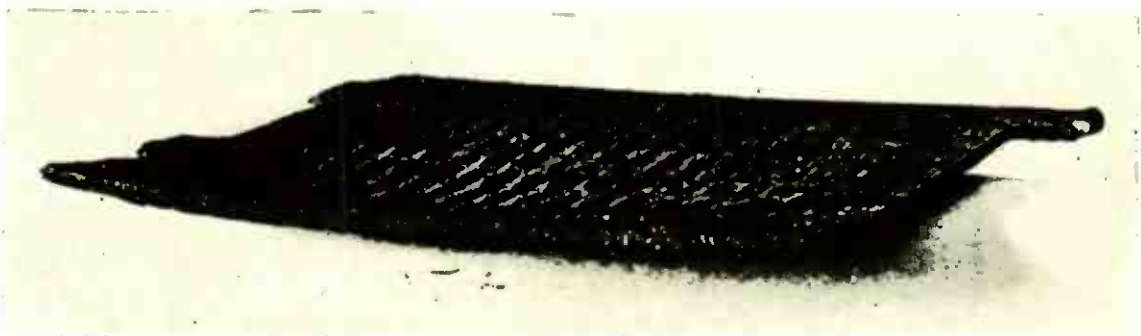

THE RESULT OF OVER-DISCHARGING

FIGURE 7: *When current is drawn from the storage battery, the acid in the solution combines with the plates and increases the volume of the material in them. When carried beyond the proper limit, this causes the plates to swell and buckle.*

Useful Tips for the Radio Listener

By Y. Z. MUTS

When to Disconnect Your "A" Battery: If you have a potentiometer connected across your "A" battery, make it a point always to disconnect your battery when you have finished listening in, or a considerable drain through the potentiometer winding will result. This is particularly important if the potentiometer is of comparatively low resistance. A panel switch affords the most convenient way to break the "A" battery circuit.

When the Batteries Give Out: If, while you are listening to a concert, the signals should become weak and turning up the rheostat does not help, you may rest assured that either the "A" or the "B" battery has breathed its last. Put the voltmeter to work.

Mount Tubes Vertically: Never mount a vacuum tube in a horizontal position, as the filament may eventually sag and rest upon the grid, making the tube useless. Always mount a tube in an upright position.

Porcelain Tubes Are Good Insulators: Even though the lead-in wire is insulated, never let it touch metal objects such as the coping around the roof, vent pipes or fire-escapes, as energy will leak through the insulation and cause partial short-circuits and weak signals. Run all wire through porcelain tubing when there is any possibility of it touching metal.

Make Sure of the Current Capacity: When you connect two or more tubes in parallel to be controlled by one rheostat, make sure that it is of proper resistance and that it will carry sufficient current to operate the tubes at full

efficiency without heating. The maximum amperage of the better grades of rheostats is specified by the manufacturers and is usually printed on the boxes. Roughly, a rheostat for use with three tubes should have three times the current capacity and one-third the resistance of a rheostat for one tube.

Large Size "B" Batteries Are More Economical: Until you have used it, the quality of a "B" battery can only be judged by its popularity and the reputation of its maker. When you buy a "B" battery select one of the large size. It will give you the most electrical energy for your money. However, in portable sets, space must be economized as much as possible and weight held down. This means a small battery. Because of its small size, the capacity is limited, and it should not be used except when it is out of the question to install a larger battery.

Be Careful of Your Tubes: Always remove the tubes from a set whenever repairs are to be made. This will prevent accidental burn out by high voltage current from the "B" battery wires which might touch the filament leads of the tubes. The tips of tubes are usually broken off by handling while taking them out of the set. A drop of melted sealing wax placed on the tip of the tube will prevent it from being damaged and also strengthen it. Whenever the set is to be removed or to be stored for a while, it is best to remove the tubes altogether and place them in the cartons in which they came or in a small pasteboard box well protected with cloth or paper to keep the delicate filament from shocks and jars.

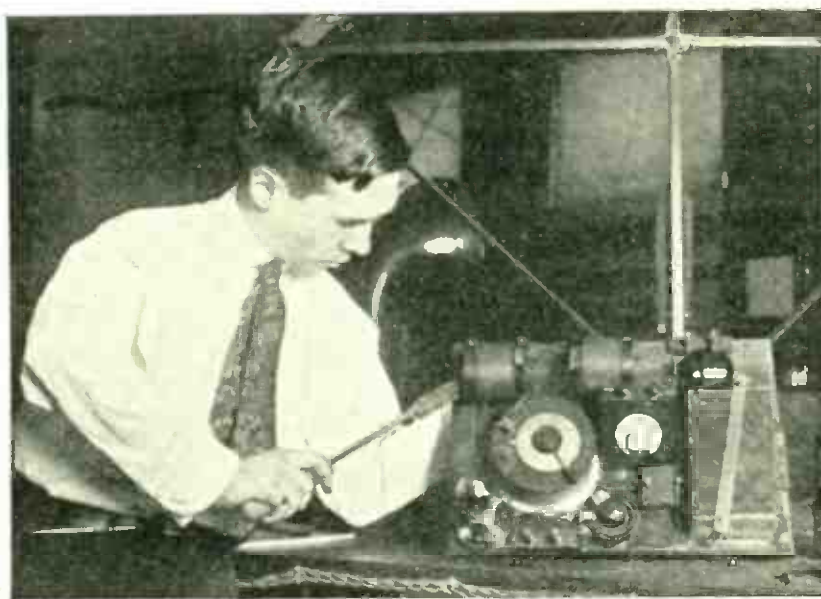

Care in using short leads and well soldered joints in the wiring helped Edward T. Dickey of New York to develop a low powered amateur transmitter that operates efficiently at wavelengths far below 200 meters.

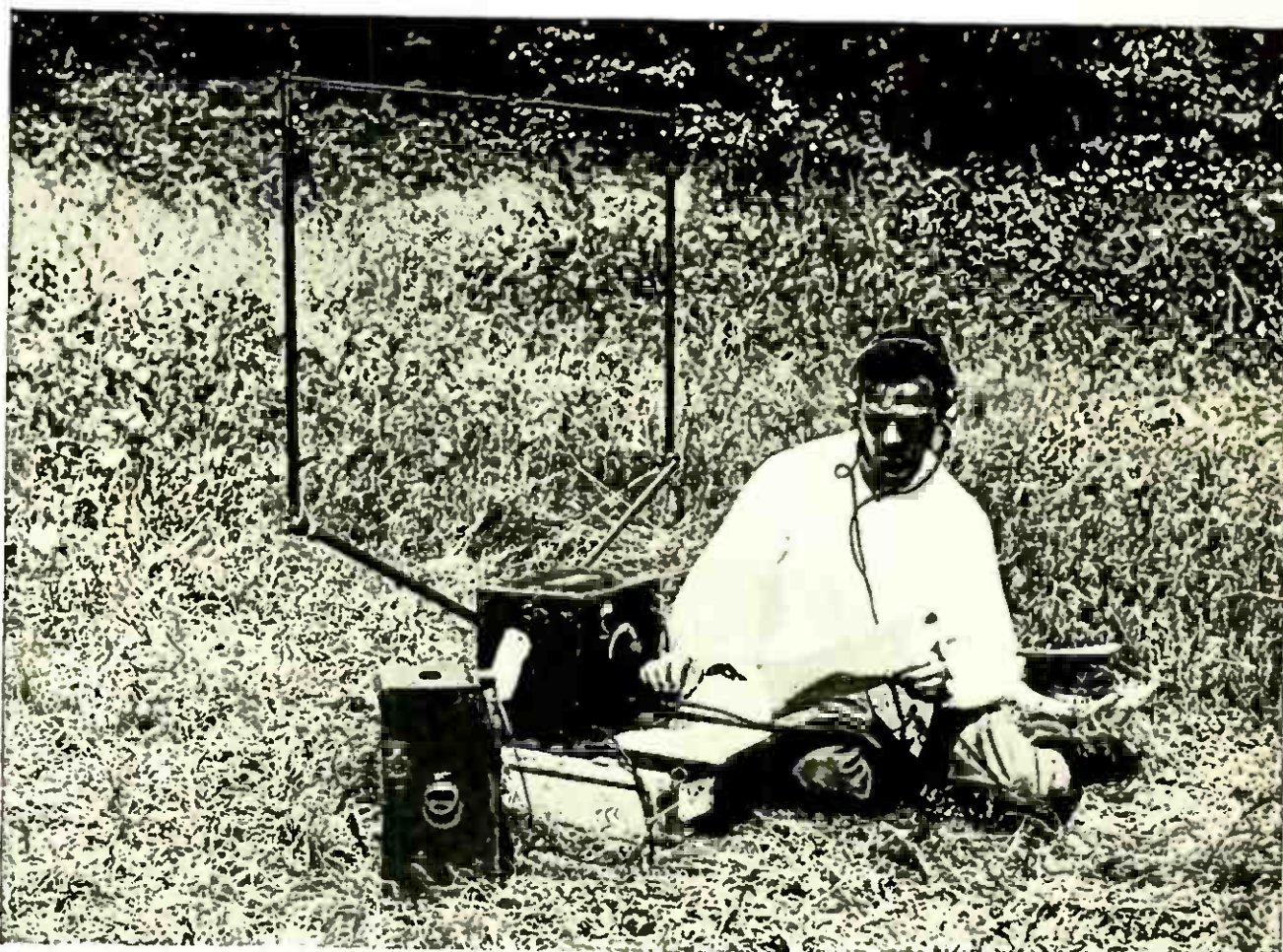

From a photograph made for POPULAR RADIO

THE TRENCH RADIO TRANSMITTING AND RECEIVING SET IN OPERATION

Students at the Signal School use this portable apparatus for communication in the field up to distances of five miles.

How the Army Teaches the Code

Some of the new and unique methods used by the Signal Corps for making skilled radio operators out of novices and "hams"

By PAUL MCGINNIS

EVERY "ham" in the United States is welcome to know how the Signal Corps directs an entire battle by radio with less than a score of characters wrong in the messages exchanged. This is the attitude of Lieutenant Colonel J. E. Hemphill, head of the Signal School at Camp Alfred Vail, New Jersey, where the latest and best methods of instruction are employed.

They know what is the matter with the "fist" of every beginner at the key

at the Signal School, and they know just how to go about teaching him to copy at a lively clip and to become practically letter perfect.

The camp literally bristles with antennas, and when there is a sham battle in progress the woods about the camp are alive with messages which are sent with precision and copied in a style which is a distinctive feature of the school's training. Messages are not written, but actually printed by the operator.

To one who is used to copying messages in the usual "long hand," as he would write a letter, any system of printing seems impossible. He realizes how fast he must write to copy at a good speed, and how slow he must go if he prints. He does not take into consideration how many unnecessary movements he makes when writing and how many of these he can eliminate by correct printing.

The Signal School has developed a unique system of printing which is an outstanding monument of efficiency both in saving time and insuring accuracy. The accompanying chart shows how few actual strokes need be made in forming the letters of the alphabet and the numerals.

The first letter on the chart is a decided shock to any operator who has been making the letter "u" in the usual way. It requires only one stroke, whereas in ordinary script it would require two or three similar movements, depending upon the position of the operator's pencil at the beginning. The round dot shows the beginning of each stroke, and the arrow shows the direction.

There is no letter on the chart which requires more movement of the fingers in printing than in writing. In actual practice the system is found to be nearly as fast as any method of writing and by far more accurate and legible.

Perhaps the chief advantage of printing lies in the fact that when one character in a word is missed, the remaining characters are formed perfectly enough so that the word can be made out. Although the Army is anxious to have all letters perfect because most messages

are sent in cipher, tests prove that its method of printing is practical for all purposes.

Just as all soldiers take the same length of step after they have been in service for a while, all army operators have the same handwriting when it comes to copying messages. Any officer can read the penciled message of any private, no matter how fast it has been copied.

There are many operators outside the army, especially the "speed merchants," who can not read their own hasty writing after it "gets cold."

This never happens at the Signal School, because all messages look alike, the old, the new, the hot and the cold. Last year's log is as readable today as ever.

There are a number of script characters which are easily confused, such as "m," "n" and "i" when they are written together hastily, whereas the same letters written the army way are easily told apart. The letter "n" is printed with one stroke running in three directions only. When the letter is made in this manner it saves the time required to make the final downward movement of the script letter and when it is finished it is easily distinguishable from any other character.

The letter "y" has an unusual form which is the result of long experiments and genuine inventive ability. The first stroke is like the letter "v" and the second completes the character in a way which distinguishes it positively, even though the operator may be somewhat careless in forming it.

An extra stroke is added to the figures 1 and 0, so as to distinguish them from the letters I and O. The 1 is underlined and the 0 has a line drawn through



A GRAPHIC RECORD OF A POOR "FIST"

This record of a student's message is made on an undulator—an apparatus that consists of a paper tape moving at a uniform rate under a pen which is fed with ink by a syphon action. The pen moves back and forth across the tape in perfect time with the student's manipulation of the key and is, therefore, a picture of his message as he sends it.

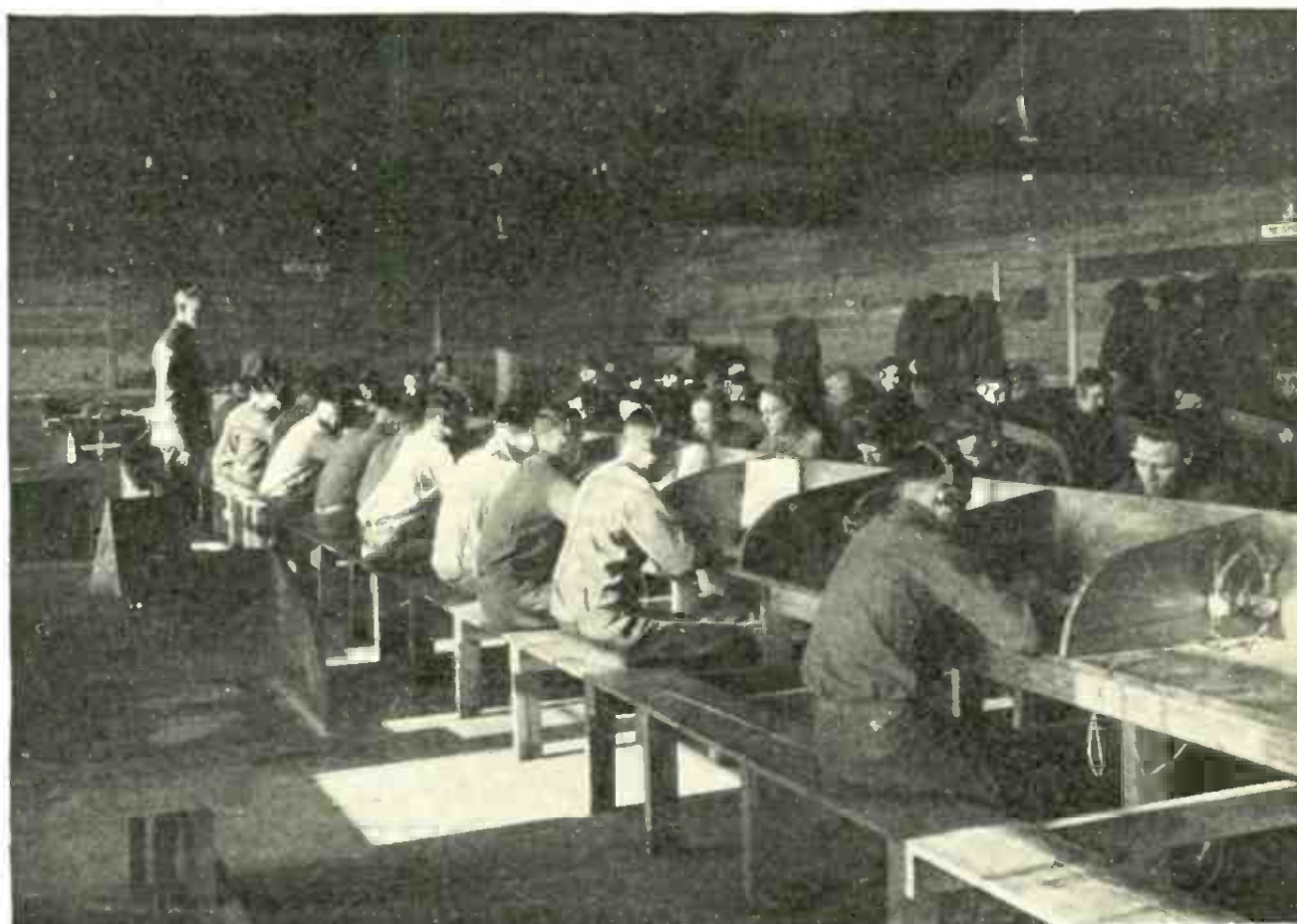

From a photograph made for POPULAR RADIO

WHERE THE STUDENTS LEARN THE CODE

A unique feature of the Camp Vail method of teaching is that the students are required to print instead of to write the messages they receive by radio.

it. The extra strokes do not delay the operator, however, because the code gives him the time of five dashes for the 0 and four dashes and a dot for the 1.

One of the chief arguments for adopting the printing system is that no operator can avoid copying abbreviations and unusual words and combinations of letters which are strange to him and which he must write plainly if he is to make a perfect record.

Europe is now so close to America, from a radio point of view, that almost any American amateur is apt to hear a foreign station sending in a foreign language. When such a thrill comes, he is glad to know all the tricks of his trade and to fill his log with the prize. The commercial operator also knows the value of accuracy in messages of importance.

The "fist" of the army operator also receives much consideration at Camp

Vail, for there is usually a point in the training of an operator where his ability to receive increases faster than his ability to transmit.

When the operator is struggling to copy ten or fifteen words a minute, he sometimes develops a wrist movement which enables him to send twenty or twenty-five words a minute, but as he progresses his hand lags. He may, after some months, be able to copy at the rate of thirty or thirty-five words a minute, but there are few operators who can send well at that rate.

The man in an army class has an advantage over a man who struggles alone at home with PX and with other "hams" who are as slow as he, but the army has rules which will help any beginner, and many who are advanced, if they have the courage to follow them.

It is usually difficult for a man to forsake his speed of nine words a minute

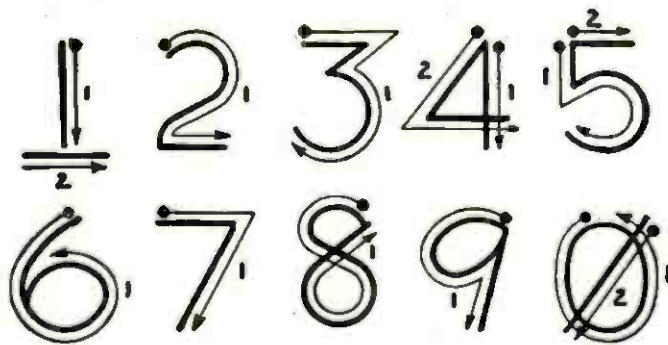
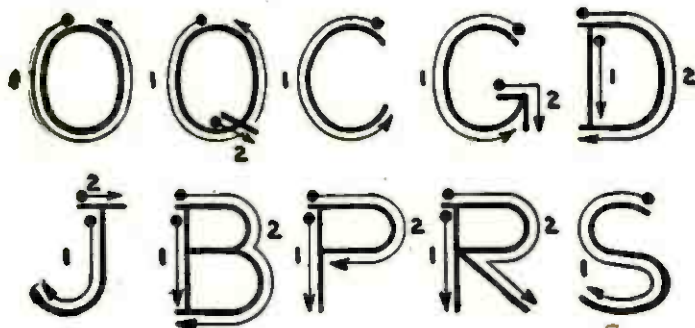

THE APPROVED METHOD OF WRITING CAPITALS.
TRY IT YOURSELF!

Students at Camp Vail are taught to move the pen or pencil in the direction of the arrows shown on each letter. This method of transcribing messages received by radio eliminates mistakes, and it may be faster than ordinary writing.

because he has a wrong wrist movement and start over again at the rate of three or four, but if he is going to be successful he must treat his arm right. His fingers, which have been trained for many other delicate tasks, perhaps, are little good to him in working a key, and this is the hardest blow to the beginner.

He can seize a key tightly with his fingers and play a lively tune on it after a few days if he is a good mechanic or an artist in any other line where manual skill is required. His wrist movement is

too awkward at first to be of any value to him, but if he is to gain any great amount of proficiency, he must forget the nimbleness of his fingers and use them merely as loose and clumsy flappers to rest almost carelessly on his key.

The chief value of his thumb and fingers lies in keeping his hand from sliding off the key. The real work, the snappy dots and dashes with which he will soon punctuate the ether are made by his wrist, moved largely by his forearm.

Dots are made by raising the wrist with a slight quiver. A series of dots is made by only one upward movement of the wrist, and such movement should require no strain upon any of the muscles of the arm, the wrist or the fingers. When the proper quiver of the wrist is mastered, five dots can be made with the single upward movement as easily as one.

The dash is made with the downward movement of the wrist. As the dash is longer than the dot, it gives the wrist plenty of time to move downward.

At Camp Vail an undulator can be switched to the key of any pupil whose sending is ragged, and he can see upon a tape just what mistakes he is making. Such a visual record is nothing short of a revelation to many operators, because few can hear themselves as others hear them.

The novice is invariably astounded when he first learns that one operator can know another by his sending just as he would know a voice over the telephone. When he gets farther into the subject of dots and dashes, however, he finds that there are few "fists" which have no foreign accent.

The undulator reveals such a brogue or stuttering on the part of an operator's hand by means of an ink line on a paper tape. The undulator used at Camp Vail feeds ink with a syphon action through a hollow point which is vibrated back and forth across the paper tape as the operator taps the key. As its response is instantaneous, the student's defects are revealed at once when his record is compared with a perfect model.

It has been found that practice with some kind of coded message is more beneficial than with messages which can be understood by the man who copies them. A few press messages are sent occasionally to enliven the lesson.

The amateur who practices with his neighbor often finds it unhandy to plan new code messages constantly, and so he

resorts to sending the news of the day from a daily paper. To make a code message out of a newspaper story, however, it is only necessary to send the story backwards. Starting at the end of the story, the operator can send five letters at a time, just as they come, with a pause in between each group of five letters. When he has finished, he can readily check the message by reading it backward.

Some three hundred officers and men are in training constantly at Camp Vail, representing all branches of the army, and if the amateur has any doubt as to the efficiency of the methods used for instructing them, he has but to call 2CXL, which is a genuine "ham" station in every way.

Before obtaining the amateur license, the station was known as WUBA, and it proved that four "fifty-watters" in parallel in a Hartley circuit could reach France and Hawaii, and actually work 6XAD in California.

There are two reasons why men at Camp Vail take pride in being real amateurs. The first is that they cannot tell when an amateur is going to contribute to radio science in a way which will be a valuable aid to his government, and the second is that they are interested in developing amateurs and helping them. The response of "hams" during the war has earned for them a definite place in the activities of the Signal Corps.

The set used for local work at the camp is perhaps more representative of the American "ham" station than any other. It consists of four five-watt tubes, and it is worked with the army call letters, BS6. This little set so far has reached out some 300 miles with only 1.5 amperes in the antenna.

Experiments are constantly made with this little outfit to help the amateur.

Officers in charge of this development work are among the best technical radio men of the country and they are genuinely interested in amateur radio.

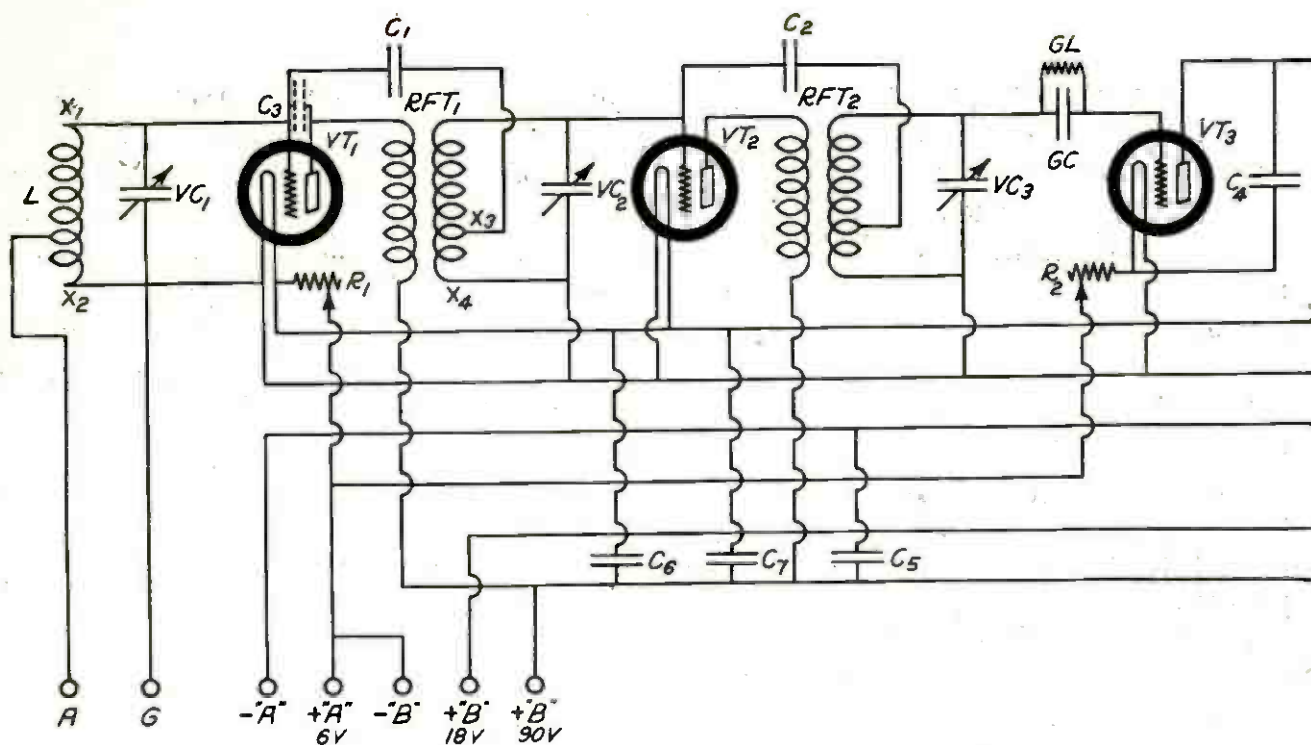

HOW TO GET THE MOST OUT OF YOUR READY-MADE RECEIVER

Q *The first of a series of articles that will describe and explain the theory, operation, equipment and care of one particular make of receiver.*

The object of this series is to present helpful information which will enable owners to obtain best results and maximum satisfaction from their receiving sets. The series will not indorse the product of any manufacturer, nor make comparisons between receivers of different types or makes. The receivers included in this series will be selected by the readers of POPULAR RADIO, from whom suggestions are invited.

By S. GORDON TAYLOR

IT is not necessary to have a thorough understanding of the theory of the neutrodyne circuit in order to operate a neutrodyne receiver successfully. But for the benefit of the reader who wants to know "how it works," the following simple description has been prepared.

How the Neutrodyne Works

In any receiver that employs radio-frequency amplification it is necessary to prevent "feed-back" or at least to reduce it to the point where it will not cause oscillation.

This "feed-back" is due to the fact that the current from the plate circuit

affects the grid circuit of the vacuum tube. It is caused by induction, if the coils of the two circuits are placed so that there is magnetic coupling, or it may result from the capacity effect of a condenser. In a radio-frequency amplifier "feed-back" may be a drawback. If care is taken to locate the coils properly, inductive "feed-back" can be practically eliminated, but there is still a capacitive effect between the electrodes of the vacuum tubes. The opposing surfaces of the grid and the plate form the two plates of a tiny condenser.

Notice that the coils of neutrodyne receivers (commonly called "neutroform-

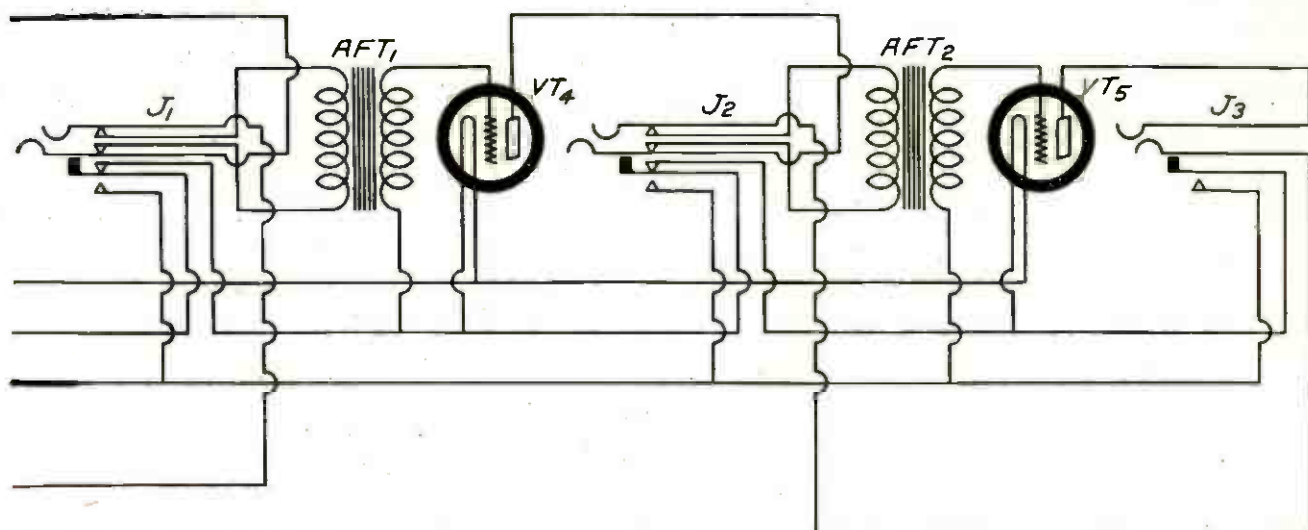

THE CIRCUIT DIAGRAM OF THE NEUTRODYNE RECEIVER

FIGURE 1: This illustration shows how the filament circuit is wired to the automatic filament jacks so that only the tubes that are actually in use are lighted. The parts indicated by letters are as follows:

L—Antenna tuning inductance;
RFT1 and *RFT2*—neutroformers or tuned radio-frequency transformers;
AFT1 and *AFT2*—audio-frequency amplifying transformers;
VC1, *VC2* and *VC3*—variable condensers for tuning;
VT1, *VT2*, *VT4* and *VT5*—UV-201-a or C-301-a vacuum tubes;

VT3—Either UV-200 or C-300 vacuum-tube detector;
C1 and *C2*—neutralizing condensers;
C4, *C5*, *C6* and *C7*—by-pass condensers;
R1 and *R2*—rheostats;
GC—grid condenser;
GL—grid-leak;
J1, *J2* and *J3*—automatic filament-control jacks.

ers”) are placed at an angle as shown in Figure 2. This practically eliminates inductive “feed-back.”

The elimination of the capacitive “feed-back” in the neutrodyne is accomplished by creating a current flow in the circuit exactly equal to but in the opposite direction to the flow of current that causes the “feed-back.” These two currents naturally balance each other and the circuit is said to be neutralized. The exact method by which this effect is carried out is to connect a portion of the coil in the grid circuit in series with a small condenser and the plate circuit.

In Figure 1 the condenser *C3* shown in dotted lines represents the capacity between grid and plate and the inductance *X1-X2* represents the inductance in this circuit. Condenser *C1* and inductance *X3-X4* make up the neutralizing circuit.

The Construction of the Neutrodyne

Five vacuum tubes are used in the Eagle Neutrodyne receiver. The purpose of the first two tubes will be given later.

The third tube (*VT3* in Figure 1) is the detector which is really the heart of any receiver. When energy is picked up by the antenna system it is in the form of an alternating current of radio-frequencies. A radio-frequency current such as this is not audible in a telephone receiver or loudspeaker because a receiver diaphragm that vibrates at such a rate would produce a note far above the range of sounds audible to the human ear. The detector tube rectifies or rather suppresses half of each of these radio-frequency waves and when the wave is modulated by a human voice as it is in broadcasting, hundreds of the half-waves combine to pull the diaphragm back and forth.

Some sort of a tuning device to tune the receiver to the wavelength of the transmitter, a detector and a telephone receiver are all that are needed to make radio reception possible. Additional vacuum tubes and accessories are necessary to increase the volume so as to make possible the use of a loudspeaker for

the entertainment of a group of persons. Others may be added to increase the range. In the Eagle Neutrodyne receiver both these ends are attained by the addition of tubes VT1 and VT2 to increase the range and tubes VT4 and VT5 to increase the volume.

Tubes VT1 and VT2 together with accompanying equipment make up two stages of tuned-radio-frequency amplification, neutralized as explained above. These tubes amplify the radio-frequency currents intercepted by the antenna before this current reaches the detector tube. While radio-frequency amplification will not increase strong signals from local stations to any great extent, it does materially increase the volume of signals from distant stations. This is because the antenna will bring in enough current from local stations to work the detector tube to nearly maximum capacity anyway.

The purpose of tubes VT4 and VT5 is to amplify the signals after they have passed through the detector and have been converted into audible frequencies.

These two tubes and the equipment that goes with them form the audio-frequency amplifier. They do not materially increase the range of the receiver because they can amplify only what is passed on to them by the detector. This type of amplification makes the use of a loud-speaker practical even on the signals from distant stations, and great volume can be obtained from the signals of nearby stations.

The Right Antenna for this Type of Neutrodyne

Any outdoor antenna should be well insulated at its ends and should be kept 10 feet or more above any roof or object which it passes over or near. If it can be erected over open ground, as from a roof to a pole in the yard, so much the better. If it is desired to fasten one end to a tree, a supporting wire long enough to keep the antenna itself entirely clear of the foliage should be fastened to the tree, and an insulator used between this supporting wire and the end of the antenna. It is a good plan

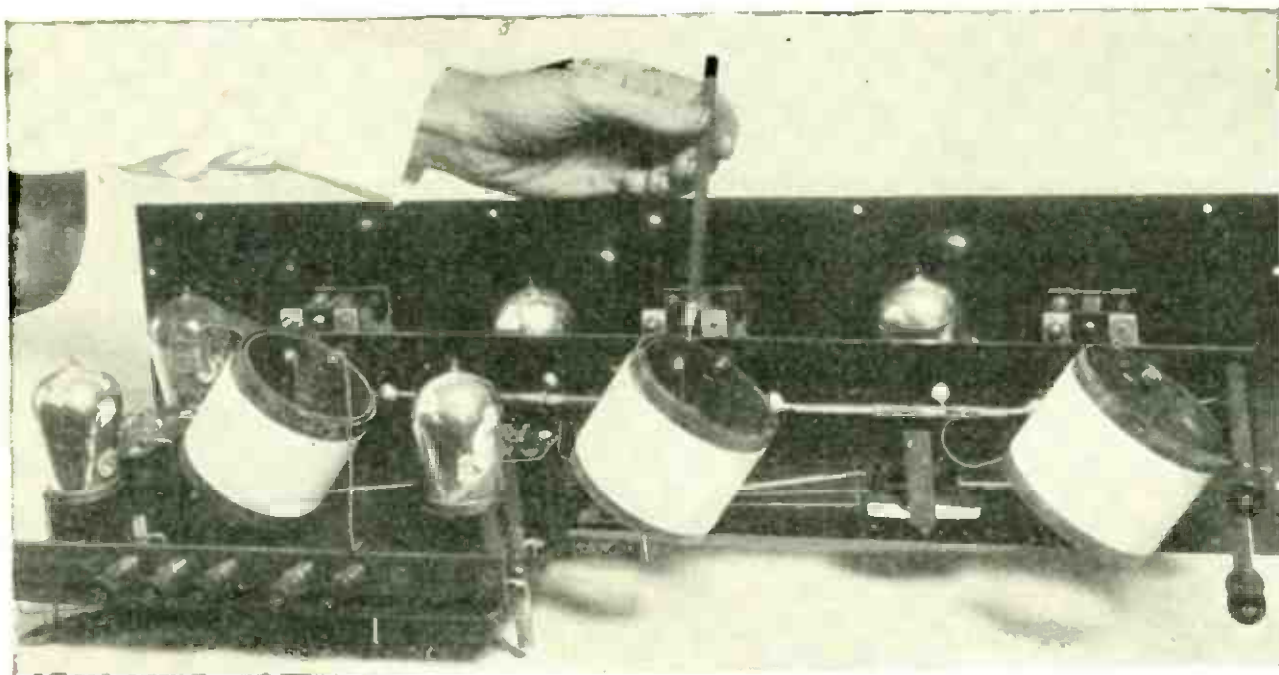

HOW THE COILS ARE PLACED TO ELIMINATE INDUCTIVE "FEED-BACK"

FIGURE 2: The tuned-radio-frequency transformers (often called neutroformers) in this receiver are placed at an angle as shown. This arrangement causes the magnetic lines of force from one coil to cut through the coil next to it at right angles, so that there is little or no inductive coupling.



LOGGING THE STATIONS YOU HEAR IS EASY WITH THIS RECEIVER

Stations are always heard at the same dial settings with any neutrodyne type of receiver, so that it is only necessary to make a record of the settings of the three large dials each time you hear a new station.

to run the antenna wire itself down from the fastening at the near end and through a porcelain tube direct to the set as this method will eliminate the joint which would otherwise be necessary between the antenna and the wire that goes to the binding post of the receiver. In fastening one end of the antenna to a tree, due allowance should be made for the swaying of the tree in the wind. Figure 3 shows how to overcome this difficulty.

The best length for the antenna will depend to a certain extent on local conditions. The ideal length for this receiver is approximately 150 feet, including lead-in. However, if one or more broadcasting stations are located within ten miles or so of the receiver it will not be advisable to use such a long antenna because of interference from the local

stations. An antenna with a total length, including lead-in, of only 50 or 60 feet may be used if necessary. Good results have been obtained on a wire about 60 feet long running around the picture moulding inside of the house. The best plan is to put up an antenna of between 100 and 150 feet and then, if there is noticeable interference from local stations, reduce this length as much as may be found necessary. In the summer time when static is bad, it is frequently found helpful to have an indoor antenna which can be connected to the receiver in place of the outdoor one in order to cut down the effect of static.

The ground connection to the receiver should be made to a cold water pipe if there is one in the house. Otherwise a ground can be made by burying a quan-

tity of wire or metal in the earth and soldering the ground lead to this. A well makes an excellent ground connection and may be used by simply suspending a piece of sheet copper or a coil of copper wire in the water with a connecting wire running to the receiver. Always make the ground lead as short as possible. Be sure to clean the water pipe with a file or a piece of emery cloth and make the connection with a regular ground clamp.

The Right Tubes to Use

It is recommended that a soft detector tube, either the UV-200 or the C-300 be used. For both the radio-frequency and the audio-frequency amplification tubes the UV-201-a or the C-301-a are recommended.

If one prefers a UV-201-a or C-301-a may be used as the detector also, but as the receiver is designed for use with the UV-200 or C-300, it is best to follow the manufacturer's advice. The one ob-

jection to the use of the soft detector tube is that it consumes about four times as much "A" battery current as does the UV-201-a. In other words, the current consumption from the storage battery will be about two amperes per hour with four UV-201-a and one UV-200 in the receiver, whereas it is only about one and one quarter amperes when five UV-201-a's or five C-301-a's are used. If you have facilities for recharging the battery, this difference is not important. To the man who has to carry his battery to the service station for recharging, however, the higher current consumption is a factor worth considering.

Be sure that the dealer tests the tubes in a receiving set before they are purchased.

This applies both when the receiver is being purchased and a complete equipment of tubes is obtained, and also later when it may be necessary to purchase a new tube from time to time. It is not sufficient to have him connect the fla-

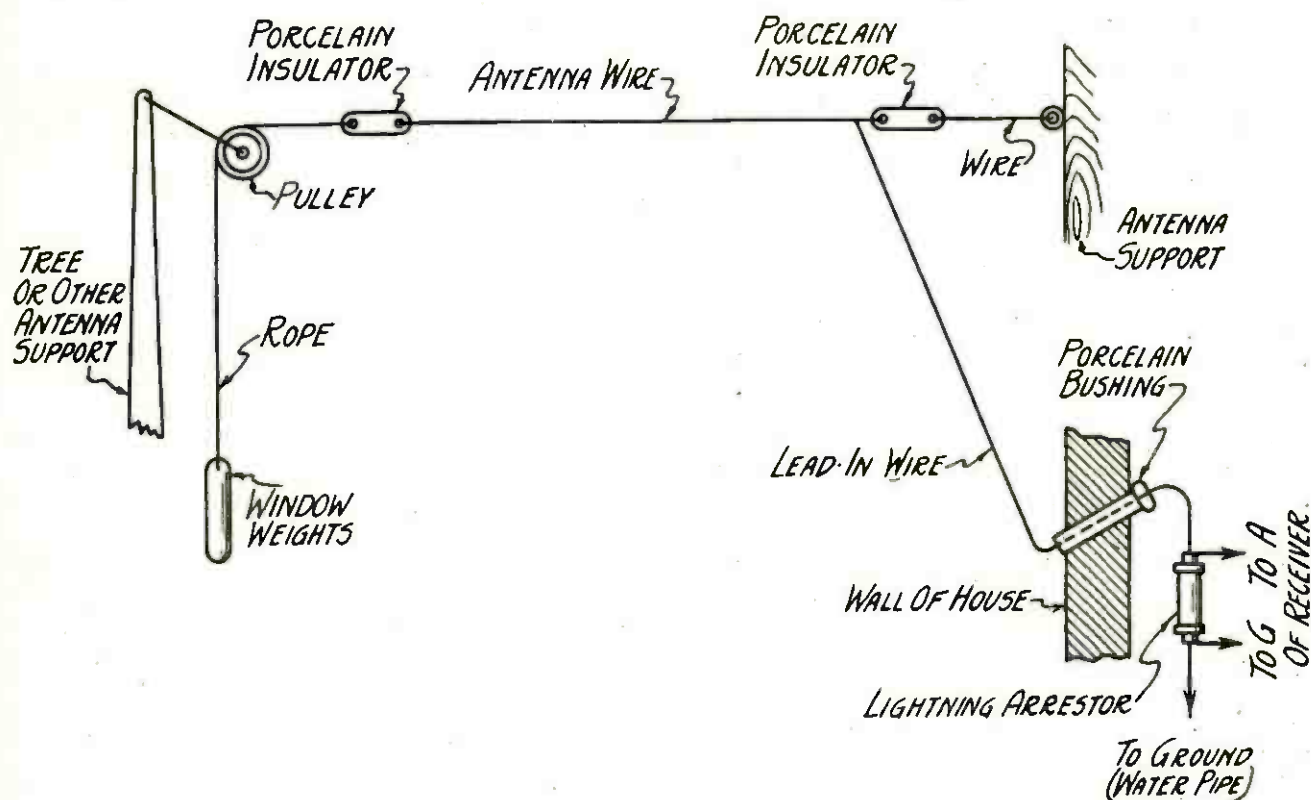

HERE IS A GOOD ARRANGEMENT FOR THE ANTENNA

FIGURE 3: It is often necessary to fasten the far end of the antenna to a tree or pole which may swing when the wind blows. The pulley and weight shown will keep the antenna strung tightly at all times. Note also the angle of the hole for the porcelain insulator which is made in the side of the house. Boring the hole at this angle prevents leaks when it rains.

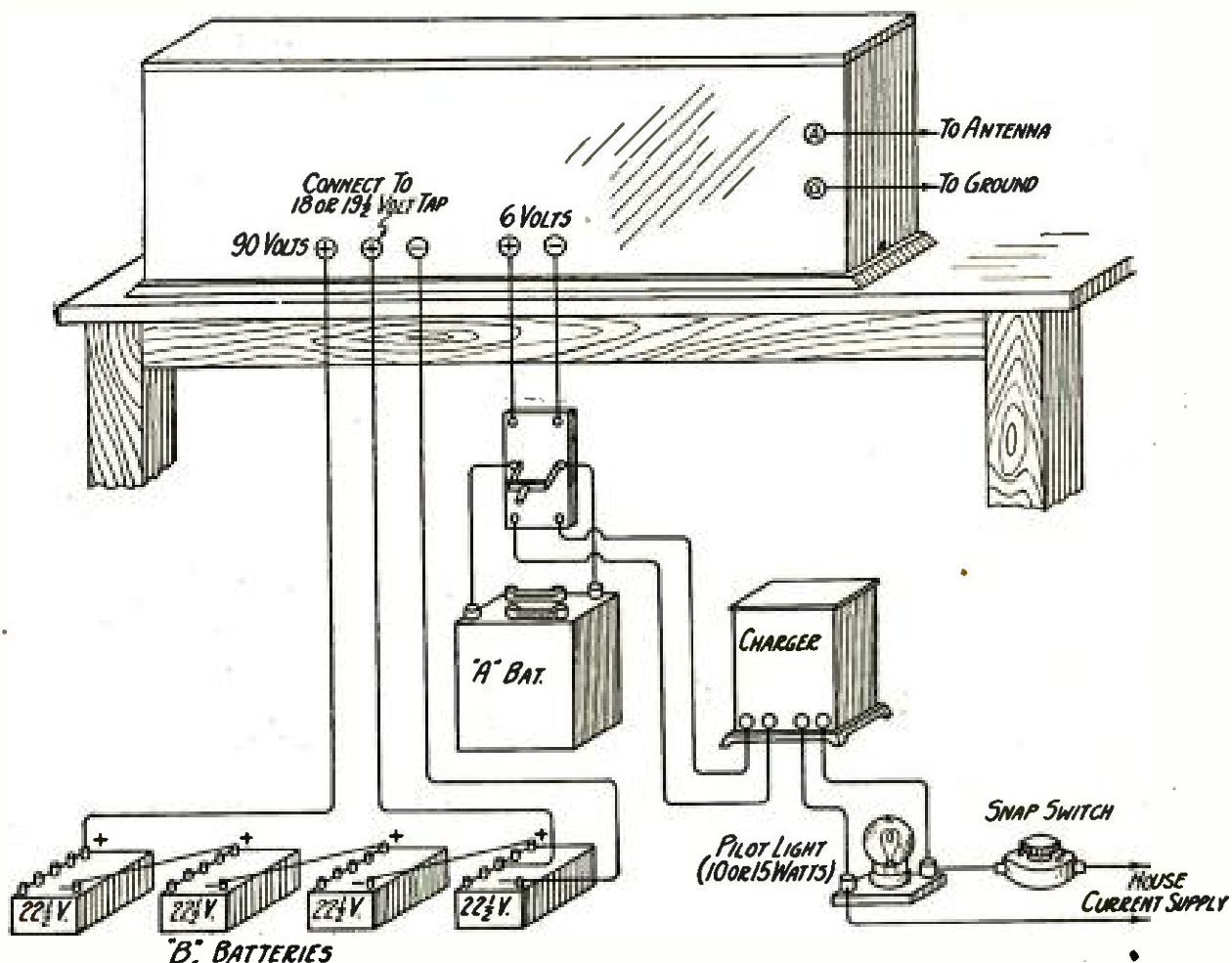

THE CONNECTIONS FOR THE BATTERY AND CHARGING EQUIPMENT

FIGURE 4: This illustration shows how to connect up the batteries that supply current to heat the filaments of the tubes and for plate supply. Note the double-pole, double-throw switch that connects the "A" battery to the receiver or to the charger. This switch prevents the possibility of short-circuits through failure to disconnect the battery from the receiver when the charger is turned on.

ment across a battery to demonstrate that the filament lights. Occasionally a tube is found, in which the filament will light but which will not work when placed in a receiver, due to some internal defect in construction. This condition is not a common one, and if one is unlucky enough to purchase such a tube the dealer will exchange it for a good one. It causes inconvenience, however, which can easily be avoided by requiring the dealer to make a proper test in the presence of the purchaser at the time of purchase.

It is not necessary to replace tubes often. You can be quite sure of at least 1,000 hours of operation from each tube and frequently a tube will last for a much longer time than this. If a receiver is used on an average of two

hours a day it is fairly certain that there will be no tube trouble for fifteen months or more, provided the filaments are burned at the proper temperature during that time. The proper temperature is the lowest temperature at which maximum volume and clearness are obtained. It will be found that as the rheostats are turned on, while a broadcasting station is tuned in, the volume of signals gradually increases as the rheostat is turned up. A point will be reached, however, beyond which there will be no noticeable increase in volume. This is the point at which the tubes should be operated. If the "A" battery is kept well charged at all times the rheostats may be left permanently adjusted at this point. As filament control jacks are used in the Eagle receiver

the current is automatically cut off when the loudspeaker plug is removed from the jack, and it is therefore not necessary to turn off the filament current by means of the rheostats, or a push-button cut-off switch.

What Batteries to Use

Figure 4 shows how to connect up the batteries. Two types of batteries are used: the "A" battery and the "B" battery. The "A" battery is a six volt storage battery with a capacity of from 60 to 100 or more ampere hours. The "B" batteries are of the dry cell type. Storage "B" batteries can also be used if desired.

The usual "A" storage battery is made up of a number of lead plates in a solution of sulphuric acid and distilled water. It is necessary to add distilled water from time to time to make up for evaporation. Be sure to keep the level of the solution above the top of the plates.

The storage battery is exactly what its name implies—a storage place for electric current. When the current is used from the battery it is necessary to put it back again by means of a charging device. You may have your battery charged at the nearest battery service station or you may buy a charger and do it yourself at home.

The best way to determine the state of charge of a battery so as to know when it needs recharging, is to use a hydrometer. This is an instrument that has a rubber bulb on one end of a glass tube and a short piece of rubber tubing on the other. Inside is a glass float and the state of charge of the battery is indicated by the depth to which this float sinks in the battery solution which is drawn up into the glass tube by means of the rubber bulb. A fully charged battery will read about 1,285 on the scale and when the float sinks down to 1,150 the battery should be recharged at once. Never let the battery stand discharged for any length of time, and

keep the level of the solution above the tops of the plates and you will get good service out of it.

Before you purchase a charger for your battery, be sure to find out what kind of electric current you have in your house.

There are chargers made for either direct current or for alternating current and it is absolutely necessary to get the type that works on your kind of current. A 2-ampere charger is satisfactory for batteries up to 60-ampere hour capacity and a 5-ampere charger is advisable for larger ones.

In Figure 4 is shown a suggested arrangement which simplifies the charging process. To charge the battery it is only necessary to throw the double-pole switch to the charge position and snap on the current.

With all five tubes burning, the Eagle Neutrodyne draws two amperes from the storage battery and you can calculate how long any particular size of battery will run the set without recharging by dividing the ampere hour capacity by two to get the number of hours the set will run. A 100 ampere-hour battery should run the set continuously for fifty hours.

A "B" battery of 90 volts is recommended for the Eagle Neutrodyne. You can buy either the small size or the large size, but it will be found that the large size is much more economical in the long run. It makes no difference whether you get four blocks of 22½ volts each or two blocks of 45 volts each. Buy new batteries when the 22½ volt batteries show a reading of only 17 volts and the 45 volt batteries get down to 35 volts. Rundown "B" batteries will make the reception noisy and may often produce a bad whistling sound.

In order to give some idea as to the life of "B" batteries with a 5 tube receiver such as the Eagle, the following table has been prepared; it shows the number of days that a 90 volt "B" battery may be expected to last when used an average of 2, 3 or 4 hours a day and

STATION LOG							
LOCATION OF STATION	CALL LETTERS	DIAL 2	DIAL 3	LOCATION OF STATION	CALL LETTERS	DIAL 2	DIAL 3
New York, N. Y.	WEAF	66	65	Tuinucu, Cuba	6KW	19	20
" "	WJZ	53	53	" "		6KW	26
" "	WJY	39	39	Detroit, Mich.	WCX	71	69
" "	WHN	29	29	" "	WWJ	73	71+
" "	WQAO	30	30	Kansas City, Mo.	WDAF	41	41-
Newark, N. J.	WOR	40	40	" " "	WHB	41	41
" "	WBS	30	30	Springfield, Mass.	WBZ	23	24
" "	WAAM	9	10	Rochester, N. Y.	WHAM	14	15+
Philadelphia, Pa.	WIP	69	68	Harrisburg, Pa.	WBAK	39	39
" "	WFI	39	39	Jefferson City, Mo.	WOS	49	49
" "	WOO	69	68	Dallas, Tex.	WFAA	61	60
" "	WDAR	37	37	Fort Worth, Tex.	WBAP	60	60
Schenectady, N. Y.	WGY	33	34	Erie, Pa.	WOAV	7	8+
Pittsburgh, Pa.	KDKA	21	21½	Syracuse, N. Y.	WFAB	6	8
" "	WJAS	27	27	Havana, Cuba	2KB	25	26
" "	WCAE	55	55	Elgin, Ill.	WTAS	14	15
Chicago, Ill.	WDAP	27	27	Zion, Ill.	WCBD	24	25
" "	WJAZ	51	51	Montreal, Can.	CFCF	49	49
" "	KYW	78	76	U.S.S. Seneca	NRE	15	16+
" "	WMAQ	51	51	Omaha, Neb.	WOAW	75	72
Cleveland, O.	WJAX	36	36	Canton, N. Y.	WCAD	14	16-
" "	WTAM	36	36	State College, Pa.	WPAB	14	16-
Atlanta, Ga.	WSB	46	46	Medford Hill, Mass.	WGI	28½	28
Cincinnati, O.	WSAI	17	18	Montreal, Can.	CHYC	25	26
" "	WLW	17½	19	Hastings, Neb.	KFKX	13	15
Louisville, Ky.	WHAS	38	38	Milwaukee, Wis.	WIAO	30	30
Washington, D. C.	WRC	57	57	Northfield, Minn.	WCAL	26	28-
" "	WCAP	57	57	San Antonio, Tex.	WOAI	35	35
Memphis, Tenn.	WMC	68	67	Los Angeles, Cal.	KHJ	38	38+
Buffalo, N. Y.	WGR	20	21	Gloucester City, N. J.	WRAX	3	6
St. Louis, Mo.	KSD	82	79	Minneapolis, Minn.	WLAG	43	43-
" "	WCK	29	30	Stockbridge, Mass.	IXU	4	6
Providence, R. I.	WJAR	31	31	Philadelphia, Pa.	WNAT	30+	31
" "	WEAN	11	12	Miami, Fla.	WQAM	14	15
So. Dartmouth, Mass.	WMAF	29	30	San Juan, P. R.	WKAQ	30	30
Davenport, Ia.	WOC	63	62	Boston, Mass.	WTAT	7+	9
Troy, N. Y.	WHAZ	34	34	Iowa City, Ia.	WHAA	62+	62

Receiver operated on first floor with antenna 50 feet long around picture moulding.

with 3, 4 or 5 tubes in use. The table refers to the large size "B" batteries.

Average hours of use each day	2	3	4
3 tubes (first jack)...	122 days	82 days	61 days
4 tubes (second jack)...	77 "	51 "	38 "
5 tubes (third jack)...	56 "	37 "	28 "

How to Control and Tune the Receiver

There are five control dials on this receiver. The two smaller ones regulate the flow of current through the tubes. Adjust these dials so that the tubes are burning as dimly as possible and still get full signal strength.

The three larger dials are used to tune the receiver to the wavelength of the transmitting station. In the Eagle receiver the large dial at the left hand end of the panel tunes the in-put circuit; the middle large dial the first stage of radio-frequency amplification; the large dial near the right end, tunes the second stage of radio-frequency amplification.

To tune to a station transmitting on a wavelength of say 400 meters, it is simply necessary to tune each of the three circuits to that wavelength by setting the three large dials at the proper points. To find the proper points it is advisable

to set VC1 at about 40 degrees. Then slowly rotate VC2 and VC3 together until a signal is heard. Then adjust VC1 until the signals are loudest, and follow this with a slight readjustment of VC2 and VC3, so that each circuit will be exactly tuned.

How to Use the Tuning Chart

When a broadcast station has been tuned in as loud as possible the next step is to make a note of the dial settings of the three large dials. When it is desired to tune in the same station again it will only be necessary to refer to these figures and set the dials accordingly. If a change is made in the antenna it will alter the settings of the first large dial but the second and third dials will not be affected. The readings of the second and third dials will be practically alike for a given wavelength.

Figure 5 shows a tuning chart. The reading of the first dial was left out purposely because (as explained above), the antenna used with the set will change this reading materially.

For the stations shown in Figure 5, the settings of dials two and three of every Eagle receiver will be approximately the same as those given.

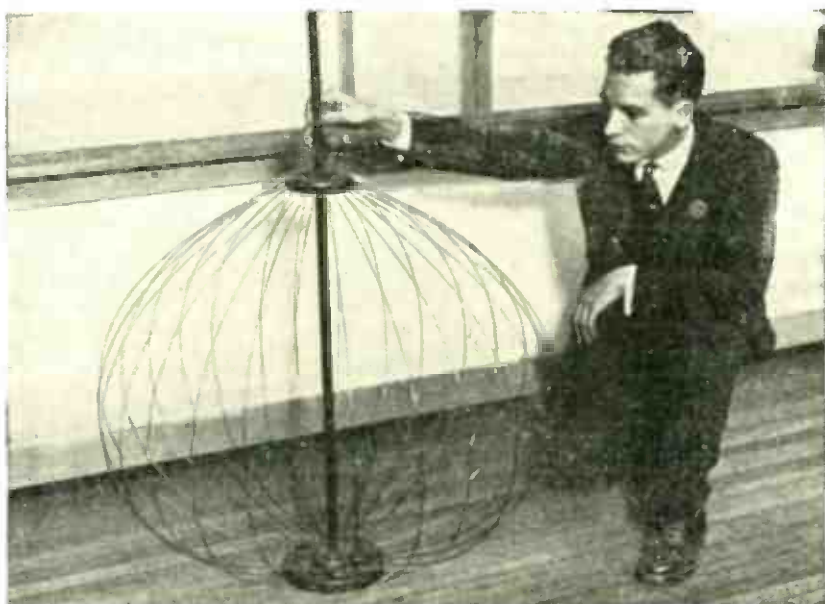

Kadel & Herbert

A UNIQUE "BALLOON LOOP"

Albert Williams entered this novel loop in a contest at a recent radio show in New York. It is claimed to be non-directional and efficient for DX reception.

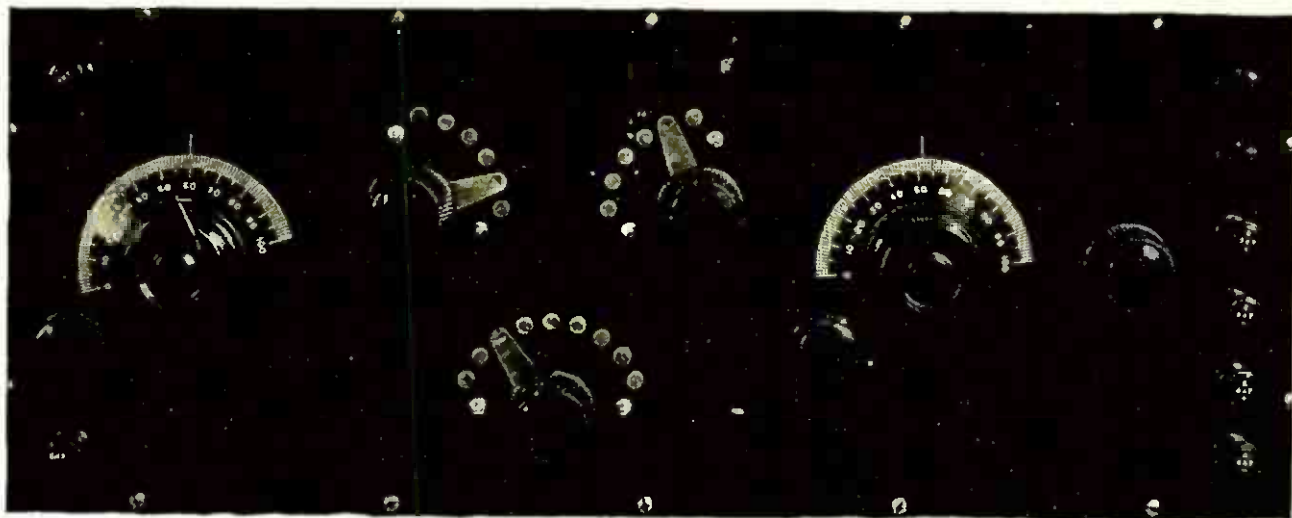

THE PANEL ARRANGEMENT OF THE RECEIVER

The antenna and ground binding post are on the left, with the battery and phone binding posts on the right. The lower switch lever controls the antenna coupling. The upper right-hand switch lever and the right-hand dial tune the secondary circuit, and regeneration is controlled by the upper left-hand switch lever and the left-hand dial. The rheostat is adjusted by the knob at the right, which is next to the binding posts. The smaller knobs close to each dial operate the geared vernier on each condenser.

Simple How-to-Build Articles for Beginners No. 4

How to build a single-tube, Reinartz-circuit receiver

By LAURENCE M. COCKADAY

COST OF PARTS: *Not more than \$20.00*

APPROXIMATE RANGE: *500 miles*

HERE ARE THE ITEMS YOU WILL NEED—

- | | |
|--|--------------------------------------|
| A and B—coils of the Schoonhoven Ray-coils for the Reinartz circuit; | G—King vacuum-tube socket; |
| C and D—Bowman "Low-loss" vernier variable condensers; | H—Unity vernier rheostat; |
| E—Dubilier micadon, .00025 mfd.; | I, J and K—Amsco switch levers; |
| F—Turn-it variable grid leak; | L—switch points; |
| | M—composition panel, 7 by 18 inches; |
| | N—baseboard, 7 by 16¾ inches. |

THE fourth receiving set of this series is the familiar Reinartz circuit employing a single "soft" detector tube. The set is for use with headphones only, unless an audio-frequency amplifier is added to it.

The set was built in the POPULAR RADIO LABORATORY with the express purpose of giving the real novice a simple regenerative receiver that is extremely easy to make and one that will give him good results.

Anyone can make it, and anyone can make it *work*.

All that is necessary is to take this article to a radio dealer and ask him to give you the parts that are specified at the head of this article.

When you have obtained the parts, take them home and lay out the instruments on the panel and the baseboard as shown in the diagram on page 578 and in the back view shown on page 579.

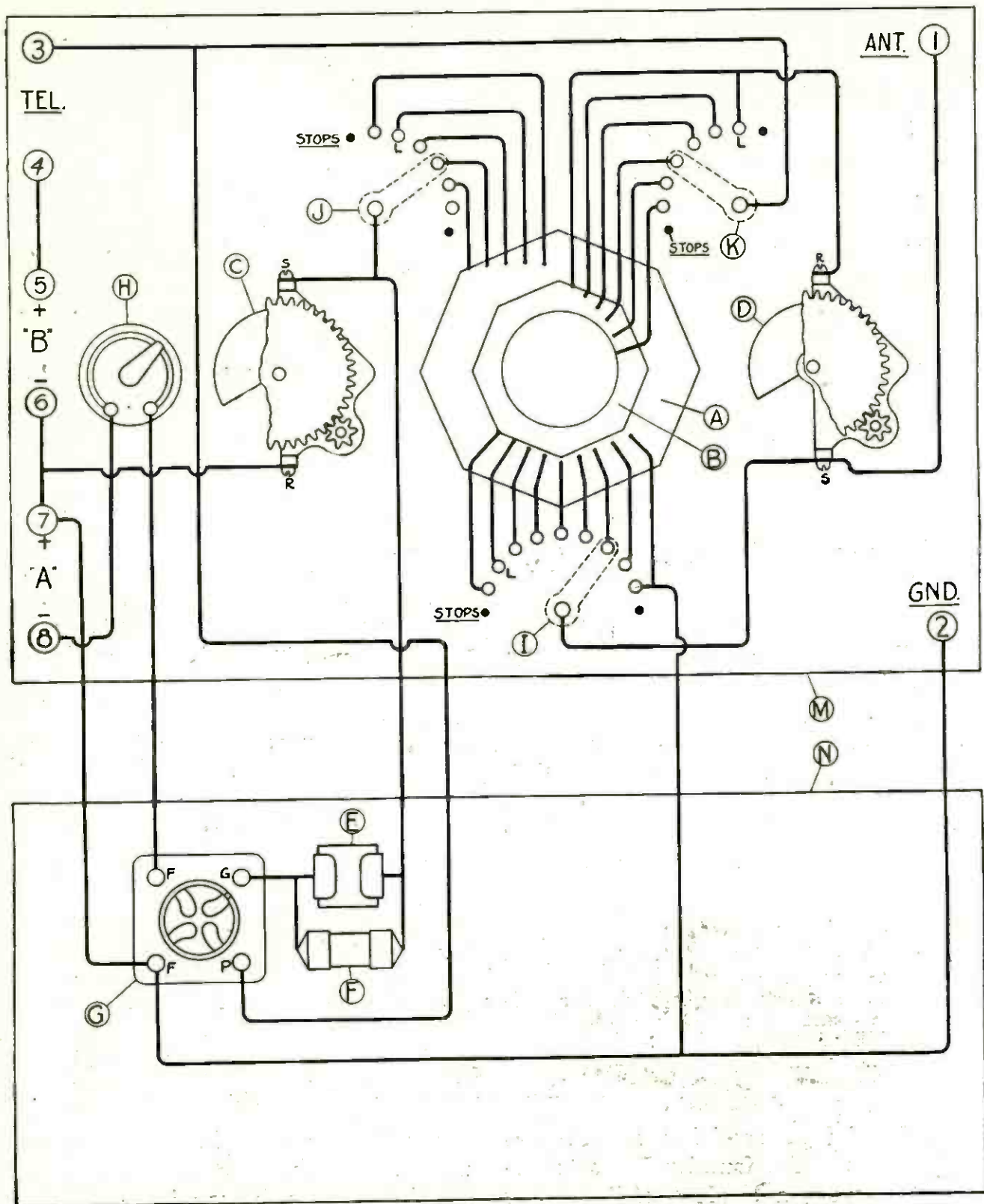

The "Picture Diagram" of the Hook-up

Even a glance at the above illustration will convince the novice that this radio set is really easy to wire up. In this diagram the instruments are shown in picture form and the connecting wires are drawn in, IN THE EXACT MANNER THAT THEY SHOULD GO IN THE SET. The upper rectangle represents the back of the panel and the instruments that are fastened to it, and the lower rectangle is the baseboard. The terminals on the various instruments are plainly shown and the instruments are marked with designating letters that reappear in the text and the list of parts.

All the parts are lettered with the same letters as given in the list of parts so you can make no mistake either in constructing the set or in wiring up the instruments. The wiring should be done exactly as shown in the picture diagram.

When you have finished wiring the set, you can connect it up for operation by following these instructions:

Connect the antenna to binding post No. 1.

Connect the ground wire to binding post No. 2.

Connect the telephones between binding posts Nos. 3 and 4.

Connect the 22½-volt "B" battery between posts Nos. 5 and 6, with the positive terminal to post 5 and the negative terminal to post 6.

Connect the 6-volt "A" battery between posts Nos. 7 and 8, with the positive terminal to post 7 and the negative terminal to post 8.

An 80 to 100-foot single-wire antenna is recommended.

Tuning the set is simple. The switch lever I controls the antenna tuning. The switch lever J and the condenser C control the secondary tuning. And the switch lever K and the vernier vari-

able condenser D control regeneration.

In order to get the best results with the set be sure that you do not turn up the rheostat H too high. Never turn it up higher than is consistent with the proper signal strength.

If you are located in the vicinity of a number of powerful broadcasting stations that operate at the same time, you will find that the switch lever I (the lower one on the panel) should be kept turned to the right as much as possible. This will give you excellent selectivity with little falling off of the signal strength.

The receiver is designed for use with the UV-200 or C-300 tube, but it will give satisfactory results with the other standard tubes if the rheostat is of the proper resistance to control the filament current and the "B" battery voltage is of the correct value for the tube you use.

Never allow the set to squeal! If you do you will not only spoil your own reception, but you will also spoil reception for your neighbors. So, keep the rheostat turned down as much as is possible without detracting too much from the signal strength. Then you will have good results and so will your neighbor.

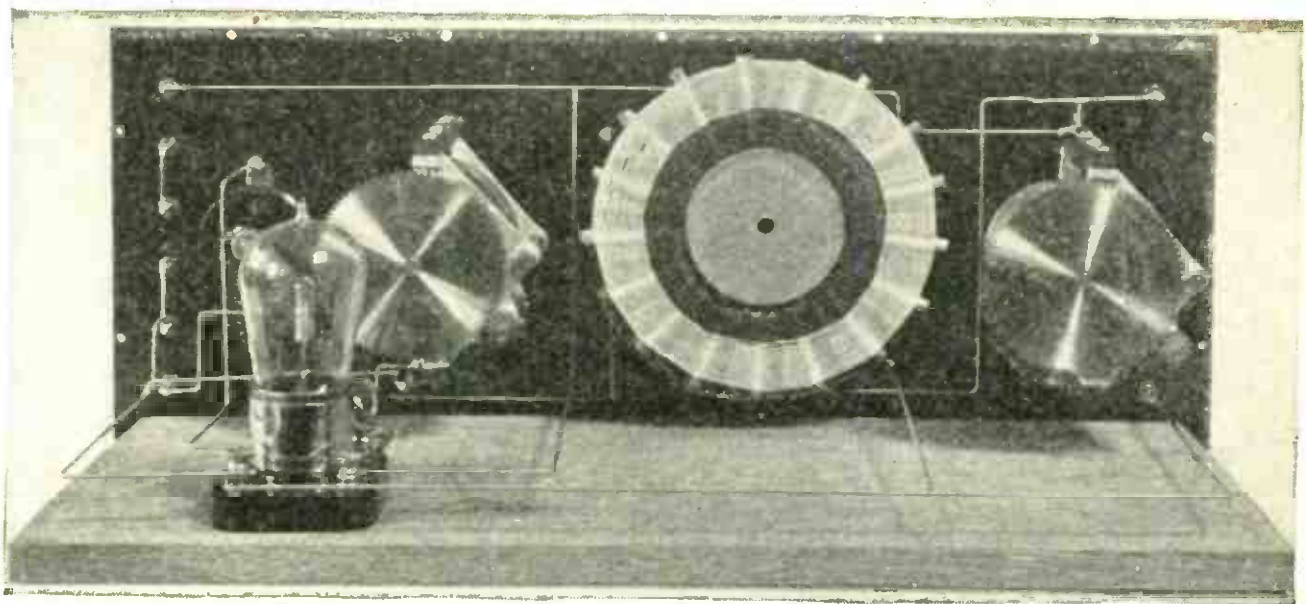

THE REAR VIEW OF THE SET

Study this view in connection with the picture diagram of the hook-up on page 578. The location and connecting points of each wire appear clearly and you can determine just how to bend the wires to get the shortest connection with the proper clearance. The coil is supported satisfactorily by the short wires running from it to the switch points.

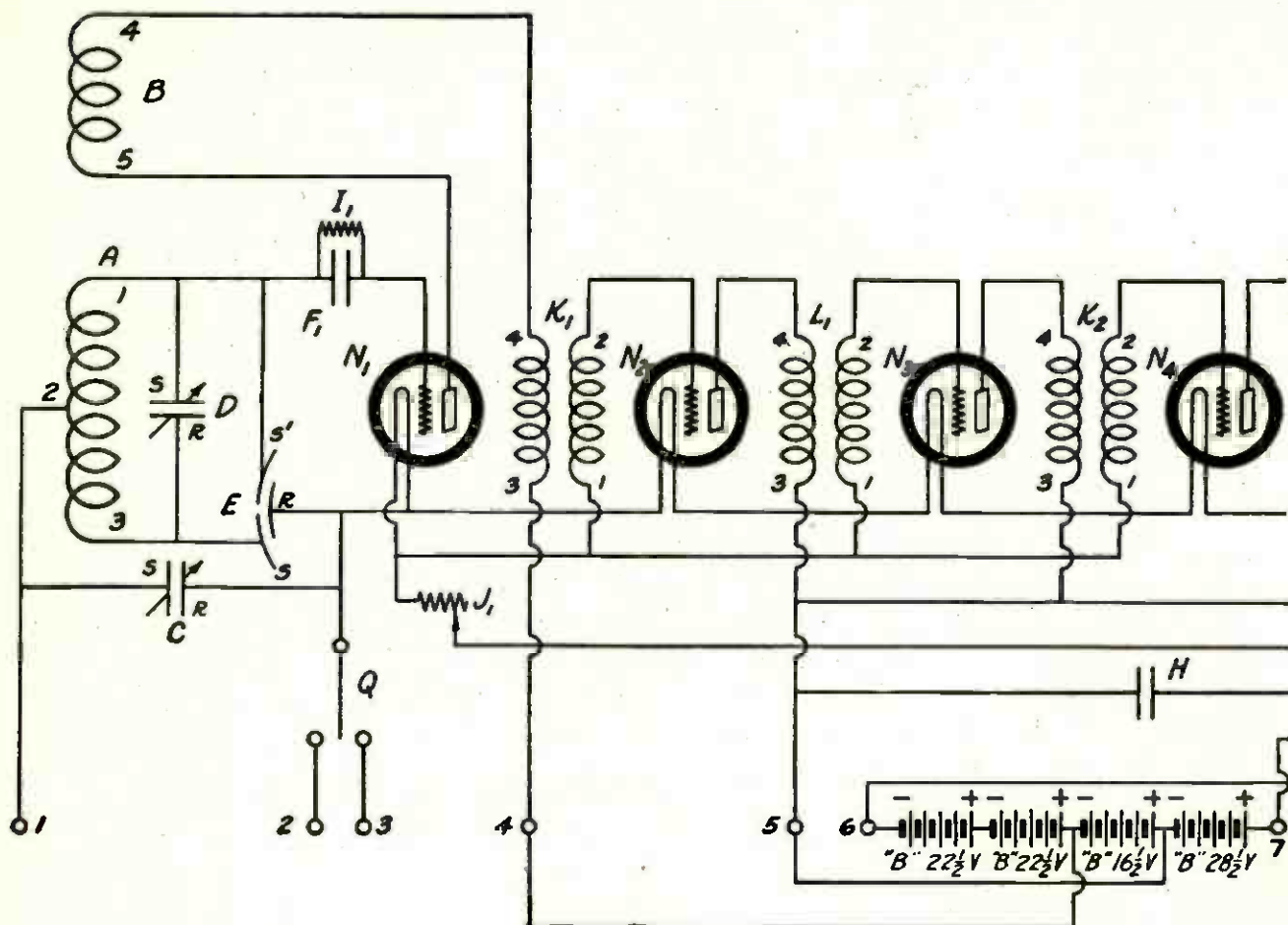

HOW TO BUILD A NON-RADIATING, 7-TUBE SUPERHETERODYNE RECEIVER

In the November issue of POPULAR RADIO, there appeared an article announcing a new development of the superheterodyne receiver in which the author told of the method used to prevent radiation. In this following article he gives all of the constructional details and the operating data so as to enable the experimenter and broadcast listener to build the set and use it on a loop for local and distance reception

By CAPT. PAUL S. EDWARDS, U. S. A.

COST OF PARTS: *About \$65.00*

RECEIVING RANGE: *Up to 3,000 miles*

HERE ARE THE ITEMS YOU WILL NEED—

A and B—Sangamo oscillator coil unit;
 C—Cardwell left hand vernier condenser, .0005 mfd., with 3 inch dial;
 D—Cardwell right hand vernier condenser, .0005 mfd., with 3 inch dial;
 E—Cardwell split stator balancing condenser;
 F1 and F2—Dubilier mica fixed condensers, .00015 mfd., with clips for grid leak;
 G—Dubilier mica fixed condenser, .005 mfd.;
 H—Dubilier by-pass condenser, .5 mfd.;

I1 and I2—Daven 1/2 and 2 megohm grid leaks;
 J1 and J2—General Radio 30 ohm type 301 rheostats;
 K1 and K2—Sangamo, type AT-60, intermediate-frequency transformers;
 L1 and L2—Sangamo, type IF-60, intermediate-frequency transformers;
 M1 and M2—Stromberg-Carlson audio-frequency transformers;
 N—Benjamin seven socket shelf, No. 8,627, with sockets N1, N2, N3, N4, N5, N6

THE COMPLETE CIRCUIT DIAGRAM

FIGURE 1: This is the hook-up for the new receiver. All the symbols for the instruments connected in the circuit bear designating letters which reappear in the list of parts below, and also in the text and the following illustrations.

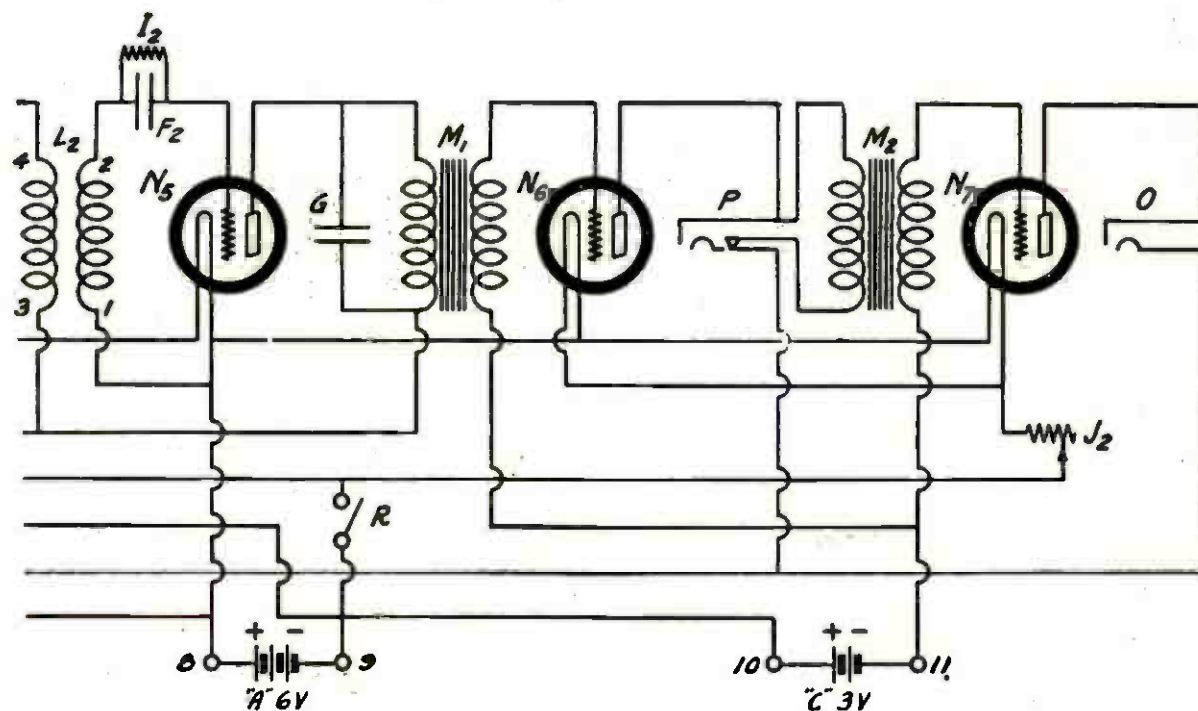

and N7 and binding posts Nos. 1 to 11;
 O—Saturn single-circuit jack;
 P—Saturn double-circuit jack;
 Q—Carter jack switch;
 R—Benjamin battery switch, No. 8,640;
 S1 and S2—Benjamin paired shelf brackets,

No. 8,629, for socket shelf;
 T—Benjamin bakelite panel for grid condenser, No. 8,632;
 U—composition panel, 7 by 18 inches;
 V—standard cabinet;
 bus-wire, screws, etc.

THE design of the new superheterodyne developed by Jackson H. Pressley, Chief Engineer of the Signal Corps radio laboratories at Camp Vail, New Jersey, is such that there is no possibility of radiation even over slight distances of a few yards.

This is made possible by the simple bridge arrangement which is used to connect the detector-oscillator tube to the loop antenna.

The set operates on a 6-volt battery and draws only $\frac{3}{4}$ ampere filament current. This is because the first five tubes are WD-12 tubes and they are operated in series. The last two tubes are either UV-201-a or C-301-a tubes operated in parallel across the 6 volts.

The set is notable for the following qualities:

1. Non-radiating;
2. Great volume on a loop antenna;
3. Good selectivity;
4. Simplicity of construction;
5. Simplicity of operation;
6. Good tone quality;
7. Long distance reception;
8. Portability;
9. Compactness.

The set is capable of picking up any broadcasting station that lies in the regular broadcasting wavelength band. It is equipped with a small switch which is used to shift from the higher range to the lower wavelength range.

Both of the two condenser controls have vernier knobs so that the dials can be set closely.

The regular wiring diagram is shown in Figure 1.

This diagram is the ordinary conventional diagram which gives the proper method for connecting up the instruments by means of symbols which represent the instruments themselves.

In Figure 2, however, is a picture diagram that shows the instruments in picture form with the wires represented by heavy black lines. In this diagram the beginner will find a help and guide that cannot be mistaken.

The Parts Used in Building the Set

In all the diagrams in this article each part

bears a designating letter. In this way the prospective builder of the set may easily determine how to mount the instruments in the correct places and connect them properly in the electric circuit. The same designating letters are used in the text and in the list of parts at the beginning of the article.

Q The list of parts there given includes the exact instruments used in the set from which these specifications were made up; but the experienced amateur will be able to pick out other reliable makes of instruments which may be used in the set with equally good results. For exact duplication of results, however, we recommend the parts specified to the novice.

If instruments other than the ones listed are

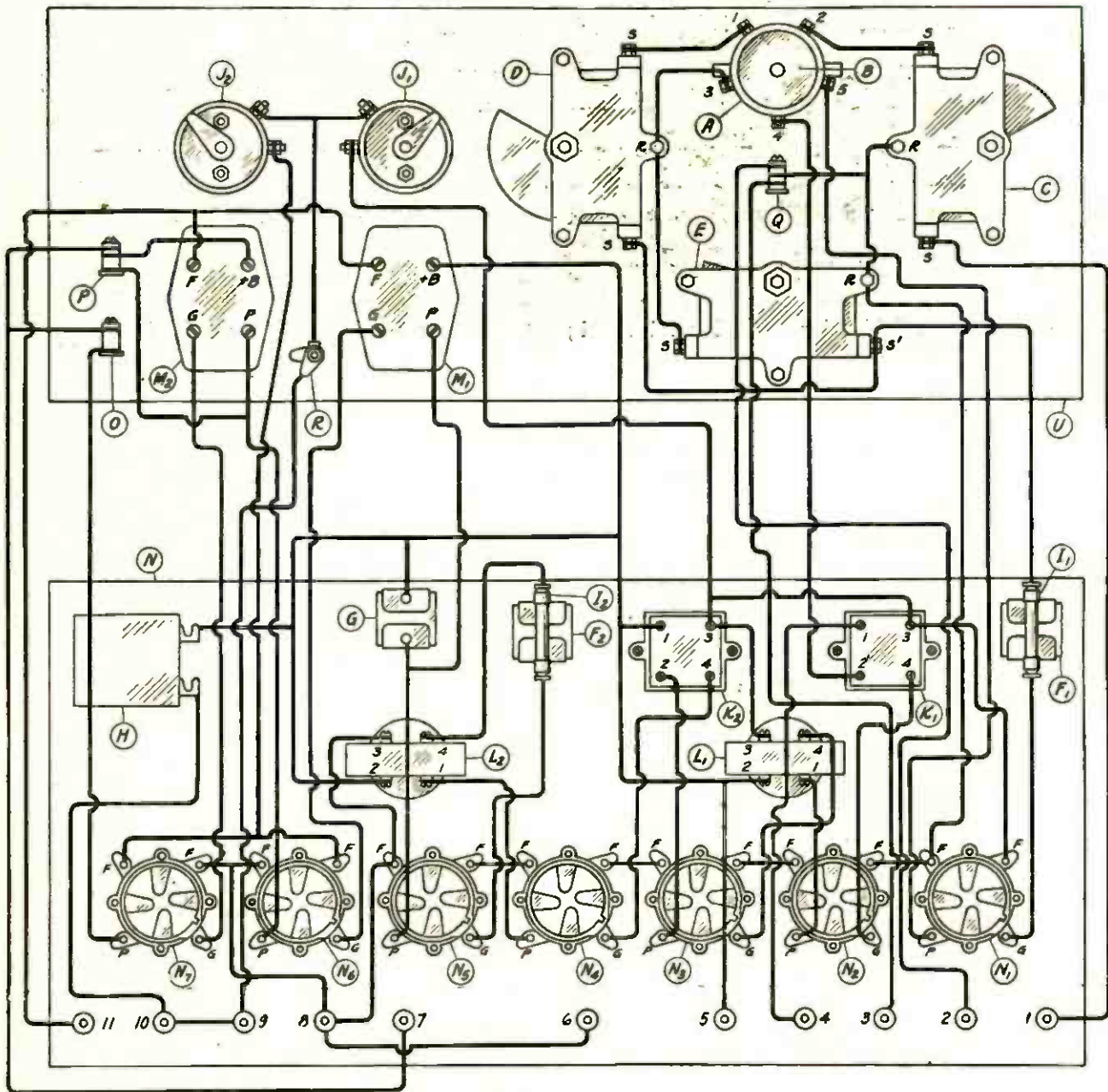

THE WORKING PLAN FOR WIRING UP THE SET

FIGURE 2: This picture-diagram shows where each instrument is placed in the receiver and how to connect up each wire after you have finished the construction work. Study this illustration carefully before you start wiring.



MR. PRESSLEY TRIES OUT HIS NEW SUPERHETERODYNE

In appearance, the new receiver resembles many of the simple three-tube outfits that are constructed to fit into a standard seven by eighteen inch cabinet. It is a giant for results, however.

used it will necessitate only the use of different spacing of the holes drilled in the panel for mounting them.

How to Construct the Set

After procuring all the instruments and materials for building the set, the amateur should prepare the panel N. (Shown in Figures 2, 3, 4, 7, 8 and 11.)

First of all, cut the panel to the correct size, 7 by 18 inches. If you can buy a panel already cut to size considerable work will be saved.

Then square up the edges smoothly with a file. The centers for boring the holes (which are necessary for mounting the instruments) should be laid out on the panel as shown in Figure 11. A convenient way to do this is to lay out all center holes on a piece of paper the same size as the panel; then the piece of paper should be pasted on the panel and the centers marked directly on the panel by punching through the paper.

If all the holes to be drilled are first started with a small drill, one-sixteenth inch in diameter or less, they will probably be more nearly centered. The holes outlined with a double circle should be countersunk so that the flat-head machine screws used for fastening the

instruments will be flush with the panel. All the rest of the holes in the panel are straight drill holes. Sizes for the diameter of these holes have not been given, but the builder will readily decide what size hole is necessary by measuring the size of the screws and shafts of instruments that must go through the holes. It is desirable to make the holes for the condenser shafts C and D at least one-sixteenth of an inch larger than the shafts so that they will not rub on the edges of the holes.

When the panel is drilled, it may be given a dull finish by rubbing lengthwise with fine sandpaper until the surface is perfectly smooth; then the same process should be repeated, except that light machine oil should be applied during the rubbing. The panel should then be rubbed dry with a piece of cheese-cloth; a dull permanent finish will be the result. Or, the panel may be left with its original shiny-black finish, if care is exercised so that it is not scratched during the drilling.

The seven socket shelf N can be bought as a unit with sockets and binding posts already mounted or the builder can construct this part from a composition panel, seven sockets and eleven binding posts. The drilling plan and dimensions of the panel are shown in Figure 12.

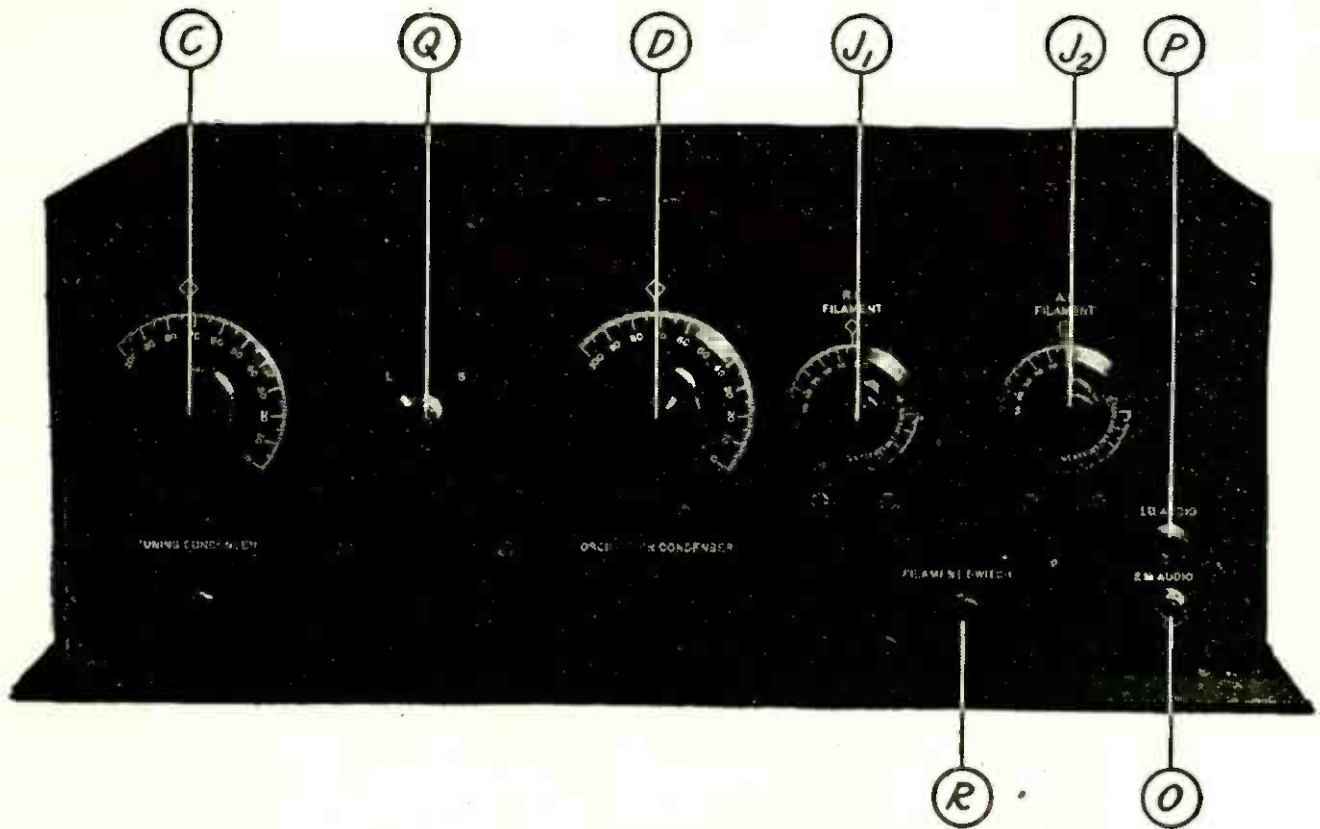

THE FRONT VIEW OF THE RECEIVER

FIGURE 3: This illustration shows the simple arrangement of the controls on the front panel. Tuning is done with dial C and the oscillator circuit is adjusted by dial D. Q is the switch used to change the wavelength range.

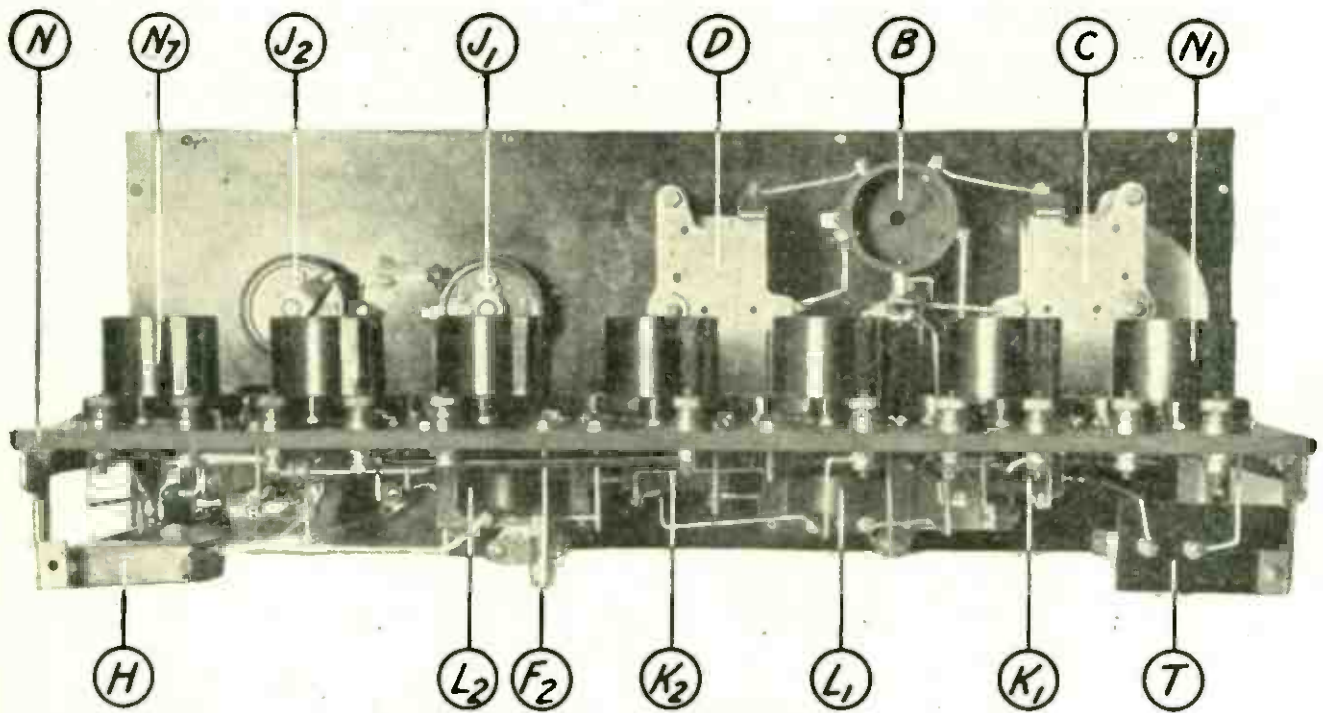

VIEW OF THE SET FROM THE REAR

FIGURE 4: This picture shows the general arrangement of all the instruments fastened to the front panel and the socket shelf. The exact locations for the instruments are shown in Figures 9, 10, 11 and 12.

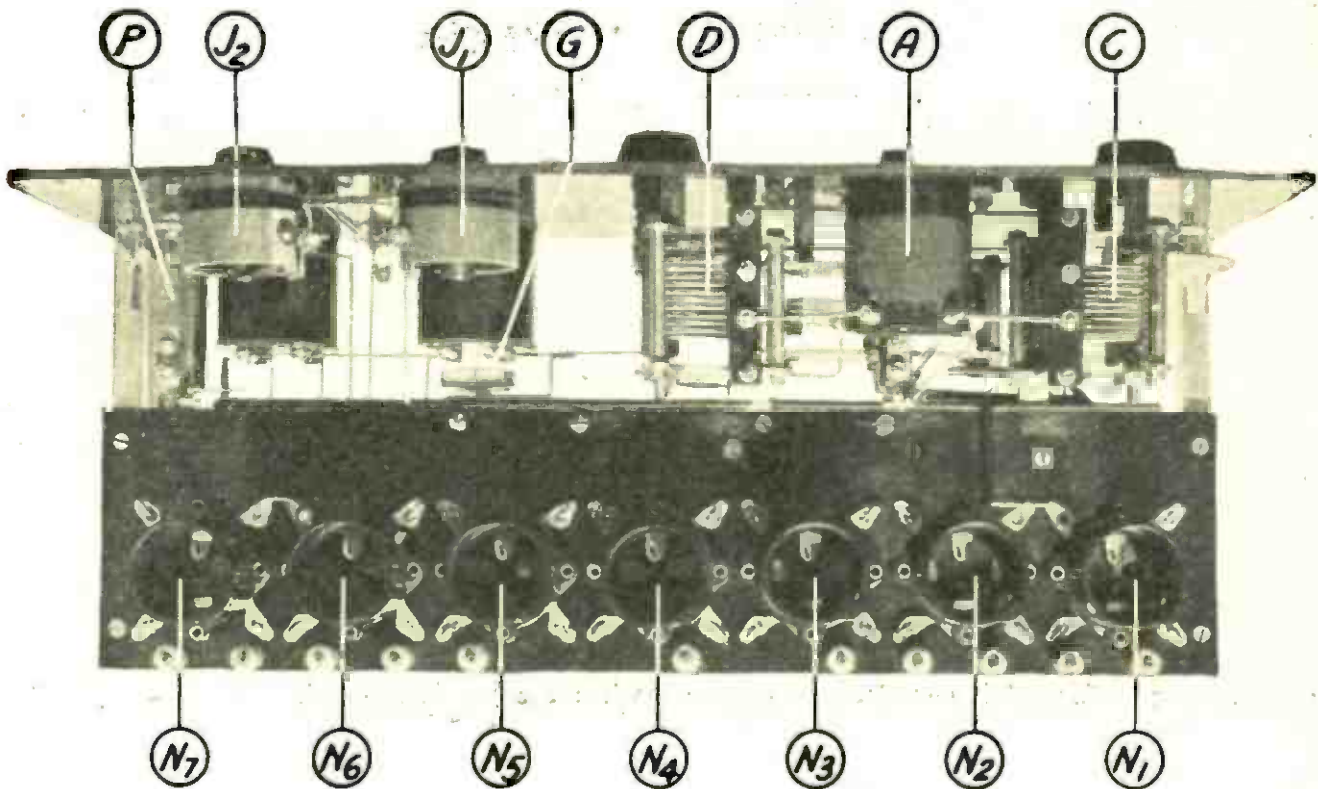

THE TOP VIEW OF THE RECEIVER

FIGURE 5: Note the neat arrangement of the wiring as seen from this position. The sockets are mounted on the socket shelf by means of hollow rivets, so that the connecting wires can be passed through the holes in the rivets.

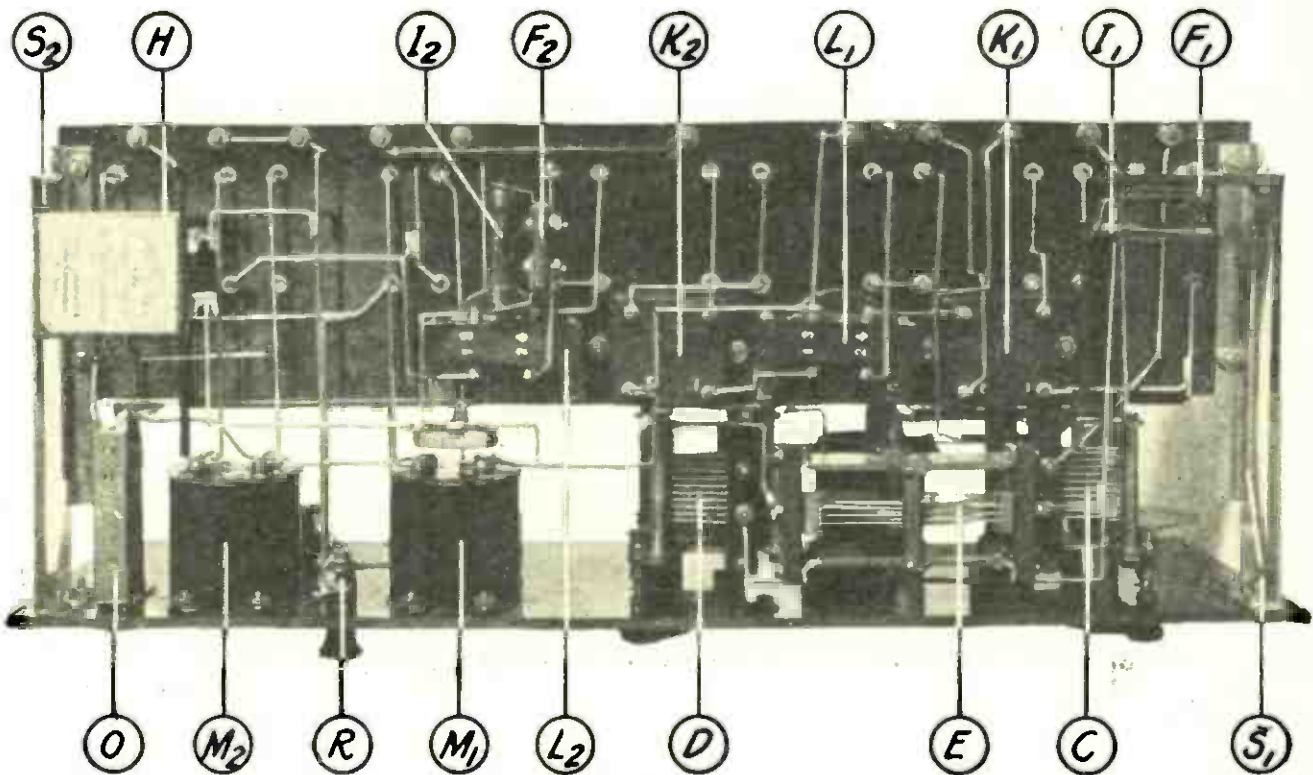

HOW THE RECEIVER LOOKS FROM THE BOTTOM

FIGURE 6: This view clearly shows the connections to the intermediate-frequency transformers as well as the positions of condensers F2 and G, which are supported by the wiring. The split stator condenser E, which is used for balancing the oscillator circuit, is made with the stationary plates divided in the middle, so that it is really a three element condenser.

The shelf brackets S1 and S2 should be purchased complete, as the construction of these parts is beyond the scope of amateur work. Strong and rigid brackets are necessary, as they support considerable weight.

First, tighten up the switches Q and R and the jacks O and P in the holes provided for them, and fit the rheostats J1 and J2 with the binding posts located as shown in Figures 4, 5 and 9. Next, mount the audio-frequency transformers M1 and M2 on the panel just below the rheostats. Be sure to set the transformers with the plus "B" and plate terminals to the right (as seen from the rear).

The oscillator coil unit A and B can now be fastened to the panel with two screws. It is placed just above the jack switch Q. (See Figures 4, 5 and 9.)

Next mount the variable condensers C and D and the split stator balancing condenser E as shown in Figures 4, 7, 8 and 9.

If you make up the seven socket shelf yourself, proceed now to assemble the sockets and binding posts on it as shown in Figures 4, 5, 7 and 8. If you bought it complete mount the intermediate-frequency transformers K1, K2, L1 and L2 on the bottom of it. (See Figures

6 and 10.) Be sure to place transformers K1 and K2 with terminals 2 and 4 toward the rear. The iron core transformers L1 and L2 should be fastened to the socket shelf with terminals 3 and 4 to the rear. This completes the work on the socket shelf.

Next fit the grid condenser F1 to the grid condenser panel T and fasten with a bolt to the corner of bracket S1 as shown in Figures 4, 6, 8 and 10. On the left hand bracket S2 solder the by-pass condenser H as shown in Figures 4, 6, 7 and 10. Now bolt the brackets S1 and S2 to the socket shelf N and the front panel U. (See Figures 4, 7 and 8.) Fitting the dials on the shafts of condensers C and D (as shown in Figure 3) completes the construction work and you are now ready to start wiring.

How to Wire the Set

Either square or round tinned bus-wire can be used to wire the set, but it will be found that the round wire is easier to handle and when the job is finished, it will look just as neat.

Before starting the wiring, study Figures 1

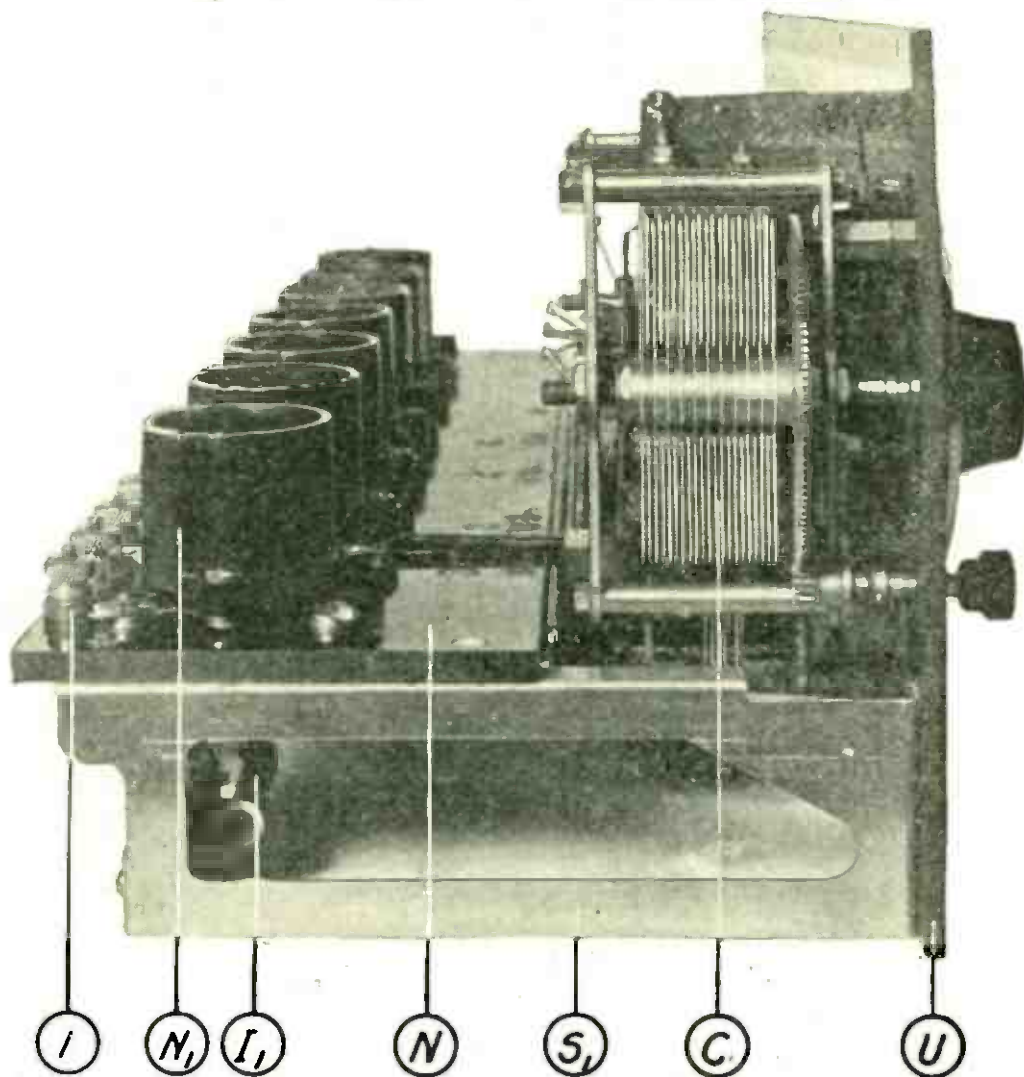

VIEW OF THE SET, AS SEEN FROM THE LEFT

FIGURE 7: This illustration shows the way to mount the tuning condenser C and shows how the socket shelf bracket S1 is fastened to the front panel.

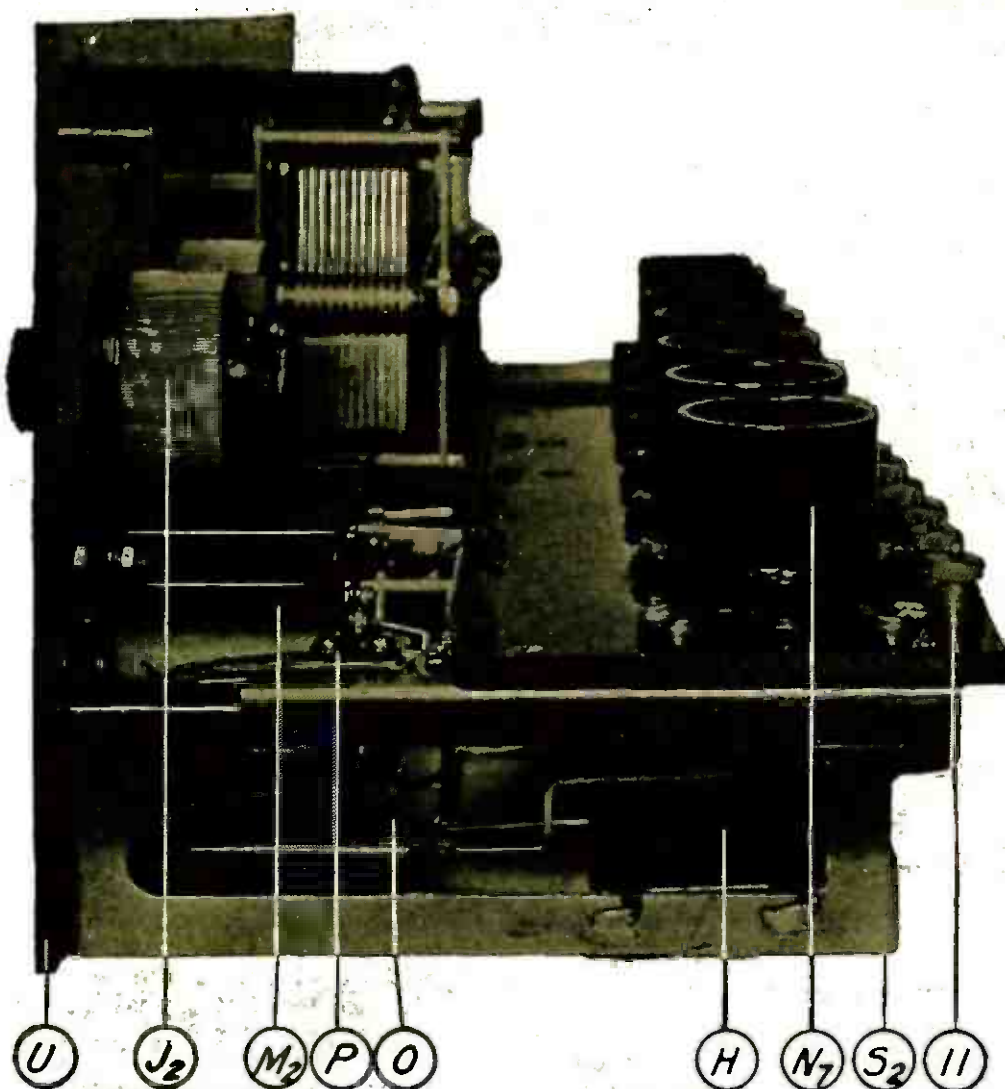

VIEW OF THE SET AS SEEN FROM THE RIGHT

FIGURE 8: This view shows how the rheostats J1 and J2, the audio-frequency transformers and the jacks are mounted on the front panel. Note that the lugs on the bottom of the by-pass condenser H are bent over and soldered to the bracket S2.

and 2 carefully and also look over Figures 4, 5, 6, 7 and 8 and note just where each wire goes and how it is bent to avoid other wires. A peculiarity of the circuit in this receiver is that the filaments of the first five tubes are connected in series instead of in parallel as is usual. The reason for this arrangement has already been explained, and as far as the wiring is concerned it simplifies matters somewhat.

It is desirable to wire up the filament circuit first. This includes the fourteen terminals on sockets N1, N2, N3, N4, N5, N6 and N7 that are nearest the front panel U, the two rheostats J1 and J2, the battery switch R, and the binding posts Nos. 8 and 9. (See Figures 1, 2, 4 and 5.) The adjacent filament binding posts on the first five sockets (N1, N2, N3, N4 and N5) are connected in series with short pieces of wire, as shown in Figure 2.

Next, wire up the oscillator coil unit A and B, the three condensers, C, D and E, the jack switch Q and binding posts Nos. 1, 2 and 3 with the grid and plate terminals of socket N1. Be sure to connect grid condenser F1 in series with the grid of socket N1 and the

right hand section (as seen from the rear) of the stator of condenser E. (See Figures 1 and 2.) The lower binding post of oscillator coil B is connected to terminal No. 1 of intermediate-frequency transformer K1 and terminal No. 4 on this same transformer is connected to the grid terminal of socket N2. Terminal No. 2 on the same transformer is connected to binding post No. 4 and terminal No. 3 to the wire that connects the rheostat J1 with the right hand (as seen from the rear) filament terminal of socket N1. This completes the wiring of the detector circuit, the oscillator circuit, the filament circuit and the first intermediate-frequency transformer K1. (See Figures 1, 2, 4, 5, 7 and 10.)

Proceed now to connect up transformer L1. Terminal No. 3 should be connected to the filament wire from rheostat J1. Terminal No. 4 connects with the grid terminal of socket N3. Binding post No. 5 is next connected to terminal No. 2 on transformer L1 and the wire continued around to terminal No. 2 on transformer K2 and the plus "B" terminal on transformer M1. (See Figures 1, 2 and 6.)

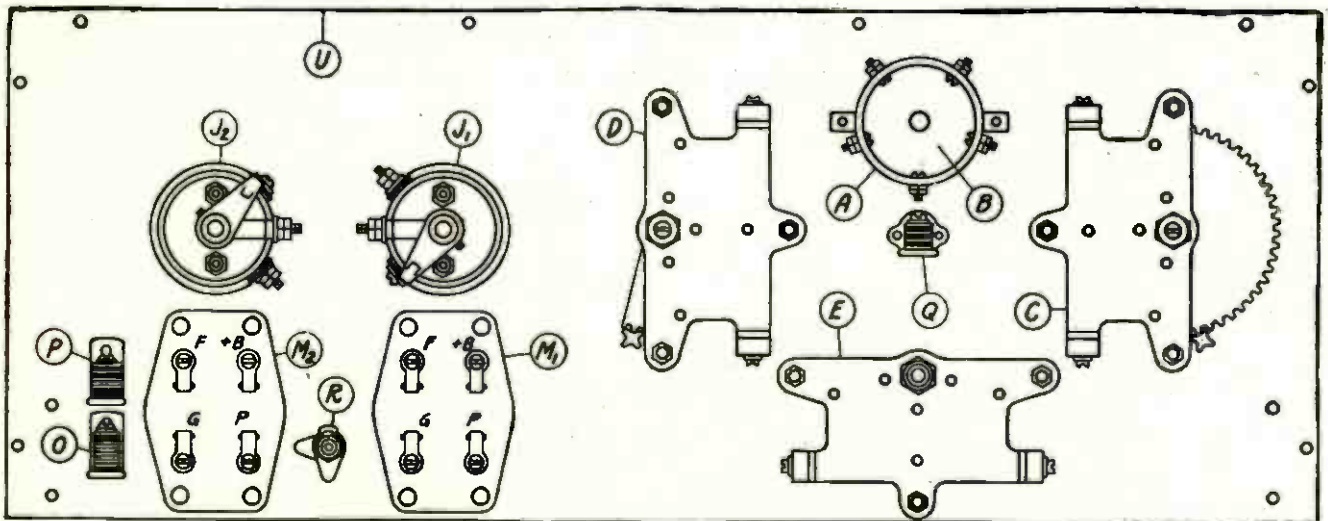

THE ARRANGEMENT OF THE INSTRUMENTS ON THE FRONT PANEL
 FIGURE 9: After the holes are drilled in the front panel U, as shown in Figure 11, the instruments should be fastened to the panel in the positions shown. Be careful to bolt the rheostats J1 and J2 to the panel with the binding posts toward each other.

Terminal No. 1 on transformer L1 is connected to the plate terminal of socket N2.

The next wiring operation is to connect up transformer K2. No. 3 terminal goes to the common lead from rheostat J1. (See Figures 1 and 2.) No. 4 terminal on the transformer should be connected with the grid terminal of socket N4. No. 2 terminal has already been connected and No. 1 terminal on transformer K2 is next connected to the plate terminal of socket N3.

Now connect up transformer L2 and you will have the intermediate-frequency circuits completed. Terminal No. 3 on this transformer should be connected to the wire that goes from the left hand (as seen from the rear) filament terminal of socket N5 to binding post No. 8, which was put in when the filament circuits were wired. No. 4 terminal

on transformer L2 should be connected to grid condenser F2 and a wire from the other terminal of the condenser is then connected to the grid terminal of socket N5. (See Figures 1, 2, 4 and 5.) No. 2 terminal on transformer L2 has already been connected to the No. 2 terminals on transformers L1 and K2. No. 1 terminal on L2 is now connected to the plate terminal of socket N4. Next connect the fixed condenser G across the wires that are connected to No. 2 terminal on transformer L2 and the plate terminal of transformer M1. (See Figures 1, 2 and 5.) By-pass condenser H should now be connected with one wire to terminal No. 3 on transformer L2 and the other to binding post No. 10, and this wire can be continued on to connect with the wire from binding post No. 9. (See Figures 1, 2, 6 and 8.)

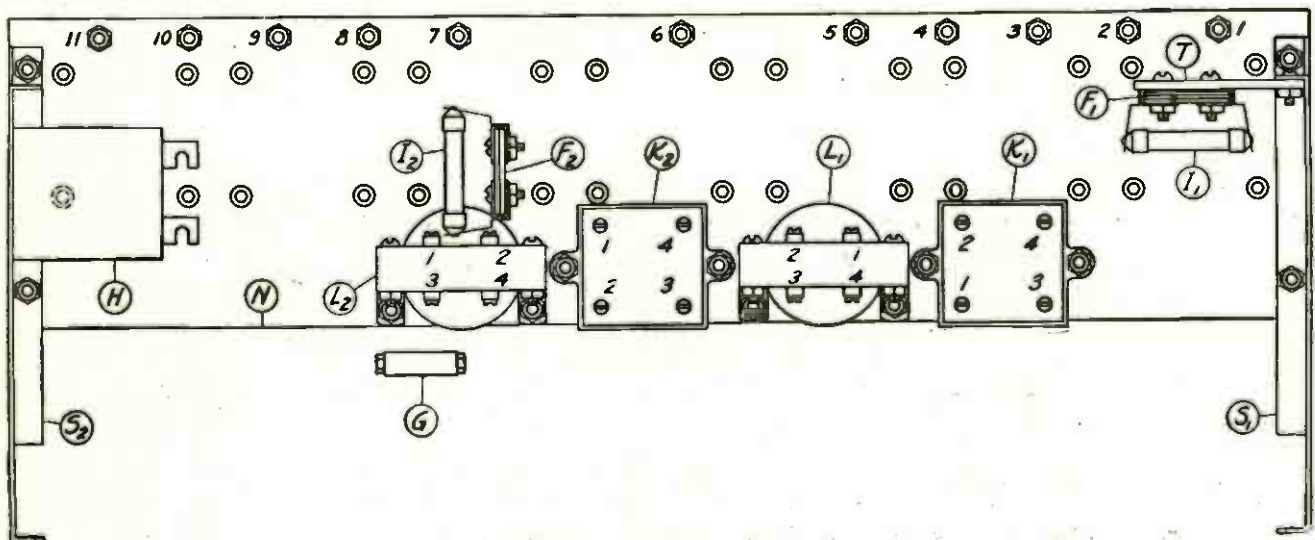

HOW THE INTERMEDIATE-FREQUENCY TRANSFORMERS ARE PLACED

FIGURE 10: Be sure to fasten the intermediate-frequency transformers to the bottom of the shelf, with the terminals arranged as shown. Note that condenser F2 is shown in the position it should occupy when supported by the wiring.

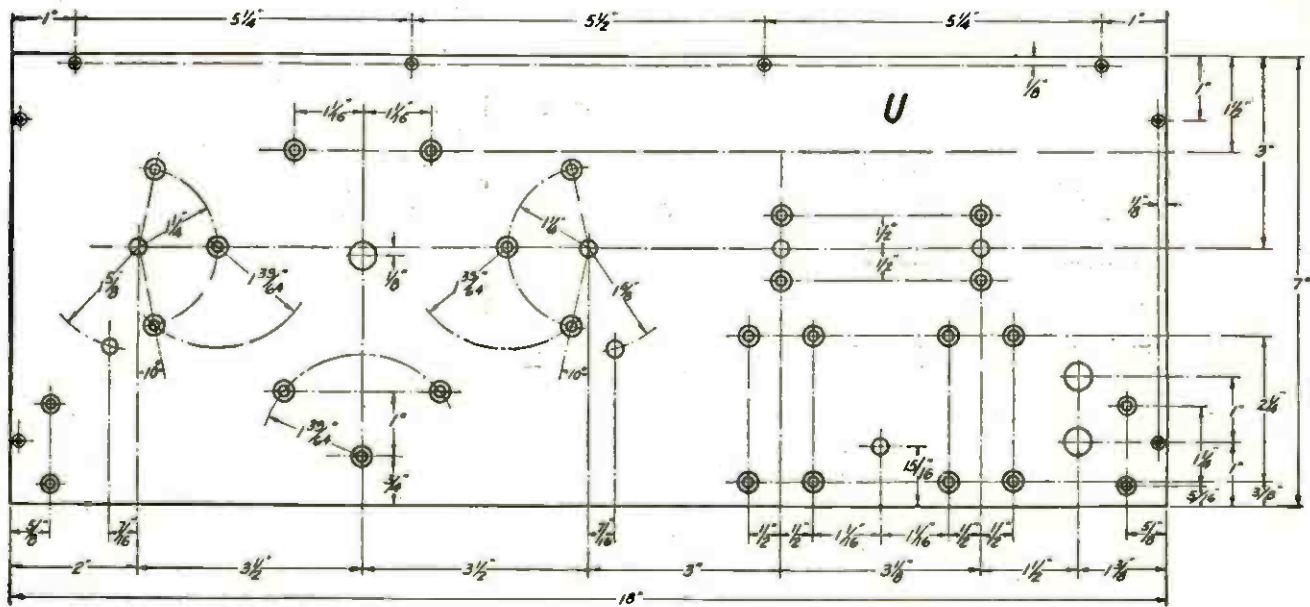

THE DRILLING PLAN FOR THE PANEL

FIGURE 11: This drawing shows where to drill the holes for mounting the instruments. The correct spacings are given for the holes. The holes outlined with a double circle should be countersunk.

Binding post No. 6 is the minus "B" battery connection and should be connected to binding post No. 8. Binding post No. 7 should now be connected to the top lugs on jacks O and P. Next, run a wire from binding post No. 11 to the filament terminals on transformers M1 and M2. (See Figures 1, 2 and 5.) The wiring is now complete except for the plate and filament connections for the last two tubes, which are placed in sockets N6 and N7 and the wire that goes to the middle terminal of jack P. First connect the grid terminal of socket N6 to the grid terminal of transformer M1. Then connect the plate terminal on this same socket to the plate terminal of transformer M2 and run a branch from this wire to the lower terminal of jack P. (See Figures 1, 2 and 6.) Now run a wire from the grid terminal on socket N7 to the grid terminal on transformer M2 and connect the

plate terminal of this same socket to the lower terminal of jack O. This completes the wiring and you are ready to install the set.

How to Install the Set

After the set has been placed in the cabinet and fastened with screws, the batteries should be connected as shown in Figure 15. Be sure that batteries are connected to the proper binding posts. You cannot make a mistake if you follow the numbers on the diagrams in both Figure 15 and Figure 2.

The set should be used with a Portenna loop. The loop should be tapped at the center and an extra wire brought out to a binding post. The three leads from the loop should then be connected to the set by means of binding posts Nos. 1, 2 and 3, with the center tap on post No. 2.

This completes the hooking up.

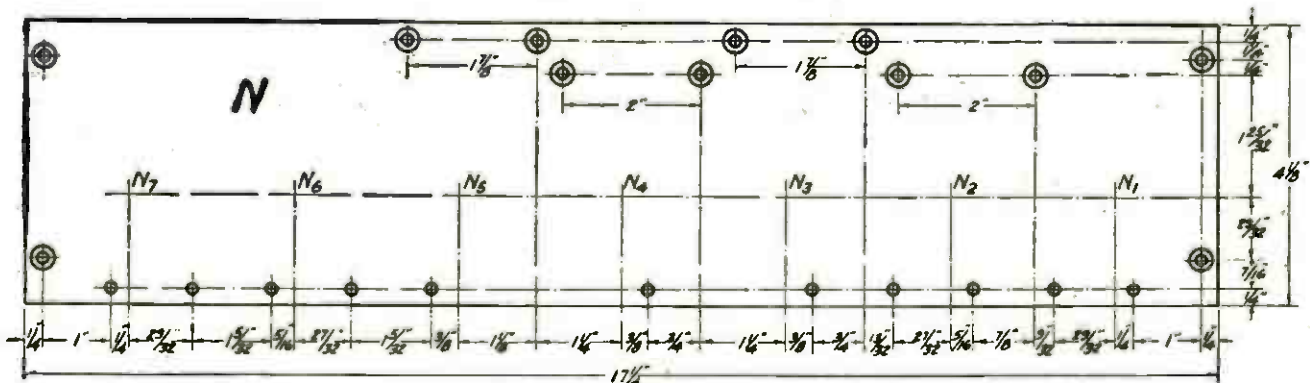

THE DRILLING PLAN FOR THE SOCKET SHELF

FIGURE 12: If you do not buy the socket shelf complete, this illustration shows where to drill the holes to fit the spring ends of standard individual sockets of the same make.

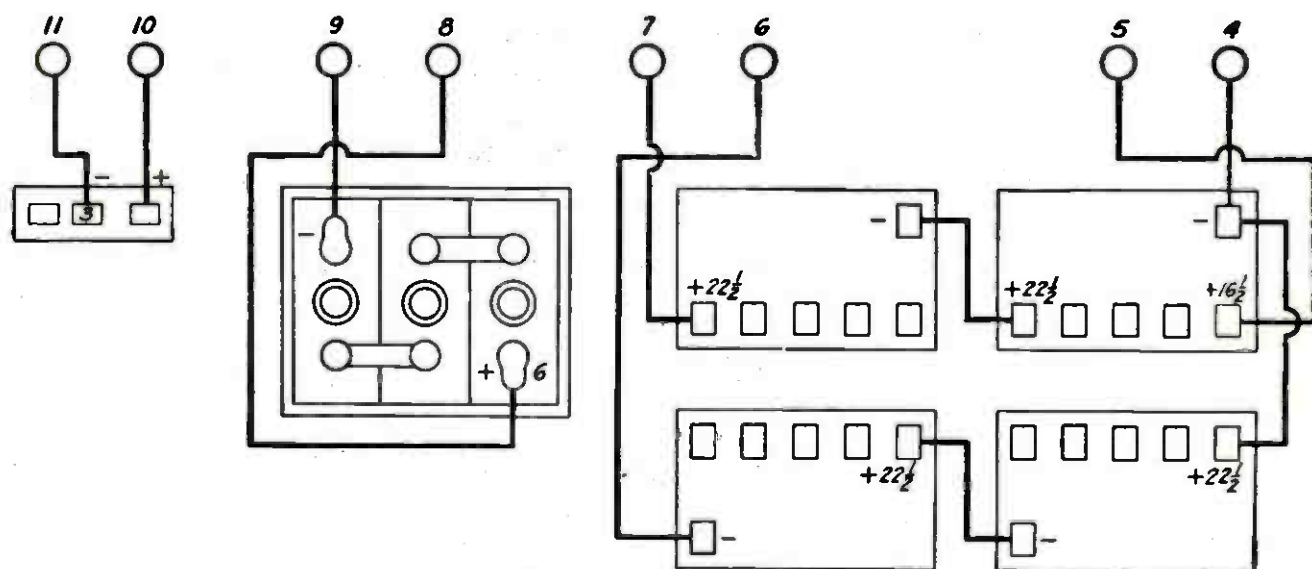

HOW TO HOOK UP THE BATTERIES

FIGURE 15: This illustration shows you how to avoid mistakes in hooking up the batteries. Note that the numbered terminals are those on the receiver so that you need only make the connections as shown and the batteries will be connected correctly.

Operating Data

To place the set in operation, insert five WD-12 tubes in the sockets N1, N2, N3, N4 and N5. Then insert two UV-201-a tubes in the two sockets N6 and N7. Next, be sure that the two rheostats J1 and J2 are turned off. Then turn the switch R and light the tubes to the correct brilliancy by means of the two rheostats before mentioned. Rheostat J1 controls the first five tubes and rheostat J2 controls the last two tubes on the right.

Insert the loudspeaker into the jack O and place the switch Q in proper position for "short" or "long" wavelength. The "short" wave position is with the pointer turned to the right.

The next job is to set the balancing condenser E. The best method for finding the balance is to connect a headset or loudspeaker in series with the 45 volt positive "B" battery lead that runs to the first tube, and then, with the oscillator dial D set at about 40 degrees, vary the balancing condenser E and the tuning condenser C until no click (or a minimum click) is heard when the tuning condenser is in tune with the oscillator circuit. This setting of the balancing condenser will be found to be

very near the maximum capacity of the balancing condenser. When the proper balance is found, the condenser E can be locked fast by means of the set screw; no further adjustment being necessary.

All that remains to do is to turn the dial C to the proper setting for the correct wavelength, and then set the condenser D to the corresponding oscillator frequency. It will soon be found that for a given wavelength of reception there will be a corresponding setting for the condenser D. This is all there is to tuning the set, except that the loop should be turned so that its edge points in the direction of the station it is desired to pick up.

For lesser volume or for use with the headphones, place the plug in the jack P instead of O.

For greater volume and greater distance the builder may use UV-201-a tubes, or C-301-a tubes for the first 5 tubes with the filaments connected in parallel off the same rheostat. This is recommended where large volume signals are required.

Working Blueprints of This Receiver

In order to accommodate readers who may desire actual-size diagrams of this 7-Tube Non-radiating Superheterodyne Receiver, a set of three blueprints has been prepared, consisting of—

- One panel pattern (actual size);
- One instrument layout;
- One picture diagram of all parts, showing the wiring.

This set of three prints will be forwarded, postage prepaid, upon receipt of \$1.10.



From a photograph made for POPULAR RADIO

HOW SECRET MESSAGES ARE RECEIVED BY INFRA-RED RAYS

Dr. W. W. Coblentz is here shown operating the receiving mechanism of the secret communication system that he has developed. Note the sectored disk which breaks up the transmitted beam in an even sequence of impulses of an audible frequency.

The "Black Light Radio"—

A Secret Communication System That Uses Infra-red Rays

A remarkable invention which may revolutionize all our present methods of short range signalling—especially for military use

By S. R. WINTERS

SECRECY is desirable in any form of communication and in warfare it is a prime necessity. All sorts of systems have been devised to make it possible to communicate by radio with the greatest amount of secrecy and with the least possibility of deliberate interference by enemy forces. But so far no system has been perfected that has these qualities to the required degree. Radio waves can be heard by the enemy as well as by the

receiving station to which the message is being sent.

Absolute secrecy in the transmission of messages over short distances, up to twenty miles, has been attained by a system developed by Dr. W. W. Coblentz of the Bureau of Standards, of the United States Department of Commerce. The veil of censorship which shrouded this invention during the world war has been lifted and for the first time the pub-

lic is given an insight into a method of signalling which cannot be detected or intercepted by the enemy.

In order to understand just how the new system works it may, perhaps, be worth while to consider the matter of the wavelengths that are used.

Everyone knows, of course, that the only difference between the waves of radio and ordinary light is a difference in the rate of oscillation. Light is a form of vibration just as are radio waves.

Violet light has the highest rate of vibration of any light which is visible to the human eye. Red light is at the other end of the scale of visibility and is the slowest vibration that affects the eye. When the vibrations are slower than the

rate which produces red light, we call them infra-red or heat waves and it is these waves that Dr. Coblentz uses in his new system.

A discovery by the Bureau of Standards that molybdenite, known to radio fans as one of the minerals that can be used in a crystal detector, is extremely sensitive to the infra-red or dark rays, made this new system possible.

Molybdenite, it was found, acted under the stimulus of infra-red rays or waves, just as selenium does when it is exposed to ordinary light.

The apparatus used by this government bureau in signalling by invisible rays, in the preliminary tests, consisted of a bolometer—an electrical instrument



From a photograph made for POPULAR RADIO

HOW MESSAGES ARE TRANSMITTED BY MEANS OF INFRA-RED RAYS

It has been found that infra-red rays can be reflected and concentrated in a single narrow beam like ordinary light so the transmitter consists, essentially, of an instrument that somewhat resembles an ordinary searchlight. The reflector and the source of light are specially adapted to the production and reflection of the infra-red band of waves.

for measuring very small quantities of radiant heat—which was used in conjunction with a telephone and a vacuum-tube amplifying unit, common to the reception of radio communications. The instrument which determined the amount of radiant heat was, in this instance, merely used as a receiver of thermal or heat radiations, the rugged requirements of warfare precluding the use of a sensitive galvanometer. The receiving equipment, in the preliminary experiments, consisted of a thin blackened strip of platinum or gold leaf and a storage battery, which were connected in the conventional way.

The response of the bolometer to radiant energy in the form of heat waves, was intensified as the electric current was passed through an audio-amplifying circuit. Radiation was emitted from an acetylene flame, and the receiving equipment was exposed to the latter by means of a rotating disk which had 15 equally spaced openings.

The radio-telephone tests in which molybdenite was used instead of a gold leaf as a receiver involved a revision of the apparatus in certain particulars. Molybdenite and a dry-cell battery, which produced 40 to 60 volts, were connected directly to the input terminals of a radio receiving outfit, with three stages of amplification. A concave silver-on-glass mirror, 16 centimeters in diameter and 50 centimeters in focal length, was employed in concentrating the radiant energy upon the sensitive photo-electric substance. When the equipment is taken afield, a mirror, the disk with multiple

holes, and the molybdenite receiver, are mounted on a camera tripod. The disk somewhat resembles the prismatic ring invented by C. Francis Jenkins for the transmission and reception of photographs and motion pictures by radio.

"It is of interest to note that, when using the sectored disk, the molybdenite is exposed to radiation for only about 1/500 of a second," observes Dr. W. W. Coblentz, in outlining additional details of his remarkable invention.

"Nevertheless, in this short interval of time, the electrical conductivity undergoes a change sufficient to produce an audible signal. Hence it may be useful for lecture-room demonstration. Good results may be easily obtained by joining the molybdenite receiver in series with a telephone and a battery of dry cells of from 40 to 80 volts. However, for a really successful demonstration it is desirable to connect the crystal and a battery of dry cells of 30 to 60 volts directly to the input terminals of an amplifier. Using a rotating sectored disc before the molybdenite receiver upon which is concentrated the light of an acetylene flame, the telephone emits a musical note of sufficient loudness to be audible in a remote part of the building.

"The method of producing a pulsating current in the telephone by interrupting the light which is incident upon the molybdenite by interposing a rotating sectored wheel is inefficient in view of the fact that only one-half of the incident light is utilized and the exposure time is only about 1/500 of a second, which is not sufficient to permit a great change in

Why the Infra-red Signalling System Insures Secrecy:

- 1: *It cannot be seen, or heard, or detected by any ordinary form of radio apparatus:*
 - 2: *The signal is sent in only one direction in the form of a beam:*
 - 3: *It can be operated without disclosing the position of the transmitter.*
-

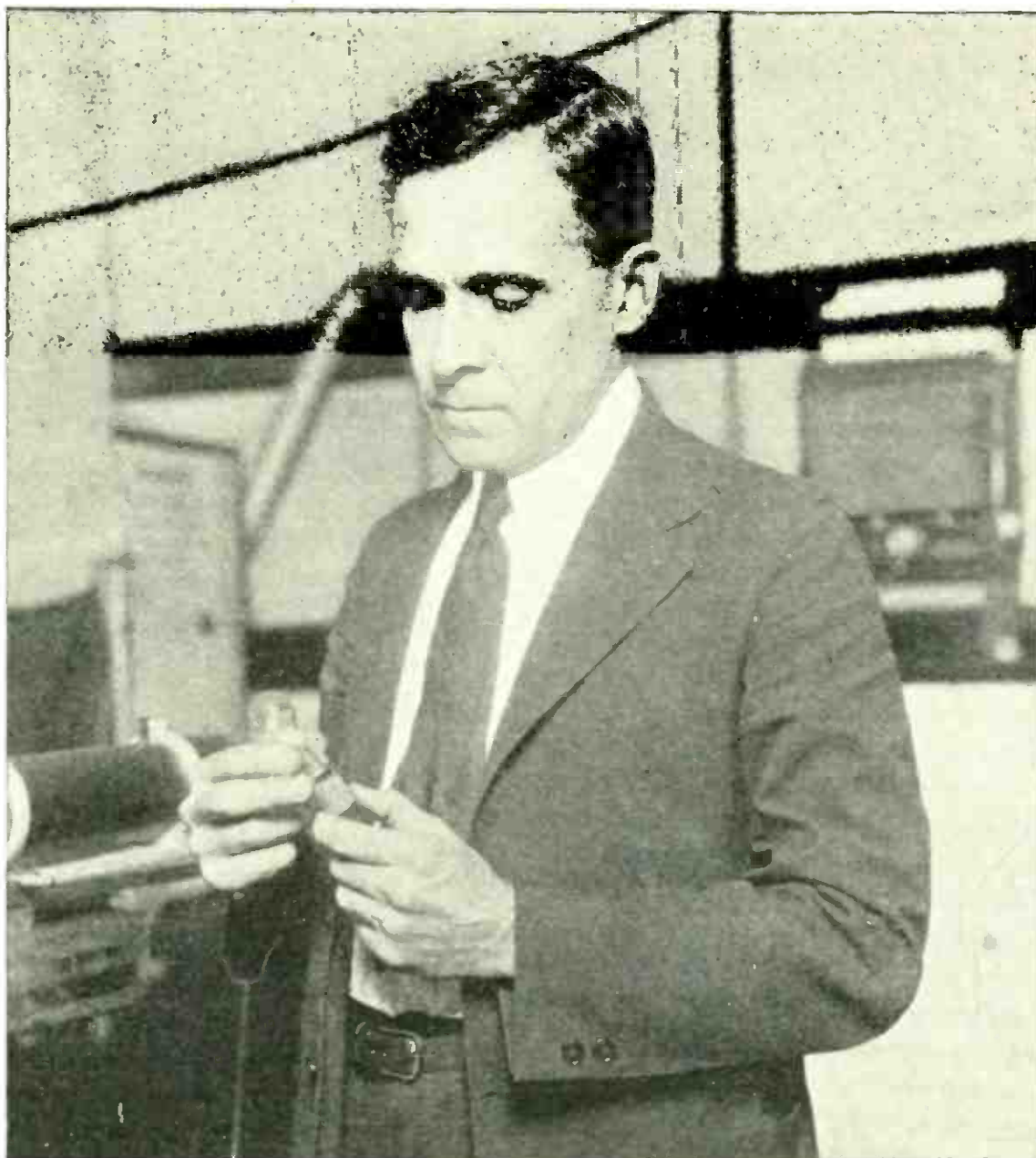

From a photograph made for POPULAR RADIO

THE CRYSTAL DETECTOR THAT IS PARTICULARLY
SENSITIVE TO INFRA-RED RAYS

"Molybdenite," known to all old-timers in the radio game as one of the mineral crystals that could be used to detect radio signals, was found by Dr. Coblenz to be extremely sensitive to infra-red rays. The small tube in his hands contains the molybdenite cell which makes the new system possible.

the photo-electrical conductivity. A signalling system which can utilize longer exposure of the receiver to the incident light will produce a greater change in the electrical conductivity.

"When using the sectored-wheel radiophone, the signal is recognized by the musical note emitted by the telephone receiver, the loudness of which is determined by the intensity of the incident radiations. The signal could be recognized also by a change in pitch of the sound

in the telephone receiver, provided apparatus can be devised to function by changing the pitch of the sound. This change in pitch was frequently observed in the French amplifier used in these experiments, but it was found to be inefficient and not reproducible. However, such a method is feasible. It is based upon the observation of T. W. Case that an audion bulb can be made to transmit a pulsating current. A change in current in the grid, or input, circuit causes a change in fre-

quency of the pulsating current, and hence a change in pitch of the sound produced in the telephone receiver. The time of exposure of the signal light can be made quite long, so as to utilize the full change in conductivity of the crystal receiver.

"This method of signalling seemed so attractive that an attempt was made to obtain a test of its efficiency as compared with the sectored-disk radiophone, using, in both devices, molybdenite for the receiver of the thermal radiations which were used in transmitting the signal.

"As we were unable to obtain the requisite apparatus and working solely upon the report that a suitably evacuated audion bulb can be made to function so as to change the pitch of the sound emitted by the telephone, the following apparatus was devised. An audion amplifier bulb, consisting of a grid, plate, and heating filament, was attached to an oil pump and evacuated to the pressure of mercury, which was found to produce the desired result. The wiring connection used was practically the DeForest audion connections with the grid potential positive. A resistance of 5 to 10 megohms is inserted in view of the fact that molybdenite has a comparatively low resistance, whereas it was found that the circuit must contain a high resistance in order to cause the audion bulb to function properly. The result of this test showed that owing to this high resistance, which was in series with the single receiver of molybdenite, but which did not function photo-electrically when exposed to light, the method of signalling by change in pitch was not so sensitive as the rotating-sectored disk radiophone. When several molybdenite receivers were joined in series so as to obtain the required high resistance when exposed to light, the sensitivity of this device was improved. As already mentioned, it is proposed to make artificial sensitive material.

"A photo-electric cell of the gas-ionic type—for example, the potassium hydride photo-electric cell—is well adapted for

use with this change-in-pitch method of signalling. The high resistance is used as ballast to the photo-electric cell. This combination was found to be the most sensitive of the radiophonic type of receivers yet tested. The applied voltage can be adjusted so that the telephone receiver emits a sound only when the photo-electric cell is exposed to light.

"Very instructive experiments can be performed with such a device. For example, the rate of charge and discharge can be adjusted so that the sound in the telephone is a series of clicks which increase in rapidity with increase in intensity of the exciting light. It is a simple task in glass blowing to arrange two electrodes and a heating strip (of platinum) to produce ionization.

"In secret signalling—the secret transmission of intelligence by means of invisible thermal radiations—radiometry attained its greatest triumphs and its most far-reaching applications.

"It is a method of signalling par excellence which, unlike electric-wave signalling, can be directed, which practically cannot be detected, and which can be operated without interference.

"The submarine can be combatted with depth bombs. Radio-telegraphy and telephony can be detected and interfered with, but the device for the secret transmission of intelligence by means of invisible thermal radiations, while still in its infancy, stands unique, as it can be operated without disclosing its position.

"Several writers (Ruhmer in Germany and Meissner in the United States) have written books which discuss secret signalling devices. Selenium was practically the only substance which was known at that time (1913) to be photo-electrically sensitive and which was discussed as a means of signalling.

"The unusually high photo-electric sensitivity, as well as the quickness of response of molybdenite to infra-red rays, renders this substance far superior to selenium as a radiophonic signalling device."



Kadel & Herbert

HE MAKES HIS LIGHTING CURRENT HEAT HIS TUBE

The inventor of this set, Mr. Aceves, is shown above trying out a tube set which operates from ordinary 110 volt alternating current instead of batteries.

A Tube Set that Requires No Batteries

By MARSHALL D. BEUICK.

RECENTLY several radio experimenters have discovered practical means of using ordinary 110 volt D.C. lighting current for the operation of tube sets. This, of course, obviates the use of "A" and "B" batteries that require recharging or become dead and must be replaced. The use of alternating current for the same purpose presents greater difficulty, since the plate and grid of the detector tubes require a direct current for operation. Mr. J. G. Aceves, of the Department of Physics at Columbia University, New York, surmounts this difficulty by first rectifying the alternating current with "S" tubes that give a direct current of slightly lower voltage for the operation of the tubes.

Mr. Aceves uses a lamp bank for resistance to cut down his voltage close to that required to heat the filament and obtains the exact voltage for oscillation

with a potentiometer or rheostat. The plate, requiring a higher voltage, is connected directly across the line, thus receiving the full D.C. voltage fed from the rectifying tubes.

This development in the use of A.C. to replace "A" and "B" batteries is particularly important because the majority of lighting circuits throughout the country are alternating current. In more isolated communities, where it is difficult to reach a charging station, the tube set operating on A.C. circuits is often desirable. There is no need to wait for a battery to be recharged, and the use of two batteries, to supplement one another while one is being charged, becomes unnecessary. At the same time, there are many amateurs who prefer to use only batteries, believing they can obtain thereby a greater degree of efficiency of operation, particularly in getting DX.

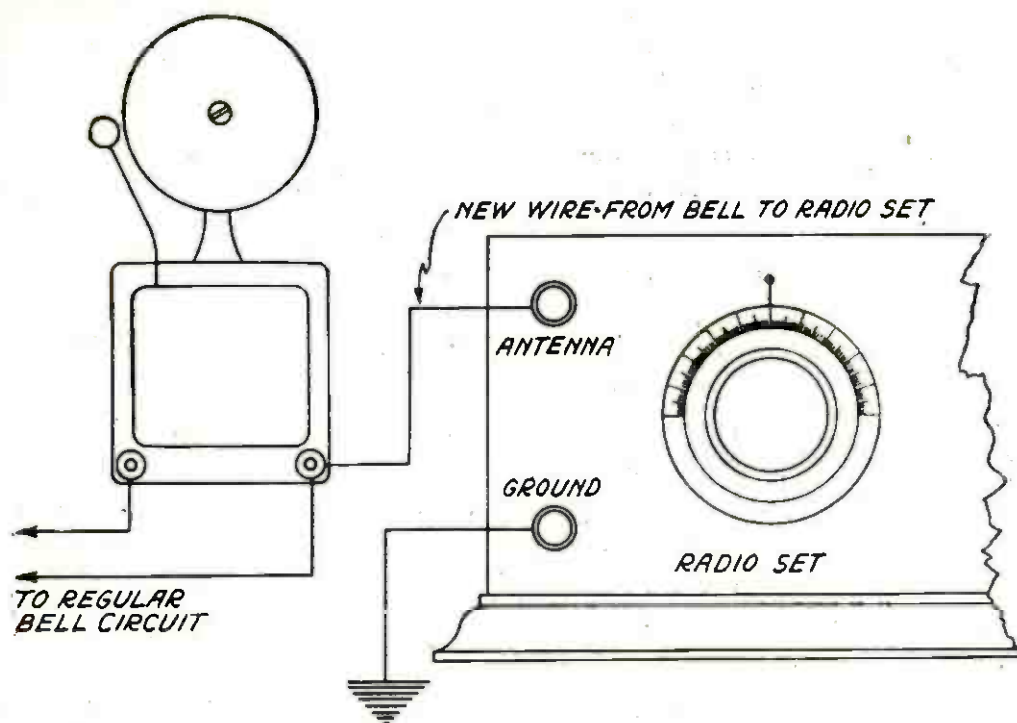

THE WIRING DIAGRAM FOR THE BELL CIRCUIT ANTENNA

When you connect the antenna binding post on your set to the nearest bell, be careful to try both binding posts on the bell and leave the wire permanently connected to the side that brings in the signals with the greatest intensity.

How to Use a House Bell Wire as an Antenna

By WILLIAM F. CROSBY

IT sometimes happens that, on account of circumstances over which the radio fan has no control, it is not possible to put up an outdoor antenna which will be suitable for the reception of broadcasting.

Here is one way to overcome this difficulty; it will enable you to receive broadcasting by making use of the ordinary "bell" circuit in the house. In every apartment house there is usually a front door bell and also a buzzer in the kitchen, which is connected for use in the dumb-waiter. This latter circuit makes a good antenna because it is not used as much as the front door bell. As a slight buzz will be heard in the receivers every time the button is pushed, and as the door bell is apt to be rung at almost any time, the dumb-waiter buzzer is the more serviceable of the two.

Using one side of this circuit will not

harm either the bell circuit or your receiver. Even when the buzzer or bell is rung, it will have no effect on the set, except that a noise will be heard.

To connect the radio receiver to such an antenna is simple. Loosen up one of the binding posts on the buzzer or bell and connect a wire to it. The other end of this wire should be run down to the antenna binding post on the radio set. In connecting this wire to the buzzer, be sure that the wire which was already on the binding post of the buzzer is put back in place, otherwise the buzzer will not ring.

Of course, it is not possible to receive much DX on an antenna of this sort, but if circumstances are right, some surprising results may be had. On local broadcasting stations, the signals should be almost as loud as with the outdoor antenna.

In some of the large apartment houses,

where the bell wiring is run all through the building, the wavelength may be a little too high for broadcasting reception; for this reason it would be well to insert a 43-plate variable condenser in the ground lead. This will reduce the wavelength and give better results.

For local work it is sometimes possible to use almost any large metallic object for an antenna; another favorite method of securing an antenna, is to make use of the spring of a bed or a couch. Simply attach a wire to the frame work and run it to the antenna binding post on the set. Be sure that where the connection is made to the bed there is no paint or rust, and if there is scrape it down until the metal is shiny; then make a good tight connection.

Running a wire around a picture moulding is another good way to secure an antenna. Get a pound or so of ordinary No. 18 annunciator wire and tack it in place over the top of the moulding where it will not show. If necessary this may be run around several rooms in order to get enough length.

These suggestions will not always work unless conditions are fairly good, although the bell antenna is the best. In some of the lower floors of the build-

ings in congested cities, the picture moulding antenna will hardly work at all, unless the location is close to a broadcasting station. The same statement holds true for the bed-spring antenna, and the builder will have to take local conditions into consideration, or resign himself to a little experimenting.

For apartment houses where clothes lines are run from the back windows, it is possible to get a kind of clothes line that looks like the regular thing. It has, however, a phosphor-bronze cable for the center; all that has to be done is to connect to one end of this "clothes line." This metallic-core rope may be secured at any ship chandlery, and is known as cotton-covered, phosphor-bronze tiller rope. It will act as a clothes line, and an antenna that is worth while.

The first thought of a beginner, upon finding that he is not permitted to erect an antenna, is to use a loop, but when he finds out that to use it he must install several stages of radio-frequency amplification, he immediately becomes discouraged. Possibly these hints may be of some assistance to the beginner in this class, as they show that the outdoor antenna is not absolutely necessary for local reception.

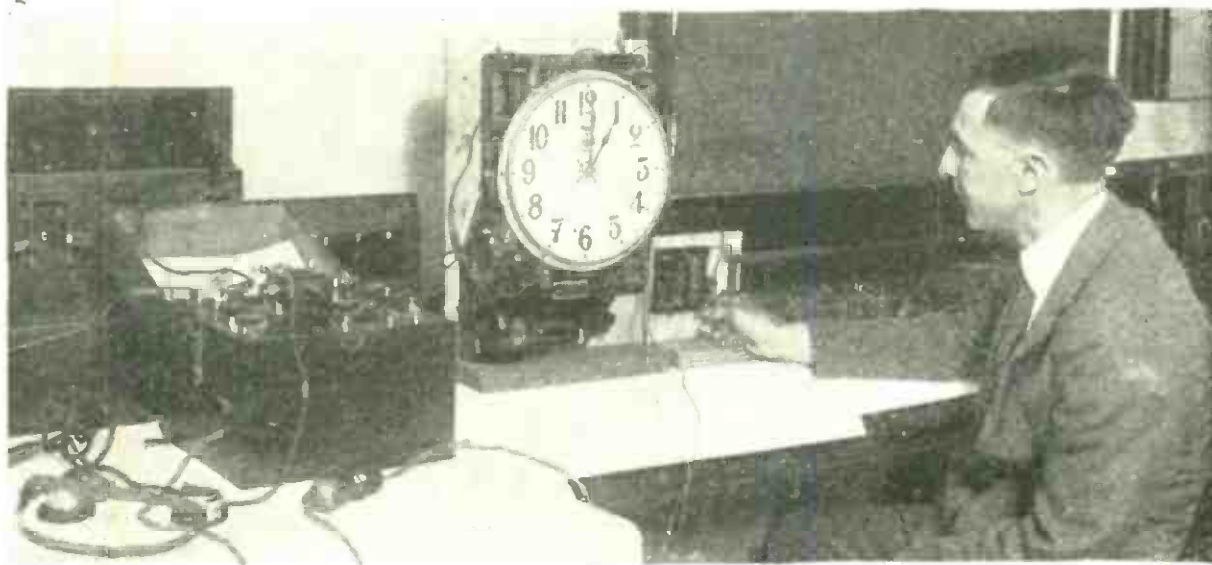

Henry Miller

RADIO SETS THIS CLOCK

A physicist at the Bureau of Standards in Washington, D. C., Mr. F. W. Dunmore, has worked out a system of retarded relays so arranged that the dots of the time signal have no effect, but the long dash that is transmitted exactly at noon and at 10 P.M. will work the mechanism and set the clock.

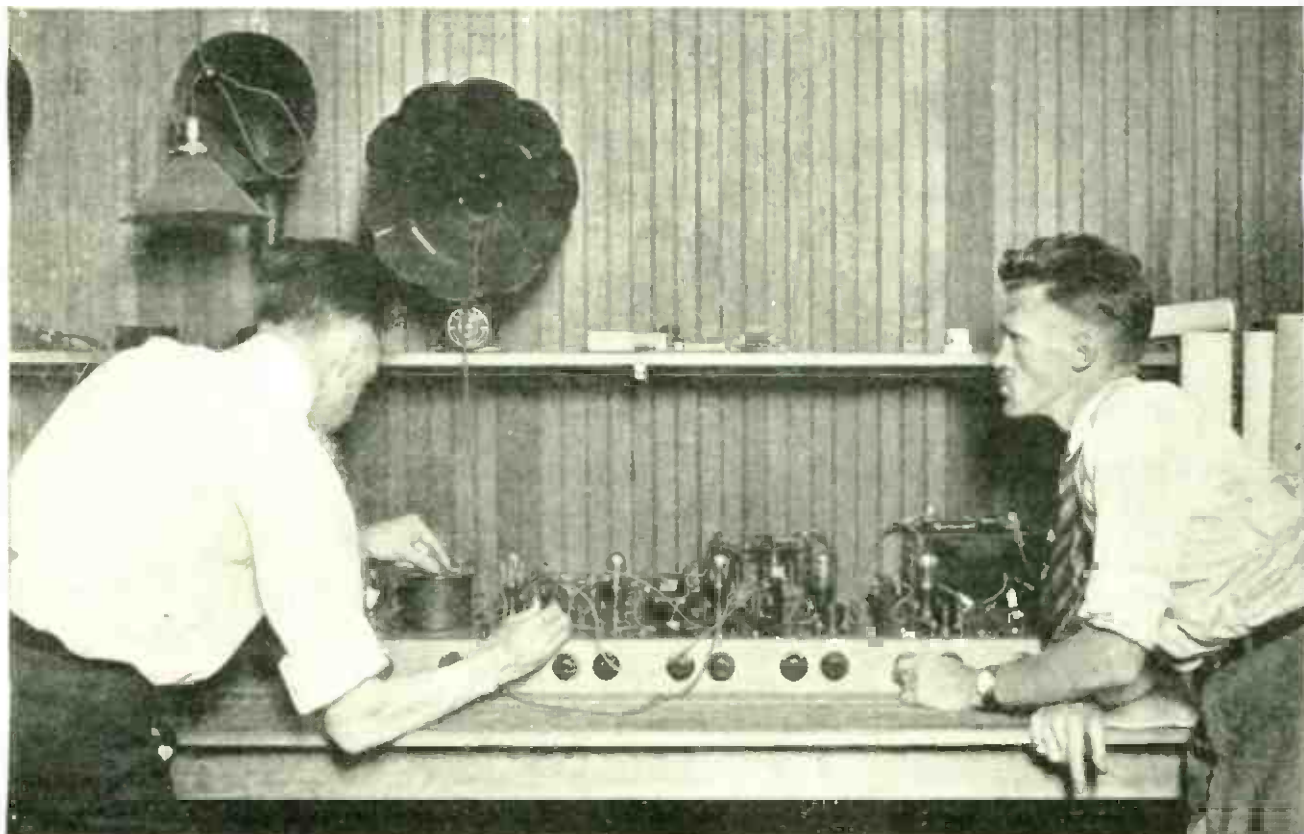

From a photograph made for POPULAR RADIO

WHERE AUDIO-FREQUENCY TRANSFORMERS ARE TESTED

In the POPULAR RADIO LABORATORY, audio-frequency transformers which are submitted for test are first measured for electrical characteristics and then placed on this test board and tried out under actual working conditions.

HOW TO SELECT YOUR Audio-frequency Transformer

An article of practical helpfulness to every
broadcast listener who wants to improve the
quality of his radio reception

By JESSE MARSTEN

THE research work going on today is bound to upset a number of notions about audio-frequency transformers which have long been prevalent among radio fans. For example, people still buy transformers by specifying the turns ratio, although the turns ratio is no criterion of the quality of a transformer. Others believe that it is necessary to use transformers having different turns ratios in the different stages of an amplifier, and manufacturers turn out different ratio transformers when, as a matter of fact, such

a procedure is only an attempt to rectify defects that exist in the transformers.

After all, the transformer which is to be used for the reception of speech and music must meet just one requirement to be classed as a high quality transformer: It must reproduce faithfully and accurately, in the secondary circuit, the sound currents which are supplied to the primary circuit. The transformer may incidentally, and it is desirable that it should, amplify as well, *i.e.*, step up the primary voltage.

Audible sound vibrations range in

frequency from as low as 16 vibrations a second to as high as 30,000 a second. But for all practical purposes, such as the transmission of high quality speech and music, we are concerned, essentially, with the range between 30 and 10,000 cycles a second. The lowest notes on the piano keyboard and the beat of the kettledrum are in the neighborhood of 25 or 30 cycles while the piccolo and organ reed may go as high as 10,000 cycles. Between these two extremes we have every other possible intermediate frequency, and all possible combinations of frequencies such as might occur in the rendition of a selection by a symphony orchestra, a band or a chorus. Even when we are apparently concerned with only one frequency (as, for example, middle C, 256 vibrations a second, as played by a violin), other frequencies are involved; for harmonics (or over-tones) are generated which are of several times the fundamental frequency, and the intensity of each of these overtones bears a certain quantitative relationship to the intensity of the fundamental. It is evident, then, that for any reproduction to sound natural, the transformer must be able to reproduce all frequencies from

30 to 10,000 cycles equally well over the entire range.

The difference between an audio-frequency transformer intended for use in radio-telegraph reception and one intended for radio-telephone or broadcast reception will at once be readily appreciated. In the case of telegraph reception we are concerned with one audio frequency which may be 500 cycles or 1,000 cycles or some other frequency of that order. The transformer may be designed to give its maximum amplification at the signal frequency, and no particular thought need be given to what happens at the other frequencies. Also the transformer can be given a high step-up ratio so that the transformer itself amplifies the signal voltage as much as possible. Ratios as high as 10 to 1 have been used without detracting from the efficiency of the transformer at the particular signal frequency used. Radio-telephone reception obviously presents a much more difficult problem and introduces considerations which are vital to good results.

What Frequency Characteristics Mean

As a measure of the quality of an amplifying transformer we may take its "frequency characteristic" which shows the relative performance of the transformer at different frequencies. Suppose we apply a given constant voltage

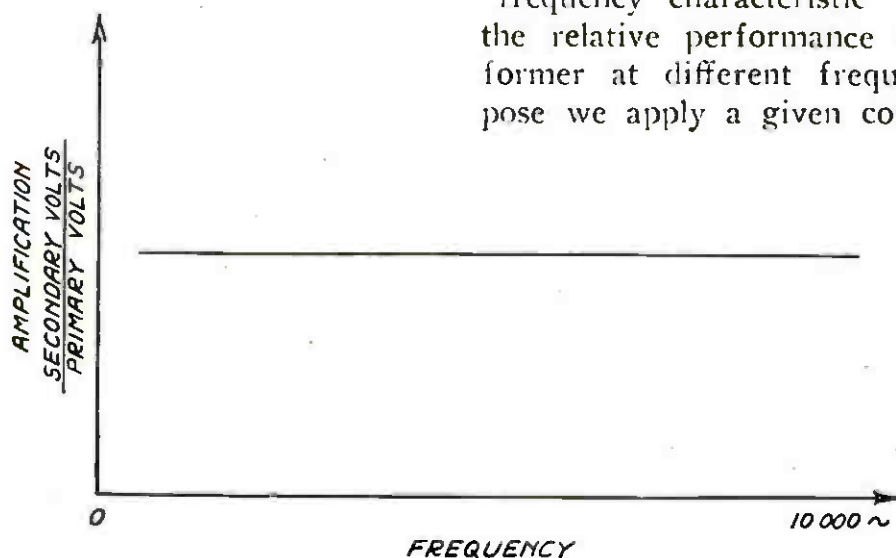

HOW AN IDEAL AUDIO-FREQUENCY TRANSFORMER SHOULD AMPLIFY

FIGURE 1: The straight horizontal line shows what the amplification response should be for an ideal transformer with changes in frequency from 60 to 10,000 cycles; it would amplify all the audible frequencies with equal intensity.

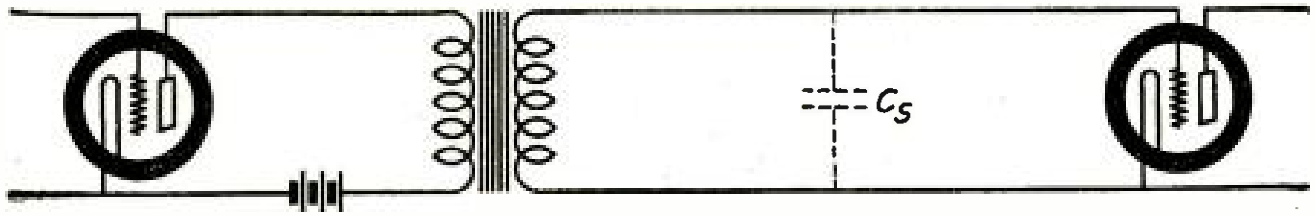

HOW DISTRIBUTED CAPACITY AFFECTS THE HIGH TONES

FIGURE 2: In Figure 2(a) shown above, the capacity of the secondary windings has the same effect as though a condenser C_s were connected across the terminals. The high turns-ratio multiplies this capacity effect so that we have the effect of a condenser C_p as shown in Figure 2(b) on the opposite page. The result is that the higher audible frequencies are by-passed around the primary winding and do not reach the grid of the following tube.

at different frequencies to the primary of the transformer and then measure the voltage across the secondary of the transformer at these different frequencies. An ideal transformer would have frequency characteristics as shown in Figure 1. This curve shows that the transformer reproduces in the secondary all the frequencies between 30 and 10,000 cycles equally well. This is the ideal which audio-frequency transformer design should approach. The greater the departure of actual transformers from this ideal the less desirable the instruments would be for broadcast reception.

How Turns Ratio Affects the Quality

The ratio of the number of secondary turns to the number of primary turns is called the "turns ratio." When a

transformer is designed for a particular frequency, the voltage across the secondary is equal to the voltage impressed on the primary times the turns ratio, provided the coupling coefficient is unity, which is very nearly the case in most closed-core transformers. But at other frequencies this is not necessarily so. One of the factors which is instrumental in producing this effect is the distributed capacity of the transformer secondary winding.

If, with a given number of turns on the primary winding the turns ratio is increased, the secondary turns increase correspondingly. The greater the number of turns on the secondary the greater is the distributed capacity of the secondary winding. This distributed capacity behaves, in effect, as a shunt

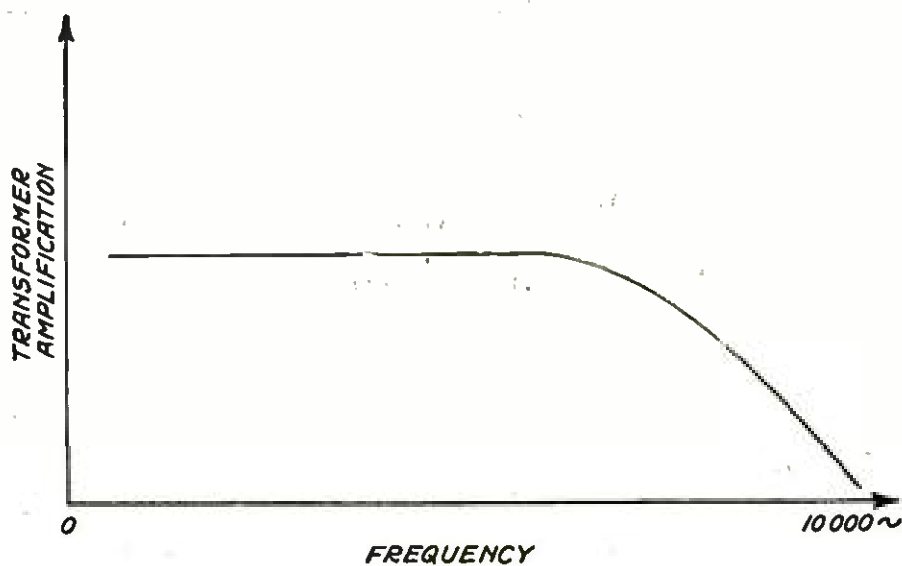

WHY SPEECH IS MUFFLED

FIGURE 3: This curve shows a falling off in amplification as the frequency is increased. The high tones are lost and the result is a muffled, drummy quality to both speech and music.

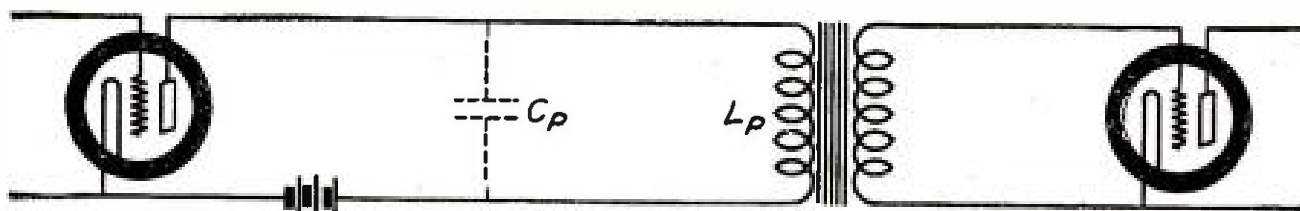

across the secondary of the transformer. Furthermore, transformer theory and practice show that this secondary distributed capacity is equivalent in its effect to a certain capacity in the primary circuit, and this equivalent primary capacity is equal to the actual secondary capacity multiplied by the square of the ratio. Thus, if a given transformer that has a turns ratio of 7 has a distributed secondary capacity of C microfarads, then it behaves as though we had a capacity of $(7)^2C$, or $49C$ microfarads capacity in the primary. In other words, the capacity effect of the secondary is multiplied about 50 times in the primary circuit, and it behaves, in effect, as though it were shunted across the primary. This increased primary capacity produces a great departure from the ideal flat frequency characteristic, and introduces considerable distortion.

A transformer for interstage coupling is generally used in connection with vacuum tubes as in Figure 2(a) where

C_s represents the distributed capacity of the secondary.

Figure 2(b) represents the same circuit, except that the secondary distributed capacity is replaced by its equivalent primary capacity. We thus have two reactances in parallel, the primary inductance of the transformer and the effective primary capacity. If there were no capacity, all the audio-frequency current in the plate circuit would flow through the primary inductance and would thus be effective in producing secondary voltage. The presence of the capacity, however, has the effect of shunting some of this audio current, and, as the reactance of a capacity decreases with increase of frequency, it will shunt *more of the high-frequency currents* than the low. Also, since this shunt current flows through the capacity rather than through the primary of the transformer, it can have *no effect in producing induced voltage* across the transformer secondary. As a result we have progressive falling off of secondary

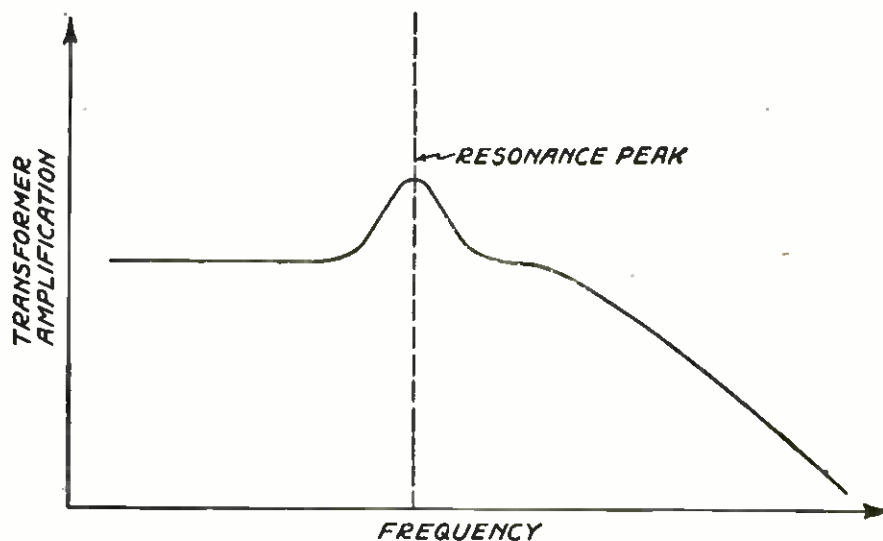

HIGH CAPACITY ALSO PRODUCES RESONANCE EFFECTS

FIGURE 4: The capacity and the inductance of the transformer form a tuned circuit and when the distributed capacity is high, the resonance point falls within the audible frequencies and excessive amplification of a particular tone is the result.

voltage as the frequency is increased, and the ideal frequency characteristic of Figure 1 begins to look somewhat like that of Figure 3. The first effect of a high turns ratio, which means high distributed capacity in interstage coupling transformers, is to produce decreased amplification at the high frequencies. The distortion characterized by the absence of the high frequencies is a muffled, drummy quality in both speech and music, and the absence of sibilants and consonants in speech.

High Capacity Produces Resonance Effects

The high distributed capacity that results from a high turns ratio produces still another undesirable effect in audio-amplifying transformers—a resonance phenomenon at the particular frequency to which the circuit $L_p C_p$ in Figure 2(b) tunes. This is a tuned parallel circuit whose impedance at resonance is a maximum. The voltage developed across it is, therefore, a maximum at resonance. Hence there will be a peak in the amplification at this frequency, and there will be another departure from the ideal transformer characteristics of Figure 1 which now begins to look like Figure 4. The distortion introduced by

such a transformer is obviously an exaggeration of the particular frequency to which the transformer constants tune, and this is often the explanation of why certain musical tones stand out prominently and conspicuously over all others in a particular receiver. If such a transformer is used in both first and second stages of an audio amplifier it will be evident that this resonance effect will be multiplied in the second stage, and the amplification characteristics will look like Figure 5.

To avoid over-exaggeration of this resonance effect, therefore, many manufacturers recommend the use of a transformer having a different turns ratio in each stage. This mitigates the evil of an over-exaggerated single frequency, but introduces instead *two* resonant periods. For, when each transformer has a different turns ratio the constants will be different, and $L_p C_p$ (Figure 2(b)), will tune to a different frequency. The combined frequency characteristics of both transformers will, therefore, be of the nature of Figure 6, where two moderately sized resonance peaks are produced as against one over-emphasized peak in Figure 5. This procedure is obviously no solution to the problem of securing uniform amplification at all

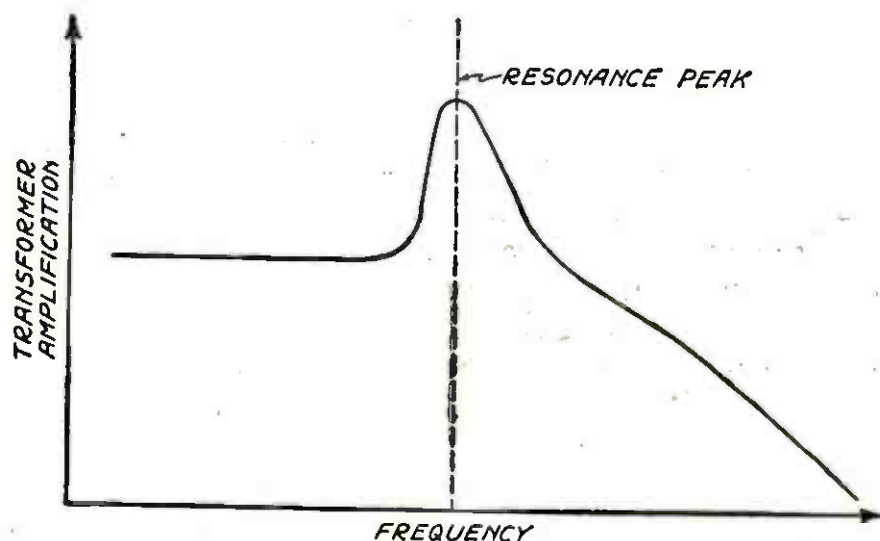

WHAT HAPPENS WHEN THE SAME TURNS RATIO IS USED FOR TWO STAGES

FIGURE 5: If a transformer which has a bad resonance point is used in each of the two stages, the distortion will be multiplied and an exaggerated resonance peak is the result.

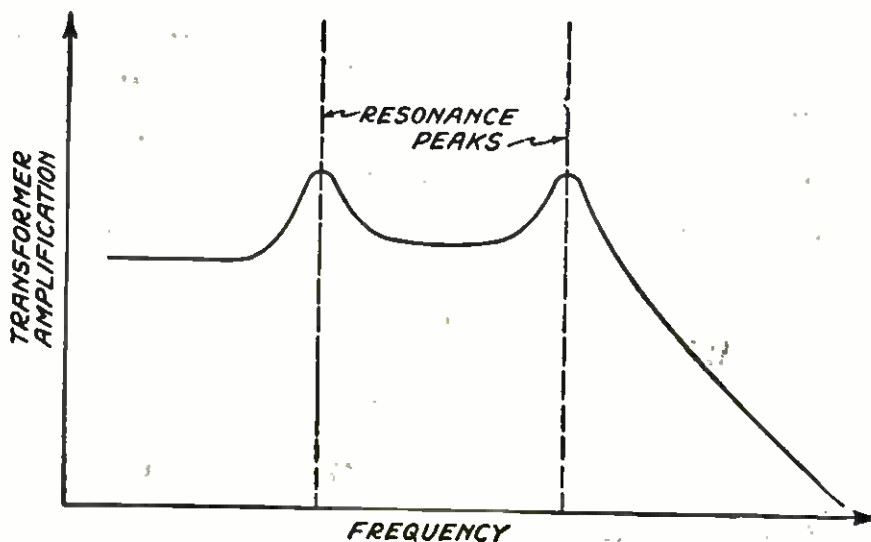

WHAT TWO DISSIMILAR TRANSFORMERS MAY DO

FIGURE 6: The curve shown is the combined effect of using a transformer which has one resonance point in the first stage, and a transformer with a different resonance point in the second stage.

frequencies. The solution is, rather, to make transformers which amplify all frequencies uniformly and the first step is to *avoid* high turns ratio which produces two irregularities in the ideal flat frequency characteristic: They are poor amplification at the higher frequencies and resonance peaks.

The high-ratio transformer will in general give greater volume than the low-ratio transformer, though this may not always be the case, as it is possible that the loss in amplification at the high frequencies will neutralize the gain obtained at the low frequencies. In electro-acoustic converters it is almost invariably true that high quality of signal is inconsistent with quantity of signal. In the case of microphones, high quality of reproduction is accompanied by *diminished* output. Similarly, in the case of transformers, high quality can only be secured *at the expense of quantity of signal*, which means that high ratios *must be* dispensed with so long as the usual grade of transformer steel is used.

Why High Primary Impedance is Necessary

The next important consideration which emphasizes the necessity of low ratios is the primary impedance of

the transformer. Transformers are connected as shown in Figure 2 with primary in the plate circuit and secondary across filament and grid. But, as the grid is at a negative potential, the secondary may be considered as though on open circuit. Therefore, the total amplified voltage produced is directly proportional to the voltage available across the primary inductance L_p , and for purposes of discussion we may regard the circuit as a reactance-coupled amplifier.

In a reactance-coupled amplifier the voltage developed across the reactance depends upon the ratio of the plate reactance to the internal resistance of the tube. The greater the reactance the greater the voltage across it. But, when the reactance reaches a value of about three times that of the valve resistance, almost maximum voltage is developed across it. Theoretically, maximum voltage is developed across the reactance when it is infinite, but for all practical purposes we may consider that maximum voltage is developed across a plate reactance when its value is three times that of the tube resistance. For any values of the reactance below this, the voltage developed across it will be less than the maximum.

Inasmuch as the reactance of a coil

is directly proportional to the frequency, maximum voltage amplification will not be secured unless the above condition is met at all frequencies. To illustrate with an actual problem, consider the case of a transformer whose primary has an inductance of 10 henrys connected in the plate circuit of a tube with plate impedance of 20,000 ohms. The reactance of the primary is given by $6fL$, where f is the frequency and L the inductance. At 1,000 cycles the reactance is equal to 60,000 ohms, which is three times the plate impedance of the tube. Above 1,000 cycles the reactance becomes greater but the voltage developed across it is practically constant. Thus, full maximum amplification is secured above 1,000 cycles with this transformer. Below 1,000 cycles, however, the reactance is less than that required for maximum voltage, and the amplification is correspondingly decreased.

The characteristics of such a transformer are shown in Figure 7, and it is seen that the low frequencies are not reproduced properly. In order that the low frequencies be taken in by the transformer, its primary inductance must be considerably greater than 10 henrys. If the primary inductance were 100

henrys, maximum amplification would be secured at 100 cycles and over, but frequencies below 100 would be dropped out. The condition, therefore, for securing the very low frequencies is that the primary inductance must be very great, in fact high enough so that its reactance at the lowest required frequency is three times the tube impedance.

But high inductances cannot be secured unless a great number of turns are used on the iron core, and for a given transformer ratio the secondary turns go up proportionally with the primary turns, which produces an increase in the distributed capacity, and a loss of high frequencies. Thus, the conditions for securing the low frequencies conflict with that for securing the high frequencies. As a result, unless radical changes are made in the weight and dimensions of an audio transformer, a compromise must be struck between the conditions for securing both low and high frequencies. Constants must be chosen which will not make the low frequency cut-off point be too high.

Light-weight Transformers Distort

The above limitations to securing a flat top characteristic for an audio-frequency transformer are, in the final analysis, the result of restricting the weight and dimensions of the trans-

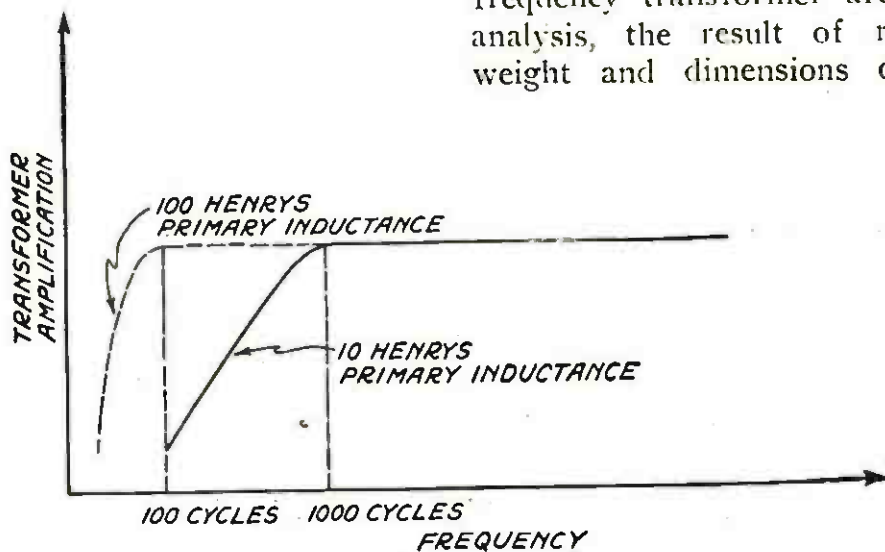

WHAT HAPPENS WHEN THE PRIMARY INDUCTANCE IS LOW

FIGURE 7: If the inductance of the primary winding of the transformer is too low, the low notes are lost because they are not properly amplified. Speech or music will then have a shrill, tinny sound.

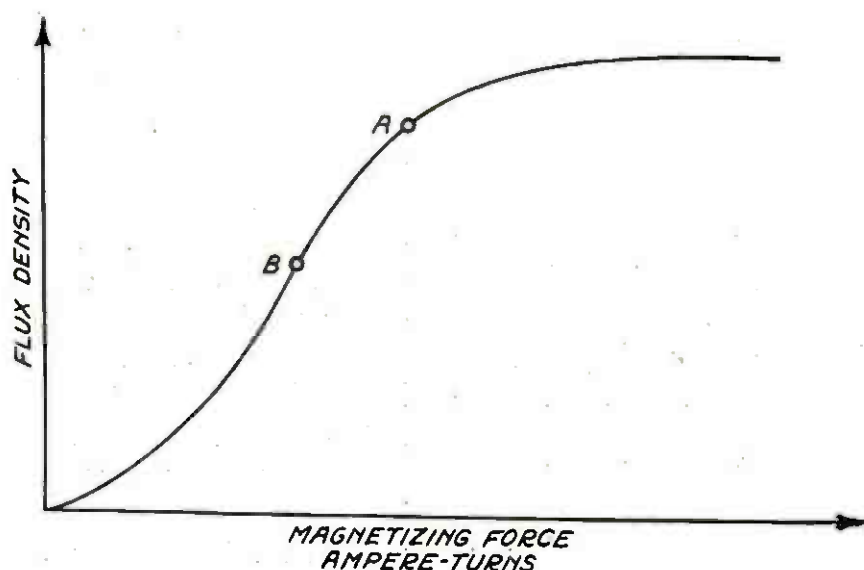

THE SIZE OF THE TRANSFORMER CORE IS IMPORTANT

FIGURE 8: *Small audio-frequency transformers often distort because the iron core is so small that it is magnetized to the point A on the curve where variations of the plate current above and below this point do not produce equal voltage variations on the grid of the next tube. The flux density should be such that the magnetization of the core will lie at point B on the curve.*

former. It is desirable to economize both in space and weight, and as a result, transformers are generally made small with not much iron. This introduces the various distortions which are present.

The relationship between the various factors involved in the magnetic circuit of an iron core is shown in Figure 8. This curve shows the flux density, or number of lines of magnetic force for a unit cross-section of the core, produced by any magnetizing force, which is proportional to the product of the current and the number of turns of wire through which it flows.

The inductance of any winding on a closed iron core, as, for example, the primary of an audio-frequency transformer, depends on the number of turns and the total flux threading the core (not allowing for leakage which is small for a closed core). For a given flux density, the total flux threading the core is proportional to the cross-section of the core. When the cross-section of core is small, as is the case in the average amplifying transformer, the flux density must be high in order that a given flux be produced. From Figure

8 it is seen that a high flux density can only be secured by a correspondingly high magnetizing force. As the d.c. plate current is fixed for any given tube and operating conditions, the number of turns must be high to secure the necessary magnetizing force. The smaller the cross-section the greater must be the number of turns. For any given transformer ratio this results in a correspondingly higher number of secondary turns, with resultant increase in distributed capacity. The consequence is that high-frequency distortion is produced, as explained under the discussion of distributed capacity.

If the size of the transformer core were increased, a given flux could be produced by a smaller flux density. For a given tube and plate current this would be secured with a smaller number of turns which, in the case of a transformer of given ratio, would result in lower distributed capacity and less high-frequency distortion. The larger the transformer the less the high-frequency distortion.

It can likewise be shown that the low-frequency distortion decreases as the size of the transformer increases. For

a given flux density and number of turns the total flux threading the larger cored transformer is greater. Therefore, the inductance will be greater, and it will take in more of the low-frequency range than a smaller transformer for reasons explained in the discussion on primary impedance. The distortions thus produced are a dropping out of the lower and upper range of frequencies.

There is another type of distortion introduced different from those mentioned above—the introduction of new frequencies. This is due to saturation of the iron core and is most likely to occur in small transformers. The current flowing through the primary of the transformer may be resolved into two components; first, the direct current of the tube, and second, the audio-frequency alternating current. The direct current is the larger of the two, and produces a certain magnetizing force and flux density which are constant. Suppose that these values are such that the transformer operates about point A of Figure 8. Then the audio-frequency current produces variations in the flux density which produce corresponding variations in voltage.

However, equal variations of the magnetizing force above and below point A of Figure 8 do not produce equal variations of flux density, due to the shape of the curve. In other words, the wave form of the secondary voltage is different from that in the primary of

the transformer, which means that distortions have occurred in the original sound. An alteration of the wave form of voltage is equivalent to the introduction of frequencies other than those originally present. If the transformer were large enough to permit the direct current of the tube to magnetize the core to the extent indicated by point B of Figure 8, this distortion would not occur, for equal variations in the audio-frequency current above and below point B would produce equal variations in flux density above and below B, because the transformer is now being worked on the straight-line portion of its magnetizing curve. This effect is similar to the working of a vacuum-tube amplifier on the straight-line portion of its characteristic rather than at the saturation point where distortions enter.

The conclusion to be drawn is that the quality of an audio-frequency transformer improves with increase in its size and the amount of active iron in it. Very small transformers are bound to give poor quality. In the past, manufacturers have been guided more by considerations of space and weight economy than by considerations of quality. This policy must now be reversed if high quality standards are to be maintained. By proper design of the transformer, by proper choice of turns ratio and transformer constants, and by a careful selection of materials, distortionless transformers *may* be made.

Advertising in Broadcast Programs Must Go

I BELIEVE that the quickest way to kill broadcasting would be to use it for direct advertising. The reader of the newspaper has an option whether he will read an ad or not, but if a speech by the President is to be used as the meat in a sandwich of two patent medicine advertisements, there will be no radio left. To what extent it may be employed for what we now call indirect advertising I do not know and only experience with the reactions of the listeners can tell.

—HERBERT HOOVER



“TROUBLE SHOOTING”

CONDUCTED BY S. GORDON TAYLOR

EVERY radio receiver requires a careful balancing of all of its parts if the best results are to be obtained. Two receivers made from exactly the same design may give widely different results, owing to variations in the parts used, the skill of the experimenters and the locations of the receiver. This department is conducted for the special benefit of readers who have built the radio receivers described in POPULAR RADIO and who want to profit from the experience of others in operating them—to learn the little kinks that get the maximum results.

The New Four-circuit Tuner with Resistance Coupled Amplifier

JUDGING from the inquiries that have been received by the Technical Service Bureau it appears that many readers who constructed the Improved Four-circuit Tuner (described in the January issue) now wish to keep up with the trend of the times by converting their receivers into the latest type of four-circuit. Below are quoted some of the most common questions they ask, as well as others from readers who are building the four-circuit receiver for the first time. The questions, with their answers, are being published for the information of those who are contemplating construction or reconstruction of this receiver.

QUESTION No. 1: Why is a .00035 mfd. variable condenser used across the secondary of the tuner, instead of the .0005 mfd. condenser used in all previous four circuit receivers?

ANSWER: Using a .0005 mfd. condenser it was found that the entire broadcast wavelength band was covered with only 70 degrees of the dial of this condenser in use. In other words, one-third of the condenser was not used. Therefore, by substituting a .00035 condenser, this useless part was eliminated and the tuning was made easier in that the waveband was spread over one-third more dial area. Stations that were formerly tuned in 6 degrees apart are now separated by 8 degrees, and stations that were on almost the same dial settings are now separated. Another advantage of this arrangement is that when the two condensers are

set on the same dial reading the capacity in the stabilizer circuit will be approximately one-third greater than that in the secondary circuit, and it has been found that this results in louder signals than are obtainable when the same capacity is used in both circuits.

QUESTION No. 2: What are the advantages of the four-circuit receiver described in the October issue, over that described in the January issue?

ANSWER: The changes made in the layout of the tuning instruments, the use of low loss condensers and the simplification of wiring have all made for greater efficiency in the tuner and detector circuits. Increased efficiency in this part of the receiver naturally permits reception over greater distances, greater detector volume, and perhaps most important of all—even greater selectivity. The advantages of the resistance coupled amplifier, over the old transformer coupled type, are also numerous. Resistance coupled amplification provides distortionless reproduction because it amplifies all frequencies in the same proportion. The volume per stage of this type of audio amplification is slightly less than that of transformer coupled amplification, but to overcome this an extra stage has been used, making a total of four stages of amplification as compared with three stages used in the Improved Four Circuit. Thus with the increased detector volume as mentioned above, plus the resistance coupled amplifier, the total volume is far

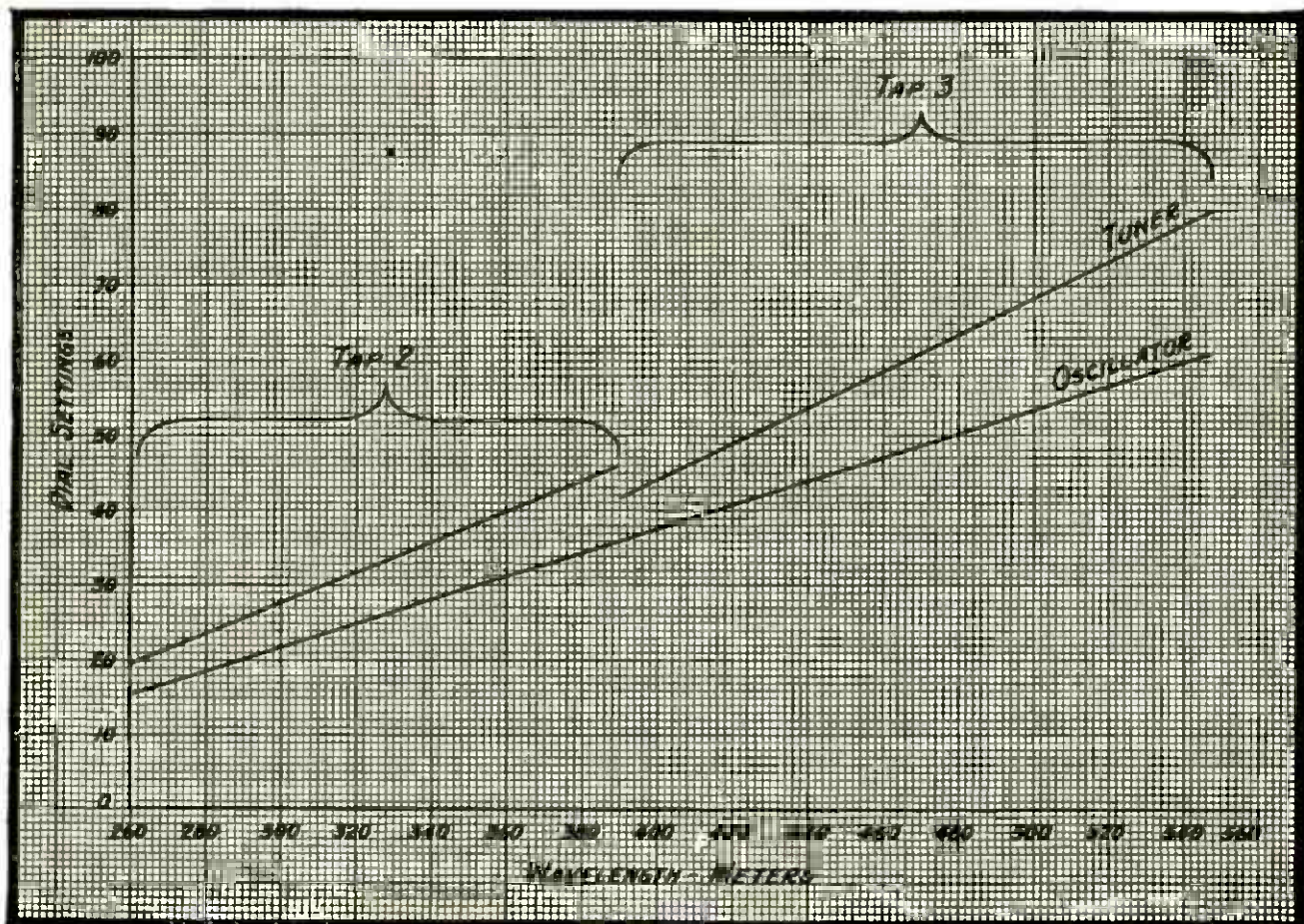

A TUNING CHART FOR THE SUPERHETERODYNE

FIGURE 1: This chart shows how to set the tuning condenser and oscillator condenser for any given wavelength when using the superheterodyne receiver described in POPULAR RADIO for September, November and December, 1923.

greater than the average five tube receiver, and is greater than the Improved Four-circuit Receiver. To sum up, therefore, the advantages of the newest four-circuit receiver are: Greater volume; greater selectivity; greater distance; more simple and sharper tuning; better quality of reproduction; elimination of the rheostats and substitution of automatic filament control in the amplifier.

QUESTION No. 3: Is the "B" battery expense higher using the resistance coupled amplifier?

ANSWER: No. There has been a general belief that a receiver using resistance-coupled amplification proved more expensive to keep up because of a higher "B" battery current consumption. Actually, this is not so. Using 135 volts on the plates of both a transformer coupled and a resistance coupled amplifier, it will be found that the latter consumes less current, and that the "B" batteries therefore last longer on the amplifier with the resistance coupling.

QUESTION No. 4: Can parts used in the Improved Four-circuit Receiver be used in the new circuit, where similar parts are called for, as in the case of the

audio transformer, the variable condensers, etc?

ANSWER: Yes. However, the variable condensers specified in the latest circuit have an advantage over the old, as explained under questions 2 and 3 above. The audio-frequency transformer may be the same as the one specified in the January issue, or any other good standard transformer, preferably with a turn ratio not higher than 5 to 1. Standard jacks may be used and separate potentiometer and rheostat will be suitable. If desired, rheostats may be used in place of the Amperite resistances for filament control. It must be borne in mind, of course, that the use of different instruments on the panel will require different drilling than that shown in the panel layout in the October issue.

QUESTION No. 5: Can dry cell tubes be used in place of the six volt tubes specified?

ANSWER: Yes. The UV-199 or C-299 tubes may be used with good results. WD-11 or WD-12 tubes are not recommended because of their comparatively poor quality as amplifiers. When UV-199 or C-299 tubes are used, the volume will be considerably less than when six

volt tubes are used. This is not due to any peculiarity of the receiver but is an inherent fault of small tubes, resulting from the smaller size of the internal elements. To use these tubes it will only be necessary to substitute suitable sockets, Amperites and rheostat. The potentiometer will not be needed and may be omitted entirely, connecting the minus side of the detector "B" battery direct to positive side of the "A" battery circuit, instead of to the potentiometer. It will also be found advisable to reduce the amplifier "B" battery voltage to about 90 when using the small tubes.

QUESTION No. 6: Can a loop antenna be used with this new receiver?

ANSWER: No. For best results this receiver requires a large antenna. A single wire, from 150 to 200 feet in length, from receiver to most distant end will be found excellent. If such a span is impractical, however, a two wire an-

tenna made up of two parallel 100 foot wires spaced about 3 feet apart will give good results. If available space is less than this, three wires may be used. An indoor aerial is not comparable with a good outdoor antenna. A loop antenna is out of the question.

QUESTION No. 7: Can the new receiver be rearranged to fit into a smaller cabinet, or must the arrangement shown in the October issue be adhered to?

ANSWER: Other arrangements are possible, of course. However, a change of this kind should not be attempted unless one has a thorough understanding of the possibility of interaction between various instruments, etc. The layout shown in POPULAR RADIO was made after careful study with a view to maximum efficiency, ease of construction and wiring. Changes are therefore not recommended.

How to Control Regeneration in the Haynes DX Receiver

(This set was described in POPULAR RADIO for September, 1923)

If trouble is found in controlling regeneration in this receiver shunt the phones with a fixed condenser of about .002 microfarad capacity. This does not apply in cases where an amplifier to go with this tuner was constructed in accordance with the plans given in POPULAR RADIO for October, 1923, as the condenser was shunted across the first jack of this amplifier.

When the tuner oscillates with the tickler dial set at a low figure (below 50, for instance), it will be well to remove a few turns from the tickler coil. The ticklers on some of the earlier Haynes couplers were designed for use with tubes which did not oscillate freely and, therefore, required a large tickler winding of about 35 turns. Later couplers, designed for the average present-day tubes, have only 20 turns on the tickler. If the latter couplers are used with tubes which oscillate poorly, it will be difficult to make the detector oscillate

at the higher wavelengths. In such case add more turns to the tickler.

What Causes Body Capacity Effect

SOMETIMES hand capacity is noticed in the Haynes receiver. Ordinarily this is due to reversed connections on the variable condenser. Always connect the stator plates to the grid-leak and condenser, and ground the rotor plates.

With the condenser connected wrong the capacity effect is caused by bringing the hand in too close proximity to the grid circuit of the receiver. With the stator and rotor plates connected as explained the part of the condenser closest to the hand (the shaft) will be at ground potential.

The last trace of this trouble may be eliminated by pasting a piece of tinfoil on the inner side of the condenser dial and connecting it to the shaft. *The tinfoil must not touch the screw-heads in the panel, however.*

How to Calibrate the Regenerative Superheterodyne Receiver

(This set was described in POPULAR RADIO for September, November and December, 1923.)

SOME question has arisen as to whether or not a tuning chart is practical with this receiver. That the receiver can be calibrated, and stations tuned in at the same dial settings whenever desired, is clearly demonstrated by a test covering a period of two weeks, the results of which are shown in the tabulation below, and in the tuning chart in Figure 1.

This tuning chart is correct only for the receiver with which it was made. If the design of the receiver as specified in POPULAR RADIO was changed materially, the tuning chart would also be somewhat different.

RECORD OF SETTINGS OF THE FIVE CONTROLS OF THE SUPER HETERODYNE

Wave-length	Tickler	Taps	Secondary Condenser	Oscillator Coupler	Oscillator Condenser
263	40	2	21	80	15
326	40	2	33	80	26
337	40	2	35	80	27
360	40	2	40	80	31
380	40	2	44	80	34
405	40	3	45	80	38
455	40	3	57	80	47
469	40	3	50	80	49
492	40	3	66	80	52
509	40	3	70	80	55
536	40	3	76	80	59
545	40	3	79	80	61

WHAT READERS ASK



CONDUCTED BY LAURENCE M. COCKADAY

In justice to our regular subscribers a nominal fee of fifty cents per question is charged to non-subscribers to cover the cost of this service, and this sum must be inclosed with the letter of inquiry. Subscribers' inquiries should be limited to one question or one subject.

Simple One-tube Set

QUESTION: I want to make a small single-tube receiver for use with an indoor antenna. Will you let me have the circuit diagram for a layout that you would recommend?

I have no chance to put up an antenna as the hotel will not allow it.

CHARLES G. HOGSON

ANSWER: The circuit for the simple set you want to use on the inside antenna is given in Figure 1.

The apparatus you will have to get for building this little receiver is listed below:

- L—tuning coil with sliders;
- VC1 and VC2—variable condensers, .0005 mfd.;
- GC—mica fixed condenser, .0005 mfd.;

GL—variable grid leak;
 R—filament rheostat, 6 ohms;
 TEL—telephones.
 The coil L should consist of 65 turns of No. 18 DSC copper wire on a 3½ inch diameter tube.

Resistance-coupled Radio-frequency Amplification

QUESTION: Is radio-frequency amplification employing resistance coupling really feasible?

J. BERTRAM DAVIES

ANSWER: Radio-frequency amplification with resistance coupling is applicable for high-wavelength work, but it is not efficient at higher frequencies such as used in broadcasting. This is due to the relatively large internal capacity of present-day vacuum tubes.

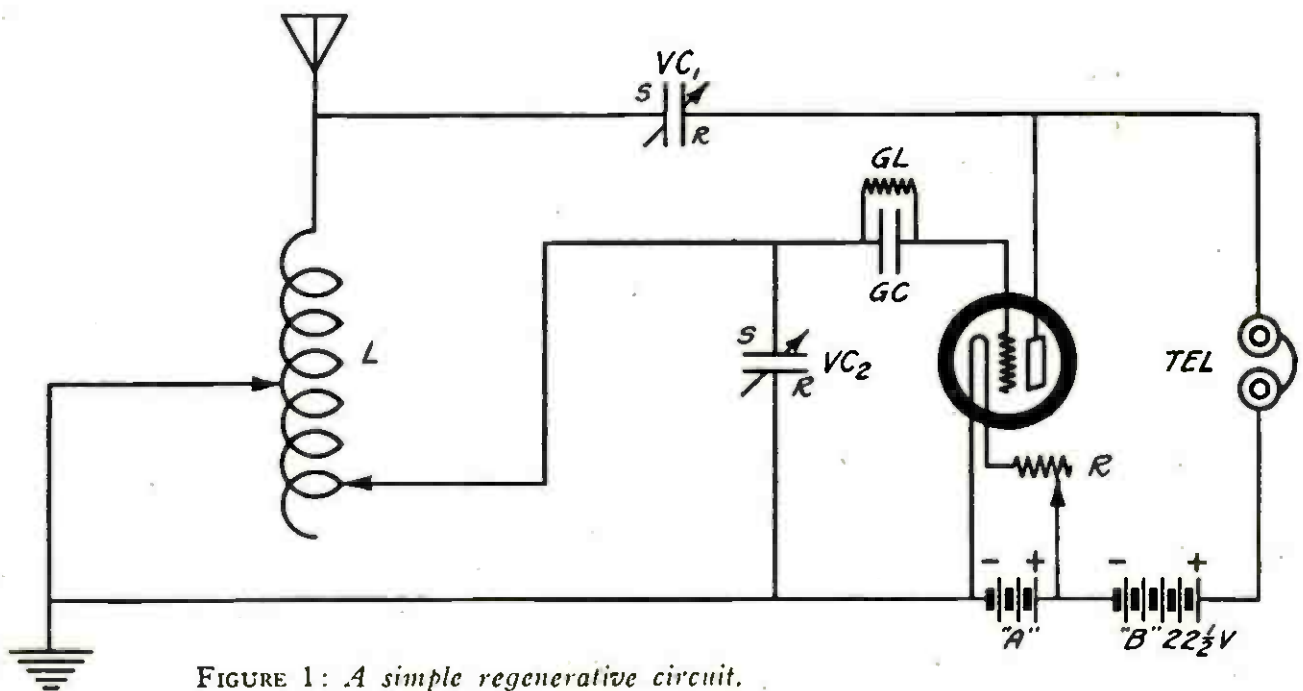

FIGURE 1: A simple regenerative circuit.

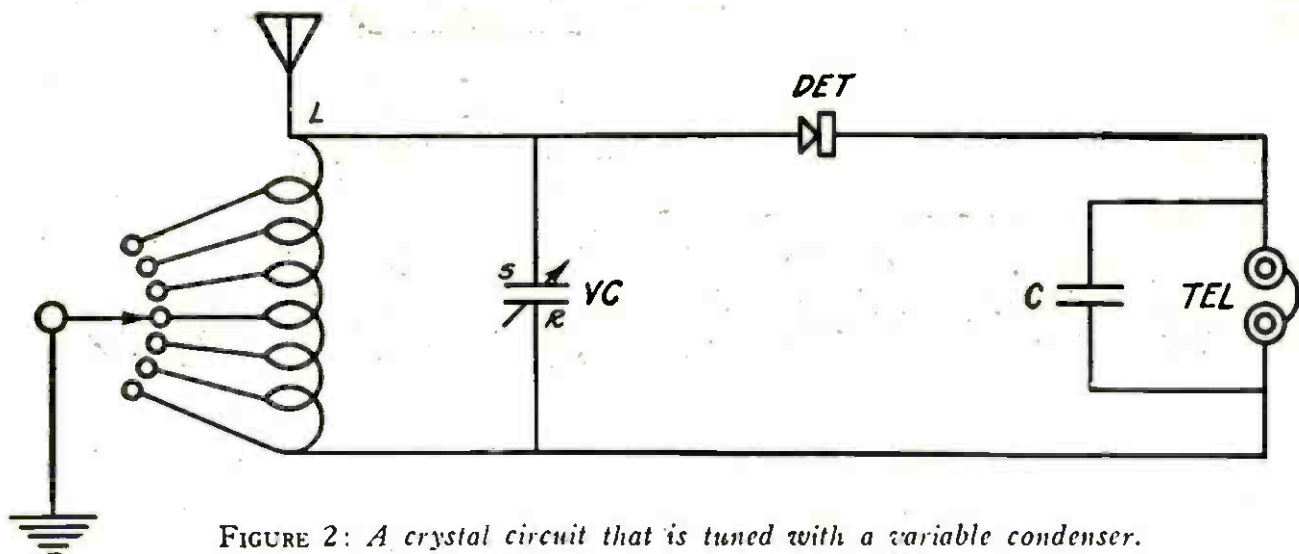

FIGURE 2: A crystal circuit that is tuned with a variable condenser.

A Simple Crystal Circuit

QUESTION: Please let me have a simple crystal circuit for use with a tapped tuning coil.

J. K. BURNS

ANSWER: You will find the circuit we have drawn for you in Figure 2. The parts required are the following:

- L—tapped tuning coil;
- VC—variable condenser, .0005 mfd.;
- DET—crystal detector;
- TEL—telephones;
- C—mica fixed condenser, .0005 mfd.

The coil L may be made by winding 70 turns of No. 18 DSC copper wire on a tube $3\frac{1}{2}$ inches in diameter. The taps can be brought out to the switch points as shown in the diagram in Figure 2.

Adequate Range of Audio-frequency Transformers

QUESTION: What, in your opinion, would be an adequate range of frequency for an audio-frequency transformer that would be satisfactory in an amplifier for reproducing speech and music? I mean what would you consider a good range for such a transformer over which the transformer should give equal voltage amplification?

H. U. F.

ANSWER: A range from 100 cycles to 5,000 cycles, with equal amplification, will cover all the frequencies that give quality and character to the voice or musical instruments. Most of the transformers on the market, even now, do not have this range on both ends of the scale.

A Whistle from an Audio-frequency Amplifier

QUESTION: I have built a set with a two-stage amplifier and it works well except for a continuous whistle that goes on all the time. Can you tell me how to eliminate this whistle? It is not objectionable, but if it can be stopped I would like to know how to do it.

HENRY J. ARBUCKLE

ANSWER: You probably have your transformers spaced too closely together. Try placing them two inches apart, with the two cores turned at right angles to each other. Another precaution you might try is to place a .00025 mfd. fixed condenser across the secondary terminals of the first transformer and a variable grid-leak across the secondary terminals of the secondary of the second transformer. If you try one or all of these, you will be able to get rid of the whistling sound and tune in the signals by themselves.

Varnished Cambric Tubing

QUESTION: Do you think it is advisable to use varnished cambric tubing or any other kind of insulated tubing on the wiring of radio sets?

HAROLD NEAR

ANSWER: There is hardly a place where this form of insulation on the wires that are used for connecting up a receiver is necessary. The use of this tubing should be discouraged on all wiring that is used in the radio-frequency parts of circuits. For covering high-voltage leads to audio-frequency circuits, however, there may be a legitimate use.

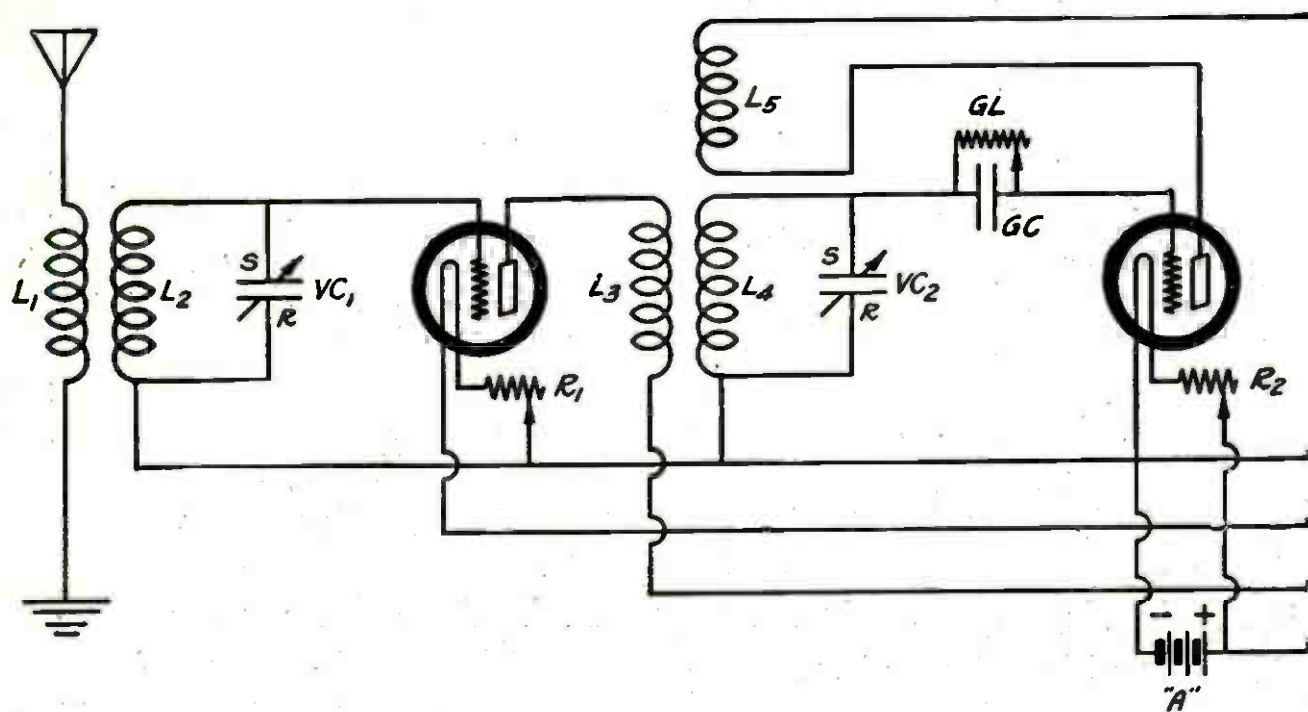

Adding a Stage of Radio-frequency Amplification to the Triple-honeycomb-coil Receiver

QUESTION: I have a three coil honeycomb receiver which I built from plans given in POPULAR RADIO, and which has been giving me excellent results on local and distance reception.

However, I would like to, if possible, increase its sensitivity for distance by adding a stage of radio-frequency amplification to it.

Can you show me how to do it? I understand wiring diagrams, so if you will be so good as to publish the complete circuit with the correct instruments and their sizes marked on it, I will be able to change my set over to comply with it.

H. JACKSON SMITH

ANSWER: We have drawn up the circuit you have asked for and it is shown in Figure 3.

The parts you need, with the proper constants, are given in the list of parts following:

L1 and L3—honeycomb coils, size L-25;

L2 and L4—honeycomb coils, size L-50;

L5—honeycomb coils, size L-35;

VC1 and VC2—variable condensers, .0005 mfd.;

C—mica fixed condenser, .0005 mfd.;

GC—mica fixed condenser, .00025 mfd.;

GL—variable grid leak;

R1, R3 and R4—filament rheostats, 20 ohms;

R2—filament rheostat, 6 ohms;

AFT1 and AFT2—audio-frequency amplifying transformers;

J1 and J2—double-circuit and single-circuit jacks, respectively.

For the first, third and fourth tubes use C-301-a tubes or DV-3 tubes or UV-201-a tubes. For the second tube (the detector) use a UV-200 or a C-300.

High-ratio Amplifying Transformers

QUESTION: Does the use of high-ratio, audio-frequency amplifying transformers necessarily mean increased amplification? Do you consider that the same quality of reproduction can be obtained from high-ratio transformers as from the low-ratio transformers?

F. H. T.

ANSWER: The use of high-ratio transformers for audio-frequency amplification should be avoided if truthful reproduction is to be accomplished.

Just because a high ratio is used with a transformer does not mean that the amplification is increased. It usually increases amplification on some particular frequencies, but the amplification at other frequencies may fall off to a very low value. This, of course, produces distortion of an extremely offensive order and should be avoided.

A transformer should have a high primary impedance at low frequencies and a low distributed capacity for the secondary windings. This alone is enough argument against the high-ratio transformer with its low primary impedance and its high distributed capacity for the secondary windings.

FIGURE 3: A stage of radio-frequency added to the honeycomb receiver.

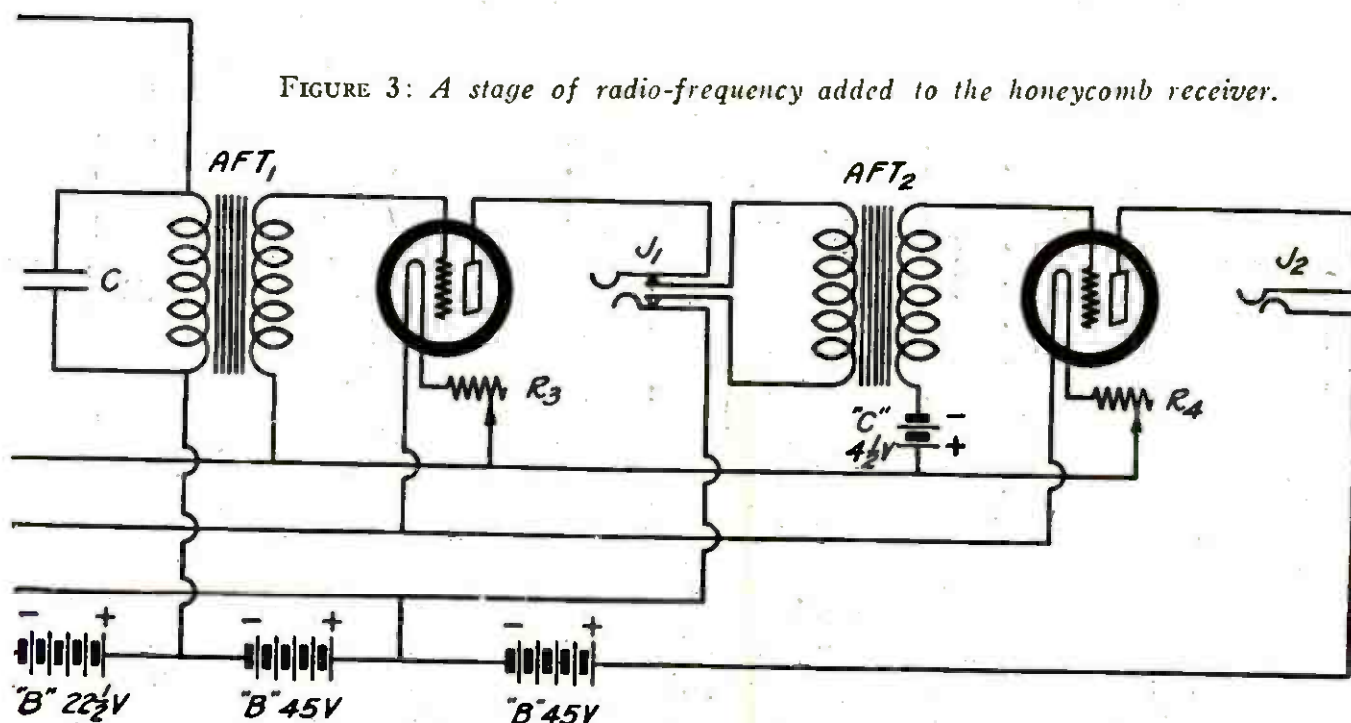

Why Tubes Cease to Operate

QUESTION: I came home last night and found that one of the children had turned the rheostats all the way on in my set and left them that way.

I tried to get the dinner concert and could hear the music but faintly, and with a lot of distortion. The tubes all light up all right, but the signals are very weak and the music sounds terrible. What can be the trouble? Are the "B" batteries "done to death?"

GEO. D. EVANS

ANSWER: The tubes have been burned at too high a temperature and they have exhausted their filament emission properties. You will have to get a new set of tubes. We recommend that you instruct the children to keep their hands off the rheostats in the future. Otherwise, you had better place the set in a position so that they cannot reach the rheostats.

The Ground Wire and How to Attach It

QUESTION: Do I have to run the ground wire straight down into the earth underneath the spot the set stands over? I was told that the radiator pipe would suffice.

Which would be the best way to fasten the ground, and what kind of wire would you recommend?

W. A. G.

ANSWER: We recommend that you fasten the ground wire to the cold-water pipe. The wire should be fastened by means of a ground clamp. First, scrape the pipe clean from paint or rust and then place the clamp around it and screw up on the nut and bolt that serve to tighten the clamp to the pipe.

Use No. 14 rubber insulated code wire for the ground lead.

The drawing on the cover of this magazine shows you clearly how to fasten the wire and the clamp.

Super-regenerative or Super-heterodyne Receivers

QUESTION: Which type of set is the most popular of the two, the super-regenerative circuit or the superheterodyne circuit? I want to build a loop receiver but I haven't been interested in radio since the "boom" which followed the invention of the super-regenerative circuit.

Now, when I look into the radio publications I see nothing of the super-regenerative circuit mentioned, but an older circuit, the superheterodyne, seems to be quite popular.

Which of these two would you advise me to try to make for use with a loop antenna?

HARRY S. ALLEN

ANSWER: We recommend one of the super-heterodyne type.

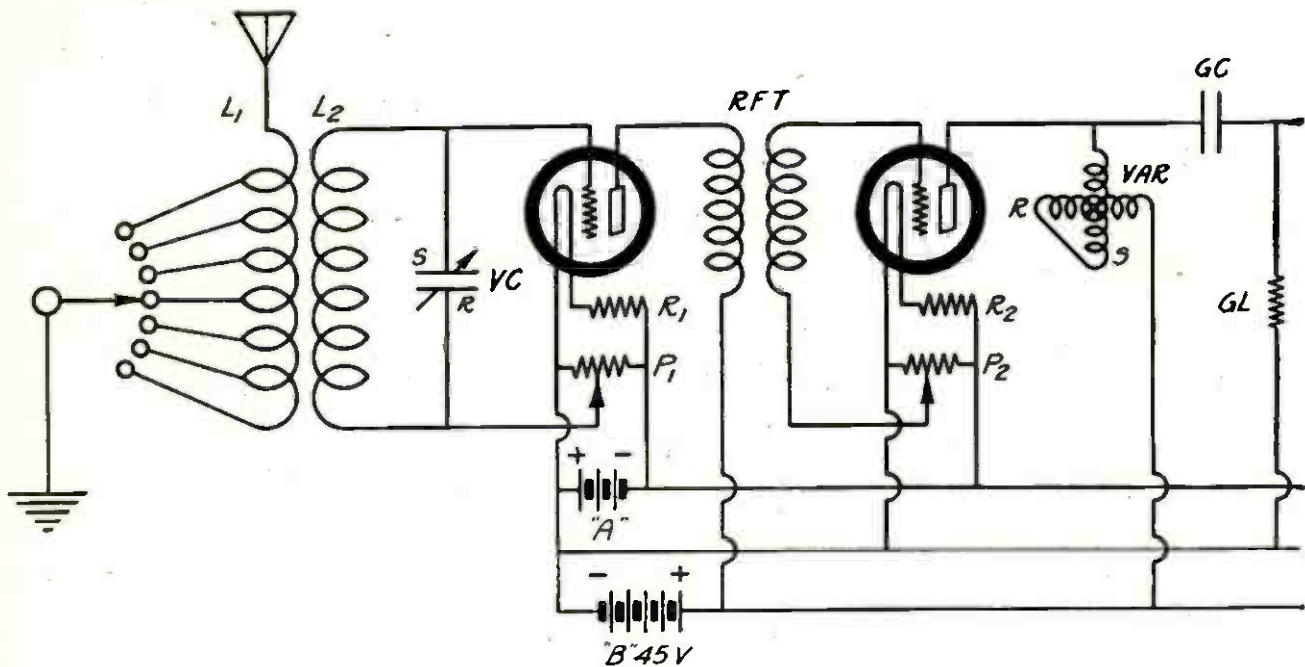

FIGURE 4: Two stages of radio, detector and two stages of audio-frequency amplification, with a novel method of tuning the radio-frequency.

Combination Radio-frequency and Regenerative Circuit for 5 Tubes

QUESTION: Can you give me a circuit for two stages of radio-frequency amplification, with a variometer-tuned input circuit to a vacuum tube detector and two stages of audio-frequency amplification?

I want to control both the radio-frequency stages by means of separate potentiometers if you think that this would work out satisfactorily.

However, make any changes or employ any means other than I have specified so that I can have a good set.

ROBT. HENNING

ANSWER: A suitable circuit is shown in Figure 4. The parts that you will need, together with the proper constants, are given in the following list:

- L1 and L2—primary and secondary coils of an ordinary variocoupler;
- VC—variable condenser, .0005 mfd.;
- VAR—variometer;
- RFT—radio-frequency transformer;
- C—mica fixed condenser, .0005 mfd.;
- GC—mica fixed condenser, .00025 mfd.;
- GL—variable grid leak;
- R1, R2, R4 and R5—filament rheostats, 20 ohms;
- R3—filament rheostat, 6 ohms;
- P1 and P2—potentiometers, 400 ohms;
- AFT1 and AFT2—audio-frequency amplifying transformers;

J1 and J2—double circuit and single circuit jacks, respectively.

The tubes recommended in the 1st, 2nd, 4th and 5th sockets are Deforest DV-3 tubes or UV-201-a tubes or C-301-a tubes. Use either a C-300 tube or a UV-200 tube in the third socket for the detector.

Hard Tubes as Detectors in Superheterodyne Circuits

QUESTION: Can hard tubes be used instead of the regular soft detector tubes for the second detector in a superheterodyne receiver? I have never tried to build such a set as yet but I intend to do it and want to be sure about the proper tubes so that I will be able to get a line on the proper size of "A" battery to use.

WALTER A. STUART

ANSWER: A hard tube will give good results in the place that you have mentioned. A soft tube is not necessary.

Wire for Winding Coils

QUESTION: What kind of wire do you think is best for winding the coils used in radio apparatus? Do you recommend silk or cotton covered?

J. K.

ANSWER: Use silk-covered wire rather than the cotton-covered wire.

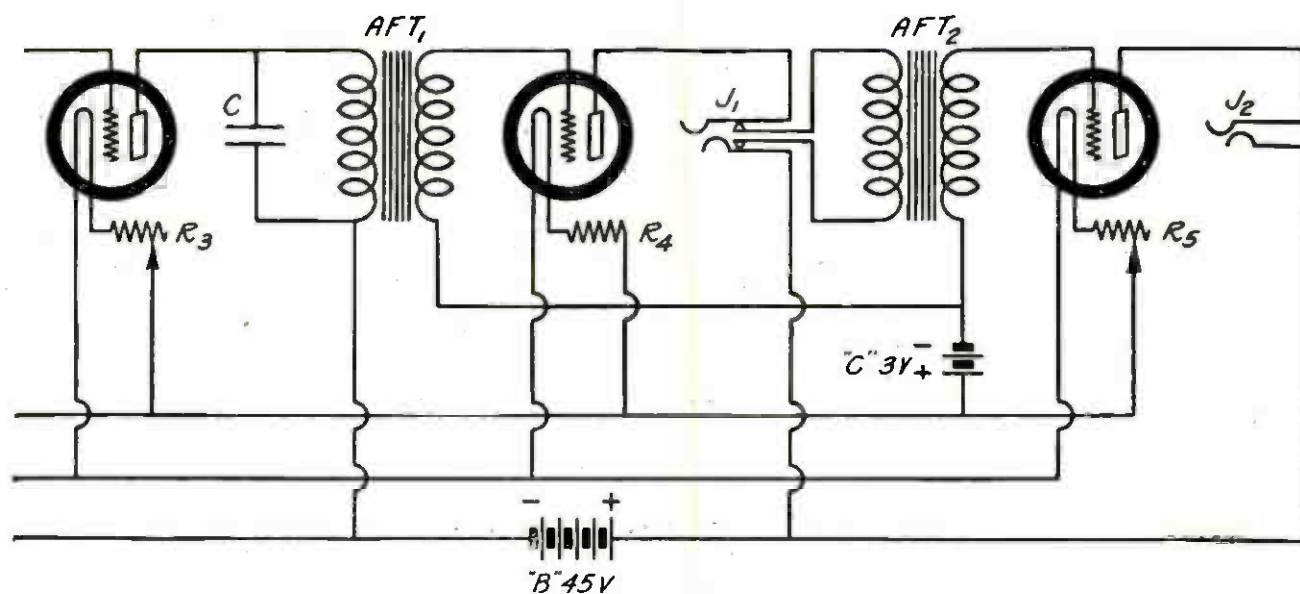

Binding Posts or Soldering Lugs

QUESTION: What is the best form of terminals for instruments and parts that are used in building radio sets? Do you think the parts should be equipped (by the manufacturers) with binding posts or with some form of soldering lugs?

THOS. J. BENTLEY

ANSWER: Most certainly the best terminal to use is the soldering lug! When a connection is once soldered it remains permanent. By casually screwing up a binding post the builder seldom obtains a good connection.

The leading manufacturers are discarding binding posts for soldering lugs and thereby are producing apparatus that gives better results in the long run.

The Best Antenna for the Four-circuit Receiver

QUESTION: What is the proper length of antenna to use with the four-circuit set employing five tubes? Would it be better to use three or four wires instead of a single-wire antenna?

GEO. REMLY

ANSWER: A two-wire antenna of about 125 feet length will give the best results for selectivity and sensitivity. A two-wire antenna is better than a single wire on account of the added capacity gained in the antenna circuit by the addition of the second wire. If the antenna of 100 feet or over cannot be put up, a four-wire antenna of shorter length will help to increase the signal strength.

The Superheterodyne on an Outdoor Antenna

QUESTION: I have been troubled during the last three months by interference that I have always thought came from a neighbor with a single-tube single-circuit receiver. But now I am wondering if the trouble can come from another cause. Is it possible that a superheterodyne, working on an outdoor antenna, could radiate?

The reason that I suspect that this can be the cause of the trouble is that there are only three of us in the neighborhood that had receiving sets. And when the chap that had the single circuit set moved away I thanked my stars and thought the trouble was over.

However, to my great surprise, it kept on the same as ever and I have checked up on the chap who has the "super." I can see him across the air shaft and whenever he puts his hands to the dials and searches for a new station I hear the birdies begin to sing.

SAMUEL UNDERWOOD

ANSWER: It is possible for the ordinary superheterodyne receiver to radiate at the frequency of the local oscillator if the coupling of this circuit and the outdoor antenna circuit is rather close.

It is for this reason that the superheterodyne should be used on a loop only unless the second-harmonic oscillator or some other method is used for keeping the local oscillator currents from the antenna.



IN THE WORLD'S LABORATORIES

CONDUCTED BY DR. E. E. FREE

New Crystal Theory Assumes Movable Molecules

IN an interesting series of papers on the theory and practice of the crystal detector published in the *Wireless World* (London),* Mr. James Strachan sets forth a new idea of what it is that makes a crystal and a catwhisker operate to detect a radio signal.

The essential action of a crystal detector consists, it will be remembered, in a rectification of the electric current. Of the radio-frequency oscillations that surge from both directions against the contact of the crystal and the catwhisker only those moving in one direction get through. The reverse pulses are stopped. The crystal is, essentially, a one-way valve for the electric current.

The new theory assumes that this rectifying action takes place altogether in the surface layers of the crystal. The molecules of galena, for example, are assumed to be a little less rigidly fixed in this surface layer than in the mass of the crystal. These surface molecules can move around a little; can turn sometimes on their axes as a cork on the surface of a river will turn over and over as it floats down stream. It is assumed, furthermore, that the electric properties of a galena molecule are not the same in all directions.

It follows that if all the molecules in the surface layers are turned, say, on their ends, the conductivity across the surface will be different than when all the molecules are turned on their sides. Furthermore, if all the molecules are on one end the conductivity may be greater in one direction than in the other, for the molecules may be more permeable to the current in this direction than in the reverse one. The molecules, in other words, may themselves be tiny rectifiers.

To the casual observer it may seem that this suggestion merely substitutes tweedledum for

* The series began in the *Wireless World* for May 21, 1924, and ended in the issue for July 16, 1924. The theory here quoted is explained in the second article, "A New Theory of Contact Detectors," in the issue for May 28, 1924, vol. 14, pages 245-249.

tweedledee. For the mystery of why a *crystal* rectifies it merely substitutes the other mystery of why a *molecule* rectifies. But this is not quite a fair criticism. Mr. Strachan's papers—which contain, by the way, many useful facts about crystal detectors—will have performed a real service if they focus the attention of crystal students on the importance of the surface layers, possibly only three or four atoms deep, with which the catwhisker actually makes its contact.

It is somewhere in this surface layer that we will find the secret of crystal action. To the Editor of this Department it seems probable that the most important part of this surface layer is the film of adsorbed gas.

On any solid surface, especially on the surface of any metal, there is always a tightly attached layer of atoms of gas, mostly the oxygen and nitrogen gases of the air. It is this attached gas—called the "adsorbed" gas—so difficult to detach during evacuation from the tungsten parts of tubes.

There is one of these layers of adsorbed gas two or three atoms thick on the surface of every crystal and on every catwhisker point. The exact nature of the adsorbed layer will depend on the chemical composition of the crystal, on the nature of its crystal surface just at that point and on its past history, for example, on its cleanliness.

Nobody knows how this layer of stuck-fast gas atoms will affect electric conductivity across the gap. The matter should be studied by physicists and by radio engineers.

Cold Waves as Radio Benefactors

THE ideas of the celebrated French expert, M. Reginald Bureau, to the effect that an intimate relation exists between radio transmission and the weather disturbances called "cold waves" and "hot waves,"* has received im-

* The conclusions of M. Bureau were described in this Department of POPULAR RADIO for September, 1924, page 307. POPULAR RADIO will publish soon a more complete description of this important work from the pen of M. Bureau himself.

portant confirmation by the United States Bureau of Standards.†

The Bureau has been observing the daylight signal strength at Washington of the long-wave signals from the transatlantic radio stations at Tuckerton and New Brunswick, N. J. "The signal strength was found," says the official statement, "to be quite uniform during most of the year, as was to be expected from the moderate distance of transmission, but with the coming of the cold waves of January, 1924, the signals rose to more than twice their normal strength. At the same time there were deviations of many degrees in the apparent directions of the sending stations, as indicated by the radio compass, even in the forenoon when long-wave compass bearings are generally free from errors.

"The end of the series of cold waves in January did not at once restore transmission conditions to the uniformity of autumn and early winter but left a condition of instability which persisted through the comparatively mild cold of February and early March. During this time the signals frequently fluctuated, going to high values for a few hours and then returning to normal without any obvious connection with weather conditions. After March 19 these irregularities entirely ceased and transmission again became normal."

† In a press statement issued by the United States Department of Commerce, for release September 28, 1924.

Observations made on other long-wave stations indicate, the Bureau goes on to say, that when the transmitting and receiving station are 50 kilometers (31 miles) apart the large variations of signal strength are not observed. These variations are large at distances of 250 or 300 kilometers (155 to 186 miles) but grow less again at 400 to 700 kilometers (249 to 435 miles.)

It is apparent, the Bureau remarks, that "either the part of the atmosphere concerned with the signal variations lies much below the Heaviside Layer (80 to 100 kilometers) or that weather phenomena are correlated with atmospheric action at much greater heights than has hitherto been supposed."

If we may trust the correlation obtained by M. Bureau in France between the rise of air currents over the mountain mass of the Alps and the disturbances of radio transmission, it is probable that both of these suggestions made by the Washington authorities will prove to have truth in them. In any event, it is apparent that the correlation between radio and the movement of air currents can no longer be neglected in radio theory. Exactly what this correlation is, is the problem that the radio engineers and the weather experts now find themselves expected to solve.

Whether some method of avoiding or cutting out static interference can be worked out from his conclusions is something which Captain Bureau himself says he cannot foresee.

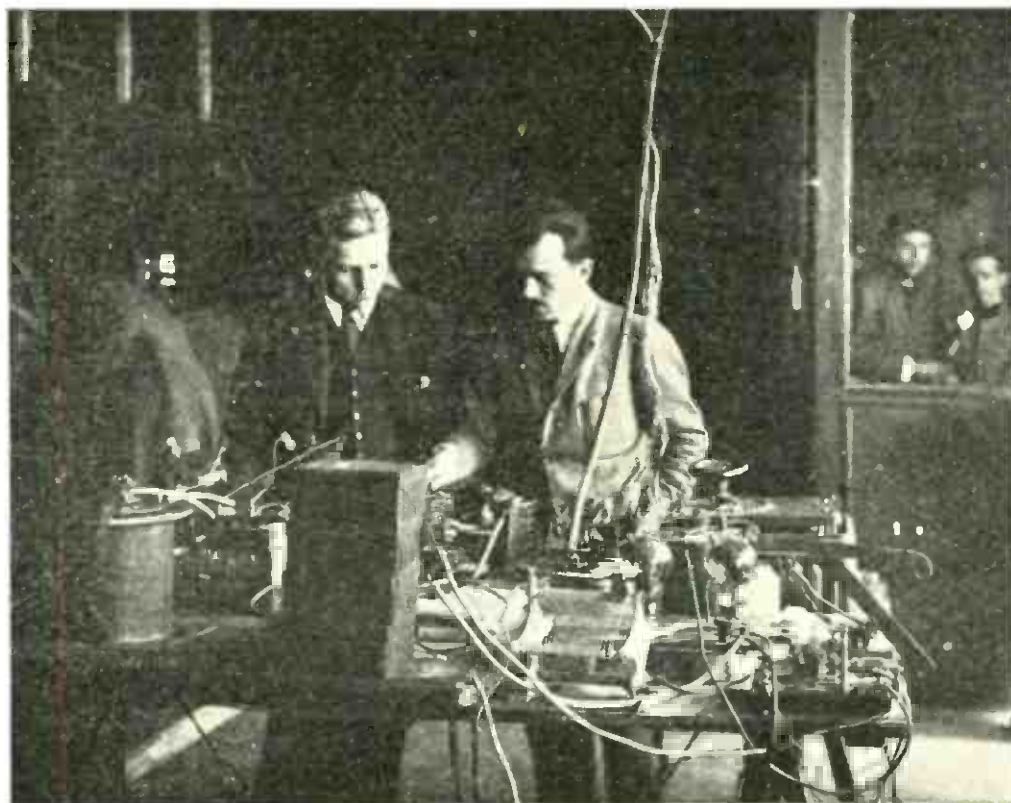

From a photograph made especially for POPULAR RADIO

WHERE SHORT WAVES ARE GENERATED AT THE EIFFEL TOWER
The Commandant of the great French radio station at the Eiffel Tower, in Paris, is demonstrating to Mr. Delano, Paris correspondent of POPULAR RADIO, a part of the apparatus used to generate the 45-meter waves and other waves of less than 100 meters which have been used in recent tests from this station.

Do 45-Meter Waves Disclose the Heaviside Layer?

THE experiments conducted in France last year by General Ferrié on transmission at a wavelength of 45 meters have produced some evidence favorable to the real existence of the Heaviside Layer. It is found that observations of the signal strength of the fundamental and its first harmonic at different distances from the transmitting station are most easily interpretable on the hypothesis that the waves have been reflected downward from the supposed conducting layer.

In reporting the results Commandant Mesny of General Ferrié's staff says: "The results are well explained by the hypothesis of a reflecting action in the high atmosphere. This action, very intense at night, is not negligible in the daytime. But the existence of a conducting layer is not yet proved in an irrefutable fashion. For this the tests must be continued to give a greater number of observations and should be modified to give greater precision."*

It is announced that additional tests are now being conducted.

Shall We Try Electrolytic Detectors Again?

ONE of the most interesting among recent phases of radio development is the tendency to resurrect devices that were tried out and discarded in the early days of radio. An instance is the electrolytic detector, once one of the most important instruments of the radio experimenter.

This device consisted essentially of a very

* "The Very Short Waves," second part, by René Mesny. *L'Onde Électrique* (Paris), vol. 3, pages 99-110 (February, 1923).

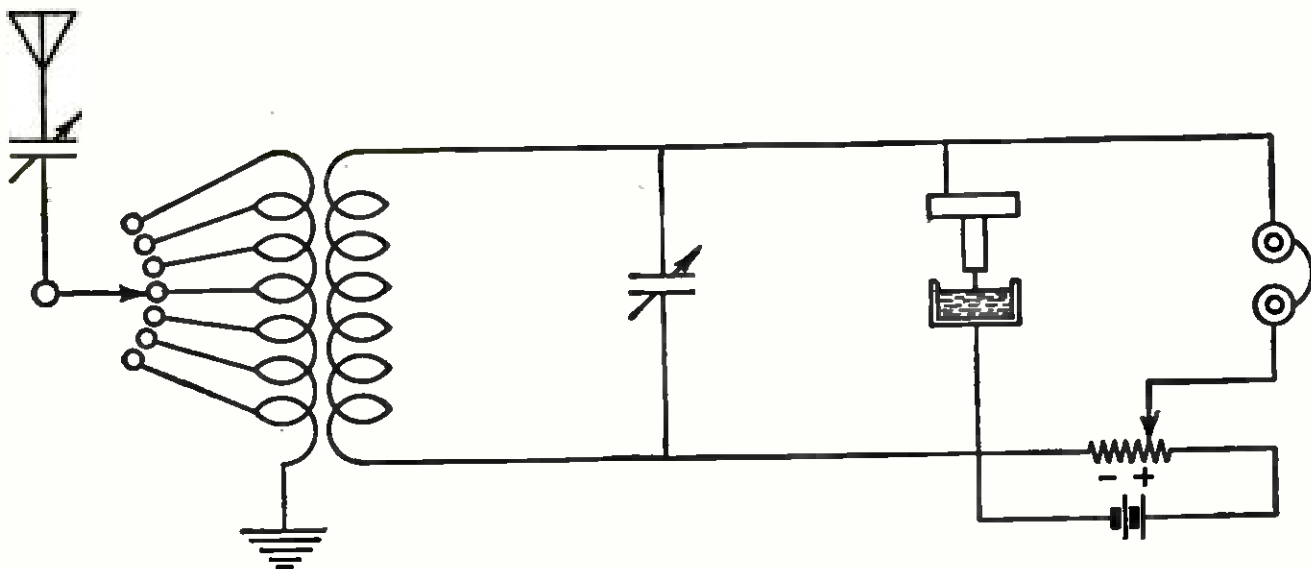

A STANDARD HOOK-UP FOR THE ELECTROLYTIC DETECTOR

The detector consists of a very fine wire, preferably of platinum or gold, the extreme tip of which dips just into the surface of a solution of sulphuric acid in a small dish. A second, larger electrode, makes contact with the acid and completes the circuit.

fine wire—usually of the kind called Wollaston wire—that just touched the surface of a ten percent solution of sulphuric acid or of some other conducting compound. The hook-ups and the operation are substantially the same as for a carborundum crystal detector which uses a biasing potential.

Although this electrolytic detector was abandoned years ago because the galena and cat-whisker combination was found to be more sensitive, it is possible that it is now worth reconsidering, especially for the modern reflex and other circuits in which a simple detector is combined with one or more vacuum tubes.

Two authors have advocated recently the revival of the electrolytic device by experimenters who want to try something new.* This is good advice. In every branch of science it is profitable, once in a while, to overhaul the discarded apparatus of previous periods. Advances in other lines may have made these once rejected devices much more valuable than when they were laid away.

* "Electrolytic Detectors and Liquid Valves," by James Strachan; *Wireless World* (London), vol. 13, pages 533-534 (Jan. 23, 1924). "Resurrecting the Liquid Detector," by Jacques Avon; *Radio* (San Francisco), vol. 6, no. 8, pages 17-18 (August, 1924). The latter article contains constructional information.

Loudness of Sounds Depends on Frequency

THE progress of science is continually proving that things are not always what they seem; sometimes they are not even what they sound like. The latest instance is the conclusion that the apparent loudness of sounds, as guessed at by the person who hears them, is not a real measure of their physical intensity. It all depends on the frequency (that is, the pitch) of the sound.



Western Electric

RADIO APPARATUS USED IN DEVICE TO TEST HEARING

Dr. Harvey Fletcher, one of the engineers who has been working on sound and on human hearing, is testing the hearing of the seated patient by means of the portable audiometer, a machine in which oscillating vacuum tubes and audio-frequency circuits are arranged to produce test tones of standard frequencies and of variable loudness.

This is one of the newest conclusions from the extensive investigations of sound that have been under way for some years in the Laboratories of the Western Electric Company.* It is one of the results of the fact that the human ear is not a simple physical instrument but is a most complex mechanism, responding to different sounds in different and very complicated ways.† With unusually loud sounds the ear introduces more or less distortion, so that

* "The Dependence of the Loudness of a Complex Sound Upon the Energy in the Various Frequency Regions of the Sound," by H. Fletcher and J. C. Steinberg. *Physical Review* (Corning, N. Y.), vol. 24, pages 306-317 (September, 1924).

† Some aspects of the modern theories of hearing were described in this Department of POPULAR RADIO for July, 1924, pages 85-88.

a mere change in the physical intensity of a sound may produce an apparent change in its quality, due entirely to the imperfections of the human ear.

There is small doubt that these fundamental studies of sound and of human hearing will prove, in the end, to have as much importance for the practical enjoyment of radio as in any other direction. As we have remarked before in this Department, successful radio reception is as much a matter of the ear as of any other part of the receiving equipment. Unless we understand the ear-machine as well as we can we will not be able to fit our electrical and acoustical apparatus to its peculiarities.

Designers of loudspeakers are giving greater heed to this research than formerly.

Complete Theory for Standing Waves on Wires

WITH the growing use of radio waves and the necessity for controlling this use—as, for example, in the official regulation of broadcasting stations—there has developed an increasing need for ways of standardizing wavemeters. The ordinary wavemeter does not measure directly either wavelength or frequency. It measures resonance; resonance of the incoming wave with a certain specified and marked setting of the wavemeter. In order that this be read off as a wavelength it is necessary that the wavemeter shall have been calibrated by comparing its various settings with known standard waves.

To obtain these standard waves there are two methods in more or less common use. One of them starts from a tuning fork or some similar standard of frequency. The tuning fork is known to vibrate, say, 200 times a second. That is, it has a frequency of 200

cycles. By comparing this known frequency with greater and greater frequencies—using an oscillograph or some similar indicator—one arrives, in the end, at standards of frequency covering the usual radio range.

The other method of obtaining a primary standard starts from a direct measurement of a length, not of a frequency. A system of standing electric waves of short wavelength is set up on two parallel wires. The nodes of this system are determined by a current-indicating or a voltage-indicating instrument. Measurement of the distance between these nodes, conveniently made with an ordinary yardstick, permits the determination of the wavelength (and, therefore, of the frequency) of the electric waves composing the standing-wave system on the wires.

This standing-wave method was proposed and used in the early days of radio, even before the tuning-fork system was developed. Later it dropped out of use until it was revived about two years ago by Messrs. Dunmore and Engel of the United States Bureau

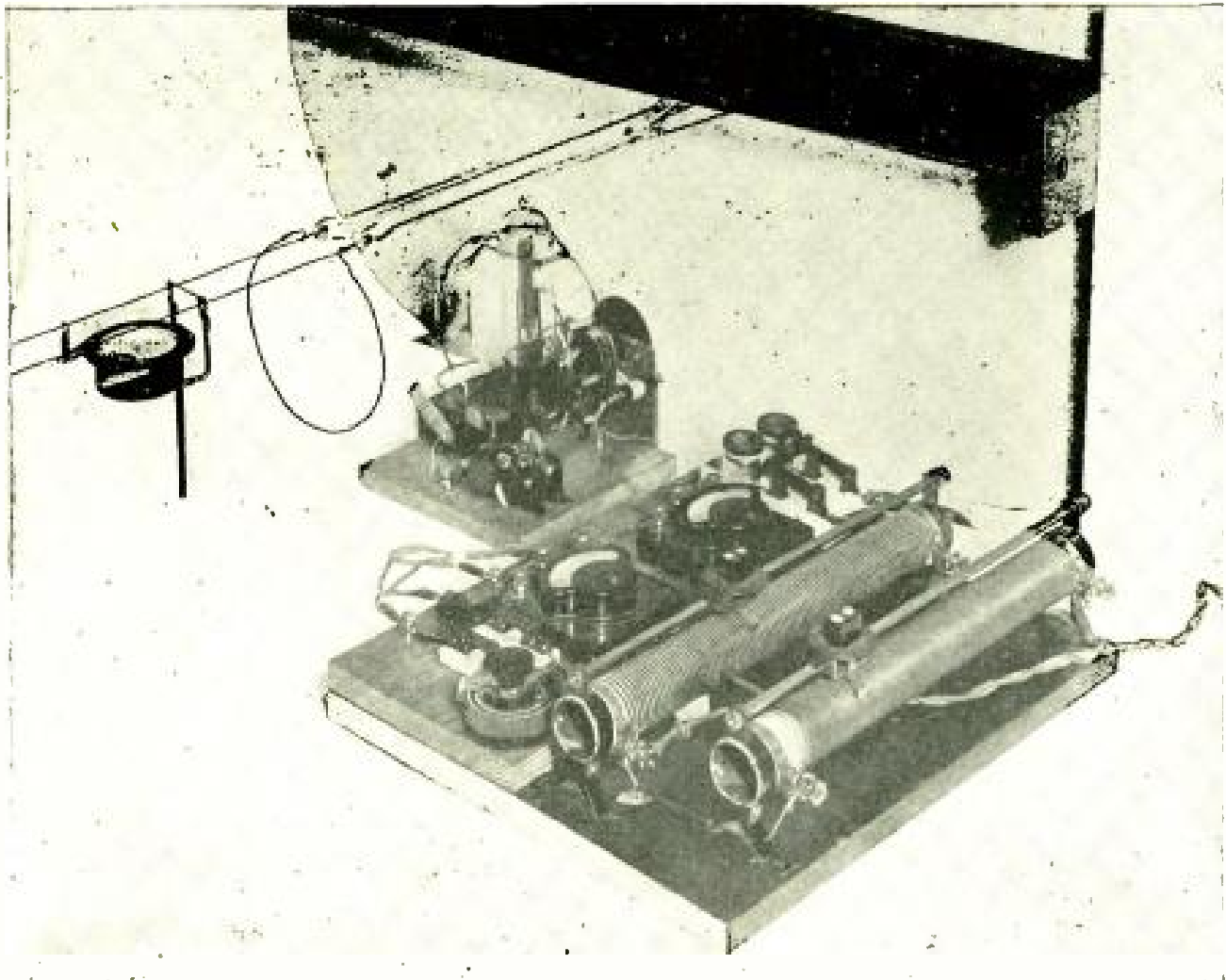

U. S. Bureau of Standards

THE OSCILLATOR THAT PRODUCES STANDING WAVES ON WIRES

This apparatus is used in the laboratories of the United States Bureau of Standards to generate the high-frequency oscillations used in setting up standing wave systems on the two parallel wires, the ends of which are shown at the left of the photograph. The loop attached to the wires picks up the energy from the transmitting loop attached to the block that carries also the oscillating vacuum tube.



General Electric

HE MADE THE NEW MEASUREMENT OF THE ELECTRON

Dr. A. W. Hull (standing at the left) is the engineer who devised the newest method of measuring the electric charge of an electron, using the emission of electrons from the hot filament of a vacuum tube. Seated at the table is Dr. Saul Dushman, well known for his investigations into methods of producing nearly perfect vacua.

of Standards.* Now the Bureau has released a second paper describing the complete mathematical theory of this method.†

The complete mathematical calculations of the waves on the wires, and of their communication to the wires from the generating oscillator, show that if certain very small corrections are applied the method is amply accurate for standardization purposes. Experimental comparison with the alternative tuning-fork method indicates, also, that the two methods are in sufficient agreement.

This development paves the way toward more simple calculations of wavelength that may prove useful to the amateur.

* "A method of measuring very short radio wavelengths and their use in frequency standardization," by F. W. Dunmore and F. H. Engel. *Proc. Inst. of Radio Engineers* (New York), vol. 11, pages 467-477 (October, 1923). Reviewed in *POPULAR RADIO* for February, 1924, page 209.

† "Theory of Determination of Ultra-radio Frequencies by Standing Waves on Wires," by August Hund. *Scientific Papers of the Bureau of Standards* (Washington, D. C.), vol. 19, no. 491, pages 487-540. Issued June 23, 1924; manuscript dated February, 1924.

New Determination of the Charge on an Electron

QUANTITATIVE physical science is based on a comparatively small number of well-established numbers, the so-called "Constants of Nature." The velocity of light is one of these; another is the intensity of gravitation; others are the number of molecules of gas in given space, the freezing point of water, the atomic weight of oxygen, the mysterious "Planck's constant" that lies, we do not yet know how, at the root of the relation between ether waves and matter.

Among these constants—the veritable foundation stones of modern science—none has more importance than the "electronic charge," the amount of electricity that resides on a single electron. Perhaps it is better to say the charge that "constitutes" a single electron; for we have no information about what an electron really is.

The values assigned to this charge of one electron rest, in the main, on the famous work of Dr. R. A. Millikan, who caught single elec-

trons on falling oil drops of microscopic size and then determined the electric charge acquired by the oil drop. Subsequently Millikan's value for this constant has been confirmed in several ways and now it is again verified in a new way, from a study of the escape of electrons from hot wires, exactly as they escape from the filament of a vacuum tube such as we use in radio.

The idea of doing this goes back to a Hungarian physicist named Schottky, who calculated that if the escape of the electrons from a filament followed the laws of chance—in addition, of course, to the special laws of electronic movement—the current produced by the electrons would show certain determinable variations. Expressing this in radio language, the filament-to-plate current of a grid-less tube, operating under unchanging conditions, will not be absolutely constant but will show certain variations depending on the probability laws which govern the escape of the electrons themselves.

Dr. A. W. Hull and Mr. N. H. Williams, of the Laboratories of the General Electric Company, have now tested this effect, using a radio-frequency amplifier by which the variations of the electron escape are increased to audibility.* This permits a calculation of the charge on the electron; the results agreeing within less than 2 percent with the value for this constant derived by Millikan.

The accepted value of this electronic charge is now 4.774×10^{-10} Electrostatic Units; which means, in ordinary units, that if a cur-

rent of one millionth of an ampere flows in a wire for one second some six million millions of electrons will have gone through the wire.

Four-electrode Vacuum Tubes

THE discussion of the "solodyne" circuits (called in Europe the "unidyne"), as described last month in this Department, has revived interest in the use of the types of vacuum tube containing an extra grid. A number of circuits for use with such tubes, either with or without the high-voltage "B" battery, have been published in magazines by European experimenters.*

These four-electrode tubes can be used in two ways. One of these ways is illustrated by the solodyne circuits. In these, the extra grid is used to pull the electrons from the filament and to shoot them over toward the plate, thus replacing, in part at least, the duty of the high potential on the plate.

The other way of using the extra grid is in hook-ups for the multiple use of the tube. For example, an audio-frequency oscillation may be handled on one of the grids while a radio-frequency oscillation is being handled on the other grid. Or two separate oscillations not far from each other in frequency may be handled on the two grids at the same time. The tube becomes, in effect, two separate tubes using the same vacuum, the same filament and the same electron stream, but different grid-to-plate circuits.

* "Determination of 'e' from Measurements of the Schrott Effect," by Albert W. Hull and N. H. Williams. *Science* (Lancaster, Penna.), vol. 60, page 100 (August 1, 1924).

* For example, a one-tube receiver, the hook-up for which is reproduced herewith, is described by "A. M. G." in the *Wireless World* (London), vol. 14, pages 418-421, 455-459 (July 9, 16 and 23, 1924).

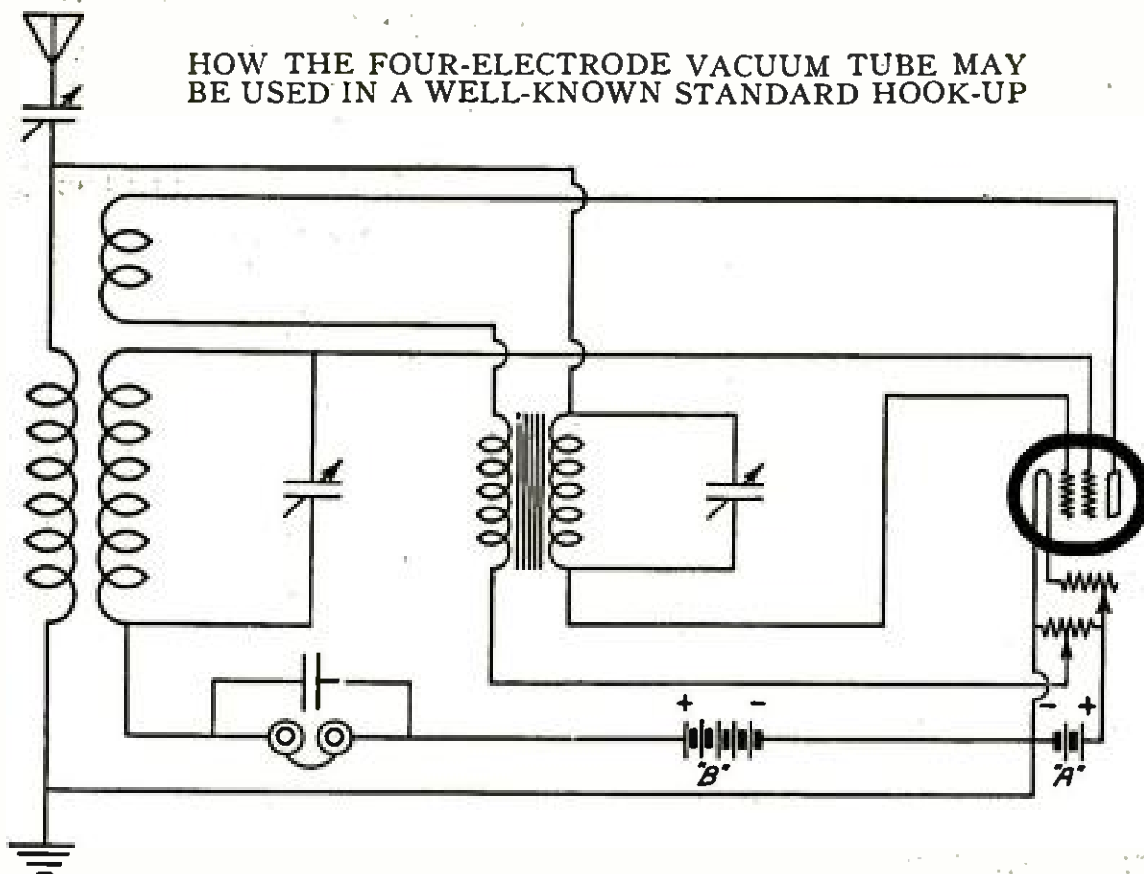

Are Vitamins a Form of Ether Waves?

EVERYONE is familiar with the discovery of the vitamins, those mysterious substances supposed to be present in very small amounts in certain foods and to be necessary to life and health. It is the vitamin in yeast that forms the theoretical basis for the yeast-eating cult of recent years. It is supposed, also, to be a content of another vitamin in cod liver oil that makes that medicine so valuable in rickets and in some similar diseases.

At first sight all this seems a long way from radio. Why should these mysterious chemicals in food be considered as having anything to do with the physics of ether waves?

Yet it seems that they do. The first inkling of any relation was the discovery, made some years ago, that ultra-violet light, and possibly other forms of ether waves, could "substitute" for vitamins in the cure of rickets. Children affected by this disease were cured by exposing their bodies to ultra-violet radiation (usually in the form of sunlight) as well as by giving them the vitamin of cod liver oil.

The next step was the remarkable discovery that the exposure of food to ultra-violet light appeared to give the food an anti-rickets property, much as though the ether waves had generated some vitamin in the food.* Finally some experiments at Yale University appear to indicate that the action of cod liver oil in curing rickets is not due to any supposed "vitamine" at all, but to the fact that this oil, as well as some other substances, has the property of giving off ether waves similar to, if not identical with, the rays of ultra-violet light. In this case at least, the "vitamin" is very probably nothing but an ether wave.

To the physician and physiologist these results are profoundly interesting—one of the most important discoveries, it is quite possible, that have been made in this century. To the radio engineer and the physicist the chief interest lies in this renewed evidence of the close relation between the reactions of living matter and the multitudinous waves and "rays" which physics is just beginning to explore.†

* This fact appears to have been discovered independently by Professor A. F. Hess of Columbia and by Dr. H. Steenbock of the University of Wisconsin. See *Science* (Lancaster, Penna.), vol. 60, page 224 (September 5, 1924) and page 269 (September 19, 1924).

† Compare "Do Radio Waves Affect Living Creatures?" *POPULAR RADIO* for October, 1924, pages 352-360.

Radio Equipment of the Leviathan

THE radio installation aboard the famous *Leviathan* is described in a recent issue of the *Radio Service Bulletin*.*

The ship possesses a 6-kilowatt Western

* *Radio Service Bulletin* (issued by the Bureau of Navigation, U. S. Department of Commerce, Washington, D. C.), no. 89, page 8 (September 2, 1924).



From a photograph made for *POPULAR RADIO*.

THE RADIO-COMPASS ANTENNA ON THE LEVIATHAN

This cage antenna erected on top of the radio room of the LEVIATHAN serves to obtain the radio bearings.

Electric telephone tube transmitter, a 2-kilowatt spark transmitter and a 750-watt Western Electric duplex telephone and telegraph transmitter. "The receiving equipment consists" says the *Bulletin*, "of two navy receivers, types S. E. 1,420 and 1,899, respectively, and two navy universal amplifiers. The telephone transmitter is also provided with a receiver. A navy coupling tube unit for the receivers permits simultaneous transmission and reception; that is, one operator can send or receive traffic on 600 meters wavelength without interfering with the transmission or reception of traffic on 2,400 meters.



THIS department is conducted by POPULAR RADIO LABORATORY for the purpose of keeping the radio experimenter and the broadcast listener informed concerning the newest inventions and the approved developments in radio equipment. Only such apparatus as has been tested and endorsed by the Laboratory is noted in these columns.

LOUDSPEAKERS

Super-speaker; Jewett Radio & Phonograph Co.
Magnavox reproducers; Magnavox Co.
Manhattan loudspeaker; Manhattan Electrical Supply Co.
Mozart loudspeaker; Mozart-Grand Co.
Atlas loudspeaker; Multiple Electric Products Co., Inc.
Music Master loudspeaker; Music Master Corp.
Loudspeaker; Wm. J. Murdock Co.

RADIO CABINETS

Solid mahogany cabinets; Nassau Cabinet Co.

DIALS

Dials; King Quality Products, Inc.
Velvet vernier dials; National Co.

HEADPHONES

Radioceive headset; Mozart-Grand Co.
Red-head phones; Newman-Stern Co.
Red-Seal headset; Manhattan Electrical Supply Co.
Headset; Kellogg Switchboard & Supply Co.
Radio phones; Wm. J. Murdock Co.

SOCKETS AND ADAPTERS

Cushioned socket; Illinois Radio Co.
Socket cushion; Illinois Radio Co.
Socket; King Quality Products, Inc.
"Thorobred" socket; Marshall Gerken Co.
Double contact tube socket; Mazda Radio Mfg. Co.

BATTERY CHARGERS AND RECTIFIERS

Handy battery charger; Interstate Electric Co.
Simplex battery charger; Interstate Electric Co.
Ultra-handly battery charger; Interstate Electric Co.
Kic-O rectifier; Kimley Electric Co., Inc.
Recto-filter; Mu-Rad Laboratories, Inc.

TUNING INDUCTANCE UNITS

Kellogg variometers; Kellogg Switchboard & Supply Co.
Kellogg variocoupler; Kellogg Switchboard & Supply Co.
Universal variometer; Langbein & Kaufman.
Variable clarifying selector; Langbein & Kaufman.
Low-loss tuner; A. C. Lopez & Co.
Controlometer; Malone-Lemmon Products.
Cockaday coils; McConnell Cable & Specialty Co.
Precision selector; Moskowitz & Herbach.

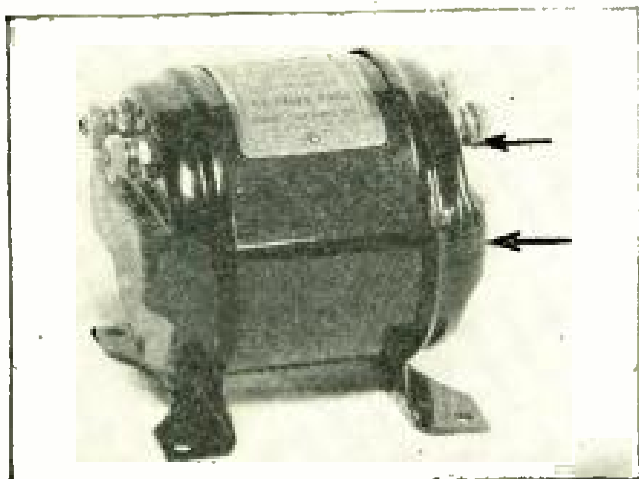

Sealed in metal shell and terminals brought out to soldering lugs.

AN EXCELLENT INSTRUMENT

Name of instrument: Audio-frequency amplifying transformer.

Description: A well designed and carefully built instrument. The core is large and the laminations are of suitable thinness. The impedance of the primary winding is sufficiently high at low frequencies and the distributed capacity of the secondary winding is low. This gives a good amplification-frequency curve with equal amplification at extremely low and extremely high frequencies. *Equipped with soldering lugs.* The whole assembly is contained within a polished metal shell.

Usage: In an audio-frequency amplifying circuit as an interstage coupling.

Outstanding features: Equal amplification over a wide range of frequencies. High amplification. Totally enclosed and protected from moisture. Terminals brought out to soldering lugs.

Maker: Karas Electric Co.

A LOOP THAT FOLDS COMPACTLY

Name of instrument: Folding loop antenna.

Description: Made of well finished wood with a central sliding portion which slides up and down and opens and closes the windings. The windings are of stranded cable mounted on insulating strips. They are tapped at six places for obtaining various wavelength ranges. The loop revolves on a pedestal which also contains a magnetic compass so that the direction of the received station may be logged as well as the tuning.

Usage: With any radio frequency set that operates from a loop antenna.

Outstanding features: Portability. Fine workmanship. High conductivity. Neat and finished appearance. Tapped windings. Well insulated. Equipped with a compass.

Maker: Amplifex Manufacturing Corp.

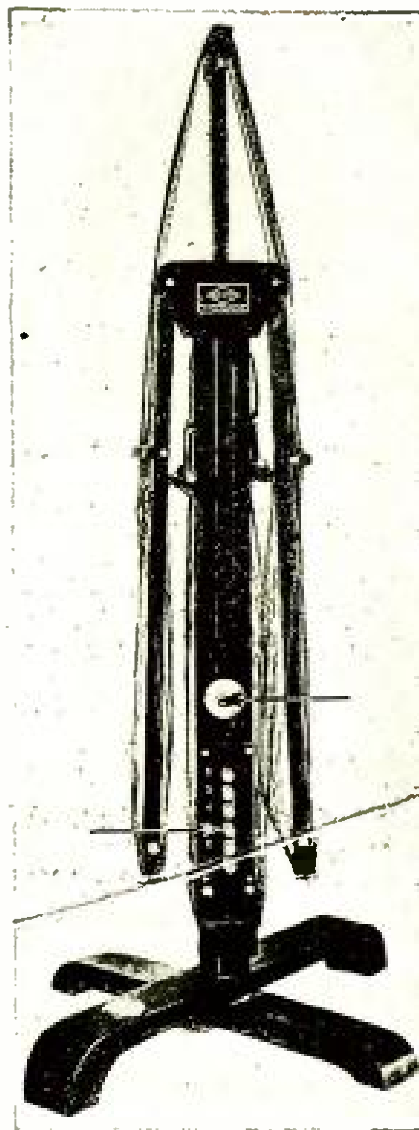

Locking arrangement that permits folding and taps brought out to binding posts.

SWITCHES

- Improved switches;* Jos. W. Jones Radio Mfg. Co., Inc.
- King switches;* King Mfg. Co.
- Mac-kontrol;* Mack Co.
- Switches;* Martin-Copeland Co.
- Keelock switch;* Metro Electric Mfg. Co., Inc.
- Automatic selector switch;* R. Mitchell Co.

BATTERIES

- "Kic-O" storage "B" batteries;* Kimley Electric Co., Inc.
- Eveready storage "A" battery;* National Carbon Co., Inc.
- Eveready dry-cell "A," "B" and "C" batteries;* National Carbon Co., Inc.

RECEIVING SETS

- Symphony receiver;* Jones Radio Co.
- Kennedy receiver;* Colin B. Kennedy Co.
- Broadcast receiver;* Magnavox Co.
- Mercury receiver;* Mercury Radio Products Co.
- "Michigan" receiver;* Michigan Radio Corp.
- "Miraco" receiver;* Midwest Radio Corp.
- "Moon" receiver;* Moon Radio Corp.

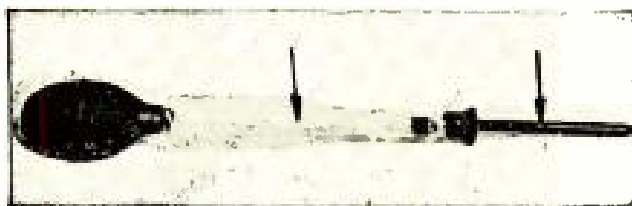

Clear scale and small hard rubber pipe.

A HYDROMETER FOR STORAGE "B" BATTERIES

Name of instrument: Hydrometer.

Description: The hydrometer float is contained in the outer glass shell with a rubber bulb at one end, for drawing up the electrolyte, and a small rubber tube at the other end, for inserting into the battery vent hole.

Usage: In connection with storage batteries for determining the state of charge or discharge.

Outstanding features: Clear view for the scale readings. Can be used with all storage "A" and "B" batteries.

Maker: Bemco Mfg. Co.

- "Murad" receiver;* Mu-Rad Laboratories, Inc.
- Murdock neutrodyne receiver;* Wm. J. Murdock Co.
- "Kodel" receiver;* Kodel Mfg. Co.
- Monarch receiver;* Krasco Mfg. Co.
- Liberty 5-tube receiver;* Liberty Transformer Co.

CRYSTAL DETECTORS

- Wonder fixed detector;* Lego Corp.
- Miller-B-metal crystal;* A. H. Miller Radio Co.
- Argentite crystal;* Mineral Products Co.
- "M.P.M." crystal;* M.P.M. Sales Co.
- NAA meter tested crystal;* Newman Stern Co.

TUBES

- Vacuum tube;* Magnavox Co.
- Myers tube;* E. B. Myers Co., Ltd.
- Solodyne tube;* Nutron Mfg. Co.
- Matched tube;* Nutron Mfg. Co.

LOOPS

- Marion folding loop;* Marion Electrical Supply Co.
- Portcna folding loop;* J. Nazely Co.

PHONOGRAPH ATTACHMENTS

- Vemco reproducing unit;* Jewett Radio & Phonograph Co.
- Phonograph attachment;* Morrison Laboratories, Inc.
- "Atlas" phonograph attachment;* Multiple Electric Products Co., Inc.
- "Accuratune" phonograph attachment;* Mydar Radio Corp.

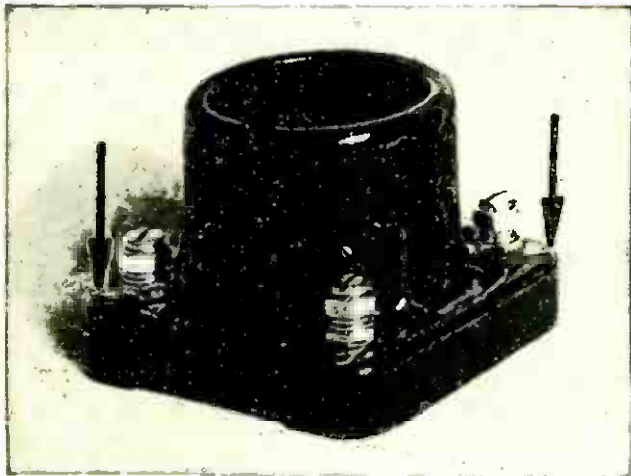

Low losses and soldering lugs.

AN EFFICIENT PORCELAIN SOCKET

Name of instrument: Vacuum-tube socket.
Description: Moulded of porcelain, which is then glazed. The spring contacts are "springy" and are brought out to soldering lugs.
Usage: For mounting standard sized vacuum tubes.
Outstanding features: Efficient. Well made. Neat in appearance.
Maker: M. M. Fleron & Son.

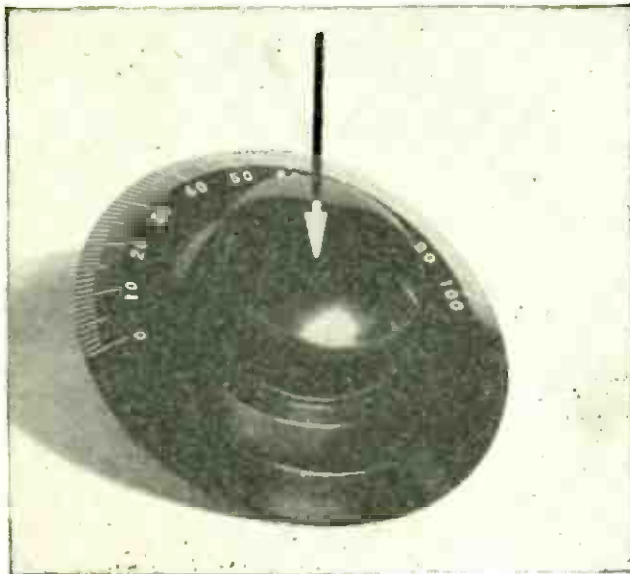

Knob turns on dial for vernier.

VELVET TUNING

Name of instrument: Vernier dial.
Description: Made in two pieces; a rotating dial and vernier knob. Moulded bakelite. The increase in rotation ratio is accomplished by a train of offset rollers located inside the vernier knob.
Usage: Attached to a condenser or a variable tuning inductance as a vernier rotation control.
Outstanding features: Extremely smooth action. No "play" or backlash. Well made and of good appearance.
Maker: National Co.

PHONE PLUGS

Plug jack; Wm. J. Murdock Co.
Plug; Jos. W. Jones Radio Mfg. Co., Inc.
Phone plug; Martin-Copeland Co.

AUDIO-FREQUENCY TRANSFORMERS

Harmonik audio-frequency transformer; Karas Electric Co.
Audio-frequency transformer; Kellogg Switchboard & Supply Co.
Audio-frequency transformer; Liberty Transformer Co.
Audio-frequency transformer; Marle Engineering Co.
Audio-frequency transformer; R. Mitchell Co.
Audio-frequency transformer; Modern Electric Mfg. Co.
"Push-pull" transformer; Modern Electric Mfg. Co.
Audio-frequency transformer; Nation Transformer Mfg. Co.
Audio-frequency transformer; New York Coil Co.

SETS IN KIT FORM

Super-heterodyne kit; Liberty Electric Corp.
Parts for 4-circuit tuner; Morrison Electrical Supply Co.
Kit for Roberts' circuit; J. Nazely Co.

RHEOSTATS

Rheostat; Jos. W. Jones Radio Mfg. Co., Inc.
Rheostat; King Quality Products, Inc.
Marshall-stat; Marshall Electric Co.

RADIO-FREQUENCY TRANSFORMERS

Intermediate wave transformer; Jefferson Electric Mfg. Co.
Vario-transformer; Langbein & Kaufman.
Air-core R. F. transformer; Liberty Transformer Co.
Radio-frequency transformer; Marle Engineering Co.
Radio-frequency transformer; New York Coil Co.
Superformer; Moskowitz & Herbach.

JACKS

"Improved" jacks; Jos. W. Jones Radio Mfg. Co., Inc.
Shar-grip jacks; Martin-Copeland Co.
Non-solder jack; Metro Electric Mfg. Co., Inc.
Plug jack; Wm. J. Murdock Co.

VARIABLE CONDENSERS

Variable condenser; Kellogg Switchboard & Supply Co.
Red Seal variable condenser; Manhattan Electrical Supply Co.
Super-vernier condenser; Martin-Copeland Co.
Variable condenser; Mignon Electric Mfg. Co.
Se-Ar-De condenser; R. Mitchell Co.
"National" condenser; National Co.
Variable condenser; New York Coil Co.
"Niagara" mignon condenser; Niagara Sales Co.
Lombardi condenser; Lombardi Radio Mfg. Co.

MISCELLANEOUS ACCESSORIES

I. C. S. radio handbook; International Correspondence Schools.
Voltmeter; International Supply Co.
"A" and "B" battery voltmeter; Jewell Electrical Instrument Co.
Lightning arrester; Jewell Electrical Instrument Co.
"Snow white" fluid; J. W. Johnstone.
"Color-cap" connectors; Howard B. Jones.
Radio record book; Kasper Brothers Co.
Contact points; King Quality Products, Inc.
"Korker" combination tool; Korker Products Co.
Lefax radio handbook; Lefax, Inc.
Alcohol blow torch; Lenk Mfg. Co.
Liberty terminals; Liberty Transformer Co.
"Listen-in" radio record; Listen-In Publishing Co.
Spring aerial and counterpoise; Mack Co.
Marco neutralizing condenser; Martin-Copeland Co.
"Bull dog" mast seat; Mast Seat Mfg. Co.
Moon radio log; Moon Radio Corp.
Electro-magnetic unit; Mozart-Grand Co.
Home-study course; National Radio Institute.

GOOD WORKMANSHIP

Name of instrument: Vernier variable condenser.

Description: The plates and the end plates are made of hard aluminum. All the other metal parts are of brass. Hard-rubber insulation is employed in two long, thin strips. The bearings are of generous dimensions and fit snugly. The connection to the rotor is made through a spiral strip of phosphor-bronze.

Usage: In any radio-frequency circuit as a method of tuning.

Outstanding features: Good workmanship. Careful assembly. Low losses. Good connection to rotor element.

Maker: Gardiner and Hepburn.

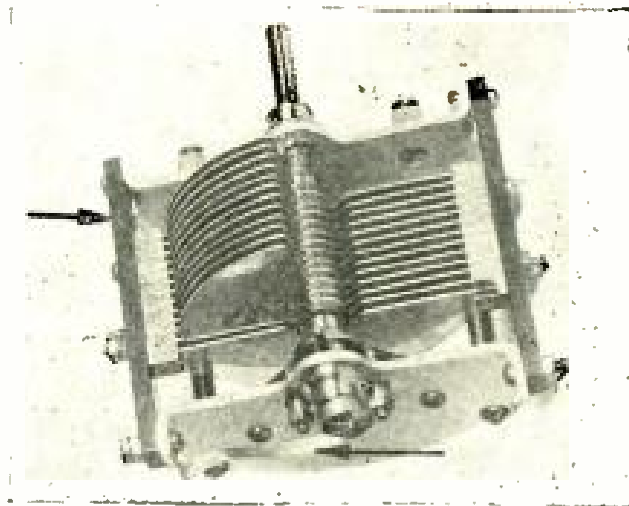

Radion insulation and soldering lugs.

A MICA CONDENSER THAT CAN BE ADJUSTED

Name of instrument: Small mica-dielectric condenser.

Description: A built-up capacity unit with dielectric of mica. The plates, which are fan shaped, can be swung around by means of a slotted screw which fits an ordinary screwdriver. This varies the capacity. Equipped with soldering lugs.

Usage: In any circuit where a small capacity condenser is used. The capacity may be adjusted to the correct value.

Outstanding features: Well made. Neat in appearance. Variable capacity.

Maker: Sterling Mfg. Co.

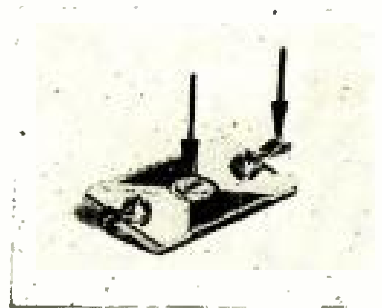

Slot for screw-driver adjustment and soldering lugs.

NOVEL COUPLING CONTROL

Name of instrument: Double-coil mounting.

Description: This mounting is made of moulded parts, and the coupling between two honeycomb coils may be varied by means of a dial on the panel to which the mounting is fastened. The motion is controlled by a cam and a spring.

Usage: In a honeycomb outfit for varying coupling between two coils.

Outstanding features: Coils may be mounted inside the set and the coupling varied from the outside by means of a dial.

Maker: Wireless Electric Co.

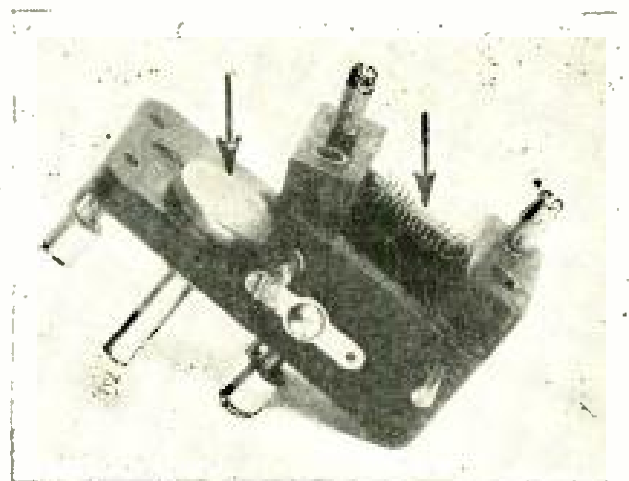

Spring controlled and cam operated.



This list of apparatus approved by the POPULAR RADIO LABORATORY will be continued as a part of the WHAT'S NEW IN RADIO APPARATUS department until all instruments, parts and complete sets have been included. The listing is alphabetical by manufacturer's name and the installment in this issue goes only to the end of the letter M.



LISTENING IN

CONDUCTED BY KENDALL BANNING

WHAT little kink have YOU discovered for increasing the efficiency of your set? What helpful bits of radio information have you picked up that will be of use to the other fellow? POPULAR RADIO will pay one cent a word for items for this department, and a monthly prize of \$10.00 in addition for the best contribution. Send your items to Listening In Editor, POPULAR RADIO, 627 West 43rd Street, New York City.

The Net Result of the Radio Conference

THE striking feature about national radio conferences is the contrasts which they present. Four years ago at this season, there was but one broadcasting station and, from a national point of view, no one was very much excited about radio broadcasting. Three years ago there were but three broadcasting stations worthy of the name. Two years ago at this time, the First National Radio Conference had been held, and the Second was contemplated for the spring. By that time, several hundred broadcasting stations had sprung into existence.

There were still a great many people who spoke of radio as a passing fad. In the light of radio's gigantic strides during the year, one is apt to feel, when considering attitudes of the past, that his memory is playing silly tricks upon him.

We speak of radio's "gigantic strides" during the year. If one speaks literally this is wholly incorrect. As an art, radio's great steps were taken almost ten years ago. The radio we now enjoy was effected basically almost ten years ago. Radio was ready then! Those who have had to do with the shaping of radio's history must now deplore the lack of that bit of imagination needed to take earlier advantage of opportunity. Imagination

has here created a great industry. The imagination of a nation, awakened at last to radio's great mission, had clearly pointed the way for enduring accomplishment when the Third National Conference convened in Washington on October 6th.

The public demands continued broadcasting, more broadcasting, better broadcasting, and broadcasting which is dependable at all hours during all seasons. To put it lightly, this is a very large order. But, in this day, no one will show surprise when it has been filled in its entirety, particularly after one has seen with what dispatch and common sense the complexities of this broadcasting business are handled by this almost spontaneous assemblage—the radio conference. Division into committees greatly facilitates the work. Seven committees have considered seven phases of the one great problem.

Committee No. 1; allocation of wavelengths for all classes of radio service;

Committee No. 2; allocation of wavelengths to broadcasting stations;

Committee No. 3; general problems of radio broadcasting;

Committee No. 4; marine radio communication;

Committee No. 5; amateur radio problems;

Committee No. 6; interference problems;

Committee No. 7; interconnection of broadcasting stations by wire and radio.

As a result of the reports of the seven

committees, the final recommendations to the Secretary of Commerce are made by the Co-ordinating Committee and, no doubt, these recommendations will rapidly find their way into common practice.

We may confidently expect less interference from telegraphic radio service; ship to shore service will now almost completely abandon wavelengths previously used in and near the broadcast bands.

The broadcasting band will be extended and a re-alignment of the various classes of service will take place, thus making room for more of both the better class of stations and stations designed for local work.

Bands designed for amateur work are also to be extended and a real opportunity given to amateurs to aid in the development of the very short wavelengths—wavelengths below ten meters.

The use of radiating receivers is severely criticised and the public is expected to co-operate with the manufacturer in abolishing this nuisance.

Other interference, such as that due to commercial electrical systems of various sorts, are to be studied in co-operation with manufacturers and distributors of electric current with a view to its gradual elimination.

Some experimentation with stations using powers up to 50 kilowatts is to be allowed in an effort to ascertain whether such powers can serve any useful purpose without blanketing smaller stations.

Definite short wave bands are to be allotted exclusively to radio interconnection work.

In welcoming the members of the conference to Washington, President Coolidge stressed the importance of the part in the life of the nation which radio now plays. In opening the conference, Secretary of Commerce Hoover stated that improvement in radio programs is essential and pointed out that this could most easily be brought about by the interconnections of stations, as in this way the programs of the large centers of art and music and all classes of events of public interest may be brought to the remote localities.

At this time, greatest dependance for interconnection may be placed in the telephone line. It is to be hoped that *dependable* interconnection by radio will soon come about. The use of a few super power stations and continued advances in the use of the short waves should insure success of this method.

Radio programs must be kept free to the consumer. Interconnection of stations by radio is cheap. Wholesale interconnection of stations by wire in most cases proves prohibitive because of expense. Who is ready to advance the funds? Still no serious attempt has been made to answer the question we have heard so long, "Who is to pay for radio?"

Radio will continue to be paid for by the good will which accrues to those who furnish programs. Let us have more of them and better ones. Let us have occasional radio interconnection of our stations with those in Europe and, above all, a great deal of interconnection of stations in Canada and the U. S. A.

—PAUL GODLEY

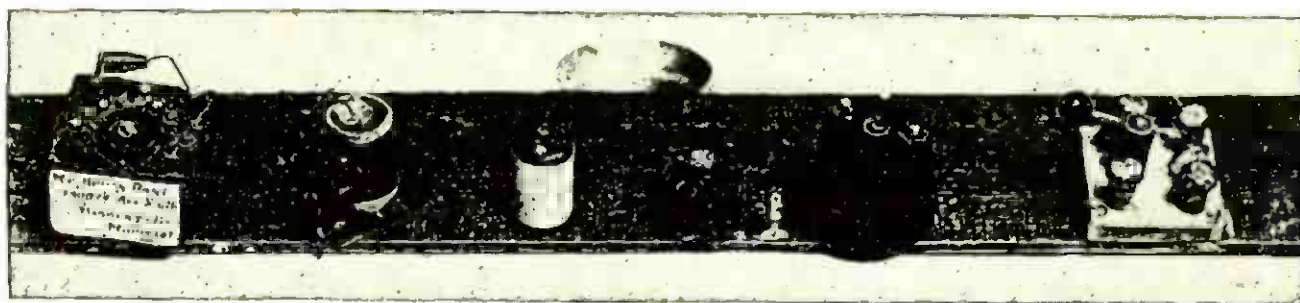

Kadel & Herbert

These six tiny pieces of radio apparatus—and every one of them works—were made by radio amateurs. From left to right may be seen two receivers, a dry battery, a crystal set, a loudspeaker unit and another crystal set.

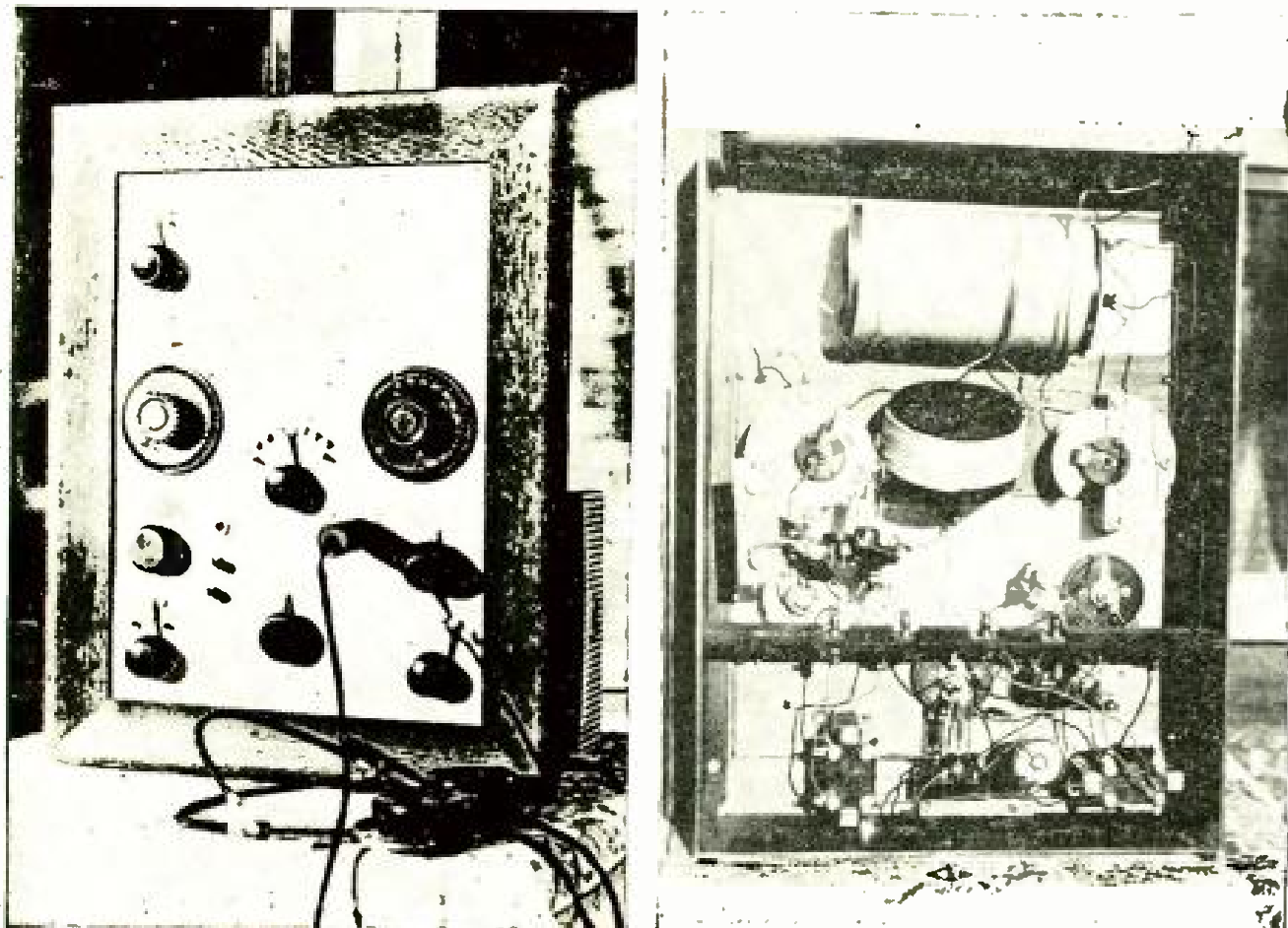

FRONT AND BACK VIEWS OF THE TUNER

The picture at the left shows the front view of the tuner built by John E. Fillmore; it is designed to be hung on the wall like a picture. At the right is the rear view of the set, showing the tuner and detector in the upper section and the amplifiers in the lower section.

A Tuner to Hang on Your Wall

TO the radio experimenter who combines imagination with technical skill the creation of unique forms of receivers is a source of constant amusement. A fan with a fanciful mind, up in Winnipeg, sends in the following description of a novel version of the four-circuit tuner:

The accompanying photographs illustrate a simple and inexpensive way of giving rein to one's fancy in the matter of experimental hook-ups. An old (or new) picture frame, a "panel" of heavy cardboard, the usual assortment of radio parts—and the thing is done.

The cardboard or composition panel (such as artists use) is held snugly in place by narrow strips of wood which, in turn, are held in place by screws angled into the frame at their edges. Wider strips of wood, similarly fastened, are used wherever needed to furnish additional support to such heavy parts as condensers or transformers.

Behind the frame is a light box frame of thin wood which has been added, partly to

screen the "works" and partly to enable the frame to stand upright on a table. A strip of wood across the rear of this framework supports posts for the battery leads. If desired, an outfit arranged in this manner can be hung conveniently on the wall with the batteries concealed by a near-by picture.

Previous to the installation illustrated, this frame held a satisfactory one-stage tuned radio detector and one-stage audio hook-up.

The present photographs show an arrangement of the Cockaday four-circuit tuner—also very satisfactory. On an indoor aerial consisting of wires strung about in the attic, it brings in stations from Edmonton, Calgary and San Francisco to Dallas and Fort Worth, Pittsburgh and Buffalo. Our local station (a government monopoly) comes in on the loud-speaker with a splendid volume and excellent quality of tone.

Referring to the illustrations; the switch at the top is now used as an "A" battery cut-off. This is a great convenience in case one wishes to leave the outfit "all set" for a local broadcast and ready to be turned on by any one who is unable to remember that there are three rheostats that must be turned off (and *all off!*) when one is tired of listening.

In the middle of the panel are seen the two condenser dials and between them the switch

and taps from the bank-wound coil seen between the condensers in the "rear" view. The three rheostat knobs need no pointing out. The plug is shown in the detector jack, while the second-stage audio jack is to the left with two posts for the loudspeaker below.

In the rear view all the parts can be readily identified except, perhaps, the third tube, the point of which barely shows.

Owing to the very light weight of the Northern Electric Peanut tubes used, no support was needed for the sockets other than the ordinary bell wire used in the wiring. If heavier tubes and sockets are used a light shelf across the framework should be used to support them.

In case one strikes a hook-up which seems to him to be final in its answer to his needs, it is a simple thing to obtain a more substantial panel and to rebuild the set with more direct leads and better connections.

—JOHN E. FILLMORE

Interference from a Heating Pad

THE hunt for interference is being pursued relentlessly, and slowly, but

surely this form of nuisance is being removed. A fan in Worcester, Mass., reports a unique source of this trouble:

For some weeks my radio receptions had been interrupted by a noise resembling that of a spark set. This noise could not be tuned out at any wave between 200 and 700 meters. The noise was at times continuous, at other times intermittent (on for four or five seconds, then off for three or four seconds); it finally became so annoying that a search was made. The trail finally led to an electric heating pad in which the thermostat contact had evidently become burned. When on low heat, the spark was too small to cause a break, but on high heat the spark in combination gave off sufficient heat to cause the thermostat contacts to open, thus causing the interruptions.

No attempt was made to determine the distance to which this interference extended; however, it was determined that no trouble was experienced one block away. The sets which were troubled were within 100 feet of the house in which the pad was being used.

—C. W. KINNEY



SCHOOLBOYS LEARN TO BUILD RADIO SETS IN SCHOOL

"Reading, 'riting and 'rithmetic," the three Rs that constitute the basis of an education, are now augmented in the Chicago public schools by radio. Here are the young fans of Chicago Boys' Club No. 5 who are taking a course in building receivers.

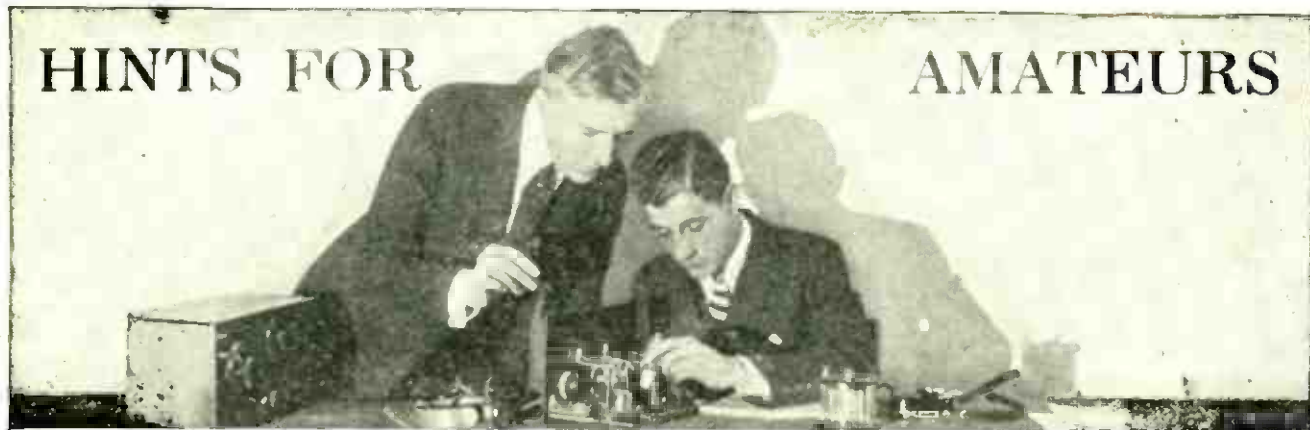

CONDUCTED BY ALBERT G. CRAIG

How to Test "B" Batteries

NEVER test a "B" battery by short-circuiting it with a screw-driver, or with any piece of metal, to see if you get a good spark. This will ruin a good battery in a short time.

Don't use a cheap pocket voltmeter!

Use a high-resistance voltmeter that is made for this purpose.

How to Stop Radiation from a Single-circuit Receiver

A SINGLE stage of radio-frequency amplification added in front of your single-circuit receiver will cut out radiation from your antenna. The radio-frequency amplifier itself should never be allowed to oscillate, however. "Neutralize" the first stage in the same manner as a neutrodyne and thus be sure that you are not disturbing your neighbors' reception.

Controlling Regeneration in a Transformer-coupled Radio-frequency Amplifier

PROBABLY the simplest method for controlling regeneration in a radio-frequency set, employing transformers for interstage coupling, is to use a potentiometer connected across the "A" battery with the lever connected to the grid return of the amplifier tubes in question.

This allows the free grid potential of the tube to be varied, so that the tendency of the tube circuit to oscillate can be controlled.

Keep Radio Apparatus Away from Open Windows

NEVER let the radio set stand before an open window. It might rain and the set would be damaged if it were to get wet. Even if the set were not touched by the water itself, it might be damaged by the moisture carried in by the atmosphere.

The Best Ground

USE a water pipe (preferably the cold-water pipe) for the ground to your receiving set. It will almost invariably give you better results than other grounds, such as the radiator, the gas pipe or fire escapes. Of course, it does no harm to use them all at once if you like, then you will be sure of getting at least one good one.

Usually the cold-water pipe is sufficient, however.

Be Careful in the Use of Soldering Fluids or Fluxes

NEVER use too much fluid or flux while soldering a joint between two wires or between a wire and a terminal. If you use too much it may bubble and run down into the windings of coils or into the insulation between jack terminals, or it may produce a semi-conducting path across any piece of insulating surface. Use only enough! And be careful with what you do use. Don't spill it.

The Correct Resistance of Rheostats for Various Types of Tubes

THE problem of determining the correct resistance of rheostats often confronts an experimenter who likes to design and build his own equipment. The proper resistance to use depends on the voltage of the "A" battery and the normal current that the tube operates on most satisfactorily.

For WD-11 and WD-12 tubes on 1½ volts a 6-ohm rheostat is satisfactory.

For UV-200 or C-300 tubes on 6 volts a 6-ohm rheostat should be used.

For single C-301-a or UV-201-a tubes or any ¼ ampere tubes on 6 volts a 30-ohm rheostat is proper.

For two C-301-a or UV-201-a tubes in parallel a 20-ohm rheostat will suffice.

For four of these tubes in parallel a 6-ohm rheostat will be sufficient.

For UV-199 or C-299 tubes on 4½ volts use a 30-ohm rheostat.

For 216-a tubes use a 6-ohm rheostat on 6 volts.

Use No Shellac or Paint on Coils

NEVER paint the coils you use in radio apparatus with any kind of paint, varnish or filler. Never use any material of this nature to stick the turns of wire tightly together. If you do you will add to the losses in the coils.

Switching Tubes Around to Increase Their Efficiency

You may be able to get an increase in efficiency equal to as much as 50 to 75 percent by merely switching the tubes around in the different sockets in your set.

First tune in a signal, and then take two of the tubes from the sockets and reverse them, putting them each in the other's socket.

Keep on doing this in various combinations until you hit on the particular combination that gives you the loudest results.

A Wavemeter Is a Handy Instrument

INCLUDED in the experimenter's list of apparatus should be a good wavemeter. This is just as true in the case of the experimenter who limits his work to receiving apparatus as to the man who goes in for research work on both receiving and transmitting equipment.

Keep one handy and it will help you in designing your new coils or choosing the right size of condensers for use with the right size coils.

Sets That Work Without Outside Antennas

If you cannot put up an outdoor antenna for any of a number of reasons, you do not have to be deprived of the enjoyment that you would get from owning a radio receiver for broadcast reception.

There are a number of manufacturers that have successful receivers that work on a small loop. You can buy one of these and obtain really good results.

The set may be a radio-frequency set, or a super-heterodyne, or a reflex receiver.

Effect of Poor Connections in Jacks

SOMETIMES a set will cease functioning or will function poorly on the last stage of audio-frequency amplification. This is almost always due to a poor connection in the jack that precedes the last stage or in one of the preceding jacks in other stages.

If you have this trouble, look in between the small silver contacts in the jacks and notice whether or not they close properly when the plug is withdrawn from them. Sometimes the springs weaken and do not allow them to close as they should.

The remedy is to take out the jack and bend the offending spring back into position, and then to replace the jack.



BROADCASTS

ITEMS of general interest that you ought to know; bits of useful information that every radio fan ought to know.

CONDUCTED BY DAVID LAY

Tide Affects Wavelength

AN amateur radio transmitting station was established recently by the American Radio Relay League for the purpose of communicating with the schooner *Bowdoin* on her return from the Arctic. After the transmitter had been rigged up an unaccountable shifting in the length of the transmitted wave took place. It was finally discovered that the rise and fall of the tide was responsible. The counterpoise was erected directly over the water and the tide changed its effective capacity.

370,000 Radio Sets on Farms

THE special survey made by the United States Department of Agriculture shows that there are now more than three times as many radio receiving sets in use on the farms in this country than there were only a year ago. The latest estimate would indicate that there are 370,000 radio sets now in use by farmers. The radio market news service by the Department of Agriculture is partially responsible for this rapid increase, as it is now broadcast from so many stations that farmers in almost any section of the country are able to receive the latest quotations with relatively low-powered receiving equipment.

Radio Helps Break a Telegraph Strike

WHEN the telegraphers working on the newspapers in Canada recently went on strike, the broadcasting station of the *Toronto Star* sent out news bulletins at regular intervals during the day, so that the papers in the various sections of Ontario were able to get the latest news in spite of the telegraphers' strike.

How Radio Would Operate in Time of National Emergency

ON Defense Day, September 11, a test was made of the possibility of linking up the broad-

casting stations of the nation so that in times of peril or national emergency the people of the entire nation might be reached instantaneously by the government. Seventeen stations took part in the test. It is calculated that at least 25,000,000 persons heard General Pershing deliver his Defense Day address.

* * *

Freak Requests by Radio Fans

REQUESTS that come to broadcasting stations range from the care of radio sets to the possibilities of success in farming on the Virgin Islands. The desire for the return of missing persons figures in a large number of requests; one large station reports that the number of requests for help in locating missing wives and missing dogs is running about even. Curiously enough, no requests have been received asking for assistance in finding lost husbands.

* * *

Lightship Combines Radio and Submarine Signals

THE Nantucket Shoals light vessel is sounding radio fog signals and the submarine oscillator synchronously. Vessels equipped with radio and submarine signal receivers may determine their distance from the light vessel with accuracy. The radio fog signal sounds, every ninety seconds, groups of four dashes for sixty seconds and then is silent for thirty seconds. The submarine oscillator sounds three groups of six blasts every ninety seconds, thus: six blasts of one second each, twelve seconds silent; six blasts of one second each, thirty-one seconds silent; silence between blasts in group, 3.5 seconds. In each reception of the characteristics of the signals the first dash of the radio fog signal and the first blast of the oscillator are sounded simultaneously; the difference in time in seconds between the reception of the dash and the blast multiplied by 1,000 gives the distance in yards separating the observing vessel from the light vessel.

A New Record for Amateurs

DURING the transpacific tests arranged by the American Radio Relay League, W. B. Wagner of San Pedro, California, succeeded in establishing communication with Frank D. Bell of Waihemo, New Zealand. This work constitutes a new world's record for amateurs, as the distance by air line between San Pedro and Waihemo is 6,900 miles. The previous record was held by Carlos Braggio of Bernal, Argentina, and Ivan O'Meara of Gisborne, New Zealand, who communicated over a distance of 6,400 miles.

* * *

Play First Presented by Radio

"SILENCE," a crook play by Max Marcin, which is now running on Broadway, was first presented by radio from station WGY. This is the first time that a company of players have had the privilege of interpreting an author's script without first witnessing a stage production—at least for any play that has been actually produced on the stage.

* * *

Radio Calls Fire Chief Back to Duty

WHEN the assistant fire chief of Hartford, Connecticut, died recently, the chief of the fire department, John C. Moran, was deep in the

Canadian woods on a hunting trip. It was necessary that the chief be recalled at once, so a call was broadcast from WBZ. The message reached Mr. Moran by way of an Indian guide—and he hurried back to duty in Hartford.

* * *

Rescued from Burning Plane by Radio

FLYING on the route from Alicante, Spain, to Oran, Algeria, a postal seaplane took fire recently following a break in the gasoline feed pipe. The airplane was forced to make a landing in the sea and the aviators had just time before they struck the water to send out a radio call for help. A motor boat set out promptly from Oran and succeeded in rescuing the aviators from the burning wreckage.

* * *

Machinery Controlled by Radio

AN interesting experiment in the remote control of heavy machinery by radio was carried out at the Wembley Exposition in England. A 500-kilowatt rotary converter installed in the Palace of Engineering was fitted with a starting and stopping mechanism that operated from a radio receiver. When the transmitting station, several miles away, sent out a given signal the great machine slowly swung into motion; and five minutes later was stopped by another type of signal from the same transmitting station.

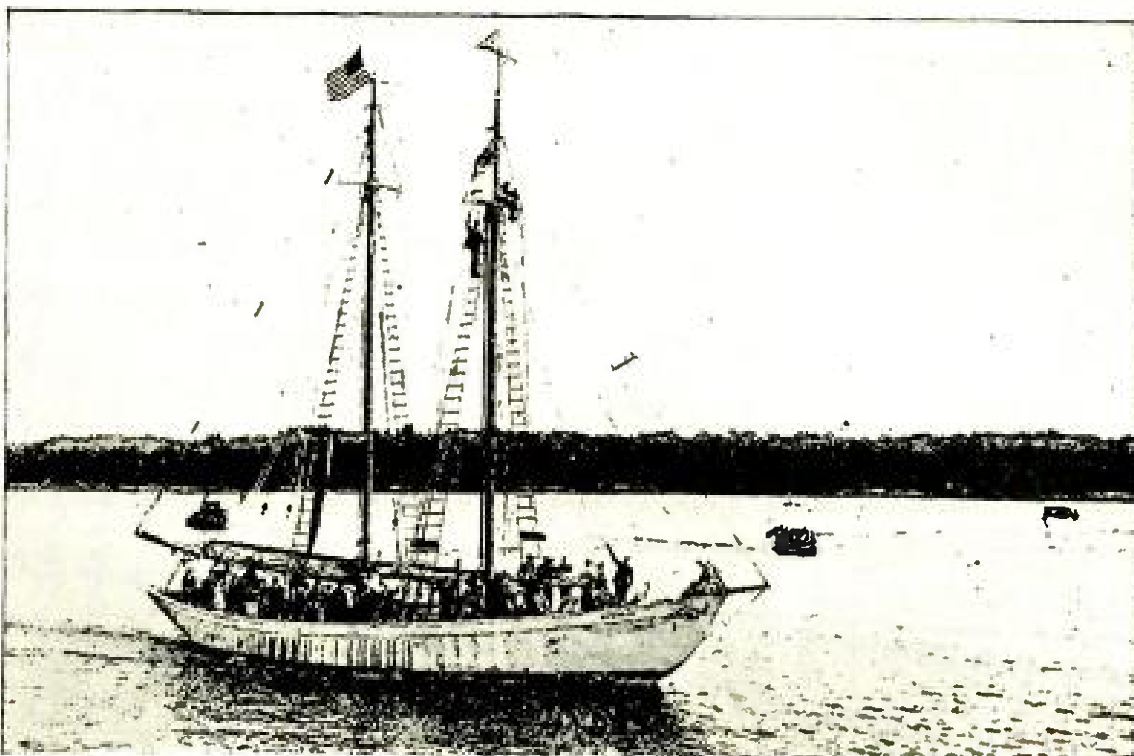

Wide World Photos

ANOTHER RADIO THEORY UPSET

The most important observation about radio phenomena that Donald MacMillan brought back from his Arctic trip was to the effect that the aurora borealis—contrary to the accepted theory—has no effect whatever upon radio reception. Intense electrical storms were frequent in the vicinity of the North Pole and they were often so severe as to make radio reception impossible, but the explorer found that the aurora itself made no perceptible difference. The above snapshot of the Arctic ship *Bowdoin* was made at Wiscasset, Maine.

Fake "Inspector" Steals Radio Sets

RADIO customers of a large New York City sporting goods store were recently victimized by an old bunco game dressed up in a new form. Shortly after a customer had had his set installed, a man would call and announce that he was the store's "radio inspector." After he had looked over the set he would report that it needed adjustments, and he would offer to take it to the repair department. The sets were never seen again.



Kadel & Herbert

AVIATOR DESIGNS OWN RADIO TRANSMITTER

Lieutenant Franklin L. Nash was one of the aviators in the welcoming squadron which greeted the world fliers near Boston. Using a 50 watt transmitter of his own design, he broadcast incidents in connection with the reception to the radio fans in the surrounding territory.

Broadcasting Station Uses Sugar Cane for Drapery

INSTEAD of the ordinary heavy fabric draperies which are used to eliminate reverberation in broadcasting studios, the walls of station WEEI in Boston are covered with a material made of dried, pressed sugar cane. It is claimed that this material controls sound more efficiently than any other known material; it is also claimed that the new form of wall coating does not have the depressing effect on the artist that is often blamed on the ordinary heavy draperies.

A New Transatlantic Cable Challenges Radio

WITHIN a year a new cable will be laid which is to connect New York with Italy for the first time. It is claimed that the new cable will be able to transmit messages five times faster than any cable now in existence. The high speed at which the new cable will be able to operate is made possible by the discovery of a new alloy known as permalloy. It is a mixture containing eighty percent nickel and twenty percent iron. It has been found to have thirty times the magnetic permeability of ordinary soft iron. The permalloy is applied in the form of a tape which is wound around the central copper core. The effect of this arrangement is to magnetically "load" the cable in much the same fashion as is accomplished by the Pupin coil on long land lines.

Radio's First Commercial Short-wave Station

THE first commercial short-wave, low-powered transatlantic radio station has been licensed; station WGH at Tuckerton, N. J., has been permitted to operate provisionally on 90, 93, 97, 100 and 103 meters by the Department of Commerce. With a transmitter rated at 20 Kw., and working on these short waves, the station expects to establish auxiliary long-distance commercial circuits to Buenos Aires, Berlin, and Paris.

The "Hushaphone" Type of Microphone

A NEW type of microphone, known as a "hushaphone," was employed recently at station WBZ in Springfield, Mass., to report a boxing match. The design of the hushaphone is such that only the announcer's voice registers on the diaphragm and the noise made by the cheering crowd does not interfere with his speech. It was thought that the radio fans would appreciate hearing the announcer without interruption from the crowd, but the letters received subsequently showed that at least half of the fans felt that the cheering and the excited comments of the crowd added much to the mental picture they formed of the combat.

CELORON

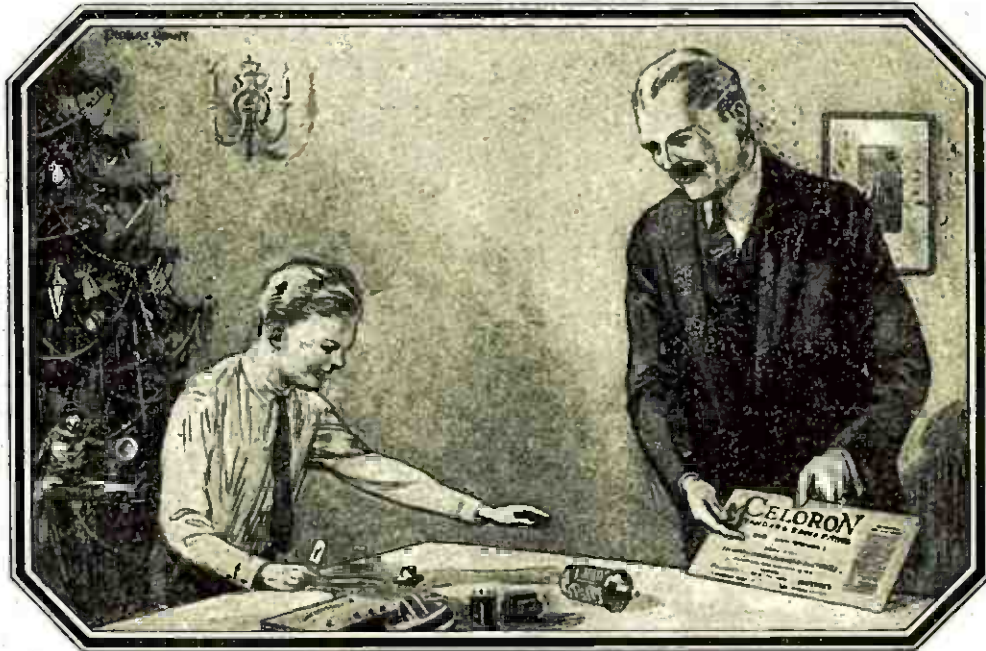

“Gee, dad, that’s a peach!”

CHRISTMAS morning—and with it gifts that make the radio fan’s heart skip a beat or two. There are tubes, batteries, a tuning-coil and beside them a beautiful, glossy-black panel. The best part about the panel is that it is a Celoron panel.

Dad used his old bean when he selected a Celoron panel. He picked Celoron because it is a bakelite panel and furnishes the insulation that delicate instruments need to give the best results. He knows that it doesn’t pay to skimp in buying a panel.

Celoron has high dielectric strength and it is practically indestructible. You can drill, tap, saw and bore a Celoron panel without fear of its chipping or cracking. It is not affected by atmospheric changes, and it never softens,

warps or buckles. It is infusible, too.

You can buy Celoron in black or mahogany finishes. These never lose their lustre or become discolored. They improve with age.

Celoron has been tested and approved by the U. S. Navy, the U. S. Signal Corps, by leading radio manufacturers, and by thousands of radio fans all over the country.

Ask your dealer to show you his assortment of Celoron bakelite panels.

CELORON A Bakelite Panel

Diamond State Fibre Company
Bridgeport, Pa., and Chicago, Ill.
Branches in Principal Cities
Toronto, Canada London, England

Send for FREE booklets

We have prepared two interesting booklets, “Getting the Right Hook-up with Celoron” and “Vulca-wood—the New Cabinet Material,” which contain many valuable suggestions for building and operating a radio set. Send for your copies, now. They are free.

Diamond State Fibre Co., Bridgeport, Pa.

Please send me without charge copies of “Getting the Right Hook-up with Celoron” and “Vulca-wood, the New Cabinet Material.”

My radio dealer’s name is.....

Name.....

Address.....

How many radio miles did you go last night?

HOW many radio miles did you travel last night?—that's the up-to-the-minute question. Did you voyage from New York to Chicago? Did you look in on Boston fifty seconds after, and on Philadelphia half-a-minute after that? If you *didn't*, why didn't you? There's fun and excitement, too, in a De Forest Radio—and it's ready to "get to work" five minutes after it enters your home.

Here is a radiophone so astonishingly simple for the work it does that it's your best introduction to the marvels of radio space. Here is one so perfectly developed that it invites graduation from other less efficient instruments.

Here is a receiving set sponsored by the very genius who made radio, as we know it, possible—an instrument that offers a really remarkable demonstration in radio performance at a price far less than any instrument whose achievements compare with it. Here is a practical, a modern Radiophone, depending upon no out-strung wire to obtain results, but which, with a simple loop the size of a picture frame, opens to you a far-flung range of concert, speech and lecture—and all with a tonal purity, a sensitive choice, as



DE FOREST RADIOPHONE



For beauty and clear reproduction

Use the De Forest Loud Speaker. It reproduces naturally, brilliantly, without distortion. Its horn is shaped to retain the full brilliancy of the original sound, and also to add volume. The complete unit

is free from rattles. Every De Forest Loud Speaker is thoroughly tested, and is guaranteed free from defects. Sold by authorized De Forest dealers only. Price, with 6 feet of cord, \$25.00.

between station and station, that is rare to any but De Forest users.

The De Forest Radiophone is a complete four-tube receiver, built on the best reflex principle. Its four tubes and crystal detector do the work of seven tubes. We could be extremely technical in telling you how the four tubes do the work of seven and why the crystal detector gives both power and economy to this instrument. If you are technically inclined we shall be glad to do so if you will write us. Technical or not, however, know this: You can get splendid results from a De Forest D-12 Radiophone. Its

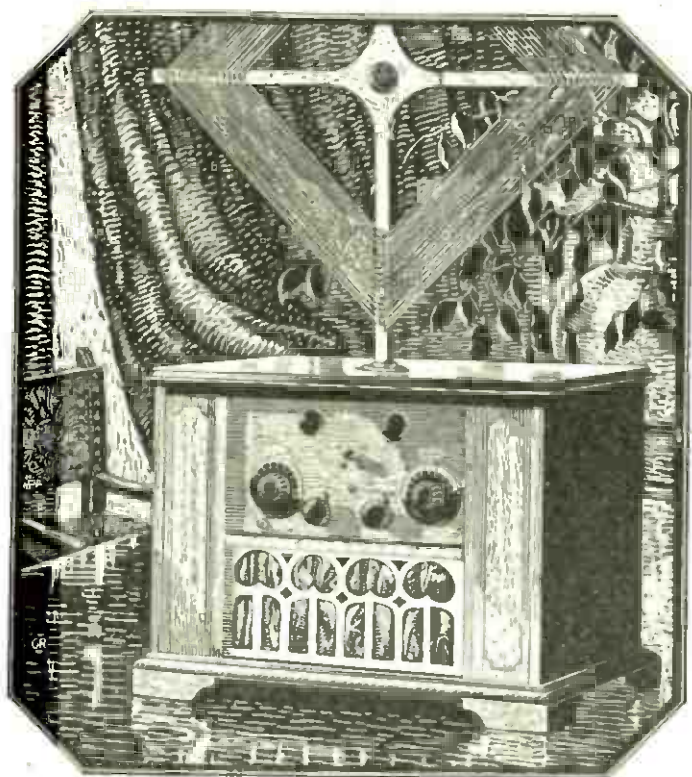

upkeep is low. Its tone is clear and pure. It can be moved easily from room to room.

Why it pays to look for the De Forest agent

De Forest from first to last stands for all that is substantial and thorough and fundamentally right in radio. De Forest agents are qualified to give you sound and practical advice and help in radio. When you find a De Forest agent you find a man who knows radio—a man who has given us his word that he will see that every instrument he sells is thoroughly inspected and properly serviced after the sale. He has been carefully picked and schooled in the operation and servicing of De Forest Radiophones.

He will install your instrument and explain to you simply how to get the fullest satisfaction and enjoyment from it.

Prices on De Forest D-12 Radiophones

(COMPLETE)

Including loop, self-contained loud speaker, four De Forest tubes, A and B batteries, and all equipment ready to operate.

With Dry Batteries

In two-tone gray and black Fabrikoid cabinet \$161.20

In two-tone Mahogany cabinet 176.20

With Storage Batteries

In two-tone gray and black Fabrikoid cabinet 180.00

In two-tone Mahogany cabinet 195.00

De Forest D-14 Radiophone

In burl walnut cabinet with loop and loud speaker built in. Price, including five DV-2 tubes, four B batteries, and storage batteries 371.50

DE FOREST RADIO COMPANY
Jersey City, N. J.

DE FOREST RADIOPHONE

Your set deserves De Forest tubes

De Forest
DV-3 Tube
for use with
Dry Cell
Batteries.



The original De Forest vacuum tube was the first of many millions of De Forest tubes that have stood foremost in quality of workmanship and performance. They are noted for uniformity, volume,

and clarity. Use DV-3 with dry batteries, DV-2 with storage batteries. They are guaranteed against defects in material and workmanship. Sold only by authorized De Forest dealers. Price \$4.00 each.



De Forest
DV-2 Tube
for use with
Storage
Batteries.

All apparatus advertised in this magazine has been tested and approved by POPULAR RADIO LABORATORY

Every one of the C-H Radio products—the famous Rheostats, Grid Leak, Potentiometer, Radio Switch and Socket—was designed by these engineers whose successes in electrical design are acknowledged throughout the world.



A Moment's Care in Buying Assures Hours of Better Reception

Your set starts with the first instrument you buy. It and every other part you put behind your panel determines the results you obtain for the money you spend.

In radio, because of its very nature, the receiving set is only as good as its weakest part. One instrument of poor design or improper construction limits the efficiency of the entire circuit.

Because of this the man who builds

his set and buys with care can be assured of maximum receiving pleasure at the lowest net cost. He can buy each part with understanding and combine in his set the cream of the engineering knowledge of the entire world.

For the delicate parts of your circuits—where the feeble energy received *must* be conserved—the Cutler-Hammer engineers, world famous for more than a quarter of a century as the master builders of all electrical control,



CUTLER-

All apparatus advertised in this magazine has been tested and approved by POPULAR RADIO LABORATORY

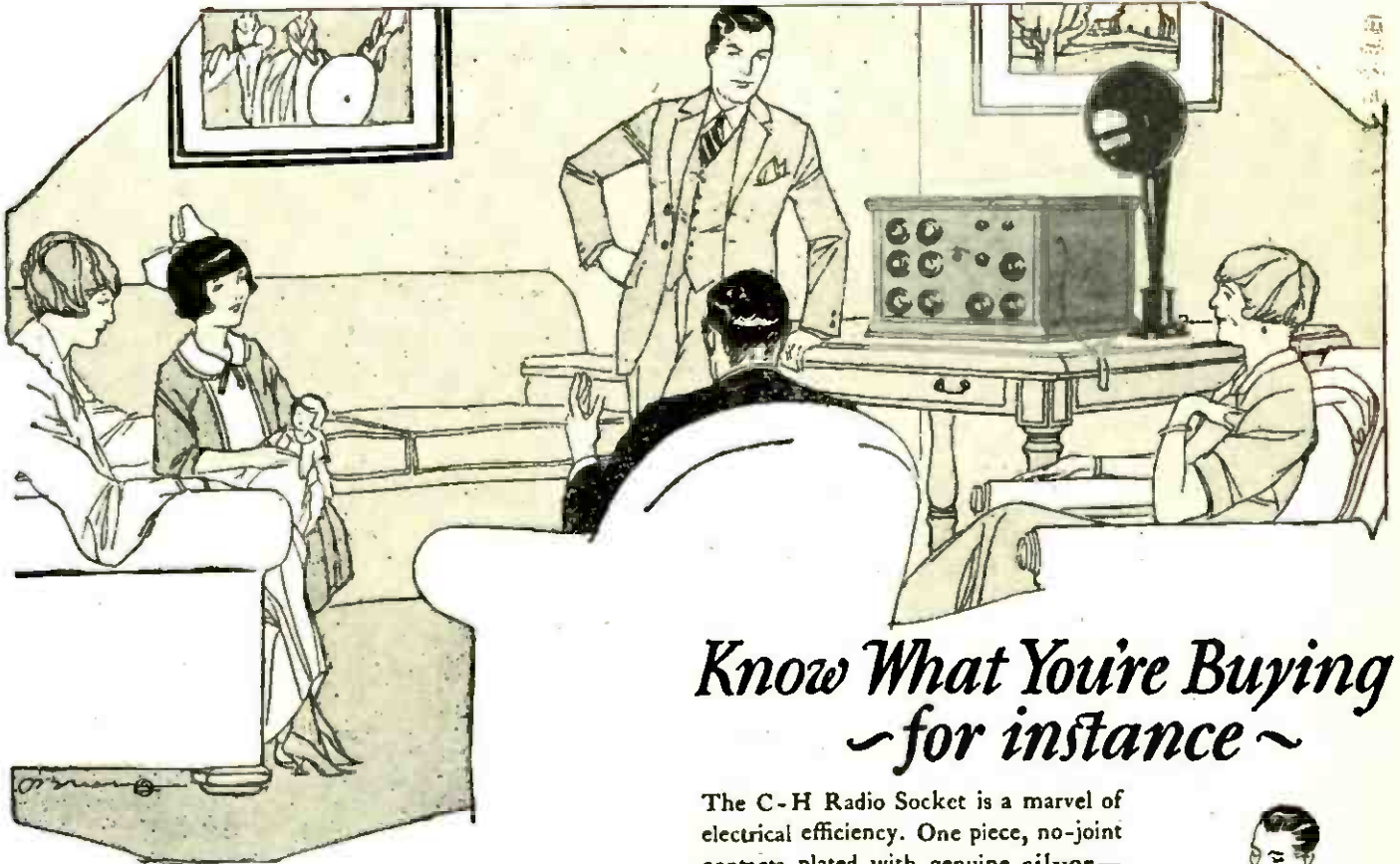

Know What You're Buying ~ for instance ~

have safeguarded the radio buyer with a trade mark that allows the most inexperienced enthusiast to buy with the confidence of seasoned engineers.

In their rheostats, grid leak, potentiometer and other radio parts, they have provided a degree of precision that means added miles of range and hours of clear, enjoyable reception. When you start to build, start right—the dealer is glad to recommend C-H parts—this trade mark is his protection and yours too.

THE CUTLER-HAMMER MFG. CO.

Member Radio Section, Associated Manufacturers
of Electrical Supplies

MILWAUKEE, WISCONSIN

Dustproof cover of C-H
Radio Switch removed
to show unique mechanism.

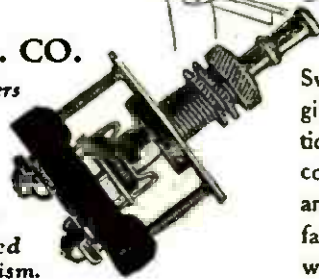

The C-H Radio Socket is a marvel of electrical efficiency. One piece, no-joint contacts plated with genuine silver—not nickel. And they are spaced wide—true low loss construction. The shell is real Bakelite and the base genuine Thermoplas. No “molded mud” or other poor construction in this socket. Prove it by holding a match to the base—it can't burn. But, be sure you see the C-H trade mark first—the dealer won't let you do that to most sockets.

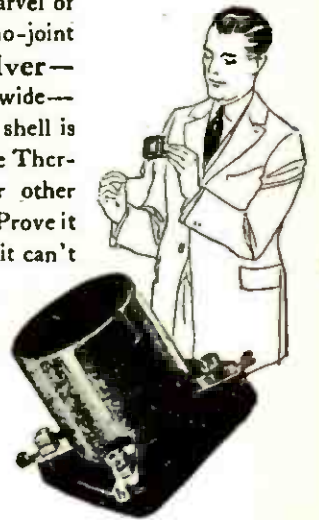

Before you buy a radio switch ask regarding its mechanism. You can now get many switches that provide the convenience of the original C-H “one-hole” mounting—and buttons that make them look like the C-H Switch from the panel front. But no switch can give you the quiet reception, and positive operation that you get with the C-H patented floating contactor construction. Know the mechanism and you will know why all the leading set manufacturers are using it as standard equipment—and why there are almost a million in use today.

HAMMER

GOLDEN-LEUTZ

PLIODYNE-6

TRADE MARK REG.

"The Perfect Broadcast Receiver"

A New Superior Broadcast Receiver

SIMPLE - LONG RANGE - HIGHEST QUALITY
NON-RADIATING - NON-REGENERATIVE

Two Stages Tuned Radio Frequency—Detector and Three Stages of Audio Frequency Amplification.



PLIODYNE 6
Front View Showing Simplicity of Control

A New Marketing Plan

Rather than sell this high grade receiver to wholesalers at \$190.00 less 50% discount we are going to sell it direct to you at wholesale, saving you \$95.00 and at the same time giving you the finest set that can be bought for twice the amount.

Inspect the "Pliodyne 6" at Our Expense

We will send the "Pliodyne 6" C. O. D. transportation prepaid with privilege of inspection. If it does not appeal to you as the finest medium priced broadcast receiver you ever saw, return it to us at our expense.

[Otherwise take advantage of

A FREE TRIAL

Accept the C. O. D. and try the "Pliodyne 6" for five days; if you are not satisfied in every way return it at our expense and we will return your money.

All apparatus advertised in this magazine has been tested and approved by POPULAR RADIO LABORATORY



AIRTRON RADIO TUBES

With the new highly developed dielectric moulded Bakelite base which eliminates all kinds of electrical losses.

Airtron Tubes

Speak for quality, volume and all other characteristics demanded of a Radio Tube. Designed and manufactured to give the highest efficiency that a Tube at the present time can possess.

Type 200—	6 volt	1 Amp.	Detector				
“ 201A—	5 “	.25 “	Det. & Ampl.				
“ 12—	1 1/2 “	.25 “	“ “ “ “				
“ 199—	3-4 “	.06 “	“ “ “ “			Standard Base	

Every Tube Guaranteed

List Price \$4.00

Sold by all Dealers, or shipped C. O. D. Direct by Parcel Post. When ordering mention Type. **Discount to Dealers**

H. & H. RADIO CO.

Dept. 102 Clinton Hill Station P. O. Box 22 Newark, N. J.

We Are Still Repairing All Types of Radio Tubes, \$2.50

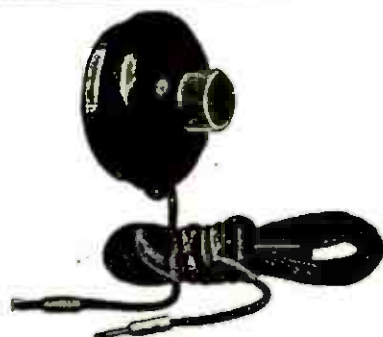

A Loudspeaker everyone can afford

INSTRUMENTAL music that keeps all its delicate, subtle high and low tones. The human voice in its natural roundness, instead of a tomb-like growl. In short, clear, mellow, natural reproduction of everything that your receiving set brings in—in volume that satisfies you. That's the result anyone who owns a phonograph can secure by simply adding an N & K Imported Phonograph Unit. Made abroad by the makers of the now famous N & K Imported Phones and Loudspeaker. Price \$7.50. Sold by better radio dealers on a five day Free Trial basis. Write for free booklet.

TH. GOLDSCHMIDT CORPORATION
Dept. P 12, 15 William St., New York
41 Common St., Montreal, P. Q.



Imported
PHONOGRAPH UNIT

Reg. U. S. Pat. Off.

CARDWELL LOW LOSS GROUNDED ROTOR CONDENSER

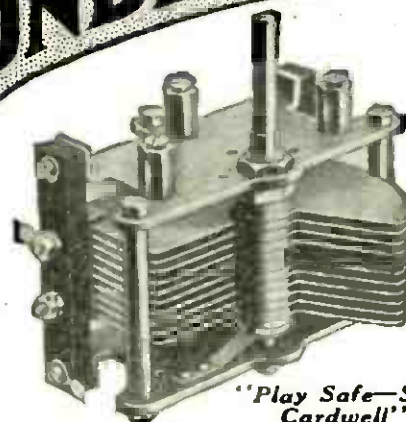

"Play Safe—Say Cardwell"

The exclusive choice of Laurence Cockaday for his new Four Circuit Tuner, described in the October issue. This again emphasizes the fact that of all the various kinds of radio apparatus on the market to-day the CARDWELL CONDENSER is the ONLY unit which is recognized by engineers and technical Editors of National prominence as the ONE best.

A Post Card Brings you an Education on Condensers
ALLEN D. CARDWELL Mfg. Corp.
81 Prospect St. Brooklyn, N. Y.



Of Course It's
a CROSLEY
 Better—Costs Less
Radio

Crosley
Head Phones
 Better—Cost Less
\$3.75

THINK of the boundless delight of that dear old mother, confined to the house by the rigors of winter or the infirmities of age, when she listens in for the first time on a Crosley Radio. Imagine the joy of the kiddies, when they awaken you Christmas morning with the glad tidings that "Santa has brought us a Crosley Radio." Then decide to make this a Crosley Christmas. There can be no gift with greater possibilities for continued happiness than a Crosley set. It carries Christmas along through the year, continually giving new thrills and happiness, and bringing pleasant thoughts of the giver.

It is a delight to operate a Crosley. The immediate response to the turn of the dials; the clearness of reception from far distant points; the real ease with which local stations may be tuned out; all help to make Crosley reception distinctive and exceptionally pleasurable. The very low cost at which this really remarkable radio performance can be obtained places Crosley sets within the reach of all—the ideal Christmas gift.

BEFORE YOU BUY—COMPARE YOUR CHOICE WILL BE A CROSLEY

For sale By Good Dealers Everywhere

*Crosley Regenerative receivers
 are licensed under Armstrong U. S. Patent 1,113,149
 Prices West of the Rockies add 10%*

Write for Complete Catalog

THE CROSLEY RADIO CORPORATION

Powel Crosley, Jr., President

1216 Alfred Street Cincinnati, O.
Crosley Owns and Operates Broadcasting Station W L W

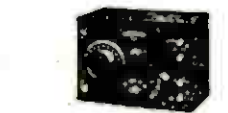

Crosley One Tube Model 50, \$14.50
 With tubes and Crosley Phones \$22.25

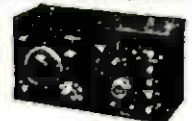

Crosley Two Tube Model 51, \$18.50
 With tubes and Crosley Phones \$30.25

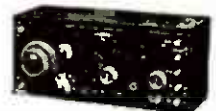

Crosley Three Tube Model 52, \$30.00
 With tubes and Crosley Phones \$45.75



Crosley Trirdyn Regular, \$65.00
 With tubes and Crosley Phones \$80.75



Crosley Trirdyn Special, \$75.00
 With tubes and Crosley Phones \$90.75



Crosley Trirdyn Newport, \$100.00
 With tubes and Crosley Phones \$115.75

Mail This Coupon At Once

The Crosley Radio Corp'n
 1216 Alfred St.
 Cincinnati, O.

Mail me, free of charge, your catalog of Crosley receivers and parts.

Name _____

Address _____

All apparatus advertised in this magazine has been tested and approved by POPULAR-RADIO-LABORATORY.



Mr. E. N. Pickerell, Chief Radio Officer, S. S. Leviathan—formerly a student of the Radio Institute of America.

Travel—Good Pay and a Big Future in Radio

Our graduates are now traveling all over the world as ship radio operators. And this well-paid profession offers the same remarkable opportunities to you.

Study at Home

Even if you know nothing about radio now—you can obtain your U. S. Government Operator's License in a few months. Our home study course will prepare you. It teaches everything from elementary electricity through code, commercial operation, and the latest developments of radio.

Since 1909

this school has been turning out qualified operators. The Radio Corporation of America conducts the school and gives employment preference to our students. Write today for details of the course and information on how you can become a trained radio operator in a few months of home study.

Advanced Radio Course

Great popular demand by the advanced student, experienced amateur and wireless operator has led to the opening of an **ADVANCED HOME STUDY RADIO COURSE**, specializing in C. W., I. C. W., telephone and radio measurements. Investigate!

Radio Institute of America

(Formerly Marconi Institute)
Established 1909

322A Broadway, New York City

Indicate by a cross X the course you are interested in:

Radio Institute of America,
322A Broadway, New York.

Please send me full information about radio opportunities today, and your

COMPLETE RADIO COURSE
ADVANCED RADIO COURSE

Name.....

Address.....



 If it's a good hydrometer,
 it's a
Perfection
HYDROMETER
 A glance instantly gives condition of your battery.

It's in the float. If the name **PERFECTION** is not on the float it is not a genuine **PERFECTION**.

Look for the name **PERFECTION**—it represents supreme quality in a hydrometer.

Abutments in nozzle preserve clear air passage and prevent clogging and leaking. Float studded to prevent sticking.

Every detail is perfected to give the Radio set owner the finest hydrometer obtainable.

\$1.00 At All Radio Dealers

Bemco Manufacturing Company
243 W. 55 St.
N. Y. City

Genuine Miller-B-Metal Crystals

Made in 3 types, ranging in price from 50c to \$1.00. Miller-B-Metal Crystals are famous for their loud, clear reproducing qualities. For reflex work anyone of these crystals gets the limit in tone value from your set. The super-sensitive quality of Miller-B-Metal is well-known—every pin point a "hot spot".

Miller Set \$1.79

Equipped with the Miller-B-Metal \$1.00 crystal this set has remarkable tone and volume. Many fans use it instead of their expensive sets for local work. There is no value like this.

*Miller guarantees every product
At your dealers or order from us direct
Literature free*

The A. H. MILLER RADIO CO.
1216 20th St. Detroit, Mich.

Nothing Electrical But the Performance

You add no electrical complication to a radio set when you install a Superspeaker.

No extra batteries or coils—nothing to wear out or get out of order.

Even the adjustment is on last-forever fundamentals—a positively operating cam of metal that stays put.

Just a simple, musical instrument that gets its music from an exceedingly sensitive reproducing unit, and amplifies by means of a strictly non-vibrating horn.

An instrument, designed and built by experienced musical instrument manufacturers who know acoustical laws and put this knowledge into practice. An instrument, therefore, from which you justly expect—and receive—amazingly different performance.

The experienced Radio operator found out long ago that there was far more to a loud speaker than a horn and a reproducing unit. Superspeaker performance alone has been striking proof that certain secrets do exist. Whatever these secrets may be, he has found that The Superspeaker gives him results he cannot otherwise duplicate. So he is content.

Do you wonder that Superspeaker demand has increased more than 1000% during 1924?

By sheer merit, The Superspeaker has won its leadership and performance. Give your set a chance to show what it can do with Superspeaker equipment!



JEWETT RADIO &
PHONOGRAPH CO.
5668 Twelfth St., Detroit, Mich.

The Superspeaker

All apparatus advertised in this magazine has been tested and approved by POPULAR RADIO LABORATORY

BARKELEW

Lightning Arresters

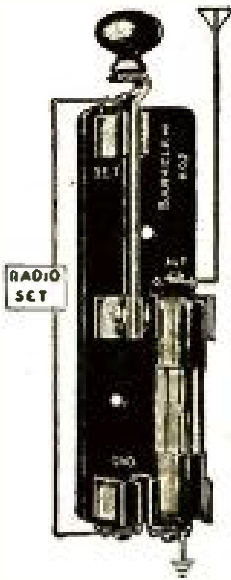

LIGHTNING ARRESTER SWITCH
No. 602 Price \$3.00

THE National Electric Code requires an approved protective device (Lightning Arrester) on the lead-in wire of every radio receiving antenna.

Our No. 602 Lightning Arrester Switch is universally recognized as the only device on the market which combines on one base all those functions essential for maximum protection.

The vacuum tube arrester is permanently in the circuit from antenna to ground, ready to "spill" any overcharge. With the switch blade the antenna may be disconnected from the radio set and thrown directly on ground.

It meets not only the requirements but also the additional recommendations of the National Electric Code. It is approved by the Underwriters' Laboratories.

Our No. 606 Vacuum Tube Lightning Arrester is less expensive but it meets all the actual requirements of the National Electric Code.

It is approved by the Underwriters' Laboratories.

For full description of each item, see our new Radio Catalog No. 32 at your dealer. If he hasn't his copy, we have one for him.



LIGHTNING ARRESTER
Vacuum Tube Type
No. 606 Price \$1.50

The Barkeley Electric Mfg. Co.
Middletown, Ohio, U.S.A.

- | | | | | | |
|-------------------------------------|-------------------------------------|------------------------------|---------------------------------|-------------------------------------|--------------------------------|
| WASHINGTON, D. C.
Mills Building | MINNEAPOLIS
1017 Lumber Exchange | NEW YORK
157 Chambers St. | CHICAGO
15 S. Clinton St. | DETROIT
McKerchey Bldg. | DENVER
Denham Bldg. |
| | | | SAN FRANCISCO
75 Fremont St. | LOS ANGELES
443 S. San Pedro St. | SEATTLE
1041 Sixth Ave.; S. |

Campbell

RADIO CABINETS

"From the Lumber to You"

Special Sizes to Order



Mounting Boards
50c each

WILL NOT WARP OR CRACK

Made of No. 1 wood finished in either Mahogany or Walnut, bright or rubbed finish to match the finest of furniture.

PRICES

Cash with order, prepaid east of Missouri River; west, add 15 cents to quoted price. Send Post Office or Express Money Order.

Panel Sizes	Imitation Mahogany	Genuine Walnut or Mahogany
7 x 10 x 7.....	\$3.00.....	\$4.75
7 x 14 x 7.....	3.30.....	5.50
7 x 18 x 7.....	3.82.....	6.75
7 x 24 x 7.....	5.25.....	9.00
7 x 26 x 7.....	6.05.....	10.00
7 x 28 x 8.....	7.25.....	11.50
7 x 27 x 9.....	7.25.....	12.50
7 x 40 x 10.....	11.25.....	18.00

Manufacturers' and Dealers' Liberal Discounts Sent Upon Request

THE PERKINS-CAMPBELL CO.

(Established 1879)

410-440 New St., Cincinnati, O.

(References: Dun or Bradstreet's)

BRAIDED COPPER RIBBON



CLEARER SIGNALS
INCREASED RANGE
TAKES LESS BATTERY CURRENT

Our newest and best radio antenna wire

Braided Flat Ribbon

Contains over one-half mile of wire strands. For out door or indoor use. In Copper—Tinned Copper—Enameled Copper. We also make round antenna wires in all types and metals. Loop wires, Litz wires, Cotton covered wires.

Ross Antenna Co.
9 Charles St., Providence, R. I.

NEW COCKADAY 4-CIRCUIT TUNER WITH RESISTANCE-COUPLED AMPLIFIER

All parts as specified by Cockaday in stock for immediate shipment. Any parts sent prepaid at factory list price.

Complete kit, including genuine Cockaday blue prints - - - - - \$64.00

Send for price list

Shipment sent C. O. D. if desired. Order by postcard, pay the postman.

RADIO SURPLUS STORES
Helena - - - - - Montana

Built to provide loud speaker entertainment from stations thousands of miles away—even while nearby stations are broadcasting.

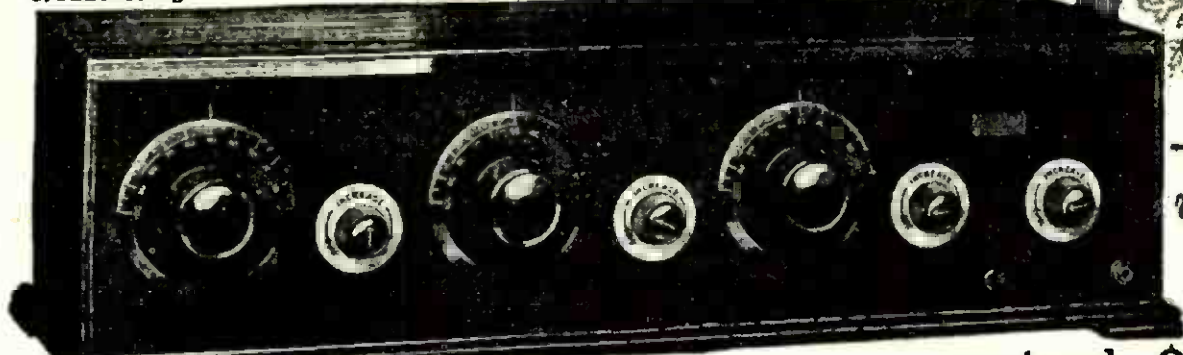
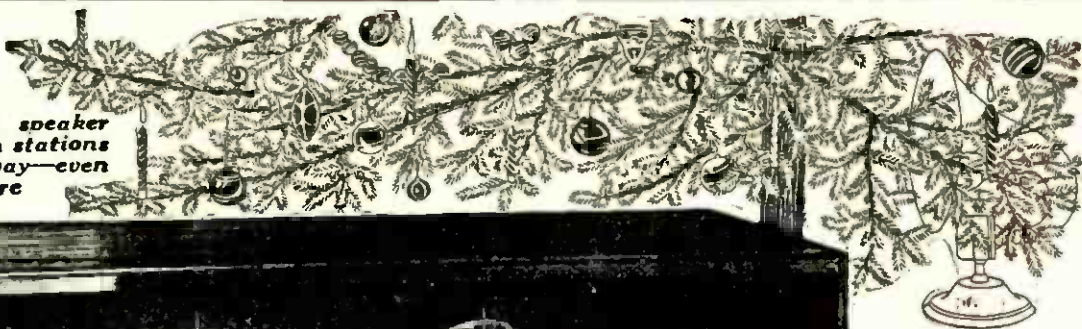

-the gift the whole family will enjoy

-costs only \$75

The Marvelous MIRACO Ultra 5

[FIVE TUBE OUTFIT, IN BEAUTIFUL SOLID MAHOGANY CASE]

Unsurpassed selectivity, sensitivity, range, volume and tone combined

A beautiful sweet toned, five tube, "coast to coast" loud speaker set—factory-built, factory-tested and factory-guaranteed by one of America's oldest and most reliable manufacturers of quality sets. Composed of the finest parts obtainable. Equipped with the latest improvements, refinements and features found on costliest sets. Encased in a handsome hand-rubbed solid mahogany cabinet. Looks and performs like \$200 set. Thoroughly tested and approved by radio's highest authorities. For only \$75—a price which has rocked the industry! Unquestionably the most astounding value offered radio lovers.

Simple to connect and operate. No experience necessary.

Even a beginner can quickly learn to cut through the locals, get far-off programs loud and clear on the speaker, log all stations and bring them back at will. Full directions with each set.

The Miraco "Ultra 5" is non-radiating, non-howling, non-distorting. Has cut-out switch—and a first stage phone jack, for tuning—on front of Bakelite panel. Bakelite sub-base under which all wiring is hidden, and other newest features. Operates on storage battery or dry cells.

Other Miraco Long Distance Sets \$14³⁵ up



The Improved Miraco 1925 Model MW—with filament switch, phone jack, etc.—is a four tube outfit that users in every state report outperforms and out-distances sets twice as expensive. Operates loud speaker on distant stations. One stage tuned r.f. amplification, detector, two stages a.f. amplification. Solid mahogany cabinet. Value beyond duplication at \$54.50.

This wonderful new Miraco Model R-3 is the three-tube, long distance, loud speaker set that has created such a sensation. Easy to tune and log. Covers wave lengths 150 to 625 meters. Detector acts also as a tuned r.f. amplifier. 2 stages a.f. amplification. Has no equal for simplicity, volume, range or clearness at anywhere near its price of \$29.50.

Miraco Model R justly deserves its title. "Radio's finest low priced quality receiver." One tube acts as a tuned radio frequency amplifier and detector combined. A great distance getter. Easy to operate and log. Covers all wave lengths 150 to 625 meters. Like all Miraco sets, it uses storage battery or dry cells. Never such value before at only \$14.35.

Send coupon for free bulletins!
or order direct from this ad

MIDWEST RADIO CORPORATION, Pioneer Builders of Sets
479-D East Eight Street, Cincinnati, Ohio.

Send free literature and full particulars about your complete line of Miraco products.

() Dealer () Jobber () Agent () User

NAME

ADDRESS

**MIRACO
RADIO
GETS 'EM
COAST TO
COAST**

NOTE: Remember that Miraco Tuned Radio Frequency Sets are built and also guaranteed by a reliable, long established concern, one of the first to build quality sets. Thousands of users endorse their satisfactory performance. Send for further testimony of coast to coast reception and proof that Miraco Sets are radio's finest low-priced receivers.

COLORADO HEARS N.Y. AND CALIFORNIA

I heard New York and California the first night on my Miraco.—Fred Knappenburg, Jr., Burns, Colo.

NEW YORK HEARS ALASKA

Received 115 stations with my Miraco including WLAJ Fairbanks, Alaska, NNW Panama, KSL San Francisco, WEV Houston, Texas, and CFAC, Calgary, Canada. E. D. Elliott, Milford, N. Y.

OHIO HEARS 12 CITIES THE FIRST NIGHT

The first night we tried out our Miraco we got Atlanta, Philadelphia, Washington, New York, Detroit, Davenport, Omaha, Hastings, Nebr., Chicago, Schenectady, Pittsburgh and Texas. We think that was real good for beginners.—W. L. Musselman, New Carlisle, Ohio.

NORTH DAKOTA HEARS 43 STATIONS FIRST 3 DAYS

Bought a Miraco, operated it three days and received: WGR, WLW, WDAP, KFI, CHOM, WJAZ, WMAI, CFAC, WTAM, KYW, KFAX, KLZ, WWJ, WOC, WPA, 9PL, KDAK, WBAP, KFKX, PWX, WOB, WHB, WDAP, WHAS, KFI, KFEB, WLAG, WBAH, WHA, KCAL, WEAF, WOAW, WCAE, KGW, WCK, WGY, RSD, WPAM, CRY, WCBG, WTAY. Who has a better record?—W. L. Johnson, Ashley, N. D.

DEALERS, AGENTS

Write for our new proposition. The nation-wide use and popularity of Miraco Sets, their amazingly low prices and the extensive advertising we are doing, makes them wanted everywhere. Send coupon today—good territory open.

All Miraco sets are factory-built, COMPLETELY ASSEMBLED, factory-tested and factory-guaranteed. They may be used with any tubes or batteries.

All apparatus advertised in this magazine has been tested and approved by POPULAR RADIO LABORATORY



Does Your Loud Speaker Sound Like a Megaphone?

Scientists Solve Baffling Radio Problems

You know how a megaphone makes the voice sound deeper. A baritone is made to sound like a bass. A soprano, like a contralto; a violin like a bass viol. The "pitch" or register is often entirely changed.

To this problem, the Dictograph sound engineers applied their 20 years' experience in the making of acute and powerful sound instruments.

Out of this has come the Dictogrand. The long awaited perfect loud speaker, constructed with an articulating, larynx-like base and an acoustically perfect horn which counterbalance any tendency for sound to deepen out of its intended register.

The Dictogrand gives you the best your receiving set can take out of the air. Your dealer will let you try a Dictogrand 5 days free. Write the Dictograph Products Corporation, 220 West 42nd Street, New York City, Department P-12, for a 5 day free trial coupon.



Two Models

Upright and Portable \$25 and \$24.50 respectively

Dictogrand

The Articulating
LOUD SPEAKER



APEX VERNIER DIAL

Do not bother with scared condensers, requiring many holes in the panel and careful lineup of pinion shafts, when this marvelous instrument provides the fine adjustment for tuning in distant stations. Ratio 10 to 1—quickly applied to any shaft. For sale by all good radio dealers. If unable to obtain, fill in coupon and enclose \$2.50 for nickel finish or \$3.50 for Gold Plated finish.

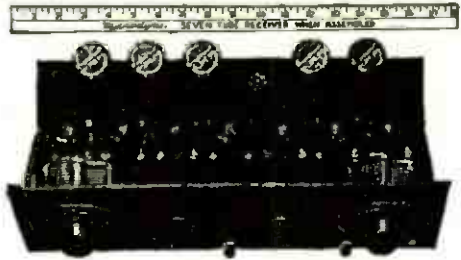

Coast To Coast On An 18-Inch Loop

Assemble Your Own 7 Tube Super-Heterodyne

—on a 7 x 18 panel in three hours, \$97.50 buys the parts complete, including drilled and engraved panels, condensers, sockets, transformers, dials, connecting plugs, cables, etc., with drawings, diagrams and instructions. Price of cabinets to fit—furnished on application. If your dealer cannot supply these parts for this complete Microdync Radio Set, fill in coupon, mail check or money order and send dealer's name.

Apex Electric Mfg. Co., Dept. 1202
1410 W. 59th Street, Chicago, Illinois.

Gentlemen: Enclosed find \$.....for which send me

Name.....
Street.....
City..... State.....

Positively Sensational!

The Fixed Detector Marvel

Radio's Latest Scientific Triumph
The most sensitive fixed detector known for Reflex and Crystal sets



Lego Wonder Fixed Detector

100% sensitive. Not so long ago many dealers believed the Reflex and Crystal set to be a thing of the past, but that was before LEGO began to show them new tricks. Buy a Lego TO-DAY. Note the difference.

For Sale by All Dealers 90c., or Sent Postpaid Insured, \$1.00

Lego Corp., 225 West 77th St., New York City

KESTER *Radio* SOLDER

(Rosin Core)

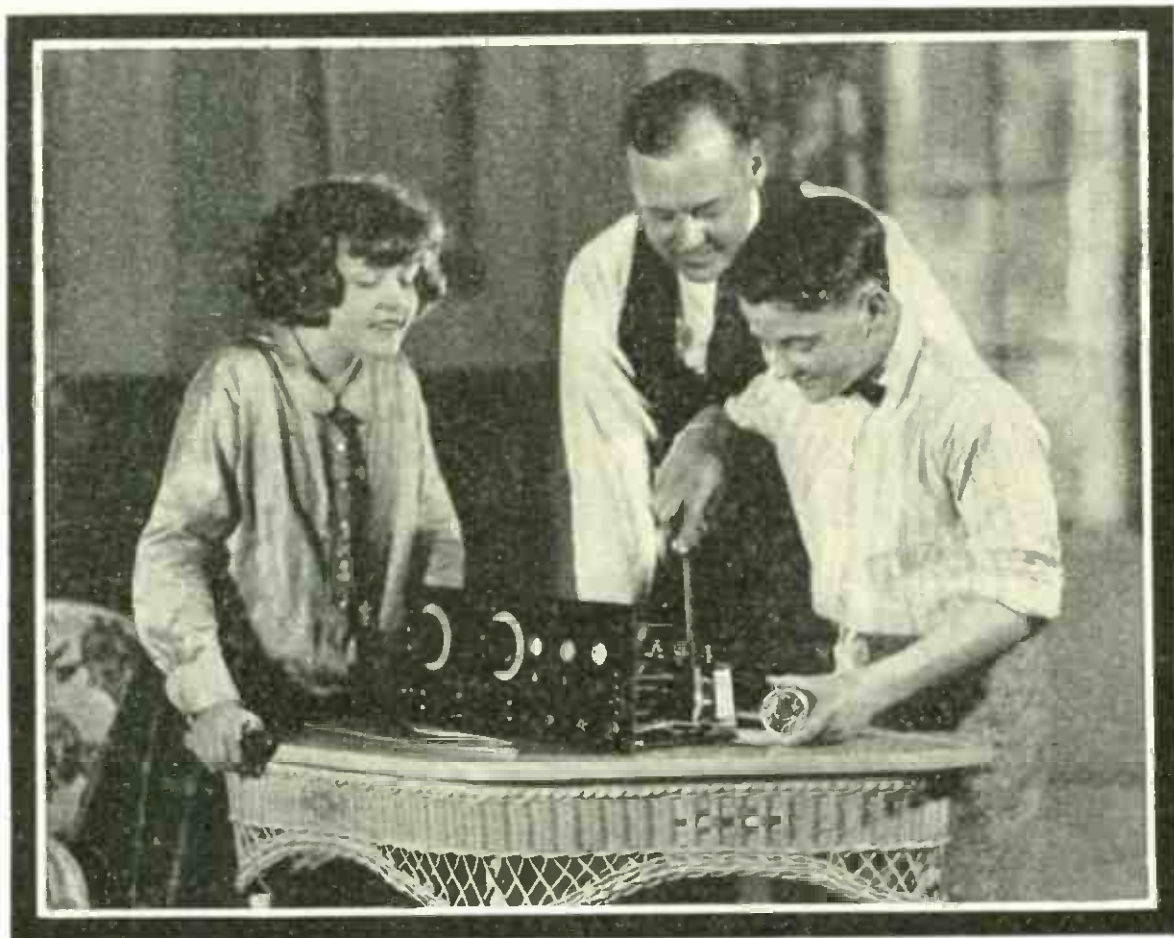

Oh boy! It Sure is Safe and Simple



**YOUR DEALER
CAN SUPPLY YOU**

IF NOT - USE THIS COUPON

Chicago Solder Company
4221 Wrightwood Ave., Chicago, Ill.
Gentlemen: Send me one can Kester Radio Solder, for which I enclose 25c in stamps.
(Postpaid anywhere in U. S. A.)

Name.....
Address.....
City..... State.....
Dealer.....

Why it is Better

"**M**ASTER of Every Note in the Orchestral Range" is the *proven* claim of the Federal #65 Audio Frequency Transformer! Volume without distortion is the basis for the beauty of Federal Tone.

From its oversize locking nuts to its heavy brass mounting feet the Federal #65 Transformer incorporates the same engineering skill that has made Federal the recognized leader in electrical communication apparatus since 1890.

Insist upon Federal parts for your "pet" hook-up. There are over 130 standard parts bearing the Federal iron-clad performance guarantee.

FEDERAL TELEPHONE AND TELEGRAPH CO.
Buffalo, N. Y.

Boston New York Philadelphia
Chicago Pittsburgh
San Francisco Bridgeburg, Can.



Federal

Standard RADIO Products

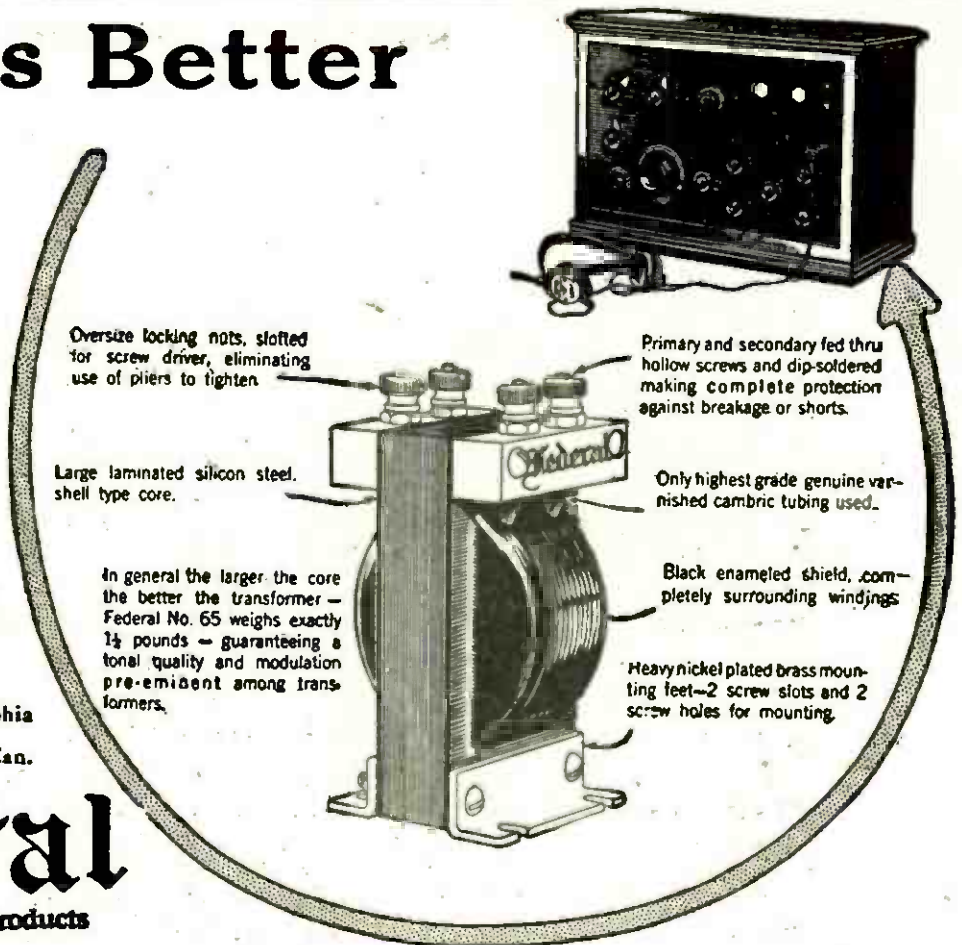

Ratios 3 1/2 to 1
and 5 to 1
\$4.25 and \$4.50

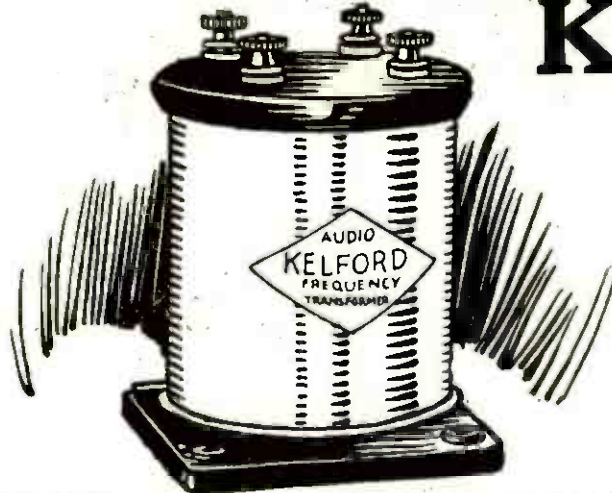

Nickel or brushed brass

KELFORD

SHIELDED AUDIO FREQUENCY TRANSFORMER

Considered by experts most perfect transformer ever constructed. Used in many of the world's finest sets. Gives great and clear volume without distortion.

Made by America's oldest manufacturer of radio parts
Send Post Card for full details

The American Specialty Co.
178 Holland Ave. Bridgeport, Conn.

Radio Dealers HEADQUARTERS

The House of a thousand values

Eight Big Warehouses Write for Catalog C1003

WAKEM & McLAUGHLIN
225 E. ILLINOIS ST. - CHICAGO

CARTER "IMP" Battery Switch

65c 

The smallest made. Here's a switch you can put on your set and leave there. Mounts like Jack. A quarter turn throws switch. Clearly indicating "On and Off". Complete, ready to install.

Pat. Jan. 30, 1923 Half Size

Any dealer can supply Insist on the original Write us for catalog

In Canada—Carter Radio Co., Ltd.—Toronto

Carter Radio Co.
1807 REPUBLIC BUILDING CHICAGO

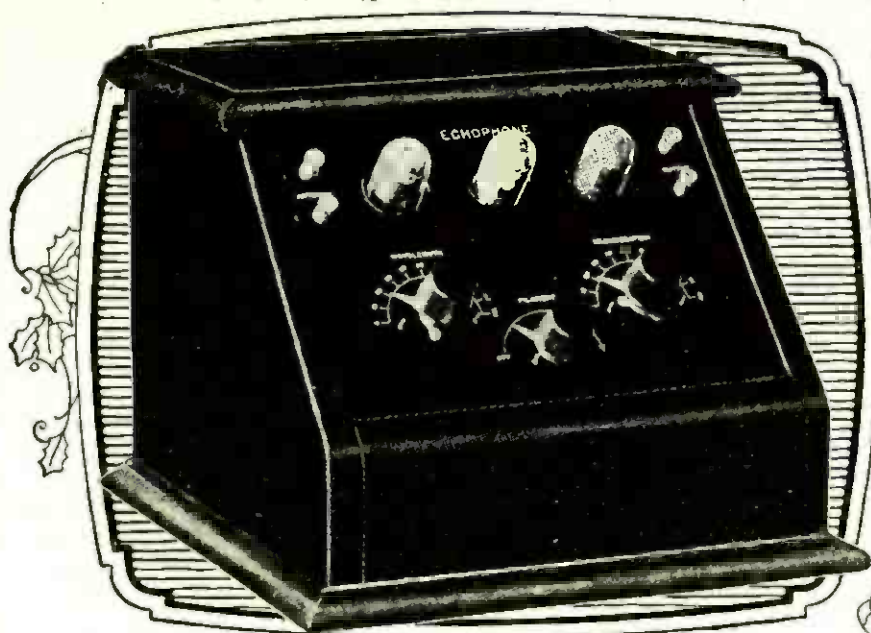

The ECHOPHONE "V-3"
The Super-Volume
3-Tube Regenerative
Without Tubes and Batteries

\$ 50.00



The Ideal Gift Distinctively Superior Yet Moderately Priced

WHEN you give your family the Echophone "V-3" for Christmas you are giving them radio entertainment of a noticeably finer quality than is afforded by any other three tube receiver on the market.

For here is a machine that brings "real music" into your home—that reproduces even on a loud speaker all high and low pitch tones, all voice modulations exactly as they are when they enter the microphone a half mile or eighteen hundred miles away. The Echophone "V-3" is a receiving set any novice can operate. It has only two tuning controls which once set bring in *only* the stations wanted. Operates with dry cell batteries, which fit into the handsome Adam Brown finished self contained cabinet.

As comparison readily reveals, such performance is available at moderate cost only in the Echophone "V-3." It is the result of special construction features and the use (through license obtained under U. S. Patent No. 1,113,149) of Armstrong's famous regenerative circuit.

For those who want the ultimate in radio reception there is the Echophone "F-5." The 5-tube combined radio and audio frequency set that assures loud speaker reception of distant stations from either loop, indoor or outdoor aerial.

Ask your dealer about these sets today. Meantime send for our descriptive folder. Address

The Armac Radio Company, Agents
1120 N. Ashland Ave., Chicago, Ill.

Manufactured by THE RADIO SHOP, 1120 N. Ashland Ave., Chicago, Ill.
Long Beach, Cal. Sunnyvale, Cal.



ECHOPHONE "F-5"
Without Tubes and
Batteries
\$110.00

ECHOPHONE

Storage Battery Results at Dry Cell Cost

THE ARMAC RADIO CO.
1120 N. Ashland Ave., Chicago, Ill.

Please send folder describing fully the Echophone "V-3" and the Echophone "F-5." My Radio dealer is

Name.....

Address.....

Dealers: Get in Touch
With Your Jobbers.

All apparatus advertised in this magazine has been tested and approved by POPULAR RADIO LABORATORY



**Cannon-Ball Headset
\$3.50**

Radio as you like it through a Camco Headset or Loud Speaker



Camco craftsmen specialize on Radio Headsets and Loud Speakers. See them at your dealer's or write for folder "Radio as you like it."

Invest your money wisely in a Camco Cannon-Ball at \$3.50 or a Camco Grand at \$4.75. Camco Loud Speaker pictured here complete with permanent adjustment Loud Speaker unit at \$9.50. West of Rockies \$10.50.

CAMCO GUARANTEE

This is a frank, liberal, ironclad guarantee covering the Camco Cannon-Ball Headset, Camco Grand Headset and Camco Loud Speaker. The quality and craftsmanship in a Camco product proves itself when it goes through the test of actual service. The Camco product that you buy must satisfy you. Every Camco dealer is authorized to cheerfully refund the full purchase price to any purchaser upon the return of a Camco product if it fails to give absolute satisfaction within a period of ten days from date of purchase.

Cannon & Miller Co., Inc.
C. Cannon
President

Dealers: Ask your jobber about Camco products or write for complete details.
CANNON & MILLER CO., Inc.
SPRINGWATER, N. Y.



**Puts the Joy
in Radio**

AFTER all, what is sweeter to your ears than the music from some DX Station coming in on the loud speaker, clear and undistorted? To insure amplification without distortion, use the "HEGEHOG." This marvelous little audio transformer, half the size of any other made, is different in design—the most efficient construction known, for transformers. It has an exclusive self-shielding feature that shuts out foreign noises. Unsurpassed for volume and tone quality. Saves space, mounts anywhere and easy to connect. Ideal for portables.

- Ratios 1 to 3, 1 to 4 and 1 to 5 - \$3.50
- Ratio 1 to 10 - - - - - 4.50

Write for Free Bulletin No. 84, showing complete line of Premier Quality Radio parts. Ask your dealer for Premier Free Hook-Ups. If he does not have them send his name and receive a set free

Premier Electric Company

3807 RAVENSWOOD AVE., CHICAGO

**PREMIER
Quality Radio Parts**

Big Dealer-discounts

Send for our new catalog

It lists and illustrates absolutely dependable, guaranteed sets and parts. Give your customers what they want—when they want it; but buy it so that you can make a good profit. We're supplying hundreds of radio dealers satisfactorily every day. Write for catalog and discounts sheet. You'll be astonished at the prices quoted.

Ask for catalog No. 9

W.E. Fuetterer Radio Supply Co.
Send for our latest catalog

W.E. Fuetterer Radio Supply Co.
2123-25 Locust
St. Louis, Mo.

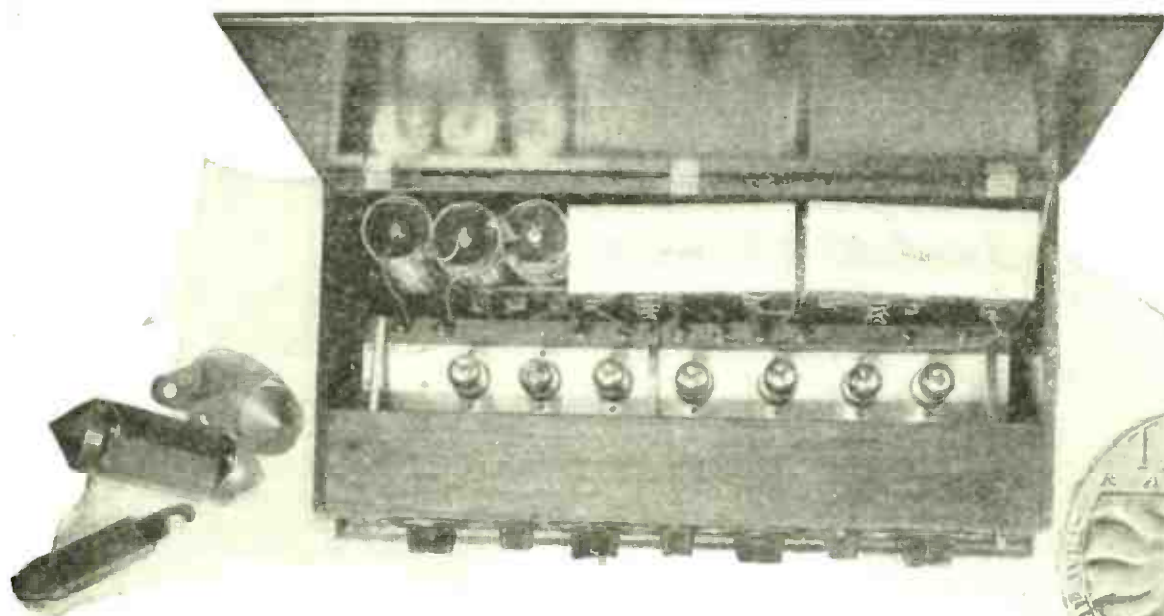

Interior view of a typical set you can build with the new Telos KIT.



You can't buy it—

but if you are the least bit handy with tools, you can build this amazing Telos set yourself in a single afternoon.

The basic goodness of Telos design is the same as it has been for three years. But now, Telos excellence has been extended to include *three* stages of tuned R. F. and super-imposed (reflexed) resistance-coupled A. F. as well.

The new Telos KIT opens up a world of fascinating possibilities in radio. As in the photo above, you can build a 5, 6 or 7 tube set, and run it all on dry cells! It will cost you less to run than any other set of like power!

You can introduce a crystal detector if desired! You can use transformer

A. F. if you prefer. But no matter what combination you select, you will find clear, unmistakable instructions in the book that comes with every Telos KIT, and you will accomplish results you never thought possible before!

Fill out the coupon now. Get your copy of the new, generously illustrated booklet, "The KIT of a Thousand Possibilities." It's free, but the edition is limited to those who are genuinely interested in superlative radio reception!

Telos Radio

Danziger-Jones, Inc.,
Dept. A, 25 Waverly Place,
New York, N. Y.

Send me at once your booklet "The KIT of a Thousand Possibilities."

Name

Address

It's Here!

New R. F. Transformer that Brings 'Em In!

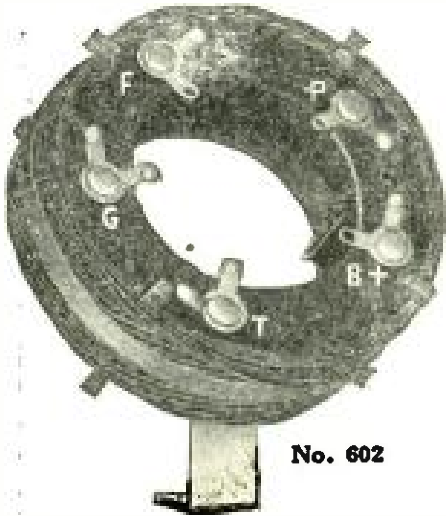

No. 602

A radio frequency transformer of the aperiodic type suitable for all sets with which tuned radio frequency is desired. Also used for one stage of audio frequency amplification ahead of regenerative sets to prevent re-radiation.

Consider these points of superiority—

No dope to hold windings in place.

Soldered connections.

Mounting bracket holds coil at correct angle.

Minimum rubber used in form.

Lowest possible loss.

Works with any .0005 condenser.

Secondary arranged with suitable taps for biasing features.

This Kellogg transformer makes the construction of a radio frequency set an easy matter, assuring best possible reception with widely varying types of circuits, including reflex.

Built and guaranteed by Kellogg Switchboard & Supply Co.

No. 602 Transformer at your dealers for \$2.35 each.

KELLOGG SWITCHBOARD & SUPPLY COMPANY

1066 W. ADAMS STREET

CHICAGO, ILLINOIS

"Just Be Sure
It's a
Hammarlund"

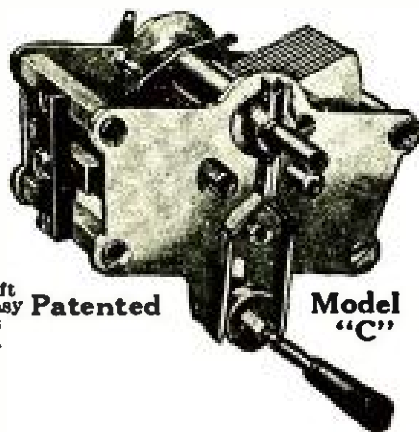

1. Clock spring pig-tail
2. Ball bearing rotor shaft
3. Cut back plates for easy tuning on low waves
4. Strongest construction
5. Losses too small to measure
6. Soldered brass plates
7. Micrometer vernier
8. Takes any size dial

HAMMARLUND CONDENSER

Write for New and Interesting Folder

HAMMARLUND MFG. CO.

424-438 W. 33rd Street

New York

Canadian Representatives
RADIO LIMITED, Montreal, Que.

"Good Parts

Make a Good Set"

USING BEL-TONE parts is like taking all the guesswork out of radio. Results are assured, each part does what it is designed to do. An unconditional guarantee goes with every BEL-TONE unit.

BEL-TONE HEADLINERS
Bel-Tone Kit for Superdyne Circuit, (Coupler and Plate coil) \$7
Bel-Tone Variocoupler . . . \$5
Bel-Tone Variometer . . . \$5
(All molded of Genuine Radion)
Bel-Tone Mounted Binding Posts \$1
ASK YOUR DEALER OR WRITE US

Bel-Tone Radio Co.

Manufacturers

161-167 Jamaica Ave., Bklyn., N.Y.



All apparatus advertised in this magazine has been tested and approved by POPULAR RADIO LABORATORY

Quality - Easily Recognized.

Gifts that will bring joy to any Radio BUILDER

TYPE 247-H Geared Condenser Price \$5.00

TYPE 231-A Amplifying Transformer Price \$5.00

TYPE 268 Variocoupler Price \$3.50

TYPE 269 Variometer Price \$5.00

TYPE 247-W Wavemeter Filter Price \$10.00

For a Merry Radio Christmas

Acceptability

In selecting articles for Christmas giving, those who choose with the true Yuletide Spirit consider *acceptability* and *practicability*. To the radio builder who knows the necessity of good apparatus, nothing is more acceptable and practical

Practicability

than General Radio parts, which are scientifically designed by radio engineers. A set built with General Radio parts is your unfailing assurance of quality reception. Ask the man who has built one.



GENERAL RADIO Co
 Cambridge, Mass.,
 U.S.A.



All apparatus advertised in this magazine has been tested and approved by POPULAR RADIO LABORATORY

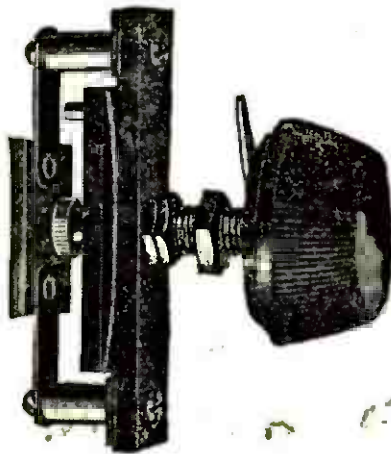

A smoothly adjustable **GRID LEAK**

that gives even regulation
from 1/4 to 8 megohms

The Centralab (formerly CRL) was one of the first and most successful variable grid leaks on the market. It gives smooth, unbroken adjustment through 900 degrees—2 1/2 turns of the knob—and gives absolutely uniform variation from 1/4 to 8 megohms. It makes possible the finest gradations and holds the value at which the knob is set. Single hole mounting.

No. 106 \$1.25
No. 107 (with .00025) condenser . . 1.60

We also manufacture the

Centralab	Centralab	Centralab
RHEOSTAT	BATTERY	NON-INDUCTIVE
No. 206—6	SWITCH	POTENTIOMETER
ohms, \$1.25	No. 300—	No. 110—400
No. 230—30	50c	ohms, \$1.50
ohms, \$1.25		No. 111—2000
		ohms, \$1.75

TO JOBBERS AND DEALERS: The trade mark of products of the Central Radio Laboratories has been changed from CRL to Centralab. Write for literature.

Centralab

CENTRAL RADIO LABORATORIES
293 Sixteenth St. MILWAUKEE, WIS.

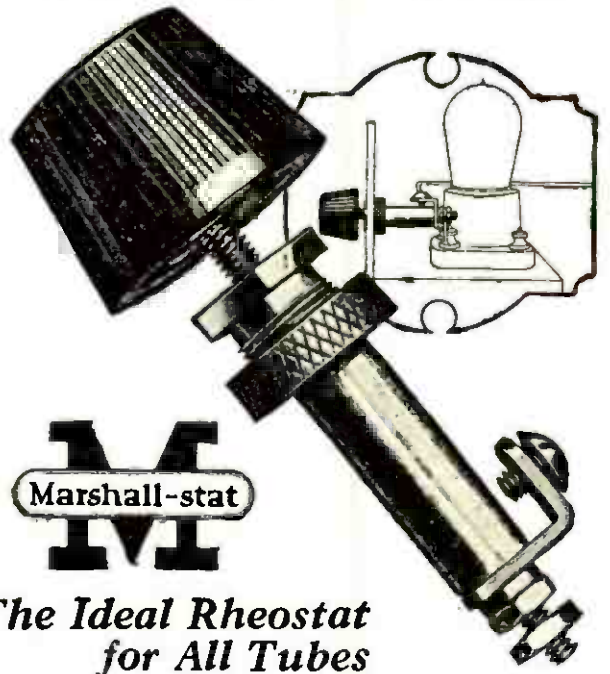

The Ideal Rheostat for All Tubes

The Marshall-stat provides a means of obtaining any desired tube adjustment with absolute precision. The Marshall-stat varies the resistance, not step by step, but smoothly, continuously, and uninterruptedly from zero to maximum.

The Marshall-stat provides vernier precision throughout its entire range. Yet there is only one knob to manipulate—no double adjustment to make.

Besides its precision and ease of operation, the Marshall-stat requires only one hole in the panel, has only two terminals, can be used with any tube or combination of tubes, and is so scientifically constructed that breakage of the specially-treated Marshall discs is impossible. Compact—note full-size cut above. Can be fitted anywhere. Price \$1.75.



MARSHALL ELECTRIC
COMPANY
3237 Locust Blvd., St. Louis, Mo.

Send for Old Man Ohm's descriptive folder on the Marshall-stat.

Best for Reflex

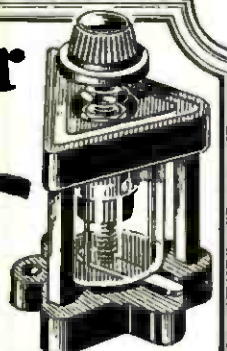

and Crystal Sets **FRESHMAN**

Double Adjustable
Crystal Detector

No more searching for the sensitive spot.—Merely turn the knob as you would a dial.

For base or panel mounting, complete with Freshman Super-Crystal \$1.50

At your dealer's, otherwise send purchase price and you will be supplied postpaid.

CHAS. FRESHMAN CO., Inc.
106-7th Avenue, New York

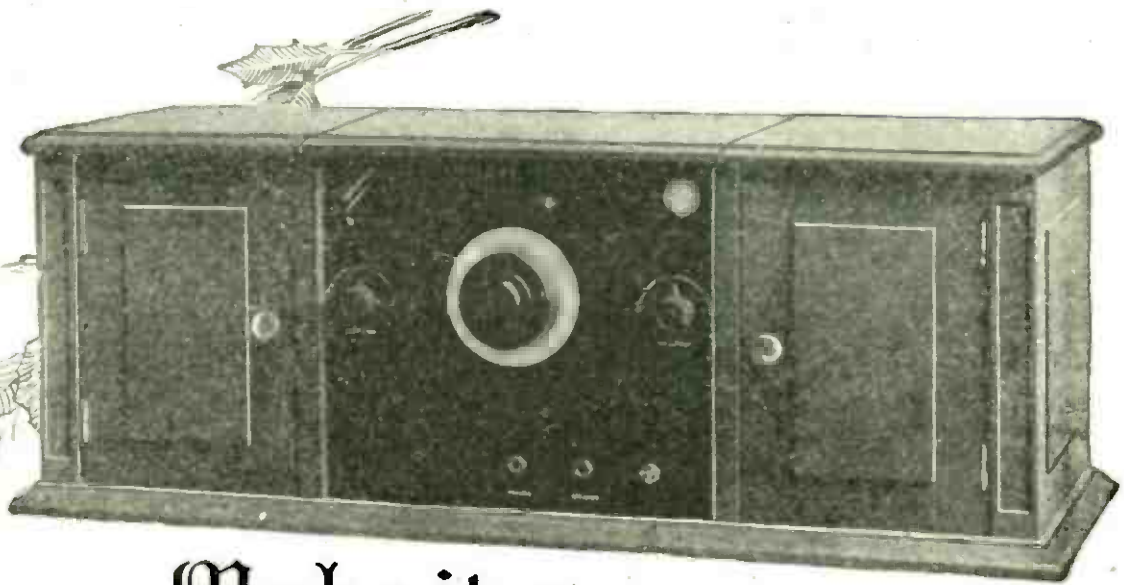

Make it a Radio Christmas

The "Brandola" is without question the most charming gift—one the entire family can operate and enjoy. With its simplified *one-dial control* it has made radio reception so simple that a mere novice can operate it with the same success as would be expected of a radio engineer. The "Brandola" is extremely sensitive and very selective—because of these features extraordinary distant range is made possible even though the set be operated within a circle of local broadcasting stations. Ask your dealer to demonstrate this feature for you.

By the use of Resistance Coupling in its amplification, the tone quality of the "Brandola" is so perfect that reception of music has been transferred into the realms of higher musical expression. The delightful clarity, mellowness and the absolute natural reproduction of the voice and musical instruments is a revelation to the radio art. Loud speaker reception of stations two thousand miles distant were recorded daily throughout the summer. Under favorable winter conditions, coast to coast reception should be obtainable with regularity.

Sold Everywhere

List Price \$125. West of the Rockies \$135. Canada \$165.

The Brandola

One Dial — Six Tubes



The J. F. BRANDEIS CORP.
39 Oxford Street, Newark, N. J.

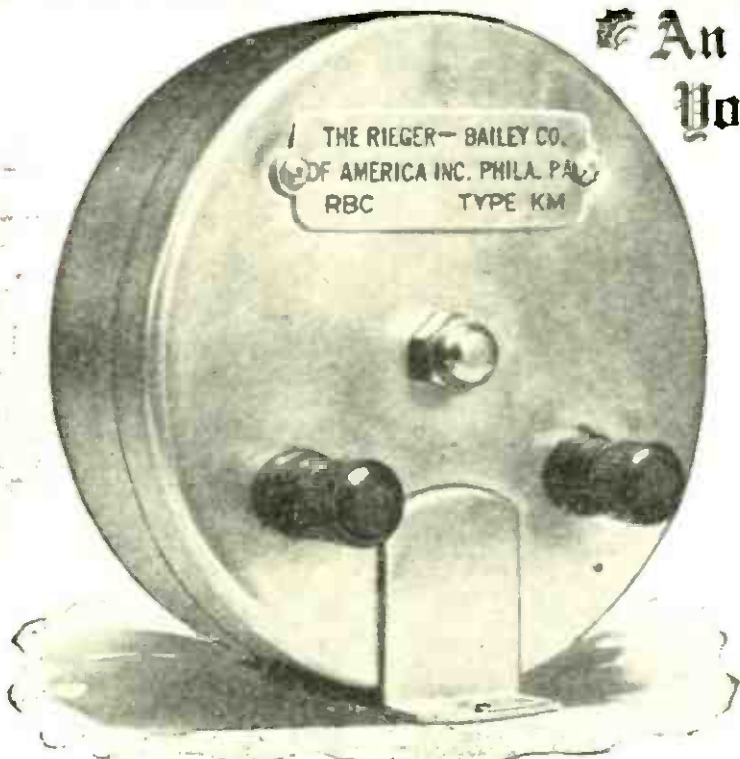

An Ideal Xmas Gift for Your Radio Friend

Salient Features

1. Each one a laboratory achievement.
2. Matched to a standard.
3. Air Core and shielded in nickeled-brass case.
4. Freedom from distortion.
5. Perfection of design eliminates the necessity of a Potentiometer and makes possible the low "B" battery consumption of 6-10 milliamperes on 8 tubes.

Pamphlet on request

The RBC-Type KM Filter, Oscillating Coupler and Transformer
Super-Heterodyne Intermediate Frequency Amplification at its Maximum

Order direct from us

THE RIEGER-BAILEY CO. OF AMERICA, INC.
815 Real Estate Trust Bldg. Philadelphia, Pa.

Duo-Spiral Folding Loop

Price
\$8.50

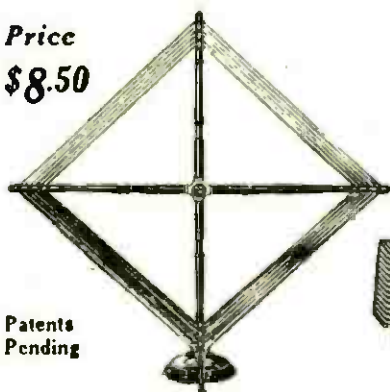

Patents
Pending

Reduces
Static

Increases
Selectivity

Easily
Portable

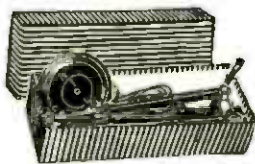

The highest development in a portable aerial. Compact, convenient and self-contained. Rotates on base, which is provided with silvered dial graduated for calibration. Handle permits adjustment without body capacity effects. Handsomely finished in silver and mahogany. Can be used anywhere.

TINY-TURN

A superior vernier control which makes perfect tuning easy. Has a gear ratio of 30 to 1. Rotates in same direction as dials. Easy to install. Fits any standard panel. Handsome nickel and ebony black finish. Price 75c. If you cannot secure DUO-SPIRAL and TINY-TURN at your dealers, write us direct.

Radio Units Inc.

1301 First Avenue Maywood, Ill.

Perkins Electric Ltd., Montreal

SIMPLEX DEX TUNER

180°

\$3.50

Spiral Wound Moulded Rotor

A high quality tuner specially designed for the Three-Circuit Untuned Primary Circuit. Unexcelled for long distance and extremely selective. Good volume. No soldering required.

At Reliable Radio Stores

SIMPLEX RADIO CO. (Mfrs.) PHILADELPHIA, PA.

"Buzz Boice" Makes It Easy To Do Hard Jobs



Hundreds of difficult operations are done quickly and much better with a **BOICE-CRANE JUNIOR BENCH SAW**

Easy to build handsome cabinets. The Junior saws, miters, sands, grinds and many other operations with ease and accuracy. Saws 1 1/4" stock. Special blades cut bakelite. Extension guide accommodates panels 24" wide. Sold on money back guarantee.

Write for descriptive catalog on bench saws, band saws and jointers.

W. B. & J. E. BOICE
Dept. 912 Toledo, O.

"Largest Builders of small Bench Machines in the World"

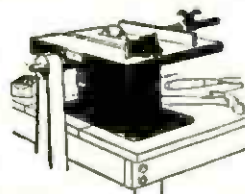

Be A Master OF THE Air

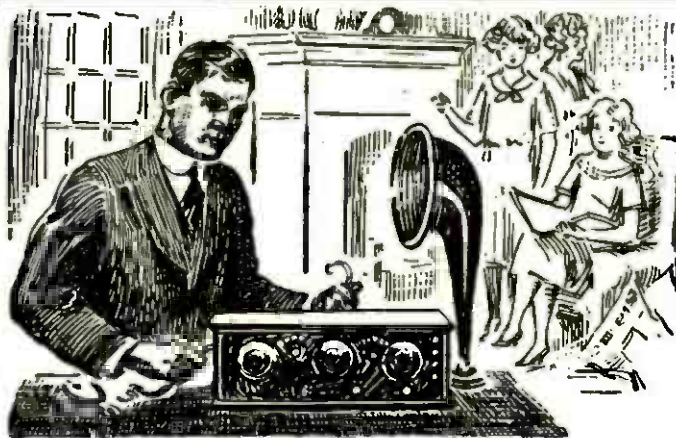

Pleasant Home Study

During the next few months you can, by devoting a few hours each week in pleasant home study, qualify yourself to get into the biggest paying field of all time. My practical, understandable course of instruction enables you to be a Master of the Air. Every problem in radio becomes an open book to you. *Be a Master of the Air and you will be a master of your future.*

\$3,000 to \$10,000
A Year as a Radio Expert

15,000 ships, hundreds and hundreds of Radio stations, with new ones springing up every day, are all keenly competing for the services of the radio-trained man. So enormous is the call for the radio expert that the man who knows his business in this field is in a position to *command* the size of his salary. On land or sea, in Government or private service, there are boundless fine paying opportunities for the man who understands radio problems and how to solve them.

RADIO where Knowledge is Power

— And Power is Cash

I show you how to construct, install, operate, repair and sell radio equipment. Instead of being a spectator in this big game with big stakes, you become an active player. I qualify you to handle every branch of radio. There is nothing theoretical or practical that is not presented to you in complete, concise form. You are standing face to face with the greatest money-making chance ever presented to you. Will you turn your back on it or will you decide now, once for all, that you will get your share of the millions being divided among radio-trained men? Right in your own neighborhood you can make easy profits. Neighbors and friends will gladly give orders for sets and pay for advice on radio problems.



A. G. MOHAUPT, B. A., M. S.
Head of the Radio Association of America, Graduate Electrical Engineer, University of Wisconsin. Former Radio Instructor for U. S. Government. Author of "Practice and Theory of Modern Radio."

I give my personal attention to every student taking my course. Your individual problems and questions are answered by myself. I work with you at every stage of the course, guiding you, directing you to your goal to be a Radio Engineer in the big pay class. My course prepares you to successfully pass Gov't examination for Operator's License.

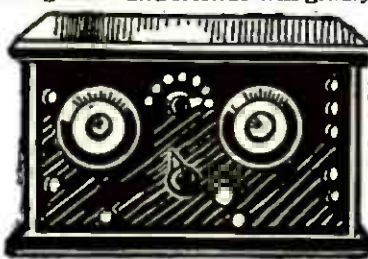

FREE 1000 Mile Radio Outfit

This set, when completed, has a range of over a thousand miles. I give it free with my course. I give you practical training by having you work on this set. The knowledge you gain is not mere book knowledge but is usable, practical experience. When you have finished my course, you can sell this set at a price that will more than pay the cost of the course.

QUICK PRACTICAL TRAINING

Everything in my course is clearly and simply stated so that you can easily understand every point I bring out. No previous experience or education is required. I give you fundamental and practical training in every angle of radio. There is no time to lose. Now is the best time to pass the other fellow by. Mail coupon today and get full information on my course, also details of the thousand mile set that I give free.

A. G. MOHAUPT, Radio Engineer
RADIO ASSOCIATION OF AMERICA
4513 Ravenswood Ave., Dept. 512, Chicago, Ill.

MAIL COUPON

A. G. MOHAUPT, Radio Engineer,
Radio Association of America,
4513 Ravenswood Ave., Dept. 517, Chicago

Please send me details of your Home Study Course—also your Free "Radio Facts" and information on how I can get a FREE 1,000 mile Radio Set.

Name

Address

City..... State.....

Hansen "BIRD-CAGE" Radios



4 Tube Radio Set \$32.50
Without Accessories

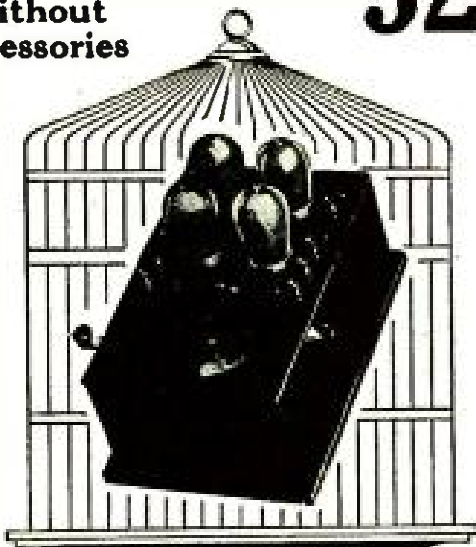

A simplified, loud speaking, long range set at a price within the reach of all.

- Hansen BOBOLINK. 2 Tube Reflex..... \$25.00
- Hansen CARDINAL. 3 Tube Reflex..... \$50.00
- Hansen BLUE BIRD. 4 Tube Radio Frequency..... \$57.50



AMERICAN CREST. This we believe to be the best high grade 6-tube loop set on the market today..... \$150.00

It is ultra selective and brings in distant stations with wonderful volume.

- 4 tube very selective E. D. Nunn..... \$90.00
- 6 tube loop E. D. Nunn..... \$135.00

The very newest in radio maps with complete station list will be sent for 10c to pay postage and handling

Write for New Catalogue

Dealers and Jobbers—Our line is interesting and profitable



Make Your Radio Joy
A Sure Thing

YOU are going to give a "radio party," or you are going on a hunt for "DX". You get yourself set for a "large" evening. Then some little unavoidable thing happens and you blow all your tubes. Money, fun and everything is lost.

The quickest way to spend \$20 is to accidentally drop a screw-driver in a five-tube set. Zip, and your money is gone as well as your fun—until the radio store opens.

Either style of KANT-BLO means protection against blowing out tubes.

Kant-Blo
SWITCH SIGNAL BINDING POST

"Lights on any Short Circuit"

The KANT-BLO is not an extra accessory to your set. It is designed as a B battery Binding Post or as an A battery filament switch. Post Style and Switch Style—are at all the best radio stores. If your dealer is out of stock send us \$2 for a KANT-BLO Binding Post Style, or \$3 for the Switch Style, and we will ship any number of KANT-BLOS direct to you, charges prepaid.

Manufactured by
GANIO-KRAMER CO., Inc.
New York

Sole Distributors
APEX RADIO CO., 503 Fifth Ave.
New York

AMERICAN BRAND
CONDENSERS

with the

~100 to 1~

Worm Drive Vernier
Finest Condenser Made
and the
Greatest Radio Value
Offered the Public

23 PLATE, only \$5.00 In Canada \$7.00

AMERICAN BRAND CORPORATION
NEWARK, N. J.

DEALERS WRITE
FOR QUICK SELLING

KITS
RADIO PARTS

WHOLESALE ONLY

HAROLD M. SCHWAB, INC.
55 VESEY ST., DEPT. C-223
NEW YORK CITY, N. Y.

HOMCHARGER

and *Christmas*



**Give the Gift
of Distance
and Volume**

YOU can give the most welcome gift of radio—increased distance and volume. This is the gift to be used and cherished for years to come.

14 GOLD SEAL HOMCHARGER features

- 1—Simple; needs no care.
- 2—Efficient; costs about 5c to charge the average battery, much less than bulb or liquid types of charger.
- 3—Quick; brings battery up to full charge overnight.
- 4—Tapers charge; cannot injure the battery.
- 5—Clean; no bulbs to break, no liquids to spill or produce fumes.
- 6—Dependable; adjusted and sealed at factory.
- 7—Lasts forever; only one moving part, the Tungsten contact, which can be replaced at \$1 after many thousands of hours of use.
- 8—Fool-proof; charges automatically, no matter which clip is attached to which battery terminal.
- 9—Safe; approved by Fire Insurance Underwriters. No danger of shock or fire.
- 10—Beautiful; sturdy metal case finished in mahogany-red and gold.
- 11—Universal; made in types for all voltages of alternating and direct current. Charges all radio "A" and "B" batteries and automobile batteries.
- 12—Quiet; its faint hum cannot be heard in next room.
- 13—Unqualifiedly guaranteed.
- 14—Popular price; sold everywhere for \$18.50; in Canada \$26. Complete, no extras to buy.

The New Silent GOLD SEAL HOMCHARGER

Anyone who can operate a radio set can use the new silent GOLD SEAL HOMCHARGER.

More than 200,000 satisfied users of the HOMCHARGER are doing this today. Give your family, your friends, everybody, the gift of better radio, resulting from the great advantages of storage battery tubes.

So "Christmassy"! Finished in handsome bright mahogany-red and gold, the new silent GOLD SEAL HOMCHARGER makes a happy, brilliant display de luxe. It has rubber feet, too, and can't mar polished tables or floors.

FREE! Get the interesting booklet, "The Secret of Distance and Volume in Radio," containing valuable information on radio at its best, and fully describing the new silent GOLD SEAL HOMCHARGER. Your dealer has it; if not, send us his name and we will mail you a copy post-paid.









THE AUTOMATIC ELECTRICAL DEVICES COMPANY

*Largest Manufacturers of Vibrating Rectifiers
in the World*

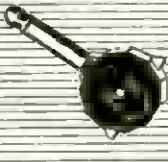
132 West Third Street, Cincinnati, Ohio

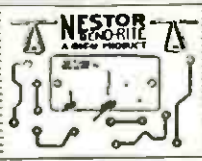
Under the same management as the Kodak Mfg. Co.

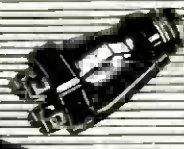
CICO

 CICO BATTERY SWITCH	 NESTOR BEND-RITE \$1	 CICO AUTOMATIC PLUG 75c.
 CICO BAKELITE RHEOSTATS Plain, \$1.35 Vernier, \$1.50	 NESTOR BEND-RITE A NEW PRODUCT	 CICO BAKELITE POTENTIOMETERS \$1.60
 CICO BAKELITE JACKS	<p>Definite angles, perfect eyes, and straight wire from point to point does make a difference in radio reception.</p> <p>The NESTOR BEND-RITE gives satisfactory results.</p>	 CICO 2-WAY PLUG 40c.

JACK PRICES
Single open No. 30 - .80
Single closed No. 31 - .85
Double circuit No. 32 - .90

SWITCH PRICES
"A" Battery No. 33 - .90
Combination "A" & "B" Battery No. 34 - \$1.00

Write now for descriptive literature

CONSOLIDATED INSTRUMENT COMPANY OF AMERICA, INC.
41 EAST 42nd STREET, NEW YORK



U.S. TOOL CONDENSERS
TRADE MARK



The Innovation of the Year



ONE PIECE STATOR
(Pat. Applied for)

An EXCLUSIVE and UNIQUE FEATURE—value immediately recognized by entire radio world. Eliminates broken contacts, soldered joints, leakage and resistance. Found in types 3 (plain) and 4 (all-vernier). CELORON END PLATES: Types 5 (plain) and 6 (all-vernier). METAL END PLATES.

CS and CV Low Price Types always in stock

ASK YOUR DEALER!
100% GUARANTEED

Write for Literature

U. S. TOOL COMPANY, INC.
116 Mechanic St., Newark, N. J.

Mfrs. of special tools, dies, jigs automatic machinery and sub presses.

Better Your Signals With

STRANDED ENAMELED ANTENNA

It offers a greater receiving area (or "skin surface") to the incoming wave than a single strand. Corrosion hinders the weak high frequency currents. The enamel coating prevents corrosion. This increases the range of your set.

Free folder describes it with other Acme products and tells how to solder.

The Acme Wire Company
Dept. P New Haven, Conn.

ACME WIRE
RADIO RADIO NEEDS

RADIO TUBE EXCHANGE

We Repair All Standard Makes of Tubes, Including

W.D. 11 or 12
U. V. 199 or C. 299
C. 11 or 12
U. V. 201A or C. 301A
D. V. 1 or D. V. 2
U. V. 200 or 201
C. 300 or 301

\$2⁰⁰

U. V. 202 Repaired, \$3.00
All tubes guaranteed to do the work.

RADIO TUBE EXCHANGE
200 BROADWAY, NEW YORK

All Mail Orders Given Prompt Attention. Orders Sent Parcel Post C. O. D.

EISEMANN

ELECTRICAL EQUIPMENT

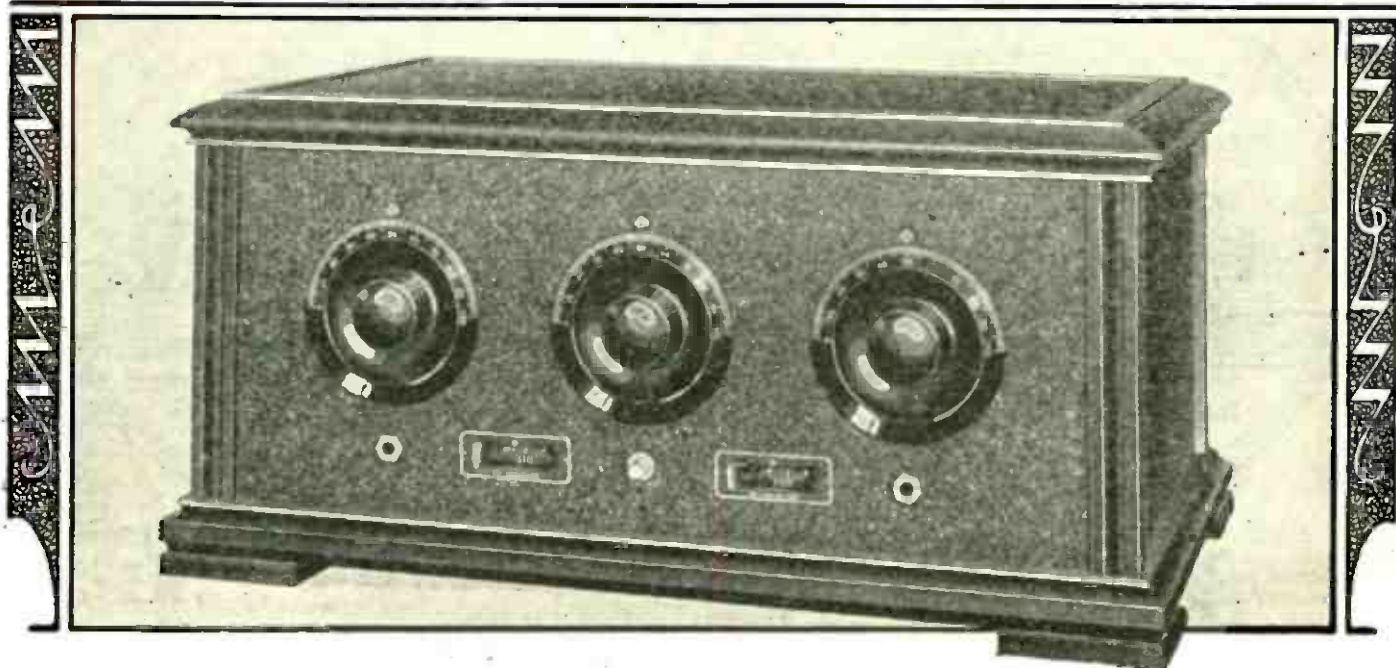

Choose Wisely!

SPECIFICATIONS

Circuit: Two stages of tuned radio frequency amplification, detector and two stages of audio frequency amplification. Non-oscillating. Non-radiating. Astatic transformers used to minimize mutual induction.

Tubes: Five in all. Jacks provided for either five or four tube operation.

Batteries: Either storage or dry cells.

Cables: Complete set supplied for "A" and "B" batteries.

Wave lengths: 200 to 600 meters, with uniform efficiency of reception.

Aerial: 75 to 125 feet, single wire.

Panel: Aluminum, with attractive crystal black finish. A perfect body capacity shield.

Dials: Sunken design. Shaped to fit the hand and permit a natural position in tuning.

Rheostats: Adequate resistance for all standard base commercial tubes.

Condensers: Single bearing, low leakage losses.

Sockets: Suspended on cushion springs which absorb vibrations.

Cabinet: Mahogany, with distinctive lines and high finish. Ample space provided for "B" batteries.

In selecting a broadcast receiver, it is well to distinguish between essential and non-essential considerations.

The circuit is important, insofar as it affects performance, but the mysterious trick names now so much in vogue are not.

Type 6-D combines the only three things that constitute true value—efficient performance, attractive appearance and fair price.

Speech and music are reproduced without distortion. Far distant stations are received with generous volume. The selectivity is extraordinary—even powerful, local broadcasting stations tune sharply. The 6-D is non-oscillating and non-radiating, with unvarying reception efficiency at high and low frequencies.

In appearance, the 6-D is strikingly attractive—a handsome mahogany cabinet, symmetrical panel layout and perfectly proportioned interior construction.

Be sure to examine the Type 6-D Receiver before you make a final selection.

For Sale by Reliable Dealers



Price, without Tubes and Batteries, \$125.00

EISEMANN · MAGNETO · CORPORATION

General Offices: 165 Broadway, New York

DETROIT

SAN FRANCISCO

CHICAGO

All apparatus advertised in this magazine has been tested and approved by POPULAR RADIO LABORATORY



Spintite WRENCHES

Why not have a gift that you want and really need in your radio work! Ask "the folks" to include Spintites in your Christmas list this year. Or, if you have a friend who is a fan, surprise him with a set of these handy little wrenches that make the hardest hook-ups easy.

Clumsy pliers simply can't do the work of Spintites. Pliers slip; Spintites grip. Yes, even in the closest quarters Spintites reach right down and take hold of the smallest nuts, enabling you to spin them on as light as if soldered, in less time than it takes to tell it. Tight joints, as you know, put an end to losses and noises due to leaky connections.

Spintites are appreciated as Christmas gifts because they are real tools, drop forged in one piece for long wear and quicker action. No separate parts to get lost. The other Stevens "Speed-Up" Tools for radio fans also make ideal holiday gifts. Write for Booklet 21 describing all the tools.

If your dealer can't supply Spintites, order direct from us. Don't take a substitute.

Stevens & Co.
Toolsmiths since 1899
375 Broadway
New York

Set of 3
Spintites in most popular sizes (round or hex, as desired)

\$ 1.00

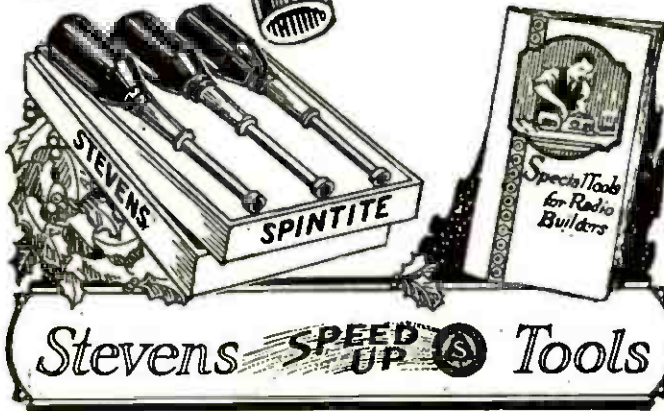

Stevens **SPEED UP** Tools

Have you your **EKKO** Broadcasting Station Stamp Album?



Here's what every radio fan has wanted—a convenient, permanent and authentic means of recording all stations heard over your set. The Ekko Album contains spaces for a stamp from each of more than 650 stations. These stamps are verified and prove your reception of the station.

Proof of Reception cards are furnished with the album. Send the card to the station, together with ten cents, to cover cost of verification, give facts which prove you have heard their broadcasting. In return they send you their verified stamp as evidence of actual reception. The stamps are beautifully engraved in different colors, an individual stamp for every station showing the call letters.

The album is 9 1/2 x 11 inches, handsomely bound in a two color cover. It contains 96 pages, with spaces for stamps of all recognized stations arranged alphabetically by states and call letters. Also an alphabetical list of the official names and other interesting features of stations, as well as a convenient log.

See your dealer today, get a copy of the Ekko Album and start a collection of these stamps. You will find this a new and fascinating method of verifying the stations you hear. If your dealer cannot supply you, send direct on receipt of price. Money back if not satisfied.

Price \$1.75

THE EKKO COMPANY
111 West Monroe Street, Chicago

BARGAIN CATALOG

Yours **FREE!** 100 Pages!



Crammed full of money-saving offers of all kinds of Radio sets complete, from a few dollars up, and parts and accessories including

Parts for "Knock-Out" Sets

developed and approved by Radio Broadcast Magazine, published by Doubleday, Page & Co., anything you may need to build or equip any set.

It's easy to do business with us, for this is "The Radio House of Friendly Service." All goods offered subject to examination and approval. No money in advance. Quick shipment. We pay transportation anywhere in U.S. Satisfaction or money back. Your questions answered free. Get this wonderful catalog—you need it—don't delay—write today! (And will you be so obliging as to add the name of one or more friends you believe will soon want radio goods? Thank you!)

LIBERTY MAIL ORDER HOUSE
Dept. 692 Z 106 Liberty St., N.Y.

The people's choice



Phusiformer

Manufactured by license agreement



The public have long been waiting for a UNIFORM, PROGRESSIVE, SYSTEMATIC method of set building. The DeRoy Phusiformer embodies this advancement.

You can start with one DeRoy Phusiformer, building a crystal or 1 Tube set and add additional units until the ultra 5 or 6 tube Receiver is completed—*Step by Step*. Eliminates tremendous cost at outset. You pay as you build—you waste nothing. Fifty or more circuits can be constructed.

Simplicity of construction and exceptional performance, are the distinguishing features. Built on entirely new principles which overcome *all* the drawbacks of present day receivers.

Price

\$9.00

With Dial **each**

If your dealer does not as yet handle DeRoy Phusiformers, send money order for required amount of Units.

Write for literature

DEROY RADIO CORP.

285 PLANE STREET

NEWARK, NEW JERSEY, U. S. A.



Edson Will Allow You \$4.00 for Your Old Headset

Another Edson achievement—the creation of a 4000-Ohm Edson Super DX Phone—enables us to make a most unusual offer.

SPECIAL OFFER: We will allow you \$4.00 each on your old headsets—regardless of age, make, or condition—to apply on the purchase price of from one to four \$8.50 Edson Super DX 4000-Ohm Headsets. **YOU SAVE \$4.00** on each phone ordered by using the Special EXCHANGE COUPON below. **Limit:** four phones to a family at special introductory price. Simply mark your name and address plainly on the package containing your old headsets and send remittance by Money Order or Registered Mail, enclosing coupon below. Act quickly; quantity limited.

Faithfully reproduces the lowest and highest tone signals that come in on your receiving set. Fully guaranteed. Regular price \$8.50. **SPECIAL INTRODUCTORY PRICE WITH COUPON, \$4.50**, including phone plug.



Dealers: Write for our wonderful selling plan.

Special EXCHANGE COUPON

This coupon and your old headsets entitle you to an allowance of \$4.00 each on from one to four 4000-Ohm Super DX Phones, valued at \$8.50 each. You pay only \$4.50 for each phone ordered. (PR-12)

EDSON RADIO SALES CO.
ELMWOOD, PROVIDENCE, R. I.

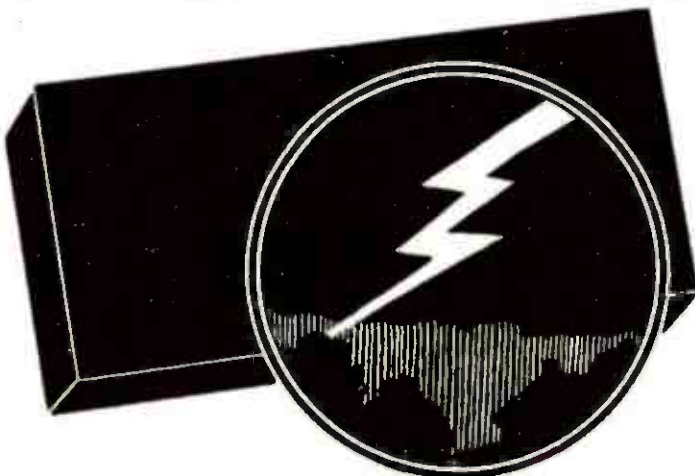

dielectric!

A Bakelite-Dilecto panel has more dielectric resistance than is ever required in radio. It affords absolute insulation.

bakelite -dilecto

(A Laminated Phenolic Condensation Material)
The U. S. Navy and Signal Corps have used Bakelite-Dilecto successfully for ten years. Makers of the largest radio sets favor it. Most practical material for amateurs' use. Use it for your next panel.

THE CONTINENTAL FIBRE CO.
Factory: Newark, Delaware

Service from:
New York, Woolworth Bldg. San Francisco, 75 Fremont St.
Chicago, Wrigley Bldg. Los Angeles, 307 S. Hill St.
Pittsburgh, 301 Fifth Av. Seattle, 1041 Sixth Av., So.



Honeycomb Coils Back and Front Panel Mountings Plain or Geared— Genuine Bakelite

The Universal all-wave inductance—accepted as standard in regard to superior construction and electrical units of measurement. Ask your "Old Timer" radio friend why sets using honeycomb coils are better; they give closer tuning, greater selectivity and range. No dead end losses, easy to operate. 16 sizes, mounted and unmounted. Interchangeable with all mountings. Be sure the set you buy or build has them.

Send 25c. for Super Heterodyne, Radio Frequency and Honeycomb Coil Circuits and Complete Catalog

CHAS. A. BRANSTON, Inc., 843 Main St., Buffalo, N. Y.
In Canada—CHAS. A. BRANSTON, Ltd., Toronto

RADIO WORLD First Nat'l Illus. Weekly

Solves all radio troubles. List stations, advance programs, full week, Q. and A. Dept. Great special features every issue. Profusely illustrated. See *Radio World* for standard sets and parts at lowest prices. All dealers. Specimen Copy 15c; \$6 year, \$3 six months, \$1.50 three months.

SPECIAL: \$1 for 8 issues.

RADIO WORLD
1493 Broadway New York

Super-Ducon

A Major Radio Invention

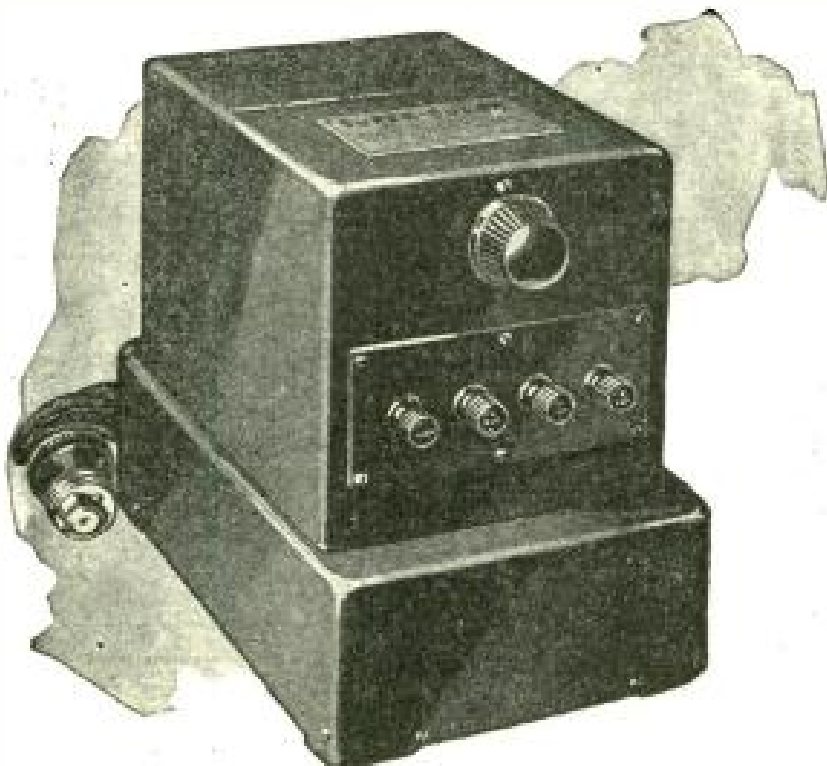

A. C. Type
\$47.50

D. C. Type
\$30.00

No more "B" batteries!

The Super-Ducon is the most important and valuable radio invention of the year. It brings many advantages to the set owners. Upkeep expenses are cut. No more of the expense and fuss of installing "B" batteries. No more poor reception due to weak batteries, but 100% performance *all* the time!

Ask your dealer for a copy of the 16-page Super-Ducon Booklet

Dubilier

CONDENSER AND RADIO CORPORATION

MODERN RADIO RECEPTION

A New Book by

Charles R. Leutz

264 Pages, 150 Illustrations
Fully Bound

Partial List of Contents—

Radiola Super-Heterodyne Diagram
Western Electric 4 B Receiver
Model C Super-Heterodyne
Model C 7 Super-Heterodyne
Long Distance Reception
Short Wave Reception
Long Wave Receivers
Pliodynes and Super-Pliodynes
Laboratory Equipment
Broadcast Transmitters
High Efficiency Amateur Transmitters
Model L Super-Heterodyne
and
Everything of importance relating to
Broadcast Reception.

Price, \$3.00 Postpaid

EXPERIMENTERS INFORMATION
SERVICE, Inc.

476 Broadway

New York City



At dealers
or postpaid

DURHAM

Grid Leaks

do improve tones

VARIABLES

Connect a Type 100—variable from 1,000 to 100,000 ohms—across the secondaries of audio transformers. Noise fades; pure tones ring clear.

FIXED—Metallic

The ideal electrical material—metal—permanently fused on glass support. Accurate tested values in 28 sizes.

PRICES:—

Variables—3 sizes . . . each, \$0.75
Fixed—under ¼ meg., 75c.; over, .50
DURHAM Bases30

All about Resistance Amplifiers—25c

Build a distortionless amplifier. Parts for two stages cost less than one good transformer. Complete detailed instruction booklet, 25c. At your dealers or postpaid.

Satisfaction Guaranteed

DURHAM & CO., Inc.
1936 Market St., Philadelphia

Canadian Dist., De Forest Radio Corp., Ltd., Toronto

VACUUM TUBES REPAIRED

WD-11, WD-12, \$2.00
UV-201A, UV-199,
And others for

Quick service. All tubes repaired by us guaranteed to work as good as new. Send your dead tubes. All you pay is \$2.00 plus Postage to Postman.

THOMAS BROWN CO.

511-519 Orange St., Newark, N. J.

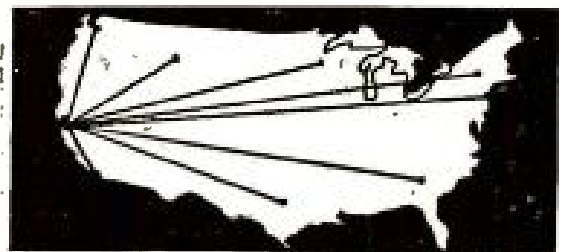

ON ONE TUBE

BIG FREE BOOKLET tells the story. California users of CROSS COUNTRY CIRCUIT hear Atlantic Coast, Canada, Cuba, Mexico and Hawaii. Atlantic Coast users hear England to California. Our new plan makes this set easiest and cheapest to build. One hour puts in operation. One tuning control. No soldering. Any Novice can do it. BIG BOOKLET FREE or complete instructions for 25c stamps or coin.

VESCO RADIO CO.

Box PR-117

Oakland, Cal.

ARISTOCRAT MODEL
 The Bestone V-60 Five-Tube Receiver in beautiful, distinctive, antique polychrome cabinet, with built-in high-grade loud speaker and battery compartment. List..... **\$165**



TRADE MARK

"The Aristocrat of Radio"

A Xmas Gift that will Thrill, Satisfy and Serve

Give the finest of all Radio Receivers for Xmas—the one every one knows as the peer of them all—THE BESTONE V-60.

Gives a new meaning to the word Radio.

There is prestige in owning a BESTONE V-60.

There is philosophy in buying the best.

A piece of furniture worthy of the machine it contains.

Write for Particulars

Manufactured, Guaranteed and Distributed by
HENRY HYMAN & CO., Inc.
 476 Broadway NEW YORK 212 West Austin Ave. CHICAGO



IMPERIAL MODEL
 Imperial Model—Bestone V-60 Five-Tube Receiver, in beautiful mahogany cabinet. **\$115**

Good Batteries Give Music — Poor Ones Give Noise



USL Radio "A" Battery in one piece hard rubber container.

Thousands of enthusiastic USL users endorse USL radio batteries. There is a reason for it. USL has built properly designed quality batteries for 25 years.

USL radio batteries cost no more. In fact, USL low prices will surprise you. Ask your local USL dealer for prices. Have him tell you why USL batteries are better.

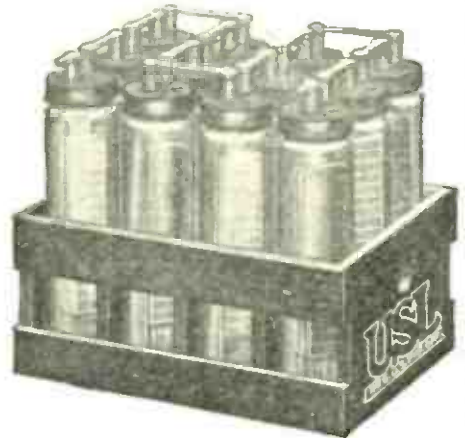

USL Radio "B" Battery Made in 24, 48 and 96 volt sizes.

For Every

USL TRADE MARK
STORAGE BATTERIES

Radio Need

U. S. LIGHT & HEAT CORPORATION., Niagara Falls, N. Y.

Loud Speaking RUBICON DUPLEX

When you raise your voice it doesn't get mushy. Neither should your loud speaker. RUBICON Duplex amplifies full tones without distortion—especially so when preceded by stages of Rubicon straight Radio and Audio.

"The Inside Story" tells why. This folder is a real help in buying transformers *intelligently*. You select according to test data—not just claims. Drop postal for your copy now.

RUBICON COMPANY
918 Victory Bldg.
Philadelphia

PEERLESS RADIO

349-P Fulton St. Brooklyn, N. Y.

COMPLETE PARTS on hand for the 5 TUBE COCKADAY FOUR-CIRCUIT TUNER with resistance coupled amplifier as specified by Laurence M. Cockaday in October's Popular Radio.

Also drilled and engraved panels for the above
Headquarters for "Hard-to-get-Apparatus."
Special discounts to builders
Send for catalogue P. "Bargains Galore."

Radio  Plate

"B" BATTERIES

are as vital to satisfactory reception as reliable tubes. The test proves them best.

**DIAMOND ELECTRIC
SPECIALTIES CORP.**

102 SO. ORANGE AVE., NEWARK, N. J.
Dealers—Jobbers, Write for Proposition

ZENITH
KENNEDY
Radiodyne
Pathé
ULTRADYNE
MURDOCK
MICHIGAN

Howard
QZARKA
MUSIO
PFANSTIEHL
PHOENIX
ANDREWS
MALONE LEMON
AUDIOLA
GATES
GLOBE
HARMONY
ODELL FERRY
PEERLESS
DUCKS DELUXE
SAAL

More set makers use



Exclusive!
THORDARSON SQUARE COIL LEAK-PROOF CONSTRUCTION
 The Thordarson-made layer-wound SQUARE coil fits snugly around the square core. No air space between coil and core (exclusive!)—no lost energy, no lost volume (especially on low notes), no leaks from primary to cause howls in set. Oversize core provides 50% larger magnetic circuit—minimizes core losses, prevents over-saturation. No rivets or screws through core to cause short circuits or odd current losses between laminations (exclusive!) Do you wonder Thordarson produces more transformers for more makers of quality sets than all competitors combined?

New!
 We announce the Thordarson **INTERSTAGE** Power Amplifying Transformer. Provides *two stages* of **POWER** amplification when inserted in circuit between Input and Output Power Amplifying Transformers. Four tubes are required, but the quality of the reception more than repays you. Only Thordarson builds a transformer of this type. Price \$8. Write for free hook-up.



Six floors, 100,000 square feet, devoted to making transformers.

THORDARSON ELECTRIC MANUFACTURING CO.
Transformer specialists since 1895
WORLD'S OLDEST AND LARGEST EXCLUSIVE TRANSFORMER MAKERS
Chicago, U.S.A.

New York City, Sept. 25, 1924
 Thordarson Electric Mfg. Co.,
 500 W. Huron St., Chicago.
 The transformers which you supplied to equip the Radio on the Schooner "Bowdoin" stood the extreme temperature of the Arctic without the slightest mishap. These transformers are in exactly the same condition today as they were the day they were installed, May, 1923.
 Sincerely yours,

Donald H. Mey
WHP

Follow their lead
 —amplify with Thordarsons!

Can you imagine nationally famous builders of sets costing up to hundreds of dollars each, jeopardizing the tone quality of their instruments with anything short of the best amplification? Of course not! Then remember, in buying transformers, that Thordarsons are standard on thirty-four makes of high-grade sets. That leading set manufacturers use *more* Thordarsons than all competitive transformers combined.

Replace your present audio frequency transformers with a pair of Thordarsons. You'll be astonished, delighted. Distorted speech will disappear. You will find they amplify with *even* volume over the *entire* musical range. Note below some of the reasons why.

Buy a Thordarson-equipped set—or follow the lead of the leading makers and build with Thordarsons. Increased production this season enables any store to supply you. If your dealer has not yet received his stock, you may order from us by mentioning his name. Interesting bulletins sent free.

They are Unconditionally Guaranteed

THORDARSON
Super
AMPLIFYING TRANSFORMERS
Standard on the majority of quality sets

Thordarson "Super" Audio Frequency Transformers are now to be had in three ratios: 2-1, \$5; 3½-1, \$4; 6-1, \$4.50. Thordarson Power Amplifying Transformers are \$13 the pair. Write for latest bulletins.

"ROYALFONE" KING OF ALL

Radio Reproduction Adapted to **YOUR Home**

The ROYALFONE Unit

For the first time—a loud speaker unit which will give natural, pleasing results in any room because the volume is perfectly adjustable. Just as you open or close the doors of your phonograph to soften or increase the volume, so you can regulate the tone intensity of radio reception to the acoustics of the room, simply by turning the adjusting knob on the back of the ROYALFONE UNIT.



Heavy nickel-plated nozzle and ample connecting cord.
\$5.00

IDEAL XMAS GIFTS

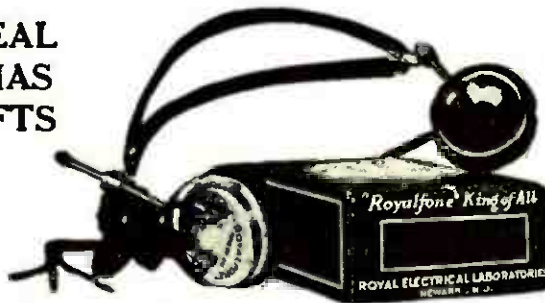

"ROYALFONE" KING OF ALL HEADSET

Ideal for locating distant stations because it will produce perfectly an audible sound from the weakest signal.

PRICE \$4.50

Write for Literature

ROYAL ELECTRICAL LABORATORIES

Newark Dept. P. R. N. J.

B. B. Copper Ribbon Antenna

- A. Has approximately three times the surface of ordinary stranded antenna wire.
- B. Gives stronger signals and greater distance. Repeated tests have brought in stations never heard on ordinary antennas.
- C. Is non-directional. By putting four complete twists in each fifty feet of length reception is uniform from all directions.
- D. Technically known as quarter hard B. B. ribbon Antenna permits proper tension without danger of stretching or tearing.
- E. Fifty feet B. B. is equivalent to 85 feet stranded.
- F. $\frac{3}{8}$ inch and $\frac{1}{2}$ inch wide for outside
 $\frac{1}{8}$ " " $\frac{1}{4}$ " " " " inside

Soft Copper Foil for Panel Shields .001 to .005 thick 4 to 8 inches wide.

Copper for stamping various parts .001 to .020 thick. $\frac{1}{8}$ to 12 inches wide.

Also thin flat brass, copper, bronze, gold metal and zinc for making various parts of Radio.

Write for prices

The Baltimore Brass Company

1204 Wicomico Street

Baltimore, Md.



INDOOR CAGE ANTENNA

A highly efficient Antenna System sold on a guarantee of Reliable Reception.



Patented. The Genuine bears the trade mark Key to the Air.

Price \$2 At your dealers—or direct by mail on receipt of price.

STAFFORD RADIO CO.

Medford Hillside - - - Massachusetts

Send for circuit diagrams of Single Tube Receiver



There is only one GENUINE EBY Binding Post

"With tops which Don't Come Off"

Eby Posts are scientifically designed, beautifully finished and their price is right.

This is our Ensign post which can be furnished either plain or engraved in twenty-five different markings.

EBYS are Binding Posts PLUS
H. H. EBY MFG. CO. Phila., Pa.





GILFILLAN NEUTRODYNE

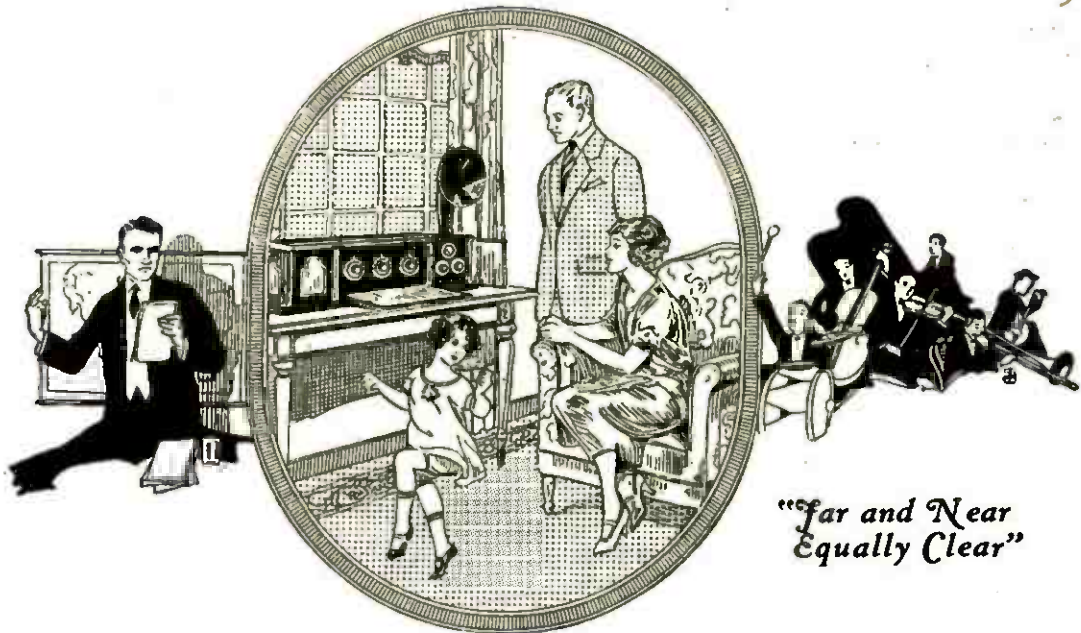

*"Far and Near
Equally Clear"*

A Christmas Gift of Permanent Satisfaction

PROOF of the superior performance of the Gilfillan Neutrodyne is coming in from every section of the country. Users everywhere tell us of their long dis-

tance feats and the wonderful clarity of tone with which stations far and near are reproduced. Convenient to install and simple to operate.

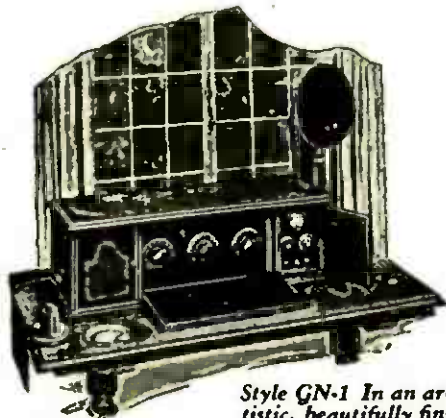

Style GN-1 In an artistic, beautifully finished two-tone American Walnut Cabinet of three panels, without accessories \$175

These sets are manufactured in our three factories, supervised by a corps of Radio Engineers of national reputation. Each set must pass a rigid test so that it reaches you ready for instant service.

Buy a Gilfillan Neutrodyne for your Christmas gift and you will have a set that is in the first rank of Radio Improvement and Achievement.

Ask your dealer for demonstration and send to our nearest office for literature.



Style GN-2 Same Neutrodyne construction and features in smaller cabinet made of American walnut, finished in two tones; without accessories \$140

GILFILLAN BROS. INC.

KANSAS CITY
2525 W. Penn Way

1815 W. 16th St., LOS ANGELES

NEW YORK CITY
225 W. 57th Street



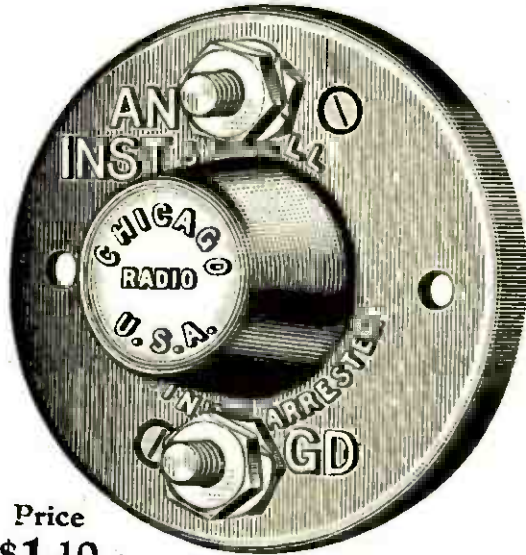

Price
\$1.10

The JEWELL LIGHTNING ARRESTER

☑ Is approved by the underwriters and complies with their radio code.

☑ Don't take any chance of having your insurance policy questioned. Install a Jewell arrester and be safe.

Buy from Dealer

Jewell Electrical Instrument Co.

1650 Walnut St. • Chicago

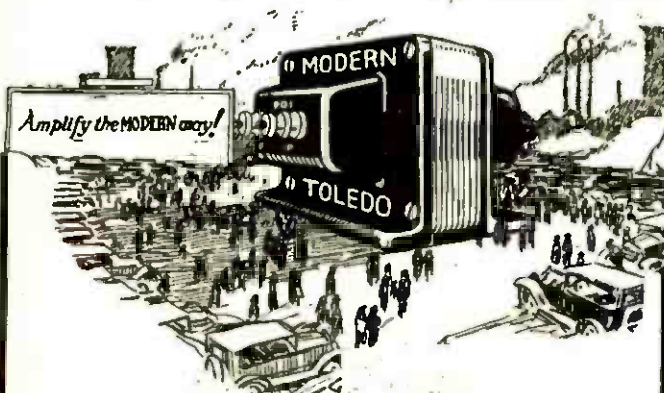

MODERN "Push-Pull" Transformers

—are recommended by the leading radio authorities everywhere for all circuits.

There's a Reason!

Price, per matched pair, \$12.50

Bulletin on request

If your dealer can't supply you, send direct

The Modern Electric Mfg. Co.

Builders of Transformers Exclusively
Toledo, Ohio

SPREAD X'MAS JOY For \$3.40

By giving these efficient little sets to friends less fortunate than yourself. Not a junky toy, but a handsomely built instrument. You'll want to keep one yourself. Ideal for invalids or youngsters. Satisfactory reception up to 25 miles. Tested and approved by Popular Radio and others. Insist on BEAVER, or if your dealer cannot supply you, we will send post paid the "Baby Grand" Crystal Set with Head Phones in handsome gift box for \$6.00, or the receiver only for \$3.40, check or money order with your order.



Beaver Machine & Tool Co.
625 N. 3rd St. Newark, N. J.

LUDWIG HOMMEL & CO

929 PENN AVENUE — PITTSBURGH, PA.

carry complete stocks of the most reputable radio apparatus — Prompt deliveries.



**THE EXCLUSIVE CHOICE
OF DR. MAC MILLAN
for his**

ARCTIC EXPEDITION

Zenith Radio Corporation

328 South Michigan Avenue, Chicago, Ill.

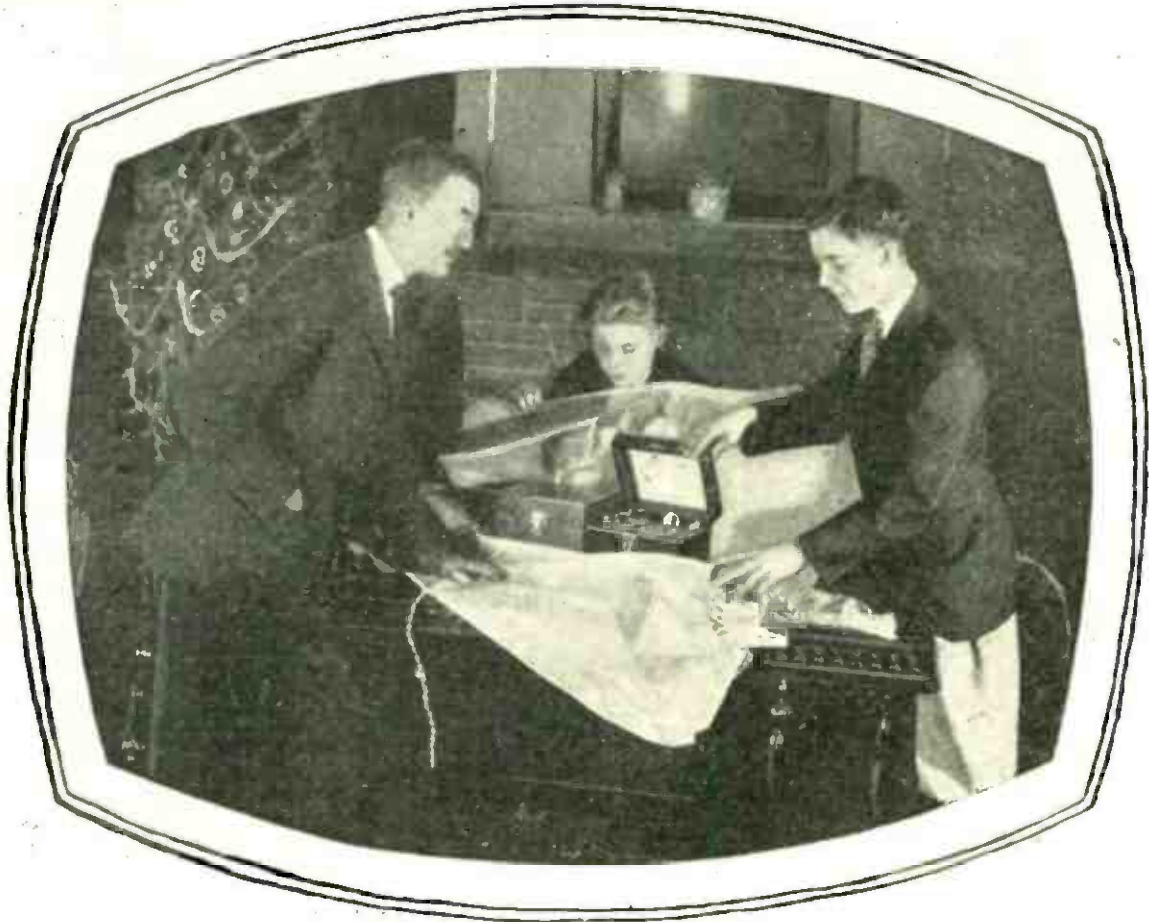

“How’dja know that was what I wanted, Dad?”

If any Dad with two eyes and a couple of ears doesn't know when his son wants a radio set, and just what kind he *must* have, it's not for lack of being told. For, one thing boys do up brown is making known their wants.

The boy who has fiddled with a cat's-whisker, or listened with envy to some friend's radio outfit, becomes a human volcano erupting radio enthusiasm all over the place. His family is deluged with it. It is this boy-enthusiasm that has put radio into so many millions of homes.

To 500,000 of these radio inoculated boys THE AMERICAN BOY is the closest of friends and

the most trusted of counsellors. It is a fund of scientific and authoritative information on every phase of radio. The natural place for these boys to turn, and the place they do turn to for their radio wants, is the advertising section of THE AMERICAN BOY.

The strongest testimony to the buying power of AMERICAN BOY readers is found in the attitude of radio advertisers in THE AMERICAN BOY. It is not at all exceptional for them to double the space they started with. Such unanimous success indicates what you may expect

for your radio products.

Copy received by Dec. 10 will appear in February.

The **American Boy**
The Biggest, Brightest Best Magazine for Boys in All the World

Detroit

Michigan



Every Question ANSWERED for only \$1.50

At last you have under one cover a Complete Radio Handbook

New Leatheroid Edition

Compiled by HARRY F. DART, E.E., formerly with the Western Electric Co., and U. S. Army Instructor of Radio. Technically edited by F. H. Doane.

514 PAGES

NO MORE need you turn from book to book, hoping to find what you want. It is all here, in 514 pages crammed full of every possible radio detail. Written in plain language, by engineers for laymen. Clears up the mysteries, tells you what you want to know.

IT EXPLAINS: Electrical terms and circuits, antennas, batteries, generators and motors, electron (vacuum) tubes, every receiving hook-up, radio and audio frequency amplification, broadcast and commercial transmitters and receivers, super-regeneration, codes, etc.

Under one cover. Yes, it is all in one volume of 514 pages of clear type with hundreds of diagrams and illustrations.

Send \$1.50 to-day and get this 514-page I. C. S. Radio Handbook—the biggest value in radio to-day. Money back if not satisfied.

—TEAR OUT HERE—

INTERNATIONAL CORRESPONDENCE SCHOOLS
Box 8253-D, Scranton, Penna.

I enclose \$1.50. Please send me—post-paid—the 514-page I. C. S. Radio Handbook. It is understood that if I am not entirely satisfied I may return this book within five days and you will refund my money.

Name.....

Address.....

Check here and enclose \$1 if you wish the cloth-bound edition.



Low-Loss Condenser

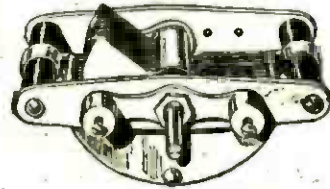

Improves Any Set!

Manufacturers of the finest radio sets are using the 23 plate Lincoln Low-Loss Condenser. For they know, after countless tests, that it will improve any set. Increases range of reception, selectivity and volume. Most efficient electrically . . . strongest mechanically . . . due to several radical improvements. Minimum capacity extremely low. Two well-known laboratories found this condenser to have a lower high frequency resistance than any other condenser of this type. A complete die-cast job, rugged in construction and fully guaranteed. Sold by leading dealers. If yours cannot supply you, order direct, giving dealer's name. Price \$4.50.

Write for Catalog

Fully describes all Lincoln Laboratory Tested and Guaranteed products . . . Lincoln Low-Loss Condenser, Lincoln Collapsible Loops, Lincoln "Long 45" Tuner, Lincoln Kit, Lincoln Oscilloscope . . . and shows 6 interesting hook-ups. Send your name and your dealer's name for a copy.

Lincoln Radio Corporation
224 North Wells St., Chicago

All Radion Products MAHOGANITE and BLACK RADION PANELS

All Stock Sizes and "That Special Size for Your Phonograph, Portable, Super or Odd Size Cabinet"

WHOLESALE

RETAIL

Send for Price List

NEW YORK HARD RUBBER TURNING CO.
212 Centre Street New York City

CRESCENT LAVITE RESISTANCES

12,000 } Ohms.
48,000 }
50,000 }
100,000 }



LIST \$1.50

Special Sizes to Order

When better resistances are made they will bear the Crescent label. Dealers write for discount.
CRESCENT RADIO SUPPLY CO. 1-3-5 Liberty St., Jamaica, N. Y.

FAHNESTOCK CLIPS

"Popular Wherever Radio Is Used"

14 Sizes in Beautiful Display Case.

Dealers write for big money-making proposition.

FAHNESTOCK ELECTRIC CO.

Long Island City, L. I.

Tower's

Bring Christmas Cheer from far and near

Think of the little hearts that will beat the faster on Christmas morn on finding in their stocking a gift so pleasing.

If you only will — Old Santa himself from way up North will talk to the kiddies, and stories tell.

No Other Gift
Can Bring Such Cheer
A Gift to Last
Throughout the Year.



Tower's Scientific Headset

Every set tested and approved by Government Licensed Radio Operators.

Tower's Scientific Headsets are guaranteed to be made of the best materials money can buy — highest test enamel, insulated magnet wire, best grade five-foot tinsel cord, unbreakable caps, polished aluminum cases — using the famous scientific head-band constructed for maximum comfort.

If your dealer cannot supply you, order direct by post card, and we will ship immediately Parcel Post, C. O. D., plus a few cents postage.

The Tower Mfg. Corp.
98 Brookline Ave, Dept. J Boston, Mass.

Scientific

When it is marked "PACENT" you can build with real confidence

Built into every Pacent Radio Essential is
the experience of over 18 years in radio

When you purchase Pacent Radio Essentials, not only do you buy the utmost in engineering skill and precision, but you are following the judgment of the engineers of over 30 of the leading radio set manufacturers.

Being one of the pioneer manufacturers in the radio industry, the Pacent Electric Company has long recognized that quality and

precision were the outstanding requirements of parts for complete satisfaction in set operation. Every Radio Essential bearing the Pacent trade mark was built up to a standard and not down to a price.

Ask for Pacent Radio Essentials and build with confidence. Your favorite dealer carries them or will get them for you. Write for complete catalog.

PACENT ELECTRIC CO., Inc., 22 Park Place, New York City

Washington Minneapolis Boston San Francisco Jacksonville Chicago
Birmingham Philadelphia St. Louis

Pacent

RADIO ESSENTIALS

PACENT Radio Essentials of known quality

Adapters
Improved Audioformer
Audioformers
Autoplug
Balcon
Coil Plug
Coil Plug Receptacle
Condensers
Detector Stand
Duojack
Duoplug
Duo Lateral Coils
Headsets, Everytone
Jacks
Jackset
Loops
Loop Plug
Loop Jack
Multijack
Plugs
Potentiometers
Rheostats
Resistances, Cartridge
Sockets
Twinadapter, etc., etc.



DON'T IMPROVISE - PACENTIZE



12 Cells
24 Volts
Solid
Rubber
Case

\$3.50
C.O.D. **SPECIAL**
INTRODUCTORY PRICE

For a limited time *only*, and to introduce this new and superior Storage "B" Radio Battery to the Public, we are selling it for \$3.50. Regular Retail Price is \$5.50. You save \$2.00 by ordering NOW. A finer battery cannot be built than the **World Storage "B" Battery**

(12 CELLS—24 VOLTS)

To ten million homes with Radio Sets—and to countless millions of prospective buyers—this WORLD Storage "B" Battery brings a new conception of battery economy and performance. Here is a battery that pays for itself in a few weeks—will last for years and can be recharged at a negligible cost. And you save \$2.00 by ordering now.

A Superior Battery Equipped With Solid Rubber Case
Has heavy duty 2 1/8 in. x 1 in. x 1-4 in. plates and plenty of acid circulation. Extra heavy glass jars allow ready observation of charge and prevent leakage and seepage of current. It holds its charge while idle, at constant voltage. You will find this battery a boon to long distance reception. It does away with a great many noises so often blamed on "static." Mail your order today.

SEND NO MONEY

Just state number of batteries wanted and we will ship day order is received. **EXTRA OFFER:** 4 batteries in series (96 volts), \$13.00. Pay Expressman after examining batteries. 8 per cent discount for cash in full with order. Send your order NOW and save \$2.00.

WORLD BATTERY COMPANY
Makers of the Famous World Radio "A" Storage Battery
1219 S. Wabash Ave., Dept. 77 Chicago, Ill.

SAVE \$2.00 BY ORDERING NOW!

Poly Plug



is the only phone plug made with the wonderful "tension slot" which permits you to pull and tug the cords all you want and still

Positive contact always maintained

It's genuine, Bakelite, too

At your dealers or by mail on receipt of purchase price

POLYMET MFG. CORP.
70-74 Lafayette St., New York



New York Coil Company's Radio Products

ANY CONDENSER CAN BE CALLED LOW LOSS, BUT ONLY ITS PERFORMANCE QUALIFIES THE NAME. In THE NEW YORK GROUNDED ROTOR scientific designing, together with the highest grade of materials and instrument workmanship combine to produce a condenser that is in a class by itself—no other condenser manufactured incorporates so many *actual improvements*.

.0005 (23 plate) without Vernier, \$4.50. Geared Vernier attachment complete \$1.50

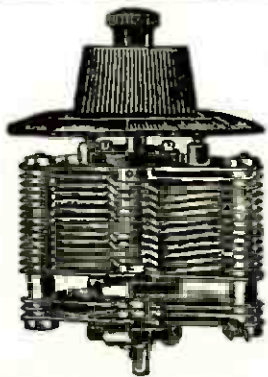
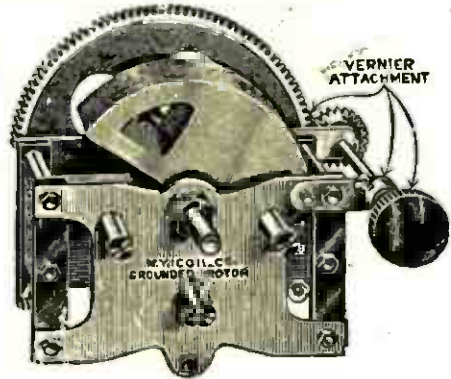

OUR STANDARD NON-GROUNDED CONDENSERS are made in four sizes with or without vernier are universally recognized for their efficiency, workmanship and low price—made possible by large production.

Price with Vernier Knob and Dial 23 Plate \$3.50. Without Vernier 17 Plate \$1.80. 23 Plate \$2.00. 43 Plate \$3.00



New York Distortionless Audio Amplifying Transformers are the standard by which others are judged. $4\frac{1}{4}$ to 1 ratio correct for all style tubes. Price \$4.00



Type A—No Clips

NEW YORK PRECISION MICA FIXED CONDENSER adds the real undistorted true tone quality to your receiver—the reason they are specified by leading Radio Engineers and used by the most discriminating manufacturers.



Type B

NEW YORK COIL COMPANY

338 Pearl Street, New York City, N. Y.

Pacific Coast—MARSHANK SALES CO., 1240 S. Main St., Los Angeles, Calif.

All apparatus advertised in this magazine has been tested and approved by POPULAR RADIO LABORATORY

ACCURATUNE

MICROMETER CONTROLS

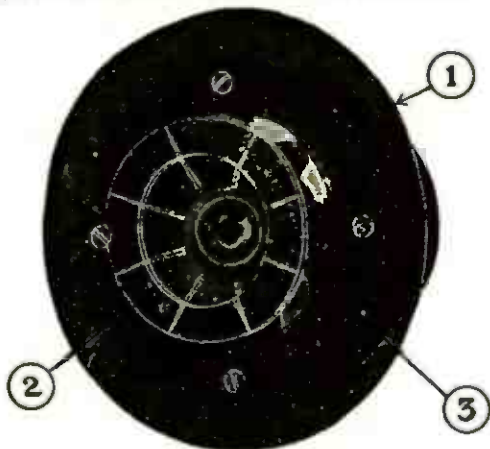

for close tuning

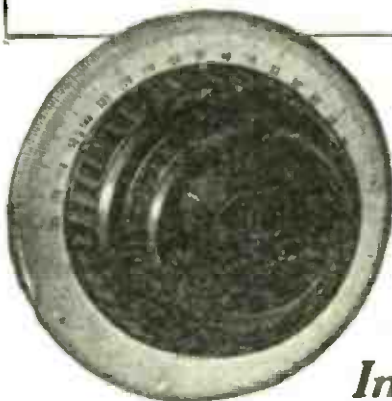

Gear'd
80-1
Ratio

Improved!

NO BACK LASH

No ordinary standards of tuning efficiency can be applied to the new improved Accuratune Micrometer Control.

Special construction of this new model offers these superior advantages:

1. **Beautiful Silvered Etched Metal Disks**—Make a pleasing contrast between Bakelite panel and dial, with finer graduations for finer tuning.
2. **Eliminates all back lash**—Gears and gear operation designed upon scientific engineering principles, producing quiet operation, eliminating all lost motion and back lash. The greatest advance in tuning devices. Increases the tuning efficiency over that of any known tuning device.
3. **Flush Panel Mounting**—Take all standard condenser shaft lengths and fit flush with panel. Eliminates the necessity of cutting off shafts before mounting dial. Accuratune Micrometer Controls fit all standard shafts and mount to always operate parallel with panel.

Accuratune Micrometer Controls log station after station you never tuned in before. Indispensable on all Super-Heterodynes. Price, \$3.50. At your dealers, otherwise send purchase price and you will be supplied postpaid.

ACCURATUNE

80-1

MICROMETER CONTROLS

The MYDAR RADIO CO. 9-B Campbell Street, Newark, N. J.
Canadian Representative: Radio Ltd., Montreal

The "LITTLE JOE" Lightning Arrester

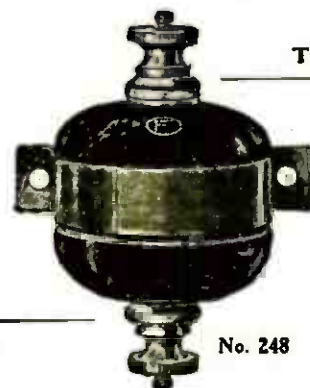

To Set

To Working
Ground

Card No. E-5841

Jan. 5, 1923, Underwriters Approval

Especially designed for Radio Work

Made of Porcelain, small, neat, rugged and serviceable. Can be suspended on antenna or fastened to wall.

Ask your dealer or write for further information

E. H. FREEMAN ELECTRIC CO.
TRENTON, NEW JERSEY

AMPLEX

GRID-DENSER

MORE distance and greater volume!
That's what GRID-DENSER will do for any set.

A turn of the knob and you have the exact capacity needed for any tube and any portion of the circuit. When men like Cockaday, Greiff, Sleeper, and Haynes specify GRID-DENSER for all their sets, there must be a reason.

Whether it's the Super-Het, Cockaday, Superdyne, Neutrodyne, or any other—replace your fixed condensers with GRID-DENSERS. You'll get stations you never heard before.

In either the .0005 with or without gridleak clips or .001 type or type N (neutralizing) **\$ 1.25**

FREE: ask your dealer for the FREE Hook-up Booklet.

AMPLEX INSTRUMENT LABS.
88 W. B'way. Dept P 12 N. Y. C.

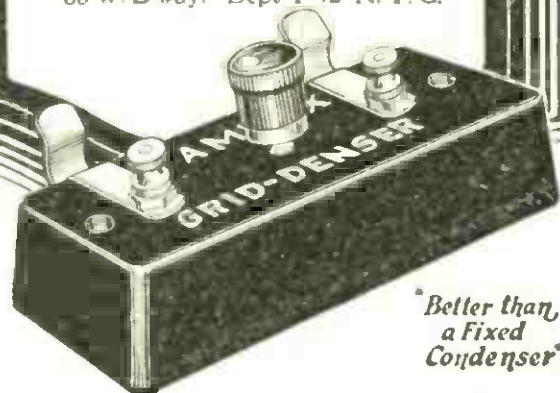

Better than
a Fixed
Condenser

SEND FOR BOOKLET

Mail coupon below for our catalog and booklet, "Some Insulation Stickers Explained."

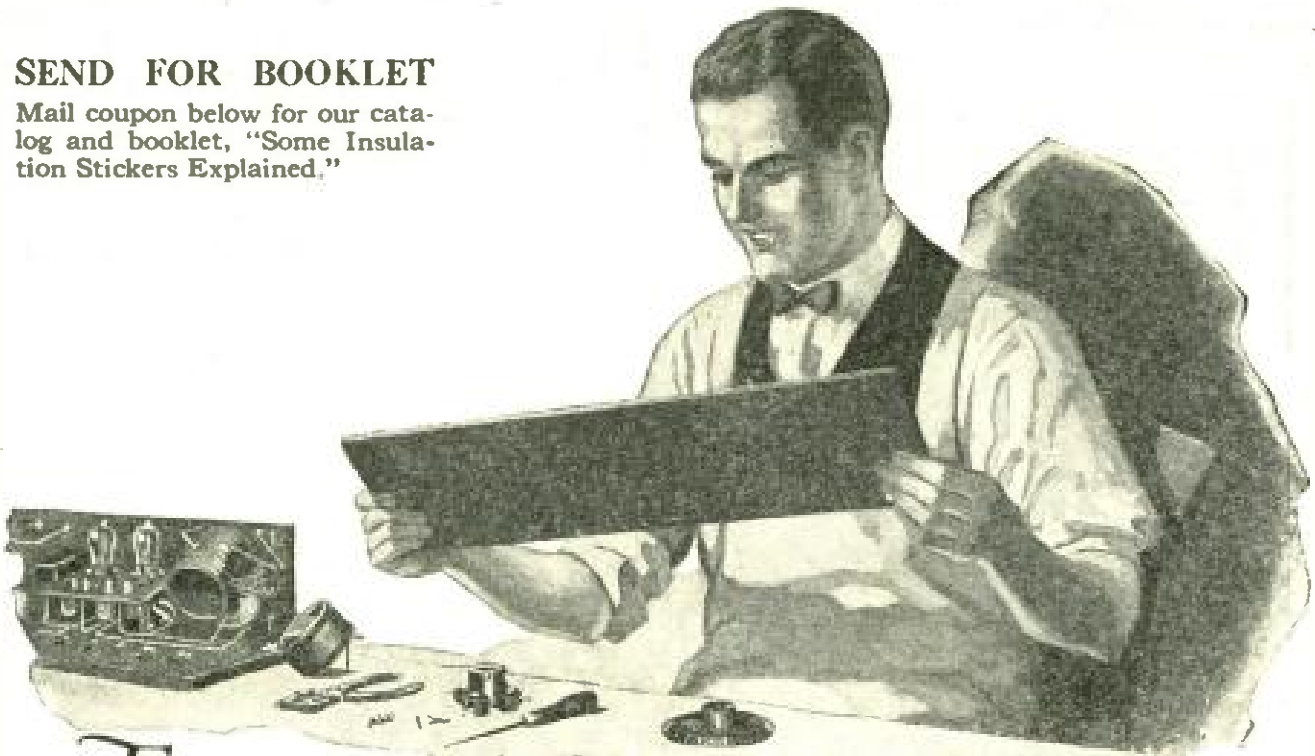

Engineers developed this special panel material for radio ONLY

THERE is nothing quite like Radion—"the supreme insulation"—for real results. The Bureau of Standard tests conclusively prove highest insulating characteristics. In the set you build, it will give you just that extra energy you may need to tune in a distant station. When you see Radion in a ready-built set, it is an evidence of general good quality in that set.

You can see the difference between Radion and common panel materials, if you will look at the finish. Radion has a high, polished finish. That keeps out dirt and moisture, which even in little particles on the surface

cause short circuits and reduce good reception. Look at Radion and other panels under a magnifying glass, if you can.

Everyone knows Radion is the easiest panel material to drill, cut and saw. There are eighteen stock sizes, two colors, black and mahogany. Sold universally by dealers who know radio. Better performance will make it worth your while to ask for it by name, and to look for the name on the envelope, and the stamp on the panel.

Radion dials to match, also sockets, binding post panels, insulators, knobs, and new Radion built-in horn.

**AMERICAN HARD RUBBER CO.
11 Mercer Street, New York City**

Chicago Office: Conway Building

*Pacific Coast Agent: Goodyear Rubber Company
San Francisco Portland*

RADION

The Supreme Insulation

PANELS

Dials, Sockets, Binding Post Panels, etc.

AMERICAN HARD RUBBER CO. P.R. 12	
11 Mercer St. New York City	
Please send me your catalog and booklet, "Some Insulation Stickers Explained."	
Name.....
Address.....
City.....	State.....

All apparatus advertised in this magazine has been tested and approved by POPULAR RADIO LABORATORY



was \$10

Now \$5

exactly the same unit

Every one has heard about Morrison, the loud speaking unit, that reproduces so faithfully and can be depended upon to give service indefinitely. It is a pleasure to offer Morrison to America's fans at just half the former price.

Exactly the same unit that always sold for \$10.

Almost the first unit on the radio market, nothing has yet surpassed Morrison's well-known reproducing qualities. For simple operation and adjustment, for long life and satisfactory enjoyment of radio, Morrison is the universal choice.

Own a Morrison and be sure

The Morrison
TONER

Attached to your Receiving Set

will give you a brand new thrill. For it performs a brand new radio feat—eliminates from radio everything but the broadcasting. With the Toner you can add another tube for three steps of Audio Frequency. Greater volume and finer tones result.

You'll never be without a Toner after you use it once.

2-color Radio Catalog describes fully the Toner and the Unit—free on request.

If your dealer cannot fill your order send direct to factory.

Morrison Products sold on a money-back guarantee.

MORRISON LABORATORIES, Inc.
345 Jefferson Avenue, East Detroit, Mich.

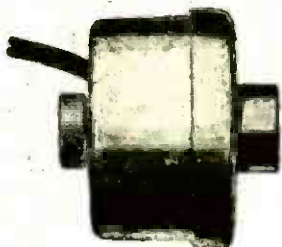

UNITY
Vernier Rheostat
Selected by the Best!



Garod Neutrodyne uses the UNITY Rheostat throughout—it's the invariable choice of the best set manufacturers. Cockaday specifies it repeatedly.

6 ohms most tubes } \$2.00
25 " 201A, 301A tubes
40 " 199, 299 tubes

The only really continuous-wire vernier rheostat—no jumping from coarse to vernier adjustment. Complete with switch.

FREE BOOKLET!
One "Tube Control" prepared by J. E. Jenkins of station W. G. N. Tells how proper tube control will increase the selectivity and quality of your radio set.



Electric Soldering Iron
Can't burn out!

That's why set manufacturers use it! Built on same principle as flatirons. Nichrome heating element. Pure mica insulation under pressure. Porcelain lining prevents heat from passing through handle. Unlimited guarantee.

\$1.50

UNITY MFG. CO. 224 N. Halsted St., CHICAGO
New York Office, C. M. HUNT, 50 Church St.

FREE
Greatest Catalog
of Radio
Bargains



Send for It Today

It contains a thousand bargains of everything in radio: parts, supplies, complete parts for sets, complete sets, etc., also a mine of very latest information on all different circuits, complete list of broadcasting stations and other valuable data. Send your name and address and we'll send FREE catalog.



American Bell Loud Speaker

\$3.95
without unit
\$6.95
with unit

With American Adjustable Unit. Wonderful volume, clear reception. Speaks for itself without coaxing. 10-inch bell—made of non-vibrating material.



HEADPHONES
"Randolph Special"
2200 Ohm moulded headset, properly designed to give strong and clear reception. Biggest headphone value ever offered.

Hundreds of Other Bargains

Our catalog is filled with bargains like these. Order direct from this ad. We prepay charges. Don't buy anything in radio before you see our catalog. FREE Service Dept.

RANDOLPH RADIO CORP.
159 N. UNION AV. DEPT. 253 CHICAGO, ILL.

Cockaday specifics

EVERYTHING that Cockaday specifies from condensers to dials and from coils to brackets is included in this AMPLEX KIT. It's the only safe and fast way to build the New Cockaday Four Circuit Tuner!

The AMPLEX KIT for the New Four Circuit Tuner has proved a revelation. Never before has set building been made so easy and results so certain. The panel is already drilled and engraved for you. The base-board is just the right size. All you need do is, follow the POPULAR RADIO Blueprint, mount and wire the parts—and before the evening is half over you are ready to tune in to that DX station 3,500 miles away.

And remember—the AMPLEX KIT for the New Cockaday Four Circuit Tuner is *officially authorized*. It is the result of co-operation between POPULAR RADIO Magazine, the Amplex engineers and the manufacturers of the parts used by Cockaday.

Build this new Cockaday Circuit with the 3,500 mile loud speaker range. Build it with an officially authorized AMPLEX KIT and be sure of results. If your dealer cannot supply you with the official AMPLEX KIT—don't wait—send us your remittance at once and we'll see that you get it immediately.

1 "Precision" Cockaday Coil Set	\$5.50	\$5.50	1 "Improved" SC Jack	\$.70	\$.70
1 "Cardwell" Vari. Cond. .0005	5.00	5.00	1 "Improved" Battery Switch	1.00	1.00
1 "Cardwell" Vari. Cond. .00035	4.75	4.75	1 "Precise" Transformer	5.00	5.00
2 "Accuratune" Dials	3.50	7.00	3 "Electrad" 1/2 meg. Leaks	.50	1.50
1 "Amplex" GRID-DENSER	1.25	1.25	3 "Electrad" Mountings	.25	.75
1 "N. Y." Fixed Cond. .00025	.35	.35	8 Binding Posts	.10	.80
9 "N. Y." Fixed Cond. .005	.60	5.40	4 Y Brass Brackets	.05	.20
5 "Benjamin Cle-ra-tone" Sockets	1.00	5.00	7 Switch points and 2 stops		.14
1 "Bradleyeak"	1.85	1.85	X1, X2, X3 Panels—3 for		.75
3 "Bradleyohms" No. 25	2.00	6.00	Bus Bar		.25
1 "Amseco Dubi Wundr"	2.00	2.00	Baseboard		1.00
1 Switch Lever	.30	.30	Set of POPULAR RADIO Blueprints and Instructions		1.10
4 "Amperites" No. 1-A with mountings	1.10	4.40			
3 "Improved" DC Jacks	1.00	3.00	Official Total List Price..	\$64.99	

FREE—A completely drilled and engraved genuine bakelite panel free with every kit

AMPLEX INSTRUMENT LABS.
88 West Broadway Dept. P. 12A N. Y. C.

The **NEW**
Cockaday Set

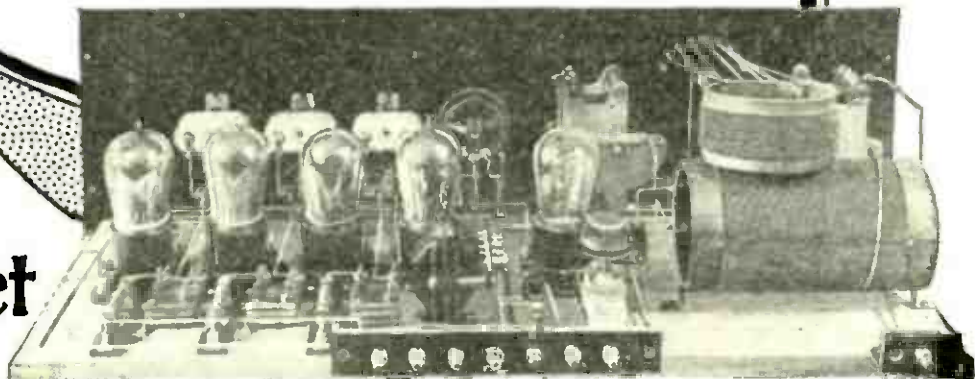

All apparatus advertised in this magazine has been tested and approved by POPULAR RADIO LABORATORY



**STRAIGHT-LINE
.0003 CONDENSER**

\$3.50

If your dealer cannot supply you, send us his name, \$3.50 plus postage for each condenser and we will fill your order direct.

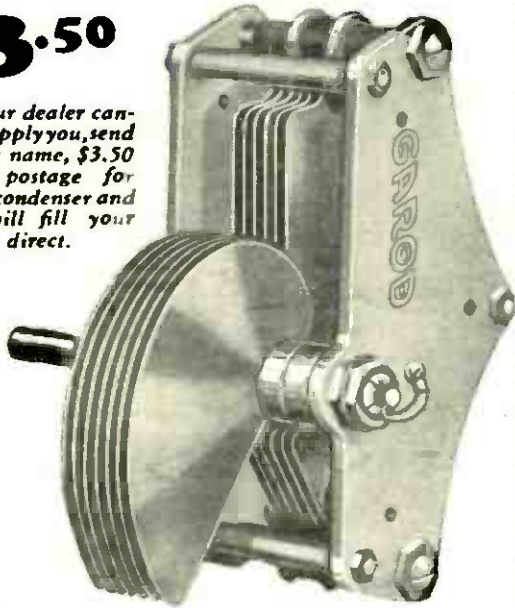

THE GAROD Condenser incorporates every refinement that can enter into a high quality precision condenser.

- Straight Line:** Specially shaped plates give "straight-line" tuning relations between dial settings and wave lengths.
- Low Loss:** A special patented design and ingeniously contrived provision for insulation assure extremely low loss.
- Brass Plates:** Brass plates, carefully designed and made, give good contacts and high conductivity.
- Grounded Rotor:** Positive ground is absolutely provided by a pigtail.
- Pigtail:** Objectionable tuning noises due to moving frictional contacts between rotor and frame are eliminated by permanent ground through pigtail.
- Ball Bearings:** A non-sticking, easy turning dial-shaft mounted on ball bearings.
- Metal Frame:** Adequate shielding and strength are provided by a frame of especially prepared, hardened aluminum alloy.
- Capacity Range:** The design gives great capacity range from .000013 MF. minimum to .0003 MF. maximum.
- Price:** Extraordinary economies due to design make all these features possible at this low price—\$3.50.

Made by
The GAROD Corp.
122 Pacific Street
Newark, N. J.



Makers of the



RADIO



SPECIALTIES

DeLux Model Speaker

Gives wonderful volume without destroying the artistic qualities of the music and without losing the human touch in voice transmission. Adjustable control mica diaphragm combined with special acoustical material horn gives forth no nasal or metallic sounds so frequently heard in many speakers. Finished in black gold to harmonize with the best of surroundings and priced within the reach of all at **\$20.00**



Popular Model

This speaker uses the same adjustable mica diaphragm used in our large speaker with a slightly smaller horn. Horn is made of sponge rubber vulcanized and gives exceptional volume. Latest style goose neck shape. Finished in dull black stipple. A small lever in the base gives instant control of tone and volume. This speaker is without doubt the equal of many horns selling at a much higher price and not to be compared with the many cheap horns on the market. Sold at the reasonable price of **\$15.00**



Other Specialties

Phonograph Unit at - - \$6.50 Head Set at - - - \$8.00
Lock "A" Bat Switch - - - - \$25

Write for Literature

THE CONNECTICUT INSTRUMENT CO.
STAMFORD, CONN.



- We represent these manufacturers:
- Cuningham Tubes
 - Magnavox
 - Atwater Kent
 - Western Electric
 - Allen Bradley
 - All American
 - Dubilier
 - U. S. Tool
 - Music Master
 - Burgess Industries
 - Grebe
 - Brandes
 - Cardwell Condenser
 - Jefferson
 - Fada
 - Crosley
 - Federal
 - Remler
 - Acme
 - Transformers
 - Cutler Hammer
 - Willard Batteries
 - Eby Binding Posts
 - Carter
 - Western Coil

25 Leading Radio Lines at Your Command Thru This Catalog

Every dealer should have The Sutcliffe Company's 96-page fall and winter Radio Catalog. The lines of 25 leading manufacturers are described, illustrated; and the wholesale price given of each item. Constituting one great stock, these Radio products are available on your order, from our Louisville warehouses. The Sutcliffe Company backs every item it sells with expert Radio Service. Dealers: Send for this catalog; make your radio purchases from it. Get the benefit of leading brands, large assortments, quick shipments, and expert and dependable service.

Write today on your letter-head. Address Dept. A-4.

THE SUTCLIFFE COMPANY
Incorporated
Louisville, Ky.

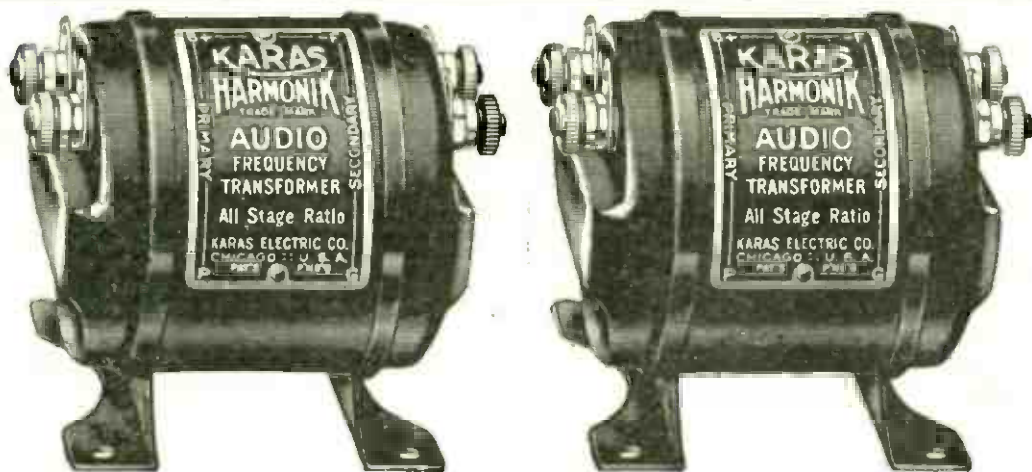

**KARAS
Harmonik**

\$7⁰⁰

Marvelous Reception

From these Scientifically Designed New Karas Harmonik Audio Frequency Amplifying Transformers

MUSIC that is absolutely true and natural. Clear, round, full mellow tones. Piano music that could never be mistaken for a harp or banjo. Speech so natural that you would instantly recognize the voice if you knew the speaker. Orchestral music poured out of the loud speaker with all the tones of each one of the instruments so accurately amplified that you feel as though you were sitting in the concert hall. This is what you hear when you listen to radio reception amplified through Karas Harmonik Transformers. It is impossible to picture in words the new thrill you will experience on hearing the exquisite musical quality of reception delivered by this wonderful new transformer.

What a revolutionary change in transformer design must have been made to account for this amazing improvement in radio reception!

An Engineering Triumph

Karas engineers, with the experience gained in building hundreds of thousands of audio transformers, worked more than a year and spent many thousands of dollars to achieve it. Distortion—that bugaboo of radio—is entirely eliminated. Low tones and very high tones are amplified equally with the middle tones. The vital harmonics and rich overtones—the qualities that distinguish music from noise—are brought out in their full beauty.

Important engineering problems had to be solved to accomplish this uniform amplification—and to deliver a high amplification factor absolutely free from the disagreeable distortion characteristic of all ordinary transformers.

Distributed capacity between turns—hysteresis and eddy current losses—and reluctance to the path of magnetic flux, all were reduced to a point never before achieved in transformer design. In every detail of construction, from the windings of the coils to the outer shielding, electrical and magnetic factors have been co-ordinated to produce that much talked of, but never-before-realized result—great volume without distortion.

Enthusiastic Endorsements

Our claims for performance of the Karas Harmonik are enthusiastically endorsed after the many rigid laboratory tests to which they have been subjected by scientists and musicians.

Individuals who have installed Karas Harmoniks in their sets write in most glowing terms of the tremendous improvement in reception. "Supersplendid" is the way one man describes it. "At last a transformer that will give undistorted two-stage amplification in a Superheterodyne," writes another. "The only transformer I have ever found that will handle a reflex circuit," says a third. So it is on every hand. The radio public is hungry for radio reception of real musical quality. And at last a transformer has been built which DOES produce it.

Far Better Reception From Any Circuit

No matter what type of receiving circuit you favor, Karas Harmonik Transformers in the audio end will make it a better set than it can possibly be with ordinary transformers. Karas Harmonik Transformers are equally superior for regenerative circuits, radio frequency sets, neutrodyne sets, superheterodynes and reflex circuits.

It requires an exceptional transformer to function properly in a reflex. It takes a remarkable transformer to handle the big volume of a "super" through two stages. Yet these are the critical tests that the Karas Harmonik is meeting every day with unvarying success. Users of Karas Harmoniks are more than satisfied. They are enthusiastic boosters.

Money-Back Guarantee

The remarkable performance of the Karas Harmonik justifies an unusual guarantee. Instead of the usual meaningless guarantee of "material and workmanship" we give you a straight-from-the-shoulder, money-back guarantee of *satisfaction*. Put a pair of Karas Harmonik Transformers in your set. Use them for 60 days. If you do not feel that they are giving you a quality of reception far beyond anything you have ever heard before, send them back to us and we will immediately refund your money without question or quibble. No strings to that offer! No reservation! You can't lose by accepting it.

Buy From Your Dealer or Direct From Us

Your dealer is authorized to make this guarantee if he has our goods in stock. We are supplying dealers as fast as the output of our factory permits. If your dealer is not yet supplied, use the coupon below. Let us send you a pair of transformers direct. Don't wait until you build a new set. Put Karas Harmoniks in your old one. It's easy to make the change. Ask your dealer today if he has secured a stock of Karas Harmoniks. If not, sit right down and mail the coupon at once. Make your set provide, for the enjoyment of yourself and family, that perfect musical quality of reception it is capable of producing.

To Jobbers and Dealers

Distribution of Karas Harmonik Transformers through regular jobber and dealer channels is being carried out as rapidly as the output of our factory permits. In the meantime mail applications will be taken care of in the order they are received, on an allotment basis. Write us for test records, discounts, etc.

To Set Manufacturers

We positively prove that Karas Harmonik Audio Frequency Transformers will vastly improve the musical quality of your set by any form of test you wish to impose. When you are convinced of this you will naturally want to use them. Write or wire us and arrangements for tests will be made promptly.

Send No Money with this Coupon!

Karas Electric Co., 4040 N. Rockwell St.,
Dept. 5839, Chicago

Please send me..... pair of Karas Harmonik All Stage Ratio Audio Frequency Transformers. I will pay postman \$7 apiece, plus postage, on delivery. It is understood that I am privileged to return the transformers any time within 60 days if they do not prove entirely satisfactory to me, and my money will be refunded at once.

Name.....

Address.....

City.....

Dealer's Name.....

Dealer's Address.....

If you send cash with order we'll send transformers postpaid.

KARAS ELECTRIC CO., 4040 N. Rockwell St., Dept. 5839, Chicago



R-D-X

COMPLETE PARTS
\$25

REFLEX RECEIVER

The set designed by M. B. Sleeper

FULL loud speaker volume on local stations, sharp tuning to get thru to distant stations. Only two controls for tuning.

The R-D-X construction kit, including Formica panel, drilled and engraved, is complete in every detail, and made up of parts from such makers as Dubilier, Paragon, Eby, Modern, and Rasla. Instructions are so clear that no technical knowledge is required to assemble the R-D-X. Send remittance TO-DAY—your R-D-X kit will be sent immediately, charges prepaid.

SPECIAL: FULL SIZE R-D-X BLUE PRINTS AND INSTRUCTIONS—\$1.00

DURRANT RADIO Limited

52 Vanderbilt Avenue, N.Y.C.

LOMBARDI GROUNDED ROTOR LOW LOSS CONDENSER

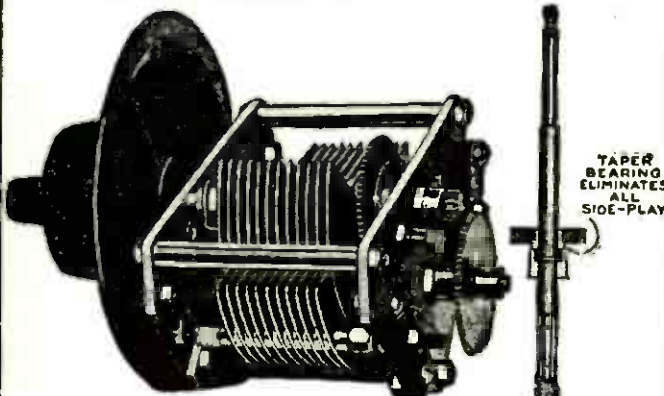

TAPER BEARING ELIMINATES ALL SIDE-PLAY

BALL BEARING GIVES FRICTION WITHOUT BINDING

An ACCURATE, ATTRACTIVE CONDENSER of moderate dimensions with the following special features:
 LOWEST DIELECTRIC LOSSES.
 PIGTAIL CONNECTION and STOP.
 GEARED VERNIER SHAFT runs thru ROTOR SHAFT making it UNNECESSARY to DRILL an EXTRA HOLE in PANEL for VERNIER and it WILL TAKE ANY SIZE DIAL.
 45 DEGREE TAPERED BEARING and BALL and THRUST TYPE with adjustable spring tension (PAT'D).
 ALUMINUM END BRACKETS and PLATES and ACCURATE SPACING.
 TESTED by VALE LABORATORY to be one of the BEST.
 Actual test sent on request.
 Condensers furnished plain or geared Vernier or with Vernier dial.

Literature sent on request

THE LOMBARDI RADIO MFG. CO.
71 MINERVA ST., DERBY, CONN.



Model A
2400 Ohms
\$4.00 List

Model B
3000 Ohms
\$5.00 List

"Distance Lends Enchantment"

Every real radio fan gets a distinct thrill when he "listens in" to far-distant stations through Repeater Phones. The remarkably beautiful tone quality, so clear and loud, gives a fascination never before experienced.

Of course there is a very definite reason for Repeater superiority. The "Single Pole" feature, exclusive to Repeater Phones, makes possible that extra power and fidelity of reproduction. Our catalogue describes this feature and others in detail—ask for yours.

If your dealer cannot supply you send order direct to factory.

Dealers

You will find Repeater Phones—a nationally advertised Product — fast-moving merchandise. Ask for our Sales plan and Discounts.

MOSS-SCHURY MFG. CO., INC.
Radio Division
2013 Franklin Street - - - Detroit, U. S. A.
The New Improved "Repeater"



Different -and superior to any other circuit!

The **SUPER-HILCO-DYNE RECEIVER**—
—a seven-tube set superior in every way and
different from the conventional super-hetero-
dyne (note wiring diagram) is made from the
\$30 **SUPER-HILCO-DYNE KIT** and about
\$45 worth of standard radio parts sold by any
dealer. It operates either on storage batter or dry cell tubes.

SELECTIVITY A fan receiving in New York next to the high voltage elevated railway tunes in or out all the nearby high-powered broadcasting stations and gets what he wants when he wants it.

DISTANCE A fan receiving in a large metropolitan hotel uses the steam radiator as his antennae and gets coast to coast reception.

TUNING Only two dials. Stations can be located today, tomorrow, or next month by turning back the dials to the place where those stations came in before.

CONSTRUCTION Inexperienced fans all over this continent have built these sets without trouble.

RADIATION Not a squeak, squawk or squeal comes from the **SUPER-HILCO-DYNE** to bother your nearest neighbor. It does not radiate.

DISTORTION Absolutely true tone qualities from the lowest note of a bass horn to the highest note of a coloratura soprano.

VOLUME You can dance any night with a **SUPER-HILCO-DYNE RECEIVER** Loud speaker reception on all stations.

WAVE RANGE 90 to 600 meters.

SIZE OF RECEIVER Only 7" x 28" panel.

Each **SUPER-HILCO-DYNE KIT** is thoroughly tested and the air core transformers are matched and balanced in our own laboratories.

Here is selectivity, great distance, volume, clarity, easy tuning, simple construction. It is **YOUR** set, custom built to **YOUR** requirements. It is the **ONE** you want; the **ONE** you have been hoping for. Order from your dealer or send for descriptive literature on the **SUPER-HILCO-DYNE KIT** and other famous Hilco radio apparatus. Address Dept. 11.

Scientific Radio apparatus that is distinctively different and superior in efficiency and appearance.

THE KIT CONTAINS
the six essential **SUPER-HILCO-DYNE** instruments, together with the required number of **HILCO Precision Fixed Condensers**, and a 20-page book thoroughly describing and illustrating in text and in blueprints all details of the **SUPER-HILCO-DYNE RECEIVER**.
Price of book separate from the kit—\$1.00.

SUPER-HILCO-DYNE BOOK

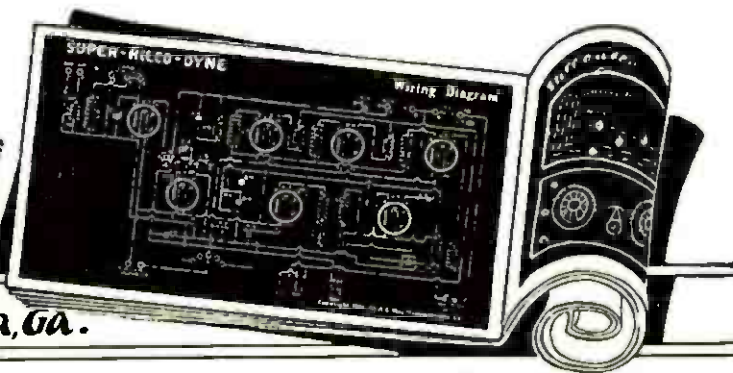

A.E. HILL MFG. CO. Atlanta, Ga.

All apparatus advertised in this magazine has been tested and approved by **POPULAR RADIO LABORATORY**

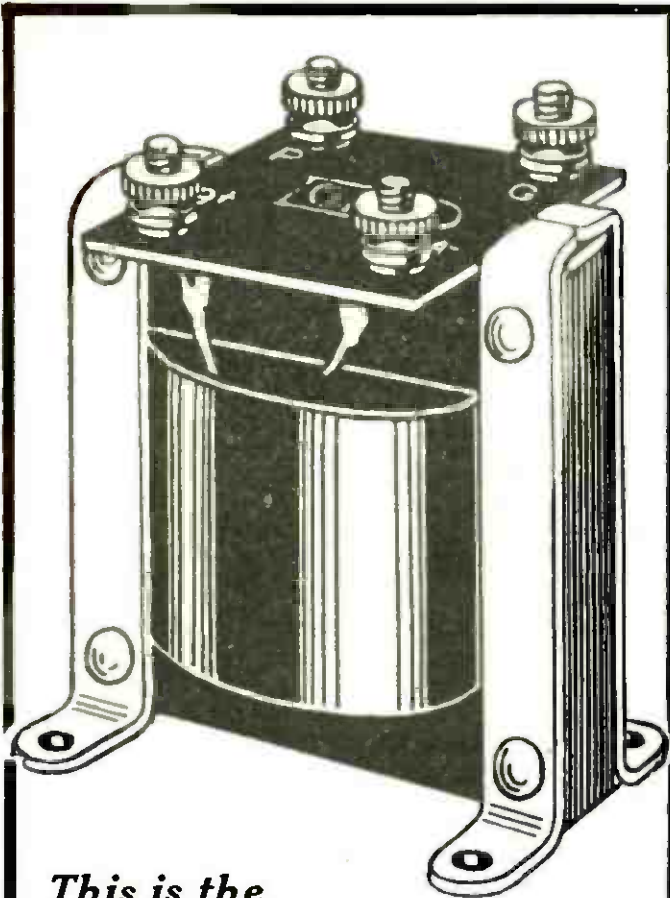

This is the
TRANSFORMER

POPULAR RADIO

Selected for the
Low-Loss "Short Wave"
Receiver

described in its November issue. Thousands of fans have found out that Dongan Type C Audio Frequency Transformer exactly meets the requirements of all hook-ups. Tone, volume, smooth-performance—all these qualities are yours by using Dongan.

Ratio $3\frac{1}{2}$ to 1 and 6 to 1
Bakelite Panel
Nickel Plated Trimmings.
\$3.50 List.

Order from your dealer or direct,
Full descriptive folder sent on
request.

VOLTMETER

An absolutely accurate instrument—the Dongan Double Duty High Resistance Voltmeter saves your batteries and gives correct readings. Ask for complete details.

Dongan Electric Manufacturing Company

2983 Franklin Street

Detroit, Michigan

Transformers of Merit for 15 years

TRADE **DXL** MARK

Variable Condenser

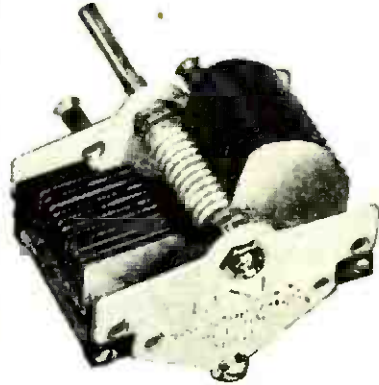

11 Plate	\$4.00
17 Plate	4.25
23 Plate	4.50
43 Plate	5.00

"Ask for a D. X. L."

STRAIGHT-LINE-LOW-LOSS

Designed especially for Super Heterodyne and all super sensitive sets. Grounded rotor plates of brass construction—aluminum end plates. Body capacity entirely eliminated. Approved by University of Michigan and found accurate with U. S. Bureau of Standards.

Write for folder giving description

If your dealer can't supply you we will furnish direct. Send money order.

MANUFACTURED BY

D. X. L. RADIO CORPORATION
DETROIT, MICH.

If
Your
Set
"Lisps"

Patent Applied for

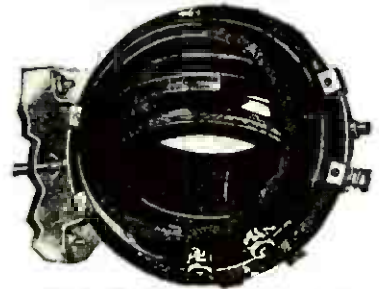

Variable Clarifying Selector

Or if the tone is fuzzy, or mixed up with other stations, you need this Selector.

It gets in between stations like a born peacemaker, and clears up the tone to full brilliance in a way that will surprise you.

It affords complete control of the antenna coupling, and replaces fixed and variocouplers, tapped coils, aerial variometers and other aerial tuners.

It works alone in any standard hook-up, and is a splendid companion for our VT25, Variotransformer, which gives the amplification of two fixed R. F. stages without condensers. The Selector is \$7.00; VT25 is \$8.50. Send for

FREE BOOK

showing complete L+K line, Greene Concert Selector hook-up, and other effective circuits. (Jobbers, Dealers, write.)

Dept. P. 654 Grand Ave., New Haven, Conn.

LANGBEIN + KAUFMAN **L+K**
High Grade "Low Loss" Tuning Devices
A Guide to TECHNICAL ACCURACY

MAGNAVOX Radio

*The Utmost
in Quality and Value*



Always look for the Magnavox
Trade Mark when buying radio.

AS the rapid progress of the radio art leads every experienced user to expect supremely high standards of efficiency in his equipment, it becomes of vital importance to know what apparatus deserves your investment in hard earned cash.

Regarding the quality of Magnavox Radio Reproducers, their distinctive characteristics are too well known throughout the radio world for special explanation or comment.

Those for whom radio has become an actual daily need, however, will welcome a brief word about the new Magnavox Radio Receivers and Vacuum Tubes.

The unique feature of the Magnavox set is the gearing together of its several resonant circuits so as to per-

mit positive control by a single dial.

The Magnavox Tubes have extremely high amplification factors, and as detectors, give sharper tuning and eliminate microphonic noises.

*It is well worth your time to examine these products at the nearest Magnavox store.
Literature on request.*

THE MAGNAVOX COMPANY OAKLAND, CALIFORNIA

New York: 350 W. 31st St. Chicago: 162 N. State St. San Francisco: 274 Brannan St.
Canadian Distributors: Perkins Electric Limited
Toronto, Montreal, Winnipeg

12R

ROYALTY

Variable High Resistances Variable Grid Leaks

WIRE WOUND

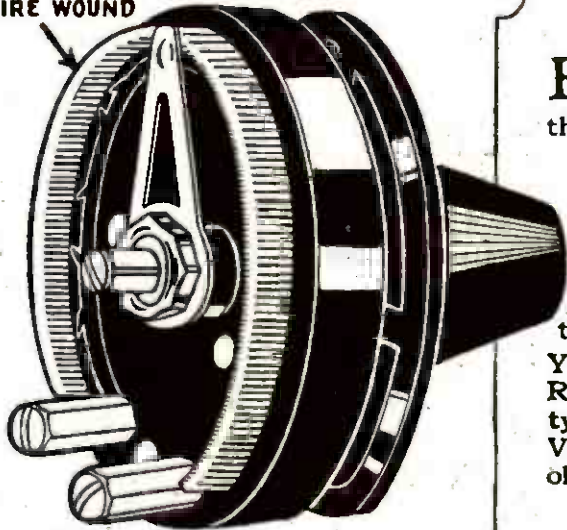

Revolutionary!

RROYALTY Variable High Resistances and ROYALTY Variable Grid Leaks represent the greatest improvements ever made in this field. They are wirewound!

This wire winding eliminates at one stroke all the common grid leak and resistance troubles. The lever arm cannot scrape away the resistance element. The grid leak and the high resistance are noiseless and positively non-inductive. The resistance value is retained indefinitely.

Your dealer has the ROYALTY Variable High Resistance (type B, 1,500 to 100,000 ohms,—type C, 500 to 50,000 ohms) and ROYALTY Variable Grid Leak (type A, 100,000 to 7,000,000 ohms).

ANY TYPE **\$1.50**

FREE—Write for the ROYALTY hook-up booklet

WIRELESS PRODUCTS CORPORATION
136 Prince Street, New York City

RADIO PRODUCTS CO.

WESTPORT, CONNECTICUT

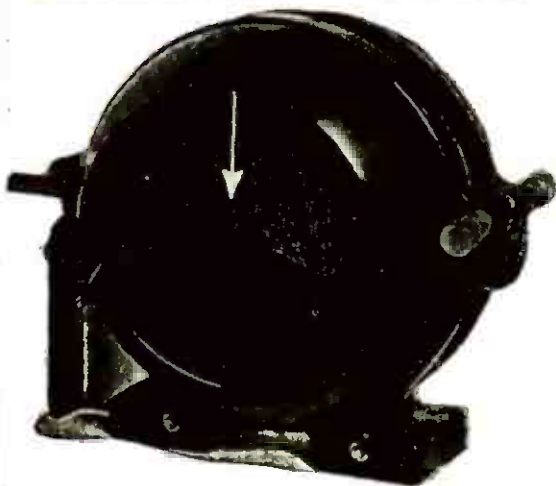

IF YOU WANT ALL WAVE LENGTHS FROM 200 TO 600 METERS

Choose the R. P. C. VARIOMETER

"Dry" windings without shellac or other covering prevent internal losses. Beautiful in appearance. May be mounted on panel or base. Bearings designed for long wear.

AT ALL RELIABLE DEALERS

Literature on request



YOU'VE ALWAYS NEEDED A C. & C. "REACHIT" WRENCH

The most-practical tool for all small hex or round nuts and screws.

Automatically clamps the object in its jaws.

Reaches into the most inaccessible places.

Indispensable to the mechanic, electrician and all radio enthusiasts.

Made of finest quality tubing with hardened jaws. High nickel finish.

Price \$1.50

If your dealer cannot supply you, will be sent postpaid, on receipt of above amount and your dealer's name.

CAUFMAN & CLOUGH CO.
WILMINGTON, DEL.

Your Set is Only as Good as You Make It!



Radio Jacks

The following features, many of them exclusively Yaxley, recommend these Jacks: One nut mounting. Springs genuine phosphor bronze. Pure silver self-cleaning contact rivets. Firm contact pressure; low resistance. Pressure assembly, assuring permanent alignment. Spring terminals tinned for soldering. Mount in 7-16" panel hole without adjusting collars.

Rheostat

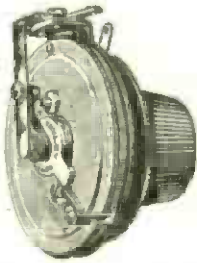

Resistance coil is stationary and the contact spring, carried on a heavy rotor arm, rides noiselessly on the flat side of the winding without producing microphonic disturbances in the tubes. A large number of turns of high resistance wire assures sharp tuning without the use of Vernier attachments. One nut mounting, can be turned to any position to suit wiring layout.

Very compact. One nut mounting in single panel hole. Hard rolled phosphor bronze springs. Pure silver contacts. Insulated from metal frame.

Midget Battery Switch

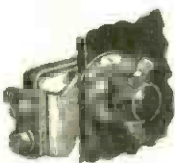

Very compact. One nut mounting in single panel hole. Hard rolled phosphor bronze springs. Pure silver contacts. Insulated from metal frame.

There is no magic in Radio. Results are governed by absolute laws of cause and effect. You cannot get out of your set any more than you put into it.

YAXLEY

APPROVED RADIO PRODUCTS

have always stood for correct design, precise workmanship and right materials. Leading makers of high-class radio equipment have adopted Yaxley made radio parts as standard for excellence. The radio public has accepted and looks to Yaxley-made jacks, plugs, rheostats and other radio parts, as the best that can be obtained regardless of price.

Yaxley Approved Radio Products are designed with a fine technical understanding of the part they play in radio receiving and they are made with a keen sense of responsibility to the radio public which underlies their guarantee of satisfaction in service.

When you want what is best for your set, ask your dealer for Yaxley products.

YAXLEY MFG. CO.

Manufacturers of Jacks, Jack Switches, Rheostats, Potentiometers, Inductance Switches, Dials and Knobs, Plugs, Battery Switches and Other Radio Parts.

Dept. P, 217 No. Desplaines St.,
Chicago, Ill.

CHARMITONE
LOUD SINGER
MODEL J-10
Complete
Ready to operate
\$25.



CHARMITONE
LOUD SINGER
MODEL H-8
Complete
Ready to operate
\$18.50

CHARMITONE
TRADE MARK REG. U.S. PAT. OFF.
LOUD SINGER

— a superior
**Musical
Instrument
for Your Radio!**

T HIS Radio Horn is rapidly becoming the favored instrument of discriminating enthusiasts, due to its remarkable musical performance, its beautiful appearance and its patented mechanical features, which assure easier and more satisfactory operation.

TWO-in-ONE Action

Tuning and amplifying off the same master phone in the base of the horn

**Supersensitive Stethoscope
Eliminates Head Phones**

Tuning is done with Stethoscope in ears, then one turn on lever in base of horn cuts out Stethoscope and operates the horn. No plugging in and out of Radio Set. Same lever also controls volume in Stethoscope and horn. Any number of Stethoscopes may be used for listening without additional drain on the batteries or loss of volume.

One-piece horn, dark gray crystalline finish; with silver plated metal parts. Made in two models; see illustration above. Extra Stethoscope, complete with all fittings, each \$1.50.

Ask your dealer to demonstrate the **CHARMITONE LOUD SPEAKER** for you. If he cannot supply you, we will send either model direct, prepaid, upon receipt of price.

DUAL LOUD SPEAKER CO.
210 West 54th Street, New York City

**Tuning Feature
Directional
Can Be Logged
Collapsible**



Patent
Applied
For

**KORACH
TUNED LOOP**

Positively the last word in loop construction. Gives remarkable results because it may be *tuned and logged*. Exclusive features give you *Selectivity and Distance* unheard of before with loop aeri-als. We want you to see for yourself. So send at once for our

GUARANTEED TRIAL OFFER

We will send this loop on ten days' trial. You are the judge. Simply send \$2.00 as a good faith deposit with your order. Deposit balance (\$14.50) with Postman when loop arrives. Try it for ten days. *If not perfectly satisfied in every way, return and you get the \$16.50 back WITH NO QUESTIONS ASKED.* You take no risk! Our offer is guaranteed, so send now.

HERMANSON-KORACH MFG. CO.
309 So. LaSalle St. Dept. 8 Chicago, Ill.

Full Particulars on Request

Dealers and Jobbers who are rated: We will ship sample on memo invoice for inspection and test. Write today.

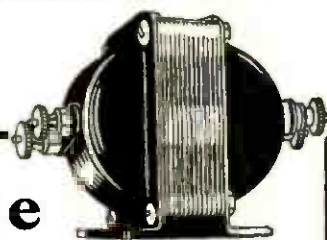

**Convince
Yourself!**

You can now secure the very highest quality

Audio Transformer \$2.95

of the very latest design for use in all circuits for only **post paid**

"Push Pull" Type \$8.50

Price per matched pair, only **post paid**

Complete information and wiring diagram packed with every Transformer. Satisfaction guaranteed or money refunded.

Crescent

Transformers

Crescent Mfg. Co.

Box 337 Central Sta.
Toledo, Ohio

Enclosed in Metal Case
Charges Quietly While You
Enjoy Local Concerts
No array of Connecting
Posts to bother with

Sterling

PORTABLE RECTIFIER



Charges "A" and "B" Batteries from A. C. Lamp Socket

Radio's favorite rectifier—the record-breaking 1924 Sterling Model—made stronger, simpler and more convenient. With this new 1925 charger of Sterling make, you can charge 6 volt "A", 24, 48 or 72 volt "B" Batteries. No array of connecting posts to confuse you. Each quarter turn of the selector switch automatically adjusts the rectifier to charge a battery of different voltage.

Model 19 for charging "A"
and "B" Batteries.
Price \$22.50.
(50 and 60 cycle)

Completely protected from dust and moisture. No metal contacts to fuse or burn out. As simple to use as an electric iron. Can't overcharge batteries.

Model 17 for charging "A"
Batteries. Price \$18.50.
(50 and 60 cycle)

THE STERLING MFG. COMPANY
2859 Prospect Avenue Cleveland, Ohio
Send for free booklet of hook-ups, log sheets and other data

Sweeter Christmas Carols On Your Radio



\$10 Complete
with Cord

Not a loudspeaker—
not an attachment—
but a complete unit,
plugged in like a loud-
speaker, that trans-
forms the electrical im-
pulses into vibrations
which, through the
phonograph needle, are
transmitted to the re-
producer of your
phonograph. It can be
used on any phono-
graph.

When the sweet, tender strains
of "Silent Night, Holy Night"
broadcast by some cathedral choir
come in over your radio Christmas
Eve, you will want a Rhamstine*
Needlephone to enjoy it to the
fullest.

RHAMSTINE* Needlephone

The Needlephone gives all the
advantages of the phonograph
without even removing the needle.
It has no metal diaphragm so it
cannot produce metallic noises. It
is more easily attached, requires no
extra equipment, and can be used
on any phonograph including the
Edison with Victor adapter.

Pay No Money. Take No Risk.

Send the coupon today, pay on
delivery, and try the Needlephone
with your own set and your own
phonograph. Try it with a soft
needle on local broadcasting and
see what pleasures await you.
Try it with a loud needle and en-
joy greater volume without metal-
lic noises. Then, if you are not
entirely satisfied, if you cannot say
you get better reproduction, re-
turn it and Rhamstine* will refund
your money.

Send this coupon today—there
will be lots of things on the air
that you will want to hear this
Christmas.

J. THOS. RHAMSTINE*

J. Thos. Rhamstine*

Woodbridge at Beaubien, Detroit, Mich. (12)
Send me the Needlephone. I'll pay the postman \$10 upon
its arrival. It is strictly understood I may return it if I desire,
within 5 days, and receive a refund in full.

Name.....

Address.....

*Radio and Electrical Products.

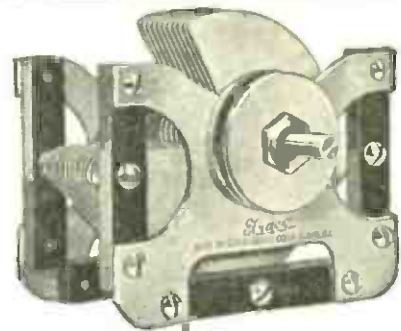

The New, Remarkable ELRACO Low Loss Condenser

Leads the field. Grounded rotor. Sin-
gle hole mounting. Brass plates. *Prac-
tically no loss.* Correct in design and
construction.

.00025 M.F. \$4.50 .0005 M. F. \$5.00
.00035 M.F. 4.75 .001 M. F. 6.50

Ask your dealer or order direct

Satisfaction Guaranteed

Elgin Radio Corporation

Radio Division, The Elgin Tool Works, Inc.
67 No. State St. Elgin, Ill.



LABORATORY MODEL

Supreme!

NO MAKESHIFTS REFLEXING SECOND HARMONICS

SILVER SUPER HETERODYNES

are unquestionably the **ULTIMATE** in present-day super design. They are superior to any other 7-tube set ever produced, regardless of cost,—Superior every way—Quality, Simplicity, Selectivity and Sensitivity.

Startling Claims

Yes . . . but claims that have been demonstrated over and over again . . . Claims that have been thoroughly investigated, and that are now acknowledged as actual facts by Radio Engineers, Editors and Fans alike.

BECAUSE

every part of every Silver Super is right the set itself, whether Laboratory or Portable Model, must be right. Reflexing, Second Harmonics and similar round-about expedients are not employed. There are no delicate balances of different circuits to demand laboratory adjustment. Reflexing overworks tubes, complicates construction and results in poor operation—all these makeshifts are left out of **SILVER SUPERS**. Painstaking experiments with hundreds of supers discovered the direct, straight-away method of construction that makes the Silver Super's 7 tubes do more work than the average 10-tube set, and that secured for **SILVER SUPERS** their remarkably high degree of efficiency—without being reflexed or "harmonic-ed." That's why **SILVER SUPERS** are supreme, and why the "men who know" acknowledge that supremacy by using them . . . that's just why you should, too!

Write for "**The WHY of SILVER SUPERS.**" *It's free!*

Portable Model Parts \$57.65
Laboratory " " 63.60

CIRCULARS

on the **SILVER SUPER SPECIALS** upon request.

THE BOOK

"**THE PORTABLE SUPER-HETERODYNE**" is just crammed full of "**DOPE**" that every fan should have. It is the one book that really takes the Super-Heterodyne apart and discards all the "kinks and twists." Drawings and Photographs in the book make it easy for you to build a Silver Super on your kitchen table, with only a Screw Driver, Soldering Iron and a pair of Pliers. Send for your copy today. Price 50c.

Eastern Distributor: 20th Century Radio Corp., 102 Flatbush Ave., Brooklyn, N. Y.

Silver-Marshall, inc.

105 SOUTH WABASH AVE.

DEPT. E

CHICAGO



Type 101

Silver Coupling Unit Small, Compact, Ultra-Efficient, \$2.50

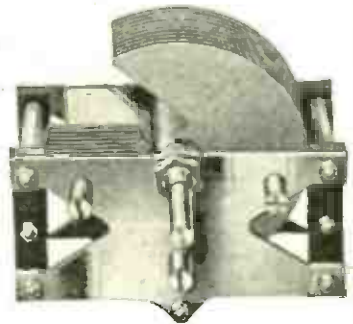

Type 301

Silver Low Loss Condenser. Loss Immeasurable; Ideal for any circuit. \$4.50



Type 401

Silver 50 KC Transformer Unit. The Original Employs 2 Interstage and a filter transformer. 1 1/2 to 3 1/2 times the efficiency of anything on the market. 14.00

DEALERS

Write for the S-M attractive Merchandising Plan.

SUPERADIO

FREQUENCY AMPLIFIER UNIT
AUDIO AMPLIFIER UNIT
VARIABLE CONDENSER

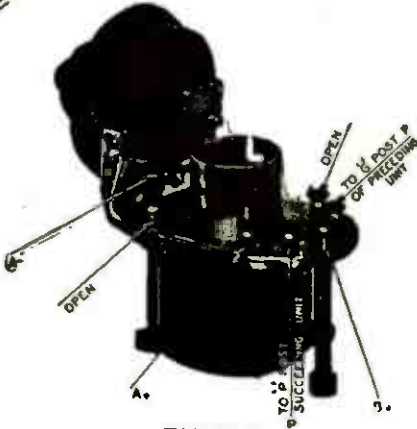

TYPE 1

A complete non oscillating tuned radio frequency unit: low-loss condenser. Type X Transformer, socket, and 8 or 30 ohm Rheostat completely wired, ready for use. Type 1-R.F. unit \$8.50; type 2-R.F.U. \$9.00

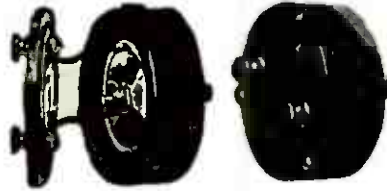

A variable low-loss condenser made of mica-mercury, built on a new principle. No rubbing contacts. Fully pigtailed; cap .0005 M.F.D. Price \$3.00. Three R.F. units and 2 A.F. units will make a 5-tube non-oscillating tuned R.F. receiver.

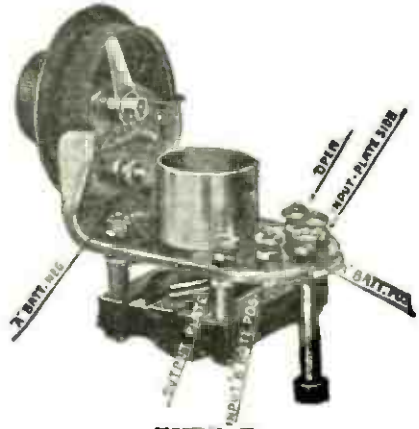

TYPE B

One complete stage of audio amplification in one unit. Transformer already wired. Rheostat 6 or 30 ohms. Type B for use with "C" Battery \$7.00. Type C for use with or without "C" Battery \$7.00.

If your dealer cannot supply you, we will send direct upon receipt of price. Circular on request

De WITT ~ La FRANGE Company Inc.
54 Washburn Avenue -- Cambridge, Massachusetts

KELFORD CONDENSERS (Low Loss - Variable)

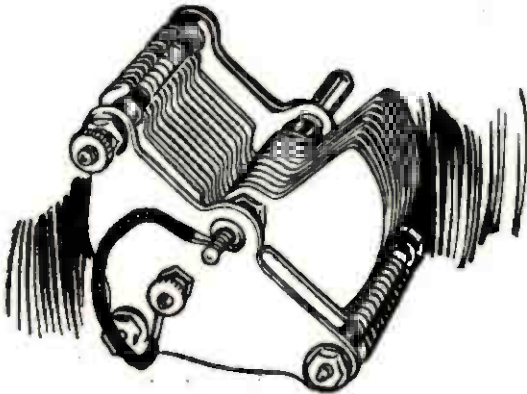

Built by America's Oldest Manufacturers of Radio Parts

One of our big sellers, because the man who builds his own wants a real condenser. Note the remarkably low prices.

From 5 to 23 plate, from \$2.00 to \$3.00 list
Drop us a postcard for full description

The American Specialty Co.
178 Holland Ave. Bridgeport, Conn.

RADIO

Large and most complete stock of Quality Radio merchandise at standard prices. Complete sets and standard parts of reliable makes. There's sixty-five years of uninterrupted service back of the "House that Satisfies." Reliable Radio merchandise is the only kind that's worth while. You can be certain of reliable, complete satisfaction and prompt delivery if it comes from Andrae.

Send for catalog

JULIUS ANDRAE & SONS CO.
127 Michigan St. Milwaukee, Wis.

ANDRAE In Business Since 1860

FARAWAY RADIO



\$29.50

Gets stations Far and near Loud and Clear

FARAWAY Radio Sets are amazing values at bargain prices. Users get stations from New York to Frisco—loud and clear. Operate with either dry cells or storage batteries. Beautiful cabinet finished in mahogany with new platinum-finished panel. SATISFACTION GUARANTEED. Don't pay \$100 to \$150. Write for our money-saving plan and literature.

2-Tube Set - \$29.50
4-Tube Set - \$9.50

Dealers - Agents: Biggest possibilities you ever heard of. Write for plan and territory quickly.

THE FARAWAY RADIO CO., 654 W. THIRD ST., CINCINNATI, O.



4 Tube Console
\$135.00

Two Beautiful Consoles

Both the four and five tube Clear-O-Dyne sets are available as consoles. Each console is a beautiful self-contained piece of furniture with space for a concealed loud speaker, and for A and B batteries and charger. The wood is a beautiful solid mahogany.

These consoles are very moderately priced—and offer an astonishing value in a set of this type.

If your dealer does not handle Clear-O-Dyne sets, write us direct.

Dealers and Jobbers: Avoid price resistance and give your customers the best possible radio set.



5 Tube Console
\$190.00

Clear-O-Dyne Model 70	\$75.00	Clear-O-Dyne Model 80	\$120.00
Clear-O-Dyne Model 71	90.00	Clear-O-Dyne Model 82 Console . . .	190.00
Clear-O-Dyne Model 72 Console . . .	135.00	Other sets from \$60.00 up.	



THE CLEARSTONE RADIO COMPANY - CINCINNATI, OHIO

All apparatus advertised in this magazine has been tested and approved by POPULAR RADIO LABORATORY

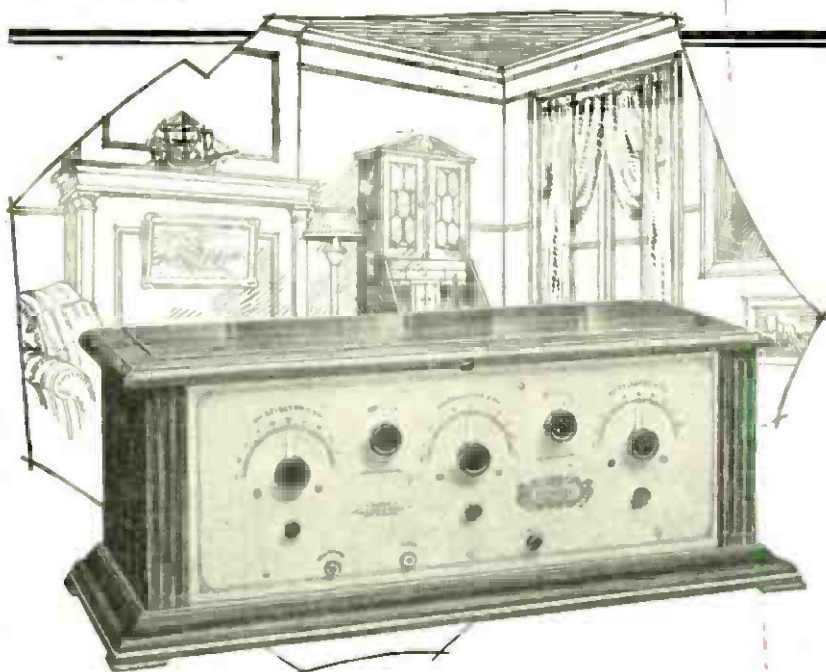

Performance
proves
this five tube

S U P E R
CLEAR-O-DYNE

to equal any set made anywhere

PRICE \$120.00

IN the hands of actual users, many of them inexperienced, this set has won its place of equality with the finest five tube sets ever made. It is equal in selectivity, and in clarity and sweetness of tone. In good radio weather it provides coast to coast reception on the loud speaker.

Your eyes will tell you that in appearance it is distinctive and beautiful and that it is well and carefully made by real craftsmen. It is an ornament in any surroundings.

You may pay more for a radio set—but you can't get more genuine satisfaction.

THE CLEAR-TONE RADIO COMPANY - CINCINNATI, OHIO

All apparatus advertised in this magazine has been tested and approved by POPULAR RADIO LABORATORY

The GIFT of GIFTS for
the Holiday Season

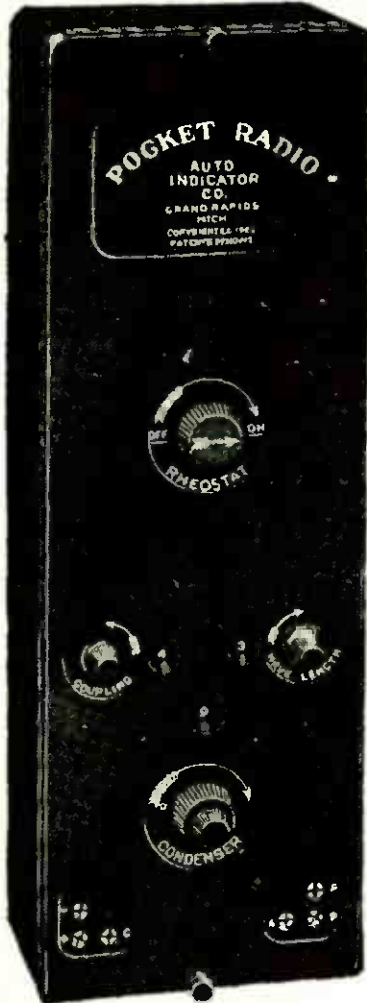

Put it in your grip
Take it with you on your trip

Announcing

The New Standard "B" Model

The most wonderful single tube set ever offered the public, introducing NEW and EXCLUSIVE features, consisting of beauty, refinement, range, clear tone and selectivity.

A Portable Outfit

Complete within itself, with tube, A and B batteries all contained in a handsomely finished, moulded bakelite case, 2 $\frac{3}{4}$ " x 4" x 12 $\frac{1}{2}$ ". Weight complete 4 lbs.

Efficiency has not been sacrificed for compactness as short leads insure maximum results. Its clearness of tone is unsurpassed. A bigger value than any other.

When used without aerial or ground this receiver is capable of reception from local broadcasting stations at short distances. When used with outside aerial and ground reliable reception is obtained from stations 1,000 miles away. Under favorable conditions twice this distance has been reported by our users.

Now — Adaunit —

For those desiring amplification with Pocket Radio our ADAUNIT PORTABLE meets every requirement, consisting of 2 stages of amplification, loudspeaking unit with built-in cabinet horn, batteries and Pocket Radio, completely housed, in a genuine leather covered case 9" x 8 $\frac{3}{4}$ " x 13 $\frac{1}{4}$ ", weighing only 19 lbs.

Travelers delight



Interior view

One of Many Letters from Satisfied Users

Auto Indicator Company—

Gentlemen: I purchased one of your pocket radio sets and have found same very satisfactory, giving our family a great deal of amusement and pleasure. I have been very successful in picking up long distance stations, having listened in on twenty-two (22) stations in one evening, including Montreal, Canada.

Mrs. Johnstone, my son and I listened for about three-quarters of an hour one evening to Station PWX Havana, Cuba, and on Sunday morning, January 6th, at a quarter of two, I listened in on Station KPO San Francisco, hearing the music quite distinctly.

Yours very truly,
(Signed): GEO. H. JOHNSTONE.

Note.—Mr. Johnstone is a Vice-President of the Wayne County and Home Saving Bank, Detroit.

Price without accessories, \$23.50

If your dealer cannot supply you, write to

AUTO INDICATOR CO.

Grand Rapids, Mich.

What's What in Super-Heterodyne

To select from various circuits and parts those which laboratory tests prove to give best results—

To work out the finest Super-Heterodyne standard that radio engineering skill can achieve—

That is the purpose of Norden, Hauck & Co., Super-Heterodyne specialists. Every member of our staff is a radio technician of recognized standing. Every test made in our laboratories is thorough and authoritative. Every piece of apparatus listed in our stock is of full laboratory standard.

You may rely upon any material and information we furnish you.

The One Way to Get a Real Super-Heterodyne

Do you want genuine radio satisfaction? Long range reception through the barrage of nearby broadcasting. Hair line selectivity. Purity of tone. Better amplification. The one instrument that can give it to you is the real Super-Heterodyne, built of laboratory apparatus to naval standards. Of all the circuits and parts tested in our laboratories, here are the finest yet produced in the art—designed by *Experimenters Information Service*:

MODEL C-7 Improved Regenerative Super-Heterodyne
 MODEL C Standard Loop Super-Heterodyne
 MODEL K Antenna Adapter for Model C
 MODEL J 2-Stage R. F. Amplifier for Model C

We furnish material (laboratory standard) that enables you to build a real Super-Heterodyne economically. Immediate shipment.

We can save you money
 Write for free information and price list

NORDEN, HAUCK & COMPANY, Engineers

Office and Laboratories

1617 Chestnut Street

Philadelphia, Pennsylvania

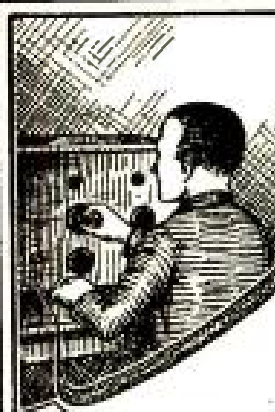

The Premier 20 Ft. Extension Cord Complete With Plug \$1⁷⁵



An Ideal Xmas Gift for Every Radio Owner
 Sold by your favorite Radio Shop or
 write us mentioning your dealer's name.

Mfg. By **Crescent Braid Co., Inc.**

Providence, R.I.

RADIO TAUGHT AT HOME

New Easy Method by Penna. State College

No more tiresome stumbling thru complicated blue-prints and pictured hook-ups—no more costly guessing or aimless experimenting—a sound working knowledge of fundamental practise and theory leading to proficiency is readily acquired thru the easily mastered correspondence courses in Radio Transmission and Reception—one elementary, one advanced—offered by the Pennsylvania State College. As this is a State Institution we can offer these very helpful courses at cost. For full information write Division A, Dept. of Engineering Extension,

PENNSYLVANIA STATE COLLEGE
 State College Pennsylvania

Manufacturers of Radio Parts

As large wholesalers only and carrying stock in eight largest cities in Australasia, we can give standard lines exclusive representation. Send us your catalogue and samples by Parcel Post, which we will pay for or return. **Not interested in sets.**

UNITED DISTRIBUTORS, LTD.

SYDNEY, AUSTRALIA
 CABLE ADDRESS "SUPERIOR"

Reference:

United Manufacturing & Distributing Co.
 9705 Cottage Grove Avenue
 CHICAGO, ILL.

The New DAY-FAN OEM Model

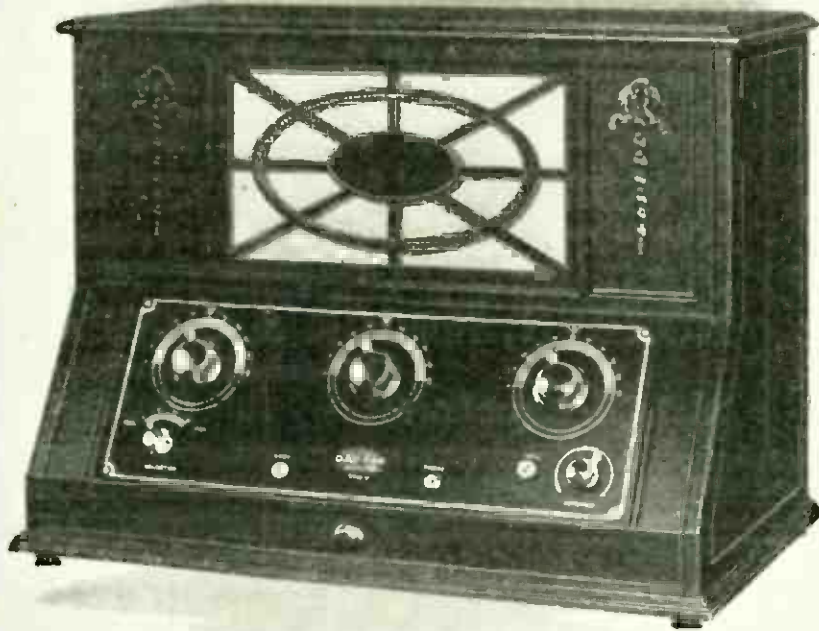

The Dayradia

A complete unit ready to attach to light socket, antenna and ground

This beautiful instrument embodies all the remarkable qualities of tone, simplicity of operation, and volume which distinguish the other OEM Models.

In addition to this, it is complete with A & B batteries and special, silent, recharging equipment.

Price complete with everything but tubes — \$225.00

THE DAYTON FAN & MOTOR COMPANY
Dayton, Ohio

Stop that "Fading" and "Frying"

WHEN you tune in your radio set, it is your "B" battery—not the broadcasting station—that you hear. To insure good, clear reception, keep your batteries in the pink of condition. Test them frequently—and to be sure that the test is accurate and dependable—use a

FREAS BATTERY TESTER

Made to U. S. Bureau of Standard Specifications by America's largest hydrometer manufacturers. Easy to read. Air-tight at every joint. Sturdily built. Packed in acid-proof package that prevents electrolyte from damaging clothes or housefurnishings.

Free Booklet

—"How to Make the Battery Talk"—tells how to improve your radio reception. Written by Major J. S. Hatcher, U. S. A., the well-known radio authority. Enclose 4 cents mailing cost.

FRANCIS L. FREAS GLASS WORKS
Conshohocken - Pennsylvania



Jobbers—Write for our attractive proposition.

GREWOL
The
PERMANENT DETECTOR
\$1.50

Sold by Good Dealers Everywhere or Direct Upon Receipt of Dealer's Name and \$1.50

Patented May 15, 1923
Serial No. 1464997
Infringement subject to prosecution

GREWOL 2 in 1 CRYSTAL Two surfaces instead of only one. Double life, double value.
2 IN 1
50c each

GUARANTEED BY
GREWOL MFG. CO.
NEWARK, N. J.

BESTONE NO. 724 !!!

Expressed by experts to be the most efficient socket

BAKELITE BASE—HEAVY NICKEL SHELL—

Sure gripping phosphor bronze contacts that always assure positive contact

Ask your dealer

HENRY HYMAN & CO., Inc.
476 Broadway New York Manufacturers 212 W. Austin Ave., Chicago



"The Musical Instrument of Radio"

Amplifying bell of natural wood—mellow and resonant.

Model VI (14" Horn) \$30

Model VII (21" Horn) \$35

Tops the Gift List

A Music Master for Christmas! A gift the whole family will enjoy. Had you thought of that? Music Master embodies all the proved principles of sound reproduction.

The sensitive reproducing unit responds to the faintest impulses. The tone chamber is heavy cast aluminum, unequaled for developing sound waves free from distortion. And the amplifying horn is natural wood, mellow and resonant like a violin.

Broadcast reception is at its best only with Music Master.

Your dealer will be glad to demonstrate it for you, or to place one in your home on trial.

Dealers Everywhere

MUSIC MASTER CORPORATION
Makers and Distributors of High-grade Radio Apparatus
 10th and Cherry Streets
 Chicago Philadelphia Pittsburg

MODEL VIII



The new Music Master Cabinet model, with "Full Floating" horn of natural wood, possessing all the wonderful reproducing qualities of the famous horn type Music Master. Handsome mahogany cabinet.

\$35

Music Master
 RADIO REPRODUCER

Connect any Music Master in place of Headphones. No batteries required. No adjustments.

ELECTRASOTE TRADE MARK PANELS

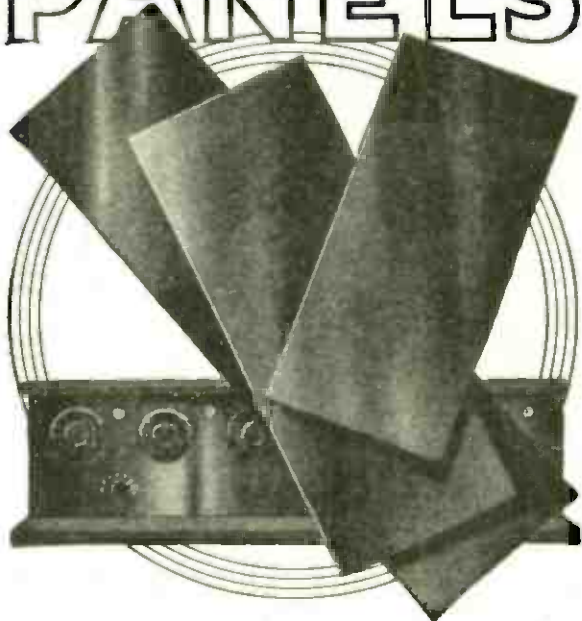

Clear reception and selectivity are what every radio fan wants. To obtain these advantages, every part should be chosen wisely—beginning with the panel.

Electrasote Panels are unaffected by climatic conditions, they will not warp or change color. Due to their electrical qualities they reduce surface leakage to a minimum. And yet they cost less than other standard panels.

Electrasote is one of the famous "sote" products introduced by The Pantasote Company, Inc.

On sale at good Radio Dealers

M. M. FLERON & SON, Inc.

Sole Sales Agents

Trenton, New Jersey



Clean Your Set "Behind the Ears"

How can you expect to get the most out of a set filled with dust and dirt? Every radio fan needs a NODUST to keep his outfit *clean and efficient!* A bright, shiny panel and a highly polished cabinet won't make your radio work any better; your set must be clean *inside.*

Each powerful blast of a NODUST shoots compressed air into every nook and corner of your set and removes all particles of dirt. You need a NODUST handy to keep your set working at its best.

NODUST

Strongly constructed of best materials, 12 inches long. Wood mountings to prevent short circuiting. Easy to operate, yet very effective. If your dealer has not received his supply yet, send us a dollar bill, and we will ship your NODUST by return mail!

PEIFFER & COMPANY

82 Liberty Street

Newark, N. J.

GLOBE LOW LOSS TUNERS

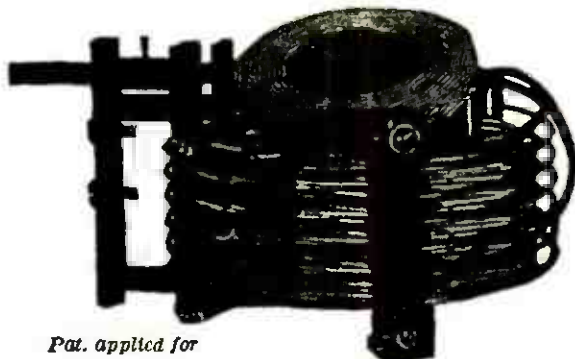

Pat. applied for

**DISTANCE VOLUME, SELECTIVITY
NO METAL—WOUND ON AIR**

Distributed capacity, the principal cause of broad tuning, reduced to an absolute minimum.

No metal parts used, therefore, no waste of signal strength due to eddy current losses.

Low Wave \$7.00; Broadcast \$7.00; Superdyne Type \$8.50

** BEWARE OF IMITATORS*

ALLIED RADIO CO. (Distributors)

GLOBE RADIO EQUIPMENT CO.

162 W. 34th St., N. Y.

** Legal action pending.*

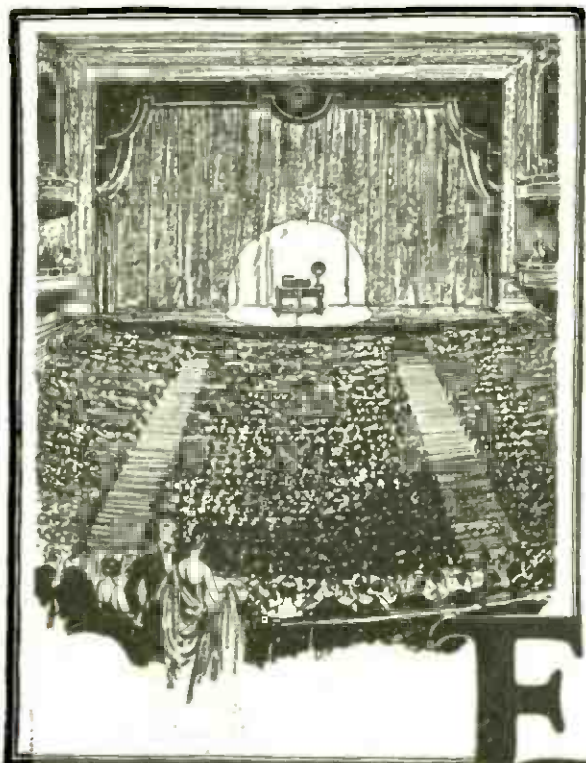

—and then
we heard

Electrola

The Musical Instrument of Radio

SUCH volume that it is necessary to warn users not to turn it on full—lest the loud speakers be thrown out of adjustment. A new five tube tuned radio circuit—developed by the pioneer makers of radio parts in this country. Batteries and tubes will last from twice to three times as long. Marvelous selectivity. These are the high spots. The whole story in a booklet. It will pay you to send for it so we can give you the nearest dealer's name and you can have the joy of your Electrola for Christmas.

The Famous Line of Kelford Radio Parts include a remarkable low loss variable condenser, laboratory precision rheostats and potentiometers and a new shielded audio frequency transformer acknowledged by radio experts to be the most perfectly constructed transformer made. These parts are more efficient because of our long experience—and at lower prices because of our facilities. Send for catalog if you know that a set is only as good as its parts.

THE · AMERICAN · SPECIALTY · COMPANY

172 Holland Avenue, Bridgeport, Connecticut

America's Oldest Manufacturers of Radio Parts

Exclusive territory for jobbers. Community agency plan for dealers. For both jobbers and dealers the highest quality merchandise and discounts worth investigating

"All DX STATIONS
Including West Coast Easily
Heard on 4-Foot loop with M.&H.
Superformers &
Precision Selector
on the Marvelous M.&H.
Super-Heterodyne"

M.&H. Precision Selector \$10

The marvelous Selectivity. Long-distance reception, etc., of M. & H. Super-Het are due to this scientific instrument. No adjustment. Last indefinitely. Hard rubber case. Illustrations are one-half actual size.



THIS is what Professor A. W. Parkes, Lafayette College, wrote us, commending wonderful perfection of Super-Heterodyne with our Superformers and Precision Selector.

"We built this set with your parts last June, the reproduction is perfect," writes Drue Allman, Homesburg, Pa. "The volume of the detector stage alone is such that speech may be heard 200 feet from loud speaker. I have heard many sets, and have operated 30, but there is only one real set—the M. & H. Super-Het."

Complete Parts for 8-Tube Super-Heterodyne Set, Special \$96.50

With Booklet giving full description and plans. Postage prepaid.

M. & H. Superformer

Designed especially for Super-Heterodyne for amplification at 6,000 meters, for use with UV-201A, C-301A, DV-2, UV-199, C-299 tubes. Small in size, minimum "feed-back." Carefully insulated for voltage greater than ever used. Guaranteed. Illustration one-half actual size.

\$7



Booklet giving description and Plan how to build Super-Heterodyne. Mailed **25c**

Dealers Write for Proposition
MOSKOWITZ & HERBACH
 512 Market St., Philadelphia, Pa.
Established 28 Years

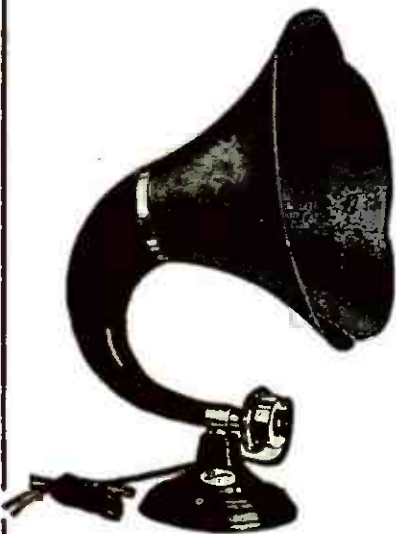

Burns

Loud Speaker
of
Distinctive Beauty

GENEROUS PROPORTIONS

Natural Tones With Volume

A Reproducer that Satisfies Aluminum Sound Column. 14 inch pyralin bell. Convenient adjuster.
 No. 205B Polished Black Flare . \$22.50
 No. 205D Mahogany Tinted Flare \$25.00

Manufactured by
American Electric
 Company

State and 64th Streets :: :: Chicago

E-Z-TOON
 (EASY TUNE)

RADIO DIALS
ASSIST THE EAR
TO GUIDE THE HAND

Smooth, easy movement. No cogs, gear back lash or lost motion. Easily installed. Take off old dials—slip on E-Z-TOON—tighten set screw. No holes to drill, no complicated adjustments.

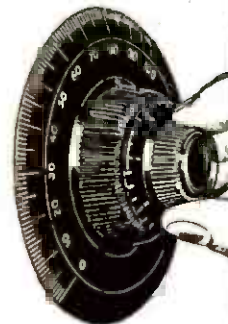

3" Dials \$2.00
 4" Dials \$2.25

E-Z-TOON Dials are two dials in one. The ratio of the outer dial to the inner dial is 50 to 1. The larger dial is for coarse tuning and the smaller dial for fine tuning. Get the stations with the outer large dial and tune them fine with the smaller dial. E-Z-TOON Radio Dials easily bring in those tantalizing stations that you fish for so hard.

Ask you dealer or write us for illustrated folder

E-Z-TOON Radio Co.
 3236 W. Washington St., Indianapolis, Ind.



A CHRISTMAS PRESENT

*that any fan
would like
to give
himself*

WHAT present could you give yourself that would please you more than a dependable battery charger? No more spilling acid on the carpets from dragging batteries through the house. No more battery-going-dead on the very evening when you particularly want your set working. No more relying on outside help for the entertainment energy in your battery—help you can't get when you *most* need it.

An ideal Christmas present. Either size. And one that will last as long as Radio.

Fool-proof, requiring no attention whatever, self-regulating and *guaranteed* fireproof by the National Board of Fire Underwriters, a Unitron is a delightful Holiday gift whether you give it or get it.

The Radio Unitron—made just as rugged and efficient as the big Unitron Industrial Battery Chargers—supplies the answer to this important Radio problem. It assures the lover of Radio, entertainment unbroken by a battery going dead without warning.

Send for the Story:

"A Little Less Noise....Please"

The Unitron Radio Battery Chargers are made in two sizes—a smaller one for small sets, and a large one for multi-tube sets. Both are efficient—each is simple, safe and *economical*. Economy is important in a Radio charger. It must do its re-charging without wasting current, and it must be so built that it never needs repairing or adjusting.

Model 00 \$18
Charges any type of A battery

The Unitrons are *low-loss* chargers. They waste no current—and that means quicker re-charging at lower cost. They have no moving parts to be adjusted, repaired or replaced—no mechanism to get out of order—and this means there never are repair bills.

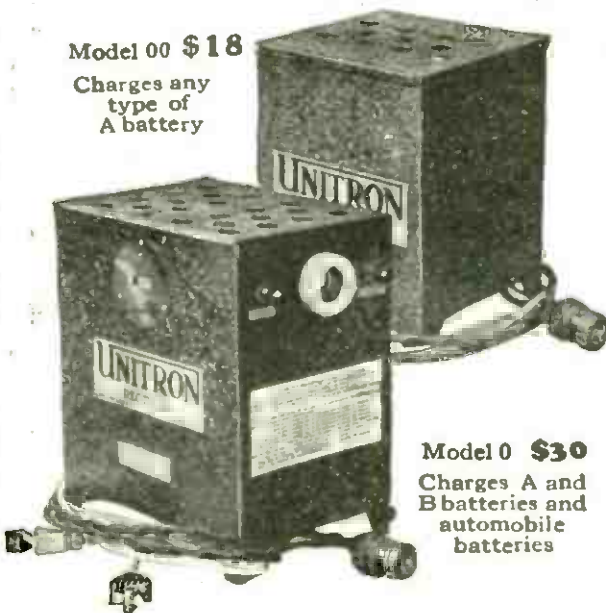

Model 0 \$30
Charges A and B batteries and automobile batteries

FOREST ELECTRIC COMPANY

Pioneer Manufacturers of Industrial Current Rectifiers

New and Wilsey Streets

Newark, New Jersey

Advertising by PICARD-SOHN, INC. N.Y.

KODEL



Tune in Christmas with a KODEL



Model P-12 Two-tube Portable. (Model P-11 with amplifying tube added, which increases distance and volume many times.)

\$22⁵⁰

Model C-13 Three-tube Receiver. Gives five-tube volume with only three tubes, due to reflex amplification.



\$28⁰⁰



\$16⁰⁰

Model P-11 One-tube Portable—the Camera of Radio—Price \$16.00 without accessories. Tube, batteries, headphones, antenna and ground wire all self-contained. Weight 4½ lbs. complete.

THIS Christmas anyone can give the best that radio offers, for KODEL radio receivers are priced so low that anybody can afford them. And they are so simple to use! Just one dial to turn, and in the stations come, near and far. Only two dials in the 3 and 4 tube sets. Santa can even bring radio to the apartment house where antennas are prohibited, for KODEL will work on ground alone—hook it to the nearest radiator!

All KODEL sets contain a unique circuit, discovered by an independent experimenter. When radio conditions are right, 1000 miles on one tube! Add tubes until the four-tube set gives you the possibility of trans-continental reception.

See the KODEL line at your dealer's. If he does not carry these marvelous sets, send us his name and address and we will send you the interesting KODEL catalog, from which you can order direct. Money returned if any KODEL set does not more than satisfy you.

DEALERS: The KODEL is a sensation wherever introduced. Write for terms.

KODEL MANUFACTURING CO.

Under the same management that made the HOMCHARGER famous.

132 West Third Street, Cincinnati, Ohio

Model C-11 One-tube Receiver. The biggest value in a one-tube radio set today.



\$10⁰⁰

KODEL Model C-14 Four-tube Receiver, illustrated here, is priced at \$32.50 (without battery cabinet, loud speaker or accessories). Battery cabinet can be furnished with any KODEL set at slight additional cost.

\$32⁵⁰

With battery compartment, \$37.00

Model S-1 KODEL Crystal Set. Sensitive, selective, low-priced.

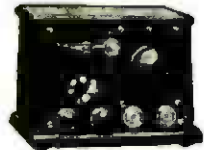

\$5⁰⁰

Model C-12 Two-tube Receiver. A great distance getter; puts local stations on the horn; single dial tuning.

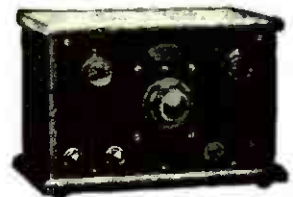

\$18⁰⁰

FREE!

Write for instructive KODEL catalog, entitled "Radio for Every Purpose and Any Purse." **FREE!**

RADIO FOR EVERY PURPOSE AND ANY PURSE—\$5 TO \$32.50

All apparatus advertised in this magazine has been tested and approved by POPULAR RADIO LABORATORY



You'll Want Both These Manhattan Radio Products

The Manhattan Junior Loud Speaker

The Manhattan Junior is the first loud speaker with an adjustable "Concert Modulator" to be marketed at the popular \$10 price. It is a real loud speaker with a reproducer unit especially constructed to operate the long air column of the horn.

The *Concert Modulator* in the base allows the reproducer unit to be adjusted to varying conditions of operation so that best results may always be obtained.

The Manhattan Junior is a good looking, well built instrument which reproduces the work of broadcasting artists with wonderful fidelity, ample volume and excellent musical quality—a wonderful value for \$10!

Hear one at your dealer's.

The Red Seal Map-Loop Aerial

The Red Seal Map-Loop Aerial is needed to complete the attractive appearance of any set designed for loop reception. It replaces the usual spider's web of wire with a handsome broadcasting map—an ornament in perfect keeping with your good looking radio cabinet and the other tasteful furnishings of your home.

In the Map-Loop the wires are concealed between two maps of the United States on which the broadcasting stations are listed and located. The frame and base are solid mahogany. Further interest and decorative quality has been given the maps through faithfully employing the odd technique of the old map masters of the seventeenth century.

The Map-Loop is not only extremely good looking but is technically correct and designed for easy, convenient operation with the super-heterodyne. Price \$20.

Manhattan Electrical Supply Co., Inc.

NEW YORK

CHICAGO

ST. LOUIS

SAN FRANCISCO

ASK FOR
Manhattan
RADIO PRODUCTS

MADE BY THE MAKERS OF THE FAMOUS RED SEAL DRY BATTERIES

All apparatus advertised in this magazine has been tested and approved by POPULAR RADIO LABORATORY



Solved! The Problem of Radio Parts

WHENEVER you hear of anyone having trouble with a circuit, nine times in ten it is because of the parts. Penny skimping does not pay.

Take the grid leak for instance. It is the heart valve of your set. Unless it provides a perfectly smooth electric path for the current to escape from the grid of your detector, miniature thunder storms crackle and rumble within the tube, smothering weak signals, distorting and muffling strong ones.

Electrad engineers specialize on important parts which are scientifically accurate and dependable. Every item is certified to give absolute satisfaction.

On sale at most good radio dealers. If your dealer cannot supply you, send us his name, and the purchase price of the item you want. We will supply you direct.

When you build your set, don't take chances. Know your important parts will perform properly. Use and insist on getting Electrad Lead-Ins, Variotoms, Audiohms, Lightning Arresters, Lamp Socket Antennas, Certified Grid Leaks, Glass Grid Leaks, Variable Grid Leak and Condenser Combined, Grid Leak Mountings, Hydrogrounds, Aerial Outfits, Fixed Resistance Units, Indorarial, Resistance Coupled Amplifier Kits, Verni Tuners.

ELECTRAD, Inc.
Dept. C, 428 BROADWAY, NEW YORK

ELECTRAD

KIC-O "B" Battery and Charger

—the ideal Christmas gift

Nothing gives more pleasure or lasting satisfaction to the radio fan than this improved outfit of KIC-O nickle-zinc storage "B" Battery and Charger. Battery is of the alkaline type giving constant current and long life. Heavy glass jars are completely enclosed in a highly finished, practically water-tight cabinet, which can safely be placed near the radio receiver.

KIC-O Multi-Polar Double Potential Chargers recharge storage "B" Batteries quickly and economically. They use both halves of the A. C. cycle and operate from the ordinary electric light circuit. Fully guaranteed.

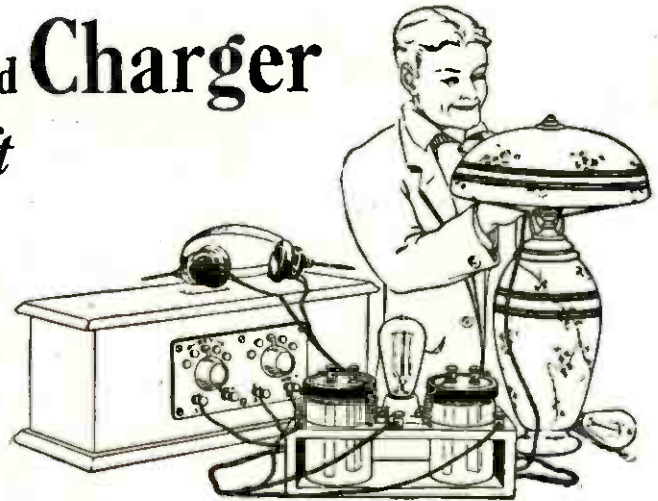

P. Z. indicates panel type with switches. CZ is plain type without switches.

Type	Voltage	Price
PZ	140	33.00
CZ	140	30.00
PZ	100	25.00
CZ	100	22.00
PZD super	100 double capacity	40.00
PZ	70	20.00
CZ	70	17.00
CZ	45	13.50
CZ	22½	7.00
CZD super	100 double capacity	37.00

KIC-O Chargers

Type K-1	single unmounted	1.50
Type K-2	single mounted	3.50
Type K-3	Multi-polar, mounted	5.00
KIC-O Special Charger Chemicals		.75



"Just what I wanted—
a KIC-O outfit."

This KIC-O equipment has been approved by the Popular Radio Laboratory

Guarantee

Your money back on any KIC-O Battery if not satisfied within 30 days' trial. Write for full information or see your dealer.

KIMLEY ELECTRIC CO., INC.

2667 Main Street
Buffalo, New York



Saws, Drills and Engraves Safely

Manufacturers

who desire to build quality into their products and who insist on speed and economy in their plants should write our nearest office for complete information on Spaulding Bakelite-Duresto.

Factory: Tonawanda, N. Y.
Sales Offices: Warehouses

484 Broome St., N. Y. C.
659 W. Lake St., Chicago.
310 E. Fourth Street, Los Angeles.
141 N. Fourth St., Phila.
15 Elkins St., Boston.
171 Second Street, San Francisco.
509 First Nat'l Bank Bldg., Milwaukee.

AVOID ruined material, wasted time—use Spaulding Bakelite-Duresto. Unlike hard rubber, it is chip-proof. Besides—due to a special Spaulding process of fabrication, Bakelite-Duresto panels retain a beautiful black, high gloss finish indefinitely; will not warp; shrink nor split; highest in dielectric properties and tensile strength. Insist on Bakelite-Duresto—the best that money can buy. Your dealer can furnish standard sizes from stock, special sizes to order. Individually packed in envelopes under Spaulding label—your guarantee of quality. Look for Spaulding Bakelite-Duresto panels in the set you buy—a sign of quality apparatus.

Write nearest office for descriptive circular

SPAULDING FIBRE COMPANY, Inc., TONAWANDA, N. Y.

Spaulding
BAKELITE-DURESTO
Panels-Sheets-Tubes & Rods

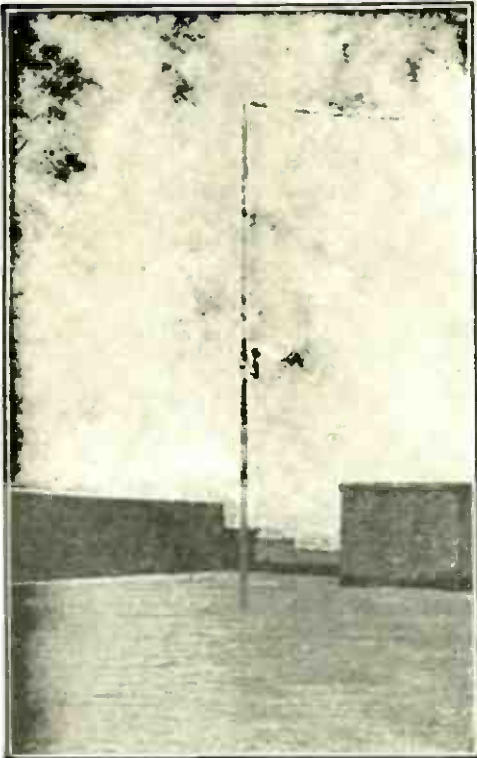

20 Ft. Mast on Roof of Apartment House



40 Ft. Mast in Yard

The HERCULES AERIAL MAST

This mast is made in sizes to get 20 ft., 40 ft. or 60 ft. clearance and is the answer to an efficient aerial system. This graceful mast is an improvement to any property, whether it is installed on the roof or in the yard. A pulley is furnished at the top for raising and lowering the antenna. All parts are made of steel and are light and strong. The mast will safely stand a 500 lb. pull at the top and will support a 6-wire cage antenna. We furnish complete blueprint plans for erecting the mast and it can be erected in a few minutes. It is shipped in sections for convenience in handling. The 20 ft. mast weighs 40 lbs., the 40 ft. mast weighs 100 lbs. and the 60 ft. mast weighs 200 lbs. Guy wires are spaced 120 degrees, or three equal spaces, 4 ft. from the base on the 20 ft. mast, 8 ft. on the 40 ft. mast and 10 ft. on the 60 ft. mast.

20 Ft. Mast	\$10
40 Ft. Mast	\$25
60 Ft. Mast	\$45

Order direct from this "Ad" and we will ship **FREIGHT PREPAID.**
Satisfaction assured

Long Range Radio Reception

It has been said time and again that the best results are obtained only by the intelligent use of the best apparatus procurable. This applies not only to the receiving equipment proper, but also to the antenna system. **THE AERIAL MUST BE EFFICIENT** if the reception of long distance stations, theoretically within range of the receiver, is desired.

Proper Aerial Clearance

Very few novices realize the importance of a good aerial installation. The feeble currents from long distance stations will never reach the receiving set if the aerial is strung too close to surrounding objects that tend to absorb the energy. It is this interference that we have experimented with for years — and present the answer — **THE HERCULES AERIAL MAST.**

Have Built Radio Towers for Years

For years we have been building radio towers for important broadcasting stations. Included among the names of our customers is the **UNITED STATES GOVERNMENT SIGNAL CORPS.** Only after years of experience and development work have we been able to perfect this wonderful steel aerial mast to sell at a price within reach of the amateur.

S. W. HULL & CO. Dept. B1
2048 East 79th St., Cleveland, Ohio

Give Your Set a Chance! Get Results

Not only will the proper aerial clearance, thus obtained, give you the pleasure of long distance radio reception, but the appearance of this beautiful mast on your property will give you a reputation. This reputation will grow as you bring in stations such as you never hoped for.

Mail Coupon for Literature



S. W. HULL & CO. Dept. B1
2048 E. 79th St., Cleveland, Ohio

Without cost or obligation on my part, send me full particulars of the **HERCULES Aerial Mast** and your **FREE FREIGHT PREPAID** offer. I am interested in a () ft. Mast.

Name.....

Address.....

City.....

Build Your Set with Goodrich Rubber

*Here's Why It Will Bring In Those
Distant Stations Clearer Than Ever*

BY scientific tests, Goodrich Rubber Radio Products show the lowest dielectric losses of any practical radio insulating materials. This quality alone means that they give the greatest efficiency in radio frequency amplification. The set built of Goodrich Products will give maximum range and selectivity for its type.

Fifty-five years of rubber manufacturing experience are a guarantee of their reliability. Build for the greatest efficiency with these—

1 1 1

GOODRICH RADIO PANELS—dielectric constant, at radio frequencies, 3.5; low moisture absorption and high softening points make them superior. They may be worked with ordinary tools, and retain their rich glossy finish. Full assortment of sizes in attractive black or mahogany colors.

GOODRICH V. T. SOCKETS—Special spring lock—releases at a touch of the finger, no turning or twisting the tube. Contacts may be cleaned without removing the tube. Eliminates danger of tube breakage. Low dielectric losses.

GOODRICH RADIOPHONE EAR CUSHIONS—Shut out all outside noises.

GOODRICH BATTERY MATS—A protection from overflowing liquids.

GOODRICH VARIOMETERS (UNWOUND)—Wind them to suit yourself.

GOODRICH HARD RUBBER TUBES—Very low dielectric losses.

GOODRICH SPAGHETTI TUBING—Will not corrode wiring.

Send for our booklet "Rubber for More Perfect Radio Reception"

THE B. F. GOODRICH RUBBER COMPANY
Akron, Ohio

ESTABLISHED 1870

Goodrich

Rubber Products
for *Radio*

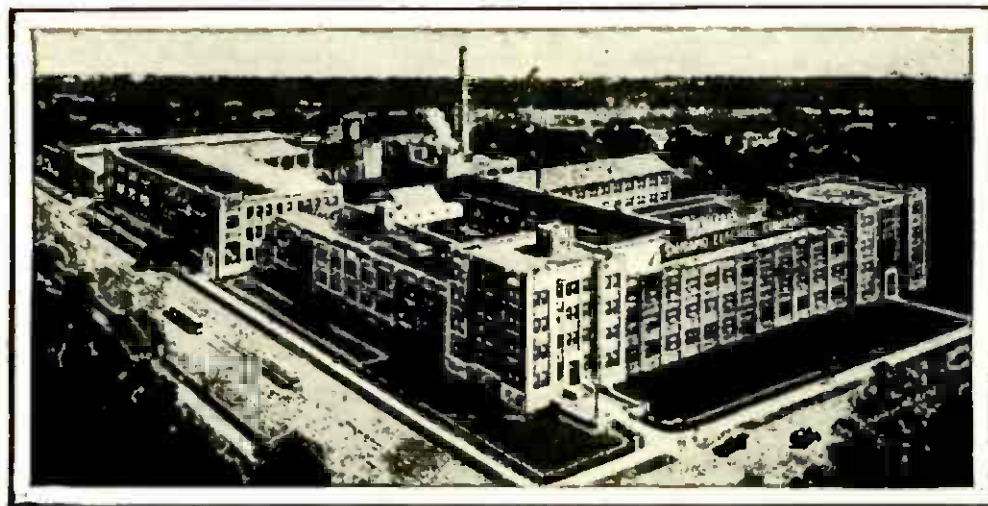

The Springfield, Illinois, plant of Sangamo Electric Company, the world's largest plant devoted to the manufacture of electrical meters and instrument transformers.

Sangamo Electric Company announces A new long wave radio frequency transformer tuned at 4500 meters

THESE R. F. transformers, the heart of the Pressley circuit, are used in Army airplane receivers to build up great volume so that long range messages can be heard distinctly above the roaring engine.

Jackson H. Pressley, Chief Engineer of U. S. Signal Corps Radio Laboratories, at Camp Alfred Vail, is the inventor. Sangamo Electric Company has secured the exclusive right to manufacture for commercial use. A set of four, with a coupler coil, all matched and tuned, can be bought for \$22.50.

Sangamo Electric Company is peculiarly well fitted to



manufacture radio instruments which require unusual accuracy. This company has been making electric meters since 1897, bringing to this business the training and careful workmanship of the watchmaker. Sangamo meters and precision transformers, as finely made as multi-jeweled watches, are used throughout the world.

Just as Sangamo pioneers brought their experience in precision manufacturing to the building of electrical devices, so they now extend skill to the making of radio transformers. The Sangamo trade mark extends its protection in one more market.

ASSOCIATED SANGAMO ELECTRIC COMPANIES

CAPACITY 3500 METERS PER DAY

SANGAMO ELECTRIC COMPANY
Springfield, Illinois

BRITISH SANGAMO COMPANY LIMITED
Pondersend, Middlesex, England

SANGAMO ELECTRIC COMPANY
OF CANADA LIMITED Toronto, Ontario

ASHIDA ENGINEERING COMPANY
Osaka, Japan

Domestic Offices—New York, Chicago, Birmingham, San Francisco, Los Angeles. Radio Division—50 Church Street, New York

8820-1

All apparatus advertised in this magazine has been tested and approved by POPULAR RADIO LABORATORY



A BATTERY FOR EVERY RADIO NEED

It makes no difference what set you are using; whether one or nine tubes, whether two or six volts, single or multiple circuit, regenerative or reflex, or one of the numerous "dynes", there is a Westinghouse battery to fit it.

Furthermore: If you are not already a user of Westinghouse Radio Batteries, you have no idea of the increased economy, reliability and all-round satisfaction to be had by using storage batteries, particularly Westinghouse Batteries, for all receiving sets.

The WESTINGHOUSE UNION BATTERY COMPANY
SWISSVALE, PENNA.

Distributor for Canada:
The Canadian Westinghouse Co., Ltd.
Offices in all principal Canadian cities

Distributor for South America, Mexico and Cuba:
The Westinghouse Electric International Company
Mexico City, Buenos Aires and Havana

WESTINGHOUSE

RADIO

"A," "B" and "C"

BATTERIES



The Sensation ^{of} Every Radio Show

The New 1925 D. T. W. Collapsible, Imported German Loop

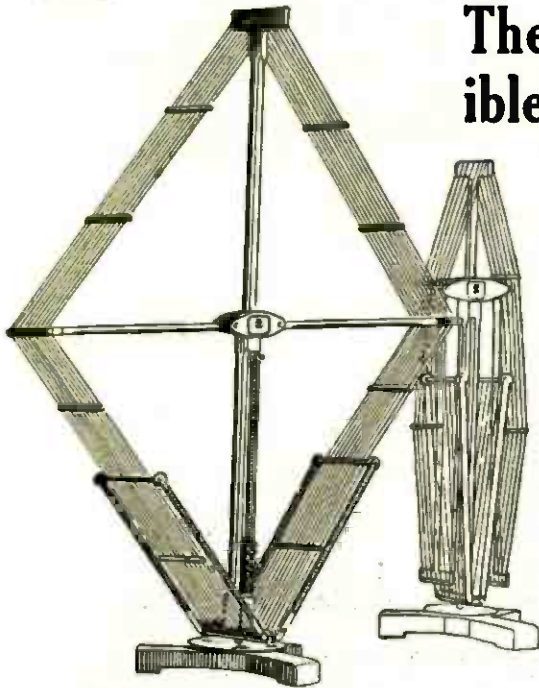

Height 42 inches Width 40 inches

A wonderful Christmas Gift at the new 1925 price **\$25⁰⁰** Formerly \$35.00

The one piece of Radio Apparatus acknowledged universally by Radio Manufacturers to be Superior.

There is no secret about its selectivity due to:

- 1—Its plan of construction.
- 2—The superior quality of materials used.
- 3—The careful attention given to every detail of construction.

The inductance consists of 14 turns of Real Litzendraht, which is made up of sixty strands of Number 38 gauge enamelled copper wire woven into three cables of 20 strands, which in turn are wound into one strand with double silk insulation. The wire is connected into plots or sections to a series of binding posts located on the upright arm, giving a wave-length range of 100-400, 200-600, and 250-800 meters. Our method of not tapping, but cutting the inductance prevents dead end losses. A table graduated into the degrees of an arc is placed at the base of the loop so that the angle of reception can be accurately determined. The loop is a distinctive instrument of truly scientific nature and uncommon beauty which will add a thrill to the performance of your set and bring in stations you never heard before.

From the Boston Traveler: "Masterpiece in construction—having no equal made in this country."

From S. Kruse, Technical Editor Q. S. T.: "Appearance and construction excellent. Certainly is a wonderful job."

John Schantz, American Institute of Electrical Engineers: "Nothing more can be, nothing more need be said about it. The results are beyond my expectations."

Manufactured by the Deutsche Telephonwerke und Kabelindustrie of Berlin, Germany, makers of telephone and scientific apparatus since 1867 and now employing over 6,000 skilled mechanics.

If your dealer cannot supply you, order direct and we will ship Parcel Post C.O.D. **\$25⁰⁰** Formerly \$35.00 Shipped in a permanent, cylindrical container. Money back guarantee.

Usual Discounts to Radio Dealers

TOBE C. DEUTSCHMANN, American Representative and Distributor

46 A Cornhill, Boston, Mass.

Reference: First National Bank, Boston, Mass.

ATWATER KENT R A D I O

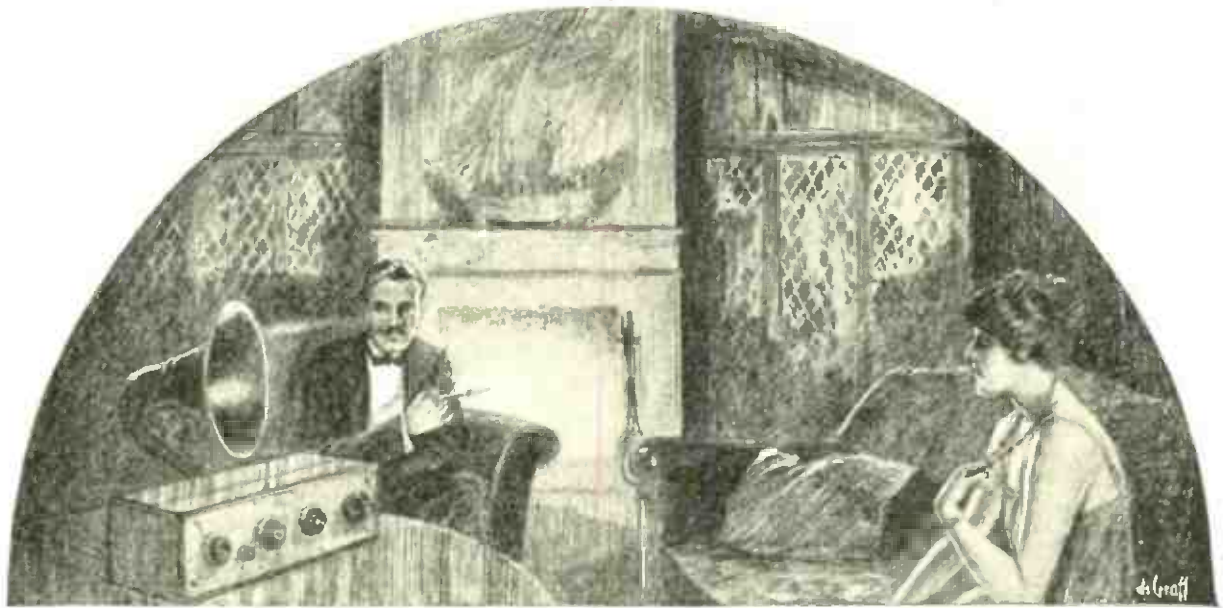

You'll Never Forget the Night

YOU'LL never forget the night you first tune in your ATWATER KENT Radio. The thrill of it will live in your memory—the sheer delight of filling your room with living voices or the music from an orchestra perhaps a thousand miles away.

Its clear reception, and the ease with which you can bring in distant stations will be a revelation to you. An added pleasure will come with the knowledge that no one possesses better radio than yours.

ATWATER KENT craftsmen, guided by the experience of skilled engineers, have fashioned the finest materials that money can buy into ATWATER KENT Radio. You will find it combines every feature that means radio satisfaction—unusual selectivity, sensitiveness, distance, volume and tonal quality.

The ATWATER KENT dealer near you will gladly help in the selection of your radio. There is a price, size and style for everyone.

Instructive literature on request

ATWATER KENT MANUFACTURING CO., 4712 Wissahickon Ave., PHILADELPHIA, PA.

THINK OF WHAT IS BACK OF IT

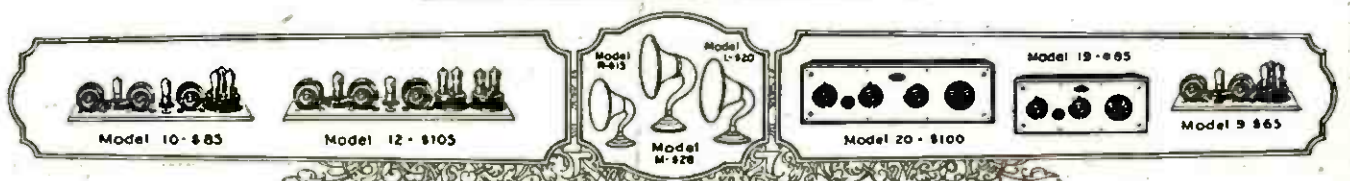

All apparatus advertised in this magazine has been tested and approved by POPULAR RADIO LABORATORY

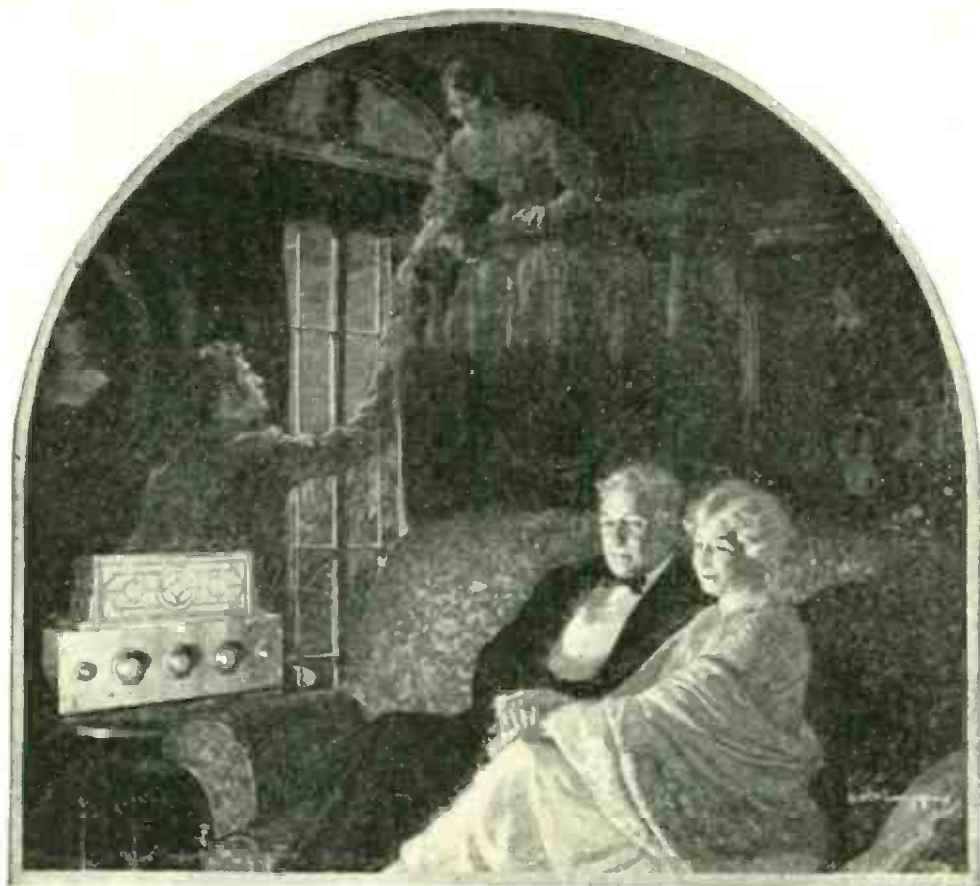

The Difference Is—*Finesse*

THE easy way to build a radio receiver is to assemble it.
The right way is to *create* it, unit for unit, testing each step.

That is why Freed-Eisemann Condensers are Freed-Eisemann-designed for Freed-Eisemann Receivers. That is why our specially wound radio frequency coils are individually matched with the condensers to achieve the greatest possible co-relation of dial readings.

Not an inch of bus wire, not a single screw is in its place without scientific consideration of its capacity and inductive effect in relation to the super-sensitive Freed-Eisemann Neutrodyne circuit.

Thus, it is in *finesse* that the Freed-Eisemann is great . . . in the trifles that make Perfection—which is no trifle.

The man who has progressively owned all types of radio receivers comes to the Freed-Eisemann at last with a new enthusiasm for radio . . . a new appreciation of what listening-in can mean. A demonstration is a revelation.

Four-tube and five-tube models. Price, \$100 up . . . slightly higher in Canada and west of the Rockies. Booklet, "Buying a Radio" free on request.



FREED-EISEMANN RADIO CORPORATION
MANHATTAN BRIDGE PLAZA, BROOKLYN, N. Y.



FREED-EISEMANN

All apparatus advertised in this magazine has been tested and approved by POPULAR RADIO LABORATORY

Pure, clear tones from your speaker, must start with your transformers

You want more than noise from your loud speaker.

You want pure tones, clear, mellow reproduction.

But no speaker can be better than your A. F. transformers.

And any speaker will be improved when you use transformers that are designed for loud speaker use!

Transformers that produce the greatest possible amount of amplification unfortunately also introduce imperfections in the tone. And the speaker magnifies such imperfections.

Fortunately, however, when the tone is clear, you don't need anywhere near so much volume of sound.

In designing MAR-CO transformers, an amplification ratio has been used, which provides the most volume that is consistent with absolute purity of tone. And, of course, they are built, like all other MAR-CO parts, with the famed MAR-CO precision that stops leaks and conserves radio energy!

So, now, those who value tone purity highly, will use two and sometimes three stages of MAR-CO amplification this Fall, and replace squeals with music!

MARTIN-COPELAND COMPANY
Providence, R. I.

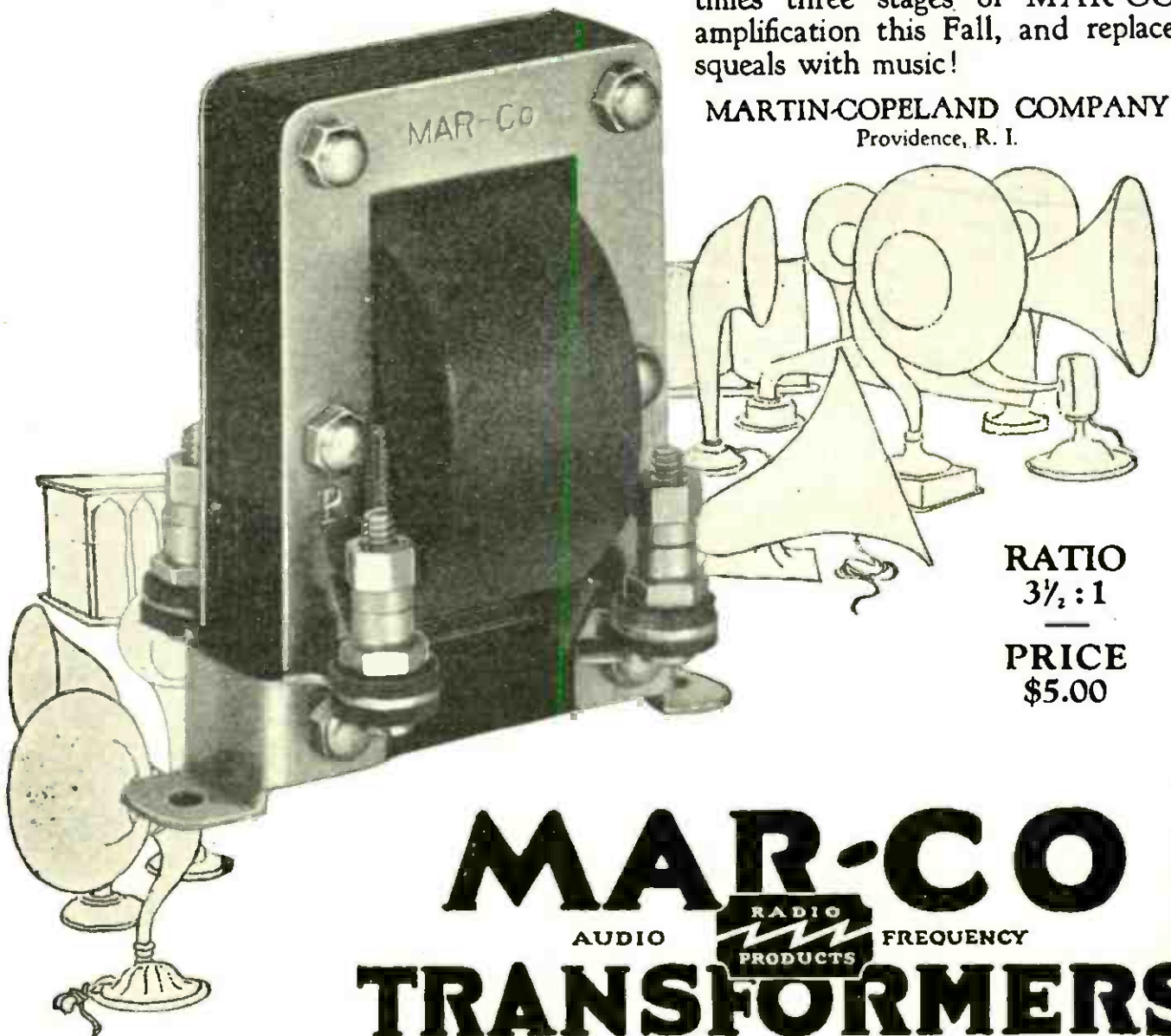

RATIO
3½:1

PRICE
\$5.00

MAR-CO

AUDIO  FREQUENCY

TRANSFORMERS

Write today for your free copy of

Ward's New Radio Catalogue



WARD'S Radio Catalogue is a big 68-page book—a real reference volume on quality Radio Equipment. In addition to descriptions of sets, parts and hook-ups, much matter of general interest to every radio fan is included. The book will prove fascinating to the confirmed radio enthusiast as well as the beginner.

Tested and guaranteed
Radio equipment sold with-
out the usual Radio profits

WARD'S Radio Department is headed by experts who know and test everything new. Who know by experience what is best—what gives the best service.

Our catalogue is prepared under their supervision. It shows all the best hook-ups, everything in parts and complete sets—so simple that you yourself can install them in a short time.

Headquarters for Radio

Today Ward's is serving thousands upon thousands of Radio fans who have written for our catalogue, who have been surprised to see how low in price the standard Radio equipment can be sold without the usual "Radio Profits."

You, too, can profit by writing for a free copy of Ward's Radio Catalogue. If interested at all in Radio, you should write for this book. See for yourself the savings.

Our 52-Year Old Policy

For 52 years we have sold quality merchandise. We never sacrifice quality to make a low price. In buying Radio Equipment at Ward's, you are buying from a house of proven dependability. Address our house nearest you: Dept. 38-R

ESTABLISHED 1872
Montgomery Ward & Co.

The Oldest Mail Order House is Today the Most Progressive

Chicago Kansas City St. Paul Portland, Ore. Oakland, Calif. Ft. Worth

Set building is simple with Dubilier Devices!



The MICADON: Use this standard fixed condenser when you build. It has permanent capacity. Its extension tabs make it easy to install. 90% of all sets made use Micadons.

The DUCON: Save the expense and labor of erecting antenna. Buy the Ducon—the standard socket plug. Just screw it into your lamp socket and it will pick up programs clearly and distinctly!

The DURATRAN: Build a powerful set by using this radio-frequency transformer. It amplifies with a constant of over twenty on the complete broadcasting band—225 to 550 meters.

Dubilier

CONDENSER AND RADIO CORPORATION

All apparatus advertised in this magazine has been tested and approved by POPULAR RADIO LABORATORY

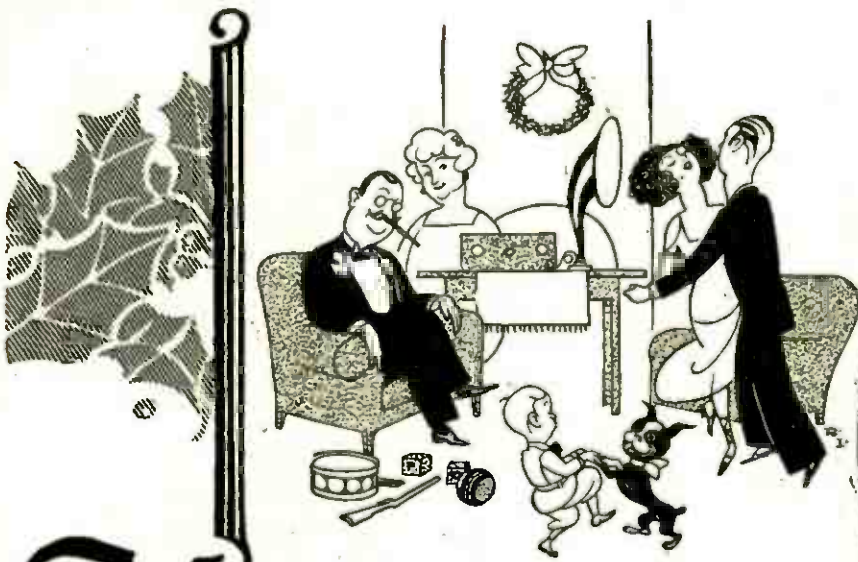

More Christmas Fun!

For a fan who has only headphones—or “just a horn”—a Radiola Loudspeaker is a Christmas inspiration! It means everybody listening in—dancing—getting the fun. It means music that is music—voice that is human voice—not “radio voice.” It means getting the best out of any set.

Remember, if you are buying a complete radio set—that no receiver can be better than its loudspeaker. And if you really care about tone quality, insist upon the Radiola Loudspeaker.

Radiola
Loudspeaker
TYPE UZ-1325
Now \$25.00



Radiola

REG. U. S. PAT. OFF.

LOUD SPEAKER

This symbol
of quality



is your
protection

RADIO CORPORATION
OF AMERICA

Sales Offices:
233 Broadway, New York
10 So. La Salle St., Chicago, Ill.
28 Geary St., San Francisco, Cal.

Here It Is!

DISTRIBUTORS FOR
Radio Corporation of America



- Westinghouse General Electric
- Baldwin Brandes Burgess
- Cardwell Crosley
- Cutler-Hammer
- Dubilier Fada Freed-Eisemann
- Freshman Frost
- General Radio Grebe
- Haynes-Griffin Magnavox
- Remler Rhamstine
- U.S. Tool Western Electric
- And other leading manufacturers

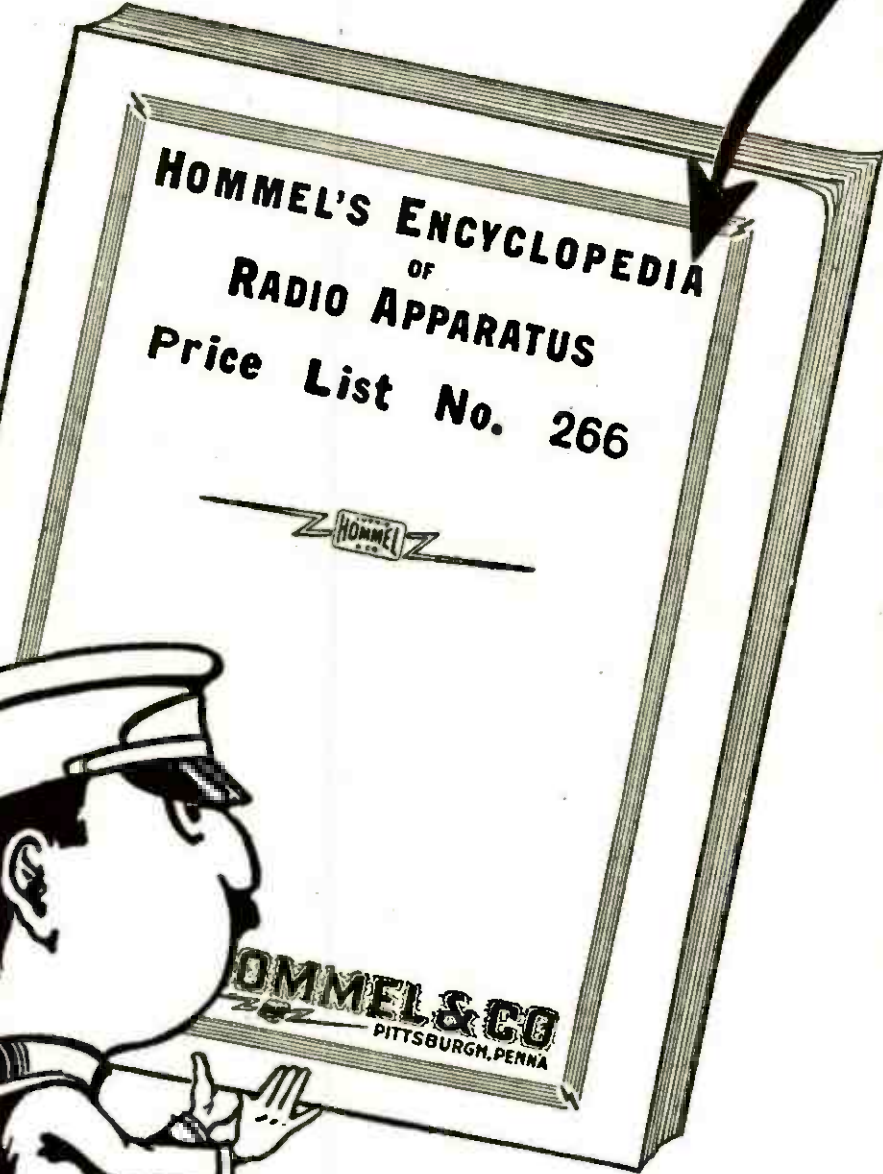

Send for it
NOW

WHOLESALE

EXCLUSIVELY

LUDWIG HOMMEL & CO

929 PENN AVENUE



PITTSBURGH, PA.

\$95.00

Completely Constructed

WITHOUT ACCESSORIES

Transportation Prepaid

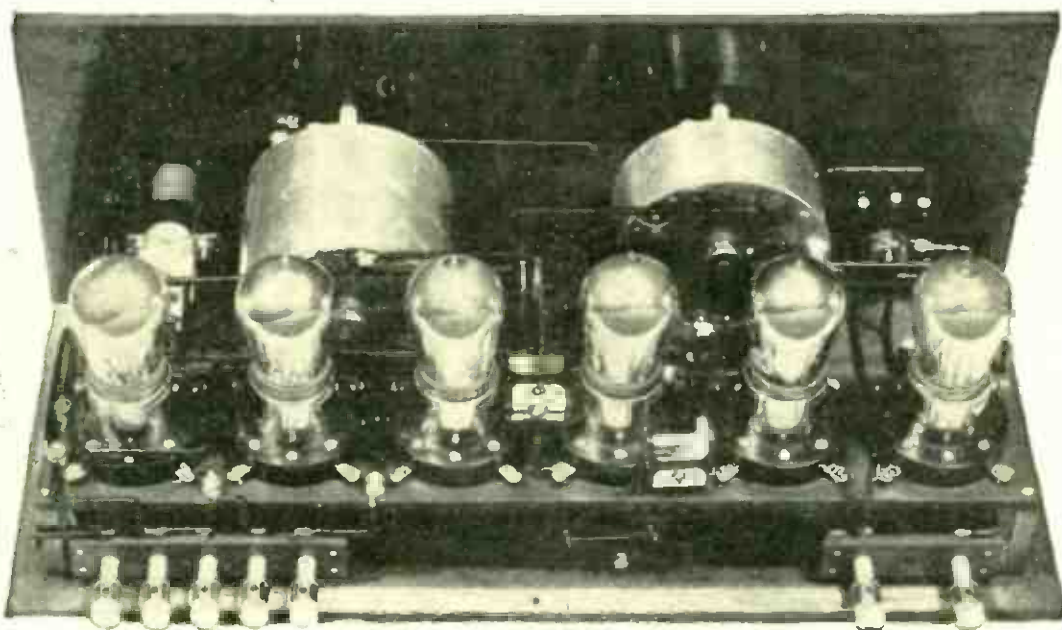

PLIODYNE 6

Interior View Showing Compact and Efficient Design

OUR GUARANTEE

We guarantee every Golden-Leutz "Pliodyne 6" to be the finest broadcast receiver that can be manufactured using 6 tubes or less and to be satisfactory to you in every way and to reach you in perfect condition.

You take no risk whatever in sending us your order, for unless you are completely satisfied with the receiver and with your saving, you may return the receiver to us and we will refund your money.

Address

GOLDEN-LEUTZ, Inc.

476 BROADWAY

NEW YORK CITY

Licensed under Farrand Agreement and Hogan Patent No. 1,014,002

NOTE: We reserve the right to withdraw the Free Trial Offer if our Factory Production is exceeded. Golden-Leutz, Inc.



Both Must Be Musical Instruments

If you are to enjoy the rich resonance of an old Cremona violin, your loud speaker must also be a true *musical* instrument. So designed and powered as to respond as faithfully to the inspiring crescendos of a Wagner opera as to the whispers of a Moonlight Sonata.

The new Bristol AUDIOPHONE does that. With its joyous, open-throated rubber horn, and its finely adjusted tone mechanism, it is on a musical plane with the noblest instrument or voice at your favorite station.

In addition to model S, shown here, the Bristol line includes Model J, \$20; Baby Grand, \$15; and the "Baby" at \$12.50.

Send for Bulletins 3011 and 3017-L, mentioning name of your dealer.

The Bristol Company, Waterbury, Conn.



Model S
AUDIOPHONE
\$25

Rubber Horn
14 1/4" diameter.
Velvet mat finish
of mottled bronze
and gold; classic
base.

BRISTOL AUDIOPHONE

TRADE MARK REG. U.S. PAT. OFFICE

LOUD SPEAKER

Further Adventures of BURGESS RADIO BATTERIES

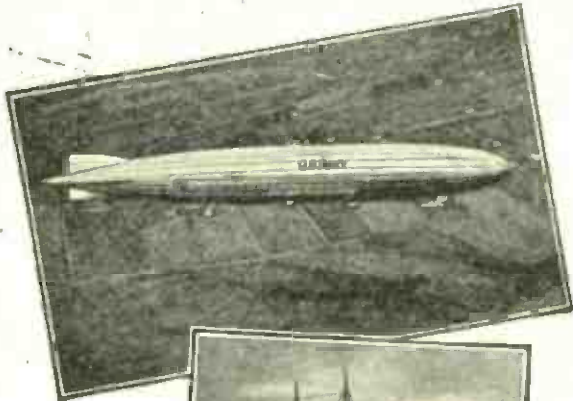

From U. & U. Photos

The Shenandoah is Equipped with Burgess Batteries and MacMillan Carried them to the Arctic

If the quality of any product may be judged in part by the standing of its users, surely Burgess quality must be considered unusually high.

Burgess Radio Batteries are found where there's need for the most efficient batteries made—in emergencies where failure brings disaster—with explorers in far-off lands—with the unsung heroes of the air service—beneath the seas with the crew of the submarines.

"Ask Any Radio Engineer"

Send for the Burgess Radio Compass. Surprising—amusing and interesting to the entire family. Sent free of charge from 203 Burgess Engineering Building, Madison, Wisconsin. Write for it.

BURGESS BATTERY COMPANY

Engineers DRY BATTERIES Manufacturers
Flashlight Radio Ignition Telephone
General Sales Office: Harris Trust Building, Chicago
Laboratories and Works:
Madison, Wisc.
In Canada:
Niagara Falls and Winnipeg



UTILITY SUPPLY COMPANY

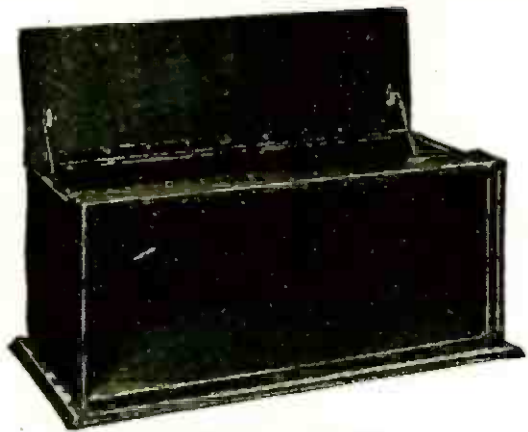

From Factory to User

High Grade Radio Cabinets, sturdy built and fine looking. Built from select genuine black walnut or birch. Elegantly finished. Tops on all cabinets hinged. Fronts of cabinets are rabbeted to take panel. Walnut cabinets have continuous piano hinges and lid holders. Birch cabinets have regular hinges. (No lid holders.) Walnut cabinets finished in French walnut. Birch cabinets finished in Adam brown mahogany. (Panels not included.) Money back if not satisfied.

For Panel	Deep	Birch No Base	DeLux Black Walnut	Monarch Black Walnut
6 x 7	7"	\$1.75	\$3.75	\$4.40
6 x 10 1/2	7"	2.25	4.65	5.35
6 x 14	7"	2.75	5.45	6.20
6 x 21	7"	3.25	5.90	6.80
7 x 12	7"	2.80	5.50	6.50
7 x 14	7"	3.00	5.80	6.70
7 x 18	7"	3.25	6.00	6.80
7 x 21	7"	3.60	6.50	7.40
7 x 24	7"	4.10	7.25	8.00
7 x 26	7"	4.75	7.80	8.50
7 x 27	7"	5.00	8.50	9.00
7 x 28	7"	5.25	9.50	10.00
7 x 30	7"	6.00	10.00	11.00
7 x 24	10"	5.60	9.25	10.00
7 x 26	10"	6.25	9.80	10.50
7 x 27	10"	6.50	10.75	11.50
7 x 28	10"	6.75	11.50	12.00
7 x 30	10"	7.00	12.00	12.50
8 x 40	8"	6.00	11.50	12.50
9 x 14	10"	3.95	6.40	7.00
9 x 21	10"	5.00	7.70	9.25
9 x 24	10"	6.00	9.50	10.50
12 x 14	10"	4.25	7.00	8.00
12 x 21	10"	4.75	9.50	10.50

Mounting Boards all sizes in stock.

F. O. B., Milwaukee, Wis.

Circular showing our complete line sent on request. Our Utility Beauty Cabinets are really beautiful. Our Monarch cabinets are the best obtainable.

UTILITY CABINET COMPANY
439-443 27th Street, Milwaukee, Wis.

"Turn-It" greatly increases the volume, secures greater distance and reduces noises

TURN-IT

ADJUSTABLE
GRID LEAK

Changes the range of resistance to suit the strength at reception

ABSOLUTELY GUARANTEED



Only \$1 at Your Dealer or Direct From Us

TURN-IT RADIO SALES, Inc.
71 Murray St., N. Y.

If it isn't a FERBEND, it isn't a WAVE TRAP

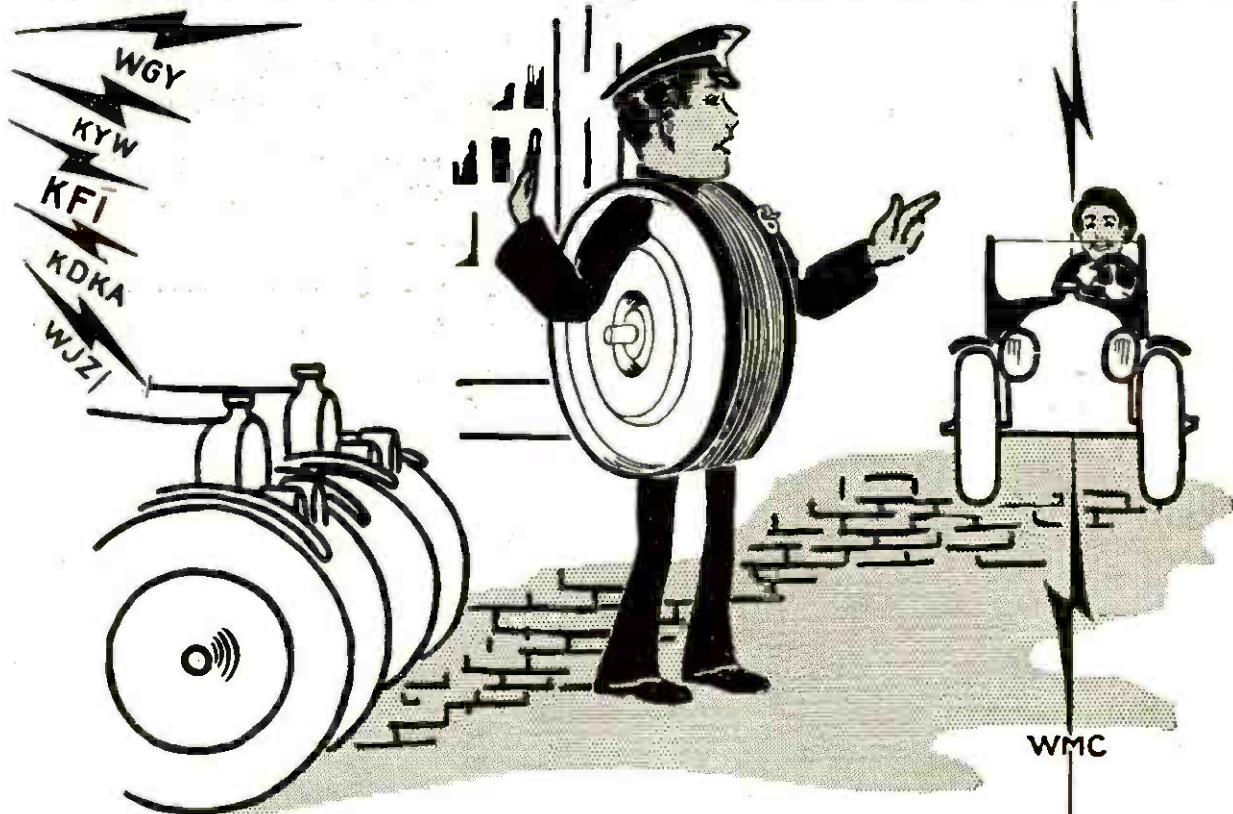

The Traffic Cop of the Air

He arranges in orderly fashion the mass and jumble of broadcasting stations that are seeking entrance to your set, and brings 'em in, one at a time, so you can enjoy them! Never reduces, but nearly always increases volume. Add a Ferbend Wave Trap to your set and "police" your reception. Regulate the traffic!

Make every night silent night! Trap out the interference. Why pay \$50.00 to \$200.00 extra for increased selectivity, when for \$8.50 you can get a genuine Ferbend Wave Trap which will absolutely cut out any interfering station, no matter how loud, how close by or how troublesome.

Guaranteed to tune out any interfering station. The Ferbend Wave Trap is designed and manufactured complete by us, after years of careful experimenting. It is not to be confused with imitations, hastily assembled from ordinary parts. The price is \$8.50. Shipment is made parcel post C. O. D., plus a few cents postage. If you prefer, you can send cash in full with order, and we will ship postage prepaid. Clip and mail the COUPON today!

FERBEND ELECTRIC CO.
21 E. So. Water St., Dept 5, Chicago

FERBEND
TRADE MARK
Wave Trap
REG. U.S. PAT. OFF.

Always look for this Trade Mark. It is your protection against misleading imitations and those who infringe on the registered name "Wave Trap" and its reputation.



FREE

Valuable Booklet on Interference and how to eliminate it. We will gladly send it FREE. Just fill in, clip and mail coupon below.

FERBEND ELECTRIC CO.
81 E. So. Water St., Dept. 5
Chicago, Ill.

Gentlemen:—Please send me:

- WAVE TRAP. Send Postpaid. I am enclosing (check, M. O., etc.) for \$8.50.
- WAVE TRAP. Send C.O.D. I will pay Postman \$8.50, plus few cents postage, when it arrives.
- FREE BOOKLET on Interference.

Name _____

Address _____

City _____ State _____

MUSIC IS IMMORTAL

The earliest history of Man was told to the strumming of primitive melody. His wars, defeats and triumphs are written in our symphonies today.

Music will outlive our present system of radio a hundred—a thousand years from now. But, until then, the RESISTANCE COUPLED AMPLIFIER—the only system that does justice to the qualities that make music live—will be first among the fans of discrimination.

Amplification truly without distortion—reproduction that is auditively perfect—is the distinctive achievement of the DAVEN SUPER AMPLIFIER illustrated below.

On Sale at Your Dealers
DAVEN RADIO CORP.

"Resistor Specialists"

Newark

New Jersey

Resistance Coupled Amplifier KITS

Without sockets and condensers

3-Stage \$8.00
4-Stage \$10.50

Complete, with sockets and condensers

3-Stage \$12.50
4-Stage \$16.00

Read the Daven "RESISTOR MANUAL" by Zeh Bouck. This manual contains the how-to-make-it data on Resistance Coupled Amplification. Sold everywhere.

Price 25 Cents

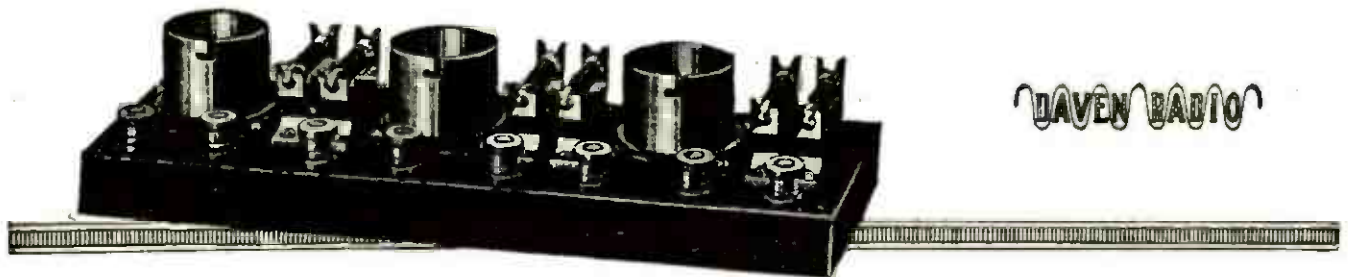



**O'NEIL
AUDIPHONE**

**LOUD—
SPEAKER**

**APACE WITH
RADIO
PROGRESS**

**The 3-Way
Control
Balanced
Armature**

*(An Exclusive Patented
Feature)*

No Blast or Chatter because the mica diaphragm of the Audiphone can be actuated ONLY by electrical impulses. The armature, through which the vibrations are transmitted, is balanced in three directions. The large permanent magnet affords a real foundation for the full range of broadcasted impulses. Not an ear-phone type Loud Speaker. Hear the Audiphone at your dealers.

PRICE
With 14 inch bell Horn \$28
With 12 inch bell Horn \$25

Sold with an Absolute-Satisfaction-or-Money-Back Guarantee. At your Dealers or Direct upon receipt of purchase price and your dealer's name.

Write for Literature
O'NEIL MANUFACTURING CO.
4739 Hudson Boulevard West New York, N. J.



Establishing a New Standard!

The New and Improved
**"READ'EM"
BINDING
POSTS**

*"The Knobs Can't
Come Off"*

**NEW MARKINGS
FULFILL EVERY
DEMAND**

The Utmost in
Quality and Appearance
at the Lowest
Price

15c.

At Your Dealers or
sent Postpaid.

THE MARSHALL-GERKEN CO.
Toledo, Ohio



B-METAL

A high resistance crystal is best for Reflex Sets. B-Metal resistance is very high. Your dealer will order it.

B-METAL REFINING CO.
7th floor
525 Woodward Ave., Detroit, Mich.

Dear Jim:

You asked me what caused the noises in your radio set.

Here's a diagram that will help you. The dotted line tells the story. B Batteries connected right to your phones. All radio sets are built this way.

When B's start to run down their current gets jumpy, and there's a crash or a sizzle in every jump.

I used to think that Old Man Static made these noises until I got my Willards and listened to the difference.

Take my advice, Jim. Get Willards. You can depend upon them to give steady current for a long, long time. Willards require very little recharging, and you can do that right at home with an inexpensive little rectifier in circuit with an ordinary light bulb.

Why keep buying batteries when Willards last for years, and give better results.

Yours noiselessly,

Sam.

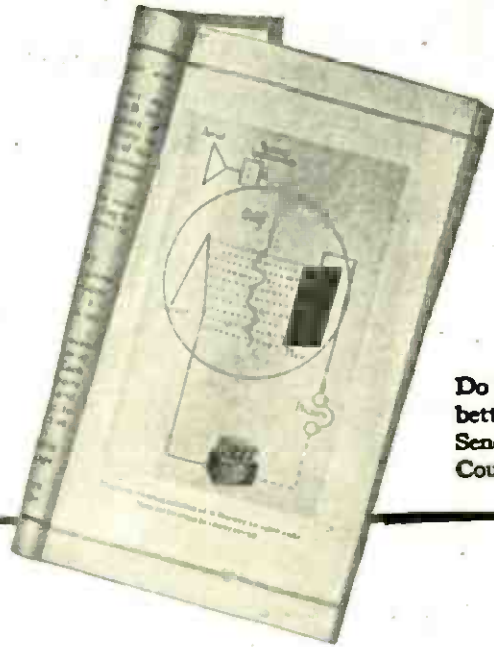

Do you want better results? Send in the Coupon.

WILLARD RADIO BATTERIES

FOR SALE AT WILLARD SERVICE STATIONS AND RADIO DEALERS.

Write to **WTAM** for this booklet
(The Voice of the Storage Battery)

WTAM is the Radio Research Laboratory and Broadcasting Station of the Willard Storage Battery Company, Cleveland, Ohio.

Its function consists of research which is being done to improve the quality of radio reception and the broadcasting of radio programs for your entertainment.

Write for WTAM's own booklet, "Better Results from Radio." Most interesting booklet ever published on this subject. Mailed to you with our compliments.



Mail me to WTAM, Cleveland, O. I'll bring you "Better Results."

Name

City and State

Street Address

P. R. 4

All apparatus advertised in this magazine has been tested and approved by POPULAR RADIO LABORATORY

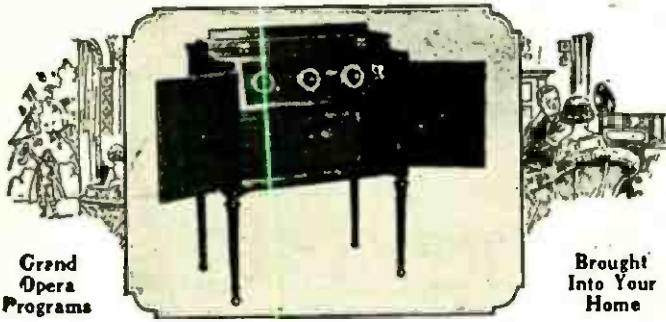

WHEN you own a Radiodyne you can hear singers' voices and orchestral harmonies faithfully reproduced thru the loud speaker. The Radiodyne brings these enjoyable programs into your home so clear and distinct that you lose nothing by not being at the opera. With the Radiodyne you will not be troubled by interference from nearby stations. The Radiodyne selects and holds the program you wish to hear.

RADIODYNE

Tunes Through New York Local Stations

"We have tuned in Kansas City, Jefferson City, Hastings, Elgin, Chicago, Dallas, Atlanta, Pittsburgh, Philadelphia and many other stations in the last three nights right thru local New York stations."

Clarence I. Goldman, New York City

Gets Over 109 Stations Loud and Clear

"Have received over 109 different stations, loud and clear. I can tune out Cincinnati and tune in Oakland without interference. I tuned in Oakland when it was just getting dusk here."

John W. Porter, New Butler, Wisconsin

Write for illustrated folder which describes the Radiodyne in detail. If you buy a radio before you have a demonstration of the Radiodyne you will surely regret it.

Western Coil & Electrical Co.

308 Fifth Street, Racine, Wis.

Astonishing Loop Results On Super-Het Circuits

The many advantages of loop reception have now been increased by the remarkable new Bodine Low-Loss Folding Loop. The stranded wire used is bank-wound on the basket-weave principle. With circuits sufficiently sensitive for loop operation, especially the Super-Heterodyne, the Bodine makes the set more selective, increases DX range, cuts down static and interference, and through lowered resistance and distributed capacity materially increases volume and clarity. You must SEE the Bodine to fully realize its big advance over the old-style loop.

If your radio dealer cannot supply you, you may send order direct to us. Shipped post-paid on receipt of \$8.50 and your dealer's name. Special Tapped Loop for Inverse-Duplex. \$10. Be sure to give make or type of circuit used.

BODINE
BASKET-WEAVE
LOOP AERIAL

BODINE ELECTRIC CO.
2256 W. Ohio Street
Chicago, Ill.

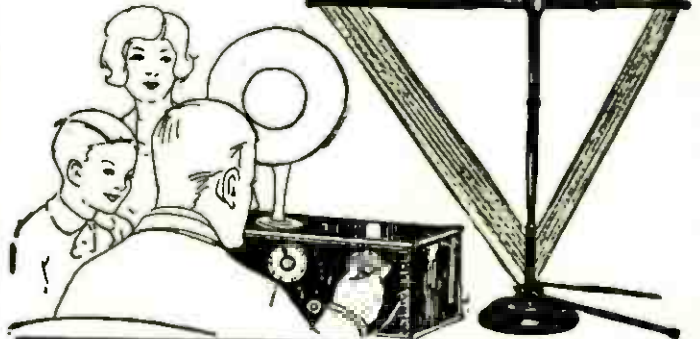

?

Will your Antenna Wire continuously resist the attacks of the elements and corrosion caused by atmospheric gases?

TINNED

"COPPERWELD"

ANTENNA WIRE

resists these destructive forces and in addition, has ample surface area and conductivity properties to meet the most exacting requirements.

Proven by—

over $\frac{3}{4}$ of a million Copperweld Antennae in service and the continued purchases by the largest amateur and commercial corporations in the world.

Buy it in cartons—

The construction directions printed on the carton explain how to build the aerial.

If you want clear radio, you must have perfect contact

Exacting tests prove efficiency of Na-Ald Sockets



"It's the contact that counts"



Socket instantly cleaned by twisting tube

CLEAR contact between socket and tube is necessary, above all, to insure clear radio reception. This contact is the important point to watch in all sets.

Perfect Contact assured with Na-Ald De Luxe Sockets. Broad wiping surface of four special dipped phosphor bronze socket clips press both on sides and ends of tube terminals making constant clean bright contacts.

Clean Easy Feature. The two to eight tubes do not have to be removed and sandpaper used to scrape contact surfaces bare. Duo-contacts easily cleaned and film of oxide between tube and socket, better known as corrosion, which can ruin contact, is quickly removed by twisting each tube back and forth in its socket two or three times. This feature of Na-Ald Sockets saves trouble and time.

Highest Insulating Qualities. Na-Ald Sockets are genuine bakelite Alden processed. This gives a socket of well-cured not-too-heavy bakelite of even cross-section throughout.

Thus Alden Processed construction insures highest insulating qualities and lowest loss. All possible current is carried from socket clips to tube terminals. This is most essential as current flow is so minute, any loss is noticeable in efficiency results.

Na-Ald Sockets are easy to mount. Sockets equipped with slotted knurled nuts. Tightened with ordinary screw-driver.

You can obtain Na-Ald Sockets at radio, electrical and hardware stores everywhere. Be sure you have Na-Ald Sockets in the set you build or buy. Sockets for all tubes. De Luxe 75c.; others 35c., 50c., 75c.

Send for free copy of radio booklet—"What to Build," giving a number of the best selected and tested circuits.

ALDEN MANUFACTURING COMPANY

Also makers of the famous Na-Ald Dials

Dept. C-1, Springfield, Mass.



HEATH

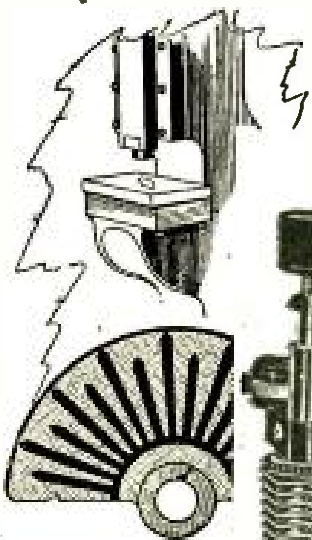

Micrometer Geared Vernier

Ordinary adjustments reduced by separate geared adjustment to hair-breadth distinction. We guarantee the Heath Vernier Condenser to be more highly selective than any condenser employing a vernier which actuates ALL of the plates.

Permanently FLAT Plates

The well known Heath process of stamping rotor plates to lasting flatness, makes the new Heath a permanently satisfactory instrument.

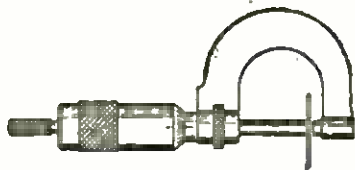
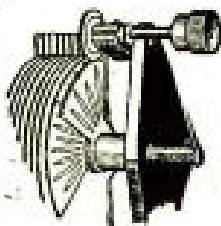
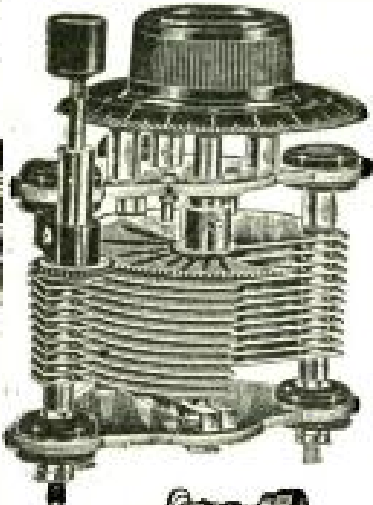

RADIANT Non-Dielectric CONDENSERS

A new type of end plate which banishes leakage and capacity effects, added to the popular Heath features of permanently FLAT Plates and the most perfect type of vernier. These advantages of Heath condensers are the best guarantee of lasting satisfaction.

PRICES FOR VERNIER CONDENSERS

	With Dial	Without Dial
No. 12 AV 12 Plate.....	\$5.00	\$4.35
No. 24 AV 24 Plate.....	5.50	4.85
No. 44 AV 44 Plate.....	6.50	5.85

Plain types in all sizes

Heath Sockets with the Exclusive Shock Absorber Feature

Bakelite base into which re-enforced phosphor bronze, self-cleaning contacts are securely embedded. Binding posts are slotted hexagon nuts. HEATH Standards of material and workmanship..... Price 75c

Heath Bakelite dials in three sizes

HEATH RADIO & ELECTRIC MFG. COMPANY

204 FIRST ST., NEWARK, N. J.

Exclusive Canadian Distributors
Marconi Wireless Telegraph Co., Ltd., Montreal, Canada.

Revolutionary



\$1.10
Everywhere

Write for
FREE
Hook-ups

AMPERITE controls perfectly and automatically the current flow from battery to tube. No Rheostat knobs on panel to turn. No ammeter needed. No worry. One AMPERITE for each tube inside the set regulates current on thermo-electric principle. Simplifies wiring and operation. Facilitates tuning. Proven in use. Adopted by 50 set manufacturers. Be sure your set is equipped with AMPERITE.

RADIALL COMPANY
Dept. PR-3 50 Franklin St., New York

AMPERITE

"means right amperes"

"Take No Chances—Use Como"

COMO DUPLEX

The World's Standard Push Pull Transformer

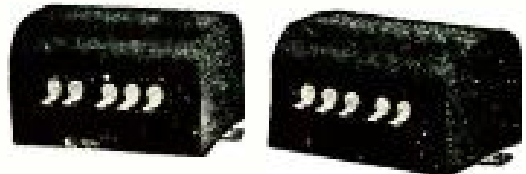

PRICE \$12.50 per pair
For maximum volume without distortion

What Prominent Writers on Radio Subjects say About Como.

Lewis B. Hagerman, Technical Editor, Chicago Post: "Actual Tests show this transformer to be far superior to any others of similar makes."

R. J. Robbins, New York Sun: "After consideration of several well-known makes of push pull transformers which are available 'COMO DUPLEX' was selected as most satisfactory."

C. White, Radio World: "COMO DUPLEX" is infinitely superior—most other push pull transformers seem to be ordinary transformers with a center tap brought out as a makeshift."

E. P. Gordon, Open Road: "A system of audio-amplification which is becoming increasingly popular. Its use... will give surprising results in both quality and volume, and is thoroughly recommended by this department."

NEED WE SAY MORE?

COMO APPARATUS COMPANY
446 Tremont St. Boston, Mass.

For Sale at Leading Dealers

Earn \$50 to \$200 a Week in RADIO

You can! Hundreds of ambitious men are already earning thousands of dollars in this wonderful new industry—you, too, can get your share. Mail coupon below for Free Book which describes fully the amazing money making opportunities in Radio and tells how YOU can earn from \$5,000 to over \$10,000 a year.

THE astounding growth of Radio has created thousands of big money opportunities. Millions of dollars were spent during the past year on Radio, and thousands of young men are needed right now to meet the ever increasing demand of work.

Men are needed to build, sell and install Radio sets—to design, test, repair—as radio engineers and executives—as operators at land stations and on ships traveling the world over—as operators at the hundreds of broadcasting stations. And these are just a few of the wonderful opportunities.

Easy to Learn Radio at Home in Spare Time

No matter if you know *nothing* about Radio now, you can quickly become a radio expert, by our marvelous new method of practical instruction—instruction which includes all the material for building the latest up-to-date radio apparatus.

Scores of young men who have taken our course are already earning from \$75 to \$200 a week. Merle Wetzel of Chicago Heights, Ill., advanced from lineman to Radio Engineer, increasing his salary 100% *even while taking our course!* Emmett Welch, right after finishing his training started earning \$300 a month and expenses. Another graduate is now an operator of a broadcasting station PWX of Havana, Cuba, and earns \$250 a month. Still another graduate, only 16 years is averaging \$70 a week in a radio store.



The National Radio Institute is America's Pioneer Radio School—established in 1914. Our course is the absolutely complete one now being offered which qualifies for a government first class commercial license. It gets you the *bigger* paying jobs in Radio.

Send for FREE BOOK

Learn more about this tremendous new field and its remarkable opportunities. Learn how you can quickly become a radio expert and make big money in Radio.

We have just prepared a new 32-page booklet which gives a thorough outline of the field of Radio—and describes our amazing practical training in detail. This Free Book, "Rich Rewards in Radio," will be sent to you without the slightest obligation. Mail coupon for it *now!*

For a short time we are offering a reduced rate to those who enroll at once. Act promptly and save money.



National Radio Institute

Dept. 32MA Washington, D. C.

NATIONAL RADIO INSTITUTE Dept. 32MA Washington, D. C.

Please send me without the slightest obligation your Free Book, "Rich Rewards in Radio," and full details of your special Free Employment Service. Please write plainly.

Name.....Age.....
Address.....
City.....State.....

PAY INCREASES OVER \$100 A MONTH



I am averaging any where from \$75 to \$150 a month more than I was making before enrolling with you. I would not consider \$10,000 too much for the

course.
(Signed) A. N. LONG,
121 No. Main St.,
Greensburg, Pa.

DOUBLES SALARY

I can very easily make double the amount of money now than before I enrolled with you. Your course has benefited me approximately \$3000 over and above what I would have earned had I not taken it.



T. WINDER,
731 Belford Ave.,
Grand Junction, Colo.

Wonderful Opportunities

Hardly a week goes by without our receiving urgent calls for our graduates. "We need the services of a competent Radio Engineer" — "We want men with executive ability in addition to radio knowledge to become our local managers"—"We require the services of several resident demonstrators"—these are just a few small indications of the great variety of opportunities open to our graduates.

Take advantage of our practical training and the unusual conditions in Radio to step into a big paying position in this wonderful new field. Radio offers you more money than you probably ever dreamed possible—fascinating easy work—a chance to travel and see the world if you care to or to take any one of the many radio positions all around you at home. And Radio offers you a glorious future!

All apparatus advertised in this magazine has been tested and approved by POPULAR RADIO LABORATORY



WHOLESALE RADIO SERVICE COMPANY

9 Church St. N.Y.C.
DEPT. P

NEW COCKADAY 4 CIRCUIT TUNER
With Resistance-Coupled Amplifier

ALL PARTS EXACTLY AS SPECIFIED BY MR. COCKADAY

List of Parts:			
1 Cockaday Precision or Gen-Win coil.....	\$5.50	1 Amsco switch lever.....	\$.25
1 Cardwell 21 pl. .0005 mfd. condenser.....	5.00	9 Switch points and 2 stops.....	.20
1 Cardwell 17 pl. .00035 mfd. condenser.....	4.75	1 Improved filament battery switch.....	1.00
2 Accuratune micrometer control dials.....	7.00	1 7 x 24 drilled panel.....	3.50
1 N. Y. mica fixed condenser .00025.....	.40	3 Electrad certified grid leaks 1/2 meg.....	1.50
1 Amplex Gridenser.....	1.25	3 Electrad grid leak holders.....	.75
5 Benjamin clearstone sockets.....	5.00	3 Bradleyohms.....	6.00
1 Amaco Dubi-Wunder comb. pot-rheo.....	2.25	1 Bradleyleak.....	1.85
4 Amperlites No. 1-a.....	4.40	3 Sub panels.....	.50
3 Improved double circuit jacks.....	3.00	1 Base board.....	.75
1 Improved single circuit jack.....	.70	8 Binding posts.....	.80
1 Precise audio frequency transformer.....	5.00	Lugs, bus wire, etc.....	1.00
9 N. Y. mica fixed condensers .005.....	5.40		
		Total.....	\$67.65

BY POPULAR DEMAND OUR FREE OFFER EXTENDED UNTIL JAN. 20th

FREE 4 Genuine U. V. 201A R. C. A. Tubes with **FREE**
every Kit Order Received until Jan. 20th

Send M. O. or Pay the Postman Postage Paid on Orders above \$5.00

ALSO COMPLETE RADIO CATALOG

Just send your name. No postage. Let us surprise you with our amazing values of all the up-to-date radio apparatus. We specialize in all COCKADAY hook-ups. Our kits are made up of the parts exactly as specified by Mr. Cockaday. We carry in stock the Cockaday improved four-circuit tuner with push-pull amplifiers, one, three and five tube kits. Also super heterodyne, neutrodyne, Reinartz, Erla, Acme Reflex and other circuits. Also all up-to-date sets and speakers. Get your radio apparatus at our wholesale cut-rate prices.

THE SENSATION OF THE RADIO WORLD'S FAIR

RAVEN Superheterodyne KIT

REG. U. S. PAT. OFF.

Kit consists of:

- 1 Filter Circuit Coil
- 3 Radio Frequency Transformers
- 3 Sockets for Standard Tubes 201 A or 301 A Completely wired in Moisture-Proof Wax
- Binding Posts Plainly Marked
- 1 Oscillator included with each "kit"



NEAT
STURDY
QUIET
COMPACT
ONLY
7 1/4" x 4 3/4" x 2 1/4"

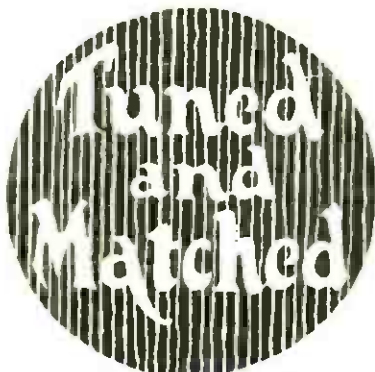

A SINGLE COMPLETE UNIT
MOISTURE PROOF
SEALED IN—STAYS ADJUSTED



RAVEN RADIO CO., - - ALBANY, N. Y.

All apparatus advertised in this magazine has been tested and approved by POPULAR RADIO LABORATORY

FRESHMAN MASTERPIECE

It's *Easy* to Build

a five tube radio frequency receiver when you use the Freshman Masterpiece Kit

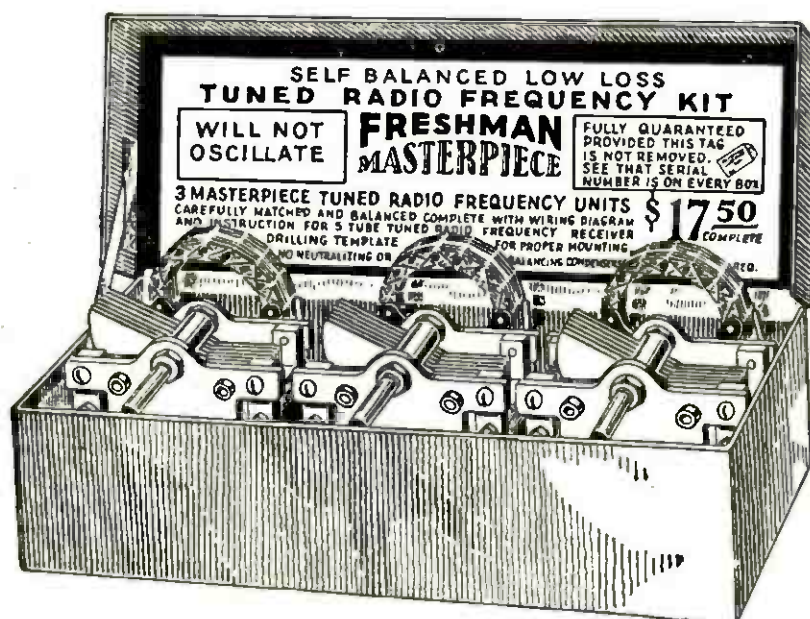

NO Neutralizing OR Balancing Condensers Required

when you build with this kit to produce a radio frequency receiver that will bring in even the most distant stations with the volume and clarity of locals. So selective that stations can be brought in day after day at the same dial settings. A set that will be the equal, if not the superior, to any 5 tube receiver on the market, and what's more, it's the easiest set in the world to operate.

Kit consists of 3 Masterpiece Tuned Radio Frequency Units carefully matched and balanced. Complete with wiring diagram and instructions for building any 5 tube tuned radio frequency receiver and also drilling template for proper mounting...

\$17.50

Each and every Freshman Masterpiece Coil bears a serial number and Trademark—our guarantee of electrical and mechanical perfection. Every genuine Freshman Coil is made of specially insulated wire to prevent short-circuiting, so often caused by inferior coils. For your protection demand only the genuine.

At your dealers, otherwise send purchase price and you will be supplied without further charge

CHAS. FRESHMAN CO., INC., 106 Seventh Ave., New York

The
NEW



**PARAGON
FOUR**

RADIO is revolutionized by this new receiver. A four-tube set whose range, using loudspeaker, is practically unlimited. Basically new, employing the new *non-radiating* Paradyne Circuit. Exquisite, natural tone. Extreme sensitiveness. And the *simplest* set ever to operate—one dial control.

May be used either as a three-tube or four-tube receiver. Operates successfully with any standard tubes, either dry or storage battery type. Built as only Paragon sets have been built in the past.

And priced one third of what you would expect to pay for such value.

Ask your radio dealer to show you this new receiver. Or write for descriptive folder.

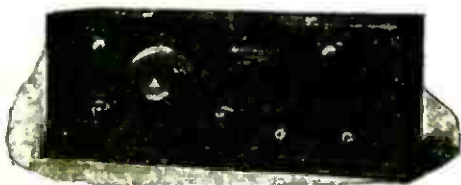

The New Paragon Four, \$65

Probably the greatest value in radio today. Employs the new Paradyne circuit—non-radiating. New type *single dial* control.

The New Paragon Three, \$48.50

An exceptionally sensitive, selective, fine-toned receiver, with amazing loudspeaker tone and volume over long distance range.

The New Paragon Two, \$27.50

Excellent tone and volume on loudspeaker from stations within moderate radius. Range for phone reception almost unlimited.

DEALERS: Write for attractive new Dealer Proposition and address of nearest Paragon Distributor

ADAMS MORGAN COMPANY, Inc.
8 Alvin Ave., Upper Montclair, N. J.

PARAGON

Look for the



Red Triangle

FORE'S

**MASTER FORE
BATTERY CHARGER**

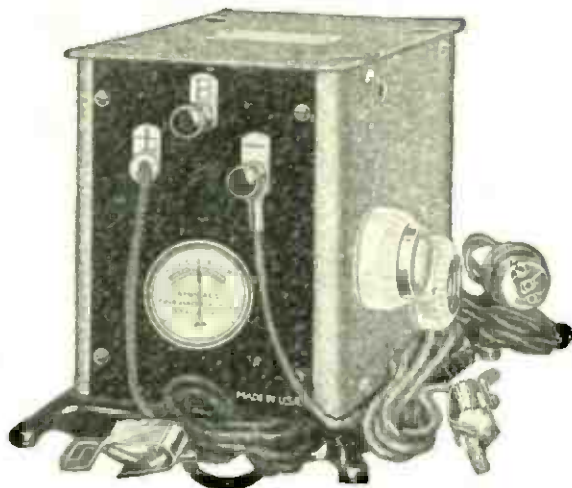

Charges Radio A-6 Volt and 48 Volt B Battery in Series or 2-48 Volt B Batteries in Multiple Any Charging Rate.

Charges 6-Volt Automobile Batteries.

The Fore Battery Charger will make anyone proud of his radio set.

Call at your jobber or dealer for them or write either address below for advice as to where they can be obtained.

Manufactured by
Fore Electrical Mfg. Co.
5255 N. Market Street
St. Louis, Missouri

Sales Department
The Zinke Company
1323 S. Michigan Blvd.
Chicago, Illinois

**MAILED ABSOLUTELY
GUARANTEED**



D-201 A., D-200, D-199, D-12,
in standard sizes to fit any
socket. The internationally
famous

DUTCH RADIO VALVE

will be \$2.25 plus
mailed for postage

Three sent for \$6.50
plus postage (any type).

Approved by Popular
Radio Laboratories.

Order from nearest point.

D. R. V. IMPORTING CO.
515 Orange St. Newark, N. J.
St. Louis Radio Tube Laboratory
3572 Olive Street St. Louis, Mo.

**FOR ANY CIRCUIT IN ANY SET
"YOU CAN'T BEAT THE DUTCH"**

METALECTRIC SOLDERING IRON

"Accepted as the logical solution to radio problems by leading amateurs, manufacturers, and Governmental departments."

Write for descriptive literature.

Post Electric Co. (Inst. Division) 30 E. 42d St., New York

Atlas

TRADE MARK

RADIO REPRODUCTION Speaker

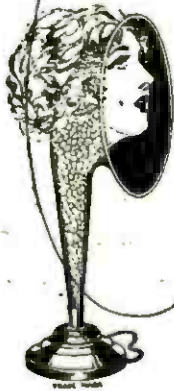

Radio... as you ought to hear it!

ATLAS Radio Reproduction is *harmonized* Radio Reproduction—a speaker in harmony with your receiving conditions. A slight turn of the *harmonizer** gives you radio as you *ought* to hear it—from near and distant stations—with 3 tubes or 8—on speech, or song, or instrumental music.

*Patent Applied for

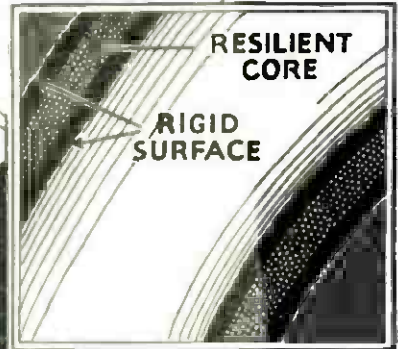
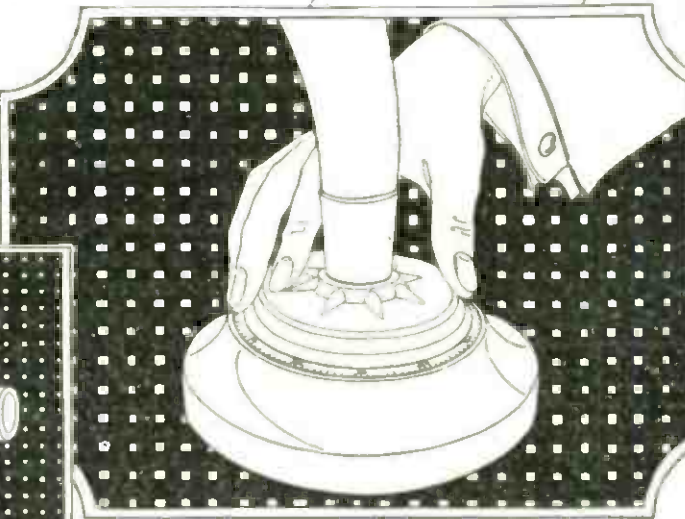

RESILIENT CORE

RIGID SURFACE

Cross-section of an Atlas horn—
—resilient in the center to absorb vibrations of the material—
—rigid at the surface to conserve the pure tones of the compound diaphragm.

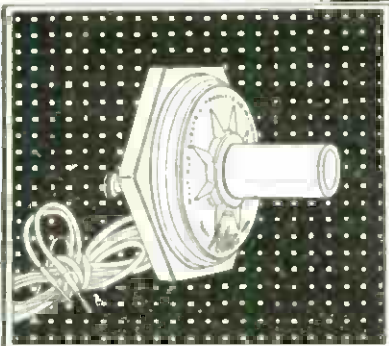

Atlas unit, complete with attachment couplings for all standard Phonographs.

Multiple Electric Products Co., Inc.
365 Ogden St., Newark, N. J. Dept. B
New York, Boston, Philadelphia, Baltimore,
Pittsburgh, Detroit, Chicago, St. Louis,
Denver, Rialto Bldg., San Francisco.

Marconi Wireless Telegraph Co. of Canada, Ltd.
Sole Canadian Distributors

DYNERGY



*The Radio Receiver Without Batteries
House Current Furnishes Power—Plug into Light Sockets*

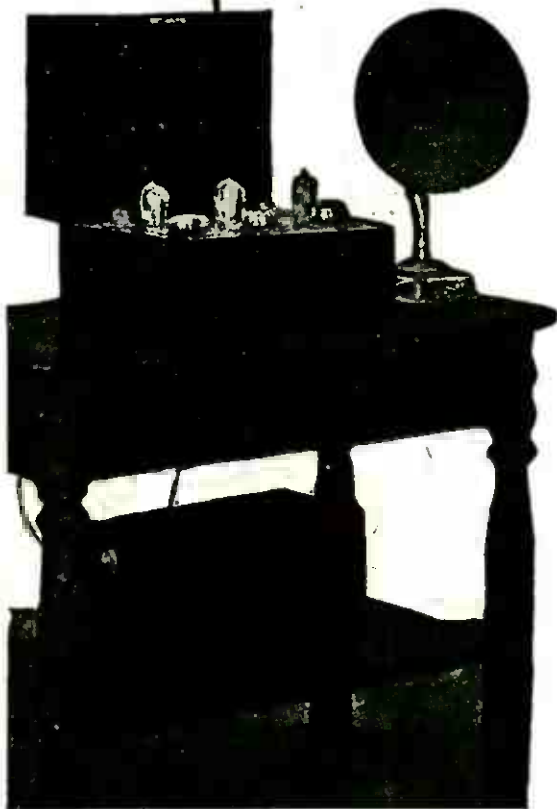

D. C. \$185
A. C. \$235
Without Tubes and Speaker. In Mahogany and Two-Tone Dupont Leather.

Buy DYNERGY—and U Buy a Power-House

Buy Batteries—and U Buy Trouble.

There are but two radio receivers to buy:

1. The Battery set—that needs A, B or C batteries;
2. The Electric set—that needs no batteries at all, that works from your electric light socket, like your electric iron or other attachment.

When purchasing your radio have that in mind, and remember—Batteries dissipate, fade out, need replacement, re-charging; upkeep expense, and cause annoyance and disgust. They make of your home a work-shop, spoil your rugs and furniture, and require you to be, become or hire an electrician. Why invest your money—whether it be \$50 or \$500—in a battery set, which is full of nuisance and continual expense?

There is only one electric radio—DYNERGY.

DYNERGY is **dynamo energy**, not energy from dying batteries.

DYNERGY gives you steady service, constant joy, and a real radio, with ability at all times, at any place, to obtain sweet, clear tone, immense volume and distant and selected stations out of the air and into your loud speaker, at a cost of less than half a cent per hour.

DYNERGY means "First Cost—last cost."

DYNERGY is a complete five tube set, not a unit or attachment.

DYNERGY is a musical instrument you or a child can operate; it is not a technical struggle. Women love Dynergy, and detest batteries.

DYNERGY is basic, permanent, built to last a lifetime; it is not a temporary affair, like a battery set, hastily to be discarded. Customers do not hesitate to invest in Dynergy.

Manufactured by

DYNAMOTIVE RADIO CORP.

47 Ninth Avenue, New York

The greatest appeal to put radio in the home is Dynergy. Over 20,000 sold in 3 months. Thousands of delighted users in homes and stores throughout country.

Under
Levenberg
Inventions

Dealers should communicate immediately with distributor in their territory, or with the factory direct.

The ADAPTO RADIO CABINET

Patents Pending

Beauty • Convenience • Adaptability



ADAPTO with home-made three tube set.

The ADAPTO Cabinet has:

- An artistic design.
- Beautifully figured wood in either mahogany or walnut.
- An easy running, non-sagging drawer for storage battery, charger, distilled water and hydrometer.
- A double-pole, double-throw switch for charging without touching a single wire.
- All wires installed ready to connect.
- Small drawer for tools, etc.
- An airtight battery compartment to prevent corrosion.
- Specially designed horn built into top—the proper place.
- A spacious shelf for B batteries, either dry or storage.

Special adapter frames permit the installation of practically ANY set, either factory built or home made.

List Price - - \$110.00

Inquiries invited from responsible dealers.

Manufactured by

L. R. Donehue Lumber Company

Radio Cabinet Division

Perth Amboy, N. J.



ADAPTO with Factory-built Neutrodyne.



The Concert Model Speaker at \$25 is the best radio affords. Easily accessible adjustment regulates tone and volume. This speaker is recommended for multi-tube sets as it will handle all the volume any set can produce.

TRIMM
Superior Reproducers

HEADSETS

Professional - - \$7.50
Dependable - - \$5.00

SPEAKERS

Concert Model - \$25.00
Home Speaker - \$10.00

PHONODAPTER

GIANT Unit - \$10.00
Little Wonder - - \$4.50

TRIMM
RADIO MANUFACTURING
COMPANY
24 So. Clinton St.
CHICAGO
U.S.A.

Member Radio Manufacturers' Association



Quality Cabinets
—Priced Exceptionally Low
Because We Sell Direct to You

No radio cabinet on the market compares with our style "A" model, pictured above, for beauty and high quality. And you save amazingly on every size, buying right from the maker. Compare prices and see for yourself.
Genuine Cuban Mahogany, beautifully finished. Front rabbetted to fit panel. Nickel-plated piano hinges. Built to resist any climate.

Size	Unfinished	Finished
7 x 10 x 7	\$1.95	\$2.60
7 x 12 x 7	2.10	2.75
7 x 14 x 7	2.25	2.90
7 x 18 x 7	2.40	3.05
7 x 21 x 7	2.55	3.20
7 x 24 x 7	2.70	3.35
7 x 26 x 7	2.85	3.50

By "finished" is meant a waxed, rubbed finish.

Unfinished and unassembled, if desired, at still lower prices.

Cabinets shipped promptly on receipt of purchase price.

Bulletin showing our complete line of cabinets, sent on request.

A. HALL BERRY

71 Murray Street.

New York

The Authorized Cockaday Coil

\$5.50



Specified in
October
POPULAR
RADIO
as

Cockaday Precision Coil

The only coil specified by Mr. Cockaday in his New Four Circuit Tuner, with resistance coupled amplification because it meets all his specifications.

The only authorized Cockaday Coil, made in strict accordance with specifications of Laurence M. Cockaday, inventor of the famous Cockaday Four Circuit Tuner. Wound on hard rubber tubing, 1/8 inch wall, with No. 18 D. S. C. copper wire which insures selectivity, greater volume, sharp tuning and maximum sensitivity. Guaranteed.

Gets distant stations easily and clearly. Hundreds have substituted this quality coil for those of inferior make and are amazed at the improved reception, selectivity and general D-X results.

At your dealers, otherwise send purchase price and you will be supplied postpaid

PRECISION COIL CO., Inc.
209-B Centre St., New York

**Modulation Plus Regeneration
In the New Ultradyne**

To the "Modulation System" of radio reception, R. E. Lacault has successfully applied the use of regeneration in the new Model L-2 ULTRADYNE.

The result is ultra-sensitivity never before thought possible. The use of regeneration produces tremendous amplification which is more noticeable when receiving weak signals.

The Radio Section of the U. S. Bureau of Standards has proven by actual measurement that regeneration becomes more effective as the received signal diminishes in strength.

Regeneration applied to the "Modulation System" allows the ULTRADYNE to respond to an extremely small amount of energy. This energy is further amplified thousands of times by the intermediate frequency amplifier before it is detected and made audible. This amplifier is designed for maximum efficiency without decreasing the tone or quality of music and speech.

The reception of distant stations is only limited by atmospheric conditions and causes beyond the control of Model L-2 ULTRADYNE.

**Loud Speaker Reception Using
Loop Aerial**

Efficient loud speaker reception using a loop aerial is possible with the Model L-2 ULTRADYNE. Ordinarily loop reception is considerably less efficient than an outside aerial. However, the application of regeneration to the "Modulation System" reduces the resistance of the loop circuit, thereby allowing the loop to pick up infinitely weak signals.

The use of a loop also increases selectivity and decreases static and other interference.

**How to Build the New Model
L-2 ULTRADYNE**

This 32-page illustrated book gives latest authentic information on drilling, wiring, assembling and tuning the new Model L-2



Ultradyne. This book explains the "Modulation System" in detail and also deals with the application of regeneration to this new system of radio reception.

It is edited by R. E. Lacault, inventor of the Ultradyne Receiver. Price 50c.

**Model L-2 ULTRADYNE
Kit Is Ready-**

This is the new Model L-2 Ultradyne Kit which contains one low loss tuning coil, one low loss Oscillator Coil, one special low loss Coupler, one type "A" Ultraformer, three



type "B" Ultraformers, four matched fixed Condensers.

The Ultraformers are new improved long wave radio frequency transformers, especially designed by R. E. Lacault, inventor of the Ultradyne.

\$30 As a precaution against substitution, R. E. Lacault's personal monogram seal (R.E.L.) is placed on all genuine Ultraformers. All Ultraformers are guaranteed so long as this seal remains unbroken.—Adv.

Selectivity!
a dominating Ultradyne Feature

AN Ultradyne receiver operating in New York City easily tunes out the powerful broadcasting of WOR, Newark, N. J.—405 meters and brings in WDAR, Philadelphia—395 meters; PWX Havana, Cuba—400 meters; WDAF Kansas City—411 meters.

Regardless of close similarity in wave-length, the Ultradyne selects any station within range—brings in broadcasting clearly, distinctly, faithfully.

In addition to this Ultra-selectivity, the Ultradyne is the most sensitive receiver known. It employs the "Modulation System" of radio reception, the achievement of Mr. R. E. Lacault, E.E., A.M.I.R.E., Consulting Engineer of this company and formerly Radio Research Engineer with the French Signal Corps Research Laboratories.

The "Modulation System" responds to weaker signals than the conventional method of detection—because it provides greater rectification. Weakest signals are made to operate the loud speaker.

Ultradyne performance is the envy of the radio industry.

Write for descriptive circular

PHENIX RADIO CORPORATION
7-9 Beekman Street New York

ULTRADYNE
MODEL L-2

BAKELITE

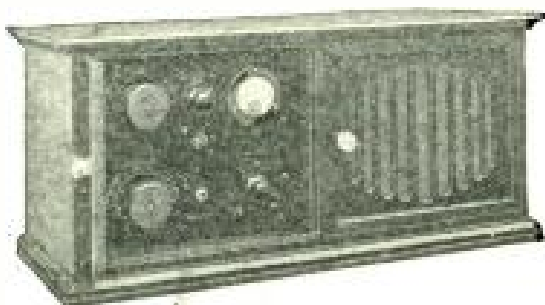

K. & C. De Luxe and Bakelite

For clear radio reception, reliable insulation is essential. That is why the Kilbourne & Clark Mfg. Co. uses Bakelite—radio's premier insulation—for this De Luxe receiving set.

Manufacturers who use Bakelite insulation guarantee good results from their radio sets. Amateurs will do well to profit by the experience of these radio experts and use Bakelite when building their own sets.

Write for a copy of
our Radio Booklet K

BAKELITE CORPORATION

247 Park Avenue, New York, N. Y.
Chicago Office: 636 West 22d Street



Send for our
Radio Map

The Bakelite Radio Map lists the call letters, wave length and location of every broadcasting station in the world. Enclose 10 cents to cover the cost and we will send you this map. Address Map Department.

THE MATERIAL OF A THOUSAND USES

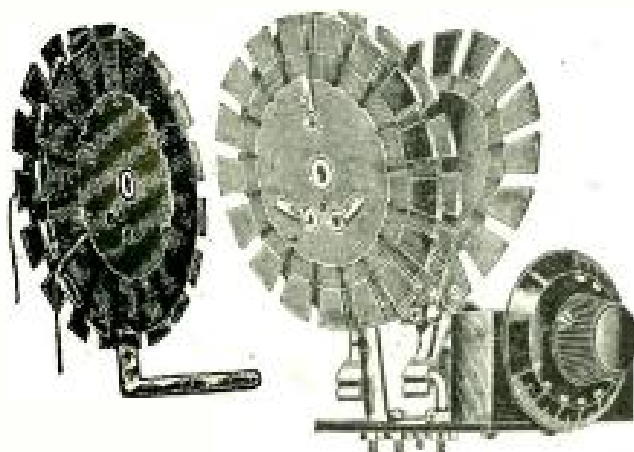

ROBERTS UNITS

(Trade Mark)

THE WONDER CIRCUIT OF THE YEAR

Combining Neutralization.—Regeneration—Reflex Developed by Walter Van B. Roberts, E.E., Ph.D. Editorially Endorsed by Radio Broadcast, as "Without Doubt The Best We Have Ever Seen."

California Actually Heard at Princeton University On The Loud Speaker, WITH TWO TUBES.

ROBERTS UNITS consist of Five Coils in Two Mountings Ready for Installation. Packed complete with all instructions. Hook-up, Schematic Print, Cut of Complete Set, etc.

"BUILD A ROBERTS AND REACH THE COAST"

Coils Mfg. under Zig-Zig
Pat. Aug. 21, 1923.

\$8.00

ROBERTS KIT

(Trade Mark)

Complete Kit of High-Grade Parts for the

ROBERTS TWO TUBE KNOCKOUT SET

Genuine Bakelite Panel, completely drilled. General Radio Condensers. F. M. C. Transformer, Sockets, Condensers, Genuine Roberts Units, Baseboard, Dials, Knobs, Busbar, Spaghetti—Everything, except Tubes, Batteries, Cabinet.

\$60 with Portena
Folding Loop (for
Local Use)

\$53 Without
Loop

J. NAZELEY COMPANY Dept. F.
571 Hudson St., (Sole Mfrs.) New York

40c

each in any value
from 1/4 to 10

FRESHMAN SUPERIOR

You can depend upon them to remain accurate at all times

Made of high resistance material impregnated throughout (not coated paper). Unaffected by climatic conditions. Will not deteriorate. Clamped between solid knurled ferrules assuring rigid construction and firm contact at all times.

At your dealer's, otherwise send purchase price and you will be supplied postpaid.

Chas. Freshman Co., Inc., 106-7th Ave., N. Y.

This Transformer Has Improved Thousands of Radio Sets

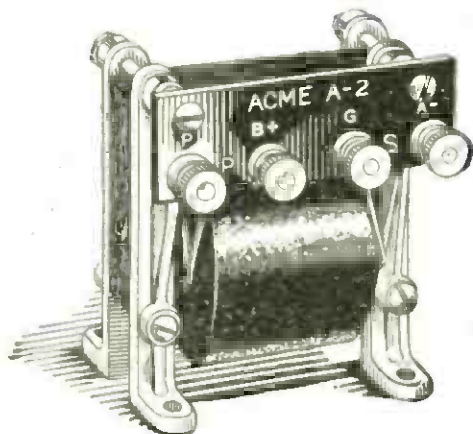

ACME A-2
—for volume

“... Your letter answering mine of December 10th came just as I got home with an ACME A-2 in my pocket. I installed it in my reflex set in place of the — and believe me you cannot exaggerate its good qualities...” From Winnetka, Illinois.

“... Am using your four-tube Acme circuit, using three audio and three radio transformers, and can pick up any 50 watt station in the U. S. A. ...” From Fitzsimons, Colorado.

These are just typical samples of testimonials picked out at random from our files. If we tried to show

them all to you, we'd have to publish a book. You couldn't read them through in a day.

But right here and now today you can, if you will, get the benefit of ACME Transformers. Use them in the set you build. Insist on them in the set you buy. Then your loudspeaker will have a chance to reproduce loud and clear without distortion.

Send 10 cents for 36-page book, "Amplification without Distortion," containing many practical wiring diagrams and many hints for getting the best out of your set.

ACME APPARATUS COMPANY

Transformer and Radio Engineers and Manufacturers
Dept. 95 Cambridge, Mass.

ACME

~ for amplification

ACME APPARATUS COMPANY,
Dept. 95, Cambridge, Mass.
Gentlemen: Enclosed find 10 cents for copy of "Amplification without Distortion."
Name
Street
City State

All apparatus advertised in this magazine has been tested and approved by POPULAR RADIO LABORATORY

CLARITY
VOLUME
ENDURANCE **\$2.30**
 By Mail

-and low Operating Cost

The Claritron



The New York Testing Laboratories, famous the country over, after exhaustively testing the Claritron tube and comparing it with a standard *High Cost* tube which retails for \$4.00, says that it not only "compares well in general", but that the *operating cost of the Claritron is "lower on the average."*

**THE CLARITRON IS A SAFE TUBE TO BUY—
 IT IS ABSOLUTELY GUARANTEED AND BACKED
 BY THE EXACTING TESTS OF EXPERTS.**

The Claritron average current consumption is only .179 amp.—much lower than the standard quarter ampere tube. This is due to the remarkable new filament wire—the heart of the tube—developed by our engineers

**SATISFACTION GUARANTEED OR MONEY REFUNDED
 AND THE PRICE IS ONLY \$2.30**

ALL TYPES TUBES (same price) Sent by Parcel Post C. O. D. or prepaid on receipt of Postal or Express Money Order

Superior Radio Co., Dept. C

176 Shepard Ave.,

Newark, N. J.

Our type 501-A identical with UV201 A standard size Detector and Amplifier

THE UNIVERSAL RADJO CRYSTAL DETECTOR

The LAST WORD for *Crystal and Reflex* circuits



Screen—prevents losing sensitive spot.

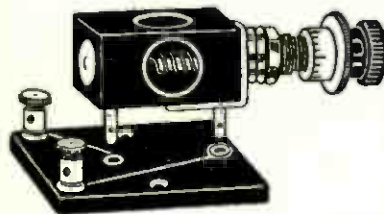

Micrometer feature permits finest adjustment.

Dustproof Casing—Window allows inspection of mineral (Pat. Pending)

Can be mounted on table; on front of panel; or **INSIDE** of panel with only knob projecting

Furnished in either Cat-whisker or Zincite-Tellurium type

PRICE (either type) \$1.50

Crystal—mounted in cup with screen—50 cents.

At your Dealer or direct from us

Jobbers write for attractive proposition.

**ELECTRIC CITY NOVELTY & MFG. CO.
 SCHENECTADY NEW YORK**



The Humphreys RADIO COIL WINDER

An Ingenious Machine Designed for the Construction of Radio Transmitting and Receiving Inductance Coils.

Primarily adapted to single layer, bank, spherical and lattice coil winding. Also adaptable to the construction of low loss self-supporting lattice and basket coils by the use of suitable winding forms.

Each machine sold with operating directions, wire data and a bench clamp.

For Industrial, Experimental and Amateur Use

Satisfaction Guaranteed List Price \$6.00

Shipments made promptly on receipt of money order

Made by **FERD HUMPHREYS, Caldwell, N. J.**

Send two cent stamp for descriptive folder

Full Mounted Four Coil Tuning Units for the Cockaday Circuit

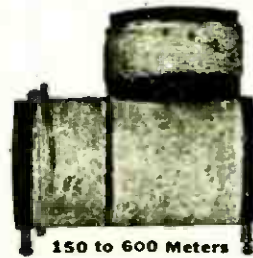

Base or panel mounting.

Best material and workmanship.

A guaranteed product, of correct design.

Direct or through your dealer.

Black or natural Bakelite or polished black rubber \$4.50 tubing, green silk wound

McConnell Cable and Specialty Co.
 424 So. Clinton Street Chicago, Ill.
 Mfrs. Coils and tuning devices.

Are You Fooled by "Low Loss" BUNK!



A RATHBUN Condenser is *Honest!*

WHY?

The losses in the best tuning inductances are extremely high in proportion to the losses in even ordinary condensers. Rathbun could make grounded-rotor, metal end-plate condensers as well as genuine Bakelite end-plates, but the efficiency of its present type is as low now as any metal

end-plate. (See Lefax report.) We are therefore not going to buncombe any one by changing our style just to play "follow the leader." Rathbun condensers are better in many mechanical

points than most high-priced condensers and they give more service. Why pay a high price to have a "low loss" trade mark that means nothing in practical engineering? Common sense on your part will help protect an honest name and favor the dealer who stocks condensers that are truthfully advertised.

What Experts Say

"It is undoubtedly true that the losses in tuning inductances such as are available for receiving set builders are so high in proportion to the losses in condensers that much of the efficiency of a so-called low-loss condenser is nullified, and to spend an excessive amount of money on a super-efficient tuning condenser where it is impossible to get a correspondingly high efficiency in the inductance is obviously a matter of false judgment.

"More important in the selection of condensers for tuning units may be the mechanical design which will afford long life and freedom from operating difficulties, together with a sensible consideration for electrical efficiency. Merely because metal end-plates are used does not guarantee that the lowest losses are secured. A good insulation end-plate type may be better."—*American Radio Journal*.

"Condensers with solid end-plates of an insulating material can be made with low losses if the insulating material is something that is good at radio frequencies, the end-plates are large, so the distance between opposite electrodes is great, and the material is not too thick."—*Q. S. T.*

NOTE THESE POINTS!

- (1) Low prices: \$1.00 to \$3.50.
- (2) One-hole mounting.
- (3) Overall plate protection.
- (4) Perfect alignment and rigidity.

Our circulars indicate that our product is original and distinctly practical. Best for the money in efficiency and service.

**IF YOU CAN GET LONGER DISTANCES
OR MORE SATISFACTION WITH
OTHER CONDENSERS, WE WILL
CHEERFULLY REFUND YOUR MONEY!**

Order direct or through your dealer!

RATHBUN MANUFACTURING COMPANY, INC.
Jamestown Dept. PR. New York

Famous Frank 8-Tube Radio SuperKit

Frank Matched Transformers



\$85⁰⁰

JUST think of it, every broadcasting station in the country within your reach. Wonderful results from near and far—New York, Chicago, San Francisco, New Orleans, all come to you—easily, quickly, beautifully clear.

This wonderful 8-tube superheterodyne is the greatest radio receiver in the world. The most amazing value ever offered in RADIO. Can be mounted on 7 x 26 inch standard cabinet, or fitted in console model.

Makes a beautiful appearance, worthy of any home. All material the finest obtainable, workmanship that will stand any test. This set will last for years and give perfect satisfaction. Works on loop or aerial.

ANY BEGINNER CAN ASSEMBLE IT PROPERLY.

Diagrams absolutely self-explanatory. Book of directions easy to follow. You can build the set in very short time, and enjoy doing it.

SEND NO MONEY AT ALL. Simply write for the set and then pay the postman when he brings it to your door. Try it in your home for two weeks. If it is not all and more than we claim, return it and get your money back. You get the complete kit for \$85.00, plus the small express charge.

EVERY PART in this kit has been **THOROUGHLY TESTED** in the factory. All parts are perfectly adjusted to fit as shown in the diagram. Our guarantee protects you against parts injured or broken in shipment. New parts will be sent to you upon receipt of defective units.

Consists of

- 1—Drilled and engraved panel 7" x 26"
- 3—Frank Intermediate Transformers
- 1—Frank Input Tuner
- 1—Frank Input Transformer
- 2—Triple Panel mounting sockets
- 1—Jewell 0-8 volt voltmeter
- 2—Base mount sockets
- 2—.0005 variable condensers
- 2—10 ohm rheostats
- 1—20 ohm rheostat
- 1—Potentiometer
- 1—A Battery Switch
- 2—Single closed jacks
- 1—Single filament control jack
- 2—.005 fixed condensers
- 1—.002 fixed condenser
- 1—.5 fixed condenser
- 2—.00025 fixed condensers with leak mounts
- 2—Grid leaks
- 2—Audio Transformers
- 1—Baseboard
- 2—Dials
- 2—Dial vernier controls
- 2—Binding Post Strips
- All necessary busbar, spaghetti and hardware
- Self Explanatory Wiring Diagram

PERFECTION RADIO CORPORATION Dept. AA
119 West 23rd Street, N. Y. C.

PERSIL RADIO SERVICE

2114 Mapes Ave.

Bronx, New York

FREE!!

A Drilled and Engraved Bakelite Panel With All Orders Placed Before December 31st for the

Latest 5-Tube Cockaday 4-Circuit Tuner

Kit Includes Parts Exactly as Specified by Mr. Cockaday, Blue Prints, Bus Wire, Etc. **64⁰⁰**

WIRED IN GENUINE MAHOGANY OR WALNUT CABINET **85⁰⁰**

Delivered Free Anywhere. Canada Add 5% to Order One-Third Must Accompany All Orders. Insured if You Wish

SEND NO MONEY



Hear what YOU like. Stations are glad to put on numbers at your request. We print special cards that get ATTENTION. All the RAGE. Thank your favorite stations. Applaud your favorite talent. They appreciate applause just the same as the musician on the stage. Be up-to-date. Get the most out of your radio set. Use Thank You Cards.

YOUR OWN NAME AND ADDRESS PRINTED FREE

on each card. Be individual. Good quality cards. High grade printing. Just a small charge for the attent on-getting Thank You Cards. 100—\$1.75; 200—\$2.25; 300—\$2.75.

Money Refunded if Not DELIGHTED

Don't send one cent. Just pay postman after cards arrive. If you prefer to send check or money order with order we rrepay postal e. You will be more than pleased. Order To-day—NOW. A postal will do.

RADIO PRINTERS, 39 Main Street, MENDOTA, ILL.

A-C DAYTON XL-5

Performance

IF you are going to expect consistently satisfactory performance from your new Receiving Set, you will be delighted with an A-C DAYTON XL-5.

In selectivity, volume, wave-length range, ease and simplicity of operation, the XL-5 is unsurpassed. In CLEARNESS of radio reception, it leads the field of fine Receivers.

The XL-5 is a five tube Super Receiver that outperforms any set in its price class. It sells on performance — performance that is a pleasant surprise to the most exacting fan — performance that will more than satisfy you.

Ask to see and hear the A-C DAYTON XL-5. Your dealer will gladly demonstrate its wonderful performance and clear reception.

THE A-C ELECTRICAL MFG. CO.
D A Y T O N . . O H I O

Radio Jobbers and Dealers: We are expanding our distributing organization. Write for complete information.

Makers of Fine Electrical Equipment for Twenty Years

The A-C DAYTON XL-5—Dark Mahogany Cabinet

\$115.00

Less tubes and batteries (\$120 Denver and west.)

Designed for use with either storage battery or dry cells.

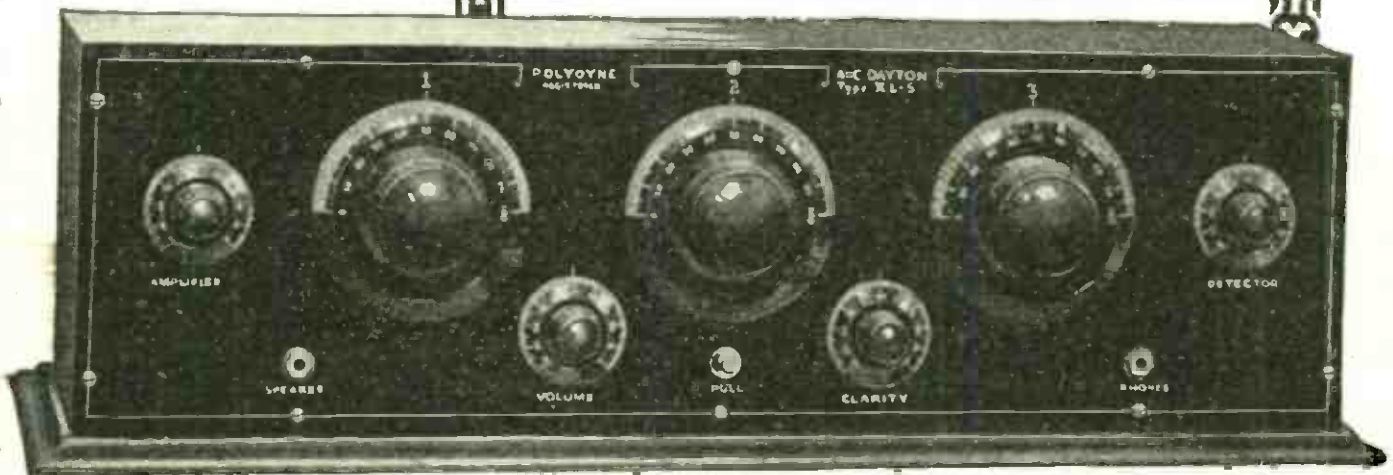
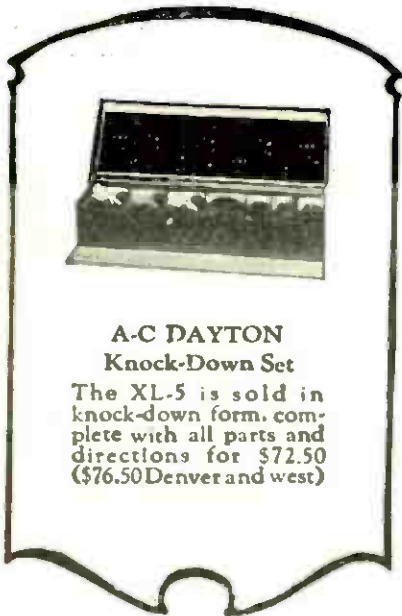

All apparatus advertised in this magazine has been tested and approved by POPULAR RADIO LABORATORY -

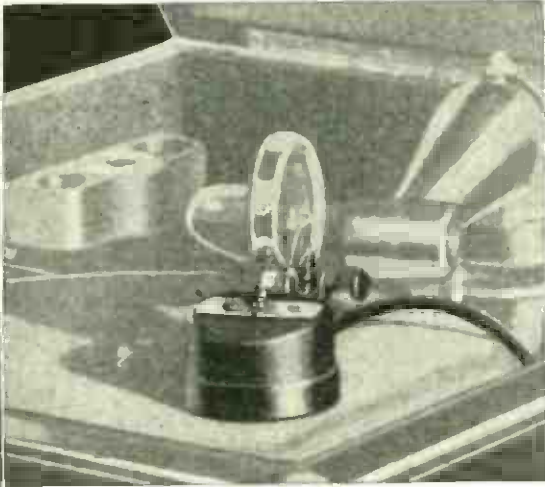

SCRAP that Unsightly Horn!

LET a Dulce-Tone link all the fine reproducing qualities of your talking machine to your radio. Dulce-Tone is NOT an attachment. Simply —

place the needle on the Dulce-Tone reed

No part of the talking machine is removed or tampered with!

Never before has the true volume of the incoming signal been combined with the supreme tonal qualities of the talking machine. Leading talking machine engineers agree that Dulce-Tone sets a new standard of radio reception.

If your nearest music store or radio dealer has not the Dulce-Tone, *do not accept a substitute*. Order direct from us. Price \$10, complete with six feet of phone cord.

THE TEAGLE COMPANY
1125 Oregon Ave. Cleveland, Ohio

Dulce-Tone

NATIONAL VELVET VERNIER

Dials and Condensers Stand the Gaff!

This test proves it. At the Radio World's Fair, New York, two *National Velvet Vernier Dials*, driving two *National DX Condensers* operated by an electric motor, ran the entire seven days of the show for a total of 324,429 revolutions. At the finish, they showed no evidence of lost motion, or back lash—and still possessed that velvety smoothness that makes Nationals so desirable.

Write for Bulletin 104 P. R.

NATIONAL COMPANY, Inc.
Cambridge, Mass.

Engineers and Manufacturers. Estab. 1914

Let Us

Build or Supply Parts

For

Any set featured in POPULAR RADIO

We Offer a Complete

CONSTRUCTION and REPAIR SERVICE

Guaranteeing Technical Accuracy, Expert Workmanship, Attractive Prices and Prompt Shipment to All Parts of the World.

We specialize on COCKADAY Circuits, SUPER-HETERODYNE, ULTRADYNE and other receivers of known merit

Write for Literature

H. E. ERICKSON, A. M. I. R. E.
Vice-President

← BROADCAST SERVICE COMPANY →
ONE UNION SQUARE, NEW YORK CITY

"Old Timers in Radio"

Of Course It Will Be a Radio Christmas!

An Investment in This—

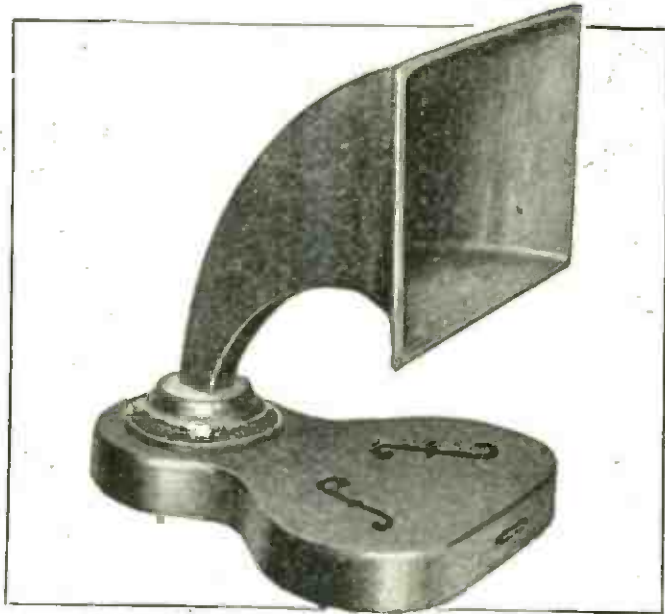

Backed Up with This—

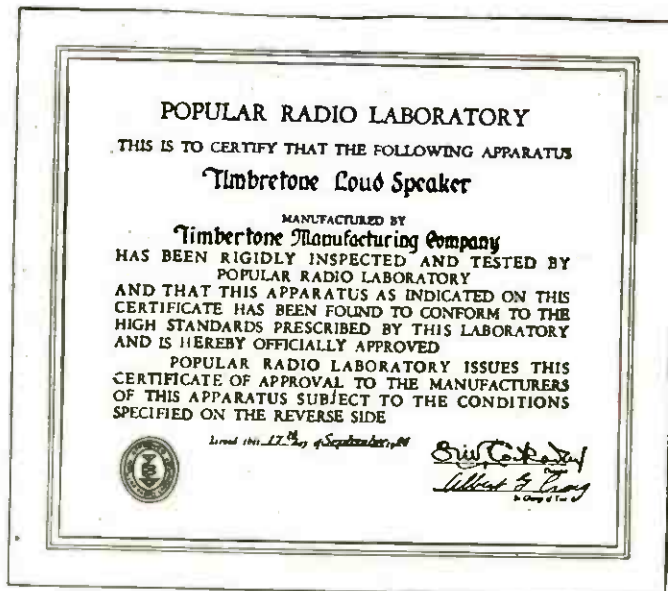

Will Pay Dividends of Happiness to the Entire Family Throughout the Year



Made in Hoosick Falls, N. Y.
by the

TIMBRE-TONE MFG. CO.

Stop antenna breaks!



BE independent of the weather. Don't let cold, wind, snow, sleet, or ice break your antenna and cut off your radio entertainment just when you want it most. You can insure your aerial against the elements with a

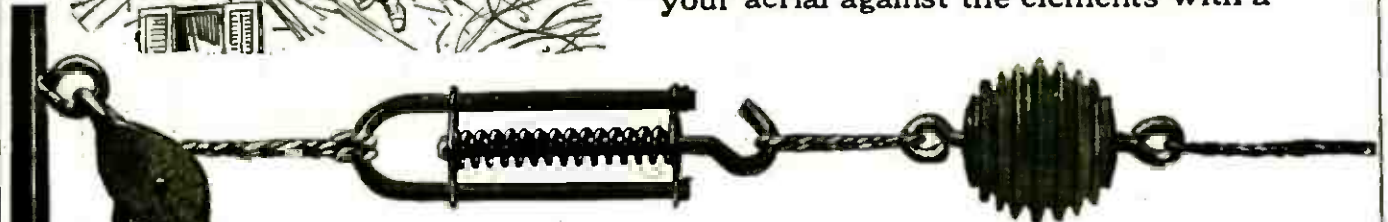

Mitchell Antenna Tensionator

It absorbs shocks and strains, keeps an even tension on your antenna, *stabilizes the tuning, and stops antenna breakage.* Isn't it worth while to know that your entertainment won't be cut off? To know that you won't have to climb out on a cold, icy roof to mend a broken wire with numb fingers?

Don't worry about antenna breakage. Install a Mitchell Antenna Tensionator today. If your dealer does not carry them order direct. No tools required. Simply insert one Tensionator between the insulator and support as shown in picture.

Price 90 cents each

R. MITCHELL CO. [Instrument makers for 47 years] 255 ATLANTIC AVENUE BOSTON, MASS.

A Christmas Suggestion— The "Ideal" Loud Speaker Console

High grade Radio Cabinet of pleasing and artistic design. Made in genuine American walnut, mahogany or quartered sawed oak. Has inbuilt loud speaker wood horn equipped with standard high grade speaker unit, same as used in our higher priced cabinets.



PRICES
Genuine Walnut
or Mahogany \$47.50
Quartered Oak \$45.00

ILLUST. CATALOG
ON REQUEST

Horn specially shaped of thin layers of resonant wood, giving wonderfully correct and pleasing reproduction of voice and music.

Battery chamber measures 17x36 inches, is 13 inches high and will accommodate all batteries and charger. Size of console—top 18x39 inches, height 32 inches.

Entire back of battery chamber is hinged and when open is held in horizontal position by stay hinges, forming convenient shelf for handling of batteries.

Doors in front open giving access to battery connections. Fitted with good hinges and artistic knobs.

Ornamental scroll grill and panel in center of cabinet.

Regular equipment includes inbuilt bakelite panel with seven binding posts and flexible wire leads ready for connection to batteries.

Wonderful value for the money. Order quick for delivery before Christmas as this console is going big.

Ideal Radio Cabinet Co., Blue Island, Ill.

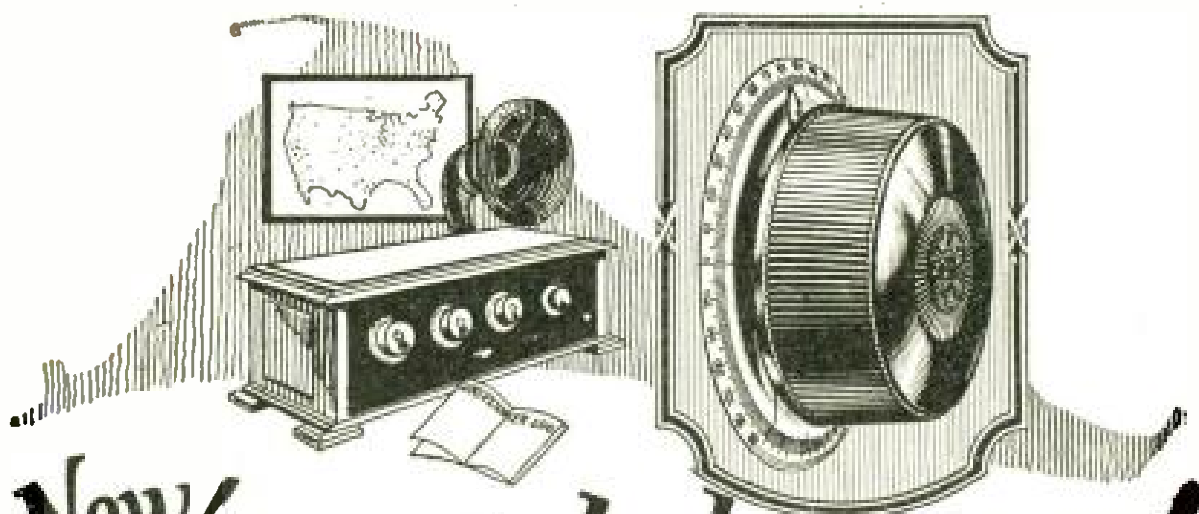

New!

tripled my log!
of stations "heard" on the second day
thru using the



50c

Don't worry any more about someone meddling with your radio set while you are away. Simply remove key from Walbert Filament Lock Switch and take it with you just as you'd take the ignition key from an auto. Sturdy, compact, efficient. Shell and key handle insulated from circuit. No finer switch, and none made with unique lock feature.

WALBERT
UNIVERSNIER
Micro-Selective Tuning Control

THAT is what the UNIVERSNIER did for A. H. Klingbeil of Ashtabula, O. Tripled his entire log in a single night! "Last night," writes Bishop Francis of Chicago, "I put 3 UNIVERSNIERs on my Neutrodyne and got 20 stations I never heard before!" You can do the same. Tune-in those hard-to-get distant stations quickly, easily, clear and loud. Get the most out of your set. Replace each of your dials with a UNIVERSNIER, the original 12-to-1 ratio micro-selective tuning dial.

WHY A 12-TO-1 RATIO IS BEST

Careful tests prove that a lower ratio is inefficient, a higher unnecessary. With higher-ratio dials the actual "searching" for stations is done with the coarse adjustment. The operator finds the vernier adjustment too slow and uses it only for "clearing-up" a

station after it has been detected with the coarse adjustment. Many stations are missed entirely with the latter. With the Universnier both "searching" and the final "clearing-up" are done easily and efficiently with the vernier adjustment. And a large knob helps do it!

COSTS NO MORE THAN A GOOD DIAL—

And does away entirely with the need for vernier condensers. Very attractive with new "dished" dial. More efficient with heavier gearing. Positive continuous vernier—No slippage! Pointer

rigid with shaft. A slight necessary amount of play in the knob prevents involuntary disturbance of vernier adjustments when the hand is removed.

Mahogany Knob and \$1.50
Gold-plated dial . . .

Black Knob and \$1.25
Silver-plated dial

At your dealer or sent postpaid on receipt of purchase price.
(Please mention dealer's name.)

Jobbers and Dealers: Write for Discounts

THE WALBERT MANUFACTURING COMPANY
933 Wrightwood Avenue Chicago, Illinois

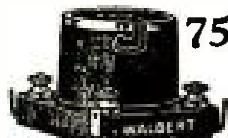

75c

The Walbert Safety Rim Socket is guaranteed not to break at the slot. Special heavy bakelite design decreases inter-element capacity thereby utilizing all available grid voltage for producing signals. (New tubes have bakelite bases for same reason.) Soldering lug and double-spring contact integral. The most attractive socket on the market.

Members of
R. M. A. and
N. R. T. A.

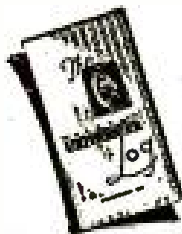

WALBERT
Parts with a Purpose

FREE!
Send 2c stamp for
FREE copy of
UNIVERSNIER
LOG BOOK.

ALL WALBERT PARTS PROTECTED BY PATS. OR PATS. PEND., U. S. AND FOREIGN



**Light up
while you
Listen!**

You are getting DX—headphones on—set adjusted just right—and you want to light your cigar, cigarette or pipe. Don't get up for matches and spoil your fun. Don't even try to scratch a match near that delicate adjustment. Clipped to the side of your radio table is your Cuno Radio Electric Match. Pick it up—press its button—the end glows instantly—light up—put it back. *During the three seconds while you are pressing that button you are using only as much of your storage battery current as is used by one vacuum tube in that time.* In a word, here's what the real radio fan has been waiting for—a light from his storage battery whenever he wants it without leaving his set. Because we are the largest makers of electric matches for automobiles in the world, we are able to sell this little specialty for the absurdly low sum of **\$1.25**. Ask your radio dealer for the Cuno Radio Electric Match with cord. If he hasn't got it, send us **\$1.25** and it comes to you by return mail in attractive box. Money back without question if you are not satisfied. Order quick if you want it for Christmas. Complete your radio pleasure with



**RADIO
ELECTRIC
MATCH**

THE CUNO ENGINEERING CORP.
Meriden, Conn.

**Where Noted
Experimenters Find
HARD-TO-GET PARTS**

4 CIRCUIT TUNER WITH RESISTANCE COUPLED AMPLIFIER	
Precision Cockaday Coil Set.....	\$5.50
Cardwell Variable Condenser .0005 Mfd.....	5.00
Cardwell Variable Condenser .00035 Mfd.....	4.75
Accuratone Micrometer Control Dials.....	3.50
Amplex Griddenser.....	1.25
Bradleyeak.....	1.85
Benjamin Cieratone Sockets.....	1.00
Amsco "Double Wonder" Potentiometer and Rheostat	2.00
No. 1-A Amperites and Mountings.....	1.10
Improved Double Circuit Jacks.....	1.00
Improved Single Circuit Jacks.....	.70
Precise Audio Frequency Transformer No. 285-A.....	5.00
Electrad Certified Grid Leaks.....	.50
Electrad Certified Grid Leaks Mountings.....	.25
N. Y. Mica Fixed Condensers .005 Mfd.....	.60
Amsco Switch Lever.....	1.30
Improved Filament Battery Switch.....	1.00
LOW LOSS TUNER FOR SHORT WAVE RECEPTION	
Radio Engineering Lab. Low Loss Tuner.....	\$10.00
E. Z. Toon Dials.....	2.00
General Instrument .0005 Mfd. Variable Condenser.....	5.50
N. Y. Coil Mica Fixed Condenser .00025 Mfd. (with Grid Leak	
Clips).....	.46
Na aid Sockets for Standard Tubes.....	.75
Bradleystat New Type.....	1.85
Amperites No. 1-A with Mountings.....	1.10
Daven 2 Megohm Grid Leak.....	.50
Dungan Audio Frequency Transformer.....	8.00
Harris and Birdseye Single Circuit Jack.....	.75
Harris and Birdseye Filament Control Switch.....	1.60
7 in. x 15 in. Radion Panel.....	1.75
SPECIAL DISCOUNTS ALLOWED ON COMPLETE KITS	
AGENTS FOR	
Sangamo Transformer	Dubilier Condensers
Benjamin Radio Accessories	Saturn Jacks
Carter Switches	Portena Loops
Stromberg Carlson Audio Frequency Transformer	
Try us on any radio parts you have been unable to secure.	MORISON Electrical Supply Co. Inc.
	C.O.D. Mail orders will be shipped promptly
Wholesale	Retail
15 East 40th Street	New York City

**RAYCOILS are Better
Use them!**

RayCoils "A" for Reinartz, Ray CoilS "B" for RCS and Ultra Audion Circuits, RayCoilS "C" for RCS, Ultra Audion and Tuned Radio Frequency Circuits, RayCoilS "D" for Tuned Radio Frequency and Neutralizing Circuits of 4, 5 and 6 Tubes, RayCoilS "E" for Reflex Circuits.

A = \$2.50	Use the RCS Circuit with or without
B = 2.00	Radio Frequency for Simplicity in operation and results. Not equalled by any set for volume and distance.
C = 2.00	
D = 2.00	
E = 2.00	

**Coils in Separate Box
With Wiring Diagram**

Working Blue Prints of four sheets 12x18 of all standard circuits, as Variometer Hookup, Reinartz one and three tube, R.C.S. three and four tube and R.C.S. five tube Tuned Radio Frequency, 50 cents a set.

We also carry a complete line of Carter, Howard, Kellogg, Modern, All-American and Trimm parts. If your dealer cannot supply you, we will mail direct.

R. C. SCHOONHOVEN
Major Q. M. R. C.
310 SENECA ST. ELGIN, ILL.

THE NEW SUPER-HETERODYNE MODEL C-7

Important Today

THE EXPERIMENTERS INFORMATION SERVICE, Inc., has been recommending the Super-Heterodyne method of reception since the early part of 1922. In February, 1923, a Super-Heterodyne of our design was installed on the S. S. *Western World*, pier 1, Hoboken, N. J., in the cabin of Dr. Horatio Belt. On the voyage to Rio de Janeiro, Brazil, at a distance of 3,000 miles, southeast of New York, the entire Greb-Gardner fight was received from WJZ, with sufficient audibility for the entire cabin full of passengers to hear the bout, blow by blow, plainly. At 3,300 miles southeast of New York, an entire evening church service was received from Pittsburgh. At that time there was not another single firm advertising or advocating the Super-Heterodyne. Since then Mr. A. Ancieux, Engineer, Trariva Elec de Arequipa, Peru, has reported consistent reception from KDKA, WDAP, WEF, WGY and others, a distance of over 5,000 miles, using a Model "C" Super-Heterodyne. The Pratt & Brake Corp., of New York City, sent a Model C to Rio de Janeiro which received American broadcast station at a distance of over 7,000 miles.

Practically all concerns now featuring Super-Heterodyne have copied our original Model C design, and to prove again that we are far in advance of competition, we present this Improved Model C-7 Super-Heterodyne as the *Most Sensitive, Most Selective, and finest reproducing Broadcast Receiver* that can be built.

7 Tubes Give the Results of 10

The Reason: — When regeneration is added to a one tube non-regenerative receiver, the increased amplification is about equal to adding two stages of the 1st Detector of a Super-Heterodyne. Heretofore it has been impossible to add regeneration in the new Model C-7 Super-Heterodyne and accordingly this has been a big loss. The new Model C-7 Super-Heterodyne has a special 1st Detector circuit with a split antenna inductance so arranged that normally the detector would oscillate continually. However, in addition, a neutralizing condenser is inserted in the circuit which gives absolute control of the oscillations to such an extent that the circuit can be adjusted to just below the oscillating point, as this adjustment gives the maximum regenerative amplification. The new circuit has a bias potential on the 1st Detector grid, in place of the usual grid leak and condenser, and this allows infinitely weak signals to be regenerated and heterodyned through the radio frequency amplifier, which an ordinary grid leak and condenser would block. On a weak signal the difference in sensitivity is very noticeable. Using a 22-foot indoor antenna in the suburbs of New York loud speaker reception has been obtained from KGO, Oakland, California. A normal range of 2,000 miles is easily obtained on an average small antenna at night under average conditions.



“The Rolls-Royce of Reception”

MODEL C-7 SUPER-HETERODYNE

Wave-length Range, 200 to 575 meters. Dimensions, 40 in. x 8 in. x 8 in.
Tube Arrangement: Regenerative Detector, Oscillator, 2 Stages Radio, Detector, 2 Stages Audio

General Information

ANTENNA: Single wire, 30 to 150 feet long. Provision has been made for use of either a short or long antenna. Indoor antenna works very satisfactorily.

TUBES: 7 Radiotrons UV201A or C201A, requiring one 6 volt storage battery and one 90 volt B Battery either dry or storage.

DRY CELL TUBES: Radiotrons UV199 or C199 may be used if desired, but the results obtained with dry cell tubes are not as satisfactory as with the Radiotrons UV201A or C201A.

LOOP: As a loop takes considerable space and is objectionable looking, and furthermore, an inefficient collector, no provision has been made for loop reception. Local reception can be had without antenna or ground. An indoor antenna 30 to 50 feet long is suggested in place of a loop.

SELECTIVITY: The degree of selectivity is so high that distance stations can easily be tuned in through the local stations. For example, with a C-7 located five miles from WJZ operating on 455 meters, WCAE Pittsburgh on 462 meters can be tuned in without interference with WJZ.

TUNING: There are only two tuning adjustments, one for the detector circuit and one for the oscillator. Each station has a definite point on each dial and will always be found at these callibrations. Individual Verniers are provided for each dial. A third Vernier controls the volume.

CONSIDERATIONS: The Second Harmonic feature could be used with a view to eliminating another tube, but we feel that the many advantages of having a separate oscillator more than compensates for the extra tube. For a similar reason we have refrained from Reflexing the circuit to reduce the number of tubes.

STANDARDIZATION: All the component parts specified are readily obtainable on the market through high-class dealers.

PARTS: The parts specified in this design are all selected with expert consideration with a view to giving the maximum results obtainable. While it may appear that certain other parts could be used to economize, we strongly recommend that you take advantage of our engineering experience and follow the specifications to the letter.

Original Blue Print showing all data, diagrams, circuits, details, etc., \$1.00, postpaid

EXPERIMENTERS INFORMATION SERVICE, INC. 476 BROADWAY, NEW YORK CITY

Designers of the Highest Class Radio Apparatus in the World

New Book, "Modern Radio Reception," by Charles R. Leutz, over 150 Illustrations, Fully Bound, \$3.00 Postpaid



Give Clearer Tones

Distortion, weak signals and inability to tune in on various stations often indicates weak or inferior batteries.

A set of Ohio Rabats will bring out a more pronounced clearness of tone, bringing in broadcast selections clear and distinct.

Rabats added to your set will surprise and please you.

RABAT Chemical Chargers for "B" Batteries
 Senior \$4.80
 Junior \$1.40

THE RADIO RABAT CO.
 1758 St. Clair Ave. Cleveland, O.

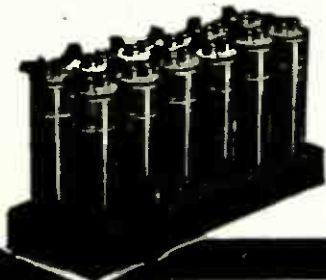

Rabat Junior
 12 cell-24 volt, \$3.96

Rabat Senior
 24 cell-48 volt 4200 milamps \$17.88
 12 volt-24 cell \$9.60



America's Best Phones
 Regardless of Price

\$5
 One Model
 One Quality
 In Canada, \$7

WE challenge comparison with America's best known headphones. Globe Phones always show up best where the opposition is greatest. And the quality is there to last for years.

There is long experience in making hearing aids for the deaf behind the amazing tone purity and reaching qualities of Globe Phones.

As beautiful as they are efficient. Leather covered head bands, heavily nickeled parts, extra powerful magnets.

If your dealer fails you, write us.

Sales Department
THE ZINKE COMPANY,
 1323 S. Michigan Ave., Chicago
 Distributed in Canada by
 Otto Higel Co., Ltd., Toronto

Manufactured by
GLOBE PHONE MFG. COMPANY
 Reading Massachusetts

LARGEST RADIO STORES IN AMERICA



509 S. State St. CHICAGO, U. S. A. Dept. P. R. 6

We guarantee our new 68-page **RADIO** Catalog will save you money

on brand new fully guaranteed, nationally advertised radio apparatus. We buy up manufacturer's and government surplus stocks, jobber and dealer bankrupt stocks, etc. Our enormous buying power permits us to pay spot cash and get rock-bottom prices—even way below manufacturer's costs. That's why our catalog is crammed with thousands of wonderful radio bargains. That's why we **GUARANTEE** to save you money.



Write for your **FREE**

copy today!

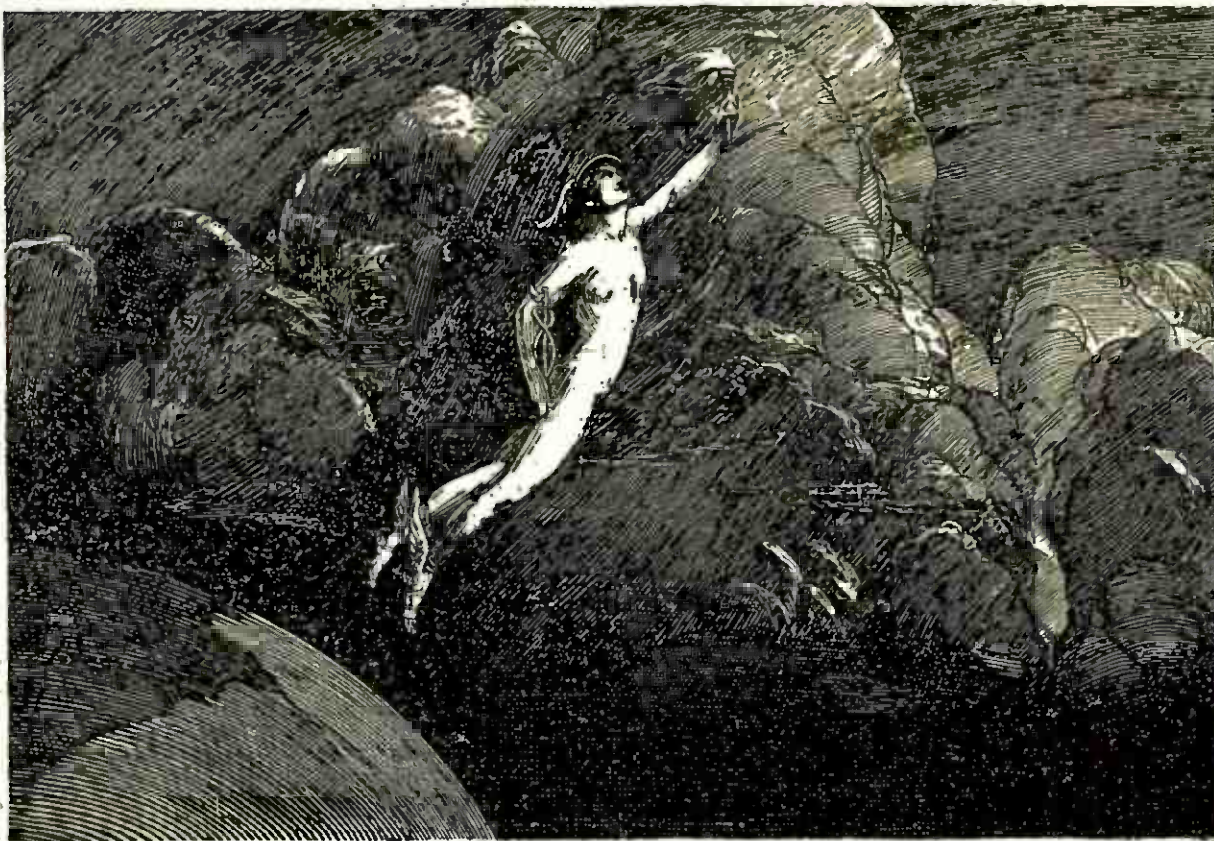

To You and Yours from Across the World

THE air holds no secrets from the *Mercury*. With incredible sensitivity and matchless fidelity of reproduction this instrument searches keenly the vast reaches of the ether at the touch of a finger.

Here is an ever-ready flood of crystal-clear melody totally without distortion. Here also are an exactness and simplicity of tuning which have been hoped for but previously never achieved.

The *Mercury* Broadcast Receiver is fortunate in that it appeals as much to the seasoned radio enthusiast as to the public at large. The wonderful performance of the *Mercury* is fittingly crowned by a physical beauty worthy of the finest home.

MERCURY RADIO PRODUCTS CO. 50 CHURCH ST., NEW YORK CITY

Visit your dealer or write direct for De Luxe Catalog

TECHNICAL

Highest existing development of Grimes Inverse Duplex System. Four tubes reflexed and equal to six straight (two tuned radio frequency, tube detector and three stabilized audio frequency). Operates from loop (furnished) also indoor or outside antenna *without change in set*. "Last word" low-loss engineering at every point.

MERCURY

BROADCAST RECEIVER

Licensed under Grimes Patents — issued and pending
"The STRADIVARIUS of RADIO"



INVERSE DUPLEX SYSTEM — INSURES NATURAL TONE QUALITY

APPEARANCE

Solid American Walnut Cabinet. Hand rubbed genuine piano finish. Inclined panel of heavy-gauge, etched ordnance bronze. Set rests on felt protecting buttons. Balanced panel arrangement of controls. All "A" and "B" dry batteries self-contained. Price, with loop; but *without* tubes and batteries, \$165.00 list.

How FIL-KO-LEAK Improves Reception

On a Neutrodyne set at Harrisburg, Pa., equipped with Fil-Ko-Stats (Scientifically Correct Radio Rheostats) a Fil-Ko-Leak was added. This set had already "logged" 150 stations from the Atlantic to the Pacific. Previously it had a fixed one meg. leak. With the calibrated Fil-Ko-Leak, in two nights 27 stations, many of them never heard before, were brought in or cleared up at the following readings in megohms, proving the advantage of being able to vary grid leak resistance accurately.

- WFAA... Dallas, Texas... 5
- WMH... Cincinnati, Ohio... 2 1/2
- WSB... Atlanta, Ga... 5
- WSH... Chicago, Ill... 2
- WGN... Chicago, Ill... 1
- WSAI... Cincinnati, Ohio... 1 1/2
- WHG... Cincinnati, Ohio... 4
- WLW... St. Louis, Mo... 4 1/2
- KSD... Zion City, Mo... 3 1/2
- WTAS... Elgin, Ill... 5
- WOC... Davenport, Iowa... 5
- KGO... Oakland, Cal... 2 1/2
- KFI... Los Angeles, Cal... 1 1/2
- WDAR... Philadelphia, Pa... 4 1/2
- WMAT... Dartmouth, Mass... 4
- WBZ... Springfield, Mass... 3
- WEAF... New York... 4
- WOO... Philadelphia Pa... 3 1/2
- WOR... Newark, N. J... 4
- WWJ... Detroit, Mich... 1
- WTAM... Cleveland, Ohio... 2
- WOS... Jefferson City, Mo... 2 1/2
- WTAK... Oak Park, Ill... 1 1/2
- KDKA... Pittsburgh, Pa... 3 1/2
- KYW... Chicago, Ill... 4
- WDBH... Worcester, Mass... 4 1/2
- KFNF... Shenandoah, Iowa... 5
- WQJ... Chicago, Ill... 3 1/2
- WDAF... Kansas City, Mo... 1
- WHK... Cleveland, Ohio... 1 1/2



Improved Reception with FIL-KO-LEAK

YOU can "log" your FIL-KO-LEAK just as you do your other tuning units. You will get stations you never heard before. You will clear up distortion on nearby broadcasters and increase volume of weak, distant stations and get them with crystal clarity. You read FIL-KO-LEAK resistance in exact terms of the megohm through a peep-hole in the panel. (It's also equipped for baseboard mounting.) Resistance element is constant and accurate, and is not affected by atmospheric conditions, wear or jarring. Every FIL-KO-LEAK is guaranteed to be perfect electrically and mechanically, and to be accurately calibrated over the operating range for all tubes (1/2 to 5 megohms). This calibration is doubly checked. Send 2c stamp to Dept. P. R. 1224 for literature on improved reception.

FIL-KO-LEAK \$2
 SCIENTIFICALLY CORRECT VARIABLE GRID LEAK Individually Calibrated
In Canada \$2.75

If your dealer has none, send his name with remittance direct to



CROSLEY

Has made and sold, during the past twelve months, more sets than any other manufacturer in the world. We know of no other sets that will give you more dependable service and real value, in their respective fields, than these.

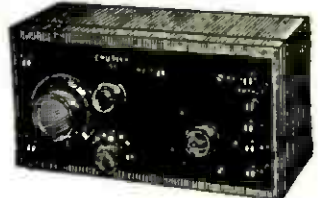

Cut Shows Crosley Model No. 51

- "Crosley" 1 tube model No. 50... \$14.50
- With tube and Crosley phones... 22.25
- "Crosley" 2 tube model No. 51... 18.50
- With tubes and Crosley phones... 30.25
- "Crosley" 3 tube model No. 52... 30.00
- With tubes and Crosley phones... 45.75

Headquarters for all Guaranteed Parts

- "Talking Tape" for indoor aeriels, 100 ft... \$1.00
- "Radiola" Loud Speaker... 25.00
- "Cockaday" Coil... 5.50
- "Exide" Storage Batteries, "A", 6 volt... 14.60
- Rechargeable Dry Batteries... .65
- "Cockaday" Four Circuit Tuner, with Resistance Coupled Amplifier and "Popular Radio" blue prints... 64.00

Everything that is Reliable in Radio. Our Service Bureau will gladly help you solve your problems. Nine years of prompt, fair and courteous dealing

Hartt & Lane, Inc.
 Wholesale and Retail
 780 6th Ave., near 44th St., New York City

TRADE MARK NONE OTHER

DUPLEX

CONDENSERS STAND THE TEST

Precision made, by trained men who really know their business. DUPLEX Condensers are used the world over.

"DR" Series

A low loss precision condenser of high value and unusually low price. Ideal for set builders who can't pay very much for each individual part.

"FR" Series

The highest quality low loss condenser made. Used by foremost set manufacturers. Condenser tests at Yale University in May, 1924, definitely determined its remarkable efficiency.

Write for "Cons" and "Facts." They are free.

The Duplex Engine Governor Co., Inc.
 50 Flatbush Ave. Extension Brooklyn, N. Y.

The Greater NEUTRODYNE EAGLE Balanced Receiver



"My Choice this Christmas"



Model B—
5 Tubes, Price \$175

Eagle Guarantee
The Guarantee that accom-
panies every EAGLE Receiver
fully protects you!



MODEL BS
A New Eagle Artistic
Console Cabinet
Price \$100

An artistic Console cabinet, for the
EAGLE, in American Walnut or Mahog-
any, with flame-proof compartments for
battery and charger.

Write for Literature
EAGLE RADIO CO.



18 Boyden Place, Newark, N. J.
Licensed by Independent Radio Manufacturers,
Inc., under Hazelton Patent Nos. 1,450,080,
dated March 27, 1923, and 1,489,228, dated
April 1, 1924. Other patents pending.

Dear Mother—

Merry Christmas! You see Santa Clause did remember
what you said about wishing you had a radio set like our,
didn't he?

In fact, Mother, this is even a better Eagle Receiver.
It's what is known as the New Model B Eagle. Your Eagle is
even simpler to operate than ours. All you have to do to
locate the different stations is turn the dials to certain
numbers, which are always the same.

Another thing: you don't have to bother with plugs
any more. You switch on the different stages and batteries
just by a turn of the center knob, which operates a multiple
(filament control) switch. Your Eagle has a number of im-
portant refinements — instruments which are exclusive
Eagle features, among them a ball-bearing die-cast
control knob and a real design rheostat.

Excuse me, Mother, I didn't mean to cover so
much good paper with my "radio ravings" but I can't
help feeling happy about this new Eagle coming out
just in time to send to you for Christmas.

I wanted to be sure I was getting the best receiver,
so I tried out all the leading makes. But none of them
could compare with the Eagle Model B for real
simplicity, quality of reception and appearance. Just one
other thing, Mother. You needn't worry should
anything happen to your Eagle as it's absolutely
guaranteed.

Now I'll sign off, Mother. Let's hear how you
make out with your Eagle. Suppose you'll be as much
of a bug as I am, in a month or so.

Loveingly, Bob



Knockout Reflex Coil No. 8
Price \$4.00 a Pair

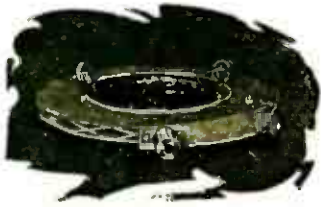

Tuned Transformer Coil No. 14
Price \$2.00

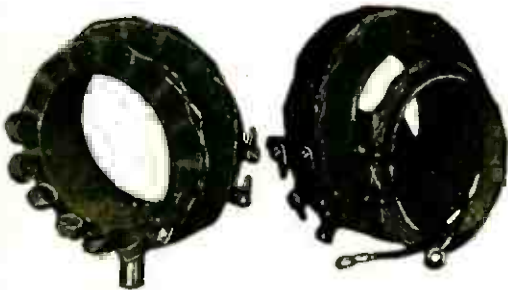

Coils for Roberts Circuit, No. 18
Price \$8.00 a Set

SICKLES

DIAMOND-WEAVE COILS

Patented Aug. 21, 1923

For the Roberts Circuit

Two units of remarkable efficiency, built specifically for the immensely popular Roberts Circuit. Primary and secondary coils in unit No. 1 are mounted on an insulating sleeve, with the primary coil left free to allow for adjustment in coupling.

Unit No. 2 contains primary, secondary, neutralizing coil, and tickler. The tickler is provided with 180 degree dial control. The tickler is also provided with an additional adjustment of coupling to conform to different characteristics of tubes or variations in plate voltage.

Among other popular Sickles products are the Tuned Radio Frequency Coil for self-neutralizing Tuned Radio Frequency Circuits, and the Knockout Reflex Coils. We manufacture coils for all popular Circuits and for special requirements.

Send for descriptive catalog

The F. W. Sickles Co.

339 Worthington Street
SPRINGFIELD, MASS.

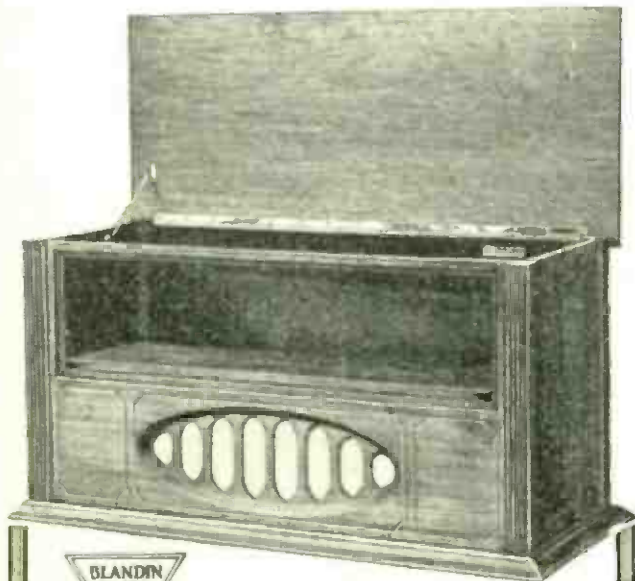

The New "35-D" Super Radio Cabinet

Panel at top 7 x 26-10 1/2". Deep enough for 8 tubes. Built-in spruce horn. Two dry cell compartments. Door in back. Built of mahogany—piano finish. Same quality and equipment as

Blandin Triple "A" De Luxe Series

Also new De Luxe sizes, 7 x 18-7"; 7 x 24-7"; 7 x 26-7 1/2"; 7 x 30-8" and 8 x 36-8". Write for illustrated price list.

Jobbers and dealers, write for discounts

BLANDIN PHONOGRAPH COMPANY, INC.
1500 16th St. RACINE, WIS.

KING QUALITY RADIO APPARATUS

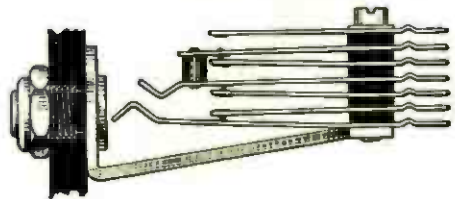

King Quality Jacks, showing side and top view



THE KING QUALITY LINE:

- | | | |
|----------------|---------------------|----------------|
| Adapters | Contact Points | Plugs |
| Bakelite Dials | Inductance-Switches | Potentiometers |
| Bakelite Knobs | Switches | Rheostats |
| Binding Posts | Jacks | Switch Levers |
| Condensers | Panel Mountings | Tube Sockets |

KING QUALITY PRODUCTS, Inc.
BUFFALO NEW YORK



Herald MODEL B



The
Big, Clear Voice
of Radio!

\$ 18

A NEW Herald—clear—loud—with a tone that is wonderfully mellow and sweet. Height 25 inches. Bell 12 inches. Fibre horn and art metal base. No batteries required. No adjustment necessary. Hear the Herald Model B at your dealer's.

Herald Electric Co., Inc.
113 Fourth Avenue, New York

HANDY CHARGER

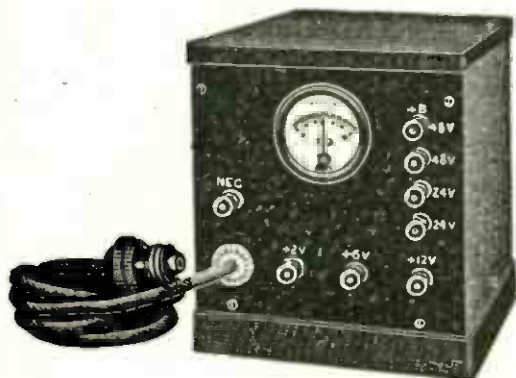

CHARGES THEM ALL

2 Volts to 48 Volts

\$18.00
F. O. B.
St. Louis

Now you can charge all of your radio and automobile batteries with the same charger. The Ultra Handy Charger makes this possible. Charges any battery from 2 volts to 48 volts. Easy to operate. Simply connect cord and plug to lamp socket.

Will not overcharge or harm your battery—even if left attached for days. Gives a taper charge. This reduces the amount of charging current as the battery becomes full.

Contacts absolutely cannot stick and give trouble. No breakable glass. No bulbs. No acid to spill. No fast wearing parts. No frequent adjustments. No auxiliaries necessary.

Only best material used. A precision WESTON Ammeter—the best—tells accurately the rate at which battery is being charged. Porcelain base. Rubber covered acid-proof battery leads, approved plugs, clips, etc., assure satisfaction. Place beautiful Mahogany finished sheet metal case anywhere. Ask your dealer for a demonstration. Or write us for free illustrated descriptive folder.

INTERSTATE ELECTRIC Co.

of St. Louis

4339 Duncan Ave.

St. Louis, Mo.

FREE

To Each Purchaser of a **World Battery**

A 24-Volt "B" Storage Battery positively given FREE with each purchase of a WORLD "A" Storage Battery. The WORLD Battery is famous for its guaranteed quality and service. Backed by years of Successful Manufacture and Thousands of Satisfied Users. You save 50%.

Prices That Save and Satisfy

Auto Batteries		Radio Batteries	
6-Volt, 11 Plate	\$12.25	6-Volt, 100 Amps.	12.50
6-Volt, 13 Plate	14.25	6-Volt, 120 Amps.	14.50
12-Volt, 7 Plate	17.00	6-Volt, 140 Amps.	16.00

Shipment Express C. O. D. subject to examination. 5 per cent discount for cash in full with order.

2-Yr. Guarantee Bond in Writing With Each World Storage Battery

proves satisfactory World performance. Mail this ad with your name and address—we will ship battery 7 day order is received; and give you your choice of "B" Storage Battery or a handsome nickel finish Auto Spotlite, FREE. Write TODAY.

WORLD BATTERY COMPANY

1219 So. Wabash Ave. Dept. 3 CHICAGO, ILL.

This FREE "B" Storage Battery takes the place of dry cell "B" batteries. Can be recharged and will last indefinitely. To be sold retail for \$6.00. It is the only battery of its kind equipped with solid rubber case—and insurance against acid and leakage. Take advantage of this remarkable introductory offer NOW. (To those who prefer it, we will send FREE a handsome nickel finish Auto Spotlite, instead of the "B" Battery. Be sure to specify which is wanted.)

GIVEN FREE
To introduce this new and superior World "B" Storage Battery to the Public



For Quality **CORBETT'S CABINETS** For Quality



NEW COCKADAY

Built to Specifications in October Issue (Rear slots and piano hinge not included in other cabinets.)

Size	Oak or Mahog. any finish	Walnut or Mahogany	Size	Oak or Mahog. any finish	Walnut or Mahogany	Size	Oak or Mahog. any finish	Walnut or Mahogany
7x12-8	\$3.80	\$4.75	7x26-8	\$5.75	\$7.20	8x36-8	\$8.90	\$11.10
7x14-8	4.00	5.00	7x30-8	6.90	8.60	8x40-8	10.60	13.25
7x18-8	4.55	5.70	7x36-8	8.00	10.00	8x26-8	6.45	8.00
7x21-8	5.00	6.25	7x40-8	9.00	11.25	Original Cockaday		
7x24-8	5.40	6.75	7x27-9	6.45	8.00	7x24-9	6.90	8.60

Cockaday Illustrated with piano hinge and lid stay 8.00 10.00
Mounting boards 35c. above 30" panel 50c. Nicely moulded top and base. Adam Brown Mahogany and Dark Oak finished with DuPont varnishes carefully hand rubbed eggshell. Accurately made of best kiln dried lumber and well packed. WRITE FOR BOOKLET offering best values in radio furniture.

TERMS—CASH WITH ORDER OR C. O. D.

CORBETT CABINET MFG. COMPANY

1415 East St.,
Pittsburgh, Pa.

5323 N. Carlisle St.,
Philadelphia, Pa.

Belden

Magnet Wire
is known the world
over for its uniformity
and high quality.

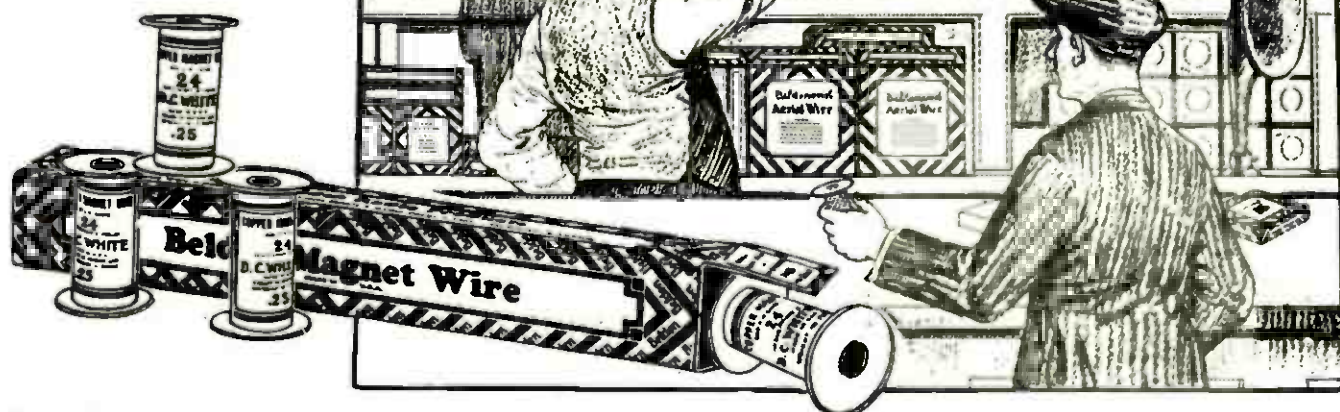

Wind Your Own Coils for the New Hook-ups!

The joy of real accomplishment comes to the radio fan who tries the new hook-ups and succeeds in making new records of long distance reception. He leads—others follow!

This fascinating work calls for special coils of new specifications. The enterprising experimenter winds his own coils to save time and to be sure that the new set will operate at the highest efficiency. To him comes the thrill of true scientific discovery and research.

Belden Radio Magnet Wire has been used for many years by famous manufacturers of radio devices. They require wire of uniform gauge, carefully insulated with high grade cotton or silk insulation from one end of the spool to the other.

You should insist on Belden Radio Magnet Wire for your own protection. Every spool is full weight, plainly marked, and of full gauge throughout. Be sure to get Belden Wire—it makes a world of difference!

Other Belden Radio Products

Our instructive booklet, "Helpful Hints for Radio Fans" describes many other Belden Radio Products, such as Enamelled Aerial Wire, Loop and Litz Wires, New Terminals, Sockets, and many other important items. Know all about these efficient radio products. Send for the booklet, now!

Radio Dealers

Belden Magnet Wire is merchandised in handy cartons of 5 spools each. Every spool is marked for weight, insulation and gauge. Send for complete dealer bulletin, by writing us on your business letterhead. Write, today.

Belden

Manufacturing Company

4636 West Van Buren Street
CHICAGO ILLINOIS

**Send for this
Free Booklet!**



Belden Manufacturing Company
4636 W. Van Buren St., Chicago, Ill.

I would like to know more about Magnet Wire. Send me your latest booklet—Helpful Hints for Radio Fans. Be sure to explain Litz Wire, too.

Name _____

Address _____



Just a few outstanding features that are definite evidence of the superiority of Bi-Metallic Headphones, the greatest value that money can buy.

Gold Plated Diaphragms

(Gold is one of the best known conductors of sound waves—and assures perfect reception.)

**Perfectly Matched and Balanced
Built for Real Comfort
Unusually Durable
Absolutely Guaranteed**

The "Gold Plate" Line



Bi-Metallic Gold Plated Bus Bar—Gold Plated Aerial Wire—and the Domino Lead-In, equipped with wing-nuts for easy attachment and Valspared against all weather conditions. Get the "Gold Plate" line at your dealer's. Free literature on request.



BIMETALLIC
RADIO PARTS CORP.

478—18th Avenue, Newark, N. J.

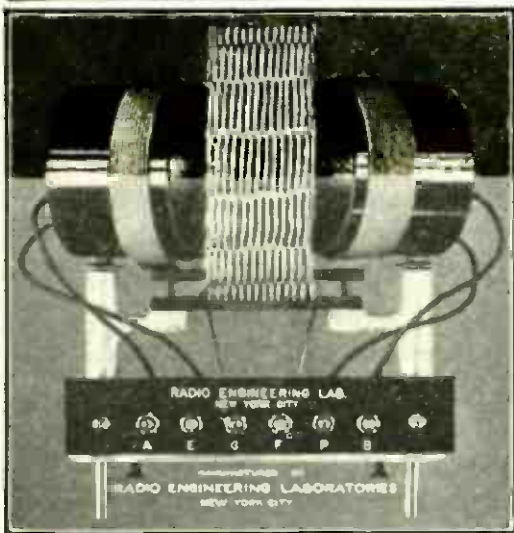

Greatest Range With Maximum Selectivity

Those Who Know Use the Original

LOPEZ LOW LOSS TUNER

Adopted by Mr. Alfred P. Lane for the Low Loss Receiver featured in November POPULAR RADIO

**LOWEST LOSSES—REGENERATES AT ALL WAVE LENGTHS
EASY TO TUNE—SECONDARY MAY BE CALIBRATED
ALL COILS WELL BACK OF FRONT PANEL
GUARANTEED TO GIVE SATISFACTION**

Circuit Diagrams, Panel Drilling Template and instructions packed with every tuner
Broadcast Type 200 to 600 meters—Regular Amateur 40 to 205 meters

Price \$10.00 each. At your DEALER'S or write
A. C. LOPEZ & CO., 334 Fifth Ave., New York City

REDUCE STATIC

by using our super-sensitive
Omni-Directional Aerial

*Collapsible, Ornamental,
Mechanically Perfect*

Can be used either as a loop or antennae inside or outside.
A wonderful value featured at a price within the range of all.



\$10.00

Prepaid in U. S. Ask your dealer or send order direct

The Portable Globe Aerial Co.
1602 Locust Dept. 34 St. Louis

RADIO FANS

Does the wire come apart on those coils that you have wound? If so, get

SAFEGUARD INSULATION

It holds your wires in place, insulates bare wires and metal, used also for stiffening form-wound coils.

Sold in 50c and \$1.00 Cans

Clear and Semi-Transparent Colors

At your dealer's or sent postpaid on receipt of price

SAFE-GUARD INSULATION CO.
Lansdale, Pa.

ENGLAND SCOTLAND WALES IRELAND NORWAY SWEDEN ITALY DENMARK HOLLAND BELGIUM FRANCE SPAIN

Give them
an Amplion
this Christmas!



The acoustically correct, pleasingly curved and exclusive "dragon-shape" of the Amplion sound conduit provides, in compact space, exceptionally long tone travel with gradual amplification. Also, the conduit is non-resonating, due to being rubber insulated at both ends. Tap it—you will not hear a "runk".

The new Amplion Dragon, Model AR-10, stands 20 1/2 ins. high. Horn is of wood, handsomely finished in mahogany. Crystalline enamel on sound conduit and unit add further attractiveness. Horn tilts to any angle. Equipped with the "Floating Diaphragm" adjustable electro magnetic unit. Requires no power amplifier or battery. Price \$42.50.

Phonograph Units
in Two Sizes



The new Amplion Junior, Model AR-111, also has the exclusive "dragon-shape", non-resonating, rubber insulated, sound conduit. Stands 15 1/2 ins. high. Metal horn, 10-in. diameter. Attractively finished over all in crystalline enamel. Horn tilts to any angle. Equipped with the exclusive "Floating Diaphragm" adjustable electro magnetic unit. Requires no power amplifier or battery. Price \$24.00.

DeLuxe, AR-114, has a wood horn similar to that on the Dragon. Price \$27.50.

The Amplion "Dragonfly", Model AR-102, "the hit of radio", is a perfect replica on a reduced scale of the new Amplion Junior. Entirely new. Stands only 9 ins. high; metal horn 5 1/2 ins. diameter. Gives amazing volume with extreme clarity and surprisingly "full" tone. Price \$13.50. Unit alone particularly adaptable for use in console sets and cabinet loud speakers.

Prices are slightly higher
in the far west



The new Amplions!

WITH THE "FLOATING DIAPHRAGM"

Amplion Vibratory Diaphragm is cushioned and kept from contact with metal by rubber gaskets. Rests on narrow ledge, lightly held there by spring ring with enough pressure to prevent "chatter" when extreme volume is desired. Diaphragm thus "floats" free from stress or undue tension, and free to vibrate in exact accord with variations of current flowing through electro magnetic system. Result: faithful reproduction over entire musical scale—without distortion.

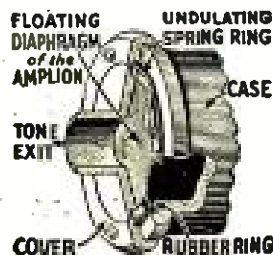

HAVE YOU seen, have you heard, the wonderful new 1925 Amplions? The latest creations of the world's oldest loud speaker makers—*thirty years experienced!*

Hear these new Amplions—in comparison with the loud speakers you thought were best. Gain an entirely new conception of how flawless loud speaker reception can be! Never before have you witnessed such supreme sensitivity, such beautiful purity, clarity, natural tone and distortionless volume over the entire musical range.

You will no longer wonder that Amplions, the world over, outsell any other loud speaker. That abroad, they outsell *all others combined*. That America, too, is demanding them in such numbers that it was necessary to form The Amplion Corporation of America to market and manufacture as soon as possible here under the Amplion patents held by Alfred Graham & Co., London, England.

Find the dealer who has been selected to demonstrate the Amplion in your locality. Or write us for literature and his name.

THE AMPLION CORPORATION OF AMERICA
Executive Offices: 283 Madison Ave., New York City

Canadian Distributors: Burndept of Canada, Ltd.
172 King St. West, Toronto

AMPLION

The World's Standard Loud Speaker

UNITED STATES CANADA JAPAN INDIA SOUTH AFRICA NEW ZEALAND AUSTRALIA SWITZERLAND

You like Westwyre Variable Condensers



the moment you see them

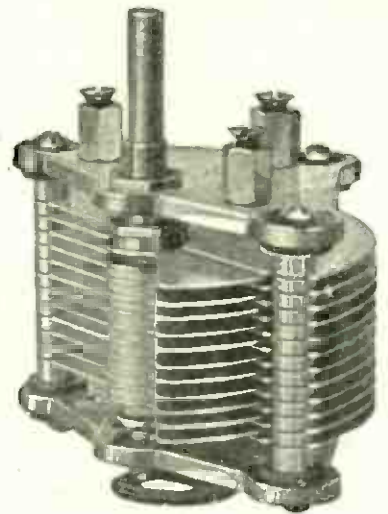

The reason—LOW LOSSES, grounded rotor, adjustable bearings, keyed shaft, high nickel polish, and their distinctive design which imitates none, but has been imitated by several. Prices and descriptive data upon application.

WESTWYRE Soldering Irons \$2.50

Junior Model \$1.50

ELF Crystal Receiver \$1.50



The Westwyre Company
Westfield, Mass.

ARROW BATTERY SLASHES Prices TO CONSUMERS ONLY

Prices Smashed!
Quality Not Sacrificed

Here is real battery quality, guaranteed to you, at prices that will astound the entire battery-buying public. Order direct from factory. Put the Dealer's Profit in your own pocket. You actually save much more than half, and so that you can be convinced of true quality and performance, we give a **Written Two-Year Guarantee**

Here is your protection! No need to take a chance. Our battery is right—and the price is the lowest ever made. Convince yourself. Read the prices!

- Special 2-Volt Radio Storage Battery, \$3.75
- Special 4-Volt Radio Storage Battery, 6.00
- 6-Volt, 60 Amp. Radio Storage Battery, 7.00
- 6-Volt, 80 Amp. Radio Storage Battery, 8.00
- 6-Volt, 100 Amp. Radio Storage Battery, 9.50
- 6-Volt, 120 Amp. Radio Storage Battery, 11.50
- 6-Volt, 140 Amp. Radio Storage Battery, 13.00

We ask for no deposit. Simply send name and address and style wanted. Battery will be shipped the day we receive your order Express C. O. D., subject to your examination on arrival. Our guarantee accompanies each battery. We allow 5% discount for cash in full with order. You cannot lose! Act quick. Send your order today—NOW.

Arrow Battery Co.
1215 South Wabash Ave.
Dept. 7 Chicago, Ill.



In She Comes!

TIP your whisker to almost any point of an NAA Meter tested crystal and the full flow of the impulse instantly hits your phones, clean, clear, steady.

Reason—no guess work in the test;—every, EVERY crystal meter-tested singly by specially made electrical instruments to a point away beyond normal sensitivity. In addition, the Newman-Stern mounting is new—patents pending—cold assembly, provides for refilling, and avoids damage to crystal by hot alloy; recessed for protection.

Perfect for Reflex

At all good jobbers and dealers, in neat turned wood box, 60c. If dealer can't supply, order direct and send dealer's name.

The Newman-Stern Co.

1748 East 12th Street
Cleveland, Ohio

Originators of tested crystals in 1914.

Oldest and Largest Producers.

Pioneers in Radio Equipment in Ohio



New NAA Meter Tested Crystals

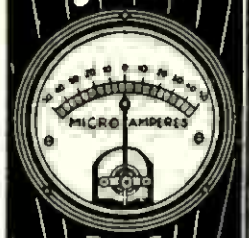

Nuggets
of
Sensitive-
ness





ADLER-ROYAL 199
 Designed and built to operate on dry cells
 Price \$165.00

A 5-tube Dry Cell Neutrodyne—all batteries within the cabinet

YOU may have your choice of two different styles of Adler-Royal Neutrodyne. Set 201A operates with the usual storage battery. Set 199 operates on dry cells. This is an achievement that has baffled radio engineers since the introduction of Neutrodyne.

Adler-Royal Neutrodyne also has separated the control for radio frequency and audio frequency. In simple language this means that

with Adler-Royal, when a station is amplified, the desired tone quality and volume is controlled without detuning or distortion.

Not only their beauty of cabinet design but the workmanship and simplicity of the sets themselves are outstanding features of Adler-Royal.

Adler-Royal is on exhibit only at the higher class stores whose reputation is an additional guarantee of the quality of the Royal line.

ADLER MANUFACTURING COMPANY, INC.
 General Sales Office: 881 Broadway, New York City
 Factories: Louisville, Ky.



ONE of the three cabinet designs of Adler-Royal Combination Radio and Phonograph Cabriole Model 10
 Price \$300.00

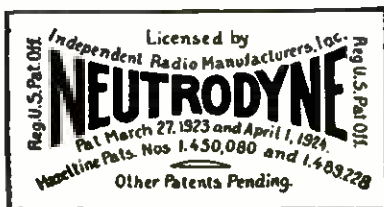

THE Adler-Royal Neutrodyne is licensed under the Hazeltine Neutrodyne patents and manufactured for us by King-Hinners Radio Co.



ADLER-ROYAL Elizabethan Floor Type Neutrodyne No. 1 in figured walnut or mahogany finish; storage battery or dry cell equipment
 Price \$350.00

Adler-Royal

NEUTRODYNE

SEND for an attractive booklet describing the complete Royal Line of phonographs, radio sets and combinations.

The KOMPENTROL *for Strong, Clear, Long-distance Reception*



This surprisingly compact set is noted for its volume and clear, natural reproduction of voice or music. Anyone can learn to operate it in a few minutes.

Let your radio dealer demonstrate the Kompentrol in your home.

Catalogue on request

KARDON PRODUCTS CO., Inc.

A five tube set that will meet the most rigid tests. The secret is in the Kompentrol (the small central dial) which prevents local stations from making an unearthly clamor while you are tuning and builds up weak signals from distant stations until they vie with the most powerful locals and without interference.

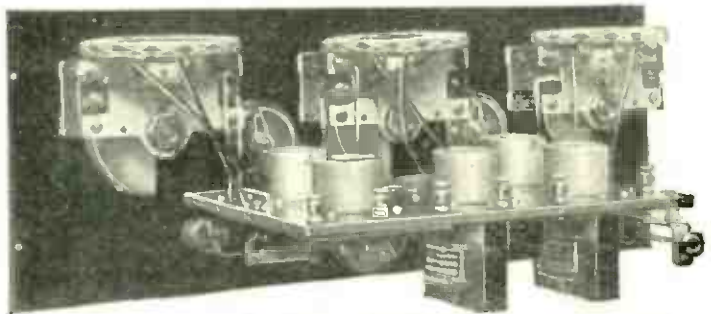

Rear View: Note Compactness of Assembly

::

101 Varick Street, New York

RAJAH

TERMINALS AND BINDING POSTS

A Positive, Solderless, Snap Connection for Aerial, Ground and Battery Leads



Patented June 20, 1924

APPROVED BY POPULAR RADIO LABORATORY and selected by L. M. Cockaday for his latest four-circuit set.

Instantaneous in operation—positive contact—just push on or pull off to make or break connection—no screws to bother with; no springs to bruise the fingers.



Patented June 20, 1924

Base of binding post secured to set by No. 8-32 screws, and fits all screw battery terminals. Snap connections quickly and permanently attached to cable without solder.

Can be readily removed and attached to other wires. You have never seen the best possible radio binding post until you see the RAJAH; which is rapidly replacing old style binding posts on sets now in operation.

Retail Price: terminal and base stud, as illustrated, 20 cents. Base studs, with screw and washer, only 6 cents.

SPECIAL INTRODUCTORY OFFER: 1 dozen terminals and studs, by mail, prepaid \$2.00

Dealers: Get in line at once for the best selling radio device you ever saw.

RAJAH AUTO SUPPLY CO.

Bloomfield

New Jersey, U. S. A.

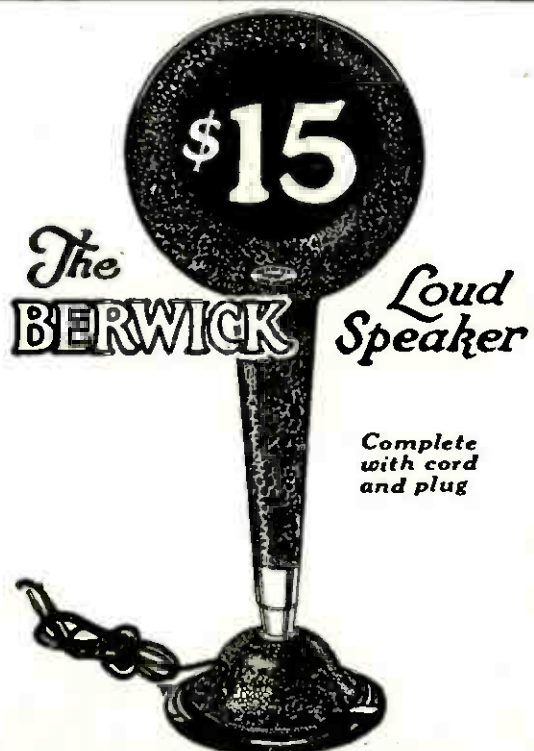

The **BERWICK** Loud Speaker

Complete with cord and plug

The Berwick Supreme Loud Speaker is without an equal even among high priced speakers. The Sliding Lever Tone and Air Gap Regulator protects the speaker from "overload." Volume—Tone—Quality, all combined in an instrument at a price within reach of all. Guaranteed for one year or money back. At your dealer's or sent direct upon receipt of price.

TRIANGLE ELECTRO TRADING CO.
632 Broadway New York City

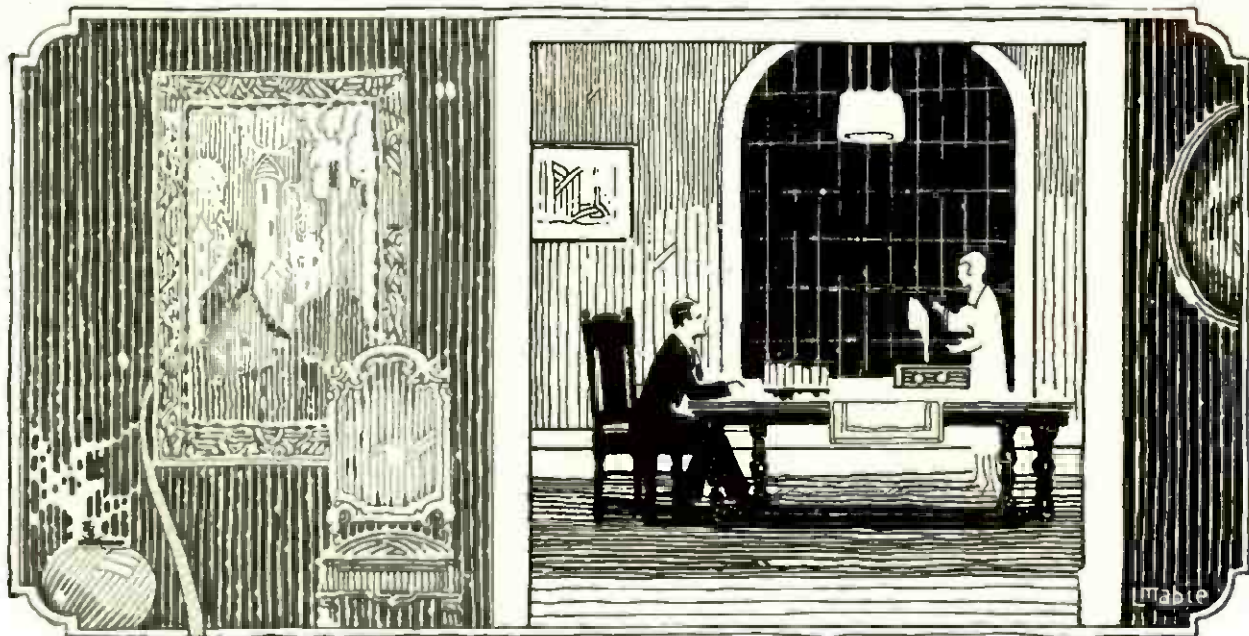

Indoors - Anywhere ! ! !

TALKING TAPE doesn't have to be carefully strung outdoors or on the roof—you don't have to buy lightning arresters, or insulators. Just put Talking Tape indoors—anywhere you find it convenient, and you'll be surprised—and delighted—at the results. It's the answer to indoor reception!

Use Talking Tape instead of a loop—the results you can obtain by following a few simple directions, supplied with each roll of Talking Tape will prove a revelation in Radio entertainment.

Ask your dealer about Talking Tape—he knows the story. Better still, buy a dollar's worth and try it yourself—that's the inexpensive way to better Radio.

Manufactured by
HOPE WEBBING COMPANY
 For Forty Years
 The World's Largest Manufacturers of Electric Tapes
 PROVIDENCE, R. I.

TALKING TAPE

The Perfect Radio Aerial

A VERY POPULAR STYLE OF RADIO TABLE

A Christmas Present Worth Having

No. 30-R

Plenty of leg room. Weight crated 85 pounds.

Send for free catalogue of Radio Furniture

Specifications—Hardwood, rubbed mahogany or golden oak finish; height over all, 31 inches; size top 24x34 inches; drawer, with lock, size 4x10x13³/₄ inches; battery cabinet, size 17x14¹/₄x16 inches.

Prices—No. 30-R—Freight paid East of the Mississippi River, Cash With Order.....\$18.00
 Rocky Mountain States.....\$20.00
 Pacific States.....\$22.50



NOTE: Cut shows battery cabinet on left, but these tables are all made with cabinet on right.

IMMEDIATE SHIPMENT

OUR LATEST STYLE

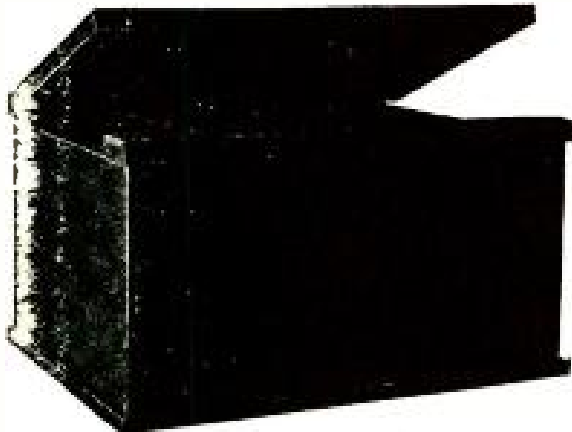

Radio Cabinets Strong and Rigid. Remember That We Pay Mail and Express Charges. It Makes Quite a Difference When Comparing Prices.

Specifications—Hardwood, rubbed mahogany finish. Top hinged, ends of top splined to prevent warping.

Panel Size	Depth	Price	Panel Size	Depth	Price
7 x 14.....	10.....	\$3.00	7 x 26.....	10.....	\$4.50
7 x 18.....	10.....	3.25	7 x 27.....	9.....	5.00
7 x 21.....	10.....	3.50	7 x 28.....	10.....	6.00
7 x 24.....	10.....	3.75			

Mail and express prepaid east of Mississippi River To Rocky Mountain States add 50 cents each To Pacific States add 75 cents each

THE SOUTHERN TOY COMPANY

Dept. P.

Hickory, N. C.



DeJUR

ONE HOLE RHEOSTAT

ASSURES PERFECT CONTROL

YOU can put this rheostat on your set in less than five minutes. It has everything—fine, clean-cut appearance, will wear for years, and is designed for maximum efficiency.

Consider these exclusive points: Non-corrosive, heat resisting, absolute contact by sliding rod on slide arm, interchangeable resistance element.

GUARANTEED—Any part replaced at any time.

At dealers everywhere. Jobbers and dealers write for discounts.

DeJUR PRODUCTS Co.
Lafayette & Broome Sts., New York

S. HAMMER RADIO CO.
305 Atkins Ave. Brooklyn, New York

Special!!

5 TUBE NEW COCKADAY 4 CIRCUIT TUNER WITH RESISTANCE COUPLED AMPLIFIER KIT

FREE GENUINE BAKELITE PANEL Drilled and engraved, worth \$8.00, with all orders for this Kit received up to January 1st.

PARTS In this Kit are exactly as specified and recommended by Mr. Cockaday in the October issue of Popular Radio, also featured in our new catalog.

WIRED This set wired complete in genuine mahogany cabinet **\$85.00**

We Specialize in Cockaday Kits



Our Sets and Kits
Approved by Popular Radio Laboratories

WRITE NEW CATALOG FOR OUR containing 28 pages, unexcelled bargains in standard nationally advertised radio accessories parts sets-kits.

Orders over \$5.00 Shipped Prepaid. Money Orders or C.O.D. One-third must accompany all C.O.D. orders. Not insured unless insurance charges included.



Buy High Grade Parts *and* **FORMICA** Panels

IF you want real results from your radio set, buy high grade parts, low loss condensers, good transformers and Formica panels! Then after you have labored over your set you will not find others using the same number of tubes who get stations you can not get. The manufacturers of the finest radio sets built in America have endorsed Formica by using it. It is the panel material of 125 leading makes.

There are reasons for this almost unanimous choice of Formica—and the reasons are longer life, no warping and sagging, low electrical losses and fine appearance. Formica works easily with ordinary tools.

Formica is made in four splendid finishes: Gloss black, dull black, mahogany and walnut. It is the standard radio panel material from coast to coast. More of it is used every year. In big sets incorporating radio frequency amplification, it is now regarded as essential for base panels and terminal strips. Mount everything on Formica. Don't let it touch wood. Dealers: Formica service and quality and the universal demand for the material make it the most satisfactory and profitable panel line you can carry.

Hear the Formica band every Wednesday Evening from 9 to 10 central time over WLW.

THE FORMICA INSULATION COMPANY
4641 Spring Grove Avenue, Cincinnati, Ohio

Sales Offices

50 Church St., New York, N. Y.
422 First Ave., Pittsburgh, Pa.
1142 Granite Bldg., Rochester, N. Y.
419 Ohio Bldg., Toledo, Ohio

1210 Arch St., Philadelphia, Pa.
1026 Second Ave., S. Minneapolis, Minn.
585 Mission St., San Francisco, California
Whitney Central Bldg., New Orleans, La.

516 Caxton Bldg., Cleveland, Ohio
9 S. Clinton St., Chicago, Ill.
708 Title Bldg., Baltimore, Md.
47 King St., Toronto, Ontario

FORMICA

Made from Anhydrous Bakelite Resins
SHEETS TUBES RODS

All apparatus advertised in this magazine has been tested and approved by POPULAR RADIO LABORATORY

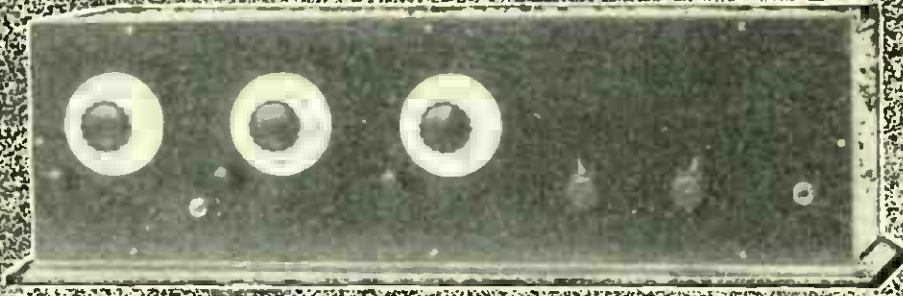

On comparing the four tube Biltmore with the eight tube Super-heterodyne, there was no difference whatever in volume. Have received San Juan, Porto Rico twice, with good volume on the loudspeaker. (Almost 4000 miles.)
 Ellison Radio Service
 315 13th Ave. E., Calgary, Alberta, Can.

The Biltmore brings them in with wonderful volume, regardless of what part of the U. S. they are in. Last night I had Boston as loud as the locals.
 George B. Hanford
 Wausa, Nebraska

Without any antenna at all, we get as far as Dallas, Texas, and with an antenna plug we get Havana, Cuba. All on the loudspeaker, and while three strong local stations were hard at it. (Pittsburgh stations.)
 The R. F. Miller Co.
 113 Frederick St., Mt. Oliver, Penn.

Biltmore Master Reflex

4 tube \$100
 5 tube \$125

Biltmore Radio Co. Boston 30
 Mass. (TR)

"NOL-LOS"

Variable Condenser

Capacity .0005 MF

Only 1 Post

Only 1 Hole

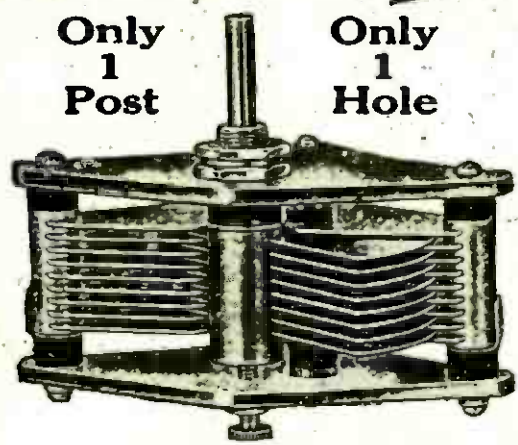

A Truly Scientific Product Extremely Sharp Tuning

Minimum Capacity .000012

"NOL-LOS" appeals to every Radio Fan and Scientific Experimenter on account of its sharp tuning, freedom from body capacity and being easy to mount in any position. Built of aluminum, it is mechanically rugged, yet light. "NOL-LOS" has been tested in the most important technical laboratories in the world, and shows 1.0 ohms resistance, which is equal to the standard condenser.

If your Dealer cannot supply you, order direct
B. GROSSER SONS CO., Inc.
 55 A Sudbury St., Boston, Mass.

Jones Multi-Plugs are supplied for panel or bracket mounting. Also (as illustrated below) with seven leads coded for attaching to binding posts of any set.

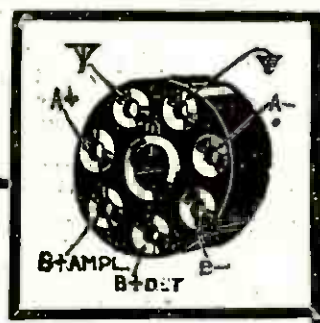

Complete \$5

One Pull

on the Jones MULTI-PLUG instantly disconnects antenna, ground, A and B batteries from your set! One push reconnects! Long cable permits placing batteries out of way—in basement, closet or elsewhere. All leads coded.

Jones MULTI-PLUG

Can't be plugged in wrong. Prevents burning out tubes or shorting batteries. 100 percent foolproof. Enables anyone to connect your set with safety. Standard on Zenith, WorkRite and many other leading sets. Jones Multi-Plugs, complete for panel mounting, \$4; for bracket mounting, \$4.50. Binding Post type, \$5.00. Carried by all jobbers. If your dealer isn't supplied, state his name when ordering. Folder free.

Pat. Applied For

HOWARD B. JONES

616 S. Canal St.

Chicago

ALADDIN HAD HIS LAMP
YOU HAVE THE MELCO SUPREME

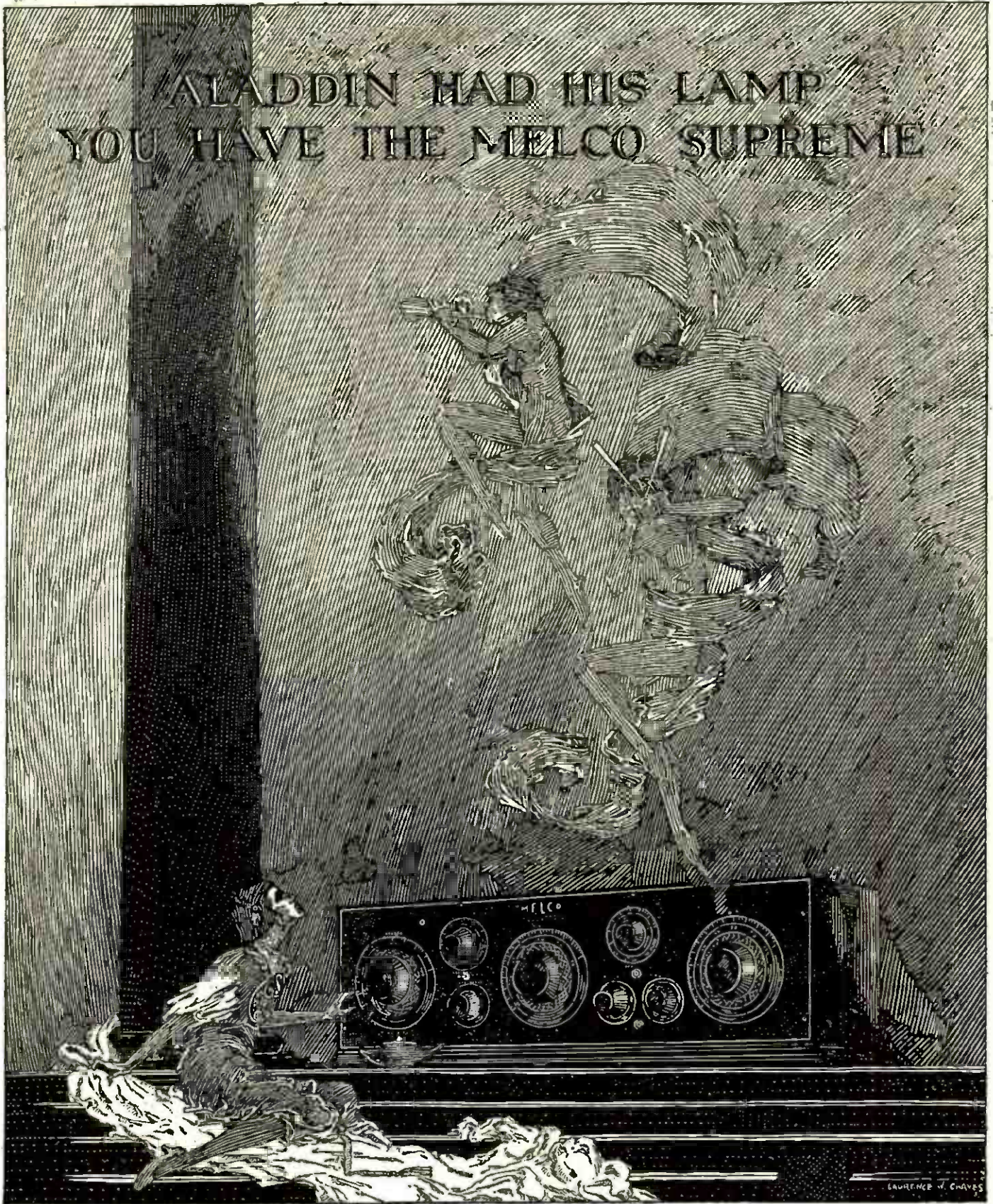

MELCO SUPREME RECEIVER

TUNED RADIO FREQUENCY

"Ask your dealer or write for interesting literature."

AMSCO PRODUCTS INC. BROOME & LAFAYETTE STREETS, N.Y.



All apparatus advertised in this magazine has been tested and approved by POPULAR RADIO LABORATORY

Authorities Agree On the GEN-WIN Low Loss Tuner with the Silver Plated Primary

REG. APP. U. S. PAT. OFF.

The U. S. Bureau of Standards table shows that silver has lowest microhm-centimeter resistance of any metal. As radio frequency currents travel on the surface of wire, GEN-WIN Low Loss Tuners are made with a Silver Plated Primary. Therefore the

GEN-WIN Low Loss Tuner

marks a step in the advance of the design of Radio Coils. It reduces series resistance by using an aperiodic primary of special silver plated copper wire. Condenser tuned secondary and self-supporting spider web feed back as well are of the latest low-loss design. A GEN-WIN Low Loss Tuner will enable you to build the most efficient regenerative set ever designed, both for DX and local reception. They are unconditionally guaranteed! With each Tuner we furnish *free* a complete set of detailed blue-prints (full size panel pattern, instrument layout, picture wiring diagram) for latest GEN-WIN Low Loss Tuner Set. Sold separately for 50c. All free with each Tuner. Write for descriptive circular. Dept. PR-12.



\$7.00

Pat App. for

At dealers everywhere
— or sent postpaid

GENERAL RADIO WINDING CO.

214 Fulton St., New York

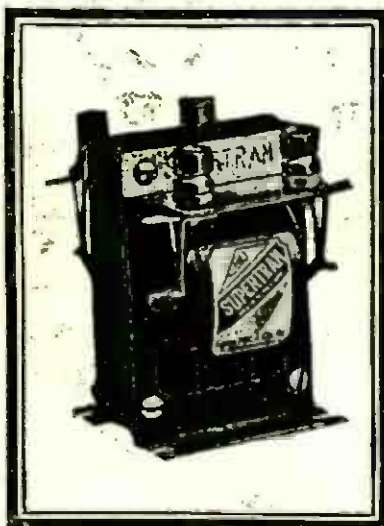

Superior!

Registered U. S. Patent Office

AUDIO TRANSFORMER

NOW IT'S SHIELDED!

The Supertran Audio Frequency Transformer is now completely shielded—absolute protection against damage to the coil while mounting. Can be used with any amplifying tube with excellent results. Brings out the deep bass notes of the piano and the high, shrill treble of the violin better than any other transformer.

\$6.00 $\frac{3\frac{1}{2}}{5}$ to $\frac{1}{1}$ Ratio

At good dealers everywhere.
Write for interesting literature.

FORD MICA CO., Inc.

33 East 8th Street

New York

DISTRIBUTORS

Wetmore-Savage
Boston

The Beckley-Ralston Co.
Chicago

Coast Radio Supply Co.
San Francisco

Excel-all Radio Co.
Bloomfield, N. J.

Radio, Limited
Montreal, Can.

ATWATER KENT LOUD SPEAKERS



THE first time you hear an ATWATER KENT Loud Speaker you will want to own one, for with it comes the final thrill—This able spokesman of radio, which gives such faithful reproduction of sound, enhances the value of any set and completes radio satisfaction.

If you are using ear-phones the discomfort will be eliminated, and your radio becomes the generous family entertainer you want it to be.

The true worth of a loud speaker is judged by the fidelity with which it reproduces broadcasts. It is this natural reproduction of sound that is the basis of ATWATER KENT Loud Speaker success.

Skilled engineers and master craftsmen, working with the finest materials, have set a new standard in the production of ATWATER KENT Loud Speakers.

Each kind of material used, each detail in design is there for a purpose, to bring about a tone that is pure, clear and natural.

Don't miss another day of this new thrill in radio. Your dealer will show you our three models.

ATWATER KENT MANUFACTURING CO.
4712 Wissahickon Ave., Philadelphia, Pa.

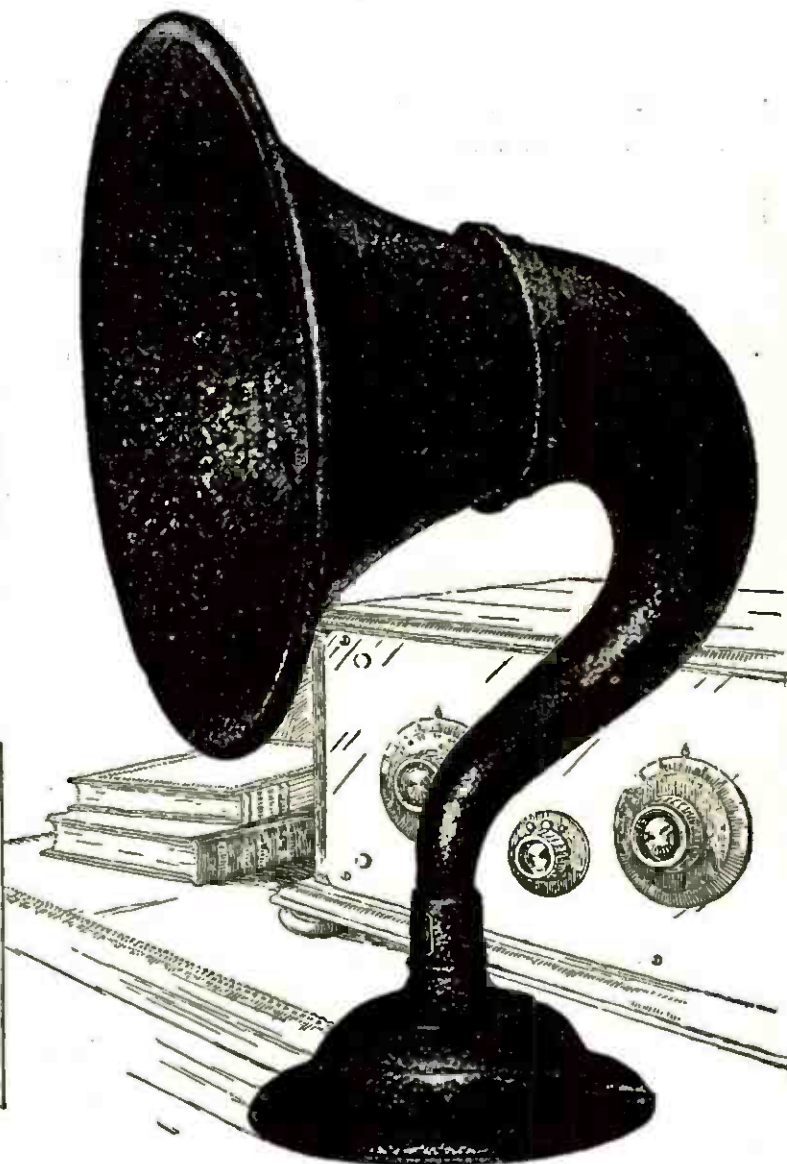
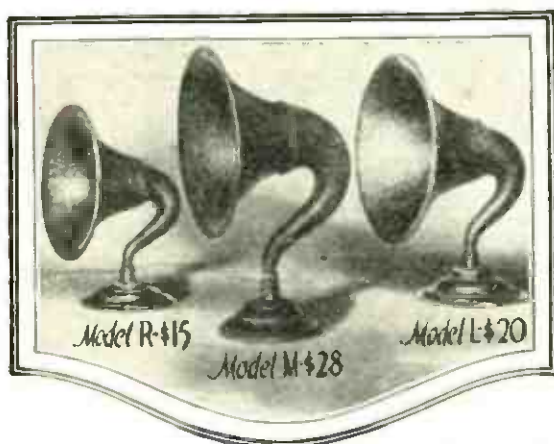

BRING OUT THE BEST FROM ANY SET

All apparatus advertised in this magazine has been tested and approved by POPULAR RADIO LABORATORY

AT LAST! A CRYSTAL SET LOUD SPEAKER

TESTED AND APPROVED BY POPULAR RADIO LABORATORY, L. M. COCKADAY, DIRECTOR

WARREN D. HOUSE'S

A Wonderful Christmas Gift

Radiograph

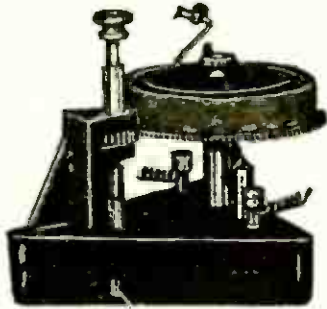

Patents granted and pending in 38 countries

THE RADIOGRAPH sits on your phonograph and operates like playing a record. A record produces sound *mechanically* by means of indentations in the grooves in which the reproducer needle travels. The same effect is obtained *electrically* in the RADIOGRAPH. A special needle travels in a *smooth* groove in a disk which has a battery action. The radio impulses from the crystal cause an electrical "slip" of the needle which reproduces clearly and sweetly whatever is coming in without additional amplification of any sort.

No Tubes, No Batteries, No Upkeep—So Simple a Child Can Operate

NO MORE HEADACHES OR STIFF NECKS FROM HEADPHONES. In an ordinary room the whole family can hear everything *comfortably*, without being anchored to a flock of headsets. Announcements are in a clear, conversational tone, and music comes in sweetly without distortion. It's like listening to a record played with a fibre needle.

The RADIOGRAPH WORKS EQUALLY WELL ON TUBE SETS, but when so used should really be called a *SOFT SPEAKER*. It is not raucous or harsh. It doesn't set your nerves on edge or drive your neighbors frantic.

Most Radio dealers will not have their shipments of RADIOGRAPHS in time for Christmas. If you want yours before Christmas, order it *immediately* by mail as we can guarantee delivery before Christmas on only the first thousand orders.

SEND NO MONEY!

Pay the Postman. Use the coupon. If you are not delighted with the RADIOGRAPH, return it within five days and your \$15.00 will be cheerfully refunded.

CENTRAL RADIO COMPANY

Dept. P.R. 1224
25 West 42nd Street, New York City
(Next Door to Aeolian Hall)

Central Radio Company
Dept. P.R. 1224
25 West 42nd St., New York City

SEND THIS COUPON

Please send me one RADIOGRAPH, complete with simple operating instructions. I will pay the Postman \$15.00 plus postage. If for any reason I do not wish to keep the RADIOGRAPH, I have 5 DAYS in which to return it and get my \$15.00 back.

Name.....

Street No.....

City..... State.....

KELFORD

Rheostats and Potentiometers

The U. S. Navy Standardizes on these fine parts. Made by America's oldest manufacturers of radio parts. High quality and remarkably low prices.

Send postcard for full particulars

Rheostats 2 to 30 ohms 75 cents to \$1.50
Potentiometers 200 and 400 ohms..... \$1.50

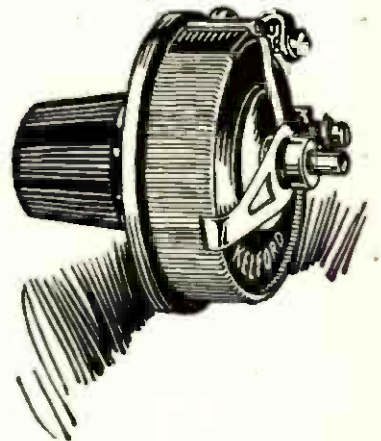

The American Specialty Co.

178 Holland Ave. : : Bridgeport, Conn.

More Power



Greater Volume

DE-TEX-IT



Complete \$1.25

LOW LOSS—POSITIVE CONTACT
FIXED DETECTOR

Best for Reflex—Requires no adjustment—will not burn out
CELERUNDUM RADIO PRODUCTS CO.
Wollaston (Boston) Mass.

OLDRAD PHONE SNUBBERS



Will get you clear reception at all times. They stop distortion and smooth out static sounds. You get rich, mellow tones, always.

Easy to insert. Never get out of order. **Absolutely Guaranteed.**

Send \$1 for a pair. Mention make and model number of your phones. If not entirely satisfied, return within 5 days and you'll get your money back. Send for a pair today.

THE O-D RADIO RESEARCH LABORATORIES
SOUTH ATTLEBORO, MASS.

AMPL-TONE

Guaranteed

Radio Headsets

2200
Ohms

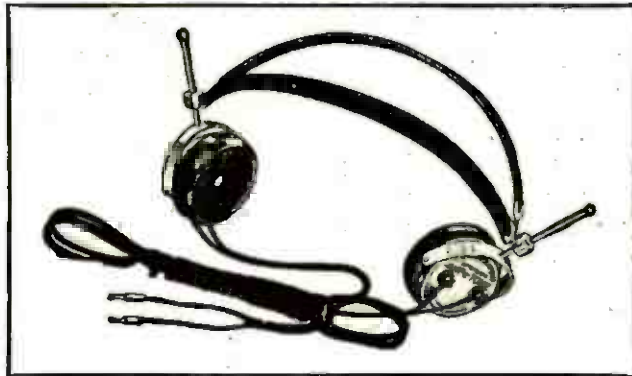

Price
\$5.00

A Real Headset at a Real Price

CHRISTMAS will soon be here and if you want to give your best friends something that they will appreciate, or your boy an article for his radio set that he will get the most out of for the money, buy Ampl-Tone Headsets. They are guaranteed in workmanship and their service is lasting. Their friends know what they are, ask them. Remember the name, Ampl-Tone.

Our phones embody precision in adjustment, accuracy of balance and nicety of spacing.

Dealers and jobbers write us for proposition

THE UNION FABRIC CO.

Successors to C. M. French Mfg. Co.

Derby, Conn.

PYREX All-Weather Insulators

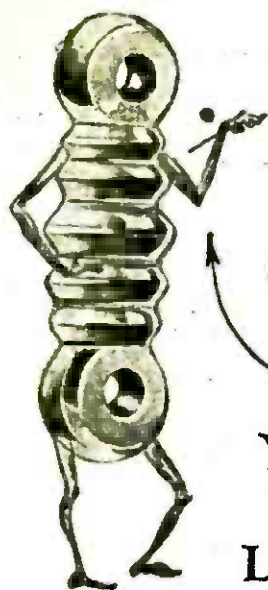

Using leaky antenna insulators to collect radio energy is like using a sieve to collect rain water.

You Can't Get Distance With Leaky Insulators!

PYREX is the ideal material for broadcast reception antenna insulators.

It has a continuous uniform structure that does not rely on a glazed surface for its insulating properties.

PYREX has a super-smooth surface to prevent the collection of soot and dust, and to allow rain to wash them off thoroughly. It does not absorb water, nor retain any surface moisture.

PYREX Antenna Insulators have an exceptionally low phase angle difference, which does not change appreciably with various wave lengths.

The United States Navy, Coast Guard, and other Government Departments use PYREX for the insulation of antennae.

Insist on PYREX Broadcast Antenna Insulators to insure your set giving its best results. Retail at 45c.

Inquiries from jobbers invited

CORNING GLASS WORKS

Industrial Division

CORNING

NEW YORK

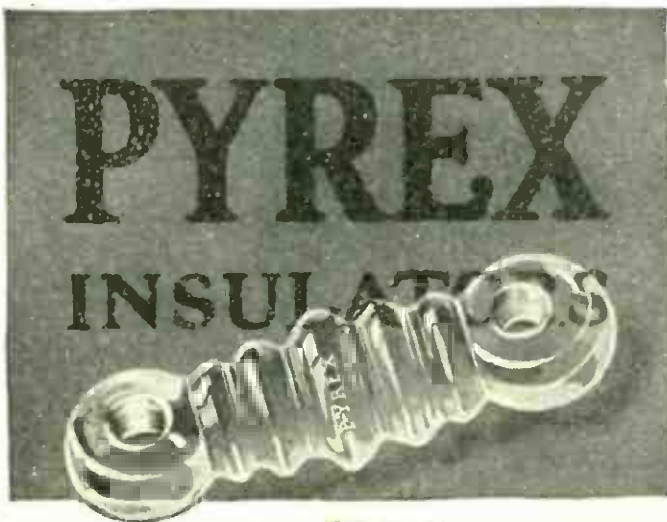

The Coil WITHOUT LOSSES

UNCLE SAM

MASTER TUNING COIL

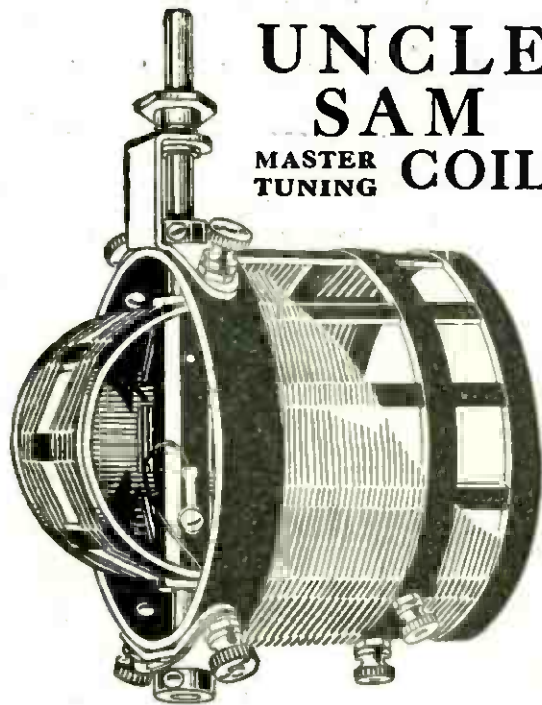

A few features of the greatest inductance in the world—

1. Wound on moulded hard rubber.
2. The only coil wound with the wonderful Ambassador Litz wire.
3. Eliminates all adhesives.
4. Has a one hole mount and thin gold plated compensating spring contacts.

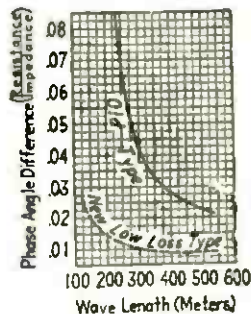

Laboratory tests prove conclusively that it is the only coil worthy of the name Low Loss.

When you build a set with this coil you build your final set

FREE! Ask your dealer or send self-addressed, stamped envelope for wiring diagrams of circuits in which this remarkable coil can be used.

UNCLE SAM ELECTRIC CO.
215 E. Sixth St. Plainfield, N. J.

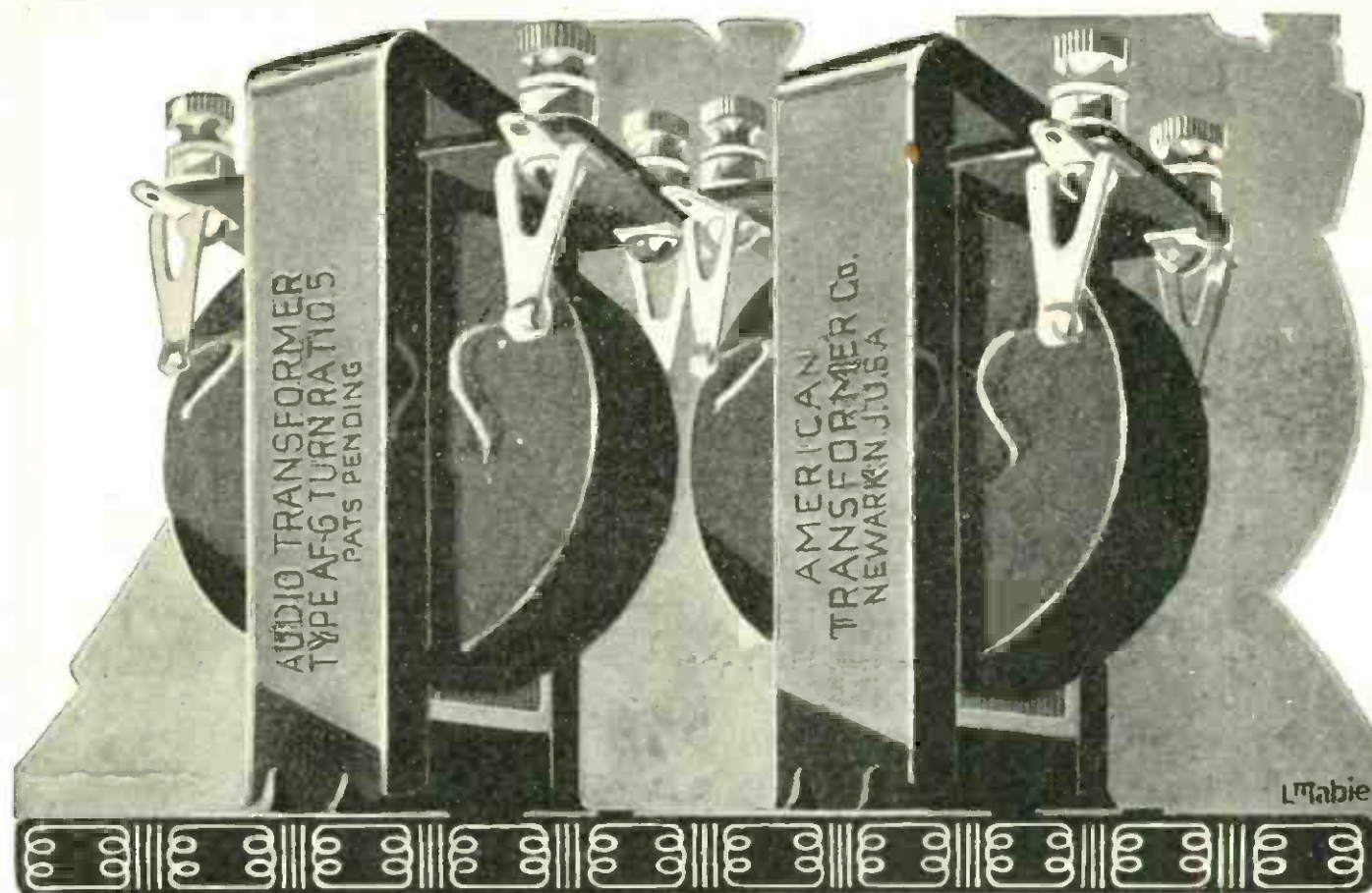

Buy AmerTrans - by the Pair!

WHEN you build an audio amplifier—use a *pair* of AmerTrans. Then you'll be sure of getting all two stages can possibly deliver with present tubes.

Use a *pair* of AmerTrans and you have the ideal combination for clarity, volume and tone quality from audio amplification.

AmerTrans Type AF-6 and AF-7, when used together, make tubes

amplify faithfully and powerfully. Each is designed to work with the other. In no other combination will you find the famous Amer-Trans "kick".

Use a *pair* of AmerTrans.

Price either type \$7.00 at your dealer's

Send for booklet giving useful amplifier information.

AMERICAN TRANSFORMER COMPANY

175 Emmet Street

Newark, N. J.



The Greater BEL-CANTO LOUD SPEAKER

IS HEAD AND SHOULDERS OVER THEM ALL
Direct from Manufacturer to You



29½ inches High
15½ inch Bell

PRICE
\$10

Plus express
charges collect

The Horn

The horn is the outcome of 3 years of experimentation and research to attain perfection for the amplification of Radio Signals without distortion. You can only obtain this advantage when you purchase a Bel-Canto. No other speaker will be equipped with this horn.

The Unit

Next to the Horn in importance is the Unit. Great care has been taken in the manufacture of our own exclusive adjustable Unit.

The Clarity of Tone

The New Bel-Canto is designed to give a crystal clear musical tone which will satisfy the most discriminating.

The Great Volume

The generous size assures an amplitude of volume in any size room. It is graceful in design and not too large.

The Metal Parts

The base is of cast-iron, ample in weight to overcome top heaviness. The other metal parts are sand cast aluminum, machined and polished, no nickel plate to wear off. No die cast threads to strip.

THE GUARANTEE

Every Bel-Canto is fully guaranteed for one year from the date of purchase against mechanical, material, or electrical defects of any kind and will be replaced free of charge with a new one if found defective in any way within that period of time. Money back any time within ten days if dissatisfied. We further guarantee to the publication carrying this advertisement that each and every speaker will be sold on the above terms and the instrument will be exactly as offered in this issue.

Call at our factory. Send us your money order, check or pay C.O.D.

We sell direct to the consumer, eliminating 3 profits—Distributor, Jobber and Dealer

BEL-CANTO MFG. CO.

BENSEL-BONIS, INC.

872 Broadway, New York City

Dept. P.R.

Phone Stuyvesant 1921



It's **INSULINE**, *the Best* *there is*

Approved
Alike By
Amateur and
Manufacturer

Not affected by varying weather conditions, Insuline is the one panel which will assure you consistently efficient performance and complete satisfaction throughout the year. Made in mahogany, black, anti-capacity and the new Frieze Finish. All made of the same famous heat-resisting Insuline.

Manufacturers, Jobbers and Dealers

We have the largest and best equipped plant for the cutting, drilling, designing and engraving of panels. We carry in stock drilled and engraved panels for the following circuits:

Fada Neutrodyne	5 tube
Ambassador	3 tube
Roberts Knockout	4 tube
Journal's Filter Tuner	1 tube and 3 tube
Journal One Knob	1 tube and 3 tube
Freshman	5 tube

If your dealer cannot supply you, write us direct, giving your dealer's name.

*Write for Literature and Prices on Insuline Tubing,
Insulators, Sockets, Dials and Ear Cushions*

RADIO PANEL AND PARTS CORP.

(INSULATING COMPANY OF AMERICA)

59 WARREN STREET

NEW YORK

WESTERN BRANCH

INSULATING CO. OF AMERICA, Madison, Wis.

DON'T SAY JUST RUBBER—SAY INSULINE

Eveready Heavy Duty "B" Battery, 45 volts. Three Fahnestock clips. Length, 8 3/16 in.; width, 4 7/16 in.; height, 7 5/16 in.; weight, 13 3/4 lbs. Price \$4.75.



Dry "B" Batteries are more economical and more dependable than any other source of plate current!

**REDUCE
Operating Costs**

THOUSANDS of people are already cutting their "B" Battery costs one-half, or even two-thirds, by using the new Eveready "B" Battery No. 770 on their heavy drain sets.

This new Eveready Heavy Duty Battery marks a marvelous advance in reducing "B" Battery costs.

If your "B" Batteries have lasted only two months on a five or six tube receiver, this Eveready Heavy Duty "B" Battery will increase the service two to three times.

Use this Eveready Heavy Duty "B" Battery on any receiving set on which the "B" Batteries last less than four months. When thus used to its full capacity, it is the cheapest as well as the best source of "B" energy ever offered.

Manufactured and guaranteed by
NATIONAL CARBON CO., INC.
Headquarters for Radio Battery Information
New York San Francisco
Canadian National Carbon Co., Limited
Toronto, Ontario

EVEREADY
Radio Batteries
-they last longer

For Christmas!

 **The Ideal Sets**
 to carry for your
Holiday Trade

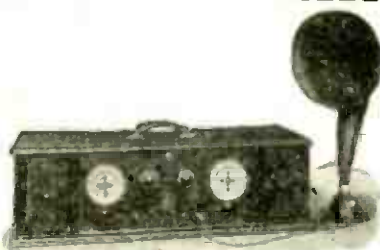

IDEAL because of their beauty of cabinet design, super-sensitivity, super-selectivity, faithful reproduction and reliability.

The Radiola VIII and Super-heterodyne require no antenna, no ground, no storage battery and are entirely self-contained. One can easily tune distance in and out in close proximity to powerful broadcasting stations.

These and other Radiolas should be carried by you if you wish to take advantage of the holiday sales possibilities of the Radiola.

Being one of the largest Radiola distributors,—we can assure prompt and satisfactory deliveries. To delay is serious—get your order in NOW!

WHOLESALE

EXCLUSIVELY

LUDWIG HOMMEL & CO

929 PENN AVENUE



PITTSBURGH, PA.

No. 1700 Super-Multiformer

List Price \$20



Puts the Super in Super-Heterodyne!

Simplicity of Design

Greater Amplification

Stability of Performance

The heart of the one control Super-heterodyne described in November Q. S. T. and December Radio by J. L. McLaughlin, our Research Engineer

PRECISE MANUFACTURING CORPORATION

Manufacturers of Complete Line of Radio Transformers
ROCHESTER, N. Y.

Branches: 53 W. Jackson Blvd., Chicago, Illinois 821 Market St., San Francisco, California
Eastern Sales Office: Niagara Sales Corp., 3-5 Waverly Place, New York, N. Y.
Canadian Distributors: Perkins Electric, Ltd., Toronto, Montreal, Winnipeg
Southern Representatives: Saal Products Sales, Inc., 35 Warren Street, New York, N. Y.

"Greatest possible volume without distortion"
—L. M. Cockaday, famous radio inventor.



No. 285-A Audio
\$5

MU-RAD

LABORATORIES, INC.
Asbury Park, New Jersey

Without "A" or "B" Battery St. Louis Hears Washington

You can do it with the MU-RAD Type MA-20, which operates without "A" or "B" Battery. Just plug into your electric light socket and tune in.

Mr. L. M. Wood of St. Louis, the first night he had his MU-RAD, tuned in Washington, Pittsburgh, Detroit, Chicago, Kansas City, Schenectady and several other Eastern stations, quickly and easily. As he says, "the reception was perfect".

The MU-RAD MA-20 is easy to operate, and the dial readings are always the same for any given station.

MU-RAD Receivers are guaranteed for 1,000 miles reception but records of many times this distance are being broken every day. Ask the MU-RAD dealer in your town to demonstrate it for you.

Write for descriptive literature before you choose all your Christmas gifts. Address Dept. B.

*The MU-RAD MA-20
that operates without
batteries*



Made by the makers of Laboratory Equipment

NOLOSS TRADE MARK TYPE 51 PYREX INSULATION

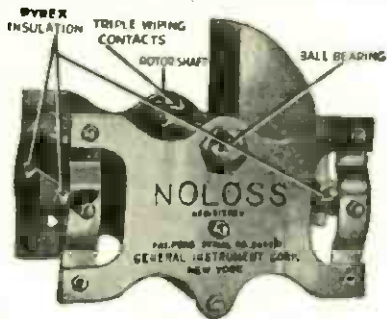

NOLOSS TRADE MARK TYPE 56 ISOLANTITE INSULATION

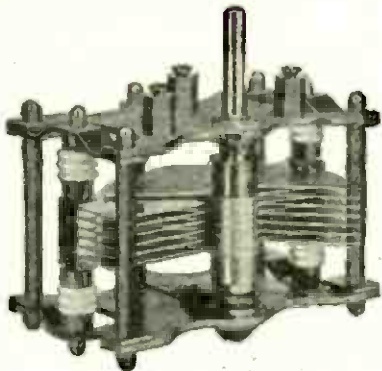

IT is now possible for the amateur to get results formerly reserved to laboratories.

The experimenter who requires every micro micro watt of energy to bring in heretofore inaudible signals must turn to General Instrument NOLOSS Variable Air Condensers.

They are constructed with laboratory methods, and insulated with laboratory insulations—Pyrex or Isolantite.

Products worthy of your purchase.

General Instrument apparatus costs a little more but is worth infinitely more.

General Instrument Corporation

Manufacturers of Laboratory Equipment

423 BROOME STREET
NEW YORK, U.S.A.

Haynes-Griffin

RADIO SERVICE, Inc.

41 West 43rd St., N. Y. City

250 W. 49th St.,
New York

MAIL ORDER DEPARTMENTS

111 So. Clark St.,
Chicago

COMPLETE PARTS and BLUEPRINTS for the **NEW COCKADAY 4 CIRCUIT TUNER** With Resistance-Coupled Amplifier

Stored in our New York and Chicago Mail Order Departments are big reserve stocks of all the "hard-to-get" special apparatus required for the marvelous new Cockaday Circuit. Order what you need directly from the list printed below and it will start to you the same day we receive your order.

Haynes-Griffin will not make any substitutions. You will receive exactly the same identical material used by Mr. Cockaday in his own experimental set, as described by him in the October issue of Popular Radio. Inferior apparatus can be made cheaper, but to use it means to sacrifice efficiency and worth-while results.

And remember—you can count upon 24 hour service from HAYNES-GRIFFIN.

Complete Parts for the New Cockaday Circuit

1 "Precision" Cockaday Coil.....	\$5.50	1 Improved Single Circuit Jack.....	.70
1 "Cardwell" Variable Condenser (.0005 mfd.).....	5.00	1 Improved Filament battery switch.....	1.00
1 "Cardwell" Variable Condenser (.00035 mfd.).....	4.75	1 "Precise" Audio Frequency Transformer No. 285-A.....	5.00
2 "Accuratune" Micrometer control dials.....each	3.50	3 "Electrad" Certified Grid-Leaks 1/2 megohm.....each	.50
1 "New York" Mica Fixed Condenser (.00025 mfd.).....	.35	3 "Electrad" Certified Grid-Leak mountings.....each	.25
9 "New York" Mica Fixed Condensers (.005 mfd.).....	.60	9 Switch Points.....each	.01
each.....	.60	2 Stops.....each	.01
1 "Amplex" Grid-denser.....	1.25	1 Switch Lever "Amsco".....	.25
1 "Bradleyleak".....	1.85	1 7 x 24 x 3/16" Grade "A" Hard Rubber Panel (Drilled).....	4.00
3 "Bradleyohms" No. 25.....each	2.00	Sub-Base 9 3/8 x 2 3/4.....	1.00
5 "Benjamin" Cle-ra-tone Sockets for U. V. 201-A tubes.....each	1.00	7 x 24 Solid Mahogany Cabinets.....	10.00
1 "Amsco" Dubl-wundr Comoination potentiometer-rheostat.....	2.00	1 Binding Post Strip 7 x 1 x 1 3/4 x 1.....	.20
4 "Amperites" No. 1-A with mountings.....each	1.10	8 Binding Posts.....each	.20
3 Improved Double Circuit Jacks.....each	1.00	Bus Bar, lugs, solder and screws.....	1.00

A genuine complete set of official blue prints with full construction and operating descriptions, as published by Popular Radio, sent post-paid upon receipt of \$1.10.

FREE ! A Brand New Radio Catalog Every Month

"Radio Dispatch", personally edited by A. J. Haynes, Associate Institute Radio Engineers, is a radical departure from all other radio catalogs.

It is issued every month, with the result that the information it contains is always new. It brings you every thirty days complete details of the newest developments in radio—what they are, why they are better, what they cost, and how to buy them as quickly as though you lived next door to the largest radio stores.

"Radio Dispatch" is sent free to everyone interested in radio. No subscription, no obligation. Mail the coupon now to our nearest store.

Write to either our New York or Chicago Mail Order Departments, —whichever is the more convenient to you.

Any of the Cockaday material sent post-paid by us anywhere in the U. S.

HAYNES-GRIFFIN RADIO SERVICE, Inc.

250 W. 49th St., New York

111 So. Clark St., Chicago

PR-12









HAYNES-GRIFFIN

250 W. 49th St.
New York City
111 So. Clark St.
Chicago

Please send me a copy of "Radio Dispatch" every month.

Name.....

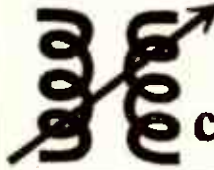
Address.....

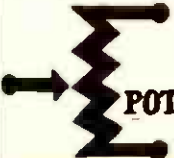
	Anti-capacity JACKS
	Anti-capacity SWITCHES
	Lower-Loss Vernier VARIABLE CONDENSERS
	Lower-Loss PHONE PLUGS
	Lower-Loss RHEOSTATS
	Lower-Loss SOCKETS
	Lower-Loss VARIO-COUPERS
	Lower-Loss GRID LEAKS
	Lower-Loss INDUCTANCE SWITCHES
	Lower-Loss POTENTIOMETERS

NO SOLDERING—LESS DRILLING—SCIENTIFICALLY BUILT

-and then hear the difference!

You know what you want from that better set you are going to build—longer DX, clearer tone, and no interference. The sure way to get what you want is to build with Jos. W. Jones parts. Aside from better results, it is twice as easy to work with Jos. W. Jones parts.

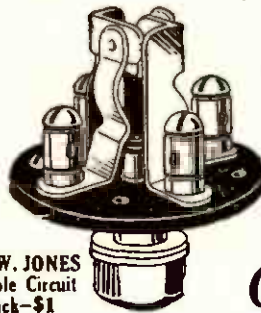

JOS. W. JONES Double Circuit Jack—\$1

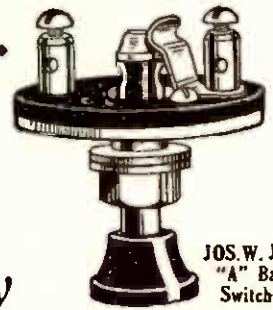

JOS. W. JONES "A" Battery Switch—\$1

JOS. W. JONES

Anti-Capacity

JACKS
5 Types

SWITCHES
5 Types

Jos. W. Jones Jacks and Switches kill capacity effects. The old-style jack and switch, because of long parallel leads, act as condensers. Jos. W. Jones Jacks and Switches pass the "juice" through without the smallest loss. Always ask for the switches with the little red button.

Low loss is a feature of all other Jones parts. That, along with less drilling and no soldering.

For Better Results Build With JOS. W. JONES

Jacks	Switches	Variable Condensers	Phone Plugs
Vario-Couplers	Rheostats	Potentiometers	Grid Leaks
	Inductance Switches	Sockets	

JOS. W. JONES

TRADE MARK

"IMPROVED"

radio parts

JOS. W. JONES RADIO MFG. CO. Inc. 40-42-44-46 W. 25th St., New York
(Formerly Radio Improvement Co.)

Headed by Jos. W. Jones—for 28 years a successful engineer and builder of precision instruments

Branch Offices

Philadelphia: 1011 Chestnut Street Boston: 99 Bedford Street



A Merry Xmas to Every Real Radio Fan!

Give them the key to perpetual satisfaction from their sets—an APCO Battery Charger that will fully charge radio batteries over-night without disconnecting a wire. Easy hook-up to ordinary lamp socket, self-polarizing, extremely quiet.

APCO "A" Charger, 7½ ampere capacity, \$18.50. For those who have storage "B" batteries, there is the APCO "B" Charger at \$10.00

At your dealer's in attractive gift boxes

APCO MANUFACTURING CO.
Providence, R. I.

APCO

BATTERY CHARGERS

FOR "A" OR "B" BATTERIES



Make it a
RADIO
X'mas!
with a
MICHIGAN
FOUR
\$150

Michigan "de Luxe" 4 tube receiver. 1 stage R.F. amplification. Built-in adjustable loud speaker. Solid mahogany case. "America's most beautiful set." MRC4, \$150

RIGHT now, settle the question of Christmas presents. Buy a Michigan Radio receiving set.

You get more real value and satisfaction from these receivers than any others, regardless of what you pay.

Distance—with greater selectivity and simplicity of operation.

Reliability—with logging and unusual tone qualities.

And each model enclosed in a cabinet designed and made by the world's best furniture craftsmen.

Models in two, three and four tubes. Styles from \$32.50 up.

Send for illustrated folder. Ask your dealer for a demonstration.

Licensed under U. S. Patent, 1,113,149-letters pending 807,388

MICHIGAN RADIO CORPORATION

33 Pearl Street

Grand Rapids, Mich.

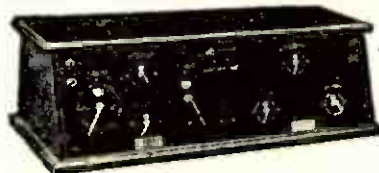

3 tube Regenerative Detector and 2 stages of amplification. The set we never could catch up on orders for last year. MRC12, \$57.00

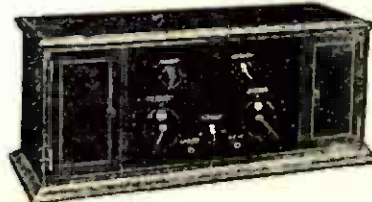

3 tubes in handsome case with inlaid panel doors and compartments for batteries, headphones, etc. MRC3, \$87.50



Michigan "Midget" 2 tube regenerative long distance wonder. MRC2, \$32.50

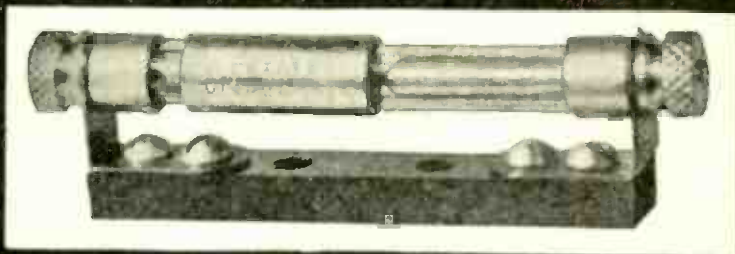

The Season's Greetings

More Power to 1925 Radio!

Here's to a wave of prosperity in tune with the waves of the ether! For regal radio is doing its part to bring cheer and happiness to all.

To the radio owner there is the satisfaction of being able to obtain better equipment than ever before—the selection of parts and devices which harmonize with the working efficiency of the set—securing radio accessories that insure accuracy of work and which lend ease and simplicity to the owner's duties.

It has been the privilege and pleasure of "Reliable" to offer a helping hand in this direction. These parts and devices assure success:

Reliable Micro Air Condenser

This device is absolutely unique. It has its imitations but not its duplications. It neutralizes with extreme ease and security. One simply moves the sliding sleeve to the point of precise balance, and then with a simple revolving motion locks the sleeve in place. Result: sharper tuning—less howl—complete balancing of circuit. This device formerly cost \$1.00. Now reduced to 60c mounted on base.

brings out the sound notes from far distant stations as softly and clearly as if listening to local stations. Distortion conspicuous by its absence. Positively eliminates leakage of magnetic flux and confines eddy currents. Price \$5.00 and \$4.50, depending on ratio.

Reliable Tuned Radio Frequency Transformer

(Air Core Type)

For absolute accuracy of coil windings, the radio fan now has accessible radio transformers upon which he can depend. Less balancing of set is necessary because each primary winding is precisely like the primary winding of its companion radio transformer; each secondary winding absolutely uniform. Windings are on highest grade Spaulding Duresto Bakelite. High lustre finish—a beautiful addition to your set. Sold in sets of three. Price \$6.00 per set.

Reliable Radio Battery Filler

In about one-third the time you've been taking to fill those pesky battery cells with water, you can keep your battery from getting thirsty by using this handy filler. And, you do it without spilling, slopping or "runovers." Both "A" and "B" wet batteries handled with ease. Holds a half gallon of distilled water. Price \$1.50.

Reliable Audio Frequency Transformer

Here is a rare achievement in the field of audio frequency amplification. This device



The Reliable Parts Mfg. Co.

2819 Prospect Ave.,
Cleveland, O.

RELIABLE Radio Devices



All apparatus advertised in this magazine has been tested and approved by POPULAR RADIO LABORATORY

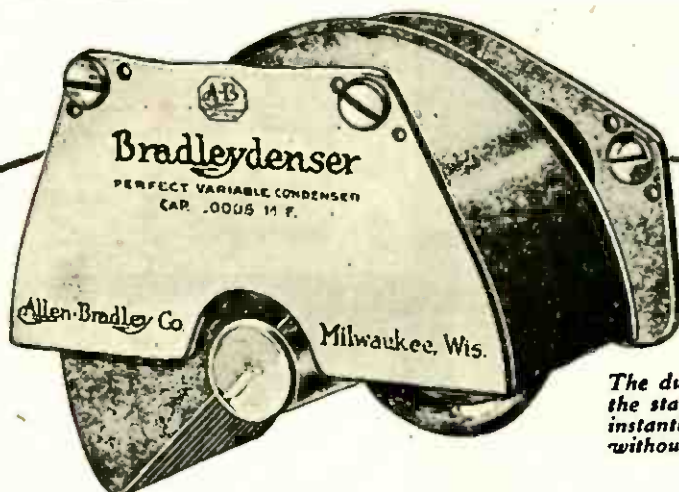

The dust cap over the stator plates is instantly removable without tools.

A Low-Loss Condenser for Selective Receivers

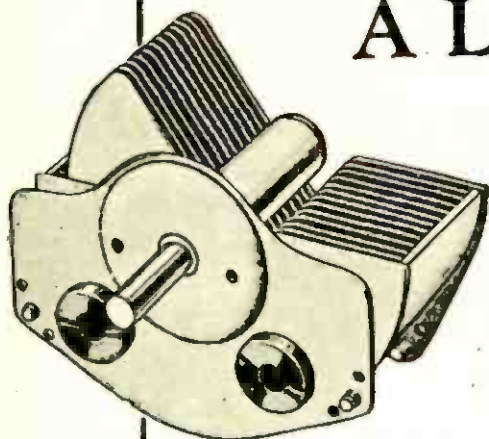

All plates are solid brass, carefully soldered at all joints. The Bradleydenser resistance does not increase, even after long use.

Standard Ratings and Prices

0.00025 M-F.	\$4.50
0.0005 M-F.	5.00
0.001 M-F.	6.00

The Bradleydenser has no vernier plates. The shaft is $\frac{1}{4}$ -in. to fit any standard dial.

THE New Bradleydenser embodies many new and important features that contribute to its high efficiency and low loss. One of the most significant innovations is the omission of the outer end-plate and the substitution of a unique bearing that maintains rigid alignment of the rotor plates without the use of unnecessary insulating or di-electric end-plates. There is almost no di-electric material in the Bradleydenser to absorb energy from the antenna oscillations.

The minimum capacity also is low, affording a wide range of control. This is an important advantage in sets to be operated from loops.

We shall be glad to send you complete information about the Bradleydenser. Drop us a line, to-day!

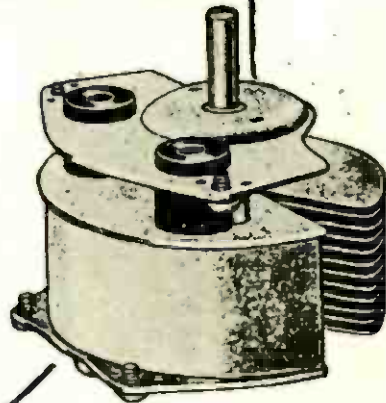

Notice the amazing reduction of insulating material to two small spacers. The di-electric loss is, therefore, very low.

Allen-Bradley Co.
Electric Controlling Apparatus

276 Greenfield Avenue
Milwaukee, Wisconsin

Sales Offices

Baltimore	Knoxville
Birmingham	Los Angeles
Boston	New York
Buffalo	Philadelphia
Chicago	Pittsburgh
Cincinnati	Saint Louis
Cleveland	Saint Paul
Denver	San Francisco
Detroit	Seattle



Another Allen-Bradley Radio Device of the same perfection and quality as the Universal Bradleystat

All apparatus advertised in this magazine has been tested and approved by POPULAR RADIO LABORATORY

3 BIG THINGS that this WINDING

does to improve Reception

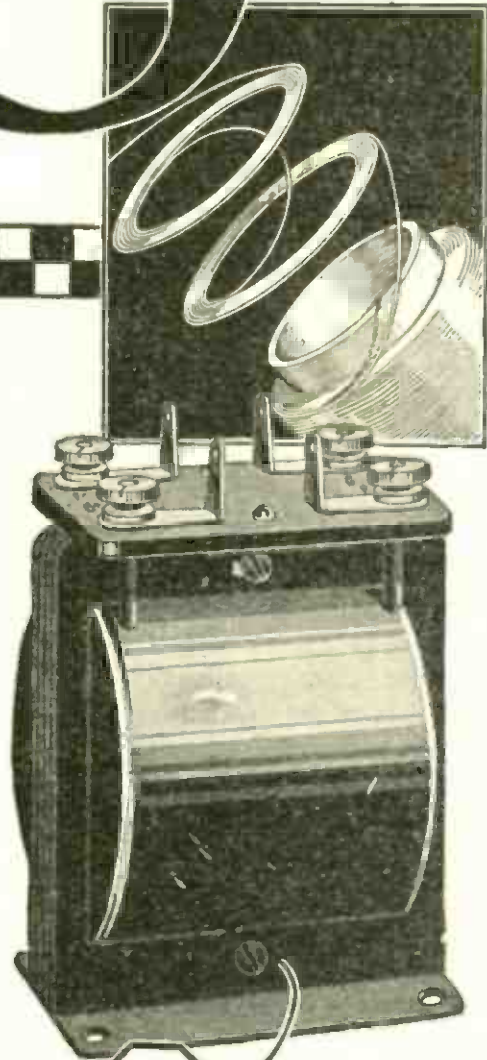

ALL transformers are alike *except* SAMSON'S. For SAMSON'S are the *only* transformers with Helical Wound Coils—with the wire wound in discs which are laid at right angles to the coil. No paper insulation is needed or used. Helical Winding gives SAMSON Transformers three big advantages:

- (1) **Maximum Amplification:** SAMSON transformers have, by scientific tests, an amplifying efficiency of 51, which is reached at lower frequency than, in any other transformer.
- (2) **Minimum Distortion:** The Helical Winding practically eliminates distortion throughout entire audio range.
- (3) **Minimum Distributed Capacity Effect:** Adjacent turns of wire in SAMSON Helical Windings are but 80 turns apart instead of 800 to 1200 or more as in others. This reduces distributed capacity, or electrical resistance, to an absolute minimum.

H.W.
stands for
HELICAL
WINDING

Samson Helical Wound Transformers

Examine SAMSON Helical Wound Transformers at your radio dealer. Test them. Use them in the set you are building; or replace transformers in the set you now have. Insist on your dealer showing you SAMSON HW Transformers.

SAMSON ELECTRIC CO.
CANTON, MASS.

Sales Representatives in Larger Cities

At Right: SAMSON HW-R1 Transformers for Super-Heterodyne circuits are perfectly matched.

NOW
\$5.00

Two Ratios
3 to 1
6 to 1

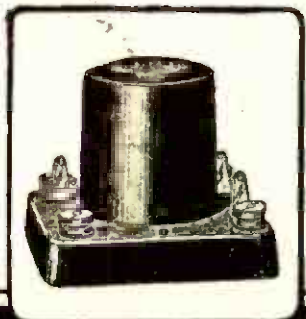

Dear Mr. Martin:

“ . . . I am anxious for you to have a good loud speaker so that the reproduction of the music will be at its best for you, so that you, as a music critic, will not be disgusted with radio music. Last week I got a Thorola from the Reichmann Company of Chicago and I am so struck with this speaker that I am writing this, my first letter of endorsement of a radio part.”

(Signed) L. A. NIXON

General Manager, THE RADIO DEALER

Thorola demand outpaces distribution. If your dealer is not stocked, we ship any model direct upon receipt of price listed.

THOROLA 4 . . . \$25

THOROPHONE
Powerplus Speaker . \$45

THOROLA 6
Phonograph Attachment \$15

THOROLA 9
Cabinet Loud Speaker \$40

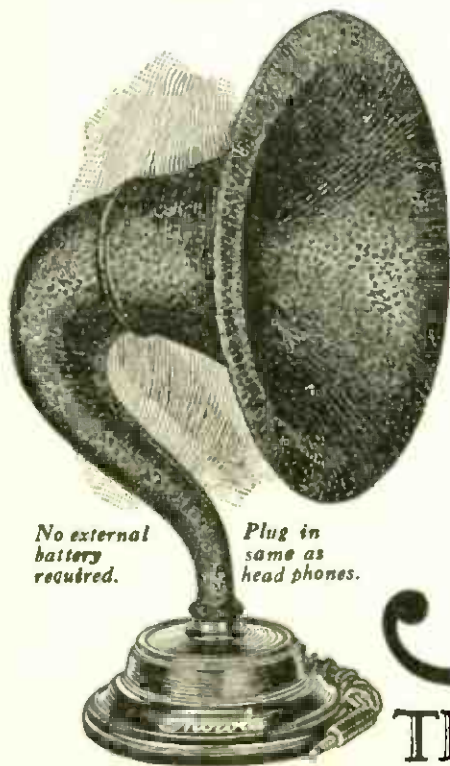

No external battery required.

Plug in same as head phones.

MR. MARTIN of the New York World is not the first music critic Thorola loud speaker has challenged in radio's behalf. Thorola raises radio beyond comparison with mere reproduced music. Thorola renders *music itself*, just as surely as instruments before the microphone. Artists pronounce Thorola "the pipe organ of loud speakers" for its matchless combination of purest tone and greatest volume, made possible only by exclusive Thorola betterments.

The Thorola Controlled Mica Diaphragm embodies the most advanced acoustic principles ever applied to a radio reproducer. The Thorola Separix literally assort vibrations, preserving the tonal blends and shades vital to real music. Thorite horn compound, itself a supreme achievement, ends "sound interference" by the horn. And the Thorola Synchronizer perfectly balances Thorola in your set, just as every other circuit factor must be balanced for perfect reception.

Expect new stations pure and strong, from superior Thorola amplifying efficiency. Bring in only the original music, speech or entertainment with Thorola acoustic improvements. Thorola is powerfully guaranteed to fulfill every claim by America's pioneer loud speaker manufacturer.

REICHMANN CO., 1729-35 W. 74th St., Chicago

Thorola

THE SPEAKING LIKENESS

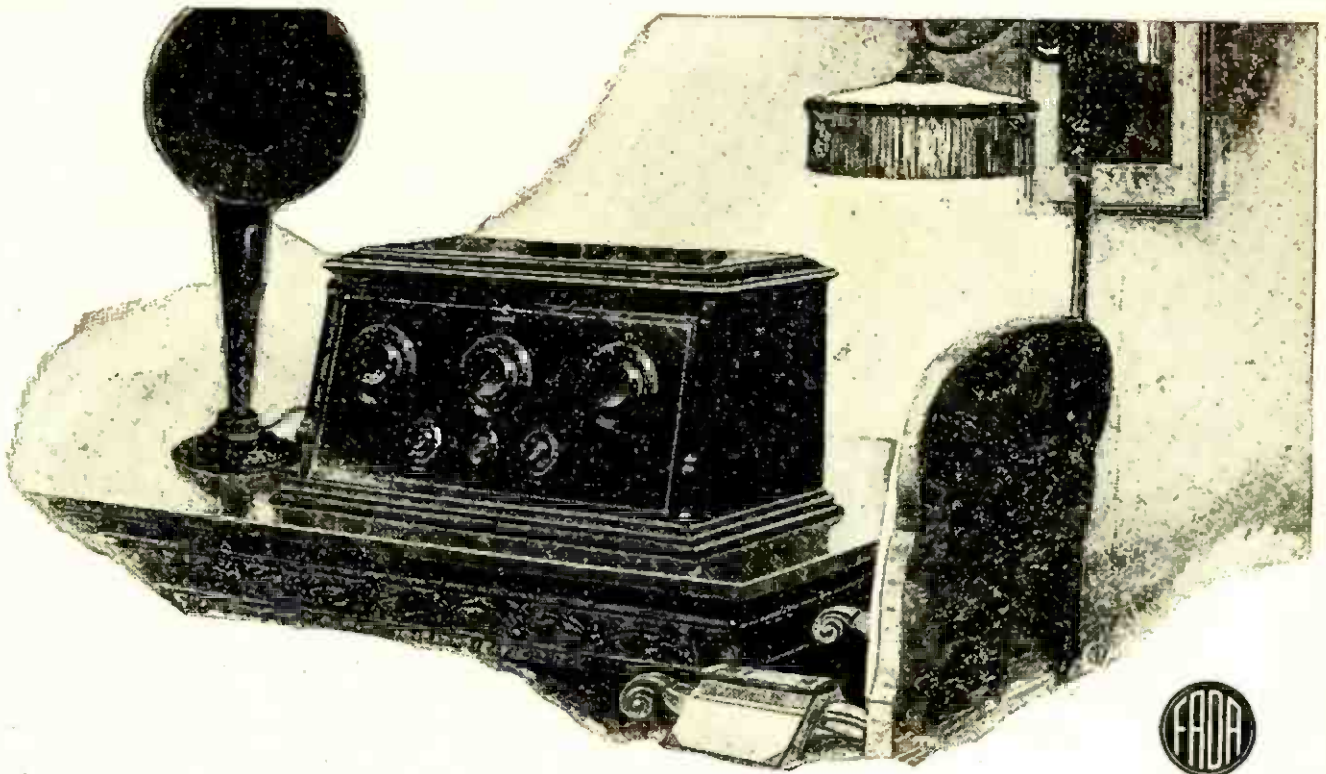

The FADA Neutroceiver will surpass anything you have expected of a radio receiver

VOLUME? The FADA Neutroceiver will give you all the controlled volume you can possibly desire. Designed to use powerful tubes and operate on either indoor or outdoor antenna, it is guaranteed to give powerful results.

Clarity? This wonderful, five-tube Neutrodyne offers you a tone quality which is unexcelled. It reproduces every tone of the human voice and of every musical instrument with lifelike fidelity.

Selectivity? Separates stations, tunes through powerful local broadcasting and brings in distant concerts—even when their wave lengths are but a few meters apart.

Simplicity of control? Anyone, without exper-

ience, can operate the Neutroceiver. You can turn your dials to previously located stations and bring them back night after night.

Beauty? As a piece of art-furniture, the FADA Neutroceiver is a masterpiece. The cabinet is solid mahogany, with the panel perfectly balanced and sloped gently to facilitate easy tuning.

Supplementing the FADA Neutroceiver and making a complete FADA line, are five other Neutrodyne receivers—three, four and five tube sets—in plain as well as aircraft cabinets. You have a price range from \$75 to \$295 from which to select. Each model extraordinary in results; each a remarkable value. See your dealer.

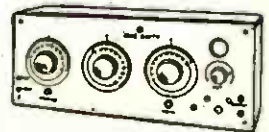

FADA "One Sixty"
No. 160-A

"The receiver that has taken the country by storm." The best known of all Neutrodyne. Four tubes. Price (less tubes, batteries, etc.) \$120.

FADA Neutrola Grand
No. 185/90-A

The five-tube Neutrola 185-A, mounted on FADA Cabinet Table No. 190-A. Price (less tubes, batteries, etc.) \$295.

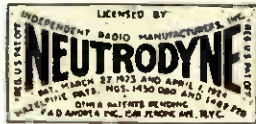
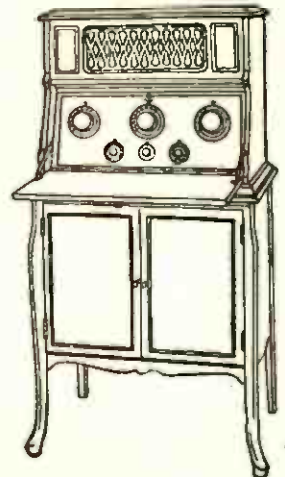

F. A. D. ANDREA, INC., 1581 JEROME AVENUE, NEW YORK

FADA Radio

All apparatus advertised in this magazine has been tested and approved by POPULAR RADIO LABORATORY

Christmas

---and the whole
world is young again

THE Air is a-quiver, the Ether crowded,
with the Yule-tide Music. The carols,
the simple songs, that carry us back to a
rose-tinted childhood are beating beat-
ing beating their soundless tattoos
at our Hearth-Stones.

Radio is the Magic-Key that translates it
all into vibrant glorious sound.

Only a Scrooge, untouched by the Christ-
mas Spirit, will leave the Key unturned.

Of course, for the utmost in Radio
enchantment, you will equip your
set with tubes of the rarest scientific
accuracy—

Quality Plus
Service
Since 1915

Cunningham

RADIO TUBES

PATENT NOTICE: Cunningham tubes are covered by patents dated 2-18-08, 2-18-12, 12-30-13, 10-23-17, 10-23-17, and others issued and pending. Licensed only for amateur experimental and entertainment use in radio communication. Any other use will be an infringement. Cunningham 40-page data book fully explaining care and operation of Radio Tubes now available by sending 10c in stamps to San Francisco Office.

Price the same
on all five
types—

C-301A
C-299
C-300
C-11, C-12

E. J. Cunningham Inc.

CHICAGO

Home Office
182 SECOND ST., SAN FRANCISCO

NEW YORK



All apparatus advertised in this magazine has been tested and approved by POPULAR RADIO LABORATORY

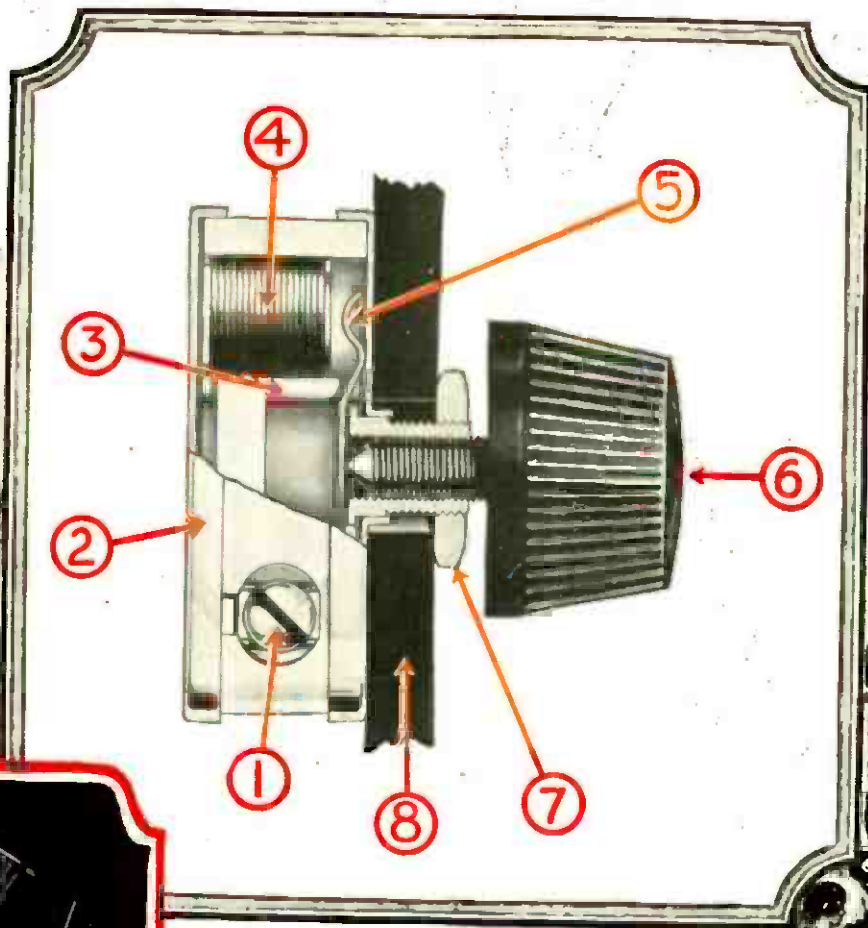

The *New* Bradleystat

Supreme in design and performance

Important Features

- 1 Two terminals suffice for ALL tubes.
- 2 Back panel extension is 11/16-inch.
- 3 Holes for table mounting are provided.
- 4 Graphite discs give stepless, noiseless control.
- 5 Internal switch opens battery circuit.
- 6 One knob provides control from 1/4 to 100 ohms.
- 7 One locknut holds Bradleystat securely in position.
- 8 Drill only one hole in panel.



ASIDE from the novel "one-hole mounting" that characterizes the Allen-Bradley line of radio devices, the most striking new feature is the extreme compactness of the graphite disc container. When mounted on the panel, the new Bradleystat extends less than three-quarters of an inch behind the panel. The same is true of the Bradleyleak and the Bradleyohm. And the Bradleyometer extends only seven-eighths of an inch.

You can improve your radio set immensely by substituting a Bradleystat for your present wire rheostat or a Bradleyleak for your old grid leak. There's plenty of room. Try it!

Allen-Bradley Co.

Electric Controlling Apparatus
276 Greenfield Avenue
Milwaukee, Wisconsin

Baltimore	Buffalo	Cleveland	Knoxville	Philadelphia	Saint Paul
Birmingham	Chicago	Denver	Los Angeles	Pittsburgh	San Francisco
Boston	Cincinnati	Detroit	New York	Saint Louis	Seattle

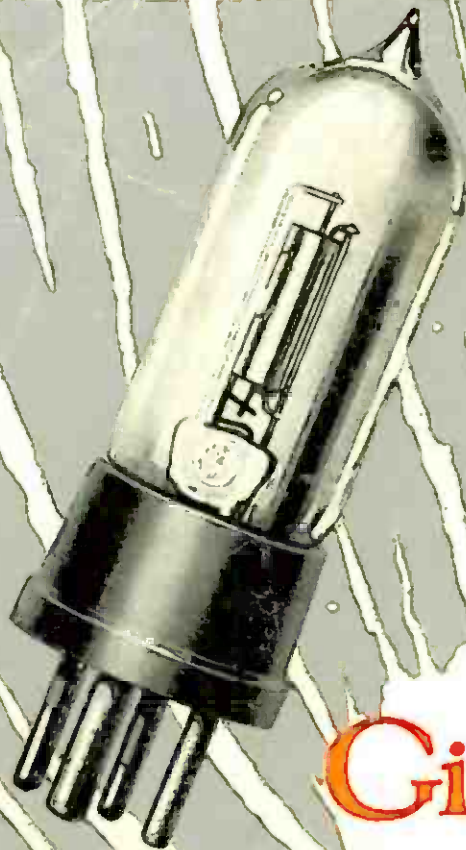

Radiotron WD-11
The ideal
dry cell tube.



Give Radiotrons for Christmas

Take a peek into any radio fan's set— and you know what to give him for Christmas. Note the type of Radiotron he uses. Go to any radio store—and when you buy, look for the name RADIOTRON and the RCA mark. Then you are sure to be giving him genuine Radiotrons. And mighty sure to be giving him the gift for a merry Christmas.



This symbol of
quality is your
protection

It isn't a genuine WD-11
unless it's a Radiotron.
It isn't a genuine WD-12
unless it's a Radiotron.
It isn't a genuine UV-199
unless it's a Radiotron.
It isn't a genuine UV-200
unless it's a Radiotron.
It isn't a genuine UV-201-a
unless it's a Radiotron.

Radio Corporation of America
Sales Offices

233 Broadway, New York

10 So. La Salle St., Chicago, Ill.

28 Geary St., San Francisco, Cal.

Radiotron

REG. U. S. PAT. OFF.