

Popular Radio

Edited by **KENDALL BANNING**

· FEBRUARY ·
1 9 2 4



In this Number—
**How to Build
a Three-Tube
Reflex Receiver**



Today's Cinderella needs no fairy godmother. She calls up Prince Charming and together they waltz at her Radio Dance, while out of the air, over her C & W Receiver, comes the rhythmic swing of Schubert melodies, Strauss waltzes, fascinating modern two-steps, played by the nations best orchestras.

Get the *Best* Program with a C & W Receiver

Tested with other broadcast receivers — on the same antenna — listening to the same stations, Model 11-B, the Cutting & Washington Receiver illustrated above, proved to give greater volume from the desired station, with less interference from all other stations.

Highly selective, a 3-tube, double-circuit regenerative receiver, with remarkably long range and clear reception. Uses dry cell A-battery; 3-UV 199 tubes; special sharp tuning C & W Circuit, shock absorbing tube mounts, automatic rheostat switches, shielded panel. Leader of the C & W Line, the set that will get your station if the station is to be had. Price complete, ready to operate, \$160.

Compare — then choose. Ask for a demonstration by the nearest C & W Dealer



Dealers—Distributors: Write at once for details of the Cutting & Washington Selling Plan—a real opportunity in Radio.

Cutting & Washington Radio Corporation
Minneapolis :: :: :: Minnesota

Cutting and Washington

Brandes



GRANDMA'S happy now! Her busy fingers and tired eyes enjoy their well-earned rest. She's busy without working. Time doesn't drag. Long hours are lightened by the world of entertainment and fun brought to her by radio. A new interest fills her life!

C. BRANDES, Inc. NEW YORK

Matched Tone TRADE MARK REG. U.S. PAT. OFF. Radio Headsets

©C. Brandes, Inc., 1924

Please refer to POPULAR RADIO when answering advertisements.

POPULAR RADIO

EDITED by KENDALL BANNING



CONTENTS for FEBRUARY, 1924

(Cover design by Frank B. Masters)

VOLUME V

NUMBER 2

Radio Enters Congress.....	FRONTISPIECE
The Coming Kingdom of the Ether.....	<i>A. M. Low</i>Page 111
How to Use the Dry-cell Tubes as Amplifiers.....	<i>Frank A. Hinners</i> 120
How I Learned to Build My Radio Sets without My Eyes.....	<i>Leroy Hughbanks</i> 126
Practical Pointers for Eliminating Interference in Long Distance Reception.....	<i>Zeh Bouck</i> 130
How to Make a Battery-charging Panel.....	<i>E. J. Quinby</i> 136
100 Best Hook-ups.....	<i>The Technical Editor</i> 141
Installment No. 4	
Teaching School by Radio.....	<i>Fred Siegel</i> 146
How to Use the Four-circuit Tuner as a Portable Set.....	<i>O. B. Parker</i> 152
Capacity Calculations—and Their Application to the Antenna.....	<i>Oliver Lodge</i> 155
Article No. 7	
Practical Hints About Insulation.....	<i>Raymond F. Yates</i> 160
How to Improve the Three-tube Four-circuit Tuner.....	<i>Laurence M. Cockaday</i> ... 164
How to Build a Three-tube Reflex Receiver.....	<i>Walter A. Remy</i> 167
Part I	
A Tube without a Filament.....	<i>Julian K. Henney</i> 177
Across the Atlantic on 100 Meters.....	<i>Leon Deloy</i> 183

DEPARTMENTS

Listening In.....	186
Hints for Amateurs.....	189
Broadcasts.....	191
What Readers Ask.....	196
In the World's Laboratories.....	202
Facts You Hunt For.....	210
Stations I Have Heard.....	212

VOLUME V

FEBRUARY, 1924

NUMBER 2

Published monthly by Popular Radio, Inc., 9 East 40th Street, New York, N. Y., telephone number Vanderbilt 9985; H. B. Emerson, President; Douglas H. Cooke, Vice-President; Kendall Banning, Treasurer. Price, 25 cents a copy; subscription \$3.00 a year in the U. S., Canada and all countries within the domestic postal zone; elsewhere \$3.50 a year, payable in advance. The International News Company, Ltd., No. 5 Bream's Bldg., London, E. C. 4, sole distributors in England. Entered as second class matter April 7, 1922, at the Post Office at New York, N. Y., under the act of March 3, 1879. Copyright, 1924, and title registered as a trade-mark by Popular Radio, Inc. Copyright in Great Britain by Popular Radio, Inc., 6 Henrietta St., Covent Garden, W. C., London, England. Printed in U. S. A.

E. E. FREE, Ph.D., *Contributing Editor* LAURENCE M. COCKADAY, R.E., *Technical Editor*

For advertising rates address E. R. Crowe & Co.
New York: 9 East 40th St. Chicago: 225 North Michigan Ave.



"The coming of a friend from a far-off land - is this not true joy?" Confucius -

Your friends of radio come to you each night through
The **GREBE**

Broadcast Receiver

Doctor *My.*

THE GREBE CR-12 Broadcast Receiver is a highly efficient Radio Instrument employing both Regeneration and Tuned Radio Frequency Amplification with only two tuning adjustments.

A Dial graduated in wavelengths enables you to locate the program you desire instantly.

Compartments are provided for all necessary batteries in the attractively finished walnut cabinet.

Requiring no cumbersome storage battery nor unsightly wires, this Instrument will grace your library or living room.

Write for "GREBE Radio in the Well-appointed Home"

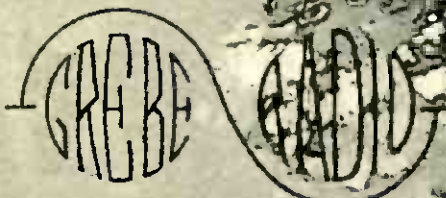

A. H. GREBE & COMPANY, Inc.
Richmond Hill, N.Y.

Western Branch, 451 East 3rd St., Los Angeles, Cal.

Licensed under Armstrong
U. S. Pat. No. 1,113,149

Type CR-12

PAGES WITH THE EDITOR

On the bulletin board of the advertising department the Editor has just read a notice that is so completely in accord with his own policy of guarding the interests of our readers that he is printing it in full below. It not only furnishes impressive evidence of the truth of this magazine's oft-repeated assertion that "*the editorial pages of POPULAR RADIO are not for sale,*" but goes even a step further; it proclaims that even the *advertising pages of POPULAR RADIO* are not for sale—unless the buyer meets the prescribed standards!

* * *

Here is the notice in full:

"LAST week alone we refused orders for 16 pages of non-radio advertising. Our advertising pages must remain as all-radio as the editorial pages.

"We refuse, monthly, from 5 to 10 pages of cut-rate-house advertising—and advertising from houses that tend to sell imperfect goods or that substitute inferior brands.

"We extend no credit to the slow-pay advertiser. This costs us, monthly, at least 5 pages of advertising from fly-by-night concerns.

* * *

"I EXPECT to secure for POPULAR RADIO within another year, an average of at least 150 pages of advertising a month and I expect to secure this volume by virtue of a courageous enforcement of three major policies;

"1st—*Unquestioned editorial integrity.* No advertiser can buy any mention of his goods in our editorial columns.

"2nd—*A reasonable advertising rate,* based on a circulation guarantee.

"3rd—*The protection of our advertisers as well as our readers* against the unfair competition of

- (a) Non-radio advertisers
- (b) Cut-rate houses
- (c) Fly-by-nights."

* * *

FROM Boston, the traditional if disputed center of culture in the United States, comes an official order from the director of the Department of Education for the renewal of the Department's subscription to POPULAR RADIO. The growing use of POPULAR RADIO in our schools and colleges furnishes gratifying evidence of the high standing that this magazine enjoys in scientific circles.

* * *

HERE is a rare chance for an experienced radio amateur with a soul for adventure—a chance that comes from a thoroughly responsible source, too, that is personally known to the Editor:

Sometime in September, 1924, a small group of scientists, photographers and adventurers (including one radio operator who is yet to be selected) will set sail from New York in a 150-foot, two-masted schooner with auxiliary engines, for a four years' cruise to the West

Indies, South America, Africa, the Mediterranean, India, China, Japan and other points, east, west, north and south.

* * *

"DON'T you know of some good young radio amateur who would like to join us and operate our radio apparatus for us? Someone who would take the trip for just pocket-money of about \$10 a week?" the leader of the expedition asked the Editor.

* * *

THE Editor cannot undertake to answer the flood of inquiries that this call for volunteers will bring in. But he *will* see that all letters addressed "The Leader of the Expedition," care of POPULAR RADIO, will be delivered to the right person.

* * *

THE demand for some of the back numbers of POPULAR RADIO, particularly for the January, 1923, number that contains Mr. Cockaday's now famous article, "How to Build a Real DX Regenerative Receiver," and for the May, 1923, number that contains his even more popular article, "How to Build the New Four-circuit Tuner," has been so widespread that these two issues went out of print within a few days. In order to accommodate our readers, however, we have had special re-prints made of these two articles; copies may be obtained for 22 cents each upon application to our Subscription Manager.

* * *

"I HAVE been a reader of your wonderful magazine beginning with your first issue and I have followed its marvelous advance. I sincerely think that POPULAR RADIO is the best magazine for the radio fan."

—A. C. CORNWALL

* * *

"CONGRATULATIONS on the chaste simplicity of your recent covers," writes Charles W. Goddard, the well-known dramatist—and perhaps the first dramatist to use radio in a play, as far back as 1906. "Whoever thought of such daring subjects—life-size productions of a piece of wire with a knot in it? Here are some suggestions for more covers equally simple:

- "1. A small rubber band
- "2. A toothpick
- "3. A baked bean
- "4. A match
- "5. A pin"

Well, at least our covers offer more variety than—constitute a departure from—the conventional pretty-girl covers!

* * *

THE silver covers that make POPULAR RADIO so distinctive in appearance (so far as the Editor knows, this magazine was the first to adopt a metal-tone cover as a standard) have proven so unusually successful that other peri-

(Continued on page 6)

*They differ in
size but not
in efficiency*

The photograph at the right illustrates the special service transformer installed at the Radio Central, Rocky Point, L. I., for talking across the ocean.

The photograph in the lower left-hand corner illustrates The AmerTran, an audio frequency transformer designed for the receiving sets of amateur and professional alike.

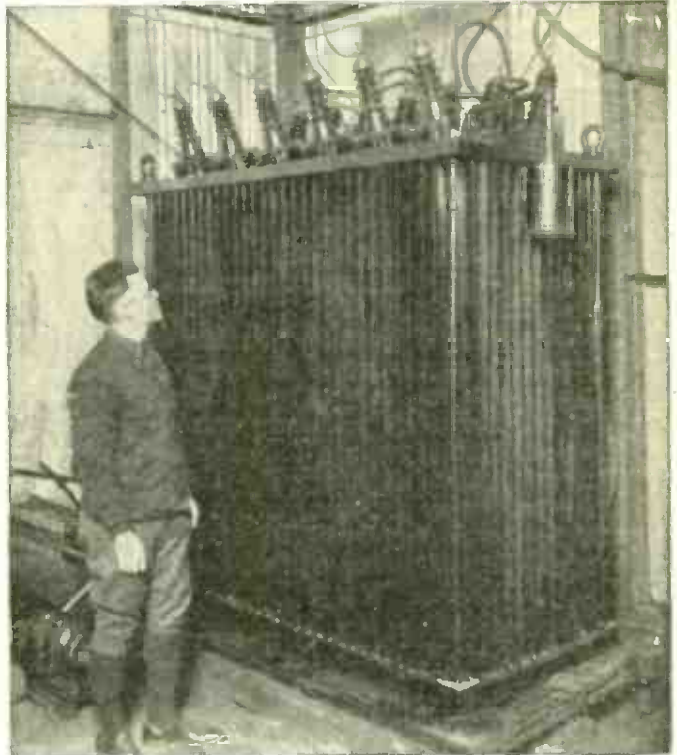

By Courtesy of Western Electric Co.

300 k.v.a., 60 cycle, 3-phase, 22,000 volt, oil-cooled special service transformer. Radio Central, Rocky Point, L. I.

—With all tubes—

AMERTRAN

TRADE MARK REG. U.S. PAT. OFF.

—In all stages—

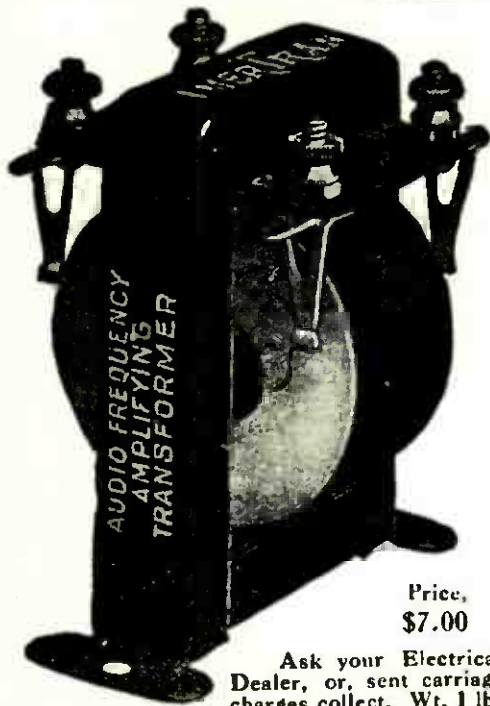

Price,
\$7.00

Ask your Electrical Dealer, or, sent carriage charges collect. Wt. 1 lb.

Each is the result of a long and varied experience in transformer design. Each represents the highest degree of radio engineering knowledge and craftsmanship.

In designing The AmerTran, the first consideration was tone quality; the second consideration, amplification. Its flat-top distortionless amplification curve assures faithful reproduction of speech and of music over the full musical scale. In one stage audibility is increased 30 to 40 times in the flat part of the curve, depending on the tube constant—the amplification is approximately 5 times the tube constant.

Type AF-6: turn ratio, 5:1

Send for Circular No. 1005

American Transformer Company

Designers and builders of radio transformers for over 22 years

175 Emmet Street :: Newark, N. J.

PAGES WITH THE EDITOR

(Continued from page 4)

odicals are following in the trail. Gold, copper and bronze covers are now beginning to peek out on the newsstands—but POPULAR RADIO still stands alone with its "sterling" standard.

* * *

FROM Earl K. Nixon of Ironwood, Michigan, comes this commentary that pigeonholes POPULAR RADIO in a niche all of its very own, and which at the same time classifies it with the world's best:

"As a subscriber and booster for POPULAR RADIO I wish to congratulate you and your management on the splendid development of your magazine as a disseminator of 'what a radio enthusiast wants to know! I consider your publication as occupying the same position in its particular province as do the *New York Times*, the *Review of Reviews*, the *National Geographic* and others of that caliber in theirs."

* * *

WHAT poet was it who sang of the "dreamy, heavy-lidded Southland"? Twice within the past week our Technical Editor has received long-distance telephone calls from eager and impatient radio fans down in Dixie who could not wait for letters to reach us; the latest call comes from B. F. Wilson of Thoebus, Virginia.

* * *

IF this practice spreads the Technical Editor will plumb have to do his work in seclusion!

* * *

No letters that come to the Editor from our readers give greater power to the editorial arm than those that endorse this magazine's policy of maintaining an absolute divorce between the advertising pages and the editorial pages—a policy that has been insistently maintained from the very beginning, and which will be maintained without fear or favor. The Editor believes that to guard the integrity of the editorial pages is a matter of fundamental importance. He believes such a policy is necessary if the readers are to be protected from endorsements and opinions that are paid for by commercial interests. More, he believes that such a policy is the only honest policy.

* * *

No advertiser or prospective advertiser has ever caused the Editor to either insert or omit from the reading pages of this magazine a single word of text or a single picture. Our principles and our opinions cannot be bought or sold.

* * *

"THE editorial pages of POPULAR RADIO are not for sale."

* * *

AND out of the mail bag the Editor again picks at random one of the scores of letters that reflects the effect of this policy upon our readers; it comes from Jack Gaerity of North Branch, Minnesota:

"The reading of your personal remarks in your most excellent magazine makes me feel as though I knew you personally, as though

you were an old friend. I want to compliment you on the high standard of your editorial policy, and to say that I think your magazine the best radio publication in America."

* * *

TWENTY months ago POPULAR RADIO was a little pamphlet of 72 pages. The issue that you hold in your hand contains 228 pages—a growth of 315 percent! One of our subscribers, Harry E. Pratt, principal of the Albany (N. Y.) High School, who has been watching this unusual growth, something more than hints at the reason for it when he writes:

"I have just been comparing your first issue with the November number. Some progress! The reason is obvious. POPULAR RADIO is justifying its name. Congratulations and good wishes!"

* * *

"YOUR magazine makes amateurs like myself feel that we are listening in on real stuff," writes R. L. Hilton of Waterville, Maine. And to prove that he is willing to back his convictions, he encloses a year's subscription.

* * *

So many readers of POPULAR RADIO have written in for extra copies of back issues that contain the famous "How to Build" articles that three issues of the magazine are now entirely out of print. In order to accommodate our friends, however, two of the much-demanded articles have been reprinted in pamphlet form. And now these reprints are going out of print!

* * *

THERE seemed to be only one logical solution to this problem of supplying reprints of these articles—to publish them in book form. And that is what POPULAR RADIO is doing.

* * *

THE seven most remarkable and most efficient sets of their kind that have been described in the pages of this magazine—ranging from the improved crystal receiver up to the new and improved four-circuit tuner and the new regenerative super-heterodyne receiver—are being published in a book that is now in the hands of the printer, *How to Build Your Radio Receiver*, edited by the Editor and by the Technical Editor of this magazine.

* * *

THE book will be ready shortly after the publication of this issue of POPULAR RADIO, and for a limited period only a copy will be presented free with a year's subscription to this magazine at the \$3.00 rate.

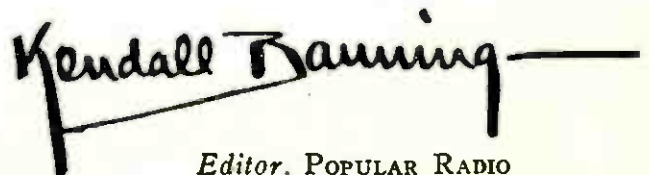

Editor, POPULAR RADIO

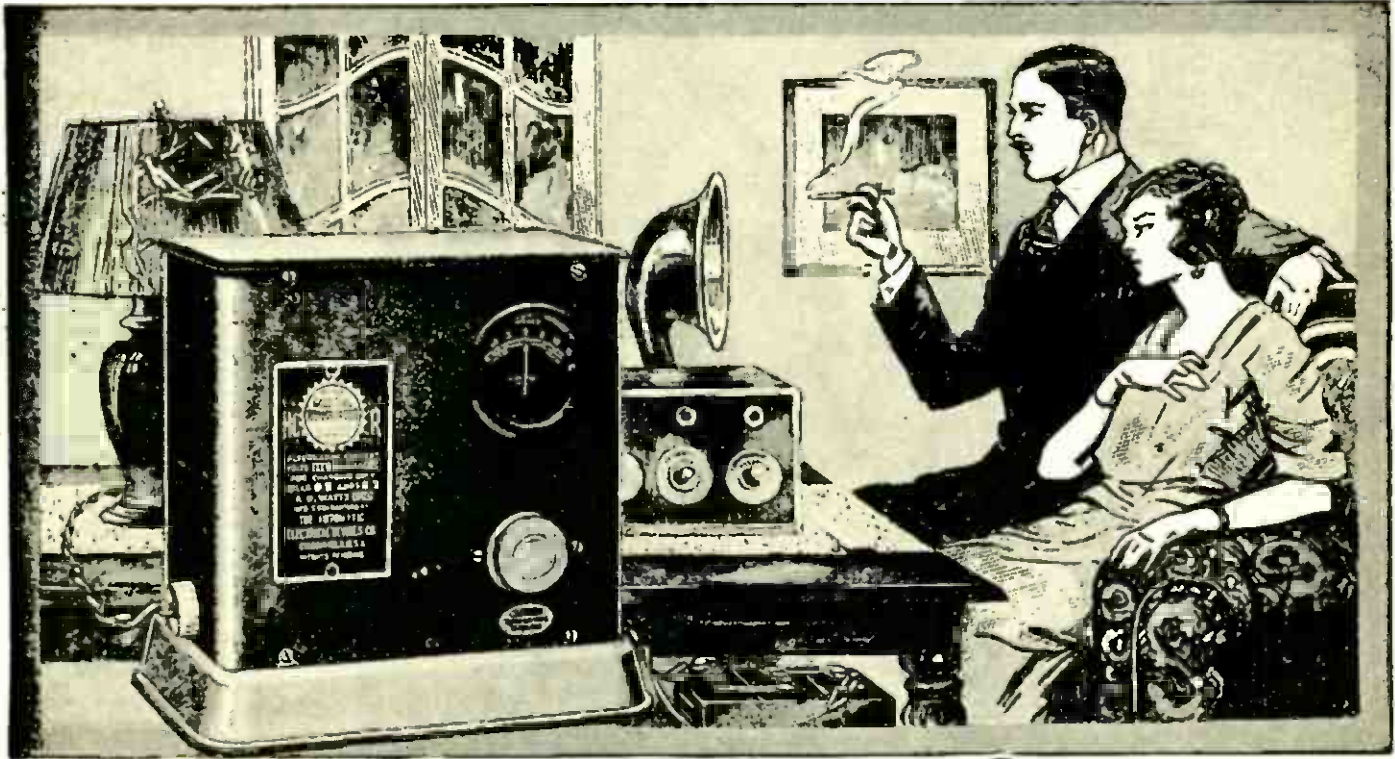

The hook-up that eliminates battery trouble

Some radio fans are still slaves to their batteries—lug them to service stations every time they need recharging—allow them to spoil many evenings' entertainment by running low.

Other fans—and they're quickly coming to be the vast majority—have found new economy and convenience in the GOLD SEAL HOMCHARGER, the world's best as well as its most popular rectifier. With it any radio or auto battery can be charged at home *overnight*—for a nickel. Simple, dependable, practically silent and absolutely safe. Beautifully finished in mahogany and gold. Approved by Underwriters. UNQUALIFIEDLY GUARANTEED. Over 150,000 now in use.

WHY PAY MORE—OR GET LESS?

Why buy a 2 or 3 ampere rectifier *without ammeter* requiring from 40 to 50 hours to charge your battery and costing twice as much to operate when, for the same price, you can secure the genuine 5-ampere GOLD SEAL HOM-

CHARGER which does a better job in one third the time and at half the cost. Fitted with high grade ammeter (eliminating guesswork) charging cable and battery clips—no extras to buy. For sale by all good dealers—\$18.50.

Insist on the GOLD SEAL

ACCEPT NO SUBSTITUTE. No other CHARGER is just as good. Insist on seeing our registered trade mark, the GOLD SEAL, on name plate and carton before purchasing.



RADIO FANS—ATTENTION!

FREE Ask your dealer for a free copy of the HOMCHARGER international list of broadcasting stations. Contains call letters, location, name and wave length of nearly every broadcasting station in the world.

DEALERS—JOBBER!

Prepare for the big HOMCHARGER year ahead by writing today for a copy of our elaborate merchandising plans. In it is illustrated many attractive sales helps that will enable you to get your share of this business.

The Automatic Electrical Devices Co., 132 West Third St., Cincinnati, O.

Largest Manufacturers of Vibrating Rectifiers in the World

GOLD SEAL HOMCHARGER

Please refer to POPULAR RADIO when answering advertisements.

Model X

**\$285 Fully Equipped With
Built-in Loud Speaker**

This radio receiving unit is a newly perfected development of the Kennedy Engineering Staff. It is unusual in that it combines extreme simplicity of operation with the same scientific accuracy and selectivity that characterized the earlier Kennedy models. After an initial setting is made only one dial is required for all tuning. And, when a dial setting of a station is once determined, that station will always "come in" at its own setting regardless of where the receiver is used.

It is stable in operation, reproduces music and voice with remarkable faithfulness and has established some unusual distance records. Responds to all broadcast wave-lengths—operates on any antennae, outside type preferred. "Re-radiation" has been practically eliminated.

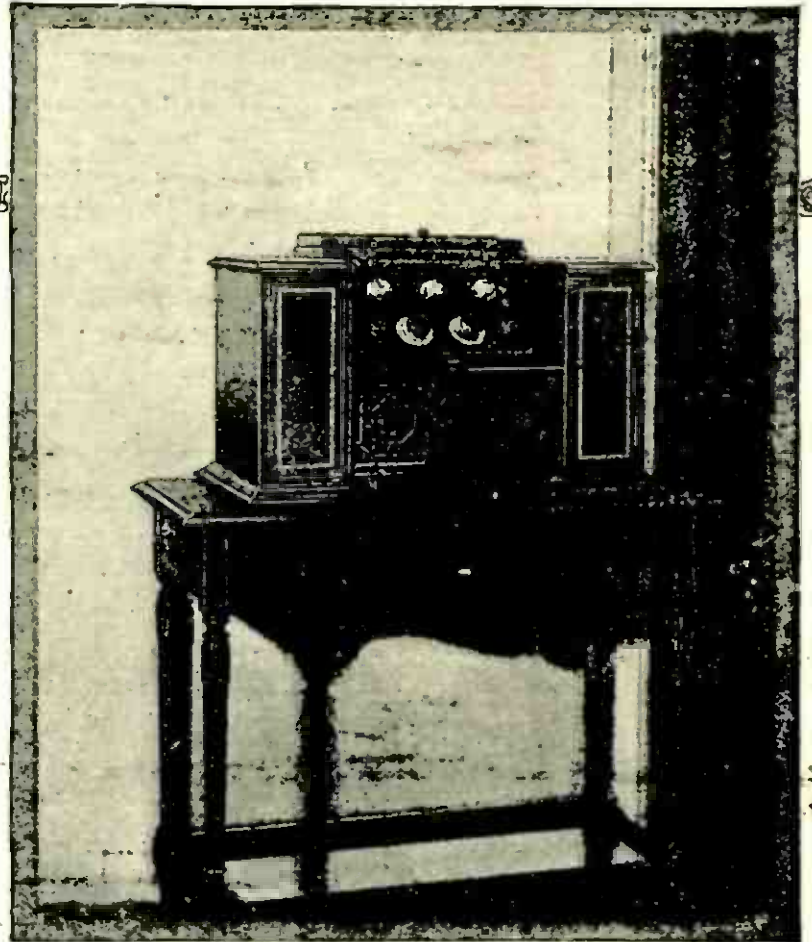

Beautiful Radio Furniture = the New Kennedy Receiver, Model X

As a graceful piece of furniture, the Kennedy Radio Receiver, Model X, makes a charming addition to any home. The cabinet is of mahogany, hand rubbed to a beautiful finish—with its delicate inlay of satinwood and ebony and the grill at the front, it is truly typical of the Sheraton design. A loud speaker of superior quality is built into the cabinet—by this means faithful reproduction of music and voice is available to an entire family or assembly of guests.

The control panel is symmetrically balanced and immediately indicates the remarkable ease with which the receiver may be operated—the angle at which it is set is the result of much study to provide greater comfort while tuning.

The receiving unit in Model X is every-

where recognized as one of the most noteworthy achievements in radio development—particularly since it sets a new standard of operating simplicity in combination with the precision and selectivity that have always been a feature of Kennedy radio receivers.

The price of Model X, completely equipped with all tubes, dry batteries, built-in loud speaker and individual Kennedy 3,000-ohm phones, with plug, is \$285.00. Other models range from \$125.00 to \$825.00, completely equipped.

Ask your dealer to show you the new Kennedy Radio, Model X, or write us direct for fully illustrated literature.

THE COLIN B. KENNEDY COMPANY
St. Louis San Francisco

All Kennedy receiving sets are regenerative.
Licensed under Armstrong U. S. Patent No. 1,113,149.

K E N N E D Y

The Royalty  of Radio



He Interprets Radio Messages from Atoms

By studying the electromagnetic waves sent out from hot atoms in the form of rays of light, Professor Niels Bohr of the University of Copenhagen, has discovered that the atoms of matter are really tiny solar systems each with suns and planets of its own. These marvelous new theories will be described in an early number of POPULAR RADIO.

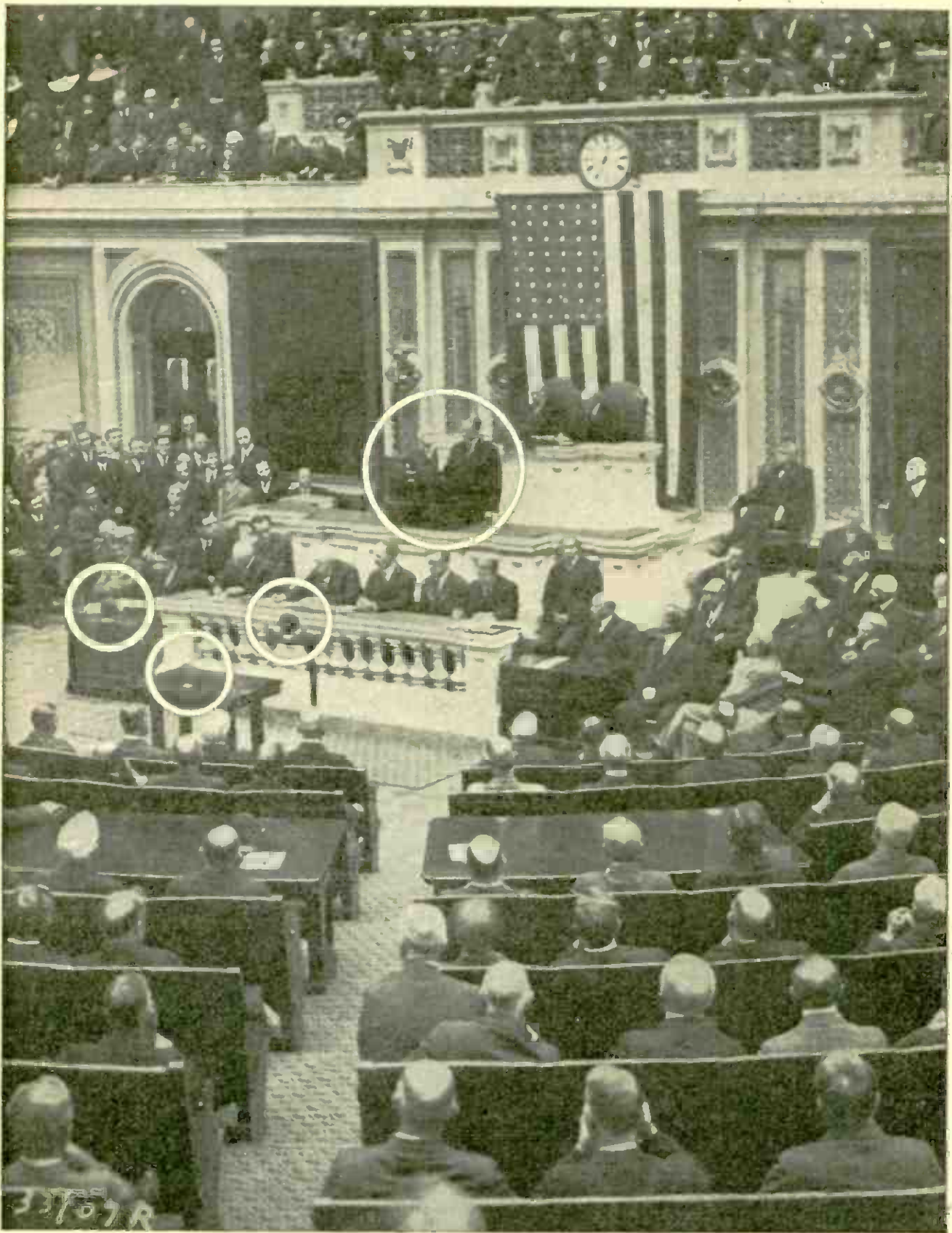

Underwood & Underwood

Radio Enters Congress

So complete were the arrangements for broadcasting President Coolidge's first message to the 68th Congress on December 10, 1923, that practically the entire United States could have listened in and heard his voice. Notice the two microphones on the Speaker's desk and the three immediately in front of it.

Popular Radio

VOLUME V

FEBRUARY, 1924

NUMBER 2



The Coming Kingdom of the Ether

Some day we will watch events that transpire at a distance as easily as we watch motion pictures now. Some day we will use radio for reading thoughts, for heating and lighting our homes, for curing our diseases, for furnishing motive power to our railroads and factories. Some of the wonders that are in store for us are told in this prophetic article by "the Edison of England"—

PROF. A. M. LOW, A.C.G.I., D.Sc., M.I.A.E., F.R.G.S., F.C.S.

THERE is not the slightest doubt that no invention since the Stone Age has developed with such amazing rapidity as radio. Already it has proved itself to be one of the most powerful forces controlled by man, and it has vast possibilities—so vast that the scientists of the world cannot predict its ultimate evolution. The fact that at present radio is without any reasonable degree of secrecy, is one illustration of the immature nature of the science.

The world's knowledge of radio science is literally in its infancy.

It is obvious, therefore, to all thinking people, that as each hundred years of the world's history has seen a greater advancement of civilization this progress cannot be expected to stop today, and in the near future we may expect rapid developments of radio and other inventions for the benefit of mankind. Already the ordinary person enjoys far greater com-

forts than the royalty of olden days, and it is interesting to take a peep into the future and try to gather some idea of what life holds in store for us.

For the benefit of those people who are inclined to scoff at logical scientific probabilities I would remind them they owe the clothes they wear, the food they eat, and the very bed they lie on, to the much abused scientist.

We have speeded up radio communication to the extent of sending a message round the world in one-seventh of a second. Having solved the problem of sending a message we now want to see the person with whom we are in communication, therefore "television"—or radio sight—may be expected to develop quicker than many other branches of radio science.* It should not be far in the future when we shall take radio sight

*See "The New Radio Movies" in POPULAR RADIO for December, 1923.

for granted in the same way as broadcasting is taken for granted at present.

More than seven years ago I obtained successful vision over half a dozen miles of ordinary telephone wire, and there is no reason why equal, or better, results should not be obtained by radio.

The possibilities of radio sight are unlimited and many events in our everyday life will no longer be barred to us owing to the expense and difficulty of transporting ourselves from place to place. Half the necessity of travel will be gone and by this means all business will be speeded up, heads of commercial firms will see and speak to each other from their office desks and the busy man who breaks a limb, instead of neglecting his work while in bed will keep in touch with things with the aid of radio. Facility of communication is the backbone of civilization and often a preventive of war.

All this will be a valuable educational asset, for when a lecture is held by a specialist at any college it will be possible to "connect" a dozen other schools by radio, the pupils seeing and hearing by that means. This will bring the most expensive education within the reach of all.

In wartime, television will have many uses, radio-controlled airplanes and torpedoes will be watched by this means and bombs will be released from the airplane at will. Laid mines will be watched and exploded by radio at any given moment. Army commanders will see their directions being carried out. It will be difficult to move troops and guns as every bush may conceal these radio "eyes."

Another important use to which television will be put will be the detection of crime, for naturally all radio developments will speed up police methods and the life of the criminal of the future will be precarious indeed.* By attaching radio microphones and television machines in the known resorts of criminals

the police could literally keep their eyes on suspected characters. This would be particularly useful in cases of blackmail, for the very walls would have "ears" and "eyes." The apparatus would be inconspicuously placed as it would require no connection, by wire or otherwise, with the watching detectives!

Another exceptionally useful branch of radio science that will help us in many ways in the future is radio control.* It will no doubt play a big part in our lives. At the present time it is in an elementary stage, but experiments are being constantly conducted in many countries with good results and it is mainly a question of time before it is brought to a sufficiently advanced stage to make many of our dreams of today the exceedingly useful realities of tomorrow.

Radio control will be used to control airplanes, torpedoes, submarines and tanks both in peace and wartime. And one valuable asset will be the fact that pilotless airplanes with smaller and lighter engines could rise to the upper air and attain terrific speeds where the wind resistance is less, although lack of air prevents a pilot flying at that height today without special precautions.

Mails could be sent by these small radio-controlled airplanes at a great speed to all parts of the world. This would be particularly useful over jungle and desert places where the present transport is difficult and slow. Fire alarms, public clocks and ticker machines will be controlled. Compass control will be given to ships from underwater cables. Pilots flying at night and in fogs will be assisted by radio control. Eventually I believe that trains, street-cars, and many motor vehicles will be controlled. It is possible that underground wires may give both direction and power to all kinds of travel in the far future.

One of the main points of radio control is that all signals are sent by a secret combination of different wavelengths, on

*See "Running Down Lawbreakers by Radio" in POPULAR RADIO for June, 1922, and "Radio Puts Out Gum Shoes" in November, 1923.

*See "How Machines Are Controlled by Radio," in POPULAR RADIO for August, 1922.

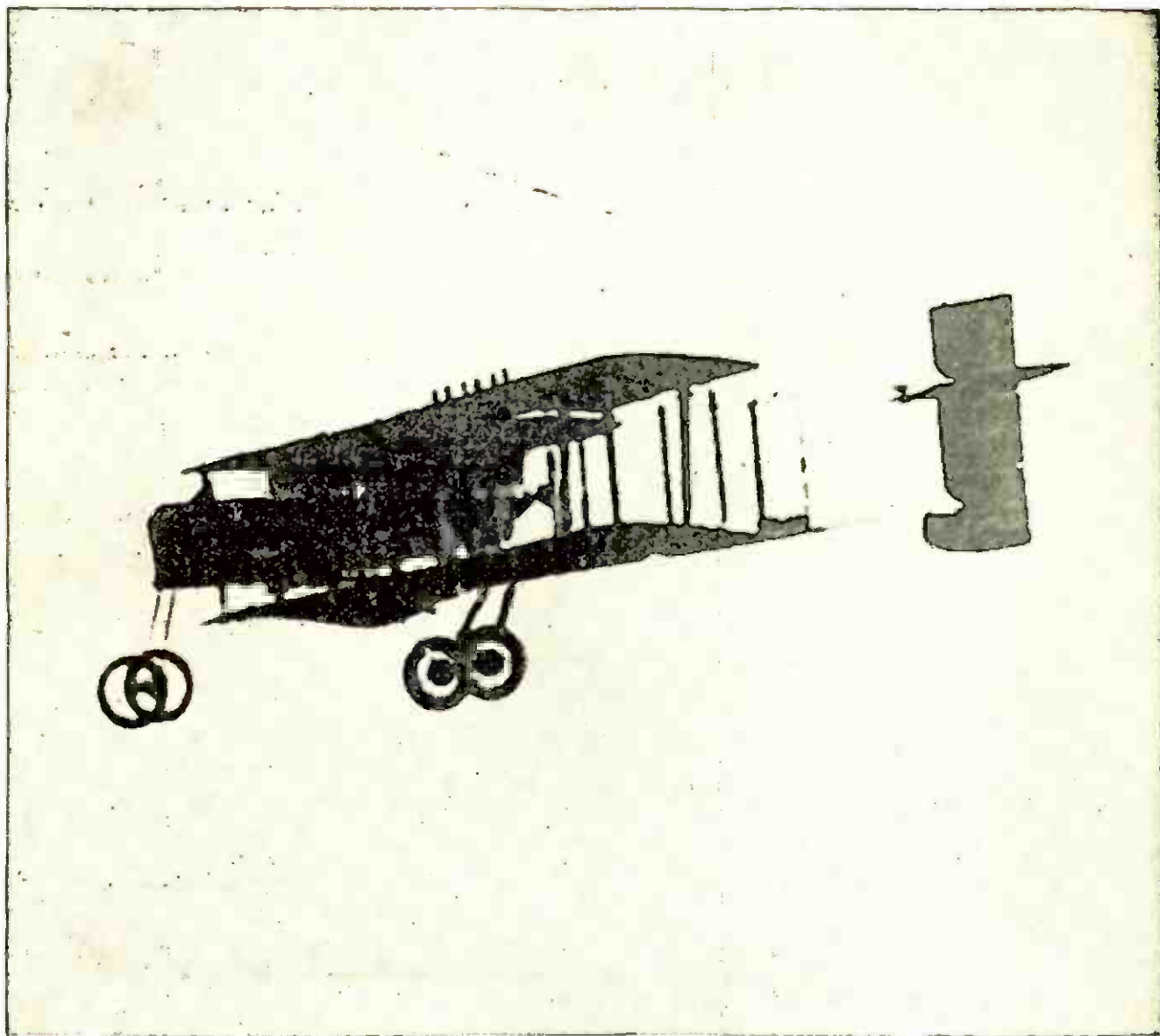

International

A RADIO-CONTROLLED AIRPLANE IN FLIGHT

In recent experiments at Villesauvage, near Paris, an airplane that was unprovided with either pilot or passenger was made to take off from the ground, fly and land safely—all by radio signals transmitted from a ground station. Its stability (which is automatic) was controlled by gyroscopes connected to auxiliary motors; when landing, the machine when about ten feet from the ground, righted itself and automatically shut off the motor. After touching the ground the motor was again automatically started and the plane rode along the earth until the stop was made.

THE AUTOMATIC PILOT

The apparatus shown in the picture at the right is the Sperry "gyroscope pilot." Once set for a given course this pilot will keep the airplane balanced and on that course without further attention.

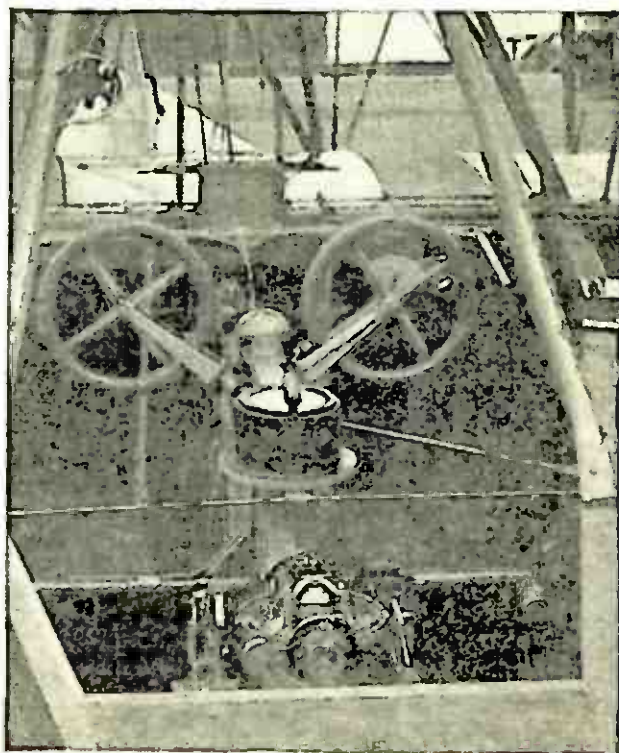

Sperry Gyroscope Co.

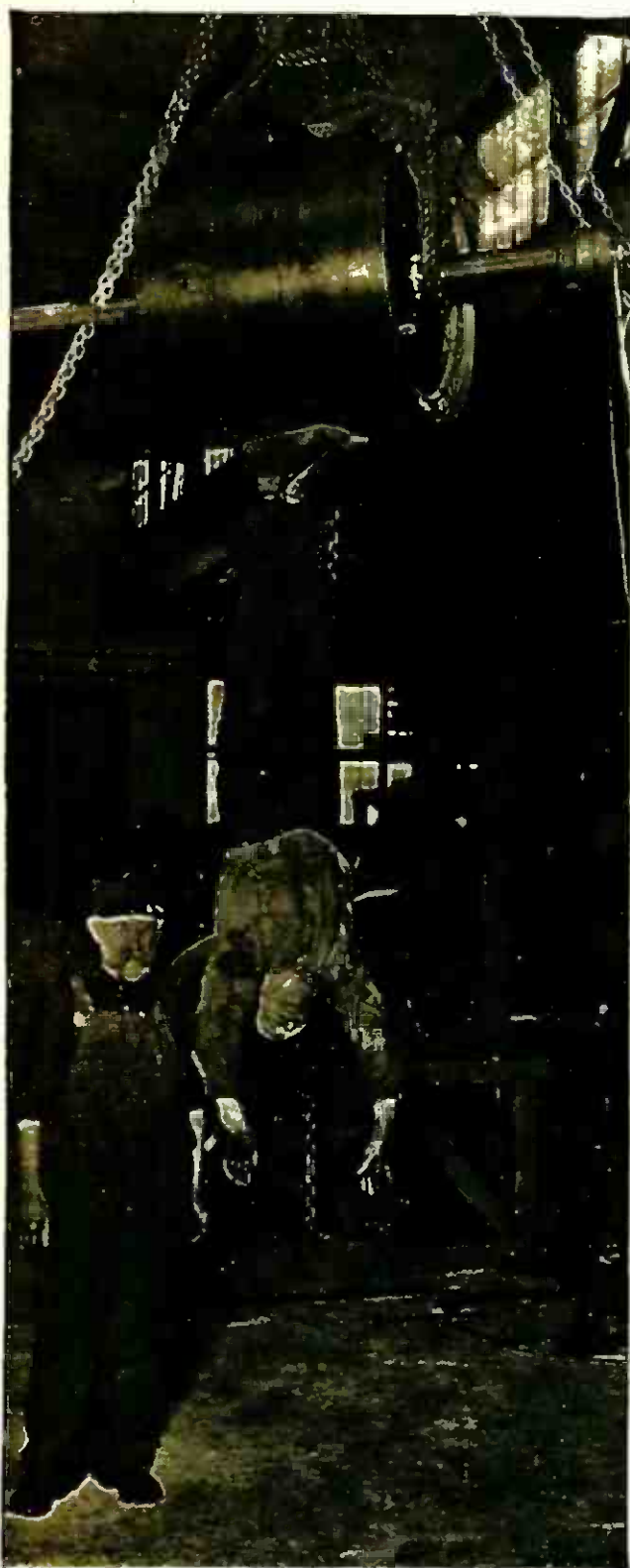

Dings Magnetic Separator Co.

HELD UP BY RADIO WAVES

This man is suspended by the attraction of this magnetic pulley for the nails in his shoes, an attraction which is transmitted, scientists believe, by a variety of electromagnetic waves originating in magnetized atoms. When we understand these magnetic waves more fully there will be, the scientists predict, not only a new knowledge of the inmost secrets of matter but many new uses for magnetism, which means, really, a new importance for all kinds of ether waves and probably for radio as well.

the principle of the ordinary letter-lock. Unless this exact combination of wave-lengths or sending speed is known and used there is little possibility of any other station gaining control of the subject.

Another interesting radio development is the transmission of photographs by that means. This is not really a difficult matter at the present for photographs could be sent by wireless and reproduced equally well—or better—than the cabled pictures published by newspapers in recent years.

While experimenting as far back as 1911, I was successful in transmitting a partial photograph over a distance of four miles—and methods have much improved since then. I believe that photographs of current events from all parts of the world will be included in the radio-broadcast programs of the future, the news bulletin being supplemented by views of the events mentioned.*

Radio photographs will be sent to the newspapers from every corner of the globe and reproduced as quickly as messages are received now. This will be particularly unpleasant for criminals who will find their description and photographs circulated with lightning speed.

Little is heard of transmission of light by radio at present, but although it is in an elementary stage it will be of value to us in the future. We are so sufficiently advanced in experiments with this branch of science that I can place six bulbs on a table, without any connection whatever, and light them with an expenditure of about two horse-power, keeping them brightly burning for any length of time. The radio-control delay in lighting or extinguishing the lamps is only three-fifths of a second.

In the far future I think radio light will be broadcast generally. All shops, houses and factories will be lighted from this source, the light being tapped through a meter as required. It is a curious fact that if we could only slow

*See "Seeing by Radio," in POPULAR RADIO for April, 1923.

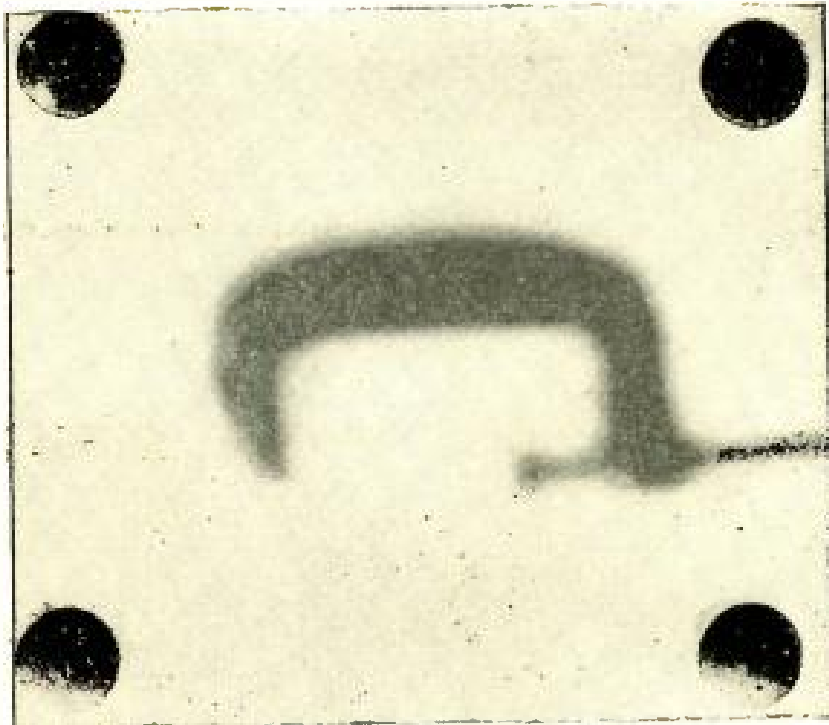

From a photograph made by C. F. Jenkins for POPULAR RADIO

THE RADIO-PROJECTED IMAGE OF A MOVING OBJECT—AS SEEN BY THE OBSERVER MILES AWAY

The inventor, Mr. C. Francis Jenkins, held up this clamp before his radio transmitter; its image was sent and received through the ether as you see it here. This is a striking example of the use of television which Professor Low foresees will soon be as common as the telephone is now.

down the speed of the radio waves sufficiently they would become visible and the whole atmosphere round a broadcasting station would be lit up!

Radio writing, on which many experimenters are now working, will assist further in the general speeding up of our lives and business by rendering travel almost unnecessary. The business man of the future will be enabled not only to see and speak to other firms, but to write to them from his chair. Documents can be signed at a distance. Checks can be signed by radio, the cashier watching by television.

Drawings and plans of every sort can be sent by radio. Survey airplanes can instantly transmit their work to the earth. Radio writing will be put to many other uses. A final invention that we still lack is a machine that will type to radio dictation!

I believe that in the far future growing children will be given by radio a continual mild curative treatment to build them into first-class citizens. Radio

heat will be sent out to districts where the weather conditions are destroying crops. The world will benefit in many strange ways by that wonderful force—radio!

Much interest has been aroused recently by reports in the European newspapers that the repeated failure of French airplanes while flying over German territory may be due to the action of secret rays discovered by the Germans, who are known to have been experimenting for some time with directional radio.

Several theories have been advanced to account for the forced landings of the French airplanes. One is that by the concentration of a secret wireless ray, or combination of rays, the magnetos of the airplane may be affected. This theory is, in my opinion, negated by the fact that magnetos in airplanes are protected by metal cowls. It would be almost impossible for a ray to reach the magnets without damaging the metal covering also. In no case has this been reported.

Another theory is that a new ray has



Crouch, London

HE PHOTOGRAPHED THE NOISE IN THE LONDON SUBWAYS

Professor A. M. Low is said to have produced more useful inventions than any other man in England. He is an expert designer of automobile and airplane engines, has invented a system of radio control for battleships and has made photographs by using the invisible infra-red rays. Recently he invented an apparatus for photographing the noise in the London subway as a part of a successful effort to make the trains less noisy.

been discovered which will melt certain metals, it being pointed out that most of the forced landings of airplanes flying between Strasburg and Prague have occurred in the vicinity of the German air-drome at Furth. I am confident that at the present time it is impossible to transmit sufficient power through the air to bring down an airplane in flight at, say, two thousand feet. The claims advanced certainly seem far-fetched and are out of all proportion to the state of experiments at present.

For some time now many scientists have been working along the lines of discovering a force which can be projected through air at airplanes; the problem is to discover the best means of

sending in the form of oscillations a force which, on coming into contact with metal will generate heat. If this force could be concentrated and made sufficiently powerful the rigging of the airplane could be melted and the machine would be brought down.

In order to dispel any doubt as to the possibility of the transmission of induced radio power at the present time I might mention that by an expenditure of about three horse-power we can totally destroy a thin iron wire at a distance of about three feet without any connection between them.

I am quite confident that in about fifty years time, with five thousand horse-power at our disposal, we should

WANTED—Five Inventions

IN the Institute of Patentees in London is kept a book in which members of the Institute and visitors are asked to set down notes of inventions that are believed to be needed by the world. It is called the "What's Wanted" book. In this book Prof. Low, the author of this article, has set down a list of what he believes to be needed inventions.

Here are five of them that relate to radio:

1. *A method of utilizing atomic energy.*
2. *A selective method of radio communication with really sharp tuning.*
3. *An efficient method of varying radio-oscillation frequencies over an almost unlimited range.*
4. *A loudspeaker that is controllable without distortion.*
5. *Improved methods of electrical storage and power transmission.*

be able to send a sufficient force to bring down an airplane in flight if it is not protected in some manner.

Even at an earlier date it should be possible to momentarily divert the several thousand horse-power of a giant airplane's engine in order to destroy the vital parts of another airplane circling within fifty yards of the first one. As practically all air fighting takes place within that fifty yard radius this should be a powerful weapon. Elementary experiments have been successful and we may expect this branch of radio science to be of real use later.

The difficulty at the present time is that we can only receive a minute fraction of the power sent out, even a short distance away, for the reason that this power is broadcast in every direction. This will be overcome in the future when radio is directional and it will become so, perhaps, by using induced currents of high frequency to break down the resistance of the air-gap or by the use of light or some other wave as a carrier.

The mistaken impression exists that the use of radio heat as a destructive agent entails sending waves of heat through the air. This, of course, is absurd for it is impossible to generate enough heat to travel any distance. It would exhaust itself on the journey. The problem is to transfer the energy as electric oscillations and make these generate heat when they actually strike the metal. It is with a view to solving this problem that experiments are now being conducted.

I have frequently been asked if I thought there would be future wars. Certainly I do think so. War is *natural*, for all nature fights. Although world war may become less frequent, I hope it will, for mankind to cease to fight would be as strange as if they lived for ever. I am in complete sympathy with the objects of the League of Nations, but it will not be successful in preventing further warfare.

The science of warfare will naturally advance considerably in the future and

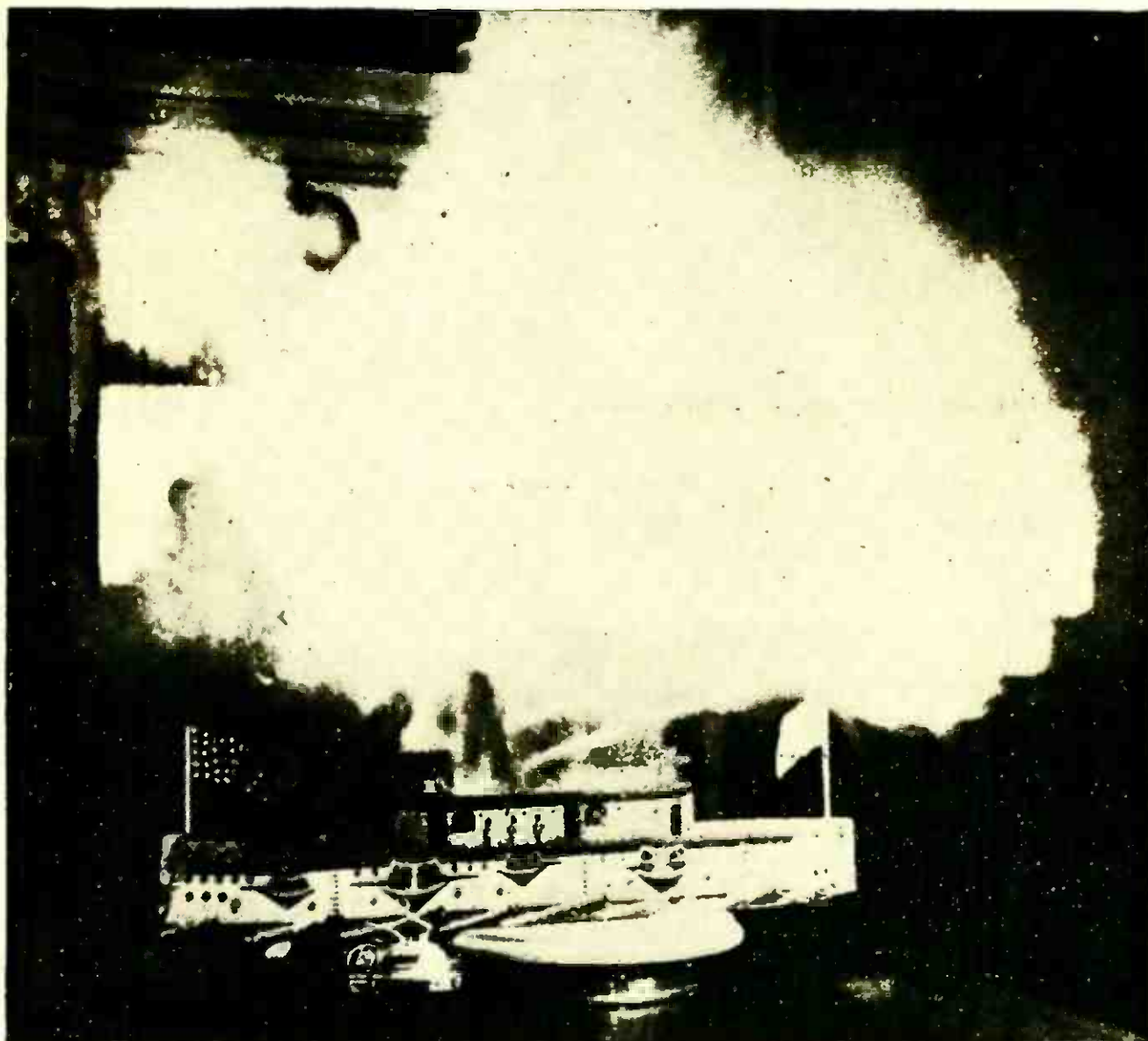

Kadel and Herbert

HOW A MODEL BATTLESHIP MAY BE BLOWN UP BY RADIO

Infernal machines secreted in the magazine of a battleship can be blown up by radio waves from outside. When the directed beams of radio energy which Professor Low foresees have been perfected it may be possible to blow up any battleship magazine in this way. Will this mean the end of war—or radio-protected battleships?

radio and other developments will make it infinitely more terrible.

A new weapon which I feel sure will be used in future warfare will be the projection of liquids heavily charged with electricity. A man standing in the path of the stream receives a shock that disables or kills. Another new weapon against airplanes may be a type of electrically-controlled rocket operated on a wire.

Deadly germs and many forms of poison gas will play a big part. Vortex-clouds of hydrocyanic-acid vapor will probably be released in the path of an in-

vading air squadron at a sufficient height to render them innocuous to those below but deadly to any one who crosses their path.

The machine gun of the present will develop into an electric-impulse gun, firing enough bullets a second to render a miss unlikely.

There will be armored boats capable of diving under water and flying in the air. Airplanes flying with silent engines will need colored searchlights to pick them out, for aerial camouflage will be a fine art.

Machinery for rapid tunnelling will be

necessary—because with the introduction of radio-sight night will afford no cover and there will be great activity underground. Future warfare will be so terrible that no country would be able to stand the strain for long.

Many absurd claims have been advanced by tricksters who profess to practise mental telepathy. At the present time this is not a scientific possibility. However, there is a real need for this development of communication and necessities have a habit of becoming realities.

Most sciences are begun by tricksters. Just as the alchemist has developed into the chemist; so mental telepathy, commencing as trickery, may develop into a scientific fact. We know that thought is an electrical process. The energy expended in thought must go somewhere, therefore, it might be utilized eventually to transmit the thought to another mind.

One might argue logically that speech of all kinds is a rough-and-ready physical

method of communication and that in the future we shall be able to converse with each other by some form of suggestion. This would enable us to do without the actual physical meeting of two people who wish to discuss an idea. After all, if I wish to convey a thought to anyone it seems very crude that before I can convey the idea that is in my mind I have to wiggle my mouth and puff irregular gusts of wind through my lips in order to produce sound!

I think that, in all probability, the future will find mental telepathy existing in some form or other.

After reviewing the amazing progress made by our civilization in recent years it is obvious that the future holds many strange and wonderful things in store for us—and who would now dare to say that such a thing as an "impossibility" exists! The study of oscillation may be the key to discoveries far more wonderful than radio. The unexplored spectrum has yet to hint to us the meaning of life itself.

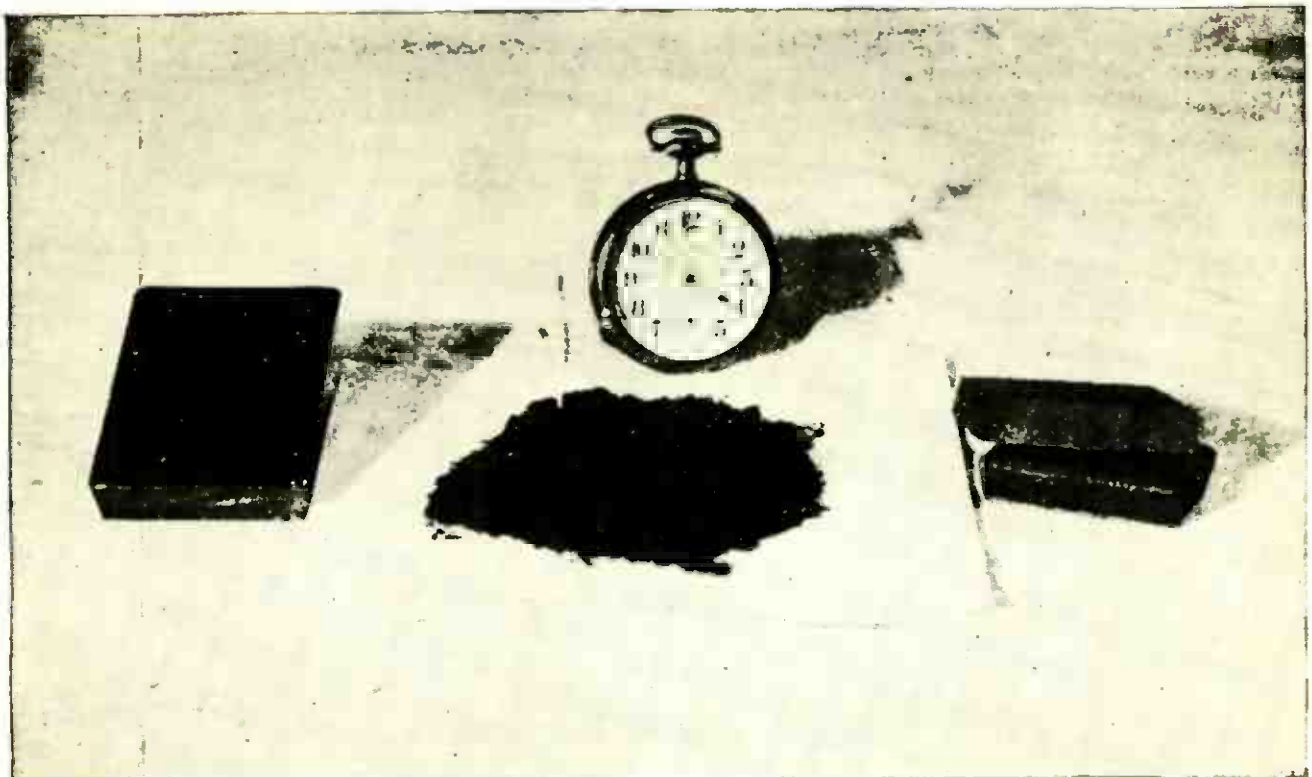

Raritan Copper Works, photographed especially for POPULAR RADIO

THIS IS WHAT IS USED IN "RADIO EYES"

Most of the devices for "seeing by radio" depend on this chemical element called selenium, which changes its electrical conductivity whenever light falls on it. The three known varieties of selenium are here shown; the glassy variety is at the left, the powder variety in the center, and the metallic variety at the right.

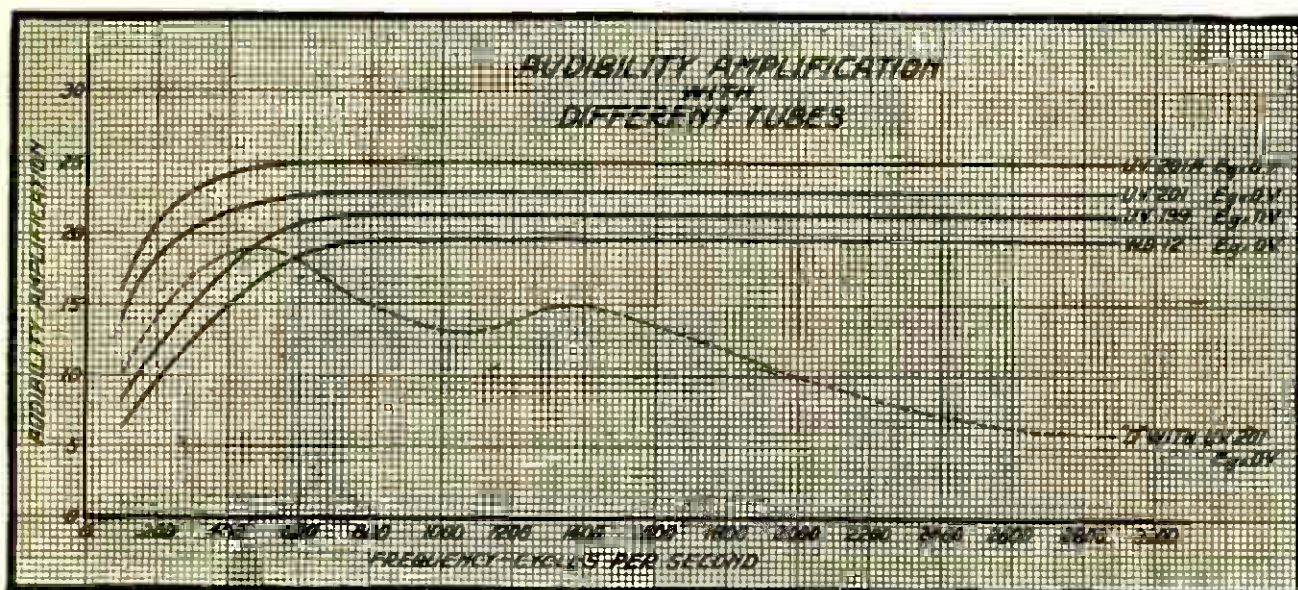

© Gregg Laboratories

A GROUP OF FREQUENCY-AUDIBILITY CURVES FOR AMPLIFYING TRANSFORMERS

FIGURE 1: *The four top curves in heavy black lines show the audibility record of one transformer used in connection with four different types of vacuum tubes. Notice that the amplification is constant over a wide range of audio frequencies. This is a good transformer; it does not distort but it amplifies with equality all the frequencies within the range shown. The lower dotted curve shows the audibility of a poor transformer. Notice how the amplification falls off at the higher frequencies. This transformer would produce distortion.*

HOW TO USE THE Dry-cell Tubes as Amplifiers

Many fans have tried to make the small dry-cell tubes work as audio-frequency amplifiers; usually they get poor results. This problem comes up often when the builder of a radio receiving set has not the facilities for charging storage batteries and must, therefore, resort to the smaller tubes. This article tells specifically how to do it.

By FRANK A. HINNERS, I.R.E.

MANY laymen who are thinking about joining the ranks of broadcast listeners, and even large numbers of broadcast listeners of experience, find it difficult to decide when to use, and when not to use the dry-cell tubes.

When portability is required above all else, the dry-cell tubes obviously recommend themselves. Even when portability is not a factor but the consideration of small first cost and low upkeep is important, the dry-cell tubes have much to recommend them. The cost of a storage battery and the charging

appliance represents a considerable sum, which is, of course, unnecessary with dry-cell tubes.

The dry-cell tube used for some purposes performs quite as well as the larger storage-battery tubes, yet for other purposes it cannot equal the large tube.

To mention some examples, the dry-cell tube fitted with the proper grid leak when used as the detector in regenerative receivers, produces results closely approaching the larger tube, if not in signal volume, certainly from the

DX standpoint. Used with the proper grid leak in non-regenerative receivers in which radio-frequency amplification is *not* incorporated, results equalling but not excelling the crystal detector are the rule. I refer to the WD-12 tube operated from a single dry cell. Operated in this type of receiver, *without* proper grid leak, results are inferior to a crystal detector. As we are considering the amplifying properties of the dry-cell tube here, its detector action cannot be described at length; sufficient to say that the dry-cell tubes, which are of the hard, highly exhausted type, are not especially sensitive detectors.

In choosing between the two general types of tubes now in use, storage and dry-cell operated, the public finds itself confused by much conflicting information. Many, attracted by the lower first cost of the dry-cell tubes, buy them with expectations of a performance equal to the larger tubes. Frequently, disappointment is a result, because the listener expects too much from this type of tube—due to no fault of the tube. Were the information regarding the dry-cell tube available in quantitative form, instead of the prevalent terms such as "good," "fair" and "poor," the truly remarkable merit of this form of tube would become known and needless disappointments, therefore, avoided.

In order to supply this quantitative information, a series of observations were conducted in the laboratory under conditions practically duplicating actual service.

An audio-frequency amplifying transformer of exceptionally good electrical design, with a four-to-one turn ratio, was used. The results obtained apply strictly to this particular make of audio-frequency transformer and therefore would not be found correct for all makes of such transformer. In general, however, the differences between the amplification obtained from the various tubes hold approximately true for other transformers of similar design

and of the same general characteristics.

In Figure 1 a family of curves is shown. The vertical axis shows the audibility or current amplification. The horizontal axis shows the audio frequencies of the alternating-current voltages applied to the vacuum tubes and the audio-frequency amplifying transformer. In the test, the amplification and the frequency of the A. C. voltage applied to the grids of the amplifier were noted. The amplification, together with the particular frequency of the input current were plotted as the observation was made. A curve drawn through the points plotted indicates how the amount of amplification obtained is influenced by the varying frequencies applied to the grids of the various vacuum tubes indicated in combination with the audio-frequency amplifying transformer. The frequencies used in the experiments correspond to the basic range of frequencies produced in music and human speech.

At points where curvature appears the change in amplification noted is the direct result of the particular frequencies applied to the grids of the vacuum tubes. At these frequencies, tones emitted from loudspeakers and headphones operated by the transformer and vacuum tubes cannot correspond, in point of volume, to the original tone acting upon the microphone in a broadcasting station. This effect is known as "distortion," and appears wherever the output does not reproduce the input with fidelity.

To illustrate to what an extent an audio-frequency transformer of poor design may be held accountable for distortion, the characteristic curve of another transformer has been added, which appears as curve "D." Obviously a transformer that produces such an erratic characteristic would be unsuited to broadcast reception. Yet, a considerable number of such transformers are being offered to the public and enjoy a wide sale.



From a photograph made for POPULAR RADIO

HOW THE TESTS WERE MADE

The author is here shown taking the measurements from which the data for the curves and tables in this article were made up. The curves were made by comparing a signal both before and after it has passed through the amplifier. The ratio of the two signals (or rather the ratio of the resistances used in balancing the two signals) is the amplification constant.

The ideal transformer would produce a straight line parallel to the frequency scale. Although the transformer used in these tests has a sloping characteristic below 600 cycles a second, at higher frequencies it produces practically uniform amplification. For this reason it is well suited to these measurements, as we are in quest of information on vacuum-tube performance.

In these measurements the amplification is expressed as "times audibility" and represents the number of times the telephone current has been multiplied in passing through the particular vacuum-tube and transformer-combination used.

In all curves shown in Figure 1, the voltage applied to the plates of the

various vacuum tubes used was 67.5, a voltage most frequently specified by transformer manufacturers. The grids of all tubes tested were connected to the negative-filament terminal. This connection is standard with most amplifier and receiving-set manufacturers.

In the table on page 123 the results obtained from the curves in Figure I have been entered, together with some further information obtained by calculation. The theoretical energy amplification obtained with UV-201-a tubes has been made the standard of comparison, its value being expressed as 100 percent.

The sound volume delivered by headphones and loudspeakers is governed

by the electric energy supplied to them. The current increase due to amplification, in itself is not a direct indication of the comparative sound output that either the headphone or the loudspeaker may be expected to produce. To determine the comparative sound volumes that may be produced by headphones or loudspeakers operated by various tube combinations, it is necessary to express the measured current or audibility increase as energy amplification, inasmuch as such devices are energy-operated.

The energy amplification may be assumed to vary as the square of the current amplification because the impedance of the load circuit was maintained constant as well as larger than the internal plate impedance of the vacuum tube. This assumption is quite correct, as the relative amplification values noted in the above table are taken along the flat portion of the characteristic and thus free from the influence of frequency changes.

The energy amplification computed in this manner is noted in column 3.

Column 4 shows the percentage output produced by the various tubes specified in terms of 201-a output. Column five shows the percent difference in output of such tubes in terms of the 201-a output.

From the observations noted in columns 3, 4 and 5, it will be seen that the WD-12 tube used as a single-stage audio-frequency amplifier delivers an energy output, equivalent, in round numbers, to 60 percent of the 201-a tube output, representing a 40 percent sacrifice in result. In the case of the 199, these figures become 73 and 27 respectively, representing a smaller sac-

rifice in result, namely, 27 percent.

Instead of using the percentages of column 4, let us refer to the energy amplifications listed in column 3.

Suppose we consider the electric energy fed to the amplifier by the detector as the energy unit. One stage of audio-frequency amplification would produce a sound volume 625 times larger than this unit with the 201-a tube; 550 times with the tube 201;* 460 times with tube 199 and 380 times with tube WD-12. These values differ considerably numerically on paper, yet the differences seem less impressive to the ears of the listener.

Two stages of audio-frequency amplification are more widely used by the listener and for this reason an appraisal of the dry-cell tube's performance in this field will perhaps prove of even greater interest. To carry these observations this further step forward, calculations are again necessary.

Amplifiers arranged in cascade amplify in geometric progression if the voltage applied to each of the grids falls within the straight portion of their grid-plate characteristic; that is, voltages whose values are below the bend in this characteristic. When so operated, the result produced by two stages of amplification "A" becomes the product "A x A." This relation applies to the amplification whether expressed as current or energy amplification. In either case the amplification for two stages is the product of the amplification of the

*The improvements in storage-battery-operated tubes are also clearly indicated. It is to be observed that tube 201-a produced a trifle less than 14 percent more energy amplification than the older 201 tube. This by itself is a considerable improvement but, when accomplished with one-fourth of the filament current formerly needed, represents a decided advance in the art of vacuum-tube manufacture.

FIGURE II								
1	2	3	4	5	6	7	8	9
ONE STAGE					TWO STAGES			
Tube	Current Ampli.	Energy Ampli.	% Output	% Diff.	Current Ampli.	Energy Ampli.	% Output	% Diff.
201-a	25	625	100	0	625	390,000	100	0
201	23.5	550	88	12	550	300,000	77	23
199	21.5	460	73	27	460	210,000	54	46
WD-12	19.5	380	61	39	380	144,000	37	63

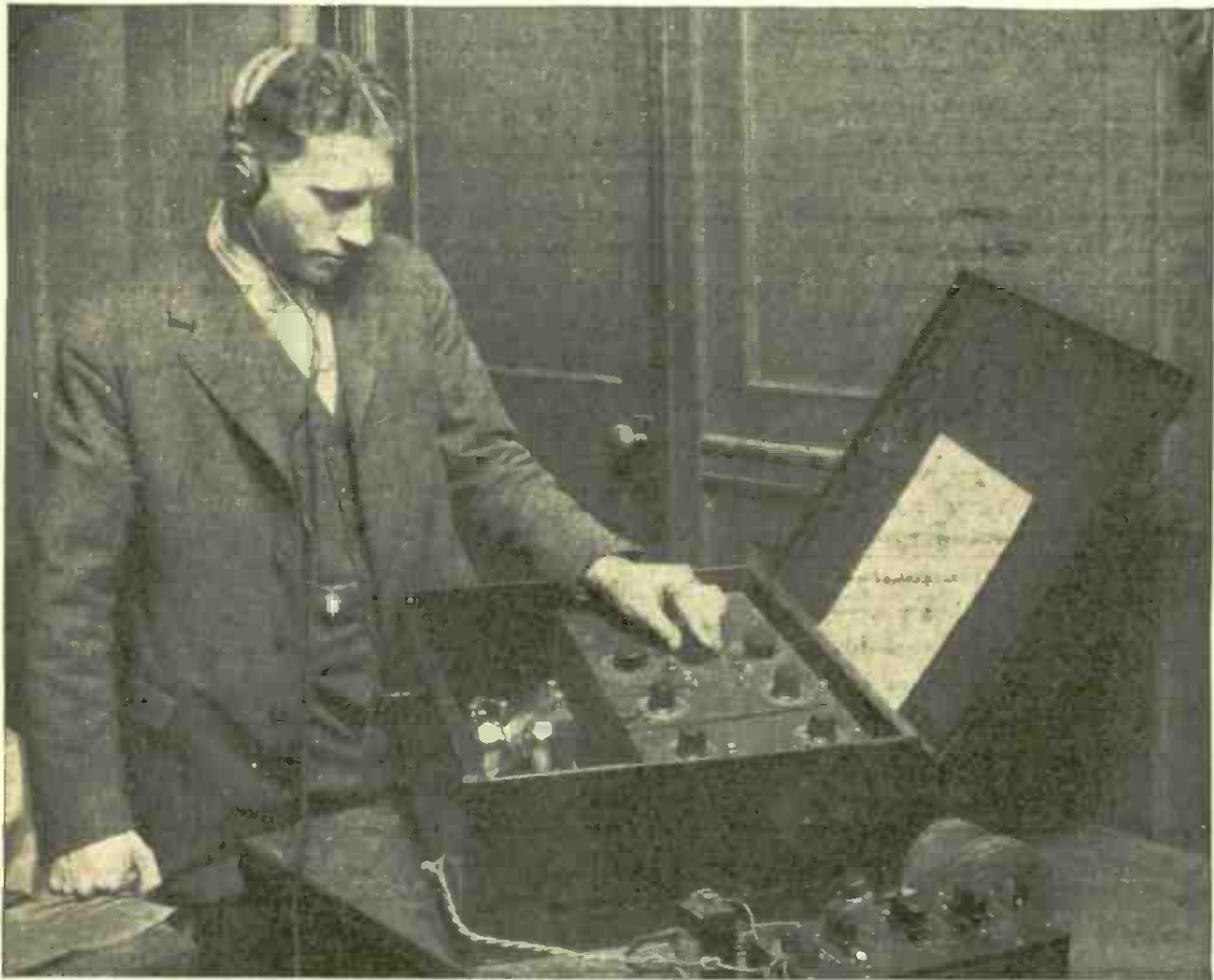

From a photograph made for POPULAR RADIO

ADJUSTING THE VACUUM-TUBE OSCILLATOR WHICH IS USED TO PRODUCE THE STANDARD SIGNAL FOR THE TEST

It is quite important that the signal follow a sine-wave curve and that its frequency be variable over the audible limits.

individual stages, however expressed, and if each stage produces the same amplification "A" the result of two stages is "A²." In the case of three stages of audio-frequency amplification, were there no very serious practical limitations, the over-all amplification produced would correspond to the third power of the amplification of the individual stage, equal amplification, of course, being obtained from each of the stages.

This geometric relation which governs the operation of the cascade amplifier is of the greatest significance, and yet it is little known to the radio listener.

Vacuum tubes are rated in terms of their individual performance, but their

operation in the cascade arrangement leads to results of a different order. Differences noted in their individual performance, which may be quite small, assume astonishing proportions in the cascade arrangement.

It may be of some interest to note how the action of the cascade arrangement would differ if it obeyed arithmetical instead of geometrical law. The case, it should be remembered, is purely hypothetical and except for purposes of illustration, it has no value whatever. Were the amplification arithmetical, two such stages of amplification would equal the sum of the individual amplification of the two stages. The values of columns 6 and 7 would be

only twice as large as the values of columns 2 and 3. A far greater number of tubes would be required to produce the amplification values noted in columns 6 and 7. The percentages noted in columns 8 and 9 would not, however, differ from those of columns 4 and 5.

Take the 199 tube as an example: This tube was 73 percent as effective as the 201-a tube. It produced 165 less energy units than the 201-a tube. Two such stages of amplification obeying arithmetical law would lack another 165 energy units, reaching a total of 330 units. This would, however, still be equal to 73 percent of the amplification produced by two 201-a tubes.

Actually, however, because the over-all amplification is the product and not the sum of the individual amplification of each tube, the resultant amplification becomes $.73 \times .73$, or 54 percent.

Referring to Table 2, we find two stages of 199 and WD-12 are, respectively, 54 percent and 37 percent as effective as two stages of 201-a amplification. The comparative loss or sacrifice in volume for two stages of 199 and WD-12 becomes 46 percent and 63 percent, respectively. Differences in performance of this order, which are enormous indeed, account in large measure for whatever disappointments listeners experience in their use of the dry-cell tubes.

These differences may be more strikingly illustrated by referring to column 7 of Table 2. Here the over-all, calculated energy amplification has been entered. Also in this case consider the energy fed to the first amplifier tube as the unit. We find that if two 201 tubes replace 201-a tubes of like number, the energy is increased 300,000

fold. For two 199 tubes, 210,000 fold, and WD-12 tubes, 144,000 fold.

Now with two 201-a tubes an amplification of 390,000 fold was noted. If we consider the loss of energy units, it is to be noted 90,000 units less are obtained with 201 tubes;* 180,000 less with 199 tubes, and 246,000 less with WD-12 tubes.

From the data obtained it must be apparent that when cost is weighed against results, the use of the dry-cell tube as a single-stage, audio-frequency amplifier is wise economy.

However, weighing cost against results, the dry-cell tubes used in the amplifier of two stages do not, in the opinion of many, represent real economy. Considering the investment represented by the receiving set, two-stage amplifier, vacuum tubes, loud-speaker and sundry accessories, the added storage-battery and charger cost is not prohibitive, particularly as each of these units is so much less effective when dry-cell tubes are used.

It should be noted, however, that the two-stage amplifier that uses dry-cell tubes produces an amplification many times greater than the amplification of the single-stage amplifier using the larger tubes. When it is considered that the two-stage amplifier fitted with dry-cell tubes costs less than a single-stage amplifier that uses the larger tube provided with its complement of storage battery and charger, the former has much in its favor. Do not, however, look for performance approaching the two-stage amplifier fitted with storage battery tubes.

*Here it is to be observed that the two-stage audio-frequency amplifier using 201-a tubes produces 30 percent more energy amplification than the older 201 tubes.

How to Build an Amateur Transmitter

Q In the coming issue of POPULAR RADIO—for March—Laurence M. Cockaday will describe how to build a CW transmitter at a total cost for parts of not more than \$70.00.



From a photograph made for POPULAR RADIO

THE AUTHOR DEMONSTRATES HOW HE FOLLOWS THE HOOK-UP DIAGRAMS

Although he was born sightless, Mr. Hughbanks has made a record of accomplishment as a lecturer, scientist and as a member of the Kansas Legislature of which any man may be proud. And among these accomplishments is his remarkable ability to build his own radio apparatus from published instructions.

How I Learned to Build My Radio Sets Without My Eyes

It is my purpose in this brief article to give to the readers of POPULAR RADIO, some idea of the methods I have employed as a sightless man, to gain a working knowledge of the art of radio, and how I learned step by step to overcome the difficulties which confronted me in the construction of my apparatus.

By LEROY HUGHBANKS

FROM my earliest boyhood I have been interested in the study of the natural sciences, especially physics, chemistry and astronomy. I was very fortunate at this period to have a teacher of serious scientific attainments; he was an inspiration to me. Every hour which was not demanded for my regular lessons I devoted to the study of the sciences, not only in the grades but in the high school and college.

The subject of radio communication was just being talked about by a few

intelligent people about the time when I began my early scientific studies. There was so little published on the subject, however, that I knew of it only as a minor branch of electrical science.

My first step in the study of this vast subject was to learn the terms used in the subject and gain some knowledge of the theory and practice of radio transmission and reception. This, of course, took considerable reading, and as there are no books on the subject in the embossed systems of printing used

by the blind, I had to have all this matter read to me. Fortunately I have a sister who has acted as my secretary for years. It was but natural that my interests should be kindled further when the great radio wave swept the country during the fall and winter of 1921 and 1922.

I decided that I wanted to learn to construct my own apparatus—at least to learn to assemble parts. This brought about new problems. Chief among them was to find some works on radio that would give explanations in full without resorting to diagrams. This I found was impossible.

My first step, then, was to solve the diagram problem. This is how I did it.

I sought out a bright young radio

experimenter in my town and had him draw me a diagram on a thick sheet of paper—a diagram that could be felt with the fingers. The first diagram that my young helper made was that of a simple crystal receiver, but I could read it with my fingers. This lad had a crystal set of his own, and I examined it thoroughly and in detail, learning the place and function of every connection. I had my helper make a crystal receiver for me, and I took it home and studied the construction of it, also I learned by reading and experimenting, why this set would receive, why a crystal would rectify and not amplify, and many other essentials.

As the next step I went to our broadcasting station here in Anthony and learned something about transmission.

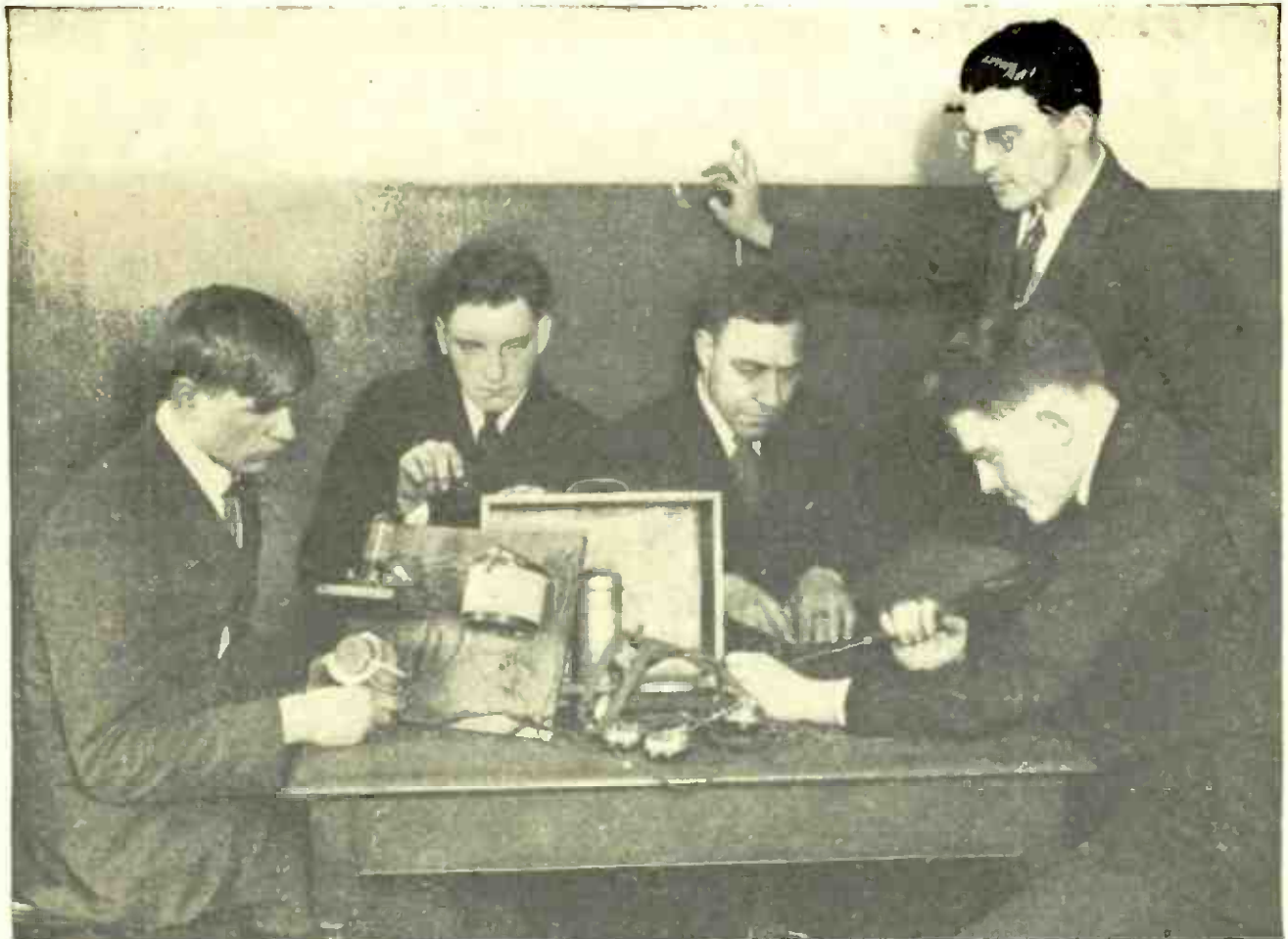

Kadel & Herbert

WHERE BLIND BOYS ARE TAUGHT TO BUILD THEIR OWN RADIO SETS

For a person with eyes to complain of the difficulty of assembling his own receiver seems almost like an admission of stupidity; students at the New York Institution for the Education of the Blind construct single-circuit regenerative receivers as part of their regular training.

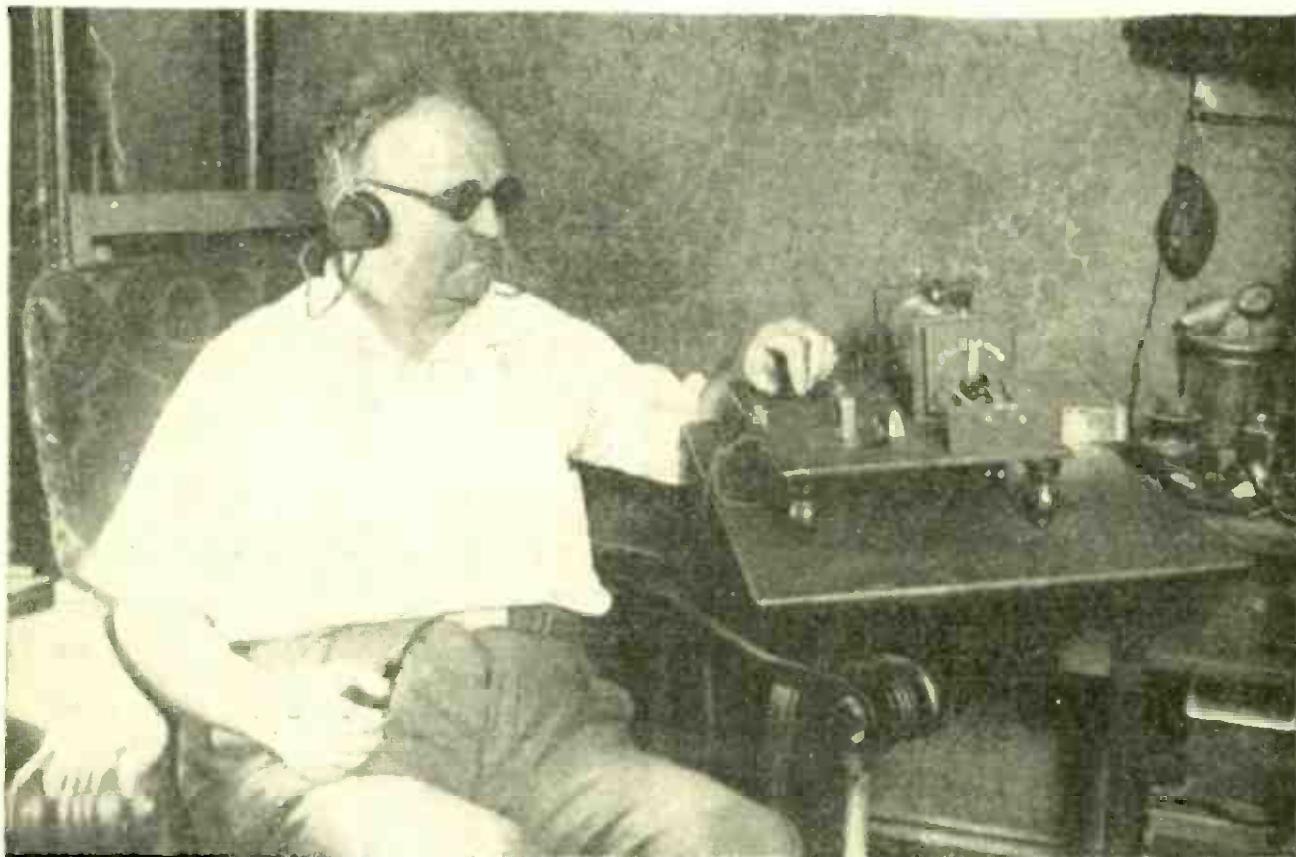

Keystone View Co.

MERELY TO OPERATE A SET IS SIMPLE—EVEN FOR A BLIND MAN
Radio is opening up a new and larger world to the sightless. The fan pictured above is a former New York police officer who lost his eyes in line of duty; he is one of thousands of blind men to whom radio comes as a godsend.

In the meantime I kept on reading and did not hurry to start the assembling of a tube receiver; neither did I allow my family to purchase a good tube outfit which they offered to do. I wanted to construct it myself and to know the whys and wherefores of it.

A complete solution to the diagram problem had not yet been found. Radio was a new subject to us all and the literature on the subject with the conflicting opinions of hundreds came pouring in every week. I really had a problem not only for myself but for all blind folks, and I wanted to solve it. I think I have done so. Once before I had had a similar one and that was in the study of Greek in college; the point for me to solve at that time was how English symbols were to be used to impart Greek meanings. Similarly, my problem in radio diagram was how to change a drawing, composed of lines and symbols, to a word picture

that would be intelligible to a blind man who could not refer to such a picture.

My young helper and I got together and turned the trick so successfully that even the most intricate diagrams now come within my understanding.

To be brief, the method is this:

The person who gives this diagram to me must know the main features of a radio circuit and understand what the symbols stand for. He merely translates these symbols into words. For example, take the symbol for antenna on the diagram; when my helper says "from the antenna binding post to connection No. 1 of the primary of the variocoupler," I would simply write, "From A. B. P. to con. No. 1 of V C."

At first I spelled the words out completely, but as I became familiar with radio terms I find this unnecessary and useless. I try to teach every one

who gives diagrams to me to be orderly and not confuse the various portions of the circuit.

Take, for example, a single-tuned circuit, the antenna circuit, speaking in terms understood by all, is a separate part of the wiring diagram and it can be given in order, step by step, from the antenna binding post to the grid of the detector tube.

I do not feel that the blind have yet recognized what radio can and will mean to them. Many of our blind young men in our schools are taught mechanical trades—broom making, manual training and piano tuning, for instance. These men should be able, with a little help, to assemble their own radio receivers.

Many people ask me just how I do these things. I have but one answer: I master my circuit to the utmost and use apparatus that is easily handled and

trustworthy. I keep in mind, for instance, that a positive "B" battery connection should never come near the "A" battery connections; the blowing out of expensive tubes is unnecessary. I find it advisable to use a tube socket with raised symbols; in this way it is a very simple matter to tell the positive, negative, grid and plate terminals from each other. I try out new circuits, use all manner of tubes in the same set, and change battery connections to accommodate the various types of tubes, and I do this alone. Up to this writing I have never blown a tube on an apparatus which I have constructed.

Some people have asked me if all of my sets work. They all do.

Radio has been a godsend to the blind, and particularly to those of us who, after leaving college or going into business, are called back to rural communities.

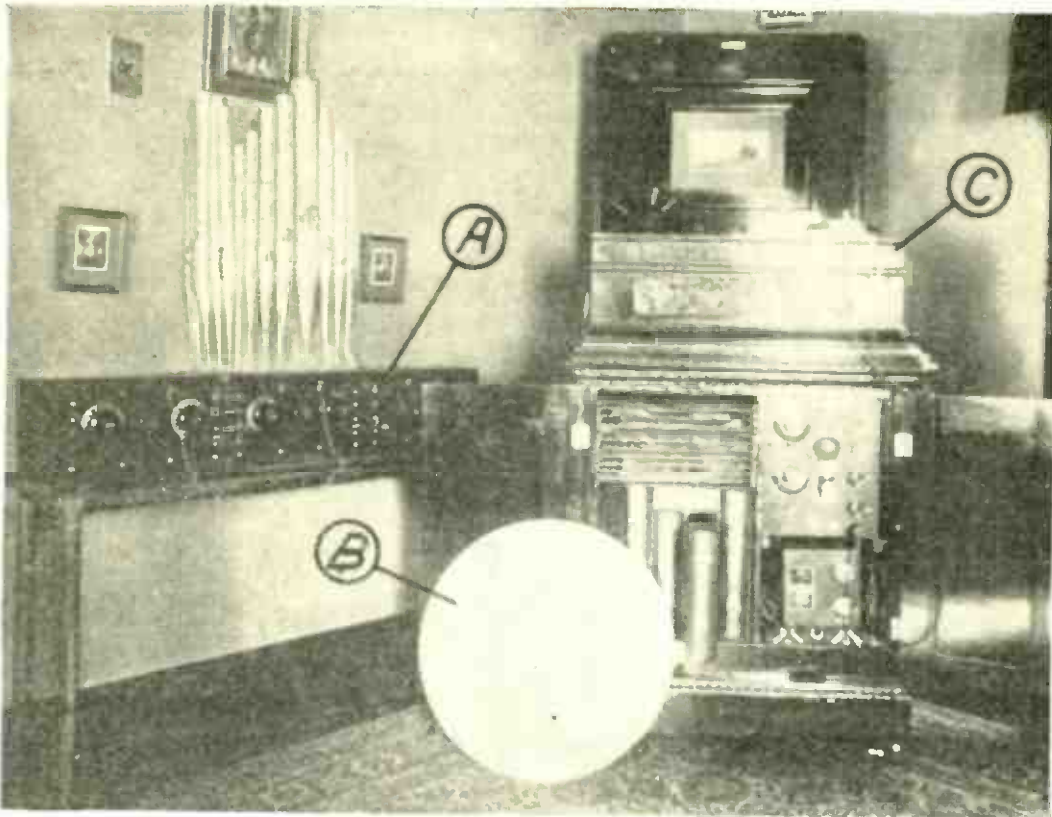

CANNED RADIO WHEN YOU WANT IT

This ingenious outfit, constructed by Mr. C. H. Hewitt, allows good programs to be saved when they come in and played over as many times as desired. A is a sensitive receiver that employs both radio and audio-frequency amplification; B is the wax-disk record on which the programs are recorded, and C is a combination sound reproducer and recording phonograph.



Photonews

PRACTICAL POINTERS FOR ELIMINATING INTERFERENCE IN Long Distance Reception

An American amateur in Bermuda recently solved the problem of consistent DX reception even through the local interference from a powerful government spark station; he did it by means of tuned radio-frequency amplification and a directional wavetrap. Information concerning the circuits used, the wavetrap and the antenna equipment is here given in detail by the man who put up the receiving apparatus which was especially designed for reception of broadcast programs from stations scattered throughout the United States.

By ZEH BOUCK

THE permanent popularity of radio broadcasting is well evidenced in the American's *insistence* on this form of entertainment wherever he may roam. In recognition of this demand, Bermuda, 70 percent of the population of which is composed of American tourists, has taken up broadcast reception on a practical scale and the more progressive hotels there have installed receivers for the benefit of their guests. The writer personally supervised the in-

stallation of one of the first, and perhaps the most efficient installation on the islands.

Due to the distance from the States (some 700 miles) and the necessity of having a loudspeaker reception and other exacting requirements, there were numerous problems to be overcome before the set could be operated satisfactorily. The manner in which these difficulties were solved is of interest to broadcast enthusiasts, who desire to

achieve the same excellent results with their own apparatus.

As the apparatus was installed primarily for the entertainment of visitors, it must first of all be capable of "delivering the goods" consistently. Signals were required of sufficient intensity to comfortably fill a good-sized music room.

The set must not be a Flewelling or conventional single-circuit tuner, or any other type of apparatus which radiates comparatively powerful continuous waves when the circuit is oscillating! (The British government is as emphatic on this point as our own government is lax.)

The apparatus must be of a design easily operated by one unfamiliar with the eccentricities of the more complicated radio circuits.

The installation must be capable of materially reducing the interference from the government station, BZB, operating a spark set on 450 and 600 meters *less than two miles away!*

During periods of heavy static, means must be provided for earphone reception of the news and stock reports which are daily posted on the radio bulletin board in the lobby of the Belmont Hotel.

The majority of these requirements rest greatly on the selection of apparatus, and were met in part, by deciding on a variocoupler two-variometer regenerative set of reliable manufacture. A set of this type combines remarkable selectivity, reducing the interference problem, with high efficiency and ease of operation. Using a good antenna and ground, with a single step of power amplification (in all, three stages of audio-frequency amplification) such a set gave powerful signals on a loudspeaker up to a distance of 500 miles over land, and at least double that distance over water. This installation, including a radio-frequency amplifier which ordinarily was not used, is shown in Figure 1.

The antenna system was of triple importance; several antennas were experimented with before results justified the expense of a permanent installation. A good antenna for ordinary reception was the least of our difficulties. The hotel is located on an elevation overlooking the picturesque Hamilton harbor, and a single wire strung from the tower of the hotel to a neighboring tree would furnish an antenna far superior to the average. However, taking directional possibilities into consideration (an important effect that is almost entirely ignored by the majority of enthusiasts) an antenna, 175 feet long, was swung from the hotel proper to the Casuarinas annex, running north and south, with a 50 foot lead-in taken from the northern end. While this did not give quite so efficient reception from the States as would an east to west, or southeast to northwest antenna (lead-in taken respectively from the west or northwest end), it furnished the greatest possible discrimination against the interfering signals from BZB two miles to the south. It was a compromise justified by results.

A smaller antenna, running east to west (lead-in taken from the west) was swung on insulators under the roof of the southern veranda. It was practically an indoor antenna, 25 feet above ground, having a total length, including lead-in, 75 feet long, and it was used with the radio-frequency amplifier. Due to the fact that the radio-frequency set, of the tuned-plate type, is an excellent factor in the elimination of interference, it was thought best, in this case, to avail ourselves to the greatest possible advantage from the directional possibilities of the smaller antenna. The loop shown in the illustration also played an important part in our receiving achievements.

The radio-frequency amplifier, as before mentioned, was not essential to loudspeaker reception under good conditions. At no time did it greatly increase the signal strength of stations

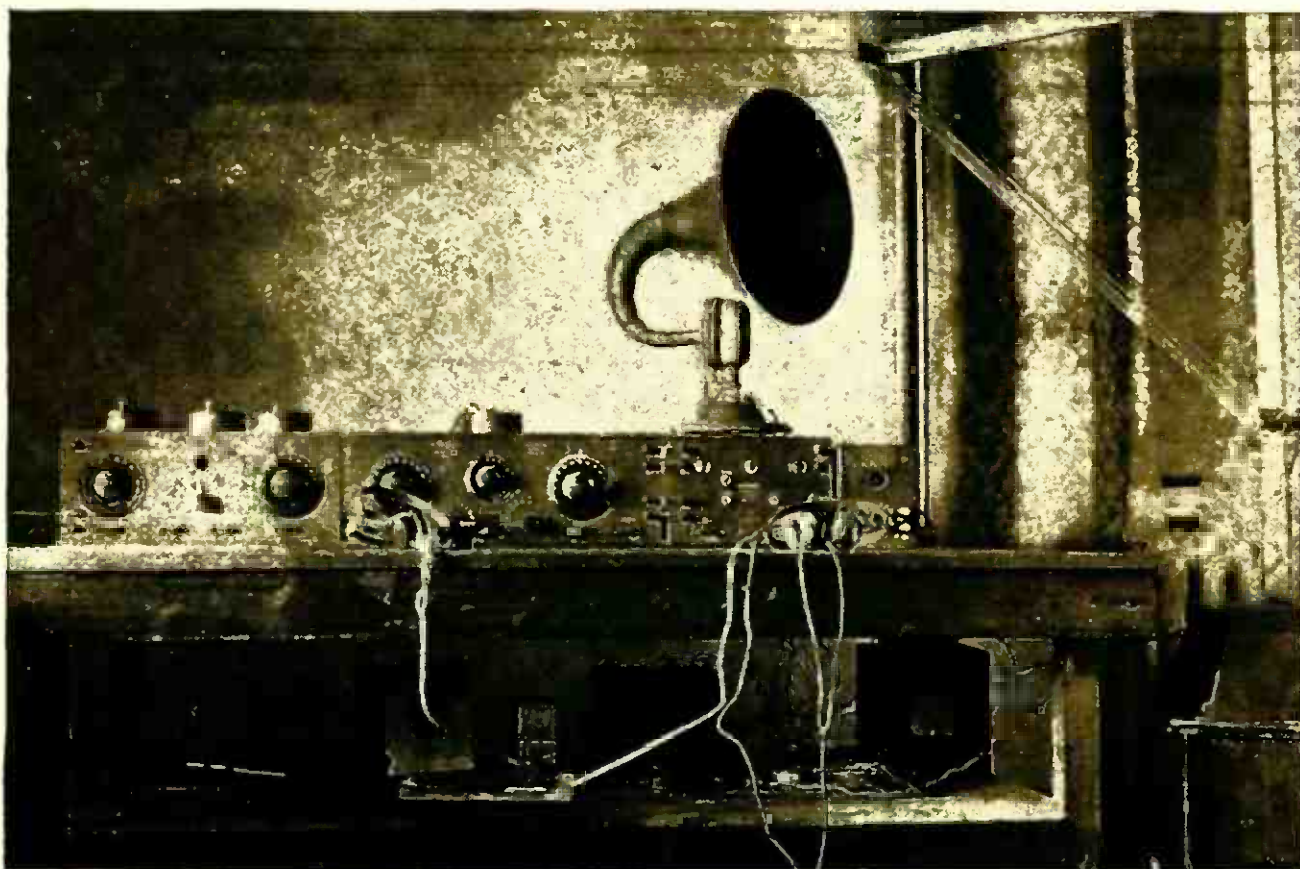

From a photograph made for POPULAR RADIO

THE COMPLETE RECEIVING INSTALLATION

FIGURE 1: *This set includes the tuned radio-frequency amplifier (on the table at the left), the twin-variometer, variocoupler tuner (center), the two-stage, audio-frequency amplifier (in the cabinet underneath the loudspeaker) and the single stage of power amplification (at the right). The edge of the directional loop-trap is shown in the upper right-hand corner of the photograph.*

on the Atlantic seaboard, and so, as it complicated tuning, it was eliminated except for the reception of stations over 1,000 miles distant (in which case this form of amplification was a great help), and on nights when 600-meter interference or static was particularly bothersome. In the first case, the radio-frequency amplifier was used in conjunction with one of the regular antennas, with the result that the QRM from the naval spark station was scarcely audible. In the case of heavy static, the loop antenna was brought into action, which, totally eliminating the "strays," enabled the operator to copy press and stock reports. Also, several of the nearer stations (6 to 700 miles) could be brought in with fair audibility on the loudspeaker. It was on loop reception that the radio-frequency amplifier proved its merit.

RADIO FREQUENCY

A radio-frequency amplifier of the tuned-plate type is not difficult to build, and, as a single stage is equal to two steps of the transformer-coupled design, it is economical in both construction and operation. The circuit is shown in Figure 2, which also indicates the preferred layout of the instruments in which various inductive and capacitative feed-back effects, disastrous in this system of amplification, are obviated. The condensers are shielded with twin plates (foil may be used) connected to each other and to the negative connection of the "B" battery. The shielding, as well as vernier adjustments on the condensers, not merely facilitate tuning, but it is indispensable to the most efficient operation of the set.

The condensers may be standard

11-plate variables, mounted on opposite sides of the panel. The inductance, L_1 , is the primary of a variocoupler, or it may be made by winding 60 turns of No. 22 S.S.C. wire on a tube three and a half inches in diameter. The coil should be tapped every fifth turn, one tap (on the panel) being left open for loop reception. The binding posts, one, two, and three, are arranged so as to permit either loop-reception, condenser-shunted (posts one and two-three, the last two shorted) or antenna-ground reception with condenser-shunted (same connections as for loop) and antenna-ground reception with condenser in series (binding posts two and three).

Potentiometer R_1 , is a 200 to 400-ohm instrument. The tube should be a "hard" one, and the plate voltage in the neighborhood of 100 volts.

The output coil, L_2 , is an L-50 honeycomb coil, or a two-bank inductance with twenty-five surface turns (for broadcast reception). In operation, L_2 , is placed in inductive relation to the detector grid circuit, i.e., within three inches of the secondary of the tuner. In a three-coil honeycomb set, this is most easily accomplished by utilizing the primary (an L-50 coil) as the output winding; while in the case of the twin-variometer regenerative set, the output coil may be placed on top of the cabinet over the variocoupler (Fig-

ure 1). Hence the tuned-plate radio amplification is to be particularly recommended to the amateur who desires to add radio-frequency amplification without making any internal alterations in his present equipment.

In thus supplementing a single-circuit receiver, the tuned amplifier is doubly useful in that it effectually blocks whatever energy the receiver would ordinarily radiate when oscillating. However, the amplifier itself is a powerful oscillator when not properly stabilized by the adjustment of potentiometer R_1 . When the amplifier is in an oscillating state, it transfers energy not only to the antenna but also to the receiving set, where it is likely to be mistaken for the beat-note of a broadcasting station. For obvious reasons this should be avoided.

It was found that some experimentation with the antenna system was necessary in order to secure the best results with this method of intensification. Using the large antenna, reception was considerably improved, and tuning greatly simplified by eliminating the ground. This also reduced 600-meter and 450-meter interference. Using the shorter antenna *with* ground, while not affecting audibility, increased the distance which could be received. This was probably due to the more marked directional effect of the smaller antenna. Tuning, however, was more critical.

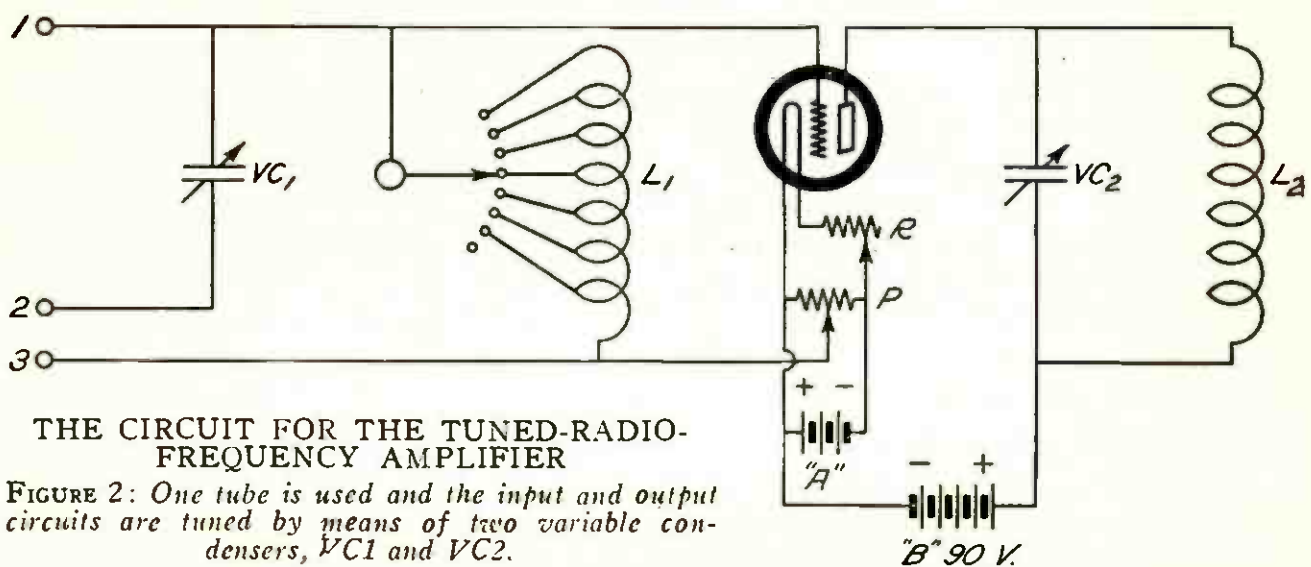

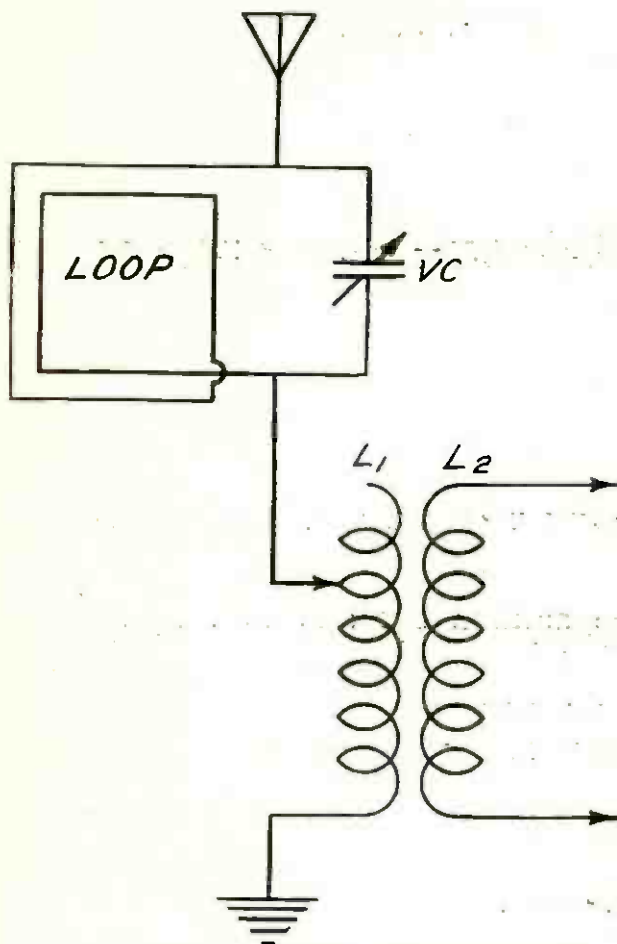

THE DIRECTIONAL WAVETRAPH

FIGURE 3: How the loop and the variable condenser are included in the antenna circuit to effectively cut down local interference.

The best results of all were obtained using both antennas and no ground, the smaller antenna being employed as a counterpoise!

The writer has hinted that tuning the radio-frequency amplifier is a delicate achievement, but by applying the following procedure, the knack is soon acquired.

Having turned the potentiometer completely to the right (or to the side connected to the negative "B" battery) the receiver proper is first adjusted, by means of the tickler or plate variometer, so that the circuit is oscillating on approximately the wave it is desired to receive. The dial of the antenna condenser, and the inductance switch are also set at the correct wavelength, or, if this is the initial attempt at tuning, at half their full values. Moving the output condenser slowly by means of the vernier adjustment from zero upwards,

the grid variometer (variometer set) or secondary condenser (honeycomb set) is twirled back and forth until the squeal or beat-note of the incoming station is brought in at its greatest intensity. (No energy will be radiated during this procedure, as would be the case were the radio-frequency amplifier not in the circuit.) The antenna condenser and inductance switch are now varied, again increasing the intensity of the squeal to a still higher maximum. At this point a zero beat is effected (the pitch of the whistle lowered until it disappears) and local oscillations just stopped by turning back the regenerative control (tickler or plate variometer). Slight changes are next made on the variometers and condensers, after which the final adjustment is effected with the potentiometer, which is turned up to the point just below where the signals become distorted.

Although the above directions may appear complex, the difficulties will vanish during an evening's experimentation.

THE LOOP

The loop designed for broadcast reception with the foregoing amplifier was of the solenoid type, three feet square and wound with nine turns of wire spaced one half inch. Tuning with the loop is identical with the process just described, excepting that one edge of the loop is first pointed in the approximate direction of the transmitting station.

The loop is especially satisfactory for reception through heavy local interference and static. However, through further experimentation with the coil antenna, another system of interference prevention was evolved which the author has termed a "directional wavetrapp." By means of this device forced oscillations from BZB were reduced without the corresponding great drop in signal intensity that accompanies straight loop reception.

The ordinary wavetrapp is nothing more than an inductance shunted by a variable condenser, which, placed in

series with the antenna, absorbs certain frequencies or wavelengths which it is desired to eliminate. However, a wavetraps of the usual design, tuned to 600 meters, will absorb energy from nearby waves, so that the strength of signals within 200 or 300 meters of the resonant frequency will be decreased.

While endeavoring to strike a happy medium in wavetraps, whereby the naval interference would be considerably reduced without an unjustifiable drop in 360-meter intensity, it occurred to the writer to utilize the directional property of the loop, hoping, in some manner, to absorb still more of the interfering signal. Carrying out the idea, the loop, or more exactly four turns of it, replaced the coil in the conventional wavetraps. The cutting down of the number of turns was compensated for by an unusually large variable condenser (.002 mfd.) by which they were shunted, it being the approved procedure in wavetraps* design to reduce the inductance while increasing the capacity (re-establishing resonance) which permits the

*Subsequent investigation has verified the theory of the directional trap suggested by the author, while also revealing the fact that this system has been known for some years, being employed in certain government sets during the war. Other experiment-

ers have placed the loop-trap in series with the detecting grid circuit, bucking the oscillations in the secondary, in which position it is quite probable that the system will be effective for greater distances than those successfully experimented with by the writer.

by-pass of the higher frequency (lower wave) currents. This arrangement (Figure 3) was remarkably satisfactory, both from the standpoint of the elimination of BZB and the comparatively negligible effect on broadcasting. The fact that the degree of interference reduction varied considerably in accordance with which side of the loop was pointed toward the offending station, suggested the theory that the directional elimination is due to currents set up in the loop, exactly identical to those being received on the outdoor antenna, but differing from them in phase (when the coil is correctly pointed) by 180 degrees, and so tend to "buck" or nullify the received currents.

The directional wavetraps is apparently superior to the conventional trap only on nearby stations, where the counter oscillations set up in the loop are sufficiently powerful to affect the incoming signals. However, it can doubtless be used to an advantage by enthusiasts located within five miles of naval or commercial stations.



Gilliams Service

A RADIO STRAW-RIDE

Entertainment need no longer be exclusively confined to amateur local talent on such old-fashioned rural dissipations as pictured above—at least not as long as a loop aerial and a loudspeaker will pick up the world's best broadcasting!

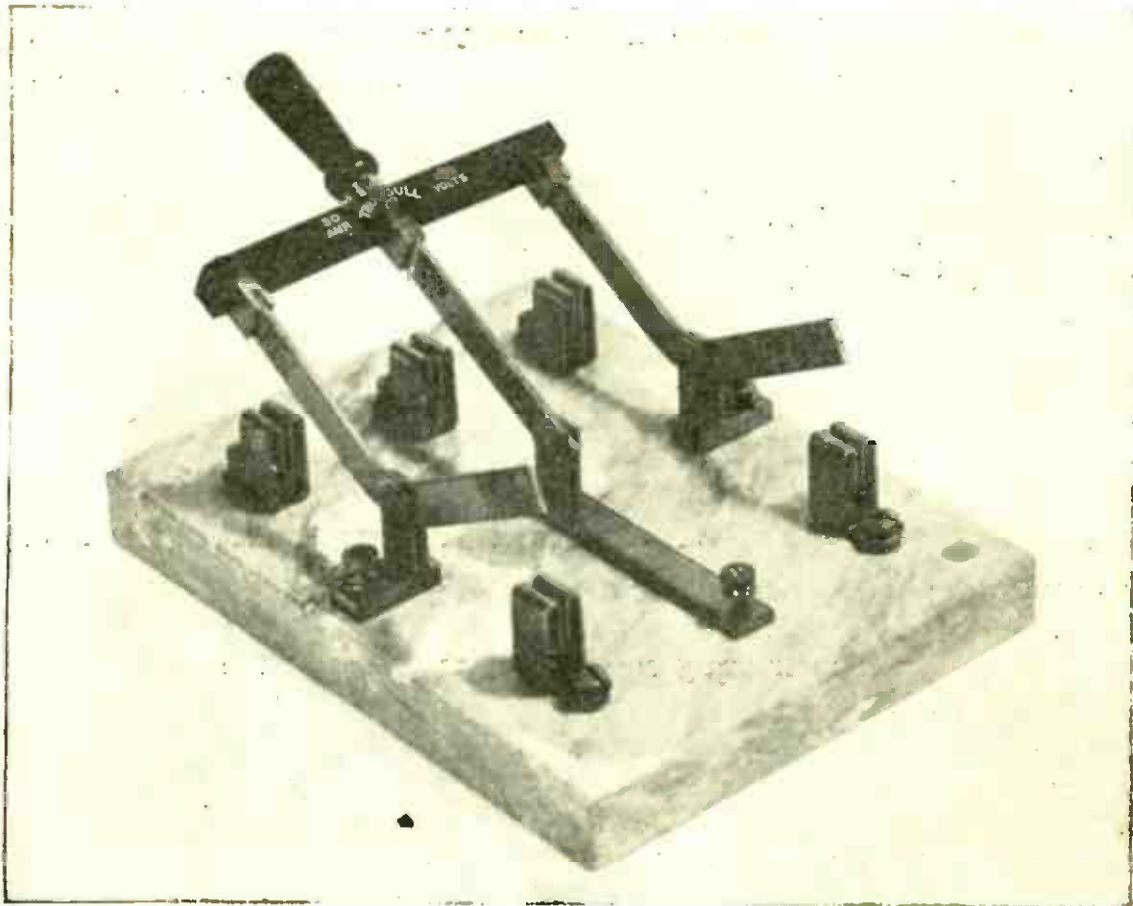

THE CHANGE-OVER SWITCH

This enables you to charge your battery or connect it to your receiving apparatus in a single operation.

HOW TO MAKE A BATTERY-CHARGING PANEL

At a cost of about \$20.00

Do you have to disconnect the wires from your battery to your set when you charge your battery? Did you ever accidentally let the two wires short-circuit? Did you ever connect the positive to the negative by mistake? Is the necessary labor to disconnect and reconnect your battery-charging apparatus irksome?

How to simplify these operations is told in this article by—

E. J. QUINBY, R. E.

HERE is a simple charging panel which makes it possible for the operator to put his battery on charge by merely pushing in one switch and, after the battery is charged up, to start his set going again by merely pulling out the same switch.

Moreover, in this charging panel provision is made for reading the voltage of the battery at all times by merely pushing a button, and for reading the

specific gravity of the acid solution at any time by means of the hydrometer which is mounted in a handy position.

Many a good battery has been abused by overdischarging merely because a convenient means for charging the battery was lacking, and the much needed charge was repeatedly postponed until serious damage to the battery resulted. Every radio installation that requires the use of a storage battery should not be

considered complete without some such device as is herein described.

This charging panel is equipped with a unique switch, which performs several duties at once. It was first designed to transfer from transmitting to receiving, or *vica-versa*. It is provided with two double-throw blades and one single-throw blade and it is mounted on an attractive marble base; furthermore, it passes the Underwriter's specifications for 125-volt service up to 30 amperes. This puts official approval on the scheme for connecting it into the domestic power supply for charging the storage battery.

The Parts Required

The parts required for building this charging panel, are listed below:

- A—Trumbull triple-pole transfer switch (radio type);
- B—storage-battery voltmeter, 0-6 volt or 0-10 volt range, panel type. (Weston, Westinghouse, General Electric or any other good make should be used);

- C—Testright battery hydrometer syringe outfit;
- D—drip glass and glass holder (an ordinary lavatory fixture may be employed).
- E—a vacuum-tube battery charger or other types of battery chargers (which operate on the vibrator principle) may, of course, be used;
- F—6-volt, 100 ampere-hour storage battery; any reliable make can be used;
- G—binding posts, large insulated type; 4 are required;
- H—front panel, 18 inches by 18 inches by $\frac{3}{8}$ inch, three-ply board;
- I—base, 12 inches by 16 inches by $\frac{7}{8}$ inch plank;
- J—braces, 1 inch by 2 inches by 20 inches long, pine, cypress, oak, or any strong wood; 4 are required. (Vertical pair will be 18 inches);
- K—brass clip (for holding hydrometer); this may be made from strip brass, or it may be purchased at any hardware store;
- L—push-button, as is used on door bells;
- M—30 feet of No. 16 rubber-covered electric-light wire;
- N—flat-head, brass wood screws, $1\frac{1}{2}$ inches long; 12 are required;
- O— $\frac{1}{2}$ -pint can of black-asphaltum varnish;
- P—hard-rubber tray (a photographer's developer tray will do).

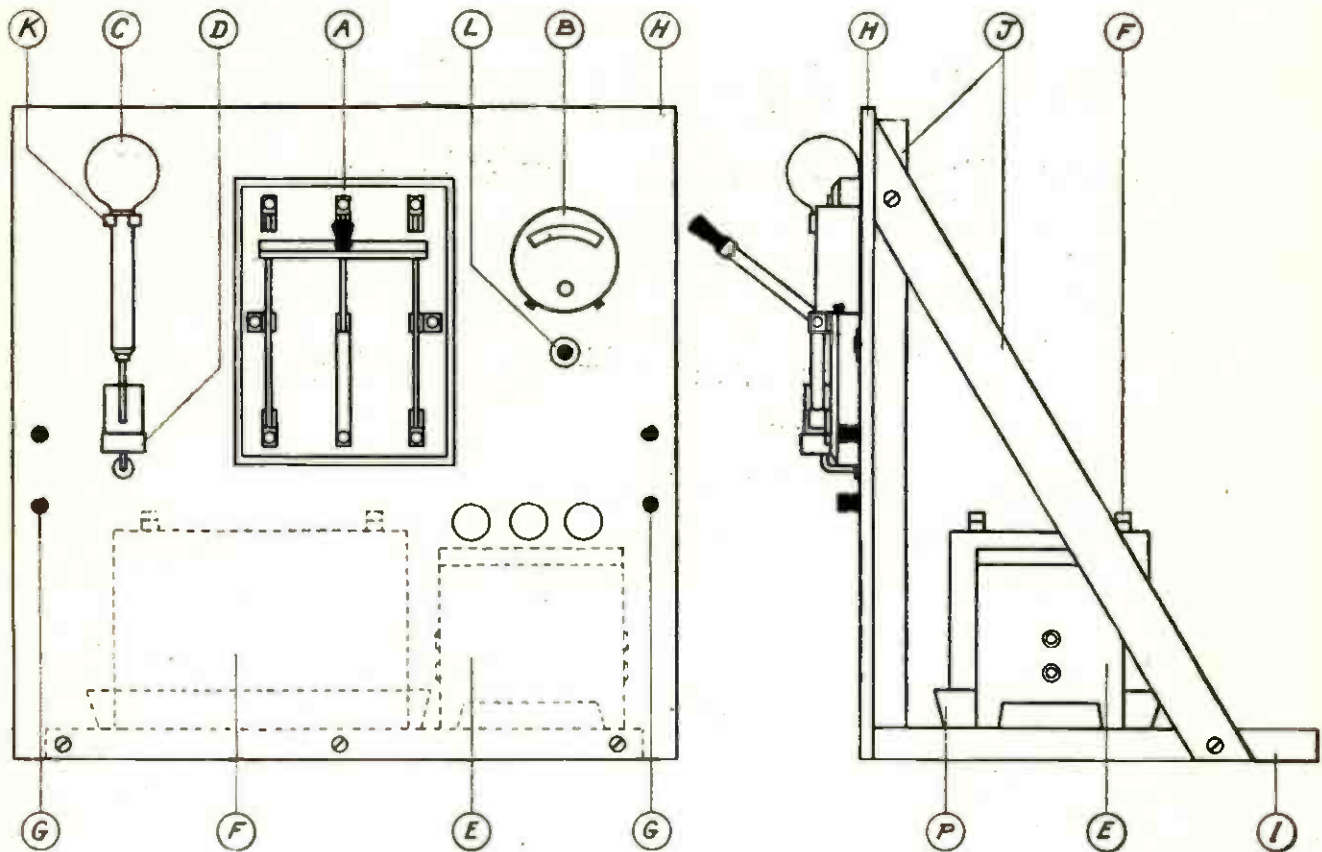

THE FRONT AND SIDE VIEWS OF THE CHARGING PANEL

FIGURE 1: This drawing shows in detail the layout for the various instruments; the charger, the battery, the change-over switch, the voltmeter, the hydrometer mounting and the drip cup.

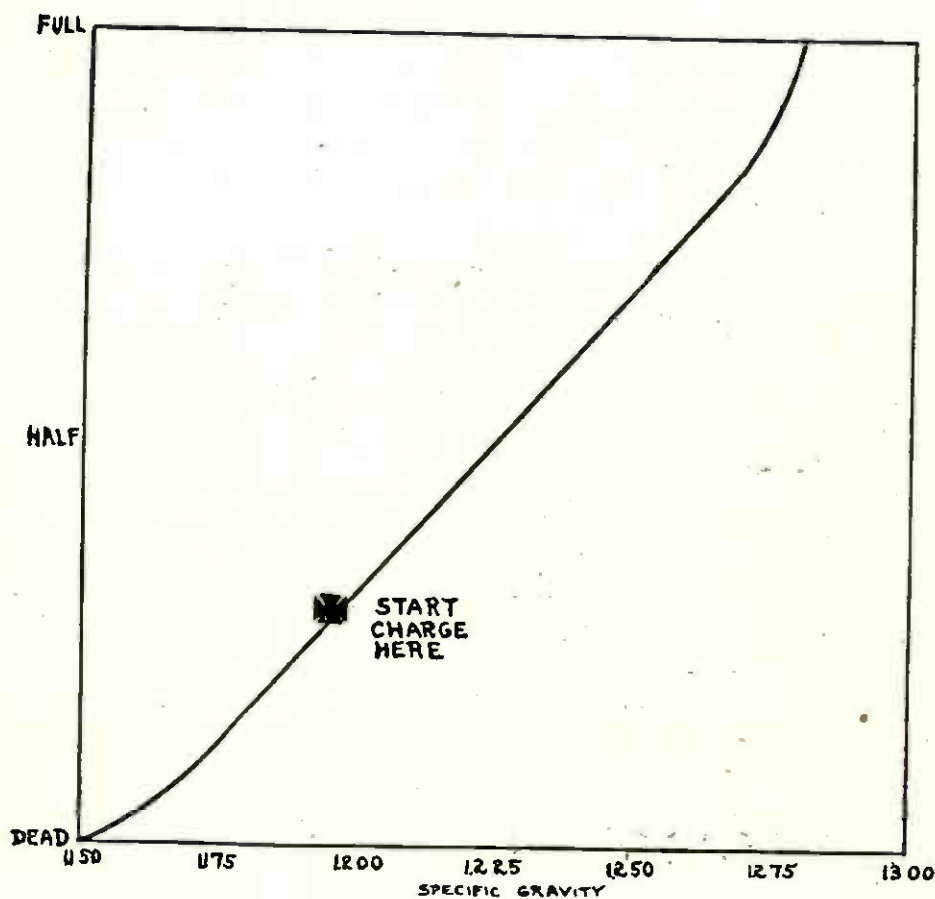

CURVE SHOWING CONDITION OF THE BATTERY DURING CHARGE

FIGURE 2: It will be noticed that as the battery is put on charge, the specific gravity of the solution increases from 1,200 up to 1,250 (at half charge) and up to 1,275 (when the battery is fully charged). This curve shows how important the hydrometer is in determining when your battery needs charging or when it is charged enough.

How to Assemble the Parts

When the experimenter has acquired all the items on this list, the panel, frame and base should be assembled.

First fasten the front panel H, to the two upright braces J, which should be located just one inch in from each edge. Three screws should be used for this purpose, on each brace.

Next, the back braces J should be attached to these front braces at the top, and run down to the sides of the base I, near the back, and secured with screws. The front panel H should be secured to the base I along the lower front edge with three screws.

Now trace around the edges of all the units to be mounted on the front of the panel H in their proper positions, and mark the locations of all holes to be drilled. Be sure to include the eight holes for wires to pass through the panel beside the eight terminals on the transfer switch A, two holes for wires to the voltmeter B, two holes for wires to the push-button L, and four holes for the binding posts G, two of which should be located near the center of the left-hand edge of the panel and the other two near the right-hand edge, directly opposite. Three holes about one inch in diameter should be drilled directly in front of the position occupied by

the rectifier, so that the operator may observe (through the front of the panel) whether the rectifier bulb is lighted or not (if the vacuum-tube type of charger is used).

After all these holes have been drilled, the woodwork should be given a generous coat of the black-asphaltum varnish (item O) and be allowed to dry thoroughly.

Next, mount the various units in their proper positions on the front of the panel H. Be sure to set the switch A so that the switch-handle is up.

Now place the storage battery F in the hard-rubber tray P, behind the panel H, on the base I, with the positive terminal to the right and the negative terminal to the left.

Behind the right-hand side of the panel H, locate the rectifier E, as indicated in the diagram (Figure 2). Move this about, a little one way or the other, until it is in the most advantageous position for observing the bulb through the peepholes in the panel H.

How to Wire the Unit

Now the unit is ready for wiring.

It will be found that the kind of wire specified under item M is sufficiently rigid to retain its shape without any supports other than the terminals to which it is connected in the circuit. Make all connections as shown

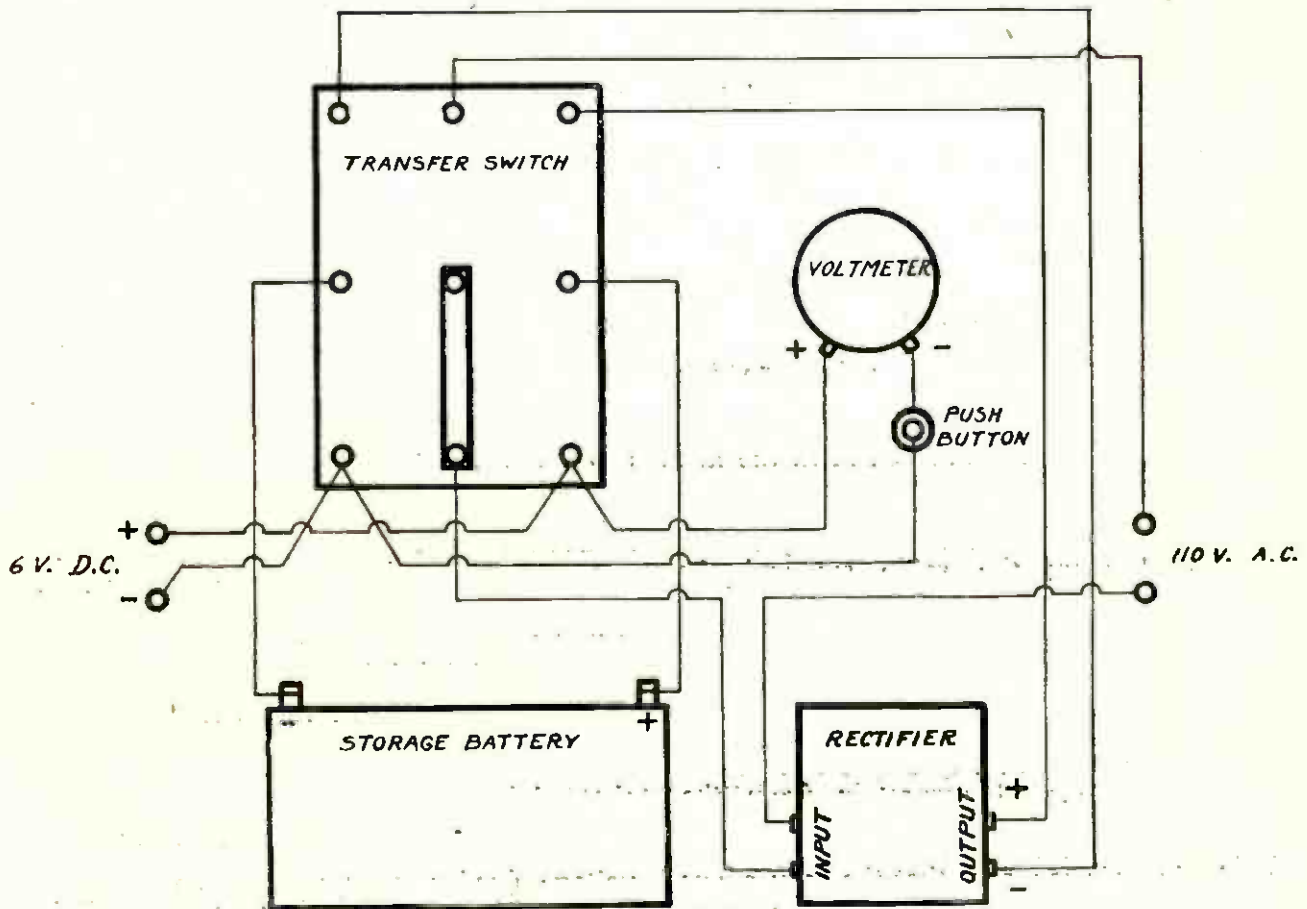

THE WIRING DIAGRAM FOR THE INSTRUMENTS

FIGURE 3: By following the connections indicated in this schematic drawing you may be sure that your battery will always be connected with the correct polarity, whether you are charging it or using it to supply your set with the necessary current for lighting the filaments.

in the diagram (Figure 4), running wires along rear of panel, and carefully check the work when the job is finished.

Be sure to see that the wire marked positive on the rectifier output, runs to the upper right-hand terminal of the switch A, and that the negative output wire of the rectifier goes to the upper left-hand terminal of the switch A.

The positive side of the storage battery F should be connected to the right-hand center terminal of the switch A, and the negative side of the storage battery should be connected to the left-hand center terminal of switch A.

The upper left-hand binding post on the panel H should be connected to the lower right-hand terminal of switch A, and also to one side of the voltmeter B.

The lower left-hand binding post on panel H should be connected to the lower left-hand terminal on switch A and also to one side of push-button L; the other side of push-button L should be connected to the remaining side of voltmeter B.

The upper center terminal of switch A should be connected to upper right-hand binding post on panel H.

One side of rectifier input should be connected to lower right-hand binding post on panel H, and other side of rectifier input

should be connected to lower center terminal of switch A.

This completes the wiring part of the job. All wires should be run straight and square, following the course shown in the diagram (Figure 4).

How to Operate the Panel

Locate the charging panel as close to the radio set as convenient and run a pair of wires from the 6-volt DC output, at the left of the panel, to the filament binding posts of the radio set; be sure to get the polarity right.

Next, connect the 110-volt AC line to the two binding posts at the right-hand side of the charging panel.

When the handle of the switch A is pushed in, the battery F is disconnected from the radio set, is reconnected to the output of the rectifier at the same moment (rectifier E is connected to the 110-volt AC line; thus the process of charging the battery is begun.

During this charging process the specific gravity of the acid solution in the cells of the battery may be read from time to time, and a watch may be maintained on the progress of the charge in this manner.

A chart showing the relationship between the specific gravity of the acid solution and the charge, is shown in Figure 3.

After expelling all the acid solution from the hydrometer syringe, it is returned to its position in the clip on the front of the charging panel, so that the lower end will set into the drip glass, thus avoiding any possibility of damage from this acid.

When the battery has reached a fully-charged condition, it is necessary merely to pull out the switch A—all the way out—and the battery F is at once disconnected from the rectifier E, and the rectifier is disconnected from the 110-volt AC line; at the same time the battery is connected once more to the radio set, without the irksome job of changing any wires.

Whenever it is desired to read the voltage of the battery F, set the switch A in the last position mentioned (handle all the way out) and then push the button L. At any time when it is desired to have the battery totally disconnected from the radio set and the rectifier also, the switch A may be set half way between the two extreme positions, so that the blades do not engage either set of jaws.

A pair of flexible wires with battery clips on each end may be kept handy, so that if desired the voltage of any single cell in the battery may be read separately from the others, by running these leads from the voltmeter to the cell desired. If the voltmeter reads backwards, it means that the connections are reversed.

In charging a battery, the charge should be continued until the cells begin to "gas" freely (that is, to emit bubbles), and carried on for about one hour after this point has been reached. The little vent caps on top of each cell should be unscrewed and laid loosely on top of the opening during the charge; this prevents dust and dirt from entering the cells and at the same time avoids the possibility of confining the gas that is generated during a charge.

It should be remembered that the acid in the solution does not evaporate, but that the water in the battery solution does evaporate and requires replacement. Add sufficient distilled or approved water to each cell *before* commencing the charge, to cover the plates of the cells about a half inch.

When reading the specific gravity of the electrolyte in each cell of the battery, draw sufficient solution up into the hydrometer syringe to float the hydrometer clear of top and bottom, being sure to exert no pressure on the bulb while taking the reading. The figure at the level where the surface of the solution circles the hydrometer-float is the specific gravity. When the reading drops to about 1,195, the battery should be placed on charge. It should never be allowed to go below 1,150. A fully-charged battery should read about 1,280. An old battery will not quite come up to this figure on full charge.

Keep the top of the battery clean and wipe a thin coating of vaseline over all metal parts on the battery, including the terminals and connection bars. After charging and after replenishing the water in a battery, it is best to wipe off the top of the battery and all parts exposed to moisture, with a rag. A fully charged battery of three cells should read a little over 6.6 volts on the voltmeter. Near the end of the safe discharge period, the voltage (under load) will drop to about 5½ volts for a comparatively new three-cell battery. When near the danger point the voltage will drop off rapidly.

Dimensions have been avoided in describing this unit, so that the man who builds it will not be tied down to any particular devices or apparatus, but can use whatever equipment he has already purchased, together with a few extra parts needed to complete the job. The satisfaction obtained from good battery service will more than repay for the work required in building this appliance.

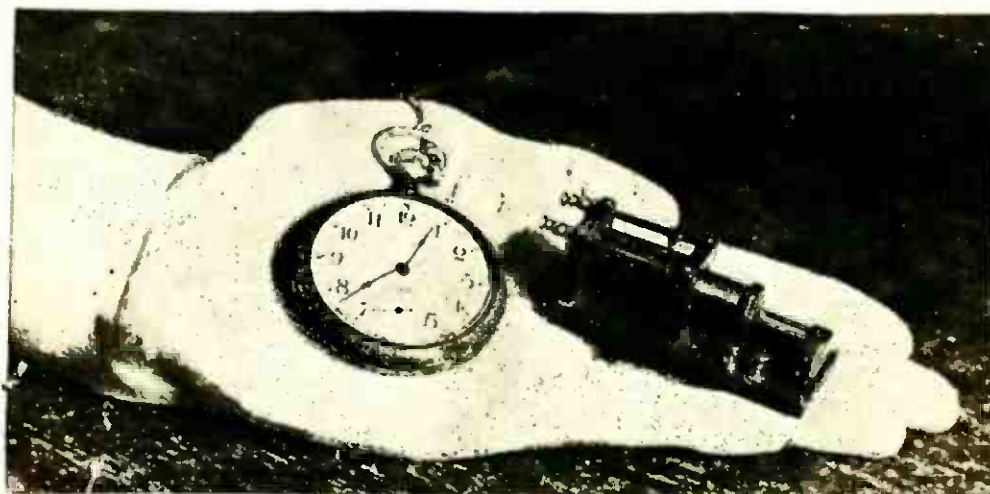

Kadel & Herbert

A MINIATURE LOOSE-COUPLER THE SIZE OF A WATCH

This baby tuner, made by M. W. Obermiller, covers the same broadcasting wavelength range as its larger brothers. It may be used with a crystal detector or with the more modern vacuum-tube detector. There are two sliders for the primary circuit and the secondary is tuned by means of a variable condenser.

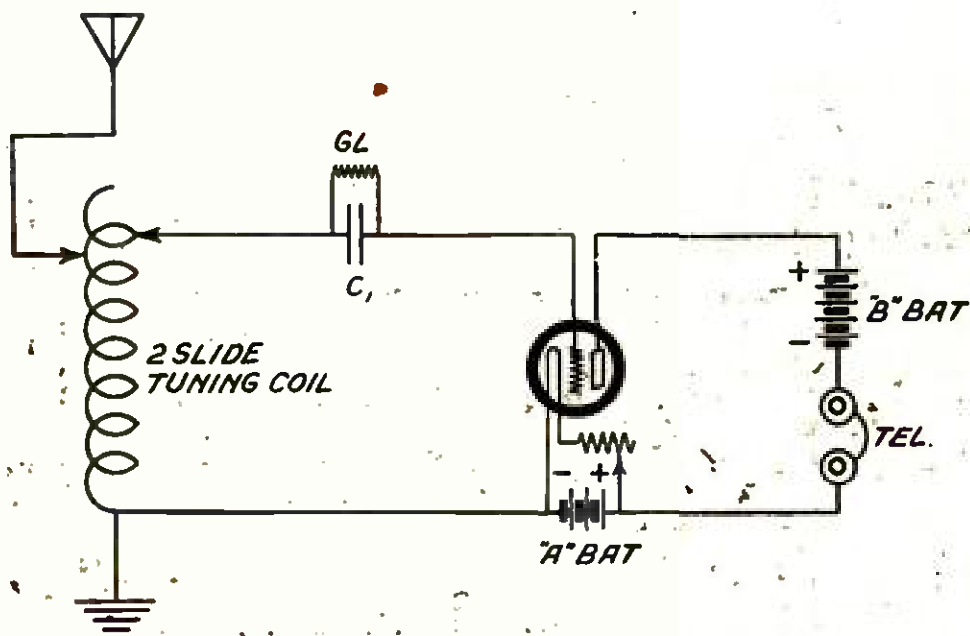

THE TWO-SLIDE TUNER, NON-REGENERATIVE CIRCUIT

Cost of parts: Not more than \$13.00 (Note: The costs of tubes and batteries are considered "extras" and are not included in the costs given in these descriptions).

Selectivity: Fair.

Operation: An easy vacuum-tube circuit, to tune. There is one slider for the antenna circuit and one for the secondary circuit. The only adjustment for the detector is

the rheostat, which controls the brilliancy of the filament.

Ease of construction: Extremely simple.*

Approximate range: 100 miles.

Outstanding features: This is probably the next set for the beginner to build after he has experimented with the crystal receiver and found out how it works. This circuit will give good clear signals. It cannot re-radiate.

**(See POPULAR RADIO, October, 1922, page 148, for constructional details.)*

100 BEST HOOK-UPS

INSTALLMENT NO. 4

IN this series of hook-ups is being published—for the special benefit of the radio novice who is undecided as to just what circuit he wants—100 of the best radio receiving circuits, each thoroughly tested. The approximate ranges given here are averages based on actual records made with receiving sets throughout the country. During the summer the actual ranges may fall to 50 percent of the value given, while in the winter, in the best of conditions, the actual ranges may exceed the values given by as much as 500 percent. All of these circuits have been described in detail in previous issues of POPULAR RADIO.

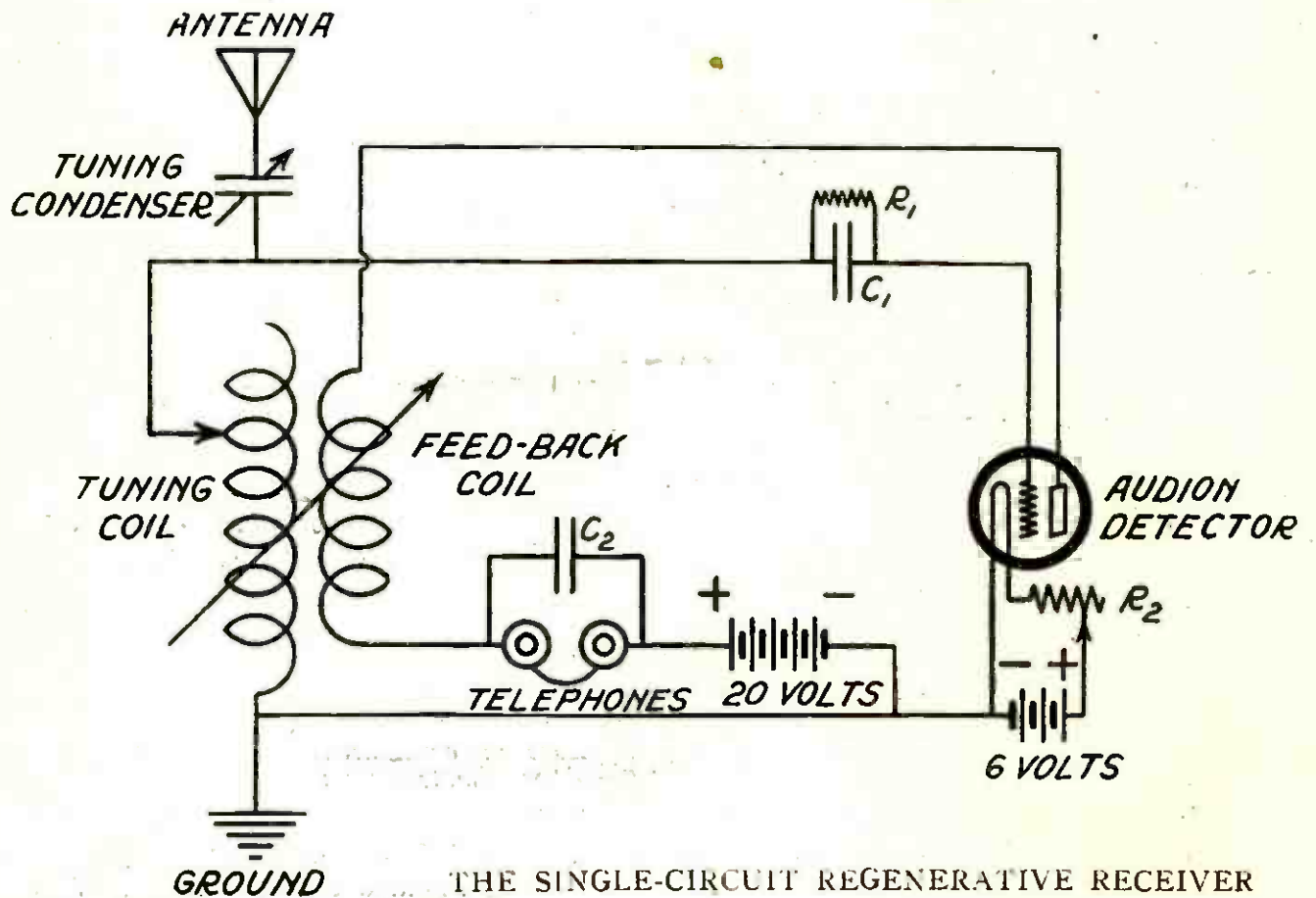

Cost of parts: Not more than \$20.00.

Selectivity: Poor.

Operation: Simple.

Ease of construction: Not complicated.*

Approximate range: 500 miles.

Outstanding features: Easy to build and easy to operate; much simpler than most regenerative circuits. The great drawback to the use of this circuit, however, lies in

the fact that it re-radiates strongly. In other words, while it is being used for receiving, it generates radio-frequency currents in the antenna system which cause radio waves to be sent out to produce interference in other receiving sets in the neighborhood. In the hands of an expert operator this might not happen but in the hands of an average radio fan it is almost sure to be the case.

**(See POPULAR RADIO, November, 1922, page 192, for constructional details.)*

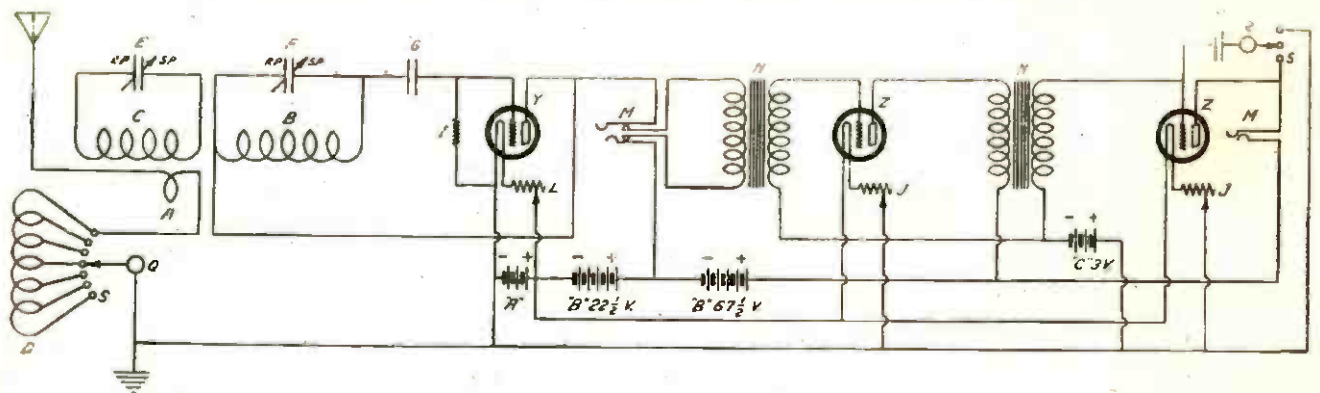

Cost of parts: Not more than \$40.00.

Selectivity: Excellent.

Operation: Very simple. There is one dial which controls the wavelength and one dial which controls regeneration. This dial can be set for the whole band of wavelengths over which regeneration will be constant.

Ease of construction: Not complicated. Be sure that the best parts are obtained, and the results will exceed expectations. Poor parts will render the circuit useless.*

Approximate range: 2,400 miles.

Outstanding features: Loudspeaker reception from distant broadcasting. Regeneration is independent of wavelength. Best sensitivity and selectivity.

**(See POPULAR RADIO, May, 1923; also August, 1923, page 165, for constructional details.)*

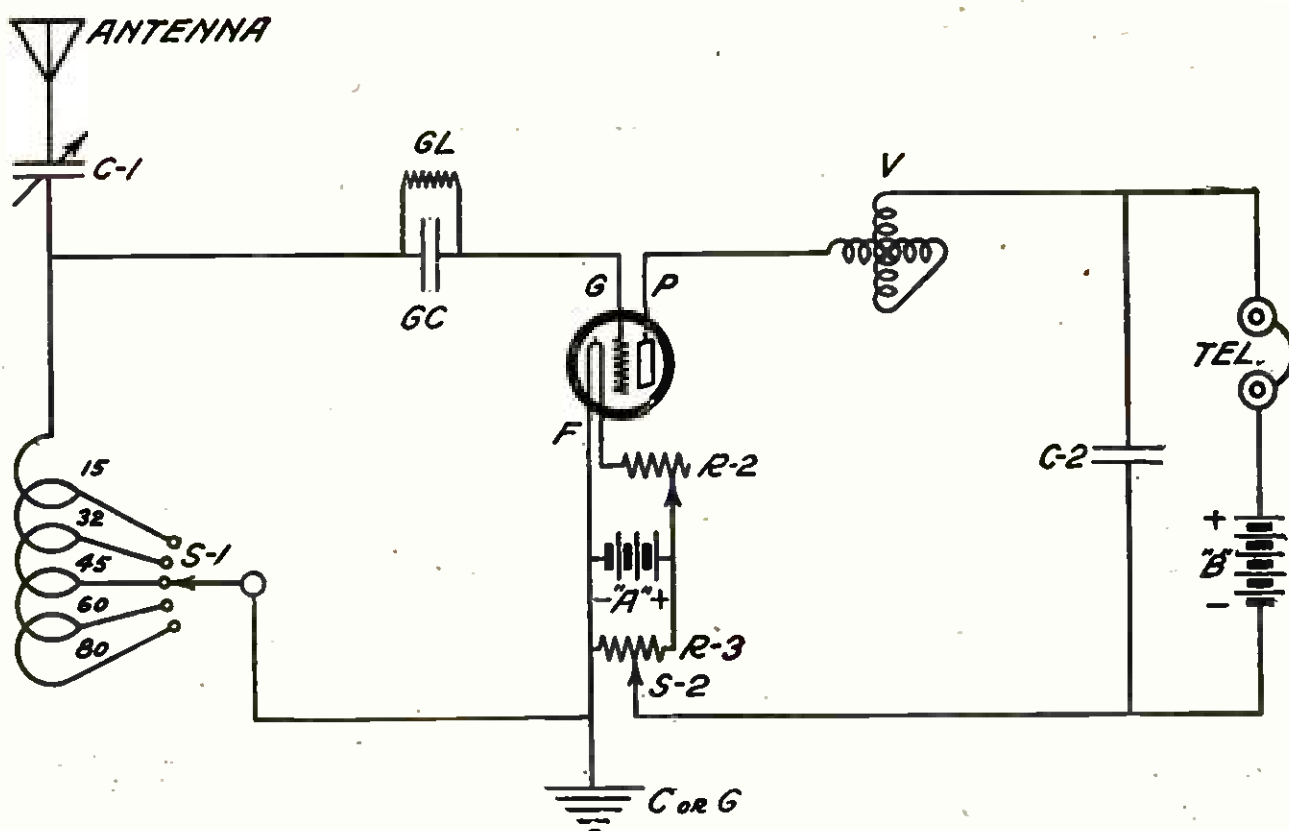

CONDUCTIVELY COUPLED, TUNED-PLATE, SINGLE-TUBE CIRCUIT

Cost of parts: Not more than \$23.00.

Selectivity: Only fair.

Operation: Simple. A variable condenser is used for wavelength control and a variometer is used in the plate circuit to control regeneration.

Ease of construction: Not complicated.*

Approximate range: 500 miles.

Outstanding features: This modification will tune a little better than the straight single-circuit set, and can be kept in more stable operation by means of the potentiometer. The set is guilty, however, of permitting interfering re-radiation in the hands of the inexperienced operator.

*(See POPULAR RADIO, June, 1923, page 430, for constructional details.)

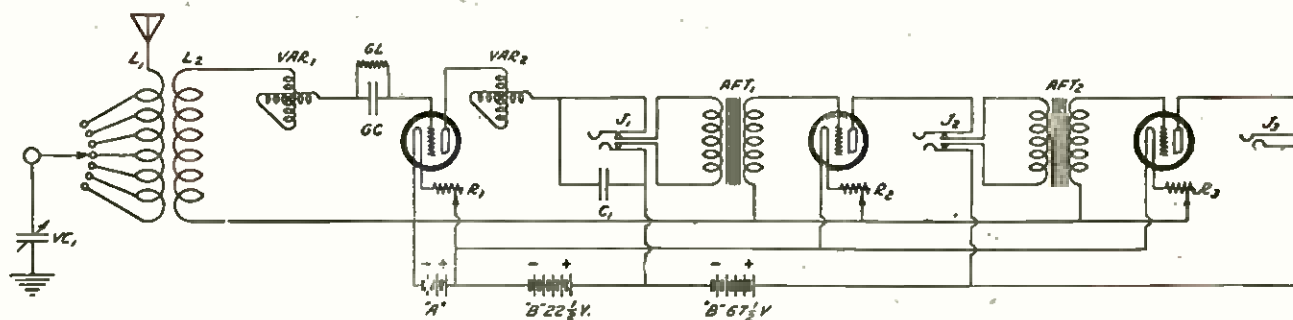

TWIN-VARIOMETER, VARIOCOUPLER REGENERATIVE CIRCUIT WITH TWO STAGES OF AUDIO-FREQUENCY AMPLIFICATION

Cost of parts: Not more than \$45.00.

Selectivity: Good.

Operation: Difficult.

Ease of construction: Just an ordinary acquaintance with tools and some ability in wiring up the circuit is necessary.*

Approximate range: 1,200 miles.

Outstanding features: All the tuning is inductive and this makes for louder signals, at a slight loss of selectivity. Both tuning and regeneration are controlled by variometers.

*(See POPULAR RADIO, October, 1923, page 329, for constructional details.)

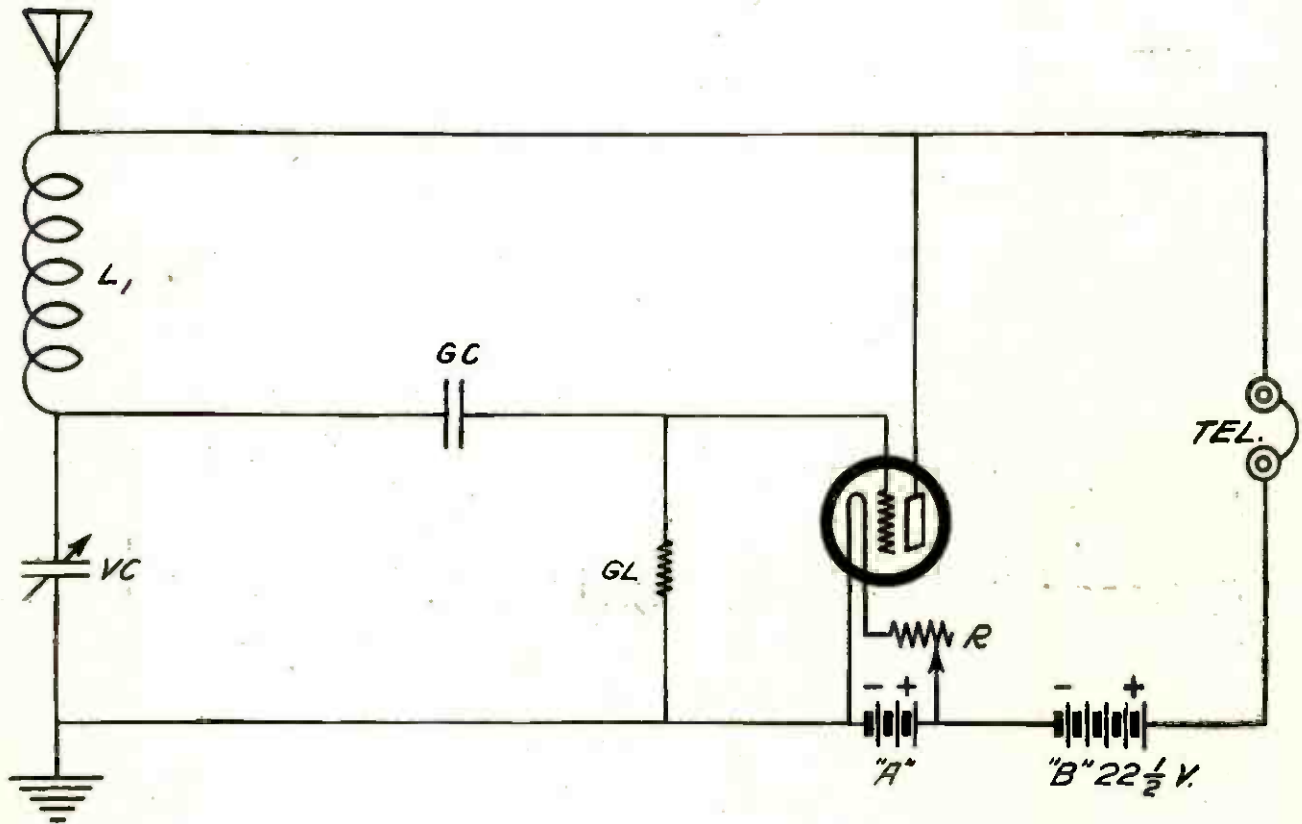

MODIFIED COLPITTS REGENERATIVE CIRCUIT

Cost of parts: Not more than \$15.00.

Selectivity: Fair.

Operation: Extremely simple. There is one tuning control, a variable condenser, and the rheostat is used as a simple means

to control regeneration.

Ease of construction: Very simple.*

Approximate range: 500 miles.

Outstanding feature: Simple to build and operate. It re-radiates.

**(See POPULAR RADIO, October, 1923, page 329, for constructional details.)*

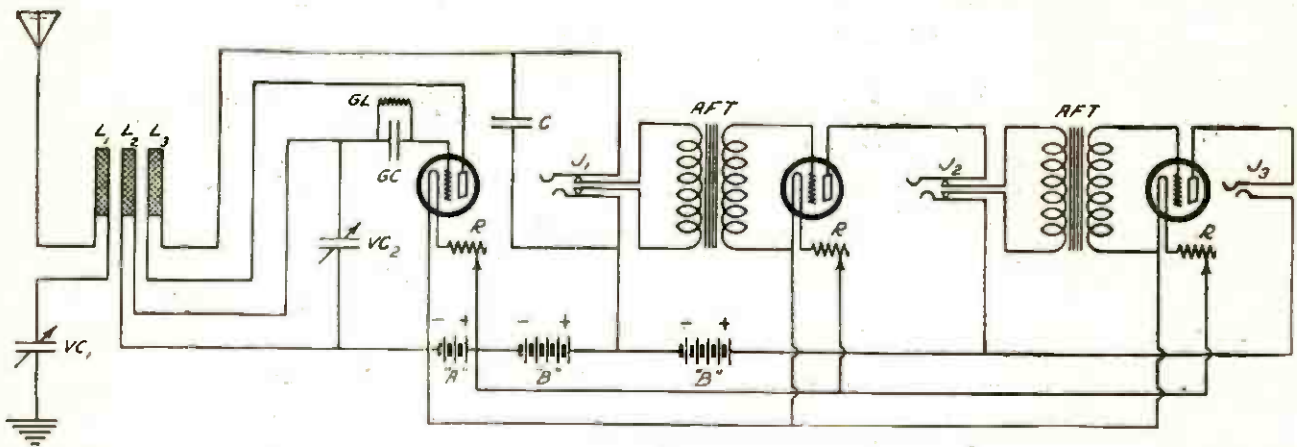

TRIPLE-COIL HONEYCOMB REGENERATIVE RECEIVER WITH TWO STAGES OF AUDIO-FREQUENCY AMPLIFICATION

Cost of parts: Not more than \$45.00.

Selectivity: Good.

Operation: Rather difficult to tune.

Ease of construction: The building of such a set is more difficult than the single-circuit tuner but better results in tuning will be

worth the extra trouble, and the amplifier will make the set suitable for loudspeaker reception.*

Approximate range: 1,200 miles.

Outstanding feature: The set can be used for reception on any wavelength range by merely changing the size of coils.

**(See POPULAR RADIO, April, 1923, page 308, for constructional details.)*

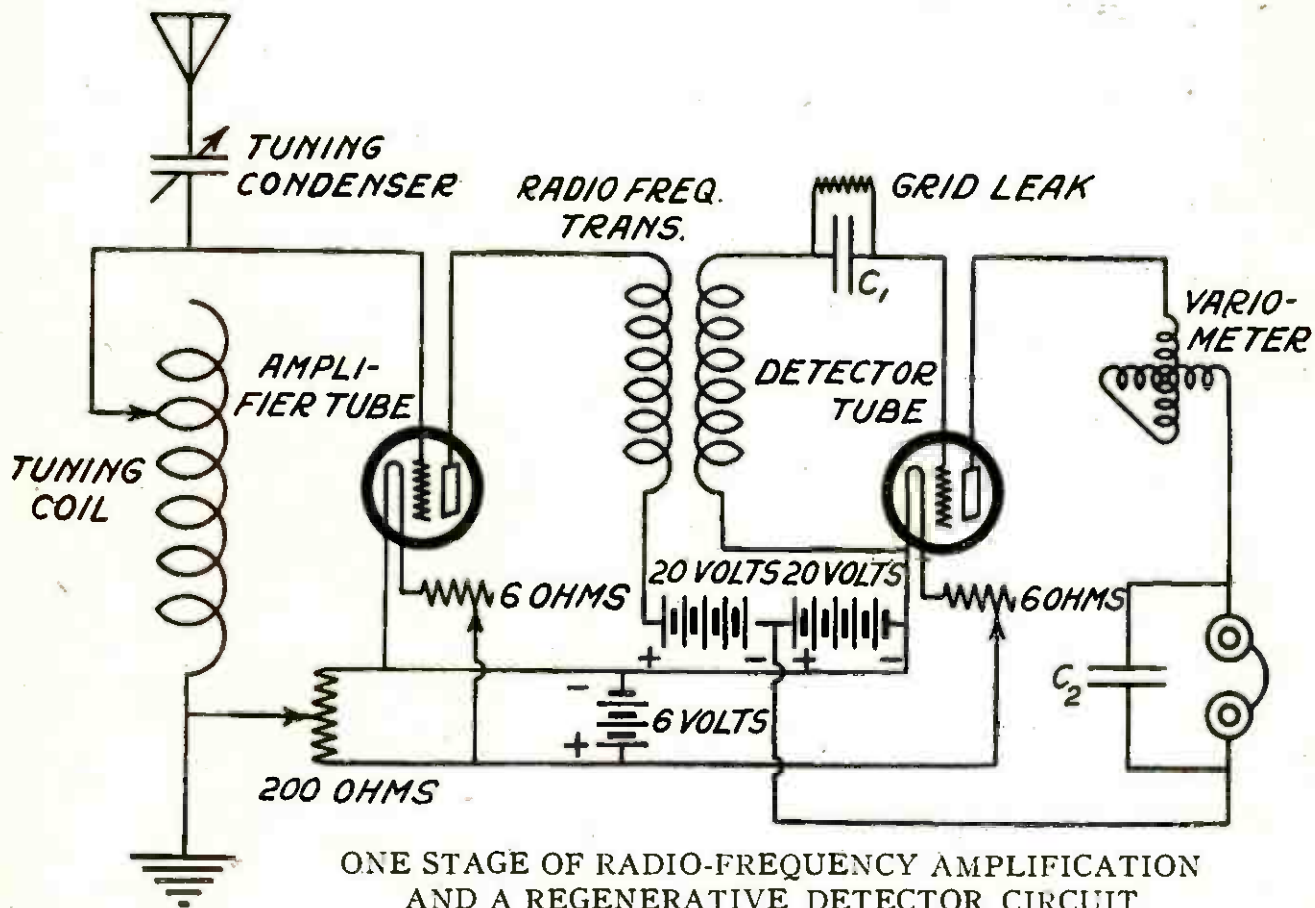

ONE STAGE OF RADIO-FREQUENCY AMPLIFICATION AND A REGENERATIVE DETECTOR CIRCUIT

Cost of parts: Not more than \$40.00.

Selectivity: Good.

Operation: Fairly simple. The antenna tuning is done with a variable condenser and a tapped coil and regeneration is controlled in the two circuits by a potentiometer and a variometer.

Ease of construction: Just an ordinary ac-

quaintance with tools and some ability in wiring up a circuit is necessary.*

Approximate range: 800 to 1,000 miles.

Outstanding features: Radio-frequency amplification gives clear reception even from distant stations and the regeneration used in combination helps in sensitivity.

*(See POPULAR RADIO, November, 1922, page 104, for constructional details.)

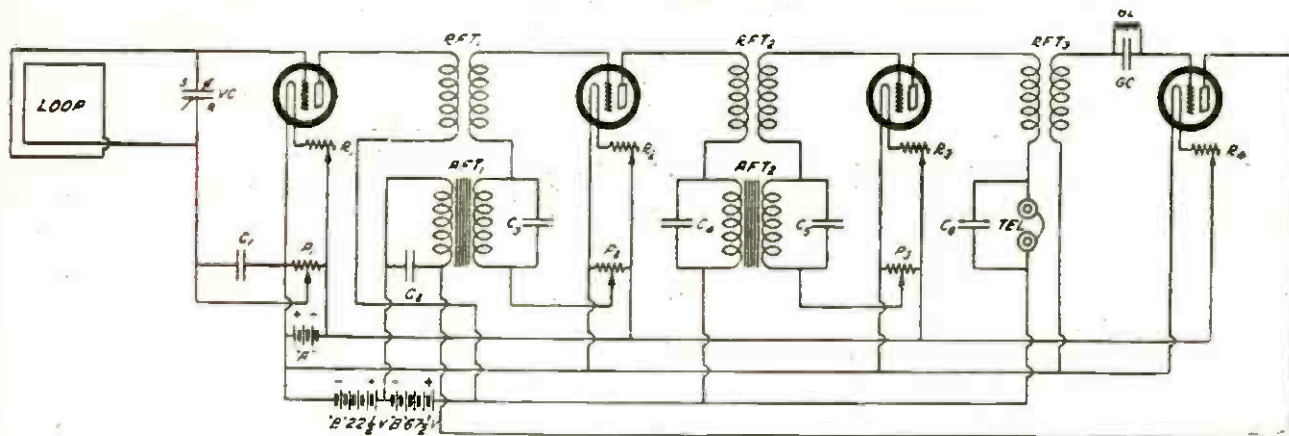

FOUR-TUBE REFLEX WITH THREE STAGES OF RADIO-FREQUENCY AMPLIFICATION, VACUUM-TUBE DETECTOR AND TWO STAGES OF AUDIO-FREQUENCY AMPLIFICATION

Cost of parts: Not more than \$60.00.

Selectivity: Excellent.

Operation: Very simple. Just one control for tuning—a variable condenser connected in shunt to the loop. Regeneration is controlled in the radio-frequency circuits by means of potentiometers.

Ease of construction: More or less compli-

cated. There are a number of precautions that must be taken to get the circuit to function properly.*

Approximate range: 1,000 miles (on a loop antenna).

Outstanding features: No outdoor antenna needed for DX reception. Simplicity of tuning. No crystal detector to bother with.

*(See POPULAR RADIO, November, 1923, page 418, for constructional details.)



Radio Corporation of America

"CLASSES IN THE NORTH ATLANTIC STATES WILL NOW COME TO ORDER"

Such is the startling announcement that may conceivably be made when teachers broadcast their lectures to the schoolrooms within radio range. The above picture shows Mr. Frank A. Rexford, head of the Civics Department of the New York City High Schools, broadcasting a school lecture as part of a demonstration to illustrate the application of radio to the educational field.

Teaching School by Radio

An experiment in broadcasting that points the way to what may prove to be an extraordinary development in our scheme of education

By FRED SIEGEL

RADIO has been discovered again—this time by the educators. After watching this new medium of communication grow from a laboratory demonstration to a tremendous power, they concluded that there might be some place for this new science in the process of education. So they have been experimenting with it as a medium for disseminating education.

Specifically, the public schools of New York City have been experimenting with it.

The methods by which radio was introduced into the classroom are suffi-

ciently novel to warrant the following report of the experiment, which was conducted at the Haaren High School in collaboration with broadcasting station WJZ:

The first demonstration was with a lesson in machine calculation, stenography and type-writing.

In the classroom was installed a receiving set; a similar installation was made at the Board of Education building.

In the classroom were installed thirty-five accounting machines; to each machine was assigned a student who had had one term of machine accounting. At the Board of Education, in the presence of the Board of Superintendents and other educators, was also installed an accounting machine with a student

operator, while at the broadcasting station there was a similar accounting machine with a student operator, by whose work the dictator was to be guided.

(Incidentally in the classroom at the high school were also four students from the stenography and typewriting department who took the speeches that were transmitted before the lesson began; these speeches were copied, transcribed and delivered to the Board of Education, before the speakers reached that place an hour later.)

A teacher conducted the lesson in machine accounting. Before he dictated the problems he explained to those who were listening in that the work of the day involved the four fundamental processes of addition, subtraction, multiplication and division, and that the student operators were trained to work by the touch system and could devote their time to listening and thinking about the problems, rather than to the operation of the machines.

Then the lesson began.

The problem was dictated. Then there was a pause, in order to allow the operators to do the work. Then the answer was given. Each step in the computation of the problem was shown on the tape which the machine

printed. A visible record was made of pupils' reactions; those who did not get correct answers were given personal attention after the lesson to correct any deficiencies in the knowledge.

The results of the experiment proved that the class in machine accounting heard, understood, and did the work as well as they would have done if the instructor were present in the room during the dictation. One girl made a record of 95 percent on the test.

Several weeks later a series of four other demonstrations of "education by radio" was held. The first was a model lesson in economics, and was conducted in regular classroom fashion. If every school within a radius of 500 miles had had a receiving set, the pupils and instructors in each of these schools could have heard how the subject was taught; they could have heard the questions propounded by the instructor and the responses of the pupils. The demonstration was considered an excellent one from every point of view.

The second experiment, held the following week, was a history lesson which was given to show an out-of-the-ordinary method of conducting a history recitation. In this in-

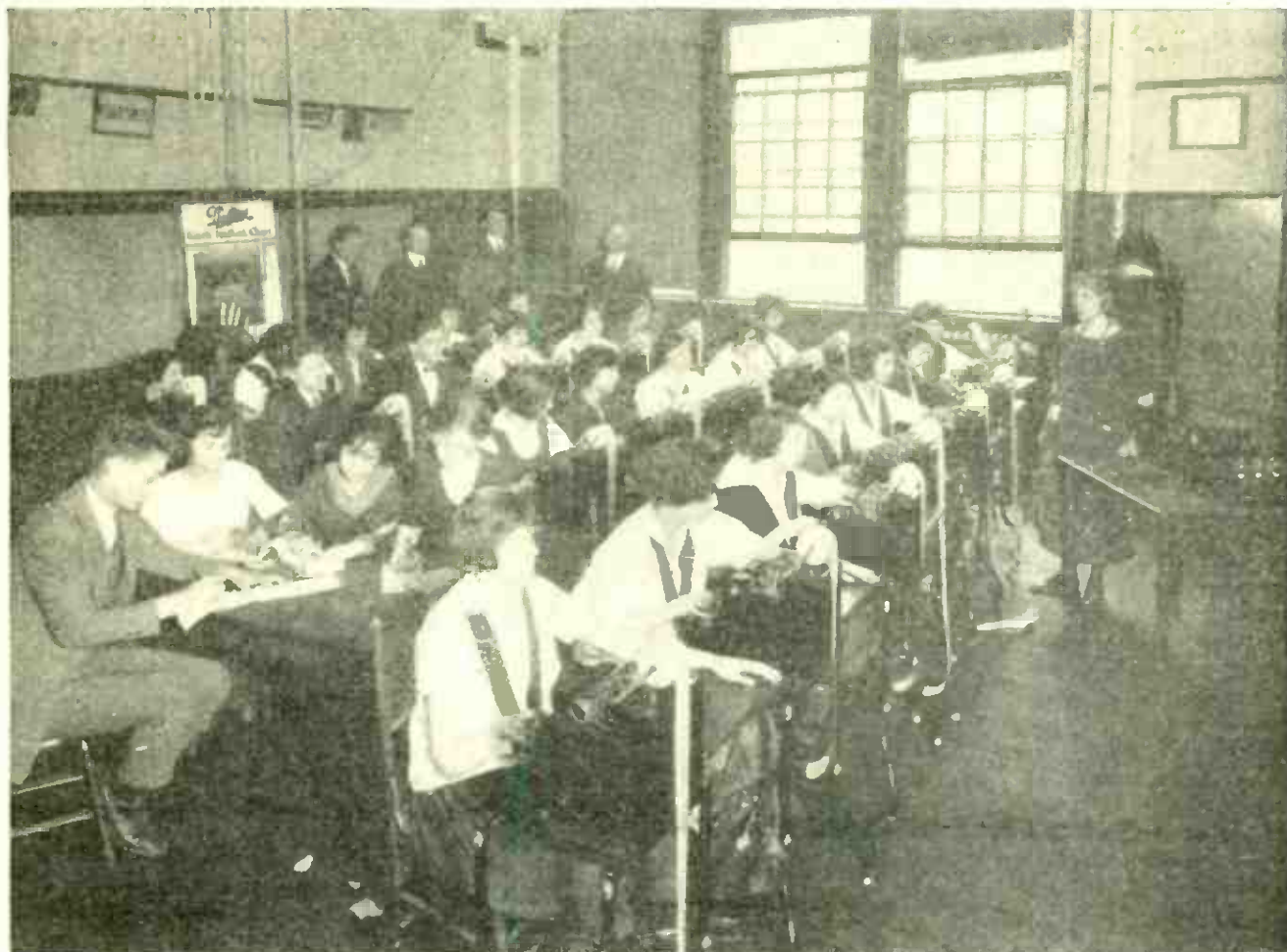

Radio Corporation of America

WORKING OUT PROBLEMS THAT COME INTO THE CLASSROOM BY RADIO

Thirty-five accounting machines were used by as many students in this classroom of the Haaren High School in New York for solving problems in machine accounting that were propounded by the instructor via station WJZ. In this manner classes could be conducted throughout the schools of a large area.

stance, as in the previous experiments, the class was present in front of the microphone. At the beginning of the lesson the teacher distributed slips of paper to the class. He then proposed ten questions, each of which could be answered "yes" or "no." As each question was read the pupil wrote either "yes" or "no" on his paper. After the questions had all been dictated the discussion began.

"Mr. X how did you answer the first question?"

Mr. X had answered "yes."

"Why did you answer 'yes'?"

Mr. X had to defend his stand. Mr. Y had answered "no"; he took exception to some of the statements of Mr. X. So the discussion began, with the instructor acting as umpire. The recitation did not revolve about the instructor but was in fact a recitation in which every member of the class took part. The demonstration was of value to every teacher and pupil who listened in; it would have been of inestimable value to the teachers and scholars in the smaller schools throughout the east.

The third demonstration was a shorthand and typewriting contest in which six high schools entered. The matter that was dictated was new to the contestants and of moderate difficulty. There were two tests, one of eighty words a minute for the less advanced students, and one at one hundred words a minute for the more advanced students. Each test was three minutes long. Before the test began there was a short practice dictation for all of the students to accustom themselves to dictation by radio. The winner of the 80-word contest had but three errors, as did the winner of the 100-word. These demonstrations show the possibilities of the uses of radio for the giving of controlled tests of all types, as the students were in widely scattered places, yet each received the dictation under the same conditions. Such practice for students in all of the schools of a large territory could thus be handled by one teacher, dictating from the broadcasting station, while the transcripts of these practice dictations could be corrected by the students themselves under the guidance of one of their own instructors.

The fourth experiment was a lesson in Community Civics. The teacher concluded his lesson with an assignment of work for class the next day. In this demonstration we have an interesting instance of how the educational head of a large group could direct the work of the teachers and pupils in his particular subject over a wide area. In this case the broad general viewpoint was presented, with suggestions for further study, new developments were explained and the background was secured upon which the class teacher could build and amplify to meet the needs of his own group of students.

Interesting as these demonstrations have been, the real significance of them lies in the broader application of radio to our educational system—an application so broad, indeed, as to foreshadow a

change in our present-day conception of what "education" really means. For example:

Training for citizenship forms an important part of the public school curriculum. The functions of the governmental agencies can best be described by those engaged in their performance. First-hand information is valuable and inspiring, but it would be physically impossible for the Governor (for example) to visit every schoolhouse in the state and describe the work of his office. This information is, of course, embalmed in text books and it is duly studied in all the schools, but how much more meaning would this information have if the sound of the Governor's voice penetrated the schoolroom, and in his own way he told of his problems and the work of the state?

It would not be at all impossible to induce the Governor to give an occasional talk to the school children of an entire state, or to induce other department heads to explain their activities. In this way the work of the teacher would be given more value and the pupil would be getting his information and inspiration from living sources.

The whole world could be his faculty! The schools in our larger cities are often honored with the presence of distinguished visitors, both from our own country and from abroad. The pupils in these schools are assembled to hear what these visitors have to say. But how many children can hear them? Only a room full. How much better would it be if these addresses could be broadcast to all of the children within the range of the sending station! In this way there would enter into the Little Red Schoolhouse the world's commanding figures in education, in science, in art and in statesmanship.

The teachers in rural schools are usually young people without much experience as teachers, with even less training for their jobs than has the average teacher in city schools. The quantity



Radio Corporation of America

HOW THE SCHOOL TEACHER BROADCASTS HIS "RECITATIONS"

In the headquarters of the Board of Education in New York the instructor propounded school problems before the microphone that carried his voice by wire to station WJZ, where it was broadcast. The problems were also worked out by students in the instructor's office; these students served as guides for the time required to complete the answers.

as well as quality of their teaching should be the best possible. Any instrument, or device which would aid in attaining this end is a great asset to the school and the community. Radio can enter here as a factor laden with unlimited possibilities.

It is not inconceivable that the state may in time have its broadcasting stations, and that each schoolhouse may be equipped with a receiver. The staffs at the broadcasting stations may consist of experts who may work out courses

of study which would be printed and distributed to the various schools. Quiz questions and suggested readings could be supplied; at stated periods the classes with the teachers in charge might gather in front of the receiving set and listen to the lesson, as presented by the instructor from the broadcasting station. After the lesson has been presented and fully covered, the follow-up work in the shape of written exercises or oral examinations could be conducted by the class teacher. In this way, it would be pos-

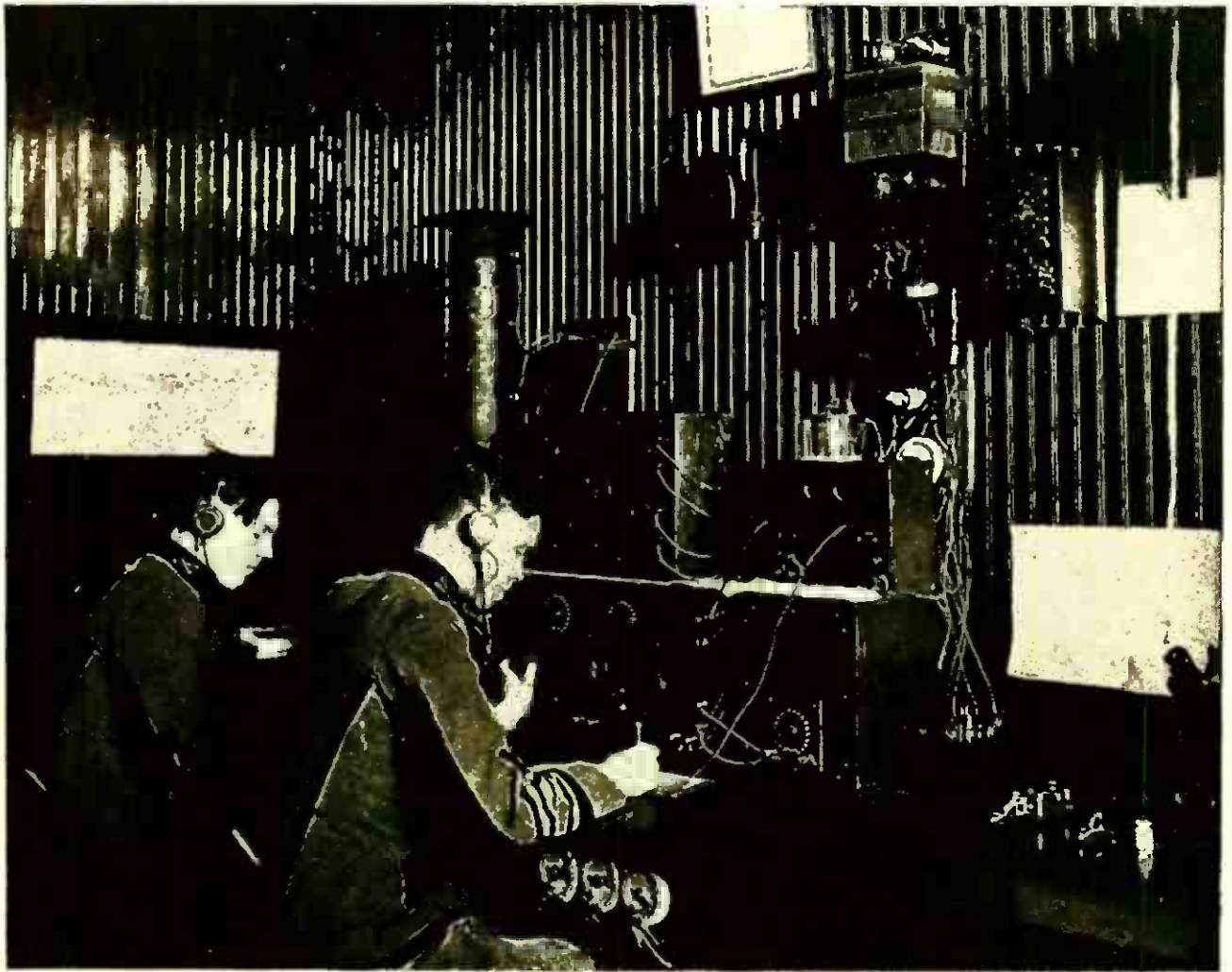

Courtesy Culver Military Academy

INSTRUCTION IN RADIO BECOMES PART OF THE SCHOOL COURSE

Work in both reception and transmitting has at least one extraordinary advantage; it teaches physical science in terms that the student can understand and in which he takes a practical interest. Courses in the theory and practice of radio are being incorporated in the curricula of both public and private schools.

sible to standardize our teaching and raise it to a higher level. Uniform examinations, which would be based upon the lessons covered and not merely upon a printed course of study, which allows a great latitude in interpretation, would then be possible. The questions could be read from the broadcasting station by the person in charge of that branch of the work, and the pupils could answer the questions after they were read. This type of uniform examinations would admit of no opportunity of knowing in advance, what the questions were to be. The other evils that go with the examination paper which has to be printed in advance and distributed with the greatest secrecy, would thus be eliminated.

All of these observations on the use of radio in the rural schools apply to the city school. Indeed, one of the greatest problems that confronts any school system is to obtain a constant supply of well-trained teachers. In this phase of educational administration radio can be of immeasurable assistance. Young teachers and teachers-in-training can learn a great deal by observing the teaching methods of their more experienced co-workers. It has always been difficult to arrange this type of observation. If a microphone were installed in the classroom and the recitation held under ordinary conditions, any number of teachers might listen in on this recitation. New methods in teaching could be presented to all of the teachers of

that subject, with the resulting benefit to the school as a whole.

In larger school systems, conferences could be called by radio; notices and instructions for the day could be announced; special announcements could be distributed to all concerned, while the subject matter is still vital. In many other ways, the efficiency of the educational system could be increased by the

use of radio for broadcasting to classes.

And some day it will be.

A start has been made. There is a vast field still unexplored both for the school man and for the radio enthusiast. But the goal is worthy of the effort. Radio can be used in educational work in a useful and important way. It is up to the radio fan to point out those ways to the school man.

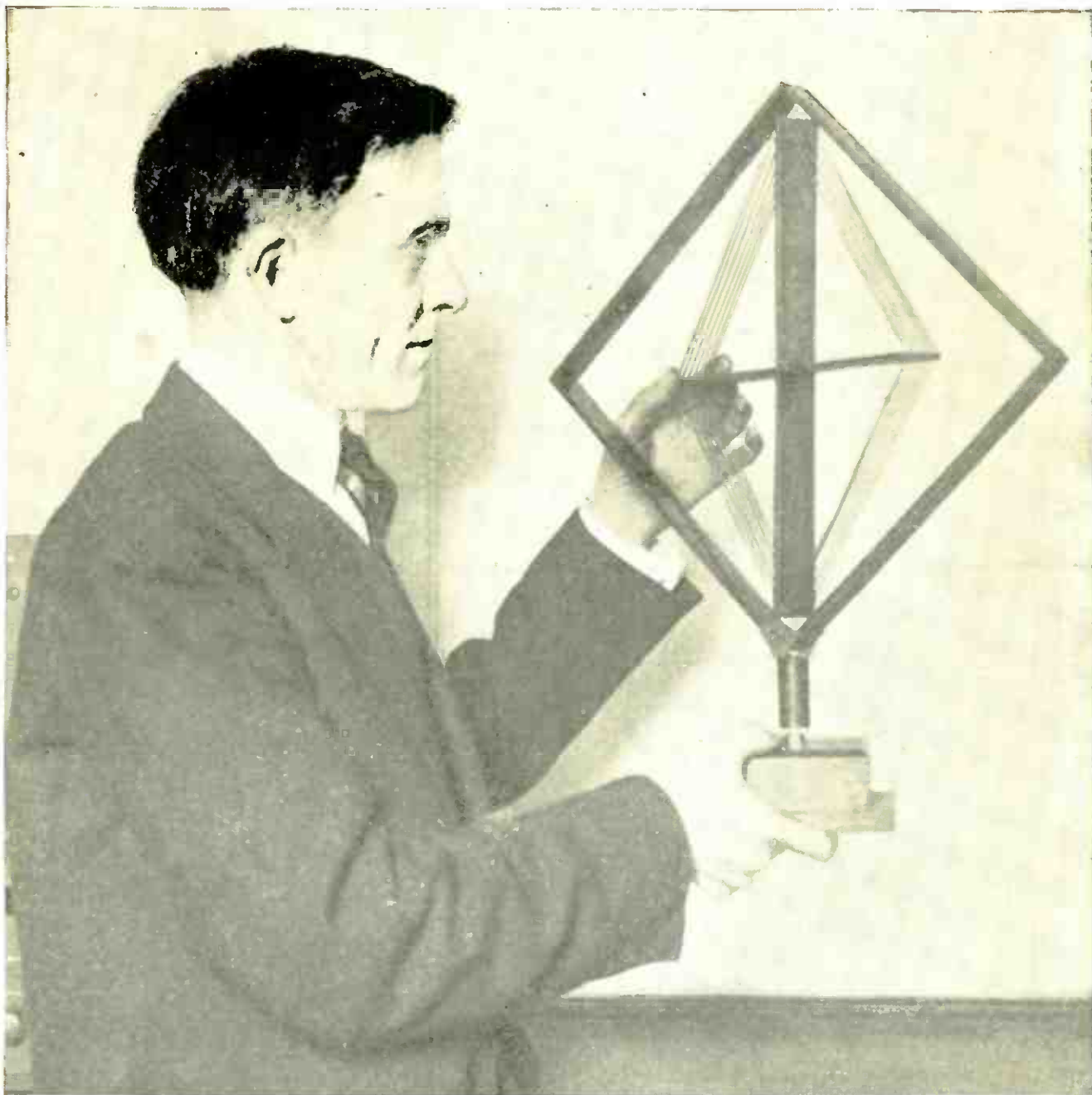

Kadel & Herbert

AN INDOOR ANTENNA THAT TUNES ITSELF

This small loop consists of two windings on a square frame. These two windings act as the coils of a variometer so that the wavelength of the antenna may be adjusted by simply revolving the inner winding. Signals from any particular direction may be picked up by turning the two windings together on a vertical axis. The loop was built by M. W. Obermiller, a New York amateur.

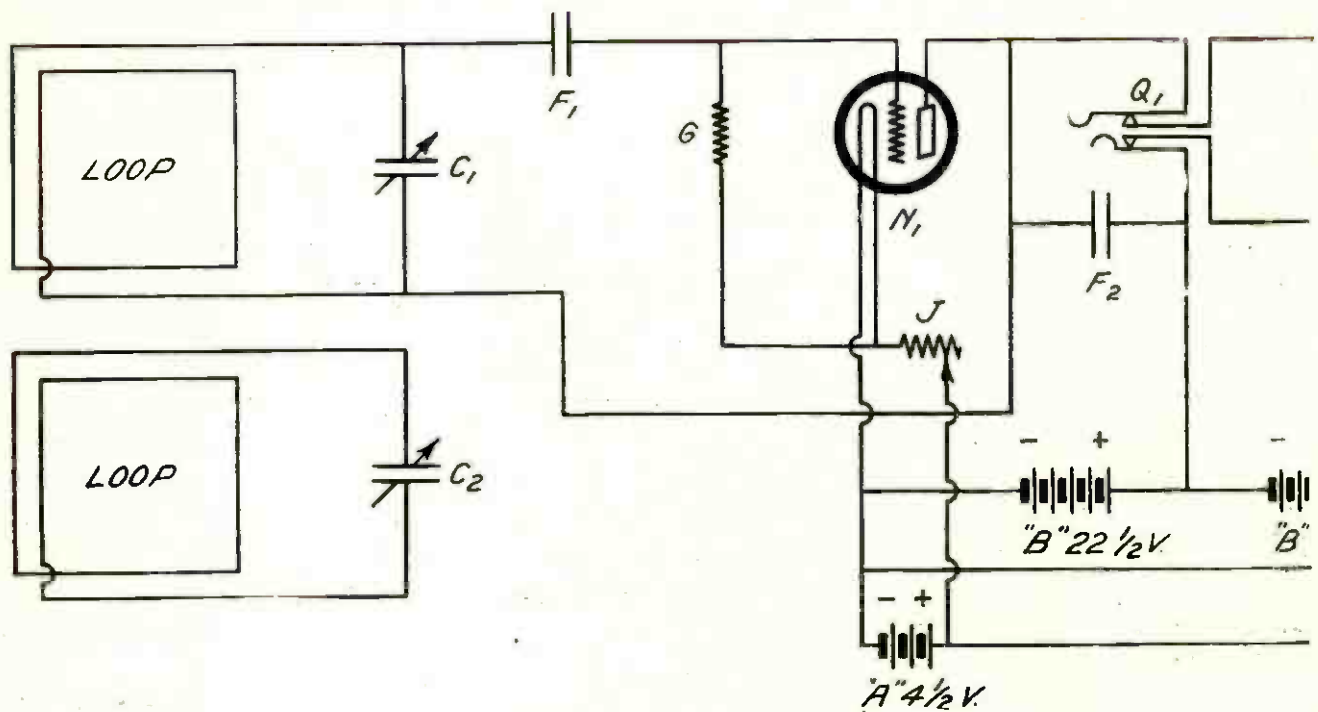

THE ELECTRICAL CIRCUIT CONNECTIONS

This diagram shows how to wire up the various instruments used in the hook-up, so that they will function properly. Be sure that they are followed out EXACTLY in order to get good results.

How to Use the Four-circuit Tuner —AS A PORTABLE SET WITH A LOOP AERIAL

Here is a clever modification of the receiver described in the May issue that makes a neat little portable receiver and which has given the author satisfactory results on local reception.

By O. B. PARKER

DURING the past summer, more than ever before, the attention of radio fans has turned to portable receiving sets. Few of these portable sets are self-contained; most of them require some sort of an antenna and a ground. If a loop antenna is used, the set requires the use of radio-frequency transformers, and only a few of these give good amplification from 200 to 600 meters.

As I have had such good results with the Cockaday circuit both with and without antenna and ground, the thought occurred to me to build a portable set that utilized this circuit in a more or less modified form. This circuit embodies

the following features:

1. loop reception without the use of radio-frequency transformers or reflex circuits;
2. uniform amplification over the entire wavelength range of from 200 to 600 meters;
3. freedom from static;
4. portability.

The following is a list of the more important parts that are required to build this set:

- A—"Ultimate" cabinet;
- B—two 7-inch by 10-inch bakelite or hard rubber panels;
- C—two .0005 mfd. Cardwell variable condensers;
- D—one first-stage Cardwell transformer (9:1);
- E—one second-stage Cardwell transformer (4½:1);
- F—two .00025 mfd. micon condensers;

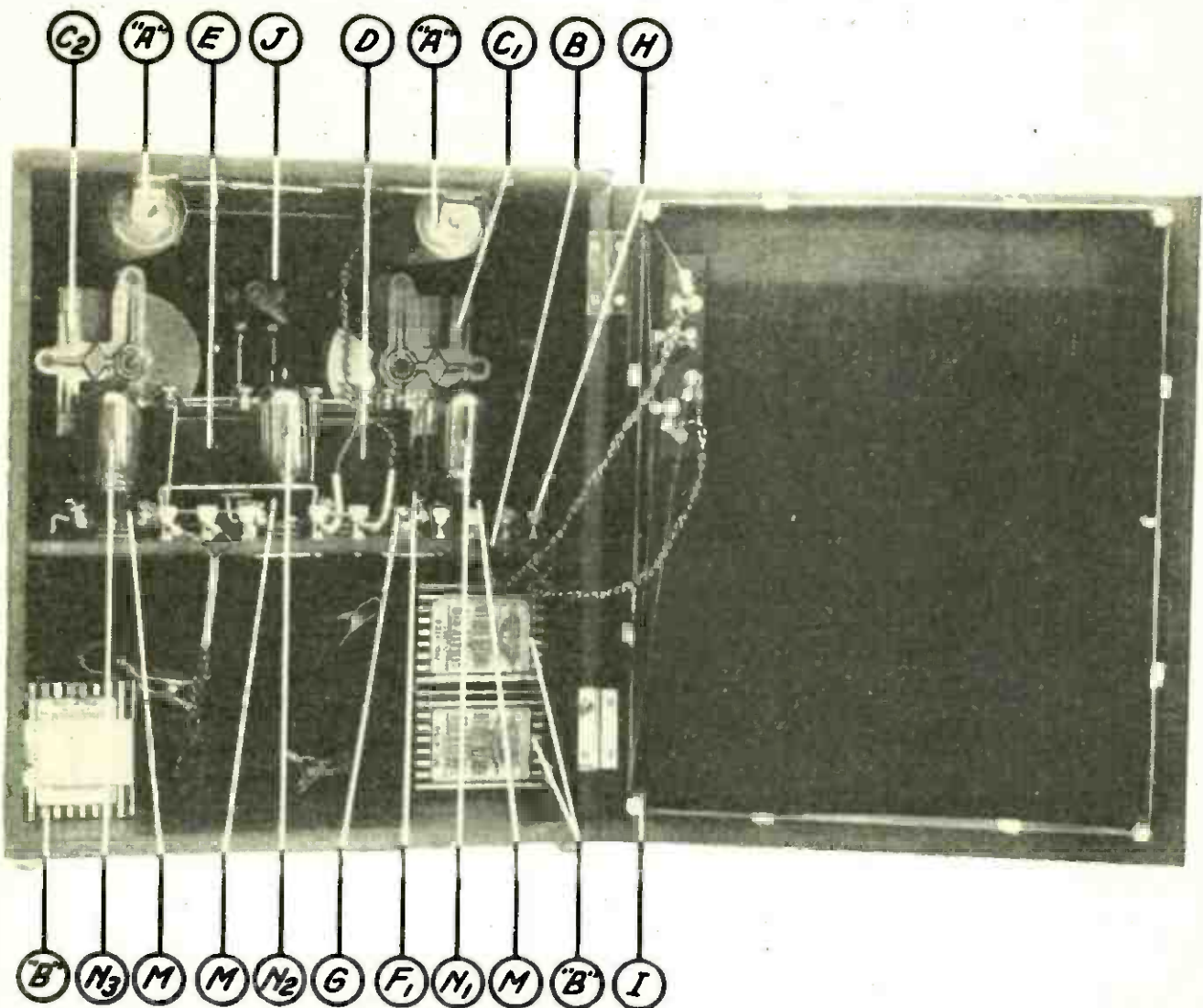
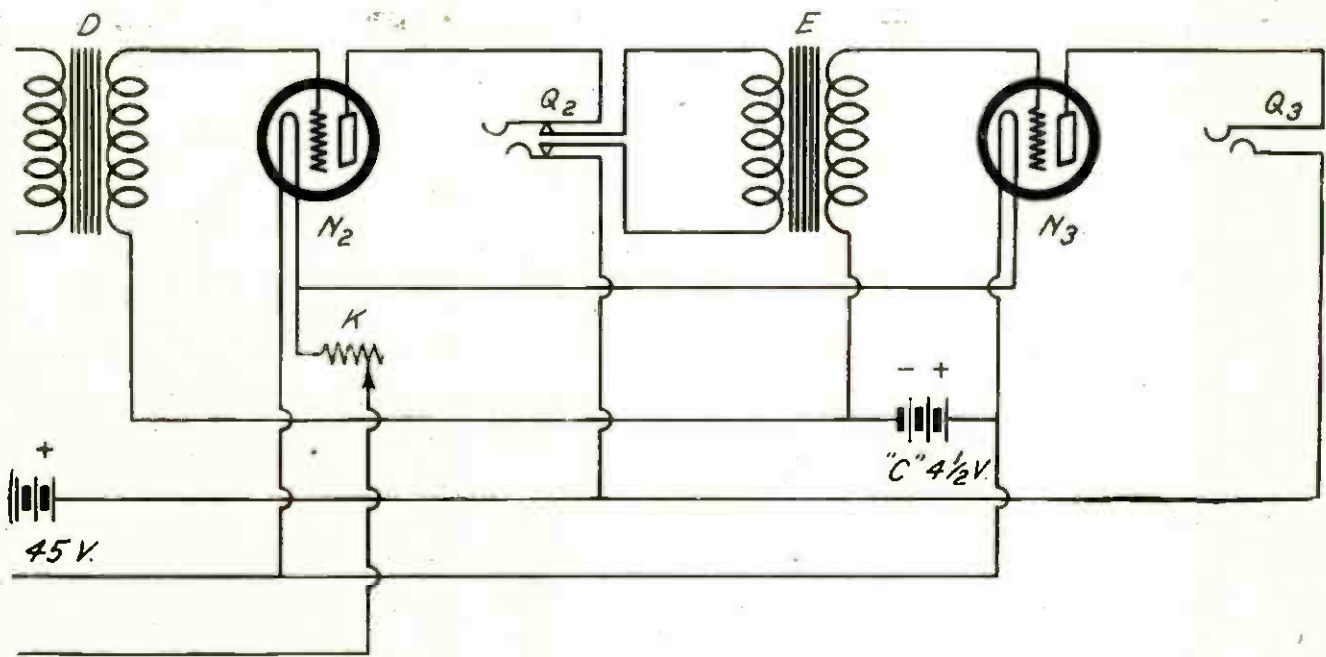

HOW THE SET IS CONSTRUCTED

This picture gives the manner in which the instruments are arranged in the cabinet. The various parts are designated by letters which correspond with those in the list of parts and the wiring diagram.

- G—one 2-megohm leak and mounting;
- H—nine binding posts;
- I—four 1-inch lengths of hard rubber tubing, $\frac{1}{4}$ -inch O.D.;
- J—30-ohm Klosner rheostat;
- K—20-ohm Klosner rheostat;
- L—12 lengths of bus-wire;
- M—three UV-199 sockets;
- N—three UV-199 tubes;
- O—two dials;
- P—two dial verniers;
- Q—three jacks; 2 single closed and 1 single open;
- R— $\frac{1}{4}$ -pound of No. 22 D.S.C. or D.C.C. wire;
- S—miscellaneous screws.

The layout of the panel depends on the individual taste of the constructor; the same observation applies to the arrangement of the amplifier.

The only details that need description are the loops. The door forms the frame for the loop. Four holes are drilled, one in each corner so that the square formed by them measures nine and one half inches on a side.

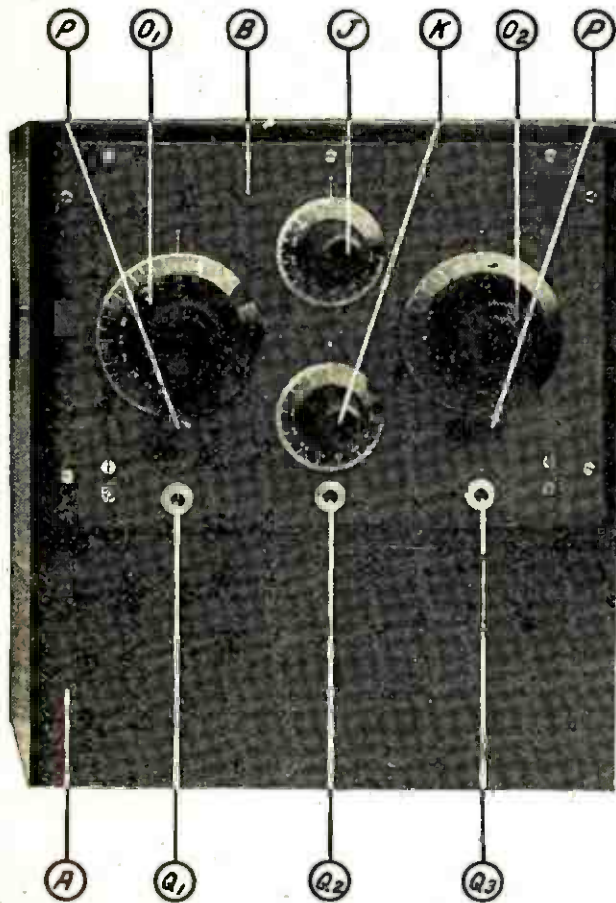

THE COMPLETE RECEIVER

The face of the panel has a neat symmetrical appearance that would not be out of place in any home. The two large dials are the tuning condensers and the two smaller ones are the rheostat controls.

Four $1\frac{1}{2}$ -inch 8/32 round-head screws are slipped in with the heads outside. Over these screws are placed the 1-inch lengths of hard-rubber tubing. A nut is put on each screw and tightened up. This forms the loop frame.

Securing the wire by means of a screw or small brad, wind on 13 turns of No. 18 D.S.C. copper wire and fasten the end. This is the main loop. Now start and wind the absorption loop right alongside of the first. This second loop has nine turns of wire. A small terminal block is fastened to the cover and flexible leads brought down to the binding posts on the sub-panel, as shown in the illustrations.

Small clips to hold the three-cell tubular flashlight batteries are mounted in the top of the cabinet. The space below the sub-panel is large enough to contain the small "B" batteries and still leave enough room for a small horn.

This set may be used on an antenna by simply fastening the regular Cockaday antenna loading coil on the inside of the cabinet door and placing it in series with a single turn of wire around the two loops. The antenna and ground binding posts are then put on the inside of the door. In this way the set may be used with antenna and ground for DX, while the loop is used for local reception.

It is very important that the condensers used in the set have practically no dielectric losses and a minimum capacity of less than .00002 mfd. The condenser should be of shielded construction with the rotor grounded.

The tuning of the four-circuit tuner, when used with a loop antenna, is done in the same manner as when the ordinary antenna circuit is in operation.

The secondary condenser is employed for picking out the various wavelengths and the stabilizer condenser is used for regenerative control. The loop must be turned with rotation about its vertical axis, to pick up stations in different directions, and this is done by swinging the door on its hinges.

Capacity Calculations

—AND THEIR APPLICA-
TION TO THE ANTENNA

Article No. 7

Many considerations enter into the calculations of antenna capacity; such, for example, as height above ground, proximity of nearby buildings and other objects, and the shape and type of the antenna itself. Those of our more experienced readers who have been following this author's series of helpful articles will profit by this newest contribution to the data he has already given them on the mathematical determination of antenna capacity.

By SIR OLIVER LODGE,
F.R.S., D.Sc., LL.D.

THE capacity of a body depends not only on itself but on its surroundings, especially on how near it is to other conductors. It also depends on the medium in which it is immersed. A condenser with glass or paraffin or mica or other insulating material between the plates has three or four times the capacity which it would have if the plates were separated only by air.

In estimating the capacity of an antenna, however, we have no medium to deal with except air, which is practically the same in this respect as absolute vacuum, or in other words, ether. For it is the ether of space and its properties on which electric capacity wholly depends. It is this which stores the energy in an elastic manner during charge, and yields it again during discharge.

The conventional unit of capacity is the farad, which is able to hold one coulomb, or c.g.s. unit of electric quantity, when charged to the potential of one volt. Such a quantity of electricity can be supplied by a current of one ampere flowing for ten seconds. This quantity is enormous, from the electro-

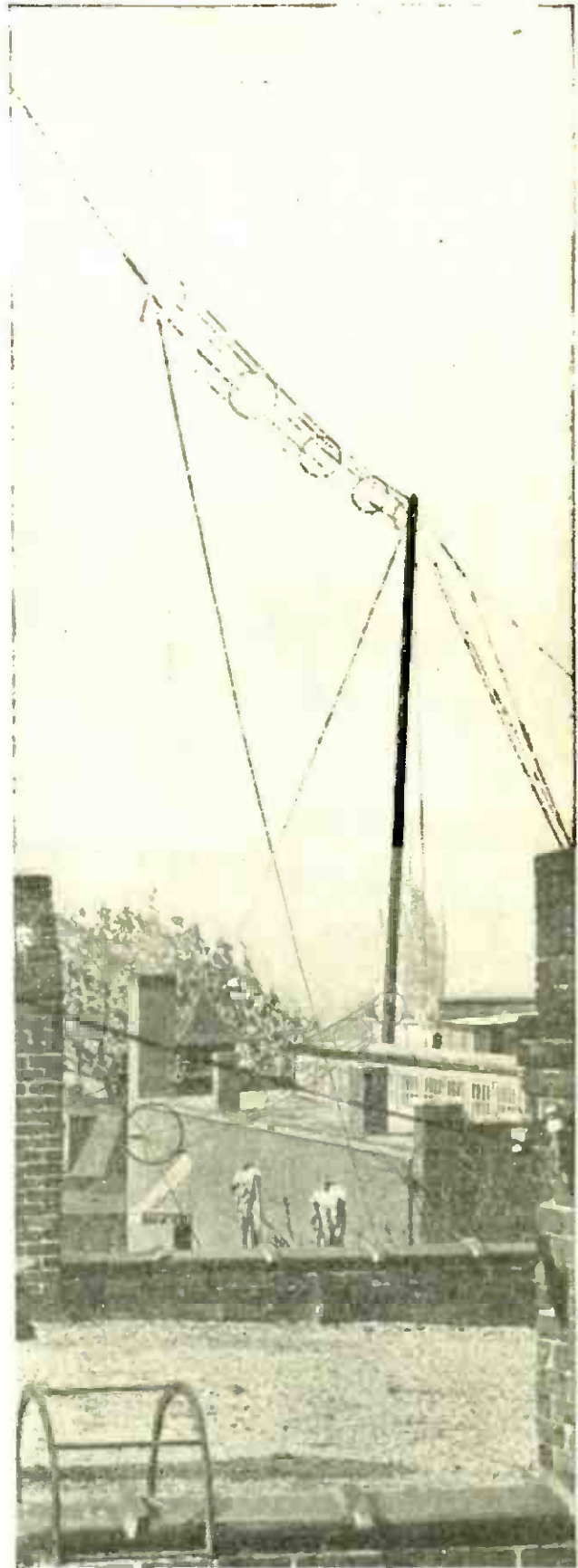

static point of view; and accordingly the cistern or capacity needed to hold it, at such low pressure as one volt, must be enormous too. Few of us have ever had to deal with one farad of capacity. We have

to be satisfied with a microfarad, that is to say, the millionth part of a farad. But even that is too big for electrostatic purposes; so we take the thousandth or even the millionth of that, and speak of millimicrofarads or even micromicrofarads.

Interpreting these capacities as lengths*, we may say:

1 micromicrofarad = 9 centimeter
 1 millimicrofarad = 9 meters
 1 microfarad = 9 kilometers

while the length equivalent to a farad would reach far beyond the moon, twenty-four times the distance of the moon, or one-sixteenth of the journey to the sun.

The figure 9 which enters into these relations is rather a nuisance, but is inevitable. It comes in because the square of the velocity of light is involved; and as that velocity in c.g.s. measure involves a 3, its square naturally contains a 9. For ordinary purposes it is sufficiently near if we consider a micromicrofarad as a centimeter, instead of 10 percent less. It would be the capacity of a knob two centimeters, or rather less than an inch, in diameter.

On this principle we can estimate the capacity of an antenna by eye. Expressed as a length, the capacity of a vertical wire is just about one-twentieth of the height of the wire. Suppose the wire were 9 meters high, its capacity would be one-twentieth of 9 meters, that is, one-twentieth or .05 of a millimicrofarad. To get a single-wire vertical antenna of a whole millimicrofarad capacity, it would have to be 180 meters, or about 600 feet high.

But we must now consider this matter a little more strictly, and show how to calculate the capacity on orthodox principles.

To get the capacity of an isolated wire of length l and diameter d we have only to calculate

$$C = \frac{l}{2 \log_e \frac{2l}{d}}$$

or what is the same thing

$$C = \frac{.217 l}{\log_{10} \frac{2l}{d}}$$

It does not matter what units l and d are measured in, provided they are expressed in the *same* units, and the capacity will come out also in the same units; that is in units of length. To interpret that in millimicrofarads is easy enough in the light of what we have just been saying.

Thus, suppose that the length is 60 feet, and that the diameter is 1/10 inch; the above fraction is

$$C = \frac{.217 \times 60}{\log_{10} \frac{120 \times 12}{10}} = \frac{13.02}{\log_{10} 14400} = \frac{13.02}{4.16} = 3.13 \text{ feet}$$

which is just about 1/20th of the length of the wire. This equals about 1 meter; so the capacity will be 1/9 millimicrofarad. Or take another example, using the upper of the two formulas above. Let the length of the vertical single antenna be 40 meters, and the diameter .8 millimeter.

The capacity

$$C = \frac{40 \text{ meters}}{2 \log_e \frac{8000 \text{ centim}}{.08 \text{ centim}}} = \frac{40 \text{ meters}}{2 \log_e 10^5} = \frac{40 \text{ meters}}{23}$$

which again would practically be one twentieth, or 5 percent, of the length, for a little extra allowance must always be made for the inevitable partial neighborhood of the earth. Interpreting this into conventional units of capacity we must divide by 9, and we find that it equals 40/207 or say 1/5 of a millimicrofarad.

If the wire is very thin, say .008 centimeter, its capacity would be rather less, but not much less; we should then theoretically have to divide the length by 27 instead of by 23. Or conversely, if the wire were thick, say 8 millimeters, which could be a thin rod, we should

*See appendix to Sir Oliver Lodge's article in Sept., 1923, issue POPULAR RADIO.

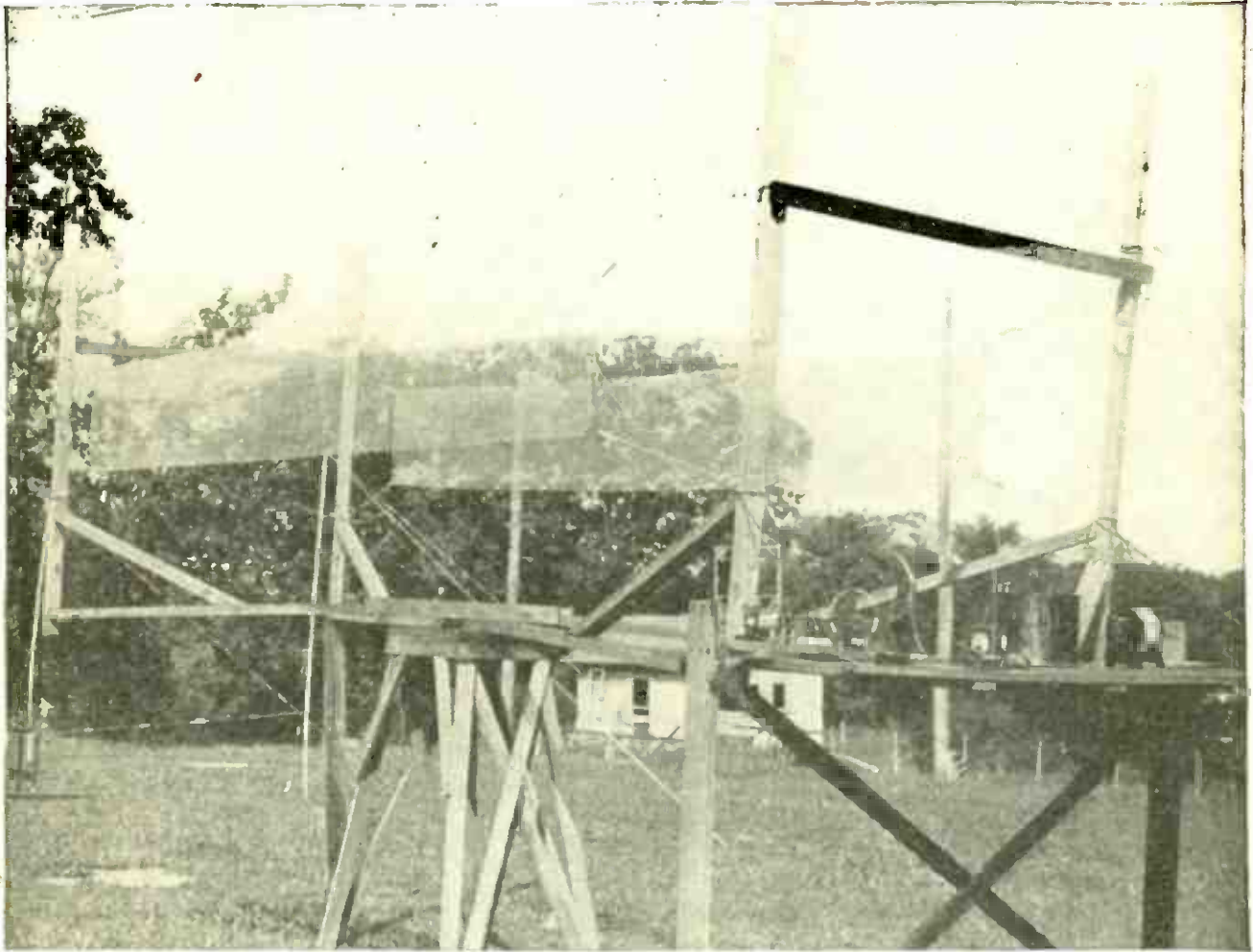

Bureau of Standards

ONE WAY OF TESTING THE CAPACITY FORM OF ANTENNA

Such an antenna, pictured above, consists of two rectangular pieces of copper-wire mesh suspended from a wooden frame by insulators. One end of the tuning inductance is connected to one plate and the other end of the coil is connected to the remaining plate.

have to divide the length by 18.4 to get the capacity. So in any practicable case we can estimate the capacity of a vertically arranged single wire as round about one twentieth of its length, with a 10 percent addition for the neighborhood of the earth.

The capacity of a horizontal wire is reckoned similarly, only then the denominator of the fraction contains four times the height above the ground instead of twice the length of the wire.

Suppose a horizontal wire at an elevation of 30 feet, of diameter 1/40th inch, and of any length l , what would be its capacity. The formula is

$$C = \frac{1}{2 \log_e \frac{4h}{d}} \quad \text{or} \quad \frac{1}{4.6 \log_{10} \frac{4h}{d}}$$

All we need to reckon is the denominator.

Now

$$\frac{4h}{d} = \frac{120 \text{ feet}}{\frac{1}{40} \text{ inch}} = 57600;$$

So

$$\log_e \frac{4h}{d} = \log_e 57600 = 10.96$$

And the capacity is $\frac{1}{22}$ one twenty-second of its length. Every centimeter of this length is practically a micromicrofarad.

But the wire for a horizontal antenna would probably be somewhat thicker; if it was 1/4 inch thick instead of 1/40 inch, the denominator would become 16 instead of 22. A double wire antenna with a space of 2 or 3 feet between the

wires would have a capacity about $1\frac{3}{4}$ times that of one of the wires. A quadruple wire would have $2\frac{1}{2}$ or $2\frac{3}{4}$ times the capacity of a single wire.

Consider a four-wire antenna with the wires a yard apart, each wire 1 millimeter diameter, and the whole arranged either vertically, or horizontally at half its length above the ground, say 10 meters high and 20 meters long. Each wire if alone would be likely to have a capacity roughly estimated at its length divided by $4.6 \times \log_{10} 40,000$, which is 21. So the capacity of the whole would be about $2\frac{1}{2}$ times the length of the antenna divided by 21, that is, 2.4 meters, or roughly about an eighth or ninth of the length of the wire grouping. If the wires were further separated, say by 2 yards, the combined capacity would be rather greater, and might be three times that of a single wire.

Examples

I might take a few examples to illustrate that the capacity of a wire antenna does not depend very much upon the thickness of the wire. Consider a vertical or isolated wire 20 meters long. If its thickness is .04 centim. or $2/5$ millim., its capacity reckoned by the formula will be:

$$C = \frac{1000}{\log \frac{2000}{.02}} = \frac{1000}{\log 10^5} = \frac{1000}{11.513} = 86.85$$

or say 90 centim. which is the same as 100 micromicrofarads.

If the thickness is $1/10$ of the above, say $1/25$ millim., the denominator of the above fraction will be 10^6 instead of 10^5 , and the capacity comes out 72 centimeters, instead of 90.

If, on the other hand, the wire is 4 millimeters thick the denominator is 10^4 , and the capacity comes out 110 centimeters.

I will take one more example, with the length expressed in feet and inches, to show that it does not matter what units are employed, so long as we deal

with them in common-sense fashion. Let l be 110 feet and d be .1 inch. Then

$$\frac{2l}{d} \text{ will be } \frac{220 \times 12}{.1} = 26400$$

So, taking the log of this as the denominator of the fraction whose numerator is the length, we find that the capacity comes out about $5\frac{1}{2}$ feet, or, with allowance for earth neighborhood, 6 feet. Every foot being 33 micromicrofarads. We can think of this as the equivalent of an isolated sphere 12 feet in diameter or as 180 micromicrofarads. Capacity can always be expressed in linear measure, but the ethereal constant K has always to be understood if any rational meaning is to be attached to the length specification of capacity. But as K is unknown, it is conventionally taken as unity, when electrical quantities are specified on the electrostatic system. It is convenient, then, to express capacities as lengths, and inductances also as lengths, for then the square root of the product of these two lengths, that is their geometric mean, gives a length proportional to the wavelength, and only requires multiplying by 2π in order to give the wavelength itself in the same length units, whatever they are.

But it will always be found that the capacity is expressed by a small length, while the inductance is expressed by a big one. One may be in meters, while the other may be in kilometers. But whether they are expressed in meters, or centimeters, or feet, or yards, matters nothing, so long as one always writes down the unit of measurement after the figures. Units of measurement ought not to appear in algebraical equations or expressions, but should always be written after arithmetical figures, except when those represent a pure number. This would avoid a great deal of confusion and trouble, and is a matter not sufficiently attended to. Hence the emphasis here laid upon what ought to be an elementary and fundamental consideration. Unfortunately mathematicians

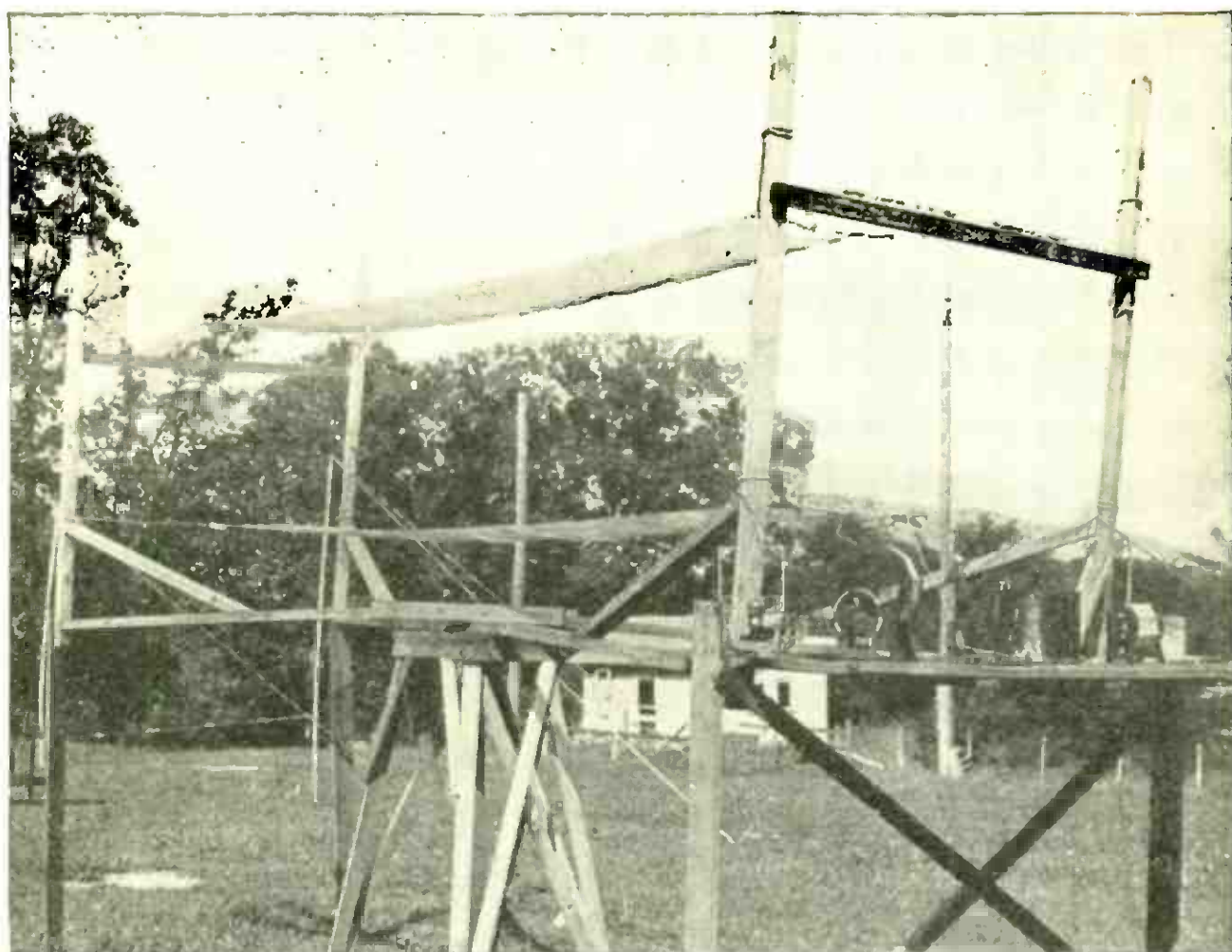

Bureau of Standards

ANOTHER SET-UP FOR TESTING OUT THE CAPACITY FORM OF ANTENNA

In this case the two mesh "plates" are suspended horizontally. The same general law for capacity determination holds true for this miniature antenna as for your own antenna which is ten or fifteen times the size.

who are not physicists do not always agree with this, and, like the late Mr. Todhunter, think that an algebraic expression is incomplete unless the units are stated. Physicists know that the units *only* ought to be stated in connection with arithmetical specifications. The velocity v , for instance, is complete in itself, and is the same thing whatever units are used; whereas a velocity 36 means nothing, unless feet-per-second, or miles-per-hour, or centimeters-per-second, are explicitly added. To say that the height of a post is 50, means nothing. But to take the height of a post as h is quite correct and complete. The post is the same height whether it

be measured in feet or centimeters or anything else. So also the velocity of light is the same velocity, however expressed, and can be written completely as either v or c , according to taste.

Units should be expressed after figures, but not after algebraic symbols; except when these are used in some shorthand technical formula, which is essentially an arithmetical one and must be so treated.

When writing down a capacity always say what units are intended, otherwise the specification may be misinterpreted many hundred-fold. A microfarad is equivalent to a length of 9 kilometres.

This might be learned by heart.

It is only a matter of time when transatlantic radio telephony will be as common as line telephony is today. How science is preparing the way for this new marvel will be told in a coming issue of POPULAR RADIO.

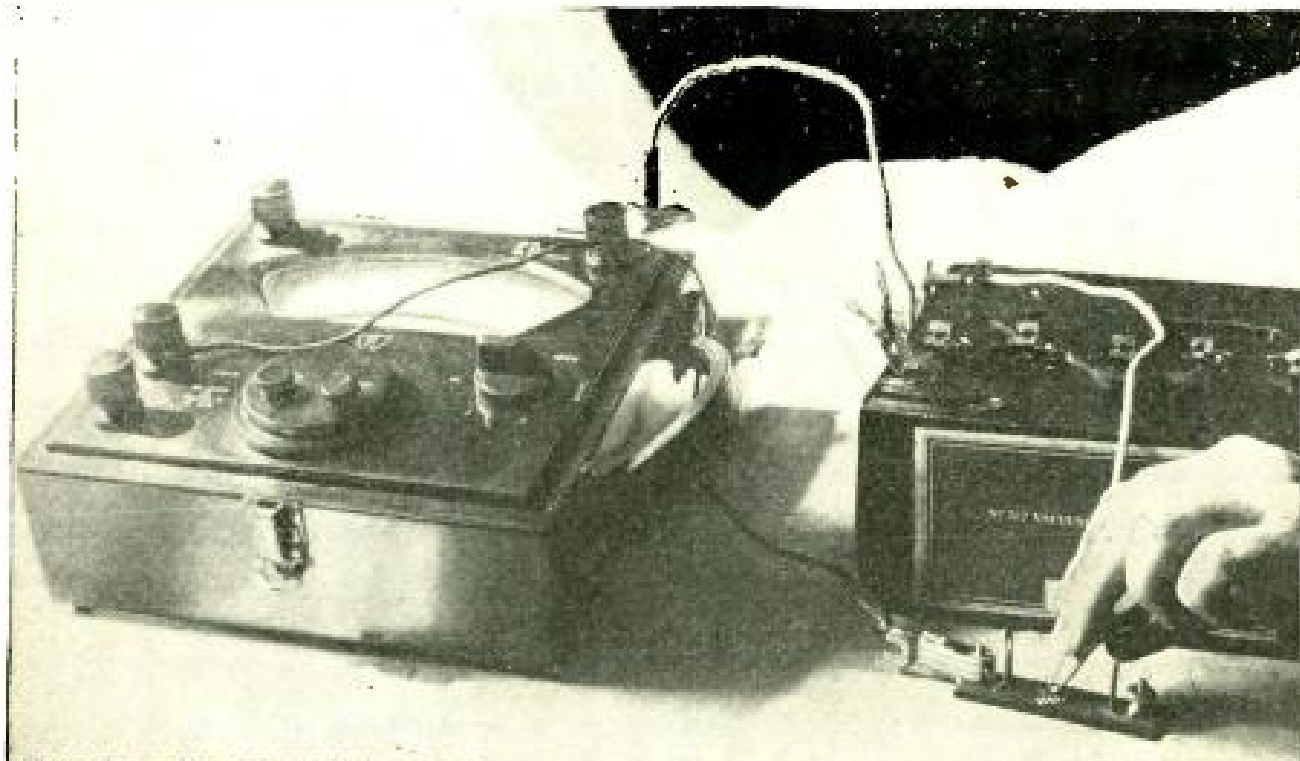

AN ELEMENTARY TEST OF INSULATION

With a regular "B" battery and an extremely sensitive microammeter connected in series with a piece of insulating material, it is sometimes possible to get a current of 15 microamperes to flow through the insulation. This test is a crude test, however, and would only serve to show up a very poor piece of insulating material.

Practical Hints About Insulation

—THAT EVERY RADIO FAN SHOULD KNOW

By RAYMOND FRANCIS YATES, R.E.

ALTHOUGH Professor Einstein did not specifically say so, insulation is a relative term. A substance that will effectively insulate at one voltage will pass current under another as freely as water passes through a sieve. Indeed, there is *nothing* that will not pass a certain quantity of electricity. Therefore, we insulate to *minimize* the leakage of currents.

Electric leakage is an insidious thing from the viewpoint of the radio fan. When a water pipe, boat or air tank leaks it is a simple matter to find the outlet and to apply the needed remedy, but in a radio set we can have a leak as big as all outdoors and still we cannot see the invisible fluid that manages

to escape. If there is anything that will quickly reduce the efficiency of a radio set, it is poor insulation. This is doubly true about transmitters, and even in receivers it is an important factor.

The degree of insulation necessary depends upon the voltage used. A water pipe that carries ten gallons of water per minute at a pressure of 60 pounds to the square inch would probably burst if the pressure in pounds to the square inch were suddenly multiplied by five. The same might hold true of a wire carrying electric current; if the voltage were suddenly multiplied by five or even by two, the insulation would become ineffective and we would experience

heavy leakage. Although insulation cannot burst, it can break down electrically and burn up when the voltage reaches the rupture point where it can puncture things in its path that offer resistance.

There are two things that are most important in considering the subject of insulation: One is *voltage*, as we have already seen. The higher the voltage the greater the resistance of the insulation must be, to effectively keep it in its path of virtue, so to speak. The other factor would probably be little suspected by the average experimenter. It is *frequency*.

The way in which frequency affects an insulating substance may be a bit obscure, but nevertheless this fact is as true as the law of gravity. Some notion of the importance of frequency and its effect upon dielectric strength (insulating strength) may be gained from the fact that an insulator that will stand up under an application of 100,000 volts at a frequency of 60 cycles per second may break down and become totally ineffective under a voltage of 20,000 at 150,000 cycles per second. From this we learn that radio-frequency currents are much more difficult to handle and insulate. They are the wilder and more unruly members of the electric-current family.

It is usual to measure resistance of insulating materials in ohms just as the degree of resistivity offered by a copper wire is measured in ohms (or fractions of an ohm). In measuring resistance of real insulators we have such "gobs and gobs" of ohms that we use a more convenient term, the megohm (1,000,000 ohms). That this term is more convenient will be appreciated when it is understood that a unit cube of a good insulating material might have a resistance of 100,000,000,000,000,000 ohms.

The dielectric strength of any substance (and by this we mean its ability to resist a voltage that would tend to break it down) can be likened to the mechanical strength of the metal in a

high-pressure tank. Any dielectric or insulating substance has a critical voltage point at which it will rupture or break down and allow current to pass through it freely. If it is a good insulator the amount of voltage that must be applied to do this is necessarily high, ranging from 1,000 to 500,000 volts for the different thicknesses of insulation.

Dielectric strength is measured in terms of the number of volts required to puncture any definite thickness of the material. It is a sort of indefinite quantity, since it is difficult to measure with any degree of accuracy. In the accompanying illustration we see a small high-potential transformer of 7,000 volts potential, set up to puncture a small thickness of insulation of the much-used "mud" variety, which is usually a combination of lampblack and shellac. The voltage at which puncturing takes place, depends upon the *frequency* of the current, the *time* during which the voltage is applied and the *size* and *shape* of the electrodes and their *distance* apart.

For instance, the use of needle points will often cause a breakdown at voltages where flat surfaces will not. This, of course, can be understood since what we might call the voltage gradient in the insulator is larger in the case of the needle points and a smaller area of the insulator is called upon to withstand the entire strain. If the same load were distributed over a larger area the insulator might successfully withhold it.

The insulating materials that we use in our radio sets should be of the best variety. The "mud" referred to should be used only where it is not called upon to resist the passage of radio-frequency currents, no matter what their voltage value may be. The writer has made a number of tests on the insulating strength of some of the lower grades of this substance and he finds that at radio frequencies they pass a considerable amount of current even when the voltage

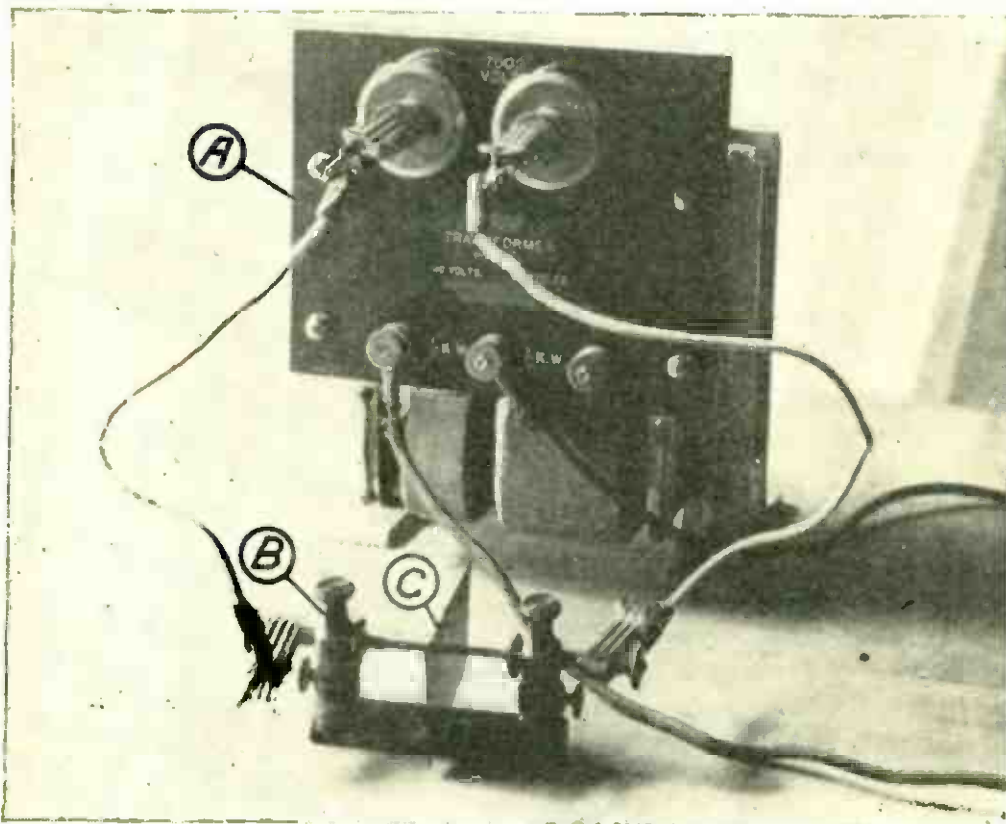

A TEST OF THE DIELECTRIC STRENGTH OF AN INSULATING SHEET

A high-potential transformer A is connected across the terminals of a spark gap B. The sheet of insulation of known thickness is then fastened between the electrodes of the spark gap and then the voltage of the transformer is raised until the dielectric strength of the sheet is overcome and a spark passes through the insulation. The voltage at which this electric breakdown occurs is the dielectric strength of the material, and it is measured in volts per mil.

is seemingly insignificant. Some of this material makes beautiful-looking grid leaks and it is only necessary to mount the binding posts in it at a definite distance apart to obtain any number of megohms or fractions of a megohm as a grid leak! Even with a direct voltage, this material shows the passage of dangerous amounts of current. A simple experiment with a microammeter, similar to that shown in the photograph gives indisputable proof of this statement. If a small piece of the stuff is connected up in series with a 100-volt "B" battery, appreciable quantities of current will be allowed to pass, even when the electrode separation is comparatively large! With a separation of $\frac{1}{2}$ inch the writer has had an ammeter reading as high as 15 microamperes. According to Ohm's Law, $R = \frac{E}{I}$. If we have a current of .00000025 amperes and a voltage of

100, it is evident that the insulation is only 4 megohms which is disgustingly low for anything that is dignified by the name of insulation. This material is probably all right to use for knobs, dials and the like, but its performance as a restrainer of electric pressure is not sufficiently noteworthy to warrant its use in radio equipment.

Any of the synthetic-resinous products are well suited to radio use whether in transmitters or receivers. They offer a fairly substantial resistance to moisture, their dielectric strength is high and their mechanical strength is enormous. The writer can say little in favor of vulcanized fibre as far as its use for radio insulation is concerned. Its use for panels is to be discouraged, since it has a terrific appetite for water and sucks in atmospheric moisture with sponge-like efficiency. Fibre has a dielectric strength of 330 volts per mil,

or 13,000 volts per millimeter with a thickness of $1/32$ of an inch. This, of course, is in the perfectly dry state (which is unusual and which can be maintained only in the laboratory under experimental conditions). Compared with this, the resinous materials show a dielectric strength of 1,000 volts per mil or 39,400 volts per millimeter in a thickness of $1/32$ of an inch. A good piece of this material has a volume resistivity of about 1,000,000 megohms (10^{12} ohms) per centimeter cube. The surface resistivity may be anywhere from 100 megohms to 10,000,000 megohms. These figures show us that any of these products can be used with perfect safety as panels and for other insulating purposes in a radio set. There are numerous grades of this type of material. One is formed by allowing sheets of paper, white duck, or cloth to soak in raw resinous liquid varnish. The sheets are then placed one on top of the other in a powerful steam-heated hydraulic press. The press comes down, giving the sheets a tremendous squeeze and heating them at the same time. When the sheets come forth from the press they are in a much changed condition. What was once 50 or 75 sheets is now a single flat block of exceptionally hard material that will resound healthily when it is struck a sharp blow with a hammer.

The sheets are welded together, forming a homogeneous material.

Other forms of insulating materials are molded. For instance, molded, synthetic-resinous or rubber materials are placed in the mold and subjected to heat and pressure at the same instant. The material fluxes and becomes almost semi-fluid, filling every interstice of the die. There is both a chemical and physical change. The chemical change is irreversible and permanent.

Most of the "spaghetti" that we buy is composed of cloth tubing impregnated with either oxidized linseed oil or raw bakelite varnish. This material should be freely used where bus or other wire comes in contact with the wooden parts of the cabinet. In no case should the connecting wires be allowed to make contact with the wood without being heavily insulated. Wood is an exceptionally poor insulator and is usually filled with atmospheric moisture.

The writer hopes that those who have read this article will give more thought to the insulation of their radio outfits henceforth. Insulation is a mighty important thing, and since we cannot see the leakage that is taking place there is only one thing left to do. That is to insulate our outfits, in the very best manner that we know how, using materials that have proven their real worth in the workaday world.

Another Measurement Chart— for use in designing a transformer

In the next issue of POPULAR RADIO will be published the 6th of the series of practical time and labor-saving charts designed by Raoul J. Hoffman. The previous articles contain charts *For Determining the Constants of Radio Circuits and Calculating Capacities of Condensers in Series*, in February, 1923; *For Determining the Dimensions of Your Coil*, in March, 1923; *For Determining the Capacity of a Condenser*, in May, 1923; *For Determining the Capacity of Your Antenna*, in July, 1923, and *For Determining the Constants of a Loop Antenna* in August, 1923.





From a photograph made for POPULAR RADIO

Preparing to revise the old four-circuit tuner and to add to it the push-and-pull power amplifier. This does not incur any large expense and greatly raises the efficiency of that already efficient tuner.

HOW TO IMPROVE THE THREE-TUBE FOUR-CIRCUIT TUNER

For the benefit of the many experimenters and radio fans who have built the Four-circuit Tuner described in the May issue of this magazine and who may not want to tear it down to build the new and improved tuner described in the January issue, we are giving in this article the necessary instructions for adding to the old set in order to bring its efficiency up to that obtained in the improved set.

COST OF PARTS: *About \$30.00*

RECEIVING RANGE: *Up to 3,400 miles*

THE ITEMS YOU WILL NEED—

One pair of Como push-and-pull amplifying transformers;
one filament rheostat, 20 ohms;
two vacuum-tube sockets;
one switch lever;
four switch points;
two switch stops;
one Bradkey-leak;

one Amplex grid-denser;
two single-circuit jacks;
two telephone plugs;
six binding posts;
one panel, 5 inches by 8 inches;
one cabinet to match set;
one Amertran amplifying transformer;
three Lavite resistances, 50,000 ohms each.

IN order to improve the old set and make it as efficient as the five-tube set described in the January issue it would be advisable to use the Amertran transformer for the first stage of amplification and shunt the primary winding with the small variable condenser (the grid-denser). The fixed grid leak should also be replaced, and the Bradley-leak inserted instead. This will help greatly in increasing the sensitivity and will allow of nicer adjustment of the circuit.

This includes all of the improvements necessary on the set itself. The rest of the work includes laying out one stage of power amplification on the new panel so that it may be (when placed in the new cabinet) set next to the old three-tube set on the right side. This will give the same volume and characteristics as the new five-tube set.

The new panel (which is the same height as the one in the old set) should be laid out with a neat arrangement of the rheostat and the two jacks. The two

jacks should preferably be placed on the same horizontal line as in the receiver, and one should be at the left of the panel and one at the right. One of these is used, in connection with the two telephone plugs and two pieces of stranded wire, for connecting the output of the receiver with the input of the power amplifier. Place one plug in the last jack of the receiver and the other plug in the first jack of the amplifier.

The switch lever and switch points should be mounted on the amplifier panel and connected to the resistances. These are used for controlling the volume output of the amplifier.

The wiring diagram for the complete amplifier is shown in Figure 1. The same "A" battery should be used as for the receiver but a separate "B" battery would be preferable for the amplifier. Two UV-201-a tubes are recommended. Be sure to use the correct value of "C" battery as indicated on the diagram.

When you want to use the set alone

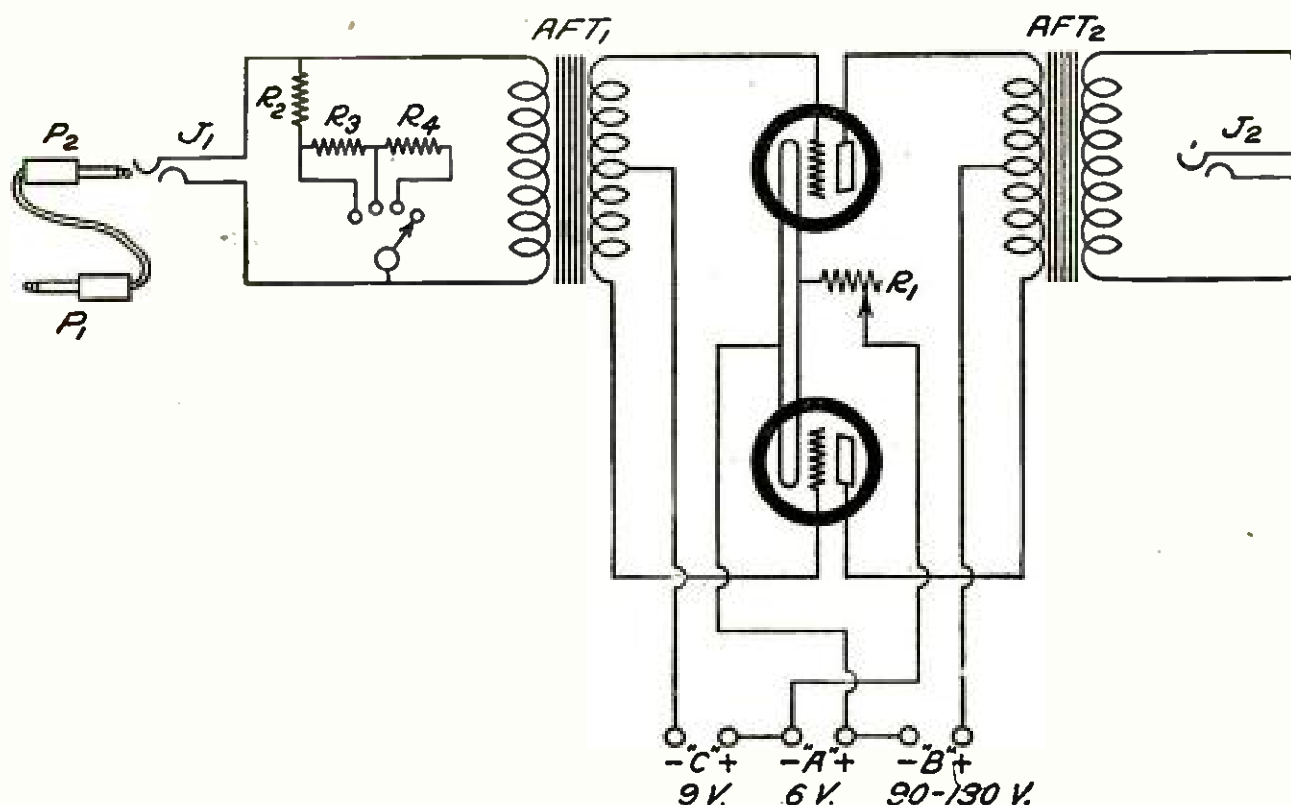

HOW TO WIRE THE AMPLIFIER PANEL

FIGURE 1: This diagram gives the proper connections for all the instruments and parts that go into the amplifier cabinet which may be placed at the right-hand side of the set. The power amplifier is plugged into the second stage of amplification by means of the Plug P₁.

without the power amplification, merely take out the interconnecting plug and insert the telephone plug on your telephones or loudspeaker. If you want to listen *with* the power amplification insert the interconnecting plug into the proper jack on the set and the proper

jack on the amplifier and insert the loudspeaker plug into the last jack of the amplifier tubes and listen in.

The addition has a good appearance and it is worth while for those who have the three-tube set and do not wish to tear it down to make the five-tube set.

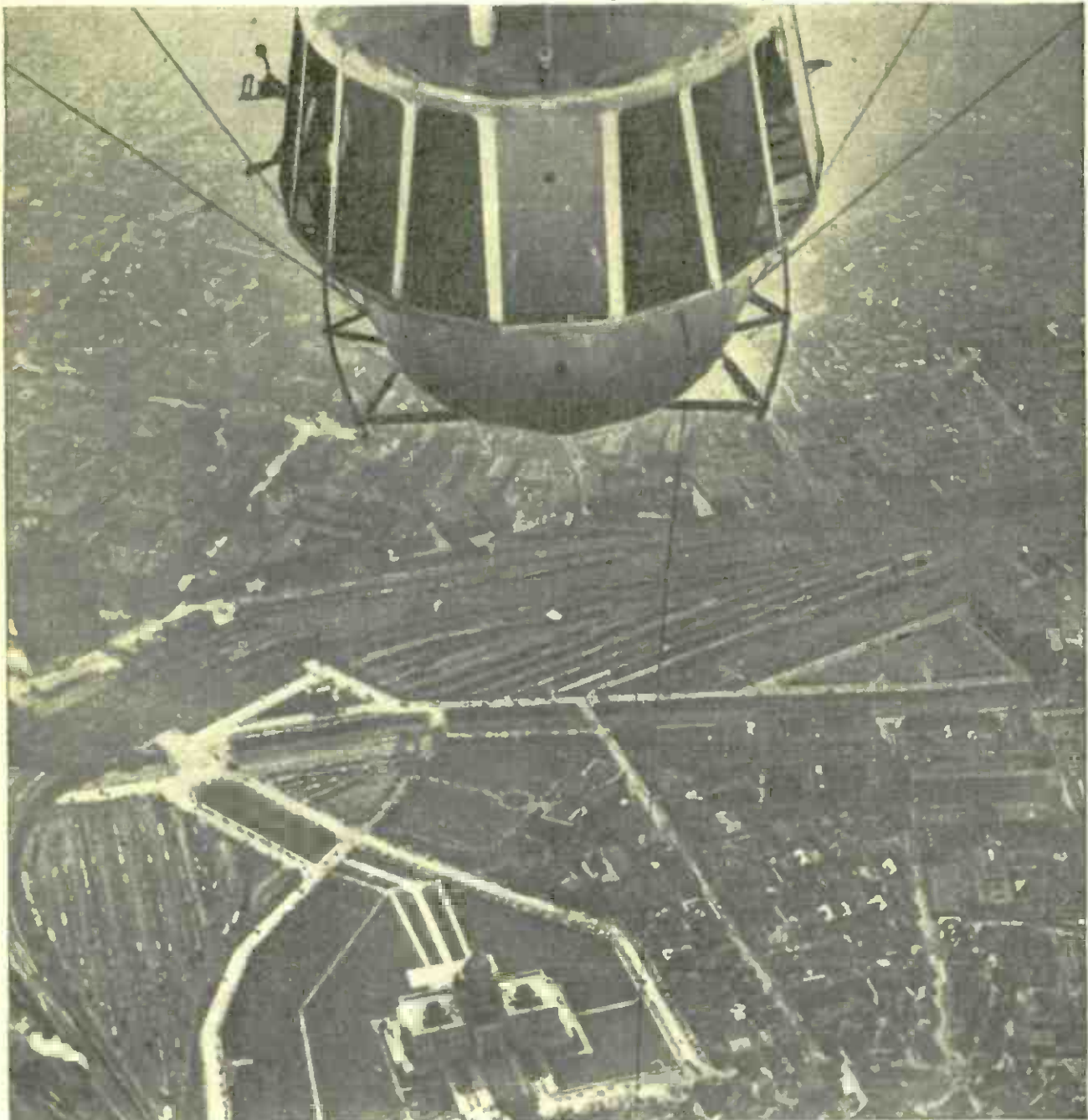

Kadel & Herbert

A RADIO STATION FOUR THOUSAND FEET IN THE AIR

This picture shows the control car of the great Navy airship SHENANDOAH, taken recently as she was flying over Providence, Rhode Island. The wire hanging downward from the side of the car is the radio antenna, which can be rolled in when the car approaches the earth. On her recent trips as far north as Boston and as far west as St. Louis, the commander of the SHENANDOAH has kept in continual touch with his base by radio. The same procedure will be followed next year when the SHENANDOAH attempts to fly to the North Pole and back.

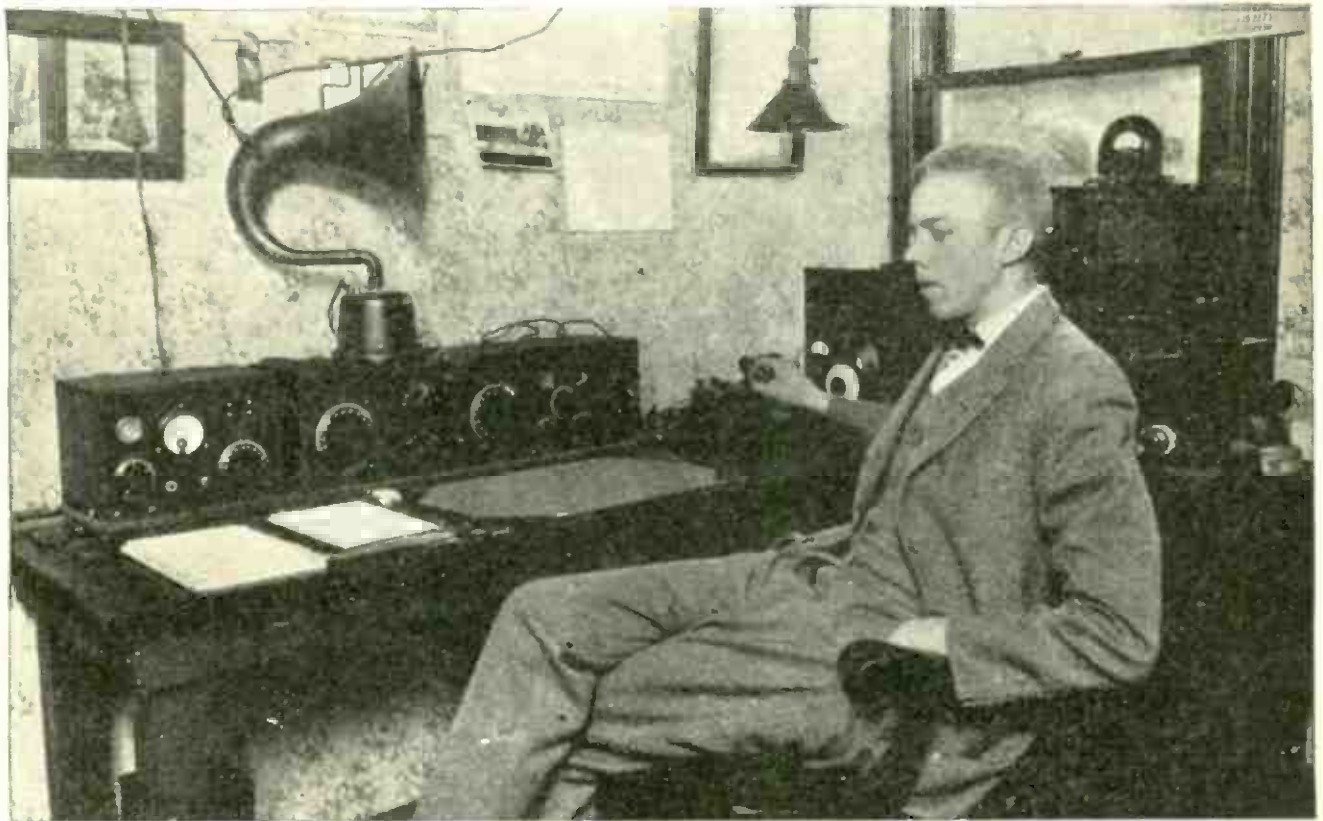

From a photograph made for POPULAR RADIO

The author is here shown seated at his receiving table upon which are arranged the three-tube set (at the right) and the oscillator (at the left).

HOW TO BUILD A THREE-TUBE REFLEX RECEIVER

PART I

By WALTER A. REMY

COST OF PARTS: *About \$70.00*

RECEIVING RANGE: *Up to 3,000 Miles*

HERE ARE THE ITEMS YOU WILL NEED—

- | | |
|--|--|
| B—primary coupler coil; | N1, N2, N3—vacuum-tube sockets; |
| C—secondary coupler coil; | O1, O2, O3—filament rheostats, 6 ohms; |
| D—grid loading coil; | P—composition panel, 7 by 24 inches; |
| B1—primary switch arm; | Q—composition panel, 3 by 9 inches; |
| D1—grid coil switch arm; | R—composition panel, 2½ by 9 inches; |
| E—variable condenser, .00025 mfd.; | S—composition panel, 1 by 9 inches; |
| F1, F2, F3—mica fixed condensers, .001 mfd.; | 7-inch by 24-inch cabinet; |
| G—grid leak and holder, 2 megohms; | 12 binding posts; |
| H—mica grid condenser, .0005 mfd.; | 4 switch stops; |
| I—mica phone condenser, .005 mfd.; | 16 switch points; |
| J—telephone jack, single circuit; | 3 vacuum-tube bezels; |
| K1, K2—radio-frequency transformers; | 2 vernier dial controls; |
| K3, K4—audio-frequency transformers; | 2 four-inch dials; |
| L—potentiometer, 200 ohms; | 4 two-inch rheostat dials; |
| M—mica fixed condenser, .002 mfd.; | ½-inch brass strip for shelf support. |

ONE of the most practical receivers that can be had is the so-called reflex receiver.

The main advantage of a reflex re-

ceiver is that it permits high amplification with a minimum number of vacuum tubes. In this circuit each tube acts as both a radio-frequency and an audio-

frequency amplifier, thus making for an economical arrangement.

The circuit is by no means new. It was developed by the French almost a decade ago. Vacuum tubes and coupling transformers for amplification were unreliable in those days and were known only to the engineers. It was the recent war that put this circuit on a practical basis.

A general idea of the action of the circuit will be helpful.

There are two kinds of amplification; radio-frequency, in which the signal received is amplified before it is rectified (or detected), and audio-frequency, in which the signal is amplified after it is rectified.

In an audio-frequency amplifier the output of the amplifier is approximately

proportional to the square of the voltage impressed on the grid of the tube. It is easily seen that strong local signals would, therefore, drown out weaker distant signals. For instance, consider that in the detector circuit of a conventional two-stage, audio-frequency amplifier receiver, a local signal is four times as loud as a distant signal. Then in the first amplifier stage it may be sixteen times as loud and in the second stage it may be two hundred times as loud. In this way the tuning of an audio-amplifier set is "broadened."

Exactly the reverse is true in radio-frequency amplification. The louder the signal the more the tubes will tend to "paralyze" and, therefore, fail to amplify. A weak signal is greatly amplified, however; that is why local stations

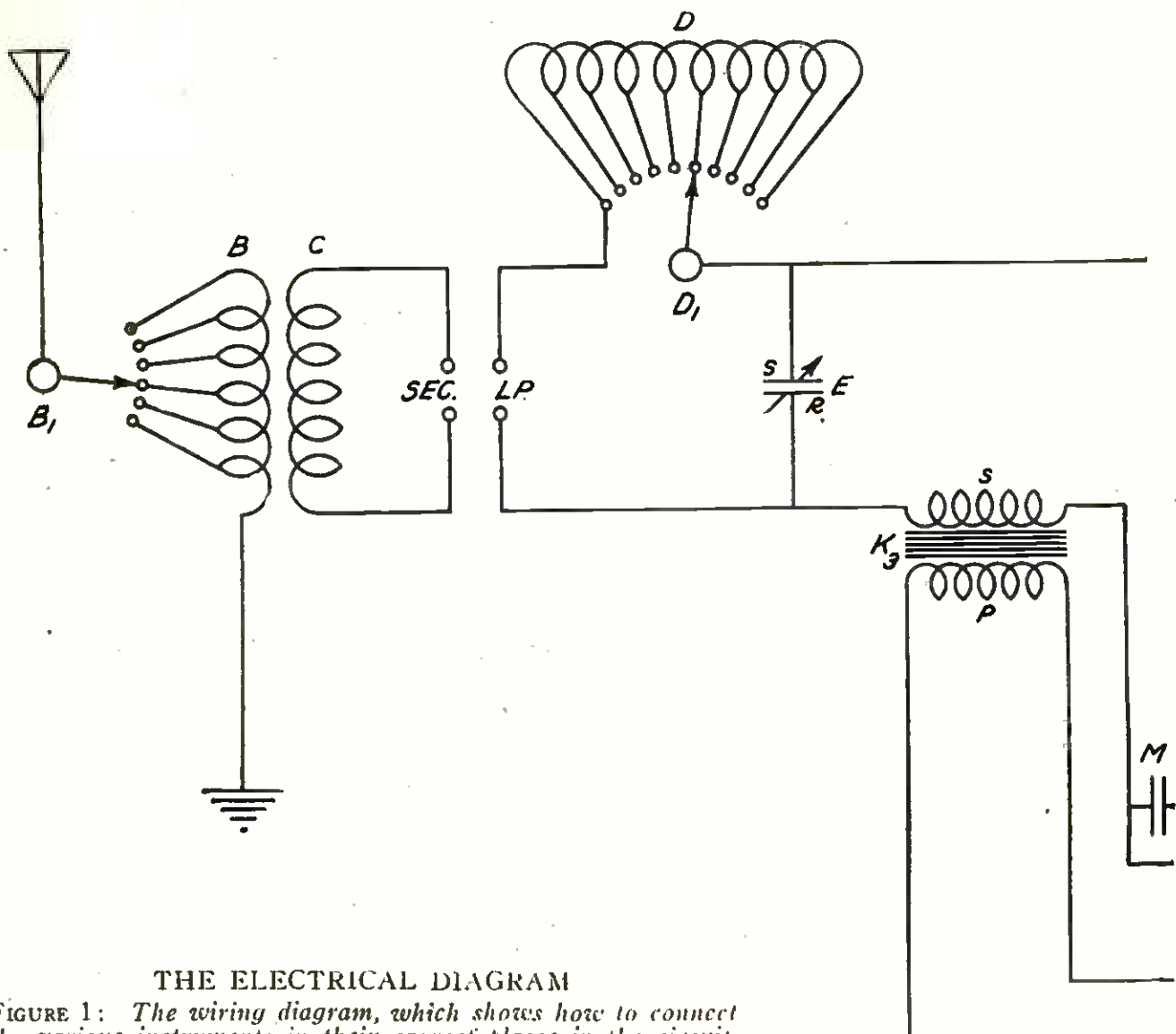

THE ELECTRICAL DIAGRAM

FIGURE 1: The wiring diagram, which shows how to connect the various instruments in their correct places in the circuit.

do not seem to be much louder on a radio-frequency set than on an ordinary outfit, while distant stations are heard almost as loud as the local stations. Hence it is clear that much sharper tuning is attained with a set that uses radio-frequency amplifiers.

The one drawback to a radio-frequency amplifier lies in the fact that the signal strength is not usually great enough to operate a loudspeaker. To overcome this objection a stage or two of audio-frequency amplification is added to the detector circuit. This necessitates the use of four or five tubes, and this involves an expense that places such a set out of reach of the average enthusiast.

The reflex circuit solves this problem.

By referring to the schematic diagram in Figure 1 it may be seen that the radio-frequency transformers are connected to the negative filament through condensers. These condensers bypass the

radio-frequency currents in each stage. The signals are then rectified and are fed into the primary of an audio-frequency transformer. The secondary of the transformer transfers the audio-frequency current (which has been rectified and converted into an audio-frequency current) back to the first tube. Here it goes through the first amplifying tube a second time. This tube is also passing the radio-frequency currents simultaneously, but no trouble occurs because an audio-frequency current can be impressed upon a radio-frequency current with little distortion effects. In the plate of the first tube the audio-frequency current cannot pass to the filament through the condenser, as the condenser will only pass the radio-frequency currents.

In this way the audio-frequency current reaches the primary of the second audio-frequency transformer where the same action takes place and the signal is finally heard in the phones, which are

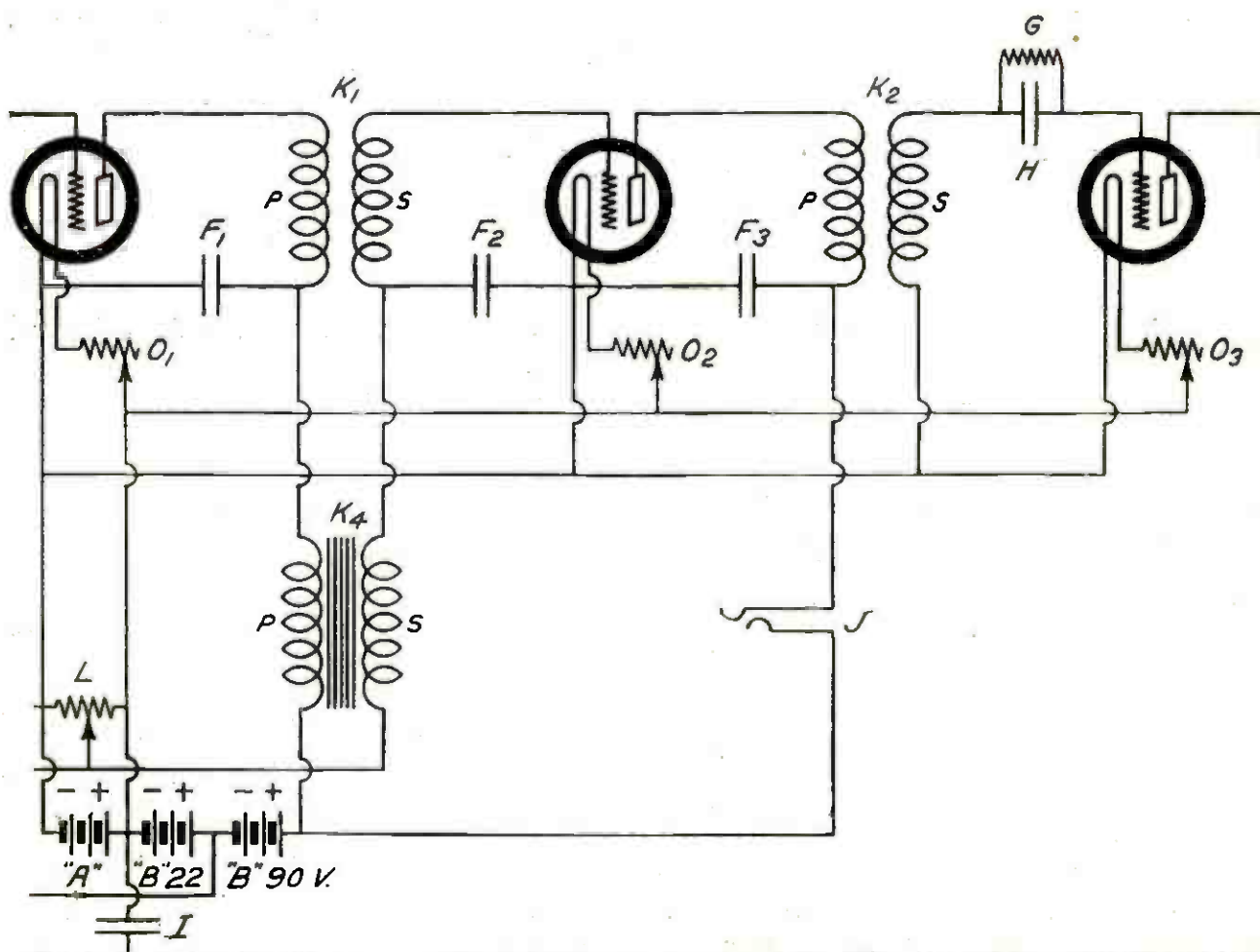

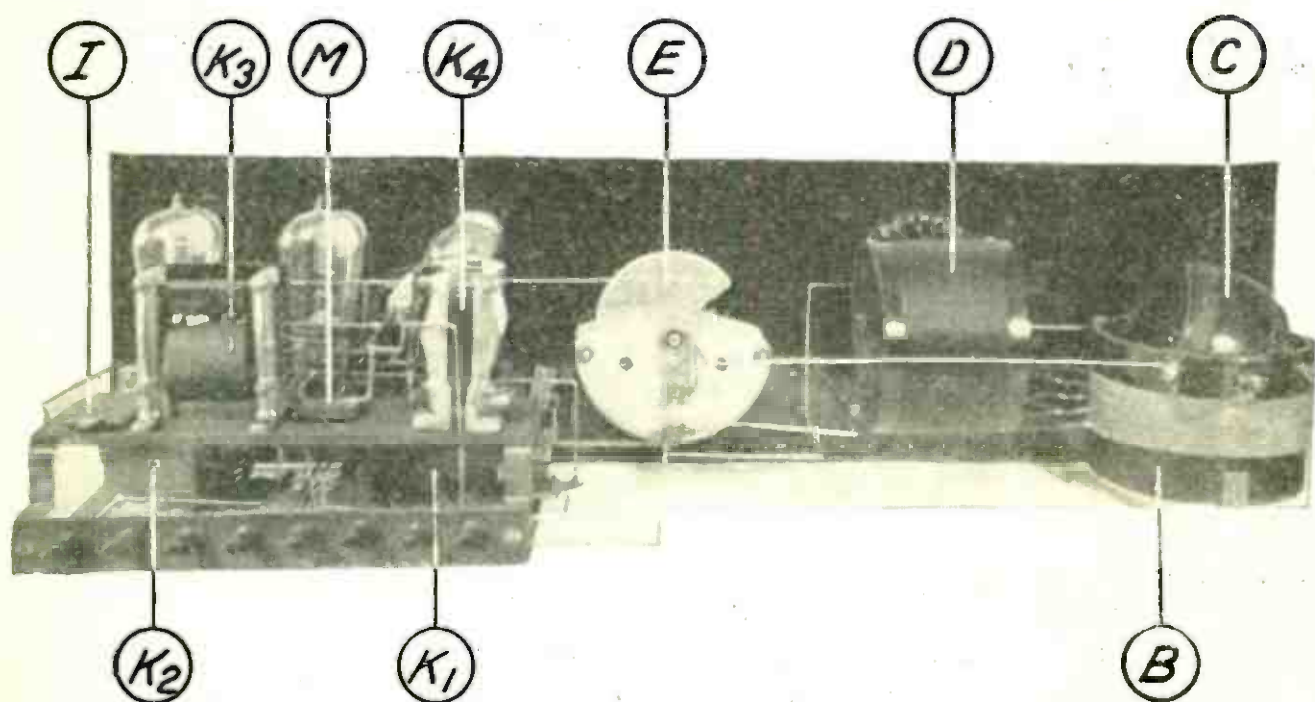

INTERIOR VIEW OF THE SET FROM THE REAR

FIGURE 2: This photograph shows the general arrangement of the instruments which are mounted on the main panel, on the shelf, and beneath the shelf. The binding posts are fastened to a thin composition strip at the back of the shelf.

in the plate circuit of the second tube. Thus we have a three-tube receiver with two stages of radio-frequency amplification, detector and two stages of audio-frequency amplification.

So much for the operation of the circuit; now for the practical construction of a reflex receiver.

The receiver described in this article was the result of several months experimentation with the circuit.* The illustration at the head of the article shows the complete outfit as used at station 2KV. The small cabinet at the left is an oscillator and will be taken up in the second part of this article. Figure 2 shows a photographic view of the outfit. This receiver is applicable to both loop and outdoor-antenna reception. Excellent results have been obtained during the past season on the broadcasting wavelengths. With an outdoor antenna, Pacific coast stations KZY, KSL, KFDB, KFI and KHJ were heard; the two latter were received often. On a two-foot loop WBAP,

PWX, WOC, and WDAP were heard as well as many other nearer stations. The results on the 200-meter amateur wavelength were equally gratifying; this will be described in a following article. The set has a range from slightly lower than 200 to above 500 meters, and uses three vacuum tubes.

The Parts Used for the Set

The list of parts given at the head of this article includes the exact instruments used in the set from which these specifications were made up; however, there are many other reliable makes of instruments which may be used in the set with equally good results.

By referring to the various drawings it will be seen that the parts listed, corresponding to the letters in the diagrams, will be necessary for the construction of the outfit.

How to Construct the Set

We will start with the construction of the tuning circuit first. The tuning circuit is rather unusual; it makes use of a variocoupler, a grid or secondary loading coil and a variable condenser. This arrangement permits greater efficiency on short waves, as the loading coil is equipped with a simple dead-ending device. The use of an antenna condenser as an aid to sharpen the tuning of its own circuit is optional.

The primary of the variocoupler is wound on a 4-inch composition tube, 3 inches long. Drill the tube as shown in Figure 5. Wind

* This circuit won first prize at the Radio Convention at the Hotel Pennsylvania, New York, March, 1923.

on the tube 48 turns of number 22 DSC. wire, starting the winding $\frac{1}{2}$ inch from the bottom. A tap is taken off every eight turns.

The secondary is wound on a moulded composition ball of $3\frac{1}{2}$ inches maximum diameter. It consists of 30 turns of number 24 DSC. wire wound 15 turns on a side.

The parts are now ready for assembly.

Cut two pieces of $\frac{1}{4}$ -inch threaded brass rod $1\frac{1}{4}$ and 3 inches long respectively. Put three $\frac{1}{2}$ -inch, 6/32 flat-head brass machine screws in the three holes on the primary as shown in Figure 5. Solder the beginning of the primary winding to the lower screw.

Now take the two $\frac{1}{4}$ -inch threaded rods and slip them through the two large holes in the primary tube, putting the long one in front. Fasten them with nuts to the rotor as shown in Figure 5. Put washers over the threaded rod between the primary and secondary so that the rotor will revolve accurately and will not wobble. The two ends of the secondary winding are soldered to the two threaded rods inside the rotor. From each of the top machine screws solder a flexible lead to the threaded rod. The two top machine screws are now the terminals of the secondary winding and the bottom screw is one of the primary terminals. The other primary terminal is the primary switch arm. Two mounting strips are made as shown in Figure 5 from $\frac{1}{2}$ -inch by $\frac{1}{8}$ -inch brass strip. They are mounted as shown and hold the variocoupler to the panel.

The grid loading coil is the next item of construction and is simply made. This is a composition tube 4 inches in diameter and 4 inches long. It is drilled as shown in Figure 6. On it are wound 100 turns of number 24 DSC. wire. Taps are taken every 10 turns. We are now ready to construct the shelf and the terminal panel.

Two brass supports are made as shown in Figure 8 from $\frac{1}{2}$ -inch by $\frac{1}{8}$ -inch brass strip. The shelf consists of three parts; the tube shelf, the transformer shelf and the terminal panel. The 3-inch by 9-inch panel is drilled as shown in Figure 8. The two audio-frequency transformers are mounted on top together with the phone and bypass condensers. The radio-frequency transformers are mounted

below the panel as shown in Figure 9. This method of mounting permits one machine screw to hold both the radio and audio-frequency transformers.

At this point it might be well to state that the author obtained best results with this set with Acme transformers in both radio and audio stages. For broadcasting, two R-2 radio-frequency transformers were used. If best amplification is desired between 400 and 500 meters the R-3 transformers should be used in place of R2's. For amateur wavelengths use an R-1 in the K1 stage and an R2 in the K2 stage in the circuit. The transformers can be easily interchanged.

The $2\frac{1}{2}$ -inch by 9-inch panel is drilled as shown in Figure 8. The three vacuum-tube sockets are mounted on the top of the panel with 6/32 machine screws. The grid leak is held underneath the panel by one of the socket screws. The three filament condensers and the grid condenser are mounted below the panel and are held in place by the wiring.

The dimensions of the terminal panel is 1 inch by 9 inches and is drilled as shown in Figure 8. It carries 8 binding posts for the antenna, ground, filament, detector and amplifier "B" batteries. No connections show on the front of the panel of the receiver. The shelf is now ready for assembly and is assembled as shown in Figures 2, 4, and 9.

The next job is to lay out and drill the main panel. This is 7 inches by 24 by $\frac{1}{8}$ inches and is drilled as shown in Figure 7. The large $1\frac{1}{8}$ -inch holes for the tube bezels require a special tool to cut them and if the builder does not feel up to the job he can drill a series of small holes for the tubes, as described before in POPULAR RADIO. Care should be taken in drilling for the vernier knobs. The holes should be drilled so that the rubber tire on the vernier makes a snug friction fit with the edge of the dial. After drilling, the panel is rubbed with emery cloth or fine sandpaper to give it a grain finish. It is then polished with machine oil and a dry flannel cloth. The marks for the dial indicators are scratched in the panel with a sharp instrument, using a straight-edge to guide the tool. The scratches are then filled in with ordinary white wax crayon.

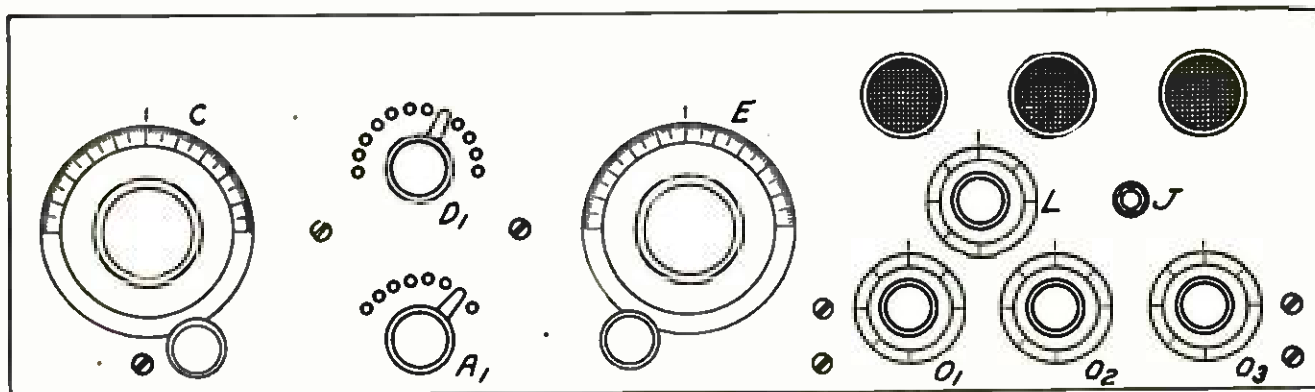

THE LAYOUT OF THE FRONT PANEL

FIGURE 3: This drawing shows in detail how the knobs and dials, the switches and the taps are mounted on the panel.

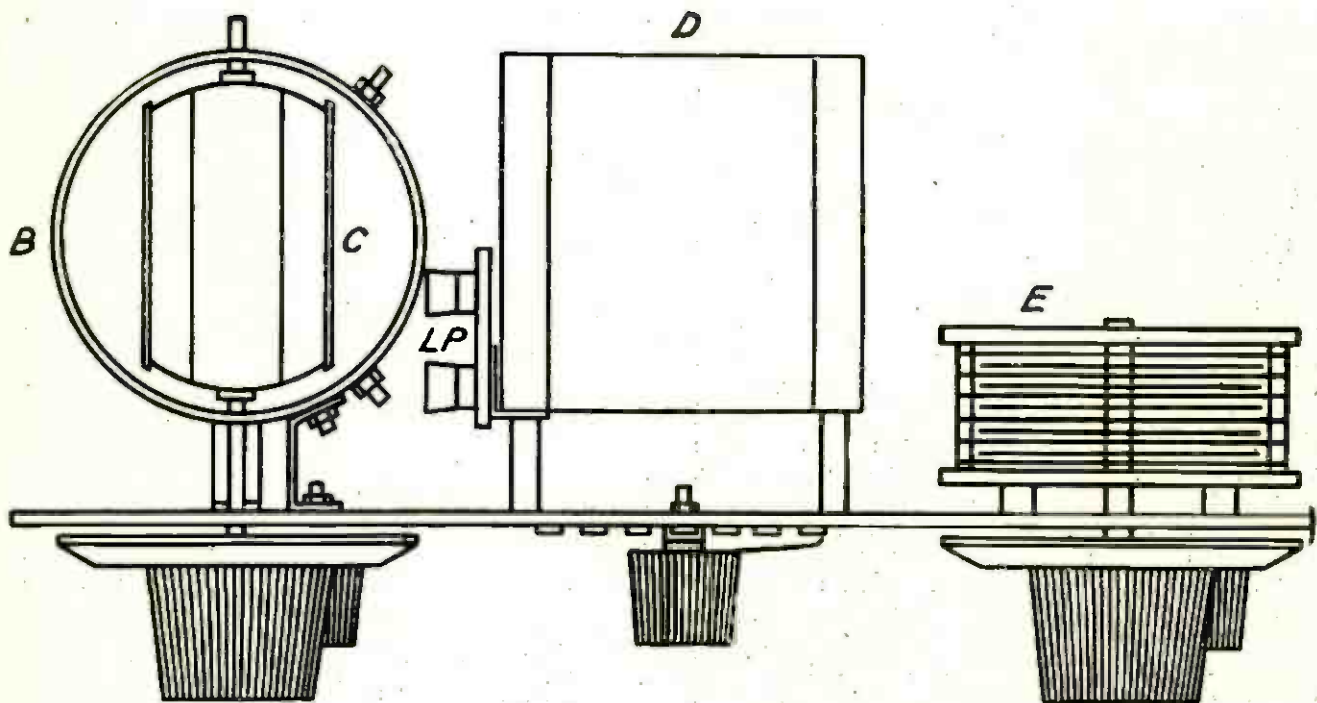

THE WORKING DRAWING FOR THE SET

FIGURE 4: This view of the receiver (from above) gives a clearer idea of the arrangement of the parts and instruments.

The various parts are now ready for assembly.

The variocoupler is mounted on the panel by means of the two brass supports with 8/32 flat-head machine screws. Leads are soldered to the primary taps and are made of No. 18 copper wire covered with empire tubing or "spaghetti." The six leads are connected to the lower set of switch points which are shown in Figure 3.

The grid loading coil is next mounted and is shown in Figure 6. Two pieces of 1/4-inch brass tubing, 1 inch long, are cut and slipped over two 1 1/2-inch, 8/32 machine screws. The loop terminal panel is now drilled as shown in Figure 6 together with a brass angle piece. The panel is of 2 by 2-inch composition. Four binding posts are mounted on the panel together with the angle piece. The hole in the angle piece is slipped over one of the long machine screws between the tube and the brass spacing tube as shown in Figure 6. The grid coil is held rigid by the long machine screws and the two brass spacing tubes. No. 18 wire leads covered with empire tubing are soldered to the taps on the coil and the upper set of switch points. A wire is soldered from the last switch point to the switch arm. This short-circuits the unused portion of the coil and in this way the arm acts as a dead-end switch.

The rheostats and potentiometer are now secured to the panel with 6/32 brass machine screws and the shelf is held to the panel by means of four 8/32 flat-head machine screws. The variable condenser and telephone jack are next mounted. The dials and switch arms should then be put on and the verriers adjusted.

The set is now ready for wiring.

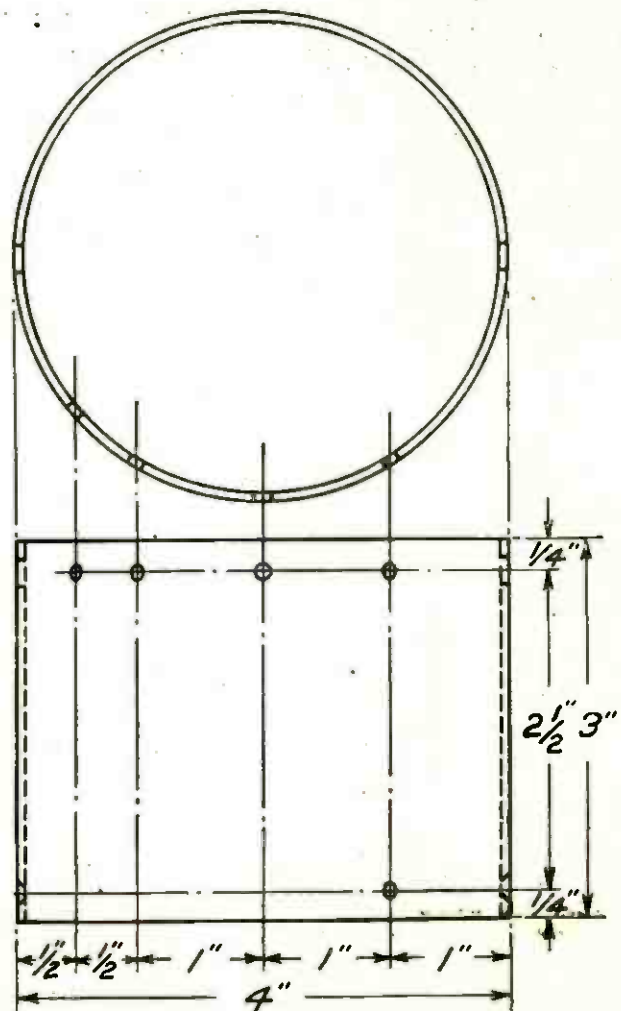

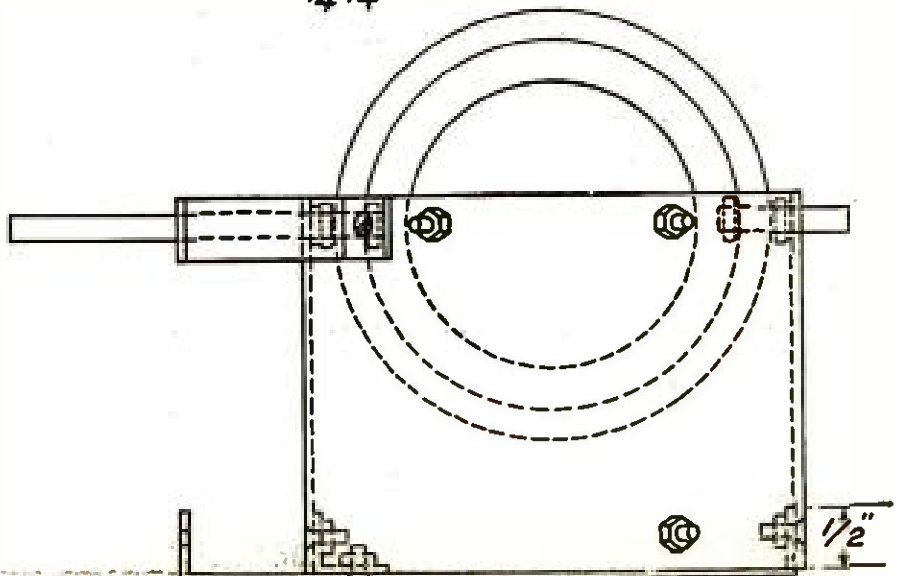
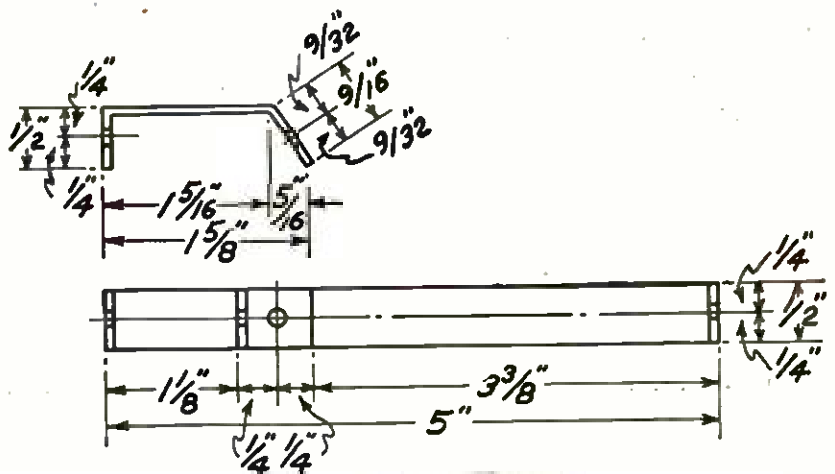
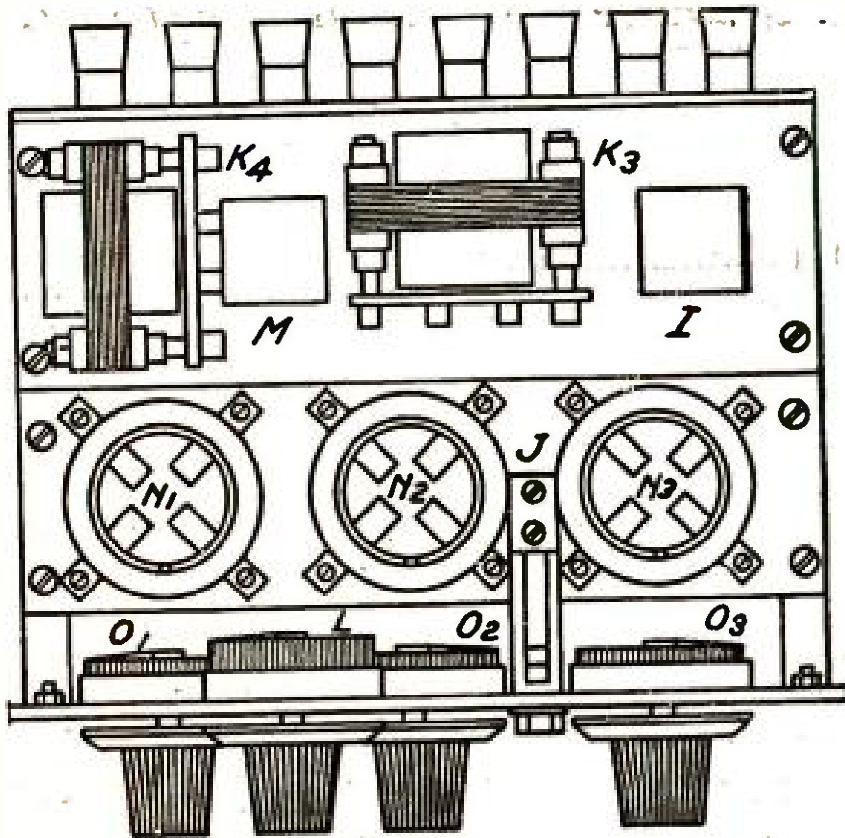

THE PARTS OF THE COUPLER

FIGURE 5: These drawings give the details of the parts of the coupler. These parts may be made by the builder of the set.

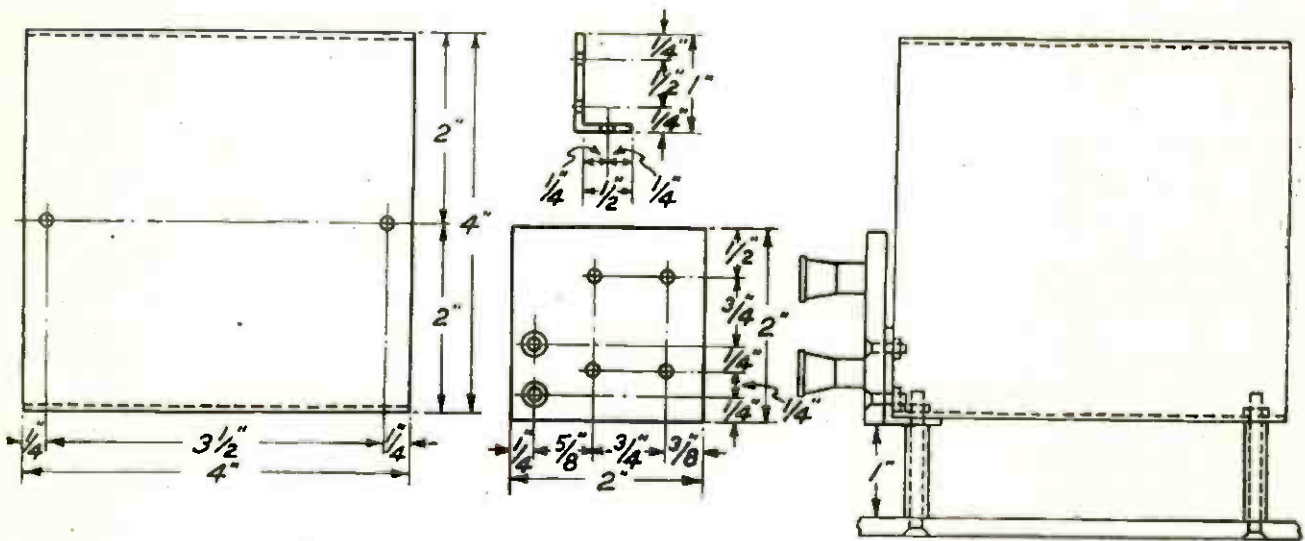

THE DETAILS OF THE GRID LOADING COIL

FIGURE 6: This diagram shows how to cut the tube and panel, and gives the dimensions for drilling the holes for mounting.

How to Wire the Set

Figure 1 is self-explanatory; it would be useless and confusing to attempt to describe how to connect this wire to that in a circuit as complicated as this. A few general hints will not be amiss, however.

Use the square tinned bus wire. It is easily handled and is very rigid.

The secret of wiring is orderly procedure. A circuit of this type appears to be hard to wire but if it is done in an orderly manner the job is completed in a surprisingly short amount of time. A great deal of time can be saved by removing the tube shelf and wiring it as a unit as far as possible. Start with the first tube and wire the radio-frequency amplifier, then the detector and finally the audio-frequency part of the system. Less mistakes are made in this way.

Mount the shelf on the panel and wire the rheostats and potentiometer. Then wire the tuning circuit.

In this circuit the secondary of the coupler is connected to one set of binding posts on

the grid-coil panel. This is the lower set. The grid coil and condenser are connected to the top set.

A neat wiring job shows up in the quiet operation of the set. Try and keep the radio and audio circuits as far apart as possible.

A standard 7-inch by 24-inch by 6 1/2-inch cabinet may be readily purchased. A slot will have to be cut out of the back with a key-hole saw so that the terminal panel and binding posts will project through the back.

Operation of the Set

The first thing to remember in operating this set is that it is just like any other new set. The adjustments are rather critical; the set would not tune sharply if they were not. It takes about two weeks to a month to learn all of the tricks of operation but the results will be worth it. Do not light up the tubes and expect to hear KHJ the first crack.

For outdoor-antenna reception the Lp and Sec. binding posts on the grid-coil panel are connected together and the antenna is con-

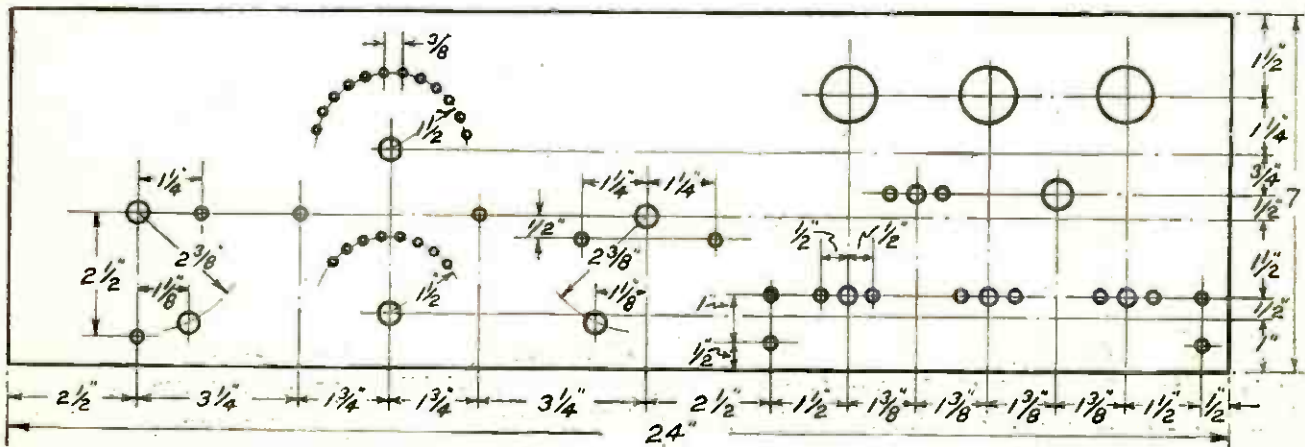

HOW TO PREPARE AND DRILL THE MAIN PANEL

FIGURE 7: This diagram gives the spacing for the drill holes for the instruments and the switches and switch points. The three large circular holes at the right are peep-holes for the tubes.

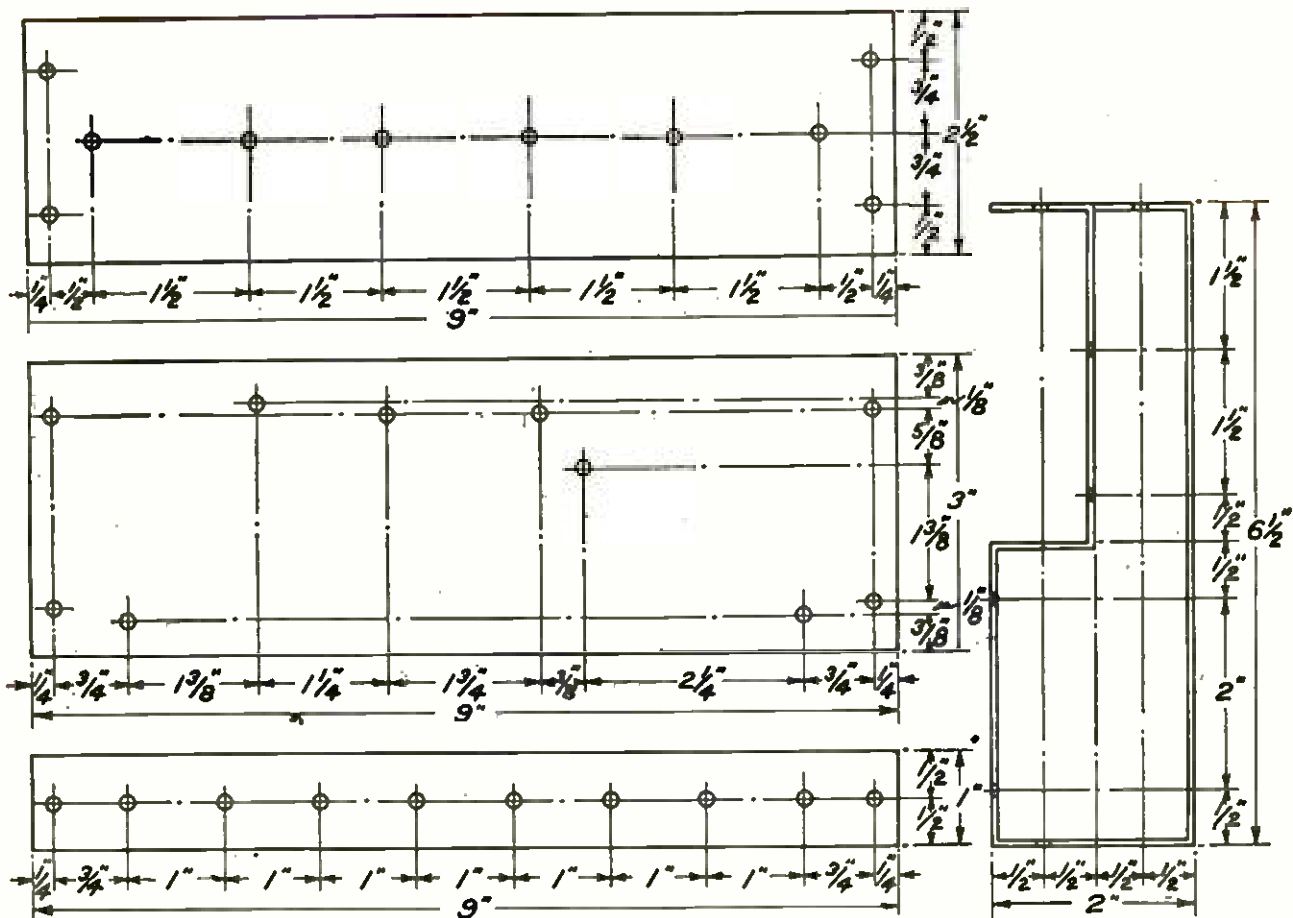

THE DIMENSIONS FOR THE SMALL PANELS AND BRACKETS

FIGURE 8: The sizes for the composition panels are given above, together with the correct spacings for the drill holes for mounting the instruments and the binding posts. The specifications of the brackets are also given.

nected to the regular terminal on the rear terminal panel. For loop reception the grid-coil binding posts are disconnected and the loop connected to the top set of posts. Only the grid coil and secondary tuning condenser are now in use.

The set is functioning properly when a high metallic sound is heard as the amplifier tubes are turned up. If this is not heard, try adjusting the potentiometer until it is heard. The potentiometer is usually worked with its lever at the negative end of the filament. A dull roar is heard when the detector filament is turned up. The set should howl when all the resistance is cut out of the filaments and the potentiometer is at the negative end of the filament. The howl can be controlled either by the filament rheostats or the biasing potentiometer. The latter method is more advisable.

To tune the receiver, set the coupler dial at about 45 degrees and use full primary inductance. Use about half of the secondary inductance and tune with the secondary condenser until the station is brought in. If you find a great deal of capacity is used, increase the grid inductance and decrease the amount of capacity used. It is always best to use a small amount of capacity and a large amount of inductance.

When the station is finally tuned in, the set can be checked by the following test:

Remove one of the amplifier tubes at a time. The set should go dead. With the amplifiers going, remove the detector tube. The signals should not be heard at all (or very faintly). If this is *not* the case then one of the amplifier tubes is detecting and should be replaced. A good reflex is largely a matter of proper tubes. The author has obtained best results with this set by using G. E. VT-14 tubes as amplifiers and a UV-200 detector. Good results were obtained with two UV-201's as amplifiers and excellent signals were obtained with a UV-201, 202, and 200 combination. The latter, however, is quite a drag on the filament battery. The second combination is the best for general use. The author has found several UV-201 tubes that were good detectors and did not work properly in the amplifier stages. UV-201 tubes are not quite as well suited for this work. WD-11 and UV-199 tubes may be used in this circuit. KZY was heard using three WD-11 tubes.

About 90 to 112 volts is right for the amplifier "B" battery, using 22½ volts for the detector tube.

Use good tested mica condensers for the filament bypass condensers. They receive the full voltage from the "B" battery and should be built to stand the voltage.

If the directions given are adhered to

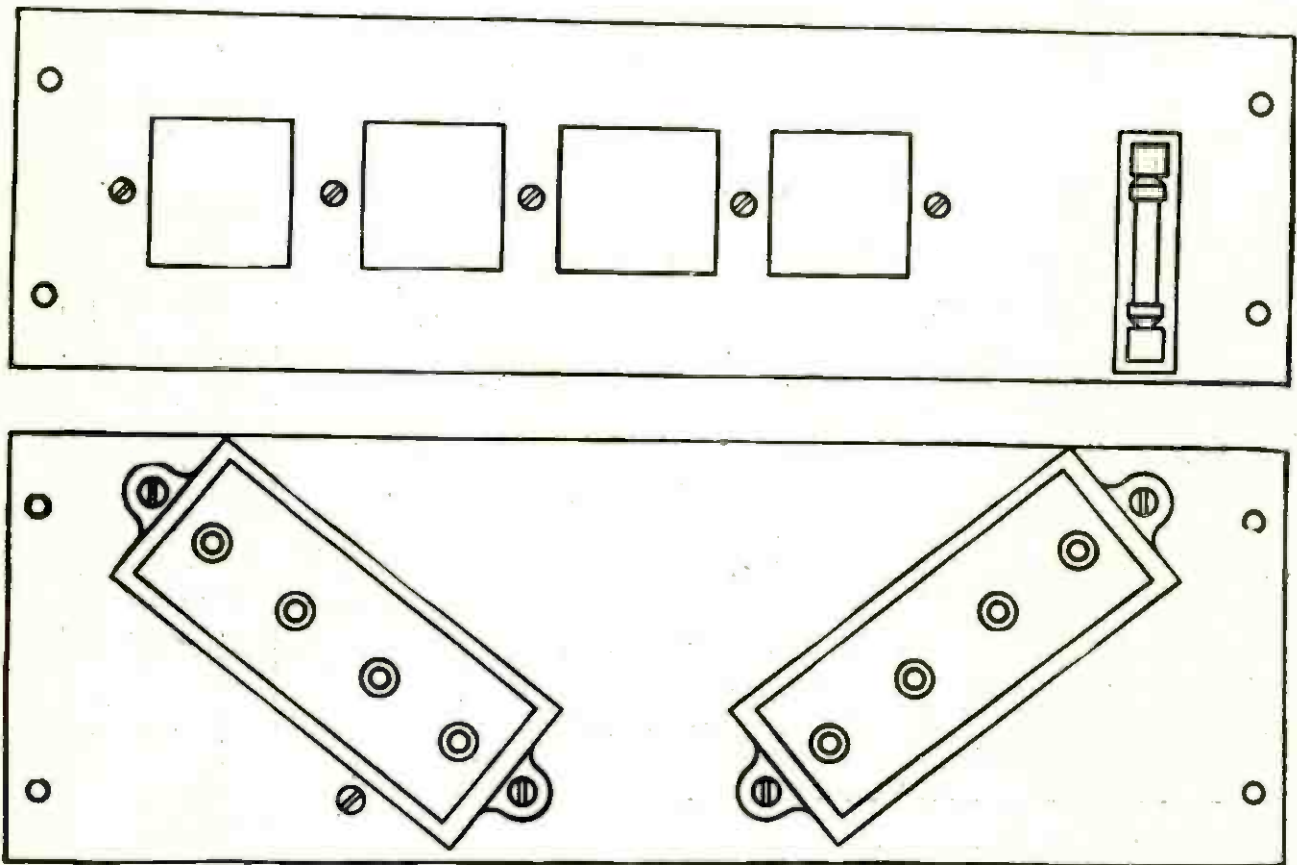

A VIEW OF THE TWO SHELF PANELS, SEEN FROM BELOW
 FIGURE 9: This drawing shows how the two radio-frequency amplifying transformers are mounted on the bottom of one panel and how the mica condensers and the grid leak are mounted on the bottom of the other panel strip.

and the constructor takes pains in the construction of the set he will have a receiver which will give him satisfaction both in DX reception accomplished, quality of speech, and in mechanical design. It is advisable that the constructor should have had previous experience with vacuum-tube sets as a reflex receiver is quite a project for a first attempt.

As will be noted, the circuit is a *non-regenerative* one. It is practically impossible to secure regeneration by the tuned plate method in a reflex receiver without causing the set to howl. In the opinion of the author, for broadcast reception the non-regenerative receiver is best because it does not distort the

voice. While a reflex theoretically should give some distortion it has been found that this circuit gives a fine mel-low quality. Everyone, without exception, who has heard the receiver here described has commented upon its pleasing tone-quality.

On low waves, where amateur CW transmitters are received, some form of heterodyne is necessary. The best way to accomplish this is to use an external oscillator, which is shown in the small left-hand cabinet in the illustration. This exceedingly useful instrument will be described and the application of the reflex receiver to amateur reception will be taken up in the second part of this article.

PART II of this article will give full instructions for building a single-tube oscillator in which the frequency of the oscillatory currents generated can be controlled. This oscillator may be used in connection with the receiver that has just been described, to allow of reception of amateur CW signals by the heterodyne method. Every radio experimenter should own an oscillator of this type.

A Tube without a Filament

Here is the new ionization tube (called the "S" tube) that has no filament to burn out and no filament current—and which consequently requires no rheostat. How this tube is made and how it is used for rectification is described in this article.

By JULIAN K. HENNEY

THE past few years have witnessed the evolution of the vacuum tube from a family of one member—the pre-war tubular audion—to a large and growing household. The family has extended itself in both directions, for the genus "vacuo" now includes everything between the tiny "peanut" variety, which burns with such a feeble glow as to be nearly invisible, and the giant tubes that have been described in POPULAR RADIO.

Between these two extremes are many tubes with many names and performing many useful functions. There is the Tungar which charges our batteries while we sleep; another important member of the family is the Kenotron, which gives us direct current from alternating for broadcast stations; then there is the great Coolidge tube that produces the mysterious and penetrating X rays of increasing importance in medicine.

A dry battery has sufficient energy to sustain life in the latest peanut tube for many hours, for only six hundredths as much current is required for this tiny device as for its ancestors. At the other end of a long line of tubes lie those monster brothers of the audion family which are able to handle as much as 100 kilowatts of energy—enough to supply a fair sized village with electricity—and 100,000 times as powerful as the lowliest member of the group.

Somewhere between these two limits is the tube without a filament, known as the "S" tube after the name of its inventor, Mr. C. G. Smith.

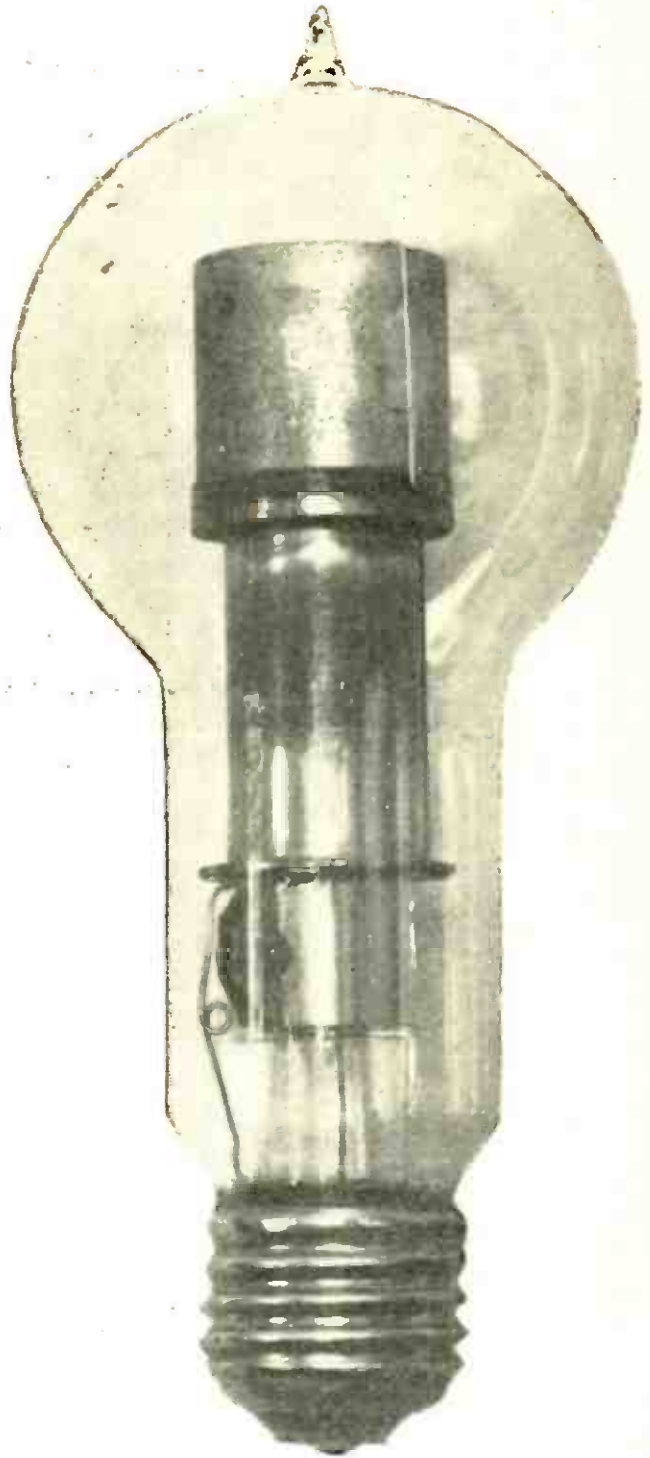

At first thought, a vacuum tube without a filament seems to be in the same category as a "ship without a sail," but such a tube does exist and paradoxical as it seems, it works.

In radio parlance, a vacuum tube means an evacuated vessel in which are two or three elements, a plate, a filament, and perhaps a grid. The action of the instrument depends upon the presence of electrons which are furnished by the heated filament. Thus it would seem that the filament would be the first

essential of a workable vacuum tube.

Yet while we have loafed along, content with tubes that require batteries, the electrons have not been idle; in fact, they are always waiting for some enterprising and inventive genius to discover some new modes of making use of their limitless capabilities. This time they have demonstrated that a vacuum tube does not necessarily signify a lighted filament shooting off electrons into the surrounding vacuum.

In order to understand the action of this new type of tube, we must remember that our friends the electrons are always present in matter, regardless of the state in which that matter may exist, solid, liquid, or gaseous. Some of the minute electrons in solids are held tightly in place in the atoms that compose the matter, and some of the electrons are free to move about, fenced in between their brothers which are held fast. In liquids the free electrons have more freedom, for the atoms themselves move about. In a gas, the free electrons have

still greater liberty, and are able to roam around among the heavier atoms of gas.

If, then, a small quantity of gas is sealed in a glass tube that contains two electrodes, a few electrons—a hundred million or so—will be shut in also: A positive potential applied to one of the electrodes would attract the electrons, as these latter are negative charges of electricity, and a drift of these minute charges would take place. Owing to the presence of the gas atoms, which are at least 1,800 times heavier than the electrons the latter will have much difficulty in finally reaching the positive plate for they will continually bump up against atoms and thereby lose their momentum.

By increasing the potential on the positive plate we can speed up the electrons, and by pumping out some of the gas we can provide a freer space in which they can move about. Thus an electron can move further before colliding with one or more of these huge atoms in a space which is comparatively free of the larger particles. As a result it will have a greater chance to get up speed before losing its momentum in a collision.

By placing a still higher potential on the plate and pumping out more and more of the gas atoms until a very good vacuum is reached, the electrons will attain enough velocity to cause some damage to an atom which happens to be in the way. As gas atoms themselves consist of a heavy positive nucleus and a certain number of electrons—one in the case of hydrogen—we can see that a high-velocity, free electron may disrupt an atom, dislodging its electron and leaving a positive part behind. Thus there are two electrons instead of one, both hurrying on their way toward the positive electrode of the tube, bumping into more gas atoms as they proceed, releasing more and more of their fellows from captivity. Thus the action goes merrily on, or as the scientists say, the action is "cumulative," which means that after the first successful collision takes place, liberating one electron, many more may follow and the

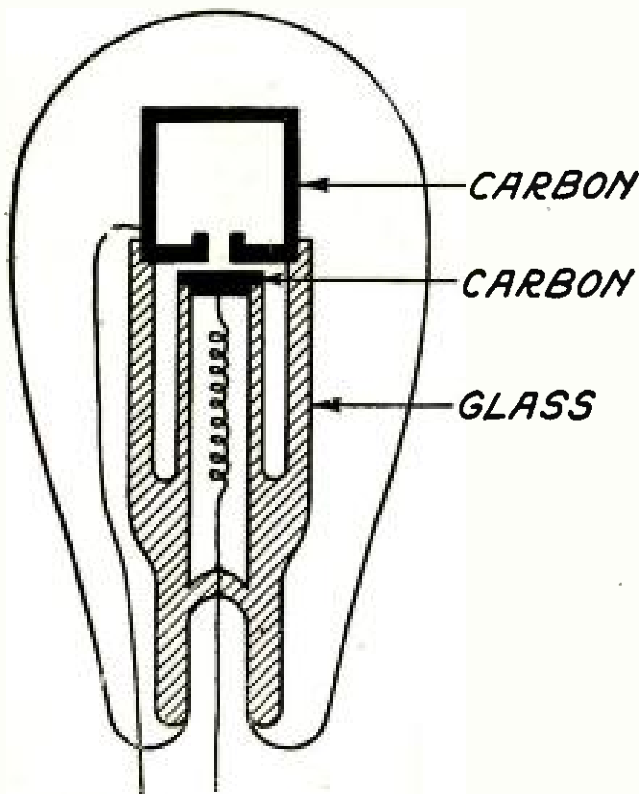

HOW THE TUBE IS BUILT

The general construction of the tube is shown in this diagram. Note the peculiar opening in the large upper electrode.

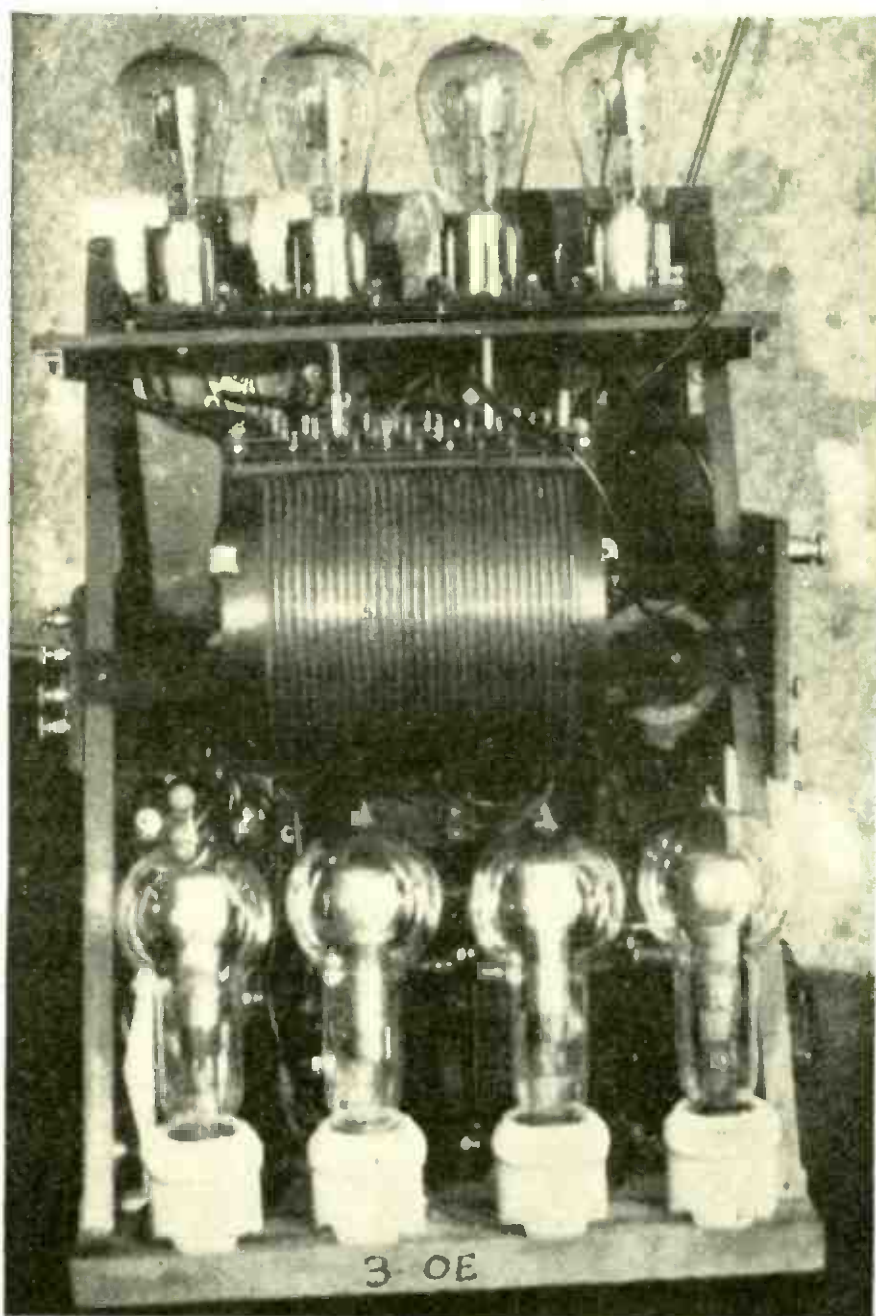

HOW THE TUBES ARE USED ON A CW TRANSMITTER

Four of the "S" tubes mounted in the CW transmitter used by Station 3OE. They are used to change the alternating current from the power transformer to direct current, for supplying the plates of the oscillators with energy.

total number of freed electrons builds up and up.

In this manner a current of electricity may be carried from one electrode to the other by these invisible carriers, and, as one might suppose, the more carriers the greater the current. As a matter of fact, it is said that at least five collisions are necessary for a continuous current. No successful collisions take place until the attainment of a potential of a certain value, depending upon the gas, and known as the "ionization potential" of

the gas. For instance this quantity for hydrogen is 13.6 volts, and for helium 29 volts. Up to the point where ionization takes place the velocity of the electrons is not sufficient to cause another carrier to be liberated.

In connection with currents through evacuated vessels, it is important to note that the distance between electrodes plays a conspicuous role. In air, and under ordinary pressure, the farther two electrodes are apart, the greater voltages it requires to maintain even a small cur-

rent across the gap. In a vacuum tube only a small current will flow unless the distance between the electrodes is large—in exact opposition to what happens in air.

When the electrodes are close together only a few electrons carry current across. By increasing the distance, or the path the electrons travel, they may get up enough momentum to batter other carriers out of gas molecules en route.

For instance, a tube may have two paths for the discharge to take place, one a short path and the other a more circuitous route. The greatest current will follow the longer path. This is due to the fact that the bulk of the current is carried on liberated electrons produced by ionization by collision.

This relation between electrode distance and current flow is important in the theory and action of the "S" tube.

Lowering the gas pressure in a tube decreases the total number of gas atoms present, and provides a greater space for the speeding electrons to move in. In-

creasing the potential applied increases the attraction of the positive plate for these tiny charges, and placing the two terminals further apart gives the charges time to get up to the minimum speed for dislodging other electrons from gas atoms and molecules.

An alternating potential applied to the tube will send the electrons back and forth through the space, and the atoms will be bombarded on all sides. If some means could be provided so that ionization by collision would take place only when one given terminal were positive, current would flow in only one direction through the tube instead of back and forth. Thus the device could be used as a rectifier, changing alternating current to direct.

So thought Mr. C. G. Smith who became interested in research in this direction* with the result that the new filamentless tube was developed.

To understand what takes place within

*In the laboratories of the American Radio and Research Corporation.

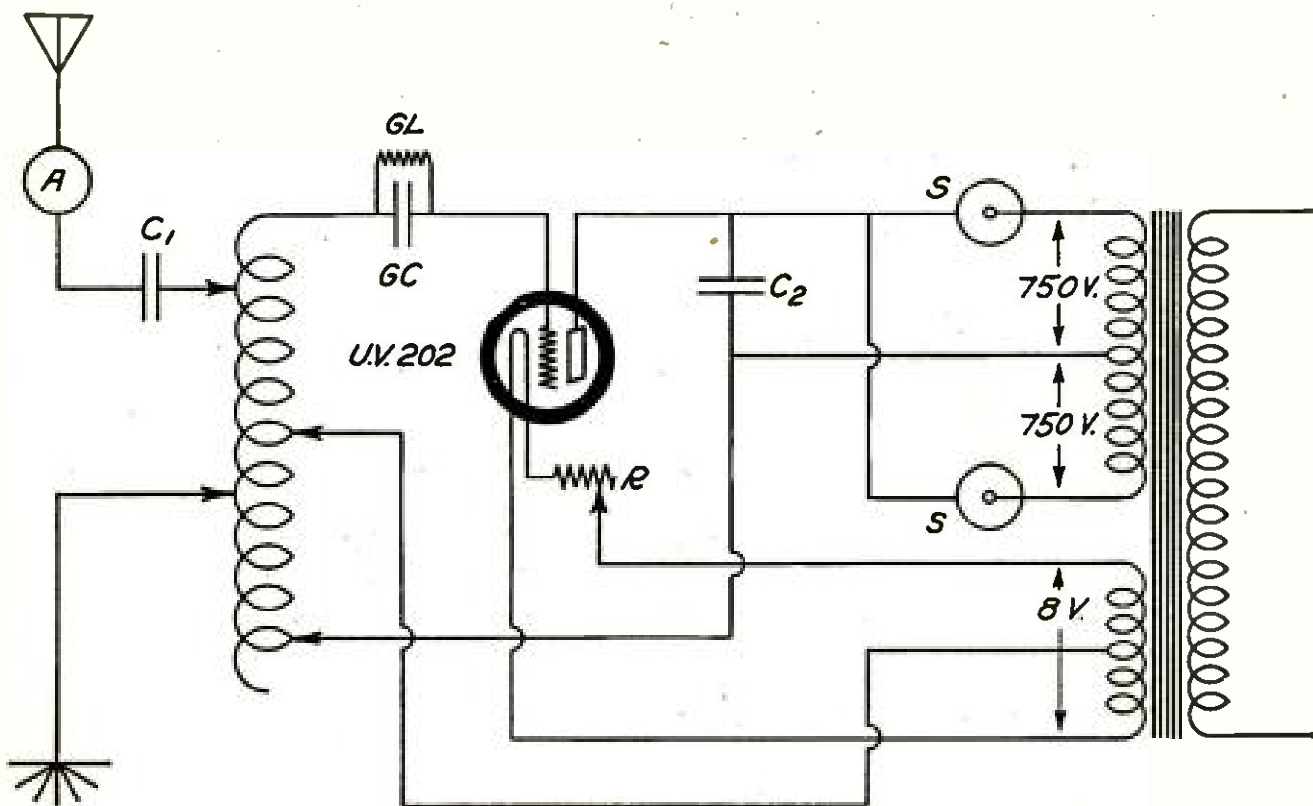

HOW TO CONNECT UP THE "S" TUBES AS RECTIFIERS

This wiring diagram shows the proper way to connect up the filamentless rectifiers to a power transformer and an oscillating circuit. The oscillating circuit shown is the Hartley.

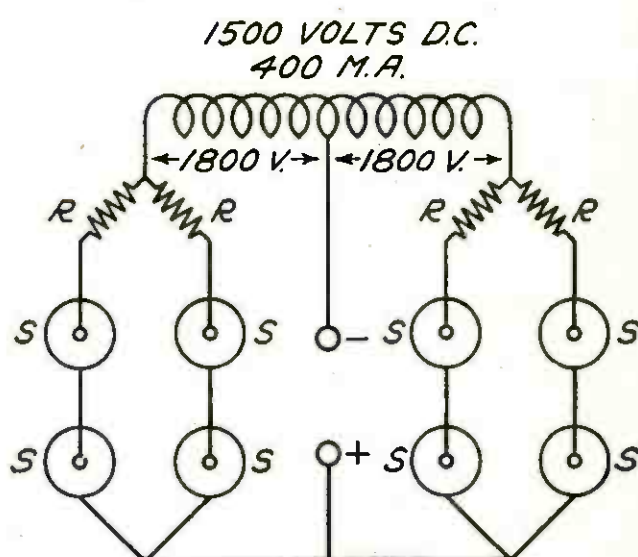
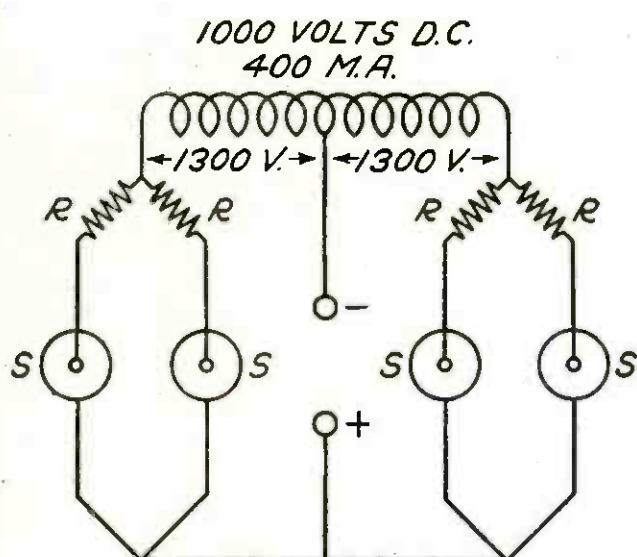
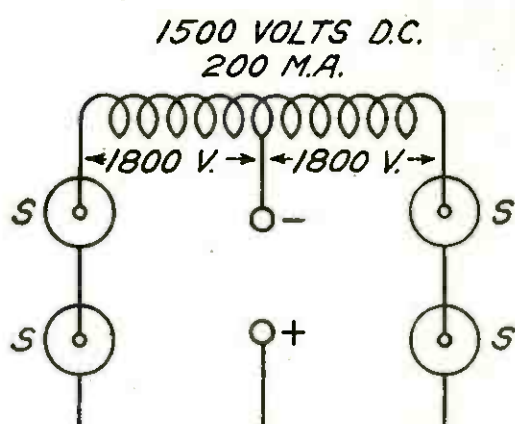
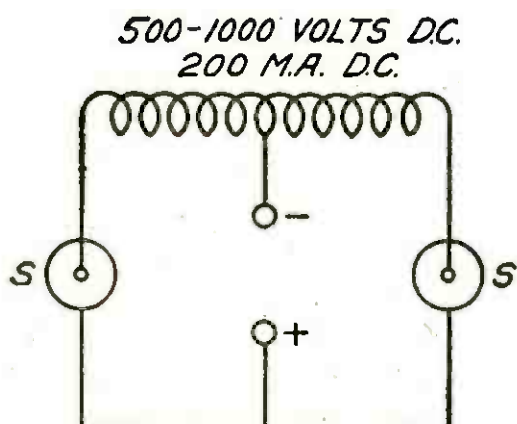

FOUR WAYS TO USE THE "S" TUBES

These four diagrams show how to connect up the "S" tubes to the secondary terminals of power transformers of different types to get different outputs in voltages and currents. The first circuit arrangement (upper left) will give a current of 200 milliamperes at 500 to 1,000 volts D.C. The second (upper right) will give a current of 200 milliamperes at 1,500 volts D.C. The third (lower left) will give 400 milliamperes at 1,000 volts and the fourth (lower right) will furnish 400 milliamperes at 1,500 volts D.C.

this tube, let us see what happens when an electron bumps another electron out of a gas atom. The two electrons are still attracted toward the positive plate although they may be thrown off their course by the collision that produced the second carrier. The remainder of the atom, the heavy positive part, is attracted toward the negative plate. Owing to its greater size and weight, its velocity toward its respective goal is relatively slow. If the potential is suddenly reversed, the electrons turning toward the new positive plate will run into a cloud of positive remains of disintegrated atoms. It is this relative mobility of the two carriers, negative electrons and positive gas ions,

that Mr. Smith has utilized in the development of the "S" tube.

Instead of using two metal electrodes for the terminals of the new tube, the general shape of the device is as shown in the illustration on page 178. When connected to a source of alternating current one terminal and then the other is alternately made positive. When the cup-shaped electrode is negative, electrons will be attracted towards the flat-surfaced anode from all parts of the cup. As the distance from inside the cup, out through the restriction to the positive terminal, is longer than that required for ionization by collision, gas atoms will be broken up by the speeding electrons

and a steady current will flow across.

When the cup is positive, a different action takes place. The positive ions, moving slowly, because of their greater mass—like a heavy football player—gather near their points of emission in a kind of fog, termed a “positive space charge.” The negative electrons are attracted to the positive plate, but only a few manage to get through the positive space charge. Those few which succeed in getting into the cup are engulfed in the cloud of sluggish positive ions, the remains of previous atomic disintegrations, and their effect is neutralized. Thus it is seen that current can flow through the tube in only one direction, and that the device acts as a rectifier, changing alternating current into a pulsating current traveling from one plate to the other, but not in the reverse direction.

Two tubes properly placed in an alternating-current circuit rectify both sides of the cycle, and instead of a jerky flow of electricity, we can get a more uniform passage, comparable to that generated by a direct-current dynamo. If the proper “filters” are used, the final product will be direct current which may be used for radiophone or telegraph transmission.

Unlike most tubes, the life of this device is not limited by the life of a fragile and disintegrating filament. The safe limit of current through the tube is about 100 milliamperes, and for heavier currents several “S” tubes may be placed in parallel. Thus the device is useful in rectifying the output of high-voltage transformers for radio-telegraph or telephone transmission. For voltages higher than a thousand a single tube may be re-

placed by two in series as shown in the diagram of connections.

The “S” tube, as produced at present, may be used for charging storage “B” batteries as well as high voltage for the plates of amplifying tubes.

The construction of the tube is typical of all vacuum-tube manufacture. The elements are assembled by hand and enclosed in the outer bulb. A seal is made then between this bulb and the slender glass neck that carries the two wires outside. The device is pumped as free from gas as possible while the elements are subjected to a potential of 800 volts and the entire tube is heated in an oven.

Even with the lowest pressure to which it is customary to pump ordinary vacuum tubes, there remains a vast number of gas molecules swarming about within the space. Professor Morecroft* estimates that “it is likely that in the highest vacuum tubes used today (10^{-8} mm of mercury) there are of the order of 100,000,000 gas molecules per cubic centimeter.” The pressure in mercury referred to corresponds to about 8×10^{-15} pounds per square inch—about 8 thousand million millionths—which is not a very great pressure.

When the “S” tube is sufficiently exhausted, helium is admitted until the pressure is about 12 mm of mercury. Helium is an inert gas, that is, it will not react chemically with other elements. It provides the necessary atoms for the process of ionization by collision.

Now that we have a tube that functions without a filament, who knows what the electrons will show the radio engineer next?

*In his book “Principles of Radio Communication.”

Is Your Receiving Antenna Put Up Correctly?

UNLESS it is, you cannot get the proper value from your receiving set, no matter how efficient that set might otherwise be. How to install an ordinary single-wire, outdoor receiving antenna—and install it right—will be told in the March number of POPULAR RADIO.

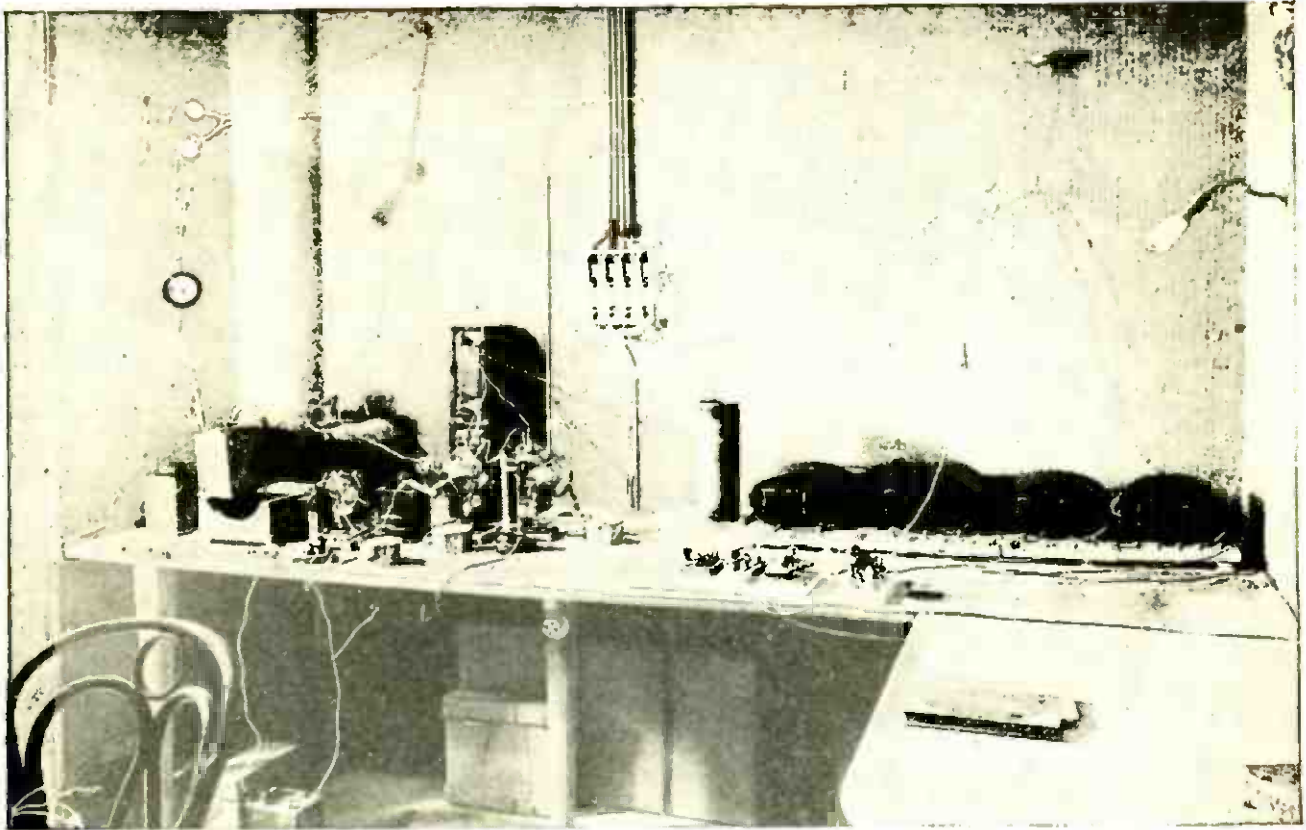

THE FRENCH AMATEUR TRANSMITTER THAT REACHED AMERICA
The two 250-watt tubes are just left of the center. To the left are the condensers for the counterpoise and the antenna, the vacuum-tube grid-leak and the inductances. To the right are the transmitting keys and the transformers.

Across the Atlantic on 100 Meters



Captain Leon Deloy of Nice, France, is not only one of the best-known radio amateurs in the world but also is President of the Radio Club of the Côte d'Azur and one of the most capable of radio engineers. Many American amateurs will remember Captain Deloy's service in this country in the latter part of the World War, when he was attached as a radio expert to the French Military Commission in America.

By LEON DELOY

ON November 27, 1923, amateur radio spanned the Atlantic in two-way communication for the first time in history. Captain Leon Deloy, of Station 8AB at Nice, France, exchanged a series of messages with the well-known American amateurs Mr. F. H. Schnell and Mr. John Reinartz. Last year, just as he was leaving the

United States to return to France, Captain Deloy said to the Technical Editor of POPULAR RADIO, "I am going back and work America on one hundred meters." He did it. In this article, written especially for POPULAR RADIO, he tells how it was done.

The accompanying simplified diagram shows the connections of the main pieces of ap-

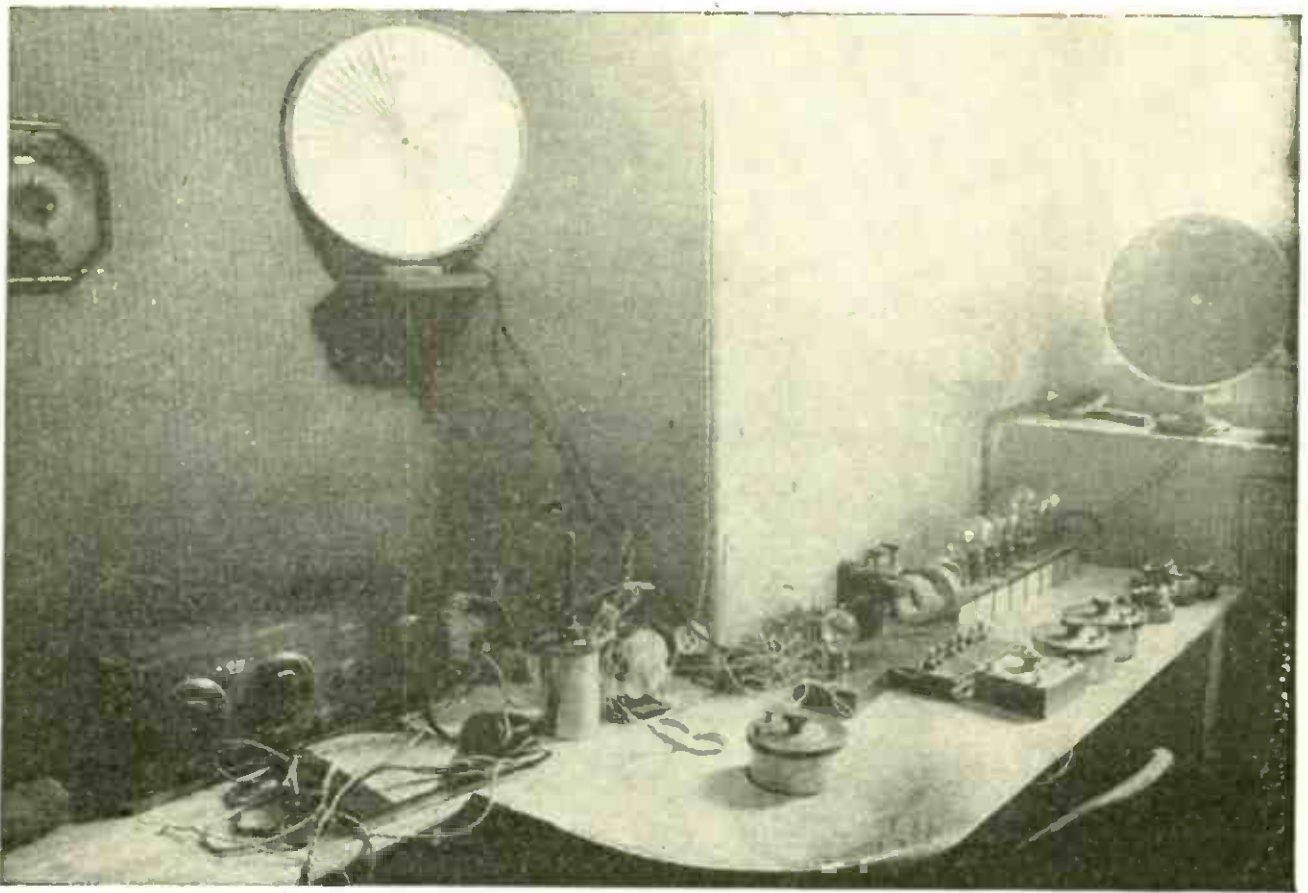

RECEIVING EQUIPMENT AT DELOY'S STATION IN NICE

The receiver at the left, directly under the disk of the loudspeaker, is the Grebe No. 13. The home-made super-heterodyne which Captain Deloy also used is on the part of the table to the right.

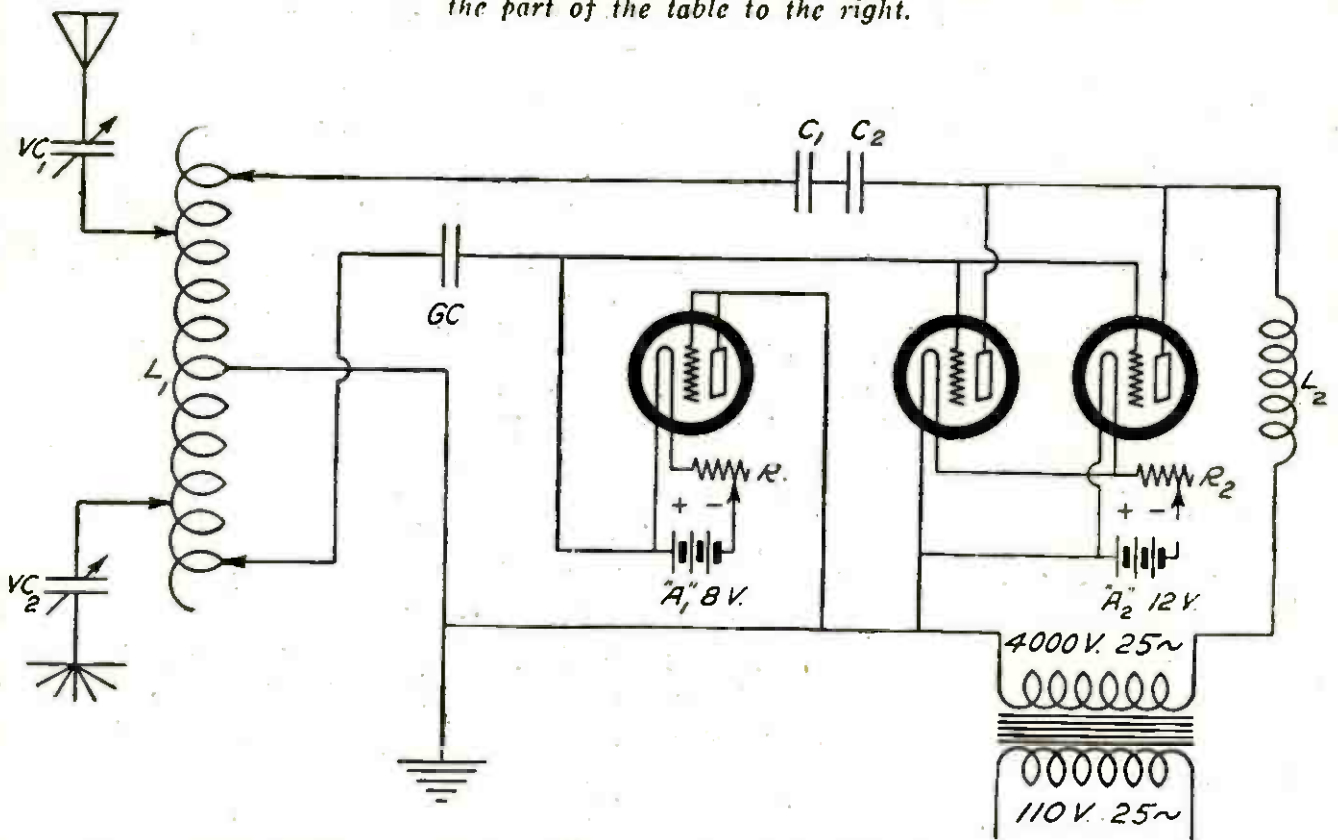

THE CIRCUIT DIAGRAM FOR THE DELOY TRANSMITTER

This arrangement, designed by an American, John Reinartz, is the one used in the transatlantic transmission. The two transmitting tubes are on the right of the diagram, the third tube being the grid-leak.

paratus employed in my station during the recent two-way communication tests carried on with American amateurs.

The antenna is a four-wire cage, ten meters long and one meter square, about twenty-five meters above ground. The down lead is taken from one end and consists of two wires two inches apart. The counterpoise is a four-wire cage, one meter square and a few meters longer than the antenna. It goes downward from the window of the operating room (which is located about ten meters above ground) to a point two meters above ground. It is nearly underneath the antenna.

The antenna and counterpoise run in a north and south direction with their insulated ends toward the south. Both the antenna and counterpoise are made of seven-strand copper cable, each strand being enameled. The variable condensers in the antenna and counterpoise are Cardwell transmitting condensers and are always kept on the same reading.

This particular combination of antenna and counterpoise with two condensers is due to Mr. John Reinartz and is certainly very efficient.

The ground system is composite: water, gas and steam pipes, lightning rod, tin roof and about eighty meters of wire fence buried in the garden mostly under the antenna. A Jewell thermocouple ammeter is used in the antenna circuit. During the tests referred to the reading was between 2.3 and 2.8 amperes. The helix is home-made with copper tubing. All the fixed condensers are home-made from photographic glass plates.

Two $\frac{1}{4}$ KW. (input) S. I. F. French tubes are used in parallel. The filaments are heated by a twelve-volt storage battery with a rheostat in series. The Chauvin and Arnoux voltmeter and ammeter connected in the filament circuit read 5.5 volts and 14 amperes. The plates are

connected through a home-made choke coil to the secondary of a 4,000-volt transformer. (In practice several transformers are used with their primaries in parallel and their secondaries in series.)

The key is in the primary of the high-tension transformer. As a grid-leak I use the plate-filament space of a 50-watt (input) S. I. F. tube the filament of which is heated by an 8-volt storage battery. This filament draws 2.5 amperes at 6 volts. Its temperature and consequently the plate-filament resistance can be varied by a rheostat, which is extremely useful in working the main tubes at their best efficiency. This grid-leak device is due to Mr. Thomas Appleby.

Although, as this is written, I have been testing with America only for the last three nights, my signals have been received there regularly and strongly. Last night (November 27) two-way communication was established for the first time in the history of radio between amateur stations of the two continents when I exchanged messages and long conversations with Mr. Fred H. Schnell and Mr. K. B. Warner of 1MO and Mr. John Reinartz of 1XAM, who reported my signals as readable on the loudspeaker and twenty feet from the phones.

For reception I use either a Grebe CR 13 receiver, which is proving very efficient and practical, or a home-made super-heterodyne which gives me regularly the voice of KDKA readable six feet from the phones with only one step of audio amplification.

With a given number of tubes the signals from 1MO are the loudest American signals I have heard so far, including all amateurs heard during last year's transatlantic tests and all the high-power stations.



THE HIGHEST RECEIVING STATION IN NEW YORK STATE

The tallest mountain in New York state is Mount Marcy, 5,344 feet above the sea. A receiving set was carried to the top recently by Hall E. Shepherd and Sherwood Marvin, an antenna wire was stretched between two boulders and concerts from WGY, WEAJ and WMAJ were picked up.



HELP your neighbor. If you have discovered any little Kink that helps to eliminate trouble in your radio apparatus, or if while experimenting with the connections of your set you should run across some interesting phenomenon, or if you should discover some new hook-up that gives better results—send it to the "Listening In" page.

How the Anti-trust Laws May Affect the Radio Fan

UNDER a request from the House of Representatives for information that would aid in determining whether or not the anti-trust laws of the United States were being violated, the Federal Trade Commission has made a careful investigation of the radio industry. The report of the Commission, recently submitted to Congress, will probably prove one of the most important documents ever issued for the radio industry. The following quotations include some paragraphs of the report that are of especial interest to the amateur and the broadcast listener.

After outlining the history and present stock ownership of the Radio Corporation of America the Commission continues:

"The Radio Corporation has entered into agreements with the various companies which own or control practically all patents covering radio devices considered of importance to the art. The number of patents involved approximates two thousand. Agreements of this character have been entered into with the General Electric Company, Marconi's Wireless Telegraph Company, Ltd., American Telephone & Telegraph Company and its subsidiary, the Western Electric Company, the United Fruit Company and its subsidiary, the Wireless Specialty Apparatus Company, The International Radio Telegraph Company, the Westinghouse Electric & Manufacturing Company, and the Radio Engineering Company of New York. With certain minor limitations, the Radio Corporation under these agreements has secured an

exclusive divisible right to sell and use the radio devices covered by the patents involved or by patents which these companies may acquire before the termination of the agreements. The agreements with the American Telephone & Telegraph Company and the Western Electric Company are to terminate in 1930, while the remainder are to terminate in 1945. Provision is made for the mutual exchange of information relating to radio, and, in most instances the Radio Corporation has granted to the other company a license under its patents to make and use devices in the particular field in which the other company is interested.

"The Radio Corporation, under these agreements, is made the selling company for practically all radio devices to be sold to the public under the hundreds of patents involved. The General Electric Company and the Westinghouse Electric & Manufacturing Company are to manufacture and to sell to the Radio Corporation only, these devices and apparatus, the Radio Corporation agreeing that sixty percent of its annual requirements would be purchased from the General Electric Company and forty percent from the Westinghouse Company. Until the expiration of the Fleming patents in 1922, the Radio Corporation had an absolute monopoly in the sale of vacuum tubes. On the expiration of these patents, the DeForest Radio, Telephone & Telegraph Company, which had retained a right to manufacture and sell, commenced the sale of such tubes to the general public. In the sale of receiving sets, the Radio Corporation has competition from seventeen concerns licensed under the Armstrong patents, although their sale of sets for use in conjunction with tubes is being contested in the courts at the present time."

The Commission then proceeds to analyze the situation with regard to ship-to-shore and international communications. With regard to the latter the Commission states:

"The Radio Corporation is the only concern now engaged in transmitting and receiving radio

messages between the United States and foreign countries and contends that in order to function properly it must of necessity secure a monopoly in this field. The company has secured a virtual monopoly and controls all the high-power stations with the exception of those owned by the Government."

In conclusion, under the head of "Sale of Apparatus" the Commission continues:

"The refusal to sell or lease apparatus to competitors for international communication purposes is included in the well-defined policy of the Radio Corporation of America. It also affixes to the apparatus sold a license notice, the object of which is to restrict the purchaser's use of the device to amateur and experimental purposes. In supplying ships with apparatus, devices and appliances, the shipowners are required to execute an agreement which provides that the apparatus, etc., furnished by the Radio Corporation is licensed only for use on board ships and aircraft in communications destined to or originating on such ships or aircraft.

"The Radio Corporation distributes its products chiefly through wholesale concerns handling electrical supplies. In order for a dis-

tributor to handle these goods it must furnish evidence that it has the facilities for conducting a wholesale business and give an initial order amounting to not less than \$25,000. Independent manufacturers of sets are not sold vacuum tubes and other patented devices for resale in connection with sets manufactured by them. This was a hardship, particularly when there was a shortage of tubes, as the dealers were unwilling to furnish them with tubes. The investigation shows that the shortage in tubes was confined to three of the six types manufactured and prevailed during 1922 and first few months of 1923. There was a marked increase in the demand for tubes as the industry developed, as is shown by the orders received by the Radio Corporation, which were as follows: 1921, 112,500; 1922, 1,583,021; and for the first nine months of 1923, 2,931,262 tubes. Although the officials of the Radio Corporation admit that they do not carry dealers who confine their orders to tubes exclusively, there is little evidence that the Radio Corporation required dealers to handle their goods exclusively or favored such dealers, in the supply of tubes, as compared with dealers who also handled apparatus manufactured by others.

"The DeForest Radio, Telephone & Tele-

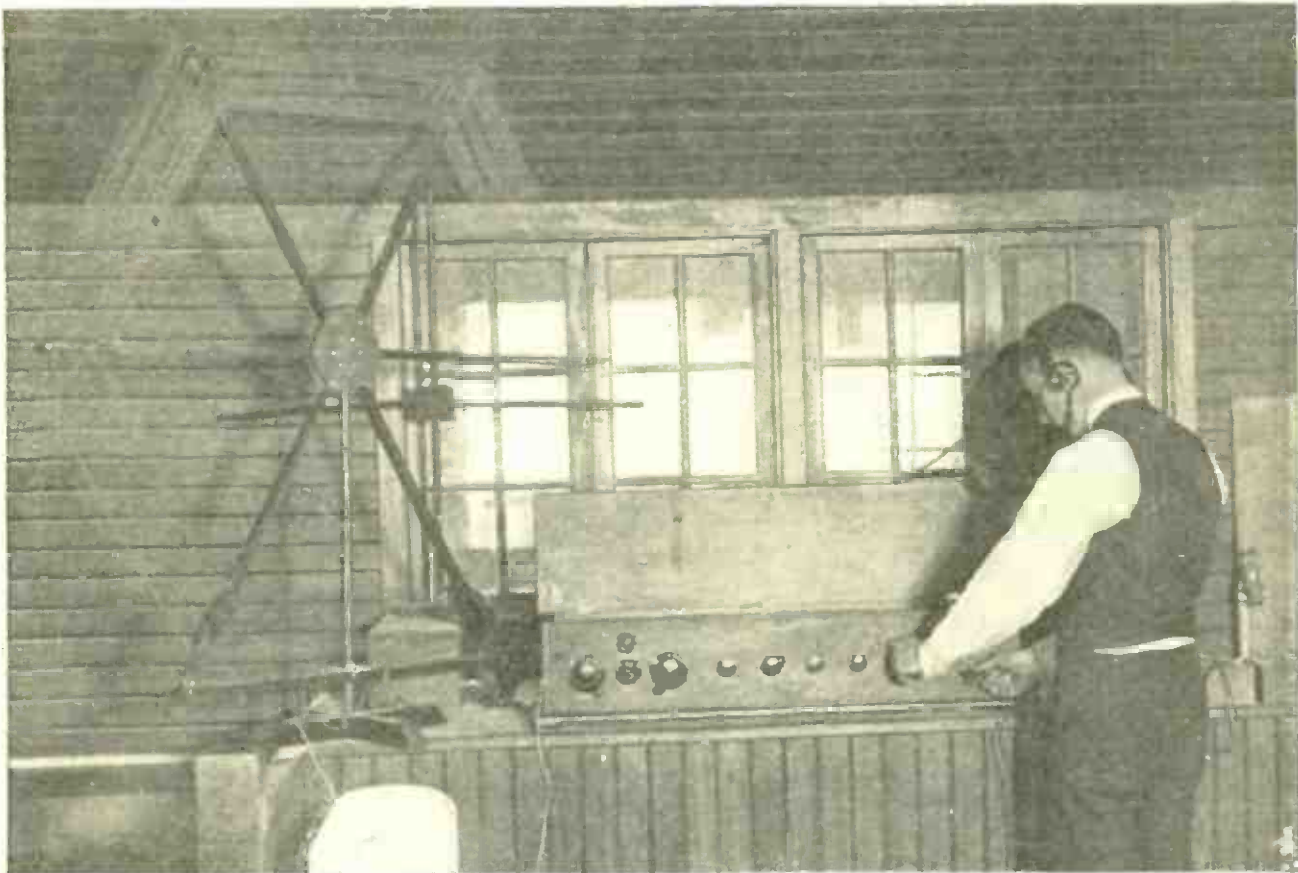

Underwood & Underwood

AMERICAN RADIO AMATEURS PICK UP EUROPEAN BROADCASTING STATIONS

*A special loop antenna, presented to Arthur Lynch, editor of **Radio Broadcast**, by Dr. J. H. Rogers, the man of "underground-antenna" fame, was used in conjunction with this super-heterodyne receiver to pick up the European broadcasting stations' signals in a recent test held at Garden City. A number of the transatlantic signals were recorded by amateurs. In a short time we will all be listening in to broadcasting from across the water.*

graph Company, which is now engaged in the manufacture and sale of a modern vacuum tube, also affixes to its product notices with respect to use similar to those used by the Radio Corporation. This company has recently adopted the policy of making the distributors of its products, agents.

"The Commission submits no conclusions in this report as to whether the facts disclosed constitute a violation of the anti-trust laws, as the House resolution under which the report was prepared called only for the facts and data as in the opinion of the Commission may aid the House of Representatives in determining whether . . . the anti-trust statutes of the United States have been, or now are, being violated . . . ; and such other facts as in the opinion of the Commission may aid the House in determining what further legislation may be advisable."

Useful Hints on the Test Buzzer

TO the beginner who is enjoying local broadcast programs through the medium of the useful and inexpensive crystal set, the following information will be of real value:

If a vibrating buzzer circuit is placed in inductive relation to either the open or closed circuits of a receiving set, the fluctuations of the battery current act inductively on the receiving circuits and set up therein feeble cur-

rents which are rectified and made audible in the head telephones.

The maximum response in the head telephone is obtained when the crystal is adjusted for the best degree of rectification (or is on the most sensitive spot); hence the buzzer affords a ready means for adjusting the detector. A perfect reproduction of the tone of the buzzer is obtained in the phones, the pitch varying in accordance with the interruptions of the vibrator.

The method of placing the buzzer in inductive relation to the antenna system is shown in Figure 1. The coils L3 and L4 are wound on a tube 1½ inches in diameter and 1¼ inches long; L2 is wound with 8 turns of No. 20 D.C.C. wire; L1 is wound with 6 turns of the same size of wire. The coil L1 is connected in series with the battery and the buzzer, and consequently when the buzzer is set into action, a change of flux takes place through L3 which sets up a difference of potential across L4 and, therefore charges the antenna system, causing it to oscillate at the particular frequency to which it is adjusted. Then, when the secondary circuit of the receiving tuner is adjusted to resonance with the antenna circuit, and the crystal detector is adjusted for the most sensitive operating condition, the loudest sound will be obtained in the phones.

The coils L3 and L4 may be placed either inside or outside of the receiving cabinet. They may be installed inside the cabinet and a pearl-center push button mounted on the panel; this gives a neat and handy mounting, as the buzzer and batteries are placed inside the cabinet out of the way.

—GUY SIMMONS, JR.

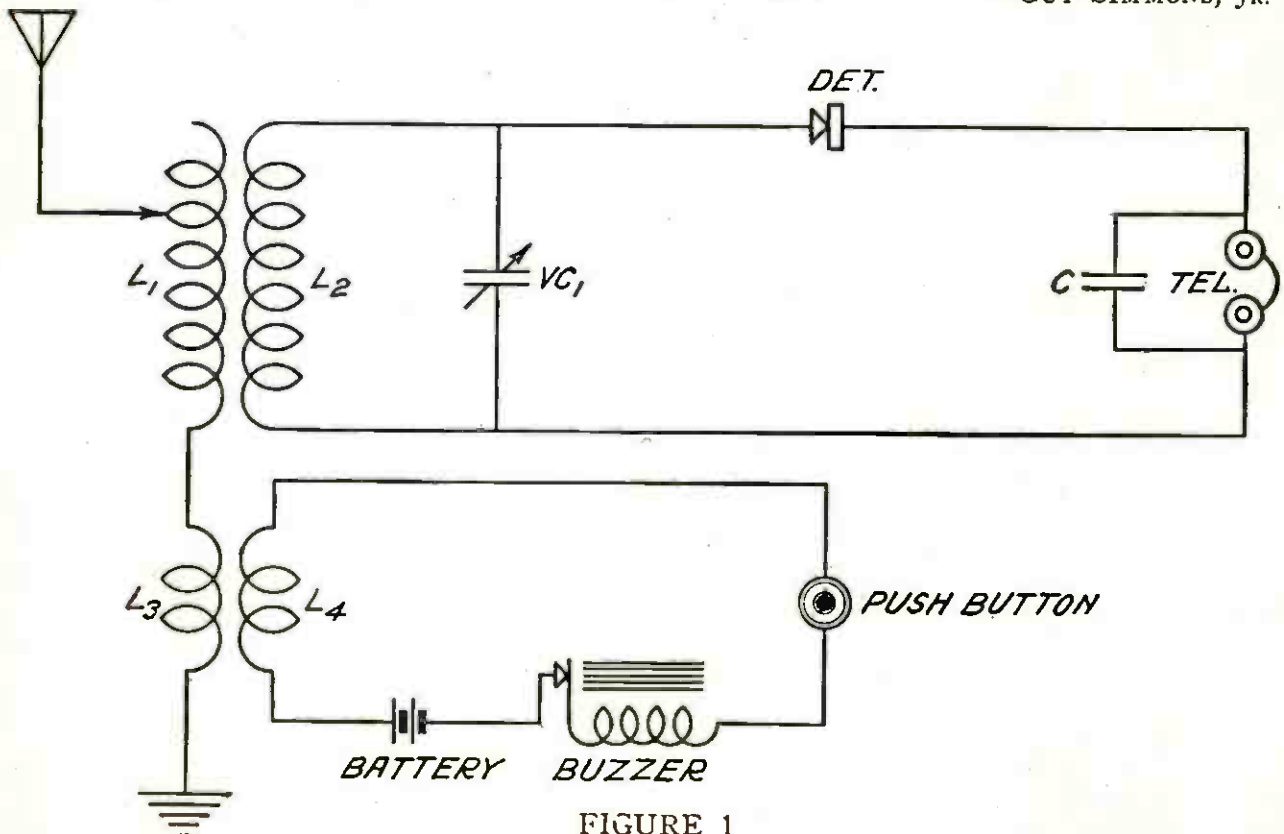
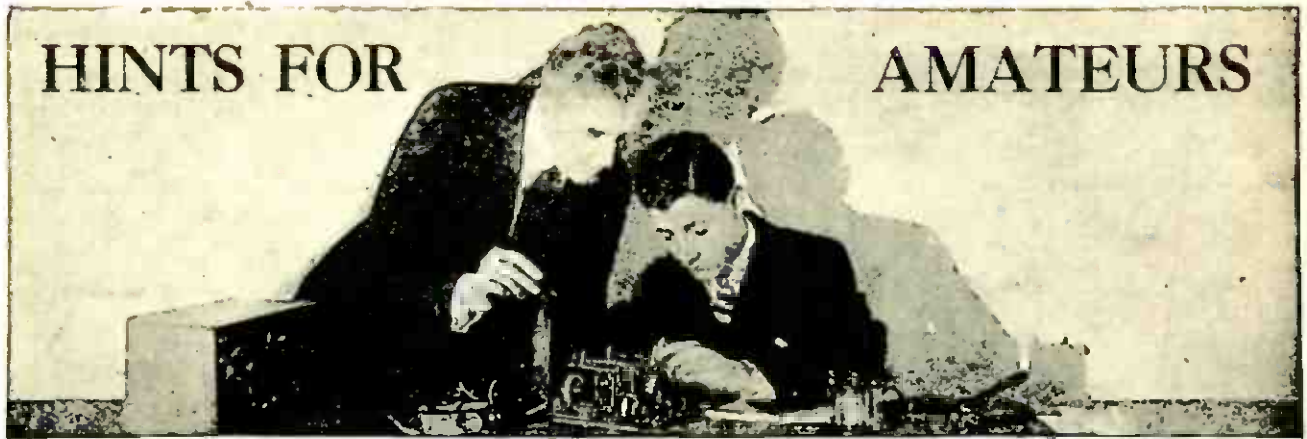

FIGURE 1

How test buzzer should be connected up to the ground circuit of the receiving set by means of two small coils L3 and L4 for the easy adjustment of the crystal detector.



Do not hook-up one of the accepted standard circuits and, after using it for awhile, with poor or indifferent results, condemn it.

If you have once decided to build a set incorporating a certain circuit, you have probably done so only after reading about someone else's splendid results with the circuit. Therefore, it stands to reason that you must have done something wrong, or neglected to do something which would have been right in building your own version of the circuit. Before condemning the circuit, try out all the connections, investigate all the instruments to see that you have the right capacities, inductances and resistances as specified by an authority, and then think of all the little places that you have skimped and done things in a hurry or substituted some cheap piece of apparatus. After you have rectified all the things that are wrong in the set and after you have really learned to tune it, then is the time to kick. However, it will usually work well and you will be enthusiastic.

But, perhaps you have expected too much from the circuit from the beginning. This all goes to show that a circuit *may be good* but the fans who use poor parts or do careless work in making it think that it is worthless.

* * *

A RHEOSTAT of the wire-wound type should have the separate turns of wire spaced accurately and all the wires should be of the same height where the sliding contact passes over them. This

will insure even regulation and prevent the lever catching on the wires as it passes over them.

The wires should be wound on tightly and the whole resistance unit should be fastened onto the rheostat base so that it cannot wobble when the the knob is turned. Be sure when buying a rheostat of this type to make these investigations and buy one that has the correct resistance for the tube you are using.

* * *

IN using insulating tubing on the wires in your receiver be sure to get the best grade of tubing. Do not use a cheap grade that is made of cheesecloth, covered with some kind of gummy rubber compound. Get good, seamless, varnished-cambric tubing that is firm and does not bend out of shape. The cheaper grade will cause you trouble; it will absorb moisture, it will corrode the copper, and it will cause electric leakage. The better grades are expensive but it pays to use them.

* * *

A VERY good way to tell when your filaments are burning at the correct brilliancy is to use a voltmeter which can be shifted so that its terminals can be connected across each tube, one at a time.

The manufacturers of the various tubes give a data sheet with the tubes which states the proper operating voltage for their tubes, and if a voltmeter is used, the rheostat can be adjusted until the reading in the voltmeter is in accordance with the voltage called for on the data sheet.

THERE are many fans who have in use in their radio receiving sets a loudspeaker of the type that employs a Baldwin phone unit for the reproducer. This unit is sometimes used with a horn, of one description or another, or in a phonograph. When these units are new, and not subjected to signals of too great a strength, the quality is good. But when they have been used for a considerable length of time, and have been forced by signals that are too strong for them, they soon develop rattles and vibrations that are objectionable, to say the least.

Sometimes they begin to chatter; sometimes they squeak on one particular note; sometimes they just give out raspy grunts.

This is almost always due to one of two causes, or both.

The little pin which connects the armature with the center of the mica diaphragm may have become loose. Or, the outer edge of the mica diaphragm may have chipped loose.

Both of these troubles may be eliminated, causing much better operation

of the loudspeaker as a whole, and probably restoring all of its original tone quality and volume.

These are the suggestions:

Drop a small quantity of shellac on the little pin joint in the middle of the diaphragm so that it will unite both the metal and the mica and stop vibration. (See Figure 1.)

Cut a narrow ring-disk of blotting paper and place it within the cap so that it laps over the edge of the mica diaphragm. (See Figure 2.)

Try these hints and see if they don't make a great difference.

* * *

KEEP the lead-in from your antenna well away from the walls of the building. Do not let it hang right alongside of any brick structure, a fire escape, a drain pipe, metal smoke stack, or any other body of large dimensions. It should swing free by a few feet: the greater distance away the better, up to a distance of about fifteen feet.

* * *

DON'T try to light up the WD-12 vacuum tube above a dull red color.



Kadel & Herbert



Kadel & Herbert

HOW TO ELIMINATE VIBRATIONS

FIGURE 1: The chatter in a Baldwin loudspeaker unit may be eliminated by placing a small quantity of shellac about the pin which connects the mica diaphragm to the armature. This prevents vibration.

FIGURE 2: A small washer of blotting paper will also stop vibration on the outer edges of the mica diaphragm. It should be placed as shown and the hard-rubber cap screwed down upon it.



ITEMS of general interest that you ought to know; bits of useful information that every radio fan ought to know.

Ambulances Equipped with Radio

SEVERAL Texas cities are equipping municipal ambulances with a radio equipment. Houston, Dallas and Fort Worth hope within a short time to have municipal broadcasting stations at police headquarters and ambulances while responding to one emergency call may pick up other calls from headquarters and go direct to the scene of the accidents. It is believed that the new method will prove a great time saving device.

New Station Operated Altogether by Batteries

IN the attempt to prevent interference and poor quality of transmission due to rotating electric machinery in the neighborhood of a transmitter, the new broadcasting station, WTAM, in Cleveland has been equipped entirely with storage-battery power. As the power of the station is 1,000 watts and the necessary voltage is 2,500 volts, hundreds of battery cells are necessary. Moving electric machinery of all kinds has been carefully excluded from the station building and from its immediate neighborhood. The quality of transmission actually attained will have much interest for students of broadcasting technique.

An Electron that was Worth \$40,000

DR. MILLIKAN of the California Institute of Technology has received the Nobel prize in physics for his work in isolating the electron and determining the exact amount of electricity on it. The prize is \$40,000.

Duplex Radiophone for Explorers

A NEW radio outfit for the use of explorers in communicating with civilization, for installation in isolated camps in the desert or jungle and for similar uses has been put on the market in England by the Marconi interests. It consists of two portable sets capable of either receiving or transmitting at either one of two wavelengths, 300 meters or 350 meters. The antenna wire is made in two sections with an insulator between. One section of the wire and one of the wavelengths is used for transmitting,

the other for receiving, the receiving part of one set being tuned to the transmitting part of the other. The outfit is made in two powers, 5 watts and 50 watts.

* * *

The Rasp in President Wilson's Voice

ONE of the most interesting features about the broadcasting of ex-President Wilson's speech on Armistice Day was the fact noticed by so many listeners that the President's voice sounded harsh and tired, the voice, one felt, of a sick and disappointed man. Probably nothing that the President or his friends could have done or could have said in print would have aroused so much personal sympathy for him (regardless of the listener's political opinions) as this simple circumstance of our being able to hear him speak. Radio is the only known way of reaching the entire public without losing the personal touch.

* * *

Multiplying Frequencies to Prevent Interference

AT the recent meeting of the British Association for the Advancement of Science Mr. John Scott-Taggart suggested a new way to minimize interference. It consists in multiplying at the receiving station the frequency of the incoming signals by a thousand or more before attempting to read them. For example, two waves of 15,000 and 15,100 meters, respectively, are too close together for distinct reception but if these frequencies are each multiplied by 1,000 (dividing the wavelengths, of course, in the same ratio), the resulting frequencies of 20,000 and 19,868 kilocycles are sufficiently far apart for distinct reception.

* * *

Radio Blamed by the Ignorant for Thunderstorms

THE claim that radio broadcasting is producing bad weather, especially thunder and lightning, seems to have been taken seriously by a large part of the farming population in Europe, with resulting opposition to the growth of the radio industry.

New Broadcasters Overseas

SINCE our last list of the European broadcasting stations (POPULAR RADIO for December, 1923, page 531) four new short-wave stations have come on the ether in Europe with regular programs. In Great Britain, the British Broadcasting Company has added two stations to their previous six. One, at Bornemouth (6BM), transmits at 385 meters; the other, at Aberdeen, Scotland (2BD), is on 495 meters, having the longest wave in use among the British stations. In France, station YN at Lyons has begun a broadcasting service on 470 meters. Music is transmitted at 5:30 A. M., New York time; news and similar material at 6:30 A. M., 10:15 A. M. and 12:15 and 2:30 P. M. In Germany a broadcasting service has been begun by two stations on 290 and 400 meters but transmission is at present irregular in time and does not reach any great distance. There is also a new station at Algiers, Africa (8AY), on 200 meters, but the only material transmitted is the weather bulletin at 8:00 A. M., New York time.



Armstrong Perry

A LOUDSPEAKER FOR THE GARDEN

This unique structure, built of stone and moulded concrete, was made by M. C. Hopkins at his lodge at Waterford, Va. When the reproducing unit at the throat of the horn is connected by two wires to his radio set, the music is broadcast to the whole village.

A New Kind of Broadcaster's Fee

COLUMBIA University is broadcasting a series of ten lectures on the poetry of Robert Browning, and every student who wishes seriously to follow the course is asked to buy a printed outline and syllabus, for which five dollars is charged. In this instance the fee is to cover only the cost of printing but the idea has, perhaps, a wider application. Might not the clients of a broadcasting station be willing to pay a small regular fee like this in order to obtain complete information conducive to better enjoyment of the programs and to greater cultural profit therefrom? Broadcasting must be paid for somehow if the quality of the programs is to be maintained and improved. It is unfortunate, we believe, to allow the advertising value of the service to carry all the cost and thus to control the nature of the material broadcast.

* * *

Police Reserves to be Radio Experts

THE New York Police Department announces that the Reserves attached to its force are to be instructed in radio and will become, it is claimed, the best trained force of radio experts in the world.

* * *

Relay Broadcasting to the Pacific Coast

THE Westinghouse Company has installed a radio relay station at Hastings, Nebraska. Concerts broadcast from Pittsburgh will be picked up at Hastings and relayed automatically to points farther west. It is planned that transmission from Pittsburgh to Hastings will be on about 95 meters and from Hastings west on about 110 meters. Thus comes another step in two developments which POPULAR RADIO has been forecasting for months: *first*, the growth of relay broadcasting and, *second*, the increasing use of the shorter waves.

* * *

German Broadcasting Begins

THE first regular private broadcasting has begun in Germany, a studio in Berlin supplying programs on a 400-meter wave. Other stations are to be installed. Broadcast listeners must secure a license and the regulations surrounding it would be considered, in America, so troublesome as to be almost prohibitive to the growth of the industry. However, the Germans are more accustomed than we are to being told what they must or must not do, so perhaps the regulations will work well enough there.

* * *

The Honor Roll of Broadcasting Stations

THE Bureau of Standards has certified six American broadcasting stations as maintaining a wavelength so exact that their transmission can be used for the calibration of wave meters. They are WGY at Schenectady, KDKA at Pittsburgh, WWJ at Detroit, WCAP at Washington, WOS at Jefferson City, Missouri, and WSB at Atlanta, Georgia. Other approved stations are the navy station at Annapolis and the Radio Corporation stations at Tuckerton, Rocky Point, Coram Hill and Marion.



Kadel & Herbert

RADIO APPARATUS USED FOR DETECTING SUBMARINE SOUNDS

The U. S. Navy is equipping its battleships and submarines with sensitive sound devices, one of which is pictured above, that enable the operator to determine the proximity of nearby passing motor-propelled vessels. The device amplifies the engine and propeller sounds which are transmitted through the water, and also enables the operator to determine from which direction they originate.

French Government Keeps Tight Rein on Radio

THE expectation that the severity of the governmental control of radio in France would presently be relaxed does not seem to have been realized. New regulations recently promulgated are, if anything, more severe than the old. All receiving sets, even for private use, must be licensed and must pay a tax. If a receiving station is used for public entertainment or any similar purpose it must pay a much larger tax. Broadcasting stations are surrounded with such a maze of regulations as to be, in effect, prohibitory except for a very few stations, mostly under strict government control. American amateurs, inclined at times to protest at the mild and non-restrictive regulations considered necessary by the United States Government, should remember that radio is a hundred times freer in this country than it is anywhere else in the world.

* * *

Will We Have Exclusive Radio News Service for Newspapers.

It is easier to recall the past than to foresee the future. Indeed the best way to foresee the future is to attempt it in the light of the past. There was a time when newspapers used no telegraph news and when the more conservative editors regarded the new invention of Dr. Morse as a dangerous and unreliable innovation in the business of news gathering. If one wanted real news one sent for an authorized statement to come by messenger or by mail. Why trust it to a wire on which anyone

might listen? This is the present attitude of many newspaper men toward radio. But fortunately there are more progressive ones. It is safe to say that in twenty years time, or possibly in five years, radio will be as indispensable in the gathering of news as the wire telegraph is today.

* * *

Edison Says Radio Gives Scientific Training

In a recent newspaper interview Mr. Thomas A. Edison went on record as to what he believes to be the greatest value of radio to the community. Radio is, he says, "one of the greatest things for young men ever brought out." It is because it gets them interested in science and in scientific literature. It teaches them to think in a scientific way. The boy broadcast listener of today is the experimenting amateur of a few months from now and the scientific research worker or engineer of future years.

* * *

Spiders Spin Trouble for Broadcast Listeners

ANTENNAS, like brains, should not be allowed to grow cobwebby. Several recent reports indicate that fans have had trouble with fading signals because adventurous spiders had stretched their webs across the antenna insulators or from antenna wires to nearby chimneys or other grounded objects. The leakage of the high-frequency impulses over a single stand of spiderweb is large enough, especially in wet weather, to decrease seriously the energy of the received signal.

Ether Waves Emitted from Furnace Pipes

RADIO waves emitted from transmitting antennas are not the only kind of ether waves that are of household importance. The shorter ether waves of radiant heat are important also—at least to those of us who live in cold countries. A part of the heat given out by radiators and stoves and furnace pipes is discharged merely by contact of the hot metal with the air around it. But another part of the heat is sent out as radiant heat waves emitted by the heated pipe. And just as the nature of an antenna system affects the radio waves emitted from it, so the nature of a furnace pipe affects its emission of heat waves. Polished pipes, for example, emit much less heat in the form of ether waves than do dull or painted pipes. If you want the heat to stay inside a furnace pipe or a steam pipe give it a shiny polished surface. If you want as much heat as possible to come out in the form of ether waves, paint the pipe black.

Fake Code on the Stage Gets Amateurs' Goat

WE all remember the complaints of the lip readers in the early days of the motion pictures. What the actors really said to each other was quite visible to persons so equipped



Fotograms

A RADIO SET FOR 60 CENTS

That is the claim made by John P. Buckley, of the Bureau of Standards, for a crystal receiver composed of two small boards wound with primary and secondary coils of No. 27 DCC wire. Connections for the taps and for all other circuits are made in the space between the boards before hooking up the set.

and it had, too frequently, no relation at all to what was supposed to be said. The same thing has turned up in radio. Several plays recently on the boards in New York have made use of radio messages supposed to be sent in code from a spark transmitter installed on the stage. The stage managers evidently forgot how many amateurs there are nowadays to whom code is as familiar as English. Anyway the supposed operator on the stage merely twiddled the spark a little and the amateurs got disgusted. There were so many protests that when an occasion arose to send a spark message as a part of the setting for a film play in one of the Broadway motion picture theaters, the manager hired a licensed operator to send out in correct code the exact message called for in the action of the play.

* * *

100,000 Miles of Carrier-Current Systems in the United States

THE rapid growth of the carrier-current or "wired-wireless" systems is attested by the recent announcement that the Bell system now includes 20,000 miles of lines equipped for carrier-current telephony and 88,000 miles equipped for telegraphy by the same radio method. The advantage is, of course, that a number of separate messages or conversations can be carried over the same wire without interference. When you talk nowadays over any of the much-used long-distance wires it is a better than even chance that you are talking for at least a part of the distance not by ordinary telephone currents at all but by radio-frequency waves carried over the wires.

* * *

Radio Links Australian Backwoods to Civilization

ONE of the great problems in the less settled parts of Australia has always been the difficulty of communication, as the continent is sprinkled rather generously with desert areas that are all but impassable. The increase of radio stations is rapidly curing this trouble and removing the isolation of even the most distant settlements.

* * *

Does the Telephone Make Us "Left-eared"?

A EUROPEAN scientist reports that people are acquiring better and better hearing in their left ears and worse and worse hearing in their right ears. He ascribes this curious development to the use of the telephone. Most people hold the receiver to the left ear so that the right hand may be free for taking notes. The continued practice of careful attention to the left ear trains that ear to hear more acutely than the other. And it *must* hear acutely, we may remark, if it is to hear anything whatsoever over the average European telephone. If this scientist is right it may be that we will find one of the benefits of radio, especially of DX work, to be an increased acuteness of hearing in *both* ears. Animals hear much more acutely than we do. Men used to hear, in prehistoric times, more acutely than they do now. Perhaps we can get back a part of this lost power.



Underwood & Underwood

HE IS COMPILING A "RADIO CENSUS"

W. E. Downey, supervisor of radio in the Department of Commerce, is at work to find out something about radio fans and radio sets in the United States. He has already estimated that 70 percent of the sets have vacuum tubes and 30 percent have crystal detectors.

Who Said Farmers Were Behind the Times?

AGENTS of the United States Department of Agriculture have made a survey of the number of radio receiving sets owned by farmers in 780 counties in farming districts. The results indicate that the number of sets on farms in the United States is probably over 145,000.

* * *

Blow up Your Loop and Listen

A NEW collapsible loop invented in Europe has the wires attached to a rubber tube like a bicycle tire. When you want to use the loop you pump up the tire which extends the loop and makes it operative.

* * *

One Radio Application in Which China Leads

THE use of a radio link in long-distance telephone service, covering a gap in the wire systems, is already in use in China according to Captain R. S. Wood in the *New York World*. A conversation between Hongkong and Peking goes by land wire to the Hongkong radio station, thence by radio to the Peking station, and thence by land wire to the instrument of the Peking subscriber.

* * *

An Absolute Vacuum of Sound

It is almost as hard to keep every trace of sound out of a room and thus obtain absolute quiet as it is to get all the air out of a vacuum tube and make an absolute vacuum. And every DX hunter knows how disturbing a very small outside noise can be when one is listening with every atom of ear for some very faint sound.

The psychological department of Princeton University is adding to its new building a room provided with every known device for keeping out sound. Although built within the larger building, this room of sound-vacuum is an entirely separate structure, having even a foundation of its own so that not the slightest pulse of sound will be conducted into it.

* * *

The Smallest Wire in the World

THE scientists of the Western Electric Company have produced a wire made of a copper-nickel alloy and far smaller than any wire previously made anywhere. The wire has a diameter of less than one five-thousandth of an inch. It is practically invisible except under the lens of a microscope. Wire so small as this cannot be drawn in the usual fashion. It has to be eaten away by acid, thus reducing the smallest drawable wire to a still smaller size. The new superfine wires are used in making vacuum thermo-couples for measuring radio-frequency currents.

* * *

A Funeral with Radio Dirge

AT the recent funeral of an assistant fire chief of the Dallas, Texas, fire department. Chopin's funeral march, played by a pianist at the central fire station, was picked up by a radio loudspeaker on a fire truck and the beautiful notes of the march resounded along the procession to the grave. The fire truck bearing the radio apparatus followed the hearse and the funeral march furnished a unique feature of the procession.

WHAT READERS ASK



QUESTION: I am starting to build one of the super-heterodyne receivers described in the November and December issues of POPULAR RADIO. Will you please give me the proper connections for the Haynes tuner circuit showing the binding posts?

I would like to have a diagram drawn up in the same style as the two diagrams showing the oscillator and the amplifier units.

I notice that the filament battery is connected with the negative terminal to the negative terminal of the "B" battery. Is this a mistake or does it make much difference which way round the "A" battery is connected? The Haynes-Griffin Company states that the instructions for connecting the "A" battery, as published in the December issue of POPULAR RADIO, are "incorrect." I have tried it both

ways and fail to find any difference whatever.

DOUGLAS EHRLICH

ANSWER: The connections for the "A" battery, as published in our December number, are correct; the Haynes-Griffin Company's statement that they are "incorrect" is misleading.

There are, however, two methods of connecting the batteries, and the circuit you require is shown in Figure 1. You will notice that the binding post connections are given in the same manner as in the units described in the November and December issues.

There is no difference, in the operation of the whole set, with the "A" battery connected in one direction or the other, as long as all the units are connected the same way. However, if the "A" battery is connected with the negative terminal to the negative terminal of the "B" battery, the oscillator tube will draw a little more plate current.

To cut down this current we suggest that you connect the batteries as follows:

top post—telephones
 next below—telephones
 third post—positive "B" battery
 fourth post—negative "B" battery

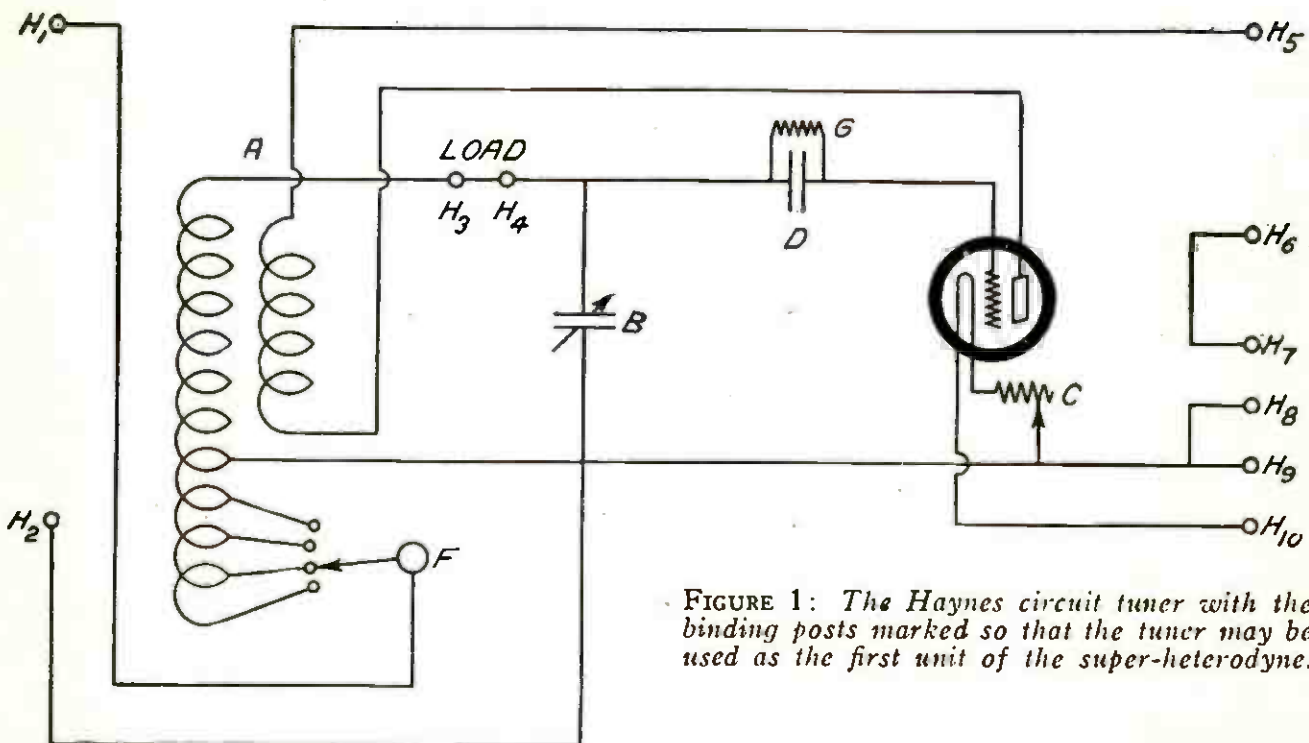

FIGURE 1: The Haynes circuit tuner with the binding posts marked so that the tuner may be used as the first unit of the super-heterodyne.

fifth post—positive "A" battery
 bottom post—negative "A" battery.

This will be found to be an improvement over the connections suggested in the December issue in that the "B" batteries will not be called upon to supply quite so much current, and they will last longer.

* * *

QUESTION: Will you please give me a diagram of the Overland circuit? Is this a double-circuit tuner or a modified single-circuit tuner? I have had an argument with some other radio fans who claim it is a double circuit while I claim it is a modified single circuit, so I am sending to get the exact diagram to make sure. We are none of us certain how the circuit works.

RAYMOND PARKER

ANSWER: The circuit you refer to, shown in Figure 2, is a single circuit, with a slight modification in that it has an extra fixed condenser of .001-mfd. capacity included in the ground lead. This same condenser is also included in the plate circuit, as a bypass condenser across the telephones and "B" batteries. The antenna tuning is accomplished by means of a variometer working in conjunction with a variable condenser.

The grid is tuned by the action of the variometer. It is tuned at the same time as the antenna tuning takes place. The circuit is regenerative.

* * *

QUESTION: Does the size of wire used on a coupler or variometer or any

kind of inductance matter much? I read in the magazines that most of them in describing a set or instrument give a specific size of wire, although they do not all use the same size. Some instruments call for No. 22 DSC, some for No. 18 SCC and a number of different sizes.

I bought quite a quantity of No. 18 and thought I would use it in all the descriptions, but first, I want to be sure that this would be all right.

A. ANDREW BORNICK

ANSWER: Yes, you should use the size of wire called for in each description. The resistance of the wire figures in the calculations in most regenerative circuits on account of damping, and the size of the wire figures in the calculations for self-inductance, and mutual coupling.

It stands to reason that if you use a smaller diameter wire its resistance will be greater, and this may impair the proper circuit characteristics.

If you use a wire that is thicker than called for and you use, say, thirty turns, the coil or winding will be longer and the coupling will not be as close as specified in the original design. This will affect the efficiency.

Then again you may use DCC instead of SCC or DSC instead of SSC wire. This will also cause fewer turns to the inch and affect the coupling and the efficiency in a similar manner.

It is best to follow the designer's specifications to exactly duplicate his results. The designers tell you what to do: go and do it! The designer tells you what to do, not because he just happened to have some of that size of wire on hand, but because it is the best to use for the set described.

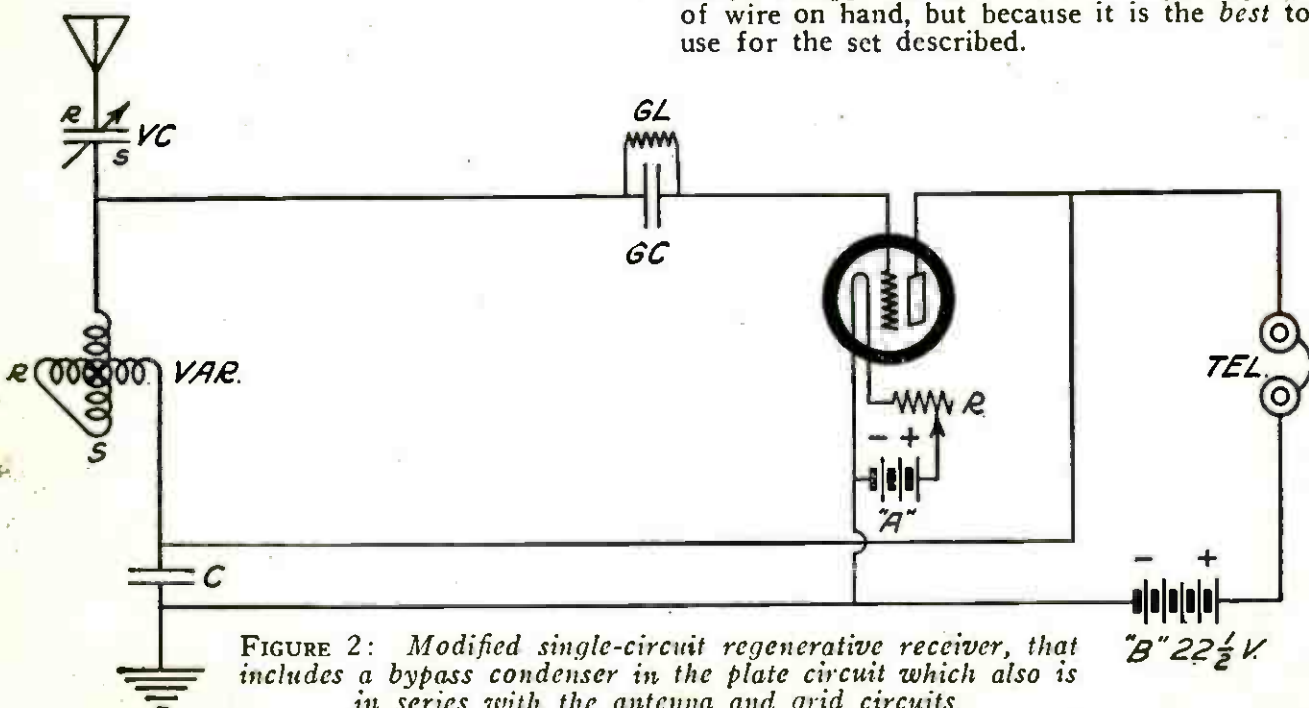
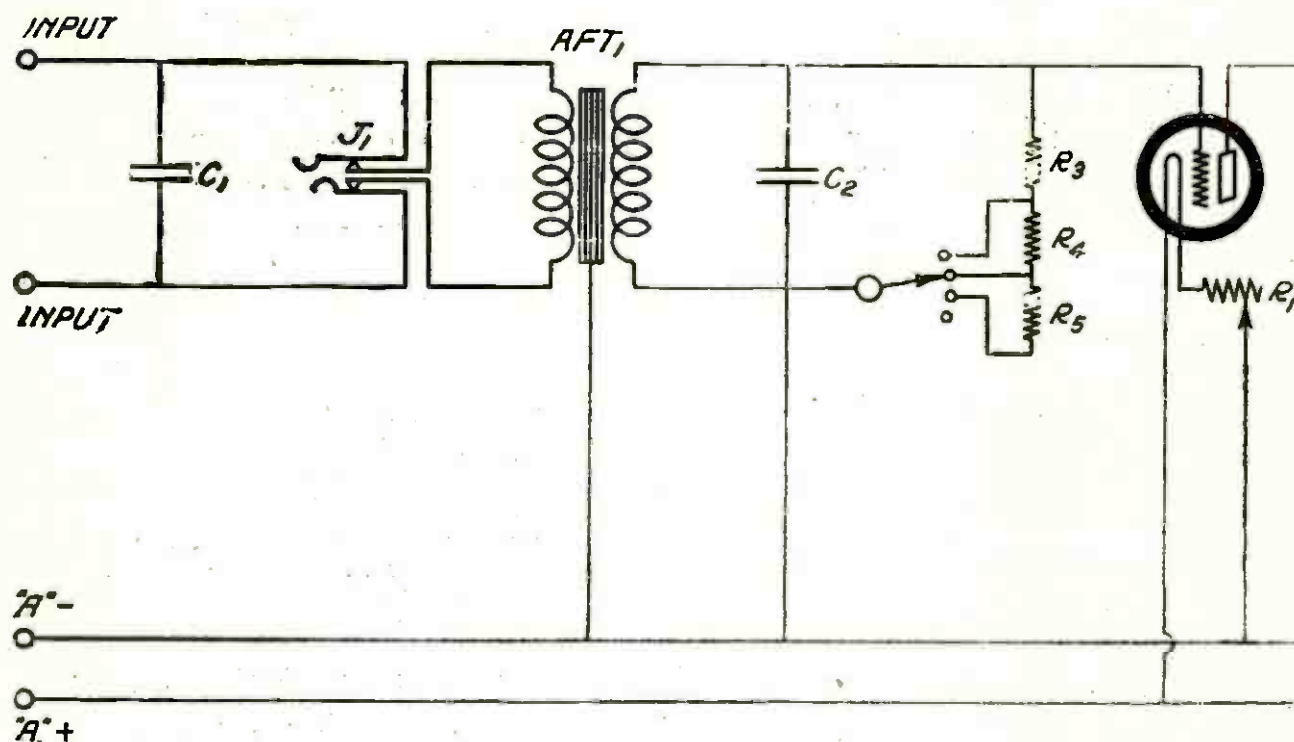

FIGURE 2: Modified single-circuit regenerative receiver, that includes a bypass condenser in the plate circuit which also is in series with the antenna and grid circuits.



QUESTION: Will you please give me a circuit showing how to add one stage of audio amplification to my detector circuit, and one stage of push-and-pull amplification? I want to use this with my regenerative receiver. Can the circuit you recommend be used with a Western Electric 10-D horn? This is what I want to use if possible. Also include a list of parts. I have two Como transformers as mentioned in your article in the January, 1924, issue of POPULAR RADIO.

DONALD K. BEARD

ANSWER: The circuit you need is shown in Figure 3. This circuit will give good results with the apparatus you want to use with it. You will need the following additional apparatus:

AFT1—audio-frequency amplifying transformer;

AFT2—input push-and-pull transformer;

AFT3—output push-and-pull transformer;

(The above two you have)

J1 and J2—double-circuit jacks;

J3—single-circuit jack;

R1 and R2—filament rheostat, 20 ohms;

R3, R4, and R5—resistances, 50,000 ohms each;

C1—mica fixed condenser, .0005 mfd.;

C2—mica fixed condenser, .00025 mfd.;

switch lever and 4 switch points;

three UV-201-a tubes or three C-301-a tubes;

three tube sockets;

"C" battery, 9 volts;

"B" battery (three 45-volt sections).

You will be able to use the same storage battery as used on your present set. Just connect the two posts marked "A" negative and "A"

positive on the diagram to the corresponding terminals of your present battery.

The switch lever connecting to the resistances R3, R4, and R5 constitute a volume control so that you will be able to get just the right amount of signal strength to meet your conditions.

* * *

QUESTION: What is the best method for tuning the grid circuit, a variometer in series with the secondary or a variable condenser shunted across the secondary winding? I mean, which is the best, from a standpoint of selectivity and sensitivity.

HOWARD SAYRE

ANSWER: This is rather a complicated question to answer. From a standpoint of selectivity alone, the condenser-tuned method would probably be preferable. The variable condenser would be connected across the secondary winding and this would give an oscillatory circuit in which the frequency is variable with a change in capacity. The capacity of the condenser would be large in comparison with the tube capacity and the capacity of the operator's hand against the dial. This means that the tuning would not be appreciably affected by body capacity. However, for a particular wavelength range the capacity of the condenser should not be too high, or the signal strength will be lessened and tuning will become extremely critical. On the other hand, with exceptionally low minimum capacity, the capacity in the circuit will approach the value of capacity encountered between the operator's hand and the shaft of the condenser.

From the standpoint of sensitivity, the variometer method would be preferable. This

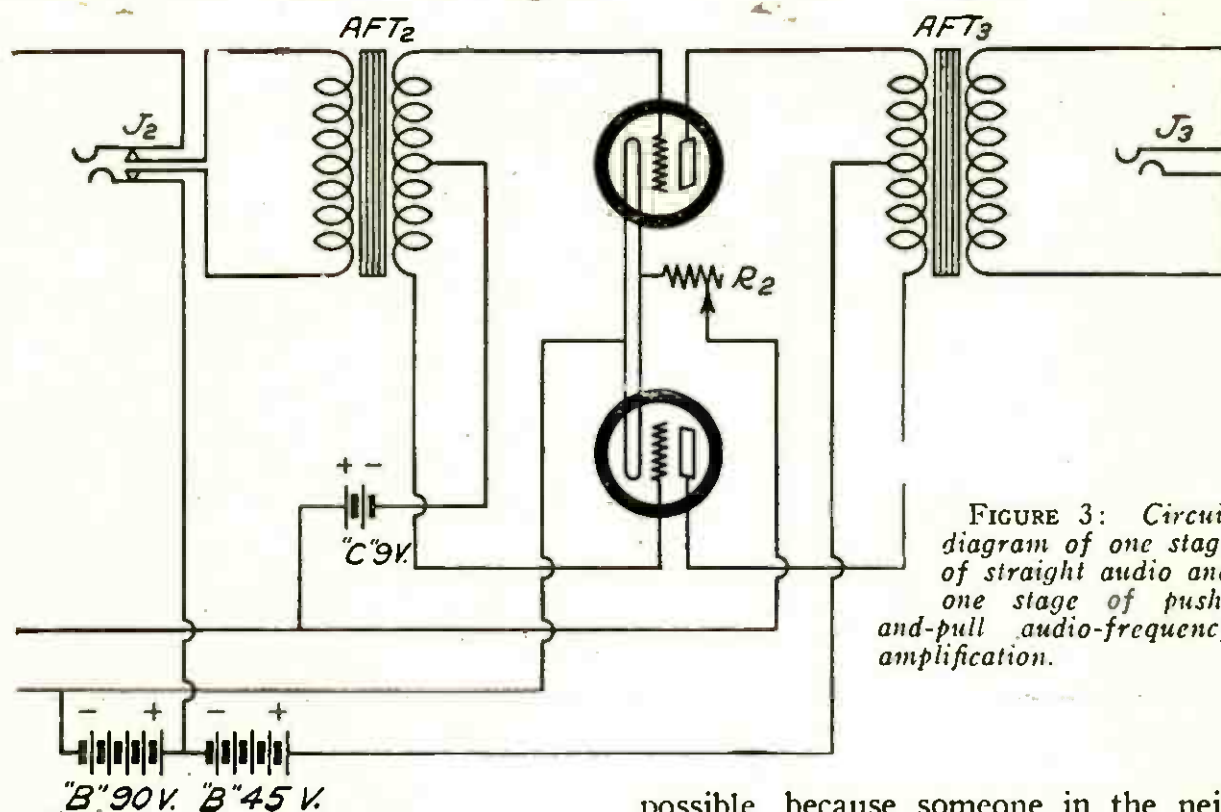

FIGURE 3: Circuit diagram of one stage of straight audio and one stage of push-and-pull audio-frequency amplification.

would allow of greater inductance in the secondary circuit with a correspondingly higher turn ratio between the antenna (primary) circuit and the secondary circuit. Theoretically, this would produce a higher grid voltage and if other conditions of resonance are satisfied this is the case, practically. This method, however, is commercially possible only on the lower wavelengths as the series variable inductance would have to be of an enormous range to cover a large wavelength band.

So you see your question takes into account too many considerations (of wavelength, of coupling between circuits, of resonance, turn ratio, cost, practicability, ease of operation, as well as circuit design) for a proper and complete answer in this space.

Considered briefly, from a standpoint of both selectivity and sensitivity, the condenser method fits *most* of the problems *most* economically.

However, some manufacturers stick to one method and some prefer the other, each with seemingly just claims for either of the two methods.

Both of the two systems make use of the same principles of electrical resonance, except that in the one, the capacity is predominant and in the other the inductance is predominant.

* * *

QUESTION: Is there any type of receiver that will eliminate the interference from nearby single-circuit receivers? What would be the best way to solve this troublesome question? It certainly is annoying to try to receive a little DX with a really good receiver and then to find that it is almost im-

possible, because someone in the neighborhood is indulging in the pastime of twisting the dials of one of these trouble-makers. I think they should be forbidden by law.

A. J. ROBINSON

ANSWER: If you have one of these single-circuit fiends in your vicinity, and he persists in allowing the set to oscillate while trying to tune in distant stations, there is no receiver on earth that will "cut him out."

The best way, at present, is to find out his location and go over and visit him, then when friendly relations are established, invite him over to your house and show him just what his set does to his neighbors' reception.

This should make him repentant and willing to learn to use his set without allowing it to oscillate. Or, you might have even better luck and convince him that he really would get better results in a receiver of the two, three or four-circuit type, or with a circuit employing radio-frequency amplification.

* * *

QUESTION: What value of "C" battery should I use on an amplifier which contains two C-299 vacuum tubes with 90 volts on the plates?

ARTHUR J. BRAUN

ANSWER: A "C" battery potential of 4.5 volts will be correct for use with these tubes. The negative terminals of the batteries should be connected toward the secondaries of the two amplifying transformers and the grids of the tubes. The positive terminals of the batteries should be connected toward the negative leg of the filaments.

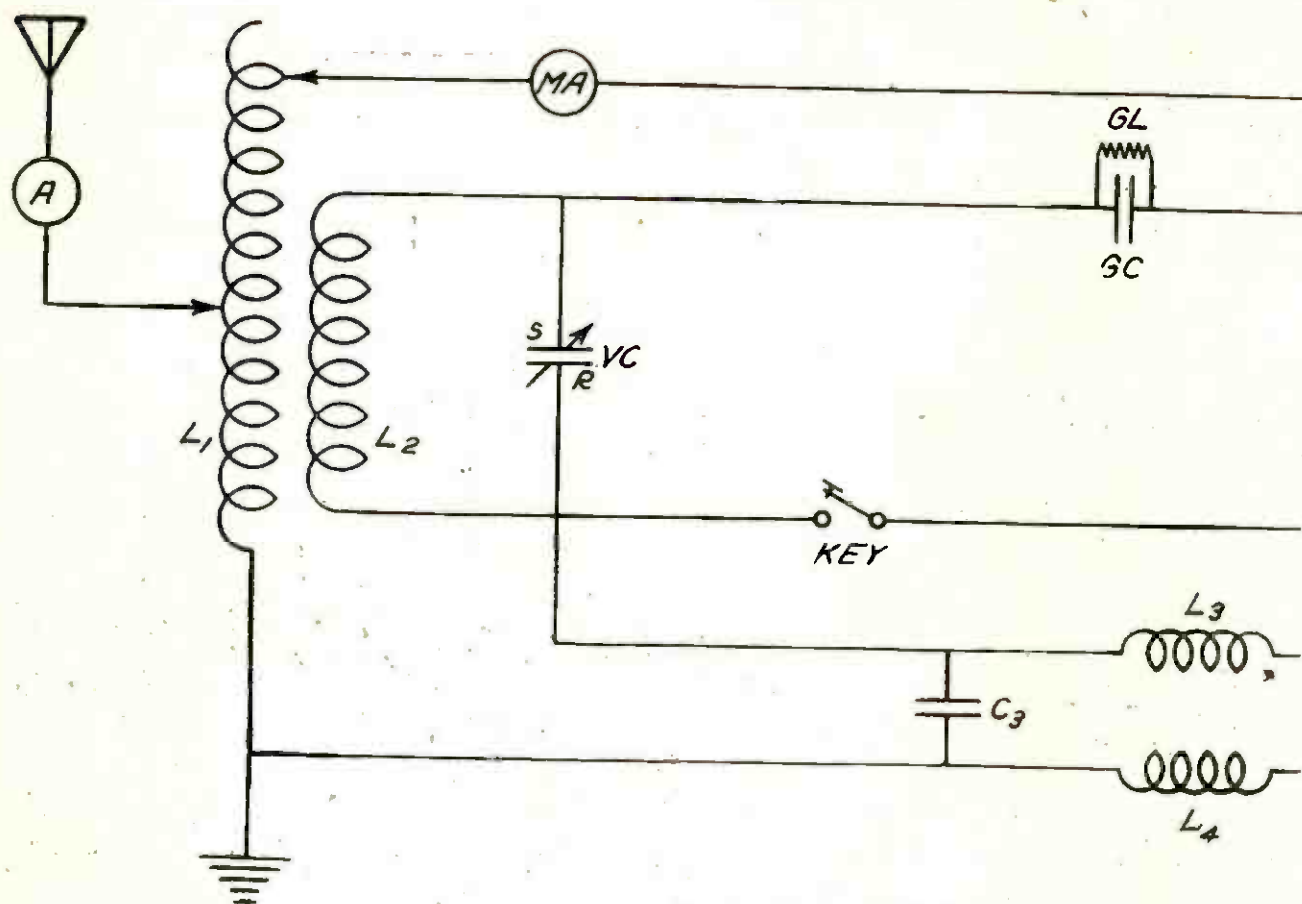

QUESTION: I want to use the circuit known as the "Inverse Tickler" circuit on my 10-watt CW transmitter. I do not know if this is the correct name for the circuit, but it is the one that uses an inductance coil with a smaller coil inside of it connected in the grid circuit of the oscillator tubes. The smaller coil is shunted by a variable condenser, as I understand it. I hope you will be able to identify the circuit I want from my meagre description.

I have made up ten electrolytic rectifier jars to use with a power transformer for the plate supply and would also like to have the dope on a good filter for taking out the hum. What I want to have is a good, pure CW signal without any hum if that is possible with an A. C. supply. Will you give me the necessary data to do this?

ARTHUR COLLINS

ANSWER: What you want, we believe, is the British Aircraft circuit which is shown in Figure 4. The larger inductance, L1, may be made by winding about 30 turns of No. 12 bare copper wire on a four-inch tube. The smaller grid-tickler, L2, can be made by winding 20 turns of No. 18 bell wire on a 3½-inch tube inserted in one end of the larger inductance. The variable condenser, VC, is a .0005 mfd.

It should be well insulated because it must stand quite a high potential.

Condensers C3, C4, and C5 are 1 mfd. paper condensers that should be capable of withstanding 500 volts, or more, continuously.

Condensers C1 and C2 should be .001 mfd. for by-passing the radio-frequency currents around the filament windings.

The choke coils L3 and L4 are audio-frequency chokes of the order of 1½ henries each. They should be capable of passing about 150 to 200 milliamperes.

The hot-wire ammeter, A, should have a full-scale deflection of 2 amperes.

The milliammeter, MA, should have a full-scale deflection of 250 milliamperes.

The two tubes, VT1 and VT2, may be two radiotrons, UV-202. It will be noticed that the key (for telegraphy) is included in the lead going from the grid circuit to the filament circuit.

The lead plates of the rectifier should all be connected towards the end of the circuit marked L on the diagram and the aluminum plates should be connected to the end marked A. This insures the proper polarity for the plate-voltage supply.

* * *

QUESTION: Should or should not, the coils on receiving sets be painted with moisture-proof paint?

FRANK BURROUGHS

ANSWER: No kind of covering varnish, paint or filler should be used on radio-frequency coils. Such use contributes to both the dielectric losses in the coils and in the value of the distributed capacity of the coils.

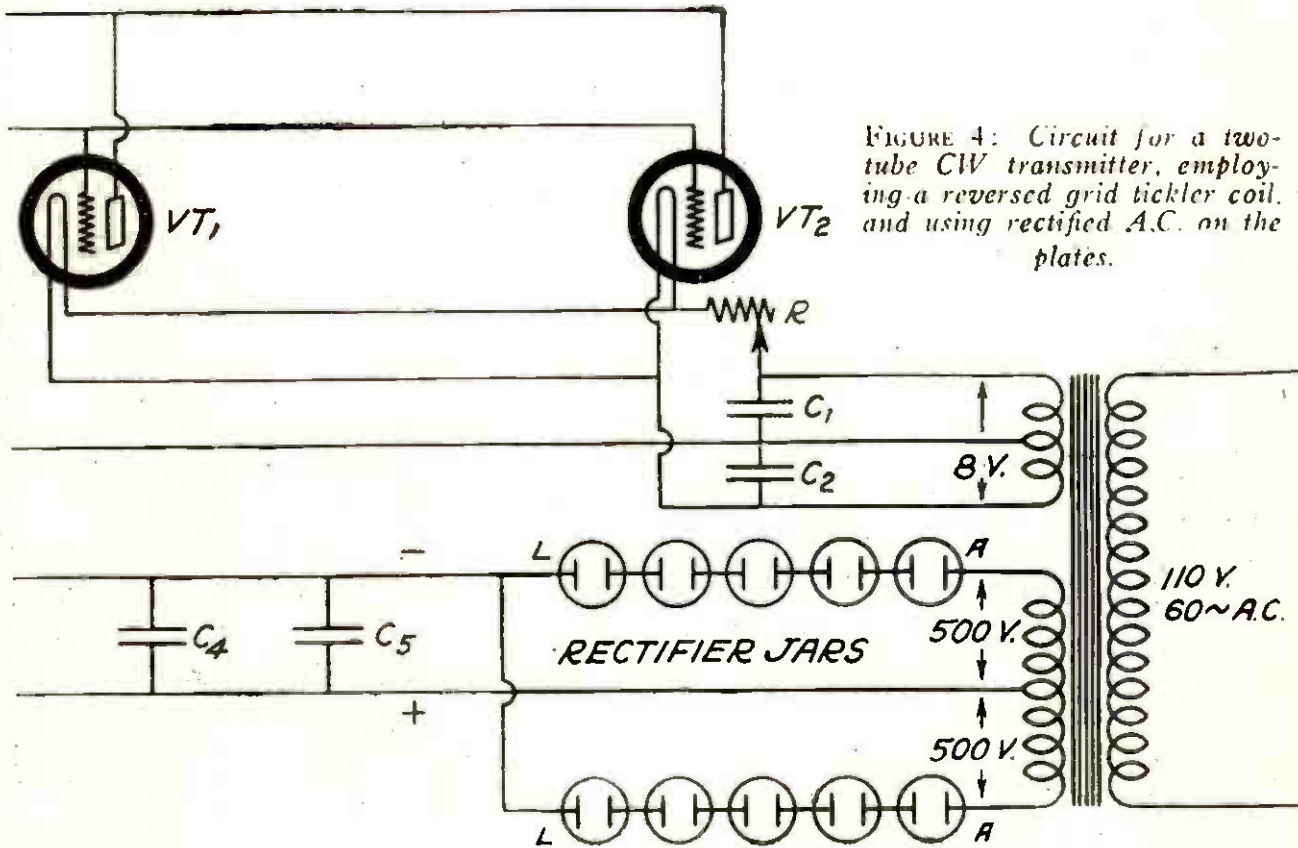

FIGURE 4: Circuit for a two-tube CW transmitter, employing a reversed grid tickler coil, and using rectified A.C. on the plates.

QUESTION: Kindly give me a hook-up so that I can use a spark coil with my CW set (one 5-watt tube). At present I am using it with 200 volts of "B" batteries but they die down too fast and I am only able to get about 25 miles. I have a Ford spark coil and I have been told that it will work as an interrupted plate supply if I use a condenser

of some kind across the secondary.
A. D. BELMONT

ANSWER: The circuit you require is shown on this page in Figure 4. This is the same circuit you sent in except that the spark coil has been substituted in place of the "B" batteries as a plate-voltage supply. This circuit will give you a signal that sounds like a straight spark-coil transmitter except that it will be sharp in tuning and will enable you to transmit to much greater distances.

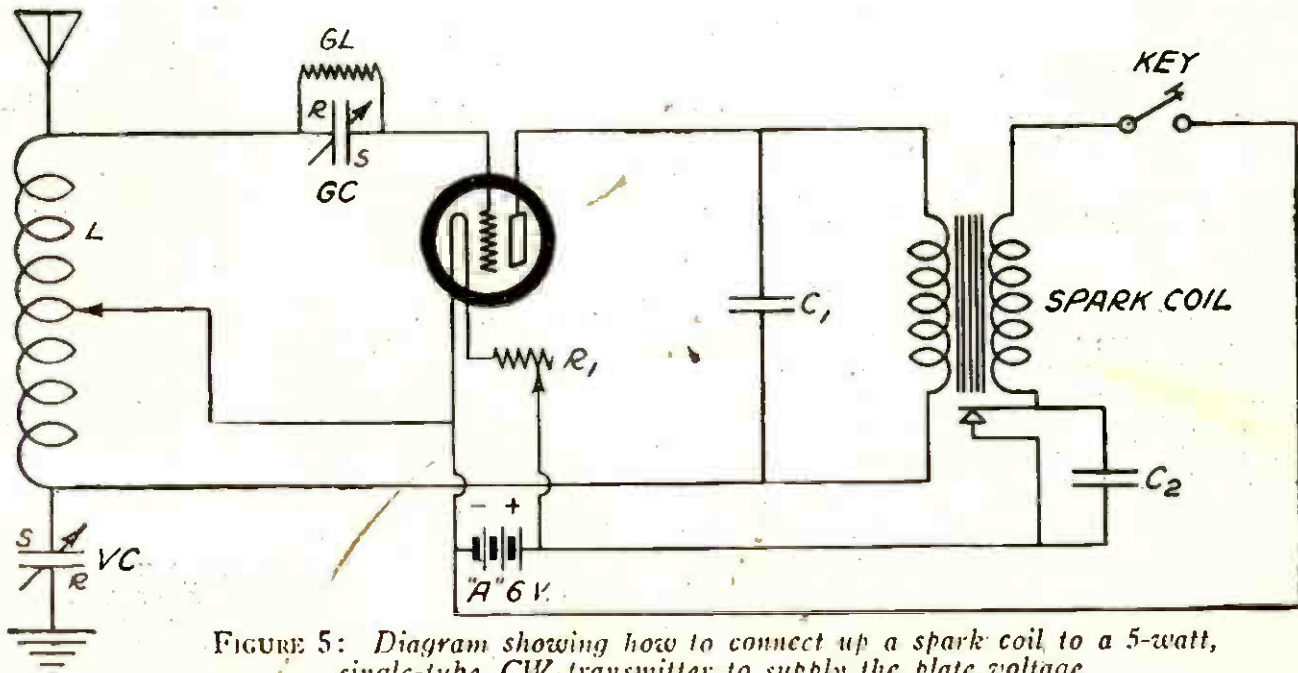

FIGURE 5: Diagram showing how to connect up a spark coil to a 5-watt, single-tube, CW transmitter to supply the plate voltage.



IN THE WORLD'S LABORATORIES

Will Radio Help Solve the Mysteries of Thought?

ONE of the first American pioneers in radio and one of the most prolific inventors who ever worked in this field is Mr. John Stone Stone, formerly of Boston, now living in San Diego, California. A short time ago, the 1923 medal of the Institute of Radio Engineers was presented to Mr. Stone in recognition of his services to radio science. In his remarks at that time* Mr. Stone made some prophecies which will interest every radio engineer who has even the slightest leanings toward scientific research.

"The art of radio communication," said Mr. Stone, "differs from other electrical arts in that the early growth of these latter has depended almost wholly on empirical developments, while the advances in the art of radio communication, even from its earliest days, have been almost exclusively through the astute application of the principles of the pure sciences. It is this fact that accounts, I believe, for the rapidity with which the art of radio communication reached its advanced achievements.

"For this reason radio communication is under a greater debt to the sciences than is any other of the electrical arts. In looking forward I am not, therefore, so much concerned to see startling advances in the art or profound modifications of its processes as I am to see it repay its debt to science. That this is imminent we may feel reasonably sure, and though I have not the hardihood to attempt to predict the exact nature of its contribution to science, I may, nevertheless, venture to point out that the audion, or three-electrode vacuum-tube amplifier, is a veritable electrical microscope whose power to magnify electrical effects is enormously greater than the visual magnifying power of the corresponding optical instrument. The microscope has made possible bacteriology, with its inestimably important applications to pathology and therapeutics.

"May we not reasonably expect, therefore, that in the near future this prodigious magnifying power of our electrical microscope will

*As reported in *Radio* (San Francisco), Vol. 5, No. 11, page 10 (November, 1923).

be used to detect and measure the minute electrical impulses upon which all our physical functions are predicated? Indeed, may we not look even further forward with the hope that by means of this electrical microscope of almost limitless magnifying and resolving power we may be able to detect and study the brain currents which accompany thought—the brain currents which may indeed be the stuff of which our thoughts are made."

Continuing, Mr. Stone suggested that the selectivity of radio receivers for a certain wavelength made them analogous to the spectroscope which separates and measures the wavelength of the rays of light. And as the spectroscope has analyzed the stars and created the science of astrophysics, so there is a possibility, Mr. Stone thinks, that a radio-spectroscope would tell us much about the condition of the other worlds off in space. "We also know," he continued, "that the heavens are pouring down on us all manner of electromagnetic waves, and I should be much surprised if they did not bear a message as significant as that brought to us by the light waves from the same source.

"There is nothing very difficult about designing a directive receiver which shall receive electric waves from any particular part of the sky to the exclusion of that from the rest of the vault. And as such a receiver is, by virtue of its selectivity, essentially of the character of a spectroscope, we have within easy reach a means of hearing and understanding whatever of nature's messages are being rained upon us from the sky. If such a directive receiver as that which I have indicated were pointed at the sun during a total eclipse it could scarcely fail to give interesting results."

Can Radio Waves Stop Automobiles?

To the repeated reports of mysterious radio waves capable of stopping the engines of French airplanes flying over Germany there is added now an experience described by the editor of a Parisian newspaper, *La Liberté*. According to this observer's report a Parisian engineer,

whose name and residence are not disclosed, has perfected an apparatus by which he can stop at will, any automobile passing in front of his laboratory.

The report is surrounded by too much secrecy as to the names, dates, places and the like to have much weight as a scientific document. We imagine that the engineering world will wait without much excitement until this atmosphere of mystery has been dispelled. It is interesting, however, to inquire whether such an interference with the operation of internal combustion engines is possible at all on the basis of what we now know about radio waves.

There are two ways, theoretically, in which such interference might be accomplished; *first*, by disturbing the current in the ignition circuit, and, *second*, by generating enough heat in the metal parts of the engine to destroy some essential element of it, as for example, a part of the wiring or some delicate adjustment of the carburetor.

The Paris reports mention the automobiles as being able to proceed again at once as soon as the interfering influence was removed. If this is correct there could not have been any interference of the second class, accompanied

by actual destruction of parts. The same is true, according to the reports, of the alleged interference with airplanes and automobiles in Germany. We must inquire, therefore, whether it is possible to have interference of the first class, that is a disturbance of the current in the ignition system.

It is very difficult to see how this could be accomplished. It is quite possible, of course, to project radio waves, either by broadcast or in directed beams, and to have them impinge against the engine of an automobile or an airplane. But the voltage thus generated in the metal parts of the engine would be at most a small fraction of a volt, quite comparable in amount with the voltages generated in ordinary radio antennas close to transmitting stations. The superposition of tiny voltages like this on the considerable voltages of the ignition circuits could have no perceptible effect.

Furthermore, the metal parts of the engine, such as the cylinders and the metal cases of the magneto or spark coils, would act as shields and would absorb the major part of the radio energy. All in all, an interfering effect by any known kind of radio waves on engine ignition seems very improbable even if

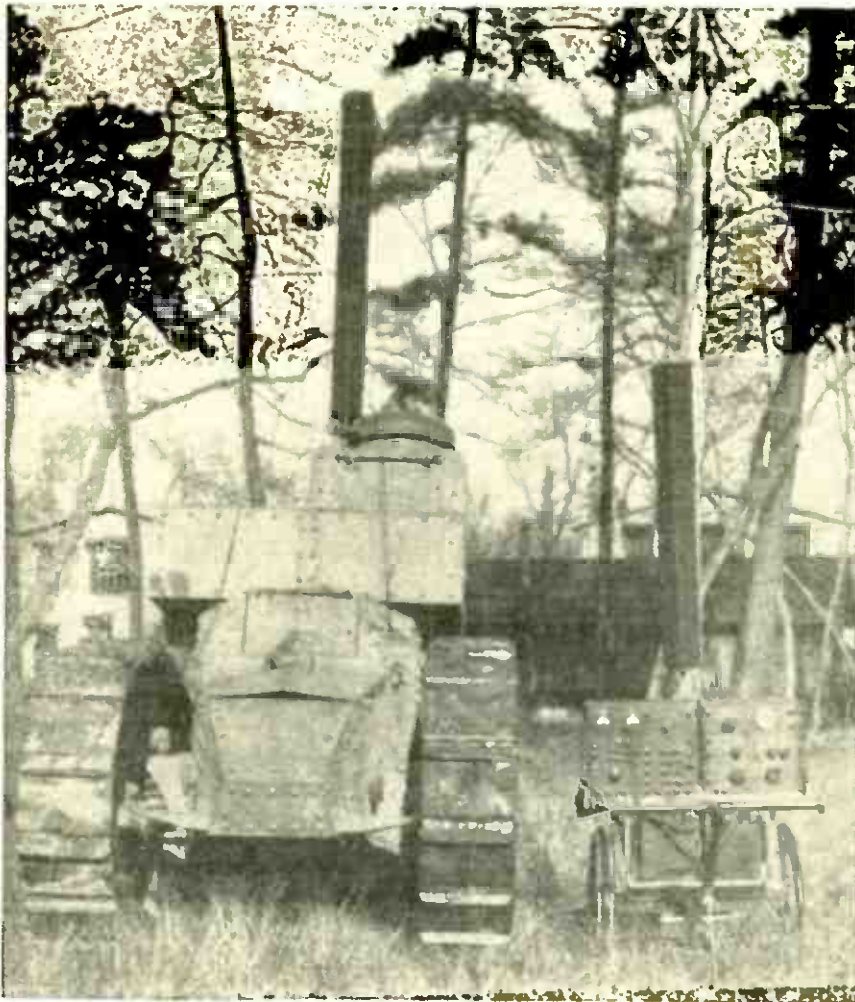

Tank School, U. S. Army

WAR TANKS NOW HAVE RADIO EARS

At the Tank School at Camp Meade, Maryland, the U. S. Army has devised a radio system for communication between the crews of armored tanks in action and their base station, which may be as much as ten miles away. The transmitting outfit is shown on the small cart at the right.

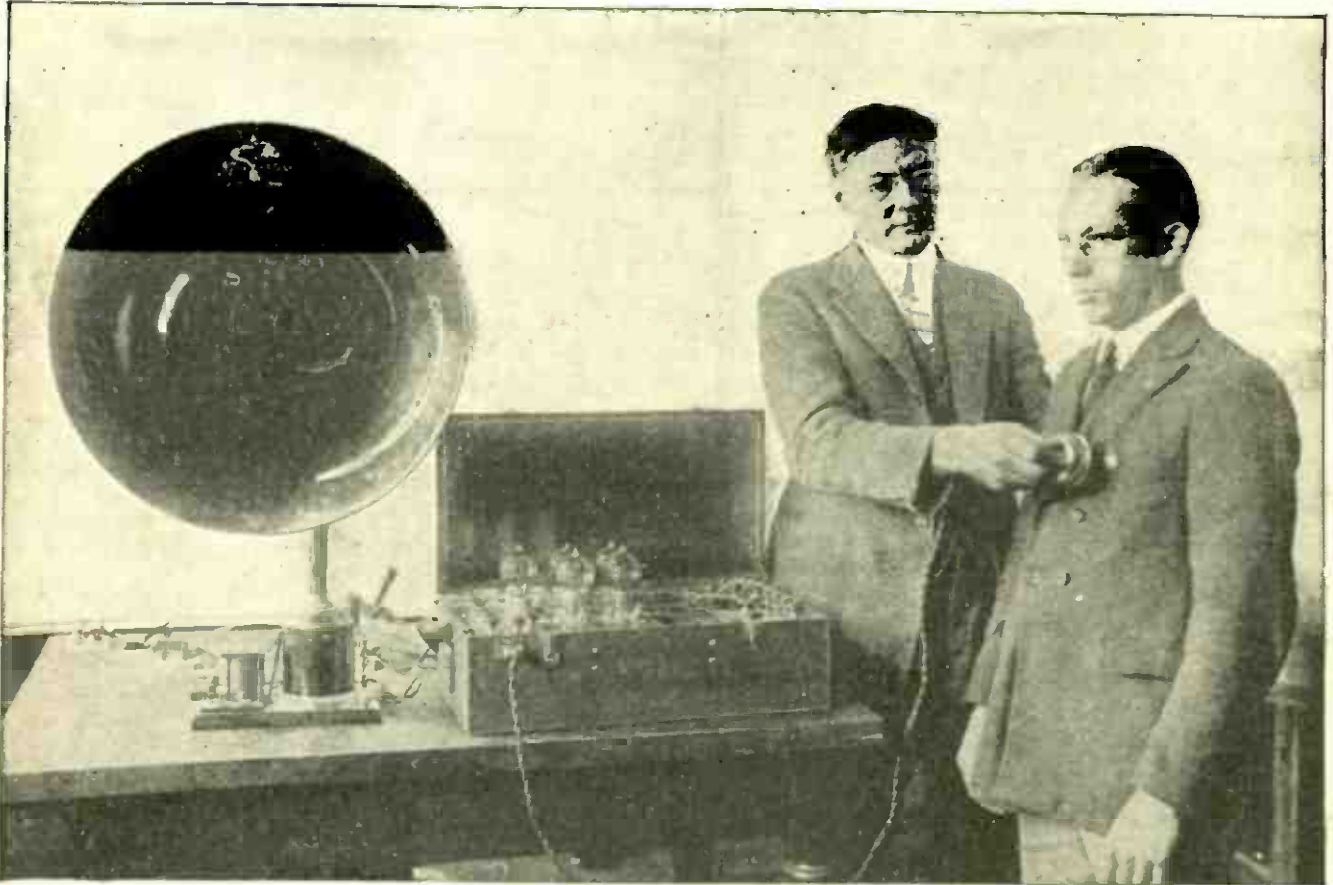

From a photograph loaned by Dr. R. B. Abbott

HEARING YOUR HEART BEAT BY RADIO

This is the first radio stethoscope ever constructed; it was developed by Dr. R. B. Abbott of Purdue University and magnifies the sounds of the beating heart so that they can be heard throughout a large room.

the waves are projected in more or less concentrated beams.

An actual heat effect sufficient to melt fine wires or delicate metal parts would be much more probable. Indeed such effects were obtained by Tesla with his powerful oscillators many years ago. Wires were melted and lamps lit at distances up to many feet away from the transmitting coils.

But such effects would be permanent and do not explain the reported observations either in Germany or in Paris. If these observations are true at all (which is, of course, still an open question) they are probably produced by some entirely new procedure the nature of which it is difficult even to surmise.

Heart Throbs that Shake the House

ONE of the newest scientific uses of radio is to magnify the sounds of the beating human heart until they seem like blows of a sledge hammer on the roof. A microphone is placed on the chest over the heart and is connected to an amplifier unit of usual character. By properly selecting and tuning the circuits it is possible to secure a magnification of many thousands without important distortion of the sounds.

The original object, of course, was medical.

Physicians place great dependence on the exact character of the heart sounds in diagnosing disease and it was a limitation of the former methods and instruments that only one person could listen to the sound at once. With the new radio devices any number of persons can listen to exactly the same sound. An instructor, for example, can discuss before his classes the varieties of heart beat and illustrate them simultaneously, all of the students hearing the heart of the same patient at the same instant. The patient need not even be before the class but may be quietly in bed in the hospital, perhaps even miles away.

This method appears to have been used first by Professor R. B. Abbott, of Purdue University, last year.* It has since been applied to medical teaching by Dr. Richard C. Cabot, of Boston † and by Dr. Leo Jacobsohn, of Berlin. ‡ Doubtless it will be before long a feature of medical work everywhere.

There is an obvious extension of this method that does not seem to have been tried. This is the *recording* of heart sounds. Since the sounds can now be given any desired intensity it will be possible to make phonograph records of them or to record them in any of the ways now available for audio-frequency oscillations, for

**Physical Review*, February, 1923.

†*Journal of the American Medical Association*, July 28, 1923.

‡*Die Umschau*, July 14, 1923.

example, by the phonofilm of Dr. Lee DeForest. A medical school can possess a set of records giving absolutely normal heart sounds, just as it now possesses models of normal human organs or motion pictures of the normal motions of the joints. Furthermore, the heart sounds of a single patient can be recorded from time to time and the progress of disease or recovery thus traced. There is a great field of research and achievement open here for some physician who is also a radio enthusiast.

Static Poses for its Portrait

At the experimental station of the British Radio Research Board at Aldershot, England, a detailed and comprehensive study of radio disturbances of the atmospheric class has been under way for some years. A number of the results were described by Mr. Watson Watt last summer in a brilliant lecture before the Radio Society of Great Britain, the text of which has since been published.* It is one of the most important contributions ever made to the study of this great bane of radio.

The investigations include two points of especial interest. One is the actual picturing of the form of the static wave. The other is the tracing of some hundreds of individual disturbances (mainly of the "click" variety)

*R. A. Watson Watt, "Observations on Atmospherics." *The Wireless World* (London), Vol. 12, pages 601-612 (August 1, 1923); discussion, pages 636-637 (August 8, 1923). The full text of this lecture should be read by every serious student of radio science. There is another paper by Watson Watt and E. V. Appleton in the *Proc. of the Royal Society* (London), Vol. 103A, pages 84-102 (1923).

to their places of origin on the map of the earth.

The pictures of the static waves are made by a special adaptation of the cathode-ray oscillograph. Photographs can be made but, in the main, the investigators have relied upon pencil drawings made from moment to moment as the wave forms appear on the oscillograph screen. A few of these drawings are reproduced herewith. Perhaps the most interesting feature of them is their variety, and this variety offers much hope to the scientist. The exact wave forms of the clicks and groans that bother us so much are certain to tell us a great deal about their origins when once we have learned to read what these wave forms mean. It is always the *unvariable* things in science that prove the hardest to unravel. If we could detect, for example, any variations in gravitation, that remarkable phenomenon would soon cease to be the mystery it is.

And so the atmospherics, because they differ among themselves, have given us, probably, the key with which to unlock their secrets.

The second feature of Mr. Watson Watt's results, the tracing of static to its geographic lair, was accomplished by training two or more direction finders in separate stations on the same static click and then plotting on the map the lines of direction, in exactly the same way in which a surveyor "triangulates" the position of a distant mountain peak. Out of all the individual clicks recorded, about 1,000 gave simultaneous records at three or more stations. In about 300 of these instances the records indicated a point of origin which was inhabited and from which simultaneous weather infor-

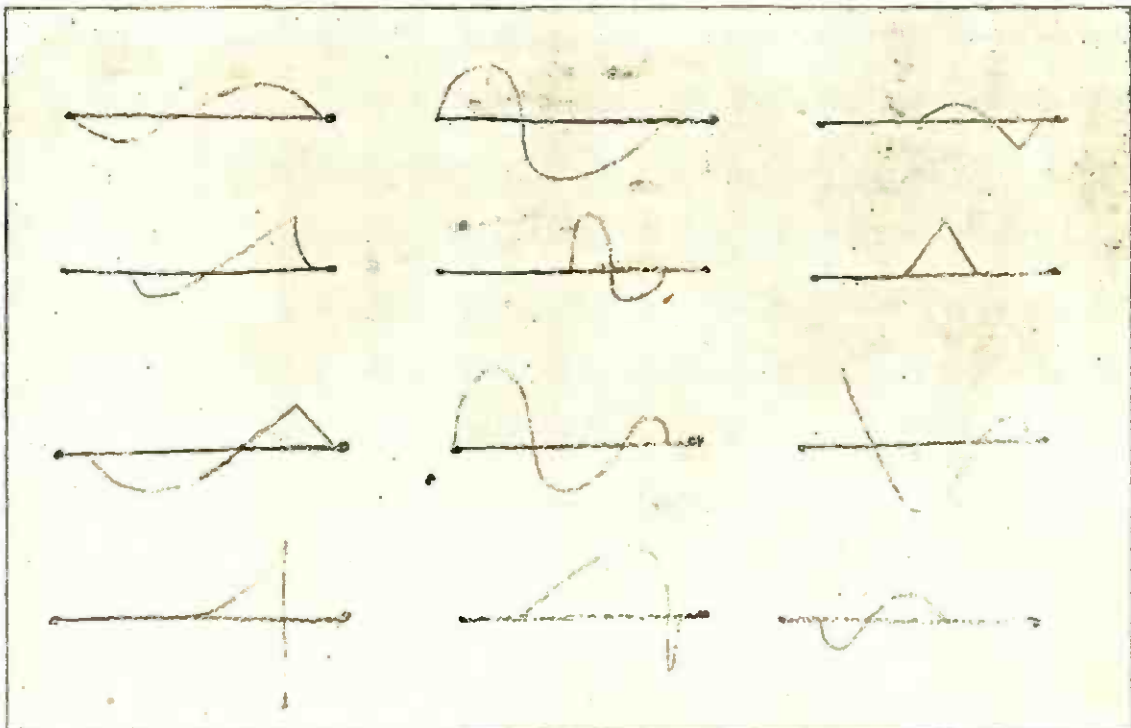

Redrawn from *The Wireless World* (London)

WHAT THE WAVES OF STATIC LOOK LIKE

The apparatus used by Mr. Watson Watt for investigating static shows a picture of the wave form of each static impulse on an oscillograph screen. These curves are reproductions of pencil drawings recording some of the typical wave forms.

mation, as, for example, the occurrence of thunderstorms, could be secured.

In only 45 of these fully traced instances was there a record of actual thunder and lightning, but in 207 instances, or *sixty-nine percent of the cases* rain was falling at the suspected locality. Static seems, then, to be more commonly associated with a mere thunderless rainstorm than with visible electric discharges of the lightning variety. So far as we know this is a new conclusion, and it seems a very important one. It is well known that electric phenomena of the general nature of a silent discharge accompany the fall of rain. The rain drops themselves are known to be electrified. Perhaps the mere formation or evaporation of clouds produces electrical changes with which the radio engineer must reckon if he is to understand transmission and control it fully.

As Mr. Watson Watt himself puts the matter. "The absence of thunder and lightning reports from rainfall areas identified as sources of atmospherics poses a very interesting problem for the meteorologist. Was the electromagnetic wave train constituting the atmospheric radiated from a discharge identical with the visible and audible discharge called lightning? If so, are such discharges taking place above the cloud sheet of all, or nearly all, rainfall areas? And if so, why are the discharges not audible? We may conclude that they are not visible in the daytime because of the opacity of the cloud sheet, but why are they not visible over the edge of the cloud sheet at night? And, if not, what possible discharge can be imagined, capable of radiating energy at a rate comparable with that involved in the propagation of atmospherics?" (A rate which Mr. Watson Watt calculates, for the typical thunderstorm atmospheric, as about that of a 20,000,000-meter-ampere transmitter, or 250 times that of the great St. Assise transmitting station in France.)

These questions remain mysterious but we may feel sure that they will not remain mysterious long. The accurate and continued recording of facts exemplified by Mr. Watson Watt's work is the first step toward an understanding. In the words with which he concluded his lecture before the Radio Society, "What is needed to clear the fog of mystery which seems to have enveloped atmospherics is not a speculation, is not a pound of theory perilously perched upon an ounce of fact, is not an occasional observation isolated in space and time with unspecified circuit constants, but is simply measurement—measurement which need not be elaborate or difficult, but which must be organized, systematic and sustained."

Continuing with some suggestions of what the British radio amateurs could do to help the study of atmospherics, Mr. Watson Watt said, "The recording of the atmospherics occurring immediately after time signals . . . can be done by most amateurs who care to add a simple recording device to their amplifiers. . . . Many of you have frame aërials with which you can make systematic directional observations on atmospherics. . . . Some of you

may care to attempt a solution of the most untouched problem of the inclination to the vertical of the wave front in atmospherics. Some might prefer to try forecasting local weather by observation of the types of atmospherics preceding different meteorological events."

These suggestions are just as live for the American amateur as for his British colleague. Why not attempt some of these really valuable scientific inquiries? Remember that Benjamin Franklin got his name in all the text-books with the simple apparatus of a key and a kite.

Will Radio Help Bring a New "Age of Aluminum"?

THERE is evident in modern industry, especially in the radio industry, an event which future historians will probably regard as a turning point in human history. It is the passage of human society from the Age of Iron, now some 3,000 years old, into the Age of newer metals—of Tungsten, perhaps, or of Aluminum.

Historians have been accustomed to divide history in accordance with the material that men used for tools. First was the Age of Stone, then the Ages of Copper and of Bronze, finally the Age of Iron. But this Iron Age was not to be, it is evident, the final one. Already it is passing into an age that will depend on other metals, probably, in the main, on aluminum.

A dozen or so of these newer metals are already indispensable to radio. Tungsten, for example, for tube filaments; selenium for light-converting devices; molybdenum for the plates of power tubes; thorium, sodium, tantalum, tellurium and several others.

Aluminum, the most promising of the new metals as a structural material, has not found as yet much use in radio but there are indications that it will. For example, antenna towers and masts made of the new aluminum alloys devised for airship construction would be far lighter than steel construction and far more durable than wood. They have been suggested and no doubt will be tried out. Aluminum panels for receiving sets, equipped, of course, with insulating bushings for the shafts of instruments, would have many advantages of permanence, lightness and automatic shielding. We have seen one fine set recently in which the panels were supported by light-weight braces of an aluminum alloy. It is not at all beyond the bounds of possibility that the alloys of aluminum, which are numerous and widely varied in their properties, will provide our grandchildren not only with airships and antenna towers but with houses and tools and furniture and many other things.

Do Clouds of Ionized Air Affect the Radio Compass?

THE appearance of a special report of the British Radio Research Board on systems of direction finding by radio, calls attention to

the fact that the radio compass, in spite of its extraordinary practical value, has not yet reached a stage of perfect dependability. American readers will recall the recent destroyer wreck on the Pacific Coast, when the radio bearings were so much distrusted by the officer in charge that they were altogether ignored. In this instance the bearings happened, it seems, to be right, but it must be admitted, even by the most enthusiastic defenders of radio, that bearings obtained by radio compass are wrong often enough to furnish a certain justification for ignoring them when they conflict with other positional data.

The systems tested and described in the British report* include the single revolving coil (frame antenna), which gives direction by the position of the coil for largest signal strength, and two other systems, the Robinson and the Bellini-Tosi, which make use of two receiving coils fixed at different angles and which determine direction by the relative strength of the signal in the two coils. The theory and operation are discussed. There is no discussion of the several other systems that have been proposed and tried, such, for example, as the systems employing coils of special shape adapted to pick up signals from a single direction only.

In our opinion, however, the chief difficulty with the radio compass lies not in the coils nor in any other feature of the apparatus. It lies in the ether. For some reason, as was pointed out by Dr. Fessenden in *POPULAR RADIO* for November, the waves do not always go outward from the radio stations on shore in straight lines. When a station is really southwest from a ship at sea the ship may receive the radio waves apparently from the south or the east or even from the southeast or northeast, an error of a full ninety degrees in the compass bearing.

The cause is probably, as Dr. Fessenden suggested, the bending of the waves by interposed clouds of ionized air or by other obstacles. The use of several simultaneous waves of widely different wavelength will help. These waves are bent, Dr. Fessenden finds, to different degrees, thus permitting, by comparison between them, a good guess as to the real direction of the sending station.

But this is at best a partial solution of the problem. What the navigators need is an apparatus that will give them automatically, without calculations or guessing, the exact direction of a sending station on shore. Perhaps some way can be found to overcome the tendency of waves to bend or possibly Dr. Fessenden or someone else can devise a receiving instrument which will make, automatically, the comparisons and calculations necessary to deduce the true direction from signals received at several different wavelengths, much as the tide machine makes, auto-

* "A Discussion of the Practical Systems of Direction Finding by Radio," by R. S. Smith-Rose and R. H. Barfield. Special report No. 1 of the Radio Research Board. Published by H. M. Stationery Office, London. Price 9 pence.

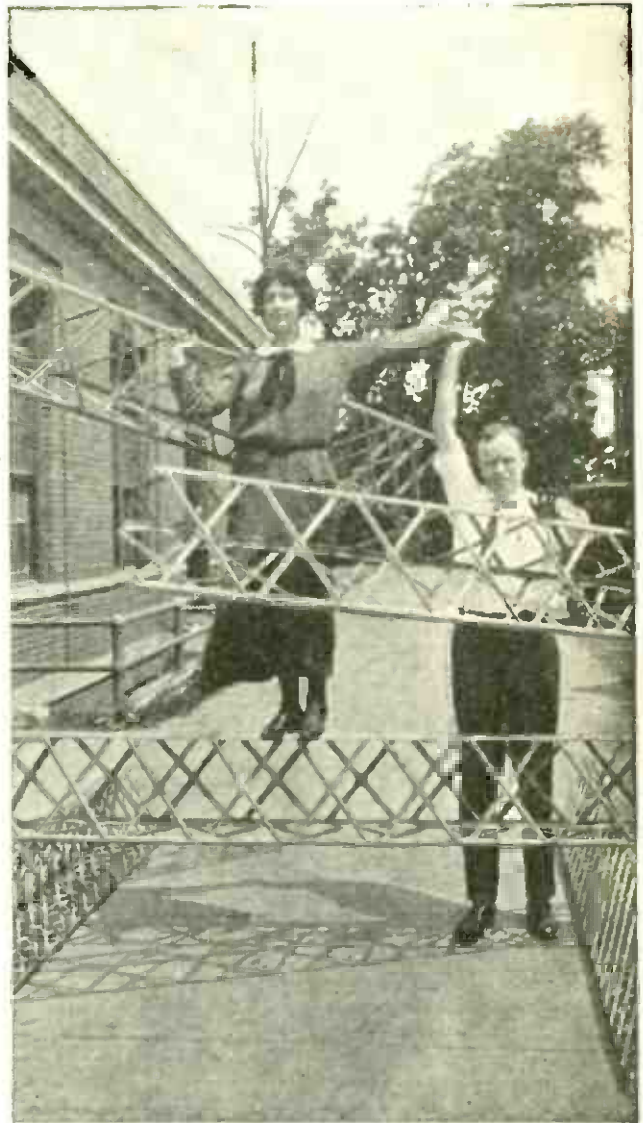

Bureau of Standards

HOLDING A METAL GIRDER ON ONE THUMB

These girders of an aluminum alloy designed for use in airships are so light that a girder capable of supporting many pounds can be suspended comfortably on a man's thumb.

matically, the calculations necessary to predict the times of the tides. The problem is one not beyond the reach of amateur experimenters and there are few devices that would be of more value to world transportation than a fully dependable radio compass.

Are Ether Waves Composed of Minute Particles?

Most of the characteristics of ether waves have been discovered and investigated with one particular kind of them, the kind we call light. This has happened, of course, because the light waves chance to be visible while the other kinds, like radio waves and heat waves and X rays and the others are not visible. To detect and examine these other kinds of waves, we need various kinds of apparatus, photographic plates for the X rays, coherers

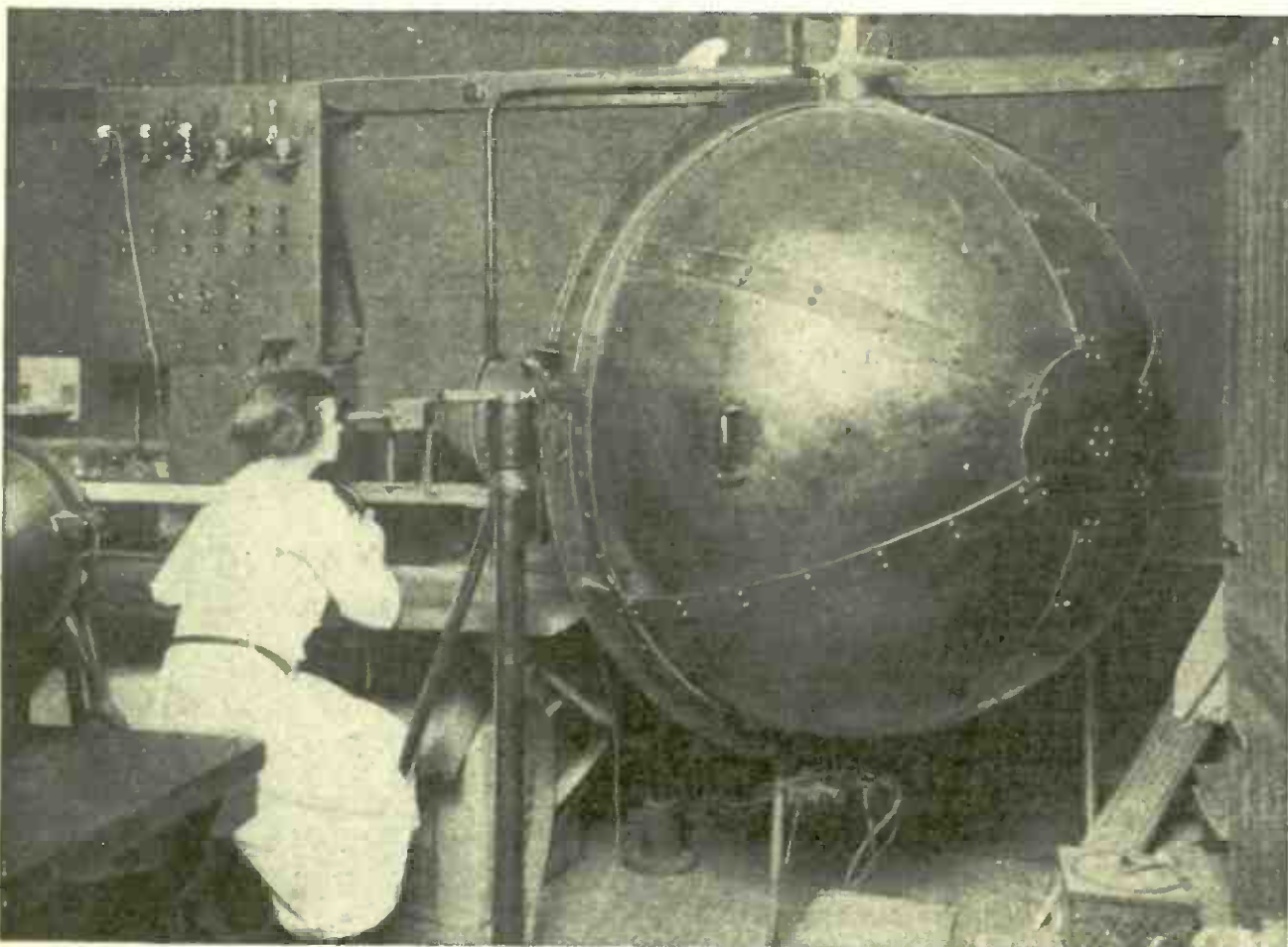

General Electric

A MACHINE THAT CATCHES ALL THE ETHER WAVES OF LIGHT

This is a spherical photometer used to measure the light rays that are sent out by an incandescent lamp. The round globe catches the rays sent out in all directions so that their total can be measured at the same instant. Similar machines have been suggested for short radio waves, but they have never been built.

or other detectors for the radio waves, and so on.

And among the ether-wave properties that have been discovered with light waves there has been for some years one that is most mysterious. This is the phenomenon of the quantum. It is, in effect, the fact that light is sent out and received in small separate particles rather than in a continuous wave. We do not know for sure that this same thing happens with radio waves, but presumably it does. All ether waves, we suspect, are really received in small chunks or squirts, like the drops of a rainstorm as contrasted with a really continuous sheet of falling water.

How can one imagine something that is a *wave* and which nevertheless appears to be in *particles*? The answer is that one cannot. That has been, and to some extent still is, one of the great mysteries of modern physics. The facts are contradictory to each other. Light is a wave. Many facts prove this. But light also seems to be in particles. An equally large number of facts prove this. Many physicists have spent sleepless nights over this mystery in the last ten years.

The present state of scientific opinion on this up-to-the-minute question has just been sum-

marized by Sir Oliver Lodge in a brilliant series of articles in the London engineering journal, *Beama*.^{*} Sir Oliver suggests a probable cause for the mystery. It lies, he says, in the structure of the atoms of matter.

Whenever we perceive light we do so, of course, through the help of matter. Our eye consists of matter arranged in atoms, as every other material thing is arranged. Without atoms we have nothing, at least nothing material. Light is produced, also, by atoms. The filament of an electric lamp shines because the atoms of matter in it are hot and give out light. A gas flame shines because the atoms in it are light givers. All other ether waves are produced, similarly, by matter. A radio wave goes out through space, not from nothing, but from the electrically charged wires (composed of matter) of the antenna.

Now it is probable, says Sir Oliver, that the property of light and other ether waves of coming in small chunks, each one of which is called a quantum, is a property not of the ether wave itself but of the atoms of matter.

^{*} "The Quantum and the Structure of the Atom and its Radiation," by Sir Oliver Lodge. *Beama*: Vol. 13, pages 11-19, 80-88, 148-157, 211-220 (July, August, September and October, 1923).

The ether wave may be smooth and continuous, as we naturally think of it. But it affects atoms or is produced by atoms, only in separate pulses.

Sir Oliver uses an excellent analogy. The atoms, he says, are like banks that pay out or receive coined money. The money is in small equal chunks, like pennies. The bank pays out or accepts so many pennies. It cannot pay out nor will it accept any fractional part of a penny. You cannot pour into a bank a continuous small stream of copper and have it accepted, nor will the bank issue coinage in a continuous metallic stream. It is either a penny or nothing.

Just so with the atom. If ether waves are to have any relations at all with the atomic banks it must be in certain small chunks of the wave, in a kind of ethereal penny. It is either one of these ether-pennies (one quantum) which the atom emits or accepts, or else it is nothing at all.

This peculiar property of atoms, responsible for this long-standing mystery of the quantum, is related, Sir Oliver thinks, to the fact that atoms consist of electrons that revolve around a central nucleus much as the planets of our solar system revolve around the sun. So long as the electrons stay each one in its own proper orbit no ether waves are given out or received. But the electrons can jump sometimes from one orbit to another, as though our earth suddenly jumped closer in to the sun and occupied thereafter the orbit of the planet Venus. When this happens a sudden pulse of ether waves, usually light or X rays, is sent out from the atom. In a flame the light is due to billions on billions of such electrons jumping busily from one atomic orbit to another. This is why the light seems, if we study it closely enough, to be in separate particles or squirts. It is in squirts; one squirt for each little electron jump.

This theory that there are a number of separate orbits for electrons inside of atoms and that the production of light or X rays or any other kind of ether waves is due, usually, to jumps of the electrons from orbit to orbit, is the famous atomic theory of the great Danish physicist Niels Bohr.* It is the latest word of science about the mysterious things that go on inside the atom.

Just how these new ideas of the atom and of the quantum will affect our theories of the longer ether waves used in radio is not yet apparent. That the radio theories will be affected in some fashion is beyond doubt. Radio waves are produced, of course, by the movement of electrons; by the surges of electric charge back and forth into the antenna. The quantum relations probably apply to these longer waves just as definitely as they apply to the shorter waves of light. Future radio theories must take them into account, and radio engineers who desire to inform themselves of scientific progress in this field will find no better introduction to it than these authoritative and clearly written articles of Sir Oliver Lodge.

*This theory will be described in an early number of POPULAR RADIO.

Measuring Radio Waves with a Yardstick

THIS has been accomplished, quite literally, at the United States Bureau of Standards. Dr. F. W. Dunmore and Mr. F. H. Engel have devised an apparatus by which radio waves are measured off in feet and inches (or in meters) directly, just as you would measure rope or wire. This was done as a part of a method developed for the calibration of standard wavemeters for the use of the Bureau's radio inspectors.*

Such wavemeters have to be checked, of course, by comparing them with some fixed standard. It is not enough merely to compare them with another meter. So Dr. Dunmore and Mr. Engel set up a wave generator consisting of a single vacuum tube and inductances and capacities designed to generate very short waves, 9 to 16 meters long. These waves were communicated to two parallel copper wires strung between supports so that a standing wave was set up in these wires. The next problem was to measure the length in meters of this standing wave.

The device for this was merely a delicate thermo-galvanometer hung on the two wires, one terminal on each wire. This galvanometer could be slid along the pair of wires like the carrier baskets sometimes used in department stores. A standing wave having been set up, the galvanometer was slid along the wires until it showed a maximum current passing through it, that is between the two wires. This place was marked. Then the galvanometer was slid along again until another place of maximum current was reached. The distance between these two places of maximum current was exactly the length of a half-wave. Putting a meter-stick on this distance gave a direct measure of the wave in meters.

These standing waves were too short, of course, to be used in direct calibration of radio wavemeters. This was accomplished by comparing the harmonics of a third circuit with the short standing waves and then using the circuit so measured to standardize the wavemeters.

By a succession of such comparisons, the wavelength used being increased step by step, it is possible to establish a definite and absolute standard of length for waves of any desired frequency.

The investigation marks, not only a substantial increase in the accuracy in wavelength measurements but a new step in the control and utilization of the very short waves. Ten years ago any wave under two or three thousand meters was considered "short," too short to be of any practical use. Nowadays these waves are the most used of all and the "short" waves are those under a hundred meters. Perhaps a decade from now we will be broadcasting at 10 or 15 meters and talking about "short" waves an inch or two long.

*Dunmore and Engel, "A Method of Measuring Very Short Radio Wavelengths and Their Use in Frequency Standardization," *Proc. Inst. Radio Engineers*, Vol. 11, pages 467-477, (October, 1923).

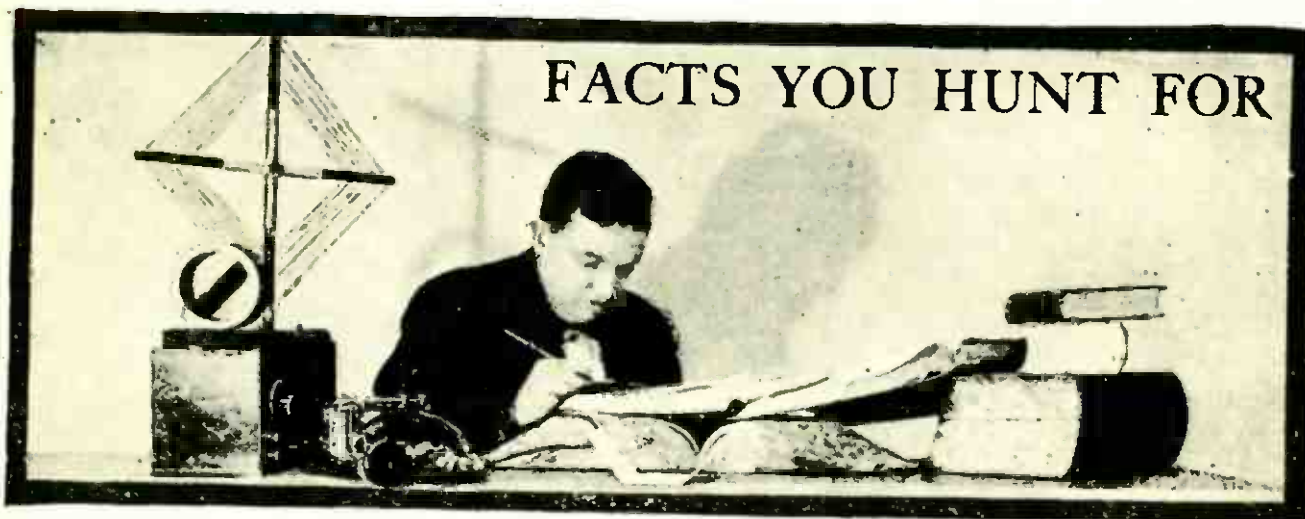

FACTS YOU HUNT FOR

A limited number of questions of general scientific interest will be answered each month in this department. Readers are invited to send in questions that have puzzled them—but the selection of questions for answer cannot be guaranteed nor can questions outside the radio field be answered by mail.

Will it do any harm to erect an antenna close to a lightning rod?

No. A lightning rod is merely a grounded wire. So long as the antenna wires do not touch it and are kept a couple of feet away from it neither the lightning rod nor the antenna will interfere with the other.

Can good "radio weather" be predicted by a barometer?

So far as now known it cannot. The barometer measures the pressure of the air and nothing else. It is true that the air pressure gives some indication of the state of the weather, especially if you have for comparison the barometer readings at many places in different parts of the country, as the Weather Bureau has when it prepares its weather forecasts. But a single barometer reading means little, even about such things as rain or temperature and, inasmuch as the effects of weather on radio transmission are still mysterious and mostly unknown, a barometer reading at your house will be practically useless in predicting the possibility or impossibility of DX work.

Why is it necessary to solder the connections of a radio set? Electricity passes easily, does it not, between two wires if they merely touch one another?

THE electricity passes easily enough if the wires really touch but unless they are soldered together they usually do not touch; they merely seem to. In between the surfaces of two wires that are wrapped together there exists, really, a tiny film of air. This air film is too thin for you to see it, but it is thick enough that feeble

electric currents cannot cross it. Soldering the wires together removes this air film and replaces it with a film of solder, which is an electric conductor. Then even the feeblest currents can pass from wire to wire without difficulty.

Why does oilcloth, used to line a panel or elsewhere around a set, make the set work less satisfactorily?

BECAUSE most varieties of oilcloth are really conductors of electricity. They contain metallic compounds like zinc-white or white-lead. These compounds are conductors. The oilcloth has a considerable capacity, just as a sheet of tinfoil has. It acts also as a channel for current leakage. It is even possible to make grid-leaks out of oilcloth.

Why is a vacuum tube worthless when the point is broken off?

BECAUSE air gets in through the tiny hole thus made and destroys the vacuum in the tube. With air in the tube the filament burns up instantly as soon as you heat it.

What is a gravity cell?

It is a kind of electric battery in which the two different liquids necessary to operate the battery are kept apart by a difference in density or "gravity." For example, the electric batteries formerly used a great deal in telegraph work, had a plate of copper at the bottom of a glass jar and a plate of zinc at the top. The two solutions were copper sulphate at the bottom of the jar and zinc sulphate at the top. The zinc solution, being lighter, floated on the copper one like oil on water.

What makes the bubbles of gas when two wires are dipped into water and an electric current is passed between them?

THE electric current decomposes the water into the chemical elements of which it is composed. These are two gases, oxygen and hydrogen. The oxygen collects at one of the wires, the hydrogen at the other. These gases make the bubbles that you see.

Why does the X-ray machine used by dentists interfere so much with nearby radio sets? Is it possible to screen off the X rays in some way?

It is not the X rays that do the damage. It is the radio waves sent out by the machine. An X-ray apparatus is operated by means of high-voltage electric current. Whenever this current is turned on or off the whole apparatus acts exactly as though it were a radio transmitter of the spark variety and sends out a pulse of ether waves. The problem of cutting out interference is exactly the same as the problem of preventing interference from high-power spark stations or from electric substations. It is a very difficult problem and has not yet been solved completely.

What material is the most perfect insulator?

THE answer to this question depends upon what you want to use the insulator for. The voltage of the current, the temperature, the degree of moisture that is about and many other things, affect the perfection of insulating materials. Some idea of the value of different insulators can be obtained from their dielectric constants. For a definition and discussion of the dielectric constant it is necessary to consult a treatise on electricity. Here are some comparative values of the constant. This does not, however, determine all the properties of an insulator.

Pitch	1	to	2
Vaseline			2.2
Paraffin	2	to	3
Ebonite			3.0
Shellac	3	to	4
Sulphur			4.0
Porcelain	4	to	7
Rock Salt			5.6
Mica	6	to	7
Glass	6	to	10
Pure Water	70	to	80
Pure Ice			93

Why is it necessary to use distilled water instead of ordinary water in making up the acid for a storage battery?

BECAUSE ordinary water is not quite pure. There are always small amounts of various chemicals dissolved in it, as you can prove by

evaporating some of it from a clean dish. A little crust or scum of solid material will be left behind in the dish. These chemicals in the ordinary water may combine with some of the materials on the plates of the storage battery and damage it for use. Distilled water is pure and does not contain any of these possibly dangerous chemicals.

I have seen mentions of the "absolute ampere" and of the "international ampere." Are there two kinds of amperes?

THERE are not exactly two kinds of amperes but there are two ways of defining this electric unit. They are almost alike, but not exactly so. The absolute ampere is based on the fundamental units of electricity used in precise scientific work. It is defined as the current which will deposit in one second, under standard conditions, .00111827 gram of silver. The international ampere is the one defined by the last international conference on electrical units. It will deposit, under the same conditions mentioned, .00111800 gram of silver. For practical purposes the difference between the two values of the ampere is negligible.

Why do some of the books say that electric current flows from the positive to the negative pole, while other books say that the electrons which compose the current flow from negative to positive?

THIS is a puzzling confusion which is due, altogether, to the fact that when we first began to use electricity we did not know what it really was. The electricians of the time of Benjamin Franklin knew that there was such a thing as electric current but they did not know which way it flowed. So they assumed, merely for convenience, that it flowed from positive to negative and this assumption got into all the books and all the mathematical formulas. Later on, we discovered that this assumption happened to be wrong. The electricity, that is the stream of electrons, really flows from negative to positive. It would be better if all the electrical formulas recognized this but it is so much of a job to change them all that most electricians continue to use the old ones.

I am told that the dust from coal smoke settling on my antenna will decrease the strength of the signals I receive. Is this true?

YES. The dust usually contains more or less iron and carbon and other substances which conduct electricity. If there is a coating of soot on the antenna it will cover the insulators as well as the wires themselves and a part of the received energy will leak away through this soot layer, just as the energy on a grid leaks away slowly through a pencil mark used as a grid-leak.

"STATIONS I HAVE HEARD"



If you are getting good results with your receiving set, tell your fellow-readers of POPULAR RADIO how you get them. Give the call letters of the stations you hear, the locations of them, the type of apparatus that you are using and How YOU ARE USING IT.

WHAT ONE TUBE CAN DO

WITH the single-tube receiver described in the April number of POPULAR RADIO, H. P. Krag of Kensal, N. D., has heard as many as eleven stations in one night in summer weather. He uses a peanut tube in the two-circuit hookup described.

His record for one evening is the following list: WLW, Cincinnati, O.; WJAZ, Chicago, Ill.; WOS, Jefferson City, Mo.; WBAH, Minneapolis, Minn.; WHAS, Louisville, Ky.; WBAP, Fort Worth, Texas; WDAF, Kansas City, Mo.; CFCN, Calgary, Can.; WLAG, Minneapolis, Minn.; WOAW, Omaha, Nebr., and WOC, Davenport, Ia.

* * *

WHAT HIS CRYSTAL DID

A VARIOCOUPLER and two variable condensers in a crystal set made entirely at home by C. E. Van Kirk of St. Paul, Minn., are tuning to Pittsburgh, Pa., Davenport, Ia., and a number of other stations. His record reception is from KSD, WHB, WCX, WWJ and KDKA. The condensers, made at home from eleven plates of brass are closely spaced to give them a capacity of almost .0005 mfd. The coupler is wound with number 22 enameled wire on a shellacked tube about $3\frac{1}{4}$ inches in diameter for the primary and a spherical wooden ball for the secondary. The clearance between the two is about $1/16$ of an inch. The primary of the coupler has 100 turns, tapped at every tenth turn, and the secondary has 60 turns. One condenser is used across the secondary and the other in the antenna circuit.

Van Kirk has been told, as holders of crystal records are usually told, that he is receiving re-radiation from a near-by tube set, but he states that he can pick up the distant stations most any night and hold them for as long as a half hour.

REFLEX ELIMINATES STATIC

ORAN DOGGERT of Catlin, Ill., says he eliminates static entirely through careful tuning of his single-tube reflex receiver, which uses dry cells.

"My record is CWA, Montevideo, Uruguay," he claims. KYJ of Los Angeles, Calif., and KQY of Portland, Ore., he receives on an average of twice a week. He uses an antenna of 130 feet, 20 feet high. He has made two loop antennas with wire taken from a Ford spark coil and has picked up WLW, Cincinnati, O., and WGY, Schenectady, N. Y. Signals are somewhat louder, he finds, when he connects both outside antenna and loop to his set.

Some of the stations he has heard are WSY, Birmingham, Ala.; WFI, Philadelphia, Pa.; WFAA, Dallas, Tex.; PWX, Havana, Cuba, and CHYC, Ottawa, Canada.

* * *

THE SINGLE-CIRCUIT AGAIN

WHILE the single-circuit set is seldom selective and although it is condemned because it sometimes sends its squeaks into a neighbor's receiver, it is still a leader as a distance getter. Dr. W. W. Lewis of Marvell, Ark., who constructed one from a diagram on page 233 of POPULAR RADIO for March, frequently hears Los Angeles and Denver with one dry-cell tube.

His antenna is a long one as antennas go for single-circuit sets, a stretch of 100 feet with a lead-in of 90 feet. He uses one variable condenser of 43 plates; a variocoupler of 60 turns, tapped every five turns, with 40 turns on the rotor, which serves as a tickler coil; the ordinary grid leak and condenser and a pair of 2,200-ohm phones.

With careful tuning he also heard Memphis, Tenn., Davenport, Ia., Kansas City, Mo., Atlanta, Ga., Ft. Worth, Tex., and a long list of others.



Now for the hook-up

THE radio set builder's eyes shine with pride as he inspects his drilled Celoron panel. He has done a good job. The finely finished Celoron panel reflects his good workmanship. He is ready to mount his instruments and make the final connections.

A Celoron panel insures good looks to the radio set. Celoron panels are finished in black, oak and mahogany. Each Celoron panel is wrapped in a dust-proof glassine envelope to protect its lustrous surface. Grit cannot scratch it. Hands cannot fingerprint it. You are the *first* to unwrap it.

Celoron, a bakelite product, has high dielectric strength. It is approved by the U. S. Navy and the U. S. Signal Corps.

Special-sized Celoron panels are cut to order from sheet Celoron. Standard Celoron panels come cut and trimmed, ready to use, in these sizes:

1—6 x 7 x $\frac{1}{8}$	5—7 x 18 x $\frac{3}{16}$
2—7 x 9 x $\frac{1}{8}$	6—7 x 21 x $\frac{3}{16}$
3—7 x 12 x $\frac{1}{8}$	7—7 x 24 x $\frac{3}{16}$
4—7 x 14 x $\frac{3}{16}$	8—12 x 18 x $\frac{3}{16}$
	9—7 x 26 x $\frac{3}{16}$

Write for our interesting booklet, "*Getting the Right Hook-Up.*" Sent free upon request.

To radio dealers: Send for special dealer price list showing standard assortments

Diamond State Fibre Company

BRIDGEPORT

(near Philadelphia)

PENNSYLVANIA

Branches in Principal Cities
Toronto, Canada — London, England

CONDENSITE
CELORON
STANDARD RADIO PANEL

"THE AIR IS FULL OF THINGS YOU SHOULDN'T MISS"



Eveready "Three"
 4½ volts, three distinct uses. Length, 4 in.;
 width, 1¾ in.; height, 3 in.; weight, 14 oz.
 At all reliable radio dealers.

This "C" Battery
 is a Wonder Worker

"THE AIR IS FULL OF THINGS YOU SHOULDN'T MISS"

For Quality Reproduction

YOU can make the loud speaker respond with a new fullness and naturalness of tone. You can save money by adding months to the life of your "B" Batteries. These things you can do by using the new Eveready "Three" as a "C" Battery.

You already have an "A" Battery for the filament and a "B" Battery for the plate. A "C" Battery is connected to the third element of your vacuum tube, the grid, affording a control that is marvelous in action on audio frequency amplifiers.

As a "C" Battery the Eveready "Three" prevents distortion and excessive flow of current from the "B" Battery, lengthening its life. It is a wonder worker that saves its small cost many times over. Connect it in your audio frequency amplifier and note the difference. Full directions on the label and in "How to Get the Most Out of Your 'B' Battery," a booklet on "B" and "C" Batteries, sent free on request.

This triple-use battery can also be used as an "A" Battery in portable sets. Light and full of pep. Its third use is as a "B" Battery booster.

Use the Eveready "Three"—a tested product of the world's leading electro-chemical battery laboratory. It serves more radio uses and effects more economies than any radio battery heretofore developed.

If you have any battery problem, Radio Battery Information Headquarters will solve it for you. Write G. C. Furness, Manager, Radio Division, National Carbon Company, Inc., 128 Thompson Ave., Long Island City, New York.

NATIONAL CARBON COMPANY, INC.

Headquarters for Radio Battery Information

New York

San Francisco

CANADIAN NATIONAL CARBON CO., Limited.

Factory and Offices: Toronto, Ontario

EVEREADY
Radio Batteries
- they last longer

DUBILIER

Radio-Frequency Amplification over all wavelengths

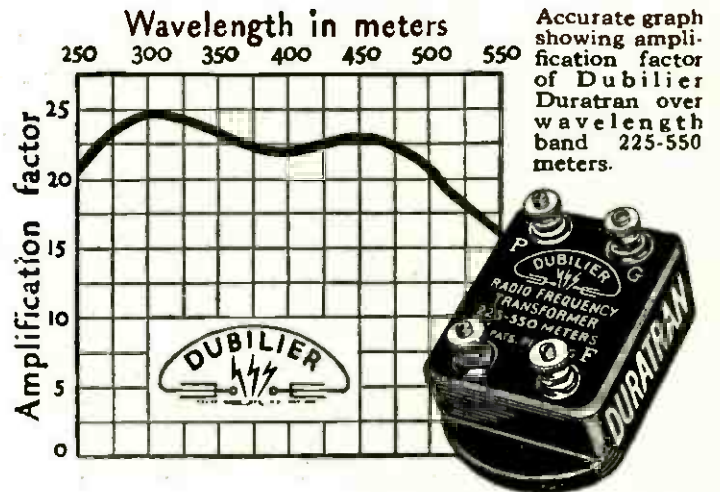

The Dubilier Duratran is the supreme radio frequency transformer.

It amplifies twenty times over the wavelength band 220-550 meters and is therefore adapted for receiving on all the broadcasting stations *equally well*.

The curve shows you exactly how uniform is a Duratran amplification over the broadcasting wavelength band.

Price \$5.00.

Write for booklet of Duratran hook-ups.

The Biggest Little Thing in Radio

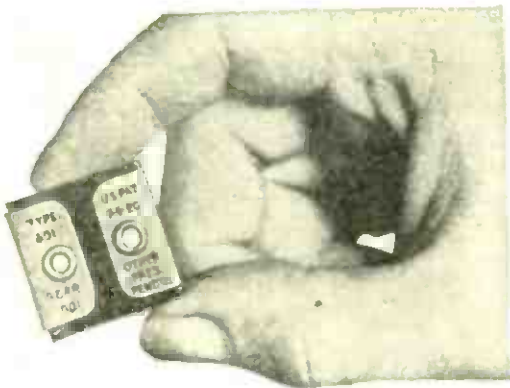

Dubilier Micadons are fixed mica condensers, permanent in capacity.

They have been adopted by the leading radio manufacturers and by discriminating amateurs.

Dubilier Micadons are made in many styles and capacities to meet any circuit requirement.

See if your set is equipped with Micadons. If it isn't, your tubes are probably oscillating too much.

Price 35 cents up.

Write for booklet of Micadon hook-ups.

DEVICES

The Ducon in a Light-Socket

*takes the place of
the antenna or loop*

The Dubilier Ducon is the standard socket-plug. Four hundred thousand are in successful use.

Simply screw the Ducon in any convenient lamp-socket, and the broadcasting station comes in strong and clear.

With the Ducon you can carry your set to any room, whenever you please, and receive from any lamp-socket.

No lightning arresters or switches are needed.

Tuning is sharper than with the usual antenna.

If unsatisfactory, your money will be refunded after five days' trial.

Price \$1.50.

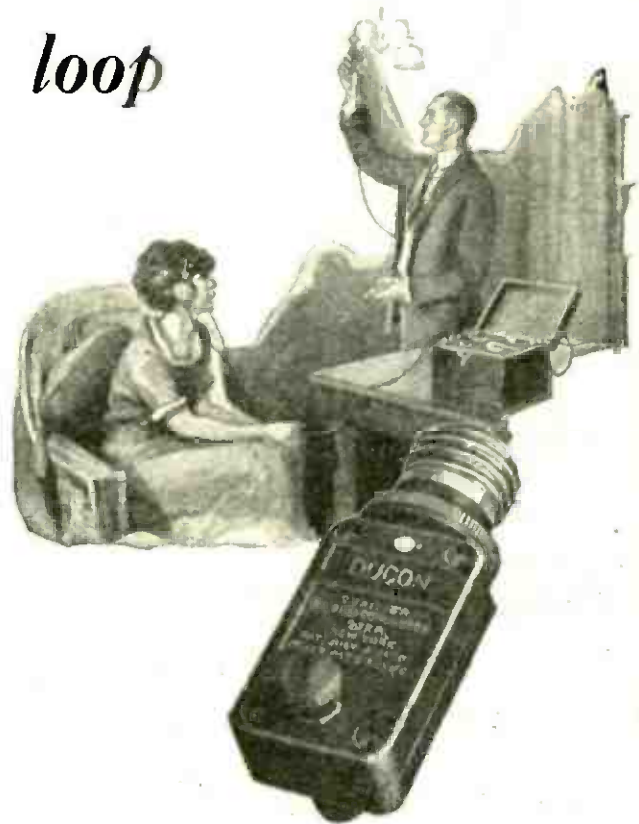

Dubilier Condenser & Radio Corporation

40-50 West Fourth Street, New York

BRANCH OFFICES

Huntington, W. Va., Atlanta, Ga., Pittsburgh, Pa., Chicago, Ill., St. Louis, Mo.,
Los Angeles, Cal., Washington, D. C.

Haynes-Griffin

RADIO SERVICE, Inc. 41 West 43rd St., N. Y. City



A. J. HAYNES
Assoc. Institute of Radio Engineers
 Designer of the Haynes Circuit

PARTS FOR THE FAMOUS HAYNES CIRCUIT

1000 Miles for \$15.00

The Identical Parts Used by Mr. Haynes in His Own Personal Receiving Set—Assuring the Utmost in Selectivity, Long Distance Range, Economy and Simplicity of Arrangement. Invaluable to experimenters converting ordinary simple regenerative sets to include the Haynes Circuit

LAURENCE M. COCKADAY, R. E., technical editor of "Popular Radio," describes the Haynes Circuit as the ideal set for the average man who demands not only the best in local reception but the extreme in long distance range as well.

Its appeal is universal: to the experienced amateur because of its astonishing long range reception and wonderful selectivity; to the radio novice because of its ease of construction and operation. So simple that no one can possibly go wrong.

The outstanding feature of Mr. Haynes' own set is its simplicity and compactness of arrangement with all the instruments panel mounted.

Most experimenters find it well worth their while to substitute parts recommended by Mr. Haynes for those they may have on hand.

The Haynes Condenser

\$3.50

Meets every requirement — extreme low minimum capacity and maximum capacity of exactly .00023 mfd. No other condenser achieves just the right balance between perfect selectivity and overcritical adjustment.



The Haynes Bank Wound Vario-Coupler

\$4.35

Furnished with only the taps you actually use and just the right number of turns on the secondary. Bank winding provides 100% efficiency on higher broadcasting wave lengths.

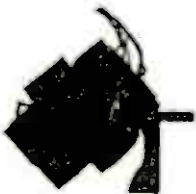

We have on hand a supply of interesting booklets describing the Haynes Circuit. Also a leaflet telling how to build the Haynes Amplifier for use with the Haynes Circuit. These Booklets will be mailed by us anywhere upon receipt of a 2c. stamp for each booklet desired.

Haynes .00023 Condenser.....	\$3.50
Haynes Bank Wound Coupler.....	4.35
Fada Rheostat.....	.75
Fada Socket (Panel Mounting).....	1.00
Switch Arm.....	.20
4 Switch Points and 2 Stops.....	.06
10 Binding Posts.....	.50
2 3-inch Dials.....	1.00
1 Dubilier Grid Condenser .00025 mfd. (with leak mounting).....	.45
1 Grid Leak 1 meg.....	.35
Bus Bar, Solder, Copper Lugs and all miscellaneous material.....	.55
7x15 Grade A Hard Rubber Panel.....	1.50
Panel Drilled for Mounting all the above instruments (extra).....	1.50

Accessories

7 x 15 solid mahogany cabinet, piano finish, \$4.25; Haynes-Griffin Head Phones (2200 ohms) \$4.75; W. D. 12, U V 201 A or U V 199 Vacuum tubes, \$6.50; 22½ volt variable B Batteries, \$1.25; 1½ volt dry cell A batteries, 40c each.

Complete parts to build the Haynes Two-Stage Amplifier cost \$15.00 additional, including drilled panel. Tubes, cabinet, and batteries are not included at this price.

All these items are in stock—prompt shipment will be made. Carriage charges prepaid anywhere east of the Mississippi River.

HAYNES-GRIFFIN RADIO SERVICE, Inc. 41 W. 43rd St. New York City
New York's Largest Radio Store

Haynes-Griffin

RADIO SERVICE, Inc. 41 West 43rd St., N. Y. City

SPECIAL SERVICE TO BUILDERS of COCKADAY CIRCUITS

January Popular Radio

IMPROVED FOUR CIRCUIT TUNER—Mr. Cockaday advises many changes from the original design of this world famous circuit, and recommends the use of new and improved apparatus.

November and December Popular Radio

SIMPLIFIED SUPER-HETERODYNE—In these two issues Mr. Cockaday tells how to construct the Separate Oscillator and the Intermediate Wave Radio Frequency Amplifier. These two units, used with the Haynes Circuit, constitute a Super-Heterodyne Receiver.

September and October Popular Radio

THE HAYNES CIRCUIT—These two articles describe the Haynes Circuit—1,000 Miles for \$15.00—reviewed in detail on the opposite page of this advertisement.

Haynes-Griffin Transformer

\$4.25



A new air core radio frequency transformer sharply tuned to 3,000 meters. Upon the use of this transformer depends much of the success of the simplified Super-Heterodyne. Haynes-Griffin Input Transformer also \$4.25.

Special Oscillator Coupler

\$3.50

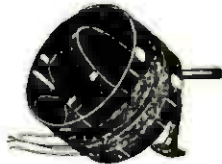

Specially designed by Mr. Haynes for use in the Super-Heterodyne. An indispensable adjunct for the proper operation of this wonderful circuit.

- 4-Circuit Cockaday Coils \$2.35
- Como "Push and Pull" Transformers, pair 12.50

The above is only a partial list of the "hard to get apparatus," now in stock. Send a 2c. stamp for complete price list.

THE IDENTICAL PARTS SPECIFIED BY MR. COCKADAY

Located in New York City, the headquarters of the radio industry, Haynes-Griffin is able to supply immediately each and every article used by Mr. Cockaday in his experimental sets. Every endeavor is made to ship within 24 hours after receipt of order.

Special apparatus designed by A. J. Haynes, and specified by Mr. Cockaday, is now on hand in sufficient quantity to meet the extraordinary public demand.

COMPLETE PRICE LIST

mailed *Free* on request. Leaflets describing the Haynes Circuit, 2 Stage Audio Amplifier, the Separate Oscillator, and Intermediate Wave Amplifier sent on receipt of 2c. stamp for each leaflet desired. Use the handy coupon.

Parcel Post Prepaid in U. S. anywhere east of the Mississippi River

New York's Largest Radio Store

Haynes-Griffin, 41 West 43rd St., New York City

Send me at once complete data and prices on all material mentioned in Mr. Cockaday's articles describing the Haynes Circuit and the Super-Heterodyne. I enclose a two-cent stamp for each of the leaflets checked below.

- Haynes Circuit
- Separate Oscillator
- Haynes Amplifier
- Intermediate Amplifier

HAYNES-GRIFFIN RADIO SERVICE, Inc.
41 West 43rd Street, New York City

Any set is better with this switch on the panel.



The C-H Radio Switch can be installed on any panel in only a few minutes. Just one 7-16 inch hole is required. Large, convenient binding posts with cupped washers make wiring easy.

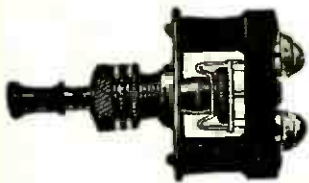

The C-H Engineers designed this radio switch mechanism so that the contact member floats, independent of the button. Touching it, or jarring the table does not cause noise in the phones.

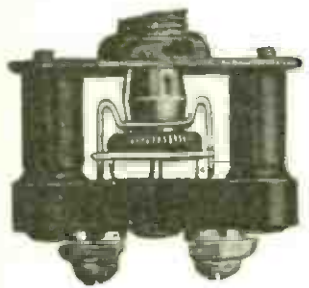

The wiping knife-blade type construction insures clean contacts for freedom from microphonic noises.

—and the Same Program Will Be There When You Want It

The Tuning of Your Set Is Not Disturbed When You Have C-H Control

The Cutler-Hammer Engineers have provided a real convenience for every panel in the little radio switch which bears their famous signature of approval, the C-H trade mark. They have built it worthy of the finest sets—yet so simple to mount that any one can install it in less than five minutes.

And it can be used to serve you in many ways. In your "A" battery circuit it makes it possible to interrupt a program without loss of the station received. It protects both your tubes and batteries and indicates at all times whether the current is *On* or *Off* (with the new tubes that do not burn bright there is no other way of knowing). It is built sturdy to do well any task you may assign, and has broad, self cleaning knife-blade type contacts that give perfect connection and freedom from microphonic noises.

Have your dealer show you the *genuine* C-H Radio Switch. Snap the button in and out! You can tell by its action that it was built by switch specialists. Their trade mark on both the dustproof case enclosing the mechanism, and on the bright orange and blue box in which the switch is sold is your protection.

THE CUTLER-HAMMER MFG. CO.

Member Radio Section, Associated Manufacturers of Electrical Supplies
MILWAUKEE · WISCONSIN

CH

RADIO SWITCH

Please refer to POPULAR RADIO when answering advertisements.



"I have a Manhattan Loud Speaker in my home because I love fine music"

Ann Pennington



R

Manhattan Electrical Supply Co.
New York City.

Gentlemen:

Your Manhattan Loud Speaker is simply wonderful. It reproduces with great fidelity the splendid musical programs that are "in the air" each night.

Before making up my mind I tried practically every make, and finally chose a Manhattan because of its superb-reproducing qualities and the adjustable Concert Modulator.

Sincerely yours,
Aina Pennington



Will you make the same test that Miss Pennington did?

Go and hear the Manhattan and you, too, will acclaim it as Miss Pennington did, "a superb musical instrument, capable of reproducing the broadcasting programs with great fidelity."

Go and hear the Manhattan and compare it with others. Compare its mellow richness of tone and its remarkable range, with the reproducing qualities of other instruments. Note carefully its adjustable Concert Modulator that banishes all distortion and makes the Manhattan Loud

Speaker adaptable to every condition, so that the best results are always possible.

Go to your nearest dealer and insist upon hearing the Manhattan, "the Loud Speaker with the Concert Modulator." Or write us for descriptive booklets.

Manhattan Electrical Supply Co., Inc.
17 Park Place, New York

Makers of the famous Red Seal Dry Battery

New York Chicago St. Louis San Francisco

MANHATTAN
"The Loud Speaker with
the Concert Modulator"

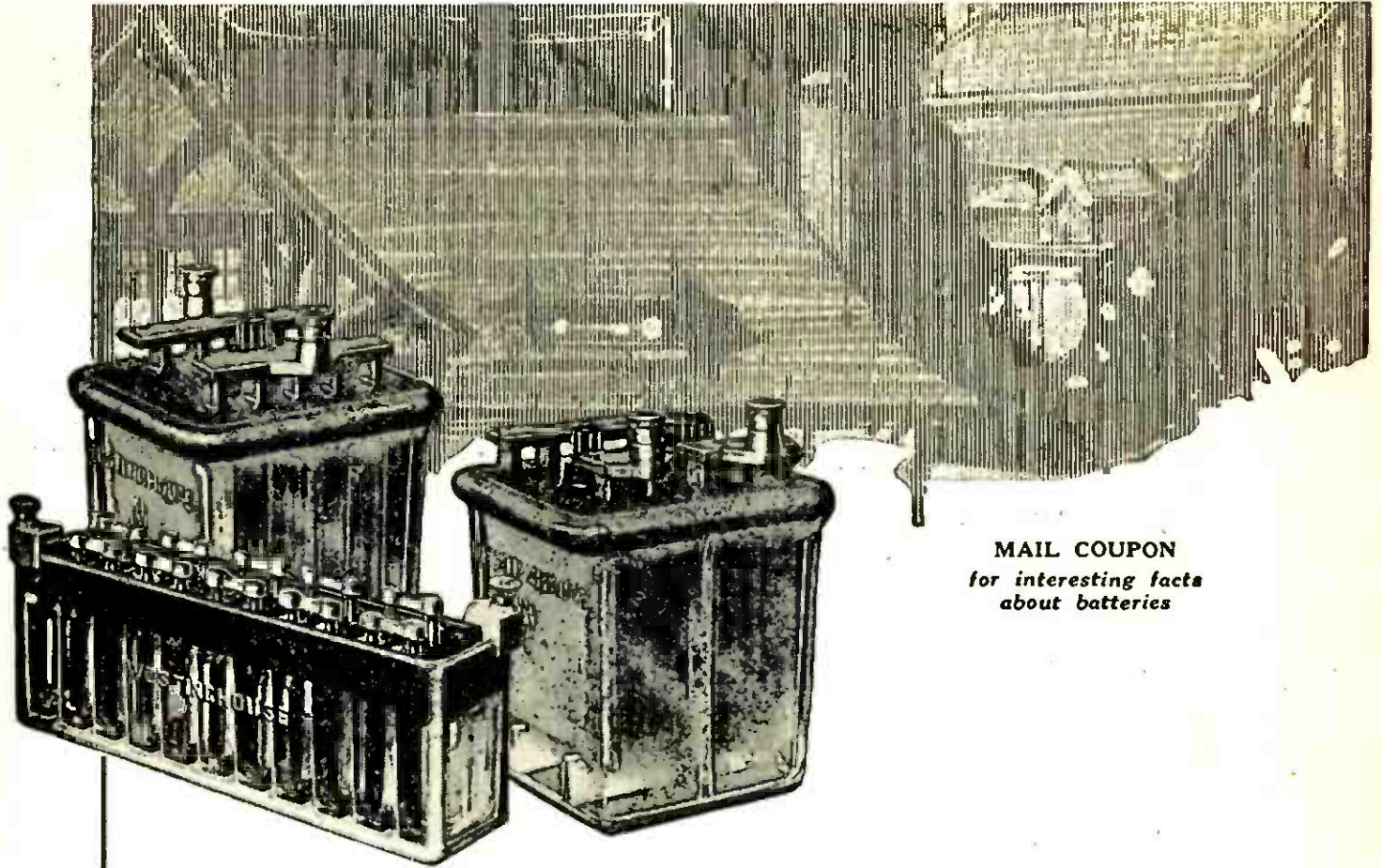

MAIL COUPON
for interesting facts
about batteries

FULL voltage battery current all the time! That's what you want. Westinghouse Radio Storage Batteries will give it to you. No more operating with run-down batteries! No more sudden drops in battery voltage! No more throwing away worn-out batteries! Westinghouse Batteries last. They hold their charge. They can be easily recharged. There's a size and type for every radio need. Built by Westinghouse, you *know* it's **RIGHT!**

Westinghouse **CRYSTAL CASE** Batteries have one-piece clear glass cases, with solid glass cell partitions and high plate rests (deep sediment spaces). Perfectly insulated against current leakage. "A" Batteries. 2 volts, for low-voltage tubes, such as WD-11 and WD-12. 4 volts, for tubes like UV-199. 6 volts, for tubes UV-201A or C-301A. Also rubber-case types. "B" Batteries. 22 volts. Regular and quadruple-capacity types. "C" Batteries in 6-volt units.

WESTINGHOUSE UNION BATTERY CO., Swissvale, Pa.

WESTINGHOUSE

RADIO

"A," "B" and "C" BATTERIES

Westinghouse Union Battery Co.
Swissvale, Pa.
Send me Westinghouse Radio Battery
Folder A-3-B.

.....

.....

.....



RHEOSTATS - POTENTIOMETERS

General Radio type 214 rheostats and potentiometers are a quality product. The base is made of genuine moulded bakelite and the wire is tightly wound on a specially treated fibre strip. A perfect, non-arcing contact is thus assured.

Where a smaller rheostat or potentiometer is required the type 301 will be found very satisfactory. These units are similar in construction to our type 214.

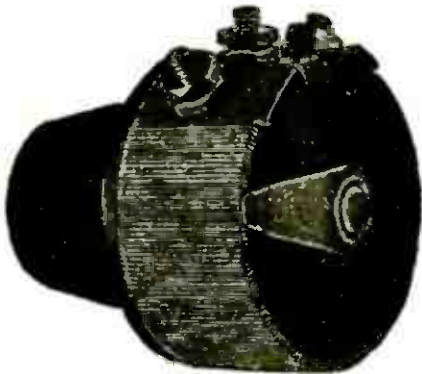

Type 214

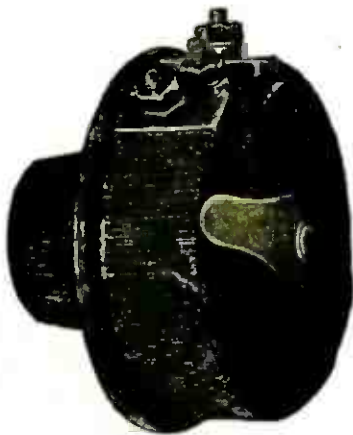

Type 301

The diameter of the 214 rheostat is three inches and that of the 301 is two inches.

G R rheostats and potentiometers also embody—

- Fineness in adjustment
- Smoothness in operation
- Temperature resistance stability

Type	Price
214 A 2 ohm Rheostat	\$2.25
214 A 7 " "	2.25
214 A 20 " "	2.25
214 A 50 " "	2.25
214 A 400 " Potentiometer	3.00
301 10 ohm Rheostat	1.25
301 30 " "	1.25
301 200 " "	1.25

Send for bulletin 916U

GENERAL RADIO COMPANY

Massachusetts Avenue and Windsor Street
CAMBRIDGE 39 MASSACHUSETTS

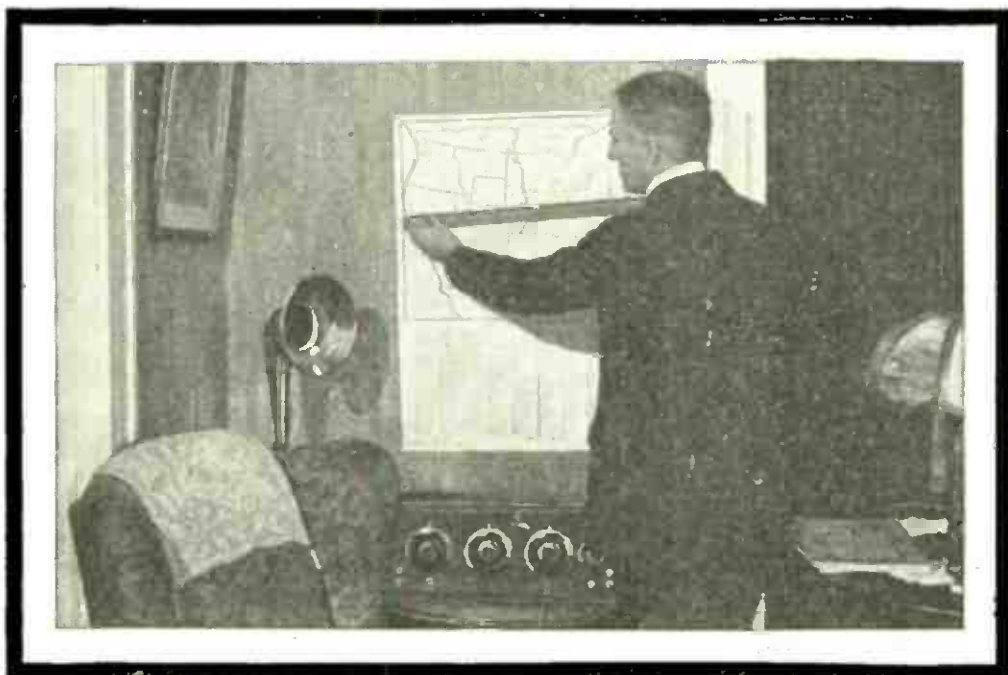

FADA "ONE SIXTY" WITH THE NEUTRODYNE CIRCUIT.

Distance

The real thrill of radio is in listening to voice or music on the loud speaker from broadcasting stations located in cities a hundred or a thousand miles away.

To tune them in almost at will is a feature that has made hosts of enthusiastic friends for the FADA "ONE SIXTY" radio receiver. Here is a four-tube receiver combining the famous Neutrodyne circuit with the craftsmanship and experience that have made the name FADA synonymous with quality in radio. It is a receiver that is the equal of any five-tube set of any type or make.

Selectivity, volume, distance and clarity are outstanding features of the FADA "ONE SIXTY" radio receiver. Once the dial readings of any station are recorded that same station can always be tuned in again by returning to the same settings—and almost always with loud-speaker volume. Price, without tubes, batteries or phones, \$120 at all dealers.

NOTE—For those who wish to build their own Neutrodyne receivers, FADA Neutrodyne parts are sold at \$25; the complete knock-down parts for four-tube set with book of instructions \$64; and the complete parts for five-tube receiver at \$65.60.

"How to Build It" book—the authority on the Neutrodyne circuit—sold by all dealers or direct for 50 cents per copy.

F. A. D. ANDREA, INCORPORATED
1581 Jerome Avenue, New York City

FADA

RADIO

\$25 for \$10

Dominating the World

THE ACOUSTICAL AMPLIFIER
BEL-CANTO
TRADE MARK

Direct from
Factory to You

**NO DEALERS
SALESMEN
JOBBER**

Their profit is your saving.

This is truly a wonderful opportunity to buy this nationally known speaker at a tremendous saving.

Call at the factory, send us your money order or pay the postmaster \$10.00 C. O. D., delivered at your door.

6 Points of BEL-CANTO Superiority

- (1) Fiber horn. Crystalline finish.
- (2) Our own adjustable loud speaking unit, giving a wide range of tone quality and volume without distortion.
- (3) The base is of cast iron, weighing four pounds, eliminating top-heaviness.
- (4) All other metal parts are of heavy cast aluminum, highly polished.
- (5) Complete instrument stands 24 inches high, 10 inch bell.
- (6) Guaranteed for one year from date of purchase against mechanical defects of any kind, and if found mechanically defective within that period of time, we will replace it with a new one without charge to you.

\$10

GUARANTEE

Money back any time within ten days if dissatisfied. We further guarantee to the publication carrying this advertisement that each and every speaker sold will be exactly as advertised in this issue.

BEL-CANTO MFG CO.

BENSIL-BONIS CO., Inc.

General Office and Factory: 417-419-421 E. 34th St., Dept. PR, New York City

RADIO FREQUENCY AMPLIFICATION WITH Ballantine Variotransformers (Patents Pending)



Model 5 \$9.60

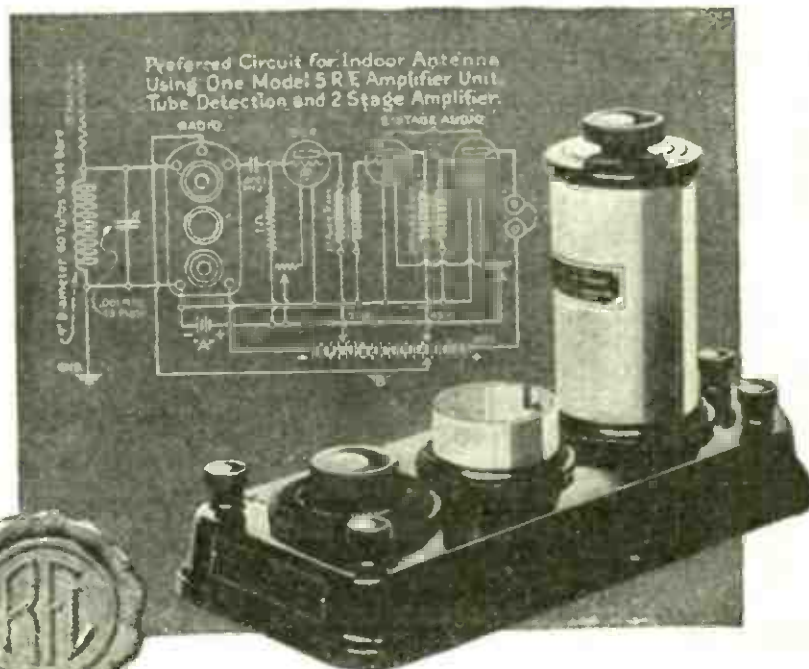

Complete Unit \$15.00

“TURN THE KNOB”

1. Continuous variation in wave length.
2. Self-contained and shielded.
3. Control of regeneration and tuning by single knob: *no potentiometer.*
4. Fits your set — either base or panel mounting.
5. Improved tone quality.

“Radio Frequency Amplification with the Ballantine Variotransformers” — a 25-page booklet — mailed free on request.

BOONTON RUBBER MFG. CO.

Pioneers in Bakelite Moulding

224 FANNY ROAD

BOONTON, NEW JERSEY

Electrad Products

Their Quality Absolutely Guaranteed

You are safe when you buy Electrad Products. They are absolutely guaranteed, electrically and mechanically, to be of the finest materials and workmanship.

Most good dealers carry them because they are fairly priced, and give their customers good service.

Double Your Distance with an Electrad Variohm



The latest invention is grid leaks. A simple turn of the knob and you can get any resistance from $\frac{1}{2}$ to 30 megohms. Eliminates circuit noises, is moisture proof and non-microphonic. Absolutely guaranteed.

Electrad Lead-in



Fits under closed window. Can be bent to any shape. Covered with fireproof insulation which prevents grounding on wet window sills. No holes in window frames and takes the place of unsightly porcelain tubes. Fitted with Fahnestock Clips.

Electrad Indorarial

Ideal for sharp tuning. Wonderful directional effects. Particularly effective where several local stations are broadcasting at once. Can be used also as ground. By using Indorarials for antenna and ground you can get any coupling you desire. Hang on wall, door or lay under rug.



Electrad Grid Leaks



Absolutely uniform unvarying fixed resistance. A superior product of dependability, in all resistance from $\frac{1}{4}$ to 10 megohms.

Dealers: Write for samples and details on our special group assortment.

ELECTRAD, INCORPORATED

Department C

428 Broadway, New York City

Coto

"Built First to Last"

Stop the Leaks with this Good Coto Air Condenser

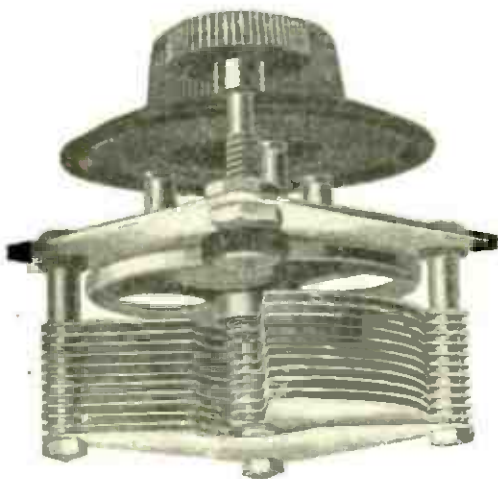

THIS high grade condenser often increases signal strength as much as an added stage of Audio Amplification. It takes full advantage of all the energy in the antenna. It avoids the insulation losses that cripple a radio set. The economy is obvious.

Coto Condensers have low losses because of single bearing construction and hard rubber insulation (the best for radio use.) The plates are of copper, soldered together and SILVER PLATED. Strong, handsome and compact, with VERNIER adjustment free from backlash. Moderately priced.

Type 3505 .0005 Mfd. **\$5** Type 3510 .001 Mfd. **\$6**

The Complete Answer to your demand for a real good Variable Condenser. Complete with handsome dial and vernier knob.

Other Coto specialties are Cotogrip Tube Sockets, Moulded Variometers and Vario-couplers with GUARANTEED range of 200 to 600 meters covering the broadcasting wave lengths, Tapped Radio Frequency Transformers, Audio Frequency Transformers (Type 4000, \$5) and Honeycomb wound Coils.

If your dealer cannot supply you, write us at once giving his name and address and a list of the Coto Radio Parts that you need. You'll get them.

COTO-COIL CO.,
87 Willard Ave., Providence, R. I.

BRANCH OFFICES:

Los Angeles, 329 Union League Bldg.
Minneapolis, Geo. F. Darling,
705 Plymouth Bldg.
Atlanta, C. P. Atkinson, Atlanta Trust Co. Bldg.

Canadian Distributors:

Perkins Electric Co., Ltd.,
Montreal Toronto Winnipeg



Type 4500
The 3 to 1 Ratio
Transformer for All Stages

You can now settle all arguments as to desirable Transformer Ratios in different stages. The question has been needlessly complicated. As usual the simple answer is most economical and best in performance.

Use Coto Specials in all stages and you will be delighted with the ample volume and freedom from distortion. Hundreds of buyers praise them. For reflex circuits they are simply great. Once you have tried them, you will recommend Coto Specials to all your radio friends. Price \$2.50

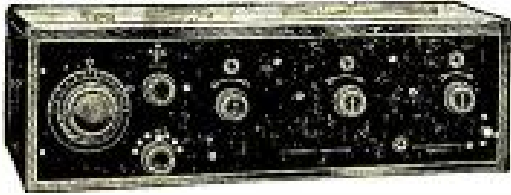

This new Ace Type 3B Armstrong Regenerative Radio Receiver is the height of perfection. It is equal to a combination of the Ace Type V and the Ace two-stage amplifier. For volume and distant reception it out-performs most sets costing a great deal more. The new Ace Type 3B has a filament switch which eliminates necessity of turning out rheostats when set is not in use. Sells for \$50.00 but worth much more. Has genuine mahogany cabinet with engraved panel.

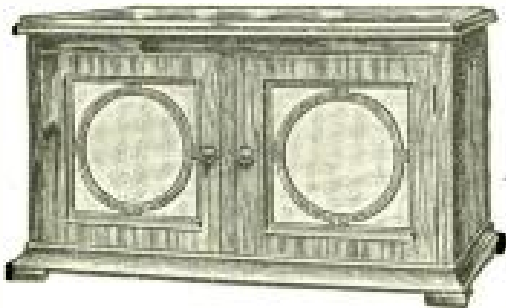

ACE TYPE 3C CONSOLETTTE

This is the last addition to the Ace Family. Has beautiful solid mahogany, wax finished cabinet. Set consists of a regenerative tuner, detector and two stages of amplification with built-in loud speaker. Due to the particular method of winding Crosley coils it is exceptionally selective. Has sufficient room inside Cabinet for dry batteries, making a complete self-contained long range receiving outfit. Phone jack for tuning with head phones; Crosley multistat; filament switch, engraved Formica panel. Uses all kinds of tubes. An efficient set at a remarkable price, \$125.00—without tubes or batteries.

Your dealer can supply you.
Ask for "Simplicity of Radio"
—your copy is free.

DEALERS: Write on your
letterhead for attractive sales
proposition.

Determining Quality

A RADIO set or product is no better than the science and skill that creates it.

Those men in this Institution who are intrusted with the responsibility of producing up to the standards of Powel Crosley, Jr., are experts who have won national recognition in their chosen scientific field.

Honest Merchandise uses Truth in Advertising

Ace Type 3B and Ace Type 3C Consolette manufactured under Armstrong U. S. Patent No. 1,113,149

THE PRECISION EQUIPMENT CO.
316 VANDALIA AVE. POWEL CROSLY, JR., Pres. CINCINNATI, OHIO

Please refer to POPULAR RADIO when answering advertisements.

The WANDERING MINSTREL of TODAY

HOW far have we progressed from the days when the minstrels, singing their self-composed ballads to the accompaniment of harp or lute, or telling their stories illustrated with crude mimicry, wandered from castle to castle in old England furnishing to the nobility practically the only entertainment available.

Today every American, no matter how far removed from the centers of activity, has within his reach up-to-the minute news and amusements that would have delighted the hearts of the nobility of old. The air is filled with merriment waiting to be captured and brought to your very fireside.

Radio is the magic wand that attracts to you the desired entertainment. Crosley Radio Receivers are the instruments by which this entertainment may be clearly and distinctly converted into a true reproduction of the original voice thousands of miles away.

You can own and enjoy a Crosley Radio Receiver. Unique features and quantity production have enabled us to offer the greatest value in radio ever produced. Actual tests by hundreds of satisfied users in all parts of America have proven that in performance, Crosley Instruments are unexcelled. And the prices are remarkably low.



CROSLEY

MODEL VI \$30
Two Tube Set

MODEL X-J 65
Four Tube Set

MODEL X-L 140
Four Tube Set
With Built-in Loud Speaker



CROSLEY
Better - Cost Less
Radio Products

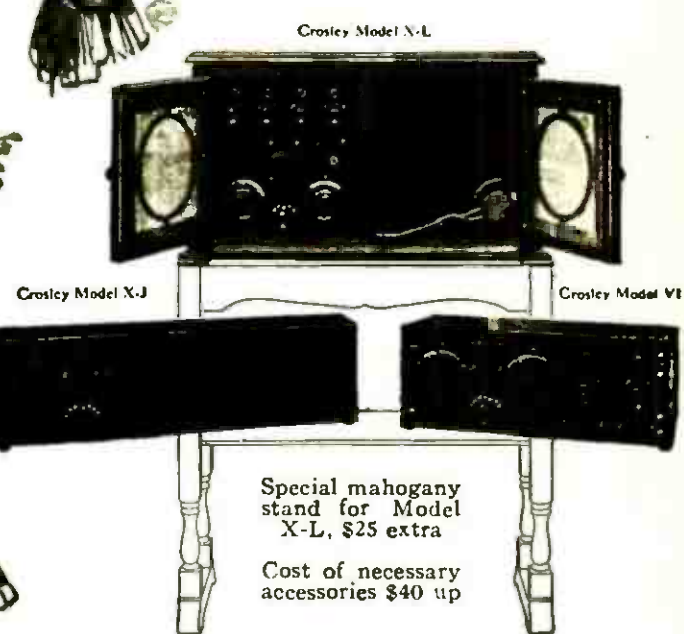

MODEL VI—\$30. A wonderfully efficient two tube set, one stage of Tuned Radio Frequency Amplification and Detector.
MODEL X-J—\$65. A four tube radio frequency set combining one stage of Tuned Radio Frequency Amplification, a Detector and two stages of Audio Frequency Amplification. A jack to plug in on three tubes for head phones, the four tubes coupled up for loud speaker.
MODEL X-L—\$140. A duplicate of Model X-J except the arrangement and mounting into a beautiful cabinet with the addition of a built-in loud speaker and space in the cabinet provided for housing the necessary batteries.

Crosley Manufacturing Company owns and operates broadcasting Station WLW

Let a Crosley Radio Receiver Bring Perpetual Entertainment to Your Home.

For bringing in distant stations no set can excel it
For Sale By Good Dealers Everywhere

Crosley Manufacturing Company
Largest manufacturers of Radio Receivers in the World
Powel Crosley, Jr., President
216 Alfred Street Cincinnati, O.

Mail This Coupon Today

Crosley Manufacturing Company
Powel Crosley, Jr., President
216 Alfred St., Cincinnati, Ohio

Gentlemen:
Please mail me free of charge complete catalog of Crosley instruments and parts. I enclose 10c for which also send your booklet entitled "The Simplicity of Radio" by Powel Crosley, Jr.

Name.....
Address.....

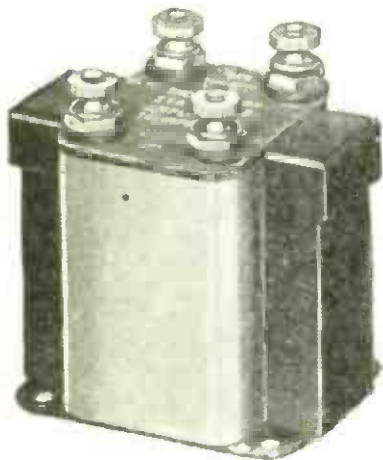

YOUR SET WILL BE A MUSICAL INSTRUMENT

WHEN YOU USE

THE THORDARSON SUPER AUDIO FREQUENCY AMPLIFYING TRANSFORMER

Heretofore, amplifying transformer manufacturers have given too much attention to volume of amplification and have sacrificed the most important function of their transformers,—that of perfectly reproducing the broadcasted programs. Consequently many listeners in have complained about the musical qualities of radio reception.

No matter how good your phonograph, you could not expect to obtain good music from a poor record. Likewise, although your loud speaker be the best, you cannot expect to enjoy radio reception if the signals you put into it have been distorted in the process of amplification.

The new THORDARSON SUPER Audio Frequency Transformer was designed to correct the shortcomings of amplifying transformers of the past and embraces the following cardinal features:

- (1) **Perfect reproduction of voice and instrument**
- (2) **Even amplification over the entire musical range. (You will be surprised to hear the amazing reproduction of the bass notes.)**
- (3) **Increase in volume to the extent that tonal purity will permit.**

This SUPER TRANSFORMER is the result of several months research work in the thoroughly equipped Thordarson laboratory and represents the culmination of twenty-eight years experience in manufacturing small transformers.

Such leading set manufacturers as the Colin B. Kennedy Company, Chicago Radio Laboratories Company (Zenith) and the Western Coil and Electric Company (Radiodyne) along with many others proclaim the merits of the THORDARSON SUPER TRANSFORMERS.

Install a pair of Thordarson Super Transformers now and your receiving set will be converted into a real musical instrument.

YOUR DEALER HAS THEM

THORDARSON

ELECTRIC MFG. CO.

CHICAGO, ILLINOIS

Now Links Two Continents!

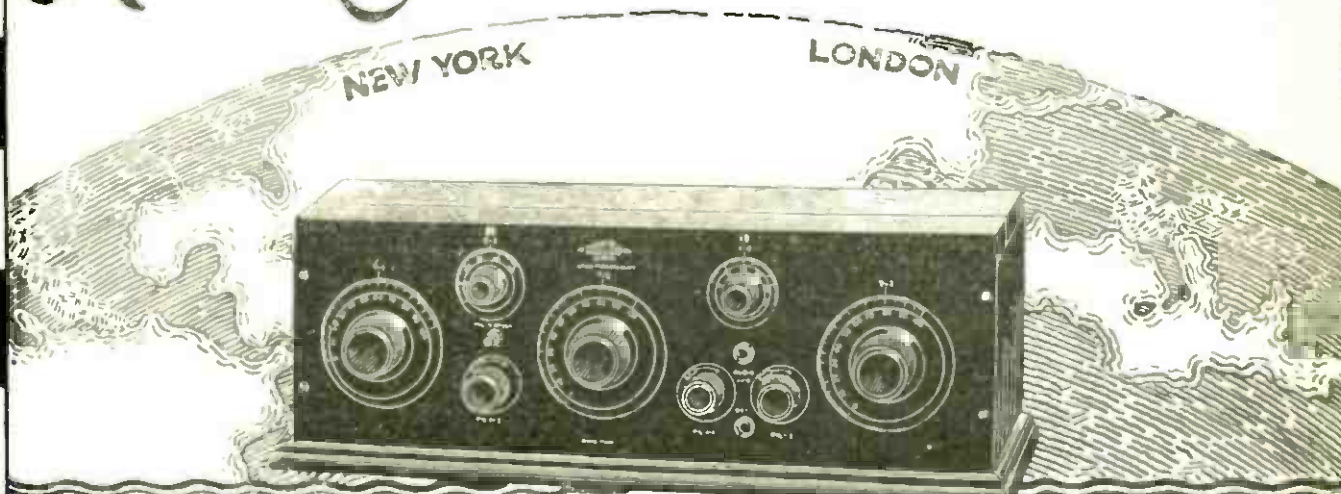

MELCO-SUPREME

Tuned Radio-Frequency RECEIVER

Satisfies Every Radio Wish

DX performances by enthusiastic owners prove conclusively that the MELCO-SUPREME is in a class by itself when it comes to

REAL LONG DISTANCE RECEPTION

- | | | |
|-----------------|----|--------------------|
| Brookfield, Mo. | to | Glasgow, Scotland |
| Brooklyn, N. Y. | to | Los Angeles, Cal. |
| Cleveland, Ohio | to | Havana, Cuba |
| Portland, Ore. | to | Schenectady, N. Y. |
| Leechburgh, Pa. | to | Dallas, Texas |
| Porto Rico | to | Philadelphia, Pa. |

(Names and addresses on request)

Extreme Selectivity — Exceptional Clarity — Simplicity of Operation

Write for complete descriptive literature

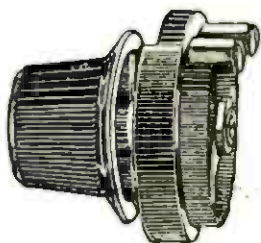

Rheostats and Potentiometers

With knob or dial—suitable for either table or panel mounting.

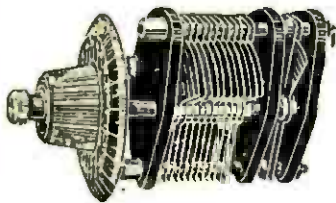

Variable and Vernier Condensers

Precision-made for accurate tuning.

AmSCO quality apparatus has been selected by Mr. Laurence Cockaday for use in his new Improved Four Circuit Tuner as described in detail in the January issue of Popular Radio.

AMSCO PRODUCTS, Inc.
FAIRBANKS BUILDING
BROOME & LAFAYETTE STS. NEW YORK CITY



An Easy Way to Cut Out Interference

Add a Ferbend
Wave Trap to
Your Set

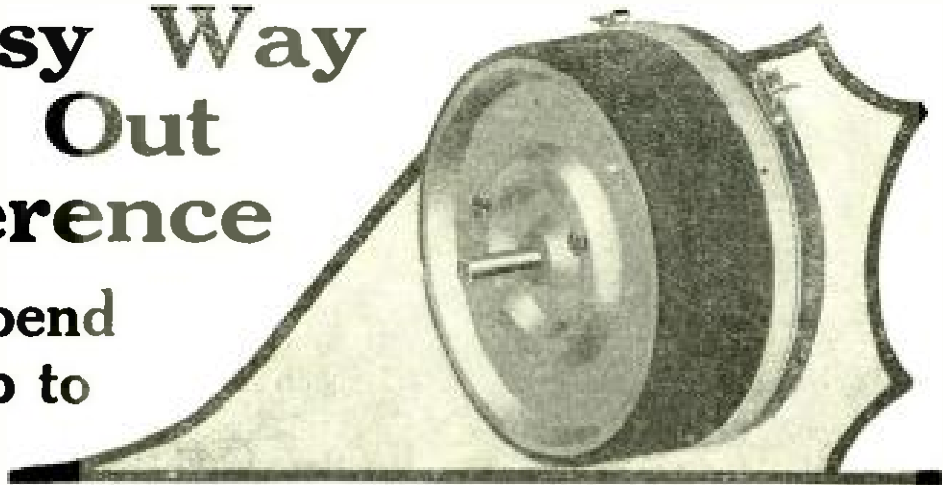

Enjoy your radio set. Get the station you want, *quickly*. Listen in on one thing at a time without annoying squawk-k-k-s or irritating whistles.

The Ferbend Wave Trap Makes Every Night Silent Night

New radio broadcasting stations are making receiving constantly more difficult. Many owners of long-distance sets are discovering powerful amplification is of little value so long as local stations are "all over the dial." Hundreds of users have solved the difficulty with the Ferbend Wave Trap—the missing link in Radio. A St. Louis user reports: "Heard Havana clearly with three St. Louis stations broadcasting. My receiver works like a new set. The 'Ferbend' is certainly a wonder!"

YOU Can Obtain These Remarkable Results

You can obtain results as satisfactory as this St. Louis user. If you don't, it doesn't

FERBEND ELECTRIC CO.

21 E. South Water St. Chicago

<p>Ferbend Electric Co. 21 E. South Water St. Chicago</p> <p>Send me a Ferbend Wave Trap. I will pay Postman \$6.00 (plus postage). I understand you guarantee the "Wave Trap" to tune out my local stations or my money will be refunded.</p> <p>Name</p> <p>Address</p>

cost you a penny for the "Wave Trap" is sold with a positive guarantee that it will tune out your powerful local stations. Don't wait. Order now at our risk.

SEND NO MONEY

You need not send a penny. Pay Postman \$6.00 (plus postage). If you prefer, send \$6.00 with order and Wave Trap is mailed *postpaid* ready for panel mounting. Money back guarantee either way. You see you take no risk, so order TODAY.

FERBEND
TRADE MARK
Wave Trap
PATENT APPLIED FOR

The
Original
Wave
Filter



The Ferbend Wave Trap can also be supplied completely mounted ready for instant use on formica panel in mahogany finished cabinet, 6 x 5 x 6, \$8.50. Get full benefit of all the distance your set will give you. Order your Ferbend TODAY.

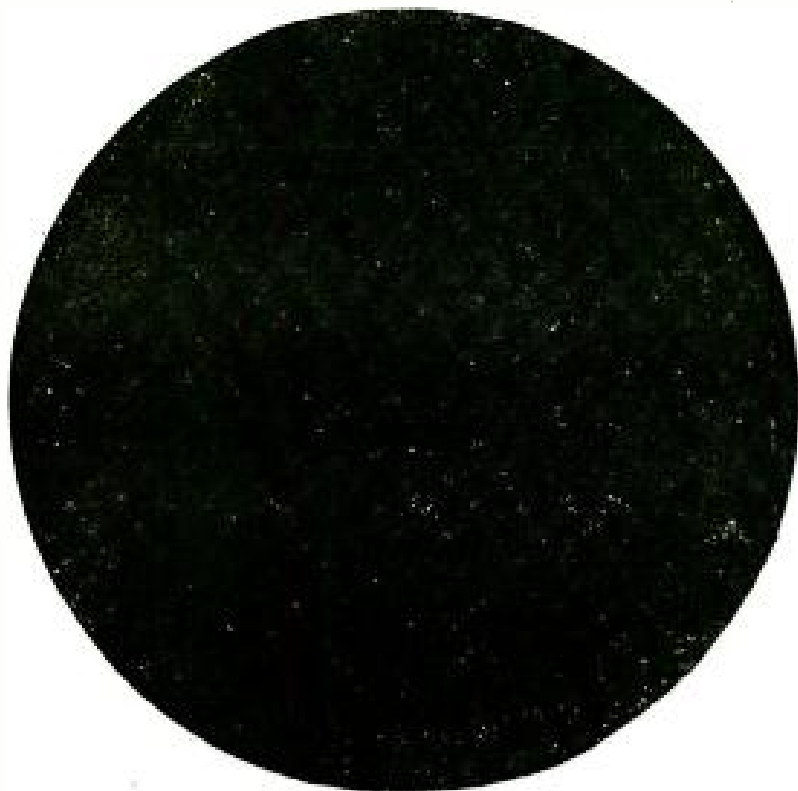

3 1/8 inches actual size of diaphragm in Timmons Talker

On Any Radio Set

Why the extra large diaphragm of Timmons Talkers give such wonderful volume

Sounds from a loud speaker are caused by the diaphragm vibrating and displacing air. The more air the diaphragm displaces the greater the volume.

Timmons Talkers have an especially large diaphragm (3 1/8 inches). This enables them to displace a great amount of air and in consequence give exceptional volume without forcing tubes. And, as you possibly know, it is the forcing of tubes that causes most distortion.

We would like you to hear Timmons Talkers and know for yourself their great volume and wonderfully clear tone.

Your dealer will be glad to let you hear a Timmons Talker in a comparison test with any loud speaker in his place. He will also give you our folder, "Volume without Noise" or write us. Type A (adjustable) \$35; type N (non-adjustable) \$25.

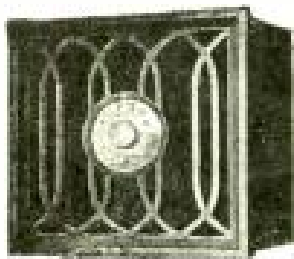

The most beautiful loud speaker in the world

J. S. TIMMONS

339 E. Tulpehocken St. Germantown, Phila., Pa.

Timmons Talkers

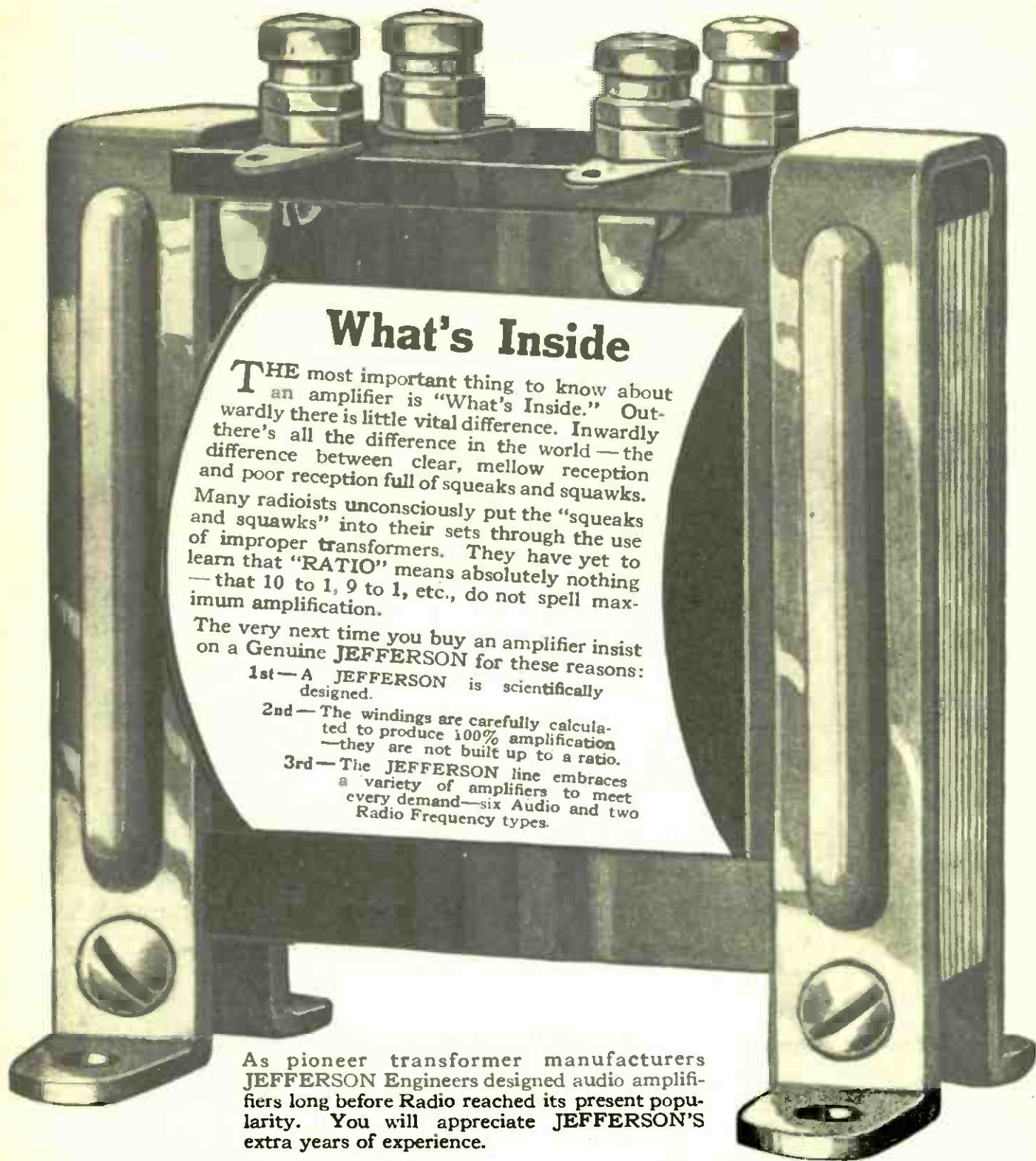

What's Inside

THE most important thing to know about an amplifier is "What's Inside." Outwardly there is little vital difference. Inwardly there's all the difference in the world—the difference between clear, mellow reception and poor reception full of squeaks and squawks. Many radioists unconsciously put the "squeaks and squawks" into their sets through the use of improper transformers. They have yet to learn that "RATIO" means absolutely nothing—that 10 to 1, 9 to 1, etc., do not spell maximum amplification.

The very next time you buy an amplifier insist on a Genuine **JEFFERSON** for these reasons:

- 1st—A **JEFFERSON** is scientifically designed.
- 2nd—The windings are carefully calculated to produce 100% amplification—they are not built up to a ratio.
- 3rd—The **JEFFERSON** line embraces a variety of amplifiers to meet every demand—six Audio and two Radio Frequency types.

As pioneer transformer manufacturers **JEFFERSON** Engineers designed audio amplifiers long before Radio reached its present popularity. You will appreciate **JEFFERSON'S** extra years of experience.

And remember this—the first cost of an amplifier is unimportant. Results count—buy an amplifier for what it will do—the service it will render—the tone and volume it will produce. Receiving is fun when one doesn't have a lot of pesky distortion to struggle with. You eliminate distortion when you use **JEFFERSON**. Your set operates

more quietly and clearly—the volume is greatly increased—distant stations are easily tuned in.

You are invited to write our Radio Engineering Department for amplification data. Attractive descriptive literature is also available. This service is gratis.

JEFFERSON ELEC. MFG. CO.,

427 South Green Street, Chicago, Ill.



Jefferson

Super-sensitive

Amplifying Transformers



Please refer to **POPULAR RADIO** when answering advertisements.

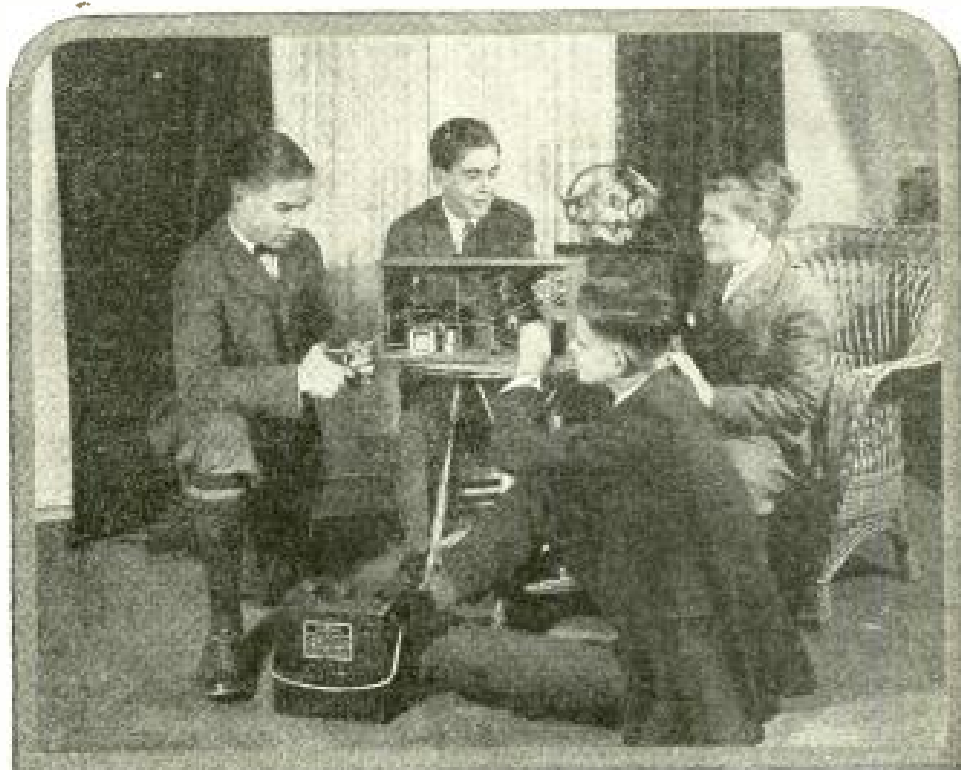

Radio is a triumph of Youth

The great names in radio are those of young men—men who, as boys, made invaluable contributions to the development and perfection of this still new wonder. Armstrong, Cockaday, Tuska, Reinartz—starting with crystal sets—brought out their inventions when in their 'teens, or early twenties. The imagination, perseverance and eternal curiosity of boyhood kept them experimenting, testing, striving for improvement.

The spirit of boyhood has not changed. Millions of boys to-day, starting with crystal sets, work their own way up the ladder. Their hoarded savings go for the parts with which to build. Success leads them to new efforts. Parents, interested, buy them better, more expensive sets to experiment with. But each new set is but the starting point for further improvement. Boys are never satisfied—their curiosity will not let them be.

**THE
AMERICAN BOY**
"The Biggest, Brightest, Best Magazine
for Boys in All the World"

is radio authority and mentor to 500,000 wide-awake, aggressive, radio-saturated boys, averaging 15½ to 16 years old. Some of them are at the bottom of the radio ladder—starting with cat's-whiskers. The vast majority are advanced radio enthusiasts who naturally turn to THE AMERICAN BOY'S stories and articles for new suggestions, new methods—and turn to its advertising columns for the newest and best radio equipment.

Half a million sons of well-to-do parents are buying somebody's radio products—spending their own money and getting their parents to spend for them. Brand the radio wants of this vast army of AMERICAN BOY readers with your name. Win their goodwill and loyalty. Open your door to their tremendous trade by advertising your products in their own respected magazine—THE AMERICAN BOY.

THE SPRAGUE PUBLISHING COMPANY

(Member A.B.C.)

548 Lafayette Boulevard, Detroit, Mich.

Please refer to POPULAR RADIO when answering advertisements.

A Trans-Atlantic Triumph



ROCKY MOUNT,
NORTH CAROLINA.
December 6th. 1923.

Mu-Rad Laboratories, Inc.,
Asbury Park, N.J.

Gentlemen:

Thought it might be a matter of interest to you to know that on last Tuesday night November 27th. on your Mu-Rad Receiver I heard Glasgow, Scotland. The signals were not very strong, but very plain. Every word of "The House That Jack Built", as broadcast from that station were heard by the writer.

K.H.J. Los Angeles, California, a distance of about 2,800 miles comes in at times loud enough for a loud speaker without extra amplification.

Very truly yours,

D. W. Christie

Over
3600
Miles

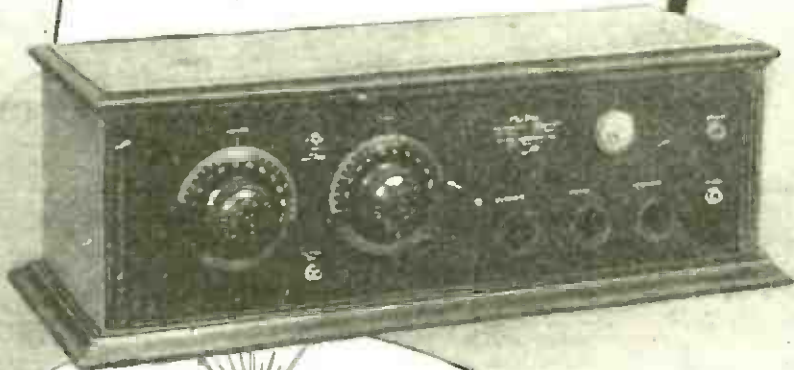

MU-RAD RECEIVER

A DESCRIPTION of actual Mu-Rad performances, without such supporting evidence, might seem exaggerated. The New Mu-Rad MA-15, a long range receiver, adds to the well known sensitivity, easy operation and selectivity of Mu-Rad receivers, loud speaker volume with only a 2 foot loop. Detector, three stages of radio frequency and two stages of audio frequency amplification. 1,000 miles Reception Guaranteed. Write for Literature.

MU-RAD LABORATORIES, INC.

809 FIFTH AVE. ASBURY PARK, NEW JERSEY

Use Graphite Disc Rheostat Says prominent radio expert

Good for
ALL tubes



Retail Price **\$1.85**
IN CANADA \$2.50
POSTAGE 10¢ EXTRA

**RADIO FACTS FOR EVERYBODY;
NEWS AND THEORY OF WIRELESS**

While Nearly All Standard Tubes Will Give Good Results. Low Vacuum Type Is Best, Says Calcatera.

LOW VACUUM TUBE IS BEST.

All standard tubes, however, will give good results.

BY JOSEPH CALCATERA.
(Radio engineer.)

Another important consideration in getting maximum efficiency from a single tube is choice of the tube to use. While practically all the standard tubes now on the market will give good results, there is one tube which gives best results. That tube is the soft or low vacuum tube especially designed for detector use. UV-200 and C-300 tubes are of this type.

In tool making and high class instrument making, the best results are obtained only when the best tools and most painstaking methods are used. So also in radio receiving, exceptional results are obtained only when corresponding care is taken. The hard or high vacuum amplifier tubes can be used as detectors and their characteristics are such that a critical adjustment of grid filament and plate currents are not required. With the soft tubes, however, best results are obtained only when the Vernier Rheostat is used.

For adjustment of filament temperature, to obtain the best operating point of the tube, a Vernier rheostat, preferably of the carbon pile resistance type, should be used. Care must be exercised in its use. The grid filament should be connected to the positive lead of the "A" battery. The rheostat should be placed in the negative lead of the "A" battery, that is between the negative of the "A" battery and one of the filament terminals of the socket.

While a considerable change in the plate voltage applied in the plate circuit of a hard or amplifier tube when used as a detector will make very little difference in the operation of the tube, the soft detector tube is very responsive to slight changes in the plate voltage. The characteristics of different tubes of the same type vary to some extent, so that a fine variable adjustment must be provided in the care of the individual requirements of the tube used.

Can Vary Adjustment.

Usually the best point will vary from 18 volts to 22½ volts. The adjustment can be varied to a certain extent by trying the lead from the plate circuit to the positive end of the battery on the different taps provided on practically all "B" batteries. In most cases, however, a finer adjustment than the 1½ volt steps provided by the taps is required and this can be obtained by the use of a potentiometer.

One end (either end, may be used) of the resistance element of the potentiometer is connected with the positive lead of the "A" battery and the other end of the resistance element is connected with the negative lead of the "A" battery.

The wiper of the potentiometer, which is connected with the movable arm or contact of the potentiometer, is connected to the plate voltage. The big variations in the plate voltage are obtained by moving the positive "B" battery lead to different taps of the "B" battery.

Clipping from
Chicago Daily News
October 24, 1923

What Is Meant by a "Carbon Pile" Rheostat?

MORE than 20 years ago, the Allen-Bradley Co. developed a successful compression rheostat for big power circuits. It was made of flat carbon discs and the electric current flowing through the column was regulated by applying or removing pressure on the discs. The idea of the carbon pile was not new, even then, but successful commercial rheostats were unknown. Graphite discs, however, soon replaced the carbon discs and to this day all Allen-Bradley rheostats are graphite disc rheostats, although many prominent engineers still speak of them as carbon piles.



THE Universal Bradleystat is sometimes called a carbon-pile rheostat. It is, however, a graphite disc rheostat. The discs are produced in an electric furnace under the most terrific temperatures known on earth. Carbon discs, carbon powder, metallic powder or other materials have long since been abandoned in favor of the reliable and noiseless graphite discs. Your radio set needs a Universal Bradleystat for long-distance range, loud reception and noiseless control. By all means, avoid substitutes. Insist on the Universal Bradleystat.

The Bradleystat Won First Place in the Radio Broadcast long distance contest. The first prize winner used a Bradleystat and the greatest mileage record was made with a Bradleystat. More Bradleystats were used in this contest than the next four types combined. Bradleystat supremacy has become an actual fact through sheer force of superior performance.



Just Mail This Coupon!

Allen-Bradley Co.,
276 Greenfield Ave., Milwaukee, Wis.

Please send me your latest bulletin on the Universal Bradleystat and why it improves radio reception.

Name

Address

Reduce Tubes by Half With Erla Synchronizing Transformers

Vacuum Tubes
in ERLA Duo
Reflex Circuits

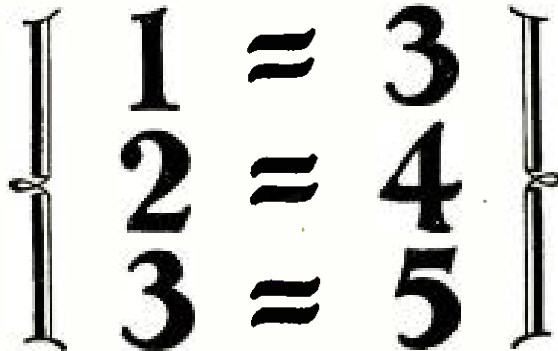

Vacuum Tubes
as Ordinarily
Employed —



Increased amplification and elimination of distortion inevitably follow installation of Erla transformers. Reflex and cascade types. \$5



Crystal troubles vanish on installing an Erla rectifier. No adjustment required. Proof against jolt and jar. Lasts indefinitely. List \$1



Look for the words "tested capacity," found exclusively on the labels of Erla fixed condensers. Made in eleven sizes. 35c to 75c ea.

Nation Wide Loud Speaker Reception With Only Three Tubes

Greater range and volume with fewer tubes than ever before are attained through Erla Duo-Reflex circuits, using Erla synchronizing radio and audio transformers.

In Erla circuits, tubes do triple duty, as simultaneous amplifiers of received radio frequency, reflexed radio frequency, and reflexed audio frequency currents. Through accurate superimposition of currents identical in phase and frequency, by means of Erla synchronizing transformers, this triple function is flawlessly performed, resulting in tremendously magnified amplification without distortion.

Even one tube provides excellent loud speaker reception over a wide range; two tubes blanket the zone ordinarily covered by four, while three tubes bring in stations on the loud speaker from coast to coast.

Other notable improvements, contributing vitally to the superiority of Duo-Reflex circuits, are the Erla fixed crystal rectifier and Erla tested capacity condensers. Combining advanced characteristics for reflex work with unduplicated uniformity, they are indispensable to complete stability and purity of reproduction.

Detailed diagrams and descriptions of Erla Duo-Reflex circuits are presented in Erla Bulletin No. 16. Ask your dealer, or write, giving your dealer's name.

Electrical Research Laboratories
Dept. R 2515 Michigan Avenue, Chicago

ERLA



Erla audio transformers add tremendously to the purity and volume of any receiving unit in which they are used. Ratios 3½ and 6 to 1. \$5



Screen unsightly openings for tube ventilation with Erla bezels, made in 1" and 1½" sizes, in bright nickel or dull enamel. List, 20c



Erla sockets combine maximum beauty and strength, with heavy, nickle-plated shell cast into moulded Bakelite base. Many other advantages. 75c

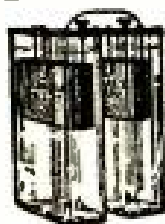

The Copper Giant "A" Battery

For WD11, WD12 and other low voltage tubes. Equal to 20 dry cells. Can stand idle for years without deterioration and requires no attention whatever. Ideal for multi-tube circuits using UV199. Write for circular.

THE COPPER GIANT BATTERY CO., Lansdowne, Pa.

PATENTS

Domestic and Foreign, Trade Marks and Copyrights. Infringement Suits and Interference Cases.

Booklet "More Light on Patents" Sent Free
MAX D. ORDMANN, Reg. Pat. Lawyer,

Mech. and Elect. Engineer,

Specializing in Radio

1503 Woolworth Bldg., N. Y. City Tel. Whitehall 7040-1

ATWATER KENT

RADIO EQUIPMENT

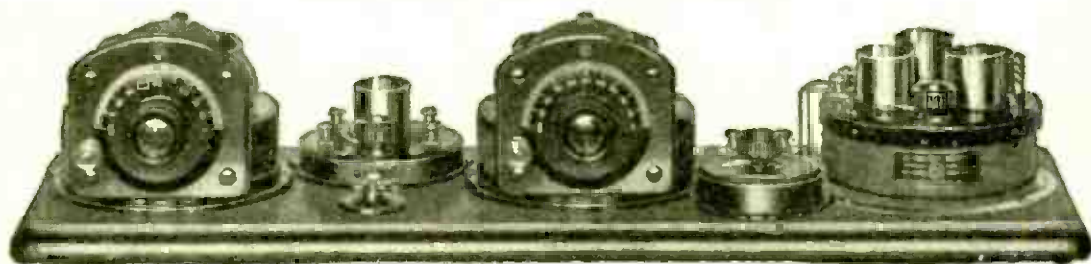

Atwater Kent Model 9 Receiving Set

Clear Reception Without Annoying Interference

THE ATWATER KENT Model 9 is an easily operated, highly efficient receiving set which gives excellent loud speaker performance on distant broadcasts. With this instrument it is easy to return to the dial settings once they have been noted.

You will find the fidelity with which the ATWATER KENT Loud Speaker reproduces tones delightfully pleasing. No batteries required.

ATWATER KENT Equipment embraces a variety sufficiently wide to meet the requirements of every user of radio. It includes complete sets and every instrument necessary for the assembling of sets from tuning unit to loud speaker.

If you are now working with a one-tube set, the ATWATER KENT 2-Stage Amplifier will give you the necessary volume to use a loud speaker.

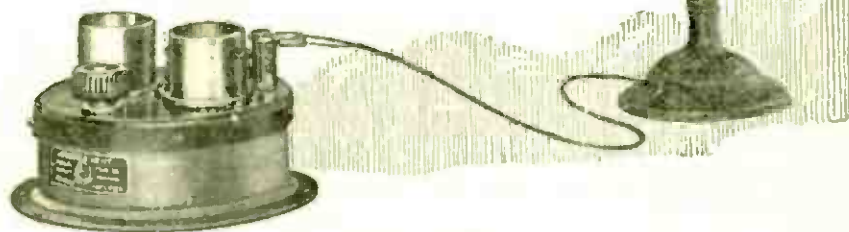

Literature describing the entire line of Atwater Kent Radio Sets and Parts sent on request

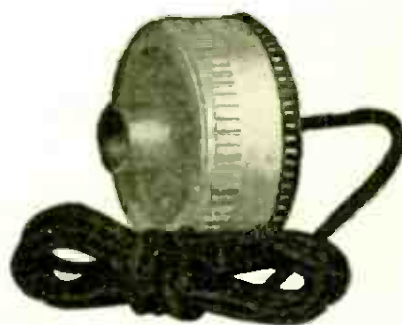

Phonograph Attachment

ATWATER KENT MANUFACTURING COMPANY, PHILADELPHIA, PA.
4933 STENTON AVENUE

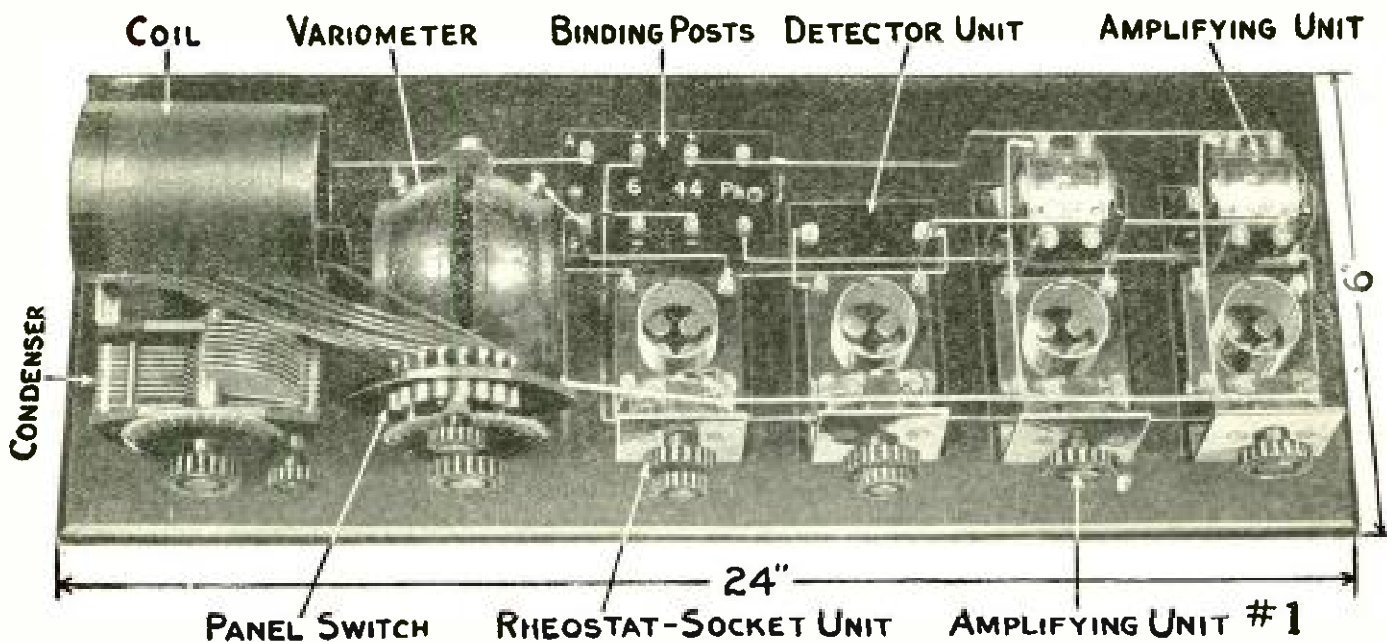

Tuned Wave Trap Radio Frequency Receiver

BUILT ON FAMOUS COPP CIRCUIT No. 4
 1 Stage Radio-frequency—2 Stages Audio-frequency
 Efficient for all wave-lengths from 200 to 700 meters
 Range up to 2000 miles

Any person can build the above set with A-C DAYTON Complete Units
\$43.35

Units packed complete in one carton with wiring diagrams, photographs, instructions, etc., for complete installation.

SEE YOUR DEALER OR WRITE US DIRECT

We manufacture a complete line of Radio Parts and Units—Catalog on request

THE A-C ELECTRICAL MFG. CO., Dayton, Ohio

Makers of Electrical Devices for over 20 Years.

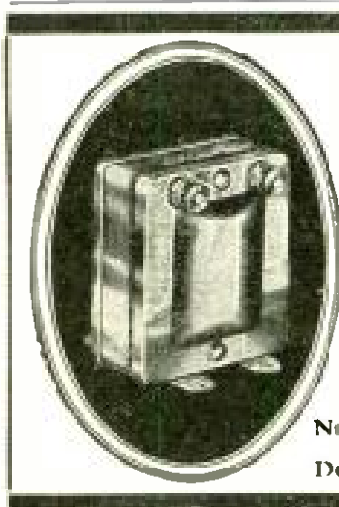

National Audio Frequency Transformers

The New 6 to 1 Ratio National Transformer is for use on the first stage of amplification. Its greater ratio means increased volume, but the tone qualities that characterize the 3 1/2 to 1 ratio have been fully retained. Price of 6 to 1 ratio \$4.50 postpaid; of the 3 1/2 to 1 ratio, \$4.00 postpaid. Dealers: Write for interesting sales proposition.

National Transformer Mfg. Co.
 154 Whiting Street
 Dept. 211 Chicago, Ill.

NA-ALD

De Luxe Dials

The artistic qualities of Na-ald De Luxe dials distinguish these dials as truly beautiful. They add to the appearance of any set in which they are used. Na-ald Dials have a high gloss finish. They are moulded of genuine Bakelite and have patented construction. Dials are matched and made in 2", 3", and 3 1/2" sizes.

Alden Manufacturing Company
 Largest makers of Radio sockets and dials in the world
 Dept. C 52 Willow St.
 Springfield, Mass.



No. 3003—4
 3 Inch
 35c, 3 for \$1.00

Please refer to POPULAR RADIO when answering advertisements.

I N D E P E N D E N C E

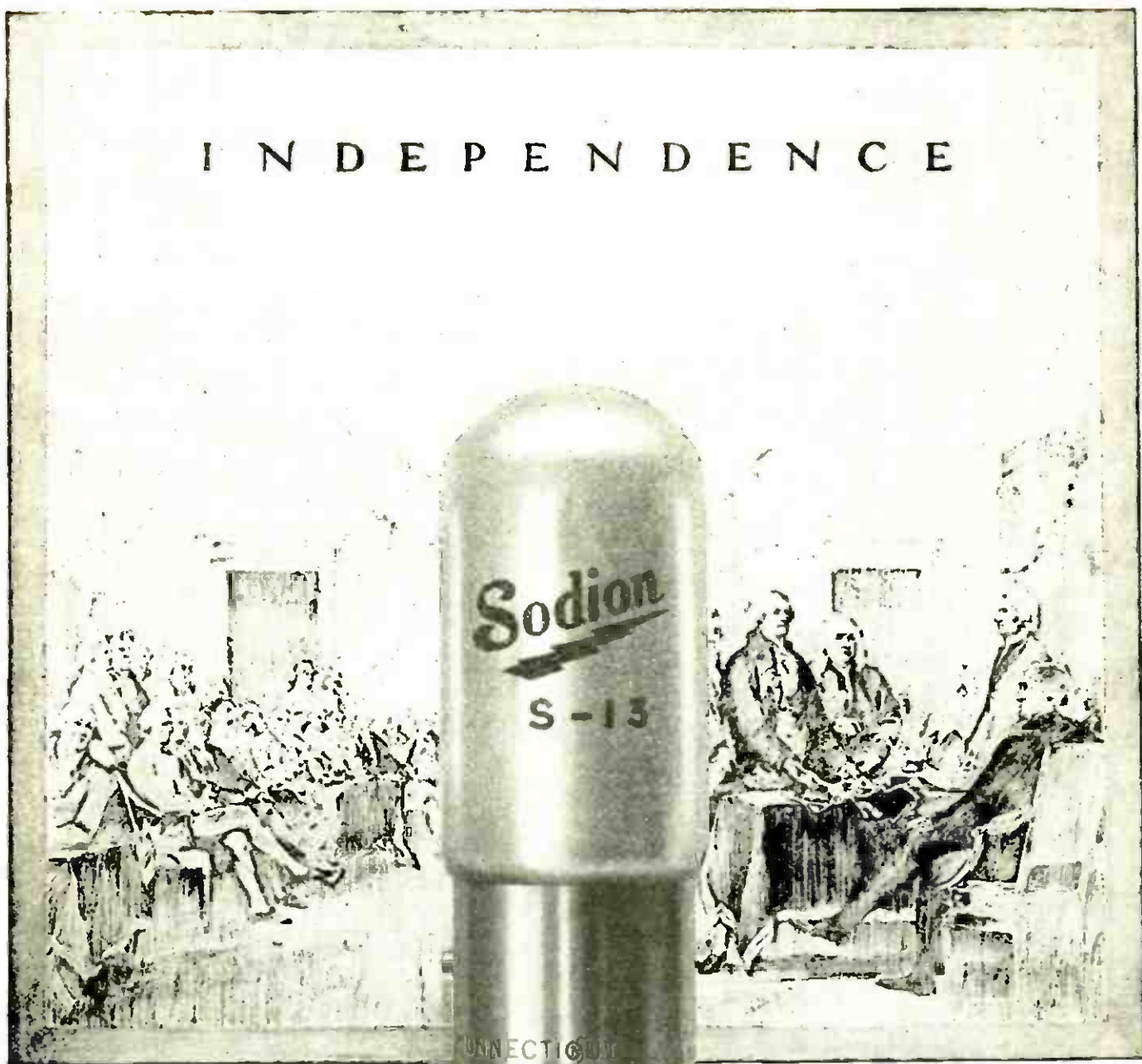

After Painting by John Trumbull

The Golden Rule Tube

The Sodion does not oscillate.

No declaration as to sensitivity, signal strength—or quality of tone—can mean half so much to every broad-minded radio enthusiast as this simple statement of fact.

For there—in five words—you have the key to the solution of the problem of eliminating the whistles, the squeals and the howls that interfere so seriously with your enjoyment of radio today.

Don't misunderstand—

The Sodion does not protect YOUR reception against these noises from other sets.

But, because it does not oscillate—because it cannot reradiate—because it cannot whistle and howl—the Sodion DOES prevent your reception from interfering in any way with the reception of others.

This, we believe, is the practical way of eliminating one of the greatest faults in broadcast Radio reception.

In point of efficiency the Sodion Tube is far more sensitive and produces stronger signals than any detector now on the market. Its tone is fully equal to that of the finest crystal with the added advantage of great volume.

Descriptive Bulletin upon request.



CONNECTICUT
MERIDEN

TELEPHONE
& ELECTRIC
Radio Division

COMPANY
CONNECTICUT



Please refer to POPULAR RADIO when answering advertisements.

WANTED! WANTED!

A NAME

to replace the Name "Acmedyne"

A set of essential parts for the above circuit will be given to the person furnishing the best substitute.

Write for rules governing the contest.

Closing Date February 15th, 1924

DANZIGER-JONES, Inc.

25A Waverly Place

New York City

RHAMSTINE★

Presents the New VICTOPHONE

—for all Phonograph and Loud-Speaking Horns



\$7.50 Postpaid
Complete with Cord

Relentless research in the field of loud-speaker units has resulted in Rhamstine★ achieving the ultimate in tone and volume. The New Victophone will exceed your expectations; you will appreciate its superiority upon comparison with other loud-speakers. Every part of this new Phonograph unit was designed and built to excel in efficiency and in beauty all other makes. It can be furnished to fit all phonographs—the Standard Type fits the Victrola, Columbia, Jewett or Sonora. Specify make of phonograph when ordering. List Price, Standard Type, \$7.50.

Order the New Victophone and test it before buying any other loud-speaker

The Rhamstine★ Electric Solder Set

New Round Type



\$2.50 Postpaid
Complete with Cord, two-piece Plug and Solder

Here is the new model—round type—electric solder set. A more handsome and heavier iron than the original flat model. The tip is easily replaced when worn out. Especially adapted for radio work. It is highly plated and polished. Can be used on 110 volts A. C. or D. C. Guaranteed one year. Order an electric solder set and solve your soldering problems. Only \$2.50 postpaid.

Manufactured by

J. THOS. RHAMSTINE★
Woodbridge at Beaubien Detroit, Michigan

**Maker of Radio and Electrical Products*

Please refer to POPULAR RADIO when answering advertisements.

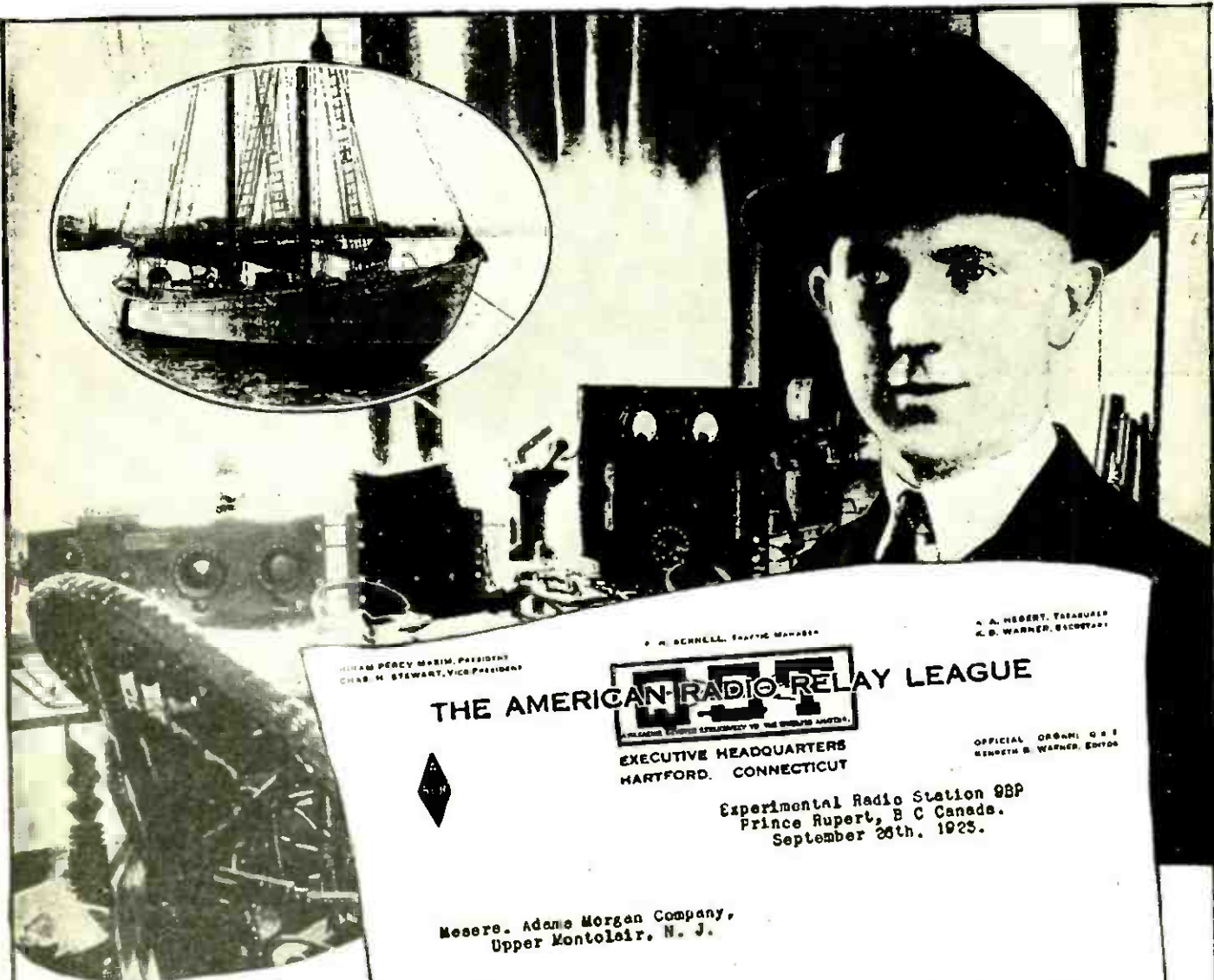

W. H. SCHNELL, TRAYNE MANAGER
 CHAS. M. STUART, VICE PRESIDENT

A. HEDERT, TALKER
 C. B. WARNER, SECRETARY

THE AMERICAN RADIO-RELAY LEAGUE

EXECUTIVE HEADQUARTERS
 HARTFORD, CONNECTICUT

OFFICIAL ORGAN OF THE
 AMERICAN RADIO-RELAY LEAGUE

Experimental Radio Station 8BP
 Prince Rupert, B C Canada.
 September 26th, 1925.

Messrs. Adams Morgan Company,
 Upper Montclair, N. J.

Dear Sirs:-

I have advised you before that I am very pleased with the results of my "PARAGON APPARATUS" but here is another victory for "PARAGON APPARATUS" which I feel you will be interested to know.

The Macmillan Arctic Expedition which left Wiscasset, Maine on June 25rd. on board the radio equipped Schooner "Bowdoin" planned to keep in touch with the outside world by amateur radio. This they were able to do until they got North of Disco Island, Greenland. After going North of that point nothing was heard of the expedition. And all interested became worried at the ship's apparent silence. The Chicago Radio Laboratory on this account offered a duplicate of the receiving apparatus aboard the "Bowdoin" as a prize to the first amateur to get into communication with the Arctic Expedition. This prize I have had the honor to win with the aid of my PARAGON Type RA-10 Regenerative Receiver and PARAGON Type DA-2 Detector-Amplifier.

Since first getting into communication with the "Bowdoin" expedition (who are in winter quarters frozen in at Refuge Harbour, which is ten miles North of Greenland Latitude 78.30 North, Longitude 72.30 West) on September 7th. I have had a working schedule with the operator and have copied one 600 word and one 181 word press message from them addressed to the New York World, together with dozens of private messages from the expedition and a complete list of amateur calls heard (a total of 646 calls) by the "Bowdoin" from July 28th to September 20th. and have forwarded all of these messages to their destinations.

When you consider that the expedition has heard hundreds of amateur stations in the Arctic but that my station has been the only one with whom they have been able to communicate, I consider this quite a record for "PARAGON APPARATUS" and am glad to be able to advise you how proud I am of my receiving apparatus.

Yours very truly
Jack Barnsley

*MacMillan's
 Link with
 Civilization*

A Paragon Radio Receiver is the most dependable link between MacMillan's courageous explorers and a civilization eager to hear of their doings.

Read this letter from Jack Barnsley whose Paragon Receiver has been picking up these vitally important messages, picking up every one, and getting every word clearly.

A Radio Receiver could have no higher recommendation.

Illustrated Bulletins on Paragon Radio Products are yours for the asking.

ADAMS-MORGAN CO.,
 20 Alvin Avenue,
 Upper Montclair, N. J.

GENUINE
BAKELITE
MOUNTED
\$1.75

"And it's real
bakelite!"



**FROST
RADIO**

TUBE CONTROL UNIT

HERE'S the finest piece of radio apparatus of its kind you ever saw! The new **FROST-RADIO** Genuine Maroon BAKELITE Tube Control Unit combines the following:

- a high grade 6 or 35 ohm vernier rheostat.
- a precision-built 400 ohm potentiometer.
- single hole mounting.
- smoothly working moving parts.
- superior design and finish.

When you install a **FROST-RADIO** Tube Control Unit on your set you end all tube control troubles—insure best results—save money. Either 6 or 35 ohm rheostat types: \$1.75. All metal parts nickel plated and hand buffed.

**Your dealer stocks
FROST-RADIO**

Go to your dealer today and examine this fine piece of apparatus. Judge for yourself if it is not the biggest value you ever saw.

Your dealer also stocks **FROST-RADIO** Sockets, Dials, Adapters, Fones, Jacks, Plugs, etc.

HERBERT H. FROST, Inc.
New York CHICAGO Kansas City

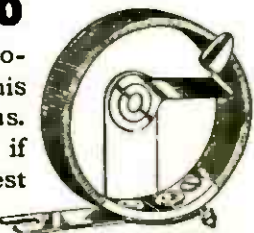

FROST-RADIO
No. 630 Resistance
Unit, 25c



CALLOPHONE

\$35⁰⁰

**You Can Hear a
Pin Drop!**

During a pause in the program reproduced through the Callophone. No metallic vibration or "static" to mar your enjoyment. Any disturbance instantly cleared by a turn of the dial controlling the diaphragm.

The Callophone Radio loud speaker is the result of years of experience in making loud speaking commercial apparatus—recognized as the finest obtainable.

The Callophone is built throughout with careful attention to each detail, and tested under actual operating conditions before leaving the factory. No extra batteries or equipment are required.

Not sold by all Radio Dealers. Sent direct from our factory to you, upon receipt of the purchase price—which will be returned to you if, after a ten day trial, you do not find it all we claim.

Incidentally, every Callophone we send out **STAYS**. We don't expect it back, because it has been tested beside every make of loud speaker, and *none can compare*.

**CALLOPHONE COMPANY
OF NEW YORK, Inc.**

216-222 Mercer Street
New York, N. Y.

I Can Qualify You as a Radio Expert in a Few Months!



E. R. HAAS
Director of
National
Radio Institute

Learn at Home

Earn \$2500 to \$10,000 a Year

Merle Wetzel, one of my students, reports that he now is making *three times* what he did before becoming a radio expert. Emmett Welch writes that after finishing my training he made \$300 a month and all expenses. George Jones says: "To your course I credit my present position as manager of this Radio Department." Hundreds of other former students enthusiastically tell of their successes as radio experts! The field of Radio today is a real treasure house of wonderful opportunities. It offers rewards beyond your fondest dreams! Mail coupon today for Free Book just out—which explains in detail the amazing opportunities in this World's Fastest-Growing Industry.

Hundreds of Big Paying Positions Waiting

Do you want to earn far more money than you ever dreamed possible? Do you want to be your own boss—to have a profitable business of your own? Do you want to travel the whole world over—and make big money while doing so?

Radio offers you all of these opportunities—and more! Radio, the new infant industry; Radio, growing with leaps and bounds; Radio, the field of endeavor with the most promising future of all!

Never in all history has an industry jumped into prominence so rapidly! Millions of dollars were spent last year on Radio. Hundreds of big-money positions were created almost overnight. Thousands of men trained in Radio were needed. And the future holds even greater promise for those who enter this fascinating field. Learn more about what Radio can offer *you*. Send for our new FREE BOOK on Radio.

**Pick Out the Job You Want
We Will Help You Get It**

This is a brief list of the positions in the Radio field today, and the salaries paid:

- Broadcasting Station Operator, \$125 to \$250 a month.
- Commercial Land Station Operator, \$150 a month and up.
- First-class Ship Operator, \$105 a month in addition to all expenses paid.
- Radio Engineer, up to \$10,000 a year.
- Radio Inspector, \$1,800 to \$4,500 a year.
- Radio Salesman, \$2,000 to \$10,000 a year.
- Radio Mechanic, \$1,500 to \$4,000 a year.
- Radio Instructor, \$150 to \$250 a month.
- Radio Draftsman, \$7 to \$10 per day.
- Radio Executive, up to \$15,000 a year.

NOTE: RADIO FIRMS
Secure Practical Radio Experts
Among Our Graduates
Write Today.

This Wonderful FREE BOOK Has Shown Thousands the Way to Bigger Money

This Free Book has opened the eyes of thousands to the glorious opportunities in Radio. If you are ambitious—if you are looking for a field which offers *big money, fascinating work, advancement, and a real future*, send for this Free Book. It costs you nothing. You obligate yourself in no way. Yet this book can easily mean all the difference between the work you are doing now and wonderful success! Before you forget—mail the coupon NOW!

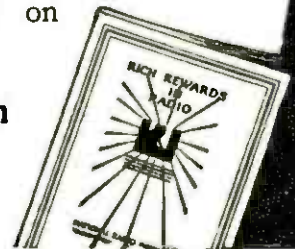

E. R. HASS
NATIONAL RADIO INSTITUTE
Dept. 32AB, Washington, D. C.

Without obligation on my part, please send me the free book, "Rich Rewards in Radio," with full details as to how I can quickly train for the position of "Certified Radio-trician" in my spare hours at home. Also tell me how your free Employment Service will help me secure a good-paying position, and about your special short-time offer. Please write plainly.

Name.....
Street.....
City..... State.....

NATIONAL RADIO INSTITUTE
Dept. 32AB, Washington, D.C.

A Good Name

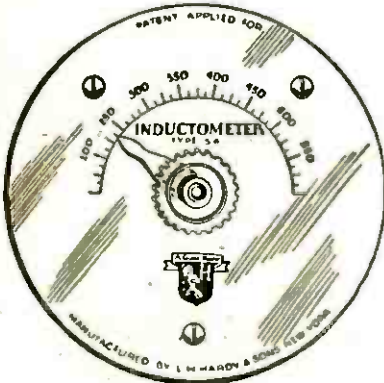

Hardy Circuit Inductometer

Patents Pending



Toroidal Transformer

- 2,500-mile type*.....\$8. 50
- 1,500-mile type..... 3. 50

* taps on sub-panel

The Hardy Circuit utilizes a specially wound inductance by which the utmost sensitivity with selectivity is attained. A transformer ratio of from 4:1 to 8:1 is secured by the Hardy design.

We guarantee the operator 2,500-mile range using our improved \$8.50 type of inductometer and over 1,500-mile range with \$3.50 type. The first has a spider rotor, sub-panel tapping design and bank wound secondary. It is sold with panel indicator and knobs.

- 200-600 Meter Type*.....\$5.00
- 3,300 Meter Type..... 9.50

* without mounting case \$2.15

After many months of testing and experimentation, our research engineer has developed a Toroid Radio Frequency Transformer for use in Neutrodyne and Super-Heterodyne circuits.

The coils are so wound that there is a minimum of capacity in the windings and the lowest dielectric loss possible. The coupling is extremely high. The external field is so small that with two inch spacing it is possible to construct a very compact receiver without use of shields.

Write For Descriptive Literature

L. H. HARDY & SONS, Inc.

528 SIXTH AVENUE
NEW YORK, N. Y.



There's No Need to Experiment with Day-Fan Radio Units

For your safety, convenience and economy, you can now get Day-Fan Radio Units assembled into sets. One of these sets will exactly meet your wants. You need not waste time and money in trying to find out

for yourself what you need to complete your outfit. See your dealer and he will suggest what Day-Fan type you should have. This will insure you better results, greater pleasure and real economy.

THE DAYTON FAN & MOTOR COMPANY :: Dayton, Ohio
Established 1889

A Transformer of Real Merit



The winding that Kellogg developed, was found to be most efficient for audio frequency transformers. Its problems involved the finding of the proper thickness of paper, the proper kind of insulated wire to provide the proper number of ampere turns, and impedance.

*Amplification
of Entire
Musical
Range
Free from
Distortion*

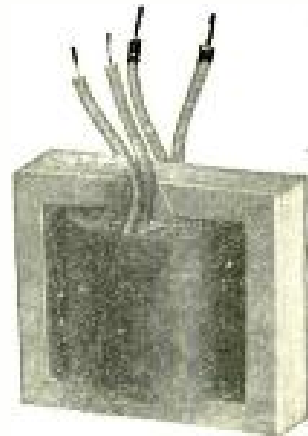

The one-piece laminations of silicon steel contain no punched holes, which in many other transformers causes eddy currents and losses. The one-piece lamination is exclusively a feature of the Kellogg transformer. It provides an exceptionally true electro-magnetic core.



To correctly shield these transformers that they may be mounted in any position desired without losses, this brass shield was designed. It is so arranged that both sides are interchangeable, locking together at the base. They are finished in a handsome maroon enamel.



The wires extend through the Bakelite top, which affords perfect insulation, and are soldered to the terminals in plain sight, where they may be inspected. This also eliminates any possibility of breakage of transformer leads.



The finished job, of which we are mighty proud. The leads are soldered to tinned terminals, which are under nickel plated nuts over which are placed knurled nuts. Each binding post is plainly marked so that it is impossible to make incorrect connections.



Amplify the pleasure of your radio set by installing Kellogg audio frequency transformers. Second to none in volume, clarity and freedom from distortion.

No. 501—Ratio 4½ to 1. No. 502—Ratio 3 to 1. Only \$4.50 each

Built and Guaranteed by
Kellogg Switchboard & Supply Company
1066 West Adams Street, Chicago

*For Transmission
or Reception!*

**"FRESHMAN SELECTIVE"
MERCURY VARIABLE CONDENSER**

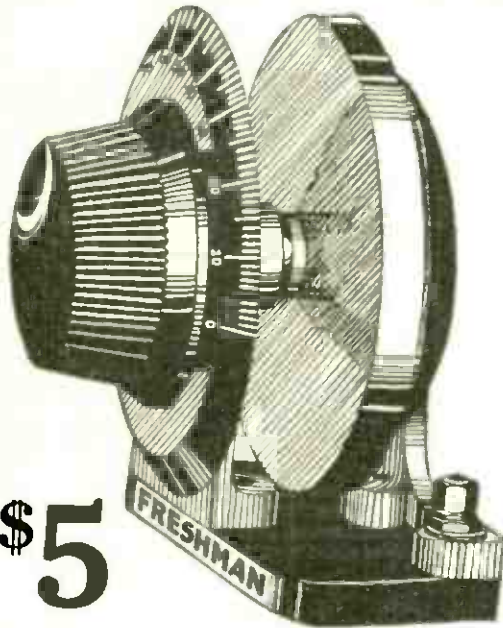

\$5

It has been conceded by the Foremost Radio Engineers that a Variable Condenser with Mercury plates is the most efficient for fine adjustment and selective tuning. Our engineers, after exhaustive experiments and research work, have developed a Variable Condenser with Mercury plates separated by heavy Mica dielectric. It is the **ONLY VARIABLE CONDENSER** the plates of which actually vary in area—**AN ENGINEERING FEAT NEVER ACCOMPLISHED BEFORE.**

- No leakage
- Absolutely quiet
- No plate vibration
- Will stand 5000 volts
- Compact and attractive
- Plates cannot collect dirt
- Cannot become short circuited

.0003 m. f. (equivalent to 17 plate)
.0015 m. f. (equivalent to 23 plate)
.001 m. f. (equivalent to 43 plate)

ALL TYPES **\$5**

All Molded Parts and Dial of the Finest Bakelite
At your dealer, otherwise send purchase price and you will be supplied postpaid

Chas. Freshman Co. Inc.
Radio Condenser Products
106 SEVENTH AVE. NEW YORK

FOUR WAY CO.

New Model

**"4-WAY"
SWITCH
PLUG ::**

At Your Dealer's

\$1.50



Switch on Loud Speaker or Head Phones by turning dial without removing Plug from Jack. Two

Head Sets may be used if preferred or both Loud Speaker and Head Set **AT THE SAME TIME**

**The new 1924 model
"4-Way" Switch Plug**

embodies many improvements, making the manipulation much easier. The improved Spring Locking Terminal Connections are far superior to binding screws. They form permanent electrical contacts which never work loose, as binding posts are apt to do.

**New SINGLE
Radio Plug—**

50¢ —the finest yet produced



—employing our positive spring terminal connections that have proved so successful in our **FOUR WAY PLUG**—never works loose.

See these beautiful plugs
AT YOUR DEALERS

Manufactured by

FOUR WAY CO.

Myrick Bldg., Springfield, Mass.



E·D·Elliott of Milford, N.Y. establishes a record

Think of getting London, England, Fairbanks, Alaska, and La Palma, Panama, when you live in New York! Yet this is the experience of Mr. Elliott, one of the hundreds of enthusiastic users of MIRACO sets. With the inexpensive outfit shown here, priced at only \$29.50, he received the following list of stations—results that would do credit to a set costing three or four times as much.

WLAY	London, England	WHAY	Wilmington
NNW	Fairbanks, Alaska	WRAY	Scranton, Pa.
PWY	La Palma, Panama	WOAY	Birmingham
CFAC	Havana, Cuba	WSB	Atlanta, Ga.
CJCY	Calgary, Can.	WMU	Washington
KFCB	Calgary, Can.	WCAT	Rapid City
KSL	San Diego, Cal.	WRC	Washington
KHQ	San Francisco, Cal.	KYW	Chicago
WJAR	Seattle, Wash.	KFCB	Phoenix
KFBU	Providence, R. I.	WWT	Buffalo, N. Y.
WEV	Lorine, Wyo.	WHAS	Louisville, Ky.
WMAT	Houston, Tex.	WCAY	Milwaukee, Wis.
WPM	Duluth, Minn.	WLW	Cincinnati, O.
WRAA	Washington	WDAW	Omaha, Neb.
WHB	Houston, Tex.	WQQ	Kansas City
KFIB	Kansas, Neb.	WPAW	Wilmington
CFCA	Hood River, Ore.	WCE	Minneapolis
CKCE	Toronto, Can.	WCX	Detroit, Mich.
CJCI	Toronto, Can.	WLAZ	Warren, O.
WRP	St. John, Can.	WAAS	Decatur, Ga.
NGE	Dallas, Tex.	WTAM	Cleveland, O.
KGA	Miami, Fla.	WWJ	Detroit, Mich.
KFEL	Oakland, Cal.	WJAZ	Chicago, Ill.
WIAZ	Denver, Colo.	WDAP	Chicago, Ill.
WKY	Miami, Fla.	WGY	Schenectady, N. Y.
WDAE	Oklahoma City	WJZ	New York City
WEB	Tampa, Fla.	WEAF	New York City
WRK	St. Louis	WOR	Newark, N. J.
WHAB	Hamilton	WHAS	Louisville, Ky.
6ZV	Galveston, Tex.	WEAB	Dodge, La.
NAA	Salt Lake City	WKD	Gainville, Ga.
WJAX	Arlington, Va.	WUQ	Washington, D. C.
WBZ	Cleveland, O.	KMO	Tacoma, Wash.
WOO	Springfield	KOB	New Mexico
WOS	Philadelphia, Pa.	WDAR	Philadelphia, Pa.
WOK	Jefferson City, Mo.	WFI	Philadelphia, Pa.
WLAG	Pine Bluff, Ark.	WIP	Philadelphia, Pa.
WFAZ	Minneapolis	KDKA	Pittsburg, Pa.
WJAB	Charleston	WCAB	Pittsburg, Pa.
WCT	Lincoln, Neb.	KMN	Butte, Mont.
WMC	Chicago	KQP	Hood River, Ore.
WBAK	Memphis	WHAZ	Troy, N. Y.
WLAK	Harrisburg	WGR	Buffalo, N. Y.
WBAN	Bellow Falls, Vt.	WMAV	Auburn, Ala.
WOC	Paterson, N. J.	KFDD	Boise, Ida.
WPAP	Davenport	WNAL	Omaha, Neb.
WMAM	Winchester, Ky.	WCAP	Washington, D. C.
WWZ	Beaumont, Tex.	WQAB	Springfield, Mo.
WBAY	New York	WFB	St. Louis, Mo.
WGL	New York	WDR	Detroit, Mich.
WMAF	Philadelphia, Pa.	WNAC	Boston, Mass.
WBAG	Dartmouth, Mass.	WBAZ	Columbus, O.
WCAP	Bridgeport	CFZC	Montreal, Que.
WHN	Decatur	WMAK	Lockport, N. Y.
WIAR	Ridgewood	WGF	Des Moines, Ia.
WRP	Paducah	WHAM	Rochester, N. Y.
WGAR	Camden, N. Y.	WCAM	Villa Nova, Pa.
WDAK	Fort Smith, Ark.	WGAY	Madison, Wis.
WCAG	Hartford, Mass.	WWI	Dearborn, Mich.
	New Orleans	WGAM	Orangeburg, S. C.
	WVAJ		
	Columbus, O.		



Radio's finest low-priced receivers

Here, in the improved MIRACOS, you'll find the same thrill of getting long distances, generally obtainable with only the most expensive and elaborate sets. To the whole family it will furnish entertainment, **unfailingly**, the whole year round—and at an initial price most every family can afford.

It isn't necessary, either, to be an expert at tuning in with the MIRACO. The operation is extremely simple. Scores of users everywhere tell us of the long-distance records they're making—Cincinnati hears 'Frisco, Denver hears Schenectady, New York hears Havana!

Such range as this is made possible through MIRACO'S many new refinements. Improved rheostats with multiple resistance windings enable you to use any type of tube, and a new aluminum shield prevents annoying body capacity effects. Shock absorbing pads prevent tube noises. Fully **GUARANTEED** against defects in material or workmanship. Price for 4-tube outfit shown above only **\$54.50**.

Other details of MIRACO receivers are explained more fully in our new bulletin. Write today for a copy.

THE MIDWEST RADIO COMPANY

812 Main Street, Cincinnati, Ohio

The Improved MIRACO

Clear as a Silver Bell



O-T SILVERTONE TUBES
(Registered)

will increase the signal strength of your set from 20 to 50 percent—even to a greater degree when used as a NEUTRODYNE detector.

Three Models

- O. T. 1A—2 to 4 volts,
Battery Draw .15 amps. Price, \$6.00
- O. T. 9—2 to 4 volts,
Battery Draw .06 amps. Price, \$6.50
- O. T. Power Tube—5 volts,
Battery Draw .25 to .35 amps. Price, \$7.50

*At your dealer or direct by mail.
Write for complete literature.*

Manufactured by DeForest Tel. & Tel. Co.

Exclusively for the

O. & T. Electric Corporation
1819 Broadway, New York
High class representatives wanted.

The O-T is the only genuine Silver-tone Tube.
Fully guaranteed.
Beware of imitations.



Use HOMMEL SERVICE to build your radio business

Complete stocks of strictly high grade nationally advertised radio apparatus are constantly carried by this Company to enable you to build your radio business on the right foundation. Your success is dependent largely on the products you sell, and your ability to serve your customers promptly.

Aligning yourself with the HOMMEL organization makes it possible for you to always have access to ample stocks of the leading lines of radio equipment without the necessity of tying up your working capital.

Let us show you how you can advantageously use Hommel Service. Write for encyclopedia 236-P

- DISTRIBUTORS FOR
Radio Corporation of America
- RCA**
- Westinghouse General Electric
 - Acme Atwater-Kent
 - Baldwin Brandes Burgess
 - Chelsea Cunningham
 - Cutler-Hammer
 - Dubilier Fada Frost
 - Freshman General Radio
 - Grebe Homecharger
 - Murdock
 - Remler Rhamstine
 - U.S. Tool Western Electric
 - And other leading manufacturers

LUDWIG HOMMEL & CO

530-534 FERNANDO ST.

PITTSBURGH, PENNA

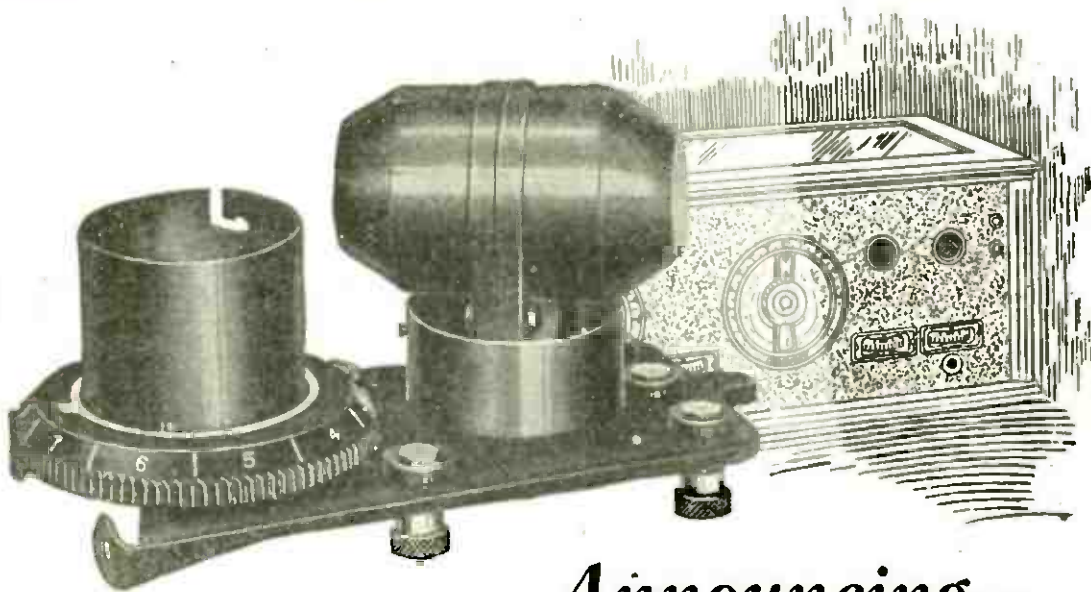

Announcing—

A New Radio Frequency Transformer

—in a combination unit, consisting of transformer, tube socket and rheostat.

Especially designed for use in tuned radio frequency circuits—the most practical method of amplifying high (radio) frequency impulses.

The trend toward radio frequency amplification is to be expected. Its advantages are many—long distance reception; the excellent results obtained with indoor aerials, and an entire absence of interference with neighboring receivers.

When incorporated in a tuned radio frequency circuit, this transformer amplifies efficiently at all wave lengths employed in present-day broadcasting.

All Eisemann units are matched one to the other, not only in their electrical co-relation but also in appearance, and, when assembled, present a harmonious whole.

Complete instructions for wiring are given, and the individual not deeply versed in Radio can build a receiver with assurance of results.

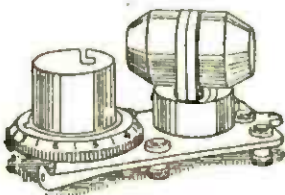
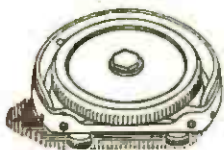
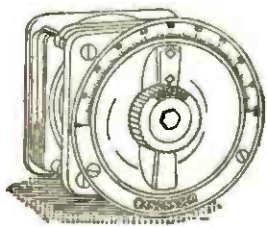
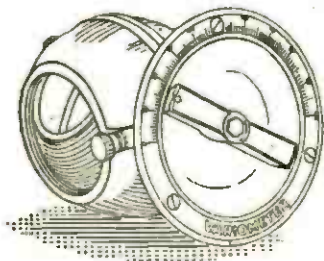

Catalog sent on request



EISEMANN MAGNETO CORPORATION

WILLIAM N. SHAW, *President*

46 Thirty-Third Street

Brooklyn, N. Y.

Quick Positive Connections!

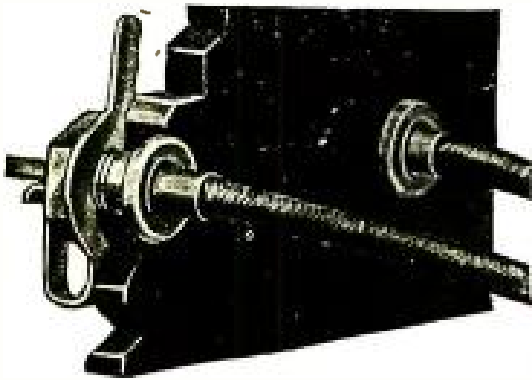

Union Radio Tip Jacks

(Patent Pending)

Price 25c

Just what you want when building your own set or experimenting with new hook ups. Not only give positive electrical contact, they improve the appearance of your set.

Two sizes for all mountings. **Standard Type A** for panels up to $\frac{1}{4}$ inch thickness, **Special Type B** for panels, cabinet walls and partitions from $\frac{1}{8}$ to $\frac{1}{2}$ inch thickness. Will firmly grip all wires from No. 11 to 24 B. & S. gauge, and can be reamed to pass and hold antenna wire, battery leads, loading coils and vacuum tube lugs.

No parts to lose, chip or deteriorate. All parts heavily nicked. Price 25c

Other Guaranteed Union Radio Parts

Dial adjusters for minute variations in capacities of variable condensers. Price 60c

Tube sockets of molded condensite highly polished. Phosphor Bronze contact springs. Reinforced bayonet slot prevents breakage. Accommodates all standard tubes. Price 70c

Should your favorite Radio Store not carry Union Radio Tip Jacks and Guaranteed Parts send your order direct to us, also write for your copy of "The Union Radio Catalogue 'A.'"

Retailers and Wholesalers

Samples of our guaranteed, reasonably priced "Quality Products" sent on request. Our terms and trade discounts are liberal. Write for our proposition.

UNION RADIO CORPORATION
200-MT. PLEASANT AVENUE, NEWARK, N.J.
NEW YORK OFFICE 116 WEST 32nd STREET.

It's the contact that counts



Na-ald Special
Socket No. 499 for
UV-199 and C-299
Tubes. Price 50c



Na-ald Adapter
No. 429 for UV-199
and C-299 Tubes.
Price 75c

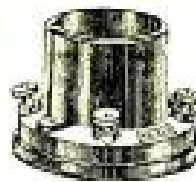

De Luxe No. 400
Price 75c

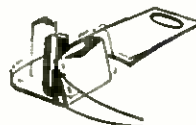

De Luxe Contact



Small Space
No. 401
35c, 3 for \$1.00



Na-ald W. D. 11
No. 411. Price 75c

Weak reception due to inferior contacts is banished when Na-ald sockets are placed in a set. Na-ald contacts exert a strong, wiping pressure on tube prongs over a broad surface, regardless of frequent removal of bulbs or variation in the length of prongs.

You can count on Na-ald sockets under all conditions. They are moulded of genuine Bakelite, with uniform cross-section and cure. These features prevent plate-to-grid losses and insure full efficiency from tubes.

Insist on Na-ald sockets and put an end to weak reception. All good dealers carry them.

NA-ALD INSIDE INFORMATION

(No. 429)

Have you realized that the matter of design in anything as simple as an adapter will make a big difference in the results obtained with a U. V. 199 or C 299 tube? Na-ald No. 429 Adapter makes it possible to use these excellent tubes in regular standard sockets. Not only must means be provided for holding the tube, but had we used flat springs or allowed broad flat surfaces to run parallel in this adapter, the capacity would rob this tube of much of its effectiveness. Again, full-surface, positive contacts were necessary. These are provided by plunger pads backed with music wire springs pressing against metal cross-overs moulded in solid Bakelite. Na-ald adapters cost but 75c, a very reasonable price in view of their assurance of the highest tube efficiency.

Write for "why a Bakelite Socket" and other descriptive literature

Alden Manufacturing Company

Largest Makers of Radio Sockets and Dials in the World—Why?

52 Willow St. Springfield, Mass.
Dept. C Cable Address, Aldenco

NA-ALD

The world's largest
selling transformers

Standard equipment
on the better sets



ALL-AMERICAN

Amplifying
TRANSFORMERS



For "Push-Pull" Circuits: The All-American Power Amplifying Transformers. Input and Output types.
\$6.00 each

for utmost volume and pure rich tone —add Power Amplification

The addition of the well-known "Push-Pull" form of amplification to your audio frequency amplifier—by means of All-American Power Amplifying Transformers—will develop maximum volume with a roundness, richness, depth and purity of tone that will delight you. Use any good loud-speaker.

All-American Power Amplifiers have been conclusively proved the most efficient, most satisfactory "push-pull transformers that have ever been made. Here, too, All-Americans lead the industry.

SPECIAL OFFER!

We will send you the latest All-American diagram and circular, describing Power Amplification; also the famous All-American book of Tested Hook-ups—on receipt of 4c in stamps to cover mailing charges.

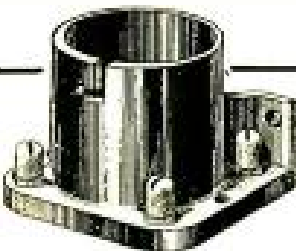

RAULAND MFG. CO. 206 Jefferson St. CHICAGO
Pioneers in the Industry

All-American Socket

One-piece molded bakelite—for panel or base mounting. Finest socket money can buy. Only 75c.

All the better dealers sell the All-American

All-American Audio

Frequency transformers. Three ratios: 3:1, 5:1, 10:1. Prices: \$4.50, \$4.75, \$4.75. The best—no need to pay more.

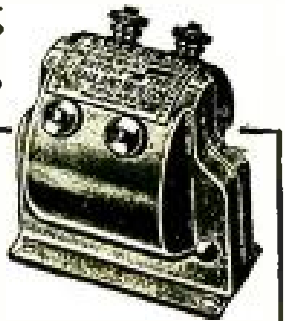

More Than 500,000 Satisfied Users

Please refer to POPULAR RADIO when answering advertisements.

An Absolute Guarantee
 with every instrument
made them famous!

SHAMROCK
 FOR SELECTIVE TUNING

180°

Vario-Coupler

List price,
\$3⁵⁰
each

DOUBLE DUTY PIG-TAIL Variometer

SHAMROCK MFG. CO.
 314 E. Market St. — Newark N.J.



— one at a time
 with a

CONTROL-O-METER

You can select the programs you want to hear if you equip your set with a Control-o-meter, and you don't need technical knowledge to get results. Just turn the dial to a number indicated on the individually calibrated chart supplied with each Control-o-meter and the interfering program disappears.

THAT'S ALL THERE IS TO IT

No matter what kind of a set or antenna you have or where you live, the Control-o-meter will allow the reception of one program without interference from another. Moreover, the addition of a Control-o-meter will not decrease the volume of distant stations.

KINDLY ADDRESS DEPT. A

MALONE-LEMMON PRODUCTS
 Made by STEPHENSON LABORATORIES
 342 MADISON AVENUE
 NEW YORK CITY

Pat. Appl. for

We are putting forth every effort to make the Control-o-meter easy to get through local dealers; but should you be unable to secure a Control-o-meter, we will ship you one postpaid on receipt of price.

\$12.50







Save 1/3 on Guaranteed Radio Equipment

**Write us a post card—
Address Dept. 38-R**

and we will send you free this 52 page catalogue of radio sets and parts. It also contains explanation of radio terms, map and list of broadcasting stations and much radio information, including an explanation of successful hook-ups and circuits.

You will be amazed at the low prices Ward's quote. A complete tube set having a range of 500 miles and more, including tube, head set, batteries, and antenna equipment, as low as \$23.50.

This catalogue contains everything for the expert and amateur. Complete sets and every improved part for building sets, all the most up-to-date devices—at the lowest possible prices.

Headquarters for Radio

Montgomery Ward & Co. is headquarters for Radio, selling everything direct by mail without the usual "Radio-profits." Why pay higher prices? Ward quality is the best and the prices will often save you one-third. Everything sold under our Fifty Year Old Guarantee—Your Money Back if You Are Not Satisfied. Write today for your copy of this complete 52-page Radio Book.

**Write to our house nearest you
Address Dept. 38-R**

Chicago Kansas City St. Paul Portland, Ore.
 Ft. Worth Oakland, Cal.

**This Radio
Catalogue
FREE**

Established 1872
Montgomery Ward & Co.

The Oldest Mail Order House is Today the Most Progressive

RADIO BIG MONEY IN A FASCINATING INDUSTRY

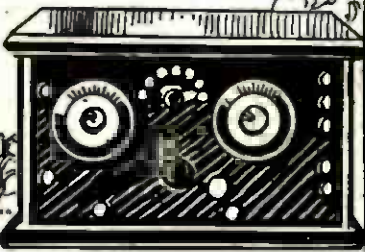

FREE With Our Home Study Course



Right at home you can speedily qualify yourself to accept big paying positions in the great field of Radio. Never before such sensational opportunity. Get in on the ground floor. We start your training by giving you this wonderful tube receiving set. Range up to 1000 miles. ABSOLUTELY FREE Our practical instruction method guarantees your success—you learn by actual work on the set.



ENORMOUS DEMAND FOR EXPERTS

From everywhere comes the call for Radio Experts. Big salaries are waiting for trained men who can construct, install, operate, repair and sell radio equipment. Tremendous profits can be made in your own neighborhood taking orders for sets. Thousands are winning success in this fastest growing industry—you can too.

Turn Spare Time Into Cash

Just a few hours each week of pleasant home study trains you in amazingly short time. Make your spare time earn you cash. We show you how. Many are earning from \$3,000 to \$10,000 a year.

A. G. MOHAUPT, Radio Engineer,
American Radio Ass'n

4513 Ravenswood Ave., Dept. 52 Chicago

Mail Coupon

A. G. MOHAUPT, Radio Engr.
American Radio Ass'n,
4513 Ravenswood Ave., Dept. 52, Chicago, Ill.

Please send me details of your Home Study Course—also your Free "Radio Facts" and information on how I can get a FREE 1000 mile Radio Set.

NAME.....

ADDRESS.....

CITY..... STATE.....

After Extensive Tests and Comparisons—We Offer The Branston-Quality-Guar- anteed Audio-Transformer

YOU can now get rid of noisy or otherwise unsatisfactory transformers and, with perfect confidence, replace them with this fully-tested-and-proved audio frequency transformer. The results will delight you and your "audiences."

You can now make up new sets, with the certainty that you have the maximum-possible amplification and best tone quality without distortion.

If your dealer has not yet secured his supply, send check or money order for as many as you need, @ \$6.50 each, or order parcel post C.O.D. Mention your dealer's name, please.



Branston Quality Guaranteed Audio Frequency Transformer. Nest, compact, efficient. It gives the results you want. Each \$6.50

Use Branston "Broadcast Coils" for Closer Selectivity



Branston D. L. Honeycomb Coils end Back and Front Geared Mountings are "Standard of the World"

Very fine adjustment, close selectivity and clearer reception for all wave lengths between 250 and 600 meters. Wound on Formica Tubes 5" diameter. Equipped with standard coil plugs. Fit any Honeycomb coil mounting.

ing. Furnished only in sets of three, Primary, Secondary, Tickler. In attractive carton, \$5.00 per set, at dealer's or by mail.



Look for this trade-mark card in your dealer's window or salesroom

Send 2c Stamp for New Honeycomb Coil Hookups

Compiled by experts and includes five good Honeycomb Coil "Hookups" and complete catalog of famous Branston Radio Apparatus. Write today. Give us name of your radio dealer. If he cannot supply you, write —

CHAS. A. BRANSTON, Inc.
Manufacturers of Branston Violet Ray High Frequency Generators
811 Main St., Buffalo, N. Y.
In Canada—Chas. A. Branston, Ltd., Toronto

"New York's Grand Opera - one of the many events enjoyed by Magnavox owners"

MAGNAVOX
Radio
Reproducers and Amplifiers



MMAGNAVOX instruments are never subject to those internal interferences which, at critical moments, are so apt to mar the performance of ordinary radio reproducers.

To measure the success which Magnavox engineers have accomplished in the design and manufacture of Magnavox products, remember that they have been sold in far larger quantities than any other radio units in the world.

- | | | |
|--|---|---------|
| Magnavox Reproducer | in. curvex horn and 1 stage of amplification . | \$59.00 |
| R2 with 18-inch curvex horn | | |
| | | \$60.00 |
| R3 with 14-inch curvex horn | A2-R consisting of electro-dynamic Reproducer with 14-in. curvex horn and 2 stages of amplification . | \$85.00 |
| | | |
| M1 with 14-inch curvex horn. | | |
| Requires no battery for the field | | \$35.00 |
| Magnavox Power Amplifiers | | |
| Magnavox Combination Sets | A1-1-stage . . . | \$27.50 |
| A1-R consisting of electro-dynamic Reproducer with 14- | AC-2-C-2-stage . | \$55.00 |
| | AC-3-C-3-stage . | \$75.00 |

Magnavox Products are for sale at Registered Magnavox Dealers everywhere. Write for new 32-page Magnavox Radio Catalogue.

THE MAGNAVOX CO., Oakland, California
New York Office: 370 Seventh Avenue
Perkins Electric, Limited, Toronto, Montreal, Winnipeg
Canadian Distributors

For every receiving set there is a /
MAGNAVOX

2R



A Vernier Condenser A Grid Control

Every Detector Tube Needs a Vari-Grid

Tube characteristics are not alike. The Vari-Grid varies the capacity of the tube. Has variable grid leak. Also used as a plate condenser. 1 3/4" wide, one hole to drill.

If your dealer cannot supply you, order direct. **\$2.25**

Write for Booklet
RANDEL WIRELESS COMPANY
 4 Central Ave. Newark, N. J.



HERE IT IS!
Two Rheostats in One

PREMIER "DUOSTAT"
 Trade Mark

You will see the advantages of this remarkable new apparatus at once. A real innovation. Think of it! One high-class Rheostat that completely replaces two of the ordinary types; does the work even more efficiently, and, in addition, greatly simplifies installation and wiring. One hole to drill, THAT'S ALL. That's what you get in the "Duostat."

Two independent resistor windings, each operating one tube. Bakelite Moulded Base, silver etched dial, "NICHROME" wire windings. Made for all types of tubes. No. 12, two windings, each 7 ohms. No. 13, two windings, each 25 ohms. No. 14, two windings, each 40 ohms. Price all types, \$3.00.

You can't afford to leave out the "DUOSTAT" in your next "hook-up." Send for our free Bulletin No. 92.

ASK YOUR DEALER
 Price **\$3.00**

Complete with silver etched dial, knob, pointer, etc.



Premier Electric Company
 3807 Ravenswood Ave. CHICAGO, ILL.

Approved!



180° Straight Coupler #56

A Real FISCHER Instrument

Wave length 550 meters. 14 soldered leads, straight wound stator on genuine bakelite tubing, bakelite rotor. Fahnestock spring clip connections, white metal mounting base, non-conductive adhesive.—in short a perfect coupler.

20 Diagrams **\$2.75 Free with Each**

For sale at your dealer's—otherwise send \$2.75 directly to the manufacturer and you will be supplied postpaid.

G. H. FISCHER & CO.
 123 Liberty Street New York City

B-T
 Products
 Are Just as
 Far Ahead



in Design, Quality and Workmanship in 1924 as in 1921

B-T products are originals, not copies—not built just to sell—but to give satisfaction.

It is our aim to please you more with the product itself than by what we say about it—

Our latest booklet will help you. It is revised each month.

Sent for 4c postage.

Better Tuning B-T
 Price 10c

BREMER-TULLY MFG. CO.
 534 S. Canal St. - Chicago, Ill.

Get more Mileage out of your Radio Receiver

With

THE FILAMENT
KONTROL

OF INFINITE
ADJUSTMENT

FIL-KO-STAT

The Scientifically Correct Radio Rheostat



FIL-KO-Stat is standard equipment of Radio Codd's "Radio Club" Receivers.



From RICHARD J. DAVIS
700 East Erie St., Painesville, Ohio
"FIL-KO-STAT cannot be beat for fine adjustment and noiseless operation. The first night after installing it I got KDZA, Tuscon, Arizona (1500 miles), KYY, San Francisco (2500 miles) and WHA, Madison, Wis., (1000 miles)—all came in clear and loud... without FIL-KO-STAT never have picked up these stations."

From LESLIE C. BILES
Maple and Burlington Aves., Delanco, N. J.
"After experiments with various filament controls, I have adopted FIL-KO-STAT as the finest instrument for controlling detector... In my humble opinion it is the greatest Radio Achievement of the year... stations never heard before... (include) WOAO, AVDAF, WCX, WOC, WSB, and WLAG on loud speaker. On Oct 28th, at 8 P.M. with powerful Philadelphia stations operating I tuned in with FIL-KO-STAT WKAQ, San Juan, Porto Rico... do not feel that I can say enough in praise of this little instrument... Many sets that are inclined to tune broadly can be improved with FIL-KO-STAT. It will positively separate stations on close wave lengths."

From H. R. HASLAM
249 W 126th St., New York, N. Y.
"Three tube standard set... wire wound rheostats gave satisfaction on local stations, but on distant reception could not get point between owing to coarseness of adjustment. With FIL-KO-STAT change was wonderful, getting distant stations never received before, even Oklahoma City quite strong despite local interference."

From JACK WALSH
Independence, Colorado
"FIL-KO-STAT certainly a wonder. Following stations received in nine days on one bulb WOAW, WDAF, WFAA, WJAZ, WOC, WBAP, WHB, KFI, KHJ, KFEL, KFIX, WSB, WMC, KLZ, KFFO, WWAC, KZN, WDA, WLAG, WDAP, WGY (2000 miles) CKCK, WOS, KOP, CFCN, WDAE, KSD, WJAD, WCBD, KDYL, WHAS, KDKA, KGW, WAAW, KFKB, KGW, WEAY, WOI, KOB. I believe the FIL-KO-STAT is the secret of my success."

You, too, will be writing letters like these when you have tried a Fil-KO-Stat in your set

Radio News Laboratories say:

This filament rheostat (Fil-KO-Stat) is designed to control the filament current of practically all types of receiving tubes now on the market. It is noted for its exceptionally infinitesimal and uniform control of the current.

For instance, the critical adjustment of a one-ampere tube is spread out over a range of four turns of the knob, thus enabling a micrometer adjustment to be obtained.



RADIO STORES CORPORATION

Sole International Distributors
NEW YORK - CHICAGO - MINNEAPOLIS - LOS ANGELES - CLEVELAND - ST. LOUIS - OMAHA - SAN FRANCISCO
HOME OFFICE, Dept. PR2, 220 West 34th Street, NEW YORK, N. Y.

YOU want more mileage out of your Radio Receiver. You can't properly tune in distant stations. You want to clear up those tube noises so exasperating when a DX announcer is telling you who he is and all you get is, "This is station brbrweezigrump". Yes, you get many distant stations but you never hear them. They're on your antenna, weak little brothers waiting to be magnified into audibility. They're there with song and story, concert and dance. How you do wish you could hear them! Condensers and couplers are all on the job, properly adjusted, but all you get are whistles and disappointments, BECAUSE:

Unless your RHEOSTAT is a FIL-KO-STAT you can't adjust the most delicate, most critical tuning unit on your set—and that's your vacuum tube.

Wave length isn't everything. There's a finer control needed. You must be able to make most minute adjustment of your filament heat and so control the electronic flow in the tube. When you do this you will have perfect reception free of all tube noises and YOU WILL HEAR DX STATIONS YOU NEVER HEARD BEFORE!!!

Regardless of what set you have, it will pay you in added pleasure and satisfaction to replace your present rheostat with a FIL-KO-STAT. It's so easy to make the change. Or have your dealer do it. And if you are building a new set, Neutrodyne, Super Hetrodyne, Radio Frequency, Phusiform, Reflex, Regenerative, any type with any kind of tube—make sure of complete reception by using FIL-KO-STAT.

IMPORTANT!

FIL-KO-STAT is not a carbon powder rheostat. Nor has it disc (which break and chip). Its resistance element is over 70 per cent metallic substances. Its full resistance is 30 ohms. And it is

UNCONDITIONALLY GUARANTEED TO GIVE SATISFACTION



Price \$2

The Fil-KO-Stat is suitable for any panel mounting. Rigid, nickel plated, drilled and tapped mountings for setting up Fil-KO-Stat on table, 15 cents additional.

In Canada—\$2.75



Guglielmo Marconi, as he appears today.
Signor Marconi is Honorary Chairman
of the Radio Institute of America

Success for You —in RADIO

The big men in radio today started—almost all of them—as radio operators. Very many of them are graduates of the Radio Institute (or Marconi Institute, as it was formerly called).

The demand for trained radio men today is too great to fill. Beginners are needed—and positions are open all the way up the ladder to the top. Train now. Radio is swiftly growing. And the opportunities grow with it.

Study at home

You can start now—at home—from the very beginnings of electricity—with the same guidance and instruction that has built the reputation of the Radio Institute. In a few months you can be fitted for your Government operator's license—and your first job.

The Radio Institute is under the auspices of the Radio Corporation of America, which places more men in radio than any other organization in the world—and gives preference to our graduates. Your opportunity is limited only by your ability.

Radio Institute of America

(Formerly Marconi Institute)
Established 1909

322A Broadway, New York City

Indicate by a cross X the course you are interested in:

Radio Institute of America,
322A Broadway, New York.

Please send me full information about radio opportunities today, and your Complete Radio Course.

Name

Address

Write for Information Today

Morrison

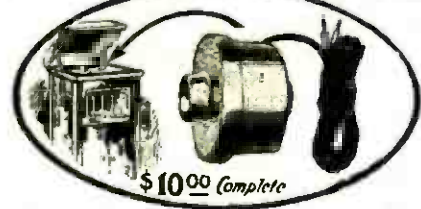

\$10.00 Complete

Loud Speaker

Enthusiastic

—is the only word that describes those radio critics who have chosen Morrison Loud Speaker. For them Radio has taken on new delights. Bright stars of the musical comedy stage, famous lecturers and singers all are theirs no matter where they live—every night as long as they care to stay awake.

Real reproduction without annoying vibrations as soft or loud as you please—that describes Morrison attached to your phonograph tone arm or used with a horn.

\$10.00

That's all Morrison costs
complete with 5 foot cord
Nickel Plated Model

This perfect little loud speaker has no rivals. We assure you your money back if you don't like it.

Ask for descriptive 2 color catalogue

DEALERS

Thousands of new radio fans have receiving sets—Christmas presents. Every one needs a Morrison Loud Speaker. We will show you how to merchandise Morrison. Ask us for our plan—at once.

MORRISON LABORATORIES, INC.

345 Jefferson Avenue East Detroit, Mich.



ANCIENT

ROME

THE far-flung conquests of Caesar's legions brought vast territories under the sway of Rome but crude methods of conveying information weakened the structure, and the empire fell.

To-day, due to Radio, the most remote settlement is in constant touch with the culture and events of the world. Geographical barriers have

disappeared, and man's horizon is unlimited. Sensitive instruments developed through painstaking care and years of experimentation have made this possible.

The Holtzer-Cabot Company, out of its twenty-five years' experience, has developed a family of superior receiving units. They bring the world to your home.

- Holtzer-Cabot Loud Speaker, \$25.00
- Loud Speaker Phonograph attachment, 10.00
- No. 2 Universal Head Phones, 9.50
- No. 4 National Head Phones, 6.00

Write for booklets explaining how the exclusive features of these instruments enable you to enjoy the wonders of Radio

THE HOLTZER-CABOT ELECTRIC CO.
 125 Amory Street, Boston, Mass.
 6161-65 South State Street, Chicago, Ill.
 Department B

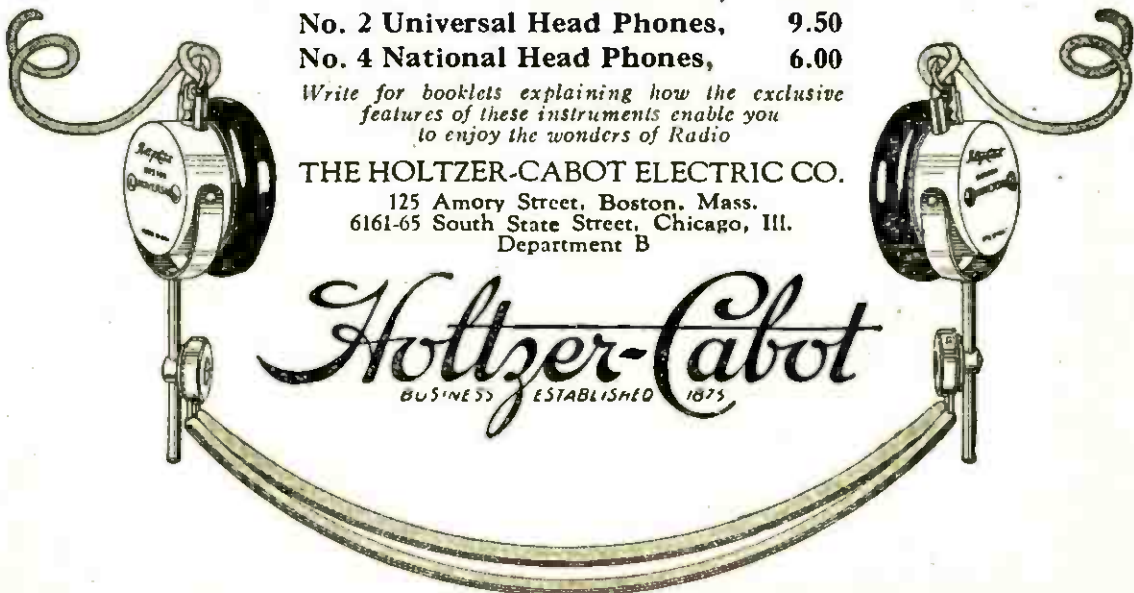

FLASH!

Another tube gone — "B" battery wires crossed for only an instant. RADECO Fuses would have saved it — they are saving thousands of tubes for satisfied radio fans. Read this letter.

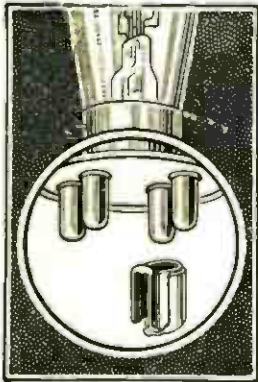

Radeco Safety Fuses

may be attached in an instant to any standard tube going in any standard socket.

In ordering, specify type of tube used

Price 50c each

*At your dealer's
or by mail postpaid*

Radio Equipment Co.

Dept. 2 20 Stuart Street, Boston, Mass.

New England's Oldest Exclusive Radio House

DEALERS: Write for our proposition

1358 Washington Street.
West Newton, Mass.

RADIO EQUIPMENT CO.
20 Stuart Street, Boston

GENTLEMEN:

I am writing to give you an experience which I recently had which may be of interest to you.

I am a radio fan, and have experimented with many types of hook-up. I have also had the unfortunate experience of "blowing" several Radio tubes. Recently a friend of mine recommended your fuses, and I purchased three for my three-tube set which I am now using. Shortly after installing these fuses, in attempting to tighten a loose connection, my screw-driver accidentally touched the "B" battery lead. All three fuses were blown and I realized that if it had not been for the Radeco Fuses I would have lost all the tubes in my set. I am inclosing herewith \$3.00 for which please send me six fuses for UV201A tubes, as I do not wish to be without them. You are at liberty to use this letter in any way.

Very truly yours,

FRANK J. BODAY.

Build a beautiful long distance set—
for much less money!

There is no thrill like the thrill you get from a set of your own creation. No joints to solder, no tools required, when you use R P M Standardized Units. Merely connect binding posts. Each R P M Unit is complete in itself. Moulded Bakelite—extremely beautiful. R P M Units are efficient in performance, superior in quality and *have absolutely no body capacity*. You can pay more but you can't buy better units. *Hook-up circuits in every package.*

This is the No. 102 R P M Mounted Variometer. Bakelite panel. A great performer. \$8

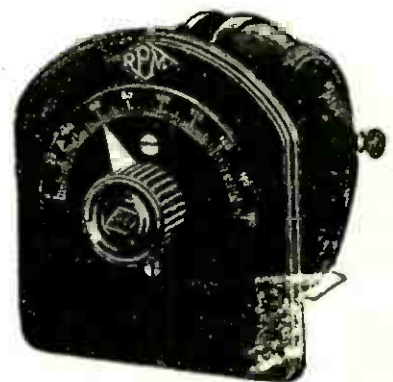

R P M instruments—being standardized—permit changes in hook-ups enabling you to try different circuits by merely rearranging units. You can start with a few R P M's Units and add additional units as desired. Twenty years' manufacturing experience and latest machinery make possible these low prices. Ask your dealer—or write us. **Unconditional Guarantee.**



A UNIT FOR EVERY RECEIVING PURPOSE. MOUNTED AND UNMOUNTED VARIOMETERS, VARIOCOUPERS, VARIABLE CONDENSERS, COUPLED CIRCUIT TUNERS. ALSO DETECTOR AND AMPLIFYING UNITS.

RADIO PRODUCTS MFG. CO.

667 W. 14th St., Chicago

Please refer to POPULAR RADIO when answering advertisements.



Are You Having Trouble Getting Short Wave Signals?

The WC-5-SW shown above picks up signals on wave lengths from 90 to 380 meters sharp and clear. It is the most practical set for low wave specialists. Built by short wave experts the WC-5-SW eliminates the trouble which transmitting amateurs are having with ordinary receiving sets. If you are interested in getting better results it will be to your advantage to investigate the WC-5-SW. Enthusiastic operators from all parts of the country write us praising its efficiency.

WC-5-SW

Built Especially for Transmitting Amateurs

The WC-5-SW is a 4 tube set. One stage of tuned Radio Frequency amplification is employed ahead of the detector to make it super-sensitive. Two stages of audio frequency are used to bring up the signal strength. Uses any type of tubes. Gives perfect control of audibility. Detector rectifies only. Uses antenna compensating condenser. Only two control adjustments. Pure negative biasing on all tubes, thus marked saving on B Battery

current. Tuned Radio Frequency sharpest known and most selective principle ever adopted. Plate potential non-critical. Mono-block tube socket. No grid plate leads on audio amplifiers. Audio amplification absolutely necessary when using low efficiency receiving antenna, i.e., underground or indoor. Mahogany cabinet, piano rub finish. Rabbited-in panel. Split lid cover. The price is \$85.00.

Write for complete description and illustrated folder on this practical set for low wave specialists. All transmitting amateurs will be interested in this literature.

OTT RADIO, Inc.

222 Main Street

La Crosse, Wis.

TOI



"Knowing radio batteries as I do, I consider yours most remarkable"—a statement made by one of the most prominent radio engineers. That is why engineers, manufacturers, amateurs and the public at large prefer Burgess Radio Batteries.

A Laboratory Product

BURGESS BATTERIES

"ASK ANY RADIO ENGINEER"

BURGESS BATTERY COMPANY

ENGINEERS - DRY BATTERIES - MANUFACTURERS
FLASHLIGHT - RADIO - IGNITION - TELEPHONE
GENERAL SALES OFFICE: HARRIS TRUST BLDG., CHICAGO
LABORATORIES AND WORKS: MADISON, WISCONSIN

BRANCHES

NEW YORK BOSTON KANSAS CITY MINNEAPOLIS
WASHINGTON PITTSBURGH ST. LOUIS NEW ORLEANS

IN CANADA

PLANTS: NIAGARA FALLS AND WINNIPEG
BRANCHES: TORONTO • MONTREAL • ST. JOHN



The De Forest Audion

is commended on Jack Binns' Radio Page of the New York Tribune as "an excellent tube around which to build a set." Such expert endorsement and the satisfaction of thousands of users of De Forest Audions is what you naturally expect from this product. Remember that De Forest invented the three-electrode vacuum tube which makes all present-day radio possible.

DE FOREST RADIO
TEL. & TEL. CO.
Dept. P. R. 6, Jersey City, N. J.

Use
De Forest
Audions

Complete
Your
Radio
Outfit



Bring out the Best in your Receiving Set with a Bristol

TRADE MARK
AUDIOPHONE
REG. U. S. PAT. OFFICE
LOUD SPEAKER

It took six years to develop and perfect the Audiophone. That is more time than the average person cares to spend on a Loud Speaker for his receiving set.

But here it is, all ready for you to use by simply connecting to the set.

No auxiliary batteries are necessary.

The tone is big, full, and rich, and without that scratchy, tinny noise so often heard in receiving. It can easily be heard all through the house, so that your own family and friends can enjoy it with you.

The finish is a beautiful dull gold bronze.

Made in three sizes—

- Senior Audiophone.....Price \$32.50
- Junior Audiophone.....Price 22.50
- Baby Audiophone.....Price 12.50

When signals are not sufficiently loud to give good results with the loud speaker, Bristol One Stage Power Amplifier is recommended to build up the power so that it can be heard even in a large hall.....Price \$25.00

Ask for Bulletin Nos. 3006 and 3011-L

THE BRISTOL COMPANY, Waterbury, Conn.

CHELTEN QUALITY RADIO PRODUCTS

THE LATEST IN CONDENSERS

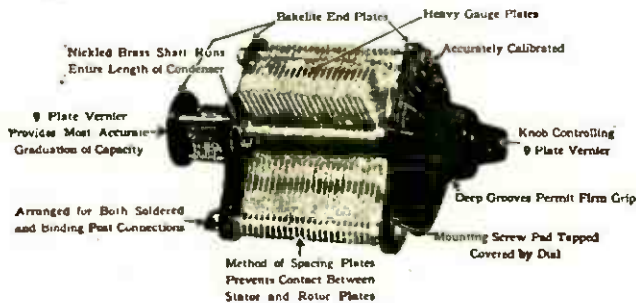

THE CHELTEN RADIOSCOPE

Accurately spaced heavy gauged plates mounted between Bakelite ends, a special Chelten 9 Plate Vernier, and many other improvements make the Chelten RADIOSCOPE stand out as one of the most selective and satisfactory Variable Condensers money can buy. The 9 plate Vernier will surprise you with its unusual selectivity. You'll find stations you never imagined your set could receive. Made in 45 and 23 Plate type.

Chelten Midget Vernier

Can be used as a Vernier with any variable condenser. Its 13 plates make possible unusually fine graduation of capacity. Will increase the efficiency of all of the better circuits. Costs but \$1.50.

Chelten Microfarad Jr.

Specially designed as a Neutralizing Condenser of Low Capacity. Has 9 plates. A turn of the knob changes the adjustment without body capacity effect. Absolutely retains adjustment. Price but \$1.75.

Send for Complete Catalogue of other Radio Products

CHELTEN ELECTRIC COMPANY
4861 Stenton Avenue :: Philadelphia

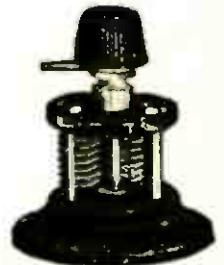

A Pleasant Surprise Awaits the User of the A C H Sharp Tuner Dials

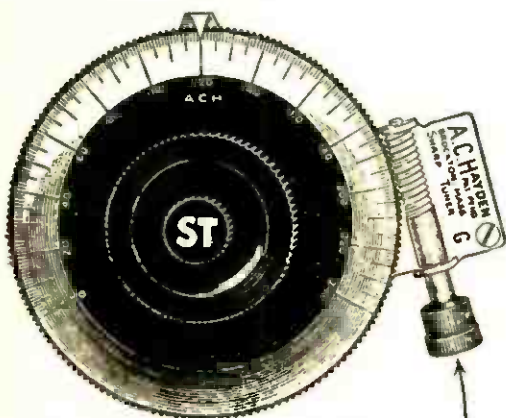

Why the A.C.H. is different

3 in. DIAL → ACH → 156-t0-1

4 in. DIAL → ACH → 215-t0-1

Rough tuning or 1,000th of an inch in either direction. Can be installed and will improve any receiving set, making difficult tuning easy.

Price 3-inch size.....\$2.50
Price 4-inch size.....\$5.00
Regular fitting 5/16 shaft 1/4 and 3/16.....5c each extra

Money Back Guarantee

The principle of the A C H Sharp Tuner has only been embodied on very expensive instruments where the most delicate adjustment is necessary, and then as a permanent part.

Extra Advantage of the A C H

1. Can be attached or removed from any instrument.
2. Rough tuning same as any dial.
3. Movement so fine that the eye cannot detect but the ear can.
4. Automatically locks instrument so no jar can disturb it.
5. Dial grounded reducing the body capacity to a minimum.
6. Special dial 2 graduations where ordinarily one.

Mail Orders Sent Prepaid in U. S. A.

A. C. HAYDEN RADIO & RESEARCH CO.

Brockton, Mass., U. S. A.

Sold by Radio, Ltd., Montreal, Can.

Barkeley Four-Phone Plug

PATENTS PENDING

Connects four phones or less in series to
any Radio Set employing standard
telephone jacks

□ □ □

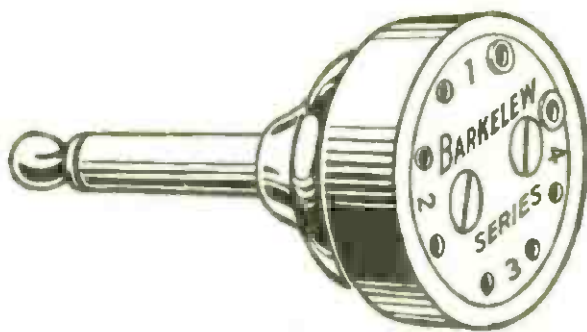

Cat. No. 616
Price \$1.50

It adds to the appearance of any set.
With all phone tips adjusted, the
diameter is but $1\frac{1}{4}$ inches

CHICAGO, ILL.
155 CLINTON ST.

BARKELEY

SAN FRANCISCO.
75 FREMONT ST.

ELECTRIC MANUFACTURING CO.
MIDDLETOWN, OHIO

Please refer to POPULAR RADIO when answering advertisements.

Every Question ANSWERED for only \$1

At last you have under one cover
a Complete Radio Handbook



JUST OUT
514 PAGES

Compiled by
HARRY F. DART,
B.S.E.E.

Formerly with the
Western Electric
Co., and U. S.
Army Instructor
of Radio.

Technically Edited by F. H. DOANE

NO more need you turn from book to book, hoping to find what you want. It is all here, in 514 pages crammed full of every possible radio detail. Written in plain language, by engineers for laymen. Clears up the mysteries, tells you what you want to know. A complete index puts everything within your reach in a few seconds.

IT EXPLAINS: Electrical terms and circuits, antennas, batteries, generators and motors, electron (vacuum) tubes, every receiving hook-up, radio and audio frequency amplification, broadcast and commercial transmitters and receivers, super-regeneration, codes, license rules. Many other features.

Under one cover. Yes, it is all in one volume of 514 pages of clear type with hundreds of diagrams and illustrations. Takes the place of eleven or more specialized texts, each costing from two to ten times the dollar you pay for this single book. Belongs in every radio-equipped home, on every amateur's table.

Send \$1 to-day and get this 514-page I. C. S. Radio Handbook—the biggest value in radio to-day. Money back if not satisfied.

TEAR OUT HERE

INTERNATIONAL CORRESPONDENCE SCHOOLS
Box 8253-B, Scranton, Penna.

I enclose One Dollar. Please send me—post-paid—the 514-page I. C. S. Radio Handbook. It is understood that if I am not entirely satisfied I may return this book within five days and you will refund my money.

Name.....

Address.....

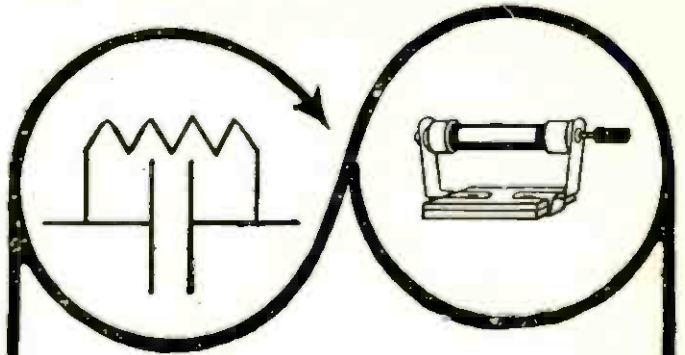

Get full benefit of regeneration

Accurate grid control
gives loudest signals
and clearest tones

Grid Leaks
Guaranteed

DURHAM Variables

For soft tubes:
No. 101-0.1 to 5
megs.

For hard tubes:
No. 201A—2 to 10
megs.

75c each

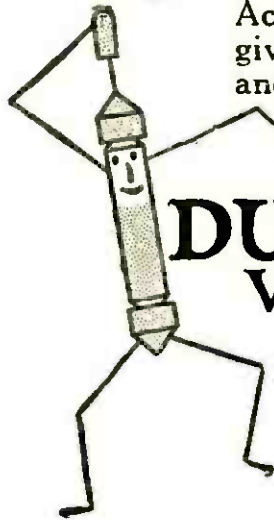

Durham Base, 30c

How DURHAMS Work

Accurate grid control eases off the point of oscillation—as recommended by the tube makers. There should be no “plop.” DURHAMS get you the full benefits of regeneration—by working clear up to the “spilling” point. Try it!

Free folder “C” gives more details. Get yours from dealer or write

Satisfaction Guaranteed

DURHAM & CO., Inc.
1930 Market St., Philadelphia

Dealers: Durham leaks will benefit your sales.
For they make friends.

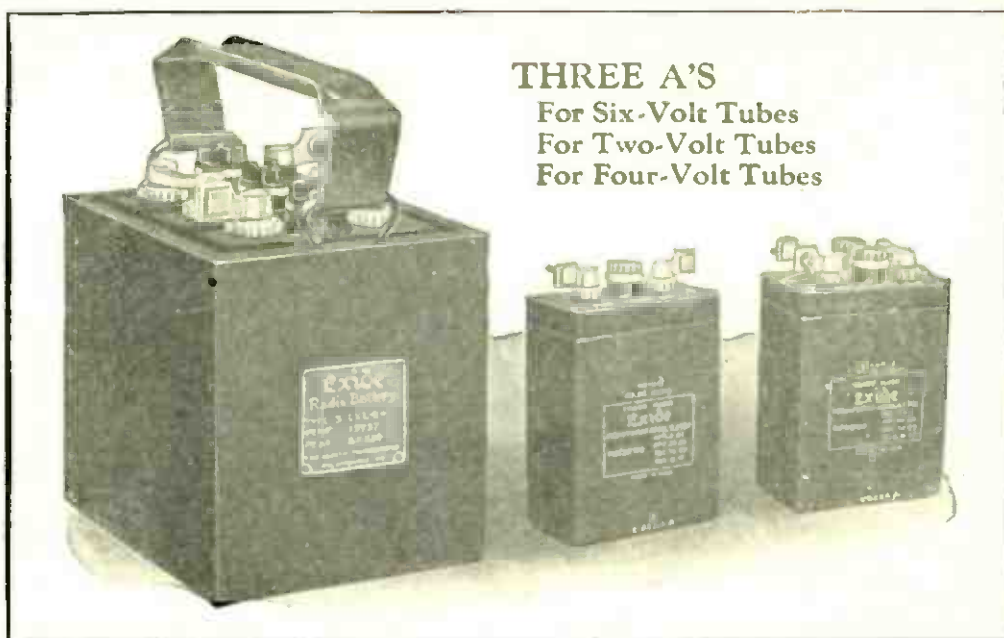

If you take radio seriously

YOU want to tune in distant stations, but there is another thing you want just as keenly—to get what you get *clearly*.

No matter how far or how near the station is, for greatest clearness and for all-round satisfaction, you must use storage batteries. Once you hook up to Exide Radio Batteries you will never be satisfied with anything less. They give uniform current, smoothly, quietly, over a long period of discharge. Like good little boys, they are seen and not heard.

For low-voltage tubes

The two newest members of the Exide family are midgets in size but giants in power. These sturdy little A batteries weigh only five and six pounds each. They furnish in full measure that uniform and unfailing power so essential to clarity and distant reception.

They were specially designed for WD-11 and UV-199 vacuum tubes, but can be used with any low-voltage tube. The two-volt Exide A Battery consists of a single cell. It will heat the filament of a WD-11 or other quarter-ampere tube for approximately 96 hours. The four-volt A battery, having two cells, will light the filament of a UV-199 tube for 200 hours.

For six-volt tubes

Like all Exide Storage Batteries, the Exide A Battery for six-volt tubes is dependable and long-

lasting. It is made in four sizes—of 25, 50, 100, and 150 ampere-hour capacities.

On land, at sea and in the air

It is the experience back of Exide Batteries that makes the Exide give such exceptional service in radio. There is an Exide Battery for every purpose. Exides run trucks, start and light automobiles, operate drawbridges, propel under the sea a majority of the world's submarines, send your voice over the wire every time you use the telephone.

A majority of all government and commercial radio plants both on land and at sea are equipped with Exide Batteries. The Leviathan is Exide-equipped. The giant dirigible "Shenandoah" carries Exide Batteries for ignition, lights and radio.

It does not pay to get any but a known-to-be-reliable storage battery for radio. Exide Radio Batteries are sold by radio dealers and Exide Service Stations everywhere. Ask your dealer for booklets describing in detail the Exide Radio Batteries, or write us direct.



Exide B Battery

Exide

RADIO BATTERIES

THE ELECTRIC STORAGE BATTERY COMPANY, PHILADELPHIA

Manufactured in Canada by Exide Batteries of Canada, Limited, 133-157 Dufferin Street, Toronto

Please refer to POPULAR RADIO when answering advertisements.

KEEPS THE RADIO SET ALIVE

HANDY CHARGER

A Battery Charger that gives a quick charge economically. No Sticking Contacts. No bulbs nor Liquids. Fully enclosed — beautiful.

SIMPLEX MODEL — For 6 volt Batteries only. The Most Practical, Most Complete Battery Charger, for only **\$16.00**

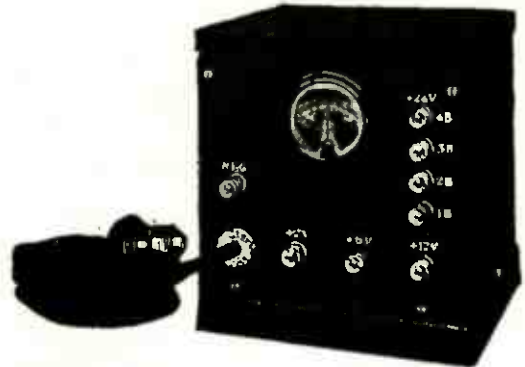

ULTRA MODEL — Charges Them All, Charges 2 volt, 4 volt, 6 volt, 8 volt, 10 volt, 12 volt and 1 to 4 "B" Storage Batteries, with WESTON AMMETER, **\$18.00**

INTERSTATE ELECTRIC COMPANY *of St. Louis, Mo.* 4015 Laclede Avenue

INSIST ON NEW YORK COIL COMPANY'S PROVEN RADIO PRODUCTS

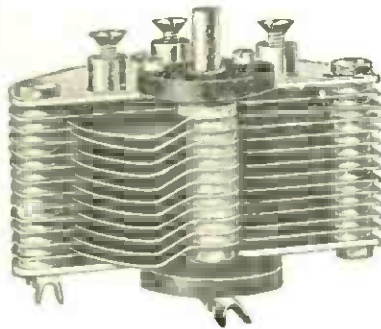

11 Plate... \$1.50
23 Plate... 2.00
43 Plate... 3.00
3 Plate... 1.25

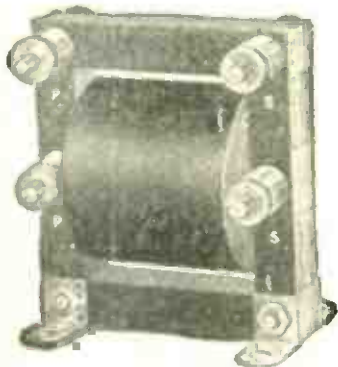

Amplifying Distortionless Transformers
Correct for any tubes.
Price \$4.00

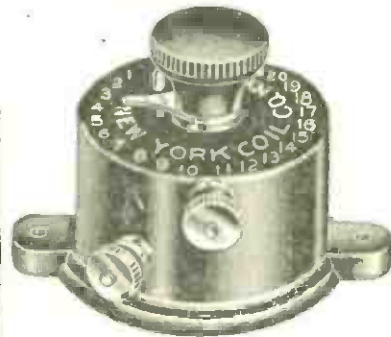

The New York Variable Grid Leak

Easily tops the field in precision, permanency and efficiency.

Price \$1.50

Mica Fixed Condensers

Of tested and permanent capacity, ranging from .0001 to .006, 35 cents to 75 cents, of superior quality.

.00025 with Leak Mountings, 45c

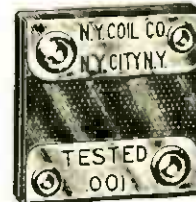

NEW YORK COIL COMPANY

338 Pearl Street

Pacific Coast—MARSHANK SALES CO., 1240 S. Main St., Los Angeles, Calif.

New York City, New York

Please refer to POPULAR RADIO when answering advertisements.



NEW MODEL D,
N & K Head Set,
 4000 ohms. 2¼ in.
 diaphragm. Heavily
 nickeled brass casing.
 Sanitary leather cov-
 ered head bands. 6 ft.
 cord, durable contact
 tips. Retail \$8.50.

*The Phones
 That the
 Fans Are All
 Talking About*

YOU have been hearing radio enthusiasts talk about "That imported head set that gives such wonderful tone"; "The head set that is so comfortable to put on"; "The head set with the big phones." It's the N & K 4000 ohm Head Set that they are all talking about.

In less than a year, with practically no advertising, thousands and thousands of these phones have been put into use by radio set owners. So enthusiastic have these owners become, that in homes where several different kinds of head sets are in use, there is always a "scrap" as to who shall use the N & K.

The N & K was designed by one of the world's leading makers, famous over a quarter century for scientific and telephone apparatus. It has *extra large phones*, 2¼ inch diaphragm, with these four results: broader range—equally good on high and low tones; greater comfort to the wearer; the exclusion of outside sounds; and a wonderful mellow tone. The casing of heavily nickeled brass—instead of flimsy stamped aluminum—provides a perfect sound chamber and a special device insures absolutely uniform distance between diaphragm and poles.

Send today for full information about the N & K.

TH. GOLDSCHMIDT CORPORATION
 15 WILLIAM STREET NEW YORK, N. Y.

Dealers:

N & K Head Sets mean easy sales, excellent profit. Use them to demonstrate your radio sets, especially the small ones, and you'll sell the set every time. There are no come-backs on N & K Head Sets. As one dealer says after handling them for a year: "I have yet to see one pair come back for repairs." Fully guaranteed. We are exclusive distributors for U. S. and Canada, and carry a complete stock of spare parts. Write for discounts.

—MORE INFORMATION—

Dept. P-2, Th. Goldschmidt Corp.
 15 William Street, New York, N. Y.

Please send me folder describing your new N & K Head Set in detail.

Name.....

Street.....

City..... State.....

I usually buy radio supplies of.....

.....
 (name of store)

Genuine—

E. J. Flewelling PARTS

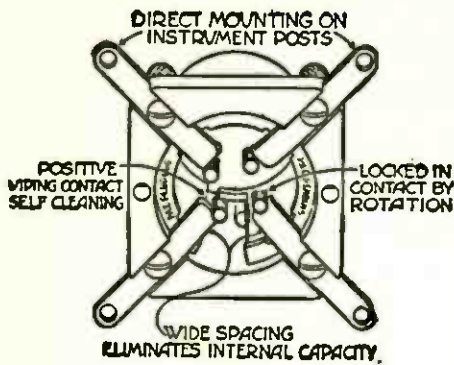

reduce internal capacity and make your set more efficient.

Sockets
\$1.00

Flewelling Sockets are acknowledged the best socket on the market. They eliminate socket noises,

Tuner

\$8.00

Flewelling Tuners are the

utmost in neatness and efficiency. No solid dielectrics in coil field; no loss producing taps or leads. Simplified tuning, produces large volume and is rigidly built.

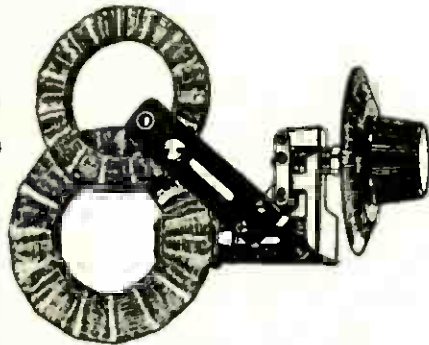

Condenser
\$6.00

Flewelling Condensers are made extra rugged, the heavy plates reduce possibility of misalignment. It is as near electrical and mechanical perfection as

human ingenuity can produce it. (At your dealer or direct.)

BUELL MANUFACTURING COMPANY

2977 Cottage Grove Avenue
CHICAGO



*"I don't need to
look at the 'B' Battery*

It's a—



**RADIO PLATE
'B' Battery —"**

B batteries are off your mind if they're Diamond Radio Plates. More material and more skill goes into them. You get MORE out of them. When other batteries would begin to weaken and create noises in your tubes—Diamond Radio Plates are still delivering the same uniform, dependable service. Look for the Diamond Trade Mark at your dealer's. Also sent direct C. O. D. Get a Diamond NOW.

LIST PRICES

- No. B-1, 22½ volts \$3.00. 5 binding posts in steps of 1½ volts.
- No. B-2, 45 volts \$5.50. 5 positive taps.
- No. B-16, 45 volts \$4.50. 5 taps from 16½ to 22½ volts.
- No. B-4, 22½ volts \$1.75. for portable sets. 5 taps.
- No. 3, Type C. 4½ volts. 3 taps 70c.

**DIAMOND ELECTRIC
SPECIALTIES CORP.**

102 SO. ORANGE AVE., NEWARK, N. J.

Dealers—Jobbers, Write for
Proposition

AMPLION

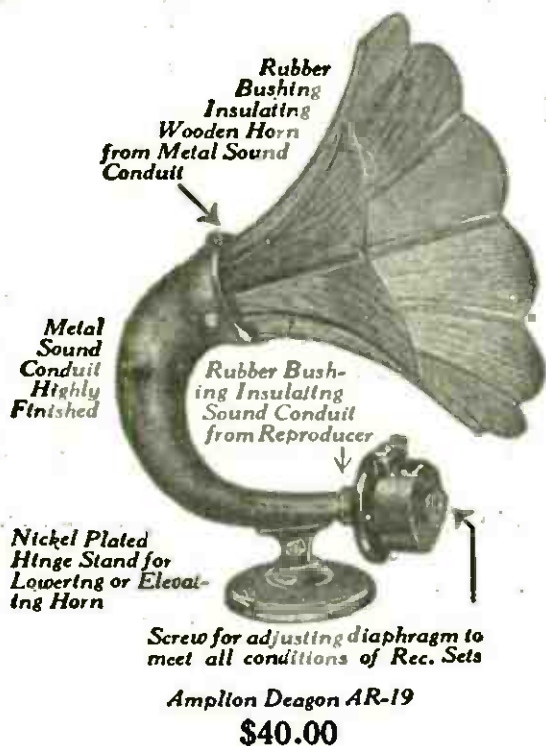

“That’s the clearest reproduction I have ever heard”

This is what one of America’s leading radio engineers said when he heard the Amplion at the New York Radio Show in October.

And added to this wonderful clearness is volume and tone quality as yet unequalled.

Simple to connect, no extra battery needed. Insist on an Amplion demonstration before you purchase a loud speaker.

Patentees: ALFRED GRAHAM & CO.
SIGNAL ELECTRIC MFG. CO.
Sole United States Distributors
Menominee, Michigan
BURNDEPT OF CANADA, LTD.
Canadian Distributors - 172 King St. W., Toronto

Points of Amplion Supremacy

1. The “Amplion” requires no power amplifier. No battery necessary.
2. Connects up to regular head phone binding posts.
3. The diaphragm is made of a special alloy found to have no equal after years of experiment with all other materials.
4. The electro-acoustical device is insulated entirely from the Horn, eliminating distortion, ring or resonance.
5. Non-vibrating wooden horn surpasses all other materials.
6. Adjustable feature makes the “AMPLION” sound true with any make of receiving set, and ensures faithful reproduction.
7. The mechanism has not been hurriedly devised to meet the radio boom; it is not new; it is a development for radio purposes of a loud speaking device that has been used by leading navies of the world for years.
8. The finish and workmanship are supreme.

AMPLION

The World’s Standard Loud Speaker

New 1924 Model

Without an equal
for fine tuning

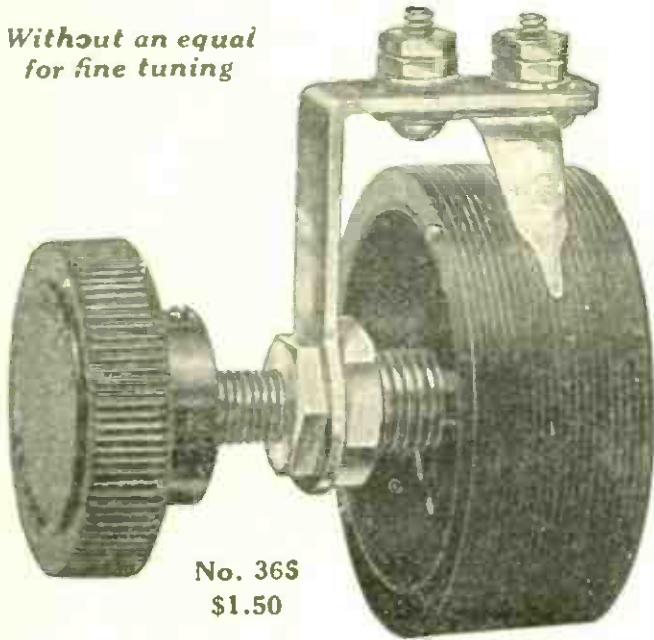

No. 36S
\$1.50

Dealers and jobbers write for our
attractive sales proposition

Precise Vernier Rheostat

Featuring:

Single hole mounting.
Single knob control.
Universal for all standard tubes.
Resistance range 0 to 30 ohms.
Critical Vernier adjustment over the entire range.

The use of this instrument produces amazing results—be convinced.

Write today for our illustrated bulletin and test chart describing our *AUDIO TRANSFORMER* and *SWITCH LEVER*.

Every instrument is sold with the guarantee of satisfactory performance. If your dealer cannot supply you, send check or money order direct to factory with dealer's name.

Precise Manufacturing Corporation
Rochester, New York

Branches
53 W. Jackson Blvd. Chicago, Ill. 821 Market St. San Francisco, Cal.
Distributed in Canada by Perkins Electric, Ltd.
Toronto Montreal Winnipeg

For Better Receiving

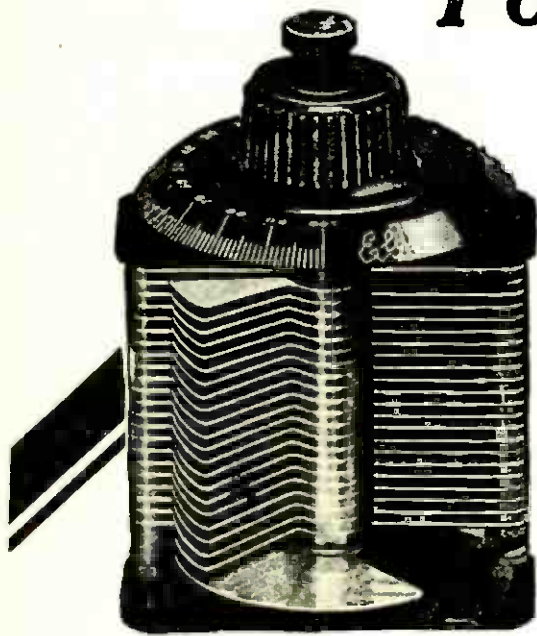

Pick up those distant stations louder and clearer. Eliminate noise and interference. You can do this when you use

Elgin PRECISION CONDENSERS

Permanent accuracy and rigidity are built into Elgin Precision Condensers. Plates are made of specially hard rolled aluminum and are of uniform thickness throughout. Special process spacers assure uniform spacing of plates. Adjustable vernier shaft makes it possible to use the Elgin Vernier Type Condenser on any thickness of panel and with dials of different thicknesses.

FULLY GUARANTEED

See your local dealer. If he cannot supply you send his name with your order to

The Elgin Tool Works

Incorporated
69 N. State St.
ELGIN, ILL.

Size	Capacity	Plain	Vernier
3 Plate	.000063 M. F.	\$1.75	\$—
11 Plate	.00025 M. F.	2.40	4.00
17 Plate	.00035 M. F.	2.75	—
23 Plate	.0005 M. F.	3.00	4.50
43 Plate	.001 M. F.	4.00	5.50

3" diameter composition dials, 50c extra

Please refer to POPULAR RADIO when answering advertisements.

Special Notice

The New 1924



LOUD SPEAKER

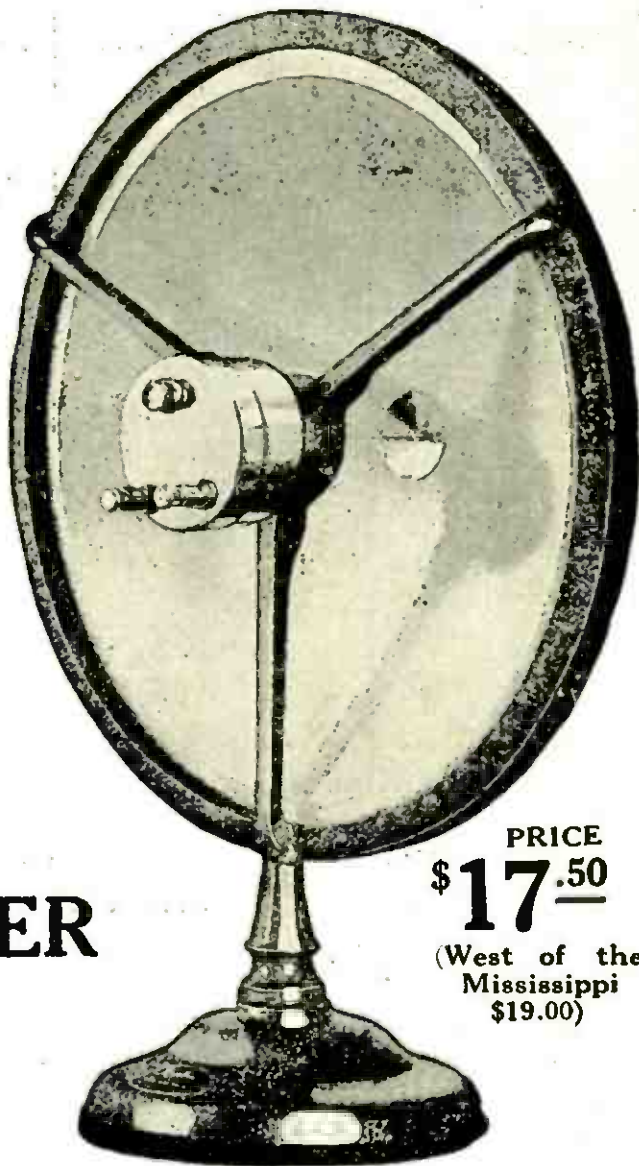

PRICE
\$17.50
(West of the
Mississippi
\$19.00)

IS NOW ON SALE

The new 1924 Pathe Loud Speaker is radically different in theory and construction design from any other loud speaker. It is scientifically perfect—the throaty voices of the horn have been finally done away with. The Pathe Loud Speaker actually reproduces distance signals clearly and without distortion.

It will add to your radio pleasure to find out the details of the new Pathe Loud Speaker. Step into your dealer's and see it or write us today for free pamphlets and full particulars.

PATHE PHONOGRAPH & RADIO CORPORATION

20 GRAND AVE., BROOKLYN, N. Y.

Western Sales Office, 533 Wabash Ave., Chicago, Ill.

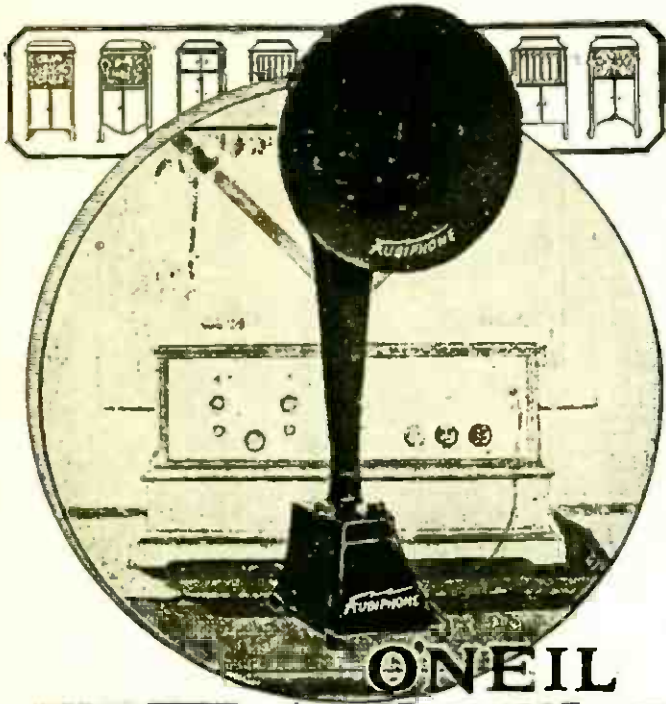

O'NEIL AUDIPHONE

THE highest standard of music reproduction, the phonograph, now equalled by the O'NEIL AUDIPHONE. Designed and built on phonograph principles by phonograph craftsmen and radio-acoustic engineers. A radical improvement over the old earphone type of loudspeaker. The entire voice or instrument is transmitted through the "laminated voice core." Diaphragm adjusted by exterior thumb screw.

No extra batteries needed. Complete, with connecting cord.

\$25

Model in antique bronze

\$30

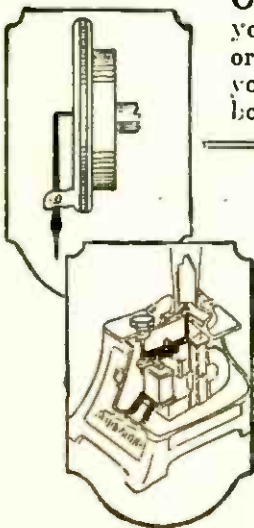

Absolute "money-back-if-not-satisfied" guarantee on every O'NEIL AUDIPHONE. Should your dealer have none on hand, order direct, C. O. D., mentioning your dealer's name. Write for booklet.

Note the similarity of construction between the phonograph reproducer (illustrated in the upper panel) and the reproducer of the O'Neil AUDIPHONE: both have a mica diaphragm set in a sound-box chamber actuated by an elbow stylus bar.

O'Neil Mfg. Co.

714 Palisade Avenue
West New York, New Jersey

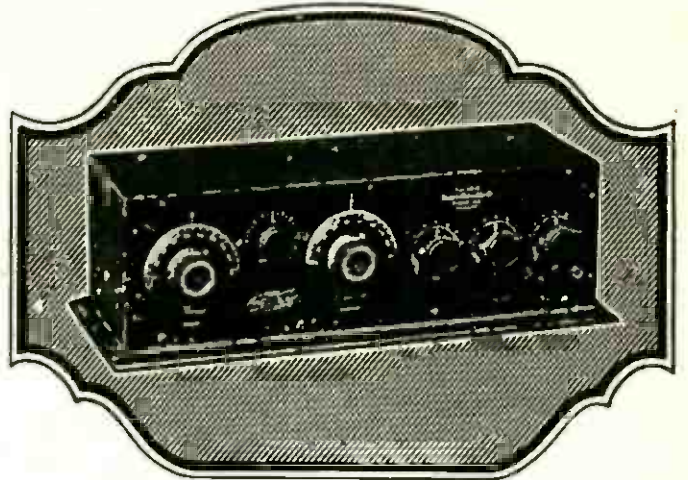

RADIODYNE

"The Voice of the Nation"

NO LOOPS - - - NO ANTENNA

The RADIODYNE is operated by simply grounding to a water pipe or radiator, and throwing a few feet of wire on the floor. Uses any standard tubes—dry cell or storage battery. Extremely selective. Simple to operate—only two controls.

Stations within a radius of 2,000 miles can be picked up on the loud speaker; any wavelength from 200 to 700 meters.

PRICE \$150.00

For use in apartments, boats, automobiles, railroad trains, etc., the RADIODYNE is enjoyable where other receiving sets would not be practical.

When interference, strays, static, etc., make other types of reception utterly useless the RADIODYNE picks up broadcast programs clear and distinct.

Write for illustrated folder which describes the RADIODYNE in detail. Every radio fan will be interested in this new type (antennaless) receiving set.

WESTERN COIL & ELECTRICAL CO.

308 5th St. :: Racine, Wisconsin





The RāBAT

a Rechargeable Wet 'B' Battery at Only \$3.96

A rechargeable wet "B" Radio battery built strictly on storage battery principles. Yet it costs only a trifle more than an ordinary dry cell battery.

The Rabat at the low price of \$3.96 has 12 cells with a total of 24 volts and ample capacity. It is noiseless, fool-proof, and compactly constructed. Built on a solid rubber base. Small, but neat and efficient. All elements visible. No internal discharge. More economical. Longer life. Higher and more continuous voltage. Easily recharged at home with aid of inexpensive Rabat Rectifier. If your dealer cannot supply you send direct.

South of Tennessee and West of the Mississippi, East of Rockies—\$4.25
West of Rockies—\$4.40
Rabat Rectifier for Recharging \$.75

THE RADIO RABAT COMPANY
301 RUSSELL BUILDING Playhouse Square CLEVELAND, O.

12 CELLS *The RāBAT* 24 VOLTS

SAVE MONEY!

An Amplex Kit costs you 20% to 30% less than the price of all the parts bought separately. Each Kit is complete. No extra parts to buy.



4 CIRCUIT COIL

Built strictly according to Cockaday's specifications. Radlon or Bakelite tubing, No. 18 DSC wire. Furnished in Kit, or separate, \$5.00.

IMPORTANT

Every part in every Kit is tested, guaranteed, and selected as the most efficient part for that Kit's circuit. Individual parts may be purchased separately at list price.

BUILD YOUR SET

The AMPLEX KIT WAY

The Safe, Simple, Money Saving Way
There is an Amplex Kit for Every Popular Circuit



3000 mile range

(By Courtesy "Popular Radio")

COCKADAY IMPROVED 4-CIRCUIT KIT

Parts	List Price Each	Parts	List Price Each
1—Panel 7" x 24" Drilled . . .	\$6.00	3—48000 Ohm Res.	\$1.25
1—4 Circuit Coil	5.00	1—Res. Mounting	1.25
2—Amplex 24 Pl. Vari. Cond. . .	5.00	1—.0005 Cond.45
5—Bakelite Sockets75	1—.00025 Cond.45
1—6 Ohm Rheostat75	2—P. E. Transformers. pr. . . .	12.50
3—20 Ohm Rheostat	1.00	1—Potentiometer	1.00
2—Grid-Densers	1.25	1—Baseboard	1.50
2—Grid Leaks, Var.75	1—Set of plans, etc.	1.50
1—Jacks, single65	12—Binding Posts10
2—Jacks, double	1.00	Bus bar, etc.50
2—Amplex Transformers.	5.00		
2—Switch Levers, etc50		

	List Price	Kit Price
1 Tube Cockaday Kit	\$26.60	\$19.75
3 Tube Cockaday Kit	53.80	42.50
5 Tube Cockaday Kit (Push Pull)	71.25	56.50

AMPLEX INSTRUMENT LABORATORIES
Dept. P :: 57 Dey Street, New York, N. Y.

SAFE AND SIMPLE!

The Amplex Kit takes the "guess" out of Radio.

DRILLED PANEL. COMPLETE INSTRUCTIONS and blue print for wiring and assembling with each Kit. No special skill or technical knowledge required. Safe and simple to build your set the Amplex Kit-Way.



"GRID-DENSER"
(Variable condenser. 0 to .0005 mfd.)

Specified by Cockaday Absolutely essential to control oscillations. Will improve any circuit. With Kit, or separately, \$1.25.

48,000 Ohm "Lavalite" Resistances, each, \$1.25

FREE

Our engineers will answer any Radio questions, or help you with any wiring or assembling problems. This service is absolutely FREE. Just write to Service Dept.

POPULAR RADIO with Your Other Favorites — at Special Club Prices!

Save money on these magazine bargains
They are figured at rock bottom prices

GLANCE over this big list of magazine bargains that have been arranged for your benefit. Here is your chance to get almost any magazine you want—and by ordering *now* with a year's subscription to POPULAR RADIO you get *both* magazines at special low prices.

If you are already a subscriber to POPULAR RADIO or to any of these other magazines, these special club offers allow you the privilege of renewing or extending your present subscription for an additional year *at a considerable saving of money.*

Fill your magazine requirements *now* for the coming year and save money. Simply check the offer you want and mail the coupon below, with your remittance, without delay.

All subscription prices quoted are for one full year, and may be sent to *one* or to *separate addresses* unless otherwise noted. (Club prices for Canada and foreign countries will be quoted on request.)

McCall's Popular-Radio \$4.00 Reg. For.....	\$3.25	Modern Priscilla Popular Radio \$5.00 Reg. For.....	\$4.00
Youth's Companion (52 issues) Popular Radio \$5.50 Reg. For.....	\$4.50	Scientific American Popular Radio \$7.00 Reg. For.....	\$6.00
American Magazine Woman's Home Com- panion (both to one address) Popular Radio \$7.00 Reg. For.....	\$5.75	Pictorial Review Modern Priscilla Popular Radio \$6.50 Reg. For.....	\$5.35

Or You Can Make Up Your Own Club of POPULAR RADIO With:

American Boy.....	\$5.00 reg., for...	\$4.50
American Magazine.....	5.50 reg., for...	5.00
Asia.....	6.50 reg., for...	5.50
Boy's Life.....	5.00 reg., for...	4.25
Christian Herald (52 issues).....	5.00 reg., for...	3.90
Collier's (52 issues).....	5.50 reg., for...	4.50
Cosmopolitan.....	6.00 reg., for...	5.50
Country Life.....	8.00 reg., for...	7.00
Delineator.....	5.00 reg., for...	4.25
Designer.....	4.50 reg., for...	3.75
Good Housekeeping.....	6.00 reg., for...	5.50
Heart's International.....	6.00 reg., for...	5.50
House & Garden.....	6.50 reg., for...	5.50
McClure's.....	6.00 reg., for...	5.00
Mentor.....	7.00 reg., for...	6.00
Movie Weekly.....	8.00 reg., for...	7.00
National Geographic.....	6.50 reg., for...	6.00
People's Home Journal.....	4.25 reg., for...	3.50
Photoplay.....	5.50 reg., for...	4.75
Physical Culture.....	6.00 reg., for...	5.00
Popular Science Monthly.....	5.50 reg., for...	5.00
QST.....	5.00 reg., for...	4.35
Radio.....	5.50 reg., for...	4.00
Radio Broadcast.....	6.00 reg., for...	5.00
Radio Digest (52 issues).....	8.00 reg., for...	7.00
Radio News.....	5.50 reg., for...	4.75
Radio World (52 issues).....	9.00 reg., for...	8.00
Today's Housewife.....	4.00 reg., for...	3.25
Vogue (26 issues).....	8.00 reg., for...	7.00
Wireless Age.....	5.50 reg., for...	4.75

Note: If you wish any TWO or more of these magazines with POPULAR RADIO, simply deduct \$2.50 from the bargain club price quoted, then add POPULAR RADIO at \$2.50. For example:

McCall's.....	\$3.25 less \$2.50=	\$0.75
Radio.....	4.00 less 2.50=	1.50
POPULAR RADIO, added at only.....		2.50

Remit this amount \$4.75

POPULAR RADIO, Dept. 22,
9 East 40th Street, New York City.

Enclosed is \$..... Please see that yearly subscriptions are at once entered in my name for each of the magazines I have checked in the special bargain club list at the right.

Name.....

Street and Number.....

City..... State.....

(If not a NEW subscription, please mark R after the name of the magazine, to indicate RENEWAL.)

Prices for Canada and foreign countries will be quoted on request.



\$25

TRADE MARK

Hear the Atlas Loud Speaker

Ask your dealer for a demonstration. Submit it to any reasonable test. Get the proof NOW.

Natural
Re-PRODUCTION

Atlas

LOUD SPEAKER

SCORES of letters, sent us by enthusiastic owners of Atlas Loud Speakers, reveal how great is the difference between ordinary loud speakers and this real radio reproducer. It is the difference between real and artificial revival of the music broadcasted. The exclusive "double diaphragm" feature responds equally true over the entire range of musical cycles. There are no distortion points. This device is adjustable to your set and particular receiving conditions. *Write for Illustrated Booklet "B."*

Letters from Users Requested

Make Your Own Loud Speaker with THE ATLAS UNIT, with phonograph attachment \$13.50

(Unit without Attachment \$12.50)

Sole Canadian Distributors: The Marconi Wireless Telegraph Company, of Canada, Limited, Montreal, Canada.

Multiple Electric Products Co. Inc.

Makers of Multiple *TIME-LAG Mono FUSES*
7 Orange Street, Newark, New Jersey

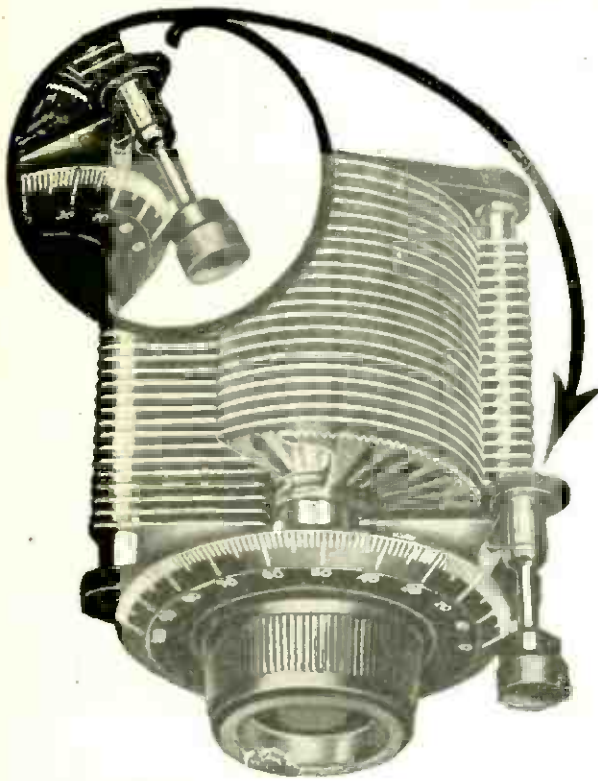

HEATH'S Radiant Condensers

When you put Heath Radiant Condensers behind a panel, you can forget about them. They will always tune as perfectly as the day you mounted them. Absolute alignment is permanent, because the plates are protected against warping and buckling by the Heath process of stamping and tempering. Each plate is PERMANENTLY FLAT.

Vernier With a Hairline Adjustment

Separate vernier adjustment—reducing gear meshed into teeth cut in rim of vernier plate. Ordinary adjustment reduced to infinite fineness. Absolutely positive adjustment—without backlash.

Write for illustrated booklet and name of the nearest Radiant Dealer.

Prices Vernier Type

13 Plate including 2 $\frac{1}{2}$ " dial and knob.....	\$5.00
25 Plate including 2 $\frac{1}{2}$ " dial and knob.....	5.50
45 Plate including 2 $\frac{1}{2}$ " dial and knob.....	6.50

Jobbers and Dealers Write Immediately for proposition

HEATH RADIO & ELEC. MFG. CO.
204 First Street Newark, N. J.

Lowest Battery Costs

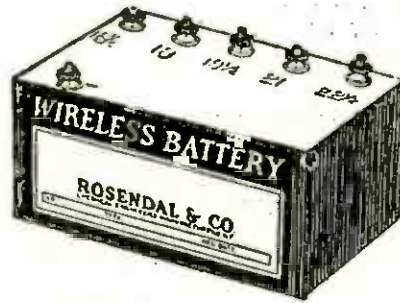

Rosendal "B" Batteries come from our own factories direct to you. They're refresh-tested — and are sent all charges pre-paid.

A Rosendal battery is built right; of raw materials that have been carefully analyzed and are known to be the best that can be had—and then compounded under Rosendal Formulas which are recognized and used by representative Battery Manufacturers throughout the country. That is why Rosendal can guarantee the battery you get.

Money back if not satisfied

	Large	Medium	Small
22 $\frac{1}{2}$ Volt plain.....	\$1.66	\$1.33	\$0.93
22 $\frac{1}{2}$ Volt variable.....	1.84	1.50	1.00
45 Volt plain.....	3.33	2.33	—
45 Volt variable.....	3.66	2.60	—

Send money order or order for C. O. D.

ROSENDAL & CO

Chemical and Radio Engineers

2 and 4 Stone Street New York

Send for descriptive circulars on other radio items

The Tube's the Thing!

Get Radio Reception Without Noise



($\frac{1}{2}$ size)

\$5

Each

MYERS TUBES

Guarantee Perfect Clarity

Hear without noise or tube hiss with Myers Tubes. They give much greater amplification, are perfect Detectors and Oscillators. They add 50% to the efficiency of your set because they reduce interference.

TWO TYPES: Myers Dry Battery Tube 2 $\frac{1}{2}$ Volts— $\frac{1}{4}$ Ampere. Myers Universal operates on either 3 Dry Cells or storage batteries. \$5.00 each. Ready for mounting. No sockets or extra equipment needed.

See that you get the New Improved Myers Tubes with the Coating. Others are not guaranteed.

At your Dealer, otherwise send purchase price and you will be supplied Postpaid.

SOLE MANUFACTURERS

E. B. Myers Co. Ltd.
Radio Vacuum Tubes

240 Craig Street,

W., Montreal, Canada



Music at its Best!

Full, clear, rich, beautiful—MUSIC MASTER brings into your home the majestic tones of the pipe organ, the incomparable master instrument of the musical world.

MUSIC MASTER gives you the *truth* of each soft strain, every arpeggio, the inspiring, kingly chords and the rich, rolling bass tones.

Why not let *everyone* hear the organ? Flood the whole room with its majestic music—simply by connecting MUSIC MASTER to your radio set.

MUSIC MASTER is equipped with a wood amplifying bell; and wood, properly shaped as a horn—furnished only with MUSIC MASTER—is the one material that makes possible the perfect reproduction of the actual, living tones themselves.

Dealers Everywhere

14-inch horn (mahogany or spruce) for the home **\$30**

21-inch horn (mahogany only) for concerts **\$35**

Comes complete, ready to attach in place of headphones. No batteries required for its operation.

MUSIC MASTER CORPORATION

Formerly General Radio Corporation

Makers and Distributors of High Grade Radio Apparatus

S. W. Corner 10th and Cherry Streets, Philadelphia

CHICAGO

PITTSBURGH

Music Master

RADIO REPRODUCER

Please refer to POPULAR RADIO when answering advertisements.



100 Volt Panel type

“The most popular in this vicinity—”

“We wish to commend your storage “B” battery,” says the Southern Radio Sales Co., Newport News, Va. Such endorsements come to us unsolicited. KIC-O Batteries always make good. Alkaline type, won’t sulphate or buckle. Life unlimited. Not harmed by short-circuiting, overcharging, idleness. Panel switches give single cell variations. Recharge from any 110-volt A. C. line with small home rectifier. Charge lasts 3 to 6 months in detector plate circuit.

GUARANTEE

Your money back on any KIC-O Battery if not satisfied within 30 days. Write for full information on “A” and “B” Batteries.

Unmounted Rectifier..... \$1.00
 Mounted Rectifier..... \$2.50

KIMLEY ELECTRIC COMPANY, Inc.
 2667 Main Street Buffalo, N. Y.

KIC-O Storage “B” Batteries—
 long service, low cost

Cells	Volts	Price, Plain	With Panels
16	22	\$5.50	
24	32	7.25	\$11.75
36	48	9.50	14.00
50	68	12.50	17.00
78	100	17.50	22.50
108	145	23.50	28.50

Bakelite Jack

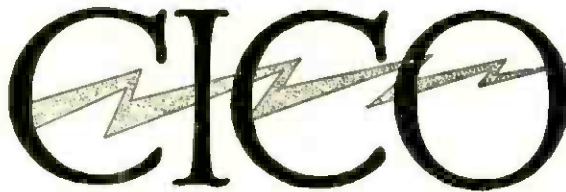

2-Way Plug

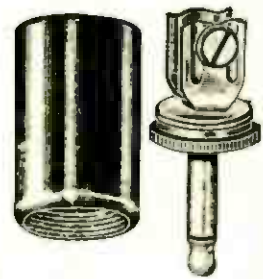

Price **60c**

The CICO Bakelite Jack is the finest article of its kind ever produced and the last word in scientific radio construction. Moulded completely from Bakelite. No metal in frame construction. Wires connected to Nickel-Plated Brass Binding Posts. No soldering necessary. Special whitened phosphor Bronze Springs used throughout. Contact points of Sterling Silver.

A Radio Plug that embodies the most advanced engineering principles. A recognized leader for 2 years Loud speaker and headphones or 2 sets of headphones can be connected simultaneously to the same plug by inserting 2 cord tips instead of one in each slot. Fits all standard jacks. Takes all types of tips.

No. 30-Single circuit open	\$.80
No. 31-Single circuit closed	.85
No. 32-Double Circuit	.90
No. 33-“A” Battery Switch	.90

Consolidated Instrument Company of America, Inc.

41 East 42nd Street
 New York

Every CICO PRODUCT is packed in a distinctive GREEN BOX and unqualifiedly guaranteed against all defects.



**18
Stock Sizes
Radion
Panels**

6x10 1/2	6x14	6x21
7x9	7x10	7x12
7x14	7x18	7x21
7x24	7x26	7x48
9x14	10x12	12x14
12x21	14x18	20x24

***Mahoganite Has
the Beauty of
Polished Mahogany***

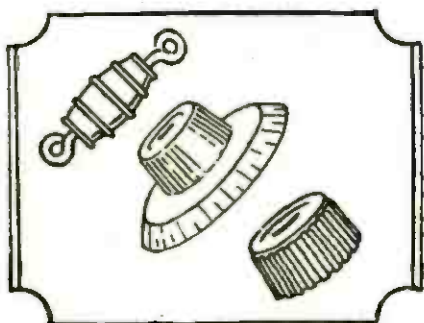

Mahoganite Radion Panels have a satin-like finish comparable to that which age and a skilled cabinet maker give to mahogany. Radion Dials and Knobs are also made in Mahoganite, to match. Sold at all good radio stores or write to us for catalog.



Look for this stamp on every genuine RADION Panel. Beware of substitutes and imitations.

RADION
The Supreme Insulation
PANELS

AMERICAN HARD RUBBER CO., 11 Mercer St., N. Y.

Please refer to POPULAR RADIO when answering advertisements.

Como Duplex Transformers

(PUSH-PULL)

The COMO DUPLEX SYSTEM of audio-frequency amplification gives the maximum volume without distortion and tube noise.



There is a combined filtering action which assures perfect results when ordinary amplification fails.

It can be added to your present amplifier, giving you power amplification on the weak signals that more of the ordinary amplification would kill.

SOLD IN MATCHED PAIRS

\$12.50 per pair

A copy of "HOW TO MAKE A POWER AMPLIFIER" is yours for the asking.

COMO APPARATUS COMPANY, 446 Tremont Street, Boston, Mass.

DID YOU GET LONDON?

At this writing, two of the three Philadelphia stations submitting authentic records of having tuned in London were equipped with the

TURN-IT

adjustable GRID-LEAK

THESE leaks fit all standard mounts, give exact values for the tubes, circuit and signals, and are so simple in operation that anyone can instantly understand and appreciate all the desirable features of this unique and practical radio mechanism. Sold either by your dealer or by

CHARLES E. BONINE
20 So. 15th Street
Philadelphia

75c.



If ordered C.O.D. add 10c

New Hook-Ups Are Easy Now

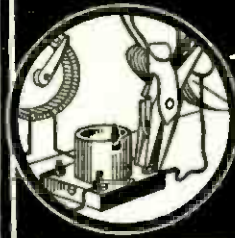

You'll save hours of labor and make connections as solid as soldering with

Stevens Spintite Wrenches

Hollow stem goes down over projecting screws—hex socket gets firm grip—ebonized handle for comfortable leverage—very easy to reach difficult places. Used by radio manufacturers.

Made in all sizes from 3-16 in. to 9-16 in.

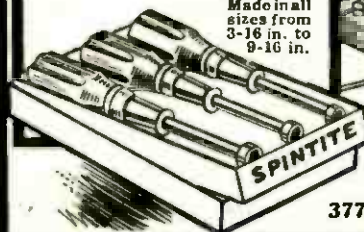

Send for set of 3 **\$1.00**
popular radio sizes
STEVENS & COMPANY
Toolsmiths since 1899
377 Broadway, New York

Stevens **SPEED UP** Tools

"The Best Built Set in America"

R-212



Licensed by I. R. M., Inc., under Hazeltine Patents



Embodying the Hazeltine Neutrodyne circuit in an improved form as to neutralization, workmanship, quality, appearance and efficiency of operation.

Radio Service Laboratories, 1000 11th Ave.

Asbury Park, N. J.

Please refer to POPULAR RADIO when answering advertisements.

Radio Fans



Here Is a Winner
 Armstrong
 Regenerative Set
 Receiving
 Radius
 600 Miles
\$23²⁵

Order Direct From
 This Advertisement.

HERE is a money saving Radio Outfit that will bring the news of the world—concerts, lectures and stock reports—into your home. Sold complete with head set, tube, batteries, aerial and ground wires, for only \$23.25! Connections simple and plainly marked. Easy to tune. Order NOW! Shipping weight, 12 pounds. Shipped from CHICAGO or PHILADELPHIA store.
 57PR9366\$23.25



Save on All Radio Supplies.

Save money on your radio supplies, and get guaranteed quality! Our big FREE Book shows hundreds of bargains in complete sets and parts. Many new hookups, complete list of broadcasting stations. Contains "How to Build an Aerial." Mail coupon!



Licensed under the Armstrong Patent No. 1113149 for amateur experimental and scientific uses only.

Sears, Roebuck and Co.
 Chicago - Philadelphia

Mail coupon today to store nearest you for Free Radio Catalog.

Send me FREE Radio Catalog No. 89P71.....

Name.....

P. O. State.....

Rural Route..... Box No.....

Street and No.....

Sears, Roebuck and Co.

The World's Biggest Mail Order House

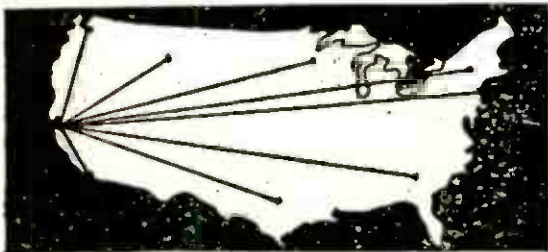

ON ONE TUBE

Broadcasting from Atlantic Coast, Canada, Mexico, Cuba & Hawaii heard in Calif. by users of the CROSS COUNTRY CIRCUIT. Range due to simplicity. One tuning control. ANY NOVICE can build easily and cheaply. Dry cell tubes used. No soldering. Complete instructions, Blue print panel layout. Assembly Photo, etc., postpaid 25 cents. Stamps accepted.
 VESCO RADIO SHOP, Box PR-117, OAKLAND, CALIF

"3000 mile"



RADIO "B" BATTERIES AT FACTORY PRICES

Greatest radio "B" battery on market. Full number voltage taps; QUALITY GUARANTEED; LOWEST PRICES; brings in concerts LOUDER AND STRONGER; will work on any tube or loud speaker. Order by number TO-DAY with check, money order or pay postman C. O. D.

- No. 122B 22½ volt variable, regularly \$2.25 ... **\$1.52**
- No. 122A 22½ volt variable, regularly 3.00 ... **1.85**
- No. 145A 45 volt, 8 taps, regularly 5.50 ... **3.25**

AYRES BATTERY CORPORATION, Cincinnati, Ohio



**Radio Apparatus
That Lives Up to Its Name**

New "Regal" No. 162
Double Arm Inductance
Switch

A 15 Point Switch complete
in one unit. No more
messy soldering. No more
drilling of holes. No more
chipped panels. Complete
with hard rubber Knob and
Dial

\$1.50



New "Regal" No. 120
Vernier Rheostat

For fine filament control
of tubes and superfine
tuning, the Regal Vernier
stands alone. Nothing
just like it on the market.
Complete with Knob
6-Ohms..... \$1.25
30-Ohms..... 1.25



New "Regal" No. 200
Audio Frequency Amplifying
Transformer

For clearness of tone,
amplification of voice
and music from nearby
and distant broad-
casting stations, is un-
equaled by any Trans-
former on the market
3½ to 1 Ratio... \$4.25
5 to 1 Ratio... 4.50



At all good dealers—otherwise write direct
for complete descriptive folder No. 24,
sending dealer's name.

AMERICAN SPECIALTY CO.
Bridgeport, Conn.

*Listen
to the Difference!*



**Phonograph \$6⁵⁰
Attachment** with 6 feet
of cord

You never heard of a high quality phonograph attachment at this price, and you never heard a tone equal to the C. I. C. Unit at any price. Long years of experience with loud speakers and head phones only have made the above price and the quality possible.

Mica diaphragm mounted between resilient cushions, an adjustable air gap, and extreme accuracy of manufacture give exceptional volume and quality of reproduction.

The unit is equipped with an adapter to fit both the Victor and Columbia phonograph, or for one dollar extra adapters will be furnished to fit Brunswick or Edison phonographs. The adapter can be removed, making it suitable for use with any of the types of horns which are designed to take a head set receiver.

You are wise in utilizing your phonograph as a loud speaker. Be equally wise in transmitting the true beauty of sound by means of the C. I. C. Phonograph Attachment.

Send for booklet "Loud Speaker Facts" which gives full information regarding the C. I. C. Loud Speaker and Phonograph Attachment

CONNECTICUT INSTRUMENT CO.
STAMFORD, CONN.

Representatives

GLOBE COMMERCIAL CO. L. D. READ
San Francisco, Los Angeles, 919 Lake View Boulevard,
and Salt Lake City Seattle

The Hines Radio Desk

Has a large compartment for batteries that is very accessible. Two good size drawers for wire, tools, parts, etc. Designed by a man of long experience in the Radio field. Constructed from selected materials and built in a modern factory by skilled workmen. Finished in Oak, Mahogany or Walnut. Complete details and exact specifications sent upon request.



HINES RADIO DESK COMPANY
Owensboro, Kentucky

better! in any circuit

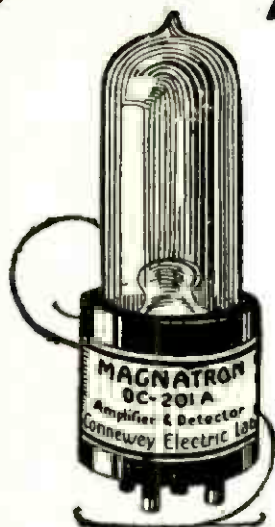

All moulded base, eliminating the capacity effects of brass shells. Draws 1/4 ampere.

DEALERS:—Write at once!

The MAGNATRON DC201A is a more sensitive detector and a more powerful amplifier. It will bring in stations you have never heard before. It will increase the volume from your loud speaker.

Get a Magnatron DC201A from your dealer today and note the difference! Like the Magnatron DC199 and the Melotron DC12A, this tube lists at \$6.50. A special price of \$5.50 if your dealer doesn't stock these tubes and you send us his name!

CONNEWAY ELECTRIC LABORATORIES
309 Fifth Ave. NEW YORK CITY

WEIGHS
ONLY
8 OZ



A \$200,000.00 COMPANY stands squarely back of the guarantee on every Scientific headset

SEND NO MONEY!

20,000 TURNS
EQUIVALENT TO
3,000 OHMS

Order TODAY
by Postcard
and Pay
Postman
on arrival

THE
PHONE
IT
TOOK
A SOLID YEAR
TO DESIGN

\$2.95

POST-PAID

**LOUD
SPEAKER
UNIT \$1.95**

We Guarantee The Scientific Headset to be the greatest value on the market. Try it for five days. If not satisfactory send it back and your money will be refunded immediately. Circular on request. Dealers wanted.

THE SCIENTIFIC ELECTRIC WORKS
98 Brookline Ave. DEPT. J BOSTON, MASS.

SUPER-HETERODYNE

"The Rolls-Royce of Reception"

TYPE "S R" Radio Frequency TRANSFORMERS

An instrument especially designed to amplify at a sharp peak of 10,000 meters, and perfected to function at maximum efficiency in the best designed receiving apparatus in the world.

THE RIEGER-BAILEY CO. OF AMERICA

Price \$7.00

at best radio dealers or direct from the manufacturer. Give dealer's name if ordered direct.

539 Real Estate Trust Bldg.

Philadelphia, Penna.

Bell Telephone Walnut 7475

DEALERS and JOBBERS

will find this a particularly active and attractive line. Write for details.

BETTER—
and at a Lower Price

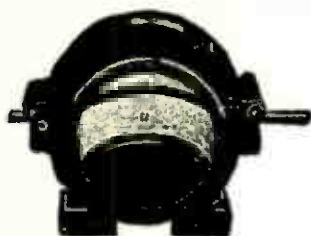

A scientifically accurate instrument for long distance tuning. R. P. C. Variometers are molded of Mahogany Bakelite. Sturdy in design, neat in appearance and easily mounted. Price \$5.00

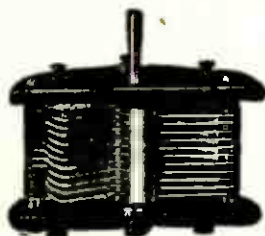

R. P. C. Variable Condensers

permit you to tune in desired stations without the least bit of interference. The design of these condensers guarantees perfect contact at all times. Price \$1.50

Dealers and Jobbers:
Write for attractive proposition

RADIO PRODUCTS COMPANY
Westport, Conn., U. S. A.

MURDOCK RADIO



the complete
MURDOCK
LOUDSPEAKER
for \$5.00

the new
MURDOCK
PLUG-JACK
for \$1.00

a pair of
MURDOCK
HEAD PHONES
\$4.00 or \$4.50

**best in
radio**

AT ALL RADIO DEALERS

If your dealer cannot supply you, send money direct and your order will be promptly filled.

WM. J. MURDOCK COMPANY
354 Washington Ave. Chelsea, Mass.

THE NEW SIMPLEX

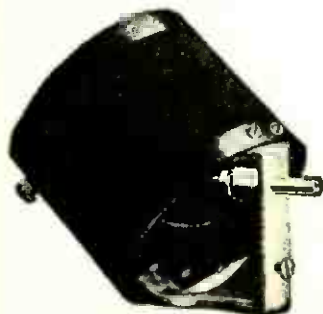

180° Vario-Coupler with Special Spider Web Rotor will bring in those distant stations you are trying for. An exceedingly efficient and neat coupling device which will cover all broadcast wave lengths up to 600 meters.

Price - - \$3.50

SIMPLEX RADIO CO.
1015 Ridge Ave. Phila., Pa.

WE REPAIR The Following RADIO TUBES



WD-11.....	\$3.50	UV-199.....	\$3.50
WD-12.....	3.50	C-299.....	3.50
UV-200.....	2.75	UV-201A.....	3.50
UV-201.....	3.00	C-301A.....	3.50
C-300.....	2.75	UV-202.....	4.00
C-301.....	3.00	C-302.....	4.00
DV-6.....	3.00	DV-6A.....	3.50

Mail orders solicited and promptly attended to.

Dealers and Agents Write for Special Discount.

H. & H. RADIO COMPANY
Clinton Hill Sta. P. O. Box 22-E. Newark, N. J.

FLERON RADIO SPECIALTIES

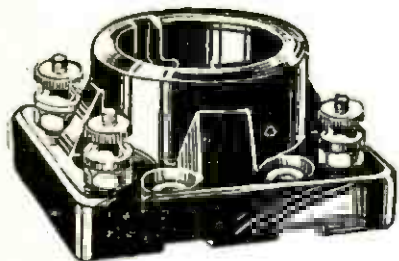

The Porcelain Sockets

Very carefully made. Brass parts nicked. Black Glaze. Two sizes. Standard Bulbs and U. V. 199. Each socket in a carton. 35c. each.

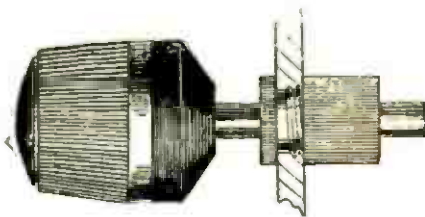

The Vernier Adjuster

The best adjuster on the market. Spring holds head away from dial when not in use. With slight adjustment spring can be made to hold head against dial if desired. Patented. 65c.



The Phono Adapter

Fits through the hole of the receiver cap and then slides on the phonograph tone arm. Fits Victor, Columbia, and others. Works perfectly. Only 35c. ea.



The Porcelain Insulators

Lowest power losses in the antenna. Dielectric absorption reduced to minimum because of very low phase difference of Fleron Porcelain. Very tough body. Solid Black Glaze. Seven sizes, 20c to \$1.00. Each insulator in a separate carton.

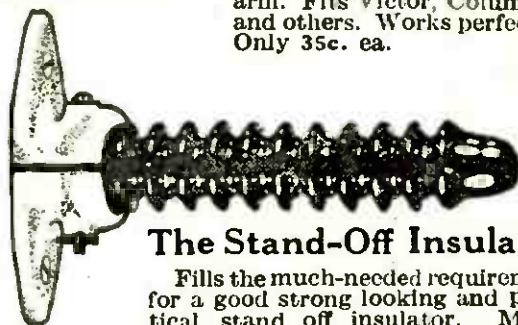

The Stand-Off Insulator

Fills the much-needed requirement for a good strong looking and practical stand off insulator. Meets every requirement of the Board of Fire Underwriters. \$1.25 each.

For Sale by all Good Jobbers and Dealers

M. M. FLERON & SON, Inc., 112 No. Broad St., Trenton, N. J.

RATHBUN SINGLE-HOLE MOUNTING SUPERIOR CONDENSERS

COMPLETELY protected mechanically and dielectrically by full circle Bakelite end shields. The entire instrument is more rigid and hence more accurate. Just one of the differences between average condensers and RATHBUN. Only one hole needed to mount, better, long brass bearings, stator plates anchored in milled tubes with a variation of less than two-tenths of one-thousandth of an inch. Write for literature and name of the nearest Rathbun dealer.

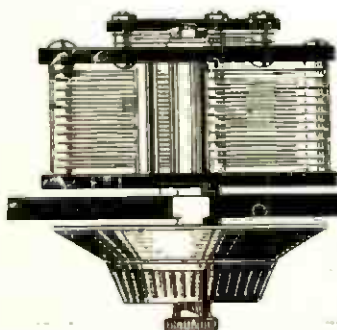

RATHBUN MFG. CO.
Jamestown, N. Y.

LIST PRICES

11 Plate	.00025	\$3.00
23 "	.0005	3.50
5 "	.000125	3.00
43 "	.001	4.50
3 "	.000075	1.00

SPECIAL FOR NEUTRODYNE

13 Plate .0003 \$3.00
Write TODAY for the name of the nearest Rathbun dealer and for illustrated literature.



No. 1001

6 1/2 Ohm Rheostat . . . \$1.10
25 Ohm Rheostat . . . 1.10
40 Ohm Rheostat . . . 1.10
Patd. 870,042

HOWARD



No. 1003

200 Ohm Potentiometer . \$1.50
400 Ohm Potentiometer . 2.00
Patd. 870,042

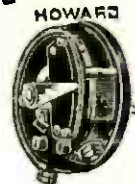

No. 1002

6 1/2 Ohm Micro-rheostat . . . \$1.50
25 Ohm Micro-rheostat . . . 1.50
40 Ohm Micro-rheostat . . . 1.50
Patd. July 10, 1923

HOWARD



No. 1004

Multi Terminal Receiver Plug, instantaneous connection for as many as six pairs of standard receiver tips . . . \$2.00
Patd. Aug. 28, 1923

Ask the man behind the counter to show you the Howard line of quality Radio Merchandise. Every piece is sold with the guarantee of satisfactory performance.

Jobbers write for discounts.

Send two cents for folder.

HOWARD RADIO CO., Inc.

4248 North Western Ave., Chicago, U. S. A.

DX-10-POINT

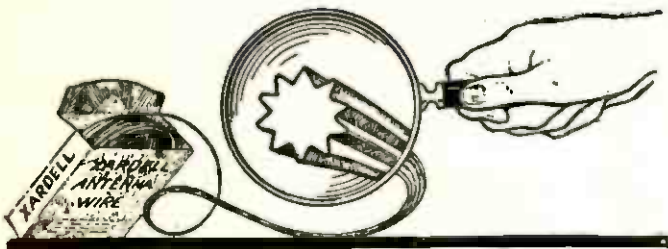

ANTENNA WIRE

\$2⁰⁰

PER
HUNDRED
FEET

Designed for long distance reception and is different and better than the usual make-shifts, being hard drawn from the finest copper, having a corrugated surface with ten collecting points on the circumference. This gives a greater collective surface to the high frequency radio currents. The result is extreme sensitiveness and increase in range and clearness of any set from the simplest Crystal to the finest multiple tube receiver.

Use this antenna wire and enjoy the full possibilities of your set.

Sold in coils 100 feet, 200 feet and 500 feet. Order direct or from your nearest dealer.

Dept. R



THE NEW

METALECTRIC SOLDERING IRON

Operates with the Simplicity—
Ease and Efficiency of a
Pencil on any Electric Current

ACCEPTED

As the Logical Solution
to Radio Soldering
Problems

Ample Heating Capacity
Handle Always Cool

\$5.50

"Worth it"



Inter-
changeable
Tip

"An All-metal
Quality Instrument
with a worthwhile Guarantee"

of Your Dealer or Write

Post Elec. Co., Mfrs. (Invt. Div.) 30 E. 42 St., N. Y. C.

Unity Rheostats



Vernier

The highest type electrical instrument made for controlling resistance.

6 Ohms—Most Tubes
25 Ohms—201-A and
301-A
40 Ohms—199 and 299
\$1.75 each—any resistance

Recommended by all Scientists familiar with it, where close adjustment is desired.

"Hear a set that uses one"

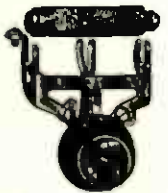

Non-Vernier or The Cartridge Rheostat

Interchangeable resistance Cartridges clip in without removing the Bracket from the panel.

Complete Rheostat \$3.80
Cartridges, any resistance \$0.35
Potentiometers . . \$1.45
Potentiometer Cartridges . . . \$1.00

Used on the
"Long 45"

UNITY MFG. CO.

224 N. HALSTED ST. CHICAGO

Send for a free circular

ACOUSTICOLA GRAND

\$35.00



Highest quality loud speaker made. CAST ALUMINUM vibrationless horn, extra large and sensitive unit. Adjustment lever tones down local stations and strengthens weak signals from distant stations just like focusing a camera.

ACOUSTICOLA

Standard Model

\$22.50

Same wonderful unit, with same lever for instantly increasing or decreasing distance between poles and diaphragm. Fitted with non-metallic horn, 21½ inches high with bell 10 inches wide.

Acousticola Phonograph Attachment

Same giant size unit with coupling to make a high grade loud speaker of any phonograph. \$10.00

Trimm Headsets

Dependable \$5.00 Professional \$7.65

Lifetime guarantee with every Trimm product. Write for Folder.

TRIMM RADIO MFG. COMPANY

Dept. 59 24 S. Clinton St. Chicago, Ill.

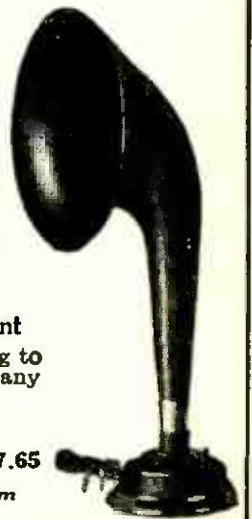

SUPERTRAN

Audio Frequency Transformer

gives

REAL LONG DISTANCE

and preserves the natural tone of Broadcasting, both vocal and instrumental, exactly as sent through the Microphone



Price
\$6.00

Can be used with any amplifying tube on the market with excellent results

At your dealer—or direct by mail on receipt of purchase price

FORD MICA CO., Inc.
14 Christopher St. New York



Simple as
A B C

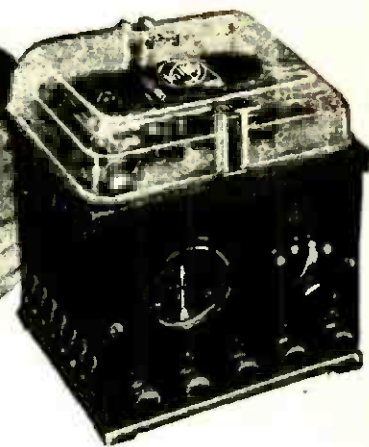

Longer distance and clear signals are the pleasing results which you can be sure of when both the A and B batteries of your set are storage batteries. No other source of power for radio equals the storage battery.

The Valley ABC Battery Charger is so simple and so easily operated that it makes storage batteries the most convenient and inexpensive source of power for radio. Enjoy radio at its best. Use storage batteries and charge them with the Valley ABC Battery Charger.

Charges 2-volt peanut tube batteries, 6-volt A Batteries, 6 and 12-volt automobile batteries, and 1 to 4 B batteries. Bakelite panel, glass top. Harmonizes with any receiving set. At good radio shops.

VALLEY ELECTRIC CO.

3157 S. Kingshighway • St. Louis, Mo.

Valley Battery Charger

EASTERN COIL SETS

for the **COCKADAY** CIRCUIT

are the standard, and in universal use due to their proved efficiency in this wonder circuit

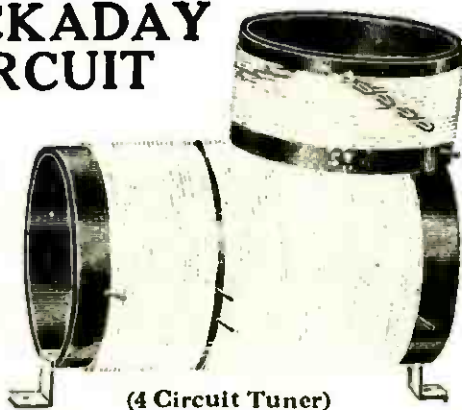

(4 Circuit Tuner)

Made as per specifications of Mr. Cockaday, "D" Coil bank-wound.

Complete assembled Set of B, C and D Coils on Hard Rubber or Bakelite tubing, wound with #18 double silk \$4.25 covered wire.

The same on guaranteed treated tubing wound with #18 Single cotton covered wire \$2.75

Original and new improved hook-ups with material lists FREE with each set of coils.

Either Set may be used for original or new improved hook-up.

Mail Orders Filled. Dealers Communicate.

EASTERN RADIO MFG. CO.

22 Warren Street, Dept. P. R. NEW YORK, N. Y.

RADIO CONSTRUCTOR plans make set building EASY!

JUST OUT!!
Complete Plans of

5 Tube Neutralized receiver, embodying Neutrodyne principle 25c
3 Tube Cockaday most popular for distance and tone 25c

Each drawing is enclosed in Manila Envelope with full size blue print for drilling panel and wiring.

BOOK OF COMPLETE PLANS 50c
of all Modern Circuits Reinartz Tuner—One Tube Reflex Honeycomb Receiver—Long Distance Receiver—Short Wave Regenerative—Two Stage R. F. Amplifier and special W. D. 11 Hookup.

Each Plan Contains FULL SIZE TEMPLATES, list of parts and diagrams.

AT ALL DEALERS
If your dealer cannot supply you, order direct giving dealer's name and address.

S. NEWMAN, Publisher, THE RADIO CONSTRUCTOR
74 Day Street New York City

POPULAR RADIO and "Radio"

**\$5.50 magazine value
for only**

\$4

FOR a limited period of time you may secure these TWO famous radio magazines for practically the subscription price of ONE of them alone! The publishers of POPULAR RADIO and "Radio" (San Francisco) have arranged this special money-saving club offer so that those who have not already made the acquaintance of these two magazines may now subscribe at a saving of \$1.50.

THIS is your opportunity to keep in touch with all of the practical suggestions, timely news and helpful hints that these TWO big radio magazines can bring you. And you get them BOTH at a low price that positively cannot be equalled after this special offer is withdrawn.

If you were to purchase these two magazines on the newsstands, you would pay \$6.00 for 12 issues of POPULAR RADIO and "Radio." If you were to subscribe for each separately, the cost would be \$5.50. But by snapping up this special club offer now, you get the same two magazines, delivered regularly to your home, for only \$4.00. A

saving to you of from \$1.50 to \$2.00.

Simply fill out and mail the attached coupon, and your subscription for both POPULAR RADIO and for "Radio" will be entered without delay. TWO monthly magazines with all the radio facts and features that any enthusiast could desire—"how to build" articles; the latest reliable hook-ups; "how radio works"; discussions by the most distinguished scientists; new developments; what the amateurs are doing; calls heard and DX records; late developments; scientific data; invaluable pointers for the broadcast listener. *And your questions answered free!*

Mail the handy coupon today.

**POPULAR RADIO, Dept. 23,
9 East 40th Street, New York City.**

Send me POPULAR RADIO and "Radio," each of these big radio magazines, for one entire year. I enclose \$4 in full payment.

NAME

ADDRESS

(Canada, \$4.50; Foreign, \$5.00)

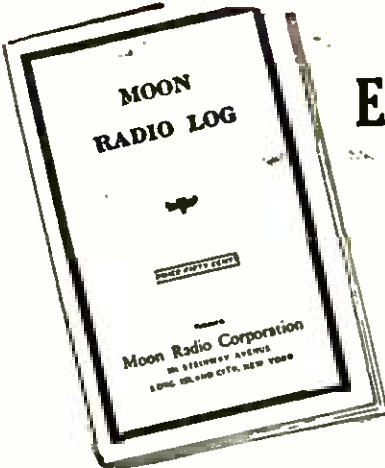

**Every Fan
Wants
a Moon
Radio
Log**

The only book out that gives you a complete, permanent record of your receptions over a long period. Has over 200 ruled logs for entering in ink all the stations received each day with spaces for call letters, distances, remarks, &c. Also gives Morse Code, latest list of broadcasting stations with new wave lengths, call letters and slogans. Bound in stiff, durable covers. Send no money with your order. Just pay the postman, on delivery, 50c. plus a few pennies postage.

MOON RADIO CORPORATION
501 Steinway Ave., Dept. B, Long Island City



The Saturn
**"Above the Ordinary"
Radio Products**

Automatic Plug
Nothing to solder or take apart. Cord terminals inserted, instantly gripped, a touch on the lever, instantly released. Each Saturn Plug sealed to protect you. Guaranteed. **\$1**

Perfect Jack
Crowfoot offset and solder and flux on blades all ready for soldering. Best materials—Spring German silver blades, rounded corner brackets of nickel-plated brass, and sterling silver contact points. Quality throughout.

List Prices	
No. 1	Single Circuit, Open 50c
No. 2	" " closed 55c
No. 3	Double " " 70c
No. 4	Single Filament control 75c
No. 5	Double " " 80c

Write for Folder
The SATURN Mfg. & Sales Co.
48 Beekman St.
New York, N. Y.

**V
E
R
S
A
T
I
L
E**

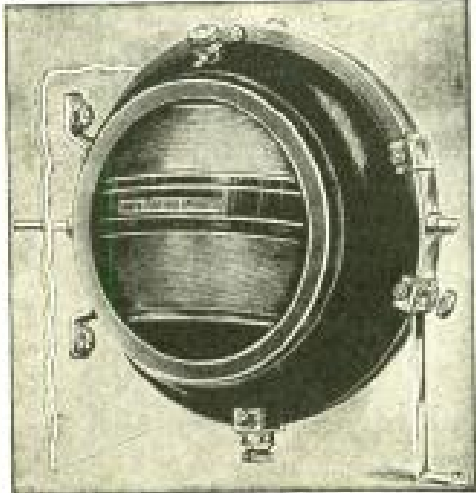

**R
E
L
I
A
B
L
E**

UNIVERSAL VARIOMETER
—SPLIT WINDINGS—

The instrument you will NEVER DISCARD for its uses are without number. List \$7.00. L & K moulded HARD RUBBER variometers, variocouplers and variotransformers are made in seven styles, an instrument for every standard circuit.

Descriptive Folder on Request

LANGBEIN & KAUFMAN
654 Grand Ave., NEW HAVEN, CONN.

**AMPL-TONE
PHONES**



\$6.00 **\$6.00**

**A THREE DOLLAR
LOUD SPEAKER
UNIT FOR
HOME MADE SPEAKER
FREE**

With Pair of Phones
Money Back Guarantee
Dealers Wanted

C. M. FRENCH MFG. CO.
SEYMOUR, CONN.

**A
loud speaker
on one tube**



Tri-Coil
A Radio Frequency Transformer that gives remarkable results in REFLEX and RADIO-FREQUENCY circuits.

Tri-Coil
Assures very long distance on all wave lengths—and preserves the natural tone of Broadcasting exactly as sent through the microphone.

Price \$2 At your dealers—or direct by mail on receipt of price.

FREE illustrated drawing of one tube "Tri-Coil" Reflex Circuit, which will operate loud speaker on request.

BROOKLYN METAL STAMPING CO.
718 Atlantic Ave.
Brooklyn New York

**FAHNESTOCK'S
LATEST RADIO HELP**

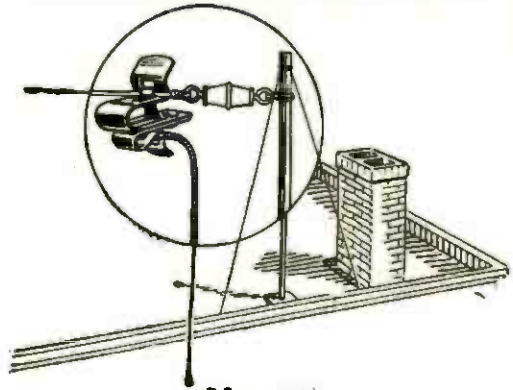

No. 31

**THE
Antenna Connector**

PRICE 10c

Snap larger connector over Antenna Wire; insert Lead-in Wire into smaller clip and a perfect connection is the result.

At Your Dealers

Fahnestock Elec. Co.
LONG ISLAND CITY
NEW YORK

**It Is Easy to Build a
NEUTRODYNE**

You can Build your own set with Kanter Charts. These are actual parts photographic blue prints that anyone can follow regardless of experience in radio

GUARANTEED

Kanter Charts for building either a Freed-Eisemann or a Fada 5-Tube Neutrodyne Set. **\$1**

At your dealer, or

KANTER RADIO SALES & MFG. CO.,
507 Fifth Ave., New York

DEALERS Send for
FREE 48 page CATALOG

Dealers who handle quality products should get our unusually attractive discounts.

All high grade standard sets and supplies

All orders shipped on day received

Write **TODAY** for Catalog

FEDERAL RADIO CO.

Distributors of

Standard Radio Sets and Supplies
1900 Harney St. Omaha, Nebr.

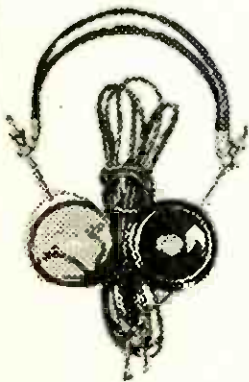

**PALL MALL
PRODUCTS**

**ESSEX STANDARD
PHONES**

Very rugged in construction,
2300 ohms

Price \$3.50

Send for our Latest Free
Radio Catalog and Price List

ESSEX MFG. CO.
119 Mulberry St. Newark, N.J.

**RADIO TUBE
EXCHANGE**

We Repair All Standard Makes of Tubes

Including	
W. D. 11 or W. D. 12	\$3.50
U. V. 200 or C. 300	\$2.75
U. V. 201 or C. 301	\$3.00
U. V. 201A or C. 301A	\$3.50
U. V. 199 or C. 299	\$3.50
U. V. 202 or C. 302	\$3.50
New 1 1/4 Volt Tubes	\$4.00



All tubes guaranteed to do the work.

RADIO TUBE EXCHANGE
200 BROADWAY DEPT. 3 NEW YORK CITY
All Mail Orders Given Prompt Attention
Orders sent Parcel Post C. O. D.

NEW COCKADAY COIL

\$5.50

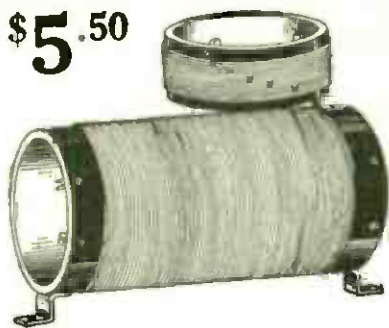

Low Dielectric Losses

Scientifically built of hard rubber wound with silk covered non-shellaced wire. Does not absorb moisture like ordinary coils. Gives low leakage, low distributive capacity, low resistance. Copper terminals—no loose ends, no stray wires. Built in strict accordance with L. M. Cockaday's specifications. Over twice as efficient by actual test, as ordinary coils. Absolutely guaranteed.

At your dealers, otherwise shipped to you postpaid.

Special proposition to dealers

PRECISION COIL CO., Inc.
209-B Centre St., New York

TYPE R-B-4



This is the set you have been looking for, and the one that you need.

Having one stage Radio Frequency, Tuned Impedance, Detector and Two Stages of Audio Frequency.

All apparatus mounted on panel 10 inches high, 21 inches long, and set in panel cabinet 10 x 21 x 10 inches deep.

Price \$125.00 without tubes or batteries

WIRELESS ELECTRIC CO.

204 Stanwix St. Pittsburgh, Pa.



Makes a Loud Speaker the equal of higher priced instruments. Attaches to phonograph or horn. Satisfies or returnable for the full purchase price. From your dealer or direct by mail. Order TODAY.

\$3.50

RADIOCEIVE
Mfg. Co.

369 Jelliff Ave. Newark, N. J.

50¢



The
PACENT
Forty

IMPROVED!
Universal Plug

The Pacent "Forty" already popular as an efficient and low priced plug, has now been greatly improved by a new type of connector, greatly simplifying the method of connection. You need only to insert the cord tips and clamp the shells together to obtain that desired biting contact. Connections are stamped to indicate polarity, and all metal parts are satin nickel finished.

Write for Pacent Catalog P-2

Pacent Electric Co., Inc.
22 Park Place : : New York

Pacent
RADIO ESSENTIALS

RELIABLE AUDIO and RADIO FREQUENCY TRANSFORMERS

Three stages of Audio Transformers to select from.
 2 to 1 and 4 to 1 ratios at \$4.45
 6 to 1 ratio at 4.95
 Radio types from 150 to 750 meter ranges \$2.75
 As an added factor of refined radio receiving use
 Reliable Neutralizing Condensers, only 75c

The RELIABLE PARTS MFG. CO.
 2819 Prospect Ave.
 Cleveland, O.

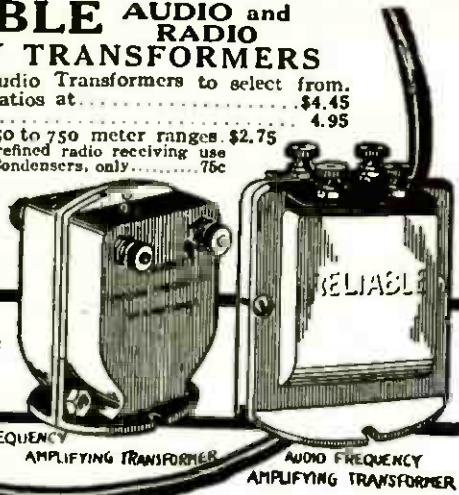

This Combination Does It!

RADIO FREQUENCY AMPLIFYING TRANSFORMER AUDIO FREQUENCY AMPLIFYING TRANSFORMER



Comfort Cushion Your Ears!

The BATES Ear Cushion takes the headaches out of headphones. Improve the hearing qualities of your set 100 per cent. with

The BATES EAR CUSHION

Slips over any radio phone—instantly and easily. Cushion your ears and hear in comfort. Costs little—worth lots.

Postpaid Anywhere in U. S. for \$1.00 per pair.

DEALERS: Write for special discounts.
 BATES Ear Cushions are fast sellers.

BATES & COMPANY

1518 Montana St. Chicago, Ill.

CATALOG E19-100, PAGES FREE

LATEST REFLEX AND NEUTRODYNE CIRCUITS

EVERYTHING IN RADIO

One of the largest complete stocks in the world. 40 diagrams of latest Hookups.

DEALERS ALL OVER THE U. S.

Making big profits handling our supplies. 24-hour service. Goods shipped same day order received.



WHOLESALE RADIO DISTRIBUTORS

Dept. P 6 West 14th St. Kansas City, Mo.

Nath. Baldwin Phones with SHELTVNE LOUD SPEAKER

COMPLETE \$10.00 Postpaid

Use your headset for 2 purposes. Exceptional combination value. Every pair of phones tested. Guaranteed to give results. Ideal home loud speaker.

WALTER SCOTT
 1157-A Broad St., Newark, N. J.

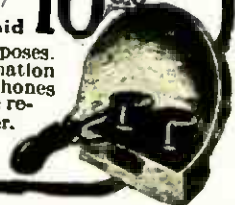

"Read'em" Binding Posts

Simplify the most complicated hook-up

Tell at a glance whether it is Antenna, Ground, Fones, A or B battery, etc. Name neatly engraved for keeps on top of each post. (See illustration.)

Knobs Can't Come Off

The irremovable knobs save time, trouble and petty annoyances. "Read'em's" add to the appearance of any set. Don't be without them. Price 15c each. Set of ten \$1.50. If your dealer can't supply you with "Read'em's" order direct.

15c each Set of ten for \$1.50

Look for the name "Read'em" on every post

The Marshall-Gerken Co.
 Dept. J, 27 N. Ontario St., Toledo, Ohio

Vacuum Tubes Repaired

WD-11, WD-12, UV-201A, UV-199

and others for

\$3.00

Quick service. All tubes repaired by us guaranteed to work as good as new.

Send your dead tubes. We prepay parcel post to you. All you pay is \$3.00 to postman. We give 48 hour service.

THOMAS BROWN CO.

511-517 Orange Street Newark, N. J.

LOS ANGELES to CHICAGO on a CRYSTAL DETECTOR

Crystals Are the Best Yet! KEEP YOURS

At Los Angeles I receive W J A Z Chicago. W O C Davenport and many other distant stations on mine—you can do the same on yours. Folks come from all over Los Angeles to hear the one I made.

I show you how to make your crystal set into the best receiver you could hope to own. Send \$1.00 for detailed instructions and 2-color wiring chart or send stamped envelope for further information.

I have no parts or sets to sell.

LOREN E. TAYLOR

2497-D Beachwood Drive Los Angeles, Calif.

IF YOU WANT THE BEST

Use **EBY ENGRAVED Posts**

A complete set at a special price.

And they're EBY posts, so the tops don't come off.

Your dealer will have them and will show you other popular markings.

\$1.50 per set



THE H. H. EBY MFG. CO., PHILA., PA.

STA-RITE RADIO BATTERIES SAVE YOU 60%

And Guarantee You in Writing 2 Years of Better Battery Performance
 STA-RITE RADIO BATTERIES are made especially for Radio and the big saving is made possible by coming direct to you instead of thru distributors, dealers, etc. Boxes are made of oak, finished in mahogany and the plates very thick and will give a steady discharge over a long period. No premiums, just good honest battery value.

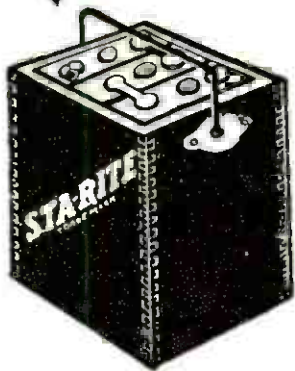

TRY TO BEAT THESE PRICES

2 Volt for W. D. 11 and 12	\$4.00	6 Volt 60 Amphr. . .	\$ 7.50
4 Volt for U. V. 199 Tubes	7.00	6 Volt 80 "	8.50
RADIO B. STORAGE Glass Jars, Heavy Plates—		6 Volt 100 "	10.00
Case of 12 Cells 24 V. . .	4.90	6 Volt 120 "	12.10
		6 Volt 150 "	14.00
		6 Volt 200 "	17.00

Get Yours Today — NOW — Send No Money

The batteries are fully guaranteed in writing and shipped subject to examination on the day your order is received. You pay on delivery or deduct 5 per cent if full cash accompanies order. You may deduct 10 per cent if two or more are ordered at one time.

STA-RITE BATTERY CO. - Dept. 5 - LOUISVILLE, KY.

FRESHMAN Variable Grid Leak and condenser combined



Accepted the World Over as the **STANDARD UNIT** for EVERY TUBE SET

It is the most compact; the most efficient; the most readily adapted to ALL grid circuits and the only one which is entirely sealed and always remains unaffected by any climatic conditions. It is the

ORIGINAL VARIABLE GRID LEAK

and although it has been steadily improved and made better there never was a time when it was not the

BEST ON THE MARKET

Complete with either .00025 or .0005 Freshman Condenser . . . **\$1.00**

Without Condenser75

At your dealers, otherwise send purchase price and you will be supplied postpaid.

Chas. Freshman Co. Inc.
Radio Condenser Products

106 Seventh Avenue

New York

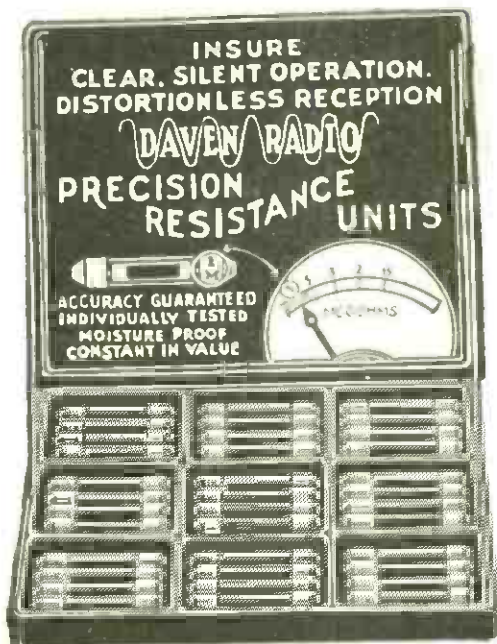

PRECISION RESISTANCE UNITS

Amateurs and Radio Engineers who have experimented in the building of Radio Receiving Sets have found that the **RADIO RESISTANCE UNITS** are unexcelled. They positively insure quietness and pure tone reception — for satisfaction sake try one and note the difference in the purity of the tone reception in your Radio Outfit.

If your Dealer cannot supply you, write

THE DAVEN RADIO COMPANY

Radio Resistor Specialists

144 Bleeker Street :: Newark, N. J.

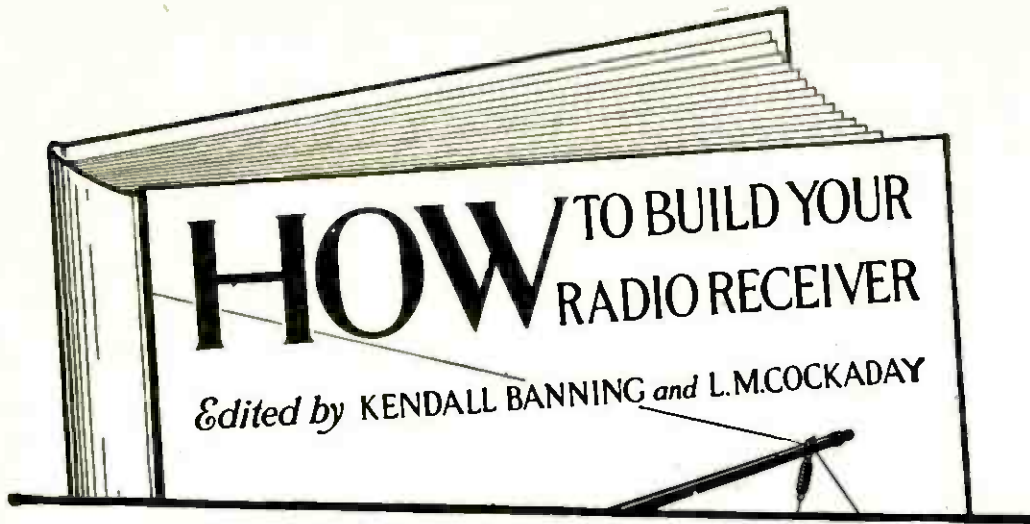

Just Off the Press!

Popular Radio's New Book "How to Build Your Radio Receiver"

The most complete and authoritative collection of material yet published in book form on how to build and operate various types of radio receiving sets

POPULAR RADIO'S new 96-page handbook, edited by Kendall Banning and Laurence M. Cockaday, is now ready for delivery. For a limited time only, as an introductory offer, it will be *given away free!*

There has long been a need for such a book as this, describing fully and completely the several different types of radio receiving sets which have proved most effective, and *how to build them.*

POPULAR RADIO'S new book, "How to Build Your Radio Receiver," has been carefully planned to fill this need. No pains have been spared to make this book the most comprehensive and valuable contribution of its kind ever published for the radio enthusiast who, with or without previous technical knowledge or training, wishes to construct a radio receiving set of his own that will meet his every requirement.

"How to Build Your Radio Receiver" gives complete specifications for the construction of *seven* separate and distinct receiving sets—covering the most amazing range and variety of circuits, from the most modern simple crystal set to the famous Super-heterodyne (see opposite page).

All working details are given—the list of parts

required and their approximate cost; complete hook-ups and circuit diagrams and *how to read them*; illustrations making all points clear, and simple instructions on how to assemble, mount, wire and operate each set.

Nor have any helpful pointers been omitted. In this new book edited by Mr. Banning and Mr. Cockaday, you will also find scores of valuable hints and suggestions about aerials, how to select your parts, how to install your set, tips on tuning, and how to learn the code.

In all, a book you will not want to be without—one that will be worth many dollars to you. Yet, if you act at once, it will not cost you a penny. We will send you a copy of this valuable handbook absolutely free with a year's subscription to POPULAR RADIO at \$3.00. If you are already a subscriber, you may renew or extend your subscription for an additional year and still secure one of the first copies of this valuable book *absolutely free.*

The Coupon printed at the bottom of the opposite page provides a convenient means for you to secure one of the first copies of this handbook free. But you must act at once!

Seven Remarkable Receiving Sets

Illustrated

Diagramed

Described

EACH of the sets described in POPULAR RADIO's new book has been selected as the most *ideal* of its kind—for distance, selectivity, tone, volume, simplicity of construction, ease in tuning, reliability and general all-around satisfaction.

You will find sets employing both crystal and vacuum tube detection, with regenerative amplification, audio-frequency amplification, "push and pull" power amplification, radio-frequency, *compensated*

radio-frequency and *intermediate wave* radio-frequency amplification.

You have your choice of crystal, one-tube, three-tube, five-tube, six-tube or eight-tube sets—the broadest selection anyone could ask for, all clearly illustrated, charted and explained in the simplest possible terms.

Here are the actual receiving sets described in this new book, "How to Build Your Radio Receiver":

A \$5 Crystal Set

The simplest up-to-date set for local broadcast reception. Approximate range, 15 miles, though distances up to 400 miles are not extraordinary. Gives clear signals on headset without distortion. No operating cost whatever.

The Haynes Single Tube Receiver

An efficient set that may be made by a novice at an approximate cost of only \$15 for parts. Simple to tune, selective, good audibility. Long distance range up to 1,000 miles on earphones. Six-volt storage battery and 22½ volt "B" battery required, or may be adapted for dry cells and dry cell tubes.

A Two-Stage Audio-Frequency Amplifier

This instrument may be added to *any* set, crystal or tube, to strengthen the received signals so that they will operate a loud speaker. It is easy to construct, efficient, and costs only about \$15 for parts. Operates on the same "A" battery that is used on the vacuum-tube detector unit.

The Cockaday 4-Circuit Tuner

A 3-tube set, famous for its high selectivity and beautiful tone. So neat and compact that it may be kept in a bureau drawer. Cost of parts about \$40. Receiving range approximately 1,500 miles on a loud speaker. Operates on 6 volt storage battery and two 45-volt "B" batteries, or may be adapted to dry cells and dry cell tubes.

A 5-Tube Tuned Radio Frequency Receiver

Two stages of tuned radio-frequency amplification, detector, and two stages of audio-frequency amplification are here employed so that the possibility of "oscillation and re-radiation" is eliminated. The set can be operated on a loop antenna and may be built at a cost of only \$90 for parts. Six-volt storage battery and two 45-volt "B" batteries required. Range about 1,000 miles on loop or indoor antenna, and 2,500 to 3,000 miles on an outdoor antenna.

The "Improved" Cockaday 4-Circuit Tuner

Probably the most important contribution yet made to the equipment of the radio fan. A compact 5-tube set with a receiving range of over 3,000 miles. Cost of parts about \$95. Wave lengths range from 150 to 675 meters. Automatic tuning and power amplification. Maximum volume of sound, excellent reproduction and no interference. Requires a 6-volt "A" battery, three 45-volt "B" batteries, one 22½-volt "B" battery and a 9-volt "C" battery.

The Regenerative Super-heterodyne Receiver

More sensitive, more selective and more simple to tune than any other 6-tube receiver yet developed. A three-section, 6-tube set employing the Haynes Single Tube Receiver as tuner. May be further extended to a four-section, 8-tube set by the addition of the two-stage audio-frequency amplifier. The cost of parts approximate \$100. Range of 3,000 to 4,000 miles on a loud speaker. Has been called the "Rolls-Royce" of radio receivers.

Q As a special introductory offer, for a limited time only, this book will be given FREE with a year's subscription to POPULAR RADIO at \$3. Simply mail your remittance with the handy coupon below, and a FREE copy of "How to Build Your Radio Receiver" will be sent you, postage prepaid. Your subscription will be entered at once.

Radio Dealers and Jobbers: Write for Our Special Letter 23AA, of Particular Interest to You.

This Coupon Entitles You to a Free Copy

POPULAR RADIO, Dept. 25,
9 East 40th Street, New York City.

Please send me, postage prepaid, a FREE copy of POPULAR RADIO's new handbook, "How to Build Your Radio Receiver," edited by Kendall Banning and L. M. Cockaday. I enclose \$3 for a year's subscription to POPULAR RADIO which entitles me to this book absolutely free of charge.

NAME.....
STREET & NO.....
CITY & STATE.....

(No extra for Canada. Foreign countries 50 cents postage extra).

Please mark here

Indicate by a circle whether your subscription is new (N), renewal (R), or an extension of your present subscription (E).

N R E

Please refer to POPULAR RADIO when answering advertisements.



For all-around efficiency in actual performance we back our "Hegehog" to the very limit. Put it in comparative tests with any transformer made. Install it in any of the latest hook-ups—Neutrodyne, Autodyne, Superdyne, Milloplex, Autoplex. Judge it for volume, tone quality and consistent performance. Give it every possible test. Then consider its size and price. If you do not find the "Hegehog" unsurpassed in every way, your money will be gladly refunded. We guarantee it unconditionally. There is nothing superior to the "Hegehog" in efficiency and for compactness. Make this test. Send for FREE Bulletin No. 92. Ratios 1 to 3, 1 to 4, 1 to 5—\$3.50; 1 to 10—\$4.50.

Ask Your Dealer

Premier Electric Company
3807 Ravenswood Ave., Chicago
AUDIO TRANSFORMER



Cut 1/4
Actual size

Guaranteed Head-Sets

"RED-HEADS" are guaranteed radio phones. You run no risk when you buy them. Money back if, after 7 days' trial, you're not satisfied that they're the best receivers on the market at the price. Why not act right now and get a pair? It'll mean getting the maximum from broadcasting from the day you put them into use.



RED-HEAD RADIO RECEIVERS

NOW READY

The new 1924 Model F \$6.50 Per Pair Complete	The new "Red-Head" Jr. \$5.00 Per Pair Complete
---	---

"Red-Heads" sent prepaid on receipt of price if you are unable to get them at your dealer's.

The NEWMAN-STERN COMPANY
Dept. PR Newman-Stern Bldg. Cleveland



The TRINITY LOUD SPEAKER

The Trinity Loud Speaker is an instrument that combines the best qualities of a phonograph reproducer in combination with electro-magnetic principles best fitted for radio amplification. Perfect reproduction of all music and speech without distortion. No storage batteries required. The instrument is of a heavy duty type and is guaranteed fully by the manufacturers.

For sale by good dealers. Literature upon request.

TRINITY RADIO CORPORATION
446 1/2 Tremont Street, Boston, Mass.

TYPE AI
\$25.00
21" Fibre Horn

YOU DON'T NEED TUBES

To hear concerts from distant Cities. **YOUR CRYSTAL SET**

will bring them in if you follow my instructions. You may already have all the parts you need and merely have it **HOOKED UP WRONG.** People using my plans hear programs clearly from stations **400 TO 1000 MILES AWAY** No TUBES, BATTERIES, AMPLIFYING APPARATUS or Special Crystal required. My **COPYRIGHTED** instructions selling for \$1.00 are written so anyone can understand. They show you exactly how to fix the set you have or make one like mine. Satisfaction Guaranteed or money refunded. Send self-addressed envelope for picture of my set and further particulars. Write me today.

LEON LAMBERT
540 So. Volutsia Street, Wichita, Kansas

NEW PYRALIN

SHELTON
LOUD SPEAKER

\$3

Made by Du Pont expressly for us. **WORKS** with any Phones. Beautiful, transparent, exceptional value. Satisfaction guaranteed.

THE SHELTON CO.
185-189 Clinton Ave.
Newark, N. J.



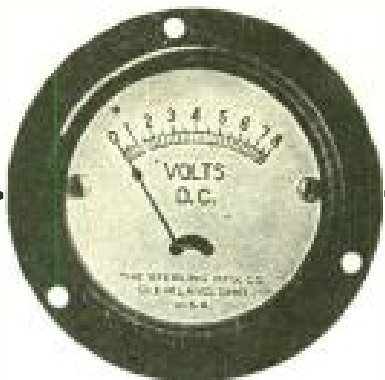

\$4⁰⁰

\$4⁰⁰

Insure the Life of Your Vacuum Tubes With a

Sterling

FILAMENT METER

Avoid a burn-out of your vacuum tube by knowing the voltage conditions with a Sterling Filament Voltmeter. Another advantage is the ease in duplicating results and quick tuning. Sterling Filament Meters are of the magnetic type, flush-mounted, always reliable and make a very attractive addition to any radio panel.

THE STERLING MFG. CO.
2843 Prospect Avenue Cleveland, Ohio

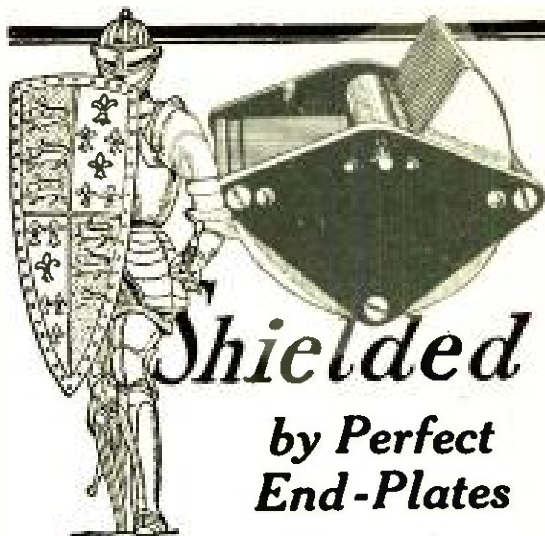

Shielded
by Perfect
End-Plates

U.S. TOOL CONDENSERS

Infinitesimally small dielectric losses in *U. S. Tool Condensers*. The end plates of *Laminated Condensite-Celeron* are non-porous, proof against all capacity leaks and non-warping. One of the details that make it well worth your while to insist upon *U. S. Tool Condensers*. Write for booklet.

U. S. TOOL COMPANY, INC.
116 Mechanic St. Newark, N. J.

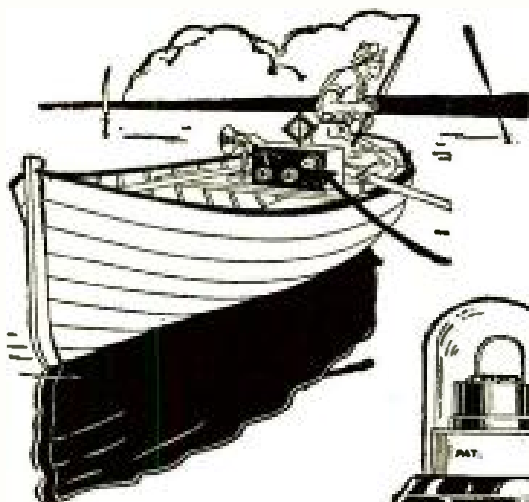

Grewol Detector

Fixed Adjustment

Don't lose patience! There is a really efficient crystal detector—the GREWOL. Fixed on the most sensitive spot.

Best for reflex circuits and crystal sets. Guaranteed not to burn out.

At your dealer's or direct upon receipt of

\$2



RANDEL WIRELESS CO.
4 Central Ave. Newark, N. J.

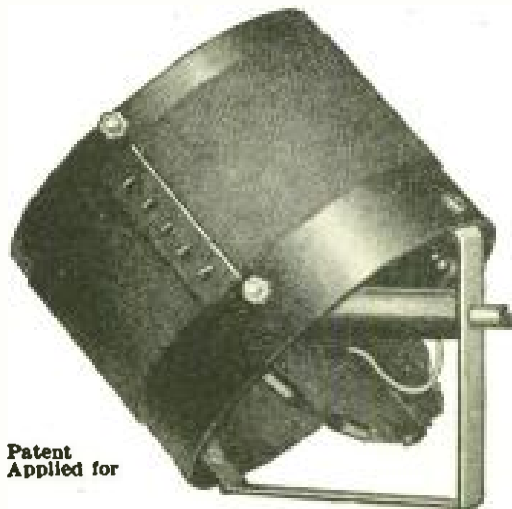

Patent Applied for

\$4.50 VARIOCOUPLER \$4.50

Here is a distinctively high grade Variocoupler at an exceptionally low price.

Check the following points and verify this claim.

- (1) Spider web rotor. The only means of obtaining minimum coupling.
- (2) Pig tail contacts.
- (3) Bakelite tube.
- (4) Green silk wire.
- (5) No live brackets.
- (6) Improved taps.
- (7) Dead shaft and no capacity effect in tuning.
- (8) 180° dial adjustment without the rotor being submerged in stator field.

THE HARTMAN ELECTRICAL MFG. CO.
Mansfield, Ohio

Free Parts for Your Radio Sets!

Your choice of these valuable premiums, free to you as a reward for securing only a few subscriptions to **POPULAR RADIO**

A FEW moments of your spare time spent in bringing **POPULAR RADIO** to the attention of your friends and acquaintances will yield you big rewards. Never before have we been able to offer such attractive and liberal premium values as these.

Glance over this broad list of radio parts and equipment that you can secure **FREE**, merely by introducing **POPULAR RADIO** to some of your friends

and acquaintances who will appreciate the opportunity of subscribing to this most interesting and helpful magazine.

Show this copy of **POPULAR RADIO** to other radio fans. The pages of the magazine will speak for itself. Then send us the names of your friends, with \$3 for each yearly subscription, and take your choice of any of the following premiums. They'll come to you *absolutely free*.

Any One of These for 2 Subscriptions:

Dubilier Ducon, and choice of any *three* Dubilier Micadon Grid Condensers of the following capacities: .00025; .0005; .001 or .002.

Pudlin Tubular Grid Leak (2 megs.); Dubilier Micadon Grid Condenser .00025; Cutler Hammer 6 ohm Rheostat, and *one* Alden Napier Socket, choice of either 201A or WD-11.

One copy of **POPULAR RADIO**'s new handbook: "How to Build Your Radio Receiver."

Three Pacent Jacks (*one* single circuit and *two* double circuit).

Bakelite Panel, size 7 x 18 inches.

22½ volt B Battery, large, choice of Burgess or Eveready.

One copy of Ballantine's "Radio Telephony."

Cutler Hammer 30 ohm Rheostat and choice of *one* Alden Napier Socket: 201A, 199 or WD-11.

Your Choice for Only 3 Subscriptions:

Bakelite Panel, size 7 x 24 inches.

Set of Mounted De Forest Coils; 35, 50, 75.

Amsco Compensating Condenser and choice of any *one* Alden Napier Socket: 201A, 199 or WD-11.

"Scientific" Headset.

Two Cutler Hammer 6 ohm Rheostats and *one* Cutler Hammer Potentiometer.

Diode Dry Cell Tube and Cutler Hammer 6 ohm Rheostat.

Big Value for 4 Subscriptions Each:

Lefax Loose Leaf Radio Handbook with full year's free supplement service.

Sleeper Variocoupler with switch lever and points, Cardwell 21 Plate Condenser or General Radio 23 Plate Condenser.

Cardwell or Se-Ar-De 17 Plate Condenser.

Cardwell 11 Plate Condenser and Pacent Jack.

U. V. 200 or C. 200 Vacuum Tube.

"Ampl Tone" Phones.

Free With 5 Subscriptions Each:

Cardwell 43 Plate Condenser.

Spiderweb Coil and Mounting.

Brandes or Holtzer. Cabot No. 4 National Phones.

Amertran Transformer.

Atwater Kent or Sleeper Variometer.

U. V. 201A or C. 201A Vacuum Tube.

U. V. 199 or C. 199 Vacuum Tube.

WD-12 or C. 12 Vacuum Tube.

WD-11 or C. 11 Vacuum Tube.

ALL premiums will be sent prepaid, immediately on receipt of your orders. If you want some particular part that is not listed here, write us and we'll tell you how many subscriptions you'll need to get it *free*. Or if you prefer *cash commissions*, just drop us a postcard asking for full particulars.

Renewals of old subscriptions or extensions

of present subscriptions count the same for you as new subscriptions. In other words, any subscription you receive entitles you to your reward in cash or in premiums. Simply send us \$3 to cover each subscription you take and we will send you your premiums.

Start today, and you'll have your required number of subscriptions in a jiffy!

POPULAR RADIO

Dept. 21

9 East 40th Street

New York City

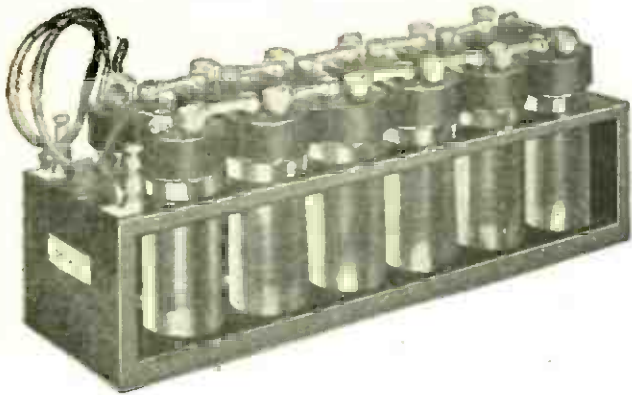

24 V **\$8.25** RADIO "B"
SENECA Post Paid BATTERY

Absolutely Quiet Dry Charged

The Seneca 24 Volt Radio B Battery is designed and constructed for long life, absolutely quiet and uninterrupted service, its separate cell assembly prevents current leakage common to other types. Seneca Batteries are shipped DRY with FULLY CHARGED PLATES and are ready for service immediately after addition of acid, without initial charging. They guarantee successful RADIO OPERATION. Send for yours today, if not satisfactory, return in 30 Days and money refunded.

Jobbers and Dealers
write for discount

SENECA BATTERY CORPORATION
1525 Main Street - - Buffalo, N. Y.

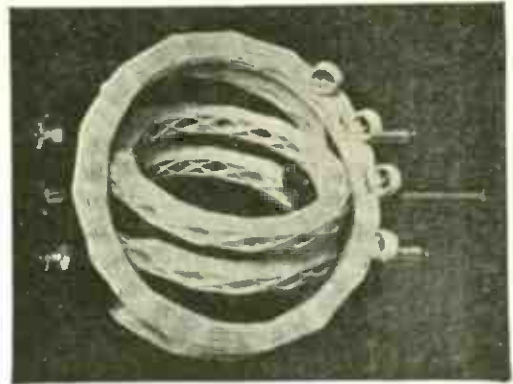

**Diamond Weave Variocoupler
An R. M. C. Product**

Seven-eighths of windings are in mid-air, thus reducing dielectric losses to a minimum.

Diamond Weave Construction reduces distributed capacity to a minimum.

The R. M. C. Variocoupler has a wave range of 150 to 600 meters. The Variometer is the same size and general construction as the variocoupler, and has a variance in inductance of 300 meters. Outside diameter of primary windings is 4 1/8"; of secondary, 3 1/4"; extreme length 5 1/4".

These R. M. C. products will greatly improve any circuit where a variometer or variocoupler can be used.

Variocoupler.....\$4.50
Variometer.....\$4.50

THE RADIO MANUFACTURING COMPANY
of Springfield, Massachusetts
Dept. B 97 Dwight Street

FOUR CIRCUIT COIL SET

\$2.50



"A" Coil covered square wire

"D" Coil bank wound

Full set A, B, C and D coils made exactly according to Cockaday's specifications. Full size blue prints and illustrated instructions with each set.

Materials for standard Four Circuit Tuner—panel, coils, condensers, verniers, grid leak, vernier rheostat, socket, jack, dials, switch, contacts, posts, busbar wire, spaghetti, etc. (no tubes or phones).

Complete for \$11.65

NEW TYPE COILS

For improved Cockaday Tuner—double silk covered wire wound on hard rubber or bakelite tubes. **\$4.00** per set

Postage additional on all orders

Send no money. Order by post card, pay the postman.

RADIO SURPLUS STORES
HELENA, MONTANA

LOUD SPEAKER
\$18.50

HEAD SET
\$4.50



"ROYALPHONE"
KING OF ALL



A complete loud speaker of superior qualities. Will reproduce music or speech with no distortion.

No extra batteries required. Will operate at one or more stages of amplification.

Comes complete with 6 foot cord. 24" high—14" bell—Crystalline Finish.

Loud Speaking Unit with special phonograph attachment

\$8.00. Can be attached to any horn or phonograph arm.

We are the makers of the "Royalphone" King of All headsets at \$4.50.

Royal Electrical Laboratories

Dept P. R., Newark, N. J.

Royalphone
KING OF ALL

Clear and Sweet

You've tried many expensive tricks to improve reception on that set of yours, but do you know that for the cost of one necktie you can get real results?

The ORIGINAL

COMSCO



COMSCO

AUTOMATIC BULL DOG GRIP PLUG

(Licensed Under Pat. Pend. Serial No. D 8010—No. 578540)

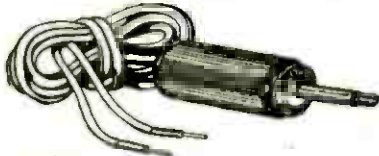

IS THE LAST LINK IN PERFECT RECEPTION

The COMSCO AUTOMATIC BULL DOG GRIP PLUG is very simple to operate. Connecting tips are inserted by a single touch, while with the flip of a small knob the tips slide out easily.

WE GUARANTEE THAT THIS PLUG saves you from short circuits and battery kicks. No more burned out phones or ruined transformers. No more broken finger nails.



For one pair phones \$1.00
For two pair phones \$1.50

FOR SALE AT YOUR DEALER
Otherwise send purchase price direct to us and you will be supplied!

GENERAL INSTRUMENT CORP.
123 LIBERTY STREET
NEW YORK CITY

Reliable RADIO Goods

Results Are Sure With RELIABLE Goods
And it's easy to get such goods—anything you want in radio equipment. Big complete stock—everything guaranteed; quick service; right prices. And you're sure it's reliable when it comes from Andrae. Get our complete catalog—free

JULIUS ANDRAE & SONS CO.
127 Michigan Street Milwaukee, Wis.

ANDRAE In Business Since 1860

"Push-Pull" Amplifying Transformers

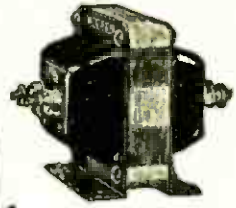

Amplify the MODERN Way

The "Push-Pull" method of amplification is the latest and best method. Used in addition to one or two stages of audio. Latest bulletin, hook-up and complete information on request. MODERN Transformers can be used with all standard tubes.

Modern 10 to 1

This type is of particular value in the new Reflex circuits where a higher secondary reactance helps maintain the equilibrium in the circuit necessary for effective operation. The audibility amplification curves of these transformers are practically flat.

Modern 4 to 1

This type is especially recommended for the most satisfactory operation in a 2-stage amplifier, using either two 4 to 1 Transformers or a 10 to 1 on the first stage and a 4 to 1 on the second stage. This latter arrangement yields greater volume.

The Modern Electric Mfg. Co.
Dept. 702 Toledo, Ohio



LOUD SPEAKING CRYSTAL SET

Stations brought in from over 1000 miles and music heard all over the room right from your present crystal set with the STEINMETZ AMPLIFYER. Get our complete catalog.

STEINMETZ WIRELESS MFG. CO.
5703 Penn Ave., Pittsburg, Pa.

Are You the Boy We Want?

We're looking for a few live wires, real "go getters," who can earn good "jack" in their spare time, taking subscriptions to POPULAR RADIO. Commissions in cash. Profitable and enjoyable work. Easy as "falling off a log."

\$31.50 in 2 Weeks

is the record of a Philadelphia lad—one of our part timers—whose motto is "Do it now, and bring home the bacon." Want me to prove to you that you can do it too? All right! Here goes—just fill out the coupon—and "let George prove it!"

Popular Radio, Inc., Dept. 28
9 East 40th Street, New York City

C'mon George! Whatcha got up your sleeve? Tell me how I can make some extra money working for good old "Pop" Radio, in my spare time, and send me a sample copy free.

Name

Address

City

State

Please refer to POPULAR RADIO when answering advertisements.



WARREN RADIO LOOP

SMALLEST LOOP ANTENNA

All the well known advantages of the loop aerial are intensified in the *Warren Radio Loop*. So small you can slip it into a coat pocket, yet as sensitive as a much larger outside aerial with all its defects. Absolutely accident proof. Write for the name of the nearest Warren dealer and our Bulletin containing latest hook-ups, TODAY.

APPROVED RADIO NEWS ASSOCIATION 1927

Type A-737 (300-700 meters) 6 inches square—non-directional.....	\$10
Type A-7236 (175-1000 meters) 6 inches square—non-directional.....	\$12
Type B-2537 (300-700 meters) 18 inches square—directional.....	\$20
Type BL-2520 (200-18,000 meters) with honeycomb coil mounting. 18 inches square—directional.....	\$25

Send for Bulletin I-102

V-DE-CO RADIO MFG. CO., Dept. F, Asbury Park, N. J.



\$8

A phone plus a FIBERTONE makes a beautiful musical instrument

The highest tonal quality undisturbed by either metallic noises or distortion is best obtainable with a fiber horn. This one factor is the reason for Fibertone's popularity. And the low price for such fineness is a sensation of the radio world. The beautiful crystalline finish of the Fibertone fits it for any place where the finer things of the home are seen.

If your dealer cannot supply you write direct.

FIBER PRODUCTS COMPANY
34 Orange St. Bloomfield, N. J.

FIBERTONE

RADIO HORN

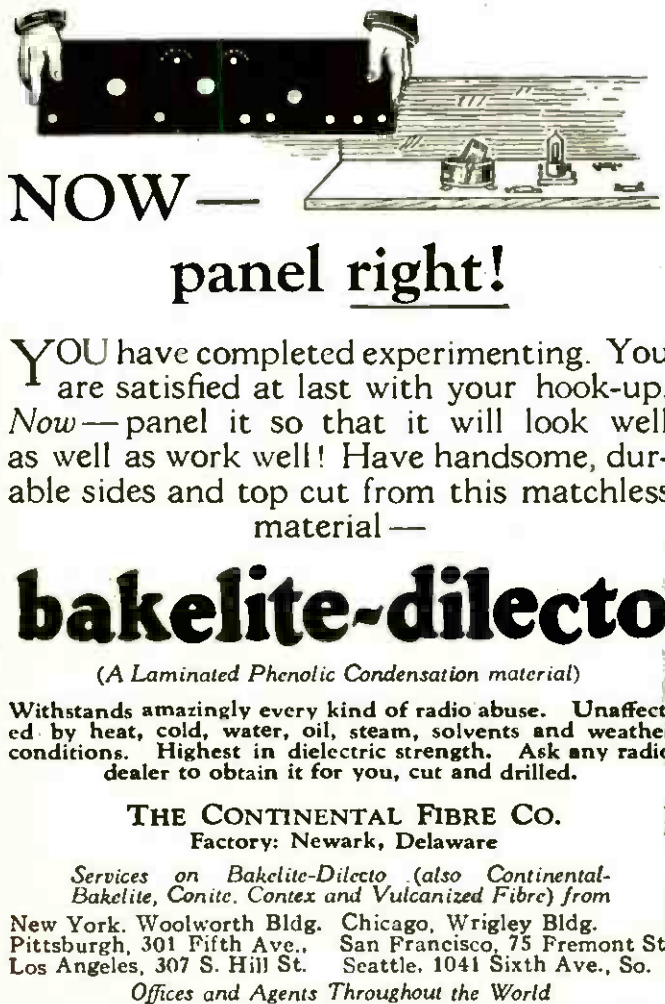

NOW — panel right!

YOU have completed experimenting. You are satisfied at last with your hook-up. Now—panel it so that it will look well as well as work well! Have handsome, durable sides and top cut from this matchless material—

bakelite-dilecto

(A Laminated Phenolic Condensation material)

Withstands amazingly every kind of radio abuse. Unaffected by heat, cold, water, oil, steam, solvents and weather conditions. Highest in dielectric strength. Ask any radio dealer to obtain it for you, cut and drilled.

THE CONTINENTAL FIBRE CO.
Factory: Newark, Delaware

Services on Bakelite-Dilecto (also Continental-Bakelite, Conite, Contex and Vulcanized Fibre) from

New York, Woolworth Bldg. Chicago, Wrigley Bldg.
Pittsburgh, 301 Fifth Ave., San Francisco, 75 Fremont St.
Los Angeles, 307 S. Hill St. Seattle, 1041 Sixth Ave., So.

Offices and Agents Throughout the World



EAGLE NEUTRODYNE

Balanced Receiver

Greater range, clearness and volume now attained by the perfect balance of tube capacities. As easily operated as a phonograph. Each Eagle Receiver individually tested. Unreservedly guaranteed.

Licensed by Independent Radio Manufacturers, Inc., under Hazeltine Patent No. 1,450,080, dated March 27th, 1923, and other patents pending.

Write for Illustrated Booklet

EAGLE RADIO COMPANY
18 Boyden Place Newark, New Jersey

EDSON

**Tone Tested
Radio Headsets**

\$3
POST PAID



2000
OR
3000
OHMS

THE lowest-priced first quality headset on the market today. Compare with headsets costing twice our price. Return ours if not satisfied. Our written guarantee protects you. Send \$3.00 by registered mail or money order. Buy direct of us and save the difference. We ship, postage pre-paid, same day order is received. Ask for our

Free Catalog of Radio Parts

EDSON RADIO SALES CO.
2 Elmwood Providence, R. I.

Free RADIO

**VACUUM
TUBE SET**



Can receive 100 miles and more
Rush your name to learn how you can get a Vacuum Tube Radio Set **ABSOLUTELY FREE**. Don't delay, write today for **FREE RADIO PLAN**

HOME SUPPLY CO.
Dept. 240 131 Duane St., N. Y. C.



Carter
"HOLD-TITE" Jack

CODE NO. 104

Phosphor Bronze Springs. Westinghouse "Micarta" insulation. Pure silver contact points. Ask your dealer. Write for catalog.

Carter Radio Co.
1807 Republic Bldg. CHICAGO

RE-NU REFILLABLE RADIO - B - BATTERIES

Your "B" battery is as strong as the weakest cell; if one cell in a sealed-in battery becomes defective, the whole battery is worthless. With a RE-NU refillable battery, one or more cells may be instantly removed and fresh ones inserted. Flashlight unit cells for refillers can be bought for a few cents in every city and town, thereby reducing your battery costs to a minimum. **NO LOOSE CONNECTIONS.**

Made in polished mahogany finished cabinet to match most expensive set, equipped with hard rubber binding terminals, and rubber feet.

Furnished only in the 22½ volt size, tapped for 16½, 18, 19½, 21, and 22½ volts.

Absolutely guaranteed or money refunded. Immediate deliveries.

Price \$4.00 postpaid in U. S. A. Cash with order or C. O. D.

STEINER BATTERY CO.
LANCASTER, OHIO

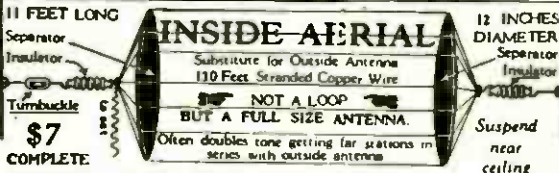

INSIDE AERIAL

Substitute for Outside Antenna
110 Feet Stranded Copper Wire
**NOT A LOOP
BUY A FULL SIZE ANTENNA.**

\$7
COMPLETE

Often doubles tone getting far stations in series with outside antenna

Unaffected by Wind-Rain-Sleet-Lightning

INTER-STATE SIGNAL (B), COLUMBUS, OHIO

PERFECTONE

As the name implies, its perfect tone enables its listeners to visualize the performers and to feel their presence. Write for details.

PERFECTONE RADIO CORP.
488-490 Broome St. New York

RUSONITE



RADIO CRYSTAL

Entire Surface Sensitive
The Recognized Standard Crystal Rectifier
Used all Over The World
Hundreds of Thousands of Satisfied Users.
Rusonite Has Revolutionized Crystal Radio Reception.

"THE PERFECT SYNTHETIC CRYSTAL"
Guaranteed
Price mounted 50c
RUSONITE CATWHISKER 14K. GOLD
Supersensitive; will not oxidize
Price 25c

Order from your dealer or direct from
Rusonite Products Corporation
15 Park Row, New York, N. Y.

RADIO WALL MAP 10c

Up to date, just off the press. Shows call letters, location, wave length, and kilocycles of all radio broadcasting stations also American Relay divisions and radio districts. Complete with scale for measuring distances. Size 28 x 34 inches printed in three colors. Postpaid for a dime.

OZARKA, INC.
865 Washington Blvd., Chicago

We Offer Cash for Your Spare Time

MAIL the little coupon today. It will mean money to you.

For every subscription to **POPULAR RADIO** that you send us, we will reward you liberally in cash commissions.

Many of your friends and acquaintances will be glad to subscribe to **POPULAR RADIO** when they see what a helpful and interesting magazine it is. You can do your friends a good turn and at the same time make money for yourself by taking their subscriptions for **POPULAR RADIO**.

Mail the coupon today for full particulars and a free sample copy.

POPULAR RADIO, Dept. 26
9 East 40th Street, New York City

Please tell me how I can make money in my spare time taking subscriptions to **POPULAR RADIO**. Send along a sample copy for me to work with; also other necessary supplies.

NAME

ADDRESS

.....

The TRIPLE SERVICE Battery CHARGER

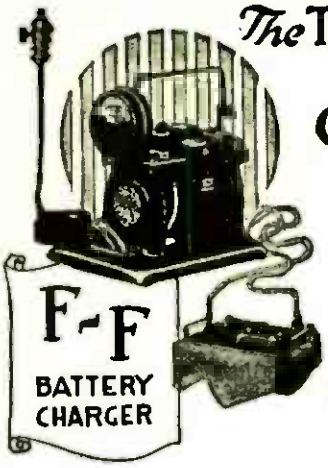

F-F
BATTERY
CHARGER

CHARGES
RADIO
BATTERIES

CHARGES
RADIO
BATTERIES

CHARGES
ALTO
BATTERIES

Buy the FF charger—a success for many years. Simple—shockproof—self exciting—automatically tapers charge. Attach two wires—turn switch—a jitney and a few hours charges the battery. No fluids to spill or corrode—no expensive parts to replace. Satisfaction guaranteed. Price \$15 to \$28. Look for the FF—buy none of the imitations—write for literature explaining many exclusive features, also name of dealer who can furnish the genuine article.

The France Mfg. Co.
10444 Berea Road Cleveland, O.

World's Greatest BATTERY BARGAIN

Written 2 Year Guarantee
Your Proof of Satisfaction

FREE

Hydrometer and "B" Battery

Read Every Word of the Special New Year's Offer—Then Act

Thousands of POPULAR RADIO Readers will profit by this amazing offer. They will buy the famous 2-year guaranteed, World battery at the lowest price ever quoted—They will get a hydrometer and a "B" Battery FREE. And they get the best battery built. It is "World" quality that makes possible our 2-year ironclad guarantee. It is "World" quality that makes "World" owners "tell their friends"—that's the best proof of performance any product can have.

Compare These Prices:

Special 200 Hour Recharge- able Storage Batteries	6 Volt 60 Amp...\$8.50
2 Volt for W.D. 11 and 12 tubes.....\$5.00	6 Volt 80 Amp...10.00
4 Volt for U.V. 199 tubes 8.00	6 Volt 100 Amp...12.50
	6 Volt 120 Amp...14.50
	6 Volt 140 Amp...16.00

Send No Money

You need not send a penny. Just clip this ad and attach your name and address. The battery will be shipped to you the day your order is received. When the battery arrives, inspect it—read our 2-year guarantee before you pay one penny. Convince yourself you are protected from every angle—that the World battery price saves you 50%. Get the "B" Battery and hydrometer FREE. Order today.

Special New Year's Offer

Clip and mail this ad with your World battery order and get this hydrometer and "B" battery free. 5% disc. for cash in full with order.

WORLD BATTERY CO.

Dept. 3, 1219 So. Wabash Ave., Chicago, Ill.

World

Distance & Volume are found in RayCoils



RayCoils "A" for Reinartz, Ray Coils "B" for RCS and Ultra Audion Circuits, RayCoils "C" for RCS, Ultra Audion and Tuned Radio Frequency for All Circuits. "D" for Neutralizing Circuits 4 & 5 Tubes.

A = \$2.50	Use the RCS Circuit with or without Radio Frequency for Simplicity in operation and results. Not equalled by any set for volume and distance.
B = 2.00	
C = 2.00	
D = 2.00	

**Coils in Separate Box
With Wiring Diagram**

Working Blue Prints of four sheets 12 x 18 of all standard circuits, such as The Variometer, Reinartz and RCS one and three tube sets. 50 cents a set.

If your dealer cannot supply you, send direct to us and we will mail them post paid anywhere in the U. S. A.

R. C. SCHOONHOVEN
Major Q. M. R. C.
ELGIN, ILL.

KEEP A RECORD

OF
Programs—Stations Heard
Dial Adjustments
Changes in Set
Weather Conditions, Etc.

Use the

LISTEN-IN RADIO RECORD

REGISTERED U.S. PAT. OFF.

THE ONLY "LISTEN IN" BOOK

Flexible cloth binding. Gold stamping. 160 pages. Printed on Bond Paper. Contains introductory article "How to Receive Radio Broadcasts" by Lloyd C. Greene, Radio editor Boston *Globe*. Many Radio Hints and Tips. Complete list of Broadcasting Stations and double page map of United States.

PRICE 75 CENTS

At Your Dealers or Sent Prepaid on Receipt of Price

LISTEN IN PUBLISHING CO.
110 Main Street
CAMBRIDGE MASS.

Noiseless - Permanent
1/4 to 10 Megohms



E. T. FLEWELLING

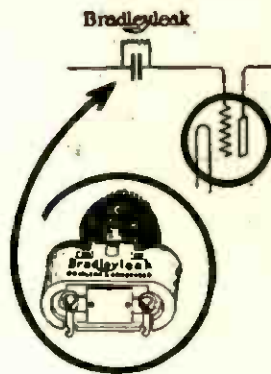

Retail Price
\$1 85
Condenser
.00025 MF
35¢ Extra

“The Bradleyleak is the best Grid Leak I have tried”
- SAYS FLEWELLING -

E. T. Flewelling, inventor of the famous Flewelling circuit, recently tested a number of Bradleyleaks in his laboratory and after a thorough test writes as follows:

“The radio market has been sorely in need of apparatus of such a high type as the Bradleyleak, and I feel that you are to be congratulated because of the action of this grid leak as shown under test. I do not hesitate to say that, so far as my tests are concerned, it is the best grid leak that I have tried and the only leak that comes anywhere near approaching the ideal. It is a high-grade piece of apparatus in every respect and I am only too glad to congratulate you again.”

The Bradleyleak is the result of 20 years' experience in the manufacture of graphite disc rheostats. It contains no carbon or metallic powder. It is distinctly a disc rheostat. A smooth range from 1/4 to 10 megohms is obtainable without steps or jumps by simply turning the adjusting knob. The Crosley laboratory found it unaffected by atmospheric conditions.

Many of the new circuits, such as the Flewelling or other highly-selective circuits, work best when equipped with the Bradleyleak. Try one on your radio set and you will be amazed with the improved operation.

Mail this Coupon — Today!

ALLEN-BRADLEY CO.
276 Greenfield Ave., Milwaukee, Wis.

Please send me your folder describing the Bradleyleak and its construction.

Name

Address

Allen-Bradley Co.
Electric Controlling Apparatus



Manufacturers of graphite composition rheostats for over 20 years.

Is Your Grid Leak Correct?

The following table gives the approximate values of grid leak resistance recommended by vacuum tube manufacturers:

Audion(DeForest) DV-6	2 Megohms
C-200	2 Megohms
C-200	2 to 5 Megohms
C-301-A	2 Megohms
UV-199	2 to 5 Megohms
UV-200	2 Megohms
UV-201-A	2 Megohms
WD-11	3 Megohms, or more
WD-12	3 Megohms, or more

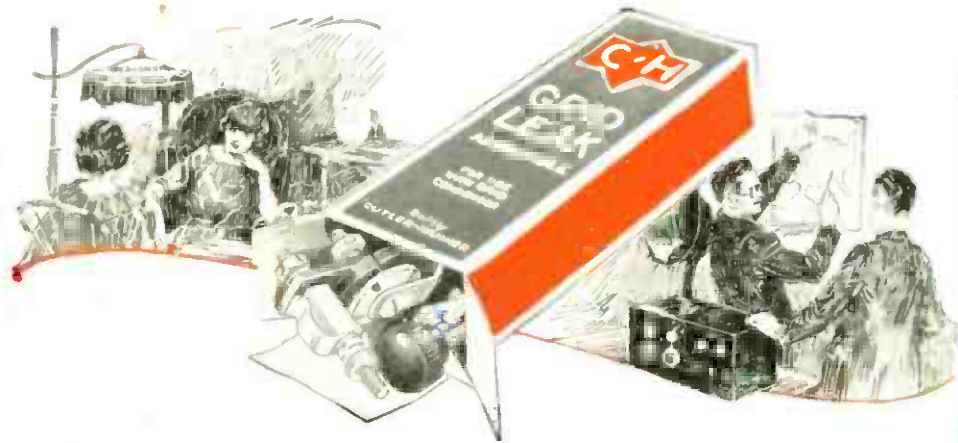

This Little Box Brings Maximum Efficiency to Your Receiving Set

Since the Cutler-Hammer Engineers announced the C-H Variable Grid Leak, thousands have learned the secret of grid control. This little instrument makes it possible for the grid condenser to discharge at just the proper rate for maximum reception, and is built with watch-like precision to give perfect results. It is quickly installed in any set without additional wiring—the short link to the grid post (adjustable to any position) assures maximum efficiency and the long insulated shaft makes adjustment from the front of the panel easy and accurate.

Put one in your set today! But insist on the C-H trademark and the orange and blue carton, for the grid circuit is the most delicate in your set and only the most precise instruments can be used with safety. Here the faint electrical pulsations are brought direct from the aerial to start through the process of amplification that finally

makes them powerful enough to violently vibrate a "loud speaker" diaphragm. False fluctuations induced by poorly constructed or improperly designed apparatus are magnified thousands of times. Insist on the grid leak by the "Master Builder" and be certain of success. Sold by dealers everywhere.



The C-H Variable Grid Leak is mounted on the grid post—where it belongs. This allows a short grid lead for maximum efficiency and the long insulated shaft to the panel prevents "body" noises.

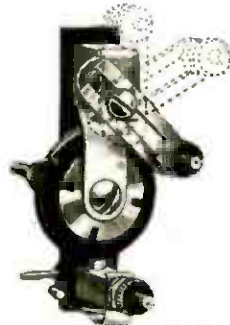

The C-H Variable Grid Leak is fully adjustable to care for any grid condenser.

THE CUTLER-HAMMER MFG. CO.

Member Radio Section Associated Manufacturers of Electrical Supplies

MILWAUKEE, WISCONSIN

"BUILT BY THE MASTER BUILDER"



Variable

GRID LEAK



Instruments of Guaranteed Quality Assure Success in Radio

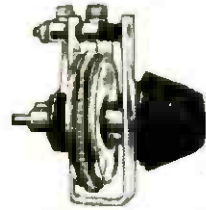

The C-H 4 Ohm Vernier Rheostat—Perfect detector tube control. Also furnished without vernier for amplifier tube control.

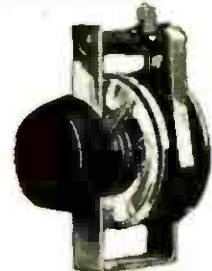

The C-H 30 Ohm Radio Rheostat—For control of the $\frac{1}{2}$ ampere, "UV201A-C301A" type receiving tubes and the "UV199-C299" type.



The C-H 125 Ohm Radio Rheostat—The rheostat that makes it possible to use a 6V storage cell with the UV199 or C299 tubes.



The C-H Variable Resistance Unit—Attach it to your present 4 ohm rheostats to obtain the required 30 ohms for the new tubes.

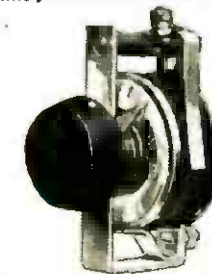

The C-H Radio Potentiometer—The potentiometer with the resistance unit that does not wear and cannot be displaced under constant usage.

A Radio Statement to the Public

KEEPING its pledge to the public, the Radio Corporation of America has concentrated its vast research and engineering forces upon the solution of certain fundamental problems facing the art—problems which have become more apparent as broadcasting stations and radio receivers multiply.

The phenomenal expansion of the radio industry, and the universal and ever-increasing appeal of radio represent an outstanding development of the present century—for this industry has grown from infancy to maturity in a space of but two years.

Briefly stated, there is today a necessity for

—*A radio receiver providing super-selectivity*—the ability to select the station you want—whether or not local stations operate. A selectivity which goes to the theoretical limits of the science.

—*Super-sensitiveness*—meaning volume from distant stations—along with selectivity.

—*Improved acoustics*—more faithful reproduction of broadcasted voice and music than has ever been possible before.

—*"Non-radiating" receivers*—a new development—a type of receiver which, no matter how handled, will not interfere with your neighbor's enjoyment.

—*More simplified operation*—a super-receiver requiring no technical skill, thus making the greatest achievements of entertainment immediately available to all members of the family.

—*A receiver for the apartment house* and populated districts, requiring neither aerial nor ground connection.

—*Another type of improved receiver for the suburban districts*, equally capable to that above, for use where the erection of an aerial presents no problem.

Painstaking search in quest of these ideals has led to new discoveries, setting new standards of excellence and performance—discoveries, which have established:

First—that improved acoustics are possible—a matter of scientific research and not of haphazard design—for truly melodious reception.

Second—that dry battery operated sets can be so designed as to give both volume and distance.

Third—that the regenerative receiver is susceptible to marked improvement providing selectivity, sensitiveness and simplicity of operation hitherto deemed impossible of accomplishment.

Fourth—that the Super-Heterodyne—the hitherto complicated device requiring engineering skill to operate—could be vastly improved—improved in sensitiveness and selectivity—and simplified so that the very novice and the layman could enter new regions of entertainment and delight.

Watch For Further Announcements

Radio Corporation of America

Sales Offices:

233 Broadway, N. Y. C. 10 So. LaSalle St., Chicago, Ill. 433 California St., San Francisco, Cal.

Radiola

REG. U. S. PAT. OFF.