

# Popular Radio

MAY 1922

15¢

In this issue —  
How to Make and  
Install Your Own  
Receiving Set





# RADIOBAT

**T**HE Great Demand for Wireless Makes Necessary a Storage Battery of Proven Quality, Designed for Radio Work.

The Radiobat is Built by the Same Organization that Built the Batteries Used in France by the U. S. Signal Corps.

*Dealers: Write at once for Territory*

**MULTIPLE**  
STORAGE BATTERY CORP.



**RADIO DEPARTMENT**  
**JAMAICA, LONG ISLAND, N. Y.**

---

# SELECTOR

A selective radio contact switch. For varying the number of turns in any kind of radio tuning coil.

The SELECTOR can be mounted on coupler or coil direct, thus reducing leads to a minimum. Short leads and positive contact in radio instrument wiring are not only necessary, but are imperative for highest efficiency.

The SELECTOR combines these essential features and in addition is compact, positive, and will give that commercial appearance to your panel.

Price \$4.25 Postpaid

## ROTORS AND STATOR SECTIONS

Carefully and accurately made from specially selected and

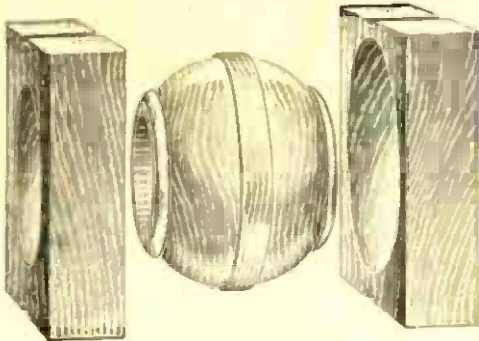

treated woods. Not "mere wood turnings" but manufactured to pattern makers standard.

Rotors packed 50 and 100 in package. Stator sections packed 100 and 200 in package.

Dealers! Send for interesting circular and attractive proposition. Write Dept. 16

**Norris Electrical Specialties Co. Inc.**

126 Liberty Street, New York

TELEPHONE RECTOR 6669

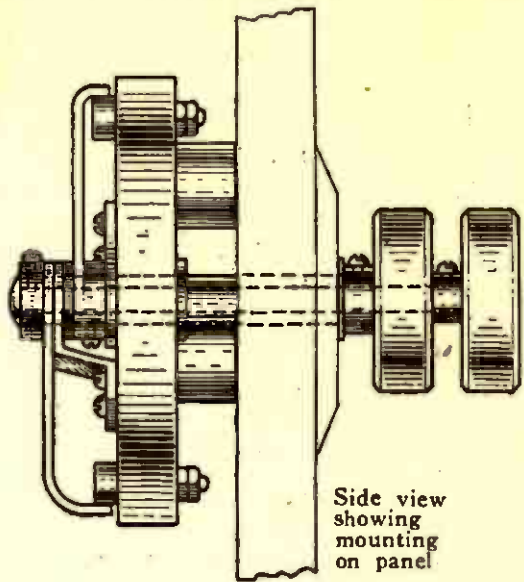

Side view showing mounting on panel

# DE FOREST for DEPENDABILITY

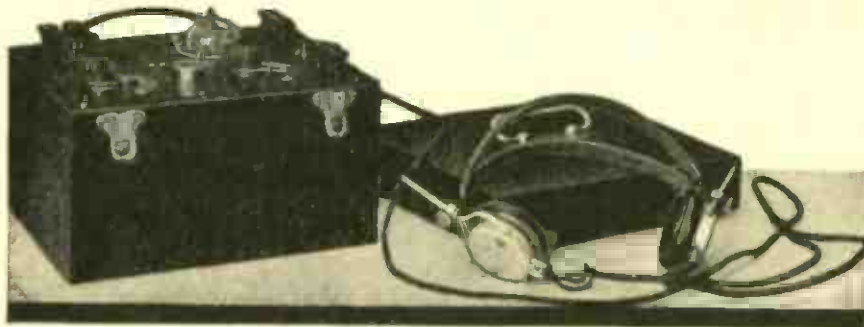

The Radiophone Receiver . . . . . Complete, \$72

When you buy a receiving set purchase a good one—get one that is made by a reliable manufacturer with a reputation for building high quality apparatus. Then you will not be disappointed.

Owners of De Forest Radiophone Receivers are enthusiastic over their simplicity of operation, their sensitivity and, above all, their dependability.

The Radiophone Receiver is but one instrument of the most complete line of radio equipment manufactured. Other outfits from \$25 to \$300. De Forest Equipment is carried by leading radio, department, electrical and sporting goods stores in every city. Insist on De Forest and enjoy broadcasting to the utmost.

**De Forest Radio Telephone & Telegraph Co.**

New York City

---

---

# MAN-DAY RADIO

*The Most Efficient Radio Outfit  
Made Today*

Really revolutionary in its efficiency. Our Circuit is patent pending. It is far more sensitive and far sharper than any circuit in existence.

The Man-Day Radio Outfit is complete and ready for setting up. It includes:

- 3000-ohm Turney 'phones;
- complete aerial and ground equipment;
- complete, tested, two-circuit tuner and detector having a range of 160 to 800 meters, and can be loaded to high wave lengths;
- lightning protection device;
- Bakelite panel, conceded the highest insulating panel made;
- German silver dial — finger-ease knob.

This complete tuner and detector enclosed in a finished cabinet with

open top, making the contents readily accessible.

At our experimental station at Lynbrook, Long Island, New York, the Man-Day Radio standard outfit has been continuously receiving music clearly and sharply, as follows:

- from Newark, N. J., 28 miles distant;
- from Schenectady, N. Y., 155 miles distant;
- and from Pittsburgh, Pa., 360 miles distant.

However, to be extremely conservative, we guarantee this set to receive telephone and music at a distance of 35 miles from the large broadcasting stations, under normal conditions.

Price, complete, \$35.00

*If your dealer has not a Man-Day Radio, write to us.*

## MAN-DAY RADIO CORPORATION

*(Prior to opening our New York Salesrooms)*

Lynbrook, L. I., New York

### *Special to Dealers*

We offer an unusual proposition to live dealers. Write today.

# POPULAR RADIO



## CONTENTS for MAY, 1922

VOLUME I

NUMBER 1

(Cover design by Adolph Treidler)

Herbert Hoover .....	Frontispiece
	Page
The American Amateur's Amiable Uncle Samuel. <i>W. G. Shepherd</i> .....	3
Are We Getting Radio Signals from Another Planet? .....	<i>E. E. Free</i> ..... 8
Harnessing Waves to Wire .....	<i>Henry Smith Williams</i> .... 14
The First of a Series of Articles on the Wizardry of "Wired Wireless"	
How to Make and Install Your Own Receiving Set .....	<i>Watson Davis</i> ..... 22
The Genius Who Put the Jinn in the Radio Bottle. <i>James H. Collins</i> .....	29
No. 1 of a Series of Articles on the Makers of Modern Miracles	
A New Broadcasting Station .....	33
"Hello, Central, Give Me the <i>America!</i> " .....	<i>John Walker Harrington</i> ... 34
A Wave Cycle from Cathay.....	<i>C. Dickson Loos</i> ..... 37
How to Tune a Regenerating Receiver.....	<i>Edgar H. Felix</i> ..... 38
The Next Step Ahead in Radio.....	<i>Waldemar Kaempffert</i> ..... 41
Symbols That Help in Reading Diagrams.....	<i>A. Hyatt Verrill</i> ..... 45
How to Make Soldered Connections.....	<i>Frederick Siemens</i> ..... 46
How Radio Waves Are Sent and Received.....	<i>Laurence M. Cockaday</i> ..... 47
A Simple "How" Article for the Beginner—Number One	
Principal Broadcasting Stations of the United States.....	50
How It Feels to Talk to 1,000,000 People.....	<i>Margery Wells</i> ..... 52

### DEPARTMENTS

Adventure in the Air.....	54
My First S O S Call.....	<i>E. H. Felix</i>
A Well Preserved Old Passenger.....	<i>David Lay</i>
Curing a Patient by Radio .....	<i>E. J. Quinby</i>
An Unintentional Broadcast.....	<i>William A. Mackay</i>
A Radio Message That Saved My General.....	<i>Capt. C. O. Van Der Vort</i>
"73" .....	
What Readers Ask.....	58
Broadcasts.....	61
What the Radio Conference at Washington Did	
President Harding Joins the Radio Fans	
Broadcasting Over Electric Light Circuits	
Hints for Amateurs.....	66
With the Inventors.....	68
Amplifying Apparatus—Wireless Signalling—Radio Receiver—Electric Wave Ranging System—Photographic Receiving Apparatus—Radio Receiver—Receiving Systems.	

VOLUME I

MAY, 1922

NUMBER 1

Published monthly by Popular Radio, Inc., 9 East 40th Street, New York City; H. B. Emerson, President; P. O. Batch, Treasurer. Price, 15 cents a copy; subscription \$1.50 a year in the U. S., Canada and Mexico; elsewhere \$2.00 a year, payable in advance. Application for entry as second-class matter is pending at New York Post Office. Copyright, 1922, and title registered as a trade-mark by Popular Radio, Inc. Printed in U. S. A.

KENDALL BANNING, *Editor*

LAURENCE M. COCKADAY, R.E., *Technical Editor*

# Is Your Receiver FULLY Equipped?

Surely you have heard of Pacentized radio receivers? Pacent manufactures radio accessories—the little things that you can add to your outfit that will make it a pleasure to operate. When you don't Pacentize you have to improvise and when you improvise in radio you sacrifice efficiency. Start right and buy a Pacent-Equipped outfit.

## A Few of the Pacent Radio Essentials

First is the Pacent Universal Plug which should be attached to the end of your 'phone and loud-speaker cord. Attached in a jiffy without solder or bother. Honestly made, beautifully finished.

**At your dealers \$1.25**

Second is the Pacent Twin Adapter. If your receiving outfit has only one jack, you need the Twin Adapter. It makes one jack serve the purpose of two. A beautiful addition to any receiver.

**At your dealers \$1.50**

Third we have the Pacent Multi-Jack. When attached to the side of a receiving set it will permit the use of three sets of 'phones or two sets of 'phones and a loud-speaker; three jacks in one.

**At your dealers \$1.50**

Write for our bulletin—PR100—describing these and other Pacent Radio Essentials.

## PACENT ELECTRIC COMPANY, Inc.

Louis Gerard Pacent, President

150 NASSAU STREET

NEW YORK, N. Y.

Member Radio Section Associated Manufacturers of Electrical Supplies.

## Klosner Vernier Rheostat



Patent Pending

The first and only Vernier Rheostat on the market having but

### ONE SINGLE KNOB

for both rough and fine adjustments. It consists of a highly finished condensite base and knob, with phosphor bronze contact springs. All metal parts are polished nickel plate. Diameter 2 1/4 inches.

The real rheostat for the modern critical tube.

**PRICE ONLY \$1.50**

Add shipping weight for one pound.  
At your dealer or direct.

**Klosner Improved Apparatus Co.**  
2404 Crotona Avenue New York City

## These Advertising Rates

Double page spread .....	\$200.00
Single page .....	120.00
Half page .....	65.00
Quarter page .....	35.00

were based on an estimated sale of fifty thousand copies of this issue. As the reports of our market investigators came in—showing the astonishing demand for a radio magazine of this character—the print order was gradually increased to 125,000.

If the sale meets even our most conservative expectations, it will of course be necessary to increase these charges; but in the meantime contracts for space will be accepted at these rates.

### POPULAR RADIO

**A. B. DELACY**

In Charge of Advertising



### Wanted—Railway Mail Clerks

**\$135 to \$190**

**A MONTH**

**Send Coupon**

**Today Sure**

**MEN—BOYS**

**Over 17**

Franklin Inst., Dept. D301, Rochester, N.Y.

Sirs: Send me, without charge:  
(1) sample Railway Mail Clerk Examination questions; (2) schedule showing places of all coming U. S. Government examinations; (3) list of many Government jobs now obtainable.

Name .....

Address .....



International.

### THE RADIO AMATEUR WILL BE PROTECTED

*"In certain countries, the government has prohibited the use of receiving instruments except upon payment of a fee. . . . I believe that we ought to allow anyone to put in receiving stations who wishes to do so. But the immediate problem arises of who will do the broadcasting, and what will be his purpose. It is my belief that, with the variations that can be given through different wavelengths, through different times of day, and through the staggering of stations of different wavelengths in different parts of the country, it will be possible to accommodate the most proper demands and at the same time to protect that precious thing—the American small boy, to whom so much of this rapid expansion of interest is due."*

*Herbert Hoover*

SECRETARY OF COMMERCE

---

# Popular Radio

VOLUME I

MAY, 1922

NUMBER I



## *The American Amateur's Amiable Uncle Samuel*

*Nowhere in the World Has the Amateur Radio Fan Either Grabbed or Been Given the Chance as Right Here in This Country. How the Foreigner is Restricted by HIS Government is Told Here by the Far-Traveled War Correspondent—*

WILLIAM G. SHEPHERD

**T**HIS is how a wireless fan in England sends a message: First he writes it out on a very thin piece of tissue paper. He twists this paper into a very tight roll and ties a string around it. Then he goes out into the yard or up on the roof, opens the door of a little shed, ties the message to the leg of a carrier pigeon he finds there and then turns the pigeon loose.

There are hundreds of thousands of these pigeon wireless fans in England. The trouble they go to in order to get a message to a friend is astonishing. It is about a three-day job.

In the first place an English wireless fan can't use one of his own pigeons. He has to get a pigeon from the friend to whom he wants to send a message. That means that he must go to this friend's house to get the bird. Very often he will take one of his own birds to his friend. Every Saturday afternoon in England you will see these wireless fans on the trains carrying cages containing one or two birds. By Saturday evening thou-

sands of birds have been taken to strange places and are crazy to fly home again as soon as they are set free.

On Sunday morning the fans have their fun. They set the birds loose with their messages. Then they keep time on their flights. If my bird gets to my home sooner than your bird to yours, then I have the better bird. The fans exchange records by mail and by Monday or Tuesday everybody knows whether the other fellow got his message or not. For over half a century this carrier-pigeon fad has been in vogue in England. There are carrier-pigeon societies and carrier-pigeon magazines and shops that carry carrier-pigeon supplies.

And the carrier-pigeon fan is the nearest thing they have to a wireless amateur in England.

**T**HE laws against the wireless amateur in England are so strong that there's hardly any use of a young man either making or buying an outfit.

I know a young man in England who is



a wireless amateur. He has plenty of money, for his father is rich. It takes a rich man to be a wireless fan in England. Every year he goes up into the mountains of Scotland with some fellow fans and there, in the wild places, they put up their outfits and practise sending and receiving and try out new parts and play all the tricks that 200,000 ordinary, every-day American fellows try out every night of their lives, if they want to, in their homes in every part of the United States.

The British navy officials have, until recent years, been very jealous of English ether. Before the war a young man had as much chance to rig up his own wireless outfit for receiving and sending as he would have had to start a new postal system in his community or dig a ditch across a public road.

Laws against the amateur are being loosened in England since the war. So many wireless operators were developed in the army and the navy that, within

the past two years, British officials have discovered that they must encourage the amateur if they want to have operators ready for military purposes.

Perhaps some day the British government will be as gentle and encouraging with the wireless amateur as Uncle Sam during the past ten years has been with the amateurs of the United States.

During some long railway journeys in England last year I saw only one antenna on a private house.

**A**CROSS the British Channel in France the amateur wireless fan, Pierre, must do everything under the bed. Let one of his ether whispers get out into the air, and he'll have a government policeman at his house in short order. The French army owns French ether, and it doesn't allow any loafing or trespassing therein. I traveled from one end of France to the other last year and criss-crossed the country but never once did I see an amateur wireless set. It is



© Keystone View Co.

#### ERECTING MINIATURE TOWERS OF BABEL

*In the country as well as in the city districts the radio amateur is indefatigable in his efforts to develop to the highest efficiency the equipment that comes within his means.*

possible that a fan here and there may have put up an antenna, but the minute his wires go up over the family roof-tree his house is under suspicion. French amateurs are allowed to receive the time signals from the Eiffel tower and the weather reports. They're not allowed by law to tune up or down to anything else. They cannot listen to government messages and they are forbidden to listen in on commercial messages. Calls for help at sea are none of their business. It isn't enough that a French amateur is willing to promise the government that he will keep secret all that he hears in the ether. Even in the secrecy of his own room he is supposed by law to tune out of all official or commercial wavelengths.

Whether the French amateurs do this or not no one knows. A copy of a commercial or government message found in the room of a wireless amateur would bring him a fine of \$100, or worse.

Some of the rich amateurs of France establish their sets in the mountains down south and experiment at short wavelengths, but they must have government permission to do this and they must take great pains not to interfere with the commercial company or the government. The French deny that Marconi discovered the principles of wireless telegraphy and they are very jealous both of the use of the ether and of their own wireless apparatus.

**I**N Germany the government owns the ether. An amateur has no more right to trespass therein than he would have to go behind the screen in the post office and help to sort letters or sell postage stamps. I tried to find wireless amateurs in Germany last winter and I discovered not one. It might be possible for an amateur to rig up an apparatus secretly and listen in on Nauen, but your true amateur is not satisfied with playing the sneak and listening without taking an active part in the throbbing of the ether waves.

In little Holland, now and then, you see the rigging of the wireless amateur

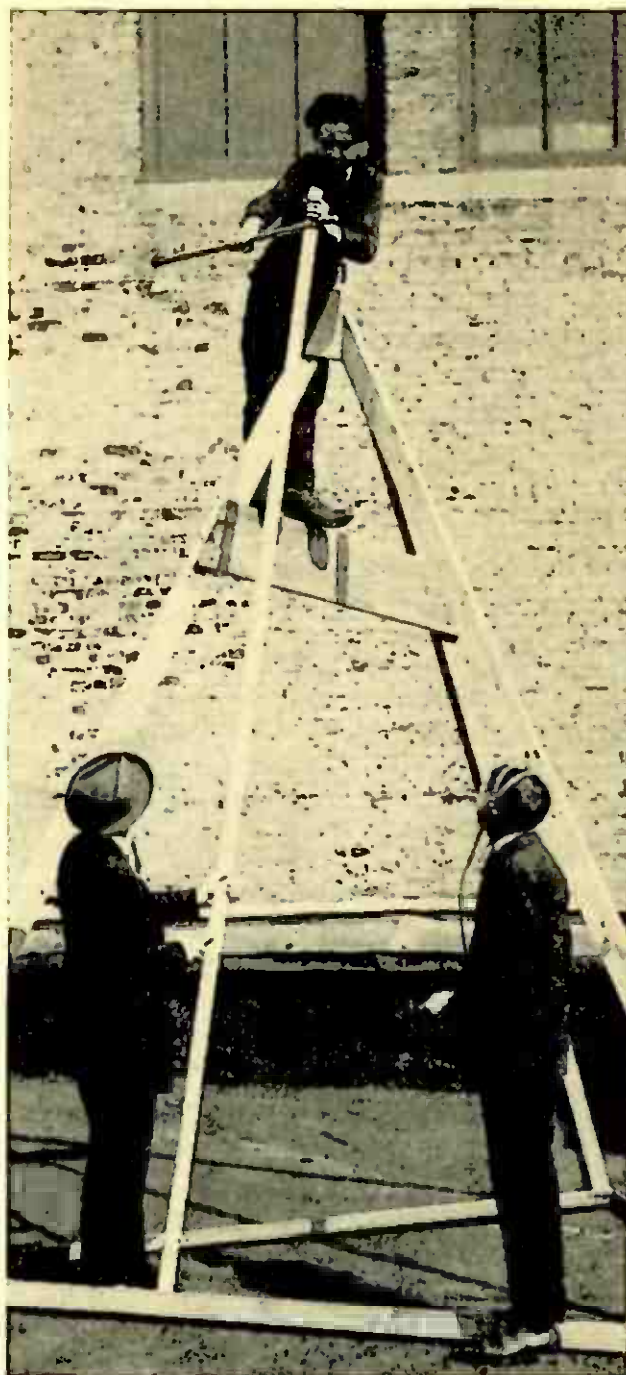

© International

#### HE JUST "DECLARED HIMSELF IN"

*The ingenious American boy waited neither for permission nor encouragement; he started years ago to work wonders with his home-made radio outfit.*

on private homes. But these are always fine big homes and you realize that here the wireless set is the toy of the rich.

Being near the sea the Dutch wireless amateur may listen in on interesting conversation. By doing this he is not breaking the law of Holland. But let him so much as send out one of his own ripples and the law comes down on him in a

hurry—military law that is never very gentle.

All of the laws that have been passed in European countries against the amateur means that very little apparatus is made for the amateur. There are no great factories that are turning out supplies for him. He cannot become a wireless fan overnight by merely stepping into a shop or sending a check to a manufacturer and buying a receiving set. He must either have a set made for him or must collect the parts, as best he can, and make his own set.

In all of Europe cheap sets are as scarce as antennae. And if you think amateur antennae are plentiful, just take a trip through Europe with a friend some time and get him to offer you \$10 for every rhinoceros you see if he'll give you \$10 for every amateur antenna he sees. You'll win, because you can take him to a zoo in every big town on the Continent, and the chances are he won't be able to

find an amateur wireless outfit from Russia to the Mediterranean.

¶ *The United States is the land of the wireless amateur, and it is an important thing for the amateurs of this country to realize this fact.*

What Uncle Sam has gained by not closing the ether to the American boy fifteen years ago can never be measured. Many of the most prominent and progressive wireless engineers of the country to-day began as amateurs less than a generation ago.

The good American fashion in which the American boy "declared himself in" on wireless ought to make us all proud of our country and its methods of government.

Up to the time of this writing, early in April, Uncle Sam has not taken any single action against wireless amateurs that has prevented the spread of amateur interest in wireless.

The American navy has had its corner



© Keystone View Co.

**YOU WOULD NEVER SEE A SCENE LIKE THIS IN EUROPE**

*What Uncle Sam has gained by not closing the ether to the American boy can never be measured. Many of the prominent wireless engineers of the country today began as amateurs less than a generation ago.*



Photo by Brown Bros.

#### NOT ALL OF THE FANS ARE YOUNG MEN

*A large proportion of the amateurs in this country are men between fifty and sixty—doctors, lawyers, business men, teachers—who have done much to develop "the radio art."*

of the ether, but it has not tried to crowd out the amateur. Indeed, it has been doing much to find a place for him.

The American army has also had plenty of room in the great void. As soon as the war was over all military regulation of the amateur was dropped. Today the army is doing all it can to develop as many amateurs in the United States as possible, and the Amateur Radio Reserve, fathered by the Signal Corps, is the direct growth of that interest.

Commercial companies have, now and then, endeavored to persuade the government to discourage the activities of the amateur but it must be said that, up to this writing, the government and its army and its navy have always been on the side of the amateur.

Because Uncle Sam has been a good

Uncle—the best Uncle a wireless amateur ever had—we have scores of thousands of amateurs in the United States today, as compared with almost none in Europe.

Here's hoping Uncle Sam never turns European.

And, for the sake of hundreds of thousands of young men in Europe who do not yet know the thrills and joys of the wireless amateur, here's hoping that European governments turn as kind as Uncle Sam. We Americans want this to be so, for if this comes about, then some day, sure as fate, amateurs will be trading lessons in languages across the Atlantic and Pacific oceans.

Night schoolrooms in France hooked up with night schoolrooms in America—!

Well, it's never safe to let your imagination run loose about wireless.

**Q** *How the Radio Is Being Developed by the Police Departments of Our Cities and Towns as Well as by the Department of Justice in Running Down Fugitives, Will Be Told in the June Issue by Fred C. Kelly, formerly of the U. S. Secret Service.*



© Underwood & Underwood

Science may yet conclude that Guglielmo Marconi was the first man on this earth to pick up a radio message directed by a superior intelligence from another world.

## Are We Getting Radio Signals *from* Another Planet?

*If Not, How Can the Recently Recorded Wireless Impulses of Tremendous Power be Explained?*

By E. E. FREE, Ph.D.

ARE wireless signals being received on the earth from some other point in space, possibly from the planet Mars? Marconi thinks that they may be; everyone knows of his success nine months ago in picking up impulses of very long wave length, believed not to be of terrestrial origin—impulses which are suggestive, to say the least, of signals sent out from some source and directed by intelligent beings.

This amazing conclusion may yet be demonstrated. That the impulses that Marconi recorded come from some source is, of course, evident. If they do not come from intelligent beings of another planet, what other possible explanation of them can be offered? Are there any "natural causes" by which wireless impulses might be generated somewhere in the universe by processes not involving intention or intelligence on the part of creatures more or less like man?

Yes. A possible explanation of these impulses may be found in what are called sun-spots.

Through an ordinary telescope (the eye being protected, of course, by a dark glass), the sun looks like a glowing disk of fire. Occasionally on this disk may be seen a darker blotch or two, sometimes very small, sometimes large enough to cover a considerable fraction of the sun's apparent diameter. These blotches are sun-spots. Astronomers know that they

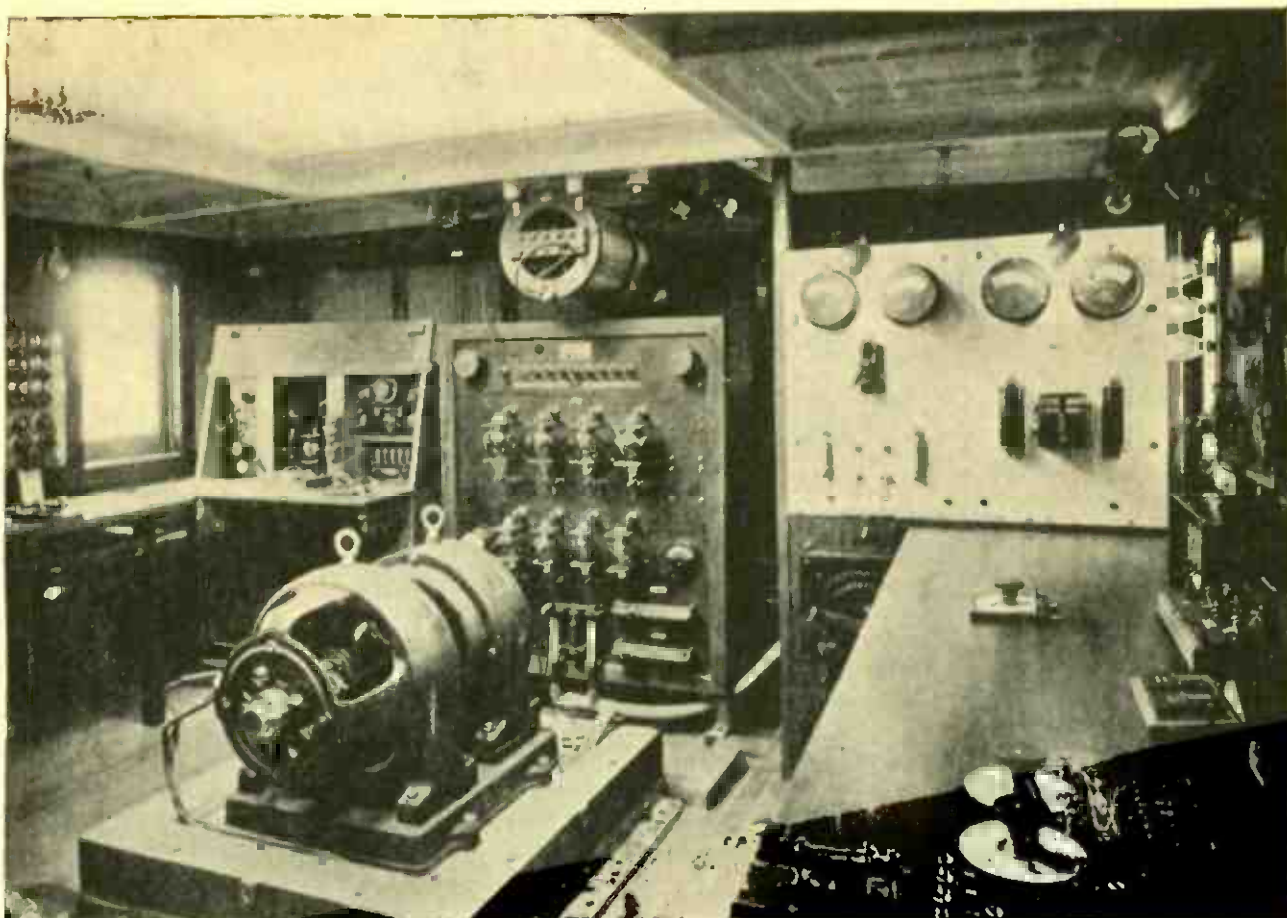

© Underwood & Underwood

#### WHERE THE MYSTERIOUS SIGNALS WERE RECEIVED

*A close-up of the equipment in the radio laboratory on board the yacht "Electra," on which Marconi recorded radio wavelengths estimated as high as 150,000 meters—about five times greater than those produced by man-made apparatus.*

are due to violent disturbances or "storms" in the surface layers of the sun.

The sun is really a great ball of hot and glowing gas. Its surface is literally a sea of fire. Or, more exactly, the clouds which fill the atmosphere of the sun are not water-clouds like those of earthly skies, but clouds of blazing, incandescent gases—clouds so hot as to be altogether beyond terrestrial comparisons. The temperature of the sun's surface is believed to be about 6,000 degrees centigrade—over three times as hot as the inside of a white-hot iron furnace, nearly twice as hot as the hottest thing ever devised by terrestrial physical science, the crater at the end of one of the carbons of an electric arc.

Naturally the clouds of sizzling gas on the sun are in constant motion, boiling up and down, surging back and forth with millions of times the velocity and power of earthly winds or cloud currents.

Imagine the sea tossing flame above a burning building and suppose this multiplied perhaps a million million times in intensity and a few more million million millions in size. This is the continual condition of the sun.

But sometimes the boilings and surgings of the solar fire clouds, the intensities of these solar storms, are especially violent; it is then that we get sun-spots. A tremendous whirlwind, perhaps, tears apart the glowing cloud envelope of the sun and gives us a glimpse of lower strata not quite so transcendently hot, or, more probably, the solar storm drives upward from the sun's surface a great ascending column of white-hot gas. During the eclipses of the sun ascending fire columns like this become visible and have been seen to rise as much as 300,000 miles above the surface, more than one-third the diameter of the sun. Such a rising stream of gas cools rapidly. As it cools

it becomes less incandescent, darker. At the same time it hides, to some extent, the more brightly glowing surface underneath. This makes a sun-spot, a visibly darker speck on the glowing disk of the sun.

It is difficult for earth men to conceive the tremendous scale of these sun-spots and the solar storms which they cause. The incandescent solar winds have been seen to blow as fast as 600 miles an hour. The diameter of a sun-spot, probably itself only the central part of the storm, may be well over 100,000 miles, more than four times the distance around the earth. Beside these solar cataclysms the most destructive earthly tornado, the most violent thunderstorms, are gentle zephyrs in the proverbial tea cup.

**A**LL this has a direct bearing upon wireless for this reason: the sun-spot storms are known to be electrical. Probably they are electrical in origin, certainly so in many accompanying occurrences. And if they are electrical at all they are like other electrical disturbances in having wireless effects, in providing

wireless waves as any electric spark would do. These wireless waves go out everywhere through space just as do the waves from the antennæ of a terrestrial sending station. A solar storm furnishes, indeed, the most powerful known sending station.

The same waves which carry the nightly concert to your household radiophone also bring to you, whether or not you recognize it, news of the latest electric storm on the sun. Whenever there is a great electric storm on the sun, or better still, when there is a more or less extended period of solar storminess, this storm is evidenced to our telescopic eye by the occurrence of a large sun-spot or of many sun-spots. From these sun-spot storms as centers there rush out into space great streams of electric energy—two kinds of energy; *first*, the wireless waves of which I have already spoken, and, *second*, streams of electricity itself, of electrons. These latter are not unlike the familiar corona discharges from high-voltage wires. Both the solar wireless waves and the electron streams have important terrestrial effects; effects, indeed,

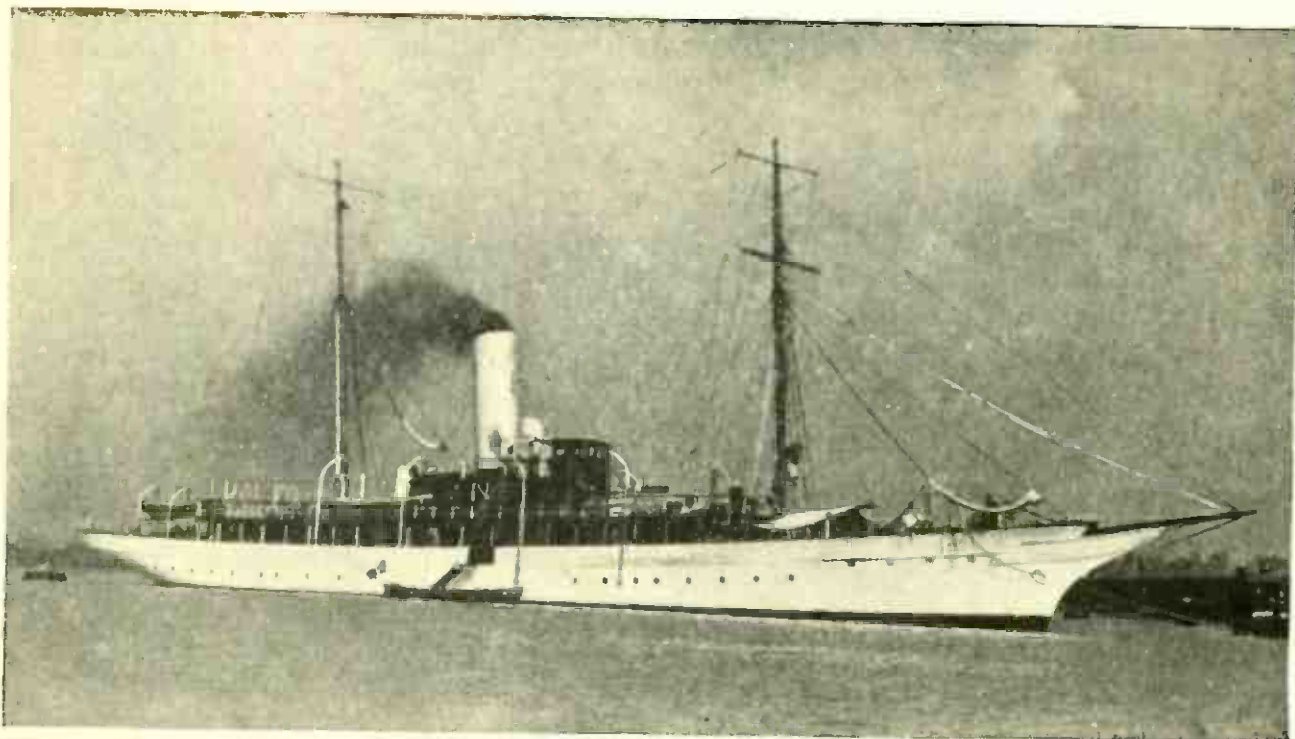

© Underwood & Underwood

#### THE BEST EQUIPPED FLOATING RADIO LABORATORY IN THE WORLD

To get away as completely as possible from interruption, Marconi conducts his research work on his private yacht "Electra," which spends much of the time cruising on the Mediterranean.



#### THESE SUN-SPOTS TRANSMIT RADIO IMPULSES OF GREAT FORCE

*The black disc in the lower left corner represents the earth. Compare it in size with the "spots" on the sun, photographed at Mount Wilson Observatory, August 8, 1917—the very disturbances which the necromancers stated augured America's participation in the World War.*

of everyday importance to man, not merely of scientific interest. For instance, the solar electric energy—we do not know whether it is the wireless fraction or the electron fraction—is perhaps the most important single influence in controlling the day-by-day variations of the weather.

A storm on the sun, although it occurs ninety millions of miles away, has more effect on the daily life of the New Yorker than a thunderstorm in San Francisco. As a matter of fact, the California storm was the offspring of the solar one, that storms on the sun control the occurrence of storms on earth. There can be no doubt at all that solar storms influence greatly the number, path and intensity of the storms on earth.

The day-by-day variations of terrestrial weather, daily as distinguished from

the seasonal variations of winter, spring, summer and fall, are the result, in the main, of two causes: variations in the amount of heat and light received from the sun; and the electrical, or perhaps electro-magnetic conditions of the earth and its atmosphere. Solar storms do not affect greatly, or immediately the amount of heat or light which the sun sends out, but they do affect, very greatly indeed, the electro-magnetic condition of the earth.

It has been shown, for instance, by numerous comparisons of the actual records, that there is a direct and important connection between the number and size of sun-spots and the occurrence on earth of what are called "magnetic storms," that is, of periods of rapid fluctuation in the direction and dip of the compass



needle, in the strength of the earth's magnetic field, and in other electric and magnetic phenomena. Wireless operators know to their sorrow the effect of these magnetic storms on ease of communication, on the prevalence of "static." There are parallel influences on the occurrence of the aurora borealis, the northern lights. Science traces all of these things to the wireless (or perhaps the electronic) effects of the solar storms.

How this happens, indeed how it literally must happen, will be clear at once to any student of wireless. Any electric disturbance, a spark, a condenser discharge, a current in a wire, sets up a wireless wave. That terrestrial thunderstorms do so is familiar knowledge. And the solar storms, being electric disturbances of tremendously greater violence, have correspondingly powerful wireless impulses,

impulses powerful enough to retain across ninety million miles of space the strength to alter seriously the electro-magnetic condition of the earth.

The more usual, every-day aspects of terrestrial weather—the rainfall, the air temperature, the frequency and violence of storms—are believed to be affected by solar wireless indirectly, by way of the more direct effects on the earth's magnetism and electricity. The solar wireless waves alter these electro-magnetic conditions. These conditions alter the weather. Discussion of exactly how these successive effects are believed to succeed and cause one another would lead us far afield into a part of meteorological science which is still imperfectly understood. It is here that wireless experts can and will help the meteorologists, and when they

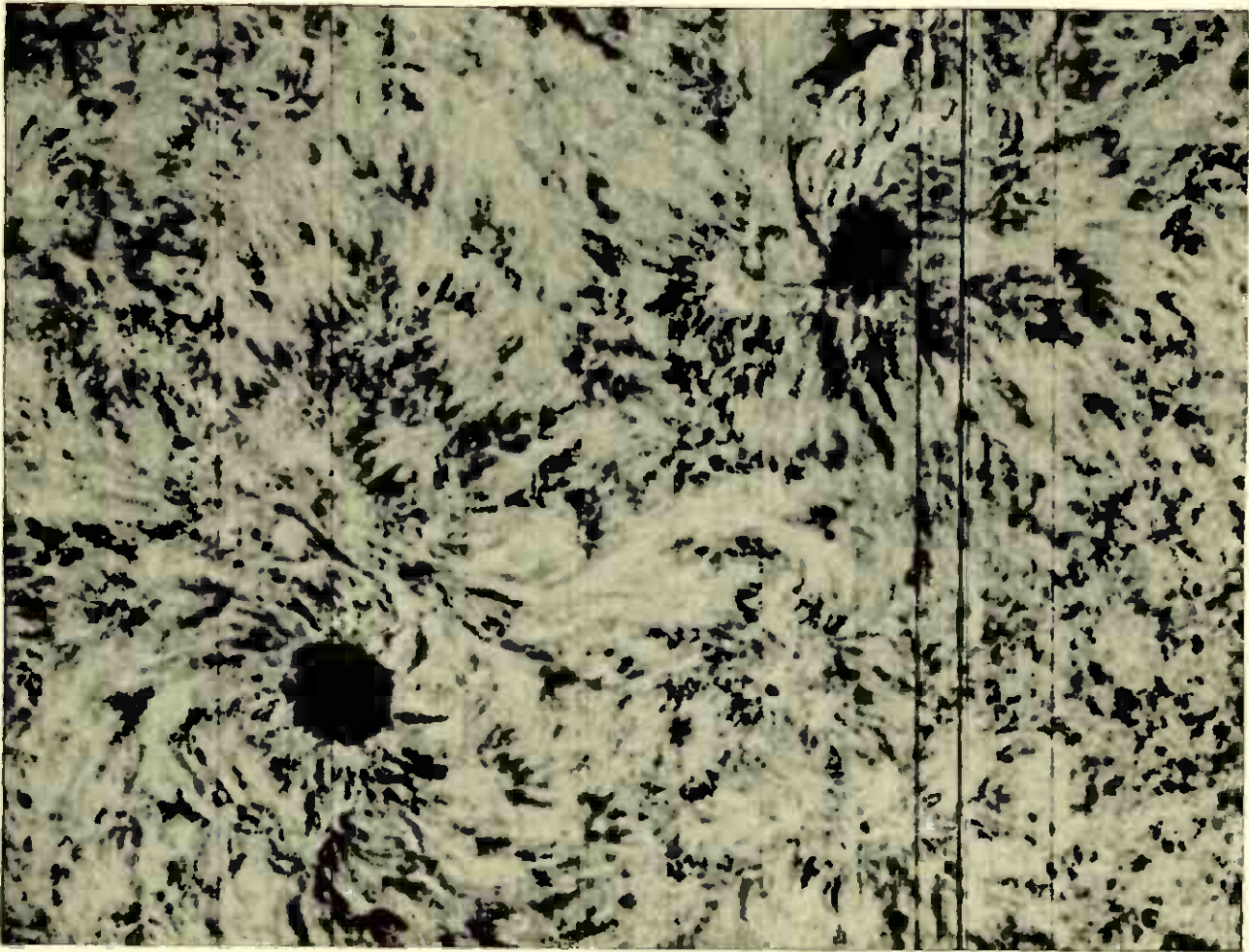

From a spectrograph taken at Mount Wilson Observatory, California

#### DO SUCH SOLAR DISTURBANCES EXPLAIN THE RADIO "SIGNALS?"

*From these inconceivably great whirlwinds of flame that sometimes shoot up 300,000 miles into space, the earth receives electrical impulses comparable to those from a radio sending station.*

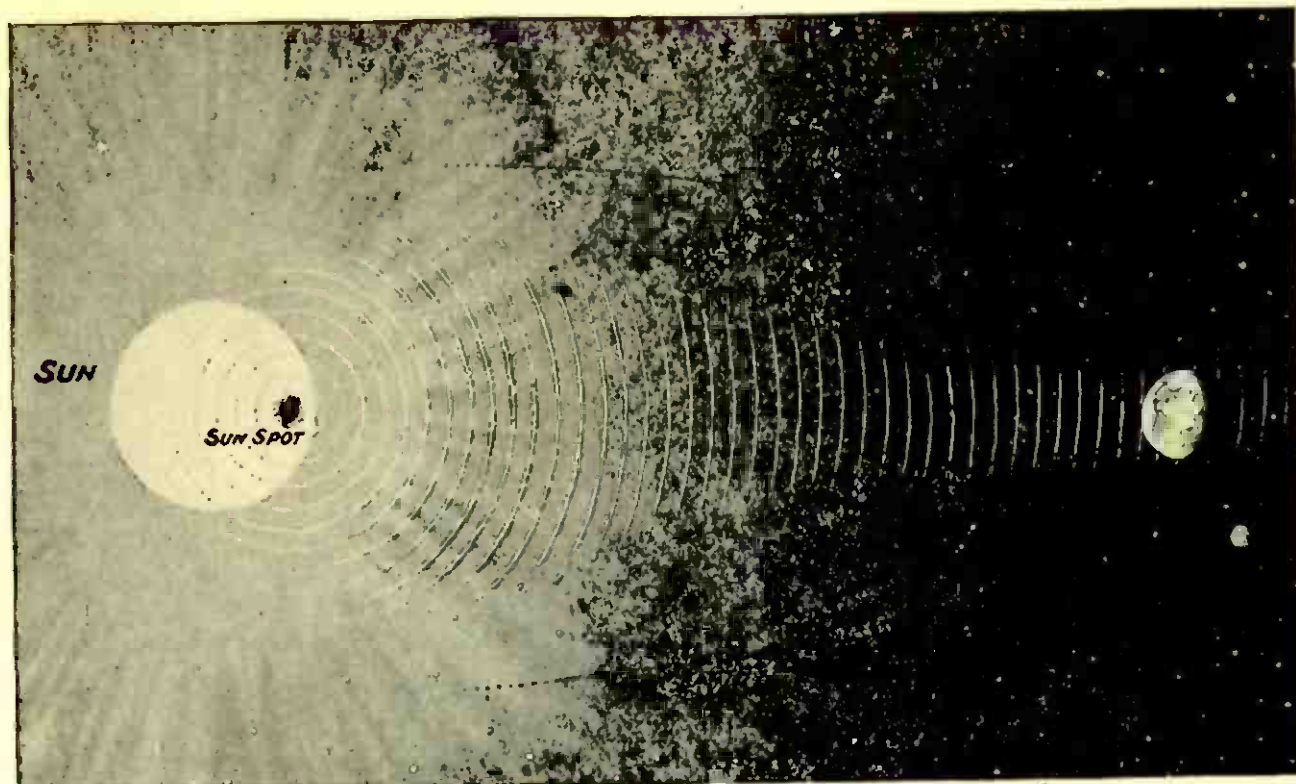

#### HOW RADIO WAVES MAY REACH THE EARTH

*That there is a direct and important connection between the size and number of sun-spots and the "magnetic storms" on earth can no longer be questioned.*

have done so there will be, doubtless, a lot of interesting things to say.

For the present we have the bare facts. Connections have been traced between solar storms and terrestrial storms. One link of these connections is known; namely, the occurrence of magnetic disturbances on (or in) the earth. The other links, still missing, offer to the wireless enthusiast one of his most alluring problems.

There are, of course, a thousand speculations which one might pursue. What are probably the wave lengths of this solar wireless? Are they, like Mr. Marconi's signals, so long as to remain entirely unperceived by the usual standard wireless apparatus?

Does the wave approach a pure tone of single wave length or is it (which is more probable) an inextricable mixture of thousands of irregular waves?

What are its relations to the shorter waves, also electro-magnetic, or ordinary light?

How is it involved with the solar streams of actual electricity, of electrons?

Or, to shift the ground of questioning earthward, what terrestrial effects still entirely unperceived by man may be traced some day to solar wireless?

All this is merely one of the possible explanations of the wireless impulses recorded by Marconi. These impulses might be coming from some other planet than the sun. There are other planets in our own family.

Mr. Marconi's signals may be, in fact, a product of Martian intelligence. Or they may be news of natural changes in the rings of Saturn, word of cataclysms in the solar system of some inconceivably distant sun.

We may yet live to read in our newspapers such headlines as this:

"Wireless seismograph of the National Observatory records great earthquake on Sirius. Other stars believed to be affected. Expected changes in the satellites of Jupiter will probably be delayed."

The daily news is already international. Is it to become interstellar?



*To the investigations of Major-General George O. Squier, augmented by the research work of the Bureau of Standards, the remarkable phenomena described in this article were made possible.*

## Harnessing Waves to Wires

*The First of a Series of Articles  
on the Wizardry of WIRED  
WIRELESS*

By DR. HENRY SMITH WILLIAMS

© Underwood & Underwood

**I**F the textile workers of America had been able to braid silk a little faster (or, to be accurate, a good deal faster), there would probably be no such thing as "wired wireless" known to radio science to-day.

Of course you do not see the connection unless you happen to know the story. The application is simple, however; Major-General George O. Squier, known to everyone as the originator of the wired wireless method, explained it personally at the outset of the paper in which he

made popular announcement of his discovery. This is how it happened:

The "key problem" in the procurement of essential Signal Corps supplies in the United States during the World War was the production of the necessary braiding machines for finishing insulated wire. The wire itself could be obtained; rubber insulation could be obtained; and there was no dearth of cotton thread for making the braid—but machinery for braiding the thread was inadequate, and could not be rapidly supplied.

All the braiding machines in the United

States in September, 1918, could produce the braided covering for only eight hundred miles of twisted pair insulated wire a month—and the American forces alone required forty thousand miles a month! And as if this was not bad enough, the allied council decided on October 1st, 1918, that it would be necessary for the United States to furnish all of this type of wire used by the allied armies in the field, beginning March 1st, 1919. The estimated minimum requirement was 100,000 miles a month, or more than twelve times the capacity output of all the American machinery in existence.

Confronted with this situation, the United States Signal Corps, with General Squier at its head, not unnaturally realized the desirability of finding a substitute for braided cotton thread.

The Signal Corps found it. Indeed, it found something not merely "just as good," but in many respects vastly better. Confronted with the shortage of braiding machines, General Squier said, in effect: "Let us try electron tubes instead." Asked to supply 100,000 miles of braided cotton a month, he said: "I will give you an unlimited quantity of electromagnetic waves instead."

Succinctly stated, what General Squier did was to run a bare wire of phosphor bronze (number 18, such as is used for Signal Corps field antennae) across the Washington channel of the Potomac River from the Army War College to the opposite shore in Potomac Park, letting it sink to the bottom and lie there absolutely unprotected. Not only was the wire not insulated, but pains had been taken to clean it entirely and free it from any grease or other material that could in the least protect it. A standard Signal Corps radio telephone and telegraph set was directly connected to each end of the wire; one set served as transmitter and the other as receiver. At the receiving end, the bare wire was directly connected to the grid terminal of an electron tube in the receiving set and the usual ground connection was left open. Tuning the

wire to a frequency of about 600,000 cycles a second, excellent telegraphy and telephony were attained.

"This experiment," declared General Squier, "demonstrated the possibility of transmitting electromagnetic waves along bare wires submerged in water, and the use of an electron tube as a potentially operated device on open wire for the reception of signals."

That statement shows the characteristic modesty of the true scientist. For the simple experiment had really resulted in a fundamental discovery, foreshadowing the opening up of an entirely new department of radio science of almost inexhaustible possibilities.

If, one of these days, you are able, sitting in your New York office, to take your telephone receiver off the hook and have a chat with a friend in London, it will be because General Squier was led (owing to the shortage of braiding machines) to find out whether he might not send a message along a bare wire under the Potomac.

**T**HERE are many interesting things to be told about General Squier's further experiments, which include successful tests of the bare wire as a carrier of messages when laid along the moist earth, and even buried under the soil; but before we come to these, let us consider the question as to how and why the electromagnetic waves follow the wire and are thus led to a definite goal, instead of radiating out into space and becoming rapidly attenuated as in ordinary radio transmission.

This question, however, can be answered only provisionally. We have to do with an extremely puzzling phenomenon. Only a very bold or reckless theorizer would have predicted, with any measure of confidence, the results which were actually attained. Ninety-nine radio operators in a hundred would have dismissed the notion that a wireless message could be sent along a wire as absurd. The very phrasing seems self-contradictory. It is more than likely that General

Squier himself was not over-confident about the success of his experiment. But his imagination conceived the thing as possible; and presently his ears told him that the possibility had become a reality. "Wired wireless" was an accomplished fact, whether or not a theory could be found to make it plausible.

The discoverer himself was content for the moment to go on with his experiments, avowing no theory by way of explanation. Doubtless that was the part of wisdom. Certainly it is better not to hamper a practical discovery by harnessing it too closely with theory at the outset. Nevertheless, no one can thoughtfully consider the phenomenon without at least attempting to form a mental picture of things that are happening along the course of the strand of copper wire that is so magically holding the electromagnetic waves in leash.

Of course it is not to be supposed that the electromagnetic waves travel in or even on the wire. By definition, these waves are undulations in the ether of space, which is supposed to be the universal medium, occupying the interstices between the electrons that are conceived as the ultimate particle of matter. According to one theory, the electron itself is only a whirl in the ether. In any event, the ether appears to ignore the very existence of matter, passing between the molecules of the most solid substance more freely than water passes through a sieve, inasmuch as there is no friction. The electromagnetic waves with which ordinary radio deals are not altogether unaffected by material substances, but to an amazing degree they appear to ignore

obstructions. As an illustration, we have just seen that the electromagnetic waves of General Squier's experiment followed the course of the wire laid along the bottom of the Potomac, apparently ignoring the presence of the water. Yet they obviously did not ignore the wire altogether—otherwise they would not have followed it.

It was not the wire itself, in all probability, that enchained the electromagnetic waves, but the electric field about the wire. An electric field, according to accredited theory is merely the condition (of "strain" or what you will) that exists in the ether surrounding an electron or group of electrons. When electrons are in transitional motion, their transit is manifested in what we term a current of electricity, and the motion of the electric field about them establishes a condition that we term magnetism. The moving electric field is parent to the electromagnetic wave; so perhaps it is not strange that an electromagnetic wave in being should have affinity for the electric field surrounding a copper wire that chances to lead out from the source of its origin.

At first thought it seems odd that the electromagnetic wave should follow a bend in the wire; but we must reflect that the electromagnetic waves of ordinary radio do not travel in a straight line, but follow the curve of the earth's surface. Possibly the electro-static conditions of the lower atmosphere have to do with the course of ordinary radio waves somewhat as the electric field about the wire has to do with the directed waves of General Squier's experiment,—the earth's surface itself representing, in this view, a magni-



#### A DIVINING ROD FOR WIRELESS WAVES

*This remarkable miniature coil antenna—a trifle larger than an ordinary walking stick—collects radio impulses when it is turned and pointed in the direction whence the impulses emanate.*

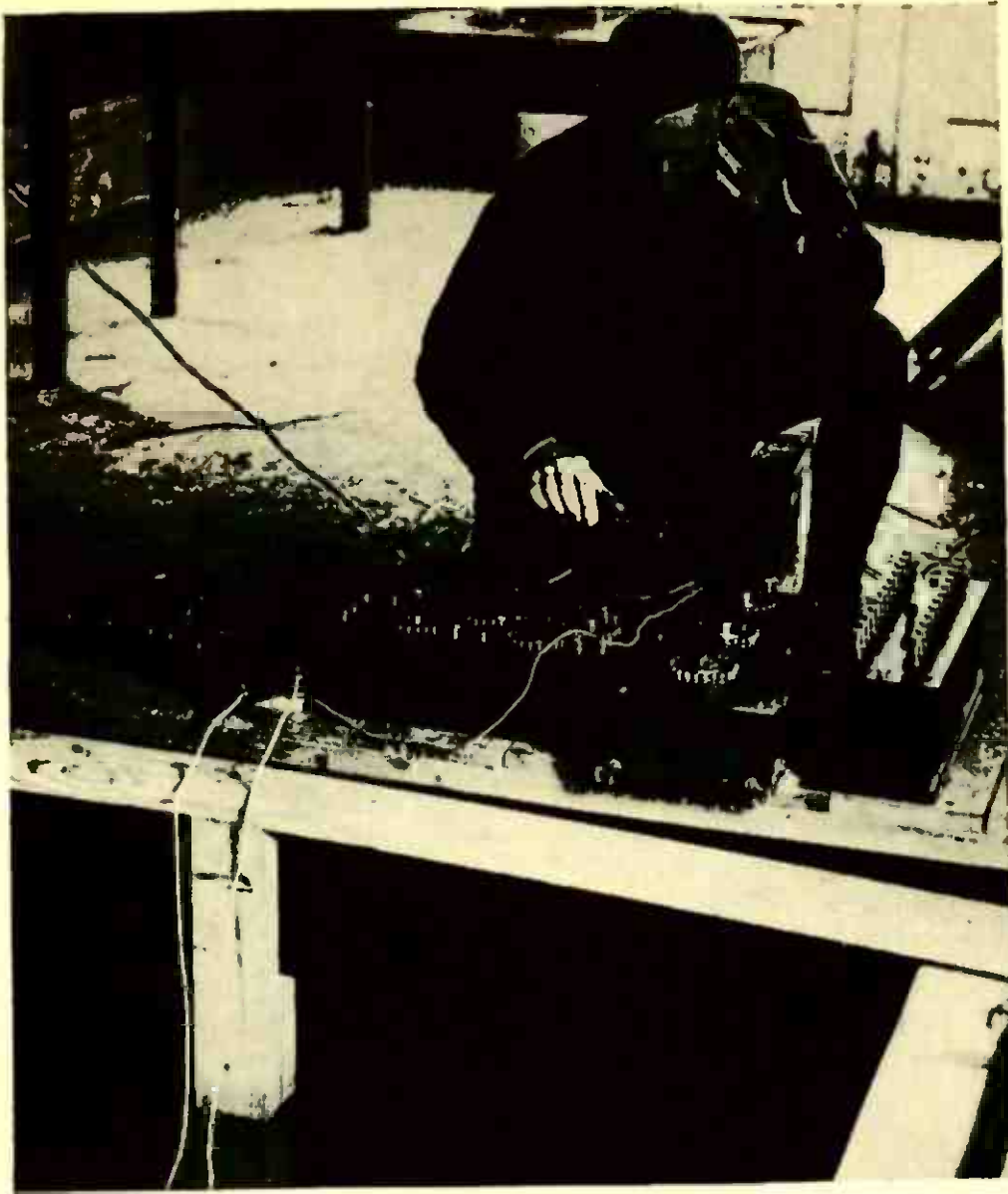

MEASURING THE HIGH FREQUENCY RESISTANCE OF  
WIRE UNDER WATER

*An experimenter at work on the impedance bridge in the Signal Corps laboratory at the Bureau of Standards in Washington.*

fied wire-surface. The familiar fact that radio messages are rapidly dissipated in the daytime, when the upper atmosphere is believed to be charged with electrons from the sun, possibly gives support to the analogy.

All this is mere theory, however, which the reader may find more or less satisfactory according to the bent of his mind; but which can neither add to nor detract from the force of observed facts, to which we now return. The traditional apple falling from the tree on the pate of Sir Isaac Newton bruised the philosopher neither more nor less because of the theory of universal gravitation.

**T**HE experiment of sending messages along the bare wire under the Potomac having thus succeeded beyond all reasonable expectation, a question naturally rose as to whether the experimenters might have drawn a false inference from their observations. Might it not be that the portions of wire out of water at either terminal had acted as antennae, and that the electromagnetic waves had passed directly through the air, as in ordinary radio transmission, or along the surface of the water?

To answer that question, the simple procedure was adopted of cutting off the main portion of the wire, leaving only

the short aerial portion at sending and receiving stations, and a few feet under water. But now messages were no longer transmitted; and this negative result was very properly interpreted as demonstrating that the messages previously sent and received had in reality been directed along the wire.

Sundry other confirmatory experiments having been made with a submerged wire, attention was directed to the possibility of conveying a directed message along a wire lying on the ground. A bare No. 16 wire was laid on the surface of the earth connecting the main laboratory of the Signal Corps and a small field station one and three-quarter miles distant. The radio telephone instruments used were standard sets utilizing an oscillating transmitter of the electron tube type. The transmitting current was about one hundred milliamperes, at any of the wavelengths available with these sets, ranging from about 200 to 550 meters. It was found that good telephone communication could be made with this equipment.

As the next important step in the series of experiments, the bare transmitting wire was buried in the earth to a depth of about eight inches. The bare No. 16 wire was laid in a plowed furrow and a second furrow was plowed alongside, completely covering the wire. The soil was moist, sandy loam, only a few feet above tide water.

The wire thus buried conveyed the electromagnetic current as before, and satisfactory communication was established for the distance of about a mile.

To make the experiment more definitive, tests were made with the buried wire not laid in a straight line, but turning at various angles. Were the wire serving only as an ordinary antenna, it was reasoned, signals would be detected in the direction of a prolongation of a straight portion of wire; but in reality the test showed that signals could be detected best in close proximity to the wire itself in all its parts, proving that the electromagnetic waves

turned the corners in order to follow the wire.

Although the soil did not prevent the passage of the message-carrying waves, it did exercise a curious influence, screening them and in effect preventing their escape from the region of the wire. Proof of this was found by moving an exploring coil along the line of the buried wire. The detecting instrument, held just above the surface, failed to reveal a signal; but when a short length of the wire was exposed by removing the earth, signals were at once appreciable, and these disappeared when the earth was put back over the wire.

General Squier comments on the importance of this phenomenon from the standpoint of military usage. It is obvious that with a buried wire radio messages could be sent in secrecy, a desideratum well nigh impossible of attainment with aerial messages.

**T**HE successful termination of the experiments above described may be said to have established the principle of "wired wireless" beyond controversy. The importance of the discovery was so patent as to excite universal interest. Although the original tests had been made to meet war-time needs, it was clear that the new method would have abundant peacetime applications as well. The possibility of sending several messages along the same wire simultaneously at once suggested itself; and it was believed, with reason, that adaptation of the method will make feasible the transmission of messages to and from moving trains. Let it here suffice to note, however, that General Squier, whose earlier experiments in multiplex telegraphy are well known, stated in his early report that the applicability of the new method to multiplexing was self-evident. It is obvious to anyone familiar with the general principles of radio transmission that it should be possible, by using different wavelengths, to send several messages simultaneously in either direction along a single wire, each message in-

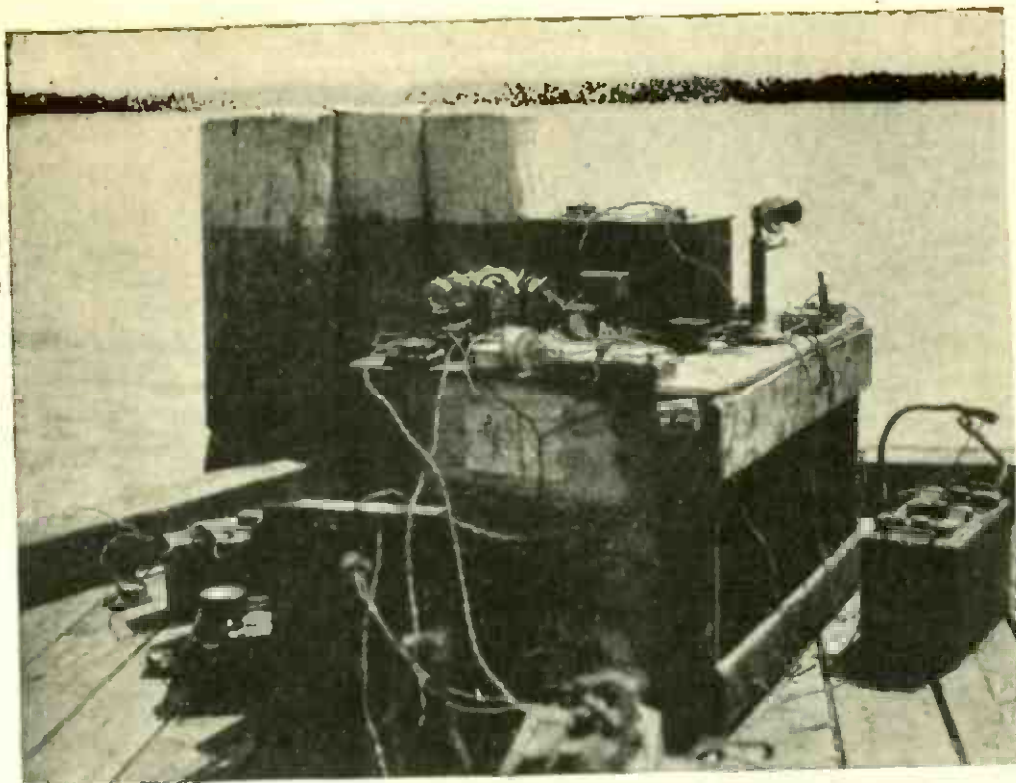

#### WHERE THE EARLY EXPERIMENTS WERE MADE

*The original transmitter used in the submarine wireless experiments between Fort Hunt, Va., and Fort Washington, Md. The bare wire over which the signals were sent is shown going over the edge of the dock at the left.*

distinguishable except to the particular instrument tuned to receive it.

Practical experiment was presently to demonstrate the validity of this assumption. In the meantime experiments designed to throw light on less patent features of the new method were undertaken, particularly in the Signal Corps research laboratory at the Bureau of Standards. One object was to determine the electrical constants of bare wire submerged in water when subjected to high frequency currents.

At the Bureau of Standards a tank was available 125 meters long, 2 meters deep, and 2 meters wide. Two wires placed in the tank served as a to-and-fro conductor, constituting a complete transmission line immersed in water. Using an electron tube oscillator as transmitter, measurements were made to determine the apparent impedance of the system with the remote end short-circuited and also open-circuited. Even at the preliminary stages, the observations as to capacity and leakage of the wire were found highly interesting.

"It was seen," says General Squier, "that at low frequencies the capacity is extremely large, about 1,200 microfarads a kilometer, the equivalent of an entire Atlantic cable, but the capacity diminishes very rapidly as the frequency is increased, and at a frequency of about 40,000 cycles a second, it practically vanishes. The leakage increases with the frequency up to about 5,000, and then begins to decrease slowly as the frequency is increased. The results were surprising, particularly the high capacity values at the low frequencies. The experiments apparently show that frequency of the current used has a marked influence on the behavior of water as a medium, and is entirely different from what it would be for direct or low frequency current.

**T**ESTS of this character, while of great theoretical importance (and that means always, potentially, of practical importance), have not the popular interest that attaches to the observations that were made by General Squier and his associates at an early stage of the investi-



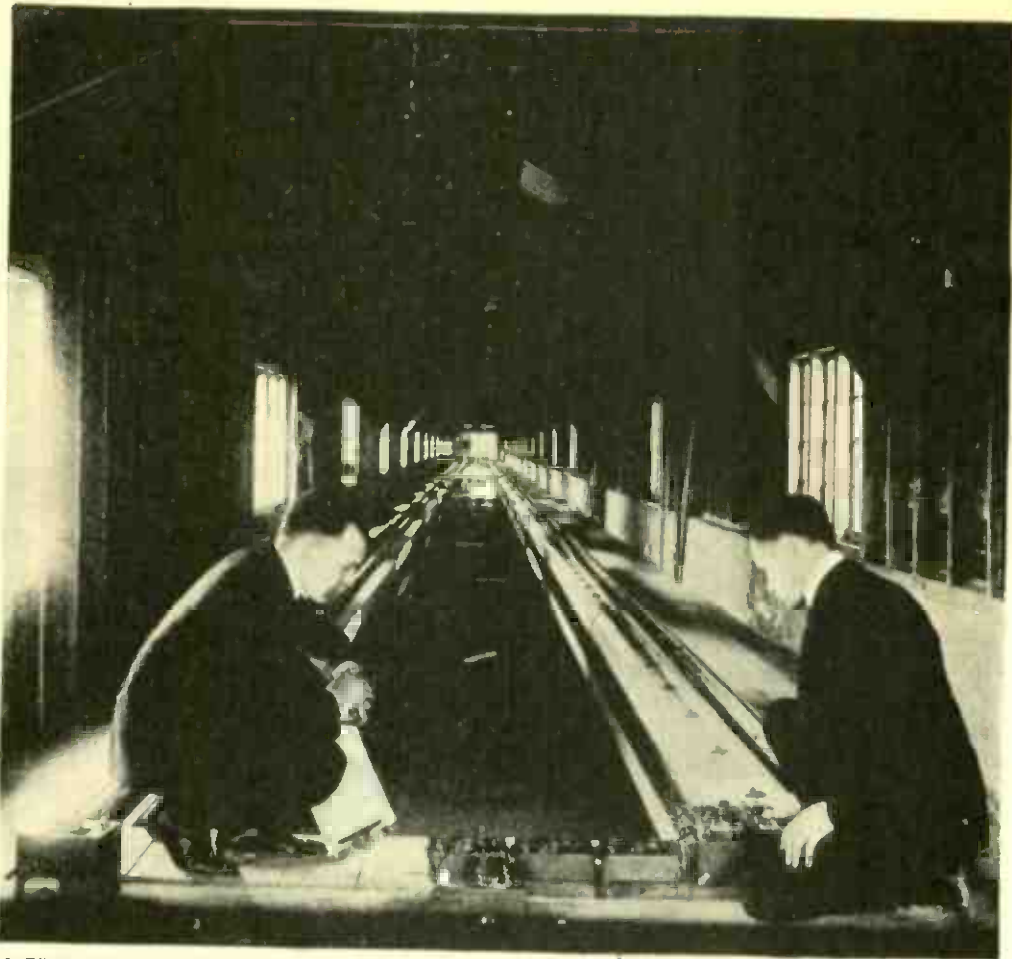

**WILL THE WAR OF THE FUTURE BE FOUGHT IN SUCH LABORATORIES?**  
*In this tank, 125 meters long, the radio experts of the United States government are carrying on their research work that has led to important changes in communication systems.*

gation with the aid of resonance wave coils of various dimensions. The use of the coil was originally resorted to in order to secure high potential points at the receiving end of the line without losing the advantage of tuning, the circuit being open, and the grid directly connected to the line. Adjustment was obtained either by moving along the coil the end of the wire connecting the grid, or by sliding along the coil a narrow metal ring connected to the grid, this constituting a capacity coupling between the grid terminal and the coil. Coils were made up of wavelengths ranging from 250 meters to 1800 meters.

One such coil, for example, was about four and a half inches (11.5 centimeters) in diameter and about twenty-three inches (58 centimeters) in length, with thirty-four turns of the wire per centimeter, and gave a fundamental wavelength of 1700 meters.

This little instrument proved a veritable divining rod. Connected to an antenna or a bare wire in water or earth, as in General Squier's experiment, it can not only be used for tuning, but at the same time wave development on the coil permits a test of the highest potential point, or point of greatest sensitiveness. More than that, the resonance wave-coil can be substituted for the ordinary antenna, itself constituting a complete antenna system. The coil may be grounded at one end or it may be entirely free. In either case it may be utilized to receive radio signals.

"It may be noted," says General Squier, "that in an antenna of this kind all the electrical constants, inductions, capacity and resistance and the electro-motive force induced in it by the incoming signals are of a distributive character, which makes it in a sense an ideal wave-conductor."

Even that does not tell the entire story

of the little resonance coil. The discovery was presently made that it possesses also remarkable directive properties. If the coil is turned about, so that its position in relation to the direction of the electromagnetic waves of ordinary radio is modified, there is a constant change in the voltage and current distribution on the coil, and a corresponding shift in the position of the point of maximum potential. If the coil is held at right angles to the direction of the transmitting station from which the electromagnetic waves are coming, these waves beat evenly against it, as will be obvious, and so produce a condition of uniformly distributed electrical constants. There is a point of maximum potential, varying somewhat with the length of the coil, frequency, and terminal conditions. This maximum may be determined in moving the terminal of the grid of an electron tube along the coil. In practise a narrow metal ring that slides freely along the coil is used. But if now the coil is turned to point more or less in the direction of the transmitting station, so that the electromagnetic waves come against it slantwise, the point of maximum potential shifts, owing to the difference in time at which the waves strike the oblique surface.

Here, then, is a direction-finder comparable to the familiar looped antenna which can be so turned as to reveal the

plane in which the electromagnetic waves are moving. But the resonance coil goes beyond this, for it was found that when it is moved about until its longitudinal axis is parallel to the direction of the electromagnetic waves (in other words, until it is pointed toward the transmitting station from which the waves emanate), the potential maximum loop, which has shifted along the shaft of the instrument, is duplicated by another loop of substantially the same amplitude at the opposite end of the coil. If now the pointing instrument is moved about a little, so that its axis is slightly out of parallel with the waves, it is observed that the potential loop at one end has greater amplitude, and that this is the end pointing toward the transmitting station—the north of the compass needle, so to speak.

Evidently, then, manipulation of the little wire-wound divining rod, held in the hand and tested with a sliding ring connected with the receiving grid, makes it possible to determine the direction of the transmitting station from which the signals proceed—a matter of tremendous significance as no one needs to be told. A looped antenna used, let us say, in Baltimore does not tell whether the message comes from Philadelphia or from Washington. But the magic coil gives the answer.



#### IN THE NEXT NUMBER—JUNE

HENRY SMITH WILLIAMS, M.D., LL.D., who is writing this series of articles, is not only a distinguished scientist who has made valuable contributions to medicine on his own account, but he is also one of our foremost living writers, with over forty volumes on scientific subjects to his credit. In the JUNE issue he will describe the latest progress that has been made in directing electromagnetic waves of radio frequency along naked wires—an amazing story of which the general public knows but little.

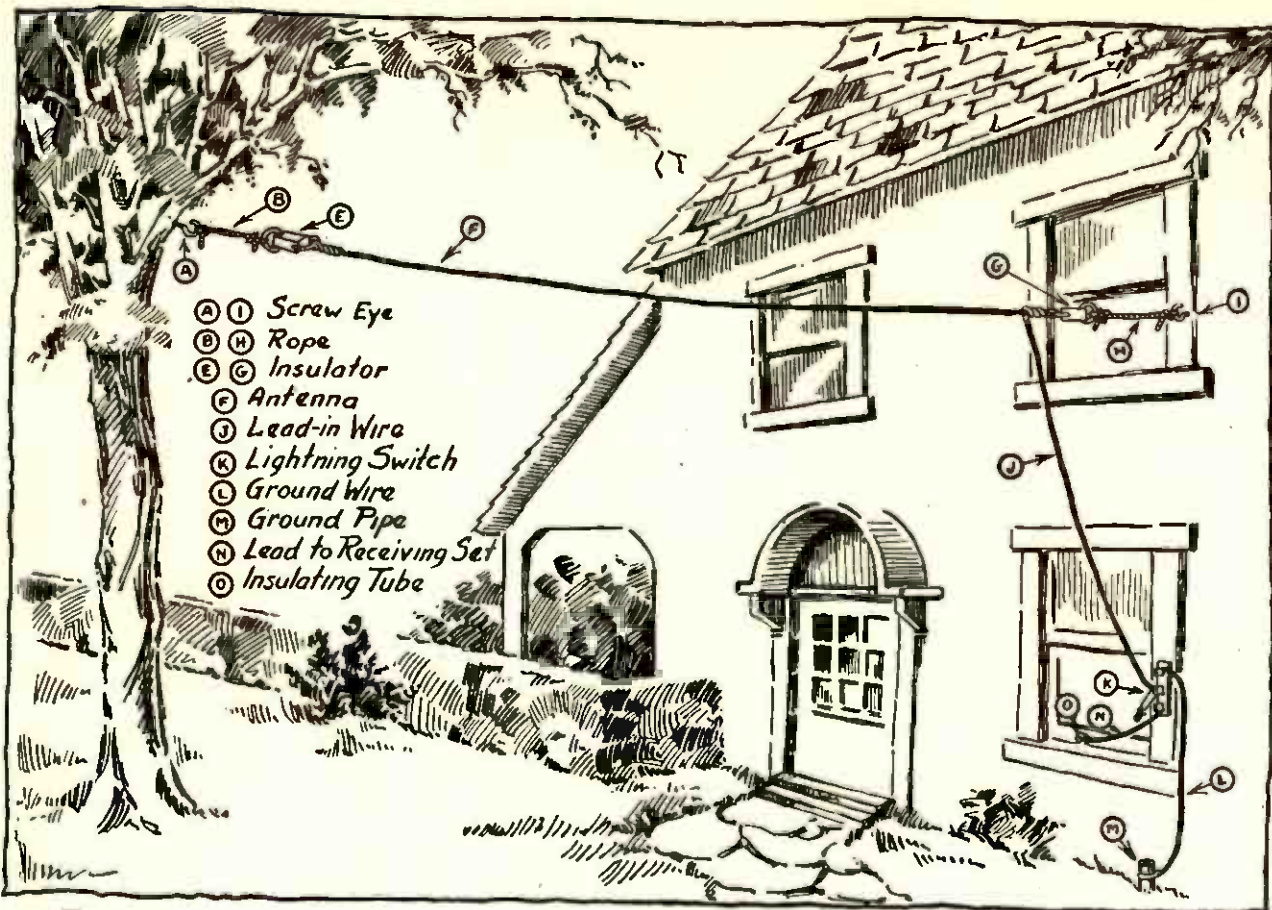

FIGURE 1; A simple arrangement of stringing the antenna between a house and tree.

# How to Make and Install Your Own Receiving Set

*If You Are Handy With Tools You Can Follow These Directions at a Cost of Between \$11.00 and \$15.00*

By WATSON DAVIS

**I**F you are handy with tools, you may make your own radio receiving set that will be quite good enough to admit you into the vast throng of listeners who are enjoying the musical programs that now fill the ether practically every night. Uncle Sam, as evidence of his helpful interest in his enterprising young nephew, the radio amateur, has carefully worked out a list of detailed instructions that tell him just how to make such a set—at a cost ranging from \$11.00 to \$15.00.

The problem of working out a practical set of instructions for making this home-made receiving set was delegated to the Bureau of Standards at Washington. This set will enable one to hear the

messages sent out from medium-power transmitting stations within an area about the size of a large city, or to hear high-power stations within fifty miles—providing those stations use wavelengths between 600 and 200 meters; that is, wave frequencies between 500 and 1500 kilocycles a second.

Here are the directions:

## *The Five Parts of a Receiving Station*

There are five essential parts of the set; the antenna, the lightning switch, ground connections, the receiving set and the phone. The received signals come into the set through the antenna and ground connection. In the receiving set these signals are converted into an electric current which produces the sound in the phone. The phone is either one or a pair of telephone receivers, worn on the head of the

listener. The purpose of the lightning switch is to protect the receiving set from damage by lightning. It is used to connect the antenna directly to the ground when the receiving station is not being used. When the antenna and the connection to the ground are properly made and the lightning switch is closed, an antenna acts as a lightning rod and is a protection rather than a source of danger to the building. The principal part of the station is the receiving set. In the set described herein it is subdivided into two parts, the "tuner" and the "detector", and in more complicated sets still other elements are added.

#### *What the "Antenna" and "Ground" Is*

The antenna is simply a wire suspended between two elevated points. Wherever there are two buildings, or a house and a tree, or two trees with one of them very close to the house, it relieves one of the need of erecting one or both antenna supports. The antenna should not be less than thirty feet above the ground and its length should be about 75 feet, as shown in Fig. 1. While this illustration indicates a horizontal antenna, it is not important that it be strictly horizontal; it is in fact desirable to have the far end as high as possible. The "lead-in" wire or drop-wire from the antenna itself should run as directly as possible to the lightning switch. If the position of the adjoining buildings or trees is such that the distance between them is greater than

about 85 feet, the antenna may still be held to a 75-foot distance between the insulators by increasing the length of the piece of rope, B, to which the far end of the antenna is attached. The rope, H, tying the antennae insulator to the house should not be lengthened to overcome this difficulty, because by so doing the antenna "lead-in" or drop wire, J, would be lengthened.

#### *The Parts of the Antenna*

A and I are screw eyes sufficiently strong to anchor the antenna at the ends.

B and H are pieces of rope 3-8 or 1-2 inch in diameter, just long enough to allow the antenna to swing clear of the two supports.

E and G are two insulators which may be constructed of any dry hard wood of sufficient strength to withstand the strain of the antenna; blocks about 1 1-2x2x10 inches will serve. The holes should be drilled (as shown in Fig. 1) sufficiently far from the ends to give proper strength. If wood is used, the insulators should be boiled in paraffin for about one hour. If porcelain wiring cleats are available they may be substituted instead of the wood insulators. If any unglazed porcelain is used as insulators, it should be boiled in paraffin the same as the wood. Regular antenna insulators are advertised on the market, but the two improvised types just mentioned will be satisfactory for an amateur receiving antenna.

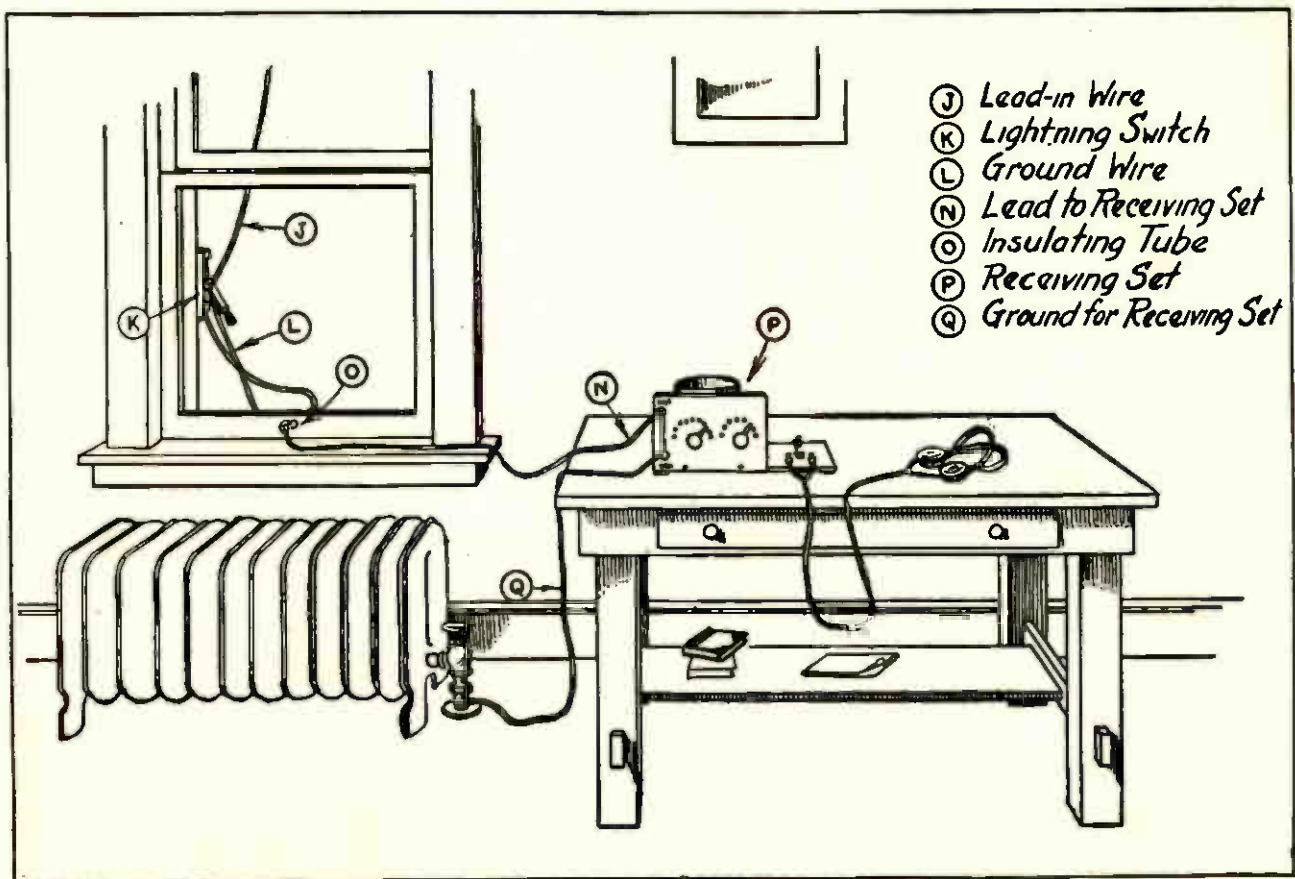

FIGURE 2; How the lead in wire is brought through the window and attached to the set. Note the ground connection on the radiator.

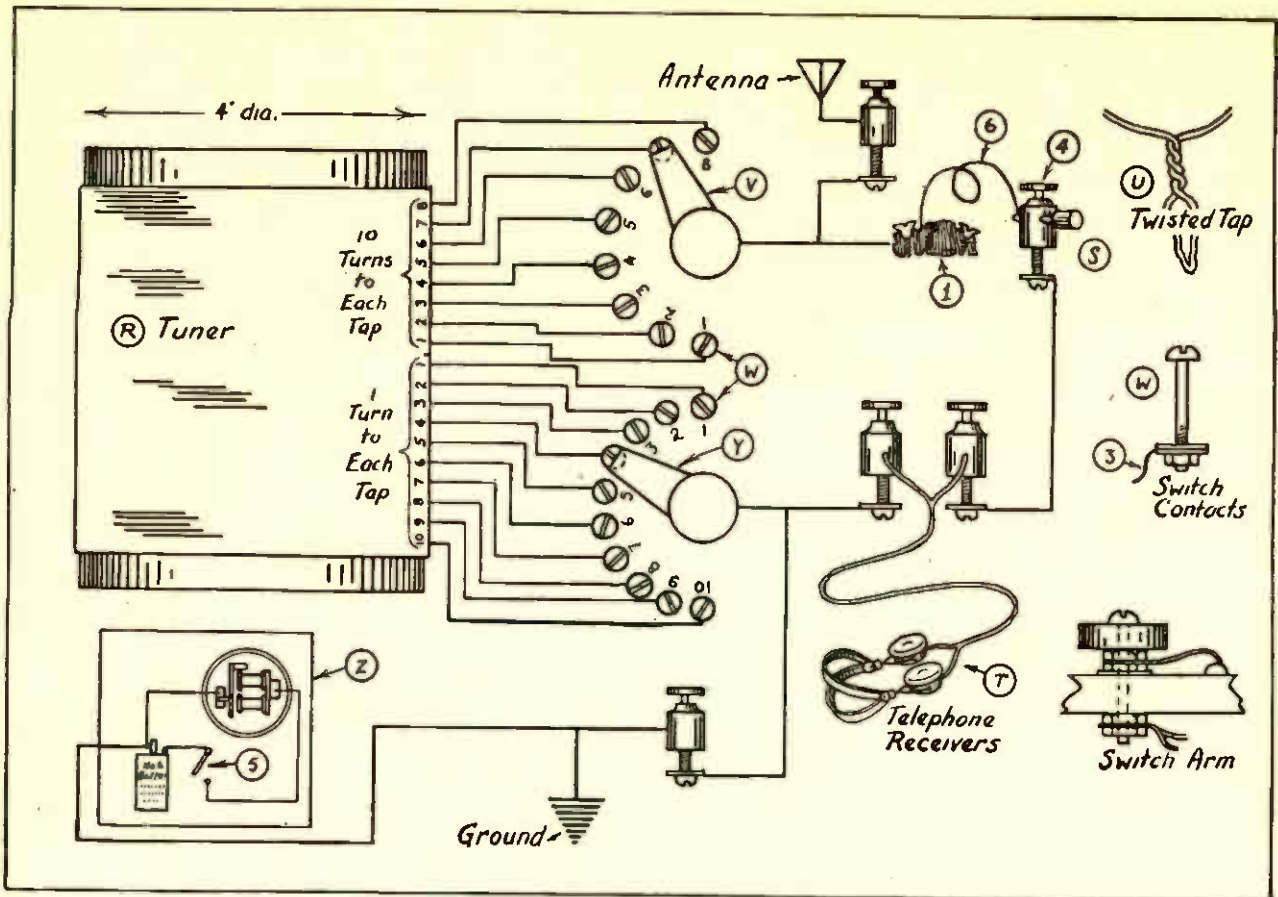

FIGURE 3; How to connect the instruments. (The buzzer test is shown in the lower left corner.)

F is the antenna about 75 feet between the insulators E and G. The wire may be No. 14 or 16 copper wire either bare or insulated. The end of the antenna farthest from the receiving set may be secured to the insulator, E, by any satisfactory method, but be careful not to kink the wire. Draw the other end of the antenna wire through the other insulator, G, to a point where the two insulators are separated by about 75 feet, twist the insulator, G, so as to form an anchor as shown in Fig. 1. The remainder of the antenna wire, J, which now constitutes the lead-in or drop-wire, should be just long enough to reach the lightning switch.

K is the lightning switch. For the purpose of a small antenna this switch may be the ordinary porcelain-base, 30 ampere, single pole double-throw battery switch. These switches, as ordinarily available, have a porcelain base about 1 by 4 inches. The lead-in wire, J, is attached to this switch at the middle point. The switch blade should always be thrown to the ground clip when the receiving set is not actually being used and to the receiver clip when it is desired to receive signals.

L is the ground wire for the lightning switch; it may be a piece of the same size wire as used in the antenna, of sufficient length to reach from the ground clip of the lightning switch, K, to the clamp on the ground rod, M.

M is a piece of iron pipe or rod driven 3 to 6 feet into the ground, preferably where the ground is moist, and extending a sufficient distance above the ground in order that the ground clamp may be fastened to it. Scrape the rust

or paint from the pipe before driving in the ground.

N is a wire leading from the receiver clip of the lightning switch through the porcelain tube, O, to the receiving set binding post marked "antenna".

O is a porcelain tube of sufficient length to reach through the window casing or wall. This tube should be mounted in the casing or wall so that it slopes down toward the outside of the building. This is done to keep the rain from following the tube through the wall to the interior.

#### The Parts of the Receiving Set

P is the receiving set, which is described in detail.

N is the wire leading from the antenna binding post of the receiving set through the porcelain tube to the upper clip of the lightning switch. This wire, as well as the wire shown by Q, should be insulated and preferably flexible. A piece of ordinary lamp cord might be unbraided and serve for these two leads.

Q is a piece of flexible wire leading from the receiving set binding post marked "ground" to a water pipe, heating system or some other metallic conductor to ground, except M (Fig. 1). If there are no water pipes or radiators in the room in which the receiving set is located, the wire should be run out of doors and connected to a special ground below the window, which shall not be the same as the ground for the lightning switch. It is essential that for the best operation of the receiving set this ground be of the very best type. If the soil

near the house is dry it is necessary to drive one or more pipes or rods sufficiently deep to encounter moist earth and connect the ground wire to the pipes or rods. This distance will ordinarily not exceed 6 feet. Where clay soil is encountered this distance may be reduced to 3 feet, while in sandy soil it may be increased to 10 feet. If some other metallic conductor, such as the casing of a drilled well, is not far away from the window, it will be a satisfactory "ground."

#### *The Tuner, the Detector, and the Phone*

The detector and phone will have to be purchased. The tuner and certain accessories can be made at home.

The tuner, R (shown in Fig. 3), is a piece of cardboard or other non-metallic tubing with turns of copper wire wound around it. The cardboard tubing may be an oatmeal box. Its construction is described in detail below.

The crystal detector, S (in Fig. 3), may be of very simple design and quite satisfactory. The crystal, as it is ordinarily purchased, may be unmounted or mounted in a little block of metal. For mechanical reasons the mounted type may be more satisfactory, but that is of no great consequence. It is very important, however, that a very good tested crystal be used; it is probable also that a galena crystal will be more satisfactory to the beginner. The crystal detector may be made up of a tested crystal, three wood screws, short piece of copper wire, a nail, set-screw type of binding post,

and a wood knob or cork. The tested crystal is held in position on the wood base by three brass wood-screws as shown at 1 in Fig. 3. A bare copper wire may be wrapped tightly around the three brass screws for contact. The assembling of the rest of the crystal detector is clearly shown in Fig. 3.

For the phone, T, in Fig. 3 it is desirable to use a pair of telephone receivers connected by a head band, usually called a double telephone headset. The telephone receivers may be any of the standard commercial makes having a resistance of between 2000 and 3000 ohms. The double telephone receivers will cost more than all the other parts of the station combined, but it is desirable to get them, especially if one plans to improve his receiving set later. If one does not care to invest in a set of double telephone receivers a single telephone receiver with a head band may be used, although it gives results somewhat less satisfactory.

The binding posts, switch arms and switch contacts may all be purchased from dealers who handle such goods or they may be quite readily improvised at home. There is nothing peculiar about the pieces of wood on which the equipment is mounted. They may be obtained from a dry packing-box and covered with paraffin to keep out moisture.

The following is a detailed description of the method of winding the coil, construction of the wood panels, and mounting and wiring the apparatus.

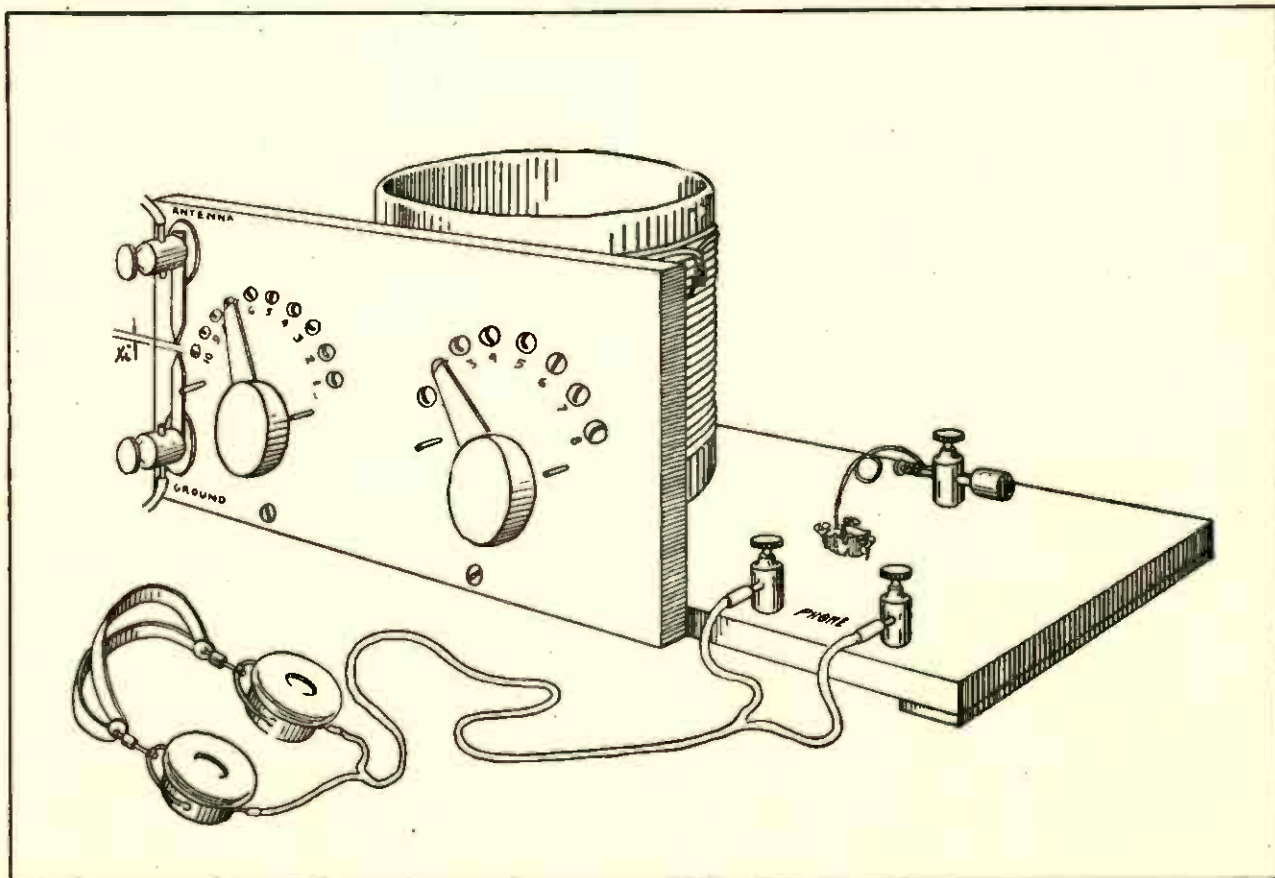

FIGURE 4; The completed receiver, with the two sets of wavelength switches mounted on the panel and the crystal detector in a convenient place for adjustment.



**I** Fastening the insulated lead in wire to the antenna wire. *F* is the antenna wire, *G* is the insulator; *H* is a piece of rope, *I* a screw eye and *J* the lead in wire.



**II** Fastening the far end of the antenna through the metal eye of the insulator. *A* is the screw eye, *B* a piece of rope, the insulator and *F* the antenna wire.

#### How to Construct the Tuner

See the tuner, R, Fig. 3. Having supplied oneself with a piece of cardboard tubing 4 inches in diameter and about  $\frac{1}{2}$  pound of No. 24, or No. 26, double cotton covered copper wire, one is ready to start the winding of the tuner. Punch two holes in the tube about  $\frac{1}{2}$  inch from one end as shown at 2 in Fig. 3. Weave the wire through these holes in such a way that the end of the wire will be firmly anchored, leaving about 12 inches of the wire free for connections. Start with the remainder of the wire to wrap the several turns in a single layer about the tube, tightly and closely together. After 10 complete turns have been wound on the tube hold those turns snugly while a tap is being taken off. This tap is made by making a 6-inch loop of the wire and twisting it together at such a place that it will be slightly staggered from the first tap. This method of taking off taps is shown clearly at U, Fig. 3. Proceed in this manner until 6 twisted taps have been taken off at every 10 turns. After these first 70 turns have been wound on the tube then take off a 6-inch twisted tap for every succeeding single turn until 10 additional turns have been wound on the tube. After winding the last turn of wire anchor the end by weaving it through two holes punched in the tube much as was done at the start, leaving about 12 inches of wire free for connecting. It is to be understood that each of the 18 taps is slightly staggered from the one just above, so that the several taps will not be bunched along one line on the cardboard tube.

See Fig. 3. It would be advisable, after winding the tuner as just described, to dip the tuner in hot paraffin. This will help to exclude moisture.

#### How to Make the Panel and Base

Having completed the tuner to this point, set it aside and construct the upright panel shown in Fig. 2. This panel may be a piece of wood approximately  $\frac{1}{2}$  inch thick. The position of the several holes for the binding post, switch arms and switch contacts may first be laid out and drilled. The antenna and ground binding posts may be ordinary  $\frac{1}{8}$  inch brass bolts of sufficient length and supplied with three nuts and two washers. The first nut binds the bolt to the panel, the second nut holds one of the short pieces of stiff wire, while the third nut holds the antenna or ground wire, as the case may be. The switch arm with knob shown at V, Fig. 3, may be purchased in the assembled form or it may be constructed from a thin slice cut from a broom handle and a bolt of sufficient length equipped with four nuts and two washers, together with a narrow strip of thin brass somewhat as shown. The switch contacts, W (Fig. 3), may be of the regular type furnished for this purpose or they may be brass bolts equipped with one nut and one washer each or they may even be nails driven through the panel with an individual tap fastened under the head or soldered to the projection of the nail through the panel. The switch contacts should be just close enough that the switch arm will not drop between the contacts but also far enough apart that the



**III** *The insulated lead in wire is brought into the house through a porcelain bushing pushed through a hole drilled in the window sash.*

switch arm can be set so as to touch only one contact at a time.

The telephone binding post should preferably be of the set screw type, as shown at X, Fig. 3.

#### *How to Connect the Wires*

Having constructed the several parts just mentioned and mounted them on the wood base, one is ready to connect the several taps to the switch contacts and attach the other necessary wires. Scrape the cotton insulation from the loop ends of the sixteen twisted taps as well as from the ends of the two single wire taps coming from the first and last turns. Fasten the bare ends of these wires to the proper switch, as shown by the corresponding numbers in Fig. 3. One should be careful not to cut or break any of the looped taps. It would be preferable to fasten the connecting wires to the switch contacts by binding them between the washer and the nut, as shown at 3, Fig. 3. A wire is run from the back of the binding post marked "ground" (Fig. 3), to the back of the left-hand switch-arm bolt, Y, thence to underneath the left-hand binding post marked "phones." A wire is then run from underneath the right-hand binding post marked "phones" to underneath the binding post, 4 (Fig. 3), which forms a part of the crystal detector. A piece of No. 24 bare copper wire about  $2\frac{1}{2}$  inches long, one end of which is twisted tightly around the nail, the nail passing through binding post 4, the other end of which rests gently by its own weight on the crystal 1. The bare copper wire which was wrapped tightly around the three brass wood-screws holding the crystal in place



**IV** *How the ground lead is attached to the water pipe by means of a ground clamp. Q is the ground wire.*

is led to and fastened at the rest of the right-hand switch arm bolt, V, thence to the upper left-hand binding post marked "antenna." As much as possible of this wiring is shown in Fig. 3.

#### *How to Make the Set Work*

After all the parts of this crystal-detector radio receiving set have been constructed and assembled the first essential operation is to adjust the little piece of wire, which rests lightly on the crystal, to a sensitive point. This may be accomplished in several different ways; the use of a miniature buzzer transmitter is very satisfactory. Assuming that the most sensitive point on the crystal has been found by method described in the following paragraph, *the Test Buzzer*, the rest of the operation is to get the radio receiving set in resonance or in tune with the station from which one wishes to hear messages. The tuning of the receiving set is attained by adjusting the inductance of the tuner. That is, one or both of the switch arms are rotated until the proper number of turns of wire of the tuner are made a part of the metallic circuit between the antenna and ground, so that together with the capacity of the antenna the receiving circuit is in resonance with the particular transmitting station. It will be remembered that there are 10 turns of wire between each of the first 8 switch contacts and only one turn of wire between each two of the other contacts. The tuning of the receiving set is best accomplished by setting the right-hand switch arm on contact 1 and rotating the left-hand switch arm over all its contacts. If the



desired signals are not heard, move the right-hand switch arm to contact 2 and again rotate the left-hand switch arm throughout its range. Proceed in this manner until the desired signals are heard.

It will be advantageous for the one using this radio receiving equipment to find out the wave frequencies, wavelength, used by the several radio transmitting stations in his immediate vicinity.

#### How to Use the Test Buzzer

It is easy to find the more sensitive spots on the crystal by using a test buzzer. The test buzzer is used as a miniature local transmitting set. When connected to the receiving set, as shown at Z (Fig. 3), the current produced by the buzzer will be converted into sound by the telephone receivers and the crystal, the loudness of the sound depending on what part of the crystal is in contact with the fine wire. To find the most sensitive spot connect the test buzzer to the receiving set, as directed, close the switch, 5, Fig. 3, and, if necessary, adjust the buzzer armature so that a clear note is emitted by the buzzer, set the right-hand switch arm on contact point No. 8, fasten the telephone receivers to the binding posts marked "phones", loose the set screw of the binding post slightly and change the position of the fine wire, 6, Fig. 3, to several positions of contact with the crystal until the loudest sound is heard in the phones, then tighten the binding post set screw, 4, slightly.

#### What the Set Costs

While the total cost of such a radio receiving station will depend upon the kind of ap-

paratus that is purchased ready made and the number of parts that are made at home, the approximate outlay of money may be listed as follows:

#### ANTENNA

Wire—copper, bare or insulated, No. 14, 100 to 150 feet (about).....	\$0.75
Rope— $\frac{3}{8}$ or $\frac{1}{2}$ inch (2 cents a foot)	
2 insulators, porcelain.....	0.20
1 pulley.....	0.15
Lightning switch—30 ampere battery switch.....	0.30
1 porcelain tube.....	1.10

#### GROUND CONNECTIONS

Wire—(same kind as antenna wire)	
1 clamp.....	0.15
1 iron pipe or rod.....	0.25

#### RECEIVING SET

$\frac{1}{2}$ pound No. 24 copper wire, double cotton covered.....	0.75
1 cardboard box	
2 switch knobs and blades, complete.	1.00
18 switch contacts and nuts.....	0.75
3 binding posts, set screw type.....	0.45
2 binding posts, any type.....	0.30
1 crystal, tested.....	0.25
3 wood screws, brass, $\frac{3}{4}$ inch long...	0.03
Wood for panels (from a packing box)	
2 pounds of paraffin.....	0.30
Lamp cord, 2 to 3 cents a foot	
Test buzzer.....	0.50
Dry battery.....	0.30
Telephone receivers.....	\$4.00 to 8.00

Total cost of set.....\$11.00 to \$15.00

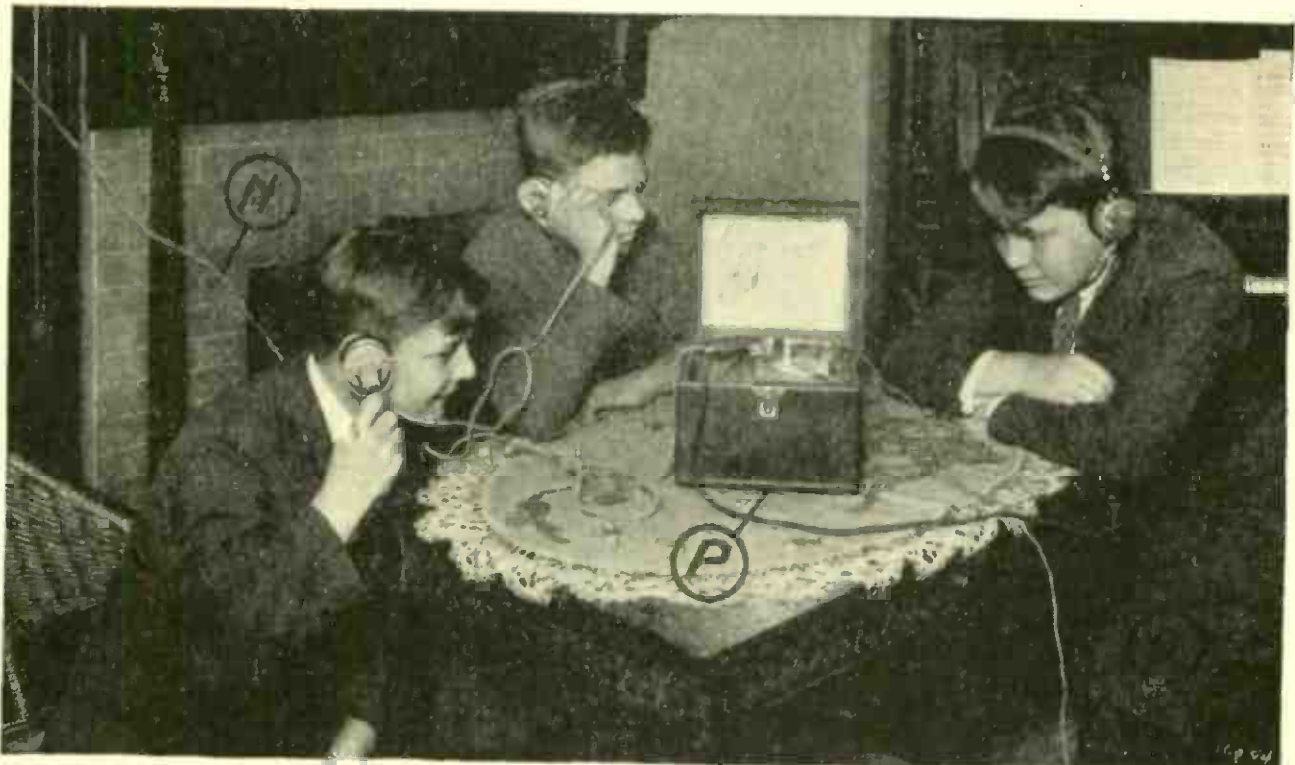

**V** The completed installation on the living room table. N is the wire leading out to the lightning switch, (which most amateurs do not provide, although it is a good protection against electrical storms). Q is the ground wire and P is the receiving set.

"MAKERS OF MODERN MIRACLES" No. 1

*The True Story of the Discovery of the "GRID"—the One Element that Was Needed to Make the Audion Tube What It Is Today.*

## The Genius Who Put *the* JINN in *the* Radio Bottle

By  
JAMES H. COLLINS

**Y**OU remember the bottle drawn up in his net by the poor fisherman in the "Arabian Nights." It held a jinn, or demon, sealed up and cast into the sea by King Solomon. The jinn began to speak to the fisherman, and finally persuaded him to open the bottle and let him out.

There is a speaking jinn in the glass bottle that makes radio telephony possible—the vacuum tube or audion. And thereby hangs a tale.

One summer night, more than twenty years ago, a scientific fisherman was casting his net of investigation into the then little-explored sea of wireless phenomena. And he caught a jinn. Or rather, the jinn spoke to the scientist, not from a bottle, but from a Welsbach gas burner. He was a free jinn, probably having escaped King Solomon. For the first time since he was created with the universe, he spoke to Man, that cosmic infant, and asked to be sealed in a bottle.

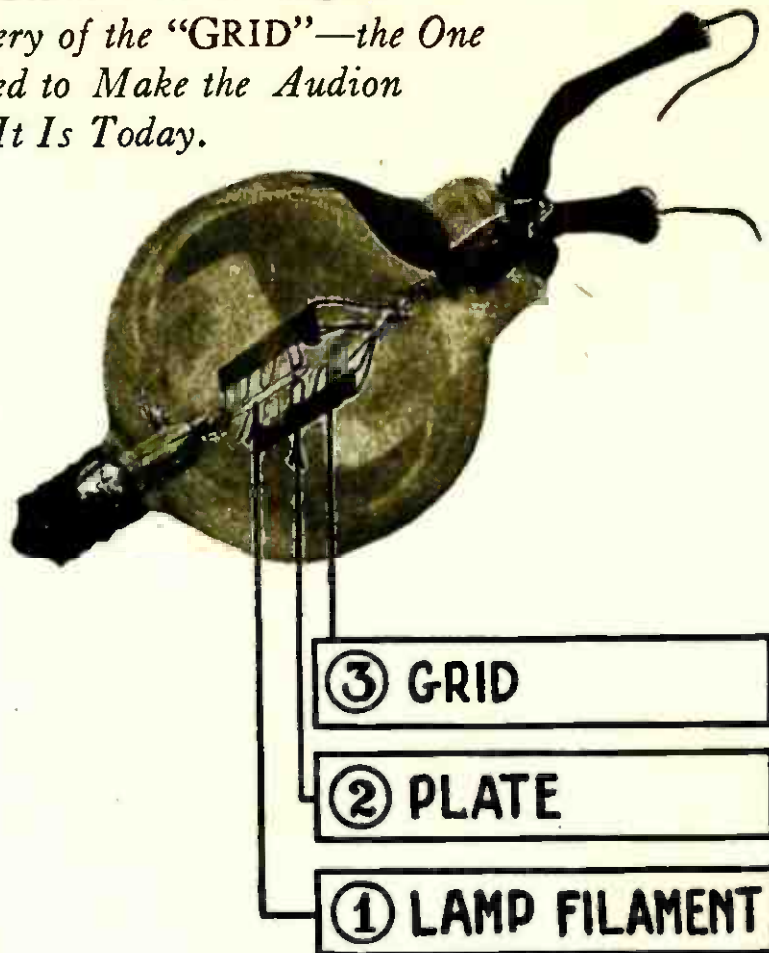

And the man sealed him up and set him at work.

The man was Dr. Lee De Forest, and the place a room in Chicago where he was conducting some night experiments in wireless. De Forest is a parson's son, and a parson's grandson. Born in 1873, at Council Bluffs, Iowa, raised in Talladega, Alabama, where his father was president of Talladega College, educated at the Sheffield Scientific School, Yale University, after serving with the Yale battery during the Spanish-American war, he went to Chicago and got a job in the Western Electric Company's experimental telephone laboratory. There he became interested in wireless telegraphy, and in 1900 quit his job to make independent experiments.

On that summer night he had a new type of electrolytic detector rigged up. His receiving apparatus was placed on a table beneath a Welsbach gas light. In a closet about ten feet away he had a spark

coil with which oscillations were made to test his receiving apparatus. The spark coil was operated by a switch closed with a string running across the floor from the table to the closet. Presently De Forest noticed that every time he pulled the string and closed the switch, the light from the gas mantle increased very perceptibly, dropping back to normal when the spark coil was thrown off.

This unexpected behavior of the gas light, which was no part of his apparatus, diverted his attention, and set him thinking. Had he discovered a new form of detector of Hertzian waves of extraordinary sensitiveness? Something in the oscillations from the spark coil affected the gas flame every time the switch was closed—until he closed the door of the closet. Then the phenomena stopped. He had found a detector, not of electrical waves, but of sound waves.

But he had also found a scientific clue. Heated gas molecules were apparently sensitive to high frequency electrical waves.

A year or more passed before De Forest had opportunity to investigate this phenomenon further. The jinn had spoken, but only in the dumb sign language. De

Forest went into the gas flame to bring him out and make him talk in a telephone receiver, if possible. He placed two needles of steel, and later platinum, in the incandescent flame, with a gap between, and connected them to a dry battery and telephone receiver. Contrary to his expectations, there was no appreciable current between the two needles in the flame. But when he tried the same experiment with a Bunsen burner he found a point in the outside envelope of the flame where current did pass, making a soft fluttering whisper in the telephone receiver. When one electrode was connected to an antenna and the other grounded in the earth, he heard for the first time signals which clearly represented the sound of the transmitting spark. This proved that his detector principle was right, and he developed the flame type of detector until, in 1903, it was actually used for receiving signals from ships in New York harbor.

Because a gas flame had obvious inconveniences, he then sought some other means of obtaining the necessary heated gas and heated electrodes. Experiments with the electric arc showed that it was a detector of the same type, but exceedingly irregular and noisy in the telephone receiver—in fact, the impatient jinn now spoke domineeringly, in deafening tones.

Then he turned to the incandescent lamp and found the same detector phenomenon in the more attenuated heated gas surrounding its filament. By a brilliant series of experiments, first with one filament or electrode, then two, and finally the famous "third electrode" or "grid," he developed and patented the "audion" in 1907.

Since then the device has been developed in unforeseen directions, and applied to so many different purposes that the jinn in the bottle has been found a true magician.

The audion is a somewhat complex incandescent lamp.

It has three internal electrodes as shown in the illustration. One is the lamp filament (1) which produces the heat to ope-



A CLOSE-UP OF THE "GRID"

*So called because it resembles a gridiron; originally it was made in the form of a wire mesh.*



Photo by Paul Thompson

### THE BOTTLES THAT HOLD THE GENII

*In Dr. De Forest's left hand is the large 250-watt oscillion or "oscillating audion" used for sending radio messages; in his right hand is the small 1-watt audion used for receiving.*

rate the device; another is the plate (2) which collects the radio currents flowing from the hot filament, and the third is a wire mesh (3) called the grid, which is placed between them. It is this third electrode that is used by the jinn to perform his miracles.

Its first job was to act as a wireless telegraphy detector of extraordinary sensitiveness. Radio telegraphy had been developed in principle, but its apparatus was so crude that messages could be sent

hardly a hundred miles. The necessary high frequency currents were produced by a cumbersome spark coil, but turned into the ether they were lost outside a very narrow radius because there was no detector sensitive enough to pick them up. Practically the only detector then known was the Marconi "coherer," a tube filled with iron filings, which was affected by radio oscillations in but a very limited degree. It required careful attention and frequent adjustment, and was so slow that



#### ALADDIN'S LAMP

*The ordinary audion or vacuum tube, as it is today—a child of the familiar incandescent lamp, and the open sesame to this world of the air.*

not more than fifteen words a minute could be received. With the audion, messages were picked up hundreds and then thousands of miles from the transmitting point.

Then the device was found to be an ideal alternating current generator, effecting great improvements and economies in the transmitting end. Alternating current is a pulsating current divided into infinitesimal halves flowing in opposite directions, reversing direction anywhere from a few to many millions of alternations per second. Dynamos were needed to generate it, and they were both expensive and limited. An ordinary dynamo was only capable of alternating current up to one thousand reversals a second, while wireless telegraphy requires from 5,000 to 3,000,000 a second. The jinn in the bottle demonstrated his power to alternate current up to a million and more oscillations a second without any mechanical apparatus whatever. Upon the current flowing from filament to plate inside the bottle, the little grid produced any desired frequency. This was done by modifying the

size and type of grid, as well as connecting the audion to outside apparatus.

Wireless telephony was still a laboratory dream. Human speech had actually been transmitted by wireless over short distances, but the necessary alternating current could only be generated by complex and expensive dynamo equipment. Wireless telegraphy requires only a single simple current, which is cut by interruptions into Morse signals. Wireless telephony calls for a mixture of alternating currents of different frequencies to convey the complex talk of the human voice. With a battery of audions at the sending end any desired combination of frequencies could be produced without mechanical apparatus. When telephone engineers went to work with the audion on one hand, and the sudden war demand for wireless telephony on the other, they accomplished marvels in a few months, and blazed the way for the remarkable popular interest in "radio" which has grown up the past year.

**T**HE audion has many other electrical uses. "Versatility" is the inventor's own word for it. It is a receiver, a transmitter, an alternator, an amplifier, a governor—what you will. Just ask the obliging jinn, or put him in the special type of glass bottle in which he can do the sort of work you want. Then leave the rest to him.

This versatility has led Dr. De Forest to center on new applications of the audion, and new types and combinations for different electrical fields, since the original detector type was patented fifteen years ago. But for years he has believed that its greatest service to the public would be along the lines of popular radio telephony, as it is being developed today. More than once a beginning has been made under his direction, one of the first efforts toward setting up a broadcasting service being made by daily newspapers which transmitted music, weather reports and news locally to be picked up with De Forest receiving equipment sold by the newspapers.

This sample of radio whetted popular interest, and led to the organized broadcasting of today, with its daily programs. And that, in turn, is only a beginning, comparable to the phonograph in its infancy when Edison believed that its chief use would be in business offices, not dreaming of its possibilities for putting

good music into every home.

Out of the present-day "radio" will undoubtedly grow programs making the musical, educational and recreational facilities of the greatest cities available to people everywhere, with the city apartment and the farmhouse wired for radio just as it is wired for electric light.

## A New Broadcasting Station

**H**AVE you been listening in lately upon a new arrival in the ether? For several weeks unannounced tests have been made that have aroused the curiosity of the amateur who has accidentally picked up the stranger. The newcomer is WGY, operated at the plant of the General Electric Company at Schenectady, New York.

A unique feature of this new station is a switchboard in the studio from which programs are sent; it is flooded with a red light when the station is in operation, as a warning to everyone present that every noise he makes will be broadcasted.

In the apparatus room, the sound waves are put through a number of steps of amplification by means of vacuum tubes which increase their volume thousands of times.

An A. C. voltage is then applied to a number of vacuum tubes, acting as rectifiers, which change the voltage to direct current. Placed between the rectifier and the modulator or molding tubes, is a high power oscillator tube. The electric power entering this tube sets the ether into vibration and upon these vibrations the electric waves, molded into shape in the modulator tubes, are sent to the antenna to go out into space.

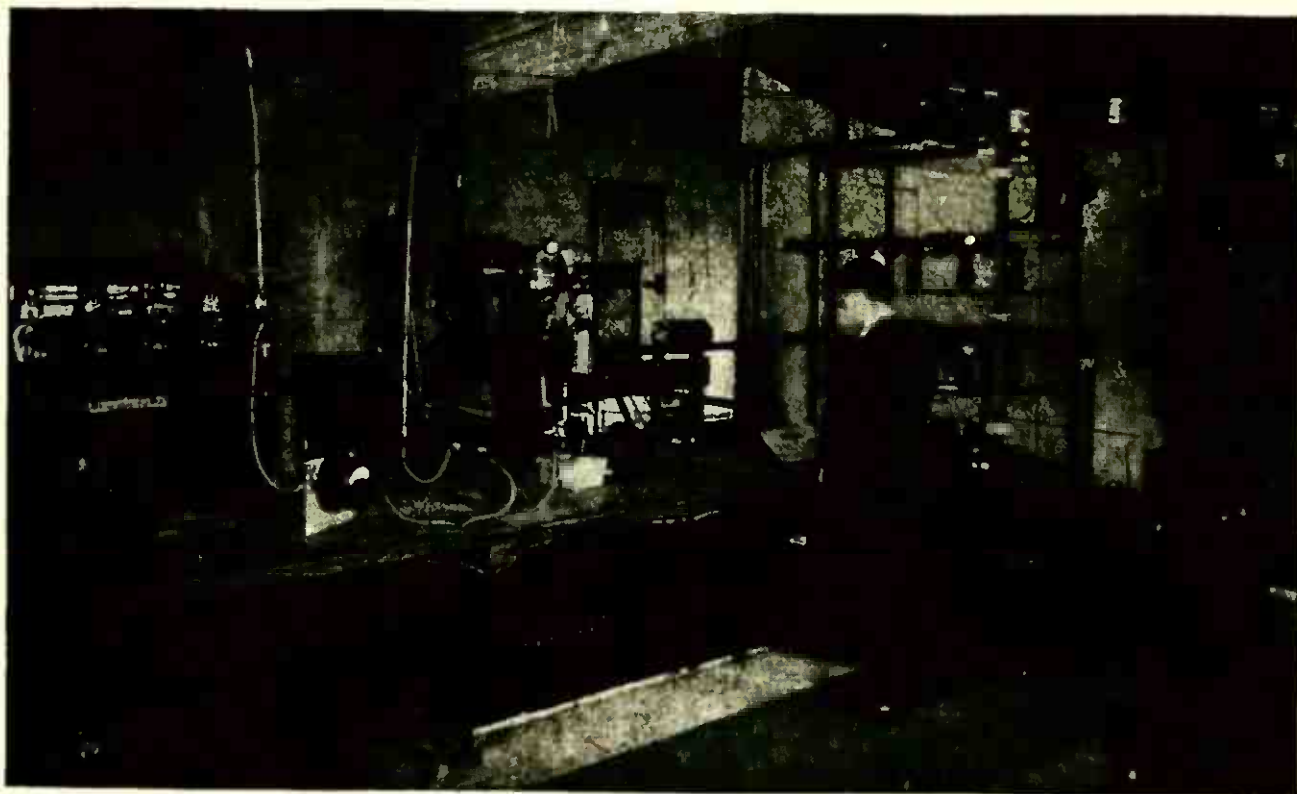
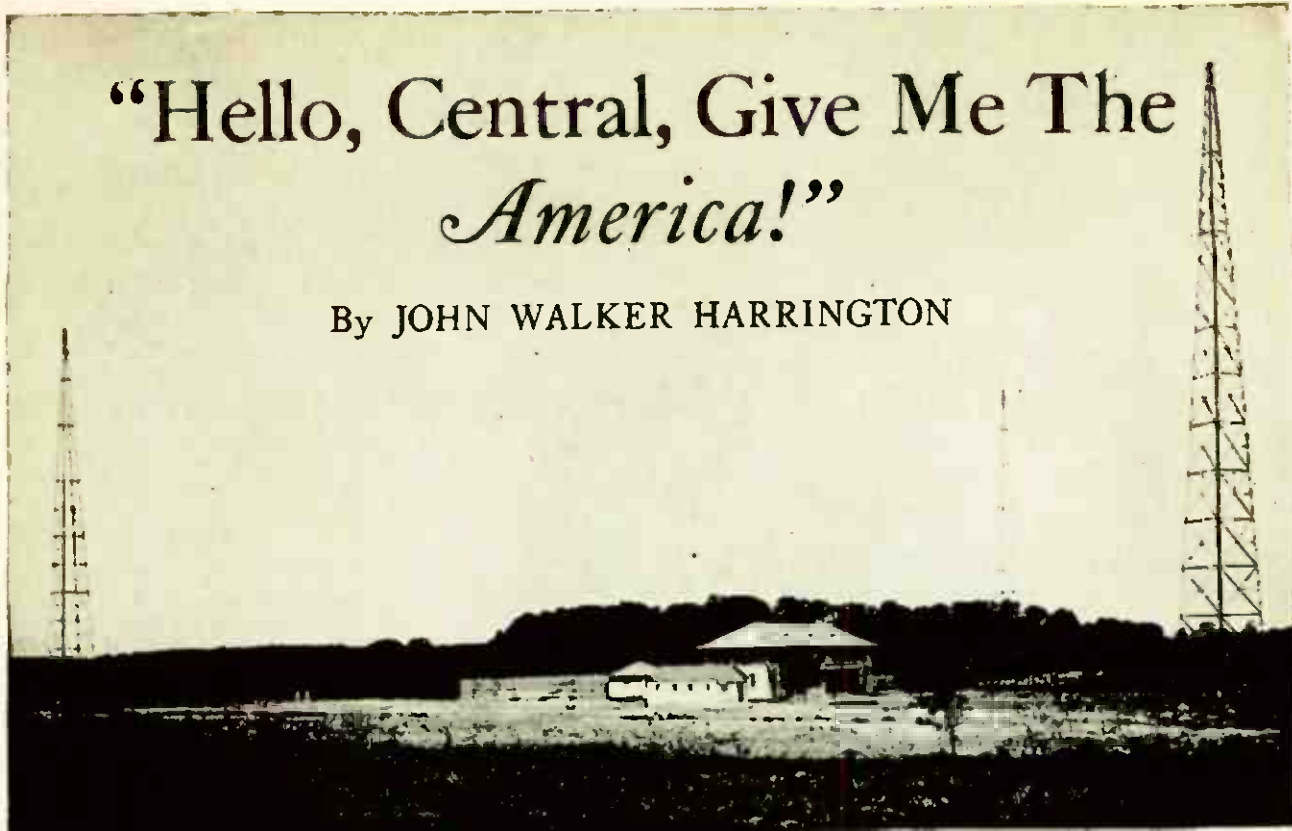

Photo by General Electric

*The transmitting room of WGY, showing the tube sets and control board.  
The studio in which the artists gather is in another building.*

# "Hello, Central, Give Me The *America!*"

By JOHN WALKER HARRINGTON



*From this radio telephone station at Deal Beach, N. J., the tests with ships at sea were conducted.*

*Were You One of the Many Thousands of Mystified Amateurs Who Listened-In Upon the Recent Radio Tests Between Ship and Shore? This Article Tells How the Experiment Was Successfully Made*

**T**WO-WAY talk by radio that enables a man at sea to talk over the land telephone lines is the latest achievement of the far-speaking art. The flawless performance which was given when the commander of the incoming ocean liner *America* recently talked when he was 360 miles at sea with H. B. Thayer, who was in his home at New Canaan, Connecticut, is a significant forecast of a new year. Mr. Thayer, as president of the American Telephone and Telegraph Company, is naturally interested in the development of the relations between the telephony of the air and that which follows the throbbing wire. The test in which he took part on the night of March 5 is only one of a series which was begun for the purpose of bringing people in the cities in touch with their friends on ocean-going vessels.

One of these days James Wilberforce Smith, or whatever his name may be, will

sit in his stateroom in mid-ocean and call up Mrs. Smith to tell her what he had for dinner. He cannot go into too intimate detail, of course, for owners of radiophones all over the world almost have a chance to listen in. They did just this the other night when Captain Rind and Mr. Thayer were talking of the future of telephony. Radio fans all over the eastern part of the country knew all about the feat, as the conversation was naturally broadcasted.

Experts may not consider it such a remarkable feat to join wire and vibrant air, but the communication of the *America* with the shore did much to make practical a whole lot of theory. That the change can be made satisfactorily was shown by the interesting tests made with the coastwise steamship *Gloucester*, from which speech was first sent by wireless to the shore, then transmitted across the Continent to the Pacific coast,

and then relayed by radio once more to Catalina Island. When the World War was over, the company, as radio fans will remember, conducted long telephone communications between Arlington and the Eiffel Tower in Paris.

Many a radio amateur, in a spirit of experiment, has invited some friend who has no receiving set to listen to something choice which he has detected in the air. Merely by placing the receiver of the radiophone over the transmitter of the ordinary telephone, he can entertain an auditor with some entertaining selections. On the lines of this unauthorized practice, and, of course, with much greater precision, the company itself con-

nected up the wireless with its own land wires. To do this it employed its wireless stations at Elberon and at Deal Beach, N. J., and such apparatus as it required in its big operating station in the skyscrapers at No. 24 Walker Street, New York City, where a group of company officials had gathered.

Owing to many factors with which every radio amateur is familiar by experience, there are obstacles to perfect communication which must be overcome in such experiments. The waves used in sending and receiving would have burned each other up, so to speak, had the two stations not been separated by the mile and half of sands. The voice of the cap-

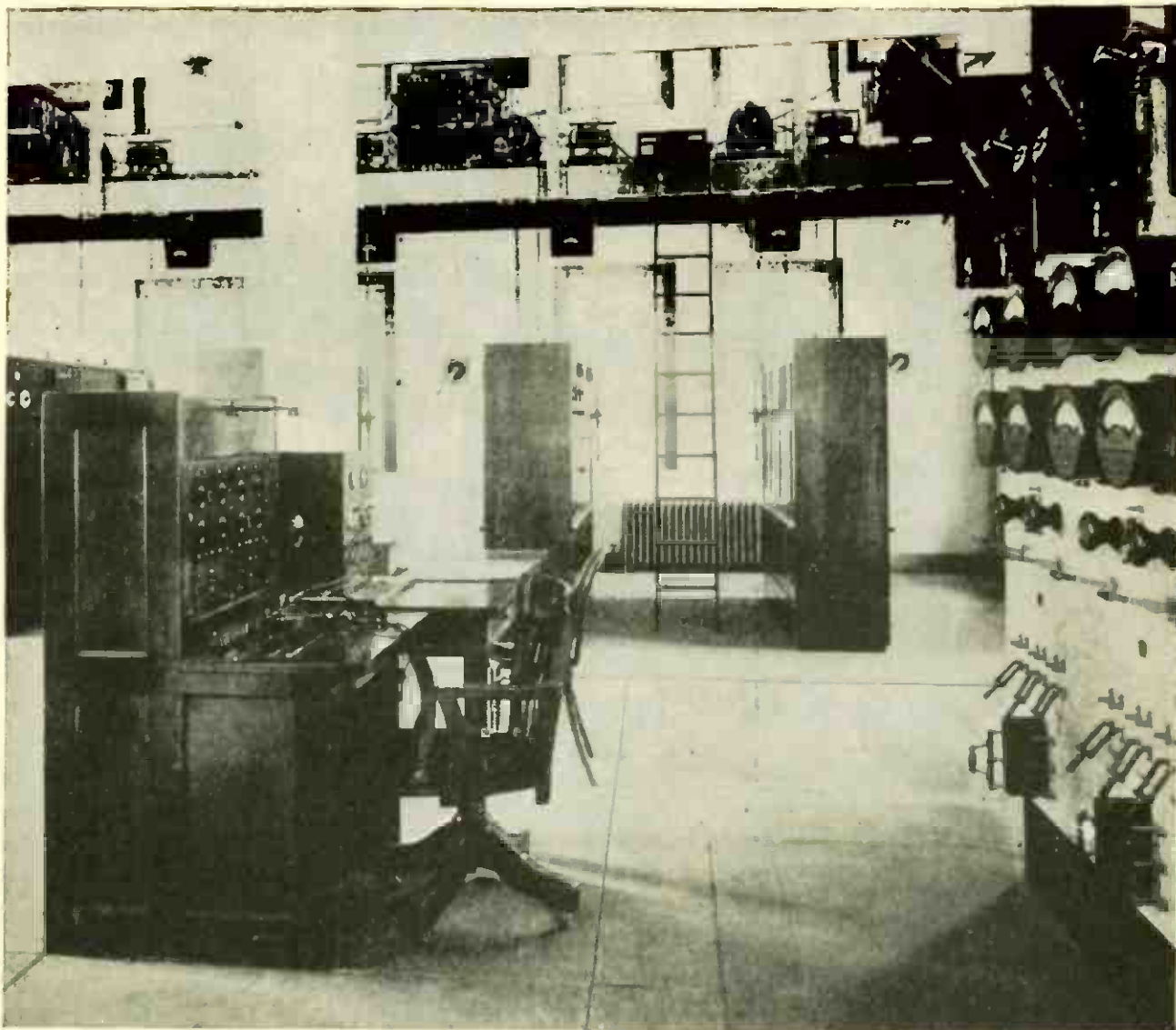

#### WHERE THE RADIO CALLS WERE RECEIVED

*At the desk in the foreground sat the operator in the Deal Beach Station when the two-way conversation with the AMERICA was carried on. The tube sets are in the background and the antennae connections are on the balcony.*



tain of the *America*, as is shown in the accompanying diagram, was carried over the sea for one hundred and twenty leagues to the Elberon station. There it was so modified that its waves were made of such frequency as to make them audible over the land lines with which it was connected. When Mr. Thayer replied to Captain Rind his voice followed the metal strands to the station at Deal Beach, and were then amplified and cast out into the air, where they were duly received on board the steamer. The two stations, on

the New Jersey beach, although so widely separated, were doing fine team work. The two currents—the going and the coming current—as far as the ship was concerned, passed through the plant in Walker Street, where greater power was imparted to them, for distribution to the telephone subscribers who cared to listen to this historic interchange of greetings.

By the use of various duplex devices the captain of the *America*, who did not have a mile and a half of beach for lee-way, was able to talk into the phone and to hear at the same time. His voice, going through the vacuum tubes, was easily spread in every direction and was caught up by the station at Elberon. Thus the two-way talk proceeded without interruption and Mr. Thayer and the captain conversed quite as easily as they might have done had they been in adjoining offices in the city. The instan-

#### RADIO WAVES HITTED TO WIRES

*This diagram shows how the wireless impulses from the ship were transferred to the telephone circuit and carried into a country home in Connecticut.*

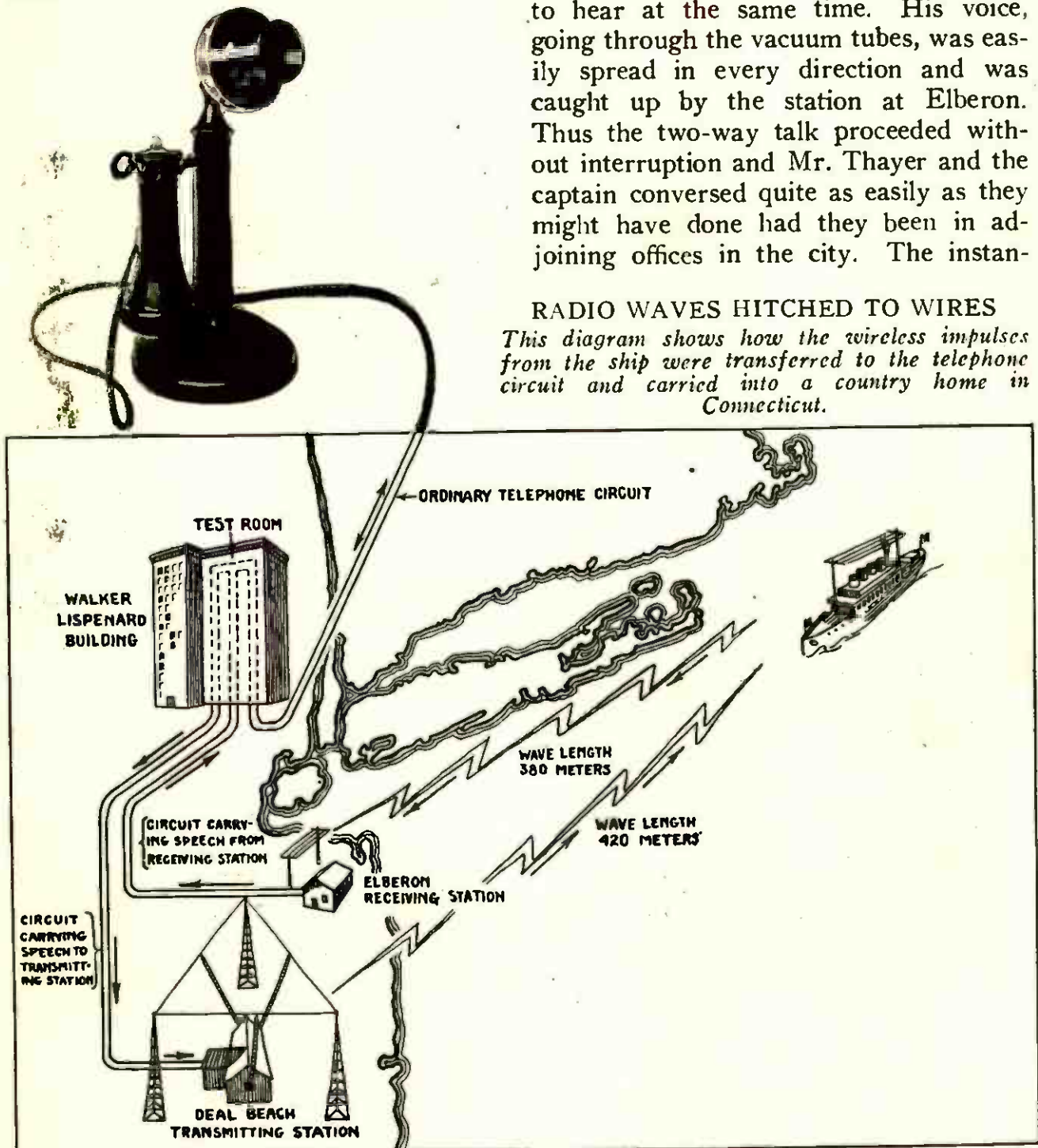

taneous replies to questions and greetings was an admirable demonstration of the new method.

It is a bit early to predict just how far-reaching this innovation will prove to be. It certainly should become of great value for communications between captains of vessels and the agents or owners ashore. Instead of a long interchange of wireless telegrams, it would give the same direct and clear understanding of orders as might be obtained by those concerned had they sat facing each other across a flat top desk. The need of just such direct interchanges has often been apparent in emergencies.

While the functions of radio and wire

transmissions are so radically different, yet they may be harmonized in many ways. The message which comes by wireless over many liquid leagues may in the first place be caught by the receiving sets of many alert fans. This was actually the case when the *America* was approaching. For the ordinary purpose of business, however, the network of land wires that reach all parts of the nation by telephone and telegraph are a powerful aid in the dispatching of information which is sent in throbbing from the realms of ether. The outcome of the latest liaison between wire and wireless will be followed closely by the disciples of radio.

## A Wave Cycle from Cathay

*Soon We Will Hear the Temple Bells of Ancient China—by Radio*

By C. DICKSON LOOS

**I**N old Cathay, where temple bells break the peaceful stillness and lazily floating junks ripple the waters, and which has basked in dreamland for four hundred centuries, there is now being erected one of the highest powered wireless stations in the world. It will establish the first direct communication between China and America.

In January, 1921, the Chinese Ministry of Communications signed an agreement with the Federal Telegraph Company of California for the erection of a high power wireless station of 1000 kilowatts at Shanghai, and for less powerful installations at Peking, Hankow, Canton and Harbin. Although the contract was concluded more than a year ago, actual work on construction has just been begun in Shanghai. This delay was due to protests from Great Britain, Japan and Denmark, who are jealous of American competition in the Orient. Claiming that the new agreement with the American company was a violation of the contract rights of their own countrymen, the Marconi Wireless Company, Limited, the

Mitsui Company, and the Great Northern Telegraph Company, the British, Japanese and Danish diplomats made every effort to block the Federal contract. For a time the Chinese Government wavered under this strong diplomatic pressure. Secretary Hughes, however, made the question a test of the "Open Door" policy in China, and pointed out that the exclusion of Americans in the wireless field was a clear case of monopoly and meant the closing of China's "open door." Abandonment of that policy would be a catastrophe to China politically and well as commercially.

The outcome of the dispute was victory for the American company. Actual construction is now under way at Shanghai. The most important feature of the contract is the establishment of direct communication between China and America. No longer will messages have to be relayed by way of Guam and Japan, as in the past. In case of war on the Pacific this will be of inestimable value to America. And it is a milestone in world history—this final link with age-old Cathay.

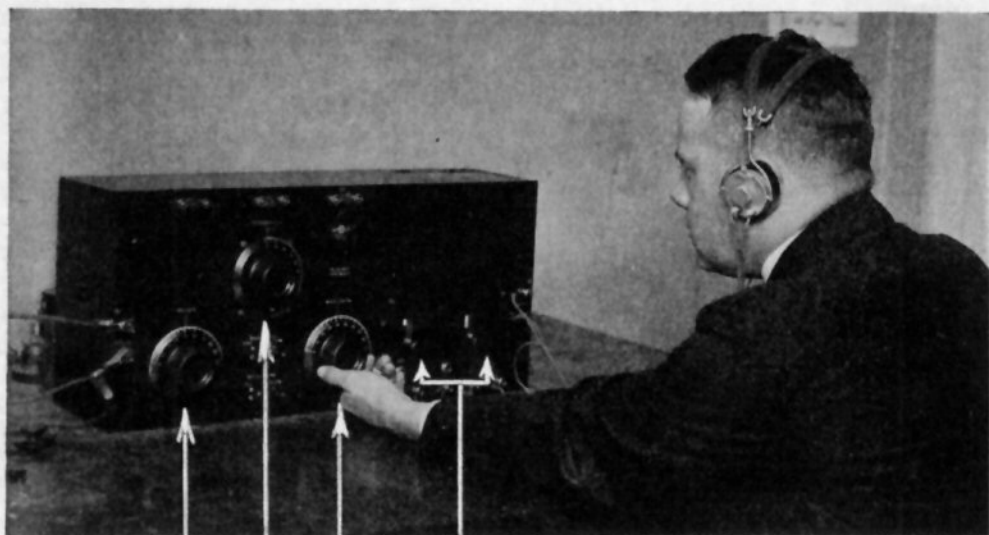

(A) COUPLING

(B) REGENERATION

(C) TUNING

(D) RHEOSTATS

## How to Tune a Regenerating Receiver

By EDGAR H. FELIX, A. I. R. E

*Have You Ever Heard Clearly Over Your Radiophone One Day—and Been Disgusted with the Results the Next? The Chances Are That Your Adjustments Were Faulty*

**T**HE sudden awakening of popular interest in radio telephone broadcasting and the consequent demand for receiving sets has placed thousands of delicate bits of mechanism in the hands of novices who have had no experience in adjusting them. The average novice regards the problem of adjusting his set as merely a matter of setting his controls in such a way that will enable him to hear the station he wants.

This haphazard and illogical method of tuning, although it may bring results after a fashion, robs the listener of much of the joy of receiving. Unskilled tuning results in weak signals, interference and uncertainty.

The tuning of a radio receiver is simple enough if the functioning of the few simple controls are known to the operator.

The usual regenerative vacuum tube receiver has the following controls, as illustrated in the diagram at the top of this page:

- A Coupling.
- B Regeneration.
- C Tuning { Antenna wavelength,  
Secondary wavelength.
- D Filament rheostats.

In some sets on the market, controls A and C are combined in a single control which adjusts the wavelength of both primary and secondary circuit. Some of the sets of the more inexpensive types are designed without a secondary circuit,

with the consequent sacrifice of selectivity. However, in all cases the process of adjustment is somewhat similar.

There are three adjustments which are made before the operator attempts to receive any particular station:

*First*, the aerial switch is placed in the receiving position;

*Second*, the filaments of the tube or tubes are lit, either by means of special switches employed for the purpose or by the automatic jack, which completes the filament circuits when the plug connected with the telephone receivers is inserted in the jack.

*Third*, the adjustment of the filament rheostat. This is gradually turned up until a slight hiss or roar is heard in the receivers. The resistance is then turned back slightly until that noise is just inaudible.

The operator is now ready to tune his set. The control knob, marked "regeneration" or "tickler," is placed at minimum.

The first step in tuning for a particular station is to adjust for wavelength. In most of the receivers that are being sold for broadcasting there is but one adjustment for this purpose; with such sets it is merely necessary to turn slowly from minimum to maximum, stopping at any point where a desired station is heard.

Some receivers are equipped with a vernier adjustment, which provides fine graduations of the main wavelength adjustment. With a set so equipped (after the rough tuning has been made in the manner just described), the signal is more accurately tuned by means of the vernier adjustment.

For receivers that have separate controls for the primary and secondary circuits, the tuning process is slightly modified. In this case to tune in correctly a particular signal both primary and secondary circuits must be adjusted to the wavelength of the desired incoming signal.

A rough adjustment of the primary circuit is first made. If the operator has no knowledge whatever of the ap-

proximate adjustment for any particular wavelength, he adjusts the primary circuit to one third or one half its maximum value. If the coupling between the primary and secondary circuits is adjustable, it is placed at maximum during the first step of the tuning process. By maximum is meant that position in which the secondary windings are closest to or parallel with the primary windings.

The wavelength of the secondary circuit is then made in the same manner as first described for the primary adjustment of the single control receiver. When the desired signal is then properly tuned in on the secondary circuit, a re-adjustment of the primary circuit is made until the point at which the signal is heard with maximum loudness is found. In some cases, a slight re-adjustment of the secondary circuit is again advisable with the result that the signal is heard with greatly increased strength.

The advantage of separate controls for primary and secondary tuning and the mutual coupling between those two circuits lies in its selectivity. If adjustments have been completed as described, and an interfering station starts in sending, it is merely necessary to decrease the coupling between primary and secondary circuits and then to re-tune the primary and secondary circuits again. Almost invariably it is possible to find a position of coupling in which the desired station is heard and the interfering station eliminated.

Once the correct adjustment for wavelength has been made, it is a simple matter to adjust the "regeneration," "tickler" or "feedback" control. This is done by slowly turning the control knob from the minimum position toward the maximum. At first this action may not produce any perceptible result; then there will be a sudden and surprising increase in signal strength. But if you increase regeneration too much, the quality of the received signals becomes distorted. At first only the high notes are affected. If the adjustment is turned still further to maximum, the music becomes

completely distorted and its tonal qualities are destroyed.

It is desirable to sacrifice signal strength in order to obtain full advantage of the purity and perfect tonal qualities of radio telephone music. The temptation is to obtain the loudest possible signal at the receiver, but the discriminating operator knows he is not striving to receive the maximum noise but the most enjoyable and most faithful reproduction of the music that is being sent out.

As a measure of economy, minimum filament brilliancy consistent with the reception of the desired signals at audible strength should be employed. When receiving music with the regeneration adjusted to its point, a reduction of filament brilliancy at once causes a cessation of regeneration. But, by increasing the degree of regeneration, the reduction in filament brilliancy can be compensated for up to the point at which regeneration is at a maximum. It is usually unnecessary to burn tubes at white heat and it is very disastrous to their long life. Consequently maximum filament brilliancy should be

avoided if regeneration takes place at lower filament temperatures.

The process of tuning a regenerative receiver may be summarized as follows:

(1) *How to Make Preliminary Adjustment:*

- a. Turn the antenna switch to the receiving position.
- b. Light the filaments by turning on the filament switch or inserting the plug into the jack which completes those circuits.
- c. Adjust filament brilliancy to the highest point at which no roar or hiss is heard in receivers.

(2) *How to Tune:*

(In the case of single circuit receivers and single control receivers):

- a. Adjust the main wavelength switch until the desired signal is heard.
- b. Adjust the vernier, in the case of two circuit receivers:
  - a. Make an approximate adjustment of the primary circuit.
  - b. Carefully tune the secondary circuit until the desired signal is heard, with the coupling at the maximum.
  - c. Retune the primary circuit.
  - d. Make the final slight adjustment of the secondary circuit.
  - e. In case of interference, change the coupling and retune the primary and secondary circuits.

(3) *How to Adjust the Regeneration:*

- a. Gradually increase the degree of regeneration from its minimum position until a sudden increase in amplification is heard; continue very slowly to increase until the note begins to be distorted.
- b. For purposes of economy, slowly reduce the filament brilliancy and simultaneously increase the regeneration until the regeneration is at a maximum without loss of amplification or distortion.

With these instructions clearly in mind the novice should meet with little trouble with his newly acquired apparatus.

ANOTHER "SMALLEST RECEIVER"

STILL another "smallest radio receiving instrument in the world" has been completed, this time by Alfred J. De Giovanni, a fourteen-year-old freshman in the Union High School at Knoxville, Pa.

His tiny instrument is slightly less than one inch square, not much larger than a nickel, but is said to record distinctly in Knoxville the programs of the large broadcasting station in East Pittsburgh, a distance of about fifteen miles.

Young De Giovanni has been making wireless outfits more than three years.



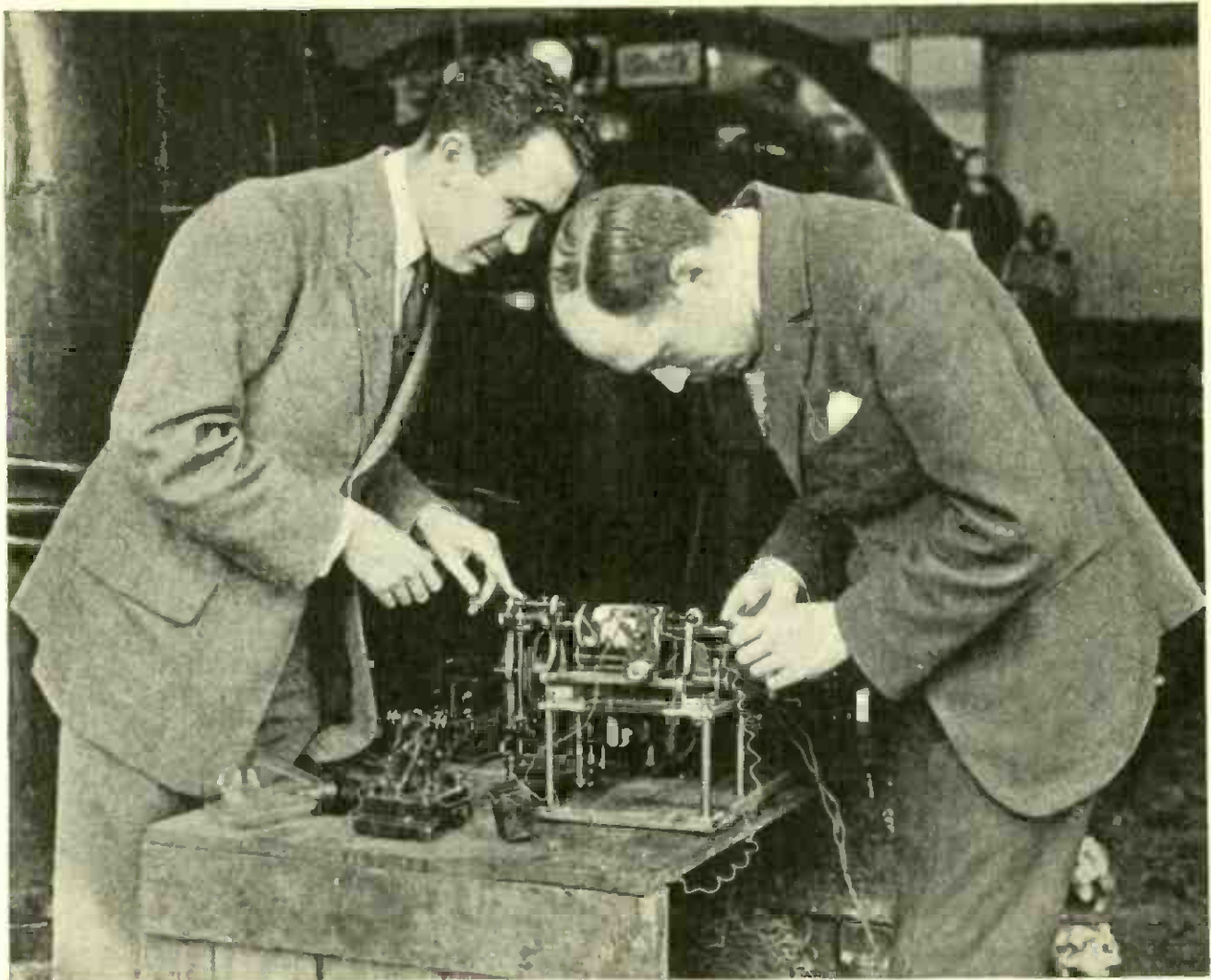

© International.

### THE FIRST STEP TOWARD TELE-VISION

*This is the transmitter of the apparatus invented by Edouard Bélin for sending pictures by radio, an adaptation of his invention for transmitting photographs over wires.*

## The Next Step Ahead *in* Radio

*Will We Soon SEE by Wireless? Will Power for Driving Machinery Be Broadcasted? And When Lightning Is Harnessed, Will Bloodless Battles Be Fought by Engines Run by Radio?*

By WALDEMAR KAEMPFERT

**W**HEN the announcer at the broadcasting station proclaims to twenty thousand listeners that "Signora Racillini, formerly of La Scala, Milan, will now sing Tosti's 'Good-Bye,'" and when the Signora pours out her full-throated best, a complicated process occurs. The pulsations of the voice—the inflections, the liquid flow of vowels, the puffs and hisses of consonants—are first converted into electric waves that ripple out through the ether with the speed of light, and the

waves are then reconverted into sound at thousands of receiving sets by telephone receivers. From beginning to end the process is a manifestation of energy. The Signora simply modulates ether waves as she sings, and the ether waves are energy waves. About one hundred and fifty horsepower would have to be placed at her disposal if she wanted her "Good-bye forever" to reach Europe.

To hear the Signora may be satisfactory enough to the ear. But I want to

see her, too. The radio telephone is an instrument for miraculously extending the range of the human voice. Can the radio engineer similarly extend human vision? If I in Toledo can hear the broadcasted voice of Galli Curci as she sings on the stage of the Metropolitan Opera House in New York, will the time ever come when I shall at the same time behold her?

The possibility seems staggering. To translate a voice first into waves of ethereal energy and back again into song or speech seems awe-inspiring enough in these days of radio marvels. But what shall be said of sending a living, moving personality through the ether—a figure that will be as intangible and yet more realistic than any motion picture, a figure that looks like Galli Curci and suits the action to the word, something that we will swear is Galli Curci?

Inventors have dreamed of the possibility. They have even made a few crude attempts at converting the possibility into a reality. It so happens that they have in selenium an element which is curiously responsive to light. The electric conductivity of selenium varies with the amount of light that falls upon it in a given time, and in that mysterious property lie possibilities of broadcasting the appearance, the gestures, the form of Galli Curci to millions of receivers.

Radio opera in the year 1972 will be optically and aurally as gratifying five hundred miles from the stage as if the vast audience were seated in the auditorium itself. Whole nations, perhaps all Europe and America, will be converted into a planetary opera house. Madagascar and Oklahoma, Norway and South Africa—half the world—will follow not merely the voices but the figures of Tristan and Isolde as they enact the greatest love tragedy ever written. Will there be just one opera in all the world, a super-opera with a super-orchestra and super-singers—an opera produced with a magnificence that eclipses anything that Paris or New York has ever attempted?

Why not?

Perhaps there will be small opera receivers for the home, and large receivers for local theatres thronged every night by hundreds who will follow on the screen the movements and voices of electrically transmitted personalities undistinguishable from their human originals in Paris or New York. Lima, Ohio, will be operatically as well off as any metropolis of Europe or America.

Perhaps the first step in the realization of what may seem now but a technical fantasy will be the transmission of photographs by radio. Knudsen, a Dane, made a few promising experiments in sending pictures by wireless ten or fifteen years ago. Creed, in England, has done even better within the last two years. The step from transmitting the elements of a lifeless photograph, a "still" in screen parlance, to broadcasting a moving picture can easily be imagined. And then will come the radiation into the ether of the human figure itself, at first in black and white and then in the colors of nature.

**W**HEN we listen to broadcasted opera we listen to transformed energy. If we can make a moving tape record telegraph signals or a telephone diaphragm vibrate to reproduce a human voice hundreds of miles away, we can also make other contrivances act. Clocks have been started and stopped by radio, lights have been turned on and off, a dozen different machines have been controlled by pulsations of waves sent through the ether, and all this long before radio broadcasting became the vogue.

Recently the United States made the interesting experiment of trying to sink one of its obsolete battleships with bombs dropped from airplanes. The old *Iowa* was the target. To mimic the conditions of battle as closely as possible the battleship maneuvered under steam.

With men on board?

Not at all. The captain of the ship was miles away. And the crew? There was no crew—only a specially designed

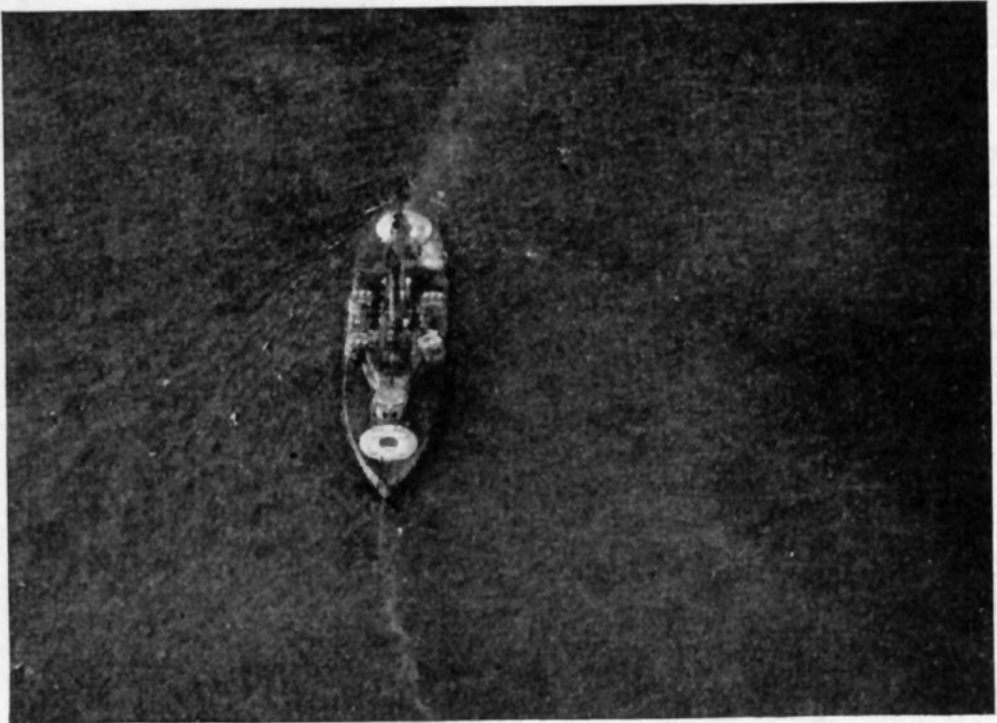

Official Photo, U. S. Navy

#### A REAL U. S. BATTLESHIP RUN BY A PHANTOM CREW.

*Not a living man was aboard the "Iowa" when she was manoeuvred at sea during the recent aerial bombing tests. She was controlled entirely by radio waves directed from a point miles distant; the guns might have been similarly directed.*

receiving apparatus which controlled the machinery. The captain had only to send out waves in a certain sequence, and the ship would move to starboard or to port, proceed straight on under full steam, or stop dead. He might have trained guns and fired them had there been any good reason for doing so.

All this makes one wonder if the naval battle of the future will be an encounter, not of ships thronged with men cheering as they see an adversary settle by the stern and plunge beneath the waves, but of lifeless ships, of naval machines rather than of vessels manned each with a crew of twelve hundred or more. The movements of either side are reported by scouts in the air and plotted on a chart. The opposing admirals control the movements of their floating machines from some safe fortification on the coast. A battle will be more than ever like that

game of chess to which it is so frequently and so aptly likened. The admiral who loses all or most of his naval machines at once notifies his government to make the best peace terms that it can. Not a drop of blood will be shed, and yet the destinies of nations may be decided.

**WHEN** we read of crewless battleships maneuvering in response to signals we are dealing with no extraordinary demonstration of radio's possibilities. After all the signals act like the pressure of the finger on the trigger of a gun; they simply set local mechanism in motion. The machines are not actually driven by the waves in the ether. This is the dramatically startling possibility to which Nikola Tesla bids us look forward.

A broadcasting station is but a power house of a special type. It radiates



energy which we use only for communicating thought.

Why not broadcast energy to drive machines?

Tesla has succeeded in wirelessly lighting electric lamps at distances of a hundred feet and more from the source of radiant energy and dreams of cities and homes electrified with power radiated from some colossal station. His plan for broadcasting power depends in large measure on resonance, and what that is anyone who has ever started a pendulum beating with a slight tap of the finger ought to know. Keep on tapping the pendulum at just the right interval, and the beat increases in amplitude steadily. The taps must be correctly timed, and this is what is meant by "resonance." Suppose that it were possible to construct a receiving apparatus which could be thus electrically tapped, as it were. Suppose, in other words, that the waves would arrive at just the right intervals to reinforce the surgings of current in the receiving circuit. Suppose that it were thus possible to pile electric impulse on electric impulse until the accumulation of them all in a properly tuned circuit would represent millions of horsepower in electric oscillations. Suppose that there was a way of turning part of that unthinkable amount of power into a motor to run a street car, light electric lamps, and perform other useful work. Surely the radio millenium would seem to have arrived.

**B**UT a possibility still remains that dwarfs even this. It is the possibility of harnessing "static." Now that thousands are "listening in" every night to broadcast concerts and lectures the term "static" promises soon to pass into the vernacular. "Static" is the sputtering, grinding and hissing that sometimes obscures reception and in summer occasionally makes it all but impossible. What is it? Simply nature's own enormous broadcasting station sending out waves into the ether, which our instruments pick up if they happen to be tuned

to the same wavelength. Whenever lightning leaps between cloud and earth or between cloud and cloud nature is sending out a crashing radio signal.

These manifestations of "static" are manifestations of energy, as much so as the broadcasting of speech and song. Can we tap this energy? Must we always be dependent on machines to generate the electric energy that our broadcasting stations hurl out into space? Sometimes we read of imaginative swindlers who claim to have "tapped atmospheric electricity," to use their own rhapsodical phrase, and who succeed in selling stock in a company which dies almost as soon as it is born. And yet in back of this swindling and of this apparent madness is the germ of a possible invention. We still speak allegorically of Franklin "harnessing the lightning." Conducting static electricity down a wet kite string is not "harnessing" anything. No one has yet harnessed the lightning. But radio is even now fashioning the harness. After all, Marconi first signalled through space with waves generated by miniature artificial lightning flashes, and before Marconi made his experiments, Popoff, a Russian, had received radio signals from distant cloud discharges. Lodge and a dozen others have thus literally drawn off infinitesimal amounts of atmospheric electricity—"static."

But how is this vast atmospheric reservoir of electricity to be drained? No one can ever guess. "Static" is always present. Waves of many different lengths are constantly being sent out. Perhaps Tesla's principle of resonance may be applied, perhaps electrical vibrations can be piled up on the same principle that enables a tapping finger to increase the swing of a pendulum enormously. But whatever the principle may be it is not altogether a wild dream to imagine a world running its factories and its trains with energy drawn from the atmosphere.

When that time comes the lightning will be really harnessed.

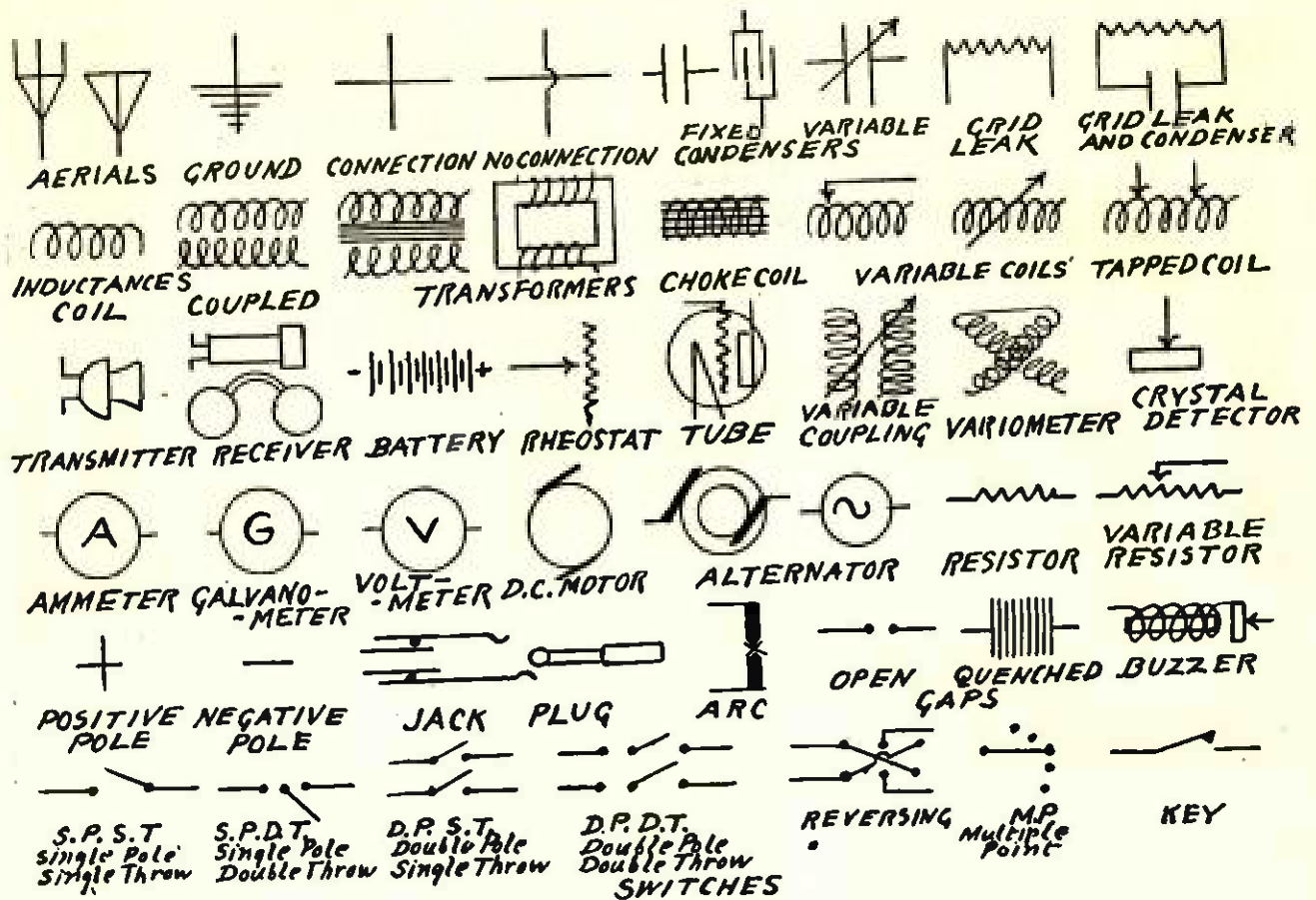

## Symbols That Help in Reading Diagrams

By A. HYATT VERRILL

**M**ANY amateurs who want to build or install their own radio sets, or to add to them, find themselves at a loss when they turn to the various magazines and books that publish diagrams. As a rule, the diagrams convey no meaning to the layman, for instead of having the various devices and instruments plainly labelled, or in the least resembling the originals, they are indicated by symbols.

The symbols used in radio are comparatively few and are shown in the accompanying illustration.

Do not, however, make the mistake that was made by an amateur who, seeing the symbols representing the primary and secondary coils of an inductance coil drawn side by side, constructed his coil in that way and wondered why his set would not work! Inductances are represented side by side in the diagrams merely to avoid confusion of lines, and the two windings should invariably be placed one over the other.

Also, bear in mind that diagrams of wiring are always shown with the wires running straight, parallel and with square corners and with a great deal of space between them. This is done for the sake of appearances in the drawing, ease in drafting and to render "reading" the diagrams easier. In following such a diagram the wires may be carried at any angle, in curves or around corners and may be placed much closer together than is indicated. If you should examine a ready-made set you would find instruments and wires packed closely together with the wires far from straight and parallel. Indeed, it is an unwise plan to carry wires parallel for any distance, as there is always a tendency to "induced" currents when this is done. The main points to remember are to cross wires as seldom as possible; to keep them well separated where they cross; to keep them as short as possible; to have them well insulated and to make good connections.



© Keystone View Co.

# How to Make Soldered Connections

*Useful Tips for the Amateur  
Who Wires His Own Radio Set*

By FREDERICK SIEMENS

**W**HEN wiring up a radio set it is important that all connections be made so that a good positive junction is formed not only between the wires and the instruments but also between the wires themselves.

There are four points to be remembered when making up a soldered joint: *First*, the surfaces of the parts that are being joined should be cleaned and polished; *Second*, the surfaces should be treated with a soldering flux; *Third*, the temperature of the soldering iron should be kept at the right heat; *Fourth*, the metal parts should be heated with the iron and just enough solder applied to cover the parts neatly.

If these precautions are taken, every joint will be a real joint, and the apparatus thus connected up will function in a quiet, clear manner, without any of the hissing, scratching, or crackling sounds that always accompany a poorly connected set.

All metal parts to be joined should be rubbed and polished to a bright, shiny finish, with emery cloth. All coverings such as lacquer, grease or oxidization should be removed from the surface of the metal.

The purpose of using the soldering flux is to cause the molecules of metal to amalgamate with the molecules of molten solder which will be applied later. There are a number of fluxes the chemical constituents of which cause this action to take place. This soldering paste may be applied with a small stick. Use only enough to cover the surfaces with a thin film, however; excessive use of paste causes a dirty joint.

A small one-half pound iron (which, by the way is made of copper), should be used. To prepare the iron, clean the point with a smooth file or emery paper to a distance of about one-half an inch from the point, and then place the iron

in a clear gas flame and heat it until a green tint is seen in the flame around the iron. Then apply the soldering flux to the point and rub a piece of solder over the cleaned surface until it is covered with a coating of solder. Then place the iron back in the flame but keep the point out of the flame. The iron should never be heated beyond the temperature at which the solder begins to turn dull gray. Remember that if the iron gets too hot it will oxidize and the solder will not stick to it and it will have to be cleaned and tinned all over again. Of course an electric iron is preferable, because the possibility of overheating is forestalled, as the iron is designed to work at the correct temperature only.

When the iron is at the correct temperature, place the point of it on the surfaces of the wires or parts to be joined,

and heat them for a moment while the flux bubbles up; then place the end of the strip of solder on the parts until enough melts and flows over the surfaces to make a neat joint. Do not use any more solder than absolutely necessary. Work the molten solder around with the point of the iron, until every crevice is filled, and then take away the iron and refrain from moving or disturbing the joint until the solder "freezes" or sets. Wipe off all excess soldering flux and the job is complete. The handiest kind of solder to use is a soft solder put up in the form of a wire about one-eighth of an inch in diameter.

After a few trials the process becomes simple, provided these precautions are taken. And the results obtained from the completed instrument will be well worth the effort.

## How Radio Waves Are Sent *and* Received

*THE FIRST OF A SERIES OF SIMPLE "HOW" ARTICLES FOR THE BEGINNER*

By LAURENCE M. COCKADAY, R. E.

**A** RADIO wave is a vibration of the ether, that supposed substance that fills space.

There are many different kinds of vibrations that travel through the ether; that is to say, certain vibrations produce entirely different results than other vibrations.

Suppose we consider, for example, a flexible reed, fastened to a stationary base as shown in Fig. 1. If we cause the reed to vibrate it will first take the position "A," and then swing back and past its original position to a third position "B," and then back to its original position again. Then the same series of movements will be gone through again. This complete set of movements is called a cycle. A cycle then, is composed of two

impulses, one in one direction and another in a reverse direction.

Now if we cause the reed to vibrate at a speed of 16 cycles a second, the reed will cause a sound wave to be propagated in the immediate space surrounding it. This wave will make itself manifest to our senses in the form of a low humming sound. Close by the reed the sound will be fairly loud, but at a distance of fifty feet it may be inaudible.

If we increase the frequency (or speed of vibration), to 500 cycles a second, the low hum will increase in pitch until it will be a shrill whistle, like the high notes of an organ.

If we continuously increase the frequency of the oscillations, when we have the reed oscillating at a frequency of

25,000 cycles a second, the sound will have gotten so high that the human ear cannot hear it. In other words, the waves that are generated around the reed have gone out of the range of frequency that we call sound waves.

As the frequency is increased it will be soon noticed that the reed begins to get warm, until, finally, by placing the hand near it we "feel" the heat wave. This heat wave is of exactly the same nature as the sound wave except that it has a different frequency and produces different results. In one case we hear the sound, with a sound recording organ called the ear, and in the other case we feel the presence of heat by our sense of touch.

As the frequency of the little reed is increased beyond this point, the heat developed finally increases until the reed begins to glow a dull red color. Instantly the wave has become a light wave and it is visible to our eyes, but the heat is still felt. This shows that the ranges of heat and light overlap in the frequency scale.

Any further increase of frequency would mean destruction to the reed through overheating, but if we could imagine its frequency as increasing without burning up, the waves sent out would pass through the ranges of color and the X-ray.

To sum up the foregoing, different ranges of frequency, say 16 to 25,000 cycles, produce waves that we call sound,

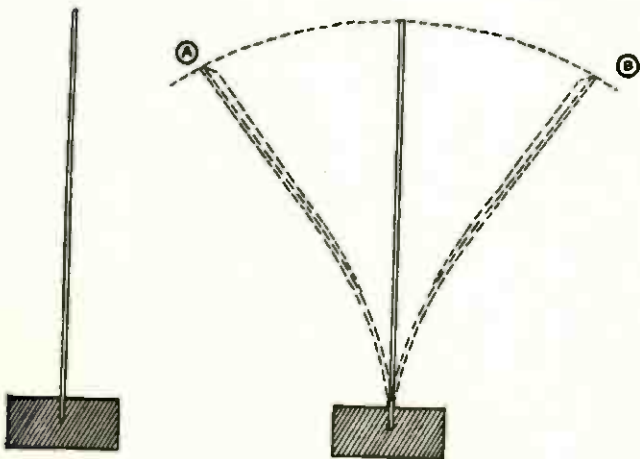

FIGURE 1. *A vibrating reed produces the most simple form of sound wave.*

and another range produces heat, light and color. Another range produces X-rays, and a similar range produces waves which we call Hertzian waves, named after Hertz, the man who discovered their existence.

And these Hertzian waves are our radio waves. The frequency of the electricity that is used to generate them lies within the ranges of 10,000 to 3,000,000 cycles a second.

We now know what a sound wave is. Did we ever notice that the seats in a theatre are invariably arranged in circles? This is done to take advantage of the fact that all waves, such as sound waves, light, heat, and radio waves travel from a point outward in ever increasing circles.

You will get some idea of how sound waves travel by observing what happens when a stone is thrown into a pool of still water. A circular wave is at once formed around the spot where the stone hits the water. This circular ripple begins to travel outwards with its diameter ever getting larger until it dies out.

If we place a cork on the surface of the water near the spot where the stone had struck, it will bob up and down violently as the wave passes by. If the cork were to be placed on the water at a distance from the same spot, the vertical movement would be much less violent because the waves would be weaker after travelling this distance.

Or take another illustration: We know that a fire built in the woods is hot on all sides and will warm people standing on one side of it just as much as it will warm those on the other side. If we move closer to the fire the heat increases because the heat waves are stronger there; if we move away, the heat decreases. This also is because the waves weaken as they travel.

The same general conditions hold true for radio waves. The transmitting station may be likened to the stone thrown into the water, and the receiving station may be likened to the corks on the surface of the water.

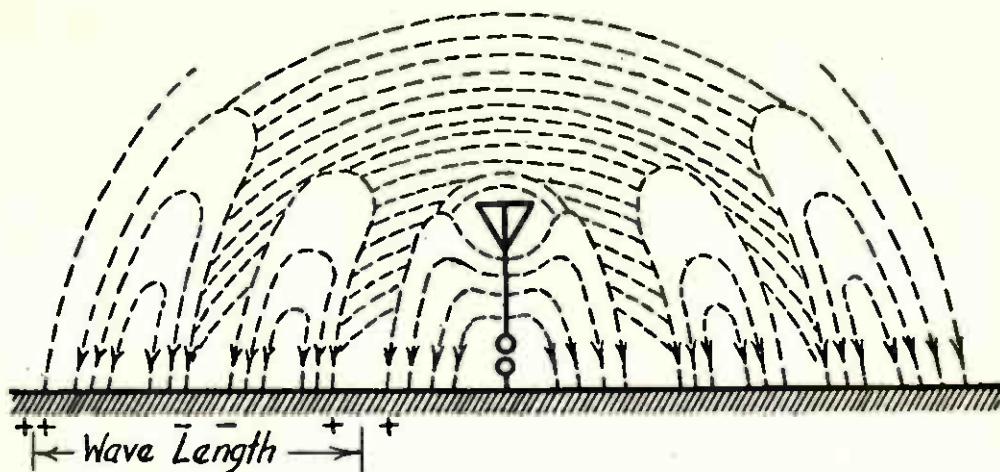

FIGURE 2; Radio waves spread out from a transmitting antenna in much the same way as sound waves spread out from a vibrating reed. The dotted lines indicate the circular radio waves.

**H**OW radio waves are sent out is illustrated in Fig. 2, which shows how they leave the antenna.

The antenna is shown, for simplicity, as a single wire vertical antenna with a spark gap as a generator of oscillations in series with the ground. For every given frequency of current jumping the gap, a wave of a certain definite length is radiated from the antenna. The length of the wave is the distance between the start and finish of one complete wave, measured along the ground. All radio waves travel with the terrific speed of light, 300,000,000 metres a second. When we know this, the wavelength of a wave radiated from an antenna can easily be calculated if we also know the frequency of the oscillations in the antenna circuit.

A table of wavelengths used for radio communication is given below as a matter of interest, showing the frequency of the currents which cause them to be emitted from an antenna:

Wave length in meters	Frequency in cycles a second	Type of station which uses each wavelength
200	1,500,000	Amateur stations
300	1,000,000	Ship stations
360	834,000	Radio telephone broadcasting stations
450	667,000	Ship stations
600	500,000	Commercial ship and shore stations
1,000	300,000	U. S. Navy
1,400	214,300	Commercial traffic
2,600	115,400	Time signals
5,000	60,000	High powered commercial stations
10,000	30,000	High powered commercial stations

15,000	20,000	High powered commercial stations
20,000	15,000	High powered commercial stations
30,000	10,000	High powered commercial stations

**N**OW let us consider how radio waves are received.

It will be noticed from the above table that as the frequency of the current in the antenna decreases, the length of the emitted wave increases.

We receive a radio wave when we erect an antenna with its insulated wires high in the air, and these wires get in the way of the advancing circular waves. When a series of waves strike the antenna they do not cause it to bob up and down like a cork, but they do produce a tangible result nevertheless. This result takes the shape of a feeble current induced in the receiving antenna which is an exact replica of the current in the transmitting antenna, but reproduced on a much smaller scale. It has the same frequency and is like it in every respect except in strength.

Thus we can readily see that it is not the electric current itself, that travels through the ether, but that the electric current does start a disturbance in the ether in the form of a Hertzian wave which travels outwards in all directions in circles. And when these waves strike another antenna which is tuned to that particular wavelength, they will induce in that antenna a current similar to the transmitting current, only of decreased intensity.

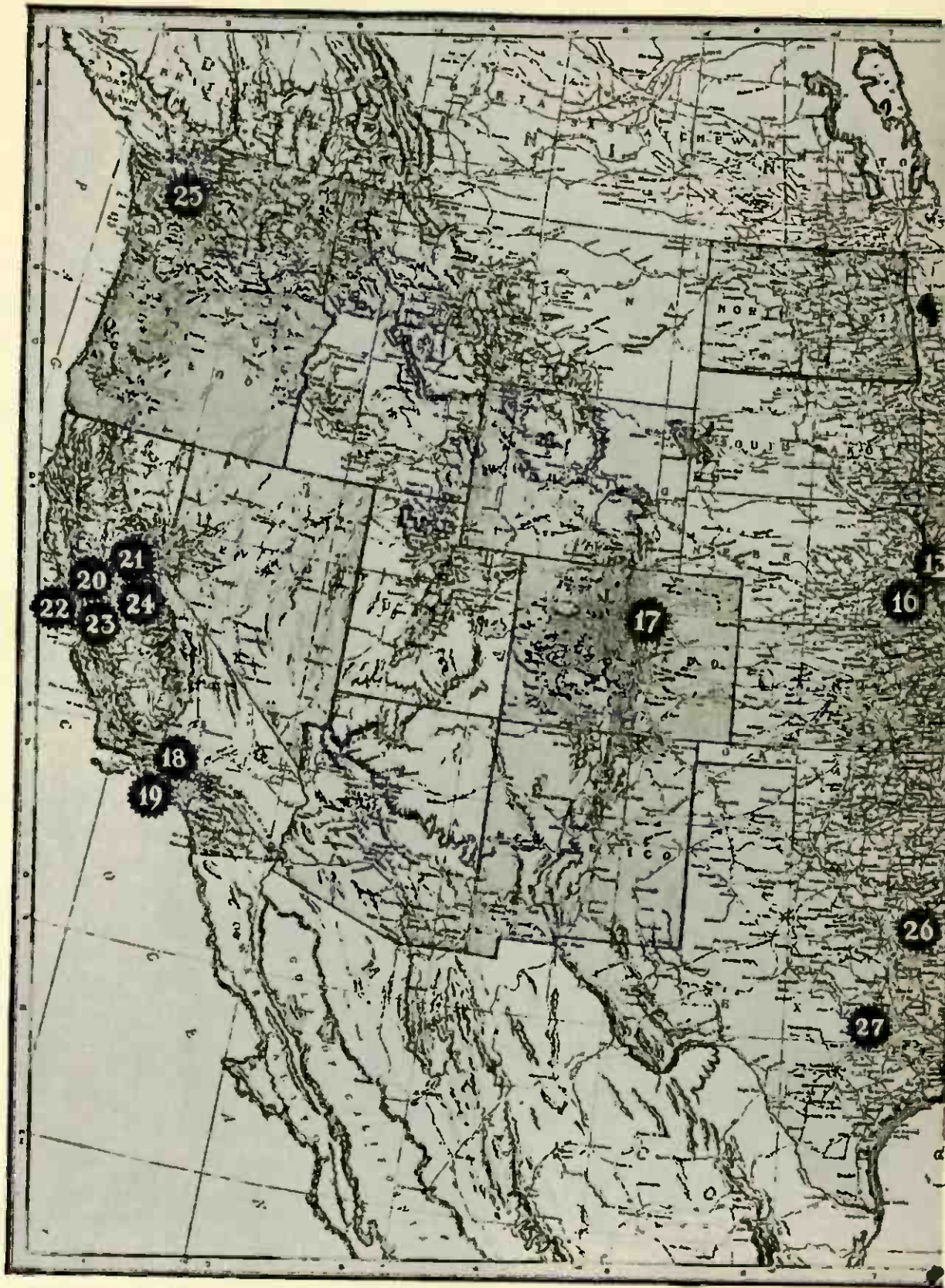

PRINCIPAL BROADCASTING STATIONS OF THE UNITED STATES

No.	STATION	STATE	CALL LETTERS	CONTROLLED BY
1	Newark	N. J.	WJZ	Westinghouse Co.
	Jersey City	N. J.	WNO	Wireless Telephone Co.
	New York	N. Y.	WDT	Ship Owners Radio Service
2	Hartford	Conn.	WQB	C. D. Tuska Co.
3	Springfield	Mass.	WBZ	Westinghouse Co.
4	Washington	D. C.	WDN	Church of the Covenant
5	Atlanta	Ga.	4CD	Carter Electric Co.
6	Pittsburgh	Pa.	KDKA	Westinghouse Co.
7	Indianapolis	Ind.	WLK	Hamilton Manufacturing Co.
8	Toledo	Ohio.	WDZ	Marshal Gerken Co.
9	Cincinnati	Ohio.	WMH	Precision Equipment Co.
10	Detroit	Mich.	WBL	Detroit News
11	Chicago	Ill.	KWY	Westinghouse Co.
12	Madison	Wis.	WHA	University of Wisconsin

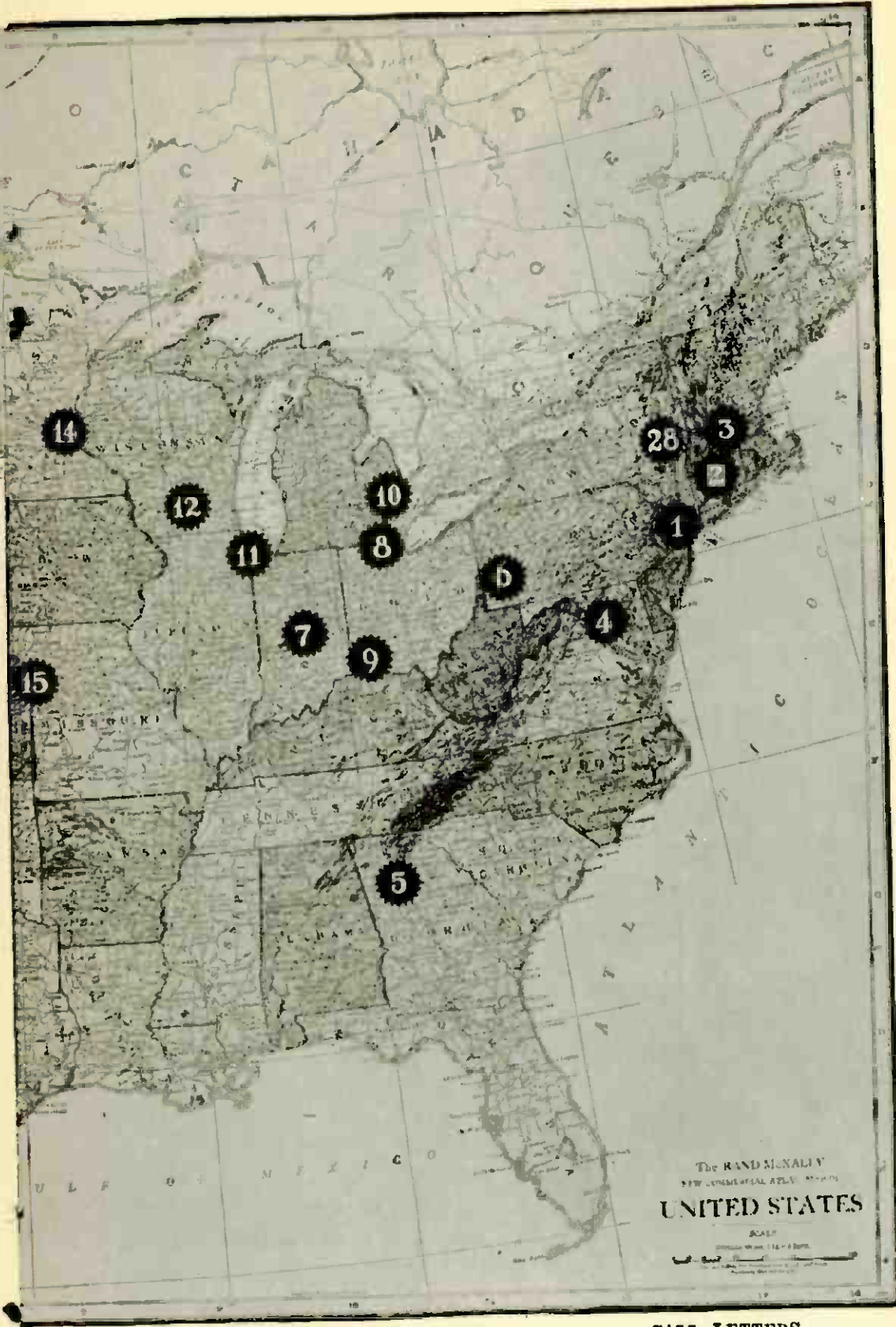

The RAND McNALLY  
NEW COMMERCIAL ATLAS  
UNITED STATES

**No. STATION**  
 13 Omaha  
 14 Minneapolis  
 15 Kansas City  
 16 Lincoln  
 17 Denver  
 18 Pasadena  
 19 Los Angeles  
 20 Oakland  
 21 Sacramento  
 22 San Francisco  
 23 San Jose  
 24 Stockton  
 25 Seattle  
 26 Dallas  
 27 Austin  
 28 Schenectady

**STATE**  
 Neb.  
 Minn.  
 Mo.  
 Neb.  
 Col.  
 Calif.  
 Calif.  
 Calif.  
 Calif.  
 Calif.  
 Calif.  
 Calif.  
 Calif.  
 Calif.  
 Wash.  
 Tex.  
 Tex.  
 N. Y.

**CALL LETTERS**  
 WOU  
 WLB  
 WOQ  
 9YY  
 9ZAF  
 KLB  
 KZC  
 KZY  
 KVQ  
 KDN  
 KQW  
 KWG  
 KFC  
 WRB  
 5ZU  
 WGY

**CONTROLLED BY**  
 R. B. Howell  
 University of Minnesota  
 Western Radio Co.  
 State University  
 Reynolds Radio Co.  
 J. J. Dunn & Co.  
 Western Radio Electric Co.  
 A. and P. Radio Supply  
 J. C. Holbrecht  
 Leo J. Meyberg Co.  
 Chas. D. Herrold  
 Portable Wireless Telephone Co.  
 Northern Radio Electric Co.  
 Police Department  
 State University  
 General Electric Co.



*"I just talked on with no encouragement, no applause, no dissent. And when I finished—silence. I was awed."*



Photo by J. Feder

Miss Wells Is  
Believed to Be  
the First Woman  
to Lecture Profes-  
sionally by Radio.

## “How It Feels to Talk *to* 1,000,000 People”

*Perhaps YOU Were One of the Silent Listeners-  
In on This First Radio Talk on Fashions by—*

MARGERY WELLS

“WE want you to speak into the radiophone,” said a sober enough looking editor. I tried to appear intelligent. I was willing to try anything once. But as a matter of fact, I hadn’t the faintest idea what a radiophone was. I could only pray that the forthcoming “conference” about it (it seemed imminent) would elucidate matters for my bewildered brain.

But the veils of mystery thickened as he trustingly went on to say: “You see, instead of putting you in print, we will put you in the air.”

I felt as though I had suddenly been transported to Mars to be confronted with new principles of life. How could I be put into the air?

First of all, I wanted to know what it

was like, so I asked if I could listen to a radiophone. Whereupon I was ushered into a room where a plain enough looking box and a set of telephone ear pieces were placed upon a table. I put the receivers to my ears and heard a strange click-click-click.

“That’s the code,” I was told.

“Oh, the code, of course,” I repeated vaguely. For half an hour I listened to clicks. I was informed that “they weren’t sending any speeches out just now.”

Finally the editor told me to go home and write a little speech—just an ordinary little speech. Then on Saturday I could go to Newark to “put it in the air.”

“To talk to a million people”—that’s what the editor said I would be doing.

At least there would be some thrill of contact with other personalities. But in the dark of the evening I reached the transmitting station, only to find it isolated and alone.

I might have known, but I didn't.

In a small, narrow room, huddled in one corner, sat the members of a jazz band, waiting to play their piece. A young man greeted me, turned tail, approached a large, round disc situated somewhere near the saxophone and solemnly said—to nothing whatever, it seemed to me:

"Miss Wells has now arrived. After one selection from the orchestra, Miss Wells will speak."

I found the only available seat—a golden oak table—to support me in my astonishment. And while I listened to the musical performance I could only think that, at least, this was a fitting introduction. . . .

The music stopped. There was a pause. Then I heard the announcer stating into his circular instrument:

"Miss Wells will now . . . ."

I wanted to flee. How could I be so absurd as to stand there in the center of an almost empty and silent room and speak about fashions, without one single glance of encouragement, without even one single slumbering personality to inspire me to wake it to life?

I walked up to this new adventure in life, fired at the last minute by the thought that here, at least, was my chance to be the most modern kind of an individual. What could be more lonely and vacant, I ask you, than a speech at night in the middle of the room where during the day the clerks of a business concern hung their hats and coats?

My voice trembled. A thrill shot through me. I was awed. At the empty coat hangers? No! At the vastness, of the newness of the experience—at the sensation of participating in the latest achievement of science.

I started off with my speech. I heard a voice at my ear telling me to talk more slowly. I cut down the speed. And that was all. I just talked on and on into utter silence with no encouragement, no discouragement, no applause, no dissent. Just a vast vacant silence. And when I finished—silence. The leader of the jazz band announced that he would play an encore. (No one had asked for it; how could he?) I sat down again on the edge of the golden oak table, and the announcer smiled patronizingly in my direction and said, "I think it got over very well."

After a while I found courage to ask an expert how far my voice had carried. He eliminated all of my remaining equilibrium by answering:

"They probably heard you in Scotland tonight."

\* \* \* \*

Now I listen to other speeches regularly. From their voices I am learning much. I find that I am thinking differently about being a radiophoner. I realize to "get over" I must be totally sincere. Only a realism of tone will transmit itself to the wires. I hear professional speakers talk over the radio and I cannot help but feel that their best grandstand plays are failing to reach the audience. They cannot depend upon mere stage presence or gestures. I hear a plain, everyday little clerk make an announcement and I am struck with the conviction which his voice carries with it. I am impressed with the fact that this is a new art, bringing into relief a whole new set of values. And like many other forms of modern art, it is the inner intention that carries conviction. It is a new art in which the mere external "front" doesn't register. To get over, the radiophoner must, first and last, be sincere.

I can understand now how the radio-  
phone is developing an entirely new type  
of public performer.

## ADVENTURE IN THE AIR



WHAT is the biggest thrill YOU ever got over the radio? Have you ever picked up a call for help? Or located a lost friend—or helped to run down a fugitive, or listened in on a conversation of peculiar personal interest to yourself? For every anecdote, humorous or grave, ranging from 50 to 300 words in length, the Editor will pay upon acceptance. Address contributions to Editor, ADVENTURE IN THE AIR DEPARTMENT, 9 East 40th Street, New York City.

### My First S O S Call

TO hear a call for help and to participate in a rescue is ever the high-water mark of adventure—and of service—that spurs the radio operator's ambitions. If the explanation offered in the writer's last paragraph is correct, the Editor can only agree that some one perpetrated a trick several fathoms low.

A commercial radio operator on his first trip to sea starts out with a feeling of responsibility that gradually wears off as day after day and week after week passes by without a thrill. Before we entered the war I knew many operators who had been several years at sea without so much as hearing a single distress call.

My own first assignment was on one of the few ship stations that was then equipped with an arc transmitter. The first operator had gone below to turn in, after showing me how to work the controls. The ship had passed Ambrose Light into a rather stormy sea and the air was full of radio traffic of the busy harbor. To pass away the time I began to familiarize myself with the equipment by "tuning in" various stations.

I had been on watch about ten minutes when I was suddenly startled by the strong signal:

"S O S, S O S, S O S."

It was piped in a shrill key; from the strength of the signal, I concluded the ship must be close by. The signals stopped without any signature to reveal the identity of the sender.

I replied at once with a "QRA?" (meaning, "What ship is that?") and signed my call briefly. On listening in again, I found the air full of calls; all the stations and ships

in the harbor were responding in an effort to locate the vessel. After half a minute there was silence again.

The S O S was repeated several times. I recognized the characteristic note of a German Telefunken quenched gap transmitter. But there was no signature. For several hours the Navy Yard station, revenue cutters and coast stations tried to learn the identity of the ship, but no reply was received and my visions of assisting in a thrilling rescue as my debut into commercial radio gradually vanished.

The source of the message was never traced, but not many weeks later our coast was visited by German submarines. The consensus among shipping men was that we were the victims of a practical joke on the part of the operator on one of the submarines that was making a trial trip prior to the visit of the U-53 at Newport.

EDGAR H. FELIX

### A Well-Preserved Old Passenger

IF the following adventure has been sent in by anyone with a less extensive experience as a radio operator at sea than the writer is known to have had, the Editor might have concluded that it emanated from the substance on which the point of the story is based.

It was the first voyage I had ever made South, and I wasn't quite used to the static interference that causes so much trouble for radio in those waters. We were on our way to Porto Rico, when we passed the passenger ship *Philadelphia* on her way back to New York. Among her distinguished passengers was an eminent citizen of San Juan, who

had been in bad health and was on his way to see a specialist in New York. He passed away while the ship was at sea, however, and the operator on the *Philadelphia* called upon me to relay certain traffic for him to and from San Juan, as he could no longer work through direct, being out of range.

I passed the first message along all right—requesting relatives to advise concerning disposal of the late passenger's remains. I got into hot water, however, when I relayed the reply to the inquiry. The static had started up pretty bad and burst after burst filled the air with such a racket that it was almost impossible for me to read the message that the big station at San Juan was sending me. I struggled with it bravely, and finally got all but part of one word. Even though I had the operator repeat it several times, as luck would have it a burst of static would always drown out that one word, along with a few others. Finally I evolved this:

*"Funeral in New York. Preserve Body  
in —me."*

This incomplete line brought up visions of my school days, when I was regaled with glass bottles containing snakes and other creatures preserved in alcohol. It occurred to me, therefore, that the mutilated word must be WINE, which in those days had plenty of good alcohol in its composition. So, jumping at this conclusion, I gave an O. K. for the message and passed it along. As a result, the late passenger finished his journey in a state of splendor seldom enjoyed these days except beyond the three-mile limit.

It later developed—when I was called on the carpet to explain my message—that the word should have been "brine."

DAVID LAY

## Curing a Patient by Radio

UNTIL a device is invented that will enable the doctor to look at the patient's tongue and feel his pulse—and collect his bill—by radio, professional calls like the following will have to be charged up to profit and loss:

Dr. Maeth, who was Chief Surgeon, the Second Mate and Smith, one of my assistants, had finally prevailed upon me to join them in a little game of poker. There was very little doing in the air at the time, so I accepted—keeping the 'phones on my ears so that I wouldn't miss anything of importance.

The old *Susquehanna* was rolling over on her beam ends and the wintry Nor'wester was humming a tune through the rigging overhead. We were a week out and had another week yet to go. Coal was poor, weather bad and we were making slow

going of it across the North Atlantic on our way to Bremen.

Maeth won the first two pots and was dealing the third hand when I heard some ship start right off with a "QST." I began to forget the game and copied what he was saying. The message ran:

*"Any ship around which has a doctor on board please answer."*

He signed off "GKL."

Automatically I touched the button which started up my motor-generator, and answered him:

*"GKL DE KOLN. This is the SS. Susquehanna. We have two doctors. What can we do for you?"*

Promptly he replied:

*"SS. Hartlepool; Chief Engineer seriously ill, now unconscious, temperature 103; had severe stomach pains."*

"Stand by," I flashed him, and I turned to the doctor. "Here's a case for you," I said as I passed him the yellow scratch paper with the message pencilled across it. His brow knitted.

"Find out what he's been eating," he suggested.

*"Canned salmon,"* came the answer. *"Gave us all indigestion."*

"Sounds like ptomaine poisoning," said Maeth, as he wrote something on the back of the paper I handed him. "Here, send them these directions."

It was less than an hour afterward when the *Hartlepool* called me again.

*"Patient greatly relieved and resting quietly. Very grateful."*

"Doc," said the Second Mate, "your practice takes you all over the North Atlantic, but when are you going to collect your bill for services rendered like that?"

"That's all right; he collects from me," I said, as I pushed across a fat pile of chips, just as I had done before several times during the evening.

E. JAY QUINBY

## An Unintentional Broadcast

ONE of the dangers of carrying on a radio conversation—and a danger that every operator overlooks at least once in his experience—is that of being overheard. No one who communicates by the air route can know just how many eavesdroppers are listening in on him.

When I first installed my set in my house in Jersey I gradually began to get acquainted with the other amateurs in my neighborhood whose instruments came within range of mine. In the course of a few weeks I could recognize the "voices"

of the different transmitters, and pick out from the medley of communications in the air the distinguishing sounds of the various "sets." In this way I picked up a radio acquaintance with 2AKO, who lived a few miles away, and with whom I began to exchange the usual amateur's greetings. As the radio acquaintance grew we expressed the mutual desire to meet personally, and 2AKO invited me to drop in—offering as a bribe some refreshments that included a drop or two of liquid that he had been guarding since pre-Volstead days for special occasions.

Plans for the party were described in detail by radio, the exact location of the house was specified, as well as the methods of reaching it, and a day and hour was set. Indeed, we anticipated every detail except one; we did not realize how many amateurs were listening in on our plans.

On the night of the party seventeen uninvited but interested amateurs showed up!

WILLIAM A. MACKAY

### A Radio Message That Saved My General

**E**VERY man who served in the famous Radio Section of the A. E. F. met with enough adventure to fill a book. Here is one that comes from a former officer of the Signal Corps:

One of the most exciting of my experiences as Division Radio Officer of the Eighth Division occurred in the St. Mihiel sector, when a radio message saved the Division Headquarters and staff from instant death.

Our second day's advance found the Division Headquarters established in an old church in the town of Bouillonville. This town had been vacated only that morning by the Germans, who had been there for the past four years; consequently it was well fortified with dug-outs and bomb-proof shelters. I had the Division radio station established in what was left of an old German battalion headquarters' dug-out, under the brow of a hill facing a small creek.

Fritz had been throwing high explosives over all day, but they did little damage, as our aero squadron had been so active in keeping the German fire control plane away that the enemy could not determine the effectiveness of his fire.

Orders had just been received covering the objective for the next day. I took my map and a copy of the field orders to the radio office to plan out the movements of my radio company, as we had two electric lights there. I had just entered the dug-out when the radio operator on duty remarked:

"Captain, have you noticed that those

shells are coming closer and closer each time?"

"No," I answered.

"Would the captain listen in and see what he makes out of this German plane, which has been sending the same code letters over and over for the last ten minutes?" he inquired.

I took the receivers. I heard the German fire-control plane sending "XZ8945" over after each shell exploded. It came to me like a flash that he was giving out coordinates or in some way directing the big gun. I copied the code and hastened to the Chief of Staff and told him my theory. While I was talking with him the General came out of the hole where he was trying to get some sleep. When I had explained my suspicions he exclaimed:

"By George, I believe you are right."

He immediately issued orders for every man to seek the large bomb-proof shelter under the church.

It was probably twenty minutes afterward when Fritz planted a shell fair and square through the room where the Division Staff had been.

The General was profuse in his thanks. And well he might have been, for the wireless had saved his life.

CAPT. C. O. VAN DER VORT

### "73"

**F**EW tales of shipwreck carry with them the spirit of that indomitable heroism that laughs at death as does the true story of the sinking early in March of the little Norwegian freighter *Grontoft*, with twenty-eight men aboard, including "a gallant wireless operator, name unknown." The *New York Tribune* thus reports his passing:

Until 10 a. m. March 2, he was an undistinguished member of that adventurous company of youths who perch on heaving hurricane decks the world around with receivers clamped to their heads, while their jests and gossip ride the ether waves. His body, with those of the nineteen others aboard the *Grontoft*, has an unmarked grave about 700 miles off Cape Race, but while the wireless hears tidings of tragedy and heroism across the seas his name will be remembered by the craft and the manner of his death.

One of the fiercest gales of a ferocious winter was lashing the Atlantic, burying mighty liners beneath mountains of water. The *Esthonia* was laboring westward toward Cape Race, still 700 miles away. At 10 a. m. Edward Hanson, braced at his table in

the wireless operator's quarters, caught an S O S.

It was from the *Grontoft*, bound from Norfolk to Esbjerg, now unmanageable and at the mercy of the storm. The call for help was sent in stereotyped form and included, as regulations require, the position of the *Grontoft*, which was forty-eight miles north-east of the *Esthonia*, almost in the wind's eye.

When he reached the end of the form message the *Grontoft's* operator kept right on talking, however, starting a series of Homeric pleasantries which may still be dimpling the ether of interstellar space with their ripples.

"God pity the boys at sea such a night as this," quoth the dauntless operator of the floundering freighter. "The old man thinks it might breeze up by night."

He paused, and above the gale the ether pulsed to the swift response of Hanson that the message had been received. Hanson flung the receiver on the table and notified Captain Hans Jorgenson of the S O S. The Cunard-Anchor liner *Cameronia* also had picked it up, but the *Cameronia* was 200 miles away and had just been swept from bow to stern by the biggest wave its skipper, Captain Blakie, had seen in thirty-five years at sea. He said, when his ship got in that it was forty feet high and about 300 feet from slope to slope.

It was up to the *Esthonia*, and Captain Jorgenson did not hesitate, although it seemed a sheer impossibility to come about in such a storm.

"Tell him that we are on the way to help him," said Captain Jorgenson to Hanson.

The operator did so. At the rate the *Esthonia* had been traveling, it should reach the vicinity of the *Grontoft* about 4 p. m., but four miles was all the staggering steamship could make in the first hour on the new course. The engines were driving ahead under forced draft, but the wind and waves exerted tremendous pressure and at intervals the screw was hoisted clear of the water while the vessel trembled and lost headway.

Another S O S was received from the *Grontoft* at 11 o'clock. When he had sent it, the freighter's wireless operator remarked to the universe:

"Well, the steward is making sandwiches for the lifeboats. Looks like we were going on a picnic."

This is in the face of a storm in which no small boat could survive five minutes, even if it reached the water right side up!

The *Esthonia* drove on at a better pace now and Hanson sent an encouraging message to the operator of the *Grontoft*. At 11:30 the skipper of that doomed vessel having other things than the wireless to occupy his mind, his operator took up the conversation on his own hook.

"The old wagon has a list like a run-down heel," he confided to Hanson with the utmost cheerfulness. "This is no weather to be out without an umbrella."

"Hold on; we'll be alongside soon," was the rejoinder of Hanson, who was unable to view the situation with the equanimity of his conferee.

Silence settled down in the ether except for occasional mutterings from far-off operators, who gave astounding statistics as to the height and breadth of waves they had observed and wanted Hanson to tell them what his square-headed skipper thought he could do in such a sea if he did find the *Grontoft*.

Hanson was in no mood for such comments, and made no answer. He was waiting for the next message from the blithe lad on the upper deck of the *Grontoft*. It came at 12.10, dictated by the captain of the freighter.

"We are sinking stern first," it ran. "The decks are wash. The boats are smashed. Can't hold out any longer."

The man who sent it seemed to feel that it was slightly out of tune. He wished to make it clear that it was the skipper's message, not his.

"The skipper dictated that," said he to Hanson. "He ought to know."

"Where did I put my hat? Sorry we couldn't wait for you. Pressing business elsewhere. Skoal!"

That was the end. The operator, alone in his deckhouse, and his fellows, clinging to the rails or the derrick mast, at the wheel or fleeing from the flooded depths of the engine room, went to the pressing business—elsewhere.

## WILL WE TALK TO THE DEAD BY RADIO?

*Will science find a way to open a line of communication with the Other World? To find the answer to these questions, Dr. Hereward Carrington, the famous investigator of psychic phenomena, is conducting a remarkable series of experiments. He will describe the nature and purpose of these investigations in a two-part article, beginning in the next number of*  
POPULAR RADIO—June.



## WHAT READERS ASK



*THIS department is conducted for the benefit of our readers who want expert help in unravelling the innumerable kinks that puzzle the amateur who installs and operates his own radio apparatus. If the mechanism of your equipment bothers you—if you believe that you are not getting the best results from it—ask THE TECHNICAL EDITOR.*

**QUESTION:** What is the meaning of the "73" that I hear the amateurs signal to each other just before they finish their conversations on their small wireless telephones? It has always been a mystery to me.

R. N. JENKINS

**ANSWER:** The signal "73" is an abbreviation which is a remnant of the old Morse telegraph days; it stands for "best regards." The amateurs still use it.

**QUESTION:** The owner of my house has refused to let me put up an aerial on the property but I have an attic 25 feet by 40 feet and I am wondering if I would get any results if I put up an indoor aerial in it. I am only five miles from one of the large broadcasting stations and that is all I care about hearing.

E. A. S.

**ANSWER:** You should expect to have very fair results with an indoor antenna constructed as suggested below, provided you use an audion receiver.

Run your antenna lead in up through the house from the place where your instruments are to be set. Starting from the floor of the attic, run the antenna wire spirally up around the walls and tack on to the wooden rafters of the walls and roof until about 200 feet of wire has been strung up. Use the water pipe for a ground and you will hear the broadcasting stations distinctly at the distance you specify.

**QUESTION:** Will I be able to hear Pittsburgh from New York with a fifteen dollar receiving set?

R. B. BERGMAN

**ANSWER:** No. If you wish to hear Pittsburgh from New York City you will have to obtain a

more sensitive receiver than can be purchased for the price you mention. Such a set would cost you at least \$150, complete.

**QUESTION:** Which is the more efficient, a two slide tuner or a loose coupler?

JOS. TAYLOR

**ANSWER:** The loose coupler will be more selective than the tuner but there are newer types of tuning instruments on the market that are better than the loose coupler. One type is known as the variocoupler, and has only two adjustments to make, as against three with the loose coupler. It is also much more selective than the loose coupler.

**QUESTION:** What is the law governing the licensing of amateur wireless stations? I want to erect a receiving set to hear the wireless telephone broadcasting that I understand is being done so extensively.

THOS. DUNN

**ANSWER:** The Department of Commerce requires all individuals who own their own sending sets to be licensed; this means that an amateur who wants to operate a transmitting station must first get an operator's license. To obtain this he is required to take an examination in radio theory and be able to transmit and receive messages at the rate of ten words a minute in the Continental Morse code. This examination is conducted by the radio inspector for the district.

After obtaining the operator's license, station license blanks will be sent to the applicant to fill out. On these the applicant must outline the general plan of his station and size of his antenna, the power used for transmitting and other details; if the apparatus is such as to conform with the limitations of the government in regard to sharpness of emitted wave, power and other considerations, the radio inspector will issue a station license, and government station call letters will then be assigned to the station for the owner's private

use. This call is then entered in the government call book under the owner's name. No license is required where the station is to be erected for receiving purposes only.

**QUESTION:** Will I be able to receive with a loop antenna with a crystal detector set?

M. TIBBEN

**ANSWER:** No. You will require two or three stages of amplification in order to increase the weak signals that are received when using a loop antenna.

**QUESTION:** Will you give me a hook-up for a receiving set that employs honeycomb coils, which will enable me to receive the European high powered stations. What size honeycomb coils will be the best to use?

**ANSWER:** The diagram, Figure 1, answers your first question. A and G are the antenna and ground; L1 and L2 are honeycomb coils, size L-750; L3 is a larger honeycomb coil, size L-1000, which is used for the tickler. C1 and C2 are rotary variable air condensers of .001 microfarads capacity, and C3 is a fixed grid condenser of .0005 microfarads capacity. R1 is a one megohm grid leak resistance which is connected in parallel with the condenser C3. R2 is a 5 ohm rheostat, for adjusting filament current.

To operate the set, first adjust the filament to proper brilliancy, then place the three honeycomb coils in as close inductive relation as possible. Adjust C1 to maximum capacity and vary C2 until the desired signals are picked up. The signal can then be increased to maximum intensity by slowly varying the coupling between coils and by retuning with condensers C1 and C2.

This circuit is known as the three-coil tickler feed back circuit, and with it it is possible to hear distinctly the foreign high-

powered stations at a distance of 5000 miles, if a good antenna is used.

**QUESTION:** I am situated midway between two broadcasting stations to which I listen every evening. When these two stations are both transmitting music I hear an extremely high-pitched whistle going continuously; when either of them stops the whistle ceases. Both stations are listed in the newspapers as transmitting on a wave length of 360 meters. Is there something wrong with my receiver or is this some unexplained electrical phenomena?

**ANSWER:** This effect has been reported by many listeners to broadcasting stations that transmit on approximately the same wave lengths. The trouble is not in your receiving set. All modern broadcasting stations now use the vacuum tube oscillator for generating the extremely high frequency currents that are used in radio telephony. The frequency of these currents lies above the frequency that the human ear can detect; that is why we hear nothing when the music stops although the radio wave is still being sent out. When two stations are generating two sets of currents of nearly the same frequency, the two currents interfere with each other and produce the peculiar whistle that you hear in the receivers. At present there has been suggested no remedy for this phenomenon except to change the wave length of one of the transmitting stations.

**QUESTION:** I have a one-half kilowatt spark transmitter with a rotary gap; my aerial consists of four wires 90 feet long with a space of 2 feet between the wires, and a lead in 60 feet long. I have been told that my wave length is over 250 meters. I have tried every way that I could think of to cut down my wave

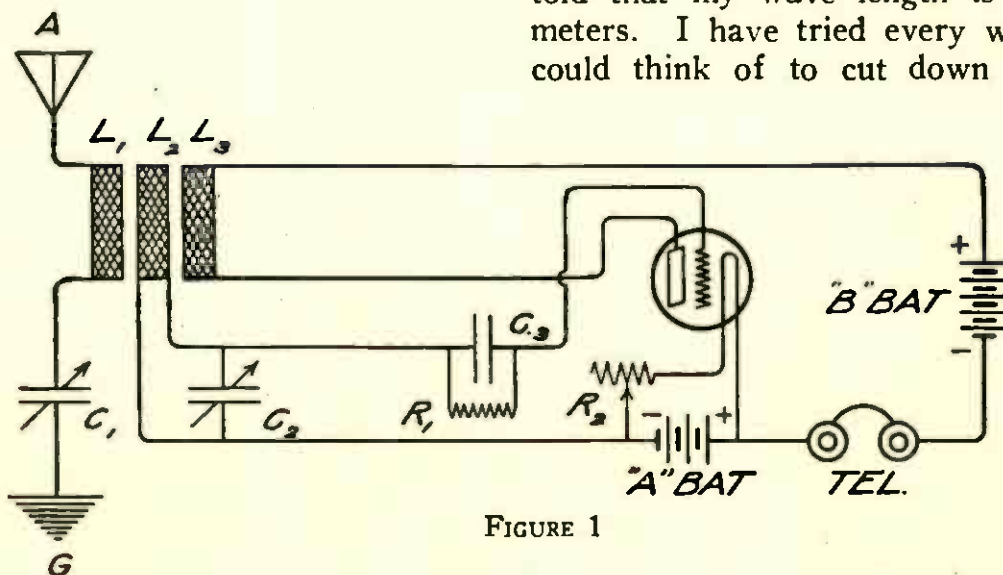

FIGURE 1



length to 200 metres, but cannot do so. Will you advise me?

ANSWER: There are two ways for you to cut down your wave length.

*First:* Decrease the size of your antenna to 60 feet by cutting off 30 feet on the farthest end from the lead in. This will cut your wave down to the required wave length of 200 metres. This is the more efficient method.

*Second:* If you do not want to change your present antenna you may insert a glass plate condenser in series with your ground lead. The condenser may be made by coating a piece of ordinary window glass, 8 inches square, with two pieces of tinfoil, six inches square, one on each side of the glass. This will leave a border of uncovered glass one inch in width around the edges of the plate. The pieces of tinfoil should be connected, one to the antenna and the other to the ground lead.

QUESTION: I have a Baldwin vario-coupler and two variometers, and I would like to get the best circuit to use them with an audion detector. How can I do it?

J. GERSTEDT

ANSWER: The diagram of connections is given in Figure 2. This circuit is very efficient, and will give you good results for radio telephone reception.

QUESTION: What size of aerial should I use to receive the music sent out from such a broadcasting station as that at Newark? What size of wire should I use?

L. T. NEWTON

ANSWER: You will get the best results if you string a single wire antenna with a horizontal length of 100 feet, as high as possible and free from obstruction, from the direction you wish to receive. A No. 14 bare copper wire will be

sufficient. Of course the antenna should be strung on insulators.

QUESTION: Will a pair of telephone receivers like those used by the telephone linemen work on a wireless set? I have received telegraphic signals with them faintly, but can get no telephone signals. My set is a home-made one.

OSCAR STEELE

ANSWER: Such telephone receivers will not work efficiently as they are not sufficiently sensitive. For radio work the receivers should be of at least 2000 to 3000 ohms resistance, whereas the telephone receivers are only of 75 ohms resistance.

QUESTION: I have just purchased for my son a complete wireless telephone sender, which was installed by an expert. Could you tell us how to keep it in running order?

ANSWER: Here are a few points to remember in caring for a motor-generator:

1. Keep the bearings well oiled. There are oil or grease cups on every bearing and these should be filled regularly.
2. Be sure that the brushes on the commutator fit evenly. When the brushes wear down, replace them. The end of the new brush should be shaped with a file or sandpaper to fit the curve of the commutator so that a good connection will be insured on the commutator, and no sparking will result.
3. Keep the motor-generator free from dust, grease and moisture.
4. See that all connections are kept tight.
5. Keep the commutator cleaned and polished. Start the motor and clean with fine sandpaper while the motor is running. Polish the commutator in the same manner with a piece of coarse canvas. It is well to remember not to place the hands on the generator terminals, while doing this job, as a serious shock may be sustained by the person doing so.

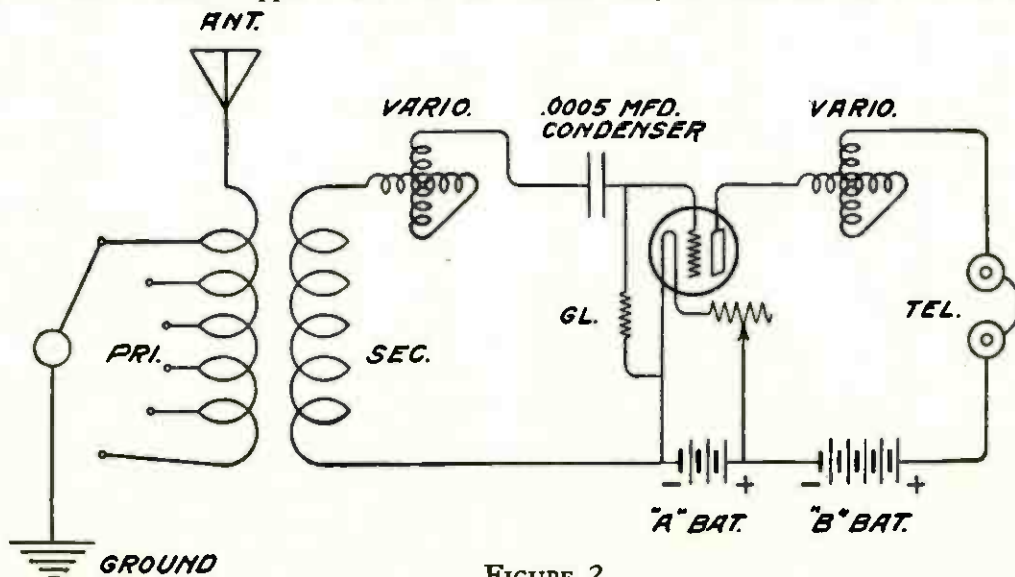

FIGURE 2



ITEMS of general interest that you ought to know; bits of information of practical usefulness to every radio amateur

## What *the* Radio Conference at Washington Did

NOT a plaything, a novelty, or a toy, but a "new addition to our national life." As radio is springing out of youth into manhood, the tentative recommendations of the radio experts who were called into conference by Secretary of Commerce Hoover, seem to assure the public that the quoted hope of Secretary Hoover expressed at the opening of the conference will come true.

It is the public and the Government who will have first rights on the roads of the ether. In essence, the conference believes that the present laws, grown inadequate, should be changed so as to give the Government, acting through the Secretary of Commerce, practically complete control over all radio transmitting stations. There are to be practically no restrictions on the receiving end of radio. Anyone may use his ears all he wishes; those who do the talking will be strictly regulated for the benefit of the public. Radio is a public utility, say the experts. It should be controlled. And the conference has seen the ease of controlling an industry before it has gotten too old and hide-bound in its ways.

The lines of communication in the ether have been re-allotted. There are now only two officially authorized broadcasting wave lengths, 360 and 485 meters, although, of course, many more are being

used. The conference has created four classes of radio broadcastings:

1. Government broadcasting by federal departments.
2. Public broadcasting by states, universities, and others disseminating informational or educational service.
3. Private broadcasting by stores, newspapers, companies and others who will distribute news, entertainment or other service.
4. Toll broadcasting by a public service radio telephone company as a paid service.

Large wave bands for broadcasting have been set aside so that the ordinary person may have the legitimate pleasure of eavesdropping on many kinds of radio telephoning. In order to do this it has been necessary to invade a large band of wavelengths formerly made sacred to military use by national law and international convention, those from 600 to 1,600 meters. Governmental broadcasting has been allotted two large wavebands, 1,050 to 1,500 meters and 1,850 to 2,050 meters, and public broadcasting allowed in the lower band. Private broadcasting, such as now sent out from Newark, Pittsburgh, Chicago and other such stations, will be permitted in a band from 310 to 435 meters, and toll broadcasting will also share this space in the ether. For a time, however, public broadcasting will be allowed in these limits.

By setting aside the waves from 275 to 285 meters for city and state public safety,

the experts of the conference look forward to a time when the news of a crime, a disaster or a happier matter of civic interest will be paged throughout a city from municipal headquarters with little delay.

The wavelengths now used by ships at sea in communicating with land, those used by aircraft, the bands utilized by fixed stations in different parts of the country for commercial point to point communication, and those used by radio beacon and radio compass stations to warn vessels of danger, are not essentially changed by the conference.

Within the various bands of wavelengths, certain waves will be assigned by the Secretary of Commerce for the particular use of certain stations. However, each transmitting station is to be limited in its power so that its normal range will have an average value of: For government broadcasting, 600 miles, for public broadcasting, 250 miles, for private and toll broadcasting, 50 miles. The same wavelengths will be used again if stations are further apart than about three times their normal range. In addition to these methods of preventing interference, the hours of operation of stations may be limited in districts of congested ether, and finally there will come a time when in certain crowded parts of the country, no more transmitting stations will be allowed.

No billboards, advertisements and cards of the ether will be allowed. The advertising done by radio will be limited to a mere aerial nameplate. "The concert tonight is with the compliments of Smith and Brown, Station XYZ." The experts evidently believe that the ether space is too valuable to use on matter that may not interest everyone.

A new profession is seen in the radio future, that of ether policemen. Of course, the radio inspectors that we now have are the forerunners of this new brand of law majesty. The ether cop will sit contentedly listening in on the rest of the wireless world. If the transmitting stations break the ether law, the ether cop

will run them down with direction finder and wave meter.

Within the band of wavelengths 150 to 275 meters, the amateur will be in control. True, the grant to him is somewhat like those given by kings of old when a group of their subjects took a new land by conquest and occupation. Not only will the amateur have this band, exclusive from 150 to 200 meters, and shared with technical and training schools from 200 to 275 meters, but the conference recommends that the amateurs do their own policing through such organizations as the American Radio Relay League and radio clubs. The band of amateur wavelengths will be divided into bands according to the method of transmission, damped wave stations being assigned the band of lowest wavelengths, interrupted or modulated continuous wave radio telegraph stations the next band, radio telephone stations the next band, and finally unmodulated continuous wave radio telegraph stations the highest band of wavelengths. It was recommended that amateurs be permitted to carry on broadcasting within the wavelengths band assigned by the Secretary of Commerce to amateur radio telephony.

In their relaying activities the amateurs will be able to span such natural barriers as mountains and lakes by special use of 310 meters.

Improvement in the science of radio is looked forward to in the report of the conference. Throughout there are provisions for adapting usage to the advances that are sure to come.

"The types of radio apparatus most effective in reducing interference should be made freely available to the public without restriction" is a major recommendation. The experts urge that the Secretary of Commerce have power to prohibit the use of existing radio transmitting apparatus and methods that result in unnecessary interference, provided that such action should not be taken unless more satisfactory apparatus and methods are commercially available at reasonable

prices and until an adequate time interval is allowed for the substitution of the more satisfactory apparatus. Receiving apparatus that set up radiations that interfere would also be prohibited.

Recognizing that radio interference hampers the use of this public utility, the conference mapped a large investigative program for the Bureau of Standards. In addition to studying the relation between range and power of stations and the best geographical distribution of transmitting stations, the Bureau of Standards was asked to give special attention to:

1. The reduction of the rate of building up of oscillations in radiating systems.
2. The reduction of harmonics in continuous wave transmitters and of irregularities of oscillation.
3. The comparison of the variable amplitude method with the variable frequency method of continuous wave telegraphy.
4. The preferable methods of telephone modulation to avoid changes in the frequency of oscillation.
5. The proper circuit arrangements of regenerative receivers to avoid radiation of energy.
6. The use of highly selective receiving apparatus, including a list of approved forms.
7. The use of receiving coil aerials instead of antennas, with special reference to high selectivity.
8. The reduction of interference with radio communication of other electrical processes, such as the operation of X-ray apparatus and electrical precipitation.
9. The study and standardization of wave meters.

A vision that extends beyond our continent attended the conference. Wavelengths, from 5,000 to 6,000 meters, were set aside for future transoceanic radio telephone experiments, and the conference suggested that when the time arrived for such tests, the Secretary of Commerce should endeavor to arrange with other countries for the use of that wave band for that purpose.

The recommendations of the conference are as yet tentative. They will undergo some slight revision before they become law. They look forward to the fulfilment of Mr. Hoover's statements made at the first session of the conference:

"We are today upon the threshold of a new means of widespread communication of in-

telligence that has the most profound importance from the point of view of public education and public welfare. The comparative cheapness with which receiving stations can be installed, and the fact that the genius of the American boy is equal to construction of such stations within the limits of his own savings, bid fair to make the possession of receiving sets almost universal in the American home.

"The wireless telephone has one definite field, and that is for spread of certain predetermined material of public interest from central stations. This material must be limited to news, to education, to entertainment, and the communication of such commercial matters as are of importance to large groups of the community at the same time."

W. D. D.

## President Harding Joins *the* Radio Fans

ON the occasion of the celebration of his first anniversary in the White House the President gave two demonstrations of the keen interest with which he is watching the progress of radio telephony in this country. Early in the day he sent a communication to the Senate requesting an additional appropriation of \$50,000 for an investigation by the Government in the field of wireless communications, and in the evening he attended the installation at the National Press Club in Washington of a radio telephone.

Although the President has been a member of the Press Club since he first came to Washington—in private life he is a newspaper man—and while in the Senate was accustomed to mingle there often with his colleagues of the press, the visit on the evening of March 4 was the first he had made since his inauguration.

The radio telephone at the National Press Club was installed under the direction of Mr. W. C. Horn, who explained the working of the radio telephone and gave a brief history of wireless communication. The National Press Club at Washington is said to be the first club in the United States to have a radio telephone of its own.

At the close of the demonstration the President was presented with a large frosted cake, bearing one lighted candle to mark his first Presidential anniversary.



International

### AN ELECTRIC LIGHT LAMP AS AN AERIAL

*Major Gen. George O. Squier demonstrates that broadcasts may be received into a room by way of the electric light circuits. But the amateur is advised to read the accompanying article before he tries this experiment himself.*

## Broadcasting Over Electric Light Circuits

**H**OW local radio telephone broadcasting may be done by means of wired wireless on an ordinary electric light circuit was demonstrated for the first time in the Office of the Chief Signal Officer of the Army on Friday, March 24, before officers of the corps, scientists and members of the press.

By this novel method the air is left clear for long distance communications. This new development in radio is believed by experts to promise a great utility by relieving the congestion in the ether due to the great number of broadcasting stations, particularly for local consumption. By purchasing an ordinary short wave radio receiving set anyone who is fortunate enough to have a direct current

electric lighting system in his house is within reach of local radio entertainment.

The demonstration included the receiving of news, music, and talks from a distant room in the Munitions Building, where a radio telephone transmitter (S. C. R. 67) was connected through an ordinary socket to the lighting circuit of the building. Music from a phonograph was transmitted to the 110 volt electric line through a standard microphone such as was developed during the war for aviators.

In General Squier's office a standard Westinghouse short-wave radio receiver was connected with the lamp socket on his desk; by merely pulling the cord, the General started and stopped the music. No head pieces and no extra wiring or antenna were used, as the sound came

from a loud-speaker on the wall near the set.

With receiving sets of similar type the entertainment could have been heard in any room of the large building. In a small town, or a large city with an overhead lighting system, anyone with a receiver could plug in and get the entertainment sent out by a central station.

All the work that was necessary to install the apparatus was to bring in the receiving apparatus, connect it to the ground, hang up the horn and screw an ordinary plug into the light fixture, just as an electrical flat iron is connected.

"Every home and every room in a hotel where there is an electric lamp can now keep in touch with the world," General Squier said.

There is no interference, no fading, and weather does not affect the broadcasting by this new method. The process is based upon General Squier's invention of "line radio" or "wired wireless" which he perfected some time ago and which permits the use of a line as a guide, although the messages go on wireless waves which follow the line. The turning of the switch, however, cuts the circuit and the sound ceases.

Future uses for the new invention suggest that a hotel can supply all of its guests with music from a sending station in the basement; a single orchestra can furnish music for the local playhouses and movies, and invalids at home or in nearby hospitals can get such entertainment as is furnished locally.

In the opinion of experts, this system could not be used over the large lighting cables in the city streets, as their electrical capacity is so great that it is believed it would take enormous currents at a very high wavelength to force the waves along the cables.

Amateurs are advised not to play with this new idea until they have more definite information on the subject than has been published as general news items by the daily papers, or there will continue to be "lights out" in certain radio homes.

## A New Radio Fog Signal

THE new lightship 105, destined for use at Diamond Shoal, off Cape Hatteras, has just passed her trials on the Hudson River. She is the largest and best-equipped light vessel in the world, according to a statement by the Lighthouse Service of the Department of Commerce, and is the first vessel of the service to carry a radio fog signaling apparatus, with the exception of the two installed on lightships off Fire Island and Ambrose Channel.

The 105 will replace the old light vessel 72, which was sunk by the guns of a German submarine on August 6, 1918. Besides a flashing light, she has three separate fog signals, a steam chime whistle, a submarine bell and the automatic radio fog signal. She is 147 feet in length over all and is a self-propelled oil burner.

The direction finding system consists of a distinctive radio signal of simple form, such as a series of dots or a combination of two dots on a 1000 meter wavelength. This signal, when picked up by a vessel, enables the master to point his radio compass in the exact direction of the signal, which he identifies, for example, as Ambrose Channel; then by picking up Sea Girt he can find his exact position by the intersection of the lines on his chart. No mathematics is necessary, and he can re-check his bearings by a third signal from another station.

By following the signal—that is, by keeping the coil aerial parallel to the direction of the signal and at its maximum sound—a due course on the point may be run. As the coil is revolved on a vertical spindle provided with a pointer, the sound diminishes, coming to a minimum when the coil is at right angles to the sound, then, with the aid of a graduated circle below the coil, the position of the coil with respect to a known direction is determined.

## HINTS FOR

## AMATEURS



Do not use any kind of paint on your radio apparatus.

\* \* \*

BE sure to keep the storage batteries for your radio set filled with distilled water. This will lengthen the life of your battery considerably, and keep it in good condition.

\* \* \*

A SENSITIVE spot on a crystal detector soon loses its sensitiveness. When your signals begin to weaken, find another spot, and when all the "spots" are worn out, buy another crystal and save yourself a whole lot of bother.

\* \* \*

Do not place the hands on the surface of the crystal which is used for a detector. Any dirt or foreign matter on its surface will interfere with its rectifying action. Keep your crystals clean by wrapping them with a piece of tissue paper and placing in a small box until ready to use.

\* \* \*

Do not try to "receive" during a thunder storm. Ground your antenna and sit back safe in the knowledge that a grounded antenna furnishes the best kind of lightning protection it is possible to obtain.

\* \* \*

Do not stand your storage battery on any expensive carpets or highly polished floors. If any of the liquid should bubble out and spill over, a nice big hole will be burnt in the floor. The liquid is a solution of sulphuric acid. Place a square piece of rubber sheeting underneath the storage battery.

Do not run your antenna across the street, as you will be violating a city ordinance, and make yourself subject to a fine.

\* \* \*

You can make a good vernier for your condensers and variometers by holding a pencil with the rubber end alongside the dial and revolving the pencil between your fingers. This will also cut down the capacity effect of your hands near the instruments.

\* \* \*

WHEN you see a blue glow in your tubes, it is a sure sign that you are using too much plate or "B" batteries on your tubes.

\* \* \*

ONE way to use a loop antenna is to shunt the loop with a variable condenser and connect one end of the loop to the grid of the detector tube and the other end of the loop to the filament circuit. All wavelength tuning will be done with the variable condenser, and directional tuning will be accomplished by revolving the loop. At least two stages of amplification should be used to get good results.

\* \* \*

NEARLY all amateurs like to tune in signals and music as loud as possible. This is not always desirable; we should learn to tune in the music and speech for quality. When we tune in a powerful broadcasting station nearby, the signals usually are so strong that the music sounds like a thunder and lightning storm scrambled up with a barnyard scene and a jazz orchestra. If you are listening on

a two step amplifier, turn down on the resistances of the three vacuum tubes a little and see what a great improvement there is in the clarity of the music. At the same time you will be increasing the life of your tubes by not burning them so brightly. \* \* \*

JOIN a radio club. The amateurs of all districts band themselves together for mutual benefit; this is one of the reasons why the radio art has gone forward in the leaps and bounds that we are now witnessing. If you are a beginner, find out the name of the amateur organization that is nearest to you. Then go to one of the meetings; visitors are always welcome. You will find there a friendly gathering of fans who will help you with your problems. At the meetings of such clubs, matters of importance to the beginner are explained in lectures, new developments in radio are discussed, and instruments which have been made by the members are exhibited.

\* \* \*

ONE of the first problems that confronts the radio amateur is to construct his inductances or coils. When he comes to this stage he should bear the following pointers in mind:

He should use a material for the tube (on which the wire is to be wound), which will not absorb moisture; cardboard is not good for such use for this reason. Some amateurs coat the tube with shellac or varnish or sometimes impregnate the tube in melted parafine to make it waterproof; this removes the trouble from electrical leakage due to the presence of moisture, but it has the disadvantage of increasing the distributed capacity of the coil, which makes the set (of which the coil is a part), "tune" broadly.

The best type of material to use is known as Bakelite, Formica, Condensite-Celeron and under various other names. These substances are built up from a number of sheets of high-grade paper which have been vacuum dried and then

impregnated with a synthetic resin; they are then subjected to a heating process and at the same time moulded into the desired shapes at tremendous pressure.

The wire should be wound on the tube and fastened tight by applying seals of sealing wax to the ends of the wires. This holds the winding in place without any shellac or parafine, which is so dangerous to tuning efficiency.

The best kind of wire to use is a copper wire with a silken covering.

When actually mounting the coils, keep all magnetic materials, such as iron screws and iron brackets, as far away from the coils as possible, as these materials will choke back the extremely weak high-frequency currents which have been received and are trying to pass through the coils. \* \* \*

TAKE great care of your telephone receivers. They are very delicate, and should be handled carefully.

Do not let anyone unscrew the caps or push his fingers into the holes from which the sound issues, as he is liable to injure the diaphragm or the fine wires with which the magnets are connected inside the caps. Above all do not drop the receivers on the floor, as this will knock part of the magnetism out of the permanent magnets and thus weaken the strength of the received signals. Every knock or jolt decreases their sensitiveness.

The best way to keep the receivers is to hang them on a hook similar to a coat hook. This will prevent them being knocked off the table to the floor.

If the receivers are treated as carefully as a watch, they will last indefinitely.

\* \* \*

A ONE wire antenna will be suitable for use for receiving. String your wire as high as possible and away from obstructions. Point the antenna in the direction that you wish to receive from for the most efficient results. The end of the antenna at which the lead-in is brought in is the pointer end and should be directed at the transmitting station you wish to listen to most regularly.





*THIS department—conducted by a patent attorney of wide experience in radio work—will keep you in touch with the latest inventions of interest on which patent rights have been granted, and which are significant contributions to radio art.*

### Amplifying Apparatus

Patent No. 1,405,523: Marius C. A. Latour, Paris, France.

This invention relates to audions or vacuum tubes and to transformers associated therewith, and is so designed as to make the lamps more effective and to eliminate objectionable tube noises.

### Wireless Signalling

Patent, No. 1,406,857; Raymond A. Heising, East Orange, New Jersey.

This invention relates to combined transmitting and receiving apparatus in which the antenna or aerial may be connected readily to one apparatus or the other as desired, in order to transmit or receive. The invention also includes means to eliminate side tone in the receiver when the transmitting system is being operated; that is, to prevent signals sent out by the transmitter from actuating the receiving system at the same station.

Briefly, the invention covers a transmitter that has a generator or oscillator, a receiver having means to control the side tone and a key controlled relay for connecting the transmitter and disconnecting the receiver and vice-versa, and relays for controlling the oscillator and side tone device, all operated by the key.

### Radio Receiver

Patent, No. 1,407,205; Robert H. Marriott, Bremerton, Wash.

In the publication of the Institute of Radio Engineers Vol. III, No. 1, 1915, Al-

fred N. Goldsmith of the City College discussed stationary aperiodic frequency changers which comprise a transformer of a special design by which the frequency of a current passing through the same could be changed.

The inventor utilizes this device as an element of a combination for the purposes of eliminating static or the effects of atmospheric electrical disturbances upon a receiver.

Briefly, the invention comprises two receiving circuits, one of which is tuned to the desired wavelength or frequency, and the other of which is tuned to a frequency of one-half the desired wavelength. Owing to the aperiodic or damped character of the static impulses, both circuits receive or respond to such impulses. One circuit only, however, receives the desired signal impulses. By means of a frequency changer as above mentioned the frequency of the static oscillations or impulses in one circuit is made equal to the frequency of the static impulses in the other circuit and are opposed and neutralized, leaving only the useful or signal oscillations.

The inventor shows several forms of his device in his patent which, however, have not been illustrated owing to their technical character.

### Electric Wave Ranging System

Patent No. 1,406,996; Joseph B. Morrill, St. Louis, Mo. (See FIGURE 1.)

This invention relates to methods and means for determining the position of

an airplane or ship by means of radio. The position of any point in space may be determined by its distance from two known or fixed points. The difference of the two distances are determined in the present invention by observing the difference in time of arrival of energy, such as electric waves simultaneously transmitted from an airplane to the observing stations or vice-versa. This difference in arrival time multiplied by the velocity of the energy (which is known) gives the difference in distance. When the distance of an undetermined point from a fixed point differs from its distance from another fixed point by a definite amount, the undetermined point lies on a hyperbola which can be readily plotted with respect to the two fixed points. If another such hyperbola be determined by comparing the distance to one of these given points with that to a third given point, the intersection of the two hyperbolas determines the position of the undetermined point. The present invention, therefore, involves the transmission of electric waves of definite frequency, amplitude and phase relation to

or from three fixed or known stations from or to the point to be determined, and by suitable phase adjusting means determining the differences in distance between each of the fixed stations and the point to be determined. From the data thus obtained it is possible to plot the position of the point to be determined and thus find its location.

The above apparatus and method is especially serviceable in determining the location of ships and planes at night.

The diagram illustrates one embodiment of the invention when electric wave energy is transmitted from the point to be determined. The energy received at spaced stations A B C is detected in the ordinary manner by receivers D and the low frequency detected currents are conducted from stations A B C over lines  $L^3L^4L^5$  to apparatus N and receiver R. The electrical lengths of lines  $L^3L^4L^5$  must be known. The several energies are then brought into phase by phase retarding or adjusting means, which indicates the difference in time arrival of the several signals and hence the differences in length of several paths.

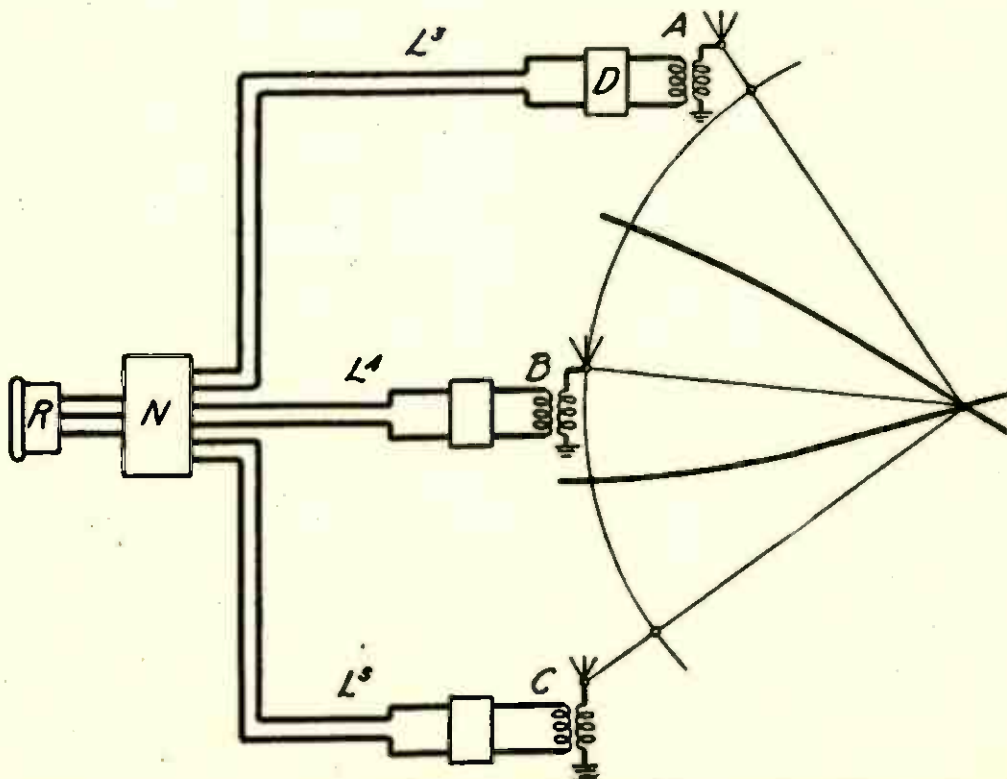

FIGURE 1. Diagram illustrating the method of determining by radio the position of an airplane or ship.

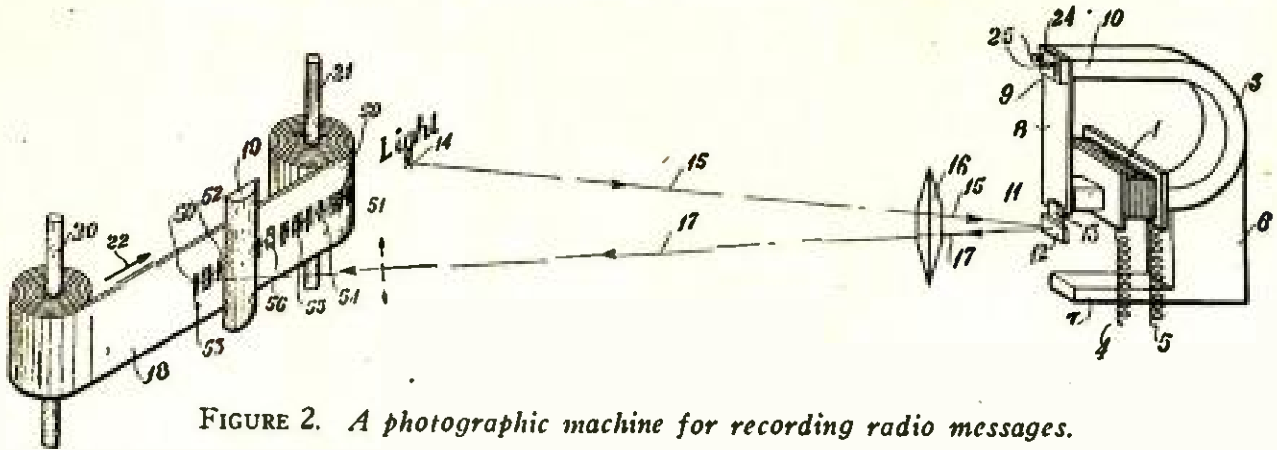

FIGURE 2. A photographic machine for recording radio messages.

### Photographic Receiving Apparatus

Patent No. 1,406,445; Charles A. Culver, Beloit, Wis. (See FIGURE 2.)

This invention relates to means for recording signals received by radio.

The apparatus illustrated in the drawing may be connected to any radio receiver, in lieu of the usual telephone, by means of the leads 4 and 5 of coil 1. The device may be used with damped wave receivers or with undamped wave receivers such as the heterodyne or beat receivers for making a permanent record of the received signal.

The coil, 1, is mounted upon one pole of the permanent magnet 3. A reed, 8, is secured at one end to the other pole of magnet 3 with its free end adjacent to the pole on which coil 1 is mounted. A mirror, 12, is suspended from the free end of reed 8 by means of a flexible strip, 13, the mirror having relatively high mass or inertia compared to the force required to flex strip 13. Reed 8 is preferably of thin, highly resilient material to provide very low damping force, and at least near its lower end must comprise magnetic material. A source of light, 14, is arranged to direct an incident ray of light, 15, on to the mirror, 12, through lens 16. The reflected ray, 17, is refracted through lens 16 on to a strip of sensitive photographic paper, 18. Upon reception of signal oscillations by the receiver, the reed 8 is mechanically vibrated in correspondence with the electrical oscillations which cause a deflection of the mirror and ray, 17, due to change of magnetic

flux between reed and magnet. The sensitive strip 18 is mounted on rolls which are driven by clockwork.

In order that reed 8 may be vibrated by or be in tune with the received electrical oscillations the period of the reed must be adjusted to be equal to the period of the electrical oscillations. The vibration rate of the reed is adjusted by varying its effective length by means of the clamping members, 24 and 25, and when its rate of vibration is of the order of the received electrical oscillations the reed responds to such oscillations. When beat reception is utilized the number of beats a second can be so adjusted as to be of the order of the rate of vibration of the reed.

A dot and dash record is indicated on the strip 18 in the diagram.

The inventor claims for the above device great sensitiveness by reason of the amplifying effect of the "beam of light pointer" and selectivity; that is, the device is not affected to any extent by static excitations.

### Radio Receiver

Patent No. 1,405,905; Francis W. Dunmore, Washington, D. C. (See FIGURE 3.)

This patent is unusual in that the public—meaning anyone—is at liberty to use the invention without payment of royalty; the specification states that "the invention described and claimed herein may be used by any other person in the United States without the payment of any royalty thereon." The application for this patent was filed by a government employee under the Act of March 3,

1883, without payment of fees, the invention being thus dedicated to the public, as it is called.

The invention relates to closed loop aeriels known as "direction finders" of "radio compasses" used to determine the location of a transmitter.

Such a loop differs from an open aerial or vertical antenna such as commonly used in connection with amateur and other reception in that while the open aerial will receive a signal originating from any point around the antenna, the loop receives a maximum signal when its plane lies in line with a given transmitter or at right angles to the wave front and receives not at all when arranged  $90^\circ$  from its position. Thus by swinging the loop until the maximum response is noted in the telephone or until the minimum response or "nul point" is noted, the direction of the distant transmitter may be accurately determined to within one or two degrees.

While the closed loop has, theoretically at least, a distinctly determinable maximum and minimum signal, nevertheless the loop, which has a vertical dimension and a capacity to ground, functions also as an open aerial or antenna; hence the combined signals received, because the loop acts both as an open and closed aerial, tend to blur or distort the maximum and minimum due to pure loop action making the apparatus less sensitive.

The closed loop requires no connection to ground in order to make it operative; it may be set up in a room, and with suitable amount of amplification, signals may be received even from European stations.

The invention of the Dunmore patent is intended to reduce the "antenna effect" and make the loop more sharply directive, that is, "to give a quieter, sharper and less distorted minimum."

For this purpose, he interposes between the loop, 1, and the audion receiver, 7, a transformer or coupling of special design. This transformer com-

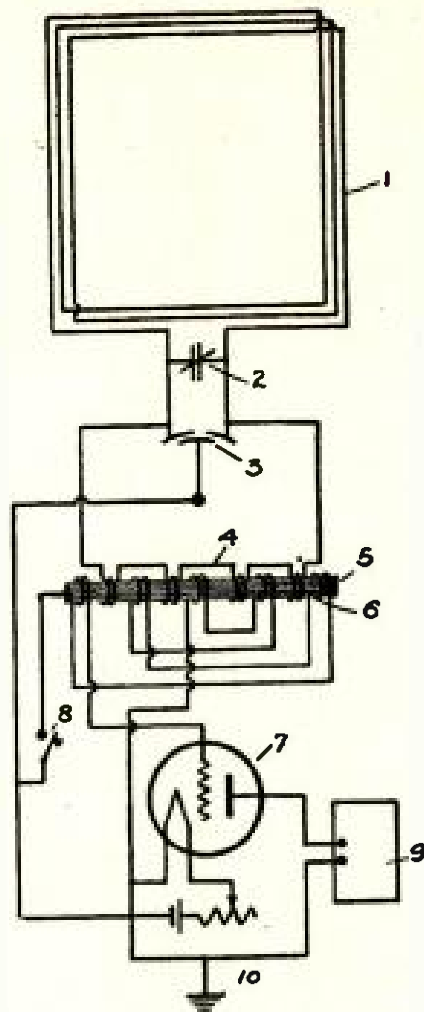

FIGURE 3. A new type of directional loop receiver.

prises a primary coil, 4, wound in one or more sections and connected across the tuning condenser, 2, which is interposed in series in the loop. The primary coil is wound on an iron core, 5, consisting of iron laminations about .001 inch thick. A secondary coil, 6, is wound in one or more sections between and alternating with the primary sections. The input terminals of an audion detector, 7, are connected in circuit with the secondary coil. The iron core and the cathode (the heated filament) of the tube have a common ground, 10. The core, 5, serves a two-fold purpose; first, to couple the loop, 1, to the detector or audion tube and distribute the capacity effect more evenly to ground; and, second, to partially bypass to earth through the core, disturbing influences such as motor and ignition noises. It should be noted that the connection of the secondary coil to

the heated filament of tube, 7, is taken centrally thereof while the end of the secondary is connected to the grid. The condenser, 3, is for the purpose of making the capacity to ground of the loop more nearly uniform along the lower edge, thereby improving the loop action.

### Receiving System

Patent No. 1,407,103; Frederick K. Vreeland, Montclair, New Jersey. (See FIGURE 4.)

Mr. Vreeland is well known as an important contributor to the development of beat reception.

The apparatus described in the above patent, however, although illustrated as of use in connection with beat reception, is of general application as with damped wave receivers.

The prime purpose of the invention is to eliminate or divert from the receiver aperiodic impulses due to static or atmospheric disturbances and even undesired signal impulses. Such aperiodic or highly damped impulses are capable of exciting oscillations in a tuned resonant circuit irrespective of its tuned frequency and cannot be eliminated by ordinary methods of tuning.

In a simple form the invention is illustrated in the diagram in which A is an antenna or aerial and B is a loading or tuning coil and E is a receiving circuit coupled to the collecting circuit by a transformer PS. The receiving circuit includes a detector D, which is shown as

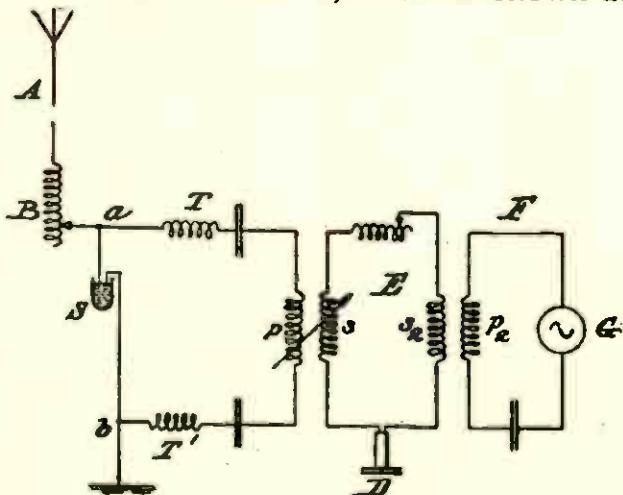

FIGURE 4. A circuit and apparatus for the prevention of radio interference from static and from nearby sending stations.

an electrostatic telephone. The electrostatic detector D is excited by a sustained oscillation of slightly different frequency from the sustained signal oscillation and produced by a local generator G coupled to the receiving circuit by a transformer  $P_2S_2$ . The connection between the receiving circuit E and the antenna A includes the "baffle elements" or coils T T<sup>1</sup> each of which is tuned to the desired signal frequency. An electrolytic cell or "intensity selective device," S, is connected to the system between the points a and b, constituting a by-pass with respect to the baffle elements and receiving circuit. By "intensity selective device" is meant a device which has the power of selectively discriminating between impulses of different intensities, i. e. of allowing the stronger impulses (such as static) to pass through it and preventing the passage of the weaker ones (such as the desired signals.)

In operating, therefore, powerful strays (static) picked up by the antenna are shunted through the device S to ground while the weaker signal impulses find free passage through the baffle elements T T<sup>1</sup> to the receiver and are superimposed on the local oscillations produced by generator G producing "beats."

The baffle elements T T<sup>1</sup> greatly increase the effectiveness of the by-pass S because of their frequency selective properties being tuned to the desired signal frequency. Hence the points a and b are points of small potential difference for signal frequencies but of relatively large potential differences for other frequencies or for aperiodic static impulses which thus tend more strongly to escape through by-pass S. The baffle elements T T<sup>1</sup> also prevent the oscillations generated by G from affecting S.

The electrolytic cell S may comprise small platinum electrodes in an acid or alkaline solution.

The inventor presents in his patent an interesting theory of the operation of the electrolytic cell to produce the results of the invention.

## RADIO INVENTIONS

**W**E shall be pleased to have you consult us with regard to patenting any new radio equipment which you may develop. Two members of our staff of attorneys, formerly with the Western Electric Company, specialize in patents relating to the radio art.

Office consultation particularly invited.

### MUNN & COMPANY

634 Woolworth Building . . . New York City  
Hanna Building . . . Cleveland, Ohio  
Tower Building . . . Chicago, Ill.  
Scientific American Bldg., Washington, D. C.  
Hobart Building . . . San Francisco, Calif.

## Noiseless Dependable Guaranteed



"B" Batteries for Vacuum Tubes

22½ to 105 Volts.

19 Sizes—Plain and Variable

### NOVO MANUFACTURING CO.

424 W. 33d St.  
New York

531 So. Dearborn St.  
Chicago

## SUCCESS INSURANCE FOR THE MAN WHO BUILDS HIS OWN

In the Laboratories of the General Apparatus Co., M. B. Sleeper, best known of radio writers, works out designs for wireless equipment so simple that it can be constructed in the kitchen table workshop, yet in appearance and operation equal to commercial apparatus.

These designs, with splendid photographs, scale drawings, and simple instructions are given in

### *Design of Modern Radio Receiving Sets Price 50c.*

Novice or experienced experimenter, you need this book. You must also have the guidance, for your constructional work, of the monthly articles in

### *Radio and Model Engineering*

Also edited by M. B. Sleeper, R. and M., at a dollar per year, is the least expensive way to assure yourself of a supply of new and practical ideas for building radio equipment of parts which can be bought from your local dealer or directly from

**The General Apparatus Co., Inc.**  
88-X Park Place, New York City

---

---

# Special Subscription Offer!

For a limited period only—until June 1, 1922—you can enter a trial subscription to POPULAR RADIO for

*EIGHT Months for Only \$1.00*

If you are a radio amateur; if you are *thinking* of becoming a radio amateur; if you have a receiving or sending set of your own or are planning to buy or borrow one; if you are contemplating the use of radio in your business or in your hours of recreation—you cannot afford to miss the next few numbers of

## Popular Radio

*A monthly magazine of practical helpfulness to the radio amateur, a magazine that tells of the latest uses of radio—the latest radio equipment—the newest inventions—the best methods of installing and maintaining radio equipment—the most significant accomplishments in the field of radio—the most important contributions to the radio art by the world's foremost scientists.*

☞ *Glance over this list of articles of practical value to the amateur—articles that cover subjects of live interest to everyone who owns a radio set—which will be found in the pages of this magazine during the next few issues:*

---

---

- 
- 
- |   |   |
|---|---|
| How to decrease the wavelength of your transmitting set | How to use your radio on your automobile                |
| How to adjust your crystal detector                     | How to solder your own connections                      |
| How to test your pair of telephone receivers            | How to select your radio equipment                      |
| How to test out a variable condenser for short circuits | How to read descriptive diagrams of installations       |
| How to receive high wavelength continuous wave signals  | How to tune a regenerating receiver                     |
| How to erect an antenna mast                            | How to qualify for a license for sending radio messages |
| How to make a loud speaker out of your phonograph       | How to make a simple crystal detector                   |
| How to make your own Tube Receiving set                 | How to build an audio frequency amplifier               |
| How to assemble your transmitting apparatus             | How to tune a transmitting set                          |
| How to keep up your storage batteries                   | How to build a radio telephone                          |
| How to prevent interference among receiving sets        | How to build a C. W. transmitter                        |
| How to build a pocket receiver                          | How to use a loop antenna                               |
| How to erect an aerial                                  | How to build a regenerative receiver                    |
| How to cut down static                                  | How to construct a radio frequency amplifier            |
| How to control machinery by radio                       | How to make wavemeters                                  |
| How to learn the code                                   | How to use a wavemeter                                  |
| How to construct a small radio set for traveling        | How to make a loose coupler                             |
|   | How to increase the wavelengths of a receiving set      |

*(Tear off this coupon here)*

COUPON GOOD UNTIL JUNE 1, 1922

POPULAR RADIO,  
9 East 40th Street, New York City

Date.....

Enclosed please find \$1.00 for which send me an eight months trial subscription in accordance with your special offer.

*(Please write your name clearly)*

NAME .....

ADDRESS .....

.....  
.....



# A PAGE WITH THE PUBLISHER

WITH this number which you hold in your hand—Volume 1, Number 1.—POPULAR RADIO makes its bow to the radio amateur.

The purpose of this magazine is two-fold:

*First*, to be of practical helpfulness to the amateur who owns or expects to own and maintain his own radio apparatus;

*Second*, to keep him informed concerning the latest and most important methods, equipment and applications of the radio art—an art that has seized the popular fancy with such amazing suddenness as to precipitate a development that promises to surpass anything in the history of science.

In the attainment of these purposes, I have obtained the services of some of the most capable radio experts and magazine makers in the country.

A glance at the preceding pages is evidence of the quality of the editorial fare with which our readers will be served.

The list of contributors to this and to the succeeding numbers is one of which any magazine, no matter how old or well established, may well be proud. It includes not only eminent scientists but world-famous writers. You know them—Hiram Percy Maxim, Nikola Tesla, Waldemar Kaempffert, Paul Godley, Dr. Henry Smith Williams, William G. Shepherd, Edwin E. Slosson, Dr. Lee De Forest, Fred C. Kelly, Homer Croy, Professor Michael Pupin, James H. Collins, Thomas A. Edison, Dr. E. E. Free, Donald Wilhelm, Will Irwin, Dr. Hereward Carrington, Edwin Bjorkman, Edwin H. Armstrong, Lincoln Stephens, T. C. Martin, Byron G. Eldred, to mention but a few.

POPULAR RADIO will be profusely illustrated with photographs, drawings and diagrams. The world is literally being scoured for pictures that convey useful and interesting information to the radio amateur.

In pursuance of our policy to serve the radio amateur, this magazine will carry the advertising only of responsible business firms whose products are known to be dependable.

Further, (and in pursuance of this policy I must depend upon the cooperation of the radio amateur himself), this magazine will take such steps as may be necessary to prevent unscrupulous manufacturers or dealers from foisting upon the market radio equipment that is fraudulent or that is sold under misrepresentations.

Readers are not only invited, but urged to notify POPULAR RADIO if any product advertised in these pages is not as represented.

In adhering to this policy, the publishers are prepared to act without fear or favor. *Popular Radio, Inc., is an independent publishing house, with no trade affiliations.*

To insure the maintenance of the high standards which the publishers have set, I have placed the editorial direction of this magazine in the hands of two men whom I here introduce to you—in case you do not already know them:

Kendall Banning, the Editor, is not only a magazine writer himself, but for several years was the Managing Editor of "System" and more recently of the "Cosmopolitan". During the war he served in the army for two years, first a major in the Signal Corps and later on the General Staff Corps—an honor attained by few reserve officers. He is now a Lieutenant-Colonel in the Signal Reserve Corps, and member of the Executive Council of the Amateur Radio Reserve of the Second Corps Area, United States Army, of which he was one of the founders.

Laurence M. Cockaday, the Technical Editor, is a member of the American Institute of Electrical Engineers, of the American Institute of Radio Engineers and of the American Association for the Advancement of Science; he is also an inventor of radio apparatus and the holder of a dozen or more patents. During the war he served the Navy as instructor in radio. He is, however, perhaps best known to the radio amateur as the owner of the famous 2 X K, one of the most active amateur stations in the country and the holder of that rare and coveted distinction—a certificate from the Department of Commerce that permits experimental work to be conducted with any apparatus on any wavelength.

Now glance through the preceding pages.

We originally intended to print 100,000 copies of this number. But when I looked over the advance proofs with our circulation manager and saw the character of the magazine, I changed my plans and we are printing 125,000 copies instead.

Do you not agree that it is a prodigal 15 cents worth?

*H. B. Emerson*

President, POPULAR RADIO, INC.

**RADIO FANS!**

**"Listen-In"**

at the first

**BOSTON  
RADIO EXPOSITION**

**Mechanics' Building**

**Boston, Mass.**

*May 3-4-5-6*

Dealers and Manufacturers  
Bring your reputation builders  
Space going rapidly—reserve yours now

*For floor plan and literature address*

**BOSTON RADIO EXPOSITION**

**60 State Street**

**Boston, Mass.**



## This WIRELESS Set *Works* Anywhere

IT'S an *ABC UNIT*, the set that comes to you ready-to-operate and complete in every detail. Phones, aerial equipment, in fact, every accessory item is included in the remarkably low price of \$35.00. This set is compact, handsome and portable. It will receive wireless telephone up to 35 miles and wireless telegraph much farther.

And later, when you want to add to your outfit, as you surely will, there are other *UNITS* that you can add on just like a sectional bookcase, without discarding a nickel's worth of your original equipment.

### Get a Copy of This Booklet

This *ABC* booklet, "How I Put Up a Complete Radio Station in Two Hours," is the true story of a young man with no previous radio or electrical experience whatever. 16 pages, 2 colors, packed with valuable and interesting information about wireless. You will be astonished to find how simple it is to get results with *ABC UNITS*. For you can easily duplicate this young man's experience.

Go to any of the dealers listed here for your copy of this booklet. At the same time, they will be glad to show you the actual *UNITS* themselves, and demonstrate their simplicity.

Or, send ten cents direct to us, and we will mail you a booklet at once. But be sure to act quickly, before the supply is exhausted. Request Booklet "K."

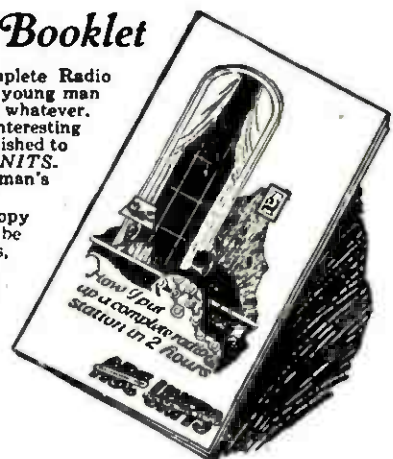

**JEWETT MANUFACTURING CORP.**  
Canadian Pacific Bldg., New York

**ABC UNITS**  
Standardized Radio Sectional Receiving