

Popular & Electricity Magazine

VAMPIRES
of the DEEP

October

15 cents

Books That Will Advance the Electrical Worker in Position and Pay

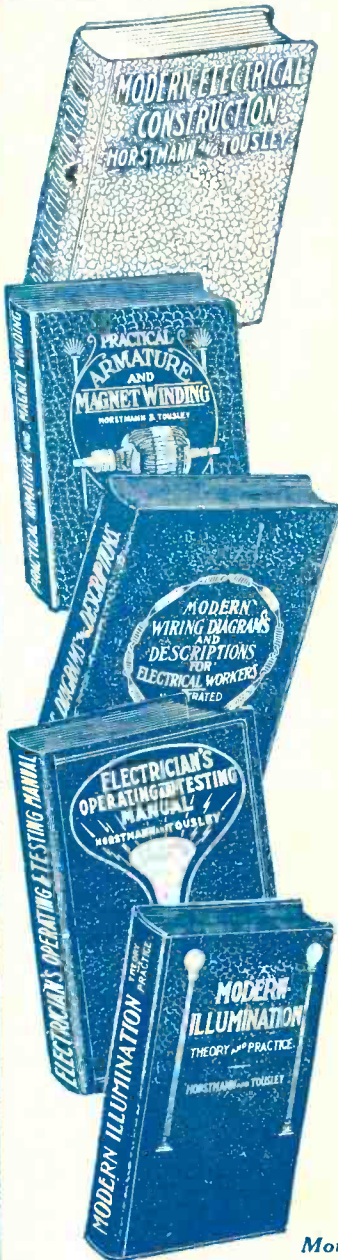

THE most practical collection of Books for the Electrical Worker ever published, having the highest endorsement of the INTERNATIONAL BROTHERHOOD OF ELECTRICAL WORKERS.

Don't overlook any opportunity of advancement through not being prepared for the job ahead. Help yourself now to books that will enable you to tackle anything in your line of work.

Modern Electrical Construction

By H. C. HORSTMAN and V. H. TOUSLEY.

This book treats almost entirely on practical electrical work. It uses the "Rules and Requirements of the National Board of Fire Underwriters" as a text, and explains by numerous illustrations and detailed explanation just how the best class of electrical work is installed.

It is a perfect guide for the beginning electrician and gives him all the theory needed in practical work in addition to full practical instructions.

340 Pages **PRICE \$1.50 POSTPAID**
173 Illustrations

Practical Armature and Magnet Winding

By H. C. HORSTMAN and V. H. TOUSLEY.

All practical armature windings are explained with special attention paid to details. All questions which are apt to arise in the minds of the electrician have been completely answered.

Numerous illustrations are shown, and these, taken in conjunction with the text, afford a ready means for either the study of the armature or as a book of reference. Various tables have been prepared especially for the work, and these will not only reduce to a minimum the number of calculations required, but lessen the possibility of errors.

The book is a most valuable aid to the electrician, either in the constructing or operating department.

231 Pages **PRICE \$1.50 POSTPAID**
Illustrated

Modern Wiring Diagrams and Descriptions

By H. C. HORSTMAN and V. H. TOUSLEY.

All elementary considerations have been omitted in this book to make room for "diagrams and descriptions" of just such character as workers require. Shows you how to wire for electric light and power, for call and alarm bells, for annunciators, burglar and fire alarms, telephone circuits, install and manage batteries, test circuits, locate "Trouble" and "Ring Out" circuits.

Gives all that ordinary electrical workers need and nothing that they do not need.

250 Pages **PRICE \$1.50 POSTPAID**
200 Illustrations

Electricians' Operating and Testing Manual

By H. C. HORSTMAN and V. H. TOUSLEY.

This book was written to instruct the practical electrical worker in the management, operation and testing of the more important electrical devices now in use. It is of particular value to a man in charge of a plant, as it will tell him how to install and operate all electrical devices, and what is more important, instruct how to readily locate and remedy any trouble that may occur.

The subject is covered thoroughly and it is all entirely practical.

360 Pages **PRICE \$1.50 POSTPAID**
Illustrated

Modern Illumination

By H. C. HORSTMAN and V. H. TOUSLEY.

Covers Electric Lighting from A to Z and is a practical guide for the electrical worker or contractor, containing all the information needed to the successful installation of good illumination.

It is the last word in illuminating science and construction—check full of the information you want—written in a way you'll understand.

275 Pages **PRICE \$2.00 POSTPAID**
Illustrated

Money refunded on any of these books if you are not satisfied.

POPULAR ELECTRICITY BOOK DEPARTMENT
54 West Lake Street **CHICAGO, ILLINOIS**

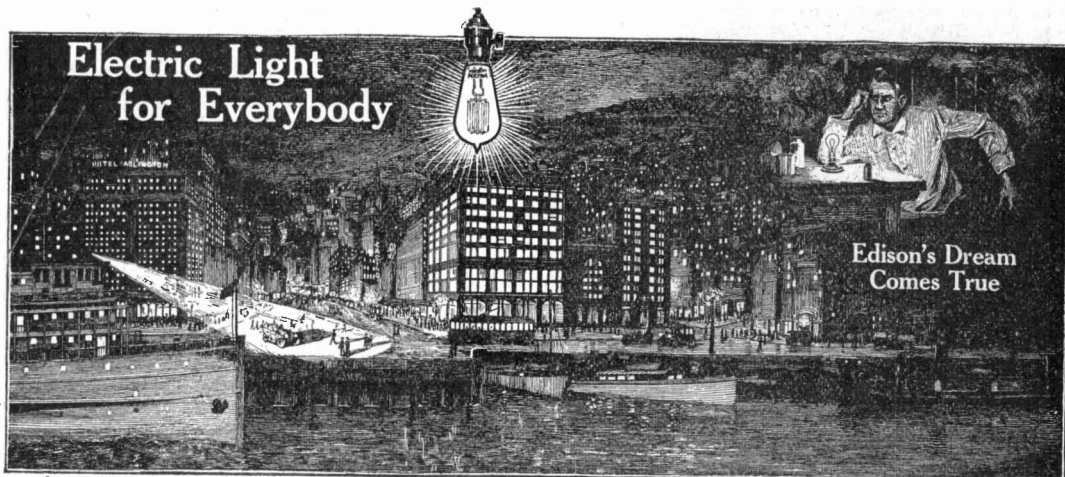

Every Way

Not only in homes, stores, offices, churches, theatres, factories and for electric signs and street lighting—but also on ferry boats, trolley cars, railroad trains, automobiles and even on battleships—these are some of the commoner uses of the

Edison Mazda Lamps

For boiler factory or dining room dome, for store window or clothes closet, for pocket flasher or auto lamp—for scores of uses—some of which would surprise you—millions of Edison Mazdas are in use today. There are sizes and styles for every lighting need.

Everywhere

Wherever any electric lamp can be used, the Edison Mazda is the most economical. It gives twice as much light as old style lamps and uses less current besides



That's why electric light users everywhere are replacing old lamps with Edison Mazdas.

Everybody

That's why electric light today is so cheap. The tiny cottage or small store can now have better electric light than was possible a few years ago for even the mansion or department store.

Ask any lighting company or electrical dealer about the best styles and sizes of Edison Mazda Lamps for your special needs. Inquire today.



This Symbol on all Edison Mazda cartons

General Electric Company



The Guarantee of Excellence on Goods Electrical

Largest Electrical Manufacturer in the World

Sales Offices in all large cities

Lamp Agencies Everywhere

3788

For our Mutual Advantage mention Popular Electricity when writing to Advertisers.



Become An Expert Electrician In Spare Time

Never has there been such a demand for technically trained electrical men as at present. The great expansion of the electrical field in all its branches is responsible for this. The trained electrical man is always sure of a good position at a good salary.

The International Correspondence Schools have made the mastery of any electrical course easy. Any ambitious man can learn in *spare time* to become an expert electrician. You can.

Courses cover Electrical Engineering, Lighting and Railways, Interior Wiring, Dynamo Running, Electric Car Running, Heavy Electric Traction, Telephone Engineering and Telegraph Engineering. Everything made clear and simple. Courses conducted by experts. No hurry or delay. The I. C. S. stands by you until you are through.

It costs you nothing and puts you under no obligation to learn *how* the I. C. S. can help you. Simply fill in and mail the attached coupon to-day. Do it *now*.

International Correspondence Schools
Box 1102-G, Scranton, Pa.

Please explain, without further obligation on my part, how I can qualify for a good position in the line of electrical work indicated in the attached coupon:

Position

Name

Street and No.

City State

PRACTICAL ELECTRICAL EDUCATION

WE teach by practical methods and a scientific system under actual working conditions, all branches of Electrical Science and Engineering. No matter what your present education is, you can master our courses. We will start you at the very point you are competent to begin, and you will advance as rapidly as your own ability and efforts warrant. Positions secured. Many of our former students earn from \$1,500 a year up immediately after graduation. Students may enter at any time. Write for free descriptive and illustrated school catalog.

School of Engineering of Milwaukee
161-171 Michigan St., Milwaukee, Wis.
"The Electrical School That Graduates Experts."
Formerly 1025 Winnebago Street

SUCCESS SHORTHAND

The best system for beginners; a post-graduate system for stenographers. Highest world's records for speed and accuracy and a greater number of court reporters than any other system in the last seven years. Instruction by mail; satisfaction guaranteed. Write for FREE catalogue.

SUCCESS SHORTHAND SCHOOL
W. L. JAMES, Chief Instructor
Suite 99, Schiller Building, Chicago, Illinois

Learn Electric Signalling



At Home—By Mail
A splendid profession. Great opportunity. Big demand by railroads for signallers. You can keep present position while learning **\$1,800 TO \$4,500 PER YEAR**. Rapid advancement from the first. Easy to learn. Takes but short time. Write today for free booklets. Do not put this off. Special offers to new students.

Department of Signaling, Desk 1407, 438 Cass St., Chicago

LAW Learn at Home

Graduate correspondence students most successful at bar examination. Cover same ground as Harvard, Michigan and other big law colleges. Guarantee to coach free, students failing to pass bar examination. **Scholarships are now open.** Scholarship students pay only for text and postage. Write today for catalog.

American Correspondence School of Law, Dept. 1407, Manhattan Bldg., Chicago

TELEGRAPHY TAUGHT

in the shortest possible time. The Omnigraph Automatic Transmitter combined with standard key and sounder. Sends you telegraph messages at any speed just as an expert operator would. Five styles, \$2 up; circular free.

OMNIGRAPH MFG. CO.
39 H Cortlandt Street New York



FRENCH-GERMAN SPANISH-ITALIAN

Is Easily and Quickly Mastered by the

LANGUAGE PHONE

Combined with the Rosenthal Method of Practical Linguistry



This is the natural way to learn a foreign language. You hear the living voice of a native Professor pronounce each word and phrase. He speaks as you desire—slowly or quickly, night or day, for minutes or hours at a time. It is a pleasant, fascinating study; no tedious rules or memorizing. It is not expensive—all members of the family can use it. You simply practice during spare moments or at convenient times, and in a surprisingly short time you speak, read and understand a new language.

Send for Booklet and Terms for Easy Payment
THE LANGUAGE PHONE METHOD
946 Putnam Building
2 West 45th Street New York

Shall You be One of these 4000?

ARE you going to be one of the 4000 new men the U. S. Navy wants this year? Or are you going to "turn down" the Navy without looking into it? Multitudes of men fail in life by refusing to investigate opportunities.

The Navy is one big opportunity; an opportunity to see the world, to step out of a humdrum life into a life of changing scenes, spice and variety; an opportunity to educate yourself by study and travel; an opportunity to learn a trade or work at one you now know (the Navy employs 50 different trades); an opportunity to rise to rank of Warrant Officer in the greatest navy in the world at \$1600 to \$2500 per year; and an opportunity to retire after 30 years' service on $\frac{3}{4}$ of your highest pay and allowances.

If you are between 17 and 25 years of age, call at the nearest Navy Recruiting Station. We'll send you the address. Hear the complete story of the Navy from officers and enlisted men there.

Or send for "The Making of a Man-o'-Warsman," a free book that tells in interesting pictures and simple language everything you want to know about Navy life, work, food, pay, play, promotion, travel, etc. Have your parents read it too. Send for a copy to-day, and you won't forget to.

Address Bureau of Navigation, Box 5, Navy Department, Washington, D. C.

UNITED STATES NAVY

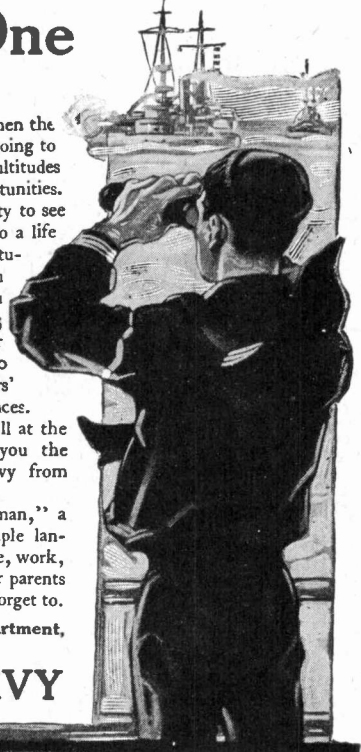

Learn Electricity

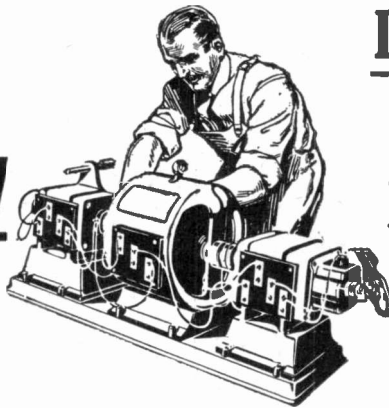

IN ALL ITS APPLIED BRANCHES

A COURSE IN ELECTRICITY

to be useful must be PRACTICAL. You cannot become the "practical man" by reading books or attending lectures. You must have at hand the tools, material and machinery to prove your theory or you are losing time and money.

We are teaching a thoroughly practical course in ELECTRICITY. In this school you learn *how* to do it by *doing* it, not by cramming your brain with useless formulas and diagrams which are usually forgotten as quickly as they are learned. In *this* school you work with your hands, you work individually and your *ability* is the only limit to your progress.

Send for free illustrated catalogue that tells you all about this practical, small cost, "LEARN-BY-DOING" school

The New York Electrical School 40 West 17th St.
NEW YORK

For our Mutual Advantage mention Popular Electricity when writing to Advertisers.



“Step
Out
of your
Old
Self”

Learn a Trade

Make \$5⁰⁰ to \$8⁰⁰ PER DAY

Big demand for Plumbers, Electricians, Brick Layers, Painters, Decorators, Draftsmen and Moving Picture Operators.

No Experience Necessary

Now—right now—thousands of trained men are needed. Graduates from our school make \$5 to \$8 a day at start. Unlimited possibilities—future assured. We teach you any one of these profitable trades in a short time AT SMALL EXPENSE. We give you the actual work to do right in the school. Our free employment bureau needs more trained men—hence, we are making a VERY SPECIAL OFFER at this time.

Start Your Own Business

Free Tools

We furnish all the tools and equipment you use in our school absolutely free. No expense to you whatever.

IF YOU WISH. Make from \$3,000 to \$5,000 a year. We give you every assistance possible. The Coyne National Trade School is the

Oldest, Largest and Best Equipped Trade School in the World

You can enter any time. Open all the year round. Day and night sessions. Tuition VERY LOW now. Easy payments if desired. We will help you pay your way through school too.

Write for Free Catalog and Full Particulars Right Away

Don't pass up this big opportunity! If you ever thought of being an electrician, plumber, brick layer, painter, decorator, draftsman or moving picture operator—write today. Come to busy Chicago where these trades pay \$6.00 a day. We will send you our catalogue and full particulars FREE AND PREPAID. No obligation on you at all—so write at once.

L. L. COOKE, Director

COYNE NATIONAL TRADE SCHOOL
39-51 E. Illinois St., Dept. 1407, CHICAGO, ILL.
Oldest and Largest Practical Trade School in America



Be a Meter Engineer

Get in the new profession. Meter Engineers are in constant demand everywhere. Exceptional opportunities, **big money**. You can learn it right in your own home during your spare time by mail.

Get in the \$3,000 Class

Experts in the profession of Electrical Meter Engineering are scarce. Central Stations all over the country will pay high salaries for your services. Write today for full particulars.

40-Page Book Free Just your name and address on a postal is enough. We will send you our 40-page book on Meter Engineering absolutely free. It tells you all about the new profession. The book is free and prepaid. No obligations of any kind.

Write Today Do not delay an instant. Here is your chance to get into the \$3,000 class. Just your name and address on a postal is enough but be sure to write today.

FT. WAYNE CORRESPONDENCE SCHOOL, Dept. 1407, Ft. Wayne, Ind.

Every Wireless Operator or Amateur Needs This Book

The handiest and most useful Book for the Wireless Operator, Amateur or Professional, ever published.

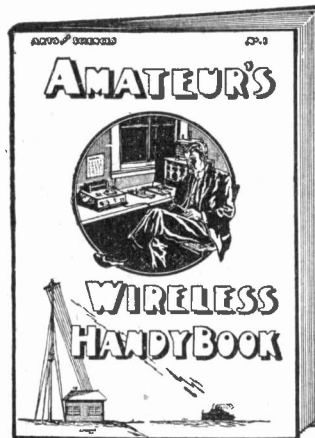

What It Will Do for You

Contains a complete list of wireless Call Letters, 1500 in all, enabling you to locate the origin of any certain call immediately; also the owner of the station or ship and power rating. The Morse and Continental Codes are shown on two large full page charts so that they can be read from a distance, also a Beginner's Speed Chart so arranged to assist in learning the Codes quickly.

All the abbreviations used by operators to save time and labor. And last but not least over 100 Hook-ups and Diagrams. No matter what instruments you have you will find a perfect hook-up that works in this book. Blank pages are provided for keeping a record of your own hook-ups.

Price Twenty-five Cents
POPULAR ELECTRICITY BOOK DEPARTMENT
54 W. Lake St., Chicago, Ill.

DRAFTING

Good Positions Big Salaries



Complete Outfit FREE to Home Study Students

Draftsmen are in constant demand and receive big salaries. YOU can qualify for a good position. Don't be content to receive a paltry salary when a little ambition and study will quickly multiply your income.

Mechanical, Structural and Architectural Drafting and Design, Contractor's Courses, etc.

Chicago Technical College

Day and Evening Classes. Home Study Courses.

Gives thorough courses, full or partial. Students study blue prints of buildings and machinery actually being constructed. Your work approved by leading Chicago architects and engineers. Correspondence courses in these subjects taught by the same experienced instructors. Low tuition, easy payments. Free employment bureau. Mention course desired and state whether you would attend the college or take home study work.

609 Athenaeum Bldg., 59 East Van Buren St., Chicago, Ill.

"HELP WANTED"

-Uncle Sam.

**Railway Mail Clerks
City Carriers, Postoffice Clerks, Clerks in Internal Revenue & Customs Services**

Thousands of appointments coming

**\$800⁰⁰ to \$1800⁰⁰ a Year
for LIFE**

No "layoffs" without pay, because of strikes, financial flurries or the whims of some petty boss. Excellent opportunities for quick advancement to Higher Government Positions. If you want immediate appointment, send TODAY for our schedule showing locations and dates of the coming examinations. Any delay means the loss of just so much time in preparing yourself for examination.

SEND UPON BELOW

Franklin Institute
Dept. G 119, Rochester, N. Y.

We Prepare Candidates Free

The Coupon, filled out as directed, entitles the sender to free sample questions, a free copy of our book, "Government Positions and How to Obtain Them," and to consideration for Free Coaching for the examination here checked.

----- COUPON -----

—Railway Mail Clerk	\$800 to \$1400	—Customs Positions	\$800 to \$1500
—Postoffice Clerk	\$600 to \$1200	—Internal Revenue	\$700 to \$1800
—Postoffice Carrier	\$600 to \$1200	—Stenographer	\$800 to \$1500
—Rural Mail Carrier	\$500 to \$900	—Clerk in the Department	at Washington \$300 to \$1500
—Bookkeeper	\$900 to \$1800	—Canadian Government Positions	

Name

Address G 119

Use this before you lose it. Write plainly.

EARN A BIG SALARY

Be An Auto Expert



Big demand and big pay for chauffeurs, repairmen, and salesmen. Our system of individual instructions by mail enables you to complete the course in 12 simple lessons at home. Send To-day for Free Book, particulars, and endorsements of 10 leading automobile makers. We assist graduates to get positions.

FREE MODEL FURNISHED EACH PUPIL.

Practical Auto School, 68M Beaver St., N. Y. City

Salesmen Wanted

DO YOU WANT A GOOD POSITION WHERE YOU CAN EARN FROM \$1,000.00 TO \$5,000.00 A YEAR AND EXPENSES?

There are hundreds of such positions now open. No former experience as a salesman required to get one of them. If you want to enter the world's best paying profession our Free Employment Bureau will assist you to secure a position where you can earn good wages while you are learning Practical Salesmanship. Write today for full particulars; list of good openings and testimonial letters from hundreds of our students for whom we have recently secured good positions paying from \$100.00 to \$500.00 a month and expenses. Address nearest office, Dept. 131

National Salesmen's Training Association.
Chicago New York Kansas City Seattle New Orleans Toronto

MEN WANTED IN AUTO BUSINESS



Big demand for trained men. Earn from \$75.00 to \$150.00 per month. Learn all about automobiles in six weeks by

THE "SWEENEY SYSTEM"

of practical experience. In our machine shop garage and on the road you learn by actual experience how to repair, drive, demonstrate and sell automobiles. Send for free catalog explaining The "Sweeney System" and showing views of the largest and best equipped auto school in the world. Write today. Now.

SWEENEY AUTO SCHOOL.
1512 Woodland Kansas City, Mo.

ELECTRICITY

Complete in One Year

SCIENTIFIC ELECTRICITY
IN ALL ITS BRANCHES

Bliss Electrical School



Studies restricted to theoretical and practical electricity, mechanical drawing and necessary engineering work. Teaches simplicity, concentration, hard work. For young men of energy and character. 20 years of greatest success. Graduates hold first-class positions. **Opens Sept. 25.** Write for new catalog.

10 Takoma Ave., WASHINGTON, D. C.

FREE BOOK ON MOTORING

**A NEW WAY OF TEACHING
GET IDEA BY MAIL
DYKES
WORKING MODEL
SYSTEM**

Explains how we can start YOU in the Auto Business as Repairman, Chauffeur, Salesman, or Auto Expert with Dyke's New Idea Working Model System of teaching by mail and our new idea Employment Plan. Let us tell you the names of some of our students and the salaries they are drawing today—more than you are making. Don't miss it—Send for Booklet NOW!

Dyke's School of Motoring, Box 2, Roe Bldg., St. Louis, Mo.

BE AN ENGRAVER

Learn at Home; Earn \$25 to \$50 weekly. We give personal instructions and furnish necessary tools Free. Terms reasonable. Complete particulars by mail.

CHICAGO ENGRAVING SCHOOL
Dept. 30, 59 E. Van Buren St. Chicago

Do You Like to Draw?

That's all we want to know

Now we will not give you any grand prize or a lot of free stuff if you answer this ad. No, we do claim to make you rich in a week. But if you are anxious to develop your talent with a successful cartoonist, so you can make money, send a copy of this picture with 6c. in stamps for portfolio of cartoons and sample lesson plate, and let us explain.

THE W. L. EVANS SCHOOL OF CARTOONING
325 Balt Bldg. Cleveland, O.



For our Mutual Advantage mention Popular Electricity when writing to Advertisers.

Special Offer

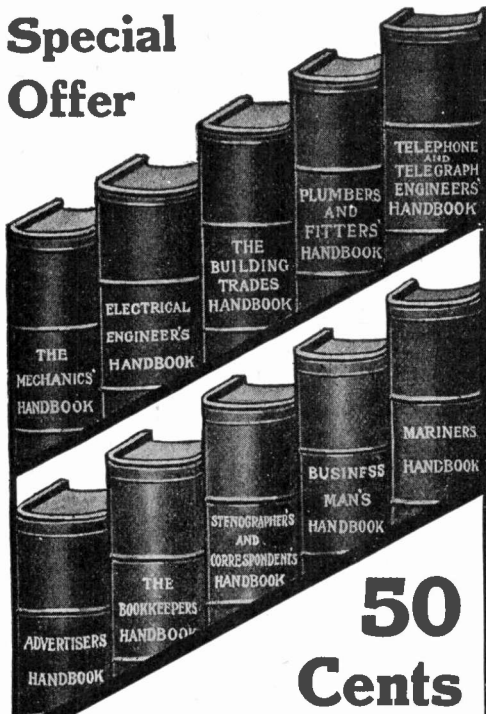

50 Cents

No books in existence contain in the same space so much knowledge about the different trades and professions as do the I. C. S. Handbooks. They are compiled from the Courses of the International Correspondence Schools, of Scranton, Pa., which have been written by the best experts in the country. These little books are, therefore, consulting experts of the highest rank—pocket memorandas of inestimable value to the executive, foreman, and managers. They are invaluable as promotion gainers for an ambitious man in subordinate positions, because they can be easily understood without a knowledge of higher mathematics, and contain just the information needed by men to secure promotion.

SPECIAL OFFER:—For a limited time we are selling these Handbooks, durably bound in cloth, with gilt titles, containing on an average of 375 pages and 175 illustrations, regularly sold for \$1.25, at a price for each Handbook of 50c.

Send the Coupon NOW!

International Textbook Company
Box 1102, SCRANTON, PA.

I enclose \$_____ for which please send me the Handbooks BEFORE which I have marked X.

- | | |
|--|--|
| <input type="checkbox"/> Mechanics' | <input type="checkbox"/> Advertiser's |
| <input type="checkbox"/> Electrical Engineer's | <input type="checkbox"/> Bookkeeper's |
| <input type="checkbox"/> Building Trades | <input type="checkbox"/> Steno. and Corr. |
| <input type="checkbox"/> Plumbers and Fitters' | <input type="checkbox"/> Business Man's |
| <input type="checkbox"/> Tel. and Telegraph | <input type="checkbox"/> Mariners' |
| | <input type="checkbox"/> Concrete Engineer's |

Name _____

St. & No. _____

City _____ State _____

HOW YOU CAN GET AN AUTOMOBILE FREE!

We want honest, sober young men in every county to learn at home to repair, run and to teach others, and then sell the COBY "FLYER"—a 6-cylinder, 50 H. P. passenger automobile, "THE WORLD'S BEST VALUE." Write for full particulars how you can get one FREE.



Address
C. A. Coey's School of Motoring
1424-26 Michigan Ave.
Dept. 45 Chicago, Ill.

EARN TELEGRAPH

Morse or Wireless. Station Agency work also taught. Splendid opportunities. Graduates assisted. We own and exclusively occupy two large modern buildings equipped with R. R. Dispatchers and Western Union Wires and Complete Wireless Station. Oldest and largest school—est. 88 years. Investment \$25,000. Endorsed by Railroad, Wireless and Western Union Officials. Expert, practical teachers. Living expenses may be earned. Tuition low. Easy payments. Correspondence courses also. Catalogs Free.

Dodge's Telegraph, Railway & Wireless Institute
21st Street Valparaiso, Ind.



QUICK, THOROUGH ELECTRICAL INSTRUCTION

A complete college course in two years. Time and money saved. Taught by graduate engineers. Practice on apparatus and machines—construction, operation and repair. Every branch of generation, transmission and application. Graduates in leading electric companies. New classes July and September

WRITE FOR DETAILS
BRYANT & STRATTON COLLEGE
No. 115 College Building BUFFALO, N. Y.



BE A BANKER

Learn a profession in a few months that will give you standing and independence the rest of your life. No matter where you live or what your occupation we will teach you by mail. No business or profession offers better opportunities. The work is pleasant, hours short, salary good. Endorsed by leading bankers. Very low cost, easy Author of Course payments. WRITE TODAY FOR CATALOG.

AMERICAN SCHOOL OF BANKING, 139 McLene Bldg., Columbus, Ohio

VENTRILOQUISM

Learned by any Man or Boy at Home. Small cost. Send today 2c stamp for particulars and proof. O. A. SMITH, Room W181 823 Bigelow St., Peoria, Ill.

LEARN WATCHMAKING Engraving and Jewelry repairing.

Earn while learning. Our school Endorsed by leading jewelers. Positions secured for graduates. Send for Free catalogue.

CHICAGO SCHOOL OF WATCHMAKING,
Dept. 30, Bush Temple Chicago

Learn to Write
I TEACH BY MAIL
WRITE FOR MY FREE BOOK
"How to Become a Good Penman" and beautiful specimens. Your name elegantly written on a card if you enclose stamp.

today. Address F. W. Tambllyn, 437 Meyer Bldg., Kansas City, Mo.



Handy Electrical Dictionary

"Just Fits The Vest Pocket"

Designed to meet the needs of the beginner, and at the same time furnish a compact, reliable reference for the electrical worker and expert.

224 pages—"Plain English" definitions of over 4,800 electrical terms and phrases—7 pages of diagrams

Everyone Interested in Electricity Needs it

Price, Cloth, 25c
Full leather, full gilt, 50c

Popular Electricity Publishing Co. Book Dept.
54 WEST LAKE STREET CHICAGO, ILLINOIS

Stop Forgetting!



Now, What Was That Fellow's Name?
I Can't Remember Those New Terms.
I Know—But Can't Find Exact Word.
What on Earth Did He Say About It?

A Perfect Memory Is the Key to Success

The mind of the average person is filled with thousands of single unrelated ideas which waver and fluctuate with every emotion, like the billows of the sea.

The man with a Wandering Mind can never hope to Make Good—he will always be a drug on the market—he has too many competitors. The great men of all ages are those who acquire the ability to concentrate and to memorize.

My method is highly recommended by ELBERT HUBBARD, PROF. DAVID SWING, and thousands of others. Ten minutes a day of your spare time will give you this training and not interfere with your work in any way.

You Can Be Trained to Remember Accurately

In the business battle — matching wits each hour of every day — the ability or inability to think on your feet, to remember instantly and accurately means gain or loss. To succeed you must be "forget-proof." Just as surely as a poorly organized business can be placed upon a basis of perfect systematization and thereby made thoroughly efficient—so can your mind be trained and made a classified indexed and cross indexed filing system of facts so that you can command, on the instant, any thought, fact or argument.

The Dickson Method of Memory Training Will Do This for You

It will enable you to classify impressions, ideas, names, facts and arguments so as to have them ready at a moment's notice at any time. It will train you to think on your feet, to converse in a natural, interesting way, to overcome self-consciousness and bashfulness, to acquire easy, logical thinking. My course is not a theory, but is purely and absolutely scientific—the result of more than 20 years of close, intimate contact with students in schools and colleges and searching their developing minds for means of strengthening their memories.

I Want to Send You My Book, "How to Remember," Absolutely FREE

Simply clip the coupon and mail it today. It will explain clearly the course that has raised thousands of men from failures to great successes. You can have this same training. My free book is the first step. Don't delay. Age, education, vocation or place of residence makes no difference. Send the coupon today.

How to Get a Free Copy of This Valuable Book

De luxe edition handsomely illustrated, richly bound. Is exactly suited to meet the needs of the man or woman who desires to be a successful public speaker. The price of this 1911 de luxe edition is \$2.00. I will, however, present a copy absolutely free to every student who enrolls for my course of memory training within ten days after reading this offer.

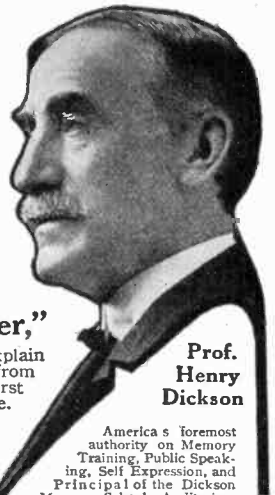

Prof. Henry Dickson

America's foremost authority on Memory Training, Public Speaking, Self Expression, and Principal of the Dickson Memory School, Auditorium Building, Chicago.

Prof. Henry Dickson
Principal, Dickson School of Memory
929 Auditorium Bldg., Chicago, Ill.
Send me free Booklet "How to Remember," also full particulars how to obtain a free copy of Dickson's "How to Speak in Public."

NAME

STREET

CITY.....STATE.....



Send the Coupon Today

For our Mutual Advantage mention Popular Electricity when writing to Advertisers.

POPULAR EDUCATIONAL FOOD CAMPAIGN

BRAINY DIET

This system is based on an *entirely unique classification of foods* according to their effects on different parts of the body: the brain and nerves, arteries and veins, muscles, liver, kidneys, lungs, bowels, skin, hair, vocal organs, sex organs, etc. Every food you eat affects a CERTAIN part or parts; every symptom therefore is traceable DIRECTLY to its cause. Read the quotations from my patients' reports to see the radical success I achieve by treating CAUSES—wrong foods, wrong combinations producing fermentation and food poisoning, or underfeeding some foods, overfeeding others.

No Foods Sold

Neurasthenia and brain hunger, which baffle all specialists, can *only* be cured by digestible brainy foods.

Thin people, after toning their digestive powers with vital foods, have increased their weight to their ideal by proper application of cereal foods, etc.

Obese people have reduced their weight without calisthenics several pounds weekly, with daily increase in energy and well satisfied appetite.

Rheumatism and tumors have been expelled from the system.

Consumptives have been cured of expectoration, coughing and night sweats within a few weeks. The specific foods which produce expectoration, and those which cause coughing, are indicated.

I have produced in myself the symptoms of various diseases: rheumatism, catarrh, expectoration, sore throat, tonsillitis, constipation, double chin, swollen glands, kidney trouble, shortness of breath, rough scalp, dry hair, sores, boils, pimples with white pus, blackheads, rash, etc., by eating certain wrong foods for a few days or weeks, and regained normal health in a few days by correct foods.

Four Instructive Booklets

- (1) **New Brainy Diet Cure** (2) **Diet vs. Drugs** (3) **Effects of Foods** (4) **Key to Longevity**

"Your criticism of osteopathy, physical culture, Fletcherism and fasting, in Booklet No. 2, was enlightening. The articles by Mr. Luther Burbank and Mr. Edison were also instructive. Your recipe for clear complexion, bright eyes and alert brain is worth dollars to any business man."

"Your little books eliminated chronic catarrh from my system in about three weeks. To put it weakly, I was astonished. I know now that butter,

Eat for Health, Energy and Brain Power**A Few Curative Principles:—**

Suitable meats, fish, game, dairy foods, etc., generate vitality and nourish the brain and nerves; starchy foods feed the muscles, and furnish staying power; tomatoes and lemons are solvents for impurities, foreign elements and waste matter—the cause of disease; green vegetables purify the blood, dislodge, disperse and carry off the waste products, provided all the other foods are properly selected and combined for individual requirements of age, weight, symptoms and occupation.

eggs and rich cream caused the trouble."

"My brain power and general efficiency have been doubled this year. I have made a fortune in real estate, and the credit is honestly yours."

"The Government should investigate and teach the Brainy Diet System for the good of the nation."

"The hints in Booklet No. 3, on foods for curing congested liver, nourishing the brain, etc., are worth untold dollars."

Send 10 cents for all four interesting instructive booklets. Send the addresses of your sick friends to G. H. BRINKLER, FOOD EXPERT, DEPT. 19K WASHINGTON, D. C.

"AFTER FOUR CENTURIES— the story of A WORLD UNITED"



The quest of Columbus finds successful culmination in the completion of the great Panama Canal—and in the Panama Pacific International Exposition, San Francisco, the "magic city of the Golden West," extends to all the earth the hand-clasp of greeting and good-fellowship. Seventeen and one-half millions of dollars, and the combined interests of 2 hemispheres, insure the exposition-marvel of the world's history—and a visit to the Panama-Pacific Exposition affords opportunity for America's greatest educational and recreational sight-seeing pleasure trip. Our fascinating Brochure of travel and Exposition sights and scenes, "AFTER FOUR CENTURIES" tells all about the Exposition and how you can, if you wish, make this wonderful trip, under a special plan, at small cost.

This Book Sent Free Replete with interesting information—
profusely illustrated—elegantly printed

Write for it today

INTERNATIONAL TOURISTS ASSOCIATION
Suite K, First National Bank Bldg., Chicago

WE WANT YOU for our representative. Big money to right parties. All or spare time. Experience not necessary. Send 2c stamp today for particulars. POPULAR ELECTRICITY MAGAZINE, Circulation Dept., Commercial Bldg., Chicago, Ill.

**ARITHMETIC
SELF-TAUGHT**

A plain, easily-understood volume for all who have not had the opportunity of learning this subject thoroughly, or who have forgotten what they once learned. 257 Pages. Requires no teacher. This great little book sent postpaid for 60 cents. Stamps accepted, leather binding, \$1. GEO. A. ZELLER BOOK CO. Established 1870.

4474 W. Belle Place, ST. LOUIS, MO.

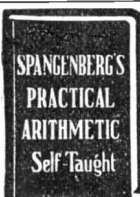
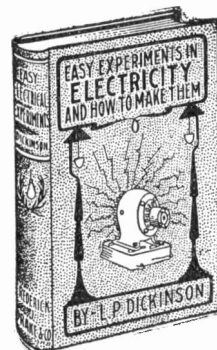
**For the Amateur
OR PRACTICAL ELECTRICIAN**

This is one of the most valuable works ever published.

Written in simple, easily understood language, fully illustrated with cuts and working drawings.

Presents a wonderfully interesting and entertaining series of electrical experiments, giving full directions for constructing apparatus required with inexpensive materials and tools easily obtained.

Shows you how to make all kinds of batteries, electric bells, rheostats, condensers, large and small induction coils, an electrophorus, an automatic circuit closer; how to construct and use telegraph and telephone instruments, measure electrical resistance and pressure and make and use galvanometers and voltmeters.

Gives detailed directions for building a 1-20 horse power motor, explaining exactly how to make each of the various parts and assemble them correctly. Shows you how to do electro-plating at home, design a small dynamo, build an electric engine, an electric locomotive, a model fire alarm telegraph, make simple arc lamps, and light lamps by electricity. Also how to make an electric bomb, electric gyroscope and other electrical toys, etc., etc.

204 pages. Handsomely stamped cloth covers.

Price \$1.00 Postpaid

Popular Electricity Book Department
54 West Lake Street Chicago, Ill.

For our Mutual Advantage mention Popular Electricity when writing to Advertisers.

"Here is Your Answer;" in WEBSTER'S NEW INTERNATIONAL DICTIONARY - THE MERRIAM WEBSTER

Even as you read this magazine you likely question the meaning of some new word. A friend asks: "What makes mortar harden?" You seek the location of Loch Katrine or the pronunciation of jujutsu. What is the Monroe Doctrine? What is white coal? etc., etc. YOU often long for a quick, accurate, encyclopedic answer. This **NEW CREATION** is an encyclopedia—equivalent in type matter to a 15 volume set. It answers all kinds of questions in Language, History, Biography, Fiction, Foreign Words, Trades, Arts and Sciences, with final authority. It is used as the standard of the State Supreme Courts which can be said of no other dictionary.

400,000 Words Defined.
2700 Pages.
6000 Illustrations.
Cost \$400,000.

The only dictionary with the new divided page,—characterized as "A Stroke of Genius."

G. & C. MERRIAM CO.
Springfield, Mass.

For Nearly 70 Years Publishers of the
**GENUINE WEBSTER
DICTIONARIES.**

Get the Best.



WRITE for Specimen Pages Illustrations, Etc. Mention Pop. Elect. and receive FREE a set of Pocket Maps.

Name _____

Address _____

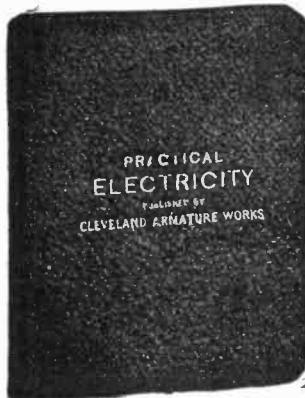

A School Within Itself

There are XX chapters in all, XIX carrying you from the fundamental principles of electricity on through the various branches to a point where the careful student comprehends the complete designing, care and operation of a dynamo or motor, and I chapter on electric automobiles, outlining their construction, care and operation, and all about storage batteries and how to handle them. Each subject is carefully written and to the point. After a student studies a subject, he is questioned on that subject in such a manner as to bring clearly to his mind the points he needs to know regarding same. A **DICTIONARY** in back of book will enable him to learn the meaning of any electrical word, term or phrase used in this book, as well as hundreds of others in common use. All required tables necessary in the study are in it. **TABLE OF SUBJECTS:**

- CHAPTER**
I—Wiring.
II—Electric Batteries, Electro Plating.
III—Magnetism.
IV—The Magnetic Circuit.
V—Magnetic Traction.
VI—Magnetic Leakage.
VII—Energy in Electric Circuit.
VIII—Calculation of Size of Wire for Magnetizing Coils.

- CHAPTER**
IX—Calculation of EMF's in Electric Machines.
X—Counter EMF.
XI—Hysteresis and Eddy Currents.
XII—Armature Reaction.
XIII—Sparking.
XIV—Winding of Dynamos and Motors.
XV—Proper Method of Connecting Dynamos and Motors—Self Excitation.

- CHAPTER**
XVI—Diseases of Dynamos and Motors, their symptoms and how to Cure Them.
XVII—Arc and Incandescent Lamps.
XVIII—Measuring Instruments.
XIX—Alternating Current.
XX—Automobiles.
A dictionary of over 1500 Electrical Words, Terms and Phrases, giving a brief meaning of all which are in common use.

\$2.00 Per Copy—Sixth Edition—30,000 Copies Sold
The offer we make of refunding money if book is not satisfactory upon examination is AN UNUSUAL ONE in connection with the sale of a book. But we have no fear of its return. Your decision will be what thousands of others have been. Money would not buy it if it could not be duplicated. We could print testimonials by the hundreds. It is best to order and be your own judge of its merits.

CLEVELAND ARMATURE WORKS, 4730 St. Clair Ave., Cleveland, Ohio
Armatures and Fields Wound, Commutators Filled **AMERICA'S GREATEST REPAIR WORKS**

For our Mutual Advantage mention Popular Electricity when writing to Advertisers.

WIRELESS AMATEURS

THERE is no need of your working in the dark when you can secure practical information on wireless matters through the experience of experts. Save time and money by investing now in several reliable books, that will not only enable you to construct wireless apparatus but also equip you with a complete knowledge of the theory and practice of wireless.

Look Over This List of Up-to-date Wireless Books and Select Those Suited to Your Needs

- WIRELESS TELEGRAPH CONSTRUCTION FOR AMATEURS**—By A. P. Morgan. Shows every detail in the construction of various outfits capable of receiving from 100 to 1500 miles and of transmitting 3 to 100 miles. Also clearly explains the purpose and action of each instrument with directions for operating and testing. 200 pages, 153 illustrations. **Price, postpaid** \$1.50
- HANDBOOK OF WIRELESS TELEGRAPHY, ITS THEORY AND PRACTICE**—By James Erskine-Murray. A book written for students, engineers and operators covering very thoroughly the theory and up-to-date practice of wireless telegraphy. 386 pages, 200 illustrations. **Price, postpaid** 3.50
- WIRELESS OPERATOR'S POCKETBOOK OF INFORMATION AND DIAGRAMS**—By L. W. Bishop. Thoroughly describes all of the latest transmitting and receiving instruments. Also contains all the tables necessary for the operator, including a table showing how to compute the sending and receiving distances for all types of instruments, with different types of aeriels. 200 pages, 150 illustrations. **Price, postpaid**..... **Leather, \$1.50; Cloth, 1.00**
- WIRELESS TELEGRAPHY AND TELEPHONY**—By C. I. Hoppough. Explains in a non-technical manner the fundamental principles of wireless and illustrates their application to the solution of practical problems which arise daily in the routine of wireless operating. 235 pages, fully illustrated. **Price, postpaid**..... 1.50
- MAKING WIRELESS OUTFITS**—By N. Harrison. A concise and simple treatise on the construction and use of simple and inexpensive equipments, for sending and receiving up to 100 miles. 61 pages, 27 illustrations. **Price, postpaid**..... .25
- PLANS AND SPECIFICATIONS FOR WIRELESS SETS, Part 1**—By A. F. Collins. Complete and detailed instructions for making an experimental set, also a one to five-mile set. 50 pages, illustrated. **Price, postpaid**..... .25
- PLANS AND SPECIFICATIONS FOR WIRELESS SETS, Part 2**—By A. F. Collins. Complete and detailed data for constructing a five to ten-mile set, also a ten to twenty-five mile set. 90 pages, 60 illustrations. **Price, postpaid**..... .25
- AMATEUR'S WIRELESS HANDBOOK**—By Powell and Cole. The handiest and most useful book for the amateur published. Contains a list of 1,500 call letters, codes, amateur's speed chart and over 100 hook-ups and diagrams. **Price, postpaid**..... .25
- HOW TO MAKE WIRELESS INSTRUMENTS**—By Twenty Experts. Up-to-date instructions for constructing wireless apparatus. 90 pages, 75 illustrations. **Price, postpaid**..... .25
- WIRELESS HOOK-UPS**—By G. E. Rudolph. No matter what instruments you have, you will find a perfect hook-up that works, in this book. 96 pages, 160 Hook-Ups. **Price, postpaid**... .25
- CONSTRUCTION OF INDUCTION COILS AND TRANSFORMERS**—By H. W. Secor. Describes fully the design and construction of various sized inductions coils and transformers. 94 pages, 72 illustrations. **Price, postpaid**..... .25
- INDUCTION COILS**—By K. Stove. Complete directions with tables for winding coils, giving $\frac{1}{4}$ -inch up to 12-inch sparks. 76 pages, 35 illustrations. **Price, postpaid**..... .25
- THE WIRELESS TELEPHONE**—By H. Gernsbach. Describes all the present systems and inventions, also contains directions for the construction of a simple wireless telephone. 80 pages, 57 illustrations. **Price, postpaid**..... .25
- WIRELESS TELEPHONE CONSTRUCTION**—By N. Harrison. A comprehensive explanation of the making of a wireless telephone equipment. 74 pages, 43 illustrations. **Price, postpaid**. .25

Popular Electricity Book Department

54 W. Lake St., Chicago, Illinois

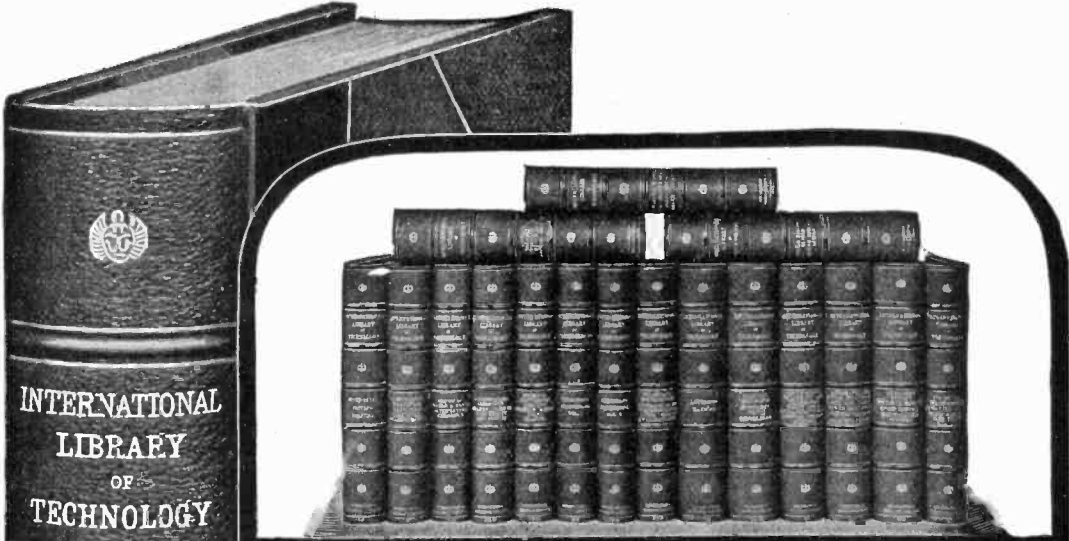

The Greatest Electrical Library in the World

The Electrical Engineering Library is part of the International Library of Technology that cost \$1,500,000 in its original preparation. It contains the knowledge given from the life experience of some of the best electrical engineering experts in the country, edited in a style that nineteen years of experience in publishing home-study textbooks has proved easiest to learn, to remember, and to apply. There is no other reference work in the world that so completely meets the needs of the electrician as the Electrical Engineering Library. The volumes are recommended by the highest authorities and are used in nearly all the leading universities and colleges. They treat of practical electrical methods, starting from the simplest problems and comprehensively covering every branch of the work. Not only can they be used to great advantage by superintendents, foremen, and engineers as an authoritative guide in their work, but since they can be so clearly understood, even by persons having no knowledge of higher mathematics, they can be used by all classes of electricians that are desirous of advancing to higher positions. The Electrical Library contains 17 volumes durably and handsomely bound in three-fourths red morocco, stamped and numbered in gold. The books are printed on a high-grade book paper, and the type is large and easy to read. Each volume is 6 by 9 inches in size. If you wish to know more about the most practical electrical library in the world, send the coupon NOW.

International Textbook Co.

Box 1102, Scranton, Pa.

Please send, without further obligation to me, full particulars in regard to your Library of Technology, with special reference to the Electrical Library.

Name _____

St. & No. _____

City _____ State _____

For our Mutual Advantage mention Popular Electricity when writing to Advertisers.

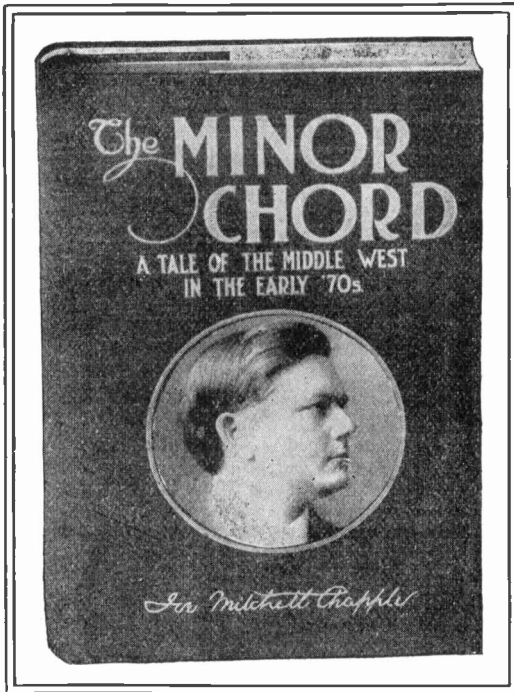

The
Great
Story
of the
Year

MR. CHAPPLE'S story of the courageous struggle of the young singer against poverty, environment and the effects of an ill-starred marriage and her eventual triumph as an operatic star cannot fail to enlist the interest and sympathy of the reader. The author's intimate acquaintance with the places and people of whom he writes is unquestioned, and his frank and detailed recital gives the book the virile strength of a biography enveloped in a strong and wholesome literary setting. The domestic affections are entwined on every page with the sure and true touch of an artist.

Price \$1.25 Net
AT ALL BOOKSTORES

CHAPPLE PUBLISHING CO., LIMITED
NEW YORK BOSTON CHICAGO

FREE *for Six Months* My New Magazine INVESTING for PROFIT

This wonderful magazine is the "Investor's Brain Partner" and often referred to as the "Little Schoolmaster of the SCIENCE OF INVESTMENT."

Don't invest a dollar anywhere until you at least read Investing for Profit Magazine

"Every investment he touches turns into money." This is a common every day expression—no doubt you know a few such men among your acquaintances. These men do not follow blind luck—they have mastered the law of Financial Success. You may watch them conceive and carry out their financial plans successfully—and you know they are not mentally stronger than you are. But it is the KNOW HOW in conjunction with brains that counts.

The education necessary to transform mind conceptions into visual realities is the element necessary to bring wealth to the dreamer. Until you learn the *real earning power* of your money—the difference between *rental* power and *earning* power—the underlying principles of incorporation—the science of investing—don't invest a dollar in anything anywhere.

Investing for Profit—A Liberal Financial Education

I claim—and I can prove it beyond the shadow of a doubt—that my magazine has not only made thousands of dollars for its readers—but it has **SAVED** them from losing many thousands of dollars in unwise investments. Until my magazine, **Investing for Profit**, appeared the small investor never had an opportunity to ask for and receive honest, unbiased, sound, logical advice and counsel in the science of investment.

Think this over. What are you worth today? How much do you expect to be worth ten years from now? And how are you going to build your fortune if you do not take advantage of the best advice and counsel you can possibly get on the subject of investing for profit? Just so surely as there is a law of gravitation, so is there a law of financial success. Without money you can accomplish practically nothing—so if you have \$5 or more per month to invest, read my magazine.

Why I make this Free Offer

It is the ambition of my life to give to the great masses of the American people for the first time in their lives comprehensive instruction in the science of investment—the knowledge which bankers and financiers hide from the masses—the true inwardness of the great problem of scientific and profitable investment—placing this information before you in facts and figures which you can easily understand. The rich man **KNOWS** the science of investment—the poor man unwittingly permits himself to lack this knowledge. This is the mission of my magazine—it is free to you for six months for the asking. In requesting it you promise nothing—oblige yourself in no way. I am glad to send it to you, for nearly everyone subscribes at the full \$1.00 price after reading it free for six months.

The number of free six months' subscriptions is limited.

Sign and mail this coupon at once

H. L. BARBER : Publisher : CHICAGO



Mail this now

H. L. BARBER, Publisher,
20 K. Jackson Blvd., Chicago:

Please send me FREE for six months *Investing for Profit* and enter my name on your list for Free Financial Advice.

Name _____

Address _____

EDWARD P. RUSSELL

WALTER S. BREWSTER

C. L. PENISTON

RUSSELL, BREWSTER & CO.

Successors to

EDWARD L. BREWSTER & CO.

BANKERS AND BROKERS

116 W. ADAMS STREET

CHICAGO

New York Office
111 BroadwayMembers New York Stock Exchange
Chicago Stock Exchange

We recommend to investors the following high-grade Preferred Stocks and Bonds

Public Service Company of Northern Illinois

*FIRST AND REFUNDING MORTGAGE 5% GOLD BONDS.

Due October 1st, 1956. Interest payable April 1st and October 1st.

Price to net better than 5%

*6% CUMULATIVE PREFERRED STOCK.

Tax exempt in Illinois. Earnings largely in excess of dividend requirements. Interest payable quarterly.

Price to net nearly 6%

* Listed on Chicago Stock Exchange.

Illinois Northern Utilities Company

FIRST AND REFUNDING MORTGAGE 5% GOLD BONDS.

Due April 1st, 1957. Interest payable April 1st and October 1st.

Price to net better than 5%

6% CUMULATIVE PREFERRED STOCK.

Tax exempt in Illinois. Dividends payable quarterly.

Price to net nearly 6½%

United Light & Railways Company

FIRST AND REFUNDING MORTGAGE 5% GOLD BONDS.

Due June 1st, 1932. Interest payable June 1st and December 1st.

Price to net better than 5½%

6% CUMULATIVE FIRST PREFERRED STOCK.

Earnings nearly three times dividend requirements. Dividends payable quarterly.

Price to net nearly 7%

Federal Sign System (Electric)

7% CUMULATIVE PREFERRED STOCK.

Earnings more than double dividend requirements. Dividends payable quarterly.

Price 100 and accrued dividends, with a bonus of 25% Common

Stock Voting Trust Certificates.

Middle West Utilities Company

6% CUMULATIVE PREFERRED STOCK.

Carries a bonus of 25% of common stock. Dividends payable quarterly. Price to net better than 6¼%.

We shall be pleased to furnish circulars regarding the above or give further information on these and other securities. Correspondence invited.

POPULAR ELECTRICITY MAGAZINE

In Plain English
HENRY WALTER YOUNG, Editor

Vol. V

October, 1912

No. 6

CONTENTS

	Page		Page
WATER FOR LOS ANGELES FROM BEYOND THE MOJAVE	513	Telephone Scratch Pad	572
DESTROYING THE VAMPIRES OF THE DEEP	516	ELECTRICAL MEN OF THE TIMES. Frank Morrison Tait	573
Alley Pole Lines	518	The Price of One Cigar	574
Prevention of Hail	519	Electrical Interests of Women	
Paddle Wheels Open and Close Bridge	520	Sonnenberg	575
Playing Tennis at Night	520	A Marshmallow Roast	576
Lightning Bores Iron	521	Marketing by Telephone	576
Ouch!!!	521	Electric Milk Warmer	577
Continental Types of Heaters	521	Do You Believe in Signs?	577
The Cable Splicer at Work	521	The Cut-Out Switch	578
THE GREAT LAKES NAVAL TRAINING STATION	522	Sterilization of Drinking Water by the Violet Ray	578
Great Causeway Across Galveston Bay	526	The Flexilite Lamp	579
Wireless on Monoplane	526	Electricity and the "New Attitude Toward Disease"	579
New York's Double-deck, Stepless Car	527	Roast Young Pig	581
Announcing Subway Stations	527	Electric Comb for Drying Hair	582
Tree Vibration for Saving Buds from Frost	528	Hints for Using the Toast Stove	582
Keeping Insects Out of Lamp Globes	528	Table Fan with Fern Dish	582
Electricity in Place of Food	529	Junior Section	
Telephone as Aid to Talking Machine Sales	529	An Interesting Trick with Static	583
RUBBER'S SECRET CONQUERED	530	Model Electrically Driven Shop	583
Theater Ear Phones	533	The Electrascore	584
Laying Lighting Cables in Japan	534	Lead Pipe Storage Battery	585
Ballbearings on Electric Cars	534	Energy from Lines of Force	585
Roadside Telephones	535	Rectifier	586
Illuminated Music	536	Dust Picture	586
A SHERLOCK OF THE SKIES	540	Indian Boys Advertise Electricity	587
Self-starting Gasoline-electric Automobile	540	"Drop in a Good One, Please"	587
Aeroplane Roundabout	541	Popular Electricity Wireless Club	
Radium Rays in Coloring Gems	541	FEDERAL WIRELESS STATION AT CENTRAL POINT, OREGON	588
How the Electric Won a Hat	542	Wireless on German Airships	591
Electrical Developments in Minneapolis	542	Alexander Wireless Bill	592
Woodpeckers Destroy Telegraph Poles	543	Electrolytic Interrupter	592
Ornamental Luminous Arc Lamps	543	Questions and Answers in Wireless	594
CADILLAC—DETROIT'S BEAUTIFUL WATER FESTIVAL	544	Carnegie School's Wireless Station	595
Automatic Annunciators at the Water Carnival	546	Directory of Wireless Clubs	595
Lighthouse Tended From the Shore	547	For Electrical Workers	
SOME SECRETS OF ELECTRICAL STAGE-CRAFT	548	Electrical Wiring	597
Engineering Education	552	Combination Lamp for Photography	601
Electric Shoveling Machine	552	Correction	601
Tablet Commemorating First Telegraphic Train Order	558	Testing for Lamps "On"	601
One of the Pioneers	556	Electric Bell Circuits and Their Installation	602
CHICAGO'S NEW POLICE PATROL BOAT No. 2	557	Fan Advertisement	609
Emergency Pumping Outfit	558	Doing Business Between Bites	609
Shooting by Searchlight	559	An Illuminated Key Sign	610
X-ray in Observing Bone Structure	559	The Jolly Gymnast	610
A 60,000 Egg Incubator	560	Fashion Cabinet	610
A Landmark That Turned a Trolley Line	562	Miscellaneous	
Milking Cows in the Pasture	562	THE INVENTOR, WHO HE IS AND WHY	611
The Steno-phone	562	ELECTRICAL SECURITIES	615
Men Wonder at New Audit Machine	564	New Books	617
Brain a Telephone Exchange	565	New Sound Proof Telephone Booths	618
Electrical Scarecrow	565	Telephone Service in Pekin	618
Electric Current at Work		Famous Church Bells Electrically Tolloed	618
Ampere Hour Meter for Electrics	566	Examining Coal with X-rays	618
A New Electric Fan Creation	566	Electric Ordering Device for Restaurants	619
Dental Engine Operated by Dry Cells	567	Electric Steel Production in Norway	619
Lamp Socket Attachment	567	Death of Henri Poincare	619
A New Insulator	567	Sir Hiram Maxim's Collision Preventor	619
Motor Driven Milking Machine	568	Determining Longitude by Wireless	620
Wall Pull Switch	569	A New Road Over the Alps	620
A Giant Drill	569	Wireless in the South Seas	620
New Type Fan Guard	570	Explosion of Radium	620
Tree Insulator	570	United States First in Communication Facilities	621
Daylight Egg Tester	570	What Horsepower Really Measures in Watts	621
Car Cleaning While on the Way	571	A Giant That Knows No Mercy	621
Magnetic Chuck	571	Short Circuits	622
Illuminated Vest Buttons	572	Common Electrical Terms Defined	624
Lighting Fixtures Part of Piano	572		
Light for Memorandum Pad	572		

RENEWALS When your subscription expires, you will find a renewal blank enclosed here. You should fill out and return with remittance at once to avoid missing a number. Positively no copies will be mailed on any subscription after same expires unless renewed, and we cannot agree to begin subscriptions with back numbers. The date on wrapper of your magazine shows issue with which your subscription ends. The extension on this date to period covered by renewal is sufficient receipt. If any other is desired it should be requested at time of renewal.

CHANGE OF ADDRESS Notify us promptly of any change in your address, giving both the old and new location. Since our mailing list for each issue closes the 5th of the preceding month (i. e., list for February closes January 5th), changes received after the 5th must necessarily take effect with issue for second month following. Postmaster as well as Publisher should always be notified of changes in order to forward mail sent to old address.

ISSUED MONTHLY BY POPULAR ELECTRICITY PUBLISHING CO., Commercial Bldg., Chicago, Ill.
YEARLY SUBSCRIPTION, \$1.50; CANADIAN, \$1.85; FOREIGN, \$2.25; SINGLE COPY, 15 CENTS

No additional copies will be sent after expiration of subscription except upon renewal.
Entered as Second Class Matter April 14, 1908, at the Post Office at Chicago, Under Act of March 3, 1879.

Copyright 1912, by Popular Electricity Publishing Co.

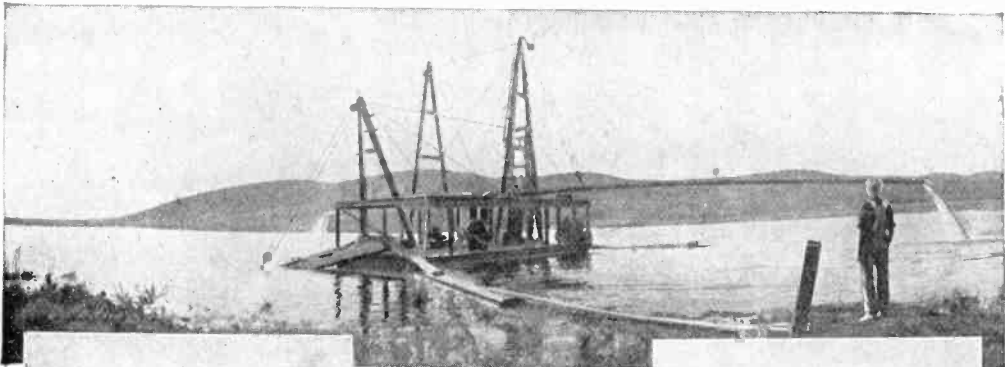

Centrifugal Drill Being Tested at Silver Lake.

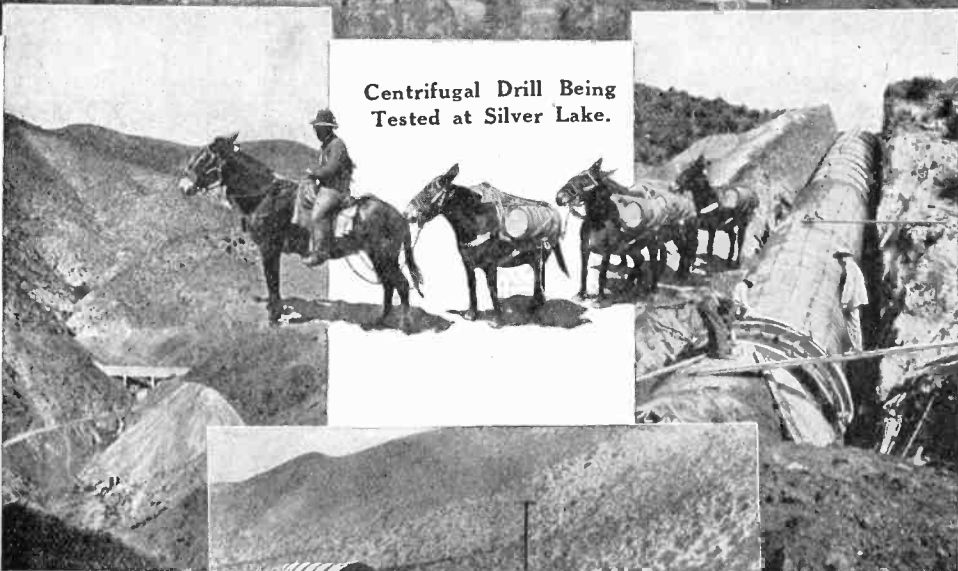

Jawbone Division Connecting Two Tunnels.



Building a Concrete Siphon.

52-Mule Team Hauling Steel Sections for the Saugus Siphon.

Some Interesting Views of the Work on the Great Aqueduct Which Is to Bring Water to Los Angeles, 250 Miles Across Mountain and Desert, Incidentally Developing 160,000 Electrical Horsepower

Popular Electricity

In Plain English

VOL. V

OCTOBER, 1912

No. 6

Los Angeles Water from beyond the Mohave

By C.L. Edholm

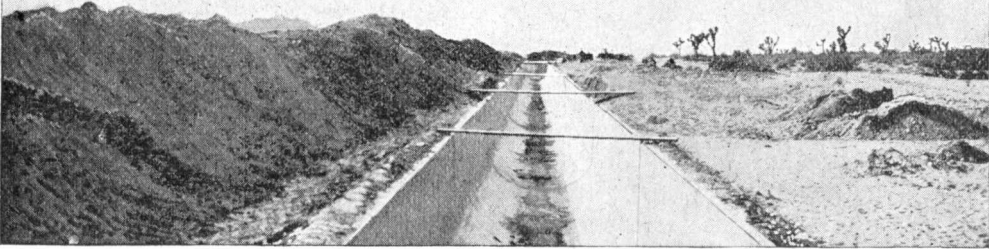

When the city of Los Angeles set out to bring water from the Sierras, a few years ago, running a series of ditches, tunnels and flumes across mountain and desert for almost 250 miles, the greatest emphasis was laid upon the fact that an enormous amount of pure water was to be brought to the city for domestic purposes and irrigation. A water famine had been threatened, owing to unusual drought, and the city was made to realize with terrible certainty that without a new source of supply there would be no future for Los Angeles.

Now, as the great work nears completion, the possibilities of the aqueduct as a generator of electric power are becoming more clearly defined, and the general public is beginning to realize that the development of the power system with a capacity of 160,000 horsepower will mean almost as much to the city as the delivery of 20,000 miner's inches of water for a thirsty land.

With the improvement of the Los An-

geles harbor, now making rapid progress, and with the opening of the Panama Canal in 1915, commerce and industry should be immensely stimulated around the south Pacific Coast, and the delivery of a vast amount of power at a low cost will be a big factor in this development.

The aqueduct is said by experts to be second only to the Panama Canal as an engineering feat, and in describing it one deals with figures which stagger the imagination. Imagine the difficulties of bringing a fair sized river a distance of almost 250 miles, through mountainous regions and across the burning sands of the Mojave desert, building conduits and boring tunnels so large that big automobiles now run through them on the engineers' trips of inspection. Imagine this work being done in a sparsely settled or uninhabited section of the country, far from the railroad and other sources of supply and in a country so rugged that even the sure footed little burros, used in the preliminary work, found it hard to

secure a foothold on the rocky ledges. This was the situation which con-

fronted the daring engineers who planned to bring a large part of the flow of the Owens River from 12,000 feet above sea level and deliver it at the door of Los Angeles, at a cost of \$23,000,000.

Today the great work is closing up the last links of the chain of conduits, tunnels and siphons, and early in the spring of 1913 we will see the aqueduct completed.

The first section of the aqueduct consists of an open trench 60 feet wide, which was dug by suction dredges that cut out the soft earth by means of huge jets of water, after the principle used in hydraulic mining. This canal carries the river around the Owens Lake and on to the Haiwee reservoir. Below this is a power drop, one of the series which will be linked up by the system. Then come miles and miles of rugged country, which was pierced by tunnels, having a total length of 32 miles, while crossing the canyons between the tunnel mouths are flumes of concrete and steel siphons, eleven feet in diameter. These gigantic steel pipes are said to be the largest in the world, and there will be nine and a half miles of them. They are built of massive plates having a thickness of from one quarter to $1\frac{1}{8}$ inches, and are so large that a motor car can be driven into the tube and have plenty of room to spare. It requires a team of 52 mules to draw a single section of this gigantic pipe.

Most notable among the siphons are the Jawbone and Soledad pipes, each of which is about a mile and a half long, and they are carried across the valleys on heavy concrete piers. Then comes a drop into the Mojave desert, which is spanned by a trench lined with concrete and furnished with a stout cover of the same material reinforced with iron rods. The cover is to prevent cloudbursts and sand storms from polluting the mountain water and filling the trench with gravel.

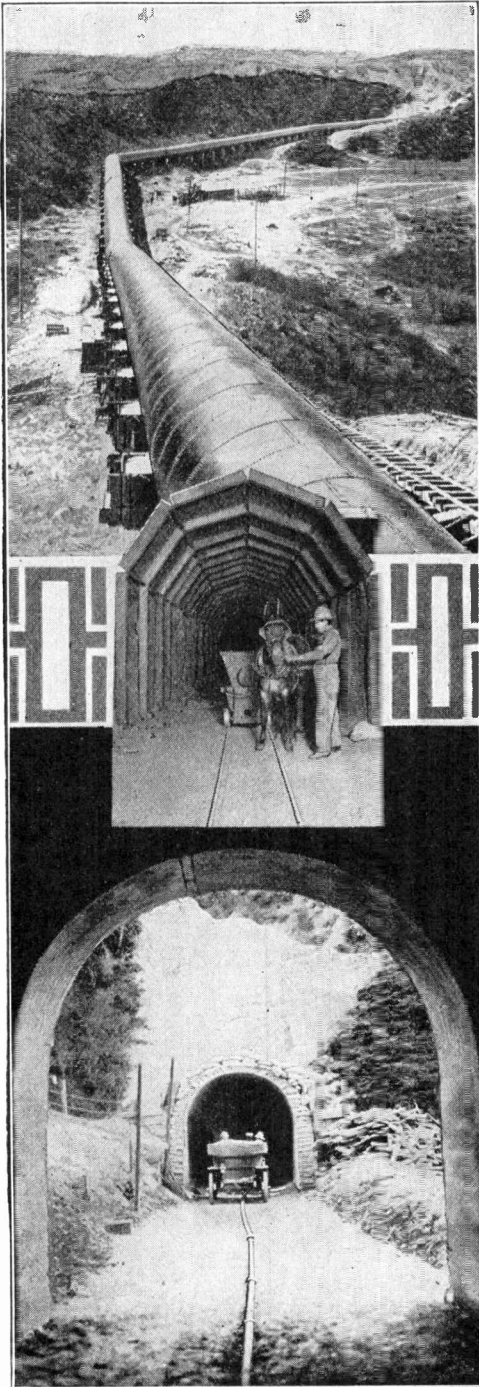

THE GREAT SOLEDAD SIPHON AND TUNNEL WORK INCIDENTAL TO ITS CONSTRUCTION

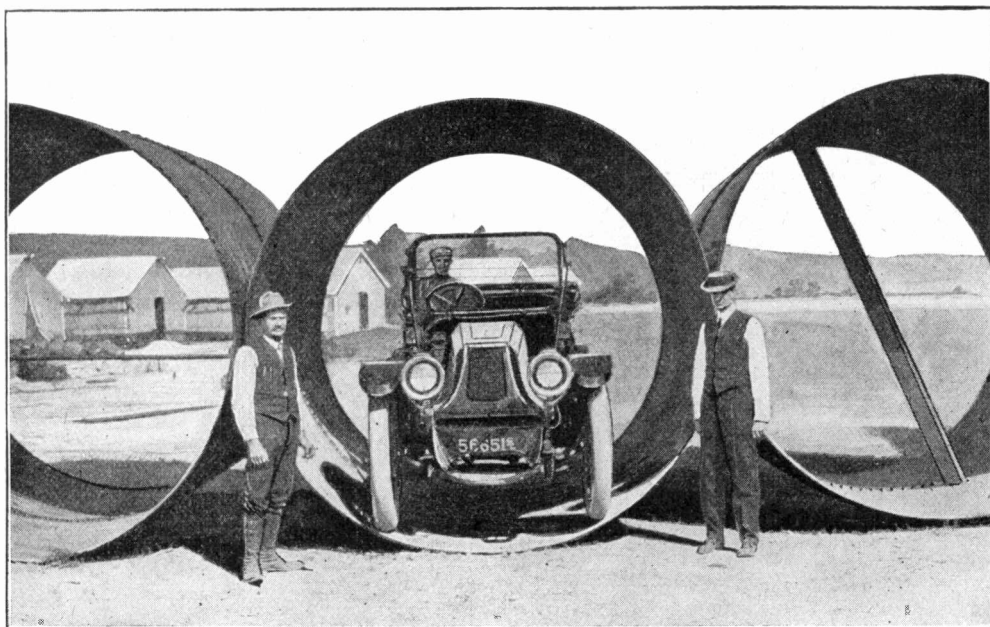

STEEL SECTIONS FOR THE SOLEDAD SIPHON

Among these concrete siphons, which have been installed where it was not expedient to use the steel pipes, is the Whitney siphon, near Newhall, which has a length of 900 feet and a diameter of ten feet inside. This pipe drops 65 feet to the bottom of the canyon, rising to a point just a few feet lower on the opposite hillside, where it connects with another tunnel. This is said to be the largest concrete siphon in the world, and in fact there are a number of features of the aqueduct construction that are record breakers.

A report was filed this summer by E. F. Scattergood, chief engineer of the aqueduct bureau. It was in this report that the figures of 160,000 horsepower were first specified as the volume of energy to be produced from the aqueduct. Heretofore the accepted estimate had been 120,000 horsepower, and it was believed that expensive auxiliary steam generating plants would have to be installed by the city. Mr. Scattergood has been working on the engineering problems involved and has found a way to add 40,000 horsepower to the original

estimate and also to eliminate the auxiliary plants.

At the present time the surveyors and right of way agents are working upon the course of a power transmission line to connect up the small plants already in operation at Division Creek, Cottonwood and Haiwee, all points far from the city, while others will be installed in Long Valley at Big Pine, in San Francisquito Canyon and at the San Fernando reservoir. Fifty foot steel towers, bearing the transmission lines, will link these various plants.

The advantage of this considerable number of power plants is obvious, as one or more might be shut down for repairs without putting the whole system out of commission, and in case of any necessity arising for stopping the flow of water in the aqueduct, the different reservoirs are of a capacity to supply power and water for several days. One of them, the Elizabeth Lake reservoir, above Power Plant No. 1, is large enough to receive the entire flow of the aqueduct for nine days.

Destroying the Vampires of the Deep

By EDWARD LYELL FOX

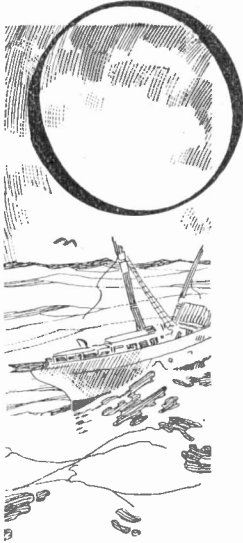

ON the wall of the Hydrographic Office there hangs a large chart of the North Atlantic. Across the pale blue space that represents water lie dark lines, the paths between our seaports and those of another world. Always these paths are the same—the same lines in the same positions. Were you to look at this chart another day, though, you would find that a number of dots clustered along the coast line had moved from one place to the other. On no day will you find the dots in the same position that they were the day before. For these dots indicate wrecks and derelicts—the vampires of the deep, ever changing, now lurking in the shadows of the coast, now drifting out to sea—deadly,

sodden hulks whose mission is to take by surprise and destroy.

On the map they are placed as little silhouettes which are moved according to the reports sent in by wireless. Sea captains are ever on the watch for the peril, and upon sighting the dark hulks creeping along the surface of the water they are quick to flash the news to the hydrographic stations. And upon the receipt of this news, trim, fast moving cutters, whose commission it is to destroy all the derelicts, steam from the nearest port. By electricity, by the wireless bearing the news, their mission is made possible. And by electricity, the working of mines, their mission is fulfilled. For the derelict, you see, is blown through the water and into the air—a vampire that can no longer tear into the bodies of unsuspecting ocean craft.

Today there are about 2,000 derelicts in the waters of the world—floating perils that go where wind and currents bid them. Every sea is made hazardous by their presence. They have crashed into ocean liners, into junks of the China Sea. To them all vessels are alike—something to be destroyed. They crash against them in the dead of night, when inky blackness hides their coming. Wrecks themselves, they seem to strive to drag all others to their own fate.

I have said that they are drifting on the Seven Seas. More particularly they seem to swarm eagerly in the Gulf Stream. From St. Augustine, Florida,

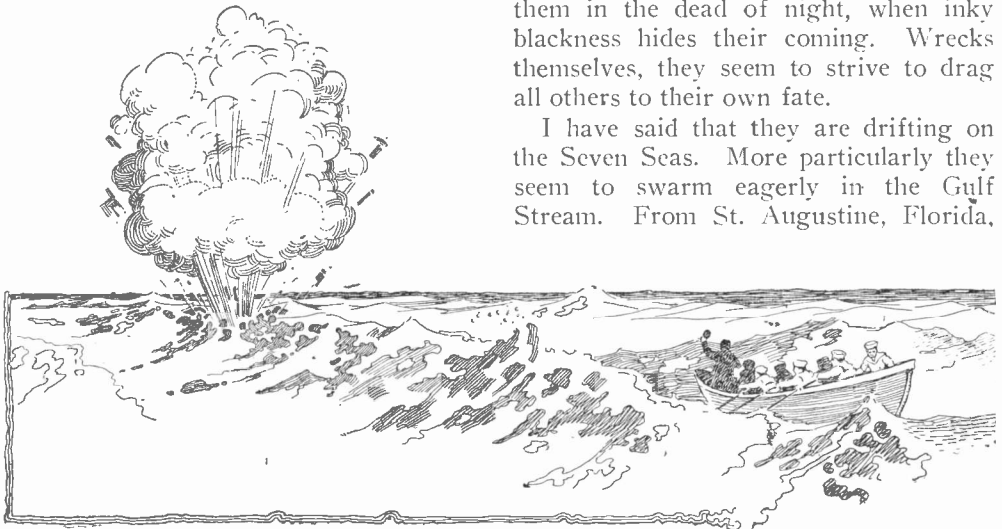

they move north in its warm waters, silent, sullen travelers that creep through the waters unpleasantly, like eels.

That is why there are so many dots swarming the Atlantic coast on the map in the Hydrographic Office. From Cape Hatteras reaching north to the Grand Banks of Newfoundland is the "graveyard of the Atlantic." It is a rolling waste where many ships are buried. It is a place where derelicts borne by the sweep of the Gulf Stream and the counter churn of the Labrador current dart about like angry sharks, eager to fasten their maws on the hull of some ship.

In the Hydrographic Office at some seaport the wireless is sounding. A message is coming through the void. It is a message of peril, coming from a steamship. It warns that a derelict has been sighted squarely in the path of ocean travel. For days the men at the station have been waiting for word of this derelict. Its position on the chart has not moved for a week. They have lost track of it. Its driftings are as a mystery. The station men have been unable to wire back over the seas, warning captains of its whereabouts. Any moment they may hear that it has attacked and wrecked.

But now the derelict has come into the light. The *Baltic* has sighted it and sent the warning humming over the seas. Now the men at the station are quick to act. At a word from their chief they relay the message to the commander of

the revenue cutter *Seneca*, laying by. The *Seneca* has been waiting for this message—waiting for the derelict's whereabouts to be revealed. And now, knowing them, it gets up steam and sails forth—a purger of the seas, on destruction bent.

And as she is steaming toward the latitude and longitude given as the hiding place of the vampire, the *Seneca* keeps in wireless touch with the station. And now, while she is racing toward the wreck, let us see exactly what her quarry is. Then we may better picture the work of destruction.

Of derelicts there are two—the kind that floats observed and the kind that floats unobserved. Most people imagine that shipwrecks are ultimately driven ashore, and that vessels reported sinking at the time of abandonment go down soon after. That is not true. Abandoned ships breed vampires of the deep. For months they float. Water logged, half sunken, pitched and torn by storm, they yet somehow seem to survive. They will live in gales that send the staunchest

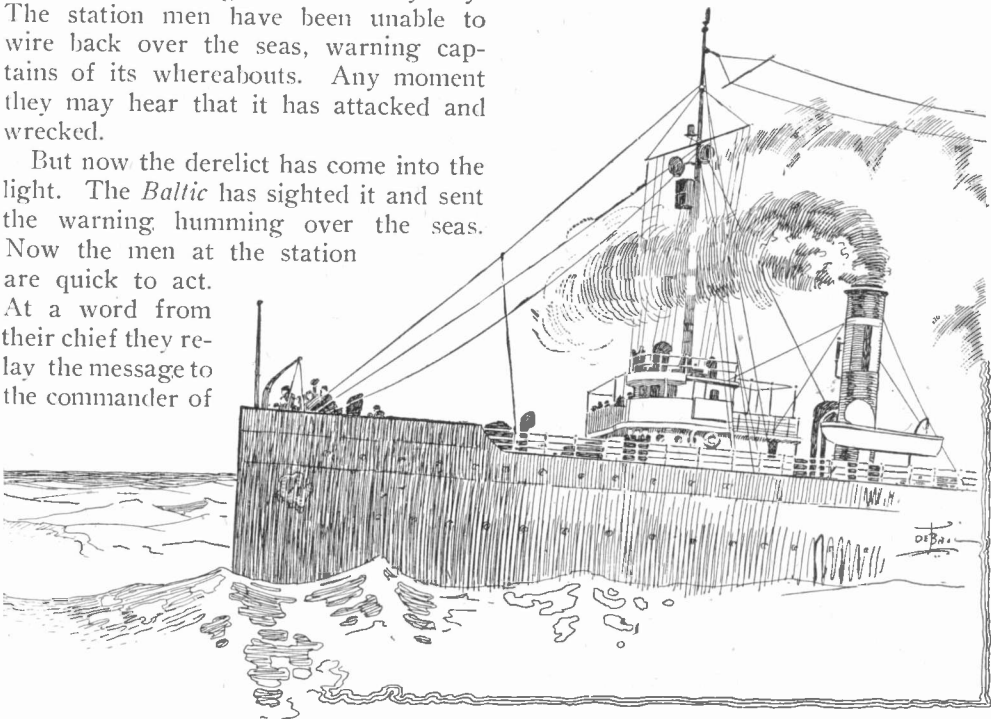

vessels to the bottom. Only Time can destroy them—that is, unless electricity takes a hand.

Too heavy to rise to the surface, and yet not water soaked enough to sink to the bottom and remain there, they crawl along just under the riding swells. Their abiding place is nowhere. From the untraveled tracks of the seas they may be carried by a storm directly in the path of navigation. Whither they go, no word goes before them. They descend unobserved, quietly, grimly. Not until they have struck is their presence known. Then they take their toll. They destroy a ship, and from it another of their kind is made. It is their way of multiplying and spreading the breed. That is why it is so important that they be destroyed.

But now the *Seneca* has steamed into the province of the derelict. High in the mast the lookout is casting his eyes on all sides. If he is not alert, the derelict may attack those on board the *Seneca*. Self preservation is strong in a vampire.

But now the tip of a submerged mass rises above a distant swell. Caught in a sudden pitch of the sea, the derelict has revealed itself. From the lookout's nest the cry sounds. The speed of the *Seneca* is reduced. It moves slowly toward its quarry. And now the work of harnessing electricity for the destruction it must do begins. From the magazines are brought mines charged with 60 pound burdens of gun cotton. From the store houses are brought insulated electric cables and a hand magneto. A small boat is lowered and the mines are taken on board. Then the boat rides over the sea toward the derelict, a risky ride if the swells are running high.

And next comes the work of placing the mines where they will create greatest explosions. If the wreck is submerged, the task is more difficult. More mines must be used. Exquisite care must be employed in their placing. Finally the explosive charges are connected by means of the insulated electric cables, and the wrecking party draws off to a safe dis-

tance. The man with the hand magneto provides the necessary current. The detonators of fulminate of mercury explode. The primers of dry gun cotton are dealt a harsh blow. The explosion is sufficient to loosen all the heavy powers of the masses of wet gun cotton. And then the derelict flies apart, its back broken, its sides flying through the air—a scraping and rending of planks, the sodden splash as they hit the water again—the sound of a vampire dying.

Alley Pole Lines

The Oklahoma Gas and Electric Company is using concrete poles extensively on its Oklahoma City lines, and many of these are employed in a form of alley con-

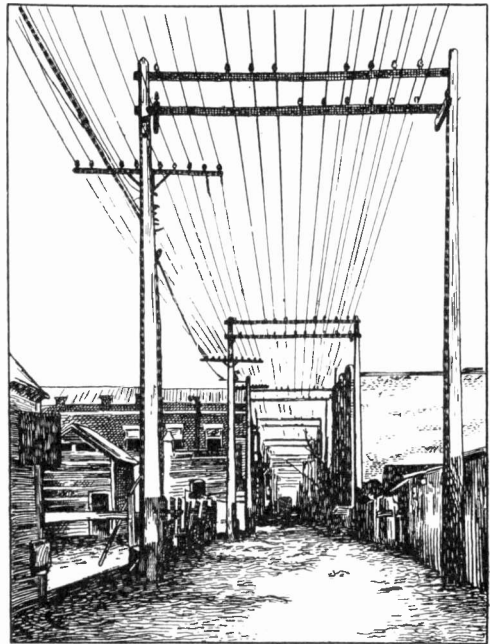

ATTRACTIVE APPEARANCE OF THE ALLEY POLE LINES

struction, shown in the sketch. This method not only removes unsightly poles from the front streets, in such localities as are not given over to underground work, but is in itself an ornament to more or less unsightly alleys, presenting almost the appearance of a continuous archway, overtopped by a roof of straight, neatly hung wires.

Prevention of Hail

A new hail destroyer is about to be put to use in France on a large scale. The device is strangely like an immense lightning rod of absolutely pure copper, and it is grounded by a copper conductor. According to the theory of the inventors, these instruments, by their effect upon currents of atmospheric electricity, are well able to prevent the formation and fall of hailstones.

The Government of the French Republic, through a special commission of senators and deputies, is trying the invention in several places, and has inaugurated a campaign of education in rural districts upon the value of electrical conductors as preventives of the disastrous hail storms.

A chain of hail destroyers of the new kind is now being constructed in valuable vine-growing neighborhoods, which have heretofore suffered ravages from hail storms. The departments of the Gironde, the Beaujolais, the Loire Inferieure and the Charente are all notable sufferers.

Americans fail to grasp the terrible damage wrought by hail in France. Each year the losses exceed the approximate estimation of from \$20,000,000 to \$30,000,000. This is constantly increasing and will cause the experiments with the new hail destroyer to be extended and the system to be greatly improved.

To determine the efficiency of the new invention with any degree of accuracy, it is realized that systematic tests over a long period will be necessary. To supervise this a committee has been formed from among the representatives of the French government.

The notion that electricity is largely

concerned with the formation, crystallization and precipitation of hailstones was first promulgated by engineers of the French Academy. The copper "hailstone killer" is called technically a "paragrole." It has multiple points and is capable of withdrawing immense quantities of electrons from the clouds to the earth. Thus the hailstones are prevented from forming, and lightning is carried off at the same time.

Paddle Wheels Open and Close Bridge

Opening and closing a temporary bridge by floating one end of it around upon a big scow is a rather unusual way to handle such structures, but is successfully used in the Chicago River at Indiana Street while a new bridge is being built.

Supporting timbers run from the

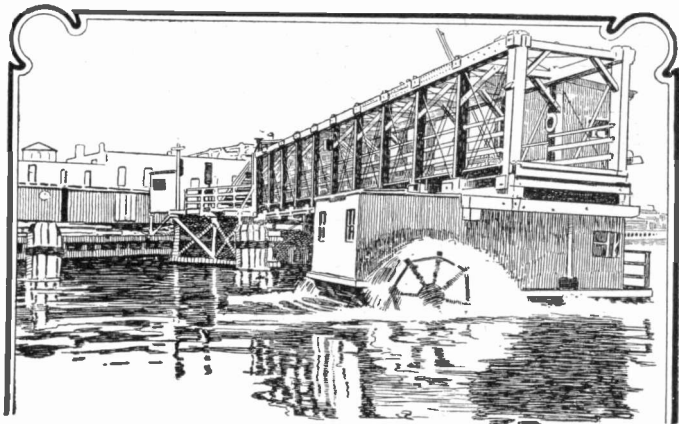

BRIDGE BEING SWUNG BY PADDLE WHEELS

bridge down to the scow and about these is built a housing enclosing a five horsepower motor geared to a shaft upon the ends of which are two old type paddle wheels. The other end of the bridge turns on a big iron pin. The sound of rushing waters accompanies the swinging of the bridge as the paddle wheels push the scow back and forth. A small switchboard and controller are located in the bridge tender's house, which is at the street level.

Playing Tennis at Night

Efforts to illuminate tennis courts, and play at night, are almost as old as the game itself. One of the first schemes tried was a strong light at each of the four corners of the court. This was a failure. There were too many shadows—the players were constantly becoming

still far from satisfactory. Diffusion was poor, and shadows were plentiful.

The peculiarly exacting conditions have apparently been met, however, by a system designed by the illuminating engineers of the Buckeye Electric Works. The lights are placed to the sides of the court, and so arranged that they brilliantly illuminate an area a few feet



THE PECULIARLY EXACTING CONDITIONS OF TENNIS PLAYING AT NIGHT HAVE PRACTICALLY BEEN MET

confused by the glare from lights and court, and the center of the court was darkest.

The next plan tried was hanging rows of arc lamps over the net and over the back lines. The lamps, of course, interfered with play, and the glare in the eyes was bad. The shadows made the ball difficult to see, and there was no diffusion of light.

Then the experts reasoned that by hanging two arc lamps over each back line, and one over each of the four service courts, success would crown their efforts. The result was another failure. The glare and the shadows were still present.

More recently another plan was tried. A long trough reflector was hung down each side of the court, and thickly studded with incandescent lamps. An improvement was noted, but results were

larger each way than the dimensions of the court itself, with a diminishing illumination extending fully 100 feet in each direction, thus preventing lost balls.

Lightning Bores Iron

During a recent electrical storm at Massillon, O., an official of the Brown Lumber Company sitting in the office was startled by a loud report like the discharge of a gun and looking up at the ceiling noticed a blaze. Smothering this out he went on with his work but soon detected the odor of gas. On examination he discovered there was a hole large enough to insert his little finger in the iron gas pipe. The lightning had come in over the electric wires, jumped off onto the gas pipe which they crossed at right angles, bored through the iron and ignited the escaping gas.

Ouch!!!

With the aid of a flashlight incased in the policeman's club, escape is impossible from a blow even in the dark, as the upward swing shows the "copper" the place to land on.



AN ELECTRICAL HINT FOR POLICEMEN

The inventor, Robert L. Litsey, of Seattle, Wash., probably was missed once and thought of the needed improvement.

Continental Types of Heaters

Electric cooking and heating utensils are now so common that we are all familiar with the usual designs followed by our

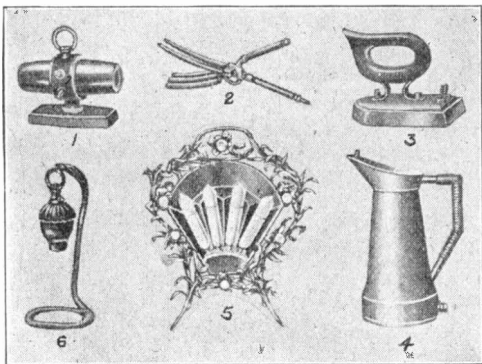

(1) CURLING IRON HEATER. (2) CURLING IRON.
(3) FLATIRON. (4) WATER HEATER. (5) RADIATOR. (6) CIGAR LIGHTER

manufacturers. Similar utensils turned out by German or French manufacturers, however, often have an altogether different appearance, in some cases so different that at first sight we scarcely recognize what they are intended for. The accompanying illustration shows some Continental designs. The curling iron heater, for instance, looks like a toy cannon, while the curling iron has the appearance of a carving set.

The Cable Splicer at Work

In this picture we are looking down into a manhole in which are several telephone cables. A "splicer" is at work



CABLE SPLICER AT WORK

connecting the wires from an incoming cable to those of an outgoing one. Instead of wiping with lead the casing of each bundle of insulated spliced wires, the Bierce cable sleeve, a metal cylinder either solid or in halves, is slipped over the splice. No solder is used, the sleeve

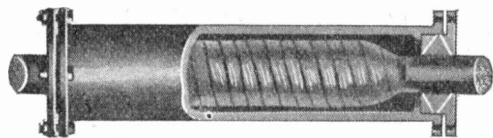

BIERCE CABLE SLEEVE

being made water tight by a rubber cone crowded about the cable at each end of the sleeve.

The Great Lakes Naval Training Station

"We must look to the Great Lakes for our sailors of the future" was the decision of the naval authorities after the war with Spain. "The American seacoast sailor is a thing of the past. There is only one place where the American sailor is to be found, and that is on the Great Lakes."

So, 33 miles north of Chicago, on a high bluff overlooking Lake Michigan, was begun, July 1, 1905, the work of transforming 182 acres of land into a place for the first inland training school for the Navy and the largest in the world. For six years Rear Admiral Ross, known as the "Father of the Station," supervised the construction of buildings, until today 2,500 men can be cared for and taught the rudiments of seamanship. When, four or five months later, four months being the usual period for training at the station, they go aboard a

In building the station, provision was made to use electricity wherever possible, from lighting the buildings to preparing the food. At the foot of the bluff, just at the water's edge, is the power house, containing three 175 kilowatt alternating current generators. From an intake 1,200 feet out in the lake, motor driven pumps in the power house bring the station water supply to the filtration plant tank, where it passes through five feet of fine sand and into a second tank, to be then forced into a 40,000 gallon standpipe in the Administration Building. Over in the Mess Hall are the chill rooms where the meat and vegetables are kept. An electric pump located in the power house, 2,500 feet away, circulates the freezing brine for keeping these at the proper

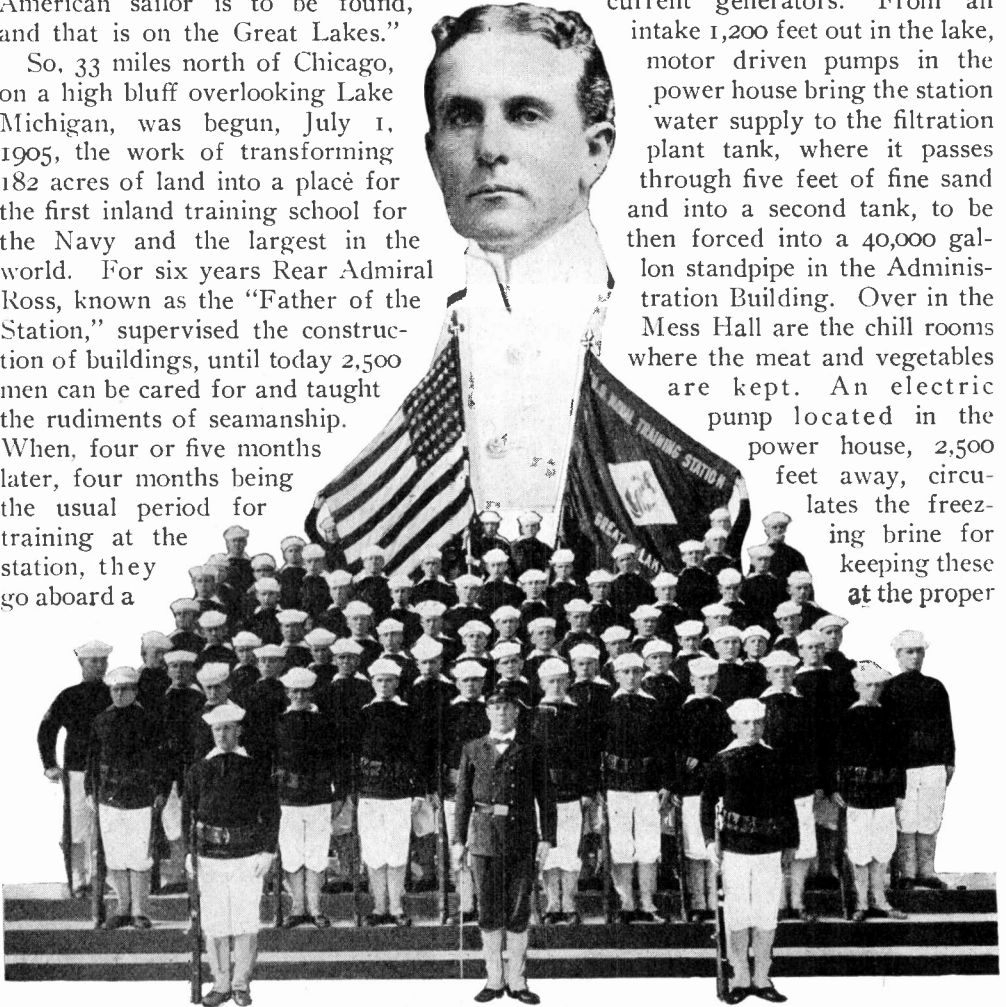

CAPTAIN O. F. FULLAM, COMMANDANT U. S. NAVAL TRAINING STATION, GREAT LAKES, AND ONE OF THE CRACK SQUADS

man-of-war, details of drill and discipline are already established and the recruit is ready to give his attention to handling the machinery of a battleship, no small part of which is electrically controlled.

temperature at all seasons of the year.

Sanitary handling and preparation of the food for a big body of men is absolutely necessary, as is also its rapid handling in large quantities. The Mess

Hall where the men are fed illustrates this feature and electricity does much of the work. A flour blender takes several grades of flour according to the desire of the baker, mixes them, sends the blend

spot as the "spuds" come from the peeler.

In the "galley" (kitchen) a meat chopper cuts up the meat in quantities ranging from 1,000 to 4,000 pounds a day according to the bill of fare, and after each meal the dishes are gathered up, placed on wooden racks and, several

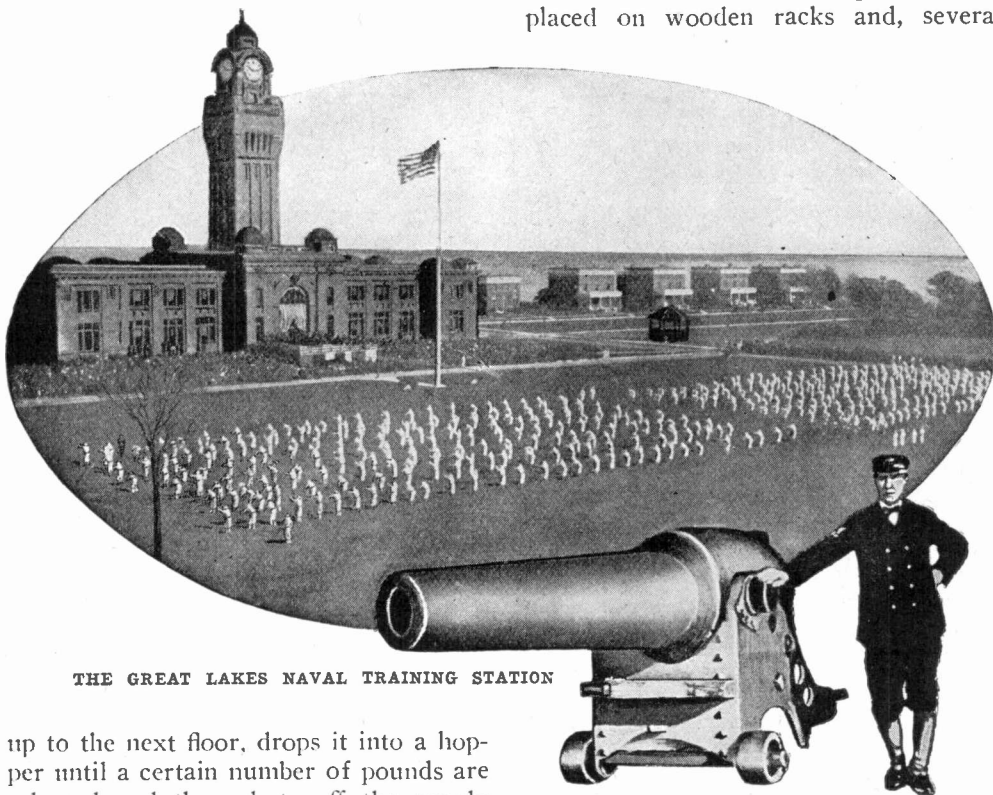

THE GREAT LAKES NAVAL TRAINING STATION

up to the next floor, drops it into a hopper until a certain number of pounds are released and then shuts off the supply automatically. From the hopper the flour drops into the dough mixer, a little later to come out in the form of loaves ready for the oven. And this is all done by electric power, from 1,600 to 3,000 loaves a day being prepared in one-half the time required to perform the same work by hand.

Then there is the egg beater which holds close to a bushel of eggs free from the shell and the ice-cream freezer with an attachment in the way of an ice crusher. A rather large "detail" would be required to peel the potatoes used at the station but a "spud" peeler does this at the throw of a switch, and a half dozen apprentices remove here and there a black

racks at a time, washed by a motor operated washer.

While electric current helps to feed the young "jackies" it also contributes to their recreation. The station has a large auditorium equipped with a stage, curtain and a moving picture machine where regular entertainments are given each week, some of the talent being such as play the best theaters in large cities.

Now, just a word as to the station and the life of Uncle Sam's future men o' warships.

At the entrance of the grounds a seaman's guard (a recruit who has already seen service on the water), rifle in hand, invites you to "come aboard"; for all

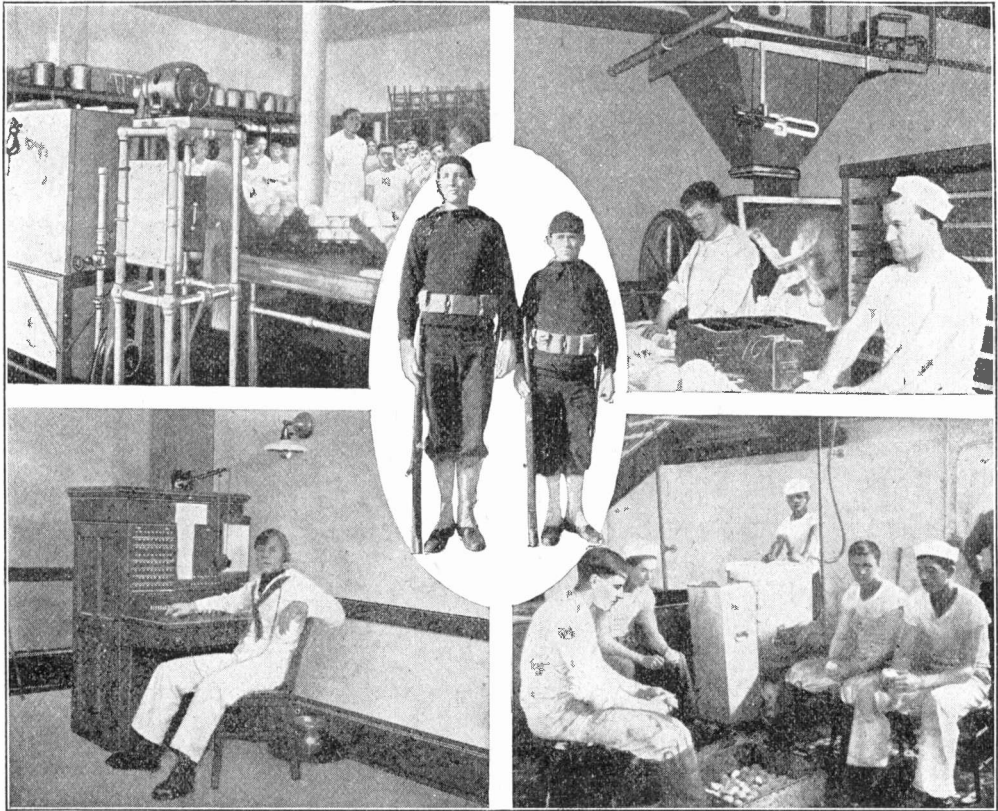

ELECTRIC DISH WASHER
ONE OF THE BRIGADE BOYS DETAILED AS
"HELLO GIRL"

ELECTRIC DOUGH MIXER
PUTTING THE FINISHING TOUCHES ON POTATOES
AFTER THEY HAVE PASSED THROUGH THE
ELECTRIC PEELER

MUTT AND JEFF—TWO CHUMS

conversation, orders, etc., take on a nautical turn the moment the station's boundaries are crossed and the recruit must think and act accordingly.

The recruits are young fellows with a longing to see the world and to experience the life in the Navy. An average young man from the farm, the small town, or the city—just an average boy of seventeen or eighteen, careless, perhaps in his dress, his walk and his grooming—comes into the receiving room and reappears from another door a little later, an embryo man o' warsman in the white duck uniform of the service. It is quite possible that his own mother would not know him. He has gone direct from the receiving room to the dressing room, where he takes off his citizen's clothes

for which he has no further use; to the barber, where he is shaved and his hair cut; he takes a bath and then goes to the doctor. The medical examination is for the purpose of discovering any defects which the recruiting officer may have overlooked and for the purpose of identification. The Government gives him a \$75 outfit of clothing and he packs up his old clothes and sends them home.

For 21 days the new recruits stay at the reception barracks, and during this time and while at the station they wear leggings to distinguish them as apprentice seamen. They are quartered in dormitories, of which there are six. The walls are hung with code signals of the Navy, so wherever the youngster looks, he is reminded of the life he has chosen,

Although they are not permitted to eat or sleep together during the 21 days in the reception barracks, there are no restrictions in regard to their out-of-door sports. They play ball as well as drill together on the parade ground. There is no danger of contagion, it is claimed by naval authorities, out of doors. Whatever of military discipline exists is not obvious. As long as the recruit conducts himself like a gentleman, he knows nothing of any such discipline. There are no sentries and the gates stand open.

The first consideration of the training school is to make its apprentice seamen physically and morally clean.

At the end of the 22 days, when all danger of any contagious disease is over, the recruit is sent to the main barracks and his work and instruction begin. He is taught the care of clothing, blankets, equipment and personal belongings. He is given a thorough course in hygienics, and is taught to swim. As soon as he knows how to care for himself, he is ready for the drill hall. The walls of the drill hall are covered with representations of flags of all nations and the signal codes. A huge compass is painted on the wall in exact representation of the compass on board a man o' war, that he may learn to box the compass, and there is a "log" and a "lead line" where he can learn the "marks" and "deeps." He is taught how to make knots, to splice ropes, to make hitches and bowlines, to coil down gear, and in the summer time he is taught how to handle boats both under sail and under oars.

After being assigned to a battalion, other drills are begun and the apprentice seaman is continued in the instruction of the semaphore (signaling with arms), is given the wig-wag (signaling with flag) and is taught the use of lights, rockets, and other night signals. He is given a rifle and is taught how to handle it. He is taught the manual of arms and target practice under warrant officers and petty officers. Many of the drill movements are timed to music.

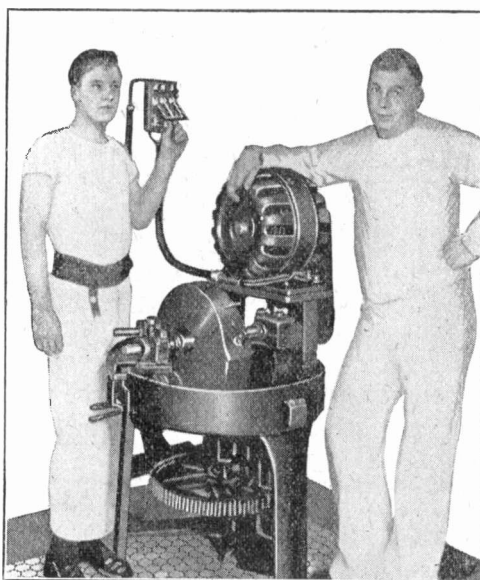

ELECTRIC MEAT CHOPPING MACHINE

The apprentice seaman must "lash up his hammock" at 5:00 a. m. and fifteen minutes later has his appetite whetted for breakfast by a cup of cocoa. Cleaning up about quarters until 6:45 is followed by bathing formation when under an immense shower bath of 80 nozzles, enough to soak a whole company (80) at one time, the men are tuned up for the day. At 7:30, breakfast. During the morning there are drills to be attended, "grinders" as the boys call them. These are not held on liberty days, (Saturday and Sunday). At 12:00 noon, squads from the various barracks march into the Mess Hall for dinner.

Realizing that no physical strength is achieved on a diet of inferior food, the Government provides for its apprentice seamen the best in the market. They have beef, pork, stews, all vegetables and fruits in season, pork and beans, and cake.

On Wednesday from 3:30 to 4:30 p. m. exhibition drill takes place on the parade grounds. Supper is served at 6:00 each day and at sundown the gates of the station are closed. Tattoo sounds at 9:00 and the "jackies" swing into their hammocks to listen to "taps" at 9:05.

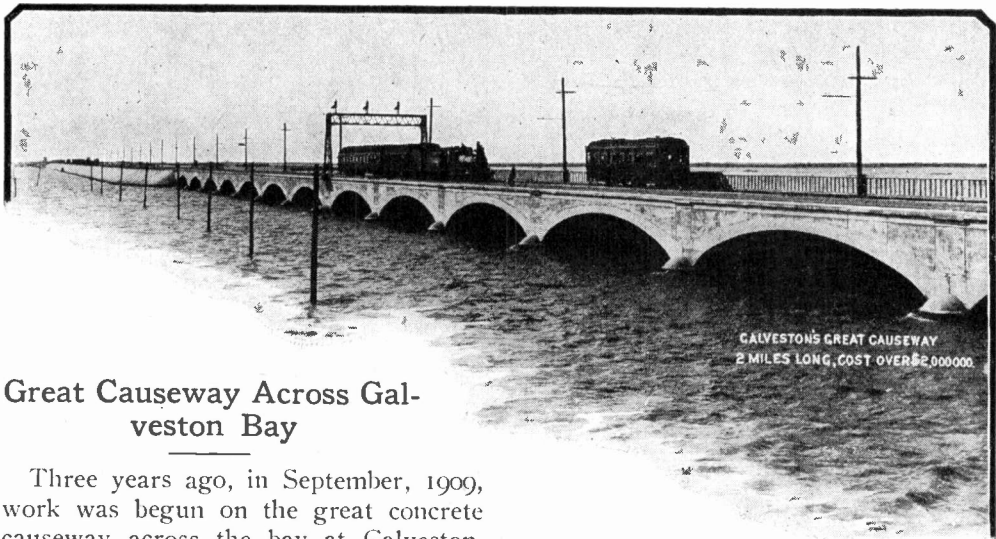

Great Causeway Across Galveston Bay

Three years ago, in September, 1909, work was begun on the great concrete causeway across the bay at Galveston, Tex. It was completed only about three months ago. It is being used by the Galveston-Houston interurban electric railway and several steam roads as well as public vehicles.

The cost of this undertaking was over \$2,000,000. The total length, including unprotected roadway, is 10,642 feet, approximately two miles. The portion shown in front in the picture is the arch bridge, 66 feet wide, with 28 arches of 70 foot span. There is also a rolling lift bridge 52 feet six inches wide.

Wireless on Monoplane

Experiments with a Marconi wireless outfit on a Flanders aeroplane are being made at the Brooklands aviation grounds, England. It is now possible to use an aerial wire contained on the machine itself, instead of a hanging wire, as formerly, and this gives the pilot the advantage of flying nearer to other machines, and obviates any trouble which might arise from a hanging wire where the landing is made in a confined space. The new Marconi aeroplane set can be put upon almost any type of aeroplane. The set has

been made up into several separately containing parts, with the idea of giving a good distribution of weight on an aeroplane. The apparatus is strongly constructed and has stood hard treatment. Primary cells or storage batteries can be used, and in the latter case a special non-spilling battery is supplied, so that there is no fear of acid splashing out and damaging the aeroplane.

It has been found convenient that the bulk of the apparatus be stowed under the pilot and passenger seats, so that it is designed with a view of placing it upside down or in any other position. The only part of the apparatus which need be exposed is the sending key and the small control switch. Beyond its uses from a military point of view, a machine thus equipped enables the pilot

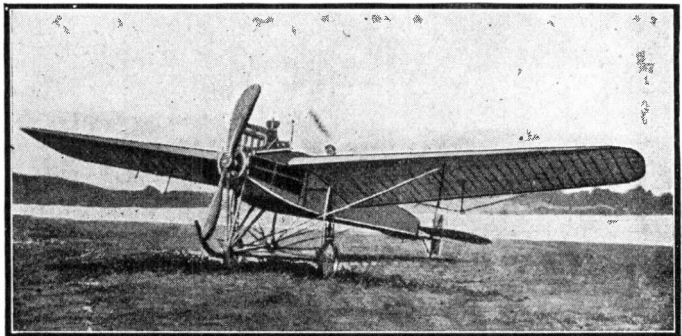

FLANDERS AEROPLANE USED IN WIRELESS TESTS

to keep in connection with the aerodrome or headquarters during a flight, which in cross country or long distance flights would be of great importance.

New York's Double-Deck Stepless Car

The stepless car—introduced for the comfort of hobble skirt wearers—has now been followed by the double-decker. It has greater seating capacity, accessibility and more speed. On entering, pas-

seengers will have to mount a step of only ten inches and will face a conductor seated at a desk. An arching roof with a central height of seven feet two inches gives plenty of head room. Access to the upper deck is obtained by a central stairway where back to back benches run the length of the car over the arch of the lower story.

Economy of space makes the new double deck car only seventeen inches higher than the present standard of cars. The new car will seat 88 passengers and accommodate 171, as compared with 60 seated in the long and 50 in the short open cars, 51 in the stepless cars, 41 to 47 in the pay-as-you-enter type and 36 and 28 in long and short closed cars.

The equipment of this street car de luxe will include an electrical street an-

Announcing Subway Trains

A recent innovation in the New York subway consists of an electric train announcer for the convenience of passengers. Those who use the subway may

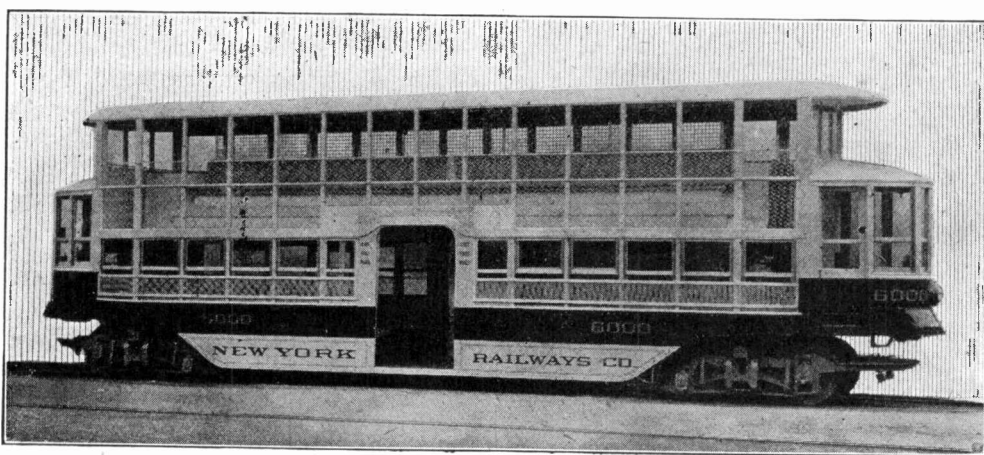

A DOUBLE-DECK STEPLESS STREET CAR

have noticed three or four box like contrivances suspended over each side of the platforms on the northbound express stations.

Near the northern or uptown end of the platform sits a uniformed employe of the Interborough Rapid Transit Company. In front of him in two oak cases situated within easy reach of his hand are mounted seven push switches, four for local trains and three for express trains. Curious passengers gather around to watch this switchman at his work. A train comes roaring into the station. A quick glance at the headlights and a button is pushed.

Instantly in each of the boxes appears the legend:

BROADWAY EXPRESS
VAN COURTLAND PARK

or if it be a Lenox Avenue train the sign will flash out that fact in plain view of all the passengers.

As the train pulls out the lower button is pushed and the sign lights go out. These signs are somewhat unique, as while the current is off no words or letters are visible. This is owing to the use of a stencil arrangement covered with colored glass.

Tree Vibration for Saving Buds From Frost

A recent invention relates to a new system of motor operated tree vibration for saving buds and blossoms from frost.



A TREE VIBRATOR IN PLACE

The new system aims to create in fruit trees a movement of the sap to the buds and blossoms that tends to vitalize them enough to resist the attacking blight of frost. This movement of the sap might be called a capillary action, and can be likened to the gentle exercising action of an electric vibrator instrument on the human system, which stimulates the flowing action of blood through the veins, especially at the point where the vibrator is applied.

The system for imparting this vibra-

tory action to buds and blossoms has been worked out and patented by Herman L. Darling of Delta, Colorado. It comprises the installation in the tree of a small electric motor having a trembling rotary motion and connected by transmitting wires to an electric current.

During the months of April and May when the orchard is subjected to sudden freezes, by means of this system, a vibratory trembling motion is imparted to all limbs of the tree, transmitted to twigs and buds and this motion starts the sap to circulating, invigorates the buds and strengthens them against the killing effects of the frost.

Keeping Insects Out of Lamp Globes

To keep insects from the inside of light globes on porches and in other out-of-door places, I have found the following

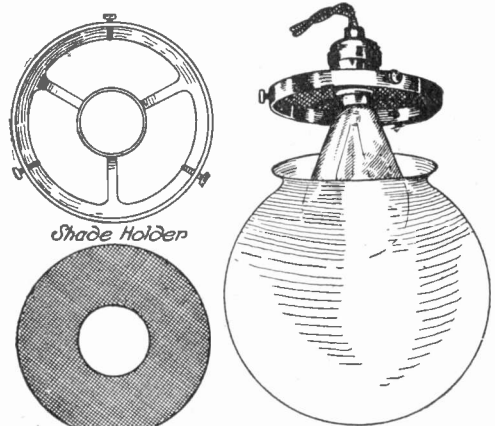

Fine Wire Screen Regular Porch Globe

LAMP GLOBE WITH INSECT SCREEN

useful: Take a piece of fine wire screen (wire gauze being preferable as it will keep out smaller insects) and cut it to fit inside the shadeholder. Then cut a hole in the center, fitting closely around the lamp socket. With the screen in place both the outer and inner globe will require less cleaning, as the screen will keep out a part of the dust as well as insects.

L. W. JAKES.

Electricity in Place of Food

At some future day, instead of taking food we will simply take electric current which will answer the same purpose, according to the somewhat startling announcement made by Prof. Bergonié at the Science Congress at Bordeaux. According to the French physician, the ancient habit of eating may one day disappear, and meals will be replaced by a sojourn of a few minutes in the electric cage which gives high frequency waves. It is known that this sets up currents within the human body so as to cause an

internal heating, without, however, doing any harm. Now this heat represents a certain amount of energy, so that it is clear that we do not need to absorb as much food as before. When the body lacks food, it is seen that some of the organs become cooler owing to a loss of energy. The electric current acts to restore energy to the organs by heating them to a certain extent. At present, even if we cannot make the current replace food, at least it may be made to aid in nutrition and economize the work of the stomach, so that less food is needed.—*Le Matin (Daily), Paris.*

TELEPHONE AS AID TO TALKING MACHINE SALES

Some dealers in graphophones and phonographs are now employing the telephone in a novel manner. They use it for the purpose of playing a record to a customer who is unable to come to the sales-

room to hear it. The accompanying illustration shows how the trick is done. It is stated many sales of records are accomplished by means of this method of demonstration.



Courtesy of the Inland Storekeeper

PHONOGRAPH BEING PLAYED INTO THE TELEPHONE TO INTEREST CUSTOMERS AT THE OTHER END OF THE LINE

Rubber's Secret Conquered

By E. LESLIE GILLIAMS

Occasionally one has a stroke of luck. Such was the accidental chemical discovery of synthetic rubber, in the making of which electricity will play a part.

It is claimed that synthetic rubber will shortly be placed upon equal terms of competition with the juice of the trees and the plants which have so long supplied the rubber of commerce. The demand for rubber, largely on account of its extensive use in the automobile and electrical industries, is increasing immensely, and the artificial rubber will come into the field none too soon.

In 1910 and 1911 the world's production of india rubber reached a total of about 80,000 tons and the world's consumption of this article was in the neighborhood of 75,000 tons. Figuring the cost of this rubber at an average of \$1.00 a pound, the total value of the production reaches \$160,000,000.

Now it is claimed that synthetic rubber, in every particular equal to the finest natural rubber, offers a possibility of a profit at a price of 60 cents per pound, with a probability of its production at 24 cents per pound or less. The only question is, can it be produced in sufficient quantities to be of commercial value? The claim is made by both English and German chemists that it can, and by the use of electricity, in hastening the process, this claim will likely be made good.

At the present time English and German chemists are disputing over their claims of precedence in finding a way to create from certain raw materials a chemical counterpart of natural rubber.

While this dispute is interesting as showing how great discoveries which have defied investigators for years are frequently finally made almost simultaneously in different parts of the world, the people at large are not greatly con-

cerned in the determining of this question of priority, but they have a very deep interest in the commercial practicability of these discoveries.

The story of how they came about is one of the most interesting that has occurred in many years in the field of chemical investigation. Two years ago Dr. F. E. Matthews, a well known chemist of England, then associated with other distinguished chemists, among them Prof. W. H. Perkin, Sir William Ramsey and the Professor Fernbach of the Pasteur Institute, was seeking a perfect and cheap process for the manufacture of synthetic rubber. It occurred to Dr. Matthews that it would be interesting to study the action of sodium upon isoprene, and he therefore sealed up some isoprene with sodium and set it aside in July 1910.

In the month of August, during a holiday he was reluctantly compelled to return to London, and discovered that the contents of the tube had become viscid and contained a proportion of a remarkably good variety of rubber.

The tube was again set inside, and on examination in September was found to contain a solid mass of amber colored rubber. Dr. Matthews was amazed when he contemplated it.

Isoprene, the basis of synthetic rubber, is an oily, volatile hydro-carbon. Its discovery is not of recent event; as long as 50 years ago it was distilled by a chemist named Williams from caoutchouc. The analysis of isoprene showed that it was chemically identical with the oil of turpentine. Since the period of its discovery, it has presented a two-fold problem. First, how to derive isoprene from abundant raw materials, and then to effect its conversion into rubber through the medium of plentiful and cheap agents.

As has been realized from the beginning of the experiment in relation to synthetic rubber, to compete with Nature's product it is necessary that this made rubber should be manufactured in large quantities and at a cost which would put it on a par at least with the expense of gathering and delivering at the factories Nature's rubber.

Professor Fernbach, working on this problem and keeping in mind the fact that fermentation is an action set up by various kinds of germs, finally discovered the germ which, when stimulated by electrical action, would convert certain plentiful starchy materials into fusel oil, and from this product he obtained cheap isoprene. It was with some of Professor Fernbach's electrically produced isoprene that Dr. Matthews learned by accident how to turn isoprene and sodium into rubber.

The great importance of Dr. Matthews' discovery is that the action is practically quantitative and not seriously affected by the presence of impurities. It may also be carried out in the cold, or with the application of very moderate electrical heat. On the other hand, all the other processes for synthetic rubber which have been proposed are either excessively slow or involve a high temperature or the addition of reagents which affect the yield and quality of the rubber.

Further, a high temperature always produces a portion of terpenes, and has also, it is claimed, a deleterious effect on any rubber which may be formed. In addition, the presence of some impurities adversely affects the yield or greatly delays the process of manufacture, a fact which perhaps accounts for the varying success of previous workers in this field.

The discovery of the process above outlined of making synthetic rubber was brought about by the association of a group of the most distinguished English chemists working together, their work being conducted largely on the principle of a committee, and of this committee Prof. W. H. Perkin acted, it might be

said, as chairman and in a suggestive and critical capacity.

With the exception, therefore, of Dr. Matthews' valuable discovery, and the remarkable experiments on starch fermentation by electricity, carried out by Professor Fernbach, whatever credit there may be attached to the work accomplished must be considered as belonging to the whole group. The names of



PROF. W. H. PERKIN, LEADER OF THE COMMITTEE OF DISTINGUISHED SCIENTISTS WHO DISCOVERED SYNTHETIC RUBBER

the chemists and bacteriologists who have been engaged in this work are Henry J. W. Bliss, M. A., Harold Davis, Harry M. Elger, M. A., Prof. A. Fernbach, Thomas Kane, Francis E. Matthews, Ph. D., Prof. W. H. Perkin, F. R. S., Charles A. Pinn, Rupert W. Pope, Sir William Ramsey, F. R. S., Paul Schwen, E. Halford Strange, Charles Werzmann and Evelyn C. B. Wilbraham.

When the scientific standing of these workers is considered, there can be no doubt of their claim that the synthetic product that they have made is really rubber and strictly comparable with natural rubbers.

The Germans, however, have not yet acknowledged the claim of priority but, on the contrary, have come forward with a counter claim that they have a method for making synthetic rubber, in which electricity also plays a part, which will soon be ready to compete with the output of the tropical forest. It is a fact that

solution of the problem, so far as Germany is concerned.

Dr. Fritz Hofmann, director in charge at Elberfeld, speaking recently on the subject, had this to say regarding the pursuit of his colleagues and himself of the secret of synthetic rubber.

"By mere chance," remarked Dr. Hofmann, "my attention was called to the question of synthetic rubber through a lecture delivered in London about six years ago by Professor Dunstan. The problem fascinated me and I found on reading up the subject that caoutchouc was based on isoprene, and what was more, I had to have synthetic isoprene and not the kind obtained by a dry distillation of rubber such as had hitherto been used.

"Moreover, it was necessary to have an abundance of the material if useful experiments were to be conducted. Thus, at the start it was apparent that a process must be discovered by which isoprene could be obtained readily and reasonably in large quantities. Besides this, isoprene of the purest quality alone would suffice in order that no mistake should be made as to the nature of the results.

"I had a task before me. There were at least 50 different methods that promised to yield isoprene, but upon a trial most of them were at fault somewhere. After two years of hard work, we reached a clearing in the woods, although there were times during that period when we were on the point of giving up in despair, and would have done so probably, if the achievement had not become a matter of honor.

"To the organic chemist coal is an ideal mother substance, and I chose it as my basic material, and in this I was justified. In March, 1909, Carl Coutelle and myself succeeded, by an electrical treatment of coal, in obtaining the first large quantity of pure synthetic isoprene—several liters. This showed us that we had the right formulae, but with the making of isoprene, we were only at the beginning of our investigations.

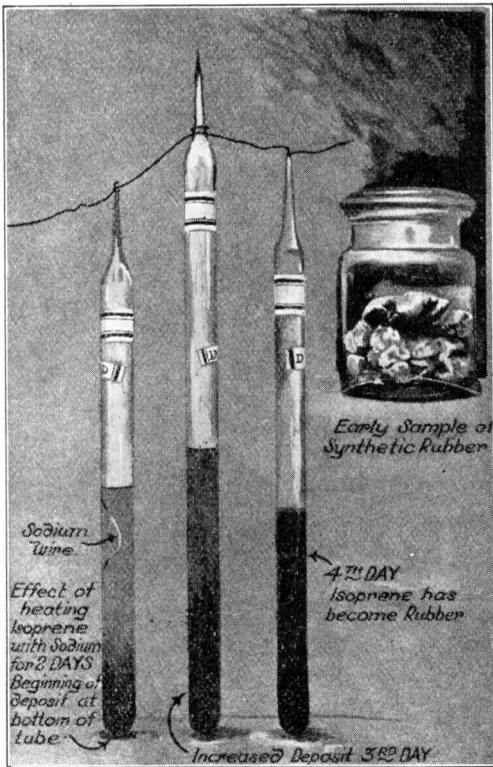

Courtesy London Illustrated News

TUBES SHOWING POLYMERIZED ISOPRENE AND SODIUM WIRE. ISOPRENE IS A MOBILE LIQUID, A "FAMILY" RELATIVE OF RUBBER; IT BECOMES SYNTHETIC RUBBER BY STANDING IN CONTACT WITH SODIUM WIRE THREE OR FOUR DAYS

they have been working on this subject for some time. In one factory alone in Germany there were 300 college bred chemists concentrating upon this discovery, and many other factories in the Fatherland joined in this international effort to find an artificial process by which rubber could be built up synthetically from raw materials readily available. But to the Elberfelder Farbenfabriken belongs the distinction of priority in the

"We were confronted next with the problem of converting this liquid into a tough, elastic, plastic colloid which was to be a successful substitute for rubber. Theoretically the task was easy, as we had several formulae on which to proceed. One was that by Bielstein, who had written that 'isoprene is converted to caoutchouc by treating it with muriatic acid.' Of course, we tried that at once, but for our pains we got nothing.

"Walach, another chemist, had written 'that the action of light would transform isoprene into a rubber like substance,' so we began again. After being exposed to light for a year and a half the contents of our test bottle had the consistency of a thin syrup.

"Next we tried all sorts of likely and imaginable physical and chemical mediums in connection with isoprene, but the wilful stuff refused to thicken. Finally, I discovered the power to perform this miracle hidden away in electrical heat. We soon recognized that the polymerizing power of this heat could be furthered by numerous chemical mixtures, but we soon found that there are many more substances that work in opposition to this end.

"In August of 1909 I attained the first rubber polymerized by electrical heat in the laboratory of the Elberfeld works. In September of that year I submitted a sample of this material to Dr. Gerlach, director of the Continental Caoutchouc and Gutta Percha Company of Hanover. He was the first to confirm that our product actually contained rubber. A month later Harris tested our synthetical material with his ozone method and by this means was able to establish that our electrical heat polymerized isoprene was veritable india rubber."

Which of the two processes, the German or the English, is the most practical for commercial purposes remains to be seen after careful experiments. At any rate, it is certain that the low cost of manufacture will be brought about by the valuable by-product, such as acetone.

Theater Earphones

There are 900,000 or more deaf people in London, according to the *London Daily Mirror*. These will shortly be enabled to hear perfectly all the plays produced at the many London theaters. An invention somewhat similar to a telephone has been perfected by Mr. G. R.

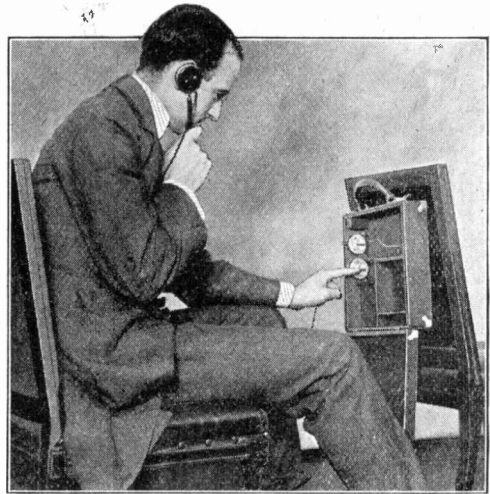

THE THEATER EARPHONE

A. Hope, and the New Theater already has several instruments installed. In a month every seat in the theater will be equipped with a little box similar to those from which opera glasses are obtained, and by placing a sixpence in the slot, an "earphone," as the new invention is called, is released for the use of the seat holder. All but the stone deaf will be able to hear.

When the user cannot hear what the actor is saying, all that is necessary to do is to place the receiver to the ear and move the little indicator around until the required strength of voice is obtained. In a test of the invention, a whisper 20 yards away could be plainly heard. The invention, explains Mr. Hope, is a delicate telephone, built not to increase the loudness of the sound so much as to make it clearer.

Laying Lighting Cables in Japan

That electric light companies in Japan are very up to date in their construction methods is indicated in the picture.

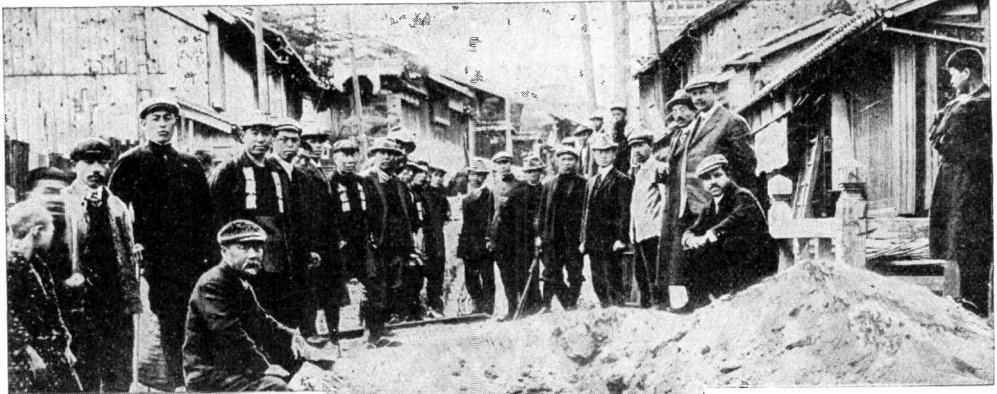

which shows a piece of underground conduit work being carried out by the native workmen of the Kobe Electric Light Company. A German firm supplied the cable and junction boxes.

Iron tape armored, asphalted lead cable with paper insulation and three sector shaped, stranded copper conductors is being used, capable of transmitting current at a pressure of 11,000 volts; it serves to connect the central station up to two substations, on the opposite side of a river. The cable ducts are at this point just dipping down to the tunnel under the stream.

Before starting to charge a vehicle battery ascertain from the vehicle or battery manufacturers the capacity of the battery in kilowatt hours; that is, the number of kilowatt hours that must be put into the battery to obtain from the vehicle its rated mileage on one charge.

Ball Bearings on Electric Cars

Ball bearings were for a long time held in small esteem by the mechanical world and were regarded as chiefly useful for bicycles, sewing machines and lawn mow-



LAYING UNDERGROUND CABLES IN JAPAN

ers. The average man of to-day, and even many engineers, would be surprised to learn that ball bearings are now successfully used in some of the heaviest classes of machinery, as in the main journals of trolley cars, for example, and in large electrical generators.

An interurban car with ball bearings has been running regularly for 3½ years on the Atlantic City and Shore Railway, making in that time about 150,000 miles. This car is equipped with 32 ball bearings, there being four bearings on each axle. The thrust is taken by the two inner bearings of each set, the outer races of the other bearings being free to move endwise in order to avoid cramping.

It is said that these bearings have been packed with grease only four times during their term of service, and have had no other attention. Recently one pair of bearings was taken out and sent for ex-

amination to George M. Bond, of Hartford, Conn., one of the world's famous experts on refined measurements. In the test of one bearing, the mean, or average radial freedom was found to be 0.000046 inch—practically nil—and the mean end play 0.00125 inch. The mean or average eccentricity of inner race was found to be only 0.00004 inch, also practically nil.

In the test of the other bearing, the mean radial freedom was found to be 0.0003 inch, the mean or average end play 0.0007 inch, and the mean or average eccentricity of inner race 0.00025 inch. It is stated by Mr. Bond that the averages above given are those of readings for each, taken at each 45 degrees division of the circle; the maximum and minimum readings in all cases being so nearly alike, practically, that the resulting averages fairly represent the condition of these bearings at the time of the test.

Roadside Telephones

The English automobilist makes certain that he will not be caught without some means of calling for help should his car break down upon the road. The Automobile Association has had erected along the main traveled highways "sentry boxes," as they are called, in which telephones are installed. In case of breakdown, the motorists are thus enabled to

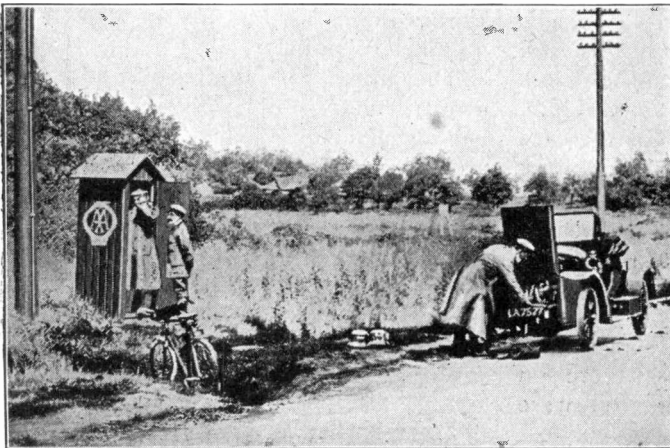

ROADSIDE TELEPHONES IN ENGLAND

telephone to the nearest repairer for assistance and to communicate with their homes and offices.

Illuminated Music

A clever musician in vaudeville entraps both the eye and the ear by having a small incandescent lamp mounted on each

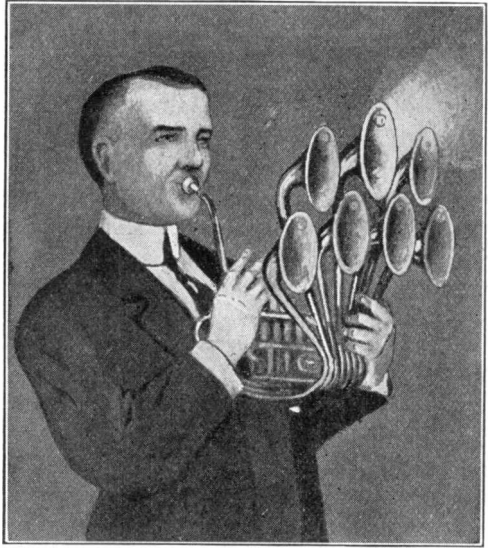

ODD SHAPED HORN WITH ELECTRIC LIGHTS

bell of the horn he uses. As he plays the lamp on the horn from which the sound issues, lights up. With the footlights out and the stage darkened, the rapid flash of one lamp after another accompanying the notes, and the reflection in the bright polished surface of the bell make the act a decided novelty.

"Telephone wires all over Edinburgh, Scotland, have been cut by suffragettes. It will be some days before communications are restored," says a cable dispatch. Consider how many more wires we have in this country to be cut.

A Sherlock of the Skies

By RENE MANSFIELD

"But I tell you it's absurd, man! You talk as though Forbes had plunged plumb through to China or was dangling from the Milky Way! He's somewhere between here and Edgarville, dead or alive, or else he and his plane have been snatched out of the heavens bodily by an unseen hand."

Ames Mitchell was pacing the brown grass, lifeless and sparse as the hair of a mummy, before Forbes' hangar. Tall, lean and nervously energetic, he was the direct opposite of the short, stocky Frenchman, of that other type of birdman, who was sitting on an overturned box beside the vacant, yawning shed.

"Of a surety, Meetchell—of a surety. But remember, my friend, we have searched every foot of ground between here and Edgarville. Not a trace of poor Forbes have we found. We see him start for Edgarville. We know that it is not possible that he go another way, because of the current. There it is. Some freak of combustion, perhaps. Pouf! he is gone—like a bubble. We do not know yet all the tricks of this wireless power. Hélas! I have no hope that we will see Forbes nor the Gull again."

"Rot!" In the single word flung at Bouvier's back, hunched into melancholy deprecation, was expressed Mitchell's faith in his friend's resourcefulness and immunity from disaster, and helpless rage at the circumstances that baffled him.

The incomprehensible fact of the case was that Forbes had started off about noon on the day before, forging straight into the blazing blue of the skies, the nose of the Gull pointed toward Edgarville, 50 miles due east, which he had intended to reach.

There were only three aeroplanes of the ten in private congress there on the remote plains of Texas that were equipped for operation by the wireless transmission of power. One of these was

Forbes' Gull, another the biplane of an English aviator, Baring, and the other Bouvier's monoplane. Although the wireless control of machinery was far past the experimental stages, the radius of the electro-magnetic waves as a source of power for the motors, so far developed for the aeroplane, was limited. It was for research and practical experiments along this line that the Ferris Aero-Development Company had offered unusual inducements to aviators of international fame to join their school of aviators in the South, where they had a manufacturing plant and had also constructed a wireless power generating plant.

Guy Forbes had proved easily not only the most intrepid but the most scientifically alert of the little group of aviators. Already he had made several sensational flights in the Gull, and the morning before he had determined to test the value of some improvements he had himself suggested in the generator, setting Edgarville as his goal. When he did not return at the time he had expected, little concern was felt, although four petrol-driven planes had started over his course, to act, if necessary, as a wrecking crew. Neither they nor the automobiles that followed later had come upon a trace of Forbes or his Gull in all the stretch of 50 miles of prairie.

The thing was mysterious and uncanny. There was no chance of Forbes having suddenly decided to fly in quite another direction, because of the necessity of keeping his engine within the focused waves of electric power.

"By George"—Mitchell bit the words into the cigar he was grinding between his teeth—"if Forbes can't be found between here and Edgarville he didn't fly toward Edgarville, current or no current.

He felt that a further search of the Edgarville route would be fruitless and

the only course of procedure that suggested itself was a visit to the power plant.

It was as yet a more or less crude sort of shack set up on a sandy little hillock about a half mile from the hangars, its low roof striped with the shadowed tracery of the network of wires that depend-

Mitchell hurried on to the shack. In the palpitating heat of the bare interior, before the radio-telegraphic controller, sat Quinn, the power operator.

"Got her on today, Quinn? What's the use? No chance of anybody flying today."

Quinn looked up impatiently as Mitch-

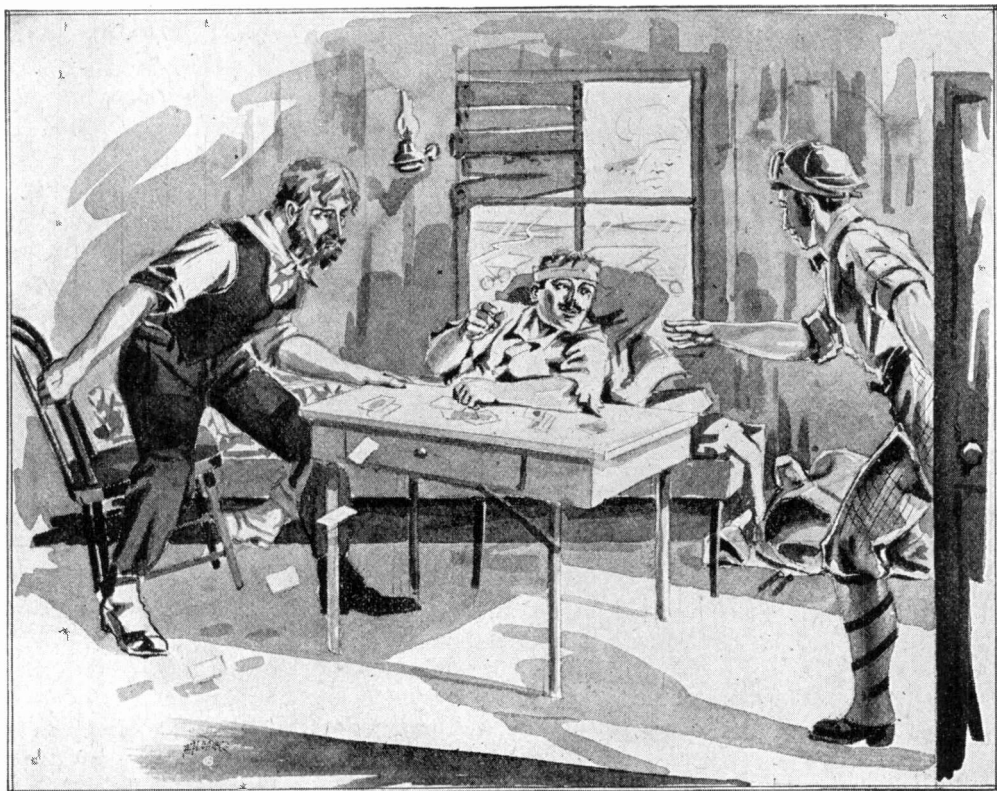

MITCHELL BURST THROUGH THE DOOR LIKE A CATAPULT

ed from a towering "L" antenna. Mitchell's long strides brought him speedily to within a stone's throw of the plant, where he came upon Baring, the English aviator, evidently returning to camp.

"Damn it all, Baring," he burst out without prelude, "this thing's got to be cleared up. There's something mighty funny about this deal; know it?"

The Englishman, startled, looked at him sharply. "Think so, Mitchell? I'm afraid your nerves are getting away with you. So long. See you later," was all he said, as he walked on.

ell's lank figure appeared in the door.

"Had a little trouble this morning. Trying out a new generator, that's all." Quinn's tone was not cordial.

"No trouble at this end yesterday, was there?" Mitchell inquired casually.

"Don't you suppose I'd have said so before now if there was?" returned Quinn.

"Why, sure, Quinn, sure. But I got to thinking this morning that perhaps you and Forbes were trying to put one over on us. It occurred to me that perhaps Forbes didn't make for Edgarville

after all,—you may have switched the current—”

“You saw him start for Edgarville yourself,” interrupted Quinn. “You know perfectly well that we haven’t been able to switch the current anyway from due east since that trouble with the gearing last week. What you talking about, Mitchell?”

“O, well, Quinn, I’m all knocked out about this thing, I tell you. Say, what was Baring doing around here, anyhow, just now?”

“Search me.”

Obviously Quinn was not conversationally inclined. He had turned to the wireless telegraph apparatus near by and was operating the transmitter busily.

Mitchell, with an unexplainable feeling that Quinn could throw some light on the mystery if he chose, sauntered around to the rear of the shack and looked over sharply, as well as he could, the structure of the aeriels. Erected on a huge revolving disk, the L antenna was so constructed that when its angle was automatically set at any degree of the disk a concentration of the electric waves took place which made possible their focalization in any desired direction. The L was pointed due east as it had stood for several days owing to the accident to the gearing of which Quinn had spoken.

Mitchell saw plainly enough that it would have been impossible to operate the disk in the present condition of the gearing. But suddenly his brows puckered into a puzzled frown. Then he got down on his knees so that he could examine carefully the sandy ground beneath the big disk, the appearance of which had caught his eye.

The entire area of ground within the circumference of the disk was a smooth stretch of sand, perfectly leveled by the winds, with the exception of a little groove that formed an arc of at least 90 degrees faintly traced in the sand near the rim of the disk. Mitchell on his knees saw that it had been caused by

the dragging over the sand of a single wire that had somehow become detached from one of the cleat insulators on the under surface of the disk. In places the narrow line was almost obliterated, where it had probably been blurred over by the breeze. Mitchell recalled that the wind had been blowing such a gale the morning before that they had all urged Forbes not to try for Edgarville until sundown. When a freakish calm followed, about noon, that lasted all the afternoon, they had said it was more of “Forbes’ luck.” If the disk had been revolved those 90 degrees while the wind was blowing at that terrific rate the little groove traced by the dangling wire would have quickly disappeared.

It must then have been revolved after the wind had died down.

It must have been revolved sometime between noon the day before and the moment when Mitchell had noticed the tell-tale tracing, which gave the lie direct to Quinn’s statements.

There was a chance that the current had been switched while Forbes was in the air, with or without his knowledge. At least the idea suggested a course of activity for which Mitchell was grateful. Assuming that at some time since the previous noon the current had been directed almost due north, as indicated by the point at which the line in the sand was broken off completely, Mitchell determined to fly low for perhaps 50 miles to the north in the faint hope that Forbes, for unexplained reasons, might have taken that course.

When he returned to camp he said nothing of his purpose, about the hangars, but quietly wheeling his biplane onto the field, rose to perhaps 300 feet and then headed straight north.

For more than 20 miles he flew low over the flat, parched country, becoming more and more miserably certain of the futility of searching this trackless waste of land and air for a clue to the vanished aviator. Sighting presently what was doubtless a squatter’s little cabin,

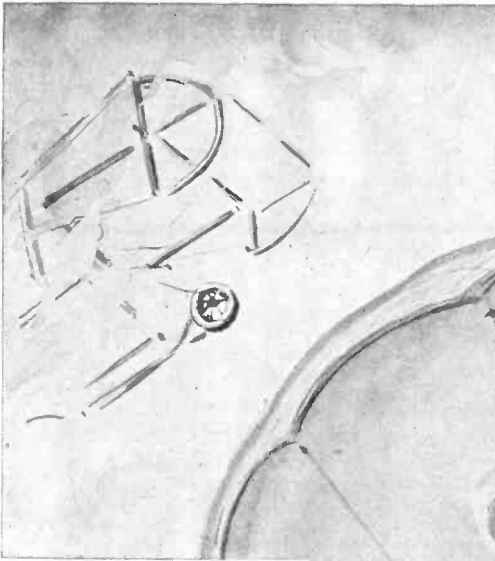

Mitchell volplaned to the ground near by, and jumping from his seat beat a lively tattoo on the sill of the open door. The startled individual who came running from somewhere in the rear, was struck dumb at the sight of the huge creature that had alighted practically on his door sill. Mitchell had twice to ask him if he had seen another such bird in the last 24 hours, or had had any other visitor.

Faith, and he'd never seen such an animal even in his dreams. As for visitors—Mitchell might see for himself the date of the passing of the last one, crudely carved there in the door—a date just eight months previous.

Disheartened, Mitchell climbed into his seat and took wing again, to the bitter disappointment of the squatter. Another 20 miles he flew, and with a forlorn but tenacious hope alighted to make inquiries at another cabin. At first he thought the place had been deserted, but his knock on the sagging, closed door brought forth a red-haired man who stepped outside and closed the door again behind him. He evinced no astonishment at the sight of the biplane and regarded Mitchell coldly

"Well?"

"See any other bird like that one yonder flying around these parts, partner?" inquired Mitchell. "Or had a visitor since yesterday noon—tall fellow with eyeglasses?"

"No, I ain't seen one or t'other. Birds like that 'ere ain't common round here, nor visitors, neither."

Mitchell prepared to set off again. The red-haired man reëntered the cabin, closing the door again after him.

Just as Mitchell was about to tilt his elevating planes for flight the thought struck him suddenly that it was rather odd that the red-



I MANAGED TO GET HOLD OF MY PARACHUTE AND SWING LOOSE

haired man had disappeared, since he had displayed no interest in the aeroplane. It argued that he must have seen one before, otherwise he would have been bent upon investigating what to him must have been a great curiosity.

(Concluded on page 606)

Self-Starting, Gasoline-Electric Automobile

The 1913 model Rambler Cross-Country car embodies a well thought out combination of the gasoline and electric

The engine is now running the machine and at the same time charging the storage battery. When the battery is completely charged it is automatically cut out. The energy it contains, however, is always ready, at a moment's notice, to

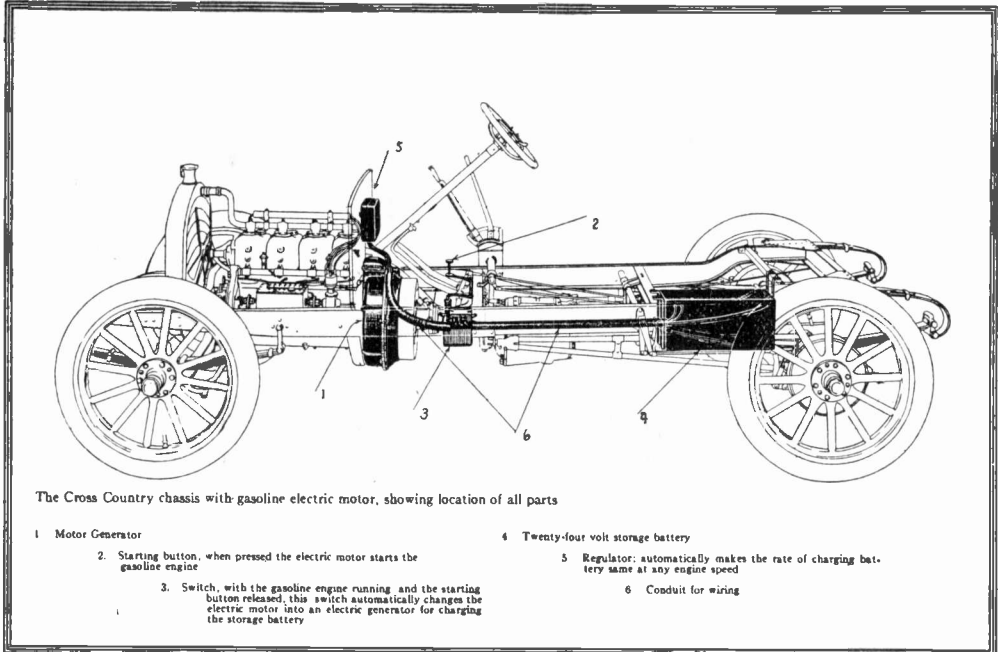

motor. The fly wheel element of the engine and the armature of the electric motor-generator being in one, a simple and positive means of starting the engine, by simply pressing a button, is obtained.

By pressing the button, current from the storage battery is passed into the motor-generator armature, and the armature, operating now as a motor, begins to revolve. Being itself the engine fly wheel, the engine is at once brought up to a speed of 200 revolutions a minute. No cranking, kicking, back-firing, etc., accompany this operation.

After the explosions start and the engine is operating regularly the motor-generator is changed, through an automatic switch, into a simple generator or dynamo. It now pumps current back into the storage battery through a regulator which keeps the charging voltage constant regardless of engine speed.

start the engine again and light all the lamps on the car.

Aeroplane Roundabout

Every year witnesses some new "glide," "coaster" or other amusement ride added to the equipment of summer parks.

A patent has been issued to James D. Walsh, St. Louis, Mo., upon an aeroplane roundabout. The device consists of a hollow central staff, a heavy vertical sliding ring from which steel arms extend, upon the ends of each of which are suspended monoplanes and biplanes arranged to seat several people. In operation the propellers of the machines are the impelling force of the device. At the start the flying machines are near the ground, but as their rapidly turning propellers increase the speed an electric motor within the inclosure at the center

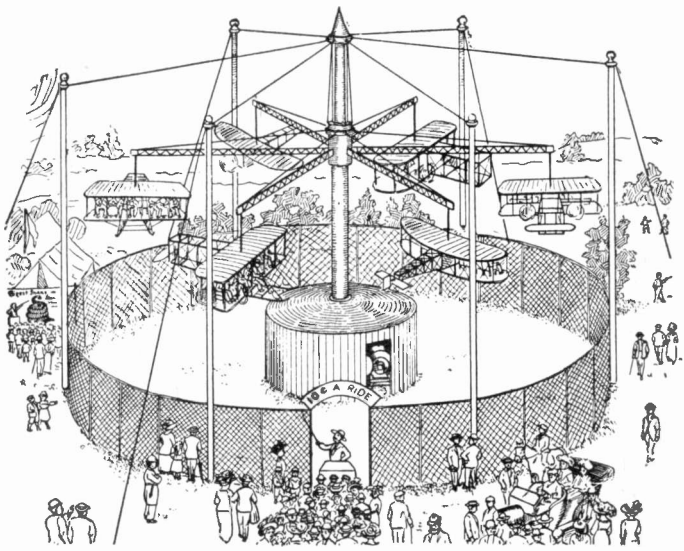

AEROPLANE ROUNDABOUT

pulls down a counterweight within the hollow central staff, lifting the flying machines gradually into the air. Electricity also operates the machine propellers.

Radium Rays in Coloring Gems

The property of radium which gives it the power to change the color of precious and semi-precious stones has been mentioned before in these pages. But some further details of this discovery of the young German chemist, Moritz von Rohr, of the Royal Institute, London, are offered. It seems that he recently purchased several varieties of sapphires and placed them in a box with a small quantity of radium bromide. The astonishing transformations of the stones after only about one month's exposure to the radium are described as follows:

<i>Original Color</i>	<i>New Color</i>
White or uncolored	Topaz-like yellow
Blue	Emerald green
Violet	Sapphire blue
Wine colored	Beautiful ruby
Inferior dark colored	Deep violet

Scarcely daring to credit the evidence of his eyes, the chemist visited the jew-

eler from whom he bought the stones at an average price of 1s. 8d. per carat, and asked what the jeweler would offer for the "new" parcel. The jeweler, suspecting nothing, even after a close examination, offered one pound seventeen shillings per carat for all the stones, with the exception of the small but exquisite ruby colored one. For this he said he was willing to give no less than 20 pounds a carat.

An *Express* representative who recently visited the Salisbury House offices of the British Radium Corporation, Limited, the owners of the pitchblende ore rights of the famous Trenfith Mine in Cornwall, was shown several corundums of various colors which had already been materially changed from their original hues by a few weeks' contact with a small glass tube containing 50 milligrams of pure crystallized radium bromide.

"I am making these experiments in coloring precious stones more as a hobby than anything else," said the director to the *Express* representative. "They are at least very interesting.

"When I mentioned the outcome of my experiments to a famous scientist, he informed me that he was not a bit surprised, but that I was apparently merely producing in a few weeks by radium emanations the same effects achieved by Nature in many thousands of years."

The San Joaquin Light and Power Corporation of Fresno, Cal., supplies electric service to seven counties in one of the most fertile farming sections of the country, the actual area being 200 miles long by 75 or 80 miles wide.

How the Electric Won a Hat

One suburbanite was telling a friend how he became converted to the electric. Said he: "I was late rising one morning, and no matter how I hurried with the bath and the shave and the breakfast, I found the clock going faster than I could go and the last of the good trains for the city gone. I was sore at my luck, and I didn't care who around the house knew it.

"With the idea of helping matters, my wife said: 'I'm going to drive in today in my electric; let me take you.' Man-like, I laughed at her proposal, made some remarks about wishing to get into town before noon: that I wasn't merely going shopping. You know how funny a man thinks he can be under such circumstances. My wife just looked



SHE DROVE ME INTO TOWN THAT MORNING

"She drove me into town that morning on time and won the hat. She called for me that afternoon and drove me home again. That was about a month ago. I haven't been on the good old suburban smoke belcher since, and the joke of it all is on my wife, for she hasn't had the use of her car since then, not even on rainy days. I have annexed it. How does she like it? Well, she says she is glad to make a sacrifice for my comfort and convenience and, besides, I have ordered a new car for her."



MAN LIKE I LAUGHED AT HER PROPOSAL

at me, and said: 'Make it a new hat, and I'll be at your office in my car ten minutes before you can get there if you go by train.'

"Something in her assurance half decided me, and something taken from my failures that morning made me answer her: 'I'll take a chance if your car is ready.'

"'Car ready,' she echoed. 'An electric car is always ready. With an electric one just gets in and it goes.'

Electrical Developments in Minneapolis

The position of Minneapolis among the electrical cities of the country will be materially strengthened by extensive improvements now being planned. H. M. Byllesby & Company, who recently assumed active management of the Minneapolis General Electric Company, announce that they will proceed to develop 35,000 horsepower on the St. Croix River above the present 20,000 horsepower development at Taylor's Falls; also that they contemplate further water power development on the Mississippi River, amounting to approximately 80,000 horsepower, which would give a total of not less than 160,000 hydro-electric horsepower, including several smaller de-

velopments, available to Minneapolis and St. Paul and vicinity. The properties at Minneapolis and St. Paul will be connected by transmission lines and the water powers of the Consumers Power Company at Cannon Falls and Mankato also will be tied in by a transmission line running south from St. Paul.

Woodpeckers Destroy Telegraph Poles

Among the most unusual of the pests that are bringing railroads a great deal of trouble and expense is the industrious



TELEGRAPH POLE
PRE-EMPTED BY
WOODPECKERS

California woodpecker common to California, northern Lower California, and Oregon, says the *Railroad Man's Magazine*. These birds have found that the telegraph poles provide an ideal place for storing food and furnishing shelter and nests for their young. The birds have made them their larders for the winter.

The accompanying illustration shows a striking example of their destructiveness. The pole in the picture has more than 500 cavities and is useless. It was taken from a section of the Union Pacific Railroad. The boring and hollowing out of the poles so weakens them that they snap off in high winds.

Crows, jays, and squirrels raid the woodpeckers' storehouses and one of the latter birds is usually present to drive off the thieves. It is said that when the birds find desirable

poles they signal one another by beating a resonant tattoo upon the timber. The sound can be heard more than a mile away.

Ornamental Luminous Arc Lamps

New Haven, Conn., has recently placed itself among the best street lighted cities of the country by the installation of luminous arc lamps. Combined with the light distribution is the

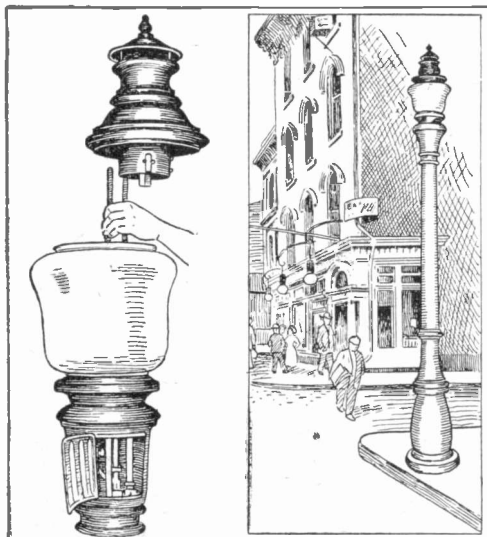

ORNAMENTAL ARC GLOBE

ornamental effect of properly designed poles for supporting the lamps. The mechanism of the lamp is below the globe, a door giving ready access. The upper electrode, which is of copper, lasts approximately 3,000 hours, while the lower electrode, which is of magnetite, is good for from 100 to 125 hours. The peculiarly shaped white globe conceals the glare of the arc and provides a clear, white light not only over the streets but upon the building fronts as well.

Ten of the largest single-phase electric locomotives ever built are now being manufactured for a Swiss railway. Each weighs 108 tons and can develop 2,500 horsepower when traveling at a speed of 50 miles per hour.

Cadillaqua — Detroit's Beautiful Water Festival

Electricity was used to paint the lily at Detroit during Cadillaqua. The wonderful Detroit River, considered by many to be the most attractive body of fresh water in America, was illuminated during Detroit's 211th birthday celebration—called Cadillaqua, in honor of Cadillac, who founded it in 1701, and the "aqua" on which most of the festivities were held—by an enormous electrical court built in midstream between Belle Isle Park and the American shore.

and green incandescent lamps, while the entire fountain was surrounded with festoons of tungsten lamps. The current was brought by cable from the Detroit side of the river.

This Court of Honor was the centerpiece for a naval pageant during the big

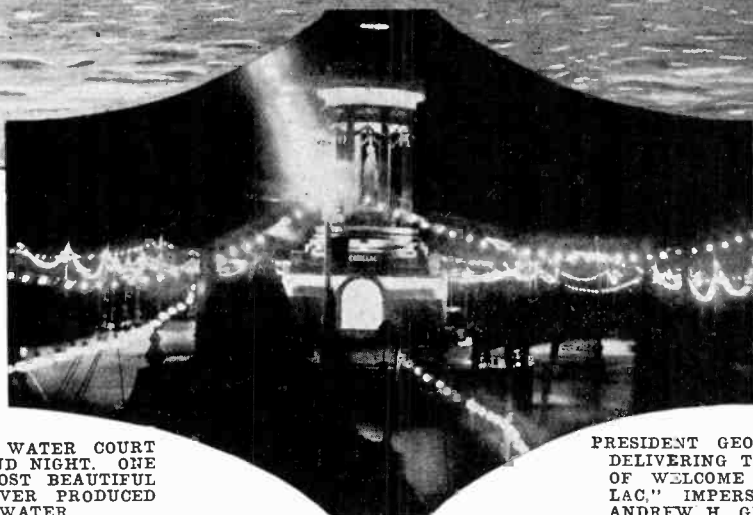
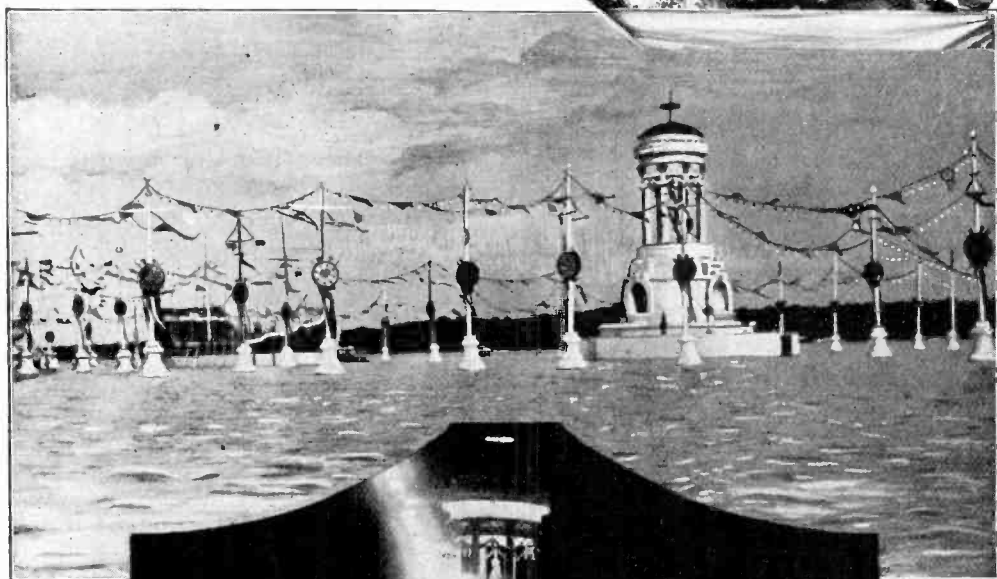

CADILLAQUA WATER COURT BY DAY AND NIGHT. ONE OF THE MOST BEAUTIFUL EFFECTS EVER PRODUCED ON FRESH WATER

PRESIDENT GEO. T. MOODY DELIVERING THE ADDRESS OF WELCOME TO "CADILLAC," IMPERSONATED BY ANDREW H. GREEN, JR.

The court was 1,500 feet long, built on piles and featured by three immense fountains and two Roman galleys. The fountains were lighted with red, white

fete. It helped in the setting of what experts have called the most wonderful effect ever produced on fresh water in America.

The night of the naval parade, myriads of small craft of every description surrounded the court, to hear the music emanating from the Roman galleys—one Roman galley containing a brass band, and the other a singing society of 300 voices.

Before the program started, a parade of boats, electrically illuminated and decorated, moved down the channel and around the water court. The "Mary Alice" of Buffalo, belonging to W. J. ("Fingy") Connors,

in many other ways, especially in the illumination of the floats in the historical parade. These enormous floats, depicting scenes from Detroit's first 50 years of history, were lighted with concealed incandescent lamps which were furnished current from storage batteries. Torch bearers marched along by the floats carrying pink torches in order to kill off whatever shadows were cast on the floats by the electric lights. Thus, the combination of electric lights and torches furnished perfect illumination for

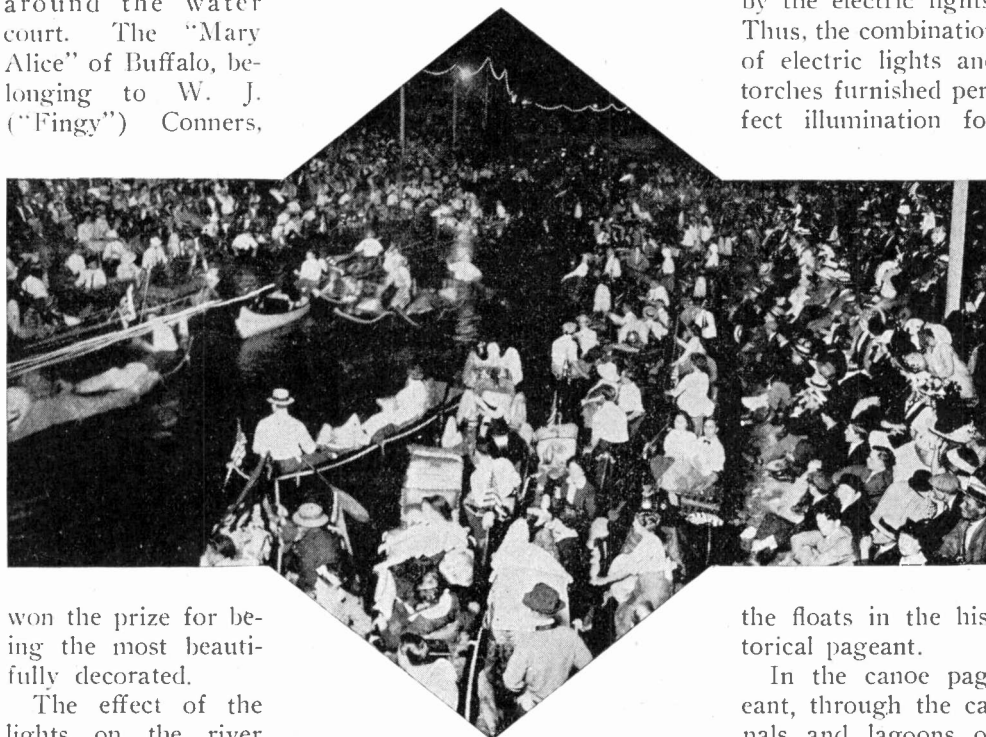

ON BELLE ISLE LAGOON WAITING FOR THE PARADE OF DECORATED CANOES

won the prize for being the most beautifully decorated.

The effect of the lights on the river produced a scene which globe trotters say never was equaled.

Nearly all the hundreds of boats were electric lighted, even the smallest canoes and power boats being festooned with garlands of incandescent lamps. They covered acres of water expanse, and as the small boats danced up and down the effect on the eye, of the myriads of lights moving about, was one of surpassing beauty. Even Detroiters, to whom brilliant river effects are commonplace, were dazzled by the brilliance of this electrical display.

Electric lighting figured in Cadillaqua

the floats in the historical pageant.

In the canoe pageant, through the canals and lagoons of Belle Isle, on the closing night of the festivities — Venetian

Night—many of the canoes were electric lighted, others depending on Japanese lanterns for their illumination. Some of the canoes featured the word "Cadillaqua" and spelled it out in electric lights, the letters showing one at a time.

It was the electric features, undoubtedly, which seemed to please the crowds most, and, by the way, the crowds set a new record for Detroit. More people were entertained in the "City of the Straits" during Cadillaqua than had ever been there before.

Automatic Annunciators at a Water Carnival

A remarkable demonstration of the utility of the automatic telephone and automatic annunciator for reporting information regarding motor boat, hydroplane and swimming races was given at the Water Carnival and Naval Review held in Chicago on Lake Michigan, August 10-17.

Despite the fact that weather conditions were decidedly unfavorable, the demonstration was made without a hitch and showed the possibilities of distributing information to people seated out of doors in a large grand stand by means of telephone and annunciator. Because of the peculiar arrangement of the grand stand, which was erected on the Government pier, reaching almost 1,000 feet north and south

from the judges' station, it was imperative that some unusual means be adopted for supplying information both as to the progress of each race and the result. Information as to the ownership, history, record and dimensions of each craft was given directly to the audience through the automatic annunciator at the beginning of each race, and then the progress of the race was made known from time to time from the judges' station far out in the lake. The moment the operator of the annunciator received this information, he spoke into an ordinary telephone, and his voice was given out to the audience through the array of horns that were strung on iron poles the entire length of the grand stand. A portion of the stand is shown in the illustration, as is also the operator as he talks into the telephone.

However, the most remarkable feature of the dem-

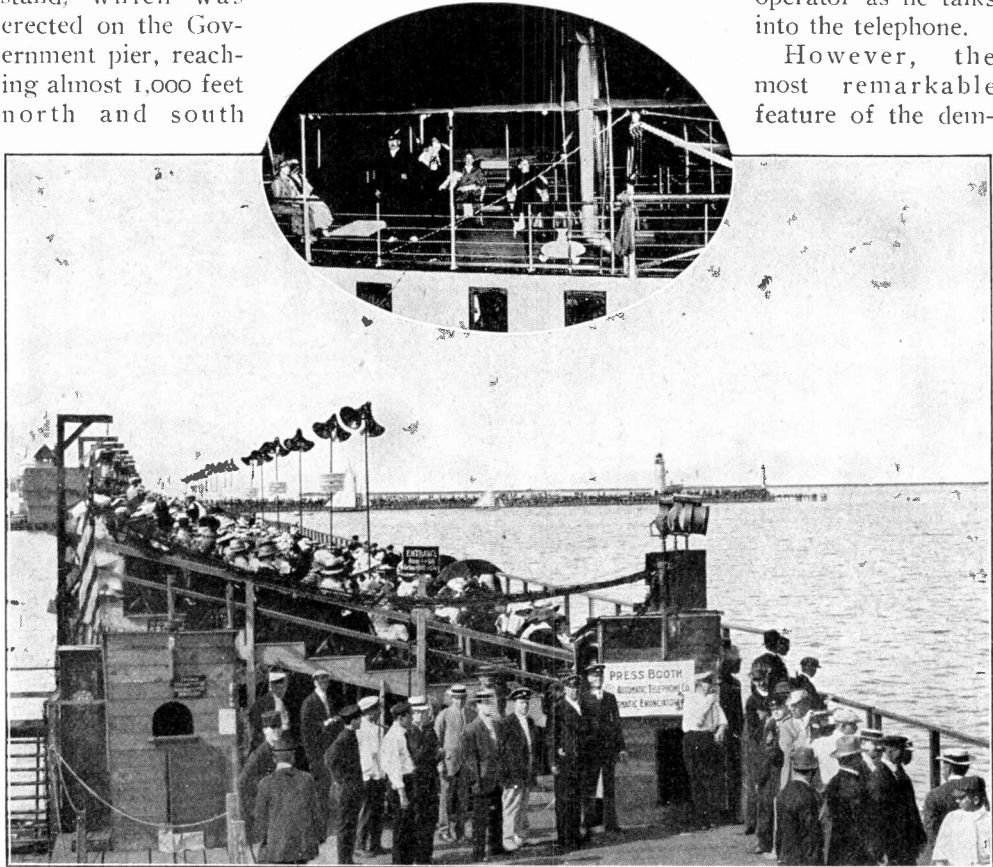

SHOWING THE GRANDSTAND AT THE WATER CARNIVAL FITTED WITH AUTOMATIC ANNUNCIATORS. ABOVE IS A YACHT ANCHORED AT NIGHT OFF THE GRANDSTAND FROM WHICH ADDRESSES WERE DELIVERED TO THE CROWDS THROUGH THE ANNUNCIATOR

onstration was addresses delivered by Mayor Harrison, Bishop Fallows and other prominent Chicagoans through an automatic annunciator from a yacht anchored 300 feet from the grand stand on the last night of the carnival. Despite the fact that the enunciation of the speakers was in the natural tone, the voice of each was amplified 150 times, so that the vast audience could hear every word as distinctly as though the speakers were standing directly in front of the grand stand. A submarine cable was stretched from the grand stand to the yacht occupied by the speakers. Owing to the inability to secure current from the city, automobile storage batteries were used.

The telephone and annunciator system was operated by the placing of 72 annunciators the full length of the pier with 40 foot centers; that is, two horns at each post, making 36 pairs, 40 feet apart. By this arrangement no person was over 20 feet distant from a horn and the sound was so concentrated that there was no rumbling noise distributed from one section of the grand stand to the other.

Also, announcements were heard in all sections of the grand stand at the same time. The entire length of the cable from the grand stand to the judges' boat was 1,135 feet. The cable was waterproof and lead covered and each of the horns at night had a covering of oilcloth because of the dampness. In addition to the annunciators, automatic telephones were installed the entire length of the pier, and the news bureaus and the newspapers had immediate access to these to communicate race results to their respective headquarters.

Lighthouse Tended from the Shore

The Platte Fougère lighthouse and fog signal, in Germany, as the first of the kind in the world, is exciting considerable interest.

The tower, a ferro-concrete structure of unusual design, contains powerful electric motors coupled to air compressors. During fog, power is transmitted from the shore station through a heavily armored submarine cable nearly $1\frac{1}{4}$

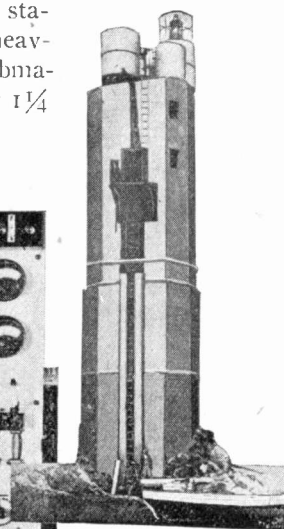
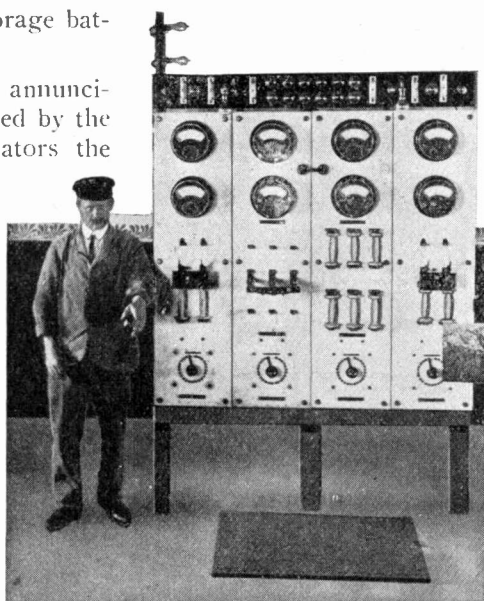

THE PLATTE FOUGERE LIGHTHOUSE AND SHORE STATION ATTENDANT

miles in length. Air is then compressed into three tanks on the sum-

mit of the tower. A clock (wound by compressed air) allows a blast to pass every 90 seconds, through a siren and horn. This fog signal has been heard to a distance of 26 miles.

The light, fixed above one of the air tanks, flashes every ten seconds, and is turned on and extinguished nightly by a clock.

The control of the motors may be accomplished from a shore station from a special switchboard, as shown in the picture; therefore the attendant need not visit the lighthouse for weeks at a time

Some Secrets of Electrical Stagecraft

By T. J. NEWLIN

PART VI

THE IMPORTANT USE OF DIMMERS

The gradual dimming of the stage lights is very important. How it is done is also quite mystifying to the layman. The lights must not be brought down too quickly or with a jump, for if they are, there is usually a little tilt between stage manager and electrician. In some cases it is the latter's fault, but more often it is the fault of a poorly constructed dimmer. Since the dimmer is one of the most important parts of a stage electrical equipment, it merits a description here.

Any one familiar with the first principles of electricity will know that when a resistance is inserted in a circuit carrying current, the flow of current will be retarded or choked down, the resistance being nothing more than a length of wire finer than the main conductor and consequently harder for the current to pass through. If a resistance is connected in circuit with an incandescent lamp, the current flowing through the filament will be reduced, and as the current is what heats up the filament and makes it glow, the insertion of resistance will cause the lamp to glow less brightly, and if enough resistance is inserted, the lamp will go out altogether.

A dimmer, used in stage work, is nothing more than resistances arranged compactly and in such manner that the electrician may throw them into or out of the circuit instantly, by means of a lever. He may also vary the amount of resistance by means of a sliding contact operated by the same lever. As shown in Fig. 31, the dimmers are made up in the form of plates or disks with the resistance wires embedded in them. These disks are then mounted behind the switchboard in banks, as shown, the number varying with the size of the stage equipment.

Now, all of the stage circuits containing the border lights and footlights of different colors have dimmers connected to them, each dimmer operated by one of the rows of handles seen in Fig. 31. These handles may be operated separately so as to control a single circuit, or in an instant several or all of them may be locked together so as to move with a single pull from the electricians' arm. Thus, by proper manipulation, the electrician is able to bring any set of lights or

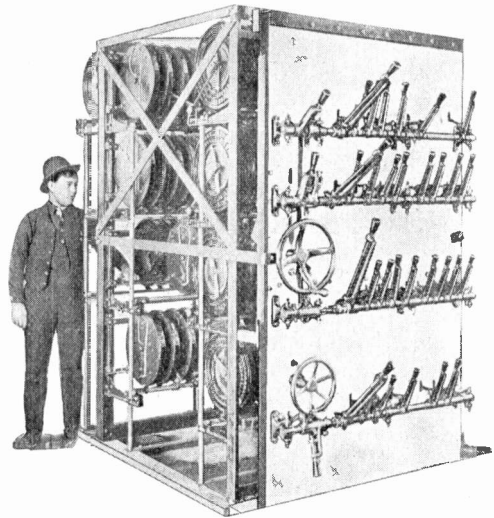

FIG. 31. DIMMERS AS USED ON A THEATER STAGE TO REGULATE THE INTENSITY OF LIGHT

all lights gradually down from full brilliancy to the merest glow, or he can perform the operation quickly, depending on how fast he moves the lever or levers. When you see the lights on the stage growing dimmer and dimmer, or coming from dimness up to brightness, you can make up your mind that back of the scenes the electrician is juggling these levers. In this way, by manipulating the intensity of the various colored lights,

such as red, amber, blue, green, etc., he helps also to produce the different color changes in sunrise, sunset, daybreak, etc.

The important thing to remember in stage work is to operate the right effect at the right time. Would it not be humorous and laughable to gaze upon an electrical change from sunset to moonlight, when, perchance, the actor might spout, "How dark it is growing! We must have light," and striking a match (to sign those papers)—the stage electrician, through negligence or inexperience, had allowed his daylight scene to stand, instead of gradually and naturally mixing his colors to produce a sunset, twilight or moonlight scene, whichever the case might happen to be?

PRODUCING THE SUNSET EFFECT

Sunset! Is there anything prettier? Is not the stage a thing of beauty as the eye beholds the gradual change? First you see the soft effect of the straw colored gelatin (or medium, as it is called behind) as it is slowly passed in front of the open light or olivette box by the several electricians behind the wings. These lamps are so set as to throw their full bath of light on stage or drops to give the best lighting effect, and as the straw colored medium is slowly replaced by the amber colored medium, the stage begins to take on that softness of the setting sun in such a manner that one hardly realizes he is viewing anything but Nature, until the amber is gradually manipulated past the arc light in the box and the deeper red medium is slowly worked into place, giving that halo of magnificence so sweet to the dream of the painter. All of this time, remember, the stage electrician at the switchboard is not idle, but is, in conjunction with his six or seven assistants, gradually cutting down through the dimmers his white lamps in the foots and borders; this allows his amber to be gradually brought up from half dimness where it was set. The red lamps are now slowly worked up through the dimmers to a full red, and "sunset" is complete.

MOONLIGHT

From the position where the sunset is left to stand, is the position from where moonlight begins. With the red lights full up, they are gradually dimmed down one-half. At this juncture the blue lights begin to show, as they have been left on "full," for the red kills the blue until the point where the mixing takes place with the red and blue, or when the red is down to one-half dimness. As the handles of the red colors are being slowly pulled down, the handles of the blues are raised to full. Perchance the scene was set at the opening to dimmed down three-fourths, but in most cases the lights are set at the "rise," as follows: reds on full; blues on full (are killed by red), and to be operated as described until the moonlight effect in all its glory shines forth. We must not lose sight of the assistants at the olivette boxes or open lamps, who, with their color mediums set at red, at the same time with the chief electrician at the switchboard are gradually replacing their red mediums with the blues. One of these olivettes or open box lights is shown in Fig. 32.

DAYBREAK

No prettier daybreak scene was ever shown than the one produced in the "Girl from the Golden West." But then we can expect this, since it is one of David Belasco's. With that infinite attention to detail that has made his name a by-word in the theatrical world, he staged this scene. Blanche Bates and her lover, "the two lives that came to naught," on the morning after the sheriff and his gang allowed her bandit lover to escape, only because they knew she loved him, are found at daybreak, lying in the open on a mound formed by the drift of the desert sand. A gray streak appears in the east as the white lights are brought up from full dimness to a slight cherry-red in the foots and borders. Then the reds are gradually cut in on the dimmers until the soft streaks of daylight appear. The

medium of the assistants is gradually changed from a soft blue on the back drops to a red, then amber and lastly straw, and the scene is complete, for the chief electrician at the board has at the same time worked up his reds to full and cut in his white, gradually working off the reds. An amber set of lamps, in place of the white, is used by some electricians to gain a softer effect.

THE SPOT LIGHT OR CHASER

The spot light, or chaser, as it is sometimes called, is used in the front balcony to spot the principals or chase the performer around the stage. It can be used also to aid in all color changes from the front of the house, behind stage, on the

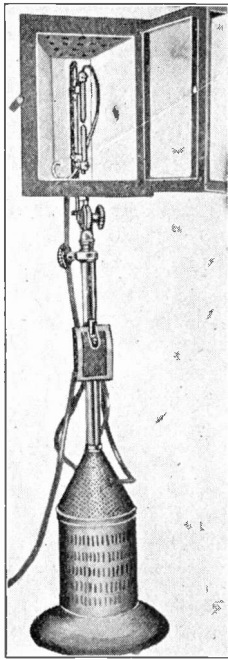

FIG. 32. OLIVETTE OR OPEN BOX LIGHT

bridge or in the flies. Fig. 33 shows a spot light, having also a "color wheel" mounted in front of the lens so that the light may be thrown on in colors.

WORKING BEHIND THE SCENES

Have you ever been behind the scenes? No? Then you "out front" can never realize the peculiarity of the things "behind." One, to see these men build giant houses at a moment's notice, would hardly realize how they can, from an apparent

pile of junk, build the most beautiful castles or set up a pile of rocks that apparently a derrick would be unable to lift. Then, again, everything is actually worked backwards, and to the uninitiated it is quite a treat to drop in and catch these automatons at work.

And precision is the by-word on the stage, and to even whisper too loud is

an unpardonable crime, especially if one of the principals or stars should happen to hear you. At the word "strike" there is a simultaneous movement in every direction, and all of the fine castles are demolished before you could say "Jack Robinson." The electric lamps are struck and placed to one side and "props" are seen scurrying to and fro, while the "grips" are grasping the set stuff and taking it to one side; at the same time the "flymen" are doing their bit in the flies, lifting the last drops and lowering the ones for the next scene, each doing his part and doing it well.

Dark changes are made in the same order as the "strike" scene above described, only, as the name implies, all changes are made in the dark. This, of course, requires greater skill, and each man has to be on the alert. Some dark changes require anywhere from ten to 20 men to produce. In "Floradora," the musical comedy that is responsible for that famous "sextette," there is one scene where a dark change is made from an exterior to a modern hotel in 30 seconds. In order to accomplish this, no expense is spared. It must be done and done right. Any dark scene, of course, depends for success upon its being performed during the short interval of time required for the eyes of the audience to accustom themselves to darkness. Before your pupils have time to dilate, the next scene is upon you in all its brilliance.

ELECTRICIAN OPENING THE SHOW

With the audience piling in "out front" about 7:30, the mumbled cry of "half hour" comes to one's ears from somewhere above or below, in one of the dressing rooms, and the stage crew begins to make a show shop out of what was a few minutes before nothing but a barren stage. About the time the scene is set, the woeful cry of "fifteen minutes" comes from somewhere with that peculiar warning known only to the stage, indicating the curtain will rise at the expiration of that period. Ten min-

utes later the musicians are sawing away on something which from "behind" sounds like a street car passing on a sloppy day.

At the first bar of the overture in a first class theater the switch which controls the ten horsepower motor is thrown, and with a sullen grumble at having been put to work, the powerful machine starts its grind, and with a gradual movement it grips the great 30 ton steel curtain that protects the audience from fire and solemnly begins to rise. At the end of the overture the signal is given for curtain. Immediately the electrician pulls the house light switch or lowers the house lights through the dimmers. At this moment, everybody ready, the stage electrician having his proper colors set for daybreak, sunset or moonlight, whichever the case might be, the stage manager pushes the red light of "warning" to the flymen, and, assuring himself again that everything is ready, he pushes the switch throwing the blue signal to "go" upon them, and the "act curtain" is seen to rapidly rise, and the show is on.

THE UNWRITTEN LAW OF THE STAGE

There is an unwritten law of the stage that no one shall touch an electric switch, push button or anything controlling electrical apparatus about the stage. The stage carpenter, props, grips, actors, all will not and dare not touch or move electrical paraphernalia. If anything is not right, it is up to the electrician's assistants to attend to it. Nor will the electrical department touch anything not electrical. So thus you see, each knowing his individual part, there is no misunderstanding. The assistants, since the famous Iroquois Theater fire at Chicago, dare not move outside of a ten foot boundary from their respective lamps. The penalty for doing so and being reported or caught by the fire warden is \$50 in Denver and Chicago and all large cities.

IN CASE OF FIRE

All rules are thrown to the dogs in event of fire. The first one to reach the

switch that controls the great 30 ton steel fire curtain throws it in; the audience must be protected first. Simultaneously all ropes controlling the stage doors and ventilators in the roof are cut with a hatchet, there for the purpose. This allows the fire doors to hold the fire in on the concrete walls of the stage, and opens roof ventilators, allowing the fire to pass out overhead. All dressing rooms having other exits, there is a chance of escape for all. The fire, being now confined to the stage, will soon pass out of the ventilators in the roof, as from the cauldron of a steel plant.

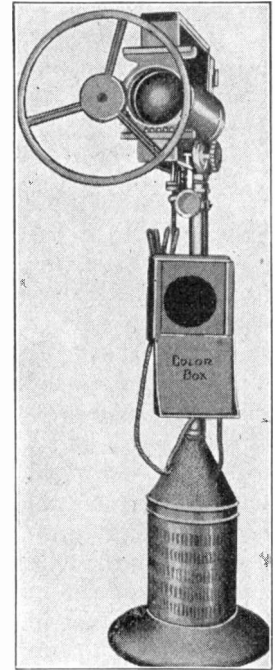

FIG. 33. SPOT LIGHT OR CHASER

THE ELECTRICIAN CLOSING THE SHOW

As the final act curtain drops to the stage, the stage electrician throws the house switch the first thing. The switch of the heavy steel fire curtain is then thrown, and, as explained previously, the latter settles to the stage apron. There is a scurrying to and fro as the final scene is struck, and with the ending of the passing out music and the cry of "All out!" from the ushers out front, the house switch is opened. The fire curtain is run up about half way and the electrician places a bunch light with five or six lamps throwing their rays from the front part or apron to the rear of the stage, so that in case of fire, any one coming in can find his way about without danger or fear of injury, and can see its location at once.

Engineering Education

By PROFESSOR FRANK P. McKIBBEN

Professor of Civil Engineering, Lehigh University, South Bethlehem, Pa.

Extracts from "Addresses to Engineering Students," edited by Waddell and Harrington, consulting engineers. This is the third of a series of similar articles by prominent educators and business men, which will be especially interesting to boys and young men who contemplate following the engineering profession.—Editorial Note.

Now that the time has arrived for engineering students to return to their respective universities and technical schools it is appropriate for them, before beginning the year's work, to survey the field with a view of deriving the greatest benefit from the time and money spent in the undertaking; in other words, to see the purpose of an engineering education.

Next to developing a strong body the student should exert his best efforts to accomplishing two things. First, he should train himself to understand and to deal with his fellow students and the teaching corps, and to make as many friends as possible in both these bodies. If this quality of mixing with men can be acquired in college, it will not only render college days more pleasant and more profitable, but it will result in a breadth of view about men and things that will make the student a more useful citizen throughout his after life. To accomplish this it is necessary, among other things, to take part in some of the various social activities which are to be found in every school, but here again a middle course must be taken and the



student must not become entangled in so many of these non-scholastic activities as to allow them to absorb his attention to the extent that other features of his training are neglected. In other words, it must not be forgotten that there are several things to be gotten out of college and no student should so specialize in the social activities as to be found wanting either in the physical or scholastic training.

The power to formulate and to solve new questions which are constantly arising in industrial, in engineering and in scientific fields is what each man should strive to obtain. To this end he must acquire methods of clear thinking, habits of industry, accuracy and reliability. Let not the standard be the quality of work that will secure the lowest passing mark, but rather let it be of a quality which creates the self-satisfaction coming from having done one's best work. In other words, no man should be satisfied until he has done the best that he is capable of doing, and he must remember that it is vastly more important to himself that he sets and maintains

a high standard in his work than it is for the teacher, or later his employer, to set it for him.

Few students realize the value of being accurate. Unfortunately this is not altogether the student's fault, because it is the custom in most engineering schools to give more work than students can do well and then to be satisfied if they do 60 per cent of it. The 60 per cent represents the usual passing grade. Under this system it is difficult for a young man to do his best, but he should strive to eliminate errors by being constantly on guard against them. Let it not be forgotten that it is results, accurate and reliable, that are wanted; that to understand the principles involved and to make numerous arithmetical or other mistakes in their application is even more serious than not to have the principles at all. In this connection it is desirable to emphasize the importance of self training. The very best teacher can only point out the way, and it is for the student then to assume the responsibility of following it. Each man should cultivate self reliance, and should closely scrutinize his own work in order that mistakes may be finally reduced to a minimum. This question of exercising care is a very serious one, and cannot be too strongly impressed upon teachers and students in our engineering schools.

A thorough understanding of the underlying principles of chemistry, mathematics and physics is very necessary in engineering, and the engineering school is by far the best place to get it. In addition to these subjects, it is essential that attention be paid to their application, as exemplified in the study of hydraulics, strength of materials and various forms of design, such as bridge and machine design. Design is especially useful because it trains the imagination, encourages resourcefulness, develops ability to attack and solve new problems, and

what is of paramount importance, it fixes the principles as no other method of instruction can. By design is meant the application of principles of mechanics to determining the size and strength of various parts of a structure without going so far into the details as to lose sight of the main problem. Let no one be deceived by thinking that he is learning bridge engineering when he is really memorizing the sizes of heads corresponding to certain commercial sizes of rivet shanks. Details such as this can be much better learned in the bridge company than in the college, while on the other hand, the principles of design can be more quickly, though no better, mastered in college.

All students of engineering should take part in the activities of their local engineering societies and should be familiar with the principal technical journals, because after graduation they will find that their college courses will really be continued in a measure by preparing and reading papers before the national engineering societies and by contributing articles to the leading engineering periodicals. Furthermore, by reading a good engineering paper there is seen the result of the applications of principles learned in the classrooms and the text-books, thus adding to the interest and enthusiasm of the college work. It is well, therefore, that while in college some knowledge be acquired of these two branches of what may be said to constitute the post-graduate course of the average engineer.

Finally, students should not attempt to specialize, but should get a broad, general training in fundamental principles, together with enough of their applications to fix them thoroughly. On the other hand, the mistake should not be made of confusing breadth with superficiality. A man can be broad and at the same time thorough.



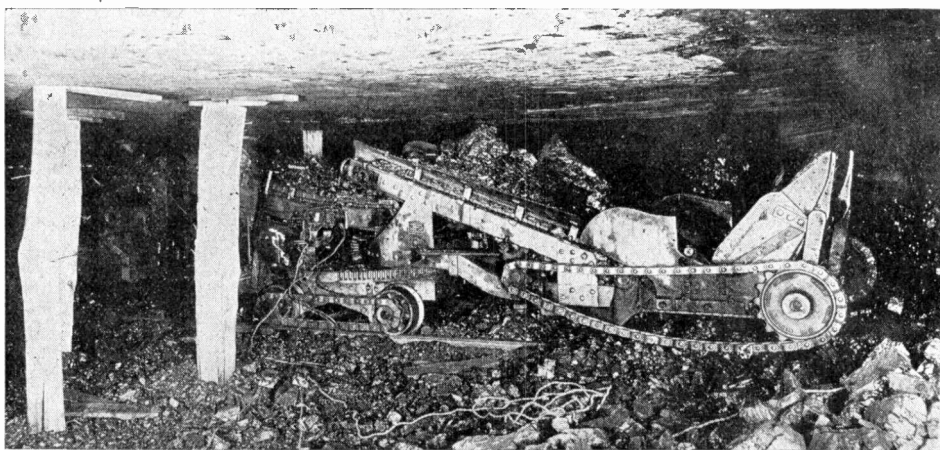
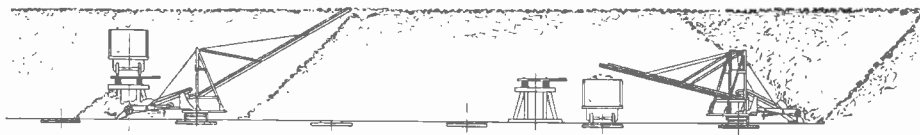
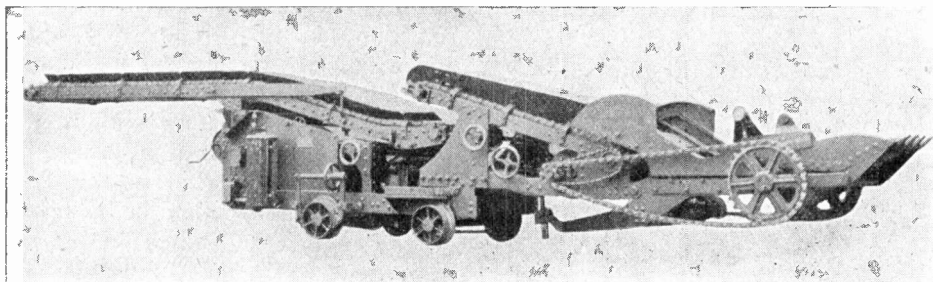

ELECTRIC SHOVELING MACHINE

Even shoveling, that most simple form of manual labor, can now be done by means of an electric shoveling machine, which may be operated by one man and will do the work of dozens of laborers. The pictures are practically self explanatory. The powerful steel shovel at the forward end is forced under the material to be handled by the forward motion of the carriage. It is then tipped up automatically and the material falls back onto the conveyors, which carry it back and up at the same time, to be deposited on a car or dump pile. Some of the things which this machine will do are to excavate rock after blasting, and all other loose materials reasonably free from water; grade for railways; strip soil for mineral deposits; handle coal and ore in mines; take the place of stock house crews in blast furnace work, etc.

The underground electric shoveling machine used for mine service is designed to work in a space 47 inches high from the top of rail to roof, while with a shallow track work can be done in a mine or tunnel 50 inches high. The lateral swing or rear conveyor provides for the loading of cars on same track occupied by the machine or on a separate parallel track.

Tablet Commemorating First Telegraphic Train Order

To Charles Minot belongs the honor of having made the first practical application of the telegraph to railroading, at Turner, now Harriman, on the Erie Railroad, in the fall of 1851.

It was known in a general way at that time that electricity, traveling at the rate

Charles Minot's operation of trains by telegraph was something of an accident. Conductor W. H. Stewart was running the westbound express train on a day when Superintendent Minot happened to be going over the road. The train, under the rule then existing, was to wait for an eastbound express to pass it at Turner's, 47 miles from New York City. The train had not arrived, and the westbound



TABLET COMMEMORATING CHARLES MINOT AND THE FIRST TELEGRAPHIC TRAIN ORDER

of 286,000 miles a second, could outstrip a brakeman carrying a red flag, but no one had conceived the idea of making electricity take his place.

Up to the time of Mr. Minot's initial experiment with telegraph orders, trains on the railroad were run on what was called the "time interval system." A "ruling" train had the right of one hour against the opposing train of the same class. But trainmen were anxious to get through, so that after waiting for the opposing train for a short time, a brakeman with a red flag would be started ahead and after 20 or 30 minutes the train would follow.

train would be unable to proceed until an hour had expired, unless the tardy eastbound train arrived in Turner within that time. There was a telegraph office at Turner, and Superintendent Minot telegraphed to the operator at Goshen, fourteen miles further on, and asked him whether the eastbound train had left the station. The reply was that it had not yet arrived at Goshen, showing that it was much behind time. Then Minot telegraphed as follows:

"To Agent and Operator at Goshen:

Hold the train for further orders.

Signed: Charles Minot, Supt."

He then wrote out this order and

handed it to the conductor, Mr. Stewart. "To Conductor and Engineer, Day Express:

Run to Goshen regardless of opposing train.

Signed: Charles Minot, Supt."

"I took the order," says Mr. Stewart, "showed it to the engineer, Isaac Lewis, and told him to go ahead. The surprised engineer read the order, and, handing it back to me, exclaimed: 'Do you take me for a d—n fool? I won't run by that thing!'

"I reported to the superintendent, who went forward and used his verbal authority on the engineer, but without effect. Minot then climbed on the engine and took charge of it himself. Engineer Lewis jumped off and got in the rear seat of the rear car. The superintendent ran the train to Goshen. The eastbound train had not yet reached that station. He telegraphed to Middletown. The train had not arrived there. The westbound train was run on a similar order to Middletown, and from there to Port Jervis, where it entered the yard from the east as the other train came in from the west."

An hour and more in time had been saved to the westbound train, and the question of running trains on the Erie and other railroads by telegraph was at once and forever settled.

Through the efforts of Mr. E. P. Griffith, superintendent of telegraph for the Erie Railroad, the question of perpetuating the memory of Minot and the first telegraphic train order was presented to the Association of Railway Telegraph Superintendents in June, 1910, and to the Old-Time Telegraphers and Historical Association in September of the same year. Out of this action came funds by contribution for the erection of the monument 400 feet west of the new station at Turner (Harriman), and in plain view of passing trains.

The stone from which the monument is fashioned was quarried from the Ramapo Mountains, on the Harriman estate.

The stone was given by Mrs. Harriman, widow of the late E. H. Harriman, and she paid for the cost of cutting.

On its face is inscribed: "From this station, Charles Minot, General Superintendent; New York & Erie Railroad, 1851, issued the first train order transmitted by telegraph." The order given above follows. At the top of the tablet, encircled by a wreath, is a vignette of Mr. Minot. At the bottom appears the following: "This tablet was erected in November, 1911, under the auspices of the Association of Railway Telegraph Superintendents and the Old-Time Telegraphers and Historical Association."

Encircling the tablet at the top, is this inscription, cut in the stone in bold letters: "What Hath God Wrought?"

One of the Pioneers

The birthdays of this odd looking motor number at least 20, if not more. In buying out an old shop I found the motor among the salvage. It was belted to a buffing wheel and taking current

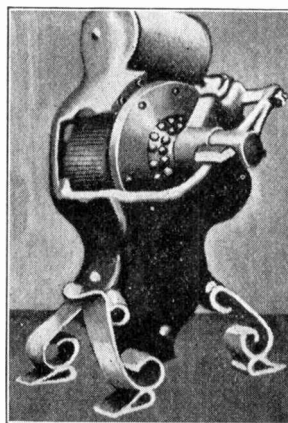

MOTOR OVER 20 YEARS OLD

from a 110 volt circuit. The base is made of wrought iron worked into peculiar shape. The ends of the armature coils are secured by two rows of screws, plainly seen in the picture, while the field coils occupy positions above and below the armature.—G. H. NOVOTNY.

Chicago's New Police Patrol Boat No. 2

Screeching whistles and tooting horns marked the launching of Chicago's new police patrol boat No. 2, July 27. As it slid down greased ways into the river it is to guard, Miss Katherine, daughter of Chief of Police McWeeney, broke a bottle of champagne over the boat's prow.

For many years Chicago has had but

is heavy and serviceable in the rough work of dodging in and out by slips, chasing "bum boats," rescuing would-be suicides and here and there lifting a bit of wreckage from the river.

The boat was designed by DeWitt C. Cregier, city custodian and fleet captain of the Chicago Yacht Club. An electric generator and storage battery furnish current to light the boat throughout, even the starboard, port, stern and bow, lantern-like lights in external appearance

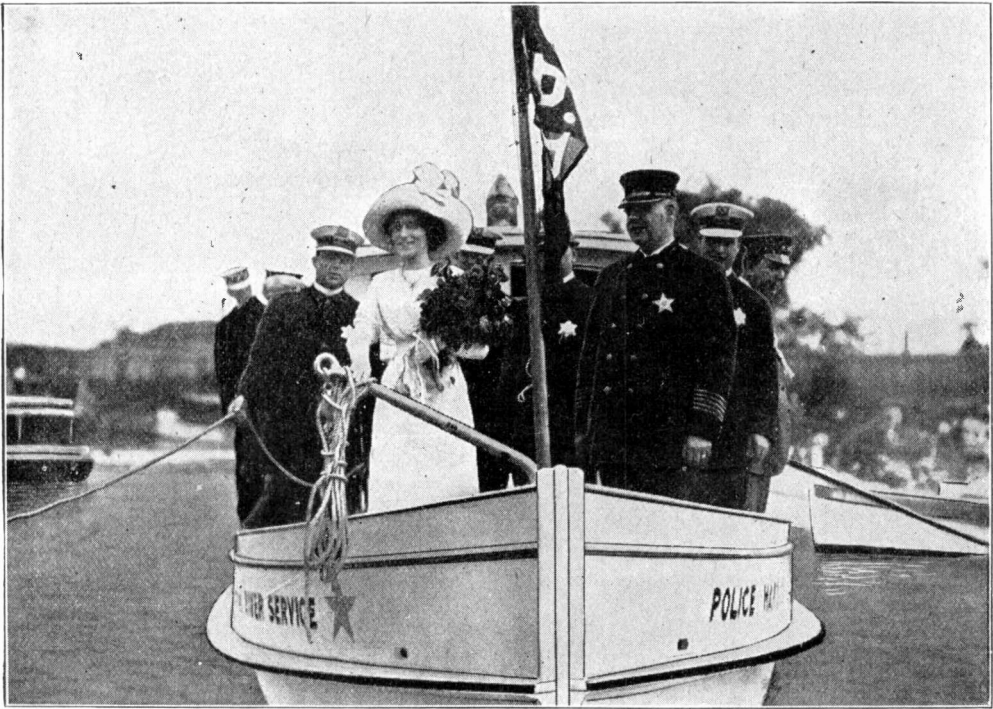

AT THE LAUNCHING OF POLICE PATROL BOAT NO. 2

one small boat to police 47 miles of river shore and 27 miles of lake front. Not until a taxicab with four passengers shot over the abutment and into the river during the opening of the bridge at Adams street did a plan for thorough river patrol make headway.

Patrol boat No. 2 is 48 feet long, eleven feet wide, draws $3\frac{1}{2}$ feet of water and is equipped with a 50 horsepower gasoline engine. It is not built for speed, though capable of making twelve miles an hour against a strong head wind, but

being fitted with an incandescent lamp within the lantern globe. A powerful electric searchlight set upon a swivel so that it can be turned at any angle enables the crew to search the dark corners of wharves and slips, and when turned downward illuminates the river bottom as if by daylight.

As proof of the confidence of Chicagoans in the ability of the boat crew in recovering people and things from the water, a man recently came and asked them to find his watch and chain acci-

dentally dropped into the river. The crew laughed and agreed to make a try for it. The loser smiled and marveled and so did the crew when the missing watch was fished out of the river ooze intact and still ticking.

Monotony is an unknown quantity to the crew and often work is well seasoned with excitement. "There's a lot of young lifters," remarked an officer at the station under the Clark Street bridge. "They'll steal anything that's loose, sneak into warehouses, pilfer in freight cars and steal fittings from unprotected boats along the river and in the harbor. The river police last year recovered \$30,000 worth of stolen property and made 60 arrests.

"Then there's the rescue work. Last year 33 persons were rescued and 67 bodies recovered from the water. Most of the people who try to 'end it all' by jumping into the river, change their mind as soon as they hit the cold water and are mighty glad to have us pull them out."

Two crews of four men each will operate the new boat.

Emergency Pumping Outfit

Four cloudbursts in 30 minutes brought on Denver a mountain of water which did much damage in the residence as well as the wholesale district, flooding cellars and carrying several acres of land with much débris down the cement walled channel of Cherry Creek. Misery was to be found everywhere that the flood had touched. Great demand existed for pumping devices, and the supply houses were unable to meet the demands. Electric motors, gasoline engines and muscle were used to operate the pumps, in many cases at very exorbitant rates—as high as \$50 per day for the apparatus without the operator.

The Denver Gas & Electric Light Company had in its garage, which was in the flooded quarter, the chassis of a 2,000 pound General vehicle truck, and quickly mounted thereon a fifteen horse-

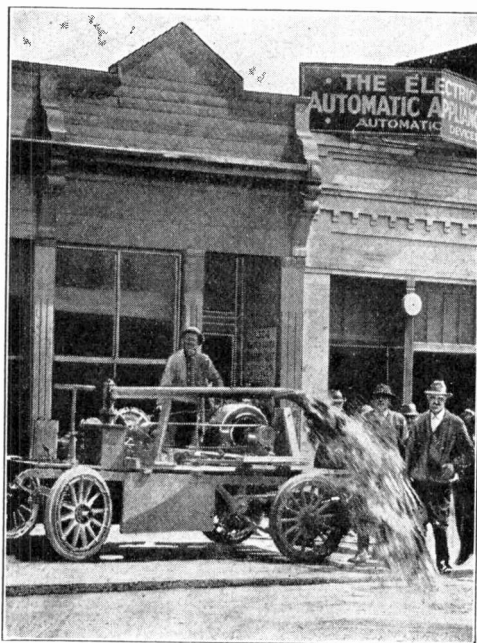

EMERGENCY PUMP IN THE DENVER FLOOD DISTRICT

power motor, belting same to a centrifugal pump with a capacity of 600 gallons per minute. The truck was driven on the sidewalk and 20 feet of five inch suction hose, with foot valve, etc., placed in the flooded basement. A 3½ inch discharge pipe carried the water to the street, where it had ready access to the storm sewer. A temporary connection of duplex cable was made to transmission lines which were in the alley adjoining. The pump was started, and in a surprisingly short time much of the mud and all of the water had been deposited on the street, and a comparatively clean and dry cellar left under the building.

After this trial, the outfit was sent to aid others who were flooded out. The charge for the motor was \$2 per hour, with a minimum which covered the time necessary to make connections. Thirty-six thousand gallons of mud and water were deposited each hour from this impromptu cellar pump. The time needed varied from 20 minutes to three hours.

Shooting by Searchlight

It is always a pleasing spectacle to watch searchlight drills at night, either from shore batteries or battleship fleets. But a real, live target practice by search-

X-Ray in Observing Bone Structure

The X-ray photograph reproduced herewith demonstrates an important phase of the utility of the ray. The sub-

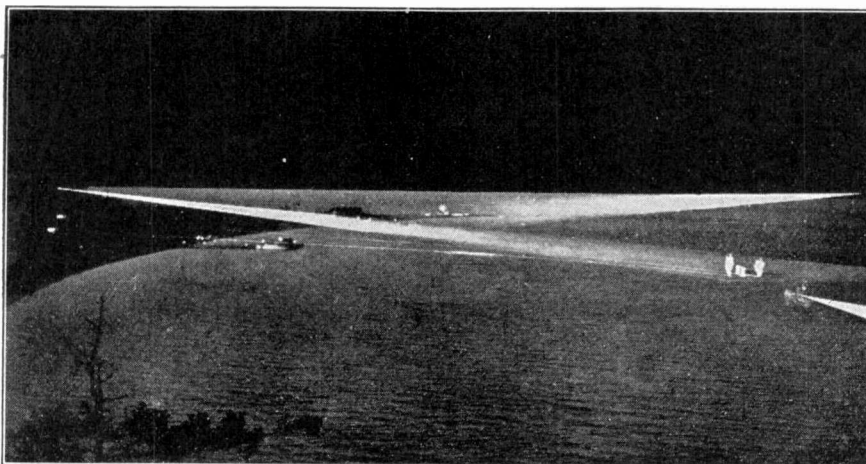

TARGET PRACTICE AT NIGHT BY SEARCHLIGHT—NOTE THE FLASHES OF THE TWO BIG GUNS AND THE FINE LINES SHOWING THE PATHS OF THE SHOTS

light, with solid shot and targets carrying red lights, is a bit of the spectacular one can't find in a wild west show or a circus.

These lights are powerful and throw a brilliant beam for long distances out to sea. They are so powerful that the gunners are able to find the target at night while it is being towed by a tug at a fast clip at long ranges. When once spotted the bombardment begins in earnest. Shooting big twelve and sixteen inch guns at night is no work for children, and practice at this time is more or less dangerous, not only to the gunners in the batteries and the men on the tender doing the target towing, but it is extremely hazardous for shipping, especially to small pleasure craft.

Some good records have been made shooting at targets at night by the aid of searchlights, and in time of actual warfare with a big target like a moving dreadnaught the artillermen feel that they can "hold the fort" longer than did the Russians at Port Arthur.

ject had developed a lameness the cause of which was not evident until the picture was taken and the negative developed. Then, at the arrow points, faint but positive indications of decay of the bones were discernible. The ordinary observer would probably pass these over, but a skilled physician notices them immediately.

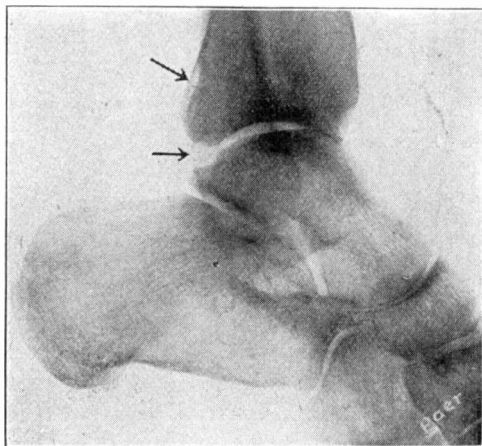

ARROWS POINT TO THE DISEASED BONE STRUCTURE

A 60,000 Egg Incubator

At Muskogee, Okla., there has been built a mammoth electric incubator of 60,000 egg capacity. The incubator it-

self is a low brick building 20 feet square. When you go to visit it, under the guidance of Mr. Hastings, the inventor and owner, you do not simply look into it—you enter and walk around inside. A



FIG. 1. MR. HASTINGS TESTING EGGS. IN THE FOREGROUND IS THE TEMPERATURE REGULATING VALVE

FIG. 2. THE EGGS MUST BE TAKEN OUT AND TURNED THREE TIMES A DAY

building of this size, filled with old style incubators, would have capacity for only about 3,000 eggs.

Under this roof can be hatched 60,000 eggs at one time, although accommodations for 30,000 are now all that are needed. The full 60,000 capacity can be ready for work, however, upon a few days' notice. The large capacity is attained by superimposing 20 trays, one above the other, so that 5,000 eggs fill a single chamber measuring about 2 by 4 by 4 feet.

The big idea in the hatching business is to get cheap chicks; and space economy, such as this mammoth incubator gives, along with the low cost of equipment, will tend to not only produce cheap chicks, but more chicks, and stronger ones.

It is a very simple idea, that of placing the trays one above the

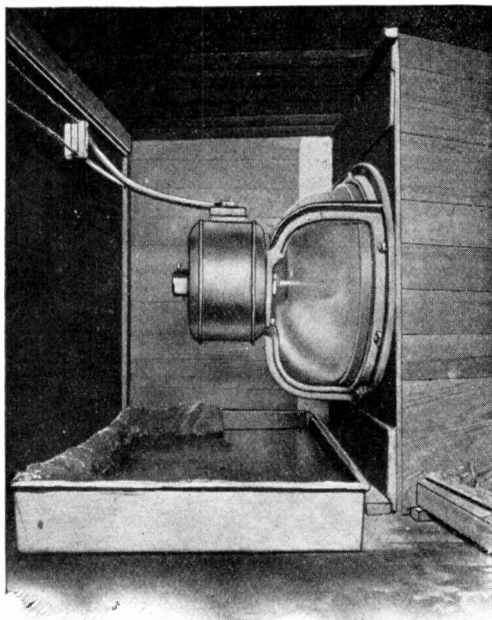

FIG. 3. THE VENTILATING FAN, LIFE OF THE INCUBATOR

other, and, like all other simple ideas, it has been tried before, but failed to work on account of the fact that it was hard to heat up such a large mass of eggs and maintain the temperature constant at all points. This was overcome, however, by the use of an electrical centrifugal fan, which drives a blast of warm air through the eggs from top to bottom and heats the entire mass of eggs (or cools it) at the will of the operator.

Upon entering the hatchery, we are first taken into a small anteroom, as shown in Fig. 1. The natural gas line which furnishes the gas for heat is shown on the wall and passes through a mercurial float valve, which is automatically controlled by the thermostat of home-made construction. This thermostat is set to operate at a desired temperature so as to close off the gas when the room becomes too hot. There are two other such arrangements on the same line, merely to check each other, so as to insure the gas being shut off when the temperature rises, and make a positive prevention against ruining many valuable eggs. The man in the picture

is Mr. Hastings, who is testing the eggs for fertility.

The anteroom contains a compartment, shown in Fig. 3, in which is placed the ventilating fan, the life of the incubator. Outside air can be admitted to this compartment whenever necessary. This also shows the pan of water underneath the fan, to keep the moisture in the air at the right amount. This fan is supplied by central station service of the Muskogee Gas and Electric Company, and the owner of the incubator keeps a duplicate on hand at all times to immediately put in place should a breakdown occur. As a stoppage of ventilation would make it necessary to throw away all the eggs in the incubator and start over again, it will be seen that the dependability of the central station service is the biggest point of the whole process.

From here we enter the main incubator, in which the temperature is constantly kept at the right amount—about 100° F. The attendant will be seen, in Fig. 2, pulling out trays of eggs for turning, which is done three times a day

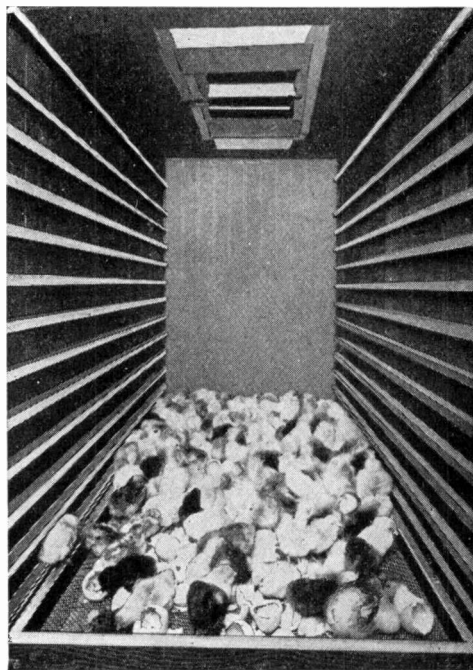

FIG. 4. A "GRAND OPENING"

by hand. In this runway the first experiments in forcing chicks by aid of the tungsten lamp were carried on. By a special time switch, light was furnished the baby chicks for eight hours, a 60 watt tungsten lamp being used, and then their light was shut off for eight hours. Fig. 4 shows a tray of chicks just out.

Mr. Norman B. Hickox, who is the contract agent for the Muskogee Gas and Electric Company, remarks: "We are always striving for business at a high load factor, so you can readily see that our friend Hastings runs his chicks at nearly 100 per cent load factor, thus resulting in an efficiency so increased that the electric chick four weeks old by far outweighs his (or her) brother or sister brooded in the old way at 66 per cent load factor."

A Landmark that Turned a Trolley Line

The new trolley line from Los Angeles to Van Nuys and Lankershim, now under construction, met with an obstacle which proved insurmountable, in the shape of an ancient sycamore tree. This was used in the early days by government surveyors in running their lines and is under federal protection as a landmark. Permission to destroy the tree and set a metal mark flush with the

ground was denied, and therefore it was necessary for the tracks of the new electric line to be laid around the tree, making quite a detour. The view shows a construction train before the old sycamore, and indicates the position of the landmark, squarely in the middle of the proposed tracks. The tree is located in a narrow gap in the hills above Hollywood, known as Cahuenga Pass.

Milking Cows in the Pasture

The latest step towards securing a maximum yield of milk from high grade cows has been taken on the Hobrechtsfelde dairy farm near Berlin, where the owners first objected to the use of milking machines on the ground that these would require the cows to be driven to the barn for the milking. Such a tramp invariably decreased the flow of the milk from each cow, so the old method of hand milking was retained until electric circuits had been strung around the farm for operating other machinery.

Now the milking is done by electricity, while the cows are out in the open pasture, thus securing the maximum output of milk from the herd, and enabling one man to milk five or six cows at a time. The milking machines in this case are of the type embodying an individual motor and pulsating pump for each machine.

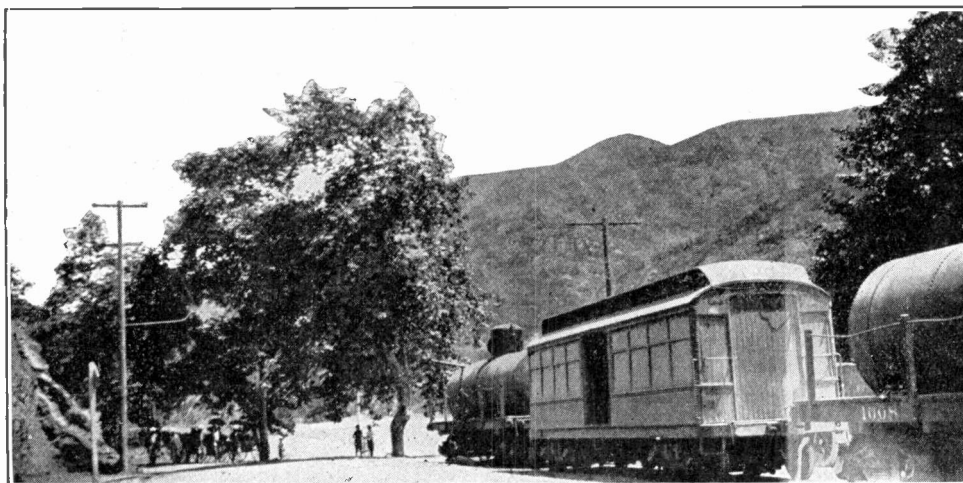

THE ANCIENT SYCAMORE IS A GOVERNMENT LAND MARK

The Steno-phone

The Steno-phone is a new office convenience, combining some of the operating features of the dictograph. The inventor is Mr. M. Bernays Johnson, of St. Louis. It is essentially a small desk telephone, but has no stand or mouth-piece, and takes up but a few inches of space. It is to be used for dictating to a stenographer in another room, when the dictation may be either direct or through shorthand notes, and as a means of communication between a number of departments in a large firm. For instance, the manager can be in touch with the filing department, bookkeeper, buyer and so on. The person using it does not have to keep his mouth near the transmitter, but can sit or stand at his convenience, anywhere in the room, speak in an ordinary tone of voice, and be sure that the other party will hear him.

The instrument has two parts, known as the dictator and the receptor. The receptor is shown in the picture. The dictator consists of a small box, some four inches square and about two inches in height, which contains a specially patented microphone, a pearl push button and a sensitive receiver, also the subject of a new patent. The receptor is similar to the dictator, with the exception that a bell is provided to attract attention, and that the cord leading from the box to the receiver is made longer. A receiver of the head band type is used on the receptor.

When the correspondent wishes to use the Steno-phone, he switches on his in-

strument and rings the person at the other end. When he is through dictating, or giving instructions, he simply cuts off the instrument with the switch, and his private office is thoroughly private; there is no stenographer to overhear conversations, and in the particular case of the stenographer, the time saved through her coming to the office, taking the letter in shorthand and returning to

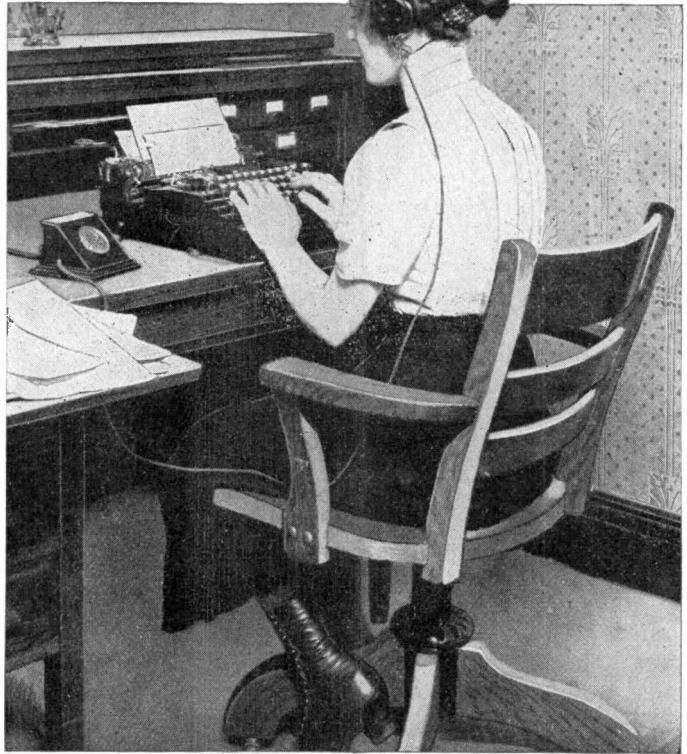

OPERATOR WRITING DICTATION. TRANSMITTED FROM ANOTHER ROOM THROUGH THE STENO-PHONE

the typewriter is saved. Should the man in the private office wish his conversations to be overheard, however, he can switch on the current, give a signal on the bell, and the stenographer will take a memorandum of all that passes.

Another use of the machine can be seen in the office of the buyer. An interesting example of the value of the Steno-phone in this regard occurred in a di-

rectors' meeting of a large coal company which was considering the purchase of a wireless telephone outfit for use in one of its mines. The agent of the wireless company was on hand, with instructions to bid as low as \$1,500 if it seemed necessary. When the subject of price came up, the coal firm admitted that its telephone equipment was costing about \$5,000 a year. The salesman said that he could save them their wire equipment at the very least. The president sent an office boy to the cost department and got the figures on the cost of the wire equipment. When the paper with the figures in question was placed on the table, the salesman got a glimpse of the figures, which made the wiring cost the mining company about \$1,500.

When asked as to his price, he named \$3,000, and a little later the deal was closed at \$2,500. Had the president used a Steno-phone, he would have saved \$1,000, for the salesman could have been worked down to his extreme figure, as he had no way of knowing the cost of the company's wire equipment.

Men Wonder at New Audit Machine

In the Baltimore & Ohio Central Building there has been for a short time a set of machines that rather awe the observer. They are uncanny. All a man has to do is to punch a few holes in cards and then those machines, operated by electricity, make the cards fairly eat, sleep and talk.

The machines are in the departments of C. C. Glessner, auditor of coal and coke receipts, and L. A. Lambert, special accountant of the road and in charge of merchandise receipts. They are used in proving shipment reports. For example, a shipment report comprising hundreds of waybills reaches the department. On each waybill are a half dozen or more sets of figures, and the total of each set of figures for all the waybills is stated in the report. That must be proved, and

hitherto it has been done by unrelieved clerical labor.

Not so now. A young man sits at a table before the first of three machines. It is called the punching machine. In front of him is a stack of waybills, piled high. Beside him is a stack of cards on which are numerals—and that is the beginning.

The station where the waybill originated has a number, and so, in the station space, the numerals on the cards are punched for that number; the date when the shipment originated is punched; the weight of the shipment; the freight charge on it; the advances, if any, and the amount, if any, prepaid. Thus on a card about seven by three inches there is a complete record of the particular shipment covered by the waybill. And the young man who does the punching can hold a pace of 2,000 cards a day without strain; can hit it up to 3,000 if necessary.

From the punching machine the stack of cards, which duplicate all the waybills of a general shipment, goes to the next machine of the set, the tabulating machine. There the stack is fixed on a shelf, a button is touched and away it goes, handling the stack at the rate of 150 cards a minute. When it is used up, somebody turns a lever, and you have your totals for the stack—so many pounds in the weight column, so many dollars in the freight charge column, so many dollars for advances and so many dollars for freight prepaid.

The stack of cards passes to the third machine, the assorting one. That one is a sort of commander of cards. It saith to one card, "Come," and it cometh; to another, "Go," and it goeth. And it tells them to "go" and "come" at the rate of 260 a minute. Any old way the man in charge of the machines wants those cards assorted after the shipment has been proved is done.

There are seven colors of cards used in connection with the machines for corrections. Cards for additions of this and for deduction of that; cards for addition

of that and for deduction of this and so on.

One day in Mr. Glessner's department a general report of shipments came in from Loraine, Ohio. There were 771 waybills in it, and the young man who did the punching of cards for each of the waybills finished up the job in two hours and ten minutes. The next machine, the tabulating one, which produces the totals, handled the stack of 771 cards in a little over five minutes.

Brain a Telephone Exchange

R. J. writes: "Has the size of one's head anything to do with the intellect or the amount of brains? Bumps projecting from either side of the head—do they indicate any extraordinary brightness? Does a bulging forehead indicate a strong memory? Where does the memory brain lie, and where the intellectual brain?"

REPLY

1. No.
2. No.
3. No.
4. Some of the functions of the brain are accurately localized; others are not.

Memory, as such, has no center. Memory of an act resides in the centers having to do with that act. It is like a man walking in the snow. The tracks are where he walked. Nobody goes around, gathers up tracks, and carries them to a center. Going over things in memory is walking in tracks.

The brain is a telephone exchange. Its quality depends on the wires which come in, and the perfection with which the different boards are "hooked up." A good brain is one with lots of wires running in and out, lots of switchboards, lots of wires running from switchboard to switchboard, and good insulation, so that the wires never cross or ground.

In the brain the system is partly automatic and partly worked by operators. Most of the operators sit at switchboards over the eyes and up to the hair line. But there are others sitting all around,

some at the back of the head, and others right over the ears.

The quality of the work done by the brain is determined by how well the exchange is organized; how often one gets the wrong number when he rings, or the busy signal when the line is not busy, or a crossed line, or 'phone out of order, or an electric shock—these are the things which show a brain to be poor. It is not the size or bulk which means intellectual capacity.

Bumps on a head have no more to do with brain work than a bay window on a telephone building has to do with the girl who sits at the board in the "Wabash" exchange of a large telephone system.—Dr. W. A. Evans in the *Chicago Tribune*.

An Electrical Scarecrow

Scarecrows lose their effect when the birds become used to their stationary appearance. A Glenn Ellyn (Ill.) genius with an electrical bent makes use of an



electric motor with suitable cranks and rods to cause the arms and legs of the scarecrow to do all sorts of wild movements, with the result that birds, especially the wary crow, give his sweetcorn and garden a wide berth. From the motor wires run to a switch in the house.

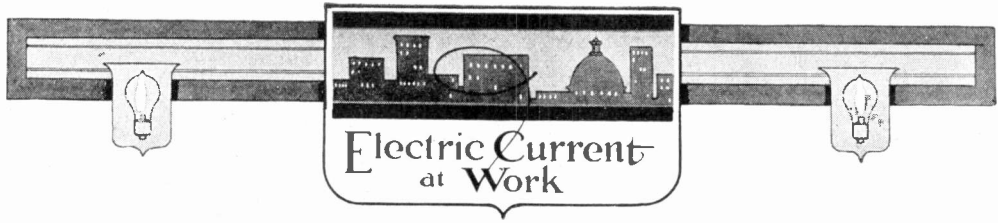

Ampere Hour Meter for Electricians

Every electric vehicle owner understands how important it is to know the exact condition of his battery.

The Sangamo ampere hour meter does for the vehicle owner what a cash reg-

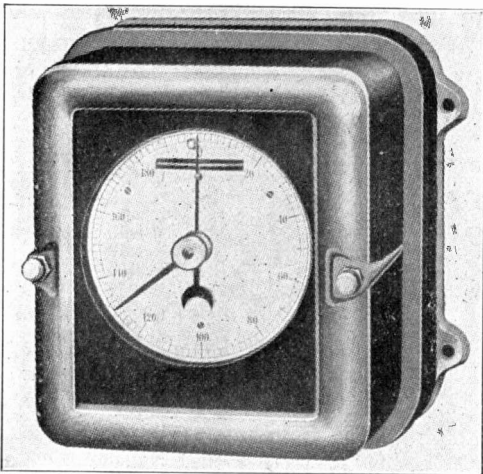

AMPERE HOUR METER

ister does for the merchant—shows everything that comes in and goes out and keeps an exact record of it.

The meter is a small electrical recording instrument, accurately built, arranged on the car so that all current from or to the storage battery will pass through it, making it run at a speed in exact proportion to the current flowing each moment. The revolutions of the meter disk are added up by suitable mechanism and recorded on the large circular dial as shown in the illustration, so with proper adjustment of the meter speed the dial reads in ampere hours—just as a clock reads hours. The large indicating hand starts from zero and runs on discharge in the direction of the hands of a clock, showing at any

time just how much you have taken from the battery, and, knowing the total capacity, therefore, just what you have left. The hand moves back the other way on charge and the meter is so designed as to run somewhat slower backward than forward by a percentage which may be easily adjusted inside the meter. This arrangement gives automatically the necessary extra charge for the battery, amounting to from ten to 20 per cent more than the quantity discharged. By allowing the large hand to touch an insulated contact at the zero mark, a circuit-breaker may be operated, thus cutting off the charge.

A New Electric Fan Creation

Something new in electric fan design is shown in the accompanying illustration of the Cyclone fan. It has a deflecting plate above the fan blades, which rotate in a horizontal position, forcing

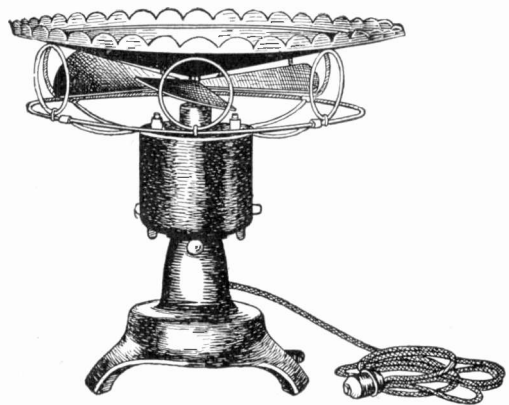

CYCLONE TABLE FAN

the air against the plate in such a way as to produce a pleasant upward circulation of air. The motor has three speeds and operates from the lamp socket.

Dental Engine Operated by Dry Cells

The most important piece of apparatus in a dentist's office is the dental engine which operates the drilling and grinding tools as they are held to the teeth.

The old style foot power engine is still used, but is rapidly being displaced

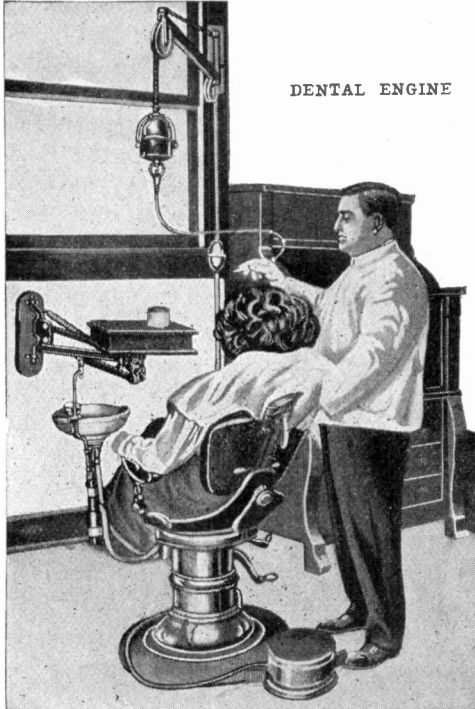

DENTAL ENGINE

by the electrically operated machine. In the illustration, one of the new machines is shown suspended in position from a wall bracket. On the floor just back of the chair is the foot controller, which enables the operator to regulate the speed of the engine from either side of the chair and vary the revolutions of the drill over a range of from 1,800 to 3,500 per minute.

One of the features of the Butler dental engine is that it will run on either direct or alternating current or upon the cells of dry battery where current from an electric light company is not available. These cells are put up in a neat wooden cabinet supplied with the engine.

Lamp Socket Attachment

The ordinary pull chain socket cannot be conveniently operated if the socket carries a reflector or enclosing globe about the lamp bulb. A patent having this point in mind has been granted to William Haas, New York City.

An arm with a clamp to secure one end to the lamp socket and a bell crank lever mounted on the end of the arm serve to pull the chain and light or extinguish the lamp by means of a pull cord attached to the bell crank lever arm.

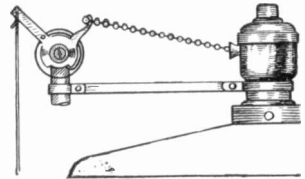

LAMP SOCKET ATTACHMENT

A New Insulator

Thomas H. Watkins, of Wakpala, S. D., is the inventor of a new type of insulator to hold a conductor without the use of tie wires. The insulator proper is made with a deep V shaped notch in the top. In this notch are re-

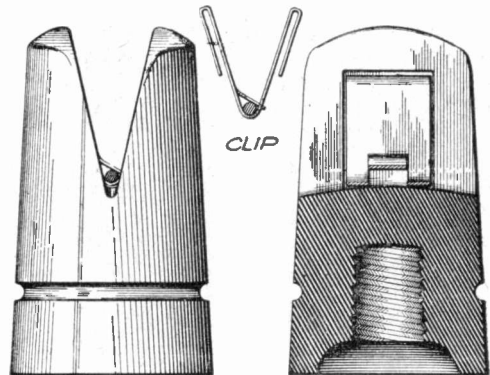

INSULATOR

cesses into which is sprung a clip, shown in the drawing. This clip holds the wire securely down in the bottom of the V when the clip is sprung into place, the little downwardly projecting tongue of the clip pressing down tighter as the top wings of the clip are pinched together to force them into the recesses.

Motor Driven Milking Machines

Motor driven milking machines of the vacuum type have given very satisfactory results in Denver, the "City of Lights," one mile above sea level. A brief description of one of the installations shows the simplicity of the equipment and its application, as well as the feasibility of this type of milking machine for milking even the most refractory cow.

A two horsepower motor is belted to a rotary vacuum pump maintaining a vacuum of sixteen inches. A pipe line is fastened to the intake or suction end of the vacuum pump and extends through each

barn over each row of stanchions. A petcock is connected to a vacuum pipe between each two cows. By this means a milking machine can be so attached that any cow or any number of cows can be milked in any barn by using a rubber hose connecting the machine to the petcock.

In each milking set of four bell shaped rubber cups, one longitudinal half of each bell is of hard rubber so that it will not collapse, the other half is of soft rubber. With a sixteen inch vacuum the

normal atmospheric pressure against the outside of the teat cup is $7\frac{1}{2}$ pounds per square inch, collapsing the soft rub-

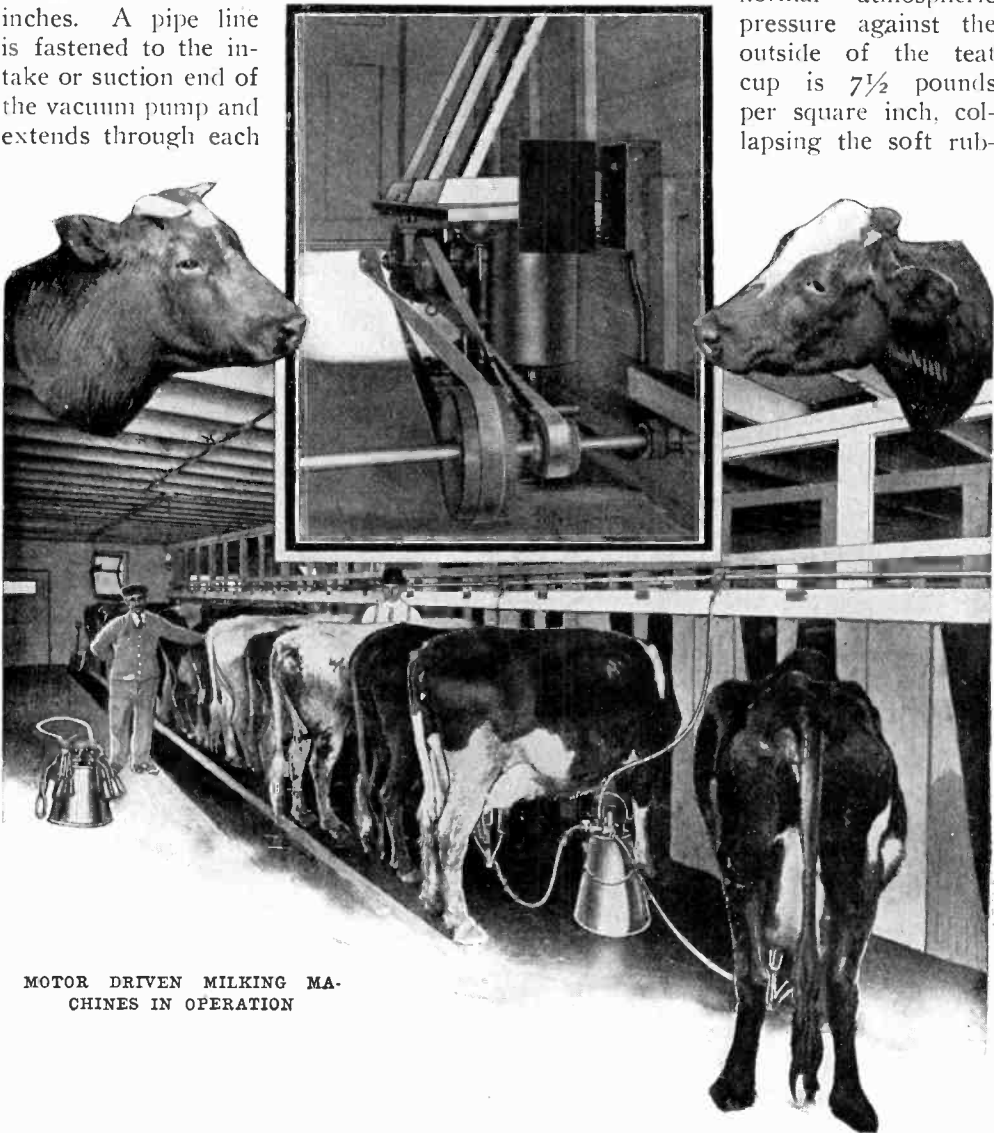

MOTOR DRIVEN MILKING MACHINES IN OPERATION

ber and squeezing the teats against the hard rubber side. A soft rubber sleeve is vulcanized to the large end of the bell shaped cup and fits snugly over the cup to keep air from leaking in. With the cup in position the bell hangs inverted with the point down. The milk runs to a point where a heavy rubber tube is connected with a small clear glass funnel provided for the inspection of milk and also shows when the flow has ceased. The rubber tubes from each of the four cups are vulcanized into a larger tube through which the milk is drawn from the vacuum into the closed tank.

The tank used to collect the milk is of six gallon capacity and shaped somewhat like an inverted milk pail.

The air pressure exhausting into a vacuum is used to operate an air engine built into the top of the tank. This engine is so arranged as to admit air to the tube at each reciprocation of the engine for a very short part of a stroke, destroying the vacuum in the tube and cups and allowing the cups to expand momentarily. When the air port is closed by the further travel of the tube, the vacuum is again established in the tube and rubber cup. The soft cup again collapses from outside pressure of air, thus eliminating the pull and jerk of the hand milker.

The number of pulsations per minute can be varied by adjusting a valve which increases or throttles the air expansion, thus speeding up or slowing down the engine. Hard milking cows may require a speed as slow as 50 pulsations per minute, while easy milkers can be milked by as low as 70 strokes of the valve per minute.

A two machine outfit will milk 20 cows per hour of average milkers and save the expense of one man milking by hand. The advantages claimed for this system are: It lengthens the fresh life of hard milkers; the milk is never touched by human hands, and is not exposed to the air, dust or dirt of the barns.

Wall Pull Switch

We are familiar with the pull chain socket, but the application of the chain to a wall switch is somewhat of an innovation. The illustration shows the Hubbell wall pull switch with a metal cover ready for installation. A slight pull on the depending chain turns the light on and off as in the case of the ordinary pull chain socket.

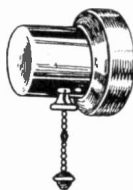

A Giant Drill

That an electric motor often operates a machine many times larger than itself is well illustrated in this picture of the Asquith radial drill made for heavy work.

Some idea of the size of the machine is given by comparing it with the man standing under the arm. While serving

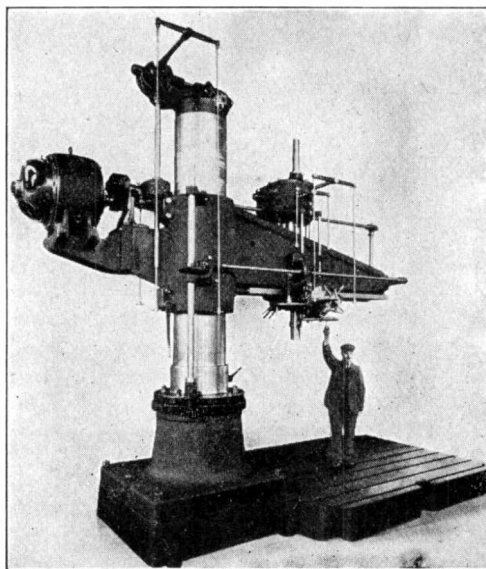

A DRILL FIVE TIMES AS TALL AS A MAN

as a counter-balance, the motor by means of rods and gearing moves the radial arm up, down or around the massive pillar to bring it upon the work. The same motor also furnishes the necessary power which is necessary for the operation of the drill.

New Type Fan Guard

A new type of fan guard, manufactured especially for the Electric Shop, Chicago, consists of concentric circles of wires close together in front of the fan and also about the fan blade tips. The fan is thus enclosed in a veritable network, which precludes the possibility of the baby or a careless individual getting the fingers dangerously close to the blades. Another feature is the use of six blades instead of four, a reduction in the amount of vibration

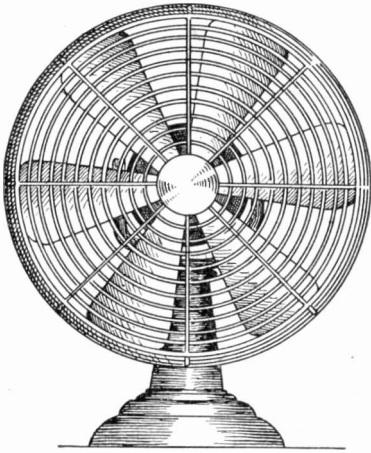

UNIQUE FAN GUARD

being thus secured, the fan running almost noiselessly. Since this fan will be largely used in residences and offices, the guard is neatly finished in bell copper.

Tree Insulator

Part of the telephone lineman's work consists in keeping the wires clear of trees and their branches, which often afford a good ground. The Morse tree insulator here shown is simple and quickly placed on the wire. It is a rectangular piece of wood that may be placed on a wire by means of two crosswise grooves deep enough to meet a shallow groove on the face. The wire passes from one crosswise groove along the face groove and out by way of the

second groove, the middle of the insulator thus held by the wire bearing

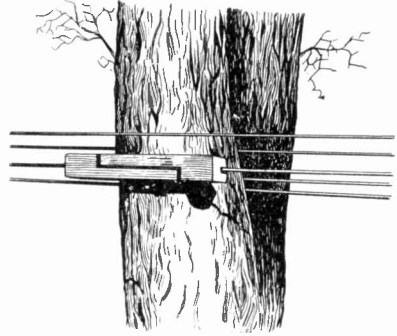

TREE INSULATOR

against the limb or tree without the use of nails or other fasteners. The wood for the insulator is thoroughly waterproofed.

Daylight Egg Tester

An electric daylight egg tester has been invented by Mr. S. J. Fish, of Jackson, Michigan, which will be an innovation in the poultry and produce business, for it is far ahead of candling in a dark room.

Electric No. 2, as it is called, is about three feet in length and contains a belt, with small metal trays about six inches apart for holding the eggs, which is run over rollers at each end of the case by the aid of a crank. This machine is

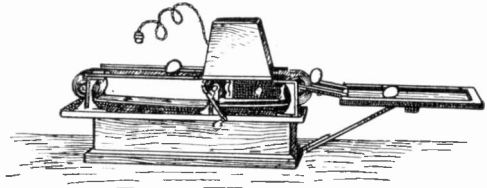

EGG TESTER

equipped with an electric lamp and a cord attachable to any electric light socket.

A hood with an opening is placed over the lamp and, as the egg passes over it, the light flashes on automatically, remaining only so long as the egg is under examination; a perfect one is a clear deep orange color, while a bad one is

black; the eggs turn automatically on the belt, enabling the tester to examine from all sides. The good eggs are allowed to roll out on a canvas table, which is done without danger of breakage, while the operator discards the ones which are spoiled.

When the ordinary lighting current cannot be secured, the machine is equipped with 24 dry batteries in multiple series, which furnish current for low voltage electric lamps.

An expert and two helpers can test about 80 cases per day with absolutely no danger from fire. Eggs are tested in a daylight room, and with great rapidity.

Car Cleaning While on the Way

The portable vacuum cleaner has simplified the cleaning of Pullman and observation cars on through trains. At one time at division points the car cleaners, with broom and dust pan, would enter cars, and while discommoding passengers, would do a poor job of cleaning. Today the cleaning is easily done while the train is on its way.

The Utility electric cleaner, without filling the air with dust, cleans the floors and cushions, depositing the dirt in a dustproof bag. The apparatus, though small, is effective and is equipped with a motor to suit the current.

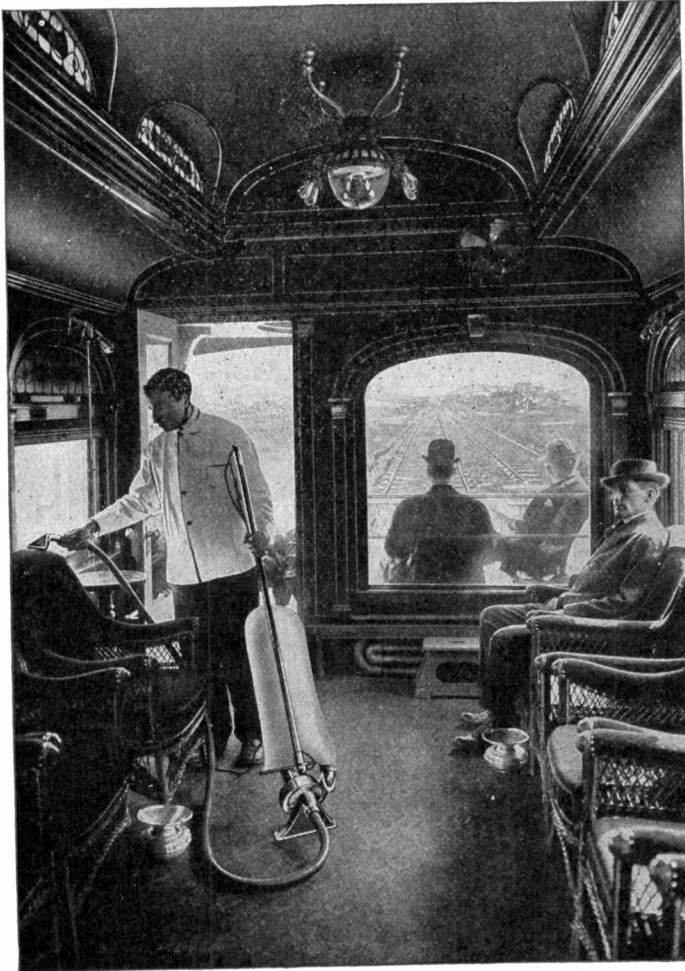

CLEANING THE OBSERVATION CAR EN ROUTE

Magnetic Chuck

A magnetic chuck is one of the newest machine shop appliances, being made to hold work on the flat beds of planers, millers, grinders, etc. The chuck is fastened to the bed of the machine. Its face contains the poles of a number of electro-magnets. By pulling out a handle on the controller, current is sent through the coils of the electro-magnets, which become very strongly energized, holding the metal piece to be worked firmly in place. For certain classes of work, as, for instance, grinding file blanks, thickness gauges, etc., it beats the old style chuck, as thin stock can be held for grinding on one face without distortion due to clamping its edges. For heavy work the holding power would not be sufficient, like everything else, it has its limitations.

Illuminated Vest Buttons

An addition to the class of devices called electrical novelties is contained in a patent issued to Everette S. Lagarde and Peter A. Augenend, Jr., Houston Texas. Illuminated vest or coat buttons are constructed to hold each a small electric lamp. A battery and push button complete the outfit, enabling the wearer to light up the buttons at his pleasure by pushing the button.

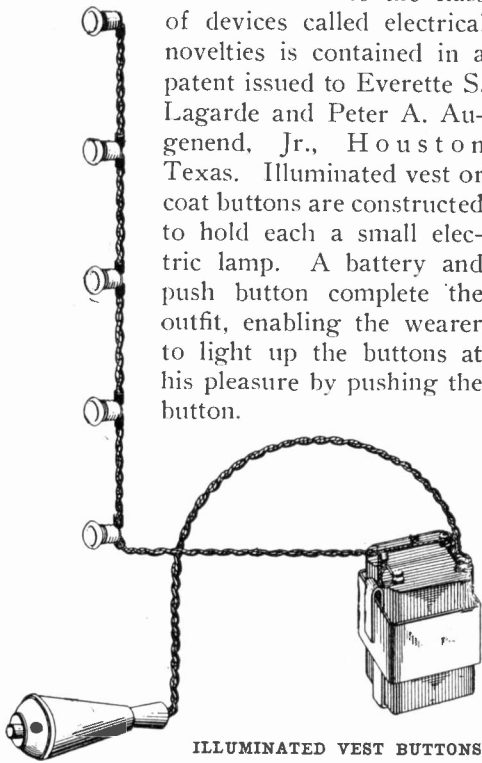

ILLUMINATED VEST BUTTONS

Lighting Fixtures Part of Piano

Something new and different in piano lighting is being put forward by one manufacturer who makes the fixture a



NOVEL PIANO LAMP

part of the piano. With the advent of wooden fixtures the matter of harmonizing these with the general appearance of the instrument should not be difficult.

Light for Memorandum Pad

It is well known that many writers keep a pencil and pad at hand to copy a choice sentence, an expression or a word that is called to mind, knowing that to let it pass may mean inability to recall it. To some this peculiarity is strongest just after retiring, and this fact has led Otto Knoerzer and Joseph W. Weis, of Hammond, Ind., to patent a small bat-

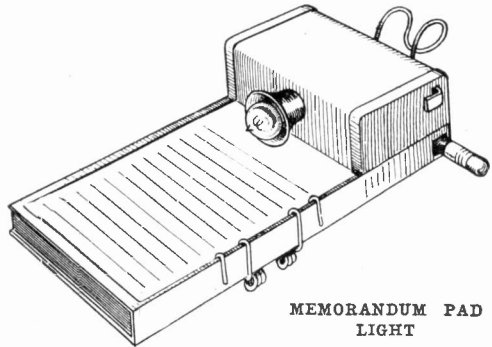

MEMORANDUM PAD LIGHT

tery and lamp to which is attached a memorandum pad. The pad is held in place by a spring, as illustrated, while a lamp is arranged to illuminate the leaf.

Telephone Scratch Pad

There are many telephone scratch pads designed to have the paper in the right place. The illustration shows one in

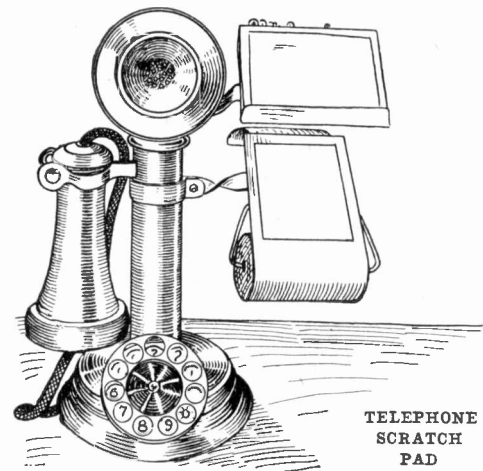

TELEPHONE SCRATCH PAD

which the paper is held upon a roller so that it may be drawn off as needed.

Electrical Men of the Times

FRANK MORRISON TAIT

One of the most exact standards by which a man can be measured is the opinion of him held by those who are employed by and work with him. By this rigid scale Mr. Frank Morrison Tait, president of the Dayton Power and Light Company, Dayton, Ohio, measures a full man and every employe swears by his president. On the other hand, Mr. Tait knows each of his men and not only that, but each man's family.

In his youth, his boy friends will tell you that his sympathies always went out to the boy or animal that was putting up a good fight on the right side and getting the worst of it, and this spirit of absolute squareness impresses everyone who comes within reach of his personality.

Mr. Tait believes firmly in the public. "Any one who wants to see me can walk into my office at any time without being stopped by an office boy or a secretary and without being asked who he is, what he wants, or 'Have you a card?'" It takes up time, but it pays.

"The public whom you are serving as a public utility," said he recently to a friend in the electric light business, "can tell you a whole lot about your company that you do not know and would be glad to hear, and one way to get its co-operation is to be open and above board. Be ready to meet your customers and the public more than half way."

And Mr. Tait practices what he talks.

In a matter, of days gone by, between the public and his company, the adjustment of some differences was made by Mr. Tait, much to the advantage of patrons, when matters might just as well have been decided the other way. Dayton papers in comment suggested on their editorial pages that presidents of other public service companies might do well to follow the example of President Tait in their dealings with the public. The following morning queries came by telephone asking, in a joking way, what the cost of such excellent newspaper publicity had been and the explanation that the effort had been to settle the difficulties justly, and that Mr. Tait had nothing whatever to do with the favorable publicity, would

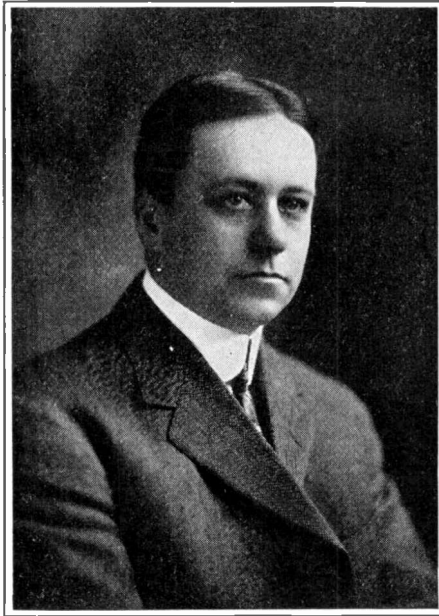

hardly suffice except to those who knew the man.

"Our men," says Mr. Tait, "are instructed to give the consumer who enters a complaint about an overcharge on a small bill just the same care and attention as is shown the consumer whose bills run into the hundreds. If we receive a hurry call to make repairs for a customer, our men are expected to use the same haste in getting there and doing the work as they would were the breakdown on their own premises.

"Even our telephone girls are chosen from the viewpoint that the public appreciates the operator with the pleasing voice and accommodating manner."

That Mr. Tait has not only built up a prosperous and highly efficient system and made Dayton a model, electrically, for the scores of rapidly growing middle sized cities all over the country to emulate, but at the same time has secured to a remarkable degree the good will and co-operation of his public, are probably factors which led the National Electric Light Association to seek him out and bestow upon him their highest office. He was elected the twenty-sixth president of the Association at the Seattle convention last June.

Mr. Tait was born in Catasauqua, Lehigh County, Pennsylvania, in 1874. Following a school course he became a telegraph operator, assistant train dispatcher and then accepted a position as night engineer of the Catasauqua Rolling Mills' lighting plant.

He next became secretary to the president of the Davis & Thomas Company, of Catasauqua, and thus acquired experience as to the use of structural iron.

In 1894, when only 20 years old, he began his central station career by becoming manager of the Catasauqua Electric Light & Power Company. Not long afterward a consolidation was effected with the local gas interests, and Mr. Tait directed the Catasauqua Gas & Electric Company until 1899. He then became connected with the public utilities of Somerville, N. J., and rebuilt all of the plants at that place, merged under the name of the Somerset Lighting Company. New London, Conn., was the next scene of his labors and he took charge of the gas and electric properties there as well as of a general machine and repair shop, developing the corporation now known as the New London Gas & Electric Company.

In 1905 Mr. Tait moved to Dayton, Ohio, to direct the affairs of the Dayton Electric Light Company, representing the interests of Mr. A. M. Young and Mr. A. N. Brady, of New York City. The company is now known as the Dayton Power and Light Company. In ad-

dition to being the president and manager of this company Mr. Tait is vice-president of the Xenia Gas and Electric Company of Xenia, Ohio.

Mr. Tait is a member of the American Institute of Electrical Engineers, of the Illuminating Engineering Society and of the American Gas Institute. He is also a member of the Country, City and Automobile clubs of Dayton, and the Engineers' Club of New York City.

The Price of One Cigar

The cartoon presented herewith represents graphically what ten cents worth of electricity a day—the price of one cigar—will do for the householder. The pictures on the left show the old way of doing things, while those on the right show the comforts and conveniences in the home which may be had for the price of even one cigar. After all, why not smoke a pipe? It's more comforting, and a little Havana smoke would pay for a lot of kilowatt hours of current.

THE PRICE OF A CIGAR
What 10 Cents a Day Will Buy

Vacuum Cleaner
One Hour a Day

AND

Electric Iron
20 Hours a Month
(Equivalent to 40 Hours Ordinary Ironing)

AND

Toaster Stove
One-half Hour a Day

AND

FOUR
25-Watt Tungsten Lamps
4 Hours Each Night
Courtesy of Service



Electrical Interests of Women



EDITED BY GRACE T. HADLEY

Sonnenberg

Sonnenberg is a magnificent estate on the upper edge of Canandaigua, New York. Twice each month during the summer the grounds are open to the public and it is estimated that 10,000 people visited the place on one day last August. The estate comprises some 300

lights. The Japanese Garden is an exact reproduction of an Oriental garden with dwarf trees, miniature cascade, lily ponds, bronze idol and exquisite Japanese house, all delightfully arranged.

The Italian Garden is beautiful with a classic fountain, marble pavilion, sunken gardens and pergolas. The pergolas have electric lamps set in the

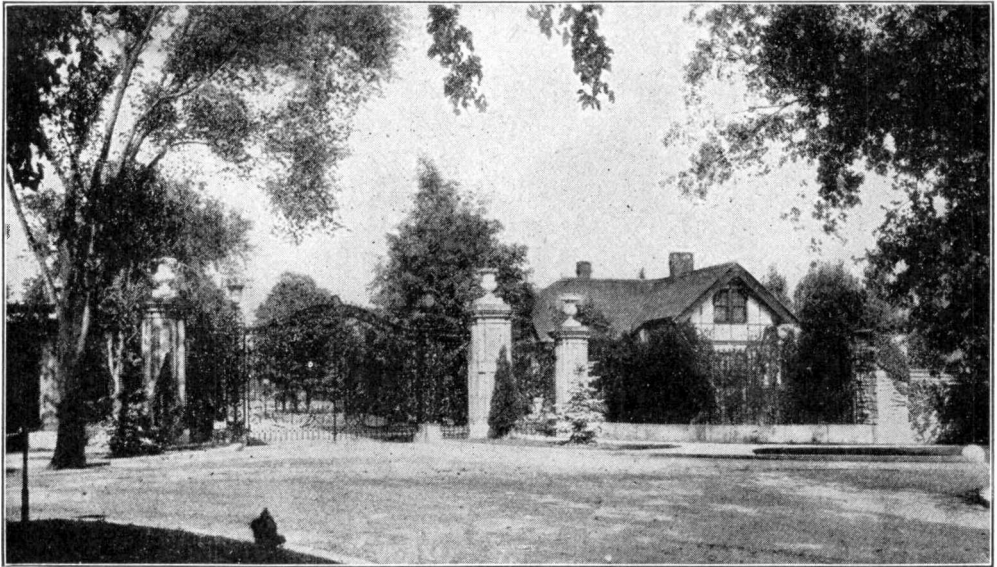

THE MAIN ENTRANCE TO SONNENBERG

acres, and about 75 acres are within walls.

Beginning at the main entrance, electricity plays an important part in the illumination of the gardens. The two lights at the great iron gateway are monster tungsten lamps. Along the pathway leading to the Japanese Garden are stone lanterns on pedestals, modeled after the Oriental pagoda, each equipped with eight candlepower cluster

beams and covered with a crystal, while the pavilions have corner cluster lights.

By night the gardens may be beautifully illuminated and the power is furnished from Niagara Falls.

The estate is the property of Mrs. F. F. Thompson of New York, and Sonnenberg is her summer home. On days when the grounds are open, hundreds of people motor from distant cities to visit these famous gardens.

A Marshmallow Roast

A marshmallow roast appeals to every woman with a sweet tooth. An electric toaster stove affords the safest and most convenient method of preparing such a feast. Nearly every one remembers the burned fingers or flushed face one always acquired trying to brown the marshmal-



AN APPEAL TO THE WOMAN WITH A SWEET TOOTH

lows before an open fire, but with an electric stove there are no burned fingers. Here the heat is localized, and this is a great advantage. Instead of sending a goodly proportion of the heat into the

room, all the heat is concentrated, leaving the surrounding atmosphere cool and pleasant.

Fudge may also be just as easily made on the electric toaster stove. Boil one cup of milk and two cups sugar in a saucepan placed directly on the toaster stove heater. Add two squares grated chocolate or five tablespoons cocoa and boil until a few drops of the mixture will harden in water. Turn off the current, add a tablespoon of butter, and flavor with vanilla. Then beat until the fudge begins to sugar and pour out into a buttered pan. Mark into squares.

Marketing by Telephone

Go into a grocery store and see the women there plodding about among the foods, sweeping up the floor with their skirts that but recently were dragged along the streets. Watch them fingering, smelling and tasting, worrying and puzzling over what to buy and what not, and then ask yourself if the home method of shopping over the telephone is not the saner.

The telephonic marketer can take her choice of the places at which she may care to trade. She may go near or far, to a big store or the little store. She may trade in the heart of the business district just as handily as at the corner grocer's.

A girl at a telephone can take down more orders in five minutes than a clerk can secure in an hour. Think of the time, trouble and clerk hire this saves, to say nothing of the protection of the grocer's stock. One sampling, curious woman can finger more profits off a stock of produce than can be made up in a

dozen sales. A telephone in a grocery store, meat market or shop of any kind is worth half a dozen ordinary clerks.

Electric Milk Warmer

It doesn't take an electric milk warmer long to win favor with mothers. No flame, no soot, no odor—nothing but heat, and that is all on the inside. How much better, how much easier, than going to the stove and lighting a fire! The Westinghouse warmer is an absolutely safe utensil to use at the bedside. It is also good for many other purposes. It will boil a pint of water in six minutes. It is very convenient when you need hotter water than you can get from the faucet.



CLEAN ELECTRIC HEAT—NO FLAME OR SOOT

Do You Believe in Signs?

"I would like to give a Hallowe'en party," ventured little Mrs. Watson timidly. "The Jack o' Lanterns are such fun and now that the house has been wired, I think I could manage some unique effects in illumination."

"Um-m-m," remarked her husband, immersed in the morning paper. He did not mean to be discourteous, but he was always absorbed in business or deep in the political news of the day.

"And there's something else on my mind," said Mrs. Watson, plucking up courage. "The gas range is acting up very badly and if I can't have another range just yet, I wish I could have some of those lovely electric utensils I saw in a window down town. A chafing dish would help me out Sunday evening with the tea, and a toaster would be fine for breakfast, or, better still, a toaster stove—"

Mr. Watson jumped up from the table, hastily kissed his enthusiastic little wife, and hurried out of the room, with her wistful words ringing in his ears.

"Seems like women are always thinking of something nowadays and never contented with what they have," he grumbled. "Time was when they cooked in a fireplace with a single iron pot, but now—" a passing street car absorbed him and the balance of the thought.

When the car stopped down town, and Mr. Watson alighted, he found himself almost directly in front of a most attractive window. Just at the psychological moment there flashed across his troubled vision these words:

DO YOU BELIEVE IN SIGNS?

There it was winking at him from the window in little electric letters of fire and below flashed another sign:

COOK WITH ELECTRICITY

Mr. Watson hurried on, but all day in the office the little letters of fire winked at him surreptitiously from musty law books, and the wistful words of his wife rang in his ears persistently.

The next morning he deliberately paused before the attractive window and studied the contents.

"It does beat all, what they do get up nowadays," muttered Mr. Watson. "I wonder what they are for. I believe—"

DO YOU BELIEVE IN SIGNS?

The little illuminated sign flashed and winked at him, until he hurried away.

The third morning he paused before the window again, not that he intended to buy, oh, no, but somehow, the saucy signs had caught his eye—

GOOD MORNING!

COOK WITH ELECTRICITY

That was the way the sign talked day after day. On the fifth day Mr. Watson walked into the store, just to look around. Not that he intended to buy—

That evening when he went home there was a bulky parcel under one arm. When Mrs. Watson opened it, she found a toaster stove with cord and switch.

"How did it ever happen," she cried, giving the donor a hug. "What made you think of it?"

"I really can't account for it," laughed her husband, "unless it means that I have come to believe in signs."

The Cut-out Switch

Many of the new electric utensils are equipped with a cut-out switch. If the utensil is attached to an overhead electric light socket, this switch obviates the necessity of reaching up to turn off the current or pulling the plug from the utensil. The on-and-off switch is used on the one-heat utensils, but the three-heat utensils must have a regular cut-out switch made especially for the utensil.

Sterilization of Drinking Water by the Violet Ray

A plant for the sterilization of 150 gallons per hour of Lake Michigan water by violet rays is in operation in Chicago. The water is used to supply water coolers for drinking purposes in office buildings and homes. The process consists of coagulation, sedimentation, double filtration and sterilization by violet rays. These rays are emitted from a Cooper-Hewitt quartz tube mercury

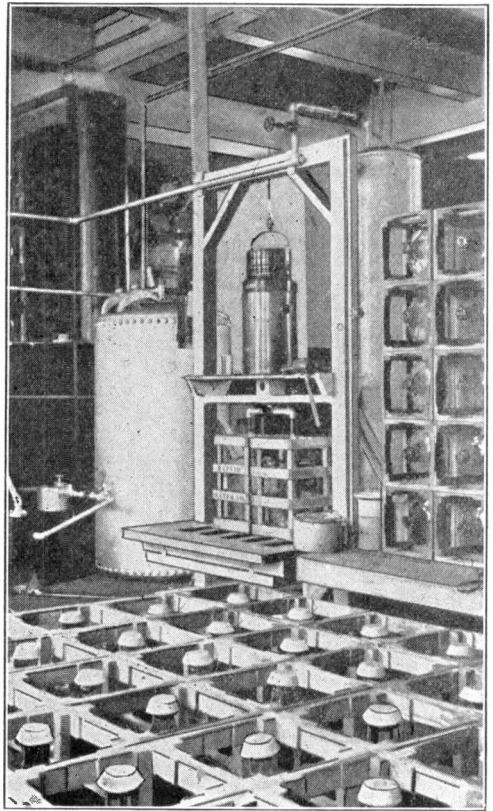

WATER STERILIZING PLANT

vapor lamp. The ordinary small size lamp is enclosed in a cylindrical case. The glass globe ordinarily used to cut out the violet rays is omitted and a five gallon copper cylinder is substituted. The best results are obtained when the mercury vapor tube is placed two and a half inches above the surface of the water.

Water from the city mains enters a closed settling tank, receives a small dose of coagulant and is given several hours' sedimentation. It then enters a second filter and received a one-half dose of coagulant. The water then enters the top of an ordinary galvanized iron 60 gallon tank open to the atmosphere and passes out at the bottom to the sterilizer. As long as the filter delivers a perfectly clear effluent, perfect sterilization is practically effected.

Another sanitary precaution consists of periodic cleansing and sterilization of the porcelain jar by a portable violet ray lamp which is carried from office to office, or home to home, and adjusted over the jar for five minutes, while connection is made to an electric light socket. The system has been approved by the Chicago Board of Health, after a thorough test.

The Flexilyte Lamp

The new Flexilyte for automobile users is a portable extension light in which the cord may be pulled out to any desired length and wound up again inside the case after using. Camping parties will find the Flexilyte just the

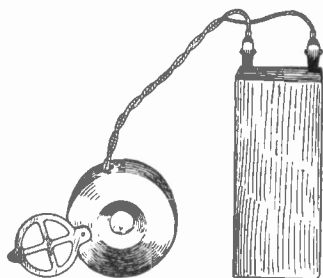

FLEXILYTE LAMP

thing for lighting the shack or tent from the automobile batteries. When touring, it can be used to illuminate guide posts, study maps by, or, if you drop something in the road, you can put a little battery into your pocket and carry the light as far as you like. A sudden shower that catches you en route will not throw the car in gloom if you have a Flexilyte to hang up on the top and

cheer the occupants of the machine.

The flexible cord winds up inside the casing on the same principle as a tape measure. With a suitable plug attachment in place of the clips on the end of the cord, the light is very convenient in the house. Mothers feel perfectly safe with a Flexilyte in the nursery, for there is no danger of fire even if it is upset or dropped on the floor. Artists can hang the light over the easel or set it up on the drawing board. Amateur photographers use it with a red bulb for developing.

Electricity and the "New Attitude" Toward Disease

Modern medicine seeks to study and to know the methods by which nature fights disease and endeavors to overcome it. When Pasteur made the discovery that many serious ailments are transmitted by means of microbes it became apparent that it was of the greatest importance to prevent such maladies from gaining a foothold, or, better still, to prevent them entirely. Hence has arisen what has been well termed, "the new attitude toward disease." The old time healing art has become the "art of preventing disease" or the "art of maintaining health."

In addition to the valuable vaccines and antitoxins which check the ravages of certain dread diseases, a new and potent factor is proving its great efficacy as an agent in helping nature to fight disease. Electrical forces and animal serums and extracts are the remedies for the future in fighting diseases now called incurable. Electricity is the most flexible, controllable and convertible form of energy known, consequently it is frequently used as the medium for the production of other forms of energy that have been found valuable in therapeutics.

In a great many of the sanitariums where the "new attitude" takes definite form, electricity plays an important part in diagnostic, preventive and curative measures. An excellent example is the

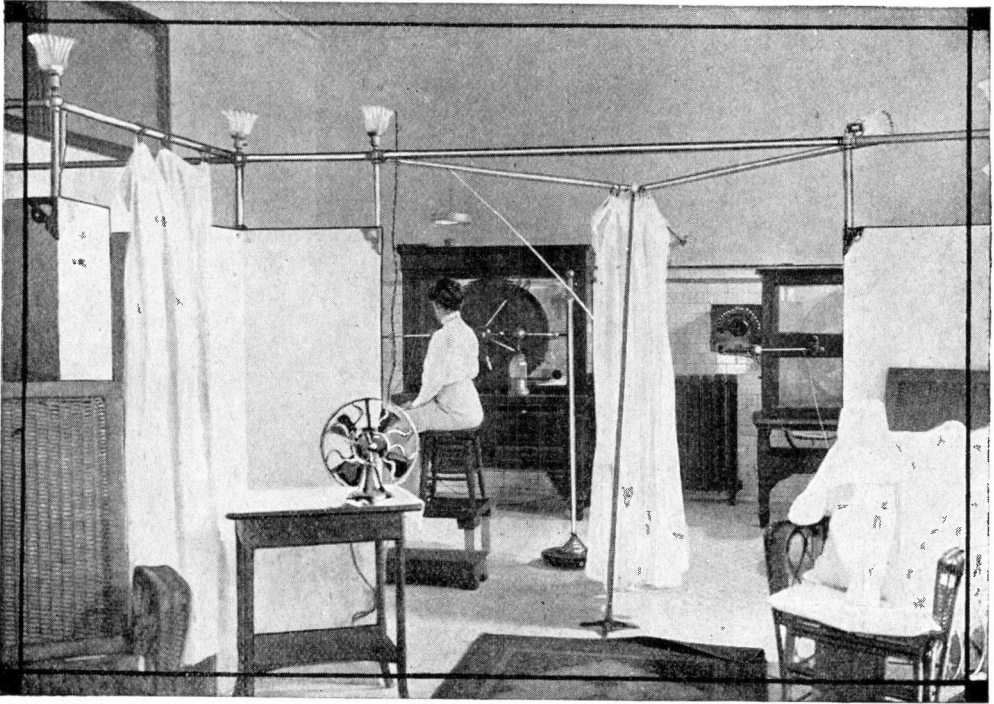

ENJOYING A "STATIC BREEZE" IN THE ELECTRIC TREATMENT ROOM

one at Clifton Springs, N. Y. The electric treatment room is a model in the line of complete equipment for electro-therapeutics. Two static machines, high frequency apparatus, the electric light cabinet, the sinusoidal currents, the X-Ray, the blue light, galvanic and faradic battery, the motor driven vibrator, are all to be found here. The therapeutic lamp and massage vibrator are both widely known and used in the medical profession in the prevention and cure of diseased conditions.

The sinusoidal current is a comparatively recent innovation in medicine and it is doing wonderful work in deep seated conditions, especially where internal medicine is not so successful. This current is applicable where the large heavy muscles are dormant; that is, the involuntary muscles.

The latest development of the electric current for medical purposes is the use of high frequency currents. The discovery of the curative properties of these currents is due to the work of Dr.

D'Arsonval, a French physician. His discoveries in this line are of such importance that he has been called the "father of high frequency." It is the conviction of many who have used these currents that they are destined to be as indispensable in the cure of stubborn chronic diseases as is the X-ray in diagnosis.

It is of interest to see just how the electric current acts on arterial diseases because there is a well known dictum in medical circles that "a person is as old as his arteries." Hypertension, or arterial tension above the normal, varying with individual characteristics and habits of life, is noted to precede structural changes, and a study of the averages shows that with advancing years the changes become more marked and resisting; that, is there is more resistance in the circulatory channels.

The symptoms present in this disease are certain poisonous conditions, increased internal resistance, high blood pressure, solidified lime deposits, dilata-

tion of the arteries, faulty elimination of carbon dioxide and the constructive process of tissue building is hampered.

Now consider the action of high frequency auto-condensation current on such conditions: First, it has a more powerful action on all forms of germ life than any other form of electricity; the high frequency current, by reason of the enormous number of oscillations per second (considerably over one million) causes the blood corpuscles to alternately contract and relax in such a way as to create a molecular massage,

this massage having a tendency to lower the increased resistance very materially; the use of a blood pressure apparatus before and after treatment shows the fall of pressure; numerous experiments have proved that the high frequency current has the property of dissolving lime substance, so the current would naturally have the same effect on the lime deposit which has attached itself to the arterial walls; as this lime deposit is dissolved and the blood pressure lowered, the arterial walls regain their normal diameter and elasticity.

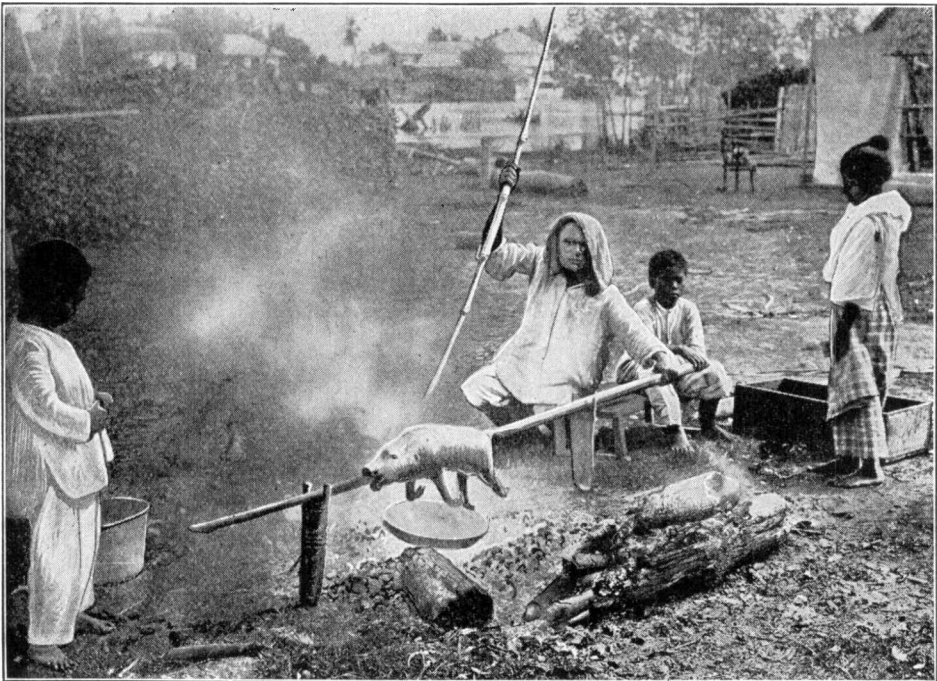

ROAST YOUNG PIG

It is interesting to contrast the primitive cooking operations shown above with those of the modern kitchen in our own country. Roast pig as prepared by Philippine women may possibly taste just as well (to the natives) as if it were prepared in the most modern electric range or fireless cooker. But it seems to require the attention of several members of the family to turn the unwieldy spit and to look on with hungry glances while the slowly swelling pig revolves above the smoking coals. Neither can this process be considered as embodying the principle of localized application of heat, which is so effectually employed in electric cooking, for in this case most of the energy goes into heating up a half acre lot, and a very little into the pig.

Electric Comb for Drying Hair

The new Pelouze electric comb is a device appreciated by the ladies for quickly drying the hair after shampooing. The comb is part of a curling iron, the latter being ready for use by remov-

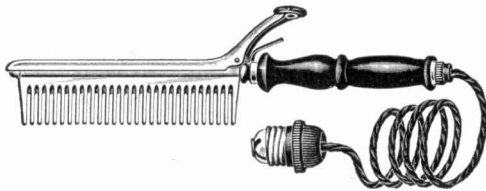

COMBINED COMB AND CURLING IRON

ing the comb. The heater and cord are made to revolve together so that the cord does not kink while in use. The temperature is so regulated in the heater that it will not burn the hair. The comb may also be had without the curling iron or the curling iron may be purchased without the comb attachment.

Hints for Using a Toast Stove

COUNTRY FRIED HAM

Use the toaster stove plate turned upside down so as to form a tray. Turn on the current and allow the toaster stove to stand until the tray becomes very hot.

Put in thin slices of raw or boiled ham and turn frequently. When nearly done, sprinkle with pepper and pour a half teaspoonful of water on each slice.

LAMB CHOPS

Use the toaster stove plate turned upside down so as to form a tray. Turn on the current and allow the toaster stove to stand about four minutes so that the tray becomes very hot.

Put in the chops and sear both sides quickly; turn them frequently as they cook. Just before serving, butter, salt and pepper them.

GRILLED SWEET POTATOES

Use the plate of the toaster stove turned upside down so as to form a tray. Turn on the current, and when the tray becomes hot, butter it and drop in large

thin slices of cold boiled sweet potatoes.

Turn the slices occasionally and cook until nicely browned. When nearly finished, sprinkle with sugar.

Table Fan with Fern Dish

A novel and artistic design of electric table fan is seen in the accompanying illustration, so constructed that all parts of the table and room receive an equal distribution of air. The deflector causes a continuous direct breeze on all sides, this result being impossible to achieve with any other form of electric fan.

This device is most efficient in its oper-

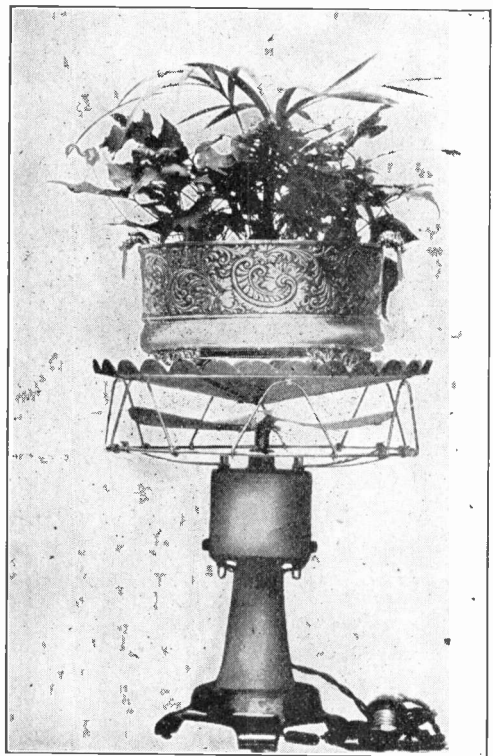

FAN AND FERN DISH COMBINATION

ation and the deflecting plate forms a convenient stand for a fern dish or flowers. The entire equipment is an ornament to the table, being beautifully finished in polished nickel and dull satin jet. A silk cord conducts the current from the plug of an ordinary lamp socket to the universal electric motor.



Junior Section

An Interesting Trick with Static

An interesting trick with static electricity, which is puzzling even to those well versed in static, can be performed in the following way: Take a saucer and fill it half full of water, and then get some fine dust such as collects on shelves, etc., and put it in the saucer so that it will float on the water; then rub the end of your finger on your hair and

repel each other, in this case the finger repelling the dust.—CHARLES OLSSON.

Model Electrically Driven Shop

The Narragansett Electric Lighting Company of Providence, R. I., has on exhibition in its offices a model motor driven shop. The purpose of the exhibit is to advertise the company's facilities, for installing and operating electric

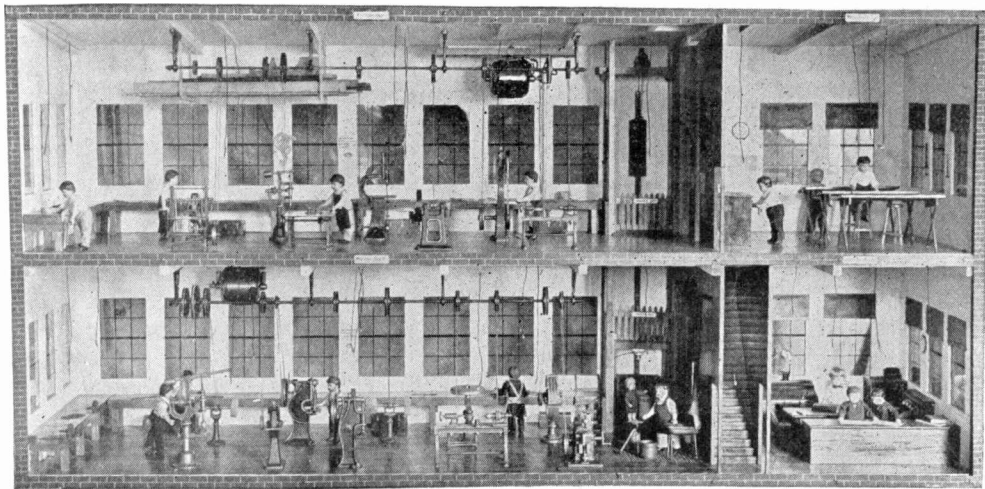

MODEL ELECTRICALLY DRIVEN SHOP

dip it into the water, and you will notice the dust will all keep away from your finger. Then dip the finger of your other hand, without rubbing it on your hair, and you will notice that the dust will not keep away as before.

By not telling the spectators that you must first rub your finger on your hair, and have them try it, will of course cause no end of wonder. The theory of this is easily explained, as two bodies containing a static charge of the same kind will

motors. The two story model is six feet long and three feet high and in miniature are shown a pattern shop, machine shop, office, drafting room and electric elevator. All details even to workbenches, office fittings, small electric lights and anti-spitting signs are presented. The miniature tools, 20 in number, are motor driven. With the exhibit is a neatly prepared and framed statement recording the fact that the company has over 18,000 horsepower in motors in service.

The Electrascore

Prof. R. A. Nokes has put another invention on the market and in the light of its usefulness to the baseball fan it has at once struck public favor. This is the Nokes Electrascore, which has been successfully demonstrated and exhibited in reporting public games.

The board is 16 by 16 feet, with fig-

ures are electric; those for the innings, balls, outs, and strikes being fourteen inches tall and the solid circle of illumination for the first and second halves of the innings having a diameter of six inches. The names of the players, arranged on either side of the field below the city they represent, are in black letters on portable white slats, which are inserted in grooves, easily adjustable.

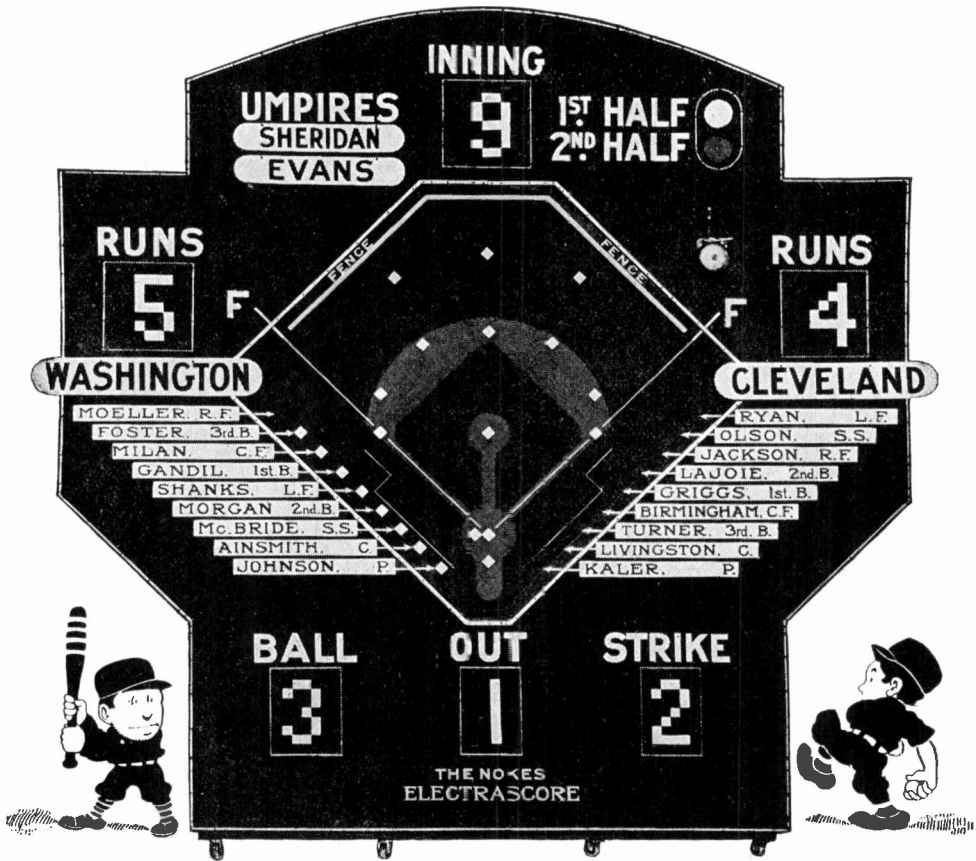

THE ELECTRASCORE, LATEST BASEBALL SCORE BOARD FOR THEATERS

ures, names of players and their respective assignments, names of contesting organizations, etc., of such size that they can be plainly read from any part of a theater. The actual field is of a strong wire screening, painted green, with the diamond broadly outlined in terra cotta. Beyond this the board is black with ample space for the various plays of the game in white lettering. All movable

From these radiate white arrows towards the field where stand, on the screening, the electric men, so to speak, in the form of white lights three inches square.

It is the field itself that is the most fascinating and, with its skillful arrangement of lights, the most unique. Beneath that screening is a network of more than a thousand lights of varying colors and thousands of feet of wire.

The chief advantage that the Electrascore has over other electric score boards is that every play or movement of ball or man is shown in actual running operation in all detail, not merely the final result. For instance, after the men are stationed at their various places in the field, each man of the opposing organization walks, as a white light, from opposite his name along the diamond to the bat in a rather human like manner. Then, as the player proceeds about the field in runs, etc., he assumes a green color of the same size, being thus readily distinguished from the white light men of the bases, etc., and the red light ball.

The ball, a red square light three inches square, moves along the field in a continuous line from every man handling it, its course from pitcher to batter being particularly well designated as to balls and strikes, also its movements upon the field. When a man has completed his play he assumes a white light and proceeds back to his place beside his name. Nor do the men at the bases remain stationary or merely disappear. They scramble about after the ball or men in a most interesting manner. Even the consultation of one player with another is recorded on the Electrascore. No movement whatever is lost. It was this very detail that Prof. Nokes was desirous of securing and it is this very feature that marks the essential difference with other score boards.

The Electrascore contains 1,500 lights, 23,000 feet of wire and has a weight of a ton. It is built primarily for a theater show, though it can be used in the open if desired. The rear of the exhibition board is a harmonious collection of electric wires, cutoffs, contacts, levers, stops, etc., for manipulating the different plays and players of the game. Here is also a small copper table, a counterpart of the large display board, on which all movements are made by electric contact as received by wire from the city of action and thence transmitted to the board viewed by the audience.

Lead Pipe Storage Battery

One morning the plumber came to our house to do some lead work with the water pipes. He gave me about two feet of half inch lead pipe. I cut the pipe in two and placed the ends in a

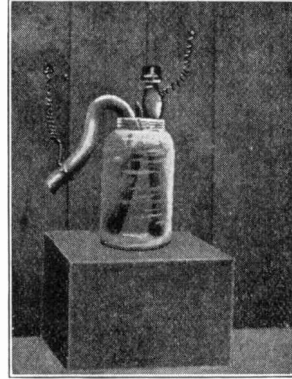

LEAD PIPE STORAGE BATTERY

Mason quart jar, separating the two pieces of pipe by a small piece of wood. I then connected wires to each, and filled the jar with ten parts of water to one part of sulphuric acid. The battery was then charged for a

day by my eight volt, half ampere dynamo. The battery proved so efficient that I used it for our front door electric bell. —J. W. QUIMBY.

Energy from the Lines of Force

An interesting experiment may be performed with apparatus connected up as in the diagram. Wind two layers of No. 18 insulated copper wire around a

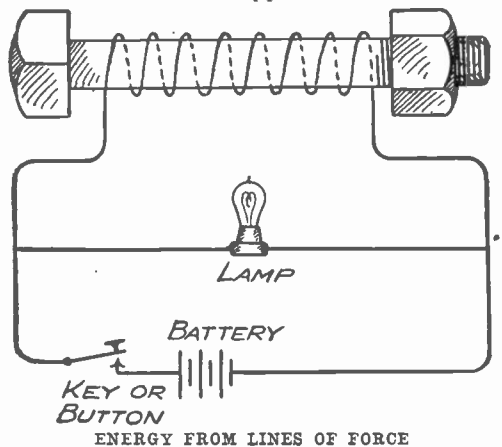

large iron bolt. Connect a two-volt lamp as shown. Press the key and the lamp brightens up, then takes on a steady

glow. Open the key and the lamp brightens and burns for a moment before going out. This effect is due to the lines of force in the bolt and coil which at the start are built up and which later send energy into the lamp as the key is opened and the lines die out.—ROWLAND G. HAZARD.

Rectifier

For the operation of shunt wound motors, spark coils for plating, and for charging storage cells, direct current is required. For such service, an electrolytic rectifier may be very easily constructed. A number of concerns furnish the aluminum and lead plates ready for use. Narrow glass receiving jars set in a row and properly spaced hold a solution

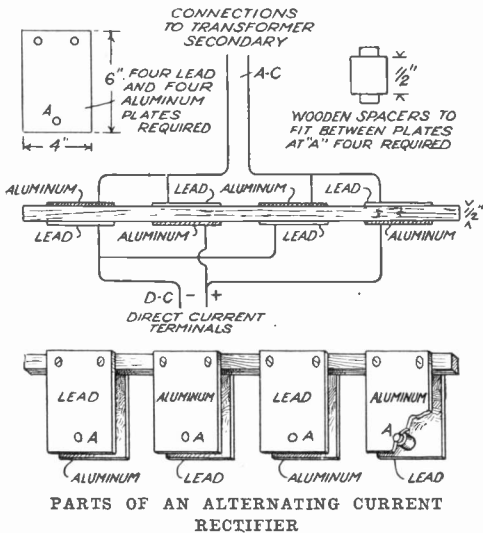

of sodium phosphate. A teaspoonful of sulphuric acid is added to each jar of the liquid.

The connections for a four cell set to a 110 volt alternating current circuit are shown in the drawing. When first connected, the rectifier may not operate properly. A sort of "forming" process must be gone through with. This may require but five minutes, and possibly in some other cases an hour.—W. G. PAULSON.

Dust Pictures

One of the properties of light is its negative atoms of electricity and their ability to produce an electric current under certain conditions. When light falls

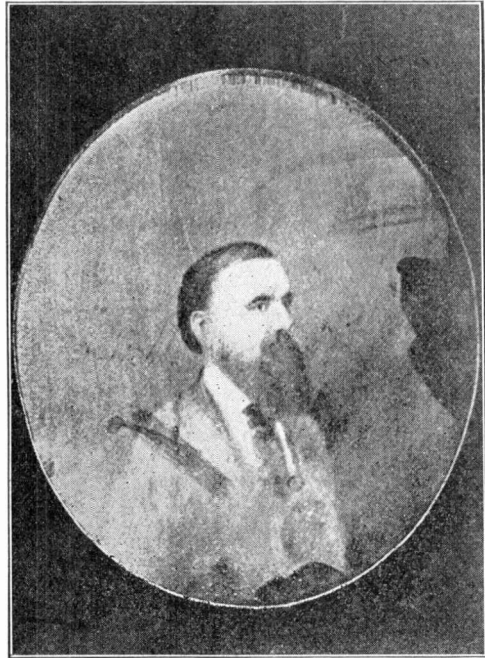

DUST-PICTURE SUPPOSED TO BE THE RESULT OF PHOTO-ELECTRIC ACTION OF SUNLIGHT

on a zinc plate, for instance, very small charges of electricity—electrons—escape from the plate. The departure of these little particles results in the plate becoming positively charged. Ultra-violet or photo-chemical rays are in general more active than visible rays of light. This phenomenon is known as the photo-electric effect.

It is highly probable that the photograph reproduced herewith represents one of the interesting results of the photo-electric effects of sunlight. This half-tone was made from a photograph of a "dust-picture" discovered by William J. Hammer a number of years ago. A picture which had hung in a frame for eight years was being removed from its frame, when a faint dust-picture was discovered on the glass. The glass had been quite

close to the picture, but not quite in contact. After some difficulty, the faint dust-picture was successfully photographed. The lighter portions of the half-tone represent dust, while the darker portions are due to less or no dust. The irregularities and scratches are due to finger-marks on the dust-picture, made when the glass was being removed from the frame.

The dust-picture is supposed to be the result of the photo-electric action of sunlight. The charged electrons which are expelled from the silver and silver compounds in the original photograph very likely carry dust to the glass. Other dust-pictures have been discovered and no doubt many have been unknowingly destroyed.

Indian Boys Advertise Electricity

W. C. Duncan, manager of the New Business Department of the Lawrence (Kan.) Railway and Light Company, sends us the accompanying picture of an effective advertising scheme employed by the company. A band composed of 36 Indian boys, who attend Haskell Institute, in Lawrence, was taken over the entire system in a special car. People all along the route were called to their front doors by the music and of course could not help but read the large signs carried on each side of the car, all of which was calculated to impress upon them the fact that their city had an up to date, hustling electric company.

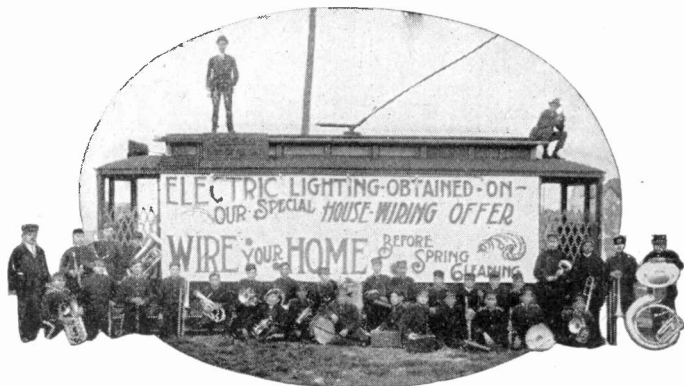

INDIAN BAND ADVERTISING ELECTRIC COMPANY

"Drop in a Good One, Please"

Joe and Wesley were slick ducks and were proud of it. They didn't live in the country. They were wise guys and game sports. They wore checked shirts and red ties, and each had a cigarette tilted



upward in his mouth. They stepped into a telephone booth and Joe called "Main 4-9-7-2." Presently the operator said, "Drop in a nickel, please."

"Say, Wes," suggested Joe, feeling in his pocket, "here's a good chance to work off that plugged nickel."

Wes dropped the plugged nickel. The bell rang clear enough, but no answer came over the line—nothing except the operator's pleasant voice, saying, "That nickel was plugged. Drop in a good one, please." Joe gasped, then dropped in a good nickel and had his talk.

"Say, Wes," he whispered, as they left the booth, "do you reckon that gal could see the plug in that nickel all the way from the exchange.

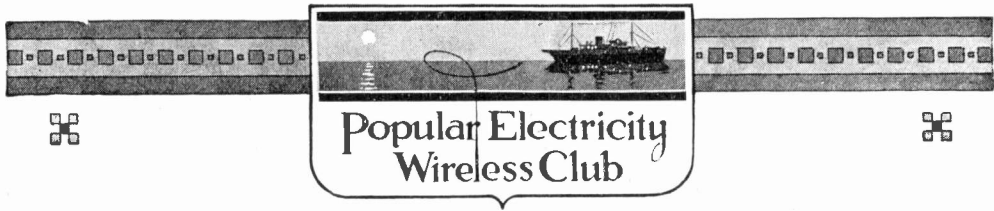

Federal Wireless Station at Central Point, Ore.

By P. J. O'GARA

The Federal Telegraph Company of San Francisco, Calif., now has in operation a wireless station at Central Point, Oregon, which is approximately midway between Portland and San Francisco. This station is a part of the system which connects the most northerly points with the southern points on the Pacific Coast, and is one of the fourteen stations now in operation.

The Federal Wireless Company is one of the three companies making use of the Poulsen system. The other companies are the Continental syndicate, which is working the European continent; the other is an English and Canadian company, later taken over by Danish capital. The Federal Telegraph Company has acquired the exclusive rights for the United States, Alaska, Cuba, Panama, Porto Rico, Hawaiian Islands and the Philippine Islands, as well as the foreign rights of Poulsen, of Copenhagen. The company's laboratories are at Palo Alto, Calif.

The new station in Southern Oregon was erected at an approximate cost of \$50,000. It is situated on the floor of the Rogue River Valley at an approximate elevation of 1,275 feet, with the surrounding country rising to elevations of between 6,000 and 7,000 feet. The station is, therefore, situated in a depression of about 4,700 to 5,700 feet, the distance from the station to the surrounding elevated country being all the way from 25 to 30 miles. However, no difficulty has been encountered on account of the topographical features surrounding the station.

The towers supporting the antenna are of select fir. They are triangular in form, stand upon solid concrete foundations, are firmly braced and trussed, and rise to a height of 304 feet, their distance apart being 550 feet. Heavy cables properly insulated so as to prevent absorption of energy keep the towers perpendicular and take up the strain of the two heavy messenger cables supporting the directional antenna, which is of the umbrella type. The messenger cables are insulated by large bell shaped insulators, and approximately 36,000 feet of seven strand No. 18 phosphor bronze wire are suspended from them, passing over two insulated cables known as the "frame," and finally to heavy copper ribbons which are insulated from low towers midway between the main towers and just outside the instrument house. The two parts of the antenna coming down from the frame to the copper ribbons do not look unlike two large fans. A single broad ribbon of copper passes through a heavy porcelain insulator through the wall of the building, and is there connected with the instruments. As the two towers stand in an east and west line, it will be seen that the antenna has a certain directional effect; the purpose being to work with stations to the north and south.

The ground connection is such as to be absolutely reliable. At the bottom of each pit, which was dug for the purpose of placing the tower foundations, a large copper plate was placed. Besides, several trenches, radiating in every direction from the operating station, were dug

approximately two feet deep, and in them were laid a number of strands of copper wire, totalling several thousand feet.

All the apparatus used is of the Poulsen type. The station is rated at $12\frac{1}{2}$ KW, but may develop fully fifteen KW. The apparatus for sending generates a 500 volt direct current arc between a copper anode and a carbon cathode in an atmosphere of hydrocarbon gas. Alcohol vapor generated by a small electric heater and fed through a tube to the arc chamber is the gas used. The copper anode and arc chamber are cooled by water circulation, which is started automatically when the arc is struck. The arc is burned in a strong magnetic field produced by large electric magnets in series with it. The arc is self striking by action of the "blow-out" magnets on closing the direct current circuit for sending. Choke coils keep the surge of the current from the line, thus preventing injury to the generator.

The power station, which is separated from the sending and receiving station, has two motor generator sets which take current from the Oregon-California Electric Power Company's lines. The motor generator sets are of two types, one being a 20 HP, three phase, 60 cycle, induction motor direct connected to a $12\frac{1}{2}$ KW, direct current, compound wound generator of 550 volts, with a speed of 1,250 revolutions per minute; the other consists of a 20 HP, three phase, 60 cycle, induction motor direct connected to a shunt wound, $12\frac{1}{2}$ KW,

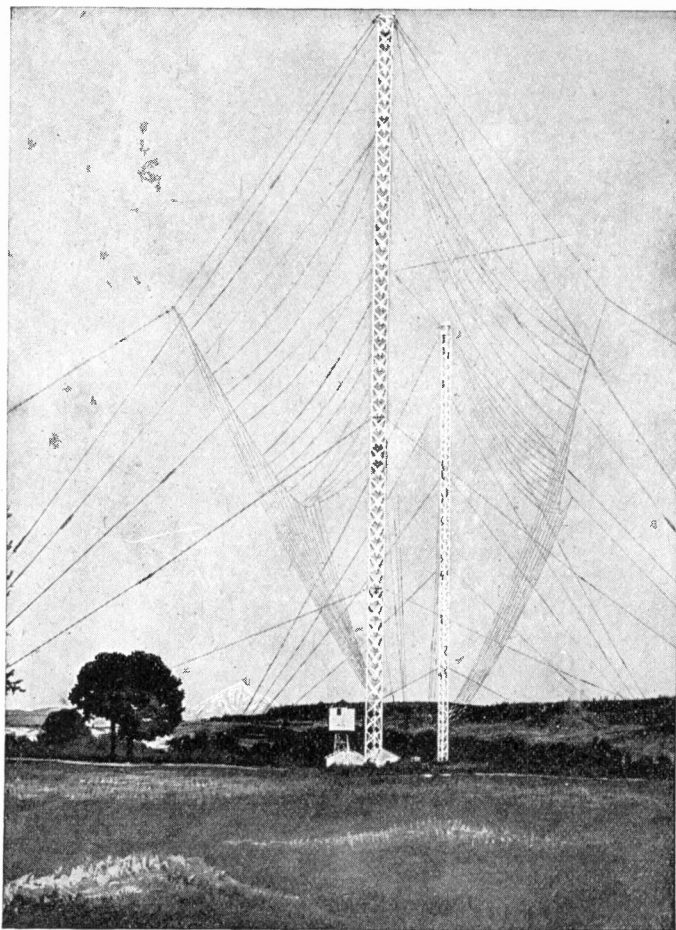

THE FEDERAL STATION AT CENTRAL POINT

direct current generator of 550 volts with a speed of 1,800 revolutions per minute. Besides these, an auxiliary gasoline power unit is used. This consists of a 25 HP. gasoline engine belted to a compound wound, 550 volt, direct current generator of $12\frac{1}{2}$ KW capacity. The engine speed is 300 revolutions per minute.

The layout is such that the three generating sets are connected to a switchboard which is supplied with a watt meter, volt meter and ammeter. Another switchboard of practically the same type is placed in the operating station. The compound wound direct current generators seem to be more efficient than the shunt wound.

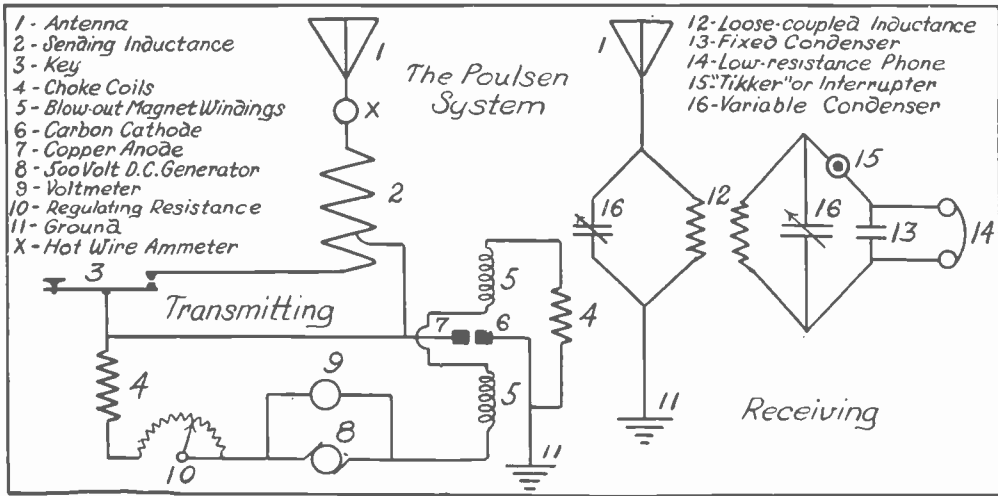

HOO-K-UP OF THE POULSEN WIRELESS SYSTEM

The interior of a Federal wireless station is more or less a puzzle to the amateur who understands the spark system. Although the Poulsen apparatus appears to be complex, it is, after all, very simple in operation. The Poulsen system is merely an improvement on Duddell's "singing arc," and consists mainly in the replacing of one of the carbon electrodes with one of copper, and burning the arc in a strong magnetic field which is surrounded with a hydrocarbon gas, such as alcohol vapor or coal gas. This arrangement, with a condenser of small capacity, and a large inductance in series shunted around it, produces undamped oscillations of very high frequency, reaching from a few hundred thousand to more than a million. The voltage used to produce this arc is about 500 to 600 volts direct current. The copper anode is connected to the antenna through a large inductance, and the carbon electrode is direct connected to the earth. This forms the oscillation circuit. No condenser is used, although the condenser effect is nevertheless produced by the capacity of the antenna and earth. The Morse key is arranged to cut in a few more turns of inductance when it is held down, thus giving out waves of greater length. Sometimes a simple Morse key of the ordinary type is con-

nected by a local battery to a sounder like instrument which acts as a relay in cutting in and out turns of the inductance. The long wave, which is known as the working wave, is given out when the key is depressed, and the short, or compensating wave, when the key is up. The Central Point station has a wave of approximately 3,000 meters in length. The new San Francisco station has a working wave of about 6,000 meters.

The receiving apparatus is very simple and unique. The antenna is connected to the earth through a variable condenser around which is shunted the primary of a loose coupled receiving transformer or inductance. The terminals of the secondary of the receiving transformer are connected through a "tikker" to a pair of low resistance phones which are in series with it. The two phones are shunted around a small fixed condenser, which is really in series with the tikker. Across the tikker and small condenser is shunted a variable condenser.

The tikker is merely an interrupter, and was invented by Pedersen, who was a colleague of Poulsen. In its first form it consisted of two cross wires in rapid vibration, which alternately make and break the circuit similar to the action of the vibrator of an induction coil. It is,

after all, nothing with an interrupter of special adjustment. The tikker now used is a small induction motor with a brass disk on one end of the motor shaft. This disk has a small groove around it in which a piece of spring wire runs as the disk turns. The disk is slotted transversely around its circumference in such a way that as it turns rapidly the wire spring running in the groove is caused to vibrate. The rate of vibration, or make and break, therefore, depends upon the speed of the motor shaft and the number of slots in the disk. The disk is connected to one side of the secondary of the loose coupled inductance and the vibrating spring to the other terminal, as described above. A very simple form of tikker is an ordinary telegraph relay connected through resistance to a 60 cycle alternating current. Although this would tend to heat the cores and coils of the relay, if kept in continued service, it will, nevertheless, operate quite efficiently as a tikker.

The operation of the receiving apparatus is as follows: The oscillations received through the antenna charge the variable condenser when the tikker is open. When it closes, the variable condenser discharges into the small condenser. Then when the tikker again opens, the small condenser discharges into the phones, causing the signals to be heard.

As will be seen, no detector is used. The reason why the ordinary detectors cannot be used is because the waves have too high a periodicity; this is why amateurs have noticed the peculiar frying noise which is made by the Poulsen arc.

The signals are read by the discharge of accumulated energy in the condensers, which accumulation takes place during intervals when the tikker is open.

The Poulsen system, by reason of using undamped waves, operates night and day with the same efficiency, sunlight seeming to have no effect on the transmission.

Wireless on German Airships

The Telefunken Company, of Berlin, Germany, has designed a special type of wireless station to be used on the big dirigible airships for which that country is noted, and which are in actual service,

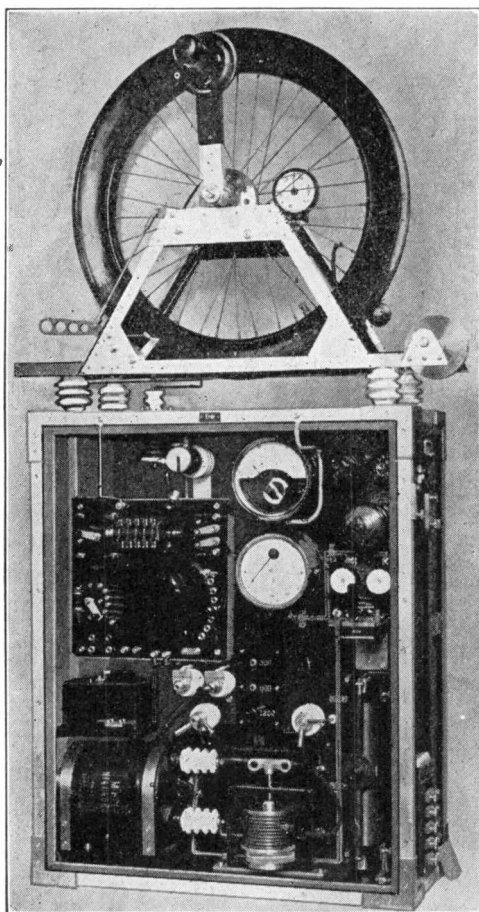

AIR SHIP WIRELESS PLANT WITH REEL FOR LOWERING AERIAL

carrying passengers, principally sightseers, from one city to another.

In view of the necessarily limited dimensions of the cars, the whole outfit had to be reduced to as small a compass as possible, and was arranged in a cabinet subdivided by a vertical partition into an open front compartment and a closed back compartment. The front compartment contains such apparatus as

is operated by hand, whereas those parts which, like the self inductions, capacities, etc., require no supervision, are placed in the closed back compartment. On top of the cabinet is installed, on four porcelain insulators, a capstan carrying an aerial wire of phosphor bronze, about 650 feet in length. The terminals connected to the source of current are fitted on the right outside of the cabinet.

The phosphor bronze aerial wire is wound on the capstan, an insulated handle allowing the length corresponding to the actual wave length to be unwound and lowered beyond the railing of the car by means of conveniently arranged pulleys. A counter dial indicates the length of wire unwound.

An antenna switch installed in the cabinet allows the receiver to be locked during transmission, while in the receiving position the same is done with the source of current, thus eliminating any risk of disturbance.

The source of current is an alternating current machine directly coupled to its exciter; its output is about 500 watts, with a frequency of about 500 cycles per second. It is operated by the airship motor. A voltmeter, as well as the speed and tension regulators and the fuses, are installed in the interior of the car. The range of this equipment is between 60 and 120 miles, and the weight 275 pounds.

Alexander Wireless Bill

The Alexander wireless telegraph bill, which has been under consideration by the House of Representatives, was recently stricken from the calendar, and there is little probability that it will pass during the present session of Congress. Representative Mann objected to a consideration of the subject at this time on the ground that it requires more study and further consideration before taking final action. The government is said to be especially anxious to secure a broad law which will secure relief from interference with wireless communication by the numerous amateurs.

Electrolytic Interrupter

The interrupter described is not a new type, but one that can be used as a Wehnelt or a Simon-Caldwell. It will run on as small a current as two amperes. Used with an open core transformer or coil wound for 110 volts, it operates efficiently.

The materials needed are: Battery jar, 5 by 7 inches; two feet of $\frac{1}{2}$ inch glass

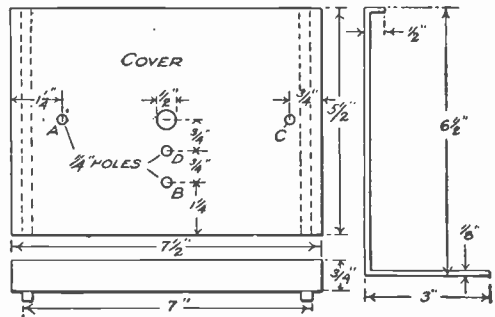

FIG. 1. COVER OF INTERRUPTER

tubing; three large binding posts; lead sheeting $2\frac{1}{2}$ by about 10 inches; interrupter rod.

Square up a piece of oak $\frac{3}{4}$ by $5\frac{1}{2}$ by $7\frac{1}{2}$ inches. Bore a half inch hole in the center and four quarter inch holes, as

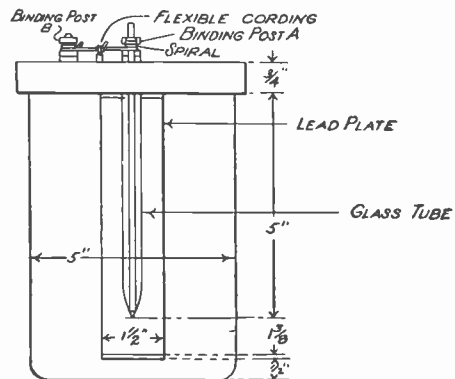

FIG. 2. ELECTROLYTIC INTERRUPTER

shown in Fig. 1. Sandpaper well, immerse in boiling paraffin for five minutes, and set aside to drip. Take the glass tubing and break off a piece seven inches long. Grasp both ends of the tube and place it in the flame of a Bunsen burner so as to heat a spot about $1\frac{1}{2}$ inches

from one end. Turn it continuously until it changes to a reddish-yellow color, then remove quickly and pull apart. The tube will be drawn to a point at one end. Break this tapering end carefully until there is a hole large enough to allow the rod to slide through. Heat this end in

to keep it from wobbling and loose enough to let it turn easily. It may be necessary to cut off portions of the wire to get the right length to hold the rod in the center of the tube. Screwing the movable part up and down raises and lowers the rod in the tube.

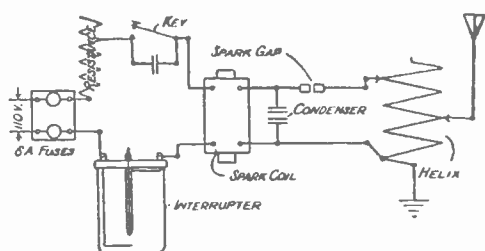

FIG. 3. CONNECTIONS OF INTERRUPTER

the flame until the hole begins to close and thicken. Remove from the flame and slide the rod into it. Only the very tip should project. Repeat the process until the hole is the right size. It is important that only a very little part of the point be exposed. Upon this depends the success of the interrupter. Take a three cornered file and file a hole in the tube about an inch and a half from the upper end. Take the lead sheeting, which should be at least $\frac{1}{8}$ inch thick, and cut a piece an inch and a half by ten inches. Bore a quarter inch hole half an inch from one end, and bend as shown in Fig. 1.

Mount three binding posts in holes (A), (B) and (C), fastening the lead to (A). Tighten up binding posts (A) and (B) permanently, but leave (C) loose. Push the glass tube down through the (half inch) hole until its flared upper edge is flush with the top of the cover. Take a piece of No. 12 bare copper wire and twist it into a spiral around the interrupter rod so that the rod will slide through rather stiffly. Leave about three inches unwound. Put the rod all the way down into the tube and move the spiral until it is even with the groove of the movable part of the binding post (B), Fig. 2. Then take the unwound wire and twist it around the groove in the movable part of binding post (B) tight enough

to keep it from wobbling and loose enough to let it turn easily. It may be necessary to cut off portions of the wire to get the right length to hold the rod in the center of the tube. Screwing the movable part up and down raises and lowers the rod in the tube. Get a few inches of flexible lamp cord, scrape away the insulation at both ends and fasten one end to the No. 12 wire and bring the other down through hole (D) to binding post (C) and fasten it. See that the lead plate is about half an inch from the bottom of the jar. The tube should not be nearer than one and three-eighths inches of the lead plate at the end. Paint the bottom of the cover with hot paraffin in order to keep the screws and wires from corroding. Mix one part of sulphuric acid and nine parts of water, always pouring the acid into the water very slowly. Let this cool and pour into the jar.

Now put the cover in place, screw down the adjusting binding post tight and shove the rod down through the spiral as far as it will go. Screw up the binding post until the point of the rod is about a quarter of an inch above the hole. Connect the apparatus as shown in Fig. 3.

It is very advisable to have a resistance in series with the interrupter when trying it for the first time, in order to prevent the fuses from blowing if something is wrong. A good resistance consists of six 32 candlepower lamps connected in multiple. Before turning on the current, screw down the vibrator on the coil tight. Turn on the current. If everything has been done per instructions, a heavy flame should leap the gap. The interrupter is now running as a Simon-Caldwell. If desired, it may be made to run as a Wehnelt by screwing down the binding post until the point is exposed. A very heavy green spark will appear at the point of the rod. The interrupter should be placed in a vessel of cold water to keep it cool while in operation.—FERNAND PINEOFFS.

Questions and Answers in Wireless

By A. B. COLE

TUNING COILS.

76. *What is the purpose of a tuning coil?*

A tuning coil is used to vary the natural wave lengths of one or more circuits. A receiving tuning coil may be adjusted to give the one or more receiving circuits the same wave length as that of any particular transmitting station. A transmitting tuning coil, or sending helix, is employed to give the spark-gap-condenser circuit the same wave length as the aerial-ground circuit. Two circuits are in resonance when they have the same wave lengths, and it is then that the one will absorb a maximum of the energy radiated by the other. The receiving set will also respond to wave lengths corresponding to $\frac{1}{4}$ and other multiples of the wave length emitted by the transmitting set, but the received signals will be stronger when both are adjusted to the same wave length.

77. *Is a tuning coil necessary in a receiving station?*

A receiving tuning coil is not a necessity for receiving over short distances, for the signals are comparatively strong and force the aerial-ground circuit to assume their wave length. But for operation over longer distances the use of a tuning coil may increase the receiving radius 100 per cent or more.

78. *Upon what factors does the maximum wave length to which a tuning coil, connected to a given aerial, will naturally respond, depend?*

Inductance, capacity and resistance of the tuning coil and its associated circuits. The resistance of the tuning coil and of these circuits should be as small as possible, for its presence causes loss, probably in the form of heat, of the received energy.

79. *Upon what factors does the inductance of a tuning coil depend?*

Diameter and material of core, length of winding, number of convolutions of wire and space and insulation between adjacent convolutions.

80. *What is the best diameter of a tuning coil core?*

Increasing the diameter of the core increases the inductance; in fact, doubling the diameter approximately quadruples the inductance. It will be seen, therefore, that the inductance of a single convolution on a tuning coil of a diameter of five inches is about four times that of a single convolution on a similar tuning coil of $2\frac{1}{2}$ inches diameter. For this reason the most accurate tuning may be obtained with a tuning coil of small diameter. When enameled wire is used the core diameter should not exceed two inches. If bare or double cotton covered wire is used, the core may be three inches in diameter.

81. *Are iron, brass or other electrical conductors suitable for tuning coil cores?*

No. A considerable loss of energy occurs in a tuning coil with such a core. This is probably due to eddy currents induced in the core by the oscillatory currents from the aerial system.

82. *Of what materials may the core be made?*

Cardboard, hard rubber, fiber, wood or almost any other non-conductor of electricity.

83. *I have wound a tuning coil on a wooden core. After two months the wire has become loose. What is the cause of this?*

Shrinkage of the core is a very common difficulty if the last three named materials mentioned in answer to question 82 are used for this purpose. They all contain a certain amount of moisture which evaporates in dry weather. If these materials are boiled for one hour in paraffine previous to winding on the wire, there will be no further difficulty.

The paraffine prevents both absorption and evaporation of moisture.

84. *How does the inductance vary with the length of the winding?*

The inductance varies directly as the length of the winding; that is, twice the length, twice the inductance, for we then have twice the number of convolutions of wire, upon which the inductance depends.

85. *Is the maximum wave length to which a tuning coil will respond equal to four times the length of wire on it?*

No. The inductance of a given length of wire wound in a coil is far greater than that of the same wire stretched in a straight line, due to the very fact that it is wound in a coil.

86. *May iron rods be used to support tuning coil sliders?*

Iron should not be employed for this purpose. The iron will complete the circuit of the magnetic lines of force generated by the coil and, from the fact that it is iron, will greatly increase the inductance of each convolution of the coil. Moreover, the passage of the lines of force through the iron will set up eddy currents in it, and loss of a portion of the received energy will result. Brass, through which but few of the magnetic lines of force will pass, is one of the best materials for slider rods.

87. *What is a straight coil tuner?*

A straight coil tuner consists of a non-conducting core, wound with a single, even layer of copper or other non-magnetic wire, in such a way that adjacent convolutions are separated from each other. Sliding contacts are generally provided so that any number of the convolutions may be used at will.

88. *What kind of insulation may the wire have?*

Enameled copper wire is the most generally used at the present time. Single silk or cotton covered copper wire is also employed to a less extent. Enameled wire has the advantage over the silk or cotton covered in that the insulation may be removed more easily so that the

sliders may touch the wire. In winding with bare wire, a thread or another wire is generally wound on at the same time, so that adjacent convolutions will be separated, and after the wire is secured in place the thread is removed. Tuning coils of the same diameter have a greater length if wound with bare wire than if with enameled wire or silk or cotton covered wire, since the convolutions are spaced at a greater distance to make certain that they do not touch. A greater length is also necessary with a bare wire winding in order to obtain the same maximum inductance, on account of the distance between convolutions. One disadvantage of the bare wire winding is that if the core should shrink, even to a small extent, adjacent convolutions are almost certain to come into contact.

Carnegie Schools Wireless Station

The Carnegie Technical Schools of Pittsburgh, Pa., have joined the colony which own wireless plants of their own. The new station is almost entirely the product of the students. Messages can be sent from the institution for a distance of 200 miles and received from as far distant as 1,100 miles. Guy W. Fagan is president of the students' wireless club.

Directory of Wireless Clubs

This directory of amateur wireless clubs and associations will be published each month. When a new club is formed the names of the officers, also the street address of the secretary, should be forwarded to us at once. Any changes that should be made in the directory, when designated by an official of a club, will be made in the next issue after receipt of such advice.

Aerogram Club.—J. Stedman, President; A. Hayward Carr, Chairman Board of Directors; Albert S. Hayward, Treasurer; Donald P. Thurston, Secretary; Walter B. Clarke, 17 May St., Newport, R. I., Corresponding Secretary.

Aerograph Club of Richmond, Ind.—H. J. Trueblood, President; Richard Gatzek, Vice President; James Pardieck, 320 South 8th St., Richmond, Ind., Secretary.

Aero Wireless Club.—A. Garland, President; W. Ladley, Vice President; D. Beard, Napa, Calif., Secretary and Treasurer.

Allegheny County (Pa.) Wireless Association.—Arthur O. Davis, President; Theodore D. Richards, Vice President; James Seaman, Leetsdale, Pa., Secretary and Treasurer.

Alpha Wireless Association.—L. L. Martin, President; F. A. Schaeffer, Vice President; G. F. Girton, Box 57, Valparaiso, Ind., Secretary and Treasurer.

Amateur Wireless Association of Schenectady, N. Y.—D. P. Crawford, President; L. Beebe,

Vice President; C. Wright, Treasurer; L. S. Uphoff, 122 Ave. "B," Schenectady, N. Y., Secretary. Amateur Wireless Club of Geneva (N. Y.).—H. B. Graves, Jr., President; C. Hartman, Vice President; L. Reid, Treasurer; Benj. Merry, 148 William St., Geneva, N. Y., Secretary.

Arkansas Wireless Association.—G. A. Rauch, President; Edward Vaughn, 2622 State St., Little Rock Ark., Secretary and Treasurer.

Berkshire Wireless Club.—Warren A. Ford, President; William Yarkee, Vice President; Charles Hodecker, Treasurer; Jas. H. Ferguson, 18 Dean St., Adams, Mass., Secretary.

Canadian Central Wireless Club.—Alexander Polson, President; Stuart Scorer, Vice President; Benj. Lazarus, P. O. Box 1115, Winnipeg, Manitoba, Can., Secretary and Treasurer.

Cardinal Wireless Club.—K. Walthers, President; F. Dannenfeler, Vice President; Miss A. Peterson, South Division High School, Milwaukee, Wis., Secretary.

Chester Hill Wireless Club.—Waller Morgan, President; Richard D. Zucker, 46 Clinton Place, Mt. Vernon, N. Y., Secretary and Treasurer.

Chicago Wireless Association.—John Walters, Jr., President; E. J. Stien, Vice President; C. Stone, Treasurer; F. D. Northland, Secretary; R. P. Bradley, 4418 South Wabash Ave., Chicago, Ill., Corresponding Secretary.

Colorado Wireless Association.—William Cawley, President; Thomas Ekren, Vice President; W. F. Lapham, 1545 Milwaukee St., Denver, Colo., Secretary-Treasurer.

Custer Wireless Club.—Franklin Webber, President; Fred Cross, Vice President; Oakley Ashton, Treasurer; Walter Maynes, 438 Custer Ave., Los Angeles, Cal., Secretary.

De Kalb Radio-Transmission Association.—Bruce Lundberg, President; Walter Bergendorf, Vice President; De Estin Snow, Treasurer; Bayard Clark, 205 Augusta Ave., De Kalb, Ill., Secretary.

Fargo Wireless Association.—Kenneth Hance, President; John Bathrick, Vice President; Earl C. Reineke, 518 9th St., Fargo, N. D., Secretary.

Forest Park School Wireless Club.—W. S. Robinson, Jr., President; William Crawford, R. F. D. No. 1, Springfield, Mass., Secretary.

Frontier Wireless Club.—Chas. B. Coxhead, President; John D. Camp, Vice President; Franklin J. Kidd, Jr., Treasurer; Herbert M. Graves, 458 Potomac Ave., Buffalo, N. Y., Secretary.

Geneva Wireless Club.—Charles B. Hartman, President; Charles Smith, Vice-President; Benjamin Merry, Treasurer; Henry B. Graves, Jr., 448 Castle St., Geneva, N. Y., Secretary.

Gramercy Wireless Club.—James Platt, President; John Gebhard, Vice President; John Diehl, Treasurer; John Jordan, 219 East 23d St., New York, N. Y., Secretary.

Greenfield Wireless Association.—Edward M. Wolfe, President and Corresponding Secretary, 4125 Haldane St., Pittsburgh, Pa.

Hannibal (Mo.) Amateur Wireless Club.—Charles A. Cruickshank, President; J. C. Rowland, Vice President; William Youse, Treasurer; G. G. Owens, 1306 Hill St., Hannibal, Mo., Secretary.

Haverhill (Mass.) Wireless Association.—Riedel G. Sprague, President; Charles Farrington, Vice President; Leon R. Westbrook, Haverhill, Mass., Secretary and Treasurer.

Hobart Wireless Association.—Asa Bullock, President; Charles Clifford, Hobart, Ind., Secretary.

Independence Wireless Association.—Boyce Miller, President; Ralph Elliott, Secretary; Joseph Mahan, 214 South Sixth St., Independence, Kan., Vice President.

Independent Wireless Transmission Co.—Harlan A. Eveleth, 72 Gray St., Arlington, Mass., Secretary.

Jonesville Wireless Association.—Frederic Wetmore, President; Webb Virmylia, Vice President; Richard Hawkins, Treasurer; Merritt Green, Lock Box 82, Jonesville, Mich., Secretary.

Lake View Wireless Club.—E. M. Wickott, President; R. Ludwig, Treasurer; R. F. Becker, 1439 Winona Ave., Chicago, Ill., Secretary.

Long Beach Radio Research Club.—Bernard Williams, 555 E. Seaside Bvd., Long Beach, Calif., Secretary.

Manchester, (N. H.) Radio Club.—Homer B. Lincoln, President; Clarence Campbell, Vice President; Elmer Cutts, Treasurer; Earle Freeman, 759 Pine St., Manchester, N. H., Secretary.

New Haven Wireless Association.—Roy E. Wilhoff, President; Arthur P. Seeley, Vice President; Russell O'Connor, 27 Vernon St., New Haven, Conn., Secretary and Treasurer.

Northwestern Wireless Association of Chicago.—Rolf Rolfsen, President; H. Kunde, Treasurer; Edw. G. Egluff, 2729 Noble Ave., Chicago, Ill., Recording Secretary.

Oakland Wireless Club.—H. Montag, President; W. L. Walker, Treasurer; W. R. Sibbert, 916 Chester St., Oakland, Calif., Secretary.

Oklahoma State Wireless Association.—T. E. Reid, President; G. O. Sutton, Vice-President; Ralph Jones, Box 1448, Muskogee, Okla., Secretary and Treasurer.

Oregon State Wireless Association.—Charles Austin, President; Joyce Kelly, Recording Secretary; Edward Murray, Sergeant-at-Arms; Clarence Bischoff, Lents, Ore., Treasurer and Corresponding Secretary.

Peterboro Wireless Club.—G. B. Powell, President; C. V. Miller, Vice President; E. W. Oke, 263 Engleburn Ave., Peterboro, Ontario, Can., Secretary and Treasurer.

Plaza Wireless Club.—Paul Elliott, President; Myron Hanover, 156 E. 66th St., New York, N. Y., Secretary and Treasurer.

Pueblo Wireless Club.—L. R. Finke, President; B. C. Howe, Treasurer; K. G. Hermann, 100 Board of Trade, Pueblo, Colo., Secretary.

Rockland County (N. Y.) Wireless Association.—W. F. Crosby, President; Tracey Sherman, Vice President; Marquis Bryant, Secretary; Erskine Van Houten, 24 De Pew Ave., Nyack, N. Y., Corresponding Secretary.

Roslindale (Mass.) Wireless Association.—O. Gilus, President; E. T. McKay, Treasurer; Fred C. Fruth, 962 South St., Roslindale, Mass., Secretary.

Sacramento Wireless Signal Club.—E. Rackliff, President; J. Murray, Vice President; G. Barnard, Treasurer; W. E. Totten, 1524 "M" St., Sacramento, Calif., Secretary.

Santa Cruz Wireless Association.—Orville Johnson, President; Harold E. Senter, 184 Walnut Ave., Santa Cruz, Calif., Secretary and Treasurer.

Southeastern Indiana Wireless Association.—R. F. Vanter, President; D. C. Cox, Vice President and Treasurer; H. Hitz, Fairmont, Madison, Ind., Corresponding Secretary.

Southern Wireless Association.—B. Oppenheim, President; P. Gernsbacher, 1435 Henry Clay Ave., New Orleans, La., Secretary and Treasurer.

Springfield (Mass.) Wireless Association.—A. C. Gravel, President; C. K. Seely, Vice President and Treasurer; D. W. Martenson, Secretary; Club Rooms, 323 King St., Springfield, Mass.

Spring Hill Amateur Wireless Association.—R. D. Thibery, President; H. P. Hood, 2nd, 2 Benton Road, Somerville, Mass., Secretary and Treasurer.

St. Paul Wireless Club.—Thos. Taylor, President; L. R. Moore, Vice President; E. C. Estes, Treasurer; R. H. Milton, 217 Dayton Ave., St. Paul, Minn., Secretary.

Tri-State Wireless Association.—C. B. DeLahunt, President; O. F. Lyons, Vice President; T. J. M. Daly, Treasurer; C. J. Cowan, Memphis, Tenn., Secretary.

Waterbury Wireless Association.—Weston Jenks, President; Alfred Upham, Treasurer; H. M. Rogers, Jr., 26 Linden St., Waterbury, Conn., Secretary.

Wireless Association of British Columbia.—Clifford C. Watson, President; J. Arnott, Vice President; E. Kelly, Treasurer; H. J. Bothel, 300 Fourteenth Ave. E., Vancouver, B. C., Corresponding Secretary.

Wireless Association of Canada.—W. Fowler, President; E. G. Lunn, Vice President; W. C. Schuur, Secretary and Treasurer.

Wireless Association of Montana.—Roy Tysel, President; Elliot Gille, Vice President; Harold Satter, 309 South Ohio St., Butte, Mont., Secretary.

Wireless Association of Savannah.—P. C. Bangs, President; A. A. Funk, Vice President; H. Jenkins, Treasurer; L. H. Cole, Cor. Liberty and Price Sts., Savannah, Ga., Secretary.

Wireless Club of Baltimore.—Harry Richards, President; William Pules, Vice President; Curtis Garret, Treasurer; Winters Jones, 728 North Monroe St., Baltimore, Md., Secretary.

Wireless Club of the Shortridge High School.—Robert C. Schimmel, 2220 N. Penn St., Indianapolis, Ind., President; George R. Popp, Vice President; Bayard Brill, Treasurer; Oliver Hamilton, Secretary.

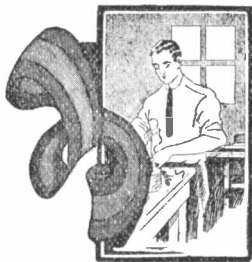

For Practical Electrical Workers

Electrical Wiring

English and American Practice Compared

By FRANK BROADBENT, M. I. E. E.

PART II.

When switches as well as fuses are used in a distribution box, the tumbler pattern is the common type used in England, and an illustration of a typical box is given in Fig. 13. This compares with

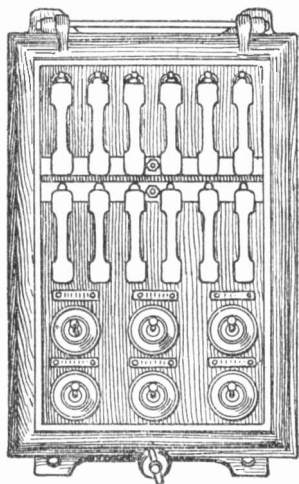

FIG. 13. ENGLISH DISTRIBUTION BOX

the American cabinet or panel board shown in Fig. 14. In the latter, double pole switches of the open type are used, a type which no respectable contractor in England would dream of using for such a purpose; in fact he would have difficulty in obtaining them, unless he imported them. Most supply systems in England are on the three-wire system, in which the middle wire is "earthed." There is no need for a switch on the earthed wire, and it is preferable not to use one, hence a single pole switch on the outer or "live" wires is almost the invariable practice.

the American cabinet or panel board shown in Fig. 14. In the latter, double pole switches of the open type are used, a type which no respectable contractor in England would dream of using for such a purpose; in fact he would have difficulty

The main fuses on an installation fed from the street mains, or, as we call them, the "house service-fuses" are, in England, usually enclosed in iron cases or boxes. Such fuses are frequently of the cartridge type and typical samples are shown in Figs. 15 and 16. It is rarely that the positive and negative fuses are fitted in one case, but usually in separate cases having hinged lids so arranged that it is not possible to open the lids or doors of both fuses at the same time. This arrangement is essential on circuits of over 250 volts in order to comply with the spirit of the Home Office regulations.

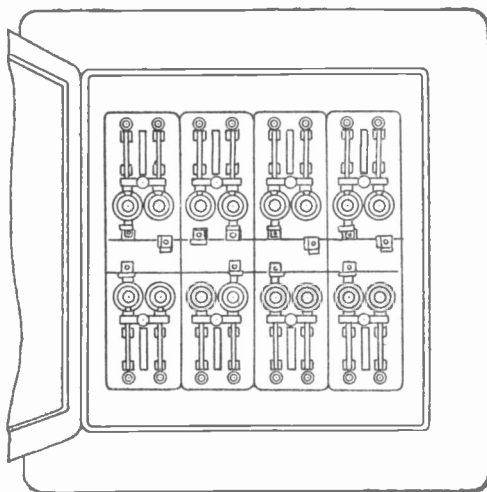

FIG. 14. AMERICAN DISTRIBUTION BOX

which require that it shall be practically impossible for any unskilled person to make simultaneous contact with both poles of a medium pressure supply service.

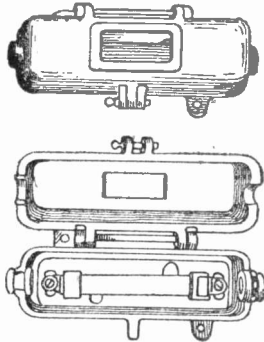

FIG. 15. ENGLISH HOUSE SERVICE FUSES AND CASE

For the same reason, separate doors are provided for positive and negative panels of a distributing box or cabinet—some simple method of interlocking the doors being provided to prevent both doors being fully opened

at one time. Generally speaking, it is necessary to provide not only main fuses at the point of supply, but also a main isolating switch by means of which the whole installation can be cut off and made dead. A typical American pattern of service entrance cabinet is shown in Fig. 17. This type of thing would not be passed in England by the Home Office or Board of Trade, nor would the insurance companies look upon it favorably, because it is necessary to open the case in order to switch off the current, and there is considerable risk of an operator

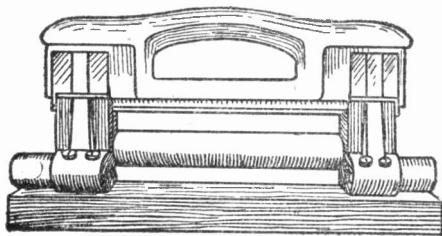

FIG. 16. ENGLISH SERVICE FUSE

touching the case and a live contact at the same time. In England, the standard practice for enclosed double pole switches is to have the switch handle outside the case, so that the switch can be put on or off without opening the doors, and therefore without risk of receiving a shock or burn. The switch should invariably be placed

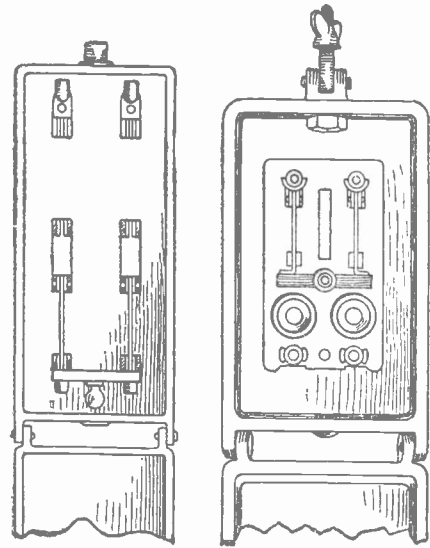

FIG. 17. AMERICAN SERVICE ENTRANCE CABINET

on the live side of the fuse, so that the fuse can be made dead before handling it for the purpose of replacement. The practice is becoming increasingly popular of combining the switch with the fuses, and the "push-and-pull" switch shown in Fig. 18 has a large sale in England. In this pattern the fuses are carried on a frame held by springs to the inside of

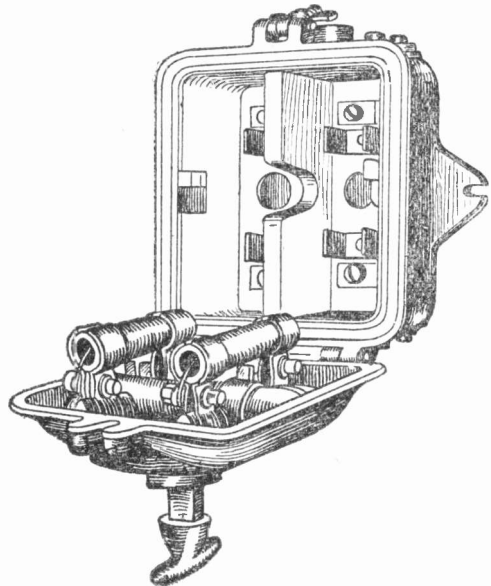

FIG. 18. "PUSH-AND-PULL" SWITCH

the switch cover and can be pushed in or pulled out by the knob. When the switch cover is opened the fuses are quite clear of the live terminals, and the switch must be "off" before the switch door can be either opened or closed, so that the thing is practically what is called "foolproof"—an Americanism, I think. In England one must, according to Home Office requirements, have a clear space of three feet between the wall and any live connection at the back of the switchboard, so that if the board can be made without any live connections at the back this useful space can be saved. A switchboard used on a factory installation designed by the writer is shown in Fig. 19.

Touching now on the smaller accessories used, such as lampholders and wall sockets, marked differences are to be observed between what is standard English and standard American practice. A glance through any American accessories catalogue would indicate that the screw socket lampholder is, if not the universal practice, at any rate the recognized standard practice. In England this type of holder is very rarely used (except, perhaps, for large candle power lamps). The bayonet holder, Fig. 20, being the recognized standard. As in the case of the screw fuse plug, the Edison screw holder may be seen on the tube railways where American equipments have been used, but apart from

this the screw socket holder is more or less of a curiosity. Keyholders, that is, lampholders embodying key switches, although they are largely used in England for domestic and other purposes, have

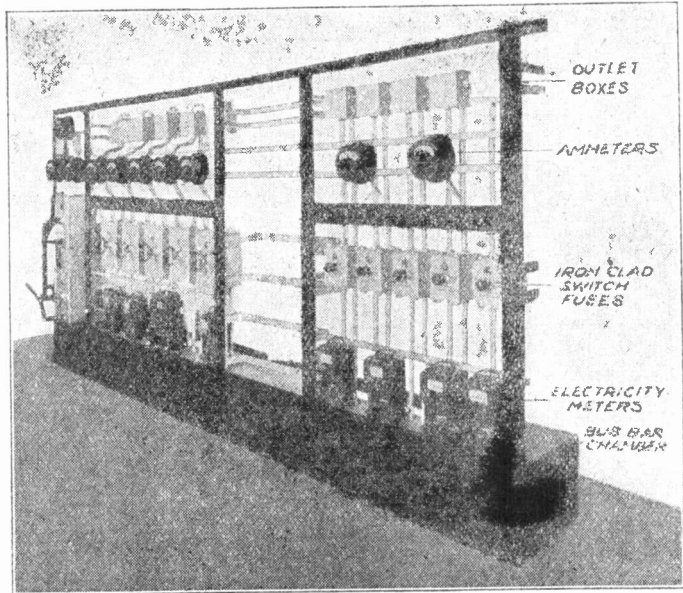

FIG. 19. ENGLISH FACTORY SWITCHBOARD

never really been favored either by the insurance companies or the Home Office authorities.

Closely allied to the lampholder is the "ceiling rose," as we call it, or, as it is called in America, the "rosette." There appear to be far more types of this in America than in England, where the ceiling rose has been so standardized as to be reduced to very few patterns. A rosette containing a fuse is now practically an unseen thing in England, and is disapproved by all the insurance companies. Neither is it permitted to tie a knot in the flexible cord so as to take the weight of the pendant on the cover of the ceiling rose, as appears to be permitted in America by the National Electrical Code. A typical ceiling rose is shown in Fig. 21, from which it is seen that a porcelain bridge is provided containing holes through which the flexible cord is threaded, the whole of the weight of the fitting being taken on this bridge and

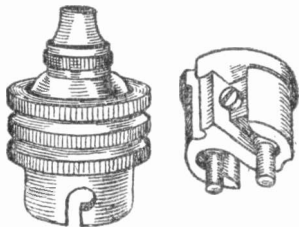

FIG. 20. BAYONET LAMP HOLDER

none of it on the cover or on the terminals.

The same differences in practice which apply to lampholders hold also with regard to "wall sockets," as we call them, or, as they are termed in America, "receptacles." Here, again, the American practice tends largely to the screw socket type of receptacle, so that a lampholder plug or fuse plug would be interchangeable for these fittings. In England the practice tends more and

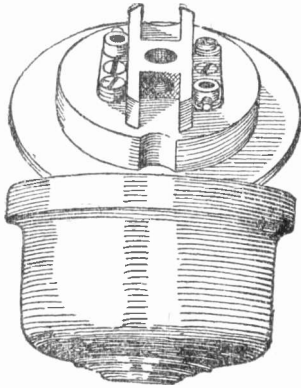

FIG. 21. "CEILING ROSE"

more towards the two-pin plug, as shown in Fig. 22.

Attachment plugs are passing through a kind of transition stage at present owing to the new rules of the Home Office. Flexible cord coming out through the end of the plug passes through the hands of the person using it. The type recently required shows the cord coming out at the side, Fig. 22.

Touching briefly on the actual wiring work of an installation, while there have been many attempts in England to introduce cheap systems, the regular practice at present is the unlined conduit system. There is still a certain amount of wiring done in moulding or, as we call it, wood casing, and in domestic installations a combination of the conduit and wood casing systems is very frequently used, the conduit being used for sunk or concealed work and the wood moulding for open or face work. The tendency, however, is more and more towards complete conduit systems owing to the requirements of the insurance companies by which all conduits must be earthed, and if this is broken up by moulding it is difficult to earth the isolated lengths. The highest

class of work is considered in England to be a complete screw conduit system, in which the conduits are metallically and electrically continuous throughout, that is to say there is no break in the metallic continuity of the system anywhere. The conduit is generally earthed on to the sheathing of the supply company's cables, which are earthed at the generating station, as is also the middle wire of the system when this happens, as is commonly the case, to be a three-wire system. By this means we are always assured that conduit is at earth potential and, moreover, it is not possible under the worst conditions to get a shock of more than half the full pressure of the system. For domestic supply the maximum pressure permissible on the outers is 500 volts, so that 250 volts is the highest pressure to which one might be subjected between earth and any live conductor.

Among the systems which have been recently introduced with a view to simplifying and cheapening wiring is that known as the "Stannos," which is a revival of the old concentric system which a few years ago was popular, particularly for ship lighting work. In the "Stannos" concentric system an insulated wire or conductor is enclosed in a copper tube, which is lapped on to the insulation by special machinery and is sufficiently flex-

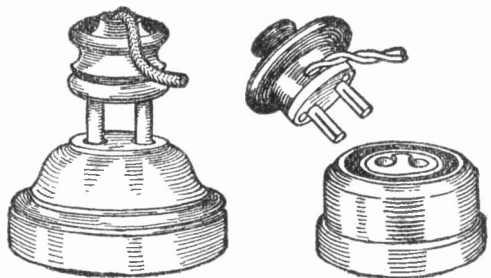

FIG. 22. ATTACHMENT PLUGS AND BASES

ible to be bent round easy curves. This system is making headway, and lends itself to interior work where it is desired to keep all the conductors exposed on the wall and ceilings.

For double wiring where it is not practicable to use the outer sheathing as a

conductor, twin conductors are made up, in which the copper tube serves merely as a protecting cover or flexible conduit, and not as a conductor. This system is being exploited by Siemens Bros., and other systems of an allied character are being put on the market by the cable manufacturing companies, among which the "Henley" wiring system might be mentioned. The difficulty with all these new systems is that they have to overcome the prejudices of the insurance companies' inspectors, as each insurance company here is practically a law to itself, and there is no central authority such as the National Board of Fire Underwriters in America.

There have been several attempts to popularize twin lead-covered wiring systems, but without success; and the flexible cord system, so popular on the continent, has no chance of success in England. To sum up, wiring practice in England has practically settled down to a conduit system, which, for the cheapest class of work, is the slip joint system pioneered by the Simplex Company, screw conduit being used whenever the customer will pay the price and for all the best work.

(The End.)

Combination Lamp for Photography

A very useful combination for photographic dark rooms is shown in the drawing. A frosted incandescent lamp is enclosed in a box,

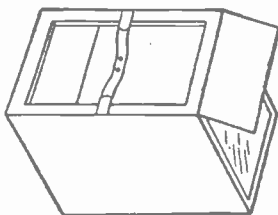

DARK ROOM LAMP

the cover of which consists of a printing frame with the glass inside. The front of the box is left open and is covered with a ruby glass. With this device printing and developing can be carried on simultaneously, thus saving considerable time. One advantage is that the printing frame is at a fixed position

from the lamp, and exposures of equal length will produce uniform results. The ruby glass can be arranged so as to be removable, and a deep yellow glass can be substituted when printing paper is being used.

Correction

In Fig. 10 on page 388 of the August issue the single wire from the three point switches on the second and third floors should be shown as connected to the right hand instead of the left hand main.

Testing for Lamps "On"

The arrangement shown in this diagram I have used to discover whether any electric lamps were lighted in a building. From the jaws to the hinges of the service switch on each side I run

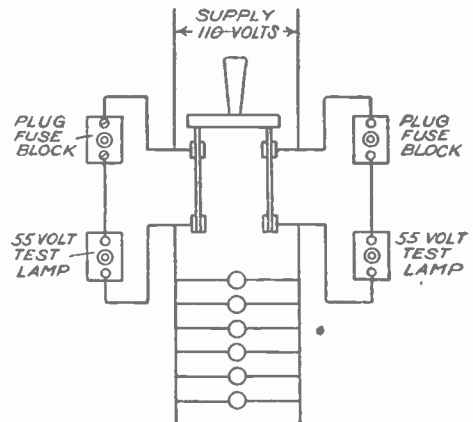

SIMPLE LAMP CIRCUIT TEST

a circuit containing a plug fuse and a 55 volt lamp in series. When the main switch is closed the lamps are out, but when the switch is open the test lamp on each side burns with a dull glow.—T. E. HEYS.

If a battery is discharged until it is practically empty, it should be charged again, at least partially, without much delay. If allowed to stand for any length of time, more than the usual number of kilowatt hours of current will be required to get it back again to a fully charged condition.

Electric Bell Circuits and Their Installation

By C. V. DAVIS

Signal wires may be supported on wood in dry places with metal staples, Fig. 1, A, driven into the timber. Never fasten more than one wire under a staple unless the wires are first protected with a tape wrapping. In damp places, ordinary staples rust and eat

hold the slack until the intermediate staples are placed.

Cleats of compressed, impregnated wood, Fig. 1, C, are good for supporting a twisted pair conductor in an exposed place, as they are neat in appearance. Either nails or screws may be used to hold them. They are particularly useful for runs over plastered surfaces, and in places where staples cannot be used. When stringing long runs of wire, compressed wood cleats at the run ends will hold the slack until the intermediate cleats are placed. These wood cleats cost less than porcelain or fiber. They can also be used to support single wires, one wire under a cleat.

Insulated nails, Fig. 1, D, having a metal stem and a head of insulating material, may be used to support twisted pair conductors, and while they are cheap, they do not support the wires as well as does the wood cleat. They do not hold a single wire well and do not properly hold back slack in long runs. The nails are made in different lengths and with heads of different colors to match surroundings.

Hard fiber cleats, Fig. 1, E, may be used where one or more single conductors are to be supported, but are not as good as the wood cleats, although they cost more. It is sometimes necessary to use them where the wire supported is too large for the standard wood cleats. The various styles are shown.

Wire for bell work in dry places is usually No. 18 copper, double cotton

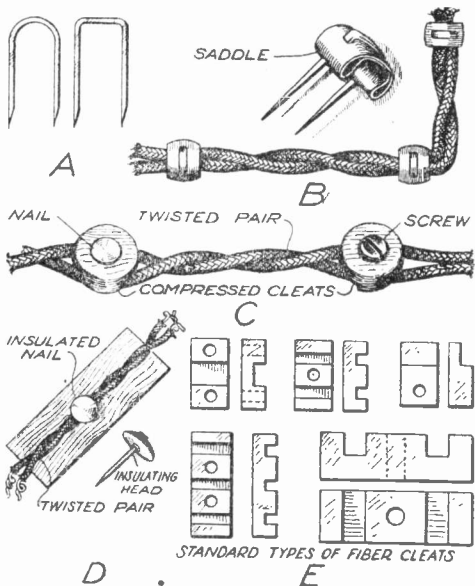

FIG. 1. BELL WIRING MATERIALS

through the insulation. It is very difficult to drive round top staples in straight; staples having square tops, of a style narrower than the ordinary double pointed tacks, are best. Zinc coated staples are preferable to coppered ones. Insulating saddle staples, Fig. 1, B, are probably as cheap in the long run as the ordinary metal ones, as two wires can be held without "shorting" under one saddle staple, and they secure the wire well at turns and prevent the metal from cutting into the insulation. In stringing a long run, a saddled staple at the end will

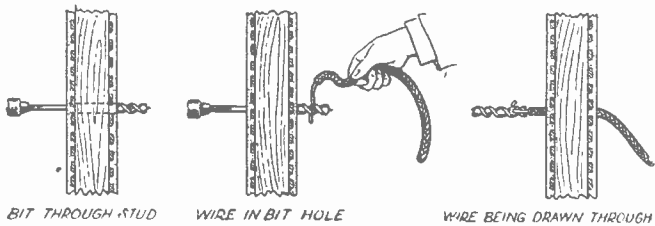

FIG. 2. USE OF STEEL FISH BIT

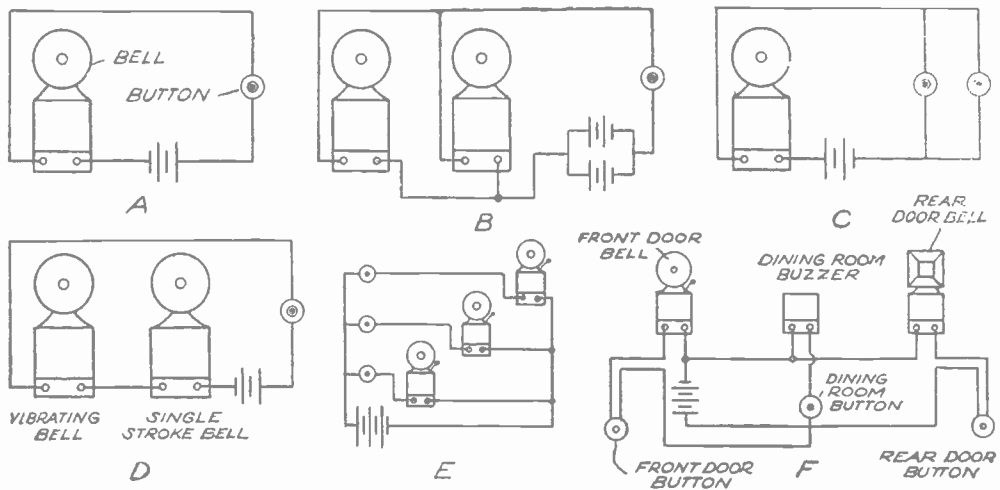

FIG. 3. BELL CIRCUITS

covered and paraffined. Where more than two or three bells are connected to the circuit, or where the circuits are long, No. 16 wire should be used. No. 14 is frequently used for battery wires. Rubber covered twisted pair wires, like those used for interior telephone wiring by the telephone companies, can often be used to advantage in damp places or where the circuits are exposed. No. 20 wire, although sometimes used, is too small for reliable work. Annunciator and twisted pair wire is made with insulating coverings of different colors, so one can be selected that will match the surroundings, and, thereby, be inconspicuous. Cables of annunciator wire, which can be obtained with practically any number of conductors from two up to 200, are very convenient and economical for large installations. In perfectly dry locations a cable having a paraffined, braided cotton covering can be used, but if it is to be exposed to dampness, a lead covered cable should be installed. The cable conductors, being covered with braids of different colors, can be readily identified. A kind of weatherproof wire called "dampproof" is quite satisfactory for exposed wiring in damp places. It is more expensive than annunciator wire, but it has a better appearance when installed.

Wires can be supported in unfinished

houses by fastening them to the studs and joists with staples. In finished houses wires can be run behind a base board or on top of the molding, or, by prying up a floor board, the wires can be placed under it. A saw cut, into which the wires can be dropped, can be made in any joist that lies across the path of the wire.

In fishing for vertical wires, a piece of small chain two feet long is attached to a length of strong cord. The chain and cord may be run through a hole bored for the wire at the top of the partition, and the noise made by the chain when the cord is pulled up and down will indicate the location of any obstruction. With the obstruction located, the floor board can be taken out and a hole bored through.

The steel fish bit, Fig. 2, is a useful tool in installing signal wires. The bit has a hole in its end. After the bit has drilled through, the wire to be drawn in is threaded into the hole and the wire and bit are together drawn back. In a floor or ceiling, the hole having been bored, it may be more convenient to first withdraw the bit and then to thread the wire through the hole at the end of the bit and to push the bit back through the hole. Good bits of this type are so tempered that they will drill through wood, masonry, wrought iron struc-

tural steel or plaster.

Electric bell circuits are shown in Fig. 3. (A) is a simple bell circuit; (B), two bells controlled from one button; (C), one bell controlled from two different points; (D), two bells in series, one vibrating and one single stroke controlled by one button; (E), three bells and three common buttons with a common return wire; (F), house bell wiring diagram. Two ordinary vibrating bells will not work well in series, so one of the two should be a single stroke bell.

Where several signal bells are located together, gongs of different types, Fig. 3, F, each of which gives a different sound, can be used. In operating bells from an electric light circuit, a bell ringing transformer, which can be purchased, may be used, and then there are no batteries to be renewed.

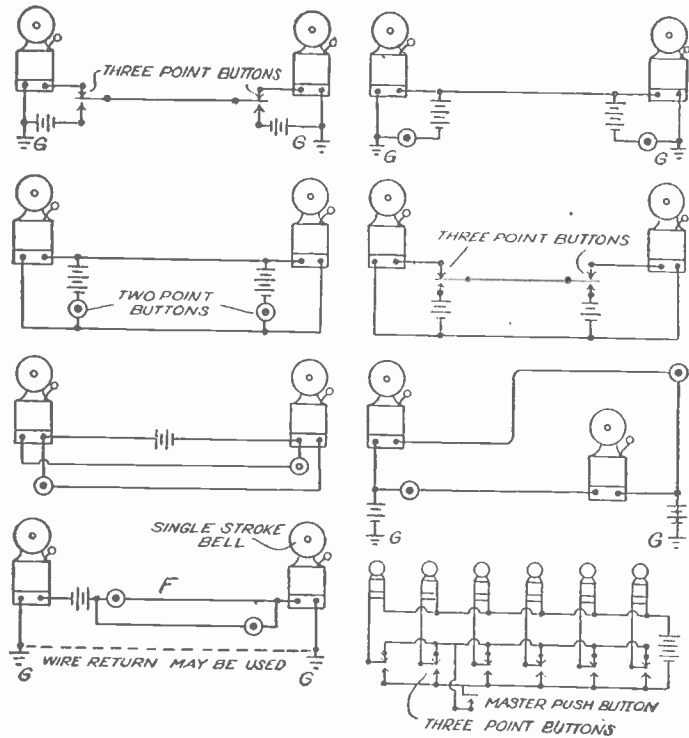

FIG. 4. RETURN CALL AND MASTER BUTTON CIRCUITS

Return call bell circuits for different services are shown in Fig. 4. These are readily understood from the diagrams. With these, when a station is signaled, the party called can signal back by pressing his button. As a general proposition, ground return circuits are undesirable, as one ground on one of the normally ungrounded wires may render the system inoperative. With the arrangement of Fig. 4, F, when the calling station is the one at the single stroke bell, the caller may be sure that the called station is ringing, because it is the vibrating bell at that station that causes the single stroke bell to ring.

Apartment house and speaking tube bell wiring circuits are shown in Fig. 5. One battery serves for all stations. Frequently a larger sized wire than for the other wiring is used for the battery wire, which supplies all of the stations. (A) is a speaking tube bell system operated from one battery. Bells on any other floor can be rung from any station. (B)

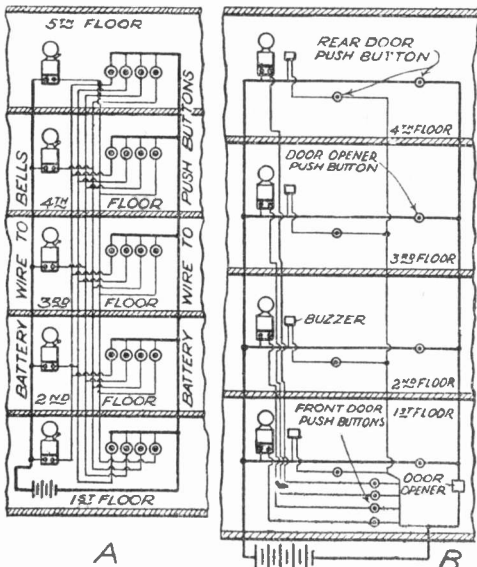

FIG. 5. APARTMENT HOUSE WIRING

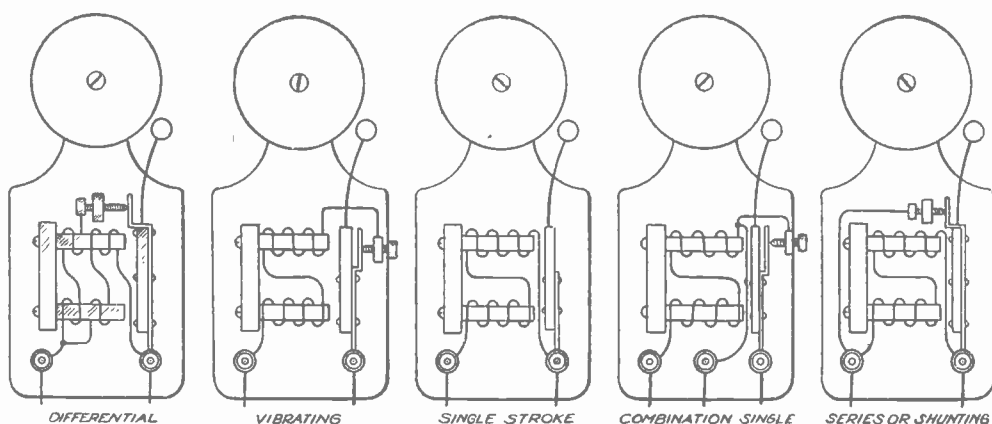

FIG. 6. WINDINGS OF DIFFERENT TYPES OF ELECTRIC BELLS

is an apartment house wiring diagram with bells for the front door and a buzzer for each rear door.

Electric bells of different types are shown in Fig. 6. The vibrating bell is the one commonly used. The single

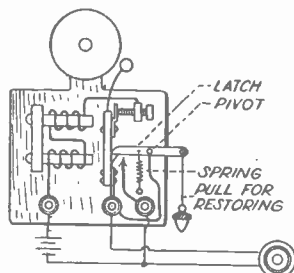

FIG. 7. CONTINUOUSLY RINGING BELL

stroke bell can be used in series with a vibrating bell, which will open and close the circuit, and thereby make the single stroke bell also operate. It is essential for satisfactory operation that the natural periods of vibration of the armatures and tappers for both bells be the same. A vibrating bell can be changed into a series bell by so adjusting the vibrating contact screw that the circuit will not be opened when the armature is drawn over. A single combination stroke and vibrating bell is a combination of the windings of a vibrating and a single stroke bell, and can be used as either by properly connecting it. A two point switch can be arranged so that a bell of this kind can be made to operate at

will, as either a single stroke or a vibrating bell.

In series or shunting bells, each time the armature is drawn over it makes a contact and short circuits the magnets, thereby demagnetizing them; the armature spring draws the armature back and the operation is repeated. Bells of this type have been designed for use on some circuits to minimize arcing at the vibrating contact.

In the differential bell, the magnets are wound differentially—that is, so that the windings oppose one another. Hence, when the armature is drawn over by one magnet winding, it makes a contact which energizes the other winding,

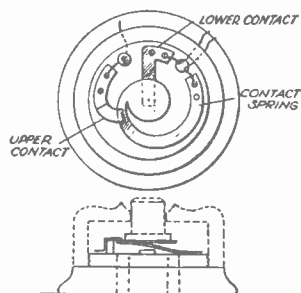

FIG. 8. DOUBLE CONTACT BUTTON

and since the two oppose, the cores are demagnetized and the armature is drawn back by its spring. There is little or no sparking with a differential bell, hence it is used on circuits of relatively high voltage.

A continuously ringing bell, Fig. 7, is so arranged that when the button is pressed and the circuit closed through the bell, the armature is drawn over and the latch released and pulled down against its contact point by a spring or by gravity. This connects a shunt cir-

cuit around the button, and the bell continues to ring until the latch is restored.

A double contact, three point or return call push button, Fig. 8, is used in return call bells and annunciator circuits. Applications of push buttons of this type are shown in the diagrams.—C. V. DAVIS.

A Sherlock of the Skies

By RENE MANSFIELD

(Concluded from page 539)

It also seemed strange that the man should keep his cabin door tightly closed, when the wind, though a hot one, made the terrific heat a little more endurable. Acting on impulse Mitchell jumped from his seat and stealing quickly around to the side of the little cabin looked into the open window. The red-haired man had seated himself at a rough table and was dealing a pack of ragged, greasy cards to the man who, with one leg swathed in clumsy bandages, lay on the bunk up to which the table had been pushed. Mitchell suppressed a yell of joy. The man with the bandaged leg was Guy Forbes!

Running around to the front of the cabin Mitchell burst through the door like a catapult.

"Forbes, old man! I knew you hadn't cashed in! I knew it. Look here, you—" turning to the squatter who had risen wrathfully, "What'd you tell me that lie for—what do you mean, anyhow—what you trying to do?"

"Why, you see, partner," the flashing look of anger had been quickly succeeded by an ingratiating gentleness of manner, "'taint every day—'taint once in a year, scarcely, I get a chanct to deal the pasteboards to anybody but meself. An' I just couldn't b'ar to have you take your friend here away. You got no idee how all-fired lonesome I——"

Mitchell turned to Forbes impatiently. "Why didn't this man try to communicate with us? And where's the Gull?"

"One at a time, Mitch, please," smiled

Forbes. "I thought some of you fellows would find me sooner or later. Rather expected you sooner, to tell the truth. And 40 miles looked like some walk to our friend here. The Gull? You know as much about her as I do. I left her a couple of hundred feet up in the air."

"But you started for Edgarville, Forbes. How in the deuce should we have known you'd strike off due north instead of east?"

"Why, man alive, I got a wireless to switch my course almost before I was out of sight of camp. You all knew that?"

"No! By George, we didn't! Forbes, there's queer work here, somewhere. Quinn must have sent that message. Why has he kept quiet about it?"

"Does Quinn use the Continental code?"

"No, he doesn't."

"The message was sent Continental. I wondered about it at the time."

"But the Gull, Forbes?"

"I told you—left her 200 feet in the air. Funny thing happened, Mitchell. Can't account for it. The aneroid barometer exploded. In no time a little tongue of flame had leaped to the upper plane. I could see the Gull was doomed."

"Half-blind, I managed to get hold of my parachute and swing loose from the crackling machine.

"Donovan, here, dragged me, still unconscious, to his cabin and between us we turned a neat trick in bandaging. He has failed to discover the slightest trace

of the Gull—must have burnt to a cinder in mid-air. Funny some of the metal work isn't lying around, though, eh, Mitchell?"

The question was put lightly, but Mitchell sensed the wary suspicion in Forbes' tone. Donovan was shuffling his cards with great precision and attention.

"O, Donovan didn't look very sharp, probably, that's all—yes, Donovan?"

"My eye sight ain't what it was—not by a long shot," replied Donovan, a shade too eagerly. "Now, like es not——"

"Sure." Mitchell cut him off sharply. "We don't care about the Gull so long as Forbes is all right. Now, lend a hand, Donovan, while we get him into my machine."

The squatter was pitifully concerned. "Why, he ain't no more fit to be moved than a baby. Things is li'ble to set in bad from that there leg o' his. Better leave him here fer a day or so. I can tend him first class——"

Mitchell drew a revolver from his hip pocket, examined it leisurely and replaced it again.

"You just get over there on the left side, Donovan," he said quietly, "and do as I tell you. There, how's that Forbes? All right? Come along, now, Donovan."

Between them they carried Forbes to the biplane and placed him in the passenger's seat. In a moment Mitchell was beside him and the plane shot up into the sky, leaving Donovan enveloped in a whirl of dust.

"Why, say, you aren't headed for camp, old man," said Forbes presently.

"I know it, Forbes. I'm not going to take you back to camp. I'm heading for El Rosa. I want you to stay there for a few days till I clear this thing up.

"Who would be interested in preventing you from accomplishing your flight to Edgarville that would have broken all wireless records and undoubtedly won for you Ferris' \$10,000 bonus, besides putting you in the way of entering the International next week as the company's

star, if you had succeeded? Anybody but Baring and Bouvier? I'm not going to tell you more now, but I think you'll hear from me in the course of a couple of days at the most."

Having established Forbes with a physician whom he knew at El Rosa, which he was able to accomplish with secrecy since the doctor's house stood in the center of a large ranch, Mitchell took wing again impatiently. Had Forbes taken notice of his course he would have seen that he flew, not toward camp, but in a bee-line for Donovan's cabin.

It was late the following afternoon that Mitchell asked Holmes, the president of the company, to call a meeting of the aviators. When they had assembled about the long table in the directors' room apprehensive of bad news about Forbes, for whom an unremitting search had been kept up, Mitchell took the floor at once, with a gravity that boded ill.

"Gentlemen," his voice was unsteady—"gentlemen, I have the painful duty of telling you that our search for Guy Forbes is ended. You will never see the Gull again, driven by that fearless, that brilliant—that——" He was scarcely able to go on. When he had his voice again under control, he said simply, "I shall try to tell you as briefly as possible what I have learned.

"Yesterday, although it had been accepted that Forbes could have flown in no direction except toward Edgarville, something seemed to prompt me to take a little spurt due north. Twenty—forty miles I flew over that desolate country which is quite uninhabited, losing hope with every mile. Just when I had made up my mind to turn back, I sighted a little shack where at any rate I determined to make inquiries.

"Gentlemen, it isn't necessary for me to tell you by what means I made certain discoveries that clear up the mystery of Forbes' disappearance. Suffice it to say that buried in the sand behind that shack I found twisted scraps of metal, and warped, charred bits of woodwork, which

is all that remains of Forbes' biplane.

"The Gull was burned almost to a cinder 200 feet up in the air. It was not an accident, gentlemen. It was a fiendishly conceived plan. I know whose work it was, and I know, beyond any question of doubt, who was responsible for Guy Forbes' horrible death."

Baring was on his feet in a moment. "I know also! I have had my suspicions from the first. I have evidence to show _____"

"It's a lie! He's alive and you——" Bouvier's lips closed with a snap over the words that had burst from him uncontrollably. It was too late.

Mitchell turned upon him savagely.

"Ah, Bouvier, you'll speak, will you? How do you know Guy Forbes isn't dead? How do you know it, I say?"

Bouvier's head fell into his hands, as he sank back into his chair. "O, I tell you everything—I tell you everything," he muttered. "I can not stand it——"

"I'll save you the trouble, you contemptible scamp," cried Mitchell. "Ten thousand dollars, and the company back of you for the International next week—you intended to win out on that proposition by fair means or foul, didn't you? You knew that if Forbes succeeded in reaching Edgárville day before yesterday your chance of breaking his record was slim.

"You bribed Quinn to leave the generating plant for an hour. You repaired the gearing temporarily, so that after Forbes was well on his way toward

Edgarville you were able to swing the L around to the north, after telegraphing him to change his course. Having calculated his speed to a nicety, when you knew him to be in the vicinity of Donovan's shack, you gave him suddenly the full voltage of the power beam, which, you knew from previous experiment, would kill the engine and in all probability explode the aneroid barometer. You then shut off the power, swung the L around again, restored the gearing to its former condition and left the rest to Donovan, 40 miles away, who was to remove any evidence of that midair tragedy that might exist. In case Forbes, by some miracle, escaped, Donovan was instructed to hold him prisoner until after the International. Too bad you didn't discover that tell-tale tracing in the sand, Bouvier. Any details you'd care to add?"

The Frenchman only sat and shook.

"Think you can get out of the country tonight?" inquired Holmes.

Bouvier bowed.

"Then git" said Holmes, forcibly, if inelegantly.

Mitchell had opened the door of a smaller room near by and Guy Forbes himself limped into the room, to be surrounded at once by a group of howling madmen.

"My little trip through the fiery furnace indefinitely postponed, fellows!" he cried above the din. "Ouch! Get away from that leg of mine."



Electricity the Silent Salesman

Some helpful hints on the use of electric current in getting up show window displays. The following schemes have all been used with remarkable success.

Fan Advertisement

The accompanying illustration shows a unique advertisement for electric fans which has been attracting considerable attention to the show windows of the

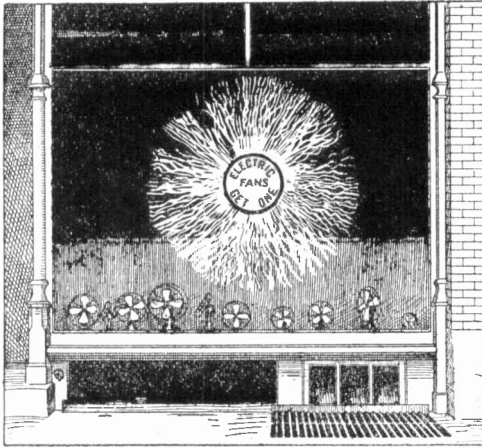

UNIQUE FAN ADVERTISEMENT

Manchester, N. H., Traction, Light and Power Company. It consists of a translucent center piece, bearing upon its white surface the words in letters of black, "Electric Fans—Get One," and from whose circumference a great number of flexible white streamers are made to radiate.

A sixteen inch non-oscillating electric fan is made to blow directly upon the center piece from a point slightly lower down and its powerful blast causes the streamers to distend themselves out in all directions.

At night the center piece is tinged with a ruddy hue by means of a colored lamp placed behind.

The device has several things about it to render it an efficient advertising arrangement, viz:—It is something new; it is prominent and it is in motion. The present scheme is the result of a number

of experiments, some of which have shown the possibility of arranging the streamers in other and as novel forms. Thus, they can be made to stand up from the window floor by a fan placed beneath and made to take the form of waving wheat or, with a little ingenuity, leaping flames.

Doing Business Between Bites

During hot summer days suggestions of cool woods and fishing are alluring. A dictagraph company is using this fact to call attention to the service its device may render to the business man in camp.

A fisherman's camp is accurately dis-

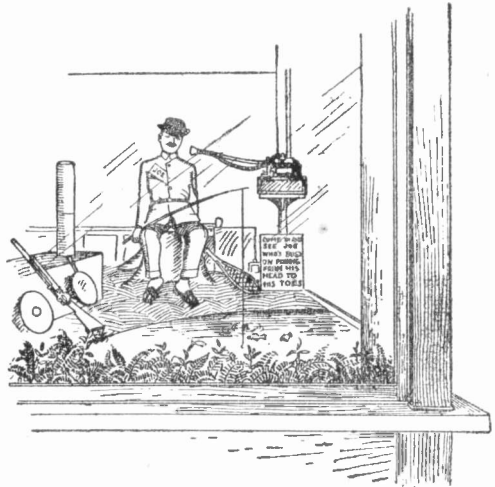

DISPLAY DICTAPHONE

played and, while the angler watches the "bobber," he may, between bites, talk his correspondence into a dictagraph and later mail the cylinder to his place of business.

Much realism is added to the scene by a concealed electric motor which operates the fisherman's arm, causing the fish pole to move and lift the hook out of the water at intervals.

An Illuminated Key Sign

A locksmith uses an illuminated glass key sign placed in his window among such articles as a shop of this kind would carry. The sign is large enough to be

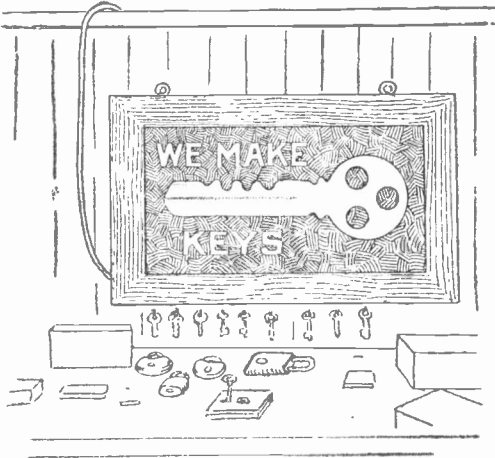

ILLUMINATED KEY SIGN

plainly seen from across the street and uses a sixteen candlepower lamp for illumination.

The Jolly Gymnast

A Chicago druggist calls attention to his window display of liniment and arnica by placing at its center the happy-go-lucky, loose-jointed figure shown in

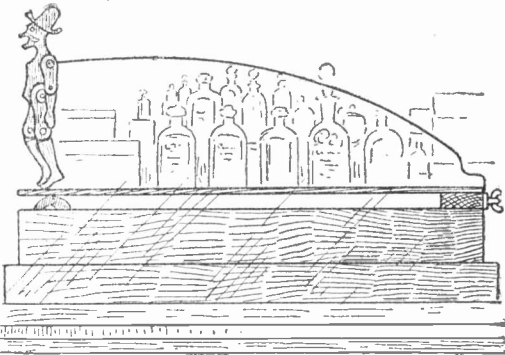

ODD WINDOW DISPLAY IN DRUG STORE

the accompanying illustration. The board under the figure's feet is made to vibrate

rapidly up and down by a small motor, causing the jolly gymnast to throw his arms wildly about and to perform all sorts of quick movements with his feet, his point of support being a length of spring wire.

Fashion Cabinet

Goods in the piece may look somewhat different when made into a garment or suit. Partly to aid in settling this question and also to serve as an attractive clothing advertisement is the purpose of the Newman fashion cabinet. The front



FASHION CABINET

of the cabinet is a piece of plate glass 20 by 36 inches, upon which is the outline of the figure of a man or woman, the surrounding glass being opaque. Behind the glass is a rotary arrangement for bringing one piece of cloth after another up close to the glass, thus making the figure outlined appear to be clad in one suit after another. The cloth changing device is operated by a small motor.

The Inventor, Who He Is and Why

By GEORGE FREDERIC STRATTON

In the marvelous achievements in engineering and mechanics which have developed the methods of Tubal Cain into the astounding equipment and products of the great steel industry of today; which have superseded the hundred oared galley of Cleopatra by the thirty thousand horsepower ocean greyhound, many of the greatest strides in the invention of machines and processes have been made by men who had genius without one iota of training. Often they have not the rudiments of education, and are without one existing example of the thing their minds were creating, to study, to emulate or to enthuse.

There's the puzzle! What psychological explanation can be made of the mind impulses of Stephenson, who evolved the locomotive at the same time that he was teaching himself simple arithmetic; of Arkwright, the barber, who thought out and perfected one of the most intricate and ingenious of machines—the spinning jenny—at a period when machinery and mechanical movements were practically unknown; of Morse, the artist, who turned from his beloved profession and devoted his life and his means to the invention of the instrumentation and installation of the electric telegraph; of Whitney, the law student, who invented the marvelous cotton gin; of Bell, the physician, who created the telephone?

There is an old axiom which, with a few others, requires rebuilding; or, better still, relegating to some antiquarian museum where age is sufficient qualification for a glass case: "Necessity is the Mother of Invention." The man who devised that was obsessed by a briefness which obliterated his meaning, or he was not an observer of inventors. Necessity has undoubtedly been an impelling and insistent motive for some inventions, but so broad and distinctive an appellation as "Mother of Inventions" is entirely

destroyed by a very cursory study of the Art, the Profession, or the Trade—which is it?

Some other Mother must be sought. Thousands of useful and valuable inventions have been made by men as the result of hobbies or pastimes. The necessity for the article had no appeal to them. It was the—perhaps—instinct to invent—an instinct which is possessed in some degree by every man, woman and child today, and has been so possessed since the men, women and children of the Stone Age found that life meant effort. Watch the most unambitious man, who, after 50 weeks of routine in the most monotonous work, gets into a camp for two weeks. He is full of suggestions and ideas for overcoming the rough places. Impracticable they may be, and often unnecessary, but he is full of the instinct of invention. Watch the young wife, or the older one, continually rearranging her home equipment for better convenience or tastier appearance; partitioning a closet, planning a new window, transforming a dull corner into a tempting alcove. It is the instinct of invention.

Above all, watch the boy, from the day he enters primary school until he goes under the discipline of a paymaster. Through every hour of every day he is planning some new way to do work, or to dodge it; to beat the other fellows in sports of skill or chance by some new movement or some new method of using an old plaything. The instinct of invention is strong in him and will stay by him—subdued, perhaps—until he dies. He may develop into a thoroughly bad man, or into a shiftless, improvident fellow, or he may become the president of these United States; but the instinct of invention never leaves him.

Yet, of all the great or little capabilities of man, or all his instincts, proclivi-

ties, ambitions and desires, this one great impelling instinct—if I am using the proper term—of invention is the only one that has been left without any attempt at systematic training and development; that is, in the line commonly accepted as invention. Every other capacity of man, physical as well as mental, has its colleges, institutes, training schools or advisory mentors. There are cults, new thought schools, isms and ologies to meet every phase of human action and human thought, except that of inventiveness.

This has not been overlooked. During the past decade, and perhaps before, suggestions have been made, in a desultory way, of the possible value of systematic training institutes for those who show marked inventive ability. But they have been met by the objections that inventors cannot be made; that invention is overdone; that the true inventor is of much too independent thought and impulse to submit to any control of those qualities; that the inventive capacity of men has been shown in a vast number of very successful results to have had no training—sometimes no education—back of it, and therefore such training seems to be unnecessary; that it may be questioned whether routine study of fundamental physical laws and conditions would not be detrimental to imagination.

Those objections indicate that the inventor who cannot help inventing is not understood. When his ideas are impractical he is called visionary; when they are eminently practical and valuable, his frequent failure to realize their rewards bring upon him the grim criticism of being utterly deficient in business sense, or even horse sense. And frequently both criticisms are fair; but are the causes—the entire lack of any effort to supply the qualities which such inventors need—are they fair?

There has been another reason given against the establishment of any especial facilities for training inventors—a reason which on the surface appears stronger than the others. It is that the man who

is filled with the inventive spirit is almost always in some position—in production, distribution, or in a profession—where he is earning a livelihood, and that no matter what the position is, it gives him an acquaintance with the requirements of himself and his associates, and consequently the opportunity to exercise his inventive faculties. He is assumed to be continually getting training in his daily association with the shortcomings of, and the call for improvements in, the appliances of the business.

That is a plausible and apparently logical assumption, but, as a lawyer would say, although the premises are correct, the deduction is incorrect. One of the most insistent points which come to any one making a very cursory study of inventors is the fact that the great majority of such men invent things which have not the remotest connection with their daily occupations.

A patent attorney in one of the Midwest cities showed me recently a record he had compiled of the occupations of his clients, and of others of whom he had been able to secure information in his visits to the Patent Department at Washington. His list gave nearly 1,000 names, and 65 per cent were of men who had secured patents for inventions or improvements on articles entirely disconnected with their regular work.

That's where the inventor is a puzzle again. A sea captain invents a rock drill; a bookkeeper invents a combination vise and anvil; a machinist invents a hay rack for farm wagons; a sawmill operator invents an adjustable sash for hot houses; a lawyer invents a steering gear for motor boats. Thousands of such incongruities can be found, but tens of thousands would prove no more conclusively than the few given that the inventor is an unknown quantity. You never know—he never knows himself—where he will break out next; and the result—the inevitable result—is an enormous waste of thought, brilliant ideas, dogged perseverance and often pathetic

self denial on articles which, although practical, are unnecessary; although marvels of ingenuity, are too costly; although simplified to the last notch, are lacking in selling appeal. The business sense—the one insistent principle of considering results as closely as methods—is too often blotted out of the inventor's brain by the fascination of his present endeavor. It has been stated by patent experts that 75 per cent of the patents secured fail to repay even the cost of securing them. The expenditure of energy, talent—yes, and downright genius—that is thereby wasted, a large proportion of which might be diverted, by proper warning, control and encouragement, to improvements for the benefit of the world, is appalling.

The inveterate inventor or the spasmodic inventor usually is actuated by irregular impulses and imaginations. At home, at work, on the street car, at a dinner or a wedding, some article or some difficulty comes to his notice which flashes into his brain the idea of an improvement or a substitute, and forthwith he invents it. The obsession is to make something that no other man has thought of. Here is where early training in logical reasoning of ultimate results—training in business principles and business acumen—would count.

Such training comes incidentally to the engineers of a great manufacturing or transportation enterprise. Such men are frequently inventors, for their work calls continually for the inventive faculty, but with it they are under the discipline of duty and the stern necessity of thoroughly considering and estimating the ultimate practical value of the invention or improvement, its cost and probable profit.

The value of a professional salaried inventor under direction and control has been demonstrated to a remarkable degree in some of the great manufacturing plants. In that of one of the great electrical machinery manufacturing companies there was employed several years

ago a plumber, working at his trade among the numerous shops. Some months after he commenced, the superintendent observed that he was very fertile in ingenious expedients, and he watched him. The watching really developed into a study. The plumber was a chronic inventor; he couldn't help it. It was found that he had secured three patents on articles not used in plumbing, in return for which he had nothing to show but the papers. He was taken off the plumbing, told to wander round the shops and "invent" savings, and warned against "monkeying" with any new devices. His work was to find saving chances or to invent them.

He wandered about the plant at will, studying the machines and the products, no matter how large or how small. The greatest boring mill or the smallest bench tool, a trifling reduction in the weight of some casting, or the substitution of some standard piece for a special piece, alike engaged his attention. He invented constantly—little things, it is true, but the aggregate saving in cost or gain in efficiency was so great that four years later he was drawing a salary of \$3,000 a year. A trifling ingenious change of a casting pattern would often save a few cents' worth of machining, and a few cents' worth of material, and in the large quantity of each part manufactured a very small saving would amount to a respectable sum in one year. For instance, three months after he had been on the job he argued for and secured a slight change in the casings of railway motors, by which two bolts and the necessary drilling were eliminated. The saving was 26 cents on an article which costs over \$200. But 30,000 of such motors are turned out of the shops each year, and the total saving was nearly \$8,000 each year. Of course, as he got settled into the work he frequently devised improvements in various apparatus, increasing its efficiency.

This case is cited because it is a fair type of others. Large manufacturers

are fully alive to the value of such men, but they find it almost impossible to obtain them. One of the great automobile manufacturers recently said:

"There are hundreds—perhaps thousands—of inventors who have the brains we want. Many of them are just earning a living at some occupation, but, although we would double or triple those earnings at the start, we can't get an inventor who'll respond to control. They switch off from work we want to any idea that occurs to them, and then their minds are too much engrossed to get back to where we want them. I suppose if we took a *young* fellow we could break him in to an understanding of business requirements and business policy; but we've got to have a man—or several—who have proved their mechanical ingenuity and ability to invent: and when they get to that stage, they seem to have no control over the direction of their efforts."

And the factory superintendent, speaking of the same thing, said: "We can get graduates of technical colleges, and young fellows from training schools, by the gross; but if I select one who shows ingenious original ideas on mechanical work, and tell him to go round the plant and see what improvements or savings he can devise on what we are making, he'll probably bring me, within a week, sketches of something entirely outside of our line. He has the same idea that all inventors have, that if a thing is patentable there's a fortune in it, and that we'll jump at it, no matter what it is, or how it's going to strike us. If there was a college of business invention, there'd be a mighty bright outlook for its students."

Of course the question comes in here as to whether the engineers or foremen are not competent to do the work for

which the shop inventor is sought. Usually they are; but just as usually they are entirely unavailable. Ask an engineer to spend two or three days, or a week, in seeing if a factory cost saving of 25 cents is possible on a hundred dollar machine, and he'll disgustedly decline to put his training and abilities to any such insignificant detail. If the request is mandatory, he will probably resign. And the foreman who has from one to three or more hundred men in his department, and has to watch orders and supplies, has no hours to spare in studying the effect of the elimination of a two cent bolt. It is work, resulting in totals of enormous amounts, that must be done by a special man, or men—the tool expert, the shop doctor, the savings expert, or simply Mr. Brown. They are all the various designations of what is really the shop inventor.

It is a profession which is very close to its beginning. The success, where the man can be instilled with the principles of sticking to one line, and studying the needs and policies of his company, is very great. But, as one manager has remarked: "The true inventor must be caught young and taught in some systematic, effective manner that his genius, his faculties and his resourceful ingenuities must not wander all over the lot; that if he engages to invent improvements and economies in a stove foundry, he is neglecting his duty and wasting his opportunities by inventing a self propelling tooth extractor or a combined baby carriage and washing machine. The college that will take such young fellows in hand, and, letting their inventive genius alone, show them the true business application and business possibilities of such genius, will do more good for America's industries than any technical college now in existence."



Electrical Securities

By "CONTANGO"

More Interesting Facts and Figures as to What Has Been Accomplished in the Past Few Years—Striking Examples of Progress and Prosperity Indicate the Solid Future Before Those Who Invest Their Money in the Stocks and Securities of the Well Managed Public Utility Corporations.

Mention has been made many times in this series of the advantages accruing to the investor by virtue of the centralization of resources and management as typified by many of the great public service corporations today. But the average reader, as he switches on his light to read these lines, very probably has an inadequate perception of the tremendous system, electrical, mechanical, clerical, which is back of the half an ampere or so of current that flows through his lamp. He knows that somewhere away in the distance there is a dynamo which sends current over the wires, but to the intricacies of the system, the thousands and millions of dollars invested in its equipment, its instant readiness to respond to the tens of thousands of little switches of thousands of small consumers, he has more than likely given little thought.

What, then, are some of the factors back of this almost universal electrical service in our great cities which make that service ready to respond to public need? So far we have dealt quite largely in generalities concerning the investment features of these great enterprises. Let us now go somewhat into the interesting features of their operation that will show why they must be, of necessity, solid and substantial propositions to the core.

If we take as an example of a public service company in a great city the Commonwealth Edison Company of Chicago, for instance, some exceedingly interesting facts may be brought out bearing on the above point. The amount of coal consumed by this company per year is upward of one million tons; per day, upward of 2,800 tons; and upward of 120 tons per hour. The figures are stupendous—just consider what they mean

to the industrial world at large. This company, in order to avoid any trouble from strikes, has to accumulate at times as much as 300,000 to 400,000 tons of coal in stock. To bring this more vividly before you, let it be suggested that the extra expenditure for fuel this year prior to April 1 amounted to about \$300,000. To quote the president of the Commonwealth Edison Company in regard to this extra expenditure: "We have to do a thing like that from two points of view—our duty to our customers and our duty to ourselves, the owners of the property. The steam railroad trains can stop and stay at a point all winter, if necessary, due to accumulations of snow, a strike of the employes, or whatever unfavorable conditions Providence or man may bring about, and it is forgotten in a day. But just imagine what would happen to a community like Chicago if our service stopped. The wheels of industry would cease. The majority of the newspapers would cease to be printed. The post-office and the courts would have to shut down. In fact, most of those things which contribute either to the comfort or discomfort of modern civilization would have to come to a standstill. At this time we pay the city of Chicago \$1,058,000 annually for taxes and municipal compensation. That amounts to \$2,800 a day, \$120 an hour, just about \$2 a minute!"

It is decidedly interesting to note the amount of money contributed for public purposes. In 1889 the Commonwealth Edison Company contributed \$6,000; in 1899 the sum was \$27,700; and in 1911, \$1,057,500 was contributed to the city in the form of taxes and municipal compensation. It might be remarked here that in

1911 the enormous sum of \$1,591,100 was spent in fuel.

To continue the president's remarks: "In 1889 there was \$797,200 invested in plant. That refers to generating and distributing stations. In 1899 the figure had reached to \$17,461,000, and in 1911 the huge sum of \$68,896,000 was so invested. And this investment is now growing at a rate of about five million dollars a year."

Whether you are greatly interested in figures or not, just consider what the foregoing means. It tells you a story of possibilities almost unique, not only in its own field, but in the great big world of financial accomplishment. And this story will undoubtedly be continued on into the future with just as startling disclosures of progress. You know, for instance, that much has already been done in the direction of electrification of steam railroads. What does this mean to the central stations where improvements will in the future be made? To quote again from the same authority:

"There is in Chicago an electrical zone about 32 miles long and from ten to twelve miles wide. Supposing the Vanderbilt roads all produced together in one group and the Pennsylvania roads in another group and the Harriman lines in yet another group, and so on all along the line. That is to say, suppose they took care of their own electrical production of energy. Then, on the other hand, suppose that the one great central station system, alluded to, produced the electrical energy, there would be a difference in the cost of the necessary investment at the start of easily \$10,000,000. In a period of, say, ten to fifteen years, the difference in the amount of invested capital required would probably amount to \$30,000,000."

We can pause here, for it marks the final point in the economy and efficiency of centralization. It means that if these railway companies wanted to go it alone, it would at the start cost them more than \$10,000,000 more than if their power was

supplied by the one great central station organization. And this is so forcibly brought to your attention to as strongly as possible impress upon you the necessity for all such consolidations, and the opportunity for the wise investor if he takes time by the forelock.

To carry the point a little further as to the future, of the total amount of business now possible in the Chicago community the Commonwealth Edison Company is supplying only about one-third, or a little more than one-third—possibly 35 per cent. It takes, in round numbers, about \$75,000,000 to operate this business at the present time. If it were possible to get all the business possible to be obtained, it would more nearly take \$250,000,000 to operate the business of manufacturing and distributing energy in all of Chicago and its vicinity.

There you have it. It is in the logical combinations of capital in public utilities, of which the above company is an example, that you find your future right before you for the possibilities of sound growth and immense growth are unlimited.

And on all this vast aggregation of capital, as stated once before, the investor may with safety net as high as five and seven per cent on the capital stock and $4\frac{3}{4}$ to $5\frac{1}{4}$ per cent on the bonds. What more could possibly be asked?

In 1889, to return to our example, the total income of the Commonwealth Edison Company from light and power and railway service was \$105,700; in 1899 the income from the same source was \$1,792,700; and in 1911 the income had reached \$13,902,300. In 1893 the same company had 4,100 customers; in 1899 it had 13,300 customers, and in 1911, 157,115.

To turn to another company: It may be mentioned that the Doherty Operating Company, a company organized by the Henry L. Doherty and Co.'s interests, one of the best known in America, will operate the newly incorporated Consolidated Cities, Light, Power and Traction Company which in June of this year sold

\$4,500,000 five per cent first lien bonds in London. Now it may be told that that sale was accomplished in a few hours. There are eleven plants in the new company's control and they operate in 21 cities throughout this country and Canada. And the point is that each property secured must come up to the Doherty standard of earnings and must be in a section of the country the past record of which is an assurance of its future growth. There again you have an illustration of the present trend of capital.

Taking at random from a long list of such undertakings, 70 of these public utility corporations, let us give an analysis of the gross earnings in the three years from 1908 to 1911, inclusive. Of the whole number, it is shown that 60 of these companies increased gross earnings, in 1908, 7 to 30 per cent over 1907; in the next year, 62 corporations made a gross gain of nearly 11.30 per cent over 1908; in 1910, 66 corporations increased gross earnings twelve per cent over 1909, and in 1911 70 corporations increased gross earnings 9.30 per cent over the previous year.

The 70 companies mentioned are composed of 25 electric railway corporations, 37 gas and electric light companies, five telephone companies and three water companies. No company shows less than \$100,000 in gross earnings. The gross earnings for these companies in the last two years to December 31 were as follows:

Gross earnings, 1911	\$266,954,444
Gross earnings, 1910	244,094,360

Increase in 1911	22,860,084
----------------------------	------------

Percentage of increase, 9.30 per cent.

As a comment, it can be said that during the extreme period of depressions in 1893 to 1896, when over one-fourth of the railroad mileage of the country was placed in the hands of receivers, conservatively capitalized and well managed public utility companies in the larger cities, almost without exception, emerged in good condition and with the

record of having promptly met all obligations. No possible severer test of the strength of the bonds of these companies as investments could be demanded than is shown by these facts.

Then we have before us the comparatively recent record of the panic of 1907. Public service corporations showed no shrinkage, but on the contrary continued to grow and increase by reason of the fact that they were supplying the public with something absolutely necessary to its mode of living.

One word more: At the time this goes into print, the stress of the general election will be more or less felt all over the country; feeling will run high, and there will be divers expressions of opinion as to the effect of the election on this or that class of investment. Money may usually be considered timid at such a time.

Do not be alarmed. There will be an active market for securities of all kinds, and the very time to get in and wisely place your money will be then, as now, for the public service corporations have nothing to fear. Rather the reverse, for the legislative aims of all parties are in the direction of proper control and therefore proper and adequate protection of such organizations, with a corresponding benefit and security to the owners of stock and holders of such securities.

NEW BOOKS

COMMERCIAL ENGINEERING FOR CENTRAL STATIONS. By Edmund F. Tweedy, New York: McGraw-Hill Book Company, 1912. 142 pages with 27 illustrations. Price, \$2.50.

This is a compilation of facts and figures of value to the commercial departments of electric light and power companies of argumentative value to lay before prospective customers. It takes up such matters as cooling the air in buildings, mechanical refrigeration for the cold storage of furs, electricity in the modern department store, ozone and its production, kilowatt hour costs in steam driven generating plants, the passenger elevator in modern office building service, etc.

SCIENCE EXTRACTS FROM FOREIGN JOURNALS

NEW SOUND-PROOF TELEPHONE BOOTHS

Soundproof telephone booths are now constructed by a German firm, and owing to the new principle which is used in their makeup, it is said that not the least sound can escape from them while the telephone is being used. The walls of the new booth are built of five layers of thin wood, with the grain crossed each time, and the layers are glued together, and then the whole is covered with a special soundproof compound, so that in this way it is not required to use deadening cushions as a lining for the booth. As the whole is made in six dismountable panels, a booth can be set up in a very short time, and the panels are not too large to be taken in through an ordinary door. Insulated openings are left in the partitions beforehand, so that there is no need of boring holes in order to put in telephone or electric light wires.—*L'Electricien, Paris.*

TELEPHONE SERVICE IN PEKIN

A telephone service is now officially organized in Peking. Two central exchanges have been installed in the city, and they are fitted up for 6,400 subscribers. What is to be noticed is that both the exchanges and lines are of home manufacture, and the Chinese government is engaged in operating the telephone system. There are already 3,000 subscribers in the Chinese and the Tartar quarters of town, and the rest of the city will be wired up in the same way before very long. In the part of town containing the foreign legations, where there were already quite a number of telephones in use, these are now connected by extending the wiring as far as the central exchanges.—*L'Electricien, Paris.*

FAMOUS CHURCH BELLS ELECTRICALLY TOLLED

The parish church on the Klosterstrasse, Berlin, with its famous 200 year old bells, is one of the best known in the city. Not long ago the bells were fitted with electric ringing apparatus. This ingenious device is the invention of a Cologne firm, and is already in use in some 30 churches in different parts of the country, among others the Limberg cathedral, where very heavy bells are set in motion. The special advantage of the new device is that it gives a two sided pull on the bells so that there is given a precise and uniform stroke of the hammer without any shaking or shocks.—*London Electrical Review.*

EXAMINING COAL WITH X-RAYS

Coal is now examined by the X-rays in order to see the quality of the substance which it contains. While pure coal is almost transparent to the rays, there can be seen differences between the various qualities of coal and even between different parts of the same specimen, so that the makeup of the coal can be noted in this way, and the amount of ash can be estimated. There are, in fact, two or three kinds of ash contained in coal—first, the foreign matter brought by wind and rain upon the wood of the forests which gave rise to the coal; then we also have the mineral matter forming part of all living plants, and again the products formed by the action of these various compounds upon each other. Examining the coal by the X-rays is likely to be very useful in the future in deciding what kind of impurities are contained in the coal and what its value is as fuel.—*Cosmos, Paris.*

ELECTRIC ORDERING DEVICE FOR RESTAURANTS

An electric waiter for hotels and restaurants is the invention of Mr. H. Quertier, and it is operated by the customer, who is in direct connection with the kitchen. On each table is a wood frame carrying a menu card, and opposite each item of the bill of fare is a button. Having chosen his dish, he presses the button and at once the number of the table and the order are displayed in the recorder in the kitchen, while an electric alarm bell rings to notify the cook. An apparatus in the kitchen automatically issues a ticket with the order details and price, and a duplicate is kept upon endless tape so as to have a check upon money and goods. When the electric printer drops the ticket into the tray, the order can be prepared and delivered with the ticket by the waiter girl at once. At Wellington, New Zealand, where it is used, the electric method has had much success.—*London Electrical Review*.

ELECTRIC STEEL PRODUCTION IN NORWAY

Electric steel production is on the increase in Norway, and two new companies have been formed for constructing plants of the kind. The first of these has a capital of about \$1,000,000, and is arranging to secure about 3,000 horsepower from a local hydraulic station. It is to erect an electric steel furnace of a new design and a very complete works with rolling mill, steam hammers, foundry, and the like, so as to be able to produce over 3,000 tons of steel annually in the shape of rolled and cast steel. The second enterprise is a steel works near Arendal, and the current comes from the Boilejos falls at Nedelven. In both these plants the electric furnaces are of the type made by the Swedish electro-metallurgic firm. It is thought that the annual product from the two steel works will not be less than 15,000 tons.—*Industrie Electrique (Bi-monthly), Paris*.

DEATH OF HENRI POINCARÉ

Europe has met with a loss in the death of Henri Poincaré, who has been considered for many years past as the greatest living mathematician. His activities bore upon many branches of science, among which electrical theory was prominent. He was born at Nancy in 1854, and after passing through the Polytechnic School he subsequently became Professor at the Paris University, which position he has kept ever since. He was a member of the leading scientific bodies, such as the French Institute and the Academy of Sciences, and was also a member of many foreign scientific societies. He wrote a number of works upon the branches of heat, light, electricity and other questions, and was one of the leading spirits in the modern scientific movement. He was a cousin of Raymond Poincaré, the French Prime Minister.—*L'Electricien, Paris*.

SIR HIRAM MAXIM'S COL- LISION PREVENTER

Sir Hiram Maxim, the well-known English inventor, is at work upon a new method for use with vessels at sea so as to be able to detect the presence of distant objects and thus avoid collisions. His idea is based upon the so-called sixth sense possessed by bats when flying in the dark, but here it is probable that there is no special sense in play, but the vibrations given by flapping the wings are reflected from walls and the like, and there seems to be a special organ in the head for observing the reflected waves so that the bat takes note of nearby objects. On the vessel a large steam siren would set up sound waves of such a low pitch that the ear would not perceive them. Such waves could travel many miles and be reflected back from icebergs or rocks, and the echo received on a large diaphragm on board. The vibrations of the diaphragm could then act to close the circuit of an electric bell so as to give the alarm.—*London Electrical Review*.

DETERMINING LONGITUDE BY WIRELESS

Several determinations of longitude have of late been made by means of wireless signals, but the most satisfactory attempt of this kind recently took place between Paris and Tunis. Wireless signals connected two clocks, one at the Eiffel Tower and the other at Bizerta, on the Mediterranean coast near Tunis, which is one of the leading French naval stations. Comparison of the two clocks gave the accurate figures for the longitude. The signals traveled the distance in 0.007 second, which works out at nearly 200,000 miles a second. When Sir George Airy, the British royal astronomer, determined the longitude of Valentia, the little island off the coast of Kerry, he had no fewer than 30 chronometers carried backwards and forwards between Valentia and Greenwich Observatory 22 times before he was satisfied.—*The Marconi-graph, London.*

A NEW ROAD OVER THE ALPS

Referring to the new Lötschberg electric railroad which crosses the Alps, it is probable that the electric locomotive trams will commence to run in the spring of 1913. Tourists will welcome this event, as they will then see some of the most attractive Alpine scenery, for the new road is to take the first rank as to the beauty of the route, and the great tunnel adds to the interest. The new electric locomotives will be more powerful than any of the steam locomotives now in use, and are to make higher speeds than on the rival St. Gothard or Mount Cenis lines. In fact, two steam locomotives would be needed to take the international 340-ton trains up the steep grades, where one of the new electric locomotives will now do it. The entire length of the railroad is 45 miles, and it mounts up to a very high point in the Alps, then descends into the Rhone valley and connects with the Simplon line. Along the route is the new electric cable incline up to the lofty summit of the Niesen, and at another

point is the Adelboden winter resort at Blue Lake. — *Revue Polytechnique, Switzerland.*

WIRELESS IN THE SOUTH SEAS

The German government has just granted a concession to the Telefunken and the German-Holland telegraph companies to build and operate two large wireless telegraph stations in the German colonies in the South Seas. The stations, which are to be laid out on the Telefunken system, will be located at Yap-Rabaul in New Guinea and Apia in Samoa, and will be valuable in making connections between leading points in the colonies, and also with the landing stations of telegraph cables. The two wireless stations will be equipped with the most recent high power apparatus, and will use about 120 horsepower. The steel towers are about 400 feet high. With the present stations it is expected to cover over-sea distances of 2,500 miles.—*London Electrician.*

EXPLOSION OF RADIUM

An explosion of radium is a somewhat unusual occurrence, and this is fortunate, for it is likely to cause a severe accident. M. B. Jost, a German scientist, was working with radium bromide in connection with one of his detecting screens of the kind which lights up or shows sparkles where the active particles of the radium bombard it. He had taken up a very small grain of powerful radium composition on the point of a knife and brought it near the screen, when it exploded with some noise and sent showers of powder to all sides. Some of it struck the screen and caused a fine display of sparkles, but the powder also entered his eye and caused much inflammation, which was difficult to cure. An explosion of unconfined radium has not been observed before, and he thinks it is due to gas from the radium collecting inside the solid particle. Before this, however, a radium tube belonging to M. Precht exploded, and this was also due to the pressure of the gas.—*Cosmos, Paris.*

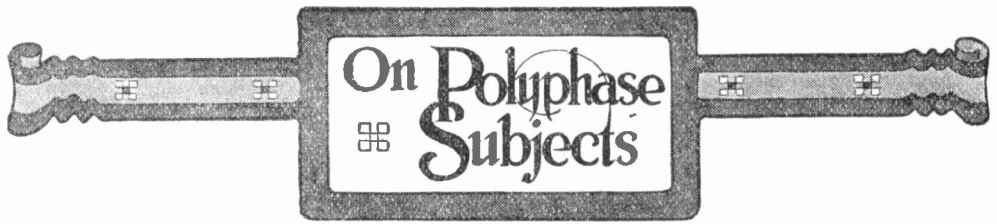

On Polyphase Subjects

Hon. O. P. Austin, chief of the Bureau of Statistics, Department of Commerce and Labor, in a recent address, cited the fact that the United States stands first in facilities of communication. We have twice as many miles of telegraph as any other country of the world, and every city and factory of the country is within speaking distance of every continent and great trading center of the world. In the number of telephone messages sent the United States surpasses the total for all Europe combined.

United States First in Communication Facilities

The Bureau of Standards has just issued a bulletin on the kilowatt equivalent of horsepower. The most frequently quoted equivalent in watts until now has been 746. Since, however, the pound weight as a unit of force varies in value as the acceleration of gravity varies, the number of foot pounds per second in a horsepower accordingly varies with the latitude and altitude. It is equal to 550 foot pounds per second at 50 degrees latitude and sea level, approximately the location of London, where the original experiments were made by James Watt to determine the magnitude of the horsepower.

The Continental horsepower, which is used on the continent of Europe, differs from the English and American horsepower by more than one per cent. Its usual equivalent in watts is 736. This difference is due to the confusion which exists in the weights and measures of 100 years ago. The metric system soon placed the various values of the horse-

power in terms of 75 kilogram meters per second, although the original English equivalent would be 76.041 kilogram meters per second.

Since a unit of power should represent the same rate of watts at all places, the Continental horsepower is best defined as 736 watts, which is equivalent to 75 kilogram meters per second at latitude 52 degrees 31 seconds. In the future 746 watts will be used as an exact equivalent of English and American horsepower.

Only those cool, self confident servants of science who take charge of our central generating stations know what terrific forces they are dealing with, and what the consequences of a single mistake will be. There is no quarter for these men, no time to draw back or to retrieve an error; the imprisoned giant knows no mercy, and with a single switch thrown in at the wrong moment, which inadvertently gives him a path of escape, he shakes off his bonds and wreaks havoc and destruction around him.

It is only when one has stood on the switchboard gallery of one of our large central stations in any of our big cities, and has been a principal actor in one of these shutdowns—as they are technically called—and has heard the vicious snap of a high tension short, and has smelled the never to be forgotten odor of copper reduced to its elemental gases, that one fully realizes the tremendous force we have at our disposal and the colossal impudence of man in daring to capture and train this mighty force as his slave.

A Giant That Knows No Mercy



“That get-rich-quick man is as busy as a bee.”

“Yes,” replied Mr. Cumrox. “He’s one of those busy bees who can’t manage to gather honey without incidentally stinging somebody.”

* * *

Teacher—“Now that you have learned about the rhinoceros, can you tell me any other animal that has a horn and is dangerous to mankind?”

Pupil—“Please, yes—an automobile.”

* * *

Knicker—“Which end of a cow gets up first?”

Butcher—“It all rises at once.”

* * *

Frightened officer—“Stand till the last ditch, my brave men. Don’t run until you have to. But as I am a trifle lame I—I think I will start now.”

* * *

A belated automobilist, whose car got to comotor “attacksia” miles from anywhere at 2 a. m., knocked at the door of the only house in sight.

“Who’s there?” asked a voice from the upper window.

“A traveler,” was the reply.

“Then travel.” And the window closed with a bang.

* * *

A man went to an insurance office to have his life insured the other day.

“Do you eyele?” the insurance agent asked.

“No,” said the man.

“Do you motor?”

“No.”

“Do you then, perhaps, fly?”

“No, no,” said the applicant, laughing. “I have no dangerous—”

But the agent interrupted him, curtly. “Sorry, sir,” he said, “but we no longer insure pedestrians.”

* * *

Three-year-old Eleanor was given a dime as a reward for docility in taking a dose of medicine. The next day her elder brother offered her a nickel to pick up a basket of chips in his place. “Hm!” refused Eleanor, “I can make more than that taking castor oil.”

Father ruefully gazed on his last shilling. “Money has wings, and house rents make it fly,” he said.

“Yes,” said his 15-year-old son, “and some houses have wings, for I’ve seen many a house fly.”

“You’re smarter than your old dad, maybe, my son, but I always thought that no part of a house except the chimney flue!”

* * *

Love has been described as “an inward indescribability of an outward all-over-ishness for a girl.”

* * *

The only thing that could be worse than a toothache and earache at the same time would be rheumatism and Saint Vitus’ dance.

* * *

A very pretty but extremely slender girl entered a street car and managed to seat herself in a very narrow space between two men. Presently a portly colored manny entered the car and the pretty miss, thinking to humiliate the men for their lack of gallantry, arose.

“Aunty,” she said, with a wave of her hand toward the place she had just vacated, “take my seat.”

“Thank you, missy,” replied the colored woman, smiling broadly, “but which gen’man’s lap was you sittin’ on?”

* * *

Mr. Wise—What would you do for me if I’d give you something to eat?

Willie Wantajob—I can saw some wood for you.

Mr. Wise—I have no wood; we do all our cooking by electricity.

Willie Wantajob—Well, you could let me turn on the electricity.

* * *

The First Burglar—Wot abaht the bloom-in’ burglar alarm?

Second Burglar—May as well put it in the bag, we can get something for the bells, p’taps.

* * *

“Is there anything you can do better than any one else?”

“Yes,” replied the small boy, “I kin good my own writing.”



C. DEBAIL

Common Electrical Terms Defined

In this age of electricity everyone should be versed in its phraseology. By studying this page from month to month a working knowledge of the most commonly employed electrical terms may be obtained.

STRAIN INSULATOR.—A form of insulator inserted in the guy wires of a trolley line or at the ends of the antenna of a wireless aerial.

STRAY FIELD.—The lines of force from the field poles of a dynamo or motor through which the wires of the armature do not pass, these lines being scattered and wasted.

STRAY POWER.—The energy lost in driving a dynamo, due to friction windage, etc.

STRIKING DISTANCE.—The space between two conductors at which a spark just begins to jump across.

SUB-STATION.—An electric plant receiving current from a main generating plant some distance away, and designed to supply consumers in the immediate neighborhood.

SULPHATING.—The formation of a coating of sulphate of lead upon the plates of a storage battery.

SWITCHBOARD.—A board usually of slate or marble upon which are switches, voltmeters, ammeters, etc., for opening and closing circuits connected to it and for measuring the voltage and current. The board may be a center of electrical distribution for a plant, station, building, etc.

S. W. G.—Abbreviation for Standard Wire Gauge.

SWINGING GROUND.—A ground upon a telegraph or other electric circuit in which the connection to earth is intermittent, usually due to wind blowing the wire.

TACHOMETER.—An instrument for finding at any instant the number of revolutions per minute of a shaft. The readings are read directly from a dial.

TANGENT GALVANOMETER.—(See Galvanometer.)

TEAZER.—A coil of fine wire wound on the field magnets of a dynamo and connected in shunt across the main circuit.

TELEGRAM.—A message sent by telegraph.

TELEGRAPH KEY.—A pivoted metal lever with a finger rest, used to close and open a telegraph circuit by pressing or releasing the lever.

TELEPHONE.—An apparatus for the transmission of speech by the use of electric current.

TELEPHONE EXCHANGE.—An office in which are centered the lines of a number of telephone subscribers, these lines being so arranged on a switchboard that any subscriber may be placed in communication with any other.

TERMINAL.—A name applied to the end of an electrical conductor and sometimes to the poles of a battery.

TERMINAL VOLTAGE.—The voltage of an electric generator at the point where the feed wires are connected to it.

TESLA COIL.—An induction coil for giving a high voltage and high frequency. It consists of a primary coil of only a few turns connected to the secondary of a spark coil, a spark gap and condenser in parallel across the connecting wires, and a secondary coil of fine wire.

THERMO-ELECTRIC PILE.—In 1822 Seebeck found that a current may be produced in a closed circuit by heating a point of contact of two dissimilar metals, such as bismuth and antimony. A number of pairs of these metals joined together form a thermo-electric pile, which is a valuable instrument in detecting differences of temperature by a galvanometer placed in the circuit.

THREE WAY SWITCH.—A snap switch so constructed that connection can be made from one wire to either of two other wires. Used to control lights from two different points.

THREE WIRE SYSTEM.—A system of feeders, invented by Edison, consisting of three main wires from the dynamo or generating station. Lamps are connected between each outside wire and the middle wire called the neutral. With lamps equally divided between the two sides no current flows through the neutral. With all the lamps on one side of the neutral wire all the current goes through the neutral. (See cut.)

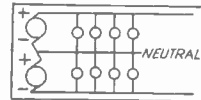

Three Wire System

TICKER.—A telegraph instrument for automatically printing information regarding stock, baseball, etc., upon a paper tape. Subscribers for these devices are stock and grain brokers, clubs and persons desiring to be kept in close touch with this kind of information.

TORQUE.—The turning force which acts upon or is exerted by the armature of a dynamo or motor.

TRANSFORMER.—A device used on alternating current to step the voltage up or down. The apparatus consists of a primary and a secondary coil wound upon a soft iron core.

TROLLEY.—A rolling metal wheel that runs on an overhead wire, taking current off for operating an electric car.

TRUNK LINES.—The lines in a telephone exchange connecting different sections of the switchboard or running between exchanges.

TURNS.—Applied to the windings of a wire about a solenoid, electro-magnet or like apparatus. A wire wound six times about a bar is said to contain six turns.

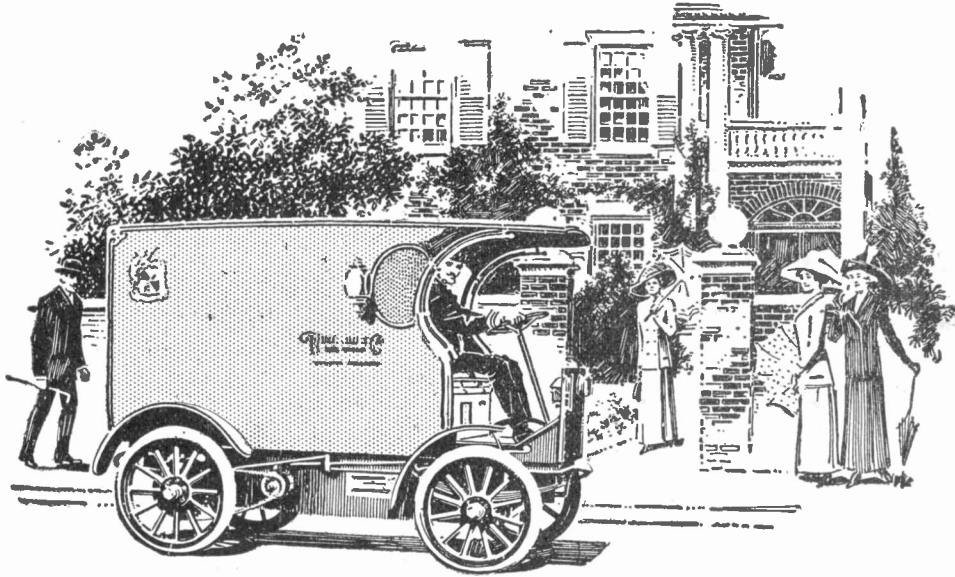

Does Your Delivery Service Advertise Your Business?

Electric Delivery Wagons will give you a higher name and fame among the entire community. The sight of an Electric Delivery Wagon is a positive relief—it is so clean, noiseless, dignified and efficient. It suggests to the public that the merchant who uses Electric Delivery Service is the sort of merchant to trade with. This is *one* big advantage to you in using Electric Vehicles—the valuable amount of advertising which their use will bring you.

Electric Delivery Wagons Will Save You Money

One Electric will do the work of several horse-drawn wagons—hence you can make more and quicker deliveries.

An Electric Delivery wagon is not affected by the elements, heat or cold—it does not have to rest, one day in five, like a hard worked horse.

An Electric consumes power only when

actually in operation—hence it is economical for your kind of service which necessitates frequent stops. Any driver now in your employ can quickly and easily learn to operate an Electric—you don't have to break in new men to learn your routes.

Power for operating Electric Vehicles is cheaper than that for any other type—and it is constantly decreasing in cost.



Upon request, this Association will gladly send you interesting literature about Electric Commercial Vehicles. Write today.

Public interest and private advantage both favor the Electric

ELECTRIC VEHICLE ASSOCIATION OF AMERICA
 BOSTON NEW YORK, 124 W. 42nd St. CHICAGO

(8)



Your Telephone Horizon

The horizon of vision, the circle which bounds our sight, has not changed.

It is best observed at sea. Though the ships of today are larger than the ships of fifty years ago, you cannot see them until they come up over the edge of the world, fifteen or twenty miles away.

A generation ago the horizon of speech was very limited. When your grandfather was a young man, his voice could be heard on a still day for perhaps a mile. Even though he used a speaking trumpet, he could not be heard nearly so far as he could be seen.

Today all this has been changed. The telephone has vastly extended the horizon of speech.

Talking two thousand miles is an everyday occurrence, while in order to see this distance, you would need to mount your telescope on a platform approximately 560 miles high.

As a man is followed by his shadow, so is he followed by the horizon of telephone communication. When he travels across the continent his telephone horizon travels with him, and wherever he may be he is always at the center of a great circle of telephone neighbors.

What is true of one man is true of the whole public. In order to provide a telephone horizon for each member of the nation, the Bell System has been established.

**AMERICAN TELEPHONE AND TELEGRAPH COMPANY
AND ASSOCIATED COMPANIES**

Every Bell Telephone is the Center of the System.

For our Mutual Advantage mention Popular Electricity when writing to Advertisers.

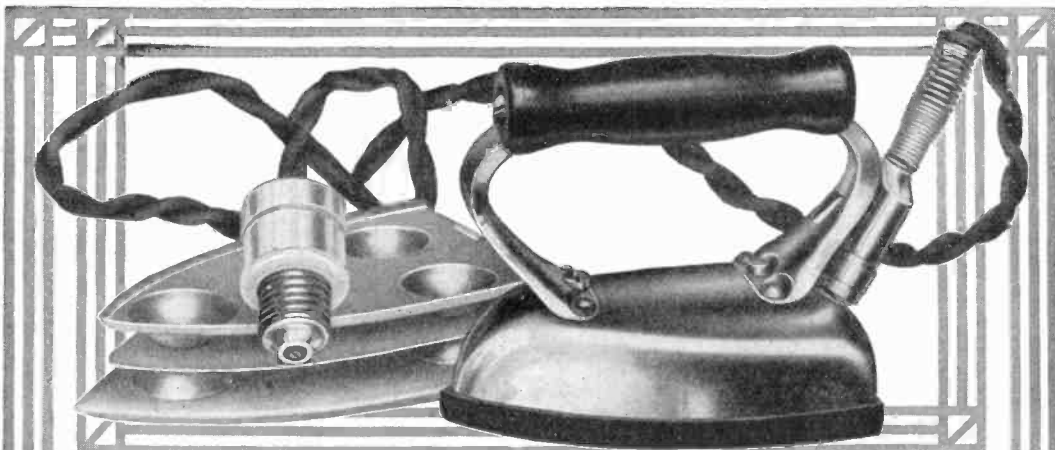

You Cannot Judge the Westinghouse Electric Iron By the Use of Any Other Electric Iron

MANY women who have discarded other electric irons make the mistake of putting all electric irons in the same class.

The Westinghouse Electric Iron is the one absolutely dependable electric iron. You get an iron-clad guarantee with it. If anything whatever happens to it you get a new iron without question.

Experienced laundresses will tell you that the smooth, *natural* ironing surface is by far the best. That is what you get in the Westinghouse Iron. No imperfections that have to be covered by nickel plating.

We want your name if you have electricity in your home. We want to tell you all the good points of the Westinghouse Iron and tell you how we protect each purchaser of the iron. Write "Westinghouse Household Dept. F, East Pittsburgh, Pa."

Westinghouse Electric & Manufacturing Company
Pittsburgh

Sales Offices in 45 American Cities

Representatives All Over the World

If Electricity Were a Liquid

IF electricity were a liquid you could see the leaks.

If you are reading this by the light of an old style incandescent lamp there's a big leak near you—in the lamp. You can't see it. But two-thirds of the current available for light is dripping away.

Are you paying for it?

Before the National Mazda lamp was perfected every user of incandescent lights was obliged to pay for current that never did him any good. Every carbon lamp leaks. National Mazda lamps stop the leak.

With the same amount of current, a National Mazda lamp will give you three times as much light as a carbon lamp.



NATIONAL MAZDA THE QUALITY LAMP

With National Mazda lamps the New York Subway is now three times as brilliantly lighted as it used to be—but the cost for current has not been increased a penny. On fast, bumping trains National Mazda lamps are being pounded all the time, yet they do not break, and continue to give their triple volume of light.

National Mazda lamps made it possible to light automobiles by electricity, because they can be operated by small equipment carried in the car. Carbon lamps cannot—too much current leaks away.

National Mazda lamps are being used in the humblest houses as well as in the finest residences, offices, factories, stores and in electric signs.

Wherever more light, better light, whiter light is needed, National Mazda lamps give it—three times as much as carbon lamps—at the same cost for current. If your home is lighted by electricity this is your personal problem—see that you use current wisely—in National Mazda lamps. They fit any socket, burn in any position, stand shocks and jars, don't fall noticeably in efficiency, don't discolor with age, and give a more bountiful and delightful illumination than you can possibly get from carbon lamps. Now you can have three times as much light, or one light three times as long, or light three rooms instead of one—without paying any more for current—with the lamps that do not leak—National Mazda.

THE NATIONAL INDEX TO THE PROPER LIGHTING OF HOMES—a Book for Users of Electric Light

If your house is wired, all the possibilities of National Mazda lighting are open to you. This book is valuable because it tells how to select National Mazda lamps for every room in the house, and how to get the most light for your money. It is the first real Index to the proper lighting of homes, and all users of electric light should have it. It is free. Send for it.

Stores, Offices and Factories
Experts from our staff of Illuminating Engineers will be pleased to consult or correspond with architects, builders and owners of Stores, Factories, Office Buildings and other large institutions where the most efficient illumination is desired.



ELECTRIC SERVICE IN THE HOME—a Book for Those Who Want Electric Light

If your house is not wired you can have it wired with less trouble and expense than you think. This book, published by the National Electric Light Association, will show you how to increase the value of your house—for use or for sale—by modernizing it with National Mazda Electric Lights. Electric lighting with National Mazda lamps is as cheap, all things considered, as lighting with oil or gas. Send for this book.



of General Electric Co.

4403 Hough Avenue
Cleveland

We are makers of all types of incandescent lamps, including carbon lamps

Where You Can Get These Lamps

National Mazda lamps are packed in blue cartons like that shown on this page. Each carton contains five lamps. Lighting Companies and thousands of electric stores sell them.

If you buy single lamps, get them from this carton.



**Razors
that
shave**

Knives that cut

Keen Kutter Safety Razors guarantee a *real shave*. Made with a "hang," these safety razors fit the natural shaving motion. The result is firm control over the razor and the beard is removed with clean-cut strokes.

Keen Kutter blades are made of the finest Swedish steel, ground with great accuracy, and are thick enough to hold their own against the stiffest beard.

The Keen Kutter Junior is wonderful value at \$1.00, which includes case, razor and seven blades. The Keen Kutter regular razor is slightly longer and different in pattern, with silver-plated frame and genuine black leather case. with 12 blades.



No. K1
Price \$3.50
Gold Plated
Price \$5.00

KEEN KUTTER

Thumb the blade of a Keen Kutter Pocket Knife and feel the keen, true edge. Buy it, use it for tough work or fine, and that edge *stays*. It lasts an incredibly long time without sharpening. When it is sharpened, if you find a flaw, take it where you bought it and your money comes back in a jiffy, without an argument. That's the Keen Kutter way of *proving* the quality of Keen Kutter tools—as well as pocket knives.

"The Recollection of Quality Remains Long After the Price is Forgotten."
Trade Mark Registered. —E. C. SIMMONS.

If not at your dealer's, write us.

Simmons Hardware Co. (Inc.)
St. Louis and New York
U. S. A.

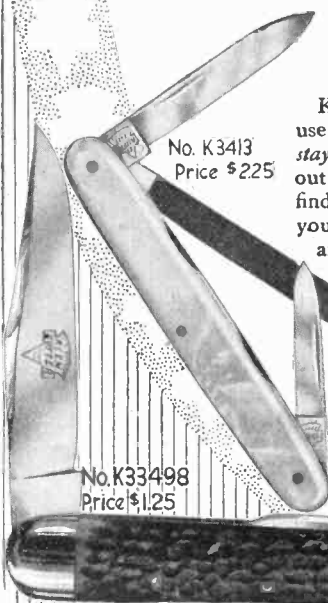

No. K3413
Price \$2.25

No. K33498
Price \$1.25



No. KJ10.
KEEN KUTTER
Junior with
7 Blades & Case
Price \$1.00

CLASSIFIED ADVERTISEMENTS

The cost of advertising in this section is 5 cts. per word.

All Classified Discounts Have Been Discontinued

Remittance must accompany order,
or advertisement will not be inserted.

Forms for the November issue close October 1st.

AERONAUTICS

COMPLETE PLANS DRAWN TO SCALE, accompanied by clear, concise building instructions: WRIGHT 3 ft. Biplane, 25c; BLERIOT 3 ft. Monoplane, 15c; "CECIL PEOLI" Champion Racer (official record 1,691 feet), 25c; "IDEAL" three foot Racer (new), 15c. Send 5c for most complete 40 pp. illustrated catalog, including rules for contests. IDEAL AEROPLANE & SUPPLY CO., 86B West Broadway, NEW YORK.

AGENTS WANTED

SMALLEST ALARM CLOCK, 10c POST-paid. W. H. Garner, B-119 South Lafayette St., Evansville, Ind.

GOOD IDEAS FOR AGENTS, MAIL ORDER men, general dealers, 10c. E. Tepper, 146 Marcy Ave., Brooklyn.

AGENTS, COST 2c, SELL 25c. SIGN LETTERS put on with roller. Sample free. Embossed Co., 2493 Milwaukee, Chicago.

AGENTS, TRY OUR UP-TO-THE-MINUTE window letters. None "just as good." Slann Sign System, 1579 St. Antoine, Detroit, Mich.

900 PER CENT PROFIT ON LIGHTNING interest table and calculator. Send 10c for outfit. Sells \$1.00. Naylor, 404 Ft. Wayne, Ind.

DON'T ACCEPT AN AGENCY UNTIL YOU get my samples and particulars. Money makers. Address SAYMAN, 706 Sayman Bldg., St. Louis, Mo.

STRIKE WHILE IRON IS HOT; ONE agent sold 577 dozen in 15 days; you can do as well. Manufacturers' Supply Co., Marshall, Minn.

AGENTS. STOP. LOOK. LISTEN. SELL the Excelsior, the best hand vacuum cleaner made. Big money. Big season just opening. Excelsior Mfg. Co., Logansport, Ind.

MANUFACTURE YOUR OWN GOODS. WE start you, furnishing everything for \$1. Wonderful opportunity. Big profits. Budlong Co., Box 157, Providence, R. I.

SAY, MR.! LOOK AT THIS WINNER. I offer it to you. Take hold now; profits big; easy work, free particulars. David Supply Co., Box 190, Casper, Wyo.

AGENTS — SALESMEN — SEASONABLE seller, latest \$3.50 electric invention, fills demand never before supplied; home, office, store, everywhere eagerly sought; repeat orders outnumber first sales; you control territory; no competition; unlimited possibilities. Write Frank W. Alden, Agency Manager, 224 Station F, Cincinnati, Ohio.

AGENTS WANTED

SEE WHAT I SAY UNDER "TYPE-writers." ATCHISON.

SEE DISPLAY AD, PAGE 53. DOUD Lighting Co., Chicago.

AGENTS. THE PEOPLE WANT THE Hoosier. It's the leader in hand vacuum cleaners. Write the manufacturers and get all the profit. Hoosier Mfg. Co., Logansport, Ind.

YALE AUTOMATIC ADDING MACHINE. All parts made of steel, nickel plated and warranted accurate. \$1.00 prepaid. Yale Mfg. Co., Dept. D-3, Newark, N. J.

\$250.00 PAID FOR DISTRIBUTING 2,000 free packages perfumed soap powder in your town. Men or women. No money required. Ward & Company, 1776 Berceau Ave., Chicago.

AGENTS MAKE \$30 WEEKLY; PERMANENT, easy work; experience unnecessary; particulars free. Pals Manufacturing Company, B-25 East 14th Street, N. Y. City.

CHANGE THE TONE OF YOUR PIANO TO mandolin tone at will with our mandolin attachment. Price \$1.50. Agents wanted. Mandopiano Co., Detroit, Mich.

EVERY HOUSEWIFE WANTS OUR PATENTED fast-selling specialties. Catalogue and sample free. C. Findly, 5923 Bertha Ave., St. Louis, Mo.

TO SELL OUR NEVERLOSE KEY TAG, made of German silver and our Ever Ready Cigar Lighter, sample lighter 40c; key tag 10c; both for 45c. Stamps taken. B. W. Miller Co., 90 S. College St., Akron, O.

\$2.50 PER DAY PAID ONE MAN OR woman in each town to distribute free circulars and take orders for concentrated flavoring in tubes. Permanent position. J. S. Ziegler Co., 445-B Dearborn St., Chicago, Ill.

DON'T ASK YOUR WIFE FOR MONEY—be independent—sell the new TAFT-ROOSEVELT-WILSON pencils. Quick sales. Immense profits. Samples and terms 10c silver. Burton E. Osborne, Camden, New York.

AGENTS EVERYWHERE. I HAVE A high-class auto specialty, mends a punctured tire in a minute. Good money for you. Write for booklet. Reliable Mfg. Co., 64-66 Ave. "C," New York.

WE WISH TO EMPLOY A FEW BRISK, wide-awake men to sell our new sanitary clothes case to the wholesale and retail trade in city and country; low prices; quick sales, large profits; no experience required; steady reliable employment. We are manufacturers. Write for particulars. Waks Mfg., 24 Miller Bldg., Cincinnati, Ohio.

MAKE \$21 NEXT SATURDAY. SELL THE Marvel Vaporizer for coal oil lamps. Fits any lamp—makes brilliant white light—no smoke or smell. Selling like wildfire—agents excited. Glasscock, Ark., made \$554 in few days. Kreiger, Mo., made \$21 Saturday. Write quick for proposition. Fairchild & Co., 473 Nasby Bldg., Toledo, Ohio.

PORTRAITS — PHOTO PILLOW TOPS, photo china plates, frames, sheet pictures, etc., at prices below lowest; guaranteed; rejects credited; prompt shipments; 30 days' credit; catalogue and samples free. Jas. C. Bailey, Desk M-7, Chicago.

AGENTS WANTED

AGENTS—PORTRAITS 35C, FRAMES 15C, Sheet Pictures 1c. Stereoscopes 25c. Views 1c. 30 days' credit. Samples and catalog free. Consolidated Portrait Co., Dept. 1406, 1027 W. Adams St., Chicago.

QUALIFIED MEN AND WOMEN, HIGH grade educational specialty, travel in south during winter, work backed by twenty-five years' success. Write today. Lewis E. Myers, Chautauqua Park, Valparaiso, Ind.

BOKARA DIAMONDS—AGENTS, EVERYONE, to wear and sell our famous bokara diamonds. Write for sample offer and catalogue free. Northwestern Jewelry Co., 1123 Wilson Ave., Chicago.

AGENTS—GET PARTICULARS OF ONE OF the best paying propositions ever put on the market. Something no one else sells. Can make \$4,000 yearly. E. M. FELTMAN, Sales Manager, 6156 Sycamore St., Cincinnati, O.

WANTED—LADY OR GENTLEMAN IN every community as demonstrator and sales agent. Permanent business for hustlers, paying \$6 to \$10 daily, with promotion to road work. DeKay Manufacturing Co., Memphis, Tenn.

DEVOTE SPARE TIME TO DIGNIFIED selling proposition; pocket sample; simply show the goods, they sell themselves. Write now for exclusive territory. Universal Case Register Company, 610 15th St., Detroit, Mich.

BIG PROPOSITION TO AGENTS. SOMETHING new. Helios pocket pen with compressed ink. Writes with water. Sample 25c postpaid. Everybody wants one. An immense Christmas seller. Wm. Muller, 419 Pine, San Francisco.

AGENTS MAKE BIG MONEY SELLING our new gold letters for office windows, store fronts and glass signs. Anyone can put them on. Write today for a free sample and full particulars. Metallic Sign Letter Co., 400 N. Clark St. Chicago, Ill.

BE INDEPENDENT! START A MAIL order business in your own home. We tell you how and furnish everything needed wholesale. An honorable and profitable business for man or woman. Particulars free. Many make \$3,000 a year. Murphy Mfg. Co., South Norwalk, Conn.

500 PER CENT PROFIT—YOUR OPPORTUNITY. Act now. Buyers everywhere for our U. S. Fire Extinguisher. Low cost; fast seller; sure profits; exclusive territory. District managers wanted. United Mfg. Co., 1135 Jefferson, Toledo, O.

AGENTS WANTED—SELL RICH LOOKING imported 36 x 68 rugs, \$1 each. R. H. Carter, Milan, Tenn., sold 115 in four days; his profits, \$57. You can do as well. Write for sample offer and unique selling plan; exclusive territory. R. Condon, Rug Importer, Stonington, Maine.

SIGN AGENTS—PAINTERS—SOMETHING new and better. Attracto ready-made Gold and Silver Letters. 21 kinds, easily applied. Make big money lettering store windows and selling sparkling chipped glass name plates. Catalogue and sample letter FREE. ATTRACTO SIGN CO., 2649 N. Clark St., Chicago.

AGENTS WANTED

PERFECTION POCKET ADDING MACHINE—Lightning seller; agents wanted. Cincinnati Specialty Mfg. Co., Dept. E, Cincinnati, Ohio.

YOU ARE LOOKING FOR MORE LONG green, you doubtless deserve it, and willing to work for it. Our soap and toilet article combinations have every ear-mark of being the real Coin Getters,—we can prove that they are. Write for our convincing proofs. Davis Soap Works, 263 Davis Bldg., Chicago.

AGENTS—SOMETHING NEW—FASTEST sellers and quickest repeater on earth. Permanent, profitable business. Good for \$50 to \$75 a week. Write for particulars. AMERICAN PRODUCTS CO., 6157 Sycamore St., Cincinnati, O.

WE MANUFACTURE GLASS PAPER. Plain glass windows made to look like real stained glass. Easily applied and beautifies the home. Something new for agents. Two sheets of this glass paper sent as a sample with catalogue in colors and complete instructions on receipt of 10c. S. H. Parrish & Co., 202 S. Clark St., Chicago.

AGENTS: HERE'S A PROPOSITION which sells itself; the agent don't hold the bag; we guarantee the sale; wonderful new invention; sells like fury at 75 cents; on market few weeks; swamped with orders now; everybody wants territory; poor salesmen making \$10 daily; good ones coining money; write quick. Lyon Sales Co., Dept. 104, Waterloo, Illinois.

AGENTS—TO SELL THE NEWEST Electric appliance on the market; sold everywhere there is electricity, in the home and office; liberal profits; sales-driving sample weighs a pound; no experience or knowledge of electricity required; it shows how to use one light instead of two and get the same results; sells for \$3.50 and saves the purchaser an investment of \$25; write for particulars. The Handy Light Co., 212 Handy Light Block, Cincinnati, Ohio.

AUTOMOBILES

AGENTS WANTED. NEW DEVICE, MENDS inner auto tubes; 2 minutes. No cement or patches. Particulars free. Hoy Bastian, Willshire, Ohio.

AUTOMOBILE MARINE MOTORCYCLE cylinders reground; new pistons and rings fitted. Makes engines equal to new. Write for particulars. CAST IRON BRAZING CO., Manchester, N. H.

REPAIR YOUR PUNCTURES IN ONE MINUTE with the Cinch Tire Repair Kit. Not affected by heat or cold. Regular price \$5.00; our price, \$3.50 prepaid. Putnam Distributing Agency, Box 250, Greenwich, Conn.

AUTOMOBILE BARGAINS. LOWEST prices and largest list in the world. All guaranteed, shipped freight prepaid, get my prices before purchasing. Runabouts, Oldsmobile, Reo, Cadillac, \$50; Fords, Buicks, \$150; Touring cars, Cadillac \$90; Reo \$150; Buick \$175; Winton \$275; Pope Toledo \$300; Ford \$300; Maxwell \$275; I have all makes on hand. I desire agents to sell my cars, write for Special Agents proposition at once. P. E. King, 217 West 125th St., New York City.

COINS AND STAMPS

FOREIGN STAMPS. TEN SETS (85 Different), 10c with approval sheets; 1,000 mixed, only 20c. F. J. Stanton, (E) Norwich, N. Y.

205 DIFFERENT FOREIGN STAMPS FREE by remitting 25c, six months' subscription Me-Keel's Stamp Weekly, Boston, Mass. Or 98 different United States.

OLD COINS BOUGHT AND SOLD—MY NEW 50 page fall coin selling catalogue just out. Free to collectors only. Buying coin catalogue sent on receipt of 10c. William Hesslein, Malley Bldg., New Haven, Conn.

\$3.00 PAID FOR THE RARE CENT OF 1856, \$25.00 for the rare silver dollar of 1858. Keep money dated before 1890 and send 10 cents for new coin value book. A. H. Kraus, 232 Kraus Bldg., Milwaukee, Wis.

FOREIGN STAMPS FREE! 100 DIFFERENT or if preferred a grand set of 10 Egyptian. Mention Gift C. 302, send 4c postage. "A. B. C." illus. priced catalogue, 870 pp., 5,000 illus., 70c, post free. Bright & Son, 164, Strand, London, Eng.

OLD COINS. \$7.75 PAID FOR RARE DATES 1853 quarters; \$20 for half dollars; we pay a cash premium on hundreds of coins; keep all money dated before 1884 and send 10 cents at once for our illustrated coin value book, size 4 by 7; it may mean your fortune. C. F. Clarke & Co., Coin Dealers, Dept. 83, LeRoy, N. Y.

FOR SALE

PONIES. MANY BREEDS STOCK. DOGS. Catalog. Beachhurst, Shelbyville, Ky.

COIN CARDS AT \$1.75 PER THOUSAND. Send for samples. Acorn Card Co., Auburn, N. Y.

ELECTRICAL GOODS, ALL KINDS; HOUSE wiring material a specialty. Price list free. Long Electrical Supply Co., Box 732, Roanoke, Va.

FOR SALE—GRAIN AND DAIRY FARM OF 560 acres. Write to Rudolph J. Udlinek, Fort Clark, No. Dakota.

FOR SALE—ENGRAVE NAME ON KNIFE blade, tools, bicycle or wireless. Complete outfit 10c. Reichart Electrics Mfg. Co., La Fayette, Ind.

REGISTERED ENGLISH BLOOD HOUNDS—puppies and grown dogs. Best blood. Max J. Kennedy, Fredonia, Kansas.

EVERYTHING BOUGHT AND SOLD. WHAT have you or what do you want? A. C. Remson, Dept. 52, Talladega, Ala.

SIMPLE WAY REMOVING CORN AND bunion over night without cost, pain, knife, medicines or harm. Information, \$1. College Pharmacy, East Lansing, Mich.

YOUR NAME AND ADDRESS STAMPED on German silver key check, 25c. Silver Key Chain free. L. D. Thompson Co., 3159 La Salle St., Chicago.

SENT FREE—SOFT HATS FROM FACTORY. Send postal for catalogue, showing big saving, and hat making; five correct styles worn. Oxford Hat Mfg. Co., Seymour, Conn.

FOR SALE, ONE WESTON AUTOMOBILE meter, reading 150 or 3 volts on full scale on one side and 100 amps. on other, complete with shunt, just been recalibrated. Price \$15.00. F. Streicher, 1227 Lincoln Ave., Pittsburg, Pa.

FOR SALE

I HAVE 50 NAMES OF AGENTS, Obtained from advertising, all from June 1912. Guarantee to have original letters. 25c coin or stamps gets them. H. Cohen, 66 Ave. "C," New York.

AMMETERS, 1,000 WATCH SIZE, NICKEL-plated, guaranteed, battery testers, in chamois leather cases. Read 0-30 amperes, 25c postpaid. Stamps taken. E. W. Electrical Co., 3525 Broadway, N. Y.

SATIN GOLD ENAMEL. HAS NO EQUAL for gilding kid, satin, buck and canvas slippers, decorating all fabrics, leather, burntwood, paper, illuminating, writing, lettering with brilliant lasting effects. Includes gold, silver, copper, blue, green, aluminum. Per pan, postpaid, 15c and 25c. Henry Chemical Co., Vallejo, Calif.

TATTOOING—IMPROVED ELECTRIC TAT-tooning machines, \$2.50 each. Sold with a guarantee. Cheapest and best line of tattooing supplies on the market. Send 15c for 6 beautiful hand colored tattoo designs. Write now for free price list. F. Barber, 1019 Vine St., Cincinnati, Ohio.

FORMULAS

TWO HUNDRED FORMULAS, HINTS, 35c. Emerson Supply Co., Minneapolis, Minn.

ANY FORMULA YOU WANT, 10c COIN. Horne, Greystone, R. I.

RECIPES AT 10c EACH FOR EVERYBODY. Address D. Tupper, Box 319, Los Gatos, Cal.

BUST THE COAL TRUST BY USING KOAL Saver, easily prepared; two formulas sent for 25c silver. Nic Jochem, Johnsburg, Ind.

FORMULAS AND RECEIPTS FOR ANY-thing, 25c each or 6 for dollar. Thos. Howard, 2420 South Elm, Spokane, Wash.

726 SELECTED FORMULAS AND TRADE secrets (in book form) 20c, or 382 for 13c. Catalog of cheap, decent, fascinating and instructive books for 1c stamp. White, Upland Place, Yonkers, New York.

GAMES AND AMUSEMENTS

HOW TO ESCAPE FROM ANY UNFAKED vault or safe—sent free. T. Torjusen, Sta. B-2, Memphis, Tenn.

SEND 10c FOR TWO STANDARD PUZZLES. and receive free, two card, two coin tricks, two joke novelties, with apparatus, and catalogues. Chicago Puzzle Works, 323 C. Eugenie St., Chicago.

PLAYS, VAUDEVILLE SKETCHES, MONO-logues, dialogues, speakers, minstrel material, jokes, recitations, tableaux, drills, entertainments, make up goods. Large catalog free. T. S. Denison & Co., Dept. 26, Chicago.

KER-CHU POWDER. A PINCH BLOWN into the air makes everyone just sneeze their heads off without knowing why. Great fun. Absolutely harmless. Sample vial 10 cents, three for 25 cents. Catalogue included. Joseph E. Mathieu, 203 Court St., Brockton, Mass.

FREE—1912 MAGIC CATALOG, 208 PAGES. illustrated. Send 6c for pocket trick and particulars. Magic Dept. 17, 270 West 39th St., New York.

GAMES AND AMUSEMENTS

STOP! DON'T YOU ENJOY A GOOD laugh? Send for Dribble glass; you can't drink from it without spilling contents on your shirt front—unless you know how. One passed to your friend to take a drink from will surely bring results. Fifty cents, postpaid, with big catalog of newest smile producers. Southern Sales Company, Box 297E, Berkley-Norfolk, Va.

INSTRUCTION

LEARN VENTRILOQUISM AT HOME. MY instructions complete. Particulars for stamp. Oliver N. Prince, Box B193, Birmingham, Ala.

BE A DETECTIVE. EARN FROM \$150 TO \$300 per month; travel over the world. Write to C. T. Ludwig, 201 Scarritt Bldg., Kansas City, Mo.

CROSS REAL ESTATE COURSE, \$3.00. George Winstel, 1624 Pleasant Street, Cincinnati, Ohio.

RAGTIME PIANO PLAYING TAUGHT BY mail. Book free. Christensen, 88 Auditorium Bldg., Chicago.

HOW TO OPEN ANY LOCK PIN-TUMBLER cylinder without keys, picks or tools. Wonderful. Valuable. Copyrighted instructions, \$1. Chas. E. Williams, Lock Box 1001, Atlanta, Ga.

START A MAGAZINE. POST CARD NOV- elty mail order business. Send 10c for samples. Full particulars. United P. E., 3 Henry St., Brooklyn, N. Y.

FOR 10 CENTS I WILL TELL YOU HOW to take the callous off your feet. No medicine used. Guaranteed. Geo. Geis, 354 Congress, Detroit, Mich.

GO ON THE STAGE, PARTICULARS FREE. Learn show card writing. Write for testimonials. Emerson Supply Company, 204, Minneapolis, Minn.

COMPLETE COURSE IN PENMANSHIP, bookkeeping, letter-writing, etc. All sent pre-paid for \$1. Williams Company, 721 Dearborn Ave., Chicago.

BUILD YOUR OWN FIRELESS COOKER; any boy can build one in an hour at a cost of \$1.50; illustrated plan and directions, 25c. E. W. Kimball, 2285 West 28th St., Los Angeles, Cal.

I WILL SEND YOU COMPLETE INSTRU- cions "How to Increase the Vocabulary and Enrich the Conversation," upon receipt of 25c coin. Joseph Greenberg, 25 Lewis Street, New York City.

UNCLE SAM IS A LIBERAL EMPLOYER. Qualify for a government position. We prepare you by mail for any civil service examination. Many vacancies now exist. Write today for free Booklet 49. Capital Civil Service School, Wash- ington, D. C.

SCIENTIFIC SODA WATER DISPENSING taught by world's largest soda fountain house. \$5,500,000 capital. Young men and women wanted at once to complete correspondence course. and fill waiting positions at high wages. Write The Liquid Carbonic Company, 229 W. Madison St., Chicago.

WILL MAKE FIRST-CLASS BOOKKEEPER of you in six weeks for \$3, or return money; distance, experience immaterial. J. H. Goodwin, Expert Accountant, Room 601, 1215 Broadway, New York.

INSTRUCTION

HOW TO RENEW OLD DRY BATTERIES at cost of 1c each. Send 15c coin to R. T. Kalb, 2631 Sutton Ave., Maplewood, Mo.

LEARN AT HOME A SALARY-RAISING handwriting from America's finest penman. Elegant specimen and journal free. Francis B. Courtney, Box B. 492, Detroit, Mich.

ELECTRICITY. ARE YOU INTERESTED? If so we can teach you all kinds of Wiring. from the simplest to the most complicated. By our Blue Print Chart Method. It is so simple any one can understand it. We show you how to wire for all kinds of Bells, Annunciators, Telephones, House Wiring, Conduit, Theatre, Isolated Plants, Dynamos, Transformers, Arc Lights. Special Treatise on all kinds of Motor Wiring. Write now for information. Electrical Wiring Diagram Co., P. O. Box 173, Altoona, Pa.

MAGIC

LEARN TO HYPNOTIZE AND MAKE FUN and money. Send for free book to M. D. Betts, Sta. 161, Jackson, Mich.

MISCELLANEOUS

TREE CACTUS, ETC. CIRCULARS, STAMP. Walter Smith, Vici, Okla.

SEE WHAT I SAY UNDER "TYPE- writers." ATCHISON.

ANSWER TO RIDDLE OF THE SPHINX; free. Warren Gares, Columbus, Ohio.

EVERYBODY! PREMIUM FREE. POST- age 3c. A. Ward, 6130 York Boulevard, Garvanza, Cal.

WRITE MOVING PICTURE PLAYS; WE'LL teach you; booklet for stamp. Photo-play, 167, Middleport, N. Y.

FRIEND, FOUND CURE FOR ASTHMA and hay fever. Particulars for stamp. "Haw- kins," Raton, New Mexico.

INCORPORATORS! SAVE MONEY, TIME, trouble. Strongest organization. Popular char- ter-guide, free. 206 Empire, Clarksburg, W. Va.

"PI, PO, PUZZLE," GREATEST NOVELTY out, fascinating, amusing, educating, 10c. Bauer, 133 East 34th, New York.

WILLS, AGREEMENTS SAFELY DRAWN, \$3.50; advice, alone, \$1.50; 20 years' practice. Mail fee with full statement. R. W. King, At- torney, Grant Building, San Francisco.

YOUR 25 WORD AD IN NEARLY 100 magazines for 75 cents. Extra words, 3 cents each. Sample magazine and list for stamp. Ad- Age, Big Flats, N. Y.

BROTHER, ACCIDENTALLY DISCOVERED Root will cure both tobacco habit and indiges- tion. Gladly send particulars. F. F. Stokes, Mohawk, Fla.

I WILL START YOU EARNING \$4.00 DAILY at home in spare time, silvering mirrors; no capital; send for free instructive booklet, giv- ing plans of operation. G. F. Redmond, Dept. H., Boston, Mass.

ANYBODY CAN MAKE GOOD CUTS WITH my simple zinc etching process; price, \$1.00; specimens and particulars for stamp. T. M. Day, Box E., Windfall, Ind.

SALESMEN WANTED

SALESMEN WANTED TO HANDLE THE Chase Shock Absorbers for Typewriters. Exclusive territory. Fine opportunity for the right men. The Chase-Dunipace Co., Toledo, Ohio.

SPECIALTY SALESMEN TO SELL BRAND new patented office convenience which fills demand never before supplied. No competition; sells at sight; large profits; exclusive territory. Elmer F. Goodwin, Sales Manager, Clarksburg, West Virginia.

WANTED—LOCAL OR TRAVELING SALES-men making small towns to handle our new attractive pocket side line. Quick shipments, prompt commissions, no collecting. State territory covered. For particulars address G. A. Johnson, 210 Sigel St., Chicago, Ill.

LARGE RETURNS FOR WHOLE OR PART time selling The Rapid Vulcanizer. Sells at sight to auto owners, garage and supply stores. Write for terms and territory. Complete outfit retails for two dollars. The Rapid Vulcanizer Co., 448 Com. National Bank Bldg., Chicago.

SCHOOLS

SEE WHAT I SAY UNDER "TYPE-writers." ATCHISON.

WHY NOT LEARN PHOTOENGRAVING, photography, commercial designing. High salaries. Thirty-second year. Bartholdi's Trade Schools, 92 Fifth Ave., New York.

WE TRAIN DETECTIVES. YOU CAN BE one. Splendid Opportunities. Travel. Earn \$100 to \$300 monthly. This fascinating profession taught practically and scientifically by mail at a nominal cost. American School of Criminology, Dept. G, Detroit, Mich.

EARN YOUR WAY THRU COLLEGE, either in the business college, or the engineering college or musical college departments. Write us for particulars at once. Logan Square College, Logan Square, Chicago.

AUTOMOBILE SCHOOL—LEARN THE AU-tomobile business, repairing and driving, in which you can earn good wages and have healthful and pleasant work. We give a thorough and practical course in road work and repairing. For full particulars address Academy of Automobile Engineering, 1420 Michigan Ave., Dept. "C," Chicago, Ill.

TELEGRAPHY

LEARN TELEGRAPHY. POSITION GUAR-anteed. Catalogue free. North-Western Telegraph School, Eau Claire, Wis.

TELEGRAPHY—MORSE AND WIRELESS—Railway Accounting (Station Agency) taught quickly. Railroad Dispatchers' and Western Union wires and complete Wireless Station in school. Splendid opportunities. Graduates assisted. Living expenses low—may be earned. Largest and oldest school—established 38 years. Investment \$25,000. Correspondence courses also. Catalog free. Dodge's Telegraph, Railway and Wireless Institute, 16th St., Valparaiso, Ind.

TRADE SCHOOL

PAINTING, DECORATING, PAPER HANG-ing, taught by actual practice. Free catalogue. Chicago School of Painting, 414 Dearborn Ave., Chicago.

TYPEWRITERS

TYPEWRITERS OF ALL MAKES—LOW prices; satisfaction guaranteed. Edward Quimby, Dover, New Hampshire.

FORCED TO SELL MY \$100.00 REMING-ton typewriter, good as new for \$17.50. Address Thomas Williams, 721 Dearborn Ave., Chicago, Ill.

STENOGRAPHER MUST SELL HER REM-ington typewriter, \$9.00. Miss King, 2230 Seventh Ave., New York City.

SPECIAL WHOLESALE PRICES—FIVE days' free trial, standard makes of typewriters, rebuilt Remingtons, Oliviers, Underwoods. Choice 300 makes, \$10 to \$15. Send for catalogue. Dearborn Typewriter Exchange, 107 Monadnock Bldg., Chicago, Ill.

THREE PENNIES A DAY, ONE DOLLAR A month, buys a standard typewriter. Your choice, Remington, Oliver or Smith Premier. Prices lower than other cash prices. Perfect machines only—guaranteed. Typewriter Installment Co., H 180 N. Dearborn St., Chicago.

BANKRUPT SALE—GREATEST SALE IN history of \$100 typewriters, standard makes, like new, low as \$10. Get one now and save the difference. Write for special price list No. 36. We pay expressage and allow three days' trial. Typewriter Inspection Co., 235 W. Fourth St., Cincinnati, O.

I WANT TO CORRESPOND WITH PERSONS who are about to buy a high-grade typewriter. object to paying the high prices generally asked by manufacturers and dealers. Any make on approval. Catalogue, bargain list and valuable information sent free. A. E. Atchison, 4125 West 21st St., Chicago.

LARGEST STOCK OF TYPEWRITERS IN America. All makes: Underwoods, L. C. Smiths. Remingtons, etc., one-quarter to one-half manufacturers' prices (many less). Rented anywhere, applying rent on price. Write for catalogue 102. Typewriter Emporium (Est. 1892), 32-34 Lake St., Chicago.

REMINGTON TYPEWRITER \$12; CALI-graphs \$6; Hammonds, Yost, Densmores \$10; Smith Premiers and Jewetts \$15; Oliver's, Underwood's, L. C. Smith and Royal's \$25. Fifteen days free trial, and one year's guarantee. Don't purchase until you get our prices. Harlem Typewriter Exchange Dept. E, 217 West 125th St., New York City.

WIRELESS

.005 MICROFARAD VARIABLE CONDENS-er, \$1. Greenhill Wireless Co., Jonesville, Mich.

WIRELESS APPARATUS—WHY NOT have the best when selecting the instruments for your station? We handle the best and most advanced type of apparatus on the market. Send 2c stamp for catalogue. The Merker-Flocker Electric Co., 957 Liberty Ave., Pittsburgh, Pa.

WIRELESS

MUST SELL COMPLETE 1 K. W. TRANSMITTING outfit. For particulars, address W. Ehrlich, 5333 Halsted St., Chicago.

WOODWORK FOR WIRELESS, ELECTRICAL and scientific apparatus. Hosbach Cabinet Works, 821 Cherry St., Philada., Pa.

RADIODILOCK, A NEW DIELECTRIC for variable condensers. Cut in circles or square, 10c postpaid, for 25 sheets. Allen Beacome, 174 West 95th St., New York City.

\$9.75 BUYS \$15.00 ¼ KILOWATT TRANSFORMERS. \$14.50 buys \$22.00 ½ kilowatt. Fully guaranteed. Nomus Electric Co., 1216 48th Ave., Cicero, Ill.

GUARANTEED DETECTOR STANDS \$1.00, and vertical zinc gap parts fully adjustable, 50c. Mite Novelty Wks., Box 161, Santa Barbara, Calif.

EXPERIMENTERS BRASS PER FOOT: ½-in. square, 8c; ¼-in. square, 12½c; 8-32 threaded, 12½c. Brass ribbon for helix, 3½c; ¼-in. tubing, 24c; spring brass, 20c. Hard rubber, sheet aluminum, glass plates, tin foil, copper and aluminum wire, \$22 enameled copper wire, 50c per lb. Instruments. Send for price list. Swain-Heiser Co., Rentschler Bldg., Hamilton, Ohio.

HELP WANTED

UNIQUE ENGINE, SMALL, POWERFUL and compact. See our display ad page 53. Amateur Mechanics & Supply Co., Chicago.

WANTED—INFORMATION REPORTERS; guaranteed \$600 yearly. No soliciting. Write James A. Palmer, Hudson Terminal Buildings, New York.

BE EXPERT DETECTIVE AND INVESTIGATOR. Many waiting positions at big pay. Stamp for particulars. National Detective Agency, Dept. 403-A, Chicago.

CAN FURNISH PERMANENT EMPLOYMENT to three educated Christian men, organizing ability necessary. State age and former occupation. Address, L. S. Higley, Valparaiso, Ind.

ANY COMPETENT PERSON DESIRING TO better his present position can learn something of advantage about different ways of getting positions by addressing Broux Publishing Co., 285 Audubon Ave., New York.

POSITIONS NOW OPEN. \$90 MO. STEADY work. Civil Service, normal, academic, business, law, real estate, auto, engineering courses taught by mail. For "Scholarship" or free "Civil Service Manual," address Carnegie College, Rogers, Ohio.

AGENTS MAKE BIG MONEY AND BECOME sales managers for our goods. Fast office sellers. Fine profits. Particulars and sample free. One Dip Pen Company, Dept. 4, Baltimore, Md.

WE TEACH YOU A TRADE IN A FEW months' time; no expense but your work. Electricity, automobiles, plumbing, bricklaying; 100 satisfied workmen today; 40 jobs going. Catalog free. United Trade School Contracting Co., Los Angeles.

HELP WANTED

EARN GOOD PAY COPYING ADDRESSES; particulars six stamps. Hinchey, 167, Middleport, N. Y.

BIG MONEY WRITING SONGS. HUNDREDS of dollars have been made by successful writers. We pay 50 per cent of profits if successful. Send us your original poems, songs or melodies today, or write for free particulars. Dugdale Co., Dept. 13, Washington, D. C.

WANTED—MEN AND WOMEN, FOR GOVERNMENT positions, \$80 month. Annual vacations. Short hours. No "layoffs." Common education sufficient. Over 12,000 appointments coming. Influence unnecessary. Farmers eligible. Send postal immediately for free list of positions open. Franklin Institute, Dept. F-54, Rochester, N. Y.

ANYONE WITH MY NEW DEVICE AND A few hours' study can obtain a fair knowledge of the principle involved in making and reading mechanical drawings. Models and sample drawing demonstrating this shortest method included with the device for \$1. The S. Knapp Studio, 236 Jefferson Ave. E., Detroit, Mich.

BE AN ELECTRICAL METERMAN—\$900 to \$1,800 a year. New field. Demand for competent metermen greater than supply. Personal, practical mail instruction qualifies you for splendid position. Graduates assisted. Write for particulars. Fort Wayne Correspondence Schools, Dept. 30, Fort Wayne, Ind.

FREE ILLUSTRATED BOOK TELLS ABOUT over 360,000 protected positions in U. S. service. More than 40,000 vacancies every year. There is a big chance here for you, sure and generous pay, lifetime employment. Easy to get. Just ask for booklet A50. No obligation. Earl Hopkins, Washington, D. C.



HERE'S A JOB
AT
\$25.00 TO \$50.00
Weekly

YOU CAN HAVE IT, TOO.

Auto experts are wanted everywhere. Short hours and fascinating work. We teach you the entire subject in 10 simple, practical lessons, and assist you to secure a good position. Study at home in spare time. No automobile necessary—we furnish free model. Expert and experienced instructors. Send for First Lesson Today—It's Free. Get started at once. Let us prove our claim. Send postal now. The Original Auto School. OWNERS—We supply competent men. EMPIRE AUTO INSTITUTE 198 Empire Bldg., Rochester, N. Y.

WE WANT YOU for our representative. Big money to right parties. All or spare time. Experience not necessary. Send 2c stamp today for particulars. POPULAR ELECTRICITY MAGAZINE, Circulation Dept., Commercial Bldg., Chicago, Ill.

MATCHLESS POCKET LIGHTER

Durable and A perfect lighter. Occupies no more space in the pocket than a pencil.
Water-proof, with perfect ignition. Satisfaction guaranteed or money refunded. Indispensable to every smoker. hunter, fisherman and automobilist.
complete with pocket clip, 35c, 4 for \$1. **Nickel Plated**
Agents and dealers wanted. **Schiller Mfg. Co., 165 Schiller Bldg., Chicago, Ill.**



Build Your Own Wireless Outfit

Wireless Telegraph Construction for Amateurs

By *Alfred P. Morgan*

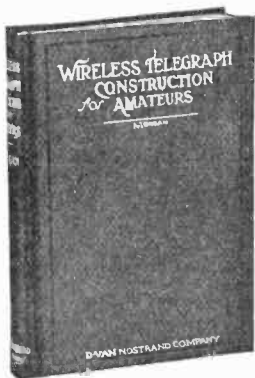

SHOWS you how to construct various outfits capable of receiving from 100 to 1,500 miles and of transmitting 3 to 100 miles, giving in minute detail full directions for the construction of each part. Also clearly explains the purpose and action of each instrument with directions for operating and testing, etc.

History and all obsolete forms of apparatus have been omitted, so the information contained is thoroughly up-to-date.

Its thoroughness is a feature not often shown in such books, this together with its splendid treatise of wireless along constructive lines make it the ideal book for an amateur.

Endorsed by Wireless Clubs throughout the country as being the most practical book published on wireless.

Contents of Chapters

I—Introduction. II—The Apparatus. III—Aerials and Earth Connections. IV—Induction Coils. V—Interrupters. VI—Transformers. VII—Oscillation Condensers and Leyden Jars. VIII—Spark Gaps or Oscillators. IX—Transmitting Helixes. X—Keys. XI—Aerial Switches and Anchor Gaps. XII—Hot Wire Ammeter. XIII—Oscillation Detectors. XIV—Tuning Coils and Transformers. XV—Receiving Condensers. XVI—Telephone Receivers and Head Bands. XVII—Operation.

200 Pages

Price **\$1.50** Postage 10c
additional

Money refunded if you are not satisfied.

153 Illustrations

Free Book Offer

As a special inducement to our readers we will include a copy of the "Amateur's Wireless Handy Book" free with every order for the above book received in response to this advertisement.

This is the handiest and most useful book for the amateur or professional wireless operator ever published, and is the only book of its kind in existence. Contains among other things a complete list of Wireless Call Letters, 1,500 in all, arranged alphabetically. The Morse and Continental Codes on two full page charts. Beginners Speed Chart so arranged to assist in learning the codes quickly. All the abbreviations used by operators to save time and labor. And last but not least, over 100 different Hook-Ups and Diagrams. Blank pages are provided for keeping a record of your own Hook-ups. Don't overlook this opportunity to secure this valuable book free. Send in your order to-day.

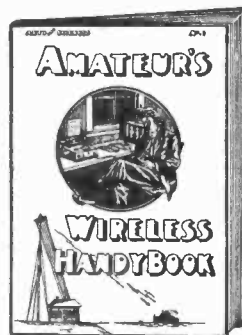

Popular Electricity Book Department, 54 W. Lake Street, Chicago, Illinois



Thousands of Electricians, Mechanics, and Apprentices Have Salaries Raised

You can be safe in judging what a man can do by what has been done—past performances—past records. In the files at the International Correspondence Schools are more than 27,000 letters that are witnesses to the marvelous results accomplished by students of the International Correspondence Schools. These letters came from all sorts and conditions of men who started with no more opportunities than you have—no more money—no more education, but today we find them in positions of responsibility and power.

A recent tabulation of the records of 1,000 students shows that the average salary at the time of enrolment for I. C. S. Courses was \$54 per month, but today, or at the time the letters of indorsement were written, the salaries have increased to an average of \$183 per month.

Such results are not due to chance. They are the reward of conscientious effort, and they should appeal to the ambitious, comfortable-loving element of laboring people.

These men took time to study, took time to find the better and more modern ways of doing things, and these are what distinguish them today from the low-wage laborers.

There is not in all the world a greater force than the I. C. S. to put new hope in the hearts of the laboring men and to teach them to attain success.

The I. C. S. are ready and willing to help you. Are you willing to be helped? Then determine what you want to be and

Mark and Mail the Coupon NOW

International Correspondence Schools
Box 1102, Scranton, Pa.

Please explain, without further obligation on my part, how I can qualify for a larger salary and advancement to the position, trade, or profession before which I have marked X.

Electrical Engineering	Mechanical Engineer
Electric Lighting	Mechanical Draftsman
Electric Railways	R. R. Constructing
Electrician	Concrete Construction
Electric Car Running	Architect
Dynamo Foreman	Contracting & Building
Wireman	Architectural Draftsman
Mining Engineer	Plumbing & Heating
Telephone Expert	Chemist
Surveyor	Bookkeeper
Civil Engineer	Advertising Man
Automobile Running	Civil Service Exams.
Agriculture	Salesmanship

Name _____

St. and No. _____

City _____ State _____

Present Occupation _____

The Lampton Lands

—fertile and beautiful



I have traveled this Union over on foot and horseback, scanning it with the eye of a practical farmer and orchardist, for maximum values at a minimum price and I can say positively I found this combination in the Lampton Lands. They have everything—big and little—conducive of a solid farming success and a good time generally—splendid roads, fine weather, picturesque beauty, unlimited opportunities for sport, plenty of schools and churches, dependable cash markets close by, no swamps, easily managed soil, unrivaled health conditions, good drainage, and an abundance of cheap local labor. In short, everything either a farmer or city man could ask for or needs to make himself and family comfortable and prosperous.

Picture a gently rolling expanse of country—bisected by clear streams—forming the crest of a tableland that rises 300 feet above the level of the Gulf of Mexico—on which there lies a crust of Orangeburg loam—rich in iron and lime and exceedingly fertile—the natural productiveness of which is doubled by a climate as genial and healthful as any on the continent. That is the Lampton Lands, a section so naturally favored that it should develop into one of the richest farming communities in all America.

**Don't
Resist
Write
at
Once**

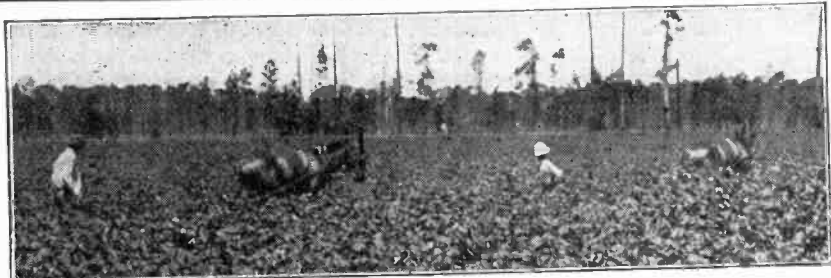

You can make ten acres on the Lampton Lands pay you \$2,000 to \$6,000 a year—you can establish there a prosperous home—the value of your place should double every year, for many years to come—and yet, I am selling this splendid property—while it lasts—for only \$15.00 to \$35.00 an acre—on business arrangements that appeal to earnest and ambitious people. There is much more to tell, but you must get my book and read the full story. Read it for essential information before you buy anywhere. Send for your copy today. If I ever get the facts into you you'll find it hard to resist the double proffer of pleasure and profit of this sunny South land bargain.

SAMUEL S. THORPE

Dept. 3, 1627 First Nat'l
Bank Bldg., Chicago, Ill.

Values You Can Get At

Compare this description with others and then reflect—this one is true to fact. Consider this—these Lampton Lands are not situated in a gloomy mountain valley nor on a parboiled desert but in a bright, flowery land on which the sun shines almost every day, and 50 inches of warm rain falls annually—and seasonably. They are not buried afar in the wilderness, but are situated in the oldest settled section of the United States, where congenial white neighbors are many, transportation is rapid and reasonable, and Mobile, the nearest port to the Panama Canal, is only 40 miles away. Finally these Lampton Lands have a flawless title, and when you buy—on terms that permit you to get the purchase money out of the soil months before you owe it—you buy—not from some option speculator, but from the sole owners, who can, and will, treat you liberally.

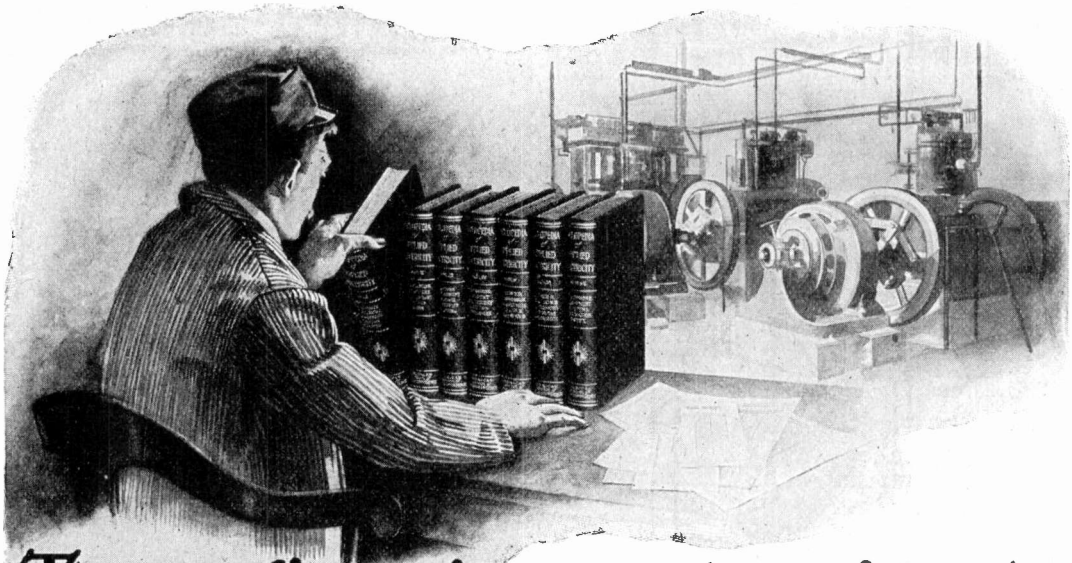

The engineer's expert assistant

stands ready to settle the difficult problems which constantly arise in every power-house—large or small. Few engineers, however experienced, can hope to successfully overcome, unaided, every one of the various obstacles arising in their daily work, yet many have no opportunity of securing expert advice—they have no one to assist them and are forced to experiment at the expense of valuable machinery. It is for just such men—men in charge of the operation of power stations or who are in any way connected with the electrical trade—that these books have been compiled. Assisted by this great reference library, you need not be dependent upon the advice and suggestions of others—you can act for yourself, confident that you are backed by the knowledge of thirty-two of the biggest electrical engineers in the country. This library is of value to the student, worker or expert, but its exhaustive treatment of electrical "troubles" and their remedies makes it invaluable to every electrician or man in charge of a small power station.

The American School's Cyclopedia of

Applied Electricity

contains 3,200 pages; 2,600 full-page illustrations, diagrams, formulas, etc., with a special cross index for quick reference. The seven large volumes are bound in half morocco and are printed in large, clear type on special quality paper.

Important Subjects Covered by These Great Books

Theory, Calculation, Design and Construction of Generators and Motors—Electrical Measurements—Electric Wiring—Electric Welding—Types of Generators and Motors—Management of Generators and Motors—Storage Batteries—Electric Lighting—Alternating-Current Machinery—Station Appliances—Power Stations—Power Transmission—Central Station Engineering—Electric Railways, including Single-Phase—The Electric Telegraph—Telephone Equipment, Systems and Operation—Wireless Telegraph and Telephone—Telautograph—Telegraphone, etc.

This Complete Cyclopedia Sent Free

The complete seven volumes, not a sample volume, will be sent, express prepaid, for seven days' free examination; returnable at our expense if the books do not contain the information you want. If you keep the books, pay \$2.00 seven days after receipt and then \$2.00 a month until you have paid the special introductory price of \$19.80. The regular price of this great Cyclopedia is \$35.00.

Just fill in and mail the coupon. It won't cost you a cent to examine the books. We know they'll be worth many times their cost to you. Mail the coupon now and you'll receive your books promptly.

Consulting Membership Free

With every set is included a year's Consulting Membership entitling you to the free advice of a staff of Electrical Engineers. This will give you practical help in handling working problems which are too specific to be taken up in detail in the Cyclopedia. There will be no limit to this service. A single problem solved for you might be worth more than the first cost of the books.

American School of Correspondence, Chicago, U. S. A.

Pop
Elec.
10-12

A. S. of C.

Please send me Cyclopedia of Applied Electricity for seven days' free examination. I will send \$2.00 within seven days and \$2 a month until I have paid \$19.80; otherwise I will notify you and hold the books subject to your order. Title not to pass until fully paid.

FREE EXAMINATION COUPON

NAME

ADDRESS

OCCUPATION

EMPLOYER

A Complete Course in Applied Electricity

Practical Applied Electricity

By DAVID PENN MORETON, B. S. E. E.

Covering every line of electrical work as taught in the Armour Institute of Technology, an institution of world wide fame.

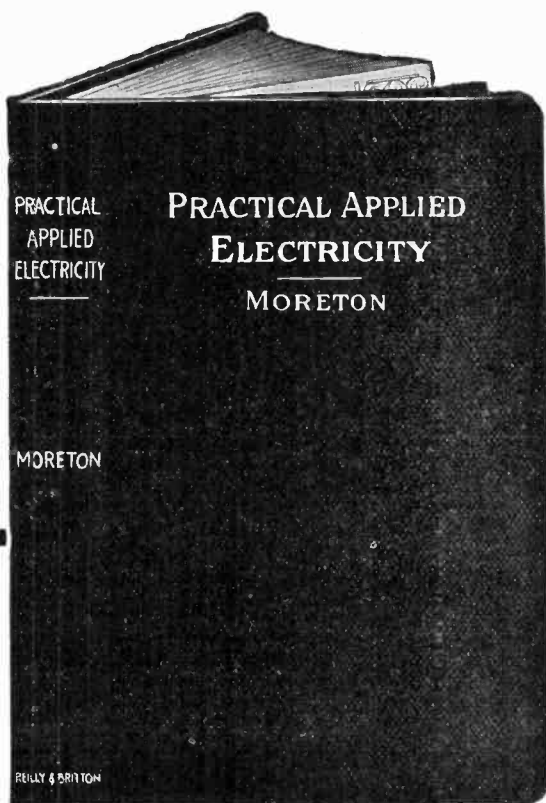

Practical Applied Electricity is the outgrowth of actual work combined with classroom experience. The author is Associate Professor of Electrical Engineering at the Armour Institute of Technology. Most of the students taking the electrical course attend the evening classes, being employed at electrical work through the day. The problems which confront these students are embodied in this book—one reason for its being so practical and up-to-date. To illustrate this valuable information, careful detailed drawings have been made under the personal supervision of the author. In plain words, this book contains the experience of a large number of ambitious electrical workers, gathered together by a recognized authority on the subject.

CONTENTS:

The Electrical Circuit and Electrical Terms Explained by Means of the Water Analogy; Ohm's Law; Series and Divided Circuits; Calculation of the Resistance of Various Circuits and Conductors; Primary Batteries; Dry and Wet Cells; Voltage; Internal Resistance and Polarization; How to Renew; Series and Parallel Connections; Tables of Data of Commercial Types of Cells; Magnetism; Permanent Magnets; Electromagnets; The Magnetic Circuit and Quantities Involved; Magnetic Properties of Various Materials; Magnetic Calculations; Instruments; Construction of Various Types of Ammeters, Voltmeters, Wattmeters, Galvanometers, etc.; Calibration of Instruments; The Dynamo; Fundamental Principle; The Magnetic Field; Commutation; Armature Reaction; Characteristics of the Series, Shunt and Compound Types of Generators; Motors, Fundamental Principle; Various Types and Their Application to Different Kinds of Work; Motor Speed Control; Variable Speed Motors; Railway Motors, Elevator Motors, etc.; Storage Bat-

tery; Fundamental Principle; Commercial Types; Application; Care of; Systems of Power Distribution; Two and Three Wires; Balancers; Motor Generator Sets, etc.; Practical Operation of Electrical Machinery; Connections in Series and Parallel; Motor and Generator Troubles How to Locate and Remedy Them; Electrical Lighting; Various Types of Incandescent and Arc Lamps; Application of Various Types; Photometry of Lamps; The Nernst Lamp; Moore Tube; Mercury Vapor Lamp; Electrical Wiring; Calculation of Conductors; How to do Exposed Moulding and Conduit Work; How to Install and Connect Heaters, Motors, Generators, Fixtures, Arc Lamps, etc.; Wiring Tables for Different Classes of Work; Alternating Current Circuit; Comparison of the Direct and Alternating Current Circuits; Quantities Involved; Series and Divided Circuits; Measurements of Power; Alternating Current Generators and Motors; Resuscitation; Numerous Miscellaneous Reference Tables.

The language is so plain, and the mathematics so simple that no one can fail to understand. Questions and answers given at the end of each chapter, impress upon the mind of the reader the more important points to be remembered.

450 PAGES 323 ILLUSTRATIONS
BLACK FLEXIBLE LEATHER BINDING

Price \$2.00 Postpaid

All interested in electricity, old or young--artisan or amateur--expert or experimenter--should own this absolute authority. Money refunded if you are not satisfied.

POPULAR ELECTRICITY BOOK DEPT., 54 W. Lake St., Chicago, Ill.

UNION MADE



Trade Mark

THE MARK OF
"QUALITY"

Signal Flannel Shirts

FOR WORK OR DRESS

THE unrivaled comfort of flannel has led us to make up a line of Signal Flannel Shirts for both *work* and *dress*.

For fall and for winter—indoors or outdoors—our warm, soft, easy Flannel Shirts, with

lay-down or military collars, are great stuff for service. They're made for *hard* and *long wear*, with big, useful flap, scout, or plain pockets. Are neat enough for any man holding any job, and are priced to meet every man's purse—\$1 to \$3. Made in all plain colors—browns, grays, blues.



Signal Detachable-Collar Flannel Shirts

are the thing for dress wear. Use the flannel collar or a regular white one. Fit well, look well, wear well. Most comfortable dress shirt ever put on the market. A classy shirt for any occasion. Many snappy patterns in many colors. Stylish double French cuffs, flap or plain pockets—*made in coat style*. Easy to put on or take off. Sell for \$1.50 and \$2.

ASK YOUR DEALER to show you the Signal Flannel Line. Insist upon seeing the Signal trade-mark—the one that our overalls and work shirts have made famous. Do it *today*—you can't get into a Signal Shirt too soon.

Hilker-Wiechers Mfg. Co., . . . 1248 Mound Ave., Racine, Wis.



TYPEWRITERS FACTORY REBUILT

Save \$25 to \$50 on manufacturers' prices. Buy our Factory Rebuilt Typewriters. Nearest-to-new on the market. Have trade-mark and guarantee like new machines. Are thoroughly rebuilt, and perfect in appearance. Satisfaction guaranteed. We are the largest rebuilt typewriter concern in the world. Branch stores in leading cities.

Write for catalog of standard makes.

AMERICAN WRITING MACHINE CO., Inc., 345 Broadway, N. Y.



BIG MAIL FREE

Your NAME PRINTED in our Mailing Directory and send to firms all over the world so they can send you FREE Samples, Catalogs, Books, Papers, Magazines, etc. Send 25c to cover cost of printing your name and you'll receive a big mail FREE. **Proof**—INGRAM, VA., Mar. 1, 1912. Gentlemen—I have already received 2000 parcels of mail, and still they come, scores of papers, samples, magazines, etc., for which I had often paid 10 to 25c each. R. T. JAMES, Send to Big Mail Co., 1-129 W. North Ave., Chicago, Ill.

WE WANT YOU for our representative. Big money to right parties. All or spare time. Experience not necessary. Send 2c stamp today for particulars. POPULAR ELECTRICITY MAGAZINE, Circulation Dept., Commercial Bldg., Chicago, Ill.

AGENTS!



AMAZING INVENTION. Entirely new kind lamp burner, generates gas, makes extremely large, powerful white light. Smokeless, odorless. Sells everywhere. Nothing like it. Exclusive territory contracts granted. Positively not sold in stores. Amazing making big money. Experience unnecessary. Sample-outfit 35c postpaid. Particulars FREE.

The RADIOLITE CO., 1516 Spitzer Bldg., Toledo, Ohio.

Central Station Mgrs. Write for this Book

We have just published a book on "Co-operative Advertising for Central Stations." It explains how you can have all the advantages of a complete advertising department of your own. It tells how you can secure ready-to-use ads of *proved* effectiveness, prepared by *experts*, illustrated by the *best* artists in the country and type-set by ad *specialists*, at a cost merely *nominal* in proportion to what it would cost you to prepare these ads for yourself.

It Means Money to You

It will pay you to *investigate* this proposition. You may find that it *just* fits into your organization, *just* answers your need, *just* supplies what you want in the way of publicity. At any rate, why not learn more about it? A request on your business stationery will bring the book and full details by return mail. Absolutely no obligation.

Wm. D. McJunkin Advertising Agency
35 SOUTH DEARBORN STREET CHICAGO

Practical Electrical Handbooks

Your Choice 25 Cents Each

ELECTRICITY—The study of, and its laws for beginners. Comprising the laws of electric current generation and flow. Ohm's law, galvanism, magnetism, induction, principles of dynamos and motors, wiring, with explanations of simple mathematics as applied to electrical calculations. By N. H. SCHNEIDER. With 55 original illustrations and 6 tables.

ALTERNATING CURRENTS SIMPLY EXPLAINED—An Elementary Handbook on Alternating Current Generators, Transformers, and Motors. By ALFRED W. MARSHALL. This book is written for those who desire elementary information about Alternating electric currents, simply written and yet intensely interesting.

PRACTICAL ELECTRICS—A universal handy book on every day electrical matters, including connections, alarms, batteries, bells, carbons, induction and resistance coils, dynamos, measuring, microphones, motors, telephones, phonographs, photophones, etc. 135 pages, 126 illustrations.

MAGNETS AND MAGNETISM SIMPLY EXPLAINED. By A. W. MARSHALL. Contents of Chapters: 1. The theory of magnets. 2. Permanent magnets. 3. Electro magnets. 4. Solenoids or tubular electro-magnets. 5. Experiments with magnets. A very clearly written explanation of an important subject. 88 pages; 49 illustrations.

ELECTRICAL CIRCUITS AND DIAGRAMS—Part 1.—Being a selection of original up-to-date and practical diagrams for installing annunciators, alarms, bells, electric gas lighting, telephones, electric power light and wiring circuits, induction coils, gas engine igniters, dynamos and motors, armature windings. By N. H. SCHNEIDER.

CIRCUITS AND DIAGRAMS—Part 2. By NORMAN H. SCHNEIDER. Alternating Current Generators and Motors: Single Phase and Polyphase Transformers; Alternating Current and Direct Current Motor Starters and Reversers; Arc Generators and Circuits; Switch-Wiring; Storage Battery; Meter Connections, etc., etc. 69 original drawings, with full explanations.

SMALL ELECTRICAL MEASURING INSTRUMENTS—How to Make and Use Them. By PERCIVAL MARSHALL. A concise treatise on the construction and use of various Electric Meters. 90 pages, 59 illustrations.

THE WIMSHURST MACHINE—How to make and use it. A practical handbook on the construction and working of Wimshurst machines, including radiography and wireless telegraphy and other static electrical apparatus. By A. W. MARSHALL. Second edition, revised and enlarged. Containing a number of sectional drawings and details to scale. 112 pages, fully illustrated.

ELECTRIC GAS LIGHTING—How to install Electric gas igniting apparatus including the jump spark and multiple systems for all purposes. Also the care and selection of suitable batteries, wiring and repairs. By H. S. NORRIE, 101 pages, 57 illustrations, paper.

PRACTICAL COMPEND OF ELECTRICITY—By JAMES A. BEATON, A. M. A Vest Pocket Compendium of instruction on all things Electrical, in theory and practice. 272 pages, 116 illustrations. Cloth binding, 25c; leather, 50c.

HANDY ELECTRICAL DICTIONARY—By W. L. WEBER, M. E. A Practical Hand Book of reference, containing definitions of every used electrical term or phrase. Indispensable as a Vest Pocket Guide to everyone interested in electricity. 224 pages, illustrated; cloth binding, 25c; leather, 50c.

DRY BATTERIES—A practical handbook on the designing, filling and finishing of dry batteries, with tables for automobiles, gas engine, medical and coil work, electric bells, alarms, telephones, experiments and all purposes requiring a first-rate battery. Fully illustrated with 30 original drawings.

MODERN PRIMARY BATTERIES—Their construction, use and maintenance, including batteries for telephones, telegraphs, motors, electric lights, induction coils and for all experimental work. By N. H. SCHNEIDER. 94 pages; 55 illustrations. The best and latest American book on the subject.

SIMPLE EXPERIMENTS IN STATIC ELECTRICITY. By P. C. BULL, M. A. Contents of Chapters: 1. Production of electricity by various means. Viz.: friction, heat, pressure, chemical action, etc. 2. Electrical attraction, repulsion, and distribution. 3. Induction. 4. Leyden jars and other condensers. 5. Mechanical, chemical and heating effects. 6. Luminous effects. 7. Miscellaneous experiments. Being a series of instructive and entertaining electrical experiments. 72 pages, 51 illustrations.

SIMPLE SOLDERING—Both Hard and Soft—Together with descriptions of inexpensive home-made apparatus necessary for this art. By EDWARD THATCHER. Contents of Chapters: 1. Soldering. 2. Soft Soldering. 3. Methods of holding work. 4. Hard Soldering and brazing. 5. Cleaning up work, polishing. 6. Standard apparatus. 7. Home-made apparatus. 84 pages; 52 illustrations.

SMALL ACCUMULATORS—How made and used. By P. MARSHALL. Giving full descriptions how to make all the parts, assemble them, charge the cells and run them, with examples of their practical application. Useful receipts and memoranda and a glossary of technical terms. 80 pages, 40 illustrations, paper.

INVENTIONS—How to Protect, Sell and Buy Them. By FREDERICK B. WRIGHT, Counsellor in Patent Causes. This book is especially written for the use of Inventors, instructing them how to place their inventions before an Attorney clearly; the rights given them under the Law, Patent specifications, Legal forms, and the many points necessary for an inventor to know how to protect himself under the American Laws. The most practical and clearly written American book on this subject, especially intended for the uninitiated. 114 pages, and 1 sample pattern drawing.

HOW TO BUILD A 20-FOOT BIPLANE GLIDER That Will Carry a Man. By A. P. MORGAN. A practical handbook on its construction and management. Enabling an intelligent reader to make his first step in the field of aviation with a comprehensive understanding of some of the principles involved. Fully illustrated with detailed drawings.

Popular Electricity Book Department

54 West Lake Street

Chicago, Ill.

3 YEARS TO PAY
for the sweet-toned
MEISTER
PIANO \$175

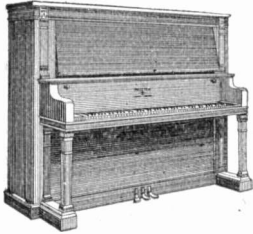

30 Days' Free Trial
In Your Own Home
We Pay the Freight

If the piano proves to be all we claim for it and you decide to buy it, these are the terms of sale:

\$1 A WEEK, OR \$5 A MONTH

No cash payment down. No interest on payments. No extras of any kind. Piano stool and scarf free.

Sold direct from the maker to you at a guaranteed saving of \$100. No dealer's profit for you to pay.

Send now for our beautiful **FREE CATALOG** which shows eight styles of Meister Pianos

Our resources exceed \$4,000,000. We sell more pianos direct to the home than any other concern in the world.

ROTHSCHILD & COMPANY
Dept. 20 T CHICAGO, ILL.

This \$3 Silver Set Free

Full Set, Worth \$3.00

6 Teaspoons Butter Knife
6 Tablespoons Sugar Shell

This handsome 14-piece Silver Set is made by the Wm. Rogers Mfg. Co., of the highest grade, good heavy nickel silver metal, finely finished, and fully warranted not to wear off. The beautiful flower design is nicely embossed on all pieces.

Half Set, Worth \$1.50

6 Teaspoons Butter Knife Sugar Shell

This half set contains 8 pieces of the same fine design and high quality as the full set described above. Comes in fancy silverware box.

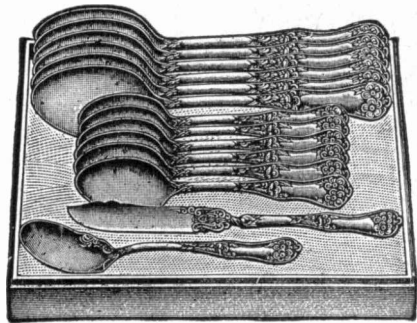

Here is this month's offer—a \$3 gift—which will never be offered again. The offer expires on Nov. 1.

If you write before then for our Home Lovers' Bargain Book—Fall Issue—we will send you with it the order for this set.

It will call for the whole set, entirely free, with any order for \$20 or over. Or it calls for the half set—a \$1.50 set—with any \$10 order or over.

4,528 Home Things
3 Cents a Day

This mammoth book pictures 4,528 bargains in housefurnishings, picked up from 200 factories. Many of the pictures are in actual colors. It's the largest exhibit ever brought together.

Furniture Carpets and Rugs **Chinaware**
Stoves Draperies **Baby Carriages**
Sewing Machines Lamps—Guns **Toys—Clocks**
Silverware

A separate Stove Book pictures 456 Empire stoves and ranges, from 89c up; also a big new book showing Illinois watches and jewelry. Every price is from 30 to 60 per cent below store prices. We guarantee the lowest prices ever quoted on articles like these.

A Year to Pay

Goods are shipped on open charge account. No interest, no security, no red tape or publicity. You pay as convenient—a little each month—by saving a few cents daily.

Goods are sent on approval, to be kept a month before you decide to buy. So you cannot make mistakes.

Over a million homes now have charge accounts with us. Some have had them for 30 years. We shall gladly open one with you on the same convenient terms.

Write Us Today

You must write at once for our Bargain Book if you want this order for the Silver Set. Both are entirely free. But the offer ends forever on Nov. 1. If you want the Stove Book or Watch and Jewelry Book also, tell us. And write us today.

Spiegel, Mau, Stern Co.

1247 W. 35th St., Chicago (288)

White Valley GEMS

Substitutes for Diamonds



Send for **FREE Catalog!** showing wonderful White Valley Gems in Rings (Ladies' or Gentlemen's), Scarf Pins, Studs, Brooches, Necklaces, Cuff Buttons, Locketts, Earrings—100 different articles and styles.

Not glass, not paste, not any kind of imitation, but beautiful, splendid gems. (White Sapphires chemically produced.)

Look like finest diamonds. Will scratch, file and cut glass. Stand acid test. Famous society women substitute White Valley Gems for real diamonds—or wear the two together confidently.

14 K. solid gold mountings. 25 year Guarantee Certificate with each gem. Ring measure sent with catalog. Will send any article in book C. O. D.—express prepaid—subject to examination—or by registered mail on receipt of price. Money refunded if not satisfactory.

WHITE VALLEY GEM CO.
742 Saks Bldg. Indianapolis, Ind.

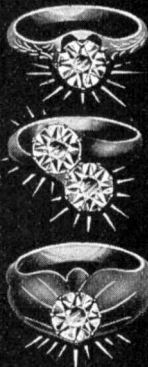

TWO VALUABLE BOOKS**Motor Troubles**

By E. B. Raymond

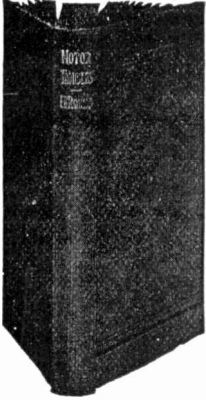
Alternating and Direct Current

197 pages illustrated
 Price \$1.50 postpaid

For many years Mr. Raymond was the General Electric Company's expert in the tracing of motor troubles, so there can be none better equipped than he to fortify you against the many difficulties that arise in this field. This book contains the right solution of every problem and is so arranged and indexed that you can instantly put your finger on the remedy.

Contents: — Starting Up. Sparking. Brush Troubles. Characteristics of the Induction Motor. Locating Faults in Induction Motors. Winding Faults. Balking of Induction Motors. Mechanical Troubles. Troubles with Synchronous Motors. Testing Generators. Testing Direct-Current Motors. Alternating Current Generators. Testing Induction Motors.

Electrical Contracting

By Louis J. Auerbacher

How to Get the Work and Do It

160 pages illustrated
 Price \$2.00 postpaid

This book starts at the beginning of the average contractor's troubles—his shop systems and his estimates.

Mr. Auerbacher covers these fully with plenty of good ideas on the short cuts, suggestions and economies which make for a better business and better profit.

Most electrical contractors do not realize that their money is lost because they lack the right shop organization and methods of keeping track of stock, and the contractor who familiarizes himself with this book will not only do better work, but he will do it at a greater profit and his customer will be better satisfied. A large part of the book is devoted to wiring systems of all kinds, forming the most useful wiring handbook on the market. It shows the latest and best methods, and, however experienced you may be, you will find plenty of new ideas in this book, as well as all of the everyday data to which you want to refer.

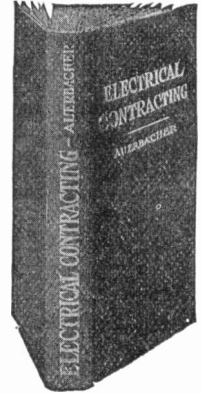

POPULAR ELECTRICITY BOOK DEPT., CHICAGO, ILL.

(5)

Bound Volume IV

NOW READY

Popular Electricity Magazine

Issues May, 1911, to April, 1912, Inclusive

SECURELY BOUND IN HANDSOME BLUE SILK CLOTH
 TO MATCH PREVIOUS VOLUMES. GOLD STAMPED.

1,200 pages of intensely interesting and instructive reading on everything electrical during the past year, illustrated with over 1,500 pictures. Practically a history of the year's progress in electrical science written in plain English.

A complete index serves to locate any desired subject immediately.

All advertising matter is excluded from this volume, making it a convenient size for your library.

Price \$2.00 Postpaid

Popular Electricity Book Department
 54 West Lake Street
 Chicago, Illinois

Are You Building?

Then let us send you copy of our new booklet P. E. 10, which tells all about the proper method of finishing floors and interior woodwork.

Johnson's Wood Dye

makes inexpensive soft woods just as artistic and beautiful as hardwoods. Tell us the kind of woods you will use and we will mail you panels of those woods artistically finished—*together with our 25c booklet—all free and postpaid.*

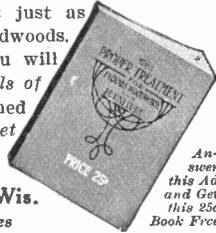

Answer this Ad and Get this 25c Book Free

S. C. Johnson & Son, Racine, Wis.
The Wood Finishing Authorities

TO THE END OF TIME OUR SMART CARDS IN CASE

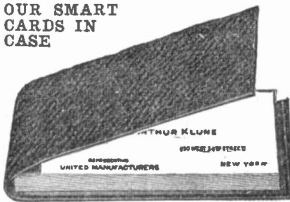

You will be judged by your acts. If you prefer not to be misjudged send in a **PEERLESS Patent Book Form Card** Its smooth edges; its genuine elegance will tell the character of man you are. Nothing else like it.

Used by the men who care for appearances and who command big pay. It ought to be used by you. Send today for sample tab of engraved cards, and get right, in the card line.

The JOHN B. WIGGINS COMPANY
SOLE MANUFACTURERS
Engravers, Die Embossers, Plate Printers,
86-88 East Adams Street Chicago



AUTOMATIC TELEPHONE

—The one logical phone. 10-second secret connections—no delays, no wrong numbers—low in cost—local and long distance. Automatic service is blanketing Chicago. For details phone or write

ILLINOIS TELEPHONE & TELEGRAPH CO.
162 WEST MONROE ST., CHICAGO, Coml. Dept. 33-111

DROP US A POSTAL CARD

for our new book catalog and pamphlet, "18 Ways to Make Money." Do it now.
Popular Electricity—Book Dept.

Complete Your Files Now and Save Money

Many back numbers of Popular Electricity Magazine are worth *ten times* the original cost, but are not to be had at any price. Issues obtainable *now* may be out of the market tomorrow. Don't wait—but act promptly, and get those you want at one-half price today.

POPULAR ELECTRICITY

54 West Lake Street

CHICAGO

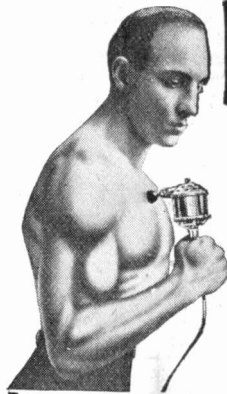

POWER for YOU!

Power from within! Strength that is *more* than mere muscular strength—the strength of perfect health, abundant nerve force—now within your own reach through

Vibration! Nine people out of every ten are only *half alive!* Are you? Listen—

All the Exhilarating Joys of Life-Strength-Youth

may be returned to you through **Vibration**. For **Vibration is Life itself**. It will chase away the years like magic. Every nerve, every fibre in your whole body will fairly tingle with the force of your own *awakened power!* Stagnation simply cannot exist. You are made over new from head to foot. *All the keen relish, the pleasures of youth,* fairly throb within you. Your blood is sent humming along through every vein, artery and tiny capillary. All the poisonous matters in your system are *washed away*. Every organ is put in *perfect working order*. Your self-confidence—*your self-respect* are increased a hundred fold. Yes, **Vibration** will do all this, and more, *much more*. And it is within your reach.

You can enjoy its wonder-working powers right at home, right in the privacy of your own room. You can give yourself the same identical treatments which you would receive in the offices of the world's most famous specialists—all without extra charge.

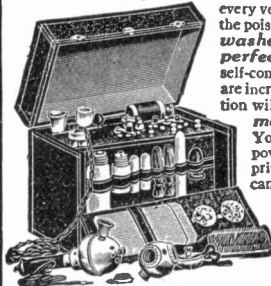

Special Offer for a Limited Time

The White Cross Electric Vibrator

is the result of years of work and experiment. It is absolutely perfect. If you have your house wired for electricity, you can connect it up as easily as an electric lamp; if not, it will run perfectly on its own batteries.

For a short time only we are making a remarkable Special Introductory Offer on the White Cross Electric Vibrator—amazing discounts—actual rock-bottom prices direct if you act at once.

FREE BOOK

Sign the coupon and mail it to us today. Get our splendid big FREE book telling you all about the marvels of **Vibration**.

Read what scientists say about it. Post yourself on what it will do for you. Learn all about the **White Cross Electric Vibrator** and our limited offer. You are under no obligations at all—all you need to do is to send the coupon *today*—you can send a postal card or a letter, but the coupon will do just as well.



SEND FOR THIS BOOK

Lindstrom, Smith Co.
218 S. Wabash Av.
Desk 1407
Chicago, Illinois

Without any obligations on my part, please send me, free and prepaid, your free book on **Vibration**, full particulars of the White Cross Vibrator and your Special 60-Day Offer.

Lindstrom-Smith Co.

218 S. Wabash Av.

Desk 1407

Chicago, Ill.

Name

Address

WRITE PLAINLY

Wagner Electric

Manufacturing Company, St. Louis, Mo.

Wagner Rectifiers

Solve the Problem of

Automobile Electric Lighting

A Wagner Rectifier will charge your storage battery over night.

It is light, small and can be carried in the battery or tool box. It works from any alternating current lamp socket and is provided with cord and plug. It charges the small storage batteries used for lighting, electric horns, ignition, etc., and makes such service inexpensive and practical.

Buy a Wagner Rectifier. Wire your car—convert your oil and gas lamps to electric—and all the inconveniences of Gas and Oil lighting are removed.

Write for Bulletin 933

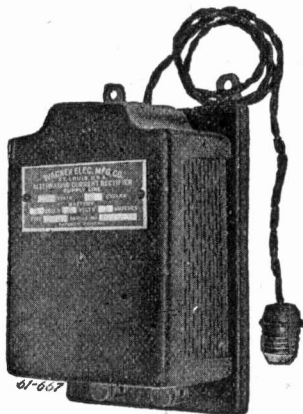

For our Mutual Advantage mention Popular Electricity when writing to Advertisers.

EDISON

His Life and Inventions

By

Frank L. Dyer
and
Thomas C. Martin

988 PAGES

Two Volumes
\$4.28 Postpaid

Practically a history
of Electricity for
the past fifty years.

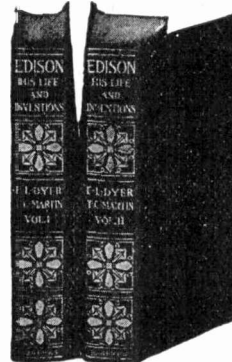

Contains among other new material
a complete list of the Edison Patents.

THE full and authoritative story of Edison's own life has never been written until now. The full story could only be given by Edison himself and his closest associates. One of the authors is his counsel, as his father and brother were before him, and he practically shares Edison's daily life. The other, who has been in the confidence of the great inventor for a long time, is one of the leading electrical experts of our country. The entire manuscript has been read and revised by Edison himself.

Scene by scene the real life and work of the great inventor are unrolled before us, the days and nights spent in developing the electric railway and storage batteries, the growth of the phonograph industry, the ore-milling work, the application of Portland cement, with its large possibilities, and the development of a new phase of modern entertainment and education in the vast business of moving pictures.

How has it been done? What are the scenes in which the inventor works? What is his daily life? What are his methods? In this book there is pictured all this personal side. The evolution of his ideas is traced, his manner of working, the scenes in his laboratory, the enthusiastic co-operation of his assistants guided by the master's brain, and the persevering industry which leads to triumph over discouragements, mistakes and obstacles.

There is a long and full Technical Appendix, describing in detail the work Edison has done. This in itself is a long-needed book.

POPULAR ELECTRICITY BOOK DEPT.
54 W. Lake St.; Chicago, Ill.

Please send me post-paid the book entitled "Edison; His Life and Inventions," in two volumes, for which I enclose remittance for \$4.28.

Name.....

St. and No.....

City.....State.....

HOOKS HERE REFLECTOR REVOLVES AGENTS

Stands in this position.

TURN SO LEFT SIDE OF ADVERTISEMENT BECOMES THE BOTTOM.

REFLECTOR REVOLVES

Newest Electric Appliance

The **HANDY LIGHT**—carry it anywhere in the house. Use it in every room. Hang on the wall—lights the **OVER DRESSER** room. Over the dresser—stand in flood of light. On table or sewing machine throws light on book or work—not in eyes. In kitchen, throws light on stove, sink,—in pantry. On bed for night reading or sickness—snap it on or off without getting up. Use one light instead of two—better results—save investment of \$25.00. Solid and substantial—made entirely of finest brass—beautiful finish. Cannot get out of order. Lasts a lifetime.

Every man and woman wants one. ZIP! It's attached to electric socket ready to use. Puts the light where you want it—everywhere—for table, dresser, bed, wall, desk, kitchen, machinery, garage—"the light of a thousand uses." For home, office, store, factory, warehouse, hotels,—tremendous field. No springs—scientific construction. Reflector revolves, will not twist cord or come loose. No competition. Liberal profits. *Sales driving sample.*

Zang's first 12 orders \$438.87. Toomey's first seven orders \$337.55. Stokes made \$275.20 in 26 days, and Cole's average is over \$270.00 a month. Brown over \$13.00 a day. Polly takes 15 orders in 10 hours and makes \$20.55. Wreath writes, "A dummy can sell **HANDY LIGHTS**." No knowledge of electricity required. *Exclusive territory.* Not sold in Stores. We own all patents. Write today.

Price **\$3.50** complete with 10 feet cord and plug.

Reduces electric bills No experience necessary Doubles illumination No work to install

No screws to adjust, weighs a pound.

THE HANDY LIGHT CO. 224 Handy Light Block, Cincinnati, Ohio

Every Live Boy Wants

any toy that actually enables him to duplicate, even on a smaller scale, the work of man, his bigger brother.

The Thordarson Toy Transformer

is at once the most amusing and instructive toy a boy can own. Attaches to any lamp socket. It is an electrical power plant in miniature, and really teaches him the practical working principles of electricity. *Alternating current only.*

A Thordarson Toy Transformer

rings bells, buzzers, operates Ruhmkorff or other induction coils and electrical toys of every description. In highly enamelled steel case. Indestructible. Prices, according to type and output, \$5, \$7, \$8 and \$10.



Ask about our Wireless Transformer

Thordarson Electric Mfg. Co.
505 South Jefferson Street Chicago

ELECTRIC Goods for Everybody.

House Lighting Plants, Lamps, Engines, Dynamos, Fan, Sewing Machine and Power Motors, Heating Pads, Laundry Irons, Toasters, Transformers, Meters, Telephones, Hand Lanterns, Submarine, Cap, Bicycle, Carriage, Automobile and Flash Lights, Storage and Primary Batteries, Belts, Bells, Books. Fortune for agents. Big Catalog, 4 cents.

OHIO ELECTRIC WORKS, Cleveland, Ohio

Telephone Troubles HOW TO FIND THEM

By W. H. HYDE

Treats entirely on how to locate and remedy all telephone troubles. 1912 Edition contains a special chapter on installing Phantom Circuits.

Price 25c Postpaid

An invaluable book for repairmen, as well as anyone who uses telephones on private or rural lines.

56 PAGES ILLUSTRATED

POPULAR ELECTRICITY BOOK DEP'T
54 W. Lake Street, Chicago, Illinois

ELECTRIC LIGHT AND POWER

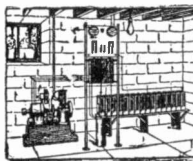

DAY AND NIGHT SERVICE
The Junior No. 1 Equipment
Direct Connected Dynamo, Gasoline Engine Set, Complete Switchboard, 18-Cell "American" Storage Battery } **\$265**
The most complete, reliable equipment ever offered at this price. We want a representative in every county.
AMERICAN BATTERY COMPANY
Est. 1889 1143 Fulton St., CHICAGO

ELECTRIC MOTORS SHOULD BE

"ROTHMOTORS"
Polishers, Grinders, Blowers
Write for Literature
ROTH BROS. & CO.
1385 W. Adams St., Chicago 136 Liberty St., N. Y.

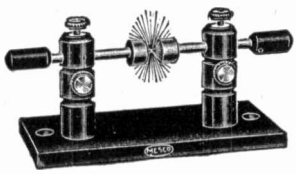

WANTED

A request from every reader for a copy of our 212 page pocket edition

Catalogue E 26

The most up-to-date catalogue issued on Telegraph and Telephone Apparatus, Wireless Telegraph Instruments, Batteries, Bells, Push Buttons, Motors, Electrically Heated Material, Spark Coils, Motor and Auto Horns, Battery Testers, Medical and Vibrator Apparatus and Accessories, Burglar Alarms, Call Bell Outfits, Early Riser Outfits, Annunciators, Electric Light Supplies, Switches, Insulated Wire, etc., etc. Fully illustrated by over 1,000 cuts. The descriptions are clear, concise and accurate. Don't wait, but write **NOW** for **CATALOGUE E 26**. It costs you nothing. The prices are right and will save you money.

MANHATTAN ELECTRICAL SUPPLY CO.
NEW YORK, 17 Park Place CHICAGO, 114 S. 5th Avenue ST. LOUIS, 1106 Pine Street

For our Mutual Advantage mention Popular Electricity when writing to Advertisers.

Telephone Men

Here Are the Latest Books in the Field. Written by
Recognized Authorities

If you're ambitious to learn and advance yourself to a better position, you need these books to be fully posted on the latest Telephone Equipment, Systems and methods now employed.

While there are many opportunities for advancement in the telephone field, it is the man who masters his work by combining book study with practice that goes rapidly to the front.

If you are in telephone work, or expect to be, get in touch with the men who are the greatest authorities in the field.

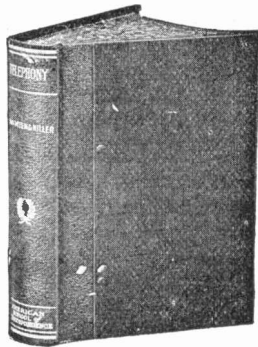

Telephony

By **SAMUEL G. McMEEN** and **KEMPSTER B. MILLER**

"Telephony" is a brand new work, just off the press. It gives the theory and practice of all phases of Telephone Engineering, with particular attention to recent developments in automatic systems. Its treatment is graphic and easy to understand, and so authoritative that it will add to the knowledge of the experienced telephone man.

It covers the installation, operation and maintenance of all types of telephone systems, discusses without prejudice the respective merits of manual and automatic exchanges, and gives special attention to the various "Troubles" that are met in actual operation.

948 Pages—7 by 10 inches

Price \$4.00, Postpaid

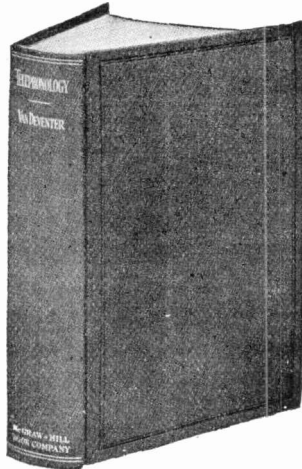

CONTENTS

I.—First Principles, Talking Equipment. II.—Signaling Equipment. III.—Commercial Talking Equipment. IV.—Magneto Instruments and Circuits. V.—Magneto Switchboards. VI.—Selective and Lock-Out Systems. VII.—Batteries. VIII.—Testing Telephone Parts. IX.—Testing Equipment and Faulty Location. X.—Measuring Instruments and Their Uses. XI.—Common Battery Equipment. XII.—Harmonic Party Line Systems. XIII.—Line and Cable Construction. XIV.—The Automatic System. XV.—Composite Systems. XVI.—Wireless Telephony.

Telephonology

By **H. R. VAN DEVENTER**

An up-to-the-minute book for everyone in the telephone business. It has nothing to do with history. Covers every detail of equipment and tells "how to do things." Is full of sound matter to solve problems and save trouble. It appeals alike to the workman, the specialist and the engineer. Contains everything that is new—wireless, combined telephone and telegraph, automatic, etc. Especially strong on testing, locating troubles and repairing.

600 Pages, 7x10—682 Illustrations. Price \$4.00, Postpaid.

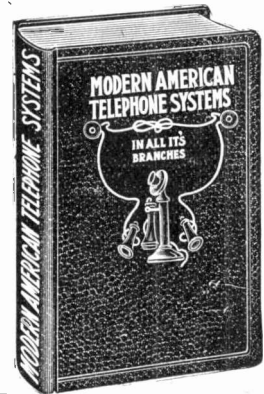

Modern American Telephony

By **ARTHUR BESSEY SMITH**

This book treats of present day telephony in a manner that can be easily understood by all. All subjects connected with modern telephone operation are treated in detail and the information regarding it is brought right down to the date of publication.

"Modern American Telephony" is the book for the telephone man and the man who wants to be one. It will pay for itself hundreds of times over in saving your time, keeping you out of trouble and helping you fit yourself for a more responsible position.

Endorsed by Managers, Wire Chiefs, Linemen and Troublemakers throughout the United States and Canada.

790 Pages—5 by 7 inches

Price \$2.00, Postpaid

We guarantee these books to be just as represented.

Money refunded if you are not satisfied.

POPULAR ELECTRICITY BOOK DEPARTMENT
54 WEST LAKE STREET, CHICAGO, ILLINOIS

Wayne Bell Transformers



Take the place of unreliable, troublesome batteries and use practically no current. Can be connected to any alternating current lamp socket and will

Operate Door Bells, Buzzers, Toys, Burglar Alarm Systems, Gongs, Annunciators, Etc.

Made in three types and sizes for different classes of work and so neat in appearance that they can be installed anywhere in homes, hotels, offices, schools, hospitals, etc.

Built to run for hours on dead short circuit without danger of burning out.

If your dealer does not have them write us and we will send our illustrated leaflet 4511.

Fort Wayne Electric Works

of General Electric Company
"Wood" Systems

1603 Broadway FORT WAYNE, IND.
Branch Offices: Most Large Cities

Will Not Burn Out

An important feature of these motors is that they will not heat under any circumstances 1/12 and 1/8 H. P. for A.C. and D.C. Finished in Black Enamel



THE
BARNES

Variable Speed and Reversible
Are especially adapted for
Washing Machines, Printing Presses,
Coffee Mills, Dental Apparatus, Vacuum
Cleaners, Wireless Apparatus, etc.

Let us figure on your requirements

BARNES MFG. CO. 107 Belmont Street
Susquehanna, Pa.

We Build Small Motors

adaptable to either
**Alternating or Direct
Current, Single Phase**
for all commercial and
domestic purposes, such
as washing machines,
vacuum cleaners, auto-
matic pianos, etc.

Manufacturers in need
of **Specially Designed
Motors** for driving some
Commercial Article,
please write us.

Our engineers are at
your disposal.

**The Holtzer-Cabot
Electric Company**

Boston, Mass., and Chicago, Ill.

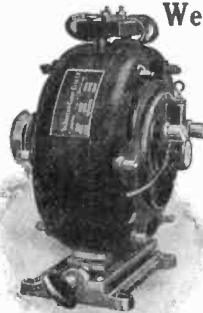

Children like the things that "Go."



Ideal Presents for Birthdays and Christmas

VOLTAMP Electrical Toys are not "make believes;" they're practical, especially well-built miniatures and have an educational as well as an amusement value that parents should consider. Greatest line of **MINIATURE ELECTRIC RAILWAYS** and Electrical Toys, also Telephone, Telegraph, Wireless and Xmas Tree Lighting Outfits; Standard instruments and materials for experimental purposes and electrical work; Dynamos, Motors, Induction Coils, Transformers, Rheostats, etc., and a line of splendid electrical novelties.

Send 5c in stamps or coin for catalog, which will be refunded on your first order for 50c or over. No postals answered.

VOLTAMP ELECTRIC MFG. CO., Park Bldg., BALTIMORE, MD.

GIVE YOUR WIFE A VACATION

W
A
S
H
E
S
B
Y
E
L
E
C
T
R
I
C
I
T
Y

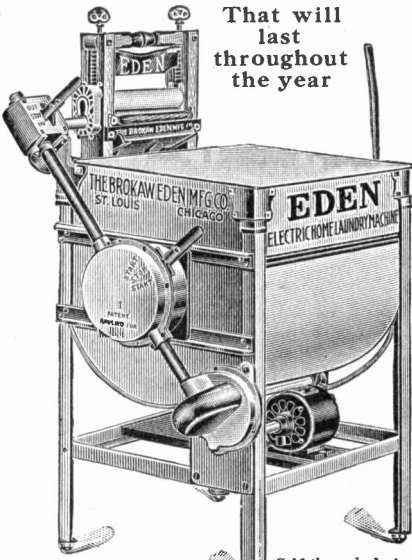

That will last throughout the year

W
R
I
N
G
S
B
Y
E
L
E
C
T
R
I
C
I
T
Y

Converts the dreaded washday into a day of pleasure

ASK

Sold through dealers and light companies everywhere—Cash or easy terms

Brokaw-Eden Mfg. Co. 1117 Olive St. St. Louis, Mo.

BENJAMIN TWO-LIGHT PLUG CLUSTER

For Doubling the Capacity of Your Sockets Without Extra Wiring



THIS IS IT

It just screws in—and the work is done. You have one light, but want two, Or you want to run an extra wire to another point for connecting some electrical appliance—fan, heater, curling-iron, flat-iron, chafing dish, etc., and still keep your light burning. You need not rewire the place to do it.

A Benjamin Plug Cluster Does the Work of Two Sockets.

Ask your electrical dealer to show you samples, or write for our descriptive list.

BENJAMIN ELECTRIC MFG. CO.
120-28 S. Sangamon St. Chicago, Ill.



A 30 Day Free Trial



in your home will demonstrate to your satisfaction how necessary the

SIMPLEX IRONER

is for economical management.

It saves your strength, health, beauty, time and money. It irons five times as fast, better and makes it easier. Servants are better contented, more efficient. Heats by gas or electricity. Operates by hand or small motor at small expense. It really costs nothing because it saves its cost every six months. Write for booklet and "Ironing Hints." Both free.

AMERICAN IRONING MACHINE COMPANY
55 East Lake Street Chicago, Ill.

SAVE

**YOUR HEALTH
YOUR GOOD LOOKS
YOUR TIME
YOUR CLOTHES
YOUR MONEY**

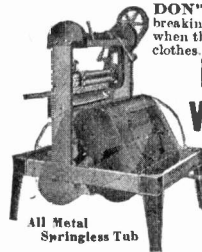

All Metal Springless Tub

DON'T grow prematurely old and haggard over a back-breaking washboard and a side-ache producing wringer, when there is a better and far cheaper way to wash your clothes.

DOMESTIC ELECTRIC WASHER and WRINGER

5 cents worth of electricity and 2 hours time will wash your clothes clean—make them look better and wear longer.

Enclosed Working Parts Easily Cleaned 15 Days' Free Trial in Your Own Laundry. Send for Catalogue and Easy Payment Plan.

DOMESTIC EQUIPMENT CO.
Dept. P. 30 W. Lake St., Chicago

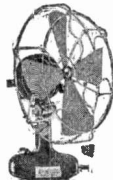

A General Utility Motor and 12-inch adjustable fan for.. **\$9.50** including cord and plug.

Powerful enough for polishing, running small lathes, sewing machines, etc.

Best fan and motor bargain ever offered, number is limited, get your order in quick.

60-cycle Alternating and Direct Current only—state which.

Regular line of fans, motors and "IMP" Torches



**178 SUMMER STREET
BOSTON, MASSACHUSETTS**

Exceptional Advantages

offered in the

Simplex Electric Chafing Dish



¶ Its cleanliness, safety, and convenience afford constant delight on the many occasions when it is used.

¶ "Simplex Quality" means Pre-eminence in design, material, finish, and durability.

¶ Simplex Clamping Contact saves current by utilizing all the heat.

¶ Three Heat Switches permit fast, medium or slow cooking.

Made in Many Popular Styles.

¶ Have you seen THE SIMPLEX FOOD COMBINATIONS? An electric stove with Saute Pan, Blazer, Tea Kettle, or Cereal Cooker.

At your Electric Lighting Company, or reliable dealers. Or write us for full information.

Simplex Electric Heating Co.

CHICAGO, 15 S. Desplaines St. CAMBRIDGE, MASS.
SAN FRANCISCO, 612 Howard St. BELLEVILLE, ONT.

Empire Port-A-Lite

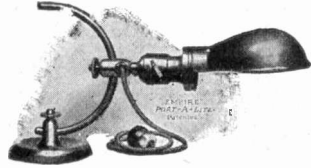

Can be adjusted to use on desk, piano, dressing table, writing desk, library table, or hung on the wall. There is no limit to its uses.

For Sale by Electrical Jobbers and Dealers.

Made Exclusively by

THE EMPIRE BRASS MFG. CO.
CLEVELAND

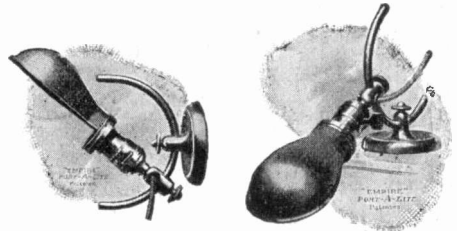

The Newdisco Electric Washer

The Newdisco is made to run by electric motor or gasoline engine. The Newdisco will wash more clothes, wash them cleaner, quicker and with less wear and tear than any other machine. The washer and the wringer may be run at the same time and the wringer is reversible. The Newdisco has been tested by Good Housekeeping Institute of New York, all our claims allowed and diplomas issued. It is made of the best material and fully guaranteed.

Write for Prices

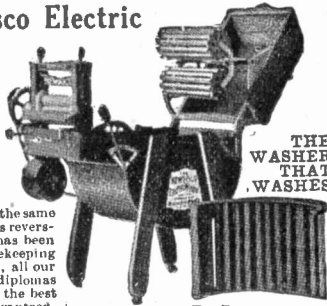

THE WASHER THAT WASHES

Newton Disc Plow Co., 220 N. Race St., Newton, Ia.

AFTER A SHAMPOO

Dry the Hair Quickly with a PELOUZE ELECTRIC COMB AND CURLING IRON

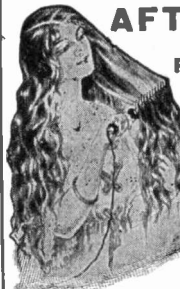

Acts as a tonic for the hair and scalp—makes the hair luxuriant—saves time and labor—works perfectly. To use Curling Iron—simply remove the comb—makes beautiful lasting waves or curls. The heater and cord revolve together, so that the cord does not kink while in use. The temperature is so regulated in the heater that it can't burn the hair.



No.	THREE STYLES	Price	If your dealer hasn't it we prepay
542	Electric Comb complete	\$3.75	expressage on receipt of price.
552	Electric Curling Iron only	3.50	
552	Curling Iron and Comb complete	4.50	

PELOUZE MFG. CO.

222-242 E. Ohio St., CHICAGO

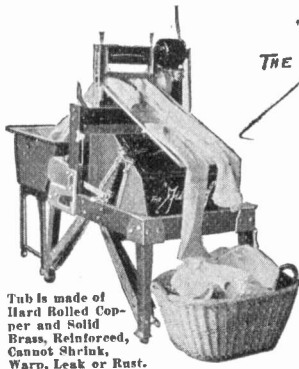

Tub is made of Hard Rolled Copper and Solid Brass. Reinforced, Cannot Shrink, Warp, Leak or Rust.

THE Judd Won't Wear Out the Clothes

The Reason Why? It's Perfectly Smooth Inside

Blankets and finest fabrics are all the same to THE JUDD, for the water is forced through the clothes a hundred times per minute. Ten or fifteen minutes will thoroughly cleanse a tub full.

Two hours to do a family washing! The electricity from any light socket will do the work at a cost of about four cents.

The special motor operates the reversible wringer and washer at the same time. Let us show you how THE JUDD works. Descriptive literature for the asking.

JUDD LAUNDRY MACHINE COMPANY

Room 335 People's Gas Building,

CHICAGO

For our Mutual Advantage mention Popular Electricity when writing to Advertisers.

BIG CATALOG

**JUST
OUT
300
BIG PAGES**

What this Big Catalog Contains: 100pp. Wireless insts. 40pp. Motors and dynamos. 20pp. Telegraph insts. 12pp. Victrolas. Etc. Etc.

ELECTRICAL and WIRELESS SUPPLIES Mailed for 6 cts., stamps or coin, which you may deduct on first order of \$1.00. Great cost of catalog, and our low prices, prohibits distribution of catalog, except to those really interested.

LOWEST PRICES 25% TO 33% SAVED in purchasing from us. Just one instance: Our flash-lights, equipped with Mazda Lamps and new Tugsten batteries (400 per cent. more power, light and service than old carbon battery) are lower in price than most dealers' cost. \$2.50 Miner's flash-light only \$1.80, post. 22c; \$1.75 "Bull-Dog" only \$1.20, post. 20c; \$1.25 Nickel flash-light only 85c, post. 6c. The same low prices on wireless instruments, motors, magnet wire, binding posts and thousands of electrical products.

**CELEBRATED
FERRON
DETECTOR**

Our magnet wire

is made by the largest factory in the U. S. S. C. and D. C. mean single and double cotton.

No.	S. C. per lb.	D. C. per lb.	Enamel per lb.
16	.37	.40	.43
20	.45	.49	.46
22	.47	.53	.49
24	.51	.61	.54
26	.57	.70	.64
28	.68	.83	.73
32	.73	.96	.86
32	.92	1.10	1.02
34	1.19	1.42	1.38
36	1.45	2.00	1.65

It yet remains the peer of all Detectors licensed for private use. Price only \$5

The Ferron Detector contains the same high grade crystal and an adjustment equally as admirable as the Pyron Detector licensed for commercial use which sells for \$25.00. License for private use permits of low price. A patron in Georgia writes: "Put Ferron in circuit and easily picked up several ships off Norfolk and New Orleans, also land stations. Signals came in so loud I could hear them with telephones removed from my ears."



FREE Wireless Course

information as many \$1.00 wireless books. Contains a comprehensive exposition of the principles of wireless; the uses and purposes of all wireless instruments; detailed instructions, with diagrams, showing every step in the erection of aerials; over 30 diagrams, made by an expert in wireless, showing "hook-ups" for practically all combinations of wireless instruments. Over 100 pages devoted to wireless. Complete sets from a few dollars, to thousands of dollars, for high class commercial equipment.

Only 6c, to show you are interested, secures you this great catalog.



STANDARD WIRELESS COILS. Note Prices:
 1/2 in. \$2.75 2 in. \$ 7.50
 1 in. 4.00 3 in. 13.75
 3/4 K. W. Transformer Coil, for line current, \$6.25
 with vibrator - - - - - 8.00

THE J. J. DUCK CO., 428 St. Clair St., Toledo, O.

Stop Buying Wireless Apparatus

and construct your own transformers, tuners, condensers, etc., from parts which we supply. Price list sent on request.

Our New

3,000 ohm telephone head set weighs only 10 1/2 ounces, has hard rubber covered split head band, five-foot silk cord, and two hard rubber covered receivers, and your money will be promptly and cheerfully refunded if it does not prove to be the most sensitive receiver on the market after a week's trial. Price \$10.00.

Four cents stamps will bring our complete catalog and place you on our mailing list

CLAPP-EASTHAM CO.
 141 MAIN ST., CAMBRIDGE, MASS.

Wireless Course Free

20 Lessons. From 1 to 20. With each purchase of \$1.00 worth of our wireless material we give you a lesson free.

Western Agents For
 THE ELECTRO IMPORTING CO.
 Same Catalog. Same Prices.
 Send 4c in stamps for catalog

ANDERSON LIGHT & SPECIALTY CO.
 134 N. La Salle St., Chicago, Ill.
 Opposite City Hall.

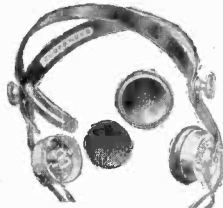

DO YOU KNOW
 that you can receive longer distances with

BRANDES RECEIVERS

than with other makes?

Send for our Booklet. It describes receivers from \$1.50 to \$13 and tells you how you may try them at your own station and convince yourself of their worth.

C. BRANDES, Inc., 111-115 Broadway, New York
 SAN FRANCISCO Ford King, 610 Balboa Bldg.
 LOS ANGELES... D. E. Cook Electric Co., 347 So. Spring St.

Sending and Receiving Wireless Outfits

COMPLETE—PORTABLE

IDEAL SETS AT A PRICE YOU CAN AFFORD TO PAY

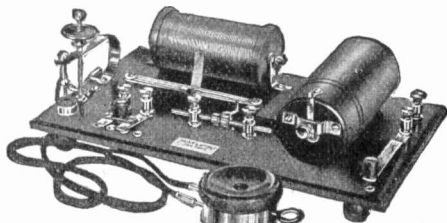

Mounted on solid oak base, size 7x12

No. 796—\$5 Value \$ 3.90

Sends ½ to 1 Mile—Receives up to 500 Miles

This new, up-to-date, guaranteed, portable set, consisting of one ¼-inch spark coil, equal to the average ¾-inch coil, and high tension vibrator, 1 combination universal detector; one 75-ohm, nicked case, exceptionally sensitive telephone receiver and cord; 1 large high efficient flat plate secondary condenser; 1 sending key; 1 condenser switch; 1 spark gap with lathe turned ¾-inch zinc spark ends; 1 tuner 4½x2 inches, latest type, wound with bare copper wire; 1 special primary condenser; 1-inch Wollaston wire; 1 double throw double pole aerial switch; 120 feet aluminum aerial wire; 2 insulators, complete directions and code. The raw material alone would cost you this amount were you to build the set yourself. Operates on two batteries. Price.....\$3.90

No. 798—Same as above, with ½-inch coil. Sending radius 1 to 2 miles. Price.....\$5.00

Mounted on solid oak base, size 8½x10 inches

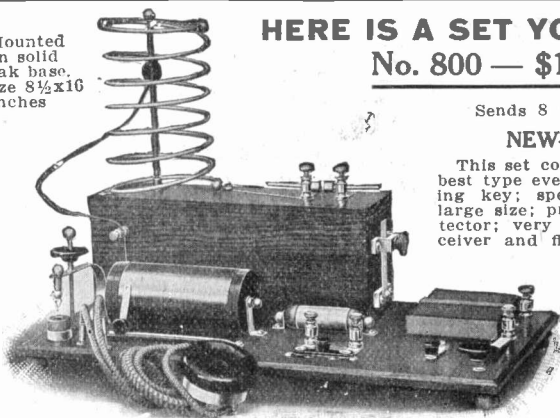

HERE IS A SET YOU'LL BE PROUD TO OWN

No. 800 — \$15.00 Value \$ 8.50

Sends 8 to 15 Miles. Receives 600 to 800 Miles

NEW—UP-TO-DATE—GUARANTEED

This set consists of a guaranteed 1-inch spark coil, the best type ever placed on the market for wireless; 1 sending key; special flat plate secondary condenser, extra large size; primary condenser; combination universal detector; very fine 1000 ohm, silk copper wire wound receiver and flexible receiver cord; the newest type bare copper wire wound tuner, exceptionally large capacity; spark gap with lathe turned 3.8-in. zinc ends; 1 condenser switch; 120 feet aluminum aerial wire; double pole, double throw switch; 2 insulators; 1-inch Wollaston wire; proper capacity sending helix; 8 to 15 miles sending, 600 to 800 miles receiving. Regular \$15.00 Value. Operates on six batteries. Price complete.....\$8.50

No. 800A. Set 800 equipped with 2000 ohm receivers and head band.....\$11.45

Wireless Spark Coils

We give a greater value in spark coils than any other firm in America. Our coils are larger than other coils of the same quoted spark length, as we put more working materials inside of them. Our vibrator platinum points are **P L A T I N U M A N D W O N ' T S T I C K** by welding together as alloy points are bound to do. We guarantee the spark lengths given below and you can have your money back if they don't come up to the values promised. These coils are put up in hardwood cases finished in an elastic varnish and then rubbed down to a dead finish making the handsomest coil on the market.

No. 200	¼ in. coil\$ 2.00
No. 201a	⅜ in. coil 3.00
No. 201b	½ in. coil 3.30
No. 201c	¾ in. coil 3.65
No. 202	1 in. coil 3.95
No. 203	1½ in. coil 5.50
No. 204	2 in. coil 7.75
No. 205	3 in. coil 15.50
No. 206	4 in. coil 25.00
No. 207	6 in. coil 50.00
No. 208	8 in. coil 75.00
No. 209	10 in. coil 100.00

For the Beginner



No. 797 Mounted on Solid Oak Base \$1.75

Receives up to 500 Miles

This consists of a combination universal detector; 75 ohm nicked case, exceptionally sensitive receiver and telephone cord; tuner 4½x2-inch latest type, wound with bare copper wire; 1-inch Wollaston wire; 2 insulators; 65 feet aluminum aerial wire. Price.....\$1.75

Equipped with 1000 ohm receiver.....\$2.70

By Mail 32c Extra

DON'T BUY BEFORE WRITING US. SEND AT ONCE FOR CIRCULAR P.

HUNT & McCREE

Laboratories
255 Washington St.

(The House of Wonderful Values)
NEW YORK

General Offices
92-94 Murray St.

For our Mutual Advantage mention Popular Electricity when writing to Advertisers.



Double Slide Bare Wire Air Dielectric Tuning Coil \$4.00

Again we come to the front with something radically new in WIRELESS. The above Tuning Coil is unique in many ways, and we guarantee that with all other things being equal, it will bring in signals louder and clearer than any other Double Slide Tuner manufactured, regardless of price.

We have gotten away from the supposedly necessary cylindrical form of core, and in so doing are enabled to air space the turns of wire from each other. The only points of actual contact of the turns with a common support are the four edges of the quadrilateral winding and these supports are of vulcanized Hard Rubber, so practically 95 per cent. of the total length of the wire is air spaced, thus reducing the chance of leakage to a minimum. Price \$4.00, express charges to be paid by consignee at destination.

The above Tuner equipped with an extra slide, thus making a Triple Slide Tuner, price \$4.50. The size of the bare copper wire is either No. 22 or 24 as you may select, prices being the same in either instance.

We are agents for the "BRANDES" Long Distance Receivers now so well and favorably known that detailed description is unnecessary.

"BRANDES" SUPERIOR TYPE, 2000 Ohms total, per pair postpaid, \$5.20

"BRANDES" TRANS-ATLANTIC TYPE, 2800 Ohms total, per pair postpaid, \$9.20

"BRANDES" IMPROVED NAVY TYPE, 3200 Ohms total, per pair postpaid, \$13.20

The above receivers are fully guaranteed, each and every phone having the name "BRANDES" plainly stamped on the aluminum case; Head bands are Hard Rubber covered in the instance of the T. A. T. and Navy and solid German Silver for the "SUPERIOR" type. Cords are green silk 6 ft. in length.

Single "BRANDES" SUPERIOR Phone, 1000 Ohms, postpaid, \$1.60

Single "BRANDES" SUPERIOR Phone, 1000 Ohms, with leather covered head band and single cord, postpaid, \$2.65

Promptness in delivery is our specialty: a large stock of phones always on hand. Send stamp for descriptive circular of Tuners together with some of our other specialties.

DAWSON & WINGER ELECTRIC COMPANY
727 South Dearborn Street Chicago, Illinois

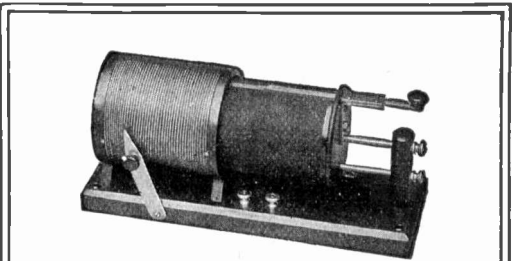

Effective Tuning

Between hit-or-miss tuning, and the effective selection of incoming signals, there is a wide difference. The one is comparative failure. The other is real efficiency. Real efficiency requires operating knowledge and good apparatus. You have the knowledge? We can supply the apparatus.

The really good receiving transformer shown here is a type of the good apparatus which we make. It will cost you \$8.00.

WM. J. MURDOCK CO.
50 CARTER STREET, CHELSEA, MASS.
162 Minna Street, San Francisco

Good News for Wireless Amateurs

PART II

of A. F. Collins book "Plans and Specifications for Wireless Telegraph Sets" giving data for 5 to 10 mile sets is **NOW READY**

This book is written in plain every-day language, and places at the disposal of every amateur the experience of America's greatest Authority on wireless apparatus, at a nominal cost. By mail, for 25c.

SPON & CHAMBERLAIN, 123 P. E. Liberty St., N. Y.



WIRELESS COILS

Our Wireless Coils are made especially for wireless, and stand second to none for this purpose. This coil shown here will, on 6 dry batteries, give a 3/4-inch spark; and with a fair sized aerial transmit from 25 to 30 miles, and with a good 0 Volt Storage Battery will do even better. For a short time only the above coil can be bought for \$10.00 net. Shipped anywhere f. o. b. Philadelphia. We also have smaller sized Wireless Coils at very reasonable prices.

F. B. Chambers & Co., 217 N. Ninth St., Phila., Pa.

Send 2-cent stamp for illustrated catalogue.

HOT WIRE AMMETERS

The obsolete type has been replaced by us with an up-to-date, sensitive and reliable instrument for alternating current, such as is used with wireless sending stations. The instrument is built into a brass case of about 2 1/2 in. overall in diam. The scale is finely calibrated to read from 0-3 and 0-4 amperes in small fractions. Introduction price, \$4.95.

COSMOS ELECTRIC CO.
136 E. Liberty St., New York

MODERN ELECTRICS

"The Electrical Magazine for Everybody"
The Authority on Wireless

For the Novice, the Amateur, the Experimenter and the Student, 112 to 144 pages monthly. With a six month trial Subscription, we are making the following FREE OFFER: Marble's Pocket Screw driver and Prest-o-lite Key. Three sizes of blades locked in nickle plated handle which closes up like a knife. Closed 3 1-2 in.—Open 5 1-4 in. Just out and it's a dandy. FREE. Send 75c. today in cash, stamps or M. O. and get six big numbers of Modern Electrics and the screw driver prepaid Absolutely Free.

MODERN ELECTRICS, 262 Fulton St., N. Y.

Y

Not send for our No. 10 Catalog of Wireless and Electrical Supplies

Containing Hi Grade Instruments of every type. The prices are right and the shipments will be prompt.

John Y. Parke & Co., Dept. A, 127 N. 7th St., Phila.

BIG CATALOG

JUST OUT
300
BIG PAGES

What this Big Catalog Contains:
100 pp. Wireless insts.
40 pp. Motors and dynamos. 20 pp. Telegraph insts. 12 pp. Victorias. Etc. Etc.

ELECTRICAL and WIRELESS SUPPLIES Mailed for 6 cts., stamps or coin, which you may deduct on first order of \$1.00. Great cost of catalog, and our low prices, prohibits distribution of catalog, except to those really interested.

LOWEST PRICES 25% TO 33% SAVED
In purchasing from us. Just one instance: Our flash-lights, equipped with Mazda Lamps and new Tungsten batteries (400 per cent. more power, light and service than old carbon battery) are lower in price than most dealers' cost. \$2.50 Miner's flash-light only \$1.60, post. 22c; \$1.75 "Bull-Dog" only \$1.20, post. 20c; \$1.25 Nickel flash-light only 85c. post. 6c. The same low prices on wireless instruments, motors, magnet wire, binding posts and thousands of electrical products.

Our magnet wire

is made by the largest factory in the U. S. S. C. and D. C. mean single and double cotton.

No.	S. C.	D. C.	Enamel
	per lb.	per lb.	per lb.
16	.37	.40	.43
20	.45	.49	.46
22	.47	.53	.49
24	.51	.61	.54
26	.57	.70	.64
28	.68	.83	.78
30	.73	.96	.86
32	.92	1.10	1.02
34	1.19	1.42	1.38
36	1.45	2.00	1.65

CELEBRATED FERRON DETECTOR

It yet remains the peer of all Detectors licensed for private use. Price only \$5

The Ferron Detector contains the same high grade crystal and an adjustment equally as admirable as the Ferron Detector licensed for commercial use which sells for \$65.00. License for private use permits of low price. A patron in Georgia writes: "Put Ferron in circuit and easily picked up several ships off Norfolk and New Orleans, also land stations. Signals came in so loud I could hear them with telephones removed from my ears."



FREE Wireless Course

Our catalog is practically a free course in wireless. Has as much wireless information as many \$1.00 wireless books. Contains the principles of wireless; the uses and purposes of all wireless instruments; detailed instructions, with diagrams, showing every step in the erection of aerials; over 30 diagrams, made by an expert in wireless, showing "hook-ups" for practically all combinations of wireless instruments. Over 100 pages devoted to wireless. Complete sets from a few dollars, to thousands of dollars, for high class commercial equipment.

Our catalog is practically a free course in wireless. Has as much wireless information as many \$1.00 wireless books.



Only 6c, to show you are interested, secures you this great catalog.

STANDARD WIRELESS COILS. Note Prices:

½ in.	\$2.75	2 in.	\$ 7.50
1 in.	4.00	3 in.	13.75
½ K. W. Transformer Coil, for line current,			\$6.25
with vibrator			8.00

THE J. J. DUCK CO., 428-430 St. Clair St., Toledo, O.



This Static Machine giving from a 2½ to 3 in. spark guaranteed, with two 7-inch Electric Composition Plates; made entirely of hard rubber and steel, works without batteries, simply turn crank and sparks and to conduct over a hundred experiments. **\$4.00**
WEIGHT 3 LBS.



This beautiful Rheostat Battery Current Regulator to regulate speed of small motors, dim lamps, for electroplating, etc., 4-in. in diameter, working on two amperes continuously, with hard rubber binding posts, nickel trimmings. **50c**
By mail extra.....7c



This Electrolytic Detector for detecting Wireless Messages is the most sensitive Detector ever made. It receives messages for over 1,000 miles. Hard rubber base, binding posts, thumb nut; polished aluminum upright. The Greatest Bargain Today **\$1.25**
By mail extra.....12c



This fine Telegraph Key mounted on hard rubber composition base with hard rubber binding posts, hard rubber knob, nickel plated trimmings, just the thing for practicing telegraphy. Double circuit. The same Key single circuit with 2 binding posts **30c**
By mail extra.....5c



Our Bull Dog Spark Coils are the latest word. Each coil guaranteed for one year. Give powerful fat spark, finely finished. For Wireless Experimenting, etc. **\$2.20**
¾-in. Coil.....**3.10**
1-in. ".....**4.50**
1½ ".....**6.50**
2 ".....**9.00**



This set of Amateur Wireless Phones, the best for wireless beginners. 2,000 ohms, leather cord, head band, six foot nickel receivers, complete set. **\$4.50**
By mail extra.....26c



This powerful 6 Volt, 60 Ampere Storage Battery guaranteed for one year, the finest value ever offered, hard rubber jars, treated wooden case, hard rubber vents, rubber covered handle. **\$8.00**
WEIGHT 24 LBS.
The same battery 6 Volt, 40 Amperes **\$6.25** same construction.



This Pony Telephone Receiver, shell and cap made of hard rubber composition, powerful magnet, nickel wound, er, wound to 75 Ohms. With two of these phones and no batteries, conversation can be held over 500 feet. Price each.....**40c**
The same Phone, wound to 1,000 Ohms for Wireless **\$1.50**
By mail extra.....7c

Send to-day 4c postage for our famous 196 page Electrical Cyclopaedia No. 10, containing 400 illustrations and over 1,500 electrical articles and instructive information on electrical and wireless subjects.

THE ELECTRO IMPORTING CO., 233B Fulton St., New York
"EVERYTHING FOR THE EXPERIMENTER"

For our Mutual Advantage mention Popular Electricity when writing to Advertisers.

The Four Famous Electric Vehicle Batteries Are the "Exide"—"Hycap=Exide"—"Thin=Exide" and the "Ironclad=Exide" Battery

Here Are Some Facts About Them:—Not Claims—Facts

- 1.—The 23 leading manufacturers of electric vehicles use and endorse these "Exide" batteries.—Why?
- 2.—The vast majority of all pleasure "Electrics" are equipped with them.—Why?
- 3.—They are manufactured by a company having twenty-four years' experience in making storage batteries and whose works are the largest in the country devoted exclusively to the battery business.
- 4.—They will run your electric car—pleasure or commercial—more miles with less attention, at less expense and with greater continuity of service—than any other battery made.
- 5.—They will not quit on hills nor in starting heavy loads, and they give satisfactory service in hot or cold weather.
- 6.—They can be recharged at a reasonable cost and require minimum attention to be kept in good order.

Don't you think it's a pretty safe deduction that these batteries are the dependable ones for your "Electric"?

The "Ironclad=Exide" Book and the "Exide" Book tell you all about these batteries.

THE ELECTRIC STORAGE BATTERY CO.

1888

PHILADELPHIA, PA.

1912

New York Boston Chicago St. Louis Cleveland Atlanta Denver
Detroit San Francisco Portland, Ore. Seattle Los Angeles Toronto
"Exide" Depots in Philadelphia, Boston, Chicago, Cleveland, St. Louis, Denver, Atlanta and San
Francisco. 860 "Exide" Distributors. Traveling "Exide" Inspection Corps.

The "Exide" Battery is best for Ignition, Illumination or Self-Starters.

A NEW BOOK ELECTRIC LIGHT FOR THE FARM

Shows you how to install and operate the most up-to-date low voltage electric light plants suitable for farms, stores and country homes in general.

Full details are given, showing how to estimate the number of lights required, their best location, wiring and the plant necessary to furnish the current.

Part I. LOW VOLTAGE ELECTRIC LIGHTING WITH THE STORAGE BATTERY. Chapters 1—Introduction. 2—The Storage Battery. 3—Estimating the Installation. 4—The Electric Plant. 5—Some Typical Plants. 6—Installation and Operation.

Part II. WIRING HOUSES FOR ELECTRIC LIGHT. Chapters 1—Introduction. 2—Planning the Wiring. 3—Completing the Installation. 4—Installing the Lights. 5—Other Methods of Wiring. 6—Materials and Notes. 7—Notes on Underwriters Rules.

190 Pages, Illustrated, Bound in One Volume. Price \$1.00.

POPULAR ELECTRICITY BOOK DEPT., 54 W. Lake Street, Chicago, Ill.

TESTED APPARATUS MEANS THE ELIMINATION OF FAULTS IN YOUR PRODUCT

Electrical and photometrical tests of every description. Checking electrical instruments of all kinds and classes. Inspecting and testing new electrical machinery, apparatus and material at factories and after installation. Tests on any electrical machinery and apparatus made anywhere. Arc and incandescent lamp tests, either electric, gas, acetylene or oil. Illumination tests made anywhere. Secondary standards of candle-power furnished. Facilities furnished to experimenters and investigators.

We have recently added to the above, Coal Testing, and are now prepared to make proximate analyses and calorific determinations on samples of coal, promptly and accurately.

ELECTRICAL TESTING LABORATORIES
80TH STREET AND EAST END AVENUE NEW YORK, N. Y.

For our Mutual Advantage mention Popular Electricity when writing to Advertisers.

LEIMAN BROS.

VACUUM PUMPS

For Portable and Stationary Plants

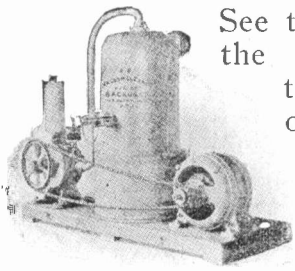

See that you get the pump that takes up its own wear with the curved wings.

The more powerful types of outfits are using our pumps, capacities from 2 to 338 cubic feet per minute, one to four sweepers. Used also for blowing.

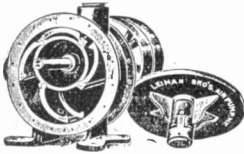

CATALOG No. 84—BLOWERS
No. 85—VACUUM

LEIMAN BROS., 62AD John St., New York

Electric Light and Power Anywhere

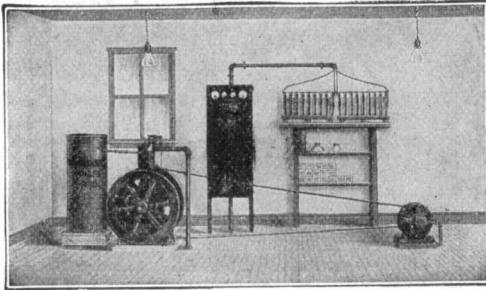

Fairbanks-Morse Electric Plants

Make it possible for every one to enjoy the benefits of electric lighting and power. Location makes no difference. Fairbanks-Morse plants are complete, independent units of ample capacity to light fully any ordinary home and will also furnish power for doing the odd jobs, such as running the cream separator, churn, washing machine, etc. Complete outfit with 2 H. P. engine, dynamo, storage battery, switchboard and 50 Mazda lamps furnished. Safest, best and most reliable lighting and power system.

Write for Catalog No. 1163TQ.

Fairbanks, Morse & Co.

900 S. Wabash Ave., Chicago, Ill.



Guaranteed Non-Magnetic

This watch, a handsome stem wind and set thin model, dust proof time piece, will positively withstand all magnetic attractions. Tested to 2000 Volts. Guaranteed accurate. Money back if not as represented. Approved by all electrical engineers. Price only \$5.00. Delivery FREE

E. KIRCHBERG, Dept. A 132 NORTH STATE ST., CHICAGO.

GRAY MOTORS FOR BOATS



Made in the Largest Plant in the World devoted to manufacturing 2-cycle marine gasoline engines.

3 H.P. with Complete Outfit ready to install \$55
ALSO 3/4 TO 36 H.P.

Guaranteed by a big responsible concern. Write for big catalog—tells and shows you all about these high grade motors and how they are made.

GRAY MOTOR CO., 1094 G M C Bldg., Detroit, Mich.

OWN YOUR HIRED HELP



Our small gas or gasoline motors will drive your washer, wringer, small dynamo and lathe. Convenient to handle, easy and sure to operate and they are strictly guaranteed.

Run on gasoline, kerosene, alcohol or gas, 1-4 H. P. \$20.00; One H. P. \$27.50.

Send stamp for catalog.

Elgin Wheel & Engine Co., Elgin, Ill.



STOP! LOOK! LISTEN! Our lamps produce a brilliant, steady, white light at one-fifth the expense of any other medium; suitable for all places and all purposes, easily installed, generator instantly interchangeable. Exclusive territory to responsible parties. Free Illustrated Catalogue showing the largest line and latest inventions, in gasoline lighting, mailed on request. **DOUD LIGHTING CO., 182 N. Sangamon St., Chicago, Ill.**



SPARKLING ASTRA DIAMOND

Brilliant as genuine. Special offer to introduce these wonderful gems—Solid Gold Stick Pin, 1K, \$1.00. Solid Gold Tiffany Ring, 1K, \$1.75. Order today—now. Catalogue free.

REGO JEWELRY COMPANY, Dept. E, CHICAGO



SMALL ENGINES

3/4 H. P. Up
Steam, Gas and Gasoline.
For Amateurs and Mechanics. Circulars for stamp. Big Catalogue Engines, Small Power Machinery and Electric Light Plants, 2 Lights Up. Sent for 10c (coin preferred). Refunded first order.

**AMATEUR MECHANICS SUPPLY CO.,
860A Monadnock Block, Chicago, Illinois, U. S. A.**



We Ship on Approval

without a cent deposit, prepay the freight and allow **10 DAYS FREE TRIAL** on every bicycle. **IT ONLY COSTS** one cent to learn our unheard of prices and marvelous offers on highest grade 1913 models.

FACTORY PRICES Do not buy a bicycle or a pair of tires from any one at any price until you write for our new large Art Catalog and learn our wonderful proposition on the first sample bicycle going to your town.

RIDER AGENTS everywhere are making big money exhibiting and selling our bicycles. We sell cheaper than any other factory.

TIRES, Coaster-Brake rear wheels, lamps, repairs and sundries at half usual prices. Do Not Wait; write today for our latest special offer on "Ranger" bicycle.

MEAD CYCLE CO. Dept. D-109 CHICAGO

Add to Your Income \$5 to \$10 a Day Made Easy

The "AMERICAN" the only Machine on the market (barring none) that sharpens and hones razors, sharpens all kind safety razor blades, scissors, pocket knives, clip-pers, etc. Will sharpen anything in need of a keen edge, also cut cylinder keys. No previous experience required. Address—**American Sharpening Machine Co., Desk 10, 184 West Washington Street, Chicago**

For our Mutual Advantage mention Popular Electricity when writing to Advertisers.

The Recognized Authority on Wiring and Construction

Standard Wiring for Electric Light and Power

As adopted by the Fire Underwriters of the United States

The only book on Wiring and Construction kept strictly up-to-date

What the 1912 Edition Contains

The latest rulings of The National Board of Fire Underwriters, explained and illustrated with line cuts and half-tones of the most modern and approved methods.

Directions for installing and operating Dynamos, Motors, Arc Lamps, Switchboards, etc.

Full details on outside wiring and construction for both telephone and power lines.

The simplest and most approved methods of inside wiring for light, heat and power, with examples worked out for both direct and alternating current for all systems—especially prepared for "Standard Wiring" by the greatest electrical engineering company in the world.

The latest data on Carbon, Gem, Tantalum, Tungsten and Mazda incandescent lamps.

All the necessary tables for every requirement of the Constructing Engineer, Contractor, Central Station and Wireman.

The Standard Symbols for wiring plans.

A special chapter on the treatment of electrical injuries, by Chas. A. Lauffer, M.D., of the Westinghouse Co.

Definitions of electrical units.

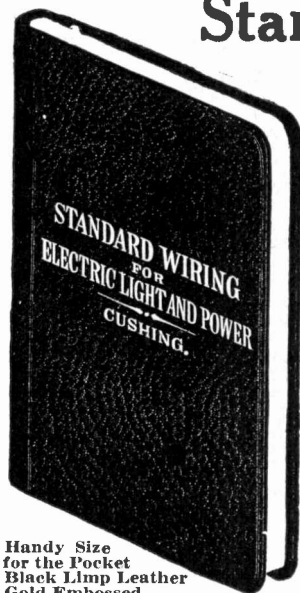

Handy Size for the Pocket
Black Limp Leather
Gold Embossed

Price \$1.00 Postpaid

POPULAR ELECTRICITY BOOK DEPT., 54 W. Lake St., Chicago, Ill.

Eighteen Ways to Make Money and Advance Yourself in the Electrical Field

WHEN seeking any line of work you should get in touch with men in the field who are doing successfully the thing you want to do. "Eighteen Ways to Make Money and Advance Yourself in the Electrical Field" is the result of personal talks with winners who are engaged in doing the things they give "pointers" about. Advice from a building electrician on how to become one, how one man became an electrical contractor, etc. You can't get anything more direct than that.

This Book May Be Your Opportunity

It may suggest a line of action that had not occurred to you and which you are in a position to act upon and make yourself financially independent. Moreover it is full of suggestions to the wide-awake fellow who is anxious to "make good."

WRITE FOR A COPY NOW SEND STAMP FOR POSTAGE

POPULAR ELECTRICITY PUBLISHING COMPANY
54 West Lake Street - Chicago, Ill.

RED DEVIL END NIPPER No. 72



6 1/2-inch
DROP FORGED STEEL
WARRANTED

A convenient size—handy and practical tool for you—its uses are unlimited. It will cut anything. It has hand-honed cutting edges and is absolutely guaranteed. It's a RED DEVIL quality tool—it's gun metal finished and you should get a sample from your local dealer. If you can't, send us his name and 80c and a sample pair will be sent you prepaid.

SMITH & HEMENWAY COMPANY
015 Chambers St., New York

Manufacturers of RED DEVIL Glass Cutters and 3000 other tools for Electricians, Carpenters, and Mechanics.

Electrician's and Inspector's

tool bag is made of extra heavy selected russet leather. The bottom is built up of one thickness each, leather, heavy strawboard and duck, and is shod with heavy steel studs. All seams are well finish. It is provided with extension straps across the ends of the opening, so as to permit of its being widened up when additional room is required. It has three retaining straps on the flap, and two extra strap loops riveted on the back for carrying a saw, bell hangers' bit, etc. It is also provided with shoulder strap for carrying. Made in sizes 16-20-24 in.

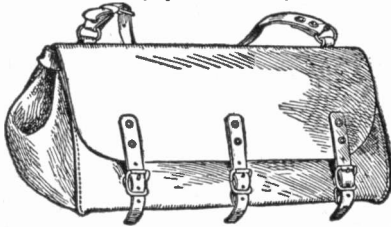

Write to us for catalogue and order from your nearest supply house.

Mathias Klein & Sons, Canal Station 3, Chicago, Ill.

10 Tools in One

This combination consists of a hollow handle of cocobola, highly polished and finely finished, and containing ten separate and distinct tools, each of which fit into the steel jaws of the chuck and perform their work perfectly.

TOOL HOLDER No. 5

The handle and chuck is 7 1/2 inches long over all. The tools are high grade, tempered steel, honed to a fine cutting edge and highly finished. The jaws of the handle close over the shoulders of the tools securely and they will not pull out when in use.

For sale by dealers at \$1.25
Send for "TOOL PRACTICE"—An Instructive Book—It's FREE.

MILLERS FALLS CO.
28 Warren St., New York

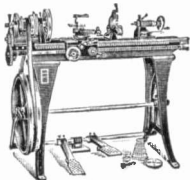
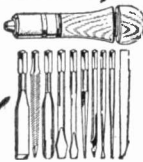

SOUTH BEND LATHES

\$75 Screw Cutting Foot Power, Steam Power or Electric Motor Drive 9 to 13 In.

South Bend Machine Tool Co., 427 Madison St., South Bend, Ind.

CATALOG FREE

Wonderful Sewing Awl

For mending harness, shoes, straps, canvas. Sews or mends anything; whole repair shop. Automatic natural tension reel, carrying waxed thread. Original perfect lock-stitch, diamond point grooved needle protects the thread, always ready.

\$1.00 only. Sample prepaid. Agents get busy. Sells on sight.

C. A. Myers Co., 6300-A Lexington Ave. Chicago, Ill.



The 170-page book, at the left, is free to you. Send for it. It's a valuable reference book. It also catalogs over 200 tools.



Pliers You See in Expert Hands

P. S. & W. No. 30 "Star Rivet" Box Joint Pliers are recognized as the highest development of plier-construction.

They've powerful leverage, snug-fitting, easy-working joints and edges that cut clean their entire length. If not abused, they last as long as the man.

And like all other P. S. & W. Guaranteed Pliers, they are backed by The MARK of the MAKER.

P. S. & W. GUARANTEED BOX-JOINT PLIERS

- | | |
|---|---|
| No. 30 Side Cutting, Black | No. 37 Diag'l Cutting, Raised Cutters, Black |
| No. 130 Side Cutting, Nickel | No. 137 Diag'l Cutting, Raised Cutters, Nickel |
| No. 300 Side Cutting, Insulated Handle | No. 43 Chain Nose, Nickel |
| No. 50 Side Cutting with Splitting Device | No. 31 Opticians' Round and Flat Jaws, Black |
| No. 9 Side Cutting, Extra Heavy, 9 inch | No. 131 Optician's Round and Flat Jaws, Nickel |
| No. 20 Flat Nose, Black | No. 38 Opticians' Concave and Convex Jaws, Blk |
| No. 120 Flat Nose, Nickel | No. 133 Opticians' Concave and Convex Jaws, Nkl |
| No. 25 Round Nose, Black | |
| No. 125 Round Nose, Nickel | |
| No. 27 Diag'l Cutting, Black | |
| No. 127 Diag'l Cutting, Nickel | |

Also a full line of Lap-joint Pliers and Splitting Clamps

The Peck, Stow & Wilcox Company MANUF'RS Of the Largest Line of Mechanics' Hand Tools Offered by Any Maker

Address Correspondence to 30 Murray St., New York City

Established 1810

Five Large Factories

PATENTS

TRADEMARKS AND COPYRIGHTS SECURED OR FEE RETURNED

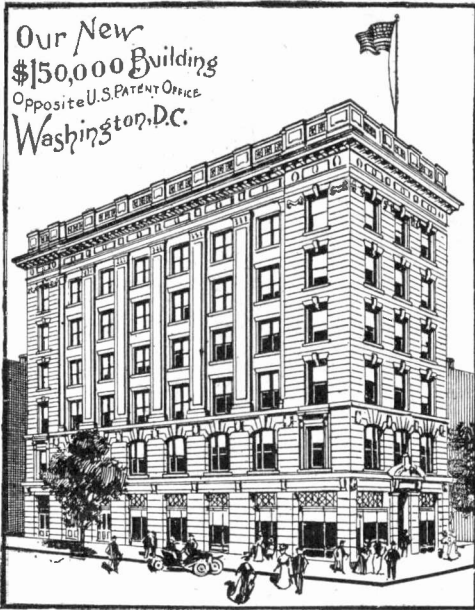

Send model or sketch and description of your invention for *free* search of the U. S. Patent Office Record.

Our **FOUR BOOKS** mailed free to any address. Send for these books; the finest publications ever issued for free distribution.

HOW TO OBTAIN A PATENT. Our Illustrated 80 page Guide Book is an invaluable book of reference for inventors and 100 mechanical movements illustrated and described.

FORTUNES IN PATENTS. Tells how to invent for profit and gives history of successful inventions.

WHAT TO INVENT. Contains a valuable list of inventions wanted and suggestions concerning profitable fields of invention. Also information regarding prizes offered for inventions, among which is a **Prize of One Million Dollars** offered for one invention and \$10,000 for others.

PATENTS THAT PAY. Contains letters from our clients who have built up profitable enterprises founded upon patents procured by us.

LIST OF PATENT BUYERS. Personal requests and letters from manufacturers and promoters for patents secured by us and suggestions of new ideas they wish to purchase.

We advertise our clients' inventions free in a list of Sunday newspapers with two million circulation and in the *World's Progress*. Sample copy free.

Electrical Cases a Specialty. We have secured many important electrical patents.

VICTOR J. EVANS & CO.

(Formerly Evans, Wilkins & Co.)

Victor Bldg., 724 9th St. N. W., WASHINGTON, D. C.

THE JOURNAL FOR THE YOUNG ENGINEER

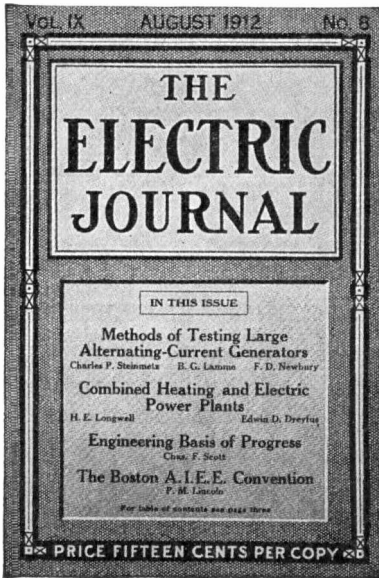

The value of articles along electrical lines depends on their reliability and the practical experience of the authors.

The Electric Journal

(Published Monthly)

is the most practical and authoritative magazine for those who wish to get up-to-date information regarding the best engineering practice. It tells how electrical apparatus is built, how to install and operate it; how to connect up meters, dynamos, transformers, motors; how to apply motors to various industries, etc. The JOURNAL has a large staff of contributors who are prominent practicing engineers, each an acknowledged expert in his particular line. The articles are written in a simple, direct style, in condensed form.

Each subscriber has the privilege of making use of

THE JOURNAL QUESTION BOX

and can thus receive free of charge valuable advice on engineering subjects direct from our contributing experts. No other electrical magazine gives this valuable service.

A subscription to the JOURNAL places you in direct touch with the latest electrical development. The cost is only \$1.50 a year. (Canadian postage 25c and foreign 50c additional.) Try it for a year. Single copies 15c each.

THE ELECTRIC JOURNAL, Penn Ave. and Ninth St., PITTSBURGH, PA.

For our Mutual Advantage mention Popular Electricity when writing to Advertisers.

WANTED-IDEAS

Manufacturers are constantly writing me for new ideas

PROTECTED BY OWEN PATENTS

FREE!

Send for the three finest patent books published and read their letters—see what they want! "SUCCESSFUL PATENTS"—tells how to proceed; "STEPPING STONES"—contains list of over 200 inventions wanted, the truth about prizes, etc.; "PATENT PROMOTION"—tells how to promote and sell your rights, chief causes of failure, etc. A simple request will bring you all three books absolutely free.

Personal Services. I help my clients sell their patents or dispose of their applications. Advice Free. No obligation incurred by writing me. Manufacturing facilities. I get you strong protection or receive no compensation.

VERY HIGHEST REFERENCES

- | | |
|---|--|
| Columbia National Bank,
Washington, D. C. | Whitehead Hosiery Mills,
Burlington, N. C. |
| American Loktile Co.,
Alexandria, Va. | Dickinson Mfg. Co.,
Des Moines, Iowa. |
| National Metal Tile Co.,
Washington, D. C. | The Fancher Drug Co.,
Bridgeport, Ill. |
| National Supply Co.
Berlin, N. H. | The Starrett Mfg. Co.,
Shelbina, Mo. |
| Louden Machinery Co.
Fairfield, Iowa. | The C. J. Loftus Co.
Youngstown, O. |
| Antholene Mfg. Co.
Hutchinson, Kans. | Lightening Gun and Cycle
Works, Okla. City, Okla. |

And an Immense number of others whose letters are printed in my booklets.

RICHARD B. OWEN, 6 OWEN BUILDING, WASHINGTON, D. C.

Inventors submitting their invention to me are protected in a tangible manner until their applications are filed.

SPECIAL!

Send me a sketch or model of your invention and I will make a search of the U. S. Patent Office Records **FREE OF CHARGE** and report to you concerning patentability, practicability, etc.

\$38.95 Buys Complete Bathroom Outfit

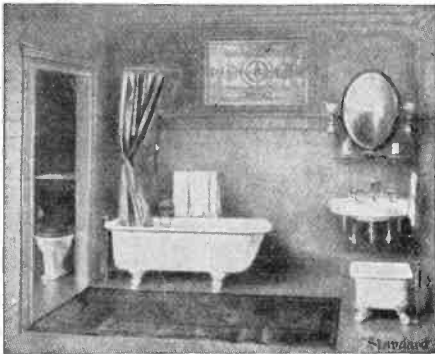

Modern Plumbing at One-Half Ordinary Cost
WATER PRESSURE SYSTEMS, from \$42.00 up. **HOT WATER AND STEAM PLANTS**. Save \$100 to \$250 on a Heating System. Plans free with every plant. **PIPE, VALVES, FITTINGS** at lowest prices. All high grade, strictly guaranteed goods. Catalog free.

JOHN HARDIN & CO.,

EST. 1876

4553 Cottage Grove Avenue,

Chicago, Ill.

CHARGES MODERATE **PATENTS** HIGH GRADE SERVICE
 BOOKLETS AND ADVICE FREE. INVENTIONS MARKETED FOR CLIENTS

Electrical and Mechanical Cases a Specialty

A. P. CONNOR Electrical and Mechanical Engineer
 121 Carroll St., S.E., Washington, D.C.
 Trade-Marks, Copyrights, Designs, Labels

PATENTS

C. L. PARKER
 Formerly Member Examining Corps. U. S. Patent Office.

PATENT LAWYERS
 12 McGill Bldg., WASHINGTON, D. C.

PATENTS, TRADE MARKS, COPYRIGHTS, PATENT LITIGATION

Handbook for Inventors, "Protecting, Exploiting and Selling Inventions" sent free upon request.

EASTERN ELECTRIC AND TRADING CO.
 Elphinstone St., Camp Karachi, India

Jobbers of Everything Electrical
 Work throughout the EAST and have best connections and facilities. Manufacturers of electrical goods of every kind should submit samples and quotations to avoid delay.

Sole Agencies Accepted

PORT for shipment of samples, etc., **KARACHI**

50 ENGRAVED CARDS OF YOUR NAME \$1.25
 In Correct Script, Copper Plate

THE QUALITY MUST PLEASE YOU OR YOUR MONEY REFUNDED
 Sample Cards or Wedding Invitations Upon Request

SOCIETY STATIONERS HOSKINS 801 CHESTNUT ST. PHILA.

Telephone Construction, Installation Wiring, Operation *and* Maintenance

By W. H. RADCLIFFE and H. C. CUSHING, Jr.

**A Practical Book Covering the Installation and Operation of
Both the Bell and Independent Systems**

Intended for the amateur, wireman or engineer who desires to establish a means of telephonic communication between the rooms of home, office, or shop, or between his home and the homes of his friends. Also for the contractor who wishes to build a small exchange in factories, or small towns.

Written In Accordance With Standard Practice

This book gives the principles of construction and operation of both the Bell and Independent instruments; approved methods of installing and wiring them; the means of protecting them from lightning and abnormal currents; their connection together for operation as series or bridging stations; and rules for their inspection and maintenance. Line wiring and the wiring and operation of special telephone systems are also treated.

Intricate mathematics are avoided, and all apparatus, circuits and systems are thoroughly described. The appendix contains definitions of units and terms used in the text. Selected wiring tables, which are very helpful, are also included.

171 PAGES

PRICE \$1.00 POSTPAID

125 ILLUSTRATIONS

Popular Electricity Book Dept., Chicago, Ill.

Do You Want Elec- trical Information ?

Then send a Two-cent Stamp
Today for a Copy of Our

Catalog of Electrical Books

containing a list of the most practical and up-to-date Electrical Books, best suited to the needs of beginners, students and the practical worker.

A complete description of each book is given to enable you to select those that contain just the information you desire.

Also ask for our Booklet,
"18 Ways to Make Money
in the Electrical Field."
Sent Free upon request.

Popular Electricity
BOOK DEPARTMENT
54 W. Lake Street, Chicago, Ill.

Just Off the Press

House Wiring

By THOMAS W. POPPE

ELECTRICAL ENGINEER AND CONTRACTOR

Absolutely new and up to the minute, describing and illustrating all up-to-date methods of installing Electric Light Wiring according to the latest rulings of the National Board of Fire Underwriters. All systems of wiring are covered, including the three-wire system now so much in use. Practical diagrams and illustrations are given to show just how the work is done.

It Solves All Problems

FOR THE PRACTICAL WIREMAN OR AMATEUR

and in fact contains all the essential information for the successful wiring of a building.

Among the subjects covered are—Planning and laying out the work—Locating the Meter—Meter Connections—Feed Wires—Switches—Plug Receptacles—Brackets—Celling Fixtures—Flexible Conduit System—Rigid Conduit System—Steel Armored Cable System—Knob and Tube System—Various Switching arrangements explained and diagramed—The easiest method of testing Three and Four-way circuits explained and illustrated—Current carrying capacity of Wires—Etc.

103 Pages, 74 Illus.

Flexible Cloth Cover, Pocket Size

PRICE, FIFTY CENTS POSTPAID

Money refunded if not satisfactory

POPULAR ELECTRICITY BOOK DEPARTMENT
54 W. Lake St., Chicago, Ill.

**WHAT 4c
A MONTH
WILL DO!**

You select your magazines according to their worth to you and irrespective as to price. But you are not adverse to a bargain—here is one.

SOUTHERN ELECTRICIAN is a technical electrical publication for the RESPONSIBLE man. Its staff of contributing editors includes the names of nearly fifty widely known engineers. About 600 reading pages a year make up a veritable encyclopedia of electrical knowledge. To readers of Popular Electricity we will send SOUTHERN ELECTRICIAN for two years and a copy of the Electrical Engineer's Handbook, cloth bound, 414 pages, 238 illustrations—one of the most valuable books of its kind ever published—all for \$1.

This is a MONEY BACK offer. Your dollar will be immediately refunded if you are not satisfied.

SOUTHERN ELECTRICIAN
921 Grant Building, Atlanta, Georgia



**WE GIVE EVERY
BOY OR
GIRL ONE**

CYCLEMOBILE ABSOLUTELY FREE

In exchange for a little time and less effort than you think. You unconsciously advertise us while playing, driving our CYCLEMOBILE on business errands or touring. The CYCLEMOBILE is a newly perfected machine not on the market for sale on account of our large exclusive contract with the inventors. It is built like a real Motor Car with two speeds, forward and reverse, besides a neutral coaster speed. The Body and Hood are Pressed Steel and second growth ash, supported on a Chassis frame of Rolled Steel angle iron, capable of carrying the weight of five full grown men. The Axles are also of Steel and wheels Rubber Tired. The front wheels pivot on regulation Motor Car steering knuckles, eliminating all danger of upsetting on curves. We simply can not give you one-hundredth part of the real Specifications in this limited space, but send in the coupon and we will TELL IT ALL.



MOTOR CAR PUB. CO.,
KANSAS CITY, MO.
Dear Sirs: Pop. Elect.
Kindly mail me full details and Specifications of your CYCLEMOBILE offering, and oblige.
Sincerely yours,

Name
Address

Learn Electricity!



**Earn \$150⁰⁰
TO
\$300⁰⁰
a Month**

Electricity is today the great motive power of the world. Its use has extended to every phase of life and industry.

Thos. A. Edison says that the field of electricity is in its infancy—that electrical workers of the future will discover uses for this great force now undreamed of.

Right now there are not enough electrical engineers to fill the big paying positions open. Every day our Free Employment Bureau has a call for Signal Engineers greater than we can fill. Therefore, we are making a very special offer to students at this time.

Write today! Send the free coupon for our catalog and free information.

**We Teach You in a Short Time
—at Small Expense**

In order to supply more electrical engineers we are charging a small tuition fee. Your tools and equipment of all kinds are furnished FREE by the School. You may have easy payments if desired. Our course of instruction is clear, simple and thorough. Our Graduates demand handsome salaries. Don't pass up this opportunity.

FREE TOOLS

We will furnish all the material and tools you use in taking our course—ABSOLUTELY FREE. All we charge is a very small amount for tuition. Many of our students earn their expenses while taking the course.

**Men Wanted
for these Trades**
Electricity Plumbing
Painting and Decorating
Moving Picture Operating
Mechanical Drawing

We also teach the trades mentioned above. There are unlimited possibilities in any one of these trades. When you have completed our course you will be in a position to demand from \$5.00 to \$8.00 a day right at the start. Or go in business for yourself and make from \$3,000 to \$5,000 a year.

**Send the FREE COUPON for
Catalog and Particulars**

No obligations on you at all. Just fill out the coupon and mail it today. Take this step towards success. Let us tell you how you can master electricity or any other profitable trade in a short time—make a bigger success than you ever dreamed of making. Fill out the coupon and mail it at once.

L. L. COOKE, Director
**Coyne National
Trade Schools**
39-51 E. Illinois St.
Dept. 9407
Chicago,
Ill.

**FREE
COUPON**

L. L. COOKE,
Director

**Coyne National
Trade Schools**
39-51 E. Illinois St.
Dept. 9407, CHICAGO, ILL.

GENTLEMEN: Without any obligations on me whatsoever, please send me your school catalog and full particulars of this offer to men—ALL FREE.

NAME.....

ADDRESS.....

Electrical Books for Boys

IF Thomas A. Edison could have obtained books of this kind when he was a newsboy on the Grand Trunk Railway he would have devoured them with great eagerness, but very little was known of electricity at that time, or of the many ways in which it is now utilized in our every-day life. However, we have not accomplished all that is to be done and it is therefore essential that the wide-awake boy equip himself with a knowledge of the principles and present day applications of this great force by reading the books now obtainable.

These books present the subject in a manner that will furnish both interesting and instructive reading for boys of all ages.

Electricity Book for Boys

By J. H. ADAMS

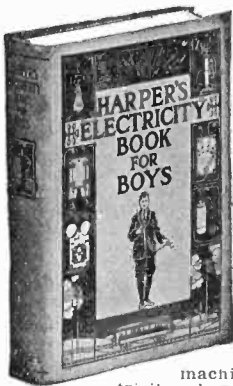

This is a book that the boy will eagerly devour. Shows him what he can do with his own hands and how he can accomplish results with inexpensive materials.

Explains briefly and in simple language the working of electricity in its daily application and has an appendix of electrical terms and phrases.

How to make simple batteries, horse shoe magnets, induction coils, burglar alarms, push buttons, electrical buzzers, bells and horns, electric alarm clocks, telephones, telegraph and "wireless" apparatus, dynamos and motors; how to run a sewing

machine, fans and toys by electricity; how to make a "Wimshurst Influence Machine" and conduct interesting experiments in frictional electricity; how to do electroplating and electrotyping, make electrical insect and animal traps, toys, etc. These are but a few of the hundreds of interesting things a boy may learn to do by studying this book.

407 Pages

274 Illustrations

Price \$1.75 Postpaid

The Boy Electrician

By E. J. HOUSTON

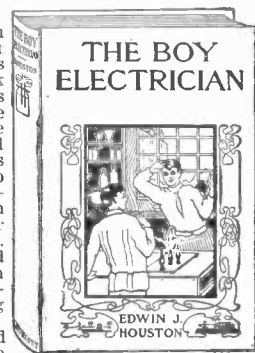

Any boy who can read this book and not become absorbed in its contents must lack those peculiar qualities which go into the make-up of a real live boy. It is a story full of fun and adventures of two bright boys who possessed marked scientific powers in addition to their fondness for baseball, swimming, and other sports, and who managed to learn a great deal about electricity while having lots of fun.

The remarkable and quaint doings of the "Jolly Philosophers," the exciting adventures they met with and the interesting experiments they carried on, can not fail to be attractive and furnish a source of amusement and instruction to boys of all ages.

If you are looking for a gift book that your boy will enjoy, and which at the same time will prove of real value to him—here it is.

326 Pages

Illustrated

Price \$1.50 Postpaid

The Boy's Life of Edison

By Wm. H. Meadowcroft

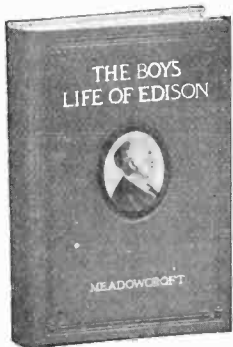

It is probably as a worker of wonders, an actual wizard of science, that Edison fascinates the imagination of almost every boy. In this picture of the real facts of the inventor's life from his early boyhood up to the present time, the reader will find that while Edison is just as great as imagined, yet this greatness has not been reached by chance, but honestly earned by the hardest kind of hard work. The wonderful things that he has accomplished have been the things that he purposely set out to do, and are not the result of some happy thought or been read by Mr. Edison and he has given it his personal endorsement.

Every boy should read it.

331 Pages

Fully Illustrated

Price \$1.25 Postpaid

Story of Great Inventions

By Elmer E. Burns

The purpose of this book is to tell in simple language how our great inventions came into being, to depict the life-struggles of the men who made them and in the telling of the story, to explain the working of the inventions in a way the boy can understand.

The stories are so woven together as to give the young reader a connected view of how our great inventions have arisen out of scientific discovery on the one hand and social and economic conditions on the other.

This well written romance of great inventors will appeal strongly to young readers as well as to many older ones.

249 Pages

Fully Illustrated

Price \$1.25 Postpaid

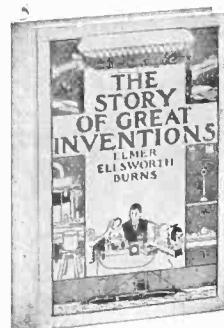

POPULAR ELECTRICITY BOOK DEPT., 54 West Lake St., Chicago, Ill.

The New Electric Lamp for You

HERE is the Electric Lamp that everyone has long been waiting for—the Port-A-Lite. Adjustable to practically any position, the Port-A-Lite makes *one* light answer the purpose of several ordinary electric lights. Can be used anywhere an electric light socket is available—in any part of the home—in the office, factory or store. It throws the light just where you need it—saves the eyes by eliminating eye-strain. Easily taken apart and re-assembled—ideal for traveling or as a bed light.

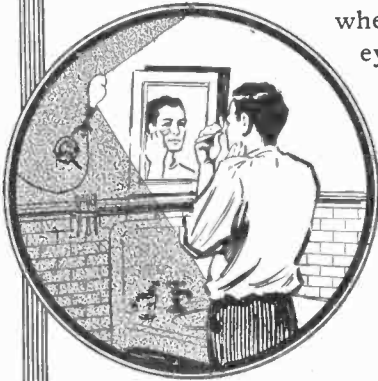

Used as a Wall Fixture

The Port-A-Lite may be easily and quickly converted into a useful wall fixture—just attach to any convenient hook. Ideal for shaving or for use in milady's boudoir—gives a clear, steady, concentrated light—put up and taken down without trouble.

Ideal Light for the Piano

The Port-A-Lite gives the best illumination for the piano. It throws the light right on the music and keyboard, leaving the eyes in restful shadow. Felt pad on base protects polish of your instrument.



The Port-A-Lite

Sent express prepaid on receipt of price

We will send you a Port-A-Lite express prepaid, equipped complete with reflector shade, silk connecting cord and felt covered base. Price, with polished nickel or brush brass finish, \$4.40; polished silver, \$6.40. Specify the name, "Port-A-Lite," and finish desired, when ordering. Write today.

ELECTRIC SHOP

Michigan and Jackson Blvds.
CHICAGO



Convenient in the Office

Any business man will appreciate the Port-A-Lite on his desk. It can be adjusted to any desired position so easily—and the light is always just where you want it. Handy also for the artist, draftsman, jeweler, etc.

As a Study Lamp at Home

Children, and older folks, too, who use their eyes for studying or reading will appreciate the Port-A-Lite. It is far more useful than any other lighting fixture—no hurtful glare on the eyes—makes fine print easy to read.



Your Choice 25 Cents Each

Practical Electrical Handbooks

WIRING A HOUSE. By HERBERT PRATT. Shows a house already built; tells just how to start about wiring it; where to begin; what wire to use; how to run it according to Insurance Rules; in fact, just the information you need. Directions apply equally to a shop. Fourth edition.

ELECTRICAL BELLS AND ALARMS—How to install them. By N. H. SCHNEIDER. Including batteries, wire and wiring circuits, pushes, bells, burglar alarms, high and low water alarms, fire alarms, thermostats, annunciators, and the locating and remedying of faults. With 56 original diagrams.

COMMUTATOR CONSTRUCTION. By WILLIAM BAXTER, JR. The business end of any dynamo or motor of the direct current type is the commutator. This book goes into the designing, building and maintenance of commutators, shows how to locate troubles and how to remedy them; everyone who fusses with dynamos needs it.

AMATEURS WIRELESS HANDY BOOK. By A. M. POWELL and A. B. COLE. The handiest and most useful book for the Amateur published. Contains a list of 1500 Call Letters, Codes, Amateur's Speed Chart and over 100 Hook-Ups and Diagrams.

MAKING WIRELESS OUTFITS. By NEWTON HARRISON, E. E. A concise and simple explanation on the construction and use of simple and inexpensive wireless equipments, for sending and receiving up to 100 miles, giving full details and drawings of apparatus, diagrams of circuits and tables. Including the Morse and Continental Codes. 61 pages, 27 illustrations.

PLANS AND SPECIFICATIONS FOR WIRELESS SETS—Part 1. By A. F. COLLINS. Complete and detailed instructions for making an Experimental Set, also a One to Five mile Set. 50 pages, fully illustrated.

PLANS AND SPECIFICATIONS FOR WIRELESS SETS—Part 2. By A. F. COLLINS. Complete and detailed Data for constructing a Five to Ten mile Set, also a Ten to Twenty-five mile Set. 90 pages, 60 illustrations.

THE MAGNETO TELEPHONE—Its construction, fitting up and use. By NORMAN HUGHES. Giving full particulars for planning out a short line, putting up the insulators, stringing wires, connecting instruments, suitable batteries. 80 pages, 23 illustrations.

THE MODEL VAUDEVILLE THEATRE. By NORMAN H. SCHNEIDER. Describing the construction of a model theatre and the making of numerous devices to be used with it. With suggestions for various novelties for an evening's entertainment, including chapters on shadowgraphs, the use of a polyopticon, lighting effects, wave effects, storms, etc., etc. Fully illustrated.

WIRING HOUSES FOR ELECTRIC LIGHT. By N. H. SCHNEIDER. Contains complete directions for wiring a house according to Insurance Rules, tells you just how to start about the wiring, what wire to use, how to estimate the materials required and completing the installation. Directions apply equally well to a shop. 86 pages; 42 illustrations.

SMALL DYNAMOS AND MOTORS—How to Make and Use Them. A practical handbook. By F. E. POWELL. Contents of Chapters: 1. General Considerations. 2. Field Magnets. 3. Armatures. 4. Commutators and Other Details. 5. Tables of Windings. 6. How to Build a Small Machine. 7. Useful Data. 8. Testing and Repairing. 76 pages, fully illustrated with detail drawings.

WINDMILLS AND WIND MOTORS. By F. E. POWELL. A practical handbook on the construction of small windmills for pumping water, generating electricity, or driving small machines. An American type windmill, diameter of sails 3 ft. A small working windmill, diameter of sails 6 ft. A small self-adjusting windmill, diameter of sails 10 ft. Description of other forms of wind motors with a chapter on the production of electricity by wind power, etc. 80 pages, with 84 illustrations and diagrams.

WIRELESS TELEGRAPHY MADE SIMPLE. By V. H. LAUGHTER and A. P. MORGAN. Complete directions for constructing a simple wireless set, illustrated.

WIRELESS TELEPHONE CONSTRUCTION. By NEWTON HARRISON. A comprehensive explanation of the making of a Wireless Telephone Equipment. Both the transmitting and receiving stations fully explained with details of construction sufficient to give an intelligent reader a good start in building a Wireless Telephone system and in operating it. 74 pages and 43 illustrations.

EXPERIMENTING WITH INDUCTION COILS. By H. S. NORRIE. A most instructive little book, full of practical and interesting experiments fully explained in plain language with numerous hints and suggestions for evening entertainments. Arranged under the following headings: Introduction; The Handling of Ruhmkorff Coil; Experiments with Sparks; Effects in the Vacuum; Induction and Wireless Telegraphy. With 36 original illustrations.

TELEGRAPHY FOR BEGINNERS—The Standard Method—An authoritative book of instruction in the methods and forms most approved, with a series of lessons. By W. H. JONES. With the Morse alphabet and the Continental code 64 pages, 19 illustrations, paper binding, 25c.

INDUCTION COILS—How to Make and Use Them. By P. MARSHALL. New edition revised and enlarged by K. STOYE. A practical handbook on the construction and use of medical and sparking coils for wireless telegraphy, gas engines, automobiles, gas lighting, X-rays, and all other purposes. With complete tables of windings for coils, giving ¼-inch up to 12-inch sparks. With full directions for the construction of mercury interrupters. 76 pages, 35 illustrations.

LOW VOLTAGE ELECTRIC LIGHTING WITH THE STORAGE BATTERY. By N. H. SCHNEIDER. Gives practical information on small low voltage electric light plants suitable for farms, stores and country homes in general. Full details are given showing how to estimate the number and size of lights required, their best location and most convenient means of control, and the plant necessary to supply the current. 85 pages; 23 illustrations.

Popular Electricity Book Department

54 West Lake Street Chicago, Ill.

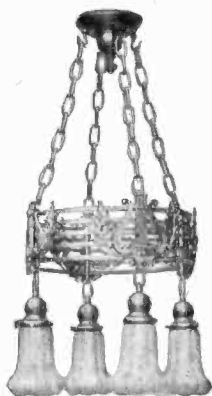

Beardslee Lighting Fixtures

In beauty of design and finish, Beardslee trade-marked lighting fixtures can not be surpassed. No detail is too small to have the careful attention of expert workmen. Designs are worked out with minute fidelity. All parts are carefully fitted.

The wide variety of Beardslee designs includes patterns suitable for every building, whatever its use and style of architecture. These designs are derived from authentic sources and are true to the school or period to which they belong.

When you build or remodel, give your personal attention to selection of fixtures. Specify the use of "B" trade-marked lighting fixtures throughout—they will add to the beauty and selling value, and are an insurance against dissatisfaction.

Write for our new booklet, "Light and Art in the Home." We shall be glad to mail you a complimentary copy. Illustrates and describes many designs suitable for residences.

Beardslee Chandelier Mfg. Co.
227 South Clinton Street, CHICAGO





My Boy! Here's Your Chance

It's more than a chance—you can make it a certainty 'because it depends entirely upon yourself. It's your opportunity to rise to one of the countless positions open to the trained man and obtain a trained man's salary.

The man who sits in his private office and "hires and fires" and lays out your work, was no more qualified to fill that position a few years ago than you are to-day. He saw **his chance** and made the most of it. He obtained his training and knowledge by study. You can do the same—the American School will help you.

You don't want to remain in the "time-clock and dinner-pail" class all your life—don't be satisfied with just a common job at small pay. Show the boys at the shop that you have it in you to advance—you owe it to yourself and to your family.

Don't be afraid to mail the coupon, you won't be bothered by agents or collectors. Like all strictly educational institutions the American School depends, for growth, upon reputation and the success of its students.

Don't let a little thing like filling in and mailing a coupon stand between you and success, congenial work and more pay. **Accept your chance to-day.**

WE HELP MEN HELP THEMSELVES

American School of Correspondence
CHICAGO, U. S. A.

This is your Opportunity

Check the course you want and mail the coupon now

American School of Correspondence, Chicago, U. S. A.

Please send me your Bulletin and advise me how I can qualify for the position marked "X." Pop. Elec. 10-12.

- | | |
|--------------------------------|---------------------------|
|Automobile Operator |Lawyer |
|Draftsman |Fire Ins. Engineer |
|Architect |Telephone Expert |
|Building Contractor |Moving Picture Op'r |
|Structural Engineer |Bookkeeper |
|Civil Engineer |Stenographer |
|Electrical Engineer |Accountant |
|Elec. Light & Power Supt. |Cost Accountant |
|Master Mechanic |Cert'fd Public Acc't |
|Sanitary Engineer |Auditor |
|Steam Engineer |Business Manager |
|Reclamation Engineer |College Preparatory |

NAME.....
 ADDRESS.....
 OCCUPATION.....

For our Mutual Advantage mention Popular Electricity when writing to Advertisers.

It's the Dust You Don't See that Carries Disease



A clean looking house may still be insanitary. That's the danger of sweeping with a broom. Shoes collect dried sputum from sidewalks and deposit its dust on rugs and carpets. You can't see it, perhaps. But it's *there*. Then comes sweeping day. Your broom fills the air with invisible, germ-laden dust. It finds its way into your lungs—into your food—settles on the floor where playing children stir it up again and become infected. The *broom* is even more dangerous than the *fly*.



Sucks Up All the Germ Laden Dust

No dirt too heavy—no dust too light and invisible to escape the FEDERAL Vacuum Cleaner. Its powerful suction searches every thread and fibre of rugs and carpets—clothing and drapery. Yet it can't injure the most delicate fabric. From the innermost depths of thick, heavy padding the powerful FEDERAL sucks out the dust and germ-laden air—making upholstery, pillows and mattresses as sweet and clean as new.

The FEDERAL is the Guaranteed Cleaner With the Powerful Rotary Pump

But don't think that just any vacuum cleaner will do this. Some are really no better than a carpet sweeper. They pick up the *surface* dust—the *visible* dirt—but not the hidden, germ-laden dust. You *can't* create a powerful suction, like the FEDERAL, with a *fan* device, a *bellows* or a *diaphragm*. One by one, these types of cleaners are passing into oblivion. You don't want a noisy, rattling, complicated machine that can't do the work—and that soon shakes itself to pieces. The FEDERAL is the machine that has stood the test of time.

The Rotary Pump in the FEDERAL revolves steadily in one direction—like a powerful turbine engine on an ocean liner. It creates a suction impossible with a fan or bellows type of cleaner. Its working parts are few—simple—easy of access. No valves to work loose—no gears to rattle—no piston to pound up and down—no bellows to wear out—just a powerful, substantial pump and a motor—both revolving in one direction—steadily, silently, without jar or jerk.



Ten Days' Free Trial Then Only \$1.75 a Week

Wouldn't you like to test the FEDERAL in your own home, free, for ten days? Let it prove our every claim for it. Then—if you are not satisfied, return it at our expense. If you want to own it, pay us only \$1.75 a week till paid for. Of all the FEDERAL Cleaners sold not one has been returned for repairs or for failure to do all we claim. Write today for full particulars of this 10-day free trial—\$1.75 per week offer. Send the FREE TRIAL COUPON today.

Vacuum Cleaner Department

Federal Sign System (Electric)
597 Home Insurance Building
CHICAGO

Name _____
Address _____
City _____

POP. EIC.
Oct. '12
Federal
Sign System
(Electric)
597 Home Ins. Bldg.
Chicago, Ill.
Kindly send me
full particulars of
your offer of the FED-
ERAL on Ten Days'
Free Trial. It is under-
stood that this places me
under no obligations.

\$1.50 WEEKLY **\$1.50**
PAYMENTS

OR \$6.50 A MONTH

This small amount each week
will buy a

Thor Electric Home Laundry Machine



THOR ELECTRIC
Home Laundry Machine

The machine that is conceded
to be the most perfect wash-
day servant known. Absolu-
tely guaranteed to do the
weekly washing and wringing
in a manner satisfactory to
the most particular housewife.

SIX REASONS

Why You Should Have a Thor in Your Home

- First: It does all the hard work and drudgery of washday by electricity.
- Second: It washes all kinds of washable goods, the heaviest blankets and daintiest laces included, spotlessly clean, without injury and without any hand rubbing.
- Third: It does the entire week's washing and wringing for the average family in 90 minutes at a cost of only 3 cents for electricity.
- Fourth: It insures the highest degree of sanitation in the laundry by doing away with the muss and slop of the ordinary washday.
- Fifth: It is used and appreciated by FORTY-SIX THOUSAND NINE HUNDRED AND EIGHTY-SEVEN housewives in the United States alone.
- Sixth: All our claims for the Thor are embodied in a Binding Guarantee Bond which is given the purchaser of every machine.

Our dealer in your city will deliver a machine to you, or we will ship to you direct, freight prepaid, for a

15 DAYS' FREE TRIAL

before you make your first payment. In accepting this offer you do not obligate yourself in any way to keep the machine.

Write today for Catalog F describing Electric Washing Machines from \$35 up

HURLEY MACHINE COMPANY

NEW YORK: 1011 Flatiron Bldg.

CHICAGO: 27 S. Clinton St.