

JULY

15 CENTS

Popular Electricity Magazine

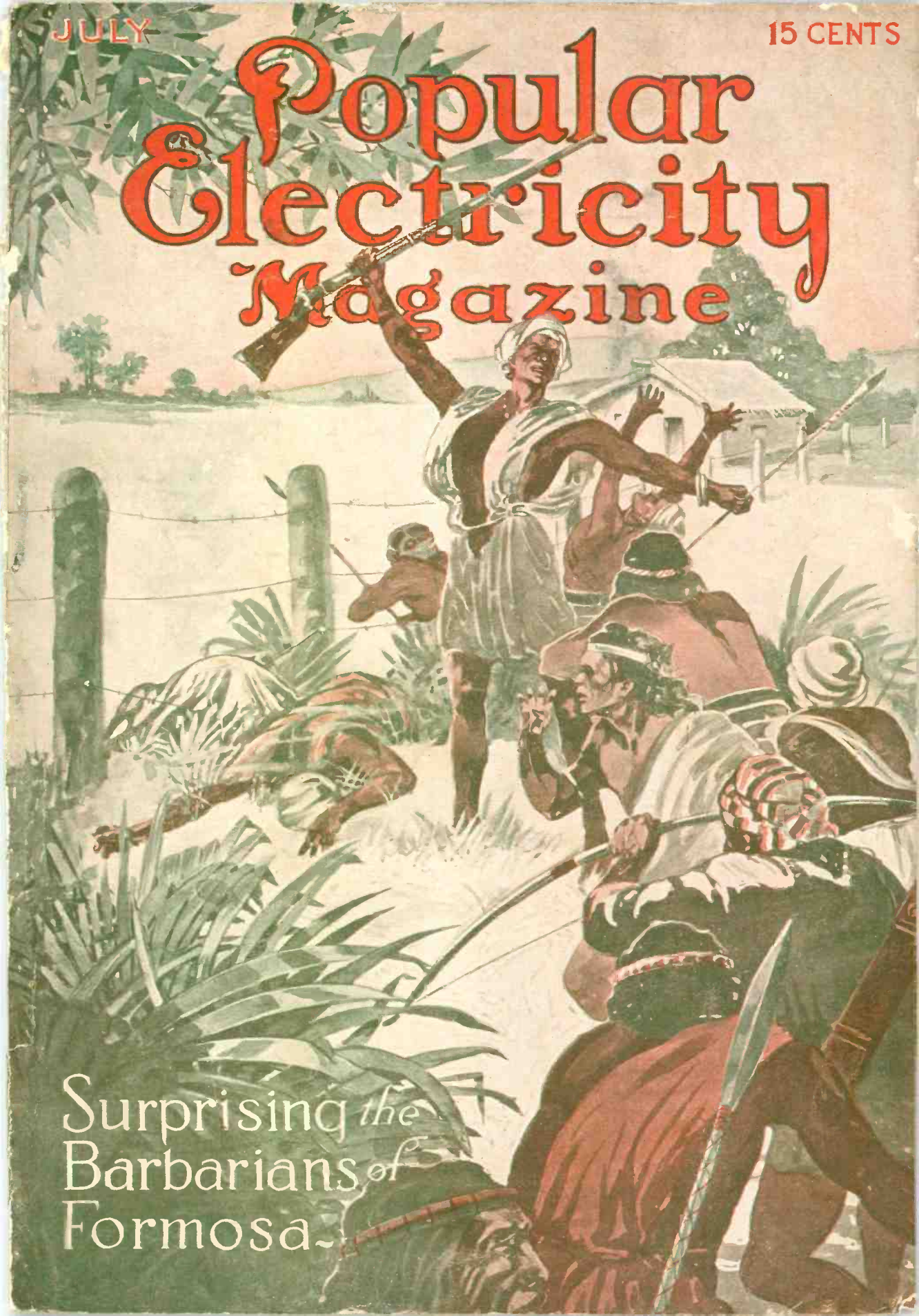

Surprising the
Barbarians of
Formosa.

Learn Electricity

EARN \$5.00 to \$8.00 PER DAY

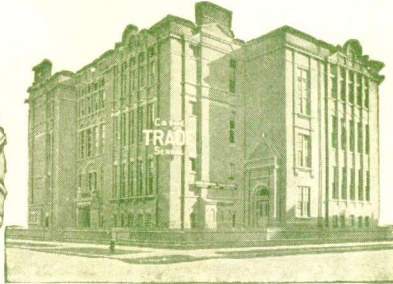
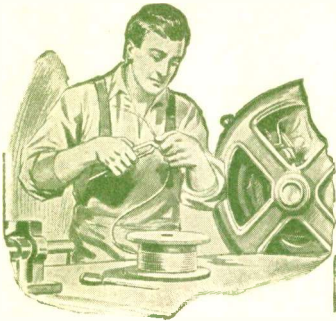

Make Your Services More Valuable and get a better job as Electrician, Plumber, Mechanical Draftsman, Painter and Decorator, Moving Picture Operator or Bricklayer. The demand for good men in these trades is greater than the supply. We assist our graduates to good jobs or we will start you in business for yourself.

\$5.00 TO \$8.00 PER DAY
 You can earn this and more if you are skilled in the way we teach trades. Our students always successful. You are not fulfilling your whole duty to yourself if you do not send the coupon attached to this announcement at once.

Our school is the oldest, largest and best equipped trade school in the world. We occupy the entire large building illustrated above. Our instructors are all practical men—expert in their trades. We teach you quickly, practically and thoroughly by actual work. Tools instead of books.

Don't be satisfied with small pay. The money you now earn won't satisfy you forever. You must increase your earnings. It costs more to live now than it used to. You need to get out of the small pay class. You can do it and we will help you. *Send us the coupon below.*

FREE TOOLS AND MATERIAL
 You have nothing extra to pay in this school. All your tools and materials are furnished free—absolutely without cost to you. Do not delay about sending the free coupon.

Here Are the Trades We Teach

Electricity offers the greatest field in the world today. Thousands more skilled electrical engineers and operators are needed. Wages are high and work steady, while the future offers the richest prizes in research work and new adaptation of electric power.

Moving Picture Operating is practically a new business and good operators are so scarce that unusually high wages are enjoyed. You can soon go into business for yourself.

Mechanical Drawing There is big demand for good mechanical draughtsmen. Engineering firms, contractors, railroads, etc., are always on the lookout for good mechanical drawing experts.

Painting and Decorating is of all the most varied and fascinating. It work and affords full scope for exercise of the artistic nature. Our special catalog tells how you can earn from \$200 to \$600 a month in the painting and decorating business.

Bricklaying A highly paid, fine, healthy, outdoor occupation. Builders are always on the watch for competent Bricklayers. You can develop into contracting work where there is no limit to your profits.

Plumbing offers easy work, short hours, big pay and steady work. It's almost impossible now to learn the trade as an apprentice. Even then it will take years and perhaps you will never thoroughly master it. Plumbers are always in demand.

FREE COUPON to Popular Electricity Readers. Send It Quick!

We are making a special proposition to the readers of Popular Electricity—a special limited offer, so cut out the free coupon which we are printing here and mail it to us today. School open all the year. You can enter any time. We have students 16 years of age to 60. Day and night sessions. Free Employment Department. Tuition and expenses very low. **Easy payments if desired.** Drawing and estimating a part of each course. Delightful opportunity for general and social culture. Ten minutes' walk to the heart of Chicago's business center. **Send coupon now.** Get our special offer today. **Address, L. L. COOKE, Director**

COYNE NATIONAL TRADE SCHOOLS
 Dept. 140Y, 39 to 51 E. Illinois St., Chicago, Ill.
 "The Oldest Practical Trade School in America."

FREE COUPON

L. L. COOKE,
 Director
 Coyne National Trade Schools,
 Dept. 140Y,
 39 to 51 E. Illinois St.,
 Chicago, Ill.

Gentlemen: Without any obligations on me, please send me your school catalogue and full particulars of this special offer to men—all FREE.

Name

Address

For our Mutual Advantage mention Popular Electricity when writing to Advertisers.

A summer evening on the porch, with a breeze like the sea shore's—that's the cooling refreshment that thousands *make sure* of with a

GE. GENERAL ELECTRIC COMPANY Electric Fan

The G-E 8-inch Oscillating Fan is the smallest fan made for homes and small offices. Anywhere in the house—attached to any lamp socket—a G-E Electric Fan banishes sultriness, keeps flies away, blows the close air out, brings the fresh, pure air in and spreads refreshing coolness.

And the cost for this comfort is trifling. The G-E 8-inch Fan gives you its coolness for

Four Hours for Only One Cent.

The 12 and 16-inch models run for almost as little—for about the cost of burning a single 16-candle-power light. By day or by night, these fans cool your kitchen, ventilate your living room, make your bedroom a place of comfortable, restful sleep.

G-E Electric Fans are so sturdy in construction that they last for a long

life-time of service. The painstaking balancing and "truing" of each part make G-E Fans quiet and smooth-running. Their running parts are enclosed and self-oiling, so these fans are free from grease or dirt.

For real summer comfort at home or at work, choose a G-E Fan for its absolute reliability, if for no other reason. They are made in fixed as well as oscillating types and in many sizes and styles for every need—but look for the G-E trade mark.

Electric shops, stores carrying electrical goods or any lighting company can supply you.

"The Twitch of a Switch"

illustrates many new and inexpensive ways of making electricity save housework and servant troubles. Send for it today.

GENERAL ELECTRIC COMPANY

The World's Largest Electrical Manufacturer

(Dept. 30-C) Schenectady, New York



The Guarantee of Excellence on Goods Electrical.

This trade mark insures reliability in anything that generates, transmits or utilizes electricity. It protects you on house-wiring materials, it is on all Edison lamps, and it identifies the most highly perfected electric flatirons, fans, cooking devices, small and large motors and apparatus.

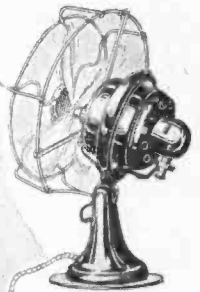

3626

For our Mutual Advantage mention Popular Electricity when writing to Advertisers.

It Helps Every Man IN THE ENGINE ROOM

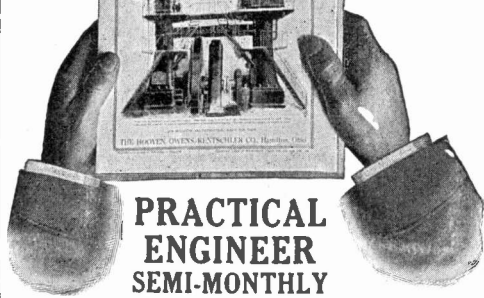
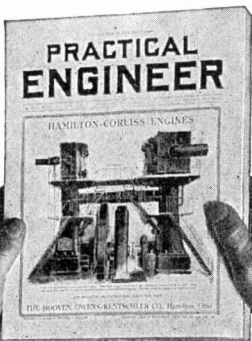

PRACTICAL ENGINEER SEMI-MONTHLY

TELLS you about the use of Steam, Electrical Equipment, Gas Engines and Producers, Pumping Apparatus, Refrigeration, Machinery Repairs, Power Costs, Power Plant Problems and how to solve them, Engineer's Arithmetic, Setting of Valves and Valve Gears. It is a magazine, sound, reliable and trustworthy—you can rely upon its teachings—the men behind it have been writing power plant information for years. They know what you like to read—keep strictly up to date—give you live current engineering events—accept articles, ideas and suggestions only from the highest practical men in the profession. Each issue takes up in detail some Special Subject in power plant operation. The special subject, "How to Test Efficiency of Motor Pulleys," will be thoroughly written up in a future issue. Wm. Foster, New Bedford, Mass., says: "I must write you my appreciation of the recent issue containing special articles on Valves and Valve Setting. They are worth a dollar alone."

Now is the best time to subscribe to Practical Engineer.

Special Offer

24 magazines and this Engine Speed Indicator for \$1.50 if you act quick

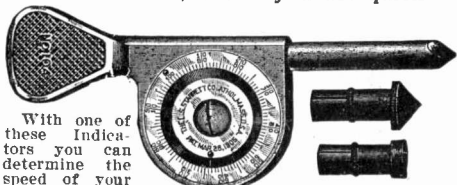

With one of these Indicators you can determine the speed of your engine or shafting and pulleys with absolute accuracy, thus saving a large amount in power costs.

Don't wait—send for 24 issues of Practical Engineer and this latest improved model No. 104 L. S. Starrett Engine Speed Indicator for the special price of \$1.50. We guarantee it to be perfect in every particular. We will refund your money if you are not entirely satisfied with Practical Engineer or the Indicator.

THIS COUPON BRINGS BOTH

Practical Engineer, 535 S. Dearborn St., Chicago P. E. 7/12

I enclose \$1.50 for a subscription to Practical Engineer and L. S. Starrett's High Speed Indicator No. 104, which is to be sent at once, postage paid. It is understood that if I am not satisfied you will return my money on request.

Name

Street & No.

City & State

Canadian Subscribers add 75 cents for extra postage. Many Subscribers Represent Us in Their Towns. Write Us for Liberal Terms.



FRENCH—GERMAN SPANISH—ITALIAN

Is Easily and Quickly Mastered by the

LANGUAGE PHONE

Combined with the Rosenthal
Method of Practical Linguistry

This is the natural way to learn a foreign language. You hear the living voice of a native Professor pronounce each word and phrase. He speaks as you desire—slowly or quickly, night or day, for minutes or hours at a time. It is a pleasant, fascinating study; no tedious rules or memorizing. It is not expensive—all members of the family can use it. You simply practice during spare moments or at convenient times, and in a surprisingly short time you speak, read and understand a new language.

Send for Booklet and Terms for Easy Payment

THE LANGUAGE PHONE METHOD
946 Putnam Building
2 West 45th Street New York



QUICK, THOROUGH ELECTRICAL INSTRUCTION

A complete college course in two years. Time and money saved. Taught by graduate engineers. Practice on apparatus and machines—construction, operation and repair. Every branch of generation, transmission and application. Graduates in leading electric companies. New classes July and September

—WRITE FOR DETAILS—

BRYANT & STRATTON COLLEGE
No. 115 College Building BUFFALO, N. Y.

FREE BOOK ON MOTORING

GET A NEW IDEA OF TEACHING
BY MAIL

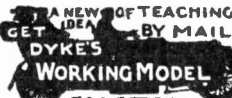

**DYKE'S
WORKING MODEL
SYSTEM**

Explains how we can start YOU in the Auto Business as Repairman, Chauffer, Salesman or Auto Expert with Dyke's New Idea Working Model System of teaching by mail and our new idea Employment Plan. Let us tell you the names of some of our students and the salaries they are drawing today—more than you are making. Don't miss it—Send for Booklet NOW!

Dyke's School of Motoring, Box 2, Roe Bldg. St. Louis, Mo.

BE AN ENGRAVER

Learn at Home; Earn \$25 to \$50 weekly. We give personal instructions and furnish necessary tools free. Terms reasonable. Complete particulars by mail.

CHICAGO ENGRAVING SCHOOL
Dept. 30, 110 West Chicago Ave. Chicago



If YOU Would Be Successful Stop Forgetting

**MEMORY
the BASIS
of All
KNOWLEDGE**

THE KEY TO SUCCESS

You are no greater intellectually than your memory. Send today for my free book "How to Remember"—Faces, Names, Studies—Develops Will, Concentration, Self-Confidence, Conversation, Public Speaking. Increases income. Sent absolutely free—Address

DICKSON MEMORY SCHOOL, 929 AUDITORIUM BLDG., CHICAGO

RICHARDSON SLIDE RULE

Complete wire table. Gives diam., mils; area sq. in., and cir., mils. Res., and weight per 1000 feet.



Electricians are frequently called upon to calculate the size of a motor to run a pump, change gear, and pulley problems, testing recording wattmeters, plotting curves, etc. The slide rule will do all this mechanically. The Richardson Direct Reading Slide Rule is especially adapted for those who wish to learn the use of this valuable instrument. It will multiply, divide, extract the square or cube roots of numbers, calculate interest and percentage. 5-inch rule in leather case \$2.50, 10-inch rule, \$2.50 including cardboard pocket case. Our new book "The Slide Rule Simplified" contains 70 full size illustrations of how to set rule, just off the press. Paper cover \$1.00, Cloth, \$1.50. Paper covered book free with either of above rules.

GEO. W. RICHARDSON,
Late Artificer U. S. Navy 4214, 24th Place, Chicago

Electrical Experience Counts

IF YOU have had practical experience at electrical work, fine positions are waiting for you in the United States Navy.

If you are a telegrapher, the navy can make you a radio (wireless) operator.

If you are already a radio operator, you can be advanced promptly to important positions.

It is very much worth the while of every ambitious young man between 18 and 25, of good physique and morals, and possessed of a knowledge of electricity, to look into the work of the Electrical Branch of the Navy.

The pay is excellent, and is clear of all living expenses. The chances to learn the trade thoroughly and to be promoted to positions of responsibility are unusual. And the healthy life, the stimulating companionship of fine young fellows, the incentive to save money are unequalled anywhere in civil life.

Send for particulars. Complete information regarding the electrical schools at the New York Navy Yard and at Mare Island will be mailed you on request. Also details that will inform you fully about pay, hours, promotion, etc. Write a post card today. Address

Bureau of Navigation, Box 5, Navy Department, Washington, D.C.

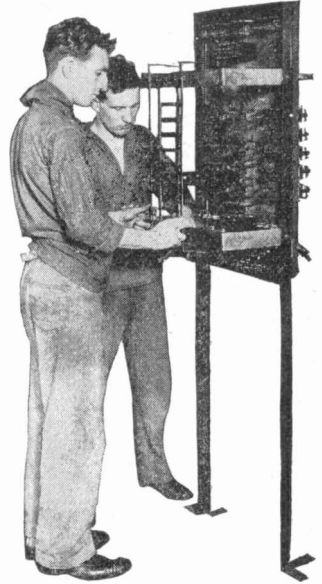

Constructing a Fire Control Telephone Board, Navy Electrical Class

UNITED STATES NAVY

DETECTIVES TRAINED BY MAIL

Easy to learn from our years of experience. New plan. Work fascinating. Salaries large. Detectives independent, and travel everywhere. Write for particulars.

FRANCIS RENO, Inspector

552 CONTINENTAL TRUST BUILDING, DENVER, COLORADO

VENTRILOQUISM

Learned by any Man or Boy at Home. Small cost. Send today 2c stamp for particulars and proof. O. A. SMITH, Room W181 823 Bigelow St., Peoria, Ill.



A Happy Marriage

Depends largely on a knowledge of the whole truth about self and sex and their relation to life and health. This knowledge does not come intelligently of itself, nor correctly from ordinary everyday sources.

SEXOLOGY

(Illustrated)

by Wm. H. Walling, A. M., M. D., imparts in a clear wholesome way, in one volume:

- Knowledge a Young Man Should Have.
- Knowledge a Young Husband Should Have.
- Knowledge a Father Should Have.
- Knowledge a Father Should Impart to His Son.
- Medical Knowledge a Husband Should Have.
- Knowledge a Young Woman Should Have.
- Knowledge a Young Wife Should Have.
- Knowledge a Mother Should Have.
- Knowledge a Mother Should Impart to Her Daughter.

Medical Knowledge a Wife Should Have.

All in One Volume. Illustrated, \$2 postpaid

Write for "Other People's Opinions" and Table of Contents

PURITAN PUB. CO., 793 Perry Bldg., Phila., Pa.

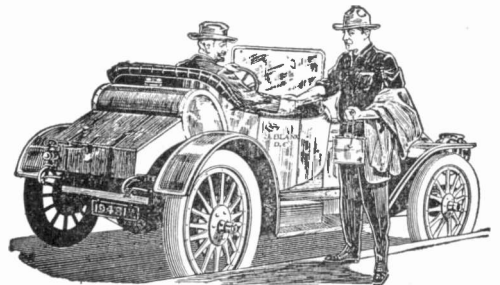

They Started Even

They worked side by side in the same shop. One was ambitious—grasped the opportunity—succeeded. He studied Chiropractic!

He is now independent.

The other was contented—he still works for machinist's wages—his family knows what high cost of living means.

Here's a great opportunity for every man or woman to enter a dignified, highly paid profession, Chiropractic, the new science which, without drugs or surgery, adjusts the causes of human ills.

Take the case of Chas. F. McCormick—a year ago he worked for \$2 a day. He studied Chiropractic and in less than a year built up a practice paying him \$150 a week. "Mac's" neighbors honor him for he accepted his chance: he made good!

So can you—you can learn Chiropractic at home through our home study course—250 lessons and 2500 photos from life. Start now. We could place 1200 graduates today if we had them and the demand for them is growing fast!

Learn about this real opportunity to get out of the small income rut. Write today.

Palmer School of Chiropractic
Home Study Department
"Chiropractic Fountain Head"

8th and Brady Streets, Davenport, Ia., U. S. A.



Become An Expert Electrician In Spare Time

Never has there been such a demand for technically trained electrical men as at present. The great expansion of the electrical field in all its branches is responsible for this. The trained electrical man is always sure of a good position at a good salary.

The International Correspondence Schools have made the mastery of any electrical course easy. Any ambitious man can learn *in spare time* to become an expert electrician. *You can.*

Courses cover Electrical Engineering, Lighting and Railways, Interior Wiring, Dynamo Running, Electric Car Running, Heavy Electric Traction, Telephone Engineering and Telegraph Engineering. Everything made clear and simple. Courses conducted by experts. No hurry or delay. The I. C. S. stands by you until you are through.

It costs you nothing and puts you under no obligation to learn *how* the I. C. S. can help you. Simply fill in and mail the attached coupon to-day. Do it *now*.

International Correspondence Schools
Box 1102-G, Scranton, Pa.

Please explain, without further obligation on my part, how I can qualify for a good position in the line of electrical work indicated in the attached coupon:

Position

Name

Street and No.

City State

ELECTRICITY

Complete in One Year

SCIENTIFIC ELECTRICITY
IN ALL ITS BRANCHES

Bliss Electrical School

Studies restricted to theoretical and practical electricity, mechanical drawing and necessary engineering work. Teaches simplicity, concentration, hard work. For young men of energy and character. 18 years of greatest success. Graduates hold first-class positions. **Opens Sept. 20.** Write for new catalog. **10 Takoma Ave., WASHINGTON, D. C.**

EARN A BIG SALARY Be An Auto Expert

Big demand and big pay for chauffeurs, repairmen, and salesmen. Our system of individual instructions by mail enables you to complete the course in 12 simple lessons at home. Send to-day for Free Book, particulars, and endorsements of 10 leading automobile makers. We assist graduates to get positions. **FREE MODEL FURNISHED EACH PUPIL.** Practical Auto School, 68M Beaver St., N. Y. City



Do You Like to Draw?

That's all we want to know

Now we will not give you any grand prize or a lot of free stuff if you answer this ad. Nor do we claim to make you rich in a week. But if you are anxious to develop your talent with a successful cartoonist, so you can make money, send a copy of this picture with 6c. in stamps for portfolio of cartoons and sample lesson plate, and let us explain.

THE W. L. EVANS SCHOOL OF CARTOONING
325 Ball Bldg. Cleveland, O.



WIRELESS TELEGRAPHY

Expert instruction—full equipment—low fees. Meets U. S. Government requirements—grants certificates—Prepares for positions with Postal Western Union, United Wireless or U. S. Government.

BOOKLET "T" FREE TO ANY ADDRESS

East Side Y.M.C.A. Telegraph School
153 East 86th St., New York

LEARN WATCHMAKING Engraving and Jewelry repairing
Earn while learning. Our school Endorsed by leading jewelers. Positions secured for graduates. Send for Free catalogue.

CHICAGO SCHOOL OF WATCHMAKING,
Dept. 30, Bush Temple, Chicago



I TEACH BY MAIL
WRITE FOR MY FREE BOOK

"How to Become a Good Penman" and beautiful specimens. Your name elegantly written on a card if you enclose stamp. Write today. Address F. W. Tamblin, 437 Meyer Bldg., Kansas City, Mo.

Electricians

are you up-to-date in house-wiring, if not, study our 75 genuine blue print drawings, of all up-to-date labor saving diagrams and connections for wiring bells, lights, annunciators, gas lights, burglar alarms, telephones, fire alarms, etc.—everything known in house-wiring to date, for saving time and material. These drawings are bound in the form of a flexible book (7x8) for convenience in using on the job. No one interested in house-wiring can afford to be without these drawings as they're a house-wiring education in themselves. Send for them, and if they don't make you more efficient as a wireman and save you a hundred times their cost as a contractor, return them and money will be refunded. 50 Cents, Postpaid.

PATENT SPECIALTY COMPANY
462 Sanchez Street, San Francisco, Cal.

Salesmen Wanted

DO YOU WANT A GOOD POSITION WHERE YOU CAN EARN FROM \$1,000.00 TO \$5,000.00 A YEAR AND EXPENSES?

There are hundreds of such positions now open. No former experience as a salesman required to get one of them. If you want to enter the world's best paying profession our Free Employment Bureau will assist you to secure a position where you can earn good wages while you are learning Practical Salesmanship. Write today for full particulars; list of good openings and testimonial letters from hundreds of our students for whom we have recently secured good positions paying from \$100.00 to \$500.00 a month and expenses. Address nearest office, Dept. 131

National Salesmen's Training Association.
Chicago New York Kansas City Seattle New Orleans Toronto

Practical Electrical Education

This school of electricity and electrical engineering is complete in every detail to give a thorough electrical training, and has, therefore, gained the title of "The Electrical School That Graduates Experts." The methods here are fully practical, with just enough lectures and theory study necessary to develop students to be experts. Drafting, mathematics, chemistry, applied electricity, with modern apparatus to experiment upon and an efficient faculty develop expert engineers here in three years.

Successful Graduates Everywhere—Names on Request—Send for:

FREE PROSPECTUS

just issued. 40 pages of interesting electricity facts and full review and illustrations of this modern school, its departments and courses. Sent free upon request. A valuable book for every ambitious young man. Send for it to-day.

Fall Semester Begins
September 3rd, 1912.

School of Engineering of Milwaukee

Stroh Industrial Building
161-171 Michigan Street
MILWAUKEE, WISCONSIN
Formerly at 1025 Winnebago Street



"HELP WANTED"

—Uncle Sam.

Mail Clerks
City Mail Carriers
Clerks in the Offices at
Washington, D. C.

Thousands of appointments coming

**\$800.00 to \$1800.00 a Year
for LIFE**

No "layoffs" without pay, because of strikes, financial hurries or the whims of some petty boss. Excellent opportunities for quick advancement to Higher Government Positions. If you want immediate appointment, send **TODAY** for our schedule showing locations and dates of the coming examinations. Any delay means the loss of just so much time in preparing yourself for examination.

Franklin Institute
Dept. D 118, Rochester, N. Y.

We Prepare Candidates Free The Coupon, filled out as directed, entitles the sender to free sample questions, a free copy of our book, "Government Positions and How to Obtain Them," and to consideration for Free Coaching for the examination here checked.

| COUPON | | | |
|---------------------|-----------------|--------------------------------|-------------------------------|
| —Railway Mail Clerk | \$800 to \$1400 | —Customs Positions | \$800 to \$1500 |
| —Postoffice Clerk | \$600 to \$1200 | —Internal Revenue | \$700 to \$1800 |
| —Postoffice Carrier | \$600 to \$1200 | —Stenographer | \$800 to \$1500 |
| —Rural Mail Carrier | \$500 to \$900 | —Clerk in the Department | at Washington \$800 to \$1500 |
| —Bookkeeper | \$900 to \$1800 | —Canadian Government Positions | |

Name
Address D118
Use this before you lose it. Write plainly.

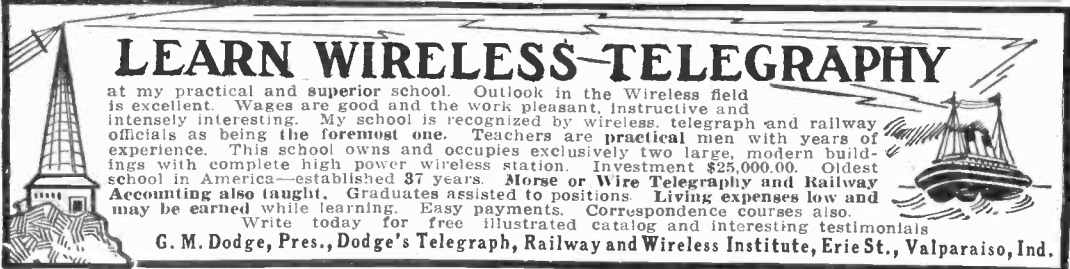

LEARN WIRELESS TELEGRAPHY

at my practical and superior school. Outlook in the Wireless field is excellent. Wages are good and the work pleasant, instructive and intensely interesting. My school is recognized by wireless, telegraph and railway officials as being the **foremost one**. Teachers are practical men with years of experience. This school owns and occupies exclusively two large, modern buildings with complete high power wireless station. Investment \$25,000.00. Oldest school in America—established 37 years. **Morse or Wire Telegraphy and Railway Accounting also taught.** Graduates assisted to positions. **Living expenses low and may be earned while learning.** Easy payments. Correspondence courses also.

Write today for free illustrated catalog and interesting testimonials

G. M. Dodge, Pres., Dodge's Telegraph, Railway and Wireless Institute, Erie St., Valparaiso, Ind.

UNCLE SAM IS BEST EMPLOYER;
pay is high and sure; hours short; places permanent; promotions regular; vacations with pay; thousands of vacancies every month; all kinds of pleasant work every where; no layoffs; no pull needed; common education sufficient. Special money back guarantee if you write today for booklet D1069. IT IS FREE.

Earl Hopkins, - Washington, D. C.

**GET A
BETTER
PLACE**



TELEGRAPHY TAUGHT

in the shortest possible time. The Omnigraph Automatic Transmitter combined with standard key and sounder. Sends you telegraph messages at any speed just as an expert operator would. Five styles, \$2 up; circular free.

OMNIGRAPH MFG. CO.
39 H Cortlandt Street New York

SPECIALIZE IN ELECTRICITY

Big demand for SPECIALISTS in Instrument and Meter work. This is one of the most important branches in the great electrical industry. Instruments and Meters are used wherever ELECTRICITY is used.

POSITIONS PAY \$900-\$1800 A YEAR.

The work is pleasant and healthful. Easily learned from our Complete Course. We will qualify YOU for a splendid paying position and assist you in getting it. Your services will always be in demand. Our booklet, "Instruments and Meters," tells all about this fascinating and profitable work. Send for it. It's FREE.

FORT WAYNE CORRESPONDENCE SCHOOL,
710 Shoaff Bldg. Fort Wayne, Indiana.

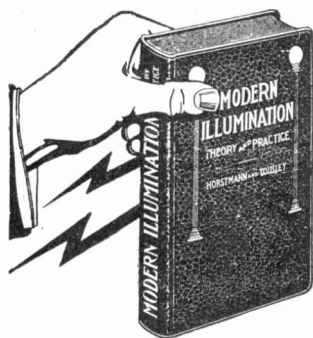

Know Electric Lighting

WHETHER you're from A to Z electrician, con-

tractor, building manager or just a plain ordinary user of electricity, you need to be posted on what the best lighting systems are and how to install them, what kind of lights are most efficient in this type of building and what in that.

"MODERN ILLUMINATION" Answers Your Questions. It's a Book of Solid, Scientific Knowledge for Student, Electrician, Contractor and User

It's the last word in illuminating science and construction—chock full of the information you want—written in a way you'll understand.

THE AUTHORS, Henry C. Horstmann and Victor H. Tousley, are recognized authorities on applied electrical science. Among the subjects they treat are: Nature and Properties of Light—Photometry and Illumination Calculations—Construction Uses, Advantages and

Disadvantages of Different Types of Lamps—Reflectors—Fixtures—Location of Lamps—Indirect Lighting. One chapter discusses Practical Requirements for Different Rooms and Buildings, another, Directions for Drawing Up Plans and Specifications.

Modern Illumination is published in pocket size, for ready reference, handsomely bound in limp green morocco, stamped with gold, and is printed in clear type on good paper. It contains over 275 pages of reading matter, with practical tables, illustrations and diagrams.

ORDER A COPY ON APPROVAL—MONEY BACK IF YOU SAY SO Send us \$2 and we'll send you a copy of "Modern Illumination," charges prepaid. Look it through and if you don't believe it's worth the price, send it back at our expense and we'll refund your money.

DESCRIPTIVE FOLDER SENT ON REQUEST

FREDERICK J. DRAKE & CO., 1322-3 Michigan Ave., Chicago

A NEW BOOK ELECTRIC LIGHT FOR THE FARM

Shows you how to install and operate the most up-to-date low voltage electric light plants suitable for farms, stores and country homes in general.

Full details are given, showing how to estimate the number of lights required, their best location, wiring and the plant necessary to furnish the current.

Part I. LOW VOLTAGE ELECTRIC LIGHTING WITH THE STORAGE BATTERY. Chapters 1—Introduction. 2—The Storage Battery. 3—Estimating the Installation. 4—The Electric Plant. 5—Some Typical Plants. 6—Installation and Operation.

Part II. WIRING HOUSES FOR ELECTRIC LIGHT. Chapters 1—Introduction. 2—Planning the Wiring. 3—Completing the Installation. 4—Installing the Lights. 5—Other Methods of Wiring. 6—Materials and Notes. 7—Notes on Underwriters Rules.

190 Pages, Illustrated, Bound in One Volume. Price \$1.00.

POPULAR ELECTRICITY BOOK DEPT., 54 W. Lake Street, Chicago, Ill.

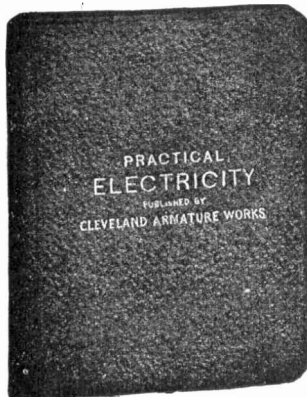

A School Within Itself

There are XX chapters in all, XIX carrying you from the fundamental principles of electricity on through the various branches to a point where the careful student comprehends the complete designing, care and operation of a dynamo or motor, and I chapter on electric automobiles, outlining their construction, care and operation, and all about storage batteries and how to handle them. Each subject is carefully written and to the point. After a student studies a subject, he is questioned on that subject in such a manner as to bring clearly to his mind the points he needs to know regarding same. A DICTIONARY in back of book will enable him to learn the meaning of any electrical word, term or phrase used in this book, as well as hundreds of others in common use. All required tables necessary in the study are in it. TABLE OF SUBJECTS:

| | | |
|---|--|--|
| CHAPTER I—Wiring. II—Electric Batteries, Electro Plating. III—Magnetism. IV—The Magnetic Circuit. V—Magnetic Traction. VI—Magnetic Leakage. VII—Energy in Electric Circuit. VIII—Calculation of Size of Wire for Magnetizing Coils. | CHAPTER IX—Calculation of EMF's in Electric Machines. X—Counter EMF. XI—Hysteresis and Eddy Currents. XII—Armature Reaction. XIII—Sparking. XIV—Winding of Dynamos and Motors. XV—Proper Method of Connecting Dynamos and Motors—Self Excitation. | CHAPTER XVI—Diseases of Dynamos and Motors, their symptoms and how to Cure Them. XVII—Arc and Incandescent Lamps. XVIII—Measuring Instruments. XIX—Alternating Current. XX—Automobiles. |
|---|--|--|

A dictionary of over 1500 Electrical Words, Terms and Phrases, giving a brief meaning of all which are in common use.

\$2.00 Per Copy—Sixth Edition—30,000 Copies Sold The offer we make of refunding money if book is not satisfactory upon examination is an UNUSUAL ONE in connection with the sale of a book. But we have no fear of its return. Your decision will be what thousands of others have been. Money would not buy it if it could not be duplicated. We could print testimonials by the hundreds. It is best to order and be your own judge of its merits.

CLEVELAND ARMATURE WORKS, 4730 St. Clair Ave., Cleveland, Ohio
Armatures and Fields Wound, Commutators Filled AMERICA'S GREATEST REPAIR WORKS

For our Mutual Advantage mention Popular Electricity when writing to Advertisers.

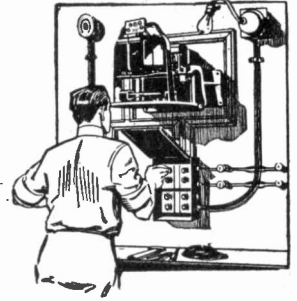
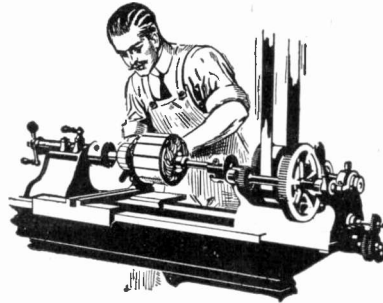

Learn by

Doing

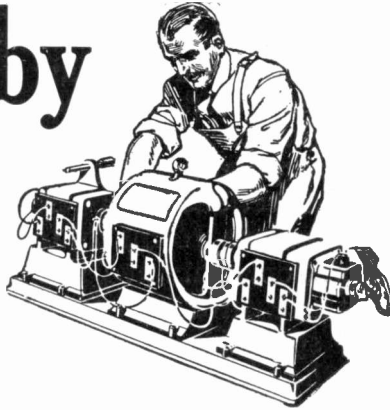

DON'T waste your time and money studying simply "wiring". You'll never get ahead in the Electrical field if "wiring" is all you know about Electricity.

We teach a complete course in the practical study of dynamos, motors, telephones, wireless telegraphy, storage battery and third rail systems, interior light and power wiring, estimating and contracting, illumination, etc.

In this school you learn *how* to do it by *doing* it—not simply by sweating over uninteresting book "statistics", unintelligible "diagrams" and listening to dry "lectures". In *this* school, you work out *with your own hands* the different problems which you see others working.

We have no "classes". Your *ability* is the only limit to your progress. *Individual instruction* by practical electrical workers. *Day and night sessions*. School open all year. *You* can start any time.

Send this Coupon for free illustrated catalogue that tells you everything about this practical, small cost, "learn-by-doing" school.



The New York Electrical School

39 West 17th Street
New York

The New York
Electrical School,
New York

Kindly send me free booklet telling all about this practical, small cost of "Learn by Doing" school.

Name.....

Address.....

P. E.
7-12

Free
Coupon

Geo. J. Cox,
President

Build Your Own Wireless Outfit

Wireless Telegraph Construction for Amateurs

By Alfred P. Morgan

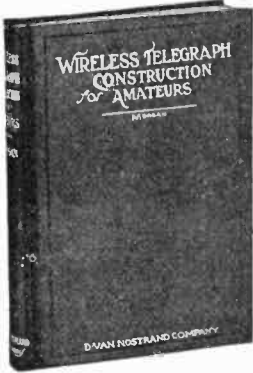

SHOWS you how to construct various outfits capable of receiving from 100 to 1,500 miles and of transmitting 3 to 100 miles, giving in minute detail full directions for the construction of each part. Also clearly explains the purpose and action of each instrument with directions for operating and testing, etc.

History and all obsolete forms of apparatus have been omitted, so the information contained is thoroughly up-to-date.

Its thoroughness is a feature not often shown in such books, this together with its splendid treatise of wireless along constructive lines make it the ideal book for an amateur.

Endorsed by Wireless Clubs throughout the country as being the most practical book published on wireless.

Contents of Chapters

I—Introduction. II—The Apparatus. III—Aerials and Earth Connections. IV—Induction Coils. V—Interruption. VI—Transformers. VII—Oscillation Condensers and Leyden Jars. VIII—Spark Gaps or Oscillators. IX—Transmitting Helixes. X—Keys. XI—Aerial Switches and Anchor Gaps. XII—Hot Wire Ammeter. XIII—Oscillation Detectors. XIV—Tuning Coils and Transformers. XV—Receiving Condensers. XVI—Telephone Receivers and Head Bands. XVII—Operation.

200 Pages

Price \$1.50 Postage 10c additional

153 Illustrations

Money refunded if you are not satisfied.

Free Book Offer

As a special inducement to our readers we will include a copy of the "Amateur's Wireless Handy Book" free with every order for the above book received before August 1st, 1912.

This is the handiest and most useful book for the amateur or professional wireless operator ever published, and is the only book of its kind in existence. Contains among other things a complete list of Wireless Call Letters, 1,500 in all, arranged alphabetically. The Morse and Continental Codes on two full page charts. Beginners Speed Chart so arranged to assist in learning the codes quickly. All the abbreviations used by operators to save time and labor. And last but not least, over 100 different Hook-Ups and Diagrams. Blank pages are provided for keeping a record of your own Hook-ups. Don't overlook this opportunity to secure this valuable book free. Send in your order to-day.

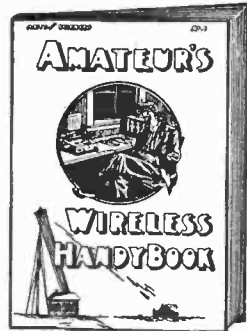

Popular Electricity Book Department, 54 W. Lake Street, Chicago, Illinois



The Greatest Electrical Library in the World

The Electrical Engineering Library is part of the International Library of Technology that cost \$1,500,000 in its original preparation. It contains the knowledge given from the life experience of some of the best electrical engineering experts in the country, edited in a style that nineteen years of experience in publishing home-study textbooks has proved easiest to learn, to remember, and to apply. There is no other reference work in the world that so completely meets the needs of the electrician as the Electrical Engineering Library. The volumes are recommended by the highest authorities and are used in nearly all the leading universities and colleges. They treat of practical electrical methods, starting from the simplest problems and comprehensively covering every branch of the work. Not only can they be used to great advantage by superintendents, foremen, and engineers as an authoritative guide in their work, but since they can be so clearly understood, even by persons having no knowledge of higher mathematics, they can be used by all classes of electricians that are desirous of advancing to higher positions. The Electrical Library contains 17 volumes durably and handsomely bound in three-fourths red morocco, stamped and numbered in gold. The books are printed on a high-grade book paper, and the type is large and easy to read. Each volume is 6 by 9 inches in size. If you wish to know more about the most practical electrical library in the world, send the coupon NOW.

International Textbook Co.

Box 1102, Scranton, Pa.

Please send, without further obligation to me, full particulars in regard to your Library of Technology, with special reference to the Electrical Library.

Name _____

St. & No. _____

City _____ State _____

For our Mutual Advantage mention Popular Electricity when writing to Advertisers.

Here Is the Advertisement
that Won the

Third Prize of \$25.00

In Our Ad-Writing Contest

Particulars of Which Were Given in the April Issue

While the Coupon is, of course, addressed to the Magazine, subscriptions in response to this advertisement may be sent through your newsdealer or direct to us as most convenient.

THE FOURTH AND LAST PRIZE-
WINNING ADVERTISEMENT WILL
APPEAR IN THE AUGUST ISSUE

Popular Electricity Magazine

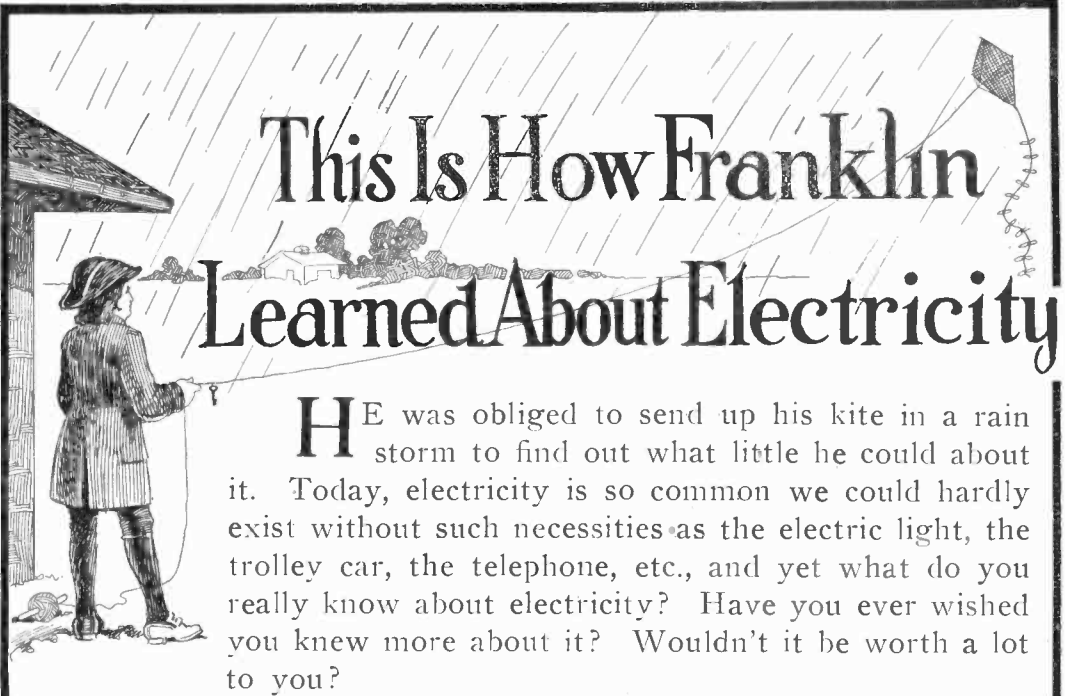

HE was obliged to send up his kite in a rain storm to find out what little he could about it. Today, electricity is so common we could hardly exist without such necessities as the electric light, the trolley car, the telephone, etc., and yet what do you really know about electricity? Have you ever wished you knew more about it? Wouldn't it be worth a lot to you?

It isn't necessary to stand out in the rain as Franklin did or spend much time or money to get up-to-date information about this interesting and important subject.

Popular Electricity Magazine

is written in plain, understandable English for people just like yourself, who are too busy to study the subject, yet wish to keep posted on Electricity and its ever increasing applications.

The Manufacturer uses dynamos in his power house, motors to drive his machines and arc and incandescent lamps to light his factory. POPULAR ELECTRICITY gives him just the information he needs in a clearer, more concise form than the technical papers.

The Merchant has learned that electricity has no rival for store and window illumination, advertising sign lighting, delivery truck and elevator service. Popular Electricity describes, each month, the latest improvements in these things and supplies him with knowledge sufficient to intelligently purchase and operate them.

The Housewife will find the articles in Popular Electricity explain plainly just what she wants to know about electric cooking and heat-

ing devices, fans, vacuum cleaners, flatirons, sewing and washing machines, etc.

Doctors and Dentists who use electrically operated apparatus extensively find many things of interest described and illustrated each month in Popular Electricity. Popular Electricity contains easily understood descriptions of the latest developments along this line.

If you are interested in the use of electricity, whether for lighting your home or illuminating a city's streets; for driving a jeweler's tiny lathe or hauling the heaviest train. Popular Electricity will give you each month ideas and information worth many times the subscription price.

Subscription price, \$1.50 per year
Canada, \$1.85; Foreign, \$2.25

Special Offer (see coupon) Good till Aug. 1

Popular Electricity Magazine

452 Commercial Bldg., Chicago, Ill.

There are no strings to this kite

POPULAR ELECTRICITY MAGAZINE,
Chicago, Ill.

Enclosed find \$1.50 (Canada \$1.85; foreign \$2.25) for a year's subscription, with Handy Electrical Dictionary (cloth) free, as per special offer.

Name.....
Address.....
Town & State.....

Send it up to us and get the Dictionary free

A Complete Course in Applied Electricity

Practical Applied Electricity

By DAVID PENN MORETON, B. S. E. E.

Covering every line of electrical work as taught in the Armour Institute of Technology, an institution of world wide fame.

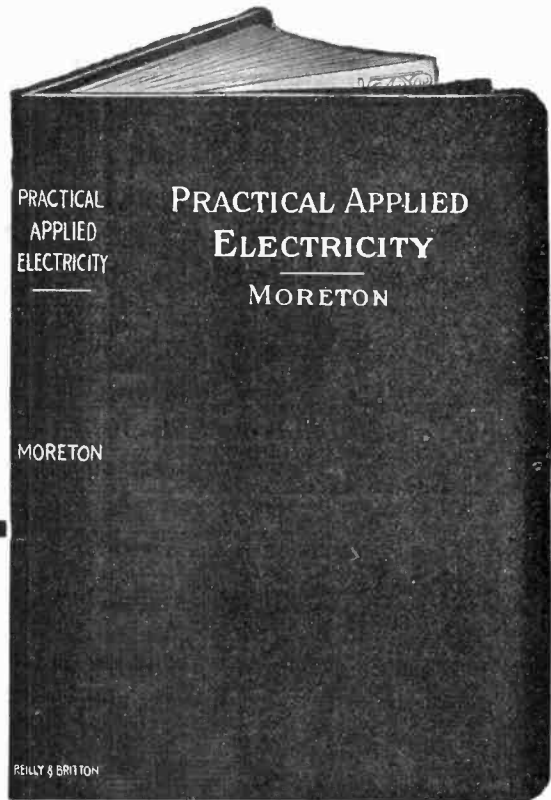

Practical Applied Electricity is the outgrowth of actual work combined with classroom experience. The author is Associate Professor of Electrical Engineering at the Armour Institute of Technology. Most of the students taking the electrical course attend the evening classes, being employed at electrical work through the day. The problems which confront these students are embodied in this book—one reason for its being so practical and up-to-date. To illustrate this valuable information, careful detailed drawings have been made under the personal supervision of the author. In plain words, this book contains the experience of a large number of ambitious electrical workers, gathered together by a recognized authority on the subject.

CONTENTS:

The Electrical Circuit and Electrical Terms Explained by Means of the Water Analogy; Ohm's Law; Series and Divided Circuits; Calculation of the Resistance of Various Circuits and Conductors; Primary Batteries; Dry and Wet Cells; Voltage; Internal Resistance and Polarization; How to Renew; Series and Parallel Connections; Tables of Data of Commercial Types of Cells; Magnetism; Permanent Magnets; Electromagnets; The Magnetic Circuit and Quantities Involved; Magnetic Properties of Various Materials; Magnetic Calculations; Instruments; Construction of Various Types of Ammeters, Voltmeters, Wattmeters, Galvanometers, etc.; Calibration of Instruments; The Dynamo; Fundamental Principle; The Magnetic Field; Commutation; Armature Reaction; Characteristics of the Series, Shunt and Compound Types of Generators; Motors, Fundamental Principle; Various Types and Their Application to Different Kinds of Work; Motor Speed Control; Variable Speed Motors; Railway Motors, Elevator Motors, etc.; Storage Bat-

tery; Fundamental Principle; Commercial Types; Application; Care of; Systems of Power Distribution; Two and Three Wires; Balancers; Motor Generator Sets, etc.; Practical Operation of Electrical Machinery; Connections in Series and Parallel; Motor and Generator Troubles, How to Locate and Remedy Them; Electrical Lighting; Various Types of Incandescent and Arc Lamps, Application of Various Types; Photometry of Lamps; The Nernst Lamp; Moore Tube; Mercury Vapor Lamp; Electrical Wiring; Calculation of Conductors; How to do Exposed Moulding and Conduit Work; How to Install and Connect Heaters, Motors, Generators, Fixtures, Arc Lamps, etc.; Wiring Tables for Different Classes of Work; Alternating Current Circuit; Comparison of the Direct and Alternating Current Circuits; Quantities Involved; Series and Divided Circuits; Measurements of Power; Alternating Current Generators and Motors; Resuscitation; Numerous Miscellaneous Reference Tables.

The language is so plain, and the mathematics so simple that no one can fail to understand. Questions and answers given at the end of each chapter, impress upon the mind of the reader the more important points to be remembered.

450 PAGES 323 ILLUSTRATIONS
BLACK FLEXIBLE LEATHER BINDING

Price \$2.00 Postpaid

All interested in electricity, old or young--artisan or amateur--expert or experimenter--should own this absolute authority. Money refunded if you are not satisfied.

POPULAR ELECTRICITY BOOK DEPT., 54 W. Lake St., Chicago, Ill.

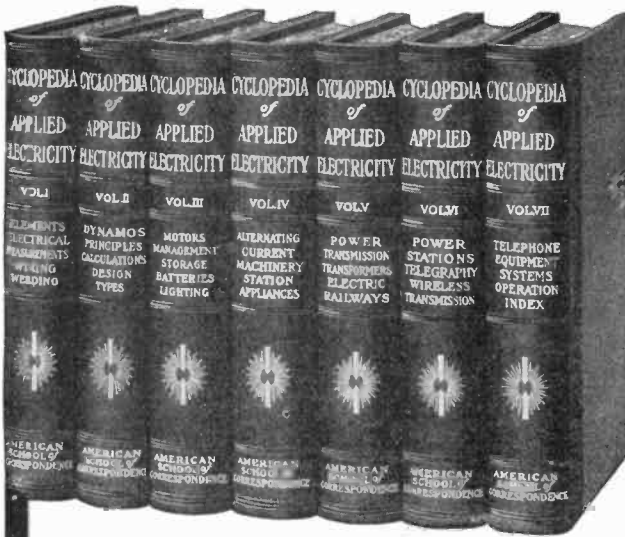

SEVEN ELECTRICAL EXPERTS

Here is a set of electrical books published especially for the student, worker and expert—every chapter written by an expert in his special line—every subject brought down to date—an absolute authority on everything electrical from wiring to alternating current machinery—from motors to power stations, etc. Read table of important subjects below.

The American School's Cyclopaedia of

Applied Electricity

is compiled from the instruction papers used in the regular correspondence work of the school; contains 3,200 pages; 2,600 full page illustrations, diagrams, formulas, etc., with a special cross index for quick reference. The seven large volumes are bound in half morocco and are printed in large, clear type on special quality paper.

Important Subjects Covered by These Great Books

Theory, Calculation, Design and Construction of Generators and Motors—Electrical Measurements—Electric Wiring—Electric Welding—Types of Generators and Motors—Management of Generators and Motors—Storage Batteries—Electric Lighting—Alternating-Current Machinery—Station Appliances—Power Stations—Power Transmission—Central Station Engineering—Electric Railways, including Single-Phase—The Electric Telegraph—Telephone Equipment, Systems and Operation—Wireless Telegraph and Telephone—Telautograph—Telegraphone, etc.

Sent Absolutely Free—Express Prepaid

The complete seven volumes, not a sample volume, will be sent, express prepaid, for seven days' free examination; returnable at our expense if the books do not contain the information you want. If you keep the books, pay \$2.00 seven days after receipt and then \$2.00 a month until you have paid the special introductory price of \$19.80.

Just fill in and mail the coupon. It won't cost you a cent to examine the books. We know they'll be worth many times their cost to you. Mail the coupon now and you'll receive your books promptly.

Another Great Free Offer

With every set is included a year's Consulting Membership entitling you to the free advice of a staff of Electrical Engineers. This will give you practical help in handling working problems which are too specific to be taken up in detail in the Cyclopaedia. There will be no limit to this service. A single problem solved for you might be worth more than the first cost of the books.

AMERICAN SCHOOL OF CORRESPONDENCE
CHICAGO, U. S. A.

Pop. Elec. 7-12

A. S. of C.

Please send me Cyclopaedia of Applied Electricity for seven days' free examination. I will send \$2.00 within seven days and \$2 a month until I have paid \$19.80; otherwise I will notify you and hold the books subject to your order. Title not to pass until fully paid.

7 DAY EXAMINATION COUPON

NAME

ADDRESS

OCCUPATION

EMPLOYER

For our Mutual Advantage mention Popular Electricity when writing to Advertisers.

A Conservative Investment Tax Exempt in Illinois Paying 7% Dividends

No investment is more worthy of investigation than the stock of the **Commonwealth Edison Company** of Chicago. Notwithstanding its astonishingly rapid growth and its present strategic position, this Company is as yet doing only a fraction of the business that it will do in the near future.

The **Commonwealth Edison Company** is at present supplying electricity for lighting and power in a territory that covers 200 square miles, but that territory is only "tapped," so to speak. There is expert authority for the statement that three times the present volume of business should naturally come to the Company's Central Station. Yet, gigantic as is the retail business of the **Commonwealth Edison Company**, it forms only one-third of its total business, two-thirds of which is wholesale. It supplies electricity to 1250 miles of street and elevated railway track and its service to smaller Central Stations extends 85 miles to the north, 55 miles to the south and 35 miles to the west of Chicago.

A very considerable portion of the Company's wholesale business is concerned in the sale of electricity for light and power to manufacturers. In this field there is still opportunity for a vast increase of business in replacing private power plants with the more economical Central Station service.

The **Commonwealth Edison Company** represents an investment of over \$70,000,000, and is paying dividends at the rate of 7% per annum on its capital stock. The future prospects of this stock are indicated by the recent advance in the dividend rate from 6% to 7%. At the present market price of about 145, the net return to the investor is nearly 5%. While the stock was paying 6% dividends it sold at average prices that yielded a smaller net return. This justifies us in the belief that **Commonwealth Edison stock** is now a more desirable investment than ever before.

Commonwealth Edison stock is listed on the Chicago Stock Exchange. We recommend this stock as an investment of exceptionally high character, paying 7% dividends, and as being exempt from taxation under Illinois laws. Full information will be gladly supplied in answer to all inquiries.

Russell, Brewster & Company

Members: { New York Stock Exchange
Chicago Stock Exchange

116 W. Adams Street
Chicago, Ill.

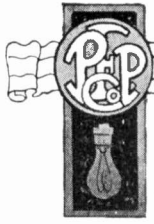

Popular Electricity

In Plain English

Henry Walter Young, Editor

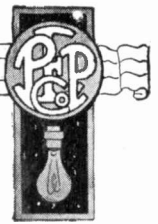

Vol. V

July, 1912

No. 3

CONTENTS

| | Page | | Page |
|---|------|---|------|
| An Ancient Industry Electrified. By Orin Edson Crockner | 209 | A Handy Contractor's Hoist | 267 |
| A Paris Duelling School | 211 | Reminder Clock | 267 |
| What the Wireless Told. By Frank Parker Stockbridge | 212 | Smallest Electric Runabout | 268 |
| Surprising the Barbarians of Formosa | 218 | Electric Pencil Holder | 268 |
| Speed Maniac New Menace to Trucks | 219 | Return Call Button Hides Call Bell | 268 |
| The Mandjovac Plant in Austria Hungary | 220 | Long Cord Turn Down Lamp | 268 |
| Some Secrets of Electrical Stagecraft. By T. J. Newlin | 221 | Electrical Men of the Times. Samuel Groenedyke McMeen | 269 |
| Electric Signal for Life Savers | 226 | Modern House with Vacuum Cleaner | 270 |
| Hydro-Electric Wonders in California. By Archie Rice | 227 | Service Kitchen Cabinet | 271 |
| The Wireless | 232 | Observations at a Household Show | 272 |
| The Romance of Wireless. By Edward Lyell Fox | 233 | Color Scheme Cookery | 274 |
| An Odd Pile Driver | 236 | Illumination of Works of Art | 275 |
| Electrical Securities. By "Contango" | 237 | What the Motorist Shall Wear | 276 |
| Picture Sending by Wire | 240 | The Tragedy of Wash Day | 277 |
| An Electrical Genius Released from Prison | 241 | Electric Boiler and Turbine Wheel | 278 |
| Electric Clocks in Electric Trams | 241 | A Miniature Pleasure Park | 279 |
| Ambition. By Winder Elwell Goldborough, M. E. | 242 | The Luminous Goblet | 280 |
| Deciphering Manuscripts with Ultraviolet Rays | 243 | Learning the Telegraph Code | 281 |
| Signal Lamp on Glove | 244 | An Odd Telegraph Set | 281 |
| Electric Refuse Wagons of Paris | 244 | To Make a Small Magneto | 281 |
| A "Boiling" Battery | 244 | Experimenting with Large Induction Coils | 282 |
| Trolley Wires for Airship | 245 | Flashlight for Signaling | 282 |
| Collecting Static Electricity from the Air | 245 | Wireless Outfits for Small Boats. By Richard H. Foster | 283 |
| First Money Earned from Telephone | 245 | Capacity of Condensers | 285 |
| Electric Chickens | 246 | Regulation of Amateur Radio Operation. By Eugene Peterson | 286 |
| First Foreign Language Over Telephone | 246 | Questions and Answers in Wireless. By A. B. Cole | 287 |
| Tower Lights of Girard College | 247 | Wireless Club Directory | 287 |
| Observation Tender for Submarines | 248 | Fishing Wire and Its Manipulation | 290 |
| Electric Photography | 249 | Water Pressure Signal | 291 |
| Telephones in Tripoli | 249 | Adjustable Water Rheostat | 291 |
| The Perfected Money Laundering Machines | 250 | A New Electric Furnace | 292 |
| Gray Squirrels Gnaw Cables | 251 | Brine Saving Device | 292 |
| Pottery Designs for Lamp Bases | 251 | Emergency Torch for Electricians | 293 |
| Remodeling Fire Engines for Electric Propulsion | 252 | Apparatus for Demagnetizing a Watch | 293 |
| Safeguarding the Lives of Little Children | 253 | A Galvanic Packing | 294 |
| Aerial Trams of a Utah Mine | 254 | Fans for Sealing Room | 294 |
| Demonstrating a Good Cigar | 255 | Wiring System for Electric Irons | 294 |
| Phonograph with Electric Brake | 255 | An Electric Water Heater | 294 |
| The Arrival of the Chauffeuse | 256 | A Simple Photometer | 295 |
| Smelting Tin at Cornwall | 256 | Illuminating the Steam Gauge | 295 |
| Lighting Effects Past and Present | 257 | Homemade Cash Drawer Alarm | 295 |
| German Sidewalk Signs | 257 | Ferris Wheel to Display Goods | 296 |
| Headlights for Victims of Night Shipwrecks | 258 | A Double Motion Display Rack | 296 |
| Immense Electrification Project for Berlin | 258 | Attracting the Isaac Waltons | 296 |
| The Carving of Stone Tablets | 259 | Auto Rotor | 297 |
| Apparatus for Breaking in Shoes | 259 | Light Fixtures on Bed | 297 |
| The Cameragraph | 260 | The Flying Fountain Pen | 297 |
| Trinity's Electric Sign | 261 | Revolving Turntable for Window | 297 |
| Electric Parade for the Shriners | 262 | Marconi Contract with British Government | 298 |
| Germany's Long Distance Wireless Operations | 262 | Increasing Simplan Tunnel Traffic | 298 |
| Electricity in Embroidery Designing | 263 | Artificial Rubber | 298 |
| Longest Nickel Street Car Ride | 263 | Electricity from Household Waste | 298 |
| Promptness of American and English Telephone Operators Compared | 264 | A New Electric Furnace | 299 |
| X-rays in Testing Precious Stones | 264 | Deadening the Hum of Live Wires | 299 |
| Portable Safety Electric Lantern | 264 | Testing Wine with a Telephone | 299 |
| A Swiss Coffee Mill | 265 | Electric Current from Sunlight | 299 |
| Three Wheeled Electric Delivery Wagon | 265 | New Books | 300 |
| Treadle Controls the Motor | 265 | All-British Cable to Canada | 301 |
| Fire and Burglar Alarm Switch | 266 | Foot Amputated by Wireless Instructions | 301 |
| A "Polychrome" Lamp | 266 | Coating Metals with Lead | 301 |
| An Approved Lamp Cord Adjuster | 266 | Short Circuits | 302 |
| Jeweler's Power Motor | 267 | Common Electrical Terms Defined | 304 |

RENEWALS When your subscription expires, you will find a renewal blank enclosed here. You should fill out and return with remittance at once to avoid missing a number. Positively no copies will be mailed on any subscription after same expires unless renewed, and we cannot agree to begin subscriptions with back numbers. The date on wrapper of your magazine shows issue with which your subscription ends. The extension on this date to period covered by renewal is sufficient receipt. If any other is desired it should be requested at time of renewal.

CHANGE OF ADDRESS Notify us promptly of any change in your address, giving both the old and new location. Since our mailing list for each issue closes the 5th of the preceding month (i. e., list for February closes January 5th), changes received after the 5th must necessarily take effect with issue for second month following. Postmaster as well as Publisher should always be notified of changes in order to forward mail sent to old address.

ISSUED MONTHLY BY POPULAR ELECTRICITY PUBLISHING CO., Commercial Bldg., Chicago, Ill.
 YEARLY SUBSCRIPTION, \$1.50; CANADIAN, \$1.85; FOREIGN, \$2.25; SINGLE COPY, 15 CENTS

No additional copies will be sent after expiration of subscription except upon renewal.
 Entered as Second Class Matter April 14, 1908, at the Post Office at Chicago, Under Act of March 3, 1879.

Copyright 1912, by Popular Electricity Publishing Co.

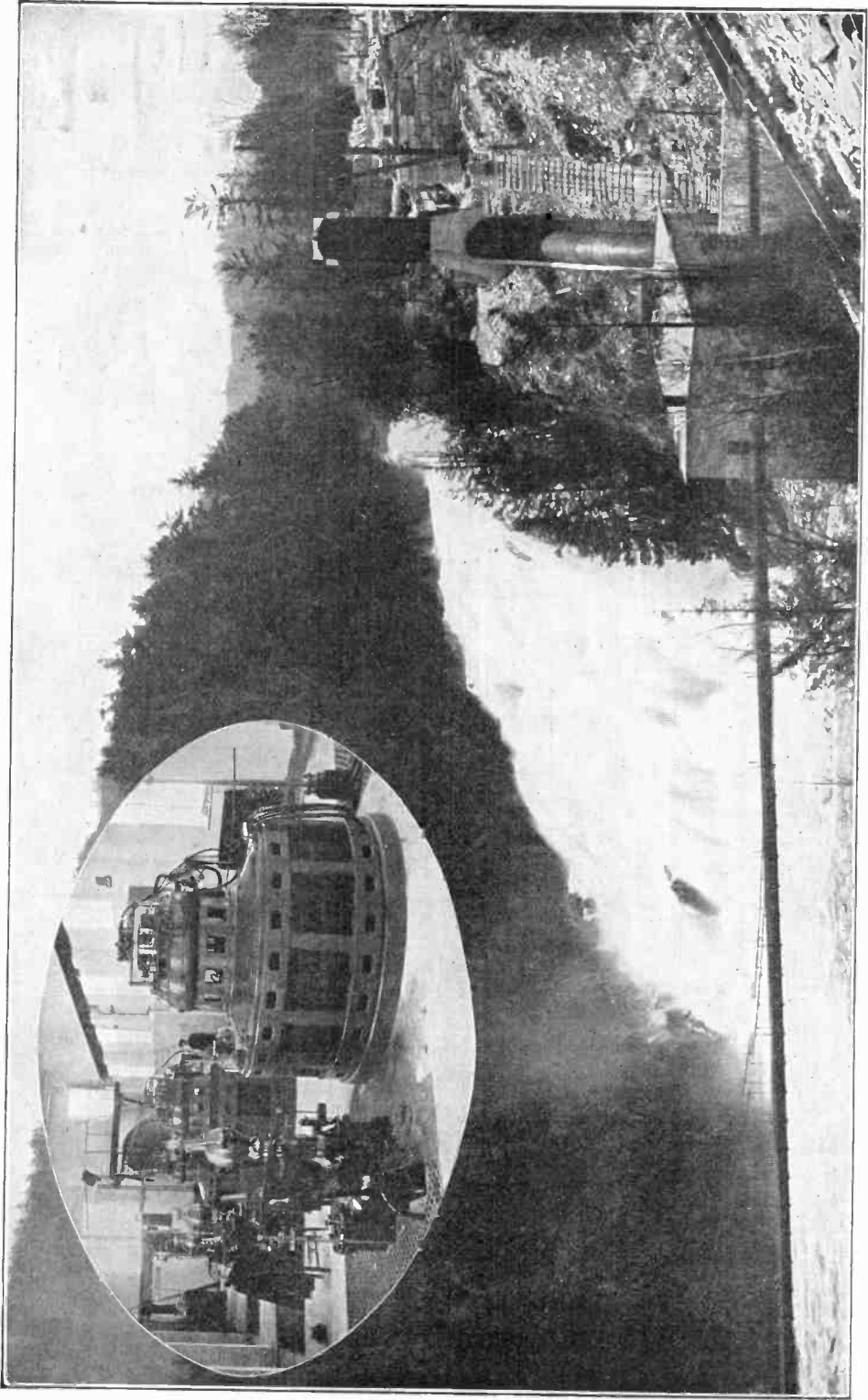

SUTHERLAND FALLS NEAR THE VILLAGE OF PROCTOR, VT., WHICH FURNISHES ELECTRICITY FOR THE WORKING OF MARBLE QUARRIES

Popular Electricity

In Plain English

VOL. V

JULY, 1912

No. 3

An Ancient Industry Electrified

By ORIN EDSON CROOKER

The quarrying of marble for building purposes is one of the oldest industries in the world, dating back to the time of Solomon's temple and probably earlier. The Parthenon, the Hippodrome and other edifices of ancient Athens were also built of marble, the quarrying of which was conducted on a large scale by the Greeks over two thousand years before the time of Christ.

It is a curious fact that while some of the methods used today in the production

of marble are identical in principle with those in use so long ago, it has remained for the application of electricity to bring this ancient industry to its great modern productiveness. For instance, the earliest known methods of sawing marble were practically the same as those in use today. Sand, running water, and a "saw" made of soft iron and without teeth are still used to cut marble into slabs and blocks. Electricity now supplies the power which in olden times came from toiling human

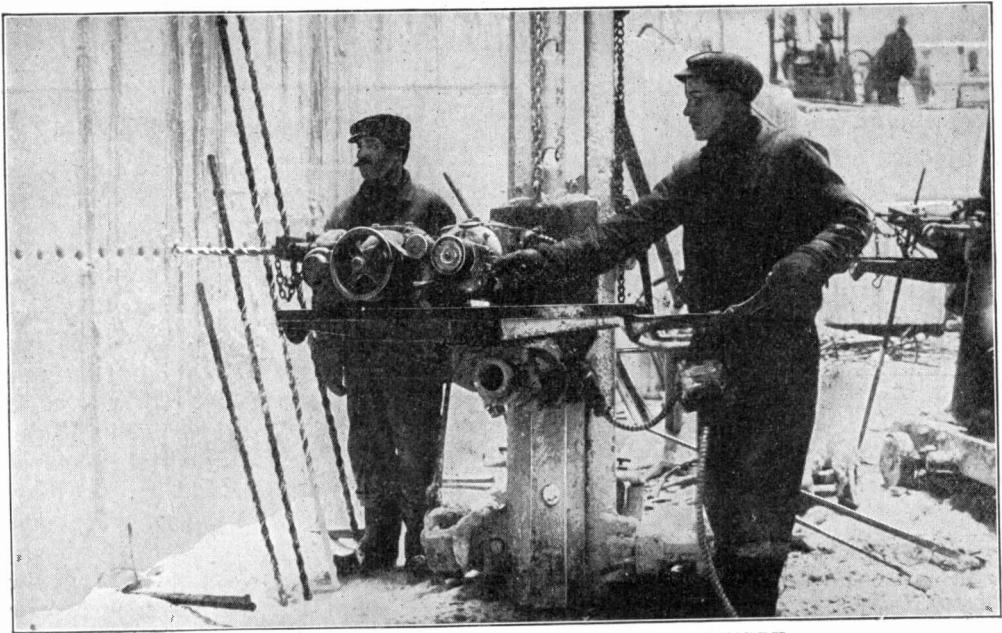

OPERATING AN ELECTRIC DRILL IN A MARBLE QUARRY

beings. This is the only difference. In the large quarries of western Vermont, the recognized center of the industry in this country, no other power is used in the many processes to which the stone is subjected. It is quarried, cut into desired sizes, polished and finished—all by electricity.

Nature seemed to anticipate the future needs of man when she prepared long

used not only in Proctor, but at West Rutland, Brandon, Florence and other points. This plant, which is one of two that are run together in a common transmission line, is made up of three units, each consisting of a 1,200 horsepower turbine connected to a 750 kilowatt generator.

The quarrying of marble is an interesting process. The first step is that of

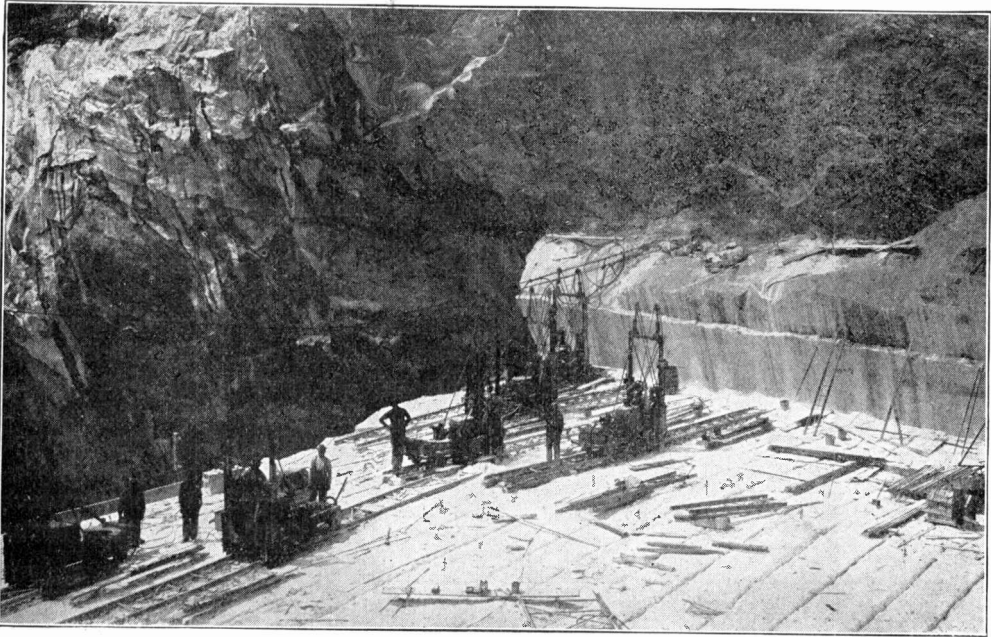

CHANNELING MACHINES AT WORK IN A MARBLE QUARRY

ages ago for the Twentieth Century marble industry of Vermont. Not only did she deposit beneath the green hills of the western part of the state seemingly inexhaustible stores of this valuable stone, but she fashioned the water courses so that in later time man could generate close at hand the power needed in its quarrying. Sutherland Falls, in the little village of Proctor—scarcely a stone's throw from the great mills where a surprisingly large proportion of the marble used in this country is finished, has always been a delight to look upon. Its tumbling waters are now more than beautiful; they have become commercially useful. An electric hydraulic power house converts them into power that is

cutting the stone into large rectangular blocks and freeing them from their position in the quarry bed. Years ago in Vermont the stone was quarried by hand, as is the case in some parts of Italy and Greece today. But this method was too slow for practical use and an inventive genius gave the world the stone channeling machine, by means of which a single skilled operator is able to do the work in a single day that formerly required from 50 to 100 men. These channeling machines, which are operated by electricity, run back and forth on rails, and the drills with which they are equipped are driven with powerful force downward into the stone, cutting a slit about an inch wide and to any desired depth up to ten feet.

It is slow work, depending somewhat on the grade of marble. Ordinarily a cut 20 feet long and eight feet deep will require from 20 to 24 hours of constant work.

When the narrow perpendicular cut has been made to the required depth, steel drills, also driven by electricity, are used to bore in from the side in a horizontal direction. Holes are made from four to six inches apart and along this line the marble is detached from its bed by means of wedges. The block thus loosened is raised to the surface by means of powerful electric derricks, after which it goes to the mill to be sawed into slabs or blocks.

In this operation the rough block of marble is placed in position under a set of "saws" made of soft iron. A stream of water carrying sand in suspension

plays over the block of stone as the saws are moved back and forth by means of electrically operated machinery. The edges of the sharp sand cut into the soft marble as the strip of iron grinds them back and forth against the stone. Here, again, time is required to accomplish results, sometimes from 20 to 30 hours being needed to cut through a block of marble five or six feet thick.

From the sawing mill the slabs and blocks go to the polishing sheds, where huge electric buffers complete the work by giving the stone a beautiful polish, and making what has hitherto been a rather unattractive piece of greyish white stone a glistening, shining slab of finished marble—a thing of beauty and probably designed to fill a useful place in some building already under construction.

A PARIS DUELLING SCHOOL

While in many countries the practice of duelling is discouraged, it still lives in Paris. It is not uncommon to read in the papers notices of a duel to take place within the next few days. The duellists have at their disposal a very convenient academy for practice, equipped with all



THE MARKSMAN PROCEEDS AS HE WOULD IN A REAL DUEL

modern comforts. This shooting gallery is specially equipped for instructing and the practice of duellists. The targets are so-called electric silhouettes, representing human figures in life size, the figures being divided into seven fields. Every shot which reaches the mark is signalled to the marksman by an electric annunciator, while a fac-simile of the target placed near him enables him to see where his bullet has struck. The range is 50 to 80 feet.

The marksman proceeds as he would in a real duel, the loader commanding: "Attention." "Fire—one, two, three." At the word fire the marksman raises his pistol and at the word three, he is required to fire.

Perhaps, as civilization proceeds, the mere hitting of the silhouette will give the Parisian duelist sufficient "satisfaction" for wounded feelings.

What the Wireless Told

By FRANK PARKER STOCKBRIDGE

C O M E A T O N C E
W E V E S T R U C K
A B E R G I T S A C
Q D O M

The disaster to the "Titanic," hugest of all steamships, which, on her maiden voyage, struck an iceberg in the North Atlantic and sank in two miles of water with the loss of 1,595 of her passengers and crew, put wireless telegraphy to the severest test it has had since the American liner "St. Paul," first of all ships to be equipped with wireless apparatus, sent her

And out of the mass of contradictory and false reports that at first buoyed up the hopes of two continents; the criticism and complaints levelled at many of those responsible for the operation of the wireless and the praise of the hero who died at his post—"Jack" Phillips, chief wireless operator of the "Titanic,"—have come not only a clearer conception of the powers and limitations of the wireless, but the more important lesson that, no matter how perfect a mechanical device may be, it is valueless without intelligent

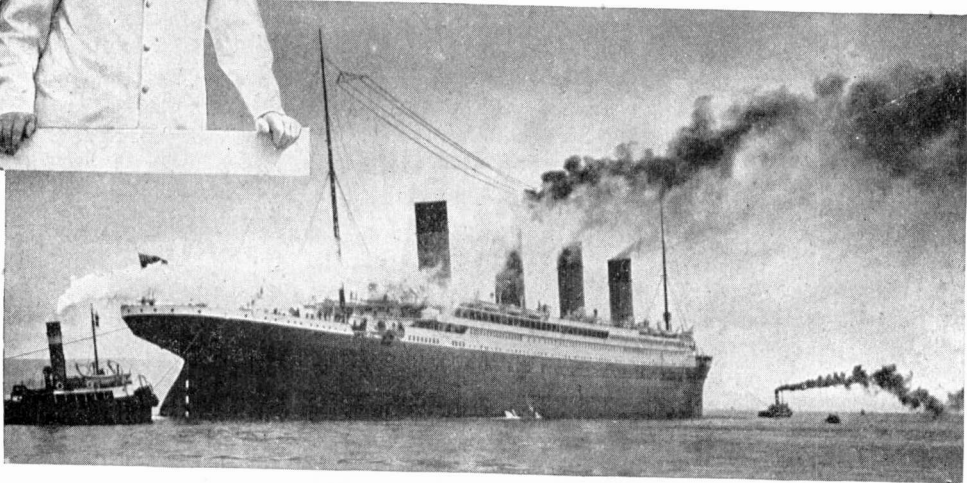
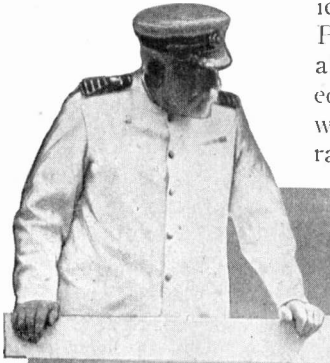

THE TITANIC STARTING OUT FROM SOUTHAMPTON ON HER MAIDEN VOYAGE. ABOVE IS CAPTAIN E. J. SMITH *Photos by Paul Thompson*

first message shoreward on Nov. 15, 1899. The attention of the whole world was focused on Signor Marconi's invention for four breathless days, while the details of the loss of the giantess of the seas percolated shoreward through space.

and resourceful men to operate it. The wireless did not fail to do all that was asked of it. The tremendous loss of life was due to human errors, and it is fair to add that the saving of 745 of the Titanic's company was due to human brav-

ery, which would have been, in all probability, futile had not the wireless done its share.

I had the privilege of discussing the Titanic disaster in all its phases with Signor Marconi himself, on the eve of his return to Europe after giving his testimony before the Senate investigating committee, and his conclusions as well as my own are embodied in this attempt to bring together, for the first time, a complete and consecutive statement of the part the wireless played in this greatest of all ocean tragedies.

It is perfectly clear that had the captain of the Titanic paid attention to the wireless warnings of ice, which the Californian and other ships sent him during the twelve hours preceding the wreck, no lives would have been lost. That he proceeded at a speed of 21 knots an hour into the very region where huge bergs were reported, and continued this speed long after dark, was a human error that the wireless could not avert. Without wireless less blame could attach to the captain who risked his ship amid the ice.

After the collision occurred, although the wireless did all it was called upon to do, it was only by accident that any ship near enough to be of assistance heard the Titanic's "C. Q. D.," and only by accident that other ships, nearer still than the rescuing Carpathia, either did not hear the call or were unable to render succor. And back of the whole tragedy lies a human error that not all the wireless equipment in the world could have overcome—the failure to provide boats enough to save all on board.

It was 10:30 o'clock on Sunday night, April 14, 1912, when Harold Thomas

Cottam, wireless operator on the Carpathia, caught the message in "Continental Code" which I have quoted at the head of this article. That he caught it was due only to the accident that, long after he was officially off duty, he was listening at his receivers in the hope of picking up some news about the English coal strike. Indeed, he had already begun to undress, with the receiving instruments still on his head, when Phillips' distress call, winding up with "O. M."—the half jocular, half affectionate sea slang for "old man"—reached him. How Captain Rostron, of the Carpathia, turned his vessel from its course and picked up the Titanic's survivors at sunrise is a story that will live long in the annals of the sea as an example



Copyright by Paul Thompson
MR. MARCONI AS HE APPEARED BEFORE
THE SENATE COMMITTEE

of prompt and courageous obedience to the call of humanity.

But there were other ships—many of them—within range, and some of them nearer than the Carpathia. Accident and human error prevented these from being of service. The Californian, her engines stopped because of the captain's cautious desire to avoid the dangers of night navigation through the ice, could have been alongside the Titanic before the latter sank—if she had carried two operators, so that one should always be on duty. Even with her engines stopped and her sending apparatus out of commission, with a wireless operator on duty at the receiving instruments she might have learned of the wreck before it was too late. The Mount Temple, her wireless in full commission, was still nearer. Her response to the Titanic's call was instantaneous, but when within only a few miles of the sinking leviathan she found

herself hemmed in by ice and unable to make further headway. Within wireless range also were the Allan liners Parisian,

have saved all on board—was a tramp freighter which, having no wireless equipment whatever, proceeded on its course all unconscious of the tragedy being enacted so close at hand.

How the wireless men on the Titanic sent out the call for help has been told by Harold Bride, second operator, who stuck to the ship until she sank and was saved when Phillips, the chief operator, lost his life. Awakening in the night he heard Phillips sending routine messages to Cape Race. With no thought but to help out his friend, he dressed and entered the operating room just as Captain Smith came in.

"We've struck an iceberg and you'd better be ready to send out a call for assistance," said the captain. "Wait until I find out how much damage has been done before you send it." So the routine work was continued, the wireless working perfectly in the crisp, cold, calm and star-lit night. In a few minutes the captain returned and ordered the call for help sent out.

"What call shall I send?" asked Phillips.

"The regulation international call for help," was the reply, and Phillips began to send out "C. Q. D."—the call to which every ship is bound to listen and respond. "C. Q." is a signal to stop sending and listen. Alone it is important but not alarming. But when followed by "D"—the signal of distress—it means "hurry to our aid."

"What are you sending?" asked Captain Smith, returning again to the wireless cabin.

"C. Q. D." replied Phillips.

The situation was still a joke to the wireless men, firm in their belief that the new ship was unsinkable, and even to the captain himself, for he also laughed when Bride remarked: "Send 'S. O. S.' It's the new signal, and it may be your last chance to send it." So Phillips interspersed his "C. Q. D." with the "S. O. S." call.

All the wireless records of the Titanic sank with her, but the story of how the

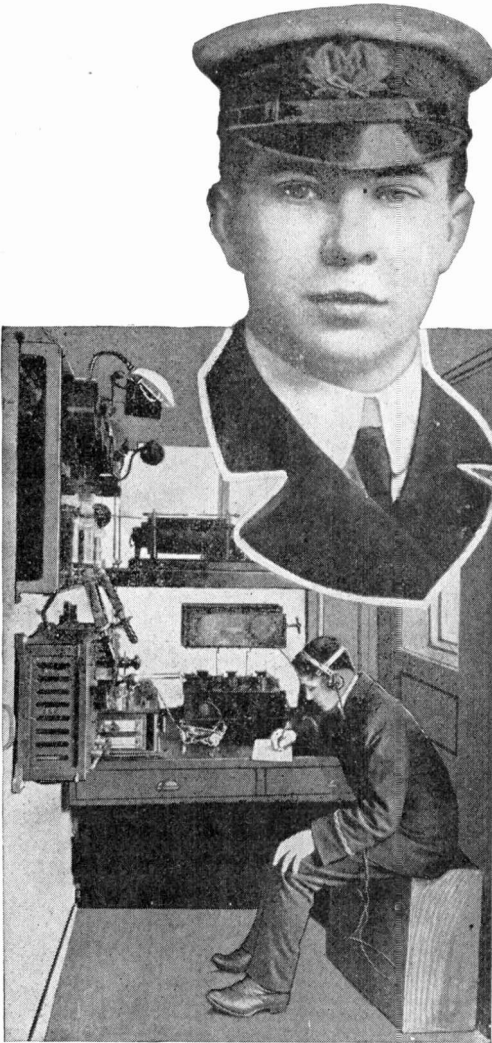

Photos by Paul Thompson and Brown Bros.
OPERATOR JACK PHILLIPS, WHO WENT DOWN WITH THE TITANIC, AND A SCENE IN THE TITANIC WIRELESS ROOM

Virginian and Tunisian, the German freighter Frankfurt, the Russian steamship Birma and the great Olympic, twin sister of the Titanic. All of these heard the Titanic's call, and all responded, but with every ounce of steam their boilers could put into their engines, they could not cover the hundreds of sea miles in time to be of service. And closer than any other ship—so close that it could



Photos by Brown Bros.

**OPERATOR COTTAM, OF THE CARPATHIA,
AND THE WIRELESS CABIN IN WHICH
HE RECEIVED THE CALL OF THE
TITANIC**

call was received has been told in the reports made by the ships that caught it. The Russian steamship

Birma picked it up at 11:50.

"C. Q. D. S. O. S. From M. G. Y. We have struck iceberg. Sinking fast. Come to our assistance. Position, Lat. 41.46 N., Long. 50.14 W. M. G. Y."

Instantly flashed the reply:

"M. G. Y. What is the matter with you? S. B. A."

"O. K. We have struck iceberg and sinking. Please tell captain to come. M. G. Y." That was the Titanic's reply, and promptly went the Birma's response:

"M. G. Y. We are only 100 miles from you, steaming 14 knots; be with you by 6:30. Our position Lat. 40.48 N.; Long. 52.13 W. S. B. A."

The Birma did not know what ship was in distress. The Frankfurt was in wireless communication now, and to her the Russian operator flashed the query:

"S. S. Frankfurt. Please who is M. G. Y.? What is your position and speed? S. B. A."

Back flashed the startling answer:

"S. B. A. Position Lat. 49.47 N.; Long. 40.10 W. M. G. Y. is the new White Star liner Titanic. Titanic O. M. I. D. F. T."

As the Frankfurt's message stopped, the agonized call for aid again clicked out in the ears of the Birma's operator:

"S. O. S. S. O. S. C. Q. D. C. Q. D. M. G. Y. We are sinking fast; passengers being put into boats. M. G. Y."

And again—last call of all to reach the Russian ship:

"C. Q. M. G. Y. Women and children in boats. Cannot last much longer. M. G. Y."

Ship after ship was catching the distress signal, responding with words of hope and cramming on speed to try to render aid.

4 a. m.—Californian now working with Virginian.

4:25 a. m.—Californian now working with Birma.

5:10 a. m.—Signaled Californian. She wants my position. We are very close together.

6 a. m.—Much jamming in wireless instrument.

6:45 a. m.—Carpathia reports twenty boatloads rescued from Titanic.

7:30 a. m.—Baltic sends service message to Californian as follows: "Stand by. You've been instructed to do so frequently." This signaled by an inspector.

7:40 a. m.—Californian gets message of no need to stand by, as nothing more could be done. Carpathia and Olympic very busy.

Only two of the ships involved in the affair were equipped with the most modern wireless apparatus—the Titanic itself and the Olympic. Each carried a five kilowatt set, with an auxiliary gasoline engine to run the dynamo in case of a breakdown of the regular engine that operated the lighting circuit. It was not necessary to use this; however, as the lights did not go out until the ship was actually plunging beneath the waves. Only the Olympic was able to get a message to shore in the hours immediately

following the sinking of the Titanic without relaying it through other ships, and all that the world knew of the disaster until Monday evening was contained in the report from Cape Race, where the Marconi station had caught the Titanic's first "C. Q. D." calls. Cape Race had communicated with the Virginian and sent that ship on its way toward the Titanic, and the Baltic and Olympic reported themselves as being on the way to render aid. But so strong was the belief that the Titanic simply could not sink that all the civilized world was shocked when, at 6:30 o'clock on Monday evening, the Olympic succeeded in getting to shore the fateful message from the Carpathia telling of the fearful catastrophe:

"Carpathia reached Titanic's position at daybreak. Found boats and wreckage only. Titanic sank about 2:20 a. m. in 41.46 North, 50.14 West. All her boats accounted for, containing about 675 souls saved, crew and passengers included. Nearly all saved women and children. Leyland liner Californian remained and searching exact position of disaster. Loss likely total 1,800 souls."

What made the shock the worse was that the public had been lulled into a false sense of security by the publication in the afternoon papers, in apparent good faith, of messages calculated to relieve all anxiety. The air had literally been full of wireless messages all day Monday, and out of the fragments someone had picked up and wired from Halifax to the press the message, "All Titanic passengers safe. Towing to Halifax." This became expanded during the day into a detailed account of the towing of the Titanic by the Virginian and Parisian—two ships that had been in communication with the shore and were known to have been heading for the wrecked vessel. But there is reason to believe that there was no intent to deceive on the part of the author of this alleged dispatch, for Captain Haddock of the Olympic received during Monday a wireless inquiry: "Are all Titanic passengers safe?" which he at first read without the

inquiring "are" and posted on the ship's bulletin board, and a little later the wireless men on the Olympic caught a message from the Asian telling of towing an oil tank to Halifax. It is entirely probable that some amateur caught fragments of these two messages and pieced them together to make the misleading report which was circulated on April 15th.

How Cottam on the Carpathia, aided by Bride, the surviving Titanic operator, who worked the wireless for two days in spite of frozen feet and other injuries, sent the long list of names of survivors and personal messages from them to their friends ashore, relaying through two and sometimes three other ships, and working almost without sleep until the Carpathia reached the port of New York, is a familiar story. How they refused—much to the indignation of some newspapers—to pay any attention to inquiries for details of the wreck while they had this mass of business in front of them is also familiar. "You couldn't expect them to turn themselves into reporters," said Signor Marconi, when I mentioned this phase of the matter to him. "The captain had sent his report of the wreck. The next business was, of course, the important news of the names of those saved, then their personal messages to their friends. If there had been a reporter on board he could have filed a report to his paper, but it would have had to be held up until these other matters were out of the way." He also refused to indorse the criticism of Bride and Cottam for failing to send more than a curt "No" to the U. S. scout cruiser Chester's inquiry as to whether Major Archibald Butt, President Taft's aide, was among the saved, or for selling the stories of their personal experiences—not reports of the wreck of the Titanic—to a newspaper.

"On the whole, you have reason for pride." I suggested to the inventor of the wireless.

"I am proud," replied Signor Marconi. "It is worth while to have lived, to have made it possible for these people to have

been saved. But I see many things that will have to be done if wireless is to be of the fullest utility. I think it will be necessary to compel all ships to carry two operators, so that one may be on duty at all times. Some of the ships failed to get the Titanic's call for help because they were receiving the news report from Cape Cod. With two operators, one could be working the news report, the other—on any ship equipped properly—could be listening for distress signals, which would not interfere with the long distance news messages."

This inability of the long distance instruments to pick up ship messages unless especially tuned to them was illustrated, by the way, by the fact that as late as Saturday, April 20, the wireless men receiving trans-Atlantic messages at Glace Bay had not heard the details of the Titanic affairs.

Mr. Marconi also pointed out the necessity for governmental control and regulation of amateur wireless experimenters, as is done in England. This could be done, he said, without imposing onerous conditions, as amateurs could be permitted to operate freely at certain specified wave lengths which are not used for commercial or marine purposes. A beginning toward closer coöperation between the commercial wireless establishments and the United States government was made when, at the suggestion of the Marconi company, the Navy Department instructed all of its naval stations and ships to cease sending while the names of the Titanic survivors were coming in, and the company itself suspended all business except between the Carpathia and the stations at South Wellfleet, Siasconset, Sagaponack and Sea Gate, which are unaffected by amateur interference.

Out of the Titanic disaster is bound to come, at any rate, a more general use of wireless, better equipment for ships and consequently greater safety at sea—but the wireless will never be able to prevent captains from running their ships into the ice, nor can it take the place of boats.

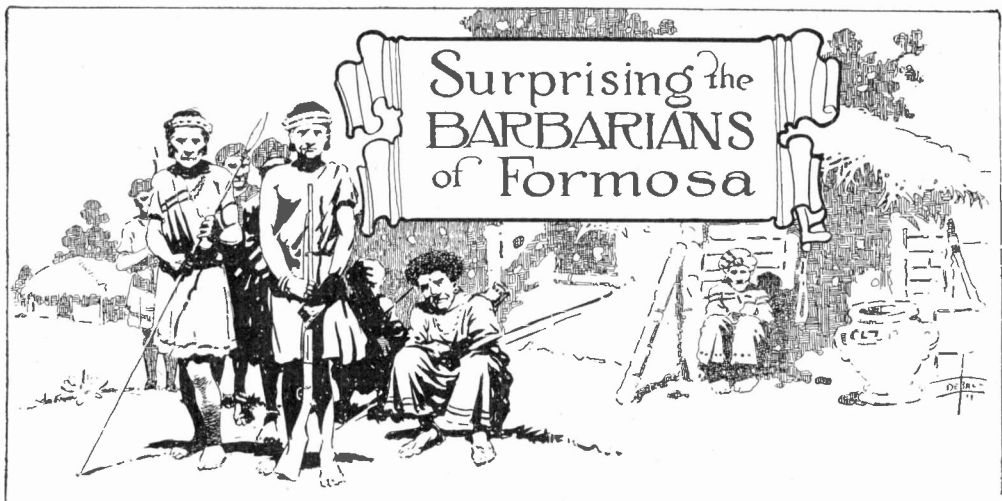

"The Japanese have always had a predilection for electricity," said Dr. Nitobe, a professor of the University of Tokio, while visiting Washington recently. "I recall a striking instance of their application of it more than fifteen years ago that was as unique as it was effective.

"In the early '90's the Japanese defeated the Chinese in war and in the indemnity, the Japanese acquired the large island of Formosa, lying off the coast of China.

"Now while the lower part of Formosa is very fertile, and grows the finest of tea and rice, being civilized as well, the upper portion, indeed by far the larger part of the island, was overrun by the bloodthirstiest of savages, who considered murder and robbery as the only genteel professions. They had been accustomed, under Chinese rule, which was no rule at all, to make descents upon the few peaceful farmers in the lower end about the time their crops were ripe, and, after killing enough of them to satisfy their lust for blood, carry away to their mountain wildernesses enough rice and tea to last them until time for another incursion.

"When the Japanese took possession and saw the state of affairs, they sent a strong military force to Formosa and drove these savage barbarians far up into the northern end of the island. Then

they brought in a host of immigrants from Japan who speedily cleared the wilderness, which was dripping with fertility, and planted their crops—but not before the Japanese authorities had stretched across the island, 300 miles from ocean to ocean, along the line between them and the savages, a simple wire fence; that was all. There was a barbed wire on top and a barbed wire on the bottom, and right between ran an innocent looking smooth wire of the telephone type.

"Pretty soon the savage natives, having found that the Japanese soldiers had gone, started to make one of their customary raids upon the crops lying so temptingly beyond the fence. They got together with their war clubs and other such grisly weapons and, starting on their bloody excursion, reached the harmless looking fence and commenced to clamber through—when the Japanese engineers who manned the powerful electric generators connected to that particular section of the fence, turned on several thousand, or million volts it was, maybe, along that innocent middle wire. That was all, but it was enough; as soon as a painted chief took hold of it to get through he dropped like a log, and so did those who tried to follow him. I am told that our people at the electric plants never stirred when they heard the wild

shrieks that arose, but merely shovelled in more coal and turned on more 'juice,' I believe you call it. The next day when a party went up to investigate they found the savages strung along the fence like so many dead cattle.

"The natives made one or two attempts, further, with like results. Then

when they found they were starving, as well as cursed by some powerful God within the magic wire, they came in and, laying down their arms, abjectly surrendered. They say they make the best farm hands in Formosa now—but they've never comprehended the mystery of the middle wire."



SPEED MANIAC NEW MENACE TO TRUCKS

That distinctly revolutionary type of hilarious individual known as the speed maniac, who became particularly progressive with the advent of the automobile, now looms up as a special menace to the motor truck industry.

Experts interested in the commercial vehicle because of its economic possibilities, declare that the driver who throws reason to the wind in the operation of a truck and hits up too fast a pace, is unquestionably the most expensive features connected with motor truck maintenance.

Tire manufacturers, in particular, attack the speed maniac and his methods. They argue that speeding is by all odds the most expensive of all the deteriorating influences to which tires are subjected.

A tire manufacturer recently said: "It makes no difference how well solid tires are made, or to what extremes the manufacturer goes to fortify them against the incessant knocks of road travel, they will not withstand the abuses of the speed maniac. Speeding is an evil that can result in but one thing—decreased tire mileage and increased tire expense. And the particularly aggravating feature of

this is that it is a matter that cannot be regulated unless a driver obeys instructions and sends the truck along at a moderate pace. Reliable drivers do this, but there is always the other fellow who, as soon as he is out of sight of the boss, throws open the throttle and burns up the pavement. Such a man is decidedly expensive to the truck owner.

"Demonstration has proved that at an average speed of twelve miles an hour the life of a tire is about twice what it is at an average speed of 20 miles an hour. Still higher speeds reduce the life of the tire proportionately. Therefore, it should not require any great amount of meditation to determine the effect of constant speeding upon an owner's tire bills."

The only way to clip the wings of the speed maniac is to furnish him with a truck that is geared for low or moderate speed and in which the power is limited, that is to say, furnish him with an electric truck. As an economic feature in the transportation of goods, the electric truck would long ago have secured the dominating position, but for the foolish notion some have derived from the gas car craze that high speed and power are essential to the moving of goods.

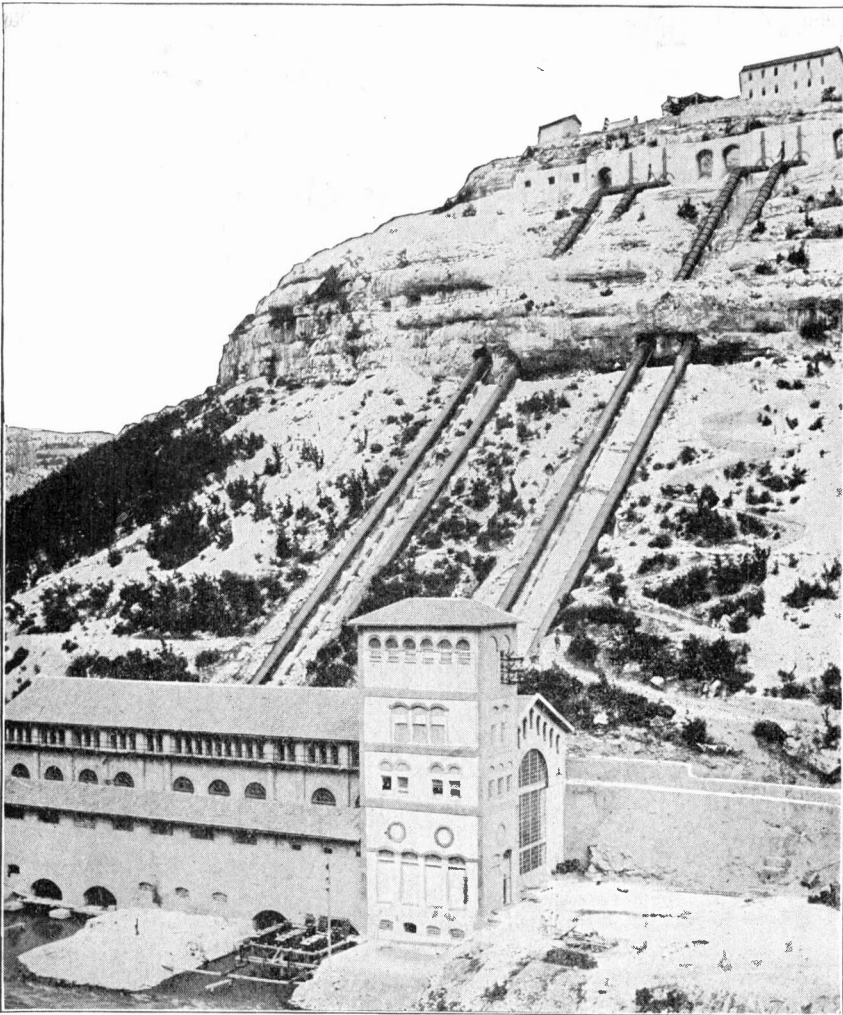

THE MANOJLOVAC PLANT IN AUSTRIA-HUNGARY

On the Kerka River in Austria-Hungary there is a waterfall with a total head of 395 feet. Above the falls a reservoir has been built from which water is carried to the top of a high bluff and from there projected down the steep slope through four steel pipes 63 inches in diameter. At the foot of the slope these terrific jets of water are directed against the blades of waterwheels, and the result is 6000 horsepower developed by each of the wheels. These in turn drive the electric generators. Such in brief is the great Manojlovac hydro-electric plant shown in the illustration. This is but one of a great number of water power plants built in Austria-Hungary in the last ten years, and producing current so cheaply that it is not only used for light and power but, very extensively, for heating and cooking.



Some SECRETS of Electrical Stagecraft

By T.J. Newlin



PART IV



THE HAIR RAISING LIGHTNING BOLT AS PRODUCED IN "KING LEAR."

In this scene the much-to-be-pitied, poor, old King Lear, after having divided his fortune among his two daughters, who flattered him into doing so by falsely claiming their great love, has finally been cast adrift, minus all of his rights, property and retinue of servants. With the few faithful adherents who follow and stand loyal to him, and who humor him in his madness, he is seen at the rise of curtain in this powerful scene, ragged and torn and with his hoary locks waving under the action of the howling wind. Both the streaked and flash lightning are seen playing intermittently, while the clouds are passing by hurriedly, each attempting to overtake the other in its mad, headlong rush.

At the very moment the distracted King Lear invokes the aid of heaven and curses and hurls maledictions upon his two faithless daughters, there is a rumble of thunder and a vivid flash of streaked lightning. Then, as portrayed in Fig. 21, with a roaring, sputtering sound the thunderbolt rushes down to the stage, and with a ripping, crashing blow it strikes the tree and explodes, hurling the tree asunder.

Nothing can compare to the amazement of the high pitched audience at this most realistic bolt of lightning which seems to be an actual, vivid manifestation of God's wrath.

In Fig. 22 is seen the apparatus as set to produce the lightning bolt. The stage lights are dimmed down in the foots and borders and, if it were not for the intermittent flashes of the spasmodic lightning, everything would be in almost total darkness. The tree is shown which breaks to pieces at the dotted lines when struck by the lightning bolt. In order to produce this lightning bolt there is stretched between the fly gallery and the floor at the foot of the tree a twisted iron wire cable with insulators at each end.

Riding on this cable is a grooved pulley (A) from which depends a weight (W). An arm projecting from this pulley carries a piece of carbon (C) which scrapes over the twisted iron wire cable. Until the bolt is started the pulley (A) is held at the upper end of the cable by a string. Leading from the stage outlet is an insulated twin conductor cable. One wire in this cable is connected to the positive terminal in the outlet and the other wire to the negative terminal. The

positive wire is then connected, as shown, to the twisted iron wire cable while the negative wire is connected through a resistance to the flexible, rubber covered wire just beneath the twisted iron wire. This flexible wire is connected to the arm which carries the carbon (C).

In order to blow up the tree at the moment the lightning bolt strikes it, there is placed beneath the tree a galvanized iron box containing a quantity of smokeless powder. In this box are two ter-

Everything being in readiness, the cue is given and the stage electrician gives a strong pull on the flexible rubber covered wire. This breaks the string and the pulley (A) rapidly descends along the twisted iron wire cable. As it passes along, the carbon (C) rubs over the convolutions of the twisted wire and the circuit is made and broken very rapidly, causing a series of sparks which represent a veritable trail of fire, descending diagonally across the stage. At the mo-



FIG. 21.—THE LIGHTNING BOLT IN KING LEAR

minals, between which is stretched a single strand of 32 gauge copper wire, this wire coming in contact with the powder. The terminals are then connected, through a switch, to two other terminals in the stage outlet by means of a twin conductor cable. Manifestly, on closing the switch, current will pass through the copper wire and bring it to a high temperature, exploding the powder with a loud report.

ment the bolt reaches the foot of the tree the assistant electrician throws in the switch which explodes the powder and also, at the same instant, "props" pull the tree over and break it at the dotted lines. Altogether, this produces one of the most hair raising scenes ever shown by electricity on the stage.

TICKLING THE OPTIC NERVE

Nothing is prettier than to behold a scene wherein a beautiful river winds its

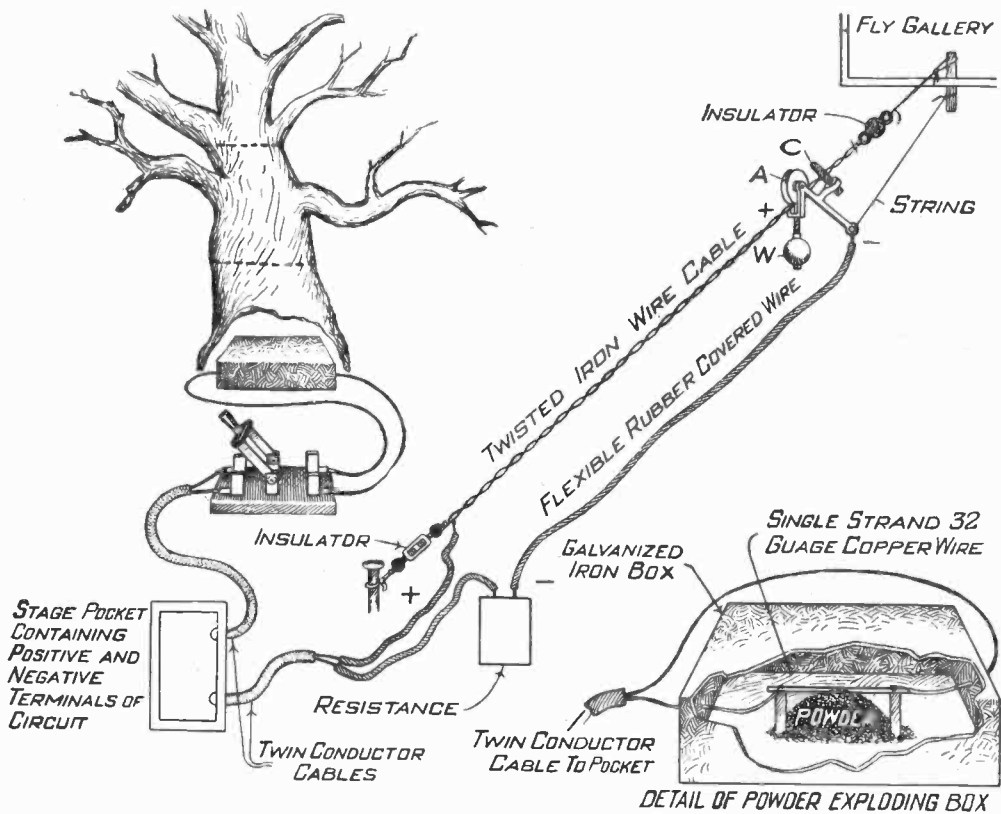

FIG. 22.—METHOD OF PRODUCING THE LIGHTNING BOLT IN KING LEAR

way across the background while silently and majestically the moon slowly rises, casting its silvery gleam upon the rippling waters below, as, intermittently, it playfully hides its smiling face behind a silver lined cloud. There are several ways of producing the rising moon effect on the stage. Some are from the brilliant brain of "those men behind," who cannot get too much credit for the contrivances they devise; and still another method is worked by the science of optics.

MOON EFFECT AS PRODUCED WITH MOTHER'S DOUGH PAN

Figure 23 represents a stage "set," showing a moon rising with the water ripple below. Formerly when this scene was shown one could readily wager that mother's dough pan had disappeared and would be missing for days to come. One of the detail drawings

shows the said purloined pan with front opening covered with translucent brown paper, back of which is a sixteen candle-power incandescent lamp with a twin wire cable attached. A rope runs through the pulley (P) attached to the gridiron above. The twin wire cable hangs from the moon pan as shown, and is run to the fly gallery and inserted in the stage pocket.

At the opening of the scene the top of the moon is seen just projecting above the upper edge of the cloud on drop (D1) which sets "up stage" to about third entrance. The electrician then pulls the rope, causing the moon to gradually rise. As it gets fuller and fuller the water ripple is gradually brought into play, making the scene so realistic as almost to baffle the critical eye of a Reynolds or a Gibson, so true to Nature does it appear in comparison.

PRODUCING WATER RIPPLE BY THE SLITTED DROPS

The credit for this simple scheme should go to the ingenious brain of the stage carpenter, as this is directly in his line. Two drops are shown in detail in Fig. 23. While (D1), the one seen from the front stands still, (D2) is swayed or oscillated back and forth across stage in front of an electric arc lamp enclosed in a lamp house. Horizontal slits are cut in (D1) and (D2) in order that the light from the lamp may transmit its rays through the slits. The intermittent opening and closing of these aper-

tures or slits as they coincide with each other in the two drops causes the rippling effect of water on the front drop (D1). Care should be exercised in order to prevent the rays from creating a glare. To offset this the electric lamp is set slightly to one side and light thrown on the rear drop at an angle of from 30 to 40 degrees. The back drop can be made just small enough to create the effect of a ripple if a large drop cannot be handled economically.

THE APPROVED MOON BOX

But of course the description I gave you of the dough pan applied to the

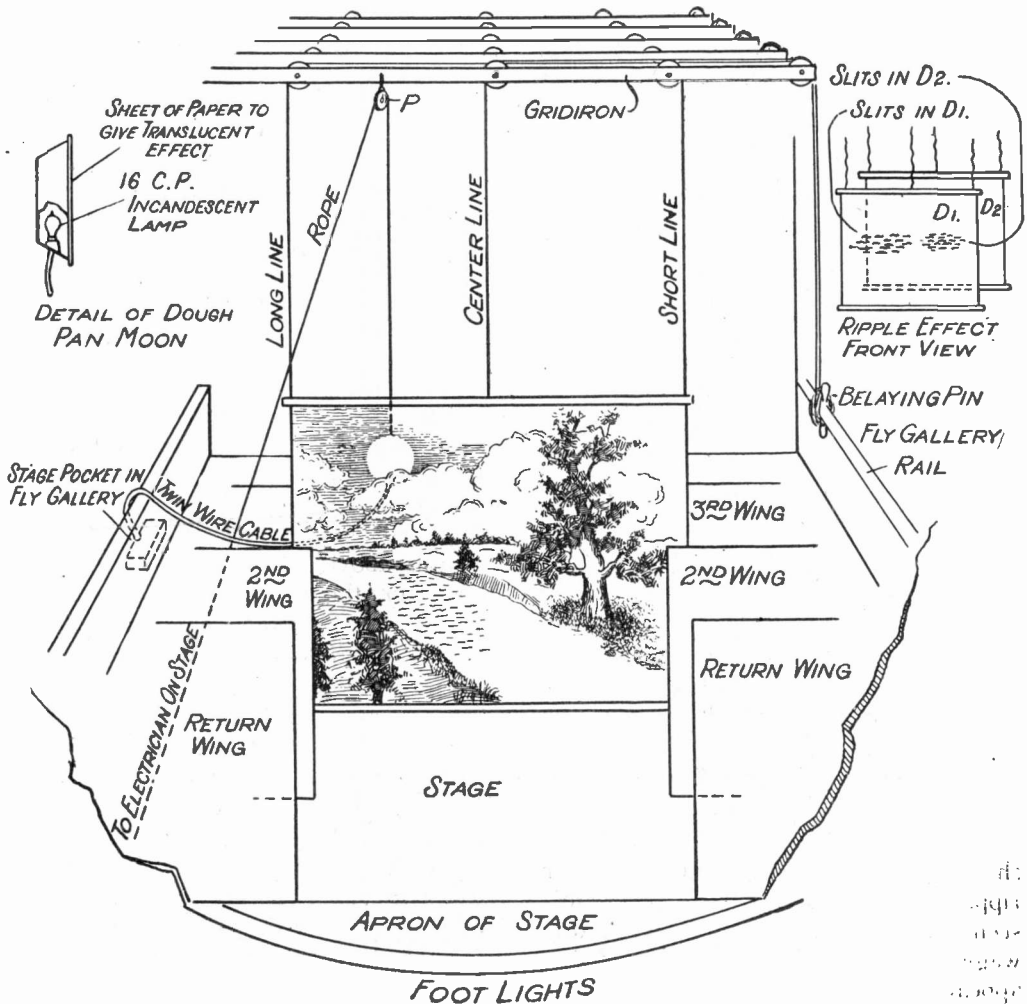

FIG. 23.—PRODUCTION OF AN ELECTRIC MOON AND WATER RIPPLE

"olden days." Today, no such crude methods will be tolerated, especially in the city of Chicago. The Iroquois Theater fire has taught the stage its immortal lesson. Shows coming from the great metropolis, New York, shake with nervous prostration as they near the Windy City, for fear the electrical effects they produce, such as lightning bolts, etc. will be turned down through rigid enforcement of the rules of the fire underwriters. So right here I will show you the approved moon pan and its construction that will pass in Chicago.

A casing of galvanized iron, shaped like a shallow box, contains four sixteen candlepower incandescent lamps as shown in Fig. 24. Over a circular flange on the outer face of the box is placed a sheet of translucent draughtsman's tracing cloth, and an iron band is thrust

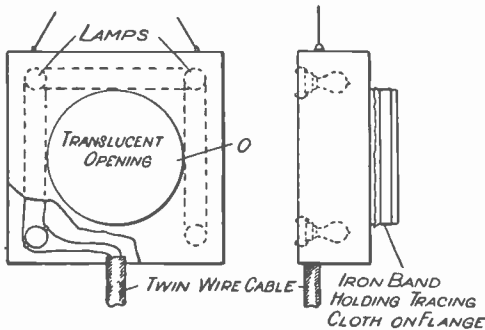

FIG. 24. THE APPROVED MOON PAN

down over it, holding it tightly over the flange like the head of a drum.

PRODUCING ILLUSIONS BY THE SCIENCE OF OPTICS

Optics: "That branch of physical science which treats of the Nature and properties of light and vision."

Every high class stage electrician usually makes a study of the science of optics; therefore you will not wonder that oftentimes he has the average optician "beat, going and coming," to use the slang phraseology of the stage. It is his field by the right of priority, and I can point out to you a dozen electricians who follow this vocation in the

summer and who fit glasses by the science of optics for the aid of the human vision. In numerous instances they have brought about true vision where the regular optician has failed. A great many electrical effects or illusions nowadays are produced by optical lenses with colored scenes painted or photographed on glass, mica or other transparent mediums, representing moon, water-ripple, ocean swell, floating clouds, streaked lightning, fire scenes, rainbow, etc. The apparatus for producing these optical illusions it is my intention presently to show and explain to you. Even those who are up in the science of optics will wonder how so simple an affair will produce such wonderful results which from "out front" mystify the best of you. But before taking up this matter, let us look a little into the laws of light.

THE LAWS OF LIGHT APPLIED TO STAGE-CRAFT

All of the effects as previously enumerated, and any others produced by means of the sciopicon, are primarily founded upon the three principal sets of laws of optics, or laws of light, namely: Reflection, refraction, and absorption, as pertains to both light and lenses. It would therefore behoove the wise electrician to look further into the subject of light with its different methods of distribution.

Optics, as a science, is too lengthy to go into here in much detail, but for the benefit of the general reader I will explain a few rules as follows:

(1) Light is a physical force which emanates from all luminous objects and travels in straight lines in all directions, never in curves. If light did travel in curves, we would be able to look around a corner through a bent tube.

(2) The angle of incidence is equal to the angle of reflection. In other words, if a ray of light strikes a reflecting surface at a given angle with the perpendicular it will be reflected away from the surface at a similar angle beyond the perpendicular.

(3) The velocity of light is 186,000 miles per second when passing through the free ether.

(4) A ray of light passing from a rarer to a denser medium is retarded. This brings about what is known as refraction, or bending of the rays. For instance, if a ray of light passing through the air (rare) strikes obliquely upon the surface of a body of water (dense), the ray will continue on through the water, but at a greater angle than before. In other words, the ray is bent downward.

(5) A ray of light passing obliquely

from a denser to a rarer medium is bent or refracted to a lesser angle with the surface upon emerging into the rarer medium. The course of a light ray through a medium of uniform density is, however, always a straight line.

(6) A ray of light passing from a denser to a rarer medium, or vice versa, but perpendicular to the surface, is not refracted or bent.

(7) Reflection of light is the bounding back of the rays of light into the medium from which they came. A mirror reflects light rays; a lens bends light rays.

In the next chapter of this series, which will appear in an early issue, some applications of the science of optics to the production of stage illusions will be reviewed. These will include the simulation of moon effects, rainbow effects and the separation of colors by the prism. The work of the Sicopticon, or mammoth projecting machine, will also be taken up.—Editorial Note.

Electric Signal for Life Savers

All along the miles of beach at Venice, Calif., the visitor sees at short distances apart a series of posts set upright in the sand. To each one is attached a life buoy, a reel of rope, a large gong, a red flag in a case, and a flagstaff on which another danger signal can be hoisted. In addition to this equipment is an electric push button which signals the life-saving crew at the station. As this beach is so long, and as bathers often venture into dangerous water, the city has placed these life-saving outfits

on the strand and they have been the means of saving many lives. The first aid to the imperiled swimmer is to use the electric push button, which summons the crew in their lifeboat. The next move would be for a volunteer to swim out with the life buoy to which a light line is attached which unreels as he proceeds. Meanwhile other spectators are sup-

posed to operate the alarm gong and wave the red flag or hoist a signal to the flagstaff. In this manner the crew could locate the danger point at once and row for it.

The Venice volunteer life savers have done excellent work, and with electrical alarms to notify them promptly of endangered swimmers, they can act with very much increased efficiency.

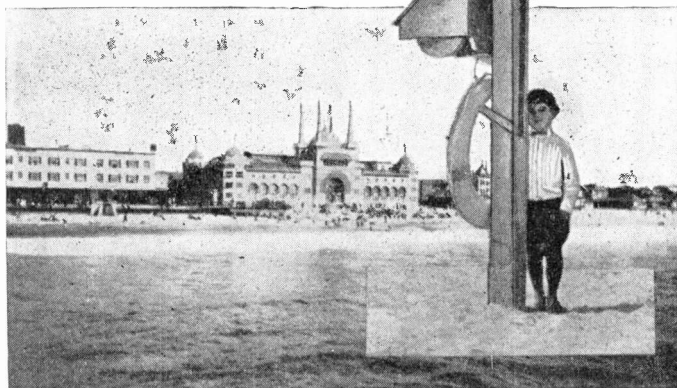

BEACH AT VENICE, CALIF., AND ONE OF THE LIFE SAVING STATIONS

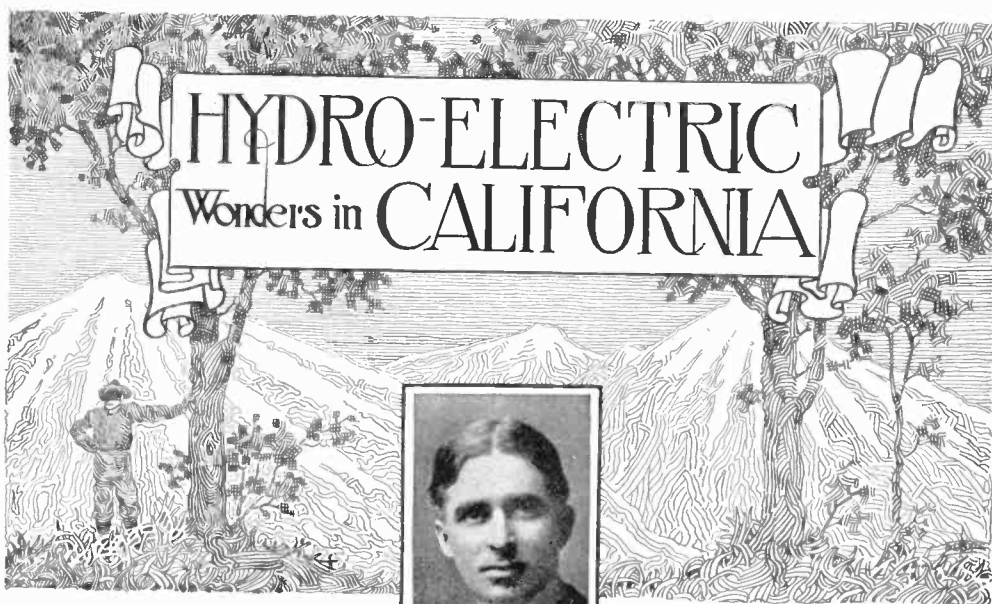

By ARCHIE RICE

This is the second article of the series. The first described how a famous gold-bearing river was diverted to produce hydraulic power. The electric energy was sent a long distance to operate huge gold-dredgers. They are riddling the river-beds and the adjacent land in a deep and desolating search for formerly unattainable auriferous gravel. The third article, which will appear in an early issue, will deal with one of the most characteristic mountain power plants, so remote and inaccessible that few have ever seen its wonders. — Editorial Note.

MOUNTAIN-MADE ELECTRICITY DOING THE WORK IN DEEP MINES

The Yuba River is an eastern branch of the Sacramento. It joins the main stream at the old mining town of Marysville, in the great valley. Back in the lofty Sierras the Yuba itself comes down out of three narrow cañons between heavily timbered lofty ridges.

On the south fork is the Yuba dam.

There was a time when thousands of miners were scattered along the course and the little branches of the Yuba, washing panfuls of gravel to get the grains and flakes and nuggets of precious gold. And old miners are still working here and there, puttering out a fair livelihood on their private claims.

Way up in the mountains of the Yuba

River country run the deep underground ledges of quartz that have held sealed through all the centuries the original sources of California's gold.

In Nevada County you see the top works of the mines that have punctured the earth nearly a mile deep with inclined or perpendicular elevator shafts. From the different floors ramify narrow, crooked hallways. They are dark and moist. The air is heavy and sultry. You feel oppressed. There is not a particle of gold in sight. It is hidden in infinitesimal particles in the chunks of grayish or whitish quartz. The underground hallways lead on and on, following the drift of the quartz veins.

At Nevada City one of these mines has produced more than \$30,000,000. It is still steadily yielding a golden harvest to the unceasing labor of day and night shifts of three hundred workmen.

That gives you an idea of the importance of California's deep mining for gold. There are scores of these big mines along the so-called Mother Lode, the route of the original gold bearing ledges.

Now you can understand why there seemed to be a market up there for electric power. It might be used for the hoists and machinery in the mines and at the stamp-mills that smash up the quartz into powder from which chemical processes can dissolve the gold.

Early miners had dammed the Yuba. At many places they had diverted little streams in ditches to bring water to placer diggings at a distance from the river.

At the quartz mines water power from smaller streams was used to operate some of the machinery. This water power came through ditches and pipe lines from places higher up in the mountains.

In 1891 the world had no long-distance transmission of electric energy. But in that year a young Californian had

an idea that the thing could be done. He owned an interest in one of those mines at Nevada City.

Down behind a high ridge back of Nevada City runs the cañon of the south fork of the Yuba. It worms its way between the lessening ridges to reach the wide open valley, 20 or 30 miles below. The man with the idea went over into that Yuba cañon and prowled along up stream. He chose a site for the Yuba dam, and promptly started workmen on the job.

A wall of muddy water came eagerly hissing its way down the cañon in the spring of 1892. When the man went to look again his dam was gone. The log framework had held about as well as so many matches and wooden toothpicks in a gutter suddenly flushed by a fire-hydrant.

In August of 1895 the man tried again to build a Yuba dam that would stay where he put it. He still cherished his idea of four years before. It was strengthened by the fact that an obscure little California plant had recently succeeded in sending electric power thirteen miles. Also, the wonderful new plant at Folsom was about to transmit power 22 miles.

Furthermore, he was figuring on gen-

The Nevada Power House on the Yuba River

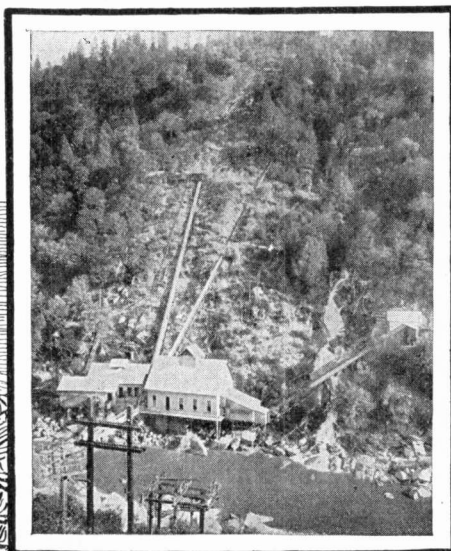

erating electricity by using a very high fall of water to produce swift force rather than ponderous volume.

The new Yuba dam was rushed to completion in three months. It had to be finished before the winter rains. A large force of men was kept constantly at the job. The heavy log cribwork was bolted down into the bedrock of the river. The framework was 28 feet high and 107 feet long across the cañon. It was to be filled with rock and gravel.

But before back filling could be started the river began to rise so rapidly that the workmen had to leave. Another torrent of muddy water came down and hid the dam.

After the flood they went back to look. Their hollow crib of logs had stuck. It was a solid masonry wall of gravel and "slickens" washed from the hydraulic mines further up in the mountains. It was a more substantial and enduring mass than they could have made.

Meanwhile a force of 110 men that had started work a month before the dam was begun got their special task completed just as the dam was finished. They had built a diverting flume system to carry water from the dam way out along the wooded and rocky slope of the left-hand bank of the river for a distance of a little more than three miles.

The downward trend of the river along there is nearly 100 feet to the mile.

The flume was given a nicely surveyed even drop of only $26\frac{2}{3}$ feet to the mile. Keeping well up along the hillside the flume finally reached a position where it had gained an elevation a little more than 200 feet above the river. From that height the water could be shot down through a pressure pipe with great force.

The flume is six feet wide and four and a half feet deep. It was intended to carry a constant flow of 5,800 miner's inches of water. A million and a quarter lineal feet of lumber were used in its construction.

Down at the bottom of the cañon, on the very brink of the river, a shelf was blasted in the solid granite at the high-water mark. And there one of California's historic hydro-electric plants was erected.

But while the actual construction work had been progressing on the dam and flume and foundations, there were greater temporary problems involving much labor. Heavy machinery was coming by rail from the east. There was no road from Nevada City. Each of the two generators weighed 11,200 pounds in one mass.

Men went to work widening and re-grading three miles of old road that went up out of Nevada City like the roof of a house. Then two miles of entirely new road had to be built along and over a rocky and wooded ridge. That com-

A Typical Storage Reservoir in the Sierras

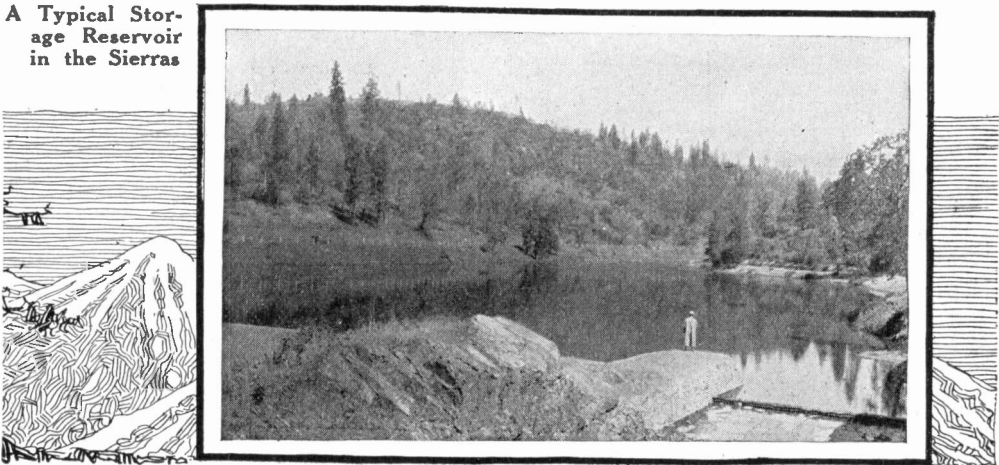

bination would get the heavy wagons out to a point half a mile up the steep slope directly over the power house and at a perpendicular height of 1,700 feet above it.

They made up their minds to lower the ponderous machinery down that half mile steep mountain slope.

Each wagon load that had come over from the town was pulled by twelve horses.

They lowered the valuable machinery cautiously down the mountain. The way had been cleared of the forest growth. Tree stumps served as capstans, about which the steel cable slowly unwound.

An avenue 60 feet wide up out of the cañon, over the ridges, and on toward the mines was hewn clean of forest growth. The smaller pine trees thus removed were used for the pole line, and that clear zone was its course. From the power house to Grass Valley the line is eight miles, and there is a way station at Nevada City, with sub-stations and transformers at both towns.

Heavy timbers clamped down by steel rods sulphured deep into the solid bed-rock were the foundations upon which that little power plant established its generating machinery.

The end of the river flume was 298 feet up the slope; the actual perpendicular fall was 190 feet to the water wheels. A steel pipe three feet in diameter de-

scended to seven pairs of nozzles, each pair striking into the windmill like little buckets of a water wheel. Three of these wheels were connected with one generator and four with the other. This force sent the generators revolving at 400 revolutions a minute. And the process produced 300 horsepower generated at a pressure of 5,500 volts.

At first the miners were very reluctant to experiment with this new power. Motors would cost money. Expensive changes would have to be made at the mines. The new enterprise might not be permanent.

Then some of the biggest deep mines tried it, and more.

The demand for power finally exceeded the capacity of the plant.

Early in 1898 an addition was made that marked another stage in the growth of California toward higher and higher water fall for her mountain power plants.

Straight up behind the power house and over the ridge nearly four miles was a little bowl-like mountain meadow with a narrow cañon outlet. So they acquired that land, went up there, built a dam across the outlet, cleared off the timber and created an

The Yuba Dam

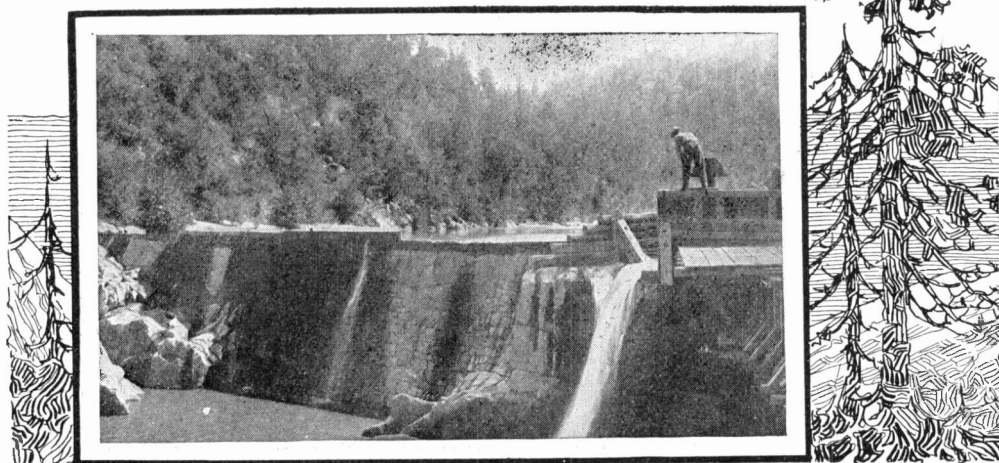

artificial lake of 42 acres, or about the area of a dozen city blocks.

They built a line of flume and ditch $2\frac{3}{4}$ miles long out toward the ridge overlooking the power house. The waterway is four feet wide and three and a half feet deep. A gorge had to be crossed. A big U-shape pipe 668 feet long was put in the depression to serve as a huge syphon, taking the water from the flume at one side and carrying it up into the flume across the cañon.

The grade of the flume line was made so gentle, to get all the fall possible, that it takes the water an hour and ten minutes to flow a little less than three miles. That is only as fast as an ordinary person walks.

But out at the end of the flume, on the ridge, 1,870 feet up the slope behind the power house, this new source of water power attained a perpendicular elevation of 785 feet above the water wheels down at the station.

A 20 inch steel pipe was laid and anchored, to shoot water down from that higher source of power.

A new and larger section was added to the little original power house. Two more generators like the others were installed. All the water wheels were then connected to a common shaft, and the combined generating capacity of the plant was raised to a regular average of 1,600 horsepower.

Isolated in that narrow cañon, they were solving the hydro-electric problems peculiar to the climatic and geological conditions of California. At that little plant things were happening and changes were being made that led to California's marvelous and gigantic hydro-electric developments of the following decade.

Reliability of water flow is absolutely necessary to a hydro-electric plant.

From an old mining ditch tapping the Yuba River 70 miles further back in the mountains the original flume supply from the Yuba dam was augmented. The dam itself was fortified by a solid granite masonry wall. That lake created high over the ridge was supplied by water brought through several miles of ditch after it had been used at a little power house located higher in the mountains.

That other power house was getting its supply from a far reaching old mining ditch system, stretching away back to the snow places of the high Sierras and combining a chain of many mountain lakes as emergency reservoirs to maintain the supply.

Today every big deep gold mine in California is run by electric power. And all the electric power is carried a long distance to the mines.

Rainfall records are not a reliable guide to the seasonal flow of water in California's mountain streams. The geological formation of the cañons is an important part of the problem. Where there is no river cañon the rainfall runs off quickly and is lost.

Forests and vegetation merely check the sudden run-off of rains. But where the geological formation is favorable the water seeps down into the slopes and later slowly percolates into innumerable little springs that maintain the stream long after the rainy season.

By their mammoth harvest of water in California's mountains the hydro-electric plants greatly benefit the farms and orchards. The flood waters they store in artificial reservoirs they hold for the summer season. When the rivers become low the storage lakes are made to yield their quota to run the plants.



THE WIRELESS

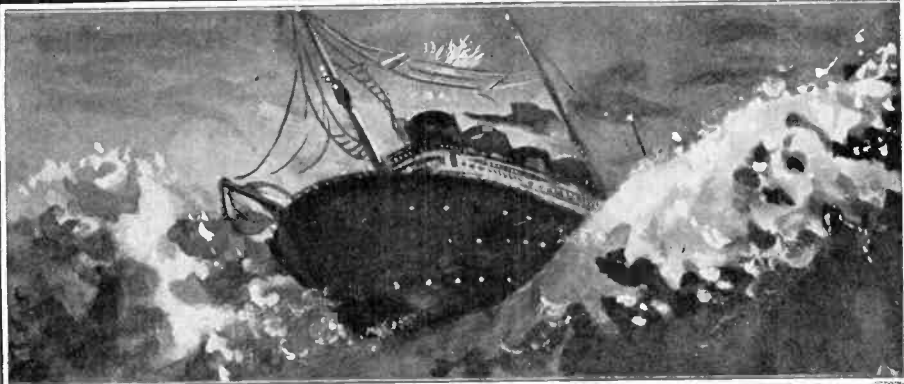

The storm king's flying squadrons
sweep
With fury o'er the sea,
Before the monarch of the deep
The ships in terror flee.

For ages past the storm king's hand
Has ever claimed its own,
And held the scepter of command
O'er seas he ruled alone.

But now a rival seeks the field;
A foe as swift as light.
The squadrons of the storm king
yield
Their spoils before his might.

His silent sentries on patrol
Outspeed the king of storm,
And when he seeks to wrest his
toll
They flash the swift alarm!

~ George B. Staff



"The Romance of Wireless"

By EDWARD LYELL FOX

If Guglielmo Marconi had not been a man of strong character, resource and patience the sinking of the *Titanic* would have been a disaster blacker even than

Martinique. Because of this man, his mind, his determination, his achievement, hundreds of the great ship's passengers were saved.

Yet, when I read the newspapers, I saw no tribute to this man to whom so much was due. I read columns about noted people who had been saved, about those who had gone down. I saw the pictures of society women who had escaped in the lifeboats. I saw plans for new safety appliances, photographs of other liners that had sunk in years gone by—but no extensive mention of Marconi. Indeed, it was not until a Senate commission began an investigation that his photograph was printed. Then it was printed only because he was one of the witnesses. The story of the man was not told—the story that had its climax in the dark *Titanic*. And this is the story that POPULAR ELECTRICITY has asked me to write—"The Romance of

Wireless." For "romance" it is. Listen:

In the shade of the Marescalchi Palace stands a small house. If you visit Bologna, that quaint Italian city, your guide

will stop before that house almost reverently. In it was born Marconi, and the natives have come, you see, to look upon him almost as an immortal. It was on April 25, 1874, that Marconi was born. The son of Joseph Marconi, by a second marriage, the baby was fortunate in coming of an Irish mother. Not infrequently the intermarriage of these races produces a genius. And this was one of the cases. From his mother—keen,

gray-eyed Anna Jameson—came persistence and alertness which has stood him in good stead; from his father came the Italian power of invention and conception.

At sixteen Guglielmo was a keen student of mathematics, chemistry and electricity. These studies were pursued in a school at Florence, and to the attractiveness of its courses is due the step that resulted in Marconi specializing in electricity.

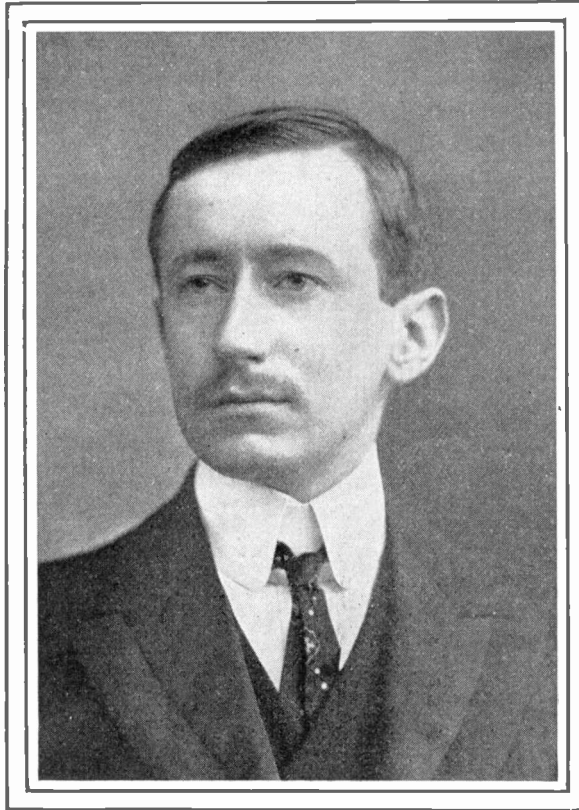

GUGLIELMO MARCONI

Photo by Brown Bros.

After Florence, he went to Leghorn and astounded the instructors there by his passion for anything pertaining to electricity. He is said to have spent fifteen hours of the day in working over his books and instruments. Becoming master of the fundamentals with the speed that bewildered all Leghorn, Marconi insisted that the professors give him problems that perplexed even the most learned of them. And always he solved them and always he confounded his teachers by the depth of his questions.

In 1894 when Marconi was immersed

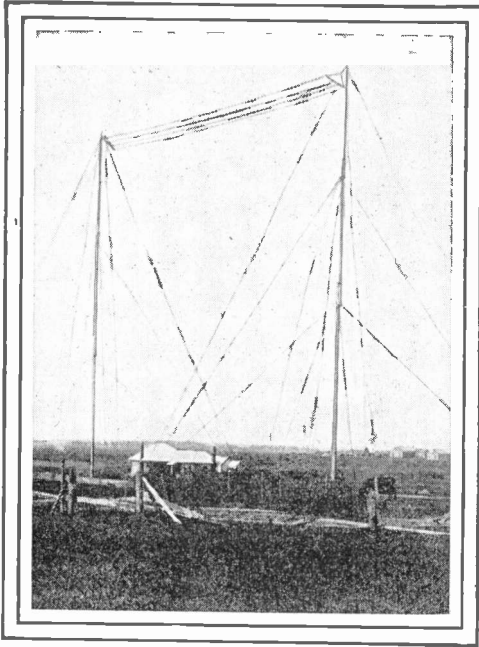

A HIGH POWER MARCONI STATION

in his researches there came to him a letter. It was from his half-brother, Luigi, who realized that Guglielmo was overworking. Now Luigi owned a pretty villa at Andorno. To this quiet haven he wanted Guglielmo to come. He wanted him to take a long rest before going back to his work; also planned a number of entertainments.

One day while Guglielmo was walking through the gardens, thinking of the fête that was to be held for him the next day, an idea came suddenly, driving every-

thing before it. It was to use the Hertzian electrical wave as a medium of communication. Instantly he forgot the villa, the gardens, the blue Italian sky—everything but the Idea. Hurrying to his room, he began working with pencil and paper, figuring out problems, making little drawings, crossing out everything and doing it all over.

The luncheon hour came and was gone. Guglielmo didn't know it. When Luigi knocked at the door of his room he did not hear him. When the door was opened he did not see him. All he saw was the calculations he had made and the Idea that floated vaguely, ever changing like a chameleon. The shadows began to deepen in the garden and yellowing evening dropped over the hills. Still Guglielmo worked on. He went without supper. The Idea was food enough. And so he worked way into the black hours of the night—worked until Luigi insisted that he take food and rest.

The next morning Guglielmo packed his bag and hurried home. The entertainments and fêtes were never held. Something new in electricity had called him. Upon arriving at Bologna, he went immediately to his little laboratory. He put the Idea to an experimental test. It was a failure. He tried other tests. They were failures. He began to work until the early mornings. He lost interest in everything else. Often he forgot to eat. He began to grow gaunt. His face looked drawn and wan. His eyes had a way of blazing suddenly. His family began to get worried. They protested against this mad idea—the folly of sending messages by electricity through void. Scientists who had heard of Marconi and what he was doing stroked their Van Dykes and smiled. At the scientific clubs he was the butt of jokes and ridicule. Some of them came to jeer whenever he appeared. "Mad Marconi" they began to call him.

That is, everybody laughed, except one man. He was Professor Augusto Righi, one of the most famous Italian savants.

Feeling that Marconi was a genius who had stumbled upon a wonderful invention, he invited him to Montese. There the professor had a beautiful summer home, and Marconi was made to feel that it was his own. Together they began to make experiments. Also, these were failures. Then came a day when one of the tests worked the way they hoped it would. The Idea was a reality.

But instead of proclaiming to the scoffers that "Mad Marconi's" dream had been fulfilled, they continued their work quietly. The others would know in time. Marconi was becoming resourceful as well as alert. And so they worked day after day, removed from the world in the little laboratory at Montese—worked until they brought their experiments to a stage that warranted them being made in public. Then they went down to the University of Bologna—down to the jeerers and scoffers. To them they showed a wonderful series of experiments, wonderful results. And the doubters rubbed their eyes and believed.

After working around Bologna, Marconi went to England. Here he continued his experiments. He established stations at Penarth and Western. Above the quiet English countryside there began to sound the crack and the splutter of the wireless messages sent and received.

The English newspapers began to tell about the slender, good-looking young Italian and the work he was doing. Reports went back to Italy, to the government, to the King. Then it was that the King directed that Marconi be invited to continue his experiments under the auspices of the Italian Ministry of War at Spezia. That was in 1898. Italy was wise. Other governments were beginning to show official recognition of Marconi's work. So heeding the call he returned to Bologna.

But with each success Marconi was becoming more and more resourceful, more independent. One day when he was at Penarth he received a telegram

commanding his presence at Windsor Castle. It was in Queen Victoria's reign. When the message came to the local post office the people were in a great state of excitement. It was in the forenoon and the word had come to hurry to Windsor. But this excitement was as nothing compared to the shock sustained in the post office when Marconi sent word back that he could not go to Windsor on that afternoon, but he would the next day. The independence of him astounded those stolid Britishers. And to that independence is due much of Marconi's success.

In 1899 he began to attract the whole world. He did this because he showed that wireless telegraphy was a sound commercial proposition. Up to this time people had regarded it in the nature of a wonderful scientific dream come true. After working at Bologna, Marconi went to France. Here he conducted a series of experiments under the patronage of a French commission. To do this work he built a station at Windreux, France, another at South Foreland Lightship, and another on the French battleship *Ibis*. Messages were sent from these stations to the *Ibis*. The *Ibis* answered them. So was it demonstrated that messages could be received and sent from a station that was in motion.

So when he received a request for the use of the wireless in reporting one of the English-American yacht races he was ready for the test. And test it was, for the newspapers were depending on the wireless for news of that race. If the wireless fell down Marconi would be lampooned the length and breadth of America. On the other hand, if it succeeded, he would have the backing of a powerful press. Of course it succeeded. Everything Marconi did these days was a success.

Indeed so sure was he of himself that he had a wireless apparatus rigged up on the steamer *St. Paul*. After seeing his instruments in place he announced that he was going to receive the news from ashore and print it in a little news-

paper on board the steamer. He did. The paper was called the *Trans-Atlantic Times*, and sold for \$1.00 a copy. Marconi turned over the proceeds to the seamen's fund. Not only was he resourceful, but wise.

But Marconi was not satisfied. Remember, his mother was Irish. He began to think of sending a message from one side of the Atlantic to the other. How the first message was sent across the Atlantic from American soil was told you in the April number of this magazine. Later, on January 19, 1903, Marconi succeeded in sending greetings from President Roosevelt to King Edward. The message hummed through space a distance of 3,000 miles—quite different from the vague dream of Andorno. The following March the *London Times* printed a 200 word dispatch received by wireless from New York. And that demonstrated beyond all doubt the availability of wireless as a means of trans-Atlantic communication. Since then many improvements have been made; improvements that made possible the saving of some of the *Titanic* passengers.

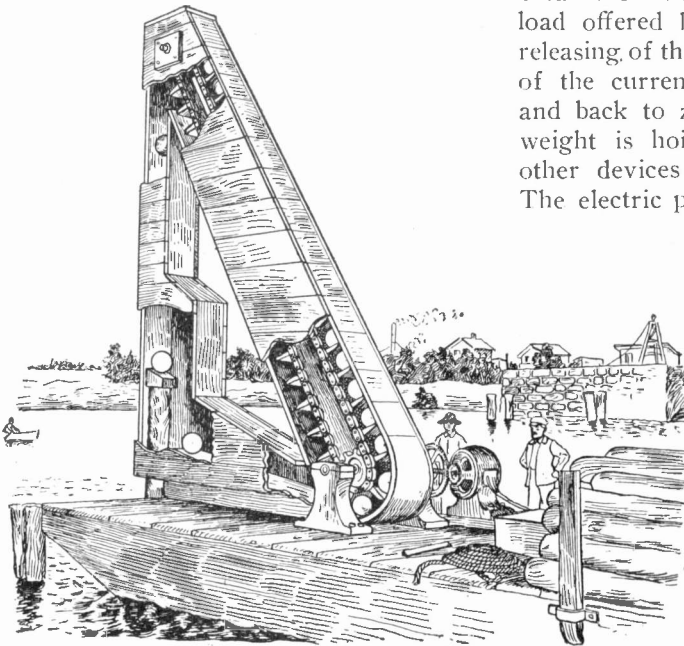

AN ODD PILE DRIVER

And Marconi is just beginning. He is never satisfied. That is because of his strong character. Those who are satisfied with themselves seldom accomplish much. Unlike most inventors, Marconi does not mind adverse criticism. He is determined, you see, to get the best results. He will listen to praise and will be pleased with it—because he is Italian. He will listen to praise and forget it—because he is Irish. A man of wonderful patience, acute observation, active imagination and a natural, practical skill, he was able to overcome the obstacles that another man would have fallen before. From the jeers of the savants of Bologna to the savior of those who saw the *Titanic* plunge beneath the dark waters is a long step. But Marconi made it possible because he is Marconi. Also, because he put electricity to one of the infinite uses that it offers to him who will take.

An Odd Pile Driver

The application of electricity to the pile driver has been heretofore impossible because of the extreme variation of the load offered by the lifting and sudden releasing of the driving weight. The rise of the current from zero to full load and back to zero again every time the weight is hoisted and dropped affects other devices fed by the same mains. The electric pile driver invented by the

late Carvl D. Haskins, noted engineer of Schenectady, N. Y., provides a steady load. Heavy metal balls are lifted by a conveyor to a point directly over the pile, the head of which is provided with a metal cap. The balls drop in quick succession upon the head of the pile, driving it down and then pass on and are picked up once more by the traveling conveyor.

Electrical Securities

The Present Situation and the Reasons Why it is the Best Time in which to Invest in the Stocks and Bonds of Electrical Enterprises — Something About the Price of Stocks and Bonds and the Market Fluctuations.

By "CONTANGO"

In various instances, with some of which you may be familiar, individuals have done well for themselves by taking the initiative and establishing electric plants in this or that center. With high rates and a local monopoly for their undertakings, there has been the opportunity, at least, for them to keep much of the benefit and profit to themselves. Today this condition is undergoing a rapid and remarkable change. Larger companies, by the process already described in previous articles, are absorbing the smaller. Big combinations are absorbing the comparatively large groups and one after the other controlling companies are being formed. These controlling and operating companies link village with village, town with town, city with city. To do this large amounts of stocks, that is, shares, are offered for public subscription and large amounts of bonds are also offered to the public in which to invest its funds. Here, then, is your opportunity.

It cannot be too strongly stated that in nearly all cases there is nothing to lose but everything to gain by such combinations of capital and managerial ability. It means growth, and rapid growth, all along the line, with the best of security behind your bonds and the certainty of increased business in front of your stock ownership or holdings of shares. But with this growth, with this linking up or absorption of small systems into the larger ones goes naturally a higher price for the shares and an increased difficulty in obtaining the bonds without considerable premium, particularly if they represent issues of the older and more firmly established corporations and have a fairly long period to run. Therefore the op-

portunity to get the best as it comes before you should never be passed by.

It is not possible nor permissible to give here the names of the various companies or pass on their particular merits at this time. That must be left to your own judgment for the present. But we have given much information in these pages as to how that judgment should be guided and what to consider and to whom to go when in doubt. How to discriminate concerning the announcements made, whether by advertisements or circular personally addressed to you.

This and the following article in the August issue will give you further particulars as to the proper prices to pay, the best kind of bonds to buy, the reasons for their varying periods of maturity, the relation of the price to the term of maturity, the average yield for them at the varying prices; then also the matter of fluctuations in stocks will be more specifically dealt with, the returns on such stock, the sale of it or of bonds when desired or necessary.

The protection given to your investments, be it in the stocks or securities of these enterprises, is really much greater than appears on the surface. In proportion as they are part of, or amalgamated with, the larger interests so do you have the protection of the greatest financial institutions in the country and indeed in the world for that matter. The part is never greater than the whole, but the part is, in healthy conditions, as important as the whole in all these systems. For it is the concentration of successfully operated parts that makes for the success of the whole system. Understanding this as all able business men and managers of the local plants and installations do, you

should be reasonably sure of the proper care and consideration of each link forming the whole chain and that the great central station or controlling center will be operated in the most efficient and economical manner. But you yourself have perhaps only a slight knowledge of the promoters, operators or organizers of such enterprises. You have therefore to depend finally on the reputation of the bond or brokerage firms offering the shares or bonds for sale.

Before going into the question of prices made to you for bonds or shares or the market fluctuations in the price of the latter, let us consider once more the present situation and future prospect in so far as they are of interest to you who are asked to buy the shares of, or invest your money in the bonds of, electrical enterprises and organizations.

To begin with, business all over the country is considered good and there is not a valid reason for any setback on account of its being the year of a presidential election. On the contrary, every indication points to continued movement in the buying and selling of shares in the latter part of the year and a further advance in their price. Therefore you will do well to get the best prices you can at the present time. A large amount of bonds of all manner of large enterprises, not to forget both retiring and new bonds of older corporations put out the first six months of this year, has been readily absorbed. During May and June, while bond houses as a whole had plenty to do, there was a lull and the volume of offerings was considerably smaller than earlier in the year. Now as this is an all round good year, it means you will have plenty of good bond opportunities in the early fall, but the point is to avail yourself of the chances presented by being first subscribers.

In the main you will, as time passes, be given your choice of investing in stocks and securities of four classes—steam railways, industrial, that is, manufacturing and distributing companies, street and in-

terurban railways and gas and electric properties. We are chiefly concerned with "Electrics," as they are called.

Therefore, it must once more be impressed on you that the earnings of railways fluctuate. When crops and business are good, railways flourish and the earnings increase; likewise the prices of the securities go up; on the other hand, during business depression prices of railway stocks and bonds go down. These fluctuations do not as a rule seriously affect the price of the bonds, but they do affect the market for the stocks, and what is true concerning steam railways is also true in regard to industrial shares and bonds. In this class is included manufacturing, the steel industry, sugar refining, biscuit and baking companies, smelters and the like.

The industrial class is subject to more violent fluctuations in gross and net earnings than any other. It is extremely sensitive and quickly feels the effect of changes in business conditions. It should, however, be observed that this is not so marked in regard to those industrials which are engaged in the supplying of human necessities. Nevertheless, they are to a certain extent the pulse of trade and respond very promptly to changes. The prices of the stocks and bonds, then, of such enterprises go up and down as do the earnings. They are traded in by speculators, who would rather deal in shares having a wide range of price than in those of a more stable character. What is true of industrials in this regard is also true of steam railways.

Street and interurban railway stocks and bonds have in recent years become more desirable to investors than formerly, owing to many things that have contributed to their stability and earning capacity—better management, the joining together and connecting up of the smaller lines into large systems forming in certain parts of the country a perfect network of electric transportation, also the steady increase in the population and the continued prosperity of the rural com-

munities. The earnings of street railways are less affected by general trade conditions than those of either steam railways or industrials, and as time goes on their shares and bonds will be regarded more favorably and will undoubtedly sell on a higher level.

As to gas and electric companies—to quote an eminent authority, member of a well known engineering firm specializing in such properties: “Those who have studied the four main classes of investments placed before the public to-day and examined into the merits and earnings of the various concerns are thoroughly and lastingly convinced that gas and electric companies show less fluctuation in earnings than any other class of business. One must understand the underlying facts and sources of revenue to appreciate the truth and strength of this broad statement.”

Electric companies do not primarily depend upon the crops or general conditions of trade or business. They depend upon the population of the cities served, and this does not fluctuate, but, taking it by and large, shows a steady increase in all sections of the country. The commodity sold is, too, a household and industrial necessity, therefore the consumption of electricity during periods of business depression does not fall off to any noticeable degree. So, for the same reason, during periods of great financial prosperity, the earnings continue to show the usual rate of growth, slightly increased by the added expenditure on the part of patrons in the direction of the purchase of electrical conveniences and contrivances.

When business conditions are unfavorable, places of amusement are not, it is true, so well patronized, but they are just as brightly lighted as when times are prosperous and every seat taken. Then, too, when people are not at the theaters,

they are probably at home where the same amount of fuel and light is consumed at one time as another, regardless of financial conditions. The use of electricity for power and manufacturing purposes may fall off somewhat when there is business depression and a tightness in the money market, but this falling off in the gross earnings from the sale of power is offset in the net result by the saving effected in the purchase of machinery, equipment, fuel and supplies at the lower prices.

Statistics show that the earnings of electric companies maintain a continual increase from year to year with no falling off in years of panic or bad business conditions. Rates for electricity are practically unaffected by outside conditions, and might be maintained constant, though as a matter of fact, with the increasing spread in its use, there is a corresponding ability to make lower rates to the public, which is done voluntarily in a great many cases and without reducing the dividends to which the stockholders are justly entitled.

There is authority for the statement that the losses sustained by investors on account of foreclosure of electric mortgages, or default in the payment of the interest on the bonds, have been less than the losses to depositors in national banks, which have not been as high as one-tenth of one per cent. For assured and steady increase in earnings, therefore, electric companies cannot be beaten. If you can invest your money in securities that will earn from 5 to 6 per cent the profits will be correspondingly larger than if you invest at a lower rate, and while it has been usual to assume that very low income-bearing securities are the safest, yet every year the safety of electric investments is increasing so that they are just as safe as the old low-priced securities, yet bring in much better returns.

Picture Sending by Wire

Although the transmission of pictures by wire and even by wireless was made possible quite a number of years ago no considerable practical use has been made of the discovery; that is, not until just recently, when a number of Paris newspapers adopted the plan.

A station is installed at Monte Carlo, the center of the Rurera region, where there are always interesting affairs happening, and a second station is located at the headquarters of *Illustration*, the lead-

ing Paris illustrated weekly. The distance is about 500 miles.

The electrical picture apparatus which is shown here is quite a new one and has been running only a short time. Dr. Korn, the inventor, found that it was not much advantage to use the action of light on selenium for sending the pictures, as he employed in his former apparatus, as it is much easier to use an electric contact running over a metallic photograph. At Monte Carlo the photographic reporter takes views, say of an aeroplane flight, and brings them to his

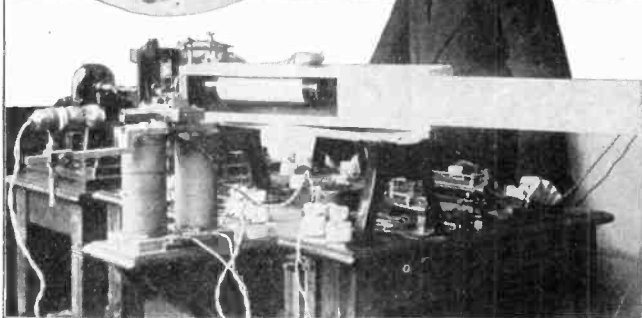
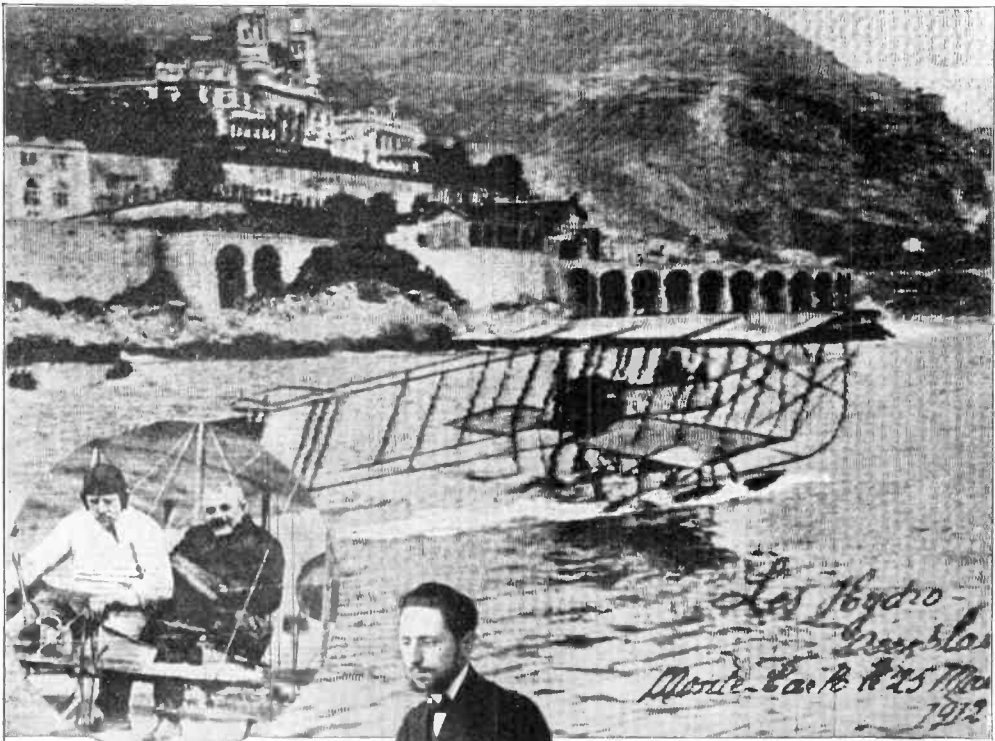

DR. KORN OF PARIS AND HIS APPARATUS FOR SENDING PICTURES BY WIRE

SOME EXAMPLES OF WORK DONE FOR A PARIS PAPER

laboratory and makes the negatives. From these, a metallic picture is made by direct printing by arc light on a sensitized copper film,

so that the result is about like a half-tone engraving except that parallel lines are used for the image instead of small dots. The copper film is quickly prepared, about like a photographic print, and it is then ready to be put into the electrical picture sender.

The operator wraps the film around a cylinder and it revolves like a phonograph cylinder so that a fixed metal point runs across all the lines, and when it strikes the bare copper it sends current. When crossing a black line made of the insulating gelatine film, no current passes, thus translating the picture into current impulses over the line.

At Paris, a shutter worked by the electric current of the line, sends a beam of light from a lamp through a pinhole in the box containing a film wrapped around a cylinder, so that the light prints a duplicate picture on the film. The operator develops it, and the photograph then goes to the engraving room to have a half-tone engraving made for printing in the paper.

An Electrical Genius Released from Prison

In order to procure a patent for an invention to draw electricity from the atmosphere and produce power therein, a convict in the Arizona state penitentiary at Florence was recently ordered released by Governor Hunt for a period of 30 days. An order was forwarded to the warden of the penitentiary to that effect, and the prisoner, Roy J. Meyers, will shortly proceed to the capital, without guard, and after securing the patent will return and surrender himself to the prison authorities. It is not expected that a pardon will be granted, but in view of the importance of the electrical device, which Meyers is said to have perfected in his cell, the authorities are willing to release the inventor for a month "on honor" so that the invention may be given to the world.

Meyer's case was brought before the Arizona legislature by Miss Kate Ber-

nard, superintendent of Charities and Corrections in Oklahoma, who made an eloquent and convincing plea in the man's behalf. She stated that a model of the device had been made in the penitentiary which had operated a 25-horsepower engine with electricity derived from the atmosphere. On advice of his friends, the model and blue prints were destroyed, but the prisoner will be able to duplicate them in Washington, and is confident of obtaining his patents. The House was so impressed by Miss Bernard's speech that a vote sustaining the governor's action was taken.

A subscription was taken for the purpose of defraying the expenses of the trip and the patent office fees, Miss Bernard heading the list with \$50.

Electric Clocks in Tramcars

It is believed that the electric railway system in Belfast, Ireland, is the only

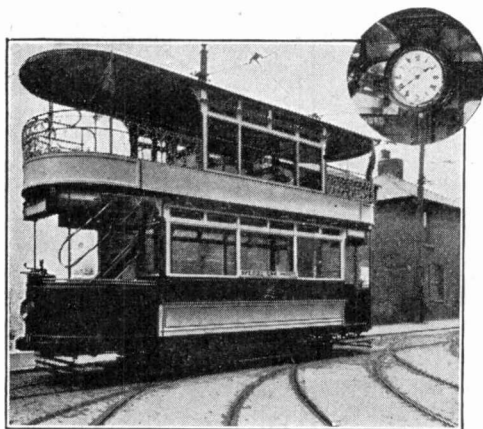

BELFAST TRAMCAR PROVIDED WITH ELECTRIC CLOCK

one employing electric clocks in its cars, some of which are of the double decked type shown in the picture. The clocks are actuated by two small dry cells which last from eighteen months to two years without renewal. The clock gets an impulse every minute which gives power to a spring which keeps the clock going for one minute, when it receives a second impulse.

Ambition

By WINDER ELWELL GOLDSBOROUGH, M. E.

Extracts from an address made in 1906 by Mr. Goldsborough, then Vice-President of the American Institute of Electrical Engineers, to the students of the Thomas S. Clarkson Memorial School of Technology, and published through the courtesy of Waddell and Harrington, consulting engineers, from a book edited by them entitled "Addresses to Engineering Students." This is the first of a series of similar articles by prominent educators and business men, which will be especially interesting to boys and young men who contemplate following the engineering profession.—Editorial Note.

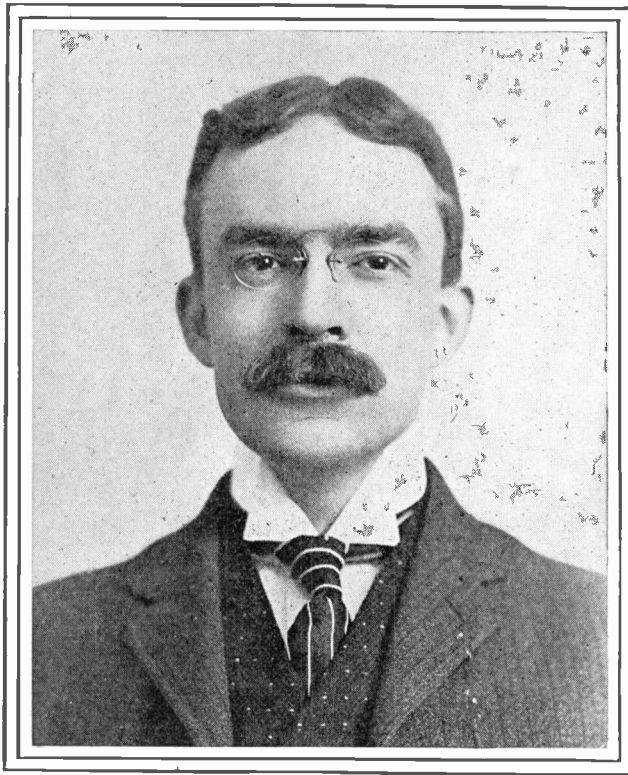

We have a great misconception of what "work" is. When I was a boy, work meant discomfiture to me. I always heard work or labor spoken of as something that no one wanted to do.

Now there are various definitions to be given to work, and the generally accepted definition of it is wrong. To my mind work is any agreeable and at the same time useful thing which a man has to do—the thing which he wants to do.

It makes no difference what that thing is.

But are there many of us here who have not felt the thrill that comes with the perfection of some one thing in which we have our heart? What young engineer, after he has created through his plans, designs and work, a large engineering plant, would be willing to be absent from the starting up of that plant for any social function or any pleasure of field or sport which you could offer him? It is

the essence of his success. His life blood has gone into the plant. It is a creature of life and being to him. And he would not give up the pleasure of being there; of working all night; of experiencing any discomfort to make that plant a success, for anything else you could give to him.

It is not the money, it is not the gain, which makes men in this country. America has been accused of being a country in which only gain is sought. That is not true. I have come in contact with too many of our men; I have seen too many of our boys; I have had them work too close to me ever for one moment to think that the dominant idea in the brains of our men and boys is money.

There are many things which a young man has to learn if he would succeed; and all of us want to succeed. If we could only, when we start out, have the knowledge of the ways and methods of mankind that we acquire in later years, it would be very valuable to use. We can't learn those things by having them told to us, because they somehow slip away. If you visit an engineering structure and study it, you can always carry it in mind and remember it and have it as a direct asset; but if you only learn of it by hearsay, you may or may not be able to retain a memory of it. And so it is with experience. We must learn it at first hand. We must acquire it for ourselves. Then why should any young man be willing during two or three or four years of his life to stay in one shop and learn but one thing, when there are so many things to learn?

I once was conversing with Dr. Robt. H. Thurston. I had been out of college about three years, and in talking over the situation with him I apologized because the old saying "A rolling stone gathers no moss" did not seem to be exemplified in what I had been doing, as I had changed my position several times in the three years. He said, "Don't worry about that. A rolling stone is the only one that gets polished." That set me to thinking. If the rolling stone gets pol-

ished—if you want a high polish, you have to roll a good deal.

So the thing for a young man to do is to get out in life and to learn all he can in one position, and then, as soon as he has acquired the better part of the knowledge of one—he is young—he ought to break off, and get another place, even if he has to begin all over again. Because—think of the experience he is going to get in the new place, the new problems he is going to have to solve.

Make trouble for yourselves, or at least what the world calls trouble; and with deliberate aforethought, if need be. Change conditions around. You have but so many years to live. And before you are 30 years old you must acquire a good deal of information.

Deciphering Manuscripts With Ultra-violet Rays

In Europe, where quartz lamps have already been introduced on a commercial scale, photographers have found that they can obtain very different effects when using these lamps in place of the more common sources of light. The reason is simple enough. The quartz allows the ready passing of the so-called ultra-violet rays of light which will not penetrate glass, and these in turn produce a different effect from the rest of the rays.

With colored vases, flowers or dress goods the effects are equally surprising and sometimes may lead to important applications. For instance, a Berlin photographer (A. Mente) has found that ink which has faded into illegibility may still be opaque to the ultra-violet rays. By photographing documents on which the ink had faded, he has been able to restore the legibility. Moreover, he has found that in some old parchments, dating back to the Twelfth Century, his quartz light photographs showed the original wording which had later been changed in a still legible ink. Such a deciphering of old manuscripts which heretofore have not been readable ought to add greatly to our knowledge of previous centuries.

Signal Lamp on Glove.

A wave of the hand may serve the automobile driver at night in notifying vehicles behind that he desires to turn out or stop, if a glove with an electric lamp mounted upon it is made use of.

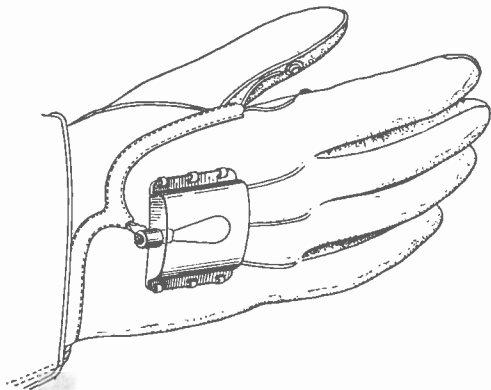

SIGNAL LAMP ON GLOVE

The inventor is Charles A. Schindler, West Hoboken, N. J. The lamp, enclosed by a transparent cover, is secured to the back of the glove. Flexible wires from the lamp connect to a battery and current is turned on by bringing the contacts on the thumb and first finger together.

Electric Refuse Wagons of Paris

The new silent running electric wagon for collecting household waste is likely to be appreciated in Paris, where it is now being introduced. As the majority of houses in the city are apartment houses which front entirely on the street, a proper method of collecting the waste had to be organized, and this was done some years ago by using large galvanized iron boxes, which were filled up by the tenants generally during the night and were then set out on the pavement by the janitor early in the morning so that the carts could collect from them. The new automobile wagons will be quite an improvement and will do

the work much quicker. The present wagons are designed to make a trip of about 20 miles a day. All the electrical gear, with storage battery, is put together in the front part along with the two front wheels, so that the front truck can be separated from the main body.

A "Boiling" Battery

A Paris inventor has just brought out what may be called a "boiling" battery, and claims that it will give six times as much power as the usual type. To show how the battery acts, he makes the following experiment. He takes a porcelain vessel which will stand the heat of the fire, or probably an ordinary enameled vessel would do, and fills it with a weak acid solution, or, better, a bichromate battery solution. Two carbon plates are put in, leaving a middle space. A zinc rod or plate is attached to a wood handle so as to dip it into the bath between the carbons. A small, low voltage incandescent lamp is connected to the carbons and the zinc in the usual way. On dipping in the zinc the current given by the battery cell is very small, and the lamp will hardly glow. Removing the zinc he puts a small flame under the vessel so as to bring it about to a boil. Putting in the zinc again it is found that the lamp now glows brightly, and the inventor claims that the current, which he measured by instruments, is six times as much. His method is the subject of a French patent.

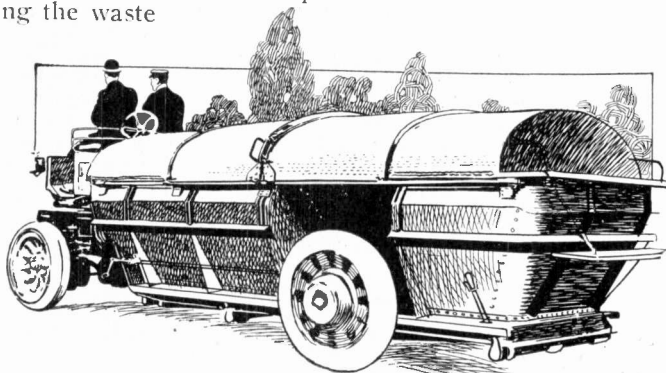

ELECTRIC REFUSE WAGON IN PARIS

Trolley Wires for Airship

To Theodore T. Kryshstofovich, St. Louis, Mo., has been granted a patent upon an invention for transmitting electricity to aerial vehicles. The air ma-

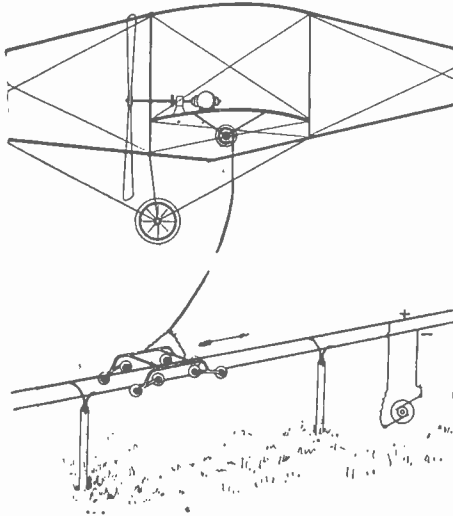

AN AIRSHIP TROLLEY

chine is equipped with a motor from which a two wire cable passes downward from a reel to a two wire trolley arrangement. By guiding the aerial craft along above the trolley the airship may be propelled by electric motors.

Collecting Static Electricity From the Air

Ever since the days of Franklin's kite inventors have been busy upon schemes for obtaining energy from the sun, wind and waves.

One of the latest ideas for collecting energy is to suspend a metallic screen in the air by means of a number of elongated balloons built to stand the wind by being equipped with rudders. Assuming that the screen will collect static electricity from the atmosphere, the screen is anchored by conducting wires which are connected to several Leyden jars for storing up the captured charges.

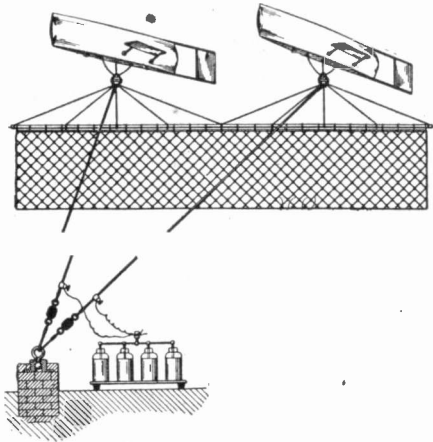

APPARATUS FOR COLLECTING STATIC ELECTRICITY

First Money Earned from Telephone

"On February 12, 1877," relates Dr. Bell, "I gave a lecture before the Essex Institute in Salem, Massachusetts, and the lines were connected with Boston. The speech was transmitted between Boston and Salem, and the audience generally could hear the sound of the speaker's voice, while those who came close to the telephone were able to converse with Mr. Watson in Boston. At the invitation of the Essex Institute this lecture was repeated on February 23, 1877. An admission fee was charged, and on this occasion certain of the proceeds were presented to me for my lecture on the telephone. I immediately went into Boston and we had a little silver telephone made, and it is interesting now to look back upon the fact that that was made from the first money made from the telephone.

"On that occasion a very interesting incident took place. A Boston Globe reporter had a brilliant idea that he would send a despatch to his paper in Boston by telephone, and on that occasion the first newspaper despatch ever sent by telephone was sent to Boston for the Boston Globe. That, I think, more than anything else, woke up the press of the world to the advantage of the telephone. That article in the Boston Globe was copied all over the world, and had a great influence."

Electric Chickens

The electric chickens have won! T. Thorne Baker, a London scientific expert, has concluded experiments in treating young fowls with high frequency electricity—the kind of electricity used in wireless telegraphy—with highly satisfactory results.

The birds thus treated are asserted to have put on 38.5 per cent more weight than those that were not treated. With the exception of the electric treatment, the birds were reared as nearly as possible under the same conditions on the same food and in the same incubators, in the same garden.

The only difference was that the elec-

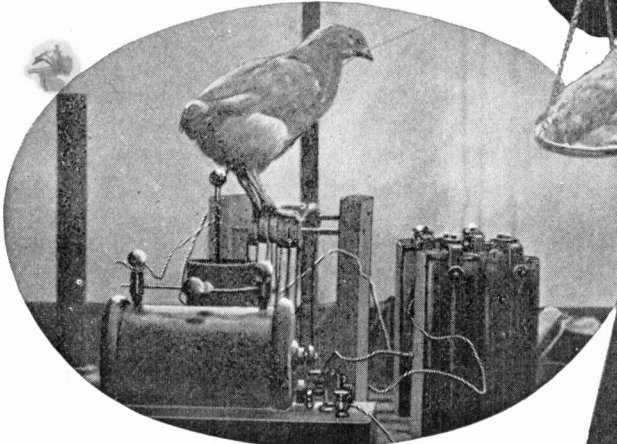

A LONDON SCIENTIFIC EXPERIMENT IN CHICKEN RAISING

trified chickens seemed happier and more placid and obviously were plumper, as the result of the high frequency, high voltage alternating current in which they basked.

The final result of the experiment is as follows:

"The cost of the treatment works out at $\frac{1}{4}$ cent per chicken," says Mr. Baker, "so that the treatment is well within the means of the chicken farmer who raises on a commercial basis, and the idea is obviously well worth his attention." The incubators used were the Hearson patent, made by Messrs. Spratt, of London, England.

First Foreign Language Over Telephone

According to Dr. Alexander Graham Bell, the first foreign language transmitted by telephone was Japanese. In telling about it recently he said:

In the early part of 1877 or the end of the year 1876, a rather interesting circumstance took place. I had among my

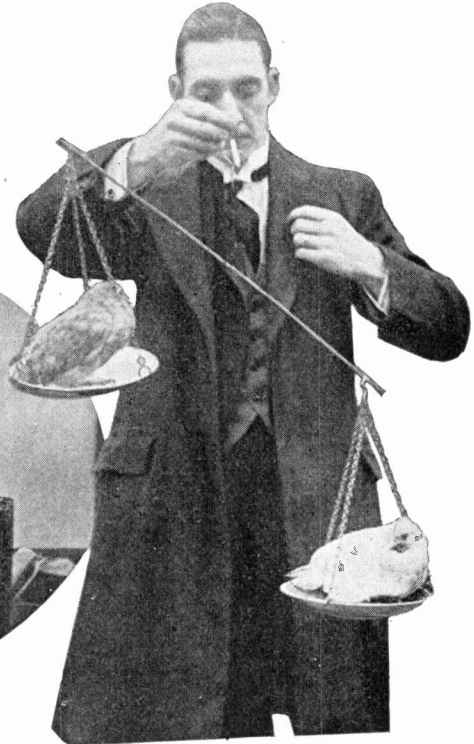

students at Boston University a young Japanese student named Tsawa. He came to me for the purpose of studying the pronunciation of English. Of course, when he heard about the telephone he became very much interested. He said: "Mr. Bell, will this thing talk Japanese?" I said: "Certainly, any language." He seemed very much astonished at that, and said he would like to try it. I said that he could try it, and he went to one end of the circuit and I stood at the other. He talked Japanese, and I reported the result to him. He asked if it talked Japanese. I said: "It talked Japanese, but I couldn't quite understand it." He was

not quite satisfied with that, and asked permission to bring some Japanese friends of his from Harvard College. I said: "Certainly." He brought two young men there, and they talked through the telephone and listened; so that Japanese was the first foreign language that was spoken over the telephone.

And these two Japanese gentlemen were exceptional men. I did not know who they were at the time, but years afterwards it was revealed to me. I was in Japan, in Yokohama, when the American residents in Japan were giving a banquet to the new Japanese Minister who was going to Washington, Mr. Kamura, now at the head of affairs in Japan. I

was asked to attend the banquet, and instead of being introduced to Mr. Kamura, he came up to me and said: "I don't require an introduction to Mr. Bell. I knew him years ago." And he turned out to be one of the Japanese students. Then I

found out about the other one in a rather curious way. The Japanese government sent to this country at the time of the Russian-Japan war, Baron Kaneko. He came to Washington and gave a lecture before the National Geographical Society. I happened to be president of that society at the time. And so when the dinner was over and the time for speaking came, Baron Kaneko said: "I knew Mr. Bell years ago," and he told his story about the use of the telephone. So those two men, the foremost men in Japan today, Baron Kaneko and Mr. Kamura, were the two men who heard the telephone in the winter of 1876-1877.

Tower Lights of Girard College

Girard College, located on Girard Avenue, is one of the particular points of interest in the city of Philadelphia. It was founded by Stephen Girard and the first 100 pupils were admitted in 1848. The bequest was left to the city of Philadelphia, as trustee, for the education of poor white male orphans from Pennsylvania, New York City and the city of New Orleans.

A peculiar feature of the provisions of endowment was that no clergyman

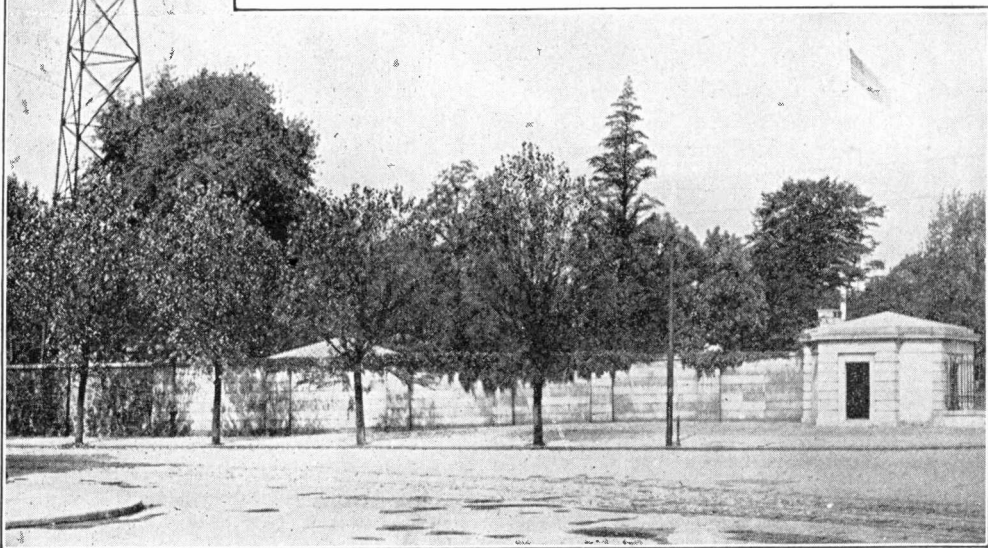
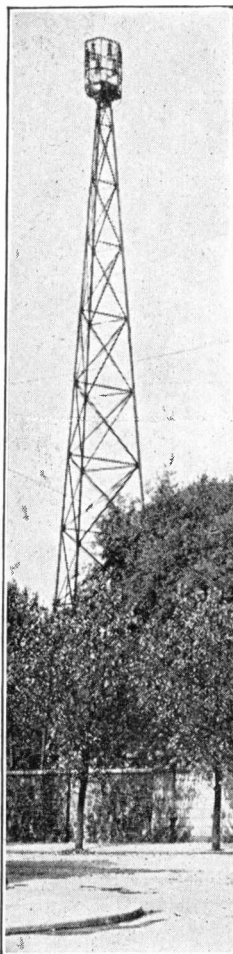

GIRARD COLLEGE GROUNDS AND ONE OF THE TOWER LIGHTS

should be allowed to enter the grounds. This restriction was made by Girard, it is said, not from any feeling of hostility against the profession, but in order to prevent the minds of the young orphans from being subjected to the strife of sectarian controversy.

The grounds of the college embrace 40 acres and are surrounded by a stone wall ten feet in height. Electric energy for supplying the lights and motors driving the various shops and laundries throughout the grounds is generated in a power house located in the western end of the enclosure.

The plant is operated 24 hours a day under the direction of the chief engineer, who has charge of all the engineering work of the college. The operating force consists of two engineers, eight firemen, one electrician and one trimmer.

A tunnel running from the power house for a distance of about three-quarters of a mile carries all the wiring, steam and hot water pipes for the laundry and other purposes. Branches leave the tunnel at various points for supplying the different buildings.

Decidedly the most novel feature of the installation is the illumination of the ground by use of Westinghouse metallic flame arc lamps mounted on steel towers. These towers are 130 feet in height and there are seven of them distributed throughout the grounds. Each tower has six lamps mounted at the top. Steps are provided on the frame work of the tower to enable the trimmer to reach the lamps.

A telephone subscriber in Athens, Ohio, requested the operator to "ring the bell" every 30 minutes from three p. m. until the next morning. Upon investigation the subscriber explained that the baby was dangerously ill and, as the house clock was not in working order, requested the calls for the purpose of giving the baby the medicine at regular intervals as prescribed by the physician. Surely the telephone is a "jack of all trades."

Observation Tender for Submarines

A New Jersey inventor, Stanley Pontiere, Ocean City, has received a patent upon a means of leaving a submerged submarine and of using the same device to observe the movements of vessels.

The egg-shaped buoy of a size to permit a person to stand erect, and to provide

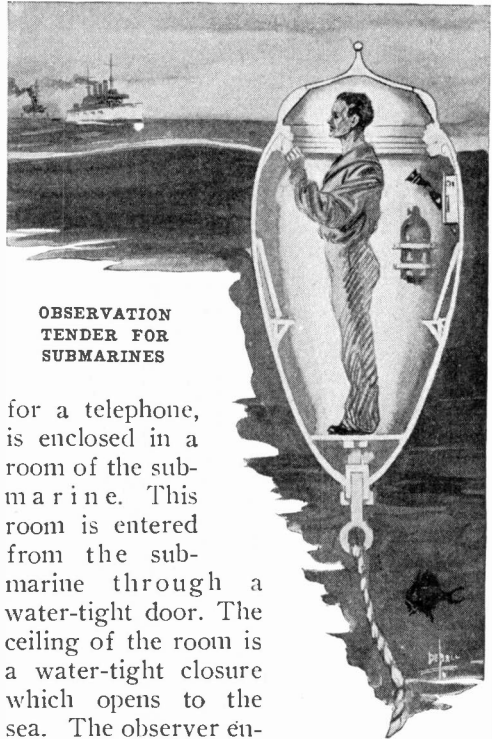

OBSERVATION
TENDER FOR
SUBMARINES

for a telephone, is enclosed in a room of the submarine. This room is entered from the submarine through a water-tight door. The ceiling of the room is a water-tight closure which opens to the sea. The observer enters the room from the submarine, closes the door, then gets into the buoy through the top, which is now securely fastened down. The buoy is then set free by opening the door to the sea, and controlled by a windlass in the room. This windlass is operated by shafting through water-tight bearings through the walls from the adjoining room. Windows in the cover of the buoy permit observations as soon as the buoy reaches the surface and the telephone connected by water-proof cable to the submarine is used to transmit information regarding the movement of vessels on the surface. A tank of compressed oxygen keeps the air pure.

Electric Photography

The accompanying illustrations are examples of photographic reproduction by means of electric photography. The process is, of course, only applicable to photography of inanimate objects because, under the disconcerting influence of a high voltage, animate beings would hardly be able to respond cheerfully to the usual "Look pleasant, please!"

The terminals of an induction coil or an electrostatic machine are connected to the terminals of a condenser which may consist of a few Leyden jars. A photographic plate with its sensitized surface uppermost is placed over a smaller sheet of tinfoil which rests upon an insulator. Upon the plate is placed the metallic object whose facsimile is desired. The terminals of the condenser are connected to the metallic object and the tinfoil sheet, respectively. The object is highly charged for an instant and on developing the negative a reproduction of the object is obtained.

The process is preferably carried out in a dark room. However, it can be done in a light room with the plate properly protected from exposure to light. The objects (A), (B) and (C) were reproduced from exposed photographic plates while (D) and (E) show the effect of using photographic printing paper instead of the sensitized plates. In the first three illustrations the lighter parts represent raised portions on the object reproduced while these parts are shown in the darker parts of the last

two illustrations. A variation of this experiment is found in substituting a plain glass for the photographic plate. If the metallic object is charged for a long time by means of an electrostatic machine, on removing the object and breathing on the spot the image of the object will be seen.

Telephones in Tripoli

The city of Tripoli, with a population of 40,000, has the only telephone exchange in the entire country of Tripoli, the seat of the present war. It has seven stations, and has always been operated by the military department of the Turkish government.

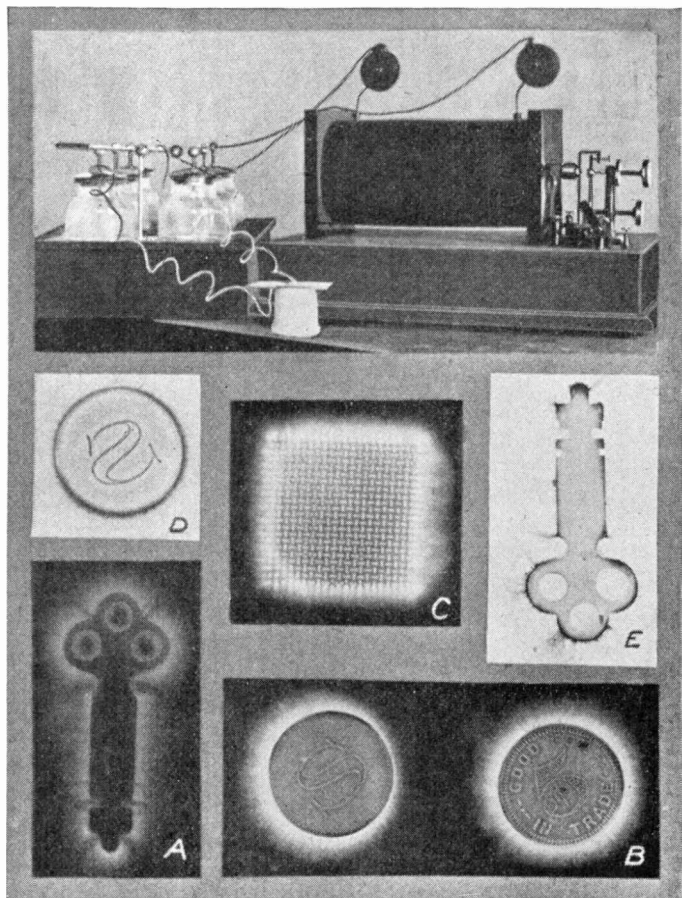

APPARATUS FOR ELECTRIC PHOTOGRAPHY AND SOME EXAMPLES OF WORK

The Perfected Money Laundering Machines

After three years of experiment and research the experts in the United States Treasury Department have finally perfected practical, electrically operated machines for laundering currency. While the idea of washing money is very old, this present achievement constitutes the first solution of the problem of laundering bank notes on a commercial scale. It will put in circulation in all parts of the

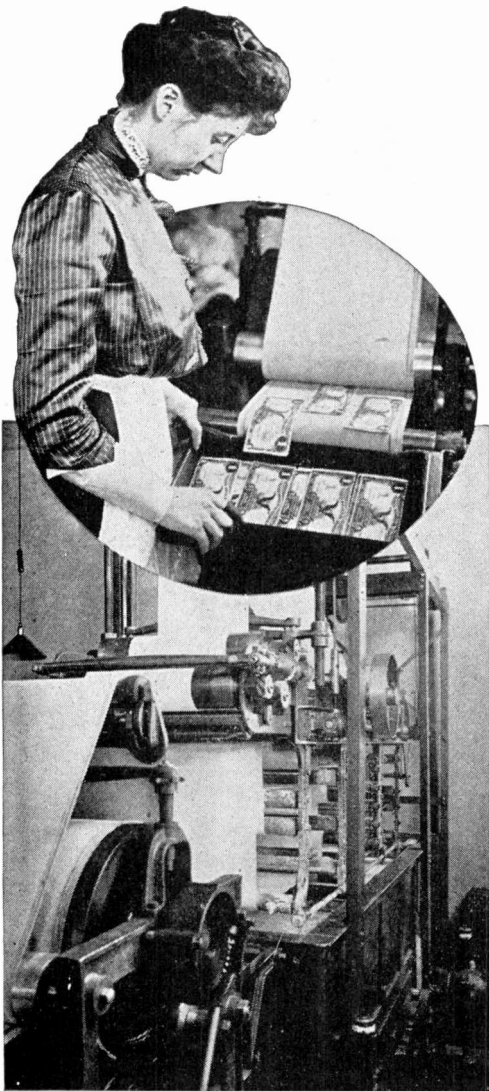

LAUNDERING MONEY IN THE U. S. TREASURY

country a vastly increased proportion of clean, sanitary currency, replacing the literally "tainted" money which is so unsightly to look upon and (presumably) unhealthy to handle.

These newly devised machines for washing and ironing our paper money will be installed not only at the Treasury at Washington but at all the Sub-Treasuries throughout the country and at all those banks whose directors find it more economical to operate a money cleaning plant of their own than to ship soiled banknotes by express to Washington to be replaced by new, as is at present the plan. Even foreign nations are planning to make use of Uncle Sam's novelty. The German government recently sent over some paper money to be rejuvenated by the newly invented machines and when it was sent home the Teutons pronounced the ink brighter than when the notes were freshly printed.

The perfected, money washing machine is twelve feet in length, eight feet in height and $2\frac{1}{2}$ feet in width and is operated by a one-fourth horsepower electric motor. In this machine the bill to be cleaned is received between two endless bands of the finest cotton duck nearly 60 feet in length, the function of which is to hold the bill flat while it is washed or scrubbed by passing back and forth over peculiarly shaped rollers. In the washing process liberal use is made of a special soap that has been developed by Uncle Sam's chemists and each bill is further bleached and sterilized by chemicals that liberate ozone when dissolved in hot water. It is claimed that the most virulent disease germs instantly succumb to this treatment and all organic matter that would serve as a breeding place for germs is removed.

After a bill has passed back and forth in the washing tank it is similarly shifted in a rinsing tank and then as it emerges from the latter is removed by a jet of air to another endless band of duck that passes over two gas heated drums where it is dried as flat and smooth as a new bill.

It requires just $2\frac{1}{2}$ minutes for a bank-note to be washed and dried, but the capacity of the machine is only limited by the dexterity of the operator. The cost of operation is estimated to be not more than 20 cents per thousand bills. Following the washing operation comes the sizing and ironing, which is performed by another remarkable machine—likewise just invented—which is operated by a $\frac{3}{8}$ horsepower motor. In the ironing process the bills are first passed on a duck apron over heated drums and are then delivered to compressed paper drums which iron them.

Gray Squirrels Gnaw Cables.

The fact that Ann Arbor, Mich., the home of the State University, is a city where trees adorn both the streets and yards, makes it a squirrel's paradise. A city ordinance protects the little animals and good treatment has apparently made

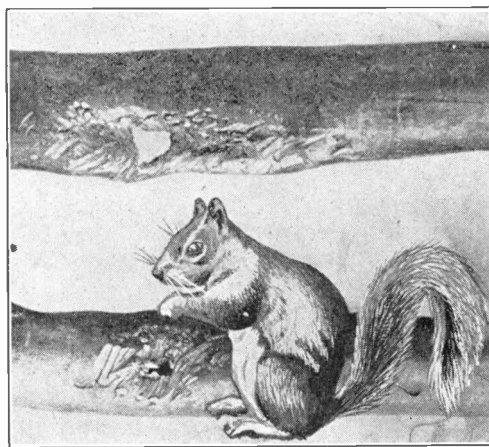

By Courtesy of the Chicago Telephone Co.

A COMMON SOURCE OF CABLE TROUBLE IN ANN ARBOR

them bold, according to accounts from the telephone company to whom they are giving trouble.

From the trees and by way of the poles the squirrels have ready access to the telephone wires and cables. Their greatest offense consists in gnawing into the lead armor of the cable, as shown in the accompanying illustration.

Pottery Designs for Lamp Bases

Molded clay supports for table, dresser or mantel electric lamps are gradually finding favor. The reason suggested for



POTTERY DESIGNS FOR LAMP BASES

this innovation is that the masses of earth, as they come from the potter's hands, express the fancies of his imagination and offer a sort of human appeal.

Four lines from Omar Khayyam, the Persian poet, bring out this thought:

*"Shapes of all sorts and sizes, great and small,
That stood along the floor and by the wall;
And some loquacious vessels were; and some
Listen'd perhaps, but never talk'd at all."*

The accompanying illustration shows several designs of Teco pottery for lamp bases.

It is asserted upon good authority that Twin Falls, Idaho, uses more electricity for heating and cooking in proportion to its population than any other city in the world. A large office building which has recently been erected is entirely heated by electricity.

Remodeling Fire Engines for Electric Propulsion

The latest piece of apparatus installed by the New York Fire Department, and one that is attracting attention not only in the city but throughout the country, is a pumping engine propelled entirely by electric power, although its pumping apparatus is the standard steam type that has been in service in the department for years.

It was constructed by the Couple-Gear Company of New York, in a wagon shop in the Bronx, under the direction of J. H. Kennard, the New York representative. The machine was turned over to the Fire Department on

distance, where the roads were clear, a speed of 20 miles was attained.

The engine was placed in commission on Wednesday, the 24th, and almost as soon as it had been backed into place it was called to a fire a mile away. The run was made in about three minutes.

The Couple-Gear engine is different from anything in the way of motor vehicles and has been devised for fire fighting purposes. Primarily it is propelled by electric motors, contained within the wheels. In addition to this, the pumping apparatus is a regular fire department engine that has seen months of service behind galloping horses. In other words, it is a converted engine rather than a new piece of apparatus.

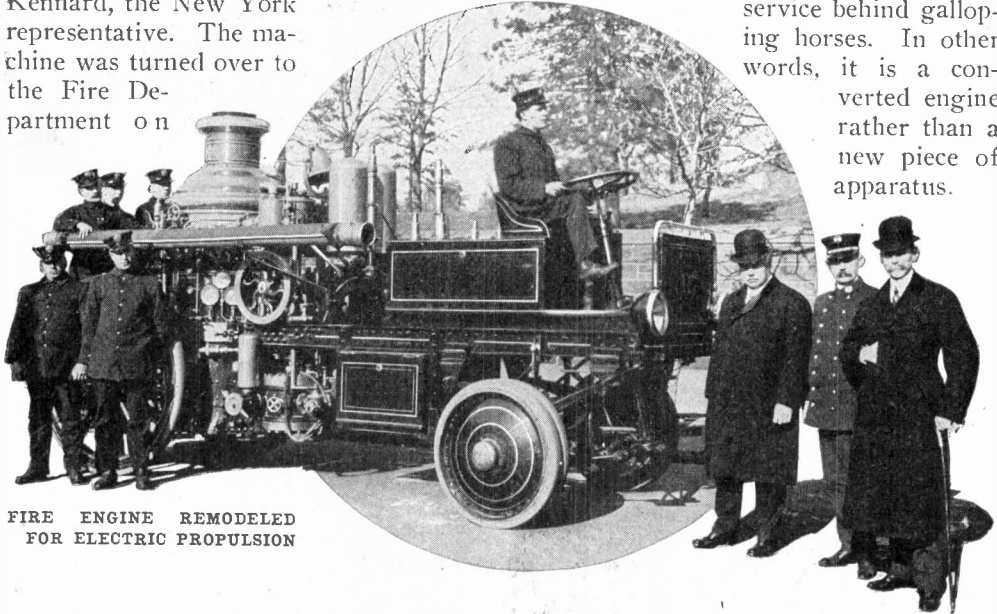

FIRE ENGINE REMODELED
FOR ELECTRIC PROPULSION

April 16 and after a week's trial was placed in actual service on the 24th. It is stationed at the house of Engine Company 117, Dekalb near Lewis avenue, Brooklyn, and has given excellent service in the short time it has been there.

The first official test was held a few days after the engine had been turned over to the city. A six mile run was made through the streets of Brooklyn, and the actual running time was 23 minutes, including the time of delays at street car crossings and the slow progress made in Brownsville, a crowded tenement district. Over some parts of the

If this apparatus meets the requirements of the department or fulfills the promises of the builders, it will prove the solution of the problem that now confronts the committee that is investigating various types of motor apparatus. There are now in the city service about 200 steamers. They represent the highest development of the steam pumping engine and are as nearly perfect as can be. They cost approximately \$6,000 each. Every engine is good for many years of service. To replace them with new automobile engines would mean an expenditure of millions of dollars.

Safeguarding the Lives of Little Children

A remarkably efficient work is being done by the Portland (Ore.) Railway, Light and Power Company in the matter of prevention of accidents to little school children. The work is carried out in the form of lectures to the children themselves, rather than to the parents, and has been going on for over two years. This year lectures have been delivered daily at the various public schools by C. H. S. King.

B. F. Boynton, claim agent of the company, who has charge of this work, writes as follows:

"Since the taking up of this work through our schools we have had injured through car accidents but two children of school age, so that you can see by the results obtained whether this has been money well spent. I am satisfied that we have not only saved the lives and limbs of numerous little ones, but that they have spread the good work and helped save the lives of older people.

"Mr. King, in his addresses to the children on the prevention of accidents, does not confine himself to cars alone, but takes up the general line of accidents children are subject to in coming from and going to school, telling them to be careful at all times in approaching all streets and highways; to be constantly on the lookout for cars, automobiles and vehicles of all descriptions. As this is a day and time when the keynote to success on the accident line is 'Prevention,' I feel that there is nothing in the world that can be done in our great broad land that will tend more to prevent accidents than by educating our little ones along that line carefully.

"This work we expect to continue permanently."

The work does not stop with the education of the children but is extended to the train service men—the motormen and conductors. Mr. Boynton says in this regard:

"Every new man, before he can be turned in and handle his car himself, either as motorman or conductor, must

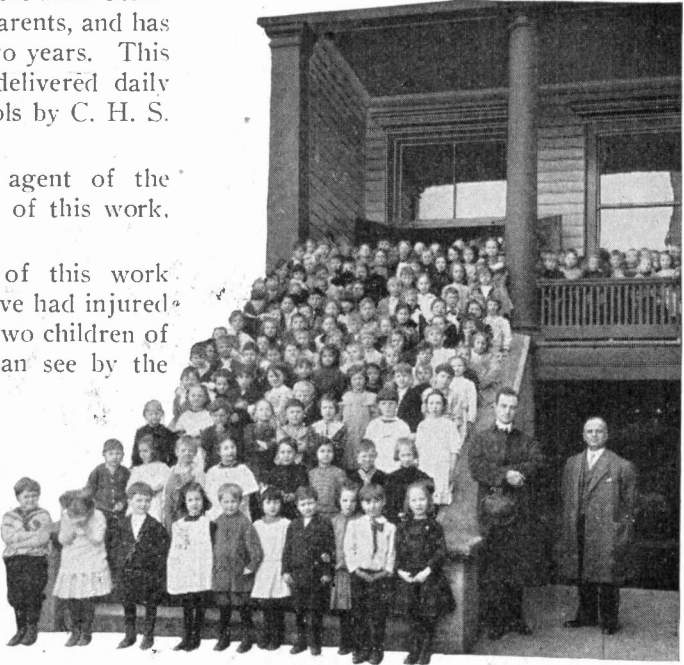

PORTLAND SCHOOL CHILDREN WHO ARE BEING INSTRUCTED IN THE PREVENTION OF ACCIDENTS

attend one of these schools of instruction, and every old man must attend one once every six months. The idea of bringing the old men in every six months is to keep the matter before them so that they will not get rusty, and it has proved very satisfactory.

"It may be said that this matter of the instruction of trainmen has been in vogue for the past five years, and at the time we started this school of instruction we were having as many accidents as we are having today and we are now carrying more than double the number of people and operating double the number of cars, so that you may figure for yourself whether we have gained results by so doing."

Aerial Trams of a Utah Mine

This view shows the workings of the Highland Boy mine of the Utah Consolidated Mining Company, Bingham, Utah. Among other equipment is an aerial tramway system four miles long for bringing ore down the mountain side. The loaded tram or bucket travels down the aerial cable by gravity and, through

the cable which holds it from traveling too fast, drives at the same time a 100-horsepower motor which acts as a regenerative brake. In other words this motor, when the loaded bucket is traveling downward, acts as a generator or dynamo and delivers current to a transmission line, and the energy of gravity is thus saved to do useful work. At any time when the weight of the downgoing tram may

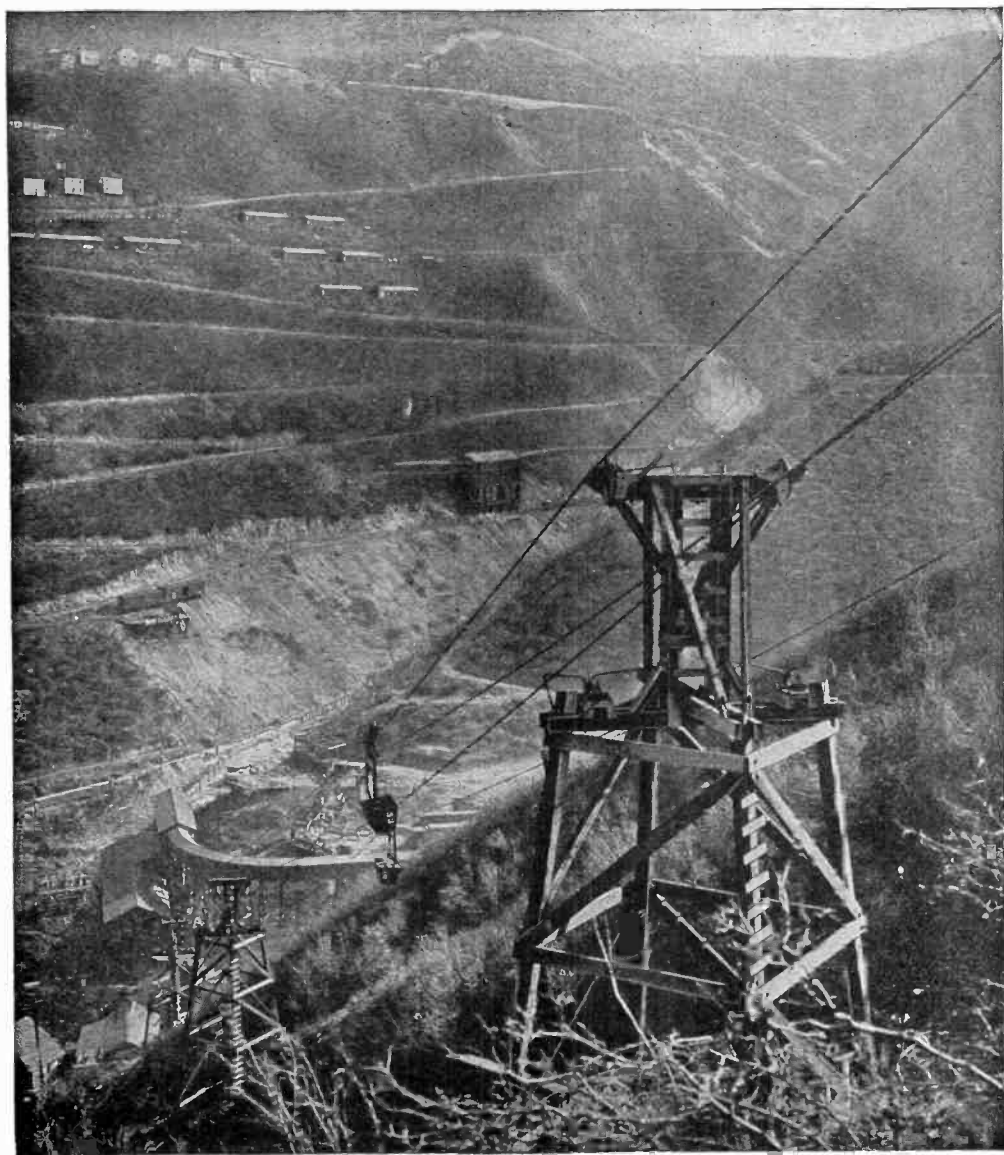

AERIAL TRAMWAY OF THE HIGHLAND BOY MINE, BINGHAM, UTAH

not be sufficient to draw the empty ones upward the motor performs its usual function and applies mechanical power to the cable, thus, in a pinch, helping gravity to do its work.

Demonstrating a Cigar

An electrically operated figure and its mechanism for demonstrating the pleasures of smoking a cigar is the subject of a patent issued to Harry E. Coates, Sacramento, Cal. A suction holder for a cigar, a piston for drawing

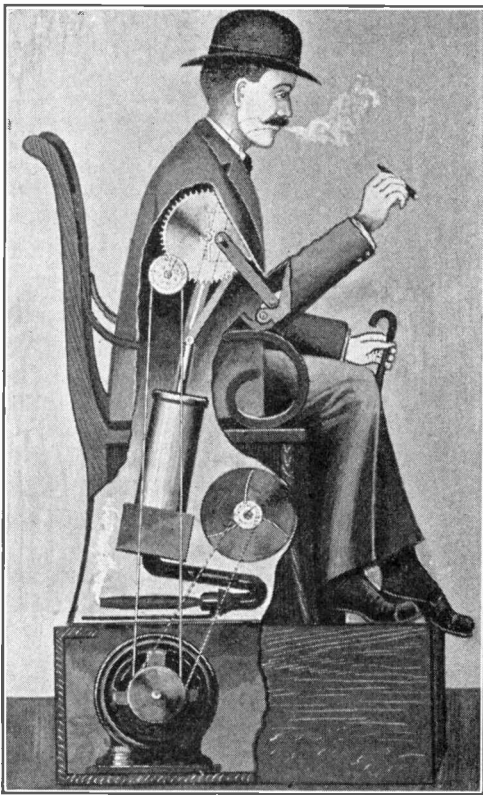

UNIQUE CIGAR DEMONSTRATION MACHINE

in the smoke and expelling it through a tube connected to the mouth of the figure, and a geared mechanism for imparting motion to the arm, are the main features of the invention. The actions of the mannikin are supposed to be very realistic as he raises the cigar to his lips, takes a whiff and slowly expels the smoke.

Phonograph with Electric Brake

Electricity adds to the enjoyment of the phonograph, removing the annoyance which every owner of a talking machine knows, of racing to the machine and stopping it at the close of each selection in order to prevent the unpleasant scratching of the needle. A tiny brake



PHONOGRAPH WITH ELECTRIC BRAKE

has recently been devised by a Los Angeles inventor which operates automatically, stopping the record at the close of the piece and allowing the listener to receive full benefit from the selection without being prepared to jump out of his chair and run for the machine as each record draws to a close.

The attachment is enclosed in a small metal case of less than two inches in length and breadth and of less than half an inch thickness. The electrical energy is derived from an ordinary dry cell, which may be set in any convenient place and wired to the brake. The latter is attached to the phonograph in an inconspicuous position. In operating the device, the record is placed in position and the arm of the phonograph (which holds the needle) is brought to the last thread of the disk. This brings it in contact with a movable upright lever. Then the arm is brought back to the beginning of the record and a spring is pressed which sets the brake ready for action. When the record has been played, the arm is once more in contact with the upright lever, which contact closes the circuit and automatically throws on the brake.

The Arrival of the Chauffeuse

College woman, medical student, chauffeuse and chaperone are a few of the claims to distinction of Mrs. Alice E. Waxham, of 2 West Ninety-fourth Street, New York, who recently entered the automobile business as the only licensed public chauffeuse in the world.

In an advertisement addressed to the women of New York, she offered to take them on shopping trips or on rides for recreation and to act as a chaperone on the automobile rides of the younger people.

Part of her work will be among the convalescents, whom she

long tours among the mountains, with breakdowns in lonely places, made her thoroughly familiar not only with the driver's work, but with the mechanical construction of the car. She came to New York five years ago and last winter decided to take up this unique occupation.

Starting in with one car which she drives herself, Mrs. Waxham has ordered a second machine. When this is placed in service it will be driven by a young woman who was a classmate of Mrs. Waxham at Wellesley College.

Smelting Tin at Cornwall

The smelting of tin has been carried on so long at Cornwall and by such economical methods that the suggestion of doing it still cheaper electrically at first provoked a general smile. However, tin is not the cheapest of metals and those who figured the costs closely found that from seven to nine per cent of the tin was

always lost under the old methods by volatilization and in the slags. To get this loss down to a lower point, the flue dust had to be condensed so as to save some of the metal which had been vaporized. This has always proven a costly and troublesome operation. Besides, the smelting furnace had to be shut down after each charge and allowed to cool, thereby wasting a good deal of the heat of the fuel.

On the other hand, an electric furnace can be operated both day and night and as the furnace is kept closed, the loss by vaporizing is practically eliminated. Tests recently made at Cornwall on a furnace capable of handling ten tons of ore per day showed that the loss of tin could be reduced to about one per cent. The cost of labor and repairs was greatly reduced, and tests showed the electric furnace could be run continuously for months.

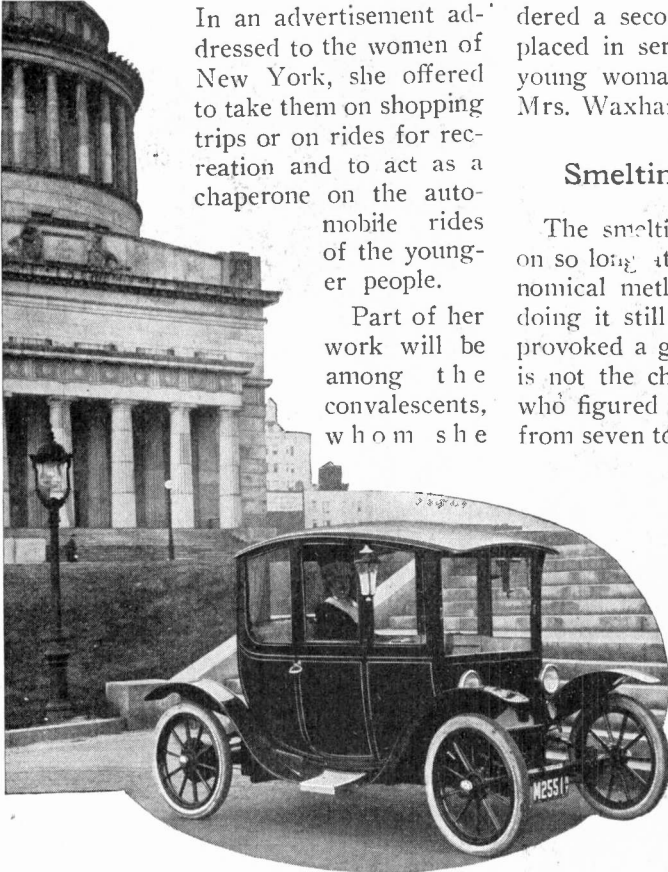

FIRST NEW YORK CHAUFFEUSE IN HER ELECTRIC AUTO

will take for recreational rides. For this reason a low swung electric coupe is used. The electric was selected because it is clean and noiseless, and therefore does not try the nerves of delicate persons. Its easy control commended it for use in the crowded shopping districts.

Mrs. Waxham has driven cars, both gasoline and electric, for many years. In fact she was the first woman of Denver to drive her own automobile. There,

Lighting Effects Past and Present

One hears a great deal these days about illumination and lighting units. It is interesting to note how little we have changed our ideas from those held by the Old Romans in the days of Pompeii, as to what constitutes a pleasing effect in diffused illumination.

A noted scientist, on returning from Europe recently, reported having seen in an old Roman cathedral thin slabs of marble used in the place of window glass in order to obtain a soft, diffused light from the brilliant sun light of the famed Italian skies. This effect was impossible with artificial light, owing to the insignificant candle power of the oil lamp,

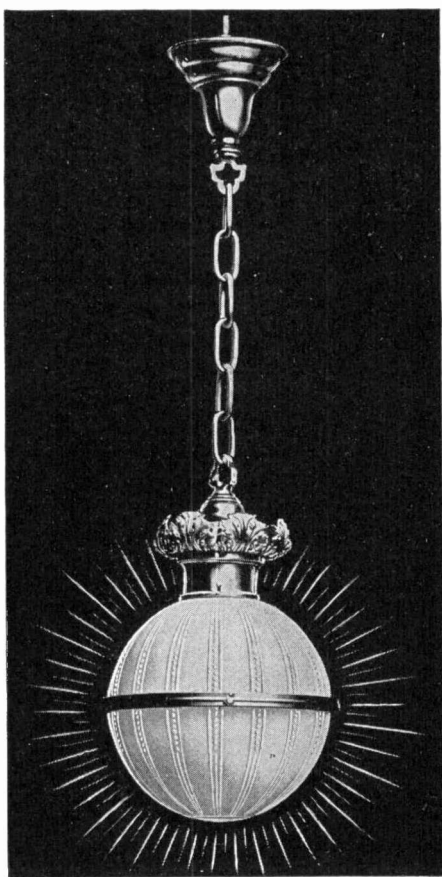

MODERN LIGHTING UNIT GIVING THE EFFECT OF THE OLD TIME MARBLE WINDOW SLAB



TYPE OF OLD ROMAN OIL LAMP

of which the cut illustrates a common type.

Today we are striving after the same effect in artificial illumination by enclosing a high candle power metallic filament electric lamp in a diffusing bowl. The accompanying cut shows a sixteen inch Haskins Lucida glass ball inside of which is used a 400 candle-power Mazda lamp. The unit emits an easy, soft, diffused light with a surprisingly small amount of absorption and produces an effect not unlike that obtained with the marble windows in the days of Pompeii.

German Sidewalk Signs

A somewhat novel advertising scheme is being introduced in some of the German cities. In the sidewalk is inserted a plate of heavy glass of the kind which is used for giving light to basements or the like, and under the glass are electric lamps which light up an advertising sign placed upon a second glass or on the under side of the heavy glass plate. This latter need not be of very large size and can show up an object such as a shoe, or spectacles, for instance, and with an arrow pointing to the store near by. Quite a number of novel effects can be produced by mounting an illuminated sign in this way, and it is sure to attract the eye of the passers-by to the walk, being in this way even more effective than a sign placed overhead.

Head Lights for Victims of Night Shipwrecks

A new life preserver to aid in rescue work in case of a shipwreck at night has been successfully tested by the German Navy. The apparatus, which weighs 5½ pounds, consists of two swimming cushions bound together by straps. The cushions lie upon the breast and back. The apparatus is provided with a small lamp fed by a battery. The lamp is fastened around the head with a band worn on the forehead, so that in an accident at night the position of the person in the water can be seen at a considerable

distance. The small electric lamp burns three to four hours and with a reflector added throws the light several hundred yards at night. In several recent tests of life saving at night the victims of the supposed shipwreck, by aid of the lamp, have been easily discovered. The life preserver can be buckled around the body in five seconds. The lamp begins to shine as soon as the buckles are fastened.

Immense Electrification Project for Berlin

A report was lately presented by the German Minister of Public Works on the proposed plan of adopting electric trains on the extensive systems of the Berlin City, King and suburban railroads. The report was presented as a foundation for a bill which it is hoped to pass. There is all the more likelihood that electric traction will be favored since the present system is now run at a loss of over \$5,000,000 a year. The proposed electric trains will be made up of twelve passenger cars or less, with two locomotives at the ends, without using any motor cars. To carry out the scheme there will be used no less than 557 electric locomotives as well as 690 passenger cars. Power for operating all the lines will come from two new 150,000 horse power steam operated electric stations. The cost of the scheme, not counting the electric stations, will be \$30,000,000. For the electric plants, feeders and substations the estimate is \$22,500,000.

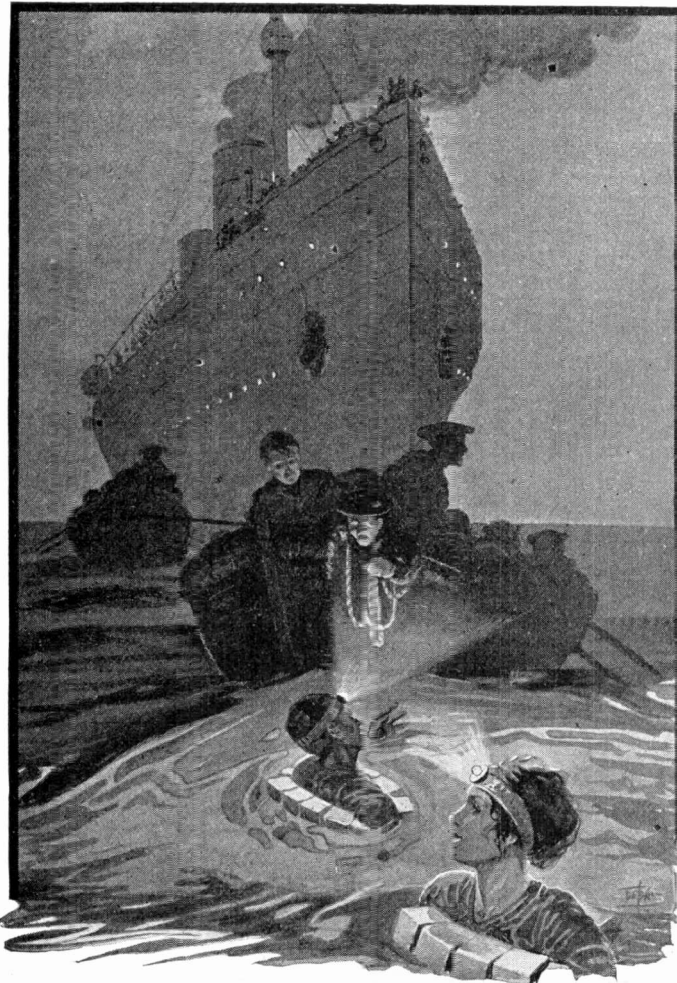

ELECTRIC HEADLIGHTS IN LIFE SAVING

The Carving of Stone Tablets

The exterior of the new central building of the St. Louis Public Library pre-

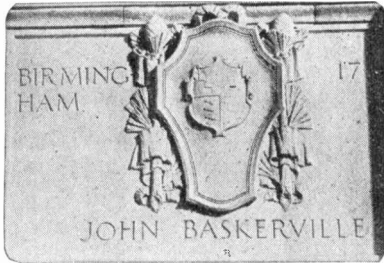

sents some interesting features in the way of ornamental accessories. Beneath each large window of the main story the trade-marks of the old printers are carved upon tablets of stone beginning with Gutenberg, Fust and Schoeffer. William Caxton's trade-mark is found on tablet three, Benjamin Franklin and Christopher Saur occupy tablet 27, John

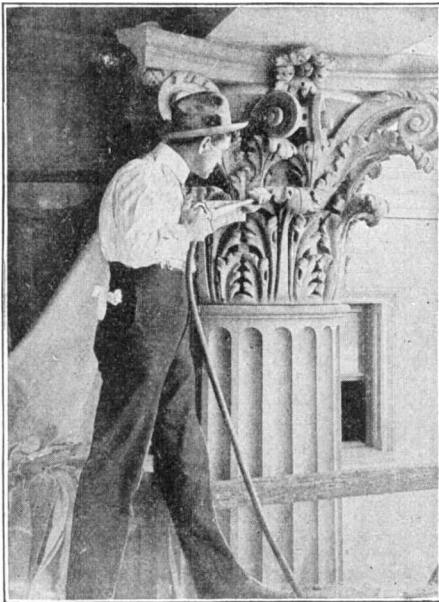

MODERN STONE CARVER AT WORK

Baskerville's mark is on tablet 28, while William Morris is on tablet 30. These old trade-marks represent important historical trade truths and illustrate the progress and gradual evolution of print-

ing as each trade-mark stands for a man who advanced the art of printing.

The carving of the thirty tablets on the St. Louis Public Library, as well as the inscription of the great literary names was done with the three-quarter inch "Keller" pneumatic carving tool, which is used for carving, lettering and chasing on granite, marble and other stone. This tool consumes about six cubic feet of free air per minute. All the work was done with an air compressor electrically driven. The workmen guide the carving tools but the compressed air and electricity do the work.

Apparatus for Breaking In Shoes

We shall doubtless be spared the sometimes painful operation of "breaking in" new shoes. Clarence P. Byrnes, Sewickley, Pa., has received a patent upon a device to do this. A last is inserted in the shoe and fastened to the machine as shown. A small electric motor operates a worm gear which moves an oscillating platform under the shoe, flexing it and giving it a motion somewhat similar to the action in walking.

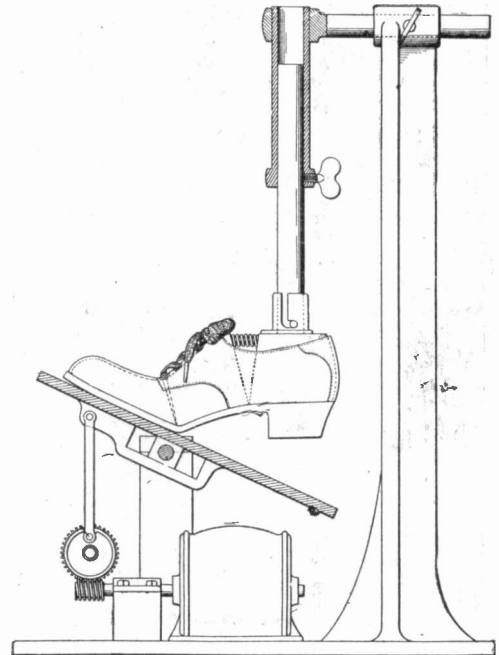

APPARATUS FOR BREAKING IN SHOES

The Cameragraph

The John Crerar Library, Chicago, where many rare and valuable books—too valuable to permit of their removal from the reference rooms—are kept, has placed at the disposal of its patrons the Cameragraph, a new invention for photographing the pages of any book or document.

The equipment, as used at the library, consists of a copyholder, a camera and two mercury arc lamps. The lamps are not required where proper light is available.

The copyholder, which resembles a small stand with a central support, is provided with two rods under which and upon a black background is placed the open book to be copied. The stand top is then shifted into a vertical position facing the camera. Focusing the lenses and arranging for the size of the picture are both accomplished by adjusting with

a crank the copyholder and lenses according to a table referring to scales laid off under each.

The blue-white light of the mercury arc lamps is now turned upon the page, the operator presses the bulb for opening the shutter and the exposure is made upon photographers' print paper instead of upon a plate or film. Within the cameragraph is 100 yards of this print paper. The interior mechanism is so arranged that after the exposure is made the operator turns a crank which draws the printed paper into a developing bath. In 30 seconds the crank is turned in the opposite direction, which removes it from the bath. A lever is now pressed, cutting off the print, which drops into a fixing bath. A plunger is then operated, which pushes the print under the surface of the fixing bath. The cover is now opened, the print taken out and washed in pure water.

Pages are photographed from any book

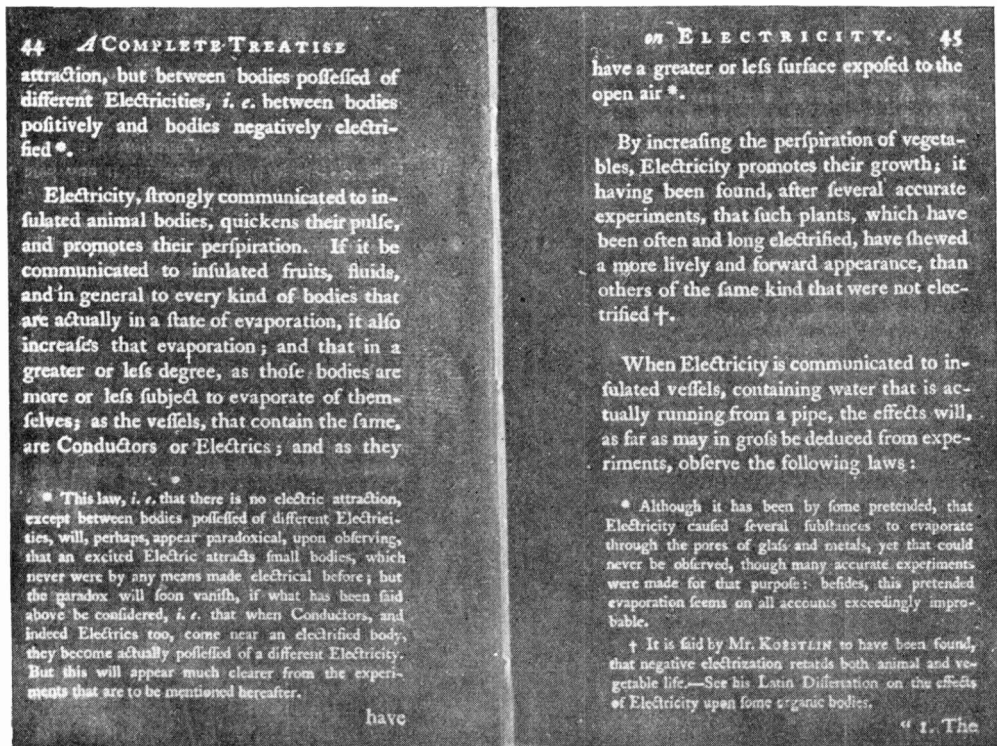

PHOTOGRAPH OF TWO PAGES FROM A BOOK PRINTED IN 1795

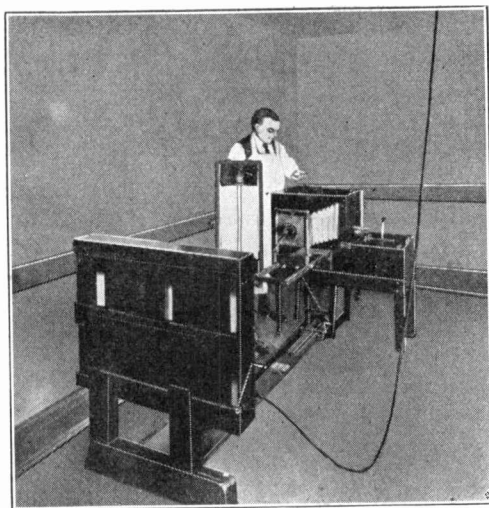

THE CAMERAGRAPH

in the library, a charge of fifteen cents a print being made. The accompanying picture is a photograph from "A Complete Treatise on Electricity. By Tiberius Cuvalls, F. R. S. Printed in London in 1795."

Trinity's Electric Sign

With the development of the institutional features of Trinity Parish House, the Reverend John H. McGann, rector of Trinity Episcopal Church, Chicago, found himself in a peculiar situation. The Parish House, a beautiful Gothic stone structure, stands adjoining Trinity Church on Twenty-sixth Street at Michigan Boulevard, in what was a decade ago the most exclusive residence district in Chicago. Within a few blocks were the mansions of the city's most famous and influential residents and among Trinity's parishioners are many families prominent in the development and fame of Chicago.

At its best, Twenty-sixth Street is poorly illuminated by the few lamp posts that did duty when it was a quiet residence side street. The location of the Parish House almost required a chart and compass after dark, certainly it did not attract or invite anyone to its doorway. Light was needed and the idea of employing an electric sign to mark the

entrance was evolved. The problem of designing and erecting such a sign was submitted to the Federal Sign System (electric) for solution.

Photographs of the building were submitted to architects Lowe and Bollenbacher, who prepared a design, the simple Gothic dignity of which blended in architectural detail with the building, and yet did not lose its force and legibility so necessary in an electric sign. The sign itself was then cast in solid metal from moulds made from the architects' drawings. The faces of the raised Gothic letters and of the cross, which measures two feet high, were made of white porcelain enameled steel. At each end the words "Parish" and "House" in milk white leaded art glass upon an amber background were illuminated from the interior and blend in pleasing harmony with the bronze surface of the sign. Massive bronze chains and square bronze rods support the sign, necessitating the piercing of the stone wall two feet thick for a secure anchorage.

Frosted carbon lamps of 180 candle-power illuminate the letters.

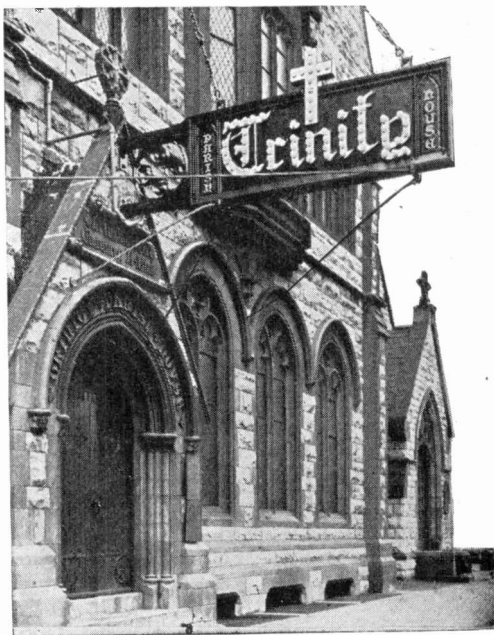

TRINITY'S ELECTRIC SIGN

Electric Parade for the Shriners

Los Angeles provided lavish entertainment for the Shriners, who held their National Conclave in that city last May, and of all the pleasures offered the guests, the electric night parade was undoubtedly the

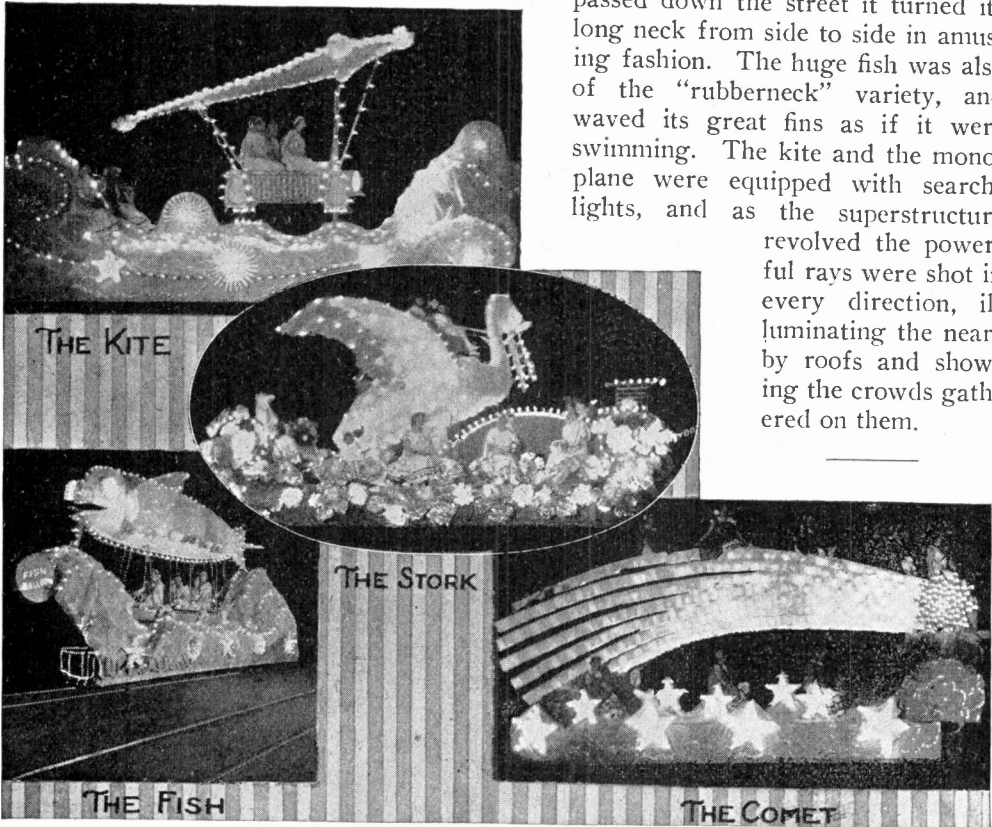

SOME FEATURES OF THE SHRINERS' PARADE IN LOS ANGELES

choicest. Fifteen floats formed the pageant, accompanied by a dozen bands and patrols of gaily uniformed nobles. The floats were built upon flat cars, operated by an overhead trolley, from which they received their light and power. The motormen were concealed under the body of the float in every case, so that the fairy-like creations appeared to move slowly through the streets under their own power. Thousands of incandescent bulbs of all colors were used to outline the designs of the floats, which were strikingly original.

Among the finest of the lot were the Monoplane, Stork, Fish and Comet. The latter was operated by a flasher so that the light in the head of the comet remained steady, while the long tail rippled with flashes of light. The stork was carried on a float full of children, and as it passed down the street it turned its long neck from side to side in amusing fashion. The huge fish was also of the "rubberneck" variety, and waved its great fins as if it were swimming. The kite and the monoplane were equipped with searchlights, and as the superstructure revolved the powerful rays were shot in every direction, illuminating the nearby roofs and showing the crowds gathered on them.

Germany's Long Distance Wireless Operations

One of the newest of the German wireless stations is now opened at Swakopmund, and it has a 300 foot tower for the antenna. It is intended largely for use in signaling to vessels, and is trying some new apparatus in connection with the vessels, one of these being the steamer "Windhuk," and with it the post is sending messages 1200 miles out to sea. The "Admiral" of the East Africa line is also engaged in the experiments.

Electricity in Embroidery Designing

The acquirement of beautiful embroidery work, such as pillow tops, doilies and a score of other fanciful creations in which every woman delights, is not at all difficult with the patterns now purchasable at department and dry goods stores. Indeed, there are small stores entirely devoted to the teaching of art needlework and the sales of supplies needed.

With the growing demand for needlework patterns, it is quite to be expected that the tracing of patterns with carbon paper should be followed by a more rapid and satisfactory method, and in this improvement electricity does the work.

The illustration is a picture taken in one of Chicago's embroidery establishments. The table and arrangement of the electrical equipment were made under the direction of Mrs. Wm. F. Graves, one of the firm, who is seated at the table. From a speed pulley on the electric motor a strong thread drive runs out along the balanced arm, then down to mechanism in the metal enclosure just above the hand of the operator. This mechanism run by the thread drive causes the needle to move up and down many hundred times a minute.

An appropriate design is first made in pencil upon a single sheet of white paper, which is then laid upon the table over frequently as many as 20 sheets of like size. The needle is now directed along the pencil outline, perforating every sheet of paper as it goes, giving 20 similar patterns. These patterns are now used to place the design upon cloth or

canvas by laying one of the sheets upon the canvas and applying a color brush, thus leaving a tracing of needle point lines.

By speeding up the needle it may be made to cut out of stencil board the figures of leaves, fruit, etc. The stencil may then be placed upon canvas or cloth and with brushes the proper colors are applied through the openings in the sten-

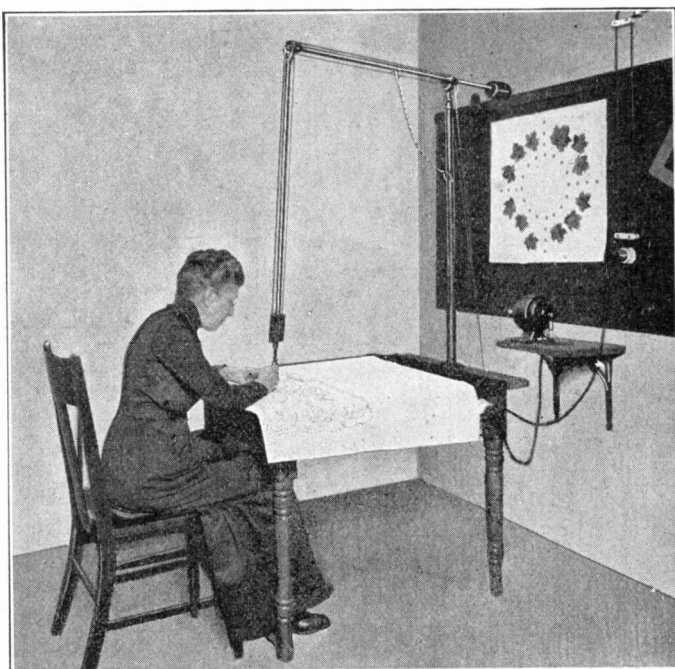

'ELECTRICAL DEVICE FOR MAKING EMBROIDERY PATTERNS.

cil. Upon the wall in the picture is displayed a pillow cover prepared in this way and ready for the design to be worked out with the needle.

Longest Nickel Street Car Ride

Chicago now furnishes the longest five cent car ride in the world—a through route car running from One Hundred and Nineteenth Street, the southern limits of the city, to Howard Avenue in Rogers Park, on the north side, a distance of 28 miles. Any patron who thinks he does not receive the worth of his nickel can transfer and ride a few more miles farther if he so desires.

Promptness of American and English Telephone Operators Compared

We are prone to look upon time, when waiting, as longer than usual and this is nowhere more evident than when using the telephone. Careful observations show the telephone operator to be quick and efficient. At the annual dinner of the London Chamber of Commerce, according to the *London Electrician*, the postmaster-general stated that during the last six months observations were made upon 50,000 telephone calls, and it was found that the time taken for a call, starting from the time of ringing up to the time of the operator answering the call was on the average 5.1 seconds. The time needed for making the whole connection was 28.6 seconds, or less than half a minute. This is to be taken as a good record in the way of quick working.

A similar record covering 55,262 calls as made in Chicago over the lines of the Chicago Telephone Company during 1911 give the average time taken for a call starting from the time of signaling for the operator to the time she answers as 3.1 seconds. The American operator has the best of her English cousin by two seconds. The time necessary for the Chicago operator to make the whole connection, which includes the time up to the moment the subscriber answers, was 25.4 seconds.

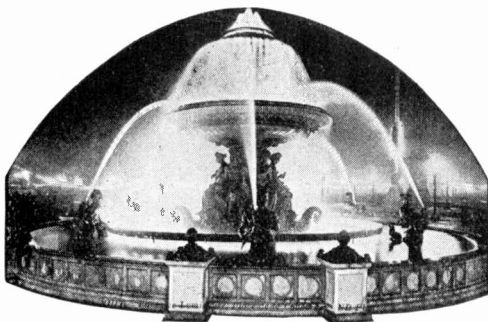

ELECTRIC ILLUMINATIONS OF ONE OF THE LARGE FOUNTAINS IN THE PLACE DE LA CONCORDE, PARIS

X-rays in Testing Precious Stones

A possible use of the X-rays to the jeweller and dealer in precious stones is for detecting imitations. The photograph herewith reproduced shows that a real diamond is practically transparent to the

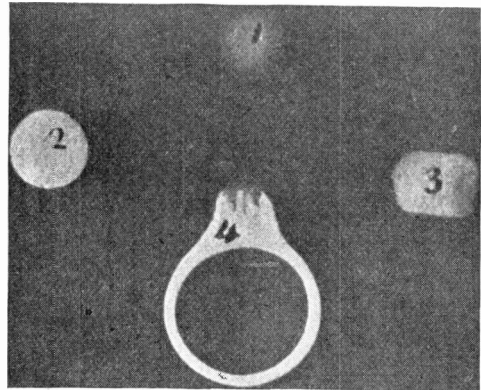

X-RAY PICTURES OF PRECIOUS STONES AND IMITATIONS

ray, giving almost no shadow on the plate, while paste and jet are quite opaque. In the picture (1) is the shadow of the diamond, (2) paste and (3) jet. A real diamond in its setting is shown at (4).

Portable Safety Electric Lantern

The substitution of portable electric battery lamps for fuel burning lamps, requiring oxygen for combustion, in mines and places where inflammable gases exist, will no doubt reduce the loss of life.

The Hubbell safety lamp is one of such designed for this purpose. In case a bulb should be broken and the filament exposed a spring cuts off the current.

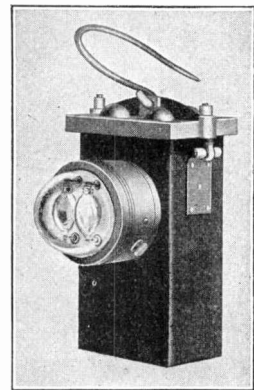

PORTABLE LANTERN

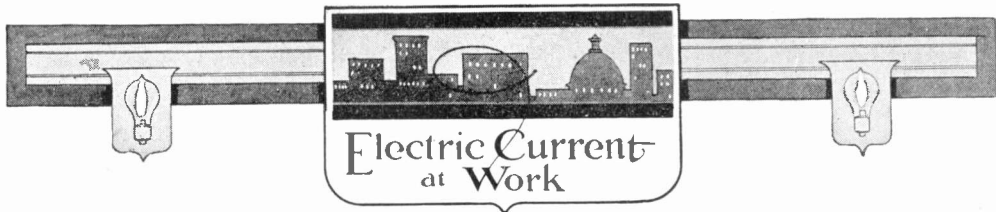

A Swiss Coffee Mill

An electrical firm in Gerlikon, Switzerland, is putting out a small electric coffee mill, very compact in its design and without gears or cumbersome parts. They are constructed in various sizes, from household mills up to large ones for retail groceries, where it is important to be able to grind a large amount of coffee or spices in a short time. The motor is completely incased inside the hopper.

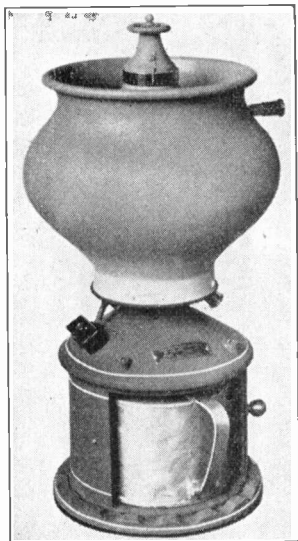

SWISS COFFEE MILL

completely incased inside the hopper.

Three-Wheeled Electric Delivery Wagon

This illustration shows a three-wheeled electric automobile manufactured in Berlin, Germany. The builders desired a machine for light commercial work that

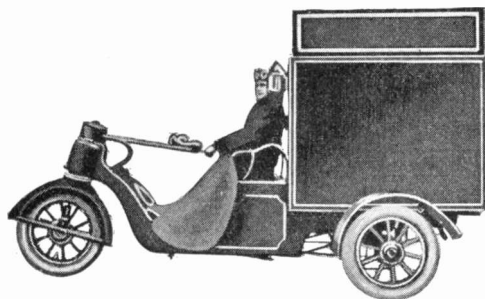

THREE-WHEELED DELIVERY WAGON

would not require too frequent charging of the batteries. The Emilthier will run 90 miles on a single charge and is here shown in service as a delivery wagon.

Treadle Controls the Motor

Every year brings less of hard work to be done in the home because electrical devices are doing the drudgery, and in this direction the sewing machine motor

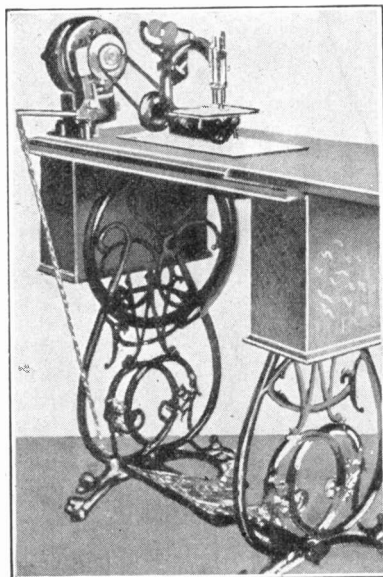

SEWING MACHINE MOTOR CONTROL

has assumed many forms in efforts to rid the task of sewing of the tiresome treading. The Fidelity motor shown in the illustration makes use of the treadle to start, stop and vary the speed. A chain connects the treadle to a lever extending from the motor by which pressure of the foot is transmitted to the motor control. A base plate is permanently attached to the machine table and the motor may be easily detached when desired.

Fire and Burglar Alarm Switch

A switch like this is employed in many fire engine houses to turn on the lights the instant a fire alarm comes in. When connected to the signal apparatus, current is sent through the magnet coils at the first tap of the bell, the locking device releases and the switch closes by the tension of a spring. The switch may also be closed by pressing a push button.

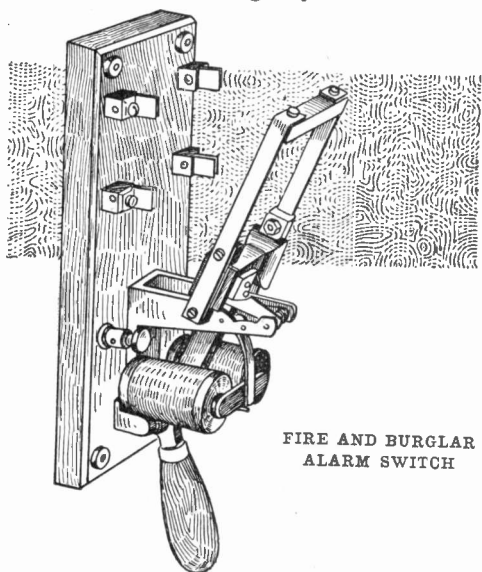

FIRE AND BURGLAR
ALARM SWITCH

As a burglar alarm connected to the windows, doors or to a rug containing contacts on the porch it may be made to light in an instant every room in the house. One cell of battery will operate it. The mechanism is finished in nickel plate and polished brass, and is mounted on black enameled slate.

A "Polychrome" Lamp

The new "polychrome" lamp is a convenient little device which photographers will find of use in the dark room. It is designed by a Parisian, Dr. Vincent, and his aim is to have an electric lamp which is easy to operate by a battery of suitable kind, and will give different colored light such as is needed in various operations. On the box containing the battery is mounted a small lamp and reflector, and in front of the lamp can be

turned a large disk which has four openings. One opening is left free for the white light of the lamp and the rest have color glasses which are easy to put in place or remove. Turning the disk about we first have the usual red dark room light, then a green light which is also used for developing purposes. The fourth hue can be yellow, for working with bromide paper, or other colors can be used such as colored papers of various kinds. A double glass disk is furnished here so that the paper can be put in and so held flat. This is a lamp which the amateur can easily make for himself.



An Approved Lamp Cord Adjuster

The insurance companies, as a rule, look with disfavor on adjusters used with ordinary lamp cord, as it is very easily frayed and worn. The illustration shows one designed to give the proper adjustment without any abrasive movement of the cord and at the same time provides a means for tilting the shade. A piece of fiber carrying a flat spring strip, under which passes the fish cord to a ring, raises and lowers the lamp. From the point where the fish cord is secured to the lamp cord is an extension carrying a piece of slotted metal, which tilts the shade when light is desired at a point not under the lamp.

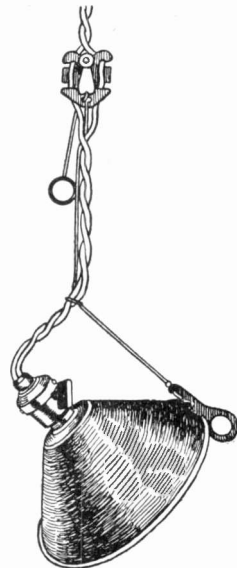

LAMP CORD ADJUSTER

Jeweler's Power Motor

The foot wheel of the jeweler and watch repairman is being replaced by the electric motor. The installation of such a motor is here shown. The first of the three switches on the bench starts and

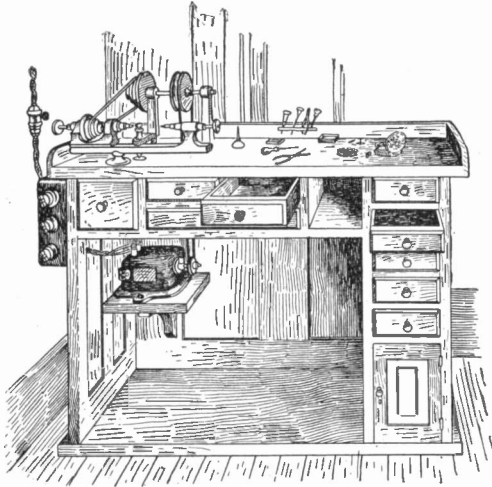

JEWELER'S POWER MOTOR

stops the motor, the second provides for three different speeds and the third instantly reverses the motor, even though it is running.

A Handy Contractor's Hoist

Wherever current is available, an electric hoist is not only economical and easy to operate, but also easy to install. If it is built with convenient handles, two men can readily carry a motor driven hoist ample for raising weights up to

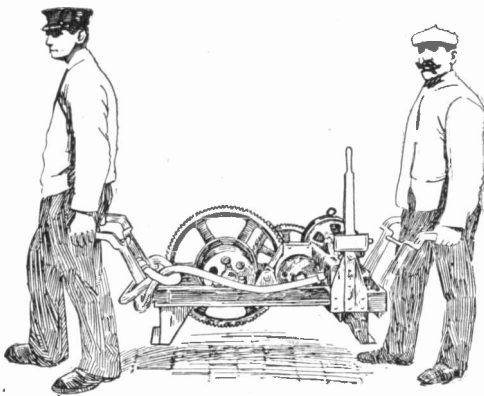

THE HOIST IS EASILY CARRIED BY TWO MEN

450 pounds. When carried to its new position, four screws are quickly inserted to hold it in place and while one man is inserting them, the other can make the needed connection to the source of current. The same portable form is also a great labor saver in elevators, lofts and other buildings where loads occasionally have to be raised at different points in the building.

Reminder Clock

A clock that may be set to ring an electric bell at a given time as a reminder of an engagement to be kept is the subject of a patent issued to G. Schneider, C. W. Rutenbeck, and H. Hill, of Cleveland, Ohio.

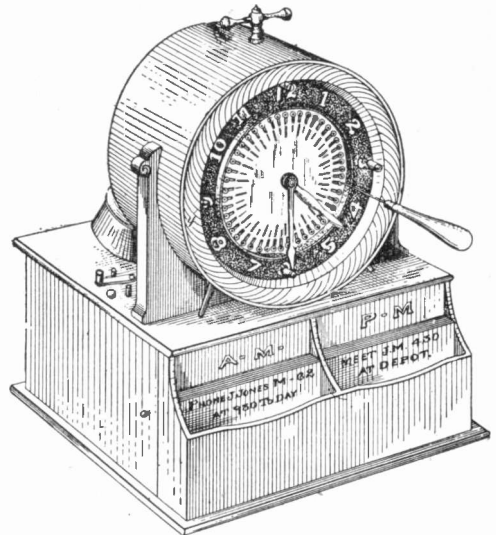

REMINDER CLOCK

Four studs, set at the quarter hours and a part of the bell circuit, are touched by an oval projection on the under side of the minute hand as it moves around the dial. To complete the circuit, however, a stud located where the hour hand will be at the required time must be moved in its slot towards the center. When both hands come in contact with their respective studs the bell rings. Upon the front of the clock base are two card cases for holding cards upon which the names of persons and times of appointments may be written.

Smallest Electric Runabout

What is believed to be the smallest electric car of the runabout type is called the Electra. It weighs only 550 pounds and is equipped with fourteen cells of battery contained under the front bonnet. Power is transmitted from the motor shafts by two standard motorcycle type V belts. Three speeds from 6 to 20 miles an hour are provided for.

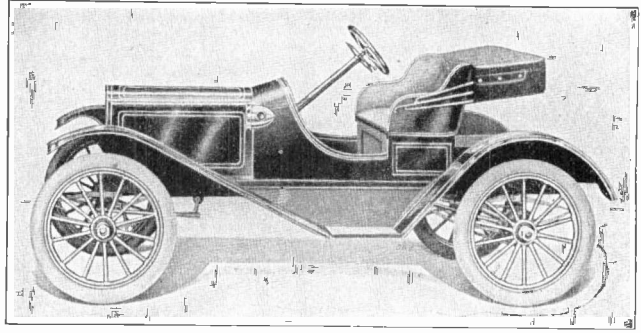

SMALLEST ELECTRIC RUNABOUT

Electric Pencil Holder

A little device is now on the market in the form of a very small battery and lamp with a pencil holder attachment. It per-

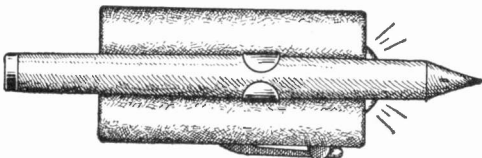

PENCIL HOLDER

mits writing in dark places, the light falling on the paper at the pencil point. It may also be used as an ordinary pocket flashlight.

Return Call Button Hides Call Bell

When the hotel clerk, in accordance with a request for an early morning call, presses a button in the office correspond-

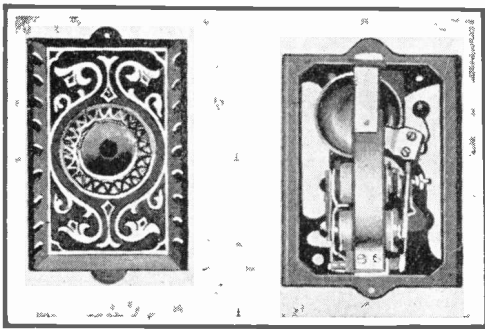

RETURN CALL BELL PUSH BUTTON

ing to the room number and thus rings a bell in the room, he cannot tell whether the call is effective until the return push button is pressed. This button either sounds a buzzer or bell, or throws an annunciator in the hotel office. The room bell and return push button are often widely separated, the latter being not always easy to find. The arrangement illustrated removes the difficulty by being constructed to conceal the call bell behind the return call button and rids a well appointed room of an exposed bell.

Long Cord Turn Down Lamp

An improvement in electric lamps which will be appreciated in sick rooms is the long distance turn down lamp consisting of the usual Hylo lamp, containing a large and small filament either of which may be turned on or off or the lamp turned out by pulling a string. A three strand silk covered extension wire, as long as may be desired, is connected to a pull chain switch, that may be placed at the head of a bed within easy reach. The lamp only need be renewed when burned out.

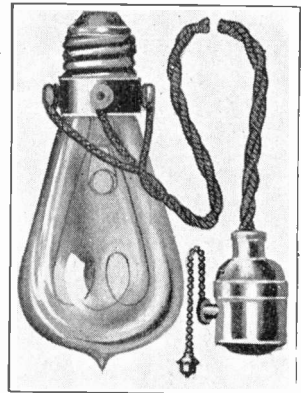

LONG CORD TURN DOWN LAMP

Electrical Men of the Times

SAMUEL GROENENDYKE McMEEN

"He is an optimist, habitual and confirmed, with a big, active brain, a happy smile and a beaming eye." Thus is Samuel G. McMeen characterized by one who has known him for years.

He was born November 28th, 1864, at Eugene, Indiana, and received a college training at Purdue University in his home state. Telephone work received his attention from the beginning of his career, his first service being with the Central Union Telephone Company in 1885. In 1893 he became assistant to the chief engineer and in 1896 assumed the office of chief engineer for the company. A still bigger place sought him when in 1902 he took charge of the telephone central office equipment department of the Western Electric Company.

Two years later the firm of McMeen and Miller of Chicago was formed. Its primary purpose was to give special attention to telephone engineering, but as much railway, light and power work is now being taken care of as work of the other class.

Among the railway projects now directed from Chicago is the Mt. Hood Railway and Power Company, Portland, Oregon, of which Mr. McMeen is president. He is also president of the Columbus Railway & Light Co., which operates the electric railway, lighting and power properties in Columbus, Ohio.

One of the large engineering problems carried through by Mr. McMeen was the

designing and building of the automatic system of the Bay Cities Home Telephone Company in San Francisco, Oakland and Berkeley, Cal. He followed this up by directing the operation of this \$9,000,000 property until upon a paying basis and in this direction Mr. McMeen

combines with his engineering skill unusual executive ability. One of the characteristics tending to his success is his care in laying down a policy and then holding unerringly to it.

Mr. McMeen has been a frequent contributor to the technical press. His most recent addition to engineering literature is a comprehensive and standard work "Telephony," in the preparation of which he collaborated with Mr. Kempster B. Miller.

Among his friends Mr. McMeen has the reputation of adding to his natural abilities as an entertainer, skill in charming the ear with his manipulations of the flute and piano. As to a hobby, he is credited with being a good chemist and physicist, having spent his leisure time in this field from mere love of the subjects. He is a member of the American Institute of Electrical Engineers, Western Society of Engineers, National Electric Light Association, Oregon Society of Engineers and the American Railway Association. He is also a member of the City and the Union League Clubs of Chicago, the Olympic Club, San Francisco, and the Arlington and Commercial Clubs, Portland, Oregon.

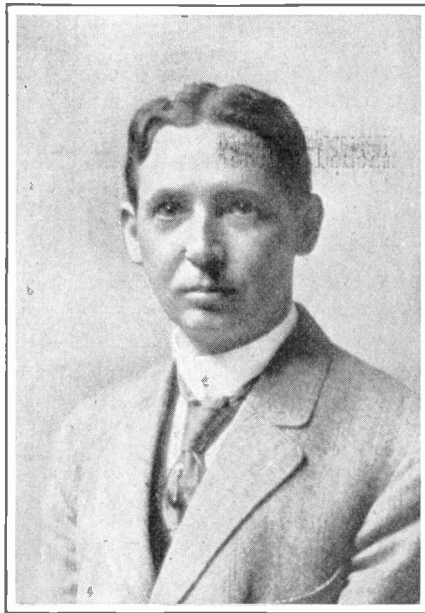



Electrical Interests of Women



EDITED BY GRACE T. HADLEY

Modern House with Vacuum Cleaner

Here is a home equipped with a vacuum cleaner in the basement. A pipe leads to the various floors. Inlet couplings are located at convenient places. One end of the hose is attached to the inlet coupling, the other end to the cleaning tool. A strong suction draws all dust through the cleaning tool, hose and pipe into a sealed dust bucket attached to the machine in the basement. The maid turns a nearby electric switch, which starts the machine in the basement, and this makes a strong suction. She moves the vacuum nozzle rapidly

over the walls, ceilings, woodwork, pictures and all furnishing which need dusting. The dust is not scattered, it is removed and the suction of air conveys it to the basement.

A ten inch vacuum renovator drawn over carpet or rug removes dirt, sand, lint, insects and moth eggs. A felted sweeper is used for hardwood or tile floors. It is so constructed as to pass under furniture, radiators or get into corners. Then the maid turns the electric switch and stops the machine.

It is maintained by some that in designing the house of the future the same consideration will be given to installing pipes for vacuum cleaning as for the present steam and water service.

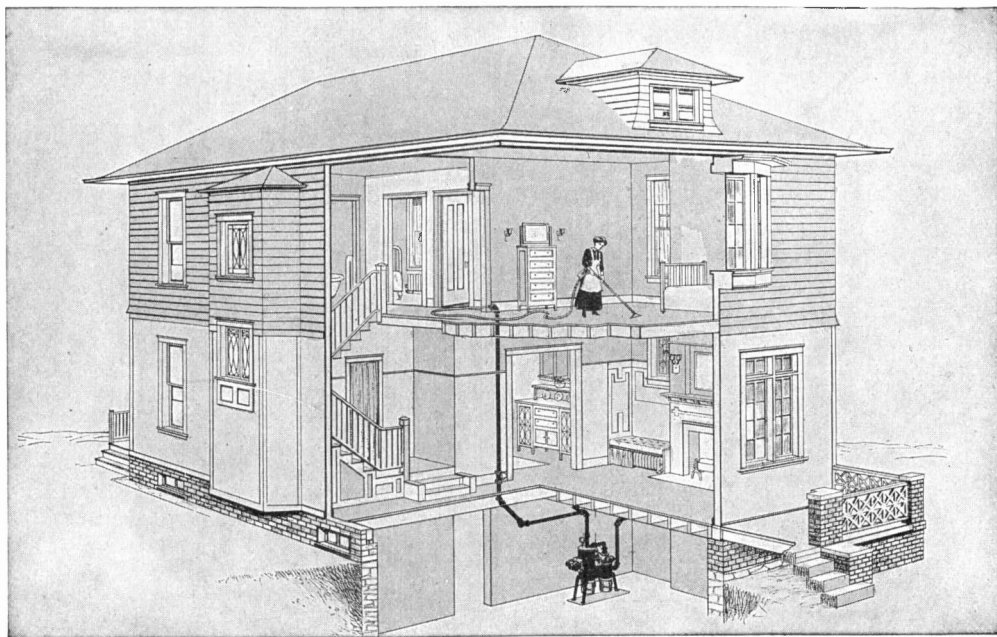

HOUSE PIPED FOR VACUUM CLEANING SYSTEM

Service Kitchen Cabinet

The Service kitchen cabinet is an ideal house combination with several services in one space. The principal features are a kitchen cabinet with flour bin and sifter, package cupboard, a metal covered table top, extension bread board, two electric

to place the stove as far as possible away from the ice box. In this new and handsome addition to the modern kitchen the cooker and the cold chamber are side by side, with the cooker well insulated, of course, with mineral wool and packed with non-conducting and fireproof material. Electricity makes possible this re-

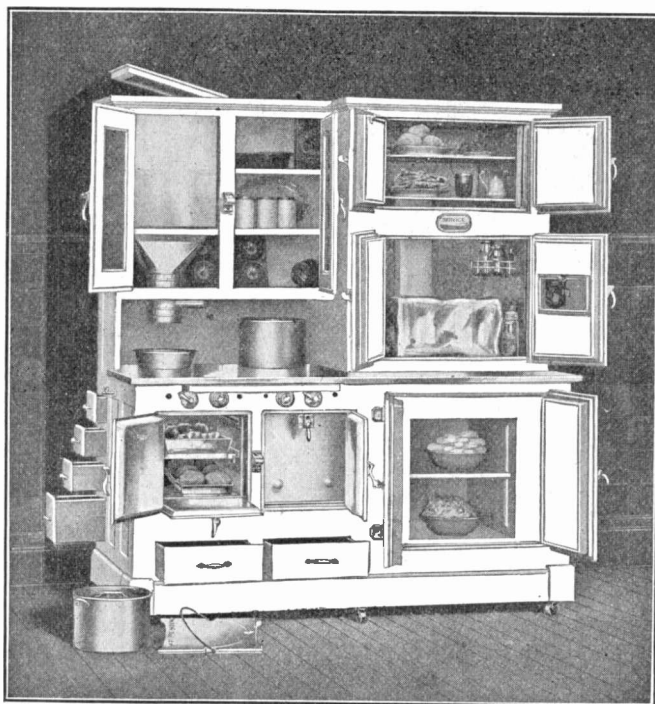

SERVICE ELECTRIC CABINET WHERE COOKER AND REFRIGERATOR ARE BUT A FEW INCHES APART

fireless cookers, storage drawers, ice box with refrigerated food chambers above and below.

The kitchen cabinet is the center of all kitchen activities. It takes the place of the old fashioned kitchen cupboard, flour barrel, pantry and kitchen table, refrigerator and fireless cooker, while occupying very little more space than an ordinary kitchen cabinet. It is a handsome piece of furniture, made of hardwood with white enamel finish.

Formerly it was considered necessary

markable combination of kitchen conveniences.

There is a place for everything. It brings kitchen utensils and provisions together where they may be easily reached as needed. It saves steps and labor. When the pie or bread is ready for the oven, a simple turn of the switch provides the necessary electric heat which is stored and confined in the aluminum lined chamber, thus affording a saving in fuel bills and of time usually deemed necessary for cooking.



PARLOR IN THE HOUSE ELECTRIC

Observations at a Household Show

Two grandmothers were there, one alert and eager eyed, another feeble and filled with the pathos of a passing generation.

"Oh," exclaimed the first, after inspecting an automatic kitchen cabinet, with two fireless cookers, electric stoves, refrigerator and cold food chamber all in one combination, "how I would like to live my life over again and have all these wonderful things to work with!"

"I am glad my time is almost up," remarked the other old lady, "because I don't think I could keep up with all these new fangled things. They are so different from anything I ever had in all my life."

"Keeping up with things electric" is the watchword for the Twentieth Century housekeeper. It is impossible to stand still in a world that moves. A Household Show is an object lesson on a large scale and it is the duty of every housewife to avail herself of such an

opportunity to keep up with things electric.

"How handsome is the House Electric!" was the universal verdict. "It certainly represents the most perfect combination of art, comfort and convenience." It was an admirable demonstration of distribution of lights, small units or large units, how to avoid glare and shadow and how to locate fixtures. In lighting the Twentieth Century home, the problem is not one of quantity, but one of quality; not how to secure enough light, but how to secure the right kind of light in the right place. The primary law of illumination is that glare must be avoided at any cost. Glare strains and blinds the eye. Light should be steady, soft and evenly distributed.

In all large rooms there should be several sources of light. In the parlor of the House Electric there was a central fixture of the indirect system and a floor lamp in gold with colored mosaic shade. It was a work of art in beauty of form

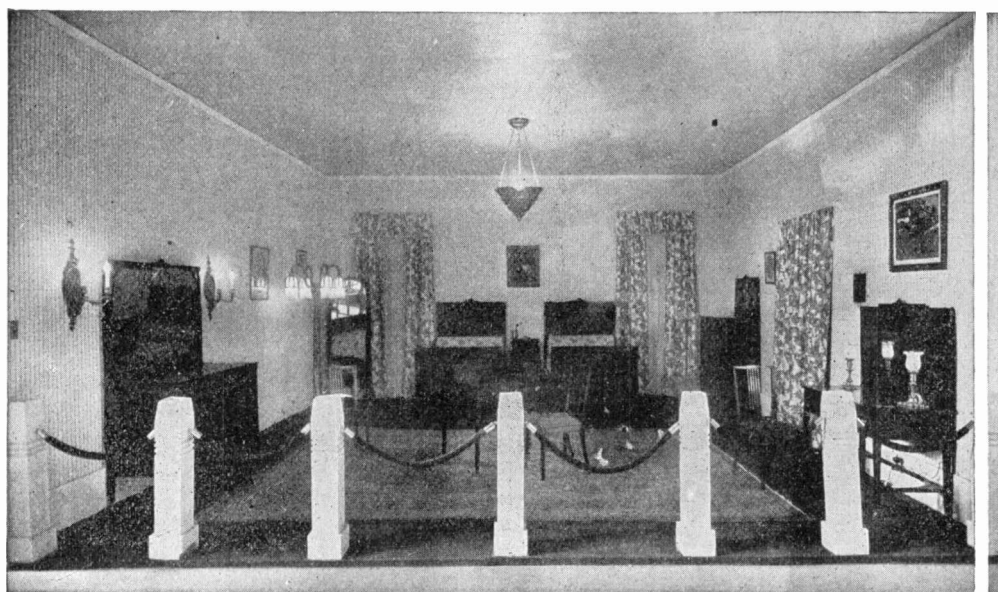

BEDROOM IN THE HOUSE ELECTRIC

and color. In any similar room, a table lamp to give a soft but brilliant light, with a genuine art lamp for another source of illumination, makes a very happy combination.

The library had a central fixture and wall brackets with candle effect. A branching floor standard, table lamp and portable lamp afforded the concentrated light necessary for reading or for library work.

For the dining room of the artistic home, brilliant general illumination is not desirable. A combination of the direct and indirect system, with wall brackets in this model home, answered every decorative and useful purpose. The furniture was carved in French Gothic style.

In the nursery there was a central fixture for general illumination and wall brackets with cunning gnomes as the decorative design, while the bedroom was illuminated by a center fixture of the indirect system, which shed a soft glow from above. A pier glass with four handsome lamps, mirrors with side brackets and a dressing table equipped with lotus bulbs, made an ideal and effective place for the mysteries of milady's toilette.

The Brown bungalow was an artistic setting for electric and combination fixtures and portables in a silver brown finish. Harmony was the keynote throughout. Fixtures, woodwork, drapery and furniture harmonized most beautifully with art glass tones in electric chandelier, wall brackets, table lamp and electric portable lamp.

"I would like to have about six hundred dollars," was the wistful and wishful remark of a housewife, "and just buy all the electric things that I see here. I have a laundry iron, an electric iron, and that has been such a comfort and convenience to me I want everything electric and I shall not be satisfied until I get what I want."

The principle of electric fireless cookers includes metal chambers with metal plugs, the chambers packed in non-conducting and fireproof material, and plates, electrically heated, made of iron for storing up heat, which, thus confined, forms a very economical method of cooking. Meals can be started and left in the cooker while the housewife goes shopping or to church.



THE GARDEN OF EDEN

The Garden of Eden was one of the clever exhibits. It was the historical garden modernized and brought up-to-date with a home laundry machine, designed to do the most laborious work in the household and do it well without fuss or complaint. It represents the open door of Paradise for every descendant of Eve. It may be attached to any electric light fixture by simply screwing in the plug, the same as a lamp is put in. It will wash everything from doll clothes to the finest fabrics. The filmiest lace curtains are washed as successfully as the heaviest spreads or blankets and everything comes out spotlessly clean and sweet.

Color Scheme Cookery

An art teacher who became the proud possessor of an electric chafing dish desired to cook some rhubarb in the spring of the year. She had seen her mother prepare the plant, so she washed and trimmed and cut it into little pieces, just as she had seen her mother do. Then her cooking knowledge failed, and as her mother was many miles away, she resorted to cook books, but not one contained a single line of advice on how to cook rhubarb. Then she proceeded in desperation to put over the plant about a quart of water and some sugar.

The chafing dish then resembled a miniature pond with tiny green fish swimming in it, so the art teacher, who was very, very skilful in art work, cast about for something to fill up the pond. Her eye fell upon several oranges, and she decided that the yellow of the oranges would look well and harmonize with the delicate green of the rhubarb, so two oranges were peeled and dropped in. The pond filled up and the color scheme was so satisfac-

tory that she decided to add part of a grapefruit and bits of lemon. She was now delighted with the hues and colors evolved by the simmering stuff, but somewhat dubious as to how it would taste. She decided to try it on father that night at dinner. With beating heart she waited while he tasted it.

"Why, Jessamine, this is delicious! What is it?"

"Oh!" cried she; "I am so glad you like it. It is a new sauce just concocted."

"I don't remember that your mother ever cooked rhubarb this way," reflected her father.

"Probably not," murmured the artistic cook. "I don't think mother ever made a fizzle of cooking plain rhubarb, and she always cooked it the plain, old fashioned way, but this is——" She searched her mind wildly for the proper term, and then added, breathlessly: "This is color scheme cookery."

The president of a big company bought an electric washing machine recently. When he sent in his check for payment, this note was attached:

"Here you are at last. Do I get a guarantee for one year? Mrs. A— did the washing this morning and I made up all the beds before any one was up in the house."

Illumination of Works of Art

A recent exhibition of paintings of the Grand Canyon of Arizona by Thomas Moran, the famous landscape painter, was an attraction at a Chicago art gallery. The main entrance room in this gallery is lighted by the semi-indirect system. Three handsome Alba bowls each containing three 60-watt tungsten lamps are suspended from the ceiling. The glare of the tungstens is thereby changed to a mild, yellow light perfectly diffused, thus rendering the illumination easy and agreeable to the eyes. All of the wonderful Moran paintings were illuminated by individual reflectors.

Some of the new art on recent exhibition is reminiscent of the Venetian attitude towards color. Arthur G. Dove's paintings are characterized by the artist himself as color experiments rather than a representation of obvious facts.

Cezanne, an artist of sunny France, turned from the rendering of the effects of light to the expression of color as it is affected by light. His hues burn with the absorbed heat and vitalizing glow of sunlight. Matisse, following out this idea, assumed the mental attitude of a primitive man who, impressed with weight or bulk of an object, might try to express those abstract qualities by line and color, and thus some of the present day French art replaces representation of form by rendering its abstraction.

Fortunately, the æsthetic capabilities of the incandescent lamp are by no means exhausted, and the color experiments of the Proportionists or Post-Impressionists, burning with the vitalizing glow of sunlight, may still be enjoyed and mar-

veled at under gray northern skies, if viewed under modern artificial illumination.

The selection of a proper illuminant to obtain true color values is a very important matter in interior lighting, particularly in an art gallery where paintings and water colors, mezzotints in colors and colored etchings are exhibited. The best illumination is that which produces color values nearly akin to diffused sunlight.

The efficiency in light distribution for an interior depends upon three important factors: The distribution of light

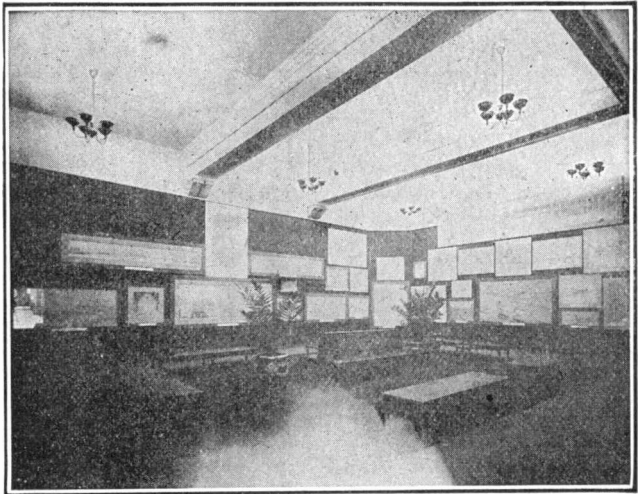

INDIRECT ILLUMINATION IN THE ART INSTITUTE, CHICAGO

emitted by the illuminating unit; the size of the unit and the locations of centers of light distribution.

A gallery in the Art Institute, Chicago, 38 by 50 feet, with ceiling nineteen feet high, has a very interesting installation of indirect illumination. Mr. Burnham, the architect, was very desirous of an illumination that would not give an annoying reflection from the glass at any angle, the pictures being in frames and glazed. In this gallery there is an elimination of individual picture reflectors and every picture is evenly illuminated. The great feature of this system is the elimination of annoying reflection from

pictures either done in oil or under glass on any wall space where the system is used.

From practical installations it has been found that about 3.5 to four foot candles constitute proper intensity for art gallery illumination. This intensity is obtained by carefully developed reflectors placed at the proper distance from ceiling inside of bowls, combined with proper ceiling and wall tints. A light cream is recommended for the ceiling and light tan for the side walls. In looking at a portrait it is desirable to secure a clear picture on the retina of the eye. In order to do this it is necessary to keep the pupil of the eye widely opened and all bright light or luminous sources of light rays must be kept from directly entering the eye. One of the chief advantages of the incandescent lamp is that it admits of pleasing, shaded, decorative effects. The less exposed the lamps are in the direct line of vision, the less amount of actual illumination is required.

What the Motorist Shall Wear

In the luxurious cars which roll through the city streets, one sees delightful visions, for to the woman who is the possessor of an electric vehicle, all fashions are possible. The motor woman who rolls leisurely out to the country club for tea, spins along the boulevard to an afternoon reception or drives through the parks on summer afternoons, must be clad in charming togs much less sportsmanlike than the severe outfit designed for a drive over country roads in the touring car, where clothing is exposed to all kinds of weather and hard usage. There are now so many women who use the electric vehicle for town use, to the exclusion of other modes of locomotion, that particular attention is paid by designers to the raiment appropriate to this service.

The modish coat of white serge or other white wool, to be worn over summer frocks, should be a part of every

woman's motoring outfit. Loose, ample, soft, light of weight and chic of line and detail, it adds much to the attractiveness of the motorist. Ratine is perhaps the most conspicuous of all white materials



ATTRACTIVE MOTOR HAT OF COARSE STRAW,
ORNAMENTED WITH TWO RIBBON ROSES AND
WITH VEIL ATTACHED

for this purpose, and certainly makes the smartest coat possible. The collar and cuffs of such a coat should be detachable, for since it is of necessity easily soiled, and ratine, being all wool, perfectly washable, coming from the tub as good as new, it is not a difficult matter to keep the coat in a perfect condition.

Tussor, pongee or gold cloth are excellent materials for the light weight wraps. There is an elegance about a coat of the heaviest quality of imported tussor, lined with Persian foulard, and decorated with very large buttons of white glass.

The latest bonnets are fashioned in exact reproduction of the fascinating, close fitting bonnets worn by the Holland milk women. Delightfully coquettish, shielding the neck and keeping the hair flat, they are ideal for motoring.

Veils are no longer simply straight and long in form. The newest ones form a



JAUNTY AFTERNOON WRAP, LINED AND TRIMMED WITH STRIPED MATERIAL

Capuchin hood, or a Burnouse loop. They are made of one long strip of mouseline de soie, simply hemstitched at the ends. This season decrees that veils shall match the motor hats.

A folded sunshade that closes and fits inside a hollow handle of turned wood is a necessary accessory for the motor woman. There is a twist of silk to match the parasol attached by a silk rosette. The handle is grained like bamboo and there is a steel stem and a hinge by which it may be adjusted to give shade in any direction.—MRS. A. SHERMAN HITCHCOCK.

The Tragedy of Wash Day

In an eastern magazine, Hashimura Togo, a Japanese boy-of-all-work, confesses his struggles with American house-keeping, especially on wash day. He describes the approach of the Hon. Maggie Kelley, prepared to drown all clothing in suds.

"Togo," she say so, "my duties require it. Cleaning things is a job full of tragedy and other grouch. It would be unnatural to laugh while washing. Clothes is pleasant to wear, but unpleasant to scrub. It is similar with everything. Dishes is joyful to eat from, but nobody admire them when the hour of the dishpan arrive. Nobody love Monday because it is sacred to splash and suds, yet if Monday was abolished by Congress, there would be no beautiful society on Saturday night."

Can't some variety of soap be invented with more poetry in it? Togo wishes to know.

"It could," she say, "but it would probably be useless to take the dirt out."

Possibly if the Hon. Maggie and Togo used an electric washing machine, the job of washing would be less tragic and there would be no necessity for soap with more poetry in it, as all modern electric washing machines are guaranteed to take the dirt out. At the same time, Togo would probably have just as many adventures and funnier, as he seems predestined to make amusement.



Junior Section

Electric Boiler and Turbine Wheel

This boiler is intended for use in connection with a step-down transformer, supplying current at a pressure of 20 volts.

Procure a quart can, such as a corn syrup can. Make a $\frac{1}{4}$ inch hole in the center of the bottom of the can and screw down thereon a little wooden cylinder about one inch in diameter and $1\frac{1}{2}$ inches high.

Make two $\frac{1}{4}$ inch holes in the side of

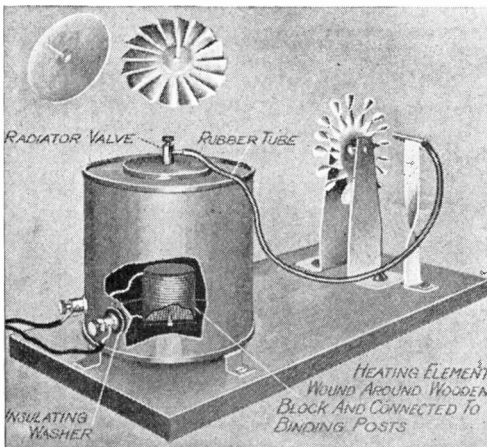

ELECTRIC BOILER AND TURBINE WHEEL

the can about two inches apart, and one inch up from the bottom, through which two binding posts with locknuts are secured. One of these binding posts must be well insulated from the side of the can with little washers of mica, fiber or rubber. One end of the heating element is soldered to the side of the can, and this latter binding post is also soldered to the can so as to be steam tight. The washers on the other binding post will prevent leakage of steam. As long as

the solder is submerged in water, it will not melt, neither will the wooden cylinder burn, around which the heating element is wound. The heating element consists of one foot of No. 28 Calido wire, or about two feet of German silver wire of the same size. A radiator valve is soldered into the can and on this is placed a piece of rubber tubing to carry the steam to the turbine wheel.

It helps materially to wrap the boiler up tightly in two thicknesses of asbestos paper to prevent loss of heat. Fill two-thirds full of water and connect to the 25 volt tap of the transformer. Using warm water to start with, steam will be up in about two minutes. The heat may be regulated by changing to a higher or a lower tap on the transformer. The heating element must always be submerged. Some current undoubtedly short circuits through the water, but enough goes through the heater element to answer the purpose. The resistance of pure water is very high.

To make the turbine, cut a disk of thin, soft tin four inches in diameter. Punch a small hole in the center, and solder on a pin to serve as a shaft. Make sixteen cuts around the periphery of the disk about $1\frac{1}{2}$ inches deep, dividing the disk into approximately equal segments. With a pair of narrow nosed pliers twist each of these segments around at an angle with the surface of the disk. Then with a pair of small, round nosed pliers bend each of the segments into crescent section to form the buckets or blades. A small drop of solder judiciously applied, or a little filing will correct the balance. Mount the wheel upon tin strips as shown.—WESLEY G. PAULSON.

A Miniature Pleasure Park

The miniature pleasure park illustrated here is a remarkable example of mechanical genius, having attracted the attention of thousands of people. This is the work of George W. Haslam, a mechanic of Pittsburgh, Pa., who spent his spare time for about three years in perfecting the many details.

The tiny park is operated by electricity, constructed upon a platform two feet high, fifteen feet long and nine feet wide. The merry-go-round is fitted with

is a group of four, are fashioned after those seen at large pleasure parks, where the occupant does the work by pulling at a rope. The Ferris wheel has six coaches filled with little people, while the roller coaster is equally well patronized by the pleasure seekers who move about in a wonderful way. At the entrance of the vaudeville show are two ballet dancers and two clowns who give a free continuous performance of amusing stunts.

The house has furnishings and electric lights, while on the lawn is a see-saw and lawn swing for the amusement of the



A TINY PARK OPERATED BY ELECTRICITY AND CONTAINED ON A PLATFORM FIFTEEN FEET LONG AND NINE FEET WIDE

animals, such as deer, tigers, elephants, bears, camels, giraffes and horses, on the backs of which ride such comic characters as "Happy Hooligan," "Gloomy Gus," "Foxy Grandpa," "Little Nemo," "Flip," "Dr. Pill," etc., etc. The aerial swing has twelve boats, in which dolls seem to be enjoying themselves immensely. The dancing pavilion has eighteen miniature people, the outside circle of six couples revolving as if in the act of waltzing. The swings, of which there

children. In the rear there is a zoo and a wind mill in operation near by. The park entrance, which faces on a paved and electric-lighted street crowded with pedestrians, autos and delivery wagons, is an elaborate one, being ornamented with tiny electric lights, statuary and fine art paintings. Extending around the entire park, which is encircled with a neat picket fence, is a double track on which electric lighted trolley cars run rapidly, propelled by storage batteries.

The Luminous Goblet.

A pleasing experiment with static electricity may be arranged in the following manner: A large goblet of thin glass is mounted by means of three small screws which clamp the periphery of its base upon a small whirling table, Fig. 1. A single narrow strip of tinfoil one-sixteenth of an inch wide is cemented over the surface of the glass, beginning under the foot of the goblet at the metallic spindle of the whirling table, with which there is electrical contact. The strip proceeds to the edge of the foot of the goblet, which it follows for about an inch, thence in a curved direction across the upper surface of the foot to the stem,

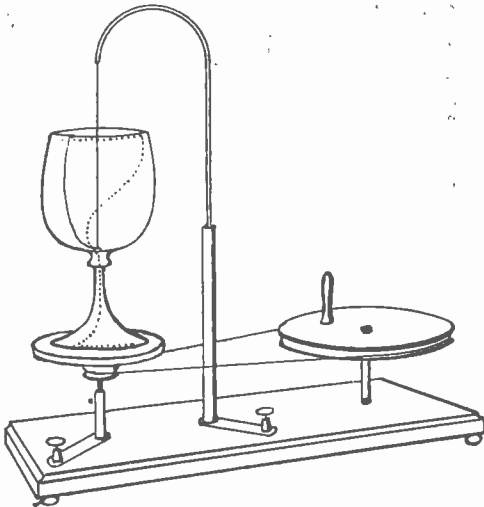

FIG. 1. ELECTRICAL AND ROTATING ATTACHMENTS OF THE LUMINOUS GOBLET

which it ascends vertically, then upward over the surface of the bowl in a sinuous path to the upper rim, after following which along the outside very near the top for about two inches it descends upon the inside and terminates at the bottom. That portion of the foil strip upon the outside of the goblet is divided transversely every eighth of an inch with the point of a sharp penknife. Current from a static machine or induction coil is led into the strip through binding ports connected respectively to the spindle of the whirling table and to the lower end of a

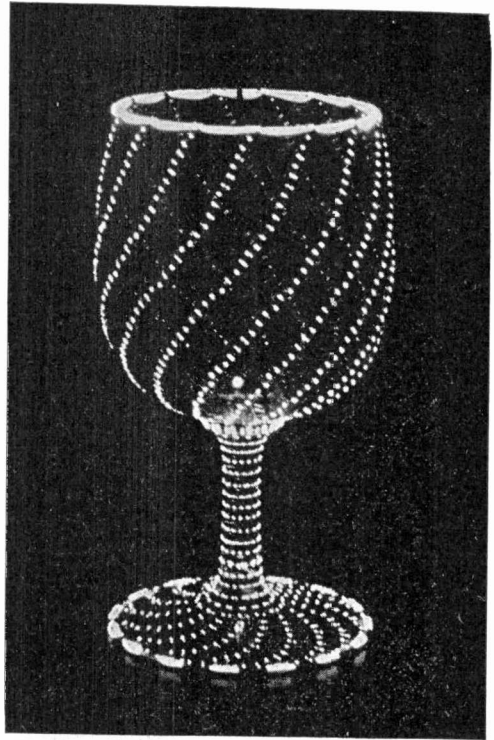

FIG. 2. THE LUMINOUS GOBLET

vertical conducting standard of stiff wire rising from the base of the apparatus at some distance from the goblet. The curved upper end of the standard terminates in a straight, stiff, slender wire, the lower end of which reaches down inside the goblet nearly into contact with the end of the tinfoil strip. A piece of glass tubing covers the lower portion of the standard for insulation. Some idea of the beauty of the experiment when performed in a dark room is obtained from Fig. 2.

Learning the Telegraph Code

Two persons who wish to assist each other in learning the telegraph code will find the apparatus and its arrangement as illustrated in the accompanying cut a great help.

Run an ordinary telephone line between the two houses, mounting the telephone upon the vertical board. In front of the telephone place a sounder and key, connected to battery. When the

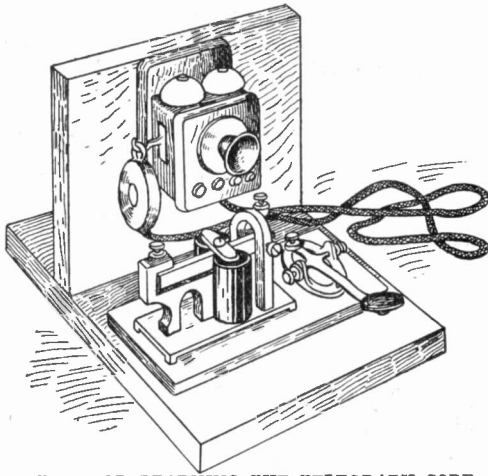

OUTFIT FOR LEARNING THE TELEGRAPH CODE

sounder is operated with the receivers off the hooks, the other party will be able to distinguish the dots and dashes. Besides this either party may talk with and criticize the other without taking the fingers from the key. Many amateurs to whom I have suggested this plan have reported most favorably upon it.

W. F. MURPHY.

An Odd Telegraph Set

An interesting and instructive telegraph set with an unusual key may be made according to the following instruc-

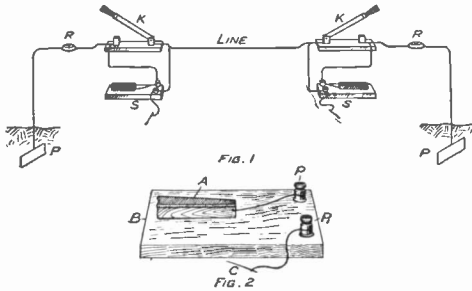

ODD TELEGRAPH SET

tions and will work over short distances. Plates (PP), Fig. 1, one of zinc and the other of carbon, are buried in the ground at the ends of the line as shown. Two small single pole knife switches are placed in the circuit at each station near the telephone transmitters (R). Shunted around each switch is (S) the key board

or "sending key." This consists of a file (A), Fig. 2, mounted upon a base of wood (B) and connected to the finding post (P). The other part of the key consists of a heavy metal pointer fitted into a wooden handle and connected by a flexible wire to the other binding post (P) of the key base. In sending, the sending party opens his switch (K) while the receiving party closes his and listens for dots and dashes in his transmitter, or watch case receiver (R). Dots are made by striking the file with the pointer and dashes are made by drawing the pointer over the file surface.

HARRY E. WAID.

To Make a Small Magneto

The magnetic field is supplied by a permanent magnet of the horseshoe type. The armature consists of eight or ten

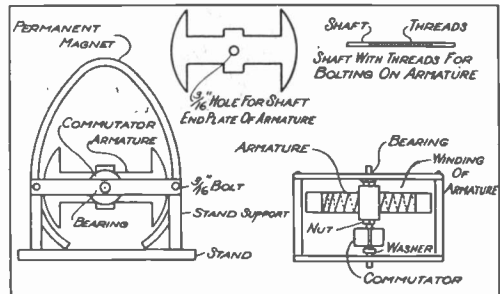

PARTS OF A SMALL MAGNETO

pieces of No. 27 sheet steel, cut as shown. The armature sheets are kept in place on the shaft by a nut which is screwed up firmly on either side before the commutator is put on. The bearings are made of heavy tin, with a $\frac{3}{16}$ inch hole in each end, and one in the center to take the shaft.

Drill four $\frac{3}{16}$ inch holes in the magnet to take the bearings.

The stand consists of four pieces of heavy tin screwed to the magnet on each side with the bearing and is nailed to the wooden base. A threaded shaft carries the armature. The commutator is a wooden cylinder which is forced onto the shaft. It is covered with tinfoil which

must be securely glued on and afterwards cut in two pieces to make the two segments.

Wind the armature with five or six layers of No. 22 magnet wire as shown and glue the two ends one to each segment of the commutator, taking care to

series with each other and with two "Franklin plate" condensers and a Tesla coil. The secondary winding of each of these spark coils contains 100,000 turns of No. 36 enamel magnet wire, or a total length in the two coils of over 23 miles.

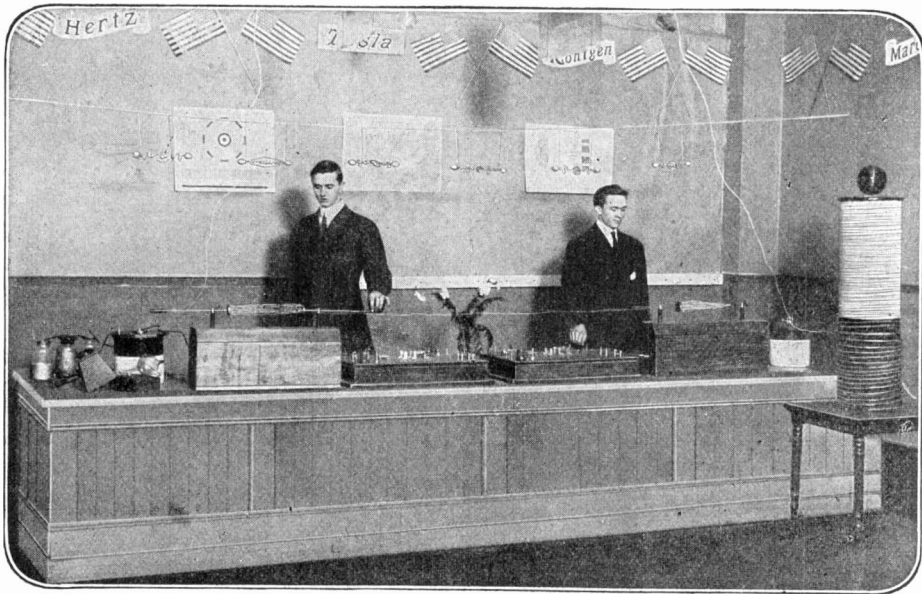

EXPERIMENTING WITH A LARGE INDUCTION COIL

get a good connection. This machine will run at high speed on dry cells.

F. D. HICKMAN.

Experimenting with Large Induction Coils

Ralph W. Smith and Fred D. Schenck, two students in the School of Engineering of Milwaukee, furnished considerable instructive entertainment at a recent public exhibition. The lighting of Geissler tubes and incandescent lamps, without wire connections, held in the field of the Tesla coil, the production of sparks several inches long from the same coil to the extended hand and the operating of the X-rays were some of the interesting experiments performed by the students.

The accompanying illustration shows two sixteen inch spark coils connected in

Flashlight for Signaling

A flashlight having two interchangeable lenses each of a different color is

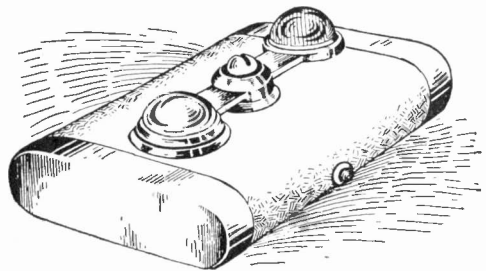

DOUBLE COLOR FLASHLIGHT

the latest novelty in this line upon the market. The lenses are secured at the ends of a metal strap pivoted in the middle so that either lens may be swung over the battery lamps. A flashlight of this type will be found serviceable for the use of Boy Scouts in their field work.

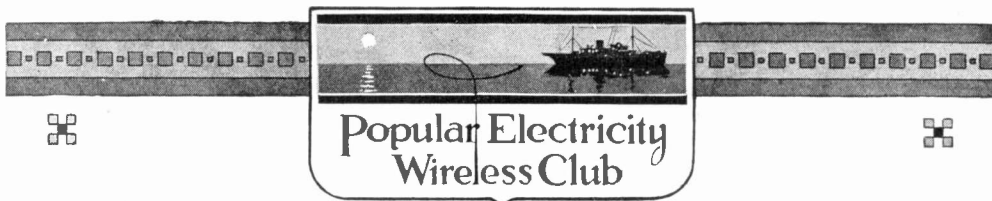

Wireless Outfits for Small Boats

BY RICHARD H. FOSTER.

Owners of small craft and motor boats are fast realizing the value of wireless for communication purposes. Motor boats, house boats and cruisers, especially those in Southern waters, find wireless valuable for receiving storm warnings, as the South is a bad place for storms. Fishing fleets as well as cruising parties find it valuable. Its latest use has been for reporting races from the judges' boat to the club house.

All this use of wireless apparatus has aided in the development of portable out-

received very favorably by motor boat people as its compactness is a valuable feature, and the apparatus is, to a large extent, protected.

The outfit herein described is a simple portable type, suited for small boats, and can be used for communication over three or four miles. Simplicity is an important feature, as the ordinary boat owner is very unfamiliar with wireless and does not care to learn a lot of rules for operating the set. The outfit described has been received very favorably by the motor boat people and is supplied by one firm on its boats. I will now describe the actual construction of an outfit of this type.

All of the apparatus used in this outfit, except the case, is to be purchased from electrical dealers. This method is cheaper in most cases.

In Fig. 1 the top half shows the outside and general appearance of the outfit, with telegraph key and aerial switch mounted on the cover; the lower half shows the interior of the case. In taking the latter photograph the case was inverted so that the receiving apparatus is on the left and sending on the right, instead of vice versa. When the case is placed with the telegraph key in front the receiving apparatus is on the right, and the sending on the left.

The case can be made by any carpenter for seven or eight dollars. It should be constructed of $\frac{1}{2}$ inch oak, the base being of one inch thickness. The case should be stained dark, like mission oak or in imitation mahogany. A dark stain wears better, however. All the dimensions of the case and the scheme for locating the different parts of the apparatus are shown in Fig. 2 and the accompanying keys.

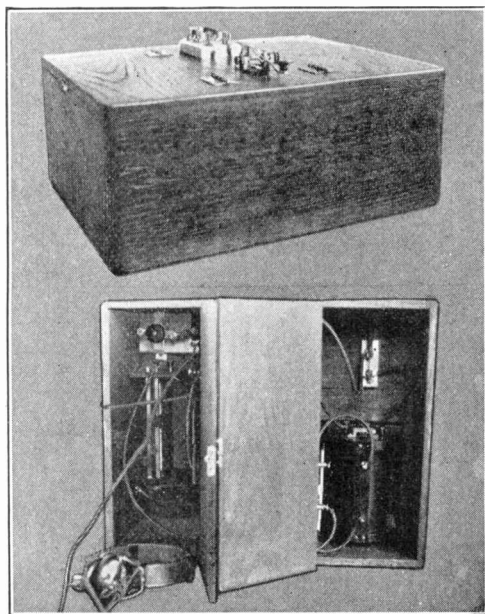
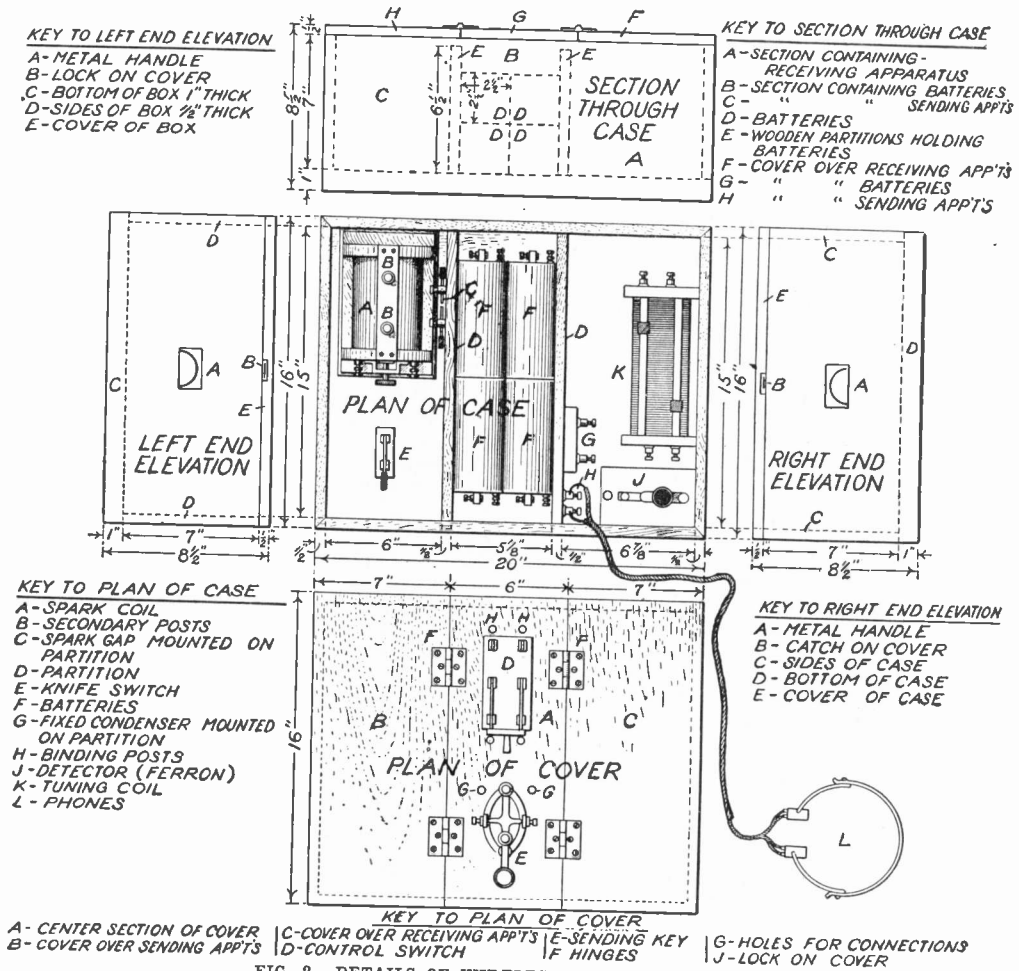

FIG. 1.—WIRELESS OUTFIT FOR SMALL BOATS

fits. Many boats only require the apparatus for a short time, and, moreover, loose apparatus requires too much room. The portable outfit has, therefore, been



The sending apparatus consists of a one inch spark coil, S. P. S. T. knife switch for controlling battery current and a small spark gap. The usual telegraph key is, of course, used. The spark coil is fastened down by wood screws. The switch is fastened the same way. The spark gap posts are removed from the wood base and mounted directly on the partition separating the sending apparatus from the batteries.

The batteries are contained in the next section. Eight square dry batteries are used.

The batteries are in two layers, and are held in place by a forced fit. If the section is exactly 5 1/2 inches in width the batteries can be forced in place and will

not shake or drop out. They can, however, be easily pried out when necessary. This is a simple and reliable arrangement.

The receiving apparatus is contained in the right hand section. The apparatus used consists of a small, double slide tuning coil, fixed condenser, crystal detector, and a pair of 1,000 ohm head phones. The fixed condenser is placed on end and glued to the partition. Two large binding posts for the phones are also mounted on this partition.

The tuning coil is firmly glued on the bottom and one side to the side of the case, as shown. The detector is either glued or fastened with screws. Extra heavy furniture glue should be used, as this will hold the heavy weight easily.

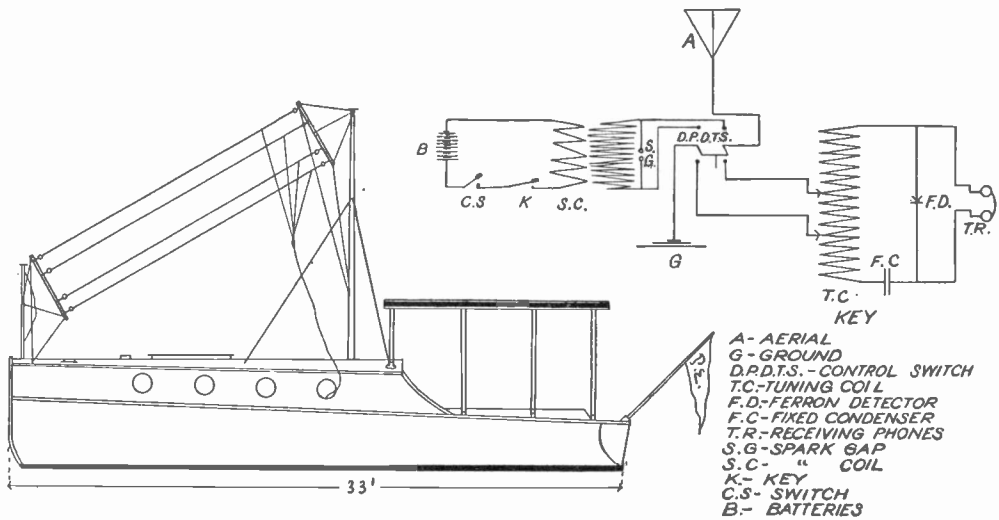

FIG. 3.—THIRTY-THREE FOOT CRUISER EQUIPPED WITH FOUR WIRE AERIAL. DIAGRAM OF CONNECTIONS

The Ferron type of crystal detector is very reliable and has always been used by the writer with good results. This completes the receiving section.

All wiring should be done with extra heavy flexible wire. Automobile primary wire is a good type. It is about $\frac{1}{4}$ inch in diameter and exceedingly flexible. It has good insulating qualities and is proof against rain and damp. The receiving compartment will be found plenty big enough to hold the head phones.

The aerial is the next question. As the outfit was practically designed for marine use, I will only describe the type used on small boats. Fig. 3 shows a 33 foot cruiser equipped with a simple four wire aerial. This is suspended from the signal mast which all boats of this size carry. Spreaders about six feet long of light wood should be used. Porcelain cleat insulators give good results. Ground is made by soldering a wire to the engine frame or bed plate. Boats having a steel hull can use this for the ground connection.

On very small boats a portable aerial mast in sections is handy to use. These can be made of bamboo or ordinary wood. The aerial itself is always constructed practically the same, whether large or small.

The method of connecting the sending and receiving apparatus is illustrated.

This outfit has many novel features worth enumerating. It is portable in every sense of the word, sending apparatus, receiving apparatus, and batteries all being contained in one case; the total size of case being only 20 by 16 by $8\frac{1}{2}$ inches; all apparatus is protected from dirt, dampness, etc.; the outfit can be easily carried around as it weighs about 50 pounds; the aerial and ground leads can be connected and disconnected in a few seconds, and finally the outfit will stand all kinds of rough handling, none of the apparatus being breakable.

All things considered, this outfit is about as compact and useful as could be desired for short distance work.

Capacity of Condensers

The following is a simple formula which may be used to determine the capacity of a condenser for use when building same or tuning up the various circuits:

$$C = \frac{2,248 Ba}{D \times 10 \times 10}$$

In this B is the inductivity of the dielectric between the tinfoil or metal plates of the condenser; a is the area in

square inches of all the dielectric sheets actually between and separating the condenser plates; and D the average thickness of the dielectric sheets in inches.

Below is a list of the most common substances that are used in the manufacture of condensers. The inductivities of these substances are given so that the formula can be worked out:

| Material. | Inductivity B. |
|-----------------------------|----------------|
| Dry Air, Ordinary Pressure. | 1.0000 |
| Manila Paper..... | 1.50 |
| Paraffin, solid..... | 1.68 to 2.32 |

| | |
|------------------------|--------------|
| Resin | 1.77 to 2.55 |
| Ebonite | 2.05 to 3.15 |
| India Rubber..... | 2.22 to 2.49 |
| Gutta Percha..... | 2.46 to 4.20 |
| Shellac | 2.47 to 3.60 |
| Glass | 3 to 3.25 |
| Mica | 4 to 8 |
| Porcelain | 4.38 |
| Light Flint Glass..... | 6.47 |
| Dense Flint Glass..... | 10 |

Where the inductivities vary, it is best to take an average result.

B. FRANCIS DASHIELL.

Regulation of Amateur Radio-Operation

By EUGENE PETERSON

The recent Titanic disaster, and the confusion in wireless operations attendant thereto, brings before the public, more forcibly than before, the need of a means for regulating amateur wireless operations. While it is true that the Titanic's call for help was not interfered with, later efforts to get detailed information made by many Navy and commercial stations were rendered unavailing because of the chaotic state of the ether. The interference in the case of the Titanic is nothing unusual. It has occurred in the case of every shipwreck and will occur again if means are not adopted to regulate radio-operations. Perhaps the reason that even more interference was not experienced in this particular instance is due to the fact that the disaster occurred at about 2 a. m., a time when few amateurs are operating.

From time to time, during the past few years, a bill has been up before the Senate for the regulating of wireless telegraph operations. The suggested remedies have been many and varied—some practical, others not. Before discussing the proposed regulations, however, it might be well to consider the offenders themselves.

Broadly speaking, amateurs may be divided into two classes—a higher and a

lower one. The former may be said to embody for the most part serious minded young men who take up wireless more as a study, good operators usually, and possessing up-to-date and selective apparatus. The other consists of dilettantes who consider wireless as a toy and treat it as such—filling the air with their meaningless dots and dashes for their doubtful pleasure of hearing the crash of their spark; operators who, whether they possess high or low powered apparatus, are aptly classified as "nuisances of the ether."

Interference with Navy and commercial stations by amateurs is mostly unintentional but sometimes malicious. The malicious interference is probably the worst and is either the outcome of a desire to get revenge on the station because of its interference in the amateur's operations, or else of a mischievous spirit. This malicious interference is generally caused by the less intelligent class and is one of most importance. If a bill be passed to regulate wave lengths or power, knowingly or otherwise, it will probably be violated. The imposition of a tax upon wireless stations will merely eliminate the owners of small stations, leaving the bigger plants to interfere, regard-

less of the kind of operator to whom they belong. Obviously the above methods do not suffice in this case.

Only the amateur himself can eliminate this evil under present conditions. He alone knows the station persistently interfering. If he will report that station to the government or commercial stations who are being interfered with, he is working for the best interests of the amateurs as a whole. Some may say that this method is cowardly and altogether childish, but what of the man who interferes? Have you ever considered the harm he does? A false message sent or interference when brought before the public gives a bad name to amateurs as a whole. The unintentional interference is usually caused by the higher class and may be eliminated by restriction of wave lengths. In cities where stations are close together, a great deal of interference is caused by forced oscillations. This cannot be eliminated by restriction of wave lengths, the only remedy being to have no stations of high power near the Navy or commer-

cial stations. A great deal of interference is also experienced because, when a station sends out 99, the amateur cannot understand him.

The most satisfactory way of solving the problem of interference is to require the owner of a station to have a license certifying that he is a capable operator. It may also be used to limit the power, if desired—to perhaps one kilowatt. These examinations for amateur licenses could be held by the government in school buildings, etc.; the expense incurred to be paid by a nominal tax on each amateur and could be held semi-annually. A speed of fifteen words Morse or Continental per minute, and a fair knowledge of adjusting should be required.

I have shown that the amateur's salvation rests mainly with the amateur himself. Any effort to regulate radio-communication without the amateur's support will be worse than useless. The license system is used in England, and no serious interference is encountered. Why not in America?

Questions and Answers in Wireless

By A. B. COLE

DETECTORS (CONTINUED)

The audion consists of an incandescent electric lamp having a platinum

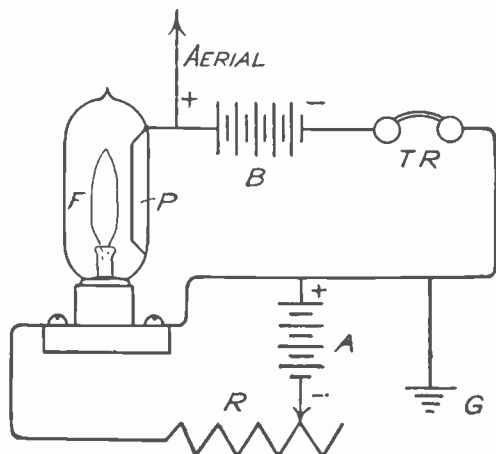

FIG. 20.—CONNECTIONS OF THE AUDION

plate near the filament within the globe. The connections for the audion are shown in Fig. 20, where (P) is the plate, (F) is the filament, (A) is the battery required to heat the filament to incandescence, and (B) is the local battery connected with the telephone receiver and the audion. Battery (A) generally has a voltage of from six to twelve, and (B) has from five to eighteen dry cells so arranged that any number may be connected as desired.

The action of the audion is said to be that of a rectifier and a relay, due to the fact that the platinum plate is comparatively cool, and the filament is hot, which causes a difference in the resistance of the path from the plate to the filament, and vice versa.

In operating the audion, the filament is brought to full brilliancy and the voltage of battery (B) is regulated to a point just below that at which a violet discharge takes place within the bulb.

The main difficulty with the audion of the present day is that the filament has a short life, and the instrument is not equally sensitive at all stages of its life.

61.—*Upon what laws is the action of an electrolytic detector based?*

The present form of electrolytic detector consists of a cup containing a dilute solution (about ten per cent) of sulphuric or nitric acid, having two electrodes immersed in this solution. One of these electrodes is of carbon, platinum, or other inactive substance, and the other consists of a very fine platinum wire (diameter generally about .0001 inch) which can be raised from or lowered into the solution very slowly. This fine platinum wire is known as Wollaston wire, which is coated with silver by the manufacturers. The silver dissolves off when it is immersed in the acid.

A local battery of two dry cells is connected with a potentiometer which is in series with a telephone receiver or

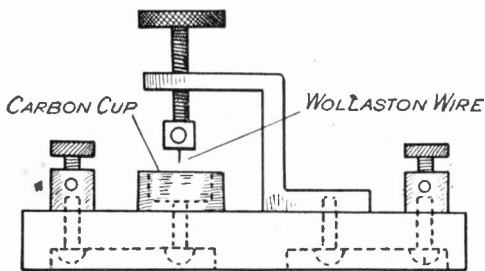

FIG. 21.—ELECTROLYTIC DETECTOR

pair of receivers and the detector, so that the voltage across the detector-telephone circuit may be varied at will. The negative pole of the battery is connected to the Wollaston wire.

The battery current flowing through the telephone receivers and the detector decomposes the water of the acid into

hydrogen and oxygen, the former appearing at the point of the Wollaston wire in the solution of acid. Hydrogen gas is a good electrical insulator, and so long as it remains at this point the battery current cannot flow through the detector. As soon as electrical oscillations flow into the detector, however, their high voltage breaks down the resistance of the hydrogen and allows the battery current to flow through the detector. As soon as the oscillations cease, the hydrogen produced at the point of the Wollaston wire prevent the battery current from passing.

The construction of an electrolytic detector is illustrated in Fig. 21.

Some believe it preferable to connect the positive pole of the battery to the Wollaston wire. In this case oxygen gas is liberated at the point of the wire and acts in the same way as the hydrogen.

In another form of electrolytic detector the Wollaston wire is replaced by a platinum wire sealed in a glass tube and filed off flush with the glass so that only a small surface of platinum is exposed.

The lead peroxide detector is sometimes considered as an electrolytic. This detector consists of a small piece of chemically pure lead peroxide held between one electrode of platinum and one of lead. A fairly heavy pressure is exerted on the peroxide by the electrodes. A local battery in connection with a potentiometer should be used with this detector as with the electrolytic.

The lead peroxide is sometimes taken from the positive plates of storage batteries, but this material is not satisfactory, as the local battery decomposes the water of the acid remaining in the peroxide and causes a hissing sound in the telephone receivers, which prevents the operator hearing signals from a distance. This detector is quite sensitive when the peroxide is pure, but is not, in our opinion, as sensitive as the silicon or the carborundum detector.

Directory of Wireless Clubs

This directory of amateur wireless clubs and associations will be published each month. When a new club is formed the names of the officers, also the street address of the secretary, should be forwarded to us at once. Any changes that should be made in the directory, when designated by an official of a club, will be made in the next issue after receipt of such advice.

Aerogram Club.—J. Stedman, President; A. Hayward Carr, Chairman Board of Directors; Albert S. Hayward, Treasurer; Donald P. Thurston, Secretary; Walter B. Clarke, 17 May St., Newport, R. I., Corresponding Secretary.

Aerograph Club of Richmond, Ind.—H. J. Trueblood, President; Richard Gatzek, Vice President; James Pardieck, 320 South 8th St., Richmond, Ind., Secretary.

Aero Wireless Club.—A. Garland, President; W. Ladley, Vice President; D. Beard, Napa, Calif., Secretary and Treasurer.

Allegheny County (Pa.) Wireless Association.—Arthur O. Davis, President; Theodore D. Richards, Vice President; James Seaman, Leetsdale, Pa., Secretary and Treasurer.

Alpha Wireless Association.—L. L. Martin, President; F. A. Schaeffer, Vice President; G. F. Girton, Box 57, Valparaiso, Ind., Secretary and Treasurer.

Amateur Wireless Association of Schenectady, N. Y.—D. F. Crawford, President; L. Beebe, Vice President; C. Wriglit, Treasurer; L. S. Uphoff, 122 Ave. "B," Schenectady, N. Y., Secretary.

Amateur Wireless Club of Geneva (N. Y.).—H. B. Graves, Jr., President; C. Hartman, Vice President; L. Reid, Treasurer; Benj. Merry, 148 William St., Geneva, N. Y., Secretary.

Berkshire Wireless Club.—Warren A. Ford, President; William Yarkee, Vice President; Charles Hodecker, Treasurer; Jas. H. Ferguson, 18 Dean St., Adams, Mass., Secretary.

Canadian Central Wireless Club.—Alexander Polson, President; Stuart Scorer, Vice President; Benj. Lazarus, P. O. Box 1115, Winnipeg, Manitoba, Can., Secretary and Treasurer.

Cardinal Wireless Club.—K. Walthers, President; F. Dannenfeler, Vice President; Miss A. Peterson, South Division High School, Milwaukee, Wis., Secretary.

Chicago Wireless Association.—John Walters, Jr., President; E. J. Stien, Vice President; C. Stone, Treasurer; F. D. Northland, Secretary; R. P. Bradley, 4418 South Wabash Ave., Chicago, Ill., Corresponding Secretary.

Custer Wireless Club.—Franklin Webber, President; Fred Cross, Vice President; Oakley Ashton, Treasurer; Walter Maynes, 438 Custer Ave., Los Angeles, Cal., Secretary.

Fargo Wireless Association.—Kenneth Hance, President; John Bathrick, Vice President; Earl C. Reineke, 518 9th St., Fargo, N. D., Secretary.

Forest Park School Wireless Club.—W. S. Robinson, Jr., President; William Crawford, R. F. D. No. 1, Springfield, Mass., Secretary.

Frontier Wireless Club.—Chas. B. Coxhead, President; John D. Camp, Vice President; Franklin J. Kidd, Jr., Treasurer; Herbert M. Graves, 458 Potomac Ave., Buffalo, N. Y., Secretary.

Gramercy Wireless Club.—James Platt, President; John Gebhard, Vice President; John Diehl, Treasurer; John Jordan, 219 East 23d St., New York, N. Y., Secretary.

Independent Wireless Transmission Co.—Starr W. Stanyan, 76 Boston Ave., West Medford, Mass., Secretary.

Northwestern Wireless Association of Chicago.—Rolf Rolfson, President; H. Kunde, Treasurer; Edw. G. Egloff, 2729 Noble Ave., Chicago, Ill., Recording Secretary.

Hannibal (Mo.) Amateur Wireless Club.—Charles A. Cruickshank, President; J. C. Rowland, Vice President; William Youse, Treasurer; G. G. Owens, 1306 Hill St., Hannibal, Mo., Secretary.

Haverhill (Mass.) Wireless Association.—Riedel G. Sprague, President; Charles Farrington, Vice President; Leon R. Westbrook, Haverhill, Mass., Secretary and Treasurer.

Independence Wireless Association.—Boyce Miller, President; Ralph Elliott, Secretary; Joseph Mahan, 214 South Sixth St., Independence, Kan., Vice President.

Jonesville Wireless Association.—Frederic Wetmore, President; Webb Virmylla, Vice President; Richard Hawkins, Treasurer; Merritt Green, Lock Box 82, Jonesville, Mich., Secretary.

Lake View Wireless Club.—E. M. Fickett, President; R. Ludwig, Treasurer; R. F. Becker, 1439 Winona Ave., Chicago, Ill., Secretary.

Long Beach Radio Research Club.—Bernard Williams, 555 E. Seaside Blvd., Long Beach, Calif., Secretary.

Manchester, (N. H.) Radio Club.—Homer B. Lincoln, President; Clarence Campbell, Vice President; Elmer Cutts, Treasurer; Earle Freeman, 759 Pine St., Manchester, N. H., Secretary.

New Haven Wireless Association.—Roy E. Wilmot, President; Arthur P. Seeley, Vice President; Russell O'Connor, 27 Vernon St., New Haven, Conn., Secretary and Treasurer.

Oakland Wireless Club.—H. Montag, President; W. L. Walker, Treasurer; W. K. Sibbert, 916 Chester St., Oakland, Calif., Secretary.

Oregon State Wireless Association.—Charles Austin, President; Joyce Kelly, Recording Secretary; Edward Murray, Sergeant-at-Arms; Clarence Bischoff, Lents, Ore., Treasurer and Corresponding Secretary.

Peterboro Wireless Club.—G. B. Powell, President; C. V. Miller, Vice President; E. W. Oke, 263 Engleburn Ave., Peterboro, Ontario, Can., Secretary and Treasurer.

Plaza Wireless Club.—Paul Elliott, President; Myron Hanover, 150 E. 66th St., New York, N. Y., Secretary and Treasurer.

Rockland County (N. Y.) Wireless Association.—W. F. Crosby, President; Tracey Sherman, Vice President; Marquis Bryant, Secretary; Erskine Van Houten, 24 De Pew Ave., Nyack, N. Y., Corresponding Secretary.

Roslindale (Mass.) Wireless Association.—O. Gilus, President; E. T. McKay, Treasurer; Fred C. Fruth, 962 South St., Roslindale, Mass., Secretary.

Sacramento Wireless Signal Club.—E. Rackliff, President; J. Murray, Vice President; G. Banvard, Treasurer; W. E. Totten, 1524 "M" St., Sacramento, Calif., Secretary.

Santa Cruz Wireless Association.—Orville Johnson, President; Harold E. Senter, 184 Walnut Ave., Santa Cruz, Calif., Secretary and Treasurer.

Southeastern Indiana Wireless Association.—R. F. Vanter, President; D. C. Cox, Vice President and Treasurer; H. Hitz, Fairmont, Madison, Ind., Corresponding Secretary.

Southern Wireless Association.—B. Oppenheim, President; P. Gernsbacher, 1435 Henry Clay Ave., New Orleans, La., Secretary and Treasurer.

Springfield (Mass.) Wireless Association.—A. C. Gravel, President; C. K. Seely, Vice President and Treasurer; D. W. Martenson, Secretary; Club Rooms, 323 King St., Springfield, Mass.

Spring Hill Amateur Wireless Association.—R. D. Thiery, President; H. P. Hood, 2nd, 2 Benton Road, Somerville, Mass., Secretary and Treasurer.

St. Paul Wireless Club.—Thos. Taylor, President; L. R. Moore, Vice President; E. C. Estes, Treasurer; R. H. Milton, 217 Dayton Ave., St. Paul, Minn., Secretary.

Tri-State Wireless Association.—C. B. DeLahunt, President; O. F. Lyons, Vice President; T. J. M. Daly, Treasurer; C. J. Cowan, Memphis, Tenn., Secretary.

Waterbury Wireless Association.—Weston Jenks, President; Alfred Upham, Treasurer; H. M. Rogers, Jr., 26 Linden St., Waterbury, Conn., Secretary.

Wireless Association of British Columbia.—Clifford C. Watson, President; J. Arnott, Vice President; E. Kelly, Treasurer; H. J. Bethel, 300 Fourteenth Ave. E., Vancouver, B. C., Corresponding Secretary.

Wireless Association of Canada.—W. Fowler, President; E. G. Lunn, Vice President; W. C. Schuur, Secretary and Treasurer.

Wireless Association of Montana.—Roy Tysel, President; Elliot Gillie, Vice President; Harold Satter, 309 South Ohio St., Butte, Mont., Secretary.

Wireless Club of Baltimore.—Harry Richards, President; William Pules, Vice President; Curtis Garret, Treasurer; Winters Jones, 728 North Monroe St., Baltimore, Md., Secretary.

Wireless Club of the Shortridge High School.—Robert C. Schimmel, 2220 N. Penn St., Indianapolis, Ind., President; George R. Popp, Vice President; Bayard Brill, Treasurer; Oliver Hamilton, Secretary.



For Practical Electrical Workers

Fishing Wire and Its Manipulation

Fishing wire is tempered steel wire of rectangular cross section, Fig. 1. It is a grade of wire that is used sometimes for corset steels and can be obtained at corset factories and at electrical supply

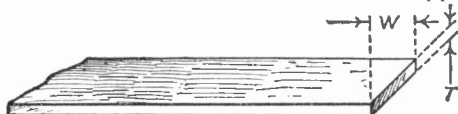

FIG. 1. STEEL FISHING WIRE

houses. A fishing wire is termed a "snake" by some wiremen. The accompanying table gives dimensions, weight and approximate cost. That a fishing

| W Width, Inch. | T Thickness, Inch. | Weight Per 100 Feet. | Approximate Price, Per pound. Per foot. |
|----------------------|--------------------------|----------------------------|---|
| 3/8 | .015 | 11 oz. | \$90.00 \$0.62 |
| 3/8 | .030 | 1 lb. 4 oz. | 60.00 0.75 |
| 3/16 | .030 | 1 lb. 14 oz. | 60.00 1.13 |
| 3/8 | .030 | 2 lb. 8 oz. | 60.00 1.50 |
| 5/16 | .035 | 3 lb. 8 oz. | 55.00 1.93 |
| 3/8 | .035 | 3 lb. 12 oz. | 55.00 2.06 |

wire may slide readily past small obstructions, hooks should be bent in its ends as shown in Fig. 2. Before bending, the

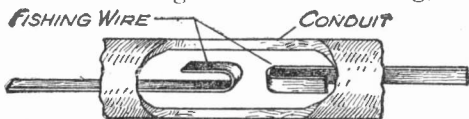

FIG. 2. HOOKING THE ENDS OF FISHING WIRE

ends should be annealed by heating them to a red heat and allowing them to cool slowly. A small brass knob riveted to the end of a fishing wire, Fig. 3, is better than a hook, as regards the ease with which the wire can be pushed through conduit. Where fishing is difficult, it is sometimes necessary to push two "snakes," with hook ends, into the wire way, one from each of the outlets, as shown in Fig. 2. The wires must be worked back and forth and twisted

around until the two hooked ends engage. Then one wire can be pulled into the duct with the other. The Swan fishing wire for conduit, shown in Fig. 4,

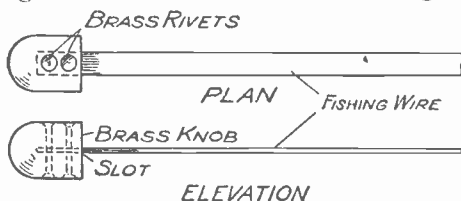

FIG. 3. FISHING WIRE WITH KNOBBED ENDS

has a patented coupling on one end and a patented "drawing-in-eye" on the other, which can be made to engage within the conduit, as shown in the illustration.

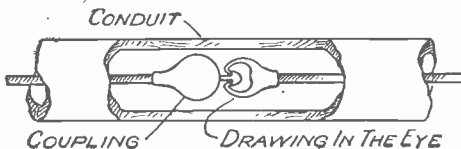

FIG. 4. THE SWAN FISHING WIRE

When fishing from two ends, as in Fig. 2, it is often advisable to tie a loop, possibly a foot long, of cord (Fig. 5), in the hook of one wire and bend down the hook. The other wire has an open hook which can be made to engage in the

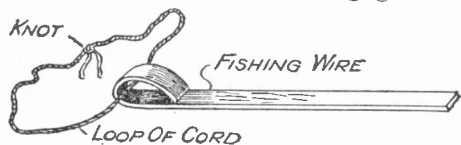

FIG. 5. USE OF THE CORD LOOP

cord loop quite readily. It has been found that a fish wire will go through conduit more readily if prepared as in Fig. 6, by loosely winding the end with small wire or cord, so that the wire or cord cannot pull off. Oiling a fish wire or attaching an oil soaked piece of waste to its end often helps in fishing conduit.

Chain is used for vertical fishing. A small chain can be made to drop down a vertical wire way with little difficulty.

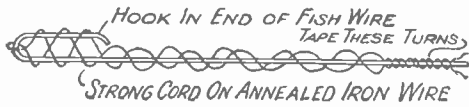

FIG. 6. TO MAKE THE WIRE DRAW EASILY

The noise made by the lower end of a chain will disclose its location almost exactly.

Galvanized steel wire can be used for fishing. Any size from No. 14 up to possibly No. 6, as occasion demands, may be utilized, and in nearly every case the flat steel ribbon wire will be found preferable.—HENRY CLOWS.

Water Pressure Signal

An ingenious attachment to a pressure gauge gives notice of abnormal pressures on an automatic sprinkler system, in case the steam regulating device on the fire pump gets out of order.

A piece of stiff brass wire in the shape of a hook is attached near the center of the indicator hand of the pressure gauge and a small metal cup containing mercury is attached to the face of the dial at the edge, just so the hand is not inter-

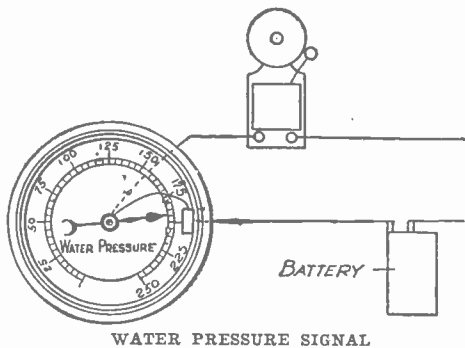

ferred with. The wire is so arranged that it moves over the dial with the hand. When an excessive pressure is registered the end dips into the mercury and in so doing completes an electric circuit which sounds a large gong, notifying the engineer of the trouble.

Adjustable Water Rheostat.

An ordinary wooden pail will serve very readily in the construction of a variable water rheostat. The inside of the pail should be thoroughly covered with hot paraffin and a wooden cover provided. In the bottom of the pail place a circular piece of copper four inches in diameter and hold this down upon a sheet of rubber by a small brass bolt. Solder the head of the bolt to the copper and

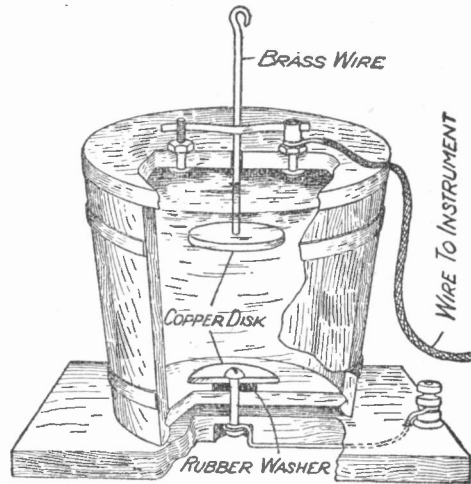

ADJUSTABLE WATER RHEOSTAT

lead a wire out to a binding post as shown. For the upper plate solder a two inch copper plate to a No. 8 copper wire of such length that when the upper disk is close to the lower disk, four or five inches of the wire will project through the pail's cover. To hold the brass wire at any position desired, solder a flat strip of spring brass to the binding post on the cover in such a position that it will press against the copper rod when swung against it and over a second projecting bolt.

This rheostat is adjustable within wide limits. Pure water has considerable resistance, but by adding a little sulphuric acid, or else common salt, this resistance is decreased. By careful adding of acid or salt and at the same time adjusting the disk a very accurate control of the current may be obtained.

A New Electric Furnace

Tungsten is a metal which is melted with the greatest difficulty. Owing to its high melting point it has displaced many metals in various industrial applications. It is now the most desirable lamp filament material known. It is very

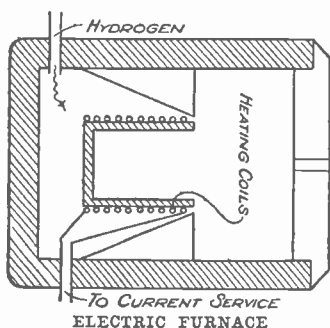

rapidly displacing platinum from use on sparking points of induction coil vibrators and promises to be used extensively in spark plugs.

Besides many other applications, tungsten is found to be a very desirable material for electric furnaces of the resistance type. The resistance furnace consists merely of a metal wire surrounded by refractory substances. It is more compact and therefore is more popular than the arc furnace in small sizes and where a temperature as high as the arc furnace is not desired.

Electric current when passed through a metal produces heat which is radiated or conducted away by the surrounding material. Of course, the highest possible temperature attainable depends upon the melting point of the resistance wire used. Platinum, which was formerly very desirable as a resistance material for this type of furnace, melts at 3200 degrees Fahrenheit, while tungsten melts at a temperature above 5000 degrees Fahrenheit. The latter metal, however, has one drawback, because it unites with the oxygen in the air at a temperature much below the melting point of platinum. This is overcome by not permitting air to come in contact with the metal. The furnace is sometimes made by using a

tube of the metal surrounded inside and outside by porcelain, but a later development is shown in the sketch. All parts are of porcelain or some highly refractory substance excepting the heating coil, which is of tungsten wire. Hydrogen gas, which has no effect on tungsten, at high temperatures is admitted through the tube in the bottom of the furnace and burns at the top of the inner vessel. A large current is sent through the coil and a very high temperature is obtained. With this furnace platinum is easily melted.

Brine Saving Device

A very simple but effective device is used in the engine room of a Chicago department store for saving the brine on a refrigerating system, which leaks out through the piston rod packing of

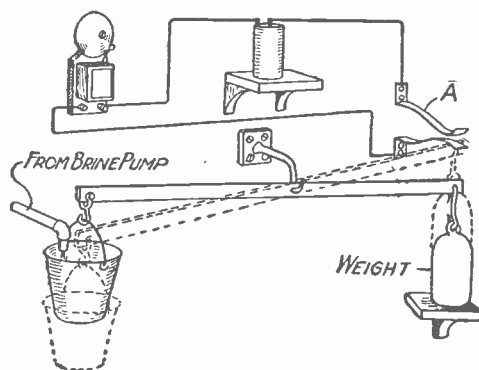

BRINE SAVING DEVICE

the pumps. The brine is pocketed at the pump and run through a small pipe into a pail which is attached to one end of a lever bar, supported in the center and with a weight at the other end not quite so heavy as a pail of brine. When full, the pail trips the lever, the apparatus takes the position shown by the dotted lines in the diagram, and in so doing presses the brass contact points together at (A), thus closing an electric circuit and ringing a bell. An attendant then empties the brine back into the system and the pail is replaced.

W. R. REYNOLDS

A Fixture Straightener.

Few outlets in ceilings are straight. Time is wasted in trying to make the

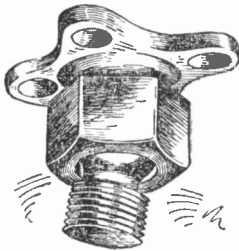

FIXTURE STRAIGHTENER

box straight and often it is loosened and weakened by attempting to do so.

The Federal fixture straightener overcomes these troubles. It is a ball and socket joint which can

be tightened or loosened by turning the nut which contains the socket. Once the fixture is plumb the nut is tightened.

Emergency Torch for Electricians

The following device, made at the expense of a few cents, will enable wiremen and others to solder all ordinary sized wires usually met with in practice and besides can be used for a variety of other purposes. An ordinary wax candle (A) is wrapped tightly with two or three thicknesses of what is known as build-

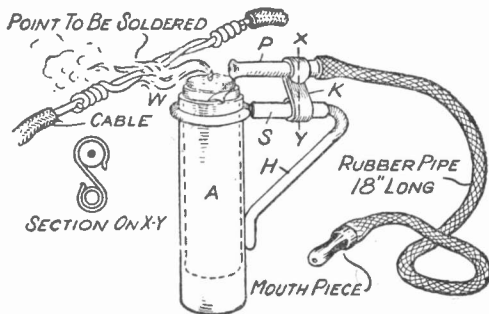

EMERGENCY TORCH

ers' paper and fits snugly into an outer metallic tube. This latter is easily made from a sheet of tinware by lapping and soldering the edges. A piece of No. 6 copper wire (H) is soldered at top and bottom to the outer tube. A smooth brass tube (S) fits over the wire tightly and is fastened to same. On this the clip (K), though tightly set, will turn to right or left of the flame, or slide lat-

erally as desired. The nozzle (P) is made from a two inch piece of common clay pipe and has on its outer end a rubber pipe as shown. When in action the molten wax is held in place by the paper cartridge surrounding it, the presence of which and its quality having much to do with the efficiency of the torch. As these burn out they are fed upward through the hollow tube by pressure from below.

-T. E. HEYS.

Apparatus for Demagnetizing a Watch

Very often those who work around electrical machinery find that their watches become "magnetized." The watch or any other article can be easily demagnetized by the very simple method shown here. Take a coil of wire such as

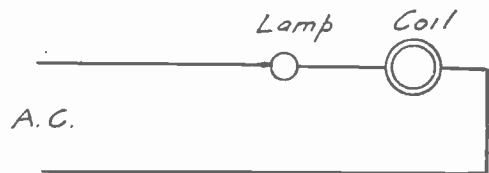

A.C.

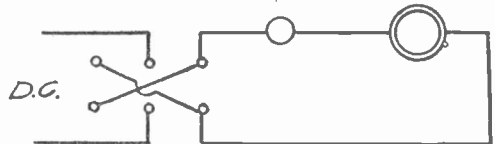

D.C.

CIRCUITS FOR WATCH DEMAGNETIZING

an old transformer coil and connect it in series with any current limiting apparatus such as an incandescent lamp. Now connect the terminals to a plug and insert the latter into any lamp socket on an alternating current lighting circuit. The magnetic field inside the coil reverses many times per second. Place the watch or any other article to be demagnetized in the coil and pull it away in the direction of the axis of the coil. Repeat the operation.

If alternating current is not at hand a reversing switch, made of a double pole double throw switch, can be used. When the reversing switch is operated rapidly the same result can be obtained, if a battery of a few volts is used.

A Galvanic Packing

Even the field of steam packings has now been invaded by electricity and in a novel way. The new packing material consists of very thin rings of paper plated on both sides with nickel or copper and

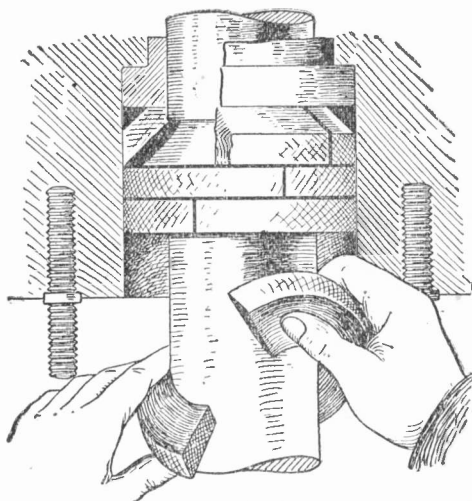

GALVANIC PACKING

alternated with layers of asbestos. Being deposited electrolytically, the plated metal is quite pure and exceedingly durable. Moreover, the friction on rods moving in boxes packed in this way is said to be only a quarter of what it is with the ordinary packings. In practice, the rings as built up from the plated paper and the asbestos are split at one side so that they can easily be inserted as shown in the cut.

Fans for Sealing Room

In a certain department of a government building where packages are wrapped, then sealed with sealing wax, the air has been laden with the smell of the burning wax. The effect upon the men who worked the entire day was such that an employe in the sealing room could be identified immediately by his pallid complexion. Electric fans were installed and the air is now constantly being changed much to the comfort and health of the workers.

Wiring System for Electric Irons

Perhaps the greatest inconvenience about an electric iron is the fact that the flexible cord is continually in the way, trailing along behind, mussing up the work, and then not getting out of the way when the iron is moved back on its return trip. Some irons are equipped

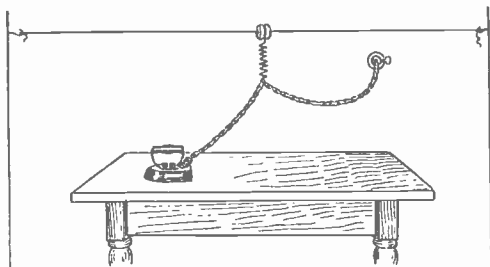

CORD SUSPENSION FOR ELECTRIC IRONS

with a light coil spring, which helps some, but whose assistance can be made more effective by using the wiring system illustrated, and which requires nothing but a couple of hooks, a coil spring, a piece of wire and a porcelain insulator, or, failing that, an empty spool do as well.

The insulator or spool is run upon the wire which is then strung across the room a little to one side of the worker's place and just high enough so that it will not catch her head. The coil spring is fastened to the insulator, which then acts as a sleeve, and the cord is hung from the spring, as shown in the diagram. The insulator slides back and forth, greatly extending the range of operation of the iron.

An Electric Water Heater

A simple water heater which is very useful during the summer can be readily made by means of a luminous radiator lamp inserted in an enveloping tin vessel. The electric lamps used in luminous electric radiators give off considerable heat. If this lamp be held rigidly in a tin vessel with the socket end upwards, a wire and plug serves to make a connection easy with any lamp socket. A small faucet

can be soldered in the bottom to add to its convenience. Carbon lamps should be used. For that reason the radiator lamp is chosen. The larger the wattage of the lamp the greater will be the amount of water heated in a given time.

A Simple Photometer

A photometer is an instrument for comparing the intensity of two sources of light. In using the photometer, one source of light must have a known candlepower; so that the intensity of the other source may be compared with it.

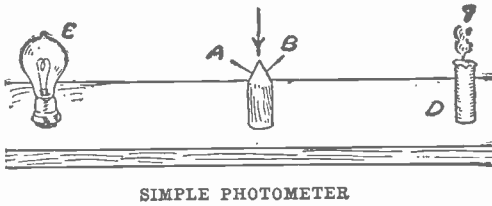

The standard for a candlepower of light is a sperm candle which burns 120 grains of spermaceti per minute. Spermaceti is a yellowish-white solid which separates from oil obtained from the sperm whale and can be made into candles in the same way that tallow candles are made. With sperm candle, a piece of wood with sloping sides and a dark room, a given light source may be tested as described. When the face (A) of the wood is illuminated by the lamp and (B) by the candle, by looking down upon the two faces in the direction of the arrow, (A) will appear brighter than (B) if the block is midway between the two lights. Now move the block towards the feeble source until the two faces have equal light. Assume the block to be 40 inches from the lamp and ten inches from the candle. As the intensity of light upon an object decreases according to the square of the distance from the source, the light of the lamp is to the light given by the candle as the square of 40 is to the square of ten, or as 1,600 is to 100, or the lamp is sixteen times as bright as the standard candle.

For the purpose of performing the experiment merely to illustrate the principle

of the photometer, an ordinary tallow candle or other source of light may be used. But it is necessary to have the relation between this source and a standard candle to find results in standard candlepower.

Illuminating the Steam Gauge

Steam gauges illuminated at the back are used in many boiler rooms. An incandescent electric lamp back of the gauge shines through a glass back, illuminating the figures printed on the frosted glass face. The great advantage

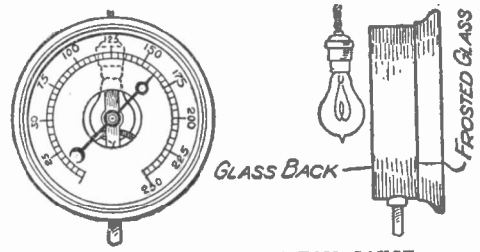

in this arrangement is the fact that there is absolutely no reflection and no bright light to hurt the eyes, as experienced in the old style gauge with the light in front.

Homemade Cash Drawer Alarm

An ordinary drawer may be readily equipped to ring a bell when opened. Above one edge secure a copper strip, regulating its length according to the position of the drawer desired to ring the bell.

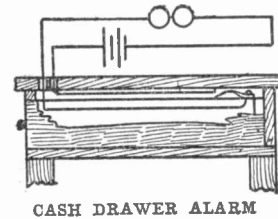

Upon the same side and on the drawer edge place a light piece of spring brass. Attach a flexible wire to the brass and connect up as shown. The bell will ring as long as the brass spring and copper strip are in contact. The bell, battery and wires may be concealed if desired, the cut being only to suggest the plan.

Electricity the Silent Salesman

Some helpful hints on the use of electric current in getting up show window displays. The following schemes have all been used with remarkable success.

Ferris Wheel to Display Goods

A revolving Ferris wheel with suspended shelving between the two circumferences is used to display numerous small articles such as perfumery, soaps,

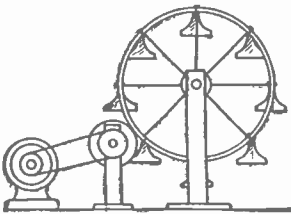

FERRIS WHEEL

talcum powder, etc., in a Chicago drug store. The device is operated by a small motor belted to a second shaft which gives motion to a friction wheel bearing against a rim of the Ferris wheel. The friction wheel's circumference is covered with a band of rubber. The whole equipment sets upon a common base.

A Double Motion Display Rack

An English firm manufactures a decidedly novel apparatus for exhibiting shoes and other articles that can be displayed in a similar manner. The equip-

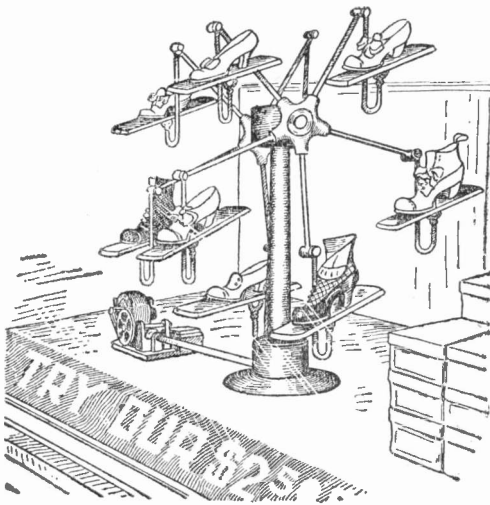

THE ROUNDABOUT FOR DISPLAYING SHOES

ment is called a "roundabout" and has a double motion. While the goods are moved in a circle by the arms they are also carried about the central pillar. A special electrical equipment drives the device.

Attracting the Isaac Waltons

A dealer in sporting goods, particularly anglers' supplies, has an attraction in his show window that receives its

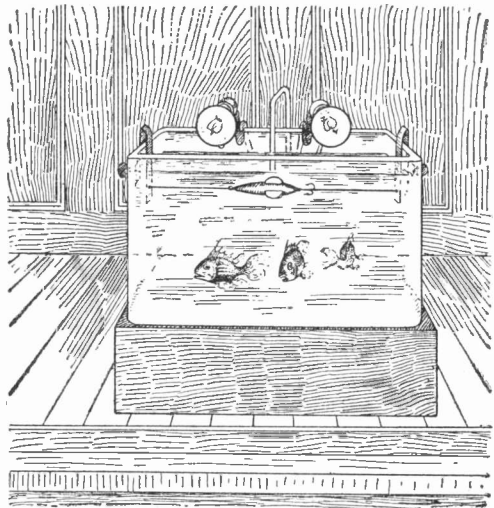

ADVERTISING ANGLERS' SUPPLIES

share of attention. It consists of a glass tank containing several gold fish whose shining yellow bodies are brightened up by two incandescent lamps fastened on the edges of the tank. Stretched across between two clamps and under water is a wire supporting an artificial minnow. The body of the minnow has upon it four curved metal fins. Upon these plays a small stream of water from a tube connected to a faucet, causing the minnow to revolve rapidly as if being drawn through the water.

Auto-Rotor

This is an English device, motor operated, for displaying goods and figures

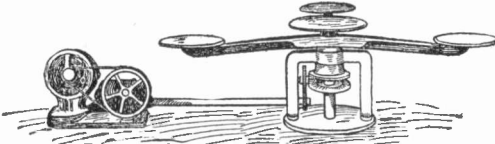

AUTO-ROTOR DISPLAY DEVICE

in shop windows. The plates are made with screw holes for fastening the articles in place. Short and long arms are provided where asked for, with gears for turning them in opposite directions. A one-twentieth horsepower motor is ample for operating the auto-rotor.

Light Fixtures on Bed

Something new in the furniture line and decidedly attractive as a show window display is a brass bedstead fitted with an incandescent lamp at the top of each post. The appearance of the bright

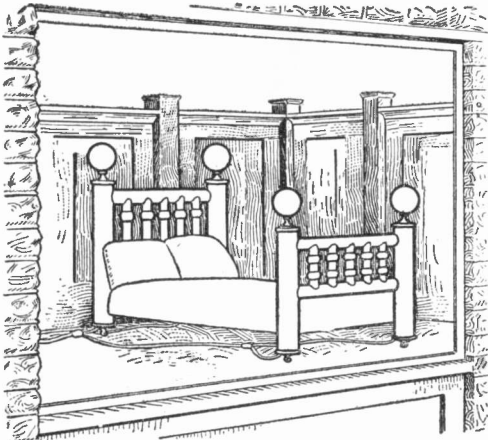

LIGHT FIXTURES ON BED

brass finish of the bed is heightened by enclosing the lamps in large cream-colored glass globes. The effect is such that with all four lights on, it would hardly be necessary to have other lighting fixtures in the room.

The Flying Fountain Pen

A big fountain pen fitted up with the accessories of a monoplane is used by a fountain pen maker as a show window attraction. Under the pen body is a small

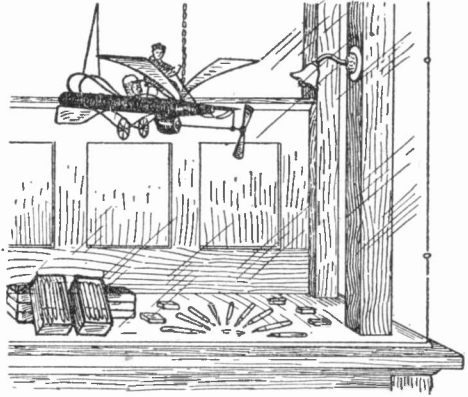

MONOPLANE WINDOW ATTRACTION

electric motor supplied by current from an adjacent lamp socket. The motor operates the propeller which keeps the equipment in motion about its point of suspension.

Revolving Turntable for Window

Jewelry, especially diamonds and brilliants, cannot be displayed to better advantage than when moving under the light of incandescent lamps. For this

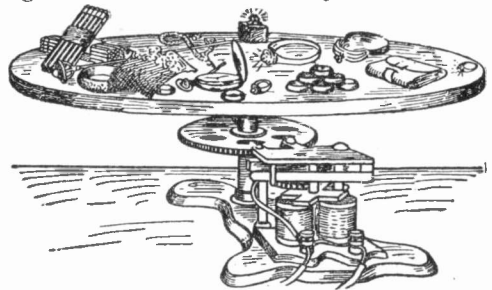

REVOLVING TURNTABLE

reason the Green revolving turntable is especially adapted to the jeweler's show window, though quite as efficient in attracting attention with other displays. The table operates on either alternating or direct current or from batteries, which run an odd looking motor which adds to the attraction.

SCIENCE EXTRACTS FROM FOREIGN JOURNALS

MARCONI CONTRACT WITH BRITISH GOVERNMENT

A contract has been recently made between the British government and the Marconi wireless company for erecting a network of stations so as to connect the British possessions all over the world. As yet the project is in its first stages and the position of all the posts has not been determined, but there will be a central post at London and it will connect with stations in Egypt, Aden, Pretoria and Singapore. These will probably be erected in the first place in order to start the network and the others will come later. The terminus stations are to be fitted with apparatus for receiving 100 or 200 words a minute. According to the statements made by the Marconi company, it is to build the stations for the government and then operate them for the first six months, after which they will be turned over to the government administration. — *Lumière Electrique, Paris.*

INCREASING SIMPLON TUNNEL TRAFFIC

The number of passengers carried through the Simplon tunnel from Switzerland to Italy, over the electric railroad, is steadily increasing. Thus, in 1907 there were 365,344 passengers carried, and in 1911 the number increased to 410,030. The freight traffic has also increased considerably. There will be quite a stimulus given to electric railroading in Switzerland by the opening up of the new Lötschberg line which crosses the Alps and connects the northern part of the country with the Simplon tunnel at the south, thus giving a direct route from Germany to Italy. France will also benefit by this, as well as all the northern countries. It is expected that the new electric line will be opened for service in the spring of 1913. Trains will thus reach the Simplon tunnel, and passengers will be transferred to the

Simplon electric trains in order to proceed on their journey to Milan, Rome and other places in Italy.—*l'Industria, Milan.*

ARTIFICIAL RUBBER

Seeing that the electrical industry as well as automobiles use great quantities of rubber, there is a good outlook for the production of artificial rubber, provided of course, that it has a good enough quality to take the place of natural rubber and is cheap as well. Several factories in Europe are now engaged in the question, and it is said that one of them is now turning out about 200 pounds of artificial rubber per day, starting with ordinary tar as a basis. To transform turpentine into rubber would seem impossible, but modern chemistry has solved as difficult problems as this, so that one day it will no doubt be an ordinary matter to produce rubber from such substances. This latter is claimed to be done by a Paris company lately organized.—*L'Electricien, Paris.*

ELECTRICITY FROM HOUSEHOLD WASTE

Electric current is now obtained in quite a number of plants in Europe by burning household waste, and this is a convenient means of getting rid of the refuse and at the same time current is had for nearly nothing. A good example is a large station erected at Frankfort, Germany, and it contains 24 furnaces for burning the waste, these being used to produce steam from six boilers. In this way there is given enough steam to run two steam turbines connected to dynamos so as to produce about 1,000 horse power. The plant is now burning about 240 tons of household waste per day, but it is soon to be enlarged so as to use a much larger quantity. It is also probable that a second plant of the kind will be built in the city before long.—*L'Electricien, Paris.*

A NEW ELECTRIC FURNACE

Dr. J. Harker is making some experiments in the National Physical Laboratory at London on an electric furnace for working at a very high heat and which does not use carbon. He obtained his idea from the Nernst lamp, and found that quite a number of substances could be made to act like the Nernst lamp; for instance, some kinds of clay pipe stem if much heated, to begin with, will then conduct the current well enough to glow afterwards by the action of the current alone. Carborundum crystal has a like effect, but does not need to be heated up beforehand. In this case the heat given by the current is so high that the silicon is volatilized off, and it burns in a cloud of silica.

A furnace was made on this idea, using a refractory tube of zirconia or other rare earths, and it was raised by means of current passing in a nickel wire winding to 500° or 600° C. Here the tube begins to conduct the current so as to allow the main or heating current to be passed through it. The first current serves as in the Nernst lamp, simply to heat up the tube to make it conducting, and is then cut off and a strong current is sent through the tube from one end to the other. Such an electric furnace is easy to build, and the heat is so intense that even platinum can be melted.—*Electrician, London.*

DEADENING THE HUM OF LINE WIRES

The question of deadening the humming sound which is heard on telegraph or telephone lines has been occupying the German telegraph department, as where the lines pass through towns they are often mounted upon houses and this is giving rise to much complaint from the noise which they make. The device which has been tried on some of the Dresden lines consists of two stout half-cylinders of cement which carry a groove on the flat side for holding the wire. The inner sides are covered with a layer

of soft cement, then the wire is laid in the groove and the two halves are bound together by wrapping with wire. The cylinder thus prepared is mounted in a suitable way upon the house in order to hold the wire.—*Revue Electrique, Paris.*

TESTING WINE WITH A TELEPHONE

Messrs. Brunot and Daussay are experimenting with a somewhat curious method of analyzing wines by the use of an electric current, and presented their first results at a meeting of the French Academy of Sciences. They find that different samples of wines will conduct the current more or less, so that we have here an indication as to their makeup. A tube filled with the wine to be tested is placed in the circuit of a telephone so that the current must pass through it. If the wine is pure it conducts the current very well so that the sounds can be heard distinctly in the telephone. On the other hand, if it is adulterated, as often happens, with certain chemical salts, the current does not pass and there is no sound to be heard.—*Report of the Académie des Sciences, Paris.*

ELECTRIC CURRENT FROM SUNLIGHT

A Danish engineer, Chas. Winther, is engaged upon what he calls a "photopile" or battery for storing up the energy of light and then giving it out in the shape of electric current. He uses certain chemical solutions which are acted upon by light, and especially by the powerful ultra-violet rays, so that they are decomposed into other substances after a time. Then nothing happens until metal plates are put into the cell, and when a current is set up by the effect of the liquid on the plates somewhat as in a battery, so that electricity is produced as a result of the original action of the light. When the cell is run down, the first salts are found to be reproduced as they were at the start, so that the cell can be again acted upon by light.—*Genie Civil, Paris.*

NEW BOOKS

ENGINEERING AS A VOCATION. By Ernest McCullough. New York: David Williams Company. 1911. 201 pages. Price, \$1.00.

A book published for the information of parents in order that they may act wisely in selecting a career for their sons. Chapters of special interest are: The Work of the Engineer, The Education of the Engineer, Home Study Courses, How to Hunt and Hold a Job, Does It Pay to Study Engineering?

KNOTS, SPLICES AND ROPE WORK. By A. Hyatt Verrill. New York: Norman W. Henley Publishing Company. 1912. 98 pages, with 148 illustrations. Price, 60 cents.

A book giving complete and simple directions for making all the useful and ornamental knots in common use. Campers, yachtsmen, travelers, boy scouts and others using rope will find it valuable.

HOUSE WIRING. By Thomas W. Poppe. New York: Norman W. Henley Publishing Company. 1912. 100 pages with 74 illustrations. Price, 50 cents.

The author writes in a manner to give readers a practical knowledge of the installation of electric lighting systems. The book should prove of special value to apprentices and helpers.

WIRING HOUSES FOR ELECTRIC LIGHT. By Norman H. Schneider. New York: Spon and Chamberlain. 1911. 86 pages with 42 illustrations. Price, 25 cents.

This book is written to illustrate only safe wiring and the rules of the Fire Underwriters are freely consulted. Fittings are illustrated and drawings made to make the text clear.

THE MODERN LOCOMOTIVE. By C. Edgar Allen. London: Cambridge University Press (New York: G. P. Putnam's Sons). 1911. 169 pages with 36 illustrations. Price, 40 cents.

A book sketching the general principles of the design and working of a modern locomotive from its predecessor 30 years ago to now. Combustion, feed-water heating and steam production are among the subjects that have received attention.

THE ROMANCE OF MODERN ELECTRICITY. By Charles R. Gibson. Philadelphia: J. B. Lippincott Company. 1910. 338 pages, with 37 illustrations. Price, \$1.50.

The author has presented in an unusually attractive manner the story of electricity and its numberless applications. Beginning with the first chapter, "How We Came to Know About Electricity," the author holds the interest of the reader, who may know very little of the technical side, to the last page.

ELECTRICITY IN LOCOMOTION. By Adams Gowans Whyte. London: Cambridge University Press (New York: G. P. Putnam's Sons). 1911. 140 pages with 18 illustrations. Price, 40 cents.

One of a series of small volumes on scientific subjects. The story is briefly told of the part electricity has taken in locomotion from the earliest tramroads and railways to the present time.

MOVING PICTURES, HOW THEY ARE MADE AND WORKED. By Frederick A. Talbot. Philadelphia: J. B. Lippincott Company. 1912. 331 pages with 133 illustrations.

The author has endeavored to deal with the subject of moving pictures in a popular manner and in a way to interest moving picture show patrons. The work is in no way a practical manual, technicalities being avoided, but is written to introduce the reader to the world of animated photography from the viewpoint of the interested spectator.

BRAZING AND SOLDERING. By James F. Hobart. New York: Norman W. Henley Publishing Company. 1912. 51 pages with eighteen illustrations. Price, 25 cents.

This book contains simple directions for handling the soldering iron, applying the solder and preparing the work. Directions are given for making solders both hard and soft for all classes of work.

MOTION PICTURE HANDBOOK. By F. H. Richardson. New York: The Moving Picture World. 1910. 176 pages with 41 illustrations. Price, \$1.50.

The information imparted in this book is for the manager of the moving picture theater and primarily for the man in the booth. The author has avoided technical terms and tells his story in a plain matter-of-fact style.

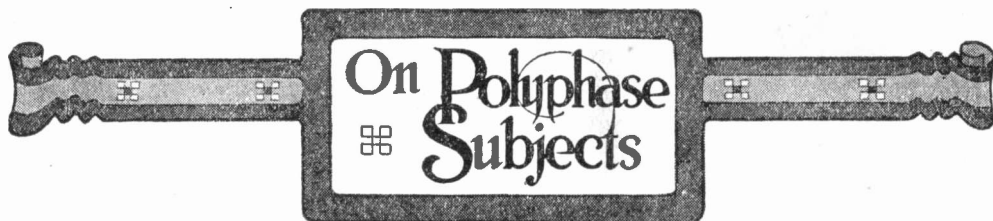

On Polyphase Subjects

A movement is on foot in England to lay an all-British cable between that country and Canada, following the recent increase in the cables which now connect England with all the African colonies, Indian and Australia and thence to the west coast of Canada so that messages reach the Atlantic by overland lines. But here the British post stops, and the cable between Canada and the mother country is in other hands. Now there is much talk of making a direct connection so as to remedy this state of affairs. Private companies are not inclined to go into the scheme, as it is not likely to be a paying one, so that the government will be obliged to take it up. Negotiations with Canada are now going on, and the question is whether this latter country will feel able to meet its part of the expense.

According to a recent press dispatch, a laborer on Swan Island, a lonely wireless station in the Gulf of Mexico, sustained a crushed foot; how the wireless operator on the island communicated with a ship 420 miles away, raised the surgeon and got him to explain the proper way to amputate, and how the operator's assistant performed the operation, is a story described by New Orleans physicians as "surgery by wireless."

On Swan Island is a wireless station, one of the links in the United Fruit chain to the tropics. When a laborer hurt his foot in a tram car accident the wireless operator concluded an operation was imperative. There were no medical books

at hand, and no one at the station ever had hacked at a fellow being. Then the operator had an "inspiration." He called a fellow craftsman on a ship passing 420 miles below into the Caribbean sea. The situation was explained to the ship's surgeon, and detail by detail he explained just how the amputation should be handled.

After the arteries had been tied and the wound dressed the patient recovered his senses and insisted on pressing at the wireless key to express his thanks. At last accounts he was getting well.

A new electric process for coating iron or steel with lead has been brought out by Mr. Cowper Coles, the eminent English specialist in electric depositing methods for metals, and it is claimed to be very economical to carry out. The amount of lead deposited on the iron can be varied as much as desired, from a fraction of an ounce up to several pounds per square foot. This is likely to open up a great increase in the application of lead coatings for various purposes in the industries, and these will be very useful; for instance, iron pipes can be lead lined inside and outside, so as to combine the strength of the iron and the protection from rust and other actions given by the lead. Such pipe can be coated only on the inside if need be, for corrosive liquids, and the method is good for the lining of pumps and for chemical vessels. It is even claimed that lead can be thus coated onto earthenware or wood, or again that it answers very well for protecting ornamental iron work.

Foot Amputated by Wireless Instructions

Coating Metals With Lead



Sunday School Teacher—"Now, children, I want a verse of Scripture from each one of you. Well, Percy."

Percy—"The Lord loveth a cheerful geezer."

* * *

A slightly inebriated gentleman was leaning against a corner of the building late at night, indulging in sundry chuckles while looking up at an immense electrical advertisement showing an automobile tire whirling round and round. A policeman stopped and asked him what amused him so. "Jush look up there m' fren'. Funnish sight I ever shaw. See the blamed milky way a chasin' its tail."

* * *

A German shoemaker left the gas turned on in his shop one night, and upon arriving in the morning struck a match to light it. There was a terrific explosion, and the shoemaker was blown out through the door almost to the middle of the street.

A passerby rushed to his assistance, and, after helping him to rise, inquired if he was injured.

The little German gazed in at his place of business, which was now burning quite briskly, and said:

"No, I aindt hurt. But I got out shust in time, eh?"

* * *

Marie—"When you spoke to papa did you tell him you had \$500 in the bank?"

Tom—"I did."

Marie—"And what did he say?"

Tom—"He borrowed it."

* * *

"I'm not afraid of woman suffrage," said Little Binks. "My wife is a militant suffragette, but up to date I am Julius Cæsar in my house."

"I guess you are, Binks, I guess you are," said Wiggles. "There ain't many deader ones than Julius Cæsar in this world."

* * *

An irate patron of a restaurant called a waiter to him and said: "I found a needle in this soup. What does it mean?"

"Beg pardon," said the waiter, who used to be a proofreader, "that's a typographical error. It should have been a noodle."

A bride, anxious not to forget to order two chickens, repeated to herself while cleaning the breakfast table, "Grocer, chickens—grocer, chickens." The words got confused—so when she 'phoned she said, "Have you any nice young grocers?" "Why—er—yes," replied the astonished grocer. "Well," piped the bride, "send me two dressed—oh, no—better send them undressed. If my husband comes home he can wring their necks and the cook can dress them."

* * *

Scotch Sexton (who has shown old lady over church and followed her to the gate without getting a tip)—"Weel, ma leddy, gin ye find when ye gang hame ye've lost yer purse, ye'll mebbe mind ye didna hae it oot here."

* * *

The following is a recipe for a Coroner's Cocktail:

Mix three chorus girls with as many men and soak in champagne until midnight. Squeeze into an auto. Add a dash of Joy and a tipsy chauffeur. Shake well. Serve at 70 miles an hour.

* * *

Jeweler—"You say the inscription you wish on the inside of this ring is to be, "Marcellus to Irene?"

Young Man (somewhat embarrassed)—"Yes, that's right. But—er—don't cut the 'Irene' very deep."

* * *

"Why did you nickname your wife 'Circumstances'?"

"Because she is something over which I have no control."

* * *

"What do you mean by keeping me standing on the corner like an idiot?" demanded an angry husband, whose wife had kept him waiting to go shopping with her.

"Now, really, dear," she replied sweetly, "I can't help the way you stand."

* * *

"What's the matter with your finger, old man? You've got it in splints."

"My oldest boy's ingenuity."

"How so?"

"He set a steel trap in his stocking to catch Santa Claus."

'THE BUG-HOUSE CABINET'-TO BE USED IN CONNECTION WITH MODERN COMBINATION KITCHEN CABINET-



-EXPLANATION OF BUG-HOUSE CABINET-
 HEN (A) LAYS EGG (B) EGG DROPS INTO INCUBATOR CHICK (C) WHEN HATCHED DROPS INTO BROODER - WHEN CHICK GROWS BIG ENOUGH TO JUMP OVER HURDLE (B) IT GOES INTO DRESSING ROOM (E) WHERE IT IS ELECTROCUTED PICKED, CLEANED (BY ELECTRIC VACUUM CLEANER) & DRESSED. THEN IT IS DELIVERED INTO ELECTRIC FIRELESS COOKER (F) OR FRYING PAN (G) ALL THE HOUSE WIFE HAS TO DO IS STAND THERE AND LISTEN TO THEM COOK.....



-HOUSE WIFE -EXPLAINING WEIRD NOISE TO HIGH-BROW VISITORS-

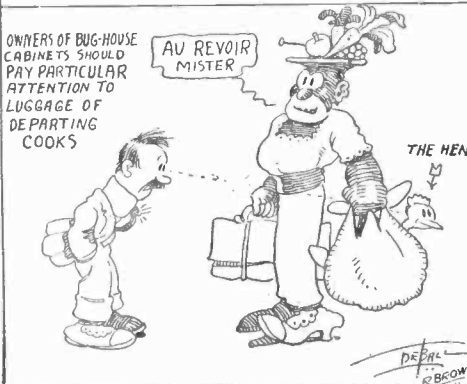

OWNERS OF BUG-HOUSE CABINETS SHOULD PAY PARTICULAR ATTENTION TO LUGGAGE OF DEPARTING COOKS



HOME LIFE OF THE INVENTOR

DEAL
R. BROWN

Common Electrical Terms Defined

In this age of electricity everyone should be versed in its phraseology. By studying this page from month to month a working knowledge of the most commonly employed electrical terms may be obtained.

POTENTIAL DIFFERENCE.—Used to refer to the difference in electromotive force or pressure between two points. For example, the wire at the positive terminal of a 110 volt dynamo has a potential difference, when compared with the earth, of 110 volts.

POTENTIOMETER.—An apparatus for measuring with a galvanometer the electromotive force of a battery. Also used in wireless "hook-ups" as a variable resistance shunted across the terminals of the detector battery to reduce this voltage to a value slightly below the critical voltage of the detector. In the case of the electrolytic detector this is the voltage required to break down the thin film of gas which collects at the "bare point."

POWER.—The rate of doing work. In mechanics 33,000 foot-pounds or one horsepower is the unit. In the electrical field the kilowatt, 1000 watts, or volt-amperes, is the unit.

PRESSURE.—An expression used to refer to voltage or potential difference. (See Potential Difference.)

PRIMARY COIL.—The coil of a transformer or induction coil receiving current from the line or battery and thus inducing magnetism in the core and current in the secondary coil.

PROOF PLANE.—A small conductor, usually shaped like a disk, fastened to an insulating handle and used to take static electricity from a body so charged. (See cut.)

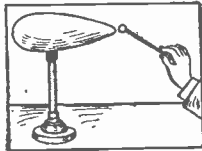

PRIME CONDUCTOR.—A metal covered sphere or other solid used to collect electricity from a static machine. The solid is usually mounted upon glass or hard rubber insulators.

PUSH BUTTON.—A switch for closing an electric circuit by pushing a button behind which are two springs which are thus crowded together, making electrical contact.

QUADRUPLIX TELEGRAPHY.—A system of telegraphy by which four messages, two in each direction, may be sent over the same wire at the same time.

RADIOGRAPH.—A photograph taken by X-rays. The object to be photographed is placed between the X-ray tube and the photographic plate. The X-rays cast upon the plate a shadow of the parts of the object, such as metal and bone, through which they cannot pass and the result is sometimes called a shadow picture. Such a photograph is also called a skiagraph.

RAIL BOND.—A heavy wire or metal plate electrically joining one rail to the next in an

electric railway system. The bonding provides a good path for the current back to the power house.

RAT-TAIL.—A term in wireless telegraphy applied to the point where the leading-in wires are gathered together and passed into the building.

REACTANCE.—In an alternating current circuit the resistance, due to inductance and capacity, offered to the flow of current.

REACTION COIL.—See Kicking Coil.

RÉAUMER SCALE.—A thermometer scale used in Europe. The freezing temperature, as registered by the mercury column on this scale, is 0° and the boiling point is 80°.

RECEIVER.—The instrument in a telephone set which receives and converts into sound waves the current impulses governed by the sound impulse upon the diaphragm of the distant transmitter.

RECEPTACLE.—An incandescent lamp socket designed to be fastened to a flat surface, as the wall. Sometimes referred to as a wall socket.

RECTIFIER.—An apparatus to obtain direct current from an alternating current circuit.

RELAY.—A receiving instrument, common in telegraphy, consisting of two electro-magnets and an armature held back by a spring when the magnets are not energized. When current passes through the magnet coils the armature is attracted, closing a circuit upon a local battery and sounder.

RELUCTANCE.—The opposition which a piece of iron, steel or other metal offers to the passage of magnetic lines of force. Sometimes termed, magnetic resistance.

RESIDUAL CHARGE.—After a Leyden jar has been charged, then discharged and allowed to stand for a few minutes, a small second discharge may be taken from it. This second discharge is termed the residual charge. According to theory this residual charge is due to the displacement of the molecules of the glass dielectric when the jar is charged and to the resuming of their original positions when the residual charge comes forth. This theory seems to be supported by the fact that jarring the condenser or jar hastens the formation of the second or residual discharge.

RESIDUAL MAGNETISM.—The magnetism left in a piece of iron or steel after the magnetizing force, such as electric current or another magnet, has been removed. Sometimes termed remanence.

RESISTANCE.—Anything placed in an electric circuit or already there which opposes the flow of the current.

What Would You Think?

The operation of this car is simplicity itself—as simple as an electric. Your wives and daughters can drive it. This center control is the best new feature brought out in this year.

EVEN makers of absolutely distinct types of automobiles recognize the desirability of the Electric—just read the sentence above, taken verbatim from a recent advertisement of a prominent automobile company.

When men who have made the study and construction of the automobile a life-work, openly voice their appreciation of the Electric—even to the extent of making it the criterion by which they ask you to judge *their* cars—it is time for you to realize that the Electric is the *ideal* car for you.

There is a wonderful sense of possession in driving an Electric—the exquisite feeling of power under your instant control—the consciousness of perfect security—the enjoyable satisfaction of gliding silently and comfortably wherever you will.

An Electric is perfectly adaptable to all phases of town use—day or night—in any weather. It is the most suitable car—the least expensive car to maintain—the car *you* should own.

Upon request, the Information Bureau of this Association will gladly send you interesting literature about the Electric Vehicle. Write today.

Before you buy any car—consider the Electric

ELECTRIC VEHICLE ASSOCIATION OF AMERICA

BOSTON

NEW YORK

CHICAGO (10)

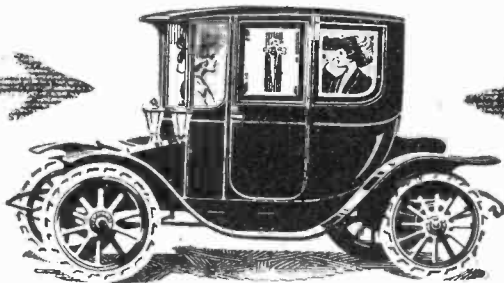

For our Mutual Advantage mention Popular Electricity when writing to Advertisers.

CLASSIFIED ADVERTISEMENTS

The cost of advertising in this section is 5 cts. per word.
All Discounts Will Be Discontinued After June 1st, 1912

Remittance must accompany order,
or advertisement will not be inserted.

Forms for the August issue close on July 1st.

AERONAUTICS

HOW TO CONTROL AN AEROPLANE, price 50 cents. Used successfully by the largest schools. Worth its weight in gold. Aviators' Exchange, 58 W. Washington St., Chicago.

AGENTS WANTED

MONEY-MAKING, PLEASANT, INDEPENDENT home work. Particulars 2c. New Century Co., Enid, Okla.

AGENTS—WRITE FOR CATALOG OF CON-
vex portraits and frames. Miller Bro., 326-328-
330 B. Way, Albany, N. Y.

AGENTS, WAKE UP! \$20 WEEKLY, COM-
bination key-ring, seven tools in one. Light-
ning seller. Sample 10c. Arthur Beers, Brad-
ley Beach, N. J.

AGENTS—OUR PATENTED SPECIALTIES
sell like wildfire; send for free catalogue and
sample worth 10c. Watchung Specialty Co.,
Dept. J, Westfield, N. J.

MAKE BIG MONEY SELLING ONLY PRACTI-
cal fruit strainer and fried food turner known.
Rapid sellers; exclusive territory. C. L. Arm-
strong, Springfield, O.

DON'T ACCEPT AN AGENCY UNTIL YOU
get my samples and particulars. Money makers.
Address SAYMAN, 706 Sayman Bldg., St. Louis,
Mo.

AS YOU CAN CLEAR \$30 WEEKLY YEAR
round mailing music evenings, why look fur-
ther? Send 10c for facts, proofs and beau-
tiful new sheet music to B. Weber Music Co.,
Boston, Mass.

THE PRESTO HEATER BOILS ANY LIQ-
uid in 10 seconds. A dozen other new electrical
appliances for agents. Apply quick for exclu-
sive territory. Presto Electrical Mfg. Co., 323
Geary St., San Francisco.

AGENTS WANTED—FADAWAY ANTI-
septic tooth bleacher. Removes tobacco stains
first application. Everybody needs it. Quick
sales; big profits. Sample and instructions, ten
cents. Dr. Vinette, Chippewa Falls, Wis.

WANTED—LIVE AGENTS TO SELL "THE
American Lady Fibre Broom" on 1 year's guar-
antee. Does away with corn brooms. Exclu-
sive territory, free samples; big, permanent
business; 1 man in every county. F. L. Hurt,
2255 S. State St., Chicago.

AGENTS WANTED

SEE WHAT I SAY UNDER "TYPE-
writers." ATCHISON.

AGENTS—BIG MONEY DISTRIBUTING
free pkgs. Borax-ee Soap Powder. Ward &
Co., 1776 Berteau, Chicago.

ROYAL ODORLESS DISINFECTANT AND
handsome silver teaspoon 10c. Satisfaction or
refund. P. E. Miles Co., Lynn, Mass.

AGENTS—EARN \$4.50 TO \$9 A DAY IN-
troducing labor and time saving necessities;
sample of summer leader, free. J. Manderbach,
Dexter, Mich.

AGENTS, BOTH SEXES, JOIN THE
money-making crowd; household necessary.
Blackledge Specialty Co., Dept. 53, 1805 Reed
Street, Philadelphia, Pa.

AM MAKING \$200 EVERY WEEK WITH
original watch proposition; there's room for
you to do the same. H. F. Walker, Box 52,
College Station, Tex.

AGENTS—MY POCKET STEEL-DIE HAND
embosser does perfect work; initial 30c, mono-
gram 75c; booklet for stamp. Box 462 (C),
Greenfield, Mass.

CONSIDER THE IMMENSE FIELD FOR A
fan motor operating by gas or gasoline and
your agency application will be sent imme-
diately. Essex & Smith Co., 4 Lock St., Buf-
falo, N. Y.

AGENTS, EITHER SEX, TO HANDLE OUR
new Oriental perfume; delightful and lasting.
A quick seller at big profit. Sample and terms
10 cents. Francis Co., 246 First St., Jersey
City, N. J.

AGENTS GET THE MONEY WITH OUR
new automatic razor stropper; finest ever in-
vented. Easy seller. Satisfaction guaranteed.
Write for terms. Auburn Supply Co., Dept. H,
7746 Peoria St., Chicago.

QUALIFIED MEN AND WOMEN, HIGH
grade educational specialty, travel in south dur-
ing winter, work backed by twenty-five years'
success. Write today. Lewis E. Myers, Chau-
tauqua Park, Valparaiso, Ind.

WE MAKE GAS PIPE STRAPS AS "BY-
Product." Prices very attractive. Easy sell-
ing for agents. Pocket samples. Write for com-
mission proposition. Peck-Hamre Mfg. Co.,
Berlin, Wis.

BOKARA DIAMONDS—AGENTS, EVERY-
one, to wear and sell our famous bokara dia-
monds. Write for sample offer and catalogue
free. Northwestern Jewelry Co., 1123 Wilson
Ave., Chicago.

BIG MONEY IN SELLING USED AUTO-
mobiles. No business so easy to learn, so profit-
able, so congenial. On \$50 to \$200 investment
our agents make \$50 to \$100 per week. We
furnish the cars and teach you how to drive,
sell and repair them. Write today for particu-
lars and territory. The Automobile and Cycle
Company of America, Dept. 2, 1769-1787 Broad-
way, New York City.

AGENTS WANTED

YOU CAN MAKE \$\$\$\$ AS OUR GENERAL or local agent. Household necessity; saves 80 per cent. Permanent business; big profits; exclusive territory; free sample. Pitkin & Company, 96 Pitkin Block, Newark, N. Y.

POCKET LIGHTER FOR CIGARS, AUTOS, etc., 50c; self-lighting mantles, 35c. Sparker, lights all gas, much safer and cheaper than matches, 25c. Wizard for stoves and lights, 50c. Agents don't pass this. Thompson Barker Specialty Co., Elmira, N. Y.

500 PER CENT PROFIT—YOUR OPPORTUNITY. Act now. Buyers everywhere for our U. S. Fire Extinguisher. Low cost; fast seller; sure profits; exclusive territory. District managers wanted. United Mfg. Co., 1135 Jefferson, Toledo, O.

WE WANT ONE SELLING AGENT IN each town to represent the Magic Electric Suction Cleaner. This is a high grade proposition—for high grade men only—that's really worth while investigating. Rosenfield Mfg Co., 14 Abingdon Square, New York.

BE INDEPENDENT! START A MAIL order business in your own home. We tell you how and furnish everything needed wholesale. An honorable and profitable business for man or woman. Particulars free. Many make \$3,000 a year. Murphy Mfg. Co., South Norwalk, Conn.

AGENTS WANTED—ELECTRICIANS AND shopmen make over \$100.00 a month in spare time selling Transparent Handled Novelty Knives and Razors. Big profits. Sales easily made. Write for terms to-day. Novelty Cutlery Co., 27 Bar St., Canton, Ohio.

AGENTS MAKE BIG MONEY SELLING our new gold letters for office windows, store fronts and glass signs. Anyone can put them on. Write today for a free sample and full particulars. Metallic Sign Letter Co., 400 N. Clark St. Chicago, Ill.

\$1,000 YEARLY FROM YOUR BACK YARD. Complete plan (170 pages illustrated), together with paying mail order proposition, \$2.00. Sent for 30c and six stamped envelopes addressed to clerks or teachers. Circular free. Science Elec. Institution, Englewood, Chicago.

AGENTS—\$300 PER MONTH; PERMANENT business; no investment; we supply you with the best vacuum cleaner ever invented to sell at a price anyone can afford to pay; settle with us weekly for machines sold; one man to a county; write at once. Braham Co., X 20, Cincinnati, O.

AGENTS MAKE ENORMOUS PROFIT handling our quick selling imported Oriental staples and novelties. Never been advertised. Reorders. Exclusive territory. Write for particulars. Joseph Kanematz, Box 529, Portland, Ore.

AGENTS—TO SELL THE NEWEST Electric appliance on the market; sold everywhere there is electricity, in the home and office; liberal profit; sales-driving sample, weighs a pound, no experience or knowledge of electricity required; it shows how to use one light instead of two and get the same results; sells for \$3.50 and saves the purchaser an investment of \$25; write for particulars. The Handy Light Co., 723 E. Eighth Ave., Cincinnati, Ohio.

AGENTS WANTED

WANTED—AGENTS SELL RICH-LOOKING imported 36x68 rugs. \$1 each. R. H. Carter, Milan, Tenn., sold 115 in four days. His profit \$51. You can do as well. Write for sample offer and unique selling plan. Exclusive territory. R. Condon, Importer, Stonington, Maine.

WE MANUFACTURE GLASS PAPER. Plain glass windows made to look like real stained glass. Easily applied and beautifies the home. Something new for agents. Two sheets of this glass paper sent as a sample with catalogue in colors and complete instructions on receipt of 10c. S. H. Parrish & Co., 202 S. Clark St., Chicago.

LOCAL REPRESENTATIVE WANTED IN each town to sell our underwear, hosiery, neckties and sweaters direct to wearer on commission. Profitable opportunity with permanent future because every article is guaranteed satisfactory or money refunded. Write for spring and summer catalogue. Steadfast Mills, 36 Courtland St., Cohoes, N. Y.

YOU ARE LOOKING FOR MORE LONG green. You doubtless deserve it, and willing to work for it. Our soap and toilet article combinations have every earmark of being the real coin getters. We can prove that they are just what you are after. We have convincing proofs. Write for them. Davis Soap Works, 263 Davis Bldg., Chicago.

SIGN LETTER AGENTS—PAINTERS—Something new and better. Attracto Gold or Silver letters. 21 different kinds. Anyone can apply them. Make big money lettering store windows and selling our sparkling, flashing, ready-made chipped glass name plates and signs. 1912 catalogue and sample letter free. Attracto Sign Co., 2649 North Clark St., Chicago.

GASOLINE SELF-HEATING FLAT IRON. Pump and sad iron stand sells for \$6. Agents' price, complete outfit, \$3.50. Riches awaiting you. Agents, this is a money-coining proposition. A few of our best agents are selling 135 outfits a month. It's wonderful how eager every family is to get this absolutely safe new air pressure self-heating sad iron. Selling like wildfire everywhere. Rush your remittance, \$3.50, for the above described outfit. Town, county and state agents wanted. Agents' money-making catalog of many other articles free. New Process Mfg. Co., Sad Iron Room 22, Salina, Kans.

AUTOMOBILES

FORD 4 CYLINDER RUNABOUT TOP, wind shield, three oil, two gas lamps, excellent condition, \$200. Wilson, 2230 Seventh Ave., New York City.

FORD 1910 TOURING, COMPLETELY AND elegantly equipped, good as new, must sell, \$300. Kokesch, 2537 Belmont Ave., Bronx, New York City.

FORD OWNERS WANTING FIVE Electric lights available any time using Ford magnets for charging a storage battery (self contained system), write American Battery Company, 1125 Fulton St., Chicago.

AUTOMOBILES

TWO AUTOMOBILES AND PORTABLE GARAGE sacrificed! One Oldsmobile "30-35" horsepower, luxurious five-passenger touring, four doors. Equipment includes everything. Cost nearly \$3,000. For quick sale \$400. One Auto-car Runabout (Doctor's model), top, windshield and full equipment, \$225. Fireproof Portable Garage \$25. Two barrels oil \$10. Shonnard, 246 Lenox Ave., New York City.

AUTOMOBILES—SAVE DEALERS' PROFITS, buy your car direct from owners. I have all makes on my lists. A few specials for Runabouts. Oldsmobiles, \$45. Reos, \$60. Cadillacs, \$75. Maxwells, \$135. Fords, \$150. Touring Cars, Cadillacs, \$90. Reos, \$150. Buicks, \$175. Fords, \$300. Ford six cylinder, \$375. Wintons, \$275. Pope Toledos, \$300. Send for my latest lists, it means dollars to you. I guarantee a saving to you of 5 per cent on any car offered by any dealer. P. E. King (Automobile Broker), 217 W. 125th St., New York City.

A. C. C. A. PRICES TALK! SPRING SALE is on! Hundreds of runabouts, racy roadsters, five and seven-passenger touring cars, elegantly and completely equipped! Guaranteed five years! Freight prepaid! We offer 29 runabouts, formerly cost \$500 to \$1,000, now \$50 up; 18 roadsters, three and four-passenger, formerly cost \$1,000 to \$2,000, now \$175 up; 36 touring cars, five, six and seven-passenger, formerly cost \$1,500 to \$5,000, now \$200 up! All best American and foreign makes, such as Packards, Pierce Arrows, Stevens, Wintons, Stoddard Dayton, Peerless, Stearns, Pope Hartfords, Locomobiles, White, Renaults, Buicks, Maxwells, Fords, etc., etc. Write today for our illustrated Catalog, the largest and most complete list of its kind ever published! The Automobile and Cycle Company of America, Dept. F. F., 1769-1787 Broadway, New York City.

AUTO ACCESSORIES

FORD T ELECTRIC HEADLIGHT OUTFITS \$7.50. Express paid. Circulars. McNicol Bros., Salem, Ohio.

CHARGE THE BATTERY YOURSELF. "American" rectifiers—all sizes. Storage batteries—all sizes. American Battery Company, 1123 Fulton St., Chicago.

TIRES—ALL MAKES, ALL GUARANTEED. 28x2½, \$4.50; 30x3, \$6; 30x3½, \$13. Write for our complete list of tires and tubes before purchasing. We ship C. O. D. Guarantee Tire Company, Dept. M, 213-219 West 125th St., New York City.

BOOKS AND PERIODICALS

CLASSY BOOKS! CATALOGUE FOR stamp. Duff Co., 2713 Mozart, Chicago.

"HEAVEN AND HELL," 400 pages; sent postpaid for 25c. E. J. Dempsey & Co., 593 Quincy St., Brooklyn, N. Y.

TELEPHONE TROUBLES AND HOW TO find them, (1912) edition. Phantom circuits and diagrams, how to install. Price, 25c. Hyde Publishing Co., Telephone Bldg., 183 5th St., Milwaukee, Wis.

BOOKS AND PERIODICALS

NEW BOOK, "JANE," 10c; CATALOGUE of books and den pictures free. Bond Pub. Co., S-3, Columbus, Ohio.

THE SECRET OF SONG WRITING, A booklet full of useful information by an expert, 25c postpaid. Chas. Metz, 306 E. 88th St., N. Y.

BOOKS ON DICE, CARDS, SLOT MACHINES, etc. Hammond B. Co., Box 1671, Hammond, Ind.

STEEL TEMPERING BOOK FOR MECHANICS and Mechanical Digest one year, special offer, 25c, Mechanical Digest, Grand Rapids, Mich.

"PERSONAL MAGNETISM," 146 PAGES, 30c. "Hypnotism's Wonders" free. Science Elec. Institution, Englewood, Chicago.

RACY BOOKS, CATALOGUE, AND 5 CLAS- sy photos 10c. National Nov. Co., 421A East 77th St., New York.

WONDERFUL BOOK ON HYPNOTISM, PER- sonal magnetism, magnetic healing and occult science sent free to anyone. Send your address today. M. D. Betts, Sta. 161, Jackson, Mich.

HAVE YOU READ "HOW TO SUCCEED"? It is the greatest satire ever written on the get-rich-quick craze. 15c postpaid. A. Ruhnau, Dept. 40, 280 Columbus Ave., New York.

STAGE PICTORIAL. FASCINATING MAG- azine. Scores of stars, chorus beauties, matinee heroes. 10c copy, \$1.00 a year, 3 months' trial, 25c. Stage Pictorial, 1493 Broadway, New York City.

MY TREATISE, ILLUSTRATED, ON deaf- ness and head noises, explains how complete, lasting relief may be effected without drugs or batteries. Experience 32 years. Book sent free by author. Geo. F. Coutant, M. D., 97B, Sta. E., New York, N. Y.

BOOKS—I. C. S. AND A. S. C. TECHNICAL books of all sorts—shopwork, electrical, mechanical, wireless, encyclopedias, dictionaries, medical, law, and standard fiction. New and second-hand. Get my prices. Geo. F. Williams, Box 408, New Orleans, La.

DON'T BUY THAT BOOK. WE LOAN standard books by mail. You can buy or return them. We plan short courses of reading for you free. Self-help; business; health; house, home and field; economic and social problems; books for writers and speakers; occultism; religion; science, etc. Lists and bi-weekly Library Critic on request. State subject in which interested. Oriental Esoteric Library, 220 Washington, D. C.

BUSINESS OPPORTUNITIES

SEE WHAT I SAY UNDER "TYPE- writers." ATCHISON.

WANTED—5,000 DISTRIBUTORS OF AD- vertising matter everywhere. American Dis- tributor, Mount Pleasant, Pennsylvania.

IF I START YOU MAKING \$40 TO \$100 monthly working spare time evenings will you pay me \$25 in six months' time for my service? Remember I promise success or forfeit any claim on my fee. Enclose 10 cents (to keep away triflers) for instructions. Joseph O. Seimiller, 841 North Lawrence St., Philadelphia, Pa.

BUSINESS OPPORTUNITIES

UNEEDA YALE ADDING MACHINE—Made of steel, nickel finished, \$1 prepaid. Yale Mfg. Co., Dept. H, Newark, N. J.

MAKE YOURSELF INDEPENDENT BY selling your own toilet preparations. Send for particulars. M. K. Thompson Co., Dept. 3, Akron, Ind.

LOOKING FOR MONEY MAKERS? OVER 100 chances made plain; all ages; male or female; dime today brings complete collection; worth dollars. Wm. Waelder, Hannibal, Mo.

FORM A CORPORATION—CONGRESS LAW for D. C. and all States; cheap. Raise money easily. U. S. Legal Corporation, Washington, D. C. Representing \$1,225,000,000.

HOW TO RAISE THE FINEST EDIBLE frogs in the world by the thousands in the city or country. A proposition for the man with little capital and small income. Write for free booklet. French Frog Farm, Box 91, Monterey, Cal.

PATENTS BRING WEALTH; PROOF ON request; \$58,000 offered for an idea; advice free; highest references. Alexander Wedderburn, Patent Attorney, Department 43, Washington, D. C.

BE INDEPENDENT; START MONEY-MAKING mail order business at home; new plans; everything furnished; only small capital required; free booklet and particulars tell how. W. E. Miller Co., Box 254, Muskegon, Mich.

WE HELP RAISE CAPITAL AT ONCE TO start you in retail—manufacturing—patent—real estate—mail order or any legitimate business by means of "Our Practical Method." Particulars free. The Business Aid Co., K 508, Detroit, Mich.

WE START YOU IN BUSINESS, FURNISHING everything. Men and women, \$30 to \$200 weekly operating our original "New System Specialty Candy and Popcorn Crispette Factories," home or small room anywhere. Opportunity lifetime; booklet free. H. Ragsdale Co., East Orange, N. J.

DON'T YOU WANT TO MAKE YOURSELF a real estate broker? We will make it easy for you without capital. You can be independent of bosses and have your own office instead of a job—swing big deals and make big commissions instead of working at details on a salary. Write today for Booklet A. No financial backing needed. U. S. Real Estate Institute, Box 46A, Asheville, North Carolina.

EARN \$10 to \$15 A WEEK AND HOLD your position besides; no canvassing. We, as manufacturers of patented just-in season specialties, have new easy mail order plans to keep factories busy. We furnish everything. Large profits. Small capital. Experience unnecessary. If you are one of the want-to-go-ahead kind, write for our most modern (copyrighted) plans. Sworn statement. J. M. Pease Mfg. Co., 550 Pease Bldg., Michigan St., Buffalo, N. Y.

TURN YOUR SPARE TIME INTO MONEY—Join us in a profitable mail order business, one that you can operate at home. Large profits; quick returns; small investment. Our 10 years' successful manufacturing experience, personal assistance and new ideas assures your success. Write for positive proof and free booklet. Pease Mfg. Co., Incorporated, 144-48 Broadway, Desk B, Buffalo, N. Y.

BUSINESS OPPORTUNITIES

TWO DOLLARS WILL START AND STOCK profitable mail order business; let me tell you how. William Hinds, 345 Ogden Ave., Jersey City, New Jersey.

\$100 TO \$500 MADE MONTHLY BY ANY-one, anywhere, operating honorable, legitimate business proposition, either locally or by mail. Guarantee no "fake" or "outfit plan." Particulars free. Address J. H. Barr, Wellsburg, N. Y.

MAKE MIRRORS AT HOME. BIG PROF-its with little outlay. One 18x36 in. mirror costs \$2.00 to \$5.00. You can silver a glass this size for 20c. Send \$1.00 in stamps or money order and we will send you EXPLICIT DIRECTIONS how to do it; also how to emboss, grind, foil, gold leaf, frost chip and make imitation stained glass. How to transfer photos on glass, bore holes in glass and cut skylights. George L. Patterson & Co., Dept. 4, Brooksville, Ky.

COINS AND STAMPS

STAMPS—105 CHINA, ETC., STAMP DIC-tionary and list, 2c. Bullard Co., Sta., A, Boston.

OLD COINS FOR SALE—5 DIFFERENT, 10c. L. J. Mathewson, Waubay, S. D.

100 DIFFERENT 15C. APPROVAL SHEETS 60%. G. J. Holt, Melrose, Mass.

FREE—25 STAMPS, 2 CENTS POSTAGE. Denniston, 492 Beaumont St., St. Paul, Minn.

FREE! 100 STAMPS FOR 2C POSTAGE and 2 collectors' names. "Hawkins," Raton, N. M.

STAMPS, 100 ALL DIFFERENT, FREE. Postage 2c. Mention paper. Quaker Stamp Co., Toledo, Ohio.

24 VARIETIES CUBAN STAMPS, 10 CENTS. List of 6,000 low priced stamps free. Chambers Stamp Co., 111 H. Nassau St., New York city.

IF YOU HAVE ANY OLD POSTAGE stamps to sell write R. Stiles, 306 Summit Ave., Schenectady, N. Y.

EVA TANGUAY PENNIES—FIVE CENTS each; enclose 2c extra for postage. Address E. T. Novelty Co., 538 S. Dearborn St., Chicago, Ill.

\$3.00 PAID FOR THE RARE 1856 CENT, \$25.00 for the rare silver dollar of 1858. Keep money dated before 1890 and send 10 cents for new coin value book. A. H. Kraus, 210 Kraus Bldg., Milwaukee, Wis.

COINS AND STAMPS

OLD COINS. \$7.75 PAID FOR RARE DATES 1853 quarters; \$20 for half dollars; we pay a cash premium on hundreds of coins; keep all money dated before 1884 and send 10 cents at once for our illustrated coin value book, size 4 by 7; it may mean your fortune. C. F. Clarke & Co., Coin Dealers, Dept. 83, LeRoy, N. Y.

DOGS

REGISTERED ENGLISH BLOODHOUNDS—puppies and grown dogs, best blood. Max J. Kennedy, Freedonia, Kan.

FOR SALE

FOR SALE—GUINEA PIGS, PIGEONS, doves, fancy mice, canary birds, John W. Ornelas, Springfield, Ill.

\$125 ELECTRIC VACUUM CLEANER, cheap, or will exchange for screw cutting lathe. Gilbert McClure, Van Wert, Ohio.

WORN-OUT DRY BATTERIES MADE BETTER than new for 3c each, 15c for receipt. Willamae, Grampian, Pa.

REGISTERED ENGLISH BLOODHOUNDS—the greatest man-trailers. Pups and grown dogs. Max J. Kennedy, Fredonia, Kans.

FOR SALE—U. S. PATENT NO. 986289, FOR door and sash holding means. Rion Hoel, 444 Hubbard, Detroit, Mich.

FOR SALE—PATENTS ON THE ONLY EXPOSURE meter of value ever invented. Wanted capital to manufacture. E. M. Woodworth, Lacolle, Que.

CALIFORNIA GEM CRYSTALS FOR SALE—direct from the mines. Lapidists, jewelers and collectors write me your wants. Albert Everitt, Escondido, California.

GENUINE MEERSCHAUM PIPES ON credit plan. Write today for catalogue and terms. Wholesale, P. O. Box No. 1303, New York City.

WANTED—TO SELL CHEAP, THREE brand new five-ton WAGON SCALES, eight by fourteen. Standard manufacture. Write Daley Scale Agency, Binghamton, N. Y., Dept. 13.

FOR 10 CENTS I WILL MAIL TO YOU 7 assorted copies of sheet music (full size and complete) and very interesting catalogue. Frank Harding, Music Printer & Publisher, 228 E. 22d St., N. Y. Established 1860.

AMMETERS 1,000 WATCH SIZE NICKEL plated guaranteed. Battery testers in chamois leather cases. Read 0-30 amperes, 25c postpaid. Stamps taken. Auto Repair Co., 521-23 West 144th Street, New York.

TYPEWRITER—OLIVER LATEST MODEL No. 5, used 2 months, cost \$100.00. Will sell for \$35.00. Sent for trial my expense. J. S., 4203 28th, Oakley, Ohio.

SECURE A HOME IN FAMOUS WILLAMETTE Valley before Panama Canal opens and doubles values. Five and ten acre tracts our specialty. Suitable terms. German Investment Company, Salem, Oregon.

MEN—IT'S NOT YOUR RAZOR THAT'S ON the hummer, it's your strop. Holley's Strop Dressing makes the strop O. K.—razor works fine (guaranteed). Write for dollar box on ten days' free trial. The C. E. Holley Co., Mfrs., Dept. 4, Ypsilanti, Mich.

SOMETHING NEW—TO ADVERTISE OUR mineral collections, curios, etc., we will sell our regular \$2.50 Genuine Nugget Stick Pins at \$1.00 each for a limited time. They are sure beauties and will last a lifetime. Just the thing for gifts. Order now. Western Supply Co., Silverton, Colo.

FOR SALE

FOR SALE—ONE 24X27 7-FT. IRON planer. W. J. Ferrell, Barberton, Ohio.

PONIES. MANY BREEDS STOCK. DOGS. Catalog. Beachhurst, Shelbyville, Ky.

FOR GOODNESS SAKE GRAB IT. NEARLY 400 formulas sent postpaid for 20c. Absolute satisfaction. Send at once to Johnson & Co., Box 231, Phoenix, Ariz.

BOYS! DEE-LIGHTED RING. LATEST novelty out. Silver plated, 10c with illustrated Kat-a-log, tricks, novelties. Parkhurst Novelty Co., East Orange, N. J.

CASTINGS FOR WOOD TURNING LATHE, machined ready to assemble, \$2.50; including metal bed, \$3.50. Smaller size, \$1.50. Murray & Allender, 113 East Burl St., Fairfield, Iowa.

LUBIN MOVING PICTURE MACHINE—Complete outfit, fire magazine with automatic take-up on bottom, snap \$75. Take 9-inch foot power lathe equal value. L. P. M., care of Popular Electricity.

EXPERIMENTERS—BRASS, PER FOOT, $\frac{1}{4}$ square, 12 $\frac{1}{2}$ c; $\frac{1}{8}$ square, 8c; $\frac{1}{2}$ square, 25c; spring brass 4 $\frac{1}{2}$ wide, 20c. Tubing, copper, aluminum. Write for price list. Swain-Heiser Co., Hamilton, Ohio.

1-30 IN. MAHOGANY 50 SQ. FT., $\frac{1}{4}$ IN. poplar 3c, 1-30 in. quartered oak 3c, in sheets, random widths, 8 inches and over by 2 ft. and up long. W. H. Snyder, 838 Jefferson Ave., Indianapolis, Ind.

EXPERIMENTERS, INVENTORS AND PROFESSIONAL BUILDERS: I can supply anything in special and regular raw material and articles for experimental and model work. Lowest market prices. Free advice for amateurs. George H. Hutt, 721 Fulton St., Chicago, Ill.

"BLACK" OPALS. AUSTRALIA'S MOST beautiful gem. Exquisite colours—deep red, blue, green, gold, violet. Order direct from Australia at Australian prices. Write for illustrated catalogue. Norman Seward, 451 Bourke Street, Melbourne, Australia.

TATTOOING—IMPROVED ELECTRIC TATTOOING machines, \$2.50 each. Sold with a guarantee. Cheapest and best line of tattooing supplies on the market. Send 15c for 6 beautiful hand colored tattoo designs. Write now for free price list. F. Barber, 1019 Vine St., Cincinnati, Ohio.

FORMULAS

FORMULAS—3 MONEY MAKERS, 25c. Reliance Supply Co., Taunton, Mass.

COLOR ELECTRIC LIGHT BULBS AND make big money. Formula for 25 cents. Chemist, Buenavista, Colo.

ANY FORMULAS, OR ANY ADVICE CONCERNING electricity, mechanic, carpentry, sheet metal work, etc., will be given for the small sum of 15c for the first questions, 5c additional for each subsequent question. O. Liger, 218 Willington St., Sherbrooke, P. Q., Canada.

FORMULAS

FORMULAS AND RECEIPTS FOR ANYTHING—25c each. E. B. Stauffer, Ephrata, Pa.

NEW EDITION OVER 3,000 FORMULAS and recipes, 40c. Roadman's Guide; 100 ways to make money, 25c. Scientific Book Shop, Syracuse, N. Y.

INSTRUCTION

MAKE YOUR OWN SPARK-COILS, INSTRUCTIONS and drawings, 20c. Nomus Electric Co., 1216 48th Ave., Cicero, Ill.

MAKE MONEY RENEWING OLD DRY BATTERIES. Complete instructions, 25c. Guaranteed. Clark, 2030 Arch, Philadelphia.

LEARN VENTRILOQUISM AT HOME. Particulars for stamps. M. Bailey, Box 253, St. Paul, Minn.

METALIZE FLOWERS, INSECTS, ETC., FOR jewelry. Pleasant home employment. Booklet and beautiful rosebud pin for a dime. A. Benson, Stewartville, Minn.

LEARN SHOW CARD WRITING. EARN from \$5 to \$10 per day by our new method. No artistic ability required. Particulars free. Dellfield Co., San Fernando, Cal., Box 268.

SHORTEST SHORTHAND SYSTEM IN THE world. Taught in four lessons for \$2 by B. Watson, 901 Title Insurance Building, Los Angeles, Cal.

PARTICULAR MEN AND BOYS: HUSHER's alphabet makes your written plans, trade secrets, cost markings, business or confidential correspondence, etc., positively unreadable to others. Resembles Chinese but easily learned. Dime each. Box 47, Greencastle, Pa.

MAGIC

LEARN TO HYPNOTIZE AND MAKE FUN and money. Send for free book to M. D. Betts, Sta. 161, Jackson, Mich.

MISCELLANEOUS

TO SELL YOUR PROPERTY, WRITE Northwestern Business Agency, Minneapolis.

SEE WHAT I SAY UNDER "TYPEWRITERS." ATCHISON.

\$10.00 EACH FOR NAMES OF PERSONS INTERESTED in patents. For conditions, address P. O. Box 2343, Washington, D. C.

SEMINISM, THE RELIGION OF THOSE who know. Copy 3 stamps. Box 433, Ft. Wayne, Ind.

ANYBODY CAN MAKE GOOD CUTS WITH my simple zinc etching process; price, \$1.00; specimens and particulars for stamp. T. M. Day, Box E., Windfall, Ind.

BECOME AN EXPERT CANDY MAKER. Send \$1.00 for course or write for particulars to W. C. Fletcher, Brandon, Vt.

YOUR ADVERTISEMENT IN 100 MAGAZINES covering United States at 3c a word. W. Crawford, Dept. 1, Box 24, Toronto, Canada.

25c POCKET KNIFE FREE, IF YOU SEND 5 names of friends and 10c for postage. Morris, 525 Bainbridge St., Philadelphia, Pa.

MISCELLANEOUS

CIRCULARS MAILED, \$1.50 PER 1,000, open to mail order propositions, Shelbyville Agency, Shelbyville, Ky.

SELL YOUR ASHES AT \$1.00 A POUND AS I am doing and coin big money. Full details 15c. Philip Wittman, Ambler, Pa.

ACCURATE MECHANICAL DRAWINGS promptly prepared by expert draftsman. Charges reasonable. Investigate. Designer, 2117 Ainslie Street, Chicago.

BROTHER, ACCIDENTALLY DISCOVERED Root will cure both tobacco habit and indigestion. Gladly send particulars. F. F. Stokes, Mohawk, Fla.

WANT RESULTS? 4C WORD, \$4.50 AN inch, \$46 per page in 120 magazines in 40 states and Canada. Grabill Co., 819 Columbia Ave., Lancaster, Pa.

WE CAN FURNISH BACK NUMBERS OF any magazine, also subscriptions for magazines at lowest prices. We buy your old magazines for cash. Fred E. Wilkins, 24 Cherry St., Danvers, Mass.

I WILL START YOU EARNING \$4.00 DAILY at home in spare time, silvering mirrors; no capital; send for free instructive booklet, giving plans of operation. G. F. Redmond, Dept. H., Boston, Mass.

POST MARK COLLECTIONS. THE NEW craze, start a collection at once. Be the first in your neighborhood. We will mail you a collection of 25 different post marks, postpaid, for only 10 cents. The Lightning Specialty, Sherbrooke, Quebec, Can.

MODEL BUILDER

WE MAKE WORKING MODELS OF ANY description, also tools, dies, punch-press work, and special machinery. Send us drawing or rough model for estimate. Send for catalogue of model supplies. The Pierce Model Works, 3405 Pierce Ave., Chicago, Ill.

MOTION PICTURES

MOTION PICTURES TAKEN TO ORDER; printing and developing done; motion picture cameras and printers bought, sold and exchanged. We teach men to operate moving picture cameras. Special Event Film Manufacturers Co., Inc., 248 West 35th St., New York City.

MOTORCYCLES

SLIGHTLY SHOP WORN PIERCE SINGLE and four cylinder motorcycles. Bargains. Number limited. Wm. B. Colburn, 18 Hanover St., Buffalo, N. Y.

MOTORCYCLES—ANY MAKE, REBUILT, from \$25 up. Motorcycle tires, \$3 up. New motorcycles at factory prices. Buy direct. Save dealers' profits. Write for catalogue. Deninger Cycle Co., Rochester, N. Y.

1912 MOTORCYCLE MANUAL, A CYCLOpaedia of useful motorcycle information. Complete Trade Directory; best Motorcycle Trouble Chart ever published. How to Tour, etc.; 125 pages, 25c a copy. Motorcycle Publishing Co., 51 Chambers St. New York.

PRINTING.

LOOK HERE!—100 LETTERHEADS, 100 envelopes, 100 return envelopes or business cards, printed for \$1, postpaid. Walden Press, Roxbury, Mass.

RUBBER STAMPS

BEST RUBBER STAMPS 10 CENTS A LINE. Money back if not pleased. O. J. Jones, Mantec, N. C.

GET OUR CIRCULAR ON SHEET BLUEING mending tissue. Perfume post cards, rubber stamps, etc. Free. W. M. Stuart, Marshall, Mich.

SCHOOLS

SEE WHAT I SAY UNDER "TYPEWRITERS." ATCHISON.

LEARN FROM THE MASTERS! COURSE covering every field of the business world. Write. Common Sense Business School, Rising City, Nebraska.

LEARN WIRELESS TELEGRAPHY BY OUR quick course for beginners and advanced students. Our instructors, practical operators and wireless construction men, reasonable rates. Continental Wireless School, 420 Market Street, San Francisco, Calif.

AUTOMOBILE SCHOOL—LEARN THE AUTOMOBILE business, repairing and driving, in which you can earn good wages and have healthful and pleasant work. We give a thorough and practical course in road work and repairing. For full particulars address Academy of Automobile Engineering, 1420 Michigan Ave., Dept. "C," Chicago, Ill.

TELEGRAPHY

LEARN TELEGRAPHY. WE SECURE YOU a position. Railroad wires in school. Catalogue free. North-Western Telegraph School, Eau Claire, Wis.

TELEGRAPHY—MORSE AND WIRELESS; railway accounting (station agency) taught quickly. Railroad dispatchers and Western Union wires and complete wireless station in school. Splendid opportunities. Graduates assisted. Living expenses low—may be earned. Largest and oldest school—established 37 years. Investment \$25,000.00. Correspondence courses also. Catalogue FREE. DODGE'S TELEGRAPH & RAILWAY INSTITUTE, 16th St., Valparaiso, Ind.

TYPEWRITERS

TYPEWRITERS OF ALL MAKES—LOW prices; satisfaction guaranteed. Edward Quimby, Dover, New Hampshire.

STENOGRAPHER MUST SELL HER Remington typewriter, \$9.00. Miss King, 2230 Seventh Ave., New York City.

TYPEWRITERS: CALIGRAPH, \$6.00; Hammond, Yost, Densmore, Williams, \$10.00; Remington, \$12.00; Smith-Premier, \$15.00; Oliver, \$24.00; Underwood, \$30.00; all makes on hand; fifteen days' trial allowed, and a year's guarantee. Send for catalogue. Harlem Typewriter Exchange, Dept. 89, 217 West 125th St., New York City.

TYPEWRITERS

REAL VALUES IN ALL MAKES OF TYPEWRITERS, guaranteed for two years. Olivers, L. C. Smiths, Remingtons and Underwoods. Choice 300 typewriters \$10 to \$15. Send for special value price list today. Dearborn Typewriter Exchange, Dept. 16, Chicago.

I WANT TO CORRESPOND WITH PERSONS who are about to buy a high-grade typewriter, object to paying the high prices generally asked by manufacturers and dealers. Any make on approval. Catalogue, bargain list and valuable information sent free. A. E. Atchison, 4125 West 21st St., Chicago.

LARGEST STOCK OF TYPEWRITERS IN America. All makes: Underwoods, L. C. Smiths, Remingtons, etc., one-quarter to one-half manufacturers' prices (many less). Rented anywhere, applying rent on price. Write for catalogue 102. Typewriter Emporium (Est. 1892), 32-34 Lake St., Chicago.

WANTED

WANTED. PERSONS TO EARN GOOD commissions getting members for Nests and Auxiliary Nests, Order of Owls, South Bend, Ind.

A FEW STUDENTS DESIROUS OF OBTAINING a working knowledge of Electrical Engineering by pursuing work in our laboratories during the summer. Tuition small. No entrance examinations. Fine opportunity for reliable men. Number limited. Write at once to Prof. F. E. Austin, Hanover, N. H., 11 South Park.

WIRELESS

CLAPP-EASTHAM RECEIVING SET \$45; cost \$85. H. K., 1332 Fulton Ave., New York City.

WIRELESS AMATEURS—ANY SPEED, Morse or Continental wireless practice 10 cents for hour call evenings. Maginnis, 136 6th Ave., New York.

INVENTIONS—WIRELESS WANTED IMMEDIATELY, patented or not patented. If for sale, send description to A. P. Connor, Electrical Engineer, Washington, D. C.

MELTS UNDER BOILING WATER. SCIENTIFIC curiosity. An alloy with melting point guaranteed under 200. Fasten your crystals with it. ½ ounce for 30 cents. stamps or coin. R. Ferguson, Leroy, N. Y.

CLOSED-CORE TRANSFORMERS, SELF-controlling, four variations. ¼ K. W., \$10; ½ K. W., \$15; 1 K. W., \$25; 2 K. W., \$50; guaranteed. Sent on trial. Send stamp for circular. Phillips-Roadhouse, Shelby, Mich.

WIRELESS STATIONS OF NORTH AMERICA, containing calls of Government and commercial stations, ship and shore, and calls, names and addresses of many amateurs, together with much useful wireless information, 25c per copy. Address, Frederick Hodges, P. O. Box 135, Berkeley, Cal.

WIRELESS

\$9.75 BUYS \$15.00 $\frac{1}{4}$ KILOWATT TRANSFORMERS. Sends 30 miles. \$14.50 buys \$22.00 $\frac{1}{2}$ kilowatt. 70 miles. Fully guaranteed. Nomus Electric Co., 1216 South 48th Ave., Cicero, Ill.

WIRELESS APPARATUS—WHY NOT have the best when selecting the instruments for your station? We handle the best and most advanced type of apparatus on the market. Send 2c stamp for descriptive matter and catalogue. The Merker-Floeker Electric Co., 957 Liberty Ave., Pittsburgh, Pa.

HELP WANTED

BIG MONEY WRITING SONGS. SEND FOR free booklet. Tells how. Conway, 49 Tuscola St., Detroit, Mich.

EARN GOOD PAY COPYING ADDRESSES; particulars six stamps. Hinchey, 167, Middleport, N. Y.

WRITE MOVING PICTURE PLAYS; \$25 weekly. Booklet for stamp. Photoplay, 167, Middleport, N. Y.

LADY AGENTS WANTED FOR THE MARVELOUS "Magic" beautifiers. Big money. Novel selling plan. Write for particulars. S. A. Brown Co., Anderson, Ind.

CAN FURNISH PERMANENT EMPLOYMENT to three educated Christian men, organizing ability necessary. State age and former occupation. Address, L. S. Higley, Valparaiso, Ind.

SALESMEN AND BRANCH MANAGERS everywhere to handle best selling proposition known. Experience unnecessary. Legitimate, permanent and commands instant attention. Big commissions. Exceptional opportunity. W. E. Bryan & Co., Cincinnati, Ohio.

WANTED—MEN AT LOS ANGELES. CAN learn trade. Fair wages after second month. Automobiles, electricity, plumbing, bricklaying. Practical work on actual jobs. 1,200 students last five years. Only few months required. United Trade School, Los Angeles.

BE AN ELECTRICAL METERMAN—\$900 to \$1,800 a year. New field. Demand for competent metermen greater than supply. Personal, practical mail instruction qualifies you for splendid position. Graduates assisted. Write for particulars. Fort Wayne Correspondence Schools, Dept. 30, Fort Wayne, Ind.

SALESMEN—SEND YOUR NAME AND ADDRESS to Raymond E. Wood, 903 E. Eighth St., Cincinnati, Ohio. I am the manufacturer's sales manager for the best household and office electric specialty ever invented. Sells for \$3.50 and \$2.50. Guarantee for credit or deposit required. Capable men only need apply. I want only a few men; the work is permanent, profitable and high-grade. You will be given territory and expected to produce business.

BIG MONEY WRITING SONGS—HUNDREDS of dollars have been made by writers of successful words or music. Past experience unnecessary. Send us your song poems, with or without music, or write for free particulars. Acceptance guaranteed if available. Washington only place to secure copyright. H. Kirkus Dugdale Co., Dept. 13, Washington, D. C.

HELP WANTED

WILL HAVE OPENINGS THROUGHOUT U. S. for young men competent to wire automobiles for lighting equipment. Mail applications invited. State qualifications. Abco, 1132 Fulton St., Chicago.

FREE ILLUSTRATED BOOK TELLS ABOUT over 360,000 protected positions in U. S. service. More than 40,000 vacancies every year. There is a big chance here for you, sure and generous pay, lifetime employment. Easy to get. Just ask for booklet A50. No obligation. Earl Hopkins, Washington, D. C.

WANTED—MEN AND WOMEN FOR GOVERNMENT positions. \$80 month. Annual vacations. Short hours. No "layoffs." Common education sufficient. Over 12,000 appointments coming. Influence unnecessary. Farmers eligible. Send postal immediately for free list of positions open. Franklin Institute, Dept. C 54, Rochester, N. Y.

MEN WANTED FOR FIREMEN AND brakemen on railroads in Chicago vicinity; \$80 to \$100 monthly; promotion, engineer-conductor; experience unnecessary; no strike; age 18-35. Railroad employing headquarters; over 5,000 men sent to positions on 1,000 official calls. State age. Address Railway Association, Dept. J, 227 Monroe Street, Brooklyn, N. Y.

BIG MONEY WRITING SONGS. HUNDREDS of dollars have been made by writers of successful words or music. Past experience unnecessary. Send us your song poems, with or without music, or write for free particulars. **ACCEPTANCE GUARANTEED IF AVAILABLE.** Washington only place to secure copyright. H. Kirkus Dugdale Co., Dept. 13, Washington, D. C.

LOCAL REPRESENTATIVE WANTED— Splendid income assured right man to act as your representative after learning our business thoroughly by mail. Former experience unnecessary. All we require is honesty, ability, ambition and willingness to learn a lucrative business. No soliciting or traveling. This is an exceptional opportunity for a man in your section to get into a big paying business without capital and become independent for life. Write at once for full particulars. Address E. R. Marden, Pres. The National Co-Operative Real Estate Company, L 604 Marden Bldg., Washington, D. C.

**YOU CAN HAVE IT, TOO.**

Auto experts are wanted everywhere. Short hours and fascinating work. We teach you the entire subject in 10 simple, practical lessons, and assist you to secure a good position. Study at home in spare time. No automobile necessary—we furnish free model. Expert and experienced instructors. Send for First Lesson Today—It's Free. Get started at once. Let us prove our claim. Send postal now. The Original Auto School. OWNERS—We supply competent men. **EMPIRE AUTO INSTITUTE** 149 Empire Bldg., Rochester, N. Y.



A New Electric Lamp of Varied Usefulness

The Electric Candelier, the very newest idea in Electric Lamps, has the picturesque appearance of an old Colonial candlestick—yet, it is safer and far more useful. In fact, any electric lighted home will find the Electric Candelier the most convenient and adaptable appliance imaginable.

The Electric Candelier is a handsome ornament for the dressing table besides giving a soft, generous light. When left beside the bed at night it is ready for instant use by means of the pull-chain socket. Also very useful in the sick-room or nursery, or in the library where the ordinary lighting fixtures do not sufficiently illuminate the titles of books out of reach.

The Electric Candelier

may be moved about freely, the distance limited only by the length of the connecting cord. Standard handsomely finished in Roman gold; 10 inches high; very light in weight. Any shade, fitting a 2¼-inch shade holder may be used. Price, equipped with pull-chain socket, long golden-brown silk cord and without shade, \$8; imported Etruscan shade as shown, \$4 extra; iridescent shade, ribbed effect, \$3; gold-ribbed opal shade, \$3.

ELECTRIC SHOP—CHICAGO

Corner Michigan and Jackson Boulevards

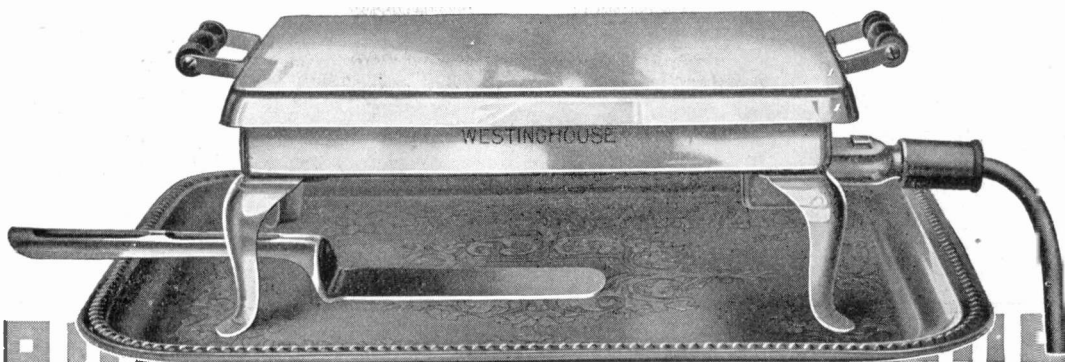

Westinghouse Electric Toaster-Stove

A Dainty Accessory to the Breakfast, Lunch, or Tea Table Service

YOU can prepare a hot dish or even a light meal directly at table with this complete electric table stove.

Toast, eggs in numberless ways, tea, coffee, muffins, a chop—many things the up-to-date woman can suggest.

To heat you merely insert plug into any electric light receptacle and turn the switch.

There is nothing about this electric stove to get out of order—no parts to renew. Use it three times a day at a cost of four cents for electric current. It is so well built that it is covered by the famous Westinghouse guarantee—"If anything happens to prevent its working electrically, you get another without cost, red tape, or bother."

The better electrical dealers and department stores can supply you. Or write on a post card—"Have a Westinghouse Toaster-Stove delivered to me," with your name and address. Send it to us and we will see that your stove is delivered immediately. Price, \$6.50.

A set of recipes for use with the Toaster-Stove will be mailed upon request.

Westinghouse Electric & Manufacturing Co., East Pittsburgh, Pa.
Department F

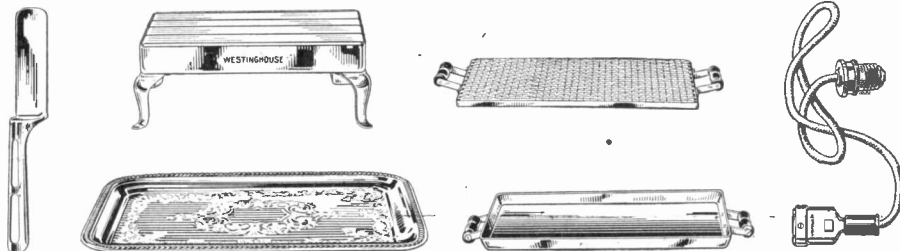



Samuel S. Thorpe
Owner of Cadillac Tract

Fine Farm for 12½c an Acre Monthly—

—make your future sure
—be master of your own time

The day approaches when you, too, will get the blue slip—be ready. Get a Home Place as a shelter for your declining years, a safe nest for the kiddies, and a well of deep contentment for Mother, while you may. I will sell you an ideal, a beautiful Home Place, that can make you happy, independent and free, near Cadillac, Mich., a fine town of live people with plenty of money—at terms (on 20 to 40 acres) of 12½c an acre monthly. It lies open and free, high and healthy, only a few hours' ride

from Chicago, all ready to pay you profits up to \$500 an acre net.

Suppose you owned 40 acres of this—half in pasture, ten acres in potatoes, five in orchard, and the balance lawn, yard, garden and cattle pens? You'd be a man of substance, whom bank presidents would earnestly shake hands with, a man worry-proof and content.

Satisfy that Heart Hunger

—it's natural, it's human, it's right. Stop pondering and longing. Don't waste energy wishing. Get you a Home Place—some money-making land—and get it now—while I hold the price down. Venture to write me for the plain story about this excellent land of mine at Cadillac, Mich. Hear my side—the Bible truth about this, your opportunity. I own this land outright, title clear and cloudless. My faith—in the shape of coin—is in it. It's located in a salubrious and charming lake-dotted, rolling country. There's plenty of sport—fishing and hunting. The climate (I prove it) is as mild as Missouri, and the soil, a loose loam, easy to work, is so rich in plant food that some farms there haven't cost a cent for fertilizers in years.

My Unparalleled Offer

This property—every acre of it—is so honestly valuable that any time within 12 months if you want your money back on the purchase price you can have it. So for a year from now, your money, which invested now gets you a Home Place at my present very low acre price, will not be spent, but saved. You can't help but be benefited whether you keep the land or not.

You see, the financial burden is trivial and the risk of



Norway Stumps Removed Free

loss is nil. I've eliminated DOUBT—the sailing is plain. Send for details. If I ever get the facts into you, you'll find it hard to stay away. You'll long to come to this pleasant, well-settled country, where crops are sure, markets are close, freights are low, shelter, elevation and drainage are excellent, people are white, roads are good, schools are thick and phones are cheap.

This land is surely going to increase wonderfully in value. The 37th Annual State Board Report says it's the natural home of the cherry—a superb apple country—and so perfectly adapted to berries and grapes they grow RANK. I'll send you a copy and let you read the SCIENTIFIC reasons why our soil and climate combine to produce "better growth of vegetation" than land you'd be glad to pay five times as much for—if you could get it.

DON'T RESIST—WRITE

Get the details—and get them now—while my terms on twenty to forty acres are as low as \$10 down and 12½c an acre, monthly. Find out from my references, including banks and governors, I am a man you can do business with safely—a man who does not exaggerate—who in fourteen years has never foreclosed a mortgage—a real estate owner who does not take advantage of the law's consent to gouge or grind, but who plays fair, practices the Golden Rule—and makes it pay.

Let me show you the road to Independence; write me NOW. Agents wanted.



The Result—Independence

SAMUEL S. THORPE, Owner of the Cadillac Tract
Dept. 3, 1627 First National Bank, Chicago, Illinois

For our Mutual Advantage mention Popular Electricity when writing to Advertisers.

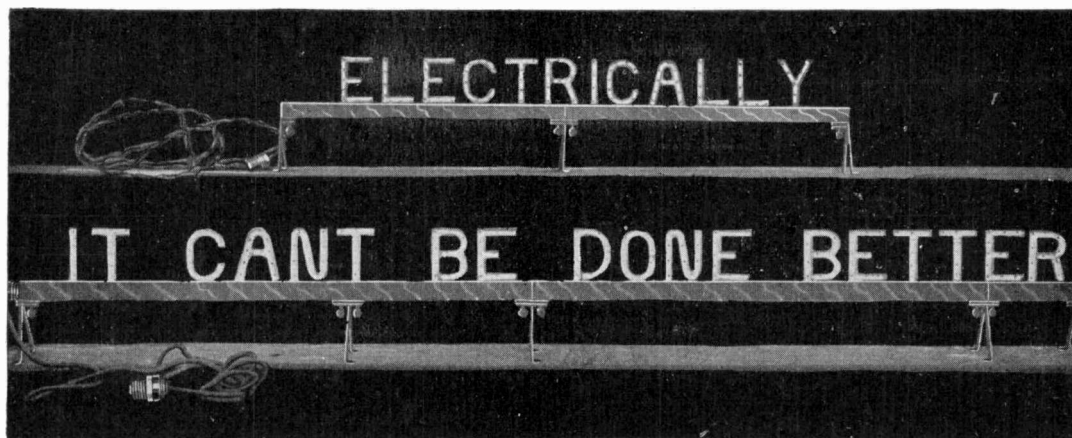

Something New in Electric Window Signs

You noticed this—the mere *illustration* of the Alpha-Bet Letter Lamp Sign. Imagine the effect of the *real* sign in your window—the wording varied to suit *your* special business requirements.

Nightly—as often as you wish—these Lamp Letters can be rearranged—formed into new words—flash forth new selling messages.

An Alpha-Bet Interchangeable Electric Letter Sign will give your window display strength and distinctiveness—emphasize the values *you* offer—compel the eye of the hundreds who pass your window.

The idea is new—bound to attract attention. The results are sure—as increased sales will demonstrate.

The expense is slight—the current consumed by each Letter Lamp being but 1/5 of what an ordinary 16 C. P. carbon lamp would require. And little or no change in your present electric light wiring need be made.

Electric Alpha-Bet Letter Lamps Fill Every Sign Requirement

Besides General Window Publicity, Alpha-Bet Signs are ideal for Show-Case, Department Designation, Special Announcements, Price Marks, Slogans—any where where an up-to-the-minute, attention-pulling, economical sign service is required.

A Word to Manufacturers

By reason of its attractiveness an Electric Alpha-Bet Window Sign that advertises *your* product is one *sure* way to obtain valuable window display space from deal-

ers. It insures you, gratis, space in their display windows which you probably could not buy from them nor command with any other display.

Why not write today, giving us an idea of your window sign requirements? Suppose you make a note to do so now, before you put this magazine aside?

Federal Sign System (*Electric*)

Chicago

Practical 25c Handbooks

No other books contain in such compact form as much reliable and up-to-date information on Electrical subjects, and at a price within reach of all

SMALL DYNAMOS AND MOTORS HOW TO MAKE AND USE THEM. A practical handbook. By F. E. POWELL. Contents of Chapters: 1. General Considerations. 2. Field Magnets. 3. Armatures. 4. Commutators and Other Details. 5. Tables of Windings. 6. How to Build a Small Machine. 7. Useful Data. 8. Testing and Repairing. 76 pages, fully illustrated with detail drawings.

WIRING HOUSES FOR ELECTRIC LIGHT By N. H. SCHNEIDER. Contains complete directions for wiring a house according to Insurance Rules, tells you just how to start about the wiring, what wire to use, how to estimate the materials required and completing the installation. Directions apply equally well to a shop. 86 pages; 42 illustrations.

LOW VOLTAGE ELECTRIC LIGHTING WITH THE STORAGE BATTERY By N. H. SCHNEIDER. Gives practical information on small low voltage electric light plants suitable for farms, stores and country homes in general. Full details are given showing how to estimate the number and size of lights required, their best location and most convenient means of control, and the plant necessary to supply the current. 85 pages; 23 illustrations.

ELECTRICAL CIRCUITS AND DIAGRAMS Being a selection of original up-to-date and practical diagrams for installing annunciators, alarms, bells, electric gas lighting, telephones, electric power light and wiring circuits, induction coils, gas engine igniters, dynamos and motors, armature windings. By N. H. SCHNEIDER.

ELECTRICAL BELLS AND ALARMS How to install them. By N. H. SCHNEIDER. Including batteries, wire and wiring circuits, pushes, bells, burglar alarms, high and low water alarms, fire alarms, thermostats, annunciators, and the locating and remedying of faults. With 56 original diagrams.

MODERN PRIMARY BATTERIES Their construction, use and maintenance, including batteries for telephones, telegraphs, motors, electric lights, induction coils and for all experimental work. By N. H. SCHNEIDER. 94 pages; 55 illustrations. The best and latest American book on the subject.

EXPERIMENTING WITH INDUCTION COILS By H. S. NORRIE, author of "Induction Coils and Coil Making." A most instructive little book, full of practical and interesting experiments fully explained in plain language with numerous hints and suggestions for evening entertainments. Arranged under the following headings: Introduction; The Handling of Ruhmkorff Coil; Experiments with Sparks; Effects in the Vacuum; Induction and Wireless Telegraphy. With 36 original illustrations.

SIMPLE SOLDERING BOTH HARD AND SOFT. Together with descriptions of inexpensive home-made apparatus necessary for this art. By EDWARD THATCHER. Contents of Chapters: 1. Soldering. 2. Soft Soldering. 3. Methods of holding work. 4. Hard Soldering and brazing. 5. Cleaning up work, polishing. 6. Standard apparatus. 7. Home-made apparatus. 84 pages; 52 illustrations.

ELECTRICITY The study of, and its laws for beginners, comprising the laws of electric current generation and flow. Ohm's law, galvanism, magnetism, induction, principles of dynamos and motors, wiring, with explanations of simple mathematics as applied to electrical calculations. By N. H. SCHNEIDER. With 55 original illustrations and 6 tables.

WIRELESS TELEPHONE CONSTRUCTION By NEWTON HARRISON. A comprehensive explanation of the making of a Wireless Telephone Equipment. Both the transmitting and receiving stations fully explained with details of construction sufficient to give an intelligent reader a good start in building a Wireless Telephone system and in operating it. 74 pages and 43 illustrations.

ALTERNATING CURRENTS SIMPLY EXPLAINED An Elementary Handbook on Alternating Current Generators, Transformers, and Motors. By ALFRED W. MARSHALL. This book is written for those who desire elementary information about Alternating electric currents, simply written and yet intensely interesting. Contents of Chapters: 1. What an Alternating Current is. 2. How Alternating Currents are Produced. 3. How Alternating Currents are Measured. 4. Transformers and Choking Coils. 5. Alternating Current Motors. 6. Rotary Converters. 7. Rectifiers. 82 pages, 32 illustrations.

INDUCTION COILS How to Make and Use Them. By P. MARSHALL. New edition revised and enlarged by K. STOYE. A practical handbook on the construction and use of medical and sparking coils for wireless telegraphy, gas engines, automobiles, gas lighting, X-rays, and all other purposes. With complete tables of windings for coils, giving 1/4-inch up to 12-inch sparks. With full directions for the construction of mercury interrupters. 76 pages, 35 illustrations.

SMALL ELECTRICAL MEASURING INSTRUMENTS How to Make and Use Them. By PERCIVAL MARSHALL. Contents of Chapters: 1. Instruments for testing the presence of an electric current, detectors, galvanometers. 2. Instruments for measuring the pressure or quantity of an electric current, amperemeters; voltmeters. 3. Instruments for measuring electrical resistance, wheatstone bridge. 4. Instruments for measuring static electricity. 5. Practical details for construction. 6. The principles upon which electrical measuring instruments work. 7. How to use electrical measuring instruments. 8. How to choose electrical measuring instruments. 90 pages; 59 illustrations.

Special Offer: FOR A LIMITED TIME WE WILL SEND ANY TEN OF THESE BOOKS TO ONE ADDRESS FOR \$2.00. TO SECURE THIS PRICE SEND US YOUR ORDER AT ONCE.

POPULAR ELECTRICITY BOOK DEPARTMENT
54 W. Lake St., Chicago, Ill.

Popular Educational Food Campaign

Free: Four Booklets Which Have Taught Many People to Cure Themselves.

A university student writes from Lincoln, Nebraska: "I have confidence in this system. It has relieved an unsightly skin and mental inertia through the valuable suggestions and hints in your four booklets. There is a mine of practical hints in them; enough to convince a sceptic were he to stick to the rules faithfully and give it a trial.

"Your little books eliminated chronic catarrh from my system in about three weeks. *To put it weakly, I was astonished.* I know now, that butter, eggs and rich cream caused the trouble. I thank you for your knowledge and hope to learn more of your system in the future."

Different Classes of Foods Cause Different Diseases.

I have produced in myself *at will* from time to time such complaints as rheumatism, catarrh, fevers, kidney trouble, blackheads, sores, dandruff, etc., by eating different classes of foods to excess, proving that the waste from each class of foods produces an entirely different disease. For instance, eggs, cream, butter, cheese, milk and salt are mucus-making foods which produce catarrh. Starch and eggs (paste-making foods) in wrong combinations congest and produce headache, dullness, brain fog, etc., while lean meats, green vegetables, and fresh, juicy fruits do not.



G. H. Brinkler, Food Expert



MUSCLE PRODUCERS



SOLVENTS



BLOOD PURIFIERS OR LAXATIVES



**NO FOODS SOLD
NO FASTING
NO EXERCISES**

A thin man, after being out of work nearly a year through weakness, was restored in three weeks to hard work as a carpenter at full pay. In such cases the change from a clogging, death-producing diet to energizing foods caused a literal transformation.

Another patient, deaf in the right ear, owing to a discharge caused by an excess of mucus-making foods (cream, butter, cheese, etc.), was completely cured of deafness and catarrh by taking correct combinations of suitable foods.

A case of kidney and bladder trouble of ten years' standing was saved from a surgical operation, and the objectionable discharge cured within ten days, because the loss of control was due entirely to the constant irritation from certain irritating foods and drinks.



Brainy Diet

A chronic sufferer, weighing 415 pounds, unable to exercise, took correct combinations of ordinary daily foods and reduced over 150 pounds (in public life, under many witnesses) gained strength with firmer flesh, and lost rheumatism.

Correct Combinations of Foods Cure Diseases.

I have always cured the above-named symptoms in a few days or weeks by returning to a correctly combined diet. The experiments have been fascinating and the results underlie success in life.

People Write:

"My brain power and general efficiency have been about doubled this year by selecting brainy foods. I have made a fortune in real estate and the credit is honestly yours."

"The government should investigate and teach the Brainy Diet System for the good of the nation."

"The hints in Booklet No. III, on foods for curing congested liver, nourishing the brain, etc., are worth untold dollars, although the books are free."

- (1) Test of Brainy Diet
- (2) Diet versus Drugs
- (3) Effects of Foods
- (4) Key to Longevity

Send 10 Cents for Mailing
Send Addresses of Your Sick Friends

G. H. BRINKLER
Food Expert, Dept. 19 G, Washington, D. C.

See FOREIGN AMERICA First

\$60 and up FOR 12 DAYS CRUISE INCLUDING BERTH AND MEALS

HALIFAX N. S.

Old World Scenes and Experiences in North America

This unique cruise to the northlands combines novelty, grandeur, delightful climate, and a charming sea voyage with absolute comfort, and remarkable economy. No hotel bills, changes or transfers, you live on the ship—it is your home for the entire cruise. A foreign tour costing four times as much could not be more delightful.

The cuisine and service are excellent, and the ships new, sweet and clean, and time in port and at sea divided to give the greatest comfort and satisfaction.

ST. JOHNS N. F.

This great tourist line to northern lands and seas will operate the large, powerful new steamships "Stephano" and "Florizel," giving the tourist seven days at sea and five days in port—2½ days in Halifax and 2½ days in St. Johns.

The ships are built especially for this cruise, are powerful, remarkably steady at sea, and equipped with every modern device for safety and comfort. Orchestra.

Don't plan your vacation without sending for handsome ill's catalog 6



RED CROSS LINE

Bowring & Company
17 Battery Place
New York



THIS TUNGSTEN FLASHLIGHT

85c POST PAID

can be used for a dozen different purposes about the house, garage, auto or launch without any danger whatever; and gives a very powerful light. Just the thing to slip under your pillow for immediate use during the night.

Send for it Today, also Agent's Proposition.

Foreign Electrical Exchange
105 N. Wabash Ave., Dept. 1, Chicago

MODERN ELECTRICS

"The Electrical Magazine for Everybody"

For the Novice, the Amateur, the Experimenter and the Student. 112 to 144 pages monthly. THE AUTHORITY ON WIRELESS.

With a six month trial subscription to Modern Electrics, we are making the following FREE OFFER: Marble's Pocket Screw driver and Prest-o-lite Key. Three sizes of blades locked in nickel plated handle which closes up like a knife, Closed 3-1-2 in. Open 5-1-4 in. Just out and it's a dandy. FREE. Send 75c. today in cash, stamps or M. O. and get Modern Electrics for six months, and the screw driver prepaid Absolutely Free.

MODERN ELECTRICS, 232 Fulton St. N. Y.

Guaranteed Non-Magnetic

This watch, a handsome stem wind and set, thin model, dust proof time piece, will positively withstand all magnetic attractions. Tested to 2000 Volts. Guaranteed accurate. Money back if not as represented. Approved by all electrical engineers. Price only \$5.00. Delivery FREE.

E. KIRCHBERG, Dept. A 132 NORTH STATE ST., CHICAGO.

WE SELL YOU AT WHOLESALE

Agents' Price One AMERICAN Motorcycle or Bicycle



\$139⁶⁵



\$18⁸⁵

Honest hand-made machines at factory cost. Write now for catalog. Say whether interested in Motorcycle or Bicycle.

AMERICAN MOTOR CYCLE CO.-117 American Bldg., CHICAGO

NORTHERN MICHIGAN LINE

The Elegant Steel Steamships

"Manitou" — "Missouri" — "Illinois" — "Manistee"

offer unrivaled service between Chicago, Charlevoix, Petoskey, Mackinac Island and other famous Summer resorts of Northern Michigan, connecting with all lines for Lake Superior and Eastern Ports.



SPECIAL SEVEN DAY CRUISES

The Steel Steamship "MISSOURI" to **COLLINGWOOD, ONT.,** and return via Mackinac, "Soo," North Channel and 30,000 Islands of Georgian Bay—
\$40.00

Including meals and berth

The Popular Steamship "MANISTEE" to **SAULT STE. MARIE,** and return via Mackinac—returning via a portion of Georgian Bay and the Scenic Grand Traverse Bay—
\$27.50

Including meals and berth

These are the finest fresh water trips in the world. You should see the magnificent scenery of the Switzerland of America. You can enjoy a delightful outing, have comfortable staterooms, excellent table and be in sight of land most of the way. For illustrated folder and book of tours, write J. C. COWLEY, S. P. A. Offices and Docks, No. End Wash St. Bridge, CHICAGO

DOES that appeal to you? We have

shirts strong and comfortable to work in—also neat and dressy enough for home wear.

We make the Signal Semi-Dress Shirt in a variety of patterns, both light and dark, and with two detached hand-turned collars, or attached soft collar. You can wear it and be *well dressed*. Cut coat style—that makes it easy to put on and take off when you are *tired* or in a *hurry*. You probably say, "I like the coat style fine but they *gap* at the waist."

That's where the *Signal Coat Shirt* differs. It laps over *three inches* at the waist, and has an *extra button* to keep the flap in place. Every Signal Shirt has two pockets, sleeves slit in the sides to keep out the dirt, double strength seams to prevent ripping. They have other pleasant features that will go a long way in making you our regular customer.



Signal Coat Shirts

in field, shop or home

"I always wear this brand."



UNION MADE



Trade Mark
The Mark of
"QUALITY"

Try a couple at our risk

Price \$1.00 (\$1.25 west of Missouri River) per garment. If your clothing man doesn't have Signal Coat Shirts, tell us his name and your size, and we will express you a couple C. O. D. Or write for folder showing styles. If you like them pay express man. If not satisfied, return at our expense.

HILKER-WIECHERS MFG. CO.,

1248 Mound Ave., RACINE, WIS.

Also makers of Signal Work Shirts and Overalls

BE AN EXPERT ELECTRICIAN LEARN IN SPARE TIME

THEY LIGHT THE WAY

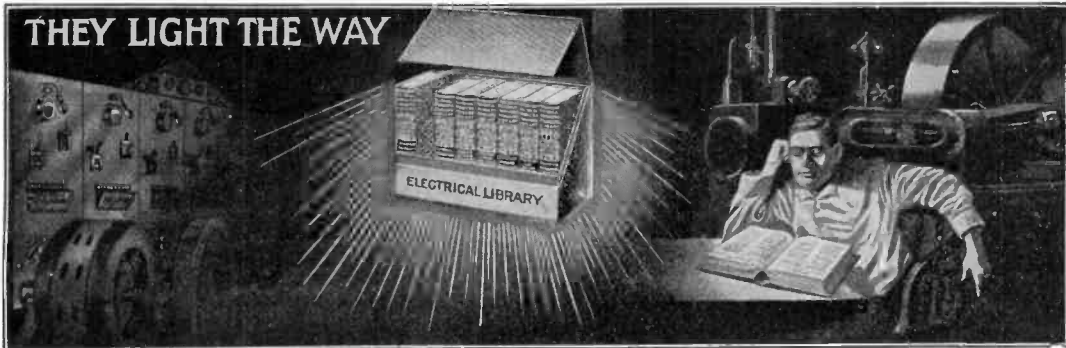

Electrical Workers' Standard Library

Text books for those who wish to easily and quickly master the Electrical profession. A Complete Course of Easy Lessons. Arranged in progressive order in Questions and Answers. Plain everyday English. Hundreds of diagrams and drawings make everything so clear that even a boy can understand.

Eight volumes, pocket size, about 380 pages each, profusely illustrated with diagrams, drawings and plates. One has about 750 pages and covers everything connected with up-to-date American Telephone practice. This volume alone has upward of four hundred engravings. A Complete Electrical Dictionary and also the Civil Service Examination Questions and Answers. Make an elegant appearance. The books are bound in full leather, round corners, and red edges. Complete in a cloth covered case, as shown above.

The FREE CONSULTATION SERVICE of this Institute for a term of THREE YEARS is at the command of every purchaser.

National Institute of Practical Mechanics.
P. Ec.:

Without any obligation on my part to purchase, please send me particulars, price and easy payment terms, of the Electrical Workers' Standard Library with the Consultation Service of your Institute.

Name.....

Address.....

Age..... Occupation.....

Employer.....

NATIONAL INSTITUTE OF PRACTICAL MECHANICS
1325 Michigan Avenue CHICAGO, U. S. A.

For our Mutual Advantage mention Popular Electricity when writing to Advertisers.



**30 Days' Free Trial
365 Days' Test
3 Years To Pay**

We Save You \$128 to \$222 On Your Piano

Send No Money Let Us Put This Piano In Your Parlor—Not a Dollar To Pay Us.

For over 69 years this celebrated Reed & Sons Piano was sold through jobbers, dealers and agents, but we have wiped out their profits, giving the saving to our customers. We offer you direct-from-factory to-home wholesale prices on Reed & Sons Pianos giving you the highest artistic quality possible, at a price much lower than your dealer would charge you for a cheap inferior instrument.

30 Days' Free Trial In Your Home—AND WE WILL PAY THE FREIGHT

Let your family and friends enjoy the beautiful tone-qualities and examine the handsome design and finish—easy responsive action. We want every owner of a Reed & Sons Piano to be absolutely satisfied. That's why, in addition to our 30 days' Free Trial in your own home, we also offer you a

365 Days' Approval Test

If we cannot satisfy you with the piano we will pay the freight for its return. This is the fairest offer ever made. It means 365 days' Approval Test, besides 30 days' Free Trial and three years' time to pay if satisfied.

A 25 Year Guarantee Bond goes with each

REED & SONS PIANO

It has a world-wide name as the sweetest-toned piano, handsomely designed—constructed to uphold a hard-earned reputation, gained during sixty-nine years. At the World's Columbian Exposition it won the highest award medal. Thousands of owners praise Reed & Sons Pianos, so will you. Own one on our plan. Prove it at our risk.

Take Your Own Time To Pay

Here is the fairest, squarest offer ever made. When absolutely satisfied, you can pay by the week, month, 3 months or twice a year—3 years' time to pay if satisfied.

BIG BOOK FREE Clip coupon below. It will secure for you our Special Proposition and Prices—all in handsome colored illustrated catalog sent free. We guarantee we can offer you a better proposition than any other piano concern in the world. A 2c stamp will save you dealer's profit.



Reed & Sons Piano Mfg. Co.

Dept. K27 Cor. Jackson Blvd. & Wabash Ave. CHICAGO, ILL.

Send me your Big Free Piano Book & Offers

Name.....

Street..... R. F. D.....

Town..... County..... State.....

Capital and Resources, \$1,750,000

Fill in the Coupon Now.

For our Mutual Advantage mention Popular Electricity when writing to Advertisers.

Are You Building?

Then let us send you copy of our new booklet P. E. 7, which tells all about the proper method of finishing floors and interior woodwork.

Johnson's Wood Dye

makes inexpensive soft woods just as artistic and beautiful as hardwoods. Tell us the kind of woods you will use and we will mail you panels of those woods artistically finished—together with our 25c booklet—all free and postpaid.

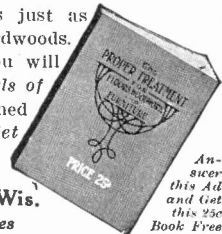

Answer this Ad and Get this 25c Book Free

S. C. Johnson & Son, Racine, Wis.
The Wood Finishing Authorities

50 ENGRAVED CARDS OF YOUR NAME \$1.25
In Correct Script, Copper Plate

THE QUALITY MUST PLEASE YOU OR YOUR MONEY REFUNDED
Sample Cards or Wedding Invitations Upon Request

SOCIETY STATIONERS **HOSKINS** 801 CHESTNUT ST. PHILA.



Your Boy's Happiness

is one of your first considerations. Have you ever thought of the tremendous importance and influence of his reading matter? There is nothing in this world that will do a boy more harm than cheap, trashy literature. **GET**

The Boys' Magazine FOR HIM!

In no other way could you give him more solid pleasure, entertainment and instruction.

This splendid magazine is chock full of just the kind of reading you want your boy to have. Clean, inspiring stories written by such noted boys' authors as Hugh Pendexter, Everett T. Tomlinson, William Heyliger, etc., etc. Practical and instructive departments devoted to Electricity, Mechanics, Photography, Carpentry, Boy Scouts of America, Stamps and Coins.

WALTER CAMP writes the editorials for THE BOYS' MAGAZINE and also conducts the Athletic department. Mr. Camp is known everywhere as America's highest authority on athletics—every boy should read his ideas of clean, manly sportsmanship.

THE BOYS' MAGAZINE is beautifully illustrated throughout—each issue has a new handsome cover in colors.

SPECIAL OFFER! In order to introduce THE BOYS' MAGAZINE to thousands of new readers we will offer to send the magazine for a whole year, together with a copy of our book "Fifty Ways for Boys to Earn Money," and also this splendid base ball glove ALL FOR

ONLY \$1.00. This glove that we give away with a yearly subscription is a high class one and one that your boy will be proud to own. It is made of finest tan leather, felt padded, leather lined, web thumb and deep pocket. We prepay all transportation charges.

Order to-day. We will refund your money promptly if you are not more than pleased with your investment.

(This offer is open to new subscribers only.)

THE SCOTT F. REDFIELD COMPANY, 1059 Main St., Smethport, Pa.
THE BOYS' MAGAZINE at all news stands, 10c a copy.

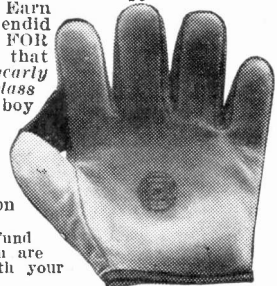

The Storage Battery for Electric Cars The "Ironclad=Exide"

The "Ironclad=Exide" will run an Electric Car—pleasure or commercial—*more miles with less expense, less attention and with greater continuity of service* than any other battery made.

The "Ironclad=Exide" Battery never "stalls" on a hill nor when starting a heavy load; gives good service in either cold weather or hot, and can be recharged at a reasonable cost.

The "Ironclad=Exide", "Hycap=Exide", "Thin=Exide" or the famous "Exide" Battery is used by twenty-three prominent electric vehicle makers. No other battery carries such an endorsement.

If you are the owner or prospective owner of an electric car, you will find "The "Ironclad=Exide" Book" to be full of useful information. Write the nearest office for a copy.

THE ELECTRIC STORAGE BATTERY CO.

1888

PHILADELPHIA, PA.

1912

New York Boston Chicago St. Louis Cleveland Atlanta Denver
Detroit San Francisco Portland, Ore. Seattle Los Angeles Toronto
"Exide" Depots in Philadelphia, Boston, Chicago, Cleveland, St. Louis, Denver, Atlanta and San Francisco. 860 "Exide" Distributors. Traveling "Exide" Inspection Corps.

The "Exide" Battery is best for Ignition, Illumination or Self-Starters.

ELECTRIC Goods for Everybody.

House Lighting
Plants, Lamps, Engines, Dynamos, Fan, Sewing Machine and Power Motors, Heating Pads, Laundry Irons, Toasters, Transformers, Meters, Telephones, Hand Lanterns, Submarine, Cap, Bicycle, Carriage, Automobile and Flash Lights, Storage and Primary Batteries, Belts, Bells, Books. Fortune for agents. Big Catalog, 4 cents.

OHIO ELECTRIC WORKS, Cleveland, Ohio

Before designing your ELECTRICAL APPARATUS

Send two cent stamp for our circular of Castings, Armature Discs, Commutators, Brushholders, etc., for Motors and Dynamos, 1-20 to 2 kw. Electrical sheet steel for Transformers, Armatures, fields etc. cut to shape. GAS ENGINES finished or castings only 1/2 to 2 h.p. We design and build small motors for machine drive and special requirements

F. E. AVERILL,
351-7th St. BUFFALO, N. Y.

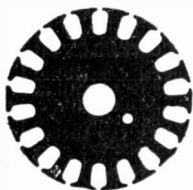

VOLTAMP ELECTRICAL APPARATUS AND SUPPLIES

Are sold on their merits and under the Voltamp guarantee of quality. Write today for our complete, fully illustrated catalog of Voltamp Products, which includes everything for experimental and general electrical work—motors, dynamos, induction coils, transformers; telephone, telegraph and lighting equipment; miniature railways, tools, toys, etc. (Send 6c in stamps or coin for catalog, which will be refunded on your first order of 50c or over. No postals answered.)

Voltamp Electric Mfg. Co., Park Bldg., Baltimore, Md.



150 KINDS IRON, WOOD, WIRE & STEEL PUZZLES

Sample with Catalog, 10 cents or 3 leaders for 25 cents.

WESTERN PUZZLE WORKS-E
St. Paul, Minn.

TESTED APPARATUS MEANS THE ELIMINATION OF FAULTS IN YOUR PRODUCT

Electrical and photometrical tests of every description. Checking electrical instruments of all kinds and classes. Inspecting and testing new electrical machinery, apparatus and material at factories and after installation. Tests on any electrical machinery and apparatus made anywhere. Arc and incandescent lamp tests, either electric, gas, acetylene or oil. Illumination tests made anywhere. Secondary standards of candle-power furnished. Facilities furnished to experimenters and investigators.

We have recently added to the above, Coal Testing, and are now prepared to make proximate analyses and calorific determinations on samples of coal, promptly and accurately.

ELECTRICAL TESTING LABORATORIES

80TH STREET AND EAST END AVENUE NEW YORK, N. Y.

For our Mutual Advantage mention Popular Electricity when writing to Advertisers.



1.6
Volts

25
Amperes

Figures That Count

In purchasing a dry battery, everyone wants a battery which will not have to be replaced every week or so. This can be avoided by the selecting of

THE 1900 DRY BATTERY

which by actual test has proven its efficiency for all kinds of work.

Send for Booklet which contains full particulars.

The Nungesser Carbon & Battery Co.
CLEVELAND, OHIO

General Sales Office: 627 W. Jackson Blvd., Chicago



This is the Stamp of Beardslee Quality

Chandeliers, Wall Brackets, Electric and Gas Portables designed to harmonize with all kinds of interior or exterior finishes, makes decorating and illuminating quite an easy task, and by the assistance of modern lighting glassware color schemes of untold beauty can be obtained.

Ask us to help you solve your fixture problem.

Beardslee Chandelier Manufacturing Co.
227 S. Clinton St., Chicago

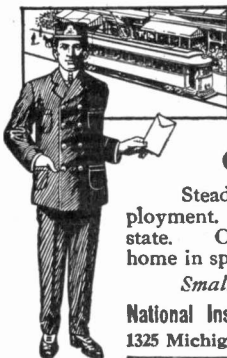

BE AN ELECTRIC MOTORMAN

GOOD PAY

Steady, healthful and pleasant employment. Positions open in every state. Our easy method teaches at home in spare time.

Small Cost. Particulars Free

National Institute of Practical Mechanics
1325 Michigan Ave. - CHICAGO, ILL.

Central Station Mgrs. Write for this Book

We have just published a book on "Co-operative Advertising for Central Stations." It explains how you can have all the advantages of a complete advertising department of your own. It tells how you can secure ready-to-use ads of *proved* effectiveness, prepared by *experts*, illustrated by the *best* artists in the country and type-set by ad *specialists*, at a cost merely *nominal* in proportion to what it would cost you to prepare these ads for yourself.

It Means Money to You

It will pay you to *investigate* this proposition. You may find that it *just* fits into your organization, *just* answers your need, *just* supplies what you want in the way of publicity. At any rate, why not learn more about it? A request on your business stationery will bring the book and full details by return mail. Absolutely no obligation.

Wm. D. McJunkin Advertising Agency
35 SOUTH DEARBORN STREET CHICAGO

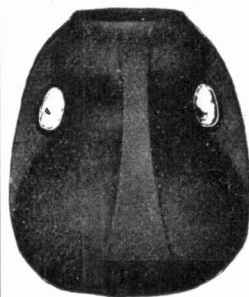

Consider

how much quality can be added by Teco Pottery Bases for Artistic Portable Lamps.

You can obtain an idea of the beauty of

Teco by securing a booklet which we have prepared.

Write us, but remember we supply only the bases, leaving the other parts for manufacturers who specialize on these parts.

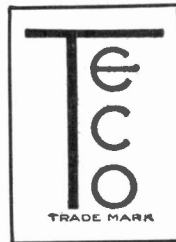

Gates Potteries

Terra Cotta, Illinois

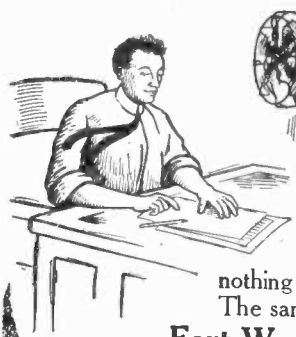

Which Would You Rather Be?

If you were one of these two men would you change places with the other for a difference of half a cent an hour?

The comfort alone is worth many times that amount, to say nothing of the difference it makes with your disposition and the work you can do. The same thing is true of those who work for you and

Fort Wayne Electric Fans Are A Good Investment

because they increase the efficiency of your help.

They are the best means of supplying refreshing, cooling breezes during the hot sultry weather, and it costs only half as much to run one as a 16 candle power incandescent lamp.

We make a size and type for every use and there's enough difference in quality to make it well worth while asking for a "Fort Wayne" when you buy a fan. If your dealer does not carry them—write us.

FORT WAYNE ELECTRIC WORKS

OF GENERAL ELECTRIC COMPANY
1603 Broadway, Fort Wayne, Ind.
"WOOD" SYSTEMS
Branch offices most large cities

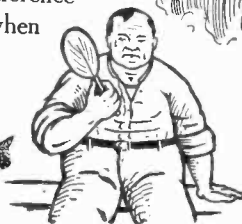

F2

COOK BY ELECTRICITY

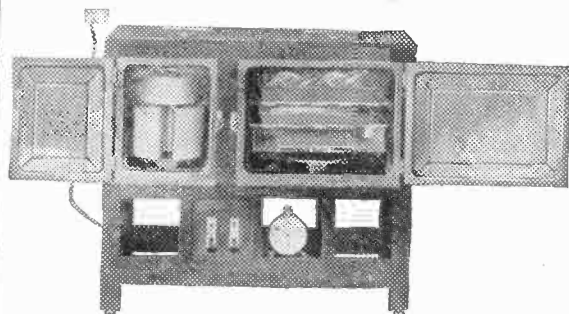

THE SILENT SERVANT

The COPEMAN AUTOMATIC ELECTRIC COOK STOVE

which has Revolutionized the Art of Cooking, is a Conservator of Time, Labor, Health and Dollars. The operation of the stove is very simple—the current being turned on at a predetermined time, and cut off at a predetermined temperature—all absolutely automatically, the stove taking on the fireless cooker principle after the desired heat has been obtained in the compartment.

The Copeman Stove will perform all the functions of any gas, coal or wood stove, and the food tastes better. These stoves are made in three sizes to accommodate families ranging in size from two to twenty people.

Write for literature and prices

COPEMAN ELECTRIC STOVE CO.
424 North Saginaw Street, Flint, Michigan

WASHING A PLEASURE

Not a Terror with a
"Domestic" Electric Washer and Wringer

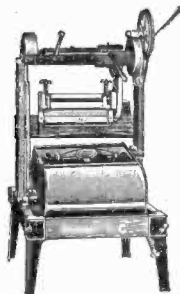

Washes clean anything washable, in from 3 to 10 minutes, without injury to the most delicate fabric. In an average family will save its cost every year. Cost of Electricity is about 2c an hour or 5c for the average family wash. The tub is made of metal; no wood to warp, shrink, leak or smell. Can be cleaned in 15 seconds. All the working parts are enclosed. Equipped with a quickly reversible metal frame electric wringer.

SIMPLE EFFICIENT DURABLE

Sent on approval anywhere in the U. S. Washing Machines. Hand, Belt and Motor Driven. \$15 to \$125. Send for Catalogue, and our easy payment plan.

DOMESTIC EQUIPMENT CO.
DEPT. P. 30 W. LAKE ST. CHICAGO

The Advice of our . . . Electrical Dept.

At your service in selecting from our BOOK DEPARTMENT electrical books to suit your needs
Popular Electricity Publishing Co.
54 W. Lake St. Chicago, Ill.

GET YOUR SHARE



Large profits—easiest—fastest—biggest seller on the market today. National Self-Heating Gasoline Iron sells everywhere—town or country. Join our force of enthusiastic agents now. No time to lose. Complete demonstrating outfit \$4.50. Write for the facts. National Stamping & Electric Works
423 South Clinton Street, Chicago, Illinois

For our Mutual Advantage mention Popular Electricity when writing to Advertisers.



THOR ELECTRIC
Home Laundry Machine

\$1.50 WEEKLY \$1.50
PAYMENTS

This small amount each week
for a short time will buy a

Thor Electric Home Laundry Machine

The machine that is conceded to be the most perfect washday servant known. Absolutely guaranteed to do the weekly washing and wringing in a manner satisfactory to the most particular housewife.

Our dealer in your city will deliver the machine to you, or we will ship to you direct, freight prepaid, for a

15 Days' Free Trial

before you make your first payment. In accepting this free trial offer you do not obligate yourself in any way to keep the machine.

Write today for Catalog F and Free Trial and Weekly Payment Plan

HURLEY MACHINE COMPANY

NEW YORK: 1011 Flatiron Building

CHICAGO: 27 S. Clinton Street

Electric Cooking

Is Practical and Economical with

Simplex Electric Ranges

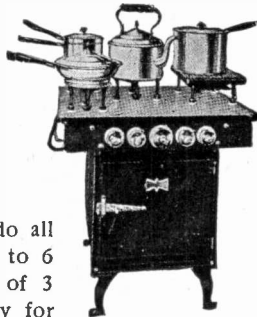

Number Five will do all the cooking for 4 to 6 persons at a cost of 3 to 5 cents per day for each person when special rates are in force. Cooking is done in a cool room, without the danger of flame, the delay of fire building, or the nuisance of dirt.

Write for the story
of "Number Five"

Simplex Electric Heating Co.

Chicago, 15 S. Desplaines St. Cambridge, Mass.
San Francisco, 612 Howard St. Belleville, Ont.

A 30 Day Free Trial



in
your
home
will demonstrate
to
your
satisfaction
how
necessary the

SIMPLEX IRONER

is for economical management.

It saves your strength, health, beauty, time and money. It irons five times as fast, better and makes it easier. Servants are better contented, more efficient. Heats by gas or electricity. Operates by hand or small motor at small expense. It really costs nothing because it saves its cost every six months. Write for booklet and "Ironing Hints." Both free.

AMERICAN IRONING MACHINE COMPANY
55 East Lake Street Chicago, Ill.

Perfect Air Circulation and Lots of it at Low Cost

can be obtained by installing the alternating current, variable speed, reversible

KIMBLE FAN

This fan is a wonderful improvement on the regular or staple type of fans, as one of its principal features is that it can be reversed from full speed forward to any speed back by simply the pulling of either one of the two chain pulls, shown by illustration. This enables the fan to be quickly converted from an exhausting to an intake fan.

Above all other features, you can be sure that your bills will be in direct proportion to the amount of air moved, as there are no resistance boxes to consume the unused current.

The starting will not pull your lights down every time you start it, as it consumes no more current in starting than at full load.

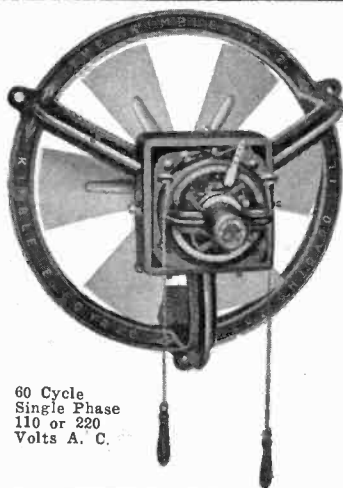

60 Cycle
Single Phase
110 or 220
Volts A. C.

KIMBLE VARIABLE SPEED MOTORS

are unequalled for machines like Printing Presses, Washing Machines, Ice Cream Freezers, Laundry Machines, Pipe Organs, Amusement Park Devices, and in fact for ALL purposes where it is desirable to vary speeds or to reverse, no other motor in the world begins to approach it for economy, efficiency and durability.

EVERY KIMBLE MOTOR IS SOLD ON A TWO YEARS' GUARANTEE

KIMBLE ELECTRIC CO., 1119 Washington Blvd., CHICAGO

| H. P. | Size fan | Price |
|-------|----------|---------|
| 1/6 | 18 | \$65.00 |
| 1/4 | 24 | 90.00 |
| 1 | 30 | 150.00 |
| 1 1/2 | 36 | 210.00 |
| 2 | 42 | 275.00 |

Write for our catalog. It's full of good information about alternating current motors, their care and use, as well as what they can do.

Will Not Burn Out

An important feature of these motors is that they will not heat under any circumstances 1/12 and 1/4 H. P. for A.C. and D.C. Finished in Black Enamel



THE BARNES

Variable Speed and Reversible
Are especially adapted for
Washing Machines, Printing Presses,
Coffee Mills, Dental Apparatus, Vacuum
Cleaners, Wireless Apparatus, etc.

Let us figure on your requirements

**BARNES MFG. CO. 107 Belmont Street
Susquehanna, Pa.**

ELECTRIC LIGHT AND POWER

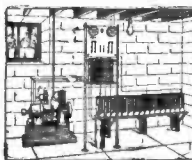

DAY AND NIGHT SERVICE
The Junior No. 1 Equipment
Direct Connected Dynamo, Gasoline } \$205
Engine Set, Complete Switchboard,
16-Cell "American" Storage Battery }
The most complete, reliable equipment
ever offered at this price. We want a
representative in every county.
AMERICAN BATTERY COMPANY
Est. 1889 1143 Fulton St., CHICAGO

ELECTRIC MOTORS SHOULD BE

"ROTHMOTORS"
Polishers, Grinders, Blowers
Write for Literature

ROTH BROS. & CO.

1385 W. Adams St., Chicago 136 Liberty St., N. Y.

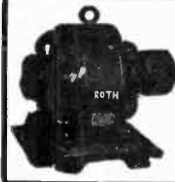

A PERFECT ELECTRIC FAN \$6.50

SIX-INCH, SUITABLE FOR INDIVIDUAL OFFICE, HOUSE OR HOSPITAL USE

8 inch fan, three speeds and switch..... \$8.50 8 5/8 inch fan, 3 speeds and switch..... \$8.85

110 VOLT ALTERNATING OR DIRECT CURRENT

FINISH: Fine black enamel; guards and blades heavily nicked on brass. All absolutely of the finest quality, noiseless, and no competition. Desk or bracket. Every conceivable adjustment. Price refunded if not satisfactory.

We prepay express and include free a 75c double-covered silk cord with plug, if you mention dealer's name and voltage desired.

Also **SIX VOLT BATTERY FANS, 6 AND 8 INCH (NOT TOYS)** at same price and with such small current consumption that they can be run economically on any wet, dry or storage batteries. Fine for boat cabins, sick rooms, and all places which lack lighting current. Special voltages wound to order.



The Carleton Company

Also an exclusive line of **SMALL MOTORS, ORIGINAL "IMP" TORCHES, TOASTERS, IRONS, BELL RINGERS, ETC.**

178 Summer Street

BOSTON, MASS.

For our Mutual Advantage mention Popular Electricity when writing to Advertisers.

BIG ELECTRICAL CATALOG AND WIRELESS

250 PAGES

THIS BIG 250-PAGE CATALOG is unquestionably the largest, most artistic, most elaborate and comprehensive catalog of its kind published.

Celebrated Ferron Detector, yet remains the peer of all Detectors licensed for private use. Price only \$5.00.

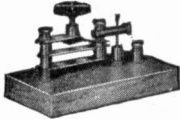

The Ferron Detector contains the same high grade crystal, and an adjustment equally as admirable as the Pyron Detector licensed for commercial use and which sells for \$65.00. Licensed for private use permits of low price. A patron in Georgia writes, "Easily picked up several ships off Norfolk and New Orleans, also land stations. Signals came in so loud I could hear them with telephones removed some distance from my ears"

MAILED FOR 6c in stamps or coin, which may be deducted on first order of \$1.00.

LOWEST PRICES ON EVERYTHING IN ELECTRICAL LINE

Attention is called to our very attractive prices on spark coils. These prices will last for a limited time only. Our spark coils are made by one of the foremost coil companies in the United States and our patrons should be quick to take advantage of the great opportunity offered to them to get these excellent spark coils at such attractive prices.

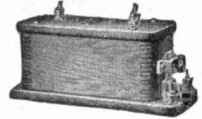

WIRELESS INSTRUMENTS

for commercial, private and experimental use.

WHAT THIS BIG CATALOG CONTAINS:

- 75 pp. Wireless Instruments
- 20 pp. Telegraph Instruments
- 30 pp. Motors and Dynamos
- 15 pp. Flashlights and Miniature Lamps
- 25 pp. Miniature Trains
- 10 pp. Launch Lighting Outfits
- 70 pp. General Electrical Supplies
- 10 pp. Mirrorscopes (will project pictures of all sizes in natural colors greatly enlarged)

Special low prices on our high grade wireless spark coils for this month only. Magazine must be mentioned when ordering at these reduced prices.

| | |
|--------|---------|
| 1-inch | \$ 8.85 |
| 2-inch | 7.00 |
| 3-inch | 14.00 |
| 4-inch | 20.00 |

J. J. DUCK 428 ST. CLAIR ST. TOLEDO, OHIO

This high grade receiving set, \$9.50
Without variable condenser, 7.50
2000 Ohm D. P. comp. head phones. 3.75
A little small comp. set . . . 6.00
1 in. induction coil guarant. 3.65
Etheric Mineral Detector . . .95

Send 3c stamp for catalogue to the
Etheric Wireless Co., 80 W. 124th St., N. Y. City

BIG OFFER ON SPARK COILS. We cap the climax with coils which stand alone in style, quality and price. As a special offer we will include free with each coil a set of 12 pieces of Apparatus and directions with which many interesting experiments can be performed. These coils are specially adapted for wireless. 1/2-in. Spark Coil and 12 pieces of Apparatus, \$1.15; 3/4 in. Spark Coil and 12 pieces of Apparatus, \$1.75; 1-in. Spark Coil and 12 pieces of Apparatus \$2.50. Send 3c for catalog. Thomas M. St. John, 846-8 9th Ave., New York

WIRELESS EXPERIMENTERS

Special prices in enamel wire for this month.

| | | | |
|--------|--------------|--------|--------------|
| No. 22 | .50c per lb. | No. 26 | .60c per lb. |
| No. 24 | .55c per lb. | No. 28 | .70c per lb. |

Send 2-cent stamp for our large wireless catalogue, including diagrams and other interesting information. We will also include our monthly aeroplane bargain sheet.

THE I. W. T. WIRELESS CO.
1038 Broadway, Brooklyn, N. Y.

WIRELESS COILS

Our Wireless Coils are made especially for wireless, and stand second to none for this purpose. This coil shown here will, on 6 dry batteries, give a 3 1/2-inch spark; and with a fair sized aerial transmit from 25 to 30 miles, and with a good 6 Volt Storage Battery will do even better. For a short time only the above coil can be bought for \$10.00 net. Shipped anywhere f. o. b. Philadelphia. We also have smaller sized Wireless Coils at very reasonable prices.

Send 2-cent stamp for illustrated catalogue.

F. B. Chambers & Co., 217 N. Ninth St., Phila., Pa.

Something worth having

Send 5 cents for our new Catalog No. 10, showing every type of wireless instrument of merit on the market and many new ones at the same prices or better than you can get anywhere else. We refund your money if you are not satisfied.

JOHN Y. PARKE & CO., DEPT. A, 125 N 7TH ST., PHILADELPHIA

DROP US A POSTAL CARD

for our new book catalog and pamphlet, "18 Ways to Make Money." Do it now.
Popular Electricity—Book Dept.

BRANDES SUPERIOR RECEIVERS

This testimonial is one of the many we receive regularly: "With an aerial 85 ft high and 95 ft. long, I have heard the following stations: NPB Sitka, Alaska, 1800 miles, 11:00 P. M. NAX Colon, Panama, 3000 miles, 10:35 P. M. NAR Key West, Fla., 2500 miles, 6:20 P. M. As my instruments are all of my own make I lay my good success to the 'phones.' Santa Ana Cal. J. E. W."

Complete 2000 ohm set, \$5.00
If the receivers do not meet with your approval, you may return them, and your money will be refunded immediately.

C. BRANDES, Inc. 111-115 Broadway, New York
Agent for San Francisco, Ford King, 623 Balboa Bldg. Los Angeles, C. E. Cook Electric Co., 745 S. Spring St.

Absolutely Free

No strings
Complete Course of Wireless Instruction in 20 Lessons—400 Illustrations.

This course embraces 20 lessons not only on wireless telegraphy but electricity in general. When you finish this course you will have an expert knowledge of wireless and general electricity. This course is not a gift—we owe it to you. It represents your discount for cash on future orders. Send today 4c postage mentioning this adv. and we will forward full information; also copy of our 196 page Electrical Encyclopedia No. 10, containing over 1,590 articles and 450 illustrations.

THE ELECTRO IMPORTING CO., 233 B Fulton Street, New York City

For our Mutual Advantage mention Popular Electricity when writing to Advertisers.

Wireless Detector Stand, \$2.75

By Mail, 15c extra

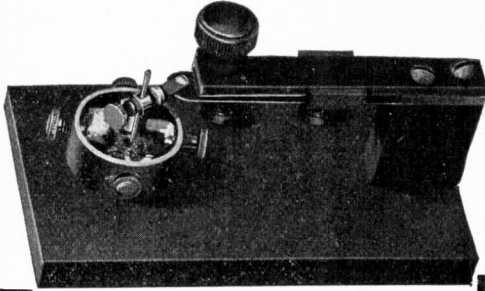

Just the Thing You Have Been Looking For

Not only is it equipped with our now justly famous **Variable Tension Slide**, but in addition to this the revolving mineral cup is designed to contain four different kinds of minerals, or four of the same kind as you please, each crystal being brought into position either by rotating the cup, or laterally moving the arm containing contact pin. This principle enables you to not only bring any desired mineral into the circuit, but any desired point of the mineral or minerals.

The pin is sterling silver or brass, as may be desired, and by soldering a very fine wire to the pin you secure conditions which are just right for the use of galena.

Base is vulcanized black fibre, 3"x5"x1/2", nicely finished as to be easily mistaken for polished hard rubber. If desired can furnish with Polished Hard Rubber Base for 50c extra.

Send 2c stamp for our **Wireless Catalogue**

DAWSON & WINGER ELECTRIC CO.
727 So. Dearborn Street, Chicago, Ill.

MURDOCK WIRELESS RECEIVERS



You want, most of all, good receivers. It is a Murdock habit to make good receivers, and it has been for more than fifteen years. For WIRELESS, the Murdock No. 50 will do well what any receiver will do, what most receivers cannot do at all, and, what is important, will keep on doing. You can buy satisfaction. Why not the Murdock kind?

2000 ohms, complete . . \$7.50
3000 ohms, complete . . 8.50

Your Money Back if the Phones Don't Make Good

WM. J. MURDOCK COMPANY
50 Carter Street, CHELSEA, MASS.
162 MINNA ST., SAN FRANCISCO

THE BLITZEN Rotary Variable Condenser

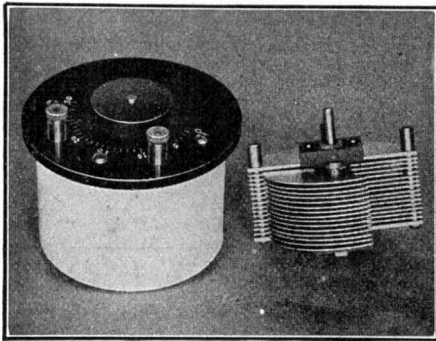

Price \$5.00

Don't chase away the small amount of energy in an incoming signal with condensers which slide in grooves and provide a large leakage path on every edge of every plate.

Capacity is large (.0008) and by filling with castor oil may be increased five times to .004 M.F. Has 15 rotary and 16 stationary aluminum plates, nickel plated brass case and hard rubber top and handle (not composition).

Better send 4c stamps for our complete catalog—today.

CLAPP-EASTHAM CO., 141 MAIN ST., CAMBRIDGE, MASS.

Aylsworth Agencies Co., 143 2nd St., San Francisco, Cal.

Western Sales Agents
J. J. Duck, 430 St. Clair St., Toledo, Ohio
Central States Agent

Every Wireless Operator or Amateur Needs This Book

The handiest and most useful
Book for the Wireless Operator, Amateur
or Professional, ever published.

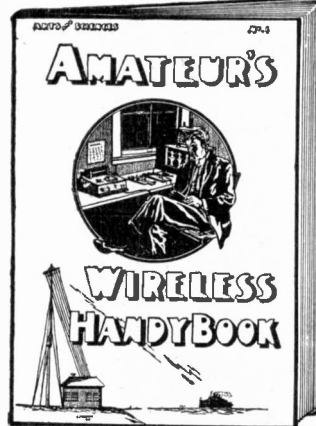

What It Will Do for You

Contains a complete list of wireless Call Letters, 1500 in all, enabling you to locate the origin of any certain call immediately; also the owner of the station or ship and power rating.

The Morse and Continental Codes are shown on two large full page charts so that they can be read from a distance, also a Beginner's Speed Chart so arranged to assist in learning the Codes quickly.

All the abbreviations used by operators to save time and labor. And last but not least over 100 Hook-ups and Diagrams. No matter what instruments you have you will find a perfect hook-up that works in this book. Blank pages are provided for keeping a record of your own hook-ups.

Price Twenty-five Cents
POPULAR ELECTRICITY BOOK DEPARTMENT
54 W. Lake St., Chicago, Ill.

Send for Our New Catalog E.26

It is pocket size, contains 212 pages, measures $7\frac{1}{4} \times 8\frac{1}{4}$ ", can be carried in the pocket, and has a mine of information to impart in clear, concise, understandable language.

It Means Money Saved to You

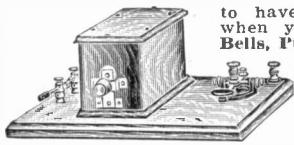

To have one to consult when you want to buy Bells, Push Buttons, Batteries, Telephones, and Telegraph Material, Electric Toys, Burglar and Fire Alarm Contrivances,

Electric Call Bells, Electric Alarm Clocks, Medical Batteries, Motor Boat Horns, Electrically Heated Apparatus, Battery Connectors, Switches, Battery Gauges, Wireless Telegraph Instruments, Ignition Supplies, etc. Do not wait until some other time, but sit down now and send your name and address, and get the best pocket edition electrical catalogue published. It costs you nothing.

Manhattan Electrical Supply Co.

New York, 17 Park Pl. Chicago, 114 S. 5th Ave. St. Louis, 1106 Pine St.

Via Wireless

S. O. S.

S. O. S.

Yours can be the thrill of receiving or sending wireless messages over many miles provided a

Thordarson Flexible Step-up Transformer

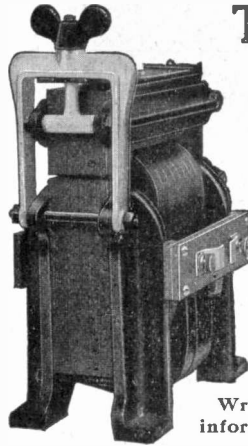

forms part of your apparatus. Power varied by simple turn of thumb-screw. Connects directly to mains—no switches, resistances or choke coils needed. Two types— $\frac{1}{2}$ K. W., 10,000 and 1 K. W., 20,000 volt output. Special windings to order.

Unequaled for Generating Ozone, Testing Insulation, Electro-static Separation, etc. Alternating current only.

The BEST. Quality considered, the CHEAPEST.

Write for circular giving full information and prices TODAY.

Thordarson Electric Mfg. Company
505 South Jefferson St., Chicago

MARINE

Wireless Telegraph Apparatus

To Owners of Motor Boats:

Here are three undisputable reasons for using wireless apparatus on any boat:

- You can call for help and be sure of getting it.
- You can receive press and market news.
- You can transmit and receive regular telegrams.

Foster Marine Wireless Outfit, 75 Mile Range Complete, Price, f. o. b. Chicago, \$75.00

I also carry full line of amateur apparatus. Correspondence on wireless matters will receive prompt attention.

R. H. Foster, 4529 Clifton Ave., Chicago, Ill.



Human Safety

DEMANDS
RELIABLE

Wireless Receivers

WE MAKE THEM

Durably Built Yet Sensitive to the Slightest Vibration.

WRITE FOR CIRCULAR 20A2

THE HOLTZER-CABOT ELECTRIC CO.
BROOKLINE, MASS., and CHICAGO, ILLINOIS

Complete Wireless Receiving Set Regular \$2.50 Value SPECIAL PRICE \$1.75

Read the messages that are flying all around you in the air. Receives messages up to 500 miles.

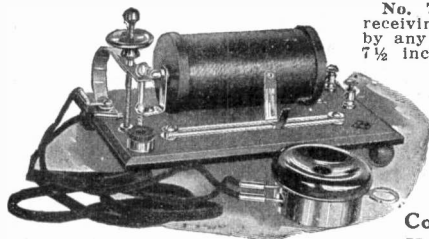

No. 797. Here is another of our great amateur offers: a complete receiving set mounted on a base at a price that cannot be approached by any other firm in America. The base of this set is of solid oak $7\frac{1}{2}$ inches long by $4\frac{1}{4}$ inches wide by $\frac{3}{8}$ inch thick. It is finished in shellac, rubbed down to a dead finish. The set consists of a combination universal detector, one 75 ohm, nickled case telephone receiver and telephone cord, 1 tuner, $\frac{1}{4}$ inch long, wound with bare copper wire by our special method that allows the turns to touch each other and yet are thoroughly insulated from each other, thereby having a wire length nearly equal to the tuners now on the market selling for \$1.75. 1 inch of Wollaston wire, 2 insulators, and 65 feet of aluminum aerial wire. Instructions and codes. Price\$1.75 (Sent by express) By mail, 32c extra.

Complete Sending and Receiving Sets, \$3.90, \$5.00, \$8.50
Hunt & McCree, 92-94 Murray St., New York

WRITE FOR CIRCULAR P.
DON'T BUY BEFORE WRITING US.

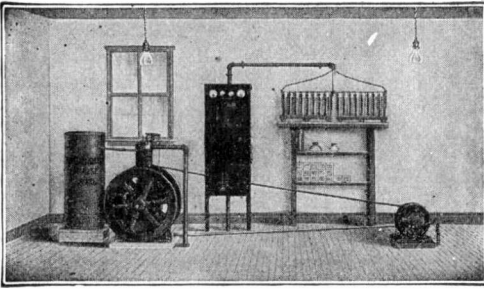

Fairbanks-Morse Electric Light Outfit

Modernize your home; use electricity generated by your own plant. Have abundant light at little cost in all your buildings at any hour merely by turning a switch. You can run all 50 lights of the Fairbanks-Morse outfit 5 hours for about 10 cents for fuel oils.

Complete Outfit \$500 Our low-voltage outfit consists of 2 H. P. gasoline engine, dynamo, belt, switchboard, storage battery and 50 Mazda lamps and fixtures. It is safe, simple, fully guaranteed.

Current can also be used for running electric fans, electric irons, vacuum cleaners, washers, sewing machines, etc. Engine can be used to operate a water system or run light farm machinery while charging storage battery.

Catalog 1163CB **WE MAKE LARGER ELECTRIC PLANTS UP TO 500 HORSE POWER.**

Fairbanks, Morse & Co.

900 So. Wabash Ave.

Chicago, Ill.

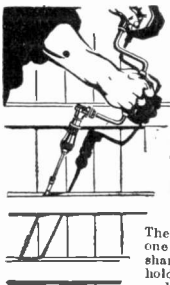

EXTENSION BIT HOLDER No. 5

MAKES DIFFICULT BORING EASY

This extension bit holder is a boon to the man who has to bore between partitions or in other difficult places.

It is so constructed as to follow a 3/8-inch bit into a hole without breaking the chuck or losing the bit.

The four jaws of the chuck are made in one piece of steel and will hold square shank bits securely. This extension bit holder is well made, strong and durable, and will perform good service even under trying circumstances. Polished and nickel plated. At all good dealers.

Price, 10 to 21 inches in length, \$1.00
Price, 24 inches in length, 1.10

An instructive book, "Tool Practice," sent FREE.

MILLERS FALLS CO., 28 Warren St., New York.



TOOL CASES Every up-to-date mechanic should have a "Gerstner" Portable Tool Case to carry his tools and keep them orderly arranged. They are practical, neat, built right and they sell at the right prices. One of our many styles will please you—if not, we'll build a special to suit you. Write for further particulars.

The Gerstner Co.

Mrs. of Mechanics' High Grade Tool Cases, 800 Germantown Street, DAYTON, OHIO

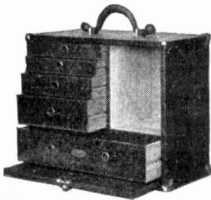

Wonderful Sewing Awl

For mending harness, shoes, straps, canvas. Sew or mends anything; whole repair shop. Automatic natural tension reel, carrying waxed thread. Original perfect lock-stitch, diamond point grooved needle protects the thread, always ready. Agents get busy. Sells on sight. C.A. Myers Co., 8300-A Lexington Ave. Chicago, Ill.

PERFECTION MARINE ENGINE 100% RIGHT

The big 1912 line of Callie Perfection Marine Engines from 2 to 30 H.P. give dollar for dollar more real service than most engines costing double their price—Perfection service is one hundred per cent right.

Without a Rival

For yachts, cruisers and ferry boats, a Perfection power plant is without a rival and simply thrives on hard, tough work. It works equally well in fresh or salt water, tide-water or stream, calm or storm. It emulates more refinements than any other engine on the market. The Igniter Equipment with the 6 H. P. and 8 H. P. insures a water-proof ignition and does away with batteries, coils, magneto and timer.

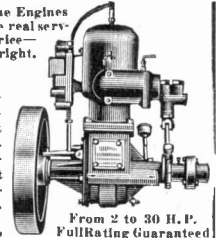

From 2 to 30 H.P. Full Rating Guaranteed

Free Book of Engines—Our new 1912 Engine Prompt Book is free for the asking—refer to it any time for the true and correct meaning standard construction. Write today while you have the subject in mind. The Perfection owner could not buy a better engine.

Callie Perfection Motor Co., 1208 Callie Street, Detroit, Mich.



We Ship on Approval

without a cent deposit, prepay the freight and allow 10 DAYS FREE TRIAL on every bicycle. IT ONLY COSTS one cent to learn our unheard of prices and marvelous offers on highest grade 1912 models.

FACTORY PRICES Do not buy a bicycle or a pair of tires from anyone at any price until you write for our new large Art Catalog and learn our wonderful proposition on the first sample bicycle going to your town.

RIDER AGENTS everywhere are making big money exhibiting and selling our bicycles. We sell cheaper than any other factory.

TIRES, Coaster-Brake rear wheels, lamps, repairs and sundries at half usual prices. Do Not Wait; write today for our latest special offer on "Ranger" bicycle.

MEAD CYCLE CO. Dept. -109 CHICAGO

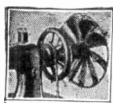

GENERAL AGENTS

Exclusive territories, great fortune selling just patented attachable Fan for Sewing Machines. Sold everywhere. Article talks itself. Retail for \$1.00. Get information.

ATTACHABLE FAN COMPANY
80 West 124th Street New York, N. Y.



KLEIN'S MARK YOUR SECURITY

It brings testimonials like this:

I have been using your tools thirty years and I think they are good.

John A. Bothley, Chief Inspector
C. & M. V. Tel Co.
Carbondale, Ill.

MATHIAS KLEIN & SONS, Canal Station 3, Chicago, Ill.



KEEN KUTTER TOOLS AND CUTLERY

Standard for over 45 Years
SIMMONS HARDWARE CO., Inc.
St. Louis and New York, U.S.A.

LOOK!
IF YOU ARE IN THE MARKET FOR A **FORCE BLOWER** and the best is none too good. Get acquainted with the **\$25.00 GREY-HOUND \$25.00** Write us for pamphlets.
THE ILLUMINATING SUPPLY COMPANY
2155 E. 9th St., Cleveland, Ohio

Here's a new
**"YANKEE" Spiral
 Ratchet Screw-driver**
 (No. 130) that means easier,
 quicker and
 surer work.

**"YANKEE"
 TOOLS**
 Make Better
 Mechanics

A spring in the handle makes it the
"Quick Return." All you have to
 do is push! The handle comes back
 of itself, ready for the next push.
 Great for working one-handed—the
 spring's pressure keeps the bit in place.

Ask Your Dealer for
**"YANKEE" Quick Return
 Spiral Ratchet Screw-Driver**
 No. 130 Price \$1.85

Supplied with three sizes of bits. Special
 attachments may be had for drilling and
 countersinking.

Get the "Yankee Tool Book"
 —sent FREE, on request.

NORTH BROS. MFG. CO., Philadelphia

"Hooray! That Screw Driver"

is just what I've dreamed about—here it is in reality."
 That's what you'll remark when you see what an every
 day necessity—what a convenient article is

MARBLES Pocket Screw Driver

No loose parts—compact—nickel—3 blades (guaranteed)—Prest-o-lite
 key. Two sizes—4 1/2 in. and 5 1/2 in., opened. Buy from dealer or direct,
 50c prepaid. Catalog Free to Sportsmen.

Marble Arms
 & Mfg. Co.
 579 Delta Ave.
 Gladstone, Mich.

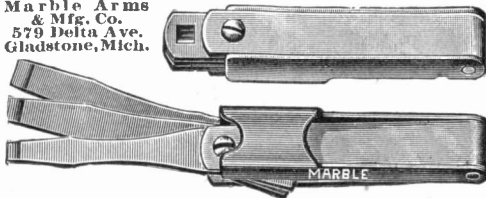

If you had one of these
Red Devil Chain Drills No. 2011
 you could drill through anything
 with a common bit brace.

The most practical attachment ever
 made for drilling IRON, SLATE,
 STONE. You want one and can get
 one from your local hardware store
 if you insist on RED DEVIL No.
 2011, automatic feed, ball-bearing
 chain drill. But if your dealer can-
 not supply the genuine RED DEVIL,
 take no substitute or imitation. Send
 us his name and \$1.50 and one only
 sample will be sent you prepaid.

Smith & Hemenway Co.
 148 Chambers St., New York

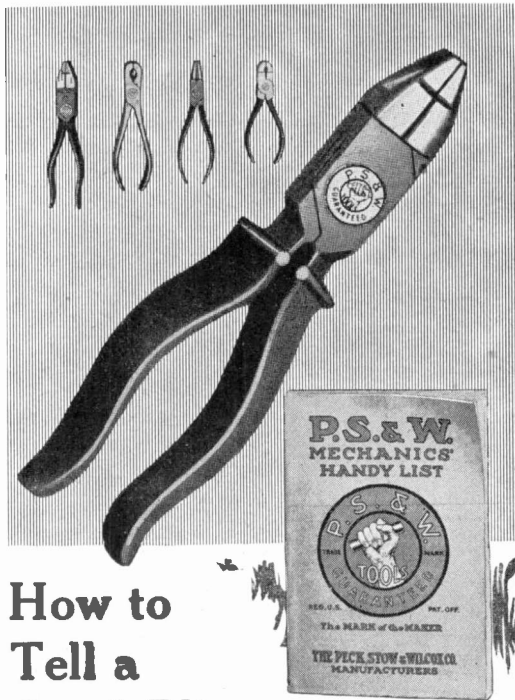

**How to
 Tell a
 Good Plier**

HOLD a P. S.
 & W. Plier
 up to the light

and see how perfectly the edges
 meet. Try it on insulated wire and
 note the clean, smooth cut. The
 easy-working, snug-fitting box-
 joint that can't work loose is an-
 other feature.

The MARK of the MAKER guaran-
 tees the material and workmanship.

This 170-page book free.
 It has 35 pages of use-
 ful reference tables, and
 contains a complete
 catalog of over 200 hand
 tools for Electricians,
 Machinists, Tinsmiths
 and Carpenters.

P. S. & W. GUARANTEED BOX-JOINT PLIERS

- | | |
|--------------------------------|--------------------------------|
| No. 30 Side Cutting, Black | No. 37 Diag'l Cutting, Raised |
| No. 130 Side Cutting, Nickel | Cutters, Black |
| No. 300 Side Cutting, Insu- | No. 137 Diag'l Cutting, Raised |
| lated Handle | Cutters, Nickel |
| No. 50 Side Cutting with | No. 43 Chain Nose, Black |
| Splicing Device | No. 143 Chain Nose, Nickel |
| No. 9 Side Cutting, Extra | No. 31 Opticians' Round and |
| Heavy, 9 inch | Flat Jaws, Black |
| No. 20 Flat Nose, Black | No. 131 Optician's Round and |
| No. 120 Flat Nose, Nickel | Flat Jaws, Nickel |
| No. 25 Round Nose, Black | No. 33 Opticians' Concave |
| No. 125 Round Nose, Nickel | and Convex Jaws, Bl'k |
| No. 27 Diag'l Cutting, Black | No. 133 Opticians' Concave |
| No. 127 Diag'l Cutting, Nickel | and Convex Jaws, Nkl |

Also a full line of Lap-joint Pliers and Splicing Clamps

The Peck, Stow & Wilcox Company
MANUF'RS Of the Largest Line of Mechanics'
 Hand Tools Offered by Any Maker

Address Correspondence to 30 Murray St., New York City
 Established 1819 Five Large Factories

PATENTS

Our New
\$150,000 Building
Opposite U.S. Patent Office
Washington, D.C.

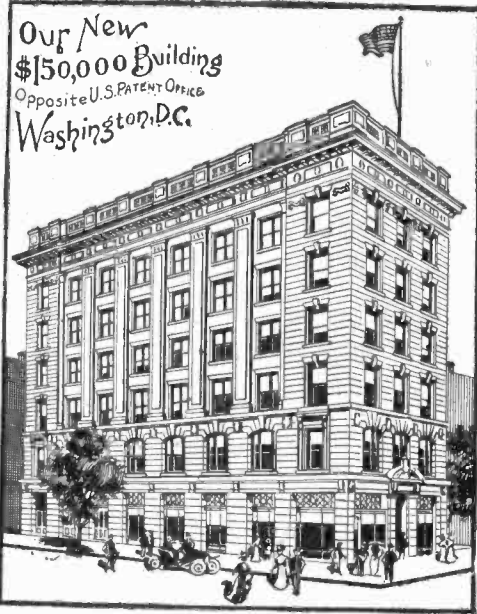

TRADEMARKS AND COPYRIGHTS SECURED OR FEE RETURNED

Send model or sketch and description of your invention for free search of the U. S. Patent Office Record.

Our **FOUR BOOKS** mailed free to any address. Send for these books; the finest publications ever issued for free distribution.

HOW TO OBTAIN A PATENT. Our Illustrated 80 page Guide Book is an invaluable book of reference for inventors and 100 mechanical movements illustrated and described.

FORTUNES IN PATENTS. Tells how to invent for profit and gives history of successful inventions.

WHAT TO INVENT. Contains a valuable list of inventions wanted and suggestions concerning profitable fields of invention. Also information regarding prizes offered for inventions, among which is a **Prize of One Million Dollars** offered for one invention and \$10,000 for others.

PATENTS THAT PAY. Contains letters from our clients who have built up profitable enterprises founded upon patents procured by us.

LIST OF PATENT BUYERS. Personal requests and letters from manufacturers and promoters for patents secured by us and suggestions of new ideas they wish to purchase.

We advertise our clients' inventions free in a list of Sunday newspapers with two million circulation and in the *World's Progress*. Sample copy free.

Electrical Cases a Specialty. We have secured many important electrical patents.

VICTOR J. EVANS & CO.

(Formerly Evans, Wilkins & Co.)

Victor Bldg., 724 9th St. N. W., WASHINGTON, D. C.

Your Dynamo Is Useless

Unless Suitable Power Is Applied to It

Get one of our small engines. They are made for the purpose, and will give you perfect service. Our "Baby" will drive a 160 watt dynamo, using either gas or gasoline for fuel, and it only costs you \$20 complete. Send stamp for catalogue.

The Elgin Wheel & Engine Company
112-114 Douglas Ave., Elgin, Ill.



SMALL ENGINES

$\frac{1}{2}$ H. P. Up
Steam, Gas and Gasoline,
for professional and amateur mechanic. Write for circulars. Big catalog listing mechanical and electrical devices, Small Power Machines and Individual

Electrical Light Plants, 2 to 60 lights, 15c (coin preferred). Refunded on first order. No free list.
Amateur Mechanics Supply Co. 860-A Monadnock Bldg. Chicago, Ill., U. S. A.



GRAY MOTORS FOR BOATS

Made in the Largest Plant in the World devoted to manufacturing 2-cycle marine gasoline engines.

3 H.P. with Complete Outfit ready to install \$55
ALSO $\frac{3}{4}$ TO 36 H.P.

Guaranteed by a big responsible concern. Write for big catalog—tells and shows you all about these high grade motors and how they are made.

GRAY MOTOR CO., 751 U. S. Motors Bldg., Detroit, Mich.

Caille Perfection Motor

Simplest construction. Best material. Most economical—Kerosene or gasoline.

\$48

$1\frac{1}{2}$ H.P.— $1\frac{1}{2}$ C.— $1\frac{1}{2}$ Hrs.
Write for Free Book and offer of 15 Days' Free Trial.

Caille Perfection Motor Co.,
320 Second St.,
Detroit, Mich.

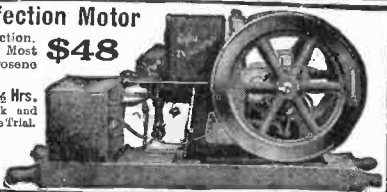

VACUUM PUMPS

For Powerful Portable and Stationary Vacuum Cleaning Plants. They take up their own wear. Powerful; Noiseless; can't get out of order.

GET CATALOG NO. 85

LEIMAN BROS., 62AD John St., NEW YORK



LATHES

Screw Cutting Foot or Power
\$75
9 to 13 inch

CATALOG FREE

SOUTH BEND MACHINE TOOL CO., 427 Madison St., South Bend, Ind.

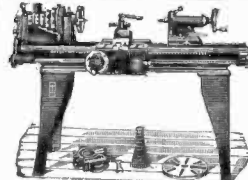

THIS MOTOR ONLY WEIGHS 26 OUNCES AND DEVELOPS 1-2 H.P. IT IS THE LIGHTEST AND MOST POWERFUL MINIATURE ENGINE IN THE WORLD.

Just the engine for Inventors and Experimenters. Especially desirable for working models of Aeroplanes, Gyroscopes, Fans, Boats, Dynamos, etc. Think of it—Our type "A" Nomic weighs only 16 ounces with complete equipment. Power $\frac{1}{4}$ H. P. Speed 2,500 R. P. M. Type "B" Nomic weighs 26 ounces, power $\frac{1}{2}$ H. P. You can carry a complete Nomic power plant in your coat pocket. Nomic Motors can be operated with Steam, Compressed Air, or Liquid Gas. With each power plant we furnish a steel cylinder which contains a thousand pounds of liquid gas. This tube can be recharged by any vendor of Soda Water, Pop, etc. at a small cost. The Nomic is a Revolution in Miniature Engine Design and we challenge the world to produce the equal of our motors. Every motor fully guaranteed as represented or money refunded without question. Prices of type "A" motor \$15.00. Type "B" motor complete \$30.00 f. o. b. Write to-day for illustrated catalogue and testimonials.

NOMIC ENGINE CO. (Ltd.), Dept. A, Aviation Field, Cicero, Ill.

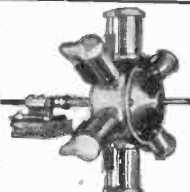

WANTED-IDEAS

Manufacturers are constantly writing me for new ideas

PROTECTED BY OWEN PATENTS

FREE!

Send for the three finest patent books published and read their letters—see what they want! **“SUCCESSFUL PATENTS”**—tells how to proceed; **“STEPPING STONES”**—contains list of over 200 inventions wanted, the truth about prizes, etc.; **“PATENT PROMOTION”**—tells how to promote and sell your rights, chief causes of failure, etc. A simple request will bring you all three books absolutely free.

Personal Services. I help my clients sell their patents or dispose of their applications. Advice Free. No obligation incurred by writing me. Manufacturing facilities. I get you strong protection or receive no compensation.

VERY HIGHEST REFERENCES

- | | |
|---|--|
| Columbia National Bank, Washington, D. C. | Whitehead Hosiery Mills, Burlington, N. C. |
| American Loktile Co., Alexandria, Va. | Dickinson Mfg. Co., Des Moines, Iowa. |
| National Metal Tile Co., Washington, D. C. | The Fancher Drug Co., Bridgeport, Ill. |
| National Supply Co., Berlin, N. H. | The Starrett Mfg. Co., Shelbina, Mo. |
| Louden Machinery Co., Fairfield, Iowa. | The C. J. Loftus Co., Youngstown, O. |
| Antholene Mfg. Co., Hutchinson, Kans. | Lightening Gun and Cycle Works, Okla. City, Okla. |

And an immense number of others whose letters are printed in my booklets.

RICHARD B. OWEN, 6 OWEN BUILDING, WASHINGTON, D. C.

Inventors submitting their invention to me are protected in a tangible manner until their applications are filed.

SPECIAL!

Send me a sketch or model of your invention and I will make a search of the U. S. Patent Office Records **FREE OF CHARGE** and report to you concerning patentability, practicability, etc.

Charges Moderate **INVENTORS** **Service High-Grade**

Get your advice on Patent matters from a technically qualified and experienced attorney. It will cost you only \$5 and may save you hundreds of dollars. My reports are reliable and complete and include a search through records, copies of patents, report as to patentability and commercial value of the inventions, and other information of value. Don't take risks by delay, but write me today.

A. P. CONNOR Consulting Electrical and Mechanical Engineer, Washington, D. C.
General Information, Booklets, and Estimates of Costs Free.

PATENTS

C. L. PARKER
Formerly Member Examining Corps, U. S. Patent Office.
PATENT LAWYERS
12 McGill Bldg., WASHINGTON, D. C.

PATENTS, TRADE MARKS, COPYRIGHTS, PATENT LITIGATION
Handbook for Inventors, "Protecting, Exploiting and Selling Inventions" sent free upon request.

“AN EDEN”
(ELECTRIC)
Home Laundry Machine
THE WORLD'S BEST
Brokaw Eden Mfg. Co., St. Louis, Chicago

CALIDO
(NICKEL-CHROMIUM ALLOY)
For HEATING APPARATUS
ELECTRICAL ALLOY CO., Morristown, N. J.

\$1,000 YEARLY PROFIT FROM YOUR BACK YARD. Complete illustrated details (170 pages) together with a profitable MAIL ORDER PLAN \$2. or sent for 3c and six stamped envelopes addressed to Ministers, Teachers or Clerks. "SCIENCE OF SUCCESS" 120pp. 25c. Circular free. SCIENCE INSTITUTE, P. O. 504 W. 59th St., CHICAGO

2 TELEPHONES COMPLETE \$5
SEND FOR OUR CIRCULAR, 83 ILLUSTRATIONS, FREE.
WESTERN TEL. MFG. CO.
160 N. 5th Ave., Chicago

FOOT AND ELECTRICAL DRIVEN
Power and Turret Lathes, Planers, Sharpeners and Drill Presses.
Write today for our Complete Catalog
SHEPARD LATHE CO.
B 131 W. 2d St., Cincinnati, O.



No. 2. Complete Electric Train Outfit, consisting of Locomotive, Tender, 2 trailers, and set of third rail track (2 straight and 4 curved). Will operate on 1 or 2 dry cells. Holiday price, complete, by express \$1.85

Acetylene Moving Picture Machine. Throws a 5x5 picture 20 feet. 500 candle power. Safer than kerosene oil. Regular price, \$10.00. Our price, with 5-ft. film..... \$4.35

Complete Wireless Outfit. Will receive 50 miles, and send two miles. Consisting of Auto Coherer, Receiver, Fixed Condenser, Double Slide Tuning Coil, 1 inch Spark Coil, Rheostat Regulator, Key, Spark Gap, and can be tuned perfectly. Regular price \$11.50. Special, by express.... \$9.35

Send 4c in stamps for our 3 Catalogs describing Electric Trains, Electrical Toys, Christmas Tree Electric Lights, Wireless Supplies

ANDERSON LIGHT & SPECIALTY CO.
KNOWN AS LABALLE LIGHT STORE
140 No. LaSalle St. Dept. B CHICAGO, ILL.

For our Mutual Advantage mention Popular Electricity when writing to Advertisers.

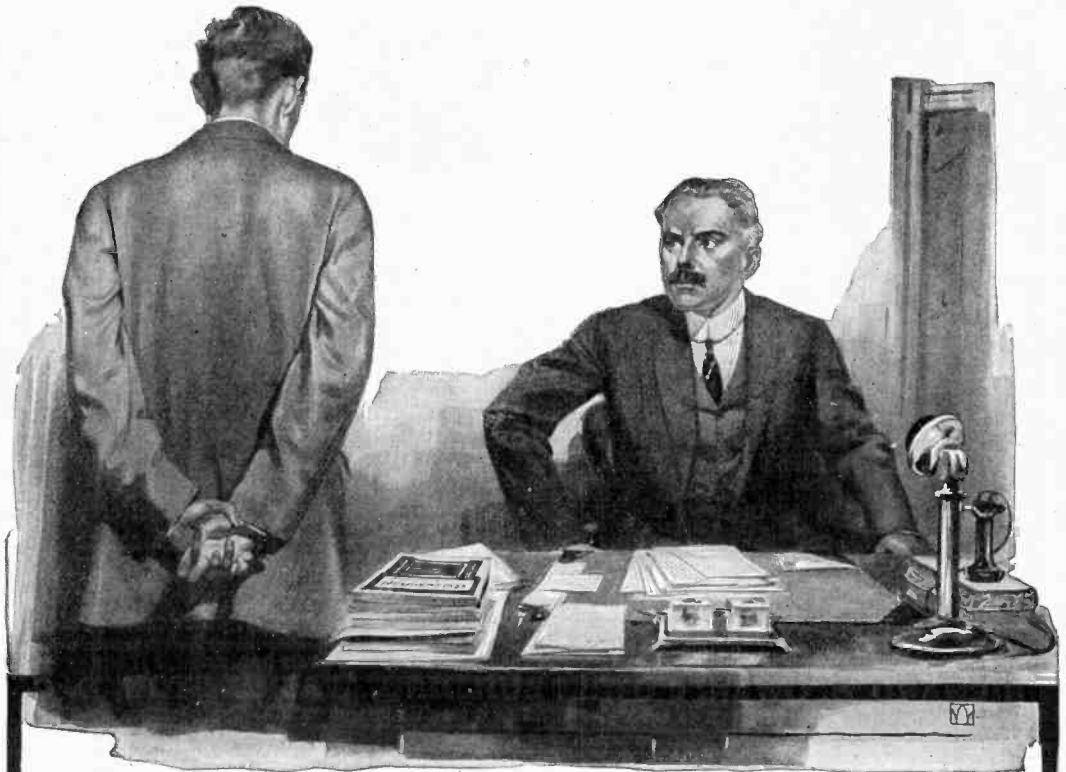

The Importance of Training

Here is a man who was in line for a better job, but, like the great majority, had not been training himself to "fill the shoes" of the man above him; he always thought that if the time ever came he could just bluff it through—special training wasn't necessary. There's where he made *his* mistake, and there's where you will make *your* mistake if you are not a trained man. The boss had only to ask a few questions to find that the man did not know anything about the other fellow's work; that he had been wasting his time instead of improving it—that he was just one of the fellows who get into a rut and stick because he didn't have sense enough to plan for the future.

The time to plan is right now; the opportunity will come when you are ready

Don't think, as this man did, that it is simply a matter of absorbing knowledge and as a matter of course promotion will follow. Don't argue with yourself "There's no opportunity here—no incentive to do better work—I have gone as high as I can in this firm—I know as much as the boss and don't see why I can't get the money."

If the opportunity for advancement is not right ahead of you with your own firm, then it *is* with another. There is always an opportunity—always a chance for a better job, for better pay—yes, just the job you have often wished you had—but mere wishing will never get you anywhere; you *must* get the training

The American School of Correspondence was founded to help just such men as you. It is one of the largest educational institutions in the world. If you will write and tell us what you want to be, how much of an education you already have, and how much time each day you are willing to devote to bettering your condition, we will send you, absolutely free of charge, our complete bulletin describing sixty-five courses of study. We will tell you how you can pay for the course you want by the week or by the month. We will do everything we can to get you started right.

If anyone offered you \$500 for two hours overtime every day for a year, you would jump at the chance, wouldn't you? Two hours study every day for the next year or two will mean more than \$500—it may mean \$1,000; that depends entirely upon yourself.

The American School does not employ agents or collectors to bother you in your home or at your work. It brings a complete college course to you in your own home, and all work is carried on privately and quietly, strictly by correspondence.

Won't you check, fill in, and mail the coupon?

AMERICAN SCHOOL OF CORRESPONDENCE
CHICAGO, U. S. A.

Opportunity Coupon

American School of Correspondence, Chicago, U. S. A.

Please send me your Bulletin and advise me how I can qualify for the position marked "X."
P. E. 7-12.

- | | |
|---------------------------------|----------------------------|
| Automobile Operator | Lawyer |
| Draftsman | Fire Ins. Engineer |
| Architect | Telephone Expert |
| Building Contractor | Moving Picture Op'r |
| Structural Engineer | Bookkeeper |
| Civil Engineer | Stenographer |
| Electrical Engineer | Accountant |
| Elec. Light & Power Supt. | Cost Accountant |
| Master Mechanic | Cert'd Public Acct't |
| Sanitary Engineer | Auditor |
| Steam Engineer | Business Manager |
| Reclamation Engineer | College Preparatory |

NAME

ADDRESS

For our Mutual Advantage mention Popular Electricity when writing to Advertisers.

**BENJAMIN PLUG
CLUSTER №92**

MADE WITH TWO
THREE OR FOUR
CIRCUITS,
MULTIPLE
OR SERIES

MAKE ONE SOCKET DO THE WORK OF TWO

*No Extra Wiring—No Labor
Simple—Durable
Just Screws into the
Present Socket*



FOR CONVENIENCE AND SATISFACTION
IN ATTACHING ELECTRICAL
DEVICES USE THE
BENJAMIN 9-0-3 ATTACHMENT PLUG →
THE SHELL TURNS INDEPENDENT OF THE
CORD. NO KINKED WIRE.



**№ 9-0-3
BENJAMIN SWIVEL
ATTACHMENT PLUG**

We have an acquired reputation for supplying the electric lighting industry useful and meritorious specialties.

Each is the outgrowth of some specific need, is distinctive in character, and by common consent singularly adapted for the purpose intended. It would be difficult to conceive of a plant or community where any extensive use is made of electrical appliances, in which they do not play a prominent part.

Housewives, storekeepers, office managers, are friends of the "Benjamin Trouble-Savers", as they are generally known. Engineers and Contractors are frequently heard saying: "When I am up against it for special fitting on a job, I pull out my 'Benjamin' catalog."

Ask your dealer to show you samples or write our nearest office for our LIGHTING SPECIALTY LIST.

BENJAMIN ELECTRIC MFG. CO.

New York
27 Thames St.

Chicago
120-128 S. Sangamon St.
FOREIGN BRANCHES:

San Francisco
151 New Montgomery St.

The Benjamin Electric, Ltd.
1-a Rosebery Ave., London, E. C., England

Benjamin Electric Mfg. Co.
64 York Street, Toronto, Canada

PUSH THE BUTTON AND HAVE LIGHT

Electric Lighting Made
Possible for Every Car

Buy a WAGNER RECTIFIER and charge your storage batteries the simplest, easiest and cheapest way. Just wire the car and convert your oil and gas lamps to electric.



The WAGNER RECTIFIER will charge the battery while you sleep. It is portable; weighs twelve pounds; put it in the tool box. Connect the rectifier to any alternating current lamp socket—connect the battery to the Rectifier—turn the switch—that is all.

*No Sloppy Chemicals
No Glass Tubes*

The Lightest Electric Light Equipment

WRITE FOR BULLETIN No. 933

Wagner Electric Manufacturing Company, Saint Louis