

Popular Electricity Magazine



September 1911

10 Cents

The School that Teaches the Best Paying Trades

Located Right in the Heart of Chicago

**Electricity
Plumbing
Bricklaying
Drafting**



**Painting
Decorating
Moving Picture
Operating**

WE OCCUPY THIS ENTIRE BUILDING

A trained man is always a successful man. Skilled men are always in demand. The world never yet had enough of them. While the ranks of the unskilled and out of work grow larger day by day. These trades pay better than many professions and are not overcrowded.

The Coyne National Trade Schools will transform even a raw country boy, the untrained city man or any ambitious man, in a few months, into a finished competent mechanic capable of earning from \$1 to \$8 a day, or starting in business for himself. Our graduates are holding the best positions in these trades in every state.



BUILDING CONTROL APPARATUS

**Students
at
Work
in
Our
Electrical
Department**



TESTING MOTORS AND GENERATORS

Ours is the most complete, practical and best equipped school in America for teaching practical trades that pay highest salaries. We teach not only the mechanical and manual part of these trades but the business side as well, so that the students are fully prepared to draw plans, estimate, take contracts or go into business for themselves.

All instruction individual. Not books but tools and actual working materials under actual working conditions employed in teaching. **Tools and materials furnished FREE.**

School open all year. Students enter any time. Tuition and expenses very low. Graduates assisted to good paying positions. Chicago alone calls for more skilled men every month than we can graduate in two years. Easy terms if desired. Enroll now.

Send your name today for a Book of the School.

LESLIE L. COOKE, Director.

Coyne National Trade Schools

30 EAST ILLINOIS STREET, CHICAGO, ILLINOIS

THE P. S. & W. No. 30

"Star Rivet" Box-Joint Plier always makes a neat, clean cut, because the jaws cannot work loose, and the cutting edges meet accurately as long as the Plier is used.

The MARK of the MAKER

is branded on every item in our large line of Guaranteed Box-Joint Pliers. It assures you of the best known type of plier construction backed by over 90 years of manufacturing experience, ability and progress.

It stands for a special high-grade steel, careful milling and finishing, thorough inspection and testing of every part and every finished tool.

We also make a full line of Lap-Joint Pliers and Splicing Clamps as well as

Four Large Lines of Guaranteed Hand Tools

for electricians, machinists, tinsmiths and carpenters. These tools are sold by practically all dealers in the United States and Canada, or can be ordered by them from any hardware jobber. Insist on The MARK of the MAKER and accept no substitute.

The Peck, Stow & Wilcox Co.

MFRS. of the Largest Line of Mechanics' Hand Tools Offered by Any Maker

Address Correspondence to 30 Murray St., New York City

Established 1819

Five Large Factories



A Handy Book for Your Tool Kit

Our 165-page "Mechanics' Handy List," shown above, contains 35 pages of valuable shop information, and a catalog of over 200 tools. Sent free at your request.

For our Mutual Advantage mention Popular Electricity when writing to Advertisers.

The New York Electrical School

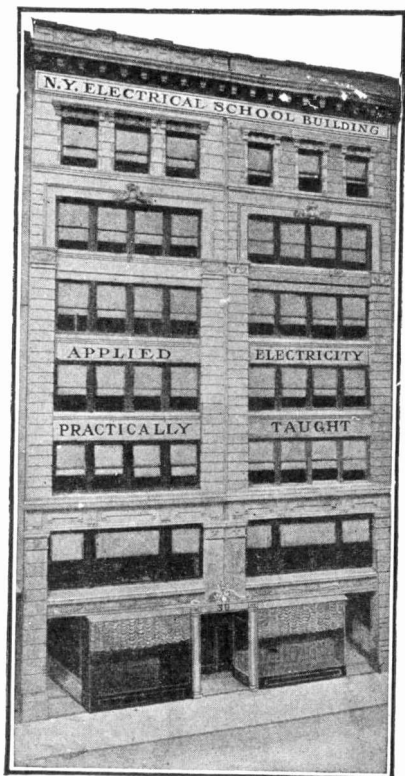

offers a theoretical and practical course in all branches of the electrical trade or profession.

Our course is not simply a wiring course nor a lecture course. It is thoroughly complete and thoroughly practical. It constitutes an electrical education not obtainable elsewhere.

It supplies that thorough training which cannot be gotten in any other way than by applying the practice to the theory at the time and place in which the theory is being given.

Through our course you

BECOME AN ELECTRICAL MACHINIST

Something more, something greater than a mere electrician. You learn all that there is to learn about electricity, and through our system of instruction become the "better man," the trained man: the electrical expert.

Fill out the coupon today and receive our illustrated prospectus explaining our course in detail. Don't delay longer and don't start your course in electricity until you have read of and understood the advantages offered through our school. Remember that everything depends on a right start, the first step of which is selecting the right school.

The New York Electrical School
39 West 17th Street, New York
Pop. Elec.-9-11

Please send illustrated prospectus of your course in ELECTRICITY to

Name

Address

Town.....State.....

Mail Coupon Today

For our Mutual Advantage mention Popular Electricity when writing to Advertisers.

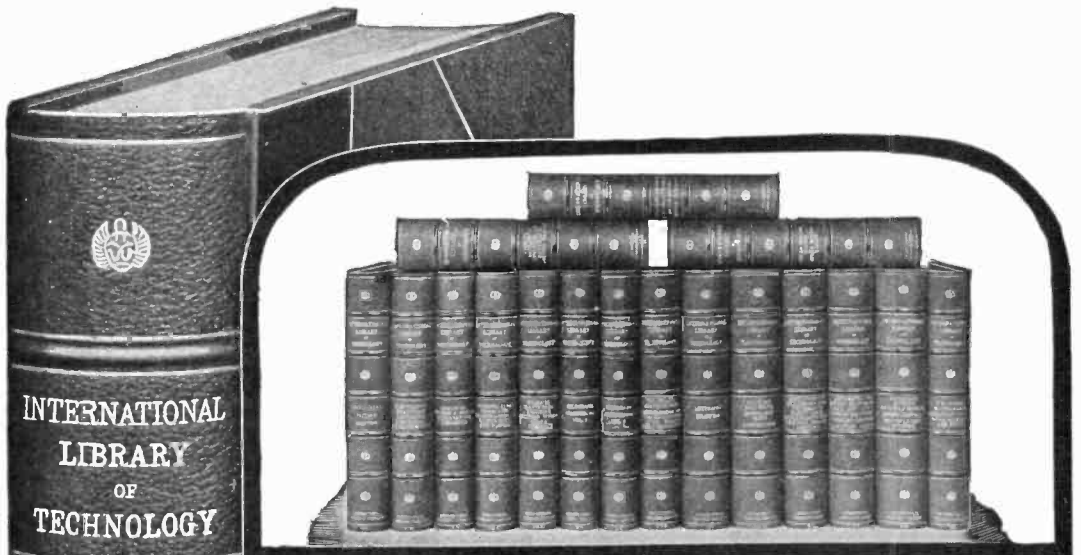

INTERNATIONAL
LIBRARY
OF
TECHNOLOGY

ALTERNATING
CURRENTS
TRANSMISSION OF
ELECTRICITY
AND POWER

INTERNATIONAL
TEXTBOOK COMPANY
13C

The Greatest Electrical Library in the World

The Electrical Engineering Library is part of the International Library of Technology that cost \$1,500,000 in its original preparation. It contains the knowledge given from the life experience of some of the best electrical engineering experts in the country, edited in a style that nineteen years of experience in publishing home-study textbooks has proved easiest to learn, to remember, and to apply. There is no other reference work in the world that so completely meets the needs of the electrician as the Electrical Engineering Library. The volumes are recommended by the highest authorities and are used in nearly all the leading universities and colleges. They treat of practical electrical methods, starting from the simplest problems and comprehensively covering every branch of the work. Not only can they be used to great advantage by superintendents, foremen, and engineers as an authoritative guide in their work, but since they can be so clearly understood, even by persons having no knowledge of higher mathematics, they can be used by all classes of electricians that are desirous of advancing to higher positions. The Electrical Library contains 17 volumes durably and handsomely bound in three-fourths red morocco, stamped and numbered in gold. The books are printed on a high-grade book paper, and the type is large and easy to read. Each volume is 6 by 9 inches in size. If you wish to know more about the most practical electrical library in the world, send the coupon NOW.

International Textbook Co.
Box 1102, Scranton, Pa.

Please send, without further obligation to me, full particulars in regard to your Library of Technology, with special reference to the Electrical Library.

Name _____

St. & No. _____

City _____ State _____

Practical Electrical Education

LEARN MORE — EARN MORE

Electrical science and engineering in all branches taught by scientific methods, under practical working conditions.

Students can enter at any time for full or special courses.

By our system of individual instruction you can complete your course as quickly as your ability warrants. No matter what your education, we start you at the very point you are competent to begin.

There is a decided scarcity of electricians and electrical engineers. We have more calls for trained students than we can fill. Many of our graduates earn \$1,500 a year and more immediately upon completion of their course.

Valuable information, full particulars of the moderate charges and illustrated catalog 1911-1912 FREE upon request. Write today. Learn more—Earn more.

Fall Semester begins September 5th, 1911.

SCHOOL OF ENGINEERING OF MILWAUKEE

Not a Correspondence School

1025-1027 Winnebago Street, Milwaukee, Wis.

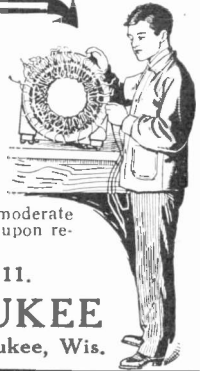

Learn Photography, Photo-Engraving or 3-Color Work

Photographers and Engravers Earn \$20 to \$50 Per Week. Only college in the world where these paying professions are taught successfully. Established 17 years. Endorsed by International Association of Photo-Engravers and Photographers' Association of Illinois. Terms easy; living inexpensive. Graduates assisted in securing good positions. Write for catalog, and specify course in which you are interested. Illinois College of Photography or 1989 Wabash Av. Bissell College of Photo-Engraving (Effingham, Ill. L. H. BISSELL, Pres.

#10 COVERS ALL LEARN TO RUN AND REPAIR AUTOMOBILES



And make money. YOU can learn with Dyke's New Idea System of Teaching by mail with mechanical WORKING MODELS (patent pending).

Let us show you letters from young men who took our course and are now driving cars and in the repair business and who have DOUBLED THEIR INCOME.

Satisfaction guaranteed. SENT ON TRIAL. Endorsed by Oldfield, Duryea, and other authorities.

Send for my FREE BOOK: "How to get into the Auto Business and Its Opportunities."

Dyke's Correspondence School of Motoring.

Box 2 Roe Building.

St. Louis, Mo.



If YOU Would Be Successful Stop Forgetting

MEMORY the BASIS of ALL KNOWLEDGE

You are no greater intellectually than your memory. Send today for my free book "How to Remember"—Faces, Names, Studies—Develops Will, Concentration, Self-Confidence, Conversation, Public Speaking, Increases income. Sent absolutely free—Address DICKSON MEMORY SCHOOL, 529 AUDITORIUM BLDG., CHICAGO

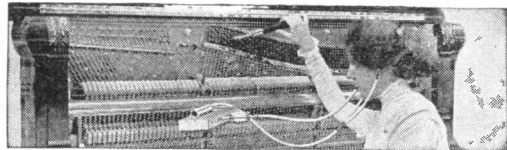

LEARN PIANO TUNING AT HOME by the aid of the TUNE-A-PHONE. A Profession that can be converted into money at any time or place in the civilized world at an hour's notice. Earn \$5.00 to \$15.00 per day. Valuable illustrated book FREE. Write NILES BRYANT SCHOOL OF PIANO TUNING, 77 Music Hall, Battle Creek, Mich.



Learn Telegraphy

MORSE and WIRELESS

At My Practical School. Splendid demand for operators and agents. We also teach Station Agency Work. Graduates assisted. We occupy our own 2 large modern buildings equipped with R. R. Dispatchers and Western Union Wires and Wireless Station Officials. Endorsed by Railroad, Wireless and Western Union. Exclusive Methods. Teachers are practical experts. Living expenses earned. Easy payments. Correspondence course if desired. Catalogs Free. GEORGE M. DODGE, Pres., Dodge's Institute. Established 1874. 21st St., VALPARAISO, I D.

ARITHMETIC SELF-TAUGHT

A plain, easily-understood volume for all who have not had the opportunity of learning this subject thoroughly, or who have forgotten what they once learned. 257 Pages. Requires no teacher. This great little book sent postpaid for 60 CENTS. Stamps accepted, leather binding \$1.

GEO. A. ZELLER BOOK CO.

Est. 1870. 4464 W. Belle Place, ST. LOUIS, MO.





WHY NOT BE AN ARTIST?

Our graduates are filling High Salaried Positions. EARN \$25 TO \$100 PER WEEK

In easy, fascinating work. Practical, Individual Home Instruction. Superior equipment. Expert Instructors. Eleven years' successful teaching. Financial returns guaranteed. Write for particulars FREE ARTIST'S of the Instruments and and Handsome Art Book. FREE OUTFIT supplies to each student.

SCHOOL OF APPLIED ART (Founded 1899)
A 70 Fine Arts Bldg., Battle Creek, Mich.



TELEGRAPHY TAUGHT

in the shortest possible time. The Omnigraph Automatic Transmitter combined with standard key and sounder. Sends you telegraph messages at any speed just as an expert operator would. Five styles, \$2 up; circular free.

OMNIGRAPH MFG. CO.
39 H Cortlandt Street New York



VENTRILOQUISM

Learned by any Man or Boy at Home. Small cost. Send today 2-cent stamp for particulars and proof.

O. A. SMITH, Room 1650, 828 Bigelow St., PEORIA, ILL.





BE AN ENGRAVER

Learn at Home! Earn \$25 to \$50 weekly. We give personal instructions and furnish necessary tools Free. Terms reasonable. Complete particulars by mail.

CHICAGO ENGRAVING SCHOOL,
DEPT. 30, 110 WEST CHICAGO AVE., CHICAGO.

For our Mutual Advantage mention Popular Electricity when writing to Advertisers.

YOUNG MAN!

ENTER THE ELECTRICAL FIELD



Electrical men are the highest paid tradesmen in the world. Electrical Instrument and Meter work is one of the most important branches in the great electrical industry. Everywhere that electricity is used for heat, light and power, Instruments and Meters are used.

Every lighting company must have trained men—meter experts—to install, test, inspect and maintain the Instruments and Meters required for measuring the electricity consumed by its patrons.

POSITIONS PAY \$900-\$1800 A YEAR

- The work is pleasant and healthful. Easily learned from our Complete Course. Advancement rapid and certain. Unlimited possibilities.

Our booklet, "Instruments and Meters," tells all about this fascinating and profitable work, and HOW WE ASSIST OUR GRADUATES. Write for it. It's FREE.

Fort Wayne Correspondence School,
910 Shoaff Bldg., Fort Wayne, Indiana.

"HELP WANTED"

—Uncle Sam.



Mail Clerks—Clerks in the offices at Washington, D. C.
City Carriers—Stenographers—Typewriters

SEPTEMBER AND NOVEMBER EXAMINATIONS EVERYWHERE—1911

\$800.00 to \$1800.00 a Year for LIFE

No "layoffs" without pay, because of strikes, financial surries or the whims of some petty boss. Excellent opportunities for quick advancement to Higher Government Positions. If you want immediate appointment, send TODAY for our schedule showing locations and dates of the September examinations. Any delay means the loss of just so much time in preparing yourself for examination.

SEND COUPON BELOW

Franklin Institute
Dept. N117, Rochester, N. Y.

We Prepare Candidates Free

The coupon, filled out as directed, entitles the sender to a free copy of our book, "Government Positions and How to Obtain Them," and to consideration for Free Coaching for the examination here checked.

-----COUPON-----

.. Railway Mail Clerk (\$800 to \$1400)	.. Customs Posit'ns (\$700 to \$1500)
.. Postoffice Clerk (\$500 to \$1200)	.. Internal Revenue (\$700 to \$1500)
.. Postoffice Carrier (\$600 to \$1200)	.. Stenographer (\$600 to \$1500)
.. Rural Mail Carrier (\$500 to \$900)	.. Clerk in the Departments at Washington (\$800 to \$1500)
.. Bookkeeper (\$900 to \$1800)	

Name

Address

N117

Use this before you lose it. Write plainly.

Don't be a Job Hunter

Send for our FREE BOOK, "The P. S. C. Way to Health for Wealth," and read how we will teach you to

Be a Doctor of Chiropractic

Chiropractic, the new science, adjusts the spine from abnormal to normal, allowing health giving mental force to flow freely to all parts of the body.

\$5,000 to \$15,000 Yearly Await Our Graduates!

If you want a real chance in life, write to-day!

The Palmer School of Correspondence
Chiropractic Fountain Head
8th & Brady Sts. Davenport, Iowa



Mechanical Drawing with Constructor's Knowledge

Highland Park College

COLLEGE OF ENGINEERING

We graduate expert draughtsmen in industrial, irrigation, railway work—practical men, who have mastered mathematics, physics, economics, principles of mechanics, kinematics, contracts, specifications, pattern, shop and foundry work, in addition to actual drawing. Complete in one year. Practical teachers with long experience. Finest equipped engineering school. Small tuition. Low cost of living. Enter any time. Catalogs.

O. H. LONGWELL, President, Des Moines, Iowa

LONG-LIVED ANIMALS TAKE VITAL FOODS



Long life thru vital foods

The everyday BRAINY or LIFE-GIVING foods are the most strengthening, healing forces in nature. They promote the highest efficiency in brain workers. When correctly combined they maintain health permanently.

Wrongly combined foods ferment and poison the system, causing rheumatism, appendicitis, apoplexy, etc., lack of appetite, and frequently death. The different foods causing expectoration, catarrh, fevers, night sweats, coughing, etc., are specified in the instructive free booklets. Fat people have reduced one pound daily by a DIGESTIBLE brainy diet of everyday foods, gaining strength, without fasting, or exercises. Thin people gain flesh by the DIGESTIBLE weight-producing foods.

NO FOODS SOLD

People write: "My brain power and general efficiency have been nearly doubled this year by selecting brainy foods. I have made a fortune in real estate, and the credit is honestly yours." "The hints in booklet number 3 on foods for curing congested liver, nourishing the brain, etc., are worth untold dollars, although the booklets are free."

SHORT-LIVED ANIMALS TAKE DEATH-PRODUCING FOODS



(1) TESTS OF BRAINY DIET. (2) DIET vs. DRUGS. (3) EFFECTS OF FOODS. (4) KEY TO LONGEVITY.

G. H. BRINKLER, Food Expert, Dept. 19 Washington, D. C.

Send 10 cents for mailing. Send the addresses of your sick friends.

For our Mutual Advantage mention Popular Electricity when writing to Advertisers.

A New Creation

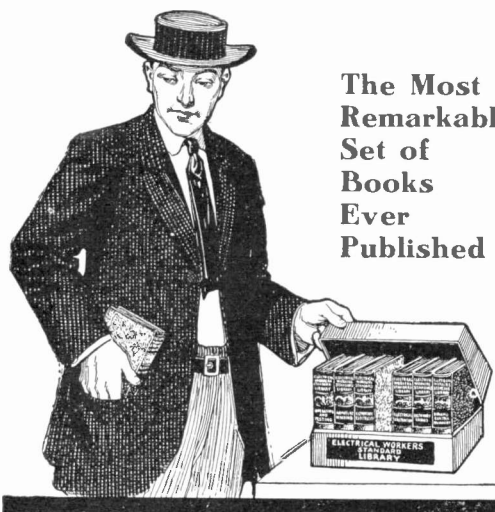

The Most
Remarkable
Set of
Books
Ever
Published

Electrical Workers Standard Library

FOR REFERENCE AND HOME STUDY

Practical—Authoritative—Comprehensive
and Up-to-Date

Especially made Pocket Size Volumes. Books that you can carry on the job. A worker's series of practical every day helps for installing the work according to the safety rules of the National Board of Fire Underwriters.

By applying the practical problems contained in the books to any job, you may be sure that the work will bear the mark of the Electrical Inspector's "O. K." The purpose of this library is to provide the beginner or the working electrician a complete treatise on Electrical Construction work as a reliable, practical guide: one that tells him exactly how to install his work in accordance with the latest improved methods.

SEVEN handy pocket size volumes, size $4\frac{1}{2} \times 7$, bound in full American Morocco, stamped in genuine gold leaf, 2500 pages, 1500 illustrations, including full page plates, working diagrams, etc. Hundreds of tables and formulas. Fully indexed for quick and easy reference. A thorough, practical authoritative Electrical Worker's up-to-date reference work for the home or shop study. For Electrical Engineers, Electricians, Railway Power Station Engineers, Linemen, Telephone or Telegraph Engineers, or for anyone engaged in electrical work.

WILL YOU EXAMINE THESE BOOKS FREE OF CHARGE?

If you are interested in Electricity, we know these books are just what you want. To convince you of this, we will send a complete set to you by prepaid express: keep them five days; examine them thoroughly and carefully: test them; apply the knowledge they contain to your every-day work. If you desire to keep them, send us \$2.00 after five days and \$2.00 a month until you have paid the special price of \$14.00. The regular list price is \$21.00. Just fill in the coupon below and mail it to us. The books will be sent you at once.

FREE EXAMINATION COUPON

National Institute of Practical Mechanics (P. E.)

Please send Electrical Worker's Standard Library for FREE examination. I will send \$2.00 within five days and \$2.00 a month until I have paid \$14.00; or notify you and hold the books subject to your order. Title not to pass until fully paid.

Name

Address

Occupation

Employer

Sold only by subscription. For further information address

National Institute of Practical Mechanics
1325 Michigan Ave. Chicago, U. S. A.

EDISON

His Life and Inventions

By
Frank L. Dyer
and
Thomas C. Martin

988 PAGES

Two Volumes
\$4.28 Postpaid

Practically a history
of Electricity for
the past fifty years.

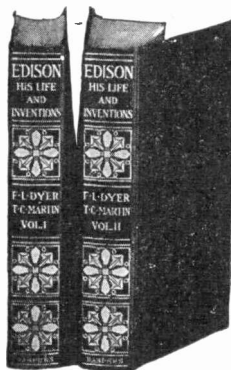

Contains among other new material
a complete list of the Edison Patents.

THE full and authoritative story of Edison's own life has never been written until now. The full story could only be given by Edison himself and his closest associates. One of the authors is his counsel, as his father and brother were before him, and he practically shares Edison's daily life. The other, who has been in the confidence of the great inventor for a long time, is one of the leading electrical experts of our country. The entire manuscript has been read and revised by Edison himself.

Scene by scene the real life and work of the great inventor are unrolled before us, the days and nights spent in developing the electric railway and storage batteries, the growth of the phonograph industry, the ore-milling work, the application of Portland cement, with its large possibilities, and the development of a new phase of modern entertainment and education in the vast business of moving pictures.

How has it been done? What are the scenes in which the inventor works? What is his daily life? What are his methods? In this book there is pictured all this personal side. The evolution of his ideas is traced, his manner of working, the scenes in his laboratory, the enthusiastic co-operation of his assistants guided by the master's brain, and the persevering industry which leads to triumph over discouragements, mistakes and obstacles.

There is a long and full Technical Appendix, describing in detail the work Edison has done. This in itself is a long-needed book.

POPULAR ELECTRICITY BOOK DEPT.

54 W. Lake St., Chicago, Ill.

Please send me post-paid the book entitled "Edison: His Life and Inventions," in two volumes, for which I enclose remittance for \$4.28.

Name

St. and No.

City.....State.....

For our Mutual Advantage mention Popular Electricity when writing to Advertisers.

Get into the automobile business without any investment.

We will enable you to get into the automobile business. More than 500 different towns need a new garage and automobile repair shop. We secure for you an agency that pays you \$175.00 for each car you sell. We supply all necessary tools. Under our system you learn the entire business, chauffeur, repair man and manager. You begin the course at home and can finish right in a factory where cars are built. We furnish you employment the day you sign a contract with us; we wait for part of our pay out of your profits. Write for Plan No. V and handsome catalogue telling about getting started in the automobile business.

The Automobile College of Washington, Inc.
Washington, D. C.



TYLER'S RAW FOOD BOOK AND HEALTH GUIDE

(Copyrighted)
PRICE 25 CENTS.

other diseases including constipation, rheumatism, appendicitis and even consumption. * * * * *

A weeks trial will convince the most skeptical, therefore, if you are depressed, feeling badly, about half sick—buy the book, adopt the new food idea and learn the art of

GAINING AND RETAINING HEALTH

by the sanest, most successful and economical method known to science simply by living wholly (or at least 1 part) on natural or uncooked foods. This book is a revelation and a source of inspiration to every ailing person. Order it today and commence the new life at once.

Byron Tyler, Food Specialist

In the lower animal world health is good, as a rule—ill-health the exception. Reverse is true of man who seeks to cultivate a perverted taste or appetite for cooked vituals—foods that have been devitalized (life principle eliminated) by artificial heat. An error of civilization which is doubtless the cause of stomach troubles and hundreds of other diseases including constipation, rheumatism, appendicitis and even consumption. * * * * *

83 Syndicate Bldg. KANSAS CITY, MO.



The Boys' Magazine Free

Send us the names and addresses of five of your boy friends and we'll send you a copy of this splendid magazine FREE. Great stories—beautiful illustrations—handsome covers in colors. Departments of Boy Scouts, Electricity, Mechanics, Photography, Carpentry, Stamps and Coins. A big Athletic Department edited by WALTER CAMP is a feature.

Address The Scott F. Redfield Co., 640 Main Street, Smethport, Pa.

The BOYS' MAGAZINE is on sale at all newsstands at 10c a copy.

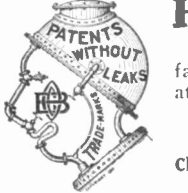

Have You an Idea?

Send sketch for free opinion. If favorable, will report exact cost. No attorney fee until patent is allowed. Satisfied Clients in Every State

O. C. BILLMAN
Cleveland, Ohio Washington, D. C.
Author of "Notes on Patents" Pop. Elect.



THE DOBSON "X" RAY. The Latest Scientific Wonder. Here is an article-boys, that will please you. With it the clothes and flesh turn transparent and the bones can be plainly seen. Just think of the fun you can have with it. Sample in strong box with catalogue and agent's prices 10 cents per mail.

QUINTARD & POLLARD - - - - - Norwalk, Conn.

WIRELESS TELEGRAPHY

Expert instruction—full equipment—low fees. Meets U. S. Government requirements—grants certificates—Prepares for positions with Postal Western Union, United Wireless or U. S. Government.

BOOKLET "T" FREE TO ANY ADDRESS

East Side Y.M.C.A. Telegraph School
153 East 86th St., New York

CYCLOPEDIA of TELEPHONY & TELEGRAPHY



Every reader of Popular Electricity can examine this great work—FREE

This cyclopaedia is brand new, up-to-date, just off the press. The theory and practice of every phase of electrical communication is thoroughly covered, also recent developments in Automatic Telephone Systems, Wireless Telegraphy and Telephony.

Written by National Experts

- The writers are men whose reputation in their respective fields is international.
- Kempster B. Miller, M. E.—Consulting Engineer and Telephone Expert.
 - George W. Patterson, S. B., Ph. D.—Head Department of Electrical Engineering, University of Michigan.
 - Charles Thom—Chief of Quadruplex Department, Western Union Main Office, New York City.
 - Robert Andrews Millikan, Ph. D.—Associate Professor of Physics, University of Chicago.
 - Samuel G. McMeen—Consulting Engineer and Telephone Expert.
 - Charles G. Ashley—Electrical Engineer and Expert on Wireless.
 - Francis B. Crocker, E. M., Ph. D.—Head of Department of Electrical Engineering, Columbia University.
 - Morton Arendt, E. E.—Instructor in Electrical Engineering, Columbia University, New York.
 - David P. Moreton, B. S., E. E.—Associate Professor of Electrical Engineering, Armour Institute of Technology.
 - Leigh S. Meith, B. S.—Managing Engineer with McMeen and Miller.

What These Books Contain

- VOL. I.—Fundamental Principles, Substation Equipment: Transformers—Receivers—Signaling Apparatus—Repeating Coils. Party Line Systems: Non-Selective—Series and Bridging—Selective—Lock-Out. Protection Electrical Hazards. Manual Switchboards: Exchanges—Trunk and Toll Lines—Operation.**
- VOL. II.—Manual Switchboards: Common-Battery Switchboards: Magneto-Multiple Switchboards, Automatic Systems: Operation—Auto-Manual System. Power Plants and Buildings: Apparatus—Power Switchboards. Special Service Features: Private-Branch Exchanges—Intercommunicating Systems—Traffic—Measured Service. Telegraph and Railway Work: Phantom, Simplex and Composite Circuits.**
- VOL. III.—Line Construction: Open Wires—Cables—Underground Construction—Distribution, Engineering and Maintenance: Development Studies—Toll Lines—Maintenance and Depreciation—Testing, Electrical Measurement, Storage Batteries.**
- VOL. IV.—The Telegraph: Messages—Railway Telegraphy—Switchboards—Repeaters—Multiplex Telegraphy—Duplex—Quadruplex. Wireless Telegraphy: Development—Selective Signaling—Apparatus—Singing Arc—Aerials—Systems. Wireless Telephony: Development—Apparatus—Systems.**

Examine These Books at Our Expense

Fill in the coupon and we'll send you the books by prepaid express. Keep them in your office for five days, examine them carefully. If they contain information of value to you and you want to keep them, send us \$2.80, then \$2.00 each month until you have paid the special introductory price of \$12.80. If you don't want the books, notify us and we will have them returned at our expense.

AMERICAN SCHOOL OF CORRESPONDENCE CHICAGO, U. S. A.

FREE EXAMINATION COUPON

AMERICAN SCHOOL OF CORRESPONDENCE:

Please send set Cyclopaedia of Telephony and Telegraphy for 5 days' free examination. I will send \$2.80 within five days and \$2.00 a month until I have paid \$12.80, or notify you to send for the books. Title not to pass until fully paid. Pop. Elect. 9-11

NAME

ADDRESS

OCCUPATION

EMPLOYER

For our Mutual Advantage mention Popular Electricity when writing to Advertisers.

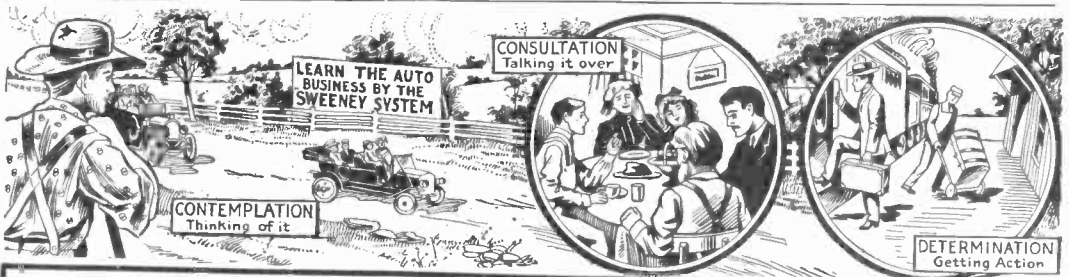

I'll Double Your Earning Ability in Six Weeks

Try My Course in Automobile Training **ONE WEEK FREE**

—Emory J. Sweeney

I want you to come to my school one week; I want you to see for yourself, absolutely without expense to you, how thoroughly and practically I teach all about the automobile. Six weeks after the day you enroll in my great practical Automobile School you will be prepared to properly repair any automobile made and drive any car or truck or open a garage and repair shop of your own. I guarantee to teach you and if you don't learn in 6 weeks you can stay until you have learned. You can learn the automobile business thoroughly in my school because I have been years in working out for quick, thorough instruction, the

"Sweeney System" of Practical Instruction

It is today the most thorough, practical, comprehensive and interesting course of automobile instruction, and embraces every point worth knowing, including vulcanizing, brazing, etc. You learn by doing the actual work on real cars with your own hands under the watchful eyes and ready suggestions of experienced instructors.

Sweeney Automobile School

1511 Woodland Ave., Kansas City, Mo.

Please send me, FREE of all charges, new, big, illustrated Catalog of your school and your One Week's Free Tuition Enrollment Blank.

NAME

ADDRESS

CITY.....STATE.....

No Books Used—Tools Given FREE The tuition is low and, after you have paid that, you do not have another cent of expense in the school. You do not learn from books, but by practical work on real automobiles in everyday use. A complete set of tools is given free to students who take Course A.

Send Coupon for FREE Catalog and One Week's FREE Tuition Enrollment Blank I want every man thinking of learning to become an Auto Expert to have my new, big, illustrated Catalog. Just send the coupon. This Catalog is just fresh from the printer. Contains articles by well known automobile men and tells EVERYTHING you want to know. Write for this great book and free enrollment blank. Send the coupon today—NOW

SWEENEY AUTOMOBILE SCHOOL
Where You Learn by the "Sweeney System"
1511 Woodland Ave., Kansas City, Mo.

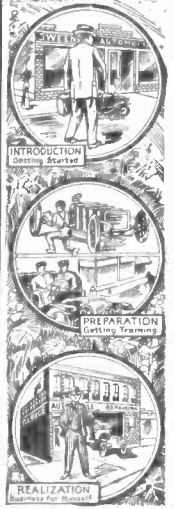

Be a Valuable Man!



The trained man is the valuable man

He is worth double the salary paid to the untrained man.

DRAFTING

We teach it in a short time by practical and thorough methods. Well-known Chicago engineers and architects are our instructors. Students have access to plans of buildings and machinery now being built. Inspection of actual construction of this work is an exclusive feature.

You may start at any time. Special courses to fit your individual need. Day and Evening classes. Students helped to positions while attending school. Light, clean and well-paying work with a brilliant future assured. Call or write for catalogue telling how you may earn more money.

CHICAGO TECHNICAL COLLEGE, 609 ATHENAEUM BLDG., CHICAGO, ILL.
For those who cannot come to Chicago our Courses by mail in Architectural, Mechanical and Structural Drafting and Design, Plan Reading, Estimating, etc., are fully explained in Folder No. 3. Write for it.

ELECTRICITY

Complete in One Year

SCIENTIFIC ELECTRICITY IN ALL ITS BRANCHES

Bliss Electrical School

Students restricted to theoretical and practical electricity, mechanical drawing and necessary engineering work. Teaches simplicity, concentration, hard work. For young men of energy and character. 18 years of greatest success. Graduates hold first-class positions. **Opens Sept. 20.** Write for new catalog.

10 Takoma Ave., WASHINGTON, D. C.

LEARN WATCHMAKING Engraving and Jewelry repairing. Earn while learning. Our school endorsed by leading jewelers. Positions secured for graduates. Send for Free catalogue. **CHICAGO SCHOOL OF WATCHMAKING, Dept. 30, Bush Temple, Chicago.**

A School Within Itself

There are XX chapters in all, XIX carrying you from the fundamental principles of electricity on through the various branches to a point where the careful student comprehends the complete construction, care and operation, and all about storage batteries and how to handle them. Each subject is carefully written and to the point. After a student studies a subject, he is questioned on that subject in such a manner as to bring clearly to his mind the points he needs to know regarding same. A DICTIONARY in back of book will enable him to learn the meaning of any electrical word, term or phrase used in this book, as well as hundreds of others in common use. All required tables necessary in the study are in it. **TABLE OF SUBJECTS:**

- CHAPTER I**—Wiring.
II—Electric Batteries, Electro Plating.
III—Magnetism.
IV—The Magnetic Circuit.
V—Magnetic Traction.
VI—Magnetic Leakage.
VII—Energy in Electric Circuit.
VIII—Calculation of Size of Wire for Magnetizing Coils.

- CHAPTER IX**—Calculation of F.M.F.'s in Electric Machines.
X—Counter E.M.F.
XI—Hysteresis and Eddy Currents.
XII—Armature Reaction.
XIII—Sparking.
XIV—Winding of Dynamos and Motors.
XV—Proper Method of Connecting Dynamos and Motors—Self Excitation.

- CHAPTER XVI**—Diseases of Dynamos and Motors, their symptoms and how to Cure Them.
XVII—Arc and Incandescent Lamps.
XVIII—Measuring Instruments.
XIX—Alternating Current.
XX—Autobionics.
A dictionary of over 1500 Electrical Words, Terms and Phrases, giving a brief meaning of all which are in common use.

\$2.00 Per Copy—Sixth Edition—30,000 Copies Sold
The offer we make of refunding money if book is not satisfactory upon examination is an UNUSUAL ONE in connection with the sale of a book. But we have no fear of its return. Your decision will be what thousands of others have been. Money would not buy it if it could not be duplicated. We could print testimonials by the hundreds. It is best to order and be your own judge of its merits.

CLEVELAND ARMATURE WORKS, 4730 St. Clair Ave., Cleveland, Ohio
Armatures and Fields Wound, Commutators Filled **AMERICA'S GREATEST REPAIR WORKS**

For our Mutual Advantage mention Popular Electricity when writing to Advertisers.

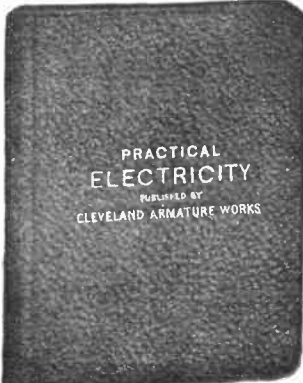

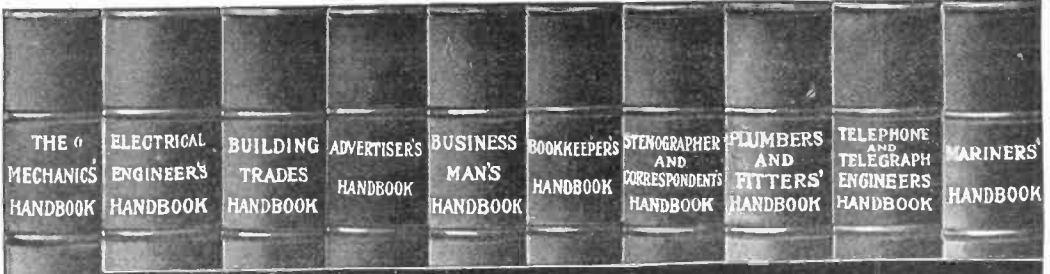

\$1.25 Handbooks for 50c.

No books in existence contain in so small space as much information about the trades and professions of which they treat as do these Handbooks. They are little giant encyclopedias of practical knowledge giving data and information that is hard to find in ordinary books. These Handbooks have been prepared by the well-known textbook writers of the International Correspondence Schools whose textbooks are recognized the world over as the most practical treatises on applied sciences ever published. These Handbooks are consulting experts of the highest rank, and are the most powerful force in the world for the promotion of ambitious men. They are an indispensable help to quicker and better work that will command advancement. They are printed on a high-grade book paper in clear type, and durably and handsomely bound in cloth with gilt titles; contain on an average of 364 pages and 175 illustrations and are regularly sold for \$1.25 each.

SPECIAL OFFER.—We are selling these Handbooks, durably bound in cloth with gilt titles, at a special price for each Handbook of 50 cents.

Mechanics—Tables; formulas; measurements; belting; mechanical powers; hydro-mechanics; strength of materials; shafting; boiler design; care of boilers; power of boilers; chimneys; exhaust heating; machine design; machine tools; slide valve; pulleys; cylinders and steam chests; pistons; gearing; transit surveying; triangulation; curves; radii and deflections; earth work; track work; electricity; etc.

Advertiser's—How to plan and write an advertisement; type and type measurements; points on printing style; display; preparation of manuscript; proof reading; engraving and printing methods; electrotypes; matrices; advertisement illustrations; magazines; newspapers, retail, department-store, general, trade-paper, and mail-order advertising; trade marks; circulars; advertising agencies; etc.

Stenographer's & Correspondent's—Advice to beginners; shorthand speed; letters of application; punctuation; correct and faulty diction; business correspondence; type-writing; abbreviations; addressing; mailing; rates of postage; duplicating work; etc.

Telephone and Telegraph—Useful tables; mechanics; electricity; magnetism; primary batteries; storage batteries; electrical measurements; telephony; tests with magnetogenerator and bell; telegraphy; Morse telegraph systems; multiplex telegraphy; etc.

Electrical Engineer's—Mechanics; electricity; electrical units; symbols and quantities; physical and electrical properties of metals and alloys; wire gauges; magnetism; dynamos and motors; electric batteries; alternating current apparatus; alternators; transformers; wattmeters; electric transmission; electric lamps; wiring; electric heating and welding; electromagnets; controllers; car wiring; etc.

Business Man's—Arithmetic; business forms; card systems; measures of extension; weight and capacity; time; value of foreign coins; duties on imports; bookkeeping; stenography; correspondence; postal information; financial terms; money and the money market; brokers and brokerage; patents; copyright and trade marks; corporations; business law; publicity; etc.

Plumbers and Fitters'—Arithmetic; involution and evolution; powers, roots, and reciprocals; circles; decimals; geometrical drawing; weights and measures; formulas; mensuration; mechanics; hydro-mechanics; building construction; heating and ventilation; gas-fitting; plumbing; etc.

Mariners'—Logarithms; trigonometry; navigation; terrestrial navigation; celestial navigation; organization of a man of war; naval ordnance; explosives; torpedoes; ship building; speed, tonnage, and fuel consumption; ropes; wind and weather; signals; nautical memoranda; etc.

Building Trades—Loads and structures; strength of materials; properties of sections; strength of rivets and pins; materials of construction; footings and foundations; masonry construction; woods used in building; qualities of timbers; joinery; framing; estimating; elements of architectural design; drainage systems; plumbing fixtures; plumbers' tables; heating and ventilation; gas and gas-fitting; etc.

Bookkeeper's—Arithmetic; formulas; tables; money; percentage; interest; equation of accounts; money and the money market; business law; financial terms; banks and banking; postal information; distances and time between various places; bookkeeping; business forms; card systems; modern office methods; cost accounting; bank bookkeeping; clearing house methods; etc.

International Textbook Co.

Box 1102, SCRANTON, PA.

I enclose \$_____ for which please send me the books BEFORE which I have marked X.

—Mechanics' Handbook —Advertiser's Handbook

—Elect. Eng. Handbook —Business Handbook

—Bldg. Trades Handbook —Bookkeeper's Handbook

—Plum. & Fit. Handbook —Sten. & Corr. Handbook

—Tel. & Tel. Handbook —Mariners' Handbook

Name _____

St. and No. _____

City _____ State _____

For our Mutual Advantage mention Popular Electricity when writing to Advertisers.

CAPITAL AND RESOURCES—\$1,750,000.

BEAUTIFY YOUR HOME
WITH THE ARTISTIC

REED & SONS PIANO

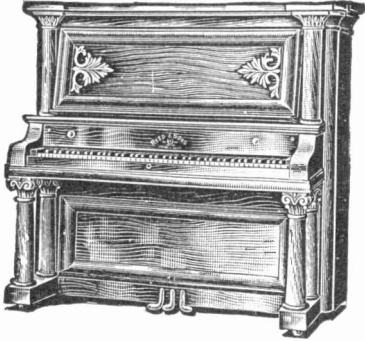

Save \$128 to \$222
on Your Piano

You want the best piano in your home—and you want to pay only the manufacturer's price for it. The Reed & Sons Piano has a world-wide name. It is the sweet-toned piano, handsomely designed, and is constructed to uphold a hard-earned reputation, gained during sixty-nine years. Thousands of owners praise it. At the World's Columbian Exposition it won the highest award metal.

Send No Money

This piano was formerly sold through dealers, agents and jobbers. Their profits have been wiped out. It is now sold direct to the buyer and the customer receives the savings that would otherwise go to the middleman. You save from \$128 to \$222, by buying a Reed & Sons Piano. Better still, a purchase plan has been arranged that makes it easy for you to pay. No money down.

30 DAYS' FREE TRIAL IN YOUR HOME

and we will pay the freight on any piano you may select. This remarkable offer will allow your family and friends to enjoy the exquisite tonal qualities and to note the attractiveness of the design and finish—and inspect the easy action. When you are absolutely satisfied, you can pay by the month, three months, or twice a year. We want you to have the great enjoyment of owning so splendid an instrument. If we cannot satisfy you with the piano we will pay the freight for its return. This is the first offer ever made. It means 365 days' Approval Test, besides 30 days' Free Trial and three years' time to pay if satisfied. We give a 25 year guarantee bond with every Piano.

NO COLLECTORS—NO INTEREST TO PAY

Our direct to the home manufacturer's wholesale prices are so low—that you can have a celebrated Reed & Sons Piano for life-long use, at a price no higher than that of an inferior, cheap piano, sold by some dealers and agents, and still obtain the highest artistic quality. The Reed & Sons Piano will be a source of pride to you all your life. Just compare the piano, illustrated above, with the Piano your dealer or agent would charge you from \$450 to \$500 for, and we know that you will readily decide in favor of the artistic Reed & Sons Piano.

BIG BOOK SENT YOU FREE

You can save money by clipping this coupon right now. It will secure for you our special proposition and prices, all in the handsomest color-illustrated catalog, sent free. We guarantee that we can offer you a better proposition than any other piano concern in the world. A two-cent stamp will save for you the dealer's profit. Fill out the coupon, now!

REED & SONS PIANO MFG. CO.
Dept. 27, Cor. Jackson Blvd. & Wabash Ave.
Chicago, Ill.

Send me your big illustrated book free.

Name.....

Street..... R. F. D.....

Town..... County..... State.....

Largest Factory to Home Manufacturers in the World.

HESS MEDICINE SANITARY LOCKER



The Only Modern, Sanitary
STEEL Medicine Cabinet

or locker finished in snow-white, baked everlasting enamel, inside and out. Beautiful beveled mirror door. Nickel plate brass trimmings. Steel or glass shelves.

Costs Less Than Wood

Never warps, shrinks, nor swells. Dust and vermin proof, easily cleaned.

Should Be In Every Bath Room

Four styles—four sizes. To recess in wall or to hang outside. Send for illustrated circular.

The Recessed Steel Medicine Cabinet HESS, 912 L Tacoma Bldg., Chicago
Makers of Steel Furnaces. Free Booklet.



THIS MORRIS CHAIR \$1 25
65c monthly—total price \$5.45. CASH

Latest design. Kiln dried heavy stock. Genuine Fabricated Leather. We have 3000 such bargains for you. And all

Sold On Credit

You use and enjoy the goods now—pay as you can. 30 DAYS' GUARANTEED FREE TRIAL. Send at once for our big illustrated catalogue. It's FREE to you.

SPiegel, May, Stern & Co.

1585 35th Street - Chicago, Ill.

FREE BOOK ON ARTISTIC WOOD FINISHING.

The best and most practical book ever published on wood finishing—how to get the best results in staining, varnishing and waxing wood, specifications of the quantities required for each job, etc. The free book and free samples of Johnson's Wood Dye in your choice of 15 shades and samples of wax or other finishing preparations, at your dealers or write us for booklet P. E. 10.

S. C. JOHNSON & SON, - - - Racine, Wis.



I will send as long as they last my 25c. Book

STRONG ARMS

For 10c in stamps or Coin.

Illustrated with 20 full page halftone cuts, showing exercises that will quickly develop, beautify, and gain great strength, in your shoulders, arms, and hands, without any apparatus.

PROF. ANTHONY BARKER

1293 Barker Bldg. 110 West 42d Street, New York

2000 Presents Free



The money that other merchant tailors tie up in big advertising we spend in buying fine, free presents for our Agents. Household goods, Bicycles, Fine Jewelry, Musical Instruments,—anything you want, free.

Sell Knickerbocker Tailor-made clothes. Just show your friends our beautiful Fall Suit Samples and our 1911-1912 Style Book and orders come easy. Besides these valuable free presents, we allow each representative customary full cash commission. Also your own clothes at net factory cost (one half your dealer's price.)

MAKE \$10 CASH ON ONE SUIT ORDER

Knickerbocker agents make \$5 to \$10 on single orders and get the free premiums extra—nothing to buy. We furnish complete agent's outfit free—express all prepaid on everything. We take all risks. Every suit shipped on approval. Wear fine clothes, make BIG money, get free any present you want. Write for big Book of Free Presents, Suit Samples, Style Book, Measuring Blanks, etc.—all FREE. No experience necessary. We give EXCLUSIVE territory. Territory going fast. Write today if you want EXCLUSIVE CONTROL in your district. Postal will do. Get our Proposition, no matter whose outfit you have. WRITE

THE KNICKERBOCKER TAILORING CO.
(2) 1922 Halsted St., Chicago.

REVERSIBLE
“Linene”
 TRADE MARK
COLLARS
 GENTS AND BOSOMS

WEAR ONE SIDE THEN THE OTHER

That's what you can do with Linene collars. Both sides are alike. 10 collars for 25 cents at the stores, or by mail 30 cents in U. S. stamps. Sample by Mail for 6 cents

State Size and Style

REVERSIBLE COLLAR CO.
 Dept. U, Boston, Mass.

VAN DYCK
 Sizes 12 to 18 Inches
 Front 14 Inches Back 11 Inches

ANGELO
 Sizes 12 to 20 Inches
 Front 21 Inches Back 1 Inch

RAPHAEL
 Sizes 12 to 20 Inches
 Front 24 Inches Back 1 Inch

RUBENS
 Sizes 12 to 20 Inches
 Front 2 Inches Back 1 Inch

DIAMONDS ON CREDIT

This Diamond Ring is our great special. Only the finest quality pure white diamonds, perfect in cut and full of fiery brilliancy are used. Each diamond is skillfully mounted in our famous Loftis "Perfection" 6-prong ring mounting, which possesses every line of delicate grace and beauty.

The three rings here shown are the most popular, although we show all sizes in our large, handsome Catalog. Each ring is solid 14 karat gold, and is cased in a dark blue velvet ring box with white satin lining.

Ask us to send you a Ring on approval. It will be sent at once, all charges prepaid. If you are not perfectly satisfied, return it at our expense.

Write for our Free Catalog containing over 2,000 illustrations of Diamonds, Watches, Jewelry, Silverware, etc. It tells all about our easy credit plan. Write today.

LOFTIS BROS. & CO., Diamond Cutters,
 Dept. D871 100 to 108 N. State St., CHICAGO, ILL.
 Branch Stores: Pittsburg, Pa., and St. Louis, Mo.

L-1220—Specially selected fine brilliant white Diamond **\$25** \$5 down, \$2.50 a month

"PERFECTION" DIAMOND RINGS

L-1221—Specially selected brilliant white Diamond **\$50** \$10 down, \$5 a month.

L-1223—Specially selected brilliant white Diamond **\$100** \$20 down, \$10 a month.

An Ideal Gift

Real Shirt Comfort For You



You don't know what shirt comfort is if you've never worn the Signal Coat Shirt. The coat style cut allows you to slip it on and off quickly, easily, smoothly, without tugging over the head or tearing when you're tired, hot and sweaty; something you can't do with old style shirts. Furthermore,

The Signal Coat Shirt

has all the good features of all other shirts added to all its own special good points which include *extra button* at bottom of breast plait for smooth fit—no gap sleeve slit, reinforced with rip-proof band—double needle machine stitching, three-inch overlap to flaps in front, skirts cut out at sides to improve fit. Full length sleeve and body. Made of fast color percales, guaranteed not to shrink. Two pockets, and two detached *hand-turned* collars or one soft attached. Extra buttonholes for attaching white cuffs.

Try a Couple at Our Risk

Your dealer should have them. If not, tell us his name, and your size and we will send you a couple by express. If you like them, pay Express Co. \$1 each. (West of Missouri River \$1.25.) If not entirely satisfied, return at our expense. Write for folder showing extra styles in neat colored patterns for semi-dress at \$1.00 and \$1.50.



Hilker-Wiechers Mfg. Co.,
 1248 Mound Avenue Racine, Wis.
 Makers of Signal Overalls and Work Clothes

Hilker-Wiechers Mfg. Co.
 1248 Mound Av. e.
 Racine, Wis.
 Send me, on approval, 2 of your signal Coat Shirts
 _____ express prepaid. Size _____
 collar attached or 2 detached

Name _____
 Street _____
 Town _____ State _____

Central Station Advertising

As advertising agents for the two largest Central Stations in the world, we have naturally acquired a fund of experience which might be drawn upon by other Central Stations to their considerable advantage.

Advertising Things Electrical

We are qualified by what we have done to give sound advice to the advertiser who is facing the problem of interesting the consumer in his product—be that advertiser large or small.

WM. D. MCJUNKIN
Advertising Agency

35 S. Dearborn Street Chicago



WHITE VALLEY GEMS IMPORTED from FRANCE
SEE THEM BEFORE PAYING!

These Gems are chemical white sapphires. Can't be told from diamonds except by an expert. Stand acid and fire diamond tests. So hard they scratch a file, will cut glass. Brilliance guaranteed 25 years. All mounted in 14K solid gold diamond mountings. Will send you any style ring, pin or stud on approval—all charges prepaid—no money in advance. Write for Free Illustrated booklet, special prices and ring measure
WHITE VALLEY GEM CO., K742 Saks Bldg., Indianapolis, Ind.

Autology

Body and Brain Perfection

DR. MORAS has written a Commonsense Book on Autology, and by so doing

placed the Standard of the Creed of Health Farther to the Front than any man who has lived for a thousand years—**Elbert Hubbard**. So you may see for yourself. Send for FREE "Guide to Autology." Address **E. R. MORAS, M. D., Dept. 12, Highland Park, Ill.**



Handy Electrical Dictionary

"Just Fits The Vest Pocket"

Designed to meet the needs of the beginner, and at the same time furnish a compact, reliable reference for the electrical worker and expert.

224 pages—"Plain English" definitions of over 4,800 electrical terms and phrases—7 pages of diagrams

Everyone Interested in Electricity Needs it

Price, Cloth, 25c
Full leather, full gilt, 50c

Popular Electricity Publishing Co. Book Dept.
54 WEST LAKE STREET CHICAGO, ILLINOIS



Do You Want Electric Light or Power for Your Country Home or Farm?

If you are out of reach of central station current and wish to install a gas engine electric outfit, either with or without storage battery, write for our Handbook, here illustrated. Alamo Electric outfits are standard. Our prices are as low as consistent with high-grade machines suitable for permanent installations. Investigate our proposition, it places you under no obligation.

The **ALAMO MANUFACTURING CO.,** 73 South St., Hillsdale, Mich.

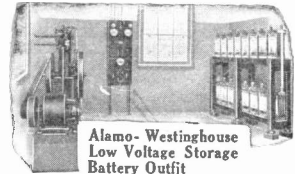

Alamo-Westinghouse Low Voltage Storage Battery Outfit

Monthly: \$1.00 a Year. Single Copy 10c.

Aviation, Aeronautics, Wireless Telegraphy



Published at 1415 Newcastle St.

Brunswick, Georgia.

Aeronautic Wireless Department alone worth \$1.00 a year

St. Paul Minneapolis *The Best of Everything*

The North Western Limited, a train of matchless luxury and solid comfort, leaves Chicago 6:45 p. m. daily, arrives St. Paul 7:15 a. m., Minneapolis 7:55 a. m.

The St. Paul-Minneapolis Express leaves Chicago 10:10 p. m. daily, arrives at the Twin Cities early next forenoon.

The Badger State Express leaves Chicago 9:30 a. m. daily, arrives St.

Paul 10:10 p. m., Minneapolis 10:35 p. m.

Another train—*The North Western Mail*—leaves Chicago 2:50 a. m.

These four splendid trains leave from the New Passenger Terminal, Madison St., between Canal and Clinton Sts., the most modern railway terminal in the world.

A. C. JOHNSON P. T. M.

Chicago and North Western Ry.
Chicago, Ill.



NW1630

Free for Six Months

My Magazine

“Investing for Profit”

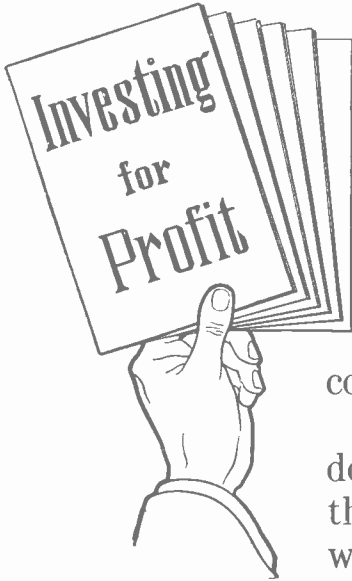

If you will send me your name and address, I will mail you this wonderful magazine *absolutely free for six months*—Special Trial Introductory Offer. Each copy is worth \$10.00 to \$100.00 to you.

Wait till you see, it is a good thing, but don't wait till every one sees it—you will then be too late. One good investment is worth a lifetime of labor.

How Small Investors Have Made Stupendous Fortunes

You know and I know that small investors have made stupendous fortunes—men who, guided by judgment and courage, have placed their funds direct into creative enterprises at their inception and thus reaped *full benefit* of the earning power of money. Today opportunity on bended knee is entreating the small investor to accept her favors—and those who heed the insistent call are achieving fortunes.

My magazine explains the rules by which small investors have made wise and profitable investments—how \$100 grows into \$2,200—the actual possibility of intelligent investment.

Learn the REAL EARNING POWER of Your Money

The real earning power of your money is not the paltry 3 per cent to 5 per cent paid by banks or corporations who have their future *behind* instead of in *front* of them.

“Investing for Profit” reveals the enormous profits bankers make, and shows how one can make the same profit—it demonstrates the *real* earning power of your money—the knowledge that financiers and bankers hide from the masses—it explains HOW small investors are making big fortunes and WHY they are made.

This and other valuable financial information is yours—it is free six months for the asking.

How to Determine the Value of Different Investments

There are thousands of salaried people today who have a small sum laid aside or who can invest a small amount each month—but who realize that they do not know how to determine the value of the different classes of investments that are offered to them daily. This condition has created a demand for a publication or institution whose express object is to help direct and guide the small investor. “Investing for Profit” is the result of a pressing need, and will be worth hundreds—even thousands of dollars to you.

If You Can Save \$5.00 a Month or More

“Investing for Profit” is for the man who intends to invest any money, however small, or who can save \$5.00 or more per month—but who has not as yet learned the art of investing for profit.

Read what Russell Sage, one of the most successful financiers of his day, said in regard to investments:

“There is a common fallacy that, while for legal advice we go to lawyers, and for medical advice we go to physicians, and for the construction of a great work to engineers—financing is everybody's business. As a matter of fact, it is the most profound and complicated of them all.”

Don't invest a dollar in anything anywhere until you have at least read one copy of my really wonderful magazine.

Mail Coupon To-Day for Free Financial Advice and Magazine

There are absolutely no strings to my Six Months' Free Trial introductory offer. I will do exactly what I say.

If you will send me your name and address on the attached coupon I will send you absolutely without charge, for six months, my magazine—“Investing for Profit.” Then you are to decide whether or not you care to continue to subscribe and want free advice on financial matters.

Surely this is a fair, square, liberal offer—so sign and mail the coupon now—before you turn this page.

H. L. BARBER

20-K Jackson Blvd.
CHICAGO ILL.

H. L. Barber

20-K Jackson Blvd.

Chicago, Illinois

Please send me absolutely Free of Charge “Investing for Profit” for six months. Later on I may want some advice on investments.

Name.....

Street.....

City.....

For our Mutual Advantage mention Popular Electricity when writing to Advertisers.

A Tax Exempt Stock That Pays 7% Dividends

As typical of the best and most up-to-date practice in the central electrical station industry in our larger cities, there is no investment more worthy of investigation than the stock of the **Commonwealth Edison Company** of Chicago. Notwithstanding its astonishingly rapid growth and its present strategic position, this Company is as yet doing only a fraction of the business that it will do in the near future.

The **Commonwealth Edison Company** is at present retailing electricity in a territory that covers 200 square miles, but that territory is only "tapped," so to speak. There is expert authority for the statement that three times the present volume of business should naturally come to the Company's Central Station.

Yet, gigantic as is the retail business of the **Commonwealth Edison Company**, it forms only one-third of its total business, two-thirds of which is wholesale. It supplies electricity to 1250 miles of street and elevated railway track and its service to smaller Central Stations extends 85 miles to the north, 55 miles to the south and 35 miles to the west of Chicago.

A very considerable portion of the Company's wholesale business is concerned in the sale of electricity for light and power to manufacturers. In this field there is still opportunity for a vast increase of business in replacing private power plants with the more economical Central Station service.

The **Commonwealth Edison Company** represents an investment of over \$70,000,000, and is paying dividends at the rate of 7% per annum on its capital stock. The future prospects of this stock are indicated by the recent advance in the dividend rate from 6% to 7%. At the present market price of about \$130.00 per share, the net return to the investor is about 5 $\frac{3}{8}$ %. While the stock was paying 6% dividends it sold at average prices that yielded a smaller net return. This justifies us in the belief that Commonwealth Edison stock is now a more desirable investment than ever before.

Commonwealth Edison stock is listed on the Chicago Stock Exchange. We recommend this stock as an investment of exceptionally high character, paying 7% dividends, and as being exempt from taxation under Illinois laws. Full information will be gladly supplied in answer to all inquiries.

Russell, Brewster & Company

Members:

New York Stock Exchange
Chicago Stock Exchange

116 W. Adams Street
Chicago, Ill.



Popular Electricity

In Plain English

Henry Walter Young, Editor



Vol. IV

September, 1911

No. 5

CONTENTS

	Page		Page
Electric Signaling on a Dirigible Balloon.....	396	Central Station Farthest North.....	438
Electrocuting Harmful Bacteria.....	397	OZONIZED WATER FOR ST. PETERSBURG.	
Lost in the Plating Tank.....	397	By Dr. Alfred Gradenwitz.....	439
COAL HANDLING IN SMALL BOILER ROOMS. 385		Motor Operates Canal Gates.....	441
SCIENTIFIC CRIME AND ITS DETECTION. By		Electric Kitchen Ventilator.....	442
Arthur B. Reeve.....	386	Rapid Hoisting with Electric Power.....	442
CATCHING SEALS BY WIRELESS. By F. M.		Air Blowers of Tremendous Capacity.....	443
Sammis.....	391	No "Four" in Japanese Telephone Directory.....	443
Moving Picture Advertises Electricity.....	395	Electric Freight Trucks.....	444
Locating the Elevator Car.....	396	Unloading River Boats.....	444
THE WIRELESS OPERATOR REMINISCENCES. 398		Street Railway Concrete Mixer.....	445
MASTER AND MEN. By Paul Lupke.....	400	An All-electric Bakery.....	445
Noiseless Telephone Call.....	403	Flowing Water in Any Home.....	446
Iron Annoys Paper Makers.....	403	Hot Coffee by Electricity.....	446
THE SHRINERS IN ROCHESTER.....	404	ELECTRICAL MEN OF THE TIMES. Norman	
Warfare of the Future.....	407	Macbeth.....	447
Pulling Cable Into Ducts.....	407	WHERE ART AND SCIENCE MEET.....	448
AUTOMOBILE ELECTRIC LIGHTING. By Geo.		Artistic Display of Household Devices.....	450
L. Chandler.....	408	A German Woman in Her Home.....	451
Electric Locomotives Dependable.....	409	Convenience the Slogan of the Modern Woman.....	452
Lighting the Streets of the Air.....	410	The Latest in Washing Machines.....	453
New Method of Reproducing the Voice.....	411	HOW TO MAKE A BELL RINGING TRANS-	
Starting an Engine with Gunpowder.....	411	FORMER. By Charles F. Fraasa, Jr.....	454
Odd Uses for an Electric Fan.....	412	Are Hailstones Electrical Products?.....	456
BERLIN'S UNIQUE PALACE OF SPORTS. By		Electrically Driven Submarine Model.....	457
A WONDERFUL MANUFACTURING PLANT. By		Electric Home for Canaries.....	458
Geo. Frederic Stratton.....	416	Making a Galvanometer.....	458
Distributing Electricity on the Farm.....	417	This Electroliter is Unique.....	459
Advice to Engineering Students.....	418	THE MULTILATOR OF THE MORSE CODE. By	
The Sidewalk the Best Signboard.....	423	Frank M. Ewing.....	460
Wire Span a Mile Long.....	423	An Electric Eraser.....	462
The Electric Press Bulletin.....	424	Soldering Iron.....	463
Why Electric Shock Causes Death.....	425	Interrupter and Cooler.....	463
The Human Wheel.....	426	Light Without Wires.....	464
Testing Rail Joints.....	427	Where to Buy the Ring.....	464
Gasoline's Annual Death Roll.....	427	It Clinches the Argument.....	465
Tolling the Church Bell.....	428	Electricity Turns the Leaves.....	465
Giant Water Turbines.....	428	For Displaying Picture Cards.....	465
Huge Flatiron Float.....	429	Construction of a Rotating Spark Gap.....	466
Current From the Wind.....	429	Regulating Detector Current.....	466
Telling the Train Dispatcher.....	429	Combination Silicon-electrolytic Detector.....	467
Gas vs. Electricity as a Cause of Fires.....	430	The Series Spark Gap.....	467
Making the Night Beautiful.....	430	Improved Perikon Detector.....	468
The Electric Dial.....	430	A Small Receiving Set.....	468
Double Crossing the Deer.....	431	The Schenectady (N. Y.) Wireless Association.....	468
Electric Street Cleaning Autos.....	431	Aerial Switch.....	469
Magnetic Influence of the Sun.....	431	How to Make a Variometer.....	470
BRILLIANT STREET LIGHTING IN WARREN. 432		Rain Spout for Aerial.....	470
Attractive Fountain Lights.....	433	To Inspect Vessels' Wireless.....	471
Nature of the Electric Arc.....	433	Wireless Queries.....	471
Protecting the Fire Fighters.....	435	Questions and Answers.....	473
Electric Car Makes a Long Run.....	435	Royalties and License Fees. By Obed C. Billman.....	475
At the Cabaret Show.....	436	The Practical Operation of Arc Lamps.....	476
Memorial to Alexander Henderson.....	437	New Books.....	476
Electrical Inertia.....	437	About the New Cover.....	477
Street Car with Connecting Rod.....	437	A Million Inhabitants But No Telephones.....	477
Train Orders Delivered on the Fly.....	438	The Definition of an Engineer.....	477
Electric Tower Wagon.....	438	SHORT CIRCUITS.....	478
		COMMON ELECTRICAL TERMS DEFINED.....	480

(See Special Notice to Subscribers on page 34, advertising section)

RENEWALS When your subscription expires, you will find a renewal blank enclosed here. You should fill out and return same with remittance at once to avoid missing a number. Positively no copies will be mailed on any subscription after same expires unless renewed, and we cannot agree to begin subscriptions with back numbers. The date on wrapper of your magazine shows issue with which your subscription ends. The extension on this date to period covered by renewal is sufficient receipt. If any other is desired it should be requested at time of renewal.

CHANGE OF ADDRESS Notify us promptly of any change in your address, giving both the old and new location. Since our mailing list for each issue closes the 5th of the preceding month (i. e., list for February closes January 5th), changes received after the 5th must necessarily take effect with issue for second month following. Postmaster as well as Publisher should always be notified of changes in order to forward mail sent to old address.

ISSUED MONTHLY BY POPULAR ELECTRICITY PUBLISHING CO., Commercial Bldg., Chicago, Ill.
 YEARLY SUBSCRIPTION, \$1.00; CANADIAN, \$1.35; FOREIGN, \$1.50; SINGLE COPY, 10 CENTS

No additional copies will be sent after expiration of subscription except upon renewal.

Entered as Second Class Matter April 14, 1908, at the Post Office at Chicago. Under Act of March 3, 1879.

Copyright 1911, by Popular Electricity Publishing Co.



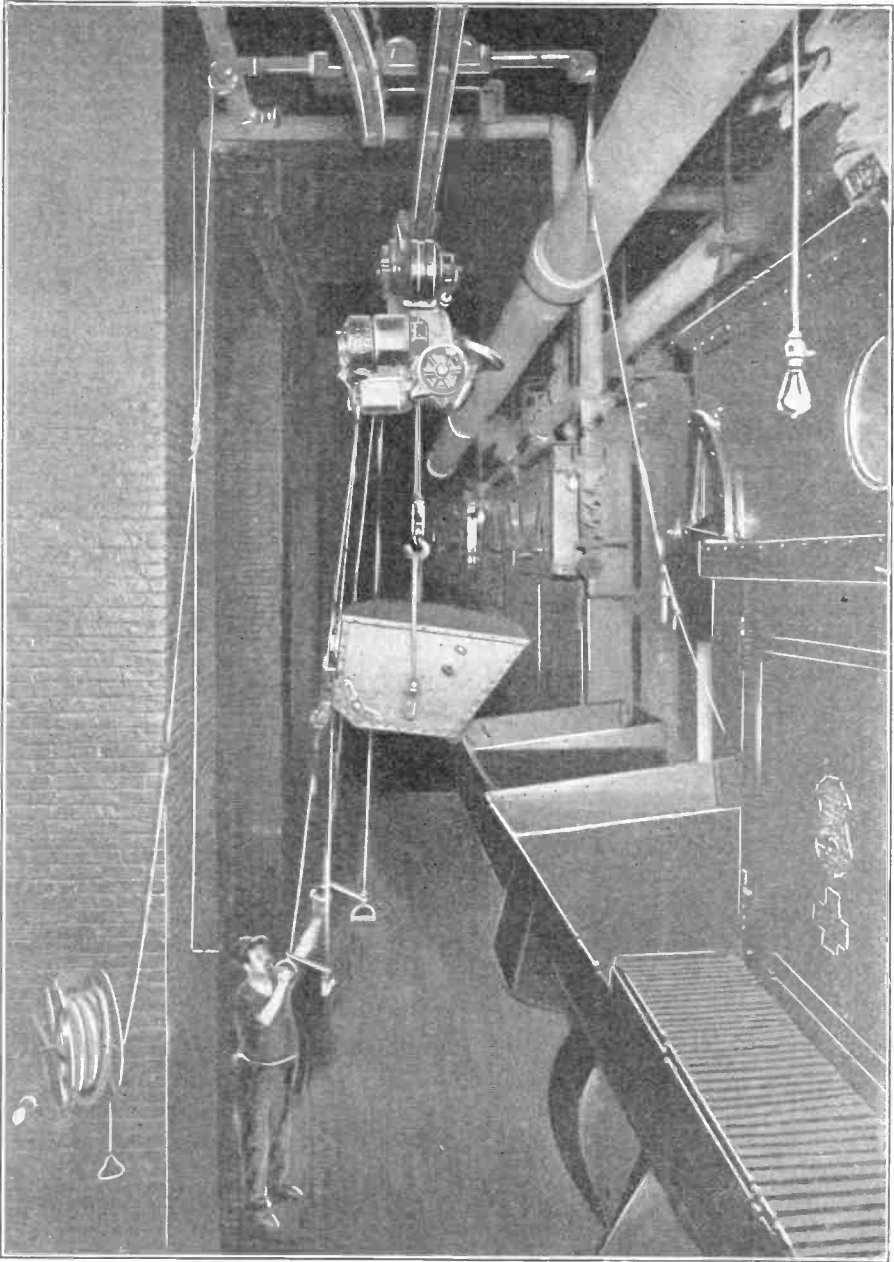

HANDLING COAL IN A BOILER ROOM WITH AN ELECTRIC HOISTER

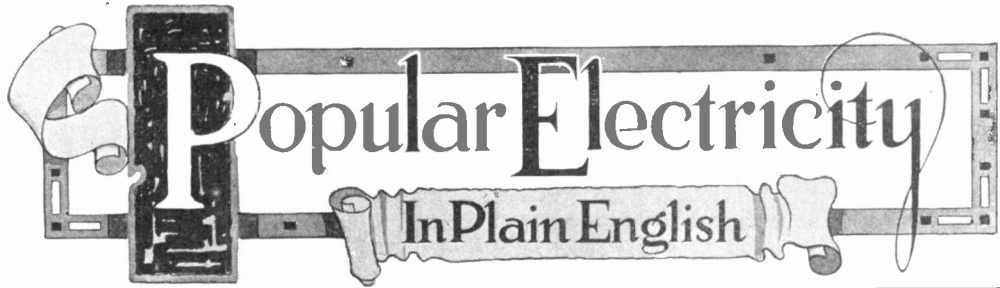

Popular Electricity

In Plain English

VOL. IV

SEPTEMBER 1911

No. 5

Coal Handling in Small Boiler Rooms

It is undoubtedly true that no two boiler rooms in a modern building present quite the same problems for a solution, as the conditions of location and space are such widely varying factors. New methods and electric devices are being constantly developed to yield the highest efficiency and convenience and at the same time be sufficiently flexible to meet all requirements.

One of the most interesting solutions of the coal handling problem is found in the new Fifth Avenue Building in New York City. It is of interest to note that this boiler room is located three stories below the street level and the coal supply is carried in bunkers, which are as favorably located in relation to the boiler room as the general conditions will permit. But the transfer of the coal from the bunkers to the hopper of the stokers presents problems of special difficulty. In this instance, the coal is handled in iron buckets, holding about 600 pounds each. These buckets are hung on the hook of an electric hoist, which in its turn is built into a trolley running on an overhead track, leading from the bunkers to the hoppers of the various stokers.

The buckets are lowered to a point opposite the mouth of the bunker chutes to permit the coal to flow into them by gravity from the bunkers. A pull on the switch then starts the electric hoist and the bucket is soon lifted high enough to enable it to start on its journey to the hoppers of the stokers. It will be seen by a glance at the frontispiece that this journey is accomplished by means of a smaller motor attached to the trolley truck and geared to drive the trolley wheels. The trip is made in a few

seconds, the coal being then discharged by dumping into the hoppers of the stokers.

There is a simple switch in the overhead truck which enables the hoist to be run to a point where it can pick up the ash cans and these are all handled as swiftly and cheaply as is the coal. The whole electrical installation is under the instant control of the operator, and the hoist will raise or lower the bucket by fractions of an inch if necessary, and the load is automatically held at all times.

The control of the trolley motor is also quite as complete, and the load may be advanced or withdrawn at will. It will be noted that the hoisting problem is not in itself particularly difficult, but the conditions under which this electric hoist operates are so onerous as to make its continued high efficiency all the more noteworthy. It is held that the temperature at the top of the boiler-room probably averages 135° F. and also a considerable amount of dust and fine particles of coal is naturally present. Still this hoist continues to perform its work, day in and day out, showing not the slightest diminution of efficiency.

It is maintained that an installation of this character is equally adapted to boiler-rooms outside of cities and wherever coal has to be transferred, no matter under what conditions. The electric hoist and overhead track show an efficiency in cost of operation against which the old method of wheelbarrows or trucks cannot compete for an instant. The combination of either a hand hoist or electric hoist with a trolley running on an overhead track marks a step in advance in the transportation of materials.

Scientific Crime and Its Detection

By ARTHUR B. REEVE

Necessity is the mother of invention, but there is no telling what invention may be the mother of. Many an invention, to the surprise of the inventor, has been employed by criminals to break the law until it almost seems as if a new brand of scientific crime had been created by modern conditions.

The successful criminal of today is no longer the man with the strong arm, the blackjack, and the jimmy. He is a man of science, often crude and limited, to be sure, but a very practical scientist. The main point is that such a criminal knows that he must employ up-to-date methods against up-to-date protection or go out of the "profession." Accordingly he sometimes gains a pretty serviceable knowledge of chemistry, physics, toxicology, often microscopy, but most of all electricity. It might be interesting but it would hardly be ethical to tell the story if science did not keep several laps ahead of the criminal in the race. Science is on the side of the law-enforcer nine times to every time it is of use to the law-breaker. The new scientific crime pays even less well than the old unscientific.

Within the past few months several very curious safe robberies have taken place in New York. In one of them the robbers practically drilled a safe full of holes. The robberies are full of scientific interest both for thieves and bankers, because of the use of electricity. They show that the time has not yet arrived for the reduction of armor on the part of people fortunate enough to have something worth stealing.

In all these cases the thieves used an electric drill. They always selected a safe that was in a dark corner, where they could work for some time without fear of being seen or interrupted. Once in the building, the thieves used an electric light feed wire to which they attached the drill, turned on the current and began to bore. As there are electric light wires in nearly every place of business and as the unscrewing of an incandescent bulb is all that is necessary for getting a connection to furnish power for anything from a mechanical toy to a sewing machine, the possibilities of electricity in

robbery would seem great. The old-style safe blower used to have a complete outfit consisting of blankets, files, soap, putty, a brace and bit, "soup," a "can-opener," and other tools. The drill is a decided improvement on this bulky outfit.

No very great acumen is required to secure protection against such methods, however. The surest thing is to have the safe in such a position that it is visible night and day to passers-by. Light is about as good a burglar expeller as one could want. But if one persists in allowing the safe-cracker to screen himself so that he can take his time at the job, then he should adopt some of the really scientific defensive methods which are numerous.

The latest burglar-proof safe is an invention called the round-about safe described in a recent issue of a German technical journal. It has been specially designed to baffle burglars with electric drills, thermit or the oxy-acetylene blow-pipe. It is a polygonal steel structure which revolves freely on ball bearings. When the outer door is shut a small electric motor is set in motion and the safe starts revolving ceaselessly and noiselessly on an axis within the stone chamber into which it is built in the wall. Any tampering with its motion causes an alarm bell to ring. So long as the safe is kept revolving of course the electric drill can have no effect, as it cannot be applied in one spot long enough to make an impression.

However, that idea is more interesting than it is practical. Electric protection today runs all the way from the simple electric gong which sounds on the street to the very elaborate system which has recently been installed in the United States Treasury. This new system makes it mechanically impossible for an intruder to lift the latch on a door or touch the knobs on a vault without setting electric gongs ringing all over the building. When the doors of the vaults swing shut after each day's business the system becomes operative automatically and when the doors close on the clerks another set of alarms is automatically

set. The electric wires all center in a watch-room which is equipped like an armorer's chamber and where guards are on duty every hour of the day and night.

Then there are other elaborate methods, such, for instance, as has the new safe of the National City Bank of New York, where over half a billion dollars in cash and securities are literally guarded from thieves by steam. A puncture into the sides

if broken imperil the life of the cracksmen by suffocation.

Light, as mentioned before, is one of the best of burglar expellers. Some time ago a Chicagoan devised an emergency method of lighting for offices and residences, by which the turning of a master switch at the head of the bed or, mechanically, by the opening of a window or door, can be made to turn on all the lights in an office or house.

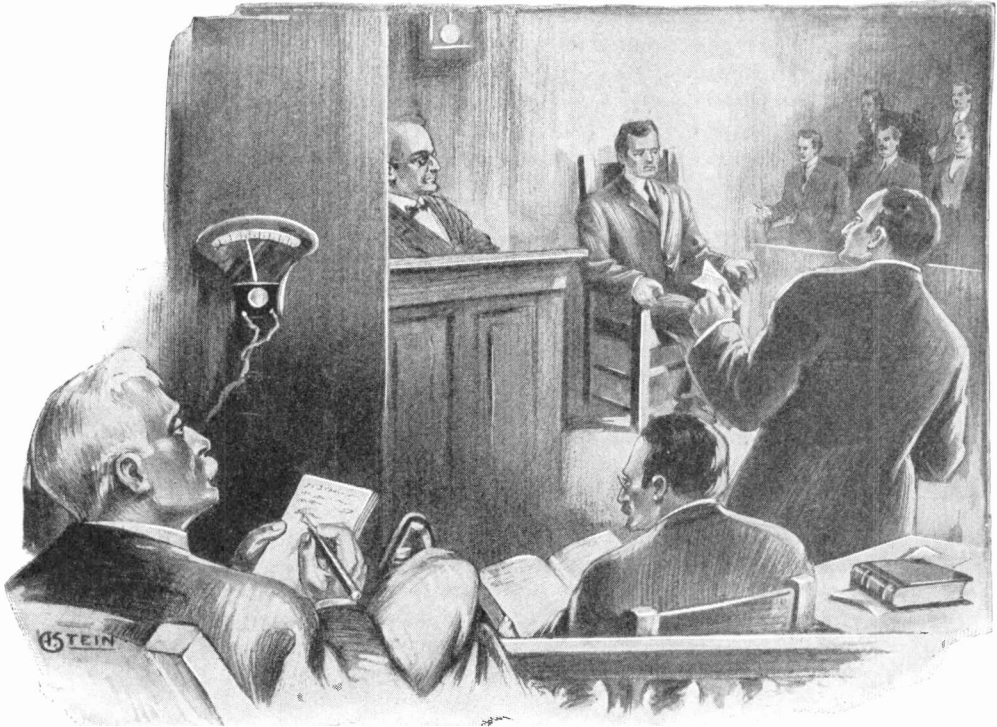

AS THE PRISONER GRIPS THE CHAIR ARMS, HIS MENTAL PROCESSES ARE INDICATED TO THE OBSERVER BEHIND THE SCREEN

of the sixteen-ton door of this safe will release a jet of steam that would scald a burglar to death if he did not retreat immediately. Within and without the safe are brass pipes so arranged that by the touch of a secret device steam is released, inside and out, rendering the interior a death pit at a moment's notice of danger.

There are other difficulties in the trade of a cracksmen that have been devised. People have thought out schemes for protecting safes by secret pockets of sulphuric and nitric acid and even the deadly fumes of prussic acid. Then, too, there are in some safes hidden glasses of liquid ammonia that

These lights may ordinarily be operated by their respective switches in the usual way, but in case the master switch is turned on they cannot be turned off by means of the individual switches. This means, of course, that once the master switch has been thrown, any intruder must beat a retreat.

Inventors are now working on a scheme to apply the wonderful element selenium to practical uses, one of which is the construction of a burglar alarm. Selenium has the very curious property that in the dark it is a very bad conductor of electricity while in the light it suddenly becomes a good conductor. This property has made it

possible to telephone over a beam of light by using a selenium cell. Most of the systems of telegraphing photographs have utilized selenium cells in one form or another. Recently Mr. William J. Hammer, a New York consulting engineer and once an assistant of Edison, suggested that the element should be used as a burglar alarm. The burglar of the future may be surprised, says Mr. Hammer, when he turns his bullseye lantern on the combination of an alluring safe. For on the front of the safe there will be a selenium cell and the moment the light strikes it a system of relays will be put into action and the cell will sound an alarm.

The growth of such services as are furnished by electric light and power companies has brought into existence an entirely new kind of thief, the expert mechanic and electrician, typified by several criminals whom the Edison Company, of New York, captured several months ago.

To make the electric light meter register less than the current used, clever rogues evolved at first the crude "jumped" and "hatpin" systems. The former consists simply in connecting a shunt wire to a point beyond the meter. As there is a small motor inside the meter the current passing through it meets with some resistance and is deflected through the new wire. When the readings are taken at the end of the month they show only about one-third of the power used. The "hatpin system" is the boring of a small hole in the meter, where it is not likely to be seen on a cursory examination, and the insertion of a thin instrument to retard the motor. Both these methods are readily discovered and most of the electric light companies maintain very effective and secret forces of detectives for the purpose. Then there is also the more brutal method of the "back-hand system" which is merely turning back the dial with a pair of pincers after prying off the covering.

But it was not until a man named Barth came along that the really scientific method was discovered. Barth was an expert electrician, and he devised the "magnet method" which defrauded the company of thousands of dollars in filching electric current. He sold hundreds of his "attachments," some of them to quite prominent people, who knew they were defrauding the company,

for they were always careful to remove the attachments before the inspectors came.

Barth's device looked like a sheet iron box with side pieces of heavier iron projecting downwards about ten inches, making a sort of stand. This was attached to the top of the meter. Inside was an ordinary electro-magnet connected by a flexible wire with the nearest electric light socket. The magnet was powerful and tended to retard the motor inside the meter. Sometimes when the current used was small it would actually cause the motor to revolve backwards. The dial could thus be driven back to zero if desired, but the users were careful not to excite suspicion by doing that, or by failing to let the meter register something. They never went so far as to claim a credit from the light company. The box was neatly finished in aluminum paint and was very appealing to the dishonest. But a confederate soon betrayed the man to the company's detectives and he was punished.

On the other hand, the telegraph, the telephone and wireless are of much more service to the criminal-hunter than to the criminal. Take for instance wireless telegraphy. Its advent has enabled the police to communicate with ships on which criminals are attempting to escape, instead of merely cabling to the port of arrival. The classic case is the capture of Dr. Crippen and Ethel Leneve on a slow steamship in mid-ocean. Scotland Yard spent upwards of \$2,500 on telegrams and cables giving descriptions of Crippen, sent all over the world. Yet at last it was by wireless that he was trapped by Captain Kendall of the steamship "Montrose."

Still, wireless has been used to circumvent the law, too. In Chicago, for instance, when poolrooms had been closed in the city, a floating poolroom outside the three-mile limit, and thus beyond the city's jurisdiction, was for some time maintained on a steamer on Lake Michigan. The quotations and reports from race tracks were all received by wireless.

During the fight against the race tracks central office detectives one day noticed what looked very much like a short wireless telegraph mast projecting from a gable of a cottage near a race track down at Coney Island. One of the men determined to watch that outfit for a time and see whether it was a toy or an illegal device.

While he watched he saw a flash of light from a little aperture in the gable, like the reflection of the sun in a looking glass. It lasted just a moment but it was enough to excite his suspicion further. And the more he thought of it, the more suspicious he became, for he had just heard that somehow, in some secret way, a group of pool-rooms was getting the racing news. Inquiry showed that the cottage belonged to

found and to their amazement and satisfaction the third race came clearly to them from the ether. Then they waited a bit and pretty soon along came the fourth race as accurately as the third. Then came the raid. They made two prisoners, one man with a telescope and the other doing the sending. It was the reflection of the sun on the glass of the telescope that had excited suspicion quite as much as the short

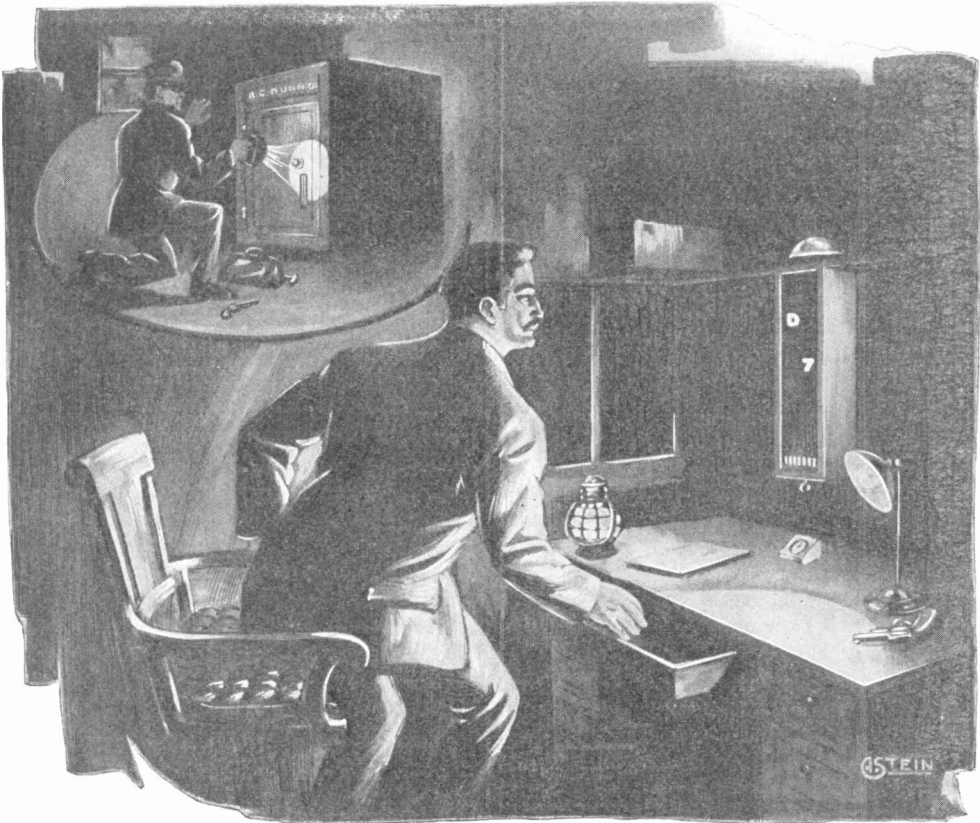

THE BURGLAR OF THE FUTURE MAY TURN IN AN ALARM BY SIMPLY THROWING HIS LIGHT ON A SELENIUM CELL

a well-known and reputable actor. But it was learned that he had let a couple of rooms in the attic to two men who, he understood, were engaged in making tests for a new trans-atlantic wireless telegraph company. That was enough for the detectives.

With the aid of an expert electrician connected with the central office, they got up a rival outfit in a neighboring cottage in the hope of intercepting some of the messages. It was a delicate matter and several days were spent before their instrument was atuned. Finally the proper adjustment was

wireless mast which had first attracted their attention. The receiving station was across the meadows in direct connection with a telephone. The rest had been easy.

Recently a Pittsburg millionaire, in a desperate effort to learn the details of the defense which his wife meant to enter to his action for divorce, spent thousands of dollars equipping his mansion with a remarkable invention by Edison, the acoustiphone. Thirteen of these instruments, each one of which will magnify a whisper 1,600 times and carry it to a given point, were installed

in the house during his wife's absence and arrangements were made to have all of the conversations which his wife held either with her attorneys or her friends taken down in shorthand.

The servants in the house were apprised of his plans because it was impossible to install the instruments without their knowledge. The most liberal inducements were given them to keep the matter secret, but one servant informed her mistress of it with the result that the husband's spies were treated to some amazing conversations, not one of which was of the slightest value in the litigation. When the wife and her attorney grew tired of the joke they took hatchets and chopped out all the wires.

One instrument was placed in the drawing room. It was in a plain black box and the electricians who put it in place suspended it under a baby grand piano. Blackened silver wires carefully concealed ran from the box down the legs of the piano to plugs in the floor, and to these, receivers similar to those used on telephones were attached. In the room containing the receivers a stenographer was stationed to take down the conversations.

In time no doubt the telegraphic transmission of photographs will be of great use in scattering broadcast the likenesses of criminals who are particularly wanted. Already this system has been put in operation between a London and a Paris newspaper and it has been tried with success between New York and Boston. Much remains to be done in perfecting the technique of telephotography, but it may now be accepted as an assured fact of the near future, and some inventors are now working on a wireless method of transmission. When these inventions are perfected they will be a new terror to the lawbreaker. The "electric eye" will follow him around the world.

The X-ray has been used more than once in helping the police to wage their relentless war on crime. In a recent case in New York a negro was arrested charged with having stolen a diamond valued at several hundred dollars. A careful search failed to discover the stone. At last the owner suggested that the negro might have swallowed it. The X-rays were applied to him and a radiograph was taken. Sure enough, the rays disclosed the diamond reposing in the intestines of the negro.

Roentgen rays will make visible what is inside of a man's body. The inside of his mind is not so easily got at by other people. But there are indirect ways. A certain person was strongly suspected of having committed a murder though direct evidence of his guilt was lacking. Circumstantial evidence was weak, so the prosecuting attorney hit upon a scientific scheme to secure a confession.

The suspected man was put upon the stand with the witness chair arranged for the occasion. It had arms upon which the witness would presumably lean his elbows and over the edge of which his fingers would naturally grip. A wire was extended along the under side of one arm; and, at the place where his fingers would naturally clasp the arm, it was connected in such a way that the pressure of his arms and fingers would be recorded on an electrical apparatus in an adjoining room.

The criminal was placed in the chair and questions were asked him, starting with simple ones so as not to excite deep emotion in the man in the chair if he were guilty. To the eye he was perfectly calm throughout the ordeal. But electricity did its work. He unconsciously telegraphed his emotions to the next room and the information thus obtained was sufficient in the hands of the attorney to secure a confession of guilt from the man. Thus one kind of electric chair sent him to the real "death chair."

Not only electricity and X-rays have been used in criminology but radium as well. What is believed to be the first case of criminal use of radium recently engaged the attention of Liege, Belgium. A wealthy old bachelor was found dead in his flat. At first it was believed that a stroke of apoplexy had killed him, but a close examination of his body revealed a curious discoloration. A specialist was called in and he gave it as his opinion that the skin looked as if it had been exposed for a long time to the emanations from radium. Thus the police were led to examine all the inmates of the house and it was found that one of them had fled. Investigation of his room showed he had been occupied in studies of radium and the police arrived at the conclusion that the old man had been done to death by a systematic application of radium rays to his head probably while he was asleep.



BELLE ISLE FROM THE SEA

Catching Seals by Wireless

By F. M. SAMMIS

Catching seals by wireless may seem a strange performance, but, nevertheless, this is what is actually being done in the Newfoundland seal fishery. It is a long cry from the capture of seals in nets, as was done in the early days, to the pursuit of them with specially equipped ships each able to break through the ice and to summon to itself, by means of the wireless equipment, the rest of the fleet when a great army of seals is sighted.

For over a hundred years seal fishing has been one of the important industries of Newfoundland. In the early days the work was carried on principally by individuals, who caught seals in nets stretched across from the land to some outlying rock and who trapped them only for their personal use. The skins were used to furnish clothing and the blubber supplied oil. In time the Newfoundlanders realized that the profits to be made from this industry were considerable and small boats started off to the ice fields in the very early spring to catch seals. By the time that they could arrive at the haunts of their prey the young had become able to leave the ice and swim in the sea and it was almost impossible to capture great numbers of them. Later, sailing vessels of some size were used, starting out from St. Johns as soon as the equinoctial gales had passed and sailing north in search of the vast fields of ice on which the young had been born, but there was much chance involved in this pursuit. With the introduction of steam craft in this work the trade was revolutionized. The vessels were enabled to go where they would and their bows were so constructed that they could run upon the ice and crush it, thus forcing their passage. When ice is encountered too thick to be broken in this way, dynamite or

powder is used to shatter it and allow the passage of the vessel.

The seals are born on the ice about the middle of February. They weigh about five pounds at birth, but in the course of five or six weeks increase to 30 or 40 pounds and are rounded out with layers of fat. They are covered with white fur and are known among the hunters as "whitecoats." It is these baby seals that are most sought by the hunters because they yield the very best kind of oil and they are not able to fight if attacked. Full grown male seals sometimes give their foes a long and hard struggle before they are killed.

When the vessels reach the ice floes on which a great number of seals are visible, the crews spring upon the ice and begin the work of destruction. Each man is armed with a club, a sharp knife known as a "sculpting knife," and a coil of rope. A blow on the nose with the club despatches the young seal, the knife is quickly drawn down the length of the body and the skin with the blubber adhering to it is stripped off and is tied together in a roll and dragged to the steamer.

Steamers are not allowed to make more than one trip a year and seals are not to be killed before March 14th or after April 10th. By these enforced restrictions the industry is made profitable and permanent.

In the spring of 1910 one of the companies operating steamers in the seal fishery decided to equip two of their vessels with wireless in order to learn whether it would be helpful in locating the seals and insure a large catch. The results were very satisfactory, indeed, the larger steamer of the two making a record capture of some 50,000 seals. This phenomenal success was entirely due to cooperation between the vessels made possible by the wireless equipments on

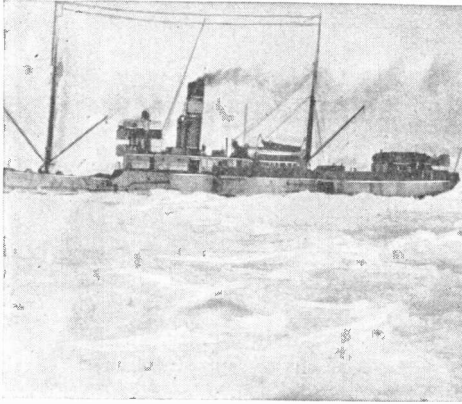

SEALING STEAMER BOETHIC

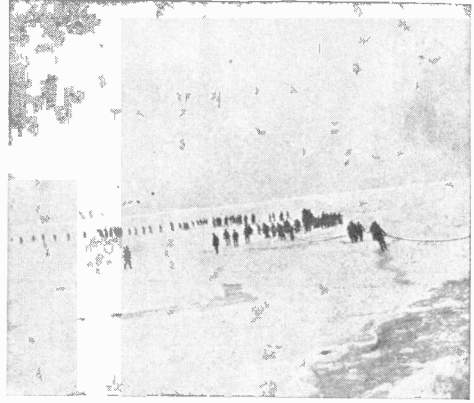

CREW PREPARING TO LOAD SKINS



HOISTING AN OLD SEAL ABOARD



STACKING THE SEALS ON THE ICE

load. The vessels acting under a prearranged plan laid their course toward different sections of the sealing grounds and communicated with each other daily, exchanging notes as to their prospects and success. One of the vessels located an enormous patch of seals and immediately advised the other as to its position and within a short time both were loaded to their full capacity.

News of the success of this new method of communication soon spread among the numerous ship owners engaged in this industry and in the spring of 1911 eight of the larger vessels were equipped with the most modern sets of Marconi apparatus. Engineers were sent to St. Johns early in February and equipment of the vessels begun in earnest. Some of the ships did not boast an electric light plant and on such a steam turbine or a storage battery set was installed.

On March 13th all is in readiness for what to the sealers is the greatest event of the year. Thousands of people line the wharves and the shore front wishing their friends a successful trip and a safe return. Success or failure, a record catch or ill luck means a great deal to the thousands of families who are dependent upon the men engaged in this annual slaughter of the seal. Amid the blowing of whistles, the ringing of bells and with hurrahs from a thousand throats the fleet steams out of the harbor northward in quest of its prey.

At the urgent request of the seal fishers, the Newfoundland government arranged to keep in commission all winter the Marconi



UNLOADING THE SHIP AT ST. JOHNS



SORTING SKINS ON THE PIER

wireless station at Belle Isle in order that they might communicate with the vessels. That part of the fleet fitted with wireless, while exchanging frequent messages, soon drifted out of sight of the remainder, each captain laying his course as his judgment directed through long and careful study during the winter of the conditions of wind and weather that would determine to considerable extent the location of the seal herds.

Ice is encountered soon after leaving St. Johns and as the vessels proceed north it becomes more dense and more difficult to penetrate. At a point about 100 miles southeast of Belle Isle the seals are usually encountered, but there is no certainty of their exact location or the whereabouts of the large herds or patches, as they are called. It is here that the wireless equipment is of great service. Each vessel acts as a scout and the news of a find is immediately communicated to the Marconi operator and by him transmitted in a private code to other vessels belonging to the same firm. The story of the part played by the wireless is best told by the operator himself, and the following extracts from his log may be of interest:

March 13th. Leaving St. Johns with the rest of the fleet, eight of us fitted with Marconi and all hands gossiping about the prospects of a good catch and a pocket full of prize money.

March 14th. Our captain, a plain fisherman, seems skeptical as to the ability of the wireless to communicate with the other ships. Send several messages for him to his



BELLE ISLE LIGHTHOUSE



YOUNG SEAL AND MOTHER

friends on other vessels and finally convince him. This ship, with bumping heavy ice and the rough seas, is doing a Virginia reel.

March 15th. Several vessels in sight. Invite the operator on nearest vessel to walk over the ice to our ship and pay me a visit. He accepts and we enjoy several hours together while both vessels buck the ice side by side. My friend has an adventuresome time getting back to his ship and falls into the sea several times en route. A rescue party of several men, sent out by the captain, finally hauls him aboard.

March 16th. In communication with Belle Isle. Hear one of the ships yarning with him and do a little eavesdropping on the side. Learn that only one of the two Marconi men is able to do duty at Belle Isle, the second man being in a bad way from an inflamed jaw.

March 18th. Went out with the men upon the ice to-day and killed seals. Surely this is a brutal business. The young seals with their beautiful eyes look at you innocently and are rewarded with a blow on the nose from a club, while others, frightened by the slaughter of their parents, cry like babies. The hood seals are so called because the male has a sack on his nose which he can inflate at will and which protects his sensitive nose from the onslaughts of an enemy.

March 19th. Not many seals the last day or so, but have just struck the main patch and immediately advise the other ship of my owners to make all speed to this location. He acknowledges receipt and is under way. This is where the value of the wireless comes in. The other ship has not had any seals but a few stragglers, but now knows where to proceed.

March 25th. We have the large patch of young seals aboard now to the number of 20,000.

March 27th. We come up to another lot of seals and increase our cargo, the value of which already is \$95,000, a goodly sum for a few days' work. The ice for the last few days has been very treacherous and the men frequently fall in and get a wetting.

With the thermometer at zero, this is no joke.

March 28th. Operator at Belle Isle asks if we have a doctor on board and receiving an affirmative answer, informs me that unless his companion receives aid at once he will lose his life. After numerous questions directed by our doctor and answers from Belle Isle, the doctor prescribes by wireless.

March 30th. Sick operator at Belle Isle not improving and seems to be in a serious condition. I inform my captain and he agrees to make a detour in order that the doctor may go ashore.

April 1st. We are now pushing our way through heavy ice endeavoring to enter the Gulf where quantities of seals are supposed to abound. After making about 30 miles against a strong tide and the ice, we are forced to abandon the attempt owing to the danger of crushing the ship.

April 3d. Finally, we are near enough to row ashore to Belle Isle through open water and, after climbing the 500-foot bluff, our doctor attends to the sick man. We leave a few victuals and some medicine and again board the ship. Certainly these wireless men at Belle Isle have a lonesome job with only the light keeper, his wife and assistant as neighbors, and they do not seem to be very sociable.

April 5th. Picking up a few scattered seals, but no large herds. Make fairly good work getting through the ice, which seems less dense now.

April 6th. Hurrah! We are homeward bound. All hands are happy. Each man will make about \$145. Give wireless good-byes to the other vessels that are to start later. The men muster on deck and give three cheers for the Marconi man for his work that brought them success.

April 10th. Arrive at St. Johns and disembark. All hands are congratulated by the owners for the good catch. The ship will be unloaded and the skins weighed and checked by a representative appointed by the crew and one appointed by the owners. After making things shipshape for the season, embark for New York and real home.



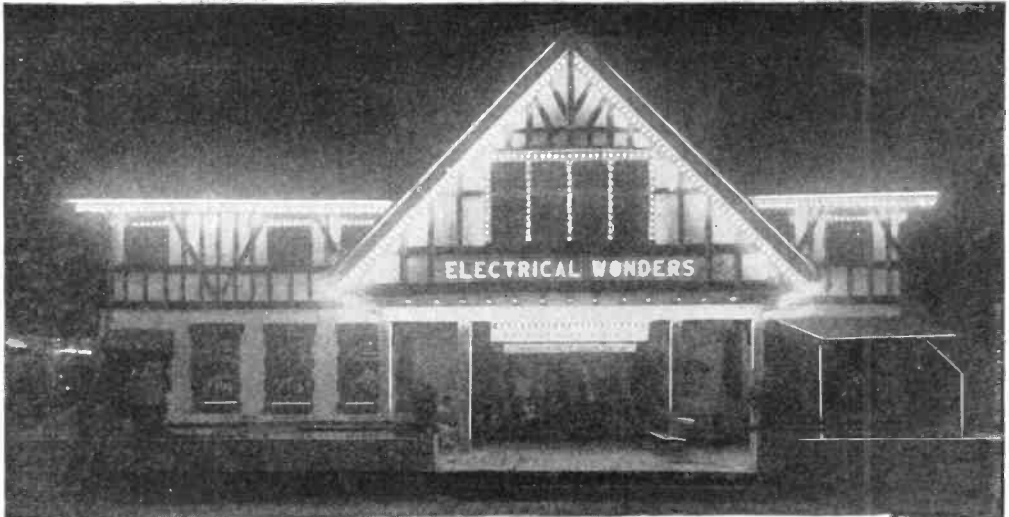

Moving Picture Advertises Electricity

A moving picture film—probably the only one of its kind ever made—which shows the thousand and one conveniences of electricity in the home—is the latest advertising innovation and amusement park venture.

Believing that people can be entertained and at the same time favorably impressed by witnessing the transformation which electricity can make in the home, the Commonwealth Edison Company “goes where the crowd goes” and runs a moving picture entitled “The Servant Problem Solved” in connection with its “House of Electrical Wonders” at White City, Chicago.

The first portion of the film, “Why Their Servant Left Them,” shows wife and “hubby” waiting for breakfast while a husky girl removes the ashes from the kitchen stove, builds and starts a fire and in smoke enough to disconcert the dog lying near, sits down to read the morning paper while things get “het up.” Hubby investigates, takes in the hopelessness of immediate breakfast, fires the servant, who is, of course, not to blame, and walks disconsolately to the club for breakfast where a friend calls his attention to the “Electric Shop” advertisement. Over-excited and smiling at the prospect of having a servant that won’t have to be fired, he loses no time in getting to the place of “things electrical” where an obliging clerk answers his queries about lamps, coffee percolators and pressing irons. The picture shows them on an elevator descending to the basement of the shop where a kitchen cabinet, vacuum cleaner, washing machine and an electric range are added to the purchases. The picture will make the heart of any true salesman beat with joy for before leaving the shop, hubby draws a check book from his inside pocket and tenders a check in full payment.

But the most interesting part of the show is yet to come. After we see the packages and boxes loaded upon an electric truck, we find hubby hurrying home to arrange some scheme to have his wife out while he remains to see the electrical men carry out the stove, coffee pot, broom, etc. Then what a change!



When wifey returns to her "home electrical," Hubby looks on while a maid dressed quite in contrast to the one fired proceeds to explain in detail how everything works.

And in the morning breakfast is on time. After She electrically toasts the bread and poaches the eggs, He fills the cups with hot coffee from the percolator and the steam is so plainly seen in the picture that a youngster viewing it exclaimed, "Say, Jim, this ain't no fake, them are real electrical things."

In concluding the show the words, "Electricity Brings Happiness," flashed on the screen invites the audience to inspect the numerous household devices in the "House of Electrical Wonders." Altogether the show is unique and as one lady expressed it in passing out, "That's as good as the dime show up by our house."

Locating the Elevator Car

When the traveling and business public wants information, this information is expected on the instant, especially if time can



THE ELEVATOR SIGNAL BOARD

be thereby saved. And this temperament is being catered to more and more by railroads, steamship lines, department stores, public buildings, etc.

This is well exemplified in Chicago's new City Hall where fourteen passenger elevators rush up and down distributing officials, politicians, job-hunters and a cosmopolitan public to twelve different floors.

Upon a marble pillar at the starter's station is a neat metal board in which are set glass bulls' eyes behind each of which is a small incandescent lamp. Each vertical row represents the elevator whose number appears at the top and as the car moves from floor to floor the proper lamp in the row flashes to show constantly the location of the car. Thus at a glance the observer can tell which cars are waiting, which are moving up and which are on their way down.

A contact-maker for each car makes and breaks the circuit of each lamp as the car moves.

Electric Signaling On a Dirigible Balloon

That electrical means should be needed for communicating between men on the same aerial craft, sounds almost like a fairy tale. Here in America the flying machines with which we have grown familiar have all been so small that the few passengers were always within touching distance of each other. This has not been true on the European continent where dirigible balloons carrying a score or more of passengers have been in service for the past two seasons and where other large ones are now being built. Notable among the latter is a torpedo-shaped dirigible which is being built for military purposes by the Siemens-Schuckert works, one of the most prominent electrical manufacturing concerns of Germany. This has a cigar shaped balloon 385 feet long and 43 feet in diameter, carrying three separate gondolas or cars. The propelling and steering machinery is in the two end cars, which are several hundred feet apart, each car having its own engineer. Orders are transmitted between the three gondolas both by visual electric signals and by a printing telegraph which records the instructions so that there can be no excuse for misunderstanding the same. This monster dirigible has four engines, each of 125 horsepower and when these are operated in unison it ought to eclipse the previous speed records for aerial vessels carrying a number of passengers.

Electrocuting Harmful Bacteria

Just how the harmful germs that cause various diseases are acted upon by the ultraviolet rays of a mercury vapor lamp is still a matter of speculation and may be slow to determine. These rays would be beyond the blue end of the rainbow spectrum, if the light were divided by a prism, and researches may show it unscientific for us to speak of electrocuting the bacteria by these rays, but it seems well established that the electrically produced ultraviolet rays annihilate bacteria of various types.

To learn the range of this action, Cernovodeanu and Henri, two investigators at the Institute for Physiology which is part of the University of Paris, have been making an extensive series of tests. The deductions already made by them cover two important points: (1) The time required for sterilizing varied very little with the temperature of the liquid containing the bacteria, which may be at ordinary room temperatures, ice-cold, or even frozen. Nor did it vary appreciably with the quantity of bacteria in the solution, as it seemed to be about the same for 10,000 as for 100,000 to the cubic inch. On the other hand an inch layer of the liquid was sterilized more quickly than one about a twelfth of an inch thick, showing that nothing was gained by treating too thin layers. The time required increased rapidly with the distance from the lamp. (2) For a given thickness of the liquid layer and a given distance from the lamp, the time needed for annihilating the bacteria varied with different species, of which a number were tried. Under similar conditions the time required was as follows: Ten seconds for *staphylococcus pogenes aureus*, a common cause of ulcerations; fifteen seconds for *vibrio cholera asiaticae*, the exciter of the asiatic cholera or black plague; twenty seconds for the *bacillus disenteriae*, the cause of dysentery so common in army camps; twenty seconds for *bacillus coli communis*, blamed for certain bowel troubles; thirty seconds for *bacillus pneumoniae*, often the cause of acute congestion of the lungs; sixty seconds for *bacillus tetani*, the bacillus which so often infects wounds due to powder and which is probably the most deadly bacteria yet known. Even with this intensely dangerous bacillus of July 4th notoriety, a single

minute sufficed, though in many of the tests two-thirds of the time given above for the various bacilli was ample.

Thus the ultraviolet rays as sent out by a mercury vapor lamp enclosed in quartz instead of the usual glass globe, were found to destroy some of the most harmful bacteria known to the medical profession when these bacteria were in solutions.

Lost in the Plating Tank

How many times has the very piece needed to complete an important order been lost for the time being in the solution of the electroplating tank? If it could only be "fished out" at once, without stirring up the solution!

The apparatus in the accompanying illustration will recover any iron or steel article right away. All that is necessary with the Abbott tank magnet is to attach one binding clip to the anode rod and the other to the cathode rod. The magnet is then energized sufficiently to pick up magnetic substance, from a needle to a piece weighing as much as five pounds.

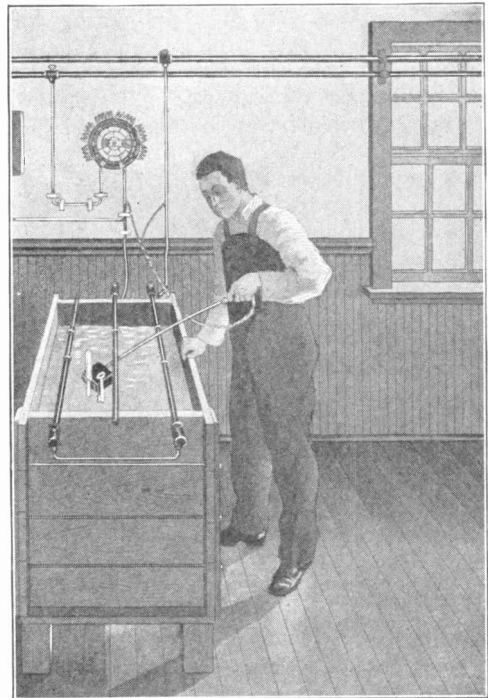

FISHING OUT LOST ARTICLES WITH THE ELECTROMAGNET



Trying For Long Distance Records

When long distance wireless work was new, records were made which certainly were puzzling to everybody, and particularly to the men who made them. To look back over those days, and think of the thrills caused by such distances when it was all so new, makes me want to say "Those were the wireless days." Enthusiasm ran high. Wireless operators bragged. They swore big lies when they fell short. They vied with one another for distance, and would stake all on a determination to win.

I had been working the wireless station at Galilee, N. J., in the summer of 1905, when I was summoned to New York by the general manager. He informed me that he wanted me to go out on the Panama Line,—the S. S. *Allianca*. Then he said:

"See how far you can work. Jessop did 275 miles when he was southbound on the *Havana*. I don't think you can do as far." This last with a challenging smile. I told him I would do my best.

We were 195 miles off Hatteras and were hitting out for the deep Atlantic. We saw our last land at Barnegat the eve before. We didn't hug the shore on our course. I was in perfect touch with the station at Hatteras, but we were not far enough away to beat the *Havana's* record of 275 miles yet.

Finally in the afternoon I got in a 250 mile report. Hatteras was on the hypotenuse of a triangle formed by New York, the *Allianca* and Hatteras. It was near sup-

per time when I got the following message from Hatteras, coming pretty faintly:

New York, Sept. 1, 1905.

You are doing fine. We all congratulate you on nice work.

C. C. G.

We were at least 275 miles from him when he sent that message. Jessop did *that* much. So I rushed to the captain and ascertained from him that we were at least 280 miles from Hatteras. I shot it in, and begged Hatteras to come back after supper and listen good for me. He OK'd my report, and promised.

After supper I went to see Chief Engineer Nelson and asked him to please give me a few more volts. He immediately gave me 125 volts and when I got back to the wireless room it was 8:15 p. m., and I had a report from the captain saying we were 336 miles southeast of Hatteras at 8 p. m. It was not quite dark, and the long distance freak was on, only we didn't know it. I gave Hatteras a call, and there he was, coming back at me fairly strong. I nervously shot my 336 mile report, and his OK was like music to me. I sat back and congratulated myself in beating the wonderful Jessop. Beat him badly, too. Now the record was mine, and I was safe from any one getting it.

The rest of the trip, and during the sixteen days we spent in Panama I thought that I was champion. I couldn't see how anyone *could* beat 336.

On returning to New York, however, I was almost stunned to find out that the operator on Ponce had worked 465 miles. And from what they told me he did it without any great effort. I made up my mind I would do an even 500 on my next trip at least. But while we were still in New York, Jessop, again southbound on the *Havana*, fired with determination, worked 752 miles direct with Atlantic City. I was more than surprised, and so was everyone.



I don't think you can do as far

When I pulled out again, bound for Panama, I was determined to put Jessop under the table. This trip was the one I spoke of in the June issue as being the one where I had picked up the news about the sinking of the scows off the New England coast, fully 900 miles away. I felt that 900 miles without any wires was just inside of the realms of possibilities.

But Jessop, goaded on, made another desperate effort on his next trip and actually did 1,225 miles. That was certainly going some. Everybody was doing some of this long distance work now, but Jessop was the main guy, and my particular ambition that winter was to beat him.

So southbound the next trip, I made a date by wireless with all the coast stations to listen for me at 11 o'clock p. m. New York time every night.

Several nights later, when we were down south, of Cuba, in the Carribean Sea, I picked up Operator V. E. Peterson, at the Galilee, N. J., station, and gave him my correct distance of 1,576 miles south of Sandy Hook. Galilee is just ten miles south of the Hook. That was the record for the year, though several hovered near to it.

In Which I Hope to Get Salvage Money

One time aboard a steamer bound from New York to Panama, we put into Key West to pick up a high official. We left Key West around 7 a. m. and proceeded towards Cape San Antonio. Shortly after noon, while in a heavy sea, I was surprised to feel the vessel suddenly and sharply turn to starboard. The first impression was that there was a man overboard, but closing the wireless room door and hurrying out on deck I saw we were going full speed towards a schooner in the distance which had up the distress signal—American Flag upside down.

The schooner was fully a mile away from us. I went up on the captain's bridge, and looking through the glass could see six men on her decks, throwing lumber overboard. Inside of five minutes we were in a little sea of our own, composed of lumber. The captain steered our ship up close, and using the megaphone asked what they wanted. The reply came back very faintly saying that they wished their ship to be towed into

Havana or Key West, either point of which was about 100 miles away. Our captain shouted back that as he had U. S. mail aboard he could not lend such assistance. He asked if there was anything else he could do, offering at the same time to provision them, or take them aboard our ship. But this offer to take them off aroused an indignant reply.

As we circled once more to get back into our track, we could discern her name on the stern, "Bonnie Bell of Mobile."

As we left her in our wake I suggested to the captain that we notify her owners, by wireless, of her dilemma.

Referring to his blue book the captain discovered that the _____ Lumber Co., Mobile, Ala., owned the "Bonnie Bell."

Picking up Key West by wireless, I sent the following message, collect:

"Bonnie Bell in distress, latitude 23 41, longitude 82 13.

Needs assistance. No immediate danger.

(Sig.) CAPTAIN EMMETT.

Havana, Cuba, wireless station overheard what we sent to Key West, and gave a copy of the message to a salvage company, which dispatched a tug to the "Bonnie Bell."

Captain Emmett told me that we had saved the owners of the "Bonnie Bell" several thousand dollars, and most assuredly I would receive a check for two or three hundred in payment of this opportune service. Upon arriving in Panama I wrote them asking what finally became of the ship. I received the following reply:

"Dear Sir:—

The "Bonnie Bell" was towed into Matanzas in a leaky condition, having thrown overboard 40,000 feet of lumber. However, we will soon have her in shape again.

Thanking you for your kindness in the matter, we are,

Very truly yours,

THE _____ LUMBER Co.

There was no enclosure.



Six men throwing lumber overboard

Master and Men

By PAUL LUPKE

In these days we hear a great deal about welfare plans, profit-sharing schemes, etc., being carried out by industrial and public service corporations. These plans are instituted with a view to bringing about a feeling of partnership and common interest between the employer and those employed. With the time ripe for such a movement in any concern and with a proper understanding on both sides, of the responsibilities of the plan and the exact nature of the benefits which will accrue, it cannot help but result in increased efficiency and betterment all around. But there must always be that proper understanding. Mr. Lupke, in a paper which he presented to the National Electric Light Association at its recent convention, on the subject of "Master and Men," made some very enlightening remarks in this connection, and his paper, practically in full, is given below.—Editorial Note.

The particular definition of master that concerns us here Webster gives thus: "A male person . . . who can in the main control another's actions," and then he adds, "formerly used with much more extensive application than now." One would hardly expect to find such grim humor in a dictionary. The man in the case, of course, is the *another*.

In the good old days when everybody who had to work at all worked from daylight to dark and slept all night, it would have seemed ridiculous to put the question, who is master and who are the men, but in these better new days, when we insist that we must have a fair share of the day for play and yet, when whole armies must work all night, the question seems quite legitimate and is by no means easily or readily answered, for are we not told with calm assurance that the very conception of such a relation of master and men is fundamentally wrong, that it is now no more than a legal fiction? Forsooth, we are all business men now, some bargaining in kilowatt-hours, some in eight-hour days, and are there not those who would make the latter a unit defined with the same

mathematical rigidity as the former? But, rest assured that conception will never prevail, for happily—and I use that word with conviction—human sentiment cannot be eliminated as a factor. Yet, studied attempt to ignore it on one side, and careless neglect in giving it sufficient recognition on the other have led us into a wilderness out of which we are trying hard to find our way; for though rational welfare plans may make us all friends, and extensive profit-sharing schemes may make us all partners, still masters and men we always must be and always will be, and wherever difficulties exist, they are largely due to the fact that we have allowed the distance between master and men to grow in proportion to the expansion of our business, and, as you know, that has been considerable. So it may have come about that to the lower levels ultimate authority filters down only through the medium of a printed fac-simile signature and that is a cold, a clammy, a dead thing. The real masters, now and then, do not know their men, and the real men just as often do not know their masters, and that is the nub of the trouble.

After one of those necessarily rare occasions on which the highest officials had visited the outskirts of their company's extensive property, an old and a young fireman were flattening their noses against the boiler room window watching the automobile whisking away the dignitaries.

"Say, Pat," said the younger, "which one was the president, the tall one under the pancake cap or the little one inside the big fur coat?"

"Dennis boy," said the old fellow, "I have worked here many a year, but I don't know: what is the use of bothering your head about it anyway? Did you notice, they peeped into the furnace standing way back against the wall, and they squinted up at the stack to see the smoke we made, and they walked around the coal pile to find out if it was all there, and, mind you, one of them scratched the old ashcart mule kind of friendly like between the ears—but

never a look or a word they had for the likes of us."

For those who understand human nature, comment on this would merely blunt the point, for those who do not, it would be useless, so I make none.

There is a way equally as far removed from apparent indifference as it is from gushing volubility, that goes straight home, and, whether it manifests itself in recognition of accomplishment or fair censure of fault, it can be made to help in welding that bond of common interest that must exist between master and men before the question at issue can be brought much nearer a permanent solution. To find that way is a problem as old as civilization.

"Asked Tzu-lu of Confucius, 'What is a gentleman?' The master said: 'A man bent on shaping his mind.'

"'Is that all?' said Tzu-lu.

"'On shaping his mind to give happiness to others.'

"'And is that all?'

"'On shaping his mind to give happiness to the people,' said the master."

And now, when we are beginning to appreciate thoroughly that Confucius is right, we are grouping our way towards the goal,—we have welfare plans and beyond that profit-sharing schemes. However, consideration of these I have set beyond my bounds and I venture only a few remarks concerning their application.

All day committee meetings at the New Willard and protracted discussions across the polished board in the directors' room are without a shadow of doubt absolutely necessary preliminaries. Still these, together with the patient and laborious working out of the details by the auditing department, constitute but the beginning of the problem. In the arduous task of preparing the details, for placing the matter properly be-

fore the men, every last man it concerns may easily be overlooked and that will lead to disappointing results. When all the blanks have been carefully prepared, printed and distributed, we are apt to sit back comfortably prepared to listen to universal paeans of praise, and are chagrined to perceive a whisper of suspicion and horrified to hear a single shrill note of dissent. The best, the most just and liberal welfare plan may meet with the

reception of the "Greeks bearing gifts" if the same care has not been exercised in presenting it as has been bestowed upon its preparation. Launching an elaborate welfare plan without any attempt to educate the men up to its appreciation, is like sowing good seed into an unplowed field; the crop is bound to be meagre. In the work of preparation nothing is so effective as a personal presentation. A few words with the red

blood of life in them are worth an avalanche of pamphlets. Our commercial departments learned that long ago; they have solicitors.

The worst effect of written communications is that we are prone to eliminate from them all that we imagine will not look well in print for fear of being misunderstood. Unconsciously we feel the inability to establish that atmosphere of friendly predisposition which only the word spoken with the enthusiasm of conviction can create, and for the subtle gesture and inflection denied to the rigid line we substitute a petty lie attempting to drive home a weighty truth. Any welfare plan no matter how liberal in conception, must be surrounded by reasonable, adequate and clean-cut safeguards, the necessity of which is at once apparent to the master but the bald, bare statement of which in cold print may prove baffling to the men; nevertheless they should be

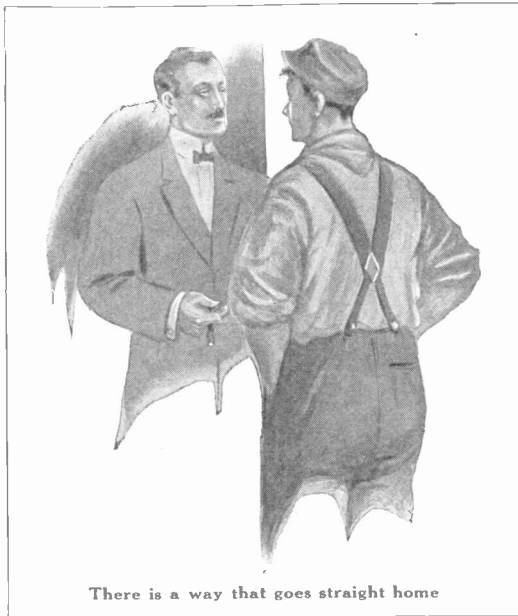

There is a way that goes straight home

told the truth about them and if the sober truth must be told it is a great deal better to tell it than to write it.

"Not long ago," said Stevenson, "I wrote a letter to a friend that came near involving us in a quarrel; but we met, and in a personal talk I repeated the worst of what I had written and added worse to that; and with the commentary of the body it seemed not unfriendly either to hear or to say."

I recall the time when I penetrated into the very lair of collective labor, hotly intent upon relieving my mind of the accumulated pressure raised by successive communications of a gravely official character; I said some very sharp and pointed things, but instead of being put out as I had rather expected, I found myself an honorary member of the clan, and the whole trouble was settled.

This then would be my humble advice as to the method of procedure when the time is ripe for the promulgation of a welfare plan. Let him whose mind has conceived the plan try earnestly to imbue those next around him with his own enthusiasm and charge them solemnly to pass it down the line undiminished, step by step, to the very last man, and when that is done, and not till then, let it hail blanks.

And if that way is right for the welfare plan, it is ever so much more important to follow it in a profit-sharing scheme, for its road is beset even thicker with pitfalls and it is absolutely necessary that we choose our steps with discretion.

Profits are something so radically new to the men that we must break the news about sharing them very gently. We are rather apt to insist that what we know is right everybody must take for granted. Masters with the long distance view ever before them, may find it hard to realize the state of mind of the man whose wealth changes

regularly from maximum to zero, or even a negative quantity, with the time between paydays as the period of a complete cycle. Here the difference between master and man is simply this; to the man five dollars are always just five dollars, to the master it is forever interest on one hundred. All that is necessary to financial success is to realize the difference early enough in life. Being a capitalist is largely a matter of habit and as you well know, habits to become fixed must be acquired young. As yet, the majority of the men, especially the

young men, concentrate their entire efforts upon raising the periodic maxima to the utter neglect of appreciation of the fact that a steadily, though gradually, increasing elevation over the zero-line is the thing that really counts most.

"We want our cash down, all of it, once a week, right here and now while we can enjoy spending it, and not when we are sick, or old

or dead," that is the frigid attitude of the men that has chilled more than one warm-hearted welfare of profit-sharing plan to the marrow.

If you can manage to educate this short-sighted view out of the men and really convince them that not every dollar they can call their own must necessarily be in the vest pocket, they are ripe for a profit-sharing plan for they will be about ready to ask for it, and that is the psychological moment for its promulgation. It is well to remember that the bane of benefits thrust upon you is the blight cast upon the prospects of maintaining your rights. That is the point on which the sneering cynic will try to get in his destructive work. There still are those sordid few who persist in announcing with great clamor, that every attempt to come nearer a satisfactory and permanent solution of the relations between master and men has an underlying base and selfish motive; that it is but bait

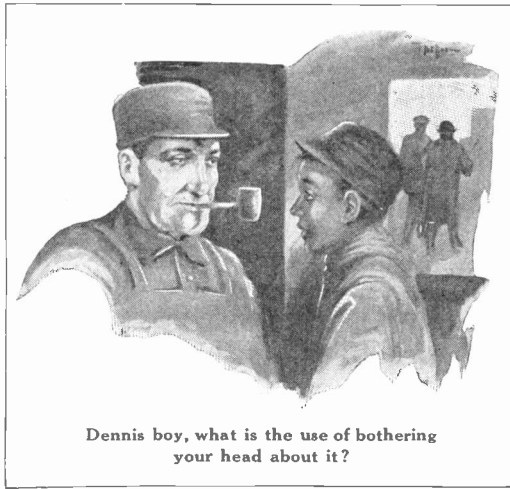

Dennis boy, what is the use of bothering your head about it?

to beguile men into refined slavery, that every offer of assistance is no more than the whip of hay dangling before the donkey's mouth from a stick tied to his neck. Perhaps we should not judge even men of that ilk too harshly; they have been making their living at that sort of thing, but their occupation is about gone, for now we are thoroughly awake. To those of us who maintain our sober judgment, it plainly appears that missteps or stubborn resistance are more often the result of conditions that befog clear vision, than innate baseness or meanness of purpose in either master or men.

Of the fact that humanity is forever moving towards a higher plane of ideals there can be no doubt. To one who can view the road over long stretches of centuries, the pitfalls of paltry years seem smoothed over and the steady ascent is apparent: to many deep in the pushing through the setbacks of troubled days seem permanent descent to lower levels. It is the business of leaders, among masters as well as men, to guide us over safe paths, to guard against abysses that must be filled with mangled corpses before they can be crossed. Even the smooth road will prove hard and long enough and demand its steady toll of the weak, the weary and the irresolute, and the way to better things will be strewn with the wreckage of the stragglers. Yet there is a sweet and glorious breath of broad and true humanity blowing through the world and blessed be he, be he master or man, who fans it with honest effort, and woe to him who strives to pervade it with the poisonous whiff of hatred.

Checking Street Car Crowds

At fair grounds, summer resorts and the like it has always been difficult to handle the crowds right after the chief event of the evening is over. Even with plenty of guards or policemen stationed near the gates, it is difficult to avoid a continued and unpleasant jamming either at the cars themselves or at the gates through which the public has access to the cars. If only those who live on the line of the approaching car were allowed to pass through the gates, much of this crowding might be

avoided. But usually it is impossible for the gateman to see the car until it is close up.

This summer the solution has been found, for high above the gat-man at one usually crowded point a megaphone called out: "Car for Bay View. Room for twenty." This message, in clear but stentorian tones, came long before the car was in sight, enabling those headed for other points to step back and let the Bay View passengers through the gate. The guard there passes some 20 of them and by the time they are boarding their car, the megaphone announces another. The explanation is simple enough, as the megaphone is on a telephone receiver connected to a transmitter half a block off where the announcer watches each car as it approaches, using what the Londoners call a "tramophone" for this purpose.

Noiseless Telephone Call

How often it happens at a convention, meeting or similar gathering that some one is wanted at the telephone. Then there is a scurrying of messengers around among

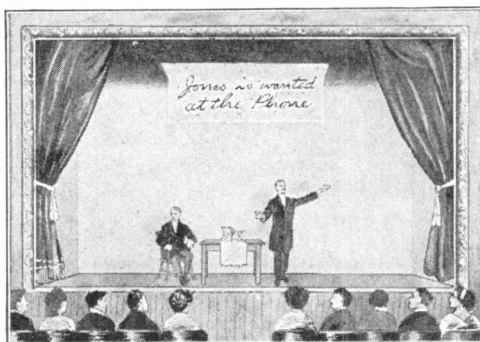

NOISELESS TELEPHONE CALL

the seats, hoarse whispers and excited pointings and gesticulations until finally the man is "landed," all of which disturbs the meeting and embarrasses the speaker. A way to avoid this confusion, and one which is simplicity itself is to mount a projecting lantern in the rear of the hall (such a lantern is available in most auditoriums) and project the call, whatever it may be, upon the background of the platform. The notice is written on transparent paper and put into the lantern as an ordinary slide. Even in the daytime and on a light background the message is easily read.

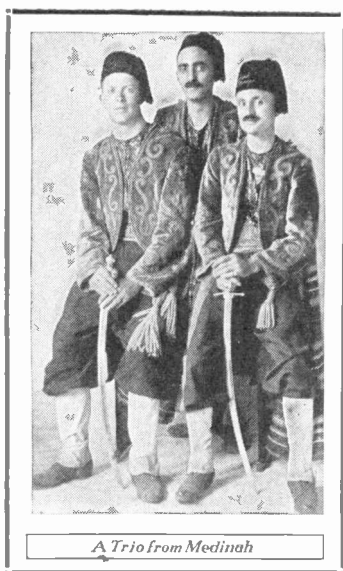

A Trio from Medinah

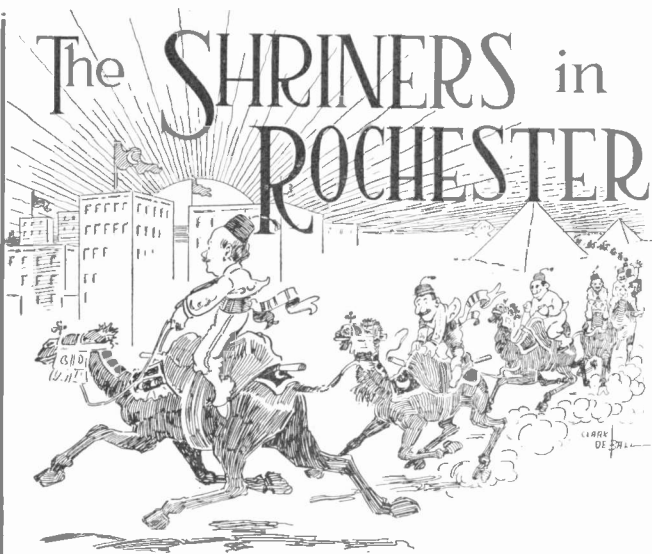

Nobles of the Mystic Shrine descended on the city of Rochester in hordes. Garbed in the gayest of costumes, like true sons of the Orient, and with banners flying, the scores of bands and marvelously well drilled patrols invaded every nook of the city. They called themselves the "Feel to Hum Bunch," these Shriners, and they made themselves at home to an extent which will long be remembered by the York State city.

Rochester, however, greeted, even welcomed, the invasion of the wearers of the fez. Every home and place of business was decorated for the occasion of the meeting,

which was on July 11th to 15th. In the daytime it was mostly a lavish display of banners which formed the outward demonstration. These were principally the flags of the various Shrines, Rochester banners and Old Glory, although once in a while a native of some foreign land would display with pride the flag of his nation. At night, however, the scene changed and it was light, light everywhere, that made the spectacle entrancing.

Even under ordinary circumstances Rochester bears the reputation of being one of the best lighted cities in the world, and

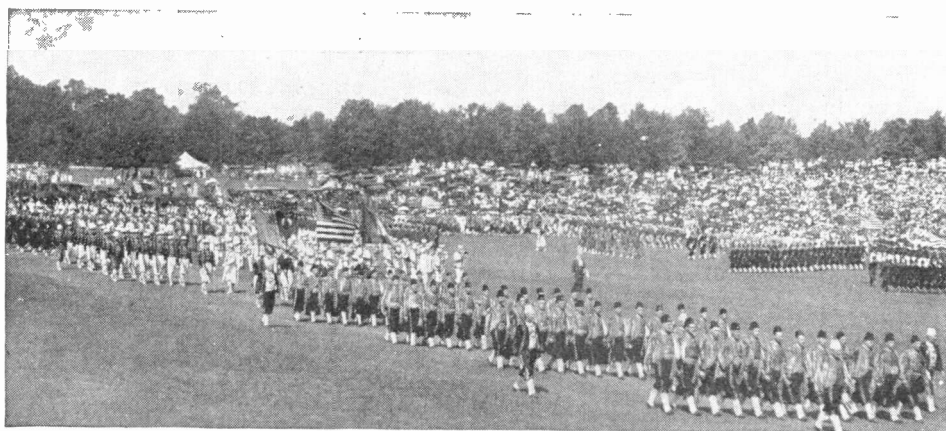

GRAND REVIEW OF THE VARIOUS ARAB PATROLS

at a time such as this, with the streets arched over and the buildings outlined with myriads of incandescent lamps, a sight was presented which was worth coming "across the hot sands" to see.

It is said that 200,000 Shriners and their guests attended the meeting. Be that as it may, it is certain that



A great parade was given by the Shriners themselves in which the famous Medinah patrol of Chicago, one of the best drilled bodies of men in the world, took conspicuous part. Weary, plodding camels—desert ships supposed to bear the pilgrims to their mecca—marched solemnly with



COPYRIGHTED BY NEWMAN

STREET ILLUMINATIONS IN ROCHESTER DURING THE SHRINERS' CONVENTION

there were from ten to a thousand of them in sight at any and all times in any and every part of the town. An aviation meet was prepared for them; a water carnival was held in their honor in which the canoes, skiffs and launches were outlined with lights:

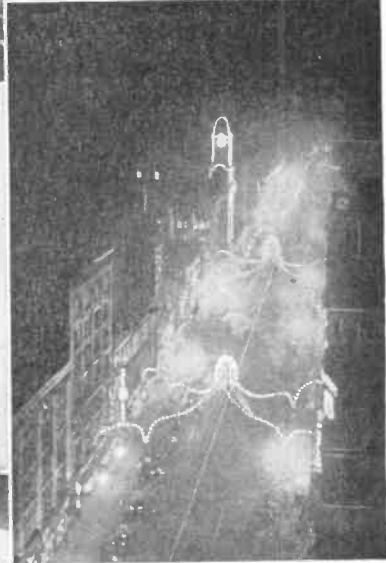

HUNDREDS OF THOUSANDS OF EXTRA LIGHTS



the rest, also seemingly "to hum." Small goats, said to be important adjuncts to the mystic ceremonies, were cheerful participants in the parade. Of the floats represented, a large buffalo covered with electric lamps and mounted on an electric truck was easily among the most attractive.

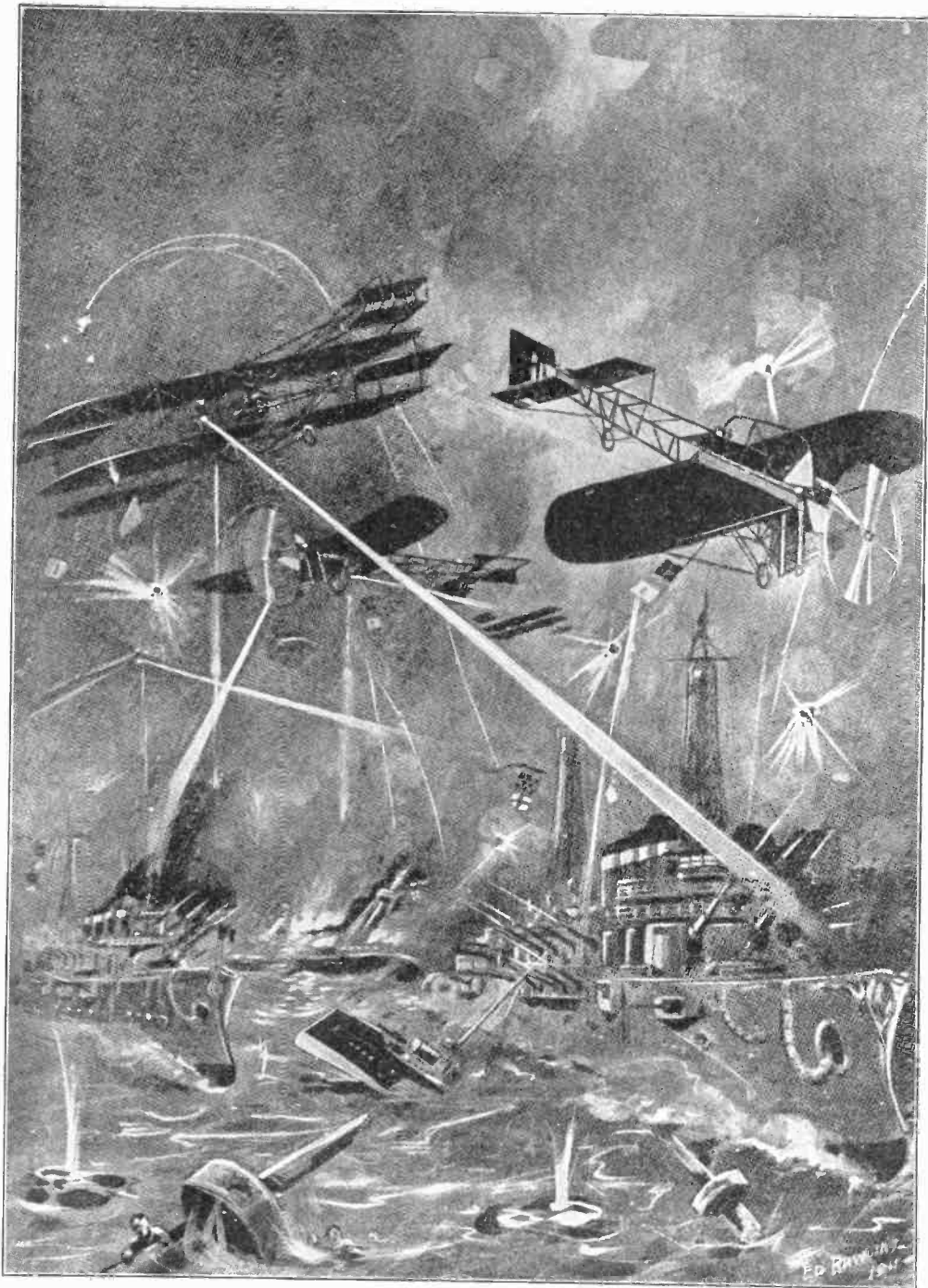

UNLESS INTERNATIONAL PEACE PREVAILS, WARFARE OF THE
FUTURE MAY BE ON THIS ORDER

Warfare of the Future

The great historical event which marked the passing of the wooden war vessel, the "Battle of the Monitor and Merrimac," now portrayed in all its vividness at Riverview Park, Chicago, has been witnessed by thousands. The battle, the night, the burning of the Congress, the moon with its ripples on the water, the storm, wind and lightning and the sunrise of the day following all leave a lasting impression upon the spectator.

Then appear in panorama the United States fleet which sailed around the world under "Fighting Bob" Evans. As the applause dies away at seeing this array of battleships sail up Hampton Roads, the ships come to anchor, and semi-darkness falls upon the famous battleground with only the signal lights at the mast head of each vessel to be seen.

There is a whir as of wings and without warning, two battlecraft of the future are dimly seen coming, not in the water, but through the air, from Newport News. Circling about above the fleet, streaks of fire show the aeroplanes dropping deadly explosives upon the anchored vessels below, while explosion after explosion is heard as the swift flying visitors, their task completed, rush away.

When morning dawns, the wrecks of three modern battleships strew Hampton Roads while the remainder of the fleet has stolen away in fear of the air dreadnaughts of tomorrow whose terrible destruction points to a time when war will cease because of its terrible cost.

And this panorama of the past and prophecy of the future is made possible by electricity, which produces mechanically the effect of ocean waves, propels the battleships, fires the guns and changes night to day. The aeroplanes are driven by small electric motors fed through small suspended cables, and are guided by wires manipulated by operators stationed near the switchboard.

The laying of a cable between Monrovia, Liberia, and Pernambuco, Brazil, which began last spring represents the final stretch in the line which is to connect Germany directly with South America.

Pulling Cable Into Ducts

After hearing an argument between two men as to the method employed in placing underground cable in the proper ducts and hearing one of them assert that it was "pushed in" while the other was positive that a pulling line was "shot through with an arrangement something like the life-saver uses," I submit the following explanation:

In "pulling in" cable the ducts are first "rodded." The rods are each about three feet long and have a coupling on each end to join them together. These are started

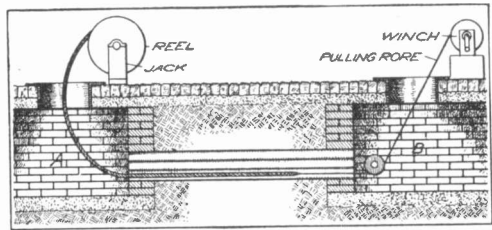

HOW CABLES ARE PULLED THROUGH

in manhole (A) and pushed toward manhole (B). When one rod is in the duct the next one is coupled to it and pushed in, another is added and so on, until the first one started appears in manhole (B). The pulling rope is usually of woven wire about $\frac{3}{8}$ -inch in diameter and is attached to the last rod and pulled through the duct and around the winch, capstan or whatever device is used for doing the work. A wire "pulling in grip" is slipped over the end of the cable and to this the pulling in rope is attached. If a clevis is used this is screwed through the armor and into the cable wire.

The reel of cable is jacked up as shown at manhole (A), the winch is manned and the cable is pulled in. A good many devices are used as "guides," to keep the pulling rope straight out from the ducts. The wheel shown in manhole (B) can be used only where the manhole is equipped especially for using it.

A capstan, which can be set straight up in the hole, turned in an iron shoe and propelled by men pushing long handles around is also used for pulling in, but the winch is the favorite method.

GEORGE M. PETERSON,

Automobile Electric Lighting

By GEORGE L. CHANDLER

The advent of the improved tungsten lamp made possible the first real progress in the development of electric lighting for automobiles. Following this came improvements in storage battery, sockets, wire and other accessory fittings, the last step being the perfecting of small dynamos which automatically maintain the battery in a fully charged condition. The consequence of these developments is that practically 60 per

cent of the high class 1912 models will be equipped with electric lights in side and tail lamps.

system, known as the "straight storage (battery) system" consists of a high capacity battery used alone, it furnishing all the current required and having its charge renewed from some outside source, as at a garage or central station.

In the early stages attempts were made to operate lights from ordinary ignition batteries which was soon found to be impracticable, as this type of battery could not de-

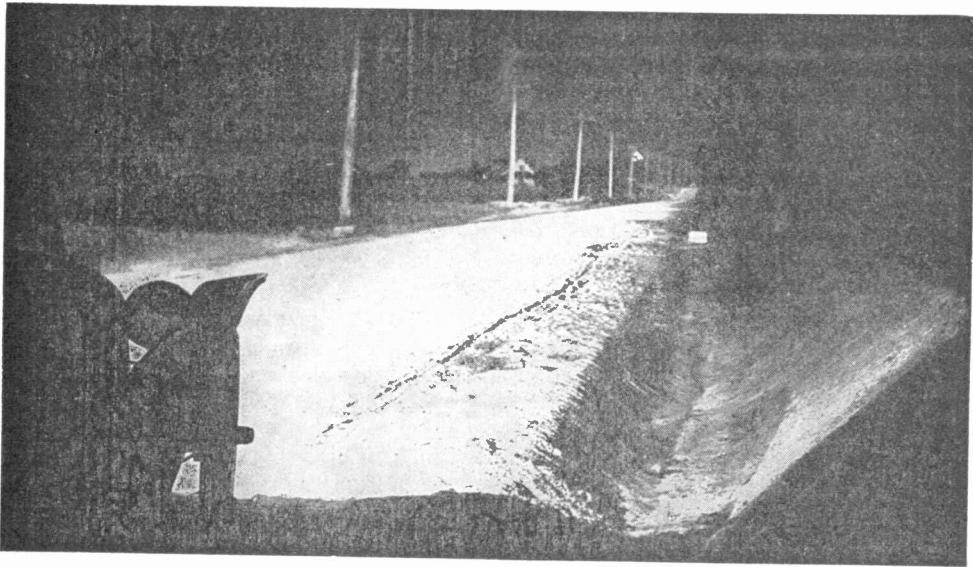

FROM A PHOTOGRAPH TAKEN BY AN ELECTRIC AUTO SEARCHLIGHT

cent of the high class 1912 models will be equipped with electric lights in side and tail lamps.

Of the various devices entering into the complete installation, the battery is the most important for the reason that it is the foundation of the entire system, acting as a reserve and regulator when used with charging dynamo and as the only source of current supply when the dynamo is not used. There are therefore two distinct systems.

In the "dynamo lighting system," the dynamo and battery are used together, current for lights being taken direct from the dynamo when the car is running in some cases, in others the dynamo being used simply to charge the battery. The other

liver the amount of current required, resulting in poor lights and injury to the battery. This condition resulted in the gradual development of a special type of battery of higher capacity, higher discharge rate and more substantial construction. The essential difference between an ordinary type of sparking battery and the improved type of lighting battery is in the battery's normal discharge rate.

Another difference and one affecting the discharge rate is in the thickness of plates of which the battery is made up. In order to obtain higher capacity and higher discharge rate in a very compact space it is necessary to use plates somewhat thinner than those used in ordinary sparking bat-

teries, this for the reason that a greater surface area of plate is presented for action of the electrotype.

In the public mind there is much confusion as to what capacity a battery will give when discharged at varying rates; for instance, an ordinary six volt 60 ampere hour sparking battery discharged at the rate of one ampere per hour will give one ampere for 60 hours, but if current from this battery is taken at the rate of six amperes the battery will not stand this discharge rate for ten hours.

Taking as an example a battery of the lighting type, known as the Elba, having a normal rating of six volts, 60 ampere hours at lighting rate, the maker gives the following figures as to its performance at various discharge rates:

Discharge at a $7\frac{1}{2}$ ampere rate the battery will give eight hours' service—total 60 ampere hours; discharge at a five ampere rate, the battery will give $14\frac{1}{2}$ hours' service—total 72 ampere hours; discharge at a one ampere rate, the battery will give 92 hours' service—total 92 ampere hours.

From the above it will be seen that a catalogue rating of a battery capacity does not convey much information unless the rate of discharge is also given.

As an illustration of the difference in construction between the ordinary sparking battery and one adapted to lighting the type before mentioned may be briefly described, the two small illustrations showing the comparative sizes.

The Elba lighting battery is made up of three individual cells in which the elements are placed, these cells being made of a special composition of rubber. These individual jars are placed in an outside wooden containing case but have between each jar and also between the jar and the case a space which is filled with semi-solid compound which acts as a cushion, thus enabling the battery to stand rough usage.

Automobile service conditions also brought out the fact that there should be what is called ample "head room" in each cell. By this is meant the space above the plates and the first cover of the cell should

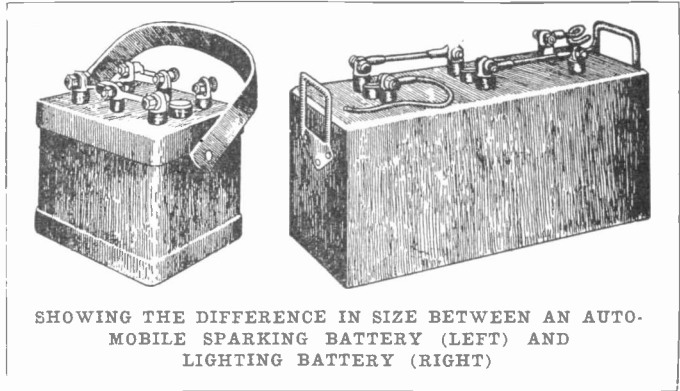

be sufficient to allow for proper expansion during charging and also that there may be no doubt about the plates being fully covered by electrolyte.

This matter of expansion is further provided for by placing between the first cover and the top cover a chamber into which the expanding electrolyte may flow when the battery is on charge, this chamber also receiving the electrolyte in case the battery is handled roughly.

The distance between the first cover and top cover is ample and space around the expansion chamber is carefully filled with a sealing compound which is poured in hot, thus thoroughly closing every possible opening between the first and second covers and preventing acid creeping up the sides of the cells and around the terminals. The top cover through which the terminal binding posts protrude, is sealed in above the expansion space, completing the cell proper.

Electric Locomotives Dependable

Can electric locomotives be depended upon to do their work regularly in ordinary railroad service, or will they cause delays just like the steam locomotives? Strong predictions have been made in the past on both sides of the question. But the answer does not lie in speculations on either side, for exact figures based on actual practice are already available from the New York, New Haven & Hartford R. R. which has electrified about 300 miles of its track. Careful records kept by this road show that for every 100,000 engine-miles there were 21 failures of steam locomotives but only nine of the electric locomotives.

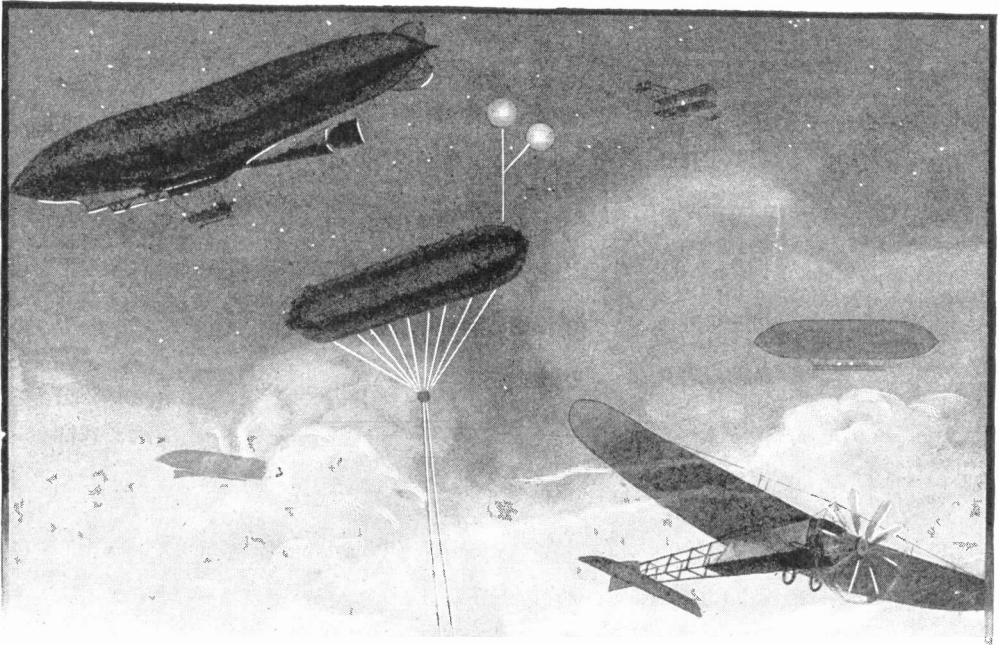

Lighting the Streets of the Air

The daring bird-man runs a risk even when flying on a clear day, and darkness but increases his peril by making him unable to know where he is or where to land safely. The street lights of some towns may be grouped so as to afford a land mark occasionally. Logically, however, guide lamps must be high in the air, floated hundreds of feet above the ground. The aviator must not be dazzled by light nor mistake such guide lights for stars. An European balloon builder seems to have

taken the right step by illuminating gas balloons upon their interior by placing incandescent lamps within, supplying the current through the anchor cables. From a large balloon one or more illuminated balloons some eight feet in diameter are anchored. By varying the color of the lamps in each balloon and by varying the position of the balloons as to each other, different messages may be signalled. To make sure that the balloons are clear of clouds or fog, a moisture indicator on the large balloon rings a bell on the grounds while the balloons are in the mist.

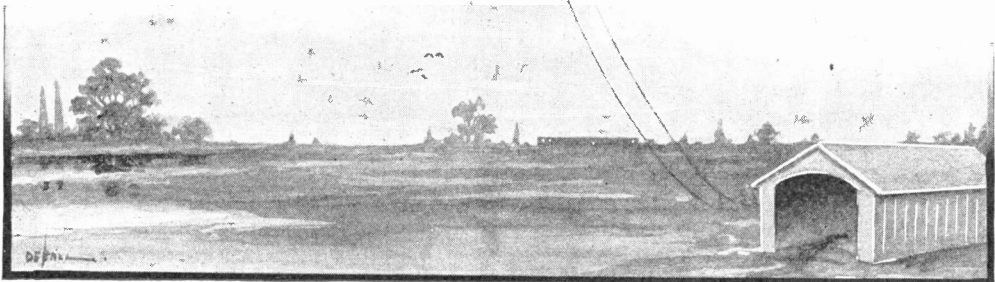

New Method of Reproducing the Voice

Seeing that the voice is made up of air coming from the lungs, it occurred to M. Lifschitz, of Paris, to use "artificial lungs" so as to reproduce the voice after the manner of a phonograph. Nature's air supply is imitated by using compressed air passing through a tube, and he is able to produce an artificial voice on this principle. Inasmuch as this is quite a departure from the usual phonograph methods, it is attracting some attention. The experiments are being made at present at the Paris University.

The inventor needed to make a record of the voice in the first place so that this could be made to act on the stream of air for imi-

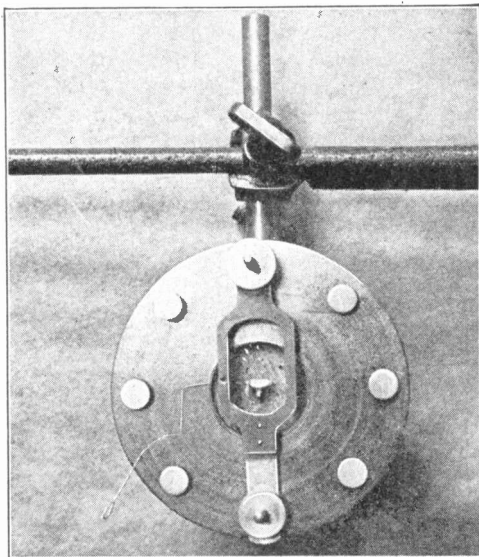

DIAPHRAGM AND SMALL MIRROR

tating the words. This he could do by mounting a small mirror on the usual mouth-piece so that talking into it caused the mirror to tremble. The mirror sends a beam from an electric lamp upon a screen, and the spot of light trembles in the same way. A photographic band, such as a moving picture band, is run along before the spot of light by an electric motor, so that this gives a record on the band corresponding to the mirror's movement. He develops the film and then etches out the printed parts so as to give a set of holes having the form of the voice waves. Then he runs the band by an

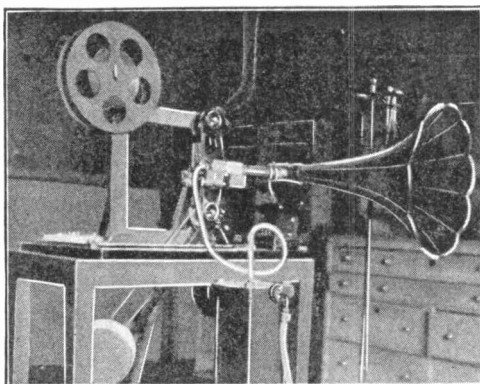

APPARATUS FOR REPRODUCING THE VOICE

electric motor at a high speed in front of the "artificial lungs" so that the stream of air must go through the holes. This has the effect of imitating the voice and the original words are given out as the person uttered them.

Starting an Engine with Gunpowder

"Like a shot out of a gun" is a favorite expression for giving the idea of great speed. Usually it is only a picturesque figure of speech, but applied to a gasoline engine recently built for the government it is literally true. This engine is used for supplying power to operate the big disappearing guns in the nation's coast defenses. The power is furnished in the form of electric current generated by a dynamo mounted on the engine shaft. These guns are rather heavy chunks of steel and the army officers in charge of them figure that the time may come when it will be very necessary to move them quickly. This means that the engine will have to get into action very rapidly. To be certain of its doing so a chamber has been placed in the top of one of the four cylinders. This chamber takes a ten gauge brass shotgun shell. Above the shell is a small knob to which a firing pin is attached. A blow of the hand on this knob fires the charge in the shell which has sufficient expansive power to "turn over" the shaft several times and insure ignition of the gasoline vapor in one of the cylinders. By the time the engineer has reached the controlling switchboard the engine has attained such a speed that the voltage and current from the dynamo are up nearly to normal.

Odd Uses for an Electric Fan

The utility of the electric fan does not lie solely in its application to furnishing a cooling breeze or as a means of reducing the temperature of a room. Its range of usefulness is not confined to the summer months but is of equal value in winter.

Many of the moving picture shows and smaller vaudeville theatres in the cities have discovered a novel form of refrigerating plant for reducing the temperature of the auditorium to a comfortable degree. The method employed is to place a large block of ice immediately in front of an electric fan. The temperature of the air is very considerably reduced by this method.

Paradoxical as it may seem, the electric fan can be used to materially assist in raising the temperature of a room as well as to lower it. One of the best methods of using a fan for this purpose in winter time is to place it in the cold air box of a hot air furnace. An opening is made in the box and the slide leading outdoors closed so that the air is drawn from the cellar and not from the outside of the house where it is many degrees colder. The result is a warmer house without any greater consumption of coal.

It is often very desirable to warm one particular room very quickly and in that case an electric fan can be laid over the register so that it will draw the air upward more quickly. In case the house is heated by means of a steam or hot water system the fan should be placed so that it will throw a current of air against the steam pipes or radiator. The result in the room will be surprising. The air will be stirred up so that all parts of it are brought into contact with the radiator and warmed.

The value of many window displays in the winter time is completely lost because of the heavy accumulation of frost on the glass. This has been eliminated in some cases by using a double layer of glass with an air space between. Such expense and trouble, however, may be avoided and the windows kept practically free from frost by directing the air from an electric fan against the glass.

Photographers find the fan invaluable for quickly drying negatives and prints. And "mi-lady" has adopted it for drying her hair.

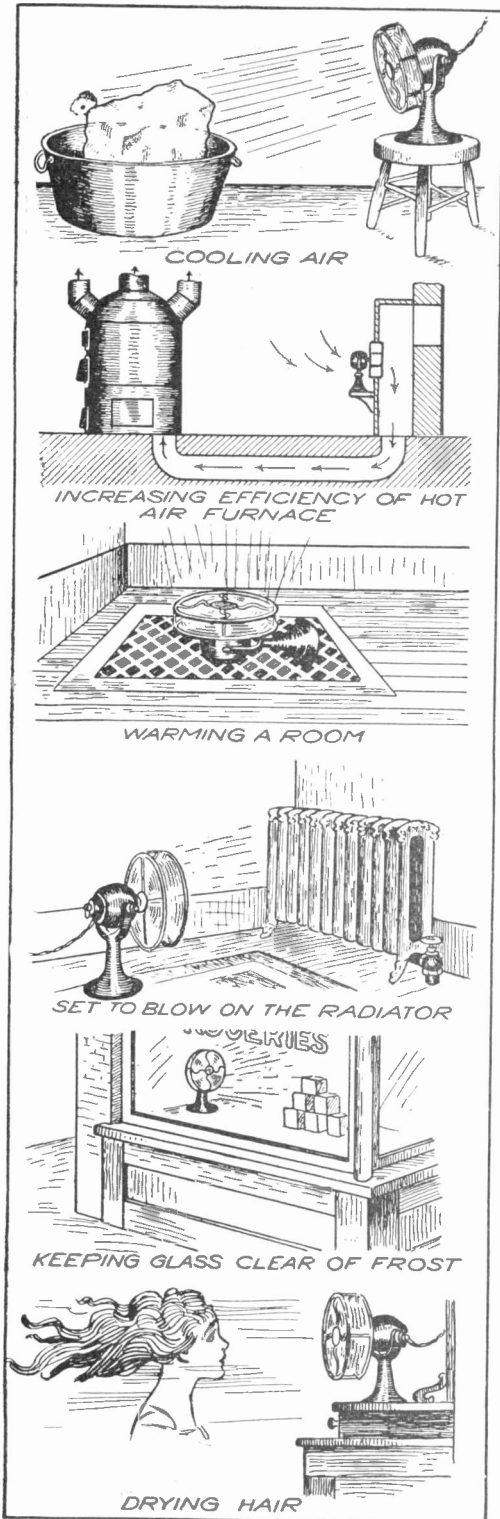

But there is a still greater field for the device and that is to attract the attention of the public to a window display. The fan then becomes more than a luxury, in fact an income producer.

A window full of toy balloons properly confined by a stop of mosquito netting or strings can be made to bob and float about in an alarming manner by means of the draft from a fan.

An ingenious pop-corn vender at Coney Island has found a novel method of attracting attention to his wares with the aid of a fan. The air blast is concentrated by means of a tapering pipe and passed up into a glass case containing a heap of pop-corn. The light flakes of corn are blown upward from the center by the air currents in a perfect fountain. They fall in a shower against the sides of the case producing a very pretty effect.

Many electrical dealers exhibiting a window full of fans appreciate the value of having them all in motion, but have found by experience that it is rather an expensive proposition to run very many of them from the city power mains. However, by properly arranging the fans the air currents from two or three running at full speed will cause all the other to revolve at a good rate if properly oiled.

The same principle may be applied in another manner and the air current from a hidden fan used to operate a miniature windmill or an aeroplane propeller.

If a window sign is made by stringing several light cardboard letters covered with tinsel or some iridescent substance onto two small threads tied to the guard, it can be made to wave and flutter in such a manner as to rouse the curiosity and attract the attention of passers-by.

A miniature volcano made of papier maché can be given the appearance of being in constant eruption by fastening a number of colored strings inside of the crater and concealing a fan beneath.

The effect of flowing water may be produced by running a number of threads from the nozzle of a hose across the window. If the breeze from an electric fan is then directed against the threads they will commence a waving motion which from a short distance is very realistic and deceptive.

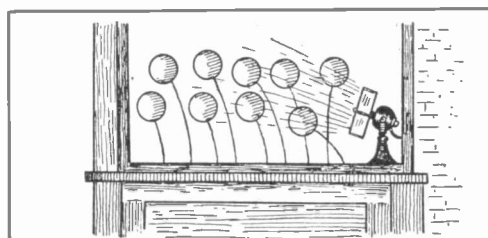

WINDOW FULL OF BALLOONS

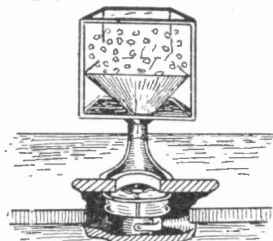

CASE OF POP CORN

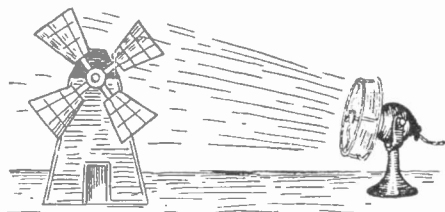

A WINDMILL OR AEROPLANE

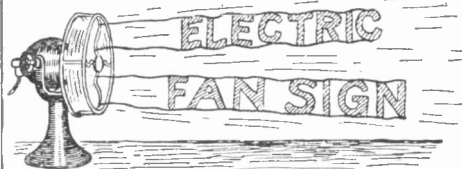

ELECTRIC SIGN



VOLCANO

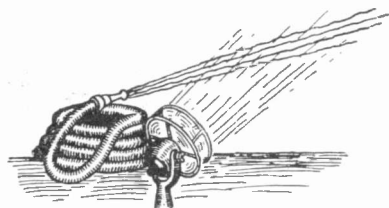

WINDOW ATTRACTION

Berlin's Unique Palace of Sports

By ALFRED GRADENWITZ

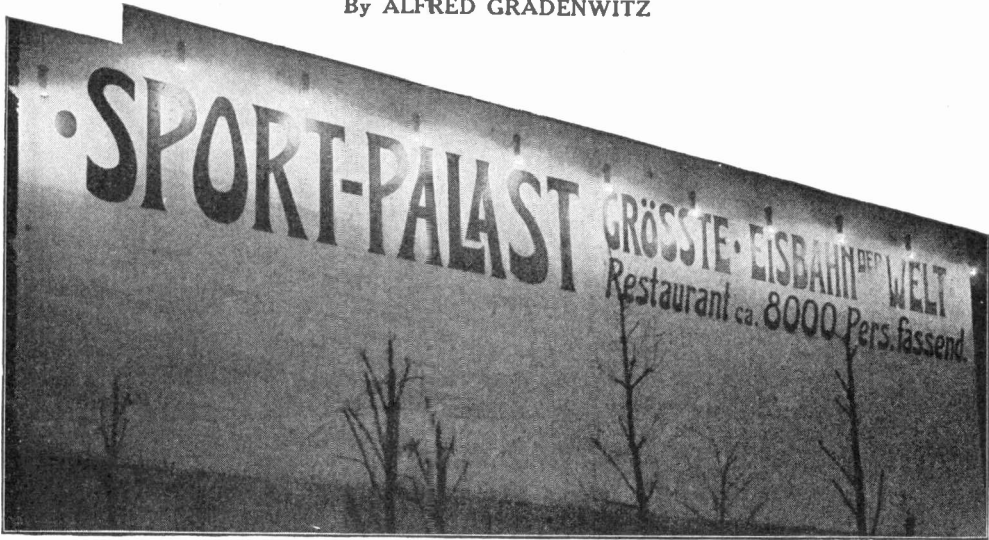

THE GREAT SIGN LIGHTED BY ELEVEN ARC LAMPS

The largest skating rink in the world is said to be the new one just opened in Berlin. This is called the Sporting Palace and, aside from skating, is used for all kinds of theatrical displays. An idea of the immensity of this amusement palace may be gained from the main interior view. The arena is 330 feet long and 148½ feet wide. It is surrounded amphitheatre fashion by a spacious platform and two balconies. For aquatic display it may be flooded with water. For ice skating, the floor is covered with a thin film of artificial ice. When wrestling matches, bull fights, etc., are on the bill a covering of plank tan bark is used.

Eighty-four arc lamps project their dazzling light directly on the arena, while further 40 arc lamps, 30,000 ordi-

nary incandescent bulbs and 6,000 metal filament lamps, distributed over the ceilings and parapets of the galleries, serve to light

the remainder of the house, thus providing a total luminous intensity of upwards of three-fourths of a million candlepower.

This arrangement produces an impression of intense brightness devoid of any marked shadow, in fact, a perfect imitation of the diffuse daylight of a cloudless sky in summer.

The dominating features are simple metal-filament ceiling lamps, which with the exception of the large ceiling covering the arena, are used everywhere to decorate the arc lamps. The facade lighted up by about 5,000 incandescent lamps produces an almost overwhelming impression, like a fairy palace of the Arabian Nights.

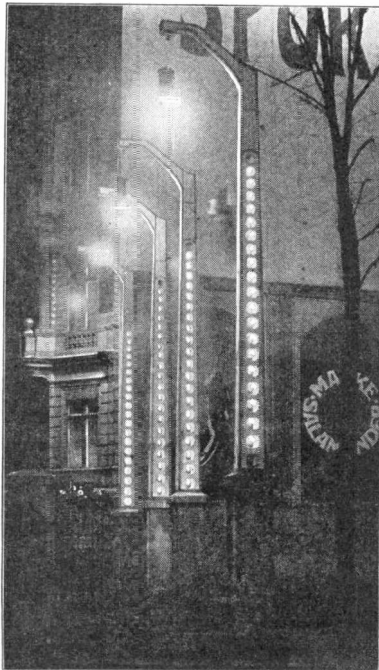

SOME OF THE LAMPS WHICH LIGHT THE FACADES.



PALACE OF SPORTS DURING A THEATRICAL DISPLAY ON THE ICE

Apart from the lighting of the building, electricity is used for the operation of a number of motors (of about 80 horsepower total output) for driving the forced-draught furnace, divers water pumps, the very efficient warm and cold air fans and a number of special kitchen utensils.

A 150 horsepower motor is provided as reserve for driving the refrigerating plant, which in normal service is operated by a 250-300 horsepower superheated steam engine. Of the four ammonia compressors used in making the ice each of 140,000 decimal heat units per hour, only two are used in normal operation. The indicated load with four compressors, inclusive of a salt-brine circulation pump, a pit pump of 10,550

gallons per hour, two circulation pumps (of about 66,000 gallons each) for the sprinkling condenser, and all the stirring devices and transmission shafts works out to be about 224 horsepower which corresponds to the maximum coal consumption when the ice sheet is first frozen. The load of 127

horsepower corresponding to the power consumption in normal operation with two compressors and the above pump and accessories, can be taken charge of by the 150 horsepower motor. The refrigerators at the same time produce the artificial ice required for the restaurant service (about 4,200 pounds per day).

The Sporting Palace is the most economical of all artificial skating rinks so far designed.



ASSEMBLY HALL AND LOBBY

A Wonderful Manufacturing Plant

By GEORGE FREDERIC STRATTON

A week's careful inspection—it couldn't be skimmed over in less time—of one of the great electrical manufacturing plants, is an education, to a receptive and understanding mind, on the enormous diversity of trades and occupations engaged in the manufacture of electrical apparatus. In the plant, to be briefly described, no less than 36 trades and professions are actively represented; the number of employes being over 25,000.

The president of the company recently stated that if the company's buildings were in one structure, 50 feet wide, it would have a length of 22 miles. Twenty-five hundred arc lamps are used for lighting these works; enough for a city of 300,000 inhabitants. In addition, 30,000 incandescent lamps are used; sufficient, if placed 40 feet apart, to light a road from New York to Boston.

There are 18,000 machine tools driven by 1,500 electric motors. The power consists of three tandem compound engines and generators of 1,500 horsepower each; turbo-generators which develop 5,000 horsepower and 1,000 horsepower transmitted from a distant hydro-electric plant.

The operations performed are of a greatly diverse character. There are great gas plants for the foundry furnaces; marble and slate yards with the finest of equipment; shops for drawing wire and twisting cables; a building where crude rubber is converted into insulations; another for porcelain manufacture, and another for making oiled muslin and other fabrics. There are brass, iron and steel foundries; an elaborate laboratory for testing materials and for experimental work; carpenters' and builders' shops with heavy construction outfits, and cabinet shops where high grade desks and office fittings for the company's own uses are designed and constructed. There is, what is said to be, the best equipped photographic workshop in the country, where are developed and printed the photographs used in the company's catalogues and instruction bulletins. There is a printing shop and bindery, employing over 100 hands, and the product of which is unsurpassed in quality.

Here are prepared all printed forms and blank books necessary in the plants and in the numerous sales agencies. All of the half-tone cuts are also made here.

There are nearly a score of lawyers and assistants in the patent department; a surgeon and an oculist in the administration building; and the foreman of one department is a regularly ordained minister and holds Sunday service at a suburban church. There are chemists and cooks, bricklayers and blacksmiths, glass-blowers and electroplaters, jewellers and engravers, painters, chauffeurs, tinsmiths, turners, tracklayers, plumbers, polishers, cabinet makers and roofers, besides all the tradesmen required in the conduct of shops containing the most elaborate equipment. There are interpreters for the reception of foreign visitors and a most efficient factory fire squad, the chief of which was secured from the New York fire department.

So complete is this plant in its machinery and appliances, as well as in its personnel, that the superintendent has said that it could be transferred to an absolute desert island, and if supplied with the crudest of raw materials, could turn out as fine output as it is now doing. The man of any manufacturing knowledge will grasp the full meaning of that, when it is further stated that the cost of many of their elaborate products is obtained by simply weighing the various metals of the finished article, figuring them at the bar prices, and adding the carefully kept cost of workmanship.

The works are so extensive, and the number and variety of operations carried on so great, that it is manifestly impossible to do more in a limited space, than give a few of the more striking and interesting facts in connection with this great industry.

The engineering and drafting staff of course initiate the operations—a staff consisting of over 400 members. Over 100 drawings a day are made, and there is capacity for printing 3,000 blue prints per day—in one year 30 miles of blue-print paper was thus used. To keep the hands busy 60 carloads of material and supplies

are brought in daily, and 20 miles of yard and shop tracks distribute these supplies to the required points. The iron foundry is said to be the largest in the world, and one of the machine shops is probably the largest unit of its kind in the world. It is nearly 900 feet long, and 165 feet wide. It represents one-sixth of a mile of the heaviest and costliest machinery that the ingenuity of man, and the resources of great capital can bring together. In this shop is the greatest boring mill ever assembled—a machine designed by the mechanical superintendent, built under his supervision, and which will bore and turn pieces up to 65 feet in diameter. It is driven by a separate power plant of its own.

There is a brass foundry, with a capacity of 25,000 pounds at one melt. The railway motor shops turn out 400 motors per week, the largest of which are of 200 horsepower. The variety of apparatus manufactured is stated to number over 200 articles of different specifications, ranging from dynamos of 130 tons in weight, down to the fan motor that a lady can hold in her hand; from the gigantic search-light to the tiny incandescent bulbs for illuminating a Christmas tree.

And these products are found wherever civilized man is found, and in places where civilized man has to go armed to avoid being eaten or sacrificed to heathen gods. From this plant went some early dynamos to Hammerfest in Norway, so far North that the night which they were installed to lighten is six months long. There are electric lights, pumps and motors in the mines of Mexico and the extreme points of South America, in the wilds of Africa and among the superstition-ridden heathens of remotest Asia.

The company erects most of its great workshops, which are models of the finest designs of factory construction. It also builds a great deal of its own machinery, besides manufacturing many of its own supplies. It even makes its own writing inks.

There are thousands of girls employed on insulations of every description; on winding small coils for fan motors and magnets, and in making incandescent lamps, three-fourths of the work is done by the young women.

Two more points will indicate the comprehensiveness of the manufacturing grasp of this great company. It owns its own copper mines on the Pacific slope, from which it obtains one-half of its great supply of that metal, and adjoining its plant it controls 20 miles of superb railroad track, upon which its latest developments in electric locomotives are tried out and tested.

Distributing Electricity on the Farm

Interest in the application of electricity to the farm recently manifested itself in a patent upon a system for distributing electricity to operate apparatus such as plows, harrows and other farm implements used in the fields. The patent is issued to Charles S. Doney, Columbia Falls, Montana. The illustration conveys something of the inventor's idea, which is to run wires out from the dynamo and on each side of the field.

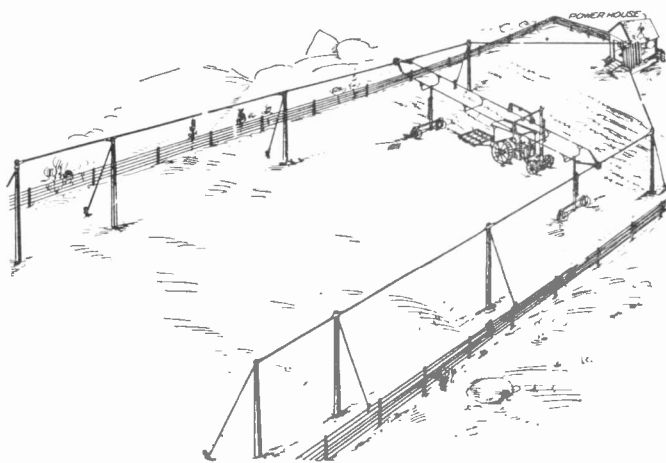

NOVEL ELECTRICAL DISTRIBUTION

Across the field and between these two wires runs a pair of wires constituting a movable trolley from which a motor driven traction engine will take current by means of a second trolley, the whole outfit being moved up the field as the ground is prepared by the plows, harrows or drills.

ADVICE TO ENGINEERING STUDENTS

Views of prominent educators on the scope of a college course and how a young man may derive the most benefit from it

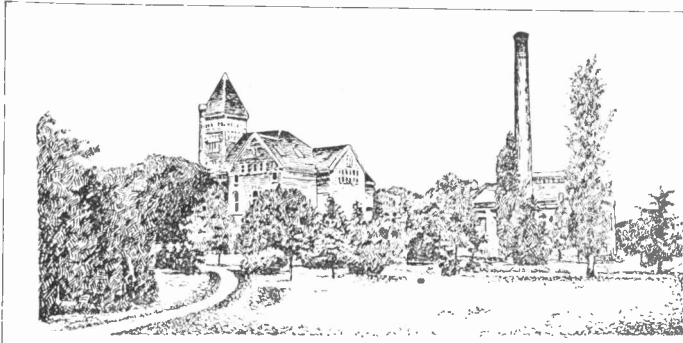

BY
C. FRANCIS HARDING
PROFESSOR OF
ELECTRICAL
ENGINEERING
PURDUE
UNIVERSITY
LAFAYETTE
INDIANA

Boys in the grammar and high schools who thoroughly enjoy making mechanical apparatus and wiring electric bells and telegraph instruments, will usually, if they follow the lines of work that they most enjoy and continue their studies through the high school and the university, become the most successful engineers, for a man can be most successful only in the work which is a pleasure and not an irksome task. Building machines and experimenting with electric circuits therefore are not only pastimes, but preparations for future success as an engineer.

He who is to be most successful in later years must also be observing. Did you ever stop to think that you can learn something of value to you from everyone you meet? Do not be afraid to ask questions and when meeting new acquaintances, strive to learn what they are most interested in and get them to tell you about it. It is not alone a high grade of scholarship in science, mathematics and engineering that counts, but an all around knowledge of men and of the things that are going on about you. Hence the introduction of many so-called "Culture studies" into the best technical engineering courses, studies which often are not appreciated and considered out of place by the student at the time, but which are always recognized of greatest value by the most prominent engineers in their later years.

Do not stop with the high school. Four years of university work may look long and the financial means not forthcoming. You have no doubt seen others giving up their education with the high school and yet earning large salaries and apparently succeeding better for the first few years than the university graduate. That is true, and there are exceptional men who remain far in advance of the average technical graduate throughout their career, but did you ever stop to think that you are comparing the exceptional with the average. Can you not imagine that same man far in advance of his present position if he too had had the additional asset of a university education? That same man will usually tell you that it has been his principal regret in life not to have secured such an education.

Work during your university course if necessary to secure the funds, even work a year or two before entering the university. Go to the university which, in your opinion, best fits your needs and which will best prepare you for the future career which you believe you should follow, but do not permit anything to discourage you from obtaining your university education, nor from following your chosen profession thereafter to ultimate success.

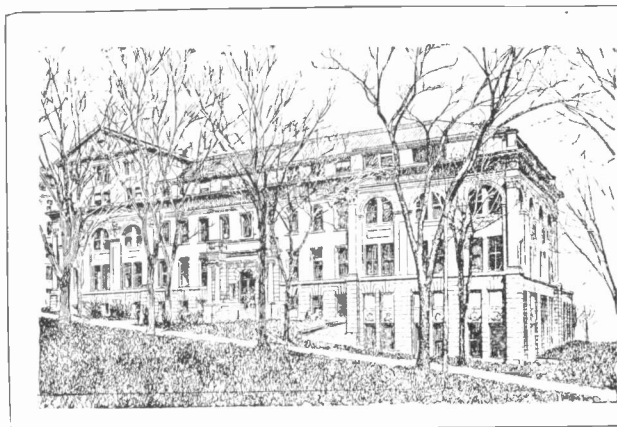

BY
MURRAY C. BEEBE
PROFESSOR OF
ELECTRICAL
ENGINEERING
UNIVERSITY
OF WISCONSIN
MADISON, WIS.

Doubtless many of the readers of POPULAR ELECTRICITY are young men who are ambitious to become electrical engineers, and it is probable that in many cases the reading of this magazine has stimulated these ambitions. It is therefore the equally important duty of the magazine to have pointed out through its columns something of the aims and ideals of the technical schools offering courses of electrical engineering. It is the purpose of this short article to point out some of the factors which make for success in this profession.

Let it be said at the outset that the very nature of electricity makes a study of its theory and applications intensely fascinating, and for this very reason many brilliant men have been developing electrical science and the electrical industries ever since their inception. This means first of all that the field is not an open one without competition.

Every young man of ambition is capable of doing something useful in the world and, fortunately, all do not have the same inclinations. To be really successful in any profession, one must have a genuine interest in and fondness for the work aside from the financial returns promised and the greatest problem which the young man has to solve and the one which many do not solve, is "What am I best fitted to do?"

Unquestionably many decide to become engineers who would really make more of a success of something else. The essential qualifications are about the same for the various branches of the engineering profession, the only real differences in the courses preparing for them being in the last two years. Many who graduate from one course such as civil or electrical engineering soon find themselves by force of circumstances working in one of the other branches of engineering. This very probability emphasizes the importance of avoiding too intense specialization during an undergraduate engineering course, for although in practice the necessity for specialization may soon appear, yet some knowledge of the other branches is essential.

Many young men choose the electrical industries as a field of work because of an unmistakable liking for the kind of work they are expected to do. Unfortunately others choose electrical work because someone has told them that "electricity is in its infancy" and offers untold opportunities. Though proficiency in the wiring of an electric bell or the setting up of a telegraph set may indicate a liking for such work it is not a sufficient qualification upon which to base the choice of electrical engineering as a profession.

The somewhat too alluring newspaper accounts and the attractive advertisements of the correspondence schools have misled many who really have no talent for such work to think they could become electrical engineers. Correspondence schools have undoubtedly exerted a marked influence in technical education, enabling many earnest students who could not attend a technical school, to obtain much useful instruction,

though the important element of personal relations of student and instructor and the facilities of the laboratories were lacking. The University of Wisconsin has organized its extension work so that, in the large industrial centers of the state, field instructors organize classes among the extension students, thus eliminating some of the difficulties in the way of instruction by correspondence only. It is true of correspondence study as of study in residence that the student profits in proportion to the effort expended by him.

We who are attempting at Wisconsin to put young men in the way of sometime becoming electrical engineers, though not immediately upon graduation, count it as fortunate if the student has had some contact with field or shop work before or during the technical course.

First of all it is important to distinguish between the trade of electrician and the profession of electrical engineering. I cast no slur upon the trade, for many who have taken electrical engineering courses are filling subordinate positions and at smaller salaries than they could be earning at the trade.

The difference between an architect and a builder, a carpenter, a plumber or an electrician is pretty generally understood. The architect conceives, that is, plans a building and the others interpret his ideas from drawings and specifications and carry them out in material form. The professional electrical engineer plans projects involving the use of electrical apparatus, perhaps co-operating with a mechanical or a hydraulic engineer or an architect depending upon the nature of the complete project. The various trades then carry out these ideas, perhaps under the supervision of a contractor.

An architect in planning a large office building or similar project may call in an electrical and a mechanical engineer to assist in planning the power plant, wiring and other engineering features. The time has passed when a man can well be both architect and builder and in the electrical industries the division of labor has been carried out to even a greater degree.

The electrical industries have been growing at a marvelous rate, doubling every five years where most other industries have been doubling every ten years, and it seems reasonable to suppose from this that there will continue to be excellent opportunities in this field for a long time to come.

Graduates of technical schools are now rapidly making their way and are being demanded in many industries where 20 or even ten years ago a decided prejudice existed against them. The manufacturers of electrical machinery and many of the operating companies deliberately choose graduates of engineering colleges to train by apprenticeship courses for their engineering, sales and executive positions. This training corresponds to the hospital experience which graduates of medical schools undergo before they are fully equipped medical practitioners.

The manufacturers of electrical machinery require the services of electrical engineers in many departments of their industry, some to design the generators, motors and accessory apparatus, others in research work relating to the industry, others are required to install and test the apparatus, and still others, called sales engineers, are employed to sell the apparatus and advise with the engineers in charge of a project as to the merits and characteristics of apparatus made by his company. Large operating companies furnishing electricity for power and lighting require electrical engineers in various capacities to operate the plants. Operating telephone companies employ electrical engineers in their engineering, plant maintenance and traffic departments.

The rapid introduction of electrical power into many of the large industries such as steel mills, increases the demand for men of technical training to operate these plants and to solve the problems in the application of electricity to new uses.

Engineering graduates have not entered the railway field to as great an extent as they have many others. It is certain however that the progress to be made in the electrification of railways within the next 25 years and more will demand the services of many electrical engineers for their construction, maintenance and operation.

The cheap power which will be furnished by our many undeveloped water powers will stimulate even more widespread applications of electricity.

The certainty that a demand for technically trained men will continue does not mean however that any one who chooses to engage in this work will be unusually successful. For two centuries before electricity became of any commercial importance whatever, many of the most brilliant mathematicians and physicists bent their energies to the solving of the laws of electricity and magnetism. To them we owe an exceedingly simple and satisfactory system of units of electrical measurement. This fact alone is sufficient to account for much of the rapid progress the electrical industries have made. Instead of being a mysterious thing of which we know very little, electricity is something about which a great deal is known. We know more of the nature of electricity than we do of gravitation and the laws of electricity are better understood than are those of many other branches of science. Electrical measurements are among the most exact which can be made and designs of electrical machinery can be more closely predetermined from well understood physical laws than can most other types of machinery and structures.

It now becomes clearer what the nature of the training of an electrical engineer should be. Of men of moderate ability the supply is sufficient to meet the demand. The electrical engineering profession has need for more men of real creative ability, broad minded men, capable of handling not only the increasingly intricate problems of the design of projects and machinery but also of perfecting the organizations essential to the carrying on of vast undertakings and of the relations of these enterprises to the public.

Hitherto the engineer has been too well content to retire from view with his purely technical problems. An engineering course supplemented by the right kind of practical experience should prove to be a direct road to the important executive positions more than it has in the past. Use should be made of every opportunity to develop latent business and executive ability.

The opportunities for men of moderate ability will depend upon the rapidity with which new and increased applications of electricity are made by the leaders of the profession, the creative minds.

Creative men have well developed imaginations and a course of training designed to produce such creative ability should develop the imaginative powers, that is, the ability to form a clear mental picture of the finished structure, before a line has been put upon paper, or a concrete conception of the physical principles involved in the operation of a machine or electrical circuit. This kind of training may be regarded as particularly important for the electrical engineer who deals so much with a form of energy visible only by the effects it produces. A mechanical or civil engineer of course can not see the energy he deals with but in general he deals with seemingly more material things.

The aim of the best schools of engineering is to train men for leadership. After a high school training the technical school requires four or five years of hard work but under such favorable conditions that really amazing progress is made by the student. Physics may be considered the foundation of the course for such studies as mechanics, electrotechnics and thermodynamics are but specialized and applied physics.

Considerable attention is paid to the study of mathematics for not only is the study of mathematical methods an exceedingly valuable mental training but ability to use them is absolutely necessary for an intelligent understanding of the laws of nature which the engineer is constantly applying to practice. Mathematics is a convenient system of symbols and of reasoning much used by physicists and engineers to express their thoughts in concise and exact form.

A careful study of practical English composition should be made because an engineer must be able to write clear specifications, reports and business letters which will permit of but one interpretation. The use of incorrect English by an otherwise intelli-

POPULAR ELECTRICITY

gent engineer will prove to be a great drawback. An excellent way for an engineer to legitimately acquire a reputation is by presenting papers before the engineering societies and it is by such an exchange of ideas that the profession as a whole is advanced. The force of accumulated and recorded knowledge is so powerful that an engineer who can not contribute to it fails to perform an important duty. The importance of an adequate training in English composition is now being recognized and met by the foremost engineering schools.

A reading knowledge of German and French is not only broadening but has practical value to an engineer who has occasion to keep informed of the work of foreign engineers. Wonderful as has been the progress of engineering in this country American engineers at the present time are not profiting as they should by the equally remarkable progress of foreign engineers.

Drawing, machine design and shop work occupy a good deal of attention in an engineering course, for drawings are the means by which engineers express their ideas to those who are to carry them out. Though the engineering student may do no shop work after leaving college, a knowledge of the fundamental operations is essential, and additional machine shop experience under commercial conditions is a valuable training. One learns most thoroughly by actually doing things and all through the course laboratory exercises are a most important part of the training.

Such studies as commercial law, political economy, sociology and accounting are generally recognized as a valuable part of an engineer's training. The difficulty has been to find room in a four year course for even the technical studies alone which are considered indispensable. Many engineering schools are strongly urging five year courses to meet this difficulty. It is possible to complete a combined literary and engineering course leading to the degrees Bachelor of Arts and Electrical Engineer in six years. This combination is recommended to those who are ambitious to reach the highest niche in the profession.

It is futile to attempt to impart anything in an engineering course but the fundamentals. Practice is best obtained in the field and the practical problems which are introduced into technical studies are for the purpose of illustrating important principles rather than to add to a stock of information. It is the aim of the best engineering schools to co-ordinate and to teach in a minimum of time particularly that fundamental knowledge which is difficult to acquire elsewhere.

The college and the instructors who have a keen personal interest in the students and graduates will have accomplished all they have attempted or can fairly be expected to do if the graduate has obtained a thorough grasp of even a comparatively few fundamental principles and an ability to analyze and reduce the practical problems, as they arise, to the principles he has mastered. In short, if he has learned to think, if he has high ideals and a genuine devotion to his work, though lacking much in practical experience he is in a position to soon acquire this and success will almost surely be his.



The Sidewalk as a Signboard

The choicest location for a sign is where people will read it. One might not believe the sidewalk a good place, but with the sign projected at your feet in letters of light, it is next to impossible not to read it. The little device which does this advertising consists of a powerful small lamp, lenses, and a stencil containing the adver-

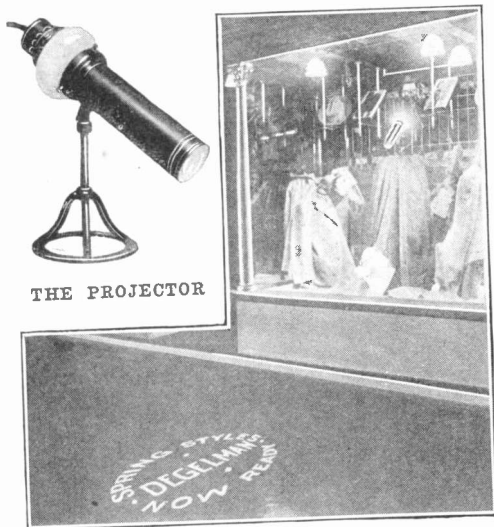

SIDEWALK SIGN

tisement. The whole thing is held in a metal tube 14 by 2 $\frac{3}{8}$ inches.

The tube is separated at the end occupied by the lamp so as to provide for the insertion of a small globe which makes the light available for illuminating the window in which the sign projector is placed. The pedestal for the tube to rest upon completes the outfit which can be placed on a bracket or attached directly to the ceiling in the window, above the door or in any convenient place and connected by a plug and cord to either alternating or direct current. The tube may be adjusted to any angle. It is focused the same as an opera glass.

The advertisement as it appears on the sidewalk is not round as shown on the stencil, but slightly elliptical, and varies from 3 $\frac{1}{2}$ feet, longest diameter, up, according to the distance of the projector above the sidewalk.

While primarily intended for sidewalk advertising, the projector may be used for throwing advertisements on walls and ceilings as well. It has been effectively used

by department stores as a wall sign to call attention to special sales.

Wire Span a Mile Long

The Susquehanna River in its course through Pennsylvania cuts directly through several mountains, forming what are known as water gaps. One of the most marked of these is found between Millersburg and McClelland stations of the Northern Central Railroad. The river at this point is about one mile wide, and stretched across the

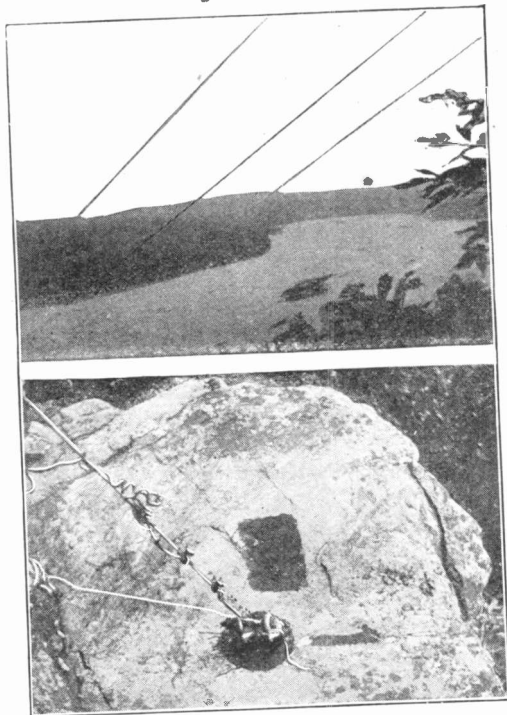

THE LONG SPAN AND METHOD OF ANCHORAGE

river from one mountain to the other is the longest span of telephone wire in the United States.

The wires, four of them, form two talking circuits of the American United Telephone Company. They are three-eighth inch twisted wire cables, 5,600 feet long and have a dip of 460 feet.

Of the two accompanying pictures one shows how the cables are held by insulated iron fastenings cemented into the rock of the mountain side, and the other shows a part of the wires at one end of their long stretch.

RAYMOND M. BASKIN.



CROWD IN FRONT OF THE NEW YORK TIMES BUILDING
WATCHING THE ELECTRIC PRESS BULLETIN

The Electric Press Bulletin

Nowadays a man need only pause for a moment or two in front of one of the great metropolitan newspaper offices and he will be informed of some great calamity. It may be an earthquake or explosion or he may learn only the baseball score; a court may have just handed down an important decision; a great man may have made some generous benefaction or just passed away. The newspapers have realized the value of the advertising gained in this manner, and employ a staff of men whose sole business it is to prepare the bulletins.

These bulletins are usually scrawled on blackboards or painted at every conceivable angle on sheets of paper; or if the news is important and has come after dark, rough magic lantern slides are prepared by scratching the news on a sheet of glass covered with lampblack or painted on ground glass.

No matter what day or what hour, a crowd is always in evidence gazing at the *Times* bulletins in New York. It is not always so much the news that is contained in these bulletins as it is the manner in which they are displayed that attracts the attention of the passers-by. Here the news is actually printed before the eyes of the public in a way that makes the previously mentioned methods seem crude. The news is exhibited practically as fast as it is re-

ceived over the telegraph or telephone wires in the office, by means of an electric press bulletin.

A large sheet of paper, 60 inches wide and 6½ feet long running over two rollers, one at the top and the other at the bottom nearly fills a window. Brief bulletins, exhibiting the last news from the center of interest of the moment, are neatly printed on it in clear letters two inches high.

Suddenly a large wheel about two feet in diameter at the bottom of the sheet begins to revolve. Then it stops and immediately the paper sheet jumps down an inch or so and then returns to its formal position. The wheel immediately starts again, comes to rest, and the paper jobs down and up. This is repeated again and again while the crowd waits and watches. The passer-by stops and looks too, for some news of an important event that the world has just brought forth is being printed.

The electric press bulletin is not a "ticker." It is operated by a small electric motor of about one-quarter horse-power. The various clutches, controls, etc., are operated by large electromagnets. The operator sits before what looks like a large typewriter keyboard. Beneath the keyboard is a large cylinder rotated by an electric motor. The cylinder is covered with small pins very much like the cylinder of a music box.

There is a pin corresponding to each character on the typewheel. This comprises the synchronising mechanism which controls the typewheel of the printer and halts the wheel so that any particular letter desired may be brought to that precise point in its revolution when it comes uppermost, and directly under the paper on which it is to be printed.

As soon as the wheel halts, a pair of electromagnets brings another portion of the

An integral part of the keyboard used by the operator is a small typewheel that prints on a strip of paper four inches in width and reproduces before the operator a miniature of the bulletins showing exactly what is being printed on the paper of the distant machines. It in fact keeps exact step with the large machines, printing when they print, spacing as they space, etc.

Several printing machines may be set up miles apart and connected to a common keyboard over single metallic telephone circuits.

The electric press bulletin in the downtown New York office of the *Times*, at Beekman street, is operated over a five-mile single telephone circuit.

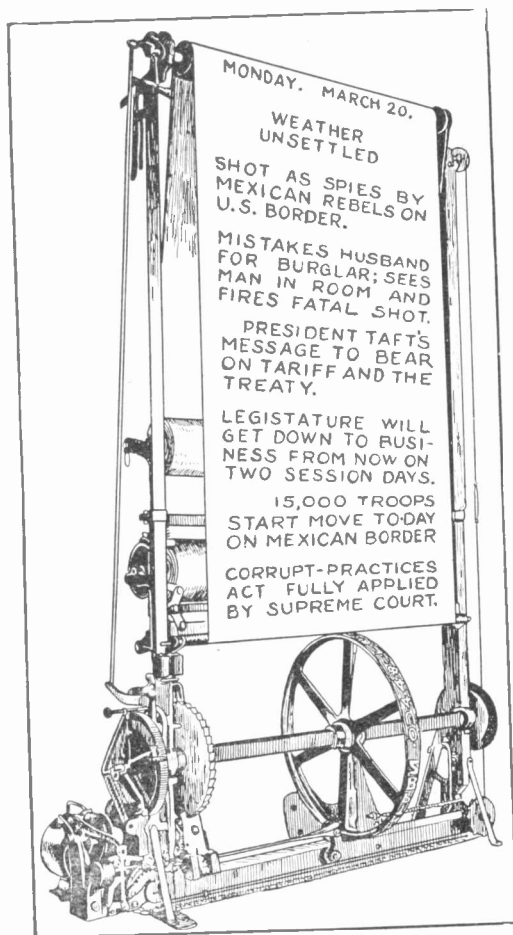

THE ELECTRIC PRESS BULLETIN

mechanism into play so that the bulletin sheet is brought down until it touches the circumference of the wheel. It is pressed there for a moment and then allowed to move up again with another letter added to its message. The typewheel is then moved down a space by another set of electromagnets and the train of action is repeated until the message is complete.

Why Electric Shock Causes Death

The reason why electric shock causes death has been the subject of much investigation among the medical fraternity and is a question often asked by the layman.

Doctors Kride and Stanton in a recent issue of the *New York State Journal of Medicine* gives as the probable chief causes of death by electric shock, "fibrillary" contractions of the heart and respiratory paralysis. By "fibrillary" contraction is meant an irregular or disarranged action or contraction of the heart muscles which destroys its regular rhythmic beat. On the breathing organs the result of a shock has much the same effect as an overdose of an anaesthetic.

As yet there is no known reliable means of restoring the normal action of the heart once it is deranged; on the other hand, if the respiratory organs are alone affected, prolonged artificial respiration enables a considerable percentage of recoveries from apparent death.

The effects produced by direct and alternating currents vary directly with the current strength (and hence with the applied voltage, with the duration of contact and with the path of current flow through the body. The frequency of alternating currents is of great importance, low-frequency currents being usually more dangerous than high-frequency currents of the same strength.

Paralysis of the heart is especially liable to result from low-pressure currents, particularly if the heart be in the path of current

flow; respiratory paralysis, however, usually follows on an insensible condition of the central nervous system brought on by high-pressure currents.

In general the lower animals are more susceptible than human beings to electric shock. Whereas 70 volts direct current is often fatal to dogs, 100 volts scarcely affects a normal man, 200 to 400 volts produces muscular cramp, and 550 volts produces almost instantaneous respiratory failure. Low-pressure alternating current shocks are liable to cause fibrillary contractions; 600 volts causes fibrillations and respiratory paralysis, but 2300 to 4800 volts usually affects respiration alone. In such cases artificial respiration should be persevered with, for hours if necessary. The medical reports of the U. S. A. electrocutions since 1890 show that a few seconds' flow of two to seven amperes (at 1500 volts, fifteen to 50 cycles per sec.) may not cause death, but with an application of 45 to 50 seconds duration, the heart's action is permanently suspended.

The Human Wheel

A "human wheel" act is one of the season's vaudeville novelties, offered as the thrilling finish of an acrobatic turn by a pair billed as Agnes Ahern & Co.. The woman in the case, resplendent in a glistening mother-of-pearl waist, ascends a ladder leading to a metal wheel which has been at the back of the stage during the earlier part of the act. Stepping inside the wheel and leaning back against its spokes, she slips hands and feet into convenient sockets and braces her head against the metal rim.

Meanwhile her partner has fitted himself with a belt having a socket for the upright which supports the wheel. Stage assistants raise the standard with its human load and help him to catch it in his belt. Then as he steps forward towards the footlights, balancing the wheel above his head, the house is darkened and current is turned on the 30 incandescent lamps which stud the rim of the wheel.

The lamps in the inner circle are frosted white so as to brightly light the spoked-woman's costume, while the outer lamps are tinted to match the colors which she happens to be wearing. Just as the men in the audience are beginning to figure on the

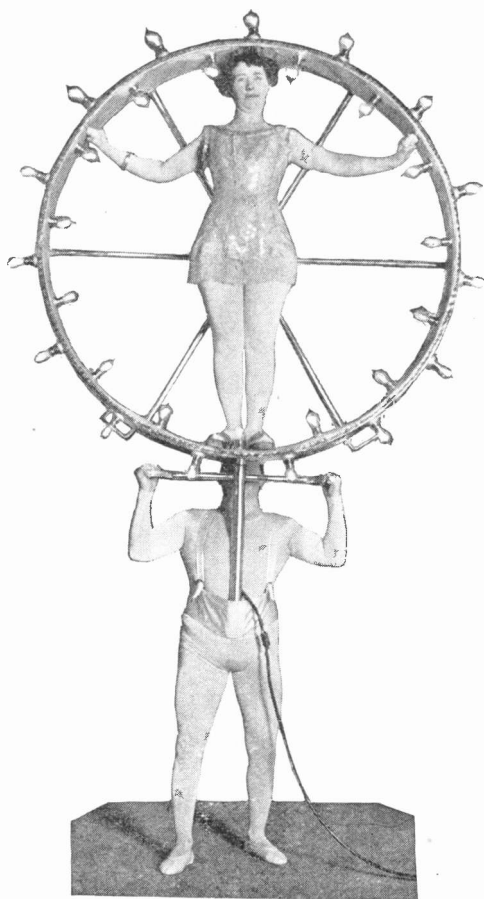

THE HUMAN WHEEL

weight which the man on the stage is balancing above him (for his partner shows a well distributed 137 pounds and the rest of the outfit cannot weigh much less) the wheel starts to rotate. A little electric motor geared to the axle has been getting busy and soon is spinning the wheel at the rate of some 30 turns per minute, so that all you can see of it is a pretty series of colored rings.

Then, after about a minute, the wheel gradually slackens its speed and stops right side up. The strong man of the team sets it back on its stand and his partner joins him at the footlights. Instead of being too dazed and dizzy to even walk straight, she steps lightly and smiles as they bow themselves out. Apparently she does not know what it is to get dizzy, but in reality she had to spend several months in training herself to stand the act, for even the rigor-

ous practicing of the skilled athlete had not schooled her to play the cool-headed spoke for the rapidly spinning wheel which she herself originated.

Testing Rail Joints

As the return current in an electric railway is carried by the track rails, made continuous by bonding the joints between the rails, it is advisable to test out the joints after bonding to see that the bond

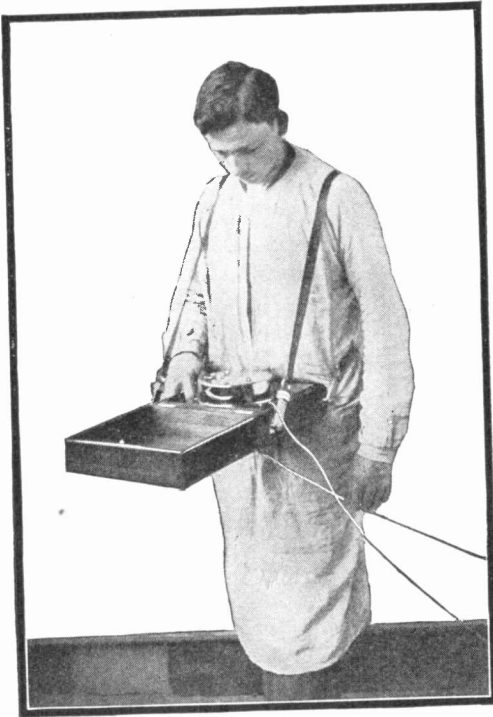

TESTING RAIL JOINTS

makes a good electrical connection. Though the resistance to the passage of current in a single poorly bonded joint may be very small, the combined resistance of a great number of joints may amount to a great deal.

Jules Richard, of Paris, has devised an instrument whose indications enable the tester to measure the resistance of a joint in a moment's time. The instrument with an attachment for gripping the rails and making contact on each side of the joint is easily carried by the tester, as the galvanometer and contact maker together weigh only 21 pounds. The contact maker,

which does not show in the picture, is connected with the wires leading down to the rail.

In using the instrument he walks along the track until he comes to a joint. Then, with a quick movement he clamps the contact device to the two rails so as to bridge the joint. The knife edges grasp the two rails at points one meter apart. Turning a switch he sends battery current through the rails and joint at a known voltage. This current is measured by the deflection of the galvanometer needle. Knowing the voltage and current it is easy to compute, by Ohms law, the resistance of the joint in ohms; that is, resistance equals volts divided by current. This resistance, when found represents the resistance of the joint plus one meter of rail length.

Gasoline's Annual Death Roll

While some of the prominent dailies have been keeping an accurate count of the deaths due to our unsane July Fourth celebrations, none of them has as yet kept a similar record of the deaths from accidents due to the use of gasoline. Occasionally we read of fires caused by the use of gasoline for cleaning gloves or the like, but the danger from this explosive liquid is by no means limited to such cases. In Germany, where the governmental records permit of more comprehensive statistics, it has been shown that 40 per cent of the serious accidents due to gasoline during 1910 were in connection with autos or other gasoline motors, the result being five dead and 58 seriously injured, besides a large number of slightly damaged persons. Any similar statistics gathered in this country would probably surprise most of our readers, but fortunately the growing popularity of the electric vehicle may help to decrease the fatalities due to grim death's evident compact with gasoline.

Berlin Road to Electrify

The greatest suburban railroad in Europe, the Berlin Stadtbahn, is about to be electrified, largely through the Kaiser's influence. The cost is estimated at \$30,000,000. Experts have decided that the plan not only is entirely practicable but that it is almost necessary in order to relieve Berlin of soot and smoke.

Tolling the Church Bell

Another picturesque figure of our grandfather's time seems doomed. In most places the church sexton has long ago lost his old task of interring the departed and now he is threatened also with losing the more frequent duty which prompted the old rhyme ending:



quently which prompted the old rhyme ending:

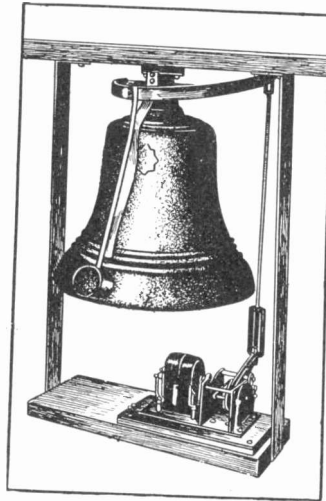

THE OLD AND THE NEW WAY OF BELL TOLLING

"The preacher told the sexton,
The sexton tolled the bell."

No longer does he need to doff his hat and tug with all his might at the bell rope: for if he but presses a button, a little electric

motor mounted near the bell will swing the massive clapper. Such modern bell ringing can be done even by men who are too feeble and rheumatic to pull the old bell ropes, so perhaps the innovation will suit many of the remaining sextons while helping to crowd them out.

Giant Water Turbines

With the question of conservation so widely discussed and with electrical and hydraulic engineers considering more seriously than ever before the utilization of the millions of horsepower now going to waste in the form of unused water power, the hydraulic turbine becomes a transformer of energy of foremost importance. Already in the United States at the plants of the Niagara Power Company and the East Jersey Company these machines are conserving energy by saving coal and utilizing water to generate electricity. In Canada at the Cataract Power Company and also at the Shawinigan Water and Powder Company immense turbines are in service. The illustration gives an idea

of the size of one of these giant machines, undoubtedly the largest pair of turbines ever built, furnished by the Morgan Smith Company to the Canadian Light and Power Company, Montreal, P. Q.

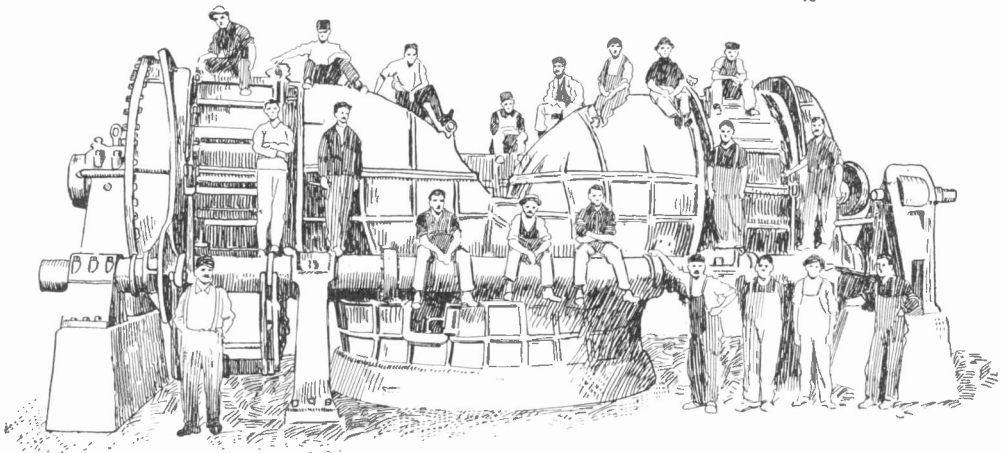

LARGEST HYDRAULIC TURBINES EVER BUILT—USED IN CANADA

Huge Flatiron Float

At the Industrial Parade at Minneapolis, July 7th, one of the most striking and forceful floats was a huge electric flatiron drawn through the streets on a truck. It was

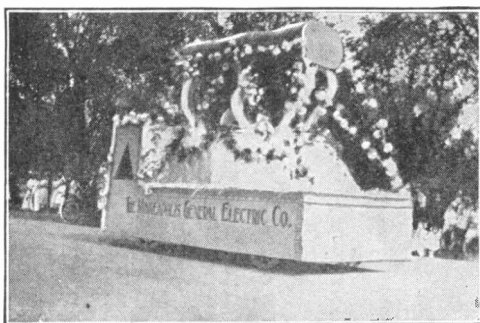

HUGE FLATIRON FLOAT

modeled after a well-known type of iron now in very common use. Some idea of its size can be obtained from the picture.

PHILIP EDELMAN.

Current From the Wind

A device that will enable a fluctuating source of power like the wind to run an electric generator at a steady speed has been often attempted. The usual scheme is a

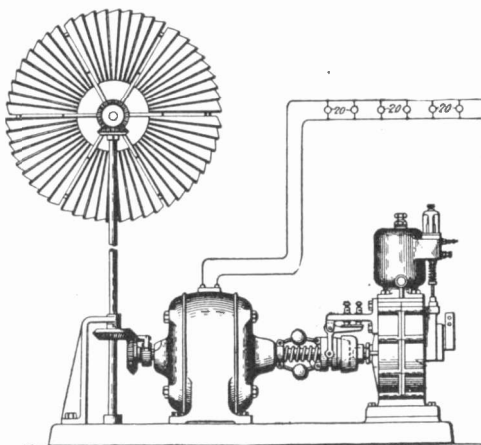

WIND AND GASOLINE MOTOR IN COMBINATION

windmill, a governor, a generator and a storage battery, the latter being charged during steady wind to be used when there is little or no breeze. The substitution of

an engine for the battery with other necessary apparatus is the subject of a patent issue to Caryl D. Haskins, Schenectady, N. Y. When the windmill speed drops to a certain point the ignition circuit of the engine is closed and by means of a clutch the loaded dynamo is run by the engine until such time as the mill speed reaches the proper point, when the clutch releases, the engine ignition circuit opens and the mill takes the load. The device is also designed to operate from a car axle, thus giving current for car lighting.

Telling the Train Dispatcher

If a railroad train does not reach a certain station or other point at the scheduled time, the train dispatcher is not only annoyed but worried.

The Kellogg portable train telephone removes this worry and saves delay. A joint-

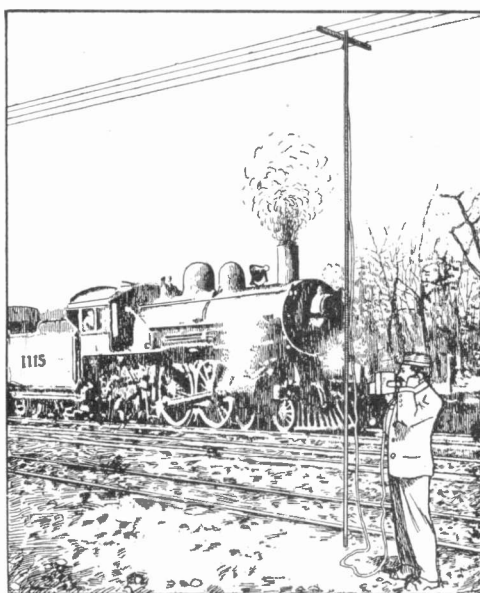

USING THE PORTABLE TRAIN TELEPHONE

ed pole in three parts, a small folding cross arm and a telephone set enable the conductor to connect with overhead wires and tell the dispatcher all about it in two minutes after a stop is made. He can also inform the dispatcher within a minute of when the train will be able to proceed.

The outfit is compact and weighs a few ounces over six pounds.

Gas vs. Electricity As a Cause of Fires

To blame electricity for fires is easy, but if the actual facts could always be bottomed the electric equipment would be found innocent in a large share of the cases where the newspapers give "crossed wires" as this cause. Even with this common tendency to blame the wiring, the comparative statistics are surprising. Thus the last annual report of the causes of fires in Germany, where the government itself compiles the figures, shows 293 fires attributed to electricity. Now the number of electric lamps in Germany is about forty million, or roughly double the number of gas lamps, hence for equal safety gas should have caused less than 147 fires. But the actual number traced to gas was 878, or just about six times as many fires in proportion to the number of lamps in use. Many of the electric fires were undoubtedly due to the crudeness of early installations, for in Europe as in America there are thousands of buildings where the wiring of 30 years ago is still in service.

Yet even with this old wiring far below the standards of the past 20 years, electricity is proving to be many times safer than gas.

Making the Night Beautiful

Electricity makes our nights almost more beautiful than the day. The distant view, from a mountain top, of a city that shines like some unfamiliar constellation, or the fairy bark or golden galleon moored before a pavilion outlined in light, makes one realize that our so-called materialistic and mechanical age has a beauty all its own. In the glorious days of Athens or Rome such illuminations, or a mere glimmer of them, would indicate some high festival or celebration of a victory. We have them every night in the year, and yet because we fail to appreciate their beauty declare that our epoch is dull and colorless.

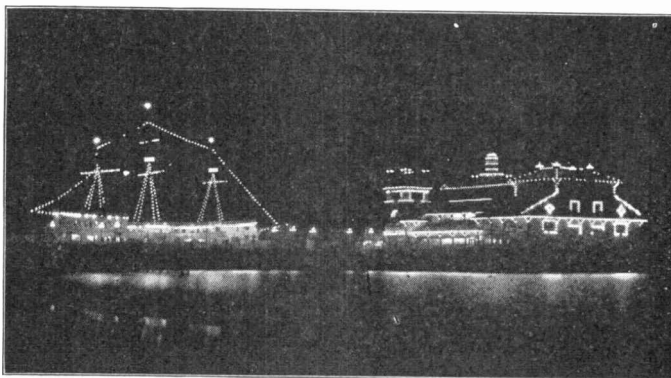

THE GLORIOUS DAYS OF ATHENS OR ROME HELD NOTHING TO COMPARE WITH THIS

The Electric Dial

In a recent campaign to raise \$500,000 in ten days, the Y. M. C. A. of Los Angeles used a mammoth dial to indicate the pro-

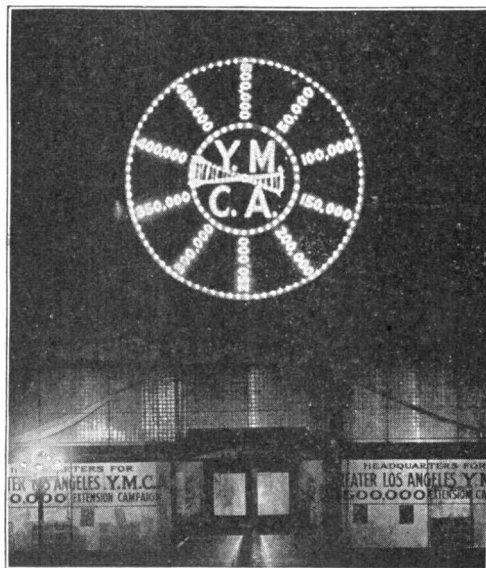

THE ELECTRIC DIAL

gress of the fund from hour to hour and from day to day, a scheme which has also created enthusiasm in other cities. By night the dial was illuminated, and as the photograph shows, there was a steady advance even during the short time needed for exposure of the sensitive plate, for the two hands shown in the picture are in reality but one. It advanced several points while the photograph was being taken.

Double Crossing the Deer

How greatly the ideas of sportsmen differ is seen even in the use of electric flashlights by hunters. The true American marksman likes to tramp through the woods and marshes in search of game, while the titled European believes in having it driven across his path. Even a monarch like Emperor William thinks it sport to sit on a specially built perch and to wait there while the drivers shoo the game across his easy range.

When it comes to hunting after dark, the American likes to stalk forth by moonlight. Or, if he carries a search lantern, he cer-

Schoenberg has ordered twelve such street scrubbers, all of which are to be in service by the middle of the coming summer.

Magnetic Influence of the Sun

The mystery of the earth's "wabbling" on its axis has been explained in certain quarters by assuming that the rotation of our planet is affected by changes in the magnetic influence of the sun.

Halm, a German astronomer, has published tables showing comparisons of observations on sun-spots and on the irregular

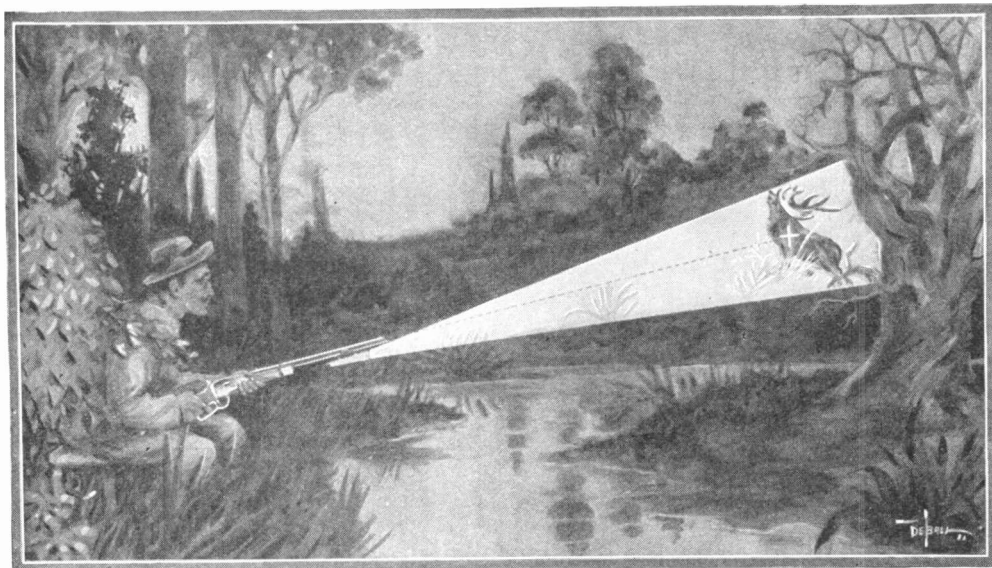

HE PULLS THE TRIGGER WHEN THE CROSS FALLS ON THE GAME

tainly would not expect that to do the aiming for him. On the other hand, the European not only fastens the flashlight to his gun, but has now cross-marked the lens so that it will show the spot at which the gun is aimed. All he has to do is to bring the shadow of the cross mark on the game and pull the trigger. Of course that means a clever use of an electric battery lamp, but is it really sport?

Electric Street Cleaning Autos

Germany, the first country to adopt electric fire engines, has again scored in pioneering the electrically driven street scrubbing automobile. The little city of

motions of the north pole, which appear to show a coincidence between the two phenomena. During a maximum of sun-spots the magnetic influence of the sun seems to be greatest, and after the passage of such a maximum the disturbance of the earth's axis diminishes. The fact that the earth's poles of magnetism do not correspond in location with its geographical poles may, according to the German view, indicate how the sun's disturbing action is applied. When the magnetism of our globe is most powerfully excited, then the strain along its magnetic axis may cause a distortion of the figure of the earth, which becomes less as the strain diminishes.

Brilliant Street Lighting in Warren



STREET SCENE IN WARREN, OHIO, SHOWING
ALSO TYPES OF ORNAMENTAL FIXTURES

Warren, Ohio, bears the distinction of being the first city in the country to adopt Mazda incandescent street lighting exclusively. Municipal improvement always arouses interest and no reform is more conspicuous than that which effects a change from gloomy to brilliantly lighted thoroughfares. It frequently happens, however, that a city ambitious to possess a "Great White Way" will confine its attention to securing one or more brightly lighted streets in the retail business section and will give but slight consideration to the proper and ade-

quate illumination of the more secluded residential districts. This incomplete course has not been followed by the people of Warren, for although the ornamental street lighting of the downtown districts compares most favorably with any of its kind seen elsewhere, the illumination of the residential streets has not been neglected.

Although Mazda lamps are employed throughout the city, the lighting system can be divided into two classes, viz.: residential and ornamental, or downtown, of which the latter naturally is the more spectacular. The



NIGHT SCENE IN FRONT OF THE PARK

most recent practice carried out in American cities—the use of ornamental standards—has been adopted. There are 86 of these, of which 62 support three lamps, one upright and two pendant. The three-light standards are located close to the curb line on the business streets. Around the spacious park, which is situated practically in the business portion of the city, are placed 22 similar standards, excepting that they only support one vertical lamp. In the center of the park directly in front of the Court House are two very artistic five-light standards. All wiring for the ornamental lighting is laid underground, thus eliminating the use of unsightly poles and exposed wiring, a feature of no mean importance in beautifying the streets of any city. Eighty candlepower Mazda

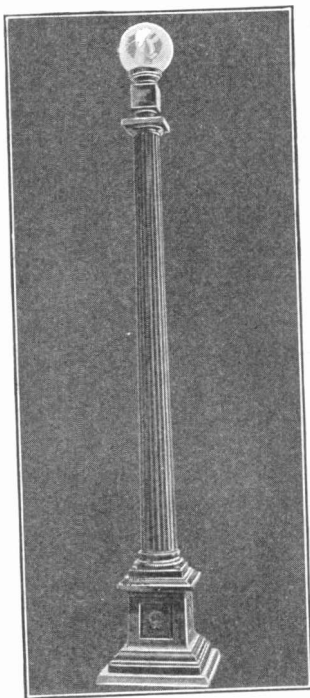

TYPE OF SINGLE LAMP
FIXTURE

lamps surrounded by 14-inch Alba globes are used in the upright position on the standards, while all pendant lamps are 40 candlepower and are enclosed in twelve-inch globes. The three-light standards have been wired up in two circuits so that the pendant lamps can be switched off at midnight, leaving the upright lamps to burn till daylight.

The residential lighting system includes 620 street series lamps, suspended from goose-neck brackets, which are attached to wooden poles and equipped with metal reflectors, suitable for 80, 60 or 40 candlepower lamps. The units are spaced as uniformly as possible along one side of each street, the distance between the units on any street depending on the amount of traffic, and to some extent on the foliage.

Attractive Fountain Lights

Under the basin of the new concrete fountain just constructed in Central Park, Los Angeles, is an arrangement of colored incandescent bulbs which adds greatly to



ARRANGEMENT OF FOUNTAIN LIGHTS

the beauty of the water by night. As the photograph shows, the drip from the basin falls like a veil over the basin's rim, and the many colored lights shimmer through this water curtain giving a constant play of changing color schemes. By day the

bulbs are not noticeable unless one stands quite close to the fountain.

Nature of the Electric Arc

According to Thompson, positively and negatively electrified corpuscles, or ions, are emitted respectively from the positive and negative electrodes, and under the influence of electric repulsion travel across the space occupied by the arc and bombard the electrode opposite to the one from which they are emitted. The high temperature of the electrode is produced by the bombardment, and the electric current itself is supposed to be conveyed across by the flying ions.

Swinton conducted certain experiments which, it is claimed, conclusively prove the truth of Thompson's explanation of the electric arc. The principal experiment consisted in deflecting either the positive or the negative ions, by means of a magnet, into a Faraday cylinder placed with its aperture just touching the center of the arc. With arcs of ten or twelve amperes, he obtained results in air at ordinary atmospheric pressure.

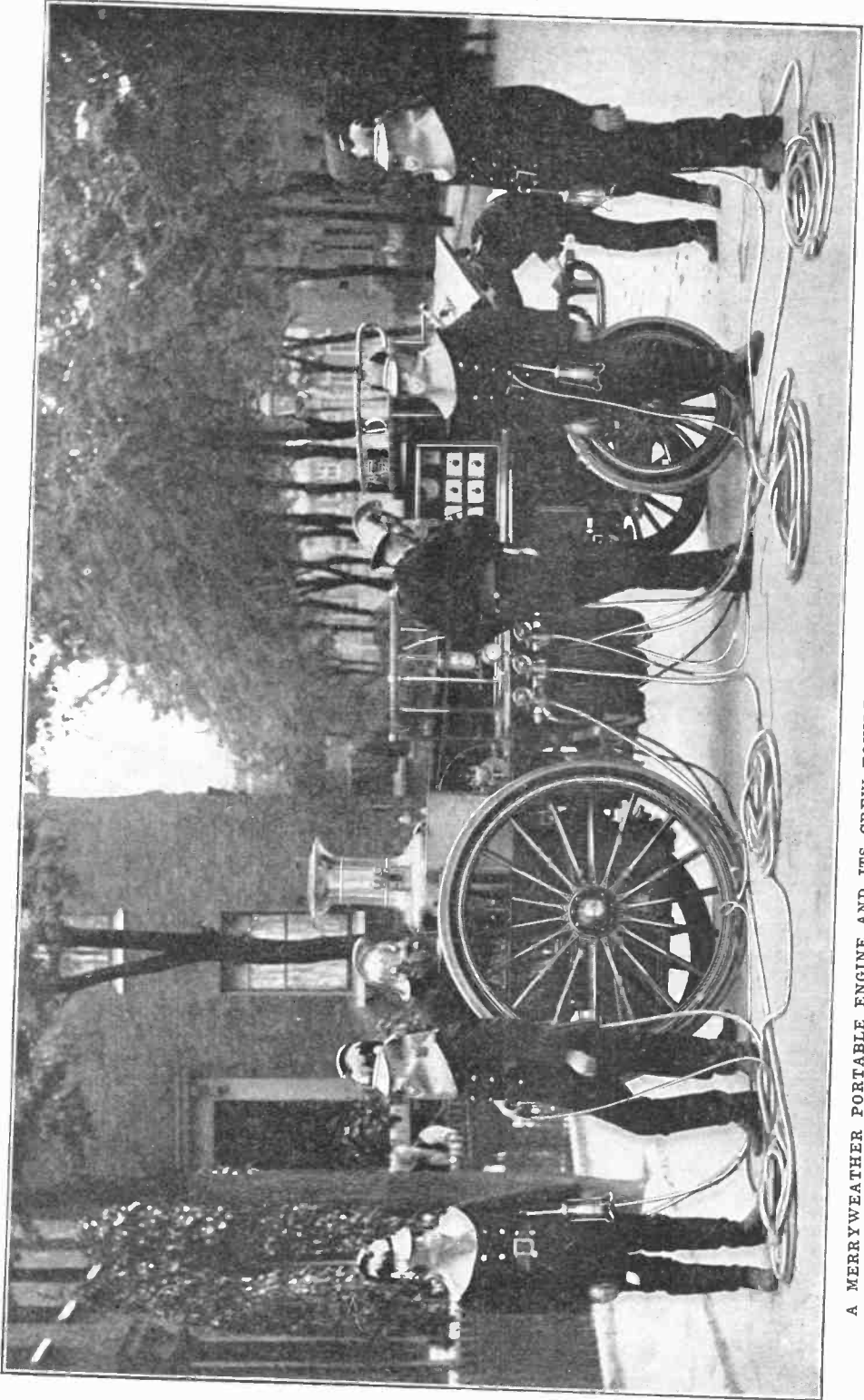

A MERRYWEATHER PORTABLE ENGINE AND ITS CREW EQUIPPED WITH SMOKE HELMETS AND PORTABLE TELEPHONE

Protecting the Fire Fighters

The fireman who enters a burning building, even if accustomed to facing an intense heat, works under three serious handicaps: The smoke which may play all around him makes it difficult for him to get a proper supply of air for breathing, without which he must either withdraw occasionally or else run the risk of being overcome by the smoke or fumes. The lack of light often obliges him to grope around in the dark, wasting time just when it is most needed, or perhaps stumbling and causing his colleagues to leave their work while helping him up. Last, but not least, the general noise and confusion attending the average fire, together with the roar of the flames and the splashing of water often make it impossible for him to hear the captain's orders or to advise the latter of conditions as he finds them.

Hence the logic of the new equipment (built by Merryweather & Sons, Ltd.) adopted by the city of Manchester for the use of its fire brigade when fighting fires in cellars or in heavy smoke. The steam fire engine used for this service has an air-pump mounted on the same truck with it and connected to six reels of flexible metallic hose mounted under the truck. Interwoven with this hose is a pair of wires leading to a small telephone switchboard. Each hose is easily coupled to the back of a masked smoke helmet which a fireman can slip over his head and which distributes the air around his face so as to keep the eyes and nose clear of smoke. Each helmet is also fitted with a telephone receiver and transmitter, so that the wearer can readily talk to the officer standing beside the engine, reporting to him as to the conditions inside the building and getting his orders instantly.

Hooked to his belt, each fireman also carries a 32 candlepower incandescent lamp, from which a cable leads to a dynamo belted to the fire engine.

Electric Car Makes a Long Run

When an electric roadster left the monument at Indianapolis at the beginning of the Four State Tour of Indiana gasoline cars, a smile of incredulity was seen on many faces.

"That's a good advertising bluff," said some one, "but of course they won't make the trip."

When the same car crossed the Mississippi at St. Louis on time, and touched the soil of the third state three days out from Indianapolis, there was a wholly different feeling.

"The electric is really making good," was heard with an expression of surprise that showed how little the average devotee of gasoline appreciates the going qualities of the up-to-date storage battery car.

J. M. Ward, the Waverly pilot, was chaffed a little on his exhibition of nerve. One St. Louis newspaper even accused him of surreptitiously tapping wires between charging stations along the route; but he took it all good naturedly, and in spite of the hard service he was doing came up smiling every night with a joke and a good word for everybody.

One of the difficulties that an electric encounters on such a run is the fact that in order to get the best mileage out of its batteries it must be run on economical speed which is several miles an hour slower than the car will make in ordinary service.

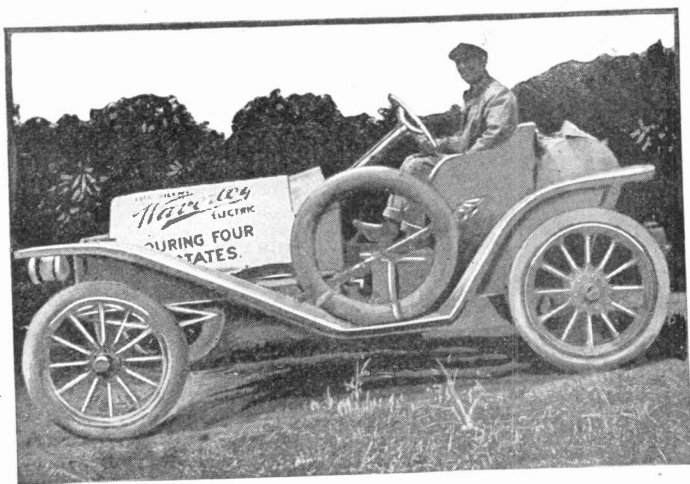

ELECTRIC CAR IN THE FOUR-STATE TOUR

At the Cabaret Show

Among the latest novelties in the way of metropolitan amusements are the "cabaret shows" given by some of the summer play-houses. These midnight performers are staged after the conclusion of the regular bill and in all instances are proving the most popular feature of the evening's entertainment.

The origin of the cabaret show is continental. The summer theatres in New York

young lady to the left wearing the pink hat, springs to your table top, while her vis-a-vis, a young man with an olive complexion and a cocked mustache sings tenor to her gay gavottes.

As soon as the footlights are turned up, and the lights in the audience down, several boys carrying trays of cigars, candies, etc., pass through the audience vending their wares. Instead of voicing a sing song cry, and disturbing the performance they walk quietly in and out among the tables and

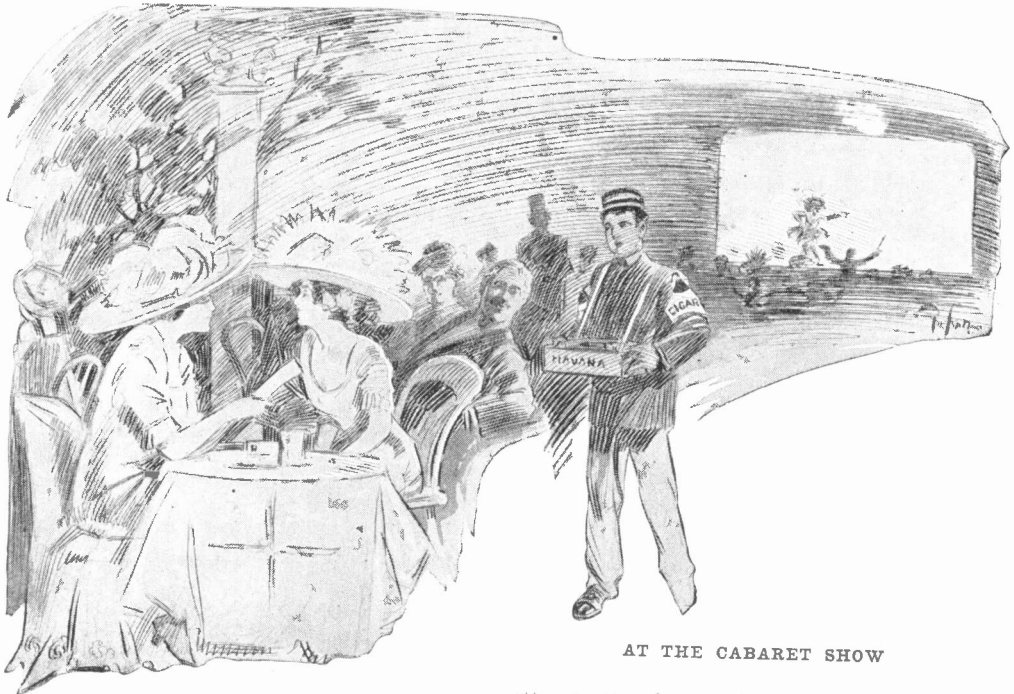

AT THE CABARET SHOW

are a unique combination of restaurant and music hall. The cabaret consists of a "revue" composed of Berlin, Viennese and Parisian attractions, starting at eleven p. m. and continuing until one a. m.

The midnight show is given in the open air and is of a very informal character. Artists who previously may have been posing as guests rise in their chairs and do their turns as the spotlight seeks them out. The stupid looking waiter who has been clumsily attempting to serve you suddenly becomes a very demon of activity, and throws plates, trays and glasses about overhead to a confederate juggler in the most alarming manner. The tastefully gowned

attract attention to themselves by means of a small incandescent electric light attached to the coat sleeves at a point just below the shoulder.

The light is provided with a small reflector which prevents it from glaring in the eyes of the spectators and confines its rays to a small arm band worn by the vender. The arm band is embroidered with a word such as CIGARS or CANDY to denote the nature of the goods offered for sale by the wearer.

The current for the lights is supplied by flexible silk covered wires leading from a small storage battery supported from a leather belt around the waist. The effect is very pleasing and the idea most certainly very novel.

Memorial to Alexander Henderson

Few men in the electrical field were better known by actual personal contact and better loved than Alexander Henderson, whose death occurred in August, 1910. Entering the electrical industry when electricity was



THE HENDERSON MEMORIAL

first used commercially, he numbered among his friends manufacturers, jobbers, contractors, inspectors and the technical press. He was always approachable and genial and his familiar "How" will be ever remembered. On Sunday, July 16, at Southampton, Long Island, a memorial was dedicated to mark his grave, the fund for the erection of which was made up of small sums from hundreds of his friends in the electrical industry.

Electrical Inertia

An odd experiment was made with an electric discharge conducted round a right-angled corner.

The corner was formed by bending sharply the conducting wire. A photographic plate, enclosed in a hard-rubber holder, was placed under the wire in such a way that the discharge would descend toward it, then turn at a right angle, and pass horizontally above it. It was found that when a negative discharge passed down the wire to the angle the electrical particles kept straight on their way instead of turning, penetrated the rubber cover and af-

fecting the enclosed plate. But when the discharge was positive no such effect was produced. The current apparently turned the right-angled corner without, so to speak, shooting off at the bend.

Street Car With Connecting Rod

Where four motors are used in running the ordinary street car, this car, which is being tried out in Cincinnati, has only two motors, although it is larger than the ordinary street car. There is one motor to each double truck and the wheels are connected with a driving rod much like a locomotive. This driving rod does away with the necessity of the extra motor to each truck and also keeps the wheels from spinning on slippery rails.

In this new type of car sliding doors, which in ordinary cars separate the front and rear platforms from the rest of the car, have been done away with. Two levers are operated by the conductor, who always stands near them, to open and close the doors for passengers entering and leaving

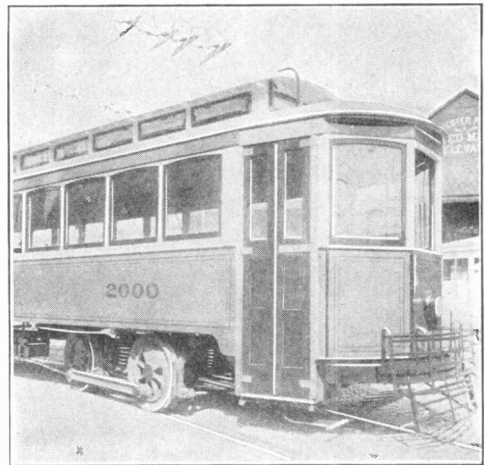

CAR WITH CONNECTING ROD

by way of the rear platform. The motorman operates the doors to the front exit. One can not leave the car or enter until the car has come to a dead stop and then only when the conductor or motorman operates the closed doors.

Fifty of these new style cars will be in use in Cincinnati by fall and some of them are being built for other cities.

Train Orders Delivered on the Fly

The Puget Sound Electric Railway Company, operating between Seattle and Tacoma, has recently reduced the running time of its limited trains. Train orders on this line are delivered by station agents, and in order to save time in the delivery of orders the station men are now delivering many orders by means of a wire loop, the conductor catching the loop at high speed. For this class of order a form is used which is not signed by members of the crew, and it is not used in restricting the rights of trains.

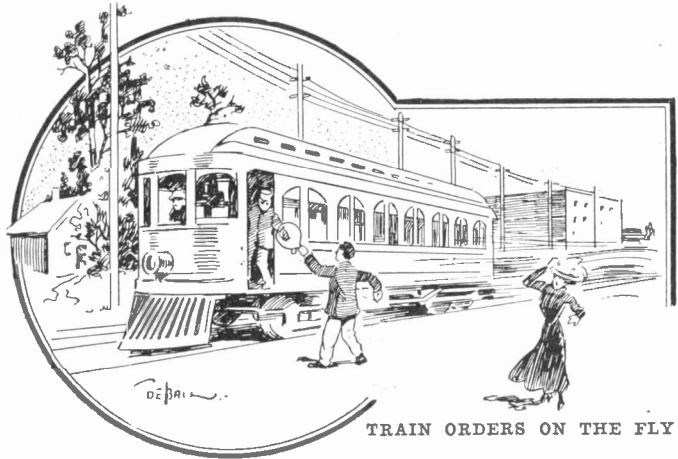

TRAIN ORDERS ON THE FLY

Electric Tower Wagon

The electric tower wagon occupies a field all its own. As a rule, such vehicles are used in emergencies only, and, if horse drawn, it is necessary to have a number of horses always on hand ready for immediate action. The application of the electric truck to this class of work entirely obviates this, as the electric tower wagon is always ready. This is particularly advantageous to companies operating trolley systems. Moreover the electric tower wagon embodies all the

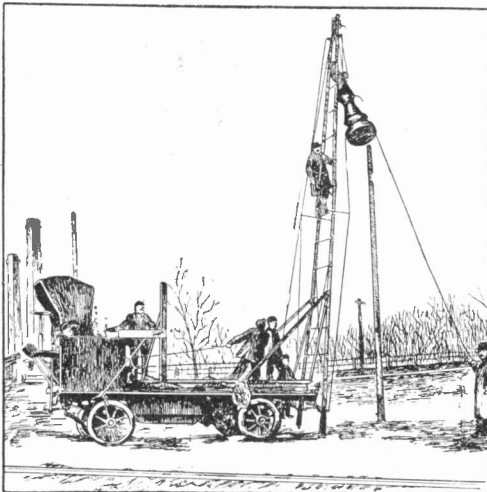

ELECTRIC TOWER WAGON

elements of a small power plant within itself. There is the motor always ready to perform heavy work expeditiously as shown in the drawing.

Central Station Farthest North

Farthest north of any electric central station is the one near Dawson, operated by the Northern Light, Power and Coal Company. The plant was installed for the purpose of supplying electrical energy to the various gold-mining companies in the Klondike region. The company has its own coal mines which furnish a semi-bituminous lignite. The station has a capacity for generating 9,000 kilowatts or over 12,000 horsepower and is operated by steam turbines.

Although the temperature variation is from 70° F. below zero to 100° F. above only one minor breakage has occurred, due to a defective joint, which was repaired in an hour. No difficulty has been experienced in operating the plant at a temperature as low as 50 degrees below zero.

The material was all shipped from Vancouver in April, 1910, transferred to railway at Skagway, and finally loaded on barges for ascending the Yukon River. The installation proceeded rapidly, so that steam was applied to the turbines by August 20, and commercial operation begun on September 2.

If oil gets upon the armature and adjacent parts of your magneto, don't be afraid to dip it into a bucket of gasoline. The armature windings are usually covered with shellac varnish and gasoline does not affect shellac.

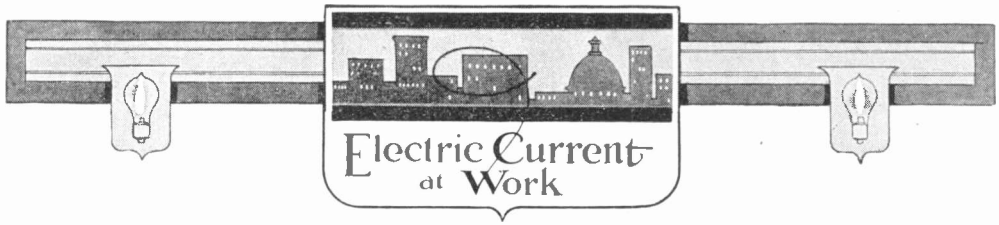

Ozonized Water for St. Petersburg

By DR. ALFRED GRADENWITZ

Commercial use of ozone on a large scale for sanitary purposes has only recently become possible by the design of suitable means of artificial production, based on what are called silent electrical discharges. Messrs. Siemens Brothers of Berlin, Germany, have been pioneers in this direction by designing an apparatus in which atmospheric oxygen is converted into ozone, by the high-tension discharges passing between cylindrical aluminium and glass poles.

As has been explained quite often in this magazine, ozone is what chemists have sometimes termed an allotropic form of oxygen; that is, a molecule of oxygen is formed, by the electrical discharge, which contains three atoms of oxygen. Oxygen in this form, or ozone, is very unstable, chemically speaking. One of the atoms of oxygen is very loosely held to the molecule and is constantly trying to escape and combine with some other free atom. Bacteria or germs, being composed principally of carbon, are

the easy prey of these outcast atoms of oxygen, which are liberated when the ozone molecule breaks down. The free atoms of oxygen combine with the carbon of the bacteria oxidizing the latter, or, in plain English, the bacteria are burned up. Consequently we say that ozone is a powerful disinfecting agent, which it is.

The first application of this method for the cleansing of the drinking water supply of a big city has recently been made at St. Petersburg, Russia, where a waterworks employing this agent has been installed. The recent cholera epidemics having shown the urgency of convenient measures for purifying the polluted water, it was thought that the ozone process would afford the only effective means of achieving this end and protecting the inhabitants against that terrible scourge, as well as from typhoid fever.

The water supply of the city of St. Petersburg has so far been from three exten-

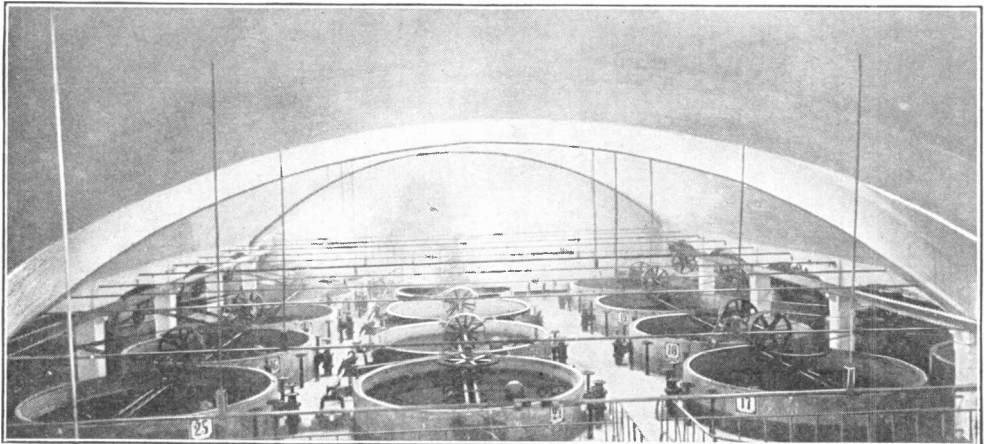

HIGH SPEED FILTERING PLANT WITH STIRRING DEVICES

sive waterworks only one of which (the largest) used sand filtering, while the two remaining poured the crude Neva water into the municipal water pipes, without any previous cleaning. The new ozone waterworks has been erected on the site of one of these primitive plants (that of Penkovaya) and suffices for a daily consumption of about 50,000 cubic meters. Previous to the application of ozone, the water is submitted to a preliminary cleaning in a high-speed filter connected with an aluminum sulphate settling tank where any suspended matter (which is specially abundant after the breaking up of the ice) is precipitated. The plant therefore comprises two parts, viz., the filtering installation and the ozone waterpower proper.

As seen in the drawing, the crude water is derived directly by pumps from the river Neva and raised into the settling tank. Before entering the latter, the water is mixed with a conveniently diluted solution of aluminum sulphate, according to the well-known American method. There are eight of these settling tanks connected by conduits with the filters. The high-speed filters, of which there are 38, are designed according to the Howatson system which bears much resemblance to the well-known American Jewell method. In fact, the main difference between the two is that Howatson uses for filling his filters a specially prepared flint in the place of the usual small-grain filtering sand. The rate of filtering per square meter is about 4.5 cubic meters per hour.

The filters are cleaned by rinsing with filtered water and simultaneous stirring of the flint by means of stirring devices. The filtered water passes through a collector directly into the sterilizing towers, while a small part

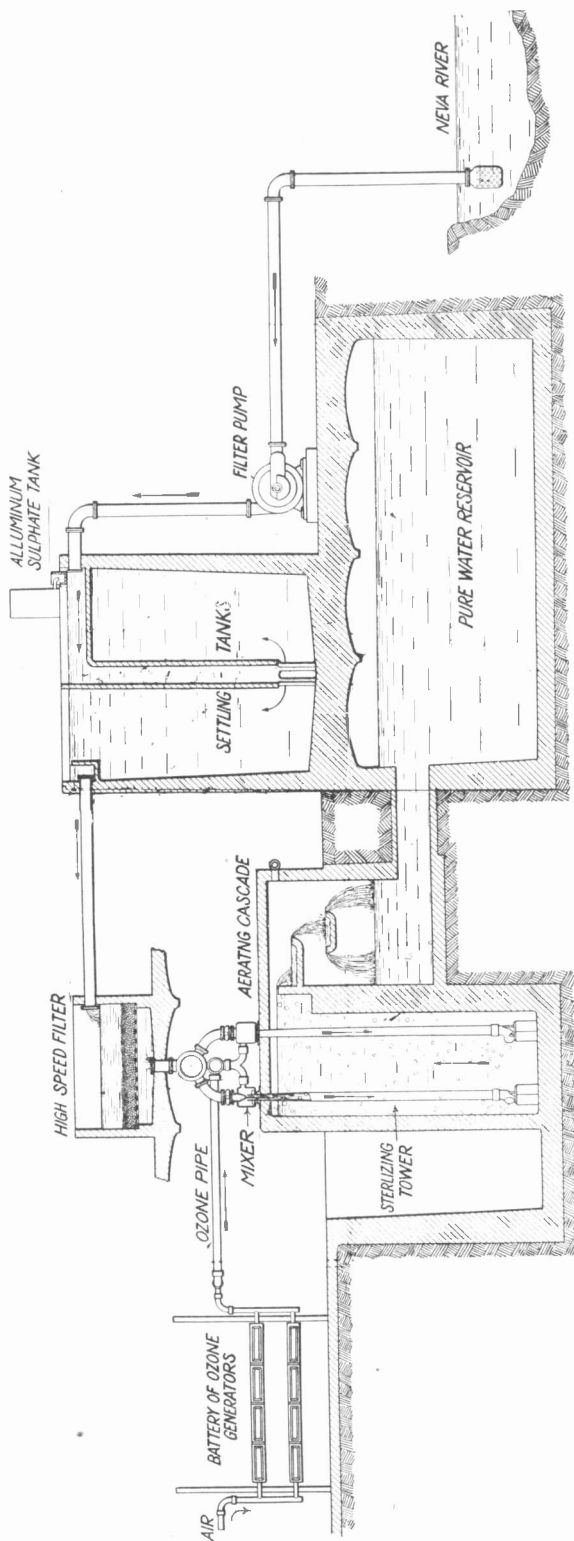

GENERAL ARRANGEMENT OF THE ST. PETERSBURG OZONIZING PLANT

is by-passed into a tank for cleansing the filters.

The ozone works proper in its turn comprises two parts, viz., the battery of ozone generators shown in one of the pictures and the sterilizing towers indicated in the drawing. The tube elements of the ozonizing battery are based on the action of silent high-tension electrical discharges between cylindrical poles of aluminum and glass. A relatively high concentration of ozone (2.5 grammes per cubic meter of air) has been chosen.

Before entering the ozonizers, the air is artificially dried to the proper degree required for a favorable output. It is conveyed through the ozonizers and conduits by a special type of injector which draws in the ozonized air from the ozonizers, under pressure, and mixes it with water before passing into the sterilizing towers. The absorption of ozone and the sterilization of the water thus produced takes place partly in these injectors and partly in towers, from the bottom of which the ozonized air is made to rise in a condition of very fine distribution and accordingly most intimate contact with water. The water then arrives through aerating cascades at a discharge conduit conveying the sterile water into the pure-water reservoirs from which it is sent by high-pressure pumps into the municipal water pipes.

Operation of the whole plant is insured by a special electric central station.

Mica Production

The United States Geological Survey gives the value of mica produced in this country in 1910 as \$337,097. The states arranged in the order of their output are: North Carolina, South Carolina, South Dakota, New Hampshire, Colorado, New Mexico and Massachusetts. The blocks of mica from the mines yield but ten per cent of usable trimmed mica most of which is used in making electrical appliances.

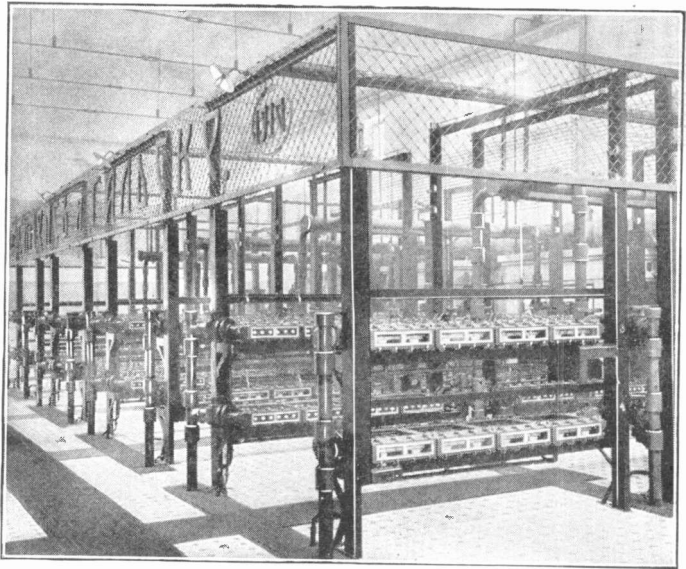

BATTERY OF OZONE MACHINES

Motor Operates Canal Gates

The canal gates of the Lachine Canal which spans the Lachine Rapids of Canada are operated by electric motors. One of these motors on the bank of the canal is

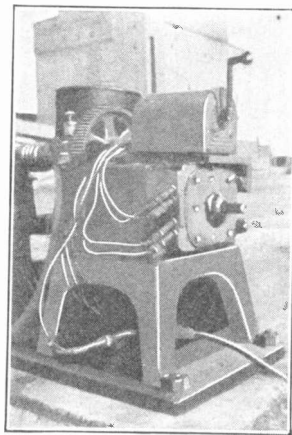

MOTOR AND CONTROLLER

shown in the illustration. The controller is at the top, the motor next and a heavy iron base is at the bottom, under which are resistance coils. The motor shaft turns a series of gears, the last of which meshes into a long toothed steel bar which is propelled back and forth to open and close the gates.

A. ST. AUBIN.

Electric Kitchen Ventilator

For carrying off the fumes from kitchens in hotels, apartment houses and institutions where cooking is done on a large scale the method usually adopted consists of simply placing hoods over the ranges and con-

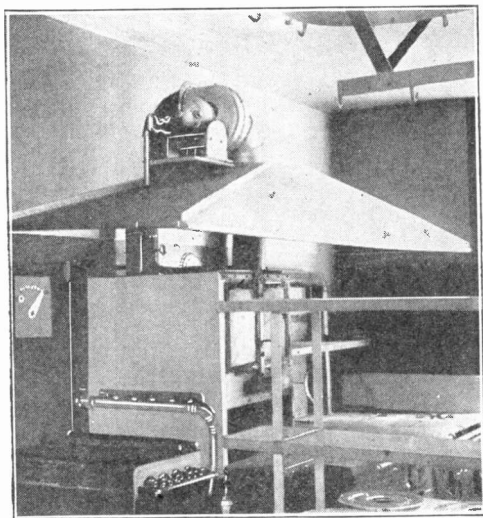

ELECTRIC KITCHEN VENTILATOR

necting the hoods to the chimney, in case the flue area is large enough, or into a separate pipe up through the roof with a ventilator on top. Such a system works fairly well when there is a good circulation of air outside but fails on a close, muggy day when kitchen ventilation and cooling are most desirable.

The most positive ventilation for an application of this kind is now readily secured by the installation of a electric utility blower, arranged in the manner shown in the photograph. It may be stated that this electric outfit is in the kitchen of the Lewis School for Stammerers at Detroit, Michigan. It was installed primarily to carry off the fumes from over the range, as the window next to the range is but a few feet away from a window in another building where the Lewis School holds some of its classes.

It was the original idea to carry away as much of the odor as possible so that it would not filter into the class rooms. The blower is handling about 400 cubic feet of air per minute and in doing this effects an air change in the kitchen once every six or

seven minutes, which provides good ventilation in addition to carrying away the odors. It is said that the hood is about six feet two inches from the floor with a rise of about two feet. A flattened area on the top is connected with the inlet pipe leading to the blower. The blower has an elbow on the outlet which is shoved up into the flue which deflects the course of the air upward.

Rapid Hoisting With Electric Power

A novel electric equipment in service for rapid hoisting of steel cylinders is seen in the accompanying illustration. By means of one of the switches over the operator's head the load is sent up in a jiffy, while a pull on the other switch handle reverses the motor and brings the load down just as quickly. It will be seen that in both cases the motor is under perfect control and may be stopped, in either lifting or lowering, at any point desired. Wherever it stops it is automatically held until it is ready to be sent up or down.

This electric device while designed primarily for moderate service and short lifts

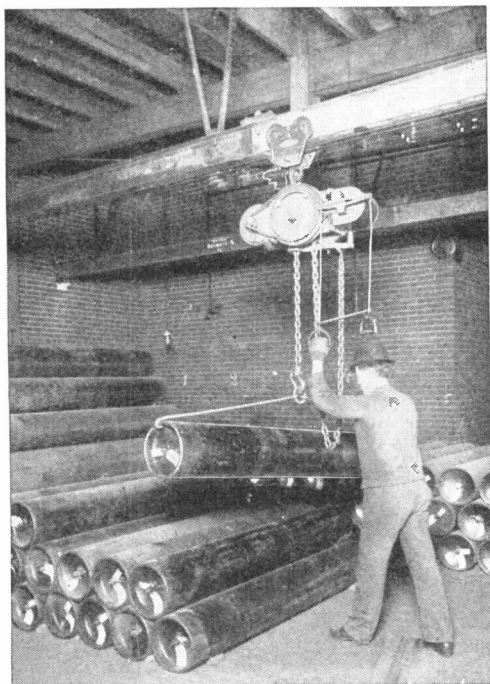

MOVING AND PILING STEEL CYLINDERS

has shown by a recent test that it will raise a one ton load, ten feet high and lower same 40 times within a period of two hours. It is held that this is harder service than the hoist should be required to stand.

Air Blowers of Tremendous Capacity

In making steel it is necessary to blow a powerful blast of air through the molten

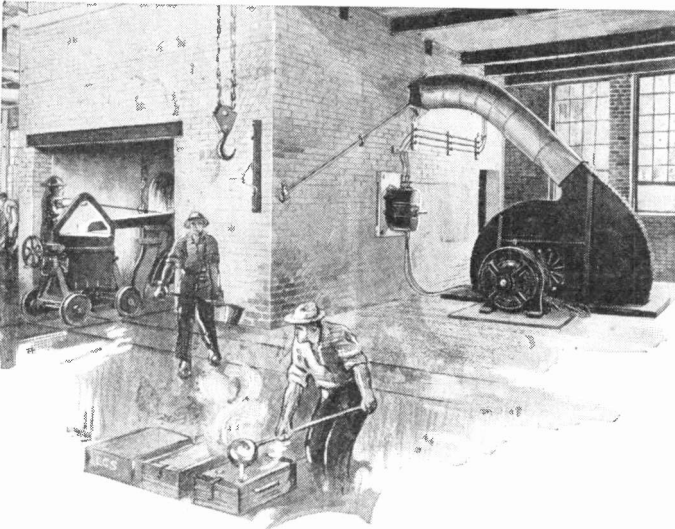

ELECTRIC BLOWER FOR A BLAST FURNACE

mass of metal which oxidizes and removes certain impurities. High pressure blowers for this purpose are now operated electrically. Also, in producing forced combustion in a cupola or oil furnace air under high pressure is necessary and is supplied by similar means.

In the two illustrations interesting examples of these blower outfits are shown. One shows a blower used in connection with a blast furnace cupola. At the left in this picture the molten metal is being drawn off preparatory to being poured into the molds as shown in the foreground.

The second illustration shows a type of oil furnace used in steel making. To

increase the rapidity of combustion an electric driven blower is employed which supplies air under pressure to the large pipe running the full length of the battery of furnaces. Smaller pipes tap this main feeder and carry the air down to the oil burners in each individual furnace.

Another application of the blowers is in the blowing of scale from dies in machine shops. This is accomplished with air under a pressure of from twelve to fourteen

ounces per square inch, and on exceptionally deep die work even higher than this. An electric scale blowing rig has been installed in the Packard Motor Car works by which air is forced through the blowing nozzles at the rate of 24,000 feet or about $4\frac{1}{2}$ miles per minute. A 50 horsepower motor is required to operate it.

No "Four" in Japanese Telephone Directory

Were you to call for a number over a Japanese telephone you would miss the number "four," "double-four" or any of its combinations. This word "four" is "shi" in Japanese, signifying death and its use is therefore carefully avoided.

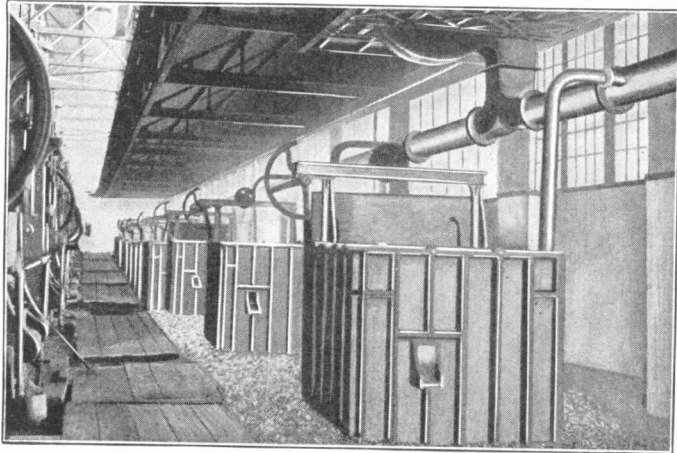

BLOWING SYSTEM FOR OIL FURNACES

Electric Freight Trucks

At Pier No. 6 of the Erie railroad, in Jersey City, electric trucks have practically

With the end gate lowered the length is ten feet two inches. The height is 20 inches and the gauge 36 inches. It may be operated up to a speed of ten miles an hour and is so constructed that it may be driven

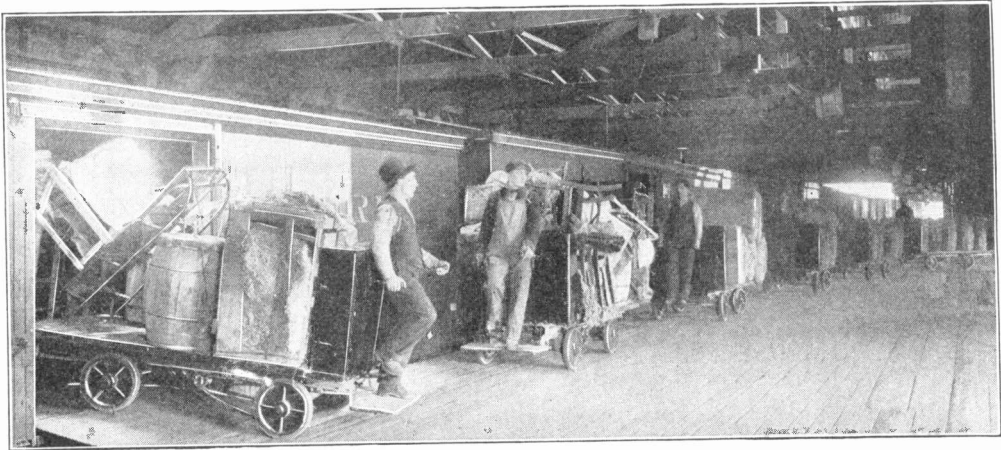

ELECTRIC FREIGHT TRUCKS IN OPERATION

done away with hand trucks for unloading freight trains. The picture shows a long line of these electric roustabouts.

The operation of the truck is a simple matter and it may be operated with equal efficiency forward or back by a porter or unskilled laborer. The truck is easily controlled and may be readily turned in a very small space. The power for operating is supplied by storage batteries in a steel receptacle.

Each truck has a loading space 42 inches wide and seven feet one inch long.

directly into a freight car, turned to either extreme end, loaded or unloaded, and reversed to the platform, thus reducing the handling to a minimum. Two thousand to 4000 pounds is a load.

Unloading River Boats

Ocean steamers come right up to docks although they draw as much as 40 feet of water. River steamers which do not draw over eight feet are not so fortunate, especially on the Mississippi which is in

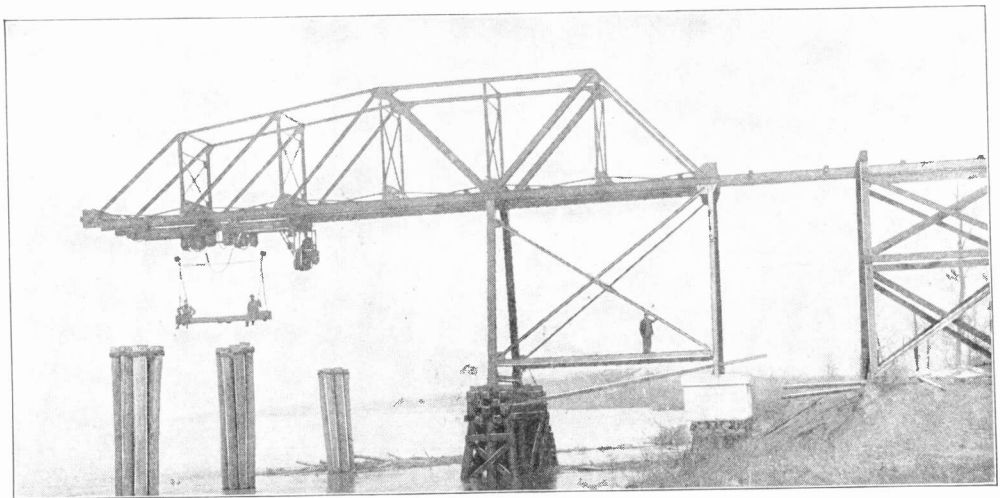

CRANE FOR UNLOADING RIVER BOATS

most places shallow near the shore. Of course, deep waterways could be dredged out but the river carries such a load of silt that the services of the dredge would be continuously in demand at many places.

The old way of loading river steamers was to run the prow into the mud and stretch long planks to shore. A huge mob of negro stevedores then moved the freight aboard by main strength. This required some time and a vast amount of labor. The modern electrical engineer has devised a much better way. It is called an electric telfer plant, "telfer" being the technical term for the work of transferring freight from boats to shore or vice versa.

The plant consists simply of an overhead track projecting out over the water. On this track runs an electric motor car which picks up the freight from the deck of the steamer and deposits it on freight cars on shore. The car gets its power from trolley wires and is provided with separate motors for hoisting and propulsion. It can handle 200 bales of cotton per hour.

It is related of an English scientist who was complimented on his learning, that he retorted: "I haven't got past the first page in the book of electricity."

Street Railway Concrete Mixer

The accompanying picture shows a big concrete mixer used by the Denver Tramway Company in repairing or building new

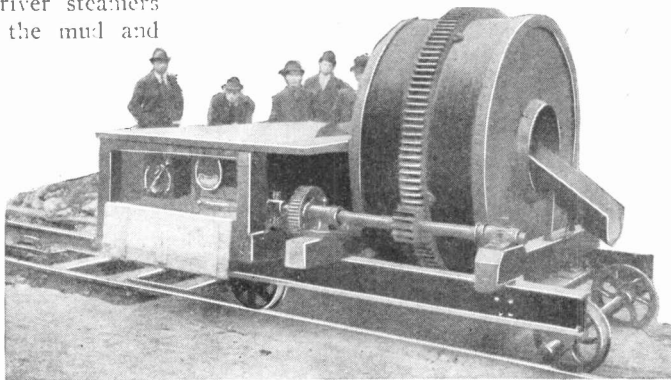

STREET RAILWAY CONCRETE MIXER

tracks. Under the platform a ten horsepower motor turns the shaft which revolves the drum, and delivers mixed concrete from the spout at the rate of ten cubic yards per hour. Sand, cement, etc., are shoveled upon the platform, thence into the turning drum, while a man with a hose keeps a proper amount of water on the mixing mass. Current is taken from the trolley through an insulated cable terminating in a hook and wooden conduit at the trolley end.

An All-Electric Bakery

Every 24 hours 40,000 loaves of bread are turned out by this electric bakery. All the machinery is driven by electricity. There are three barrel dough mixers, together with a flour lifter and conveyor, all grouped on a five horsepower motor. Then there are a dough divider, egg beater, loaf moulder, cake machine and a 700 loaf revolving oven, the latter electrically heated.

This interesting plant is in Muskogee, Okla., and the current for its operation is furnished by the Muskogee Gas and Electric Company.

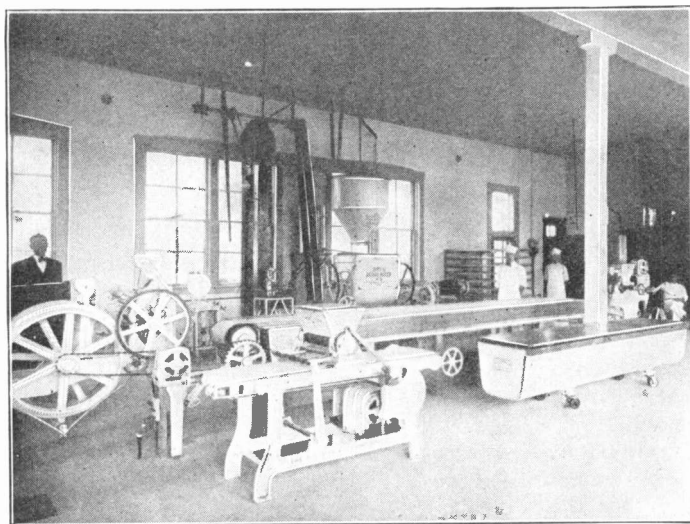

IN THE ALL-ELECTRIC BAKERY

Flowing Water in Any Home

One of the inconveniences of country and suburban life is the lack of flowing water in the house. Electricity, however, has come to the rescue making possible city and

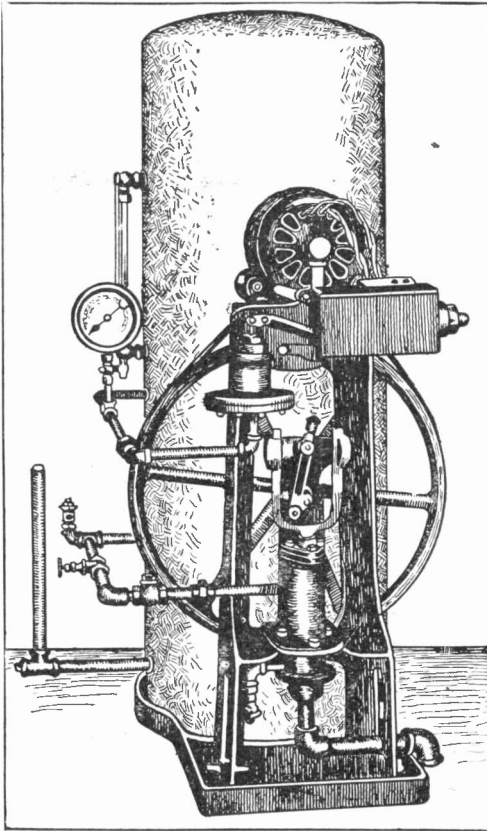

SANITARY WATER LIFT

town conveniences in the matter of water on each floor and a bathroom and kitchen supply.

By attaching the Dayton sanitary water lift to the water piping of the house and connecting to a well, spring, lake or other source of supply, water under pressure may be had at small cost. In fact at ten cents per kilowatt hour the average cost of pumping 1000 gallons of water is nine cents. The outfit consists of a small electric motor, pump, water tank and an automatic switch which is operated by pressure. When the pressure in the tank falls to 20 pounds the switch closes the circuit and starts the

motor which continues to run until the pressure reaches 35 pounds when the switch opens the circuit.

Equipped with either an alternating or a direct current motor, a tank of suitable size to meet requirements and compactly set on an iron frame the outfit is readily installed and self-regulating.

Hot Coffee By Electricity

No more cold coffee in the dinner pail for the mechanic who has electric lights in his shop, for as the photograph shows, a small electric heater will heat it for him in a jiffy. It consists of a three-inch cylinder of polished and nickel plated metal, an insulated wire of any desired length and an ordinary plug that will fit the standard socket. By merely screwing the plug into

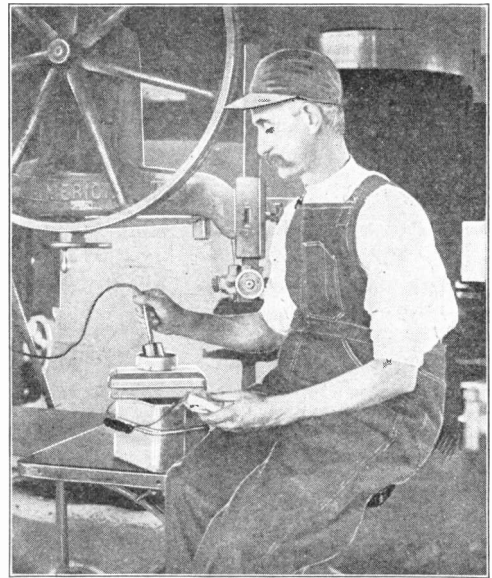

A CUP OF COFFEE HEATED IN A MINUTE

the socket, immersing the heater in his cold coffee and turning on the switch, the workman can have a hot drink with his cold lunch. Of course, he can take it home nights and use it to heat water for a wash and shave, or lend it to his wife to warm the baby's milk, but that is another story. There are countless times when one needs hot water in a hurry, and this little heater seems to fill the bill.

Electrical Men of the Times

NORMAN MACBETH

Ever since the electric light was first invented men have been working and scheming and experimenting to devise more efficient lamps. "More candle power for less watts" has been the slogan. Of late years, too, there have been made great advancements in the methods of placing lights, the use of scientific reflectors and reflecting surfaces, the proper distribution of light, etc. These things have all led to the development of a special kind of engineer—we call him the illuminating engineer.

There is much that is theoretical and technical and much that requires good horse sense in this comparatively new profession of illuminating engineering. One of the men who has been able to combine very intelligently the theory and the practice is Mr. Norman Macbeth, one of the foremost young engineers in this line work, and he now holds the responsible position of illuminating engineer of the Westinghouse companies.

Mr. Macbeth was born in Stayner, Ontario, Can., in 1873. The early part of his professional career was in the gas and electric lighting field, especially in that end of the business which brought him in contact with the consumer, and it was here that he became interested in the problems which have to do with giving the people the best light and the most light for the least money. In 1908 he engineered, in Philadelphia, the first complete installation of inverted gas lamps to be designed in strict accordance with illuminating engineering principles. After that his services were sought by the makers of Welsbach mantles and in two years' time he had established for them a

well equipped department of illuminating engineering as applied to gas lighting.

But there was a greater call in the field of electricity. When the decreased cost of

electricity, owing to the development of the tungsten lamp, opened up to the central stations a broader field, before served by gas, the importance to electric lighting interests in general of having in the electric field illuminating engineers equally familiar with gas and electric illumination was readily apparent. The great electrical company by which Mr. Macbeth is now employed saw the need of such a man and simultaneously saw the man, so now the electrical industry claims him as one of its own.

If you follow the technical periodicals you will find that he is a frequent contributor. You will find that he was the first to work out the "flux polar diagram" for determining mean spherical candle power. You will find that he was the inventor of the Macbeth illuminating engineering calculator, known to every illuminating engineer and considered as useful to him in making calculations in illumination as is the regular slide rule to other engineers.

Mr. Macbeth is a member of both the American and British Illuminating Engineering Societies; the Franklin Institute; the National Electric Light Association; the National Commercial Gas Association, and the American Association for the Conservation of Vision. He was also one of the lecturers in the Johns-Hopkins University course in illuminating engineering given under the auspices of the Illuminating Engineering Society.





Electricity in the Household



Where Art and Science Meet

By T. VERNETTE MORSE

Modern lighting has changed the entire working capacity of the world by turning darkness into daylight. It has solved many of the problems of the city builder. When an accident occurs to the electric plant, half of the city is in darkness.

In the art field it is an invaluable adjunct to the art gallery. Stained glass which was formerly wholly dependent upon sunlight for its marvelous brilliancy is now carefully designed for artificial lighting.

Many of the beautiful brilliantly lighted dining rooms in large hotels where the glow of delicate color combines with harmonious furnishings, giving comfort and warmth to everything, are simply lined with false windows that are wholly dependent for their beauty upon the row of electric lights placed back of them. Such a room has the effect of perfect sunshine, although it may not contain a single outside window. Invisible ventilators, also, are so arranged that they are constantly introducing fresh air and oxygen. You may enter such a dining room as this in almost any city, be served with elegant refreshments and leave without realizing that the light and atmosphere have not been furnished by Nature.

Similarly, a great deal of study may be put upon the matter of lighting the home. Here, too, plenty of light without glare should be the effect aimed at.

At night stained glass windows have no decorative quality except to the passerby, but by carefully considering the subject, colored lamp shades may be selected that will not only soften the interior lighting but bring out its best qualities, both from the utility and decorative standpoint.

After a hard day's work the eyes as well as the mind crave a rest. A great glare of brilliant light is never restful.

The first purpose of the artificial light is that we may see without effort and without strain of the eye, consequently all living rooms should have the effect of shaded sunlight.

There is no more perfect light for any purpose than that produced by the shadow of a large tree on a sunny day. The soft green tones of the surroundings are harmonious and restful, but purchasers of green lamp shades should remember that foliage is not transparent, and the effect is vastly different from the ghastly green light transmitted through green glass.

A lamp shade occupies two distinct functions in home utility and decoration. It should be selected with the greatest of care. The glass shade that looks well by day in the shop, is frequently a perfect eyesore when placed in the home. The reason for this is that glass depends wholly for its effect upon the light beneath, and the shade that is designed for gas should not be used for electricity.

This question has received so much attention from artists like John Lafarge and Tiffany that there is no excuse for inartistic combinations in art glass. Unfortunately, however, the market is still ruled too largely by commercialism and it is very easily possible to buy a monstrosity unless one is a student of art and can discern the difference.

Color affects the eye in precisely the same manner that sounds affect the ear. Gay colors like gay sounds produce a feeling

of exhilaration and activity; deep heavy colors are masterful and stern, with their accompanying dignity; the tints and tones are soothing and restful like a sweet melody. The truly poetic artist appreciating this, handles his colors accordingly and the result is symphonies in color.

The sentiment of color is but little understood. Only the master hand is capable of selecting the tones, hues and degrees of color that harmonize with his subject and its surroundings.

The positive colors are pure red, yellow and blue, but in really good pictures there



ELIZABETHAN DESIGN

is very little positive or pure color. The colors of the most brilliant paintings (there is a vast difference between brilliancy and gaudiness) are more or less subdued. Good pictures are never glaring.

The simple dome, the square and the cube forms of modern lamp shades lend themselves admirably to decorative colorings, and the artist will produce designs in color that are veritable flowers. In the best of these the colors flow into each other without a discordant note.

Positive or forceful colors should only be used with dim lighting. The clear brilliancy of the electric light gives them a

crude effect that is far from pleasing to good taste.

Colored glass is one of the most fascinating materials in which to work. The design being absolutely dependent upon the effect of the various lights on transparent color, the artist first selects his subject or design and then adjusts the light in such a manner that it will express the vibration of color as well as its harmony, carefully combining the different shades that will blend in perfect harmony either by way of contrast or unity.

If all glass lamp shades were designed in this manner there would be no opportunity for making a mistake in the selection of a shade, but unfortunately they are not. Too many of the shades upon the market are designed and made merely to sell, and as a rule they are sold in broad daylight.



COLONIAL DESIGN

The color scheme that is attractive by daylight is usually crude when lighted at night, and the result is far from satisfactory.

When people learn to select really good things in house furnishings of any kind, there will be no inferior articles upon the market for manufacturers will not produce wares that are not salable.

In the meantime people of good taste—being in the minority—must insist upon artistic combinations in color as well as form,

for it is color that rules the decorative scheme of the home.

A careful inspection of the shops brings to light surprisingly few good examples, that really conformed both in design and color to the canons of art.

In shapes the best are domes with designs suitable to that style. The dome is a conventional floral form, that takes readily to floral coloring. The variety of color that may be introduced into the dome is quite remarkable providing tertiary tones are used.

The Colonial shape is also a form which may be enriched with a great play of artistic sentiment when given plenty of breadth.

The square form being more severe requires a dignified handling suggestive of geometric forms. The Elizabethan or six sided with its direct paneled effect gives great scope for the artist's ability.

Manufacturers for the sake of variety are given to using designs that are made for specific colors for an entire line of shade: in different combinations of color, and the result is similar to crazy patchwork which the women of taste soon learned to subdue beneath a lace covering.

In purchasing shades never select one until it has been illuminated by the same light you wish to use, and make sure that the sales room is sufficiently dark to show the colors perfectly.

Select it first of all for its general effect and breadth of harmonious coloring. If the color values are true with plenty of browns, soft yellows, grey greens, and blues, it is usually a safe investment, but if the colors are sharp and crude, pass them by for in time they will become tiresome, and unwholesome to the color sense.

Unique and odd shapes are usually a very poor investment and should be avoided. Yellow and its accompanying tones give a warm light, blues and greys are cool. Complete shades of blue or green tones are most unsatisfactory, green sends forth a ghastly light, and woe be to the man or woman who selects them, but when carefully combined with amber, yellow greens have a most charming effect.

In small detail effects dark colors combine perfectly with light glass. If the color furnishings of the room call for green during the day, a certain touch may be given

to the amber which now comes in such a variety of shades that it is almost indescribable.

The expense of glass lamp shades will be reduced at least half when the public has learned to select and demand only that which is good in form and artistic in coloring.

Lamps in a room are like gems in a wardrobe, they may flash and gleam with the light of vulgarity or they may express so thoroughly the culture, refinement and proper adornment of the home as to become a befitting adjunct to the good taste and expression of a family.

Art education is slowly but surely dominating the manufacturing interests of the country. It is their only salvation in these days of sharp competition with foreign countries.

Every good article that goes into the home helps to further the demand for something still better.

There was a time when the taste was created by a desire for the most expensive surroundings that money could produce, but a desire for artistic education has taken possession of the people and sooner or later it will turn the current of good taste toward the uplift of the people through the necessities of life, and make better the things we are obliged to live with.

Artistic Display of Household Devices

The effectiveness of a show window display depends among other things upon the artistic and unusual, also upon the close relation the things exhibited bear to real life. The passer-by has all these points impressed upon him in observing the show windows of the Electric Shop, Michigan Avenue and Jackson Boulevard, Chicago, a home of "things electrical."

As if transported suddenly to the land of the Lilliputians, one sees a miniature laundry presided over by two life-like wax figures—little women with hair and dress perfectly arranged as to every detail. One little lady smiles over a perfect miniature working model of an electrically driven washing machine and assures the on-looker beyond the shadow of a doubt of the ease of doing the washing the "electric way,"

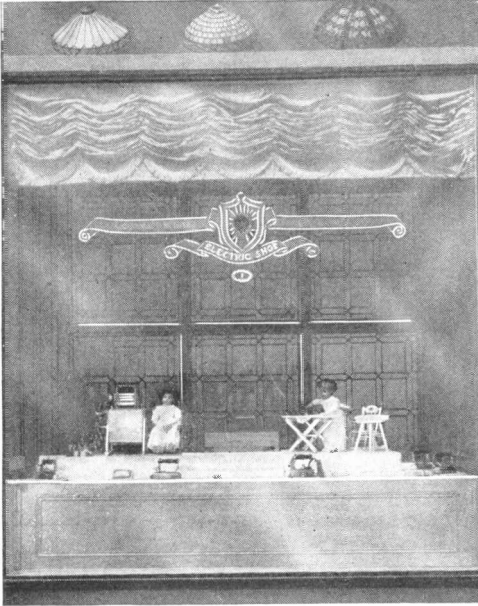

DISPLAYED IN MINIATURE

for in her lap is a tiny magazine. Ironing day is shown to be quite as easy and cool a task by another little housewife doing the pressing with an electric iron.

The observer thus attracted invariably carries his observation further to the adjoining window where a full sized washing machine may be seen surrounded by instantaneous water heaters, chafing dishes, coffee percolators, etc. Such a display may make

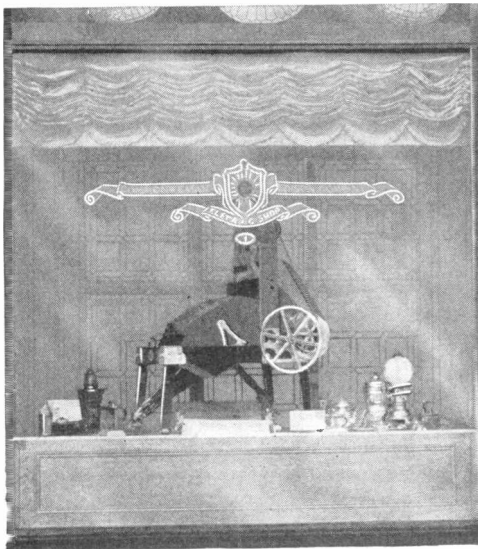

THE REAL THING

the observer an immediate customer, and if not, at least a future patron when such devices are required.

A German Woman in Her Home

It is generally conceded that in Germany women believe that being a good housekeeper and economically and efficiently directing the affairs of the home represents the highest plane for their activities. In view of reputation which the German woman has for thrift and careful management, especially in the kitchen, it is inter-



GENERAL UTILITY MOTOR IN A GERMAN KITCHEN

esting to see how one of them directs her efforts in the domain which is exclusively hers.

The picture (by courtesy of the Berlin Electrical Works) shows the corner of a German kitchen and an application of a form of small household motor somewhat similar to the types which are becoming so popular here. In this case it is attached to a bread slicing machine. It is equally applicable, however, to pitting cherries, grinding coffee, paring apples, cutting meat, etc., where the necessary attachments are available.

Convenience the Slogan of the Modern Woman

An old lady of the pioneer days up in the woods of Michigan used to ride in a rattling one-horse wagon to town or across the country to some neighbors. Outspoken and honest, she had one hobby which she never failed to expose to friend or stranger alike. On the farms, particularly in the newly settled country, she always com-

business methods in every possible way and some of their appliances have been adapted to the economical and convenient running of a home.

As an example, it is quite possible, according to the *Edison Monthly*, that the original application of the vacuum-cleaning idea was in saw and planing mills, where piping fitted with a large exhaust fan opens to the outside of the building while pipe openings close to the floor are distributed



HOUSE PIPED FOR VACUUM CLEANING

pared the size and appearance of the house with that of the barn. A small house and a large well-built barn meant to her a story of few conveniences for the housewife and without further investigation the "man of the house" was branded accordingly and vice versa. Without doubt, the old lady was pretty nearly right.

In modern days, however, while external appearances tell some things, more than an exterior examination of a house is necessary to determine how many labor-saving devices are within.

Men have been careful to modernize their

about. Shavings and sawdust are swept underneath these openings and drawn up by air suction and deposited outside. The appropriation of the idea, therefore, to the modern house by installing a stationary vacuum cleaning plant in the basement, with a stand-pipe going up through the building with outlets at different floors where convenience dictates is in a way an adaptation of the sawmill system on a more perfect scale.

The portable portion of the outfit consists of a metal tool and sufficient hose to reach the corners. Convenience is also met

by having ordinary snap switches installed on all floors to start or stop the motor for producing the vacuum, and without trouble as to the disposition of the dust and dirt the cleaning is easily accomplished. By opening a drawer in the part of the outfit in the basement the sweepings are removed as easily as you empty ashes from the furnace.

The Latest in Washing Machines

Simplifying the construction of the washing machine, so that the most inexperienced servant can run it without constant supervision, has been the problem before manufacturers ever since the electric began to supplant the hand operated machines. How well they have succeeded everyone knows who has had occasion to inspect some of

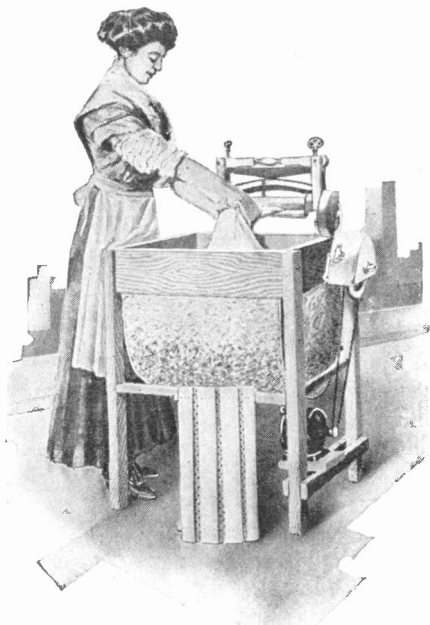

WASHING MACHINE AND WRINGER DRIVEN BY ONE MOTOR

these apparently almost perfect labor-saving devices.

Simply applying a motor to the machine is not a difficult task to any designer, but there are quite a number of details which must not be overlooked. For instance, the motor and its connections must be as nearly waterproof as possible, the transmission mechanism must be without complication,

the arrangement of parts must be such that no oil or grease can get on the clothes, it must be easy to start, easy to stop and without mystifying levers and switches, for the ordinary servant is no electrician. Above all, it must *wash* quickly and thoroughly

The New King washer, a cylinder machine, fulfills these requirements.

The clothes are washed by tumbling them around within the cylinder, which is revolved inside a metal tank filled with hot suds. The cylinder is driven by a motor and does not change its direction of rotation. Linen can be washed in ten minutes without damage to the finest fabrics. Blankets and heavy goods can be washed with equal success.

The transmission machinery consists of a belt and but one pulley, outside of the motor pulley, and one gear. By means of a simple lever the transmission gear can be thrown from washer to wringer, as desired. There is no raising or lowering of the cylinder to engage the gears, and when the transmission gear is in the wringing position the cylinder can be lifted out. All gears are

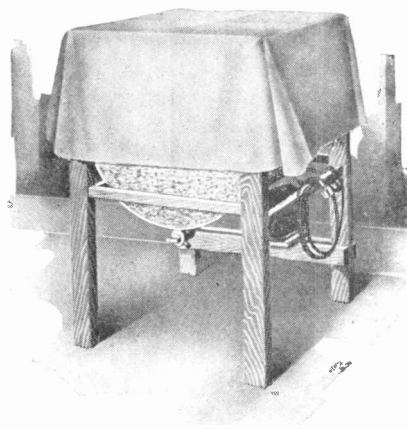

FORMS A TABLE WHEN NOT IN USE

completely protected so that accidents are impossible.

The wringer has ballbearings and is so arranged that the rolls are automatically thrown out of gear if they become stuffed; this arrangement prevents the motor from becoming overloaded. When not in use, the wringer can be dropped down at the side of the washer, and the machine then forms a convenient table and not an obstruction.

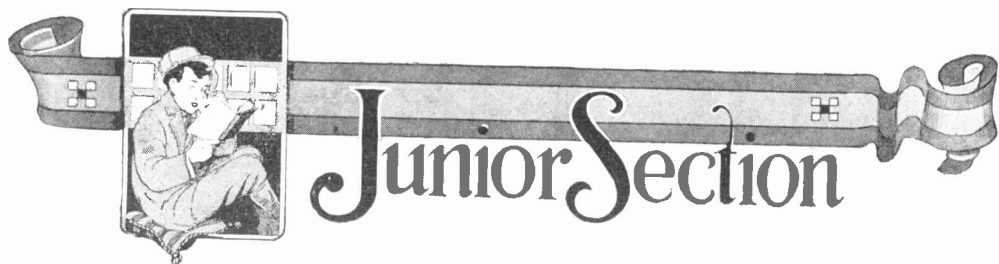

How to Make a Bell Ringing Transformer

By CHARLES F. FRAASA, JR.

Because dry batteries polarize and weaken after short periods of activity, and their short life makes frequent renewals necessary, there has long been a demand for an efficient substitute for the dry battery, which will compare favorably with it in price. The small bell ringing transformer, which is now very popular, has satisfied these demands in every respect: it will operate continuously for any length of time; does not weaken or deteriorate after one or more hours of use; and no renewals are necessary, as the life of the transformer is indefinite. Though there is a difference in first cost, the transformer saves enough in battery renewals to more than balance this difference in a short time.

The small transformer described in this

article is such that it will easily ring a four-inch bell, or light a ten volt, one-half ampere, four candlepower Tungsten sign lamp. A tap is also provided for obtaining a current of five volts, $\frac{1}{2}$ ampere.

The core of the transformer is made of

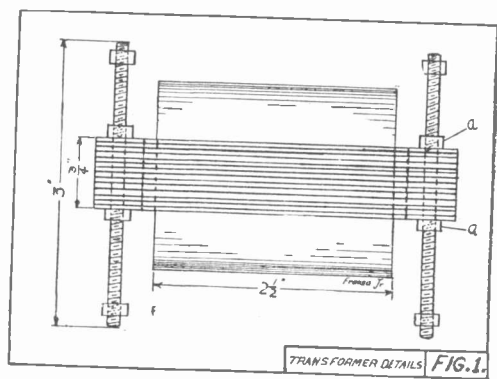

TRANSFORMER DETAILS FIG. 1.

article was designed primarily for use as a bell ringing transformer for 110 volt, alternating current, lighting circuit, but will be found to be very useful in the amateur experimenter's laboratory for ringing bells, operating buzzers, lighting small lamps, and for any other purpose in which a current not to exceed ten volts and one-half ampere is required. The capacity of

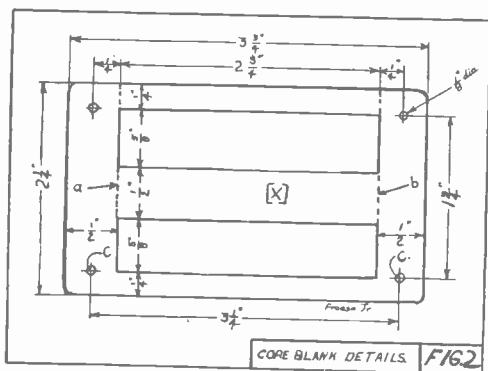

thin sheets of steel, cut to the shape and dimensions shown in Figs. 1 and 2. The core is cut from No. 27 sheet steel, which is about .0172 inch thick, of which there will be required about 44 pieces to make an actual thickness of $\frac{3}{4}$ inch. This sheet steel is obtainable at almost any tinshop, and a piece about eighteen inches square should be purchased, from which should be cut the required 44 pieces, each $2\frac{1}{4}$ inches wide by $3\frac{3}{4}$ inches long. Then clamp these sheets together and drill the four $\frac{1}{8}$ -inch holes (c) in the corners, Fig. 2. The windows in the core are cut $\frac{5}{8}$ by $2\frac{3}{4}$ inches. To cut these with a shear it is necessary to cut into the core, as indicated by the dotted line (a). Half of the sheets should be cut at (a), and the other half at (b), and when assembling them, these joints are to be staggered. Cutting the

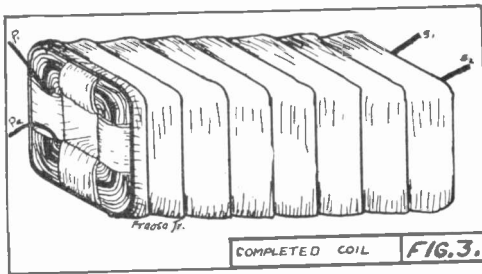

core open in this way makes it possible to cut out the windows with a shear, and to assemble the core in a form wound coil.

Fig. 4 shows the method of winding the coil, which is shown in Fig. 3. Cut a block of wood (a), $\frac{1}{2}$ by $\frac{3}{4}$ by 4 inches, and mount it so that it can be rotated. Wrap on this block about ten layers of

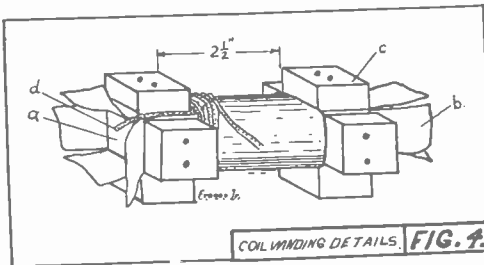

heavy wrapping paper four inches wide. Then put a strip of oiled muslin or tape (b) about five inches long on each side of the block, and fasten the four blocks (c) on each end of the block (a), one on each face, leaving a space of $2\frac{1}{2}$ inches between them.

In the space between the blocks (c) wind on two layers of shellaced bond paper, and then four layers of oiled muslin. On this wind evenly and in layers, 3,124 turns of No. 34 enamel covered magnet wire, winding a layer of oiled muslin between every three or four layers of the wire.

When the primary winding is completed, wind on it four layers of oiled muslin, and wind the secondary of 284 turns of No. 24 enamel covered magnet wire, winding it evenly and in layers. When one-half the number of turns, or 142 turns are wound on, leave out a loop of wire about four inches long, for a five-volt tap. After completing each winding, test for grounds, and if a ground is found the faulty coil should be rewound. Then remove the end blocks (c), and pull the cloth ends (b) back over the coils from

both ends, drawing them tightly to the centre. Then wind on the whole coil a layer of friction tape, to hold the ends in place and protect the wire, and then remove the coil from the winding block. The coil will then appear as in Fig. 3. If the reader desires, the coil may then be dipped in shellac, or some other insulating varnish, and when dry may have a piece of book-binders' cloth wrapped around it.

The next step is to assemble the core in and around the coils. Bend the centre strip of the core (x) Fig. 2, back at right angles to the rest of the sheet, and put it in the coil; then bend the core sheet straight again. The next sheet should be put in from the other side so as to stagger the joints, continue this with the rest of the sheets until they are all assembled.

Cut and thread four $\frac{1}{8}$ -inch rods, each about three inches long, and mount the core of the transformer upon them between the two nuts (a) on each rod, as shown in Fig. 1. Turn these nuts on as tightly as possible.

The case, shown in Figs. 5 and 6 is made of No. 24 stove pipe or Russia iron, seamed together on an edging machine. You can have this made at any tinshop at a small expense. The two primary bind-

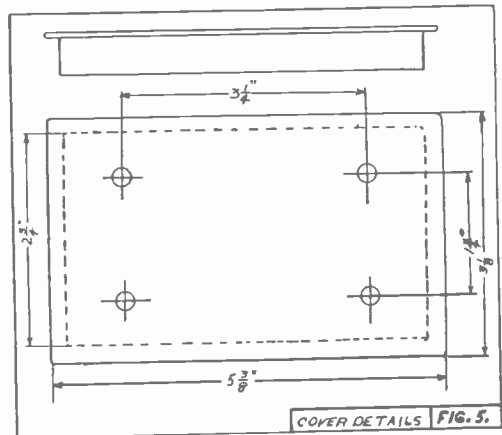

ing post holes in the one end, and the three secondary binding post holes in the other end, as well as the holes in the cover and in the bottom should be punched while the stock is still flat. The cover should fit the case proper as closely as possible.

The base lugs (a) Fig. 6, shown in detail in Fig. 7, should be cut from some $\frac{1}{8}$

or $\frac{3}{8}$ by $\frac{1}{2}$ -inch strip iron or brass and bent to the shape shown, and should have the slots (s) cut in the ends for the fastening screws, and the bolt holes (H) drilled in the top. The case and the lugs should be well enameled or japanned.

After screwing the nuts (b) Fig. 6 on the rods, put the transformer in the case and adjust to the proper height, and then, after placing the base lugs, Fig. 7, on the rods, screw on the bottom nuts (c). Procure five binding posts and carefully insulate each by placing a fibre washer (a) on the head, and wrap a small piece of tape (b) around the binding post as shown in Fig. 8. Then insert the binding posts in the holes in the ends of the transformer case with the heads to the inside. Put an insulating washer (c) over the part projecting from the case, and after making

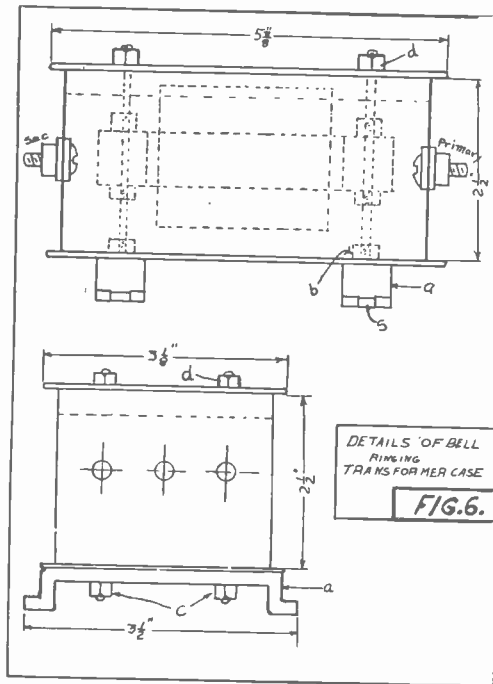

connections, screw on the thin nuts (d) to hold the binding posts tightly to the case. The two primary ends should be connected to the two primary binding posts and the two secondary ends to the first and third secondary binding posts, leaving the second for the secondary loop, which should be bared of insulation, and connected to it. The cover may now be put on, and tight-

ened in place by the nuts (d) Fig. 6. This completes the transformer.

A transformer made according to the above directions is very useful and efficient, and presents a finished and workmanlike appearance.

If carefully constructed, the transformer consumes practically no current while not

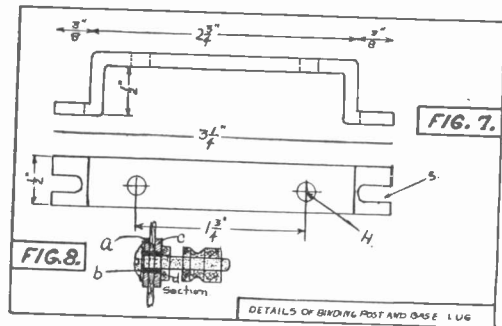

in operation, and may be left on the lines continuously.

The transformer should be connected to the lines in the same manner as dry batteries, using the same wiring and pushes, etc.

Are Hailstones Electrical Products?

Like many another commonplace article, the ordinary hailstone is really a complex object and one that has caused a great deal of speculation as to the way in which it is produced. The larger ones in particular are not masses of a uniform composition, but are usually composed of concentric layers of solid, transparent ice alternating with snow-white or soft ice, often with a clump of tightly pressed snow as the center.

Oftentimes these cloud missiles attain to sizes which result in a dangerous and devastating bombardment. For instance, the accompanying picture of a hailstone was taken by W. Harvey Merwin, one of the readers of POPULAR ELECTRICITY in Milan, Italy. He writes that hailstones of this size or larger averaged one in every square yard of street surface after the storm. The particular one shown had a diameter of nearly three-quarters of an inch. It contained a solid center of ice and a thin shell of snow.

The common supposition has been that these hailstones were carried down by gravity and whirling winds so as to strike

colder and warmer regions of air alternately and thus add the successive layers of soft and of hard material. This explanation sounds plausible enough, but does not account for the jaggedness of some of the layers which show numerous pointed projections or peaks.

Can this formation of irregular peaks on the successive surfaces of the hailstones be due to electrical causes, since hailstones are always accompanied by a considerable display of lightning and thunder? Such a novel explanation is offered by Dr. Alfred Schmidmayer who bases his deductions on some quite simple experiments. If we moisten a metal knob, the resulting drop of water will hang on the knob and as it increases in size it will form a rounded point like the tip of a dull pencil. Now if

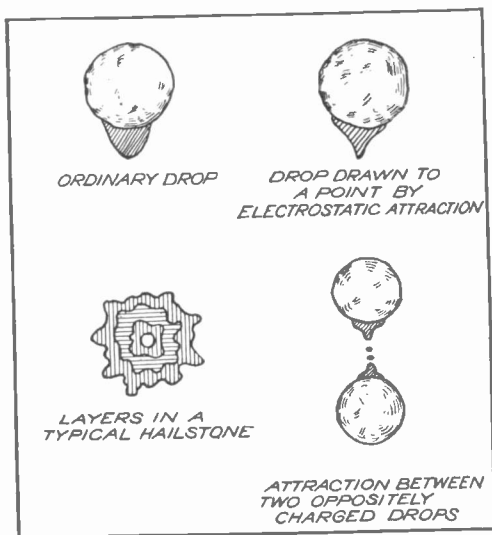

HOW HAILSTONES MIGHT BE FORMED ELECTRICALLY

we bring an electrically charged object near this drop to attract it, the drop will change to a much more sharply pointed or peaked shape. So also, if we give opposite electrical charges to two metal balls (as by making them the terminals of a static machine), each ball having a drop of water on it, these drops will attract each other and finally some droplets will pass from one to the other.

Now it seems to be a well established fact that at least part of the clouds present during a hailstorm, or just before the same are strongly charged electrically. Then

if a snow kernel falling from the higher cloud regions passes through such a highly charged cloud, it will gather a film of moisture on it and this will be attracted by the charged drops which it passes so that points will be formed on it which will freeze in passing through the colder air. Another gathering of moisture from cloud

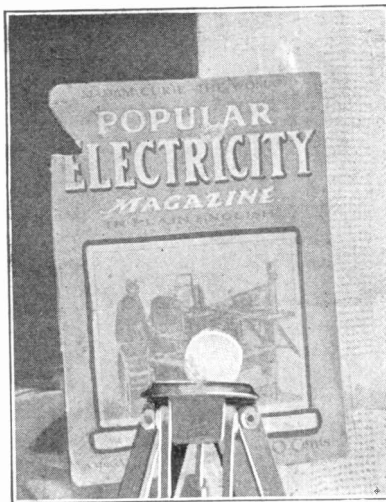

LARGE HAILSTONE WHICH FELL DURING A STORM IN MILAN, ITALY

particles, a repeated pointing of this wet film by the attraction of the charged particles which it is passing and we have added another irregular layer. In this way the attraction due to the static charges in the clouds below those in which the snowy kernel of the hailstone is formed, may account for the composite hailstone as we know it and if this theory should be generally accepted we will have to count the hailstone as one of Nature's electrical products.

Electricity Driven Submarine Model

A ten foot model of a new type of submarine boat has been operated with great success in Balboa Bay, not far from Los Angeles, California, and high speed has been attained by its electrically driven propellers. They are located near the prow, instead of at the stern, and are enclosed in metal sleeves, or tubes, through which the water is forced with such power as to send the boat forward, while submerged, at a 20 knot clip. One photograph shows

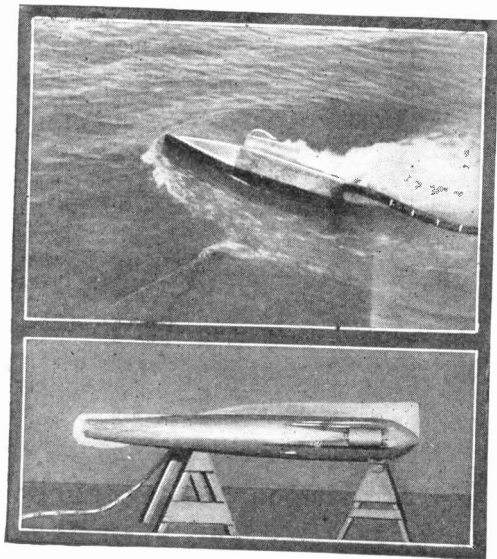

ELECTRIC SUBMARINE

the model emerging from the water, and as it is slightly tilted only one of the propeller tubes is visible. The electric cable is also shown behind the propeller, this being used to transmit the energy from a dynamo on the following motor boat to the electric motor within the model. Of course, on the full size boat now being built, the power will be generated within the vessel. Speed, safety and ease of operation are claimed for this new craft by its inventor, who has produced something radically different from the submarine now in use.

Electrical Home for Canaries

Electric lights and bells, elevators, water on tap, and an automatic feeding device form part of the equipment of "Hotel Canary," a luxurious bird house which it took five years to build. It was the hobby to which Mr. Arthur Dunning, of Berlin, devoted himself during his spare time from the year 1906, and it has just recently received its finishing touches. The tower is lighted with incandes-

cent bulbs, operated by a battery in the "machine room" down-stairs. A winter garden with diminutive plants and fountains and rooms for 22 guests should make it famous in the feathered world. The "hotel" stands 51 inches high, has a front of 75 inches and a depth of 15 inches.

Making a Galvanometer

An instrument for detecting and also for measuring small currents may be readily made by the amateur who has a few carpenter tools at his disposal.

Provide a substantial wooden base (A) dimensioned as shown. In this base one inch from the edge and equidistant from the edges (H H) drill a $\frac{3}{8}$ -inch hole. In the hole fit a round standard of wood (B) $\frac{3}{8}$ -inch in diameter and eight inches long, gluing firmly in place. Take an electro-magnet (C), one off an old electric bell will serve the purpose, and fasten it firmly to the base two inches away from the upright piece (B). If the magnet has a screw hole in the end of the core this is an easy task; simply bore a small hole in the base and insert the screw and fasten the magnet to the wooden base. If the magnet has a rivet in the end, rivet it to a piece of sheet iron and screw this latter to the base. Select two corners of the base which will be suitable for binding posts (D) and bore small holes and put the binding posts in. Then connect

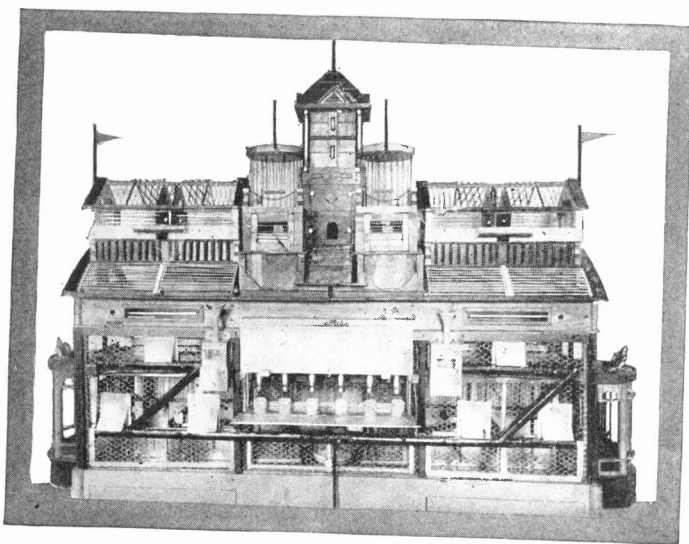

ELECTRIC HOME FOR CANARIES

the wires from the electro-magnet one to each binding post.

In two pieces of wood (E) cut $\frac{3}{8}$ -inch grooves (F), and in each of these bore holes (G) to fit a battery screw. These pieces are to serve as a clamp.

Procure a small piece of cork and stick a sewing needle (H) into it and by testing in water get it so that the needle goes to the bottom very slowly. Now take the sewing needle and magnetize it by rubbing it on a permanent magnet. Put the cork in boiling paraffine for a minute to prevent it from becoming water-logged when it is put into water, and then after taking out stick the needle back into the cork.

Next take a piece of glass tube $1\frac{3}{8}$ -inch in diameter and six inches long and seal one end up tightly with a cork and some good sealing wax. By means of the clamps set the tube upright with the sealed end resting on the top of the electro-magnet. Fill the tube with good clear water and put the needle and cork into it, letting it go to the bottom. Now put the current on the terminals of the electro-magnet, and if the needle does not move reverse the wires. If directions have been followed carefully the

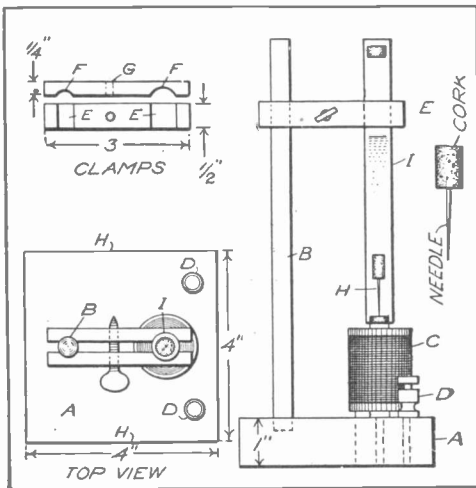

DETAILS OF GALVANOMETER

needle should rise to a certain height for a given current and remain there until the circuit is broken, when it will fall again.

With a little patience the instrument can be made very sensitive, and if the maker cares to construct a scale for it, it will be a fairly accurate meter. F. J. MORROW.

This Electrolier is Unique

There is not, probably, in all the world another electrolier like the one in a certain tabernacle in Los Angeles. This electrolier is formed of the discarded crutches, walking sticks and pipes of people who are said to have been cured of their infirmities and bad habits in this institution. They were

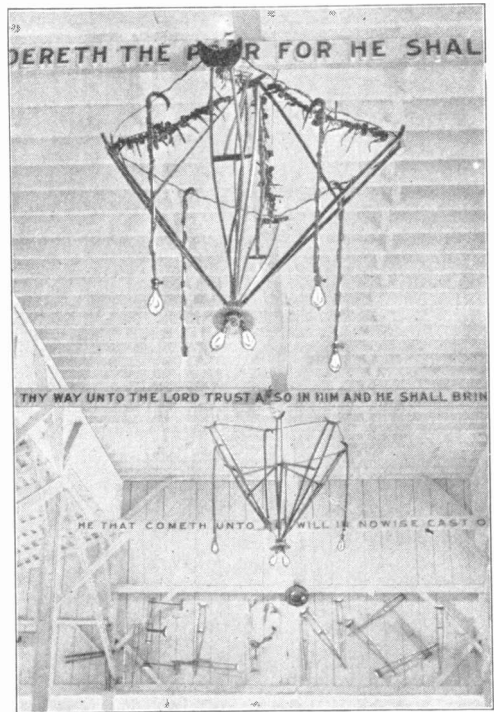

ELECTROLIER MADE OF CRUTCHES AND CANES

left at the institution by the grateful former victims, and the evangelists who preach the doctrine of healing by faith made these relics into the two unique electroliers shown in the picture. They were wired together into a symmetrical design and hung from the rafters, incandescent bulbs being attached to the ends of several of the canes and crutches.

The first furnace to be installed in Southern Russia for making electric steel has recently been completed and put in operation at Makievka. It is of the Hérault type and has a capacity of between three and four tons.

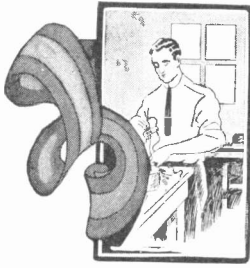

For Practical Electrical Workers

The Mutilator of the Morse Code

By FRANK M. EWING

There is nothing in this world more exasperating or nerve racking than for a train dispatcher or an operator to struggle along, quite frequently under difficulties, trying to receive from a mutilator of the Morse telegraph alphabet. When the quality of Morse is good it is a great pleasure to work and an experienced operator can answer questions or carry on a conversation while he is receiving without any discomfort. If the sending is mutilated then the mechanism of the ear thus combines the functions of both separator and transformer, while almost every nerve is strained in order to properly translate the mutilations.

There is really no excuse for operators remaining in ignorance of their defects provided they are open to conviction. The bad senders endeavor to back up their claim of good Morse by mentioning one or two operators "who receive from them all day without breaking," not taking into consideration the fact that those patient and good-natured victims evidently familiarized themselves with their combinations and put down what they mean instead of what they send. The various characteristics of bad sending noticed are as numerous as those existing between the different styles of chirography or conversation of different people. The peculiarity of their sending lies in the lengthening of the first or last dot of a spaced letter, running the spaced dot letters together, dropping dots off some of the letters, running some letters of words together and spacing the others, making different combinations out of them and not allowing the proper interval of time for the letter and the spaces. Thus R sounds like "Ti," C like "It," figure 3 like "V," the

word coat like "Is at," "them" like "Thw," Emporium like "Wposium," Harrisburg like "Hasspburg," etc., and almost every word transmitted must be figured out by the receiver by making due allowance for the mutilation.

Accurate sending is more desirable than high speed. It is well to remember that operators are no judge of their own Morse, and therefore should not try to see how fast they can send until they have had considerable experience. Who has ever heard a mutilator admit that his sending is poor? Now and then one may concede that his speed is below par, but as to the quality of his Morse, there can be no question, the fault is always with the receiver.

Some entertain the erroneous idea that firm transmission of the alphabet depends largely upon the pressure brought to bear on the key, and by pursuing that course do not allow the muscles of the fingers to fully relax between the formation of one dash or dot and another. The result is that a dot is lengthened into a short dash. The custom of timing for ascertaining the speed of sending should be very sparingly indulged in, for it is likely to produce careless habits.

The speed of sending should be graduated to suit the capacity of the receiver; the latter should never be crowded. Fast sending is seldom indulged in by strictly first-class operators, but fast time is made by them on account of their firm, steady, even gait.

Accept the average receiver's opinion regarding your sending before you decide for yourself that your sending is all right, for the poorest operators often think their sending is good. If the receiver tells you that

you do not space properly, or calls your attention to some particular fault, do not get angry, but take the hint, and try to remedy your weak points. There should be no difficulty in correcting one's faults, as a mutilated Morse character can be detected instantly by anyone who will listen carefully to his own sending.

It was thought that the introduction of automatic transmitting machines would put a ban on the bad sender, hence his future toleration depended upon reform or a machine. Experience has shown it simply divides mutilators into two distinct classes, those using the Morse key and those using transmitting machines. Statistics show if a person is a poor excuse handling one instrument, he rarely becomes an artist in handling another. Of machine sending there is this to say: The class employing an ordinary typewriter keyboard like the Yetman transmitter, will transmit perfectly formed Morse characters provided the disks are clean and the electric contact is good, and they enable some senders who have lost their grip to do good work. All that is required is to simply touch the characters and the machine transmits them over the wire; but if the disks are allowed to accumulate dust, or become rough, the signals will be light owing to high resistance, or drop out altogether. The machines operated by a side motion on an ordinary key (with the exception of some of the dot letters) require as many movements of the hand as does the Morse key.

Sending machines are so trying to receivers and so unsafe when not properly adjusted that the advisability of prohibiting their use is being seriously considered. Automatic sending devices are very often so adjusted that dots are made at the rate of 80 or 100 words a minute, while the actual speed made by the operator is only 30 or 40 words a minute. Everyone especially at repeating stations notices that the signals from sending machines are thin and drop out when not properly adjusted and manipulated. Sending operators always know when the dots are needlessly fast and they can add to the comfort of the receivers and help to make good signals by giving careful attention to the adjustment of their sending machines.

Better results might be obtained from sending machines if the tinkering process

were not applied to them. No machine on earth will hold up or withstand the onslaughts of a professional tinker who imagines he is thoroughly familiar with the mechanism of all kinds of machines. A great many machines of various types have been literally ruined in a short time in the hands of these artists. If a machine is properly adjusted and simply let alone it will last indefinitely, doing good work if proper care and judgment are exercised in handling it.

It is amusing to hear operators with one or two years' experience, comparatively young men in the point of years of service, with practically no sending worth speaking of during their assigned hours, say their arm is playing out and they must get a sending machine in order to save their arm from playing out entirely. The reason they want a sending machine is because it is something new, they want to try it out and experiment with it. There are a great many operators in the telegraph field who are troubled with a tired feeling and they will surround themselves with all kinds of utensils and devices in order to see how near they can get something to do their work without them making any effort to do it themselves. On the other hand we have men in the field who have done the heaviest kind of telegraphing for a period of 30 or 40 years transmitting the prettiest Morse you would wish to listen to with the ordinary Morse key; never complaining about their arm giving out nor expressing any desire to try an automatic sending machine.

The "go as you please" sender, for whom no apology can be made, is the product of pure carelessness or indifference. Quite frequently we see him in a telegraph office in a lounging attitude with his feet elevated on the table higher than his head while sending, simply tapping the key and making no effort to send perfectly formed Morse characters. When he is through sending he will sit upon the table with his feet upon his chair in order to accumulate as much dirt upon the chair as possible before using it to receive. When he is called to receive he will sit down upon the dirty chair, wrapping his legs around the top of his typewriter, which he imagines is a very graceful and easy position to receive in.

The "go as you please" sender is the operator who never sends two consecutive

words or sentences at the same rate of speed, or in the same style, and is never sure of a word until he hears the last letter completed and is then so surprised at his execution that he usually stumbles all over the word that follows.

The proper position for holding the key and the one adopted by the majority of the most speedy and perfect operators, is to rest the first and second fingers on the top and near the edge of the key button, with the thumb against the edge of the key button. Curve the first and the second fingers so as to form the quarter section of a circle. Avoid straightness or rigidity of these fingers and the thumb. Partly close the third and fourth fingers. Rest the elbow easily upon the table, allowing the wrist to be perfectly limber. When the proper "swing" is acquired, the forearm moves freely in conjunction with the wrist and fingers. The fingers and thumb should act as the end of a lever, the wrist and forearm doing the work. Let the grasp on the key be moderately firm, but not rigid. Grasping the button tightly will quickly tire the hand and destroy control of the key, causing what is termed telegraphers' cramp. Avoid too much force or too light a touch, and strive for a medium firm closing of the key in order to obtain uniform duration of the period of electric contact. It is not the heavy pressure of the key but the evenness of the stroke that constitutes good sending.

Telegraph repeaters can be adjusted for both light and heavy senders, but not for an uneven sender. A telegraph repeater adjusted for either a light or a heavy sender might be out of adjustment for a perfect sender. The motion should be directly up and down, avoiding all side pressure. Never, of course, allow the fingers or thumb to leave the key; that is, do not tap or strike the key with the fingers, or allow the elbow to leave the table. It is well to remember there are others working in the office, quite often at the same table, and they don't want to be disturbed with your efforts to demolish the key. The correct method of sending is an easy one, and when it is properly done, an operator should be able to send for twelve hours continuously without tiring.

Since the typewriter has come into general use for writing down the telegraph messages as the operator receives them from the sounder, making the receiver's work

much easier, there is no danger of worrying an experienced operator by sending too fast. A good typewriter operator can write from 60 to 70 words a minute and more, but an expert telegraph operator cannot send steadily over 40 or 50 words a minute; consequently a receiver has plenty of time, in addition to writing the message, to insert the "time received," the operator's personal sign, etc., even when receiving at the fast rate mentioned. Every young operator should learn to operate the typewriter rapidly and accurately.

An Electric Eraser

One of the most tiresome and tedious tasks in drawing room practice is to erase parts of drawings or tracings. In building

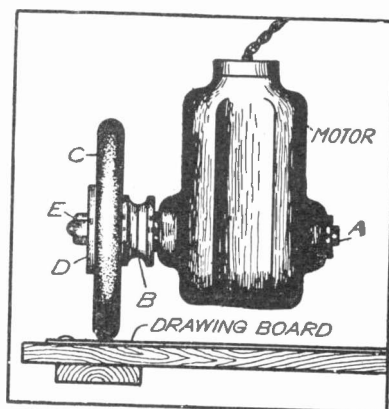

ELECTRIC ERASER

a machine changes are often made, making it necessary to change the drawings.

The illustration shows an eraser attached to a small motor, which is a great convenience to a draftsman. A small toy motor, driven by one or two ordinary dry batteries, can be used for the purpose.

If the armature shaft (A) projects far enough beyond the pulley (B), the pulley can be left on, otherwise it will have to be taken off. Thread the end of shaft (A) far enough to take nut (E). Cut a hole the diameter of the shaft (A) in a large round eraser or rubber (C). Slip the eraser (C) and a large washer (D) on the shaft. Screw on nut (E) and the eraser is ready for use.

G. B. TANIS.

Soldering Iron

Something unusual in the design of electric soldering irons is shown in the ac-

(P) in the bottom of the test tube with a three-cornered file. Provide a $\frac{1}{8}$ -inch copper rod (D) for the test tube and after fitting it with a binding screw insert

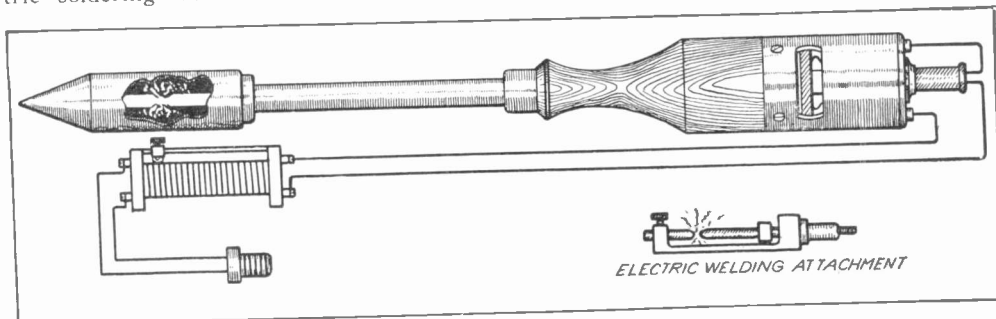

CONSTRUCTION OF THE ARC HEATED SOLDERING IRON

companying illustration. A carbon arc within the point heats the iron. Under the name of "Arc-soldering Iron" a patent on the device has been granted to Michael Danko, Chicago.

In the handle is a coil and solenoid. From here wires run within the rod to which the point is attached to the two carbons. Normally the carbons in the tip are held together by a spring. When current is turned on the iron the solenoid, by a small rod through the center of the handle, draws one carbon away from the other thus creating an arc. Current control is provided for by an adjustable rheostat between the iron and the attachment plug.

If it is desired to use the tool for welding, the tip may be removed and the welding attachment put on, thus providing an exposed arc suitable for use by jewelers in their finer welding work.

Interrupter and Cooler

To make this device procure a battery jar (E) of the type shown. Fill half full of water and carefully pour in three ounces of sulphuric acid. Do not pour the water onto the acid. Mix well and let stand to cool off. Make the wooden cover in two parts, one to fit closely into the mouth of the jar and the other a little larger. Glue the two together and the larger part will rest on the rim of the jar. Drill a $\frac{1}{8}$ -inch hole in the cover (A) for a lead rod (C) and a second for a test tube (F), then paint with two coats of shellac. File a pin hole

through a cork into the tube. Now put the lead rod (C) in place. In a gravity battery jar (J) filled one-quarter full of

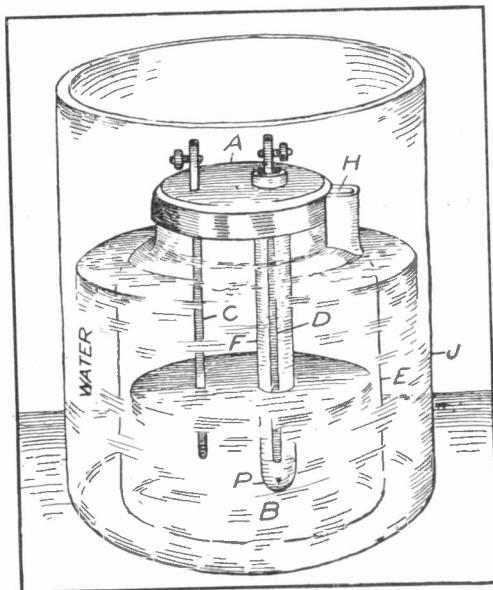

INTERRUPTER AND COOLER

water place the interrupter. I have found this arrangement most satisfactory.
MICHAEL RUSSO.

The electric vehicle can be considered as a moving power plant, and all sorts of devices can be shown in operation during the evening hours, in cities where electricians are used, which cannot fail to bring forth favorable criticism. Many lighting companies have used this emergency method of lighting for lawn fetes, fairs, etc.

Electricity the Silent Salesman

Some helpful hints on the use of electric current in getting up show window displays. The following schemes have all been used with remarkable success.

Light Without Wires

One of the latest show-window attractions is shown in the accompanying illustration. The observer standing outside perceives a large pane of heavy plate glass mounted in an upright position and having an incandescent lamp mounted on the upper edge

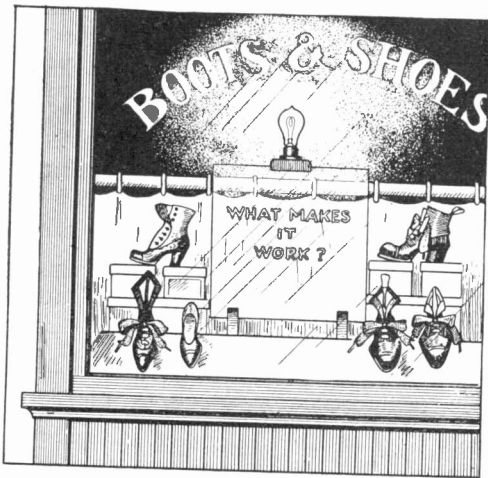

THE LIGHT WITHOUT WIRES

and burning brightly. The ordinary person cannot detect from this position any connecting wires through which the current might be led to the lamp and his curiosity is further heightened by the words "What Makes It Work?" painted on the glass below.

Numerous solutions are offered, the most common one being that the lamp is lighted by an induced current. But a large coil of wire would be necessary in order to light a lamp by this method and since such is not in evidence it is not the correct solution.

It merely takes, however, a pair of sharp eyes in order to solve the secret of its operation. The edges of the glass pane which are purposely made very ragged contain a narrow groove through which a green silk covered wire passes. The edges of a sheet of glass appear green when viewed from the side, and the wire being of the same color it is almost impossible to dis-

tinguish it. The illusion is further heightened by covering the wire and the edge of the glass with a collodion solution. A tungsten lamp may be used in preference to one having a carbon filament because the higher efficiency and smaller current consumption of the former makes possible a smaller wire. The wires lead from the edge of the glass down through the pedestal and to a plug or cutout box.

Where to Buy the Ring

Happy couples seeking the mystic band of gold are attracted to the window of a progressive jewel merchant by a miniature forge and smith. The figure, anvil, forge—all are of bronze and are rendered more ar-

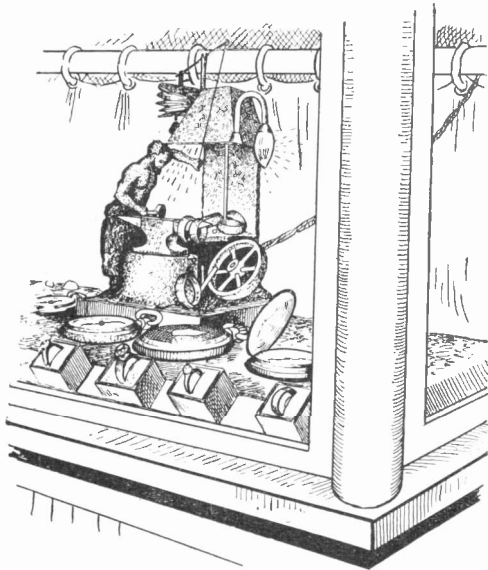

JEWELER'S WINDOW ATTRACTION

tistic by a tiny electric lamp up in the hood which throws its light upon the red coals on the forge, caused by a concealed red lamp placed beneath. A third, small, frosted lamp throws a subdued light upon the finished rings lying carelessly about, awaiting Cupid's call.

It Clinches the Argument

A belt manufacturer effectively places before the public one of the reasons why his belting is the best. A wooden tank three-quarters full of water is provided with two pulleys so arranged that a belt made of the material advertised and placed on the pul-

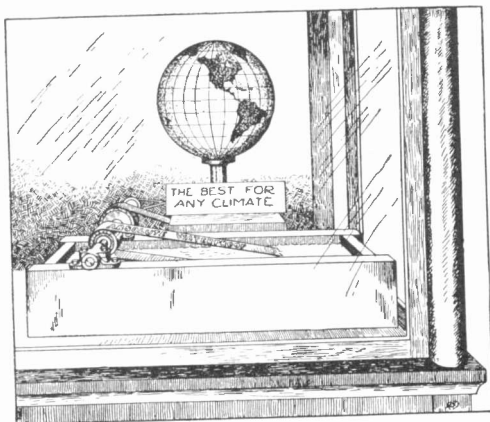

A TRYING TEST FOR BELTING

leys must constantly run through the water at one end of the tank. Waterproof lettering on the belt and a revolving globe to proclaim worldwide use, whatever the climate, attracts nearly every passer-by. An electric motor in a proper enclosure is used to drive the display.

Electricity Turns the Leaves

A clever electrical device is in the shape of a large book with sixteen-inch pages, the

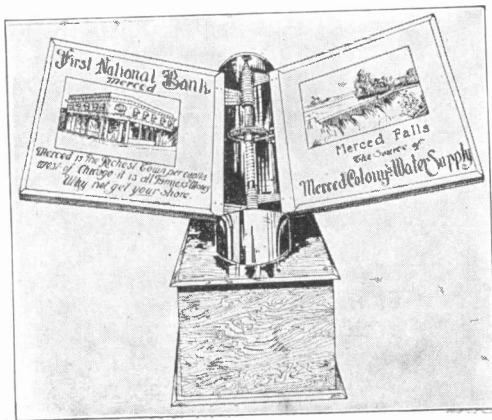

CLEVER WINDOW ATTRACTION.

leaves being turned every 30 seconds by means of a small motor. The ingenious turning mechanism is shown between the open leaves, and when the machine is placed in a show window, it usually holds a crowd. Of course the money-making side of this device is the advertising space afforded by the 22 pages of the book, and its value as an advertiser is demonstrated by the fact that in ten days 60,000 people stopped to look at it operate when it was displayed in Portland, Oregon.

The space required is 2½ by 3 feet, so that it does not interfere with the display of merchandise, while the expense of operation is trifling, being only 40 cents per month.

For Displaying Picture Cards

An adaptation of the Ferris wheel now so common in summer amusement parks is here shown as a window device for displaying picture postcards. Mounted upon suit-

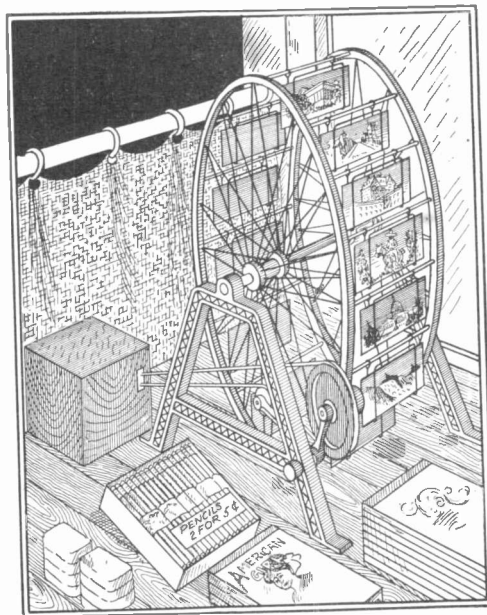

FERRIS WHEEL FOR POSTAL CARDS

able bearings and belted to a small enclosed motor the wheel may be run in either direction, bringing to view one card after another held in a wire rack suspended on a rod between the two rims.

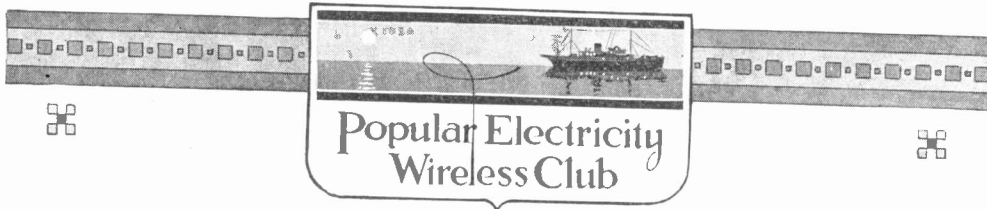

Popular Electricity
Wireless Club

The Construction of a Rotating Spark Gap.

The real source of power in transmission is the condenser and a high spark frequency. It is the aim of this article to describe in a short and simple form the construction of a device to obtain this high spark frequency. Zinc is the best of all metals for spark electrodes. The ordinary spark gap of to-day such as is used for high and low tension transformers is either of the upright or the horizontal type, the former giving better service though the latter is mostly adopted by amateur wireless experimenters. By increasing the spark frequency at the sending station, the effective sensitiveness of the receiving station is increased many hundred times. The circuit formed by the condenser, spark gap and inductance is called the

to the frequency of the charging current. A rotary spark gap allows proper radiation and an accurate high frequency oscillating circuit. To make the rotary spark gap, procure a small battery motor sold at any electrical shop for about \$1.25 and fasten it onto a base four inches square by one-half inch thick. Provide a metal pulley large enough, so that after grinding away the groove of the pulley you will be able to obtain a flat surface and a circle (P) of about three-fourths of an inch to an inch in diameter.

Place the pulley firmly on the armature shaft of the motor. Drill holes in the rim of the pulley and tap for a 6-32 or 8-32 thread. Screw into each of these threaded holes a piece of zinc formed into the shape of an L and threaded at one end.

The post (S) may be made of brass and connected in the base to binding post (E). The arc of the circle (O) is of zinc, about No. 18, formed into the shape shown and supported by the 1/2-inch rod (R) which is threaded and screwed into it. The other binding post (F) of the radiating circuit is connected to the spark gap by a heavy wire attached to the rear bearing of the armature shaft. A battery containing a switch in the circuit is connected to binding posts (BB) to operate the motor. The aerial and one terminal of the secondary of the oscillating transformer is connected to (E); the ground connection and the other terminal of the transformer is connected to binding post (F). When the sending circuit is not working the battery switch is left open.

H. GROSSMAN.

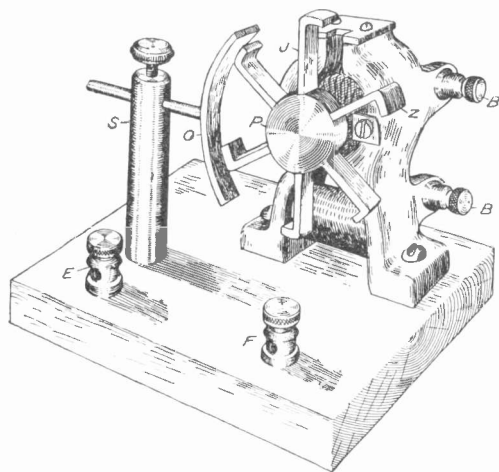

ROTATING SPARK GAP

closed or oscillating circuit; that formed by the aerial, inductance and ground connection, the open or radiating circuit. During the transmission of wireless signals less energy per wave train will be radiated on a short gap than on a long one. If the spark gap is too short, an arc is formed and no oscillations take place except those due

Regulating Detector Current

I have found that to regulate the battery current flowing through a detector of a wireless receiving set one may adjust the zinc rod of the sal ammoniac cell, assuming that this kind is used. Simply raise and lower the zinc, holding it in place by means of a small wedge.—CLAUDE MUTCHLER.

Combination Silicon-Electrolytic Detector

This detector is a combination of the silicon and electrolytic detectors, but, of course, any combination can be used. Per-

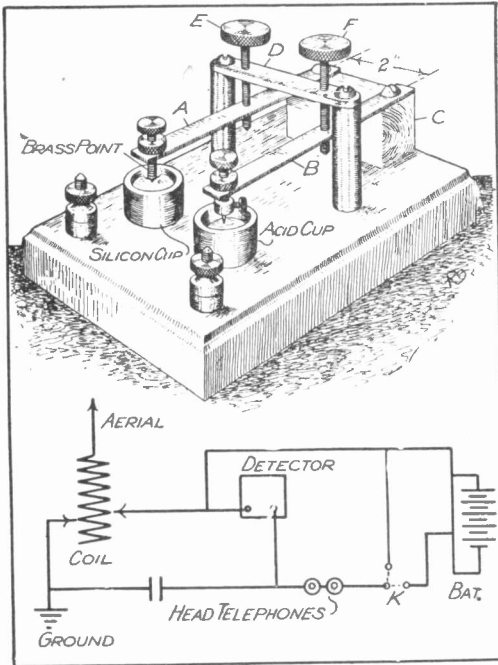

SILICON-ELECTROLYTIC DETECTOR AND ITS CONNECTIONS

sonally I find the silicon and the electrolytic to be the best, as they are very sensitive. The silicon is used for ordinary work and the electrolytic for long distance work.

In the figure (A) and (B) are two pieces of spring brass, $\frac{1}{2}$ -inch wide and five inches long. They are fastened firmly to (C) which is a block of hard rubber or wood. (A) carries the brass electrodes of the electrolytic detector. (E) and (F) are two brass screws, each two inches long and fitted with fiber or rubber knobs to adjust with. They pass down through (D) and move (A) and (B) up or down. (D) is a piece of $\frac{1}{4}$ -inch square brass rod three inches long and is held above the base by means of two pieces of $\frac{1}{4}$ -inch square brass tubing, each $2\frac{1}{2}$ inches long. Two bolts, each three inches long pass through the tubes, and hold (D) firmly and parallel above the base. When (E) or (F) is screwed down, (A) or (B) moves the

brass electrode or platinum wire into contact with the silicon or acid. The block (C) is 2 by $\frac{3}{4}$ by $2\frac{1}{2}$ inches. (A) and (B) are connected to one binding post, and the cups are connected to the other post. If the silicon is being used and a change to the electrolytic is desired, merely raise (E) and lower (F) until the desired effects are obtained. If a battery is used, close the switch (K) as shown in the connection diagram.

B. FRANCIS DASHIELL.

The Series Spark Gap

The series spark gap has a distinct advantage over all other types except the revolving spark gap. By using the series gap a large cooling surface and a higher pitch to the sound is obtained. By means of this increased pitch a greater distance can be covered and the signals are more easily discernible at the receiving end.

The electrodes are made from a wet cell zinc, and all holes are tapped 8-32. A

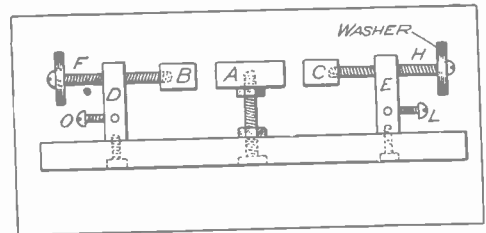

SERIES SPARK GAP

tap and drill can be bought at a supply house for about 20 cents.

The parts and dimensions are as follows: (A) the central electrode, is one inch long and drilled and tapped in the center so it can be fastened to the base as shown. (B) and (C) are the two movable electrodes, and are drilled and tapped in one end of each as shown. Each is $\frac{3}{4}$ of an inch long. (D) and (E) are two pieces of $\frac{1}{4}$ -inch square brass each two inches long. They are tapped and drilled as shown. (F) and (H) are two brass machine screws, each two inches long. Two fiber washers are glued under the heads to serve as knobs. (O) and (L) are small screws to hold the connecting wire in place.

The base is made of hard rubber $\frac{1}{2}$ inch thick and 6 by 2 inches. Hard wood may be used if hard rubber can not be procured.

B. FRANCIS DASHIELL.

Improved Perikon Detector

I take pleasure in presenting to the amateur, a new form of detector, which is extremely simple, inexpensive, easy to construct, besides being very sensitive. This detector is the conception of Mr. Tom Daly, formerly of Columbus, Miss., but now residing in Memphis, Tenn.

He built the one shown in the illustration and sent it to me with the wish that all

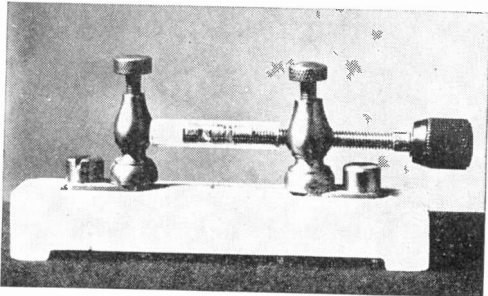

IMPROVED PERIKON DETECTOR

amateurs might have the benefit of his experiments.

This is only a modified form of the well-known perikon, with several improvements, not the least of which is its freedom from dust. As is well known, dust is the greatest source of annoyance with which we have to contend, in wireless.

The base is a Western Union fuse block, and on this are mounted two binding posts. The glass tube is a filler for a fountain pen, or medicine dropper, which has been cut off to the proper length. The tube is securely fastened to the binding post by being cemented to a short piece of brass wire, and one end of the wire is clamped in the post. The hole in the other binding post is threaded and a screw, 1 1/2 inches long, made to fit. On the end of this screw fasten a small rubber knob.

From a piece of wire slightly smaller than the tube, cut two pieces each 1-8 inches long. The crystals used in this detector are necessarily small and from a number of small ones, it is easy to find several sensitive ones. First drop into the tube a crystal of zincite, then one of copper pyrites, next the two small brass plugs with a short spiral spring between them. Connect to the other instruments as when using the

silicon detector and run the long screw up against the brass plugs until the proper pressure has been applied. If you are careful to short circuit this detector when sending, you will find that it will stay in adjustment for weeks. When it becomes necessary to adjust, back the screw out and gently tap the tube with a pencil.

E. F. WAITS.

A Small Receiving Set

The accompanying photograph is of an unusually small, compact, and yet complete wireless receiving set. Some idea of its size may be obtained by comparing it with the condensed milk can upon which it is setting.

The parts as shown are: A loose-coupled tuner with one slide and no secondary ad-

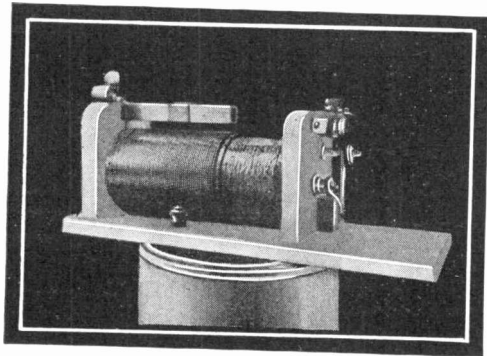

SMALL RECEIVING SET

justment, a silicon detector and a fixed condenser.

With an aerial fifteen feet high and ten feet in length I have heard GO, the Congress Hotel, Chicago at a distance of 35 miles.

B. B. BIGNALL.

The Schenectady (N. Y.) Wireless Association

The Amateur Wireless Association of Schenectady recently organized with the following officers: W. Hughes, president; D. F. Crawford, vice-president; L. Beebe, secretary; R. Smith, assistant secretary; P. F. Cornish, treasurer. Those in and near Schenectady interested in wireless telegraphy or telephony are invited to address communications to the secretary at 1143 Albany Street.

Aerial Switch

Some time ago I was asked to build a portable wireless station capable of both receiving and transmitting. As everything about it was required to be durable and compact, I did not wish to install a large and cumbersome aerial switch, so I used one of the following instruments with success.

As the drawings are almost self-explanatory only a few words will be necessary to explain its operation. The switches are simply telephone cams, manufactured by the standard makers. The De Veau and Western Electric Companies. The former is superior, in this case, as this cam may also be used as a detector buzzer-test without the aid of a push button.

To operate the former instrument: When the cam shown by the contact points in Fig. 1, is in its closed position, the primary circuit to the induction coil is closed and the detector is short-

circuited. If the cam lever is moved the full stroke in the opposite direction, the buzzer is operated so as to test the detector. In the vertical position the receiving instruments are set in operation.

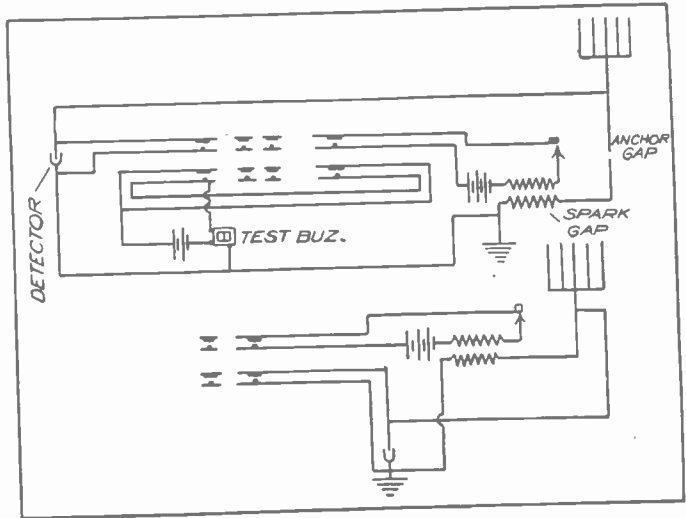

FIG. 1 DE VEAU CAM USED AS AERIAL SWITCH

In the latter cam (Western Electric, Fig. 2), the primary circuit may be closed and detectors short-circuited by having the lever in its vertical position. Placing it horizontal, the spark coil circuit is open and the receiving instruments are set for action. No detector test may be obtained from this cam.

This type of aerial switch will prove valuable to both portable and stationary wireless plants of medium power. The wiring diagrams show connections using one or separate aeriels for receiving and sending. If one aerial is used, an anchor gap must be inserted in the circuit.

GEORGE UZMANN.

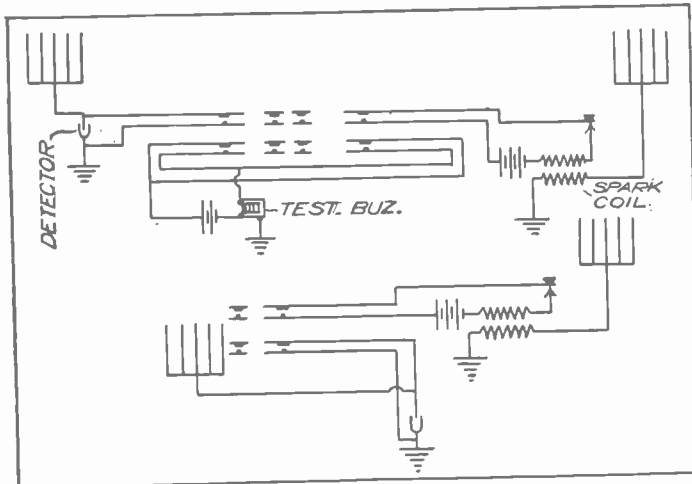

FIG. 2 WESTERN ELECTRIC CAM USED AS AERIAL SWITCH



How to Make a Variometer

A variometer makes possible a variation in the frequency of a receiving circuit by inductance without resorting to the sliding contacts of tuning coils.

I have built three variometers and find the one here described the best. The following material is needed:

80 feet of No. 22 enameled wire; one piece of cardboard 2 by 19 inches; one piece of cardboard 2 by 16 inches; one piece of $\frac{1}{4}$ -inch brass rod $7\frac{1}{2}$ inches long; one piece of $\frac{1}{8}$ -inch brass rod 5 inches long; two brass binding posts; a box with inside dimensions $6\frac{1}{2}$ by $6\frac{1}{2}$ by $5\frac{1}{2}$ inches.

Make two cylinders of the cardboard, one six inches in diameter and the other five inches in diameter. Upon the six-inch cylinder wind 40 feet of the No. 22 enameled wire, as specified Fig. 1 (A), leaving a $\frac{3}{8}$ -inch space in the middle. This space allows a $\frac{1}{4}$ -inch rod to pass through the cardboard without interfering with the wire. Now wind the five-inch cylinder as specified in Fig. 1 (B). Bore $\frac{1}{4}$ -inch holes at opposite points through the two cylinders in the $\frac{3}{8}$ -inch space and pass the $\frac{1}{4}$ -inch rod through the holes in both coils, Fig. 2, al-

now be rotated by the rod (C) Fig. 2, while the outside coil may be made stationary, the whole being placed in a box with a projecting knob (K) and building posts (P). Rubber washers (R) should be placed between the coils. Connect the two coils with eight inches of flexible wire as indicated and use the same also to connect to binding

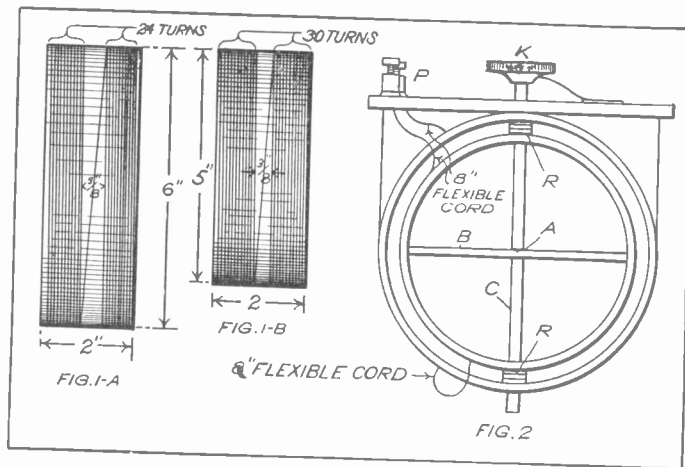

DETAILS OF THE VARIOMETER

posts (P). By turning the inside coil the two coils may be set to buck each other, or to have their turns in the same direction, or be set at any intermediate position. A scale and pointer on the cover of the box may be put in place and marked 0° and 180° . This variometer works well over 500 miles. The variometer is connected in the same way as a single slide tuning coil, that is, in series with the aerial, detector and ground.

OTTO L. WEIDMANN.

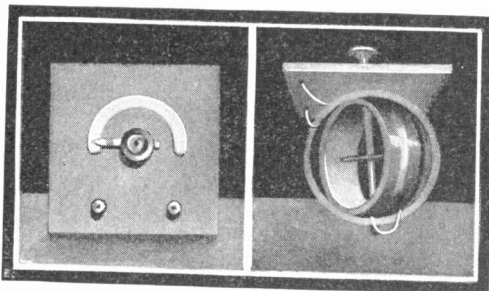

VARIOMETER AND COVER OF ENCLOSING BOX

lowing the rod to project $\frac{1}{2}$ -inch at top and bottom. Drill a $\frac{1}{8}$ -inch hole at (A) Fig. 2, in the vertical rod and slide the five-inch rod (B) Fig. 2, through and also through the inner cardboard cylinder. Solder at (A) Fig. 2. The inner coil can

Rain Spout for Aerial

While experimenting recently I connected my portable wireless set to the rain spout on one side of the house. This spout is 55 feet long. For a ground I drove a piece of water pipe into the earth. I succeed in picking up Chicago seven miles away and also heard Milwaukee talking to Chicago.

The set used consisted of a double-slide tuning coil twelve inches long and $1\frac{1}{2}$ inches in diameter wound with double cotton-covered wire No. 20, a homemade silicon detector, a paper condenser 4 by 5 inches and a pair of 1,200 ohm receivers. EDWARD G. EGLOFF.

To Inspect Vessels' Wireless

The Department of Commerce and Labor of the United States has appointed three inspectors of wireless apparatus on vessels. As all outgoing vessels carrying more than 50 passengers are required by law to have a wireless equipment to call for help in case of trouble, it is the duty of these inspectors to go aboard vessels and pass upon the efficiency of this equipment and ascertain also the qualifications of operators.

WIRELESS QUERIES

Answered by A. B. Cole

Questions sent in to this department must comply with the same requirements that are specified in the case of the questions and answers on general electrical subjects. See "Questions and Answers" Department.

Long Distance Receivers; Four-inch Coil

Questions.—(A) Is a 3200 ohm receiver more efficient for long distance receiving than one wound to 1000 ohms? (B) In speaking of a pair of 1000 ohm receivers, does this expression mean that each receiver is wound to 1000 ohms, or that the total resistance of both is 1000 ohms? (C) Can you give me correct dimensions for a four-inch coil with secondary wound in sections?—D. H. S., Lima, Ohio.

Answers.—(A) Some operators can do much better work with a high resistance receiver, and some can do as well with one of less resistance. The results depend entirely upon the ear of the operator, if both receivers are of similar construction and the same detectors are used.

(B) The expression "pair of 1000-ohm receivers" should properly mean that each receiver has a resistance of 1000 ohms. Some dealers, however, have created doubt as to the meaning of this expression by listing a "1000-ohm head set," each receiver in which has a resistance of 500 ohms.

(C) Follow the table given on page 163 of the June, 1910, issue, giving the secondary a diameter of $4\frac{1}{2}$ inches. Build the secondary in sections not wider than $\frac{1}{8}$ inch, separating them by disks of Empire cloth or cardboard impregnated with paraffine.

Why Spark Gap at Center of Helix

Question.—What are the advantages of placing the spark gap in the center of the helix?—E. F. E., Chicago, Ill.

Answer.—This arrangement has the advantage of requiring less space than the ordinary methods.

Transmission Line Induction; Wireless Code

Questions.—(A) Can a wireless telegraph station be safely operated within 100 yards of a 22,000 volt A. C. circuit? (B) Is the same code used for wireless telegraphy as for telegraph lines?—M. B., Atlanta, Ga.

Answers.—(A) Yes, but the induction from the transmission line will make it somewhat difficult to read distant stations.

(B) Both, the Morse and Continental are the most generally used.

Wireless Without Aerial

Question.—(A) I understand that wireless telegraphy can be accomplished without aerials. If this is the case, please give diagram of connections.—B. B. M., Albany, Ga.

Answer.—(A) Wireless telegraphy without aerials is satisfactory only for short distance working. The aerial is one of the most important parts of all practical wireless systems of the present time. It is possible to use only a ground connection up to about a thousand feet. It is also possible to construct a set as described in the February, 1910, issue, under "A Simple Wireless Telephone Set," substituting a buzzer for the telephone transmitter, and using the set as a wireless telegraph outfit.

The Wireless Telegraph Operator

Questions.—(A) Will you kindly tell me what the average salary of a wireless telegraph operator is? (B) What is a good book to read and study to become a wireless operator? (C) With whom should I communicate regarding a position as operator on a trans-Atlantic ship?—A. L. T., Kansas City, Mo.

Answers.—(A) From \$30 to \$150 per month, often with room and board.

(B) A good book from which to learn the elementary principles is Morgan's "Wireless Telegraph Construction for Amateurs," which we send postpaid for \$1.50.

(C) Marconi Company of America, 27 Williams Street, New York City.

Long Distance Detector; Heating of Detector; Sending Distance with 1½-Inch Coil

Questions.—(A) Which of the following detectors is the best for longest distance working—silicon, galena, molybdenite, ferron, carborundum, electrolytic perikon? (B) Why does the spark of the sending station die down? I hear M. S. W. very loudly, but the sound decreases until I set my buzzer in operation, when it becomes as loud as before. I use a silicon detector with a fine needle point. (C) How far can I transmit with a 1½-inch coil, helix, condenser, spark gap, key and batteries?—F. A. W., Dorchester, Mass.

Answers.—(A) Probably the perikon and galena detectors are best for this purpose, and we prefer the former of these.

(B) The phenomenon which you mention is probably due to the heating of the point on the silicon upon which the needle rests, on account of the very strong signals which you hear. Either the needle point or the silicon is slightly oxidized due to this, and consequently greater resistance is introduced into the circuit. This resistance is broken down by the waves sent out by your buzzer.

(C) Up to about twelve miles over water or level land, to a similar station, if you use an aerial at least 50 feet high and 50 feet long, consisting of four or more parallel wires.

Sending Radius; Aerial; Spark Gap

Questions.—(A) I live on a hill whose altitude is 900 feet. It is 30 miles from the sea, and I can see about 40 miles over the water. What would be my average sending distance in that direction with a four-inch coil in connection with a helix, series gap, glass plate condenser and suitable horizontal looped aerial 30 feet above the earth? (B) How long should the aerial be and how many wires should it contain to obtain the best results with the above coil? (C) How many gaps and how wide should they be in a series gap for the above coil?—K. K., Santa Barbara, Cal.

Answers.—(A) You should be able to send at least 40 miles in the day time under average weather conditions in your locality.

(B) The aerial should be at least 100 feet long, consisting of four or more parallel wires. Increasing the height of the aerial above the earth will increase the radius.

(C) The number and length of the gaps will depend upon the capacity of the condenser. Five or six gaps each ⅛ inch long will give good results.

Carborundum Detector; Spiral Aerial

Questions.—(A) I have made several detectors, but fail to obtain satisfaction from the carborundum type. Please explain method of using this detector, and probable cause of my difficulty. (B) Would a tower one hundred feet high, with antenna wire wound spirally around it, say ten feet in diameter, be as effective as the same length, stretched between poles?—C. F. T., Madera, Cal.

Answers.—Your difficulty is probably due to the use of carborundum which is not of the sensitive variety. The proper kind of carborundum is supplied in large crystals varying in color from light green to black. Not every piece of carborundum of the same color is equally sensitive. Some pieces of this material give best results in series with one cell of dry battery, the receivers and potentiometer, while others require the use of two or three cells of battery. One of the best means of holding the carborundum is to support it between two flat pieces of battery carbon. A fairly heavy pressure should be exerted upon it by the supporting electrodes.

(B) Such an aerial would probably be as efficient as the ordinary types, but would have a very long natural wave length, due to its spiral shape, which would give it a high inductance.

Range; List of Wireless Stations; Resistance Coil Data

Questions.—(A) What is the approximate range of the following instruments, aerial 70 feet high at one end, 60 feet at the other, consisting of three aluminum wires, 1500 meter loose coupled tuner, two variable condensers, capacity about .001 M. F., fixed condenser, silicon detector, Electro Importing Co.'s 1000 ohm professional type receivers? (B) Where can I obtain information regarding the wave length, power, etc., of the Canadian stations? (C) Please give data for reactance coil to be used in series with a one-inch coil on 110 volt A. C.—E. B. S., Windsor, N. S., Can.

Answers.—(A) About 800 miles over level land or water, in the winter at night, receiving from high power commercial stations.

(B) Send fifteen cents in coin or money order to the Supt. of Documents, Washington, D. C., and ask for a copy of "Wireless Telegraph Stations of the World."

(C) Core 1½ inches in diameter, eight inches long, made of iron core wire. Winding, eight layers of No. 14 D. C. C. magnet wire.

Questions and Answers

Rules:—Questions must be addressed to the “Question and Answer Department” and contain nothing for other departments. Full name and address of the writer must be given; only three questions may be sent at one time; 2-cent stamp must be enclosed for answer by mail. No attention will be paid to questions which do not comply with these rules.

Four Station Telegraph Line

Questions.—(A) Three boys and myself would like to construct a telegraph line so that any one of us can call any other one. Will you show a diagram for connecting the instruments? (B) Is there any law prohibiting private wires crossing the street?—H. C. W. Philadelphia, Pa.

Answers.—(A) The diagram shows how to connect the equipment. The two-point switch should be up at all stations except the one sending. Station No. 4 for example, calls any other station by a pre-

point in the lamp circuit; (5) the use of solid carbons will cause A. C. arc lamps to jump.

Reduction of Aluminum

Question.—What is the Hall process of obtaining aluminum?—J. S., Chicago.

Answer.—In the Hall process used at the Niagara Falls' refineries, vats are made of iron and lined with carbon plates which also serve as cathodes, anodes being made of large carbon cylinders. The solution is

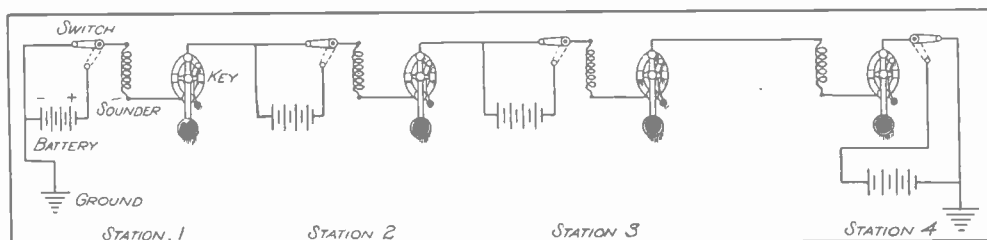

arranged code of signals by throwing his switch down thus cutting in his battery. This way of connecting consumes no battery when the line is not in use. The number of stations may be increased or decreased as desired.

(B) Ordinances regulate the running of wires in cities and you had better consult the electrical inspector of your neighborhood.

“Jumping” of Arc Lamps

Question.—What causes arc lamp carbons to “jump”?—C. E. McK., Brown City, Mich.

Answer.—There are several causes for this: (1) If damp carbons are used they jump when the current is first turned on, the water turning to steam; (2) oil and grease on the carbons; (3) a too loose or too tight dash pot; (4) poor contact at some

molten cryolite (a fluoride of sodium and aluminum) which is brought to a temperature of about 1700° F. The aluminum oxide separates into aluminum and oxygen, the oxygen going to the anode and combining with its carbon forming carbon dioxide. The aluminum settling to the bottom is drawn off. Current at an intensity of 5000 amperes and at six or eight volts is used, one pound of aluminum being obtained for every ten kilowatt-hours expended.

Cells and Vat for Plating

Questions.—(A) Will you give the name of two cells suitable for use in small electroplating? (B) What form of vat for a beginner is best?—E. J. B., Greenville, Mich.

Answers.—(A) The Bunsen cell is often used. Also the Daniell because of its constancy and cheapness. When the Bunsen

cell is loaded to its full capacity, means should be provided for ventilation to allow the escape of the fumes of nitric peroxide. As soon as the cell becomes green in the solution from the peroxide it should be recharged. (B) A good form of vat for a beginner to use is a clear glass accumulator cell thirteen inches long, five inches wide and fourteen inches high, and about $2\frac{1}{2}$ gallons of solution. With such a vat the process may be watched and the vessel being of glass, short circuits are avoided.

Circuit of Telephone Repeating Coil

Question.—Will you please explain the windings of a telephone repeating coil.—J. M. B., Lancaster, Pa.

Answer.—As shown by the diagram there are four windings in the coil, two at each end of the core. One is an outside winding. The other an inside winding. These coils act upon each other in the same

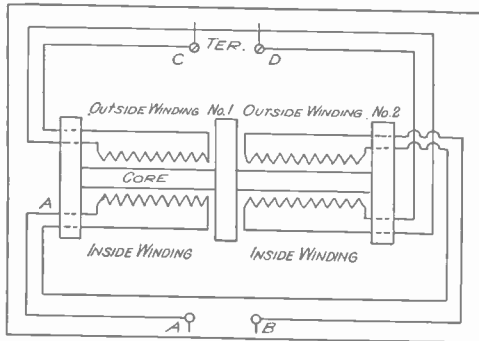

TELEPHONE REPEATING COIL

manner as the two coils of a transformer, and are a form of induction coil. If a grounded line is connected directly to a metallic line a noisy circuit often results. By placing a repeating coil in the switchboard cord circuit so there shall be no direct connection between grounded and metallic line the greater part of the noise is avoided.

Magneto Output; Telephone Transmitter

Questions.—(A) What voltage and amperage has a telephone magneto that will ring through 1000 ohms at 1500 revolutions per minute? (B) What is the difference in the construction of a telephone transmitter for use on a line one mile long and a line 50 miles long?—C. R. A., Winnifred, Alberta, Canada.

Answers.—(A) A test of different sizes of one make of generators gives the following: Three bar, 65 to 90 volts, 150 to 200

milliamperes; four bar, 70 to 90 volts, 250 to 300 milliamperes; five bar, 75 to 110 volts, 325 to 400 milliamperes.

(B) There is no difference. Induction coils, repeating and loading coils are called into service.

Telephone Transmitter and Induction Coils

Questions.—(A) Will a transmitter giving service on a line one mile long give as good service on a line fifty miles long? (B) What resistance should an induction coil have for use on a one-mile line? On a fifty-mile line with 75-ohm receivers?—C. R. A., Winnifred, Alberta, Canada.

Answers.—(A) The transmitter now in common use is the "solid back" type. This transmitter will work equally well on either a one-mile or a 50-mile line.

(B) An induction coil with a primary resistance of nine ohms and a secondary winding of 250 ohms will give better results on a 50-mile line than a coil with the same primary and a secondary of say 24 ohms. It is well to keep the resistance of the secondary as low as possible when the coil is used in bridging telephones, as when a high wound coil is used the voice currents are hindered from passing through the coil by impedance and are forced through the ringer.

Dynamo Efficiency

Question.—What should be the efficiency of a dynamo?—J. K., Marshall, Ill.

Answer.—The commercial efficiency or the ratio of the output to the input varies with the size of the dynamo ranging from 75 per cent in the smaller sized dynamos up to 95 per cent in the larger ones.

Production of Ozone

Question.—Will you kindly advise the method used to produce sparks from 60 cycle 110 volt current to produce ozone.—L. J. M., Oskosh, Wis.

Answer.—Ozone is ordinarily produced by high tension discharges between needle points. This current is stepped up by a transformer somewhat after the order of the wireless telegraph transformer; that is, it will step up the voltage from 110 to 10,000 or 12,000 volts. This pressure will produce a silent or brush discharge between the two sets of needle points, not more than one-fourth inch apart, which are connected to the two high tension terminals of the transformer.

Royalties and License Fees

Amount of Compensation—Liability of License

By OBED C. BILLMAN, LL. B., M. P. L.

ROYALTIES AND LICENSE FEES—*In General.*—A license under a patent is ordinarily granted in consideration of the payment of a license fee or royalty.

ROYALTY DEFINED.—A royalty is a compensation paid to one who holds a patent, for the use of the patent or for the right to act under it, generally at a certain rate for each article manufactured.

IMPLIED PROMISE.—A promise to pay a reasonable compensation for the use of a patent need not be express, but may be implied or inferred.

CONSIDERATION.—The grant of a license under a valid patent is a sufficient consideration for an agreement to pay the purchase price of the license without reference to the value of the patent.

WHO MAY RECOVER.—Royalties are, of course, ordinarily recoverable by the licensor, but where the licensor is not the real owner of the patent, the latter and not the former is entitled to recover from the licensee. The equitable owner under a verbal assignment may recover royalties.

LACHES.—The licensor may lose his right to recover by delay in bringing suit.

THE RESCISSION OF THE LICENSE by the licensor does not destroy his right to recover royalties already earned, but no royalties can be recovered thereafter.

THE LICENSOR HAS NO LIEN FOR ROYALTIES on articles manufactured under the license.

AMOUNT OF COMPENSATION.—Where the amount of royalty and the conditions and terms of payment are expressly agreed upon by the parties, such agreement is, of course, controlling. Where the contract provides for the payment of a certain royalty on each article sold, and binds the licensee to pay royalties on not less than a stated number of articles a year, he is liable for royalties on at least such stipulated number, without reference to the number of articles sold. So also where the contract provides

that the amount of royalties shall not be less than a specified sum. Where the license fee or royalty is not fixed by agreement, the licensor is entitled to a reasonable compensation. What is a reasonable compensation is to be determined by the testimony of experts and other evidence as to the value of the invention.

INTEREST may be allowed on royalties.

LIABILITY OF LICENSEE—*In General.*—In general a licensee who exercises the license is liable for the stipulated fees. The licensee is liable for the stipulated royalty if he uses any part of the invention, unless his liability is expressly limited.

DEFENSES—*In General.*—A licensee who has acted under and received the benefits of the license cannot defend an action for the stipulated royalties or license fee on some immaterial ground not affecting his enjoyment of the license, as that the licensor had not fully performed his contract as to the formal execution or delivery of the license; or, where the license is not exclusive, that the licensor has granted licenses to other persons who are using the invention.

ARTICLES NOT COVERED BY PATENT.—The licensee is not liable for royalties on articles manufactured by him which are not covered by the patent. But he is liable where he uses an article equivalent to that patented though in a different form. And a licensee under a patent, who has for several years manufactured, stamped, advertised, and sold an article as made under such patent, and paid royalties thereon to the licensor, is estopped thereafter in an action for further royalties to deny that such article was covered by the patent.

THE FACT THAT THE LICENSEE DID NOT USE THE INVENTION is no defense where he has had the exclusive right to do so.

INFRINGEMENT BY LICENSOR.—It has been held that the fact that the licensor has infringed the exclusive right of the licensee is no defense to an action of royalties, though

in such case the licensee would have a right of action against the licensor.

FRAUDULENT REPRESENTATION BY THE LICENSOR may constitute a good defense.

UNPATENTED INVENTION.—One who agrees to pay royalties for the use of an unpatented invention cannot defend an action for such royalties on the ground that the invention was not patented, or that after the agreement a patent was refused. But the refusal of a patent prior to the agreement is a good defense.

INVALIDITY OF PATENT—General Rules.—A licensee who has manufactured or sold a patented article under a license cannot defend an action for the agreed royalty or license fee, on the ground that the patent is invalid, where there has been no eviction or disturbance. In such case he is estopped to deny validity of the patent, especially where he has, in his agreement, acknowledged its validity and agreed not to contest it. To constitute a defense, something corresponding to eviction must be proved. But where by reason of the invalidity of the patent the license is excluded from the full exercise of his right, either by the licensor or by strangers, he may defend an action for royalties on the ground of failure of consideration. Until the patent is annulled or adjudged invalid, the licensee receiving its benefits must pay the agreed license fees.

THE LICENSEE MAY RENOUNCE THE LICENSE and place himself in the attitude of an infringer, defending on the ground that the patent is invalid, and in such case the doctrine of estoppel does not apply. But where the licensee under a patent apparently valid continues to manufacture or sell the patented article without giving notice of such renunciation, and without any judicial determination that the patent is invalid, he is presumed to act under the license, and the invalidity of the patent is no defense to an action for royalties. The licensor is entitled to assume that his licensee remains such until the latter, by a clear, definite and unequivocal notice, throws off the protection of the license and stands admittedly an infringer if the patent is valid. And such notice must be in good faith and not a mere pretense of renunciation.

BUT WHERE THE PATENT HAS BEEN ANNULLED OR DECLARED VOID, no royalty can

thereafter be recovered and no notice of renunciation is necessary. And where the patent has been annulled or declared void by competent authority, this is a complete defense to an action for further royalties.

EXPRESS AGREEMENT.—Where by the agreement of the parties the payment of royalties is to cease in case the patent should be declared void by a court of competent jurisdiction, the licensee cannot set up the invalidity of the patent as a defense until it has been so declared void.

THE BURDEN OF ESTABLISHING THE INVALIDITY OF THE PATENT is on the licensee defending on that ground.

FALSE REPRESENTATIONS by the licensor as to the validity of the patent are no defense to an action for royalties, where the licensee has not been injured thereby or has not repudiated the license.

ACTION AGAINST THE GOVERNMENT AS LICENSEE.—The general principles as to when a licensee may or may not deny the validity of the patent apply where the government is the licensee, and a plea by the government that the patentee was not the first inventor is an ordinary defense and not a proceeding to vacate the patent.

NEW BOOKS

THE PRACTICAL OPERATION OF ARC LAMPS. By National Carbon Company. Cleveland. 1911. 71 pages with 24 illustrations.

A book giving first hand, practical information on the operation and proper care of the arc lamp.

POWER. By Charles E. Lucke. New York: The Columbia University Press. 1911. 316 pages with 223 illustrations. Price, \$2.00.

A series of lectures in which the enormous effect that the substitution of mechanical power for hand and animal labor has had on society, and conditions of living is pointed out.

WIRELESS "HOOK-UPS." By H. Gernsback. New York: Modern Electrics Publication. 1911. 88 pages with 171 diagrams and illustrations.

The student of wireless telegraph who has a good set of instruments is often unable to get proper results because his connections are faulty. This book is intended to assist in finding the right "hook-up."

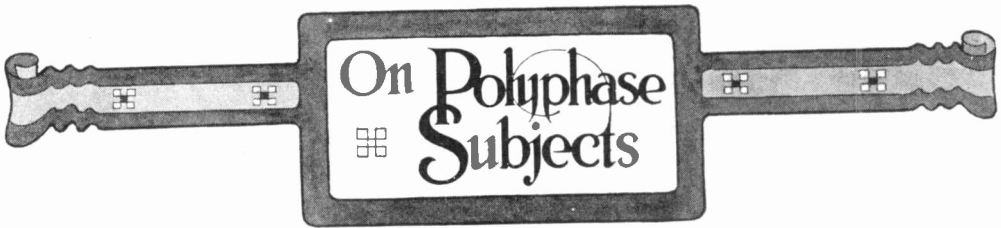

On Polyphase Subjects

Some marked changes are evident in this issue. The cover, for one thing, is a whole lot different and we hope better. Decided improvements have also been made in the typographical appearance of the inside of the magazine in the way of department headings, etc.

We realize fully the joys ahead of us in selecting subjects for cover designs and getting them onto paper in a manner that will suit the majority. We do not hope to suit everyone, for some will be sure to find that a pose is studied, a hand is unshapely or the eyes are crossed, if it is a human figure. If the picture is an airship, the planes will not be at the proper angle, or if the view be of a machine, some one will discover with consternation that there is a cam missing and it would never work.

But what we do aim at is to make the magazine in a broad way better and more attractive—in short we want to give you more than your money's worth.

As the cover of the magazine is its show window, so to speak, we are going to put on it each month a new illustration which will be strongly indicative of some application of electricity; a picture which you may look forward to with pleasurable anticipation and which, when you see it, will impress upon you even more forcibly than before that electricity is a great force to help you in the daily routine of your lives.

In an address at the dedication of the new college of engineering of the Northwestern University, Mr. **The Definition of An Engineer** John S. Hayford, director of engineering, thus speaks of the engineer. "Somebody has defined the engineer as a man who can do with one dollar what any fool can do

with two. When all members of the profession appreciate and act on that definition, the public can well afford to pay princely salaries to its engineers. How many millions of dollars do you suppose might be saved annually in the United States if high-class engineering were substituted for mediocre engineering? Let me give you an example in just one single industry: Steam power plants for generating electric current. One of the most prominent engineering firms in this country recently authorized the following statement: 'If good engineering were used in the design and operation of electric light stations in the United States, a saving might be easily made of one-fourth cent per horsepower hour, and that would have amounted last year to no less than \$37,000,000.'

That a city of over 10,000 should have no telephone system, seems hard for us to believe when we find such equipment even in towns with a population of only a few hundred. Then what shall we say to a city with over a million inhabitants where plans are only now being made for installing telephones? Such is Constantinople, where the former Sultan had barred the modern facilities for which a large share of the people have been clamoring. If this were a city of one race, where the religious prejudices controlled against innovations, its backwardness would be more excusable. But only half of the population is Turkish, while the rest speaks Greek and French. Such a cosmopolitan place certainly should profit by modern methods and the concession has finally been granted for a telephone exchange to be in service within two years.



Short Circuits

What is the difference between (1) a gardener, (2) a billiard player, (3) a gentleman, and (4) a sexton? Answer: The first minds his peas, the second minds his cues, the third minds his p's and q's, and the fourth minds his keys and pews.

* * *

"He used to kiss me every time we passed through a tunnel before our marriage," said the little woman, with sad reflections.

"And does he do so now?" asked her bosom friend.

"No; he takes a drink."

* * *

All the seats were taken when a neatly dressed young girl, evidently a lady's maid, entered the room. The tall youth rose with a polite bow and offered her his seat.

"I hate to deprive you, sir," she said, as she took it.

"Don't mention it, Miss," replied the young Chesterfield; "it's no depravity."

* * *

Thomas was an old gamekeeper on Sir Greville's Scotch estate, says Sir William Kennedy in "Sport in the Navy." When he was 60 years old he contracted measles and was very ill for a time.

Sir Greville, with characteristic kindness, sent the old man some hothouse grapes and a pineapple. The next time the two met, Sir Greville asked Thomas how he liked the fruit.

"Weel, Sir Greville," answered the gamekeeper, "the plums was good, but I dinna think much o' the turnip."

* * *

In an Illinois town that you can't find on the map, the fire department has an unexcelled record for conscientiousness and devotion to duty. One night the church bell clanged out an alarm with the code taps that indicated "fire north of square."

In instant response the fire department jumped on his horse and galloped to the rescue. He had not gone far when a second alarm announced a second fire, this time to the south. An anxious citizen, speeding toward his southside property, called out to the passing marshal:

"Hi, Jake! you're headed the wrong way! There's a big blaze to Greening's."

The fireman was no sark. "Keep it a-goin', Ed!" he shouted. "I'll be over in less 'en ten minutes!"

* * *

Pat and Mike, who hadn't met for years, encountered each other one day.

"Hello," says Mike. "You're lookin' fine. Are yer workin'?"

"Shure I am, an' a fine job I have."

"What are yer workin' at?"

"I'm a bill poster."

"A bill poster? Ain't that a coincidence? Shure I'm a bill poster myself."

"Now ain't that wonderful! What kind of bills do ye be bill postin'?"

"Shure, I'm bill postin' for a play actress av the name av Elsie Janis."

"Elsie Janis? Well, well, if that don't beat all, I'm bill postin' fer her father."

"Father? G'wan! You don't mean Elsie Janis's father?"

"That same."

"What's his name, then?"

"Why, Hunyadi Janis!"

Mother: Samuel, where are those green apples that I left in the pantry?

Samuel: They're with the Jamaica ginger that was in the medicine chest.

* * *

Carpenter (to his apprentice): "Well, Willie, have you sharpened the tools?"

Willie: "Yes, all but the 'and-saw, and I haven't quite got all the gaps out of it."

* * *

Speaking of newspaper clippings—Infuriated when informed by her husband that he was about to desert her, the wife of George Abbott fired three bullets at him, one taking effect, at Bloomington, Ill., yesterday and he may die.

* * *

It happened in Topeka. Three clothing stores are on the same block. One morning the middle proprietor saw to the right of him a big sign "Bankrupt Sale," and to the left, "Closing Out at Cost." Twenty minutes later there appeared over his own door, in larger letters, "MAIN ENTRANCE."

* * *

Mrs. Brown could only buy two aisle seats, one behind the other. Wishing to have her sister beside her, she turned and cautiously surveyed the man in the seat next. She finally leaned over and timidly addressed him: "I beg your pardon, sir, but are you alone?"

The man, without turning his head the slightest, but twisting his mouth to an alarming degree and shielding it with his hand, muttered: "Cut it out, kid, cut it out—muh wife's with me."

* * *

A man traveling westward in a through express one day last week left his seat in the crowded dining car just after he had ordered his luncheon. He went to get something he had forgotten in the Pullman.

When he returned, in spite of the fact that he had left a magazine on the chair in the diner, he found a handsomely dressed woman in his place. He protested with all the politeness he could muster, but the woman turned on him with flashing eyes.

"Sir," she remarked haughtily, "do you know that I am one of the directors' wives?"

"My dear madam," he responded, "if you were the director's only wife I should still ask for my chair."

* * *

A woman missionary in China was taking tea with a mandarin's eight wives. The Chinese ladies examined her clothing, her hair, her teeth and so on, but her feet especially amazed them.

"Why," cried one, "you can walk and run as well as a man!"

"Yes, to be sure," said the missionary.

"Can you ride a horse and swin, too?"

"Yes."

"Then you must be as strong as a man!"

"I am."

"And you wouldn't let a man beat you—not even if he was your husband—would you?"

"Indeed I wouldn't!" the missionary said.

The mandarin's eight wives looked at one another, nodding their heads. Then the oldest said, softly:

"Now I understand why the foreign devil never has more than one wife. He is afraid!"

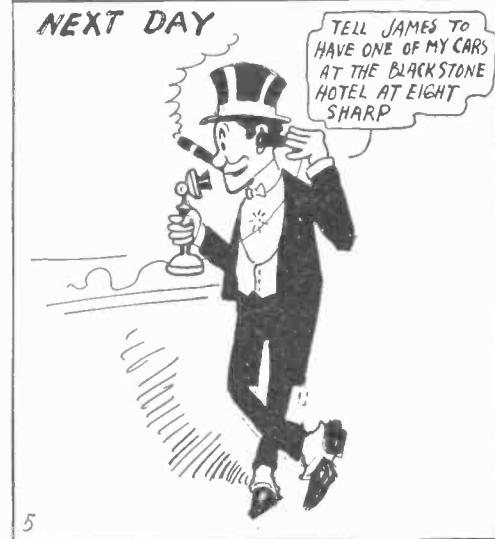
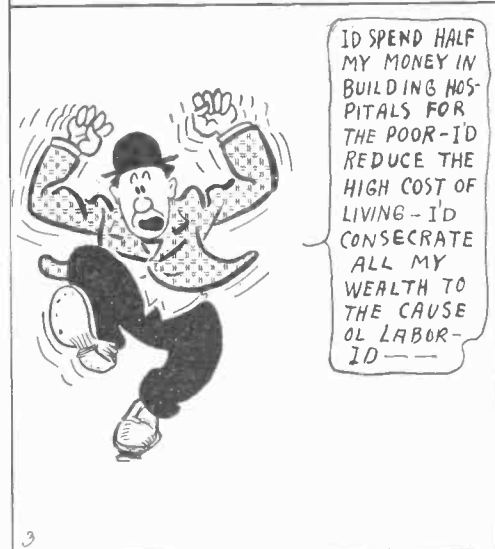

Common Electrical Terms Defined

In this age of electricity everyone should be versed in its phraseology. By studying this page from month to month a working knowledge of the most commonly employed electrical terms may be obtained.

ELECTROLYTIC INTERRUPTER.—A device sometimes used in connection with an induction

coil to interrupt the current. One type consists of a negative lead plate electrode immersed in a jar of dilute sulphuric acid. Near the plate a glass tube containing mercury and having a platinum wire at its tip is suspended. When electric current is passed through the acid electrolyte, the current is very rapidly interrupted by the formation of gases on the small platinum electrode.

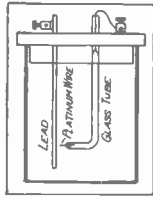

Electrolytic Interrupter

ELECTRO-MAGNET.—A mass of iron in which lines of force have been established by the passage of an electric current through a coil surrounding the iron.

ELECTRO-MAGNET CLUTCH.—An appliance usually in the form of a disk which on being attracted by a magnet facing it adheres to the magnet, thus imparting motion to the shaft on which the disk is mounted.

ELECTRO-MAGNETIC FIELD.—A wire or coil of wire carrying an electric current creates about itself a field of force, the presence of which may be known by bringing iron filings for instance into this field, the iron filings telling something of the direction and strength of this field. These lines of force when so created are called an electro-magnetic field.

ELECTRO-MAGNETISM.—A branch of electrical science devoted to the study of the relations of a field of force to the current used to produce it, and also given over to the investigation of the effect of this magnetism or force upon various substances. Specifically used to refer to magnetism produced by an electric current.

ELECTROPHORUS.—A ingenious instrument devised by Volta in 1775. A round cake (B) of shellac or sealing-wax, a wooden disk (A) covered with tinfoil and a piece of woolen cloth, or cat fur constitute the outfit. Rubbing the cake with the fur negatively electrifies it. Placing the wooden disk insulated by its glass handle upon the cake results in an electrification as shown (2). Touching the disk frees the negative or repelled electricity (3), leaving the condition shown in (4).

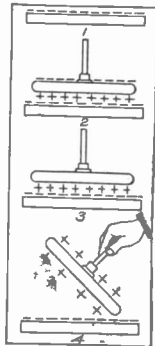

Electrophorus

ELECTROPLATING.—A process of depositing a metal coating upon the prepared surface of an object by suspending the object from the cathode of a plating solution, placing a plate at the anode like the metal deposited in the electrolyte and turning on the current. Low voltage direct current is used.

ELECTROPOISON FLUID.—The depolarizing fluid used in zinc-carbon cells such as the Grenet. One formula by weight is as follows: One part of potassium bichromate in ten parts of water to which $2\frac{1}{2}$ parts of sulphuric acid should be gradually added. Another formula: To three pints of water add five fluid ounces of concentrated sulphuric acid, then add six ounces of pulverized potassium bichromate.

ELECTROSCOPE.—An apparatus for telling the presence of an electric charge and for determining whether it is positive or negative. In one type two gold leaves are hung in contact with each other from the end of a conductor. When excited by the nearness of a charge of electricity they diverge. The leaves are enclosed in a glass vessel so that the air will not affect their action.

ELECTROTHERM.—A term applied to the ordinary heating pad in which an asbestos mat containing resistance wire is the heating element.

ELECTROSTATIC ATTRACTION AND REPULSION.—The attraction and repulsion of statically charged bodies. Two pith balls suspended by a silk thread are often used to illustrate the law that similarly charged bodies repel each other and oppositely charged bodies attract each other.

ELECTROSTATIC INDUCTION.—If a glass rod rubbed with silk be brought near an insulated conductor such as a tinfoil covered globe the portion of the globe nearest the rod becomes negatively electrified, while the portion farthest from the rod holds a repelled charge of positive electricity. This distribution is brought about by electrostatic induction in accordance with the law that like charges repel each other and unlike charges attract.

ELECTROTYPE.—The reproduction of a form of type by taking the impression in wax upon which plumbago is then sprinkled or brushed over, after which the impression is electroplated.

E. M. F.—An abbreviation for "electromotive force."

END CONNECTORS.—Copper plates used to connect the armature bars in a "bar armature."

EQUATOR OF MAGNET.—A point in the magnet where it exercises neither the power of attraction nor repulsion. A point of no polarity or a neutral point.

To Appreciate the Way One Westinghouse General Utility Motor Does a *Dozen* Things You Must Go See It Work!

☞ The Westinghouse General Utility Motor is the only SINGLE Electric motor in the world that will run a sewing machine, a jeweler's lathe, a mechanical window sign, an advertising sign flasher, small blowers for ventilating or for forcing a draught in a furnace, buffing wheels, grinding wheels, lap wheels and any small power machine, such as bottle cleaners, small drills, jig saws and so forth—simply by the use of a few different attachments.

☞ If you are at all interested in the use of electric power *economically* in the home or shop, write us for the General Utility booklet which describes fully this wonderful motor and what it does.

☞ If you request it we will also tell you the name of a dealer near you who will show you the motor and how it works. When you write, tell us you are a reader of Popular Electricity, and address the letter "Westinghouse Dept. of Publicity, East Pittsburg, Pa."

Westinghouse Electric & Manufacturing Co.

PITTSBURG

SALES OFFICES IN 40
AMERICAN CITIES

REPRESENTATIVES ALL
OVER THE WORLD

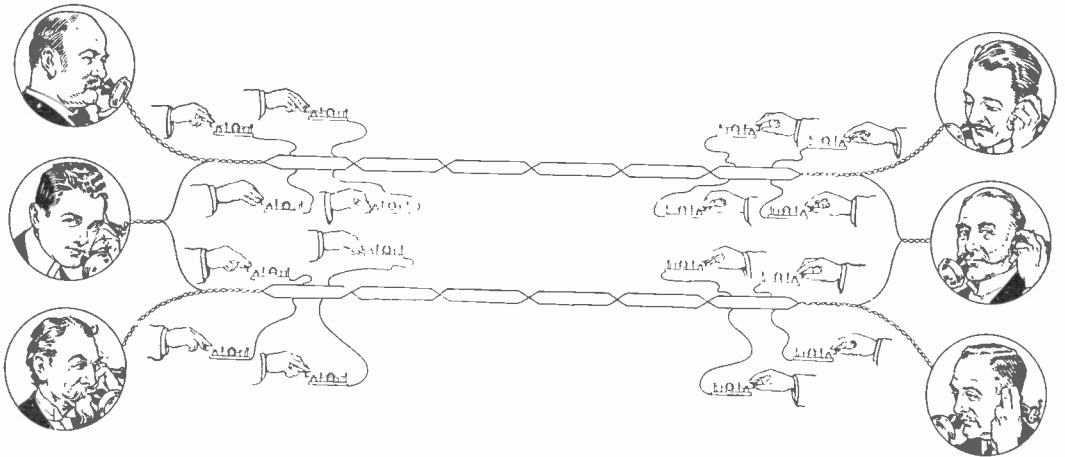

Double Tracking The Bell Highway

Two of the greatest factors in modern civilization—the telephone and telegraph—now work hand in hand. Heretofore each was a separate and distinct system and transmitted the spoken or written messages of the nation with no little degree of efficiency. Co-operation has greatly increased this efficiency.

The simple diagram above strikingly illustrates one of the mechanical advantages of co-operation. It shows that six persons can now talk over two pairs of wires *at the same time* that eight telegraph operators send eight telegrams *over the same wires*. With such joint use of equipment there is economy; without it, waste.

While there is this joint use of trunk line plant by both companies, the telephone and telegraph services are distinct and

different. The telephone system furnishes a circuit and lets you do your own talking. It furnishes a highway of communication. The telegraph company, on the other hand, receives your message and then transmits and delivers it without your further attention.

The telegraph excels in carrying the big load of correspondence between distant centers of population; the telephone connects individuals, so that men, women and children can carry on direct conversations.

Already the co-operation of the Western Union and the Bell Systems has resulted in better and more economical public service. Further improvements and economies are expected, until time and distance are annihilated by the universal use of electrical transmission for written or personal communication.



**AMERICAN TELEPHONE AND TELEGRAPH COMPANY
AND ASSOCIATED COMPANIES**

One Policy

One System

Universal Service

For our Mutual Advantage mention Popular Electricity when writing to Advertisers.

THE SILENT RUNNING

Federal Vacuum Cleaner

CLEANS QUICKLY
and EASILY WITHOUT
NOISE or VIBRATION

Simple
in
Construction
Easy to
Operate



See a
"Federal"
Before
You
Buy

WILL NOT GET OUT OF ORDER

Bulletin No. 1438 Sent Free Upon Request

Federal Sign System (Electric)

501 Home Insurance Building, Chicago

==

A Porch
May Be a
Summer Home

==



==

By Night
As Well As
By Day

==

Mazda Lamps for Summer Evenings

Don't stay in the house these warm summer evenings to finish the newspaper or the book you have been reading.

With a Mazda Lamp on the porch you will triple the light of the old style lamps and not increase the current consumption—these lamps are made in varied sizes for service everywhere.

The Mazda Lamp gives three times as much light for the same current as other lamps—and the best light, white, soft, restful, cool; a boon for the summer nights.

Mazda Lamps are sold everywhere. See opposite page.

National Electric  Lamp Association

CLEVELAND

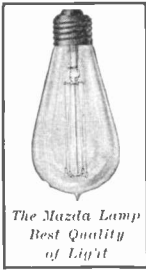

*The famed "Mazda" Lamp is made the
right way,*

*To brighten the night as the sun does the
day;*

Lasting in service and triple in shine,

Its sizes are varied and number just nine.

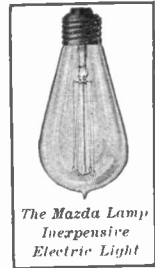

Mazda Lamps are sold by the following member companies of the National Electric Lamp Association and their dealers everywhere. At the nearest "Electrical Store" they have Mazda Lamps and will be pleased to explain them to you.

THE BANNER ELECTRIC CO.,
YOUNGSTOWN, O.

THE FOSTORIA INC. LAMP CO.,
FOSTORIA, O.

THE BRILLIANT ELECTRIC CO.,
CLEVELAND, O.

THE GENERAL INCANDESCENT
LAMP CO., CLEVELAND, O.

THE BRYAN-MARSH COMPANY,
CENTRAL FALLS, R. I.

THE MONARCH INCANDESCENT
LAMP CO., CHICAGO, ILL.

THE BRYAN-MARSH COMPANY,
CHICAGO, ILL.

NEW YORK & OHIO COMPANY,
WARREN, O.

THE BUCKEYE ELECTRIC CO.,
CLEVELAND, O.

THE SHELBY ELECTRIC CO.,
SHELBY, O.

THE BUCKEYE ELEC. LAMP CO.,
MEXICO CITY, MEX.

THE STANDARD ELECTRICAL
MFG. CO., WARREN, O.

THE COLONIAL ELECTRIC CO.,
WARREN, O.

SUNBEAM INCANDESCENT
LAMP CO., CHICAGO, ILL.

THE COLUMBIA INC. LAMP CO.,
ST. LOUIS, MO.

SUNBEAM INCANDESCENT
LAMP CO., NEW YORK CITY.

FEDERAL MIN. LAMP CO.,
CLEVELAND, O.

THE STERLING ELECTRICAL
MFG. CO., WARREN, O.

THE WARREN ELECTRIC & SPECIALTY CO.,
WARREN, O.

National Electric



Lamp Association

CLEVELAND

Classified Advertisements

The cost of advertising in this section is 5 cents per word for one insertion, with

5% discount for 3 insertions
10% discount for 6 insertions
15% discount for 9 insertions
20% discount for 12 insertions
within one year.

Remittance must accompany order, or advertisement will not be inserted. Forms for the October issue close on Sept. 1st

AERONAUTICS

COMPLETE PLAN DRAWN TO SCALE with full instruction for building the only Wright 3-ft. Bi-plane Model that positively flies. 25c postpaid. Drawing and directions for three-foot Model Bleriot Monoplane, 15c. Stamp brings most complete, interesting and instructive catalogue published. IDEAL AEROPLANE & SUPPLY CO., 82½ West Broadway, New York, N. Y.

MODEL BALLOONS AND FLYING MACHINES. How to Make Them, by J. H. Alexander. Contains complete directions for constructing models with five folding plates of working drawings, also an account of the progress of aviation. \$1.50 postpaid. Popular Electricity Book Dept.

AGENTS

AGENTS—500 PER CENT PROFIT IN SIGN Letter Business for you. Particulars. Sample free. Burkhard Co., Butler, Pennsylvania.

"NEVER RUBBED A BIT!" CONVINCING thousands! ¾ time saved. Marvelous washday help. Agents, big profits! "Cameo," Detroit, Mich.

SMALLEST ALARM CLOCK, BIBLE AND Telescope, 10c each, prepaid. W. H. GARNER, B-119 South Lafayette St., Evansville, Ind.

"PERFECTION POCKET ADDING MACHINE—lightning seller. Agents wanted. Cincinnati Specialty Mfg. Co., Dept. E, Cincinnati, Ohio.

AGENTS WANTED—TO SELL PATENTED household article, one that sells at sight. Write for particulars. Ellery & Company, P. O. Box 320, Albany, N. Y.

DON'T ACCEPT AN AGENCY UNTIL you get my samples and particulars. Money makers. Address, SAYMAN, 706 Sayman Bldg., St. Louis, Mo.

AGENTS—MY NEW FRUIT JAR HOLDER sells like hot cakes; big profit; write for particulars and let me prove it. George M. Corsey, 58 Park Ave., Woodbury, N. J.

ONE MILLION AGENTS WANTED—FAST seller costing 5c., selling 50c. Every firm needs. Orders to \$50. Postal brings samples. Embossed Co., 2600 Milwaukee Ave., Chicago.

WE MANUFACTURE GLASS PAPER. Plain glass windows made to look like real stained glass. Easily applied and beautifies the home. Something new for agents. Two sheets of this glass paper sent as a sample with catalogue in colors and complete instructions on receipt of 10c. S. H. Parrish & Co., 202 S. Clark St., Chicago

AGENTS

2-TICLE-U, 3c. STIX, STOCKTON, CAL.

AGENTS MAKE MONEY QUICK SELLING patented household specialties; new leader; sells itself; Government recommends it; write for catalogue, Household Specialty Co., 36-38 Palisade Ave., Englewood, N. J.

AGENTS, PORTRAITS 35c, FRAMES 15c, Sheet Pictures 1c. Stereoscopes 25c. Views 1c. 30 days' credit. Samples and catalogue free. Consolidated Portrait Co., Dept. 1406, 1027 W. Adams St., Chicago.

SIGN PAINTING AGENTS 1,000 PER cent. profit. Best and cheapest window letter made. Samples free. Success positively guaranteed. Experience unnecessary. Embossed Letter Co., 2559 Milwaukee Av., Chicago.

BIG CHANCE FOR HUSTLERS—OUR Salary Plan offers splendid opportunities for making money. Send stamp for particulars. Popular Electricity Magazine, Circulation Department, Commercial Bldg., Chicago.

AGENTS—WE MANUFACTURE SPECIALTY never placed on market before. Not for sale in stores. Household necessity. Sample and particulars 10c. LeRoy Specialty Co., 76 Park Place, Room 102, New York.

MAKE \$20.00 DAILY OPERATING OUR Minute Picture Machines. Experience unnecessary. Small investment; large profits. Free book, testimonials, etc. Write, American Minute Photo Co., Dept. 37, Chicago, Ill.

STICKERS! STICKERS! ALL KINDS, all prices. Every business needs them. Invaluable advertising can be done with these little, inexpensive messengers. Send today for complete price list. Attractive agents' offer. Dept. 7, St. Louis Sticker Co., St. Louis, Mo.

AGENTS MAKE BIG MONEY SELLING our new gold letters for office windows, store fronts and glass signs. Any one can put them on. Write today for a free sample and full particulars. Metallic Sign Letter Co., 400 N. Clark St., Chicago, Ill.

AGENTS WANTED—NEW, INTERESTING, profitable, easy work. Spare time or permanent. Sell our useful specialties. Our original selling plan will double your sales. Particulars and \$2.00 premium offer free. Fair Mfg. Co., 2 Wis. St., Racine, Wis.

YOU CAN MAKE \$\$\$\$ AS OUR GENERAL or local agent. Household necessity; saves 80 per cent. Permanent business; big profits; exclusive territory; free sample. Pitkin & Company, 96 Pitkin Block, Newark, N. Y.

PEERLESS AUTOMATIC DRAFT REGULATOR puts on draft while you sleep insures warm house when you arise. Price \$5.00. Write for circular D. Liberal Discount to agents. O. K. Landis, 423 Charlotte St., Lancaster, Pa.

BE INDEPENDENT! START A MAIL order business in your own home. We tell you how and furnish everything needed wholesale. An honorable and profitable business for man or woman. Particulars free. Many make \$3,000 a year. Murphy Mfg. Co., South Norwalk, Conn.

AGENTS

MY! HOW THEY FALL FOR OUR "Lucky Eleven" toilet combination (\$3.20 value). You sell for \$1.00. Other fellows making \$6, \$12, \$15, \$20 and \$25 daily. Will put you on Easy Street. Great crew managers' proposition—good for \$100 profit weekly. This is only one pippin in our "27 varieties." We manufacture—you save middleman's profit. Our new colored circular is like seeing the real goods. Free to workers. Get aboard. Act today. Davis Soap Works, 263 Davis Bldg., 1429 Carroll Ave., Chicago.

AGENTS—BIGGEST MONEY MAKER known. The new Canchester Incandescent Kerosene Lamp revolutionizes old lighting methods. Burns air, not money. Six times brighter than electricity, gas or acetylene at 1-10th cost. Burns with or without mantle. Burner fits any lamp. Saves 75 per cent. oil. No trimming wicks. Showing means selling. Territory going fast. Write today. Handsome outfit furnished. Canchester Light Co., Dept. P. E., 9, Chicago.

AGENTS, VELOX RAPID POLISHING Cloth cleans and polishes all silver and light metal instantly without the aid of polish. It does the work in half the time and outbids the best silver polish ever devised.

RAPIDITY IS ITS WATCH WORD.

No dirty household with VELOX in drawer. Indispensable to the masses. Full sample particulars 10c. VELOX, 1019 Washington Avenue, New York.

AUTOMOBILES

BARGAINS IN AUTO ACCESSORIES. IT will pay you to deal with us and save lots of money. Ask for our bargain sheet. Emden & Co., 1303 Michigan Blvd., Chicago.

AUTOMOBILES—SAVE DEALERS PROFITS, buy direct from the owners. I have all makes on my lists. Runabouts from \$50 up. Touring cars from \$100 up. Get my prices before purchasing. King, Automobile Broker, 217 West 125th St., New York City.

AUTO CASES AND TUBES GUARANTEED 28x3, \$9.50, tube \$3.03. 30x3, \$10.00, tube \$3.10. 30x3½, \$14.25, tube, \$3.75. 32x3½, \$14.75, tube, \$4.25. Prices are for tubes by mail. Send for complete list. I ship allow examination on receipt of 10 per cent of order. Try them. Many have reordered. Vanderpool's, Springfield, Ohio.

BOOKS

ANY BOOK IN PRINT. STATE SUBJECT wanted. Antlers, 1707 Tremont St., Denver, Colo.

MY BOOK OF 300 FORMULAS 10c. H. Jacobus, 214 Avon Ave., Newark, N. J.

SHERLOCK HOLMES DETECTIVE STORIES. Intensely exciting. Ten Cents. George Winstel, 1624 Pleasant St., Cincinnati, Ohio.

WONDERS AND SECRETS OF HUMAN Magnetism. Startling Facts. 2 cents. New Man Publ. Co., Ravenna, Nebr.

BOOKS—I. C. S. and A. S. C. SETS. Technical books of all sorts—shopwork, electrical, mechanical, wireless, encyclopedias, dictionaries, medical, law, and standard fiction. New and second-hand. Get my prices. Geo. F. Williams, Box 408, New Orleans, La.

BOOKS

PRACTICAL SCIENTIFIC BOOKS ON Modern Subjects, Trades, etc. Catalogue free. Clarence E. Hardage, Syracuse, N. Y.

CLASSY BOOKS! CATALOGUE FOR stamp. Paul Duff, E. 2713 North Mozart St., Chicago.

LEARN MODERN SHOW CARD LETTERING, Designing, etc. New book of 400 illustrations, 2000 advertising phrases, pages 6x9 giving practical common sense instruction, \$1.00 prepaid. Clarence E. Hardage, Syracuse, N. Y.

TELEPHONE TROUBLES AND HOW TO Find Them, and Construction Cost-Units, new 1911 edition; price, 25c. Hyde Pub. Co., Telephone Bldg., 183 Fifth St., Milwaukee, Wis.

BOOKS! BOOKS! OUR 368 PAGE bound volume containing over 3,000 valuable formulas, processes, etc. Price, 50c. postpaid. E. Tietjens, 125 Bloomfield St., Hoboken, N. J.

"THREE LITTLE BOOKS FOR LADIES," postpaid in plain cover, 25c. They tell what you want to know. O. K. Pub. Co., Clerk 191, Decatur, Ill.

NINE DEGREE COURSE IN HYPNOTISM—sold originally for \$5—sent prepaid with year's subscription to Wheel of Life, the great "Cheer Up" monthly for 25c. Life Pub. Co., St. Louis.

PLAIN GAS ENGINE SENSE: A BOOK for the fellow who doesn't know anything about it. Primary instructions of the sensible variety and in plain language. Price 50c. Gas Power, St. Joseph, Mich.

BUSINESS OPPORTUNITIES

FREE—SEND FOR MY CIRCULARS THAT will put you on the right road to success. Free. Frank Cote, K., Saco, Maine.

MAKE PAINT AT COST OF 1c A POUND. Complete formula 10c. Gorman, 1200 Devisadero, San Francisco.

TRAIN A SALES FORCE, IN EXCLUSIVE territory, on a universal demand, money back proposition. J. N. Webb, Arcade, Norfolk, Va.

WE START YOU MANUFACTURING article which brings 1000% profit. No competition. Sample and particulars, 25c. "Tallala," Box 365, Talladega, Ala.

MOTION PICTURE MACHINES, FILM Views Magic Lanterns, Slides and similar Wonders for Sale. Catalogue free. We also buy Magic Machines, Films, Slides, etc. Harbach & Co., 809 Filbert St., Philadelphia, Pa.

BE INDEPENDENT—START MONEY Making. Mail Order Business at Home. New Plans. Everything furnished. Only small capital required. Free Booklet and Particulars tell how. W. E. Miller Co., Box 254, Muskegon, Mich.

START AN EASY AND LUCRATIVE business. We teach you how to establish a successful collection business and refer business to you. No capital required. Little competition. Rare opportunities. Write for Free pointers today. Am. Collection Service, 428 State St., Detroit, Mich.

BUSINESS OPPORTUNITIES

"HOW TO JUDGE A PATENT" OR "PATENT Sense and Patent Nonsense" sent free to Inventors and Manufacturers. Obed Billman, Cleveland, Ohio, Author of "Notes on Patent Law," Popular Electricity.

"WAY TO SUCCESS IN THE MAIL Order Business," tells how I made \$18,000.00 in three years, exposes "outfit" scheme, etc. Worth DOLLARS to you. Free on request. H. System, 108, Marion Kentucky.

"MONEY MAKING FACTS" OF INTEREST to everyone. Mining and Oil Finance analyzed and discussed. My booklet free upon request. Mark E. Davis, 1004 Broadway, Oakland, Cal.

LEARN THE SILVER-PLATING BUSINESS and be assured of a good living for life. C. R. Cable of Virginia earns \$9.50 a day. You can do the same. Simple instructions. Write for free descriptive pamphlet. HUMBOLT PUBLISHING CO., 4743 State St., Chicago, Ill.

MAIL DEALERS: WRITE FOR OUR 25 Big Propositions. ALL NEW—No Competition. Make 25c profit on every dollar order. A few Leaders sent Free. Complete Outfit 10c. Mail Dealers Wholesale House, 407 Franklin Bldg., Chicago.

START A NEW BUSINESS, THE "AMERICAN" razor honing and safety razor blades sharpening machines earns \$5 to \$10 a day. We furnish the outfit and teach you how, no previous experience required, address Illinois Cutlery Co., Dept. 4, 184 Washington St., Chicago.

AM IN ACTIVE TOUCH WITH EVERY plumber, well driller, hardware and agricultural implement dealer in the United States. Will advertise and sell article of merit that can be sold to that and the farm trade. HOEPEL, 500 Aldine Square, Chicago.

IF YOU HAVE ANY SPARE TIME, NO matter how little, and are honestly ambitious to make the most of it, write for our Salary Plan and learn how you can increase your income quickly and easily. Full particulars on receipt of stamp. Address, Popular Electricity Magazine, Circulation Department, Commercial Bldg., Chicago.

MAKE MIRRORS AT HOME. BIG PROFITS with little outlay. One 18x36 in. mirror costs \$2.00 to \$5.00. You can silver a glass this size for 20c. Send \$1.00 in stamps or money order and we will send you EXPLICIT DIRECTIONS how to do it; also how to emboss, grind, foil, gold leaf, frost chip, and make imitation stained glass. How to transfer photos on glass, bore holes in glass and cut skylights. George L. Patterson & Co., Dept. 4, Brooksville, Ky.

INCORPORATE YOUR PATENTS AND business under Arizona Laws. No annual or franchise tax. Members exempt from corporate debts. No public statements required. Stock can be made non-assessable and full paid for anything of value. Charters cannot be repealed by subsequent laws. Hold meetings and do business anywhere. Capitalization does not effect cost. Cost very small. Particulars, laws and forms free. Southwestern Securities & Investment Co., Box D488, Phoenix, Arizona.

BUSINESS OPPORTUNITIES

\$100 MONTHLY AND EXPENSES TO trustworthy men and women to travel and distribute samples; big manufacturer. Steady work. S. Scheffer, Treas. M. T. Chicago.

MAKE MORE MONEY. THE TWENTIETH Century Bargain Bulletin will show you how. Green stamp brings copy. Howard Scheneman, Tolleston, Indiana.

FORM A CORPORATION — CONGRESS LAW for D. C. and all States; cheap. Raise money easily; advice free. U. S. Legal Corporation, Washington, D. C. Representing \$1,225,000,000.

COINS AND STAMPS

FOREIGN STAMPS, 255 MIXED, 10c.; 255 old United States, 10c.; 1,000 United States, 25c. Stamps Bought List, 4c.; 50 different foreign or United States, 5c. each. Herman Kleinman, 3641 Marshall St., Philadelphia, Pa.

STAMPS—105 CHINA, ETC., STAMP Dictionary and list, 2c. Bullard Co., Sta. A, Boston.

STAMPS, 100 ALL DIFFERENT, FREE. Postage 2c. Mention paper. Quaker Stamp Co., Toledo, Ohio.

FREE—200 FOREIGN STAMPS INCLUDING obsolete Turks Island, Canton, Guadeloupe, Tasmania, Congo, (Pictorials), Morocco, and Gwalior, Surcharged, and other good varieties. Send 4c for postage. Lighbrown Stamp Co., Palmerston Road, Southsea, England.

ELECTRICAL MATERIAL

MAGNET WINDERS, TAPPING MACHINES, Water Motors and Fans. Inventions developed. Special articles to order. Cleveland Specialty and Manufacturing Co., Cleveland, Ohio.

FOR SALE

INDIAN-MADE BASKETS. PRICE AND photos free. F. GILHAM, Highland Springs, Cal.

ELECTRIC MOTORS 1-15 to 1 H. P. Cheap. COSMOS ELECTRIC CO., 136 Liberty St., New York.

"BRAZILIAN LUCKY BUG." SAMPLE 10c. History free for stamp. Gorman, 1200 Devisadero, San Francisco.

BOOKS ON ALL ELECTRICAL SUBJECTS —Send for our free illustrated catalogue. Popular Electricity Book Department.

\$10 BUYS 7 SECOND HAND TYPE Q 150 ampere-hour Edison cells. Bargain for experimental work or ignition. Address Roe Tappan, New Carlisle, Ind.

LATHES—SEND FOR FREE CIRCULAR showing bargains on small Screw Cutting Engine Lathes. S. B. Tool Co., Dept. O, South Bend, Ind.

ATTENTION—\$2 FOUNTAIN PEN ONLY 50c. \$3 pen either German silver filigree cap and barrel or gold filled filigree 75c. \$5 pen, solid 11 kt. gold, pearl barrel, 2 gold bands, gold filigree cap. \$1.25. Every one with patent safety clip; guaranteed or money refunded. Buy direct. Independent Mfg. Supply Co., Reno, Nev.

FOR SALE

12 FIRE ALARM APPARATUS COMPLETE in cast iron boxes, 15 in. high. Just a job lot, splendid condition. COSMOS ELECTRIC CO., 136 Liberty St., New York.

TELEPHONES, TYPEWRITERS, SMALL Motors and Generators bought, sold and rebuilt. SUTTLE EQUIPMENT CO., McLeansboro, Ill.

LUBRICATORS AND CUPS FOR SHAFTING and Loose Pulleys. No drip or dirt. Very economical. Swain Lubricator Co., New No. 328 W. Lake St., Chicago.

TWO K. W. TRANSFORMERS; condenser case; eighteen 4x12 Leyden jars; one Helix, very heavy 15x20 inch of No. 00 brass and all rubber insulated. Heavy oak Commercial Set. Value, \$150.00. \$75.00 takes it. P. Kienzle, 1826 Seward St., Chicago.

FOR THE PHOTOGRAPHER

ENLARGEMENTS FREE WITH DEVELOPING; films 10c, prints 3c, Photoelectric Shop, Rock Island, Ill.

FILMS, DEVELOPED, ANY SIZE 10c prints on post cards 3c each. Good work promptly finished. Chas. Hoffman, New Lexington, Ohio.

GAMES AND AMUSEMENTS

CACHOO—THE GENUINE SNEEZE POWDER. Sample, 10c. Dozen, 80c. Hundred, \$5.00. Percy Ewing, Decatur, Ill.

IGNITION

GASOLINE IGNITION. DRY CELL Batteries. Will demonstrate formula and process of manufacture to intending manufacturers only. J. Dougan, 234 Smith St., Winnipeg, Manitoba. References.

INSTRUCTIONS

FORMULAS FOR ANYTHING 20c, SEVEN for \$1.00. Gorman, 1200 Devisadero, San Francisco.

INCREASE YOUR KNOWLEDGE OF electricity. Send for our illustrated catalogue of electrical books. It's free. Popular Electricity Book Department.

SHORTHAND IN SEVEN LESSONS. Most rapid readable system and figures. Quickly learned at home. Textbook, 35c. Send 10c. now and 25c. later, or return book. Unigraph Co., Omaha, Neb.

HOW TO GO ON THE STAGE! PARTICULARS and large catalogue of wigs and makeup free. Percy Ewing, Decatur, Ill.

CANDY MADE WITHOUT COOKING. Formulas 12c. Gorman, 1200 Devisadero, San Francisco.

FREEZE WATER BY ELECTRICITY—This is actually done experimentally. 25c stamps for particulars. E. A. Martin, 907 S. 12th St., Springfield, Ill.

LEARN TO PAINT BEAUTIFUL ART glass pictures. Inexpensive. Easily learned. Big profits. Particulars for dime. L. A. Bowes, Bluefield, West Va.

INSTRUCTIONS

PRACTICAL FORMULAS 25c EACH. GEO. F. LOSEE, Indian Orchard, Mass.

REMARKABLE DISCOVERY OF A SUFFERER! Sure cure for indigestion and all stomach troubles. Anyone can make it at home at small cost and it's also a delicious food and money-saver. Full particulars \$1.00. Your money back if not delighted. W. A. Horton, 611 W. 12th St., Rome, Ga.

"HOW TO BECOME A SUCCESSFUL Electrician," by Prof. T. O'Conor Sloane. Every young man who wishes to become a successful electrician should read this book. It tells in simple language the easiest and surest way the studies to be followed, methods of work and field of employment. 202 pages. Postpaid, \$1.00. Popular Electricity Book Department.

WRITE ELECTRICAL ENGINEER FOR Reliable Data: (1) Any National Code Rule explained (4 years inspector), \$1.00. (2) What book contains information you want, 50 cents. (3) Send information and plans and find out how to wire your house or cottage, \$3.00. (4) Address of manufacturer of any electrical device on market, 15 cents. Electrical Engineer, 3957 Fullerton Ave., Chicago.

KENNEL

WANTED — BIRD DOGS TO TRAIN; game plenty; two trained dogs for sale. H. H. Smith, O. K. Kennel, Maryland, Md.

MAGIC

MYSTERIOUS HINDOO BAG TRICK CAN be done on stage or in parlor. They tie you in the bag, you get out. You are declared marvelous. Fools them all. Explanation 25c stamps. E. A. Martin, 907 S. 12th St., Springfield, Ill.

MISCELLANEOUS

"\$50.00 FRENCH SECRET" IS YOURS FOR 12c. Gorman, 1200 Devisadero, San Francisco.

TATTOOING MACHINES. F. BARBER, 1019 Vine St., Cincinnati, Ohio.

3c A WORD GETS YOUR AD IN ENTIRE list 100 magazines including Wheel of Life. Life Pub. Co., St. Louis.

ANYBODY CAN MAKE GOOD CUTS with my simple zinc etching process; price, \$1.00; specimens and particulars for stamp. T. M. Day, Box E., Windfall, Ind.

LEGAL OPINIONS, REPORTS AND Collections in all states. Reasonable fee. Charles Fitzgerald, Attorney-at-Law, Roanoke Bldg., Chicago.

DON'T THROW AWAY DRY BATTERIES, renew them, I tell you how, low cost, also formula for making battery, 15c stamps. F. Krycek, 1320 Martha St., Omaha, Nebraska.

BROTHER—ACCIDENTALLY DISCOVERED Root will cure both tobacco habit and indigestion. Gladly send particulars. F. F. STOKES, Mohawk, Fla.

MOSKEETOPUNK IS THE LATEST, best and only sure cure for mosquito troubles. For the home or camp. No bad odor; no humbug. Guarantee in every box. 25c. Five for \$1. Moskeetopunk Co., Pekin, Ill.

MISCELLANEOUS

SEND TWO RED STAMPS FOR TEN Rare Formulas. Gorman, 1200 Devisadero, San Francisco, Calif.

MAGAZINES AND PERIODICALS—AMERICAN or Foreign—I can save you money. Send me list of publications you want and I will quote you lowest prices. John Hanrey, 4652 Hazel Ave.

NEW MAIL ORDER BOOKS. PULLING illustrated circulars furnished. Samples and prices sent free. J. C. Burrow, Pub., 533 Fourth St., Louisville, Ky.

DON'T MARRY UNTIL YOU HAVE YOUR friend's character told from their handwriting; send specimen and 2c to Gordon Gordon, Grant St., Camden, N. J.

RAISE GINSENG—\$1.00 PER SQUARE foot of ground. \$25,000 on half acre. Grows anywhere; half city lot a bonanza. 10c. brings booklet. Sheboygan Ginseng Gardens, Sheboygan, Wis.

SAVE MONEY ON SUBSCRIPTIONS. Send me a list of magazines or periodicals in which you are interested and I will quote you lowest subscription prices. John Hanrey, 4652 Hazel Ave.

SAVE THE PIECES—BROKEN CYLINDERS, crank cases, shafts, gears, and housings promptly repaired just like new, at one-third the cost and guaranteed. Address Welding Dept., Bertschy Motor Co., Council Bluffs, Ia.

I WILL START YOU EARNING \$4.00 daily at home in spare time, silvering mirrors; no capital; send for free instructive Booklet, giving plans of operation. G. F. Redmond, Dept. H, Boston, Mass.

MODEL BUILDER

MODELS MADE FOR INVENTORS. LOW prices. S. H. Merryman, Towson, Md.

INVENTORS—WE MAKE ELECTRICAL work of any description to order, models, experimental work, patterns, dies. Ludlow Model Works, Ludlow, Ky.

INVENTORS—WE BUILD MODELS. Do experimental work, light manufacturing, dies and tools. Geo. Schwarz & Co., 123 Liberty St., New York.

MOTORCYCLES

MOTORCYCLE CASES AND TUBES 28x2, corrugated, \$5.00. Bailey \$5.50, tube \$2.40. 28x 2¼, corrugated, \$5.75. Bailey \$6.25, tube \$2.65. 28x2½, corrugated, \$6.25. Bailey \$7.00, Nobby \$7.75, tube \$2.66. Single or double clinch. Guaranteed cases and tubes, Bailey type single clinch 28x2¼, \$7.75, tube \$2.65. 28x2½ \$8.30, tube \$2.82. Price of tubes is by mail including postage. Send postoffice order for tubes and 25 per cent on cases and I ship allow examination. Wm. Vanderpool, Springfield, Ohio.

MOTORCYCLES—SAVE DEALERS PROFITS, buy direct from the owners. I have all makes on my lists. Indians and Marsh's from \$25 up. Hundreds of other machines at comparatively low prices. Get my prices before purchasing. King, Automobile Broker, 217 West 125th St., New York City.

MOTORCYCLES

MOTORCYCLES, NEW AND SECOND-hand; motors, castings and accessories. Our Attachable Motor Outfit converts any bicycle into a motorcycle at small cost. Write for catalogue and bargain list. Shaw Mfg. Co., Dept. 31, Galesburg, Kan.

PATENTS

PATENT—ADVICE AND BOOKS FREE. Highest references. Best results. I procure patents that protect. Watson E. Coleman, Patent Lawyer, 622 F St., N. W., Washington, D. C.

PICTURES AND POSTCARDS

JUST GIRLS—20 POST CARDS OF GIRLS, 25c. No trash or landscapes. O. K. Pub. Co., Decatur, Ill.

YOU'LL GET CARDS FROM EVERYWHERE. Membership 10c. Idaho Card Exchange, Dept. O., Box 906, Boise, Idaho.

MOVING PICTURE POST CARDS. Beautiful Dancing Girl. Life like motion. DIME. A Ferguson, Springfield, Missouri.

IF YOU REALLY WANT TO EXCHANGE postcards try our splendid club. Lists circulate in many countries. Membership 10c. HALEYON Exchange, Box 133, Erie, Pa.

DECORATE YOUR "DEN" WITH "ART Gems." Three bewitching poses, 25c., six for 50c. One 6½x8½ photograph free with every order for six. All real photographs. Money back if not pleased. Art Photo Co., 1409 P. E., Grand Rapids, Mich.

PATENTED POST-CARD NOVELTY FOR Sale. An invention of merit that has universal demand and will revolutionize the sale of souvenir post cards. This is no fake but a sure winner, has no competition, and is worth your while to investigate. Sample and full particulars on request. Freeman T. Hulse, Atty., Bay Shore, New York.

SAN FRANCISCO EXPOSITION CITY'S marvellous reconstruction from greatest fire in nation's history. Emerges world's most modern, beautiful, picturesque city. 24 different artistic colored scenes showing this, including 20 scenes of former ruins. Mailed, 50c. 4 sets, \$1.50. L. Douglas, 51 Octavia St., San Francisco.

PRINTING

100 ENGRAVED STYLE VISITING CARDS 25c. 100 Neat Business Cards or Envelopes 40c. Retter, Box 142-C, Tippecanoe City, Ohio.

PRINTING FOR EVERYBODY. 100 EACH of noteheads, envelopes and cards, neatly printed to your order, prepaid \$1.00. Union Pub. Co., Dept. E, Uniondale, Ind.

SPECIAL IN PRINTING.—50 NOTE heads, envelopes and 50 cards, 50c postpaid. Samples for stamp. The Oak Press, 506 Fairview Ave., Dept. E, Seattle, Wash.

"PRINTING THAT ATTRACTS" AT Rock Bottom Prices. Send 2c. stamp for samples and price list. We Print Anything. The Eastern Printing Works, 1506 Eastern Ave., Baltimore, Md.

PRINTING

1,000 IMITATION TYPEWRITER LETTERS, full size, \$2.00; envelopes, letterheads, statements, billheads, \$1.50. Elegant set samples free. P. Good's Printery Harrisonburg, Va.

REAL ESTATE

TO SELL YOUR PROPERTY WRITE Northwestern Business Agency, Minneapolis.

RUBBER STAMPS, ETC.

YOUR NAME AND ADDRESS ON AIR-cushion rubber stamp 20c. Including pad 30c. Smith Supply, Waukegan, Ill.

RUBBER STAMPS AND SPECIALTIES—best prices—prompt delivery—Most complete line. Don't buy till you see my big catalogue. Free. Theo. Helbling, 607 Marquette Bldg., Chicago.

SCHOOLS

GET A PRACTICAL ELECTRICAL EDUCATION! Full information and illustrated book are FREE. Write at once, 1025 Winnebago St., Milwaukee, Wisconsin.

BECOME A WIRELESS EXPERT. OUR mail course will enable you to master Wireless. Teaches what you want to know. Write now. Kenosha Wireless School, Kenosha, Wis.

\$200 TO \$600 MONTHLY EASILY MADE fitting eye glasses. Short, easy mail course. Reduced tuition. Big demand for opticians. Write today for free "Booklet O." National Optical College, St. Louis.

FREE TUITION BY MAIL: CIVIL SERVICE, drawing, engineering, electric wiring, agricultural, poultry, normal, academic, bookkeeping, shorthand courses. Matriculation \$5. Tuition free to first applicant. Apply to CARNEGIE COLLEGE, ROGERS, OHIO.

AUTOMOBILE SCHOOL—LEARN THE automobile business, repairing and driving, in which you can earn good wages and have healthful and pleasant work. We give a thorough and practical course in road work and repairing. For full particulars address Academy of Automobile Engineering, 1420 Michigan Ave., Dept. "C," Chicago, Ill.

SITUATION WANTED

POSITION WANTED BY AN A-1 ALL-around electrician, inside wireman and a first-class man on motor or generators, any voltage up to 600 volts. I would like a position in the Western States. Address A. B. Knox, Plainville, Conn.

TELEGRAPHY

TELEGRAPHY—MORSE AND WIRELESS; Railway Accounting (Station Agency) taught quickly. R. R. Dispatchers and Western Union Wires and complete Wireless Station in school. Splendid opportunities. Graduates assisted. Living expenses low—may be earned. Largest and oldest school—established 37 years. Investment \$25,000.00. Correspondence courses also. Catalogue FREE. DODGE'S TELEGRAPH & RAILWAY INSTITUTE, 16th St., Valparaiso, Ind.

TRADE SCHOOLS

ELECTRICITY, PLUMBING, BRICKLAYING, PAINTING and DECORATING and MECHANICAL DRAFTING, taught quickly by expert workmen. Actual work takes place of books. Tools and materials furnished FREE. Splendid positions always open. Oldest, largest and best equipped trade school. Write for Catalogue. COYNE NATIONAL TRADE SCHOOLS, 86 E. Illinois St., Chicago.

TYPEWRITERS

\$10.00 FOR A REAL REMINGTON TYPEWRITER. 5 per cent. discount for cash with order. Also have large stock of all other makes of typewriters. Donald Price, 40 Dearborn St., Chicago, Ill.

TYPEWRITERS \$12; PHONOGRAPHS \$9; Motorcycles \$60. Rent, terms. Knights, 275 12th St., St. Louis, Mo.

GENUINE TYPEWRITER BARGAINS, NO matter what make, will quote you lowest prices and easiest terms, or rent, allowing rental on price. Write for big bargain list and catalogue 14. L. J. Peabody, 278 Devonshire St., Boston, Mass.

LARGEST STOCK OF TYPEWRITERS IN America. All makes: Underwoods, L. C. Smiths, Remingtons, etc.; one-quarter to one-half manufacturers' prices (many less). Rented anywhere, applying rent on price. Write for catalogue 102. Typewriter Emporium (Est. 1892), 92-94 Lake St., Chicago.

TYPEWRITERS: CALIGRAPH, \$6.00; Hammond, Yost, Densmore, Williams, \$10.00; Remington, \$12.00; Smith Premier, \$15.00; Oliver, \$24.00; Underwood, \$30.00; all makes on hand; fifteen days' trial allowed, and a year's guarantee. Send for catalogue. Harlem Typewriter Exchange, Dept. 89, 217 West 125th St., New York City.

WIRELESS

PACIFIC COAST CALL LIST. 266 GOVERNMENT and commercial wireless stations. Ten cents. Ford King, 623 Balboa Building, San Francisco.

BRONZE CASTINGS OF BODY AND lever of key described in July 1910 issue of POPULAR ELECTRICITY, 75c postpaid. Englewood Bronze Co., 5338 Emerald Ave., Chicago, Ill.

WIRELESS TRANSFORMERS. OPERATE on 110 or 220 volts A. C. Capacity $\frac{1}{4}$, $\frac{1}{2}$, 1 and 2 K. W. Require no reactance coils nor resistance. Send stamp for photo and prices. Crosby Electrical Co., Holyoke, Mass.

2KW COMPLETE, COMMERCIAL WIRELESS outfit for sale at factory cost \$150.00. Also 5KW at \$300.00. Address, NATIONAL ENGINEERING CO., No. 146 Church St., Dayton, Ohio.

MAKE YOUR OWN WIRELESS APPARATUS. We furnish working drawings. Silicon, Vertical Perikon, Carborundum Detectors, Helix, Single or Double Slide Tuners, 15c each. Receiving Transformer 30c, Rotary Spark Gap 25c. Remit by Postal or Express money order. Stamps not accepted. Junior Wireless Co., 1788 Brooklyn Ave., Brooklyn, N. Y.

WIRELESS

COMPLETE WIRELESS STATION GUARANTEED to send 1-4 mile, receive 500. Combination Electrolytic-Mineral Detector, 90 ohm Receiver, 3 foot cord, 65 foot serial wire, special Spark Coil, Spark Gap, Leyden Jar, Key, Aerial Switch, Insulators, diagrams. Price, \$2.75 complete. Sending set, only \$1.75; receiving, \$1.40. 3c for catalogue. Franklin Electric Co., 846 Ninth Avenue, N. Y., N. Y.

A DECIDEDLY NEW ROTARY VARIABLE Condenser, \$10.00, the best out. 1-2 K.W. Alwco Sending Transformer with condenser and spark gap, \$35.00. Complete Receiving Set with 1000 ohm double-pole receiver, \$5.95. Guaranteed double-pole 1000 ohm receivers, \$1.75 each; pair with split head-band and six foot silk cord, \$5.25. Double-slide Tuning Coils wound with spaced bare wire, \$2.25. Slider rod, 10c foot; sliders, 23c. Reliable apparatus and supplies of all kinds. Send stamp for catalogue. Alden Wireless Co., Dept. D, Campello, Mass.

HELP WANTED

SEND FOR FREE BOOKLET, ALL About Patents and Their Cost. Shepherd & Campbell, 500 B. Victor Bldg., Washington, D. C.

WANTED—A MAN OR WOMAN TO ACT as our information reporter. All or spare time. No experience necessary. \$50 to \$300 per month. Nothing to sell. Send stamp for particulars. Sales Association, 611 Association Building, Indianapolis, Ind.

\$25 WEEKLY AND EXPENSES TO MEN and women to collect names, distribute samples and advertise. Steady work. C. H. Emery, M. N. Chicago, Ill.

CIVIL SERVICE EXAMINATIONS OPEN the way to good Government positions. I can coach you by mail at small cost. Full particulars free to any American citizen of eighteen or over. Write today for Booklet E 50. Earl Hopkins, Washington, D. C.

WANTED—ACTIVE, EDUCATED MEN and women of good address. High grade educational specialties. Our plan has become a necessity in homes having children. Commission or guaranteed income. Give references. Address, Chautauqua Mfg. Company, Valparaiso, Ind.

PLOTS WANTED FOR MOTION PICTURE Plays. You can write them. We teach you by mail. No experience necessary. Good writers earn \$50 a week. Demand increasing. For particulars address Ass'd Motion Picture Schools, 916 Chicago Opera House Building, Chicago.

WANTED—MEN TO LEARN WATCH-making. Earn pay while you learn. Write for our free book "How to be a Watchmaker." Stone Watchmaking School, 908 Globe Bldg., St. Paul, Minn.

CHALLENGE SAFETY SWING. The all-year-round Picnic-Maker for children. Best \$1.50 seller ever. Exclusive field. Use in porch, tree or doorway. Student sold 85 first week. Lady 28 first 2 days. Another over 600 in 10 consecutive weeks. Write at once. Chautauqua Mfg. Company, Valparaiso, Ind.

HELP WANTED

BIG MONEY WRITING SONGS. SEND for free booklet. Tells how. Conway, 49 Tuscola St., Detroit, Mich.

WANTED—MEN BY LARGE CONTRACTING company. Can learn trade of plumbing, electricity, bricklaying, automobiles, in few months. No apprentice or helper's work and no expense. \$20,000.00 contract work going. Catalogue free. United Trade School Contracting Co., Los Angeles.

BIG MONEY WRITING SONGS. THOUSANDS of dollars for anyone who can write successful words or music. Past experience unnecessary. Send us your song poems, with or without music, or write for free particulars. ACCEPTANCE GUARANTEED IF AVAILABLE. Washington only place to secure copyright. H. Kirkus Dugdale Co., Dept. 13, Washington, D. C.

WANTED—MAIL CLERKS; CITY MAIL Carriers; Clerks in the Government offices at Washington, D. C. September examinations everywhere. Thousands of appointments. Average salary about \$1100. No "Layoffs." Short hours. Annual vacations. Common education sufficient. City and Country residents equally eligible. Political influence unnecessary. Send immediately for schedule giving places and dates of September examinations. Free coaching. Franklin Institute, Dept. M-53, Rochester, N. Y.

TERRITORY MANAGERS IN EXCLUSIVE territory, low-priced hand machine makes \$5 to \$6 worth of staple article in universal use for 40c or from waste material free. Sells quick, city or country, a real time and money saver. One man made \$159.60 first day. Babcock says, "Will wager can sell 8 out of 10 calls." No competition, big money handling sub-agents, personal training and free sample given to workers. Only a few keen, clean, ambitious men needed. Chicago Appliance Factories, Dept. G-311, 22 Quincy St., Chicago.

THE NEW STATE AUTOMOBILE LAWS make it impossible for incompetent or untrained persons to hold a chauffeur's license and at the same time makes it possible for properly registered and licensed chauffeurs to demand higher wages. Don't waste your time and money in small, new, or poorly equipped schools, but come direct to the largest in the business. WE GUARANTEE A MAN HOLDING OUR DIPLOMA to pass state examination. GREER COLLEGE OF MOTORING, 1159 Wabash Avenue, Chicago, Illinois. THE ONLY SCHOOL CARRYING THE ENDORSEMENT OF THE TRADE.

MAGIC POCKET TRICK FREE
Catalog included, send 6c stamp.
Dept. 17 270 W. 39th St., New York



Big Mail FREE

Your NAME PRINTED in our Mailing Directory and sent to 10,000 firms all over the world so they can send you FREE Samples, Catalogs, Books, Papers, Magazines, etc., etc. Send 20c to cover cost of printing your name and you will receive a big mail FREE.

Ingram, Va., Jan. 7, 1910. Mr. Anderson, I have already received more than 2,000 parcels of mail, and still they come, scores of papers, samples, magazines, etc., for which I had often paid 10 to 25c each. R. T. James, Send to ANDERSON, The Mail Man, 565K, Jamestown, N. Y.



Doubt or Confidence



Are you in doubt, or do you know that there are better things ahead?

Doubt never raised a man's salary—confidence makes many fortunes.

The purpose of the International

Correspondence Schools is to give a man confidence in himself by training him in the line of work he prefers. With this equipment he goes to any employer with confidence in his ability to fill the position he seeks.

I. C. S. training is today one of the greatest recommendations that a young man can have. Great employers value it because it is *real*.

A man with I. C. S. training applies to such concerns as Baldwin's Locomotive Works, Cramp's Shipyard, Westinghouse Electric Company, the great Railroad Systems, or any other branch of industry, with the confidence that he will have an opportunity not offered to the untrained man.

To learn about the I. C. S. it is only necessary to mark and mail the attached coupon. For example, if you desire to become a Civil Engineer you put a cross opposite that occupation. Or, if you desire to become a Mechanical Draftsman, Electrical Engineer, Architect, Advertising Man, Stenographer, Bookkeeper, or fill any other occupation mentioned, you simply mark the position you prefer.

Mark and mail the coupon and the I. C. S. will show you exactly how to accomplish what you desire and will place at your disposal the best industrial training that can be given to any man—young or old.

Mark and Mail the Coupon TODAY.

International Correspondence Schools
Box 1102, Scranton, Pa.

Please explain, without further obligation on my part, how I can qualify for a larger salary and advancement to the position, trade, or profession before which I have marked X.

Electrical Engineering
Electric Lighting
Electric Railways
Electrician
Electric Car Running
Dynamo Foreman
Dynamo Tender
Wireman
Mining Engineer
Telephone Expert
Civil Engineer
Automobile Running

Mechanical Engineer
Mechanical Draftsman
R. R. Constructing
Concrete Construction
Architect
Contracting & Building
Architectural Draftsman
Plumbing & Heating
Chemist
Bookkeeper
Advertising Man
Civil Service Exams.

Name _____

St. and No. _____

City _____ State _____

Present Occupation _____

For the Person Who Travels

The United Service Combination Lamp for Oil or Electricity Satisfies a Long Felt Need.



Showing Incandescent Electric Lamp in place and one section of Shade removed

This Lamp has been especially designed to meet the needs of the person who desires the best possible light wherever he goes. Where there is electric light, it may be attached to any socket

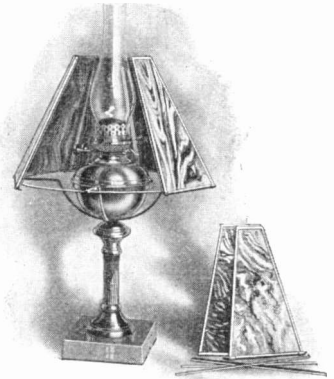

Showing Oil Fount in place with portion of Shade removed

to make a solid and artistic reading lamp. Elsewhere the cord may be detached and the oil fount put in place of the bulb, making an oil lamp of unusual beauty and attractiveness. Thus one is relieved of discomfort and headaches caused by insufficient illumination and always assured of a clear, mellow radiance.

In the United Service Lamp an ingenious idea is found combined with the art of the best designers and the skill of expert lamp makers. The standard is beautifully polished and modelled on Colonial lines. The shade is of exquisite art glass in amber, white, opalescent, olive green or dark gold colors. It can be easily taken apart, lies flat, and the entire lamp can be packed in little space. No better or more durable combination lamp is sold at any price.

An Attractive Addition to Any Home

Built on lines simple, yet rich and dignified, the United Service Lamp is an attractive addition to the furnishings of any home.

Price, lamp complete with collapsible shade, oil fount, lamp chimney and connecting cord, F. O. B. Chicago - - - - - **\$15.00**

Lamp complete with special shade, instead of collapsible shade and holder - - - - - **\$11.00**

Collapsible shade and special holder only **\$8.00**

Electric portable with cord and plug (without shade) - - - - - **\$4.00**

Oil fount, Duplex burner and chimney (will fit any standard Edison socket) - - - - - **\$3.00**

Lamp complete weighs 12 lbs.

Total shipping weight, boxed, 20 lbs.

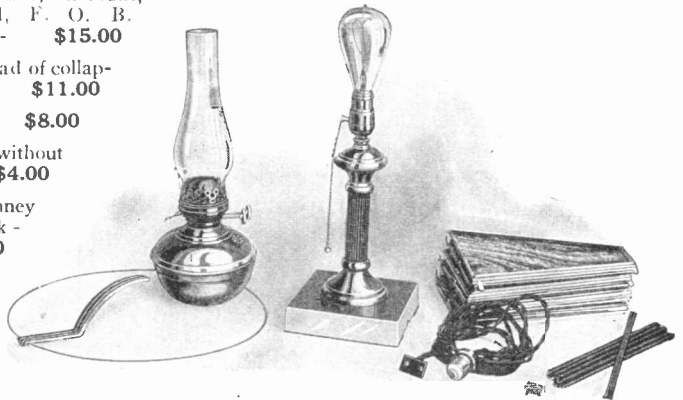

Showing all parts, taken down ready for shipment. Can be carried in suitcase

*In Ordering, specify color
of shade desired*

ELECTRIC SHOP—CHICAGO

JACKSON AND MICHIGAN BOULEVARDS

For our Mutual Advantage mention Popular Electricity when writing to Advertisers.



One of the Hundred Uses of this Electric Stove*

BOILS

Water
Tea
Coffee
Candy
Soups
Potatoes
etc.

COOKS

Cereals
Rarebits
Vegetables
etc.

Getting breakfast quickly is but one of the many conveniences possible with this electric stove. It is ready for service anywhere, any time with ordinary cooking utensils and with percolators, chafing dishes, and the like.

Simply turning a switch produces either of three different grades of heat, low, medium or high. This handy stove is flameless, safe, clean, reliable and will last a lifetime.

G-E Disk Stoves are made in five different sizes — price \$4.50 and upwards. The G-E line also

includes electric twin-disk hot plates and domestic ranges, similar in size and usefulness to gas hot plates and ranges. Get them from lighting companies and electrical supply dealers everywhere. Write for 60-page illustrated price list of fifty electric heating and cooking devices.

*Through the use of Calorite (an alloy made and used exclusively by the General Electric Co.) this stove will give a quicker and cheaper heat than any other electric stove of its size.

FRIES

Eggs
Meats
Fritters
Doughnuts
Oysters
Fish
Potatoes
etc.

TOASTS

Bread
Crackers
etc.



General Electric Company
SCHENECTADY, NEW YORK

3122



OUR NEW BOOK CATALOG NOW READY

MOST COMPLETE ELECTRICAL BOOK CATALOG PUBLISHED

A description of the most up-to-date and practical books **of all publishers**, best suited to the needs of beginners, students and practical workers.

Every electrical subject is covered, and only the best books in each particular line are listed. The description is very complete, showing the contents of each book, to assist you in selecting those best suited to your purpose.

We know these books to be just as represented, and do not hesitate in recommending them to our readers.

Don't buy electrical books until you have seen this new catalog. Everyone interested in electricity should have a copy.

SEND TODAY

Inclose 2c Stamp for postage

Use Coupon Below

Popular Electricity Book Department, 54 W. Lake St., Chicago, Ill.

Enclosed find 2c stamp for which please send me your **New Catalog** as advertised.

Name _____

Address _____



SMALL MOTORS FOR ALL PURPOSES



We manufacture motors (both alternating and direct current) for every

small power purpose. We build them in sizes from one-hundredth horse-power up.

Regardless of what mechanical appliance you wish to operate, we can supply you with a Fort Wayne motor particularly adapted to your requirements.

No one motor ever built can run all kinds of devices equally well, so we have developed a variety of types to meet all conditions. For years we have been making the motors used on the leading vacuum cleaners, water pumps, meat grinders, washing machines, vibrators, etc. Tell us what you want to run and we will advise you what kind of a motor it will need and how much it will cost to buy and operate it.

Our new bulletin 1122 contains descriptions and illustrations of some twenty applications which have saved time and money for Manufacturers, Merchants, Doctors, Dentists, Housewives, etc. We want to mail you a copy—FREE. It will pay you to send for this bulletin and read it before you buy motors of any kind.



Fort Wayne Electric Works

"OF GENERAL ELECTRIC COMPANY"

1603 Broadway
Fort Wayne, Ind.

Branch Offices:
Most Large Cities



For our Mutual Advantage mention Popular Electricity when writing to Advertisers.

SPECIAL NOTICE!

To Subscribers Regarding Delivery
of Their Copies Each Month

THE Postoffice Department is inaugurating a change for the transportation of periodical mail matter by fast freight to certain distributing points, which will mean a slight increase of from two to four days in the time of delivery for those sections of the country affected.

In so far as possible, efforts will be made to overcome this by earlier mailing, but if your copy of the October issue and future issues is a few days late in arriving, you will understand the reason, and we ask your indulgence for the unavoidable delay.

POPULAR ELECTRICITY MAGAZINE

Practical 25c Handbooks

UP-TO-DATE AND WRITTEN IN PLAIN ENGLISH

MAGNETS AND MAGNETISM—A very clearly written explanation of an important subject. By A. W. Marshall. Contents of Chapters: 1—The Theory of Magnets. 2—Permanent Magnets. 3—Electro Magnets. 4—Solenoids or Tubular Electro-Magnets. 5—Experiments with Magnets. 88 pages; 49 illustrations.

WINDMILLS AND WIND MOTORS—By F. E. Powell. A practical handbook on the construction of small windmills, for pumping water, generating electricity, or driving small machines. An American type windmill, diameter of sails 3 ft. A small working windmill, diameter of sails 6 ft. A small self-adjusting windmill, diameter of sails, 10 ft. Description of other forms of wind motors with a chapter on the production of electricity by wind power, etc. 80 pages with 84 illustrations and diagrams.

ELECTRIC BELLS AND ALARMS—How to install them. By N. H. Schneider. Including batteries, wire and wiring, circuits, pushes, bells, burglar alarms, high and low water alarms, fire alarms, thermostats, annunciators, and the locating and remedying of faults. With 56 original diagrams.

SMALL DYNAMOS AND MOTORS—How to make and use them. A practical handbook, by F. E. Powell. Contents of Chapters: 1—General Considerations. 2—Field Magnets. 3—Armatures. 4—Commutators and other Details. 5—Tables of Windings. 6—How to Build a Small Machine. 7—Useful Data. 8—Testing and Repairing. 76 pages, fully illustrated with detail drawings.

HOW TO MAKE WIRELESS INSTRUMENTS—By 20 Wireless Experts—A treatise for the experimenter and amateur on the construction of wireless instruments and apparatus. Complete directions for making a "Two-mile Wireless Set" also for constructing numerous approved wireless apparatus for both high and low power sets. 94 pages, illustrated.

THE WIRELESS TELEPHONE—By H. Cernsbach—Written for the student and experimenter and those engaged in research work in Wireless Telephony. Describes all the present systems and inventions, also contains complete directions for constructing a simple Wireless Telephone. 80 pages, 57 illustrations.

CONSTRUCTION OF INDUCTION COILS AND TRANSFORMERS—By H. W. Secor. Describes fully the design and construction of various sizes of induction coils and transformers. The Tesla coil and its uses is covered thoroughly. Details are given for the construction of open and closed core transformers. Complete with numerous tables and data. 94 pages, illustrated.

WIRING A HOUSE—By Herbert Pratt. Shows a house already built, tells just how to start about wiring it; where to begin; what wire to use; how to run it according to insurance rules in fact just the information necessary for wiring a house or shop. Tables showing the current carrying capacity of wires are also given.

Popular Electricity Book Dept., Chicago, Ill.

For our Mutual Advantage mention Popular Electricity when writing to Advertisers.

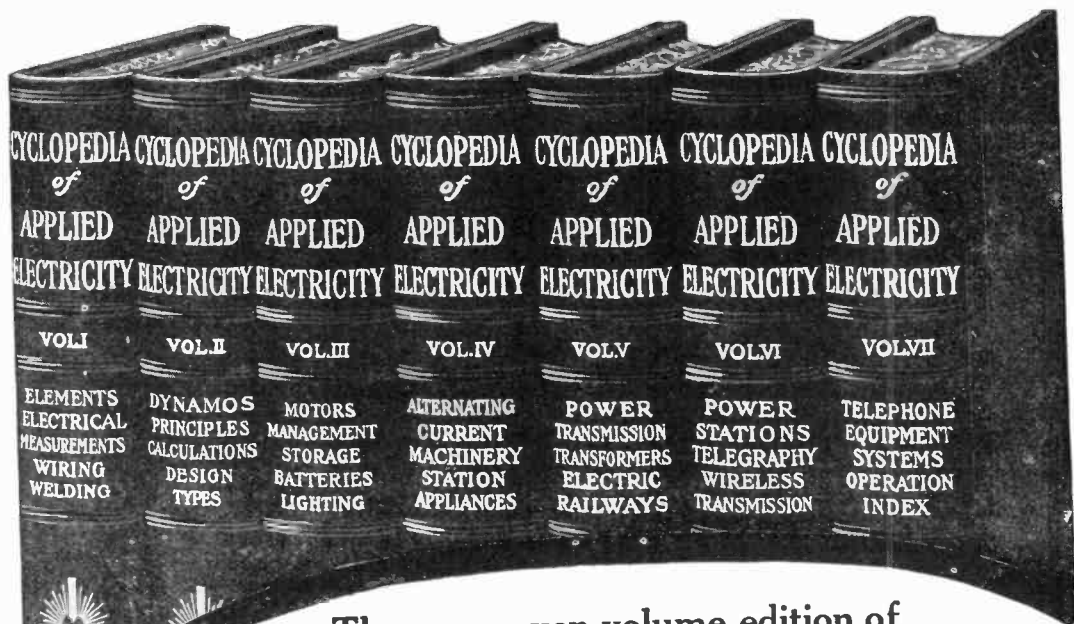

The new seven volume edition of
Electrical Knowledge

This is the greatest electrical reference library, for the expert and student. These books are published especially for the ambitious man who is training himself for advancement, for the wide awake man who is likely to be called upon for work outside of his regular line—for the man who needs at his elbow, for ready reference, an accurate down-to-date work on Electricity.

Seven volumes, 2,996 pages with over 2,000 full page illustrations, diagrams, formulas, etc., printed in large clear type on special quality paper; bound in half morocco; titles printed in 22 karat gold.

Read what this great **Cyclopedia of Applied Electricity** Contains

Theory, Calculation, Design and Construction of Generators and Motors—Electrical Measurements—Electric Wiring—Electric Welding—Types of Generators and Motors—Management of Generators and Motors—Storage Batteries—Electric Lighting—Alternating Current Machinery—Station Appliances—Power Stations—Power Transmission—Central Station Engineering—Electric Railways, Including Single-Phase—The Electric Telegraph—Telephone Equipment, Systems and Operation—Wireless Telegraph and Telephone—Telautograph—Telegraphone, etc.

We Want You to Examine This Great Cyclopedia, Free of Charge

The complete seven volumes, not a sample volume, will be sent, express prepaid, for five days' free examination; returnable at our expense if the books do not contain the information you want. If you keep the books, pay \$1.80 five days after receipt and then \$2.00 a month until you have paid the special introductory price of \$19.80.

The Table of Contents above will give you some idea of the tremendous scope of this work, but only an examination of the books will reveal their full value to you.

Just fill in and mail the coupon. It won't cost you a cent to examine the books. We know they'll be worth many times their cost to you. Mail the coupon now before the busy season begins and you will receive your books promptly.

AMERICAN SCHOOL OF CORRESPONDENCE
 CHICAGO, U. S. A.

FREE EXAMINATION COUPON

NAME.....
 ADDRESS.....
 OCCUPATION.....
 EMPLOYER.....

Pop. Elect. 9-11

A. S. of C.

Please send me Cyclopedia of Applied Electricity for five days' free examination. I will send \$1.80 within five days and \$2 a month until I have paid \$19.80; otherwise I will notify you and hold the books subject to your order. Title not to pass until fully paid.

For our Mutual Advantage mention Popular Electricity when writing to Advertisers.

In the September Number of
The COLUMBIAN MAGAZINE

Read "How the 'Interests' Control America,"
By Senator Joseph L. Bristow of Kansas

The Senator believes that the faith and hope which animated the founders of the Republic should be the guiding light of the nation today. From his first entry into public life, as a journalist, as assistant postmaster general, and as Senator, Joseph L. Bristow has fought fraud, and upheld the rights of man against tyrannous greed and monopoly. His views, therefore, on public questions are worthy of serious reflection.

Read "Politics and the Divine Passion,"
By John Lopez

Here again we see the world go round in the same old unvarying way as it did in the ancient days of Paris and Helen, of Alexander and Thais, of Anthony and Cleopatra.

Read "Bohemia"
 "The Boy Scouts"
 "A Ready-made Husband"
 "The Stablash Sisters"
 "The Perriwigs"

All delightful midsummer fiction, stories that are bound to please and hold your undivided interest.

And There is also another article that you shouldn't miss—the story of a brave city magistrate's fight for the children—especially if you have children of your own. It is called "Polecat Fighting," and its author is George Creel.

15 Cents a Copy At All News-Stands \$1.50 by the Year

The COLUMBIAN MAGAZINE

66 West 35th Street New York City

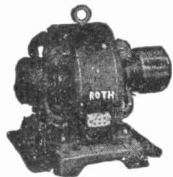

The Gregory Bargain List of Electrical Machinery

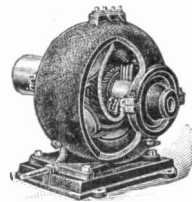

We have the largest stock of second hand electric motors and generators in America and buy and sell, rent, exchange and repair electrical machinery of all kinds. Send for our "MONTHLY BARGAIN SHEET," showing complete stock with net prices.

FOR SALE 220 VOLT D. C. MOTORS

H. P.	Speed.	H. P.	Speed.	H. P.	Speed.
1 3/8	Lundell.....1450	12 10	National MP.....1500	1 35	Western Elec. MP, comp 850
1 4	Wiley, MP, comp.....900	4 10	Gen. Elec. MP.....1375	1 35	Amer. Eng. Co., MP.....670
1 5	Gen. Elec. MP.....1725	1 10	Crocker-Wheeler, MP.....1100	1 35	Commercial, MP.....550
1 5	Western Elec. MP.....1100	1 15	Gen. Elec. MP, comp.....1200	1 35	Elec. Mch. Co., MP.....850
1 5	Sprague-Lundell, encl.....1100	1 15	Roth, MP.....750	1 35	Ideal, MP type D, new.....550
40 5	National, MP, new.....950	1 15	Crocker-Wheeler, MP.....725	1 35	Crocker-Wheeler, MP.....675
1 5	Gen Elec. backgeared 1100-140	37 15	National, MP, new.....725	1 40	Northern, MP, comp.....900
1 5	Gen. Elec. MP.....675	1 15	Sprague-Lundell, 6-pole.....650	1 40	C. & C. type FP.....650
1 7 1/2	Roth, MP.....1500	1 15	Gen. Elec. MP.....780	2 40	Western Elec. MP.....450
1 7 1/2	Northern, MP.....1300	1 15	Gen. Elec. MP.....625	1 45	National, MP.....825
1 7 1/2	Gen. Elec. MP.....1525	1 20	Fairbanks-Morse, MP.....975	1 50	C. & C. type M. P. L.....530
3 7 1/2	Sprague Lundell encl.....1070	1 30	Gen. Elec. MP.....875	1 50	Western Elec., 6-pole.....450
14 7 1/2	National, MP, new.....1100	1 30	Allis-Chalmers, MP.....875	1 55	Northern, MP.....800
9 7 1/2	National, MP, comp.....950	4 30	Northern, MP, comp.....565	1 55	Westinghouse, MP, comp.....625
1 7 1/2	Westinghouse, MP.....1350	1 35	National, MP, new.....575	1 60	Western Elec., 6-pole.....850
2 17 1/2	Crocker-Wheeler MP, comp.....875	1 35	Western Elec. MP.....1015	1 60	C. & C., comp.....580
1 7 1/2	Western Elec. MP.....650	1 35	Allis-Chalmers MP.....1150		
1 10	Western Elec. MP.....1550	1 35	Western Elec., MP, comp 1050		

All machines fully guaranteed.

Machines sent on approval to responsible parties.

GREGORY ELECTRIC CO

THE PIONEER BARGAIN HOUSE

WAREHOUSE AND WORKS: 16th AND LINCOLN ST., CHICAGO, ILL.

Thordarson Toy Transformers

Amuse and Educate

The Thordarson Toy Transformer is the best and most reliable transformer made to reduce house current for operating any electrical toy or device. It comes in four styles and can be attached to any alternating current lamp socket. No danger—does away with constant trouble and expense with batteries. Indestructible and impervious to moisture. No limit to its uses in the hands of an ingenious boy.

- No. 1, Toy Transformer.....\$ 8.00
- No. 1A, Toy Transformer..... 5.00
- No. 2, Toy Transformer..... 10.00
- No. 2A, Toy Transformer..... 7.00

Write for particulars

Thordarson Electrical Mfg. Co.
220 South Jefferson Street, Chicago

Will Not Burn Out

An important feature of these motors is that they will not heat under any circumstances.

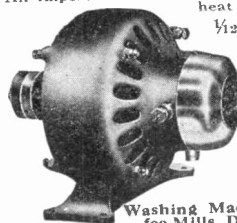

1/2 and 1/8 H.P. for A.C. and D.C.
Finished in Black Enamel.

THE BARNES

VARIABLE SPEED AND REVERSIBLE

Are especially adapted for
Washing Machines, Printing Presses, Coffee Mills, Dental Apparatus, Vacuum Cleaners, Wireless Apparatus, etc.

Let us figure on your requirements

BARNES MFG. CO., 107 Belmont Street
Susquehanna, Pa.

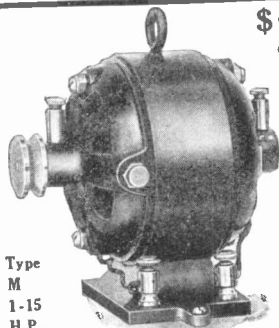

\$3.50 for this
HIGH GRADE MOTOR

Runs on a. c. and d. c. current, 110 volts. Includes complete set of blue prints showing how to assemble. Has laminated field and armature, mica insulated commutator, 316 carbon brushes, bronze bearings, brass grease caps, pulley and terminals. Assembled complete ready to run

\$5.50

Set of blue prints showing motor in detail 12c. Catalogue 4c.

Type
M
1-15
H.P.

JOSEPH WEIDENHOFF
1215 S. Ashland Ave. CHICAGO, ILL.

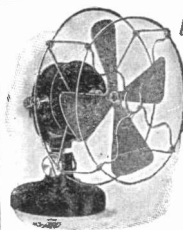

A PERFECT 110 VOLT FAN FOR \$6.50

Electrically, Mechanically and Aesthetically Perfect

Finish, black enamel and nickel. Any adjusting fan is not needed. You can buy a larger or a higher priced fan but you positively can not get a better one. Noiseless and sturdiness. Say whether for alternating or direct current, and give dealer's name. We prepay express and guarantee satisfaction. Six volt battery fan at same price.

The Carleton Company

178 Summer St., Boston, Mass.

For our Mutual Advantage mention Popular Electricity when writing to Advertisers.

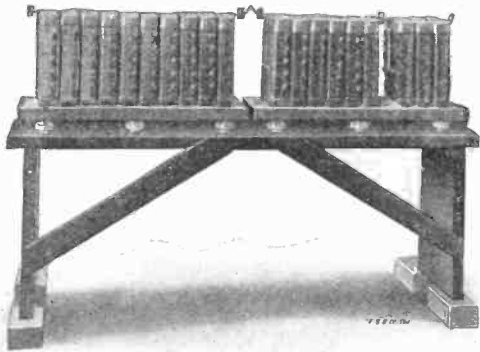

A 24 HOUR ELECTRIC SERVICE

A small storage battery which is occasionally charged from a small dynamo run by a gas engine, together with a simple switchboard, comprise a complete electric lighting plant—making it possible to have electric lights available for use any hour of the day or night.

These small electric lighting plants for use in summer hotels, suburban homes, farms, etc., where Central Station current is not available, are very simple to install and operate, occupy only a small space, are inexpensive and give absolutely reliable service.

The "Chloride Accumulator" used with these small electric lighting plants is the same type of battery used by the large Central Stations, Electric Railways, Telephone and Telegraph Companies, etc. This battery is not complicated and can be easily cared for with very little time or attention.

Our book "How to Have your Own Electric Lighting Plant," which can be secured from any Sales Office will give you complete information

THE ELECTRIC STORAGE BATTERY CO.

1888 PHILADELPHIA, PA. 1911
 New York Boston Chicago St. Louis Cleveland Atlanta
 Detroit San Francisco Portland, Ore. Seattle Los Angeles Denver
 Toronto

The "Exide" Sparking Battery gives the most reliable ignition service for gas engines.



1.6
Volts

25
Amperes

Figures That Count

In purchasing a dry battery, everyone wants a battery which will not have to be replaced every week or so. This can be avoided by the selecting of

THE 1900 DRY BATTERY

which by actual test has proven its efficiency for all kinds of work.

Send for Booklet which contains full particulars.

The Nungesser Electric Battery Co.
CLEVELAND, OHIO

General Sales Office: 627 W. Jackson Blvd., Chicago (2)

Just off the Press—1911 Edition Standard Wiring for Electric Light and Power

as Adopted by the
Fire Underwriters
of the
United States

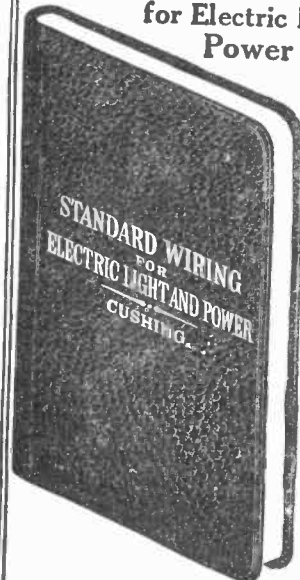

Containing the National Electric Code, explained with numerous illustrations, together with the necessary tables and formulae for outside and inside wiring and construction for all systems. Everything revised right up-to-date. Handy size for the pocket. Black limp leather binding—gilt embossed.

Price prepaid

\$1.00

Free for 2 paid yearly
Subscriptions
to

Popular
Electricity

POPULAR ELECTRICITY BOOK DEPT.
54 W. Lake St., CHICAGO, ILL.

Send for our illustrated Catalog—FREE

For our Mutual Advantage mention Popular Electricity when writing to Advertisers.



CUTLER-HAMMER ELECTRIC IRONS

Please Everybody

You will want to do the ironing, if you use a Cutler-Hammer Electric Iron.

The heat is only in the iron. All walking from the ironing board to the stove and back again is saved and even the lifting of the iron is eliminated.

This shortens the time of ironing at least one-third and makes ironing easy.

Cutler-Hammer Irons have a patented back stand. They stand alone. A separate metal stand is not needed.

A special ring connection prevents strain on the terminals of the cord, insuring a good electrical connection at all times.

Cutler-Hammer Irons, Water-Heaters, Disc Stoves, Radiators, Curling Iron Heaters, etc., are interestingly described and illustrated in our 32-page booklet. May we send a copy to you?

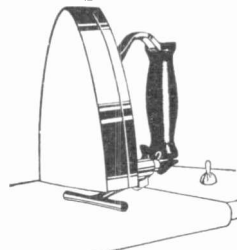

Household Electric Iron made in 5, 6 and 7 pound sizes

Chicago: Peoples Gas Bldg.
Boston: 176 Federal Street
Cleveland: Schofield Bldg.

New York: Times Bldg.
Pittsburgh: Farmers' Bank Bldg.
Philadelphia: 1201 Chestnut St.

THE CUTLER-HAMMER MFG. CO., MILWAUKEE

PACIFIC COAST AGENTS:—Olis & Squires, 579 Howard St., San Francisco. W. B. Palmer, 416 East 3rd St., Los Angeles

ALL-METAL SELF-CLEANSING

Electric Washer

And WRINGER Complete for

\$65

Positive Drive—No Springs to break. Will wash any washable fabric clean, quickly at trifling cost. Will save its cost in 8 months in wear and tear of clothes alone, to say nothing of time, money and hard work. We will ship to you direct anywhere in the United States. A year's guarantee goes with every Washer sold.

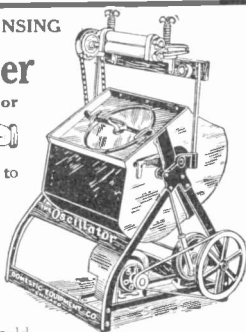

Send for folder

Domestic Equipment Co., Dept. P, 30 W. Lake St., Chicago

PELOUZE ELECTRIC IRON

The most economical iron. Heats quickest. The only iron with control of heat at your finger tip. "Look for the Switch."



All leading dealers

PELOUZE ELECTRIC HEATER CO.
232-242 E. Ohio Street - Chicago

Comet Electric Stoves and Ranges

Let us send you our Catalog of Electric Camping Outfits and Fireless Cookers—will do many times the work of other stoves and cookers. Our Summer Kitchen Outfits are a big success—Write today.

Comet Electric Stove Co., Detroit, Mich.

ELECTRIC LIGHT AND POWER

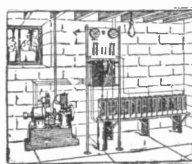

DAY AND NIGHT SERVICE
The Junior No. 1 Equipment
Direct Connected Dynamo, Gasoline Engine Set, Complete Switchboard, 16-Cell "American" Storage Battery } **\$265**
The most complete, reliable equipment ever offered at this price. We want a representative in every county.
AMERICAN BATTERY COMPANY
Est. 1889 1143 Fulton St., CHICAGO

BARGAINS IN ELECTRIC APPLIANCES

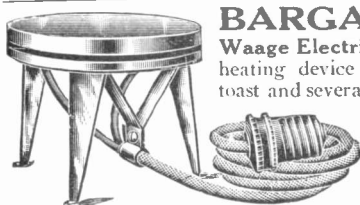

Waage Electric Stove \$3.00. A handy little heating device for use in making tea, coffee, toast and several other things. It has a polished nickel finish and can be used on the dining table. Especially convenient for the sick room, hospital or office as there are no odors as from gas or oil heaters. Complete with 6 foot cord and plug. **\$3.00.**
Send for price list on our heating devices



Waage Soldering Irons
Price \$3.00 and Upward. Smaller than other makes—Has double the efficiency—Will save its cost in a month's time.

WAAGE ELECTRIC CO., 674 West Madison Street, CHICAGO

For our Mutual Advantage mention Popular Electricity when writing to Advertisers.

Contribute to Hot Weather Comfort in Your Home
THROUGH THE PURCHASE OF A

**Thor Electric Home
Laundry Machine**

No other method can equal the work of this machine.

Made in Galvanized Steel, Zinc, Copper, White Enamelled Cast Iron and in Solid Porcelain. Sizes to meet all requirements.

Prices to suit every purse, yet every machine guaranteed.



**Thor Electric Home
Laundry Machines**

are now doing the weekly laundry work in 31,876 homes.

Laces, Blankets and all kinds of washable goods made spotlessly clean without injury and without any laborious work.

Cost of electricity to operate less than 2 cents per hour.

Sold for Cash or on Monthly Payments

Send for Free Illustrated Booklet No. 50

HURLEY MACHINE COMPANY

1011 Flatiron Building, NEW YORK

27 South Clinton Street, CHICAGO

QUICK IRONING By Electricity

Your bed and table linen, all plain clothes and flat pieces ironed in a few minutes—better finish than flat iron—with no labor at all, at one tenth the expense of hand work by the



SIMPLEX IRONER
"THE BEST IRONER"

Simple. Child operates. Just feed clothes through. Costs but 3c an hour to heat and run by any small electric motor, by gas or gasoline—or can be run by hand. Catalog and "Ironing Hints" free.

Write today for 30 day Free Trial Offer.

AMERICAN IRONING MACHINE CO., 55 E. Lake Street, Chicago, Ill.



THE *Judd*

Electric Washer

For the home "Makes Good." Let us tell you why. Write today.

Judd Laundry Machine Co.,
129 N. Wabash
CHICAGO

Wringing from rinsing water while machine is washing another load

TESTED APPARATUS Means the Elimination of Faults in Your Product.

Electrical and photometrical tests of every description. Checking electrical instruments of all kinds and classes. Inspecting and testing new electrical machinery, apparatus and material at factories and after installation. Tests on any electrical machinery and apparatus made anywhere. Arc and incandescent lamp tests, either electric, gas, acetylene or oil. Illumination tests made anywhere. Secondary standards of candle-power furnished. Facilities furnished to experimenters and investigators.

We have recently added to the above, coal testing, and are now prepared to make proximate analyses and calorific determinations on samples of coal, promptly and accurately.

ELECTRICAL TESTING LABORATORIES
80th Street and East End Avenue
NEW YORK, N. Y.

For our Mutual Advantage mention Popular Electricity when writing to Advertisers.

Let Electricity Make Pure Air for You

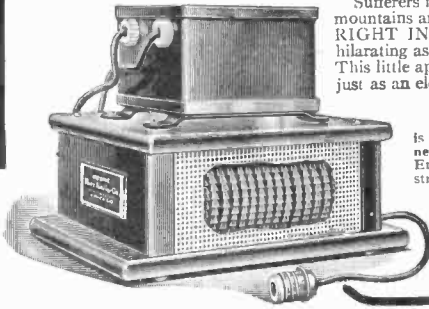

Sufferers from many ailments travel thousands of miles to breathe the OZONE of the mountains and pine forests. Yet a recent scientific invention enables everyone to have—**RIGHT IN THEIR OWN BEDROOM**—air constantly as pure, refreshing and exhilarating as the purest oxygen-filled atmosphere of the piny woods and mountain peaks. This little apparatus is operated by electricity and "ozonezes" the air of the closest room just as an electric storm purifies the out-door air. The

OZONE PURE AIRIFIER

is of greatest benefit in the treatment of Asthma, Hay Fever, Catarrh, Insomnia, Nervousness, Pneumonia, Typhoid and Scarlet Fevers, Diphtheria, Bronchitis, Tuberculosis, etc. Endorsed by highest medical and scientific authorities thoroughly tested and demonstrated success.

Central Station, Electric Jobber and Dealer, this is the latest Electrical Appliance on the market. Write now for illustrated catalogue, price list and descriptive matter and plan of placing for liberal trial.

We want distribution throughout the United States in Every Place Where Electrical Appliances are Sold.

OZONE PURE AIRIFIER COMPANY
307-314 Rand McNally Bldg. CHICAGO, ILL.

Simplex Electric Table Range

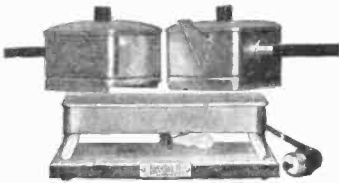

THE NEWEST
Household Convenience.

SEND FOR BOOKLET "O"
"Dining-room Table Cooking"

Simplex Electric Heating Co.
CAMBRIDGE, MASS.

Monadnock Block
CHICAGO

612 Howard Street
SAN FRANCISCO

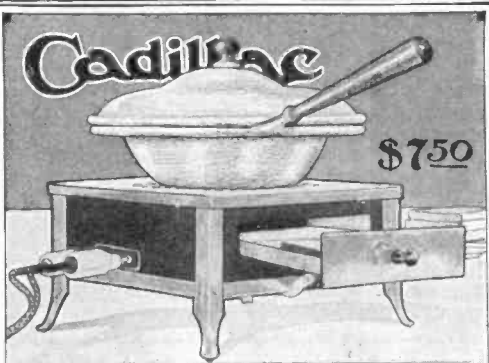

\$750

Keep cool, save time, save steps and cook better this summer with a

CADILLAC

COMBINATION ELECTRIC STOVE AND TOASTER

It will cook eggs on the grid above the burner and toast in the drawer below at the same time at your breakfast table. Simply attach to any light socket and turn the button. You can regulate the heat as desired and keep things warm at the table. Finished in nickel and black enamel and sent prepaid on receipt of \$7.50.

CADILLAC ELECTRIC MFG. CO.
116 Mitchell St. Cadillac, Mich.



TO BE CLEAN

YOU NEED

The "BEE" Suction Cleaner

IT

costs only \$65.00 with complete equipment.
weighs only 20 lbs. No Jar or Vibration.
equals the highest priced machines in efficiency.
does the best work with the least effort.
has NEW and EXCLUSIVE FEATURES.

SOLD ONLY BY RELIABLE AGENTS.
BIRTMAN ELECTRIC CO., CHICAGO, U. S. A.

For our Mutual Advantage mention Popular Electricity when writing to Advertisers.

Murdock Wireless Apparatus

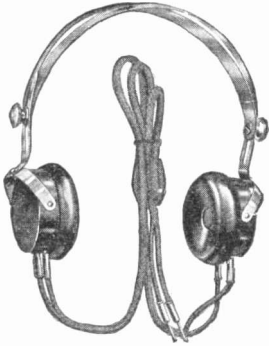

SATISFACTION CERTAIN

with Murdock phones. They are favorites with wise operators, because they **prove** under actual work, to be **sensitive** and **reliable**. Prices to suit.

Other apparatus of the "better" kind.

WM. J. MURDOCK CO.

50 Carter Street
CHELSEA, MASS.
162 Minna St. SAN FRANCISCO
221 S. Clinton St. CHICAGO

Wireless Supplies

WE are Western Representatives for **The Electro Importing Co.**, carrying a complete stock.

Same catalog. Same prices.

Anderson Light and Specialty Co.

70 La Salle St. (Opposite New City Hall.)
CHICAGO, ILLINOIS

HERE IT IS! WIRELESS TELEGRAPH APPARATUS FOR YOU

Special Prices for September

No. 605 Our famous adjusted detector.....	\$.75
No. 616 Our special Wireless Receiver.....	.50
No. 600 Special Detector in our catalogue.....	2.00
No. 700 Double slide Tuning Coil in our catalogue.....	1.60
No. 701 Double slide Tuning Coil 12 inches long.....	2.15
No. 900 Potentiometer in our catalogue.....	.90
No. 920 Fixed Condenser in our catalogue.....	1.00
No. 625 Fixed Condenser in our catalogue.....	.75
No. 930 Spare Gains in our catalogue.....	2.25
No. 800 Variable Condenser in our catalogue.....	.55
No. 304 Auto-coherer outfit complete.....	5.55
No. 610 High Resistance Receivers in our catalogue.....	6.00
No. 615 Double Pole 2000 ohm Receivers guaranteed.....	4.00
No. 14 Aluminum Wire for aerials per pound.....	.50

Don't buy any goods till you get our Special Price List, which we issue monthly. If you haven't got one send for it to-day. We ship all orders same day when received. Send 2 cent stamp for our catalogue now. Write **To-day**.

The Broadway Wireless & Elec. Nov. Co.
782 Broadway, Brooklyn, N. Y.

ENAMEL
INSULATED



MAGNET
WIRE

ENAMEL WIRE is supplanting silk and cotton covered because The Insulation is better, because it requires less space, because it is cheaper.

FEVAL WIRE has a dielectric strength in excess of 75 volts per .0001 inch of insulation. The evenly distributed enamel covering adheres tenaciously yet is resistant and elastic, never cracking. No change at 400° to 500° F. All sizes, Nos. 16 to 40.

MANUFACTURERS: We have an attractive contract proposal to offer covering your requirements for 12 months.

INDIVIDUALS: We will furnish small quantities for spark coils and magnets.

FEVAL ENAMEL INSULATED WIRE CO.
129 N. Curtis Street CHICAGO

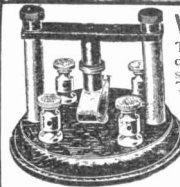

WONDERFUL NEW DETECTOR

The perfect detector found at last. No adjustment of minerals, no sloppy acids, 25 per cent more sensitive and 50 per cent louder than any other. The only detector that is always on the job.

PRICE \$1.75, Postage 16c Extra. Send 2c in stamps for large illustrated catalogue of electrical specialties and Wireless Apparatus.

FRANKLIN ELECTRIC NOVELTY & MFG. CO., 847 Ninth Avenue, New York, N. Y.
Levy Electric Co., San Francisco, Western Agents

SPECIAL NOTICE

The I. W. T. Wireless Co. Removed to 1038 Broadway, Brooklyn, N. Y.

The company is now occupying an entire four story building devoted exclusively to the manufacture of wireless telegraph apparatus. We will now be able to give our customers better attention and ship all orders same day when received. We carry a large stock of all our goods. Send 2 cent stamp for our large wireless catalog.

THE I. W. T. WIRELESS CO.

1038 Broadway Brooklyn, N. Y.



WIRELESS COILS

No. 1— 1-4 in. to 3-4 in. spark.....	\$3.50
No. 2— 3-4 in. to 1-1-4 in. spark.....	4.50
No. 3— 1-1-2 in. to 2-1-2 in. spark.....	9.00

These high-grade guaranteed coils are not over-rated.

Send your money and coil will be shipped to you same day. Thousands of them in use.

LEMKE ELECTRIC CO., Dept. P. E., Milwaukee, Wis.

WIRELESS TRANSFORMERS

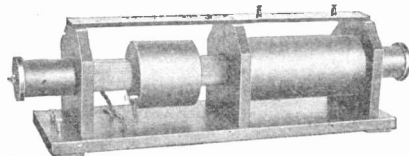

1-2 K. W.
\$30.00

Send for Catalogue

E. S. RITCHIE & SON, 117 Cypress Street, BROOKLINE, MASS.

\$ EASY MONEY \$ LOTS OF IT \$

for our representatives. Send stamp today for particulars of our Salary Plan. Very Liberal. Won't interfere with your present employment.

Popular Electricity Magazine, Circulation Dept.
Commercial Bldg., Chicago, Ill.

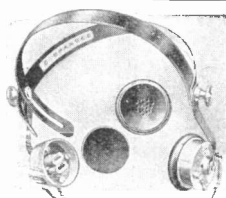

Brandes Long Distance Receivers

Guaranteed the best long distance reading receivers made. Money refunded if not satisfied.

Imperial Navy type.....	\$13.00
Transatlantic type.....	9.00
Superior type.....	5.00

C. BRANDES

111-113 Broadway, New York

The Efficiency of a Wireless Telegraph Set

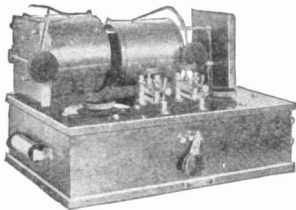

Depends on correct designs, accurately wrought by skilled workmen from the best materials. The possession of these requisites makes CLAPP-EASTHAM products the standard by which all others are measured.

Our catalogue is a liberal education in modern methods. Sent for 4c in stamps.

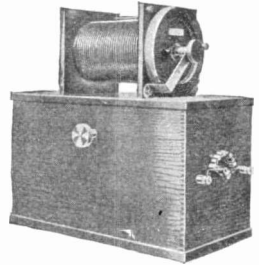

Western Representatives:
AYLSWORTH AGENCIES CO.
143 Second St. San Francisco, Cal.

CLAPP-EASTHAM COMPANY
139 Main Street - - - Cambridge, Mass.

PONY TELEPHONE RECEIVER

As per cut 2 1/4" diameter, weight 6 oz., 75 ohms.

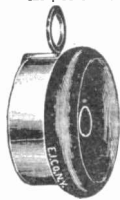

This is the best 75 Ohm receiver made regardless of price. It does not make any difference if you pay \$1.00 or more for your receiver, you cannot get a better one than ours. Using and cup are of hard rubber composition, beautiful finish, hook can be taken off; receiver is made so that it will then fit any standard swivel head-band. Receiver has powerful magnet, silk covered copper winding. By connecting up two (2) receivers without batteries, one can talk over a distance of 250 feet using nothing but the two receivers. Price, 35 cents. By mail, extra 8 cents. Same receiver wound to 1,000 ohms for Wireless, special this month \$1.25.

Send 4 cents postage for our great 196-page cyclopedia No. 9 containing the greatest assortment of Electrical and Wireless instruments in the U. S., 400 illustrations. Postals not answered.

THE ELECTRO IMPORTING CO.,
233-B Fulton Street New York, N. Y.
"Everything for the Experimenter"

Wireless Transformers Open Core Type, 1-4 K. W.

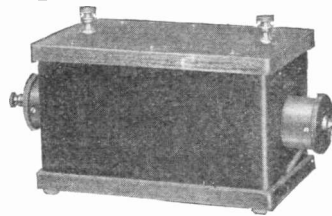

\$18.00

Larger Capacities in Proportion

Send 2c stamp for our catalog

Dawson & Winger Electric Co.
727 S. DEARBORN ST. CHICAGO, ILL.

New Wireless Wonder

Aerofield receiving outfit, receives up to 75 miles, consists of 1000 ohm D. P. receiver and attachment. Price complete \$4.00. A wonderful instrument for a low price. Send 3c stamp for catalog.

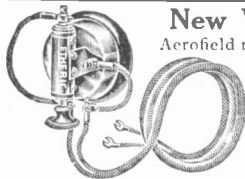

ETHERIC ELECTRIC CO.
278 Lenox Ave., New York, N. Y.

2,000 ORDERS FOR WIRELESS GOODS

Is what we expect to fill in September. Our line is complete. Our prices the lowest. Our location central, and goods are quality. That means orders. We want you.

THE ILLUMINATING SUPPLY CO.

2155 East Ninth Street CLEVELAND, OHIO

WIRELESS BARGAINS

FROM AUGUST 15 TO SEPTEMBER 22

- "BWAENCO" Adjustable Spark Gap \$.35
- "BWAENCO" Mineral Detector75
- "BWAENCO" Fixed Condenser Square Seamless Brass Tubing, 7 x 2 x 275
- "BWAENCO" Tuning Coils Double Slide, \$1.50. Single Slide 1.25
- "BWAENCO" Porcelain Base Knife Switches, S. P. D. T. 20c, S. P. S. T.14

Send Stamp for Big Bargain Bulletin No. 88

BROOKLYN WIRELESS COMPANY
766 BROADWAY, BROOKLYN, N. Y.

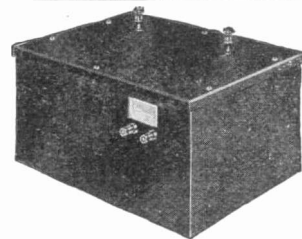

Just Press The Key

Let a W - M transformer do the rest. Satisfactory operation positively guaranteed.

1/4 Kw. - \$16.00
1/2 Kw. - 20.00

Larger sizes for all frequencies, voltages listed in leaflet "C." Write for a copy.

Worts-McKisson Mnfg. Co., Dept. E., Toledo, O.

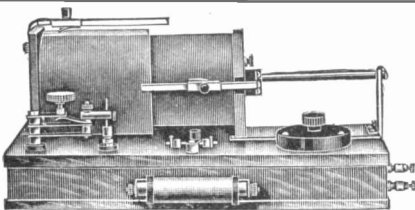

Late improvements in Receiving Transformer and Ferron Detector not shown in cut.
No. 6040, price (with two Ferron Detectors) \$45.00
Complete Set, unmounted - 32.00

BIG 200-P. ELECTRICAL AND WIRELESS CATALOG

Mailed for 6c. Stamp

Commercial Wireless Equipment from 1 K.W to 25 K.W.

One of our patrons from California voluntarily writes as follows: "I think that it is only right for me to express my appreciation to you for the receiving set No. 6040 that you supplied me with some two weeks ago. I have never seen anything that can be compared to it. I have received messages from stations sixteen hundred miles distant, on three occasions I picked up Honolulu in the Hawaiian Islands and heard signals very clearly," etc.

J. J. DUCK, 428 St. Clair St., TOLEDO, OHIO



An Expansion Bolt

simple in construction, easily attached, assures great strength, is rigid and suitable for fastening any kind of a fixture to a wall of stone, brick, cement, tile, etc.

There are many ways of using these bolts that you should know about and that are shown in our catalog No. 10.

Send for it and also free working samples.

Star Expansion Bolt Company
147-149 Cedar Street - New York City

SELF REGISTERING

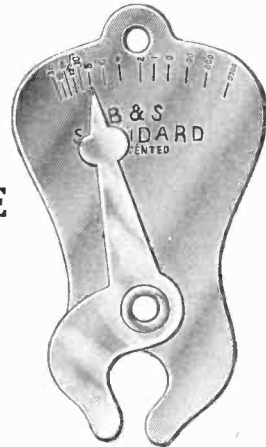

WIRE

GAUGE

Illustration Full Size

AN accurate, quick reading wire gauge. Will register instantly the B. & S. standard size of any wire from Nos. 0000 to 18 inclusive. Made of hardened finished steel. Can be carried on the key ring or small safety chain, or in the vest pocket.

PRICE \$0.25

Catalogue 24E of other Novelties and General Supplies on request

MANHATTAN ELECTRICAL SUPPLY CO.

New York, 17 Park Place Chicago, 112 S. Fifth Ave.

**6 MONTHS
FREE
TRIAL**

Luther Diamond Tool Grinder



In your own way, at your own work, try this Carborundum hand and foot power grinder for six months with the privilege of sending it back—25 times faster than the grindstone—6 times more efficient than emery—equipped with genuine Carborundum wheels—big time and labor saver for every user of tools. Write today for 6 months' free trial offer—also McClure's story of Carborundum.

**LUTHER GRINDER
MFG. CO.**

62E Madison St.,
Milwaukee,
Wis.

The Extension Bit Holder

shown here has been one of our most popular and best selling tools among electricians and others.



It allows for a quick and easy release of the bit from the chuck and for an easy insertion, but it has a grip that is absolutely secure. One of the chief reasons it is such a useful and efficient tool to work with is that it will follow a $\frac{3}{8}$ " or larger bit into a hole. This is because the outside diameter of the shell is less than $\frac{3}{8}$ ".

Send for the Free Book "Tool Practice"

Millers Falls Co., 28 Warren St., New York

Another New "YANKEE" PUSH BRACE, No. 75

Drives Wood Augers up to 5-8 inch easier and quicker than a Bit Brace. Drives or Draws Screws, and takes all the small tools used in a bit brace. A handy tool for crowded corners.

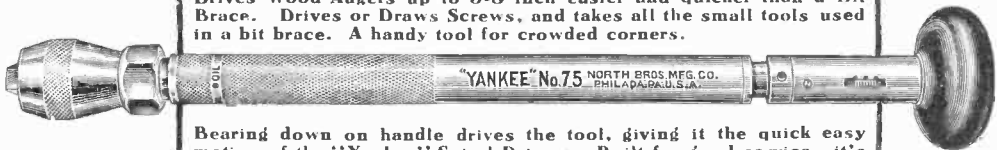

Bearing down on handle drives the tool, giving it the quick easy motion of the "Yankee" Spiral Drivers. Built for good service—it's a "Yankee." Let your dealer show you one.

Send for Book of Labor Savers

NORTH BROS. MFG. CO., Dept. C, Philadelphia, Pa.

This Kerosene Engine Cuts Your Expenses 75%

THE rapidly rising price of gasoline, now 6 to 16 cents higher than kerosene, absolutely makes operation on gasoline too expensive. The Perfection Kerosene Engine operates on any engine fuel. You can always run this engine at a great fuel saving and get the greatest amount of work done. The Perfection vaporizes its own kerosene and so makes it as efficient as gasoline—something other engines cannot do.

The Perfection is very light, portable, has only three moving parts, runs everything about the place, is lower in price than any other engine of its capacity on the market.

"PERFECTION" Kerosene Engine

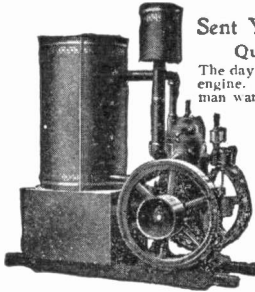

Sent You on 15 Days Free Trial
Quick Shipment Guaranteed

The day we get your order we will ship your engine. No delays at this time of the year—a man wants his engine and wants it quick. We have ready right now the very engine you require. Get your order in quick. See your dealer at once and ask him to let you have a copy of our Free ENGINE BOOK, which shows the sizes and styles of the "Perfection" and explains this very attractive offer. Your dealer will send any "perfection" engine to your farm for 15 days and let you return it if you are not satisfied. Ask him about it. If he does not carry the "Perfection" write to us and we will send you our Free Engine Book direct.

CAILLE PERFECTION MOTOR CO.
202 Second Ave., Detroit, Mich.

A Country Home

is not complete without Electric lights. They are so restful to the eyes, perfectly clean and there is no danger of a fire or explosion.

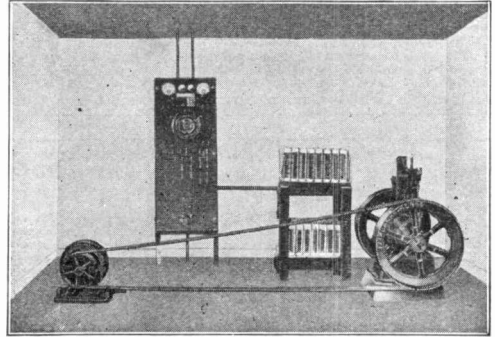

This low voltage outfit is made especially for country homes, stores, clubs and hotels and consists of our 2 H.P. special Electric Gasoline Engine, Dynamo, Switchboard, Storage Battery, 50 Mazda Lamps and Electric Fixtures, complete for \$500.00. Send for Bulletin No. CE1163 for detailed description of this outfit.

Fairbanks, Morse & Co.
Wabash Ave., and Eldridge Place, Chicago

The Man on The Pole



AND THE MAN ON THE GROUND

Both appreciate tools that are efficient, helpful, reliable of proven quality, made of true steel by mechanics skilled in the art of making tools and under the personal charge of the boss.

WRITE FOR BOOKLET

MATHIAS KLEIN & SONS
Canal Station 3, Chicago, Ill.

LEIMAN BROS.

BLOWERS VACUUM PUMPS

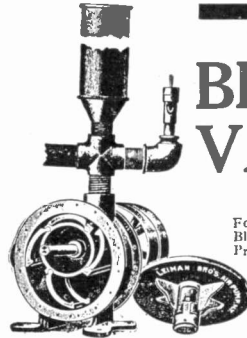

For all Gas and Oil Appliances. Sand Blasts, Boat Whistles, Calliopes, Gas Producers, Gas Boosting, Testing

VACUUM CLEANING

Take up own wear. Small Piston. Big Air Space. No Springs. Powerful. Noiseless. Can't get out of order.

Blower Catalog No. 84
Vacuum Catalog No. 85

LEIMAN BROS. 62 AD John St., NEW YORK

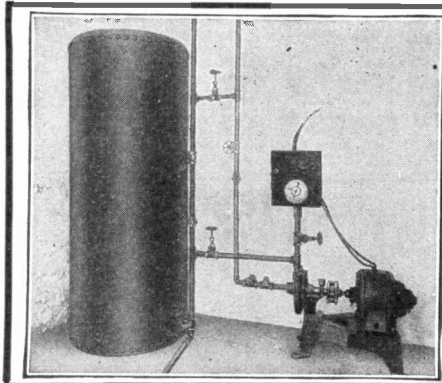

"ECONOMY" System of Automatic Water Supply.

will furnish an abundant supply of clean, aerated water, without the use of a roof or large storage tank.

Will stand the most severe service for long periods of time without skilled care. Installed in basement. Consists of a pump, direct connected by insulated flexible coupling to an electric motor, an automatic switch and a pneumatic tank.

Water is pumped into tank against air pressure. When maximum pressure is reached the automatic switch opens and stops pump. When pressure is lowered, the automatic switch closes starting pump.

The pump is the centrifugal type and has no valves, gears or cams to get out of order. Nothing complicated about the system. Any plumber or handy man can install by following instructions.

Especially adapted for schools, flat buildings, suburban homes, office buildings, hotels and factories.

We also manufacture — Bilge Pumps—Sewerage Ejectors—Condensation Pumps and Receivers—Cellar Drainers—Centrifugal and Triplex Pumps for all work—Hot Air Engines—Vacuum Cleaning Apparatus—Air Washers—Purifiers and Cooling Apparatus.

Watch for our ads telling you all about them.

THOMAS & SMITH, Inc.

116-118 North Carpenter Street

CHICAGO, ILL.

For our Mutual Advantage mention Popular Electricity when writing to Advertisers.



ELECTRICITY

The most wonderful and fascinating study of the age. Everybody should have a copy of the new "Voltamp Electrical Products"—our 112-page Catalog, now ready. The most complete and interesting book ever issued. Full of illustrations and descriptions of Voltamp Novelties, Motors, Dynamos, Telegraph and "Wireless" Instruments, Spark Coils, Lamps, Flashlights, Transformers, etc. Everything Electrical for the experimenter. The greatest line of Miniature Electric Railways ever shown. Catalog with valuable coupon sent only for 6c in stamps or coin. (No postals answered.)

VOLTAMP ELECTRIC MFG. CO., Park Bldg., Baltimore, Md.



THIS ELECTRIC FLASHER with a TUNGSTEN LAMP 85c

Throws a very powerful ray of light and is so compact that you hardly notice it in your pocket. Beautifully finished, nickel trimmed, and ready for use the minute you receive it. Write to us at once about our wonderful agents' proposition, full particulars and territory. We carry a full line of Electrical Novelties.

FOREIGN ELECTRICAL EXCHANGE
105 N. Wabash Avenue Dept. 1 Chicago, Ill.



GRAY MOTORS

6 HORSE POWER COMPLETE \$89.50
1, 2 & 3 Cylinders, 3 to 36 H.P.

Absolutely Guaranteed by a RESPONSIBLE concern.

Write for complete catalog—tells all about how these high grade motors are built in the largest plant in the world devoted exclusively to the manufacture of 2-cycle motors. Gray Motor Co., 951 U. S. Motors Bldg., Detroit



ROTH ELECTRIC MOTORS
POLISHING LATHES
FORGE BLOWERS
SPECIAL MACHINERY

ROTH BROS. & CO.
1358 W. Adams St. Chicago, Ill. 136 Liberty St. New York City

MINIATURE LAMPS AND ELECTRICAL GLASS WORK

For your experimental purposes we are willing to take your ideas and give them back to you as finished working products provided they are all practical. *Better write us.*

THE ECLIPSE INCANDESCENT LAMP CO.
TOLEDO, OHIO



MAKE EASY MONEY INSTALLING Schwarze Electric Bells

They cure all Bell troubles and save their cost. For any current. Send \$1.50 today for sample Silver-Toned House Bell, all charges prepaid anywhere in the United States.

Schwarze Electric Co.
5 Main Street Adrian, Mich.

No. 24 RED DEVIL



"It's all in the wheel"

For 3, 2c stamps we will send any Glazier 1. No. 024 Glass Cutter Smith & Hemenway Co., 150 Chambers St., New York

For our Mutual Advantage mention Popular Electricity when writing to Advertisers.

We Sell You At Wholesale

Agents' Price One **AMERICAN** Motorcycle or Bicycle

We give 30 Days' Free Trial and Prepay the Freight. Write for our introducing offer and catalog and say whether you want Motorcycle or Bicycle. Do it now.

AMERICAN MOTOR CYCLE CO., 119 American Bldg., Chicago



FOOT AND ELECTRICAL DRIVEN Power and Turret Lathes, Planers, Sharpeners and Drill Presses

Write today for our Complete Catalog

SHEPARD LATHE CO.
B. 131 W. 2nd St., Cincinnati, Ohio

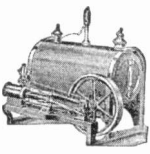

ENGINES Gas, Gasoline, Steam and Electric (1 1/2 H. P. up)

Motors, Dynamos, Storage Batteries, Lamps, Telegraph and WIRELESS instruments, Printing Presses, Postcard Projectors, Phonographs, Miniature Railway Equipment. Large illustrated catalog sent for 15c. Refunded on first order for \$1. **AMATEUR MECHANICS SUPPLY CO., 518A, 219 S. Dearborn St., Chicago.**

UTILITY, Flash Light and Searchlight Electric Alarm Clocks

Send for descriptive—you will be surprised at the conveniences.

DARCHE MFG. CO.
2117 S. Halsted Street CHICAGO

LIGHTING PERFECTION BY The Eye-Comfort System of Indirect Illumination

PARTICULARS WILL INTEREST YOU. ASK FOR THEM

NATIONAL X-RAY REFLECTOR CO.
235 W. Jackson Blvd., Chicago, Ill.

RIDER AGENTS WANTED

In each town to ride and exhibit sample 1912 model. Write for Special Offer. Finest Guaranteed 1912 Models \$10 to \$27 with Coaster-Brakes and Puncture-Proof Tires. 1910 and 1911 MODELS ALL OF BEST MAKES..... \$7 to \$12

100 Second-Hand Wheels
All makes and models, good as new Great Factory Clearing Sale. \$3 to \$8

We Ship on Approval without a cent deposit, pay the freight & allow **10 Days' Free Trial**

TIRES conster-brake wheels, lamps, and sundries, half usual prices. DO NOT BUY till you get our catalogue and offer. Write now.

MEAD CYCLE CO., Dept. W-109 CHICAGO

THE LITTLE HUMMER ENGINE



Get one to drive your small dynamo. It is the most powerful engine of its size on the market and the latest thing out in its line. Send for our Folder It is FREE.

THE ELGIN WHEEL & ENGINE CO., ELGIN, ILL.

PATENTS AND PROFIT.**"A Talk to the Inventor"**

FREE BOOK explains WHAT YOU SHOULD KNOW before applying for a Patent; WHAT TO INVENT; HOW TO SELL YOUR PATENT; WHAT NOT TO INVENT. Write for it today. Send sketch for advice.

H. L. WOODWARD, 728 9th ST., WASHINGTON, D. C.
BY PATENT OFFICE

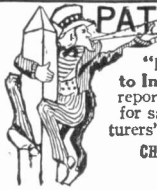
**PATENT YOUR IDEAS**

\$8.70 for one invention. Book, "How to Obtain a Patent" and "What to Invent" sent free. Send rough sketch for free report as to patentability. Patents advertised for sale at our expense in fourteen Manufacturers' Journals. Patent Obtained or Fee Returned

CHANDLEE & CHANDLEE, Patent Attorneys

Established 16 Years

974 F. Street, Washington, D. C.

PATENTS GUIDE BOOK

TELLS HOW TO OBTAIN AND
SELL PATENTS

100 MECHANICAL MOVEMENTS

MAILED FREE

F. G. DIETERICH & CO., Patent Lawyers
Uray Block Washington, D. C.

Patent Your Invention

The only way to protect it. Let us send you our free search and contingent fee proposition. Free booklet.

Milo B. Stevens & Co., Attys.,

Established 1864.

640 F St., Washington. 351 Monadnock Blk., Chicago.
Guaranteed by Bankers' Register and highest rating by Martindale's Law Directory.

Write Articles For Magazines

It is pleasureable spare time work and there is good money in it.

If you think you have a "nose for features," as the editors say, here's your chance to go to work.

Send 2-cent stamp for our Free Pamphlet—

*"What to Write and
How to Write It"*

Popular Electricity Pub. Co.

Commercial Building
CHICAGO

PATENTS

TRADE MARKS AND COPYRIGHTS

Secured or Fee Returned

Send model or sketch and description of your invention for free search of the U. S. Patent Office Records.

Our **FOUR BOOKS** mailed free to any address. Send for these books; the finest publications ever issued for free distribution.

HOW TO OBTAIN A PATENT. Our Illustrated 80 page Guide Book is an invaluable book of reference for inventors and 100 mechanical movements illustrated and described.

FORTUNES IN PATENTS. Tells how to invent for profit and gives history of successful inventions.

WHAT TO INVENT. Contains a valuable list of inventions wanted and suggestions concerning profitable fields of invention. Also information regarding prizes offered for inventions, among which is a **Prize of One Million Dollars** offered for one invention and \$10,000 for others.

PATENTS THAT PAY. Contains fac-similes of unsolicited letters from our clients who have built up profitable enterprises founded upon patents procured by us. Also endorsements from prominent inventors, manufacturers, senators, congressmen, governors, etc.

We advertise our clients' inventions free in a list of Sunday newspapers with two million circulation and in the World's Progress. Sample copy free.

Electrical Cases a Specialty. We have secured many important electrical patents.

VICTOR J. EVANS & CO.

(Formerly Evans, Wilkins & Co.)

Victor Bldg., 724 9th St. N. W. WASHINGTON, D. C.

PATENTS

C. L. PARKER
Ex-Examiner U. S. Patent Office
PATENT LAWYER
12 MCGILL BLDG.
WASHINGTON, D. C.

Patents, Trade Marks, Copyrights, Patent Litigation

Handbook for inventors, "Protecting, Exploiting and Selling Inventions" sent free upon request.

PATENTS

THAT PROTECT AND PAY

Books, Advice, Search and List of Inventions Wanted! **FREE**

Send sketch or model for search. Highest References. Best Results. Promptness Assured.

WATSON E. COLEMAN, Patent Lawyer

622 F Street, N. W.

Washington, D. C.

WANTED—IDEAS

The demand for good patentable ideas is greater than ever before. Am constantly in receipt of letters from parties desiring to buy patents procured through me. Electrical devices, tools of all kinds, advertising novelties, agents' supplies, mail order articles, and many other inventions are sought after. Protect your ideal! Write for "Stepping Stones" (containing over 200 inventions wanted) and new guide book "Successful Patents." Clients' patents sold free. My personal services. Highest references.

RICHARD B. OWEN

Dept. 6,

WASHINGTON, D. C.

CAPITALIZE YOUR BRAINS

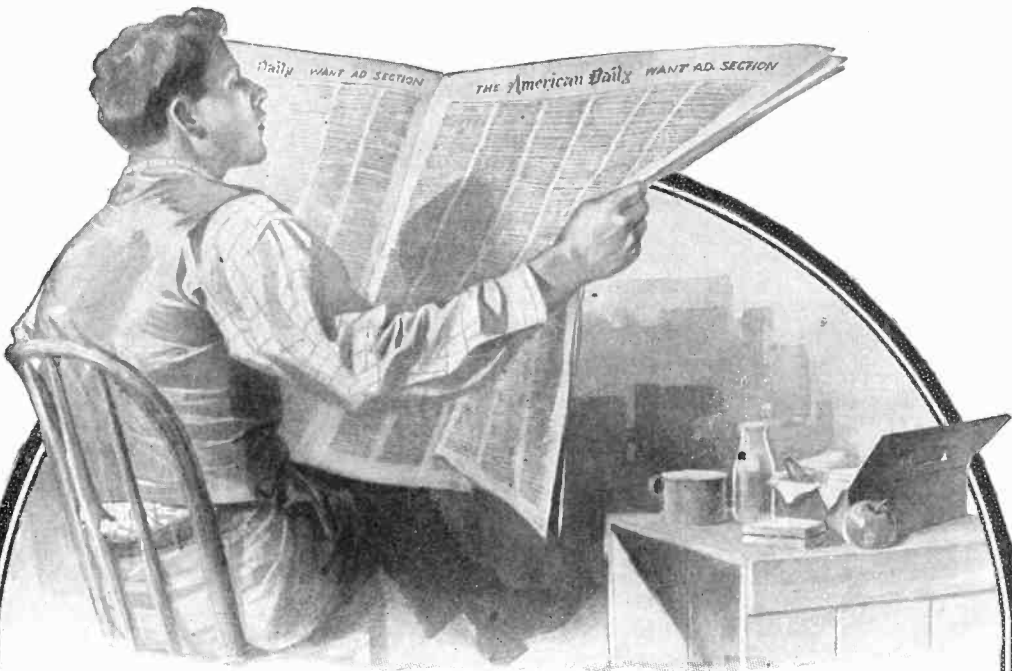

Trained Men Wanted

Every year thousands of *good jobs* are seeking *trained men* through the daily press. You won't have to look for a good job if you have the necessary training to fill one—*the job will look for you*—the "Help Wanted" columns in every daily paper prove this.

The American School of Correspondence offers every ambitious man a chance to make more money and get a better job.

Every man has "got it in him" to make good. Lack of time is no excuse. An hour a day spent now will be worth ten hours a little later on. A better job, a better man, a pleasanter home, and a future full of prosperity—all these and more will be yours for a few hours a week and a few cents a day spent now—before you're too old and your ambition is gone.

Check the coupon and send it to us now. Tell us what you want to be—what your ambitions are, then tell us what you are doing now. We'll be glad to advise and help you. There is no obligation attached to this. We'll tell you frankly just what we can do, the rest is "up to you."

The American School is an educational institution. No agents, representatives or collectors are employed. If you send us the coupon, we'll not bother you by sending an agent. All of our business will be carried on privately by correspondence.

American School of Correspondence
CHICAGO, U. S. A.

OPPORTUNITY COUPON

American School of Correspondence, Chicago, U. S. A.
Please send me your Bulletin and advise me how I can qualify for the position marked "X." Pop. Elect. 9-11

- | | |
|---------------------------------|---------------------------|
| Draftsman | Fire Ins. Engineer |
| Architect | Telephone Expert |
| Building Contractor | Moving Picture Op'r |
| Structural Engineer | Bookkeeper |
| Civil Engineer | Stenographer |
| Electrical Engineer | Accountant |
| Elec. Light & Power Supt. | Cost Accountant |
| Master Mechanic | Cert'd Public Acc't |
| Steam Engineer | Auditor |
| Sanitary Engineer | Business Manager |
| Reclamation Engineer | College Preparatory |

NAME

ADDRESS

OCCUPATION

For our Mutual Advantage mention Popular Electricity when writing to Advertisers.

\$665 BUYS THE MATERIAL NEEDED TO BUILD THIS HOME!

Price includes Blue Prints; Architect's Specifications; Full Details; Working Plans and Typewritten Material List

OUR HOUSE DESIGN NO. 84

A cozy, attractive cottage that cannot but win the admiration of all those who appreciate a comfortable home, including the bay, its size is 24 ft. wide x 27 ft. deep. Contains six rooms and bath—Parlor, Dining Room, Kitchen, Reception Hall, and Pantry downstairs, three Chambers and Bath upstairs.

The general construction and design of this house represent the greatest possible economy combined with convenience of arrangement, dependability, and harmony and beauty of appearance.

The material we furnish for construction has been selected with extreme care and is of most excellent quality throughout. Our Guaranteed Building Proposition insures you of ample quantity of the quality specified, prompt shipment, safe arrival and absolute satisfaction on the entire deal. Every home builder should take advantage of this extraordinary money-saving opportunity. Write today for more complete information and description.



We Save You Big Money on Lumber and Building Material!

The Chicago House Wrecking Co. is the largest concern in the world devoted to the sale of Lumber, Plumbing, Heating Apparatus and Building Material direct to the consumer. No one else can make you an offer like the one shown above. We propose to furnish you everything needed for the construction of this building except Plumbing, Heating and Masonry material. Write for exact details of what we furnish. It will be in accordance with our specifications, which are so clear that there will be no possible misunderstanding.

How We Operate

We purchase at Sheriffs' Sales, Receivers' Sales and Manufacturers' Sales, besides owning outright sawmills and lumber yards. Usually when you purchase your building material for the complete home shown above, elsewhere, it will cost you from 50 to 60 per cent more than we ask for it. By our "direct to you" methods we eliminate several middlemen's profits. We can prove this to you.

What Our Stock Consists of

We have everything needed in Building Material for a building of any sort. Lumber, Sash, Doors, Millwork, Structural Iron, Pipes, Valves and Fittings, Steel and Prepared Roofing. Our stock includes Dry Goods, Clothing, Furniture, Rugs, Groceries, etc., Machinery, Hardware, Wire, Fencing—in fact, anything required to build or equip. Everything for the Home, the Office, the Factory or the Field, besides everything to wear or to eat. Send us your carpenter's or contractor's bill for our low estimate. We will prove our ability to save you money. WRITE US TODAY, giving a complete list of everything you need.

Free Book of Plans

We publish a handsome, illustrated book, containing designs of Houses, Cottages, Bungalows, Barns, etc. We can furnish the material complete for any of these designs. This book is mailed free to those who correctly fill in the coupon below. Even if you have no immediate intention of building, we advise that you obtain a copy of our FREE BOOK OF PLANS. It's a valuable book.

Our Guarantee

This company has a capital stock and surplus of over \$1,000,000.00. Absolute satisfaction guaranteed in every detail. If you buy any material from us not as represented, we will take it back at our freight expense and return your money. We recognize the virtue of a satisfied customer. We will in every instance "Make Good." Thousands of satisfied customers prove this. We refer you to any bank or banker anywhere. Look us up in the Mercantile Agencies. Ask any Express Company. Write to the publisher of this publication. Our responsibility is unquestioned.

\$2.00 Buys a Complete Set of Blue Prints We send you a set of plans for the house described above, including the necessary specifications and complete list of material, transportation charges prepaid, for the low cost of \$2.00. This is only a deposit, a guarantee of good faith, and the proposition to you is that after receiving these blue prints, specifications and list of material, if you can place an order with us for complete bill of material, we will credit your account in full for the \$2.00 received, or we will allow you to return these plans, specifications, and list of materials to us and we will refund \$1.50, thereby making the total cost to you 50 cents.

High Grade Bathroom Outfits!



The price of this Bathroom Outfit \$37.50.

Plumbing material direct to you at Bargain prices.

We have everything needed in Plumbing Material. Our prices mean a saving to you of 30 to 60 per cent.

Here is an illustration of a bathroom outfit we are selling at \$37.50. Your plumber would ask you about \$60.00 for this same outfit. It is only one of many other complete outfits that we are offering at prices ranging from \$25.00 to \$50.00.

Write for Our Free Plumbing Material Catalog No. 891.

Hot Air Furnaces!

Don't let the contract for your hot air furnace until you get our figures.

We will cut your local dealer's price in half. We can furnish you a complete equipment, including pipes, registers, furnace; everything required at a price not much more than what an ordinary heating stove would cost you. Complete hot air heating plants \$48.00 up.

Get our heating catalog at once. Tells you all about it. Write us today. We guarantee to save you money. We loan you tools. We make you plans. Every heating plant we sell is backed by our guarantee bond.



Hot Water Heating Plants!

We guarantee to save you 50 to 75 per cent on a modern hot water heating plant for your home.

We make you complete plans and instructions and help you out every way we possibly can. We loan you tools. Every plant backed by our guarantee bond. We furnish the material; you get the plant installed. Cut out the local dealer's profit and cut the cost in half. Thousands of our plants installed and working perfectly in every part of the country. Write today for our Special Heating Catalog. Tells all about our heating proposition. We can furnish Heating Apparatus for any building, no matter how large. Tell us your needs. Write for Free Special Heating Catalog No. 891.



Water Supply Outfits Modern Air Pressure Water Supply Systems at prices ranging from \$48 to \$200. They are strictly new, first-class and complete in every detail. Even though you live in the country, you can enjoy every city comfort at little expense. Why not investigate this. We are ready to furnish you with all facts free of charge. All material fully guaranteed. We also have a complete stock of Pipe, Valves and Fittings at 40 to 50 per cent saving.

Gasoline engines at low prices.

CHICAGO HOUSE WRECKING CO., Thirty-Fifth and Iron Sts., CHICAGO

Acetylene Lighting Outfits.

Write today for our circular describing our modern house and barn lighting outfits; economical, simple and better than any other isolated system; no odor, smoke or soot.

Price for complete outfit for an 8 room house, including Generator, Piping, Tools and necessary Gas fixtures, \$150.00

Other outfits at proportionate prices. Suitable for homes, stores, hotels or for any place where light is needed.

Send Us This Coupon

Chicago House Wrecking Co.

I saw this ad in Popular Electricity.

I am interested in.....

NAME.....

TOWN.....

CO.....STATE.....

The Popular Electric *Flat Iron*



The G.E. flat-iron has been made popular by the hundreds of thousands of happy women who have discarded forever the tiresome drudgery of the old-fashioned sad-iron.

It is the G.E. flat-iron that has made the fatiguing duty of ironing, one of pleasure for the legion of delighted mothers, wives, sisters and sweethearts.

General Electric Company

PRINCIPAL OFFICE: SCHENECTADY, N. Y.