

TESLA AND HIS WIRELESS AGE

POPULAR ELECTRICITY

MAGAZINE

IN PLAIN ENGLISH
(NON TECHNICAL)

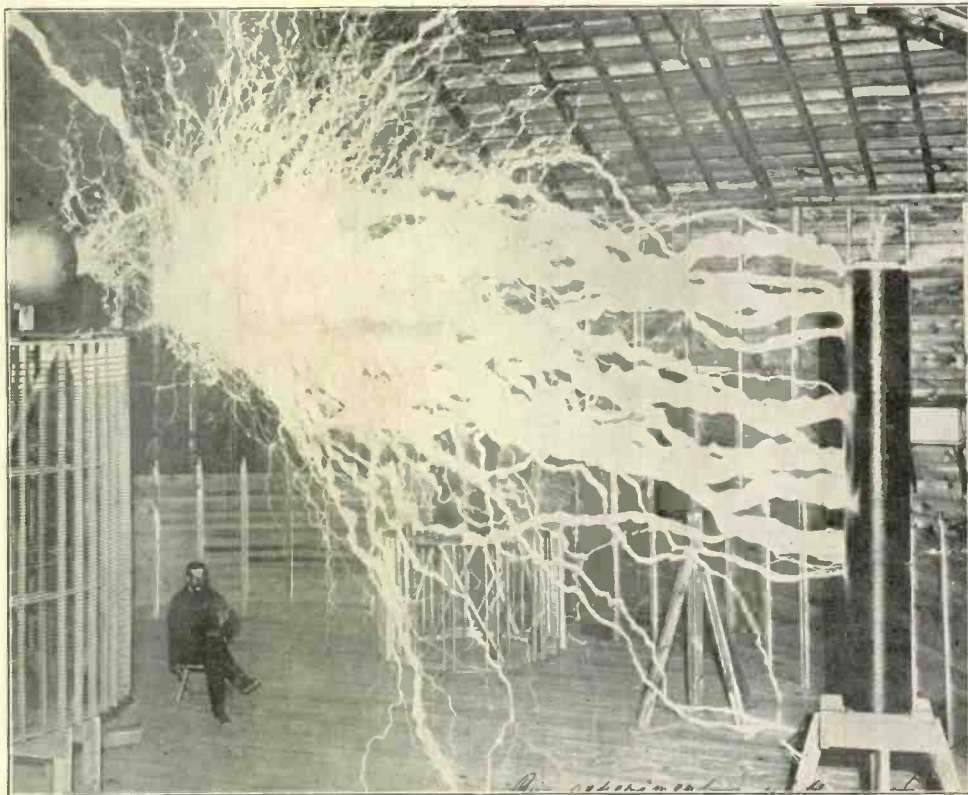

A MINIATURE THUNDERBOLT FROM A TESLA TRANSFORMER

See Page 97

Vol. IV

JUNE, 1911

No. 2

A MAGAZINE FOR EVERYBODY

10 Cents



Dirt taken out of one rug after being broom swept

THE SIMPLEX IS JUST AS EFFECTIVE AND MORE SERVICEABLE THAN ANY OTHER VACUUM CLEANER as—

IT IS NOT COMPLICATED
IT IS SELF-CONTAINED

IT HAS NO WHEELS
IT HAS NO GEARS

IT HAS NO MOTOR
IT HAS NO BELTS

It has no long rubber hose to rot, wear out and tangle

It weighs but five pounds (complete)

It takes up no more space than the old-fashioned broom. A child can use it as it requires so little exertion.

RESPONSIBLE
AGENTS
WANTED

Send For Our FREE Book:

"CLEANLINESS Is Next To GODLINESS"

SIMPLEX CLEANER CO.

1741-1749 Berwin Ave.,

CHICAGO

SENT TO YOU BY
PREPAID EXPRESS

GUARANTEED FOR
TWO YEARS

FULLY PAID FOR

A
**SIMPLEX
VACUUM
CLEANER**

FOR ONLY

Five Dollars

CLEANS carpets, rugs, cushions, draperies, clothing and all fabrics CLEAN, and just as good as ANY high-priced Electric Outfit.

IT'S SANITARY, makes no dust, as it draws ALL of the dirt and dust UP AND OUT of the carpets and rugs by a POWERFUL SUCTION and RETAINS it in an AIR TIGHT dust chamber, where it can be easily removed and emptied out of doors.

THE SIMPLEX VACUUM CLEANER does exactly THE SAME WORK and is used in exactly the same manner as all of the high-priced Electric Cleaners, namely, the cleaner is moved back and forth over the carpets, rugs or articles to be cleaned, without any of the many disadvantages of the higher priced cleaners.



The MARK
of the MAKER
is put on P.S. & W.
Guaranteed Pliers—
and put on to stay.

We wouldn't be so anxious to
have it there—and have you see
it—if we didn't know—

That it represents the top notch
in over 90 years of manufactur-
ing experience.

That it is known to expert
Electricians, Machinists, Carpen-
ters, and Tinsmiths everywhere as the
mark of four large lines of Guaranteed
Hand Tools that you can trust—*because
you know who made them.*

List of P. S. & W. Guaranteed Box-Joint Pliers.

- No. 30, Side Cutting, Black Finish
- No. 130, Side Cutting, Nickel-plated
- No. 330, Side Cutting, Full Polished Head
- No. 300, Side Cutting, Insulated Handles
- No. 50, Side Cutting with Splicing Device
- No. 0, Side Cutting, extra heavy—9-inch
- No. 20, Flat Nose, Black Finish
- No. 120, Flat Nose, Nickel Plated
- No. 25, Round Nose, Black Finish
- No. 125, Round Nose, Nickel Plated
- No. 27, Diag'l Cutting, Black Finish
- No. 127, Diag'l Cutting, Nickel Plated
- No. 227, Diag'l Cutting, Full Polished
- No. 37, Diag'l Cutting, Raised Cutters—Black
- No. 137, Diag'l Cutting, Raised Cutters—Nickel
- No. 237, Diag'l Cutting, Raised Cutters—Full Polished
- No. 43, Chain Nose, Black Finish
- No. 143, Chain Nose, Nickel Plated
- No. 47, Chain Nose with File Jaws—Black
- No. 147, Chain Nose with File Jaws—Nickel
- No. 31, Opticians' Round and Flat Jaws—Black
- No. 131, Opticians' Round and Flat Jaws—Nickel
- No. 33, Opticians' Concave and Convex Jaws—Black
- No. 133, Opticians' Concave and Convex Jaws—Nickel
- No. 700, Glass Pliers, Flat Jaws—Black

Also a full line of Lap Joint
Pliers and Splicing Clamps

Why the P. S. & W. Box-Joint is the best possible type of plier- construction.

Because the joint fits perfectly, works
smoothly and never can work loose
from wear.

Because the jaws are carefully
adjusted and milled.

Because the cutting edges
meet accurately and cut sharp
and clean as long as the plier
is used.

Because you cannot
get these results from
any other type
of plier con-
struction.



A Handy Book for All Tool Users

Write today for our 165-page "Mechanics Handy
List." It contains many pages of valuable shop-
information and a catalogue of over 200 Tools for
Electricians, Machinists, Carpenters and Tinsmiths.

The Peck, Stow & Wilcox Co.

MFRS of the Largest Line of Mechanics'
Hand-Tools Offered by any Maker

Address Correspondence to 30 Murray St., New York City

Established 1819

Five Large Factories

For our Mutual Advantage mention Popular Electricity when writing to Advertisers.

This system is endorsed by BARNEY OLDFIELD, CHAS. DURYEA and other leading authorities. Complete course right now—only \$10.00.

LEARN TO RUN & REPAIR AUTOMOBILES. YOU CAN

LEARN THE AUTOMOBILE TRADE
The Best Profession in the World





With this New Idea System anyone who can read can learn. **POSITIVELY**—the only plan for successfully teaching by mail. Mr. Dyke published the first book on autos printed in the U. S., but reading was not practical enough, so two years ago he originated the idea of teaching Automobile Engineering and Repairing by mail with clever and wonderful **REAL WORKING MODELS** of all important moving parts of the Automobile (only two models illustrated.) They show the parts in operation while you study. **Dyke's course costs but \$10.00**—it is far more complete than others and easier to understand. In addition to 12 books there are 120 charts, and working models of real metal moving parts—all sent you at one time. Diploma on examination.

INCREASED THEIR INCOME
 "I am now driving a Winston Six; do all my own repairing." Edw. Dwyer, Montclair, N. J.
 "I am now repairing tires and motors." Ben Rhoemaker, Berwick, Pa.
 "I am now doing auto repair work; increased my income 50 per cent." L. P. Sayers, Bogus, Kans.

WE HAVE HELPED HUNDREDS—many are driving cars, others are repairmen, some have opened their own repair shops. We can show testimonials from hundreds. Let us prove our claims, so show us letters from Barney Oldfield and other leading authorities endorsing this system.

SEND FOR MY FREE BOOK

"How to Get into the Auto Business and its Opportunities"

Dyke's Cors'p School Motoring, Box 2, Roe Bldg., St. Louis, Mo.
A. L. Dyke originated the first Auto Supply Co. in America

LEARN TO REPAIR AND RUN AUTOMOBILES

Let me train you for the Automobile Business and assist you to **EARN BIG MONEY.**

as a chauffeur expert repairer, salesman, garage manager or agent. My graduates start out into agencies, liverys, taxicab and repair companies and make good. Attend my school in Kansas City—the big practical school you've heard so much about—for a few weeks and become an expert. Learn every part and its mechanical operation thoroughly and practically by working on real automobiles in my shops and on the road.

Which Free Book Do You Want?

Write for one of my interesting free books and learn all about the tremendous opportunities everywhere in this new business and my course of instruction.

Book A—About my big school in K. C.
 Book B—Home Study Course.

KANSAS CITY AUTOMOBILE SCHOOL,
Largest, Best Equipped in the U. S.
Oldest in the West.
2157 E. 15th, Kansas City, Mo.



STAMPS FREE 100 all different for the names of two collectors and 25 postage. Special Offer—100 diff. stamps, 1000 hinges, Album and mill. scale, all for 10c. 10 Annual stamps 10c. 500 all diff. stamps 60c. 20 diff. foreign coins 25c. Old Morocco Coast coin 10c. We buy stamps and coins. Buying lists 10c each. Big Price Lists free. **TOLEDO STAMP CO., Dept. E, Toledo, Ohio, U. S. A.**



Learn Telegraphy

MORSE and WIRELESS
At My Practical School. Demand for operators greater than supply. We also teach Station Agency Work. Graduates assisted. We occupy our own 2 large modern buildings equipped with K. R. Dispatchers and Western Union Wires and Wireless Station. Endorsed by Railroad, Wireless and Western Union Officials. Exclusive Methods. Teachers are practical experts. Living expenses earned. Easy payments. Correspondence course if desired. **Catalogs Free.**
GEORGE W. DODGE, Pres., Dodge's Institute, Established 1874. 21st St. VALPARAISO, IND

Line LEARN TO BE A Meter METERMAN Load

COMPLETE COURSE OF INSTRUCTION—BY MAIL!

Electrical workers are the highest paid class in the world. This field of electrical work is not overcrowded. The work is fascinating and healthful. It leads to rapid advancement and unlimited opportunities.

The demand for competent metermen far exceeds the supply. This is a new field. Electrical Meters and Instruments are being installed faster than men can be trained to handle them.

Our course covers every phase of Meter and Instrument work. It is the only course of its kind on the market. Very complete—thoroughly practical.

Our instruction is personal. We will qualify you for a splendid position paying a large salary. Your services will always be in demand. This is your opportunity. **Act now.**

40-page illustrated Catalog giving full particulars of course, sent **FREE.** Write for it—**TODAY.**

610 Shoaff Bldg. FORT WAYNE CORRESPONDENCE SCHOOL Fort Wayne, Ind.



A School Within Itself

There are XX chapters in all, XIX carrying you from the fundamental principles of electricity on through the various branches to a point where the careful student comprehends the complete designing, care and operation of a dynamo or motor, and I chapter on electric automobiles, outlining their construction, care and operation, and all about storage batteries and how to handle them. Each subject is carefully written and to the point. After a student studies a subject, he is questioned on the subject in such a manner as to bring clearly to his mind the points he needs to know regarding same. A **DICTIONARY** in back of book will enable him to learn the meaning of any electrical word, term or phrase used in this book, as well as hundreds of others in common use. All required tables necessary in the study are in it. **TABLE OF SUBJECTS:**

| | | |
|---|--|---|
| <p>CHAPTER</p> <p>I—Wiring.</p> <p>II—Electric Batteries, Electro Plating.</p> <p>III—Magnetism.</p> <p>IV—The Magnetic Circuit.</p> <p>V—Magnetic Traction.</p> <p>VI—Magnetic Leakage.</p> <p>VII—Energy in Electric Circuit.</p> <p>VIII—Calculation of Size of Wire for Magnetizing Coils.</p> | <p>CHAPTER</p> <p>IX—Calculation of EMF's in Electric Machines.</p> <p>X—Counter E.M.F.</p> <p>XI—Hysteresis and Eddy Currents.</p> <p>XII—Armature Reaction.</p> <p>XIII—Sparking.</p> <p>XIV—Winding of Dynamos and Motors.</p> <p>XV—Proper Method of Connecting Dynamos and Motors—Self Excitation.</p> | <p>CHAPTER</p> <p>XVI—Diseases of Dynamos and Motors and how to Cure Them.</p> <p>XVII—Arc and Incandescent Lamps.</p> <p>XVIII—Measuring Instruments.</p> <p>XIX—Alternating Current.</p> <p>XX—Automobiles.</p> <p>A dictionary of over 1500 Electrical Words, Terms and Phrases, giving a brief meaning of all which are in common use.</p> |
|---|--|---|

\$2.00 Per Copy—Sixth Edition—30,000 Copies Sold

The offer we make of refunding money if book is not satisfactory upon examination is AN UNUSUAL ONE in connection with the sale of a book. But we have no fear of its return. Your decision will be what thousands of others have been. Money would not buy it if it could not be duplicated. We could print testimonials by the hundreds. It is best to order and be your own judge of its merits.

CLEVELAND ARMATURE WORKS, 4730 St. Clair Ave., Cleveland, Ohio
AMERICA'S GREATEST REPAIR WORKS

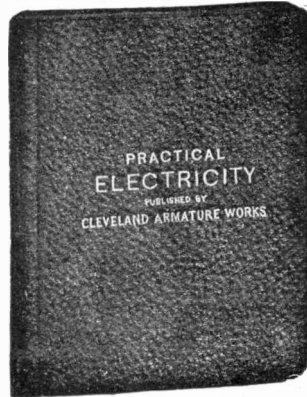

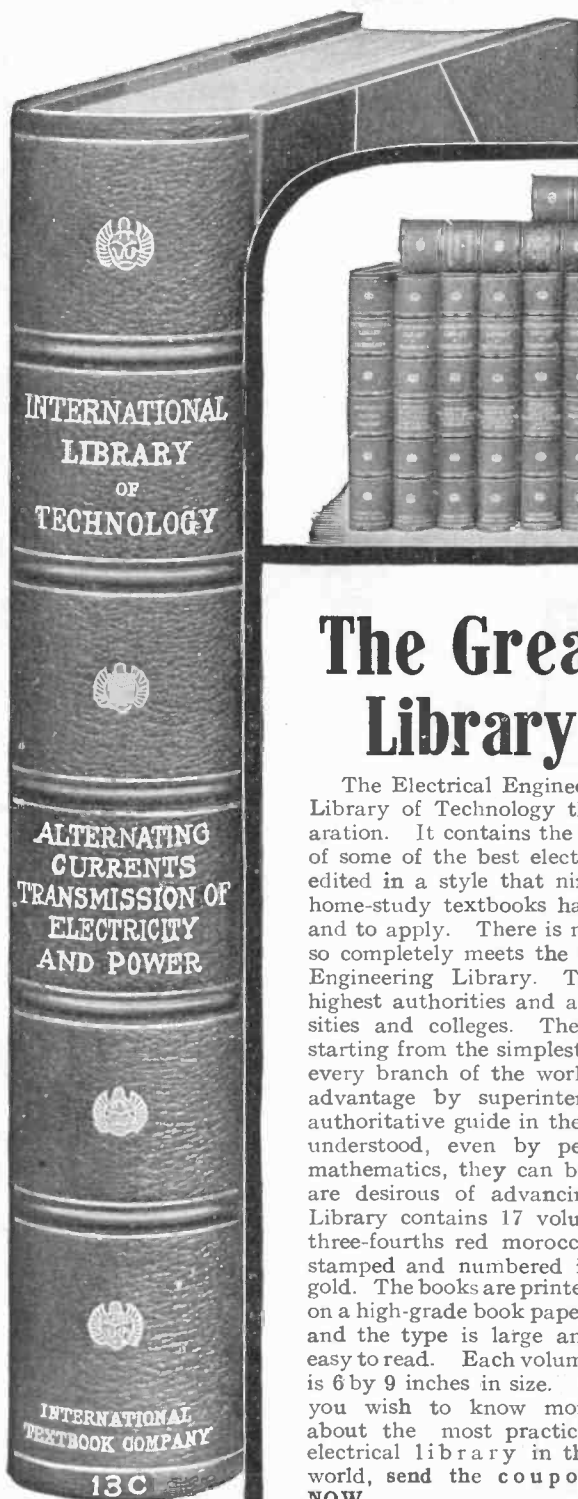

The Greatest Electrical Library in the World

The Electrical Engineering Library is part of the International Library of Technology that cost \$1,500,000 in its original preparation. It contains the knowledge given from the life experience of some of the best electrical engineering experts in the country, edited in a style that nineteen years of experience in publishing home-study textbooks has proved easiest to learn, to remember, and to apply. There is no other reference work in the world that so completely meets the needs of the electrician as the Electrical Engineering Library. The volumes are recommended by the highest authorities and are used in nearly all the leading universities and colleges. They treat of practical electrical methods, starting from the simplest problems and comprehensively covering every branch of the work. Not only can they be used to great advantage by superintendents, foremen, and engineers as an authoritative guide in their work, but since they can be so clearly understood, even by persons having no knowledge of higher mathematics, they can be used by all classes of electricians that are desirous of advancing to higher positions. The Electrical Library contains 17 volumes durably and handsomely bound in three-fourths red morocco, stamped and numbered in gold. The books are printed on a high-grade book paper, and the type is large and easy to read. Each volume is 6 by 9 inches in size. If you wish to know more about the most practical electrical library in the world, send the coupon NOW.

International Textbook Co. Box 1102, Scranton, Pa.

Please send, without further obligation to me, full particulars in regard to your Library of Technology, with special reference to the Electrical Library.

Name

St. & No.

City State



Learn Photography, Photo-Engraving or 3-Color Work

Photographers and Engravers Earn \$20 to \$50 Per Week. Only college in the world where these paying professions are taught successfully. Established 17 years. Endorsed by International Association of Photo-Engravers and Photographers' Association of Illinois. Terms easy; living inexpensive. Graduates assisted in securing good positions. Write for catalog, and specify course in which you are interested.

Illinois College of Photography or 989 Wabash Av.
Bissell College of Photo-Engraving, Effingham, Ill.
L. H. BISSELL, Pres.

LEARN TO BE A WATCHMAKER

Bradley Polytechnic Institute
Horological Department
Peoria, Illinois



Largest and Best Watch School in America. We teach Watch Work, Jewelry, Engraving, Clock Work, Optics. Tuition reasonable. Board and rooms near school at moderate rates. Send for Catalog of Information.

BRADLEY, H. Peoria, Ill.



IF YOU STAMMER

attend no school till you hear from me. Largest school in the world, employing the advanced natural method for the cure of stammering, stuttering, etc. No sing-singing or time-beating. If let run, stammering will wreck your life's happiness and handicap your endeavors. I cured myself and thousands of others by my method and can cure you. Beautiful 88 page book and Special Rate sent FREE.

Lee Wells Millard, Pres., North-Western School for Stammerers, Inc., 940 First St., Milwaukee, Wis.



Do You Like to Draw?

That's all we want to know. Now we will not give you any grand prize—or a lot of free stuff if you answer this ad. Nor do we claim to make you rich in a week. But if you are anxious to develop your talent with a successful cartoonist, so you can make money, send a copy of this picture with 6c. in stamps for portfolio of cartoons and sample lesson plate, and let us explain.

THE W. L. EVANS SCHOOL OF CARTOONING
325 Kingmoore Bldg., Cleveland, O.



LEARN PIANO TUNING AT HOME by the aid of the TUNE-A-PHONE. A Profession that can be converted into money at any time or place in the civilized world at an hour's notice. Earn \$5.00 to \$15.00 per day. Valuable illustrated book FREE. Write NILES BRYANT SCHOOL OF PIANO TUNING, 77 Music Hall, Battle Creek, Mich.

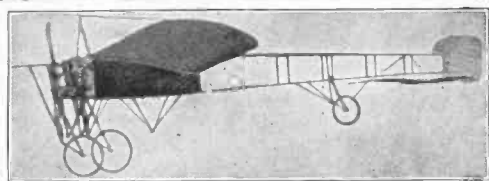

THE AMERICAN SCHOOL OF AVIATION CORRESPONDENCE COURSE

Under the auspices of the American Aeronautical Society. Technical and Practical training for the Aviator, Designer and Inventor. Send for particulars. M. K. KASMAR, Secretary, 1950 North Ave., Chicago, Ill.

For our Mutual Advantage mention Popular Electricity when writing to Advertisers.

New York Electrical School

Offers to men and boys a theoretical and practical course in applied electricity without limit as to time.

Instruction individual, day and night school, equipment complete and up-to-date. Students learn by doing, and by practical application are fitted to enter all fields of electrical industry fully qualified. School open all year. Write for free prospectus.

40 West Seventeenth St. NEW YORK

WHY NOT BE AN ARTIST?

Our graduates are filling High Salaried Positions.
EARN \$25 to \$100 PER WEEK

In easy, fascinating work. Practical, Individual Home Instruction. Superior equipment. Expert Instructors. Eleven years' successful teaching. Financial returns guaranteed. Write for particulars of the instruments and supplies to each student.

SCHOOL OF APPLIED ART (Founded 1899)
A 70 Fine Arts Bldg., Battle Creek, Mich.

LEARN WATCHMAKING

ENGRAVING AND JEWELRY REPAIRING

Practical specialists in charge of all instruction. Students trained for the best paying positions. Earn while learning. Our school is endorsed and recommended by leading jewelers. A few months will make you an expert. Positions secured for graduates. Demand for watchmakers greater than the supply. Write for free catalog.

CHICAGO SCHOOL OF WATCHMAKING
Department 30 Bush Temple, CHICAGO

If YOU Would Be Successful Stop Forgetting

MEMORY the BASIS of ALL KNOWLEDGE. You are no greater intellectually than your memory. Send today for my free book "How to Remember"—Faces, Names, Studies—Develops Will, Concentration, Self-Confidence, Conversation, Public Speaking, Increases Income. Sent absolutely free—Address DICKSON MEMORY SCHOOL, 929 AUDITORIUM BLDG., CHICAGO

Salesmen Wanted

Trained Salesmen earn from \$1,200.00 to \$10,000.00 a year and expenses. Hundreds of good positions now open. No experience needed to get one of them. We will assist you to secure a position where you can get Practical Experience as a Salesman and earn a good salary while you are learning. Write today for full particulars, list of good positions now open, and testimonials from hundreds of men recently placed in good positions.

Address Nearest Office, Dept. 133
National Salesmen's Training Association
Chicago New York Kansas City Seattle New Orleans

ELECTRICITY

Complete in One Year

SCIENTIFIC ELECTRICITY
IN ALL ITS BRANCHES

Bliss Electrical School

Studies restricted to theoretical and practical electricity, mechanical drawing and necessary engineering work. Teaches simplicity, concentration, hard work. For young men of energy and character. 18 years of greatest success. Graduates hold first-class positions. Opens Sept. 20. Write for new catalog.

10 Takoma Ave., WASHINGTON, D. C.

Increase Your Earnings!



Train yourself for a responsible position, educate yourself to increase your earning capacity and fit yourself for a professional life by studying

DRAFTING

Our courses are the most practical ever planned and cover all branches. Hundreds of plans of buildings and machinery in course of construction are at the disposal of students who can also inspect actual work of construction. Short, practical courses. Full or sectional courses, as needed. Day and evening classes. *Students assisted to obtain positions while attending school.* Entrance can be made at any time—no examinations required. Start at once your step towards a lucrative career—call, or write for catalogue. Do it today.

Correspondence Courses in *Architectural, Mechanical and Structural Drafting and Design, Plan Reading, Estimating, etc.* If interested in Correspondence Courses write for Folder No. 3.

CHICAGO TECHNICAL COLLEGE, 609 Athenaeum Bldg., Chicago

DO IT NOW!

Send your name and address with 2c stamp for particulars of our Salary Plan for representatives.

Popular Electricity Magazine, Circulation Dept. Commercial Bldg., Chicago, Ill.

DR. FOOTE'S "WONDER" BOOK
ON HEALTH—DISEASES—FREAKS—MARRIAGE—PARENTAGE—HUMAN NATURE

A peep into the Mysteries of the INNER-MAN. This remarkable book is a thought-awakener, and is as intensely interesting as a novel. It contains more truths, common-sense, vital facts, valuable advice and information than your doctor would give you for \$10. In two sections,—240 pages and 40 illustrations. Sent by mail postpaid on receipt of Price—10c. Write TO-DAY, Murray Hill Book Co., 106 East 28th St., N.Y.

“HELP WANTED”
—Uncle Sam.

Railway Mail Clerks
Clerks in the Departments at
Washington, D. C.
City Carriers—Postoffice Clerks
Examinations Announced Everywhere July 15
Over 15,000 positions will be filled
during 1911.

\$800.00 to \$1800.00 a Year
for LIFE

No "layoffs" without pay, because of strikes, financial surries or the whims of some petty boss. Excellent opportunities for quick advancement to Higher Government Positions.

If you want immediate appointment, send TODAY for our schedule showing locations of the coming examinations. Any delay means the loss of just so much time in preparing yourself for examination.

We Prepare Candidates Free

SEND COUPON BELOW

Franklin Institute
Dept. K 119, Rochester, N. Y.

The coupon, filled out as directed, entitles the sender to a free copy of our book, "Government Positions and How to Obtain Them," and to consideration for Free Coaching for the examination here checked.

COUPON

- .. Railway Mail Clerk (\$800 to \$1400)
- .. Postoffice Clerk (\$600 to \$1200)
- .. Postoffice Carrier (\$600 to \$1200)
- .. Rural Mail Carrier (\$500 to \$900)
- .. Bookkeeper (\$900 to \$1800)
- .. Customs Posit'ns (\$600 to \$1500)
- .. Internal Revenue (\$700 to \$1800)
- .. Stenographer (\$600 to \$1500)
- .. Clerk in the Departments at Washington (\$500 to \$1500)

Name
Address K 119

Use this before you lose it. Write plainly.

BE INDEPENDENT



We occupy our own building. actual working materials in teaching. Individual instruction. Low expenses. Easy terms. Graduates placed. Your success assured. Write today for large illustrated catalog.

HOLD A POSITION OF DIGNITY through which you can earn highest wages or start a business of your own. Learn a fine trade in three to five months, and be a master mechanic independent for life, do not be satisfied to be a mere clerk at \$15 per week, earn \$5 to \$8 per day—right from the start, Electrical work, Plumbing, Bricklaying, Mechanical Drawing, Painting, Decorating and Paper Hanging, taught at the most successful trade institute in the world. No books, but tools and



L. L. Cooke, Pres.

COYNE NATIONAL TRADE SCHOOLS

74 E. Illinois Street,

CHICAGO, ILL.

PRACTICAL ELECTRICAL EDUCATION



We teach by practical work and scientific methods under practical working conditions. All branches of Electrical Science and Engineering taught.

Students can enter at any time for the full or special courses.

No matter what your education, we start you at the very point you are competent to begin. By our system of individual instruction you can complete our course as quick as your ability warrants.

We have more calls for trained students than we can fill.

Handsome illustrated catalog and terms, free upon request.

Summer Term—Without Extra Charge—begins June 19th, 1911



SCHOOL OF ENGINEERING
235 - 1037 WINNEBAGO ST. MILWAUKEE WIS.

A COMPLETE Electrical Workers' Library

By HENRY C. HORSTMANN and VICTOR H. TOUSLEY

Positively up-to-date and written
for the men who do the work

We defy any publisher in the world to produce a more practical collection of books for the electrical worker than this series. The immense sale of these popular books since date of publication has been greater than any electrical books ever sold to working electricians.

The Reason?

They are *practical* and do not confuse the worker. They also have the *highest endorsement* of the *International Brotherhood of Electrical Workers*.

To substantiate this claim we offer the sum of *One Hundred Dollars* to any publisher who will produce a sworn statement showing a greater sale of any similar book or books treating on the subject matter than these do, for the length of time they have been on the market.

As to our reputation for keeping business promises, we will refer you to any bank or business house in Chicago.

For the next ninety days we are making a special introductory offer of the complete set of four volumes, neatly cased (regular price \$6.00).

Our special introductory price to electrical workers \$5.00, prepaid to any address upon receipt of price. To all persons ordering this set by return mail, we will present, free of charge, our *Handy Electrical Dictionary* for the Vest Pocket, bound in red Russia Leather, gold edges, indexed, 224 pages, illustrated. If the books ordered are not found entirely satisfactory in every way, they may be returned and your money will be cheerfully refunded. To electrical workers already having any of the below enumerated volumes, we will supply single copies of any one or more books at \$1.50 each, postpaid to any address in the world.



| | |
|---|---------------------------|
| Electrical Wiring and Construction Tables | 120 pages 70 diagrams |
| Modern Electrical Construction | 340 pages 173 diagrams |
| Modern Wiring Diagrams and Descriptions | 250 pages 200 diagrams |
| Practical Armature and Magnet Winding | 232 pages 128 diagrams |

Each volume is substantially bound in full Persian Seal Grain Morocco Leather, stamped on the outside covers in genuine gold leaf, round corners, red edges, pocket size, printed on super-calendered book paper.

Address all Orders to the Publishers

Frederick J. Drake & Company
222-1325 Michigan Avenue CHICAGO, U.S.A.

EDISON

His Life and Inventions

By
Frank L. Dyer
and
Thomas C. Martin

988 PAGES

Two Volumes
\$4.28 Postpaid

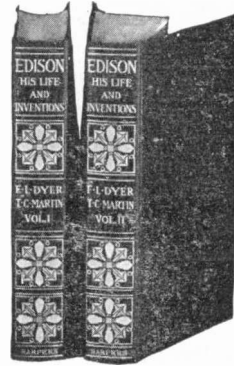

Practically a history
of Electricity for
the past fifty years.

Contains among other new material
a complete list of the Edison Patents.

THE full and authoritative story of Edison's own life has never been written until now. The full story could only be given by Edison himself and his closest associates. One of the authors is his counsel, as his father and brother were before him, and he practically shares Edison's daily life. The other, who has been in the confidence of the great inventor for a long time, is one of the leading electrical experts of our country. The entire manuscript has been read and revised by Edison himself.

Scene by scene the real life and work of the great inventor are unrolled before us, the days and nights spent in developing the electric railway and storage batteries, the growth of the phonograph industry, the ore-milling work, the application of Portland cement, with its large possibilities, and the development of a new phase of modern entertainment and education in the vast business of moving pictures.

How has it been done? What are the scenes in which the inventor works? What is his daily life? What are his methods? In this book there is pictured all this personal side. The evolution of his ideas is traced, his manner of working, the scenes in his laboratory, the enthusiastic co-operation of his assistants guided by the master's brain, and the persevering industry which leads to triumph over discouragements, mistakes and obstacles.

There is a long and full Technical Appendix, describing in detail the work Edison has done. This in itself is a long-needed book.

POPULAR ELECTRICITY BOOK DEPT.

54 W. Lake St.; Chicago, Ill.

Please send me post-paid the book entitled "Edison; His Life and Inventions," in two volumes, for which I enclose remittance for \$4.28.

Name.....

St. and No.....

City.....State.....

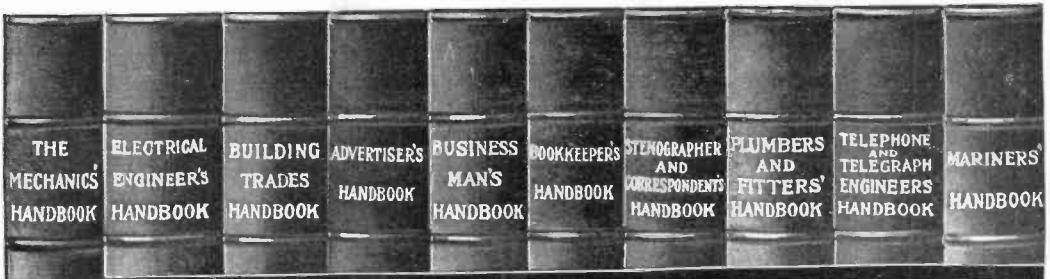

\$1.25 Handbooks for 50c.

No books in existence contain in so small space as much information about the trades and professions of which they treat as do these Handbooks. They are little giant encyclopedias of practical knowledge giving data and information that is hard to find in ordinary books. These Handbooks have been prepared by the well-known textbook writers of the International Correspondence Schools whose textbooks are recognized the world over as the most practical treatises on applied sciences ever published. These Handbooks are consulting experts of the highest rank, and are the most powerful force in the world for the promotion of ambitious men. They are an indispensable help to quicker and better work that will command advancement. They are printed on a high-grade book paper in clear type, and durably and handsomely bound in cloth with gilt titles; contain on an average of 364 pages and 175 illustrations and are regularly sold for \$1.25 each.

SPECIAL OFFER.—We are selling these Handbooks, durably bound in cloth with gilt titles, at a special price for each Handbook of 50 cents.

Mechanics'—Tables; formulas; measurements; belting; mechanical powers; hydro-mechanics; strength of materials; shafting; boiler design; care of boilers; power of boilers; chimneys; exhaust heating; machine design; machine tools; slide valve; pulleys; cylinders and steam chests; pistons; gearing; transit surveying; triangulation; curves; radii and deflections; earth work; track work; electricity; etc.

Advertiser's—How to plan and write an advertisement; type and type measurements; points on printing style; display; preparation of manuscript; proof reading; engraving and printing methods; electrotypes; matrices; advertisement illustrations; magazines; newspapers; retail, department-store, general, trade-paper, and mail-order advertising; trade marks; circulars; advertising agencies; etc.

Stenographer's & Correspondent's—Advice to beginners; shorthand speed; letters of application; punctuation; correct and faulty diction; business correspondence; type-writing; abbreviations; addressing; mailing; rates of postage; duplicating work; etc.

Telephone and Telegraph—Useful tables; mechanics; electricity; magnetism; primary batteries; storage batteries; electrical measurements; telephony; tests with magnetogenerator and bell; telegraphy; Morse telegraph systems; multiplex telegraphy; etc.

Electrical Engineer's—Mechanics; electricity; electrical units; symbols and quantities; physical and electrical properties of metals and alloys; wire gauges; magnetism; dynamos and motors; electric batteries; alternating current apparatus; alternators; transformers; wattmeters; electric transmission; electric lamps; wiring; electric heating and welding; electromagnets; controllers; car wiring; etc.

Business Man's—Arithmetic; tables; business forms; card systems; measures of extension; weight and capacity; time; value of foreign coins; duties on imports; bookkeeping; stenography; correspondence; postal information; financial terms; money and the money market; brokers and brokerage; patents; copyright and trade marks; corporations; business law; publicity; etc.

Plumbers and Fitters'—Arithmetic; involution and evolution; powers, roots, and reciprocals; circles; decimals; geometrical drawing; weights and measures; formulas; mensuration; mechanics; hydro-mechanics; building construction; heating and ventilation; gas-fitting; plumbing; etc.

Mariners'—Logarithms; trigonometry; navigation; terrestrial navigation; celestial navigation; organization of a man of war; naval ordnance; explosives; torpedoes; ship building; speed, tonnage, and fuel consumption; ropes; wind and weather; signals; nautical memoranda; etc.

Building Trades—Loads and structures; strength of materials; properties of sections; strength of rivets and pins; materials of construction; footings and foundations; masonry construction; woods used in building; qualities of timbers; joinery framing; estimating; elements of architectural design; drainage systems; plumbing fixtures; plumbers' tables; heating and ventilation; gas and gas-fitting; etc.

Bookkeeper's—Arithmetic; formulas; tables; money; percentage; interest; equation of accounts; money and the money market; business law; financial terms; banks and banking; postal information; distances and time between various places; bookkeeping; business forms; card systems; modern office methods; cost accounting; bank bookkeeping; clearing house methods; etc.

International Textbook Co.

Box 1102, SCRANTON, PA.

I enclose \$_____ for which please send me the books BEFORE which I have marked X.

- Mechanics' Handbook
- Advertiser's Handbook
- Elect. Eng. Handbook
- Business Handbook
- Bldg. Trades Handbook
- Bookkeeper's Handbook
- Plum. & Fit. Handbook
- Sten. & Corr. Handbook
- Tel. & Tel. Handbook
- Mariners' Handbook

Name _____

St. and No. _____

City _____ State _____

Electrical Talks—Flash No. 12

ANOTHER little instance of how a magazine on electricity by getting out and circulating among the people, can put new ideas into their heads and incite them to buy, "won't do no harm."

Here is a telegram from a big hotel in Minneapolis. The fact that they grab Popular Electricity, find the things they want and then resort to telegrams to set the wheels in motion as soon as possible is not the whole point in question. There is a great, big idea back of it—an idea we have been hammering away at for three years.

315a 8j 3j NL

Minneapolis Minn Apr 6 11

Popular Elec Pub Co

Commercial Bldg Chgo

Send name of manf. of electric fountain described page 1116 april

issue of magazine also name of manf. glass globes and pillars

described in same number wire answer our expense

Radisson Hotel

315a

This telegram tells you point blank, Mr. Electrical Advertiser, that if you haven't made provisions to do your share in telling the people about your product you have overlooked a large element in your advertising problem.

The product of every single electrical manufacturer is built eventually to meet the needs of the public. But the public must be told.

No doubt the Minneapolis General Electric Company is sitting up nights to think of ways to tell its consumers how they may use electric current to advantage.

Minneapolis has some good electrical supply dealers who are exerting themselves likewise.

The technical and trade journals are valiant in their efforts to keep both the central stations and the dealers posted.

But all these efforts combined do not carry the propaganda to all the people—and these people are hungry for information.

The consequence, in this particular case, is that the managers of a great hotel read Popular Electricity to find out how to use current.

Your advertisement appearing in this magazine from month to month will pay in direct business obtained; it will boost for your friends the central stations; it will gratify and assist the dealers who handle your product, and it will go hand in hand with your advertising in the technical papers.

POPULAR ELECTRICITY MAGAZINE.



Here is the Standard Reference Work on Electricity

and we want you to examine it absolutely free of charge in your own home or office. Read our Liberal Selling Plan—it tells how we will send you the great six-volume

Cyclopedia of Applied Electricity

upon receipt of the coupon and allow you to examine it free of charge.

We have confidence in this great cyclopedia; we know that it is the reliable authority on electricity. It is compiled from the instruction papers of the American School of Correspondence, written by thirty of the world's greatest electrical experts. We want you to endorse our claims and for this reason we make you this free offer.

If you want to be an expert—an authority on everything electrical, you need a work that covers every phase of electrical engineering—a work that will tell you what you want to know in plain English without technical terms and formulas. That is just what you have in this cyclopedia. These books cover every branch of electricity thoroughly, exhaustively, from the elements of electricity to the design and construction of power and central stations. Read "Important Subjects Covered," and then mail the coupon. The six volumes contain 2,896 pages, 7x10 inches in size; 2,000 special illustrations, photographs, plates, diagrams, tables, etc., beautifully bound in half morocco; titles stamped in 23-karat gold.

This Is Our Liberal Selling Plan

Upon receipt of the coupon the books will be sent you, express prepaid, for 5 days' free examination. If you decide to keep the books, send us your initial payment of \$2.00 within five days and \$2.00 every month until you have paid the special price of \$18.80. The regular price is \$36.00. If, after thoroughly examining the books, you do not see your way clear to keep them, notify us and we will send for them at our expense. Send the coupon today.

P. E. 6-11

A. S. of C.

IMPORTANT SUBJECTS COVERED

Types of Dynamos and Motors; Elevators; Direct-Current Motors; Electrical Measurements; Electric Lighting; Electric Railways; Alternating Current Motors, etc.; Electric Welding; Mercury-Vapor Converter; Management of Dynamos and Motors; Power Stations; Central-Station Engineering; Central-Station Design; Storage Batteries; Power Transmission; Electric Wiring; Electric Telegraph; Wireless Telegraphy; Telephony; Automatic Telephone; Wireless Telephony, etc.

Please send set Cyclopedia of Applied Electricity for 5 days' free examination, also Technical World for one year. I will send \$2.00 within 5 days and \$2.00 a month until I have paid \$18.80, or notify you and hold the books subject to your order. Title not to pass until fully paid.

For a short time we will include as a monthly supplement, for one year, the TECHNICAL WORLD MAGAZINE. This is a regular \$1.50 monthly, full of Twentieth Century scientific facts, written in popular form. Also contains the latest discussion on timely topics in invention, discovery, industry, etc.

AMERICAN SCHOOL OF CORRESPONDENCE
CHICAGO, U. S. A.

NAME

ADDRESS

OCCUPATION

REFERENCES

For our Mutual Advantage mention Popular Electricity when writing to Advertisers.

Complete—Authentic—Up-to-the Minute

Wireless Telegraph Construction

FOR AMATEURS

By ALFRED POWELL MORGAN

220 Pages - - - 153 Illustrations

Price \$1.50 Postpaid

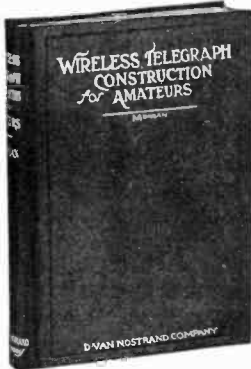

The author has written a number of articles for Popular Electricity, whose readers will at once recognize the value of his new work.

Meets the demand for a practical work on construction of wireless telegraph instruments, and is unusually complete, giving in minute detail full directions, down to the smallest screw, for each part in the construction of various outfits capable of receiving from 100 to 1,500 miles, and of transmitting 3 to 100 miles. Also clearly explains the purpose and action of each instrument in connection with a complete wireless outfit.

History and all obsolete form of apparatus have been omitted, so that the information contained is thoroughly up-to-date.

READ THIS LETTER

Popular Electricity Book Dept.,
Chicago, Ill.

Pittsburgh, Pa.

Dear Sir:—Shipment of the book "Wireless Telegraphy Construction for Amateurs" received. We are delighted with the book and find that it fits our case exactly. The book cannot be commended too highly. Its thoroughness is a feature not often shown in such books. Its size, together with its splendid treatise of Wireless along constructive lines, makes it the ideal manual for an amateur.

THE PITTSBURGH WIRELESS TELEGRAPHY CO.

A LIST OF CHAPTERS

I. Introductory

The Transmission and Reception of Electric Waves; The Generation of Electrical Oscillations; Theory of Electric Waves; Tuning.

II. The Apparatus

Commercial Apparatus; Finishing Cabinet Work; A 400 Mile Receiving Outfit; A 1,000 Mile Receiving Outfit; 5, 10, 20, 30, 40, 50, 100 Mile Transmitting Outfits.

III. Aerials and Earth Connections

Advantages of Various Types; Directive Aerials; Aerial Insulators; Wires; Leading in Insulators; Wave Length; Calculation of Strain; Erection of an Aerial; Arrangement of Spars; Sending and Receiving Ranges; Earth Connections; Fire Insurance Underwriters Rules.

IV. Induction Coils

Principle of Induction Coils; Effects of Changes in Design; Core; Primary; Reducing Kick-back; Insulating Tube; The Use of Enamelled Wire; Forming the Sections; Connecting the Sections; Impregnating the Sections; Mounting; Construction of 1-2, 1, 2, 4, 6 Inch Spark Induction Coils.

V. Interrupters

Influence of Changes in Design; Simple Mechanical Interrupters; An Adjustable Independent Interrupter; Condensers; Mercury Interrupter; A Simple Mercury Interrupter; Electrolytic Interrupters; A Simple Wehnelt Interrupter; A Simple Simon Interrupter; A Large Simon-Caldwell Interrupter; A Large Wehnelt Interrupter.

VI. Transformers

Principles of Transformers; A 1-4 K. W. Open Core Transformer; Construction of a 1-4 K. W. Closed Core Transformer; Construction of a 1-2 K. W. Closed Core Transformer; Construction of a 1 to 2 K. W. Closed Core Transformer; Impedance and Reactance Coils, Type "E" Transformer.

VII. Oscillation Condensers and Leyden Jars

Action of Condensers; Calculation of Capacity; Table of Capacities; Leyden Jars; Construction of Leyden Jars; Glass Plate Condensers; Construction of an Adjustable Glass Plate Condenser.

VIII. Spark Gaps or Oscillators

The Adjustment of a Spark Gap; Simple Spark Gaps; Construction of Spark Gaps for Transformers.

IX. Transmitting Helices

Construction of Closely Coupled Helices; Construction of Loosely Coupled Helices; Connection Clip; Tuning a Transmitter.

X. Keys

Commercial Wireless Keys; Construction of Simple Wireless Keys; Construction of a Commercial Wireless Key.

XI. Aerial Switches and Anchor Gaps

A Simple Aerial Switch; A Triple Pole Aerial Switch; A "T" Aerial Switch; Construction of Anchor Gaps.

XII. Hot Wire Ammeter

Construction of a Simple Hot Wire Ammeter; Construction of a Sensitive Hot Wire Ammeter.

XIII. Oscillation Detectors

Construction of a Universal Detector; Electrolytic Detectors; Adjustment of an Electrolytic Detector; Construction of a Shoemaker Detector; Construction of a Stone Detector; Delaney Lamp Detector; Construction of a Simple Electrolytic Detector; Increasing the Sensitiveness of an Electrolytic Detector; Tantalum Detectors; Crystal Detectors; Sensitive Minerals; Carborundum Detectors; Silicon Detectors; Mounting Crystals; Fusible Alloys; Perikon Detector; Selection of Minerals; Lead Peroxide Detector; Construction of a Lead Peroxide Detector; Construction of a Magnetic Detector; The Audion; Construction of a Simple Audion.

XIV. Tuning Coils and Transformers

Construction of Simple Tuning Coils; Sliding Contacts; Construction of Loose Couplers; Construction of a Combination Closely and Loosely Coupled Tuning Coil; Construction of Potentiometers.

XV. Receiving Condensers

Construction of Fixed Condensers; A Simple Variable Condenser; A Sliding Plate Condenser.

XVI. Telephone Receivers and Headbands

How to rewind a Telephone Receiver; Readjusting Telephone Receivers; Construction of a Headband.

XVII. Operation

Learning the Codes; Arrangement of the Station; Operating Rules; Electrical Terms and Definitions.

Handsomely Bound in Silk Cloth

Popular Electricity Book Dept.

Chicago, Ill.



The Boys' Magazine

is the greatest magazine in the world for boys. Each issue is filled with fascinating stories and absorbing articles all of intense interest to every live boy. Also each issue contains departments devoted to Electricity, Mechanics, Photography, Carpentry, Stamps and Coins. A big Athletic department edited by

WALTER CAMP

is a regular feature. Everyone knows that Mr. Camp is the highest authority on this subject in the country. This department is of great value to every boy who wishes to excel in Athletic sports. A new handsome cover in colors each month. Beautifully illustrated throughout.

SPECIAL OFFER: For Only 50c We Will Send You THE BOYS' MAGAZINE for six months and a "REACH" Base Ball Fielder's Glove transportation charges prepaid. This glove is made of fine brown tan leather, felt padded and leather lined, patent inside lump, web thumb and deep pocket. Send along your subscription. We will refund your money promptly if you are not more than pleased with your investment.

Address, THE SCOTT F. REDFIELD CO., 640 Main St., Smethport, Pa. (THE BOYS' MAGAZINE is on sale at all newsstands at one a copy)



THIS MORRIS CHAIR \$1 25

65c monthly—total price \$5.45. Latest design. Kiln dried heavy stock. Genuine Fabricoid Leather. We have 3000 such bargains for you. And all

Sold On Credit

You use and enjoy the goods now—pay as you can. 30 DAYS' GUARANTEED FREE TRIAL. Send at once for our big illustrated catalogue. It's FREE to you.

SPIEGEL, MAY, STERN & CO.

1538 35th Street - Chicago, Ill.

ARITHMETIC SELF-TAUGHT

A plain, easily-understood volume for all who have not had the opportunity of learning this subject thoroughly, or who have forgotten what they once learned. 257 Pages. Requires no teacher. This great little book sent postpaid for 60 CENTS. Stamps accepted, leather binding \$1. GEO. A. ZELLER BOOK CO. Est. 1870. 4464 W. Belle Place, ST. LOUIS, MO.

SPANGENBERG'S
PRACTICAL
ARITHMETIC
Self-Taught



Body and Brain Perfection

DR. MORAS has written a Commonsense Book on Autology, and by so doing placed the Standard of the

Creed of Health Farther to the Front than any man who has lived for a thousand years—**Elbert Hubbard**. So you may see for yourself. Send for FREE "Guide to Autology." Address E. R. MORAS, M.D., Dept. 12, Highland Park, Ill.

WHEN desirous of information inquire at the information Dept. of Popular Electricity Pub. Co.

Central Station Advertising

As advertising agents for the two largest Central Stations in the world, we have naturally acquired a fund of experience which might be drawn upon by other Central Stations to their considerable advantage.

Advertising Things Electrical

We are qualified by what we have done to give sound advice to the advertiser who is facing the problem of interesting the consumer in his product—be that advertiser large or small.

WM. D. MCJUNKIN Advertising Agency

167 Dearborn Street Chicago

LOFTIS SYSTEM Diamonds on Credit

You Can Easily Own a Diamond or Watch. Pay one-fifth on delivery, balance in 8 equal monthly payments. Catalog free. Write today. LOFTIS BROS. & CO., Dept. F685, 92 State St., Chicago, Ill.



12 Art Panels 50c

Beautiful Duo Tint Reproductions of Famous Paintings—Panel Size 7x10 These pictures are real gems—the most exquisite portrayals of

"WOMAN BEAUTIFUL"

ever shown in one collection. We send a full set of 12 in handsome Art Portfolio, packed flat and safe delivery guaranteed, together with lifelike miniatures of 70 other beautiful and catchy den pictures for only 50c coin, money order or U. S. stamps. Send at once. Money back if not satisfied. Or send \$1.25 for same set hand-colored.

Florentine Art Company Dept. F.6, 2009 Prairie Ave., Chicago, Ill. FREE—Order panels at once and we will include "Free" a beautiful den picture in colors.



We Want You to be a User-Agent of Everyman's Safety Razor. Send 45 Cents for a Sample Razor

Our factory has a reputation. The Blades used in Everyman's Safety Razor are the finest blades in the world. No better blade at any price. Our Handle is Scientifically Correct. We guarantee our razor to shave as well as any, and will cheerfully refund the full price to any one who is not pleased. Thousands have been sold without a single return. The first razor will be sent postpaid on receipt of 45 cents, together with full details of our Special Offer to Agents.

Everyman's Safety Razor Company, Dept. P. E., 116 Nassau St., New York



For our Mutual Advantage mention Popular Electricity when writing to Advertisers.

The Edison Storage Battery

is as different from all other storage batteries in construction, as in the result it gives.

There is no lead or acid in the construction of the Edison. The plates are nickel and iron in an alkaline (potash) solution—and the container is welded, fluted, nickeled steel—no rubber jars.

The result is a battery of about half the weight of a lead battery of equal capacity, or double the capacity of a lead battery of equal weight—a battery that can't sulphate or deteriorate, but that actually increases in capacity after a number of discharges; a battery that is not injured by overcharging, by complete discharge or by standing idle, either charged or discharged, for any period of time. And besides requiring far less attention and care than any other storage battery made, the Edison will outlast three or four lead batteries.

Three of the foremost electric pleasure vehicles, Detroit, Bailey, and Waverly, are already regularly equipped with the Edison Storage Battery—and these vehicles have made trips over country roads averaging well over 100 miles on a single charge and a number of city runs of over 200 miles on a charge have been made.

Whatever your storage battery requirements are, write today for our new catalog and ask for special information regarding the performance of the Edison in the field in which you are most interested.

Edison Storage Battery Company
117 Lakeside Ave., Orange, N. J.

LITHOLIN

THE broiling, sizzling sun of summer's hottest day cannot wilt a

Litholin Waterproofed Linen Collar

As fresh looking when you quit work at night, as when you start in the morning. Cool and flexible. Launder with a damp cloth.

The same collar will serve for work or play, day after day. *Litholin* is the same collar you have always worn—only waterproofed.

At your dealer's, or by mail on receipt of price. Write for booklet.

Collars
25c each

Cuffs
50c a pair

The Fiberloid Co.
7 & 9 Waverly Place, N. Y.



Have you ever read *The* Wide World Magazine?

It is of
more absorbing interest than the wildest fiction

It gives
more information and education than half a dozen school books.

It is
better than a newspaper. It tells of the strange and curious happenings of the world of to-day, in short stories that are as true as they are delightful.

Get a copy and read it and learn what a wonderful world it is that you live in.

Only 10 Cents

Of all Newsdealers



FREE

For Six Months

INVESTING For PROFIT

I am making this great offer to introduce my new magazine—*Investing for Profit*, which tells of the enormous profits made from judicious investments—profits the magnitude of which bankers and large corporations strive to hide from the masses. It explains the rules by which small investors have made stupendous fortunes—how \$100 grows into \$2200—how you can determine the *Real Earning Power* of your money.

One good investment is worth a life-time of labor. Don't invest a dollar in anything until you have read at least the first issue of this wonderful magazine.

If you can save only \$5 or \$10 a month, *Investing for Profit* is *absolutely indispensable* to you, as the less you have to invest the more certain you should be that your investments are not only highly profitable but reliable in every particular.

Send a postal today for your first copy.

H. L. BARBER, Publisher
R. 417, 26 Jackson Blvd., Chicago, Ill.



Linene

COLLARS
CUFFS AND BOSOMS

For Travelling

Linene collars are invaluable. They may be thrown away when soiled. Both sides being finished alike, they may be first reversed and two wearings secured for the price of a single collar. Try them the next time you travel.

10 collars for 25 cents at the stores, or by mail 30 cents in U. S. stamps. SAMPLE BY MAIL for 6 cents.

STATE size and style

REVERSIBLE COLLAR COMPANY
Department W, Boston, Mass.



Two 4-ply Collars,
Two handy Pockets
With every SIGNAL Shirt

Oh! the Comfort Of That Signal Shirt

Honest, you don't know what you're missing if you wear any shirt but the Signal. They fit as though *tailored* to measure. The finish is as perfect in every detail as the most modern machines, and expert hands working *together*, can turn out. And they're

Cut Coat Style

so you slip in and out easy as can be. No tearing the yoke when sweaty, no tugging over your head when tired.

"Extras," found only in the Signal shirt, are: Button at bottom of breast plait, to improve fit; fronts lap 3 inches; sleeve-slit placed in side, to keep out dirt; and faced with double continuous piece, proof against ripping.

If your dealer hasn't the Signal Coat Shirt, tell us his name and your size and we will send you one by express. C. O. D.

Send for a Couple. Price \$1.00
West of Missouri River, \$1.25

If you like them, pay Express Company. If not entirely satisfied, return at our expense.

Write for folder showing styles in neat colored patterns with collars to match at \$1. and \$1.50

Hilker Wiechers Mfg. Co.

1248 MOUND AVE., RACINE, WIS.



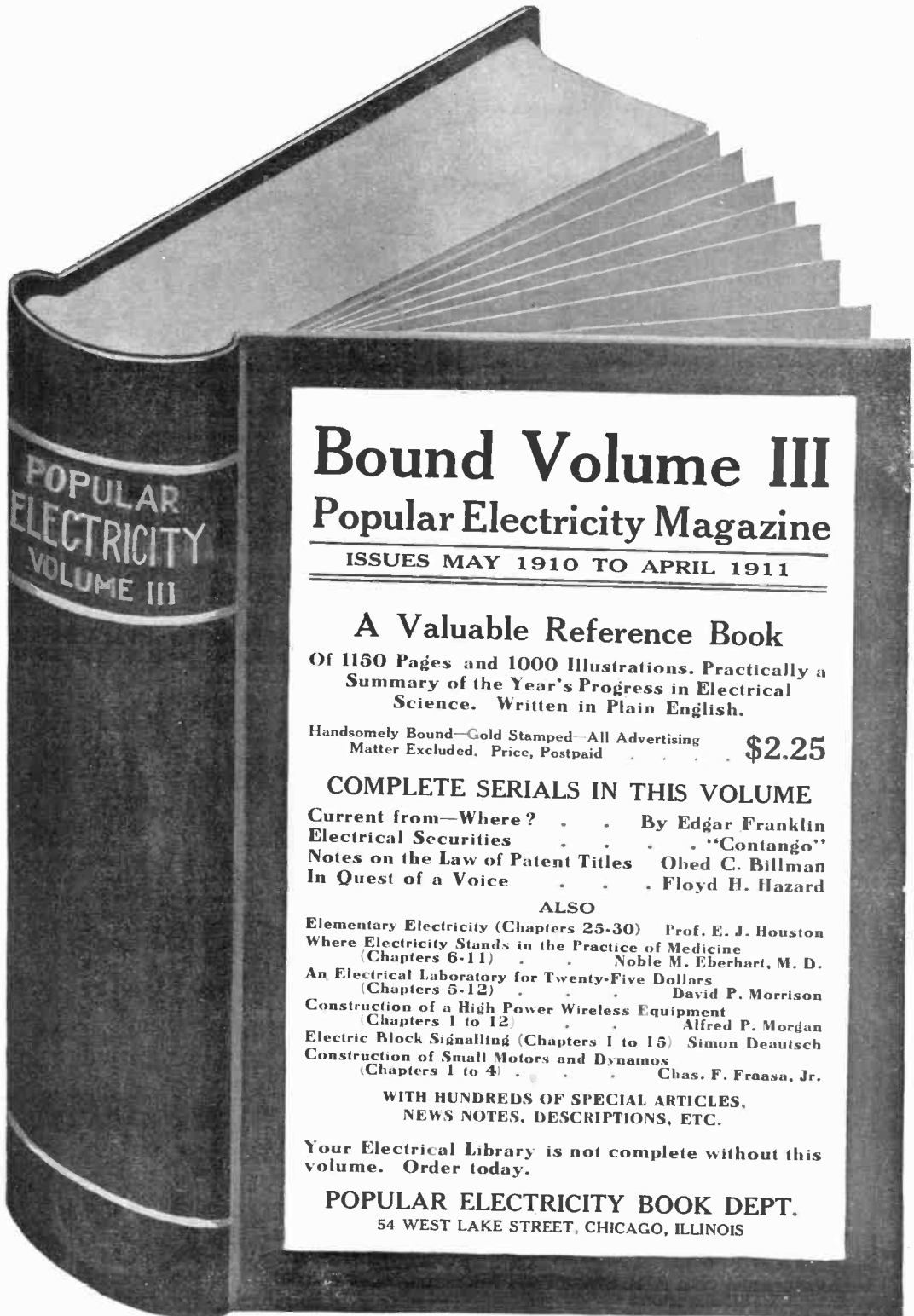

POPULAR ELECTRICITY
VOLUME III

Bound Volume III

Popular Electricity Magazine

ISSUES MAY 1910 TO APRIL 1911

A Valuable Reference Book

Of 1150 Pages and 1000 Illustrations. Practically a Summary of the Year's Progress in Electrical Science. Written in Plain English.

Handsomely Bound—Gold Stamped—All Advertising Matter Excluded. Price, Postpaid **\$2.25**

COMPLETE SERIALS IN THIS VOLUME

Current from—Where? . . . By Edgar Franklin
 Electrical Securities "Contango"
 Notes on the Law of Patent Titles Obed C. Billman
 In Quest of a Voice Floyd H. Hazard

ALSO

Elementary Electricity (Chapters 25-30) Prof. E. J. Houston
 Where Electricity Stands in the Practice of Medicine
 (Chapters 6-11) Noble M. Eberhart, M. D.
 An Electrical Laboratory for Twenty-Five Dollars
 (Chapters 5-12) David P. Morrison
 Construction of a High Power Wireless Equipment
 (Chapters 1 to 12) Alfred P. Morgan
 Electric Block Signalling (Chapters 1 to 15) Simon Deautsch
 Construction of Small Motors and Dynamos
 (Chapters 1 to 4) Chas. F. Fraasa, Jr.

**WITH HUNDREDS OF SPECIAL ARTICLES,
NEWS NOTES, DESCRIPTIONS, ETC.**

Your Electrical Library is not complete without this volume. Order today.

POPULAR ELECTRICITY BOOK DEPT.
54 WEST LAKE STREET, CHICAGO, ILLINOIS



POPULAR ELECTRICITY

IN PLAIN ENGLISH

HENRY WALTER YOUNG, Editor



Vol. IV

June, 1911

No. 2

CONTENTS

| | Page | | Page |
|--|------|---|------|
| TESLA AND HIS WIRELESS AGE. By Arthur B. Reeve | 97 | Meat and Food Chopper | 149 |
| COPPER WIRE FROM ORE TO POLE. | 102 | Electric Drills | 150 |
| FIVE EPOCH MAKING ELECTRICAL INVENTIONS (THE TELEPHONE). By Elmer E. Burns | 108 | Making Rail Bends | 151 |
| "Day Letters" Succeed Night Letters. | 111 | Scraper and Polisher for Mosaic Floors. | 151 |
| Fire Damp Detector | 111 | Cleaning Tarnished Silverware | 152 |
| THE WIRELESS OPERATOR REMINISCENCES. | 112 | Temperature Alarm for Nurses | 152 |
| THE BARMEN-ELBERFELD SUSPENDED RAILWAY. By Livingston Wright | 115 | Sawing Logs with Toothed Chains | 153 |
| Motor Operates Under Water | 116 | Cutting Wall Paper Friezes | 153 |
| Eleven Messages Over One Wire | 116 | Wind Direction Indicator | 154 |
| THE Turbine Engines | 117 | Sitting on an Electric Switch | 155 |
| HOW RADIUM IS MADE AND KEPT. By Arthur B. Reeve | 118 | Ruby Lamp for Dark Room | 156 |
| Ozone Stops Meat Decay | 121 | Removing Insulation from Wire | 156 |
| Marvelous Increase in the Use of Telephones | 121 | One Way of Demonstrating a Razor Strop | 157 |
| In the Country of the Bernese Oberland | 123 | Demonstrating a Wood Grainer | 157 |
| Interurban Funeral Car "Dolores" | 123 | Watching the Apples Bake | 157 |
| Where Skill and Accuracy Prevail | 124 | Exhibiting a Compartment Trunk | 158 |
| To the Pyramids by Electric Car | 125 | Novel Display of Diamond Setting | 158 |
| Measuring Smoke | 126 | Fan Aids Window Display | 159 |
| Dirigible Ballons as Sign Boards | 127 | Motor Exhibits Household Furnishings. | 159 |
| Electric Trains for the Giovi Tunnel | 128 | ELECTRICAL MEN OF THE TIMES. Theodore Newton Vail. | 160 |
| Yarn Singeing by Electricity | 128 | Illuminative Devices for British Coronation. | 160 |
| THE TROPICAL TROLLEY TROUBLE. By Edgar Franklin | 129 | Power for the Mississippi | 161 |
| Illumination of a Flower Shop | 132 | The Letters of a Bachelor Girl | 162 |
| Electric Block Signaling. By Simon Deutsch | 133 | A Ladies' Luminous Purse | 164 |
| New Fire Alarm System | 136 | Beautiful French Lamp. | 164 |
| Automatically reversing the trolley | 137 | Where Art and Science Meet. By T. Vernet | 165 |
| Battles with Dust and Snow | 137 | Morse | 165 |
| A "CONVERSATIONAL" SUBWAY. By C. B. Edwards | 138 | Two Currents From One Outlet | 167 |
| Testing Grain Stalks With a Saw. By Albert Scheible | 140 | CONSTRUCTION OF SMALL MOTORS AND DYNAMOS. By Chas. F. Fraaza, Jr. | 168 |
| Wind Mill Plant in an Old English Church | 141 | ELECTRICITY IN VAUDEVILLE. By H. F. S. | 170 |
| Platinum makes Gold Seem Cheap | 141 | The Young Edisons' Club | 172 |
| Three-color Stereopticon | 142 | Toy Torpedo Batteries. | 173 |
| Electric Tower Wagon | 143 | A HIGH POWER WIRELESS EQUIPMENT. By Alfred P. Morgan | 174 |
| He Wanted the "Tellingfoam" no more. | 143 | Wireless Across America. | 177 |
| Largest Storage Battery in the World | 144 | LATEST FIELD SET FOR THE SIGNAL CORPS. By R. H. Langley | 179 |
| All in a Day's Work. | 145 | Allegheny County Wireless Association | 180 |
| Street Lighting on Mission Posts | 146 | Transmitting Halices | 181 |
| Trains Carry Electric Plants | 146 | Sensitive Relay for Wireless Telegraphy | 182 |
| Plant for Fixing Nitrogen | 146 | Cocher not Practicable for Operators' Alarm. | 182 |
| Turbines Reduce Station Cost | 147 | Wireless Queries | 183 |
| Motors Adjust Big Telescopes | 147 | QUESTIONS AND ANSWERS | 185 |
| Heat as the Family Doctor | 147 | Disclaimers: Annulment and Repeal of Patents. By Obed C. Billman | 187 |
| Herrgott Fabrics | 148 | New Books | 188 |
| A Stamping Washer | 149 | Machinery for Overtime Work | 189 |
| | | Long-distance Entertainment | 189 |
| | | Electric Pumps in Horticulture | 189 |
| | | SHORT CIRCUITS | 190 |
| | | COMMON ELECTRICAL TERMS DEFINED. | 192 |

RENEWALS When your subscription expires, you will find a renewal blank enclosed here. You should fill out and return same with remittance at once to avoid missing a number. Positively no copies will be mailed on any subscription after same expires unless renewed, and we cannot agree to begin subscriptions with back numbers. The date on wrapper of your magazine shows issue with which your subscription ends. The extension on this date to period covered by renewal is a sufficient receipt. If any other is desired it should be requested at time of renewal.

CHANGE OF ADDRESS Notify us promptly of any change in your address, giving both the old and new location. Since our mailing list for each issue closes the 5th of the preceding month (i. e., list for February closes January 5th), changes received after the 5th must necessarily take effect with issue for second month following. Postmaster as well as Publisher should always be notified of changes in order to forward mail sent to old address.

ISSUED MONTHLY BY POPULAR ELECTRICITY PUBLISHING CO., Commercial Bldg., Chicago, Ill.
 YEARLY SUBSCRIPTION, \$1.00; CANADIAN, \$1.35; FOREIGN, \$1.50; SINGLE COPY, 10 CENTS

No additional copies will be sent after expiration of subscription except upon renewal.

Entered as Second Class Matter April 14, 1908, at the Post Office at Chicago. Under Act of March 3, 1879.

Copyright 1911, by Popular Electricity Publishing Co.

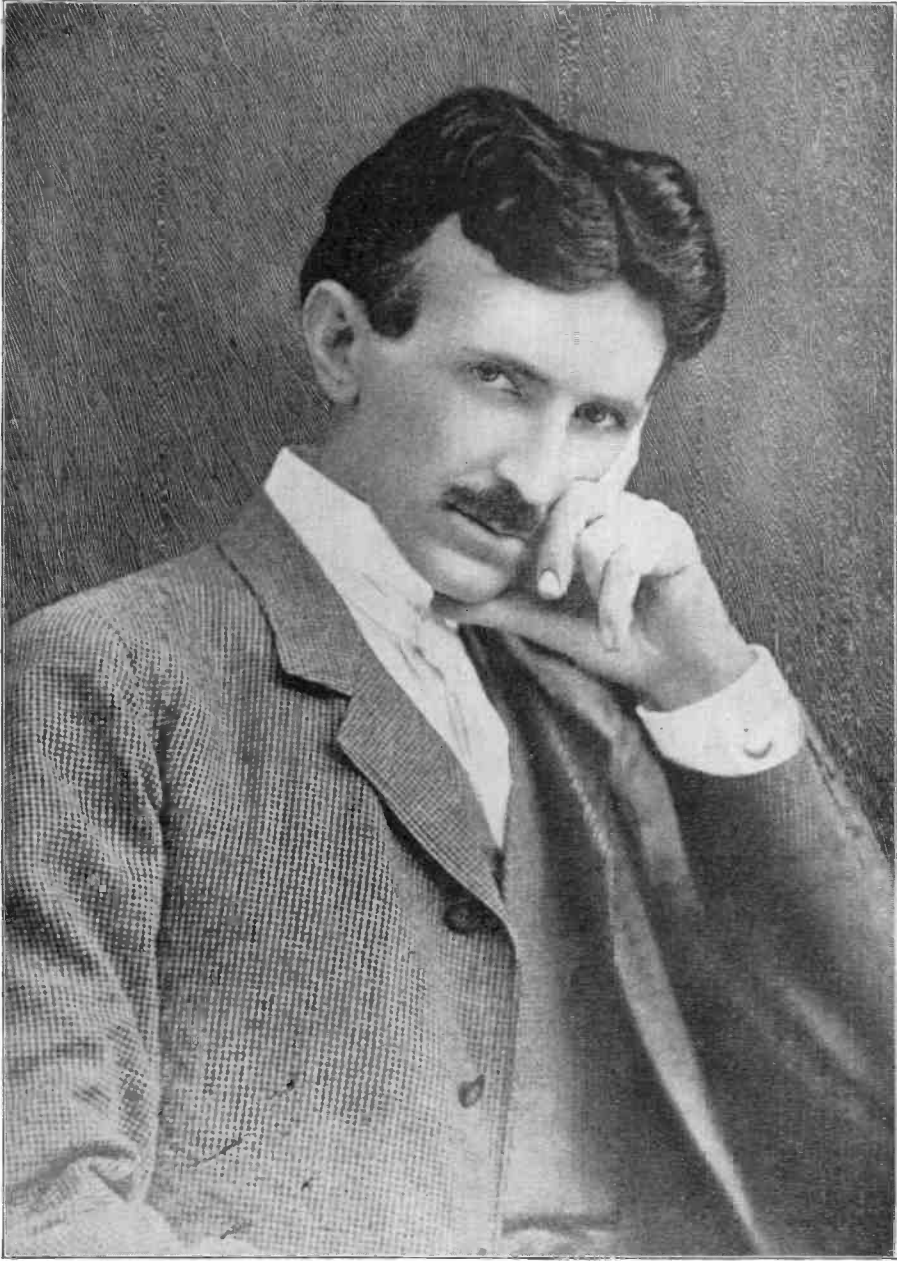

NIKOLA TESLA

Popular Electricity

In Plain English

VOL. IV

JUNE 1911

No. 2

Tesla and His Wireless Age

By ARTHUR B. REEVE

"I have produced electrical oscillations which were of such intensity that when circulating through my arms and chest they have melted wires which have joined my hands, and still I have felt no inconvenience. *I have energized with such oscillations a loop of heavy copper wire so powerfully that masses of metal placed within the loop were heated to a high temperature and melted, often with the violence of an explosion. And yet into this space in which this terribly destructive turmoil was going on I have repeatedly thrust my head without feeling anything or experiencing injurious after effects."

The speaker was a tall, spare man with a clean-cut, thin, refined face and eyes of exceptional keenness. He was sitting at a broad flat-top desk in his office on the twentieth floor of the Metropolitan Tower, and his eyes wandered restlessly in just pride from a photograph of his old friend Lord Kelvin on one wall to a large photograph of electrical streamers rivaling the lightning on the other. The speaker was Nikola Tesla.

But before describing his wonderful theories and experiments in the wireless transmission of energy, let me say something of the man and his life. And first of all, it



TESLA'S "WORLD SYSTEM" PLANT AT WARDENCLIFFE, LONG ISLAND

must not be forgotten that today over four million horsepower of water falls are harnessed by Tesla's alternating current system. That is like saying that forty million men—untiring, working without pay, consuming no food, shelter or raiment—are constantly laboring to provide for our wants. In these days of conservation, it is interesting to note that this vast electrical energy derived from waterpower saves a hundred millions of tons of coal every year. Our trolley roads, our subways, many of our electrified railroads, the incandescent lamps in our homes and offices, all use a system of power transmission of this man's invention.

Nikola Tesla was born at Smiljan, Lika, in the border country of Austria-Hungary in 1857. He was the son of a Greek clergyman and orator and Georgia Mandic, herself somewhat of an inventor like her father before her. The young Tesla attended the schools of Lika and Croatia, and later the Polytechnic at Gratz as well as the University of Prague, in Bohemia. At Gratz he saw and operated a Gramme machine for the first time, and was so struck with the objections to the use of commutators and brushes that he made up his mind to remedy that defect in dynamo-electric machines.

Tesla began his practical career in Buda Pesth in 1881. His first electrical invention was a telephone repeater. Later he was engaged in various branches of engineering and manufacture in Paris, and in 1884 he came to the United States. Here he found employment for a while with the Edison Company in Orange, New Jersey. After the prescribed period of residence he became a naturalized American citizen.

After numerous scientific addresses and papers and inventions like the third brush regulation he entered business for himself, the Tesla Electrical Company of New York being formed in 1887. Already he had conceived his great idea of the rotating magnetic field, which makes possible the transmission of power by alternating current, a system extensively used over long distances. His work with dynamos, transformers, induction coils, oscillators, arc and incandescent lamps, involving alternating currents of high frequency and high potential, at once brought him great fame. In fact, the immense stimulus of Tesla's work to the study of alternating current motors would alone stamp him a leader in the field of elec-

tricity if he had contributed nothing else. It has sometimes been asserted that Professor Ferraris anticipated Tesla in the rotating magnetic field, but as a matter of fact Ferraris was purely theoretical, halting and impractical in his work. The mere fact that he published a paper describing his work subsequently to Tesla's discoveries must rank only as one of those curious and frequent scientific coincidences. Ferraris himself stated some years ago that Tesla could not possibly have known of his (Ferraris's) work. These notable patents were acquired by Westinghouse, and were the subject of much litigation before being finally upheld.

A mere list of Tesla's inventions and discoveries is formidable. In 1886 he was the inventor and discoverer of a system of arc lighting, and in 1888 came the Tesla motor and system of alternating current power transmission, popularly known as the two phase and three phase multiphase, or polyphase systems. A system of electrical conversion and distribution by oscillatory discharges came in 1889, and a year later studies in the generation of high frequency currents and their effects. The transmission of energy through a single wire without return was announced in 1891, while from that year until 1893 he was engaged in investigation of high frequency effects and phenomena.

In 1893 he announced a system of wireless transmission of intelligence, and in 1894 and 1895 his work was on mechanical oscillators and generators of electrical oscillations. During the years 1896 to 1898 he was interested in research in radiation and the discovery of material streams and emanations. Finally in 1897 he first announced his "high potential magnifying transmitter" which, as he claims, makes possible a system of economical transmission of power without wires. From that date down to the present he has been constantly at work on this idea. No other human being knows anything like as much about this fascinating subject as Tesla.

Among his other inventions should be mentioned what he calls the art of telautomatics (1898-'99), a system for controlling the entire operation of, say, a boat by wireless impulses at a distance, even out of the range of vision. In 1899 and 1900 he was engaged in experiments in burning atmospheric nitrogen and the production of other

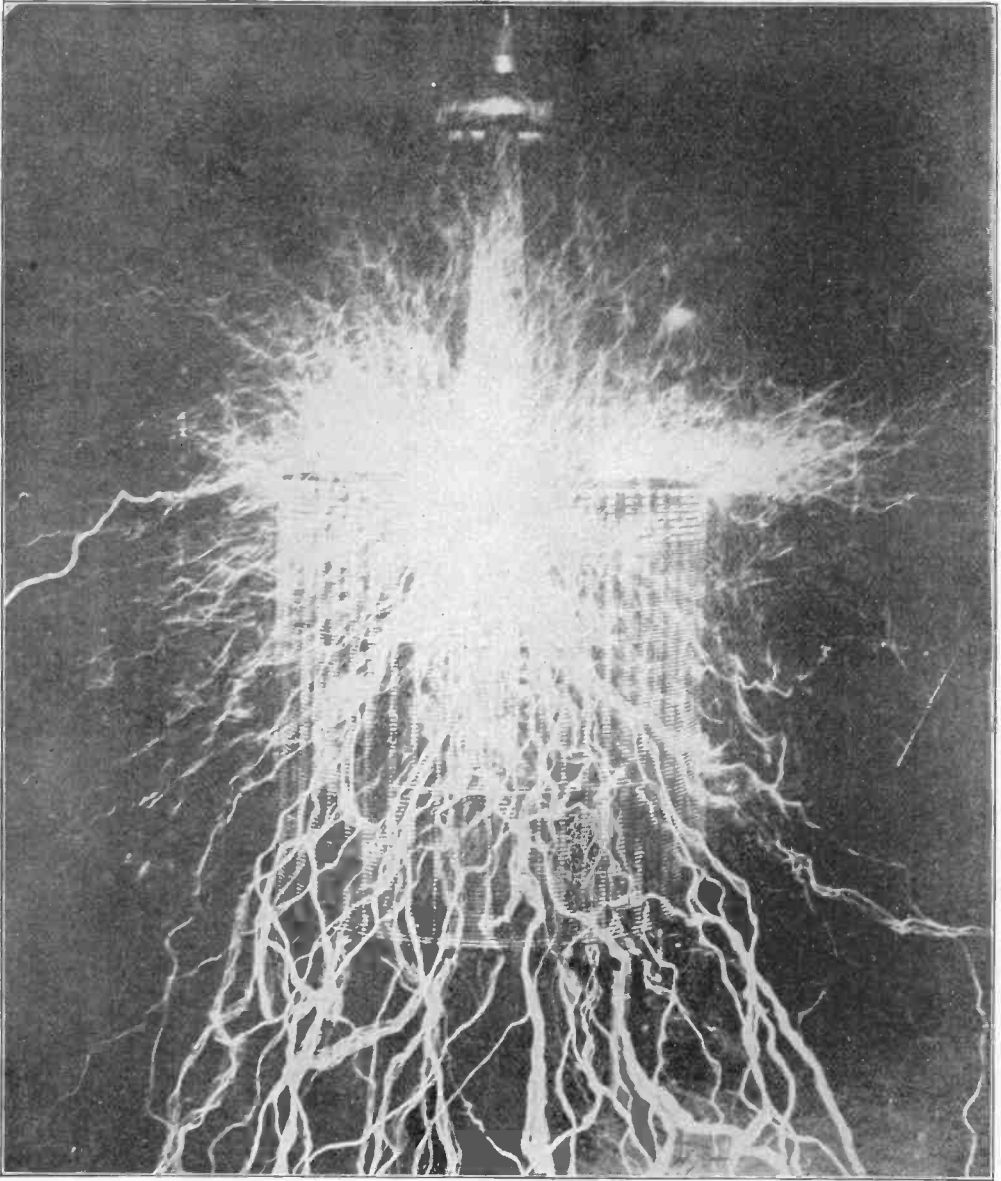

ONE OF TESLA'S "MAGNIFYING TRANSMITTERS" STRONGLY EXCITED

electrical effects of transcending intensity, while during the next two years he was working on methods and apparatus for magnifying feeble effects. From 1902 to 1903 he studied the problem and art of individualization, and since then his work has been in world telegraphy and telephony and in the designing and building of a large power plant for the transmission of power without wires, which I shall describe presently.

But as most people associate Tesla with high frequency, high potential electrical currents, rather than with such things as his electrolytic meter, his dynamo commutators and brushes without sparks, and the thousand and one other notable contributions he has made, I cannot leave the subject without another word. Prior to Tesla's inventions only direct current was used. Now we use alternating current. As one of the

justices who decided a case in his favor some years ago well put it:

"It remained to the genius of Tesla to capture the unruly, unrestrained and hitherto opposing elements in the field of nature and art and to harness them to draw the machines of man. It was he who first showed how to transform the toy of Arago into an engine of power. The Arago rotation taught the schoolboy fifty years ago how to make a plaything, and that plaything embodied the principle which Tesla discovered—that a rotating field could be used to rotate an armature. He first conceived the idea that the very impediments of reversal indirection, the contradiction of alternation, might be transformed into power, producing rotations, a whirling field of force. What others looked upon as invincible barriers, impassable currents, and contradictory forces he seized and, by harmonizing their directions, utilized in practical motors in distant cities the power of Niagara."

And now for Tesla's scheme of wireless transmission of energy. A few years ago it may be remembered he stood in the theater of the Royal Institution with oscillatory currents of unheard of voltage playing about his unharmed head. This taste for the sensational has always been one of Tesla's commanding characteristics. He prides himself on it. Others may criticise Tesla for this love of the sensational, but he himself will sit for hours talking about some of his seemingly impossible exploits, while the mention of one of the inventions which, as he says, "the world calls practical," will fail to elicit from him so much as a wink of an eyelash. As he himself told me, it is doubtful if anyone ever performed so many really dramatic, hair-raising experiments as he. He is as proud of them as a boy. The zest with which he tells of how, after showing Sarah Bernhardt his most dare-devil exploits, she hurried away almost in a state of nervous collapse, is equalled only by the off-hand manner in which he mentions currents of 80,000,000 vibrations a second, and his descriptions of sparks and flames in his laboratory experiments which rival, if not equal, the lightning itself. I recall that, in referring to one of his experiments, somewhat like that in the opening paragraph of this article, he anticipated my inquiry by saying: "I don't do that any more; it is too dangerous."

But though there may be much of the pure love for the dramatic in Tesla's announcements, there is really more of what may be called truly scientific imagination. Such experiments with all their elaborate stage setting Tesla believes to be of far greater practical importance than even those of his inventions "which the world calls practical." For, as he tersely put it: "The economic transmission of power without wires is of all-surpassing importance to man."

It all began, as he will tell you, in his observations—"revelations" he calls them—during a great thunderstorm on July 3, 1899. Out of it came his "high potential magnifying transmitter," and such patents along this line of wireless transmission as Nos. 645,576 and 649,621, for transmission of electrical energy in any quantity to any distance with transmitting and receiving apparatus movable, as in ships and balloons.

"We are on a conducting body insulated in space, of definite and unchangeable dimensions and properties," he says. "It will never be possible to transmit electrical energy economically through the body and its environment except by essentially the same means and methods which I have discovered, and the system is so perfect now that it admits of but little improvement."

"Under certain conditions," says Tesla, "the atmosphere which is normally a high insulator assumes conducting properties and so becomes capable of conveying any amount of electrical energy. I would undertake to transmit through my body with such currents the energy of all the dynamos at Niagara."

To carry out his ideas he has devised a plant of which he says: "A popular error which I have often opportunity to correct is the belief that the energy of such a plant would dissipate itself in all directions. This is not so. Electricity is displaced by the transmitter in all directions equally through the earth and air, but energy is expended only at the place where it is collected and used to perform some work. A plant of 10,000 horsepower might be running full blast at Niagara, and one flying machine of 50 horsepower might be in another place. Only 50 horsepower would be furnished by the plant.

"Although the electrical oscillations would manifest themselves all over the

earth at the surface as well as high in the air, virtually no power would be consumed. My experiments have shown that the entire electrical movement which keeps the whole globe a-tremble can be maintained with but a few horsepower. Apart from the transmitting and receiving apparatus the only loss incurred is the energy radiated in the form of Hertzian or electro-magnetic waves which can be reduced to an entirely insignificant quantity."

Finally, as to the now famous Tesla Tower. This is a huge mushroom shaped tower at Wardencllyffe, Long Island, New York, a place some 60 or so miles out from the city along Long Island Sound. This tower is 185 feet high from the ground to the top of the cupola. The smallest dimension across the base of uprights is 97 feet. The height to the ledge of the cupola is 153 feet, while the cupola itself is 65 feet in diameter. The tower has eight sides, with a staircase and lift for reaching the cupola platform. It is from this cupola that wireless vibrations are to be shot out in any desired voltage to given points scattered over a very wide radius. Not only so, but Tesla dreams of making it a receiving station to which can be transmitted a ceaseless day and night service of millions upon millions of volts from such power plants as those of Niagara. Thence such a force could be transmitted to run the street cars, the elevateds, the subways, the factories, the electric lights, the railroads, the automobiles, the ferries, the trucks, the heaters in the cellars and the clocks in the parlors of the great city of New York.

Tesla's dream also includes the erection of towers similar to this at Wardencllyffe at convenient places, everywhere, for the purpose of distributing wireless energy for all these purposes over their respective areas. Some towers would be supplied with power from such sources as Niagara Falls or Victoria Falls. Or plants will be erected alongside or between the main uprights, each distributing a huge horsepower under a tension of millions of volts. Mr. Tesla declares he can handle the most amazing voltage from such towers with absolute safety, and his dream is of an America dotted over with these towers, each supplying all the energy for, say, an area of 30 miles about and spaced from each other 60

miles in such a manner that practically every inch of ground is covered by his new wireless service.

Not only wireless power service but wireless telegraph and telephone service will be furnished by this network of towers, covering the entire earth and making it possible for a man in New York to talk directly with his friend in London. Tesla dreams of the day when a man may dictate his orders in San Francisco and they may be set up and printed directly in New York, of a day when not merely photographs will be transmitted by wireless, but when one can actually see over the wireless the friend to whom he is talking in some distant part of the earth, watch his facial movements, "see" him as plainly as if he were in the room. In fact the possibilities of the wireless age of the future as Tesla conceives it are boundless.

That is why he is more interested in schemes that are called "visionary" than in those of his inventions which "the world calls practical."

As he himself has put it in a recent statement: "A systematic research carried on for a number of years with the object of perfecting a method of transmission of electrical energy through the natural medium has led me to recognize three important necessities: First, to develop a transmitter of great power; second, to perfect means for individualizing and isolating the energy transmitted; and third, to ascertain the laws of propagation of currents through the earth and atmosphere."

All these things he now believes can be done. He believes that he has discovered a means of pouring electrical energy into the air, as it were, without loss except at the point where a properly tuned instrument will be able to draw it out, at the point where it is needed.

"When the great truth accidentally revealed and experimentally confirmed is fully recognized," he says in speaking of the inventions with which he believes he will make the wireless age a fact, "it will be seen that this planet, with all its appalling immensity, is to electric currents virtually no more than a small metal ball, and that by virtue of this fact many possibilities, each baffling imagination and of incalculable consequence, are rendered absolutely sure of accomplishment."

Copper Wire From Ore to Pole

Next to silver, copper is the best conductor of electricity known. Moreover the supply is adequate to the demand, although somewhat complex processes are required to recover it from its natural state and put it into the form of a conductor for electric current.

Ninety-five per cent of the copper of this country is mined in the Lake Superior, Rocky Mountain and Sierra Nevada regions. The lake region is one of the most interesting localities, mineralogically speaking, in the world. The copper bearing rocks are very distinctly stratified beds of trap, sandstone and conglomerates which rise at an angle of about 45 degrees from the horizontal sandstone which forms the basin of Lake Superior. One peninsula extending out into the lake has developed copper in profitable amounts, which is present here for the most part in the metallic state, almost chemically pure.

The amount of copper in these ores averages only about three per cent, the balance being rock which is so intimately mixed

with the metal that both must be taken out together. On account of this large amount of worthless matter, the ores are first subjected to a mechanical process whereby the metal is concentrated into a small bulk and the rock rejected. "Lake" copper is so pure that it is merely put through the final melting without the refining usually necessary.

The deposits in the Rocky Mountains and the Sierra Nevadas comprise a territory nearly one-half the area of the United States, and in geological formations and nature of mineralization show all the phases from the original unaltered sulphide deposits to the most highly altered oxides and carbonates. In this district we find the mystery-shrouded names of Butte, Bisbee, Leadville, Clifton, Globe and Black Range, names which have spelled fortune or despair, rejoicing or suffering, to the thousands of prospectors who have discovered and re-discovered their wonderful richness.

On account of the extremely low percentage of copper in most of its ores, the

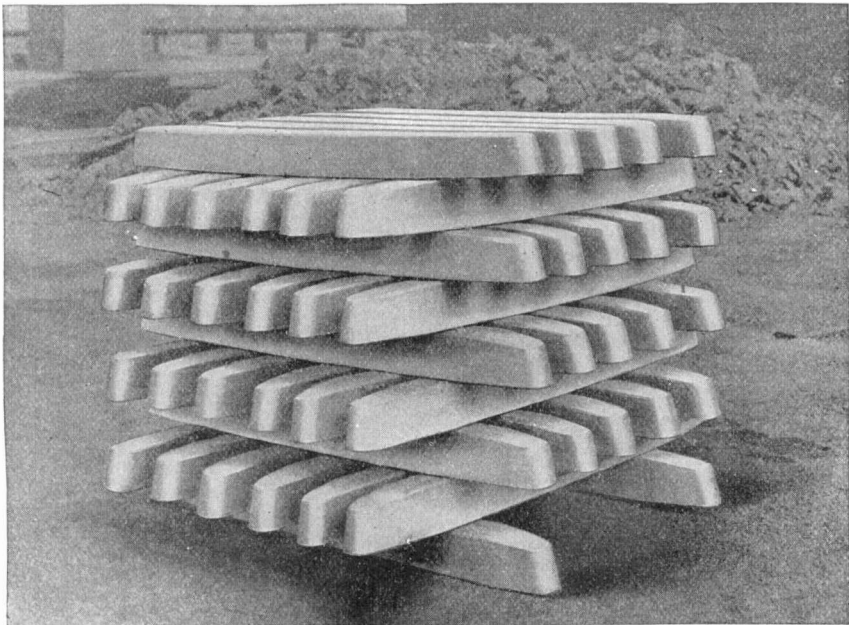

BILLETS OF COPPER READY FOR THE WIRE MILL

usual method of procedure, as we have seen is to first obtain this metallic portion in as small a bulk as possible. This is a mechanical process and results in concentrating the heavy minerals, and washing away, or otherwise separating the worthless rocky portion or "gangue," as it is called. The "concentrates" resulting from this process are afterward treated to obtain the copper in the same manner as an ore.

A "sulphide ore," that is, an ore in which copper appears in chemical combination with sulphur, is in some cases first "roasted" or heated so that the sulphur is burned off, leaving the copper and iron, which is almost always present, in an oxidized or burned form. This is then smelted with coke. In another process, however, the raw sulphide ore is thrown into a blast furnace and is made to smelt itself. This is one of the very simple discoveries that have meant so much to the copper industry.

Formerly a copper mine had a dozen or more great smouldering heaps piled up in its yard, breathing out clouds of stifling sulphur. Nothing would grow for miles around, the men themselves had a white, bleached-out appearance, and besides, thousands upon thousands of dollars worth of precious fuel was being wasted. This has all been changed, the "raw" unroasted ore is now thrown into the furnaces, the sulphur itself burned and made to smelt the mass, producing, on account of its chemical nature, a highly impure, yet very valuable, compound with iron and sulphur, called "matte." This "matte," which consists of about half copper, is poured while yet molten from the furnace into a "converter," a large vessel shaped like a barrel laid on its side, and the iron and sulphur are burned out by blowing air through the mass.

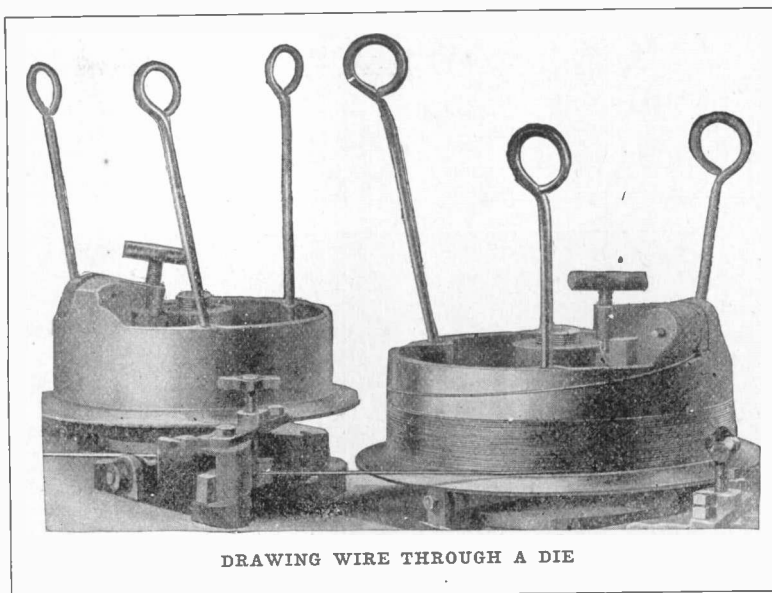

DRAWING WIRE THROUGH A DIE

Here again the despised and hated element, sulphur, by burning and generating heat, has made possible one of the most labor and time-saving processes known to the metallurgy of copper. The result of this operation is "blister" copper, so called on account of the blistered appearance of the surface caused by the quantities of gases absorbed by the metal.

If copper ore occurs in an oxidized or carbonate form, or roasted ore is used, a blast furnace is also utilized for the reduction. Oxidized or sulphide ores are also often mixed, and the matte is "blown" and blister copper produced as before.

This blister copper contains about 99 per cent of copper, but is much too impure for commercial use. The refining now depends upon whether the copper has a sufficient amount of the precious metals to pay for utilizing the electrolytic process. If so, the blister copper is cast into plates of a suitable size and shape, and the copper is dissolved and deposited almost chemically pure on other plates by means of an electric current passing through an acid solution of copper sulphate. The impurities and other metals do not deposit with the copper, but are dropped as a residue or "slime" on the bottom of the tank, to be recovered and refined later.

The blister copper, or "electrolytic" copper, as the case may be, is then charged into

a refining furnace and melted by means of a very pure fuel, so that the metal may not occlude any deleterious gases. A charge of twelve to twenty tons of pig copper is put in the furnace—a simple bowl-shaped hearth, covered and provided with doors for

be removed to prevent the extreme brittleness and lack of conductivity of an over-oxidized metal. This is done by "poling" the bath. A stick of green hardwood as large as possible is introduced into the bath. The stick burns and the metal is violently



WHERE COILS OF INSULATED WIRE ARE WRAPPED FOR SHIPMENT

skimming and stirring—and the metal is melted as quickly as possible. The process is now one which depends greatly upon the skill of the refiner.

After the metal is melted, and the last traces of sulphur have been removed by combination with the oxygen from the flame, the process known as "rabbling" or "flapping" is begun. This is a violent agitation of the metal by means of small rabbles or pokers through one of the side doors. This motion so far has not been duplicated mechanically, and it means a tedious and slow operation of about two hours' duration. During the flapping, samples are frequently taken in a hemispherical mold about an inch in diameter. When the "set" or appearance of the solidified metal in this mold indicates that sufficient work has been done upon it, the surplus oxygen must

be removed by the gases given off. The surface of the bath is covered with charcoal to prevent further oxidation, and samples are very frequently taken. This is continued an hour, more or less, according to the size of the bath and the amount of oxidation, until the test piece shows "tough pitch" or the removal of the excess of oxygen, and that the metal is in its toughest condition.

This "tough pitch" condition is absolutely essential for the requirements of rolling and wire drawing, as copper in this state possesses at the same time the highest degree of conductivity and an extremely tough and ductile nature. The metal is now poured into ingot molds or wire bars, in which condition it comes to the wire making works for conversion into all manner of sizes and shapes for electrical conductors.

The drawing process consists, briefly, in reducing the diameter of the wire by pulling it through tapering holes in iron or steel plates, thus reducing its diameter and increasing its length with each draft until the wire has undergone a sufficient number of drafts and consequent reductions to bring it to the proper diameter.

When the finer sizes of wire are to be produced, the total reduction cannot be made in one series of drafts, as there is a limit to the size of a hot-rolled rod, and the wire therefore must be treated at intervals to relieve the internal strains produced by the cold working. This treatment, called annealing, consists in heating the metal uniformly to a sufficiently high temperature to remove the internal molecular strains and to make the metal once more soft and ductile.

A scale forms on the wire as a result of the annealing. This is again removed in an acid bath, and the wire lined and baked and sent to the drawing frames. This may be repeated many times before the necessary amount of reduction has been attained.

Copper is generally handled somewhat differently in the annealing process, as pre-

is at a high temperature, from coming in contact with the air. By this means it is possible to obtain an annealed wire as bright as when it comes from the drawing frames. So the process goes, drawing as far as feasible, annealing and drawing again until the finest size of magnet wire are finally produced, by drawing through holes skillfully drilled in diamonds.

As the physical condition of the wire depends largely upon the number and amount of the drafts, the proper regulation of these to produce the best results, especially in the case of hard drawn copper, requires much study and long experience. Many drafts, each giving only a slight reduction, produce an entirely different effect from few drafts, even though the ultimate reduction in area be the same. Drawing the same size of wire on blocks of different diameters will vary the physical characteristics. Various methods of annealing will produce various results, and so on. There is a multitude of details, each of which has its own effect.

Cold drawing or cold rolling a rod or annealed wire invariably increases its hardness, stiffness, elasticity and tensile strength and at the same time decreases its elonga-

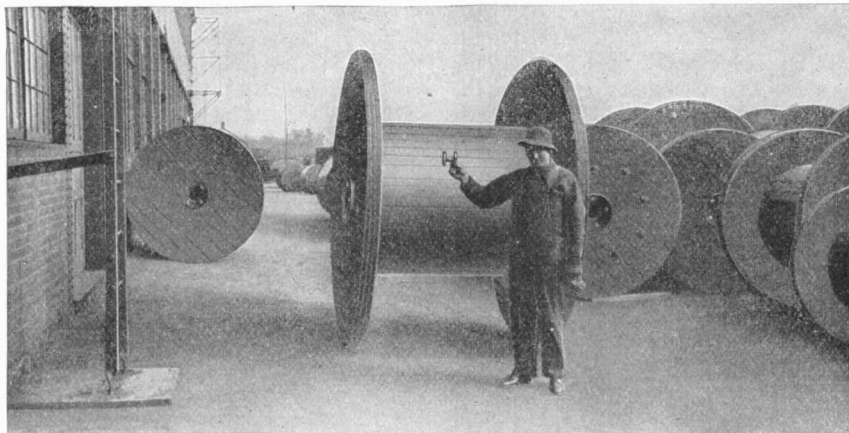

WIRE AND CABLE REELS—THE TINY REEL IS FOR MAGNET WIRE

cautions are taken to prevent the formation of scale. Especially is this true in the case of fine magnet wires, for instance, where oxidation would seriously affect the properties of the wire. This is done by "bright annealing," which is accomplished in various ways by preventing the metal, while it

tion, ductility and electrical conductivity. The amount of these changes, however, is not directly proportional to the per cent of reduction in sectional area or to the amount of work expended on the metal. Statements have been made to the contrary, but many experiments and careful observations



STRINGING WIRE FROM A SPECIALLY CONSTRUCTED BLADE

have established beyond a doubt the accuracy of the foregoing. The actual changes in the physical properties of a wire by cold working are affected by many factors, as already stated, and the final effect is difficult to forecast; hence long experience with these problems is exceedingly valuable both to the maker and to the user of wire.

The tensile strength and elongation of wire vary considerably with its size. Annealed or soft copper wire varies in tensile strength from 30,000 pounds per square inch in the coarser sizes to 42,000 pounds in the

fine sizes. Hard drawn copper varies in tensile strength from 45,000 to 68,000 pounds per square inch according to size.

Copper conductors are often tinned and telegraph wire is usually galvanized. The methods of supplying these coatings, while simple to describe, are nevertheless in actual performance complex, requiring careful supervision and expert workmanship.

The principle of the process is to pass a wire first through a tank of acid whose function is to clean the wire; next through a water tank where the acid is washed off;

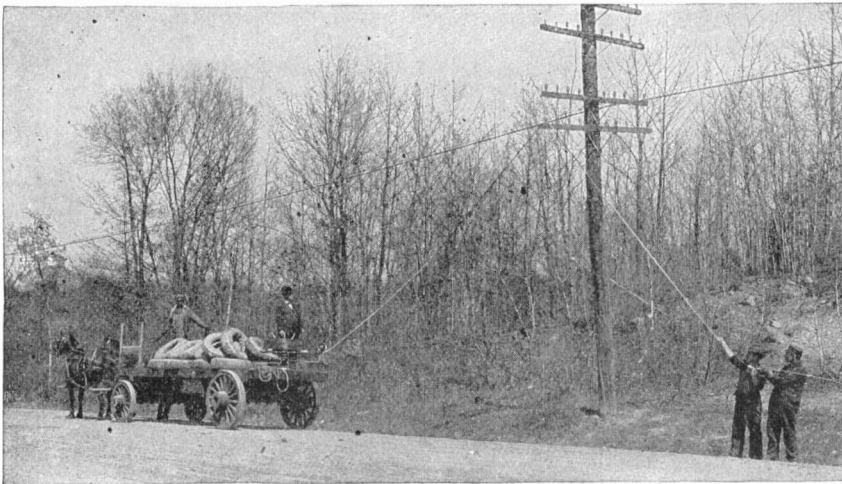

ON THE CROSS ARM AT LAST

next through a flux, and then into the molten tin or zinc. It is not hard to get the tin or zinc to adhere over almost all of the surface, but the absolute perfection demanded by the trade requires that every portion of the wire must be covered with a uniform thickness of metal which must be bright and which will not peel or crack.

Many can no doubt remember the time when neither the manufacturer nor the purchaser gave any particular attention as to how goods were packed or shipped so long as they arrived at their destination in comparatively good condition. But these conditions have changed steadily within the last few years, and today practically all complete and up-to-date specifications make special mention of the method of packing and shipping.

It is necessary that wire be properly coiled to prevent snarling and other difficulties. Coils are now formed to standard dimensions, evenly wound and securely bound with strong and durable material, both ends of the coil being accessible for test purposes and only one length in a coil, unless otherwise specified. These coils are protected by paper or burlap, or both if conditions require it. The covering materials are selected for the purpose, cut to proper dimensions so as to protect the wire in the most complete way, without giving a surplus amount of material which would increase the tare weight. All wires are inspected when being wound into coils and also at the time of papering or burlapping. Each individual coil is papered or burlapped by hand, which gives a good opportunity to detect any visible mechanical defects. All coils are accurately measured or weighed before shipment and properly tagged with strong, durable tags on which are given full details. The size of the coil is arranged so as to be most convenient for handling, packing or shipping according to the kind and size of wire in the coil.

When wire is purchased for the purpose of stringing on poles, the general impression is that it is easier to handle if placed on

reels than in coils; but if this question were given a little thought, it is believed that persons having such an idea would be convinced otherwise. They should take into consideration the transportation of wire in coils as against wire on reels, the increased amount of coiled wire that can be stored in a given space as compared with the same amount placed on reels; the increased cost of freight, due to weight of reels, the necessity of keeping reels in good condition after being emptied, the amount of handling incurred because of empty reels, return transportation charges and the necessary clerical work and supervision required. With coils, all labor and responsibility cease after the wire is strung. It is not recommended, however, to coil solid wire that is larger than 1-0 B. & S. gauge, except in special cases.

A suitably constructed blade, as shown in one of the illustrations, will fit any standard coil. With the lead arm and swivel sheave, it makes the uncoiling of the wire during process of stringing on poles or other places a very economical and easy process, and avoids the possibility of snarls, provided the coil is properly placed upon the blade. With this lead arm and sheave, the wire may be drawn over a cross-arm on a pole, when the coil is almost directly under the cross-arm, if lack of space requires this to be done. This system of handling wire also reduces the amount of apparatus that would be required for operating reels, such as bars, jacks and so on. Blades of similar construction can be placed on any ordinary wagon, and, with the exception of lifting coils of the largest sizes of wire, one man, usually the teamster, can operate the uncoiling of the wire. After finishing the day's work of stringing wire by the coil method, there are no empty reels to be collected, cared for and returned to the manufacturer, and no credit to be looked out for.

[The illustrations and data presented in this article were obtained through the courtesy of the American Steel and Wire Company.—Editorial Note.]



Five Epoch-Making Electrical Inventions

By ELMER E. BURNS

III. THE TELEPHONE

A very pretty romance is connected with the beginning of the telephone. Mabel Hubbard, a child of four, lost her sense of hearing during a severe attack of scarlet fever. Her parents were advised by teachers of the deaf to give up all hope of teaching her to understand ordinary speech. They were told that, her sense of hearing gone, she would lose the power of speech which she had acquired. So far was this from proving true that the girl was taught in the same way as her sister, who could hear, and given a liberal education which included a year in Germany, for she had learned to understand German as well as English by watching the movements of the mouth. A young Scotchman, Graham Bell, as he was then called, became his father's assistant in University College in London, afterward moved to America to become a teacher in the Horace Mann School in Boston. While there he met Miss Hubbard and a few years later the talented young lady became Mrs. Bell.

It was Graham Bell who conceived and carried into execution the idea of an electric speaking telephone and it was the Honorable Gardiner Green Hubbard, father of Mabel Hubbard, who made the telephone financially possible. At one time during Bell's experiments when he had given up the greater part of his professional work that he might have time for his work on the telephone and in consequence was suffering for lack of money, he endured the suffering rather than let Mr. Hubbard know of his condition. He afterward wrote: "On account of the peculiar relations then beginning to arise between myself and Mr. Hubbard, I was unwilling that he should know of the condition in which I was placed. These relations will be understood when I say that Miss Hubbard is now my wife." Mr. Hubbard had agreed to pay the expense of the experiments but it was not understood that he should pay for Bell's support.

To understand the process by which the telephone was worked out we must bear in mind that Bell was engaged in two distinct

lines of work. One was a multiple telegraph, a telegraph which he thought would make possible the sending of a number of messages over one wire at the same time. A number of metal reeds like tuning forks of different pitch were arranged so that each reed when set in vibration would rapidly make and break an electric circuit. The depression of a key would send the interrupted current from any one of these reeds through the line wire. At the other end of the line a similar set of reeds was arranged so that each reed formed the armature of an electro-magnet. All of these electro-magnets were on the same circuit. When the current from one of the reeds in the first set was sent through the line wire, the reed of the same pitch at the other end would respond. The shorter or longer duration of the sound would indicate the dots and dashes of the Morse alphabet. The current from any number of reeds of the first set could be sent through the line wire and the reeds of the second set corresponding in pitch would respond. Bell said "The idea of increasing the carrying power of a telegraph wire in this way took complete possession of my mind and it was this practical end that I had in view when I commenced my researches in electric telephony."

Bell had in mind the thought of transmitting the sound of the voice electrically in this way as well as the sending a number of telegraphic messages. He had noticed that if one sings a loud clear tone into an open piano certain wires are set vibrating and these wires together give out very nearly the same sound as that which is sung. A number of tuning forks or steel reeds of different pitch will act in the same way. A sort of harp formed of steel reeds of different pitch was to form the transmitter and a similar arrangement of reeds operated by electro-magnets formed the receiver.

The second line of work leading up to the telephone was what Bell called "visible speech." This was a device by which he

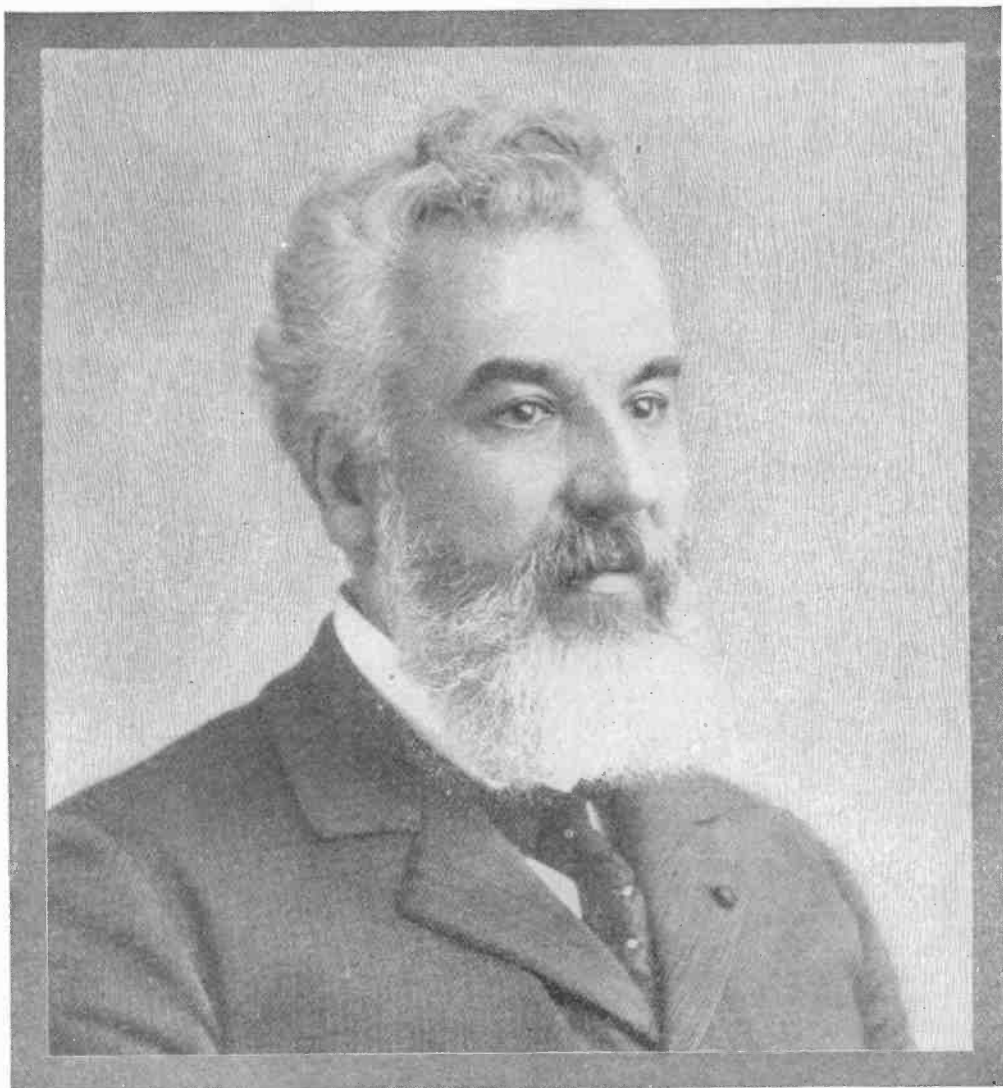

ALEXANDER GRAHAM BELL

intended that the deaf should be enabled to see the effects of the different sounds of the voice and so be enabled better to understand and use ordinary speech. He first used a phonautograph, an instrument very much like the modern phonograph except that the needle point instead of making impressions in a wax cylinder traced a wavy line on smoked glass. He wondered if a phonautograph modeled after the human ear would not produce better results. A friend who was a physician suggested to him that he use a real ear and aided him by preparing a human ear in such a way

that as the ear drum vibrated it moved a short stylus of hay over a smoked glass making tracings similar to those of the phonautograph. Thus Bell was able to demonstrate the actual effect of the different sounds of the voice upon the drum of the human ear. In this experiment two of the bones of the middle ear were left adhering to the ear drum as they are in the living ear. Bell was struck by the exceeding lightness of the ear drum compared with the weight of the bones which it moved. It seemed to him that, if a membrane as thin as tissue paper could carry these bones as it

vibrated, a heavier membrane might vibrate a piece of iron in front of an electro-magnet and the membrane and iron replace the complicated system of steel reeds in his multiple telegraph. This membrane would respond to sound of any pitch and the piece of iron vibrating in front of an electro-magnet would vary the strength of the electric current flowing through the magnet coils and so send electric impulses, corresponding in pitch to the sound, over the line wire. This undulating electric current, he thought would vibrate a similar piece of iron and stretched membrane at the other end of the line by means of an electro-magnet and so reproduce the sound. It was this idea carried into execution which resulted in the telephone.

The first public exhibition of the telephone was at the Centennial Exposition in Philadelphia in 1876. In the transmitter and receiver there used, the diaphragm was a membrane of gold beater's skin tightly stretched and the soft iron armature of an electro-magnet cemented to the membrane. Not long after this Bell found that a disk of soft iron served the purpose better than the membrane.

On June 2, 1875, Bell wrote to Mr. Hubbard: "I have accidentally made a discovery of the very greatest importance in regard to the transmitting instruments. I have succeeded today in transmitting signals without any battery whatever!" He had accidentally vibrated a metallic reed near an electro-magnet in his multiple telegraph while the circuit was closed without batteries and was surprised to hear a sound of the same pitch and quality given out by the corresponding reed at the other end of the line. This was the beginning of the hand telephone, an experimental equipment consisting of two receivers connected by two wires with which conversations can be transmitted short distances without batteries. Incidentally it illustrates the fact that the telephone can be operated with a very feeble current compared with that required for the telegraph.

Bell's patent dated March 7, 1876, was not for a telephone but for "certain new and useful improvements in telegraphy." One of these "improvements" was "the method of and apparatus for transmitting vocal and other sounds telegraphically."

Mr. Elisha Gray of Chicago is an example of a man missing fortune and fame by a hair's breadth. Gray was electrician for the Western Electric Manufacturing Company, and like Bell was working on a harmonic multiple telegraph and also on a telephone. He was advised by General Stager, general superintendent of the Western Union Telegraph Company to give up his experiments on the telephone, because it could never be anything more than a toy, and to continue his work on the harmonic telegraph. As a result of this advice, Gray delayed his work on the telephone. But for the delay he might have had the honor and the millions. As it was, Gray filed a caveat on the day that Bell filed an application for a patent and later in the day so that the courts held that Bell's application was not subject to Gray's caveat.

Gray had all the elements of the telephone. In his transmitter he employed a variable resistance and Bell made use of magnetic induction but there was a variable resistance in Bell's patent specifications and there was an electro-magnet in Gray's receiver.

One thing more was needed to prepare the telephone for commercial success. The transmitter invented by Bell was not suited to long distance work. A transmitter that would send more powerful impulses along the line wire was a necessity from a practical point of view. It was known for a number of years before the granting of Bell's patent that an increase of pressure at an electrical contact diminishes the resistance but this principle was not applied in the telephone until 1877 when Edison's carbon transmitter appeared. The Hughes microphone appeared about the same time.

The microphone is a device for hearing small sounds. So sensitive is the Hughes microphone that a fly walking along the base of the instrument causes a sound in the receiver. Though it was not patented, all successful transmitters now in use are based on the principles of this invention. The current flows through a loose carbon contact. If the carbon is made to vibrate thus varying the pressure, the resistance varies, therefore the strength of the current varies and the varying current causes vibration of the disk in the receiver. The Hughes microphone made clear the importance of a loose carbon contact also that

the change of resistance takes place at the contact and not within the carbon. The carbon dust transmitter used for long distance work as a modification of the Hughes microphone in which there are many particles of carbon and therefore many points of contact.

Even the microphone would have little effect over a long line because of the great resistance of the line wire. But if the microphone of the transmitter is made part of the circuit of the primary of an induction coil, alternating currents will be induced in the secondary and these high potential alternating currents flowing over the line wire reproduce the sound with high efficiency in the receiver. The Hunnings transmitter, patented in England in 1878 and in the United States in 1881, was the first of the granular type. Its construction was extremely simple. It consisted of two diaphragms of platinum foil separated by a space of about a tenth of an inch. This space was partly filled with granules of hard carbon.

At this point in its development the telephone was full grown. It was no longer a toy but a practical working instrument for the electrical transmission of speech to any desired distance.

In its early history the telephone inspired little confidence in the business world. The patent which ten years after it was issued could not have been purchased for \$25,000,000 was at first considered worthless. A good illustration is the case of Thomas A. Watson, a workman in the shop at 109 Court Street, Boston, where the instruments for the first commercial Bell telephones were made. Bell on account of his financial straits proposed to pay Mr. Watson for his labor in shares in the Bell Telephone Company. Watson very reluctantly accepted the offer. Later these shares made Mr. Watson a millionaire. The fundamental patent expired in 1893 and there is now no patent in existence that gives any company a monopoly of the telephone business.

"Day Letters" Succeed Night Letters

The Western Union Telegraph Company has inaugurated a new form of telegraph service called the "day letter." The day letter is designed as the day companion to the

night letter, which has become familiar to wire users.

The rate charged for a day letter of 50 words or less is one and one-half times the night letter rate, and for each additional ten words or less, one-fifth the initial charge. For example—the Chicago-New York night letter rate is 50 cents; the day letter rate is one and one-half times that, or 75 cents; with 15 cents for each additional ten words. The New York-San Francisco night letter rate is \$1.00; the day letter rate \$1.50, with 30 cent. for each additional ten words.

Fire Damp Detector

At last it seems that the old-time foe of the miner, the so-called "fire damp" (composed chiefly of methane, light carburetted hydrogen), is to lose much of its danger, as an electrical cut-out has been invented by two engineers at Newcastle-on-Tyne which will automatically shut the current off the electric motors used in mines when fire-damp is present, and which will also give a warning signal that explosive gas is present.

The principle of the new safety device is quite ingenious. The detector part embodies a pair of long strips with their free ends a little apart, each made of two dissimilar metals such as brass and iron. When a current is passed through such compound strips, they will bend, due to the heat, but ordinarily both will bend alike and still keep their tips from touching. One of these strips, however, is connected with a coil of copper, while the other is connected with a coil of platinum, which latter metal has the curious property of absorbing hydrogen when present near it and of getting hot in so doing. When it does this, the current no longer flows through the platinum coil as readily as before, its resistance being changed by the heat, hence the strip connected with it will not heat or bend as much as its mate and the two will touch each other. In doing so, they close a circuit which lights a red light, rings a bell, or operates a cut-out to disconnect any motors which may be exposed to the dangerous gas. This simple safety device is said to be so sensitive that it will operate with as little as 2 per cent. of fire-damp present, thus announcing the explosive gas long before this would be detected by the old methods.



The
Wireless Operator
 Reminisces.
 By
John Baskerville

Viewing the "Southern Cross"

Sometimes, indeed very often, the wireless operator aboard ship cheers passengers in distress, and jollies along the sad. The real operator cannot afford to be a grouch. Because he knows nothing of astronomy is no good reason why he cannot explain some of it to the inquisitive passengers.

The "Southern Cross" has a lot of them guessing. It is visible on southern waters, but Northerners don't know it when they see it (I mean for the first time) as they journey in the tropics. I knew the captain once to put up a bulletin saying for those who wished to see the "Southern Cross" to be on deck and look astern at 4 o'clock in the morning. Those appearing at 4 a. m. saw it, low in the horizon, but were surprised to see it rocking to and fro. They tiptoed back and roused the other "victims" and told them to hurry and see it before it set. As daylight came, a pair of black wires could be discerned leading off the lower afterdeck, and the "Southern Cross" was in tow, having a set of incandescent lamps fixed on a cross and rigged upright on a float. Soon the cross was pulled in, and torn up by the passengers for souvenirs. But all the time the victims of the joke were out looking for the real Cross, it shone serenely in the sky where God had put it.



Viewing the Southern Cross

The Captain Fails to "Get the Goods on Me"

Several years ago when wireless was extremely young, I was on one of the passenger ships of the Panama Railroad Steamship Company, running from New York to Colon. During the first trip with the wireless aboard everybody was very much interested in all that the wireless man did. The captain requested that I bring him a copy of all that transpired (no matter whose business it happened to be). I did all I could to accommodate him. One night when we were about 900 miles from New York I copied New Haven, Conn., station direct and learned that one of the New York-Portland boats had collided with a bunch of scows and sunk some of them around noon that day, in a fog. So I went up and remarked to the captain: "The — collided with a dozen scows at noon today off the coast of Massachusetts and sunk one of them. The — undamaged."



"What are you handing me?"

"What you handing me?" asked the captain, straightening up. I repeated my assertion. "Please put that down on a piece of paper," he said, "I want to get the goods on you." When he returned to New York, he wrote a letter to the captain of that steamer and asked him what he knew about the enclosed (my notes). The other captain replied, verifying me at every turn. He was very enthusiastic over the wireless per-

formance. So was my captain. So was I. After this incident he never asked for anything written to "get the goods on me," as he termed it. But he was in his element when he could come up and hear about other people's business.

We Create Excitement on Lake Michigan

A successful wireless operator must be ingenious. He should be an optimist. If he possesses wit, his path is easier than ever. I am going to tell you a few experiences showing the value of the above characteristics, though I do not possess them:

One time, not so very long ago, in company with another operator, I went aboard a small steam yacht which had just been equipped with wireless.

We were to follow the Chicago-Mackinac yacht races and report from time to time the leader and any details considered good for the newspapers, via wireless.

The sailing yachts made a good start, followed by our yacht, and were all making good headway when our ship's dynamo lost its magnetism, and refused to furnish the current necessary for working the wireless apparatus. We were in a bad fix. We could hear other ships and land stations, but we could not say a word. Our installing engineers were aboard and all hands joined in the effort to make the dynamo generate, but we couldn't make it deliver the juice. It was decided to return to Chicago and

have some experienced man to fix the machine. We still intended to follow the races, too, so wished we could save time by asking Chicago to have a man to meet us at the dock, but we had no power and couldn't ask anything just then.

Then it occurred to me that Edison had once used a steam whistle for telegraphing across a short space. I had done the stunt before, across the harbor at Colon, Panama. I determined to try this idea on the steamer Missouri, then rapidly approaching us. I hastened to the bridge and told the captain of the idea.

"Go to it!" he said. And I did. We surely created some excitement when I began to call "MN MN SG" with the whistle. The Missouri was very close then and I saw her operator who was on deck prick up his ears and listen. Then in shrill blasts, long ones for dashes and short ones for dots, I tooted the following message, as brief as I could:

"Ship's dynamo lost magnetism; tell Chgo hv man at dk 2 fx it."

The operator was "on" and disappeared into the wireless room, and an instant later my partner in our wireless room heard him say:

"OK DE. Got you fine. But you made some noise." Then we heard him tell the news to the Chicago station, and we heard Chicago promise to have a man at the landing.

Small craft of all kinds thought we were in distress when we made so much noise, and they made for us to assist if possible.

We accomplished our purpose as far as the electrician was concerned, as he was at the dock when we arrived, but he was unable to restore the magnetism to the ship's dynamo and though the steam yacht followed the yachts in hopes that we would be fixed soon, the trip had to be abandoned the next day on account of our inability to get in the news.



"Go to it," he said.

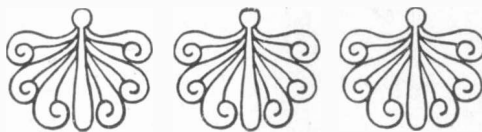

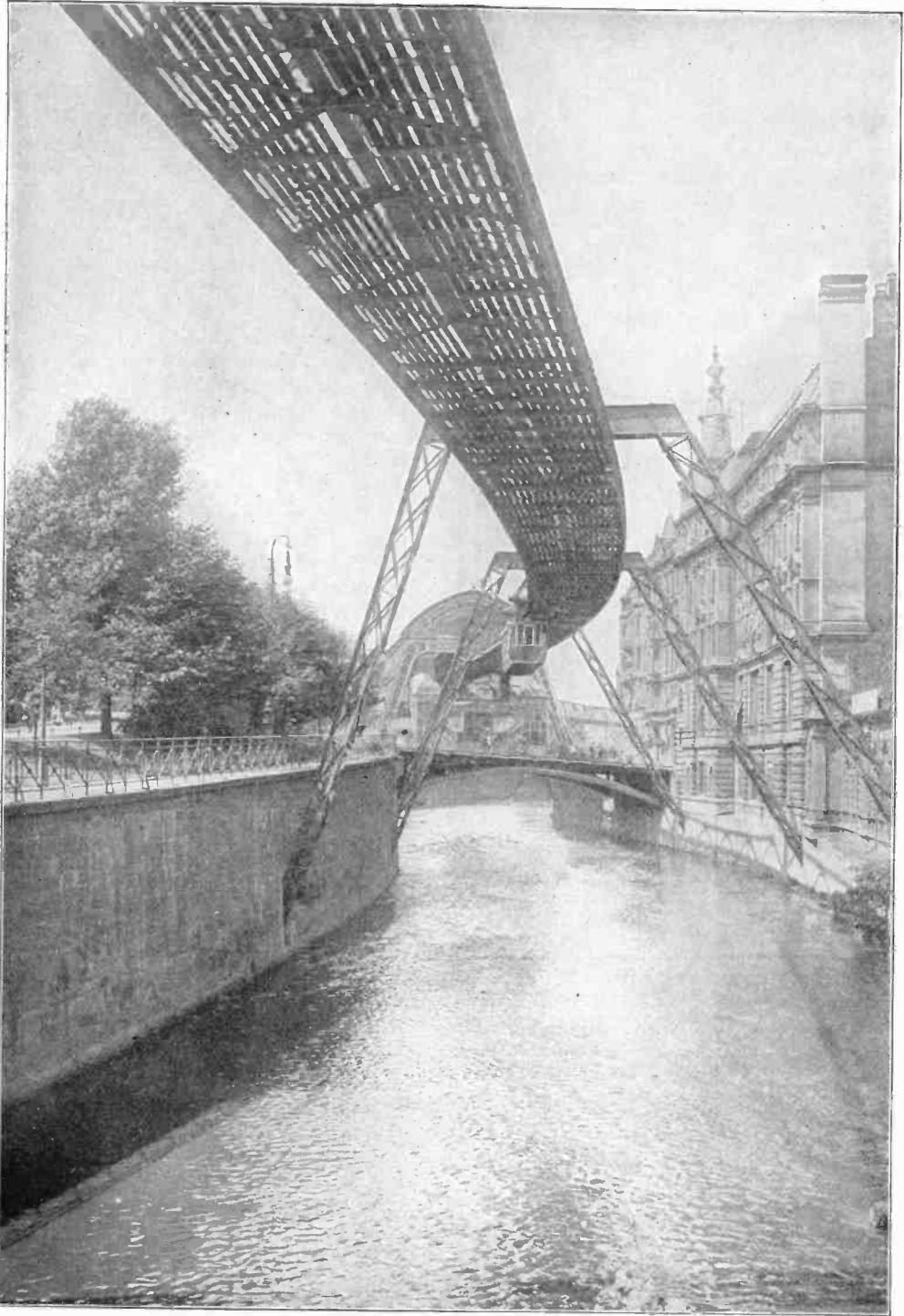

"THEY HUNG A RAILWAY OVER THE RIVER"—THE BARMEN-ELBERFELD
SUSPENDED LINE

The Barmen-Elberfeld Suspended Railway

By LIVINGSTON WRIGHT

Probably no railway project of the world ever proved the laughed-at success and the sneered-at benefit to transportation experts that has the remarkable enterprise in Germany. When it was first built most of the railway men seemed to think it a contrivance merely designed to serve as a "freak road" and advertise a little German community.

But the more we know of German ways the more it is to understand that the quiet, painstaking, methodical, plodding, profound Germans do not fritter away time nor work for the mere amusement of the globe.

They hung a railway over a river! Fact. And while the world was smiling, much as it did when there was talk of sending John Ericson's "cheese-box," the Monitor, down

to Hampton Roads, this road began to make money and prove a startling success.

Here are a few of the things that these eight miles of hung-by-the-gills railway have proven.

Costs far less than any other elevated type; third rail is out of the way; far safer, and practically impossible for passengers to get hurt; 29-ton cars as effectual as 100-ton; requires only 450 horsepower motors as against the 1,000 to 3,000; quieter, dustless, sanitary; no danger of collisions or cars running off the track; can not get blocked with snow; twice the speed of a surface trolley or elevated of common type; takes sharper curves and with absolute safety; can be operated in space otherwise

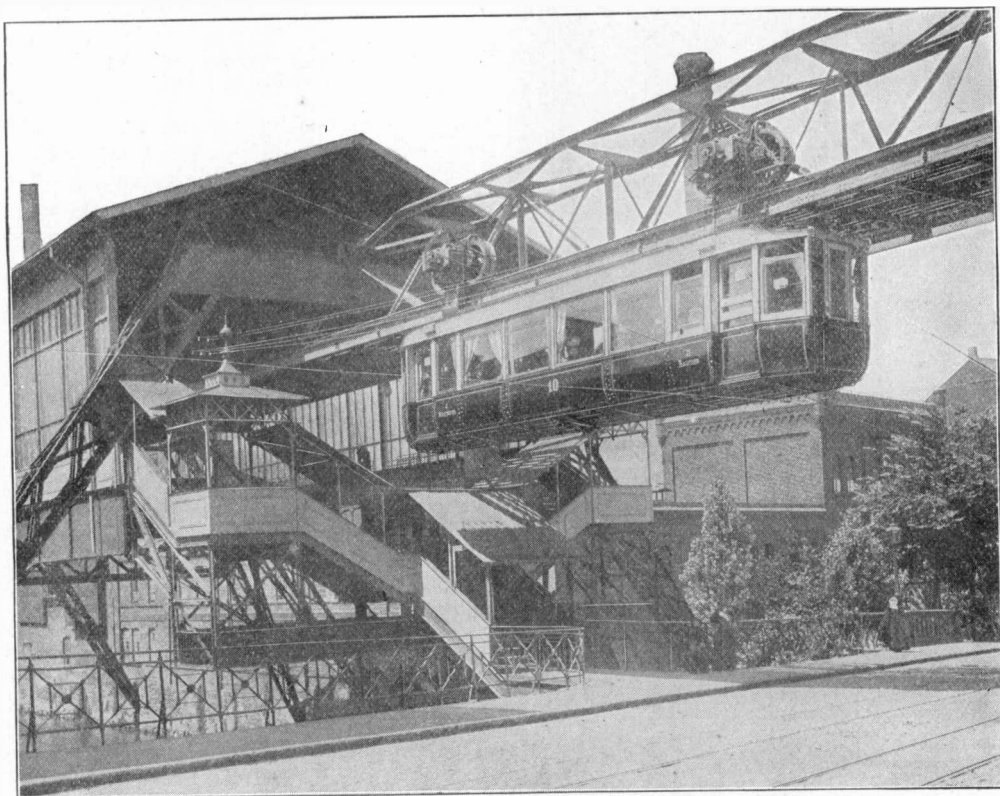

CAR AND STATION OF THE BARMEN-ELBERFELD SUSPENDED RAILWAY

impossible to use—over alleys, rivers, or surface obstructed ways.

In the words of the chap before the jury who had to admit to his lawyer that he'd been dishonorably discharged from the army, "Lord, ain't that 'nough!"

In the short time comparatively that the Barmen-Elberfeld suspended railway has been in operation, it has passed from ridicule to making engineers and municipal authorities do more studying of it and admiring its financial, safety and convenience revelations than any other municipal innovation on the globe.

Motor Operates Under Water

This looks like rather a tough proposition for a motor to undertake; that is, to operate a pump when both are suspended under water. Nevertheless the seemingly impos-

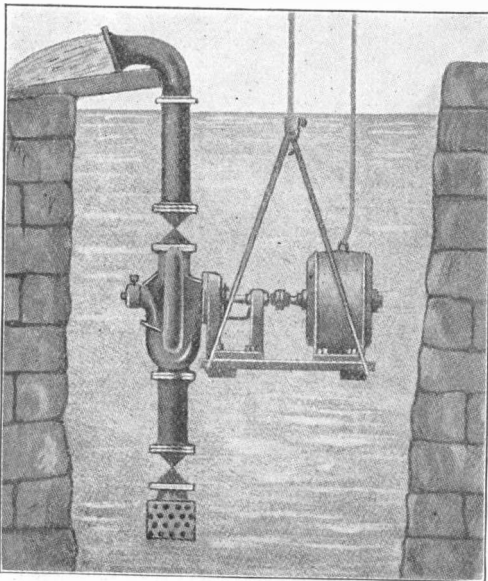

MOTOR OPERATING A PUMP UNDER WATER

sible has been accomplished by a motor designed and patented by an Englishman, W. R. MacDonald. The first illustration shows how the motor and pump can be employed in unwatering a mine, the set being submerged and lowered as the water-level falls, while the delivery pipe is lengthened correspondingly. The suction pipe and strainer shown in the figure are not really necessary. The temperature of the motor windings being kept down by the water which

circulates freely through the interior of the motor, the resistance is also prevented from rising, and thus a high efficiency is obtained, though the winding can be run at a

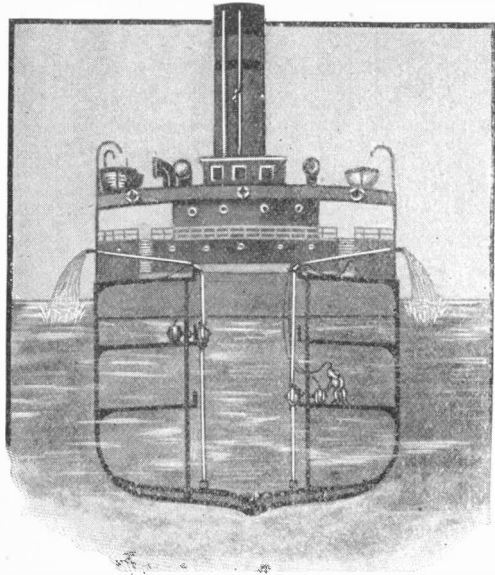

SUBMERSIBLE MOTORS PUMPING OUT A STRANDED SHIP

high current density. A small motor also is able to give out a very large output.

The motor is of the induction type, which has no commutator or similar parts to be injured by the wet. The part which corresponds to the revolving armature in an ordinary motor, called the rotor, is so designed that the windings are in, no way protected from the water. The stator windings, however, are made waterproof.

Eleven Messages Over One Wire

Between Chicago and New York the American Telephone and Telegraph Company has in operation four wires over which eleven messages can be transmitted simultaneously. These wires constitute in the first place two ordinary metallic telephone circuits capable of carrying two telephone messages in the ordinary manner. From these two circuits a third telephone circuit is derived which is called a phantom circuit. Then, in addition, the wires are utilized, in accordance with the well-known system of quadruplex telegraphy, to send eight telegraph messages.

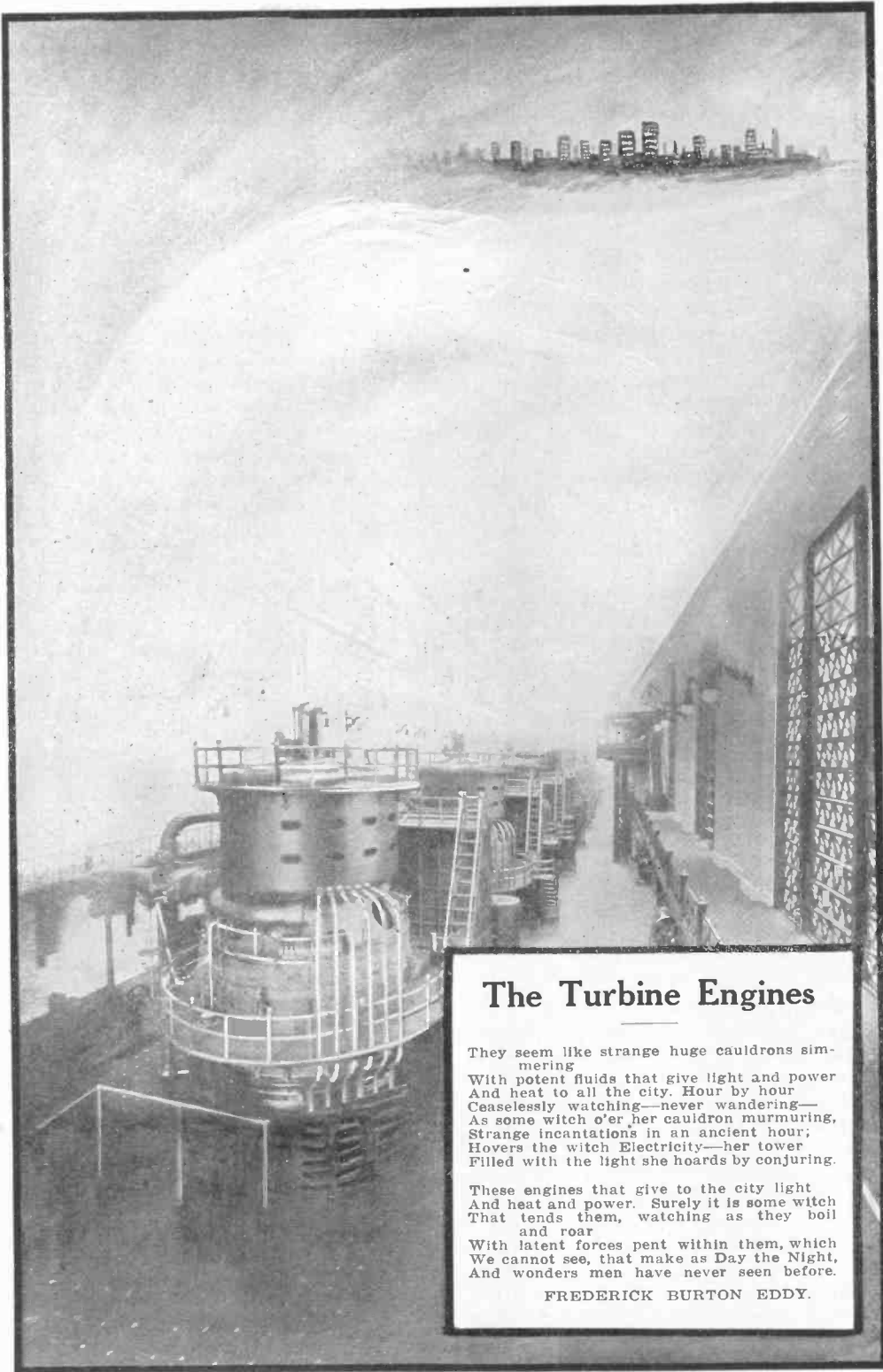

The Turbine Engines

They seem like strange huge cauldrons sim-
mering
With potent fluids that give light and power
And heat to all the city. Hour by hour
Ceaselessly watching—never wandering—
As some witch o'er her cauldron murmuring,
Strange incantations in an ancient hour;
Hovers the witch Electricity—her tower
Filled with the light she hoards by conjuring.

These engines that give to the city light
And heat and power. Surely it is some witch
That tends them, watching as they boil
and roar
With latent forces pent within them, which
We cannot see, that make as Day the Night,
And wonders men have never seen before.

FREDERICK BURTON EDDY.

How Radium is Made and Kept

By ARTHUR B. REEVE

The manufacture of radium is a long and toilsome process. In Bohemia, where the most famous mines are located, at Joachimsthal, it is a government secret guarded closely by the Austrian officials, though as a matter of fact the process is sufficiently well known, so that anyone possessing a mine yielding pitchblende need not worry about how he is to recover the radium. At Nogent-sur-Marne, in France, there is a radium "factory" which is well known. Here huge hoppers are the first part of the apparatus which attracts the attention of the visitor. These hoppers receive the carloads of pitchblende which are shipped in after having been obtained in various parts of the world.

Next, the ore is passed to crushers which reduce the rocks and lumps in short order to a fine powder. This powder is then conveyed into a large steel vat where it is subjected to a strong bath of

The process has now reached its crucial stage. The residue is next treated with diluted hydrochloric acid and this time the valuable radium salts have risen from their base surroundings and are held in solution. The actual process is not so quickly disposed of as this, but roughly speaking, these are the principal stages in the extraction of radium. The precious fluid is drawn off and carefully filtered and then it is mixed with sulphuric acid. That produces a precipitation and the solid matter thus secured is radium bearing sulphate, and this is only slightly radioactive, more treatment with

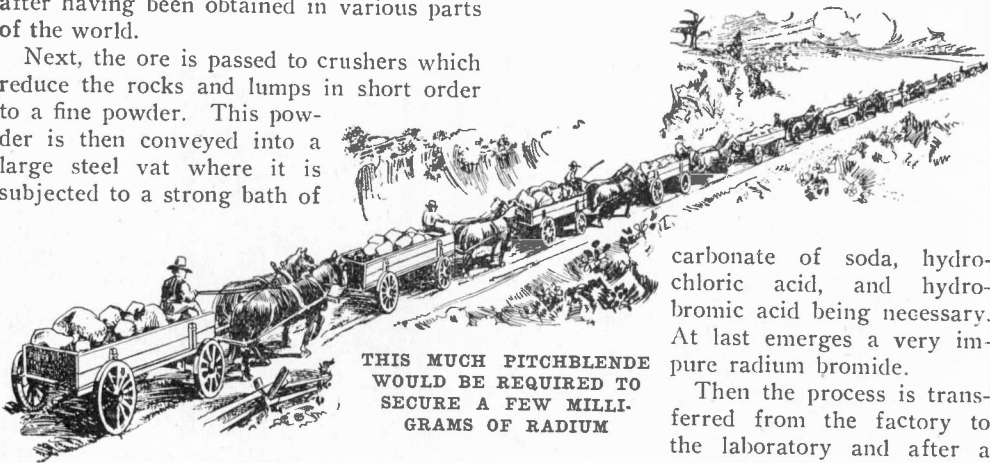

THIS MUCH PITCHBLENDE
WOULD BE REQUIRED TO
SECURE A FEW MILLI-
GRAMS OF RADIUM

carbonate of soda, hydrochloric acid, and hydrobromic acid being necessary. At last emerges a very impure radium bromide.

Then the process is transferred from the factory to the laboratory and after a constantly increasing crys-

hydrochloric acid. After receiving this treatment there is found remaining in the bottom of the vat a muddy mass. This dirty residue contains the precious metal. It is washed with pure water, and after this washing a strong solution of carbonate of soda is poured on it. At the edge of the vat stand workmen whose duty it is constantly to stir the mixture with large wooden paddles. In fact this part of the process is not much more romantic than is a steam laundry. Finally the liquid is again drawn off. The same sort of a mass of dirty mud, though not so much of it, remains in the bottom of the vat still. Again it receives a copious bath of water and again the liquid is drawn off, leaving still less of the mud.

tallization of the radium bromide, the mass obtained is one thousand times as radioactive as uranium. In other words, the ton of original material has now been reduced to something like one ounce. It has still various processes to undergo which reduce it in weight to one one-hundredth. The whole series of treatments takes from one to four months and at the end of that time pure radium bromide is extracted. Now, by the process known only to Madam Curie herself, pure radium itself can be isolated from this compound.

Yet in spite of its almost priceless value and the long process of extraction, radium salts really come from material which, within only a decade or so, was practically

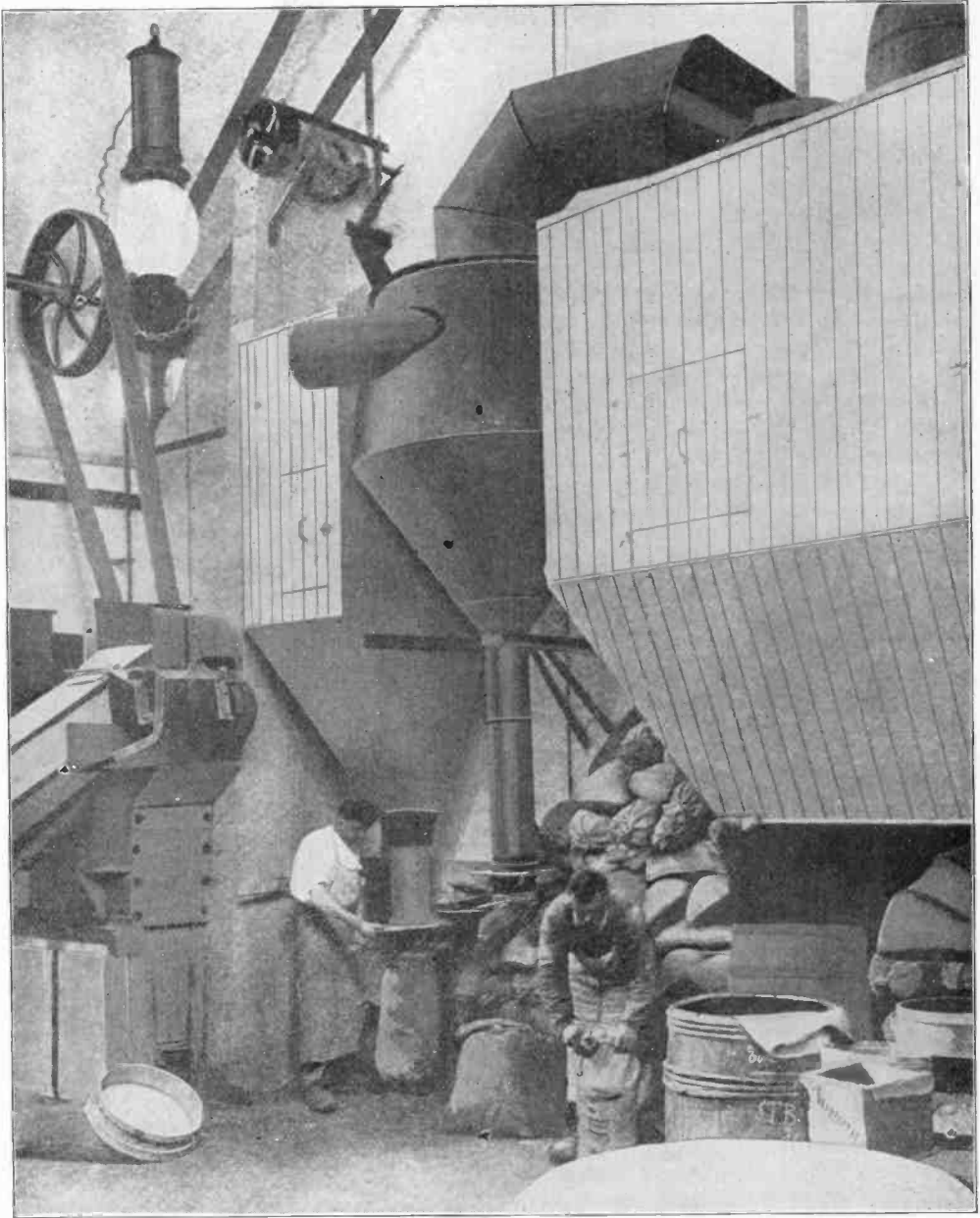

THE SIFTING TANKS IN A RADIUM FACTORY DESIGNED FOR THE TREATMENT OF PITCHBLLENDE RESIDUE AS OBTAINED IN THE MANUFACTURE OF URANIUM. THESE RESIDUES ARE THE MOST IMPORTANT OF RADIUM-HOLDING MATERIALS. AT THE END OF TWO AND A HALF MONTHS ONE OR TWO MILLIGRAMS OF RADIUM BROMIDE WILL BE OBTAINED FROM EACH TON OF RESIDUE.

a waste. The English company which owns the mine in Cornwall, from which a great part of the radium supply in Great Britain is now derived, some time ago paid nearly a

dollar a ton to have 100 tons of this residue carried away and dumped on the waste heaps outside the town. "I would gladly," said the secretary of the company recently,

"give \$25,000 to-day to recover that waste pitchblende. I do not know where it is now, but it was dumped on building land and some of the workmen of the town are now living over radium beds and do not know it."

In fact it is said that even in London there are several hundred tons of this "waste," as it was once spoken of, which were carted away from the scrap heap of a company engaged in extracting uranium, and used for levelling and laying out roads and the filling of foundations of houses. Pitchblende, it may be mentioned, has been used in coloring glass, and many people who possess old samples of that art to-day harbor, unknown to them, a most minute trace of radium.

Not the least of the problems connected with the most wonderful and expensive of metals, radium, is its preservation. If the making of radium is attended by almost insuperable difficulties the care of it after it is extracted is no less difficult. Not only has this precious substance to be guarded against thieves in the flesh, but it has actually to be guarded against itself, lest perchance it silently and stealthily disappears.

The scarcity and costliness of radium have given rise to what are known as "radium banks," where the metal is kept on deposit, as it were, and loaned out at a good stiff rate of interest when needed. Such an institution has been in existence for some time in Paris and another in Austria. Over a year ago a similar "bank" was organized in London and one is now projected in New York. Radium banks differ from business banks in that their loans and discounts are in radium, not in gold, while their clients are not business men but scientists and physicians. The bank rate on radium is enormous. As much as \$200 has been charged for the use of a tenth of a gram for a single day. A gram is only fifteen and a half grains. For each succeeding day after the first, one-half of one per cent. of the value of the radium is charged—over 180 per cent. per annum.

For the English bank, known as the British Radium Corporation, a remarkable safe, the first of its kind ever constructed, has been built by the famous English firm of Chubb & Sons. This safe has been designed by the technical advisers of the corporation especially for the storage and protection of radium. Though only three feet high, it

weighs a ton and a half. In order to make it as far as possible proof against the skill of the most expert burglars as well as against the risks of loss by emanation, the greatest ingenuity had to be exercised. The dilemma was that experiments had shown that practically the only metal which would withstand the great penetrating power of the radium emanations was lead, while lead was anything but burglar proof.

The only solution of the difficulty was to construct a safe with an interior of lead and an exterior of steel. An inner shell was made composed of lead three inches thick

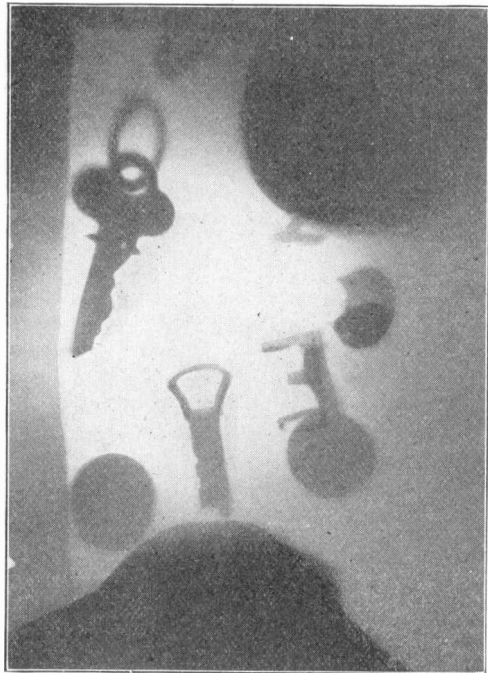

FROM A PHOTOGRAPH TAKEN WITH RADIUM

and the outer casing was of steel of the same thickness. Another difficulty was the fitting of the door to prevent the escape of emanations in that way. It was lath-turned and of circular formation, a "dead fit" to the uttermost thousandth of an inch. No ray can possibly escape. By means of an especially ingenious contrivance, any wear and tear on the door by usage in opening and shutting is immediately remedied.

Still another safeguard which had to be taken was to prevent loss of emanations when the door is opened. To overcome this, two valves have been fixed to the door

through which tubes of mercury are passed for the collection and storage of the emanations. Most of the radium stored in this safe comes from the radium mines of Cornwall, in which the corporation has a large interest. It is hoped soon to provide about a thousand milligrams of radium a month from this source, which at the current value of \$90 a milligram means a lot of money for exactly one gram.

Ozone Stops Meat Decay

Thanks to the enforcement of our national pure food laws and the activity of the health departments in our larger cities, most thinking people now have a wholesome fear of formaldehyde and similar food preservatives, for these preservatives have themselves, been found to be harmful in their action on the human system. The real solution of the food-preserving problem would seem to involve some means not in themselves deleterious to mankind, as for instance the icy coldness of refrigerators.

But even in the refrigerators and cold storage warehouses the lowered temperature does not kill the micro-organisms which cause decomposition, but only impedes their action. The only practical alternative is to kill off these micro-organisms, which can be done by mixing a sufficiently high percentage of ozone with the air. This was first tried at the slaughter houses of Cologne where it was found that sides of meat which already showed mold between the bones were so disinfected after three days of exposure to ozonized air that the mold had disappeared and no unpleasant odor could be detected in the meat when boiled. Moreover, the presence of the ozone soon eliminated the obnoxious odor so common in meat storage houses, and bacteriological tests proved that this was actually due to the sterilizing of the air. Even as little as a 30 minute action of the ozonizer reduced the quantity of germs fully one-half without requiring the admission of fresh air. The same was true in storage rooms where the musty smell of old straw had formerly prevailed. Such odors are invariably an indication of unwholesome conditions, hence it is easy to see how the ozonizing (which requires only a very simple and compact electrical device) is actually doing in practice what our pure food laws have long been trying to effect.

Marvelous Increase in the Use of Telephones

According to the report of the American Bell Telephone and Telegraph Company for the year 1910, the number of subscribers' stations which constituted the system was 5,882,719, an increase of 740,027 for the year. Of these 1,852,050 were operated by local, co-operative and rural Independent companies or associations having sub-license or connection contracts. The total mileage of wire used for exchange and toll service was 11,642,212 miles, of which 1,162,186 miles were added during the year. These figures do not include the mileage of wire operated by connecting companies. Including the traffic over long-distance lines, but not including connecting companies, the daily average of toll connections was about

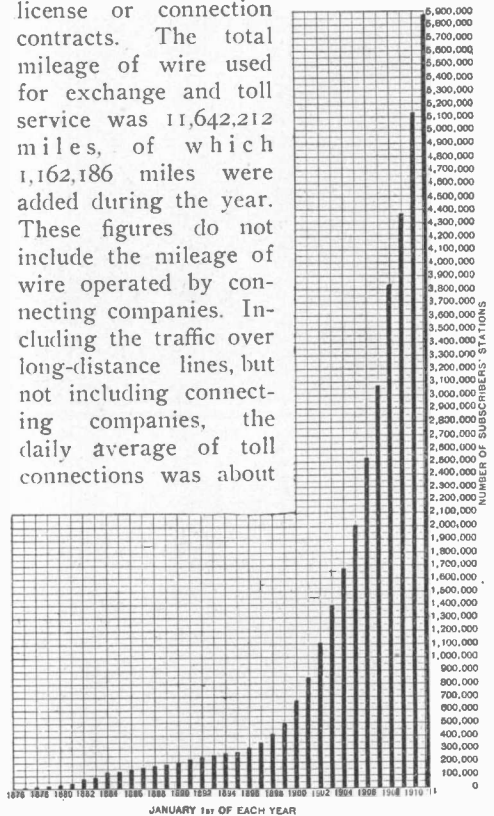

CHART SHOWING INCREASE IN THE USE OF TELEPHONES

602,500, and of exchange connections about 21,681,000, an increase over the previous year of almost 100,000 toll connections and almost 2,000,000 exchange connections.

A glance at the diagram will show more forcefully than words how rapidly people have taken to the telephone in the last decade. It should be remembered also that the figures are only those of the Bell companies and a few connecting Independent companies. In addition there are millions of Independent stations which are not plotted.



ON THE ROAD TO THE STOCKHORN



THE EDEN OF EUROPE

In the Country of the Bernese Oberland

Beautiful mountain scenes in Switzerland have been pictured frequently in POPULAR ELECTRICITY. That these mountains have been made readily accessible, some of them even to their very tops, is one of the consequences of electric traction development. One of the regions much frequented by tourists is that about the town of Murren and the Stockhorn, the latter a mountain in the Bernese Oberland, between which two points an electric mountain railway is now in operation. This part of the country is said to be one of the most beautiful in all Switzerland, and who will doubt it, even when looking at a picture? A picturesque stretch of this mountain line is shown in the first illustration.

The second illustration shows a part of Switzerland which is said to be the Eden of Europe. It is situated in the Italian part of Switzerland and shows the Swiss-Italian Lakes. It has repeatedly been planned to surround the whole lake with an electric railway so that one may be able to enjoy the beauties of this country. But the population is poor there, the riches only consisting in the beauty of the country, so that only a small part of the country enjoys today the electric car service, which starts from Mendrisio and running between the Lakes of Lugano and the Lake Maggiore. Some day, when the country is better known by the tourists it might pay to complete this

electric railway, only part of which is installed in this modern Garden of Eden.

Interurban Funeral Car "Dolores"

In ancient times men bore the dead on their shoulders to a final resting-place. Today the automobile hearse and the funeral car are a part of this last tribute to the departed.

The "Dolores," as the car is appropriately called, is one of the latest funeral cars built, and is in service over the Cleveland, Southwestern and Columbus Railway. It is divided into three compartments, one for the casket, one for the pallbearers and a third main compartment. Just back of the motorman's vestibule is the casket compartment with space for two caskets and shelf room for floral offerings. The interior is draped in black throughout and two outward opening doors on either side permit the caskets to be set in place.

Wicker chairs furnish the pallbearers' compartment, and upholstered plush seats are provided in the other compartments. The interior of the car is trimmed with quarter-sawed oak, the draperies being of green and purple.

The outside of the car is finished in Mercedes gray trimmed with black. When under way the motorman and conductor may communicate with each other by means of a speaking tube running from the front to the rear of the car. The car has a seating capacity for 42 people.

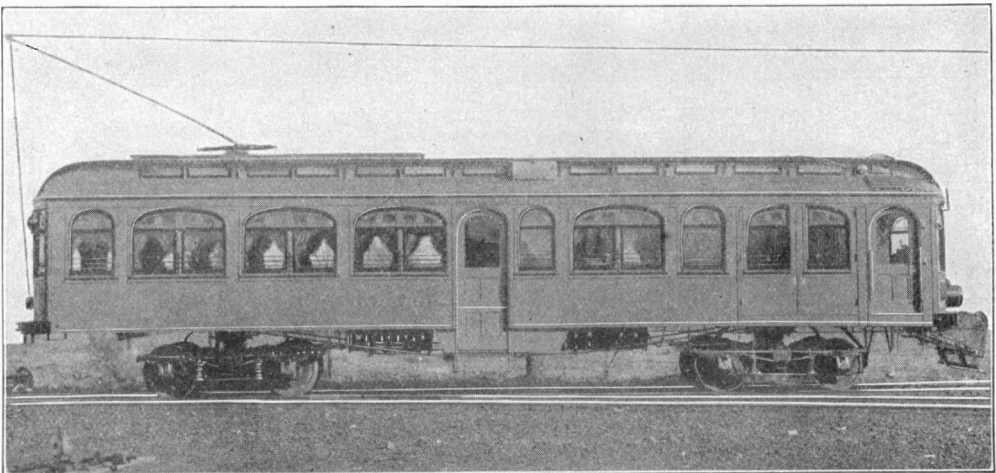

INTERURBAN FUNERAL CAR "DOLORES"

Where Skill and Accuracy Prevail

In probably no other industry except it be in the cutting of diamonds or in the making of optical instruments, is such extreme care and accuracy exercised as in the building and testing of electrical measuring instruments. After principle and design, pains in the small details is of greatest importance and in this latter work man has seemingly turned his mind into a micro-

of a great electrical manufacturing company, where seconds are divided into hundredths and accuracy is carried to the ten thousandths of an inch, belongs to the realms of practical utility rather than to art. The colors on the sides of a piece of pottery, are displayed in the soft tint of an oriental rug, where strands are knotted perhaps 700 times to the inch, are ever where

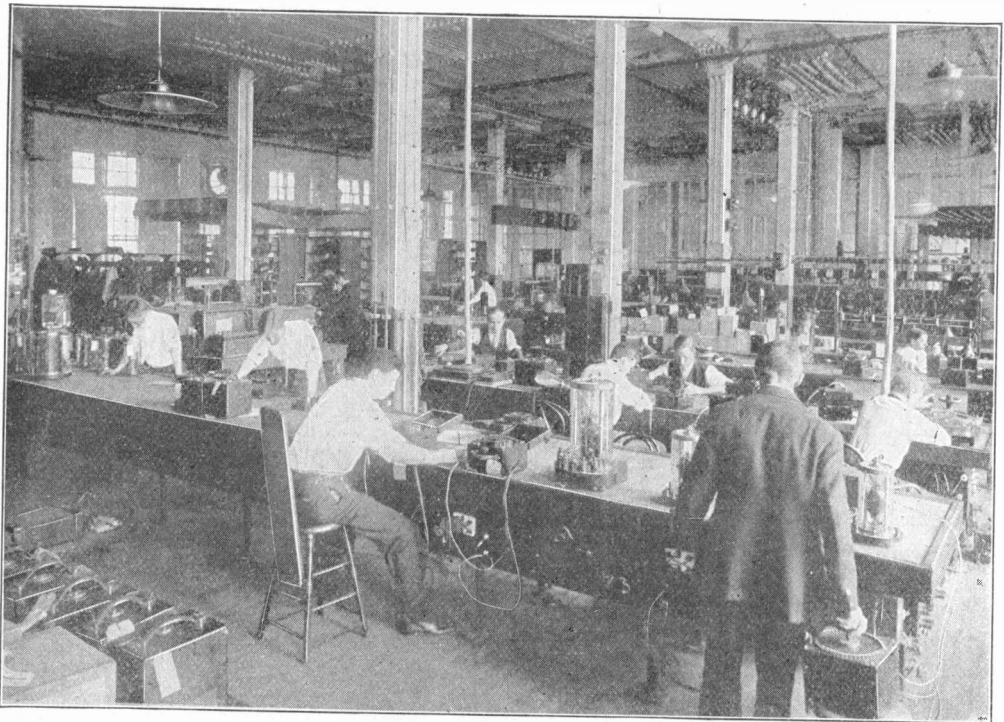

VIEW IN THE STANDARDIZING LABORATORY

scope for the perfection of little things. One recalls the story of the smallest needle in the world, sent as a present from Queen Victoria to the Empress of China, who, after a brief interview with the royal jewelers returned the present to her Britannic Majesty, but with the needle converted into a needle case, which, upon the removal of the cover, was found to contain a half dozen smaller needles each perfect as to finish and taper and each with its small eye precisely drilled.

But unlike the needles of the Empress, the product of the instrument department

they appeal to the eye, while the skill of the unknown worker expressed in the finely turned threads of a screw or in the delicately shaped and polished jewel of an electric instrument is hidden under an unassuming metal cover and shows itself only in the perfect and accurate operation of the instrument.

In the design of some electrical measuring instruments such as certain alternating current meters for instance, simplicity has been attained by following the plan of the human skeleton and attaching all movable parts to a central support—a rigid back-

bone. The current and potential coils are supported from this frame and kept in a fixed relation to each other. All movable parts are surrounded by a laminated shield protecting the interior coils from magnetic fields. The magnets are of a specially selected material which after hardening has been subjected to several artificial aging processes. The small coil springs which control the actions of the scale needle are also subjected to the most careful treatment and finishing process.

None of the small parts are of such importance as the jewels, which are made of Ceylon sapphire imported without limitations as to selection. Only that portion of the shipment is used which upon microscopic inspection shows to be perfect.

These jewels are cut with diamond dust and given an extremely high polish—the highest which it is possible to obtain. Each jewel is worked upon repeatedly, inspected, again worked upon, again inspected, until it is brought either to the right degree of polish and curvature, or else rejected.

The importance of this careful cutting and polishing becomes apparent upon examination of the shafts which are balanced on the jewels. These are made of drawn phosphor-bronze tubing with pivotal points of glass-hard steel swedged into their extremities. In the history of instrument manufacture no greater point of interest has been developed than the exact treatment of these pivots to insure a pivoted suspension of such delicacy of adjustment as to assure practically absolute accuracy. The pivots are made of especially selected steel which is ground, polished and burnished under a microscope, being subjected to the same rigid inspection which is given to the jewel. The radius of curvature at the end must not be more than .0015 nor less than .00125 of an inch and the polish must show no flaw or blemish when inspected under a binocular microscope. The weight supported on these points is extremely small, almost immeasurable and insignificant, but the area of contact is also so small that high pressure results and only the highest quality of workmanship and material will insure low friction. When carefully built the completed instrument finds its way to the standardizing laboratory shown in the accompanying picture, where it is subjected to rigid tests.

To the Pyramids by Electric Car

By means of the electric car the Pyramids, rightly regarded as Egypt's principal sight, are now brought within easy reach of Cairo. The tracks, as may be seen from

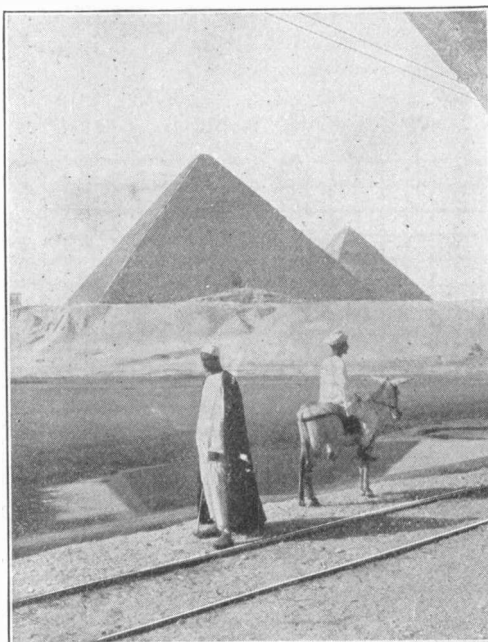

ELECTRIC RAILWAY AT THE PYRAMIDS

the accompanying illustration, run to within a few yards of these wonderful monuments of the ancients. The Great Pyramid, the largest of them all, has a base of 764 square feet and rises to a height of 480 feet. The stone of which it has been built has an aggregate weight of 7,000,000 tons, easily rendering it the greatest of stone-built erections.

There have recently been installed at the University of Illinois two electric furnaces. One of these is a Hoskins resistance furnace and the other a Colby induction furnace. Both are of twenty-kilowatt capacity. The furnaces will be used for the purpose of studying the changes that can be brought about in the mechanical and physical characteristics of cast iron through the influence of the soaking process or prolonged heating which it is possible to maintain.

Measuring Smoke

Smoke is smoke. But, on the other hand, there is smoke and smoke. All of it is bad but some of it is worse. In general, the blacker and denser smoke is, the more objectionable it becomes. But how is it possible to measure this density?

Prof. Ringlemann, of Paris, has figured out a way to do it. Cards are ruled like

comparison for the railway locomotives.

The locomotives burn only 18 per cent. of the total coal, but they make 43 per cent. of the total smoke. In addition to making nearly half the total smoke, they make the worst kind of smoke. One-tenth of all coal burned in locomotive grates is thrown out the stack as cinders. Which means, in Chi-

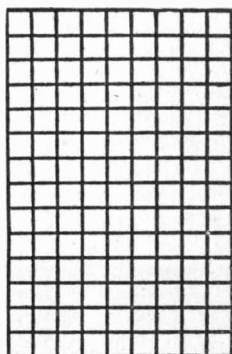

No. 1.

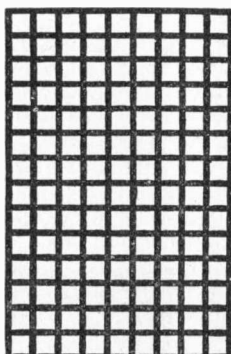

No. 2.

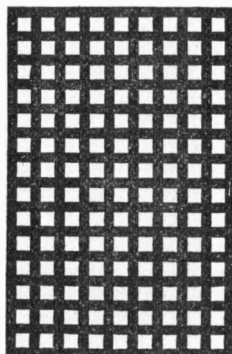

No. 3.

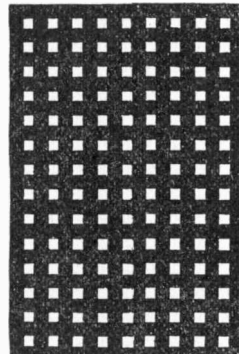

No. 4.

SIMPLE CARD-COMPARISON METHOD FOR DETERMINING THE DENSITY OF SMOKE

those shown. The black lines cover, respectively, 20, 40, 60 and 80 per cent. of the surface. Add a card without lines and one all black, at the two extremes, and you have all grades of density. When these cards are hung up at some distance from the observer they appear various shades of gray. Hence, by looking first at the cards and then at the smoke, it is possible to get a pretty accurate line on the density of the smoke which is pouring out of any particular source.

This method was used by the smoke department of the City of Chicago to determine which stacks were the worst offenders. At the same time a record was kept of the amount of coal burned in the various classes of grates. Then the amount of coal was compared with the amount of smoke, which was an especially odious

comparison for the railway locomotives. In Chicago, that 560 tons of cinders are dropped on the city every day.

The reason for this is that the coal in locomotive grates is burnt under a strong forced draft created by the exhaust from the cylinders. This draft is necessary and cannot be dispensed with. Therefore, the steam locomotive is a confirmed and in-

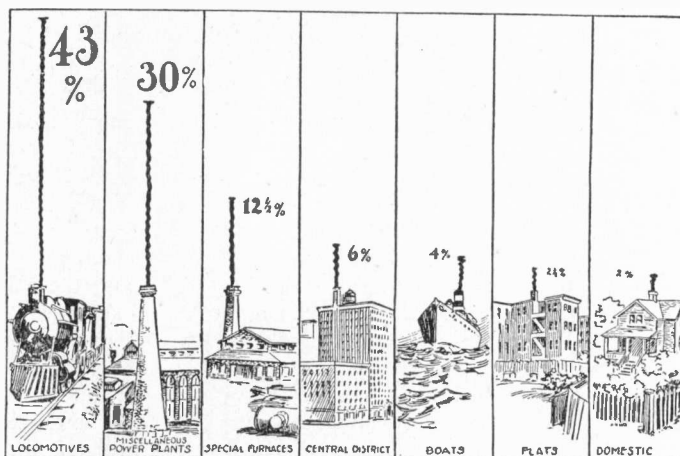

PROPORTION OF TOTAL SMOKE IN CHICAGO MADE BY DIFFERENT CLASSES

curable smoker. The big electric power plant, on the other hand, can burn the same fuel and get more energy out of it with very little smoke.

All of this is an argument, of course, not

only for the electrification of railroads within a city, but also for the substitution of electric power from large, practically smokeless central stations for that from numerous small isolated plants.

DIRIGIBLE BALLOONS AS SIGN BOARDS

While the German courts have decided that Count Zeppelin is entitled to the exclusive use of his name, so that the same cannot be used promiscuously as a catch name for all sorts of merchandise, this does not mean that the famous builder of the first commercially successful dirigibles is opposed to modern advertising. On the contrary, some of the balloons operated by his company are already being used for advertising purposes.

The first demonstration of this was made by the dirigible "Parseval VI." which left its aerodrome near Berlin one evening at 7:30 with a small number of passengers and with an electric stereopticon attached to the car. Thirty different advertising legends were shown in rotation while the balloon cruised above the city for nearly an hour and a half at a height of about 500 feet. The surprise created by these changing aerial signs can well be imagined, even among progressive citizens of Berlin.

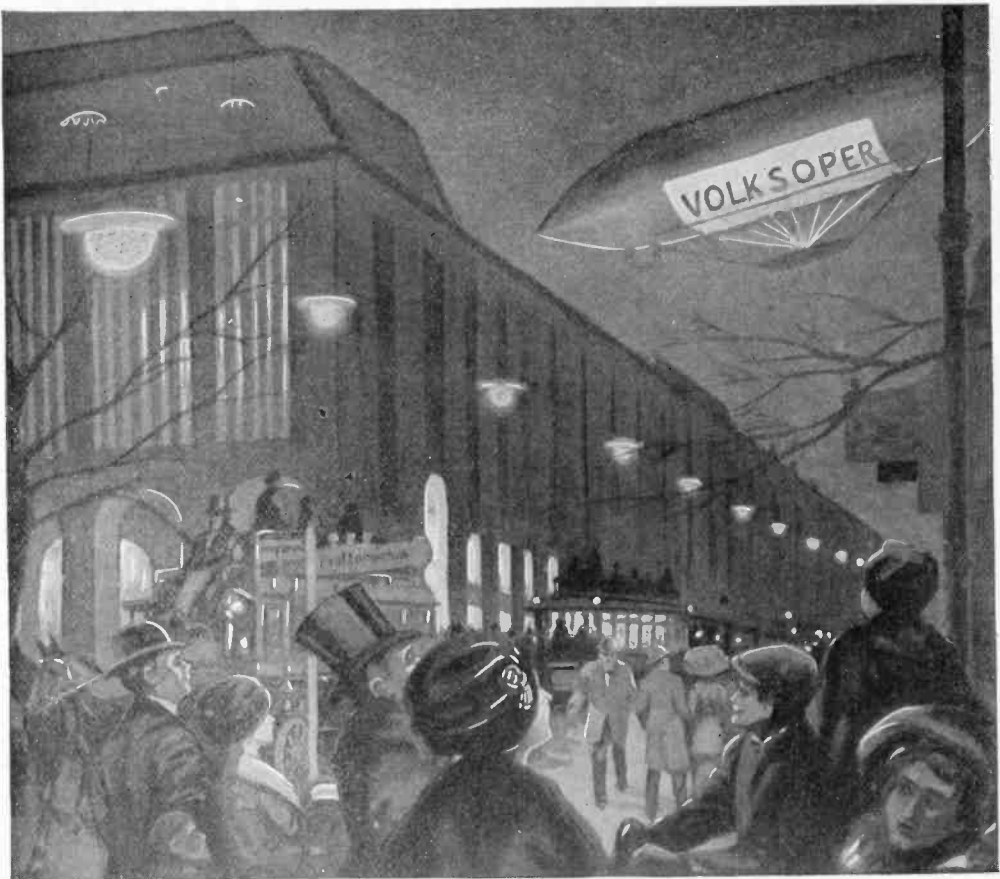

PARSEVAL VI DOING AN ADVERTISING "STUNT"

Electric Trains for the Giovi Tunnel

The Giovi tunnel in Italy is situated between the stations of Pontedecimo and Bussalla on the line between Genoa and Milan. The traffic is very heavy, this being the most important line between Genoa, the greatest shipping center, and Milan, the greatest manufacturing center of Italy. In addition to general freight and passenger traffic hundreds of cars of coal are daily sent over the Giovi line from Genoa to Milan. Electrification became necessary on account of the impossibility of coping with the increase in traffic with steam locomotives. The artificial ventilation of the tunnel, owing to its great length, could not be improved any more and the condition of the atmosphere in the tunnel was such that an increase in the number of trains or steam locomotives would endanger the safety of the service.

The new Giovi locomotives, of the Westinghouse type, are built for freight service and have a normal operating speed of 28 miles per hour. They can also be used for passenger service, as their speed capacity is as high as it is considered safe to use on

the Giovi line. The locomotives have also a fourteen miles per hour speed, which is intended for switching purposes and for regenerating power when the trains are running down hill.

The picture herewith shows one of these locomotives drawing a train of considerable length. The locomotive weight is not more than 60 tons, normally, but this can be increased to 75 tons by means of ballast to allow the locomotive to pull heavier loads.

Yarn Singeing by Electricity

Another triumph of electricity in textile manufacture has to be recorded. The singeing of yarns has hitherto been carried on by the process known as "gasing." But with this operators have to contend against difficulty of control and fouling of the air. A machine for yarn singeing by electricity has now been introduced. The actual burning takes place in an insulated platinum-alloy tube, electrically connected. The fluff and upstanding fibers are quickly removed, without in any way damaging the yarn itself. The process is quick and clean, and, of course, gives off no evil fumes.

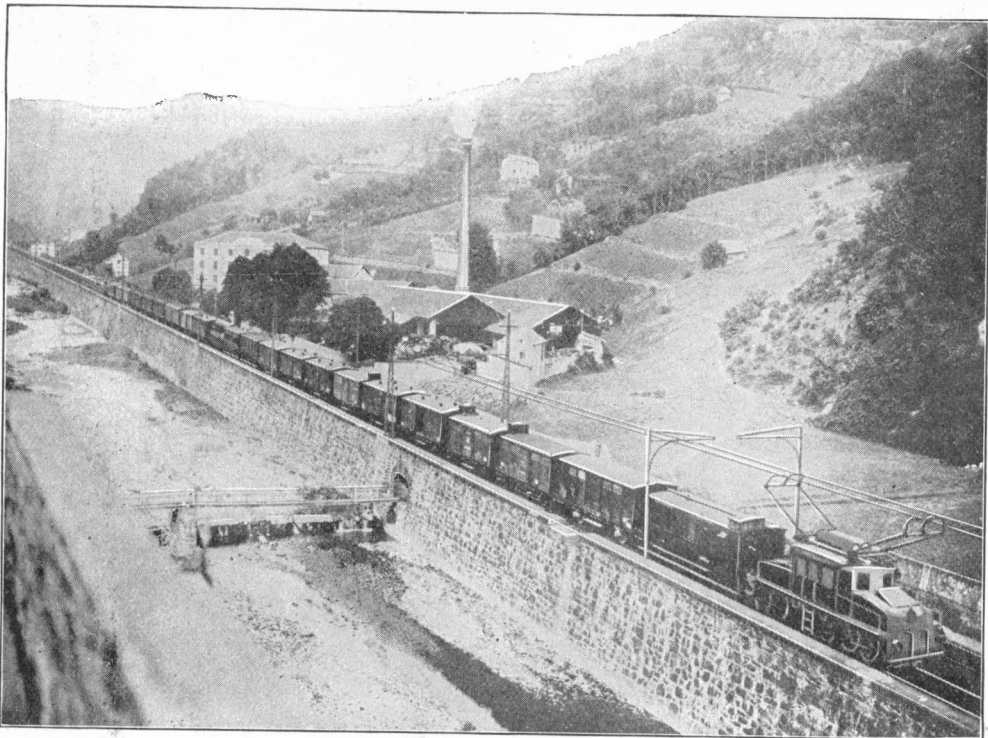

ELECTRIC LOCOMOTIVE AND TRAIN ON THE GIOVI TUNNEL ROUTE

The Tropical Trolley Trouble

By EDGAR FRANKLIN

I.

The hotel, perhaps, should be called El something, or the Casa something else. As a matter of fact, it is simply Ruiz's, just as it has been for twenty-odd years; and at that it is the most comfortable hostelry in Bonhora, if not in the whole of equatorial America.

Big and white, it stands almost on the shore of the little republic's seaport city of San Felipe. It boasts, in addition to its conventional patio, a broad veranda on the ocean side; and there the shadows are deep and cool and soothing.

But the shadows seem to soothe neither March nor Williams this early afternoon. These two, sitting here awake while the rest of San Felipe enjoyed the siesta their Northern bodies refused to accept, were silent, to be sure; but it was the silence

of angry, pitch-black gloom. March, small and dark and wiry, drummed upon the table between them until his partner's nerves snapped out with:

"Stop that, will you! It's too confounded ridiculous!"

"What? The drumming?"

"No! The whole business! The—"

And there Williams stopped. It happened that they were no longer alone. Albeit that at this hour every good citizen of San Felipe was wont to snore comfortably, someone had stepped softly to the veranda from the depths of the house. Now, before they could turn, a voice split the sleepy stillness:

"Well, by the piper that played before Moses! So this is what became of you!"

Together they whirled about. Together, they leaped to their feet. And together

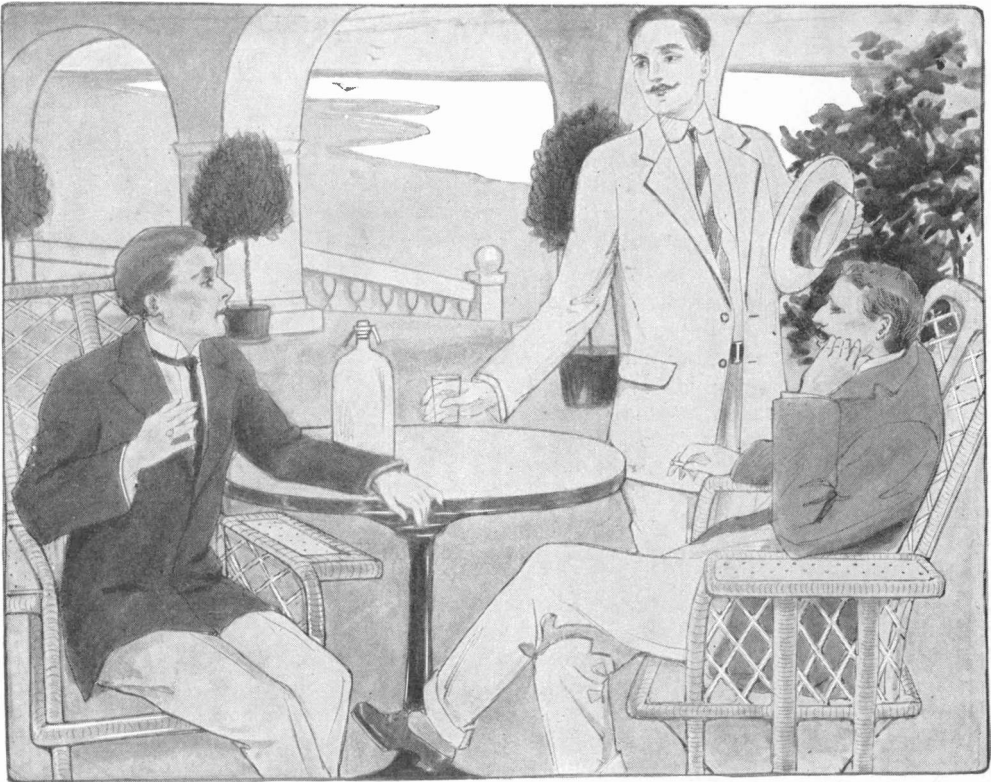

SOMEONE STEPPED SOFTLY TO THE VERANDA FROM THE DEPTHS OF THE HOUSE

they wrung the hands of a calm, powerful person in white—a man of perhaps thirty-five. And some five minutes later as they thrust him into a chair, one definite sentence in March's voice detached itself from the babel of words:

"The New York police department in Bonhora!"

The stranger, having mopped his forehead mechanically, grinned.

"Who are you after, Beston?" Williams asked eagerly. "Whoever escaped to Bonhora, that they had to send a detective—"

"Hold on! I'm not here officially, you know!" Beston protested. "I'm supposed to be on sick leave. I've been in bed for two months, and the doctor sent me down here to lose half my pay for another one and get warmed through. That's all. But you two! I haven't seen either of you for three years. I—what the dickens ever brought you here?"

A queer little chill seemed to come into the afternoon heat. March glanced at Williams and Williams at March, and the latter said sourly:

"We came down here to invest our little savings and—some other peoples'—and build 'em a trolley line."

"And?"

"We built it. It runs from here to Querero—40 miles of single track with ten turn-outs. It opened for business ten days ago."

"And?" Beston repeated, looking curiously from one acid face to the other.

"And it's due to close up about ten days hence!" Williams snapped.

"Well—why?" Beston asked, placidly.

"Because somebody hereabouts doesn't like the idea of a trolley line, it appears. They're working to bust this one. They tear down our overhead wire every other day, regularly!"

"Why not lock 'em up and—sort of stop worrying about it?" the detective asked wonderingly.

Again the queer look passed between the partners. They ended by drawing their chairs close to Beston on either side; and at a nod from his associate March said crisply:

"We're not advertising this thing, Beston, but you'd better hear about it. You won't have anything to suggest, because you're a

professional detective; but—well, the trouble is just here. Every other day—it has happened four times now, and it's due to happen today—somebody just takes hold of our overhead wire and smashes it. The funny feature is that the somebody is never around at the time."

"What?"

"It's a fact. The trick has been pulled off four times now, usually about 20 minutes before a car was due to pass. It has been right out in the open country each time, the ground is soft as muck—and yet there isn't a footprint anywhere in the neighborhood!"

Mr. Beston's interest seemed to quicken. He leaned forward and stared at March.

"Do I understand that somebody has been yanking down your wire?"

"Yanking it down—or up—hard enough to snap it, at all events."

"It isn't smashing of its own weight, or because it's poor quality, or something like that?"

"It certainly is not."

"Well, then," laughed Beston, "somebody simply walks along the ties, pulls it down and walks off along the ties. There goes the no-footprint mystery."

March stared at him with dry disgust.

"Beston," he said, "did you ever see a trolley wire come down and hit the ground and the rails? Was there a certain amount of activity in the neighborhood at the time? Did you happen to note anyone dancing accurately from one tie to another, four feet apart, while the live wire was crashing and thrashing around at the rate of a million twists per second?"

"I suppose a man *would* be rather likely to step off the tracks, wouldn't he?" the detective chuckled thoughtfully. "Well, then, somebody stands beside the tracks at a safe distance—"

"But they don't! There isn't a sign of a soul anywhere in the neighborhood."

"Are you *dead certain* of that?"

"We've looked over every inch of ground for hundreds of feet."

"Then somebody comes along in an aeroplane or a balloon and yanks it up."

"We thought of that, you know," March said, with all seriousness. "There isn't such a thing in the country. If one ever turned

up, it would be heard of all over Bonhora within two hours."

"Well—does it—does it always happen at the same spot?" Beston asked, in some bewilderment.

"Twice at the Marosa bridge. Once at El Toro. Once at Casima, outside the village. Always about this time in the afternoon, and nobody saw anyone about in any instance." Williams supplied.

"But you've had the line watched?"

"Murdock, our foreman, went up to the Marosa bridge," March said, tensely. "Something knocked him off the bridge and into the stream. When he landed there nobody was in sight and the wire was down."

For a moment, Beston stared.

"Where's Murdock?" he asked. "Or is this all a cheap joke on me?"

"It's no joke, and Murdock's in the hotel," said March, rising. "Wait!"

II.

It was some five minutes later that March returned with one somewhat wan-looking Irish-American citizen, palpably filled with quinine.

Beston looked hard at him some two or three minutes before:

"So you're the man that was knocked off the bridge?"

"I was that."

"Well, what knocked you off?"

"Av I knew that, d'ye suppose I'd not have caught it?" Murdock inquired.

"Umum." Beston smiled a little. "Tell me about it."

"It was after the first bust, up at Marosa," Mr. Murdock said, tersely. "I went there to have an eye out an' catch the feller that pulled down the line. Well, there's the trestle up there, and I was standin' on the edge of it, lookin' about, back and front and sideways. There wasn't a livin' soui in sight."

"Nor overhead, either?" Beston asked curiously.

"Nor overhead, either. Nor, what's still more, behind me. And then somewan hit me on the back of the head with a club, and I went down in the water and the rocks. When I got my wits, I was climbin' up-stream t' get away from the wire, bangin' around up there."

"And there was still nobody in sight?"

"Not a soul! Nor the footprints of wan!"

"That the whole story?"

"It's all I know, except that I lost me rubber gloves whin I fell and it was black night before we could get a car by the spot."

"Well—that's all, Murdock," Beston said.

"It's not quite all," said the gentleman, sourly, "for the chills I got bid fair to stick till me dyin' day."

He left; and Beston, whistling softly, said nothing until March exploded:

"We've lost four full half days in ten days of operation. At this rate, we'd have to have a repair crew that would eat up the profits of three lines. We have every prospect of queering the new service altogether and—"

"And how was it done?" Williams asked.

Mr. Beston threw up his hands.

"Good heavens! I don't know how it was done—a spook, or an invisible flying machine, or a translucent, sky-blue roc tangling his claws in the wire. That's not the point. The point is that you have an enemy and that enemy is going to put you out of business. Who is it?"

"We haven't an enemy in the whole republic."

"Bosh! Who opposed your new line."

"Nobody. The whole country was tickled to death at the innovation. The Government has shown us every courtesy, and the populace even hired bands and played tunes all along the line when the first car went through."

"Well, who wants to acquire your line, then?"

"Not a soul in the place. It's the first real American enterprise in the country, and it's too big for any loose native capital to buy, even if they wanted it. It's too small for outside money to bother with. That's the cold truth, Beston, whether you believe it or not. We canvassed every inch of every possible situation before we even bought a rail."

"Very well. Who's contemplating a revolution? Who's opposed to the Government?"

"Beston," March said gently, "this is a banana republic, but it isn't a fictional one. There is no revolution in sight and never has been. All the really big men are in the Government now or have their hands full

with their plantations, and they're all sleepy and happy. They're glad as can be to have a trolley line, and if we have only reasonable business, the Government's going to finance half of the next one. And everybody has done everything in their power to smooth the way for us and—"

"Well, confound it! Who did your line drive out of business, then?" Beston demanded desperately.

"Only the mail coach line," Williams laughed grimly. "That was run by an old chap and his two sons. They all wanted to get out of the business, and we bought them out at their own price. They purchased a plantation with the money, and they write us a letter of fervent thanks every day, even now."

"It seems to be a lovely, happy little country," the detective commented, dryly. "Everybody's satisfied but you—"

"And we're so satisfied that we'll have to jump back to New York if this keeps up." March sighed. "Even now one fool newspaper has begun to demand that somebody start a new coach line, so that people with a real earnest desire to go to Querero can make the trip."

"Yes?" Beston asked sharply. "Who's behind the paper? Why are they demanding it? What have they against you? Who—"

Williams laughed hopelessly.

"You don't understand, Beston," he said. "This isn't really a demand, and we know the fellow who runs the paper intimately. He fairly sobs in print over our failure to put up a good service, and he asks that some public-spirited citizen start the stage-coach line temporarily—just until we're in fine running shape."

For a time, Beston whistled softly. Then he shrugged his shoulders.

"I fear, fond children, that you're both mistaken," he smiled.

"But we are not!" Williams said. "We have absolutely no enemies; and if we had a whole raft of them, how the dickens could anybody do a job like that, over and over, without ever going to the spot or—"

"I didn't mean it in that way," the detective smiled. "I meant that your equipment isn't as good as you fancy. It's smashing of its own accord."

"Then you can lose that notion, too!" March said hotly. "Money can buy no bet-

ter stuff than we have put in that line, and—"

He stopped there. Murdock had shuffled out to the veranda, and his eyes were wide.

"The power-house is on the 'phone!" he stated hastily. "Jones just called up from Marosa!"

"What?"

"Yes, sir!" cried Murdock. "The blasted wire's down again!"

(To be concluded.)

Illumination of a Flower Shop

An exceedingly artistic lighting arrangement for a conservatory or flower shop is here shown, reproduced from a picture in *Mittcilungen*, a publication of the Berlin Electricity Works. The room is lighted

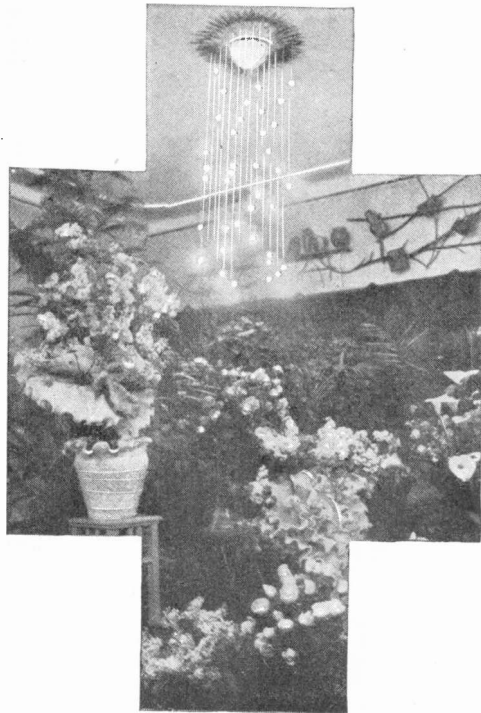

APPROPRIATE FLOWER SHOP LIGHTING

principally by a cluster of suspended miniature lamps which harmonize perfectly with the flowers and foliage. The lamps are partially enclosed in little calyx-shaped metallic shades and themselves present almost the appearance of a spray of blossoms.

Electric Block Signaling

By SIMON DEUTSCH

PART VII

Railroad signaling is generally broadly divided into two parts, namely, block signaling and interlocking. Interlocking is used where two roads or more cross each other at grade, or where a great many tracks converge, and is a method by which a number

terminals it was soon found to be an absolute necessity. Without it the excessive cost of keeping men at the switches in the yards, the danger of collisions because of imperfect hand signaling and the necessary delays to guard against these dan-

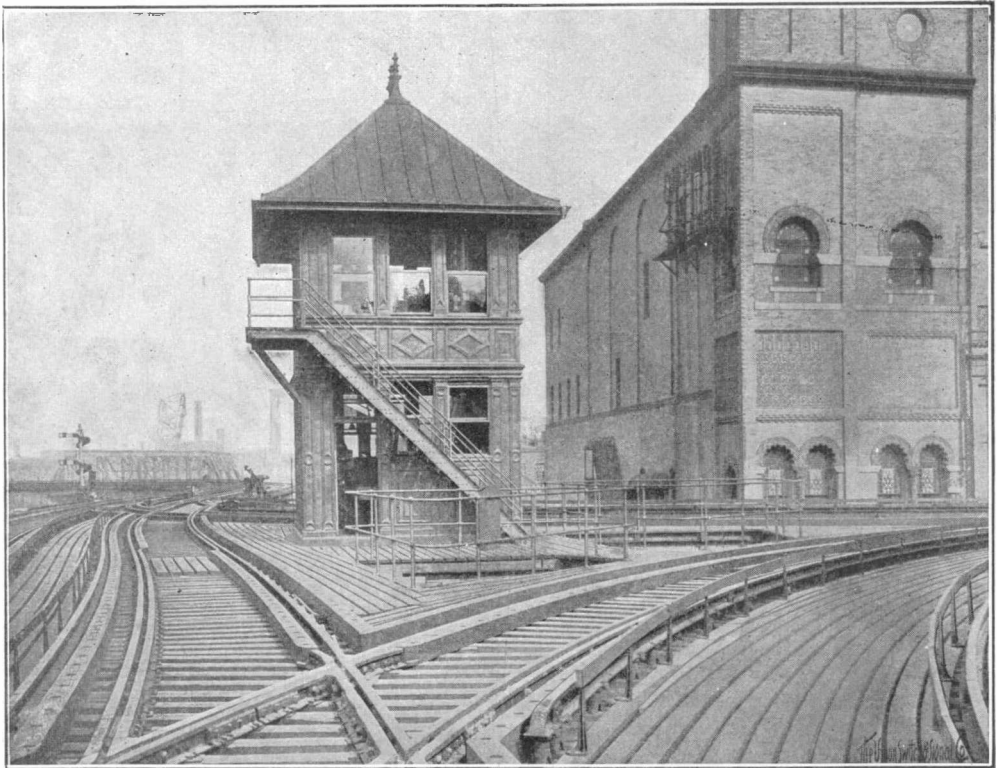

FIG. 25. INTERLOCKING PLANT ON AN ELEVATED RAILWAY

of switches and signals operated by levers from a central point or controlled therefrom, are so connected with relation to each other, that in their normal condition a "Stop" signal is displayed to every train approaching the interlocking, and the operator must follow a predetermined sequence in setting up a route for a train.

Interlocking was first introduced in the United States about 1870 and although its progress at first was very slow, yet it was sure, as at large passenger

terminals it was soon found to be an absolute necessity. Without it the excessive cost of keeping men at the switches in the yards, the danger of collisions because of imperfect hand signaling and the necessary delays to guard against these dan-
gers, generally put a serious embargo on traffic. The question of interlocking therefore was one of economy even more than one of safety, and interlocking plants were introduced mainly at terminal yards, junctions, and crossings. At grade crossings between two or more roads it economized in time, fuel and wear, by making it unnecessary for every train to stop before crossing, as was formerly required. As the speed of trains increased, interlocking was found to be of great economy at all points where

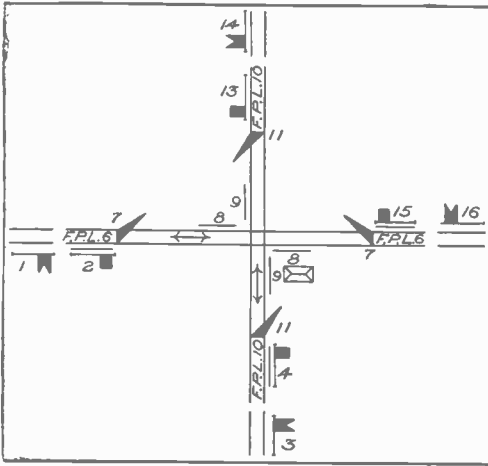

FIG. 26. TYPICAL INTERLOCKING PLAN,
SINGLE TRACK CROSSING

much switching was done, for it obviated the slackening of the speed of fast trains, and our best lines now have interlocking plants at their busiest points.

Practically the first plant that was installed in the United States was placed in service in 1874 on the New York Central and Hudson River Railroad and remained in service until 1888. This interlocking plant, which was entirely mechanical, was very similar to the earlier plants used in England, that country being the birthplace of interlocking.

The Pennsylvania Railroad was also early in the field in introducing interlocking in this country but it sent to the well known firm of Saxby & Farmer, of London, England, for a complete machine, which was placed in service on the New York division in 1875. The following year the Saxby & Farmer Company sent a complete model of their system of interlocking and block signals to the Centennial Exposition in Philadelphia, which perhaps did more than any other

one thing to acquaint railroad officials in this country with the systems of interlocking and block signals which were then extensively used on the European railroads. Soon after this the elevated roads of New York were built and at the most important points interlocking plants were installed. In Fig. 25 is shown an interlocking plant on an elevated road.

The layout of a simple interlocking plant such as ordinarily exists where one road crosses another at grade, showing the arrangement of signals, derails, etc., is illustrated in Fig. 26. When a train approaches a crossing and is to proceed, then, in order to display the proper signal, it is necessary for the operator to move certain levers in their predetermined sequence. It is not in his power to display "Proceed" to any train without locking the levers controlling the signals and derails on tracks having conflicting train movements, and the "Stop" signals remain displayed to trains on all other tracks and cannot be changed until the above train has moved beyond the interlocking plant, after which it is first nec-

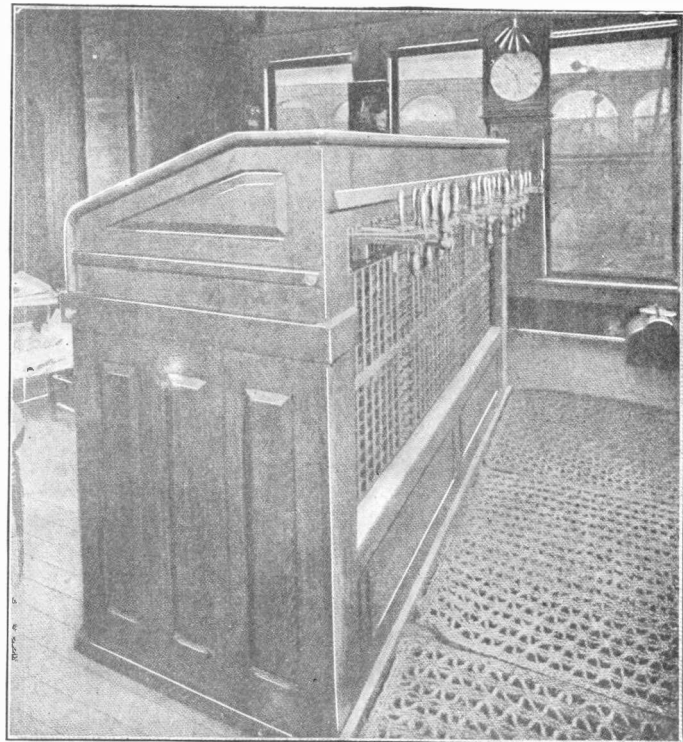

FIG. 27. ELECTRIC INTERLOCKING MACHINE

essary for the operator to restore the "Stop" signals on the route which has just been in use, before he can set up a clear route for any other train.

Interlocking plants extend their operations out on each track to a point at which a "Distant" signal is displayed to an engineer of an oncoming train, to remind him that an interlocked crossing is about half a mile ahead, and that he must stop or "Proceed Under Caution" as may be indicated by this signal. The "Distant" signal is the one with the fishtail blade, and shown in Fig. 26, as being the ones located farthest from the crossing. The "Home" signal which is used to verify the "Distant" signal is placed about 500 feet from the crossing and just ahead of the derail as shown, so that should the engineer disregard both the "Distant" and the "Home" signal, his train will be derailed in order to prevent it from colliding with another train at the crossing.

This derail which is a form of a switch, disconnecting the main rail, is so interlocked with the other levers of the interlocking machine that it will be set to derail a train when the signals show "Stop," and it is impossible to change the signals to show "Clear," without first closing this derail so as to make the main line track continuous.

In order to prevent the man in the interlocking tower from throwing a switch under a train after it has passed the "Clear" signal and entered within the interlocking limits, steel bars of about 50 feet in length, called "detector" bars are placed so that the wheels of a train will prevent the tower man from raising this bar which in turn will prevent him from throwing the switch. Detector bars are still used on most of the mechanical interlocking plants, but other methods have superseded this where traffic is heavy.

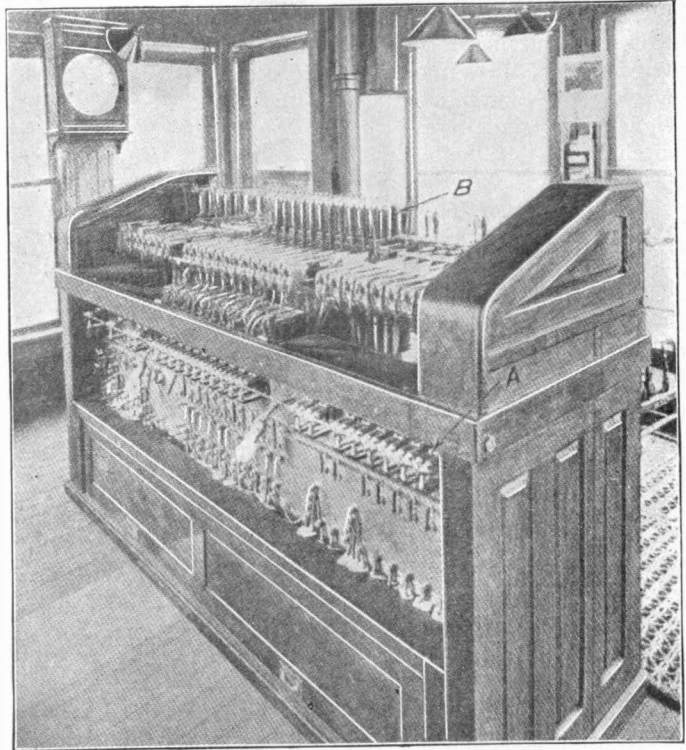

FIG. 28. BACK VIEW OF ELECTRIC INTERLOCKING MACHINE, CASE REMOVED

The next step was "Time Locking," which consisted of an arrangement making it necessary for a certain time to elapse before signals which were set at "Clear," could be changed to "Stop." This allowed the train ample time in which to pass through the plant. However, as the traffic and speed increased these methods became unsatisfactory, and it remained for the "Electric Lock" to solve the problem as to safety, speed and reliability. It is here that the track circuit again performs an important duty in conjunction with the electric lock. With this combination when a clear route has been given to an approaching train, the apparatus passes beyond control of the man in the interlocking car so far as moving of the switches is concerned while the train is within the limits of the interlocking plant. The signals, however, can be set to "Stop" position at any time, as it may be necessary to protect a train within the interlocking limits from following trains.

The fatigue incident to working mechanical levers at a busy interlocking plant is

often severe, so that if the plant is large, it is sometimes necessary to employ quite a few men on each of the three shifts of eight hours each. Further, the distance at which signals, switches, etc., can be operated mechanically, is limited. Thus as the interlocking plants grew larger it became necessary to operate them with some kind of power. Power operation of switches and signals, generally termed "Power Interlocking" first came into use with the electro-pneumatic block signals. Although a great deal of success was attained by the use of compressed air controlled by electromagnetic valves, still the system was not flexible enough. The moisture in the air condensing in the pipes would freeze in cold weather and often interfere with the proper working of the plant. Furthermore, this called for two kinds of power and consequently tended to complicate conditions.

Again it remained for electricity to solve the problem, and "All Electric" interlocking plants were built, and at the present time more of these are being installed than of any other kind of power interlocking. Of course the mechanical interlocking plants outnumber by far any other type of interlocking plants, in that they are most economical in first cost and maintenance for points not having heavy traffic. The "All Electric" interlocking plant did not come into general use until about 1900, but it is now rapidly supplanting practically all other forms of power interlocking plants. In Figs. 27 and 28 are shown two views of an electric interlocking machine as used on the electrified portion of the New York Central and Hudson River Railroad.

It is hoped that this article together with the foregoing ones will serve to give the reader who is not familiar with the subject of block signaling or interlocking, some idea of the reasons for the existence of this extensive and highly interesting art. The subject of signaling now engages the attention of some of the best engineering talent, and the signal companies of this country are employing millions of capital; part of which is appropriated for the solution of new problems which arise from day to day. Their engineers as well as those of the railroad companies have met and are meeting innumerable intricate problems with brilliant success. In the comparatively short period of development in the field of signaling, a great

deal of ingenuity has been directed towards the development and improvement of apparatus to a highly scientific stage, and has been probably carried further than actually justified by operating conditions. There is now a general feeling in favor of simplifying the art and creating a more popular interest in this work, all of which will in turn encourage better and broader development.

(The End).

New Fire Alarm System

A new system of fire alarm to send in an alarm when fire starts in a building, and do this while the fire is in the "water bucket stage," as insurance men say, has been patented. The system is based on the principle that air expands when heated. The air alarm portion consists of a small hollow wire or copper alloy, one-eighth of an inch in diameter. To protect this hollow wire if cut or injured, a tiny insulated wire conductor is run in it. If the hollow wire is cut or broken, the electric circuit in the little wire is broken and a "trouble alarm" is sent to the alarm company headquarters, fire headquarters hearing nothing about it.

Loops of the hollow wire are strung around the ceiling or concealed behind molding of the rooms, houses or buildings to be protected, the loops ending in a detector which is a disk containing a diaphragm.

If a fire starts in the room the air in the hollow tube expands suddenly, pushes against the diaphragm and sets off the fire alarm box. In case of a slow change in temperature the diaphragm is not affected as a small hole into the air chamber allows the air pressure in the wire and room to equalize. Sudden expansion of the air such as a fire would cause, however, actuates the diaphragm.

With the "thermostats" now in use the air about the thermostat must reach an extreme temperature of 160° F. before the solder melts and causes an alarm. The new system would work promptly even if the fire started in a room at zero temperature.

A recent consular report from Shanghai, China, gives the wages of Chinese electricians as 40 cents a day in United States currency.

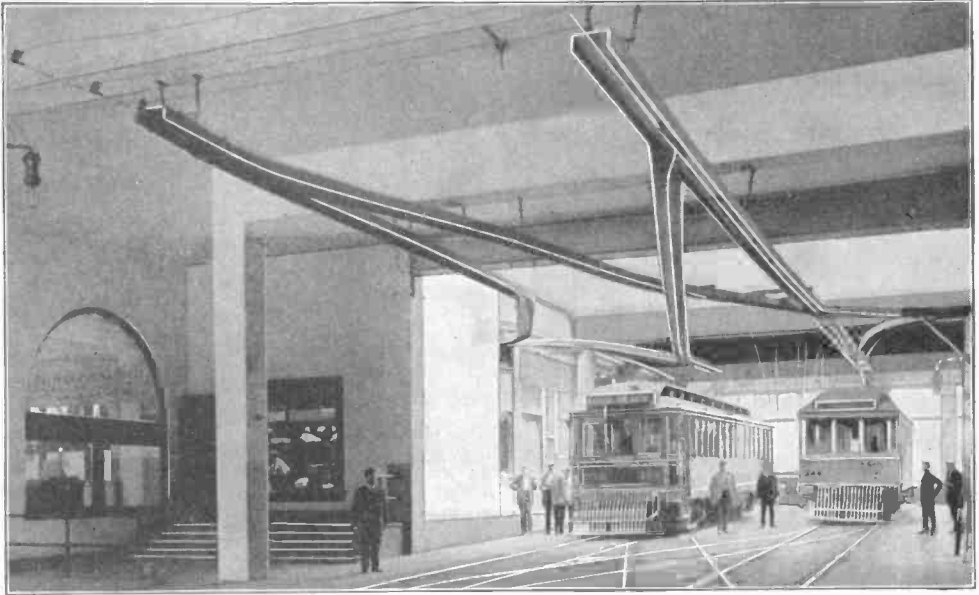

AUTOMATIC TROLLEY REVERSER

Automatically Reversing the Trolley

An ingenious switching device is used in the Los Angeles, Cal., depot of the Pacific Electric Railway. Trains are allowed from three to five minutes to get in and out of the depot, and often consist of four or five cars. The switching device saves time by turning the trolley automatically with the movement of the car. Inverted troughs are arranged like a Y switch, as illustrated.

These troughs are lined with sheet copper which is connected to the trolley wire; the wheel therefore receives current from any point on which it may bear while moving in the trough.

When the motion of the car is reversed, the Y trough forces the trolley wheel to the end of the Y until it is at right angles to the car and the further movement of the car draws it back through the other branch of the Y, finally restoring it to the trolley wire, but in the opposite position.

Battles with Dust and Snow

One of the problems of street railway companies is to keep the roadbed free from dust in summer and clear of snow in winter. A McGuire-Cummings car designed for both seasons without much modification is here illustrated. The snow plow can be readily removed, while the car serves as a sprinkler during the summer. When heavy snow comes the weight of the water tank makes the car heavy enough to give it sufficient tractive force to plow through the drifts.



COMBINED SNOW PLOW AND SPRINKLER CAR

A "Conversational" Subway

By C. B. EDWARDS

Within the next few months there will be opened a "Conversational Subway" which, regardless of snow, sleet or hail, will transport through a continuous wooden conduit over 300 miles in length the voices of 99 individuals at the same time. In addition, the same underground route allows 296 telegraphers to send messages while the 99 individuals are telephoning. Those who have had "party line" service would undoubtedly consider it enough to have 99 receivers clicking off the hook without almost 300 telegraph operators "hanging on the line."

Making the final and important connecting link between the cities of Washington, Baltimore, Wilmington, Philadelphia, New York and Boston, this new undertaking is nothing more or less than a lead covered cable containing the copper conducting wires and measuring less than three inches in diameter.

New York, Boston, Philadelphia, Chicago and Milwaukee have tasted of the advantages of underground telegraphic and telephonic service and for several years past, resulting in uninterrupted service year in and year out. Not until the winter of 1909 however, was it fully demonstrated that the underground conduits were so vastly superior to the aerial wire stringing in point of service. During the inauguration of President Taft in Washington, a fierce blizzard sprang up which quickly put a stop to all railroad traffic; all communication by wire was paralyzed at once and the peculiar combination of sleet and cold tore down mile after mile of wire by sheer weight. Add to this the effect of a 30 or 40 mile gale and some idea of the widespread havoc wrought may be gained. Communication was not only impossible for the present but prospects for the restoration of the service within less than a week were not good, as was subsequently proved. Meantime no news of the inauguration was possible to the outside world and not until the wireless telegraph was called to the aid of the press did a single bulletin arrive at the newspaper offices of the big New York dailies. The

blizzard registered no effect on the underground conduit service afforded between New York and Philadelphia, and their communication went on uninterrupted.

To provide against the recurrence of such a contingency the American Telephone and Telegraph Company decided to connect Philadelphia to Baltimore and Washington and give perpetual communication between these great centers of commerce and population. To carry through this plan meant the digging, conduiting, and covering up of over 100 miles of telephone cable. The enormity of the task before the great organization was evident, but with system and the aid of the best engineers the work has gone steadily forward till the end of this part of the undertaking is already in sight.

It should be remembered that laying a telephone cable is not simply a matter of reeling off the requisite length as a cable ship would do and burying it under a few feet of earth. First the route must be surveyed, then after the ditching has been staked out in the wake of the surveyors the laborers are put to work and a trench varying from four to five feet in depth, according to the soil conditions encountered, opened. The next part of the procedure is to level up the ditches and lay the wooden conduit pipes. These pipes, termed pumplogs are laid four side by side in the trenches and the earth filled in over them. When this has been completed, manholes are located at intervals of 500 feet and the telephone cables drawn through and spliced.

As the manholes are the only means of access to the cables once they are laid they assume great importance in a work of such magnitude and consequently much planning and designing was put on this feature of the job alone. Over 1000 of these manholes or "splicing boxes" were required and the concrete type with expanded metal reinforcement was designed especially for the task in hand.

To provide cement material for manhole slabs, concrete posts, and other special

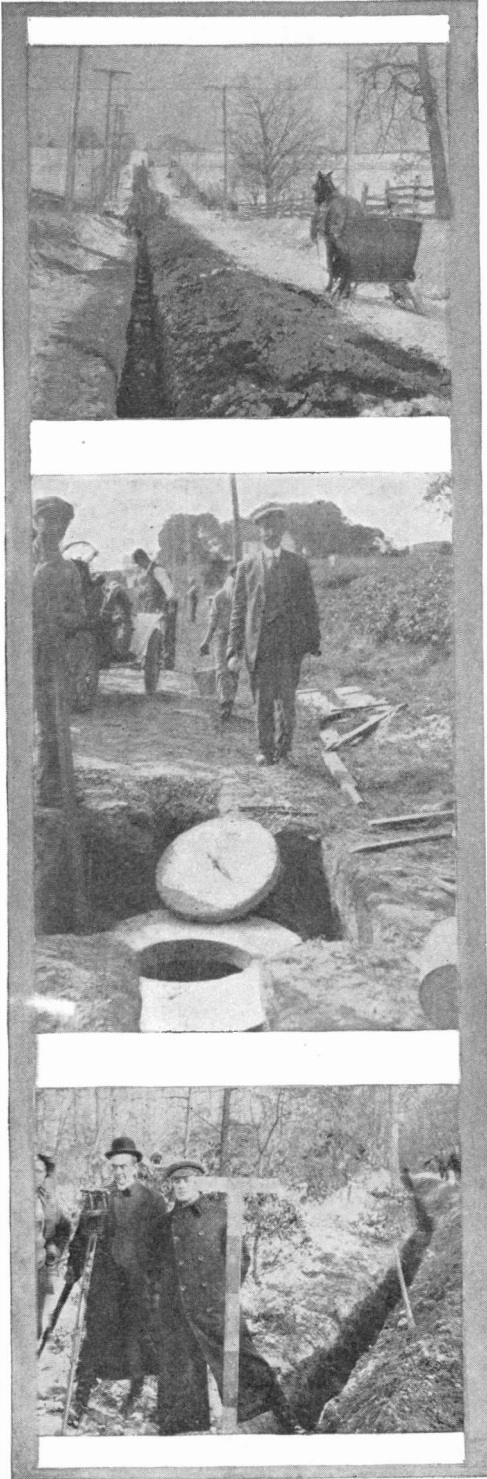

PUTTING THE WIRES UNDER GROUND

work, a large concrete plant was established at Baltimore especially for this purpose. It was found necessary for this concrete plant to put out material for 25 manholes each day to keep up with the steady advance of the three gangs of men laboring on the same work in three separate states. From this number of manholes constructed each day it is possible to gather some idea of the speed with which the work was carried forward by the combined construction forces. Putting in manholes at intervals of 500 feet and building 25 each day would show that the work was carried forward at the rate of 2.3 miles a day including stream and bridge crossings. As four conduits are laid side by side in the trenches over nine miles of conduit was laid each working day.

Between Wilmington, Delaware, and the District of Columbia, 50 bridges were crossed, each bridge presenting its own peculiar difficulties to the crossing of the conduits by hangers under the structure or, where this was not possible, by nailing the four wooden pipes containing the cables to the floor. In every case the cables were thoroughly protected and the average individual crossing one of the bridges over which the cables will soon carry their countless messages would scarcely realize that the innocent looking creosoted wooden box contains several hundred connections between New York, Baltimore, and Washington. Even one maliciously inclined to cut off all communication would find it no easy job to go through the wood coverings and the steel armor which protects all the cables wherever they are exposed to view.

The cable proper, while presenting the same external appearance and dimensions as the present cable between New York and Philadelphia, is quite different from any cable hitherto installed. The copper wires are larger and so arranged that from each two pairs of the large gauge wires it is possible to secure three complete telephone and eight complete telegraph circuits. There are, in addition, a number of pairs of smaller wires contained within the lead sheath which are intended for the toll service between the intermediate cities along the route although they may be used for telegraph service with equal facility. At intervals along the cable the wires are sup-

plied with "loading coils," the recent invention of Prof. Michael I. Pupin of Columbia University, and described in the May issue of POPULAR ELECTRICITY. They tend to do away largely with the sounds which interfere with distinct telephonic communication for long distances.

An interesting feature of the laying of this cable is that as each of the three sepa-

rate construction forces are rapidly drawing closer and closer to the points of final connection they are traversing the exact route which was chosen by Prof. Morse, the father of the telegraph, for an underground telegraph line between New York and Washington when "chained lightning" was in its first stage of taming to the services of man.

Testing Grain Stalks With a Saw

By ALBERT SCHEIBLE

Few problems are more vital to the welfare of the grain raiser than that of guarding against loss by the ravages of insects

exterminating the parasites and by determining what varieties of plants will best withstand their attacks. That there is a decided difference in the power of resistance of different species of the same cereals to the devastating insects or fungi was known some 50 years ago; but with the continual

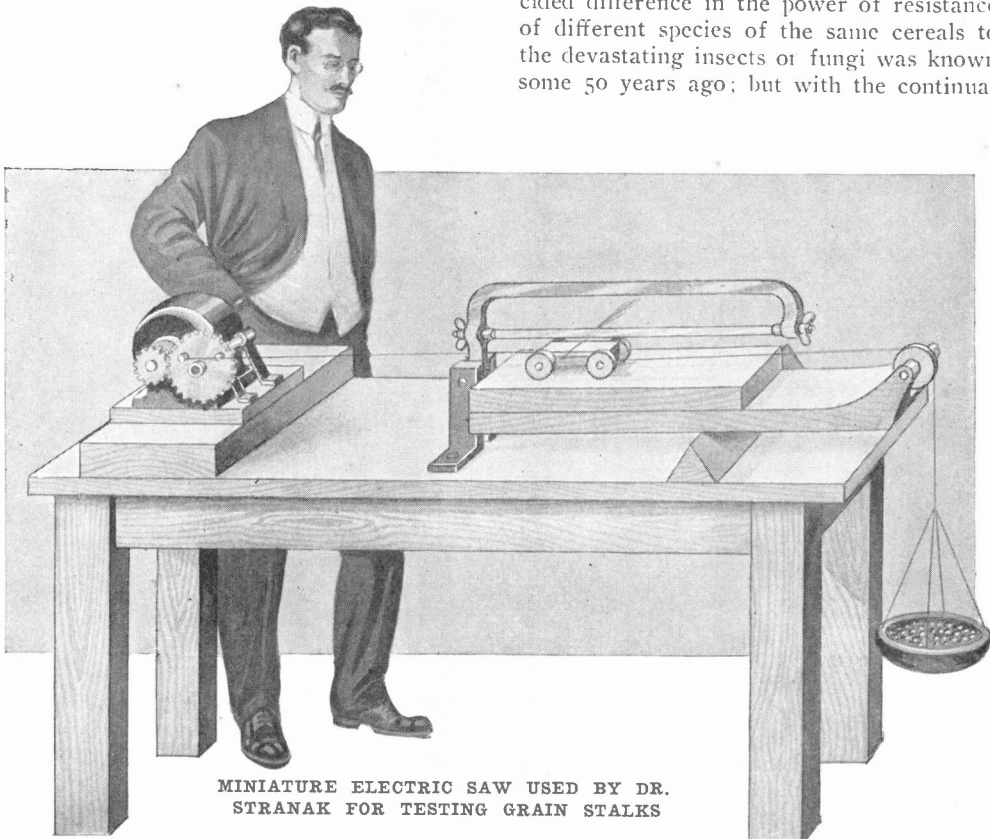

MINIATURE ELECTRIC SAW USED BY DR. STRANAK FOR TESTING GRAIN STALKS

and of parasitic fungi. All over our country the various agricultural experiment stations have for years been endeavoring to reduce these losses, both by finding means of

developing of new varieties and the changed conditions met in different localities, there still is much to be learned as to their comparative powers of endurance. In basing

such comparisons on actual records of the percentage lost through such causes during a season, it may take several years to show definite conclusions and by the time these are reached the varieties tested may have proven unpromising for other reasons. If there was some way of determining in advance the susceptibility to the devastating influences much time and loss might be saved.

One way of making such an advance comparison would consist in noting the difficulty of penetration of the various stalks, for the insect which would harm the cereal must first bore through the surface of the stalk or scratch it away. So, also, the spores of fungi (such as the so-called "rusts"), after being blown against the stems, must get a hold through the outer protecting layer. In either case, the toughness of this outer layer should indicate its probable resistance to the ravaging influences.

Reasoning along this line, Dr. Fr. Stranak of the Bohemian High School at Prague has built a miniature electric saw with which he can compare the stalks of different cereals. Unlike our usual power-driven saws, the saw itself is not driven back and forth in Dr. Stranak's arrangement, but the little carriage on which the stalk rests is drawn to and fro under the saw by an electric motor. The runner on which the carriage travels is pivoted on a sharp block and tilted more or less by varying the weights put into a pan at the end of a string attached to the carriage. Of course the saw itself has exceedingly fine teeth, too fine to cut the stalk at all unless somewhat pressed against it, and the weights needed to secure this pressure show the comparative toughness of the stalk, or at least of its protective coating. Tests made with this apparatus have already shown that Dr. Stranak was right in assuming that the greater the weight required to make the saw cut stalks of a given size, the better the resistance of the stalk to fungi or insects. For instance, figures on seven different varieties of wheat stalks show that these withstood the ravages of the wheat fly during 1910 in substantially the same ratio as that of the saw pressure required to cut them, so that the clever Bohemian professor's miniature saw ought to prove a great time and money saver for those interested in testing and raising cereals.

Windmill Plant of an Old English Church

Probably one of the most novel methods of providing lighting for a church is that employed at the old Coseley Church situated a few miles out from Birmingham, England.

About 600 feet from the church is the

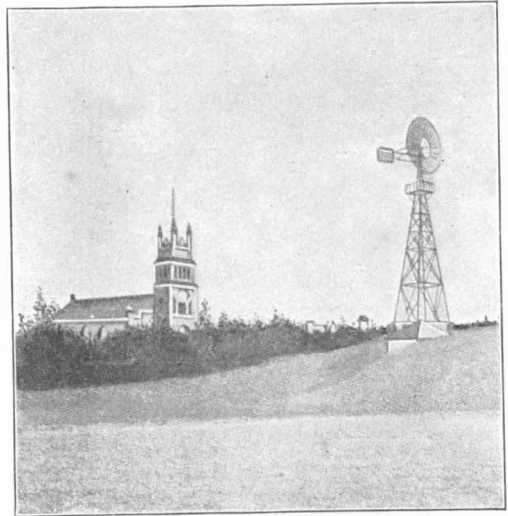

OLD ENGLISH CHURCH AND ITS WINDMILL PLANT

mouth of a disused coal mine around which are huge piles of tailings. Upon one of these a steel tower 60 feet high is erected and a windmill eighteen feet in diameter installed. At the base of the tower in a small house is an electric generator which is run by the mill. The current thus generated feeds 27 lamps in the church, two in the chapel, two in the vestry; operates a motor for pumping the pipe organ and also lights 30 lamps in the rectory. A storage battery in the rectory is a part of this unique lighting plant.

Platinum Makes Gold Seem Cheap

The demand for platinum in the electrical industry, together with the requirements for it among jewelers, dentists and photographers, have caused the price, according to recent quotations, to go to \$43 an ounce for hard metal or the alloy with the metal, iridium. This price for platinum makes gold a cheap and common metal, the latter being worth \$20.67 an ounce.

A Three Color Stereopticon

With the development of the electric projecting arc and the high power tungsten lamp, new fields of usefulness have been opened to the stereopticon. This has naturally led to perfections in the stereopticon itself, not the least important of which is the recent invention of a Frenchman by the name of Andre Cheron who has developed an electric color stereopticon and camera combined. By the use of this outfit three different negatives are used as slides and projected on the same spot on the screen.

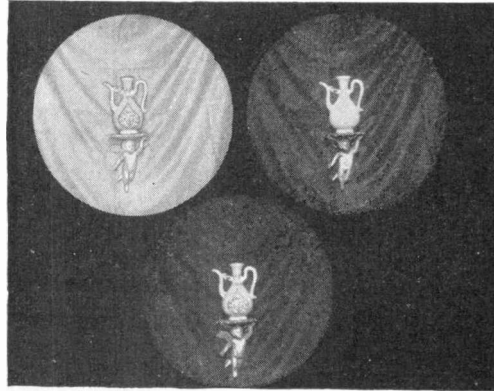
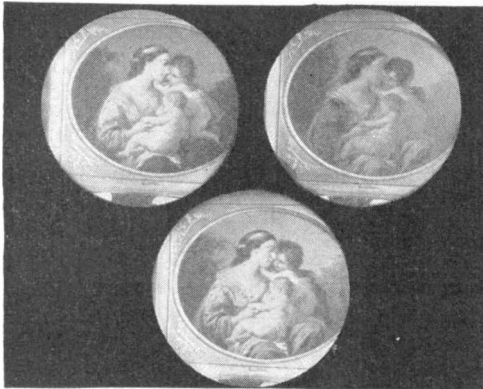
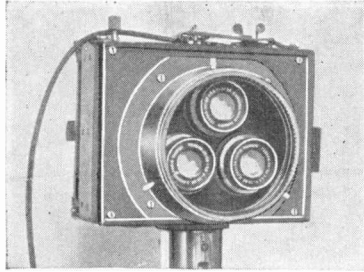

In the projection of the pictures on the screen the principle followed out is the same as that employed by the photo engraver who makes the color plates for magazine covers, etc., which are printed by the so-called three color process. There are three primary colors used in this kind of printing—red, blue and yellow. The engraver makes three cuts of a picture, one to bring out the yellow, another the blue and a third the red features of the picture. These are worked up with great care and shaded off to almost nothing at some points and left strong at others. Then the printer takes the three color plates and makes three impres-

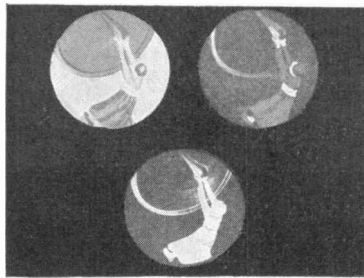

THREE COLOR STEREOPTICON
AND SOME OF THE LAN-
TERN SLIDES

sions on the paper, one on top of another. Those parts of a yellow and a blue plate, for instance, which overlap in printing leave a green; blue and yellow mixed as is well known, makes green. Similarly yellow and red make orange, blue and red make violet, etc. Consequently, when properly made the three plates may be made to print almost any color or shade desired.

Now, coming back to the stereopticon. When the negatives are taken, using the device as a camera, what are known as achromatic lenses are used in the three openings in conjunction with what are known as colored

screens or filters, so that the rays of light from the copy are screened or filtered before reaching the sensitive plate. Three negatives of an object are thus taken on a single plate. One negative will then be taken of the yellow rays, only, all others being filtered out by the corresponding lens and color screen "violet." The second negative would be taken of the blue rays,

only through the orange filter, and the third of the red rays through the green filter.

After development a positive lantern slide may be made from the three negatives giving what appear to the eye to be three

black and white images, but with different degrees of shading in each. Some of these are shown in the illustration.

Now, using the camera as a projector, an arc or tungsten lamp is placed behind the positive slide and the projector automatically focuses the light, through the three positives and their respective openings, upon the screen, the images being superimposed upon each other. Each positive allows light of only one color, red, blue or yellow to pass through and the resulting picture on the screen is the result of the three colored projections, giving all the shades and tints which could be obtained by the three-color printer with his three plates.

Electric Power Wagon

The startling spectacle of two or three repair men apparently bearing down upon the observer on stilts, and that, too, at automobile speed, may become a common sight when double-deck electric tower wagons come into extensive use. The one shown in the picture is used by the Philadelphia Electric Company for repairing arc lamps and other line work.

This wagon is the only one ever built which may be operated either from the usual driver's seat, or from a seat which is 13 1-2 feet above the ground. The driving mechanism is so arranged that from either position the driver may control the vehicle perfectly as regards steering, applying power, brakes, etc.

The vehicle is equipped with platform which may be readily swung to either side of the vehicle extending six feet from the center of the tower. By use of this, the driver is enabled to trim not only the lamp close to the curb, but the inside lamp as well. The bridge in any position will carry at the extreme end 700 pounds without any perceptible deflection.

This car, which is a Commercial truck, electric driven, has proved satisfactory regarding reliability and economy. Roughly speaking, this economy is obtained by the fact that it is operated by one man, thus eliminating the man formerly required to hold the horse while the trimmer worked on the lamps. The Philadelphia Electric Company asserts that it actually does the work, with one man in 33 1-3 per cent. less time

than was formerly required with a horse, wagon and two men.

There is a further saving by the vehicle as regards inspecting and correcting of faulty lamps. This work was formerly done by an inspector with a motorcycle, who, after making a list of faulty lamps instructed the driver of the horse tower



ELECTRIC
TOWER
WAGON

wagon as to their location. Inspection is now done by the tower wagon, again eliminating a man and the motorcycle. This inspection and correction of lamps is accomplished by the electric vehicle in 3-5 the time formerly required by the horse and motorcycle method.

The Stavanger Elektro-Staalverk Bolaget is the name of a new company which has been formed at Stavanger, Norway, with a capital of \$120,000, to establish a plant for the electrical production of steel. The plant will have an annual capacity of 3,000 tons, and will be mainly devoted to the production of steel for shipbuilding purposes.

He Wanted the "Tellingfoam" No More

Mr. A. S. Hibbard, until recently general manager of the Chicago Telephone Company, vouches for the authenticity of the following letter, which was received by the company's Elgin manager from a subscriber on a farmers' line some distance from that city. The letter, as printed, was not altered in any way and is an example of unpremeditated humor. Here it is:

"Dear Sir: Latest month Im tell it the manager I no want the tellingfoam no more. Before she had it the tellingfoam I have



"VEN DE BELL TINKLES, I TAKE DER HOOK OFF DER NAIL"

some repairing men from Elgin for dinners or supper, but she is not satisfaction with the too much little salarie from the company she take the repairing men for boarding, so I make it no cent no more.

"Latest month I pay \$2 at charges and I owing only 45. I tell her if some peoples tellingfoam from hotel let them know it, Now she coming with 50c toll for what it is I dont know. I want no paid it to take the tellingfoam out or shut open the connection. I wont no paid this month anyhow.

"I notification her 16 days.

"It is better you look in the matter. I no sure no body in mine house tellingfoam this month.

"I never use him.

"I tink minselluff this a robber and a tief business. Anny how it makes me a damn nonsense and troubelings. Ven der pell tinkles I take de hook off der nail and I listen to none of my business. Some neighbors, foolishness women telling questions about a new sunbonnet she yust bought but dident pay for it yet or maybe else one says for a hollufah hour 'I dink its going to rain Mrs. Smith is going to soon have it a new Gas stove mit leaks in it. I dont know vich aindt it.'

"Dere is too much expenses and rubber-necks connected mit tellingfoams. Come vid a ax and unscrew it from de vall off or I kick it in der faces. I am shust mad mit angriness about der whole damn bizziness.

"Yours truly, Good day."

Largest Storage Battery in the World

The Consolidated Gas, Electric Light and Power Company of Baltimore, Md., will install an enormous battery to be used for emergency service—the largest in the world.

This battery will consist of 152 cells of the "Exide" type, each cell containing 133 plates. Each of the 152 lead lined wooden tanks will measure 4 feet 2 inches in height, 21 $\frac{3}{4}$ inches wide and 6 feet 6 $\frac{7}{8}$ inches long, and will weigh, without plates or electrolyte, 940 pounds. The total weight of the entire battery equipped with plates and electrolyte, when ready for service, will be approximately 1,079,200 pounds.

This battery, when fully charged, will supply sufficient electric current to light 120,000 twenty-five watt tungsten lamps for one hour or 240,000 such lamps for 20 minutes, having an output of 4,000 horse power.

According to reports from Berlin, Drs. Leimbach and Loewy have succeeded in sending wireless telegraph messages underground between the potash mines in the North Harz Mountains over a distance of about one and one-half miles at a level of 1600 feet below the surface.

All In a Day's Work

Here is a 240-foot Great Lakes steamer tied up at the docks of the Inland Steel Company at Indiana Harbor. She carried a load of 1,960 long tons of pig iron. At 7:35 a. m., or 20 minutes after docking, two lifting magnets were at work unloading the cargo onto the dock. Viewed in the larger picture, these magnets do not appear to be equal to the task. One would imagine that it would be like emptying a barrel of salt a pinch at a time. Yet by 5:35 p. m. the same day the whole cargo of 1,960 tons had been deposited on the dock in this manner. The total number of lifts for the two magnets was 1,281; the average load per lift was 3,427 pounds.

This remarkable record was made with lifting magnets of the Cutler-

Hammer "Mississippi" type, so called because the first application of this particular type was in fishing up a boat load of nails, barbed wire, etc., from the bed of the Mississippi River not far from New Orleans, La.

The smaller illustration gives a good idea of the size of one of these magnets with its load of over a ton and a half, consisting of heavy chunks of pig iron.



SHOWING THE SIZE OF A LIFTING MAGNET AND ITS LOAD



LIFTING MAGNETS MAKING A RECORD

Street Lights on Mission Posts

Riverside, one of the most beautiful cities of California, has set a good example in adorning its thoroughfares with electric light posts in keeping with the "City Beautiful" idea, and at the same time reminiscent of the historical traditions of the town. These street lights are designed on the lines of a belfry, such as was installed by the

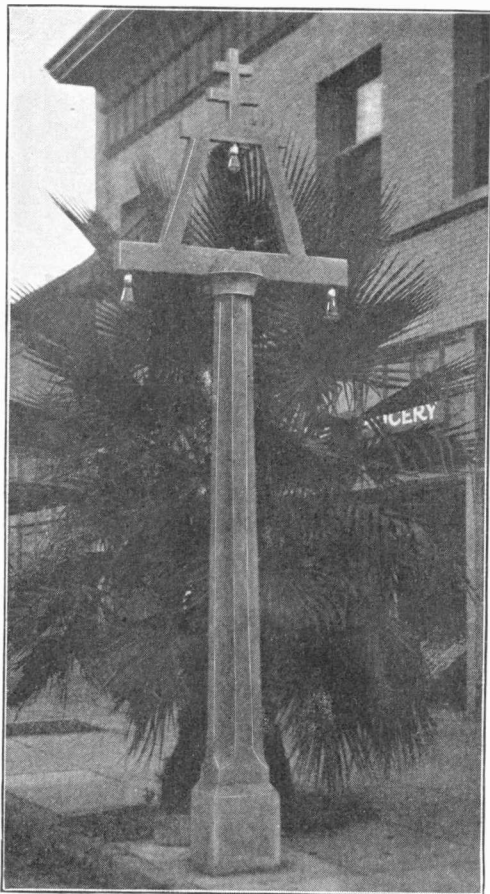

MISSION LAMP POST

Padres in their missions when they made the first white settlements in the Southwest. The cross carries three tungsten bulbs, as shown in the cut. The posts are of reinforced concrete and of exceptionally graceful design, the shaft rising from a twelve-inch square base and tapering as an octagon, the alternate sides of which are concave. Unlike the cast iron lamp posts which they supplant, they harmonize with their surroundings, the palm trees along the

curb forming a pleasing background that offers the right contrast in line and color.

Trains that Carry Electric Plants

During the past few years there has been a marked effort on the part of the railroads to light more trains by electricity. Explosions of illuminating gas and fires caused by dripping oil lamps were the direct cause of this movement towards electric lighting.

The chief dangers of gas and oil for train lighting exist in time of serious wrecks. Time and time again the old oil lamps have overturned, scattering inflammable oil about and setting the train on fire. In cases where the cars are overturned and twisted about, the gas tubes and pipes have broken, causing serious explosions and the fires started by the gas lamps quickly follow the trail of leaking gas throughout the train.

The Chicago, Burlington & Quincy Railroad has equipped all its through trains with electric lighting, 67 of the best locomotives being equipped with Curtis turbo-generators. These little steam turbines, which whirl small but powerful electric generators, are mounted on top of the locomotive boiler and take up so little room that they are hardly noticeable. Each turbine secures its steam from the main boiler. As all the coaches are wired and fitted for electric lights all that is necessary in making up the train is to lock the cable connections between the engine and the first coach, an operation that takes but a second or two.

Plant for Fixing Nitrogen

The Pauling process for making nitric acid by the fixation of atmospheric nitrogen is being applied at a new plant in La Roche, France. Electric energy for the process is developed from waterpower by four turbo-generators of 2,000 horsepower each. The furnaces are arranged in groups of three, and each has two electric arcs in series.

The air is preheated and compressed before entering the furnace. On leaving it, the gases have a temperature of about 1,000°C. and contain from 1.1 to 1.5 per cent of NO. On cooling the latter reacts with the oxygen to form NO₂, or nitrogen dioxide. This is absorbed by the water in absorption towers through which the gases pass.

Turbines Reduce Station Cost

One effect of the development of the steam turbine has been the increase in size of electric units for central stations. It is now possible to install generators of from 15,000 to 20,000 kilowatts, which is more than double the size formerly possible with reciprocating steam engines. Consequently, a station of a given capacity can now be built on about half the ground once required.

Motors Adjust Big Telescopes

Had the astronomer in his search for new stars and comets to adjust the telescope by hand his work would be most laborious, and distract too much from his study of distant worlds. In the Observatory of Treptow-Sternwarte, Germany, all of this adjusting is done by electric motors.

A strong motor below the heavy base swings the structure and telescope horizontally, while a smaller one raises and lowers the tube with reference to the horizon. As the earth turns, the star or constellation in the field of the telescope would gradually move from view, but a small motor running at the proper speed moves the end of the great tube backward just fast enough to compensate for the earth's rotation. Control of this complicated mechanism is within easy reach of the observer as he stands at the lower end of the great magnifying glass.

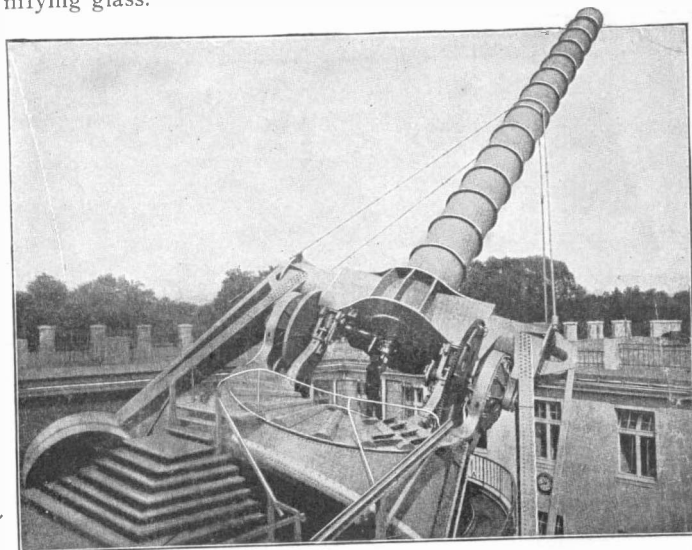

THE TREPTOW-STERNWARTE TELESCOPE

Heat as the Family Doctor

A dry, steady warmth applied in the right place is often the greatest help in re-

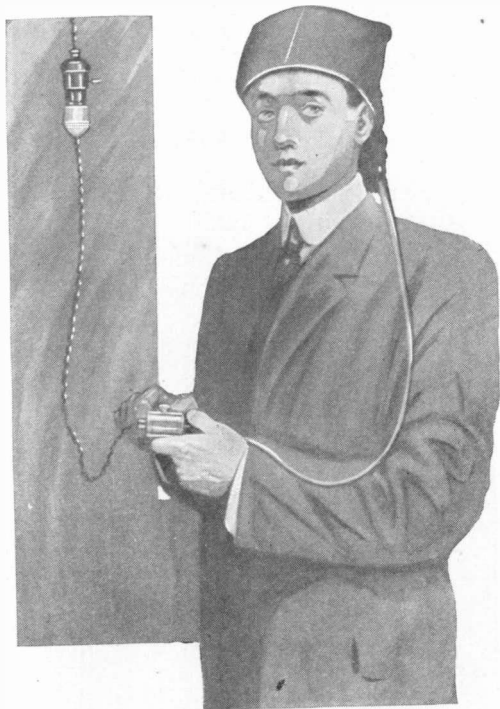

THE ELECTRIC CAP

lieving pain and treating diseases. Not until the electric blanket was successfully operated did the disadvantages of the hot water bottle, such as its weight, uneven heat and so on become prominent. The electric blanket has passed from the experimental stage to that of a practical necessity. Not only this, but it is made in many different shapes so as to be most convenient for special uses, as for a chest and back pad, cap, collar, sweating jacket, etc. In its soft eiderdown cover the warming pad or blanket is the ideal comforter and the foe of pain. Control is arranged so as to give a low, medium or high temperature by the turn of a switch.

ELECTRIC CURRENT AT WORK

NEW DEVICES FOR APPLYING ELECTRICITY

Herrgott Fabrics

The problem of incorporating an electric heating wire directly into a woolen or other textile fabric appears to be successfully solved by a French engineer, M. Herrgott. In this way he obtained many kinds of

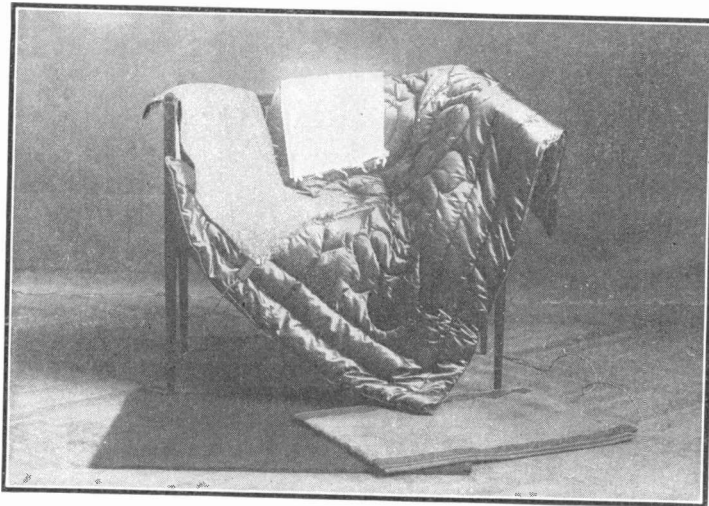

HERRGOTT FABRICS

fabrics which are very well adapted for domestic use, and other kinds can find employment in the industries. What he desired was to produce carpets, covers or knitted fabrics which have all the appearance of the ordinary but at the same time are heated by the electric wires which they contain. Such fabrics will add much to modern comfort and appear to be quite in the line of progress among the growing applications of electricity.

As explained before the French Academy of Sciences, what characterizes this system is the fact that the heating wire is placed in the thread which goes to weave the fabric. This almost invisible wire is, however, so disposed that the usual appearance as well as the flexibility of the fabric is pre-

served. It is to be remarked that instead of using a few wires carried to a high heat, there are as many wires as threads; accordingly the wire is of great length and in consequence needs to be but very slightly heated in order to produce a given temperature. The threads are made of a core of wool around which is wound spirally a special flexible nickel wire. The nickel wire is, in fact, a flat braid made of many fine wires. After

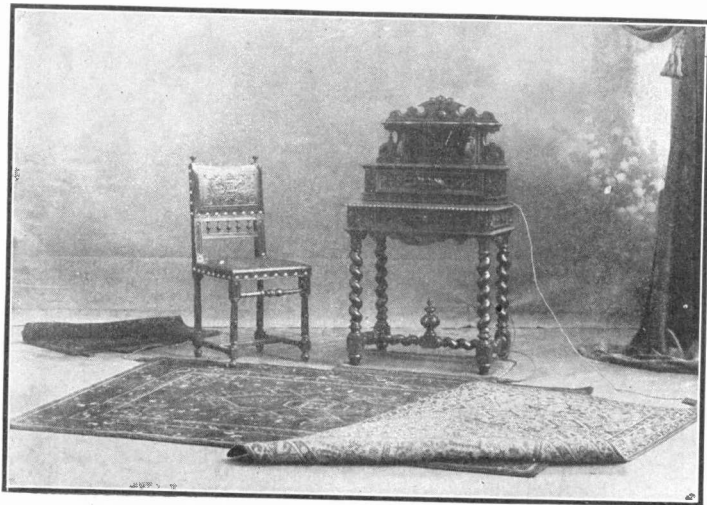

ELECTRICALLY HEATED RUGS

wrapping the nickel on the wool thread a covering of any suitable thread is braided on, wool, silk or cotton, as the case may be.

A flexible thread is thus obtained which can be woven on a loom or otherwise treated as an ordinary thread. The nickel wire is well protected and does not break, as the strain is taken by the textile threads and not by the metal. Such fabric has a high electric resistance and can thus be put at once on a 50 or 100-volt circuit and holds a definite temperature. It might seem inadvisable to press the threads tightly together as in weaving, but the wire has only to heat a minute width of tissue and its temperature need not be high in order to give what heat is needed. The contrary would be true if but a few wires were used. The same applies to the voltage between wires, which is extremely low and not dangerous. Pure nickel is used, as it does not oxidize, and as its resistance increases rapidly with temperature so that it becomes self-regulating.—*Electrical Review and Western Electrician.*

A Stamping Washer

The application of electricity to the operation of washing machines has not only been the means of doing away with "Blue Monday," in thousands of homes, but has also resulted in a broader development of the washing machine itself. After the first manufacturer applied a motor successfully others took up the plan and almost immediately there was great strife among them to see who could get up the most compact and serviceable machine. Old time machines, which were once considered good enough, were overhauled from top to bottom, new wrinkles added, entirely new types designed, until now the noiseless, effortless wonders are almost works of art.

Most of the types have already been described in these pages, but here is a new one which goes under the somewhat fanciful name of the "Home Queen," which deserves mention. This washer operates on the "stamping" principle—it does not rub the clothes. It has rather a long body or tank on the top of which two arms are mounted which

work up and down and remind one of the walking beam of an old-time steamboat. Inside the tank are two sets of stampers which do not interfere with each other and these in treading up and down work the clothes thoroughly in the suds.

A Meat and Food Chopper

The adaptation of the old-fashioned chopping bowl to a modern meat and vegetable chopper is one of the latest developments in electrical kitchen utensils. A motor turns

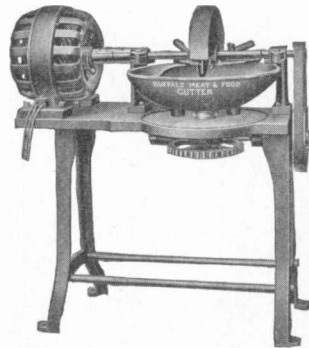

ELECTRIC FOOD CHOPPER

a shaft upon which knives are mounted. As the bowl revolves every position of its contents is brought under the knives, while a sort of plow does the mixing. For hotels and restaurants where large quantities of minced chicken, hash, hamburger steak, etc., are served, the appliance saves time and labor.

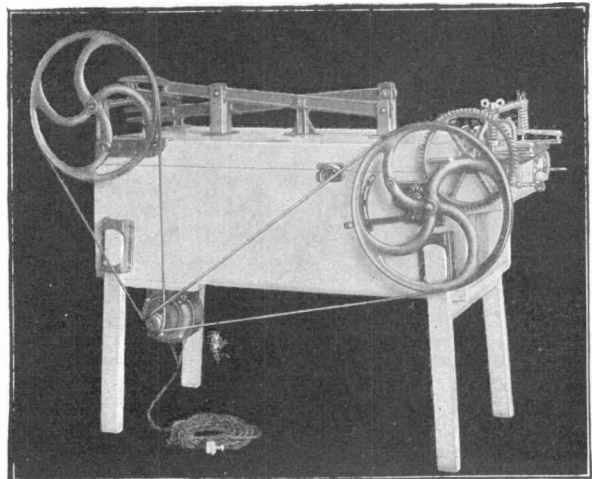

A STAMPING WASHER

Electric Drills

Many have wondered how it was possible to drill holes part way through an iron ring, such, for instance, as shown in Fig. 1. The picture shows how this is done by means of an electric motor driven drill and a flexible shaft, which works the drill. This electric drill is very easily moved about so that one single motor can be employed all over the factory.

Another drill, as illustrated in Fig. 2, is likewise an electric drill to be used on

iron work. Two very powerful magnets hold the frame of the drill against the iron, so that the workman has nothing to do whatever except to feed the drill with the hand wheel and watch the machine do the work.

Fig. 3 shows the electric-magnetic drill in use on iron construction. Any one who has ever had to drill into iron will readily understand the advantage of such an apparatus and how practical it is.

The time will come when all of our tools shall be electrically driven. Then the tinsmith will bring his electric soldering iron

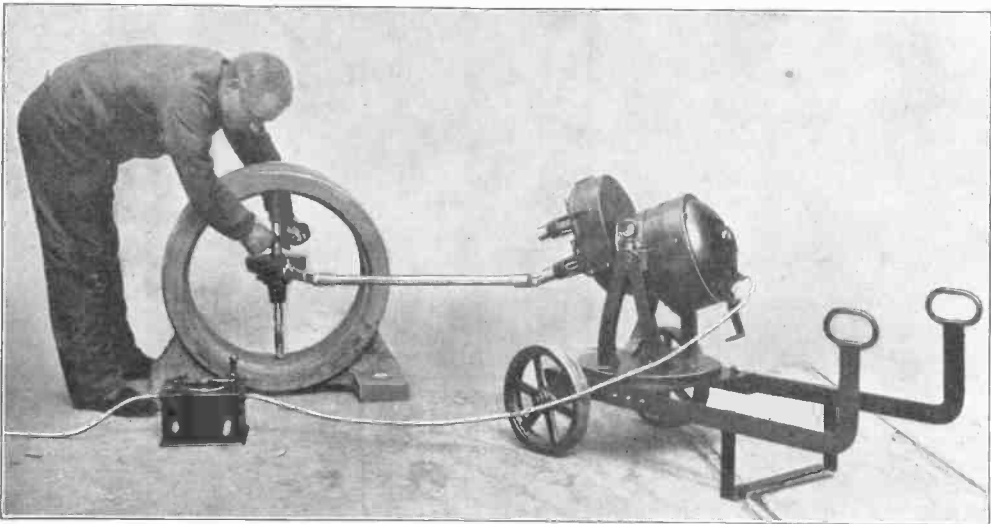

FIG. 1. HOW IT IS POSSIBLE TO DRILL HOLES ON THE INSIDE OF A CIRCLE



FIG. 2. ELECTRO-MAGNETIC DRILL FOR BENCH WORK

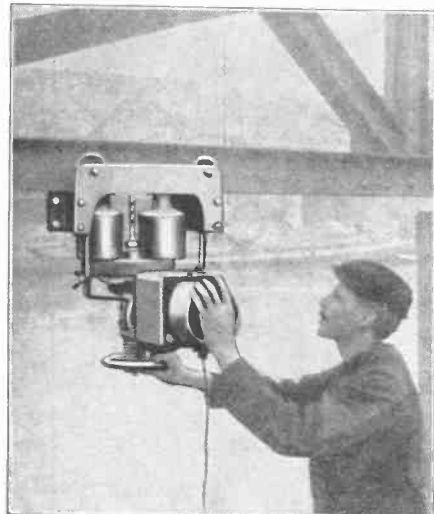

FIG. 3. ELECTRO-MAGNETIC DRILL WORKING IN A TICKLISH PLACE

along with him and plug it to the next current source and run his wires somewhere through a window to the roof for soldering the gutters, etc. The carpenter will bring all his movable tools and use the current wherever he is at work. His motor will be also movable, on wheels, so as to enable it to be brought to and from the work.

A portable or movable motor will be found eventually in every household to do all kinds of work requiring power.—EMILE RUEGG.

Making Rail Bends

Some years ago one of the popular diversions for amateurs consisted in making easles, brackets, lampstands and the like out of thin bands of steel—the so-called "Venetian iron work." Those who enjoyed this will remember the fascination of shaping scrolls and other ends by rolling the strip around forms or by curving it between

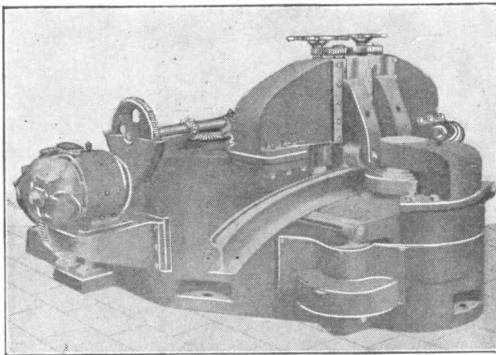

RAIL BENDING MACHINE

round-nosed pliers. The steel used might seem stiff at first, but with power applied in the right way it quickly yielded and assumed the new shapes. Carrying out the same principle on a much larger scale merely means large bending devices and increased power. Thus, our illustration shows how readily a tall, grooved rail, as used nowadays for street car tracks in most of our large cities, responds to the steady but powerful pull of the electric motor mounted at one end of the machine. Two wheels at the top of the bender vary the curve, so as to give any radius that would be practical in modern service.

The Canadian Pacific Railway now dispatches trains by telephone over 2,254 miles of track.

Scrubber and Polisher for Mosaic Floors

The accompanying illustration shows a novel electric floor scrubbing machine at work on a Mosaic floor in the City Hall at Philadelphia, Pa. It was designed for keeping floors of every description clean and polished.

This electric scrubber is one of the most simple labor-saving devices ever invented



POLISHING A MOSAIC FLOOR

for cleaning any kind of floor, and also for polishing waxed floors. It can be operated from any electric light socket and will scrub anything from a common wood or cement floor to the finest polished oak floor without danger of injuring it. Only sufficient water from the tank on the handle is sprayed on the floor to keep the brush working properly, and with the rotary motion and simple manipulation of the machine very little water is left to be mopped or wiped up after scrubbing.

The whole machine consists of a small $\frac{1}{4}$ horsepower motor mounted on a polished

aluminum shell containing a revolving plate, and to this is automatically attached a scrubbing brush or a grinding disk as may be required. All working parts are enclosed within a dust and waterproof case. The gears and ball bearings are noiseless, run in grease and require very little attention.

The weight of the machine is only about 45 pounds and all the parts are made interchangeable, and can be replaced when necessary. It has a scrub brush and soft polishing brush as well as a steel wire brush and sandpaper disk for grinding. It is connected to the electric current outlet by a 25-foot waterproof cable and attachment plugs.

Cleaning Tarnished Silverware

Everyone familiar with the first principles of electricity knows that when wires from a battery are dipped into water, the latter is decomposed into oxygen and hydrogen. The hydrogen when thus freshly liberated (or as the chemists call it, "nascent") is chemically very eager to combine with some-

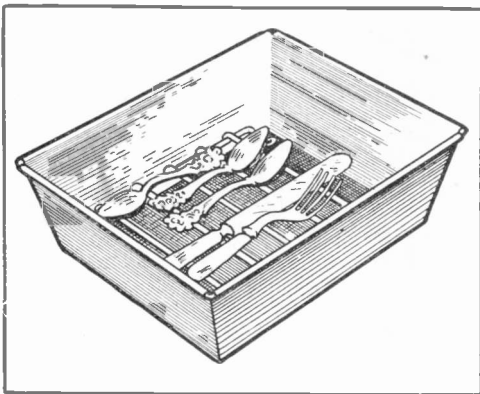

THE "SILVER CLEAN" PAN

thing and will seize upon oxygen if this is near at hand. Thus if the hydrogen is set free from a wire ending in a tip of tarnished silver, it will combine with the oxygen in the tarnish, which latter is an oxide of silver, leaving the silver bright.

Some years ago an Englishman named Ransford suggested that instead of using a separate battery, the silver and the metal of a pan in which it was placed could themselves form the elements of the needed battery. Recently two Wisconsin men have

improved on this method and are offering a "silver-clean pan" operating on the battery principle. It consists of a grid of zinc shaped so as to be raised above the bottom of the pan and having the ribs of the grid heavily coated with tin. The pan is partly filled with warm water to which a tablespoon each of common salt and of baking soda (salaratus) are added. This makes an alkaline solution and the dissimilar metals immersed in it act as a battery which sends current through the silverware, liberating the hydrogen which removes the tarnish. The action is very quick, five seconds being sufficient where the tarnish is only slight, while for a more marked accumulation one or two minutes may be needed. In either case no harm is done by leaving the silver longer in the pan than necessary, as the active hydrogen will not touch the silver itself but only affects the unsightly oxide.

Temperature Alarm for Nurses

Even a conscientious nurse may not notice a change in the temperature of the sickroom until this has gone many degrees beyond the advisable limit. Being unwilling to take chances in serious cases, the up-to-date Lon-

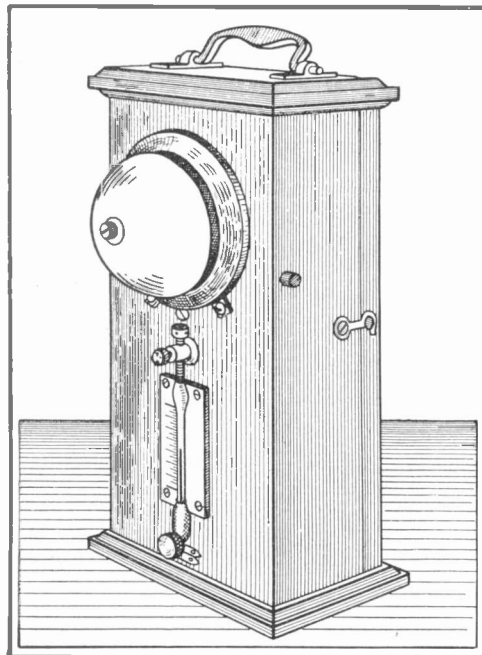

TEMPERATURE ALARM

don nurse brings a temperature alarm with her: A little battery and bell outfit with an adjustable thermometer attached to it for closing the circuit automatically. After setting the thermometer to the maximum safe degree of heat she is free to attend to her other duties, knowing that the little bell will promptly warn her if the temperature should happen to crawl above the safe point.

Sawing Logs with Toothed Chains

In working stone it has long been customary to do the cutting by means of an endless wire cable which drags a mixture of sand and water with it so that the sand gradually wears through the stone. Now if, instead of the loose particles of sharp sand, we had steel teeth fastened rigidly to the wire cable, this could be used in cutting softer materials such as wood. That is practically what a New York manufacturer has done in building a line of electrically driven saws having endless chains fitted with short teeth. By lengthening these chains, it is easy to cut logs of six, twelve or even twenty feet in diameter.

Cutting Wall Paper Friezes

In papering rooms or hotels, the effect of the friezes and borders is often enhanced

by cutting out the design so as to have it stand out more sharply against the background. Anyone who has done this by hand knows what a tedious job it is to prepare even a few yards of such a cut border. But

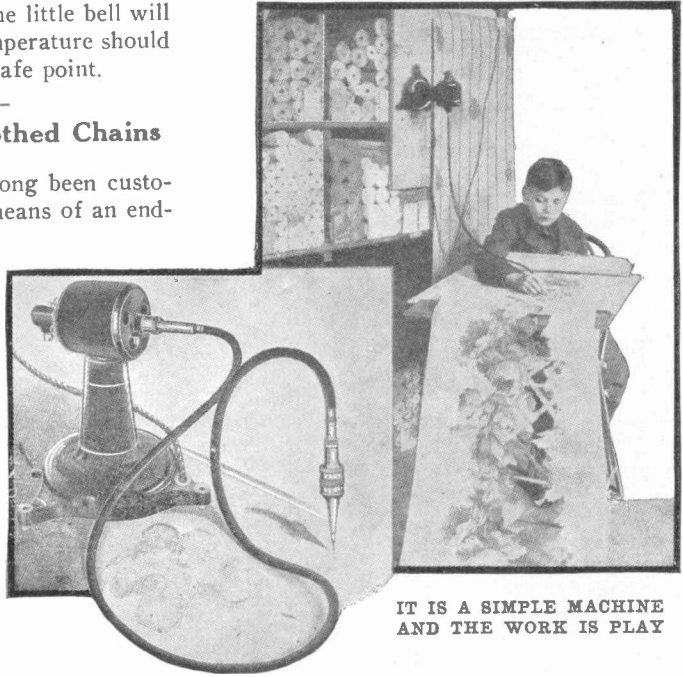

IT IS A SIMPLE MACHINE AND THE WORK IS PLAY

if current is available, a little electric tool will do the cutting so quickly that long stretches of such borders can be turned out very quickly. In fact, there is a fascination to it that any bright boy will enjoy, besides being a great time saver for the paper-hanger.

Brazil Becoming "Electrified"

There is a growing demand in Brazil for all kinds of electric-lighting supplies. Of an annual importation of about \$3,500,000 in electrical supplies and apparatus, the United States furnishes approximately 50 per cent, Great Britain and Germany furnishing most of the remainder in about equal shares.

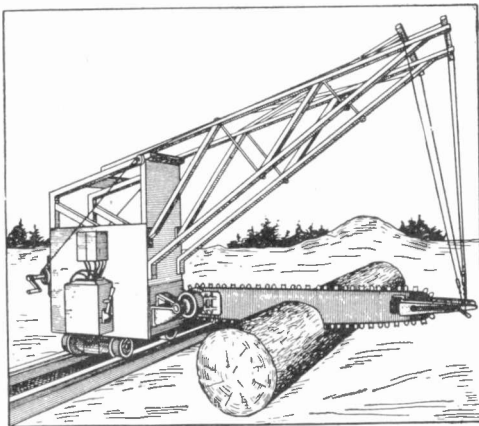

ELECTRIC SAW

A wireless station capable of communicating with vessels at a distance of 2,000, or possibly 3,000 miles, will be erected at Fort Myer, just outside of Washington, D. C.

FOR PRACTICAL ELECTRICAL WORKERS

HOW TO MAKE AND OPERATE ELECTRICAL DEVICES

Wind Direction Indicator

An electric weather vane to tell the direction of the wind can be constructed at a small cost, and should prove a source of considerable interest and usefulness to its builder.

The vane itself should be located where the wind may have direct access to it from all quarters of the compass. A large arrow of light material should first be constructed along the usual lines. A brass shaft secured by rivets or screws may support the vane.

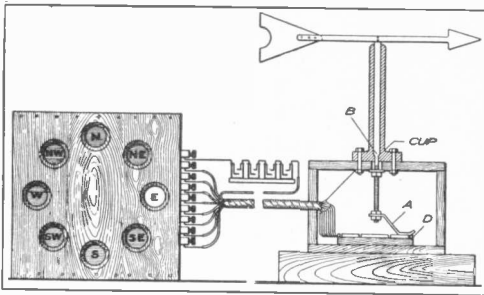

FIG. 1. WIND DIRECTION INDICATOR

The shaft should turn easily, though snugly, in a bearing (B), Fig. 1. The lower end should be threaded for several inches and of smaller diameter than the shaft proper—a ratio of, say, $\frac{1}{8}$ to $\frac{1}{4}$ of an inch. Where the smaller diameter changes to the larger, the shaft should taper about 60° so that it may revolve smoothly in the cup of (B). If it is within the scope of the builders' tools, a steel ball bearing may be constructed instead of the ordinary bearing, so there will be less friction. Enough stress cannot be laid upon the necessity of a frictionless bearing, as otherwise the vane will be unresponsive to light winds. It is hardly necessary to mention that at all points where friction is liable to occur there should be applied plenty of thin, non-gumming lubricating oil.

At the lower end of the bearing, where it tapers to form the cup, a small hole should

be bored to admit the passage of the threaded portion of the shaft. The bearing and its base, both of which may be cast

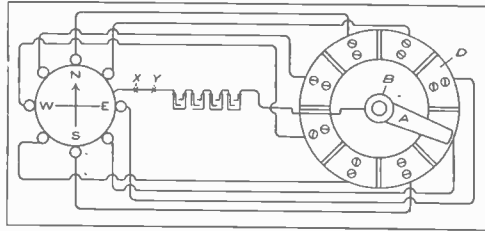

FIG. 2. ELECTRICAL CONNECTIONS

in one piece, will resemble an inverted "T" and should be secured by bolts or lags to the top of a stoutly constructed waterproof box. Inside this box will be the revolving contact and the commutator from which wires lead to the indicator.

The revolving contact (A) may be a piece of light weight spring brass strip $\frac{1}{4}$ inch wide, bent and bolted to the threaded shaft (B) and lightly touching the commutator (D). Eight commutator segments are necessary. They should be spaced $\frac{1}{8}$ inch apart, each tapering from $\frac{3}{8}$ to $\frac{1}{2}$ inch, secured in a ring, Fig. 2, upon a block of hardwood or fibre, and this screwed to the bottom of the box, centrally under the axis of the revolving contact.

Electrical connection of the segments and contact with the indicator will be made by means of a nine-strand cable made up of No. 18 annunciator wires. These should be well paraffined when assembled into cable form and the bundle taped and tarred to resist the weather.

The indicator consists of a square box of convenient size, stained and varnished. In the top should be bored a circle of eight holes, each $1\frac{1}{2}$ inches in diameter, spaced equidistant, and on the bottom side of which are fastened ground glass plates, with the directions of the compass painted in black: i. e., first hole "N," next hole "NE," etc. Directly underneath each hole should be

mounted a miniature Mazda $3\frac{1}{2}$ volt lamp of about $1\frac{1}{2}$ candlepower, and consuming .3 of an ampere. These lamps should be mounted in miniature receptacles upon the bottom of the box, and a terminal of each brought out to one wire and that led through the batteries connected to the revolving contact of the vane. The other terminal of each light should be connected, as shown in Fig. 2. It is obvious that care should be observed in connecting each wire to its proper segment so that, for instance, when the vane is influenced by a northerly wind, the contact will be upon the segment that is electrically connected with the "N" light.

In computing the voltage of the batteries for the lamps there are several things to be taken into consideration. In the first place, as will be seen from the drawing of the commutator, Fig. 2, the contact may be touching two segments at the same time, which causes current to flow through two adjacent lights. This is by no means undesirable, for, instead of having an eight-point indicator as originally intended, we have a sixteen point, which is twice as accurate.

The problem next arises as to the voltage drop, through resistance if the vane is situated at any great distance from the indicator. Up to 50 feet the drop will be unnoticeable for the small amount of current used, but for distances greater than that it had best be considered. The voltage drop may be readily calculated by Ohm's law: Volts drop = amperes \times ohms. For example, if the vane is 100 feet from the indicator, the actual length of the single conductor being 200 feet (100 feet each way), and No. 18 copper wire is employed, the resistance of which runs .623 of an ohm per hundred feet, and one lamp is burning, drawing .3 of an ampere, the drop is $.3 \times 2$ (.623) or .3738 volt. As two lights may burn simultaneously, thus doubling the amperage in the circuit, this drop may be doubled or equal .7476 of a volt.

I have had excellent results from the Daniel or Crowfoot cell, which gives 1.08 volts. To light two $3\frac{1}{2}$ -volt Mazda lamps, three cells are necessary, and for the additional $\frac{3}{4}$ volt drop, one more cell is required.

One of the most unique characteristics of this vane-indicator is that the direction of the wind may be accurately shown hundreds

of feet away from the vane itself. To save current it is advisable that a push button or single pole switch be inserted in the circuit between (X) and (Y) so that the circuit may stand open only when observations are being made. Lamps will burn out on the average of one a week if the current is left on 24 hours a day.

GEORGE WORTS.

Sitting on an Electric Switch

Telephone booths frequently have an electric lamp for which the current is turned on by an automatic switch when the door is closed, the light being turned off again when the door is opened. This plan works admirably, but obliges the person using the phone to close the door behind him and un-

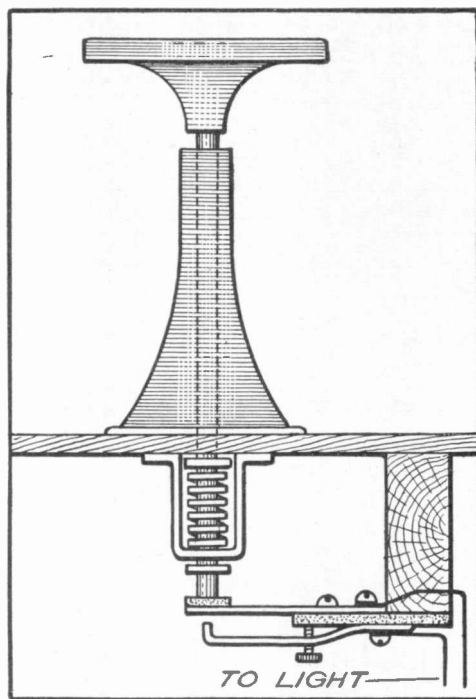

TELEPHONE BOOTH SWITCH

less there is also an electric fan in the booth, he may find his stay in it very uncomfortable. Where there is not much noise outside of the booth, even a partial closing would shut this out without cutting off the ventilation. Hence, instead of fastening the switch for the electric light to the door, a clever Yankee has inserted it under the stool in the booth on which the telephone

user sits when at the phone, practically allowing him to sit on the switch.

Ruby Lamp for Dark Room

Electrical experimenters interested also in photography will find this dark room lamp a great convenience.

The base consists of a hexagon-shaped piece of oak about five-eighths inch thick and four inches across, nicely finished and beveled. To this is fastened with glue and long screws from the under side, an upright

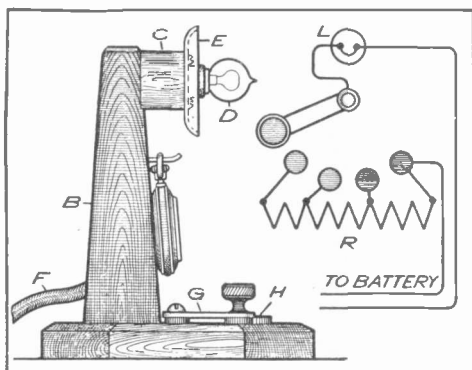

RUBY LAMP FOR DARK ROOM

post or column (B) of the same material, about six inches high, rectangular in cross section, and tapered as shown. For greater firmness this may be mortised into the base if desired. At the top inside face of this column a miniature receptacle (C) is secured. A disk of sheet brass (E) two inches in diameter is fastened over the outside of this receptacle to act as a reflector.

A small resistance is placed in the base to dim down or regulate the light.

As only a few ohms is required, and the current to be carried is small, this resistance may consist of fine insulated copper magnet wire (No. 30), wound on a little cylinder of asbestos, and then glued in a slot cut in the under side of base. Two or three leads are taken at about equal distances apart from this wire, and run to small brass screws, arranged in the arc of a circle on the upper side of the base. One of these is shown at (H). A small switch (G) completes the rheostat.

If the lamp is to be used considerably storage cells should be used, although dry batteries may serve for intermittent use.

The wires to the bulb are concealed in a hole bored the length of column (B).

The miniature bulb (D) is a four or six volt bulb of ruby glass. This is on the market, and can be purchased at about the same price as the clear glass bulb. However, if one of these is not available, a suitable red color may be given an ordinary bulb, by dipping it in a little white shellac varnish mixed with Easter egg dye.

If it is desired to make the above lamp entirely self-contained it may be mounted on the top of a neat varnished box in which the batteries are contained.

JAMES P. LEWIS.

Removing Insulation from Wire

The usual way of removing insulation from a wire is by the use of a knife which often slips, cuts the hand or nicks the wire.

A new tool wire skinner here shown can be used on wire up to No. 4. It splits a twin wire exactly in the middle by one pull, cutting the outer braid on both sides. A second stroke splits the insulation on one

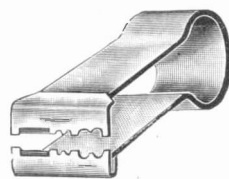
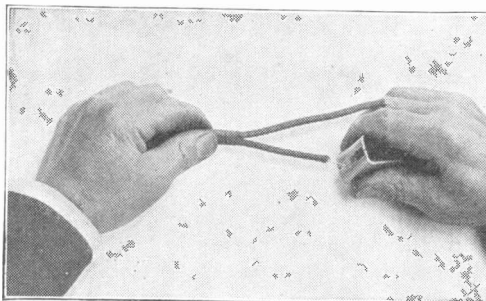

WIRE SKINNER AND HOW TO USE IT

of the single wires, while the last operation shown in the illustration removes the insulation from the wire, leaving it clean and ready for soldering.

The tool is made of tempered steel and is $3\frac{1}{2}$ inches long by $1\frac{1}{2}$ inches wide, and can be readily carried in the pocket.

Electricity the Silent Salesman

Some helpful hints on the use of electric current in getting up show window displays. The following schemes have all been used with remarkable success.

One Way of Demonstrating a Razor Strop

The salesman of today must be ready to answer by demonstration the inevitable "show me" of the buyer, particularly if a mechanical device is the article sold.

The illustration tells how in show windows a safety razor manufacturer displays his strapping device and razor, causing the former to roll back and forth upon a level surface, sharpening the blade on the spiral strap just as a user would in getting it ready for service. On the corner of the box the razor is mounted in such a way that

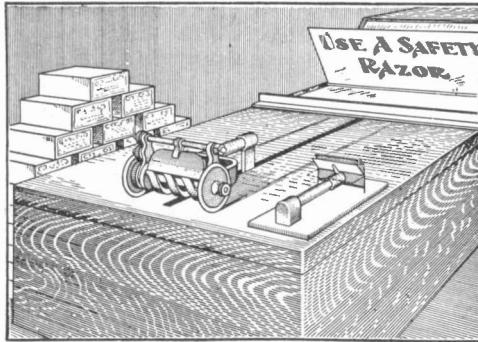

STROPPING THE RAZOR BLADE BY MOTOR

as the handle is turned the head opens up and allows the insertion of the blade, the whole display being an argument to the spectator of the ease and simplicity with which this razor may be handled and kept in order. A small electric motor inside the box operates the exhibit.

Demonstrating a Wood Grainer

"We have passed the age of paint for interior decoration, and have learned to appreciate the beauties of natural wood."

This is the statement of manufacturers of a ready-to-use graining process, and to impress the public with the idea and at the same time show the ease with which the graining process is accomplished, the appa-

ratus in the picture is used to demonstrate in hardware store windows the way the thing is done. A sponge for applying the "compound," a "self-grainer" and a tool for giving an oak-grain effect are carried on an

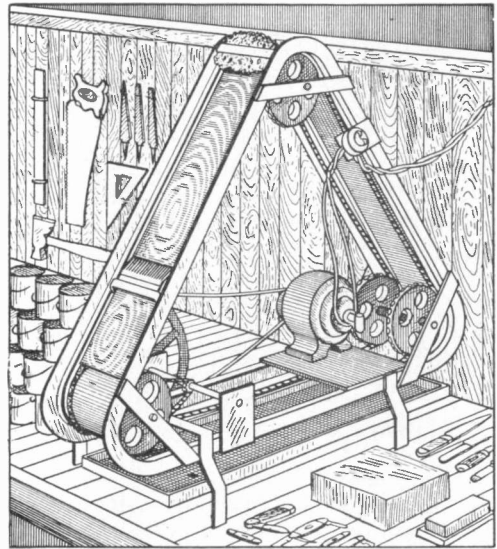

DEMONSTRATING A WOOD GRAINER

endless chain around the triangular device, each doing its part upon a board held on the front side, the apparatus taking its power from a small electric motor on the base.

Watching the Apples Bake

Many restaurants attract attention to the fact that they are feeding the people by placing in or near the window some cooking device and preparing upon it certain food in full view of prospective customers on the street.

A patent on an electric apple baker for this purpose has been issued to W. F. Fowler and C. H. Mead, Indianapolis, Ind. A number of vertical tubes containing insulated heater wire are mounted on a suitable base or dish-like disk also containing resistance wire. The core is removed from each

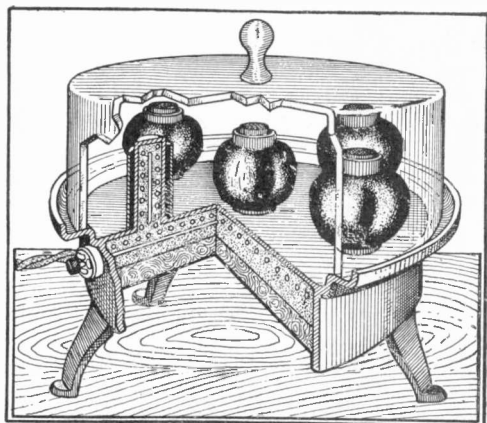

WINDOW ATTRACTION FOR RESTAURANTS

apple and an open ended tube inserted. This prevents the apple from sticking to the baker while cooking and also is just large enough to slide over a heater tube as shown. A glass bell is now placed over all and an electric switch turns on the current allowing the public to watch the baking process and grow hungry.

Exhibiting a Compartment Trunk

Many firms selling articles for household or personal use place demonstrators in their

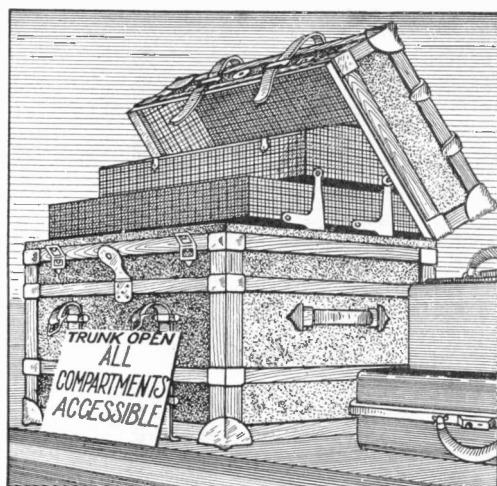

OPENS AND SHUTS BY MOTOR

show windows to explain in pantomime and by printed cards the special advantage of the article in question.

In some cases an electric motor has taken the place of the demonstrator as is shown in the cut. A trunk has its cover opened and closed by a motor installed behind it. The particular feature to which attention is called is noted on a card. This information is impressed upon the spectator as the cover lifts, and in so doing arranges the compartments in a position to make any of them readily accessible.

Novel Display of Diamond Setting

Judging the value, perfect cut and other qualities of a diamond requires the services of an expert, and even he sometimes fails to detect a "phoney" stone, for there are diamonds and near-diamonds.

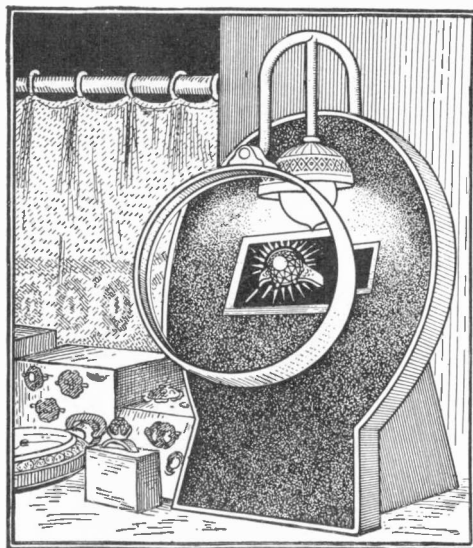

DISPLAYING DIAMOND SETTING

To display his ring settings to a better advantage and at the same time invite the public to examine his stock, a Chicago jeweler uses in his show window the unique arrangement here illustrated.

The easel faced with black velvet has attached to it a nickel-plated lighting fixture containing a ground glass electric lamp and supporting a magnifying or reading glass. The glass is so placed as to show the stone magnified and under a strong light.

Fan Aids Window Display

This picture shows how an enterprising Chicago cigar dealer attracted the attention of an ever-changing crowd during business

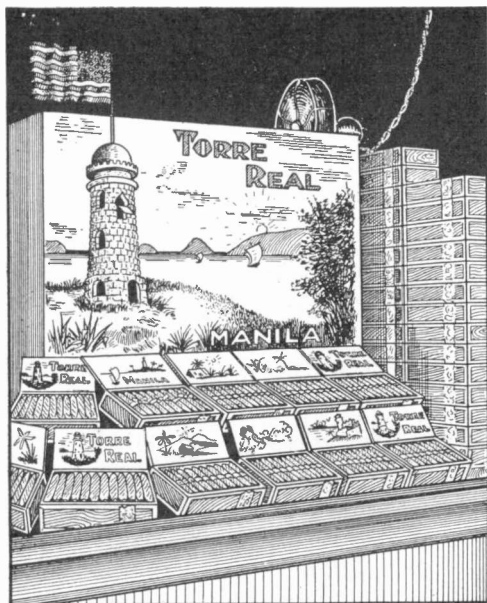

FAN OPERATED WINDOW ATTRACTION

hours to a fresh stock of Manila cigars which he displayed in his window. An electric fan which otherwise would have been idle furnished a breeze which continuously waved a flag that the ingenious artist made to appear as a part of a tropical scene on the Philippine Islands, the location of the tobacco plantation.

Motor Exhibits Furnishings

Ingenuity seems to have overstepped itself in building a piece of furniture to use either as a davenport or as a billiard table. The transformation is deftly made by tilting the back over from the first position into the position shown in the lower picture. The manufacturers demonstrate the davenport-billiard table in their show window by using an electric motor concealed behind the davenport to do the tilting.

The two pictures at the right are almost self-explanatory. The floor of a show window is cut out and built into a platform which revolves on a concealed shaft. This shaft is geared to an electric motor which in turning the platform exhibits the piano from all angles.

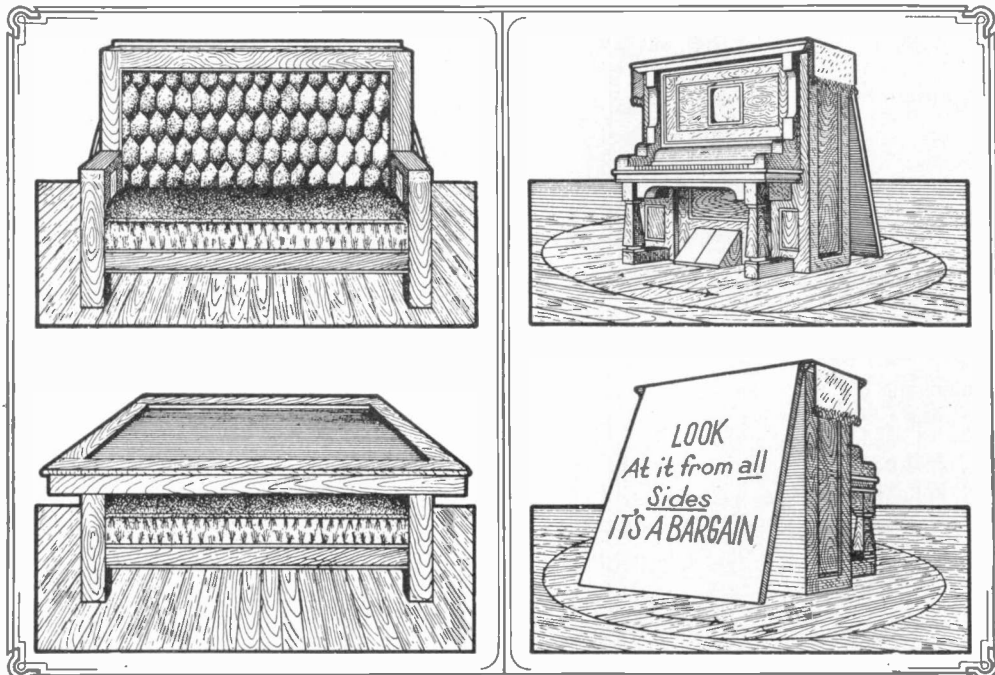

MOTOR-OPERATED MOVING DISPLAYS

Electrical Men of the Times

THEODORE NEWTON VAIL

There is to-day a man who is called "Chief of American Wires." He heads a great system of organized capital which nears the billion dollar mark and which is unique in the position that every dollar of capitalization represents actual property value. The man is Theodore Newton Vail, president of the American Telephone and Telegraph Company. Interwoven with the story of his life is the story of the telephone. From the time when Alexander Graham Bell was struggling with human ear drums and improvised electromagnets until the present time, when we talk a thousand miles over glistening circuits of copper, the name of Vail has been linked with the magic of the wires.

Mr. Vail was born in Ohio on July 16, 1845. His father was Daniel R. Vail, whose ancestors were English Quakers. His mother, Phoebe Vail, was of Dutch and French descent. As a boy he was educated in the Morristown, N. J., public schools and later in Morrison Academy. Then he studied medicine for a while, but gave it up to learn telegraphy. Thus, again, we find one of the great electrical pioneers receiving his early training at the key of the telegraph instrument.

In 1878, when Mr. Vail was general superintendent of railway mails, at Washington, the promoters of the original telephone wanted a man to put it upon a business basis. They chose Mr. Vail as their organizer. An association was already formed to take over the Bell patents. Besides Prof. Bell there were three other men in this company—Gardiner C. Hubbard,

Bell's father-in-law; Thomas Sanders, a man with some capital for those days, and Thomas A. Watson, a mechanical genius and assistant of Bell. This original company was split up into the New England Telephone Company and the Bell Telephone Company, and Vail was made general manager of the latter. Later the two were consolidated again under the name of the National Bell Telephone Company. This was in 1879.

Then followed a period of rapid development, and the establishment of many telephone companies under short term licenses from the parent organization. But the great leader early recognized that the Bell interests were so important that there was a partnership right in them having a value outside of the mere patent rights.

He wanted to build up a business which would outlive all patents. In pursuance of this policy the American Telephone and Telegraph

Company was formed in 1885 to take control of the long distance business and eventually to absorb all the constituent companies. Before this was accomplished, however, Mr. Vail withdrew from the management and embarked in enterprises of his own in South America. Later he retired to his farm in Vermont and cut loose from all business cares.

For nearly 20 years Mr. Vail was in retirement, then, like Cincinnatus of old, he was recalled and once more prevailed upon to lay hold of the threads of what had become an immensely greater fabric. This is perhaps the most remarkable accomplishment of all. At the age of 62 he once

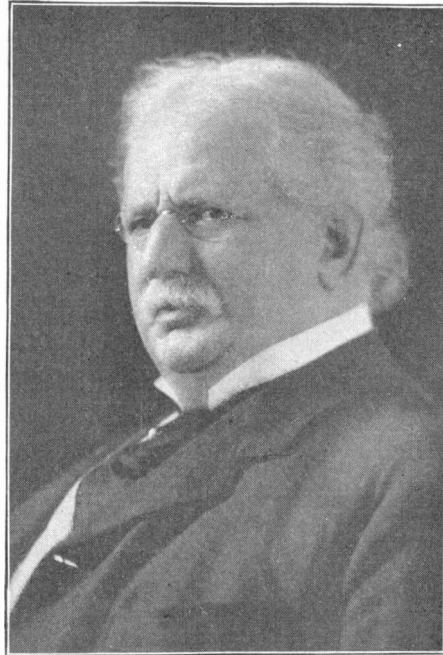

more took up the duties of president of the mighty organization which the energies of his early life had put into being. Soon after he assumed control, came the panic of 1907 and upset business generally; but, be it said to his everlasting credit, that in the year of depression which followed, his company was almost the only great industrial organization which at the end of the year showed an increase in net earnings. So much for the man of 62.

A little later we find him bringing together the American Telephone and Telegraph Company and the Western Union Telegraph Company, for over 20 years in costly litigation which could result in no advantage to either. The only way to bring about amiable relations, as Mr. Vail saw it, was to secure control of the Western Union, which he set out to do. And as usual his efforts were successful.

To-day Mr. Vail is remarkably well preserved and as his life approaches the allotted span he stands as an example of broad success, which, as he himself expressed it, "depends on singleness of purpose, clear perception of what is desired and to be accomplished, and capacity to recognize true values of men and things and properly place them."

Illuminative Devices for the British Coronation

Never before has there been a lighting display along the streets of any city which can even approach what is being prepared for the coming coronation of King George V. Heretofore, when the people of London or of any other large city have joined enthusiastically in some celebration, the city authorities, together with some of the leading merchants, hotels and clubs, have contributed to the display by suitable lighting effects. But beyond the use of the little candle or grease "fairy lamps," or possibly of Japanese lanterns, the smaller store-keepers and the populace in general have been able to show their enthusiasm only by the bunting and flags which they displayed by day. The expense of erecting any appropriate electrical decorations and the difficulty of procuring the same have heretofore confined their use to the larger establishments, but with the general spread of electric lighting into homes and business places

of all sizes and kinds, the Londoner of to-day is no longer willing to be limited in this way.

To aid him in thus showing his patriotism in truly up-to-date manner, British electrical firms have developed an unusual array of "Coronation Illuminative Devices" which by their ease of installation and moderate cost, as well as their beauty, are making a strong appeal to the loyal Englishmen. These include a variety of lamp-strips, *i. e.*, miniature lamps and sockets fastened to thin strips of metal which can be bent into all sorts of shapes so as to form letters, borders or other designs. Then there are dazzling crowns and the initials G. R. (Georgius Rex) wrought in many styles and sizes and offered completely wired. Equally striking in their beauty are the electrical transparencies in which artistic designs on stained glass are lighted by incandescent lamps, these also being shipped ready to attach.

Power from the Mississippi

The dam, which will stretch across the Mississippi River from Keokuk, Iowa, to Hamilton, Illinois, a distance of seven-eighths of a mile, will, undoubtedly, be the largest in the world, with the exception of the monster dam on the Nile at Assuan, which, as will be readily recalled, is for irrigation and not for hydro-electric purposes. The "Father of Waters" is to be put into harness and first to furnish 120,000 delivered horsepower, and eventually 200,000.

The magnitude of the plant is not, however, the only thing of interest. The great market for the product is also a most interesting subject for consideration. The plant is not likely to be completed and in operation before July, 1913, and yet of the primary installation of 120,000 delivered horsepower, 60,000 horsepower has already been contracted for by the public service companies of St. Louis on 99 years' leases. St. Louis, though the largest, is only one of many points to be affected by this new hydro-electric development. A glance at the map of the United States will show how advantageously this plant is located in the center of one of the most flourishing sections of the Middle West. Within a transmission distance of practically 200 miles are an unusually large number of flourishing cities and towns.

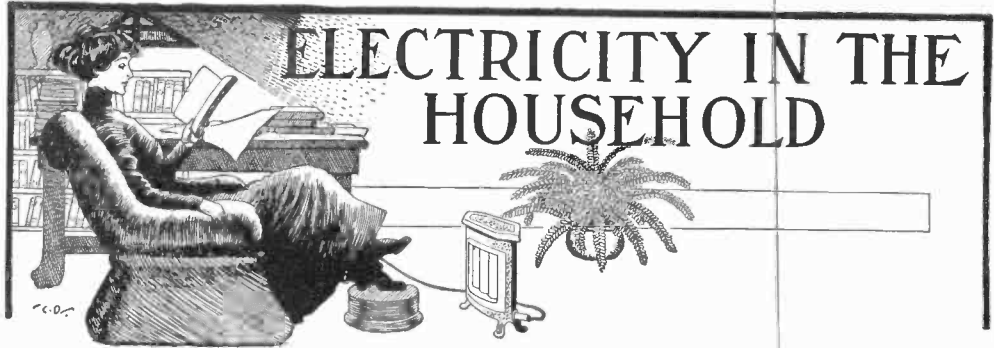

The Letters of a Bachelor Girl

Dear Edna:

Since my last letter so much has happened I hardly know where to begin. I think you would be interested most of all in the unique shower we girls gave for Esther. You will remember her as that stunning girl who visited the Knox's at Lake Geneva last summer. She had so many affairs given for her of the usual engagement variety that we wanted to have something entirely different and Madge and I feel highly elated over the success of our original idea, the electric shower, for indeed not one of the girls had ever attended anything of this kind before.

When we told them of our plans, they were very enthusiastic and promised to help make it the most brilliant event of all the engagement affairs. As Esther was constantly rushing about attending to the many details essential to the preparation of the trousseau, it was easy to make our arrangements without her having the slightest suspicion of them. When we confided our scheme to her mother, she was perfectly delighted and entered into the spirit of it so enthusiastically she inspired us all to

even greater efforts. She said Esther's uncle in New York had sent as his wedding gift an electric automobile.

The shower was given at Marie Curby's. On the eventful afternoon she took Esther motoring while the rest of us met at Marie's and put on the final touches. During the ride Marie taught Esther how to drive the electric. Esther was greatly pleased and had no idea that it really belonged to her, and of course, Marie had a terribly hard time keeping the secret.

During their absence the girls had taken possession of the Curby house. The electrical contrivances had been delivered, and made a most imposing display, piled up in pretty boxes. After we had visited the electrical shops individually and collectively we decided just what each girl was to give and we divided the cost on the more expensive articles. It was such fun selecting our presents, and they seemed so wonderfully practical that every one of us declared then and there, "An electrical shower for me, when the happy day arrives."

At the hour appointed Marie brought Esther back—when they entered they found



THAT STUNNING GIRL AT LAKE GENEVA

the shades down and the house darkened and apparently deserted for we were hidden in the conservatory off the dining room awaiting their coming. The dining room was beautifully decorated. A bisque cupid driving butterflies that were lighted by tiny electric bulbs was in the center of the table. Cupid was blindfolded with a piece of rose silk, denoting love is blind, and he carried a gold dart for each girl, in the quiver on his back. The little God of love was sur-

and it was some time before she realized what it meant. I think Cupid told the story first.

The luncheon was perfect. We had boullion, Spanish chicken, grape salad, and at each plate were beautiful cases filled with stoned olives and salted nuts, and compotiers with wintergreen wafers, and candied mint and rose leaves. The ice cream was strawberry molded in the shape of roses, with leaves of pistachio ice.

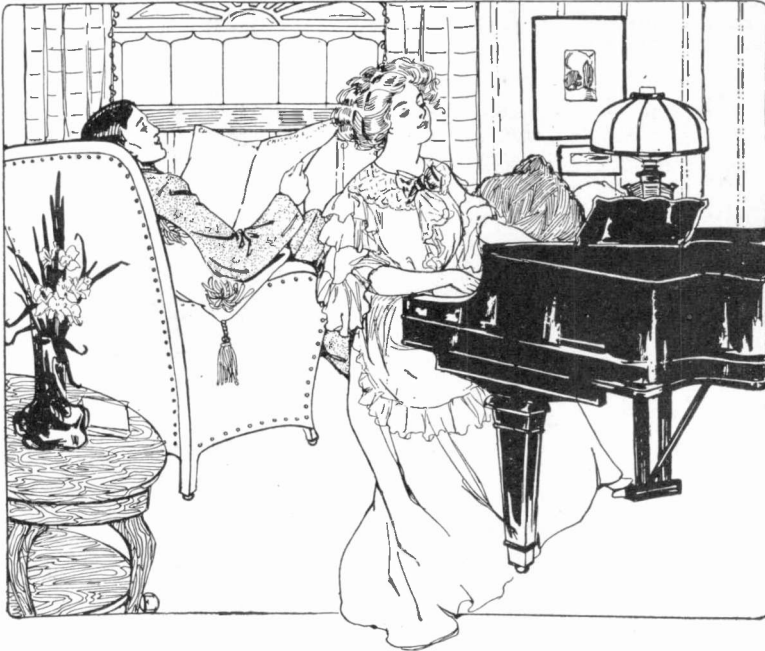

EVERY GIRL LOOKED FORWARD TO A LIBRARY OF HER OWN WITH JUST SUCH A LAMP

rounded by a hedge of pink roses, also lighted, and over which his butterfly steeds looked as if any minute they might carry him. Rose-colored spectacles with gold rims were the place cards, for every one looks at Cupid through just such lenses. Now don't they, dear?

The dining room was all dark, but when the girls reached the door, click, on came the lights, and every butterfly and rose glowed as if by magic. It was truly beautiful, and Esther stood amazed at the effect, and the great surprise it all was to her. With a gurgle of delight she exclaimed, "Oh, how wonderful!" We rushed toward her and actually carried her to her seat of honor at the table. Her blue eyes spoke volumes, but she was so bewildered with the unusualness of it all that she said little,

Marie's management of the luncheon was indeed a credit to her.

In the conservatory was arranged a table on which were displayed the gifts, most of them boxed. Each box was decorated with pink hearts and cupids, and there were boxes of every shape and size. The girls spent a great deal of time decorating the boxes, and they were so pretty she can find many uses for them in her dresser for gloves, handkerchiefs, etc. Esther had no idea what was in store for her until the work of unwrapping began.

Every one was excited and for a brief moment silence reigned as the first gift was unwrapped in a hush of expectancy.

It was a handsome five o'clock tea kettle in brass. The prospective bride was more than delighted to find it electrical, and we

all expect to be present at the first tea in her new home. The next package, after much unwrapping revealed a library lamp in soft greens, and there were murmurs of "Ohs" and "Ahs," for every girl looked ahead to the time when she would have a cozy library of her own with perhaps just such a lamp.

Then came a dear little waterheater in nickel, a percolater and toaster, just the thing for any breakfast table. Next a Japanesey looking den lamp—quaint enough to inspire one with all sorts of dreams of fame and fortune. This gift was from one of the girls who could not spend much, but it was greatly appreciated. Another inexpensive gift was a heating pad, a practical thing too. A corn popper, waffle iron,

food warmer, and a cooker for cereals were things every housewife would delight in having. There was a chafing dish in which one can make such delicious things, that several of we girls are going to invest and not wait for any special event. For some of us, doing light housework they are indispensable, and after the theatre, rarebit can be prepared in one so easily at home. The last gift was a candlestick for the bride's dressing table—it had a little silk rose-leaf shade which harmonized with Esther's pink and white complexion for she was quite flushed with excitement. The array of gifts was encouraging to all the prospective brides, for I know every one will look forward to an electrical shower.

Lovingly,
VIVIAN.

A Ladies' Luminous Purse

The man who stays out late at night can easily carry a flash lamp to light his way up the stairs and, if need be, to help him find the keyhole, for there are plenty of pocket battery lamp outfits now sold on the market.

But milady has no pockets, so what is she to do if out late herself? Naturally, the

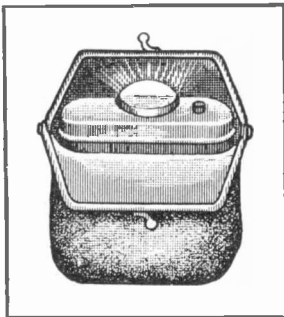

THE LUMINOUS PURSE

answer comes from England where the suffrage seekers have been following the customs of the sterner sex in so many ways. There the woman who strikes a dark place opens what seems to be her purse and flashes a beam of light from it, for the chamois skin bag dangling from her wrist is really nothing more than a little search-light in disguise.

Beautiful French Lamp

The French designers are very resourceful when it comes to planning artistic effects in bronze and brass work, and their efforts

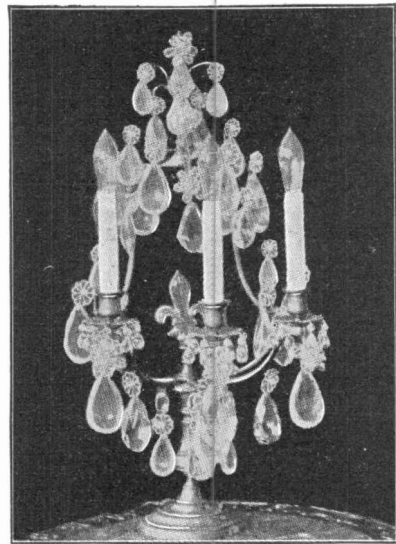

BEAUTIFUL FRENCH LAMP

have extended to the field of ornamental electric fixtures. A beautiful French portable lamp is shown in the picture. The supporting parts are of bronze and the lamps are of the shape of candles. The pendant ornaments are of the purest crystal.

Where Art and Science Meet

By T. VERNETTE MORSE

The old time "song of the shirt" when "band and gusset and seam" were laboriously stitched by hand, seems like a far away dream when compared with modern "ready-to-wear" methods.

In those days the garments were perfectly made. The finest of embroideries were wrought with infinite care into the finest of linens. Rare and delicate laces, representing fortunes, were a part of every woman's wardrobe, and many a dainty garment has been handed down from generation to generation, as an example of former distinction, for it was then considered a great accomplishment to be a fine needle-woman.

A beautiful garment of this character is valued by descendants of the Colonial dames as a mark of family superiority, but second to the family crest.

Possibly those small and carefully set stitches of the Colonial Priscillas may have helped somewhat in forming the character of their descendents, for is not character a composition of patience, perseverance and quality, crowned with graciousness?

"To sit by the fire and sew a fine seam" is no longer a woman's province any more than it is man's to shoe his own horses and grind his own grain. Times have changed.

Men, being out in the world, have adapted themselves more readily to the new conditions than women.

A man will supply himself with the necessary conveniences to transact his business with dispatch. He may spend the entire day in a little eight by ten office, but it will be furnished with a desk

having all sorts of compartments to fit his correspondence and special papers. His office chair turns with automatic precision at the approach of a visitor. The filing cabinet is perfect in its appointment, and everything systematized to meet the demands of his business. Not so with the woman, she has been taught to do without the necessary tools required for perfect system in the house. She has, for the want of a hammer, been obliged to drive a nail with the heel of her slipper so many times, that she has uncomplainingly accepted the situation; but with all of these disadvantages the progress of the world shows that



NO SEWING ROOM IS COMPLETE WITHOUT A MOTOR DRIVEN MACHINE

she has driven her nails most thoroughly. But why this makeshift in woman's domain any more than in that of man, because she has accomplished so much with little or no conveniences, must she always be expected to continue in the same rut?

One reason why women can not better adopt the labor-saving devices of the pres-

ent, is that most of them are invented by men who know more of the theory than of the actual requirements of woman's work. He is great on invention, but until he has really mastered the technique of house cleaning and dish washing, there are many things that cannot penetrate his fertile mind.

To return to the family sewing which is usually done in the home. The first thing the housewife should do is to select with care the necessary machinery and other equipment. Be sure that every article that goes into the sewing room is the best of its kind, and will accomplish the work with the least expenditure of physical strength.

No matter what furnishings are put into the sewing room the principles upon which the work must be accomplished are just the same as those evolved by the grand dames who did the work by hand. These principles in the hands of the present generation, with its better knowledge of art and science, will produce by the aid of modern conveniences equal results.

Nothing has ever replaced the needle and modern machinery handles it with almost human skill. The woman who has mastered the principles of art, until she understands the beauty of line in dress, may, with good technical skill, be able to do her family sewing and dressmaking, for about one-third the expense necessary to purchase the elusive "ready-to-wear" garments, and with a much greater degree of satisfaction.

The first requirement of a good sewing room is plenty of light. It should be cool in summer and warm in winter. Have the carpenter put up some shelves, leave one or two of them open. Have doors made to fit over the others to keep the dust from the supplies, and unfinished work. For pat-



CONNECTING TO THE CURRENT SUPPLY IS A SIMPLE MATTER

terns there is nothing better than the flat canvas bags, with a brass rod at the top—leaving both sides open. These bags will hang flat against the wall, taking up but little space. Fold all patterns flat—it requires too much time to use a pattern that has been rolled.

Have a large cutting table with a smooth top. It should be long enough to cut out a skirt easily. The top should be of unfinished wood on which the tracing wheel may be used, without injury to the surface.

For pressing there should be at least two electric irons, one long and narrow for small work and a heavy one for tailored gowns. Electric irons are ideal for the sewing room—they heat so quickly that no time is wasted. Every woman knows what it means to be obliged to wait for an iron to heat before she can proceed with the work. The seam may not be over an inch in length, but until it is properly pressed, not

another stitch can be taken on the garment. With electricity the iron is properly heated by the time one has placed the work in the proper position on the board.

No sewing room is now complete without one of the electric motors which may be attached to any machine, doing away with foot-power, thus relieving women of many illnesses which are caused by constant machine work.

With a bright sunny room fitted up with the necessary equipment of shelves, tables, drawer and an electric sewing machine motor and electric iron the family sewing becomes a pleasure instead of a drudgery.

If you are building a new home, consult the architect in regard to the sewing room. Even architects are beginning to understand that they can no longer plan houses for women to rebuild, and they are taking into consideration the small details and conveniences of home life as well as the general appearance.

Women are beginning to understand that system in the house is just as important as system in the office, and they are working accordingly.

Club life has done much to promote these ideas, and assist in the general progress, giving to woman the leisure that is necessary for study and recreation.

Two Currents from One Outlet

Suppose you desire to operate some current consuming device, such as a flat-iron or a curling-iron, and need a light to work by at the same time? The situation is embarrassing if there is only one light socket available. In that event the Benjamin current tap solves the problem.

The operation of this current tap is not difficult to understand. At the top is a

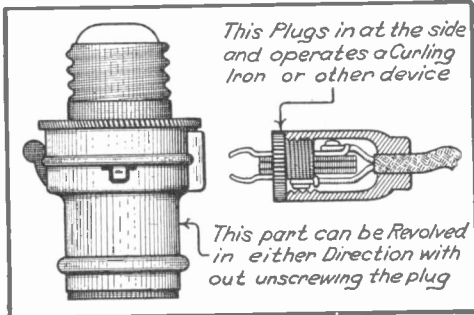

DOUBLE CURRENT TAP

threaded plug which screws into the lamp socket. Below this is the body of the tap, which has interior threads for the lamp. The body of the tap is made so that it will revolve without unscrewing the plug. Thus it can be turned readily in any direction convenient for accommodating the attachment plug supplying the curling-iron or

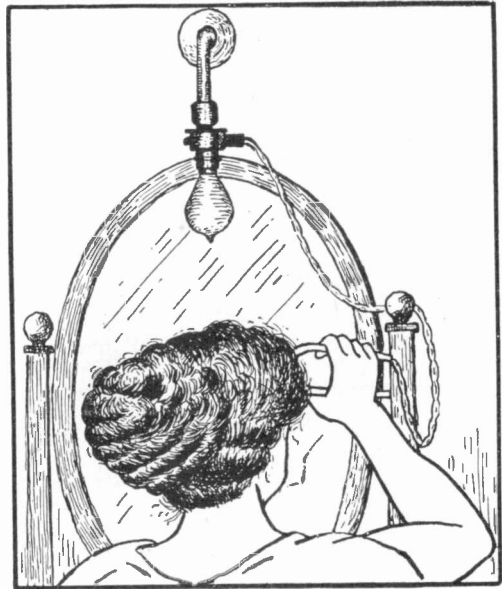

LIGHT AND HEAT FROM THE SAME SOCKET

other device. The latter plug is inserted by simply pushing it into an opening in the side of the tap body. Then you are ready to use the curling-iron and have a light at the same time. Or, if the light is not necessary, it may be turned off by a special switch and the iron operated alone. This type is known as the multiple type.

There is another type made, known as the series type, which is used in connection with portable heating devices, which will not operate from the ordinary lighting current unless a lamp is placed in series with them to prevent an injuriously heavy current from flowing. By the operation of a simple switch the lamp in this type may be burned alone if desired.

Furthermore, by using a low (two to four) candle power lamp on the extension cord in series with an ordinary lamp of the same voltage in the main socket the smaller lamp becomes a good night lamp and may be used in any desired location that the length of the cord will permit.

JUNIOR SECTION

A wholesome, fascinating study is the study of electricity. No boy who spends his spare time and his spare money in making and learning to operate electrical apparatus will go far wrong. This department is for such boys.

Construction of Small Motors and Dynamos

By CHAS. F. FRAASA, Jr

CHAPTER VI.—ASSEMBLY AND TESTS

Figs. 26 and 27 show the terminal blocks for the machines. A base cut from a piece of hard wood is fastened to the top of the field magnet frame by two small machine

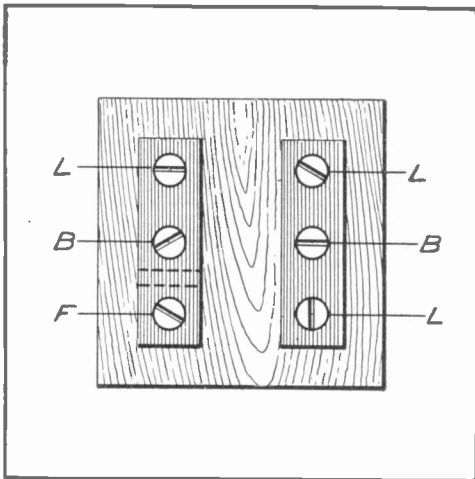

FIG. 26. FOR SHUNT FIELD CONNECTIONS

screws in holes tapped in the frame. The connection screws (B) (L) and (F) are brass wood screws and are screwed into the wooden block holding the brass strips in place.

With shunt field connections, Fig. 26, the current generated reaches the brush connection screws (B) (L) and is conveyed by the brass strips to the line terminals (L L), and to the shunt field terminals (F F). If it is desired to insert a resistance in series with the shunt field, cut away one of the strips as shown by dotted lines between the

screws (B) and (F) and connect one terminal of the rheostat to (B) and the other to (F).

With the field winding connected in series, Fig. 27, the armature current flows to the screw (B), through the brass strip to the field connection (F), through the field to the other connection screw (L), and then to the line, returning at (L), to the armature through (B).

To insert a rheostat in series with the series field, cut the strip to the right, be-

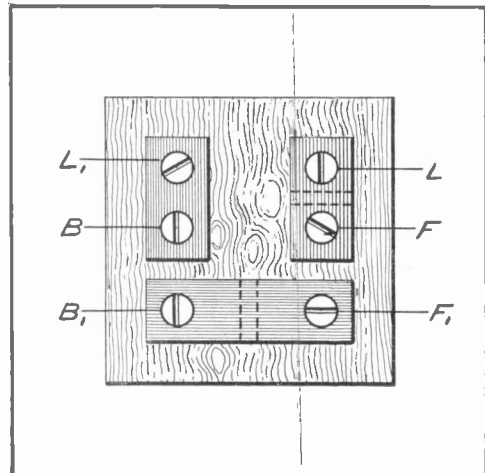

FIG. 27. FOR SERIES FIELD CONNECTIONS

tween (L) and (F) as shown by dotted lines, or cut the lower strip between (B) and (F). Connect the rheostat terminals to the screws (L) and (F) or (B) and (F). Suitable fuses should be inserted in each line of the current.

Now assemble the machine, put the brushes in place and make all connections. To enable the machine to start generating, a small initial magnetism should be established in the field magnets of the machine. This may be done by causing a battery current to flow momentarily through the windings. Then without any load on the dynamo if shunt, and with the circuit closed through a small resistance if series, start the armature to revolving in the direction in which it is to operate as a generator, and bring up to the proper speed. Adjust the brushes to a neutral position which will be found by trial, and test for the presence of a current. If the dynamo fails to generate, one of several things may be the cause of failure. Examine the field connections and see that they are such that the magnetic poles produced are north and south in alternate order. If this is all right, it is probable that the current which it should generate is opposite in direction to that of the battery current which magnetized the poles, and consequently the initial residual magnetism opposes the field current magnetization. In this case pass the battery current through the coils in the opposite direction and try the generator again. If the generator then fails after repeated trials with the magnetism in the poles frequently reversed, examine the whole machine and see that all connections make good contact, and that the brushes bear well on the commutator. Test the field and armature coils for short circuits and broken circuits with a bell or buzzer and battery.

To find whether or not the armature connections are at fault, cut the field windings out of the armature circuit and excite separately. Then remove the brushes from the commutator and drive at as high a speed as possible, and if much heat is developed, or if the armature smokes or emits an unpleasant odor, there is a fault in the armature winding or connection which should be corrected. A wrong connection in the armature may be traced out by comparing the paths between brushes with directions already given for armature winding. If everything remains cool place the brushes upon the commutator again and with a voltmeter in the armature circuit, run the machine at proper speed, and shift the brushes until the maximum reading is obtained. The brushes are now in a neutral position.

Remove the batteries from the field circuit, and connect the field circuit to the armature circuit for running.

When using these machines as motors, they should be provided with a suitable motor starter, and be protected by fuses. The shunt motor is very useful for work requiring a constant speed and the series for work requiring a large starting torque.

The alternating current machine is yet to be completed. A pair of collector rings should be fastened to the shaft, and connected to the armature. Turn down a piece of oak to two inches in diameter and about $1\frac{1}{4}$ inches long, leaving a ridge in the center about $\frac{1}{4}$ inch high and $\frac{1}{4}$ inch wide, and shellac well. Cut off two rings $\frac{1}{2}$ inch wide from a piece of two inch (internal diameter) pipe and put over the ends of the wooden cylinder, bringing each close up to the ridge. Then fasten the rings to the wood by means of small flat headed countersunk brass wood screws, and turn down the rings to a smooth surface.

The connections for the collector rings of the alternating current machines are: (1) thirty-three coil winding, ring 1 to segments 1 and 18; ring 2 to 9 and 26. (2) thirty-nine coil winding, ring 1 to segments 1 and 20; ring 2 to 10 and 30. (3) forty-five coil winding, ring 1 to segments 1 and 23; ring 2 to segments 12 and 35.

The collector rings may be on either side of the armature, but if on the side opposite the commutator, the wires passing through the slots to connect to the segments should be specially insulated from the winding by tape. When these wires are so placed, the space left in the top of the slot may be very small, but there should be room enough left for thin wooden wedges to keep the coils in the slots.

The brushes on the collector rings may be of either carbon or copper. If of copper, the contact area may be increased by using a brush composed of several strips of sheet copper soldered together at the brush holder end. Only two brushes are required, one on each ring.

When operating the alternating current generator, start with no load and bring on the load when the magnetism is in the field, and the voltage is up. The output will be 50, 100, 300 or 800 watts, according to which machine has been constructed, and these machines are practically double gen-

erators, since the collector rings deliver 110 volts A. C. and the commutator 155 volts D. C., for the excitation of the field. A direct current load may be carried at the same time with an A. C. load, but the sum of the two should not exceed the full rated capacity of the machine. All the full rated current may be taken from the commutator

at 155 volts, giving almost one-half again as great an output as the same armature with a two-pole field and 110 volts.

These machines may also be run as rotary converters, taking 110 alternating on the collector ring side, and giving 155 volts on the direct current side.

THE END.

Electricity in Vaudeville

By H. F. S.

About three years ago I witnessed a vaudeville act, which, to say the least, was out of the ordinary. The man billed himself as "The man who can't be electrocuted." He opened his act by letting his coil discharge around a sheet of plate glass coated on both sides with tinfoil. The total length of the spark—which was a brilliant white and made a very loud noise—was eighteen inches. He then let the spark jump directly between terminals of his coil to prove that it would jump the full eighteen inches.

Next he connected a high-frequency coil to the circuit and performed such "stunts" as drawing a six-inch spark from one terminal of the coil to the ends of his fingers, lighting paper, cloth, etc., from sparks drawn from his fingers and toes, and lighting a gas jet from the tip of his tongue.

His wife was with him; they allowed a spark to jump between their lips as they kissed; "The true spark of love," he announced. He also did several tricks which I do not remember now. Making such a good showing—a "hit," as it is called in theatrical circles—that while a couple of friends and I were talking it over we decided we would like to try our hand at it too, especially as we knew the principle upon which his act was based.

There were three of us originally, but after spending about a year in unsuccessful but interesting experimenting, one dropped out, leaving my partner and myself to finish things by ourselves. After building a couple of Tesla coils which were unsuccessful, we finally built one which would give a six-inch spark. But the insulation would not stand the strain and we had it to rebuild.

We then made three more coils—each one larger and better insulated than the last—before we completed one which suited.

We then began experimenting to see what we could do in the line of "stunts." Our outfit when completed—we built everything but the switches—consisted of a 10,000-volt, two-K. W., open-core transformer; an oil-insulated, glass-plate condenser; a small switchboard, regulating rheostat; one high-frequency coil, wound with a ratio of 120 turns to 1, and a smaller high-frequency coil wound with a ratio of 2 turns to 1; a muffled spark gap, and a miscellaneous bunch of lamps, geisler tubes, etc. We did not have our spark gap muffled at first, but after rebuilding our transformer we were forced to use one for the protection of our eyes and ears from the intense light and the explosive noise given out while the transformer was in action.

The secondary winding of our large Tesla coil was but eighteen inches long and the terminals were placed nineteen inches apart, but by placing a sheet of glass between the terminals the spark would jump around, making a total length of twenty inches or more. This spark was a brilliant white and very thick at all times. We found that we could draw a seven or eight-inch spark from one terminal of the coil, even though the other terminal was not connected to anything. This spark was too strong to take on the bare flesh (the frequency being too low), so we always let it jump to a piece of metal held in the hand. When holding one terminal of the coil a spark one and one-half to three inches long could be drawn from any part of the body. Unprepared paper,

cloth, etc., could easily be lighted from this spark with no worse effects than the heat generated by the spark—which was considerable. Geisler tubes would light up brightly when brought within a foot of the body, or when one terminal was held in the mouth with the other terminal free. A trick we always liked to play on a spectator was to take hold of one terminal of the coil and then allow a spark to jump from our other hand to them through their clothes. They would always back off as if we had the measles. The spark burned considerably when jumping through the clothes.

Some idea of the strength of the coil may be had when it is known there was a current of 20 to 25 amperes in the primary. As the coil was wound 120 to 1, there would be about 2-10 ampere in the secondary. When the primary of the coil was short circuited by a file or other small piece of metal, it would be lightly welded to the wires. The current would burn out two No. 30 copper wires when connected in parallel across the primary terminals. Still either winding could be short circuited through our bodies with hardly any shock at all.

One day I grasped one secondary terminal tightly, then gradually approached the other terminal, when my free hand got within fourteen inches of it a spark jumped and I got such a shaking-up that I don't believe I will ever forget it. Since then I always take a firm hold of the terminals before turning on the current.

The small Tesla coil was wound with No. 7 wire for the primary and No. 14 for the secondary. Although it would give only a half-inch spark at the secondary, it would melt a No. 30 copper wire connected from one terminal to the other. We connected one terminal of an ordinary 16-candle-power lamp to one terminal of the coil, and taking the other terminal of the lamp in my hand I grasped the other terminal of the coil. On starting the current the lamp was immediately burned out although only a very slight shock was felt. After burning out several lamps we found that if we let the current go through both of our bodies before reaching the lamp it would burn all right. We then made suitable terminals for holding the ends of the wires in the mouth; thus we allowed the current to pass through the lamp while suspended from mouth to mouth. A slight tickling sensation was felt in our

necks and wrists, otherwise the current did not affect us in any way. This coil would burn out any "geisler-tube" at the first spark. (We spoiled several.)

It took us two years to get our outfit completed, and by that time there were several others in the field, and, as the prospects were not very bright for another act of that sort, we abandoned the idea of using it.

Although almost anyone can do these tricks, I wish to emphasize the fact that it is *dangerous*. Before trying any of the above tricks, the experimenter should thoroughly understand what he is doing. Even though one does understand, a little carelessness may cause instant death. Never let a wire be nearer another one than necessary, and do not under any circumstances touch the transformer terminals while the current is on. It is best to have two switches in the low-tension circuit for safety's sake.

I never saw "The Man Who Tamed Electricity," but that he uses high-frequency currents and a few fakes besides, is almost certain. Unprepared paper can be lighted, but prepared paper will light more readily. In regards to the trick of knocking a spectator down with a shock from the hand—it can be done. With practice one can take a shock which will be severe to another, unused to it. By knowing what muscles to brace, the performer can take a shock which will floor a spectator, because the innocent spectator does not know what strength of shock to expect or where he is going to get it. One way, which is easier upon the performer, is to have a heavy flexible copper ribbon, connected to a copper band around each wrist; then the current does not affect him but little, as the wrists are the place where the current is felt the most. Most of the "stunts" done by the different performers can be faked, but most of them can also be done in reality—by using high-frequency current. I would not advise boys to try any of the above experiments, unless there is an older person to oversee them, as there is too much danger to any one who is a little careless.

Note: Our coil when completed gave a current of about 100,000 alternations per second, which is really too low. A frequency of at least 300,000 should be used where the spark is to be taken on the bare flesh, and then it should not be allowed to play on one spot too long.

THE YOUNG EDISONS' CLUB

Under this heading will be published letters from readers of the Junior Department. These letters should describe briefly and accurately your experiences in the making and operation of electrical devices and in the performing of electrical experiments. See how good an "engineering report" you can make of your investigations.

The Young Edisons' Club:

I was experimenting with a watch door bell and battery, and found I could fix it so that it would ring at a certain time. Remove the crystal of your watch, bend the large hand up a little, then place the end of the small wire at the point showing the time you want to get up, and when the little hand comes around it will touch it and

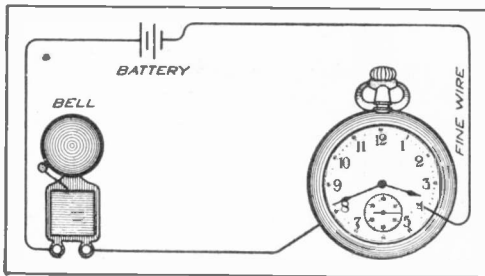

NOVEL ALARM SWITCH

the large hand will pass over it. Connect the other end of this wire to the battery. Then put a coil of bare wire under your watch and connect the other end to post of the bell. Then connect the other bell post and battery together. When the little hand comes around it will touch the wire and make a contact and ring the bell.

Leechburg, Pa.

JOHN LONG.

The Young Edisons' Club:

It was during the time when I was most interested in electricity that the idea of wiring a telephone transmitter behind the sofa where my sister and her beaux sat nearly every night, entered my mind. The next day the folks went to the city to do their Spring shopping. "Luck surely is with me," I thought, as I went to my room to get the telephone parts ready. All I needed was a set of batteries, a small switch, a receiver and transmitter. The latter I had purchased the summer before just for curiosity's sake. I wired the transmitter to one end of a long piece of lamp cord which I had carefully laid along in the most ob-

scure places, so as not to be noticed by the folks. I laid the transmitter behind the sofa with a megaphone attachment, so that I could hear what they said more plainly. I then connected the receiver, batteries and small switch in the circuit upstairs in my room. That evening my mother noticed a strip of wire which I had not hidden properly and she asked about it. I told her that I was going to do a little experimenting with it, and she said she didn't mind. A few minutes later I hid the wire that my mother had noticed, for fear my sister might notice it also. I went to my room a little earlier that evening than usual. About ten minutes later the bell rang and one of my sister's beaux came in. As soon as I heard the front door close I closed the switch. A moment later the conversation began. I don't believe I ever laughed so hard before as I did during the whole of the conversation.

[For obvious reasons we refrain from printing this young Edison's name and address.]

The Young Edisons' Club:

Dry cells are much the same as the common liquid battery in their construction; that is, the materials used are nearly the same. I have been successful in making dry cells after the following plan:

First, procure a piece of good sheet zinc about $\frac{1}{8}$ inch thick and $8\frac{1}{2}$ inches long, by 6 inches wide. Roll this into a cylinder $2\frac{1}{2}$ inches in diameter; this will give you a chance to lap the edges over about $\frac{5}{8}$ of an inch at the seam. Solder the seam on the outside of the cylinder and the inside of the seam should be covered with asphaltum to cover the solder. Of course just the seam should be covered and no other part of the inside of the cylinder. Now cut a disk that will just fit inside of the cylinder and solder it into one end, so as to form a watertight jar or receptacle for the paste.

Before putting the paste into the receptacle you must procure the carbon ele-

ment, or the positive pole of your battery. If you can get an old carbon from another old and worn out dry cell, you can make good use of that by cleaning it thoroughly, or in case you cannot get one of these you can take three of the common carbons used in arc lamps and tie them together with rubber bands at top and bottom of the rods.

Now you are ready to assemble the battery. Before you mix up the paste you might as well take a piece of the very thin blotting paper, say about $\frac{1}{2}$ inch thick, and line the inside of the whole receptacle with it.

Prepare your paste by mixing $\frac{1}{4}$ pound of zinc oxide, 1-3 pound of sal ammoniac, $\frac{3}{4}$ pound plaster of Paris, $\frac{1}{4}$ pound chloride of zinc. Mix into a paste by adding about $\frac{1}{2}$ pint of water. This should be distilled water, or, better still, common rain water.

When you have the paste all ready, put in about $\frac{5}{8}$ of an inch of paste, then set your carbon into the jar in, the center, of course, then you can proceed to fill the receptacle to within about $\frac{3}{4}$ of an inch from the top, pressing the paste in tight.

Leaving about $\frac{3}{4}$ inch at the top to seal the battery in, you proceed to clean all paste or such materials as might be around the top, and wipe the zinc off dry and clean. Next melt enough pitch or asphaltum to fill up this space, get this hot enough so it will fill up all parts of the top and make it airtight, but before pouring this into the space it is best to sprinkle a little sawdust on the top of the paste so as to have a dry surface to pour the hot wax onto.

L. M. OLSEN.

805 Lake St., Bellingham, Wash.

Toy Torpedo Battles

As a modern variation of the old war game played with peas as cannon balls and toy ships as targets, our European cousins are beginning to use magnetized projectiles which can serve both as torpedoes and as floating mines. A needle stuck through an ordinary pea might answer, but would rarely be light enough to float well; hence the German boys use a pair of cork balls with a magnetized piece of a fine knitting needle connecting them. The gun used is the usual spring actuated toy cannon, from which a single projectile is fired alternately

by the players, either the corks or the needles being painted to show by which side they were fired.

The scoring takes account of the usual practice of protecting vessels above the water line with a heavy coat of armor, which makes them more vulnerable below the surface of the water than above the same. If a projectile strikes the vessel directly above the water line, it counts 5; if below the water line, 15. If it does not immediately strike the vessel, it is left to drift in the



A TORPEDO BATTLE

water and serves as a mine buoy, counting 10 if it strikes a vessel belonging to the other side. Whenever a vessel is struck in either one of these three ways, both it and the projectile which struck it are taken out of the water. Vessels hit by a player's own projectiles are likewise removed, scoring the same points for the opposing side. When all vessels have been "sunk," they are replaced, the game continuing until one side scores a total of 100 points. Of course the toy boats used in the game must have metal hulls which will attract the magnetized projectiles whenever these get near them, and much of the players' skill goes to directing the shots from their opposing vantage points so that they will drift towards the enemy's boats. Then in case any two floating projectiles strike each other, they are assumed to have exploded and are taken out of the water without scoring for either side.

POPULAR ELECTRICITY WIRELESS CLUB

Membership in Popular Electricity Wireless Club is made up of readers of this magazine who have constructed or are operating wireless apparatus or systems. Membership blanks will be sent upon request. This department of the magazine will be devoted to the interests of the Club.

A High-Power Wireless Equipment

By ALFRED P. MORGAN

PART XIV.—VARIABLE CONDENSER

The only form of variable condenser of any real value for receiving purposes in wireless telegraphy is one having air as a dielectric. There are no losses of energy due to dielectric hysteresis when this mode of construction is employed.

The form of variable condenser most commonly employed in wireless telegraph apparatus consists of two sets of semi-circular plates,—one set being connected together and fixed rigidly in position and the other set being connected together and capable of rotation about a central axis. When this latter set is rotated so as to bring a greater or lesser area of the two sets of plates into an interlapping position, the capacity of the condenser is varied.

Fig. 153 shows several circuit diagrams employing a variable condenser in addition to the loose coupler for tuning purposes. In the first diagram, the condenser is inserted between the primary of the loose coupler and the ground. The condenser in this position has the effect of shortening the wave length of the aerial circuit so that it is adapted to receiving *short* wave lengths. The second, third and fourth

methods increase the wave length of the aerial and adapt it to *longer* wave lengths. The last method employs three variable condensers. This method produces a decrease in the wave length of the antenna and adapts it to shorter waves. It is possible to make very fine adjustments with this circuit and obtain the best resonance. This circuit is hard to handle, however, without

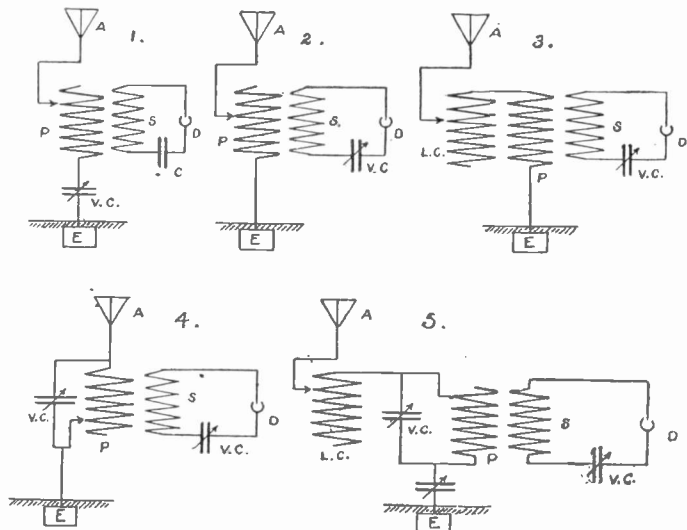

FIG. 153. CIRCUIT DIAGRAMS

considerable experience in its adjustment. When the inductance of the secondary of the receiving transformer is accurately adjustable in the manner of the instrument described in Chapter XIII, the condenser in the detector circuit (known as the sec-

ondary condenser) need and a fixed condenser may be used. The circuit diagrams illustrated by (1), (2) and (4) in Fig. 153 are the ones most commonly employed.

The most desirable plates to use in building a variable condenser are those having ears or lugs attached, through which the binding rods that hold the condenser pass. These are shown in Fig. 154. However, it requires special dies to stamp these out and they can only be obtained at considerable expense. It is, therefore, more expedient for the amateur to use an ordinary semi-circular plate for this purpose. These plates can

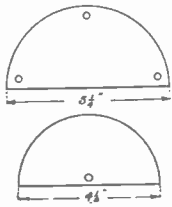

FIG. 155. SEMI-CIRCULAR PLATES

be obtained in the open market, already stamped out and it is advisable to purchase them in this form rather than to attempt to cut them out with a pair of shears and risk bending them out of shape. Thirty-one semi-circles are required, sixteen of them $5\frac{1}{4}$ inches in diameter and fifteen $4\frac{1}{2}$ inches in diameter. Three holes are bored in the larger plates and one in the smaller plate. The location of the holes is indicated in Fig. 155.

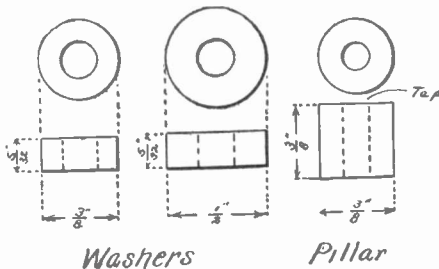

FIG. 156. BRASS WASHERS AND PILLAR

The plates are separated by brass washers, Fig. 156, $\frac{3}{8}$ inch thick. Those which separate the larger plates are $\frac{3}{8}$ inch in diameter, while those separating the smaller

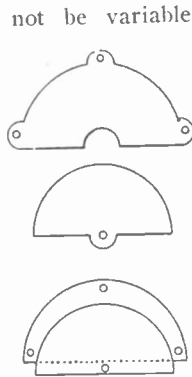

FIG. 154. SHOWING INTERLOCKING POSITIONS

movable plates are larger, namely $\frac{1}{2}$ inch, in order to insure the plates being parallel.

The smaller plates are assembled first by passing a $\frac{3}{32}$ brass rod alternately first through a plate and then a washer. The ends of the rod are threaded with an 8-32 die and two threaded brass washers $\frac{1}{2}$ inch in diameter and $\frac{3}{8}$ inch thick screwed down against the plates so that they are held firmly in position and cannot turn on the shaft. The fixed plates are assembled with one rod passing through them near each corner and one in the center of the curved edge. The ends of the rods here also are threaded with an 8-32 die and a brass washer $\frac{3}{8}$ inch thick with $\frac{3}{8}$ -inch threads. This is screwed down against the plates.

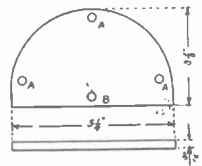

FIG. 157. FIBRE ENDS

After drilling the plates previous to assembling, file off any burrs around the holes very carefully. If this is not done carefully, the plates will be separated by a distance greater than the thickness of the washers and the plates will be thrown out of alignment. The plates may be either brass or aluminum, No. 20 B. & S. gauge.

Two pieces of fibre $\frac{1}{8}$ inch thick are cut to the dimensions and shape shown in Fig. 157. The holes (A A A) are bored in the

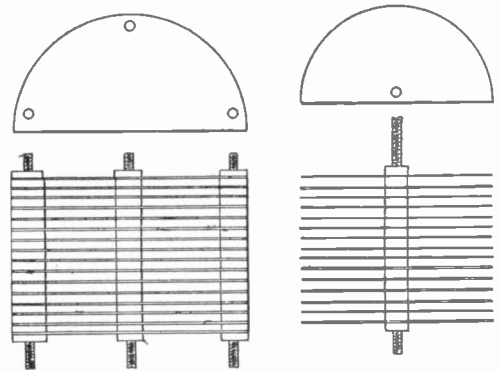

FIG. 158. ASSEMBLY OF PLATES

same relative positions as the three holes in the larger plates. The lower piece of fibre is held in position by means of three 8-32 hexagonal brass nuts screwed onto the rods. After the upper fibre is in place the rods should be cut off so that only $\frac{1}{8}$ inch

projects above the surface. Three small brass pillars $\frac{3}{8}$ inch long and of the same diameter are bored through their axis and threaded with an 8-32 die. They are then screwed firmly down onto the ends of the rods as in Fig. 158.

The hole (B), Fig. 157, is in such a position that when the shaft of the movable

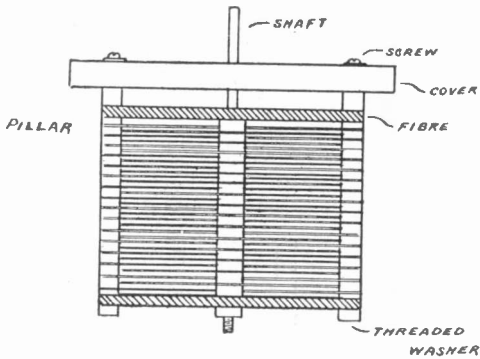

FIG. 159. CONDENSER UNIT ATTACHED TO COVER

plates is slipped through, the brass washers will just clear the fixed plates and not make contact with them.

The condenser complete, as shown in Fig. 159, is enclosed in a hardwood case built according to the dimensions in Fig. 160. It is supported from the cover by three 8-32 round headed brass machine screws passing down through the latter into the pillars screwed on the tops of the rods. A pol-

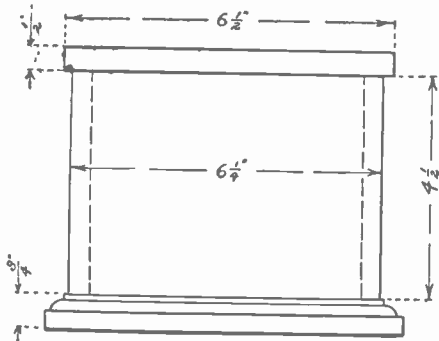

FIG. 160. CONDENSER CASE

ished brass washer is placed under the head of each of the screws to better the appearance.

The top of the case is fastened down by eight brass screws countersunk so that they are level with the surface. Connections

are established by soldering one wire to one of the binding rods which hold the stationary plates in position. The wire is then led out to the screw connecting with a brass binding post mounted on the cover. A second wire is soldered to a small strip of spring brass which is fastened to the under side of the cover with a round headed wood screw and then bent upwards so that it rubs against the shaft of the movable plates. The other end of the wire is attached to a second binding post.

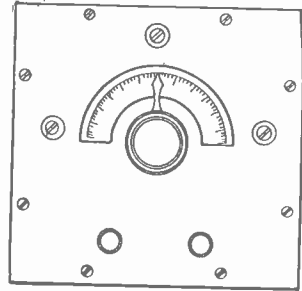

FIG. 161. TOP VIEW OF INSTRUMENT

The condenser is provided with a brass scale mounted on the top of the box and a pointer so that the amount of condenser in the circuit may be seen at a glance. The details of the pointer and the scale are indicated in Figs. 161 to 163. The pointer is cut out of sheet brass with a pair of tin snips and then finished with a file. It is attached to a small brass bushing by soldering. The bushing is split with a hacksaw and slipped over the shaft. The handle attached to the shaft is an ordinary typewriter knob. These may be readily obtained from dealers in wireless goods or from a typewriter manufacturer. They are provided with a hollow metal bushing having an internal diameter of one-quarter of an inch, so that it will just slip down over the bushing. After the plates have been turned so that the movable plates do not interlap with the stationary plates the pointer is set to zero and the set screw on the knob tightened so as to maintain the position.

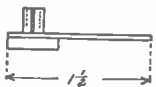
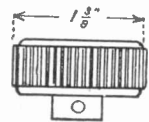

FIG. 162. DETAILS OF POINTER AND KNOB

The plates must under no circumstances rub against or touch one another. They must be brought into alignment by careful trueing and perhaps the insertion of one or two thin sheet brass washers between the

stationary plates and the fibre at the top or bottom so as to raise or lower the movable plates as the case may demand.

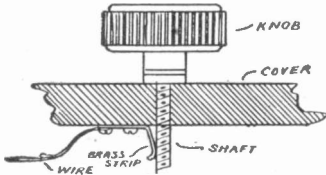

FIG. 163. METHOD OF CONNECTING WITH MOVABLE PLATES

The instrument is finished by staining, filling and polishing.

(To be concluded.)

Wireless Across America

It is now proposed to establish a trans-continental line of wireless telegraph stations for commercial purposes. The company which has been formed to accomplish this difficult task is known as the Poulson Wireless Telegraph and Telephone Company. A start toward this end has been made by equipping stations at Los Angeles, San Francisco, Cal., and El Paso, Tex. The last has but recently been completed. The company asserts that immediately after the station at El Paso was in shape communi-

tion was established in the daytime between it and the San Francisco station, a distance of 1,250 miles.

The power used at San Francisco and El Paso is twelve and sixteen kilowatts, respectively, although further experimenting will undoubtedly lead to a considerable reduction in the energy required. At both plants the antennae are supported by two 300-foot towers located 370 feet apart, and consist of two sets of fans, each of 22 wires, suspended from a steel cable and guyed laterally. This double fan type of aerial has been found the most suitable by the Poulsen experts. The ground connections are in the form of radiating copper wires buried four feet in the sand and extending on one side of the lot into the Rio Grande river and on the other into an irrigation canal. The accompanying cut gives a very good idea of the El Paso station towers before the antennae were in place.

The towers are built in sections, each of six feet. The entire construction is of Oregon pine and is bolted to a foundation framework of 12-inch California redwood embedded in the sand. Each tower is supported by five sets of guys. The towers are calculated to withstand the pressure of wind blowing 100 miles per hour.

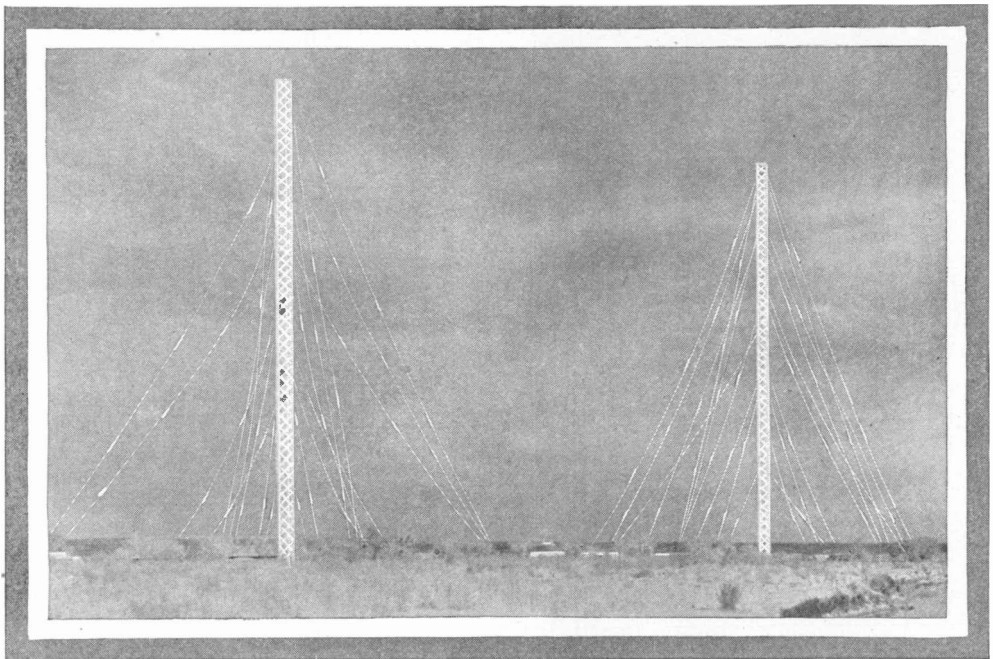

THE EL PASO PLANT

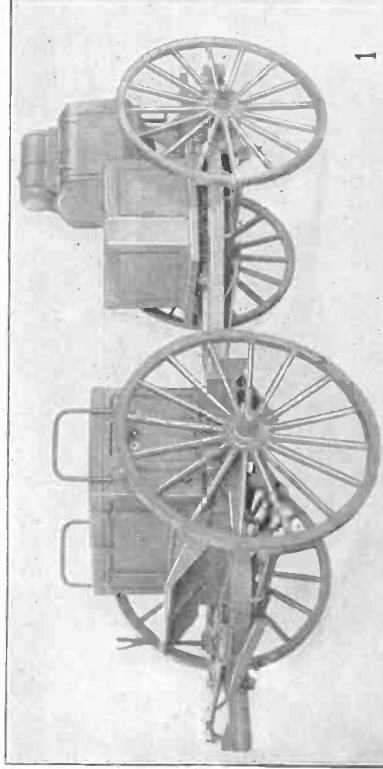

1

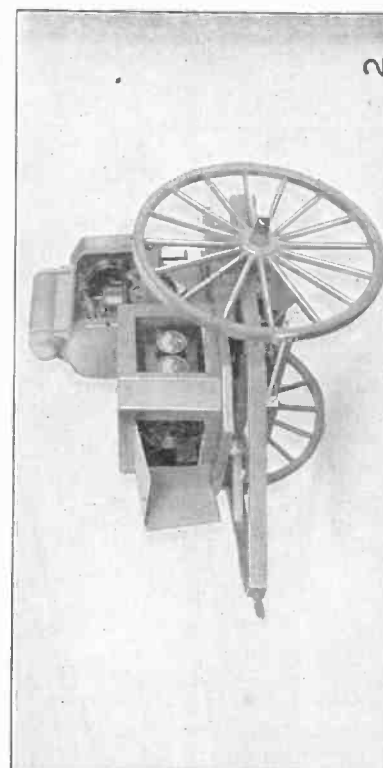

2

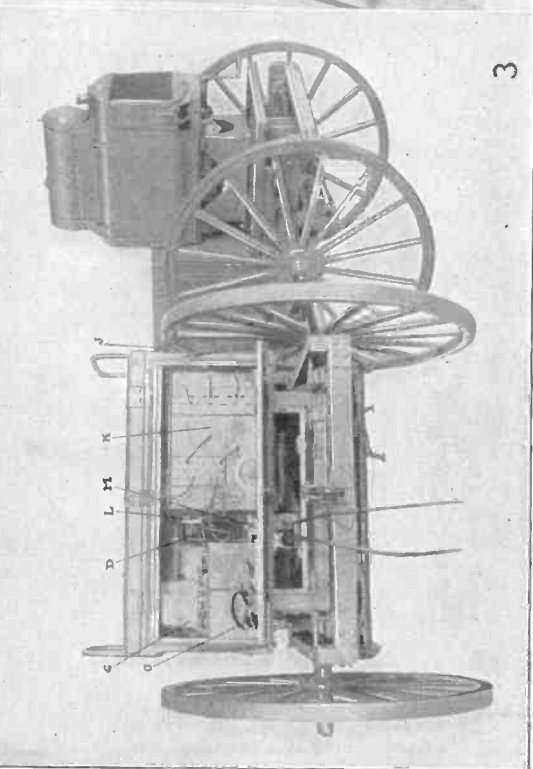

3

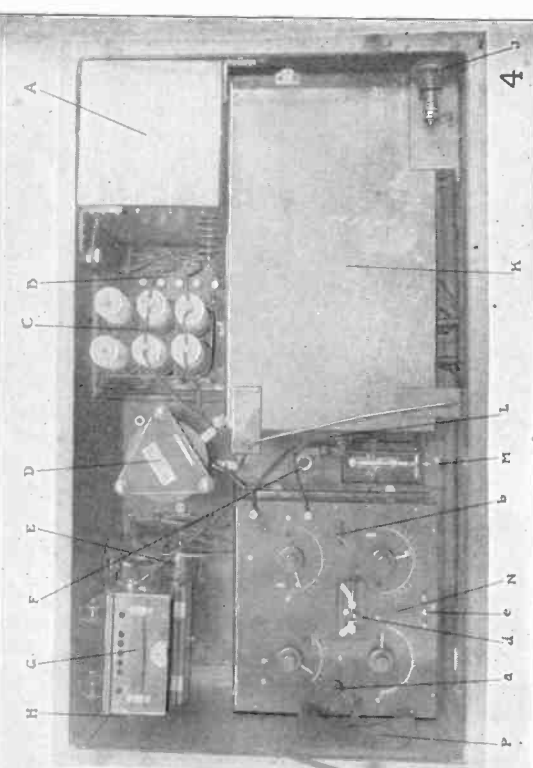

4

LATEST FIELD SET FOR THE UNITED STATES SIGNAL CORPS

Latest Field Set for the Signal Corps

By R. H. LANGLEY

There are a great many men today who are looking forward to the next war in which any of the great world powers engage with the keenest interest. There are so many developments of modern science which will have an immediate effect upon warfare that we can today amuse ourselves imagining what the next war will be like. Among these developments are the submarine, the aeroplane, the Maxim gun silencer, and perhaps as important as any in its actual effect upon war, the self-contained field wireless equipment. There are those who say that so many inventions have been developed and so great will be their effect that war, as we have known it, will be impossible. It is not our aim here to discuss this question, but we will endeavor to describe the last mentioned of these inventions in its latest form.

The illustrations show a field set that was delivered to the Signal Corps early in 1911. It will be seen at once that this outfit is much simpler than those of a similar type which the Signal Corps has had previously. It will also be seen that it is built upon the standard "Pintle Wire Wagon" chassis and designed to be drawn by four horses. The forward cart, as shown in Fig. 1, is fitted with a pole and whiffle-tree and is the instrument cart proper as has been the practice in all previous sets for this service. The rear cart, Fig. 2, which is attached to the forward cart and drawn by it by a special form of coupling which admits of very rapid separation of the two carts, is the power cart. It is fitted with a brace which is let down when the rear cart is detached and supports it in a horizontal position. Both the carts are equipped with brakes that are so effective as to practically lock the wheels. It is thus unnecessary to block the wheels when the carts are set up in the field for operation.

The power cart, shown in detail in Fig. 3, has mounted upon it a gasoline engine and a generator. The engine is an eighteen horse power Sultan, four cylinder and four stroke cycle. It is mounted facing the rear of the cart, with its radiator on the rear

side. Its gasoline tank is mounted on top of the engine itself so that a gravity feed is obtained. The engine is water cooled and has the usual fan to force air through the radiator. No batteries are provided for starting, but the magneto is relied upon to give the spark at once.

The engine rests upon a heavy casting and is direct coupled to the generator. This is a Diehl machine and delivers two kilowatts of energy at 110 volts, 500 cycles. The exciting current is 110 volts, direct current, and is also used in the instrument cart as will be seen later. To take the current from the power cart to the instrument cart where it is used, two cables are provided which plug into sockets at the front of the power cart and the rear of the instrument cart. One of these conductors is for the alternating current and the other for the direct current.

The casing over the engine and the generator is of sheet steel and is so constructed that any part of the apparatus is easily accessible. On one side of the generator is a panel carrying fuses and switches and a rheostat and handle for regulating same. On the other side of the engine is a panel on which are mounted a Weston voltmeter and ammeter.

The instrument cart is very compact. On the chassis is mounted a wooden box, the top of which acts as a seat for the driver and operator when the cart is being moved into action or on the march. The top is hinged so that when it is desired to move any of the apparatus from the wagon it may be opened. The rear side of the box is hinged at the bottom and acts, when open as a desk or shelf for the operator. The opening of this door gives access to all the adjustments of the set and to the key. Beneath this large box and setting down into the chassis of the cart is a smaller box in which parts of the field antenna are stored during transit of the equipment. The cables for connecting the power cart to the instrument cart electrically are also carried here, as well as spare fuses and wire, etc. The

sockets for plugging in the cables will be seen in the front of this lower box.

The wireless equipment itself is of the quenched spark type. It is of two kilowatt capacity and has an efficiency from 60 to 75 per cent actual radiation. Considering the plan view, Fig. 4, and also the end view with door open, Fig. 3 of the instrument cart, in the upper right hand corner will be seen the transformer (A) standing on end. Just in front of the transformer and at the bottom of the box is an adjustable reactance (B) to give resonance between the transformer circuits. Next to the reactance are the condensers (C), six units being held in rack, two being spare. Next is the discharger or spark gap (D) and beside it a fan (E) to keep it cool. This fan is operated on the direct exciting current from the power cart and is controlled by the switch (F). Above the fan and in plain view from the rear of the cart when the back is open is a hot wire ammeter (G) showing the radiation in amperes. This instrument is on the ground side of the closed oscillating circuit and from its other terminal the connection to ground is made through a bushing (H) similar to the antenna bushing, but located near the bottom of the box on the left hand side at the rear. The antenna bushing is shown at (J) and has a spring contact so that the antenna wire may be slipped under the knob on the outside and a good connection made very quickly. The large box (K) is the transmitting tuner and is a direct coupled inductance so arranged that any wave length between 200 and 1,200 meters may be had, and the change from one wave to another is accomplished in a very short time. The method of making these adjustments may be learned from a study of the front of the box. The box contains two large helices side by side and connections from these are brought out every few turns to the jacks seen on the front of the box. A variometer at the bottom makes perfect resonance obtainable. One of the coils is a loading coil and the other a coupling coil. The power switch is at (L) and the key at (M). The receiver is entirely contained in the box (N) and consists of four units, a loose coupler, two

variable condensers, and a variometer. By means of the two switching knobs (a) and (b) the connections are so altered that any wave between 200 and 2,000 may be accurately tuned to. The detector (d) of the "perikon" type is mounted on the top of the box. Phones (O) are connected to the posts (e), of which the center one is dead to make it possible to connect two sets of phones in series. When the cart is on the march, the phones are carried in the bag (P). This completes the wireless equipment of the cart, and while it is very simple and easy of adjustment, it is very efficient and complete.

The antenna used with this set is the regular portable type used by the Signal Corps. It consists of a 60 foot hollow spruce mast in ten sections. It is guyed half way up and also near the top and six wires run from the top in the form of an umbrella. For a ground, six wires are laid on the earth running radially from the mast under each of the six wires of the antenna. The whole is so constructed that it may be put up in a very few minutes. Its fundamental wave length is about 200 meters and its capacity about one one-thousandth of a microfarad. The sending radius of the outfit is 150 to 200 miles and the high pitch of the musical note emitted by the quenched spark transmitter makes it very readable even when severe interference is to be met with. The tuner, although simple, which is used for receiving, is very effective, as its tuning is very sharp, as is also the wave sent out by the transmitter.

In any outfit for field work, the question of rigidity of the apparatus and resistance to shock and jouncing over rough roads, is important. In the outfit in question, all parts which could in themselves resist shock, were bolted fast. Other parts, such as ammeters, which would be wrecked by severe shock, were mounted upon springs which absorbed the shock. To prove whether the precautions which had been taken in this direction were effective or not, the set was given a very severe test. At the end of half an hour's rumbling over the roughest kind of road, not one screw was found loosened and the delicate instruments remained in perfect condition.



Transmitting Helices

In many stations the transmitting helix is an important instrument. It serves the same purpose in the transmitting set as the tuning coil does in the receiving outfit. In stations using spark coils rated at $1\frac{1}{2}$ inch spark or less, it is doubtful that the use of a helix would improve the transmitting radius, but where a larger coil or a transformer supplies the high tension current the helix is practically a necessity. Not only can a greater distance be covered by such a station with the help of a helix, but the transmitting apparatus can be given a definite wave length, thereby enabling the receiving operator to hear the station through interference.

There are two forms of helices in general use at the present time. One form consists of a spiral of wire wound in one plane, and the other form is a true helix in shape. In the first form of helix the advantage is that of occupying small space, and the main disadvantage is that the outer turns of wire or ribbon have a greater inductance than the inner turns, with the result that it is not such a simple matter to tune the circuits connected to the helix. The second form of helix mentioned above requires more space, but each turn has an inductance equal to that of every other turn, and better insulation can be obtained between turns.

In all transmitting instruments it is desirable to have as low an ohmic resistance and as low a high frequency resistance as possible. The ohmic resistance is that which is generally known by the term "resistance." The high frequency resistance is one which is due to the fact that high frequency currents are not evenly distributed throughout the conductor, but flow nearer the surface, the higher the frequency. For this reason a helix should be wound with a wire of low ohmic resistance, having a large surface.

In order to obtain as little high frequency resistance as possible, some helices are wound with copper or brass ribbon. Personally, I am not in favor of using metal ribbon for this purpose because of the comparatively sharp edges, from which there is certain to be some brush discharge and consequent loss.

Some of the large commercial stations have helices wound with copper tubing, which has a low ohmic resistance and a low

high frequency resistance on account of its large surface.

The following tables give dimensions for helices similar to that shown in the figure:

COILS UP TO ONE INCH SPARK.

Diameter of winding, 5 inches.
Number of turns, 10.
Size of wire, No. 10.
Kind of wire, copper or aluminum.
Distance between turns, 1 inch.
Feet of wire needed, 13.

COILS FROM $1\frac{1}{2}$ TO 4 INCH SPARK AND TRANSFORMERS UP TO $\frac{1}{2}$ K. W.

Diameter of winding, 8 inches.
Number of turns, 10.
Size of wire, No. 8.
Kind of wire, copper or aluminum.
Distance between turns, $1\frac{3}{8}$ inches.
Feet of wire needed, 22.

For transformers of from $\frac{3}{4}$ K. W. to two K. W. the helix may have the same di-

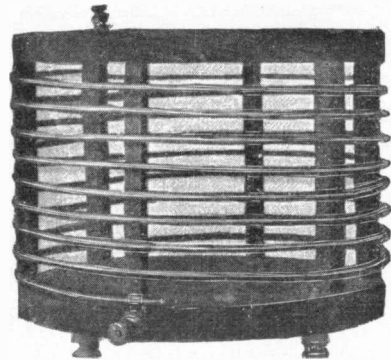

TRANSMITTING HELIX

mensions as the large one described above, but the wire should be of copper, and should be not smaller than No. 6.

The wire of a helix for low powers may be supported on frames of well seasoned wood, but in the larger helices the supports should be made of fiber or hard rubber, or can be constructed of porcelain knobs held in place by non-conducting rods passing through their centers.

In tuning a transmitting station it will be found that one-quarter of one turn either way may throw the set out of tune, and it is therefore advisable to have an operator at a receiving station at a distance advise the transmitting operator when the signals come in best.

A. B. COLE.

Sensitive Relay for Wireless Telegraphy

The ordinary coherer will only work up to a few miles and is very uncertain in its action. For this reason it is seldom used in the amateur station.

With this relay I am going to describe how it is possible to use a sounder or call bell system. The device works on the lever principle. A series of three levers are connected as shown, so that when the first is moved very slightly the others multiply this motion, thus closing an electrical circuit.

Fig. 1 shows a plan. No special dimensions are necessary, but will give them for the benefit of the reader. The base is

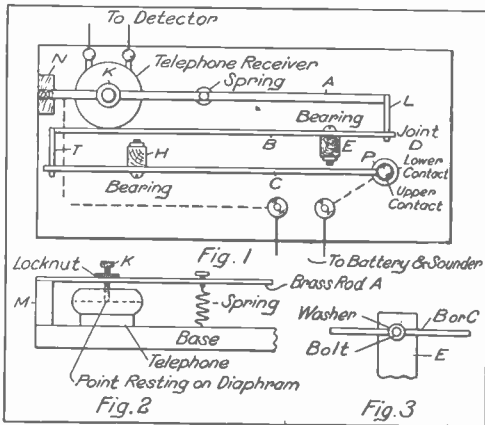

SENSITIVE RELAY

15x7 inches. (A) is a piece of spring brass $\frac{1}{8}$ by $\frac{1}{4}$ by 10 inches. It is fastened to (M), which is an upright, so as to be two inches above the base. An adjustable screw (K) passes through (A). The end of (K) should rest on the center of the diaphragm of a sensitive telephone receiver. Fig. 2. The spring is to keep (K) in close contact with the diaphragm. (L) is a piece of $\frac{1}{8}$ inch round brass $1\frac{1}{2}$ inches long. (B) and (C) are two pieces of brass each $\frac{3}{8}$ by $\frac{1}{4}$ by 10 inches long. (T) is similar to (L). At the ends of (B) and (C) two holes are drilled that will just allow (L) and (T) to fit tightly and yet work very easily. The dimensions on (A), (B) and (C) are as follows: (N) to (K), 2 inches; (K) to (L), 10 inches; (L) to (E), 2 inches; (E) to (T), 10 inches; (T) to (H), 3 inches; (H) to (P), 9 inches.

When the parts are set up on the base a very light touch on (K) should close contact at (P). When connected to a good wireless set a message causes the diaphragm to be pulled down slightly causing (K) to drop. This movement of (A) is transmitted and multiplied to (P) which closes the contact and works a sounder which is in series with a battery

B. FRANCIS DASHIELL.

Coherer Not Practicable for Operator's Alarm

The coherer is one of the oldest forms of detector. It is composed of metallic filings enclosed in a glass tube, having two plugs of metal so arranged that their pressure on the filings can be varied. In the better forms of coherers the glass tube is exhausted of air to prevent oxidation of the filings. The filings are generally of the proportion of 10 per cent silver and 90 per cent nickel.

The coherer cannot be used in connection with telephone receivers, but requires a relay which in turn operates a decoherer and a sounder. The decoherer is often an electric bell so arranged that the hammer strikes the glass tube and shakes or decoheres the filings.

Some amateurs have been led to believe that the coherer will give satisfactory results as a device to call the operator when he is not at his instruments. This is not true in general, as will be explained in the following:

The coherer is not a sensitive instrument as compared with the modern detectors. Furthermore, it is not reliable, and will not stay in adjustment. We doubt that this instrument will respond to a two K. W. commercial station at a distance of more than ten miles if used in the average amateur station, even in connection with a good 250 ohm relay. It cannot be depended upon to respond to even such a station for more than five or ten minutes without being readjusted, since it is affected by every station within its responding radius whether in tune or not, providing that such stations use a comparatively high voltage at the top of the aerial for transmitting.

The chief field of the coherer at the present time is that of lecture work where the distance between the stations is small.

A. B. COLE.

WIRELESS QUERIES

Answered by A. B. Cole

Questions sent in to this department must comply with the same requirements that are specified in the case of the questions and answers on general electrical subjects. See "Questions and Answers" Department.

Spark Gap; Electrolytic Interrupter and Coil; Calling Instrument; Aerial

Questions.—(A) Explain the use of a spark gap in wireless telegraphy. (B) In some stations an electrolytic interrupter is used to operate a coil on 110-volt alternating current circuits. It is also possible to operate a coil on such a circuit by tightening the interrupter until it will not operate and connect the coil across the line without an interrupter. Why is the interrupter used in the former case? (C) Is there an instrument by which a person is notified if called while he is not at his instruments? (D) What is the cause of the musical hum in a wireless or telephone receiver? (E) What is the object in having one end of an aerial higher than the other end?—W. C. S., Biloxi, Miss.

Answers.—(A) When the key is depressed, the aerial becomes charged to a high potential. When this potential has reached a certain point, determined by the length of the spark gap, it suddenly discharges, and a spark passes across the gap. The potential of the aerial is thereby suddenly decreased. The sudden variation in potential produces the electromagnetic waves which are radiated. The purpose of the spark gap is therefore to allow the aerial to become charged and then to provide a means of suddenly discharging it.

(B) Using the former arrangement, the high frequency of the interruption produced by the interrupter gives a greater spark length than could be obtained in the latter way.

(C) The only practical device at the present time consists of a coherer in connection with a relay, the latter operating a bell or other signal. The coherer is unreliable and is far from sensitive, and is to be recommended only for very short distance working and for lecture purposes.

(D) This is probably caused by induction from electric light or power wires in the vicinity.

(E) In general, the higher the aerial, the better the results obtained with it. One end is higher than the other in some aerials, because it was not possible to raise the lower end.

Transformer on 110 Volts D. C.

Question.—(A) Can a transformer be operated on 110 volts D. C. in series with an electrolytic interrupter?—M. W., Ireton, Iowa.

Answers.—(A) A closed core transformer will give practically no results at all, and some types of open core transformers will give fair results, while other open core transformers will give no better results than the closed core type.

Detectors; Untuned Set; 15-Mile Aerial; Potentiometer Resistance

Question.—(A) Why are several detectors used in some wireless sets, and how are they connected? (B) Will the length of the aerial affect the transmission and reception of messages by an untuned set? (C) Please give dimensions of aerial for transmitting ½-mile and receiving from 10 to 15 miles. (D) Can Portland cement be used as insulating material? (E) What material can be used for the high resistance element of a potentiometer?—A. J. M., Waukesha, Wis.

Answers.—(A) Some detectors give loud sounds on short distance working, but are not sensitive for long distance operation. Other detectors are thrown out of adjustment when the transmitting key is depressed. Several detectors are used so that the advantages of all can be obtained. A switch is arranged to cut in any one detector at one time.

(B) Yes, the longer the aerial, within limits, the better.

(C) Four wires, each 40 feet high and 50 feet long.

(D) No, it would not be satisfactory for high tension circuits.

(E) A high resistance carbon rod is sometimes used. The rod of a hard lead pencil will give fair results.

Comparison of Aerials; Receiving Distance

Questions.—(A) Of two aerials, of the same height, which would give better results, one 15 feet long consisting of four wires, or one of two wires 30 feet long? (B) Should I have any difficulty in sending and receiving over a distance of 600 feet, with no high objects between the stations, using a ½-inch coil, zinc spark gap, auto-coherer, 75-ohm receiver and water rheostat in place of potentiometer? The aerial is 30 feet long, consisting of four wires.—G. S., Greensburg, Kan.

Answers.—(A) The former would be better for transmitting, and the latter for receiving.

(B) There should be no difficulty, provided that you have a good ground connection at each station.

Revolving Spark Gap; Series Spark Gap

Questions.—(A) Please explain the operations of the revolving spark gap. What are the advantages of this type of gap? (B) Explain the operation of a series gap. What are the advantages of this type of gap? (C) Which of the above gaps is more easily constructed, and which would give the best results for amateur use?—H. O., Kibbie, Mich.

Answers.—(A) The revolving spark gap consists of a metallic disk rotated by a motor or other means so that the spark is extinguished at regular intervals. If properly timed with reference to the capacity and inductance of the aerial circuit and the frequency of the current supplied to the transformer, the aerial will have time to radiate all the energy supplied to it before another spark passes across the gap. This form of gap will also raise the pitch of the spark. For these reasons the revolving gap increases the efficiency of the set.

(B) The series gap consists of several gaps in series and its main advantage is that of large and effective cooling surface, which increases the efficiency. A higher pitch can also be obtained with this type of gap.

(C) The series gap is the more easily made, and will give good results for your purpose.

Variometer Wire; Condenser Connections

Questions.—(A) Which of the following sizes of wire would be most satisfactory for a variometer the outer coil of which is $5\frac{1}{2}$ inches in diameter and whose inner coil is 5 inches in diameter; No. 18, No. 24 or No. 32? (B) Can a variometer be used in connection with a single slide tuning coil? If so, how? (C) I have two receiving condensers of capacities of .088 and .078 M. F. respectively. If these are connected in series, what is the resulting capacity? If connected in parallel?—L. R. W., Normal, Ill.

Answers.—(A) We should use No. 18 wire.

(B) The combination of the variometer and the single slide tuning coil can be used to increase the wave length to which the station will respond. If the variometer is of the transformer type, the tuning coil is connected in series with the primary. If it is of the type in which the two coils are connected together, the tuning coil is connected in series with it and the aerial. (C) The resulting capacity would be .0414 M. F. for the series connection and .166 for the parallel connection.

Sliding Tube in Induction Coil.

Question.—One of my friends has a $\frac{3}{4}$ -inch induction coil with a brass tube which snugly fits the outside of the core and slides back and forth. When the tube nearly covers the core the secondary current is feeble; when it is drawn off, the current in the secondary increases. The sliding of the tube does not increase or decrease the battery current as far as I can see. Will you explain?—I. C., Flint, Mich.

Answer.—While the brass tube does not in any way decrease or increase the battery current it prevents the core from receiving the full magnetic effect of the current in the primary winding, some of the energy being used in producing eddy currents in the brass tube. Likewise the magnetism of the core is some of it absorbed by the tube instead of affecting the secondary.

Insulators; Voltage of One-Inch Coil; Helix and Electrolytic Interrupter

Questions.—(A) Which is the best of the following for insulating high frequency currents: Glass, porcelain or hard rubber? (B) What voltage is required in an induction coil to give a one-inch spark? (C) What size of wire and how much would be required for a helix to be used in connection with a one K. W. transformer? (D) How can I make an electrolytic interrupter?—G. F., Aurora, Ill.

Answers.—(A) For outdoor work glazed porcelain is probably the best. In wiring for best results glass should never be used, as ordinary insulators made of this material contain a certain amount of metallic salts which reduce the insulating qualities for high tension lines.

(B) This depends upon the size, shape and composition of the spark gap terminals and some other factors, but an instantaneous voltage of 20,000 may be taken as an average.

(C) Twenty-two feet of No. 6 copper wire wound in ten turns of a diameter of eight inches. The turns should be spaced $1\frac{3}{8}$ inches apart.

(D) A simple and fairly satisfactory interrupter is made by arranging a No. 14 platinum or German silver wire so that it can be lowered slowly into a glass jar containing a solution of from 5 to 10 per cent of sulphuric acid in water. The other electrode is a lead plate.

Condenser with One-inch Spark Coil

Question.—Please tell me how much tinfoil is needed in a condenser to be used with a one-inch spark coil.—R. E. Cromwell, Vinegar Haven, Mass.

Answer.—Use 800 square inches of foil.

QUESTIONS AND ANSWERS

Rules:—Questions must be addressed to the "Question and Answer Department" and contain nothing for other departments. Full name and address of the writer must be given; only three questions may be sent at one time; 2-cent stamp must be enclosed for answer by mail. No attention will be paid to questions which do not comply with these rules.

Carrying Capacity of Carbon Brushes; Voltage Generated; Fusing Motors

Questions.—(A) What is the carrying capacity per square inch of carbon brushes? (B) Upon what does the voltage of a dynamo depend? (C) What rule should be followed in regard to the size of fuses to protect motors?—A. R. K., Louisville, Ky.

Answers.—(A) From 30 to 40 amperes.

(B) The following formula gives the relation of the various factors upon which the voltage of a dynamo depends:

$$\text{Voltage} = \frac{F \times W \times S \times R. P. S.}{10^8}$$

in which

F = the total number of lines of force or flux.

S = the number of slots in the armature.

W = the number of wires per slot.

R. P. S. = the number of revolutions per second.

(C) Motor leads or branch circuits must be designed to carry a current at least 25 per cent greater than that for which the motor is rated. Where the wires under this rule would be overfused in order to provide for the starting current, as in the case of many of the alternating current motors, the wires must be of such size as to be properly protected by these large fuses.

Separators; Battery Solution; "Flashing" a Cell

Questions.—(A) What are "separators" in batteries? (B) What solution is used in the Edison primary cell? (C) What is meant by "flashing" a cell?—H. G. W., Glen Ellyn, Ill.

Answers.—(A) India rubber bands or other materials used in batteries to keep the plates from touching in the cell; particularly applied in secondary batteries where the plates are near together.

(B) A saturated solution made by stirring granulated potash into water placed in the cell jar.

(C) The E. M. F. of a cell is sometimes tested by placing one end of a short wire on the positive terminal of the cell and rapidly touching the negative strip and in this way producing a flash if the cell has life. It is an old method of testing and spoils the plates without giving any accurate results. Using a lamp or voltmeter is the proper way to make such a test, which, with the reading taken with an acidometer, will enable you to tell if the cell is in good condition.

Charging Voltage

Question.—In charging storage batteries what voltage should be used?—G. J. W., Los Angeles, Cal.

Answer.—Ordinarily the charging current at starting should be five per cent higher than the normal voltage of the battery. After 20 or 30 minutes the voltage may be raised ten or fifteen per cent above the normal voltage of the battery and continued until the charging is nearly completed, when the voltage may be raised to 30 or 40 per cent above the normal pressure of the battery.

Carrying Capacity of Copper Wire.

Question.—Will No. 14 B. & S. gauge wire be sufficient to carry current to 20 sixteen-candle-power 110-volt carbon filament lamps?—W. U. B., Mansonville, Quebec, Canada.

Answer.—Yes. No. 14 B. & S. gauge wire is rated in the National Code to carry twelve amperes. On page 32 of the last edition of the Code you will find a table of carrying capacity of copper wires from No. 18 wire to 2,000,000 circular mil cable.

Tesla Coil

Question.—Please explain what a Tesla coil is and what can be done with such a coil.—L. E. F., Madison, Maine.

Answer.—See "Construction of a Tesla High-Frequency Apparatus" on page 728 of the December, 1910, issue.

Watts in Horsepower.

Question.—How many watts will a one horsepower motor require?—A. A., Cincinnati, Ohio.

Answer.—Not considering efficiency, 746 watts will be required. Figuring efficiency which accounts for friction, windage and other losses enough extra watts must be added to 746 to take care of these losses if the motor is to furnish one horsepower output. With one kilowatt you will be on the safe side.

Dielectrics; Foucault Currents; Best Conductors

Questions.—(A) What is the meaning of the term "dielectrics"? (B) What are Foucault currents? (C) What are the two best conductors?—E. J. B., Greenville, Mich.

Answers.—(A) Glass, sealing-wax, silk, shellac, gutta-percha and air are examples of "non-conductors" of electricity. On this account they are used to make supports and handles for electrical apparatus where it is important that the electricity should not leak away. They are called also "insulators." Farady designated them "dielectrics."

(B) Electric currents produced in conductors and dissipated in heat. They may be produced in the armature core by the armature current; hence one reason for using a laminated armature core. They are also spoken of as eddy currents.

(C) Silver and copper.

Flaming Arc Electrodes; Lamination Insulation

Questions.—(A) Why is there a wire in the electrodes of a flaming arc lamp? (B) What is the composition of the carbons used in arc lamps giving a white light? (C) Is thin paper suitable to use between the laminations of an armature?—E. McK., Brown City, Mich.

Answers.—(A) The carbons used in lamps that are designed to burn long hours are usually about sixteen inches long. Without a wire to reduce the resistance of such a long carbon the lamp would burn with different voltages during the run.

(B) Cerium salts, a by-product of the Welsbach mantle manufacture, are the principal ingredients of electrodes, giving a white light. Cerium fluoride forms two-thirds of the core mixture in the electrode and calcium salts the rest.

(C) No, because with the heating of the armature the paper chars, crumbles to pieces and leaves the disks loose. A thin coating of linseed oil will serve the best.

"Bug" and "Bug Trap"

Question.—What is the meaning of the terms "bug" and "bug trap" as applied sometimes to electrical apparatus?—J. C. S., Chicago.

Answer.—The term "bug" is sometimes used to designate some fault or trouble in the connections in any electrical device. The "trap" signifies any arrangement used to overcome the "bug." The terms are said to have originated in quadruplex telegraphy and have gradually found way to other electrical apparatus.

The term "bug" is also applied to the fibre pieces or insulators placed on the upper edge of the canopy of an electric light fixture to insulate it from a metal ceiling, or one of metal lath and plaster.

Re-energizing an Old Compass Needle.

Question.—I have an old compass that does not indicate positively enough. How can I remedy this?—L. F. D., Davison, Mich.

Answer.—Re-energize the needle by winding it with a few turns of wire and passing a battery current momentarily through the wire; or stroke it upon a strong permanent magnet taking care to bring opposite poles of needle and magnet together.

Soldering Fluid

Question.—In "Don'ts for the Electrician" in the April issue is the following: "Don't use acid in soldering a wire." Will you suggest a soldering fluid?—J. B., Columbus, Kansas.

Answer.—The following formula for a soldering fluid is suggested in the National Electrical Code: Saturated solution of zinc chloride, five parts; alcohol, four parts; glycerine, one part.

Gas Lighting Coil Data.

Question.—Please give dimensions, wire, etc., for a ten-inch gas lighting coil.—H. T., Pittsburg, Pa.

Answer.—Provide a core of soft iron wires, enough to make a bundle $\frac{3}{4}$ inch in diameter and ten inches long. Wind on five layers of No. 18 wire and connect in series with one side of the gas lighting circuit.

Voltage Variation and Candlepower.

Question.—(A) What effect will a slight variation in voltage have on the candlepower of a carbon lamp? On a tungsten lamp?—S. J. P., Leetonia, Ohio.

Answer.—A one per cent variation in voltage produces a candlepower variation of about 5.6 per cent with the carbon lamp, and about 3.7 per cent with a tungsten lamp.

Disclaimers: Annulment and Repeal of Patents

By OBED C. BILLMAN, L. L. B., M. P. L.

DISCLAIMERS—*In General.*—A patent claiming more than the patentee has a right to claim is wholly void, and will not support a suit. To avoid the harsh operation of this rule the statute provides that the owner of the patent may cure the defect and avoid the defense under specified conditions, by filing a disclaimer of the part to which he is not entitled, and that then the patent shall be valid for all that part which is truly and justly his own.

CONDITIONS OF DISCLAIMER.—*Inadvertence, Accident, or Mistake.* A disclaimer is permitted only where the excessive claims were made through inadvertence or mistake and without any willful default or intent to defraud or mislead the public. But it is immaterial whether the mistake be one of law or fact.

EXCESS MUST BE SEPARABLE.—A disclaimer is permitted only where the part disclaimer is distinct and separable, and the part remaining is a material or substantial part of the thing patented, and in itself patentable.

TIME OF FILING.—A disclaimer will not be permitted after an unreasonable delay in filing it. But subject to this rule, a disclaimer may be made at any time, even after suit is brought upon the patent, though where the disclaimer is not filed until after suit brought the plaintiff is not entitled to recover costs. What constitutes an unreasonable delay is a mixed question of law and fact, and depends upon the circumstances of each particular case.

NECESSITY AND PROPRIETY OF DISCLAIMER.—Whenever the part claimed without right is a material and substantial part of the thing patented, a disclaimer is necessary in order to save the patent. But immaterial and unessential features need not be disclaimed, because they are not regarded as covered by the claim. A disclaimer can be used only to get rid of excessive matter; it cannot be used to change the invention covered by the patent, or to reform the spe-

cifications and descriptions. A disclaimer may be used to disclaim one or more separate claims leaving the remainder to stand, or a claim in a reissue unlawfully broadened, or a separable part of a single claim, or one of two or more inventions embraced in a single claim, or for the purpose of limiting a process to its application to certain classes of materials, or to limit a patent for a class to a particular variety. A disclaimer may be used to avoid the effect of having included in a patent more devices than can properly be made the subject of a single patent. A void claim may be disclaimed whatever the reason for its invalidity. One of the elements of a combination cannot be disclaimed because not separable.

WHO MAY DISCLAIM.—A disclaimer may be filed by the patentee, his personal representatives or assigns. Several co-owners of undivided interests in a patent must all join in a disclaimer.

REQUISITES OF DISCLAIMER.—The disclaimer must be made in writing, attested by one or more witnesses, and recorded in the patent office. The person filing the disclaimer must state therein the extent of his interest in the patent, and indicate with sufficient clearness the part of the patent disclaimed.

OPERATION AND EFFECT OF DISCLAIMER.—The disclaimer when duly made and recorded in the patent office becomes a part of the original specification to the extent of the interest of those who made it. The patent must be construed the same as it would be if the matters disclaimed had never been included in it. The only effect of the disclaimer is to limit the nature of the invention secured by the patent; it does not affect those portions of the patent not disclaimed.

ANNULMENT AND REPEAL OF PATENTS.—IN GENERAL.—The only authority competent to set a patent aside, or to annul it, is vested in the courts of the United States and not in the patent office.

INTERFERING PATENTS.—Whenever there are two or more interfering patents, any per-

son interested in any one of them, or in the working of the invention claimed under either of them, may have relief against the interfering patentee, and all parties interested under him, by suit in equity against the owners of the interfering patent, and in such suit the court may adjudge and declare either of the patents void in whole or in part, or inoperative or invalid in any particular part of the United States, according to the interests of the parties in the patent or the invention patented. In such suit the sole issue for determination is that of priority of invention as between the interfering patentees, and no question of patentability is involved. Therefore, while the court may declare either patent void, it cannot declare both patents void. The proceeding may be dismissed upon a determination that no interference in fact exists, for the jurisdiction exists only in the case of interfering patents. The court has jurisdiction to grant such relief by injunction or otherwise as will make its determination effectual.

VOID AND FRAUDULENT PATENTS.—Where a patent has been fraudulently obtained, or obtained through accident or mistake, or where its subject-matter could not lawfully be granted, it may be repealed or annulled by bill in equity brought in the name of the United States, though this has been doubted or denied on principle. But the government cannot maintain a bill in equity to cancel a patent merely because of an error of judgment on the part of the patent officer in granting it, or for want of novelty or utility or upon the ground of interference, as in all such cases any party interested has other adequate remedies.

NEW BOOKS

WIRELESS OPERATORS' POCKETBOOK OF INFORMATION AND DIAGRAMS. By Leon W. Bishop. Lynn, Mass.: Bubier Publishing Company. 1911. 200 pages with 119 diagrams and illustrations. Price, cloth, \$1.00; leatherette, \$1.25; leather, \$1.50.

This book is published in the form of a manual for wireless operators and for those who have already some knowledge of wireless. The intent of the author is to give enough of the theory of the circuits and of each piece of apparatus so that any one interested may understand it and its working.

TELEGRAPHIC TRANSMISSION OF PHOTOGRAPHS. By T. Thorne Baker. New York: D. Van Nostrand Company. 1910. 141 pages and 64 illustrations. Price, \$1.00.

The author describes the various systems experimented with in transmitting pictures by telegraphy and devotes one chapter to the endeavors made to transmit photographs by wireless.

HOW TO MAKE A WIRELESS SET. By Arthur Moore. Chicago: Popular Mechanics Company. 1911. 84 pages and eleven illustrations. Price, 25 cents.

Explains in an understandable way the construction of a wireless outfit suitable for transmitting four or five miles. The matter is arranged to enable any bright boy to do the construction work at small cost.

A WORKING MANUAL OF HIGH FREQUENCY CURRENTS. By Noble M. Eberhart, M.D., Chicago: New Medicine Publishing Company, 1911. 300 pages with 63 illustrations. Price, \$2.00.

In treating this subject the author gives little space to various forms of apparatus beyond outlining a type or two. The intent of the manual is to provide the busy physician with a means of learning how to use high frequency currents understandingly in his practice.

THE GYROSCOPE. By V. E. Johnson. New York: Spon and Chamberlain, 1911. 52 pages with 25 illustrations.

An interesting treatise upon an old device which may yet enter into a field of usefulness during this century. Numerous experiments are suggested, and working drawings and explanations contained in the book. The application of the gyroscope to the mono-rail problem is also discussed.

SPONS' WORKSHOP RECEIPTS. VOLS. III AND IV. LONDON: E. & F. N. Spon (New York: Spon & Chamberlain). 1909. Vol. III, 228 pages, 257 illustrations; Vol. IV, 544 pages, 321 illustrations. Price \$1.50 per volume.

This valuable series is now complete. The four volumes, to use a somewhat hard-worked phrase, "comprise a veritable storehouse of information." Give a man the necessary materials and set him down on a desert island he could, if he lived long enough, make about everything a civilized community could care for, from acetelyne lights to wire ropes.

ON POLYPHASE SUBJECTS

One of the most difficult problems in factory management is that of balancing the work in different departments so as to keep all of them profitably busy. Even in a single part of the establishment this may be difficult, as some classes of work require a greater use of certain machinery than others. For instance, if any new items have an unusual number of holes to be bored and threaded, the available drill presses and tapping machines may not be sufficient to do this part of the work fast enough to keep up with the other operations. Then it becomes necessary to run overtime on these backward operations, and with belt driven machinery this means that the whole shop equipment has to be run for the sake of a few machines. However, if electric power has been installed for the individual machines, these can be operated without the expense of running any others. For this reason, the adding of a few electrically driven machines often means a great economy for shops even when these may not feel ready to change their whole equipment to the more adaptable method of propulsion.

Probably the most novel entertainment ever provided for a company of guests was made possible by the long-distance telephone on the evening of April 11th. Mr. V. N. Bethel, vice-president of the American Telephone and Telegraph Company, invited the social organization known as the Cliff Dwellers to dinner at his home in Montclair, N. J.

By means of giant transmitters in Boston, Washington, Detroit, Chicago, New York and other cities, prominent after-dinner speakers, vocalists and entertainers of all sorts contributed to the joy of the participants.

Special receivers were arranged in Mr. Bethel's dining-room in Montclair, so that

his guests might hear the different features of the entertainment provided for them without difficulty. There were a large number of these receivers, and the voices sounded as clearly and distinctly as though the speakers were in the same room with the guests.

The Chicago end of the entertainment began about nine o'clock, central time. Two circuits were provided in the office of the local telephone company, one an "order" circuit, so that the people in Montclair could signal when the fun was to begin, and the other a talking circuit over which the speaker, the singer or the entertainer might project himself a thousand miles into the presence of the New Jersey society.

W. R. Abbott, one of the executives of the Chicago Telephone Company, and the superintendent of the suburban telephone service, made the opening address. Following Mr. Abbott, Wilbur D. Nesbit talked. Then the next speaker was from Detroit, followed by Angus S. Hibbard of Chicago, the versifier of the Chicago Association of Commerce, who sang a song he had composed especially for the occasion into the transmitter.

The small cultivators in the immediate neighborhood of Seville, Spain, are rapidly substituting electric power for the old noria, or endless chain of buckets worked by a mule or bullock, with which they have hitherto raised the water from their wells for purposes of irrigation. An European paper states that the electric company of Seville has made arrangements for supplying current over the horticultural zone which extends for some two or three miles round Seville, and within the first year 56 installations were made, with a total of 362 horsepower. The current is paid for by the hour, according to the size of the motor.

Long-Distance Entertainment

Electric Pumps in Horticulture

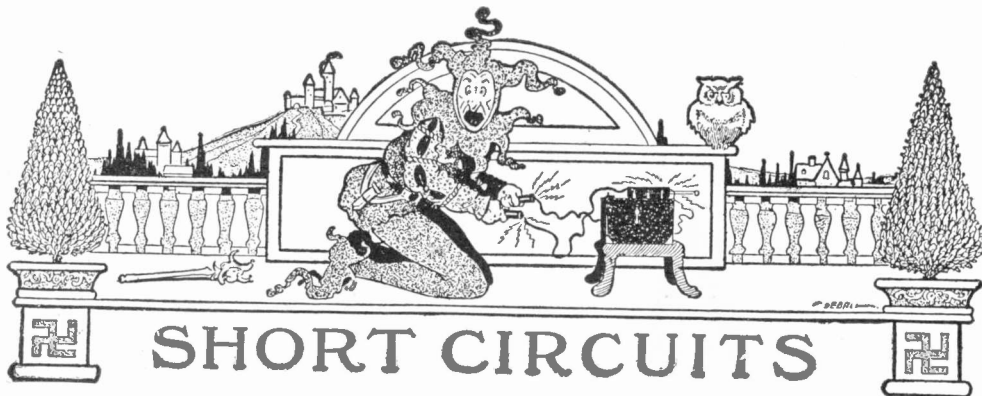

SHORT CIRCUITS

She had visited the Baldwin locomotive works and, later, told some of her friends how a locomotive is made.

"You pour," she said, "a lot of sand into a lot of boxes, and you throw old stove-lids and things into a furnace, and then you empty the molten stream into a hole in the sand, and everybody yells and swears. Then you pour it out and let it cool and pound it, and then you put it in a thing that bores holes in it. Then you screw it together, and paint it, and put steam in it, and it goes splendidly; and they take it to a drafting-room and make a blue-print of it. But one thing I forgot—they have to make a boiler. One man gets inside and one gets outside, and they pound frightfully, and then they tie it to the other thing—and you ought to see it go!"

* * *

I once knew a man whose wife was continually nagging him. She nagged and nagged until finally the poor fellow died. Then she was sorry, very sorry. So she erected a handsome tombstone on his grave, on which was carved the following inscription:

"Rest in peace until I join you."

* * *

"No, I've no desire to attend King George's coronation. Besides, I'm sure I wouldn't stand any show for a seat. All the best places will be taken up."

"By the nobility?"

"No, by the moving-picture makers."

* * *

A chemist, who was for many years the manager of a concern in Massachusetts manufacturing various high-grade explosives, recently revisited the place of his former employment. During a talk with his old friends of the institution, he made inquiry with reference to a certain colleague by the name of Jenkins.

"By the way," said the chemist, "what has become of Jenkins? Fine fellow."

"Fine chap, indeed!" agreed the foreman, "and very skillful in the use of chemicals. But a little absent-minded—Jenkins. See that discoloration on the wall over there?"

"Why, yes; but what has that to do with Jenkins?"

"That is Jenkins."

* * *

Hearing a faint rustle in the dark hallway below, the elder sister, supposing the young man had gone, leaned over the balustrade and called out:

"Well, Bessie, have you landed him?"

There was a deep, sepulcher silence for some moments. It was broken by the hesitating, constricted voice of the young man:

"She has."

* * *

"Does the razor hurt, sir?" inquired the barber, anxiously.

"Can't say," replied the victim, testily, "but my face does."

Summer Boarder—"Have you seen anything of my little son Reginald?"

Country Boy—"Yes'm; the fellers has taken him over to the crick, swimmin'."

Summer Boarder—"Oh, heavens! I'm afraid he'll get drowned."

Country Boy (consolingly)—"Oh, he won't get drowned, ma'am. The fellers is only goin' to shove him into that two-foot mud-hole wot's full uv snappin'-turtles an' blood-suckers an' see how many'll fasten onto him—that's all."

* * *

A stout old gentleman was having trouble with the telephone. He could hear nothing but a confused jumble of sounds, and finally he became so exasperated that he shouted into the transmitter:

"Is there a blithering fool at the end of this line?"

"Not at this end," answered a cool, feminine voice.

* * *

"Oh, yes," Mrs. Smith told us, "my husband is an enthusiastic archæologist. And I never knew it till yesterday. I found in his desk some queer looking tickets with the inscription, 'Mudhorse, 8 to 1.' And when I asked him what they were he explained to me that they were relics of a lost race. Isn't it interesting?"

* * *

Miss ———, who has charge of the children of the city playground, has trouble, as all playground instructors have, in preventing profanity among the youngsters. One of the little policemen of the playground ran to her the other day and shouted:

"Miss ———, there's some kids over there cursing like hell."

* * *

Borrower—Could you let me have \$5 if I bring it to you tomorrow?

Brown—Certainly. Bring me the \$5 tomorrow and I'll let you have it.

* * *

"You have such strange names for your towns over heah!" said a titled Englishman. "Weehawken, Hoboken, Poughkeepsie, and ever so many others, don't you know?"

"I suppose they do seem strange to English ears," said the American thoughtfully. "Do you live in London all the time?"

"Oh, no," replied the Briton. "I spend part of my time at Chipping Norton, and then I've a place at Pokes-togg-on-the-Hike."

* * *

"See, here, Niggah," said one colored man to another, "did yo' ever drink any of dis yere 'pollinarius water?'"

"Doan know what it is," was the reply. "What it like?"

"It's whlte, jus' like any other water."

"What's it taste like?"

The first negro pondered and scratched his head. "Well," he said, "it taste like—it taste like yo' foot was asleep."

FIRST HE TRIES
TO PRY IT OFF
WITH HIS THUMB



1

THEN, AFTER TRYING AN OLIVE
SPOON AND A PICKLE SLICER,
HE TRIES TO SPEAR IT
WITH A TOOTH PICK



2

THEN HE TRIES BRUTE
FORCE AND A CAN OPENER



3

OH SHAME ON HIM—



4

HA! THE ELECTRIC
VACUUM CLEANER—



5

BUSINESS OF
PATTING DOME



6

Common Electrical Terms Defined

In this age of electricity everyone should be versed in its phraseology. By Studying this page from month to month a working knowledge of the most commonly employed electrical terms may be obtained.

DECOMPOSITION, ELECTROLYTIC.—The separation of a compound or liquid into its constituents by passing an electric current through it. Called also electrolysis.

DE-ENERGIZE.—To cut off from an electric motor or other current consuming device its supply of electrical current or energy.

DE-ENERGIZE.—To cut off the electric current from any device depending upon this for its operation. Commonly applied to an electro-magnet.

DEFLECTION.—Applied to a magnetic needle which is swung out of its magnetic plane by magnetic disturbance. Used also in referring to the movement of the needle of an electrical measuring instrument such as a voltmeter or ammeter when calibrating same, as, in speaking of a full swing of the needle across the scale, the term "full scale deflection" is used.

DEMAGNETIZATION.—The removal of magnetism from a substance capable of retaining it after being once magnetized. A magnetized watch may be demagnetized by turning it rapidly at the end of a twisted string and at the same time gradually withdrawing it from the poles of a powerful dynamo. Steel may be demagnetized by jarring it or by heating it to redness.

DEPOLARIZATION.—Overcoming the polarization of a cell of battery by either chemical or mechanical means. The bubbles that collect at the negative plate of a primary cell offer a resistance and interrupt the flow of current. The cell is then said to be polarized. Nitric acid as in the Grove cell overcomes this polarization by chemical means. In the Smee cell depolarization is brought about by coating the negative plate with platinum.

DETECTOR.—A device for rendering audible the electrical oscillations or waves received by the aerial of a wireless set. For example, in the silicon detector the high frequency currents upon reaching the silicon are transformed by some peculiar rectifying property of the mineral into weak pulsating direct current, and this flowing through the telephone receiver produces an audible sound. Also applied to a testing device consisting of lamps or a voltmeter by means of which it may be determined whether the wiring is grounded or clear and upon what feeder a ground, if shown, is located. (See cut.)

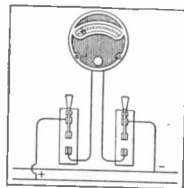

DETECTOR

DIACRITICAL CURRENT.—The current which passed through a helix surrounding an iron core brings the core up to one-half its magnetic saturation.

DIAL TELEGRAPHY.—Another name for step-by-step telegraphy. In this system a pointer moves around a lettered dial each operator being provided with one. By an escapement wheel and electromagnet the sending operator spells out on his own dial the words he wishes to have sent and spelled out on the receiving dial.

DIAMAGNETIC.—Farady in 1845 used powerful electro-magnets (see cut) to examine the magnetic properties of a large number of substances, and found that while many, like iron, are attracted to a magnet, others like bismuth, antimony, zinc and lead are repelled. The first class of substances he called paramagnetic or simply magnetic and the second group diamagnetic. Blood is diamagnetic while ozone has recently been found to be quite strongly magnetic.

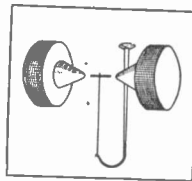

FARADAY'S APPARATUS

DIAPHRAGM.—The disk of iron (see cut), in either a telephone receiver or transmitter, thrown into motion by electric currents from the line or by sound waves.

DIELECTRIC.—In electricity a non-conductor or insulator. It usually refers to the material interposed between the oppositely charged coatings of a condenser as between the coatings of a Leyden jar.

DIELECTRIC STRENGTH.—A slab of glass three inches thick has been pierced by the discharge of a powerful induction coil. The resistance which glass, air and other dielectrics offer to such a break down is termed dielectric strength.

DIELECTRIC STRESS.—It has been shown by Siemens that the glass of a Leyden jar is warm after having been several times rapidly charged and discharged, and Maxwell has suggested that the molecules of the glass are subjected to a strain or stress, when charged, from which they do not at once recover.

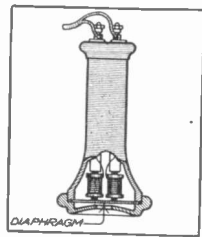

DIAPHRAGM

It's Printype!

"What a beautiful typewritten letter—as plain as print—as easy to read as a primer! It must be the new Oliver PRINTYPE! I wish all our correspondents used The Printype Oliver Typewriter!"

—A composite quotation from ten thousand business and professional men on being introduced to Printype

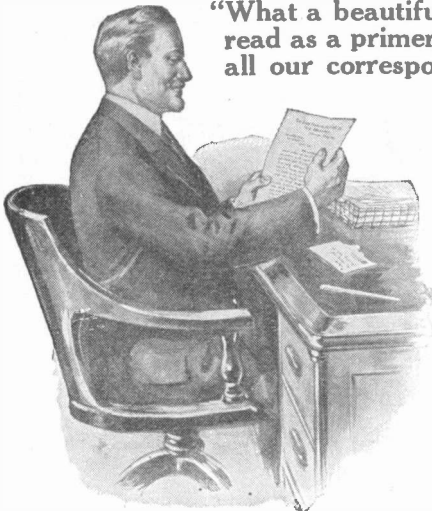

ALL eyes are watching Printype. Its attraction is irresistible. Its beauty and grace, in a typewritten letter, are alluring, attention-compelling. Although absolutely new to *typewriting*, its counterpart—Book Type—has been used on all the world's presses since the printing art had its inception. It is the Oliver ideal of perfect typography applied to typewriter uses.

We had brought the machine to its maximum of efficiency. We had added, one by one, a score of great innovations. There remained but one point—that was *the type itself*.

Then came the inspiration which meant a *revolution in typewriter type*. We would design and produce a new typewriter type face, conforming to the type used in newspapers, magazines and books.

We did! It's here! It's PRINTYPE!

Printype is not an experiment. It is, in all essentials, the type that meets your eye when you read your morning paper, your magazine or your favorite novel. Now that Printype is an accomplished fact, the thought occurs to thousands, why didn't typewriter manufacturers think of it years ago? The same question was asked when, over ten years ago, we introduced *visible writing*.

A Long Step in Advance

The change from the old-style thin outline letters known as Pica Type, universally used up to now on all standard typewriters, to the new, beautiful, readable Printype, is one of vast significance. It means relief from the harmful effect on eyesight of the "outline" typewriter type. For Printype is as easy to read as a child's primer.

It means less liability of mis-reading, due to blurring of outline letters, whose sameness frequently makes the words run together. Printype letters are *shaded*, just as Book Type is shaded.

It means less danger of costly errors, due to confusing the numerals. No possible chance of mistaking 3 for 8 or 5 for 3—each figure is distinct. It means a degree of typographic beauty never before known in typewriting.

And now, because of its *newness*, it has the enhanced charm of *novelty*.

Printype Now Famous

The reception of Printype by the business public has been most enthusiastic. We withheld any formal announcement until the machine had been on the market for one year. Personal demonstrations were its only advertising. The resulting sales were stupendous. Printype letters soon began to appear among commonplace old-style correspondence. Wherever received, these mysterious, distinctive, beautiful letters awakened immediate interest. Business men began asking each other, "What's that new kind of typewriter that writes like real print?" Thus the fame of Printype grows as its beauty and utility dawn on the business world.

Ask for Book, Specimen Letter and Demonstration

We will gladly send you a Printype Book, together with a letter written on The Printype Oliver Typewriter. This letter will be a revelation.

Our great sales organization enables us to make an improvement of this character *immediately and simultaneously available to the public*. Press the button and see how quickly an Oliver Agent will appear with a "Printyper," ready to tell you all about it and write several Printype letters for you. Address Sales Department

Printype — OLIVER Typewriter

The Standard Visible Writer

Printype Aids Eyes

The manifold merits of Printype are a constant source of surprise. Printype is restful to eyesight. It delivers its message in the most easily readable form.

The constant reading of thin outline letter typewriting plays havoc with the eyes. It sends thousands to oculists and opticians. A comparative test of Printype and ordinary typewriting will win you to the type that reads like print.

We Have Not Raised Our Price

We do not ask a premium for The Printype Oliver Typewriter. We have declared a big dividend in favor of typewriter users by supplying this wonderful type, when desired, on the new model Oliver Typewriter.

Our price is \$100, the same as our regular model with Pica Typewriter Type.

"17-Cents-a-Day" OFFER

You can buy the new Printype Oliver Typewriter on the famous "17-Cents-a-Day" Purchase Plan. A small first payment brings the machine. Then save 17 cents a day and pay monthly. You can turn in any make of typewriter on your first payment.

If the Penny Plan interests you, ask for details.



(116)

THE OLIVER TYPEWRITER COMPANY, 768 Oliver Typewriter Bldg., CHICAGO

For our Mutual Advantage mention Popular Electricity when writing to Advertisers.

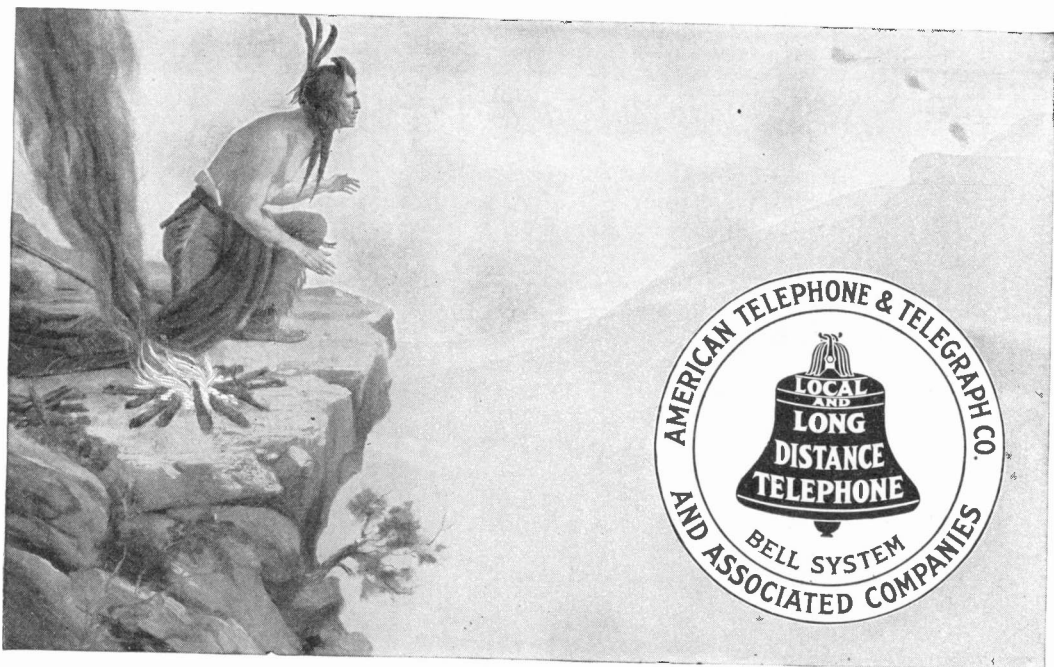

Civilization—from Signal Fire to Telephone

THE telephone gives the widest range to personal communication. Civilization has been extended by means of communication.

The measure of the progress of mankind is the difference between the signal fire of the Indian and the telephone service of to-day.

Each telephone user has a personal interest in the growth of the whole telephone system.

He is directly benefited by every extension of his own possibilities. He is indirectly benefited by the extension of the same possibilities to others, just as he is benefited by the extension of the use of his own language.

Any increase in the number of telephones increases the usefulness of each telephone connected with this system.

The Bell System is designed to provide Universal service.

**AMERICAN TELEPHONE AND TELEGRAPH COMPANY
AND ASSOCIATED COMPANIES**

One Policy

One System

Universal Service

For our Mutual Advantage mention Popular Electricity when writing to Advertisers.

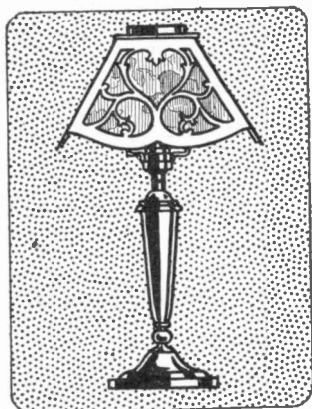
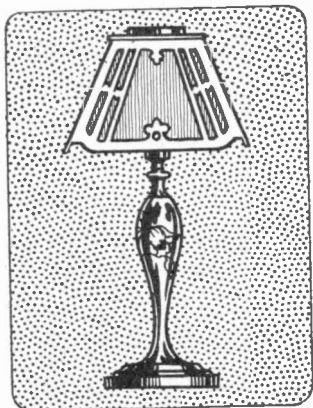
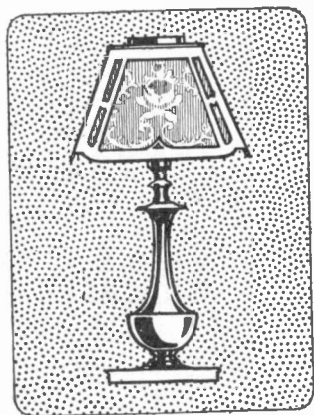

Dainty Designs in Electric Lamps

For Writing Desk or Boudoir

The shades of these very attractive and useful lamps are of wrought metal work, allowing the panels of hand painted glass to show through.

The standards are massive and graceful, and come in a variety of finishes.

These lamps stand from 10½ to 11 inches high. They are fully equipped with sockets, cord and plugs, etc.

Prices Reduced During May

From \$11.50 to \$6.75

Over 2,000 Things Electrical to Choose From

ELECTRIC SHOP—CHICAGO

Michigan and Jackson Boulevards

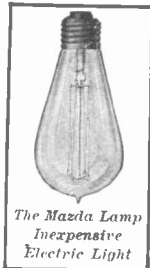

*The Mazda Lamp
Inexpensive
Electric Light*

Electric Light Is the Artistic Light

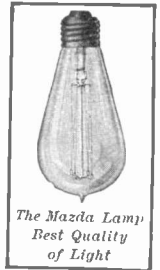

*The Mazda Lamp
Best Quality
of Light*

IT IS LEAST EXPENSIVE

WHAT is the magical something which makes a home inviting, interesting and "different"? A bit of color—the clever grouping of furniture or pictures, an antique or an unusual drapery, each have their part, but

Of what avail are color harmonies and artistic furnishings with garish, inappropriate lighting?

Craftsmen and designers have brought into being wonderful shades and fixtures. Electric bulbs are made in many sizes and so improved that electric light is cheaper than any other light.

The Mazda Lamp is a wonderful, current economizing electric lamp, which will produce $2\frac{1}{2}$ times the light for the same current consumption as the old style lamp.

The Mazda Lamp is sold by dealers and lighting companies everywhere.

National Electric Lamp Association
CLEVELAND



Facts in Plain English

House Wiring has a mistaken rating. It is not necessary to raise the dust and tear down the house to wire it. The modern electrician works quietly and cleanly without disturbance.

Electric Light is now cheaper because Mazda Lamps produce $2\frac{1}{2}$ times the light of the old style lamp and thereby cut the cost to a figure less than all other practical illuminants.

See your lighting company or electrical dealer, they will show the Mazda Lamp to you.

| | |
|--|---|
| THE BANNER ELECTRIC CO., Youngstown, O. | THE GENERAL INC. LAMP CO., Cleveland, O. |
| THE BRILLIANT ELECTRIC CO., Cleveland, O. | FEDERAL MIN. LAMP CO., Cleveland, O. |
| THE BRYAN-MARSH COMPANY, Central Falls, R. I. | NEW YORK & OHIO COMPANY, Warren, O. |
| THE BRYAN-MARSH COMPANY, Chicago, Ill. | THE SHELBY ELECTRIC CO., Shelby, O. |
| THE BUCKEYE ELECTRIC CO., Cleveland, O. | THE STANDARD ELECTRICAL MFG. CO., Warren, O. |
| THE BUCKEYE ELECTRIC LAMP CO., Mexico City, Mexico | SUNBEAM INC. LAMP CO., Chicago, Ill. |
| THE CLEVELAND MINIA. LAMP CO., Cleveland, O. | SUNBEAM INC. LAMP CO., New York City |
| THE COLONIAL ELECTRIC CO., Warren, O. | THE SUNBEAM INC. LAMP CO., of Canada, Toronto, Ont., Can. |
| THE COLUMBIA INC. LAMP CO., St. Louis, Mo. | THE WARREN ELECTRIC & SPECIALTY CO., Warren, O. |
| THE FOSTORIA INC. LAMP CO., Fostoria, O. | |

National Electric Lamp Association
CLEVELAND

Classified Advertisements

The cost of advertising in this section is 5 cents per word for one insertion, with

- 5% discount for 3 insertions
- 10% discount for 6 insertions
- 15% discount for 9 insertions
- 20% discount for 12 insertions within one year.

Remittance must accompany order, or advertisement will not be inserted. Forms for the July issue will close on June 1st.

AERONAUTICS

BLERIOT MONOPLANE, ALUMINUM, bamboo construction, 30 ft. flier. Reberts, 344 Cumberland, Brooklyn, N. Y.

THREE SCIENTIFIC KITE OUTFITS (different models) postpaid 50c. Percy Ewing, Decatur, Ill.

MODEL AEROPLANE SUPPLIES. Send stamp for catalogue B. McCutchen Aero Company, 2043 W. Tioga St., Philadelphia, Pa.

FLYING MACHINE SUCCESSFUL model air travelers of International reputation. Catalogue explains fully. American Flying Machine Company, Racine, Wis.

EVERYTHING FOR THE MODEL Aeroplane builder—wood, ballthrust bearings, rubber, ribs, struts, etc. Send us your name. Goff Aeroplane Co., 219 S. Dearborn St., Chicago.

WANTED—MECHANICS FOR AEROPLANE factory, work in metal and wood; also aviators, wireless operators, electricians, and others wishing to learn. Eagle Aeroplane Co., Brunswick, Ga.

SPECIAL OFFER TO AMATEURS. Man-carrying glider, can be equipped with power. To any amateur club or person interested, \$50.00. Send for particulars. Amateur Aero Promoters, 253 Benjamin T., Grand Rapids, Mich.

COMPLETE PLAN, DRAWN TO SCALE, for building a Three Foot Flying BLERIOT MONOPLANE model with full instructions. 15 cents Postpaid. Stamps bring list of Materials. Ideal Aeroplane & Supply Co., 1200½ Bedford Ave., Brooklyn, N. Y.

AGENTS

2-TICLE-U, 3c. STIX, STOCKTON, CAL.

YOU CAN MAKE \$\$\$\$ AS OUR GENERAL or local agent. Household necessity; saves 80 per cent. Permanent business; big profits; exclusive territory; free sample. Pitkin & Company, 96 Pitkin Block, Newark, N. Y.

STERLING IGNITERS. LIGHTS GAS or Gasoline, Sample 25 cents. Sterling M. Co., Box 766, Trenton, New Jersey.

MAIL DEALER'S AND AGENT'S SPECIALTIES; sells like wildfire; big profits; write for Circulars. Rheu. Electric Supply Co., Box 391, Detroit, Mich.

AGENTS

BIG MONEY SELLING GOLD AND SILVER glass window novelty and changeable signs; illustrated catalog. Climax Novelty Co., 301 Gray Bldg., St. Louis.

AGENTS, QUIT PEDDLING! DO IT BY mail! Your spare time worth \$25 weekly. Investigate our Unique Mail Business. Amazing profits for shrewd people. Write for details. Fredericks & Co., 777 Unity Bldg., Chicago.

AGENTS MAKE MONEY SELLING THE Dollar Adding and Subtracting machine. Particulars Free. J. Bassett, 5921 Indiana Ave., Chicago, Ill.

BIG CHANCE FOR HUSTLERS—OUR Salary Plan offers splendid opportunities for making money. Send stamp for particulars. Popular Electricity Magazine, Circulation Department, Commercial Bldg., Chicago.

WHY PAY \$1.00 PER FORMULA WHEN we give Dry Powder Fire Extinguisher and 375 others for 15c. Make your own goods and save money. The Barstow Co., Box 18 Oakland, Cal.

AGENTS WANTED EVERYWHERE for rheumatism electric appliances; quick sales, big profits; field unlimited. For terms and territory write Rheumatism Electric Supply Co., Dept. 19, Detroit, Mich.

BOKARA DIAMONDS—AGENTS, EVERYONE wanted to wear and sell these Famous Gems. Big profits. Samples offer and catalogue free. Northwestern Jewelry Co., 80 Northwestern Bldg., Chicago.

MAKE \$20.00 DAILY OPERATING OUR Minute Picture Machines. Experience unnecessary. Small investment; large profits. Free book, testimonials, etc. Write, American Minute Photo Co., Dept. 37, Chicago, Ill.

GET AWAY FROM WAGE SLAVERY! You can make more money in a business of your own. If you are tired of working for other people, if your income is too small, if you are looking for something to do during your spare time, write us for our big money making propositions. Dales Commercial Co., 725 Front Street, Ventura, Cal.

AGENTS, \$50 WEEKLY; WE MANUFACTURE the best needle case made; a wonderful seller; 500 easily carried; 200 to 400 per cent profit; talking unnecessary; our copyrighted "trust scheme" envelopes do the work; general agents can make over \$100 weekly; send 10c. for a 25c. sample containing 115 needles; particulars free; buy direct from the factory. Paty Needle Co., 205 Union Square, Somerville, Mass.

A LARGE MANUFACTURER OF Vacuum Cleaners wants exclusive representatives in each County. Only men of ability considered. Men now selling Vacuum Cleaners preferred. Our proposition should give the right man an income of \$300.00 per month the year around. This machine is operated with ease by one person and sells for \$10.00 under factory guarantee. Sample machine shipped you for inspection without remittance. The Braham Manufacturing Company, X-20, Cincinnati, O.

AGENTS

SEE WHAT I SAY UNDER "TYPE-writers." ATCHISON.

"PERFECTION POCKET ADDING MACHINE—lightning seller. Agents wanted. Cincinnati Specialty Mfg. Co., Dept. E, Cincinnati, Ohio.

PINLESS CLOTHES LINE AGENTS coin money; sample, prepaid, 25c. 501 Lumber Exchange, Portland, Ore.

CAPABLE AGENTS MAKE BIG MONEY handling our Electric Specialties. Presto Heater boils liquids in One Minute. P. E. Mfg. Co., 323 Geary, San Francisco, Cal.

DON'T ACCEPT AN AGENCY UNTIL you get my samples and particulars. Money makers. Address, SAYMAN, 706 Sayman Bldg., St. Louis, Mo.

EASY MONEY—LOTS OF IT. ALL OR spare time. Send stamp for particulars of our liberal Salary plan. Popular Electricity Magazine, Circulation Department, Commercial Bldg., Chicago.

AGENTS MAKE BIG MONEY SELLING our new gold letters for office windows, store fronts and glass signs. Any one can put them on. Write today for a free sample and full particulars. Metallic Sign Letter Co., 400 N. Clark St., Chicago, Ill.

WE MANUFACTURE GLASS PAPER. Plain glass windows made to look like real stained glass. Easily applied and beautifies the home. Something new for agents. Two sheets of this glass paper sent as a sample with catalogue in colors and complete instructions on receipt of 10c. S. H. Parrish & Co., 202 S. Clark St., Chicago.

LIVE AGENTS WANTED—HUSTLERS to handle our attractive 1911 combination packages of soap and toilet articles with valuable premiums. One Michigan agent made \$65 in 47 hrs., another \$21 in 8 hrs., another \$22.50 in 10 hrs. Write today. DAVIS SOAP WORKS, 263 Davis Building, 1429 Carroll Ave., Chicago.

AGENTS—BIGGEST MONEY MAKER known. The new Canchester Incandescent Kerosene Lamp revolutionizes old lighting methods. Burns air, not money. Six times brighter than electricity, gas or acetylene at 1-10th cost. Burns with or without mantle. Burner fits any lamp. Saves 75 per cent. oil. No trimming wicks. Showing means selling. Territory going fast. Write today. Handsome outfit furnished. Canchester Light Co., Dept. P. E., 6, Chicago.

AUTOMOBILES

AUTOMOBILES—OVER FOUR HUNDRED bargains, \$95.00 upward. All guaranteed! Freight prepaid! Write now for latest illustrated bulletin. Motor Car Exchange, Dept. A, 217 West 125th St., New York City.

CHAUFFEURS BLUE BOOK, 40 ILLUSTRATIONS; shows how to drive, adjust and maintain automobile and pass examinations, 50c. License guaranteed. Chas. Milword, 1546 N. 60th, Phila., Pa.

AUTOMOBILES

BARGAINS IN AUTO ACCESSORIES. IT will pay you to deal with us and save lots of money. Ask for our bargain sheet. Emden & Co., 1303 Michigan Blvd., Chicago.

BOOKS

STIX, STOCKTON, CAL.—MENDER, 3c.

PRACTICAL SCIENTIFIC BOOKS ON Modern Subjects, Trades, etc. Catalogue free. Clarence E. Hardage, Syracuse, N. Y.

CLASSY BOOKS! CATALOGUE FOR stamp. Paul Duff, E. 2713 Mozart St., Chicago.

TELEPHONE TROUBLES AND HOW TO Find Them, and Construction Cost-Units, new 1911 edition; price, 25c. Hyde Pub. Co., Telephone Bldg., 183 Fifth St., Milwaukee, Wis.

345 MONEY MAKING SECRETS 5c—Boys own toy maker book, 5c. Big prize combination 5c. All three 10c postpaid. P. E. Greenhalgh, Sta. C, Brooklyn, N. Y.

AN ELECTRICAL LIBRARY FREE. Send stamp for illustrated book catalog and full particulars. Popular Electricity Magazine, Circulation Department, Commercial Bldg., Chicago.

FOUR TWENTY-FIVE-CENT BOOKS for 50 cents. Gouge Work and Indented Woodwork, Wood-carving for Beginners, Designing and Drawing. Dyes, Stains, Inks and Lacquers. Sampson Publishing Company, 1140 Beacon Bldg., Boston, Mass.

"WIRING A HOUSE," BY H. PRATT. Shows a house already built; tells you just how to start about wiring it; where to begin; what wire to use; how to run it according to insurance rules; in fact, all the information necessary for wiring a house and shop. Postpaid, 25c. Popular Electricity Book Department.

LEARN AT HOME, IN A FEW EVENINGS, how to construct, operate and repair automobiles, Commercial Trucks, Flying Machines, Motorcycles, Motor Boats, Gasoline Engines, Electric Motors. Big demand with good pay, for competent men. Thousands of positions open. Let us help you in place and pay. A postal card will do. Address, Extension Department, The Charles C. Thompson Co., 549 Wabash Ave., Chicago, Ill.

FOR FORTY CENTS WE WILL SEND our five excellent 10c books on Tempering Steel, Making and Fixing Electric Bells and Batteries, How to Grind and Set Edge Tools, How to Make an Annunciator, Small Electric Motor to be Built Without Castings, all practical and well illustrated. Sampson Publishing Company, 1140 Beacon Bldg., Boston, Mass.

"LOVERS' SECRETS," AN INVALUABLE book on Love, Courtship and Marriage. Contains 210 large pages of winning advice, 50c. "Occult Forces," Key to Personal Magnetism, 146 pages, 30c. "How to Win Success," 362 pages (illustrated), \$2.00. "The Power of Personal Influence," Your Latent Forces and How to Use Them, 128 pages, 25c. All for \$3.00. Catalogue free. A. W. Martens, Pub., P. E. E., Burlington, Iowa.

BOOKS

NINE DEGREE COURSE IN HYPNOTISM—sold originally for \$5—sent prepaid with year's subscription to Wheel of Life, the great "Cheer Up" monthly for 25c. Life Pub. Co., St. Louis.

BOOKS—I. C. S. and A. S. C. SETS, TECHNICAL books of all sorts—shopwork, electrical, mechanical, wireless, encyclopedias, dictionaries, medical, law, and standard fiction. New and second-hand. Get my prices. Geo. F. Williams, Box 408, New Orleans, La.

BUSINESS OPPORTUNITIES

SEE WHAT I SAY UNDER "TYPE-WRITERS." ATCHISON.

TRAIN A SALES FORCE, IN EXCLUSIVE territory, on a universal demand, money back proposition. J. N. Webb, Arcade, Norfolk, Va.

\$90 PER MONTH TO TRUSTWORTHY people for distributing samples and catalogues at home. Steady work. \$45 expense allowance. S. Scheffer, Treas., M. Q., Chicago.

LEARN TO MAKE ELECTRIC SIGNS. IT is easy to learn with my instructions. Being practical myself, I know how. Write. Wm. H. Kenedy, 925 Congress E., Detroit, Mich.

"WAY TO SUCCESS IN THE MAIL Order Business," tells how I made \$18,000.00 in three years, exposes "outfit" scheme, etc. Worth DOLLARS to you. Free on request. H. System, 108, Marion Kentucky.

"MONEY MAKING FACTS" OF INTEREST to everyone. Mining and Oil Finance analyzed and discussed. My booklet free upon request. Mark E. Davis, 1004 Broadway, Oakland, Cal.

BIG PROFITS—SELLING VULCAN Fountain and Stylo Pens. Well advertised, easy to sell. Write for catalogue, liberal discounts. J. A. Ullrich & Company, 27 Thames Street, New York.

MAKE MORE MONEY! START A MAIL Business; operate a "Silent Salesman" system; evenings; possibilities unlimited. The best money making plans are in "Booster." Get away from wage slavery! "Booster" starts you in business for yourself with small investment. Send 10c for two months trial. BOOSTER MAGAZINE, Dept. PE, 208 N. Fifth, Chicago.

START A CANDY KITCHEN! A FULL \$15.00 Course in Candy Making for only \$1.00. You can earn \$50 a week operating a Candy Kitchen. Write us for particulars. Allen & Co., 818 E. 47th Place, Chicago.

FASCINATING. MONEY-MAKING MAIL Order Business at home. Any one anywhere can conduct it. New plans. Everything furnished. Free booklet tells how. Write today. W. E. Foote, Box 254, Muskegon, Mich.

LEARN THE SILVER PLATING BUSINESS and be assured of a good living for life. C. R. Cable of Virginia earns \$9.50 a day. You can do the same. Simple instructions. Write for free descriptive pamphlet. Humbolt Publishing Co., 4743 State St., Chicago, Ill.

BUSINESS OPPORTUNITIES

START A NEW BUSINESS—THE AMERICAN Razor Honing and Safety Blade Sharpening Machine earns \$5.00 to \$10.00 a day. We teach you how. No previous experience required. Illinois Cutlery Co., Dept. 4, 171 Washington St., Chicago, Ill.

"HOW TO JUDGE A PATENT" contains the Patent claim of Selden Automobile, Morse Telegraph, and Bell Telephone. An "eye opener" to Inventors and Manufacturers. Obed Billman, Cleveland, Ohio. Author of "Notes on Patent Law," Popular Electricity.

MOTION PICTURE MACHINES, FILM Views Magic Lanterns, Slides and similar Wonders for Sale. Catalogue free. We also buy Magic Machines, Films, Slides, etc. Harbach & Co., 809 Filbert St., Philadelphia, Pa.

IF YOU ARE TIRED OF WORKING for other people, if your income is too small, or if you are looking for something to do during your spare time, write us for our big Money Making proposition. It will put you right. Humbolt Publishing Co., 4743 State St., Chicago, Ill.

HAVE YOU ANYTHING TO ADVERTISE? Our Rate Book tells you all about Advertising Mediums. Rates. Circulation, Closing Dates, etc. Sent for 10c.; worth dollars. Folder free. Correspondence invited. Dearborn Advertising Agency, 452 Franklin Bldg., Chicago.

VALUABLE TRADE SECRETS, OFFERED by a Southern Chemist not to be had elsewhere; Lightning Paint Remover, Maple Flavor, Butter Color, Liquid Sulphur, Bismuth Harmless Hair Dye, Artificial Rubber, Improved Battery Fluid, besides 2,500 other formulas, shop secrets, result of 20 years conscientious collecting. Worth many times the price asked: \$1.00. Write today. Supply Limited. I can furnish reliable formulas for anything. Liscomb Miller, Evack Chemical Co., Marietta, Georgia.

EARN \$10 TO \$15 A WEEK AND HOLD your position besides. No Canvassing. We, as manufacturers, of patented just in season specialties have new easy mail order plans to keep our factories busy. We furnish everything. Large profits. Small capital. Experience unnecessary. If you are one of the want-to-go-ahead kind, write for our most modern plans. Sworn statement. J. M. Pease Mfg. Company, 107 Pease Bldg., Michigan St., Buffalo, N. Y.

INCREASE YOUR INCOME—MAKE your spare time pay dividends. Send stamp today for particulars of our Salary Plan. Best chance you ever had to make money quickly and easily. Popular Electricity Magazine, Circulation Department, Commercial Bldg., Chicago.

IF YOU HAVE ANY SPARE TIME, NO matter how little, and are honestly ambitious to make the most of it, write for our Salary Plan and learn how you can increase your income quickly and easily. Full particulars on receipt of stamp. Address, Popular Electricity Magazine, Circulation Department, Commercial Bldg., Chicago.

BUSINESS OPPORTUNITIES

ABSOLUTELY ONLY CORRECT MAILING List every American Fruit Grower's address ever compiled; Limited number, type-written, offered under restrictions June 1st. INVALUABLE! NEVER YET CIRCULARIZED. Apply, The American Fruit Union, Cincinnati, O.

BE YOUR OWN BOSS—OUR Liberal Salary Plan offers a splendid opportunity to make money quickly and easily. Experience not essential. Need not interfere with present employment. Full details on receipt of stamp. Address, Popular Electricity Magazine, Circulation Department, Commercial Bldg., Chicago.

DON'T YOU WANT TO MAKE YOURSELF a real estate broker? We will make it easy for you without capital. You can be independent of bosses and have your own office instead of a job—swing big deals and make big commissions instead of working at details, on a salary. Write today for Booklet A. No financial backing needed. U. S. Real Estate Institute, 500 Fifth Ave., New York.

MAKE MIRRORS AT HOME. BIG PROFITS with little outlay. One 18x36 in. mirror costs \$2.00 to \$5.00. You can silver a glass this size for 20c. Send \$1.00 in stamps or money order and we will send you EXPLICIT DIRECTIONS how to do it; also how to emboss, grind, foil, gold leaf, frost chip, and make imitation stained glass. How to transfer photos on glass, bore holes in glass and cut skylights. George L. Patterson & Co., Dept. 4, Brooksville, Ky.

COINS AND STAMPS

FOREIGN STAMPS, 255 MIXED, 10c.; 255 old United States, 10c.; 1,000 United States, 25c. Stamps Bought List, 4c.; 50 different foreign or United States, 5c. each. Herman Kleinman, 3641 Marshall St., Philadelphia, Pa.

10 DIFFERENT FOREIGN COINS 25c, 20 different, 50c; 10 different old U. S. coins \$1.00, 5 different Confederate bills 25c, 10 different, 50c; 5 different Broken Bank Bills 40c, 5 different Foreign Bills 35c. Burgess Coin Co., 1018 Huron, Toledo, Ohio.

COINS—10c LIBERTY HEAD, 5c SILVER, 3c nickel, 2c piece, large cent, U. S. ½ cent, Connecticut cent; war cent, 10c U. S. note, Confederate note, Georgia war note, one copper and nickel foreign coin lot for \$1.00 delivered. Good beginners set. Other coins on application. William Hesslein, 674 Elm St., New Haven, Conn.

\$7.75 PAID FOR RARE DATE 1853 QUARTERS. \$20.00 for a half-dollar. We pay a cash premium on hundreds of old coins. Keep all money dated before 1884 and send 10 cents at once for our New Illustrated Coin Value Book, 4x7. It may mean your fortune. Clarke & Co., Coin Dealers, Dept. 83, Le Roy, N. Y.

ELECTRICAL MATERIAL

MICA, WASHERS AND DISCS, MADE to order, also cut and uncut mica. Send us your order. The Otter Hill Mica Mines, Findlay, Ohio.

ELECTRICAL MATERIAL

INDUCTION COIL, MEYER, SIX INCH. Very cheap! Wm. C. Broenen, Care Noyes Bros. & Cutler, St. Paul.

500 AMMETERS 25c EACH POSTPAID for testing batteries. Handsomely nickeled watch size indicate 0-30 Amperes. Chamois leather case with each. Stamps taken. Automobile Repair Co., 521-23 West 144th St., N. Y.

"HI-LIFE" STORAGE BATTERIES. BEST for Automobile sparking and lighting. These are high grade batteries at a remarkably low price. Guaranteed. Give us a trial or write for particulars. Discounts to the trade. Northwest Mfg. Co., 1247 Wells St., Chicago, Ill.

EXPERIMENTER BARGAINS. WE bought the entire stock of a dissolved Electrical Novelty concern and can sell very cheap: Motors up to ¼ H. P., Telegraph Relays, Sounders, Telephones, Magnetos, Bells, Arc Lamps, Jar Batteries, Nickel Parlor Battery Stands, Bell Electric Bicycle Lamps, Clamond Telephone Receivers and Transmitters, Magnetic Grips. Cosmos Electric Co., 136 Liberty St., New York.

FOR SALE

FOR SALE—MOVING PICTURE FILM, 1c. foot. H. Davis, Watertown, Wis.

UNUSED I. C. S. ELECTRICAL ENGINEERING Volumes, latest edition, \$25, C. S. Hatch, Bermick, Me.

I. C. S. MECHANICAL DRAWING course, complete with instruments. \$30 takes it. Russell Hall, White House Sta., N. J.

FOR SALE—EMERY WHEEL STANDS. \$3.00. Frank MacVicar, 214 Milton Ave., Syracuse, N. Y.

FORMULA—FOR RENEWING OLD dry batteries at low cost, 15c. John L. Dickson, Mount Union, Pa.

LUBRICATORS AND CUPS FOR SHAFTING and Loose Pulleys. No drip or dirt. Very economical. Swain Lubricator Co., New No. 328 W. Lake St., Chicago.

BOOKS ON ALL ELECTRICAL SUBJECTS—Send for our free illustrated catalogue. Popular Electricity Book Department.

I. C. S. COMPLETE COURSE ELECTRIC Lighting and Railroads with 4 reference books like new, less than half original price. Marx Mason, Postal Telegraph Co., Cleveland, Ohio.

LATHES—SEND FOR FREE CIRCULAR showing bargains on small Screw Cutting Engine Lathes. S. B. Tool Co., Dept. O, South Bend, Ind.

PAT. NO. 613559 FOR SALE. SAFETY and automatic elevator. This will avoid law suits, save lives annually. Write owner for particulars. E. J. Mounts, Iowa Park, Texas, P. O. 24.

FOR SALE—COMPLETE SET OF CASTINGS, with blue prints of 3-4 H. P. gasoline stationary engine, includes governor and timer, screws, etc. \$10.00. Comet Motor Works, 512 W. Monroe St., Chicago, Ill.

FOR SALE

WANTED—ALL KINDS OF MACHINERY for manufacturing shop. Fred. C. Dickow, 35 S. Desplaines St., Chicago.

FOR SALE OR EXCHANGE—FOX NO. 3 Typewriter, absolutely good as new. Write for specimen work, terms. W. B. Pope, Athens, Georgia.

FOR THE PHOTOGRAPHER

FILMS, DEVELOPED, ANY SIZE 10c prints on post cards 3c each. Good work promptly finished. Chas. Hoffman, New Lexington, Ohio.

MAKE PHOTOS CHEAP! GET OUR catalog—cameras, supplies, developing, enlarging, exposure, meter included, 10c. Rex Bromide Co., E. Lincoln Park Sta., Chicago.

EVERY WORKER IN PHOTOGRAPHY should read THE CAMERA, \$1.00 a year. Send twenty-five cents for three months' trial subscription. THE CAMERA, Philadelphia, Pa.

GAMES AND AMUSEMENTS

THREE CARD TRICKS, 10c. BAMBERG, 1193 Broadway, New York.

PLAYS, VAUDEVILLE SKETCHES, MONOLOGUES, Dialogues, Speakers, Minstrel Material, Jokes, Recitations, Tableaux, Drills, Musical Pieces, Entertainments, Make Up Goods. Large catalogue free. T. S. Denison & Co., Dept. 26, Chicago, Ill.

JAPANEZE PERFUMED SNEEZE POWDER in patent bellows 10c. Classy shooting Cigarette box; cure for cigarette grafters 25c. With illustrations 40 latest jokers' novelties. Genesee Specialty Co., Dept PE, Retsof, N. Y.

TRICKS, MAGICAL APPARATUS AND Supplies—Amateurs supplied as well as the great professional. Easy, interesting and entertaining, amuse and astonish your friends, 4c stamps brings our four catalogues; Magical Apparatus, Latest Supplement, Marvelous Card Effects and Trick Novelties and Jokers. Send now. Read & Co., 817 East 43rd St., Chicago, Ill.

IGNITION

SEND 25c, COIN OR STAMPS, FOR A three months' trial subscription to IGNITION—the big new monthly magazine specializing on engine troubles. Carefully and practically edited; profusely illustrated; handsomely printed. Helpful from cover to cover. IGNITION, 1459 Monadnock Bldg., Chicago.

INSTRUCTIONS

CORRECT FORMULAS, 20c EACH. Malalane Company, 1411 Longfellow Avenue, New York.

GO ON THE STAGE. WILL TELL YOU how. Write for descriptive circular. It is free. Address, Percy Ewing, Decatur, Ill.

AMERICA'S FINEST PENMAN WANTS to hear from every reader of Popular Electricity who desires to write a better hand. Francis B. Courtney, Cedar Rapids, Iowa.

INSTRUCTIONS

USE OF LOGARITHMS AND HOW TO figure any electrical formula, \$3.00. Capt. C. Nielsen, Box L 448, Willits, Cal.

INVENTOR: BE A PATENT ATTORNEY. Get your own patent for \$35. Complete instructions only \$2. Patent attorney, Box 565, Columbus, Ga.

DRY BATTERIES RENEWED BY ANYONE for 10 to 25c per doz. Saves half your battery expense. Particulars free. Fairmount Co., Leightons Corners, N. H.

FORMULAS FOR ANYTHING, 25c. EACH. Our 368-page volume, containing 3,000 valuable formulas, 50c. coin. "Chemists," 125 Bloomfield St., Hoboken, N. J.

INVESTMENT

FREE—"INVESTING FOR PROFIT" MAGAZINE. Send me your name and I will mail you this magazine absolutely FREE. Before you invest a dollar anywhere, get this magazine; it is worth \$10.00 a copy to any man who intends to invest \$5.00 or more per month. Tells you how \$1,000 can grow to \$22,000; how to judge different classes of investments, the REAL EARNING POWER of your money. This magazine six months FREE if you write today. H. L. Barker, Publisher, R423 20 Jackson Blvd., Chicago

MECHANICAL ENGINEER

LET ME DEVELOP AND BUILD YOUR "Inventions" to a practical and commercial basis. Where others fail, I produce results. Benj. Brownstein, Mechanical Engineer & Expert Designer, Ellwood City, Pa.

MISCELLANEOUS

DIES, MODELS, SPECIAL MACHINERY. Ask for estimates. Box 316, Fulton, Ill.

ACCOUNTS COLLECTED ANYWHERE—Fidelity Credit Co., 808 Clay, Richmond, Va.

SEE WHAT I SAY UNDER "TYPEWRITERS." ATCHISON.

MAGIC GHOST HEAD—SHINES IN dark—10c. Bamberg, 1193 Broadway, N. Y.

WANTED. A 2 K. W. ROTARY converter to give 110 volts A. C. from 110 volts D. C. Must be in good working condition. Send description and price. Postoffice box 60, Toledo, Ohio.

98 KINDS IRON, WOOD, WIRE AND Steel puzzles. Sample leader with catalog ten cents. Western Puzzle Co., St. Paul, Minn.

AUTHORS—SHORT STORY PLOTS written, \$1.00 each, cash with order. Edward Gamble, East Liverpool, Ohio.

3c A WORD GETS YOUR AD IN ENTIRE list 100 magazines including Wheel of Life. Life Pub. Co., St. Louis.

CACHOO THE GENUINE SNEEZE producing powder. Sample 12c. With catalogue jokes. Percy Ewing, Decatur, Illinois.

SHEET MUSIC—LATEST POPULAR songs 15c each. Write for circular. Jersey Music Company, 2903 Westfield Ave., Camden, N. J.

MISCELLANEOUS

IRON, BRASS AND ALUMINUM CASTINGS, Metal Specialties, Patterns, Models, Polishing, Plating and Japanning. North Chicago Tool Works, North Chicago, Ill., 3 Broadway.

IF YOU WANT THE LATEST AND MOST practical books on electricity, send for our free illustrated catalogue. Popular Electricity Book Department.

ANYBODY CAN MAKE GOOD CUTS with my simple zinc etching process; price, \$1.00; specimens and particulars for stamp. T. M. Day, Box E., Windfall, Ind.

RAISE GINSENG—\$1.00 PER SQUARE foot of ground. \$25,000 on half acre. Grows anywhere; half city lot a bonanza. 10c. brings booklet. Sheboygan Ginseng Gardens, Sheboygan, Wis.

WE BUY SELL AND REBUILD, TELEPHONES, Typewrites, Meters, Electric Fans, small Generators and Motors, we invite your correspondence. Suttle Equipment Co. McLeansboro, Ill.

SIX MONTHS SUBSCRIPTION WITH three back numbers, for fifty cents. Special limited offer. All back numbers contain strong practical articles. Electrician and Mechanic, 1140 Beacon Bldg., Boston, Mass.

I WILL START YOU EARNING \$4.00 daily at home in spare time, silvering mirrors; no capital; send for free instructive Booklet, giving plans of operation. G. F. Redmond, Dept. H, Boston, Mass.

CLEAN YOUR GLASSES INSTANTLY SO they stay clean. Magic cleaner clears lenses perfectly. Dimmed glasses impair eyesight. Send stamped envelope for free sample, to F. H. Smith, Dept. N, Main St., Akron, Ohio.

GREAT ELECTRICAL PHENOMENON. Cold can be produced and water frozen by electricity. Yet only in the experimental stage, great thing to experiment on. Send 25c for diagram and particulars. E. A. Martin, Clrk E. Springfield, Ill. 907 S. 12th St.

\$1.50 WILL BUY COMPLETE SET OF castings and all material for a neatly designed automatic steam engine of 1-16 H. P. Engine has rotary valve with adjustment for wear. Blue prints and instruction sheets 25c. Complete engine ready to run \$6.00. Dept. G., Elgin Wheel & Engine Co., Elgin, Ill.

THE SLIDE RULE WILL HELP YOU to solve your electrical problems. See illustrated advertisement elsewhere. Ex. Chief Electrician U. S. Navy, 4214 24th Place, Chicago.

GET A LUCKY BUG STICK PIN; ONE of Nature's wonders imported from Brazil; beautiful color, best winner of 20th century—said to bring owner good luck. Sent in suitable case with complete history 25c. Genesee Specialty Co., Dept. PE, Retsof, N. Y.

GET "THOUGHT FORCE FOR Health" by Julia Seton Sears, M. D. We will send it with a copy of Ella Wheeler Wilcox's New Thought booklet and three months' trial subscription to THE NAUTILUS, magazine of self-help, for 10c. Address The Elizabeth Towne Co., Dept. 205, Holyoke, Mass.

MISCELLANEOUS

SAVE THE PIECES—BROKEN CYLINDERS, crank cases, shafts, gears, and housings promptly repaired just like new, at one-third the cost and guaranteed. Address Welding Dept., Bertschy Motor Co., Council Bluffs, Ia.

WANTED SMALL SPECIALTIES AND novelties also children's wearing apparel and household utilities for exclusive mail order house just organized. Reynaud & Co., Whitehall Building, New York.

ADVERTISERS!!! SPECIAL YOUR 25 Word Advertisement in 250 magazines for \$1.00. Extra words 6c. (1,000,000 readers) 300 formulas 20c. Redbordered Gummed Stickers 3,000 for 95c. Kellner Advertising & Printing Works, Louisville, Ky.

WANTED — REPRESENTATIVES Everywhere. Pleasant Work, Liberal Proposition. Experience not necessary. All or spare time. Need not interfere with present employment. Send stamp at once for particulars of salary plan. It's a winner. Popular Electricity Magazine, Circulation Department, Commercial Bldg., Chicago.

INCORPORATE YOUR PATENTS AND business under Arizona Laws. No annual or franchise tax. Members exempt from corporate debts. No public statements required. Stock can be made non-assessable and full paid for anything of value. Charters cannot be repealed by subsequent laws. Hold meetings and do business anywhere. Capitalization does not effect cost. Cost very small. Particulars, laws and forms free. Southwestern Securities & Investment Co., Box D488, Phoenix, Arizona.

FREE. A CALIFORNIA HOME SITE in Los Angeles vicinity. To advertise and develop our holdings, we will, as special offer, give to any responsible applicant replying to this from your locality, and properly qualifying with us, a full sized lot in new townsite tract, being settled on our properties. This is your opportunity to secure what is rapidly becoming beyond the means of most; a Home-site in the famous Los Angeles section; the most attractive and rapidly increasing community in the world. Write and be convinced to your profit. Syndicate Sales and Development Co., Box 1302, Los Angeles, Cal.

MOTORCYCLES

MOTORCYCLE CASES AND TUBES; made by the Morgan & Wright Co. My prices are very interesting. Send for price list. Wm. Vanderpool, largest tire dealer in the Central States, Springfield, Ohio.

MOTORCYCLES—ENORMOUS VARIETY of American and imported makes—Indians, Marsh's, \$35.00—hundreds of other bargains! Shipped freight prepaid! Write now! Large illustrated bulletin free! Motorcycle Exchange, Dept. B, 217 West 125th St., New York City.

MOTORCYCLES, NEW AND SECOND-hand; motors, castings and accessories. Our Attachable Motor Outfit converts any bicycle into a motorcycle at small cost. Write for catalogue and bargain list. Shaw Mfg. Co., Dept. 31, Galesburg, Kan

PATENTS

SEE WHAT I SAY UNDER "TYPE-writers." ATCHISON.

SEND FOR FREE BOOKLET, ALL About Patents and Their Cost. Shepherd & Campbell, 500 B. Victor Bldg., Washington, D. C.

INVENTORS—LET US SELL YOUR patents. We are manufacturers' agents. Write for plan. Atlantic Supply Co., Long Branch, N. J.

PATENTS, WITHOUT ADVANCE AT-torney fee. Payable when patent allowed. Send sketch for free report. Books free. Ful-ler & Fuller, Washington, D. C.

PATENTEES, MANUFACTURERS quick selling articles, undisputed merit re-quested, communicate, have both men and money quickly market; Globe Specialty Co., 40 Vine St., Cincinnati, O.

PATENT YOUR IDEAS AND MAKE money; sell your patent or start a business on it; I assist my clients sell their patents; send sketch; book free. H. Sanders, 35 So. Dearborn St., Chicago, Ill.

PATENT—ADVICE AND BOOKS FREE. Highest references. Best results. I procure patents that protect. Watson E. Coleman, Patent Lawyer, 612 F St., N. W., Washington, D. C.

C. L. PARKER, PATENT ATTORNEY, ex-examiner U. S. Patent Office, 912 G St., Washington, D. C., Inventors' handbook, "Pro-protecting, Exploiting and Selling Inventions" sent free upon request.

PICTURES AND POSTCARDS

FINE ART! 35 CENTS FOR GENUINE hand colored photographs of 3 life like beau-ties. Drabold, 669 E. Congress, Deroit, Mich.

FIFTEEN BEAUTIFUL POSTCARDS of New York for 12 cents. Ben Levy, 47-49 Maiden Lane, New York City.

"BEAUTY POSES" FOR THE "DEN" gems of art. "Bewitching poses" genuine pho-tographs "panels" 12 inches high, 2 for 25c, 5 for 50c. Curtis Co., 146 W. 73rd St., Chicago.

YOU'LL GET CARDS FROM EVERY-where. Membership, 10c. Idaho Card Exchange, Dept. O, Box 906, Boise, Idaho.

PRINTING

SPECIAL OFFER—250 BOND LETTER-heads and 250 bond envelopes, \$1.75. Patterson Press, Beaver Falls, Pa.

GUMMED LABELS, 3000 \$1.00 CATA-logues free. Advertising specialties. MacTag-gart, 13th Arch, Philadelphia, Pennsylvania.

PRINTING PRESSES, TYPE & SUP-plies. Instruction book and catalog free. L. M. Carroll & Company, 168 Washington St., Chicago.

REAL ESTATE

TO SELL YOUR PROPERTY WRITE Northwestern Business Agency, Minneapolis.

RUBBER STAMPS, ETC.

CATALOGUE OF RUBBER STAMPS and samples of printed pencils, Free. W. M. Stuart, Marshall, Mich.

STAMPS, STENCILS, SEALS, CHECKS, Punches and Dies. Presswork. Dickey-Grabler Co., Cleveland, Ohio.

RUBBER STAMPS AND SPECIALTIES—best prices—prompt delivery—Most complete line. Don't buy till you see my big catalogue. Free. Theo. Helbling, 607 Marquette Bldg., Chicago.

SAFETY RAZOR BLADES

MADE SHARPER THAN NEW, 2½c EA. Write for Mailing Wrapper. P. MacNeill, 168 Congress St., Boston.

SAFETY RAZOR BLADES SHARP-ened. Gillette's Gem's and all thin models 2c each. Star blades 10c. Old style razors honed 25c. Keen Edge Co., 1007 Oregon, Oshkosh, Wis.

SCHOOLS

SEE WHAT I SAY UNDER "TYPE-writers." ATCHISON.

LEARN WIRELESS ENGINEERING and make yourself valuable. Our mail course enables you to become a Wireless Expert at the least expense. Write now for particulars. Kenosha Wireless School, Kenosha, Wis.

\$200 TO \$600 MONTHLY EASILY MADE fitting eye glasses. Short, easy mail course. Reduced tuition. Big demand for opticians. Write today for free "Booklet O." National Optical College, St. Louis.

PLUMBING, ELECTRICITY, BRICKLAY-ing and Mechanical Draughting, taught by expert workmen. Short time and small cost. Positions always open. Catalogue free. Write today. Coyne National Trade Schools, 79 E. Illinois St., Chicago.

FREE TUITION BY MAIL. CIVIL SER-vice, Mechanical Drawing, Stationary En-gineering, Electrical Engineering, Electric Wiring, Agriculture, Poultry, Normal, Book-keeping, Shorthand, and Typewriting Courses. For Free Tuition, apply Carnegie College.

WE TRAIN DETECTIVES. YOU CAN be one. Splendid opportunities. Travel, Earn \$100 to \$300 monthly. This facinating profes-sion taught practically and scientifically by mail at a nominal cost. AMERICAN SCHOOL OF CRIMINOLOGY, Detroit, Mich., Dept. G.

GREER COLLEGE OF MOTORING—offers practical instruction in automobile en-gineering. Correspondence and resident, day and evening courses. See our ad under Help wanted, and send for our 32 page booklet "How to Drive"—FREE. Greer College of Motoring, 1459 Wabash Avenue, Chicago, Ill.

STUDY MATHEMATICS, ENGINEER-ing, or Science by private correspondence. Same courses, same books as in Resident Schools of Technology. Use your old books, or we will suggest the best. State instruction desired. Griswold Inst., 725 E. 46th St., Los Angeles, Cal.

SCHOOLS

AUTOMOBILE SCHOOL—LEARN THE automobile business, repairing and driving, in which you can earn good wages and have healthful and pleasant work. We give a thorough and practical course in road work and repairing. For full particulars address Academy of Automobile Engineering, 1420 Michigan Ave., Dept. "C," Chicago, Ill.

A DRAFTSMAN FOR \$20.00. DRAWING course during summer at special reduction. Everything \$20.00, drawing outfit included. Become a draftsman by studying at home. The greatest offer ever made to men who want to rise to a better position, more pay, cleaner work and shorter hours. If interested in yourself, write for enrollment blank and catalog D. The School of Railway Signaling, Utica, N. Y., U. S. A.

TELEGRAPHY

TELEGRAPHY, BOTH MORSE AND wireless, taught quickly, also Station Agency Work. R. R. Dispatcher's and Western Union wires, and complete wireless station in school. Big demand for operators. Living expenses earned. Correspondence courses if desired. Catalogues free. Dodge's Institute, 16th St., Valparaiso, Ind. Est. 1874.

TYPEWRITERS

TYPEWRITER ON TERMS. MEIER, Russell, Kan.

NOT \$100 FOR \$22 FOR GOOD \$100 Visible Oliver, guaranteed 5 years, others \$10 to \$35. Rent applies. Knight's, 259 12th, St. Louis, Mo.

GENUINE TYPEWRITER BARGAINS—No matter what make, will quote you lower prices and easiest terms. Write for big bargain list and illustrated catalogue. L. J. Peabody, 364 Minot Bldg., Boston, Mass.

\$10.00 FOR A REAL REMINGTON TYPEWRITER. 5 per cent. discount for cash with order. Also have large stock of all other makes of typewriters. Donald Price, 40 Dearborn St., Chicago, Ill.

LARGEST STOCK OF TYPEWRITERS IN America. All makes: Underwoods, L. C. Smiths, Remingtons, etc.; one-quarter to one-half manufacturers' prices (many less). Rented anywhere, applying rent on price. Write for catalogue 102. Typewriter Emporium (Est. 1892), 92-94 Lake St., Chicago.

I WANT TO CORRESPOND WITH PERSONS who are about to buy a high-grade typewriter, object to paying the high prices generally asked by manufacturers and dealers. Any make on approval. Catalogue, bargain list and valuable information sent free. A. E. Atchison, 4125 West 21st St., Chicago.

TYPEWRITERS: CALIGRAPH, \$6.00; Hammond, Yost, Densmore, Williams, \$10.00; Remington, \$12.00; Smith Premier, \$15.00; Oliver, \$24.00; Underwood, \$30.00; all makes on hand; fifteen days' trial allowed, and a year's guarantee. Send for catalogue. Harlem Typewriter Exchange, Dept. 89, 217 West 125th St., New York City.

WIRELESS

ALUMINUM MAGNET WIRE. NO. 40 B & S Silk covered 3½ Ohms per yard, sold cheap. Cosmos Electric Co., 136 Liberty, N. Y.

LARGE SUPPLY WIRELESS GOODS taken in payment of debt. Will sell cheap. Send 2c for catalog or call. French, Room 926 Tribune Bldg., New York.

SPECIAL PRICES—1,000 OHM WIRELESS receiver, double pole, special thin diaphragm, hard rubber case, wound with copper wire, \$1.75. Leather covered head-band, double, \$1.00, single, 60c. "National" receiving condenser, 30c. Waterhouse Bros., Bourne, Mass.

STOP—IF YOU ARE INTERESTED IN wireless you need a good book on the subject. "Wireless Telegraph Construction for Amateurs," by Alfred P. Morgan, is the most complete and up-to-date book published, containing detailed directions for the construction of outfits capable of sending 3 to 100 miles and of receiving 100 to 1,500 miles, also explaining clearly the workings and purpose of each part. 200 pages fully illustrated. Postpaid, \$1.50. Popular Electricity Book Department.

OUR CATALOGUE TELLS WHY THE Alwico Sending Transformer is Positively the Best on the market. Prices of ½ K. W. size, with condenser and spark gap \$35.00. Complete Receiving Set with 1000 ohm double-pole receiver \$5.95. Guaranteed double-pole 1000-ohm receivers \$1.75 each; pair with split head-band and six foot silk cord \$5.25. Double-slide Tuning Coils wound with spaced bare wire \$2.25. Slider rod \$1.10 foot; sliders \$2.3. Reliable apparatus and supplies of all kinds. Send stamp for catalogue. Alden Wireless Co., Dept. D, Campello, Mass.

HELP WANTED

MEN OR WOMEN TO WRITE HUNDREDS of letters from samples; industry without experience can earn \$25 weekly; self addressed envelope. Brooks Copy Co., Box 337, Washington, D. C.

CIRCULAR MAILERS WANTED EVERYWHERE. Write Walters Printery, Brooklyn, N. Y.

MAKE OFFER ON PATENT 966486, JUST issued. Must have help to handle. Fortune awaits hustler who will invest. R. W. Talley, Clarendon, Texas.

\$90 PER MONTH AND EXPENSES TO men to travel, advertise and put out catalogues. Big mail order house. Silverton Company, M. L., Chicago, Ill.

WANTED—MEN TO LEARN WATCHMAKING. Earn pay while you learn. Write for our free book "How to be a Watchmaker." Stone Watchmaking School, 908 Globe Bldg., St. Paul, Minn.

CUTLERY SALESMAN WANTED. OLD established house. Good commission. Must deposit cost of samples, about \$100, at start. Splendid permanent position. Write for particulars to Barnsley Mfg. Co., Monett, Mo.

HELP WANTED

WANTED DISTRIBUTERS OF ADVERTISING matter everywhere. Address Oliver P. Barkley, Mount Pleasant, Pennsylvania.

CIVIL SERVICE EXAMINATIONS open the way to good Government positions. I can coach you by mail at small cost. Full particulars free to any American citizen of eighteen or over. Write today for Booklet. E-50, Earl Hopkins, Washington, D. C.

MOTION PICTURE PLAYS WANTED—you can write them. We teach you by mail. No experience necessary. Writers earn \$50 a week. Demand increasing. For particulars address Ass'd M. P. Schools, 112 Clark St., Chicago, Ill.

SOUND MEN, 21 TO 40 YEARS OLD wanted at once in every state, for Electric Railway Motormen and Conductors; \$60 to \$100 a month; no experience necessary; fine opportunity; no strike; write immediately for application blank; Railway X-511, 203 Dwight Bldg., Kansas City, Mo.

WANTED—A MAN OR WOMAN TO ACT as our information reporter. All or spare time. No experience necessary. \$50 to \$300 per month. Nothing to sell. Send stamp for particulars. Sales Association, 611 Association Building, Indianapolis, Ind.

AUTO SALESMEN, CHAUFFEURS—Make big money. Sell our loud, simple, reliable "SAMSON" ELECTRIC HORN. Special offer to Agents. Write quick to A. S. Cook, Agency Supt., American Electric Company, State & 58th Sts., Chicago, Ill.

WANTED—MEN BY LARGE CONTRACTING company. Can learn trade of plumbing, electricity, bricklaying, automobiles, in few months. No apprentice or helper's work and no expense. \$20,000.00 contract work going. Catalogue free. United Trade School Contracting Co., Los Angeles.

A COMPLETE COURSE IN PRACTICAL Automobile Engineering under experienced instructors, with all modern equipment and appliance. Our four-story building offers special accommodation to out-of-town students. Call or write for our liberal proposition on Resident or Home Courses. Automobile School of Chicago, 1339 Michigan Ave., Dept. P E

BIG MONEY WRITING SONGS. Thousands of dollars for anyone who can write successful words or music. Past experience unnecessary. Send us your song poems, with or without music, or write for free particulars. ACCEPTANCE GUARANTEED IF AVAILABLE. Washington only place to secure copyright. H. Kirkus Dugdale Co., Dept. 13, Washington, D. C.

WANTED! AT ONCE—RAILWAY Clerks; City Carriers; Postoffice Clerks; Government Clerks at Washington, D. C. Thousands of appointments coming. Positions are Life Positions. Average salary about \$1100.00. No "Layoffs." Short hours. Annual vacations. Common education sufficient. Political influence not needed. Send postal immediately for list of all positions open and free bulletin describing examinations. Franklin Institute, Dept. K 53, Rochester, N. Y.

HELP WANTED

CIVIL SERVICE GOVERNMENT POSITIONS are very desirable for young people. Full information and questions recently used by the Civil Service Commission free. Columbian Correspondence College, Washington, D. C.

WANTED AT ONCE—200 YOUNG MEN with nerve, to learn aviation; we have booked exhibition flights all over the country covering the entire summer, and we must have aviators; we teach you the business; factory instruction and trial flights on our own exhibition field; special course to out of town students. If you want to enter the best paid profession and the only one in which there is no limit to the money any one can make, write Chicago School of Aviation, Dept. 179, Chicago, Ill.

THE AUTOMOBILE BUSINESS OFFERS magnificent opportunities to sober and reliable men. Learn this business in the Largest, Oldest and Best equipped school where only PRACTICAL INSTRUCTION is given. We give a thorough knowledge of theory and principles without the use of books, driving instruction on all modern machines, and PRACTICAL REPAIR SHOP EXPERIENCE. Our graduates holding the best positions all over the United States at salaries ranging from \$80.00 to \$150.00 per month. Send for our 32 page booklet "How to Drive" free. Greer College of Motoring, 1459 Wabash Avenue, Chicago, Ill.

MAGIC POCKET TRICK FREE
Catalog included, send 6c stamp.
Dept. 17 270 W. 39th St., New York

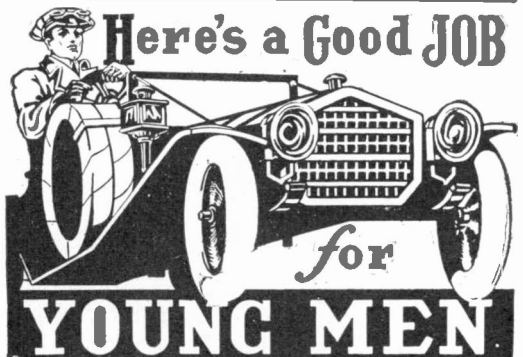

**Earn \$25 to \$50 Weekly
In Automobile Business**

Chauffeurs, Automobile Salesmen, Demonstrators and Repairmen are in big demand everywhere. The field is new, work pleasant, and anyone can learn. We teach you in 10 weeks of study during spare time to become thoroughly efficient. Our course of instruction by mail is simple, practical and very interesting. Free model of automobile to every student. Besides, we assist you to secure a good position.

First Lesson Sent Free—Write Now

Don't miss this offer

Send us a postal today

**Empire Auto Institute, 601 Empire Bldg.
Rochester, N. Y.**
The Original Automobile School
Chauffeurs and competent men supplied owners and garages.

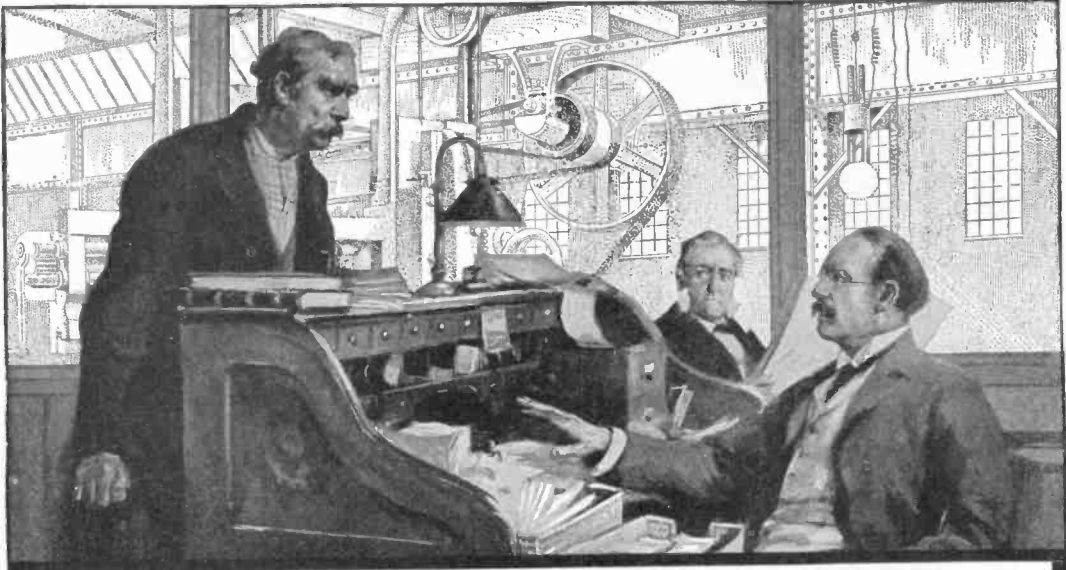

On Which Side of the Desk Are YOU?

In every business there is a desk with two sides. The man on the one side thinks and makes money—the man on the other side works and draws “wages.” On which side of the desk are YOU?

The man before the desk works with his *hands* and is paid for his *labor*. The man behind the desk works with his *head* and is paid for his *knowledge*. It is merely a question of “knowing how.”

For 19 years the International Correspondence Schools, of Scranton, Pa., have been enabling people to advance in position and earn more money. Every month there are received at the I. C. S. over 400 voluntary letters telling of positions bettered and salaries increased through study of I. C. S. Courses. The writers of these letters are not men of genius—not the sort known as “gifted,” “naturally bright,” etc. They are plain men that have studied diligently the work of their choice. Spare-time study won their advancement.

Thousands that have doubled, tripled, or quadrupled their salaries made their start by marking and mailing an I. C. S. coupon.

If you want to raise *your* salary, mark and mail the attached coupon. Mailing the coupon will bring to you a full explanation of the I. C. S. salary-raising plan.

Mark and mail the coupon NOW.

International Correspondence Schools

Box 1102, Scranton, Pa.

Please explain, without further obligation on my part, how I can qualify for a larger salary and advancement to the position, trade, or profession before which I have marked X.

Electrical Engineering
 Electric Lighting
 Electric Railways
 Electrician
 Electric Car Running
 Dynamo Foreman
 Dynamo Tender
 Wireman
 Mining Engineer
 Telephone Expert
 Civil Engineer
 Automobile Running

Mechanical Engineer
 Mechanical Draftsman
 R. R. Constructing
 Concrete Construction
 Architect
 Contracting & Building
 Architectural Draftsman
 Plumbing & Heating
 Chemist
 Bookkeeper
 Advertising Man
 Civil Service Exams.

Name _____

St. & No. _____

City _____ State _____

Present Occupation _____

The Popular Electric Motor

ELECTRICITY is the cheapest power in the world for the average person.

What intelligent workman would spend his energy running a foot lathe when a little electric motor will do it better for a cent an hour? He would rather spend the cent and devote all his attention to the work in hand.

What woman would ruin her constitution running a sewing machine when an inexpensive motor will run it for a good day's sewing at the cost of a loaf of baker's bread?

And when the same motor will do **that** and grind the knives and clean the silver and run any kind of a light machine for any purpose or a blower to ventilate the house in the summer and force up the furnace fire in the winter—what excuse is there for any man or woman not getting the benefit of cheap electric power?

The Westinghouse General Utility Motor

is the popular electric motor because it will do a dozen or more things around the shop, store, house, barn or garage—**the one motor**—with the aid of different attachments. And will do them as well as if a different motor were designed for each particular thing.

Send for the little book—free to readers of Popular Electricity—telling all about this wonderful little motor and showing pictures of it and its different attachments. You can have the book by writing to “Westinghouse Dept. P, East Pittsburg, Pa.”

Westinghouse Electric & Manufacturing Company

Pittsburg, Pa.

Sales Offices
in 40 American Cities

Representatives
all over the world

For our Mutual Advantage mention Popular Electricity when writing to Advertisers.

CYCLOPEDIA of TELEPHONY & TELEGRAPHY

Four Volumes, 1,728 pages, 7x10 inches, 2,000 illustrations.

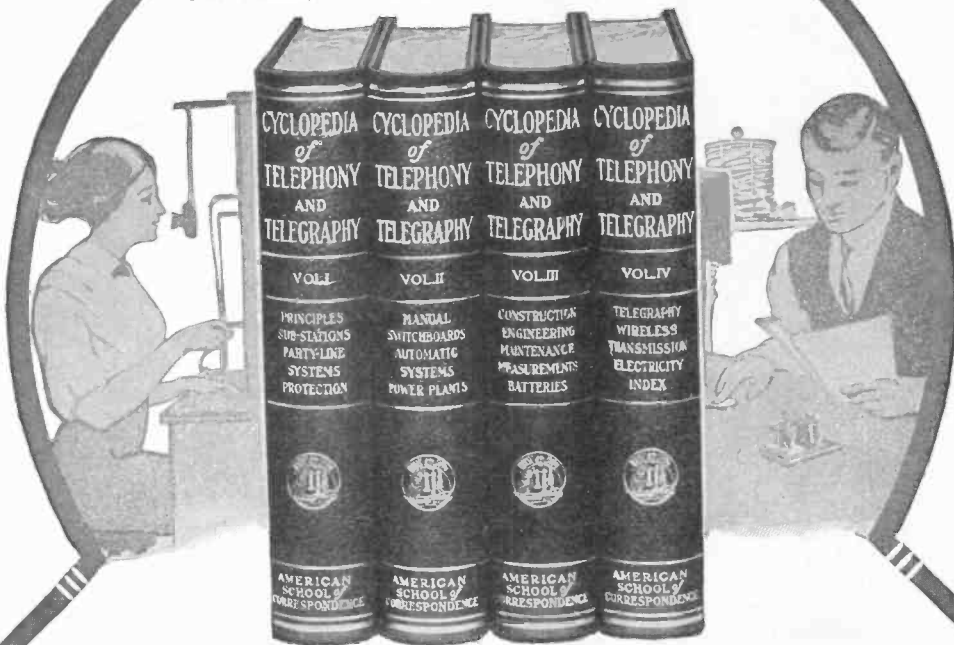

This cyclopedia is brand new, up-to-date, just off the press. The theory and practice of every phase of electrical communication is thoroughly covered. Recent developments in Automatic Telephone Systems, Wireless Telegraphy and Telephony are given special attention.

WRITTEN BY NATIONAL EXPERTS

These writers are men who are largely responsible for the progress in the art of communication—whose reputation in their respective fields is international. You will recognize them at a glance.

Kempster B. Miller, M. E.—Consulting Engineer and Telephone Expert.

George W. Patterson, S. B., Ph. D.—Head Department of Electrical Engineering, University of Michigan.

Charles Thom—Chief of Quadruplex Department, Western Union Main Office, New York City.

Robert Andrews Millikan, Ph. D.—Associate Professor of Physics, University of Chicago.

Francis B. Crocker, E. M., Ph. D.—Head of Department of Electrical Engineering, Columbia University.

Morton Arendt, E. E.—Ass't Prof. Electrical Engineering, Columbia University, New York.

David P. Moreton, B. S., E. E.—Associate Professor of Electrical Engineering, Armour Institute of Technology.

Leigh S. Keith, B. S.—Managing Eng'r with McMeen & Miller.

Samuel G. McMeen—Consulting Engineer and Telephone Expert.

Charles G. Ashley—Electrical Engineer and Expert on Wireless Telegraphy and Telephony.

Pop. Elect. 6-11

WHAT THESE BOOKS CONTAIN

- Vol. I. Fundamental Principles.** Substation Equipment—Transmitters—Receivers—Signalling Apparatus—Repeating Coils. Party-Line Systems—Non-Selective—Series and Bridging—Selective—Lock-Out. Protection—Electrical Hazards. Manual Switchboards—Exchanges—Trunk and Toll Lines—Operation—Restoration.
- Vol. II. Manual Switchboards—Common-Battery Switchboards—Magneto-Multiple Switchboards. Automatic Systems—Operation—Auto-manual System. Power Plants and Buildings—Apparatus—Power Switchboards—Offices. Special Service Features—Private-Branch Exchanges—Intercommunicating Systems—Traffic—Measured Service. Telegraph and Railway Work—Phantom, Simplex and Composite Circuits—Train Dispatching—Orders.**
- Vol. III. Line Construction—Open Wires—Cables—Underground Construction—Distribution. Engineering and Maintenance—Development Studies—Toll Lines—Maintenance and Depreciation—Testing. Electrical Measurement. Storage Batteries.**
- Vol. IV. The Telegraph—Messages—Railway Telegraphy—Switchboards—Repeaters—Multiplex Telegraphy—Duplex—Quadruplex. Wireless Telegraphy—Development—Selective Signalling—Apparatus—Singing Arc—Aerials—Systems. Wireless Telephony—Development—Apparatus—Systems.**

WILL YOU EXAMINE THESE BOOKS AT OUR EXPENSE?

Fill out the coupon in the corner and we'll send you the books by prepaid express. If you want to keep them, send us \$2.00, then \$2.00 each month until you have paid the special introductory price of \$12.80. The regular price is \$20.00. If you don't want the books, notify us and we will have them returned at our expense. This special price also includes a year's subscription to the TECHNICAL WORLD MAGAZINE, a regular \$1.50 monthly, full of interesting, scientific topics written in popular form.

American School of Correspondence, Chicago, Ill., U. S. A.

FREE EXAMINATION COUPON

A. S. of C.

Please send set Cyclopaedia of Telephony and Telegraphy for 5 days' FREE examination. I will send \$2.00 within 5 days and \$2.00 a month until I have paid \$12.80 for books and magazine, or notify you and hold the books subject to your order. Title not to pass until fully paid.

NAME.....

ADDRESS.....

OCCUPATION.....

REFERENCE.....

We Recommend to Illinois Investors the following **Tax-Exempt Stocks**

1. **Commonwealth Edison Company, of Chicago*—The largest Central Station Company in the world, with an investment of over \$70,000,000, paying dividends at the rate of 7% per annum. This Company has made a phenomenal growth in the past few years and prospects for the future justify us in the belief that the stock-holders will be materially benefited thereby. This is indicated by the recent advance in the dividend rate from 6% to 7%. At the present market price of about \$130 per share, the net return to the investor is about 5 $\frac{3}{8}$ %. While the stock was paying 6% dividends it sold at average prices which yielded a smaller net return. This justifies us in the belief that it is now a more desirable investment than ever before.

2. *North Shore Electric Company*—This Company supplies electric current for light and power to the prosperous and growing residential and manufacturing districts surrounding Chicago, from the Wisconsin line on the North to the Indiana line on the South and East. This Company is paying dividends at the rate of 4% per annum, which rate will eventually be undoubtedly increased. Market price about \$87.00 per share.

3. *Illinois Valley Gas & Electric Company*—Recently organized to supply gas and electricity in the thriving cities and towns of the mining and manufacturing districts in the vicinity of Streator and Ottawa. This Company is paying regular dividends at the rate of 6% on its Cumulative Preferred stock, which is selling at \$85.00 per share and accrued interest, to net the investor better than 7 $\frac{06}{100}$ %.

The fact that all three of these companies are controlled by practically the same interests under the presidency of Mr. Samuel Insull, insures their harmonious operation with the most efficient management.

Detailed information regarding these investments will be sent upon request.

* Listed on the Chicago Stock Exchange.

Russell, Brewster & Company

Members:

New York Stock Exchange
Chicago Stock Exchange

116 W. Adams Street
Chicago, Ill.

For our Mutual Advantage mention Popular Electricity when writing to Advertisers.

Popular Educational Food Campaign



G. H. BRINKLER, Food Expert
Washington, D. C.

Brain Power and Health

FROM CORRECT COMBINATIONS OF YOUR DAILY FOODS

IMPORTANT! READ THIS—Psychologists talk nonsense when they say that there is enough power in any man to accomplish what he has in view. Millions are failures through lack of energy and brain power, the result of indigestible and stupefying foods.

Indigestible, irritating foods and the retention of their waste matter cause disease, lack of concentration, dissipation of energy, and homeliness (double chin, dull eyes, bad skin, wrinkles and a fagged face, etc.). Twenty-three years success in England and America.

NO FOODS FOR SALE

During thirteen years of personal experiments in co-operation with S. Leppel and others, I have learned to produce in myself various diseases, each by eating certain wrong foods for a few days or weeks. They are:—**Rheumatism, catarrh, sore throat, tonsilitis, constipation, double chin, swollen glands, kidney troubles, shortness of breath, rough scaly skin, dandruff, sores, boils, pimples with white pus, blackheads, rash, dry hair, and numerous other symptoms**, and I can cure these symptoms of ill-health in a few days by correct foods. The foods which cause expectation, catarrh, cough, constipation, tumors, etc., are specified in my valuable, **instructive free booklets**

RESULTS

A thin man, after being out of work nearly a year through weakness, was restored in three weeks to hard work as a carpenter at full pay. In such cases the change from a clogging, death-producing diet to energizing foods, caused a literal transformation.

Another patient, deaf in the right ear, owing to a discharge caused by an excess of mucus-making foods (cream, butter, cheese, etc.) was completely cured of deafness and catarrh by taking correct combinations of suitable foods.

A case of kidney and bladder trouble of ten years' standing was saved from a surgical operation, and the objectionable discharge cured within ten days, because the loss of control was due entirely to the constant irritation from certain irritating foods and drinks.



Brainy Diet

A chronic sufferer, weighing 415 pounds, unable to exercise, took correct combinations of ordinary, daily foods and reduced over 150 pounds (in public life under many witnesses) gained strength with firmer flesh and lost rheumatism.

INSTRUCTIVE BOOKLETS

"A suggestion from your booklet relieved my catarrh in two weeks and gave me confidence in your methods."

"The Government should investigate and teach the Brainy Diet System for the good of the nation."

"My brain power and general efficiency have been about doubled this year by taking brainy foods. I have made a fortune in real estate and the credit is honestly yours."

"The hints in booklet No. III, on foods for curing congested liver, nourishing the brain, etc., are worth untold dollars, although the books are free."

- | | |
|--------------------------|----------------------|
| (1) TESTS OF BRAINY DIET | (3) EFFECTS OF FOODS |
| (2) DIET VERSUS DRUGS | (4) KEY TO LONGEVITY |

Send 10 Cents for Mailing

Send the addresses of your sick friends to

G. H. BRINKLER
FOOD EXPERT

Dept. E

Washington, D. C.

For our Mutual Advantage mention Popular Electricity when writing to Advertisers.

A COMET ELECTRIC FIRELESS COOKER

MAKES AN IDEAL SUMMER KITCHEN

An Electric Stove — A Fireless Cooker — A Refrigerator — All in One
— Solves the Summer Cooking Problem

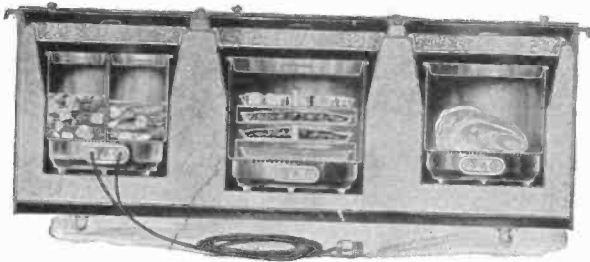

Our 3 oven cookstove (sectional view) is one of the most wonderful kitchen appliances ever invented—think of it—cooks, roasts, boils, fries, stews and freezes all in one operation, and eliminates all the kitchen dirt, trouble, mess, smoke, etc. Absolutely sanitary and clean throughout. It is a positive pleasure for any housewife to cook a meal. We recommend it to cook a meal. Not a particle of heat

for solving all the trying situations at meal time in summer or at summer homes. radiates. Just attach to your lighting circuit and you have fire and heat immediately. The cost of operation and its current consumption is almost nothing.

This shows outside view of "Comet" stove. Beautifully finished, equipped with ball bearing casters and can be moved to any part of the house. Highly nickeled finishings, making it an ornament for any home. Ask for catalogue and prices.



Comet Fireless Cooker

To meet the demand for a Fireless Cooker, where electric current is not available, we can supply Comet Stoves without the Electric Heater, especially equipped for this purpose.

A special plug is used to close the holes ordinarily used for the electric connections, together with two heaters or radiators for each oven.

Comet Electric Frying-Pan

By means of a thorough insulation, the heat furnished by the electric current is retained and concentra-



ted beneath the cooking dish, which can be used as a frying-pan, spider, chafing-dish, broiler, toaster, also by placing a cover over the top a pie, cake, biscuits, etc., can be baked in it. Outside is aluminum and highly polished.

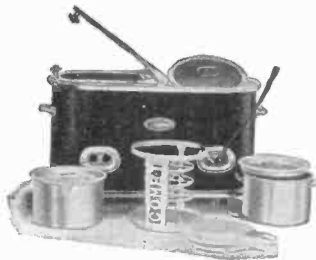

(Two oven stove with outfit)

The above shows a two oven "Comet" cookstove. Can be used as an electric cooker or fireless cooker. Marvelously handy for small families, to be used in flats, camps, summer homes, motor boats, automobiles, etc., etc., hundreds of uses.

We carry the most elaborate lines of electric cookstoves and fireless cookers on the market—absolutely guaranteed in every respect workmanship perfect.

Comet Automatic Clock Regulator

This clock can be set at any number of minutes up to two hours, when the time for which it was set expires, it shuts off the electric current, sounds a warning gong and stops. A great convenience if one wishes to be away from home during the day; also reduces electric bills.

This hot plate shown here has proven to be extremely popular

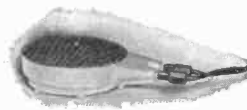

with travelers, as it can be carried in either your trunk or bag—have your own heater with you for your ironing, in your room, use it for heating beverages, etc., etc.

Dealers, Central Stations, Consumers everywhere should get our catalogues and price lists, at once. We know and can prove absolutely the wonderful performances of our stove—and it's economical and safe and convenient to use.

Comet Electric Stove Company

280-A 18th Street, DETROIT, MICH.

Let Us Put This Piano in Your Parlor
Not a Dollar To Pay Us!

SEND NO MONEY

Enjoy This Piano—Take Your
Own Time—Sent to You
on 30 Days' Free Trial

Write right now and let us put this piano
in your parlor — not a dollar to pay us.

Let us send you our big, free, actual photograph,
color-illustrated, handsome book, and offers to trust
you absolutely with any celebrated and artistic
Reed & Sons Piano on as long time as you want,
even three years or more, if you are satisfied after
30 Days' Free Trial. Not a cent to pay down—
not a dollar for any of our beautiful styles you
select from the book we send you on



REED & SONS PIANOS

Established 1842. Given Highest Award
at World's Columbian Exposition, 1893

We've sold through dealers, jobbers and agents—for over
68 years—but now we have cut out their big profits and are
giving the savings to our customers. We have made our
direct-to-you wholesale factory prices so low that you can
have a celebrated Reed & Sons Piano, for lifelong service, at
a price as low as the price of many "cheap" made pianos—
and get the highest artistic quality. Our 25-year guarantee
bond goes with every Reed & Sons instrument. Hundreds
have had generations of enjoyment from our pianos. So can
you on our plan and prove it positively at our risk.

Now Sold Direct to
You From Factory

Saves you from \$128.00 to \$222.00 on
price. No Security
— No Interest to
Pay—No Col-
lectors.



Also Self-Playing Pianos

Reed & Sons Self-
Playing Pianos now
sold on the most
liberal plan. Thou-
sands who "never
knew a note" are now
enjoying our Self-
Players. See our
offers and prices
all explained in
handsome color-
illustrated catalog
sent Free.

Take Your Own Time
—On Trying and Pay-
ing — We Pay Freight
Both Ways.

Take 30 Days' Free Trial in your home with your
family and friends to judge the beautiful tone quality
—handsome exclusive design and finish—easy action
and splendid satisfaction. After a full year's enjoy-
ment send our Reed & Sons Piano or Self-Playing
Piano back and we'll pay the freight if not exactly as
represented. That's the fairest offer ever made. It
means 365 Days Approval Test, besides 30 Days' Free
Trial and 3 years' time to pay if satisfied. When abso-
lutely satisfied you can pay \$1.00 a week, or by the
month, or 3 months, or twice a year. We don't care
how. Suit your own time. We want you to be happy
with one of our pianos or self-playing pianos—prove it
at our risk—right now. Write right now—a Postal To-
day—or the Coupon—For Our Big Book.

REED & SONS PIANO MFG. CO., 265 Wabash Ave.
CHICAGO, ILL.
Capital and Resources, \$1,750,000.00—Largest Factory-to-Home
Piano Manufacturers in the World.



Big Book Free

Reed & Sons Piano Mfg. Co.,
265 Wabash Ave., Chicago, Ill.

Please send me your Big Color Illustrated Piano Book and offer
FREE. Everything at your risk.

Name _____

Address _____

Town _____ State _____

365 Days Approval Test



\$11.50 FOR THIS

Lowdown Washdown Combination

The best and most sanitary closet on the market. Deep seal syphon action washdown vitreous china bowl, solid oak, copper lined tank, seat attached to bowl with nickel-plated hinges, brass nickel-plated supply pipe and two inch flush connection.

35 to 70% Saved on Everything in Plumbing and Heating

- Iron enameled kitchen sink, sink and back cast in one piece \$9.00
- Porcelain-enameled lavatory, complete with nickel-plated faucets, and nickel-plated trap \$7.00
- Complete three-piece porcelain enameled Bath Room outfits \$24.95

Complete Water System for Country Homes

Write for Catalogue No. 11 today—It's a money saver.



John HARDIN Co.
Established 1876
4553 Cottage Grove Ave., Chicago.

"CURE YOURSELF BY ELECTRICITY"

New Book—Illustrated from Life—Sent FREE to all who write.

Write to-day for our new Free Book—"Cure Yourself by Electricity"—illustrated with photos from life. Shows how the New Home Batteries cure Rheumatism, Neuralgia, Lumbago, Headache, Insomnia, Constipation and all nerve affections and diseases arising from sluggish circulation; also how they afford electric baths and beauty massage without cost at home.

THIS BATTERY

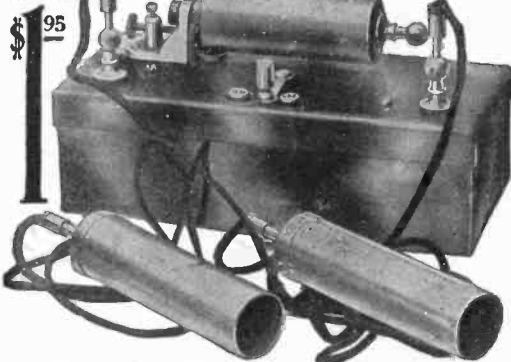

Every Home Should Have a Home Battery.
We send our batteries without a cent in advance (prices \$1.95 and up) and allow 10 DAYS' FREE TRIAL. Write for our Book.
DETROIT MEDICAL BATTERY CO.,
580 Majestic Bldg., Detroit, Mich.

HESS MEDICINE SANITARY LOCKER



The Only Modern, Sanitary STEEL Medicine Cabinet

or locker finished in snow-white, baked everlasting enamel, inside and out. Beautiful beveled mirror door. Nickel plate brass trimmings. Steel or glass shelves.

Costs Less Than Wood

Never warps, shrinks, nor swells. Dust and vermin proof, easily cleaned.

Should Be In Every Bath Room

Four styles—four sizes. To recess in wall or to hang outside. Send for illustrated circular.

HESS, 912 L. Tacoma Bldg., Chicago
Makers of Steel Furnaces. Free Booklet.

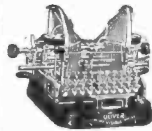

No Deposit Nothing Down \$50
— 1/2 Regular Price

We put the best typewriter in the world right in your home or office. Shipped on approval. Use it five days. If you want to keep it send us \$5 a month. You get the same value as tho you paid \$100 for this standard No. 3 Olivet (Visible) machine. Buying from us saves the 100 per cent agency profits other people pay. Our booklet is worth \$50 to you, because it saves you that much. It's FREE. Tell us where to send your copy. (34)

Typewriters Distributing Syndicate, 159 "V," N. State Street, Chicago

WHEN desirous of information inquire at the information Dept. of Popular Electricity Pub. Co.

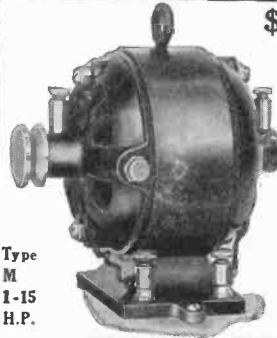

\$3.50 for this HIGH GRADE MOTOR

Runs on a, c. and d c current, 110 volts. Includes complete set of blue prints showing how to assemble. Has laminated field and armature, mica insulated commutator, 3-16 carbon brushes, bronze bearings, brass grease cups, pulley and terminals. Assembled complete ready to run

\$5.50

Set of blue prints showing motor in detail rec. Catalogue 4c.

Type M 1-15 H.P.

JOSEPH WEIDENHOFF
1215 S. Ashland Ave. CHICAGO, ILL.

HESS Sent on Approval FURNACE



We will deliver a complete heating equipment at your station at factory prices and wait for our pay while you test it during 60 days of winter weather.

The entire outfit must satisfy you or you pay nothing. Isn't this worth looking into? Could we offer such liberal terms if we didn't know that the Hess Furnace excels in service, simplicity, efficiency, economy?

We are makers—not dealers—and will save you all middlemen's profits. No room for more details here. Write today for free 48-page booklet which tells all about it.

Your name and address on a post card is sufficient.

No. 45 "Lender" Hess Steel Furnace Price \$49
Delivered East of Omaha and North of Ohio River
Pipe and Regulators Extra

HESS, 912 Tacoma Bldg., Chicago

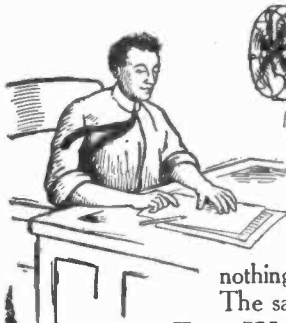

Which Would You Rather Be?

If you were one of these two men would you change places with the other for a difference of half a cent an hour?

The comfort alone is worth many times that amount, to say nothing of the difference it makes with your disposition and the work you can do. The same thing is true of those who work for you and

Fort Wayne Electric Fans Are A Good Investment

because they increase the efficiency of your help.

They are the best means of supplying refreshing, cooling breezes during the hot sultry weather, and it costs only half as much to run one as a 16 candle power incandescent lamp.

We make a size and type for every use and there's enough difference in quality to make it well worth while asking for a "Fort Wayne" when you buy a fan. If your dealer does not carry them—write us.

FORT WAYNE ELECTRIC WORKS

"Wood Systems"

1603 Broadway, Fort Wayne, Ind.

Branch offices most large cities



F2



Magnificent Steel Launch \$96

Complete With Engine, Ready to Run

18-20-25 and 27 ft. boats at proportionate prices. All launches tested and fitted with Detroit two-cycle reversible engines with speed controlling lever—simplest engine made—starts without cranking—has only 3 moving parts—anyone can run it. The Safe Launch—absolutely non-sinkable—needs no boothouse. All boats fitted with air-tight compartments—cannot sink, leak or rust. We are sole owners of the patents for the manufacture of rolled steel, lock-seamed steel boats. Orders filled the day they are received. Boats shipped to every part of the world. Free Catalog, Steel Rowboats, \$20. (83)
MICHIGAN STEEL BOAT CO., 1366 Jefferson Avenue, Detroit, Mich., U. S. A.



ROTH

ELECTRIC MOTORS
POLISHING LATHES
FORGE BLOWERS
SPECIAL MACHINERY

ROTH BROS. & CO.

1358 W. Adams St.
Chicago, Ill.

196 Liberty St.
New York City

ELECTRIC

GOODS FOR EVERYBODY.

World's headquarters for
Dynamos, Motors, Fans,

Toys, Railways, Batteries, Belts, Bells, Pocket Lamps, Telephones, House Lighting Plants, Books. If it's electric we have it. *Undersell all.* Fortune for agents. Big Catalogue 4 cents. **OHIO ELECTRIC WORKS, CLEVELAND, OHIO,**

2 H.P. Gasoline Engine \$36.00

With Complete Equipment

| | |
|---------------------------|---------|
| 4 H. P. Water Cooled..... | \$64.00 |
| 3 H. P. Air Cooled..... | 78.50 |

A full line of Portable and Marine Engines in all sizes, at the same extremely low prices. Brand new and guaranteed strictly high grade. 30 days free trial, or money back if not satisfactory. Enormous stock of Electrical supplies, Shafting, Hangers, Pulleys, Belting, everything in the line of machinery at a saving to you from 30 to 75 per cent. Write us your wants.

Chicago House Wrecking Co., Chicago

4 H.P. STATIONARY GASOLINE ENGINE \$76.00 COMPLETE



For Farmwork, Irrigation or Pumping, Factory use and Electric Lighting.

3 to 20 h.p.—perfectly governed—guaranteed by a responsible firm. Write for full description.

GRAY MOTOR CO., 651 Charlotte, DETROIT MICH.

"Runs Like A Scared Rabbit"

Writes Cleburne Grady, Montgomery, Ala., who while yet a green hand at motors averaged 12.92 miles per hour on a 8.62 mile river trip.

Perfection Marine Motor



The "Perfection" is so worthy of the name it needs little attention. Just a regular flow of gasoline and a good spark will keep it working on hard towing, ferrying or pleasure jaunts—and it will last as long as

Write for catalog. **CAILLE PERFECTION MOTOR CO., 106 Caille St., Detroit, Mich.**
Send for our Stationary Kerosene Engine Catalog if interested

the boat. We build 2, 2½, 3½, 4, 6 and 8 H. P. in the single cylinder and 8 to 30 H. P. in the two, three and four-cylinder engines. Prices range from \$40 to \$450 according to type and horse power.

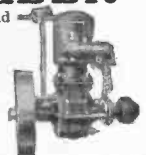

Murdock Wireless Apparatus

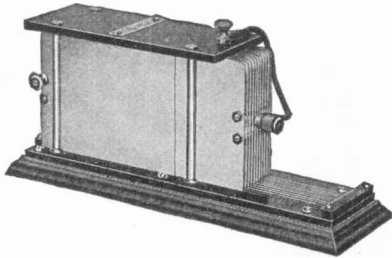

Efficient service is the secret of the success of this popular instrument. Mechanical superiority and electrical perfection guaranteed. The addition of this condenser to **any** receiving set means increased range and selectivity. Price . . . **\$8.00**

WM. J. MURDOCK CO.

50 Carter Street
CHELSEA, MASS.

162 Minna St.
SAN FRANCISCO

221 S. Clinton St.
CHICAGO



POTENTIOMETER

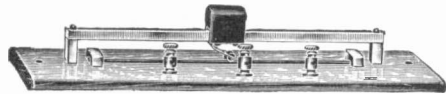

Our Potentiometer regulates current and voltage very gradually. The slider maintains perfect contact with the resistance rod which is practically indestructible.

This instrument and a complete line of high-grade wireless instruments are described in our 80-page Manual of Wireless Telegraphy and Catalog No. 1 E which will be mailed upon request.

Manhattan Electrical Supply Co.

NEW YORK
17 Park Place

CHICAGO
112-114 So. Fifth Ave.

Brandes Long Distance Wireless Receivers IMPORTANT ANNOUNCEMENT

We beg to announce our latest Model Improved Navy Receivers for professional use. These receivers are sold with a written guarantee that they are the best **long distance reading** receivers that money can buy. We send them on trial to those who wish to verify by test, the truth of this statement. Their price is \$13.00 complete set.

We also have other high-class wireless receivers for both amateurs and professionals, from \$1.50 each to \$9.00 a pair.

Send stamp for new literature to Dept. E.

C. BRANDES, The Wireless Receiver Specialist

No. 111 Broadway, New York

Ford King, No. 163 Belvedere St., San Francisco, Cal.

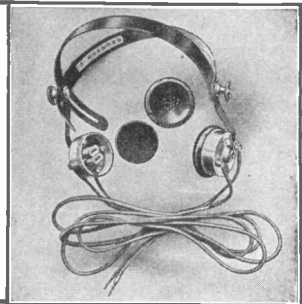

WIRELESS TRANSFORMERS

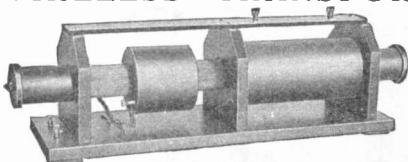

1-2 K. W.
\$30.00

Send for
Catalogue

E. S. RITCHIE & SON, 117 Cypress Street, BROOKLINE, MASS.

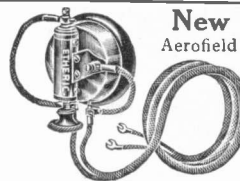

New Wireless Wonder

Aerofield receiving outfit, receives up to 75 miles, consists of 1000 ohm D. P. receiver and attachment. Price complete \$4.00. A wonderful instrument for a low price. Send 3c stamp for catalog.
ETHERIC ELECTRIC CO.
278 Lenox Ave., New York, N. Y.

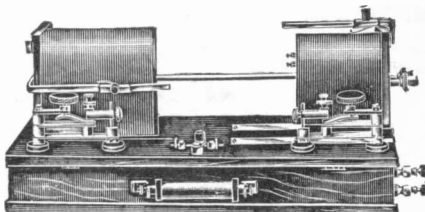

No. 6040 Receiving Set - - - \$45.00
Complete Set, unmounted - - - 32.00

BIG 200-P. ELECTRICAL AND WIRELESS CATALOG

Mailed for 4c. Stamp

Commercial Wireless Equipment from 1 K.W to 25 K.W.

This catalog contains 60-pp. wireless instruments. 15-pp. motors and dynamos. 20-pp. telegraph instruments. 35-pp. miniature trains and electrical toys. 40-pp. electrical novelties. 30-pp. general electrical supplies.

J. J. DUCK, 428 St. Clair St., TOLEDO, OHIO

HERE IT IS

Wireless Bargains Expire July 20th

| | |
|---|--------|
| Our 1/4 K. W. Transformer No. 8050 for..... | 8 6.00 |
| Our 1/2 K. W. Transformer with vibrator for..... | 7.50 |
| Our Loose Couple coil tuner No. 675 for..... | 6.50 |
| Our tuning coil No. 9950 in our catalog for..... | 1.75 |
| Our tuning coil No. 8486a in our catalog for..... | 2.25 |
| Our Fixed Condenser No. 562 in our catalog for.... | 1.00 |
| Our Auto-Coherec Outfit No. 1098, catalog for..... | .60 |
| Our Potentiometer No. 9250 in our catalog for..... | 1.00 |
| Electro-Lytic Detector No. 1280, catalog for..... | 1.00 |
| Enameled Wire 20, 22, 24, B. & S., per lb., for.... | .38 |
| Enameled Wire 24, 26, 28, B. & S., per lb., for.... | .45 |
| 15 Plate Rotary Type Variable Condenser for..... | 4.00 |
| 25 Plate Rotary Type Variable Condenser for..... | 6.00 |
| 37 Plate Rotary Type Variable Condenser for..... | 10.00 |
| 51 Plate Rotary Type Variable Condenser for..... | 12.50 |

All orders received at the above listed prices on or before July 20, 1911, will receive prompt and best attention. ORDERS WILL BE SHIPPED SAME DAY WHEN RECEIVED. Send 2-cent stamp for catalog.

I.W.T. Wireless Co., 726 1/2 Broadway, Brooklyn, N.Y.

90 miles with 1/4 Kw. "W-M" Transformer

Worts-McKisson Mfg. Co., Toledo, Ohio.

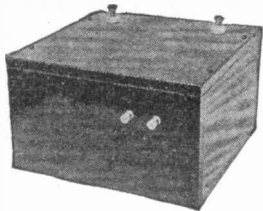

Gentlemen:—Your 1/4 Kw transformer received and must say it works to perfection. I have talked to steamships 90 miles from shore IN THE DAY TIME. Can and will recommend your instruments whenever I have the opportunity.

Yours very truly,

J. J. Watters,

Port Richmond, N.Y.

Our new leaflet "C" listing 21 different sizes of transformers for any frequency or voltage, fresh from the press. Write for a copy.

Worts-McKisson Mfg. Co., Dept. A., Toledo, O.

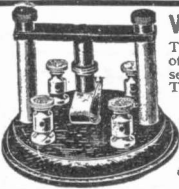

WONDERFUL NEW DETECTOR

The perfect detector found at last. No adjustment of minerals, no sloppy acids. 25 per cent more sensitive and 50 per cent louder than any other. The only detector that is always on the job.

PRICE \$1.75, Postage 16c Extra. Send 3c in stamps for large illustrated catalogue of electrical specialties and Wireless Apparatus.

FRANKLIN ELECTRIC NOVELTY & MFG. CO., 847 Ninth Avenue, New York, N. Y. Levy Electric Co., San Francisco, Western Agents

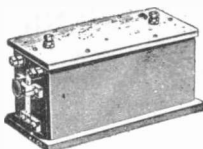

Spark Coils

We build more Spark Coils for experimental work than any other concern in the U. S. Coils are built specially for Experimental and Wireless work.

| | |
|-----------------------|-------------------------|
| 1/4 inch Spark \$2.20 | 1 1/2 inch Spark \$6.50 |
| 1/2 inch Spark 3.10 | 2 inch Spark 9.00 |
| 1 inch Spark 4.50 | 2 1/2 inch Spark 13.50 |

All coils guaranteed for one year. Sell also all kinds of Spark Coil Parts.

Send today 4 cents postage for our famous 196 page Electrical Cyclopeda containing 400 illustrations, information on Wireless, Experiments, Etc.

THE ELECTRO IMPORTING CO. New York, N. Y.
233 B Fulton Street
"Everything for the Experimenter"

WIRELESS TELEGRAPH APPARATUS

Our Type E Transformer Is

The only transformer combining the greater efficiency of a closed core transformer with absence of spark gap troubles as secured by the open core type.

The only distinctive wireless transformer.

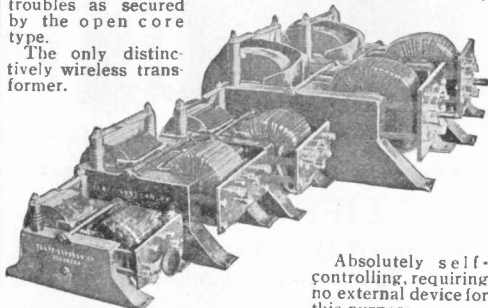

Absolutely self-controlling, requiring no external device for this purpose.

1/4, 1/2, 1, 2 and 3 K. W. Type E Transformers.

More type E transformers are in use than any other one type including many in use by the United States Government, Railroad and Steamship Companies, SEND FOR OUR CATALOG.

The most complete and up-to-date wireless catalog published—is just from the press and fully describes apparatus of absolute reliability. Sent for 4c stamps.

Clapp-Eastham Company

137 MAIN ST.

CAMBRIDGE, MASS.

1200 Miles

This double slide tuning coil, in use in Chicago, is tuning in Key West, Fla., 1200 miles away. That's "going some" for \$3.50. This is the one you want. Like Commercial Companies use. Extra length. Fine

\$3.50

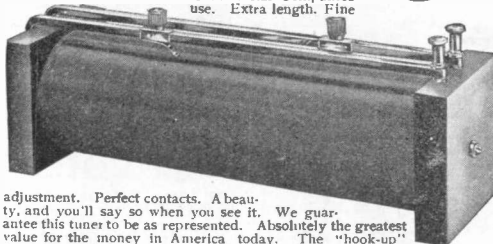

adjustment. Perfect contacts. A beauty, and you'll say so when you see it. We guarantee this tuner to be as represented. Absolutely the greatest value for the money in America today. The "hook-up" free with each instrument. Send two cent stamp for our catalog.

DAWSON & WINGER ELECTRIC CO. 727 S. Dearborn St., Chicago, Ill.

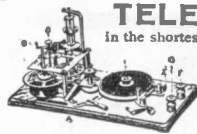

TELEGRAPHY TAUGHT

in the shortest possible time. The Omnigraph Automatic Transmitter combined with standard key and sounder. Sends you telegraph messages at any speed just as an expert operator would. Five styles, \$2 up; circular free.

OMNIGRAPH MFG. CO.

89 H Cortland Street New York

Wireless Bargains—BROOKLYN WIRELESS—Wireless Bargains

"MARK OF QUALITY"

| | |
|---|--------|
| "BWAENCO" Fixed Condenser (like cut) square or tubular brass; seamless..... | \$0.75 |
| "BWAENCO" Fixed Condenser box type 63x43x1 1/2..... | .65 |
| "BWAENCO" Tuning Coils, double slide..... | \$1.50 |
| "BWAENCO" 1/4-K-W Transformers with fine vibrators..... | \$9.00 |
| "BWAENCO" Pericon or Mineral Detector..... | \$1.00 |
| "BWAENCO" Adjustable Spark Gap..... | .35 |
| "BWAENCO" Variable Condenser tubular sliding seamless brass..... | 2.00 |
| "BWAENCO" leather adjustable double headband silver clips..... | \$1.25 |
| "BWAENCO" Spark Coils 1/4-inch..... | \$2.20 |
| "BWAENCO" Spark Coils 1/2-inch..... | \$3.75 |
| "BWAENCO" Spark Coils 3/4-inch..... | \$3.00 |
| "BWAENCO" Spark Coils 1-inch..... | \$4.00 |
| "BWAENCO" Spark Coils 1 1/2-inch..... | \$6.00 |
| "BWAENCO" Spark Coils 2-inch..... | \$9.00 |
| No. 8-14 Aluminum Aerial or Helix, or No. 14-22 enameled Wires per pound..... | 17.00 |
| No. 8-22 Bare Copper Wire per lb..... | .50 |
| No. 8-22 Bare Copper Wire per lb..... | .40 |
| 100 feet coil Galvanized Standard Guy Wire..... | .35 |

BROOKLYN WIRELESS CO., 766 Broadway Brooklyn, N. Y.

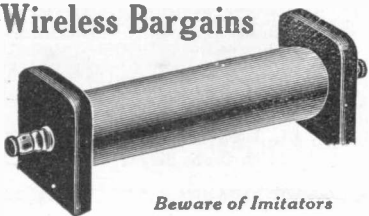

Beware of Imitators

ENAMELED WIRE BARGAINS

We still have left a few sizes of our "old formula" enameled wire. It's perfectly good—especially for wireless windings—but we don't care to sell it as regular stock. We will close it out at the following **EXTRA-ORDINARILY LOW PRICES. CASH MUST ACCOMPANY ORDER.** No order accepted for less than \$1.00.



| Size | Feet per lb. | Price per lb. |
|------|--------------|---------------|
| 20 | 320 | \$.28 |
| 22 | 509 | .30 |
| 24 | 810 | .33 |
| 30 | 3240 | .56 |
| 34 | 8093 | .94 |
| 36 | 12813 | 1.26 |

AMERICAN ELECTRIC FUSE CO.
Nims Street MUSKEGON, MICH.

"HI-LIFE"

STORAGE BATTERIES
Guaranteed

The "old and tried" with new and improved features. Our special three post battery will give 2 volts, 4 volts, or 6 volts as desired.

Efficient and powerful for automobile sparking and lighting and all other purposes where storage batteries can be used.

Special Sizes to Order.
Entire Lighting Outfits Furnished
Correspondence Solicited



PRICES REMARKABLY LOW

Address **NORTHWEST MFG. CO.** Responsible Dealers
1247 Wells St. - - Chicago, Ill. Wanted

Wireless Supplies

WE are Western Representatives for The **Electro Importing Co.**, carrying a complete stock. Same catalog. Same prices.

Anderson Light and Specialty Co.
70 La Salle St. (Opposite New City Hall,)
CHICAGO, ILLINOIS

WIRELESS GOODS Double slide tuning coil, having the improved slider, the only slider in the country that does the work, complete for \$2.00. Our non-inductive potentiometer guaranteed to 500 ohms, we do not use pencil rods in our potentiometers, complete for \$1.10 postpaid.

SPECIAL SEND FOR IT SPECIAL
We are selling the best wireless goods on the market, prices on application. Send Stamp for our Large Wireless Catalogue. The only complete wireless catalogue on the market today.

THE BROADWAY WIRELESS & ELEC. NOV. CO.,
782 Broadway, Brooklyn, N. Y.

WIRELESS COILS

- No. 1— 1-4 in. to 3-4 in. spark \$3.50
- No. 2— 3-4 in. to 1 1-4 in. spark 4.50
- No. 3— 1 1-2 in. to 2 1-2 in. spark 9.00

These high-grade guaranteed coils are not over-rated.

Send your money and coil will be shipped to you same day. Thousands of them in use.

LEMKE ELECTRIC CO., Dept. P. E., Milwaukee, Wis.

ENAMEL INSULATED



MAGNET WIRE

ENAMEL WIRE is supplanting silk and cotton covered because The Insulation is better, because it requires less space, because it is cheaper.

FEVAL WIRE has a dielectric strength in excess of 75 volts per .0001 inch of insulation. The evenly distributed enamel covering adheres tenaciously yet is resistant and elastic, never cracking. No change at 400° to 500° F. All sizes, Nos. 16 to 40.

MANUFACTURERS: We have an attractive contract proposal to offer covering your requirements for 12 months.

INDIVIDUALS: We will furnish small quantities for spark coils and magnets.

FEVAL ENAMEL INSULATED WIRE CO.
129 N. Curtis Street CHICAGO

Wireless Telegraph Construction for Amateurs

By **A. P. Morgan**



This new book was written to meet the demand for a **practical** work on the construction of wireless telegraph instruments, and is unusually complete, giving in minute detail full directions, down to the smallest screw, for each part in the construction of various outfits capable of receiving from 100 to 1500 miles, and of transmitting 3 to 100 miles.

The Author has written a number of articles for **POPULAR ELECTRICITY**, whose readers will at once recognize the value of his new work.

The 153 illustrations are mostly of apparatus, specially made and previously put in operation, so that it is all entirely practical. Contains 200 pages bound in cloth; price \$1.50.

POPULAR ELECTRICITY Book Dept.,
CHICAGO, ILL.

CUTLER-HAMMER

Electric Heating Devices

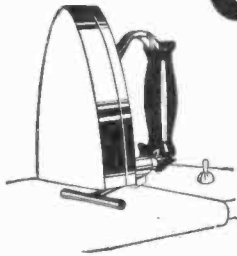

Electric Iron—5, 6, 7 lbs.
No separate stand needed

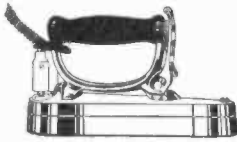

3 lb. Sleeve Iron



Electric Shaving Mug

Electric irons provide the greatest convenience during the hot summer months. The Cutler-Hammer Electric Iron is convenient and economical to operate. It retains its heat unusually long and requires no separate obstructive stand.

The Sleeve Iron weighs only 3 pounds and is adapted for ironing laces, doilies, etc., and because of its light weight is convenient for taking along when traveling.

The Electric Shaving Mug is also unusually handy in warm weather. The Cutler-Hammer Disc Stove should be in every household. It can be used in a hundred ways in the kitchen, dining room, bed room and sick room. Connection can be made to any lamp socket.

Our 32-page booklet will tell you about our entire line,—copy free on request.

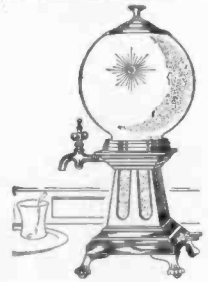

Portable Water Heater
Three quart size
Hot water in 45 seconds



Electric Disc Stove

The Cutler-Hammer Mfg. Co., Milwaukee, Wis.

New York: Hudson Terminal (50 Church St.) Philadelphia: 1201 Chesnut St. Chicago: Peoples Gas Bldg.
Pittsburg: Farmers' Bank Building Boston: 176 Federal Street Cleveland: Schofield Bldg.

PACIFIC COAST AGENTS:

Otis & Squires, 155 New Montgomery St., San Francisco. W. B. Palmer, 416 East 3rd St., Los Angeles



No More "Battery Trouble"

Cease sending for the electrician to "fix that bell." Let the electric light current ring your annunciators, burglar alarms, etc. Our

"Junior" Transformer

will do it more cheaply than any other way. Consumes no current, and can't be damaged by short circuits. Fire-proof and durable. For alternating current only. Price \$3.00, at dealers or direct from us.

THORDARSON ELECTRIC MFG. CO.

214 Jefferson Street

CHICAGO

Will Not Burn Out

An important feature of these motors is that they will not heat under any circumstances.

1/2 and 3/4 H.P. for A.C. and D.C.
Finished in Black Enamel.



THE BARNES

VARIABLE SPEED AND REVERSIBLE

Are especially adapted for
Washing Machines, Printing Presses, Coffee Mills, Dental Apparatus, Vacuum Cleaners, Wireless Apparatus, etc.

Let us figure on your requirements

BARNES MFG. CO., 107 Belmont Street
Susquehanna, Pa.



The Thor Electric Home Laundry Machine

Has no equal for

**Efficiency Durability
Simplicity and
Low Cost of Operation**

Every home will eventually have a THOR Electric. Sold for cash or on monthly payments.

Write for new free Booklet 50

NEW YORK: 1010 Flatiron Bldg.

Hurley Machine Company

37 So. Clinton St.
CHICAGO

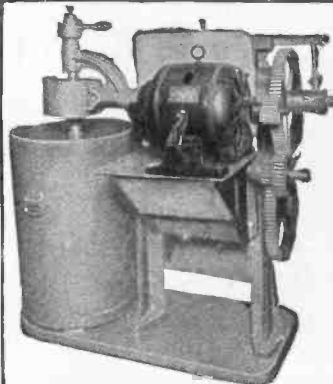

The Dewsberry ELECTRIC Power Freezer

Will enable you to produce a better grade of ice cream at a lower price and in less time than by any other method.

These machines are built unusually substantial, and are guaranteed to give satisfaction.

Made in 20 and 40 quart sizes. The 40 quart size runs both fast and slow on A.C. current. Write to-day for circular

R. A. Dewsberry
216 N. Morgan St.
CHICAGO.

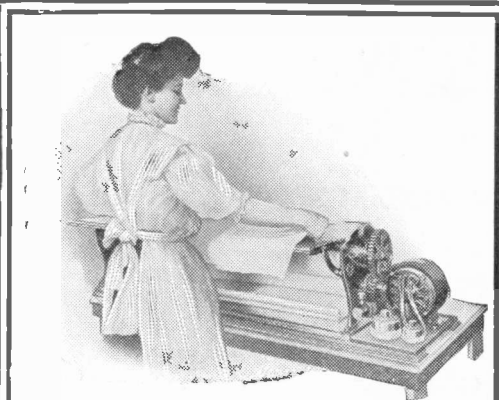

Try this Machine for 30 days

At the end of that time you will be only too glad to buy it.

The Simplex Ironer will iron your plain clothes, table linen, doilies, curtains and bed linen much quicker than it can possibly be ironed by hand and make it easier and do it better, at less expenses for fuel. It costs but 2 cents an hour to run by a small electric motor, or can be operated from any Electric Washing Machine.

Write today for booklet on the **Simplex**, also **Ironing Hints**, both sent free.

American Ironing Machine Co.
55 E. Lake Street - Chicago, Ill.

SOLD ON TRIAL

Here is THE modern Electric Cooker—built like a range, of planished steel and aluminum—does all that a range does. Bakes, boils, stews, fries, and roasts perfectly. No wood to split or warp.

A few minutes current from any electric light socket starts it—then the imprisoned heat cooks the food.

Detroit Fireless Electric Stove
(Six Sizes)

**Hygienic
Delicious
Economical
Convenient**



Protected Heating Element

The Detroit Fireless is the only Electric Cooker ever made with the heating element protected against effects of steam and acids from cooking, yet easily removed from bottom of cooker. Famous "Everware" Aluminum utensils. **Positive guarantee on every part.**

Get Our Trial Offer Write today for Catalog of our Electric and other Fireless Stoves, and our new TRIAL OFFER.

Detroit Fireless Stove Co 102 Jefferson Ave.,
DETROIT, MICH.
A good deal for dealers—ask about it.



**A PERFECT
110 VOLT
FAN FOR
\$6.50**

Electrically,
Mechanically and
Aesthetically Perfect

Finish, black enamel and nickel. Any adjustment for home and office, telephone booth, picture show, or where a ceiling fan is not needed. You can buy a larger or a higher priced fan but you positively can not get a better one. Noiseless and sparkless. Say whether for alternating or direct current, and give dealer's name. We

The Carleton Company

propay express and guarantee satisfaction.
Seven volt battery fan at same price.
178 Summer St., Boston, Mass.

"Domestic" Electric Washer and Wringer

Oscillating, Self Cleaning, All Metal Tub, Reversible, Metal Frame Winger, Positive Drive, Automatic Belt Tightener, Inclosed Working Parts. No Springs to Break.

SEND FOR BOOKLET

Domestic Equipment Co.
New No. 30 W. Lake St., Chicago

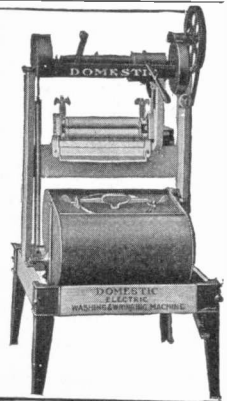

A CADILLAC COMBINATION STOVE AND TOASTER

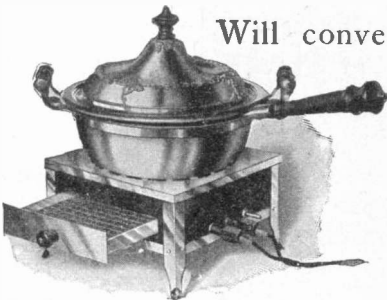

Will convert your old fashioned dangerous, alcohol chafing dish into a modern, sanitary, electrical device.

Price - - - \$7.50

ASK US MORE ABOUT IT.

Cadillac Electric Manufacturing Co.
16 Mitchell Street, Cadillac, Mich.

Let Electricity Make Pure Air for You



Sufferers from many ailments travel thousands of miles to breathe the OZONE of the mountains and pine forests. Yet a recent scientific invention enables everyone to have—**RIGHT IN THEIR OWN BEDROOM**—air constantly as pure, refreshing and exhilarating as the purest oxygen-filled atmosphere of the piny woods and mountain peaks. This little apparatus is operated by electricity and "ozonezes" the air of the closest room just as an electric storm purifies the out-door air. The

OZONE PURE AIRIFIER

is of greatest benefit in the treatment of Asthma, Hay Fever, Catarrh, Insomnia, Nervousness, Pneumonia, Typhoid and Scarlet Fevers, Diphtheria, Bronchitis, Tuberculosis, etc. Endorsed by highest medical and scientific authorities a thoroughly tested and demonstrated success.

Central Station, Electric Jobber and Dealer, this is the latest Electrical Appliance on the market. Write now for illustrated catalogue, price list and descriptive matter and plan of placing for liberal trial.

We want distribution throughout the United States in Every Place Where Electrical Appliances are Sold.

OZONE PURE AIRIFIER COMPANY

307-314 Rand McNally Bldg.

CHICAGO, ILL.

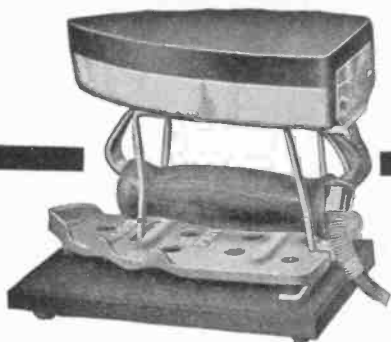

Every Woman

Has some dainty ribbons or laces which cannot stand being rubbed with the iron, or some pieces of velvet on which she wants to raise the nap. This Simplex attachment enables her to do it safely, conveniently and perfectly. Just one of the features of the 1911 Model Simplex Iron. Ask your lighting company or dealer to show you a Simplex Household Iron or let us tell you more about it.

Simplex Electric Heating Co.
CAMBRIDGE, MASS.

CHICAGO
Monadnock Block

SAN FRANCISCO
612 Howard St.

Let Electricity Do Your Washing

For 1c
Per Week

The *Elmo Washer* will do a big week's washing in one hour. Don't let your wife wear herself out at the hardest kind of drudgery in order to save this penny, when with



The Elmo

the heaviest washing becomes play. The machine is extra well built of finest cypress, with powerful motor built to use minimum current. Has reversible wringer operated by same motor.

The low cost of *The Elmo* complete will surprise you. Write now for our free booklet and particulars.

Don't be penny wise and pound foolish. Spend the penny and save your wife.

Grinnell Washing Machine Co.
GRINNELL, IOWA



TO BE CLEAN YOU NEED

The "BEE" Suction Cleaner

IT

costs only \$65.00 with complete equipment.
weighs only 20 lbs. No Jar or Vibration.
equals the highest priced machines in efficiency.
does the best work with the least effort.
has NEW and EXCLUSIVE FEATURES.

SOLD ONLY BY RELIABLE AGENTS.

BIRTMAN ELECTRIC CO., CHICAGO, U. S. A.

For our Mutual Advantage mention Popular Electricity when writing to Advertisers.

Electric Lighting at Small Cost

You can install your own electric lighting plant for \$350 and upward. Sufficient electricity for 15 or 20 lamps can be generated for only a few cents each day.

This company has designed small electric lighting plants consisting of gas engine, dynamo, switchboard and storage battery, that require little space, are absolutely safe, easily installed and can be operated by nearly any one.

The engine is run but a few hours each day to charge the storage battery.

The "Chloride Accumulator"

furnished with these plants is the same type of battery as is used by the large electric lighting companies in New York, Chicago, Philadelphia, etc., by the electric railways, Western Union and Postal Telegraph companies, Bell Telephone companies, etc.

The battery furnishes current nearly all of the time so that the use of the best storage battery insures the most reliable service.

If your home, farm or factory is not near a public electric lighting station, write our nearest Sales Office for our book "Small Electric Lighting Plants." It will show you how easily a plant can be installed, how easily it may be operated and the small cost of maintaining it.

THE ELECTRIC STORAGE BATTERY CO.

1888 PHILADELPHIA, PA. 1911

New York Boston Chicago St. Louis Cleveland Atlanta Denver
 Detroit San Francisco Portland, Ore. Seattle Los Angeles Toronto

The "Exide" Sparking Battery gives the most reliable ignition service for gas engines.

Let the Slide Rule Do Your Work--Do Your Work

Engineers, Electricians, Draftsmen, Superintendents, Managers, Master Mechanics, Estimators and Business Men:

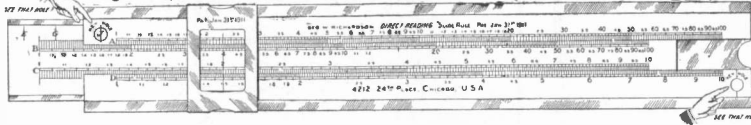

Your time is too valuable to waste in solving problems or checking over the work of others. The Richardson Slide Rule will do it mechanically. One of the most valuable instruments ever offered to mankind is the Slide Rule. Not until the above rule was designed did

it become possible for a person of a limited education to learn to operate it. Besides, the usual price has been reduced one-half, and the free instruction book is written so you can understand it.

This Slide Rule will multiply, divide, solve proportion, extract the square and cube roots, find the decimal equivalent of vulgar fractions or vice versa, calculate interest, percentage. In addition to above the rule is direct reading for forty-four other problems, such as the Horse Power of Engines, Pumps, Boilers, Belts, Water Falls; size of motor to run a pump, size of duct for ventilating; percentage a recording wattmeter is "Slow" or "Fast"; radiation and size grate, and steam main required; change gear and pulley problems; areas, circumference and diameter of circles. You simply place the key to the problem in the key hole (the key is printed in red) and answer is given direct. This Rule is my latest improved type now being placed upon the market for the first time. "See sectional cut" curved slide bound with aluminum. No other like it. Good Value. Price \$2.50 mailed to any part of the world, with substantial pocket case and instruction book. Stock aluminum 1 1/8 inches with runner. Scales celluloid printed and polished in two colors and washable. Illustrated circular sent upon application.

GEO. W. RICHARDSON, Ex-Chief Electrician U. S. Navy 4214 24th Place, CHICAGO, U. S. A.

TESTED APPARATUS Means the Elimination of Faults in Your Product.

Electrical and photometrical tests of every description.
 Checking electrical instruments of all kinds and classes.
 Inspecting and testing new electrical machinery; apparatus and material at factories and after installation.
 Tests on any electrical machinery and apparatus made anywhere.
 Arc and incandescent lamp tests, either electric, gas, acetylene or oil.
 Illumination tests made anywhere.
 Secondary standards of candle-power furnished.
 Facilities furnished to experimenters and investigators.

We have recently added to the above, coal testing, and are now prepared to make proximate analyses and calorific determinations on samples of coal, promptly and accurately.

ELECTRICAL TESTING LABORATORIES

80th Street and East End Avenue

NEW YORK, N. Y.

For our Mutual Advantage mention Popular Electricity when writing to Advertisers.

We Sell You At Wholesale Agents' Price, One



American Motorcycle or Bicycle

As an introductory offer we give 30 Days' Free Trial and prepay the freight. Hundreds of people will snap up this introducing proposition. The number of machines we sell on this liberal basis is limited—first come, first served. Here is our plan:—You ride the motorcycle or bicycle for 30 days. If it is not satisfactory, you may return it. If you like it, it's yours at the wholesale agents' price. The American Motorcycles are highest grade made, easy to start, simple to handle and powerful. You do not have to be a mechanic to run one. The American won the 1910 F. A. M. Western Endurance Contest, scoring 1000 per cent perfect. The American Bicycles are the best on the market. We give a Life Guarantee.

We have a money making proposition for five agents. Our enormous advertising campaign makes it easy to sell American machines. Don't delay a moment. Our catalog and introducing offer will interest you; it's free. Write us which you want, motorcycle or bicycle. Do it now. AMERICAN MOTOR CYCLE CO., 116 American Bldg., CHICAGO, ILL.

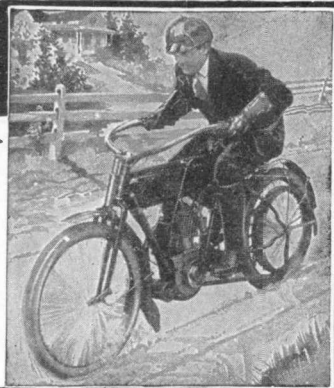

THE 1900 DRY CELL

IS THE BATTERY OF KNOWN QUALITY

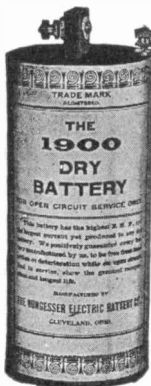

Which can only be proven by its use, at which time you will agree that the high electromotive-force and great efficiency make it the best battery on the market.

This cell is made with the view of obtaining the longest possible life under the most exacting requirements.

Recommended especially for Experimenters, Small Wireless Outfit, Gas Engine Ignition, Telephones and all open circuit work.

Write today and secure our catalog, which gives full particulars regarding sizes and prices.

The Nungesser Electric Battery Co. CLEVELAND, OHIO

GENERAL SALES OFFICE 627 W. Jackson Blvd. CHICAGO

Motorcyclists!



Here are the newest motor cycle improvements. Your machine may have one or two of them, but you can not ride in such safety, comfort or satisfaction unless you have them all. Every one of them is found in the R. S. MOTORCYCLE. Ball Bearing Motor, Mechanically Operated Valves, Shock Absorbing Seat Post, Auxiliary Brake on Belt Rim, Foot Controlled Belt Tension Device, Adjustable Foot Rest. These and other features are the regular standard of the R. S. On other motorcycles they are furnished only as extras at extra prices. Write for 1911 catalog. Established dealers—write today for open territory and agency proposition.

READING STANDARD COMPANY Makers Renowned Reading Standard Bicycles 406 Water St., Reading, Pa.



THE BEST METER IN THE WORLD

These instruments are designed for all kinds of Automobiles, Motor Boats, Gas Engines, Etc. The best wherever testing is necessary.

Send for our Catalog now

PRICES: Ammeters \$1.50
Volt Meter - 1.75
Volt-Ammeter - 2.00

THE STERLING MFG. CO. 416 American Trust Bldg. CLEVELAND, OHIO

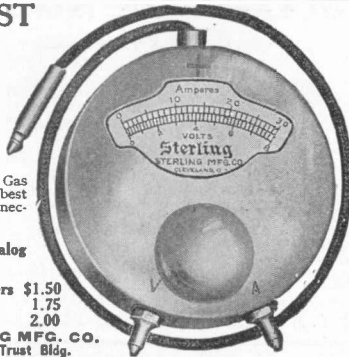

10 DAYS FREE TRIAL

prepaid, to any place in the United States without a cent deposit in advance, and allow ten days free trial from the day you receive it. If it does not suit you in every way and is not all or more than we claim for it and a better bicycle than you can get anywhere else regardless of price, or if for any reason whatever you do not wish to keep it, ship it back to us at our expense for freight and you will not be out one cent.

LOW FACTORY PRICES We sell the highest grade bicycles direct from factory to rider at lower prices than any other house. We save you \$10 to \$25 middlemen's profit on every bicycle. Highest grade models with Puncture-Proof tires, Imported Roller chains, pedals, etc., at prices no higher than cheap mail order bicycles; also reliable medium grade models at unheard of low prices.

RIDER AGENTS WANTED In each town and district to ride and exhibit a sample 1911 "Ranger" Bicycle furnished by us. You will be astonished at the wonderfully low prices and the liberal propositions and special offer we will give on the first 1000 sample going to your town. Write at once for our special offer. **DO NOT BUY** a bicycle or a pair of tires from anyone at any price until you receive our catalogue and learn our low prices and liberal terms. **BICYCLE DEALERS**, you can sell our bicycles under your own name plate at double our prices. Orders filled the day received. **SECOND HAND BICYCLES**—a limited number taken in trade by our Chicago retail stores will be closed out at once, at \$3 to \$5 each. Descriptive bargain list mailed free.

TIRES, COASTER-BRAKE line at half usual prices. **DO NOT WAIT**, but write today for our Large Catalogue beautifully illustrated and containing a great fund of interesting matter and useful information. It only costs a postal to get everything.

MEAD CYCLE CO. Dept. T-109 CHICAGO, ILL.



SEBCO SCREW ANCHORS NEVER PULL OUT

Every Mechanic and Electrician has work for which the Sebco Screw Anchors and Sebco Expansion Bolts are particularly adapted. There is no better method of fastening all kinds of iron work, brackets and Electric fixtures to walls and floors of tile, brick, stone, concrete, etc.

Send for free working samples and illustrated catalog No. 10.

STAR EXPANSION BOLT CO.
147-149 Cedar St., New York

6 MONTHS FREE TRIAL

Luther Diamond Tool Grinder



In your own way, at your own work, try this Carborundum hand and foot power grinder for six months with the privilege of sending it back, 25 times faster than the grindstone—6 times more efficient than emery—equipped with genuine Carborundum wheels—big time and labor saver for every user of tools. Write today for 6 months' free trial offer—also McClure's story of Carborundum.

**LUTHER GRINDER
MFG. CO.**
62B Madison St.,
Milwaukee,
Wis.

The
Wheels
are
Genuine
Carborundum

IF IT IS A

STAR HACK SAW BLADE



For MACHINE USE 12x5-8
there is no "better" or "just as good"
Made of the Best Material, Possess
Great Strength and Durability

The recognized STANDARD for over a quarter of a century, by which Hack Saw Blades are judged. All Dealers keep them. Send for Leaflet—fully descriptive.

MILLERS FALLS CO.
28 Warren Street New York

HELIX CLIPS



Actual Size

UNIVERSAL TEST CLIPS are just the thing to use as Helix Clips. Made of cold-rolled and blued spring steel. Nickel-Plated. The nose is thin for close quarters, yet the jaws have a spread of 5/8 in. Note the side jaws. The stiff spring holds the clip straight out wherever applied. It will not sag down and make contact with adjacent parts.

Used with magneto and microphone test sets, with volt-meters, and in general laboratory work.
Used on shop test benches, portable lamps and ignition cell charging outfits.

15c each or \$1.25 for a box of 10.
R. S. MUELLER & CO. 421 High Ave., S. E. CLEVELAND, O.

THE BEST ARGUMENT

about the value of tools bearing the name **KLEIN** is that with few exceptions, all linemen insist on having genuine **Klein's**, though imitations abound.



Send for booklet 8-S (no charge).
Buy from your Supply or Hardwareman. Insist on
genuine **Klein's**.

MATHIAS KLEIN & SONS
Station U-3, Chicago, Ill.

Here's Another New "YANKEE" "Quick Return" No. 130



Same as the No. 30, but with a Spring in the handle that drives the spindle back, ready for the next push. A great advantage for overhead work or where only one hand can be used. Takes all the Attachments used in the No. 30.

Send for Tool Book Free. Tells you about 35 Styles and 75 Sizes
A postal brings it to you FREE. Your dealer sells "YANKEE" Tools.

NORTH BROS. MFG. CO., Dept. C. Philadelphia, Pa.

For our Mutual Advantage mention Popular Electricity when writing to Advertisers.

This Kerosene Engine Cuts Your Expenses 75%

YOU should not even consider engines that operate on gasoline only. The rapidly rising price of gasoline, now 6 to 16 cents higher than kerosene, absolutely makes operation on this fuel too expensive. The Perfection Kerosene Engine operates on any engine fuel. When you purchase it you are on the safe side—proof against all fluctuations of the market. You can always run this engine at a great fuel saving and get the greatest amount of work done. The Perfection vaporizes its own kerosene and so makes it as efficient as gasoline—something other engines cannot do.

The Perfection is very light, portable, has only three moving parts, runs everything about the place, is lower in price than any other engine of its capacity on the market.

PERFECTION Kerosene Engine

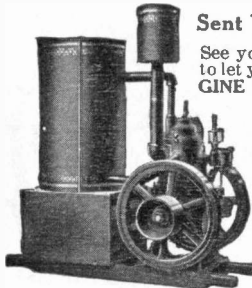

Sent You on 15 Days Free Trial

See your dealer at once and ask him to let you have a copy of our Free ENGINE BOOK, which shows the sizes and styles of the "Perfection" and explains this very attractive offer. Your dealer will send any "perfection" engine to your farm for 15 days and let you return it if you are not satisfied. Ask him about it. If he does not carry the "Perfection" write to us and we will send you our Free Engine Book direct.

CAILLE PERFECTION MOTOR CO.
202 Second Ave., Detroit, Mich.

Electric Light For Farms, Stores, Factories

No need to live in town to have electric lights. No matter where you live our safe, low voltage plant lights your place brilliantly and economically.

50 Lights Cost 5c an Hour with Gasoline
at 10c per Gallon

Operates electric fans, electric flat-irons—the same engine will furnish power for other purposes.

Write
Today
for
Catalog
No.
CH 1163

50-Lamp Outfit
Complete, \$500

Larger Plants up
to 500 H. P.

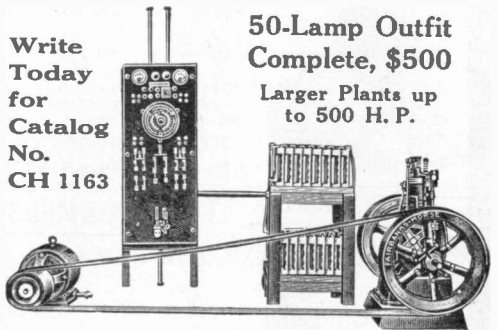

Fairbanks, Morse & Co.

900 So. Wabash Ave.

Chicago, Ill.

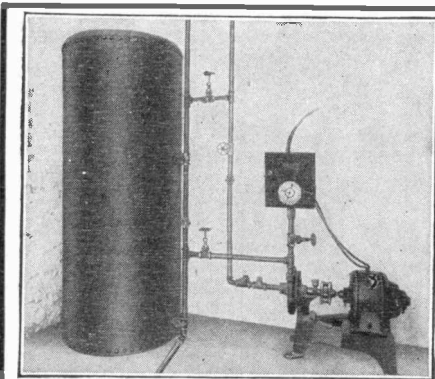

"ECONOMY" System of Automatic Water Supply.

will furnish an abundant supply of clean, aerated water, without the use of a roof or large storage tank.

Will stand the most severe service for long periods of time without skilled care. Installed in basement. Consists of a pump, direct connected by insulated flexible coupling to an electric motor, an automatic switch and a pneumatic tank.

Water is pumped into tank against air pressure. When maximum pressure is reached the automatic switch opens and stops pump. When pressure is lowered, the automatic switch closes starting pump.

The pump is the centrifugal type and has no valves, gears or cams to get out of order. Nothing complicated about the system. Any plumber or handy man can install by following instructions.

Especially adapted for schools, flat buildings, suburban homes, office buildings, hotels and factories.

We also manufacture:— Bilge Pumps—Sewerage Ejectors—Com densation Pumps and Receivers—Cellar Drainers—Centrifugal and Triplex Pumps for all work—Hot Air Engines—Vacuum Cleaning Apparatus—Air Washers—Purifiers and Cooling Apparatus.

Watch for our ads telling you all about them.

THOMAS & SMITH, Inc.

116-118 North Carpenter Street

CHICAGO, ILL.

5 Years' Absolute Guaranty On this Wonderful Detroit Marine Engine

You Are the Only Judge of the engine and its merits. 25,000 satisfied users. Material and workmanship guaranteed for five years.

Greatest Engine Bargain
Ever Offered!

Fewest moving parts of any practical engine on the market. Nothing complicated or liable to get out of order. Only three moving parts. Extra long plastic white bronze bearings. Vanadium steel crankshaft. Adjustable steel connecting rod. All bearing surfaces ground. French gray iron castings. Water-proof ignition system. Runs at any speed from trolling to racing.



Starts without cranking. Reversible while in motion.

Perfectly counter-balanced. No vibration.

30 Days' Trial

Try the engine for 30 days. If you are not fully satisfied, return it and we will promptly refund all money paid us.

Demonstrator Agents wanted in every boating community. Special wholesale price on first outfit sold. Single cylinder, 2-3 h. p. Double cylinder, 3-20 h. p. 4-cylinder, 20-50 h. p. Thoroughly tested before shipment. Comes to you complete with boat fittings and ready to run. Write for free catalog, testimonials and details of the greatest protective guaranty ever offered. Suitable for any boat from canoe to cruiser. Also railroad truck car. All sizes in stock ready to ship. Write today for our wonderful demonstrator offer. [74]

DETROIT ENGINE WORKS
1366 Jefferson Avenue, DETROIT, MICH.

ELECTRICITY
VOL-TAMP

The most wonderful and fascinating scientific study of the age. Every Boy, Girl and Grown-up should know about it. The new "VOL-TAMP ELECTRICAL PRODUCTS"—our 112 Page Catalog now ready, the most complete and interesting book ever issued—is full of illustrations and descriptions of the latest VOL-TAMP Electrical Novelties—Motors, Dynamos, Toys, Machine Models, Telegraph and "Wireless" Instruments, Ruhmkorff Coils, Spark Coils, Gelsler Tubes, Switches, Meters, Lamps, Flashlights, Transformers, Tools, etc., The greatest line of Miniature Electric Railways ever shown. Anything Electrical for Anybody. Prices consistently low.

Send for this Catalog—6 cents in stamps or coin, which will be refunded on first order of 50 cents or over. No postals answered.



VOL-TAMP ELECTRIC MFG. CO., Park Bldg., Baltimore, Md.

KEEP THE FACTORY RUNNING
MOTORS TO RENT
ONE H. P. AND LARGER

GREGORY ELECTRIC CO.

16th and Lincoln Sts., Chicago. We have the largest stock of SECOND-HAND electrical machinery in the world. Send for our "Monthly Bargain Sheet" showing complete stock with net prices. All machines completely overhauled, tested and shipped practically "as good as new."

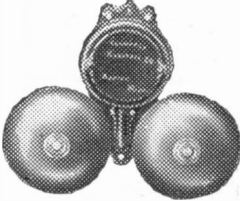

MAKE EASY MONEY INSTALLING
SCHWARZE ELECTRIC BELLS

They cure all Bell troubles and save their cost. For any current. Send \$1.50 today for sample silver-toned house bell, all charges prepaid anywhere in the United States.

SCHWARZE ELECTRIC CO.,
5 Main St., ADRIAN, MICH.

Big Mail FREE

Your NAME PRINTED in our Mailing Directory and sent to 10,000 firms all over the world so they can send you FREE Samples, Catalogs, Books, Papers, Magazines, etc., etc. Send 20c to cover cost of printing your name and you will receive a big mail free.

Ingram, Va., Jan. 7, 1910. Mr. Anderson, I have already received more than 2,000 parcels of mail, and still they come, scores of papers, samples, magazines, etc., for which I had often paid 10 to 25c each. R. T. James, Send to ANDERSON, The Mail Man, 5651, Jamestown, N. Y.



110 or 220 VOLT A.C. CIRCUIT.

TRANSFORMERS

Bell Ringers and experimental
Type A 110 to 6 volts \$3.00
Type B 110 to 2, 4, 6, 8 and 12 volts \$5.00

K-B Electric Mfg. Co.
Mansfield, Ohio.
Send Stamp for Circular

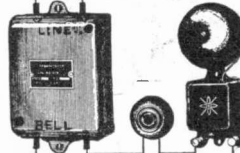

ELECTRIC SHAVING MIRROR

The best light for shaving. Special \$3.75 reflector throws the light on lower part of the face only. No glare in the eyes or on the mirror. The 6 in. x 9 in. French plate mirror is mounted on a heavily nicketed frame. Both mirror and reflector are adjustable to any angle. Can be packed in suit case for traveling. Sent complete with lamp and silk attachment cord to any address on receipt of price. Write for our booklet "Federalites."

Federal Electric Co., Lake & Desplaines St., Chicago



WHITE VALLEY GEMS IMPORTED from FRANCE

SEE THEM BEFORE PAYING!

These Gems are chemical white sapphires. Can't be told from diamonds except by an expert. Stand acid and fire diamond tests. So hard they scratch a file, will cut glass. Brilliance guaranteed 25 years. All mounted in 14K solid gold diamond mountings. Will send you any style ring, pin or stud on approval—all charges prepaid—no money in advance.

Write for Free Illustrated booklet, special prices and ring measure

WHITE VALLEY GEM CO., 742 Saks Bldg., Indianapolis, Ind.



LIGHTING PERFECTION BY
The Eye-Comfort System of Indirect Illumination

PARTICULARS WILL INTEREST YOU. ASK FOR THEM

NATIONAL X-RAY REFLECTOR CO.
235 W. Jackson Blvd., Chicago, Ill.

"SEAVEY" MITRE BOX
MEETS EVERY REQUIREMENT

Cuts Any Angle

Special Offer: On return of this "Ad" and \$2.00 one of these Mitre Boxes will be shipped to any reader of "Popular Electricity." Offer good for 30 days from date of issue.

PORTABLE CAN BE CARRIED IN THE TOOL KIT

Weights a Pounds

SMITH & HEMENWAY CO., 108 Duane Street, NEW YORK CITY

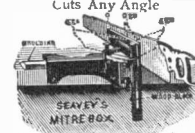

Now is the Time
to reserve space if you intend exhibiting at the
Eighth Annual Electric Show 1912
Electrical Trades Exposition Co.
150 Michigan Avenue,
Homer E. Niesz, Mgr. CHICAGO, ILL.

ELECTRIC LIGHT AND POWER
DAY AND NIGHT SERVICE
The Junior No. 1 Equipment

Direct Connected Dynamo, Gasoline Engine Set, Complete Switchboard, 18-Cell "American" Storage Battery } \$265

The most complete, reliable equipment ever offered at this price. We want a representative in every county.

AMERICAN BATTERY COMPANY
Est. 1889 1143 Fulton St. CHICAGO

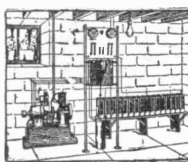

BOYS! Are you interested in Mechanics, ELECTRICITY, Hunting, Fishing, Trapping, Philately, Athletics, etc. Then send 25 cents for a three months trial subscription to the NATIONAL YOUTH. Chock full of interesting serial and short stories dear to the heart of every boy.

THE NATIONAL YOUTH
Kedzie Building Chicago, Ill.

IMPORTED NOVELTIES at Bargain-Prices

We show here two imported novelties at a less price than you can buy elsewhere. **ELECTRIC FLASHER 55 cts. postpaid**—beautiful in design and workmanship. Fine nickeled finish, size 2 1/2 x 3 1/2 inches, absolutely guaranteed for longer life and greater brilliancy than all others. Genuinely imported. We have some of the greatest and most wonderful bargains in electrical novelties ever known. All warranted and absolutely imported. **AUTOMATIC-LIGHTER 85 cts.** Cost \$1.00 everywhere else—guaranteed to always be in working order—carry no matches, just press the button and you have your light. Small, compact and easy to carry in your vest pocket or can be carried as watch charm, beautifully nickel finished. Different from other lighters. No toy.

FOREIGN ELECTRICAL EXCHANGE, Dept. 1, 90 Wabash Ave., Chicago



PATENTS THAT PROTECT and PAY

Advice free. Terms reasonable. Highest references. Best results.

Send sketch or model for FREE examination and opinion.

Recommended Patent Lawyer in the Bankers' Register and SPECIAL LIST OF SELECTED LAWYERS. Also in Martindale's Law Directory, Sharp and Alleman's Directory of Lawyers, The Gast-Paul Directory of Lawyers, and Kime's International Law Directory.

ALL BUSINESS GIVEN PROMPT AND PROPER ATTENTION

A large list of strong recommendations furnished free

WATSON E. COLEMAN, Patent Lawyer, 622 F St., N. W., Washington, D. C.

PATENTS

C. L. PARKER
Ex-Examiner U. S. Patent Office
PATENT LAWYER
12 MCGILL BLDG.
WASHINGTON, D. C.

Patents, Trade Marks, Copyrights, Patent Litigation

Handbook for inventors, "Protecting, Exploiting and Selling Inventions" sent free upon request.

PATENTS AND PROFIT.

"A Talk to the Inventor"

FREE BOOK explains WHAT YOU SHOULD KNOW before applying for a Patent; WHAT TO INVENT; HOW TO SELL YOUR PATENT; WHAT NOT TO INVENT. Write for it today. Send sketch for advice.

H. L. WOODWARD, 726 9th St., Washington, D. C.
BY PATENT OFFICE

IS IT PATENTABLE?

Is it practical and likely to bring returns? To aid in spending your money wisely, get an unbiased opinion from one who has had twenty years of practical experience in perfecting and marketing profitable inventions.

Albert Scheible RESEARCH ENGINEER CHICAGO
17 N. La Salle St.

PATENTS

secured or fee returned. Free expert search of official records. Send for free handbook.

MILO B. STEVENS & CO., Attys.

ESTABLISHED 1864

800 14th St., WASHINGTON, D. C. 351 Monadnock Block, CHICAGO

Guaranteed and recommended by the Bankers' Register. Highest rating by Martindale's American Law Directory.

WANTED—IDEAS

The demand for good patentable ideas is greater than ever before. Am constantly in receipt of letters from parties desiring to buy patents procured through me. Electrical devices, tools of all kinds, advertising novelties, agents' supplies, mail order articles, and many other inventions are sought after. Protect your ideal. Write for "Stepping Stones" (containing over 200 inventions wanted) and new guide book "Successful Patents." Clients' patents sold free. My personal services. Highest references.

RICHARD B. OWEN
Dept. 6. WASHINGTON, D. C.

CAPITALIZE YOUR BRAINS

For our Mutual Advantage mention Popular Electricity when writing to Advertisers.

PATENTS

TRADE MARKS AND COPYRIGHTS

SECURED OR FEE RETURNED

Send model or sketch and description of your invention for free search of the U. S. Patent Office Records.

Our Four Books mailed free to any address. Send for these books; the finest publications ever issued for free distribution.

HOW TO OBTAIN A PATENT

Our Illustrated 80 page Guide Book is an invaluable book of reference for inventors and contains 100 mechanical movements illustrated and described.

FORTUNES IN PATENTS

Tells how to invent for profit and gives history of successful inventions.

WHAT TO INVENT

Contains a valuable list of inventions wanted and suggestions concerning profitable fields of invention. Also information regarding prizes offered for inventions, among which is a

PRIZE OF ONE MILLION DOLLARS

offered for one invention and \$10,000 for others.

PATENTS THAT PAY

Contains fac-similes of unsolicited letters from our clients who have built up profitable enterprises founded upon patents procured by us. Also endorsements from prominent inventors, manufacturers, Senators, Congressmen, Governors, etc.

WE ADVERTISE OUR CLIENTS' INVENTIONS FREE

in a list of Sunday newspapers with two million circulation and in the *World's Progress*. Sample copy free.

ELECTRICAL CASES A SPECIALTY

We have secured many important Electrical patents.

VICTOR J. EVANS & CO.

(Formerly Evans, Wilkins & Co)

Victor Bldg., 724 9th St. E Washington, D. C.

PATENTS: For facts about Prize and Reward offers and Inventions that will bring from \$5000 to 10 Million Dollars; and for books of Intense Interest to Inventors, send 8c postage to Pubs. Patent Sense, Dept. 52, Barrister Bldg., Washington, D. C.



PATENT YOUR IDEAS

\$8,500 for one invention. Book, "How to Obtain a Patent" and "What to Invent" sent free. Send rough sketch for free report as to patentability. Patents advertised for sale at our expense in fourteen Manufacturers' Journals. Patent Obtained or Fee Returned

CHANDLEE & CHANDLEE, Patent Attorneys

Established 16 Years

874 F. Street, Washington, D. C.

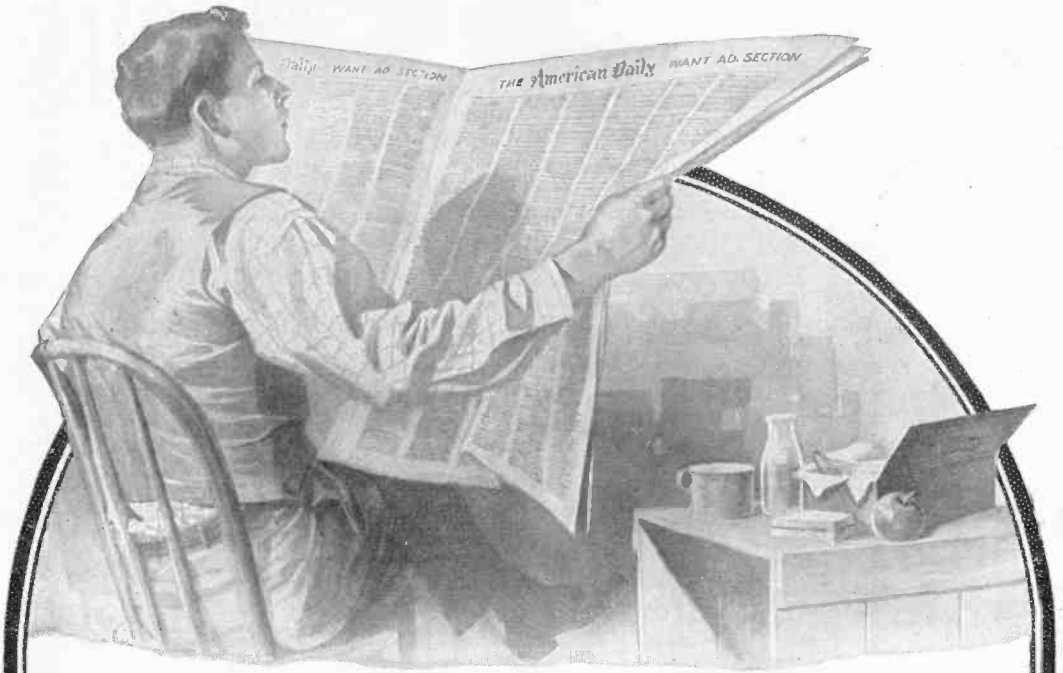

Thousands of Trained Men Wanted

Every year thousands of *good jobs* are seeking *trained men* through the daily press. You won't have to look for a good job if you have the necessary training to fill one—*the job will look for you*—the "Help Wanted" columns in every daily paper prove this.

Read this special proposition which the American School of Correspondence has decided to offer every ambitious man:

If you lack the time and money to stop work and take a course in training, the American School will *lend you the cost of the training you need* and let you make your own terms about repaying us.

This is the greatest offer that has ever been made to men who have "got it in them to make good." We have studied this matter carefully and know that there are thousands of men who are capable and ambitious, but simply lack the money necessary to pay for their training. These are the men we want to help.

Check the coupon and send it to us today so we can explain fully our "*Deferred Tuition Plan*"—how we will lend you the cost of tuition and not ask you to pay us back until the increase in your pay equals the amount of the loan.

The American School is an educational institution. It does not employ agents, representatives or collectors. Signing the coupon will not place you under any obligations whatever or bring an agent to your door. All business will be carried on privately—by correspondence.

American School of Correspondence
CHICAGO, U. S. A.

Opportunity Coupon

American School of Correspondence, Chicago, U. S. A.
Please send me your Bulletin and advise me how I can qualify for the position marked "X."

- | | |
|----------------------------|-----------------------------------|
| Draftsman | Book-keeper |
| Architect | Stenographer |
| Civil Engineer | Accountant |
| Automobile Operator | Cost Accountant |
| Electrical Engineer | Systematizer |
| Mechanical Engineer | Certified Public Accountant |
| Moving Picture Op'r | Auditor |
| Steam Engineer | Business Manager |
| Fire Insurance Eng'r | Commercial Law |
| College Preparatory | Reclamation Engineer |

NAME.....
ADDRESS.....



Iron More—Work Less

EVERY woman who has tried one, knows that the week's ironing can be finished in one-third less time with an electric iron than with any of the old-fashioned sad-irons. Electric irons abolish the many weary steps, hard work and petty inconveniences that make sad-ironing a drudgery.

The smooth, glossy finish of the clothes is convincing evidence of the superior quality of workmanship, possible only with electric irons.

Electric Flatiron

The General Electric Company's six-pound Flatiron will do more work in less time than any other standard electric iron of equal weight because it can transform more electricity into more heat when required than any other six-pound iron.

It is the only electric iron containing the renowned "Calorite" heating unit, pronounced by experts to be practically indestructible. With this heating unit the G-E Iron, with ordinary care, will last a lifetime.

Our records show that 999 of these irons out of every thousand give perfect satisfaction for many years.

Nearly half a million happy women already use G-E irons and the next three or four years will see as many more satisfied users.

Twenty-five hundred electric lighting companies and dealers sell this iron but, if you cannot get one locally, send \$5.75 and we will deliver one promptly through our nearest representative. A three deck stand, attaching plug and eight feet of extra flexible cable are sent with every iron.

Be sure to state the voltage of your lighting circuit.

General Electric Company

Dept. 30-H., Schenectady, N. Y.

2806

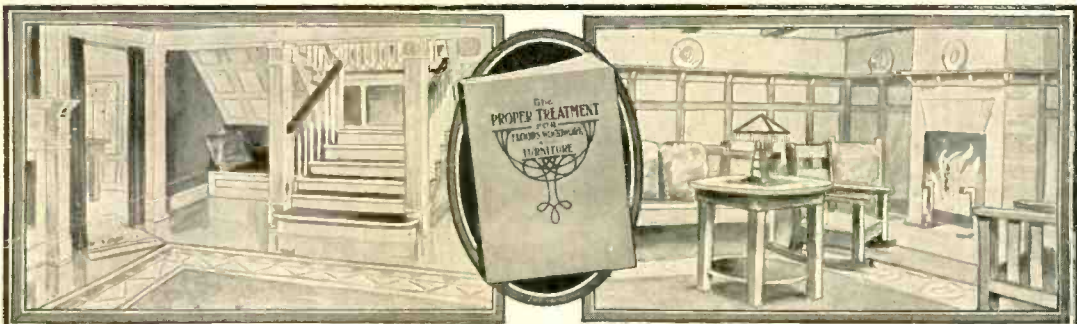

Johnson's Wood Dye

Endorsed by Architects—Contractors—
Painters — and Home Owners Everywhere

JOHNSON'S Wood Dye is not an ordinary *stain*—but a permanent Wood Finish of great beauty and durability for all interior trim and furniture of every character. Johnson's dye is now extensively used by leading architects and contractors everywhere for finishing Red Gum—Cypress—and other soft woods as well as the most expensive hard woods. It gives the wood a lasting, beautiful finish without raising the grain—and when used in connection with Johnson's Prepared Wax it produces the beautiful, dull, artistic finish now so popular.

Instruction and Specification Book FREE

Let us furnish you a copy of the latest edition of our beautiful and profusely illustrated book on Wood Finishing, together with a sample of any shade of dye desired. Johnson's Wood Dye is made in 15 standard shades as listed below, and with it you can obtain any desired effect with the most inexpensive woods.

- | | |
|------------------------|-----------------------------|
| No. 126 Light Oak | No. 131 Brown Weathered Oak |
| No. 123 Dark Oak | No. 132 Green Weathered Oak |
| No. 125 Mission Oak | No. 121 Moss Green |
| No. 140 Early English | No. 122 Forest Green |
| No. 110 Bog Oak | No. 172 Flemish Oak |
| No. 128 Light Mahogany | No. 178 Brown |
| No. 129 Dark Mahogany | Flemish Oak |
| No. 130 Weathered Oak | No. 120 Fumed Oak |
| | Half Gallons—\$1.50 each |



Don't you want this Book — Free — and samples of the Dye and Wax? Ask your local dealer for them. We have supplied him for your use but if he does not furnish you with them drop us a postal and we will see that the samples and book reach you at once. Ask for Booklet P. E.-6.

To Architects: Beautiful sample panels of all woods now in use for interior trim will be furnished to you upon request, finished with our Dye and Wax. These give the exact effects obtainable by their use.

S. C. Johnson & Son
The Wood Finishing Authorities
Racine, Wis.